



KEMPER®

DISTINCTIVE CABINETRY FOR YOUR HOME

SPECIFICATIONS GUIDE

Effective February, 2018. Supersedes all prior versions.

MORE HANDS-ON

Design is a process to be embraced, so dig deeper into what's next from Kemper®. Explore the thinking behind our new door styles. See how further expansions and continuous innovation help streamline your project and simplify your life. Ask questions. Then turn the answers over in your imagination. And when inspiration takes hold, don't let go. Because, like our cabinetry, ideas are what you make of them.

KEMPER
DISTINCTIVE CABINERY®



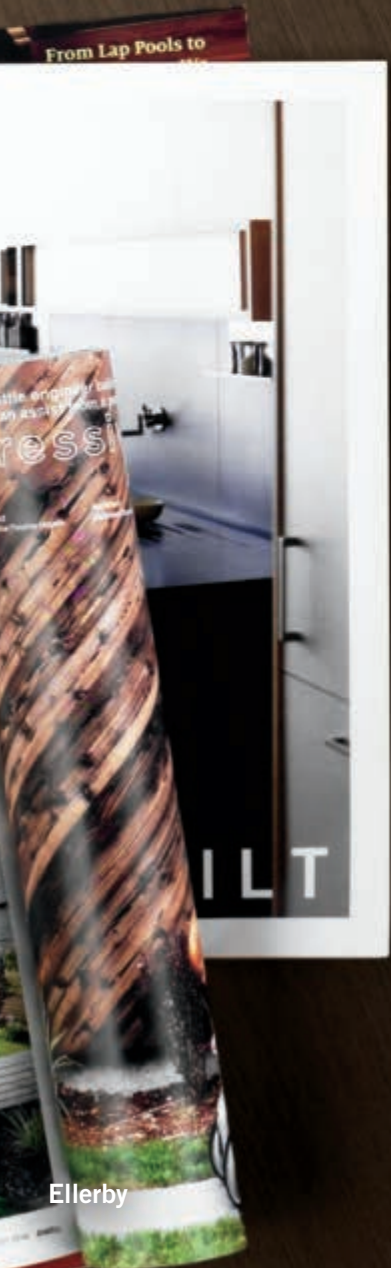

Ellerby

MEANT FOR EACH OTHER

The best partnerships are those that happen naturally. A traditional raised-panel door, Ellerby is designed to effortlessly pair with Painter, our new contemporary flat panel style we'll introduce to you shortly. And unlike its predecessor, its availability has been expanded to include more wood types. Complementary qualities that make Ellerby and company that much easier to sell and order.

ELLERBY

SPEC BOOK PAGE 13

Ellerby features a profiled, slab drawer front and is available in Maple, Cherry, Oak and Hickory.



ELLERBY

Maple Sahara



LIFE IN TRANSITION

Change is inescapable, so run with it. This is the idea behind Painter, our newest flat panel door made readily available across multiple wood species. As with our aforementioned style option, it's designed to close the gap between past and present, while opening up many more simple, inspirational mix-and-match opportunities.

PAINTER

SPEC BOOK PAGE 19

Painter features a profiled, slab drawer front and is available in Maple, Cherry, Oak and Hickory.



PAINTER

Maple Sahara



Kodiak & Grizzly



Antler

KODIAK & GRIZZLY

SPEC BOOK PAGE 23

As consumer preferences move from warm tones to cool neutrals, we pursued a premium process to arrive at showstoppers Kodiak and Grizzly. These new, richly-finished options, featuring deep browns with gray undertones, fill your need for more aggressive dark wood finishes. And they mix well with modern hues, while drawing out the inherent beauty and variation in wood grains across all types.

Kodiak and Grizzly are available on Maple, Cherry, Alder, Rustic Alder, Oak and Hickory.



KODIAK
Rennie Maple



GRIZZLY
Rennie Maple

ANTLER

SPEC BOOK PAGE 28

Presenting a sleek, vertical Beech wood grain appearance with tones ranging from warm whites to gray tans. Designed to enhance our modern Genova slab door style, Antler provides a lighter color option and opens your design to a variety of cabinet frame and box color options, as well as premium trim items to complement your design. A light laminate has never felt more in its element.

Antler cabinet box color options include Cloud and White, and Morel on Cherry, Maple, Oak and Hickory.

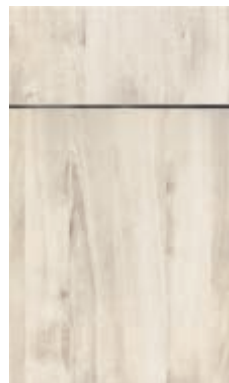

ANTLER
Genova Wood Grain Laminate



Larsen Maple Moonstone

MATCHING LAMINATE ENDS FOR LAMBSWOOL AND MOONSTONE

SPEC BOOK PAGE 25

If you like the sound of reduced potential order errors and field installation costs, you'll love the sight of our two newest ways to create perfectly matched cabinetry ends.



LAMBSWOOL

*Justin Maple Door with Slab
Drawer Front*



MOONSTONE

*Justin Maple Door with 5-Piece
Drawer Front*

CUSTOM DOORS EXPANSION

DOORSLAB

SPEC BOOK PAGE 539

We've opened our custom sized door program to include three modern slab styles. Doors arrive with hinge routing complete and ready for your specialized application.



GENOVA

Wharf Finish



TROXEL

Obsidian Finish



TARO

High Gloss White Finish

ENHANCED GUIDE FOR PULL-OUTS

SPEC BOOK PAGES 232, 328, 494

Four of your favorite pull-out cabinets have been upgraded to change the current side-mount guide to an undermount SmartStop guide. Not only will there be easier installation and adjustment in the field, but improved functionality as well. Includes Base Pantry Pull-out, Base Utensil Pantry Pull-out, Hearth Pier Pull-out, and Vanity Pull-out.

SSO PROGRAM ENHANCEMENT

The Special Sales Order Program has been enhanced with the addition of SP. (Special Product) codes in 2020 to allow for easier ordering and tracking of SSO orders. Contact Customer Service for engineering approval and quote prior to placing order.



Manchester



Dewitt



Fairbrook

MORE EXPANSIONS, FEWER EXCEPTIONS

To further streamline your sales and design process, we wanted to see how far we could go to simplify our door style selection. The result: Those options with limited availability were eliminated while styles most popular with consumers were given access to an expanded list of wood species. Mix and match. Done and done.

MANCHESTER EXPANSION

SPEC BOOK PAGE 18

Once available exclusively in Maple, this popular transitional style now includes your choice of Cherry and Oak wood types.



CHERRY OAK

DEWITT EXPANSION

SPEC BOOK PAGE 12

Hickory, Alder and Rustic Alder species options offer more ways to put a modern spin on this popular door style. Also available in Maple, Cherry and Oak.



HICKORY ALDER RUSTIC ALDER

FAIRBROOK EXPANSION

SPEC BOOK PAGE 13

Introducing Oak into the current wood species options for Fairbrook, already in Maple and Cherry, means you have one fewer design obstacle to overcome.



OAK



Base Easy Reach Cabinet with Adjustable Shelves

WALL BOX COLUMN PULL-OUTS IN NEW HEIGHTS

WBCPO.. ,WBCPO.. OL
 SPEC BOOK PAGES 186-88

When elbow room is at a premium, pull-outs prove highly effective at tucking away extra pantry items or a large spice collection. And where a standard 30" high option won't cut it, four taller size options, 33", 36", 39" and 42", help you rise to the challenge.

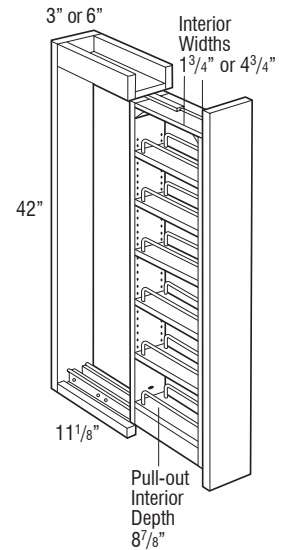

BASE EASY REACH CONFIGURATION OPTIONS

BERAS..
 SPEC BOOK PAGE 300

Adjustable criss-cross design shelves accommodate taller items without sacrificing space or compelling you to put a Lazy Susan in the corner.

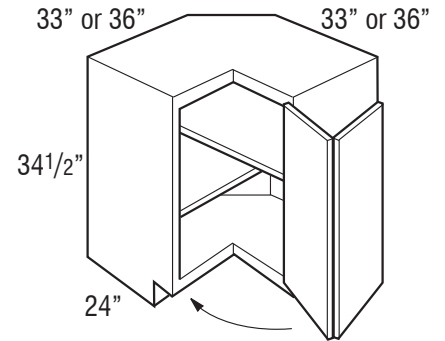

TRAY DIVIDER AS AN ACCESSORY

TDKIT..
 SPEC BOOK PAGE 601

Any of the five available heights can be field-trimmed for a tailored fit, during or after install. The many choices are yours. Requires a full top. Standard construction is Natural Maple Laminate, while APC and WLI are also available.

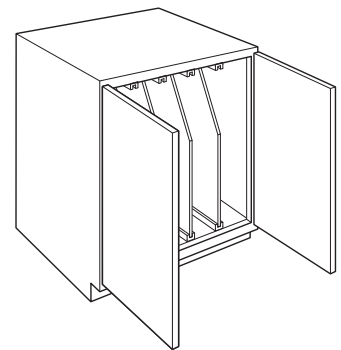

WALL BOX COLUMN PULL-OUT AND BASE CABINET TIERED DRAWER FOR K-CUP® STORAGE

WBCPOKCUP., WBCPOKCUP..OL, B18KCUPL/R, 3DB18KCUP, 4DB18KCUP
 SPEC BOOK PAGES 190, 192, 242, 316, 320

Someone had to think up a more hospitable space for modern beverage stations and the requisite K-Cups® and drink accoutrement. So, we created two. A Wall Box Column Pull-out with available Overlay Filler options and a Tiered Drawer offer multiple dimension and configuration options to keep your countertops uncluttered and critical pick-me-ups conveniently within reach.

K-Cup® is a registered trademark of Keurig Green Mountain, Inc.

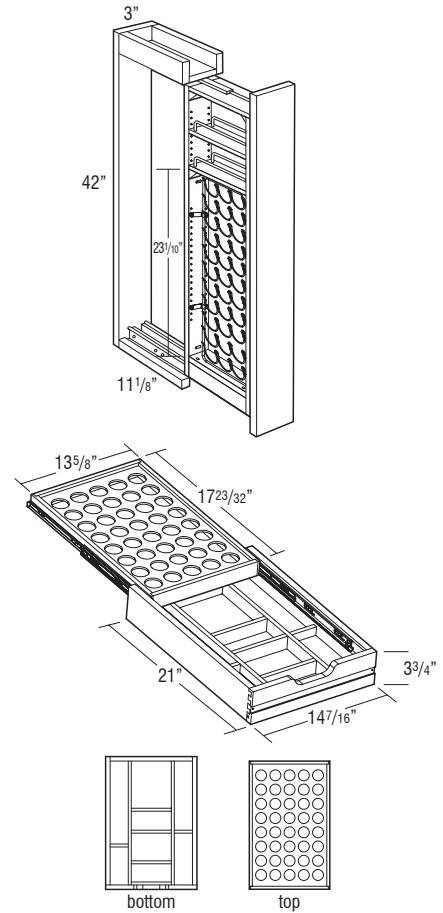

BASE FOOD STORAGE ORGANIZER CABINET™

B..FSCOL/R
 SPEC BOOK PAGE 268

What a great idea; a smarter container for food containers. This welcome advance in cabinetry storage provides greater visibility and access to both containers and lids. Plus, it comes in two convenient widths for more design flexibility—another common challenge, conquered.

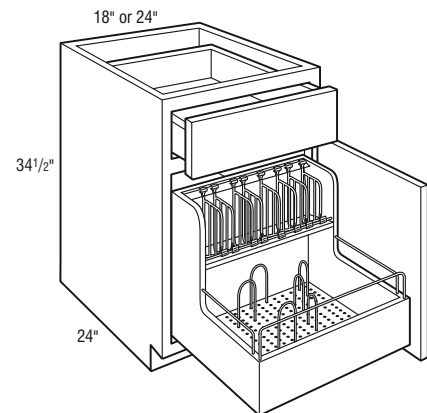

BASE WASTEBASKET EXPANSION

BWB152, BWB15FH2, BWB15FHRT2
 SPEC BOOK PAGES 320-322

Twin 27-quart wastebaskets, available in three 15" wide configurations, make it easy to send trash and recycling packing, while pulling the most out of limited interior space.

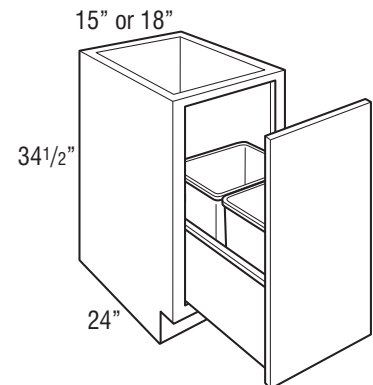
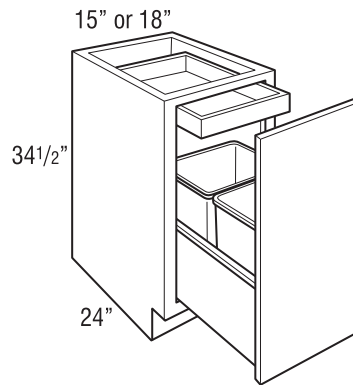
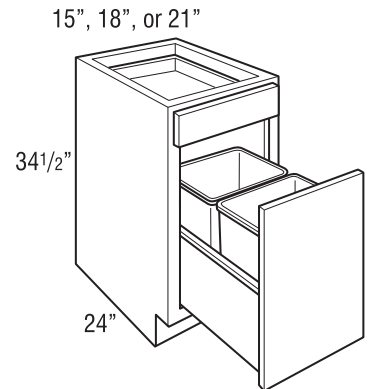

BASE CABINET WITH MIXER LIFT OFFERING SMART STOP FEATURE

B..FHMIXSC,MIXFHSC..
 SPEC BOOK PAGE 276

Who knew baking could be so hard on your back? This smooth-gliding, soft-closing innovation eliminates the need for unnecessary bending, stooping and potentially dangerous lifting.

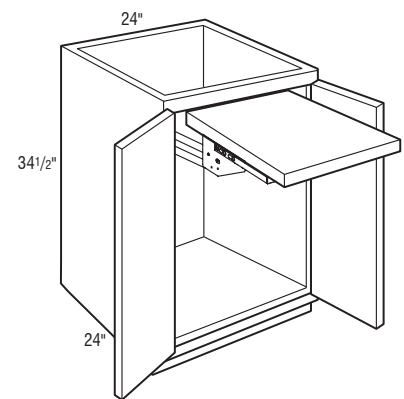

PANTRY WALK-THROUGH CABINET

PWT..

SPEC BOOK PAGE 394

Tall cabinets feature full height doors and are built without backs or bottoms to create a walk-through design that matches your choice of cabinetry. So, rather than disrupt design continuity, create customized pantry doorways to serve as a cohesive element that enhances your room.

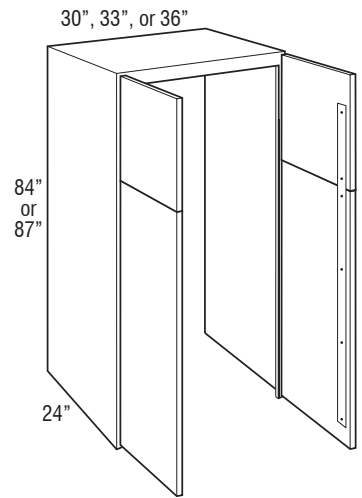

SHIPLAP WOOD HOODS

JWHSHPSTR..., JWHSIPT..., JWHSHPCH

SPEC BOOK PAGES 214-216

Choose our Shiplap Straight or Tapered Hood to achieve the farmhouse look without incurring extra cost or complexity in sourcing the necessary materials. Both are compatible with all existing blowers and are available with or without matching corbels. Then pick one of three or four standard widths, and trim the height as you see fit.

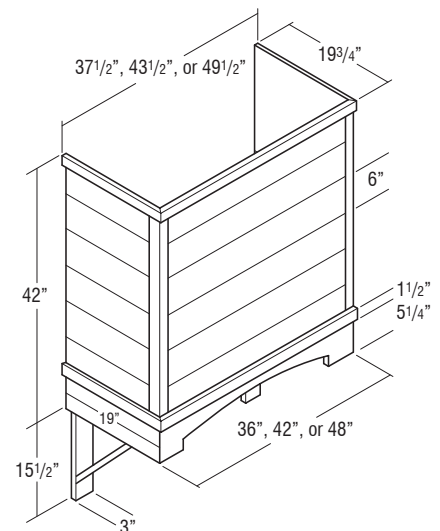
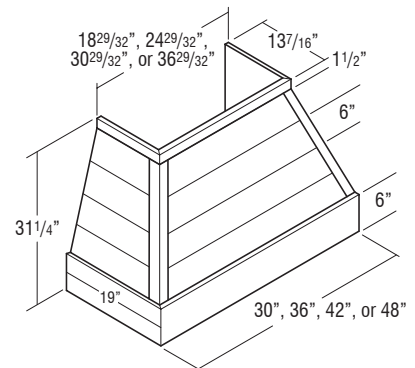

COVE CORBELS

CORBELCOVE..
SPEC BOOK PAGE 586

Cove Corbels in two sizes and five wood types support your design aspirations with the perfect balance of flexibility, reliability and affordability. The streamlined design pairs nicely with Shaker or transitional designs. Available in Maple, Alder, Cherry, Hickory and Oak.

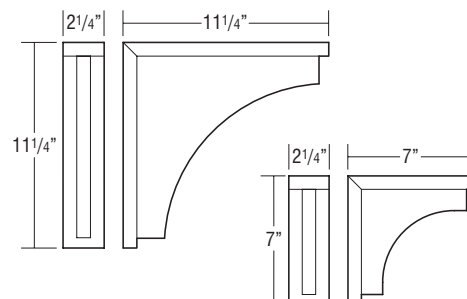

OVERLAY FILLERS COMPATIBLE WITH MODIFIED FULL OVERLAY DOORS

OL3..MFO, OL6..MFO
SPEC BOOK PAGES 529, 531

Clean lines are hallmarks of contemporary design. Consistently providing you with more moulding options that are compatible with the MFO modification door heights and eliminate the need for field modification is classic Kemper.

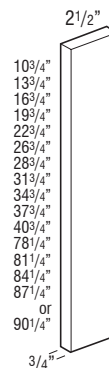

DRAWER BOX AND GUIDE IMPROVEMENTS

Smoother guides and wider boxes that extend beyond the face frame make our drawers that much sturdier to better handle the welcome increase in overall volume. More storage and better performance!



WALL CABINET 24" AND 27" HEIGHT CHANGES

SPEC BOOK PAGES 100-108

A half-inch can make all the difference. By adjusting our 23.5" and 27.5" high Wall Cabinets to actual 24" and 27" heights, we eliminated the need to figure in size differences or use fillers when stacking. Wall Cabinets use the correct height dimension, while Tall Cabinets and Tall Panels with upper sections aligning with these Wall Cabinets use new nomenclature with "AH" for Aligned Height.

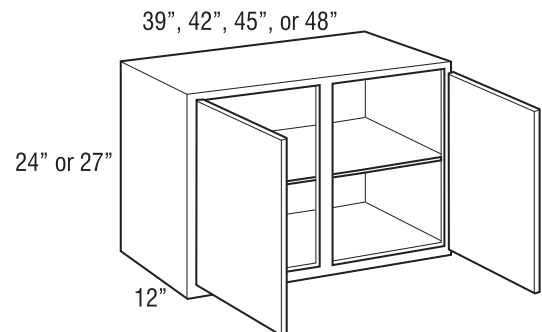

NATURAL INTERIOR ON WHITE CABINETS

SPEC BOOK PAGE 30

As far as consumers are concerned, natural wood grain laminate interiors that prove equally durable and cleanable are the way to go. Still want white? Order it as a modification using the WLI modification with APC orders.

Note: Change effective 4/9/2017

MATCHING INTERIOR PLYWOOD FOR DECORATIVE DOORS IN 2020

For added convenience and fewer delays due to ordering errors, Matching Interior Plywood (MIP) will now be automatically selected in 2020 for Cut-for-Glass, Mullion and Aluminum Frame Doors. When MIP is not desired, simply choose the NOMIP option. Orders not created with 2020 are not affected.



CUSTOM APPLIANCE CUT-OUTS ON NEW TALL OVEN CABINETS

ACS

SPEC BOOK PAGE 40

Site installers are in no hurry to incur the costs and inconvenience of cut-out errors. Custom cut-outs make the whole process—from order to install—considerably more straightforward, regardless of appliance choices. The smart choice was to make Appliance Cut-out Single available on new Narrow Stile Oven Cabinets with 1.5” wide frame stiles.

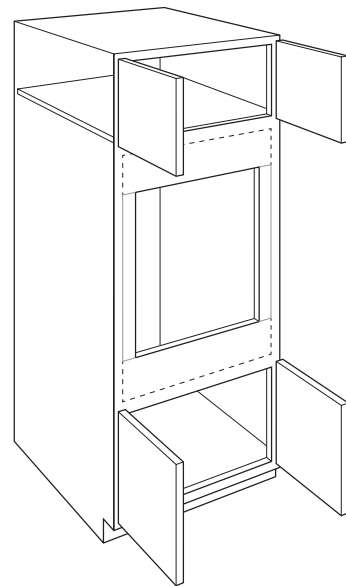

DISCONTINUATIONS:

Door Styles:

Henshaw in Alder and Rustic Alder
Danbury in Oak
Wakefield in Oak

Finishes:

Cider in all species
Whiskey Black Oak
Cattail Oak and Hickory

Art & Textured Glass Panels:

Chalet, Edgemont, Maison, Manor, Meriden, Plantation, Usonian,
Villa, Wescott, and Bronze Fabric

Mouldings:

DE8 (Dentil Moulding, replaced with new design MDENTIL8)
GREEKM (Greek Aztec Insert)
INSERTBARO (Baroque Insert)
JBIJINSERTM (Bijou Insert Mldg)
JCOSINSERTM (Cosmo Moulding Insert)
JINSERTFRM (Frieze Mldg)
JLRINSBARO (Baroque Light Rail Insert)
JLRINSBIJ (Bijou Light Rail Insert)
JLRINSCOS (Cosmo Light Rail Insert)
JLRINSMAD (Madeline Light Rail Insert)
JMADINSERTM (Madeline Moulding Insert)
PR8 (Plate Rail)
WCM4 and WCM7 (Window Casing Modern)
WCT4 (Window Casing Traditional)
STKMLD12 (Stacked Moulding Kit #12)
STKMLD15 (Stacked Moulding Kit #15)

Trim and Accessories:

Bread Box Lids (BBX..)
CD and DVD Inserts (CDI.., DVDI..)
Cookbook Rack (CBR)
Dishwasher Door Kits And Panels (DWD, DWP..)
Drawer Front Fold-Down Hinge (E71MINIHINGE)
Tiered Cutlery Dividers - Plastic (TCD..)

Corbels & Embellishments:

CORBELBARO (Baroque Corbel)
GROVLY (Grape Overlay)
JBIJFOOT (Bijou Bun Foot)
JBV38 (Baroque Valance 38" Wide)
JBV50 (Baroque Valance 50" Wide)
JCORBELACAN5 (Acanthus Corbel 5" High)
JCORBELBIJ (Bijou Corbel 14" High)
JCORBELMAD4 (Madeline Corbel Small)
JCORBELMAD6 (Madeline Corbel Medium)
JCORBELMAD9 (Madeline Corbel Large)
JCORBELWEAVE14 (Weaved Corbel 14" High)
JCORBELWEAVE7 (Weaved Corbel 7" High)
JCOROVLY (Corinthian Onlay)
SHOVLY (Shell Overlay)
SV72 (Scalloped Valance 72" Wide)

Cabinets:

3 Drawer Base Special (3DB..SP)
Base Box Column Pull-out with Fluted Fillers (BBCPO.FF)
Base Cooking Center (BCC..)
Base Dishwasher (BDW..)
Base Open Basket (BOBB.., BOBP..)
Recycling Trash Base (RRC..DR, RRC..)
Base Recycling Center (BRC..)
Microwave Cooking Center (MCC..)
Sink Base With Clipped Corners (SB..CC)
Utility Drop Zone (UDZ..24)
Vanity Cosmetic Cabinets (VCC..)
Wall 2-Drawer with Tiered Insert (W2D..TI)
Wall Box Column Pull-Out with Fluted Fillers (WBCPO..FF)
Wall Cookbook Recipe Organizer (WCRO2130)

Troxel Textured Laminate Arctic

KEMPER[®]



BEAUTY. FUNCTION. STRENGTH. PERFORMANCE.



Kitchen Cabinet Manufacturers Association
Environmental Stewardship Program
All Products Impact the Environment
For ESP Program Criteria, Visit kcmra.org

kempercabinets.com

KEMPER® WARRANTY SHEET



LIFETIME LIMITED WARRANTY

Kemper® Cabinetry warrants the original consumer purchaser for as long as they own their home that the Kemper Cabinetry products will be free from defects in material and workmanship under normal use. This warranty is only applicable to products used in residential applications within the United States and is not transferable to subsequent owners.

Should defects in material or workmanship exist during the applicable warranty period in any Kemper Cabinetry product, Kemper Cabinetry will elect at its discretion to either repair or replace the defective material or component, free of charge. This warranty covers only parts and materials of the products supplied by Kemper Cabinetry. Not covered under this warranty are counter tops, appliances, plumbing fixtures, etc. or the costs, including labor, to remove and reinstall materials and related components such as fittings, appliances, etc.

This warranty shall become void if the cabinets are in any way modified, improperly installed or damaged prior to or during the installation. Furthermore, this warranty will not apply to cabinets damaged by misuse, neglect, abuse, acts of God, exposure to moisture, exposure to extreme temperatures or the effects of normal wear and tear.

Natural woods may vary in color, characteristics and exhibit subtle changes as they age. For example, painted face frames may eventually have visible cracking around the joint area and cabinet colors may darken or lighten over time. Sunlight, smoke, household cleaners and other environmental conditions may also affect the color match over time. These variations are considered to be the nature of the material in relation to their environmental exposure and are not covered under this warranty.

Kemper Cabinetry reserves the right to alter design, specifications and material without obligation to make similar changes to products previously manufactured.

The repair(s) or replacement(s) are contingent upon the current product offerings of styles and construction options within the Kemper Cabinetry, products at the time of the warranty claim. If a warranty claim is filed after a Kemper Cabinetry product becomes obsolete; Kemper Cabinetry reserves the right to honor the warranty in one of the following fashions:

1. To replace the affected component with a new component of the same style.
2. To replace the affected component and any other component(s) in the residential application to achieve a uniform appearance with a similar and comparable product style of the originally purchased style.

If components are replaced, Kemper Cabinetry cannot guarantee that the finish of these replacements will exactly match the finish and appearance of the components in the residential application. This is due to the changes that occur during the woods' natural aging process, affecting its color and grain.

THIS WARRANTY IS THE EXCLUSIVE WARRANTY OF KEMPER CABINETRY AND IS IN LIEU OF AND KEMPER CABINETRY DISCLAIMS ALL OTHER WARRANTIES, EXPRESSED OR IMPLIED, INCLUDING THE IMPLIED WARRANTIES OF MERCHANTABILITY AND FITNESS FOR A PARTICULAR PURPOSE.

This warranty gives you specific legal rights and you may have other rights, which vary from state to state. Some states do not allow the exclusion or limitation of incidental or consequential damages, so the above limitations or exclusions may not apply to you.

To obtain replacement(s) under this limited warranty, first contact your authorized Kemper Cabinetry dealer or distributor, who will arrange for inspection of the cabinet. A dated sales receipt as proof of purchase is required to obtain benefits from this warranty. If you have difficulty obtaining assistance, please write to:
MasterBrand Cabinets, Inc. Attn: Consumer Affairs, One MasterBrand Cabinets Drive, Jasper, IN 47546

TERMS AND CONDITIONS

KEMPER® CABINETS LIFETIME LIMITED WARRANTY AND GENERAL INFORMATION



Specifications in material, construction and design are subject to change without notice as conditions require, or as improvements are developed.

All orders are subject to credit approval.

To avoid errors, orders should be filled out on Kemper Cabinet forms.

All cabinets are manufactured to individual order and cannot be cancelled or changed after manufacturing has begun. Cycle ship orders cannot be changed after the cut-off date.

Returns will not be accepted without prior written authorization.

Kemper cabinets carry a Lifetime Limited Warranty. This limited warranty does not cover misuse*, improper storage, improper installation, labor costs or defects incurred during installation, storage or transportation. We reserve the right to repair or replace any defective material after field inspection by our representative. For complete warranty details, please refer to the Kemper Warranty Document.

A product count and inspection must be performed before signing the Bill of Lading. Shortage, obvious damage and occurrences of mishandling must be noted on the Bill of Lading before it is signed. Replacement orders must then be made with Kemper Customer Service. A signed Bill of Lading with no notations will indicate a complete and damage free shipment.

Sales are only to approved, authorized accounts.

Please make reference to the cabinet selection guide for information pertaining to characteristics of wood. This information will tell you the reactions that natural woods might develop under certain conditions after product is finished.

DISCONTINUED PRODUCT POLICY

60 days minimum notice to reps and customers announcing the discontinuation of a product line.

Product will no longer be available for order after the discontinuation date. Only warranty orders will be considered. Even with warranty orders we will have the option to replace customer's defective product with the same discontinued product they originally purchased, or replace all doors originally ordered with a current product that is similar in appearance.

TABLE OF CONTENTS	
Index	A-G
Characteristics	1-2
12-Step Finishing Process	3
Humidification	4
Door Styles	5-21
Premium Color Palette	22
Unfinished	23
Finish Techniques	23
Finish Availability Chart	24-27
Specifications	28
Construction Features	29
Modification/Upgrade Compatibility Chart	30
Construction Upgrades	31
Drawer Front Upgrades	32
Drawer and Door Options	33
Custom Modifications	34-50
Door Modification/Specialty Doors	51-55
Glass Inserts	56-65
Cabinet Dimensions	66-72
Design Checklist	73
NKBA Guidelines	74-75
Storage Solutions Reference Chart	76-77
Wall Cabinets	78-161
Hearths	163-172
Base Cabinets	173-248
Universal Design Cabinets	249-252
Tall Cabinets	254-296
Office & Furniture Cabinets	297-310
Vanity Cabinets	311-340
Fillers	341-348
Wainscoting	349-349
Custom Hinged Doors	350-351
Decorative Appliance Panels	352-354
Panels & Skins	355-366
Moulding	367-377
Valances	377-378
Embellishments	378-401
Contemporary Embellishments	402
Lighting & Lighting Accessories	403-404
Decorative Hardware	405
Accessories	406-413
Roll Tray Kits	414-416
Guide Kits and Parts	416
Stain, Paint, & Touch-Up Tools	417
Hinges	418
Parts	418
Sales Support Tools	419
Stacked Moulding Kits	420-428
Agreements	429-431

Description	Code	Page Number
Abbe Foot	ABFOOT	393
Acanthus Foot	JACANFOOT	393
Acanthus Insert	JACANINSERTM	370
Acanthus Leg	JACANTHUSLEG	380
Acanthus Light Rail Insert	JLRINSACAN	375
Acanthus Moulding	ACAM	371
Acanthus Ornament	ACO	378
Acanthus Overlay	ACOVLY	378
Acanthus Tile	JTILEACAN	379
Add Toekick	ADDTK	45
All Plywood Construction	APC	31
Aluminum Frame Doors w/Frost Glass	ALF	51
Angled Corner Sink Front Bottoms	ACSFB	209
Angled Corner Sink Fronts	ACSF	208
Angled Corner Sinks	ACS	208
Angled Fluted/Plain Fillers	BLVDF	345
Appliance Cut-out, Single	ACS	39
Arched Valance	AV	377
Art Corbel 9"	CORBELART9	397
Arts & Crafts Bracket	JBRACKETART	400
Arts & Crafts Open Corbel	JCORBELARTO	400
Asymmetrical Base Easy Reach	BER	217
Asymmetrical Base Easy Reach w/Adjustable Shelves	BERAS	218
Asymmetrical Easy Reach Wall Corners	ER	127
Asymmetrical Solid Wood Super Lazy Susan	SLSW	221
Asymmetrical Super Lazy Susan w/Chrome Rail	SLSR	220
Asymmetrical Super Susans	SLS	220
Authentic Ends	AUTHL, AUTHR	34
Back Panel Moulding	BPM	371
Back Sockets	BKSOCKET	416
Bar Leg	BARLEG	380
Baroque Leg	JBAROQUELEG	381
Base Bin Tray Pull-Out Cabinets	BBTP	235
Base Box Column Pull-Outs (Plain, Overlay)	BBCPO	240
Base Buffet	B..B	175
Base Buffet Three Drawer	3DBB	228
Base Buffet Three Drawer w/Deep Drawer	3DBBDD	231
Base Buffet w/Roll Trays	B..RTB	187
Base Built-In Microwave Cabinet w/Drawer	BBMWD	242
Base Cabinets	B	173-252
Base Cabinets Four Drawer	4DB	231
Base Cabinets Four Drawer w/Cutlery Insert Wood Organizer	4DB..WTCD	232
Base Cabinets Four Drawer w/Wood Tiered Cutlery Divider Drawer	4DB..WTCD	232
Base Cabinets Four Drawer w/Wood Tiered K-Cup® Drawer	4DB..KCUP	233
Base Cabinets Full Width w/Roll Trays & Swing-Outs	BCFW..SP	214
Base Cabinets Three Drawer	3DB	228
Base Cabinets Three Drawer Corner	3CDB	223
Base Cabinets Three Drawer w/Deep Drawer	3DBDD	230
Base Cabinets Three Drawer w/Warming Drawer	3DB..WD	230
Base Cabinets Three Drawer w/Wood Tiered Cutlery Divider Drawer	3DB..WTCD	229
Base Cabinets Three Drawer w/Wood Tiered K-Cup® Drawer	3DB..KCUP	229
Base Cabinets Two Drawer	2DB	225
Base Cabinets Two Drawer w/Drop-In Range	2DB..DR	227
Base Cabinets Two Drawer w/Drop-In Range & Warming Drawer	2DB..WD	227
Base Cabinets Two Drawer w/File Drawer	2DB..FD	225
Base Cabinets Two Drawer w/Pegged Dish Organizer	2DB..PDO	226
Base Cabinets Two Drawer w/Roll Tray	2DB..RT	226
Base Cabinets Two Drawer w/Roll Tray & Pegged Dish Organizer	2DB..RTPDO	227

Description	Code	Page Number
Base Cabinets w/Full Height Doors	B..FH	177, 179
Base Cabinets w/Mixer Shelf	B..FHMIXSC	197
Base Container Organizer Pantry Pull-Out	BCOPP	239
Base Corner Cabinets	BC	211
Base Corner Cabinets w/Pull-Out	BC..PO	212
Base Corner Full Width Cabinets	BCFW	212
Base Corner Full Width Cabinets w/Curved Pull-Out	BCFW..CPO	213
Base Corner Full Width Cabinets w/Pull-Out	BCFW..PO	213
Base Corner Inside	B..CIA	224
Base Corner Outside	B..COA	224
Base Corner Peninsula	BPC	245
Base Corner Peninsula, Full Height Door	BPC..FH	245
Base Drawer Cabinets	DB	224-232
Base Drop-In Range Cabinet	B..DR	241
Base Easy Access Cabinets	BEAS	181
Base Easy Reach	BER	216
Base Easy Reach w/Adjustable Shelves	BERAS	217
Base End Cabinet	BEC	224
Base End Shelves	BQRES	246
Base Full Height w/Tray Divider	TD..FH	197
Base Lazy Susan Corner w/Center Hinge Door	BLS	215
Base Lazy Susan Corner w/Revolving Door	BLS..DR	214
Base Message Center	BMC	241
Base Microwave Cabinets	BMW	244
Base Microwave Cabinets w/Deep Drawer	BMWD..DD	243
Base Microwave Cabinets w/Drawer	BMWD	243
Base Microwave Cabinets w/Roll Tray	BMW..RT	244
Base Mixer Kit	MIXKITFHSC	406
Base Open Cabinets	BOC	246
Base Open Cabinets w/Drawer	BOD	247
Base Ovens	BO	242
Base Pan Storage	BPS	406
Base Panel w/Filler Attached & Authentic End	BEP..AEL, AER	362
Base Pantry Pull-Outs	BPP	239
Base Paper Towel Cabinet	BPT	174
Base Paper Towel Cabinet Full Height	BPT..FH	178
Base Paper Towel Cabinet w/Wastebasket	BPT..WB	234
Base Paper Towel Cabinet w/Wastebasket Full Height	BPT..WBFH	235
Base Pots & Pans Pull-Out	BPPP	193
Base Rotating Deep Bin	BRDB	222
Base Spice Drawer	BSD	237
Base Transition Cabinets	BTC	223
Base Utensil Pantry Pull-Out	BUPP	239
Base Utensil Pantry Pull-Out w/Knife Block	BUPPKB	240
Base Wastebasket	BWB	233
Base Wastebasket Full Height	BWB..FH	234
Base Wastebasket Lids	BWBFHLID, BWBLID	406
Base Wine Cubby	BWC	237
Base w/Can and Wine Bottle Pull-Outs	B..CWP	194
Base w/Food Storage Container Organizer	B..FSCO	193
Baseboard Moulding	BBM	373
Baseboard - Sculpted	BBMSC	373
Baseboard - Shaker	BBMSH	373
Baseboard - Swooped	BBMSW	374
Bases w/Cutlery Insert	B..CIW	175
Bases w/Drawer & Lid Organizer & Roll Trays	B..RTLO	191
Bases w/Full Height Doors & Roll Trays	B..FHRT	188
Bases w/Lid Organizer & Roll Trays	B..FHRTLO	192
Bases w/Roll Trays	B..RT	186
Bases w/Roll-Out Tray Divider	B..TDRO	196
Bases w/Tray Dividers	TD	196
Bases w/Wood Cutlery Insert & Roll Trays	B..RTCW	190
Bases w/Wood Tiered Cutlery Divider Drawer	B..WTCD	176
Bases w/Wood Tiered Cutlery Divider Drawer & Roll Trays	B..RTWTC	190

Description	Code	Page Number
Bases w/Wood Tiered K-Cup® Drawer	B..KCUP	176
Bases w/Wood Tiered K-Cup® Drawer & Roll Trays	B..KCUPRT	191
Bookcases Tall	TBC	300-301
Bookcases Tall w/Doors	TBCD	302-303
Bookcases Wall Furniture	WFBC	298
Box Column Fillers (Wall, Base, Tall)	BCF	345-346
Braided Moulding	BRAIDM	370
Broom Clip	BRMCLP	406
Buffet Leg	JBUFFETLEG	381
Bumper Pads	BUMPERPADS	418
Cabinet Box Only	CBO	36
Cabinet Case Only	CCO	36
Cabinet False Panel	CFP	36
Cabinet Frame Only	CFRMO	50
Cabinet Front Only	CFNTO	50
Cabinet Panel Edge Moulding	CPE	371
Cabinet w/No Door, w/Drawer	CND	36
CabMat™	CABMAT	406
CabMat™	CMAT	41
CabMat™ Vanity	CABMATV	406
Cap Moulding	CAPM	374
Celtic Corbel	CORBELCELT	397
Celtic Insert	INSERTCELT	370
Celtic Light Rail Insert	JLRINSCELT	375
Celtic Overlay	JCELOVLY	378
Celtic Rosette	ROSETTCELT	379
Classic Fluted Leg	JFLUTELEG	383
Classic Fluted Leg, Small	JFLUTELEGS	383
Classic Fluted Leg, Small Split	JFLUTELEGSS	383
Classic Rope Leg	JROPELEG	388
Classic Rope Leg, Small	JROPELEGS	388
Classic Rope Leg, Small Split	JROPELEGSS	388
Classic Tall Crown Moulding	CLTCROWN	367
Clear Caster	CASTERCLR	402
Contemporary Light Rail	JINSERTLRC	375
Cooking Utensil Divider	CUDD	407
Corner Door Cabinets	CD	141
Corner Fillers	CF	341
Corner Tambour Cabinets	CT	140
Cornice Tall Crown Moulding	COTCROWN	367
Cosmo Corbel, 7" Small	JCORBELCOS7	397
Cosmo Corbel, 13" Large	JCORBELCOS13	398
Cosmo Corbel, 13" Large Deep	JCORBELCOS13D	398
Cosmo Foot	JCOSFOOT	393
Cosmo Leg	JCOSMOLEG	381
Countertop Edge Moulding (Contemporary & Traditional)	CCM, TCM	371
Country Sink Base w/CabMat™	CNTYSB..CM	210
Country Sink Bases	CNTYSB	209
Cove Corbel	CORBELCOVE	398
Cove Crown Moulding	COVECROWN	367
CPU Bases	CPU	306
Craftsman Foot	JCRAFTFOOT	393
Craftsman Open Bracket	JCORBELCRAFTO	400
Crescent Metal Corbel	CORBELCRBN	402
Cross Grain Veneer Back Skin 1/4" Panels	BP..CRSGR	357
Custom Doors w/Hinge Routing	DOOR	350
Custom Doors w/Hinge Routing, Slab Styles	DOORSLAB	351
Cut for Glass Doors	CG, CG.BTM, CG.TOP	52
Cutlery Dividers	CIW, WTCD	407
Decorative Appliance Panels	DAPNL	352
Decorative Door Panel Kits, Base End	BED	364
Decorative Door Panel Kits, Tall End	TED	365
Decorative Door Panel Kits, Wall End	WED	365
Decorative Split Turnings 3"	J3SPRING	396
Decorative Split Turning End	SPRINGEND	396

Description	Code	Page Number
Decorative Split Turning Reed	SPRINGREED	396
Decorative Split Turning Rope	SPRINGROPE	396
Decorative Split Turning Spool	SPRINGSPPOOL	396
Deep Roll Tray	DRT	42
Dentil Moulding	MDENTIL	370
Desk Door Drawer Bases	DDO	303
Desk Double File Drawer Bases	DDFD	305
Desk Drawer Bases	DDR	304
Desk Easy Reach	DER	307
Desk File Drawer Bases	DFD	304
Desk Wastebasket Full Height Bases	DWB..FH	305
Diagonal Base Cabinet w/Full Height Door	DAB..FS	215
Diagonal Base Cabinet w/Full Height Door & Lazy Susan	DAB	215
Diagonal Base Cabinet w/Full Height Door & Super Lazy Susan	DAB..SLS	216
Diagonal Corner Moulding	DCM	376
Diagonal Wall Cabinets	DW	119-121
Diagonal Wall Cabinets w/Lazy Susan	DW..S	120
Diagonal Wall Cabinets w/Lower Door	DW..D	121
Diagonal Wall Cabinets w/Lower Door & Lazy Susan	DW..DS	123
Diagonal Wall Cabinets w/Tambour	DW..T	121
Diagonal Wall Cabinets w/Tambour & Lazy Susan	DW..TS	123
Diagonal Wall Peninsula Cabinets	DW..P	125
Door Panel - Solid Reverse Raised	DPSRR	33
Drawer Front Flat 5-Piece	DF5PC	32
Drawer Front Raised 5-Piece	DFR5PC	32
Drawer Front Slab	DFSLB	32
Drawer Guide Kits	DGK	416
Drawer Guide Spacer Block	SPACERBLK	416
Ductless Conversion Kit	CONVERSION	162
Easy Reach Wall Corner Cabinets	ER	126
EasyTrax™	ET	42
Edgebanding	EDGEBAND	408
Egg & Dart Moulding	EGD	370
End Extended Back	EXBKL, EXBKR	38
End Panel/Base	BEP	358
End Panel/Base Lazy Susan	BLSBEP	359
End Panel/Tall	TEP	359
End Panel/Vanity Base	VBEP	360
End Panel Skins/Base	BEPS	355
End Panel Skins/Tall	TEPS	355
End Panel Skins/Wall	WEPS	356
English Bar Column	ENGBARCOLUMN	382
English Country Leg	JENGCNTYLEG	381
English Island Column	ENGISLCOLUMN	382
Estate Leg	JESTATELEG	383
Estate Leg, Small	JESTATELEGS	382
Estate Leg, Small Split	JESTATELEGSS	382
Extended Stile	EXL, EXR	39
Exterior Shelves	ES	408
Face Frame and Door on End	FFDL, FFDR	34
False Panel Clips	FALSEPNLCLIP50, PFALSEPNLCLIP50	416
Filler Return	F..R	341
Fillers	F	341
Finger Pull	PULLH	402, 405
Finished Back Skins	BP	356
Finished Ends	FB	34
Flat Scribe Moulding	SM	371
Floating Island Bases	FIC	238
Floating Island Bases without Top	FICNT	238
Floating Shelves	FS	153
Flush Toekick	FTK, FTK.FNT.P, FTK.P	45
Flush Toekick Arch	FTKAV, FTKAV.FNT.P, FTKAV.P	45

Description	Code	Page Number
Flush Toekick Furniture	FTKEV, FTKFV.FNT.P, FTKEV.P	45
Fluted/Beaded Fillers	FBF	344
French Country Foot	JFRNCNTYFOOT	393
French Country Leg	JFRNCNTYLEG	384
French Leg	FRNLG	393
Full Depth Shelf	FD	41
Full Depth Shelving	SK	409
Full Overlay Crown	FOLCROWN	367
Furniture Drawer Window Bench	FDWB	308
Furniture Drawers	FD	307
Furniture Finished Plywood Ends	FPEB	34
Furniture Valance	FV	377
Glass Shelf Kits	JGSK	409
Hardware Decorative Pulls and Knobs	KNOBH, PULLH	405
Hearth Liner	HL	172
Hearth Mantels	HM	170-171
Hearth Piers	HP.21	168
Hearth Piers w/Pull-Out	HPP.21	169
Hearth Shelf	HS	172
Heat Shields	ANGLHEATSHIELD, ANGLHSHIELDSS, STRHEATSHIELD, STRTHSHIELDSS	410
Hinge Angle Restriction Clip	HINGERESCLIP	418
Hinge Shim	HINGESHIM	418
Hinges	HINGE	405
Increased Depth	ID	37
Insert Crown	INSCROWN	367
Inside Corner Moulding	ICM	376
Installed Roll Tray	RT	42
Inverted Frame	INVFRM	40
Island Leg	ISLLEG	385
Ivy Moulding	IVYM	372
K-Cup® Insert	WBCPOKCUP	410
Large Corbel	LGCORBEL	397
Large Outside Corner Moulding	LOSC	376
Large Shaker Crown	LSHAKER	368
Large Square Foot	LGSQFOOT	394
Large Straight Angle Crown Moulding	LSACROWN	367
Lazy Susan Pull-Out	LSP	222
Library Moulding	LBRM	372
Lid Organizers	LO, LO24DP	410
Lidstay	LIDSTAY, LIDSTAYHD	418
Light Baffle Moulding	LB	374
Light Installed Battery Strip	LTI	42
Light Rail Moulding	LRM	375
Lighting & Lighting Accessories	—	403-404
Lille Foot	LIFOOT	395
Linen Closet	LC	335
Linen Closet Hamper Liner	LCHAMPERLNR	410
Linen Closet w/Removable Hamper	LCRH	335
Linen Storage Cabinets	LT	336
Loose Toekick	TKP	47
Madeline Foot	JMADEFOOT	394
Madison Foot	JMADFOOT	394
Matching Interior Plywood	MIP	35
Medicine Cabinets (Single & Tri-View)	MC, TV	340
Medium Straight Angle Crown Moulding	MSACROWN	368
Metal Feet	FOOTMETAL	402
Metro Bar Column	METBARCOLUMN	385
Metro Island Column	METISLCOLUMN	386
Metropolitan Foot	JMETROFOOT	394
Mirror Frame Moulding	WMF	372

Description	Code	Page Number
Miscellaneous Parts	BRKOFFSCREW, BUMPERPADS, INSTALLSCR, INSTALLSCREWS, MC16HDW/WCATCH, PDM, RETCLIP.BAG, SHELFPEDS, TVHDW/WCATCH	418
Mission Corbel 6"	CORBELMIS6	398
Mission Corbel 9"	CORBELMIS9	398
Mission Insert	JMISINSERTM	370
Mission Leg	DLEMISSION	386
Mission Light Rail Insert	JLRINSMIS	375
Mission Rosette	ROSETTEMIS	378
Mission Tile	JTILEMISSION	379
Mullion Doors	MD, MD.BTM, MD.TOP	53
Mullion Doors, Prairie	PRMD, PRMD.TOP	55
Mullion Doors, Shaker	SHMD, SHMD.TOP	54
Ogee Edge Moulding	OGEEEM	372
Olde World Corbel 4"	JCORBELOWD4	399
Olde World Corbel 5"	CORBELOWD5	399
Olde World Corbel 7"	JCORBELOWD7	399
Outside Corner 135° Moulding	OC135	376
Outside Corner Moulding	OCM	376
Oven Cabinets Double	OCD	281-282
Oven Cabinets Double w/Drawer	OCD..DD, WD	283-286
Oven Cabinets Double w/Drawer & Extended Opening	OCD..WDE	287-288
Oven Cabinets Single	OCS	275-276
Oven Cabinets Single w/Drawer	OCS..DD, WD	277-280
Oven Installation Kit	OCINSTALLKIT	410
Oven Microwave Cabinets	OMC	291-292
Oven Microwave Cabinets w/Drawer	OMC..DD, WD	293-296
Overlay Fillers	OL	342
Overlay Fillers for Modified Full Overlay	OL..MFO	342
Panels w/Filler Attached	BEPF, TEP, WEP	361-363
Pantry Top Units	PTU	268
Pantry Top Units w/Pull-Out	PTUP	269
Pantry Top Units w/Shelves	PTUS	267
Pantry Units	PY	272
Pantry Walk-Through	PWT	274
Pegged Dish Organizer	PDO, PDOPOSTS	410
Peninsula	P	50
Plinth Block	PLBLOCK	395
Plinth Block Filler 3"	FFP, BFPC	379
Plinth Block Filler 6"	FFP	380
Plywood Ends	PE	31
Pots & Pans Organizer Bases w/Drawer	B..PS	192
Pots & Pans Pull-Out	PPP	410
Power Pads	JPWRPOD	411
PowerGlide™ Compact Drawer Outlet	DRWPWR	43, 411
Prepare Cabinet for Finished Bottom	PFINBTMB	38
Printer Bases	PRB	306
Push to Open Wastebasket	PTOWB	43
Quarter Round Moulding	QRM	377
Quattro Dimming Receiver	QDIMREC	404
Quattro Wall Controller	Q4ZONECON	404
Queen Anne Leg	JQUNANNELEG	386
Raised Panel Arch Valance	JRPV	377
Recessed Island Toekick	RECTKALL	47
Recessed Panel Arch Valance	JRCPV	377
Recessed Toekick on Back or Side	RECTKKB, RECTKL, RECTKR	47
Reduced Depth	RD	37
Reed Leg	JRDLEG, RDLEG	386
Roll Tray Kits	RT	414
Roll Tray Kits Deep	DRT	414

Description	Code	Page Number
Roll Tray Plug In Bracket	RTBKXSXP	416
Roman Weave Leg	JWEAVELEG	387
Rope Moulding	RPM	371
Rosette (Traditional)	TROSETTE	378
Rosette 3"	FFRC, BFRC	379
Rosette 6"	FFRC	379
Sample Frame & Doors	DOORSAMPLE	419
Scalloped Valance	SV	377
Scooped Drawer	SCPDRW, SCPDRWB, SCPDRWL, SCPDRWR	33
Scroll Corbel 6"	CORBELSCR6	399
Scroll Corbel 9"	CORBELSCR9	399
Scroll Rosette	ROSETTESCR	378
Segmented Super Susan	SSS	218
Shaker Corbels	JCORBELSHKR	400
Shaker Crown Moulding	SHKRCRM	368
Shelf Pull Down	SHLFPD	411
Shelf Support Bracket	SHELFBRKTSN	402
Shoe Moulding — Convex Inside Corner	SHM	377
Single Bead Edge Moulding	SBE	372
Single Bead Moulding	SBM	372
Single Bead Pilaster	SBP	372
Single Door Medicine Cabinet	MC	340
Single Outlet Cover	JSOC	401
Single Rocker Plate	JSRC	401
Sink Base Caddy	SBCADDY	411
Sink Base SuperCabinet™	SB..S	203
Sink Base SuperCabinet™ w/CabMat™	SB..SCM	203
Sink Base SuperCabinet™ w/Caddy	SB..SCDY	204
Sink Base SuperCabinet™ w/Tilt-Out Trays	SB..STS	205
Sink Base SuperCabinet™ w/Tilt-Out Trays & CabMat™	SB..STSCM	205
Sink Base SuperCabinet™ w/Tilt-Out Trays & Caddy	SB..STSCDY	206
Sink Base w/CabMat™	SB..CM	199
Sink Base w/Caddy	SB..CDY	199
Sink Base w/Tilt-Out Trays & CabMat™	SB..STCM	202
Sink Base w/Tilt-Out Trays & Caddy	SB..STCDY	202
Sink Bases	SB	198-201
Sink Bases w/Drawers Below	SB..D	206
Sink Bases w/Tilt-Out Trays	SB..ST, SB..CSST	201, 203
Sink Front Bottoms	SFB	207
Sliding Towel Rack	STR	411
Small Corbel	SMCORBEL	397
Small Cove Crown Moulding	SMCOVECROWN	368
Small Crown Moulding	SCM	368
Small Light Rail Moulding	SMLR	375
Small Scribe Moulding	SSM	372
Snack Bar Support	SBS	399
Soffit Filler Moulding	SFM	369
Soffit Trim Moulding	TSTM	373
Solid Wood Crown Moulding	SWCRM	369
Solid Wood Large Crown Moulding	SWLCRM	369
Solid Wood Super Lazy Susan	SLSW	219
Solid Wood Tall Crown Moulding	SWTCRM	369
Solid Wood Victorian Crown Moulding	SWVCRM	369
Space Fillers	S96	342
Special Size Vanity	MV	334
Spice Rack Pull Down	SPD	411
Spice Racks	SRCH	411
Spindle Rail Moulding & Cornerpost	SR, CORNERPOST	373
Spool Decorative Leg	SPLEG	390
Spool Leg	JSPLEGT	390
Spool Leg, Small	JSPLEGS	389
Spool Leg, Small Split	JSPLEGSS	389
Square Bar Leg	JSQBARLEG	391

Description	Code	Page Number
Square Bar Leg, Split	JSQBARLEG3S	391
Square Corner Sinks	CS	207
Square Foot	JSQFOOT	394
Square Foot, Split	JSQFOOTS	395
Square Island Leg	JSQISLLEG	391
Square Island Leg, Split	JSQISLLEG3S	390
Stacked Diagonal Wall Cabinets	STDW	124
Stacked Wall Cabinets Double Door	STW	109-111
Stacked Wall Cabinets Single Door	STW	106-110
Stacked Wall End Cabinets Double Door	STWEC..D	131
Stacked Wall End Cabinets Single Door	STWEC	130
Stacked Wall Transition Cabinets	STWTC	135
Stain & Paint	STAIN, PAINT, SSC	417
Straight Angle Crown Moulding	SACROWN	368
Straight Tambour Cabinets	ST	139
Straight Valance	VV	378
Starter Moulding	STR8	370
Starter Moulding, Shaker	STRS	370
Super Susans	SLS	219
Super Susans w/Chrome Rail	SLSCR	220
SuperCabinet™, 30"	BSC30PR, R, RP, RS, SR	182
SuperCabinet™, 36"	BSC36PRP, PRS, SRP, SRS	184
SuperCabinet™ Gourmet	BSCG	183, 185
SuperCabinet™ Version 2, 30"	BV2SC30PR, RP, RS, SR	183
SuperCabinet™ Version 2, 36"	BV2SC36PRP, PRS, SRP, SRS	185
Super Lazy Susans w/Chrome Rail	SLSCR	220
Tablet Holder	TABLEHLDR	411
Tall Built-In Microwave Cabinet	TBMWB	289-290
Tall Crown Moulding	MTCROWN	368
Tall Panel w/Filler Attached & Authentic End	TEP..AEL, AER	363
Tall Pantry Pull-Outs	TPP	269
Tapered Leg	TAPLG	395
Tapered Wood Hood Blower	TWHBLOWER	162
Tapered Wood Hoods	TWH	161
Tilt-Out Trays, Plastic	TOT	412
Tilt-Out Trays, Stainless Steel	TOTSS	43, 412
Tilt-Out Trays, Stainless Steel Slim	TOTSSS	43, 412
Toeboards	TB	374
Toekick Cap	TKC	374
Toekick Drawer	DRWTK	48
Toekick Vacuum	CABVAC, VACBAG, VACL, VACR, VACTK	48, 412
Toekick Tulip Foot	TKTLFOOT	395
Touch Latch	TOUHLATCH	402
Touch-Up Tools	GLAZEPEN, MTUK, TUK	417
Traditional Light Rail	JINSERTLRT	375
Traditional Open Corbel	JCORBELTRADO	401
Tray Divider, Chrome	CTDK	412
Tray Divider Kit	TDKIT	413
Tray Divider Roll-Out Kit	TDRO	413
Tray Dividers	TD	44
Tray Shelves	TRAYSHLF	154
Triple Bead Edge Moulding	TBEM	373
Triple Bead Pilaster Moulding	TBP	373
Tri-View Medicine Cabinets	TV	340
Truss Metal Corbel	CORBELTRSS	402
Tulip Foot	TLFOOT	395
Tulip Leg	JTULIPLEG	392
Under Counter Drawers	UCD	334, 334
Universal Design Base Cabinets	B..UD	249
Universal Design Base Cabinets w/Roll Tray	B..RTUD	250-250
Universal Design Base Microwave Cabinets	BMW..UD	252
Universal Design Fillers	BF, TF, FR..UD	253

Description	Code	Page Number
Universal Design Single Oven Cabinet	OC..UD	252
Universal Design Sink Base Cabinets	SB..UD	251
Universal Design Sink Base Cabinets w/Tilt-Out Trays	SB..STUD	251
Universal Design Super Susan	SLS..UD	251
Universal Design Three Drawer Base Cabinets	3DB..UD	252
Universal Design Toeboards	TB8UD	253
Universal Design Vanity Desk Leg	VDLUD	253
Urn Leg	JURNLEG	392
Utility Cabinets	U	254-258
Utility Cabinets w/Roll Trays	U..RT	259-260
Utility Easy Access Cabinets	UEAS	261-264
Utility Organizer Cabinets	UOC	265
Utility Organizer Drop Zone Cabinet	UOCDZ	266
Utility Storage w/Pantry Pull-Out	US	271
Utility Storage w/Pantry Pull-Out and Pot and Pan Rack	US..PP	271
Valance Top Rail	TVRAV, TVRFV, TVRVV	40
Valley Forge Moulding	VFR	375
Vanity Angle Corner Sink Front	VACSF	333
Vanity Angle Corner Sink Front Bottoms	VACSFb	333
Vanity Base Easy Reach	VER	319
Vanity Base Wastebasket	VBWB	321
Vanity Bases	V	311-313
Vanity Chrome Roll-Out Rack	VCCR	413
Vanity Desk Legs	VDL	366
Vanity Door Drawer Bases	VB	318
Vanity Drawer Bases	VDB	320
Vanity Four Drawer Bases	4VDB	321
Vanity Grooming Pull-Out	VGPO	323
Vanity Hamper	VH..FH	334
Vanity Hamper w/Drawer	VBH	335
Vanity Mirror	VM	339
Vanity Mirror w/Side Pull-Outs	VMP	339
Vanity Pull-Out	VP	323
Vanity Sink Bases w/False Drawer Fronts	VSb	314-315
Vanity Sink Bases w/U-Shaped Roll-Out Tray	VSb.....U	315
Vanity Sink Bases w/Wastebasket	VSb.....WB	316
Vanity Sink Bases SuperCabinet™ w/Tilt-Out Trays	VSSB.....ST	317
Vanity Sink Bases SuperCabinet™ w/Tilt-Out Trays & Wastebasket	VSSB.....STWB	316
Vanity Sink Drawer Bases	VSD	324-329
Vanity Sink Drawer Bases w/Eight Drawers	VSD	332
Vanity Sink Drawer Bases w/Eight Drawers & False Panel	VSD..FP	333
Vanity Sink Drawer Bases w/Six Drawers	VSD	331
Vanity Sink Drawer Bases w/Six Drawers & False Panel	VSD..FP	331
Vanity Sink Three Drawer Bases	VS3D	330
Vanity Utility Cabinets	VU	336
Vanity Wall Cabinets	W	338
Vanity Wall Hung Cabinets	VWH	336
Vanity Wall Mirror Cabinets	VWM	338
Vanity Wall Towel Bar	VWTB	338
Vanity Wastebasket	VWB	321
Void Toekick	VTK	49
Wainscoting	WAIN	349
Wall Appliance Garage Door	WAGD	139
Wall Appliance Garage Vertical Lift Door	WAGVLD	140
Wall Base Double Door Cabinets	WB	180
Wall Base Single Door Cabinets	WB	180
Wall Box Column Pull-Outs (Plain, Overlay)	WBCPO	141
Wall Box Column Pull-Outs w/K-Cup® (Plain, Overlay)	WBCPOKCUP	143
Wall Built-In Microwave Cabinets	WBMW	137
Wall China Display Cabinets	WCD	149
Wall China Display Cabinets w/Doors	WCD	150
Wall Corner Cabinets	WC	112-117
Wall Corner Decorative Shelf	WCS	154

Description	Code	Page Number
Wall Corner Double Door Cabinets	WC	113-117
Wall Corner Inside	W..CIA	129
Wall Corner Outside	W..COA	128
Wall Corner Single Door Cabinets	WC	113-117
Wall Decorative Shelves	WS	154
Wall Double Door Cabinets	W	79-101
Wall Easy Access Storage Cabinets	WEAS	101
Wall End Cabinets	WEC	130
Wall Message Center	WMC	155
Wall Microwave Cabinets	MW	136
Wall Microwave Double Door Cabinets	MW	136
Wall Open Cabinets	WOC	148-149
Wall Organizers	WO	152
Wall Quarter Round End Shelves	WQRES	132-133
Wall Refrigerator Cabinets	W	96
Wall Refrigerator Pull-Out	W..PO	87, 91, 94
Wall Refrigerator Vertical Lift	WVL	86, 90
Wall Shelf Pull Down	W..SHLFPD	146
Wall Single Door Cabinets	W	78-100
Wall Spice Drawers	WSD	153
Wall Spice Pull Down	W..SPD	146
Wall Spice Pull-Out	WSP	145
Wall Spice Rack Cabinets	WSR	147
Wall Susan Kits	WSK	413
Wall Three Drawer Cabinets	W3D	105
Wall Top Hinge Cabinets	WTH	79-90
Wall Transition Cabinets	WTC	134
Wall Two Drawer Cabinet	W2D	102, 104
Wall Vertical Lift	WVL	85-90
Wall Wine Cubbies	W	152
Wall Wine Racks	WNR	151
Weave Foot	JWEAVEFOOT	394
Weave Insert	JWEAVEINSERTM	371
Weave Light Rail Insert	JLRINSWEAVE	376
White Laminate Interior	WLI	35
Wide Scribe	WSCRIBE	373
Window Casing—Traditional	WCT	374
Wine Glass Holders	WGH	413
Wine Storage Cabinet	WSC	151
Wood Hood Arch	WHA	155
Wood Hood Blower	BLOWER	161
Wood Hood Canopy Arched	WHCA, JWHCA	159
Wood Hood Canopy Square	WHCS, JWHCS	159
Wood Hood Chimney	WHC	156
Wood Hood Contemporary Straight	JWHCONSTR	156
Wood Hood Island Arch	JWHIA	160
Wood Hood Island Square	JWHIS	160
Wood Hood Linear, Tapered	JWHL	157
Wood Hood Shiplap Chimney	JWHSHIPCH	158
Wood Hood Shiplap, Straight	JWHSHIPSTR	157
Wood Hood Shiplap, Straight w/Corbels	JWHSHIPSTRCB	157
Wood Hood Shiplap, Tapered	JWHSHIPT	158
Wood Hood Shiplap, Tapered w/Corbels	JWHSHIPTCB	158
Wood Hood Square	WHS	156
Wood Tiered K-Cup® Drawer	KCUP	408
Wood Tops, Four Sided	4TWT	310
Wood Tops, One Sided	1TWT	309
Wood Tops, Three Sided	3TWT	309
Wood V-Grooved Beaded Skin 1/4" Panels	BP..VG	357
Wood V-Grooved w/Triple Beaded Front 3/4" Panels (Base, Tall, Wall)	BEP, TEP, WEP..VG	364

Code	Page Number
1TWT	309
2DB	225
2DB..DR	227
2DB..FD	225
2DB..PDO	226
2DB..RT	226
2DB..RTPDO	227
2DB..WD	227
3CDB	223
3DB	228
3DB..KCUPI	229
3DB..UD	252
3DB..WD	230
3DB..WTCD	229
3DBB	228
3DBBDD	231
3DBDD	230
3TWT	309
4DB	231
4DB..CIW	232
4DB..KCUPI	233
4DB..WTCD	232
4TWT	310
4VDB	321
ABFOOT	393
ACAM	371
ACO	378
ACOVLY	378
ACS	39, 208
ACSF	208
ACSFBI	209
ADDTK	45
ALF	51
ANGLHEATSHIELD	410
ANGLHSHIELDSS	410
APC	31
AUTHL, AUTHR	34
AV	377
B	173-252
B..B	175
B..CIA	224
B..COA	224
B..CIW	175
B..CWP	194
B..DR	241
B..FH	177, 179
B..FHMIXSC	197
B..FHRT	188
B..FHRTLO	192
B..FSCO	193
B..KCUPI	176
B..KCUPIRT	191
B..PS	192
B..RT	186
B..RTB	187
B..RTCIW	190
B..RTLO	191
B..RTUD	250
B..RTWTCD	190
B..TDRO	196
B..UD	249
B..WTCD	176
BARLEG	380
BATTLI	403
BBCPO	240
BBM	373
BBMSC	373
BBMSH	373
BBMSW	374
BBMWD	242
BBTP	235
BC	211
BC..PO	212
BCF	345-348
BCFW	212
BCFW..CPO	213
BCFW..PO	213
BCFW..SP	214
BCOPP	239
BCP	245

Code	Page Number
BCP..FH	245
BEAS	181
BEC	224
BED	364
BEP	358
BEP..AEL, AER	362
BEP..VG	364
BEPF	361
BEPS	355
BER	217
BERAS	217
BF	253
BFPC	379
BFRC	379
BKSOCKET	416
BLOWER	161
BLS	215
BLS..DR	214
BLSBEP	359
BLVDF	345
BMC	241
BMW	244
BMW..RT	244
BMW..UD	252
BMW..WD	243
BMW..DD	243
BO	242
BOC	246
BOD	247
BP	356
BP..CRSGR	357
BP..VG	357
BPM	371
BPP	239
BPPP	193
BPS	406
BPT	174
BPT..FH	178
BPT..WB	234
BPT..WBFH	235
BQRES	246
BRAIDM	370
BRDB	222
BRKOFFSCREW	418
BRMCLP	406
BSC30PR, R, RP, RS, SR	182
BSC36PRP, PRS, SRP, SRS	184
BSCG	183, 185
BSD	237
BTC	223
BUMPERPADS	418
BUPP	239
BUPPKB	240
BV2SC30PR, RP, RS, SR	183
BV2SC36PRP, PRS, SRP, SRS	185
BWB	233
BWB..FH	234
BWBFHLID, BWBLID	406
BWC	237
CABL	404
CABLRIG	404
CABMAT	406
CABMATV	406
CABVAC	412
CAPM	374
CASTERCLR	402
CBO	36
CCM	371
CCO	36
CD	141
CF	341
CFNTO	50
CFP	36
CFRMO	50
CG, CG..BTM, CG..TOP	52
CIW	407
CLTCROWN	367
CMAT	41
CND	36
CNTYSB	209

Code	Page Number
CNTYSB..CM	210
CONFLX	404
CONVERSION	162
CORBELART9	397
CORBELCELT	397
CORBELCOVE	398
CORBELCRBN	402
CORBELMIS6	398
CORBELMIS9	398
CORBELWD5	399
CORBELSCR6	399
CORBELSCR9	399
CORBELTRSS	402
CORNERPOST	373
COTCROWN	367
COVECROWN	367
CPE	371
CPU	306
CS	207
CT	140
CTDK	412
CUDD	407
DAB	215
DAB..FS	215
DAB..SLS	216
DAPNL	352
DB	224-232
DCM	376
DDFD	305
DDO	303
DDR	304
DER	307
DFD	304
DFF5PC	32
DFR5PC	32
DFSLB	32
DGK	416
DIMM	404
DLEMISSION	386
DOOR	350
DOORSAMPLE	419
DOORSLAB	351
DPSRR	33
DRT	42, 414
DRWPWR	43, 411
DRWTK	48
DW	119-121
DW..D	121
DW..DS	123
DW..P	125
DW..S	120
DW..T	121
DW..TS	123
DWB..FH	305
EDGEBAND	408
EGD	370
ENDRIG	404
ENGBARCOLUMN	382
ENGISLCOLUMN	382
ER	126
ES	408
ET	42
EXBK, EXBKR	38
EXL, EXR	39
F	341
F..R	341
FALSEPNLCLIP50	416
FB	34
FBF	344
FD	41, 307
FDWB	308
FFDL, FFDR	34
FFP	379
FFRC	379
FIC	238
FICNT	238
FLEX	403
FOLCROWN	367
FOOTMETAL	402
FPEB	34

Code	Page Number
FR..UD	253
FRNLG	393
FS	153
FTK, FTK..FNT.P, FTK.P	45
FTKAV, FTKAV..FNT.P, FTKAV.P	45
FTKRV, FTKRV..FNT.P, FTKRV.P	45
FV	377
GLAZEPEN	417
HINGE	405
HINGERESCCLIP	418
HINGESHIM	418
HL	172
HM	170-171
HP..21	168
HPP..21	169
HS	172
ICM	376
ID	37
INSCROWN	367
INSERTCELT	370
INSTALLSCR, INSTALLSCREWS	418
INVRM	40
IR	404
ISLLEG	385
IVYM	372
J3SPRING	396
JACANFOOT	393
JACANINSERTM	370
JACANTHUSLEG	380
JBARQUELEG	381
JBRACKETART	400
JBUFFETLEG	381
JCELOVLY	378
JCORBELARTO	400
JCORBELCOS7	397
JCORBELCOS13	398
JCORBELCOS13D	398
JCORBELCRAFTO	400
JCORBELOWD4	399
JCORBELOWD7	399
JCORBELSHKR	400
JCORBELTRADO	401
JCOSFOOT	393
JCOSMOLEG	381
JCRAFTFOOT	393
JENGCNTYLEG	381
JESTATELEG	383
JESTATELEGS	382
JESTATELEGSS	382
JFLUTELEG	383
JFLUTELEGS	383
JFLUTELEGSS	383
JFRNCNTYFOOT	393
JFRNCNTYLEG	384
JGSK	409
JINSERTLRC	375
JINSERTLRT	375
JLRINSACAN	375
JLRINSCELT	375
JLRINSMIS	375
JLRINSWEAVE	376
JMADEFEET	394
JMADFEEET	394
JMETROFOOT	394
JMISINSERTM	370
JPWRPOD	411
JQUNANNELEG	386
JRCPV	377
JRDLEG	387
JROPELEG	388
JROPELEGS	388
JROPELEGSS	388
JRPV	377
JSOC	401
JSPLEGS	389
JSPLEGSS	389
JSPLEGT	390
JSQBARLEG	391
JSQBARLEG3S	391
JSQFOOT	394

Code	Page Number
JSQFOOTS	395
JSQISLLEG	390
JSQISLLEG3S	390
JSRC	401
JTILEACAN	379
JTILEMISSION	379
JTULIPLLEG	392
JURNLEG	392
JWEAVEFOOT	394
JWEAVEINSERTM	371
JWEAVELEG	387
JWHCA	159
JWHCONSTR	156
JWHCS	160
JWHIA	160
JWHIS	160
JWHL	157
JWHSHIPCH	158
JWHSHIPSTR	157
JWHSHIPSTRCB	157
JWHSHIPT	158
JWHSHIPTCB	158
KCUP	408
KNOBH	405
LB	374
LBRM	372
LC	335
LCHAMPERLNR	410
LCRH	335
LEADFLX	404
LEADRIC	404
LGCORBEL	397
LGSQFOOT	394
LIDSTAY, LIDSTAYHD	418
LIFOOT	395
LO, LO24DP	410
LOSC	376
LRM	375
LSACROWN	367
LSHAKER	368
LSP	222
LT	336
LTI	42
MC	340
MC16HDW/WCATCH	418
MD, MD.BTM, MD.TOP	53
MDENTIL	370
METBARCOLUMN	385
METISLCOLUMN	386
MIP	35
MIXKITFHSC	406
MSACROWN	368
MTCROWN	368
MTUK	417
MV	334
MW	136
OC..UD	252
OC135	376
OCD, OCD..DD, OCD..WD, OCD..WDE	281-288
OCINSTALLKIT	410
OCM	376
OCS, OCS..DD, OCS..WD	275-280
OGEEM	372
OL	342
OL..MFO	342
OMC, OMC..DD, OMC..WD	291-296
P	50
PAINT	417
PDM	418
PDO, PDOPOSTS	410
PE	31
PFALSEPNLCLIP50	416
PFINBTMB	38
PLBLOCK	395
PPP	410
PRB	306
PRMD, PRMD.TOP	55

Code	Page Number
PTOWB	43
PTU	268
PTUP	269
PTUS	267
PUCK	403
PULLH	402, 405
PWT	274
PY	272
Q4ZONECON	404
QDIMREC	404
QRM	377
RD	37
RDLEG	386
RECTKALL	47
RECTKBK	47
RECTKL	47
RECTKR	47
RETCLIP..BAG	418
RIGID	403
ROSETTCELL	379
ROSETTEMIS	378
ROSETTESCR	378
RPM	371
RT	42, 414
RTBKXSXP	416
S96	342
SACROWN	368
SB	198-201
SB..CDY	199
SB..CM	199
SB..D	206
SB..S	203
SB..SCDY	204
SB..SCM	204
SB..ST	201
SB..STCDY	202
SB..STCM	202
SB..STS	205
SB..STSCDY	206
SB..STSCM	205
SB..STUD	251
SB..UD	251
SBCADDY	411
SBE	372
SBM	372
SBP	372
SBS	399
SCM	368
SCPDRW, SCPDRWB, SCPDRWL, SCPDRWR	33
SFB	207
SFM	369
SHELFBRKTSN	402
SHELFPEGS	418
SHKRCRM	368
SHLFPD	411
SHM	377
SHMD, SHMD.TOP	54
SK	409
SLS	219, 220
SLS..UD	251
SLSCR	220
SLSW	219, 221
SM	371
SMCORBEL	397
SMCOVECROWN	368
SMLR	375
SPACERBLK	416
SPD	411
SPLEG	390
SPRINGEND	396
SPRINGREED	396
SPRINGROPE	396
SPRINGSPPOOL	396
SR	373
SRCH	411
SSC	417
SSM	372

Code	Page Number
SSS	218
ST	139
STAIN	417
STAND	403
STDW	124
STR	411
STR8	370
STRS	370
STRTHEATSHIELD	410
STRTHSHIELDSS	410
STW	106-110
STWEC	130
STWEC..D	131
STWTC	135
SV	377
SWCRM	369
SWLCRM	369
SWTCRM	369
SWVCRM	369
TABLETHLDR	411
TAPLG	395
TB	374
TB8UD	253
TBC	300-301
TBCD	302-303
TBEM	373
TBMWB	289
TBP	373
TCM	371
TD	44, 196
TD..FH	197
TDKIT	413
TDRO	413
TED	365
TEP, TEP.AEL, TEP.AER	359, 363
TEP.VG	364
TEP	363
TEPS	355
TF	253
TKC	374
TKP	47
TKLFOOT	395
TLFOOT	395
TOT	412
TOTSS	43, 412
TOTSSS	43, 412
TOUCHLATCH	402
TPP	269
TRAYSHelf	154
TROSETTE	378
TSTM	373
TUK	417
TV	340
TVHDW/WCATCH	418
TVRAV, TVRFV, TVRVV	40
TWH	161
TWHBLOWER	162
U	254-258
U..RT	259-260
UCD	334, 334
UEAS	261-264
UOC	265
UOCDZ	266
US	271
US..PP	271
V	311-313
VACBAG	412
VACL, VACR, VACTK	48
VACSF	333
VACSFb	333
VB	318
VBEP	360
VBH	335
VBWB	321
VCRR	413
VDB	320
VDL	366
VDLUD	253

Code	Page Number
VER	319
VFR	375
VGPO	323
VH..FH	334
VM	339
VMP	339
VP	323
V3SD	330
VSb	314-315
VSb.....U	315
VSb.....WB	316
VSD	324-331, 332
VSD..FP	331, 333
VSSb.....ST	317
VSSb.....STWB	316
VTK	49
VU	336
VV	378
VWB	321
VWH	336
VWM	338
VWTB	338
W	78-101, 152, 338
W..BC	297
W..CIA	129
W..COA	128
W..PO	87, 91 94
W..SHLFPD	146
W..SPD	146
W2D	102, 104
W3D	105
WAGD	139
WAGVLD	140
WAIN	349
WB	180
WBCPO	141
WBCPOKcup	143, 410
WBMW	137
WC	112-117
WCD	149
WCS	154
WCT	374
WEAS	101
WEC	130
WED	365
WEP.VG	364
WEP	364
WEPS	356
WFBC	298
WGH	413
WHA	155
WHC	156
WHCA	159
WHCS	159
WHS	156
WLI	35
WMC	155
WMF	372
WNR	151
WO	152
WOC	148-149
WQRES	132-133
WS	154
WSC	151
WSCRIBE	373
WSD	153
WSK	413
WSP	145
WSR	147
WTC	134
WTCd	407
WTH	79-90
WVL	85-90

CHARACTERISTICS OF WOOD TYPES

No matter which species you choose for your new kitchen or bath cabinetry, please keep in mind that no two pieces of wood are exactly the same. Stains are likely to exaggerate the difference between open and closed grains and other markings in wood. Grain variation and color change should be expected. As hardwood ages, it will darken when exposed to different types of light. Color differences or changes in wood can also be caused by exposure to harsh chemicals, extreme heat or moisture. Additionally, wood species exhibit other defining characteristics, such as mineral deposits/streaks, knots, sap runs, pin holes and wormholes. These markings make the wood unique and contribute to its enduring beauty.



Alder has a straight fine textured grain similar to Cherry and Maple. Although classified as a hardwood, it is moderately light in weight and considerably softer than other species. Therefore, care must be taken as it will dent and mar easily. Alder may exhibit grain and color variations, sapwood can be distinguishable from the heartwood, tight pin knots are sometimes present.



Cherry is characterized by its red undertones, but may vary in color from white to a deep, rich brown. Cherry is a close-grained wood with fairly uniform texture, revealing pin knots and curly graining. All wood will age with time and the finish will darken. This is especially true for Cherry. This is a sought-after quality in Cherry cabinetry, and those who select it expect this evolution.



Hickory is a strong, heavy hardwood known for distinctive graining patterns. Contributing to its dramatic appearance is a wide variation in color and streaking, ranging from white to dark brown. This contrast in color can appear in a single door panel. Hickory also contains random knots and wormholes that further contribute to a varied appearance. These exaggerated characteristics are to be expected and are considered desirable in Hickory cabinetry.



Maple is a close-grained hardwood that is predominately white to creamy-white in color, with occasional reddish-brown tones. While Maple typically features uniform graining as compared to other wood species, characteristic markings may include fine brown lines, wavy or curly graining, bird pecks and mineral streaks. These traits are natural and serve to enhance Maple's natural beauty.



Oak is a strong, open-grained hardwood that ranges in color from white to pink and reddish tones. Streaks of green, yellow and even black may appear due to mineral deposits. Oak may also contain wormholes and wild, varying grain patterns. This distinct graining is considered a desirable quality.



Rustic Alder is characterized by its light brown and reddish undertones and may contain a variety of pin holes, open and closed knots of various sizes and colors, small cracks, bird pecks, mineral streaks, and grain variation. Some knots may have small holes through the panel. Larger holes will not be filled. In addition, the wood will contain color difference caused by variations in minerals found in the soil, creating visible mineral tracks.

Sound Closed Knot (not moveable) – Expected in Rustic Alder up to approximately 3" diameter.

Sound Knot with Cracks – Expect sound knots with open cracks up to approximately 1" in length.

Open Knot (through door) – Expected in Rustic Alder with open area up to approximately 3/4" diameter. Note: 3/4" diameter is about the size of a penny. Holes created by open knots pass completely through the door and are desirable for this rustic look.

Unsound Knot (moveable core) – Not to be expected.

Knot Cluster (cluster of tight sound knots) – To be expected in Rustic Alder.

Worm Holes/Pin Holes (can go through door) – Can be expected on Rustic Alder up to approximately 1/4" diameter.

Worm Tracks – Can be expected on Rustic Alder in sizes up to approximately 1/8" wide by 8" long.

CHARACTERISTICS OF GLAZING/PAINT

Characteristics of Glazing

A professional layer of glaze can add another layer of beauty to your cabinets. First, our craftsmen apply a wood toner, which accentuates the grain's natural attributes. We then add the glaze, by hand, adding depth, dimension and an understated sheen that's guaranteed to endure.

What to expect from glazed cabinetry...

- Glazing will range from a consistent, even appearance to varied coverage.
- You should expect the result to yield a subtle to dramatic look based on the complexity of a cabinet door's design, as glaze may collect in the corners and grooves.
- Printed materials and online, electronic presentations can only do so much. It's important to both see and touch actual finished samples to ensure your satisfaction.

Characteristics of Paint or Opaque Finish

Paint may develop hairline cracks in the finish, most notable around the joints. This is a result of natural expansion and contraction of the genuine hardwoods used in the manufacturing of this product. Hairline cracks are not considered a defect in the cabinetry or finish.

CHARACTERISTICS OF SPECIALTY LAMINATES

Specialty Laminates feature design leading, high definition wood grain or high gloss laminates on doors, drawer fronts, overlay fillers, and Premium trim items. The surfaces are laminate based materials with an integrated top coat that provides superior beauty, durability, and performance while meeting or exceeding all of the KCMA performance standards. The core panel material is made of MDF to ensure a consistent and stable product. Additional coordinating trim items in the cabinet box color are also available.

A heat shield is required to separate all laminate products from heat producing units to be in compliance with cabinet warranty.

CHARACTERISTICS OF PURESTYLE™ & THERMOFOIL

PureStyle™ is the process of wrapping durable laminate materials around door frames and select trim and premium mouldings resulting in products with crisp styling features and a surface that provides abrasion resistance and meets/exceeds all of the KCMA performance standards. PureStyle™ products are wrapped (versus form pressed onto a Medium Density Fiberboard (MDF) slab like thermofoil) and has a clear, integrated top coat for superior durability. The lineals and core panel material are made of MDF to ensure a consistent and stable product.

These doors offer the durability of a laminate and the beauty of paint and finished wood while bringing peace of mind to those who care about creating a better environment—both inside and outside of their homes.

Textured wood grain PureStyle™ doors feature design leading, high definition wood grain laminates on doors, drawer fronts, overlay fillers, and Premium trim items. The surfaces are laminate based materials with an integrated top coat that provides superior beauty, durability, and performance while meeting or exceeding all of the KCMA performance standards. The core panel material is made of MDF to ensure a consistent and stable product. Additional coordinating trim items in the cabinet box color are also available.

Thermofoil doors and drawer fronts feature a shaped MDF core covered with a seamless vinyl material on the face and edges, and a melamine layer on the back. The vinyl material is applied to the MDF with an adhesive, and heat and pressure are used to create a product with excellent wear and heat resistance properties.

KEMPER CABINETS' 12-STEP FINISHING PROCESS

- 1. Wood Selection** – The selection of the finest woods including Alder, Cherry, Hickory, Maple, Oak, and Rustic Alder is the essential first step of Kemper's 12-step finishing process.
- 2. Sanded to Perfection** – Our sanding utilizes a fine grit paper, both with and against the wood grain. This process is completed on a vacuum table, allowing for a wood surface that is free of dust particles.
- 3. Achieving Natural Wood Tone** – Toner is applied to selected finishes, enhancing the naturalistic wood appearance.
- 4. Stain Application** – A hand-sprayed deep penetrating stain is evenly applied to all surfaces for even coverage on all profiles.
- 5. Removal of Excess Stain** – The wood is hand-wiped to remove excess stain, emphasizing the cabinet's natural wood grain.
- 6. Catalyzed Sealer** – A tough, clear, catalyzed sealer is hand-sprayed on to protect the grain from moisture.
- 7. Drying Process** – For added durability, the sealed wood is oven cured to lock in the beauty of wood.
- 8. Hand-Sanded** – To achieve an ultra-smooth finish, we hand-sand the material one last time.
- 9. Dust Removal** – The resulting loose dust particles are removed from the surface of the wood.
- 10. Catalyzed Top-Coat** – A premium quality catalyzed clear top-coat is applied to protect the wood from environmental elements.
- 11. Final Top Coat Cure** – The top-coat is cured to guarantee the strongest, most beautiful finish.
- 12. Final Inspection** – This last inspection is very thorough, ensuring quality and beauty. Our gift to you is that every cabinet is crafted with care.

HUMIDIFICATION

The natural response of wood to changes in humidity is much more dramatic than most people realize. Here is a table showing (a) how much a cabinet door panel is likely to shrink in a low humidity environment, (b) how much a cabinet door is likely to expand in excess humidity, and (c) the total potential range of dimension changes from a muggy summer to a cold dry winter.

Total Potential Movement (inches) of solid wood panels

Species	Panel Dimension (inches)	(a) Winter	(b) Summer	(c) Annual Range
Alder/Rustic Alder	19.75	-0.27	0.25	0.52
Cherry	19.75	-0.26	0.25	0.51
Hickory	19.75	-0.34	0.31	0.65
Maple	19.75	-0.49	0.10	0.59
Oak	19.75	-0.32	0.31	0.63

Notice the annual dimension change for a solid wood panel can approach three-quarters of an inch! For this reason, cabinet doors are typically manufactured at a targeted range of 40% – 50% relative humidity. This usually works very well because even low humidity environments stay between 20% and 70% in normal years with typical cooking and washing activities.

In extremely cold, dry winters, some doors can be exposed to conditions that are below 20% relative humidity for weeks at a time. Exposure to sustained conditions such as these would cause panels to shrink and will not be considered defective. New construction intensifies this issue since the heat is on but no one is living in the home to raise the humidity levels. Conversely, where in-home humidity exceeds 70% relative humidity for extended periods of time, panels will swell and this will not be considered defective.

Steps Consumers Can Take To Protect Real Wood Furnishings

- **Keep an eye on the humidity inside the home.** Reasonably accurate digital thermometers-hygrometer units are available to measure humidity.
- **Maintain the humidity at or above 20% when the temperature is below 20°F and over 35% when the temperature is above 20°F.** Some ways this may be accomplished are installing a whole-house humidifier on the furnace, running a portable humidifier in key rooms, or placing pans of water near the heat registers.
- **Don't over-do it.** Significant condensation on windows is a sign the humidity levels are too high for outside temperature conditions.
- **Recognize that finished wood responds to humidity over several days to several weeks.** It takes time before the wood returns to normal after any correction to the environment.

WOOD DUST WARNING:

When cutting, sanding, sawing, or shaping cabinets or wood products, you are likely to generate wood dust. For your own safety, we recommend that you wear a protective mask to prevent breathing wood dust. We also recommend eye protection to avoid injury by flying wood chips or sawdust during cabinet installation.

CARB COMPLIANCE:

Kemper is committed to offering solutions that meet or exceed air emissions rules and regulations. All composite wood products used in the construction of our cabinets for end panels, shelves, tops, bottoms, backs, toekicks, and corner blocks are compliant with the California Air Resources Board (CARB) regulations for formaldehyde emissions.

FULL OVERLAY DOOR STYLES

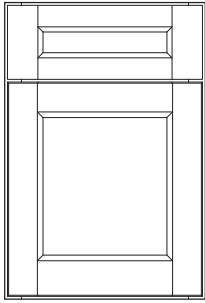

Amstead Square
(page 8)

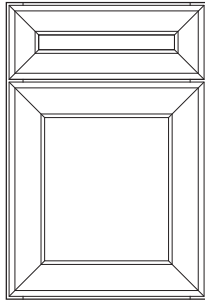

Ashridge Square
(page 8)

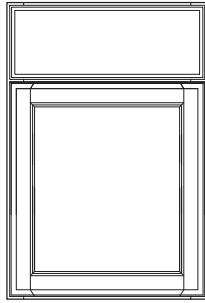

Baxter Square
(page 8)

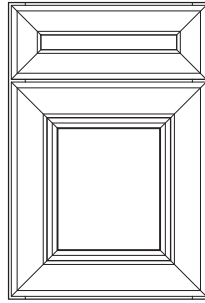

Belmont Square
(page 9)

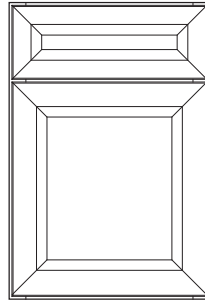

Butler Square
(page 9)

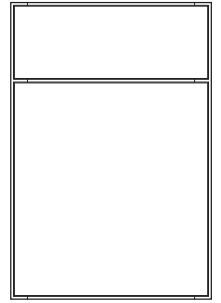

Caprice Slab
(page 9)

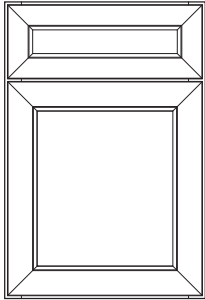

Cotter Square
(page 10)

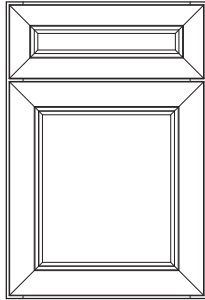

Darby Square
(page 10)

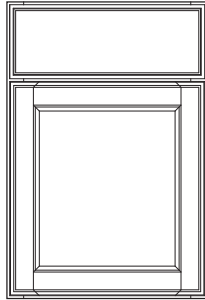

Dutton Square
(page 11)

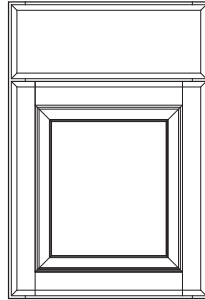

Ellerby Square **NEW**
(page 12)

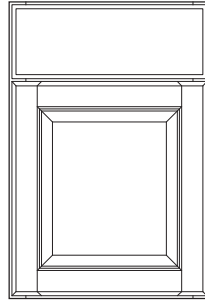

Gallatin Square
(page 12)

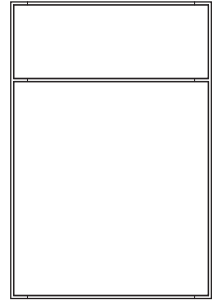

Genova Slab
(page 13)

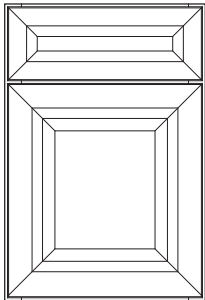

Hardin Square
(page 13)

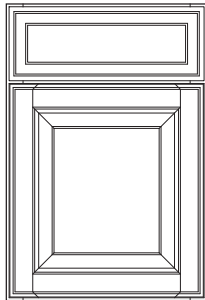

Herrington Square and Arch
(page 14)

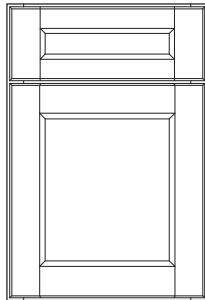

Justin Square
(page 14)

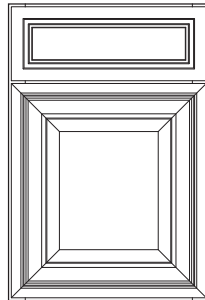

Kingston Square
(page 15)

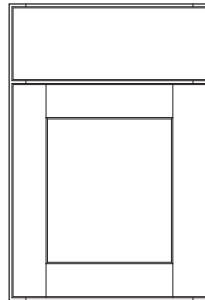

Larsen Square
(page 15)

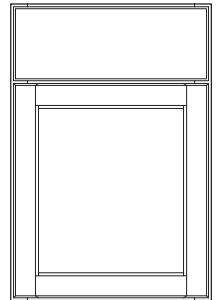

Lawton Square
(page 16)

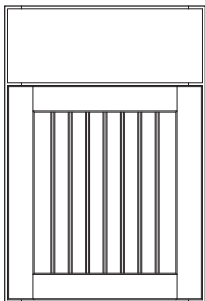

Lynnville Square
(page 16)

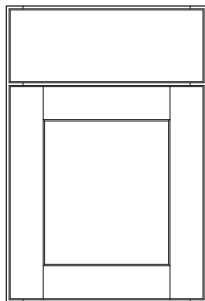

Northrope Square
(page 17)

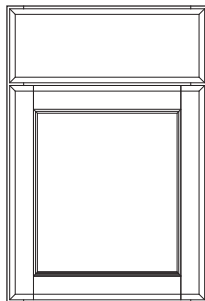

Painter Square **NEW**
(page 18)

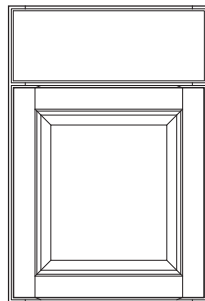

Rennie Square and Arch
(page 18)

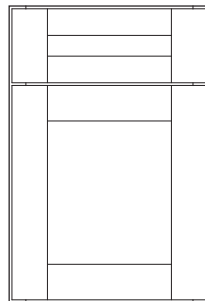

Shafer Square
(page 19)

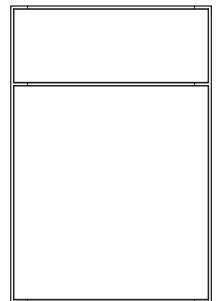

Taro Slab
(page 19)

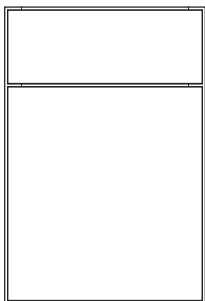

Troxel Slab
(page 20)

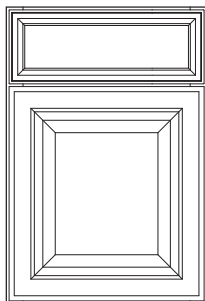

Vaille Square
(page 20)

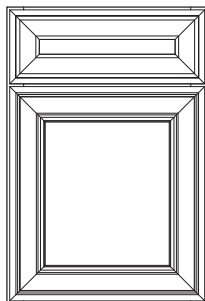

Warwick Square
(page 21)

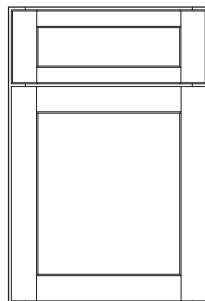

Whitman Square
(page 21)

PARTIAL OVERLAY DOOR STYLES

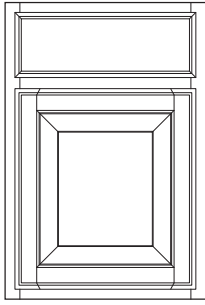

Dewitt Square and Arch
(page 11)

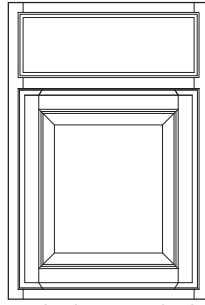

Fairbrook Square and Arch
(page 12)

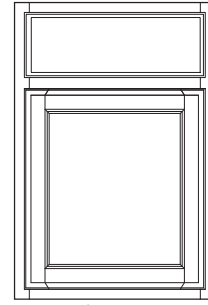

Manchester Square
(page 17)

FULL AND PARTIAL OVERLAY SPECIFICATIONS

Full Overlay

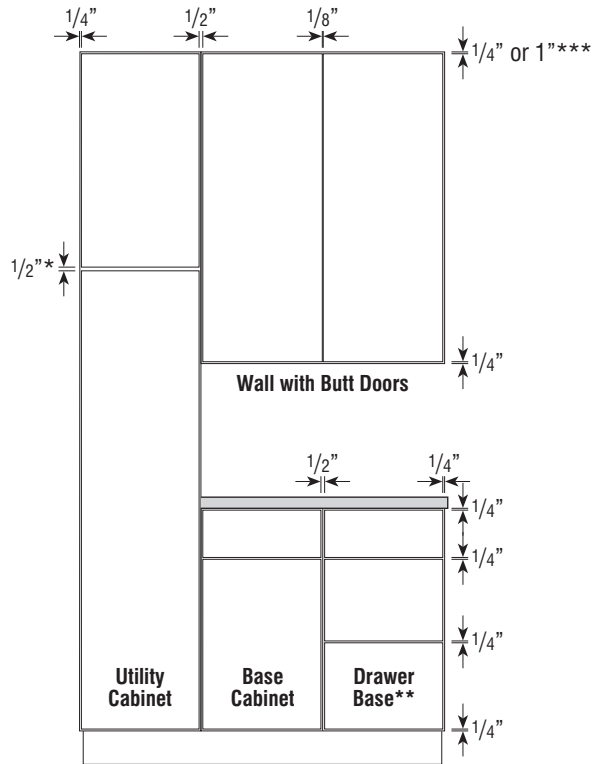

Partial Overlay

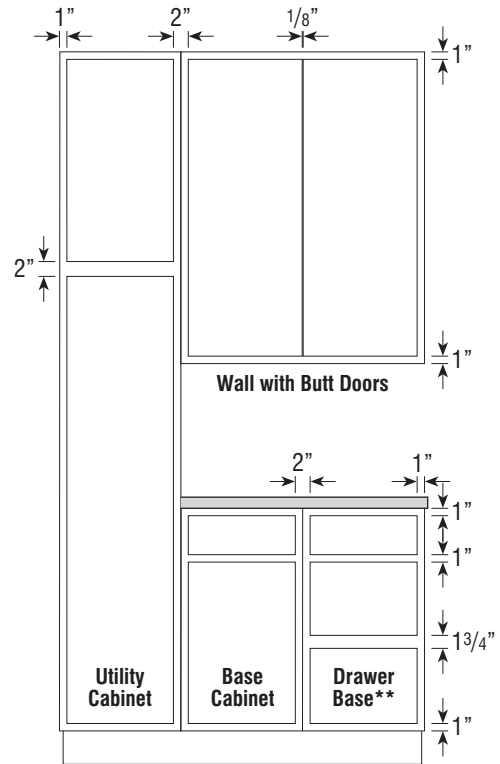

*1" on 90" high utilities

**34 1/2" high application shown. On 32" high Full Overlay three drawer applications (drawer bases and sink bases with drawers), the reveal above the bottom drawer front is 1/2".

***1" reveal when MFO is chosen

One double door center stile cabinet has the same reveal as two single door cabinets.

DOOR STYLE SPECIFICATIONS

Arch/Cathedral

- 9" wide wall cabinets will come in Arch or Cathedral if an Arch or Cathedral door style is selected.
- Base cabinets ordered in Arch/Cathedral will have Square doors.

Cherry

- When Cherry door styles are ordered, it is recommended to apply a finished end option or a veneer end panel for exposed ends due to the natural aging of Cherry.

Maple

- When an Opaque finish or an Opaque Glaze finish is specified, the door and/or drawer front center panel may be constructed of Medium Density Fiberboard (MDF), except when Lynnville or Warwick styles, or when Distressing or Heirlooming are specified. MDF provides a smoother finish when painted, and is more resistant to warping, expansion, and contraction.

Rustic Alder

- See trim section for availability of Rustic characteristics on trim items.

All Door Styles

- All doors and drawer fronts are 3/4" thick unless otherwise noted.

Door and Drawer Front Side Profiles

- Veneer and MDF components are shown with grey shading on side profiles. Solid wood components do not have shading.

Wood Grain

- Shaker door styles (Lynnville and Whitman) have a vertical grain direction on the drawer front center panel.
- Genova drawer fronts have vertical grain.
- See reference images for wood grain direction on all other door styles.

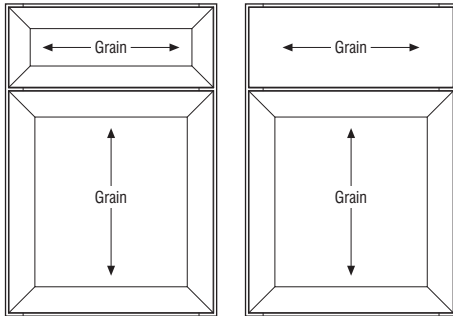

DOOR STYLES

Amstead	Alder	Cherry	Hickory	Maple*	Oak	PureStyle™	Rustic Alder	Specialty Laminates	Thermofoil
	Availability	—	✓	—	✓	—	—	—	—

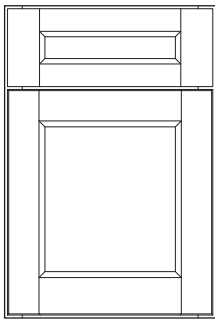

Square Base

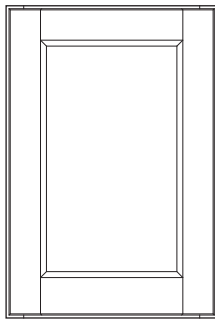

Square Wall



Optional Drawer Front: Slab (DFSLB)

Door Options

ALF	CG	DPSRR	MD	SHMD	PRMD
•	•		•		

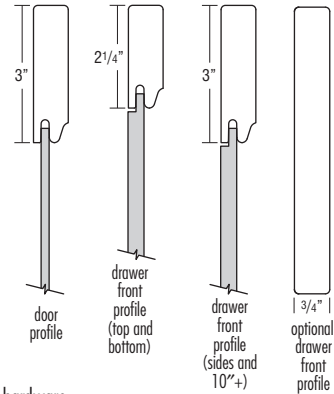
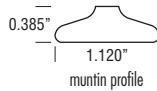

- Square Base and Square Wall Doors
- Veneer Flat Panel
- Full Overlay
- 5-Piece Drawer Front

- See page 70 for 5-piece drawer front dimensions when specifying decorative hardware.
- *When an Opaque finish or an Opaque Glaze finish is specified, the door and/or drawer front center panel may be constructed of Medium Density Fiberboard (MDF), except when Heirlooming is specified. MDF provides a smoother finish when painted, and is more resistant to warping, expansion, and contraction.

Ashridge	Alder	Cherry	Hickory	Maple*	Oak	PureStyle™	Rustic Alder	Specialty Laminates	Thermofoil
	Availability	—	✓	—	✓	—	—	—	—

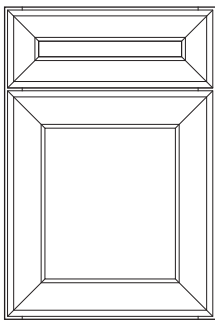

Square Base

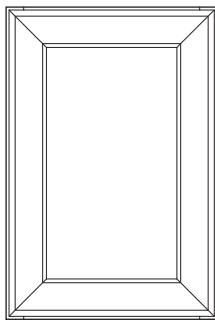

Square Wall

Door Options

ALF	CG	DPSRR	MD	SHMD	PRMD
•	•		•		

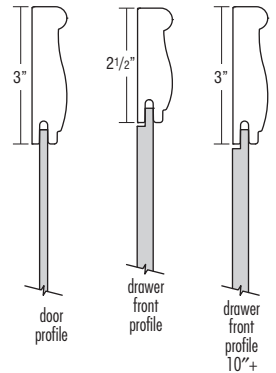
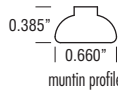

- Square Base and Square Wall Miter Doors
- Veneer Flat Panel
- Full Overlay
- 5-Piece Drawer Front Mitered to Match Door

- See page 70 for 5-piece drawer front dimensions when specifying decorative hardware.
- *When an Opaque finish or an Opaque Glaze finish is specified, the door and/or drawer front center panel may be constructed of Medium Density Fiberboard (MDF), except when Heirlooming is specified. MDF provides a smoother finish when painted, and is more resistant to warping, expansion, and contraction.

Baxter	Alder	Cherry	Hickory	Maple*	Oak	PureStyle™	Rustic Alder	Specialty Laminates	Thermofoil
	Availability	—	✓	—	✓	—	—	—	—

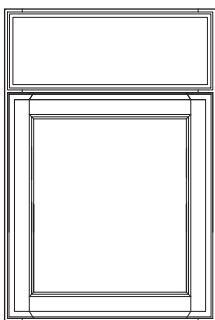

Square Base

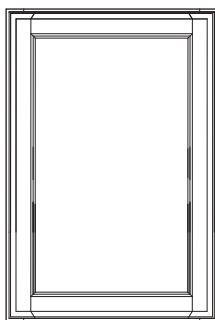

Square Wall

Door Options

ALF	CG	DPSRR	MD	SHMD	PRMD
•	•		•		

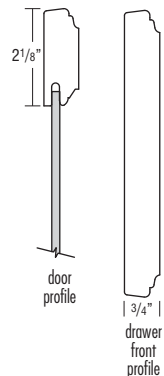
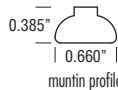

- Square Base and Square Wall Doors
- Veneer Flat Panel
- Full Overlay
- Profiled Slab Drawer Front

- Reverse Bevel Profile, Decorative Hardware Not Required
- *When an Opaque finish or an Opaque Glaze finish is specified, the door and/or drawer front center panel may be constructed of Medium Density Fiberboard (MDF), except when Heirlooming is specified. MDF provides a smoother finish when painted, and is more resistant to warping, expansion, and contraction.

DOOR STYLES

Bellmont	Alder	Cherry	Hickory	Maple*	Oak	PureStyle™	Rustic Alder	Specialty Laminates	Thermofoil
	Availability	—	✓	—	✓	—	—	—	—

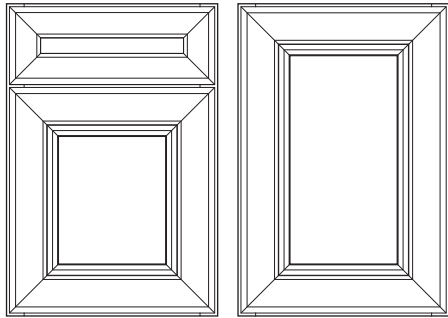

Square Base

Square Wall

Door Options

ALF	CG	DPSRR	MD	SHMD	PRMD
•			•		

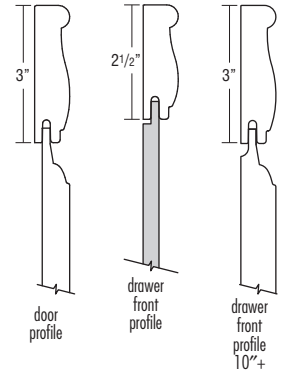
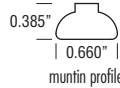

- Square Base and Square Wall Miter Doors
- Solid Raised Panel on Door and Large Drawer Fronts
- Full Overlay
- 5-Piece Drawer Front Mitered to Match Door
- Distressing Available

- See page 70 for 5-piece drawer front dimensions when specifying decorative hardware.
- *When an Opaque finish or an Opaque Glaze finish is specified, the door and/or drawer front center panel may be constructed of Medium Density Fiberboard (MDF), except when Distressing or Heirlooming are specified. MDF provides a smoother finish when painted, and is more resistant to warping, expansion, and contraction.

Butler	Alder	Cherry	Hickory	Maple*	Oak	PureStyle™	Rustic Alder	Specialty Laminates	Thermofoil
	Availability	—	✓	—	✓	—	—	—	—

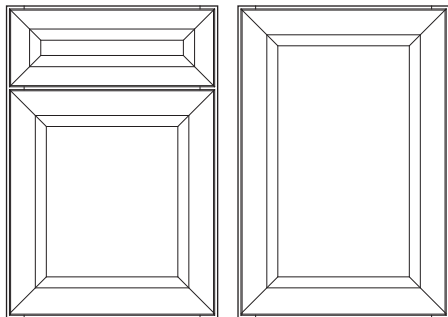

Square Base

Square Wall

Optional Drawer Front:
Slab (DFS LB)

Door Options

ALF	CG	DPSRR	MD	SHMD	PRMD
•					

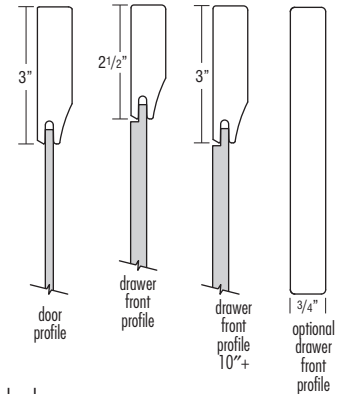

- Square Base and Square Wall Doors
- Veneer Flat Panel Mitered Door
- Full Overlay
- 5-Piece Drawer Front Mitered to Match Door

- See page 70 for 5-piece drawer front dimensions when specifying decorative hardware.
- *When an Opaque finish or an Opaque Glaze finish is specified, the door and/or drawer front center panel may be constructed of Medium Density Fiberboard (MDF), except when Heirlooming is specified. MDF provides a smoother finish when painted, and is more resistant to warping, expansion, and contraction.

Caprice	Alder	Cherry	Hickory	Maple	Oak	PureStyle™	Rustic Alder	Specialty Laminates	Thermofoil
	Availability	—	✓	—	✓	—	—	—	—

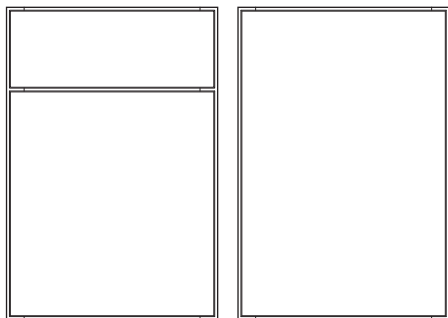

Slab Base

Slab Wall

Door Options

ALF	CG	DPSRR	MD	SHMD	PRMD
•					

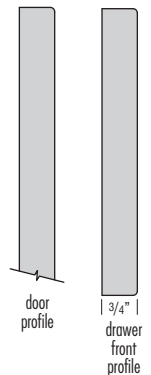

- Veneer Slab Doors and Drawer Fronts
- Veneer Face and Back
- Wood Edging on All Edges

- Furniture Board Core
- Full Overlay
- Grain direction is vertical on doors and horizontal on drawer fronts.

DOOR STYLES

Cotter	Alder	Cherry	Hickory	Maple*	Oak	PureStyle™	Rustic Alder	Specialty Laminates	Thermofoil
	Availability	—	✓	—	✓	—	—	—	—

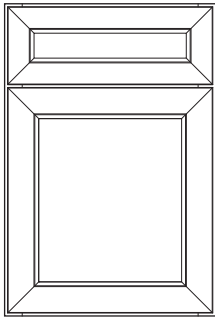

Square Base

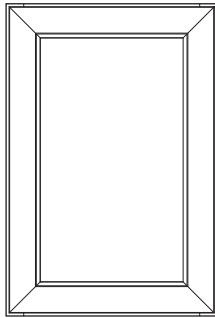

Square Wall



Optional Drawer Front: Slab (DFS LB)

Door Options

ALF	CG	DPSRR	MD	SHMD	PRMD
•	•		•		

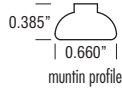

door profile

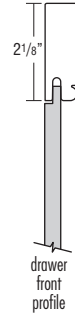

drawer front profile

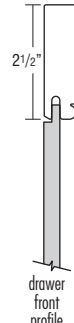

drawer front profile 10"+



optional drawer front profile

- Square Base and Square Wall Miter Doors
- Veneer Flat Panel
- Full Overlay
- 5-Piece Drawer Front Mitered to Match Door

- See page 70 for 5-piece drawer front dimensions when specifying decorative hardware.

*When an Opaque finish or an Opaque Glaze finish is specified, the door and/or drawer front center panel may be constructed of Medium Density Fiberboard (MDF), except when Heirlooming is specified. MDF provides a smoother finish when painted, and is more resistant to warping, expansion, and contraction.

Darby	Alder	Cherry	Hickory	Maple*	Oak	PureStyle™	Rustic Alder	Specialty Laminates	Thermofoil
	Availability	—	—	—	✓	—	—	—	—

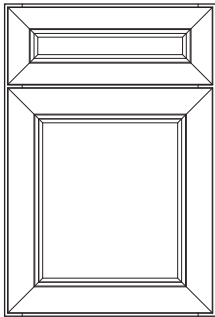

Square Base

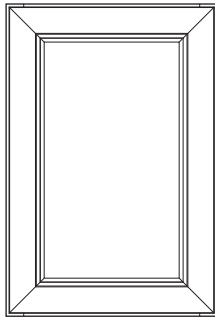

Square Wall



Optional Drawer Front: Slab (DFS LB)

Door Options

ALF	CG	DPSRR	MD	SHMD	PRMD
•	•		•		

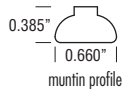

door profile



drawer front profile

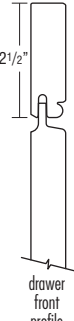

drawer front profile 10"+



optional drawer front profile



- Square Base and Square Wall Miter Doors
- Solid Raised Panel
- Full Overlay
- 5-Piece Drawer Front Mitered to Match Door
- Distressing Available

- See page 70 for 5-piece drawer front dimensions when specifying decorative hardware.

*When an Opaque finish or an Opaque Glaze finish is specified, the door and/or drawer front center panel may be constructed of Medium Density Fiberboard (MDF), except when Distressing or Heirlooming are specified. MDF provides a smoother finish when painted, and is more resistant to warping, expansion, and contraction.

DOOR STYLES

Dewitt

	 Alder	Cherry	 Hickory	Maple*	Oak	PureStyle™	 Rustic Alder	Specialty Laminates	Thermofoil
Availability	✓	✓	✓	✓	✓	—	✓	—	—

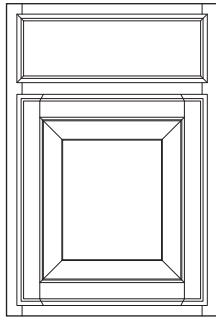

Square Base

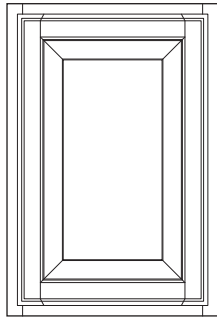

Square Wall

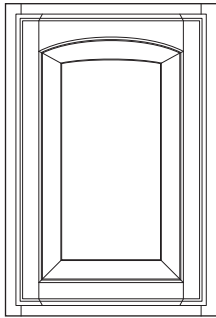

Arch Wall

Door Options

ALF	CG	DPSRR	MD	SHMD	PRMD
•	•		•		

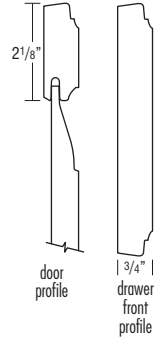
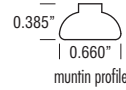

- Square Base and Square or Arch Wall Doors
- Solid Raised Panel
- Partial Overlay
- Profiled Slab Drawer Front
- Distressing Available

- Reverse Bevel Profile, Decorative Hardware Not Required

*When an Opaque finish or an Opaque Glaze finish is specified, the door and/or drawer front center panel may be constructed of Medium Density Fiberboard (MDF), except when Distressing or Heirlooming are specified. MDF provides a smoother finish when painted, and is more resistant to warping, expansion, and contraction.

Dutton

	Alder	Cherry	Hickory	Maple*	Oak	PureStyle™	Rustic Alder	Specialty Laminates	Thermofoil
Availability	—	✓	—	✓	—	—	—	—	—

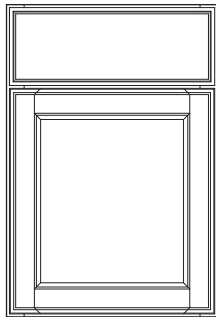

Square Base

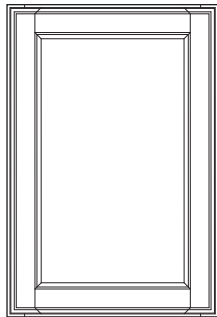

Square Wall

Door Options

ALF	CG	DPSRR	MD	SHMD	PRMD
•	•		•		

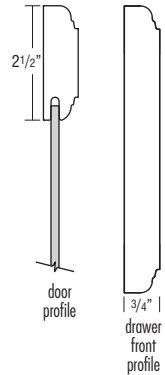
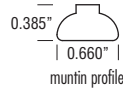

- Square Base and Square Wall Doors
- Veneer Flat Panel
- Full Overlay
- Profiled Slab Drawer Front

*When an Opaque finish or an Opaque Glaze finish is specified, the door and/or drawer front center panel may be constructed of Medium Density Fiberboard (MDF), except when Heirlooming is specified. MDF provides a smoother finish when painted, and is more resistant to warping, expansion, and contraction.

DOOR STYLES

Ellerby 	Alder	Cherry	Hickory	Maple*	Oak	PureStyle™	Rustic Alder	Specialty Laminates	Thermofoil
	Availability	—	✓	✓	✓	✓	—	—	—

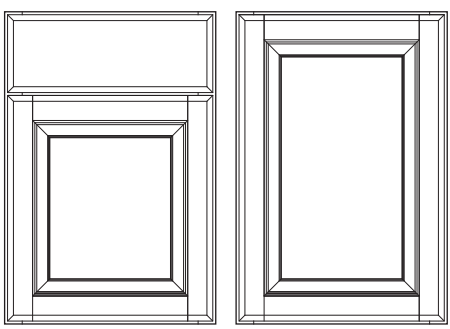

Square Base Square Wall

Door Options

ALF	CG	DPSRR	MD	SHMD	PRMD
•			•		

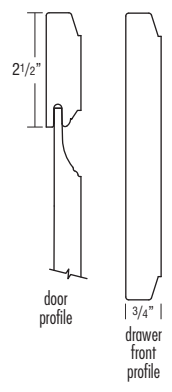
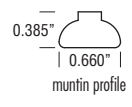

- Square Base and Square Wall Doors
- Solid Raised Panel
- Full Overlay
- Profiled Slab Drawer Front

- Distressing Available
- *When an Opaque finish or an Opaque Glaze finish is specified, the door may be constructed of Medium Density Fiberboard (MDF), except when Distressing or Heirlooming are specified. MDF provides a smoother finish when painted, and is more resistant to warping, expansion, and contraction.

Fairbrook 	Alder	Cherry	Hickory	Maple*	Oak	PureStyle™	Rustic Alder	Specialty Laminates	Thermofoil
	Availability	—	✓	—	✓	✓	—	—	—

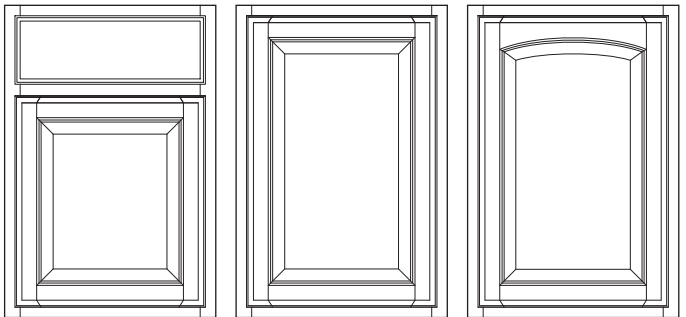

Square Base Square Wall Arch Wall

Door Options

ALF	CG	DPSRR	MD	SHMD	PRMD
•			•		

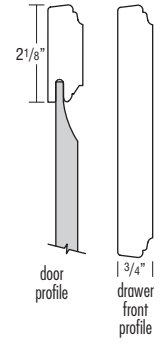
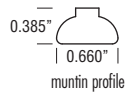

- Square Base and Square or Arch Wall Doors
- Veneer Raised Panel
- Partial Overlay
- Profiled Slab Drawer Front

- Reverse Bevel Profile, Decorative Hardware Not Required
- *When an Opaque finish or an Opaque Glaze finish is specified, the door and/or drawer front center panel may be constructed of Medium Density Fiberboard (MDF). MDF provides a smoother finish when painted, and is more resistant to warping, expansion, and contraction.

Gallatin	Alder	Cherry	Hickory	Maple	Oak	PureStyle™	Rustic Alder	Specialty Laminates	Thermofoil
	Availability	✓	—	—	—	—	—	✓	—

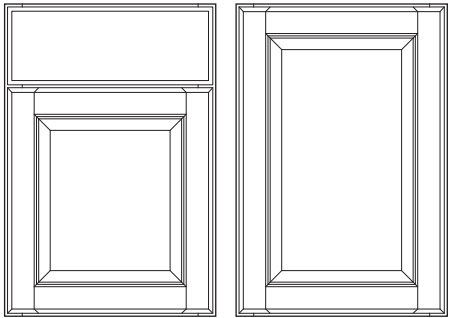

Square Base Square Wall

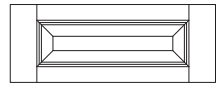

Optional Drawer Front:
Raised 5-Piece (DFR5PC)

Door Options

ALF	CG	DPSRR	MD	SHMD	PRMD
•			•		

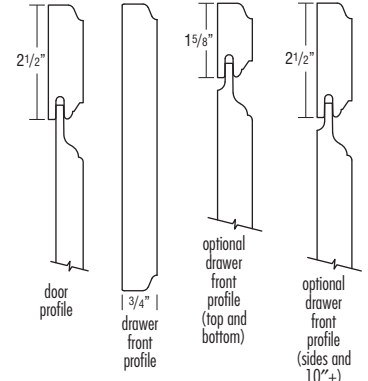
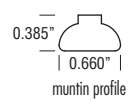

- Square Base and Square Wall Doors
- Solid Raised Panel
- Full Overlay

- Profiled Slab Drawer Front
- Distressing Available
- See page 70 for 5-piece drawer front dimensions when specifying decorative hardware.

DOOR STYLES

Genova	Alder	Cherry	Hickory	Maple	Oak	PureStyle™	Rustic Alder	Specialty Laminates	Thermofoil
	Availability	—	—	—	—	—	—	—	✓

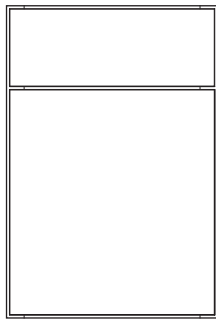

Slab Base

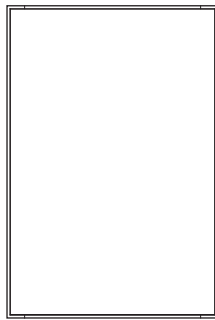

Slab Wall

Door Options

ALF	CG	DPSRR	MD	SHMD	PRMD
•					

Specialty Laminate Finishes

	NEW Cloud	Dover	Lambswool	NEW Morel	Seal†	Thatch	White
Antler ^{NEW}	•			•			•
Elk					•	•	
Wharf		•	•				•



3/4" |
door profile



3/4" |
drawer front profile

- Textured Laminate Slab Door and Drawer Front with Matching Edgebanding
 - Vertical Grain Pattern
 - Full Overlay
 - Doors, drawer fronts, overlay fillers, and selected premium trim items will be in the selected laminate. **All other cabinet components and trim items will be in the selected cabinet box color.**
 - A heat shield is required to separate Genova doors, drawer fronts, overlay fillers, and all textured laminate products from heat producing units to be in compliance with cabinet warranty.
 - For complementing Contemporary Embellishments, see page 402.
- †Choice construction features non-matching laminate ends. Requires a veneer end upgrade (PE or APC) with FB, FPFB, Authentic End upgrade, or a field applied skin or door kit to achieve a matching cabinet end panel. Wood Tone Stain box colors will have visible vertical grain matching end panels.

Hardin	Alder	Cherry	Hickory	Maple*	Oak	PureStyle™	Rustic Alder	Specialty Laminates	Thermofoil
	Availability	—	✓	—	✓	—	—	—	—

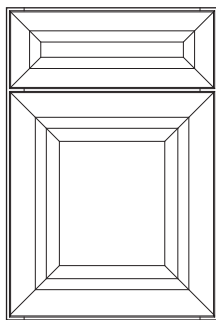

Square Base

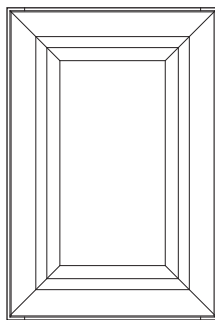

Square Wall



Optional Drawer Front:
Slab (DFSLB)

Door Options

ALF	CG	DPSRR	MD	SHMD	PRMD
•	•				

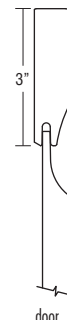

3" |
door profile



2 1/2" |
drawer front profile



3" |
drawer front profile 10"+



3/4" |
optional drawer front profile

- Square Base and Square Wall Doors
- Solid Raised Panel Mitered Door
- Full Overlay
- 5-Piece Drawer Front Mitered to Match Door
- Distressing Available
- See page 70 for 5-piece drawer front dimensions when specifying decorative hardware.
- *When an Opaque finish or an Opaque Glaze finish is specified, the door and/or drawer front center panel may be constructed of Medium Density Fiberboard (MDF), except when Distressing or Heirlooming are specified. MDF provides a smoother finish when painted, and is more resistant to warping, expansion, and contraction.

DOOR STYLES

Herrington	Alder	Cherry	Hickory	Maple*	Oak	PureStyle™	Rustic Alder	Specialty Laminates	Thermofoil
Availability	—	✓	—	✓	—	—	—	—	—

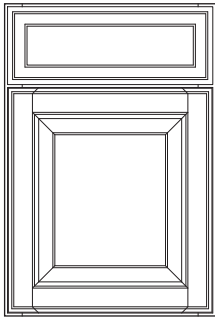

Square Base

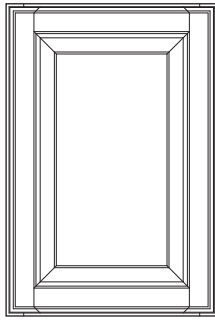

Square Wall

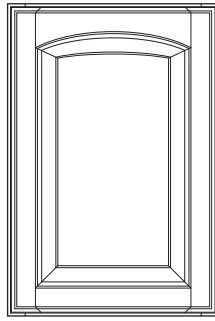

Arch Wall



Optional Drawer Front:
Slab (DFSLB)



Optional Drawer Front:
Raised 5-Piece (DFR5PC)

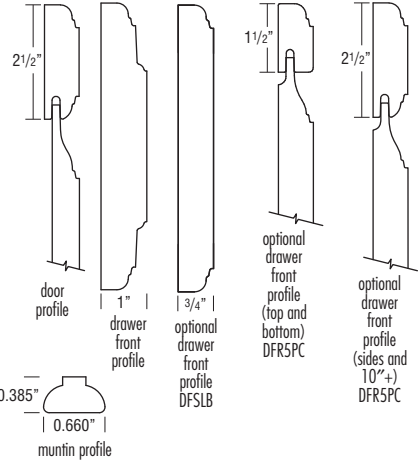

Door Options

ALF	CG	DPSRR	MD	SHMD	PRMD
•	•		•		

- Square Base and Square or Arch Wall Doors
- Solid Raised Panel
- Full Overlay
- 1" Raised Profile Drawer Front
- Distressing Available

- See page 70 for 5-piece drawer front dimensions when specifying decorative hardware.
- *When an Opaque finish or an Opaque Glaze finish is specified, the door and/or drawer front center panel may be constructed of Medium Density Fiberboard (MDF), except when Distressing or Heirlooming are specified. MDF provides a smoother finish when painted, and is more resistant to warping, expansion, and contraction.

Justin	Alder	Cherry	Hickory	Maple*	Oak	PureStyle™	Rustic Alder	Specialty Laminates	Thermofoil
Availability	—	✓	—	✓	—	—	—	—	—

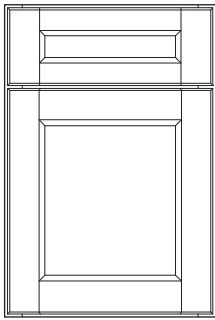

Square Base

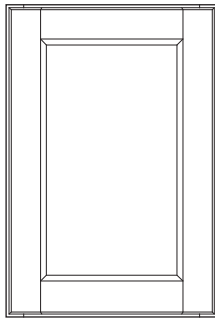

Square Wall



Optional Drawer Front:
Slab (DFSLB)

Door Options

ALF	CG	DPSRR	MD	SHMD	PRMD
•	•		•		

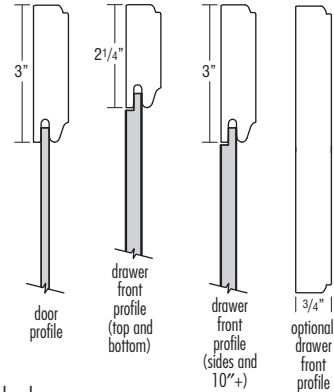

- Square Base and Square Wall Doors
- Veneer Flat Panel
- Full Overlay
- 5-Piece Drawer Front

- See page 70 for 5-piece drawer front dimensions when specifying decorative hardware.
- *When an Opaque finish or an Opaque Glaze finish is specified, the door and/or drawer front center panel may be constructed of Medium Density Fiberboard (MDF), except when Heirlooming is specified. MDF provides a smoother finish when painted, and is more resistant to warping, expansion, and contraction.

DOOR STYLES

Kingston	Alder	Cherry	Hickory	Maple*	Oak	PureStyle™	Rustic Alder	Specialty Laminates	Thermofoil
	Availability	✓	✓	—	✓	—	—	—	—

Optional Drawer Front:
Flat 5-Piece (DFF5PC)

Door Options					
ALF	CG	DPSRR	MD	SHMD	PRMD
•	•		•		

0.443" muntin profile

3" door profile

3/4" drawer front profile

2 1/2" optional drawer front profile

3" optional drawer front profile 10"+

- Square Base and Square Wall Miter Doors
 - Solid Raised Panel on Door and Large 5-Piece Drawer Fronts
 - Full Overlay
 - Solid Routed Drawer Front
 - 5-piece 6 1/4" and 6 3/4" high drawer fronts have a flat center panel, 10" and taller drawer fronts have a raised center panel.
- Distressing Available
 - See page 70 for 5-piece drawer front dimensions when specifying decorative hardware.
- *When an Opaque finish or an Opaque Glaze finish is specified, the door and/or drawer front center panel may be constructed of Medium Density Fiberboard (MDF), except when Distressing or Heirlooming are specified. MDF provides a smoother finish when painted, and is more resistant to warping, expansion, and contraction.

Larsen	Alder	Cherry	Hickory	Maple*	Oak	PureStyle™	Rustic Alder	Specialty Laminates	Thermofoil
	Availability	✓	✓	—	✓	✓	—	✓	—

Optional Drawer Front:
Flat 5-Piece (DFF5PC)

Door Options					
ALF	CG	DPSRR	MD	SHMD	PRMD
•	•		•	•	•

0.227" muntin profile

3" door profile

3/4" drawer front profile

2 1/4" optional drawer front profile (top and bottom)

3" optional drawer front profile (sides and 10"+)

- Square Base and Square Wall Doors
 - Veneer Flat Panel
 - Full Overlay
 - Slab Drawer Front
- See page 70 for 5-piece drawer front dimensions when specifying decorative hardware.
- *When an Opaque finish or an Opaque Glaze finish is specified, the door and/or drawer front center panel may be constructed of Medium Density Fiberboard (MDF), except when Heirlooming is specified. MDF provides a smoother finish when painted, and is more resistant to warping, expansion, and contraction.

DOOR STYLES

Lawton	Alder	Cherry	Hickory	Maple*	Oak	PureStyle™	Rustic Alder	Specialty Laminates	Thermofoil
	Availability	✓	✓	—	✓	—	—	✓	—

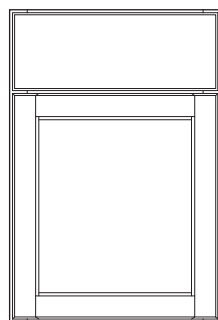

Square Base

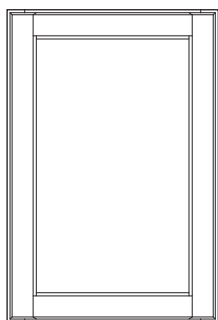

Square Wall

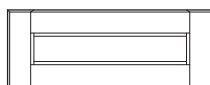

Optional Drawer Front:
Flat 5-Piece (DFF5PC)

Door Options

ALF	CG	DPSRR	MD	SHMD	PRMD
•	•		•	•	•

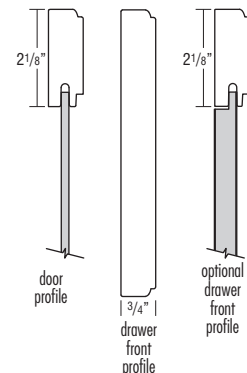
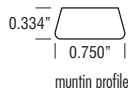

- Square Base and Square Wall Doors
- Veneer Flat Panel
- Full Overlay
- Profiled Slab Drawer Front

- See page 70 for 5-piece drawer front dimensions when specifying decorative hardware.
- *When an Opaque finish or an Opaque Glaze finish is specified, the door and/or drawer front center panel may be constructed of Medium Density Fiberboard (MDF), except when Heirlooming is specified. MDF provides a smoother finish when painted, and is more resistant to warping, expansion, and contraction.

Lynnville	Alder	Cherry	Hickory	Maple	Oak	PureStyle™	Rustic Alder	Specialty Laminates	Thermofoil
	Availability	—	✓	—	✓	—	—	—	—

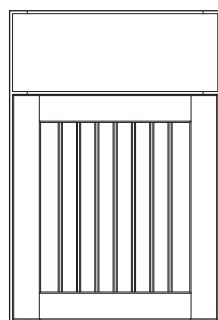

Square Base

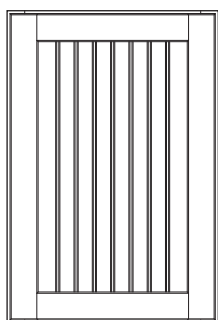

Square Wall

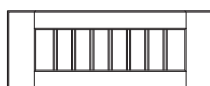

Optional Drawer Front:
Flat 5-Piece (DFF5PC)

Door Options

ALF	CG	DPSRR	MD	SHMD	PRMD
•	•		•	•	•

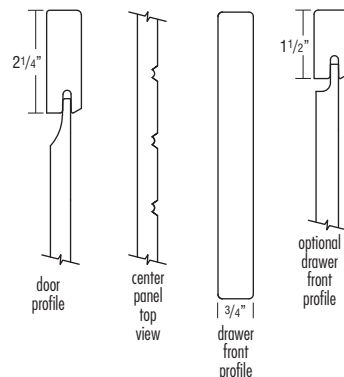
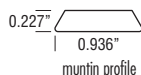

- Square Base and Square Wall Shaker Style Doors
- Solid Reverse Raised Beaded Panel
- Full Overlay
- Slab Drawer Front
- When DFF5PC is selected on a 2DB48, drawer front will have a vertical cross rail with two center panels.

- Will not use MDF center panel on Opaque or Opaque Glaze finishes. See page 7 for more details.
- Beaded center panel on 5-piece drawer fronts will not align with doors when used on cabinets with double doors and a full width drawer.
- See page 70 for 5-piece drawer front dimensions when specifying decorative hardware.

DOOR STYLES

Manchester

	Alder	NEW Cherry	Hickory	Maple*	NEW Oak	PureStyle™	Rustic Alder	Specialty Laminates	Thermofoil
Availability	—	✓	—	✓	✓	—	—	—	—

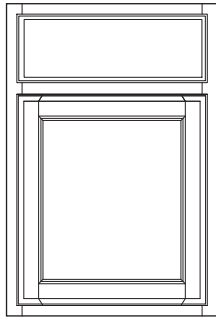

Square Base

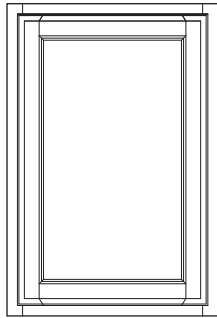

Square Wall

Door Options

ALF	CG	DPSRR	MD	SHMD	PRMD
•	•		•		

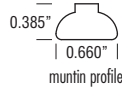

muntin profile

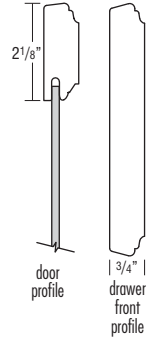

door profile

3/4" drawer front profile

- Square Base and Square Wall Doors
- Veneer Flat Panel
- Partial Overlay
- Profiled Slab Drawer Front

- Reverse Bevel Profile

*When an Opaque finish or an Opaque Glaze finish is specified, the door and/or drawer front center panel may be constructed of Medium Density Fiberboard (MDF), except when Heirlooming is specified. MDF provides a smoother finish when painted, and is more resistant to warping, expansion, and contraction.

Northrope

	Alder	Cherry	Hickory	Maple*	Oak	PureStyle™	Rustic Alder	Specialty Laminates	Thermofoil
Availability	✓	✓	—	✓	✓	—	✓	—	—

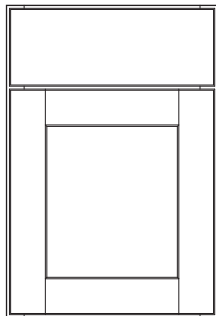

Square Base

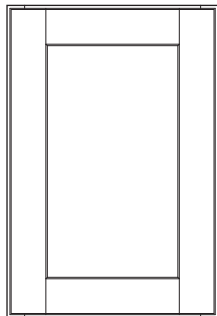

Square Wall

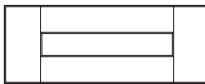

Optional Drawer Front:
Flat 5-Piece (DFF5PC)

Door Options

ALF	CG	DPSRR	MD	SHMD	PRMD
•	•		•		•

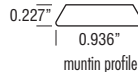

muntin profile

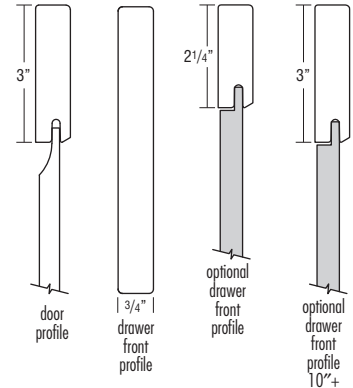

door profile

3/4" drawer front profile

optional drawer front profile

optional drawer front profile 10"±

- Square Base and Square Wall Doors
- Solid Reverse Raised Panel Door
- Full Overlay
- Slab Drawer Front

- See page 70 for 5-piece drawer front dimensions when specifying decorative hardware.

*When an Opaque finish or an Opaque Glaze finish is specified, the door and/or drawer front center panel may be constructed of Medium Density Fiberboard (MDF), except when Heirlooming is specified. MDF provides a smoother finish when painted, and is more resistant to warping, expansion, and contraction.

DOOR STYLES

Painter 	Alder	Cherry	Hickory	Maple*	Oak	PureStyle™	Rustic Alder	Specialty Laminates	Thermofoil
	Availability	—	✓	✓	✓	✓	—	—	—

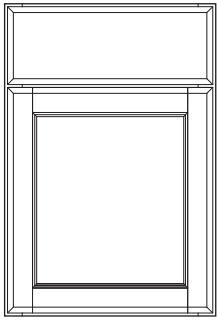

Square Base

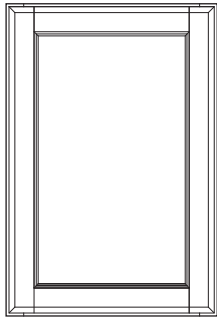

Square Wall

Door Options

ALF	CG	DPSRR	MD	SHMD	PRMD
•			•		

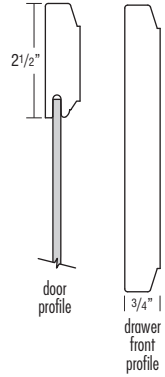
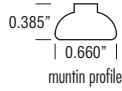

- Square Base and Square Wall Doors
- Veneer Flat Panel
- Full Overlay

- Profiled Slab Drawer Front

*When an Opaque finish or an Opaque Glaze finish is specified, the door may be constructed of Medium Density Fiberboard (MDF). MDF provides a smoother finish when painted, and is more resistant to warping, expansion, and contraction.

Rennie	Alder	Cherry	Hickory	Maple*	Oak	PureStyle™	Rustic Alder	Specialty Laminates	Thermofoil
	Availability	—	✓	—	✓	—	—	—	—

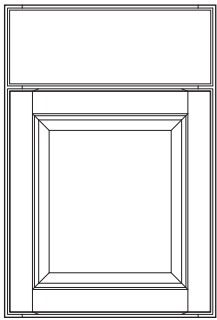

Square Base

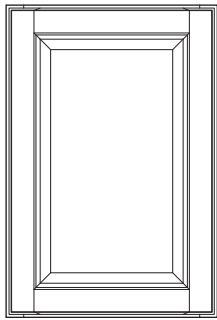

Square Wall

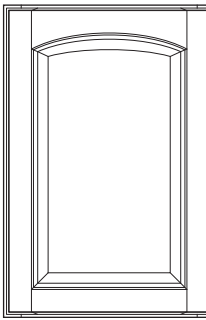

Arch Wall

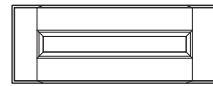

Optional Drawer Front:
Flat 5-Piece (DFF5PC)

Door Options

ALF	CG	DPSRR	MD	SHMD	PRMD
•			•		

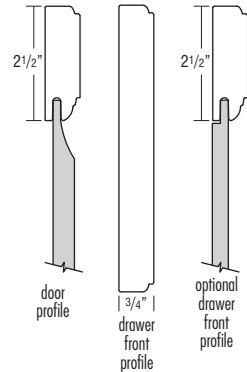
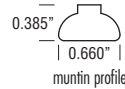

- Square Base and Square or Arch Wall Doors
- Veneer Raised Panel
- Full Overlay
- Profiled Slab Drawer Front

- See page 70 for 5-piece drawer front dimensions when specifying decorative hardware.

*When an Opaque finish or an Opaque Glaze finish is specified, the door and/or drawer front center panel may be constructed of Medium Density Fiberboard (MDF). MDF provides a smoother finish when painted, and is more resistant to warping, expansion, and contraction.

DOOR STYLES

Shafer		Alder	Cherry	Hickory	Maple	Oak	PureStyle™	Rustic Alder	Specialty Laminates	Thermofoil
Availability		—	—	—	—	—	✓	—	—	—

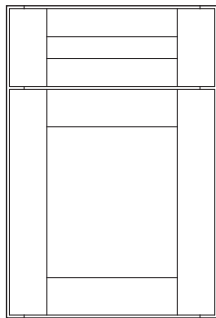

Square Base

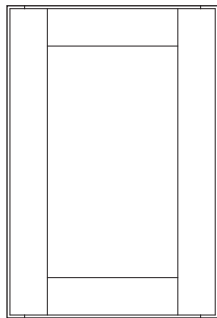

Square Wall

Door Options

ALF	CG	DPSRR	MD	SHMD	PRMD
•					

Cabinet Box Color Options

Seal†	Thatch
•	•

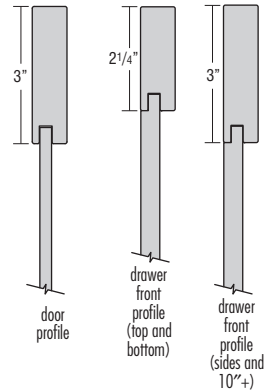

- Square Base and Square Wall Doors
- Textured Woodgrain Laminate Wrapped MDF Door and Drawer Rails
- Full Overlay
- 5-Piece Drawer Front

- Doors, drawer fronts, overlay fillers, and selected premium trim items will be Elk. All other cabinet components and embellishments will be in selected cabinet box color and specie.
- See page 70 for 5-piece drawer front dimensions when specifying decorative hardware.

†Choice construction features non-matching laminate ends. Requires a veneer end upgrade (PE or APC) with FB, FPFB, Authentic End upgrade, or a field applied skin or door kit to achieve a matching cabinet end panel. Wood Tone Stain box colors will have visible vertical grain matching end panels.

Taro		Alder	Cherry	Hickory	Maple	Oak	PureStyle™	Rustic Alder	Specialty Laminates	Thermofoil
Availability		—	—	—	—	—	—	—	✓	—

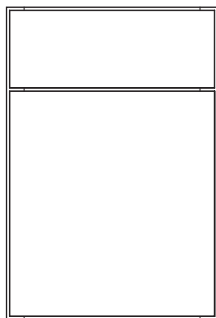

Slab Base

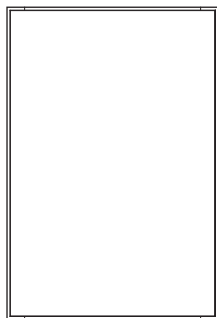

Slab Wall

Door Options

ALF	CG	DPSRR	MD	SHMD	PRMD
•					

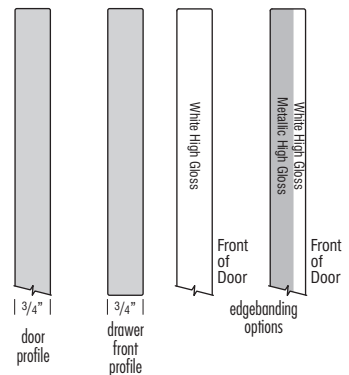

- High Gloss Laminate Slab Doors and Drawer Fronts with Two Edgebanding Options
- Full Overlay

- Doors, drawer fronts, overlay fillers, and selected premium trim items will be in White High Gloss (see Trim section for availability of premium trim items). Backs of doors, drawer fronts, and Premium panels will be white melamine. **All other cabinet components and embellishments will be Painted White.**
- A heat shield is required to separate Taro doors, drawer fronts, overlay fillers, and all high gloss laminate products from heat producing units to be in compliance with cabinet warranty.
- For complementing Contemporary Embellishments, see page 402.

DOOR STYLES

Troxel		Alder	Cherry	Hickory	Maple	Oak	PureStyle™	Rustic Alder	Specialty Laminates	Thermofoil
	Availability	—	—	—	—	—	—	—	✓	—

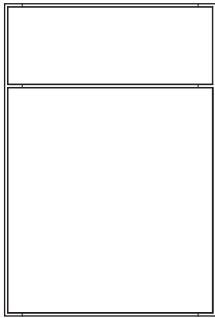

Slab Base

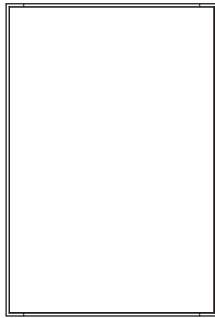

Slab Wall

Door Options					
ALF	CG	DPSRR	MD	SHMD	PRMD
•					
			•		

Specialty Laminate Finishes	Cabinet Box Color Options				
	Black†	Cloud	Dover	Storm†	White
Arctic		•	•		•
Obsidian	•			•	



3/4" door profile



3/4" drawer front profile

- Textured Laminate Slab Door and Drawer Front with Matching Edgebanding
- Horizontal Grain Pattern for Contemporary Styling
- Full Overlay
- Doors, drawer fronts, overlay fillers, and selected premium trim items will be in the selected laminate. **All other cabinet components and trim items will be in the selected cabinet box color.**

- Doors and overlay fillers greater than 48" high will be two pieces. Doors will be doweled together with zinc connector pins and black plastic spacers. Replacement doors will be drilled and doweled but require field assembly.
 - A heat shield is required to separate Troxel doors, drawer fronts, overlay fillers, and all textured laminate products from heat producing units to be in compliance with cabinet warranty.
 - For complementing Contemporary Embellishments, see page 402.
- †Choice construction features non-matching laminate ends. Requires a veneer end upgrade (PE or APC) with FB, FPEB, Authentic End upgrade, or a field applied skin or door kit to achieve a matching cabinet end panel. Wood Tone Stain box colors will have visible vertical grain matching end panels.

Vaile		Alder	Cherry	Hickory	Maple	Oak	PureStyle™	Rustic Alder	Specialty Laminates	Thermofoil
	Availability	—	—	—	—	—	—	—	—	✓

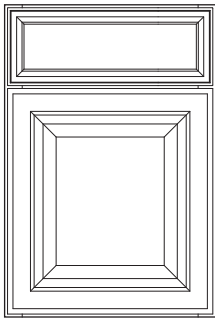

Square Base

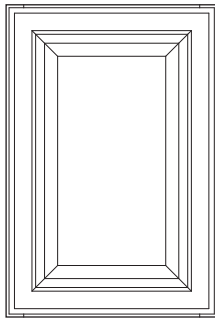

Square Wall

Door Options					
ALF	CG	DPSRR	MD	SHMD	PRMD
•					
			•		

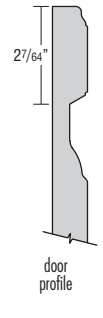
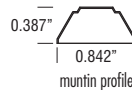

2 7/64" door profile

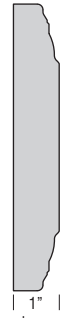

1" drawer front profile

- Square Base and Square Wall Doors
- Thermofoil MDF Raised Panel
- Full Overlay
- 1" MDF Raised Profile Drawer Front

- Thermofoil will not withstand sustained temperatures in excess of 170°F. A 3" filler or heat shield is required between any thermofoil surface and any heat source to be in compliance with cabinet warranty. Failure to use a 3" filler or heat shield will void the cabinet warranty.

DOOR STYLES

Warwick	Availability	Alder	Cherry	Hickory	Maple	Oak	PureStyle™	Rustic Alder	Specialty Laminates	Thermofoil
	—	—	✓	—	✓	—	—	—	—	—

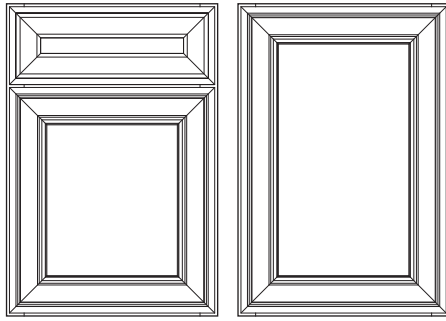

Square Base

Square Wall

Door Options

ALF	CG	DPSRR	MD	SHMD	PRMD
•	•		•		

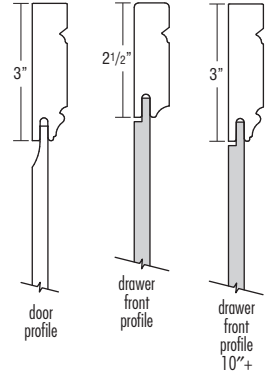
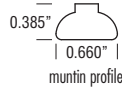

- Square Base and Square Wall Miter Doors
- Solid Reverse Raised Panel Door
- Full Overlay
- 5-Piece Drawer Front Mitered to Match Door

- Will not use MDF center panel on Opaque or Opaque Glaze finishes. See page 7 for more details.
- Faux Inset Design. Recommended for use with Faux Hinges (see page 405).
- 1/4" space filler or extended stile modification is necessary when applying faux hinge (strap or barrel) on varying depth cabinet or next to an appliance to allow for full door swing clearance.
- See page 70 for 5-piece drawer front dimensions when specifying decorative hardware.

Whitman	Availability	Alder	Cherry	Hickory	Maple*	Oak	PureStyle™	Rustic Alder	Specialty Laminates	Thermofoil
	✓	✓	✓	✓	✓	—	—	✓	—	—

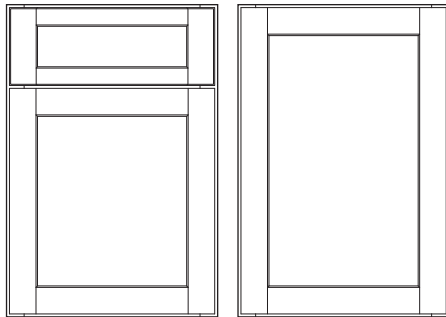

Square Base

Square Wall

Optional Drawer Front:
Slab (DFSLB)

Door Options

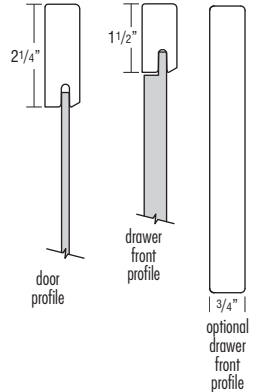
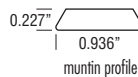

ALF	CG	DPSRR	MD	SHMD	PRMD
•	•	•	•	•	•



- Square Base and Square Wall Shaker Style Doors
- Veneer Flat Panel (Solid reverse raised door center panel is available as a modification, see DPSRR on page 33.)
- Full Overlay
- 5-Piece Drawer Front

- See page 70 for 5-piece drawer front dimensions when specifying decorative hardware.
- *When an Opaque finish or an Opaque Glaze finish is specified, the door and/or drawer front center panel may be constructed of Medium Density Fiberboard (MDF), except when Heirlooming is specified. MDF provides a smoother finish when painted, and is more resistant to warping, expansion, and contraction.

PREMIUM COLOR PALETTE

	OPTION NAME	DESCRIPTION/LIMITATIONS	MATCHING LAMINATE ENDS [▲]	DISTRESSING AVAILABILITY	HEIRLOOMING AVAILABILITY
Wood Tone Stains	Grizzly 	A deep brown finish with grey undertones and beautiful depth.	✓	✓	N/A
	Kodiak 	A dark brown finish with grey and yellow undertones and a deep, rich hue.	✓	✓	N/A
	Storm	A semi translucent stone grey finish that allows the natural tones and characteristics of the wood to show through.	N/A	✓	✓
Wood Tone Glazes	Black Forest	A two tone finish. A medium toned finish that is highlighted with a dark glaze.	✓	✓	N/A
	Coffee	A two tone finish. Dark glaze over a warmer toner that emulates a soft, old-world look and enhances the door profiles.	✓	✓	N/A
	Palomino	A two tone finish. A light toned finish that is highlighted with a dark espresso glaze. The glaze is meant to be seen primarily in the profiled areas and has minimal affect to the overall color.	✓	✓	N/A
	Whiskey Black	A warm finish with a rich dark patina to create a true reproduction of a period style antique.	✓	✓	N/A
Opagues*	Black	An opaque black finish which embodies a consistently dark and cool hue.	N/A	✓	✓
	Cloud	A cool grey opaque finish.	✓	✓	N/A
	Coconut	A warm white opaque finish.	✓	N/A	N/A
	Dover	A clean and inviting opaque white color with the slightest hint of a grey undertone.	✓	N/A	N/A
	Egret	A darker, off-white finish on the cooler grey side.	✓	✓	N/A
	Forest Floor	A rich brown opaque finish reminiscent of its name.	N/A	✓	✓
	Juniper Berry	A pale antique blue opaque finish.	N/A	✓	✓
	Lambswool	A light, neutral toned khaki opaque.	✓	✓	N/A
	Maritime	A dark, navy tone opaque.	N/A	✓	✓
	Moonstone	A mid-grey opaque with cool, pale-blue undertones.	✓	✓	✓
	Pearl	A subtle creamy white color.	✓	N/A	N/A
	Seaside	A turquoise blue opaque.	N/A	✓	✓
White	A subtle white color.	✓	N/A	N/A	
Opaque Glazes*	Amaretto Crème	When glaze is applied, the opaque (Cloud, Coconut, Dover, Egret, Lambswool, Maritime, Moonstone, or Pearl) is highlighted with a dark brown glaze.	✓	✓	✓***
	Grey Stone	When glaze is applied, the opaque (Cloud, Coconut, Dover, Egret, Lambswool, Maritime, or Pearl) is highlighted with a grey glaze.	✓	✓	✓***
	Oasis	A two toned finish, applying a turquoise blue opaque finish enhanced with a coffee colored glaze. The glaze accents the profiles and accentuates the overall color of the door.	N/A	✓	✓
	Tidal Mist	A two tone finish, applying a pale antique blue opaque finish enhanced with a light brown glaze to create a shadowing effect. The glaze accents the profiles and accentuates the overall color of the door to emphasize the highs and lows.	N/A	✓	✓
	Toasted Almond	When glaze is applied, the opaque (Cloud, Coconut, Dover, Egret, Lambswool, Maritime, Moonstone, or Pearl) is highlighted with a medium brown glaze.	✓	✓	✓***

[▲]In Choice construction, cabinets will have matching laminate ends. Where not available, ends will be Natural Maple laminate and a finished end treatment would be needed for an exposed end.









*On wood products, normal movement is typical due to change in climatic conditions. This will cause hairline cracks at stile, rail and panel joints. This hairline cracking is a normal characteristic of opaque or painted finishes and will not be considered a reason for product replacement. Finish agreement required, see page 430.

***Available on Maritime and Moonstone only.

UNFINISHED				
	OPTION NAME	DESCRIPTION/LIMITATIONS	DISTRESSING AVAILABILITY	HEIRLOOMING AVAILABILITY
Standard Finish	Unfinished	Must upgrade to PE or APC. When cabinets are finished by an outside source, finish is not covered under warranty. Interiors of cabinets will be Natural Maple laminate for PE and clear coated hardwood veneer for APC. For finishable interiors, MIP must be specified.	✓	N/A

FINISH TECHNIQUES		
	OPTION NAME	DESCRIPTION
Techniques	Distressing	Provides a rustic look through the carefully crafted application of distressing characteristics such as dents, wormholes, chisel marks, and other signs of wear on solid wood doors, drawer fronts, face frames, and selected trim items (veneer parts will not be distressed). The distressing technique creates a finish with unique and appealing imperfections, similar to those of time-worn antiques. Distressing characteristics are more visible with glaze finishes (face frames and trim items without detailed profiles will not feature glaze hang-up on distressed areas). Not available to order with Coconut, Dover, Pearl, and White.
	Heirloom	Available on select finishes. The finish will be sanded through the base coat to expose the surface of the wood. This type of sand through on the edges and profiles creates a naturally worn appearance. If a finish is chosen with a glaze, the glaze will be applied after the sanding has been done. This will enhance those areas of exposed wood to take on the darker characteristic of the applied glaze. Not available on Caprice, Fairbrook, and Rennie. Select trim pieces will feature Heirloom characteristics. See Trim section for availability.

FINISH AVAILABILITY

			MAPLE																											
Finish Category	Finish Name	Matching Laminate Ends [△]	Heirlooming* 	Amstead	Ashridge	Baxter	Bellmont	Butler	Caprice	Cotter	Darby	Dewitt	Dutton	Ellerby 	Fairbrook	Hardin	Herrington	Justin	Kingston	Larsen	Lawton	Lynnville	Manchester	Northrope 	Painter 	Rennie	Warwick	Whitman		
				Wood Tone Stains	Brierwood	✓		✓	✓	✓	✓	✓	✓	✓	✓	✓	✓	✓	✓	✓	✓	✓	✓	✓	✓	✓	✓	✓	✓	✓
Buckskin	✓		✓		✓	✓	✓	✓	✓	✓	✓	✓	✓	✓	✓	✓	✓	✓	✓	✓	✓	✓	✓	✓	✓	✓	✓	✓	✓	
Cattail	✓		✓		✓	✓	✓	✓	✓	✓	✓	✓	✓	✓	✓	✓	✓	✓	✓	✓	✓	✓	✓	✓	✓	✓	✓	✓	✓	
Chocolate	✓		✓		✓	✓	✓	✓	✓	✓	✓	✓	✓	✓	✓	✓	✓	✓	✓	✓	✓	✓	✓	✓	✓	✓	✓	✓	✓	
Cranberry	✓		✓		✓	✓	✓	✓	✓	✓	✓	✓	✓	✓	✓	✓	✓	✓	✓	✓	✓	✓	✓	✓	✓	✓	✓	✓	✓	
Grizzly 	✓				✓	✓	✓	✓	✓	✓	✓	✓	✓	✓	✓	✓	✓	✓	✓	✓	✓	✓	✓	✓	✓	✓	✓	✓	✓	
Havana	✓				✓	✓	✓	✓	✓	✓	✓	✓	✓	✓	✓	✓	✓	✓	✓	✓	✓	✓	✓	✓	✓	✓	✓	✓	✓	
Henna	✓				✓	✓	✓	✓	✓	✓	✓	✓	✓	✓	✓	✓	✓	✓	✓	✓	✓	✓	✓	✓	✓	✓	✓	✓	✓	✓
Kodiak 	✓				✓	✓	✓	✓	✓	✓	✓	✓	✓	✓	✓	✓	✓	✓	✓	✓	✓	✓	✓	✓	✓	✓	✓	✓	✓	✓
Morel	✓				✓	✓	✓	✓	✓	✓	✓	✓	✓	✓	✓	✓	✓	✓	✓	✓	✓	✓	✓	✓	✓	✓	✓	✓	✓	✓
Natural	✓				✓	✓	✓	✓	✓	✓	✓	✓	✓	✓	✓	✓	✓	✓	✓	✓	✓	✓	✓	✓	✓	✓	✓	✓	✓	✓
Sahara	✓				✓	✓	✓	✓	✓	✓	✓	✓	✓	✓	✓	✓	✓	✓	✓	✓	✓	✓	✓	✓	✓	✓	✓	✓	✓	✓
Seal	✓				✓	✓	✓	✓	✓	✓	✓	✓	✓	✓	✓	✓	✓	✓	✓	✓	✓	✓	✓	✓	✓	✓	✓	✓	✓	✓
Storm	✓		✓		✓	✓	✓	✓	✓	✓	✓	✓	✓	✓	✓	✓	✓	✓	✓	✓	✓	✓	✓	✓	✓	✓	✓	✓	✓	✓
Thatch	✓				✓	✓	✓	✓	✓	✓	✓	✓	✓	✓	✓	✓	✓	✓	✓	✓	✓	✓	✓	✓	✓	✓	✓	✓	✓	✓
Tundra	✓				✓	✓	✓	✓	✓	✓	✓	✓	✓	✓	✓	✓	✓	✓	✓	✓	✓	✓	✓	✓	✓	✓	✓	✓	✓	✓
Unfinished	✓				✓	✓	✓	✓	✓	✓	✓	✓	✓	✓	✓	✓	✓	✓	✓	✓	✓	✓	✓	✓	✓	✓	✓	✓	✓	✓
Wood Tone Glazes	Black Forest	✓			✓	✓	✓	✓	✓	✓	✓	✓	✓	✓	✓	✓	✓	✓	✓	✓	✓	✓	✓	✓	✓	✓	✓	✓	✓	✓
	Coffee	✓			✓	✓	✓	✓	✓	✓	✓	✓	✓	✓	✓	✓	✓	✓	✓	✓	✓	✓	✓	✓	✓	✓	✓	✓	✓	✓
	Palomino	✓			✓	✓	✓	✓	✓	✓	✓	✓	✓	✓	✓	✓	✓	✓	✓	✓	✓	✓	✓	✓	✓	✓	✓	✓	✓	✓
	Whiskey Black	✓			✓	✓	✓	✓	✓	✓	✓	✓	✓	✓	✓	✓	✓	✓	✓	✓	✓	✓	✓	✓	✓	✓	✓	✓	✓	✓
Opagues 	Black	✓	✓	✓	✓	✓	✓	✓	✓	✓	✓	✓	✓	✓	✓	✓	✓	✓	✓	✓	✓	✓	✓	✓	✓	✓	✓	✓	✓	
	Cloud	✓		✓	✓	✓	✓	✓	✓	✓	✓	✓	✓	✓	✓	✓	✓	✓	✓	✓	✓	✓	✓	✓	✓	✓	✓	✓	✓	
	Coconut	✓		✓	✓	✓	✓	✓	✓	✓	✓	✓	✓	✓	✓	✓	✓	✓	✓	✓	✓	✓	✓	✓	✓	✓	✓	✓	✓	
	Dover	✓		✓	✓	✓	✓	✓	✓	✓	✓	✓	✓	✓	✓	✓	✓	✓	✓	✓	✓	✓	✓	✓	✓	✓	✓	✓	✓	
	Egret	✓		✓	✓	✓	✓	✓	✓	✓	✓	✓	✓	✓	✓	✓	✓	✓	✓	✓	✓	✓	✓	✓	✓	✓	✓	✓	✓	
	Forest Floor	✓		✓	✓	✓	✓	✓	✓	✓	✓	✓	✓	✓	✓	✓	✓	✓	✓	✓	✓	✓	✓	✓	✓	✓	✓	✓	✓	
	Juniper Berry	✓		✓	✓	✓	✓	✓	✓	✓	✓	✓	✓	✓	✓	✓	✓	✓	✓	✓	✓	✓	✓	✓	✓	✓	✓	✓	✓	
	Lambswool	✓		✓	✓	✓	✓	✓	✓	✓	✓	✓	✓	✓	✓	✓	✓	✓	✓	✓	✓	✓	✓	✓	✓	✓	✓	✓	✓	✓
	Maritime	✓		✓	✓	✓	✓	✓	✓	✓	✓	✓	✓	✓	✓	✓	✓	✓	✓	✓	✓	✓	✓	✓	✓	✓	✓	✓	✓	✓
	Moonstone	✓		✓	✓	✓	✓	✓	✓	✓	✓	✓	✓	✓	✓	✓	✓	✓	✓	✓	✓	✓	✓	✓	✓	✓	✓	✓	✓	✓
	Pearl	✓		✓	✓	✓	✓	✓	✓	✓	✓	✓	✓	✓	✓	✓	✓	✓	✓	✓	✓	✓	✓	✓	✓	✓	✓	✓	✓	✓
	Seaside	✓		✓	✓	✓	✓	✓	✓	✓	✓	✓	✓	✓	✓	✓	✓	✓	✓	✓	✓	✓	✓	✓	✓	✓	✓	✓	✓	✓
Opaque Glazes 	White	✓		✓	✓	✓	✓	✓	✓	✓	✓	✓	✓	✓	✓	✓	✓	✓	✓	✓	✓	✓	✓	✓	✓	✓	✓	✓	✓	
	Cloud w/Amaretto Crème	✓		✓	✓	✓	✓	✓	✓	✓	✓	✓	✓	✓	✓	✓	✓	✓	✓	✓	✓	✓	✓	✓	✓	✓	✓	✓	✓	
	Cloud w/Grey Stone	✓		✓	✓	✓	✓	✓	✓	✓	✓	✓	✓	✓	✓	✓	✓	✓	✓	✓	✓	✓	✓	✓	✓	✓	✓	✓	✓	
	Cloud w/Toasted Almond	✓		✓	✓	✓	✓	✓	✓	✓	✓	✓	✓	✓	✓	✓	✓	✓	✓	✓	✓	✓	✓	✓	✓	✓	✓	✓	✓	
	Coconut w/Amaretto Crème	✓		✓	✓	✓	✓	✓	✓	✓	✓	✓	✓	✓	✓	✓	✓	✓	✓	✓	✓	✓	✓	✓	✓	✓	✓	✓	✓	
	Coconut w/Grey Stone	✓		✓	✓	✓	✓	✓	✓	✓	✓	✓	✓	✓	✓	✓	✓	✓	✓	✓	✓	✓	✓	✓	✓	✓	✓	✓	✓	
	Coconut w/Toasted Almond	✓		✓	✓	✓	✓	✓	✓	✓	✓	✓	✓	✓	✓	✓	✓	✓	✓	✓	✓	✓	✓	✓	✓	✓	✓	✓	✓	
	Dover w/Amaretto Crème	✓		✓	✓	✓	✓	✓	✓	✓	✓	✓	✓	✓	✓	✓	✓	✓	✓	✓	✓	✓	✓	✓	✓	✓	✓	✓	✓	✓
	Dover w/Grey Stone	✓		✓	✓	✓	✓	✓	✓	✓	✓	✓	✓	✓	✓	✓	✓	✓	✓	✓	✓	✓	✓	✓	✓	✓	✓	✓	✓	✓
	Dover w/Toasted Almond	✓		✓	✓	✓	✓	✓	✓	✓	✓	✓	✓	✓	✓	✓	✓	✓	✓	✓	✓	✓	✓	✓	✓	✓	✓	✓	✓	✓
	Egret w/Amaretto Crème	✓		✓	✓	✓	✓	✓	✓	✓	✓	✓	✓	✓	✓	✓	✓	✓	✓	✓	✓	✓	✓	✓	✓	✓	✓	✓	✓	
	Egret w/Grey Stone	✓		✓	✓	✓	✓	✓	✓	✓	✓	✓	✓	✓	✓	✓	✓	✓	✓	✓	✓	✓	✓	✓	✓	✓	✓	✓	✓	
	Egret w/Toasted Almond	✓		✓	✓	✓	✓	✓	✓	✓	✓	✓	✓	✓	✓	✓	✓	✓	✓	✓	✓	✓	✓	✓	✓	✓	✓	✓	✓	
	Lambswool w/Amaretto Crème	✓		✓	✓	✓	✓	✓	✓	✓	✓	✓	✓	✓	✓	✓	✓	✓	✓	✓	✓	✓	✓	✓	✓	✓	✓	✓	✓	
	Lambswool w/Grey Stone	✓		✓	✓	✓	✓	✓	✓	✓	✓	✓	✓	✓	✓	✓	✓	✓	✓	✓	✓	✓	✓	✓	✓	✓	✓	✓	✓	
	Lambswool w/Toasted Almond	✓		✓	✓	✓	✓	✓	✓	✓	✓	✓	✓	✓	✓	✓	✓	✓	✓	✓	✓	✓	✓	✓	✓	✓	✓	✓	✓	
	Maritime w/Amaretto Crème	✓		✓	✓	✓	✓	✓	✓	✓	✓	✓	✓	✓	✓	✓	✓	✓	✓	✓	✓	✓	✓	✓	✓	✓	✓	✓	✓	
	Maritime w/Grey Stone	✓		✓	✓	✓	✓	✓	✓	✓	✓	✓	✓	✓	✓	✓	✓	✓	✓	✓	✓	✓	✓	✓	✓	✓	✓	✓	✓	
	Maritime w/Toasted Almond	✓		✓	✓	✓	✓	✓	✓	✓	✓	✓	✓	✓	✓	✓	✓	✓	✓	✓	✓	✓	✓	✓	✓	✓	✓	✓	✓	
	Moonstone w/Amaretto Crème	✓		✓	✓	✓	✓	✓	✓	✓	✓	✓	✓	✓	✓	✓	✓	✓	✓	✓	✓	✓	✓	✓	✓	✓	✓	✓	✓	
	Moonstone w/Toasted Almond	✓		✓	✓	✓	✓	✓	✓	✓	✓	✓	✓	✓	✓	✓	✓	✓	✓	✓	✓	✓	✓	✓	✓	✓	✓	✓	✓	
Oasis	✓		✓	✓	✓	✓	✓	✓	✓	✓	✓	✓	✓	✓	✓	✓	✓	✓	✓	✓	✓	✓	✓	✓	✓	✓	✓	✓		
Pearl w/Amaretto Crème	✓		✓	✓	✓	✓	✓	✓	✓	✓	✓	✓	✓	✓	✓	✓	✓	✓	✓	✓	✓	✓	✓	✓	✓	✓	✓	✓		
Pearl w/Grey Stone	✓		✓	✓	✓	✓	✓	✓	✓	✓	✓	✓	✓	✓	✓	✓	✓	✓	✓	✓	✓	✓	✓	✓	✓	✓	✓	✓		
Pearl w/Toasted Almond	✓		✓	✓	✓	✓	✓	✓	✓	✓	✓	✓	✓	✓	✓	✓	✓	✓	✓	✓	✓	✓	✓	✓	✓	✓	✓	✓		
Distressing Technique	Distressing						†				†	†		†		†	†		†											







*Heirlooming not available on Caprice, Fairbrook, and Rennie.

△ In Choice construction, cabinets will have matching laminate ends. Where not available, ends will be Natural Maple laminate and a finished end treatment would be needed for an exposed end.

† Distressing not available on Coconut, Dover, Pearl, or White.















 Signed finish agreement required, see pages 429-431.

FINISH AVAILABILITY

		CHERRY																										
		Matching Laminate Ends [▲]	Heirloom [*] 	Amstead	Ashridge	Baxter	Bellmont	Butler	Caprice	Cotter	Dewitt	Dutton	Elberby 	Fairbrook	Hardin	Herrington	Justin	Kingston	Larsen	Lawton	Lynville	Manchester 	Northrope	Painter 	Rennie	Warwick	Whitman	
Wood Tone Stains	Brierwood	✓		✓	✓	✓	✓	✓	✓	✓	✓	✓	✓	✓	✓	✓	✓	✓	✓	✓	✓	✓	✓	✓	✓	✓	✓	
	Buckskin	✓		✓	✓	✓	✓	✓	✓	✓	✓	✓	✓	✓	✓	✓	✓	✓	✓	✓	✓	✓	✓	✓	✓	✓	✓	
	Cattail	✓		✓	✓	✓	✓	✓	✓	✓	✓	✓	✓	✓	✓	✓	✓	✓	✓	✓	✓	✓	✓	✓	✓	✓	✓	
	Chocolate	✓		✓	✓	✓	✓	✓	✓	✓	✓	✓	✓	✓	✓	✓	✓	✓	✓	✓	✓	✓	✓	✓	✓	✓	✓	
	Cranberry	✓		✓	✓	✓	✓	✓	✓	✓	✓	✓	✓	✓	✓	✓	✓	✓	✓	✓	✓	✓	✓	✓	✓	✓	✓	
	Grizzly 	✓		✓	✓	✓	✓	✓	✓	✓	✓	✓	✓	✓	✓	✓	✓	✓	✓	✓	✓	✓	✓	✓	✓	✓	✓	
	Havana	✓		✓	✓	✓	✓	✓	✓	✓	✓	✓	✓	✓	✓	✓	✓	✓	✓	✓	✓	✓	✓	✓	✓	✓	✓	
	Henna	✓		✓	✓	✓	✓	✓	✓	✓	✓	✓	✓	✓	✓	✓	✓	✓	✓	✓	✓	✓	✓	✓	✓	✓	✓	✓
	Kodiak 	✓		✓	✓	✓	✓	✓	✓	✓	✓	✓	✓	✓	✓	✓	✓	✓	✓	✓	✓	✓	✓	✓	✓	✓	✓	✓
	Light	✓		✓	✓	✓	✓	✓	✓	✓	✓	✓	✓	✓	✓	✓	✓	✓	✓	✓	✓	✓	✓	✓	✓	✓	✓	✓
	Morel	✓		✓	✓	✓	✓	✓	✓	✓	✓	✓	✓	✓	✓	✓	✓	✓	✓	✓	✓	✓	✓	✓	✓	✓	✓	✓
	Natural	✓		✓	✓	✓	✓	✓	✓	✓	✓	✓	✓	✓	✓	✓	✓	✓	✓	✓	✓	✓	✓	✓	✓	✓	✓	✓
	Sahara	✓		✓	✓	✓	✓	✓	✓	✓	✓	✓	✓	✓	✓	✓	✓	✓	✓	✓	✓	✓	✓	✓	✓	✓	✓	✓
	Seal			✓	✓	✓	✓	✓	✓	✓	✓	✓	✓	✓	✓	✓	✓	✓	✓	✓	✓	✓	✓	✓	✓	✓	✓	✓
	Storm		✓	✓	✓	✓	✓	✓	✓	✓	✓	✓	✓	✓	✓	✓	✓	✓	✓	✓	✓	✓	✓	✓	✓	✓	✓	✓
	Thatch	✓		✓	✓	✓	✓	✓	✓	✓	✓	✓	✓	✓	✓	✓	✓	✓	✓	✓	✓	✓	✓	✓	✓	✓	✓	✓
	Tundra	✓		✓	✓	✓	✓	✓	✓	✓	✓	✓	✓	✓	✓	✓	✓	✓	✓	✓	✓	✓	✓	✓	✓	✓	✓	✓
Unfinished	✓		✓	✓	✓	✓	✓	✓	✓	✓	✓	✓	✓	✓	✓	✓	✓	✓	✓	✓	✓	✓	✓	✓	✓	✓	✓	
Wood Tone Glazes	Black Forest	✓		✓	✓	✓	✓	✓		✓	✓	✓	✓	✓	✓	✓	✓	✓	✓	✓	✓	✓	✓	✓	✓	✓	✓	
	Coffee	✓		✓	✓	✓	✓	✓		✓	✓	✓	✓	✓	✓	✓	✓	✓	✓	✓	✓	✓	✓	✓	✓	✓	✓	
	Palomino	✓		✓	✓	✓	✓	✓		✓	✓	✓	✓	✓	✓	✓	✓	✓	✓	✓	✓	✓	✓	✓	✓	✓	✓	
	Whiskey Black	✓		✓	✓	✓	✓	✓		✓	✓	✓	✓	✓	✓	✓	✓	✓	✓	✓	✓	✓	✓	✓	✓	✓	✓	
Distressing Technique	Distressing						✓				✓		✓		✓	✓		✓										







*Heirloom not available on Caprice, Fairbrook, and Rennie.
 ▲In Choice construction, cabinets will have matching laminate ends. Where not available, ends will be Natural Maple laminate and a finished end treatment would be needed for an exposed end.
 Signed finish agreement required, see pages 429-431.
 Cherry laminate sides are intentionally 15-20% darker than face frames and doors at the time of manufacture to compensate for the expected darkening of face frames, doors, etc., as they are exposed to natural sunlight.

FINISH AVAILABILITY

				ALDER						RUSTIC ALDER 					HICKORY				OAK									
		Matching Laminate Ends [▲]	Heirlooming* 	 Dewitt	Gallatin	Kingston	Larsen	Lawton	Northrope	Whitman	 Dewitt	Gallatin	Larsen	Lawton	Northrope	Whitman	 Dewitt	 Ellerby	 Painter	Whitman	Dewitt	 Ellerby	 Fairbrook	Larsen	 Manchester	Northrope	 Painter	
Wood Tone Stains	Brierwood	✓		✓	✓	✓	✓	✓	✓	✓	✓	✓	✓	✓	✓	✓	✓	✓	✓	✓	✓	✓	✓	✓	✓	✓	✓	✓
	Buckskin	✓		✓	✓	✓	✓	✓	✓	✓	✓	✓	✓	✓	✓	✓	✓	✓	✓	✓	✓	✓	✓	✓	✓	✓	✓	✓
	Cattail	✓		✓	✓	✓	✓	✓	✓	✓	✓	✓	✓	✓	✓	✓												
	Chocolate	✓		✓	✓	✓	✓	✓	✓	✓	✓	✓	✓	✓	✓	✓					✓	✓	✓	✓	✓	✓	✓	✓
	Cranberry	✓		✓	✓	✓	✓	✓	✓	✓	✓	✓	✓	✓	✓	✓												
	Grizzly 	✓		✓	✓	✓	✓	✓	✓	✓	✓	✓	✓	✓	✓	✓	✓	✓	✓	✓	✓	✓	✓	✓	✓	✓	✓	✓
	Havana	✓		✓	✓	✓	✓	✓	✓	✓	✓	✓	✓	✓	✓	✓	✓	✓	✓	✓	✓	✓	✓	✓	✓	✓	✓	✓
	Kodiak 	✓		✓	✓	✓	✓	✓	✓	✓	✓	✓	✓	✓	✓	✓	✓	✓	✓	✓	✓	✓	✓	✓	✓	✓	✓	✓
	Light	✓															✓	✓	✓	✓	✓	✓	✓	✓	✓	✓	✓	✓
	Morel	✓		✓	✓	✓	✓	✓	✓	✓	✓	✓	✓	✓	✓	✓	✓	✓	✓	✓	✓	✓	✓	✓	✓	✓	✓	✓
	Natural	✓		✓	✓	✓	✓	✓	✓	✓	✓	✓	✓	✓	✓	✓	✓	✓	✓	✓	✓	✓	✓	✓	✓	✓	✓	✓
	Sahara	✓		✓	✓	✓	✓	✓	✓	✓	✓	✓	✓	✓	✓	✓	✓	✓	✓	✓	✓	✓	✓	✓	✓	✓	✓	✓
	Seal			✓	✓	✓	✓	✓	✓	✓	✓	✓	✓	✓	✓	✓	✓	✓	✓	✓	✓	✓	✓	✓	✓	✓	✓	✓
	Thatch	✓		✓	✓	✓	✓	✓	✓	✓	✓	✓	✓	✓	✓	✓	✓	✓	✓	✓	✓	✓	✓	✓	✓	✓	✓	✓
	Tundra	✓		✓	✓	✓	✓	✓	✓	✓	✓	✓	✓	✓	✓	✓	✓	✓	✓	✓	✓	✓	✓	✓	✓	✓	✓	✓
Unfinished	✓		✓	✓	✓	✓	✓	✓	✓	✓	✓	✓	✓	✓	✓	✓	✓	✓	✓	✓	✓	✓	✓	✓	✓	✓	✓	
Wood Tone Glazes	Black Forest	✓		✓	✓	✓	✓	✓	✓	✓	✓	✓	✓	✓	✓					✓	✓	✓	✓	✓	✓	✓	✓	
	Coffee	✓		✓	✓	✓	✓	✓	✓	✓	✓	✓	✓	✓	✓	✓	✓	✓	✓									
	Palomino	✓		✓	✓	✓	✓	✓	✓	✓	✓	✓	✓	✓	✓					✓	✓	✓	✓	✓	✓	✓	✓	
	Whiskey Black	✓		✓	✓	✓	✓	✓	✓	✓	✓	✓	✓	✓	✓													
Opagues	Black 		✓																									
Distressing Technique	Distressing			✓	✓	✓				✓	✓					✓	✓			✓	✓							

▲ In Choice construction, cabinets will have matching laminate ends. Where not available, ends will be Natural Maple laminate and a finished end treatment would be needed for an exposed end.
 Signed finish agreement required, see pages 429-431.

FINISH AVAILABILITY

		Matching Laminate Ends [▲]	SPECIALTY LAMINATES			PURESTYLE™	THERMOFOIL	
			Genova	Taro	Troxel	Shafer	Vaille	
Laminate Finishes	White	✓					✓	
	Antler w/Cloud Cabinet Box 	✓	✓					
	Antler w/Morel Cherry Cabinet Box 	✓	✓					
	Antler w/Morel Hickory Cabinet Box 	✓	✓					
	Antler w/Morel Maple Cabinet Box 	✓	✓					
	Antler w/Morel Oak Cabinet Box 	✓	✓					
	Antler w/White Cabinet Box 	✓	✓					
Textured Laminate Finishes	Arctic w/Cloud Cabinet Box	✓			✓			
	Arctic w/Dover Cabinet Box	✓			✓			
	Arctic w/White Cabinet Box	✓			✓			
	Elk w/Seal Hickory Cabinet Box		✓			✓		
	Elk w/Seal Maple Cabinet Box		✓			✓		
	Elk w/Seal Oak Cabinet Box		✓			✓		
	Elk w/Thatch Hickory Cabinet Box	✓	✓			✓		
	Elk w/Thatch Maple Cabinet Box	✓	✓			✓		
	Elk w/Thatch Oak Cabinet Box	✓	✓			✓		
	Obsidian w/Black Maple Cabinet Box				✓			
	Obsidian w/Storm Maple Cabinet Box				✓			
	Wharf w/Dover Cabinet Box	✓	✓					
	Wharf w/Lambswool Cabinet Box	✓	✓					
	Wharf w/White Cabinet Box	✓	✓					
	High Gloss Laminate Finishes	White w/Matching Edgebanding	✓		✓			
		White w/Metallic Edgebanding	✓		✓			

▲In Choice construction, cabinets will have matching laminate ends to match the cabinet box color. Where not available, ends will be Natural Maple laminate and a finished end treatment would be needed for an exposed end.

THINGS TO REMEMBER ABOUT FINISHED ENDS AND CABINET INTERIOR FINISHES

On cabinets with PLYWOOD ENDS (PE) or ALL PLYWOOD CONSTRUCTION (APC) modifications, cabinet sides are plywood with an unfinished veneer exterior. You can finish the exposed ends in your kitchen with one of several decorative options, as follows:

1. Leave the ends UNFINISHED if the cabinets are installed against each other or against the wall.
2. Purchase a 1/4" VENEER SKIN for field installation. This brings the cabinet side flush with the face frame.
3. Specify FURNITURE FINISHED PLYWOOD ENDS (FPEB). See page 34 for details.
4. Specify AUTHENTIC ENDS (AUTHL or AUTHR) or Face Frame and Door on End (FFDL or FFDR). See page 34 for details.
5. Specify cabinets with FINISHED ENDS (FB), factory installed. Both ends of the cabinet use 1/2" plywood veneer panel that is factory finished on the exterior to match the door and frame.
6. Purchase Wall, Base or Tall END DECORATIVE DOOR PANELS (WED, BED, TED). These are a skin and a door that can be attached to finish the exposed end. This will extend the total cabinet run by the thickness of the door.
7. Purchase a Wall MESSAGE CENTER. This will extend the cabinet run by the thickness of the panel or storage shelf.
8. Cabinets specified with MIP have matching veneer interior and exterior. Some cabinets are provided with standard MIP construction, such as:

Wine Rack Cabinets	BOC, BOD - Base Open Cabinets
Wall China Display Cabinets	WOC - Wall Open Cabinets
CPU Base Cabinet	Bookcase Cabinets
9. All Wall Organizer and Wall/Base Spice Drawer Cabinets are frameless doweled construction and feature 3/4" furniture board with matching finished veneer interior and exterior.

CONSTRUCTION FEATURES

	CHOICE (CHC)	PLYWOOD ENDS (PE)*	ALL PLYWOOD CONSTRUCTION (APC)*
Doors & Drawer Fronts	See "Door Styles" pages 8-21 for door and drawer front configuration and construction details.		
Face Frames	3/4" solid hardwood.		
I-Beam Braces	1/2" furniture board dadoed into face frame, end panels and back panels.		Plywood dadoed into face frame, end panels and back panels.
Cabinet Sides	1/2" furniture board with Natural Maple interiors. Exteriors are laminate that match the color of the face frame, with exception of Black, Forest Floor, Juniper Berry, Maritime, Oasis, Seal, Seaside, Storm, and Tidal Mist.	1/2" unfinished veneer plywood with Natural Maple interiors.	1/2" unfinished plywood with clear coated hardwood veneer interior.**▲
	Optional Furniture Finished Plywood Ends (FPEB) modification: Cabinets will have 3/4" finished veneer end panels to achieve a Furniture End appearance. See page 34 for more details.		
Cabinet Tops & Bottoms	1/2" furniture board with Natural Maple interior and exterior surfaces.		1/2" plywood with clear coated hardwood veneer interior and exterior.**▲
Cabinet Backs	3/8" furniture board with Natural Maple interior. Base cabinets have 3mm system holes for easy drawer and tray installation.		3/8" plywood with clear coated hardwood veneer interior.**▲ Base cabinets have 3mm system holes for easy drawer and tray installation.
Adjustable Shelves	3/4" furniture board with Natural Maple to match interiors. Shelves are adjustable in wall and base cabinets unless otherwise noted.		3/4" plywood with clear coated hardwood veneer to match interiors.** Shelves are adjustable in wall and base cabinets.
Finish	Multi-step finishing process where the finished components are sanded, stained, and sealed before a catalyzed top coat is applied.		
Hinges	Smart Stop™ fully concealed, integrated cup hinge with self-closing feature; 6-way adjustable. Hinge features deactivation option. Some cabinets utilize a 170° or 107° 4-way adjustable hinge. See page 418 for details.		
Drawer Box and Roll Tray Construction	All Styles: Four-sided clear coated hardwood. Corners are dovetailed and glued. Drawer bottom is 5.2mm laminated plywood fully captured in box sides, front and back.		
Drawer and Roll Tray Guide	Double fully concealed, ball bearing, self-aligning, full extension guide with Smart Stop™ self-closing mechanism and fast clip removal system. Smart Stop engages when the drawer or roll tray is approximately 2" from closing, applying resistance to the self-closing mechanism. Optional (Roll Trays): EasyTrax™ (ET) height adjustment system. All guides have a maximum weight capacity of 90 lbs. Drawers and roll trays have a maximum weight capacity of 15 lbs. per square foot.		
Toekick	Unfinished furniture board toekick to allow application of finished toeboard materials. A variety of laminate and wood toeboard skins and baseboard mouldings available in 8' lengths; see ACCESSORIES section. When APC is selected, toekick will be plywood.		
Warranty	Lifetime limited warranty. Please see written warranty for detailed information.		
Interior Cabinet Components	A few interior components are manufactured from laminated furniture board because they provide for the most durable, aesthetic application. Some examples include the BCFW48SP (swing-out shelf), SLS33/36 (fixed shelf), and PY18/36 (swing-out and door mounted racks).		

CHOICE CABINET CONSTRUCTION

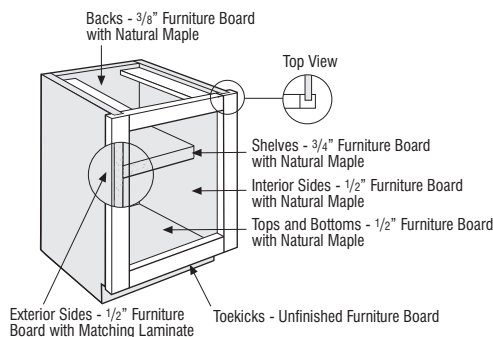

See page 31 for Plywood Ends and All Plywood Construction.

CHOICE DRAWER CONSTRUCTION

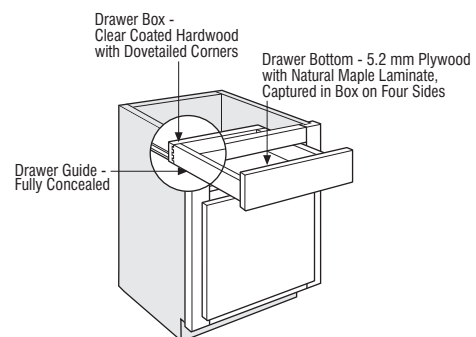

See page 31 for Plywood Ends and All Plywood Construction.

*All plywood components meet ANSI/HPVA HP-1 standards and may contain MDF or particleboard.

**White Laminate Interior (WLI) modification is available on White cabinets to replace the clear coated hardwood veneer with White laminate.

▲ Cabinets with limited interior visibility, such as Drawer Bases (2DB., 3DB., 4DB.), appliance cabinets without doors, and others may have a laminated plywood cabinet interior.

CONSTRUCTION UPGRADES

See page 30 for modification compatibility. Requests for non-published modifications may be treated as a Special Sales Order which will require feasibility, leadtime review and approval. Please check with your customer service representative before placing your order.

OPTION NAME	APPLICABLE CABINET GROUP	DESCRIPTION/LIMITATIONS
Plywood Ends (PE)**	Most cabinets with sides	Replaces standard cabinet ends with unfinished 1/2" plywood exterior ends. See page 29 for more details.
All Plywood Construction (APC)**	Most cabinets with sides	Replaces standard cabinet construction with plywood for 1/2" ends, top, bottom, 3/4" shelves, and 3/8" back. Exterior of cabinet ends are unfinished. Cabinet interior and exterior of top and bottom are clear coated hardwood veneer***. See page 29 for more details. White Laminate Interior (WLI) modification available on White cabinets (painted White or Laminate) in APC, see page 35.
	Selected trim panels	Replaces standard panel material with plywood. Exterior side is finished. Interior side is clear coated hardwood veneer.

PLYWOOD ENDS CONSTRUCTION UPGRADE (PE)

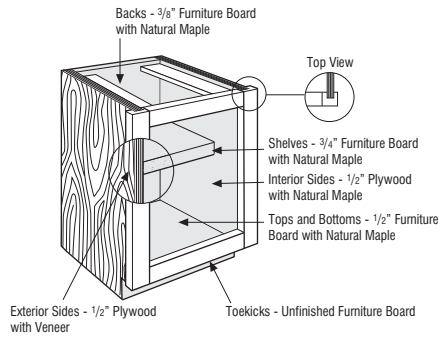

ALL PLYWOOD CONSTRUCTION UPGRADE (APC)

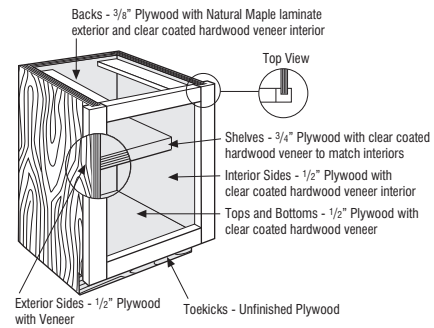

*When a cabinet is specified with FPEB in a design where PE has been selected for the entire kitchen (through Styles & Pricing Tab and Construction Options menu), both modification charges will apply. To avoid the additional charge for PE, use attachments to specify PE for all other cabinets instead of selecting it for the entire kitchen.

**All plywood components meet ANSI/HPVA HP-1 standards and may contain MDF or particleboard.

***Cabinets with limited interior visibility, such as Drawer Bases (2DB., 3DB., 4DB.), appliance cabinets without doors, and others may have a laminated plywood cabinet interior.

DRAWER FRONT UPGRADES

See page 30 for modification compatibility. Requests for non-published modifications may be treated as a Special Sales Order which will require feasibility, leadtime review and approval. Please check with your customer service representative before placing your order.

OPTION NAME	APPLICABLE CABINET GROUP	DESCRIPTION/LIMITATIONS
Drawer Front Flat 5-Piece (DFF5PC)	Base, tall, and vanity cabinets on Kingston, Larsen, Lawton, Lynnville, Northrope, and Rennie	Replaces the standard drawer front with a 5-piece drawer front (see images with applicable door styles). Must upgrade all drawer fronts on a cabinet where applicable. See page 70 for 5-piece drawer front dimensions when specifying decorative hardware.
Drawer Front Raised 5-Piece (DFR5PC)	Base, tall, and vanity cabinets on Gallatin and Herrington	Replaces the standard drawer front with a 5-piece drawer front (see images with applicable door styles). Must upgrade all drawer fronts on a cabinet where applicable. See page 70 for 5-piece drawer front dimensions when specifying decorative hardware.
Drawer Front Slab (DFSLB)	Base, tall, and vanity cabinets on Amstead, Butler, Cotter, Darby, Hardin, Herrington, Justin, and Whitman	Replaces standard drawer front with slab drawer front. Must upgrade all drawer fronts on cabinet where applicable.

DRAWER FRONT FLAT 5-PIECE (DFF5PC)

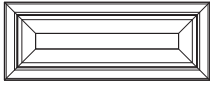

Kingston*

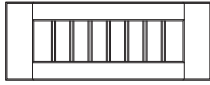

Lynnville



Larsen



Northrope

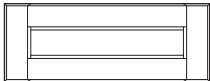

Lawton

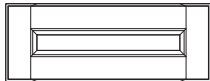

Rennie

*Kingston 5-piece 6 1/4" and 6 3/4" high drawer fronts have a flat center panel, 10" and taller drawer fronts have a raised center panel.

DRAWER FRONT RAISED 5-PIECE (DFR5PC)

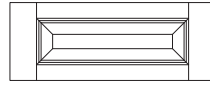

Gallatin



Herrington

DRAWER FRONT SLAB (DFSLB)



Amstead
Butler
Cotter



Herrington



Justin

DRAWER AND DOOR OPTIONS

See page 30 for modification compatibility. Requests for non-published modifications may be treated as a Special Sales Order which will require feasibility, leadtime review and approval. Please check with your customer service representative before placing your order.

OPTION NAME	APPLICABLE CABINET GROUP	DESCRIPTION/LIMITATIONS
Door Panel - Solid Reverse Raised (DPSRR)	Most cabinets and panels with doors. Available on Whitman only.	Replaces Whitman veneer flat door center panel with a solid reverse raised center panel. Drawer fronts are not affected by this door option.
Modified Full Overlay (MFO)	Most wall and tall cabinets and some panels with doors	Reduces the size of a Full Overlay door by 3/4" allowing for a top face frame reveal of 1" to allow for face mount moulding application. Overlay Fillers are available in MFO heights to align with doors, see pages 342 and 344 for OL..MFO. Not compatible with Add Toekick modification. When Authentic End(s) are ordered in conjunction with Modified Full Overlay, the Authentic End will match the face frame reveal. Not available on Aluminum Frame Doors. Not available on Caprice, Genova, Shafer, Taro, Troxel, Vaille, and partial overlay styles. Not available on Kingston mullion doors.
Scooped Drawer (SCPDRW) (SCPDRWB) (SCPDRWL) (SCPDRWR)	Most base cabinets	Replaces top drawer box with a 2" high drawer box to allow for clearance of cooktops, etc. Only top drawer will be modified when specified on drawer bases. On base cabinets with two top drawers, L, R, or B must be specified. Increases clearance for cooktops from 2" to 3 3/8". When SCPDRW is selected on 2DB18-2DB42, top drawer will utilize a 6 3/8" high drawer box, creating a clearance of 6 5/8" for the cooktop. Not available on Shafer.

DOOR PANEL - SOLID REVERSE RAISED (DPSRR)



MODIFIED FULL OVERLAY (MFO)

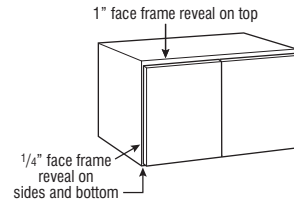

SCOOPED DRAWER (SCPDRW/SCPDRWB/SCPDRWL/SCPDRWR)

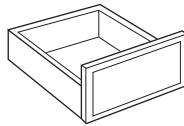

END PANEL MODIFICATIONS

See page 30 for modification compatibility. Requests for non-published modifications may be treated as a Special Sales Order which will require feasibility, leadtime review and approval. Please check with your customer service representative before placing your order.

OPTION NAME	APPLICABLE CABINET GROUP	DESCRIPTION/LIMITATIONS
Authentic Ends (AUTHL) (AUTHR)	Most wall, base, tall, and vanity cabinets	<p>Modifies cabinet end panel(s) with applied decorative door(s) onto FPEB upgraded end panel(s).</p> <p>Includes FPEB modification — If AUTHL or AUTHR upgrades are specified, the opposite end panel is also FPEB.</p> <p>Available on most cabinets with depths of 9", 12", 15", 18", 21", 24" and 27". Custom doors must be specified for other depths not listed. 9" depth available on cabinets 30" high or taller.</p> <p>12" and 15" high wall cabinets will have double door configuration on 21" and 24" deep applications.</p> <p>For tall cabinets, non-miter doors have two panels on the bottom door.</p> <p>Decorative door for wall and tall cabinets will match style chosen on order, i.e., arch, cathedral or square.</p> <p>27" deep cabinets will have double door configuration. Office base cabinets (29" high) will have double door configuration when specified on 24" deep cabinets.</p>
Face Frame and Door on End (FFDL) (FFDR)	Most wall, base, tall, and vanity cabinets	<p>Creates a working door on the end of the specified cabinet. Opposite end panel will be FPEB. Side cabinet configuration will match front configuration.</p> <p>On Base and Tall cabinets, recessed toe space is standard on the side specified with FFDR or FFDL (if any flush toekick modification is specified, FFD side of cabinet will also be flush). 12" deep cabinets specified with FFDL or FFDR and FTKAV or FTKFV will receive a standard flush toekick.</p> <p>Full depth shelves standard. Glass shelves not compatible with the FFD modification.</p> <p>Doors will always be hinged on the back of the cabinet. Option not available on both ends of cabinet. Not available on peninsula cabinets. Available on cabinets in depths of 12", 15", 18", 21", and 24".</p> <p>If glass is specified, the FFD door will also be glass. When ordered with MD on 12" deep cabinets, the FFD door will be Cut for Glass.</p>
Finished Ends (FB)	Cabinets with PE or APC modification; both ends will be finished	Creates a matching finished 1/2" veneer plywood exterior.
Furniture Finished Plywood* Ends (FPEB)	Most wall, base, tall, office, and vanity cabinets	Replaces standard cabinet ends with 3/4" finished veneer end panels to achieve a Furniture End appearance. Both exterior sides are finished. Includes PE upgrade and standard laminate interior. Order APC for clear coated hardwood veneer interior. Matching Interior Plywood (MIP) is available. Not available with extended stiles or on cabinets with frameless construction.

AUTHENTIC ENDS (AUTHL/AUTHR)

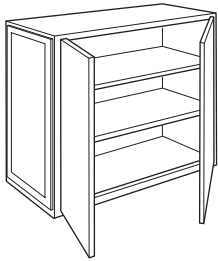

Wall cabinets

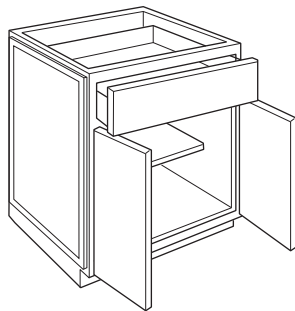

Base and Vanity cabinets

FURNITURE FINISHED PLYWOOD ENDS (FPEB)

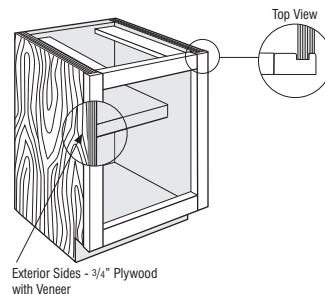

Exterior Sides - 3/4" Plywood with Veneer

FACE FRAME AND DOOR ON END (FFDL/FFDR)

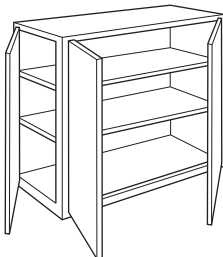

Wall cabinets

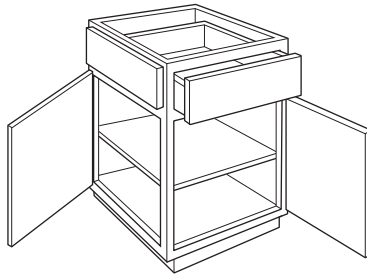

Base cabinets

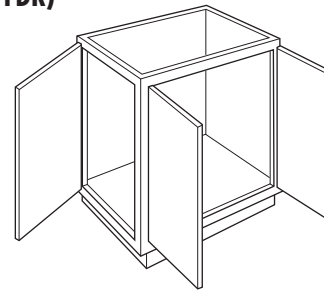

Vanity cabinets

*All plywood components meet ANSI/HPVA HP-1 standards and may contain MDF or particleboard.

FINISH MODIFICATIONS

See page 30 for modification compatibility. Requests for non-published modifications may be treated as a Special Sales Order which will require feasibility, leadtime review and approval. Please check with your customer service representative before placing your order.

OPTION NAME	APPLICABLE CABINET GROUP	DESCRIPTION/LIMITATIONS
Matching Interior Plywood (MIP)	Most cabinets	Finishes the interior and exterior of the cabinet. Cabinet construction features 1/2" plywood ends, top, bottom, and 3/8" back. Shelves are upgraded to full depth 3/4" veneered plywood. Interior wood accessories feature a natural finish and will not match cabinet exterior. When a decorative door option is chosen in 20/20, Matching Interior Plywood (MIP) is a preselected option. If MIP is not desired, it can be deselected by choosing NOMIP.
	Most end panels with fillers attached	Replaces standard panel material with veneer plywood finished on both sides.
White Laminate Interior (WLI)	White cabinets with APC	Replaces clear coated hardwood veneer plywood interior with White laminate plywood interior. Only available on cabinets in White (painted Maple or Laminate) that are specified with APC. WLI only affects the cabinet box interior and shelves, interior accessories will not change.

MATCHING INTERIOR PLYWOOD (MIP)

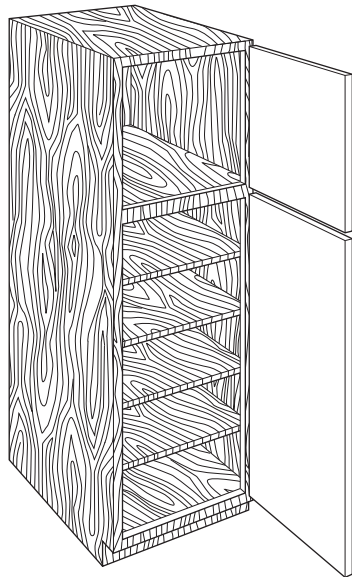

Tall cabinets

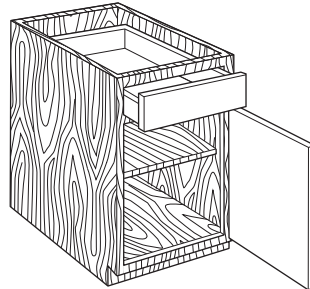

Base cabinets

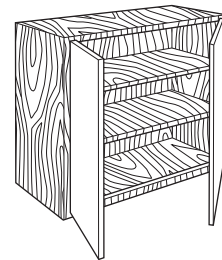

Wall cabinets

WHITE LAMINATE INTERIOR (WLI)

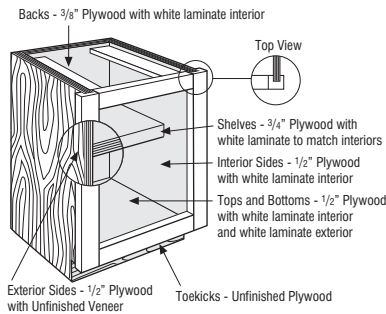

BOX MODIFICATIONS

See page 30 for modification compatibility. Requests for non-published modifications may be treated as a Special Sales Order which will require feasibility, leadtime review and approval. Please check with your customer service representative before placing your order.

OPTION NAME	APPLICABLE CABINET GROUP	DESCRIPTION/LIMITATIONS
Cabinet Box Only (CBO)	Most wall, base, tall, and vanity cabinets	Removes doors, drawer fronts, and any accessory items attached to a door or drawer front. Drawer box and any interior components attached to the cabinet box will be included. Frames will not be drilled for hinges.
Cabinet Case Only (CCO)	Most wall, base, tall, and vanity cabinets	Removes doors, drawer fronts, drawer boxes, interior components, and mini touch-up kits. Frames will not be drilled for hinges.
Cabinet False Panel (CFP)	Most base and vanity cabinets with a top drawer	Replaces top drawer with false panel. Not available with deep drawers.
Cabinet with No Door, with Drawer (CND)	Most wall, base, tall, and vanity cabinets with door(s) and drawer(s)	Removes door(s). Complete drawer(s) with drawer front(s) and interior components remain in cabinet. Frames will not be drilled for hinges.

CABINET BOX ONLY (CBO)

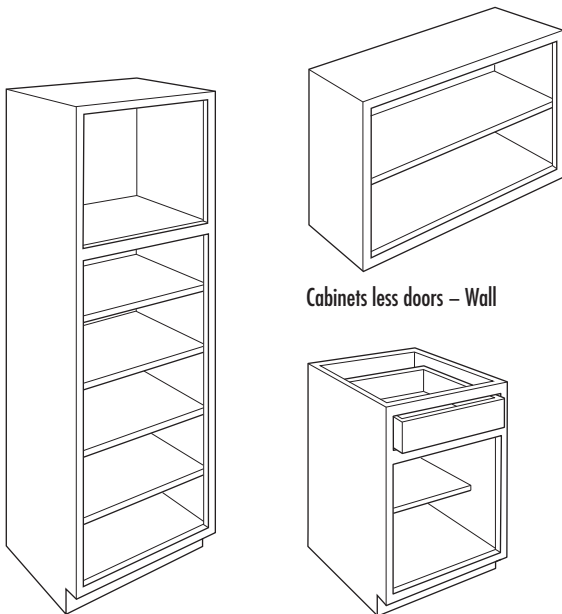

Cabinets less doors – Wall

Cabinets less doors – Tall

Cabinets less doors and drawer fronts – Base

CABINET CASE ONLY (CCO)

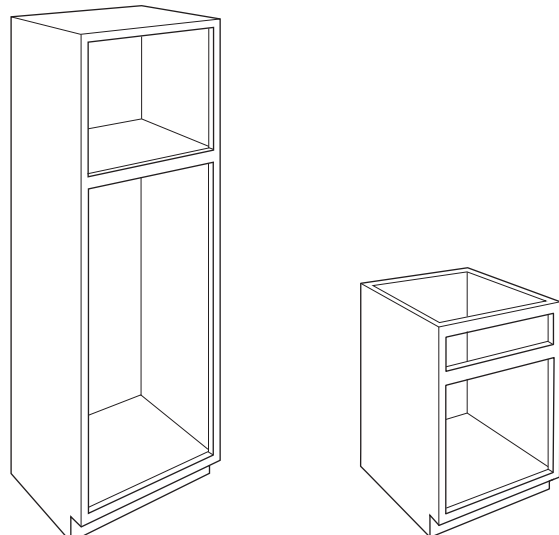

Cabinet case only – Tall

Cabinet case only – Base

CABINET FALSE PANEL (CFP)

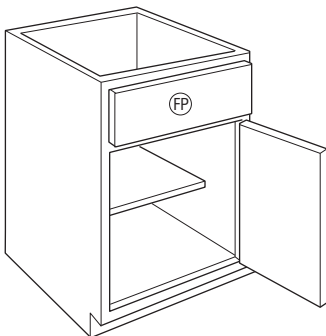

Base and Vanity cabinets

CABINET WITH NO DOOR, WITH DRAWER (CND)

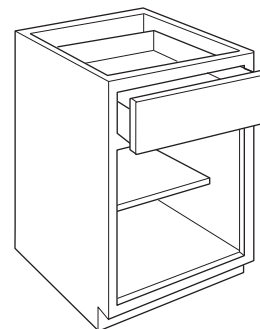

Base and Vanity cabinets

BOX MODIFICATIONS (cont'd)

See page 30 for modification compatibility. Requests for non-published modifications may be treated as a Special Sales Order which will require feasibility, leadtime review and approval. Please check with your customer service representative before placing your order.

OPTION NAME	APPLICABLE CABINET GROUP	DESCRIPTION/LIMITATIONS
Increased Depth (ID)	Most wall and vanity cabinets	Increases the depth of wall and vanity cabinets in 1" increments to a maximum depth of 24". Increased depth wall cabinets should be either floor mounted or stacked to maintain stability. Any specified shelving is included and is always full depth. Wall peninsula cabinets may be increased in 1" increments to 18" maximum.
	Most base, tall, and vanity cabinets without drawers or roll trays	Increases the depth of base, tall, and vanity cabinets without drawers or roll trays in 1" increments to 27". When depth beyond 24" is desired on tall cabinets, the 24" deep cabinet must be modified. Any specified shelving is included and is always full depth.
	Oven Cabinets	Increases the depth of oven cabinets in 1" increments to a maximum depth of 27". When oven cabinets with drawers are increased, drawer depth will not change. Any specified shelving is included and is always full depth.
	End panels	Increases the depth of end panels in 1" increments to a maximum depth of 36". 31"-36" depths available on plywood panels only. AEL/AER panels are only available in 3" increments up to a maximum depth of 36".
Reduced Depth (RD)	Most base, tall, and vanity cabinets with drawers or roll trays	Reduces the depth in 1" increments to a minimum depth of 12". Any specified shelving is included and is always full depth. The dimension is specified as the distance from the front of the face frame to the back of the cabinet.
	Most base, tall, and vanity cabinets without drawers or roll trays	Reduces the depth in 1" increments to a minimum depth of 6". If reduced depth to 8" or less, toekick will not be included. Any specified shelving is included and is always full depth. The dimension is specified as the distance from the front of the face frame to the back of the cabinet.
	Most wall cabinets	Reduces the depth in 1" increments to a minimum depth of 6". Any specified shelving is included and is always full depth. The dimension is specified as the distance from the front of the face frame to the back of the cabinet. Wall top hinge cabinets can only be reduced to 9" depth minimum.
	End panels	Reduces the depth in 1" increments to a minimum depth of 6".
	Roll tray kits	Reduces the depth in 1" increments to fit a minimum cabinet depth of 12".

Cabinet Depth	Drawer Box and Roll Tray Exterior Depth			Clearance Behind Drawer Box or Roll Tray and Back Panel		
	Standard Drawer Guides	Heavy Duty Drawer Guides and Backsockets (2DB42 and 2DB48, bottom drawers of 3DBDD.., 3DBBDD.., and VWH2D..)	Heavy Duty Side-Mount Guides (DDFD)	Standard Drawer Guides	Heavy Duty Drawer Guides and Backsockets (2DB42 and 2DB48, bottom drawers of 3DBDD.., 3DBBDD.., and VWH2D..)	Heavy Duty Side-Mount Guides (DDFD)
24	21	21	21	2 3/4	2 3/4	2 3/4
23	21	18	18	1 3/4	4 3/4	4 3/4
22	18	18	18	3 3/4	3 3/4	3 3/4
21	18	18	18	2 3/4	2 3/4	2 3/4
20	18	N/A	N/A	1 3/4	N/A	N/A
19	15	N/A	N/A	3 3/4	N/A	N/A
18	15	N/A	N/A	2 3/4	N/A	N/A
17	15	N/A	N/A	1 3/4	N/A	N/A
16	12	N/A	N/A	3 3/4	N/A	N/A
15	12	N/A	N/A	2 3/4	N/A	N/A
14	12	N/A	N/A	1 3/4	N/A	N/A
13	9	N/A	N/A	3 3/4	N/A	N/A
12	9	N/A	N/A	2 3/4	N/A	N/A

INCREASED DEPTH (ID)

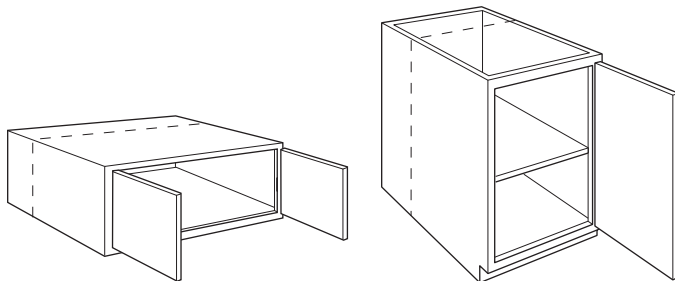

Wall cabinets

Base cabinets

REDUCED DEPTH (RD)

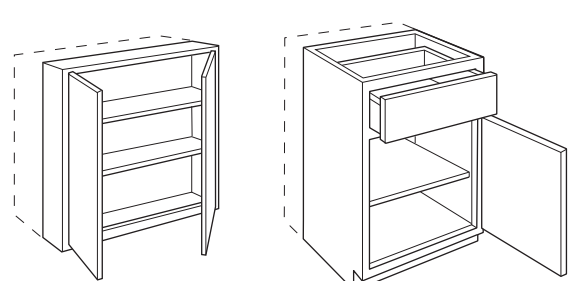

Wall cabinets

Base cabinets

BOX MODIFICATIONS (cont'd)

See page 30 for modification compatibility. Requests for non-published modifications may be treated as a Special Sales Order which will require feasibility, leadtime review and approval. Please check with your customer service representative before placing your order.

OPTION NAME	APPLICABLE CABINET GROUP	DESCRIPTION/LIMITATIONS
End Extended Back (EXBKL) (EXBKR)	Select wall, base, and tall cabinets	<p>Extends cabinet end panel back in 1" increments, available up to 6" per side. Includes FPEB modification with 3/4" finished veneer end panels on both ends.</p> <p>EXBKL and EXBKR are compatible with each other and can be specified with either the same dimension per side or unique dimensions if desired. Compatible with Authentic Ends when End Extended Back is specified in 3" increments.</p>
Prepare Cabinet for Finished Bottom (PFINBTMB)	Most wall cabinets	<p>Prepares cabinet for installation of a separately purchased and field installed applied 1/4" end panel skin to create a flush finished bottom on a single cabinet or multiple cabinets that are bridged between taller adjacent cabinets.</p> <p>Features factory installed spacer blocks against the cabinet bottom, along the face frame, back, and end panels. Cabinet back and end panel heights are 1/4" less than the face frame, leaving clearance for the applied skin. Cabinet end panel bottom edge remains unfinished.</p> <p>Panel utilized for flush bottom must be purchased separately using 1/4" end panel skins (see WEPS__, TEPS__, or BEPS__ on pages 355-356) or 1/4" custom panels (see DAPNL1/4 on page 352), and requires cabinet installer to cut to size before installation.</p> <p>If used on the end of a run, moulding or a full height end panel skin must be purchased separately to cover exposed unfinished edge of applied skin for the flush finished bottom. Not compatible with FPEB, AUTHL/AUTHR, FFDL/FFDR, and EXBKL/EXBKR modifications.</p>

END EXTENDED BACK LEFT (EXBKL)

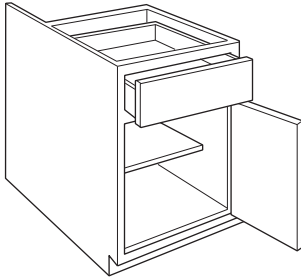

END EXTENDED BACK RIGHT (EXBKR)

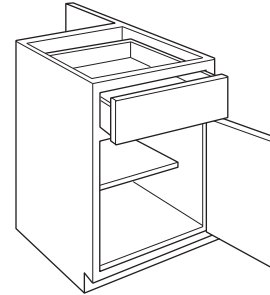

PREPARE CABINET FOR FINISHED BOTTOM (PFINBTMB)

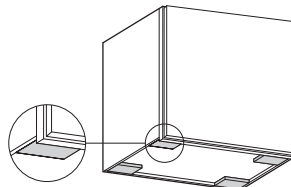

FACE FRAME MODIFICATIONS

See page 30 for modification compatibility. Requests for non-published modifications may be treated as a Special Sales Order which will require feasibility, leadtime review and approval. Please check with your customer service representative before placing your order.

OPTION NAME	APPLICABLE CABINET GROUP	DESCRIPTION/LIMITATIONS
Appliance Cut-out, Single (ACS) 	Most Oven Cabinets	Creates a custom cut-out area for field-ready oven installation. Custom Width dimension available in 1/4" increments, with a minimum of 1/2" to a maximum of 6" less than the standard opening. Frame side stiles will not be notched. Custom Height dimension available in 1/4" increments. <ul style="list-style-type: none"> • Cut-out area will be centered. • Available on oven cabinets specified with an (N) for Narrow Stile, with 1 1/2" wide frame side stiles. See cabinet specifications for available cut-out dimensions.
Extended Stile (EXL) (EXR)	Most cabinets with a face frame	Extends face frame width beyond its normal width by specified dimension to eliminate the need for field installed fillers, available in 1/2" increments from 1/2"-3". For example, a 1 1/2" wide face frame with EXL2 will have a width of 3 1/2" on the left side of the cabinet. Extended Left: EXL.5, EXL1, EXL1.5, EXL2, EXL2.5, EXL3 Extended Right: EXR.5, EXR1, EXR1.5, EXR2, EXR2.5, EXR3 EXL and EXR are compatible with each other and can be specified with either the same dimension per side or unique dimensions if desired. When ordered with Peninsula (P) modification, both face frames on specified side will be modified.

APPLIANCE CUT-OUT, SINGLE (ACS)

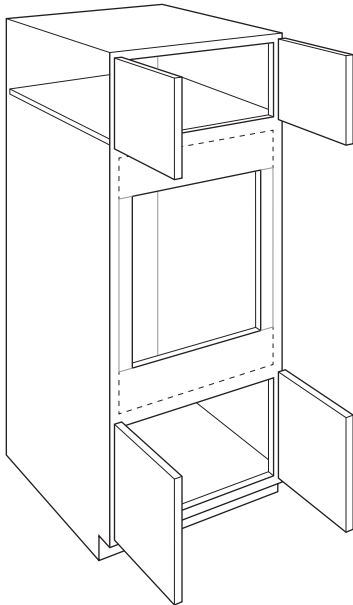

EXTENDED STILE LEFT (EXL)

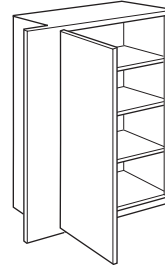

Cabinets with a face frame – Wall

EXTENDED STILE RIGHT (EXR)

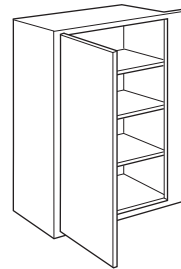

Cabinets with a face frame – Wall

FACE FRAME MODIFICATIONS (cont'd)

See page 30 for modification compatibility. Requests for non-published modifications may be treated as a Special Sales Order which will require feasibility, leadtime review and approval. Please check with your customer service representative before placing your order.

OPTION NAME	APPLICABLE CABINET GROUP	DESCRIPTION/LIMITATIONS
Inverted Frame (INVFRM)	Most cabinets with a face frame cross rail Tall Panels with Filler Attached and Authentic Ends	Inverts face frame openings. Drawer openings relocated to the bottom of a base cabinet must always be a working drawer. Opening sizes for doors do not change, standard drawer opening changes to 4 1/2" high. On tall and stacked walls, when INVFRM is ordered in conjunction with CG (cut for glass), top and bottom locations should be specified after the frame is inverted. Glass only available on doors for 41 1/2" high or less. Doors on inverted frame cabinets may not align with adjacent cabinet doors. On Tall Panels with Filler Attached and Authentic Ends, when INVFRM is selected, doors will be inverted (no face frame) to align with tall cabinets with the modification.
Valance Top Rail (TVRAV) (TVRFV) (TVRVV)	Base Open Cabinets, Bookcases, Wall Open Cabinets	Modifies the top rail with an arch, furniture, or straight valance.

INVERTED FRAME (INVFRM)

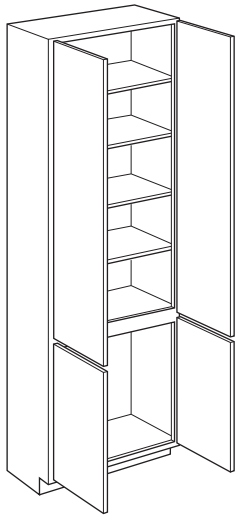

Tall cabinets

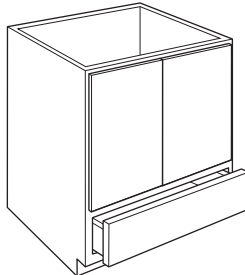

Base cabinets

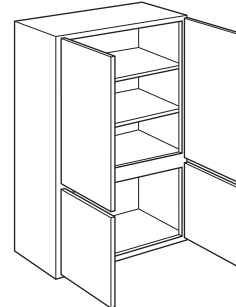

Wall cabinets

VALANCE TOP RAIL, ARCH (TVRAV)

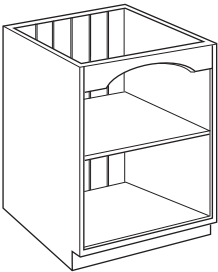

VALANCE TOP RAIL, FURNITURE (TVRFV)

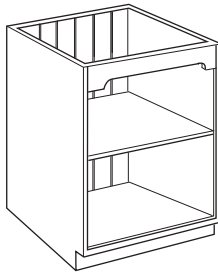

VALANCE TOP RAIL, STRAIGHT (TVRVV)

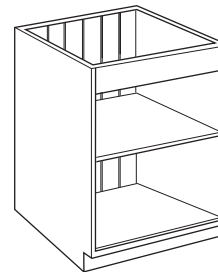

INSTALLED INTERIOR MODIFICATIONS

See page 30 for modification compatibility. Requests for non-published modifications may be treated as a Special Sales Order which will require feasibility, leadtime review and approval. Please check with your customer service representative before placing your order.

OPTION NAME	APPLICABLE CABINET GROUP	DESCRIPTION/LIMITATIONS
CabMat™ (CMAT1) (CMAT2)	Most sink base and vanity cabinets	Installs removable CabMat™, size is determined by face frame opening width and cabinet depth. CMAT2 is only available on vanity cabinets designed for double bowl applications. Not available with Reduced Depth modification. When ordered with Increased Depth modification, CabMat™ size does not change. Vanity cabinets with face frame openings of 24" and 30" will utilize CabMats sized for 21" and 27" openings.
Full Depth Shelf (FD)	Base cabinets with standard half depth shelves	Replaces standard shelf with full depth shelf.

CABMAT™ (CMAT1/CMAT2)

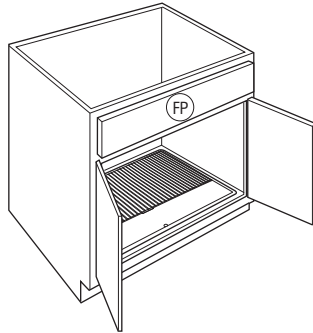

Base cabinets (CMAT1)

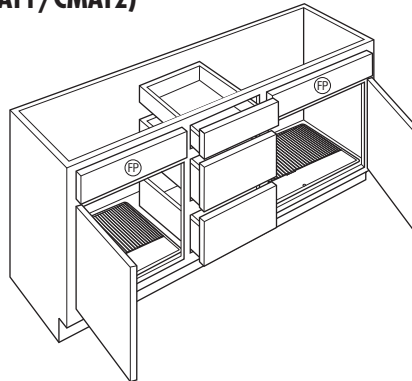

Vanity cabinets with double bowl (CMAT2)

FULL DEPTH SHELF (FD)

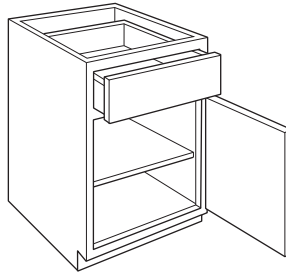

INSTALLED INTERIOR MODIFICATIONS (cont'd)

See page 30 for modification compatibility. Requests for non-published modifications may be treated as a Special Sales Order which will require feasibility, leadtime review and approval. Please check with your customer service representative before placing your order.

OPTION NAME	APPLICABLE CABINET GROUP	DESCRIPTION/LIMITATIONS
Deep Roll Tray (DRT)	Most cabinets with roll trays	Replaces standard roll trays with a 6 3/8" high deep roll tray. Replaces bottom roll tray only on base cabinets and bottom 2 roll trays on utility cabinets.
EasyTrax™ (ET)	Most cabinets with roll trays	Includes pre-installed upright wooden system that allows for easy height adjustment of roll trays.
Installed Roll Tray (RT)	Select base and tall cabinets	<p>Installs specified number of roll trays (1-5 per side). Example, for two roll trays, specify 2RT.</p> <p>On cabinets with center stile, specify RTL for roll trays in left side and RTR for roll trays in right side. RTL and RTR should be selected for roll trays in both sides.</p> <p>When 1RT is specified on a base cabinet, the roll tray is installed in the lowest position and one half-depth adjustable shelf is included. On utility cabinets for lower section, 1RT includes three shelves, 2RT includes two shelves, and 3RT includes 1 shelf. No shelves for lower section are included with 4RT or 5RT.</p>
Light Installed Battery Strip (LTI.BS) (LTI.BSB) (LTI.BSL) (LTI.BSR)	Select base, office, and vanity cabinets	<p>Installs a battery operated LED light inside the cabinet door opening(s).</p> <p>LTI.BS installs one LED light inside the cabinet door opening.</p> <p>LTI.BSB installs two LED lights inside both left and right cabinet door openings. On corner cabinets, installs one LED light for the top section and one LED light below fixed shelf for bottom section.</p> <p>LTI.BSL installs one LED light in the left door opening.</p> <p>LTI.BSR installs one LED light in the right door opening.</p> <p>Battery operated - (4) AAA batteries (not included). Motion activated. Low power usage (0.3W). Plastic aluminum finish. Dimensions: Length 11.93" (303mm), Width 0.67" (17mm), and Depth 0.55" (14mm).</p>

DEEP ROLL TRAY (DRT)

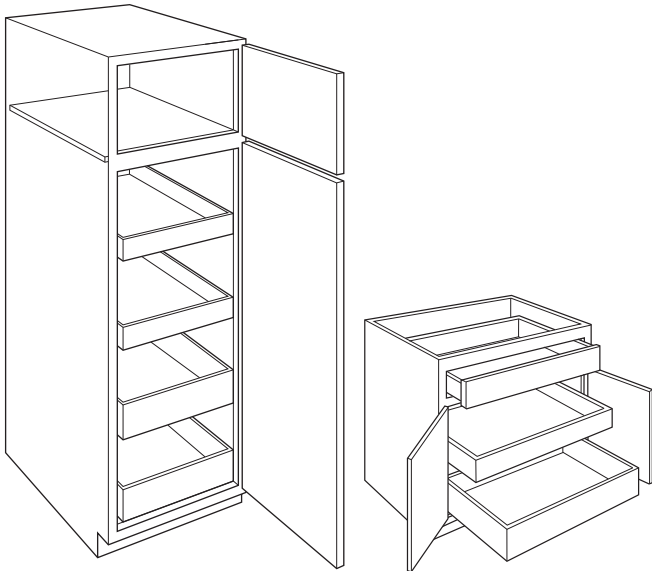

Tall cabinets

Base cabinets

INSTALLED ROLL TRAY (RT)

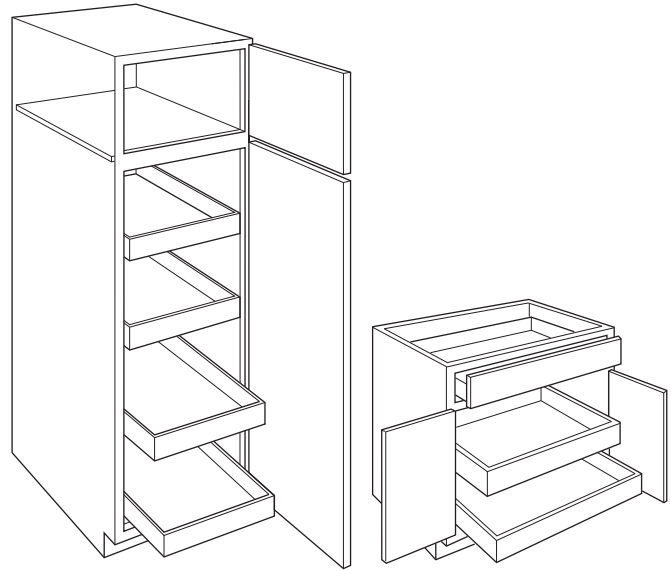

Tall cabinets

Base cabinets

LIGHT INSTALLED BATTERY STRIP (LTI.BS/LTI.BSB/LTI.BSL/LTI.BSR)

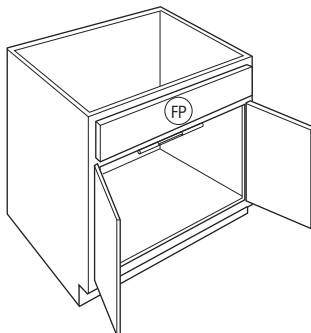

Base cabinet (LTI.BS)

EASYTRAX™ (ET)

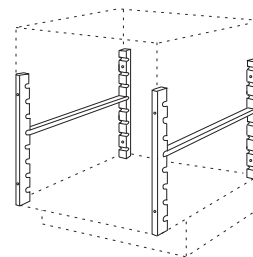

INSTALLED INTERIOR MODIFICATIONS (cont'd)

See page 30 for modification compatibility. Requests for non-published modifications may be treated as a Special Sales Order which will require feasibility, leadtime review and approval. Please check with your customer service representative before placing your order.

OPTION NAME	APPLICABLE CABINET GROUP	DESCRIPTION/LIMITATIONS
PowerGlide™ Compact Drawer Outlet (DRWPWR) (DRWPWRB) (DRWPWRL) (DRWPWRR)	Most base cabinets with a top drawer	Installs PowerGlide™ Compact Drawer Outlet into the drawer box. Includes two 120V electrical plug-ins and two 2.1 amp rated USB charging ports with a total rated capacity of 15 amps. Cord has 3 ft. of length hanging freely from back mounting bracket. The cord is 14 gauge wire and features a standard 3-prong plug and is required to be plugged into an approved GFCI outlet for all applications. Outlet is ETL approved-compliant for electrical and other safety standards to U.S. and Canadian safety including UL standards. Outlet face plate measures 5.22" x 2.3" and will extend 3/4" into drawer box. Available on base cabinet widths of 18"-36". For use in cabinet depths of 15", 18", 21", and 24". Only compatible with RD in 3" increments. Also available as a field installed accessory, see DRWPWR1 on page 411.
Push to Open Wastebasket (PTOWB)	Base cabinets with door mounted wastebasket pull-outs	Changes the guide mechanism on wastebasket pull-outs to a mechanical push to open guide with Smart Stop. Available on 24" deep cabinets only. Does not change other drawer guides on the cabinet.
Tilt-Out Tray, Stainless Steel (TOTSS) Stainless Steel Slim (TOTSSS)	Cabinets with false panels	Installs one stainless steel tilt-out tray inside of each false panel. Available as standard depth (2" deep) or a slim version (1 11/16" deep) to be used in narrow spaces. Standard trays protrude 1 1/16" into cabinet. Slim trays protrude 3/4" into cabinet.

POWERGLIDE™ COMPACT DRAWER OUTLET (DRWPWR/DRWPWRB/DRWPWRL/DRWPWRR)

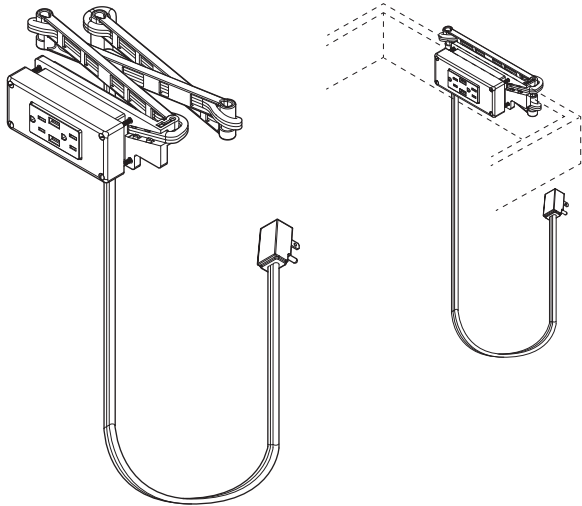

TILT-OUT TRAY, STAINLESS STEEL (TOTSS) & STAINLESS STEEL SLIM (TOTSSS)

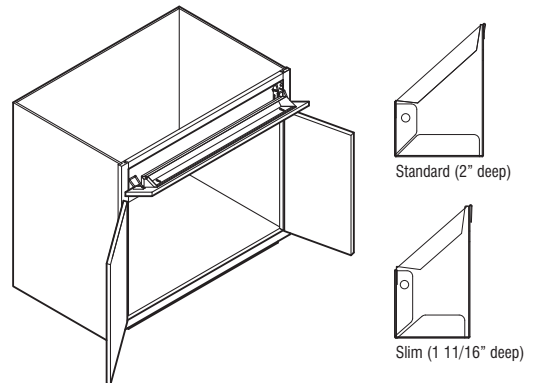

PUSH TO OPEN WASTEBASKET (PTOWB)

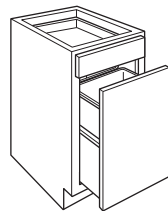

INSTALLED INTERIOR MODIFICATIONS (cont'd)

See page 30 for modification compatibility. Requests for non-published modifications may be treated as a Special Sales Order which will require feasibility, leadtime review and approval. Please check with your customer service representative before placing your order.

OPTION NAME	APPLICABLE CABINET GROUP	DESCRIPTION/LIMITATIONS																		
Tray Dividers (TD)	Most wall, full height base, and tall cabinets	<p>Installs removable Tray Dividers. Plywood dividers match the interior of the cabinet. Rails for dividers are Natural Maple regardless of the color of the interior of the cabinet.</p> <p>Number of dividers is predetermined based on cabinet width. See chart below.</p> <p>Available only in the top of Stacked Walls and Tall Cabinets.</p> <p>Available with Reduced Depth modification (12" minimum) and Increased Depth modification (27" maximum). When cabinet is increased to 27", tray dividers will be 24" deep set back 3" into the cabinet.</p> <p>Base Full Height cabinets will have a top. Not available with Peninsula modification.</p> <p>Available on cabinets with frame height openings of 15"-27" with full top and bottom panels.</p> <table border="1" style="margin: 10px auto; border-collapse: collapse;"> <thead> <tr> <th style="text-align: center;">Cabinet Width</th> <th style="text-align: center;"># of Dividers</th> <th style="text-align: center;">Mod Name</th> </tr> </thead> <tbody> <tr> <td style="text-align: center;">9"-12"</td> <td style="text-align: center;">1</td> <td style="text-align: center;">1TD</td> </tr> <tr> <td style="text-align: center;">15"-18"</td> <td style="text-align: center;">2</td> <td style="text-align: center;">2TD</td> </tr> <tr> <td style="text-align: center;">21"-24"</td> <td style="text-align: center;">3</td> <td style="text-align: center;">3TD</td> </tr> <tr> <td style="text-align: center;">27"-30"</td> <td style="text-align: center;">4</td> <td style="text-align: center;">4TD</td> </tr> <tr> <td style="text-align: center;">33"-37"</td> <td style="text-align: center;">5</td> <td style="text-align: center;">5TD</td> </tr> </tbody> </table>	Cabinet Width	# of Dividers	Mod Name	9"-12"	1	1TD	15"-18"	2	2TD	21"-24"	3	3TD	27"-30"	4	4TD	33"-37"	5	5TD
Cabinet Width	# of Dividers	Mod Name																		
9"-12"	1	1TD																		
15"-18"	2	2TD																		
21"-24"	3	3TD																		
27"-30"	4	4TD																		
33"-37"	5	5TD																		

TRAY DIVIDERS (TD)

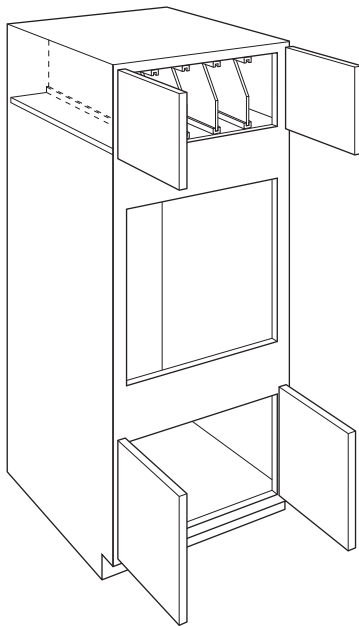

Tall cabinets

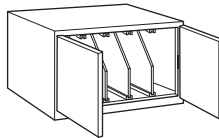

Wall cabinets

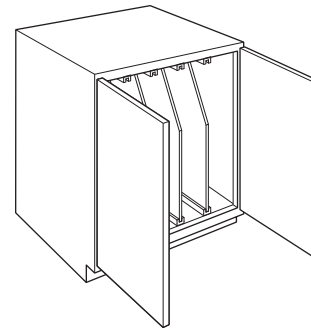

Base cabinets

TOEKICK MODIFICATIONS

See page 30 for modification compatibility. Requests for non-published modifications may be treated as a Special Sales Order which will require feasibility, leadtime review and approval. Please check with your customer service representative before placing your order.

OPTION NAME	APPLICABLE CABINET GROUP	DESCRIPTION/LIMITATIONS
Add Toekick (ADDTK)	Most wall cabinets	<p>Creates a 4 1/2" toekick on the front of cabinet. Cabinet top changes to use I-Beam construction when ADDTK is selected. ADDTK with reduced depth is available on cabinets 9" deep or larger.</p> <p>Peninsula cabinets are available with ADDTK 15" deep and larger. Depths of 14" and less will not have ADDTK available.</p> <p>Furniture drawers will be available with ADDTK option down to a reduced depth of 12".</p> <p>All cabinets will feature square doors to match cabinets on order. If arch door style is ordered, 20/20 layout will show arch doors, however, square doors will be sent.</p> <p>Available with compatible toekick modifications. See the Modification/Upgrade Compatibility Chart on page 30 for details.</p>
Flush Toekick (FTK) (FTK.FNT.P) (FTK.P)	Most base, tall, and vanity cabinets, and wall cabinets with ADDTK	<p>Extends the face frame to the floor eliminating the toe space. Not available when either RECTKL or RECTKR modifications are used. Not available on 93" or 96" tall cabinets due to separate pedestal base toekick.</p> <p>When FTK is ordered with the Peninsula modification, only the working drawer side will receive a flush toekick.</p> <p>When FTK.FNT.P is ordered with the Peninsula modification, both sides will receive a flush toekick.</p> <p>When FTK.P is ordered with the Peninsula modification, only the peninsula side will receive a flush toekick.</p>

ADD TOEKICK (ADDTK)

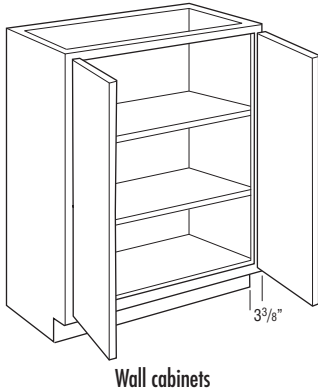

FLUSH TOEKICK (FTK)

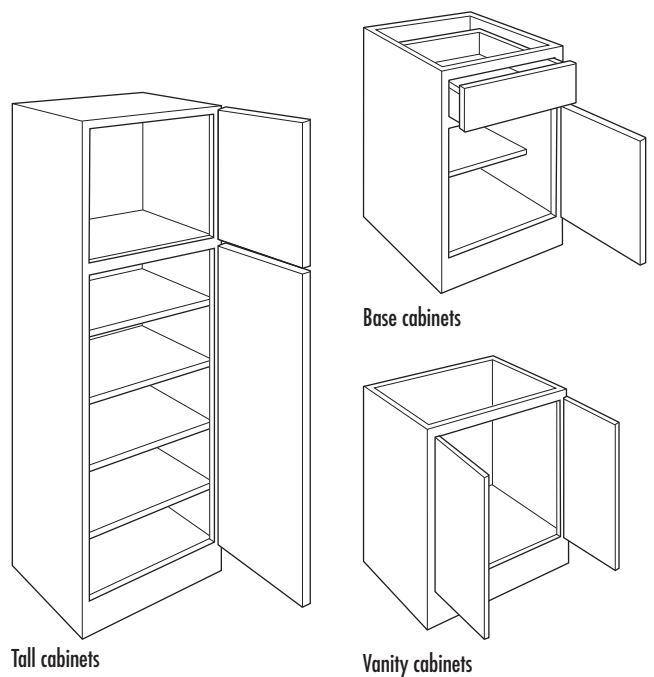

FLUSH TOEKICK FRONT & PENINSULA (FTK.FNT.P)

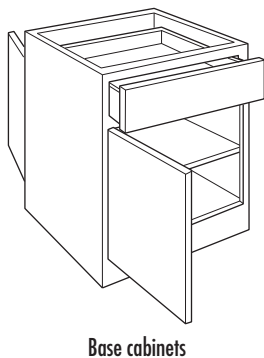

FLUSH TOEKICK PENINSULA (FTK.P)

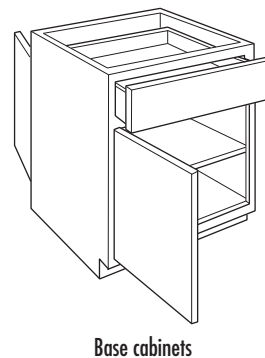

TOEKICK MODIFICATIONS (cont'd)

See page 30 for modification compatibility. Requests for non-published modifications may be treated as a Special Sales Order which will require feasibility, leadtime review and approval. Please check with your customer service representative before placing your order.

OPTION NAME	APPLICABLE CABINET GROUP	DESCRIPTION/LIMITATIONS
Flush Toekick Arch (FTKAV) (FTKAV.P) (FTKAV.FNT.P)	Most base, tall, and vanity cabinets, and wall cabinets with ADDTK	Creates an arch flush toe space. Valance replaces standard toekick creating a full open area beneath cabinet floor. When FTKAV.FNT.P is ordered with the Peninsula modification, both sides will receive an arch flush toekick. When FTKAV.P is ordered with the Peninsula modification, only the peninsula side will receive an arch flush toekick. Not available on 93" or 96" tall cabinets due to separate pedestal base toekick.
Flush Toekick Furniture (FTKFV) (FTKFV.P) (FTKFV.FNT.P)	Most base, tall, and vanity cabinets, and wall cabinets with ADDTK	Creates a furniture flush toe space. Valance replaces standard toekick creating a full open area beneath cabinet floor. When FTKFV.FNT.P is ordered with the Peninsula modification, both sides will receive a furniture flush toekick. When FTKFV.P is ordered with the Peninsula modification, only the peninsula side will receive a furniture flush toekick. Not available on 93" or 96" tall cabinets due to separate pedestal base toekick.

FLUSH TOEKICK ARCH (FTKAV)

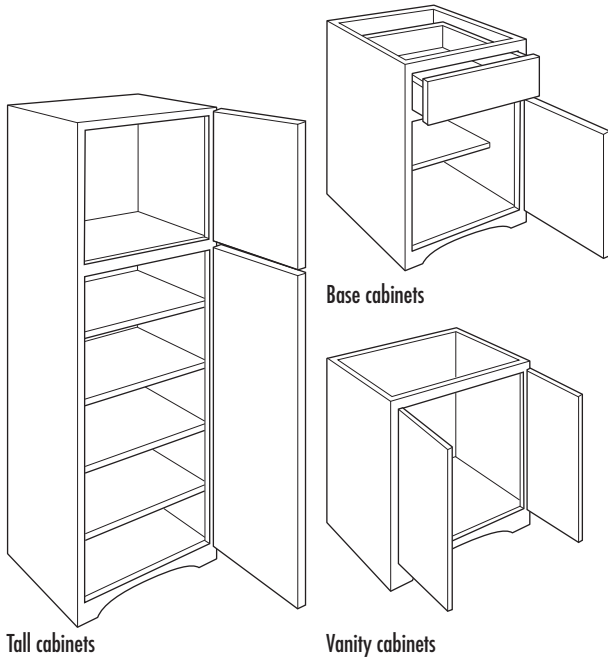

FLUSH TOEKICK FURNITURE (FTKFV)

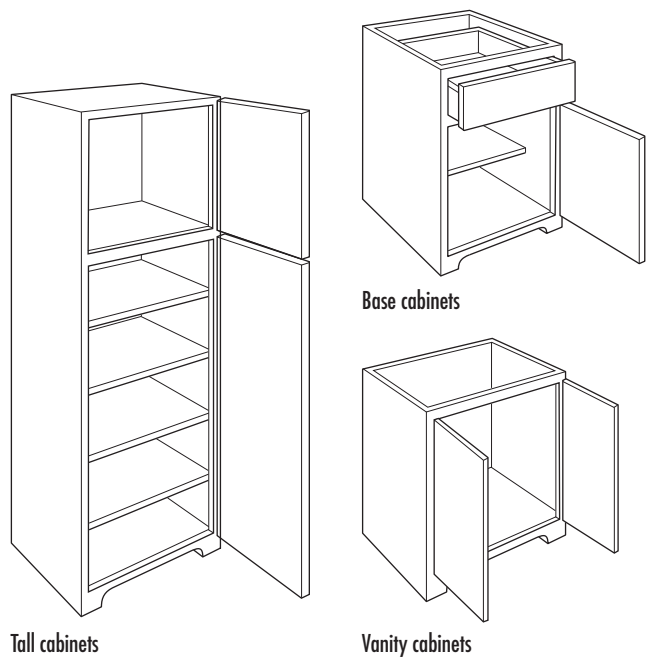

TOEKICK MODIFICATIONS (cont'd)

See page 30 for modification compatibility. Requests for non-published modifications may be treated as a Special Sales Order which will require feasibility, leadtime review and approval. Please check with your customer service representative before placing your order.

OPTION NAME	APPLICABLE CABINET GROUP	DESCRIPTION/LIMITATIONS
Loose Toekick (TKP)	Most tall cabinets	Available on 84", 87", and 90" tall cabinets. Removes and ships the toekick separately. Not compatible with other toekick modifications. Pedestal is designed to create a Recessed Left or Right Toekick (RECTKL or RECTKR) application during field installation, or can be centered. Pedestal must be covered with toeboard material.
Recessed Island Toekick (RECTKALL)	Most base and vanity cabinets, and wall cabinets with ADDTK	Creates a 3 3/8" recessed toekick on the right, left, and back of cabinet. The entire toekick area will have non-matching material and requires any exposed toekick area to be covered.
Recessed Toekick on Back or Side (RECTKBK) (RECTKL) (RECTKR)	Most base and vanity cabinets, and wall cabinets with ADDTK	Creates a 3 3/8" recessed toekick on the back (RECTKBK), left (RECTKL), or right (RECTKR). When either the RECTKR or RECTKL are used, FTK is NOT available. The entire toekick will have non-matching material and requires any exposed toekick area to be covered. On RECTKL and RECTKR, the back will have a 1/2" recessed offset and non-specified side will have a 1/2" recessed offset to allow for application of toeboard material. 93" and 96" tall cabinets have RECTKL or RECTKR standard on loose pedestal. For recess toekick applications of both left and right, order RECTKL.R. On 9" wide cabinets, only one side can be recessed. RECTKBK only available on cabinets at least 15" deep.

LOOSE TOEKICK (TKP)

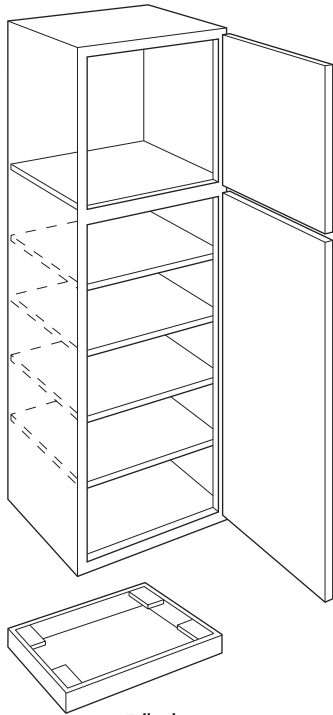

Tall cabinets

Pedestal is reduced in width for RECTKL or RECTKR during field installation.

RECESSED ISLAND TOEKICK (RECTKALL)

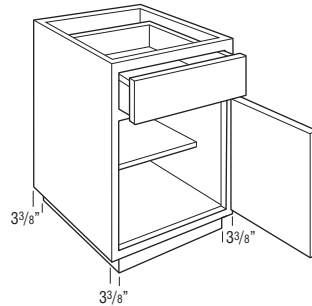

Base cabinets

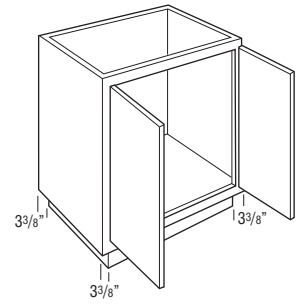

Vanity cabinets

RECESSED TOEKICK - BACK (RECTKBK)

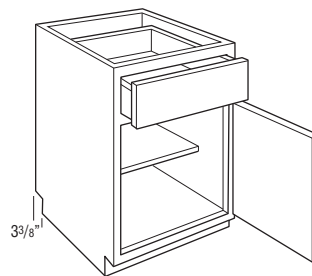

Base cabinets

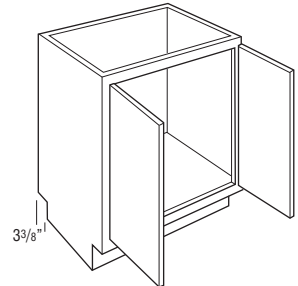

Vanity cabinets

RECESSED TOEKICK - LEFT (RECTKL)

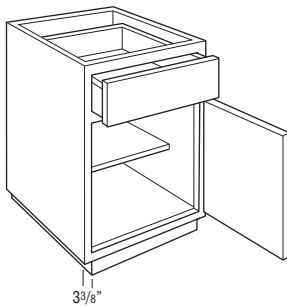

Base cabinets

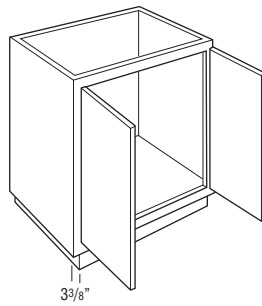

Vanity cabinets

RECESSED TOEKICK - RIGHT (RECTKR)

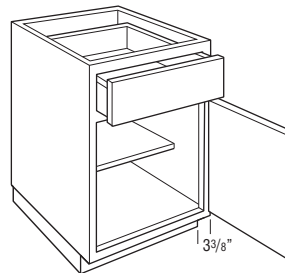

Base cabinets

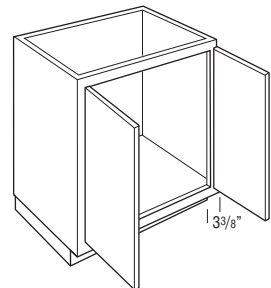

Vanity cabinets

TOEKICK MODIFICATIONS (cont'd)

See page 30 for modification compatibility. Requests for non-published modifications may be treated as a Special Sales Order which will require feasibility, leadtime review and approval. Please check with your customer service representative before placing your order.

OPTION NAME	APPLICABLE CABINET GROUP	DESCRIPTION/LIMITATIONS
Toekick Drawer (DRWTK)	Most cabinets with a standard toekick, and wall cabinets with ADDTK	Replaces standard toekick with a toekick drawer. Available on most 21"-24" deep cabinets in 18", 21", 24", 27", 30", 33", and 36" widths that have standard toekick construction. Front of toekick drawer is unfinished, allow enough toeboard to cover. 1" clearance below toekick drawer. Exterior dimensions of drawer are 3 3/8" tall and 15" or 18" deep. Toekick drawer uses a push to open full extension guide, does not have soft-close feature.
Toekick Vacuum (VACL) (VACR) (VACTK)	Most base cabinets with a standard toekick	Prepares cabinet for field installation of a 120V compact vacuum cleaner into the toekick area of base cabinets and includes vacuum shipped with cabinet order. Toekick area is routed for vacuum to be inserted and screwed into place. VACTK prepares the cabinet for vacuum installation in the center of the front toekick. VACL prepares the cabinet for vacuum installation in the center of the left end panel, in the toekick area. VACR prepares the cabinet for vacuum installation in the center of the right end panel, in the toekick area. Flooring installation must be compatible with the vacuum by ensuring the bottom of the cabinet is flush with the top of the flooring to allow clearance for the tray to open for changing the bag. The flooring should either be installed under the cabinets or the cabinets can be raised to the flooring level. Vacuum is 120V-60Hz, rated current of 5 amps, and rated input power is 650W. Cord is 10 ft. from the right side of the unit and features a standard 3-prong plug for use in any household outlet. Includes a 0.5 gallon vacuum bag and filter installed along with five replacement bags and one replacement filter. Additional packs of replacement bags available, see VACBAG on page 412. Includes two plastic covers for field installation (stainless steel look and white). Built-in switch can be gently tapped to turn the unit on, a 10 second timer will automatically turn the unit off. Should not be installed in a sink base, bathroom, outdoors, or in other wet environments. Do not expose to moisture, rain, or snow. Do not pick up water or sweep water into the vacuum. VACTK is available on most base cabinets with a 22" minimum depth and 18" minimum width. VACL and VACR are available on most base cabinets with a 21" minimum depth and 21" minimum width.

TOEKICK DRAWER (DRWTK)

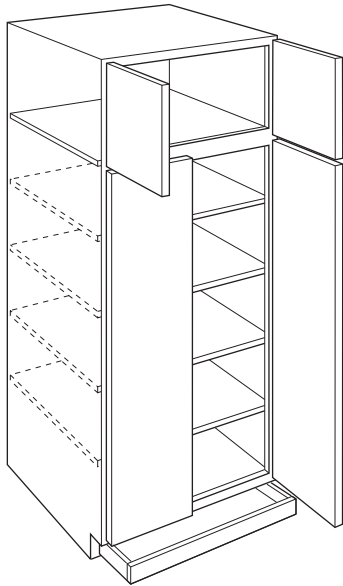

Tall cabinets

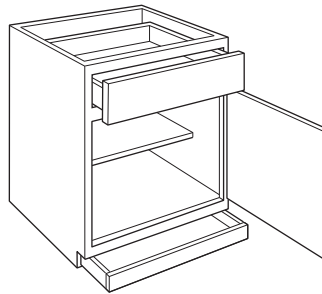

Base cabinets

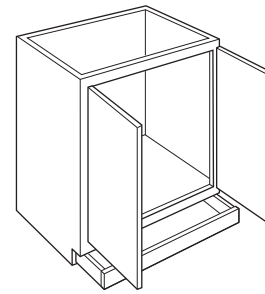

Vanity cabinets

TOEKICK VACUUM (VACL/VACR/VACTK)

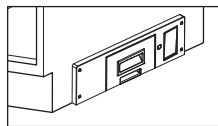

VACL/VACR (shown)
(Cabinet End Panel)

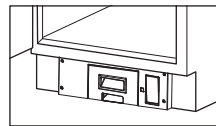

VACTK
(Front)

TOEKICK MODIFICATIONS (cont'd)

See page 30 for modification compatibility. Requests for non-published modifications may be treated as a Special Sales Order which will require feasibility, leadtime review and approval. Please check with your customer service representative before placing your order.

OPTION NAME	APPLICABLE CABINET GROUP	DESCRIPTION/LIMITATIONS
Void Toekick (VTK)	Most base, tall, and vanity cabinets	Removes the toekick. Only available when the cabinet has a standard toekick (not available when flush toekick is standard or when cabinet has a separate pedestal base). When ordered on 84", 87", or 90" tall cabinets, pedestal will not be included. When VTK is specified on cabinets to be used with a countertop, cabinets must also be supported from the floor, not just attached to the wall. Failure to properly install cabinets in this situation will void the warranty.

VOID TOEKICK (VTK)

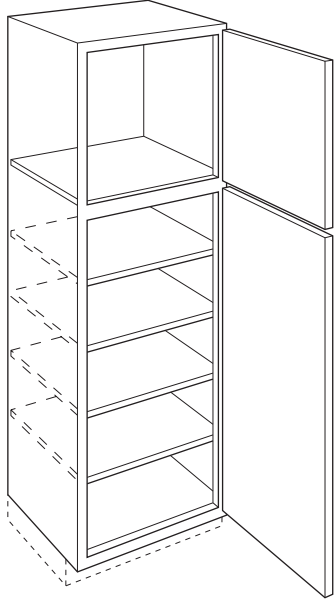

Tall cabinets

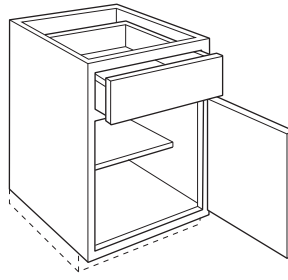

Base cabinets

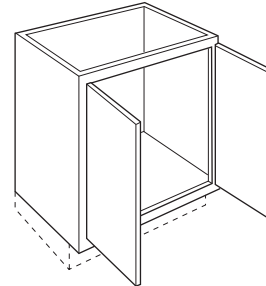

Vanity cabinets

CONFIGURATION MODIFICATIONS

See page 30 for modification compatibility. Requests for non-published modifications may be treated as a Special Sales Order which will require feasibility, leadtime review and approval. Please check with your customer service representative before placing your order.

OPTION NAME	APPLICABLE CABINET GROUP	DESCRIPTION/LIMITATIONS
Cabinet Front Only (CFNTO)	Most cabinets with a face frame	Creates a door and/or drawer front assembled with a frame. Doors are attached with the specified hinges and drawer fronts are cleated.
Cabinet Frame Only (CFRMO)	Most cabinets with a face frame	Creates a cabinet frame only. No box, doors, or drawer fronts are included.
Peninsula (P)	Most wall and base cabinets	Creates a peninsula cabinet that is 1/4" deeper than the standard cabinet depth. If ID or RD is specified, cabinet will be 1/4" deeper than specified cabinet depth. Any cabinet with a toekick must be at least 15" deep (either standard with a toekick or when ADDTK is specified). Single door cabinets are hinged on the same cabinet end, for example a W1230L will feature a Left hinge on the front side and a Right hinge on the peninsula side. Not available on tall cabinets (oven, utility, and pantry) or multi-drawer base cabinets. Cabinets with drawers can only be reduced in 3" increments.

CABINET FRONT ONLY (CFNTO)

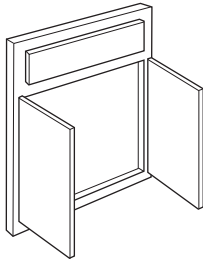

Cabinet front only – Wall, Base, and Tall

CABINET FRAME ONLY (CFRMO)

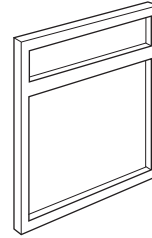

Cabinet frame only – Wall, Base, and Tall

PENINSULA (P)

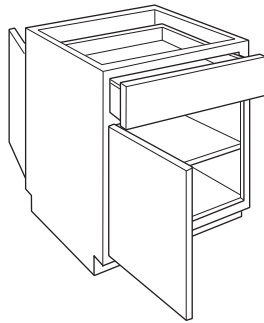

Base cabinets

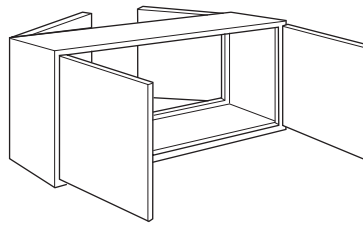

Wall cabinets

ALUMINUM FRAME DOOR OPTIONS

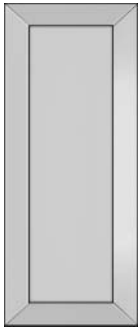

ALF
Aluminum Frame Door
in Aluminum finish
with Frost glass

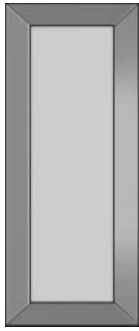

ALFBS
Aluminum Frame Door
with a Brushed Stainless
Steel look with Frost glass

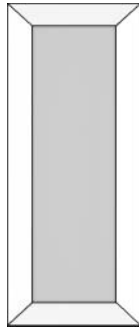

ALFW
Aluminum Frame Door
with a White powder coat
finish with Frost glass

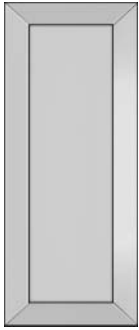

ALFM
Aluminum Frame Door
in Aluminum finish with
matching center panel

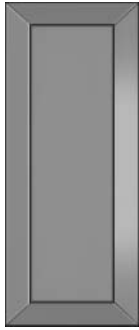

ALFBSM
Aluminum Frame Door
with a Brushed Stainless
Steel look with matching
center panel

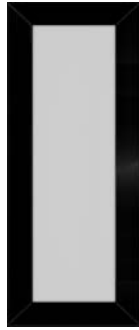

ALFOR
Aluminum Frame Door
with an Oil Rubbed
Bronze powder coat finish
with Frost glass

ALF AVAILABILITY

Cabinet Width	Cabinet Height					
	12"	15"	18"	21"	30"	36"
W12	–	–	–	–	✓	✓
W15	✓	✓	–	–	✓	✓
W18	✓	✓	–	–	✓	✓
W21	–	–	–	–	✓	✓
WTH30 & WTH30..24	✓	✓	✓	✓	–	–
WVL30 & WVL30..24	–	–	✓	✓	–	–
WTH36 & WTH36..24	✓	✓	✓	✓	–	–
WVL36 & WVL36..24	–	–	✓	✓	–	–

- All aluminum doors will be full overlay with miter construction.
- Cabinet face frame and end panels will be matched to the finish specified.
- Cabinet will have standard interior or can be ordered with MIP option.
- Aluminum and Brushed Stainless doors have an anodized finish.
- White and Oil Rubbed Bronze doors have a powder coated finish.
- Frost glass and matching panel are installed in door. Removal of glass or matching panel will void warranty.
- Door rails are 2 1/4" wide.
- All Aluminum Frame door options are represented by ALF in Door Options availability grids.
- ALFM and ALFBSM frames and center panels are created with different manufacturing processes, which results in a slight difference in the appearance of each surface. The frame is an anodized aluminum extrusion, and the center panel is a double sided metal sheet applied to a hard-bore core.
- When a decorative door option is chosen in 20/20, Matching Interior Plywood (MIP) is a preselected option. If MIP is not desired, it can be deselected by choosing NOMIP.

CUT FOR GLASS DOORS (CG)

Cathedral, Arch and Square - Glass not included

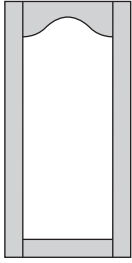

Cut for Glass
Cathedral

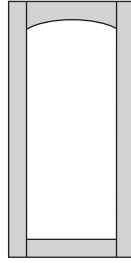

Cut for Glass
Arch

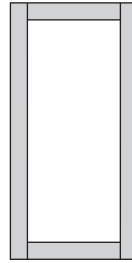

Cut for Glass
Square

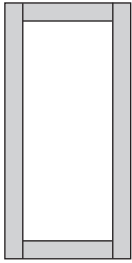

Cut for Glass
Shaker Styles -
Lynnville & Whitman

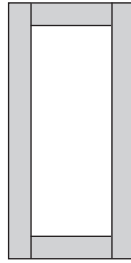

Cut for Glass
Wide Rail Shaker
Larsen & Northrope

- Not available in Caprice, Genova, Shafer, Taro, Troxel, and Vaille.
- If desired for use with Caprice, using a shaker style such as Larsen, Northrope, or Whitman is recommended.
- Not available on bifold doors.
- Specify Cathedral/Arch/Square, Door Style, and Finish when ordering Cut For Glass Doors.
- Custom door sizes available. See pages 350-353.
- Glass clips included with door.
- For cabinet availability, please see modification grids.
- CG.TOP and CG.BTM are specified on cabinets with upper and lower doors to designate which doors should be Cut for Glass. See Door Options grid for SKU availability.
- When a decorative door option is chosen in 20/20, Matching Interior Plywood (MIP) is a preselected option. If MIP is not desired, it can be deselected by choosing NOMIP.

MULLION DOORS (MD)

Cathedral, Arch and Square - Tempered glass included

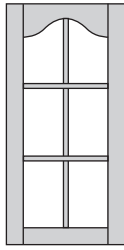

Mullion Cathedral

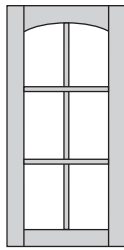

Mullion Arch

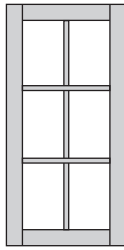

Mullion Square

- Available in all door styles except Butler, Caprice, Genova, Hardin, Shafer, Taro, and Troxel.
- Custom Door Sizes not available.
- For Mullion Door availability, please see modification grids in wall section.
- Includes Mullion Door and fully tempered clear glass for safety.
- Textured glass may be ordered to replace clear glass, except Bevel.
- On acknowledgment, textured glass will be listed with MDI modification.
- MD.TOP and MD.BTM are specified on cabinets with upper and lower doors to designate which doors should be Mullion Doors. See Door Options grid for SKU availability.
- Shelves will not align with mullions.
- Kingston mullion doors are not available with Modified Full Overlay (MFO).
- When a decorative door option is chosen in 20/20, Matching Interior Plywood (MIP) is a preselected option. If MIP is not desired, it can be deselected by choosing NOMIP.

MULLION CATHEDRAL/ARCH/SQUARE LITES GRID

Cabinet Width	Cabinet Height						
	18"	24"	30"	33"	36"	39"	42"
W15	G		D	D	D	A	A
W18	G		D	D	D	A	A
W21			E	E	E	B	B
W24			E	E	E	B	B
W24 (butt)			D	D	D	A	A
W27 (butt)			D	D	D	A	A
W30 (butt)	G	G	D	D	D	A	A
W33 (butt)			D	D	D	A	A
W36 (butt)	G	G	D	D	D	A	A
W42			E	E	E	B	B
W45			E	E	E	B	B
W48 (butt)			D	D	D	A	A
WC33			D	D	D	A	A
WC36			D	D	D	A	A
WC39			D	D	D	A	A
WC42			D	D	D	A	A
WC45			D	D	D	A	A
WC48			D	D	D	A	A
DW30/DW30T			D				
DW33/DW33T				D			
DW36/DW36T					D		
DW39/DW39T						A	
DW42/DW42T							A

Mullion Door Configurations

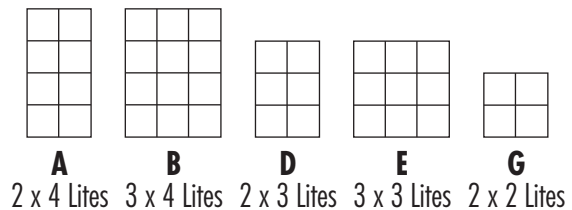

SHAKER MULLION DOORS (SHMD)

Tempered glass included

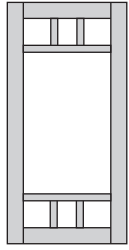

54

DOOR MODIFICATION/SPECIALTY DOORS

- Available in Larsen, Lawton, Lynnville, Northrope, and Whitman.
- Custom Door Sizes not available.
- Shelves will not align with mullions.
- For Mullion Door availability, please see modification grids in wall section.
- Includes Mullion Door and fully tempered clear glass for safety.
- Textured glass may be ordered to replace clear glass, except Bevel.
- On acknowledgment, textured glass will be listed with SHMDI modification.
- When a decorative door option is chosen in 20/20, Matching Interior Plywood (MIP) is a preselected option. If MIP is not desired, it can be deselected by choosing NOMIP.

MULLION SHAKER LITES GRID

Cabinet Width	Cabinet Height						
	18"	24"	30"	33"	36"	39"	42"
W15†	H		H	H	H	H	H
W18	H		H	H	H	H	H
W21			H	H	H	H	H
W24			H	H	H	H	H
W24 (butt)			J	J	J	J	J
W27 (butt)			J	J	J	J	J
W30 (butt)†	H	H	H	H	H	H	H
W33 (butt)			H	H	H	H	H
W36 (butt)	H	H	H	H	H	H	H
W42			H	H	H	H	H
W45			H	H	H	H	H
W48 (butt)			J	J	J	J	J
WC33			H	H	H	H	H
WC36			H	H	H	H	H
WC39			J	H	H	H	H
WC42			J	H	H	H	H
WC45			J	H	H	H	H
WC48			H	H	H	H	H
DW30/DW30T			H				
DW33/DW33T				H			
DW36/DW36T					H		
DW39/DW39T						H	
DW42/DW42T							H

†Larsen and Northrope will have "J Configuration" for 15" and 30" wide cabinets and all DW cabinets.

Shaker Mullion Door Configurations

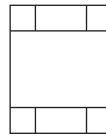

H
3 x 3 Lites



J
2 x 3 Lites

PRAIRIE MULLION DOORS (PRMD)

Tempered glass included

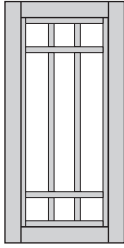

- Available in Larsen, Lawton, Lynnville, Northrope, and Whitman.
- Custom Door Sizes not available.
- Shelves will not align with mullions.
- For Mullion Door availability, please see modification grids in wall section.
- Includes Mullion Door and fully tempered clear glass for safety.
- Textured glass may be ordered to replace clear glass, except Bevel.
- On acknowledgment, textured glass will be listed with PRMDI modification.
- When a decorative door option is chosen in 20/20, Matching Interior Plywood (MIP) is a preselected option. If MIP is not desired, it can be deselected by choosing NOMIP.

MULLION PRAIRIE LITES GRID

Cabinet Width	Cabinet Height						
	18"	24"	30"	33"	36"	39"	42"
W15†	K		K	K	K	K	K
W18	K		K	K	K	K	K
W21			K	K	K	K	K
W24			K	K	K	K	K
W24 (butt)			L	L	L	L	L
W27 (butt)			L	L	L	L	L
W30 (butt)†	K	K	K	K	K	K	K
W33 (butt)			K	K	K	K	K
W36 (butt)	K	K	K	K	K	K	K
W42			K	K	K	K	K
W45			K	K	K	K	K
W48 (butt)			L	L	L	L	L
WC33			K	K	K	K	K
WC36			K	K	K	K	K
WC39			L	K	K	K	K
WC42			L	K	K	K	K
WC45			L	K	K	K	K
WC48			K	K	K	K	K
DW30/DW30T			K				
DW33/DW33T				K			
DW36/DW36T					K		
DW39/DW39T						K	
DW42/DW42T							K

†Larsen and Northrope will have "L Configuration" for 15" and 30" wide cabinets and all DW cabinets.

Prairie Mullion Door Configurations

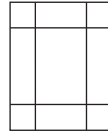

K
3 x 3 Lites

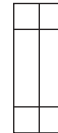

L
2 x 3 Lites

ART GLASS PANELS

56



Anson



Avondale

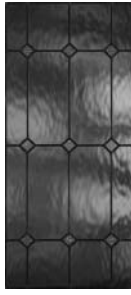

Cambridge



Charlotte

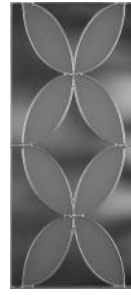

Ellington



Lanai

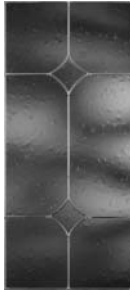

Lonsdale

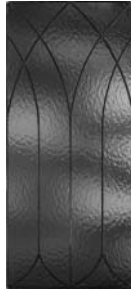

Lyndhurst

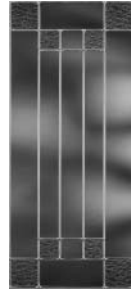

Pavillion

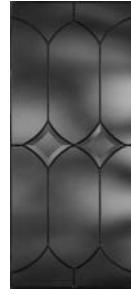

Portico



Quincy



Waterbury



Wickford

- Cut for Glass door must be ordered separately. See page 52 for door style availability.
- For glass shelf kits, see page 409.
- Door frame may reduce amount of glass shown.
- No changes or cancellations will be accepted after 24 hours from acknowledgment of order.
- Art glass will be packaged separately from applicable cabinet(s) and shipped with cabinet order for field installation.

GLASS INSERTS

ART GLASS PANELS

Anson

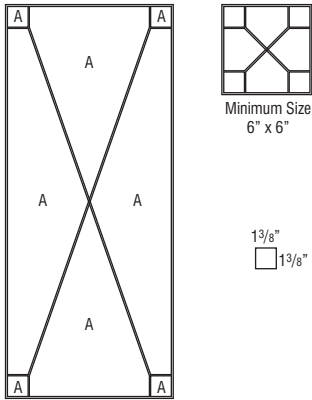

Glass Type:
A) Clear Seedy 100SDY

Metal Type:

$\frac{3}{16}$ " H-Ch Zinc Proglaze2 (all)
Black Patina Finish

- Suggested to use with Square doors.

Cambridge

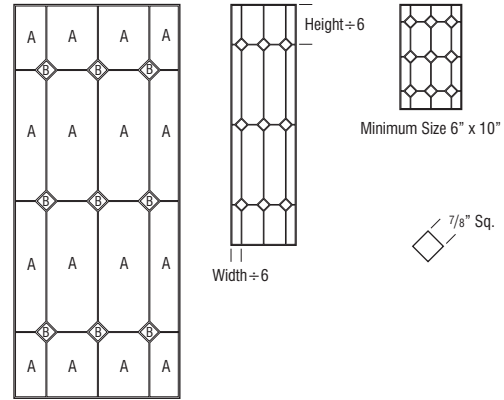

Glass Types:
A) Clear Waterglass 100W
B) Clear Sparkolite

Metal Type:

$\frac{3}{16}$ " H-Ch Zinc Proglaze2 (all)
Black Patina Finish

Avondale

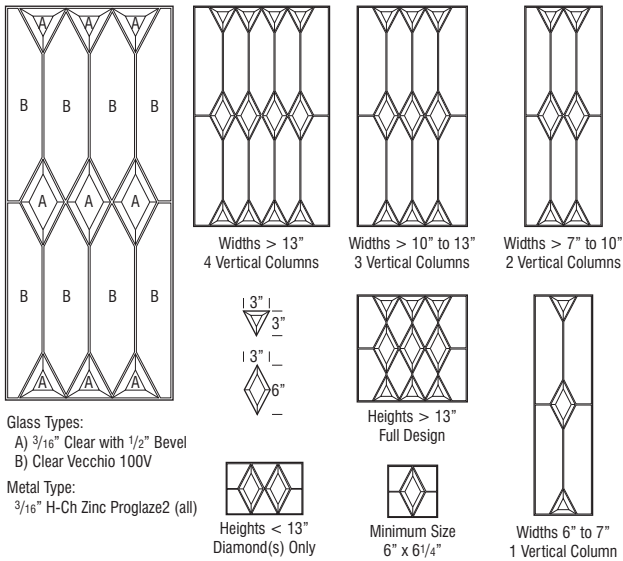

Glass Types:
A) $\frac{3}{16}$ " Clear with $\frac{1}{2}$ " Bevel
B) Clear Vecchio 100V

Metal Type:

$\frac{3}{16}$ " H-Ch Zinc Proglaze2 (all)

- Suggested to use with Square doors.

Charlotte

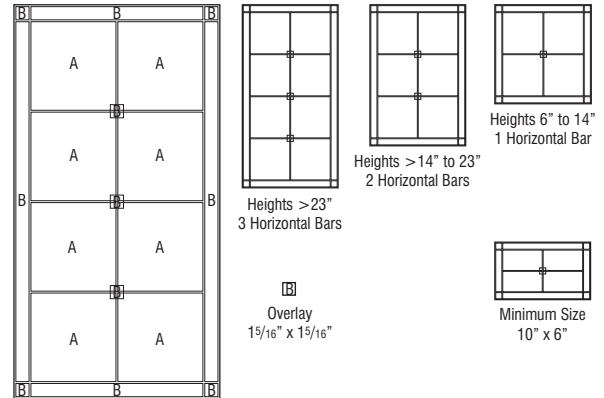

Glass Types:
A) $\frac{1}{8}$ " Clear
B) Frost Etch 100

Metal Types:

$\frac{3}{16}$ " H-Ch Zinc Proglaze2 (all)
 $\frac{1}{8}$ " U-Ch Zinc (overlays)

- Suggested to use with Square doors.

ART GLASS PANELS

Ellington

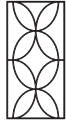
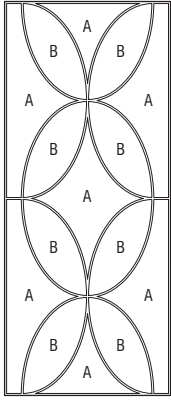

Heights > 12"
Full Design

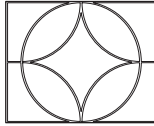

Heights 6" to 12"
1 Center Diamond



Minimum Size
6" x 6"
1 Center Diamond

Glass Types:

- A) 1/8" Clear
- B) Frost Etch 100

Metal Type:

3/16" H-Ch Zinc Proglaze2 (all)

- Suggested to use with Square doors.

Lonsdale

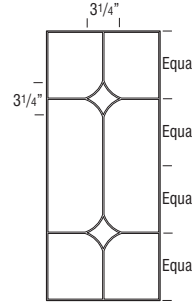
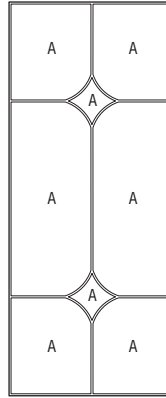

Heights > 9"
Two Stars



Heights 6" to 9"
One Star

Minimum Size
6" x 6"

Glass Type:

- A) Seedy Clear 100Sdy

Metal Type:

3/16" H-Ch Zinc Proglaze2 (all)

Lanai

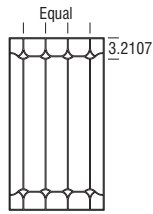
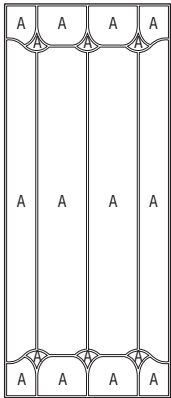

Widths > 16"
4 Vertical Columns



Widths > 11" to 16"
3 Vertical Columns



Widths 6" to 11"
2 Vertical Columns

Glass Type:

- A) 1/8" Clear

Metal Type:

3/16" H-Ch Zinc Proglaze2 (all)

Lyndhurst

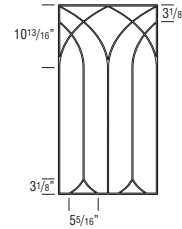
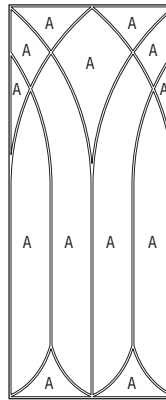

Widths > 11"
3 Vertical Bars
Equally Spaced

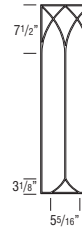

Widths 6" to 11"
1 Vertical Bar
Centered

Glass Type:

- A) Clear Rough Rolled 100RR

Metal Type:

3/16" H-Ch Zinc Proglaze2 (all)
Black Patina Finish

Minimum Size 6" x 12"

ART GLASS PANELS

Pavillion

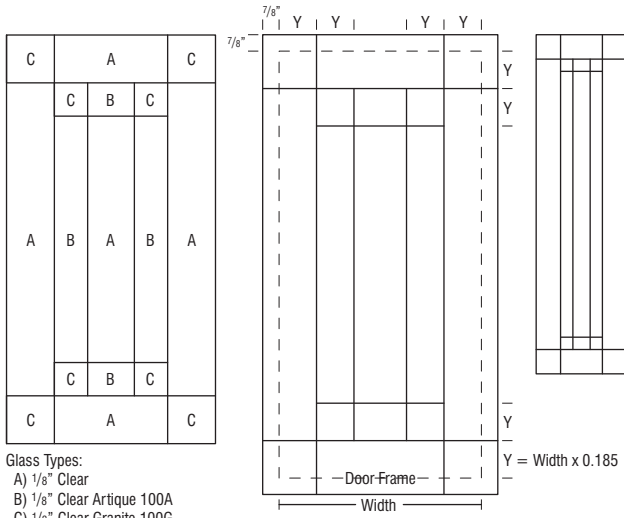

Glass Types:
 A) 1/8" Clear
 B) 1/8" Clear Artique 100A
 C) 1/8" Clear Granite 100G

Metal Type:
 3/16" H-Ch Round Zinc Proglaze2 (all)

- Suggested to use with Square doors.

Quincy

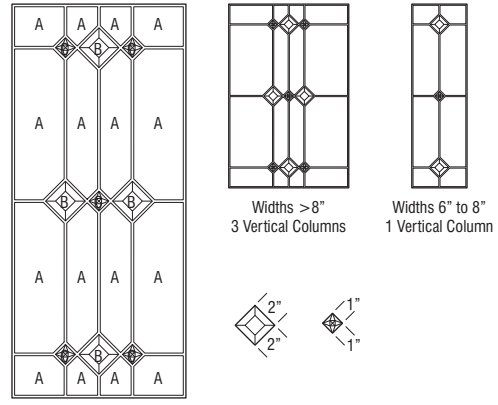

Glass Types:
 A) Clear Waterglass 100W
 B) 3/16" Clear with 1/2" Bevel
 C) Clear Faceted Jewel

Metal Type:
 3/16" H-Ch Zinc Proglaze2 (all)

Minimum Size 6" x 10"

- Suggested to use with Square doors.

Portico

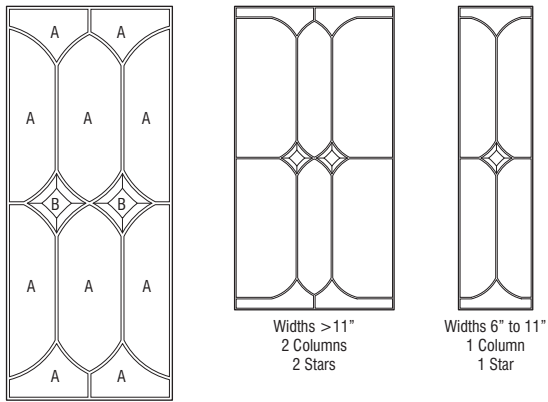

Glass Types:
 A) 1/8" Clear
 B) 3/16" Clear with 1/2" Bevel

Metal Type:
 3/16" H-Ch Zinc Proglaze2 (all)
 Black Patina Finish

Minimum Size 6" x 12"

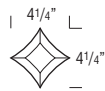

Waterbury

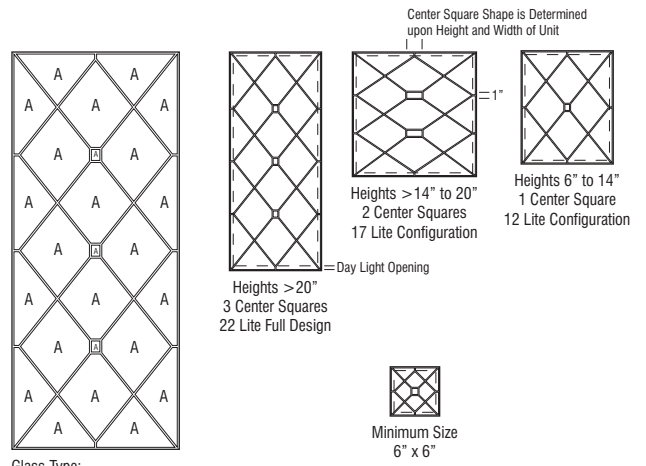

Glass Type:
 A) Clear Waterglass 100W

Metal Type:
 3/16" H-Ch Zinc Proglaze2 (all)
 Black Patina Finish



ART GLASS PANELS

Wickford

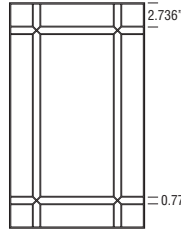
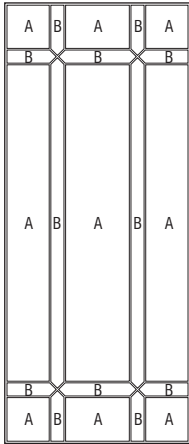

Widths >9"
2 Vertical Columns



Widths 6 1/2" to 9"
1 Vertical Column
Centered



Minimum Size
6 1/2" x 10"

Glass Types:
A) Clear Artique 100A
B) Clear Granite 100G

Metal Type:
3/16" H-Ch Round Zinc Proglaze2 (all)

- Suggested to use with Square doors.

INSTALLED TEXTURED GLASS PANELS



Antique



Bevel



Centurian



Clear



Cocoa Rice Paper

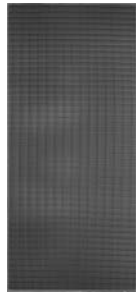

Cross Reeded



Frost



Hammered

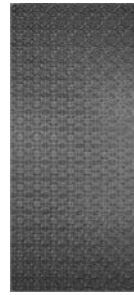

Morisco

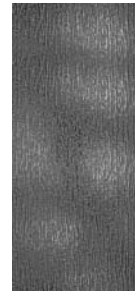

Rain



Reeded



Rice Paper



Seeded



Silhouette

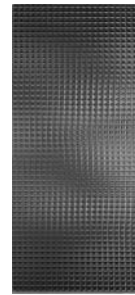

Strelli

- Textured glass panels available in Vaille only when Mullion Door is ordered because Cut for Glass Door is not available.
- Cut for glass door must be ordered separately. See page 52.
- For glass shelf kits, see page 409.
- On order acknowledgment, decorative glass selection will be shown with selected CG modification.
- When textured glass is ordered for use in wall top hinge (WTH) or wall vertical lift (WVL) cabinets, glass design will be turned horizontally and may not match desired pattern.
- All glass is fully tempered or has a safety lamination.
- Textured glass panels will be factory installed when ordered with a CG door.
- Door frame may reduce amount of glass shown.
- No changes or cancellations will be accepted after 24 hours from acknowledgment of order.

INSTALLED TEXTURED GLASS PANELS

Antique



- Glass type: Antique
- Panel thickness: 1/8"

Centurian

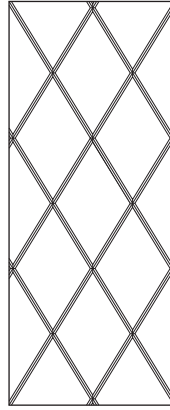

Maximum Size 24" x 48"

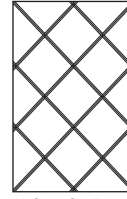

All Sizes Configured to 17 Lite



Minimum Size
7 1/2" x 8"

- Glass type: Frost Etch
- Panel thickness: 1/8"

Bevel

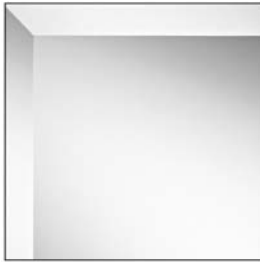

- Glass type: Clear
- Panel thickness: 1/4"
- Suggested to use with Square doors.
- Not compatible with Mullion Doors.

Clear



- Glass type: Clear
- Panel thickness: 1/8"

Cocoa Rice Paper

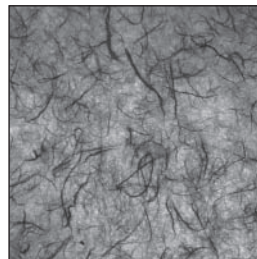

- Glass type: Cocoa Rice Paper
- Panel thickness: 9/32"

INSTALLED TEXTURED GLASS PANELS

Cross Reeded

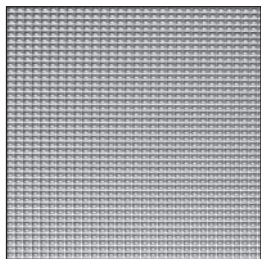

- Glass type: Cross Reeded
- Panel thickness: 5/32"

Morisco

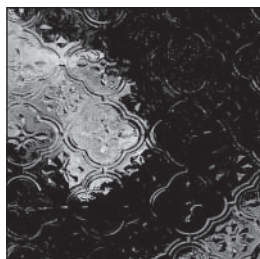

- Glass type: Morisco
- Panel thickness: 1/8"

Frost



- Glass type: Frost
- Panel thickness: 5/32"

Rain

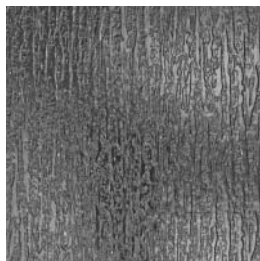

- Glass type: Rain
- Panel thickness: 5/32"

Hammered

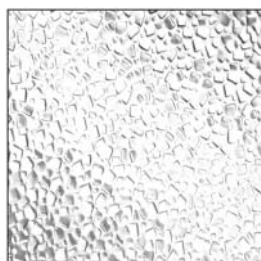

- Glass type: Hammered
- Panel thickness: 5/32"

Reeded

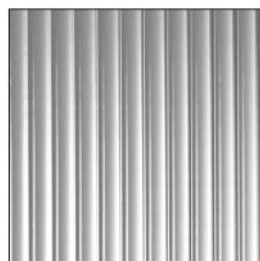

- Glass type: Reeded
- Panel thickness: 5/32"

INSTALLED TEXTURED GLASS PANELS

Rice Paper

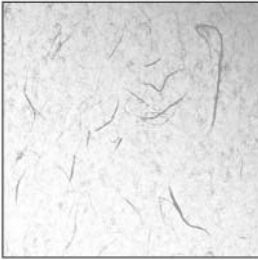

- Glass type: Rice Paper
- Panel thickness: 9/32"

Silhouette

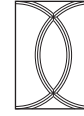
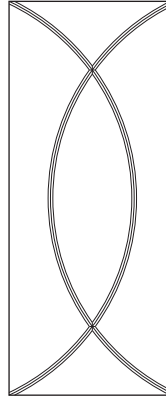

Minimum Size
6" x 8 1/2"

- Glass type: Frost Etch
- Panel thickness: 1/8"
- Suggested to use with Square doors.

Seeded

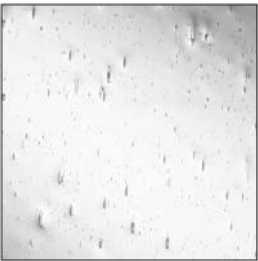

- Glass type: Seeded
- Panel thickness: 9/32"

Strelli

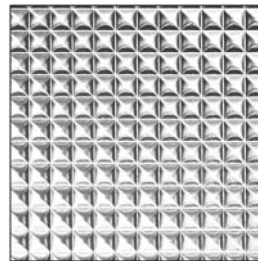

- Glass type: Strelli
- Panel thickness: 5/32"

ART & TEXTURED GLASS PANELS

ART GLASS PANELS

STYLE	PANEL THICKNESS	CAMING MATERIAL
Anson	1/4"	Zinc Black Patina
Avondale	1/4"	Zinc
Cambridge	1/4"	Zinc Black Patina
Charlotte	1/4"	Zinc
Ellington	1/4"	Zinc
Lanai	1/4"	Zinc
Lonsdale	1/4"	Zinc
Lyndhurst	1/4"	Zinc Black Patina
Pavillion	1/4"	Zinc
Portico	1/4"	Zinc Black Patina
Quincy	1/4"	Zinc
Waterbury	1/4"	Zinc Black Patina
Wickford	1/4"	Zinc

TEXTURED GLASS PANELS

STYLE	PANEL THICKNESS
Antique	1/8"
Bevel	1/4"
Centurian	1/8"
Clear	1/8"
Cocoa Rice Paper	9/32"
Cross Reeded	5/32"
Frost	5/32"
Hammered	5/32"
Morisco	1/8"
Rain	5/32"
Reeded	5/32"
Rice Paper	9/32"
Seeded	9/32"
Silhouette	1/8"
Strelli	5/32"

CABINET DIMENSIONS

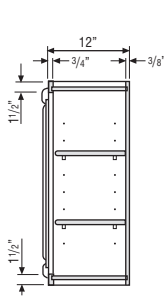

WALL CABINET

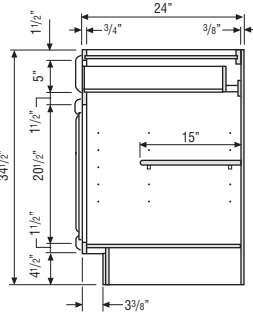

BASE CABINET

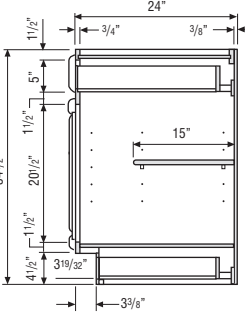

**BASE CABINET
with TOEKICK DRAWER**

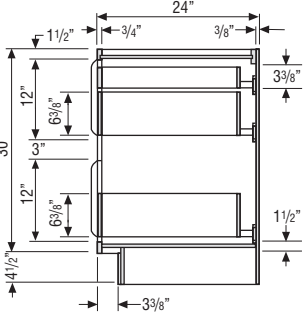

**TWO-DRAWER
BASE CABINET
with ROLL TRAY**



**THREE-DRAWER
BASE CABINET**

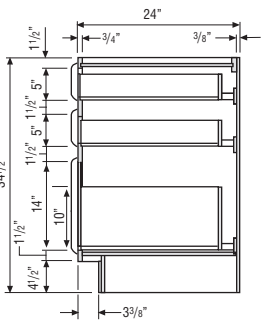

**THREE-DRAWER
BASE CABINET
with DEEP DRAWER**

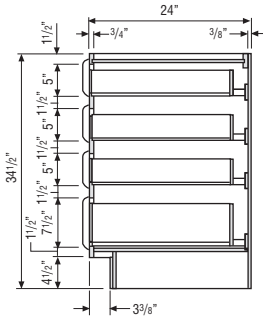

**FOUR-DRAWER
BASE CABINET**

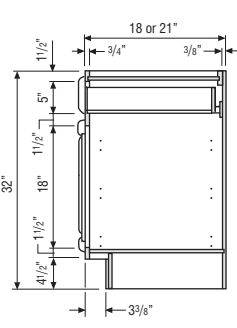

**32" HIGH
VANITY CABINET**

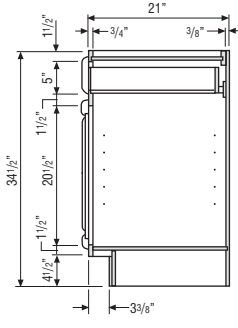

**34 1/2" HIGH
VANITY CABINET**

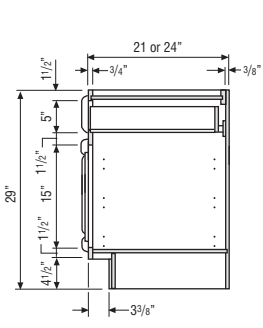

DESK BASE CABINET

CABINET DIMENSIONS

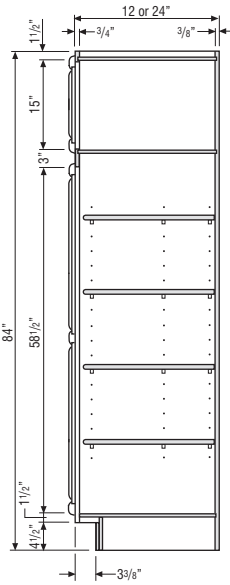

UTILITY CABINET

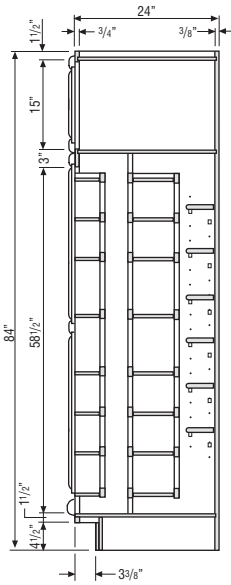

PANTRY CABINET

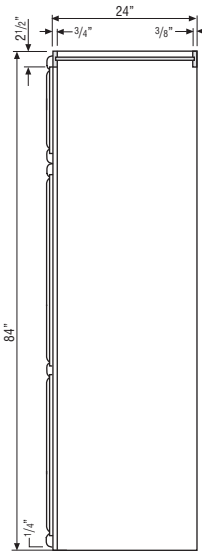

**PANTRY
WALK-THROUGH**

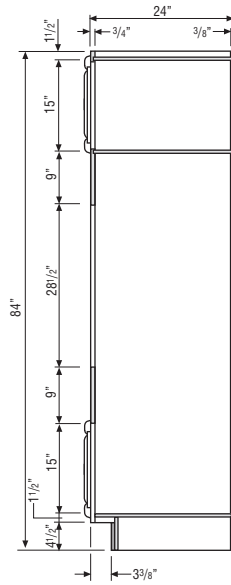

**SINGLE
OVEN CABINET**

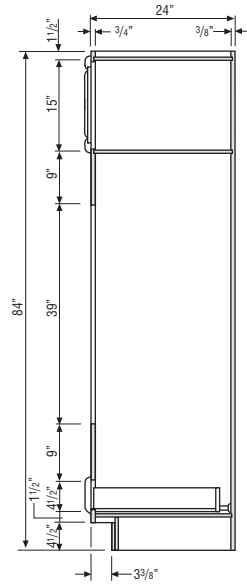

**DOUBLE
OVEN CABINET**

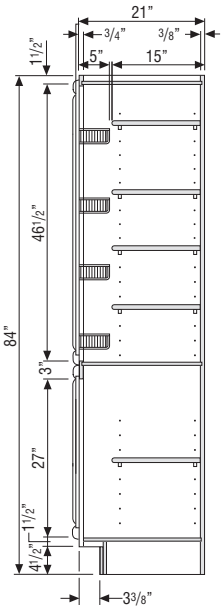

LC/LCRH

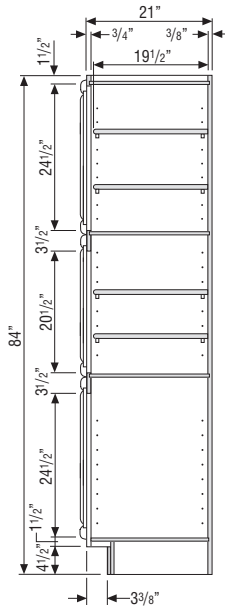

VANITY UTILITY

CABINET DIMENSIONS

84" HIGH APPLICATION

Number after Wall Cabinet Represents Height of Cabinet

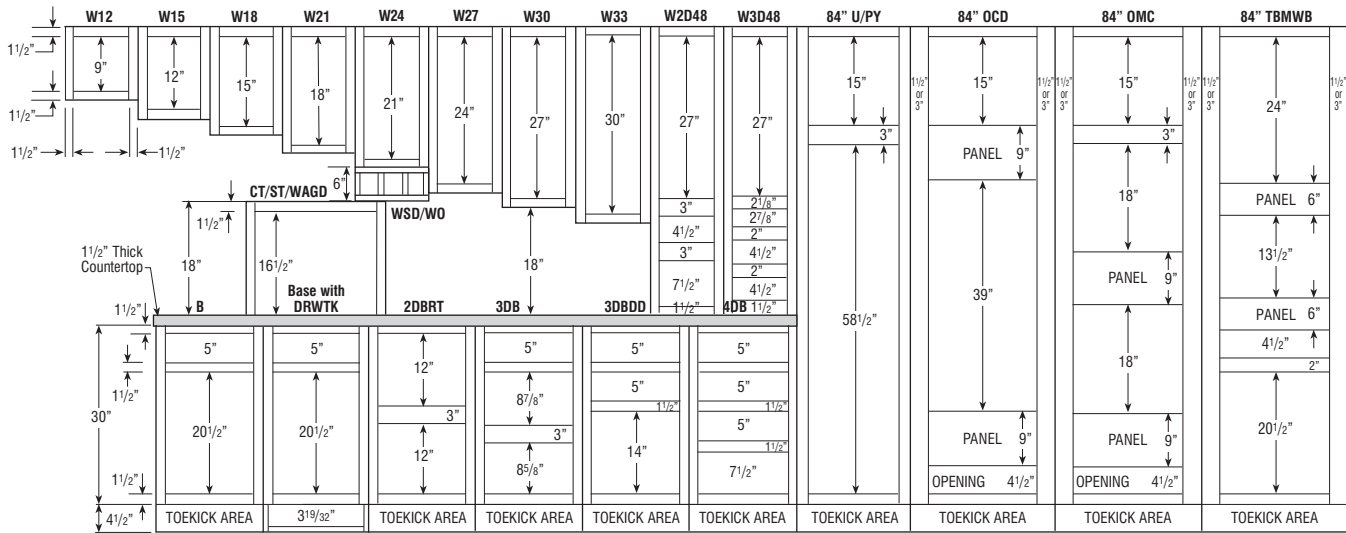

87" HIGH APPLICATION

Number after Wall Cabinet Represents Height of Cabinet

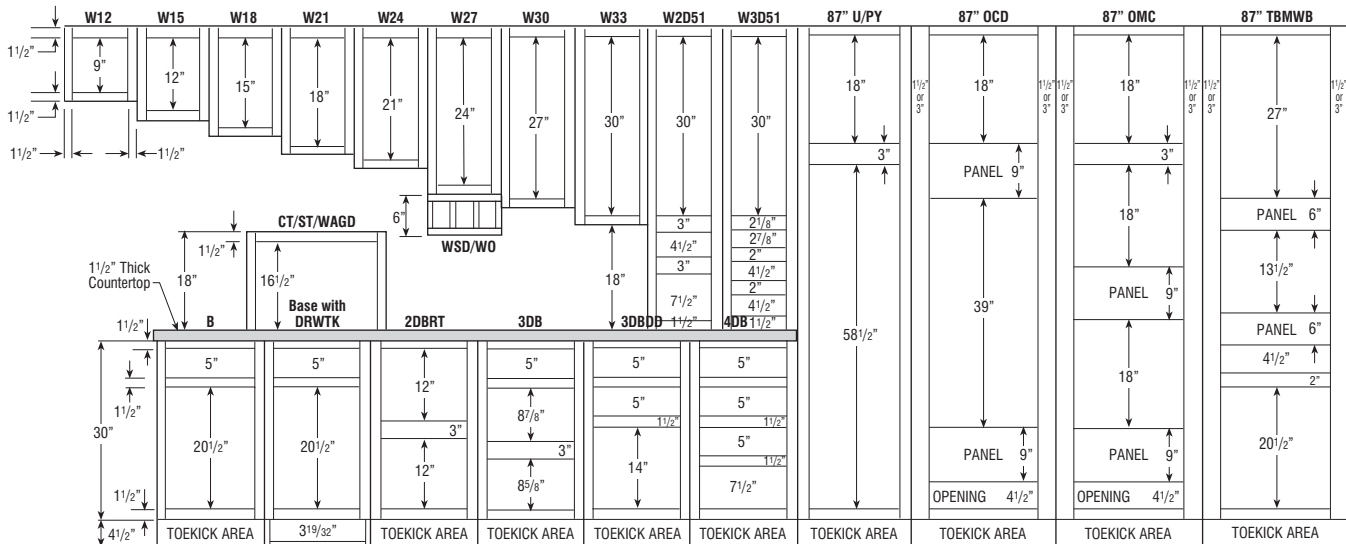

- 1 1/2" Top and Bottom Rails - Wall and Base Cabinets.
- 1 1/2" Vertical Stiles.
- 3" Center Vertical Rails on Wall and Base Cabinets to Divide Double Door Cabinets on 39" Wide and Over.

Full Overlay Door Styles:

- 1/4" Reveal Around Doors (1/4" of Face Frame Shows).
- Frame Opening + 2 1/2" = Door Size for Base/Wall Cabinets.
- 4 1/2" or 5" High Drawer Opening = 6 1/4" Drawer Front.
- 7 1/2" High Drawer Opening = 10" Drawer Front.
- 8 5/8" and 8 7/8" Drawer Opening = 11 3/8" Drawer Front.

1/2" Overlay Door Styles:

- 1" Reveal Around Doors (1" of Face Frame Shows).
- Frame Opening + 1" = Door Size for Base/Wall Cabinets.
- 4 1/2" or 5" High Drawer Opening = 5 1/2" Drawer Front.
- 7 1/2" High Drawer Opening = 8 1/2" Drawer Front.
- 8 5/8" and 8 7/8" Drawer Opening = 9 7/8" Drawer Front.

CABINET DIMENSIONS

90" HIGH APPLICATION

Number after Wall Cabinet Represents Height of Cabinet

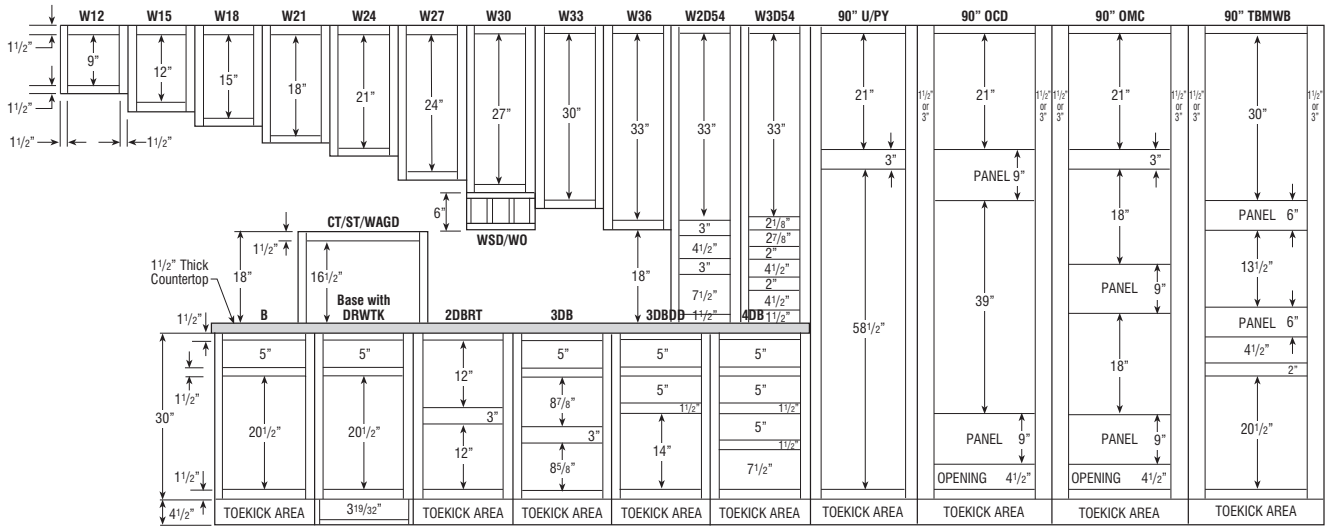

93" HIGH APPLICATION

Number after Wall Cabinet Represents Height of Cabinet

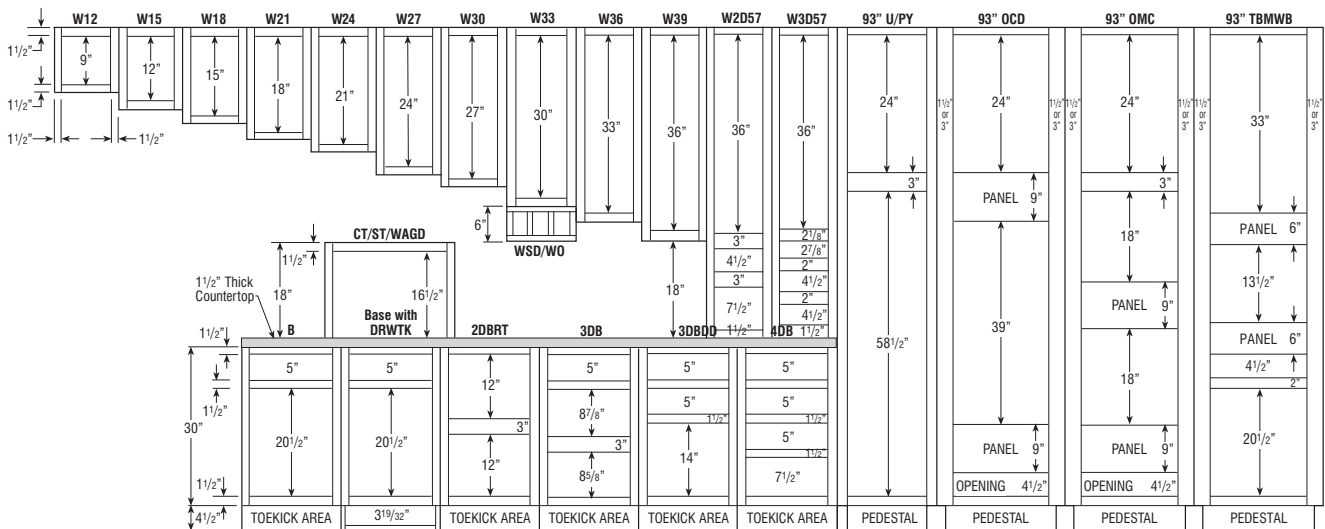

- 1 1/2" Top and Bottom Rails - Wall and Base Cabinets.
- 1 1/2" Vertical Stiles.
- 3" Center Vertical Rails on Wall and Base Cabinets to Divide Double Door Cabinets on 39" Wide and Over.

Full Overlay Door Styles:

- 1/4" Reveal Around Doors (1/4" of Face Frame Shows).
- Frame Opening + 2 1/2" = Door Size for Base/Wall Cabinets.
- 4 1/2" or 5" High Drawer Opening = 6 1/4" Drawer Front.
- 7 1/2" High Drawer Opening = 10" Drawer Front.
- 8 5/8" and 8 7/8" Drawer Opening = 11 3/8" Drawer Front.

1/2" Overlay Door Styles:

- 1" Reveal Around Doors (1" of Face Frame Shows).
- Frame Opening + 1" = Door Size for Base/Wall Cabinets.
- 4 1/2" or 5" High Drawer Opening = 5 1/2" Drawer Front.
- 7 1/2" High Drawer Opening = 8 1/2" Drawer Front.
- 8 5/8" and 8 7/8" Drawer Opening = 9 7/8" Drawer Front.

CABINET DIMENSIONS

96" HIGH APPLICATION

Number after Wall Cabinet Represents Height of Cabinet

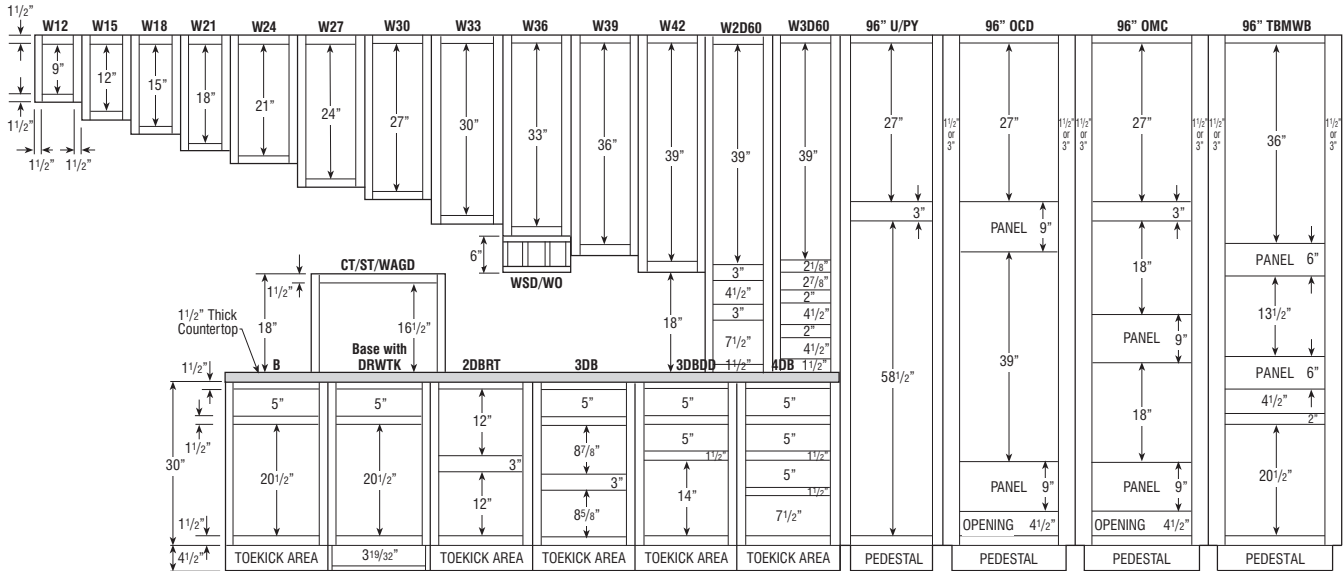

5-PIECE DRAWER FRONT DIMENSIONS CHART

5-PIECE DRAWER FRONTS	DRAWER FRONT WIDTH	DRAWER FRONT HEIGHT	PANEL FLAT WIDTH	PANEL FLAT HEIGHT
Amstead	8 1/2"	6 1/4"	2 1/2"	1 3/4"
Ashridge	8 1/2"	6 1/4"	3 1/2"	1 1/4"
Bellmont	8 1/2"	6 1/4"	3 1/2"	1 1/4"
Butler	8 1/2"	6 1/4"	3 1/2"	1 1/4"
Cotter	8 1/2"	6 1/4"	4 1/4"	2"
Darby	8 1/2"	6 1/4"	3 5/8"	1 3/8"
Gallatin DFR5PC	8 1/2"	6 1/4"	1 5/8"	1 1/8"
Hardin	8 1/2"	6 1/4"	3 1/2"	1 1/4"
Herrington DFR5PC	8 1/2"	6 1/4"	1 1/4"	1"
Justin	8 1/2"	6 1/4"	2 1/2"	1 3/4"
Kingston DFF5PC	8 1/2"	6 1/4"	3 1/2"	1 1/4"
Larsen DFF5PC	8 1/2"	6 1/4"	2 1/2"	1 3/4"
Lawton DFF5PC	8 1/2"	6 1/4"	2 1/8"	2 1/8"
Lynnville DFF5PC	8 1/2"	6 1/4"	4"	3 1/4"
Northrope DFF5PC	8 1/2"	6 1/4"	2 1/2"	1 3/4"
Rennie DFF5PC	8 1/2"	6 1/4"	3 1/2"	1 1/4"
Shafer	8 1/2"	6 1/4"	2 1/2"	1 3/4"
Warwick	8 1/2"	6 1/4"	3 1/2"	1 1/4"
Whitman	8 1/2"	6 1/4"	4"	3 1/4"

Drawer sizes are representative of a 9" wide base cabinet.

CABINET DIMENSIONS

29" HIGH DESK CABINETS

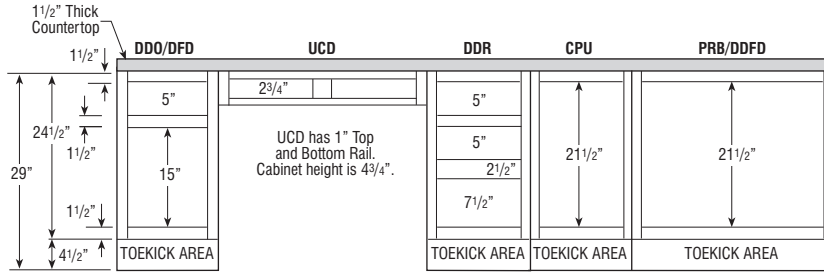

32" HIGH VANITY CABINETS

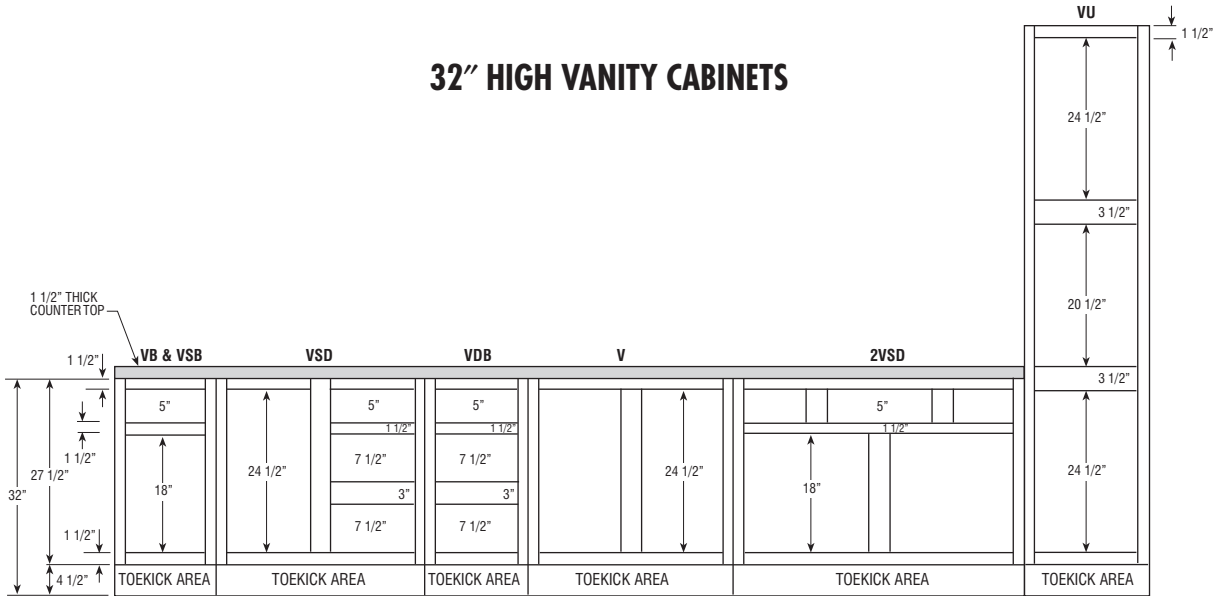

34 1/2" HIGH VANITY CABINETS

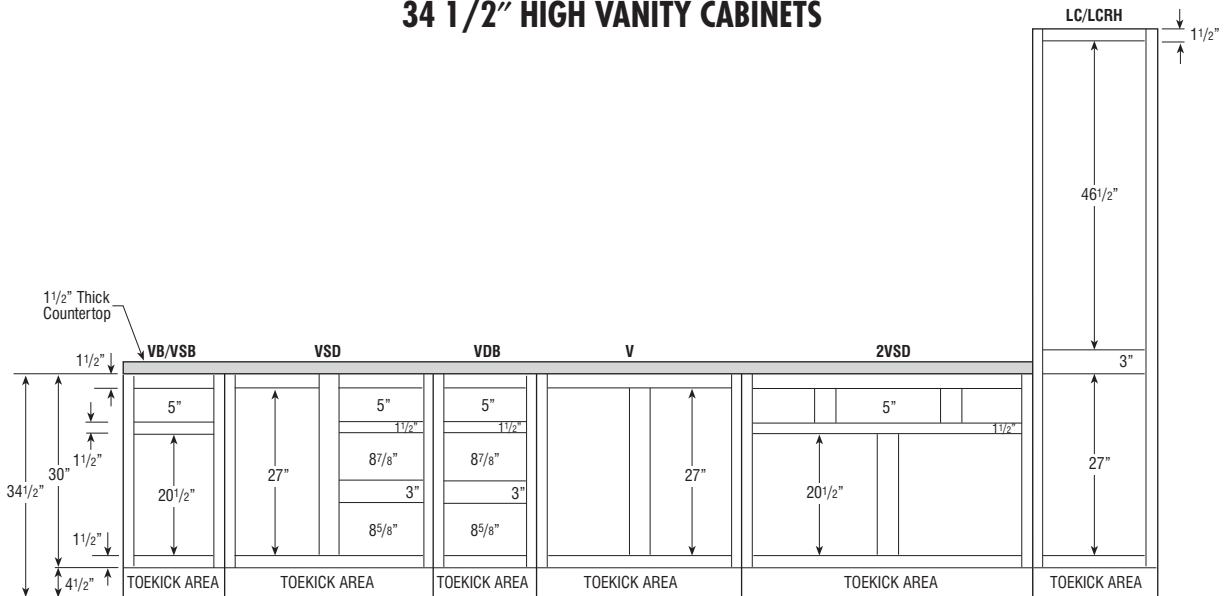

CABINET DIMENSIONS

DIMENSIONS FOR CORNER INSTALLATIONS (45° DIAGONAL)

12" DEEP CABINETS

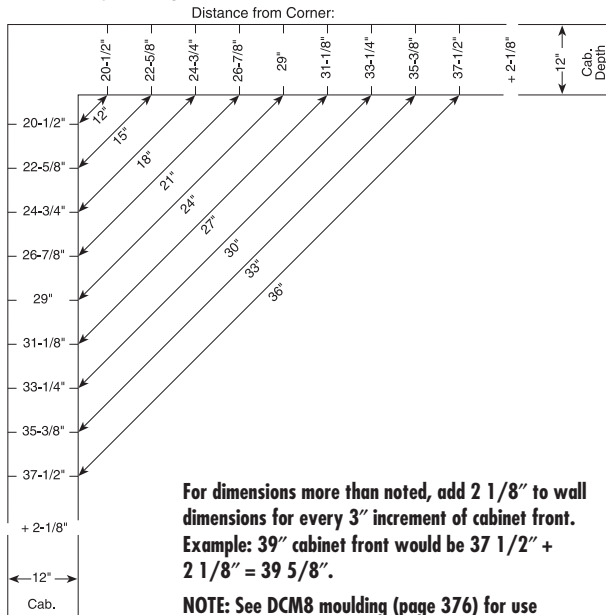

For dimensions more than noted, add 2 1/8" to wall dimensions for every 3" increment of cabinet front.
 Example: 39" cabinet front would be 37 1/2" + 2 1/8" = 39 5/8".

NOTE: See DCM8 moulding (page 376) for use between cabinets adjacent to 45° corner installations.

24" DEEP CABINETS

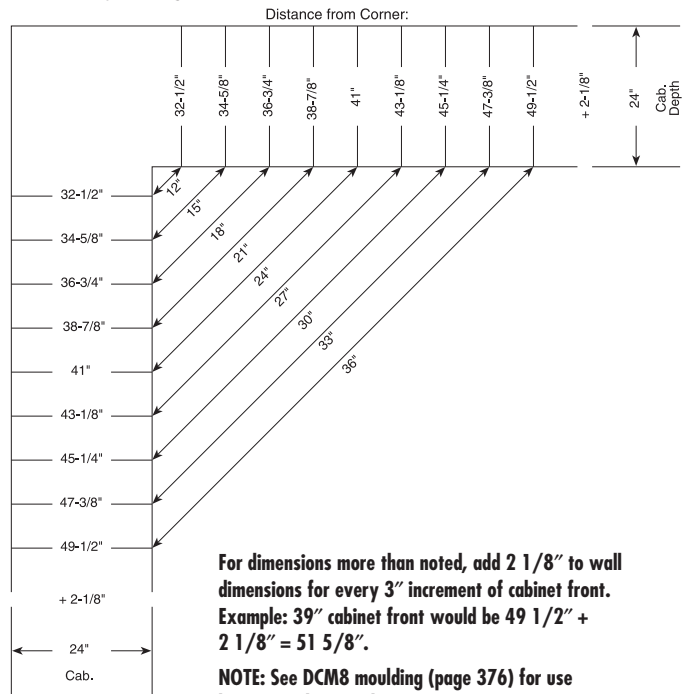

For dimensions more than noted, add 2 1/8" to wall dimensions for every 3" increment of cabinet front.
 Example: 39" cabinet front would be 49 1/2" + 2 1/8" = 51 5/8".

NOTE: See DCM8 moulding (page 376) for use between cabinets adjacent to 45° corner installations.

INSTALLATION HEIGHT REQUIREMENTS

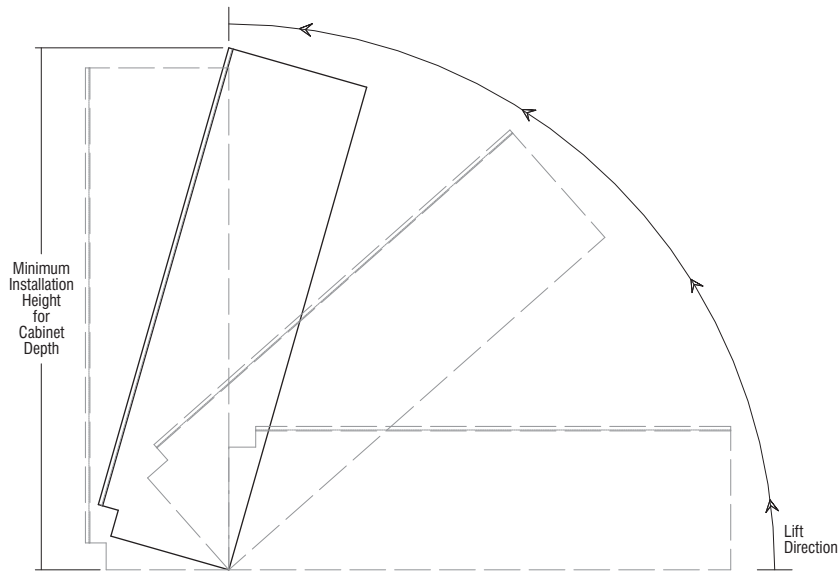

Height of ceiling needs to be considered for installation of tall cabinets. Cabinet height below includes toekick area:

Cabinet Height	Minimum Installation Height for Cabinet Depth		
	21"	24"	27"
84"	86 19/32"	87 3/8"	88 1/4"
87"	89 1/2"	90 1/4"	91 3/32"
90"	92 7/16"	93 5/32"	93 31/32"
93" *	90 31/32"	91 23/32"	92 17/32"
96" *	93 29/32"	94 5/8"	95 13/32"

*Separate pedestal base included with cabinet to be installed after cabinet is in an upright position.

KEMPER CABINETRY'S DESIGN CHECKLIST

CONSTRUCTION OPTIONS

Consider exposed end options:

- Modify exposed cabinet ends to PE or APC.
- Adding a veneer finished end (FB) will age uniformly with the rest of the kitchen.
- Apply 1/4" veneer skin to hide 1/4" reveal. This will allow the ends to age uniformly with the rest of the kitchen and will make it flush.
- Apply decorative door kit (BED, WED, TED). This kit includes 1/4" veneer skin, decorative doors, and screws for field installation.
- Upgrade exposed cabinet ends with Authentic Ends (AUTHL/AUTHR) or Furniture Finished Plywood Ends (FPEB) Modification.

WOOD AND FINISH CHARACTERISTICS

Review specific details with the customer:

- Mineral Streaks, Birdseye Dots, Grain Variations (especially Hickory and Rustic Alder).
- Color Variations/Darkening (especially Natural/Light Cherry).
- Finish Variations (Glazes are "consistently inconsistent"), hairline cracks may develop at frame joints on painted frame.
- Underside of cabinets are Natural Maple. Use light rail or cabinet panel edge and skin to hide, especially when designing with peninsula wall cabinets. For cabinets that are bridged between taller adjacent cabinets, specify PFINBTMB modification. See page 38 for more details.

STORAGE SOLUTIONS

Review storage and usage needs with Customer. See chart on pages 76-77 for more Storage Solutions.

- Cooking Solutions:
 - Wall Spice Rack Cabinet
- Storage Solutions:
 - SuperCabinet™
 - Base Rotating Deep Bin
 - Pegged Dish Organizer
 - Wall Message Center
- Clean-up Center:
 - Trash/Recycle Basket Base

CLEARANCES

- Add fillers between end cabinets and walls on full overlay door styles.
- Allow space between door/window trim and end cabinets for countertop and top moulding overhang.
- Include refrigerator door hinges in overall refrigerator height when placing cabinets above it.

Maintain a minimum clearance of 3" by pulling blind corners as follows:

- Full Overlay: 1 1/4", Standard Overlay 1/2". (More is needed in certain situations such as when adjacent to an appliance or when using oversized pulls or knobs.)
- Allow sufficient clearance (3") on each side of accessory cabinets (such as roll-out trays, swing-out units, etc.). Doors on these cabinets must open fully for accessories to be functional.
- Ensure the height between the cooktop and range hood is 24" to meet NKBA guidelines.

Qualify customer carefully on upper cabinet/microwave advantages/disadvantages as follows:

- Minimum of 18" from cooktop to upper cabinet/above the range microwave which allows for easy access to either, but less room over back burner.
- Minimum of 21" from cooktop to upper cabinet/microwave which allows for access to large pots on back burner of cooktop, but longer reach to microwave.

FILLERS

- Place fillers toward end of run where least conspicuous if needed.
- Attach overlay fillers on top of the base, wall, or tall fillers when using full overlay door styles to maintain a consistent reveal. Don't forget to include blind corner fillers.
- Add a filler at least 6" wide to accommodate a decorative onlay when the filler is used as valance.

VARYING HEIGHTS AND DEPTHS

- Also increase the depth of a wall cabinet run when you increase the height (so moulding on adjacent cabinet will kill into the side of the taller cabinet).
- Skin the sides of tall cabinets to keep adjacent base and wall cabinets out from reveal of tall cabinet.
- Add increased depth on tall end panels for a built-in look for deep refrigerators.
- Account for the additional support needed for wall cabinets with a depth of 18" or greater. This can be achieved by installing a soffit or end panels.

MATCHING INTERIOR CABINETS/GLASS OPTIONS

- Verify cut for glass or mullion door option is available on desired cabinet size. (See pages 52-55 for available cut for glass/mullion door sizes.)
- Verify glass insert option is available for desired cut for glass door size chosen.
- Verify matching interior option has been selected for all open or glass cabinets.
- Use light rail and skin to hide color variation between bottom of cabinets with and without matching interior.
- Verify mullion door lite grid matches customer expectations.

MOULDINGS

- Order rosettes and plinths in beaded or fluted styles to match fillers.
- Verify correct amount of crown moulding has been ordered.
- Order toekick caps.
- Order extra scribe.

ISLANDS AND PENINSULAS

- Consider standard height bars are 34 1/2" tall and require 19" knee space. Raised bars are 42" tall.
- Consider base peninsula cabinets (P) are 24 1/4" deep and require 12" of knee space. Use back panels/doors to flush non-P cabinets with P cabinets.
- Use recess toe on sides and back or BBMB when using multiple base cabinets to create an island.
- Use outside corner moulding if a skin is exposed on the back of the island.

APPLIANCES

- Note for all consumers, appliances are not included with any cabinetry product.
- Do not place dishwashers next to diagonal front cabinet (interference) or next to a range (no countertop support).
- Verify refrigerator door has enough clearance to open beyond 90° so refrigerator drawers can be utilized. Refer to appliance manufacturer's specs.
- Add TF696FH, as it may be required to frame around built-in microwave ovens and other built-in items. Refer to appliance manufacturer's specs.
- Order appliance panels.

SPECIAL CONSIDERATIONS

- Consider V-Groove skins and/or decorative doors on exposed cabinet sides in glazed kitchen.

MISCELLANEOUS

- Order full size touch-up kit (mini touch-up kit included with standard sink base).

TIPS TO THE INSTALLER

#10 x 2 1/2" installation screws are furnished and packaged inside all cabinets. Proper wall stud or ceiling joist installation is essential for Wall and Peninsula cabinets to support weight. Whenever possible, cabinets should be attached to each other for additional strength. Excessive weight should not be put on cabinets hung by themselves. Shimming may be required to ensure proper alignment. Wallboard alone is not strong enough to support the cabinets.

Our Warranty does not cover damage caused by improper installation. Please be sure to install cabinets properly. If you have questions, please contact your representative or customer service.

kitchen planning guidelines

DOOR/ENTRY

- Door opening should be at least 32" wide, requiring a minimum 2' 10" wide door.

DOOR INTERFERENCE

- Entry door should not interfere with safe appliance operation or appliance doors.

DISTANCE BETWEEN WORK CENTERS

- With three work centers, the total distance traveled should not be more than 26' with no single leg of the triangle less than 4' or more than 9'.
- With more than three work centers, each additional travel distance to another work center should be no less than 4' or more than 9'. Each leg is measured from the center-front of the appliance/sink. No work triangle leg should intersect an island/peninsula by more than 12".

SEPARATING WORK CENTERS

- A tall obstacle should not separate two primary work centers. A properly recessed tall corner unit is acceptable.

WORK TRIANGLE TRAFFIC

- Major traffic patterns should not cross through the basic work triangle.

WORK AISLE

- The work aisle should be at least 42" for one cook and at least 48" for multiple cooks.

WALKWAY

- The walkway width should be at least 36".

TRAFFIC CLEARANCE AT SEATING

- Allow 32" of clearance from the table to wall/obstacle if no traffic passes behind a seated diner. If traffic passes behind the diner, allow at least 36" to edge past or 44" to walk past.

SEATING CLEARANCE

- 30" high tables/counters should allow a 24" wide by 18" deep space for each seated diner and at least 18" knee space.
- 36" high counters should allow a 24" wide by 15" deep space for each seated diner and at least 15" kneespace.
- 42" high counters should allow a 24" wide by 12" deep space for each seated diner and at least 12" kneespace.

CLEAN-UP/PREP SINK PLACEMENT

- With only one sink, locate it adjacent to or across from the cooking surface and refrigerator.

CLEAN-UP/PREP SINK LANDING AREA

- Include at least a 24" wide landing space on one side of the sink and 18" on the other.
- If all the countertop at the sink is not the same height, plan a 24" landing space on one side of the sink and 3" of countertop frontage on the other, both at the same height of the sink.

PREPARATION/WORK AREA

- Include a section of countertop at least 36" wide x 24" deep next to the sink for a work area.

DISHWASHER PLACEMENT

- Nearest edge of dishwasher should be within 36" of nearest edge of sink. Provide at least 21" of standing space between the edge of the dishwasher and countertop frontage/appliances/cabinets which are placed at a right angle to the dishwasher.

WASTE RECEPTACLES

- Include at least 2 waste receptacles, one near the sink and the other nearby for recycling.

AUXILIARY SINK

- Provide at least 3" of countertop frontage on one side of the auxiliary sink and 18" on the other side, both at the same height as the sink.

REFRIGERATOR LANDING AREA

- Include at least 15" of landing area on the handle side of the refrigerator, 15" on either side of a side-by-side refrigerator, 15" of landing space which is no more than 48" across from the front of the refrigerator, and 15" above or adjacent to any under-counter style refrigerator.

COOKING SURFACE LANDING AREA

- Include a minimum of 12" of landing area on one side of the cooking surface and 15" on the other.
- If cooking surface is at a different countertop height than the rest of the kitchen, then the 12" and 15" landing areas must be the same height as the cooking surface.
- For safety reasons, in an island or peninsula situation, the countertop should extend a minimum of 9" behind the cooking surface if the counter height is the same height as the cooking surface.

COOKING SURFACE CLEARANCE

- Allow 24" between the cooking surface and a protected noncombustible surface above it.
- At least 30" of clearance is required between the cooking surface and an unprotected/combustible surface above it.
- If a microwave/hood combination is used, then the manufacturer's specifications should be followed.

COOKING SURFACE VENTILATION

- A correctly sized, ducted ventilation system is recommended for all cooking surface appliances. The recommended minimum is 150 CFM.
- Code requires that the manufacturer's specifications be followed. Minimum exhaust rate for a ducted hood is 100 CFM and must be ducted to the outside.
- Make-up air may need to be provided. Refer to local codes.

COOKING SURFACE SAFETY

- Do not locate cooking surface under an operable window.
- Window treatments above cooking surface should not use flammable materials.
- Place a fire extinguisher near the kitchen exit away from cooking equipment.

MICROWAVE OVEN PLACEMENT

- The ideal location for the bottom of the microwave is 3" below the principle user's shoulder, but no more than 54" above the floor.

MICROWAVE LANDING AREA

- Provide at least 15" above, below, or adjacent to the handle side of a microwave oven.

OVEN LANDING AREA

- Include at least 15" next to or above the oven.
- A 15" landing area that is not more than 48" away is also acceptable as long as the oven does not open into a walkway.

COMBINING LANDING AREAS

- If two landing areas are adjacent to one another, determine a new minimum for the two by taking the longer of the two and adding 12".

continued

kitchen planning guidelines (continued)

COUNTERTOP SPACE

- A total of 158" of countertop frontage, 24" deep, with at least 15" clearance above is needed to accommodate all landing, preparation, work, and storage areas.

COUNTERTOP EDGES

- Clipped or round corners, rather than sharp edges, are recommended on all counters.

STORAGE

- The recommended total shelf/drawer frontage for a small kitchen (less than 150 square feet) is 1400", for a medium kitchen (151 to 350 square feet) is 1700", and for a large kitchen (greater than 350 square feet) is 2000".

Sizes:	S	M	L
Wall	300"	360"	360"
Base	520"	615"	660"
Drawer	360"	400"	525"
Pantry	180"	230"	310"
Misc.	40"	95"	145"

- The totals for wall, base, drawer, and pantry shelf/drawer frontage can be adjusted upward or downward as long as the recommended total stays the same.

STORAGE AT CLEAN-UP/PREP SINK

- The recommended total for a small kitchen is 400", a medium kitchen is 480", a large kitchen is 560", and should be located within 72" of the centerline of the main clean-up/prep sink.

CORNER CABINET STORAGE

- At least one corner cabinet should include a functional storage device.

ELECTRICAL RECEPTACLES

- GFCI (Ground-Fault-Circuit-Interrupter) protection is required on all receptacles servicing countertop surfaces within the kitchen.

LIGHTING

- Every work surface should be well illuminated. At least one wall switch-controlled light must be placed at the entrance.
- Window/skylight area, equal to at least 8% of the total square footage of the kitchen, or a total living space which includes a kitchen, is required.

bathroom planning guidelines

DOOR/ENTRY

- Doorway opening should be at least 32", requiring a minimum 2' 10" wide door.

DOOR INTERFERENCE

- The door area should include clear floor space for maneuvering which varies according to the type of door and the direction of the approach.

CEILING HEIGHT

- Bathroom floor to ceiling minimum height is 80". A shower or tub with a shower head shall have a minimum floor to ceiling height of 80" above a minimum area 30" x 30" at the shower head.

CLEAR SPACE

- Plan a clear space of 30" from the front edge of all fixtures to any opposite bath fixture, wall, or obstacle.
- A minimum space of at least 21" is required in front of a lavatory, toilet, bidet, and tub, with a 24" minimum space in front of a shower entry.

SINGLE LAVATORY PLACEMENT

- The distance from the centerline of the lavatory to the sidewall/tall obstacle should be at least 20".
- The minimum distance required is 15". The minimum distance required between a wall and the edge of a lavatory is 4".

DOUBLE LAVATORY PLACEMENT

- The distance between the centerlines of two lavatories should be at least 36".
- The minimum distance required is 30".
- The minimum distance required between the edges of two lavatories is 4".

LAVATORY/VANITY HEIGHT

- The height for a lavatory varies from 32" to 43" to fit the user.

COUNTERTOP EDGES

- Clipped or round corners, rather than sharp edges, are recommended on all counters.

SHOWER SIZE

- The interior shower size should be at least 36" x 36". The minimum interior shower size required is 30" x 30".

STORAGE

- Provide adequate, accessible storage for toiletries, bath linens, grooming and general bathroom supplies.
- Storage of frequently used items should be 15" to 48" above floor.

ELECTRICAL RECEPTACLES

- All GFCI receptacles should be located at electrical appliance points of use.

Load bearing floors and shelves meet KCMA standards of 15 lbs. per square foot. Warranty does not cover overloading beyond this point.

To view a complete and updated list of the NKBA Guidelines, visit <http://www.nkba.org/guidelines/default.aspx>

© Copyright 2010 National Kitchen & Bath Association

STORAGE SOLUTIONS REFERENCE CHART

Wall Cabinets	Description	3"	6"	9"	12"	15"	18"	21"	24"	27"	30"	33"	36"	39"	42"	45"	48"	Page
W18__SPD	Wall Spice Pull Down						•											145
W36__SHLFPD	Wall Shelf Pull Down												•					146
WBCPO___, OL	Wall Box Column Pull-Outs (Plain, Overlay)	•	•															141, 142
WBCKKUP3___, OL	Wall Box Column Pull-Outs w/K-Cup® (Plain, Overlay)	•																143, 144
WEAS_____	Wall Easy Access Storage Cabinets					•	•				•		•					101
WMC_____	Wall Message Center	•																155
WSC_____	Wine Storage Cabinet				•	•	•	•	•									151
WSP_____	Wall Spice Pull-Outs			•	•													145
WSR_____	Wall Spice Rack Cabinets						•	•										147
Hearths																		
HPP9__21	Hearth Pier w/Pull-Out			•														169
Base Cabinets																		
2DB__RT	Two Drawer Bases w/Roll Tray						•	•	•	•	•	•	•					226
2DB36PDO	Two Drawer Base w/Pegged Dish Organizer																	226
2DB36RTPDO	Two Drawer Base w/Roll Tray & Pegged Dish Organizer																	227
3DB__WTCD	Three Drawer Bases w/Wood Tiered Cutlery Divider Drawer					•	•	•	•									229
3DB18KCUP	Three Drawer Base w/Wood Tiered K-Cup® Drawer						•											229
3DBBD__	Three Drawer Base Buffet w/Deep Drawer																	231
3DBDD__	Three Drawer Bases w/Deep Drawer																	230
4DB__CIW	Four Drawer Bases w/Cutlery Insert Wood Organizer					•	•	•	•									232
4DB__WTCD	Four Drawer Bases w/Wood Tiered Cutlery Divider Drawer					•	•	•	•									232
4DB18KCUP	Four Drawer Base w/Wood Tiered K-Cup® Drawer						•											233
B__CIW	Bases w/Cutlery Insert Wood Organizer					•	•	•	•									175
B__FHMIXSC	Base Cabinets w/Mixer Shelf						•	•	•									197
B__FHRTLO	Bases w/Lid Organizer & Roll Tray																	192
B__FSCO	Base w/Food Storage Container Organizer						•		•									193
B__PS	Pots & Pans Organizer Bases w/Drawer							•										192
B__RTCIW	Bases w/Cutlery Insert Wood Organizer & Roll Tray					•	•	•	•									190
B__RTLO	Bases w/Drawer & Lid Organizer & Roll Tray																	191
B__RTWTCD	Bases w/Wood Tiered Cutlery Divider Drawer & Roll Tray					•	•	•	•									190
B__TDRO	Bases with Roll-Out Tray Divider					•	•											196
B__WTCD	Bases w/Wood Tiered Cutlery Divider Drawer					•	•	•	•									176
B18CWP__	Base w/Can and Wine Bottle Pull-Outs						•											194
B18HCWP__	Full Height Base w/Can and Wine Bottle Pull-Outs						•											195
B18KCUP	Base w/Wood Tiered K-Cup® Drawer						•											176
B18KCUPRT	Base w/Wood Tiered K-Cup® Drawer and Roll Trays						•											191
BBCPO_, OL	Base Box Column Pull-Outs (Plain, Overlay)	•	•															240
BFTP24	Base Bin Tray Pull-Out																	235
BFTP24FH	Base Bin Tray Pull-Out Full Height																	236
BFTP24FHFPD	Base Bin Tray Pull-Out Full Height w/Pet Feeding Drawer																	236
BFTP24FPD	Base Bin Tray Pull-Out w/Pet Feeding Drawer																	236
BC__PO	Base Corners w/Pull-Out																	212
BCFW__PO	Base Corners Full Width w/Pull-Out																	213
BCFW48CPO	Base Corner Full Width w/Curved Pull-Out																	213
BCFW48SP	Base Cabinet Full Width w/Roll Trays & Swing-Out																	214
BCOPP12	Base Container Organizer Pantry Pull-Out					•												239
BEAS__	Base Easy Access Storage Cabinets					•	•											181
BMC24	Base Message Center	•																241
BPP__	Base Pantry Pull-Outs			•	•													239
BPPP__	Base Pots & Pans Pull-Outs								•		•							193
BPT__WB	Base Paper Towel Cabinet w/Wastebasket					•	•											234
BPT__WBFB	Base Paper Towel Cabinet w/Wastebasket Full Height					•	•											235
BRDB36	Base Rotating Deep Bin																	222
BSC3OPR, R, RP, RS, SR	SuperCabinet™																	182
BSC36PRP, PRS, SRP, SRS	SuperCabinet™																	184
BSCG__	SuperCabinet™ Gourmet																	183, 185
BUPP__	Base Utensil Pantry Pull-Out			•	•													239
BUPPKB__	Base Utensil Pantry Pull-Out w/Knife Block			•	•													240
BV2SC3OPR, RP, RS, SR	SuperCabinet™ Version 2																	183
BV2SC36PRP, PRS, SRP, SRS	SuperCabinet™ Version 2																	185
BWB__	Base Wastebaskets					•	•	•										233
BWB__FH	Base Wastebaskets Full Height					•	•	•										234
CNTYSB__CM	Country Sink Base w/CabMat™																	209
LSP36	Lazy Susan Pull-Out																	222

• Available widths

continued

STORAGE SOLUTIONS REFERENCE CHART

Base Cabinets, cont'd	Description	3"	6"	9"	12"	15"	18"	21"	24"	27"	30"	33"	36"	39"	42"	45"	48"	Page
SB__CM, SCM, STCM, STSCM	Sink Base w/CabMat™										•	•	•					199, 202, 204, 205
SB__D	Sink Bases w/Drawers Below								•	•	•	•	•	•	•	•	•	206
SB__S	Sink Base SuperCabinet™										•	•	•					203
SB__STS	Sink Base SuperCabinet™ w/Tilt-Out Trays										•	•	•					205
SB36CDY	Sink Base w/Caddy												•					199
SB36SCDY	Sink Base SuperCabinet™ w/Caddy												•					204
SB36STCDY	Sink Base w/Tilt-Out Trays & Caddy												•					202
SB36STSCDY	Sink Base SuperCabinet™ w/Tilt-Out Trays & Caddy												•					206
SISCR__	Super Lazy Susans w/Chrome Rail												•					220
SISCR____	Asymmetrical Super Lazy Susans w/Chrome Rail												•					221
SSS36	Segmented Super Lazy Susan												•					218
Tall Cabinets																		
PTU____24	Pantry Top Units						•	•	•	•			•					268
PTUP__4924	Pantry Top Units w/Pull-Out						•	•										269
PY____24	Pantry Units																•	272, 273
TPP____24	Tall Pantry Pull-Outs			•	•	•	•											269, 270
UEAS____12, 24	Utility Easy Access						•	•					•	•				261-264
UOC24__6	Utility Organizer Cabinet		•															265
UOC24__9	Utility Organizer Drop Zone Cabinet								•									266
US21__24	Utility Storage w/Pantry Pull-Out								•									271
US21__24PP	Utility Storage w/Pantry Pull-Out & Pot and Pan Rack								•									271
Vanity Cabinets																		
LC188421	Linen Closet						•											335
LCRH188421	Linen Closet w/Removable Hamper						•											335
VBH183421	Vanity Hamper w/Drawer						•											335
VBWB153421	Vanity Base Wastebasket					•												321
VGPO123421	Vanity Grooming Pull-Out				•													323
VH183221FH	Vanity Hamper						•											334
VMP__32.5	Vanity Mirror w/Side Pull-Outs								•		•							339
VP93421	Vanity Pull-Out			•														323
VS__3421WB	Vanity Sink Bases w/Wastebasket								•		•							316
VS30__21U	Vanity Sink Bases w/U-Shaped Roll-Out Tray										•							315
VSSB__3421ST	Vanity Sink Base SuperCabinet™ w/Tilt-Out Trays										•	•	•					317
VSSB__3421STWB	Vanity Sink Base SuperCabinet™ w/Tilt-Out Trays and Wastebasket										•	•	•					316
VWB15__21	Vanity Wastebasket Full Height					•												321
VWB15__21RT	Vanity Wastebasket Full Height w/Roll Tray					•												322
VWH__23.521U	Vanity Wall Hung Double Door w/U-Shaped Pull-Outs										•		•					337
Modifications																		
CMAT1 (Base, Universal)	CabMat™										•	•	•					41
CMAT2 (Vanity)	CabMat™								•	•	•	•	•					41
DRWTK	Toe-kick Drawer						•	•	•	•	•	•	•					48

• Available widths

WALL CABINET NOMENCLATURE

All Wall Cabinets are 12" deep unless otherwise noted.

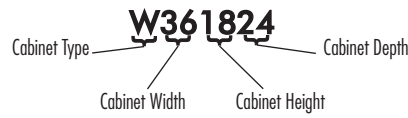

MODIFICATIONS GRID KEY

- Available
- STD Standard on these cabinets
- storage Storage Solutions Organization Cabinet
- 5 DAY** 5 Day Express Response Item

CUSTOM MODIFICATIONS

CONSTRUCTION UPGRADES

DOOR OPTIONS

Mod.	Description	Mod.	Description	Mod.	Description	Mod.	Description	Mod.	Description
ADDTK*	Add Toekick	EXL	Extended Stile - Left	MIP	Matching Interior Plywood	APC	All Plywood Construction	ALF	Aluminum Frame Doors
AUTHL	Authentic End - Left	EXR	Extended Stile - Right	P	Peninsula	PE	Plywood Ends	CG, CG.BTM, CG.TOP	Cut for Glass Doors
AUTHR	Authentic End - Right	FB	Finished Ends	PFINBTMB	Prepare Cabinet for Finished Bottom			DPSRR	Door Panel - Solid Reverse Raised
CBO	Cabinet Box Only	FFDL	Face Frame and Door on End - Left	RD	Reduced Depth			MD, MD.BTM, MD.TOP	Mullion Doors
CCO	Cabinet Case Only			TD	Tray Dividers			MFO	Modified Full Overlay
CFNT0	Cabinet Front Only	FFDR	Face Frame and Door on End - Right	TVRAV	Valance Top Rail, Arch				
CFRMO	Cabinet Frame Only			TVRFV	Valance Top Rail, Furniture				
CND	Cabinet with No Door, with Drawer	FPEB	Furniture Finished Plywood Ends	TVRVV	Valance Top Rail, Straight				
EXBKL	End Extended Back - Left	ID	Increased Depth	WLI	White Laminate Interior				
EXBKR	End Extended Back - Right	INVFRM	Inverted Frame						

*ADDTK available with compatible toekick modifications. See the Modification/Upgrade Compatibility Chart on page 30 for details.

Model	Cubic Feet
W1212 L or R	1.5
W1512 L or R	1.9
W1812 L or R	2.2

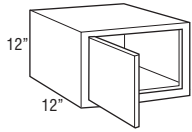

Custom Modifications

ADDTK	AUTHL AUTHR	CBO	CCO	CFNT0	CFRMO	CND	EXBKL EXBKR	EXL EXR	FB	FFDL FFDR
•	•		•	•	•		•	•	•	
FPEB	ID	INVFRM	MIP	P	PFINBTMB	RD	TD	TVRAV TVRFV TVRVV	WLI	
•	•		•	•	•	•			•	

Construction Upgrades

APC	PE
•	•

Door Options

ALF	CG	CG.BTM	CG.TOP	DPSRR	MD	MD.BTM	MD.TOP	MFO
•†	•			•				•

†Not available on 12" wide

WALL DOUBLE DOOR, 12" HIGH

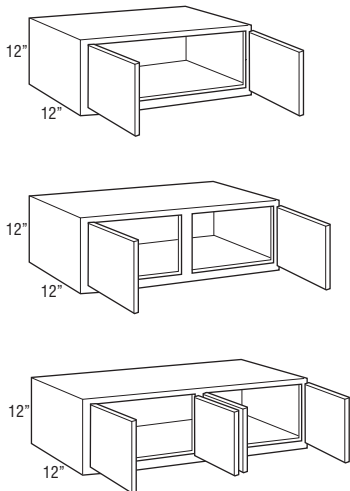

Model	Cubic Feet
W2112	2.6
W2412	3.0
W2712	3.3
W3012	3.7
W3312	4.1
W3412	4.0
W3612	4.4
W3712	4.4
W3912	4.8
W4212	5.1
W4512	5.3
W4812	5.7

• 42" or wider will feature four doors.

Custom Modifications

ADDTK	AUTHL AUTHR	CBO	CCO	CFNTO	CFRMO	CND	EXBKL EXBKR	EXL EXR	FB	FFDL FFDR
•	•		•	•	•		•	•	•	
FPFB	ID	INVFRM	MIP	P	PFINBTMB	RD	TD	TVRAV TVRFV TVRVV	WLI	
•	•		•	•	•	•			•	

Construction Upgrades

APC	PE
•	•

Door Options

ALF	CG	CG.BTM	CG.TOP	DPSRR	MD	MD.BTM	MD.TOP	MFO
	•			•				•

WALL TOP HINGE, 12" HIGH

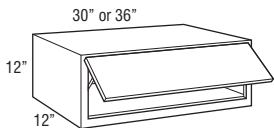

WTH3012	3.7
WTH3612	4.4

- Utilizes doors from 30" and 36" high wall cabinets. Grain on center panels and slab doors will run horizontally and door rail configuration on non-miter doors will be unique from adjacent cabinet doors. Genova will have standard vertical grain pattern. Troxel will have standard horizontal grain pattern.
- Not available on Lynnvile.
- When ordered in Arch/Cathedral door styles, door will be Square.
- Art Glass not available.
- Cabinet may utilize one or two lift mechanisms depending on door size and weight. Door lift mechanism tension can be field adjusted.
- Depth can be reduced to a minimum of 9".
- Door will open a maximum of 107° due to hinges. For applications close to a ceiling, door angle can be restricted to 86° with a Hinge Angle Restriction Clip (HINGERESCLIP, see page 418).
- Lift mechanisms and mounting brackets will be visible if used with transparent textured glass.
- Lift mechanism not available for order for field installation, only available factory installed.

Custom Modifications

ADDTK	AUTHL AUTHR	CBO	CCO	CFNTO	CFRMO	CND	EXBKL EXBKR	EXL EXR	FB	FFDL FFDR
	•		•		•		•	•	•	
FPFB	ID	INVFRM	MIP	P	PFINBTMB	RD	TD	TVRAV TVRFV TVRVV	WLI	
•	•		•		•	•			•	

Construction Upgrades

APC	PE
•	•

Door Options

ALF	CG	CG.BTM	CG.TOP	DPSRR	MD	MD.BTM	MD.TOP	MFO
•	•			•				•

WALL REFRIGERATOR DOUBLE DOOR, 12" HIGH, 24" DEEP

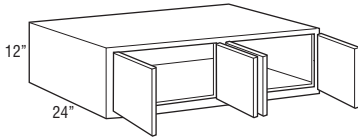
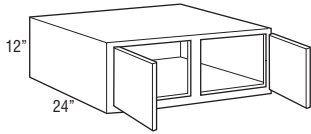
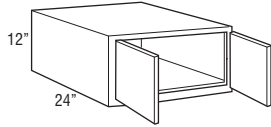

Model	Cubic Feet
W241224	5.5
W271224	5.9
W301224	6.8
W331224	7.4
W341224	7.3
W361224	8.1
W371224	8.0
W391224	8.7
W421224	9.4
W451224	9.9
W481224	10.5

- 24" deep cabinets must be fully supported by screws installed in a structural member in the ceiling or soffit, and into adjacent cabinets.
- Load limit is 15 lbs. per square foot of load bearing surface.
- 42" or wider will feature four doors.

Custom Modifications

ADDTK	AUTHL AUTHR	CBO	CCO	CFNTO	CFRMO	CND	EXBKL EXBKR	EXL EXR	FB	FFDL FFDR
•	•		•	•	•		•	•	•	
FPEB	ID	INVFRM	MIP	P	PFINBTMB	RD	TD	TVRAV TVRFV TVRVV	WLI	
•			•		•	•			•	

Construction Upgrades

APC	PE
•	•

Door Options

ALF	CG	CG.BTM	CG.TOP	DPSRR	MD	MD.BTM	MD.TOP	MFO
	•			•				•

WALL TOP HINGE REFRIGERATOR, 12" HIGH, 24" DEEP

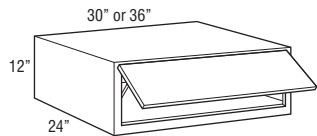

WTH301224	6.8
WTH361224	8.1

- Utilizes doors from 30" and 36" high wall cabinets. Grain on center panels and slab doors will run horizontally and door rail configuration on non-miter doors will be unique from adjacent cabinet doors. Genova will have standard vertical grain pattern. Troxel will have standard horizontal grain pattern.
- Not available on Lynnville.
- When ordered in Arch/Cathedral door styles, door will be Square.
- 24" deep cabinets must be fully supported by screws installed in a structural member in the ceiling or soffit, and into adjacent cabinets.
- Load limit is 15 lbs. per square foot of load bearing surface.
- Art Glass not available.
- Cabinet may utilize one or two lift mechanisms depending on door size and weight. Door lift mechanism tension can be field adjusted.
- Depth can be reduced to a minimum of 9".
- Door will open a maximum of 107° due to hinges. For applications close to a ceiling, door angle can be restricted to 86° with a Hinge Angle Restriction Clip (HINGERESCLIP, see page 418).
- Lift mechanisms and mounting brackets will be visible if used with transparent textured glass.
- Lift mechanism not available for order for field installation, only available factory installed.

Custom Modifications

ADDTK	AUTHL AUTHR	CBO	CCO	CFNTO	CFRMO	CND	EXBKL EXBKR	EXL EXR	FB	FFDL FFDR
	•		•		•		•	•	•	
FPEB	ID	INVFRM	MIP	P	PFINBTMB	RD	TD	TVRAV TVRFV TVRVV	WLI	
•			•		•	•			•	

Construction Upgrades

APC	PE
•	•

Door Options

ALF	CG	CG.BTM	CG.TOP	DPSRR	MD	MD.BTM	MD.TOP	MFO
•	•			•				•

WALL SINGLE DOOR, 15" HIGH

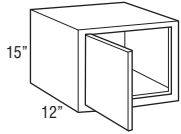

Model	Cubic Feet
W1215 L or R	1.8
W1515 L or R	2.3
W1815 L or R	2.7

Custom Modifications

ADDTK	AUTHL AUTHR	CBO	CCO	CFNTD	CFRMO	CND	EXBKL EXBKR	EXL EXR	FB	FFDL FFDR
•	•		•	•	•		•	•	•	
FPFB	ID	INVFRM	MIP	P	PFINBTMB	RD	TD	TVRV TVRFV TVRVV	WLI	
•	•		•	•	•	•			•	

Construction Upgrades

APC	PE
•	•

Door Options

ALF	CG	CG.BTM	CG.TOP	DPSRR	MD	MD.BTM	MD.TOP	MFO
• [†]	•			•				•

[†]Not available on 12" wide

WALL DOUBLE DOOR, 15" HIGH

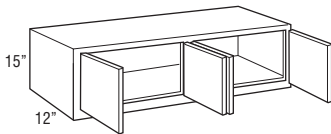
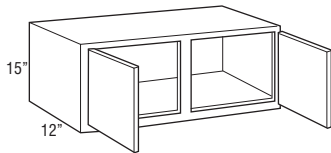
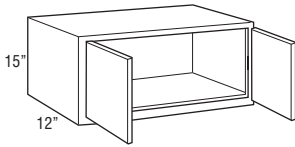

W2115	3.2
W2415	3.6
W2715	4.0
W3015	4.5
W3315	4.9
W3415	4.9
W3615	5.4
W3715	5.3
W3915	5.8
W4215	6.1
W4515	6.5
W4815	6.9

• 42" or wider will feature four doors.

Custom Modifications

ADDTK	AUTHL AUTHR	CBO	CCO	CFNTD	CFRMO	CND	EXBKL EXBKR	EXL EXR	FB	FFDL FFDR
•	•		•	•	•		•	•	•	
FPFB	ID	INVFRM	MIP	P	PFINBTMB	RD	TD	TVRV TVRFV TVRVV	WLI	
•	•		•	•	•	•			•	

Construction Upgrades

APC	PE
•	•

Door Options

ALF	CG	CG.BTM	CG.TOP	DPSRR	MD	MD.BTM	MD.TOP	MFO
•	•			•				•

WALL TOP HINGE, 15" HIGH

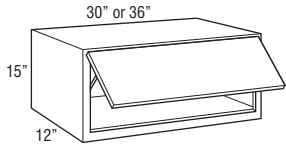

Model	Cubic Feet
WTH3015	4.5
WTH3615	5.4

- Utilizes doors from 30" and 36" high wall cabinets. Grain on center panels and slab doors will run horizontally and door rail configuration on non-miter doors will be unique from adjacent cabinet doors. Genova will have standard vertical grain pattern. Troxel will have standard horizontal grain pattern.
- Not available on Lynnville.
- When ordered in Arch/Cathedral door styles, door will be Square.
- Art Glass not available.
- Cabinet may utilize one or two lift mechanisms depending on door size and weight. Door lift mechanism tension can be field adjusted.
- Depth can be reduced to a minimum of 9".
- Door will open a maximum of 107° due to hinges. For applications close to a ceiling, door angle can be restricted to 86° with a Hinge Angle Restriction Clip (HINGERESCLIP, see page 418).
- Lift mechanisms and mounting brackets will be visible if used with transparent textured glass.
- Lift mechanism not available for order for field installation, only available factory installed.

Custom Modifications

ADDTK	AUTHL AUTHR	CBO	CCO	CFNTO	CFRMO	CND	EXBKL EXBKR	EXL EXR	FB	FFDL FFDR
	•		•		•		•	•	•	
FPEB	ID	INVFRM	MIP	P	PFINBTMB	RD	TD	TVRAV TVRFV TVRVV	WLI	
•	•		•		•	•			•	

Construction Upgrades

APC	PE
•	•

Door Options

ALF	CG	CG.BTM	CG.TOP	DPSRR	MD	MD.BTM	MD.TOP	MFO
•	•			•				•

WALL REFRIGERATOR DOUBLE DOOR, 15" HIGH, 24" DEEP

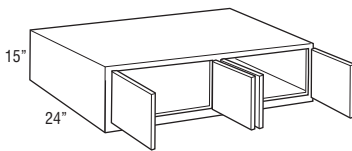
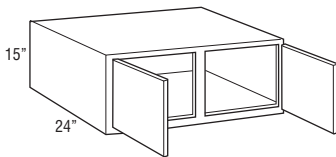
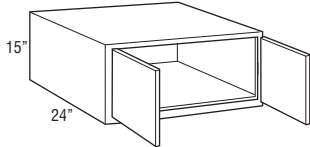

W241524	6.7
W271524	7.2
W301524	8.3
W331524	9.1
W341524	9.0
W361524	9.8
W371524	9.7
W391524	10.6
W421524	11.3
W451524	12.0
W481524	12.8

- 24" deep cabinets must be fully supported by screws installed in a structural member in the ceiling or soffit, and into adjacent cabinets.
- Load limit is 15 lbs. per square foot of load bearing surface.
- 42" or wider will feature four doors.

Custom Modifications

ADDTK	AUTHL AUTHR	CBO	CCO	CFNTO	CFRMO	CND	EXBKL EXBKR	EXL EXR	FB	FFDL FFDR
•	•		•	•	•		•	•	•	
FPEB	ID	INVFRM	MIP	P	PFINBTMB	RD	TD	TVRAV TVRFV TVRVV	WLI	
•			•		•	•			•	

Construction Upgrades

APC	PE
•	•

Door Options

ALF	CG	CG.BTM	CG.TOP	DPSRR	MD	MD.BTM	MD.TOP	MFO
	•			•				•

**WALL TOP HINGE REFRIGERATOR,
15" HIGH, 24" DEEP**

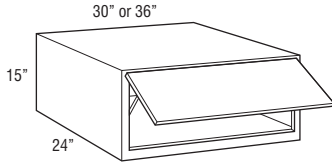

Model	Cubic Feet
WTH301524	8.3
WTH361524	9.8

- Utilizes doors from 30" and 36" high wall cabinets. Grain on center panels and slab doors will run horizontally and door rail configuration on non-miter doors will be unique from adjacent cabinet doors. Genova will have standard vertical grain pattern. Troxel will have standard horizontal grain pattern.
- Not available on Lynnville.
- When ordered in Arch/Cathedral door styles, door will be Square.
- 24" deep cabinets must be fully supported by screws installed in a structural member in the ceiling or soffit, and into adjacent cabinets.
- Load limit is 15 lbs. per square foot of load bearing surface.
- Art Glass not available.
- Cabinet may utilize one or two lift mechanisms depending on door size and weight. Door lift mechanism tension can be field adjusted.
- Depth can be reduced to a minimum of 9".
- Door will open a maximum of 107° due to hinges. For applications close to a ceiling, door angle can be restricted to 86° with a Hinge Angle Restriction Clip (HINGERESCLIP, see page 418).
- Lift mechanisms and mounting brackets will be visible if used with transparent textured glass.
- Lift mechanism not available for order for field installation, only available factory installed.

Custom Modifications

ADDTK	AUTHL AUTHR	CBO	CCO	CFNTO	CFRMO	CND	EXBKL EXBKR	EXL EXR	FB	FFDL FFDR
	•		•		•		•	•	•	
FPFB	ID	INVFRM	MIP	P	PFINBTMB	RD	TD	TVRAV TVRFV TVRVV	WLI	
•			•		•	•			•	

Construction Upgrades

APC	PE
•	•

Door Options

ALF	CG	CG.BTM	CG.TOP	DPSRR	MD	MD.BTM	MD.TOP	MFO
•	•			•				•

WALL SINGLE DOOR, 18" HIGH

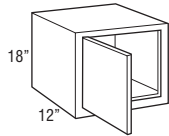

W1218 L or R	2.2
W1518 L or R	2.7
W1818 L or R	3.2
W2118 L or R	3.8
W2418 L or R	4.3

Custom Modifications

ADDTK	AUTHL AUTHR	CBO	CCO	CFNTO	CFRMO	CND	EXBKL EXBKR	EXL EXR	FB	FFDL FFDR
•	•		•	•	•		•	•	•	•
FPFB	ID	INVFRM	MIP	P	PFINBTMB	RD	TD	TVRAV TVRFV TVRVV	WLI	
•	•		•	•	•	•	•		•	

Construction Upgrades

APC	PE
•	•

Door Options

ALF	CG	CG.BTM	CG.TOP	DPSRR	MD	MD.BTM	MD.TOP	MFO
	•			•	• [†]			•

[†]Not available on 12", 21", and 24" wide

WALL DOUBLE DOOR, 18" HIGH

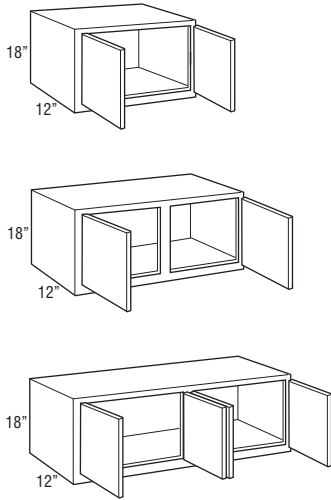

Model	Cubic Feet
W2418	4.3
W2718	4.8
W3018	5.3
W3318	5.4
W3418	5.8
W3618	6.3
W3718	6.3
W3918	6.8
W4218	7.3
W4518	7.6
W4818CS	8.3
W4818	8.3

Custom Modifications

ADDTK	AUTHL AUTHR	CBO	CCO	CFNTO	CFRMO	CND	EXBKL EXBKR	EXL EXR	FB	FFDL FFDR
•	•		•	•	•		•	•	•	•
FPEB	ID	INVERM	MIP	P	PFINBTMB	RD	TD	TVRAV TVRFV TVRVV	WLI	
•	•		•	•	•	•	•*		•	

*Not available on 39", 42", 45", and 48" wide

Construction Upgrades

APC	PE
•	•

Door Options

ALF	CG	CG.BTM	CG.TOP	DPSRR	MD	MD.BTM	MD.TOP	MFO
•	•			•	•†			•

†Available only on 30" and 36" wide

WALL TOP HINGE, 18" HIGH

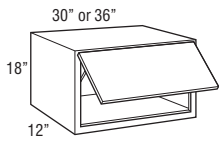

WTH3018	5.3
WTH3618	6.3

- Utilizes doors from 30" and 36" high wall cabinets. Grain on center panels and slab doors will run horizontally and door rail configuration on non-miter doors will be unique from adjacent cabinet doors. Genova will have standard vertical grain pattern. Troxel will have standard horizontal grain pattern.
- Not available on Lynnvile.
- When ordered in Arch/Cathedral door styles, door will be Square.
- Art Glass not available.
- Cabinet may utilize one or two lift mechanisms depending on door size and weight. Door lift mechanism tension can be field adjusted.
- Depth can be reduced to a minimum of 9".
- Door will open a maximum of 107° due to hinges. For applications close to a ceiling, door angle can be restricted to 86° with a Hinge Angle Restriction Clip (HINGERESCLIP, see page 418).
- Lift mechanisms and mounting brackets will be visible if used with transparent textured glass.
- Lift mechanism not available for order for field installation, only available factory installed.

Custom Modifications

ADDTK	AUTHL AUTHR	CBO	CCO	CFNTO	CFRMO	CND	EXBKL EXBKR	EXL EXR	FB	FFDL FFDR
	•		•		•		•	•	•	
FPEB	ID	INVERM	MIP	P	PFINBTMB	RD	TD	TVRAV TVRFV TVRVV	WLI	
•	•		•		•	•	•		•	

Construction Upgrades

APC	PE
•	•

Door Options

ALF	CG	CG.BTM	CG.TOP	DPSRR	MD	MD.BTM	MD.TOP	MFO
•	•			•				•

WALL VERTICAL LIFT, 18" HIGH, 12" DEEP

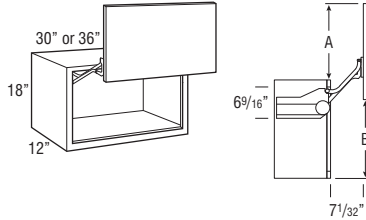

	Full Overlay	Partial Overlay
A	16 13/16"	16 1/16"
B	17 5/16"	18 1/16"

Model	Cubic Feet
WVL3018	5.2
WVL3618	6.1

- Utilizes doors from 30" and 36" high wall cabinets. Grain on center panels and slab doors will run horizontally and door rail configuration on non-miter doors will be unique from adjacent cabinet doors. Genova will have standard vertical grain pattern. Troxel will have standard horizontal grain pattern.
- Decorative hardware required.
- See side view drawing for required clearances.
- Lift mechanism features a single motion for up and out movement with Smart Stop, tension can be field adjusted.
- Lift mechanisms and mounting brackets will be visible if used with transparent textured glass.
- Lift mechanism not available for order for field installation, only available factory installed.
- Hardware extends 1" into opening on each side.
- Art Glass not available.
- Not available on Lynnvile.
- When ordered in Arch/Cathedral door styles, door will be Square.

Custom Modifications

ADDTK	AUTHL AUTHR	CBO	CCO	CFNTO	CFRMO	CND	EXBKL EXBKR	EXL EXR	FB	FFDL FFDR
	•		•		•		•	•	•	
FPEB	ID	INVRM	MIP	P	PFINBTMB	RD	TD	TVRAV TVRFV TVRVV	WLI	
•	•		•		•				•	

Construction Upgrades

APC	PE
•	•

Door Options

ALF	CG	CG.BTM	CG.TOP	DPSRR	MD	MD.BTM	MD.TOP	MFO
•	•			•				•

WALL REFRIGERATOR SINGLE or DOUBLE DOOR, 18" HIGH, 24" DEEP

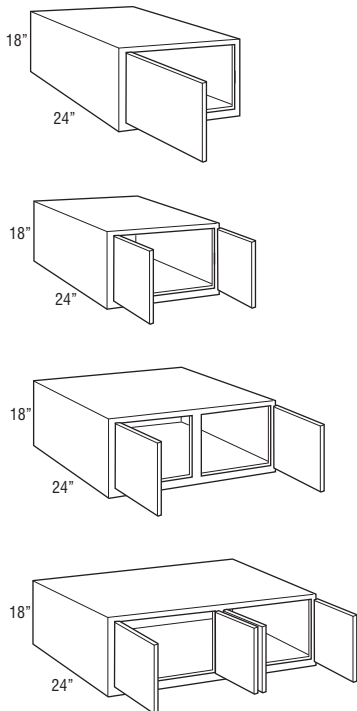

W241824 L or R	7.8
W241824	7.8
W271824	8.5
W301824	9.7
W331824	10.6
W341824	10.6
W361824	11.6
W371824	11.5
W391824	12.6
W421824	13.4
W451824	14.1
W481824CS	15.2
W481824	15.2

- 24" deep cabinets must be fully supported by screws installed in a structural member in the ceiling or soffit, and into adjacent cabinets.
- Load limit is 15 lbs. per square foot of load bearing surface.

Custom Modifications

ADDTK	AUTHL AUTHR	CBO	CCO	CFNTO	CFRMO	CND	EXBKL EXBKR	EXL EXR	FB	FFDL FFDR
•	•		•	•	•		•	•	•	•
FPEB	ID	INVRM	MIP	P	PFINBTMB	RD	TD	TVRAV TVRFV TVRVV	WLI	
•			•		•	•	•*		•	

*Not available on 39", 42", 45", and 48" wide

Construction Upgrades

APC	PE
•	•

Door Options

ALF	CG	CG.BTM	CG.TOP	DPSRR	MD	MD.BTM	MD.TOP	MFO
	•			•	•†			•

†Available only on 30" and 36" wide

**WALL TOP HINGE REFRIGERATOR,
18" HIGH, 24" DEEP**

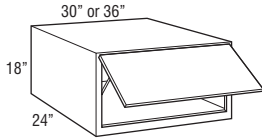

Model	Cubic Feet
WTH301824	9.7
WTH361824	10.6

- Utilizes doors from 30" and 36" high wall cabinets. Grain on center panels and slab doors will run horizontally and door rail configuration on non-miter doors will be unique from adjacent cabinet doors. Genova will have standard vertical grain pattern. Troxel will have standard horizontal grain pattern.
- Not available on Lynnville.
- When ordered in Arch/Cathedral door styles, door will be Square.
- 24" deep cabinets must be fully supported by screws installed in a structural member in the ceiling or soffit, and into adjacent cabinets.
- Load limit is 15 lbs. per square foot of load bearing surface.
- Art Glass not available.
- Cabinet may utilize one or two lift mechanisms depending on door size and weight. Door lift mechanism tension can be field adjusted.
- Depth can be reduced to a minimum of 9".
- Door will open a maximum of 107° due to hinges. For applications close to a ceiling, door angle can be restricted to 86° with a Hinge Angle Restriction Clip (HINGERESCLIP, see page 418).
- Lift mechanisms and mounting brackets will be visible if used with transparent textured glass.
- Lift mechanism not available for order for field installation, only available factory installed.

Custom Modifications

ADDTK	AUTHL AUTHR	CBO	CCO	CFNTO	CFRMO	CND	EXBKL EXBKR	EXL EXR	FB	FFDL FFDR
	•		•		•		•	•	•	
FPEB	ID	INVFRM	MIP	P	PFINBTMB	RD	TD	TVRAV TVRFV TVRVV	WLI	
•			•		•	•	•		•	

Construction Upgrades

APC	PE
•	•

Door Options

ALF	CG	CG.BTM	CG.TOP	DPSRR	MD	MD.BTM	MD.TOP	MFO
•	•			•				•

**WALL REFRIGERATOR VERTICAL LIFT,
18" HIGH, 24" DEEP**

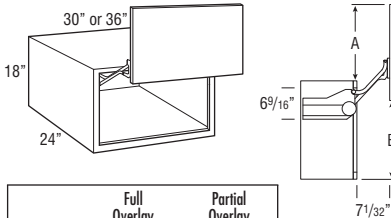

	Full Overlay	Partial Overlay
A	16 13/16"	16 1/16"
B	17 5/16"	18 1/16"

Model	Cubic Feet
WVL301824	9.4
WVL361824	11.2

- Utilizes doors from 30" and 36" high wall cabinets. Grain on center panels and slab doors will run horizontally and door rail configuration on non-miter doors will be unique from adjacent cabinet doors. Genova will have standard vertical grain pattern. Troxel will have standard horizontal grain pattern.
- Decorative hardware required.
- See side view drawing for required clearances.
- Lift mechanism features a single motion for up and out movement with Smart Stop, tension can be field adjusted.
- Lift mechanisms and mounting brackets will be visible if used with transparent textured glass.
- Lift mechanism not available for order for field installation, only available factory installed.
- Hardware extends 1" into opening on each side.
- Art Glass not available.
- Not available on Lynnville.
- When ordered in Arch/Cathedral door styles, door will be Square.
- Depth can be reduced to a minimum of 12".

Custom Modifications

ADDTK	AUTHL AUTHR	CBO	CCO	CFNTO	CFRMO	CND	EXBKL EXBKR	EXL EXR	FB	FFDL FFDR
	•		•		•		•	•	•	
FPEB	ID	INVFRM	MIP	P	PFINBTMB	RD	TD	TVRAV TVRFV TVRVV	WLI	
•			•		•	•	•		•	

Construction Upgrades

APC	PE
•	•

Door Options

ALF	CG	CG.BTM	CG.TOP	DPSRR	MD	MD.BTM	MD.TOP	MFO
•	•			•				•

**WALL REFRIGERATOR PULL-OUT,
18" HIGH, 24" DEEP**

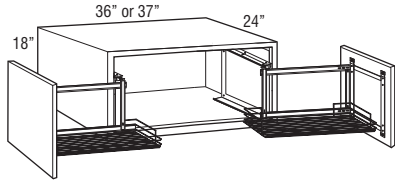

W361824PO L or R
W371824PO L or R
W361824PO
W371824PO

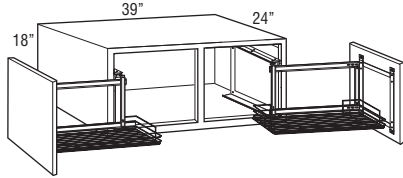

W391824PO L or R
W391824PO

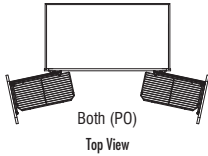
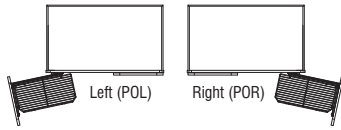

WALL SINGLE DOOR, 21" HIGH

12", 15", 18", 21", or 24"

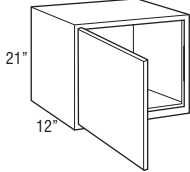

Model	Cubic Feet
W361824PO L or R	11.2
W371824PO L or R	11.5
W361824PO	11.2
W371824PO	11.5
W391824PO L or R	12.6
W391824PO	12.6

- Door-mounted pull-out with a chrome wire rack that extends fully to the front of the cabinet then opens to the side for easy accessibility to contents. Designed for use above refrigerators or other high applications. Smart Stop not included.
- Available installed in either the left side, right side, or both sides.
- For sufficient pull-out clearance, 13 1/8" of adjacent space is required for door to open fully when installed near a wall or corner.
- Chrome rack is 10" wide and 20 13/16" deep.
- 24" deep cabinets must be fully supported by screws installed in a structural member in the ceiling or soffit, and into adjacent cabinets.
- Load limit is 15 lbs. per square foot of load bearing surface.

Custom Modifications

ADDTK	AUTHL AUTHR	CBO	CCO	CFNTO	CFRMO	CND	EXBKL EXBKR	EXL EXR	FB	FFDL FFDR
•	•	•			•		•	•	•	
FPFB	ID	INVFRM	MIP	P	PFINBTMB	RD	TD	TVRAV TVRFV TVRVV	WLI	
•			•		•				•	

Construction Upgrades

APC	PE
•	•

Door Options

ALF	CG	CG.BTM	CG.TOP	DPSRR	MD	MD.BTM	MD.TOP	MFO
				•				•

W1221 L or R	2.7
W1521 L or R	3.3
W1821 L or R	3.8
W2121 L or R	4.4
W2421 L or R	5.0

Custom Modifications

ADDTK	AUTHL AUTHR	CBO	CCO	CFNTO	CFRMO	CND	EXBKL EXBKR	EXL EXR	FB	FFDL FFDR
•	•		•	•	•		•	•	•	•
FPFB	ID	INVFRM	MIP	P	PFINBTMB	RD	TD	TVRAV TVRFV TVRVV	WLI	
•	•		•	•	•	•	•		•	

Construction Upgrades

APC	PE
•	•

Door Options

ALF	CG	CG.BTM	CG.TOP	DPSRR	MD	MD.BTM	MD.TOP	MFO
	•			•				•

WALL DOUBLE DOOR, 21" HIGH

24", 27", 30", 33", 34", 36", or 37"

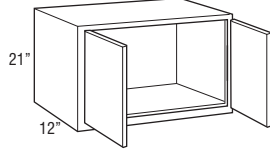

39", 42", 45", or 48"

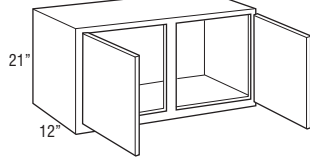

48"

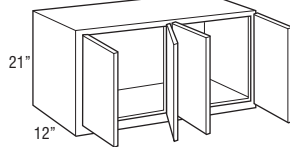

Model	Cubic Feet
W2421	5.0
W2721	5.6
W3021	5.6
W3321	6.7
W3421	6.7
W3621	7.2
W3721	7.3
W3921	7.8
W4221	8.5
W4521	8.8
W4821CS	9.7
W4821	9.7

Custom Modifications

ADDTK	AUTHL AUTHR	CBO	CCO	CFNTO	CFRMO	CND	EXBKL EXBKR	EXL EXR	FB	FFDL FFDR
•	•		•	•	•		•	•	•	•
FPFB	ID	INVERM	MIP	P	PFINBTMB	RD	TD	TVRAV TVRFV TVRVV	WLI	
•	•		•	•	•	•	•*		•	

*Not available on 39", 42", 45", and 48" wide

Construction Upgrades

APC	PE
•	•

Door Options

ALF	CG	CG.BTM	CG.TOP	DPSRR	MD	MD.BTM	MD.TOP	MFO
	•			•				•

WALL TOP HINGE, 21" HIGH

30" or 36"

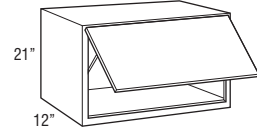

WTH3021	5.6
WTH3621	7.2

- Utilizes doors from 30" and 36" high wall cabinets. Grain on center panels and slab doors will run horizontally and door rail configuration on non-miter doors will be unique from adjacent cabinet doors. Genova will have standard vertical grain pattern. Troxel will have standard horizontal grain pattern.
- Not available on Lynnville.
- When ordered in Arch/Cathedral door styles, door will be Square.
- Art Glass not available.
- Cabinet may utilize one or two lift mechanisms depending on door size and weight. Door lift mechanism tension can be field adjusted.
- Depth can be reduced to a minimum of 9".
- Door will open a maximum of 107° due to hinges. For applications close to a ceiling, door angle can be restricted to 86° with a Hinge Angle Restriction Clip (HINGERESCLIP, see page 418).
- Lift mechanisms and mounting brackets will be visible if used with transparent textured glass.
- Lift mechanism not available for order for field installation, only available factory installed.

Custom Modifications

ADDTK	AUTHL AUTHR	CBO	CCO	CFNTO	CFRMO	CND	EXBKL EXBKR	EXL EXR	FB	FFDL FFDR
	•		•		•		•	•	•	
FPFB	ID	INVERM	MIP	P	PFINBTMB	RD	TD	TVRAV TVRFV TVRVV	WLI	
•	•		•		•	•	•		•	

Construction Upgrades

APC	PE
•	•

Door Options

ALF	CG	CG.BTM	CG.TOP	DPSRR	MD	MD.BTM	MD.TOP	MFO
•	•			•				•

WALL VERTICAL LIFT, 21" HIGH, 12" DEEP

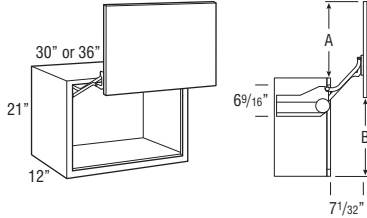

	Full Overlay	Partial Overlay
A	16 13/16"	16 1/16"
B	17 5/16"	18 1/16"

Model	Cubic Feet
WVL3021	5.9
WVL3621	7.1

- Utilizes doors from 30" and 36" high wall cabinets. Grain on center panels and slab doors will run horizontally and door rail configuration on non-miter doors will be unique from adjacent cabinet doors. Genova will have standard vertical grain pattern. Troxel will have standard horizontal grain pattern.
- Decorative hardware required.
- See side view drawing for required clearances.
- Lift mechanism features a single motion for up and out movement with Smart Stop, tension can be field adjusted.
- Lift mechanisms and mounting brackets will be visible if used with transparent textured glass.
- Lift mechanism not available for order for field installation, only available factory installed.
- Hardware extends 1" into opening on each side.
- Art Glass not available.
- Not available on Lynnvile.
- When ordered in Arch/Cathedral door styles, door will be Square.

Custom Modifications

ADDTK	AUTHL AUTHR	CBO	CCO	CFNTO	CFRMO	CND	EXBKL EXBKR	EXL EXR	FB	FFDL FFDR
	•		•		•		•	•	•	
FPEB	ID	INVRM	MIP	P	PFINBTMB	RD	TD	TVRAV TVRFV TVRVV	WLI	
•	•		•		•				•	

Construction Upgrades

APC	PE
•	•

Door Options

ALF	CG	CG.BTM	CG.TOP	DPSRR	MD	MD.BTM	MD.TOP	MFO
•	•			•				•

WALL REFRIGERATOR SINGLE or DOUBLE DOOR, 21" HIGH, 24" DEEP

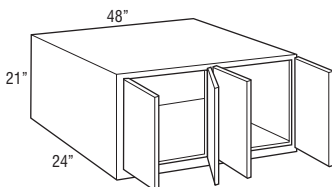
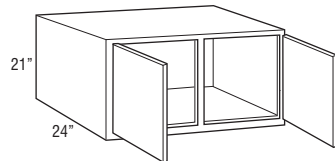
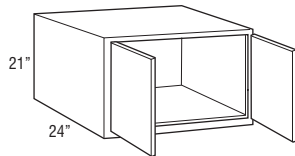
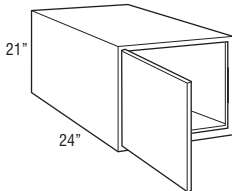

W242124 L or R	9.0
W242124	9.0
W272124	9.8
W302124	11.1
W332124	12.2
W342124	12.2
W362124	13.3
W372124	13.3
W392124	14.3
W422124	15.2
W452124	16.3
W482124CS	17.3
W482124	17.3

- 24" deep cabinets must be fully supported by screws installed in a structural member in the ceiling or soffit, and into adjacent cabinets.
- Load limit is 15 lbs. per square foot of load bearing surface.

Custom Modifications

ADDTK	AUTHL AUTHR	CBO	CCO	CFNTO	CFRMO	CND	EXBKL EXBKR	EXL EXR	FB	FFDL FFDR
•	•		•	•	•		•	•	•	•
FPEB	ID	INVRM	MIP	P	PFINBTMB	RD	TD	TVRAV TVRFV TVRVV	WLI	
•			•		•	•	•*		•	

*Not available on 39", 42", 45", and 48" wide

Construction Upgrades

APC	PE
•	•

Door Options

ALF	CG	CG.BTM	CG.TOP	DPSRR	MD	MD.BTM	MD.TOP	MFO
	•			•				•

**WALL TOP HINGE REFRIGERATOR,
21" HIGH, 24" DEEP**

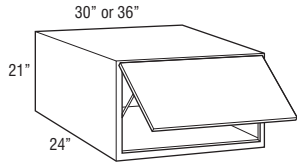

Model	Cubic Feet
WTH302124	11.1
WTH362124	13.3

- Utilizes doors from 30" and 36" high wall cabinets. Grain on center panels and slab doors will run horizontally and door rail configuration on non-miter doors will be unique from adjacent cabinet doors. Genova will have standard vertical grain pattern. Troxel will have standard horizontal grain pattern.
- Not available on Lynnville.
- When ordered in Arch/Cathedral door styles, door will be Square.
- 24" deep cabinets must be fully supported by screws installed in a structural member in the ceiling or soffit, and into adjacent cabinets.
- Load limit is 15 lbs. per square foot of load bearing surface.
- Art Glass not available.
- Cabinet may utilize one or two lift mechanisms depending on door size and weight. Door lift mechanism tension can be field adjusted.
- Depth can be reduced to a minimum of 9".
- Door will open a maximum of 107° due to hinges. For applications close to a ceiling, door angle can be restricted to 86° with a Hinge Angle Restriction Clip (HINGERESCLIP, see page 418).
- Lift mechanisms and mounting brackets will be visible if used with transparent textured glass.
- Lift mechanism not available for order for field installation, only available factory installed.

Custom Modifications

ADDTK	AUTHL AUTHR	CBO	CCO	CFNTO	CFRMO	CND	EXBKL EXBKR	EXL EXR	FB	FFDL FFDR
	•		•		•		•	•	•	
FPFB	ID	INVFRM	MIP	P	PFINBTMB	RD	TD	TVRAV TVRFV TVRVV	WLI	
•			•		•	•	•		•	

Construction Upgrades

APC	PE
•	•

Door Options

ALF	CG	CG.BTM	CG.TOP	DPSRR	MD	MD.BTM	MD.TOP	MFO
•	•			•				•

**WALL REFRIGERATOR VERTICAL LIFT,
21" HIGH, 24" DEEP**

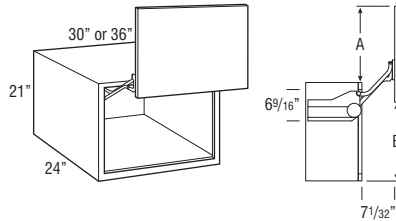

	Full Overlay	Partial Overlay
A	16 13/16"	16 1/16"
B	17 5/16"	18 1/16"

Model	Cubic Feet
WVL302124	10.9
WVL362124	12.9

- Utilizes doors from 30" and 36" high wall cabinets. Grain on center panels and slab doors will run horizontally and door rail configuration on non-miter doors will be unique from adjacent cabinet doors. Genova will have standard vertical grain pattern. Troxel will have standard horizontal grain pattern.
- Decorative hardware required.
- See side view drawing for required clearances.
- Lift mechanism features a single motion for up and out movement with Smart Stop, tension can be field adjusted.
- Lift mechanisms and mounting brackets will be visible if used with transparent textured glass.
- Lift mechanism not available for order for field installation, only available factory installed.
- Hardware extends 1" into opening on each side.
- Art Glass not available.
- Not available on Lynnville.
- When ordered in Arch/Cathedral door styles, door will be Square.
- Depth can be reduced to a minimum of 12".

Custom Modifications

ADDTK	AUTHL AUTHR	CBO	CCO	CFNTO	CFRMO	CND	EXBKL EXBKR	EXL EXR	FB	FFDL FFDR
	•		•		•		•	•	•	•
FPFB	ID	INVFRM	MIP	P	PFINBTMB	RD	TD	TVRAV TVRFV TVRVV	WLI	
•	•		•		•	•	•		•	

Construction Upgrades

APC	PE
•	•

Door Options

ALF	CG	CG.BTM	CG.TOP	DPSRR	MD	MD.BTM	MD.TOP	MFO
•	•			•				•

WALL REFRIGERATOR PULL-OUT, 21" HIGH, 24" DEEP

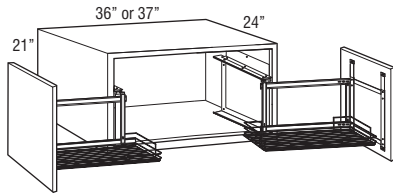

W362124PO L or R
W372124PO L or R
W362124PO
W372124PO

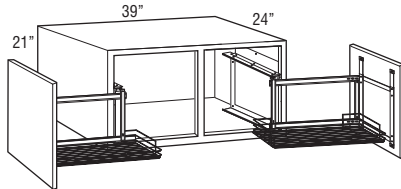

W392124PO L or R
W392124PO

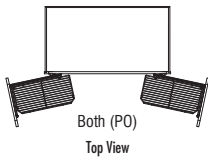
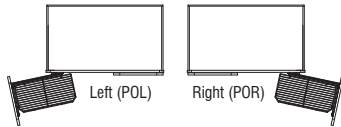

Model	Cubic Feet
W362124PO L or R	13.3
W372124PO L or R	13.3
W362124PO	13.3
W372124PO	13.3
W392124PO L or R	14.3
W392124PO	14.3

- Door-mounted pull-out with a chrome wire rack that extends fully to the front of the cabinet then opens to the side for easy accessibility to contents. Designed for use above refrigerators or other high applications. Smart Stop not included.
- Available installed in either the left side, right side, or both sides.
- For sufficient pull-out clearance, 13 1/8" of adjacent space is required for door to open fully when installed near a wall or corner.
- Chrome rack is 10" wide and 20 13/16" deep.
- 24" deep cabinets must be fully supported by screws installed in a structural member in the ceiling or soffit, and into adjacent cabinets.
- Load limit is 15 lbs. per square foot of load bearing surface.

Custom Modifications

ADDTK	AUTHL AUTHR	CBO	CCO	CFNTO	CFRMO	CND	EXBKL EXBKR	EXL EXR	FB	FFDL FFDR
•	•		•		•		•	•		
FPFB	ID	INVFRM	MIP	P	PFINBTMB	RD	TD	TVRAV TVRFV TVRVV	WLI	
•			•		•				•	

Construction Upgrades

APC	PE
•	•

Door Options

ALF	CG	CG.BTM	CG.TOP	DPSRR	MD	MD.BTM	MD.TOP	MFO
				•				•

WALL SINGLE DOOR, 24" HIGH

12", 15", 18", 21", or 24"

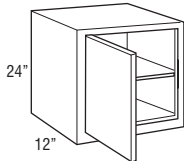

W1224 L or R	3.0
W1524 L or R	3.6
W1824 L or R	4.2
W2124 L or R	4.3
W2424 L or R	5.5

Custom Modifications

ADDTK	AUTHL AUTHR	CBO	CCO	CFNTO	CFRMO	CND	EXBKL EXBKR	EXL EXR	FB	FFDL FFDR
•	•	•	•	•	•		•	•	•	•
FPFB	ID	INVFRM	MIP	P	PFINBTMB	RD	TD	TVRAV TVRFV TVRVV	WLI	
•	•		•	•	•	•	•		•	

Construction Upgrades

APC	PE
•	•

Door Options

ALF	CG	CG.BTM	CG.TOP	DPSRR	MD	MD.BTM	MD.TOP	MFO
	•			•				•

WALL DOUBLE DOOR, 24" HIGH

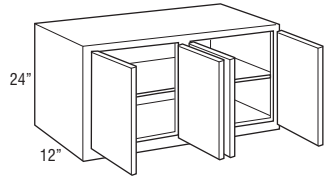
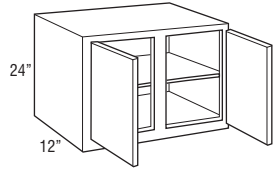
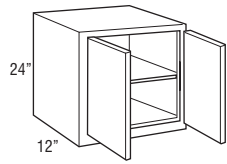

Model	Cubic Feet
W2424	5.5
W2724	6.1
W3024	6.8
W3324	7.4
W3424	7.6
W3624	8.0
W3724	8.2
W3924	8.6
W4224	9.3
W4524	9.9
W4824CS	10.5
W4824	10.5

Custom Modifications

ADDTK	AUTHL AUTHR	CBO	CCO	CFNTO	CFRMO	CND	EXBKL EXBKR	EXL EXR	FB	FFDL FFDR
•	•	•	•	•	•		•	•	•	•
FPEB	ID	INVERM	MIP	P	PFINBTMB	RD	TD	TVRAV TVRFV TVRVV	WLI	
•	•		•	•	•	•	•*		•	

*Not available on 39", 42", 45", and 48" wide

Construction Upgrades

APC	PE
•	•

Door Options

ALF	CG	CG.BTM	CG.TOP	DPSRR	MD	MD.BTM	MD.TOP	MFO
	•			•	• [†]			•

[†]Available only on 30" and 36" wide

WALL REFRIGERATOR SINGLE or DOUBLE DOOR, 24" HIGH, 24" DEEP

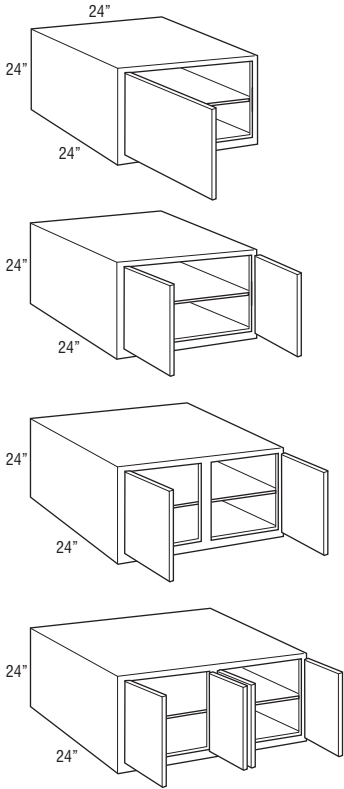

Model	Cubic Feet
W242424 L or R	10.5
W242424	10.5
W272424	10.9
W302424	12.4
W332424	13.6
W342424	13.9
W362424	14.7
W372424	15.1
W392424	15.9
W422424	17.1
W452424	18.4
W482424CS	19.6
W482424	19.6

- 24" deep cabinets must be fully supported by screws installed in a structural member in the ceiling or soffit, and into adjacent cabinets.
- Load limit is 15 lbs. per square foot of load bearing surface.

Custom Modifications

ADDTK	AUTHL AUTHR	CBO	CCO	CFNTO	CFRMO	CND	EXBKL EXBKR	EXL EXR	FB	FFDL FFDR
•	•	•	•	•	•		•	•	•	•
FPEB	ID	INVRM	MIP	P	PFINBTMB	RD	TD	TVRAV TVRFV TVRVV	WLI	
•			•		•	•	•*		•	

*Not available on 39", 42", 45", and 48" wide

Construction Upgrades

APC	PE
•	•

Door Options

ALF	CG	CG.BTM	CG.TOP	DPSRR	MD	MD.BTM	MD.TOP	MFO
	•			•	•†			•

†Available only on 30" and 36" wide

**WALL REFRIGERATOR PULL-OUT,
24" HIGH, 24" DEEP**

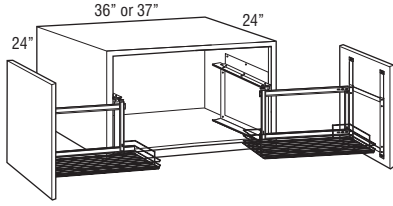

W362424PO L or R
W372424PO L or R
W362424PO
W372424PO

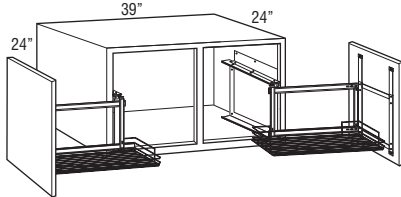

W392424PO L or R
W392424PO

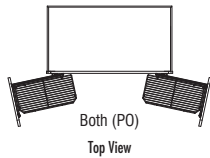
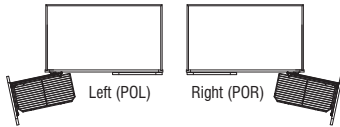

Model	Cubic Feet
W362424PO L or R	14.7
W372424PO L or R	15.1
W362424PO	14.7
W372424PO	15.1
W392424PO L or R	15.9
W392424PO	15.9

- Door-mounted pull-out with a chrome wire rack that extends fully to the front of the cabinet then opens to the side for easy accessibility to contents. Designed for use above refrigerators or other high applications. Smart Stop not included.
- Available installed in either the left side, right side, or both sides.
- For sufficient pull-out clearance, 13 1/8" of adjacent space is required for door to open fully when installed near a wall or corner.
- Chrome rack is 10" wide and 20 13/16" deep.
- 24" deep cabinets must be fully supported by screws installed in a structural member in the ceiling or soffit, and into adjacent cabinets.
- Load limit is 15 lbs. per square foot of load bearing surface.

Custom Modifications

ADDTK	AUTHL AUTHR	CBO	CCO	CFNT0	CFRMO	CND	EXBKL EXBKR	EXL EXR	FB	FFDL FFDR
•	•		•		•		•	•	•	
FPEB	ID	INVERM	MIP	P	PFINBTMB	RD	TD	TVRAV TVRFV TVRVV	WLI	
•			•		•				•	

Construction Upgrades

APC	PE
•	•

Door Options

ALF	CG	CG.BTM	CG.TOP	DPSRR	MD	MD.BTM	MD.TOP	MFO
				•				•

WALL SINGLE DOOR, 27" HIGH

12", 15", 18", 21", or 24"

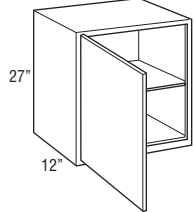

W1227 L or R	3.4
W1527 L or R	4.1
W1827 L or R	4.9
W2127 L or R	5.6
W2427 L or R	6.3

Custom Modifications

ADDTK	AUTHL AUTHR	CBO	CCO	CFNT0	CFRMO	CND	EXBKL EXBKR	EXL EXR	FB	FFDL FFDR
•	•	•	•	•	•		•	•	•	•
FPEB	ID	INVERM	MIP	P	PFINBTMB	RD	TD	TVRAV TVRFV TVRVV	WLI	
•	•		•	•	•	•	•		•	

Construction Upgrades

APC	PE
•	•

Door Options

ALF	CG	CG.BTM	CG.TOP	DPSRR	MD	MD.BTM	MD.TOP	MFO
	•			•				•

WALL DOUBLE DOOR, 27" HIGH

24", 27", 30", 33", 34", 36", or 37"

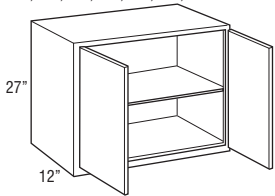

39", 42", 45", or 48"

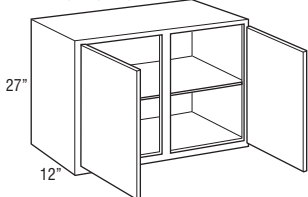

48"

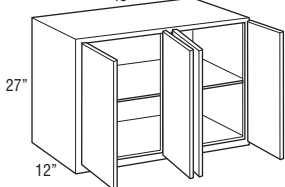

Model	Cubic Feet
W2427	6.3
W2727	7.1
W3027	7.8
W3327	8.5
W3427	8.5
W3627	9.3
W3727	9.2
W3927	10.0
W4227	10.7
W4527	11.0
W4827CS	12.2
W4827	12.2

Custom Modifications

ADDTK	AUTHL AUTHR	CBO	CCO	CFNTO	CFRMO	CND	EXBKL EXBKR	EXL EXR	FB	FFDL FFDR
•	•	•	•	•	•		•	•	•	•
FPEB	ID	INVERM	MIP	P	PFINBTMB	RD	TD	TVRAV TVRFV TVRVV	WLI	
•	•		•	•	•	•	•*		•	

*Not available on 39", 42", 45", and 48" wide

Construction Upgrades

APC	PE
•	•

Door Options

ALF	CG	CG.BTM	CG.TOP	DPSRR	MD	MD.BTM	MD.TOP	MFO
	•			•				•

WALL REFRIGERATOR SINGLE or DOUBLE DOOR, 27" HIGH, 24" DEEP

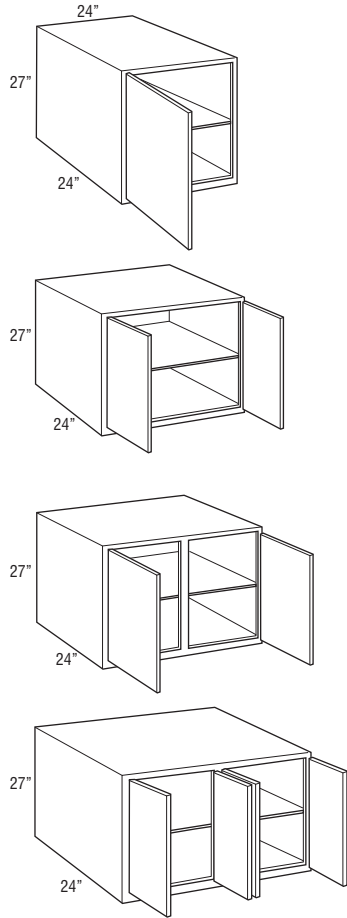

Model	Cubic Feet
W242724 L or R	11.3
W242724	11.3
W272724	12.7
W302724	14.4
W332724	15.7
W342724	15.5
W362724	17.0
W372724	16.8
W392724	18.4
W422724	19.2
NEW W452724	21.3
NEW W482724CS	22.6
NEW W482724	22.6

- 24" deep cabinets must be fully supported by screws installed in a structural member in the ceiling or soffit, and into adjacent cabinets.
- Load limit is 15 lbs. per square foot of load bearing surface.

Custom Modifications

ADDTK	AUTHL AUTHR	CBO	CCO	CFNTO	CFRMO	CND	EXBKL EXBKR	EXL EXR	FB	FFDL FFDR
•	•	•	•	•	•		•	•	•	•
FPFB	ID	INVERM	MIP	P	PFINBTMB	RD	TD	TVRAV TVRFV TVRVV	WLI	
•			•		•	•	•*		•	

*Not available on 39", 42", 45", and 48" wide

Construction Upgrades

APC	PE
•	•

Door Options

ALF	CG	CG.BTM	CG.TOP	DPSRR	MD	MD.BTM	MD.TOP	MFO
	•			•				•

WALL SINGLE DOOR, 30" HIGH

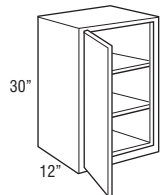

W930 L or R	2.9
W1230 L or R	3.7
W1530 L or R	4.5
W1830 L or R	5.3
W2130 L or R	6.1
W2430 L or R	6.9

- Cathedral styles in partial overlay will feature a unique raised design on 9" wide cabinets.

Custom Modifications

ADDTK	AUTHL AUTHR	CBO	CCO	CFNTO	CFRMO	CND	EXBKL EXBKR	EXL EXR	FB	FFDL FFDR
•	•	•	•	•	•		•	•	•	•
FPFB	ID	INVERM	MIP	P	PFINBTMB	RD	TD	TVRAV TVRFV TVRVV	WLI	
•	•		•	•	•	•	•		•	

Construction Upgrades

APC	PE
•	•

Door Options

ALF	CG	CG.BTM	CG.TOP	DPSRR	MD	MD.BTM	MD.TOP	MFO
•†	•			•	•‡			•

†Not available on 9" and 24" wide

‡Not available on 9" and 12" wide

WALL DOUBLE DOOR, 30" HIGH

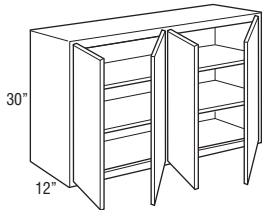
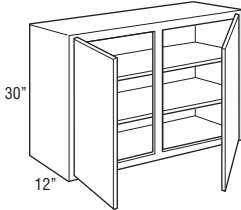
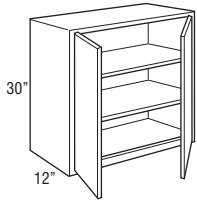

Model	Cubic Feet
W2430	6.9
W2730	7.7
W3030	8.5
W3330	9.3
W3630	10.0
W3930	10.8
W4230	11.6
W4530	12.2
W4830CS	13.2
W4830	13.2

Custom Modifications

ADDTK	AUTHL AUTHR	CBO	CCO	CFNTO	CFRMO	CND	EXBKL EXBKR	EXL EXR	FB	FFDL FFDR
•	•	•	•	•	•		•	•	•	•
FPFB	ID	INVRM	MIP	P	PFINBTMB	RD	TD	TVRAV TVRFV TVRVV	WLI	
•	•		•	•	•	•	•*		•	

*Not available on 39", 42", 45", and 48" wide

Construction Upgrades

APC	PE
•	•

Door Options

ALF	CG	CG.BTM	CG.TOP	DPSRR	MD	MD.BTM	MD.TOP	MFO
	•			•	•†			•

†Not available on 39" wide

WALL SINGLE DOOR, 33" HIGH

9", 12", 15", 18", 21", or 24"

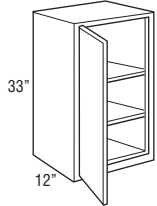

W933 L or R	3.2
W1233 L or R	4.1
W1533 L or R	5.0
W1833 L or R	5.9
W2133 L or R	6.7
W2433 L or R	7.6

• Cathedral styles in partial overlay will feature a unique raised design on 9" wide cabinets.

Custom Modifications

ADDTK	AUTHL AUTHR	CBO	CCO	CFNTO	CFRMO	CND	EXBKL EXBKR	EXL EXR	FB	FFDL FFDR
•	•	•	•	•	•		•	•	•	•
FPFB	ID	INVRM	MIP	P	PFINBTMB	RD	TD	TVRAV TVRFV TVRVV	WLI	
•	•		•	•	•	•			•	

Construction Upgrades

APC	PE
•	•

Door Options

ALF	CG	CG.BTM	CG.TOP	DPSRR	MD	MD.BTM	MD.TOP	MFO
	•			•	•†			•

†Not available on 9" and 12" wide

WALL DOUBLE DOOR, 33" HIGH

24", 27", 30", 33", or 36"

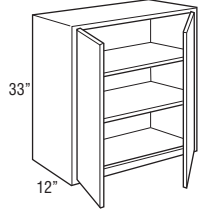

W2433
W2733
W3033
W3333
W3633

39", 42", 45", or 48"

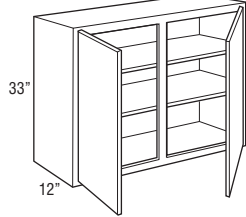

W3933
W4233
W4533
W4833CS

48"

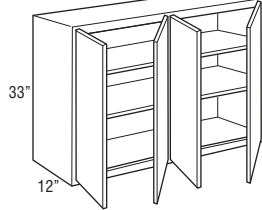

W4833

Model	Cubic Feet
W2433	7.6
W2733	8.5
W3033	9.4
W3333	10.3
W3633	11.2
W3933	12.1
W4233	13.0
W4533	13.3
W4833CS	14.8
W4833	14.8

Custom Modifications

ADDTK	AUTHL AUTHR	CBO	CCO	CFNTO	CFRMO	CND	EXBKL EXBKR	EXL EXR	FB	FFDL FFDR
•	•	•	•	•	•		•	•	•	•
FPEB	ID	INVERM	MIP	P	PFINBTMB	RD	TD	TVRAV TVRFV TVRVV	WLI	
•	•		•	•	•	•			•	

Construction Upgrades

APC	PE
•	•

Door Options

ALF	CG	CG.BTM	CG.TOP	DPSRR	MD	MD.BTM	MD.TOP	MFO
	•			•	†			•

†Not available on 39" wide

WALL SINGLE DOOR, 36" HIGH

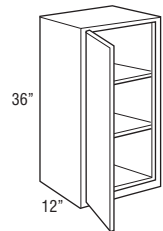

W936 L or R	3.5
W1236 L or R	4.4
W1536 L or R	5.3
W1836 L or R	6.3
W2136 L or R	7.2
W2436 L or R	8.2

• Cathedral styles in partial overlay will feature a unique raised design on 9" wide cabinets.

Custom Modifications

ADDTK	AUTHL AUTHR	CBO	CCO	CFNTO	CFRMO	CND	EXBKL EXBKR	EXL EXR	FB	FFDL FFDR
•	•	•	•	•	•		•	•	•	•
FPEB	ID	INVERM	MIP	P	PFINBTMB	RD	TD	TVRAV TVRFV TVRVV	WLI	
•	•		•	•	•	•			•	

Construction Upgrades

APC	PE
•	•

Door Options

ALF	CG	CG.BTM	CG.TOP	DPSRR	MD	MD.BTM	MD.TOP	MFO
•†	•			•	‡			•

†Not available on 9" and 24" wide

‡Not available on 9" and 12" wide

WALL DOUBLE DOOR, 36" HIGH

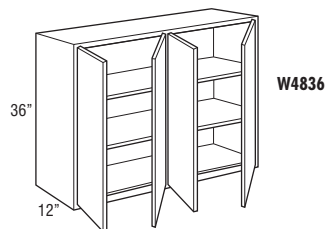
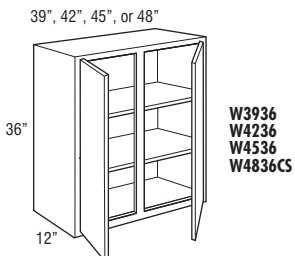
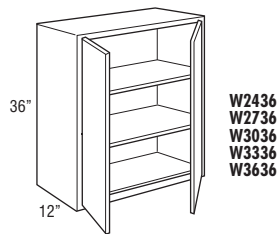

Model	Cubic Feet
W2436	8.2
W2736	9.1
W3036	10.0
W3336	11.0
W3636	11.8
W3936	11.8
W4236	13.8
W4536	14.5
W4836CS	14.5
W4836	14.5

Custom Modifications

ADDTK	AUTHL AUTHR	CBO	CCO	CFNTD	CFRMO	CND	EXBKL EXBKR	EXL EXR	FB	FFDL FFDR
•	•	•	•	•	•		•	•	•	•
FPEB	ID	INVFRM	MIP	P	PFINBTMB	RD	TD	TVRAV TVRFV TVRVV	WLI	
•	•		•	•	•	•			•	

Construction Upgrades

APC	PE
•	•

Door Options

ALF	CG	CG.BTM	CG.TOP	DPSRR	MD	MD.BTM	MD.TOP	MFO
	•			•	•†			•

†Not available on 39" wide

WALL SINGLE DOOR, 39" HIGH

9", 12", 15", 18", 21" or 24"

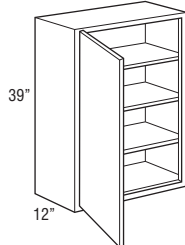

W939 L or R	3.7
W1239 L or R	4.7
W1539 L or R	5.7
W1839 L or R	6.8
W2139 L or R	7.8
W2439 L or R	8.8

• Cathedral styles in partial overlay will feature a unique raised design on 9" wide cabinets.

Custom Modifications

ADDTK	AUTHL AUTHR	CBO	CCO	CFNTD	CFRMO	CND	EXBKL EXBKR	EXL EXR	FB	FFDL FFDR
•	•	•	•	•	•		•	•	•	•
FPEB	ID	INVFRM	MIP	P	PFINBTMB	RD	TD	TVRAV TVRFV TVRVV	WLI	
•	•		•	•	•	•			•	

Construction Upgrades

APC	PE
•	•

Door Options

ALF	CG	CG.BTM	CG.TOP	DPSRR	MD	MD.BTM	MD.TOP	MFO
	•			•	•†			•

†Not available on 9" and 12" wide

WALL DOUBLE DOOR, 39" HIGH

24", 27", 30", 33", or 36"

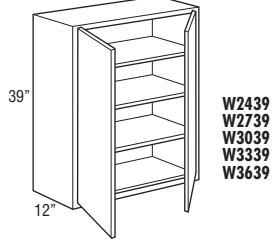

W2439
W2739
W3039
W3339
W3639

39", 42", 45", or 48"

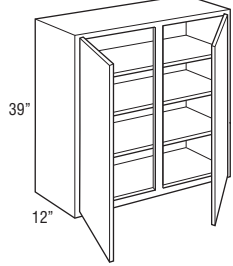

W3939
W4239
W4539
W4839CS

48"

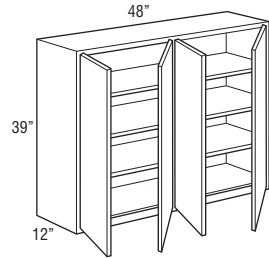

W4839

Model	Cubic Feet
W2439	8.2
W2739	9.1
W3039	10.0
W3339	11.0
W3639	11.9
W3939	11.8
W4239	13.8
W4539	15.6
W4839CS	16.9
W4839	16.9

Custom Modifications

ADDTK	AUTHL AUTHR	CBO	CCO	CFNTO	CFRMO	CND	EXBKL EXBKR	EXL EXR	FB	FFDL FFDR
•	•	•	•	•	•		•	•	•	•
FPEB	ID	INVERM	MIP	P	PFINBTMB	RD	TD	TVRAV TVRFV TVRVV	WLI	
•	•		•	•	•	•			•	

Construction Upgrades

APC	PE
•	•

Door Options

ALF	CG	CG.BTM	CG.TOP	DPSRR	MD	MD.BTM	MD.TOP	MFO
	•			•	• [†]			•

[†]Not available on 39" wide

WALL SINGLE DOOR, 42" HIGH

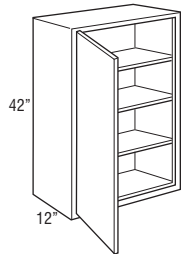

W942 L or R	4.0
W1242 L or R	5.1
W1542 L or R	6.2
W1842 L or R	7.3
W2142 L or R	8.3
W2442 L or R	9.4

• Cathedral styles in partial overlay will feature a unique raised design on 9" wide cabinets.

Custom Modifications

ADDTK	AUTHL AUTHR	CBO	CCO	CFNTO	CFRMO	CND	EXBKL EXBKR	EXL EXR	FB	FFDL FFDR
•	•	•	•	•	•		•	•	•	•
FPEB	ID	INVERM	MIP	P	PFINBTMB	RD	TD	TVRAV TVRFV TVRVV	WLI	
•	•		•	•	•	•			•	

Construction Upgrades

APC	PE
•	•

Door Options

ALF	CG	CG.BTM	CG.TOP	DPSRR	MD	MD.BTM	MD.TOP	MFO
	•			•	• [†]			•

[†]Not available on 9" and 12" wide

WALL DOUBLE DOOR, 42" HIGH

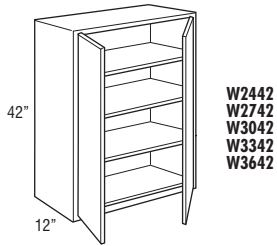

W2442
W2742
W3042
W3342
W3642

39", 42", 45", or 48"

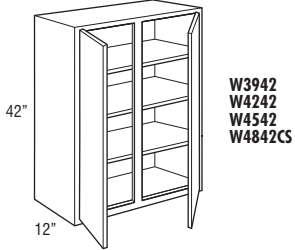

W3942
W4242
W4542
W4842CS

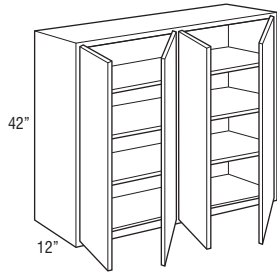

W4842

Model	Cubic Feet
W2442	9.4
W2742	10.4
W3042	11.5
W3342	12.6
W3642	13.7
W3942	14.8
W4242	15.9
W4542	17.0
W4842CS	18.1
W4842	18.1

Custom Modifications

ADDTK	AUTHL AUTHR	CBO	CCO	CFNTO	CFRMO	CND	EXBKL EXBKR	EXL EXR	FB	FFDL FFDR
•	•	•	•	•	•		•	•	•	•
FPEB	ID	INVFRM	MIP	P	PFINBTMB	RD	TD	TVRAV TVRFV TVRVV	WLI	
•	•		•	•	•	•			•	

Construction Upgrades

APC	PE
•	•

Door Options

ALF	CG	CG.BTM	CG.TOP	DPSRR	MD	MD.BTM	MD.TOP	MFO
	•			•	†			•

†Not available on 39" wide

WALL EASY ACCESS STORAGE CABINET, 30" HIGH

storage
SOLUTIONS

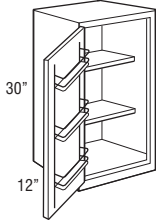

WEAS1530 L or R
WEAS1830 L or R

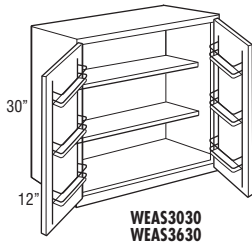

WEAS3030
WEAS3630

WEAS1530 L or R	4.5
WEAS1830 L or R	5.3
WEAS3030	8.5
WEAS3630	10.0

- Adjustable shelves are 7 1/2" deep.
- Each door features a chrome and wood three-tiered rack.
- Door rack width is 10 7/8" on 15" and 30" wide cabinets.
- Door rack width is 13 7/8" on 18" and 36" wide cabinets.
- Door rack depth is 3 1/2".

Custom Modifications

ADDTK	AUTHL AUTHR	CBO	CCO	CFNTO	CFRMO	CND	EXBKL EXBKR	EXL EXR	FB	FFDL FFDR
•	•	•	•	•	•		•	•	•	
FPEB	ID	INVFRM	MIP	P	PFINBTMB	RD	TD	TVRAV TVRFV TVRVV	WLI	
•			•		•				•	

Construction Upgrades

APC	PE
•	•

Door Options

ALF	CG	CG.BTM	CG.TOP	DPSRR	MD	MD.BTM	MD.TOP	MFO
				•				•

**WALL TWO DRAWER CABINET,
18" HIGH, 12" DEEP**

12", 15", 18", 21", 24",
27", 30", 33", or 36"

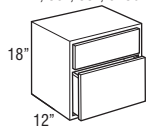

Model	Cubic Feet
W2D1218	2.2
W2D1518	2.7
W2D1818	3.2
W2D2118	3.8
W2D2418	4.3
W2D2718	4.7
W2D3018	5.2
W2D3318	5.6
W2D3618	6.1

- Drawer front to face frame reveal is justified to the top to be consistent with both full and partial overlay. Bottom reveal is 1" for both full and partial overlay.

Custom Modifications

ADTK	AUTHL AUTHR	CBO	CCO	CFNTO	CFRMO	CND	EXBKL EXBKR	EXL EXR	FB	FFDL FFDR
•	•	•	•		•		•	•	•	
FPEB	ID	INVERM	MIP	P	PFINBTMB	RD	TD	TVRAV TVRFV TVRVV	WLI	
•	•		•							

Construction Upgrades

APC	PE
•	•

Door Options

ALF	CG	CG.BTM	CG.TOP	DPSRR	MD	MD.BTM	MD.TOP	MFO

**WALL TWO DRAWER SINGLE DOOR
CABINET, 48", 51", 54", 57",
or 60" HIGH, 12" DEEP**

15", 18", or 24"

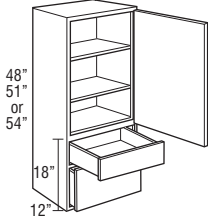

27" Frame
Opening
Height for 48"

W2D1548 L or R
W2D1848 L or R
W2D2448 L or R

30" Frame
Opening
Height for 51"

W2D1551 L or R
W2D1851 L or R
W2D2451 L or R

33" Frame
Opening
Height for 54"

W2D1554 L or R
W2D1854 L or R
W2D2454 L or R

15", 18", or 24"

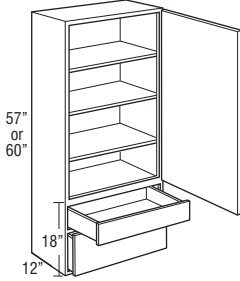

36" Frame
Opening
Height for
57"

W2D1557 L or R
W2D1857 L or R
W2D2457 L or R

39" Frame
Opening

W2D1560 L or R
W2D1860 L or R
W2D2460 L or R

Model	Cubic Feet
W2D1548 L or R	6.5
W2D1848 L or R	7.8
W2D2448 L or R	10.4
W2D1551 L or R	7.5
W2D1851 L or R	8.9
W2D2451 L or R	11.6
W2D1554 L or R	7.2
W2D1854 L or R	8.5
W2D2454 L or R	11.1
W2D1557 L or R	7.5
W2D1857 L or R	8.9
W2D2457 L or R	11.7
W2D1560 L or R	7.9
W2D1860 L or R	9.4
W2D2460 L or R	12.3

- Drawer front to face frame reveal is justified to the top to be consistent with both full and partial overlay. Bottom reveal is 1" for both full and partial overlay.

Custom Modifications

ADDTK	AUTHL AUTHR	CBO	CCO	CFNTO	CFRMO	CND	EXBKL EXBKR	EXL EXR	FB	FFDL FFDR
•	•	•	•		•	•	•	•	•	
FPEB	ID	INVFRM	MIP	P	PFINBTMB	RD	TD	TVRAV TVRFV TVRVV	WLI	
•	•		•						•	

Construction Upgrades

APC	PE
•	•

Door Options

ALF	CG	CG.BTM	CG.TOP	DPSRR	MD	MD.BTM	MD.TOP	MFO
	•			•	•			•

WALL TWO DRAWER DOUBLE DOOR CABINET , 48", 51", 54", 57", or 60" HIGH, 12" DEEP

24", 27", 30", 33", or 36"

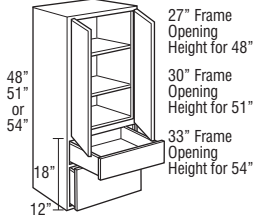

- 27" Frame Opening Height for 48" **W2D2448**
- W2D2748**
- W2D3048**
- W2D3348**
- W2D3648**
- 30" Frame Opening Height for 51" **W2D2451**
- W2D2751**
- W2D3051**
- W2D3351**
- W2D3651**
- 33" Frame Opening Height for 54" **W2D2454**
- W2D2754**
- W2D3054**
- W2D3354**
- W2D3654**

24", 27", 30", 33", or 36"

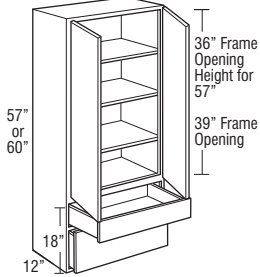

- 36" Frame Opening Height for 57" **W2D2457**
- W2D2757**
- W2D3057**
- W2D3357**
- W2D3657**
- 39" Frame Opening **W2D2460**
- W2D2760**
- W2D3060**
- W2D3360**
- W2D3660**

Model	Cubic Feet
W2D2448	10.4
W2D2748	11.8
W2D3048	13.1
W2D3348	14.3
W2D3648	15.6
W2D2451	11.6
W2D2751	12.6
W2D3051	13.9
W2D3351	15.2
W2D3651	16.5
W2D2454	11.1
W2D2754	13.3
W2D3054	14.7
W2D3354	16.1
W2D3654	17.5
W2D2457	11.7
W2D2757	14.0
W2D3057	15.5
W2D3357	16.9
W2D3657	18.4
W2D2460	12.3
W2D2760	14.7
W2D3060	16.3
W2D3360	17.8
W2D3660	19.4

• Drawer front to face frame reveal is justified to the top to be consistent with both full and partial overlay. Bottom reveal is 1" for both full and partial overlay.

Custom Modifications

ADDTK	AUTHL AUTHR	CBO	CCO	CFNTO	CFRMO	CND	EXBKL EXBKR	EXL EXR	FB	FFDL FFDR
•	•	•	•		•	•	•	•	•	
								TVRAV TVRFV TVRVV		
FPEB	ID	INVFRM	MIP	P	PFINBTMB	RD	TD		WLI	
•	•		•						•	

Construction Upgrades

APC	PE
•	•

Door Options

ALF	CG	CG.BTM	CG.TOP	DPSRR	MD	MD.BTM	MD.TOP	MFO
	•			•	•			•

**WALL THREE DRAWER SINGLE DOOR,
48", 51", 54", 57", or 60" HIGH**

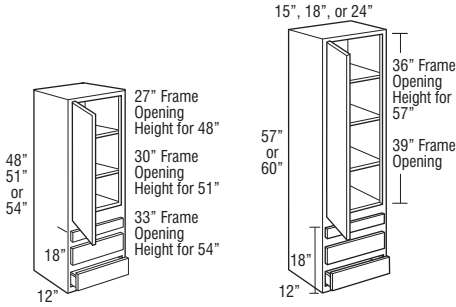

W3D1548 L or R
W3D1848 L or R
W3D2448 L or R

W3D1551 L or R
W3D1851 L or R
W3D2451 L or R

W3D1554 L or R
W3D1854 L or R
W3D2454 L or R

W3D1557 L or R
W3D1857 L or R
W3D2457 L or R

W3D1560 L or R
W3D1860 L or R
W3D2460 L or R

Model	Cubic Feet
W3D1548 L or R	6.5
W3D1848 L or R	7.8
W3D2448 L or R	10.4
W3D1551 L or R	7.5
W3D1851 L or R	8.9
W3D2451 L or R	11.6
W3D1554 L or R	7.2
W3D1854 L or R	8.5
W3D2454 L or R	11.1
W3D1557 L or R	8.3
W3D1857 L or R	9.7
W3D2457 L or R	12.7
W3D1560 L or R	7.9
W3D1860 L or R	9.4
W3D2460 L or R	12.3

- Includes one shallow depth drawer and two standard drawers.
- Top drawer will be slab drawer front for all 5-piece drawer and Drawer Front Raised applications.
- Drawer front to face frame reveal is justified to the top to be consistent with both full and partial overlay. Bottom reveal is 1" for both full and partial overlay.

Custom Modifications

ADDTK	AUTHL AUTHR	CBO	CCO	CFNTD	CFRMO	CND	EXBKL EXBKR	EXL EXR	FB	FFDL FFDR
•	•	•	•		•	•	•	•	•	
FPEB	ID	INVFRM	MIP	P	PFINBTMB	RD	TD	TVRAV TVRFV TVRVV	WLI	
•	•		•						•	

Construction Upgrades

APC	PE
•	•

Door Options

ALF	CG	CG.BTM	CG.TOP	DPSRR	MD	MD.BTM	MD.TOP	MFO
	•			•	•			•

WALL THREE DRAWER DOUBLE DOOR, 48", 51", 54", 57", or 60" HIGH

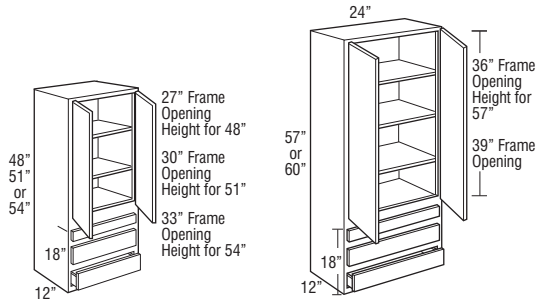

W3D2448
W3D2451
W3D2454

W3D2457
W3D2460

Model	Cubic Feet
W3D2448	10.4
W3D2451	11.6
W3D2454	11.1
W3D2457	12.7
W3D2460	12.3

- Includes one shallow depth drawer and two standard drawers.
- Top drawer will be slab drawer front for all 5-piece drawer and Drawer Front Raised applications.
- Drawer front to face frame reveal is justified to the top to be consistent with both full and partial overlay. Bottom reveal is 1" for both full and partial overlay.

Custom Modifications

ADDTK	AUTHL AUTHR	CBO	CCO	CFNTO	CFRMO	CND	EXBKL EXBKR	EXL EXR	FB	FFDL FFDR
•	•	•	•		•	•	•	•	•	
FPFB	ID	INVERM	MIP	P	PFINBTMB	RD	TD	TVRAV TVRFV TVRVV	WLI	
•	•		•						•	

Construction Upgrades

APC	PE
•	•

Door Options

ALF	CG	CG.BTM	CG.TOP	DPSRR	MD	MD.BTM	MD.TOP	MFO
	•			•	•			•

STACKED WALL CABINETS SINGLE DOOR, 48" HIGH

12", 15", 18", 21", or 24"

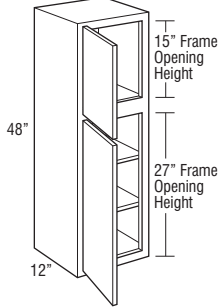

STW1248 L or R	5.8
STW1548 L or R	7.0
STW1848 L or R	8.3
STW2148 L or R	9.5
STW2448 L or R	10.7

- Bottom doors will always be square.

Custom Modifications

ADDTK	AUTHL AUTHR	CBO	CCO	CFNTO	CFRMO	CND	EXBKL EXBKR	EXL EXR	FB	FFDL FFDR
•	•	•	•	•	•		•	•	•	•
FPFB	ID	INVERM	MIP	P	PFINBTMB	RD	TD	TVRAV TVRFV TVRVV	WLI	
•	•	•	•	•		•	•		•	

Construction Upgrades

APC	PE
•	•

Door Options

ALF	CG	CG.BTM	CG.TOP	DPSRR	MD	MD.BTM	MD.TOP	MFO
		•	•	•		• [†]	• [†]	•

[†]Not available on 12", 21", and 24" wide

STACKED WALL CABINETS DOUBLE DOOR, 48" HIGH

24", 27", 30", 33", or 36"

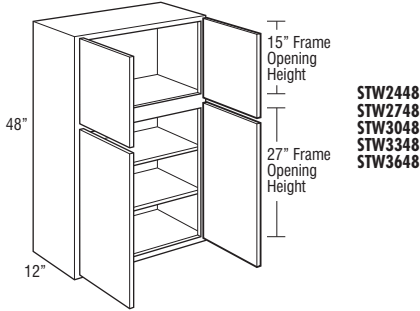

39", 42", 45", or 48"

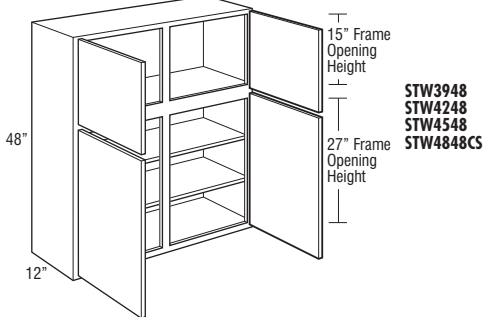

48"

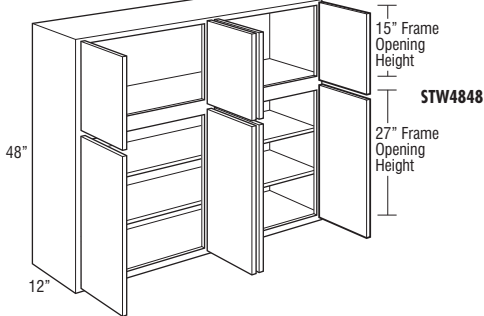

Model	Cubic Feet
STW2448	10.7
STW2748	12.0
STW3048	13.2
STW3348	14.4
STW3648	15.7
STW3948	16.9
STW4248	18.1
STW4548	19.0
STW4848CS	20.6
STW4848	20.6

- Bottom doors will always be square.

Custom Modifications

ADDTK	AUHL AUTHR	CBO	CCO	CFNT0	CFRMO	CND	EXBKL EXBKR	EXL EXR	FB	FFDL FFDR
•	•	•	•	•	•		•	•	•	•
FPEB	ID	INVRM	MIP	P	PFINBTMB	RD	TD	TVRAV TVRFV TVRVV	WLI	
•	•	•	•	•*		•	•*		•	

*Not available on 39", 42", 45", and 48" wide

Construction Upgrades

APC	PE
•	•

Door Options

ALF	CG	CG.BTM	CG.TOP	DPSRR	MD	MD.BTM	MD.TOP	MFO
		•	•	•		•†	•†	•

†Available only on 30" and 36" wide

STACKED WALL CABINETS SINGLE DOOR, 51" HIGH

12", 15", 18", 21", or 24"

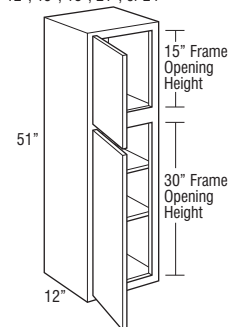

STW1251 L or R	6.2
STW1515 L or R	7.5
STW1851 L or R	8.9
STW2151 L or R	10.2
STW2451 L or R	11.6

- Bottom doors will always be square.

Custom Modifications

ADDTK	AUHL AUTHR	CBO	CCO	CFNT0	CFRMO	CND	EXBKL EXBKR	EXL EXR	FB	FFDL FFDR
•	•	•	•	•	•		•	•	•	•
FPEB	ID	INVRM	MIP	P	PFINBTMB	RD	TD	TVRAV TVRFV TVRVV	WLI	
•	•	•	•	•		•	•		•	

Construction Upgrades

APC	PE
•	•

Door Options

ALF	CG	CG.BTM	CG.TOP	DPSRR	MD	MD.BTM	MD.TOP	MFO
		•	•	•		•†	•†	•

†Not available on 12", 21", and 24" wide

STACKED WALL CABINETS DOUBLE DOOR, 51" HIGH

24", 27", 30", 33", or 36"

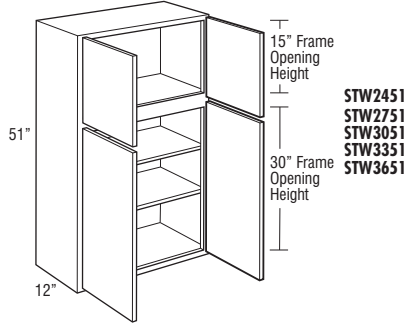

39", 42", 45", or 48"

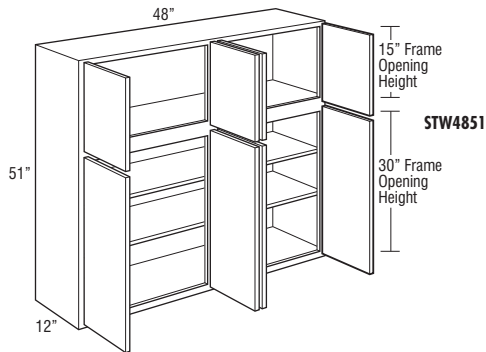
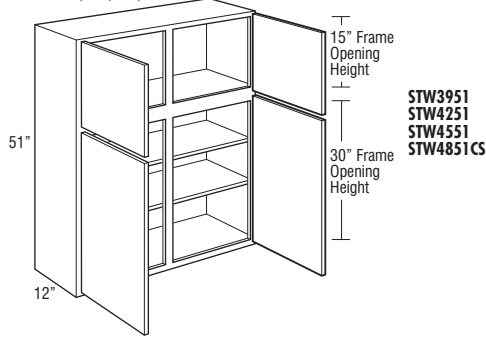

Model	Cubic Feet
STW2451	11.6
STW2751	12.9
STW3051	14.3
STW3351	15.6
STW3651	17.0
STW3951	18.3
STW4251	19.7
STW4551	20.2
STW4851CS	22.4
STW4851	22.4

• Bottom doors will always be square.

Custom Modifications

ADDTK	AUTHL AUTHR	CBO	CCO	CFNTO	CFRMO	CND	EXBKL EXBKR	EXL EXR	FB	FFDL FFDR
•	•	•	•	•	•		•	•	•	•
								TVRAV TVRFV TVRVV	WLI	
•	•	•	•	•*		•	•*		•	

*Not available on 39", 42", 45", and 48" wide

Construction Upgrades

APC	PE
•	•

Door Options

ALF	CG	CG.BTM	CG.TOP	DPSRR	MD	MD.BTM	MD.TOP	MFO
		•	•	•		•†	•†	•

†Available only on 30" and 36" wide

STACKED WALL CABINETS SINGLE DOOR, 54" HIGH

12", 15", 18", 21", or 24"

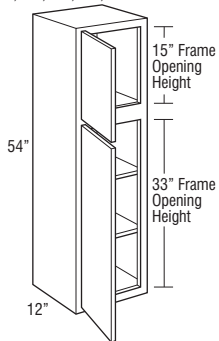

STW1254 L or R	6.5
STW1554 L or R	7.9
STW1854 L or R	9.3
STW2154 L or R	10.6
STW2454 L or R	12.0

• Bottom doors will always be square.

Custom Modifications

ADDTK	AUTHL AUTHR	CBO	CCO	CFNTO	CFRMO	CND	EXBKL EXBKR	EXL EXR	FB	FFDL FFDR
•	•	•	•	•	•		•	•	•	•
								TVRAV TVRFV TVRVV	WLI	
•	•	•	•	•		•	•		•	

Construction Upgrades

APC	PE
•	•

Door Options

ALF	CG	CG.BTM	CG.TOP	DPSRR	MD	MD.BTM	MD.TOP	MFO
		•	•	•		•†	•†	•

†Not available on 12", 21", and 24" wide

STACKED WALL CABINETS DOUBLE DOOR, 54" HIGH

24", 27", 30", 33", or 36"

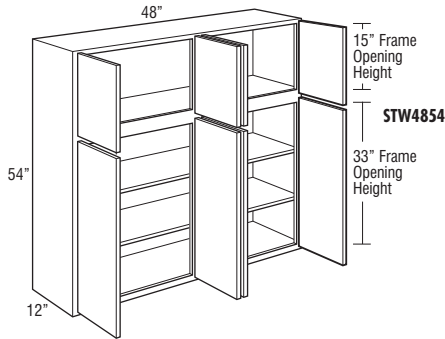
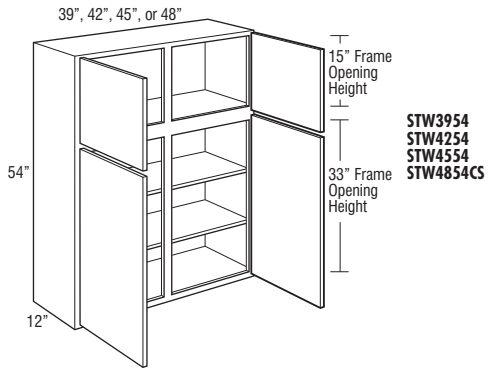
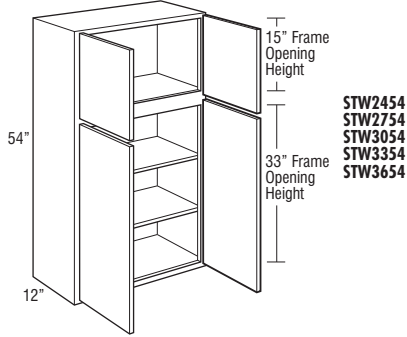

Model	Cubic Feet
STW2454	12.0
STW2754	13.4
STW3054	14.8
STW3354	16.2
STW3654	17.5
STW3954	18.9
STW4254	20.4
STW4554	21.3
STW4854CS	25.9
STW4854	25.9

- Bottom doors will always be square.

Custom Modifications

ADDTK	AUHL AUTHR	CBO	CCO	CFNTD	CFRMO	CND	EXBKL EXBKR	EXL EXR	FB	FFDL FFDR
•	•	•	•	•	•		•	•	•	•
FPEB	ID	INVRM	MIP	P	PFINBTMB	RD	TD	TVRAV TVRFV TVRVV	WLI	
•	•	•	•	•*		•	•*		•	

*Not available on 39", 42", 45", and 48" wide

Construction Upgrades

APC	PE
•	•

Door Options

ALF	CG	CG.BTM	CG.TOP	DPSRR	MD	MD.BTM	MD.TOP	MFO
		•	•	•		•†	•†	•

†Available only on 30" and 36" wide

STACKED WALL CABINETS SINGLE DOOR, 57" HIGH

12", 15", 18", 21", or 24"

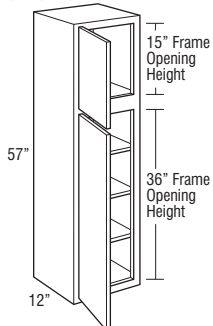

STW1257 L or R	6.8
STW1557 L or R	8.3
STW1857 L or R	9.4
STW2157 L or R	11.2
STW2457 L or R	12.7

- Bottom doors will always be square.

Custom Modifications

ADDTK	AUHL AUTHR	CBO	CCO	CFNTD	CFRMO	CND	EXBKL EXBKR	EXL EXR	FB	FFDL FFDR
•	•	•	•	•	•		•	•	•	•
FPEB	ID	INVRM	MIP	P	PFINBTMB	RD	TD	TVRAV TVRFV TVRVV	WLI	
•	•	•	•	•		•	•		•	

Construction Upgrades

APC	PE
•	•

Door Options

ALF	CG	CG.BTM	CG.TOP	DPSRR	MD	MD.BTM	MD.TOP	MFO
		•	•	•		• ^j	• [†]	•

†Not available on 12", 21", and 24" wide

STACKED WALL CABINETS DOUBLE DOOR, 57" HIGH

24", 27", 30", 33", or 36"

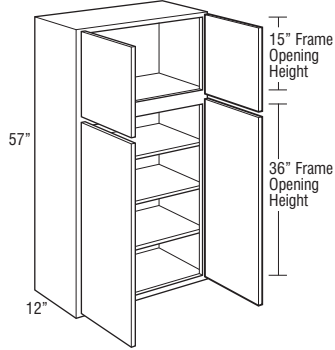

STW2457
STW2757
STW3057
STW3357
STW3657

39", 42", 45", or 48"

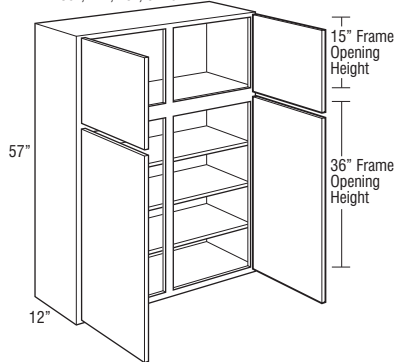

STW3957
STW4257
STW4557
STW4857CS

48"

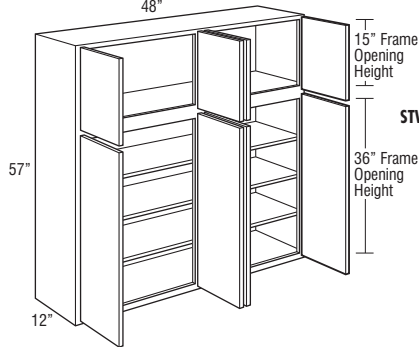

STW4857

Model	Cubic Feet
STW2457	12.7
STW2757	14.2
STW3057	15.6
STW3357	17.1
STW3657	18.5
STW3957	20.0
STW4257	21.4
STW4557	22.5
STW4857CS	24.3
STW4857	24.3

• Bottom doors will always be square.

Custom Modifications

ADDTK	AUTHL AUTHR	CBO	CCO	CFNT0	CFRMO	CND	EXBKL EXBKR	EXL EXR	FB	FFDL FFDR
•	•	•	•	•	•		•	•	•	•
FPEB	ID	INVERM	MIP	P	PFINBTMB	RD	TD	TVRAV TVRFV TVRVV	WLI	
•	•	•	•	•*		•	•*		•	

*Not available on 39", 42", 45", and 48" wide

Construction Upgrades

APC	PE
•	•

Door Options

ALF	CG	CG.BTM	CG.TOP	DPSRR	MD	MD.BTM	MD.TOP	MFO
		•	•	•		•†	•†	•

†Available only on 30" and 36" wide

STACKED WALL CABINETS SINGLE DOOR, 60" HIGH

12", 15", 18", 21", or 24"

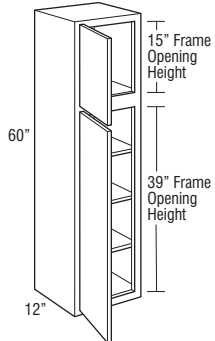

STW1260 L or R	7.2
STW1560 L or R	8.7
STW1860 L or R	10.2
STW2160 L or R	11.8
STW2460 L or R	13.3

• Bottom doors will always be square.

Custom Modifications

ADDTK	AUTHL AUTHR	CBO	CCO	CFNT0	CFRMO	CND	EXBKL EXBKR	EXL EXR	FB	FFDL FFDR
•	•	•	•	•	•		•	•	•	•
FPEB	ID	INVERM	MIP	P	PFINBTMB	RD	TD	TVRAV TVRFV TVRVV	WLI	
•	•	•	•	•		•	•		•	

Construction Upgrades

APC	PE
•	•

Door Options

ALF	CG	CG.BTM	CG.TOP	DPSRR	MD	MD.BTM	MD.TOP	MFO
		•	•	•		•†	•†	•

†Not available on 12", 21", and 24" wide

STACKED WALL CABINETS DOUBLE DOOR, 60" HIGH

24", 27", 30", 33", or 36"

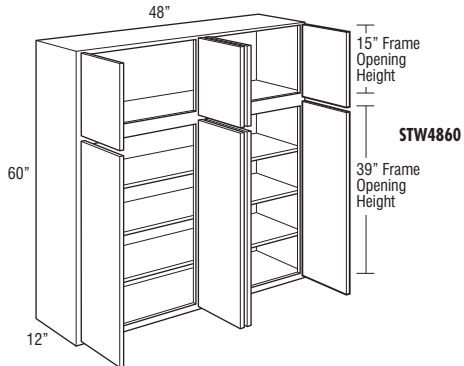
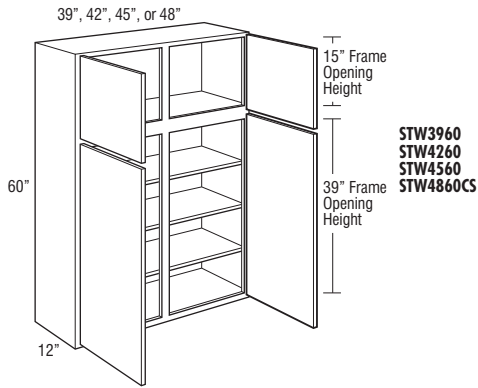
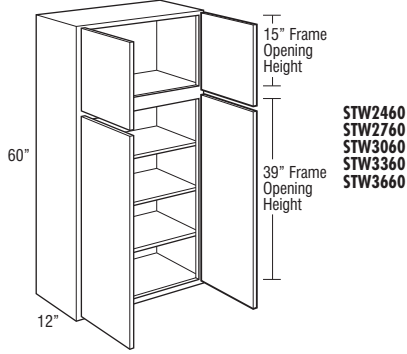

Model	Cubic Feet
STW2460	13.3
STW2760	14.9
STW3060	16.4
STW3360	17.9
STW3660	19.4
STW3960	21.0
STW4260	22.5
STW4560	23.6
STW4860CS	31.7
STW4860	31.7

• Bottom doors will always be square.

Custom Modifications

ADDTK	AUTHL AUTHR	CBO	CCO	CFNTO	CFRMO	CND	EXBKL EXBKR	EXL EXR	FB	FFDL FFDR
•	•	•	•	•	•		•	•	•	•
FPEB	ID	INVFRM	MIP	P	PFINBTMB	RD	TD	TVRAV TVRFV TVRVV	WLI	
•	•	•	•	•*		•	•*		•	

*Not available on 39", 42", 45", and 48" wide

Construction Upgrades

APC	PE
•	•

Door Options

ALF	CG	CG.BTM	CG.TOP	DPSRR	MD	MD.BTM	MD.TOP	MFO
		•	•	•		•†	•†	•

†Available only on 30" and 36" wide

Wall Corner Cabinets

- Wall corner cabinets may be installed flush to the wall (left) or pulled up to 3" away from wall (right) to accommodate odd dimensions in a kitchen design. In either case, the adjoining run of 12" wall cabinets plus a 3" filler will butt against the solid wood panel.
- When a cabinet is "pulled" it will use proportionally more wall space, for example, a 30" wide WC pulled 2" will use 32" of space.
- The L or R in the cabinet's nomenclature indicates the location of cabinet void.
- Blind side of wall corner cabinets cannot be installed next to a range hood or microwave shelf unit due to door interference.

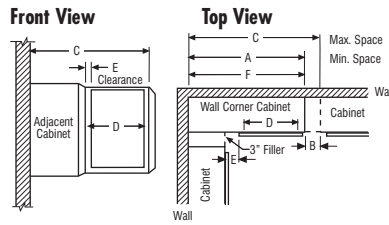

NOTE: All outside stiles are 1 1/2" wide

Model	A Min. Space	B Max. Pull*	C Max. Space	D Cabinet Opening	E* Full Overlay		E Partial Overlay		F Actual Cabinet
					At Min.	At Max.	At Min.	At Max.	
WC24..	24"	5"	29"	7 1/2"	1 3/4"	6 3/4"	2 1/2"	7 1/2"	24"
WC27..	27"	4 1/2"	31 1/2"	9"	3 1/4"	7 3/4"	4"	8 1/2"	27"
WC30..	30"	5"	35"	13 1/2"	1 3/4"	6 3/4"	2 1/2"	7 1/2"	30"
WC33..	33"	4 1/2"	37 1/2"	15"	3 1/4"	7 3/4"	4"	8 1/2"	33"
WC36..	36"	5"	41"	19 1/2"	1 3/4"	6 3/4"	2 1/2"	7 1/2"	36"
WC39..	39"	4 1/2"	43 1/2"	21"	3 1/4"	7 3/4"	4"	8 1/2"	39"
WC42..	42"	4 1/2"	46 1/2"	24"	3 1/4"	7 3/4"	4"	8 1/2"	42"
WC45..	45"	4 1/2"	49 1/2"	27"	3 1/4"	7 3/4"	4"	8 1/2"	45"
WC48..	48"	4 1/2"	52 1/2"	30"	3 1/4"	7 3/4"	4"	8 1/2"	48"

*Minimum/maximum space between inside edge of door and face of filler/adjoining cabinet.
If cabinet is pulled to maximum stated dimension, filler will need to be cleated for proper attachment.

WALL CORNER SINGLE DOOR, 24" HIGH

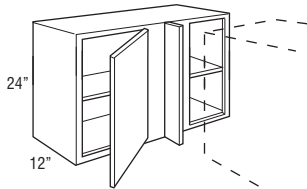

Model	Cubic Feet
WC2424 L or R	5.5
WC2724 L or R	6.1
WC3024 L or R	6.8

- Face Frame and Door on End modification not available on the void side of the cabinet.
- Includes one 3" filler, shipped unattached.
- L or R indicates void. R (right) void shown.

Custom Modifications

ADDTK	AUTHL AUTHR	CBO	CCO	CFNTO	CFRMO	CND	EXBKL EXBKR	EXL EXR	FB	FFDL FFDR
•	•	•	•	•	•		•	•	•	•
FPFB	ID	INVERM	MIP	P	PFINBTMB	RD	TD	TVRAV TVRFV TVRVV	WLI	
•	•		•	•	•	•			•	

Construction Upgrades

APC	PE
•	•

Door Options

ALF	CG	CG.BTM	CG.TOP	DPSRR	MD	MD.BTM	MD.TOP	MFO
	•			•				•

**WALL CORNER SINGLE DOOR,
30" HIGH**

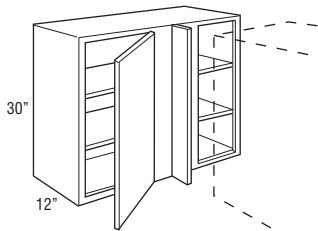

Model	Cubic Feet
WC2430 L or R	6.9
WC2730 L or R	7.7
WC3030 L or R	8.5
WC3330 L or R	9.5
WC3630 L or R	10.0

- Face Frame and Door on End modification not available on the void side of the cabinet.
- Includes one 3" filler, shipped unattached.
- L or R indicates void. R (right) void shown.

Custom Modifications

ADDTK	AUTHL AUTHR	CBO	CCO	CFNTO	CFRMO	CND	EXBKL EXBKR	EXL EXR	FB	FFDL FFDR
•	•	•	•	•	•		•	•	•	•
FPEB	ID	INVFRM	MIP	P	PFINBTMB	RD	TD	TVRAV TVRFV TVRVV	WLI	
•	•		•	•	•	•			•	

Construction Upgrades

APC	PE
•	•

Door Options

ALF	CG	CG.BTM	CG.TOP	DPSRR	MD	MD.BTM	MD.TOP	MFO
	•			•	•†			•

†Available only on 33" and 36" wide

**WALL CORNER DOUBLE DOOR,
30" HIGH**

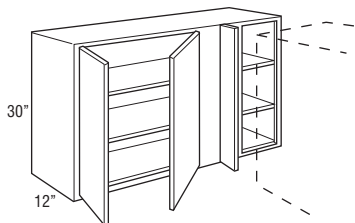

WC3930 L or R	10.3
WC4230 L or R	11.6
WC4530 L or R	12.2
WC4830 L or R	13.2

- Face Frame and Door on End modification not available on the void side of the cabinet.
- Includes one 3" filler, shipped unattached.
- L or R indicates void. R (right) void shown.
- WC3930 Peninsula and Mullion Door options cannot be ordered together due to the unavailability of Mullion Doors for the W3930 side.

Custom Modifications

ADDTK	AUTHL AUTHR	CBO	CCO	CFNTO	CFRMO	CND	EXBKL EXBKR	EXL EXR	FB	FFDL FFDR
•	•	•	•	•	•		•	•	•	•
FPEB	ID	INVFRM	MIP	P	PFINBTMB	RD	TD	TVRAV TVRFV TVRVV	WLI	
•	•		•	•	•	•			•	

Construction Upgrades

APC	PE
•	•

Door Options

ALF	CG	CG.BTM	CG.TOP	DPSRR	MD	MD.BTM	MD.TOP	MFO
	•			•	•			•

**WALL CORNER SINGLE DOOR,
33" HIGH**

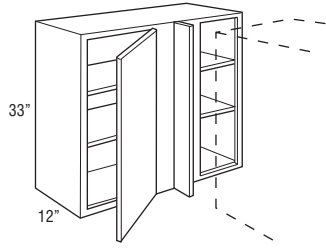

Model	Cubic Feet
WC2433 L or R	7.6
WC2733 L or R	8.5
WC3033 L or R	9.4
WC3333 L or R	10.3
WC3633 L or R	11.2

- Face Frame and Door on End modification not available on the void side of the cabinet.
- Includes one 3" filler, shipped unattached.
- L or R indicates void. R (right) void shown.

Custom Modifications

ADDTK	AUTHL AUTHR	CBO	CCO	CFNTD	CFRMO	CND	EXBKL EXBKR	EXL EXR	FB	FFDL FFDR
•	•	•	•	•	•		•	•	•	•
FPEB	ID	INVFRM	MIP	P	PFINBTMB	RD	TD	TVRAV TVRFV TVRVV	WLI	
•	•		•	•	•	•			•	

Construction Upgrades

APC	PE
•	•

Door Options

ALF	CG	CG.BTM	CG.TOP	DPSRR	MD	MD.BTM	MD.TOP	MFO
	•			•	• [†]			•

[†]Available only on 33" and 36" wide

**WALL CORNER DOUBLE DOOR,
33" HIGH**

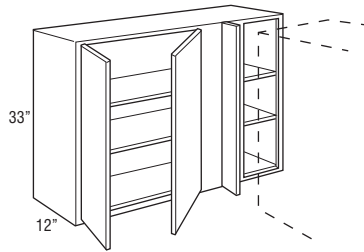

WC3933 L or R	11.7
WC4233 L or R	12.6
WC4533 L or R	13.5
WC4833 L or R	14.3

- Face Frame and Door on End modification not available on the void side of the cabinet.
- Includes one 3" filler, shipped unattached.
- L or R indicates void. R (right) void shown.
- WC3933 Peninsula and Mullion Door options cannot be ordered together due to the unavailability of Mullion Doors for the W3933 side.

Custom Modifications

ADDTK	AUTHL AUTHR	CBO	CCO	CFNTD	CFRMO	CND	EXBKL EXBKR	EXL EXR	FB	FFDL FFDR
•	•	•	•	•	•		•	•	•	•
FPEB	ID	INVFRM	MIP	P	PFINBTMB	RD	TD	TVRAV TVRFV TVRVV	WLI	
•	•		•	•	•	•			•	

Construction Upgrades

APC	PE
•	•

Door Options

ALF	CG	CG.BTM	CG.TOP	DPSRR	MD	MD.BTM	MD.TOP	MFO
	•			•	•			•

**WALL CORNER SINGLE DOOR,
36" HIGH**

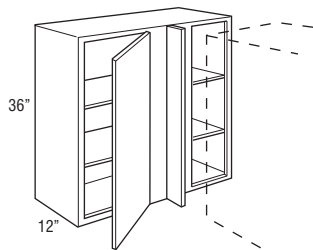

Model	Cubic Feet
WC2436 L or R	8.2
WC2736 L or R	9.1
WC3036 L or R	10.0
WC3336 L or R	11.1
WC3636 L or R	11.9

- Face Frame and Door on End modification not available on the void side of the cabinet.
- Includes one 3" filler, shipped unattached.
- L or R indicates void. R (right) void shown.

Custom Modifications

ADDTK	AUTHL AUTHR	CBO	CCO	CFNTO	CFRMO	CND	EXBKL EXBKR	EXL EXR	FB	FFDL FFDR
•	•	•	•	•	•		•	•	•	•
FPEB	ID	INVFRM	MIP	P	PFINBTMB	RD	TD	TVRAV TVRFV TVRVV	WLI	
•	•		•	•	•	•			•	

Construction Upgrades

APC	PE
•	•

Door Options

ALF	CG	CG.BTM	CG.TOP	DPSRR	MD	MD.BTM	MD.TOP	MFO
	•			•	•†			•

†Available only on 33" and 36" wide

**WALL CORNER DOUBLE DOOR,
36" HIGH**

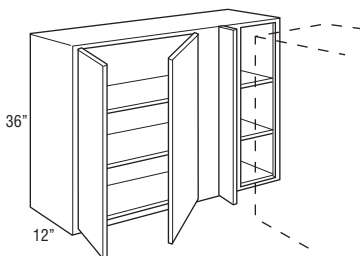

WC3936 L or R	12.7
WC4236 L or R	13.7
WC4536 L or R	14.6
WC4836 L or R	15.6

- Face Frame and Door on End modification not available on the void side of the cabinet.
- Includes one 3" filler, shipped unattached.
- L or R indicates void. R (right) void shown.
- WC3936 Peninsula and Mullion Door options cannot be ordered together due to the unavailability of Mullion Doors for the W3936 side.

Custom Modifications

ADDTK	AUTHL AUTHR	CBO	CCO	CFNTO	CFRMO	CND	EXBKL EXBKR	EXL EXR	FB	FFDL FFDR
•	•	•	•	•	•		•	•	•	•
FPEB	ID	INVFRM	MIP	P	PFINBTMB	RD	TD	TVRAV TVRFV TVRVV	WLI	
•	•		•	•	•	•			•	

Construction Upgrades

APC	PE
•	•

Door Options

ALF	CG	CG.BTM	CG.TOP	DPSRR	MD	MD.BTM	MD.TOP	MFO
	•			•	•			•

**WALL CORNER SINGLE DOOR,
39" HIGH**

24", 27", 30", 33", or 36"

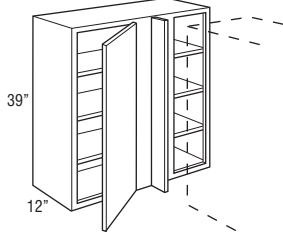

Model	Cubic Feet
WC2439 L or R	8.8
WC2739 L or R	9.8
WC3039 L or R	10.8
WC3339 L or R	11.8
WC3639 L or R	12.5

- Face Frame and Door on End modification not available on the void side of the cabinet.
- Includes one 3" filler, shipped unattached.
- L or R indicates void. R (right) void shown.

Custom Modifications

ADDTK	AUTHL AUTHR	CBO	CCO	CFNT0	CFRMO	CND	EXBKL EXBKR	EXL EXR	FB	FFDL FFDR
•	•	•	•	•	•		•	•	•	•
FPEB	ID	INVFRM	MIP	P	PFINBTMB	RD	TD	TVRAV TVRFV TVRVV	WLI	
•	•		•	•	•	•			•	

Construction Upgrades

APC	PE
•	•

Door Options

ALF	CG	CG.BTM	CG.TOP	DPSRR	MD	MD.BTM	MD.TOP	MFO
	•			•	• [†]			•

[†]Available only on 33" and 36" wide

**WALL CORNER DOUBLE DOOR,
39" HIGH**

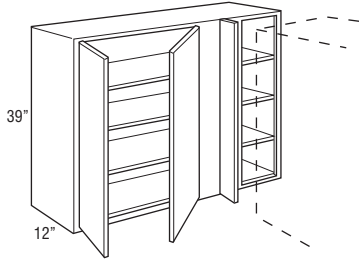

WC3939 L or R	13.8
WC4239 L or R	14.8
WC4539 L or R	15.8
WC4839 L or R	16.8

- Face Frame and Door on End modification not available on the void side of the cabinet.
- Includes one 3" filler, shipped unattached.
- L or R indicates void. R (right) void shown.
- WC3939 Peninsula and Mullion Door options cannot be ordered together due to the unavailability of Mullion Doors for the W3939 side.

Custom Modifications

ADDTK	AUTHL AUTHR	CBO	CCO	CFNT0	CFRMO	CND	EXBKL EXBKR	EXL EXR	FB	FFDL FFDR
•	•	•	•	•	•		•	•	•	•
FPEB	ID	INVFRM	MIP	P	PFINBTMB	RD	TD	TVRAV TVRFV TVRVV	WLI	
•	•		•	•	•	•			•	

Construction Upgrades

APC	PE
•	•

Door Options

ALF	CG	CG.BTM	CG.TOP	DPSRR	MD	MD.BTM	MD.TOP	MFO
	•			•	•			•

**WALL CORNER SINGLE DOOR,
42" HIGH**

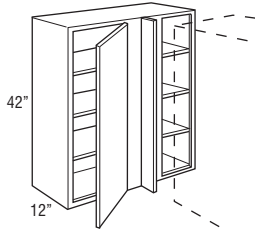

Model	Cubic Feet
WC2442 L or R	9.4
WC2742 L or R	10.5
WC3042 L or R	11.6
WC3342 L or R	12.7
WC3642 L or R	13.8

- Face Frame and Door on End modification not available on the void side of the cabinet.
- Includes one 3" filler, shipped unattached.
- L or R indicates void. R (right) void shown.

Custom Modifications

ADDTK	AUTHL AUTHR	CBO	CCO	CFNTO	CFRMO	CND	EXBKL EXBKR	EXL EXR	FB	FFDL FFDR
•	•	•	•	•	•		•	•	•	•
FPEB	ID	INVFRM	MIP	P	PFINBTMB	RD	TD	TVRAV TVRFV TVRVV	WLI	
•	•		•	•	•	•			•	

Construction Upgrades

APC	PE
•	•

Door Options

ALF	CG	CG.BTM	CG.TOP	DPSRR	MD	MD.BTM	MD.TOP	MFO
	•			•	•†			•

†Available only on 33" and 36" wide

**WALL CORNER DOUBLE DOOR,
42" HIGH**

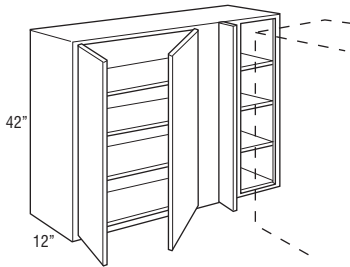

WC3942 L or R	14.8
WC4242 L or R	15.9
WC4542 L or R	17.0
WC4842 L or R	18.1

- Face Frame and Door on End modification not available on the void side of the cabinet.
- Includes one 3" filler, shipped unattached.
- L or R indicates void. R (right) void shown.
- WC3942 Peninsula and Mullion Door options cannot be ordered together due to the unavailability of Mullion Doors for the W3942 side.

Custom Modifications

ADDTK	AUTHL AUTHR	CBO	CCO	CFNTO	CFRMO	CND	EXBKL EXBKR	EXL EXR	FB	FFDL FFDR
•	•	•	•	•	•		•	•	•	•
FPEB	ID	INVFRM	MIP	P	PFINBTMB	RD	TD	TVRAV TVRFV TVRVV	WLI	
•	•		•	•	•	•			•	

Construction Upgrades

APC	PE
•	•

Door Options

ALF	CG	CG.BTM	CG.TOP	DPSRR	MD	MD.BTM	MD.TOP	MFO
	•			•	•			•

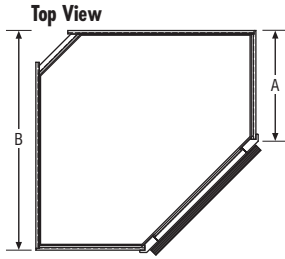

Diagonal Wall Cabinets with Increased or Reduced Depth

		RD9	RD10	RD11	STD	ID13	ID14	ID15	ID16	ID17	ID18	ID19	ID20	ID21	ID22	ID23	ID24
Cabinet Depth	A	9"	10"	11"	12"	13"	14"	15"	16"	17"	18"	19"	20"	21"	22"	23"	24"
Wall Space	B	21"	22"	23"	24"	25"	26"	27"	28"	29"	30"	31"	32"	33"	34"	35"	36"

DIAGONAL WALL, 12", 15", or 18" HIGH, 24" x 24"

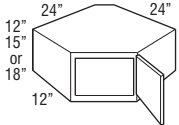

Model	Cubic Feet
DW122424 L or R	5.5
DW152424 L or R	6.7
DW182424 L or R	7.8

- Cabinets require 24" x 24" of corner wall space.
- Full overlay styles use 38NPOHINGE, see page 418.

Custom Modifications

ADDTK	AUTHL AUTHR	CBO	CCO	CFNTO	CFRMO	CND	EXBKL EXBKR	EXL EXR	FB	FFDL FFDR
	•		•	•	•				•	•*
FPEB	ID	INVERM	MIP	P	PFINBTMB	RD	TD	TVRAV TVRFV TVRVV	WLI	
•	•		•		•	•			•	

*Available only on 18" high

Construction Upgrades

APC	PE
•	•

Door Options

ALF	CG	CG.BTM	CG.TOP	DPSRR	MD	MD.BTM	MD.TOP	MFO
	•			•				•

DIAGONAL WALL, 24" or 27" HIGH, 24" x 24"

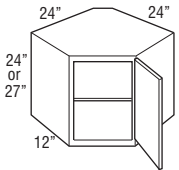

DW242424 L or R	10.2
DW272424 L or R	11.3

- Cabinets require 24" x 24" of corner wall space.
- Adjustable shelf cannot be removed/retrofitted.
- Full overlay styles use 38NPOHINGE, see page 418.

Custom Modifications

ADDTK	AUTHL AUTHR	CBO	CCO	CFNTO	CFRMO	CND	EXBKL EXBKR	EXL EXR	FB	FFDL FFDR
	•	•	•	•	•				•	•
FPEB	ID	INVERM	MIP	P	PFINBTMB	RD	TD	TVRAV TVRFV TVRVV	WLI	
•	•		•		•	•			•	

Construction Upgrades

APC	PE
•	•

Door Options

ALF	CG	CG.BTM	CG.TOP	DPSRR	MD	MD.BTM	MD.TOP	MFO
	•			•				•

**DIAGONAL WALL, 30", 33", 36", 39",
or 42" HIGH, 24" x 24"**

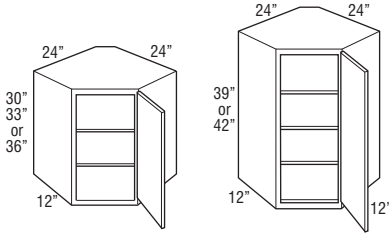

DW302424 L or R
DW332424 L or R
DW362424 L or R

DW392424 L or R
DW422424 L or R

Model	Cubic Feet
DW302424 L or R	12.5
DW332424 L or R	13.9
DW362424 L or R	14.9
DW392424 L or R	16.0
DW422424 L or R	17.2

- Cabinets require 24" x 24" of corner wall space.
- Adjustable shelves.
- Full overlay styles use 38NPOHINGE, see page 418.

Custom Modifications

ADDTK	AUTHL AUTHR	CBO	CCO	CFNTO	CFRMO	CND	EXBKL EXBKR	EXL EXR	FB	FFDL FFDR
	•	•	•	•	•				•	•
FPEB	ID	INVERM	MIP	P	PFINBTMB	RD	TD	TVRAV TVRFV TVRVV	WLI	
•	•		•		•	•			•	

Construction Upgrades

APC	PE
•	•

Door Options

ALF	CG	CG.BTM	CG.TOP	DPSRR	MD	MD.BTM	MD.TOP	MFO
	•			•	•			•

**DIAGONAL WALL, 12", 15", or 18"
HIGH, 27" x 27"**

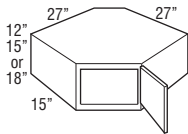

DW122727 L or R	6.8
DW152727 L or R	8.3
DW182727 L or R	9.7

- Cabinets require 27" x 27" of corner wall space.
- Full overlay styles use 38NPOHINGE, see page 418.

Custom Modifications

ADDTK	AUTHL AUTHR	CBO	CCO	CFNTO	CFRMO	CND	EXBKL EXBKR	EXL EXR	FB	FFDL FFDR
	•		•	•	•				•	•*
FPEB	ID	INVERM	MIP	P	PFINBTMB	RD	TD	TVRAV TVRFV TVRVV	WLI	
•	•		•		•	•			•	

*Available only on 18" high

Construction Upgrades

APC	PE
•	•

Door Options

ALF	CG	CG.BTM	CG.TOP	DPSRR	MD	MD.BTM	MD.TOP	MFO
	•			•				•

**DIAGONAL WALL, 24" or 27" HIGH,
27" x 27"**

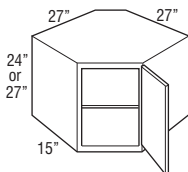

DW242727 L or R	12.7
DW272727 L or R	14.1

- Cabinets require 27" x 27" of corner wall space.
- Adjustable shelf cannot be removed/retrofitted.
- Full overlay styles use 38NPOHINGE, see page 418.

Custom Modifications

ADDTK	AUTHL AUTHR	CBO	CCO	CFNTO	CFRMO	CND	EXBKL EXBKR	EXL EXR	FB	FFDL FFDR
	•	•	•	•	•				•	•
FPEB	ID	INVERM	MIP	P	PFINBTMB	RD	TD	TVRAV TVRFV TVRVV	WLI	
•	•		•		•	•			•	

Construction Upgrades

APC	PE
•	•

Door Options

ALF	CG	CG.BTM	CG.TOP	DPSRR	MD	MD.BTM	MD.TOP	MFO
	•			•				•

DIAGONAL WALL, 30", 33", 36", 39", or 42" HIGH, 27" x 27"

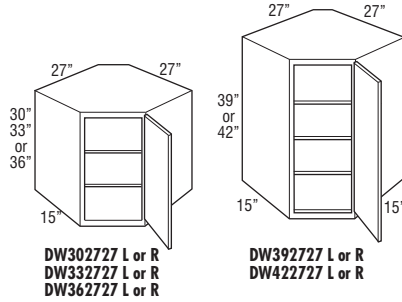

Model	Cubic Feet
DW302727 L or R	14.7
DW332727 L or R	16.1
DW362727 L or R	17.6
DW392727 L or R	20.0
DW422727 L or R	20.5

- Cabinets require 27" x 27" of corner wall space.
- Full overlay styles use 38NPOHINGE, see page 418.

Custom Modifications

	AUTHL AUTHR	CBO	CCO	CFNTO	CFRMO	CND	EXBKL EXBKR	EXL EXR	FB	FFDL FFDR
	•	•	•	•	•				•	•
FPEB	ID	INVFRM	MIP	P	PFINBTMB	RD	TD	TVRAV TVRFV TVRVV	WLI	
•	•		•		•	•			•	

Construction Upgrades

APC	PE
•	•

Door Options

ALF	CG	CG.BTM	CG.TOP	DPSRR	MD	MD.BTM	MD.TOP	MFO
	•			•	•			•

DIAGONAL WALL with LAZY SUSAN, 30", 33", 36", 39", or 42" HIGH, 24" x 24"

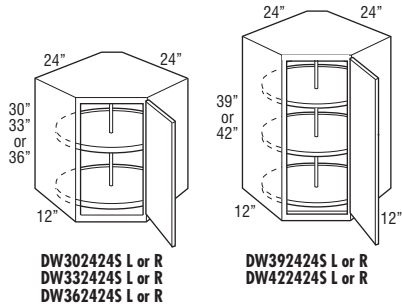

DW302424S L or R	12.5
DW332424S L or R	13.9
DW362424S L or R	14.9
DW392424S L or R	16.0
DW422424S L or R	17.2

- Cabinets require 24" x 24" of corner wall space.
- Plywood shelves are 18" in overall diameter with a 17" interior diameter and 1" high lip.
- Shelves rotate independently.
- Full overlay styles use 38NPOHINGE, see page 418.

Custom Modifications

	AUTHL AUTHR	CBO	CCO	CFNTO	CFRMO	CND	EXBKL EXBKR	EXL EXR	FB	FFDL FFDR
	•	•	•	•	•				•	•
FPEB	ID	INVFRM	MIP	P	PFINBTMB	RD	TD	TVRAV TVRFV TVRVV	WLI	
•			•		•				•	

Construction Upgrades

APC	PE
•	•

Door Options

ALF	CG	CG.BTM	CG.TOP	DPSRR	MD	MD.BTM	MD.TOP	MFO
	•			•	•			•

**DIAGONAL WALL with TAMBOUR,
48", 51", 54", 57", or 60" HIGH,
24" x 24"**

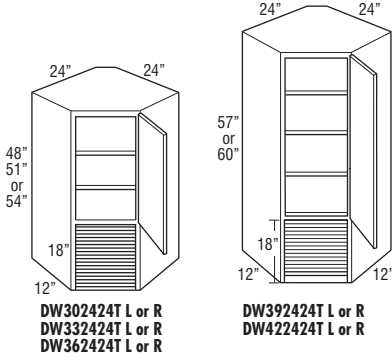

Model	Cubic Feet
DW302424T L or R	19.6
DW332424T L or R	21.0
DW362424T L or R	21.9
DW392424T L or R	23.9
DW422424T L or R	24.3

- Cabinets require 24" x 24" of corner wall space.
- Full overlay styles use 38NPOHINGE, see page 418.

Custom Modifications

ADDTK	AUTHL AUTHR	CBO	CCO	CFNTO	CFRMO	CND	EXBKL EXBKR	EXL EXR	FB	FFDL FFDR
	•	•	•	•	•				•	
FPFB	ID	INVRM	MIP	P	PFINBTMB	RD	TD	TVRAV TVRFV TVRVV	WLI	
•	•		•			•			•	

Construction Upgrades

APC	PE
•	•

Door Options

ALF	CG	CG.BTM	CG.TOP	DPSRR	MD	MD.BTM	MD.TOP	MFO
	•			•	•			•

**DIAGONAL WALL with LOWER DOOR,
48", 51", 54", 57", or 60" HIGH,
24" x 24"**

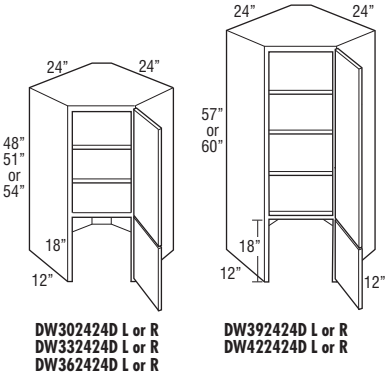

DW302424D L or R	19.6
DW332424D L or R	21.0
DW362424D L or R	21.9
DW392424D L or R	23.9
DW422424D L or R	24.3

- Cabinets require 24" x 24" of corner wall space.
- Bottom door will always be square.
- Bottom section does not have floor.
- Mullion Doors not available on bottom door.
- Full overlay styles use 38NPOHINGE, see page 418.

Custom Modifications

ADDTK	AUTHL AUTHR	CBO	CCO	CFNTO	CFRMO	CND	EXBKL EXBKR	EXL EXR	FB	FFDL FFDR
	•	•	•	•	•				•	
FPFB	ID	INVRM	MIP	P	PFINBTMB	RD	TD	TVRAV TVRFV TVRVV	WLI	
•	•		•			•			•	

Construction Upgrades

APC	PE
•	•

Door Options

ALF	CG	CG.BTM	CG.TOP	DPSRR	MD	MD.BTM	MD.TOP	MFO
		•	•	•			•	•

**DIAGONAL WALL with TAMBOUR,
48", 51", 54", 57", or 60" HIGH,
27" x 27"**

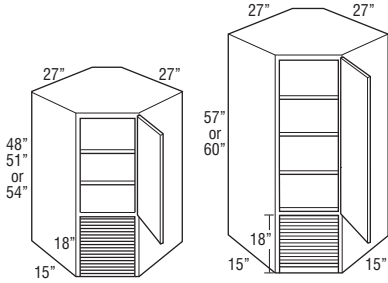

DW302727T L or R
DW332727T L or R
DW362727T L or R

DW392727T L or R
DW422727T L or R

Model	Cubic Feet
DW302727T L or R	22.2
DW332727T L or R	23.1
DW362727T L or R	24.9
DW392727T L or R	25.7
DW422727T L or R	27.7

- Cabinets require 27" x 27" of corner wall space.
- Full overlay styles use 38NPOHINGE, see page 418.

Custom Modifications

	AUTHL AUTHR	CBO	CCO	CFNT0	CFRMO	CND	EXBKL EXBKR	EXL EXR	FB	FFDL FFDR
	•	•	•	•	•				•	
FPEB	ID	INVERM	MIP	P	PFINBTMB	RD	TD	TVRAV TVRFV TVRVV	WLI	
•	•		•			•			•	

Construction Upgrades

APC	PE
•	•

Door Options

ALF	CG	CG.BTM	CG.TOP	DPSRR	MD	MD.BTM	MD.TOP	MFO
	•			•	•			•

**DIAGONAL WALL with LOWER DOOR,
48", 51", 54", 57", or 60" HIGH,
27" x 27"**

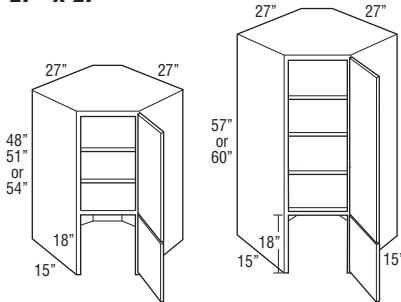

DW302727D L or R
DW332727D L or R
DW362727D L or R

DW392727D L or R
DW422727D L or R

DW302727D L or R	22.2
DW332727D L or R	23.1
DW362727D L or R	24.9
DW392727D L or R	25.7
DW422727D L or R	27.7

- Cabinets require 27" x 27" of corner wall space.
- Bottom door will always be square.
- Bottom section does not have floor.
- Mullion Doors not available on bottom door.
- Full overlay styles use 38NPOHINGE, see page 418.

Custom Modifications

	AUTHL AUTHR	CBO	CCO	CFNT0	CFRMO	CND	EXBKL EXBKR	EXL EXR	FB	FFDL FFDR
	•	•	•	•	•				•	
FPEB	ID	INVERM	MIP	P	PFINBTMB	RD	TD	TVRAV TVRFV TVRVV	WLI	
•	•		•			•			•	

Construction Upgrades

APC	PE
•	•

Door Options

ALF	CG	CG.BTM	CG.TOP	DPSRR	MD	MD.BTM	MD.TOP	MFO
		•	•	•			•	•

DIAGONAL WALL with TAMBOUR and LAZY SUSAN, 48", 51", 54", 57", or 60" HIGH, 24" x 24"

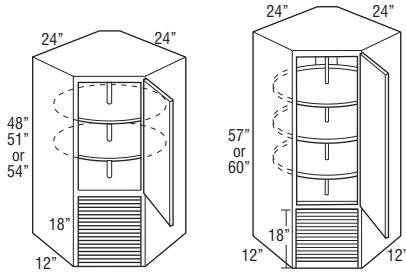

DW302424TS L or R
DW332424TS L or R
DW362424TS L or R

DW392424TS L or R
DW422424TS L or R

Model	Cubic Feet
DW302424TS L or R	19.6
DW332424TS L or R	21.0
DW362424TS L or R	21.9
DW392424TS L or R	23.9
DW422424TS L or R	24.3

- Cabinets require 24" x 24" of corner wall space.
- Plywood shelves are 18" in overall diameter with a 17" interior diameter and 1" high lip.
- Shelves rotate independently.
- Full overlay styles use 38NPOHINGE, see page 418.

Custom Modifications

ADDTK	AUTHL AUTHR	CBO	CCO	CFNTO	CFRMO	CND	EXBKL EXBKR	EXL EXR	FB	FFDL FFDR
	•	•	•	•	•				•	
FPFB	ID	INVFRM	MIP	P	PFINBTMB	RD	TD	TVRAV TVRFV TVRVV	WLI	
•			•						•	

Construction Upgrades

APC	PE
•	•

Door Options

ALF	CG	CG.BTM	CG.TOP	DPSRR	MD	MD.BTM	MD.TOP	MFO
	•			•	•			•

DIAGONAL WALL with LOWER DOOR and LAZY SUSAN, 48", 51", 54", 57", or 60" HIGH, 24" x 24"

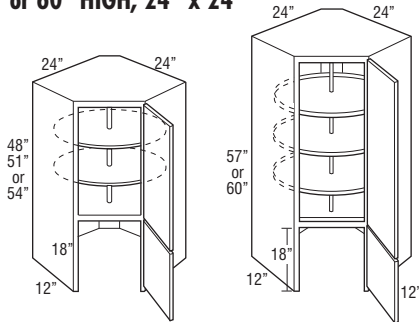

DW302424DS L or R
DW332424DS L or R
DW362424DS L or R

DW392424DS L or R
DW422424DS L or R

DW302424DS L or R	19.6
DW332424DS L or R	21.0
DW362424DS L or R	21.9
DW392424DS L or R	23.9
DW422424DS L or R	24.3

- Cabinets require 24" x 24" of corner wall space.
- Bottom door will always be square.
- Bottom section does not have floor.
- Mullion Doors not available on bottom door.
- Plywood shelves are 18" in overall diameter with a 17" interior diameter and 1" high lip.
- Shelves rotate independently.
- Full overlay styles use 38NPOHINGE, see page 418.

Custom Modifications

ADDTK	AUTHL AUTHR	CBO	CCO	CFNTO	CFRMO	CND	EXBKL EXBKR	EXL EXR	FB	FFDL FFDR
	•	•	•	•	•				•	
FPFB	ID	INVFRM	MIP	P	PFINBTMB	RD	TD	TVRAV TVRFV TVRVV	WLI	
•			•						•	

Construction Upgrades

APC	PE
•	•

Door Options

ALF	CG	CG.BTM	CG.TOP	DPSRR	MD	MD.BTM	MD.TOP	MFO
		•	•	•			•	•

**STACKED DIAGONAL WALL,
48", 51", or 54" HIGH**

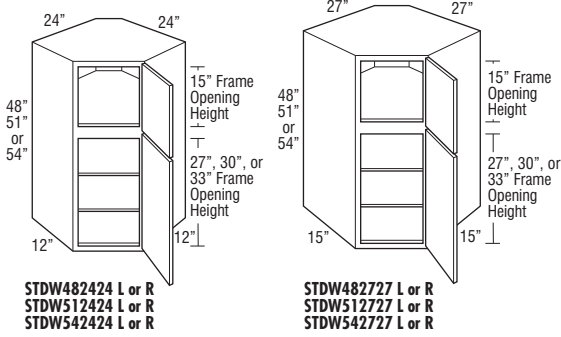

Model	Cubic Feet
STDW482424 L or R	19.6
STDW482727 L or R	23.4
STDW512424 L or R	21.0
STDW512727 L or R	26.1
STDW542424 L or R	21.6
STDW542727 L or R	24.1

- Cabinet requires 24" x 24" or 27" x 27" of corner wall space.
- Bottom doors will always be square.
- Full overlay styles use 38NPOHINGE, see page 418.

Custom Modifications

ADDTK	AUTHL AUTHR	CBO	CCO	CFNTO	CFRMO	CND	EXBKL EXBKR	EXL EXR	FB	FFDL FFDR
	•	•	•	•	•				•	
FPEB	ID	INVERM	MIP	P	PFINBTMB	RD	TD	TVRAV TVRFV TVRVV	WLI	
•	•	•	•			•			•	

Construction Upgrades

APC	PE
•	•

Door Options

ALF	CG	CG.BTM	CG.TOP	DPSRR	MD	MD.BTM	MD.TOP	MFO
		•	•	•				•

**STACKED DIAGONAL WALL,
57" or 60" HIGH**

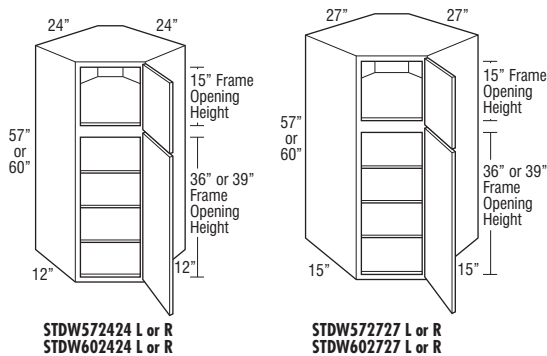

STDW572424 L or R	21.9
STDW572727 L or R	26.4
STDW602424 L or R	24.3
STDW602727 L or R	29.3

- Cabinet requires 24" x 24" or 27" x 27" of corner wall space.
- Bottom doors will always be square.
- Full overlay styles use 38NPOHINGE, see page 418.

Custom Modifications

ADDTK	AUTHL AUTHR	CBO	CCO	CFNTO	CFRMO	CND	EXBKL EXBKR	EXL EXR	FB	FFDL FFDR
	•	•	•	•	•				•	
FPEB	ID	INVERM	MIP	P	PFINBTMB	RD	TD	TVRAV TVRFV TVRVV	WLI	
•	•	•	•			•			•	

Construction Upgrades

APC	PE
•	•

Door Options

ALF	CG	CG.BTM	CG.TOP	DPSRR	MD	MD.BTM	MD.TOP	MFO
		•	•	•				•

**DIAGONAL WALL PENINSULA,
30", 33", 36", 39", or 42" HIGH,
24" x 24 1/4"**

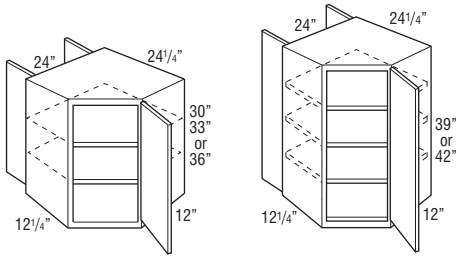

Model	Cubic Feet
DW302424PLL	12.5
DW302424PLR	12.5
DW302424PRL	12.5
DW302424PRR	12.5
DW332424PLL	13.9
DW332424PLR	13.9
DW332424PRL	13.9
DW332424PRR	13.9
DW362424PLL	14.9
DW362424PLR	14.9
DW362424PRL	14.9
DW362424PRR	14.9
DW392424PLL*	16.0
DW392424PLR*	16.0
DW392424PRL*	16.0
DW392424PRR*	16.0
DW422424PLL*	17.2
DW422424PLR*	17.2
DW422424PRL*	17.2
DW422424PRR*	17.2

- RL door hinging shown.
- Full overlay styles use 38NPOHINGE, see page 418.
- *When ordered with MD, shelves will not align with mullions.

Custom Modifications

ADDTK	AUHL AUTHR	CBO	CCO	CFNTO	CFRMO	CND	EXBKL EXBKR	EXL EXR	FB	FFDL FFDR
		•	•	•	•				•	
FPEB	ID	INVFRM	MIP	P	PFINBTMB	RD	TD	TVRV TVRFV TVRVV	WLI	
•			•	STD	•				•	

Construction Upgrades

APC	PE
•	•

Door Options

ALF	CG	CG.BTM	CG.TOP	DPSRR	MD	MD.BTM	MD.TOP	MFO
	•			•	•			•

Diagonal Wall Peninsula

Diagonals are different. All PLL, PLR, etc. designations refer to wall openings as well as hinge location. A PLL is left hinged on the kitchen (DW) side. Peninsula side is 24" wide and features butt doors. The second L or R in the product code indicates the position of the butt doors relative to the DW side.

NOTE:

All Peninsula wall cabinets must be fully supported by screwing into ceiling or soffit, and by screwing into adjoining cabinets. Weight load limit is 15 lbs. per square foot.

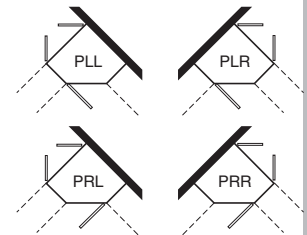

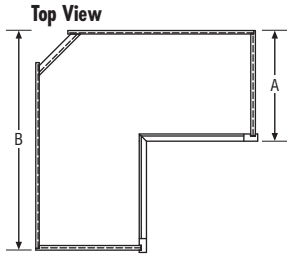

Easy Reach Wall Corner Cabinets with Increased or Reduced Depth

	RD9	RD10	RD11	STD	ID13	ID14	ID15	ID16	ID17	ID18	ID19	ID20	ID21	ID22	ID23	ID24	
Cabinet Depth	A	9"	10"	11"	12"	13"	14"	15"	16"	17"	18"	19"	20"	21"	22"	23"	24"
Wall Space	B	21"	22"	23"	24"	25"	26"	27"	28"	29"	30"	31"	32"	33"	34"	35"	36"

EASY REACH WALL CORNER, 30", 33", 36", 39", or 42" HIGH, 21" x 21"

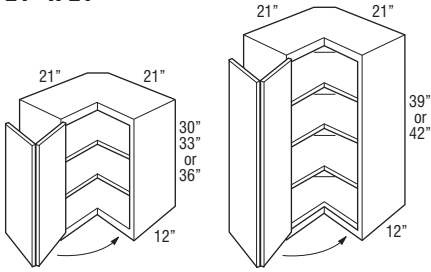

Model	Cubic Feet
ER302121 L or R	9.9
ER332121 L or R	10.3
ER362121 L or R	11.8
ER392121 L or R	12.7
ER422121 L or R	13.7

- Decorative hardware screws must be countersunk to prevent scratching of adjacent cabinets face frame of ER.
- Adjustable shelves.
- Hinged door opens 170°.
- Integrated soft close hinge not included.

Custom Modifications

ADDTK	AUTHL AUTHR	CBO	CCO	CFNTO	CFRMO	CND	EXBKL EXBKR	EXL EXR	FB	FFDL FFDR
	•	•	•						•	
FPEB	ID	INVFRM	MIP	P	PFINBTMB	RD	TD	TVRAV TVRFV TVRVV	WLI	
•	•		•		•	•			•	

Construction Upgrades

APC	PE
•	•

Door Options

ALF	CG	CG.BTM	CG.TOP	DPSRR	MD	MD.BTM	MD.TOP	MFO
				•				•

EASY REACH WALL CORNER, 30", 33", 36", 39", or 42" HIGH, 24" x 24"

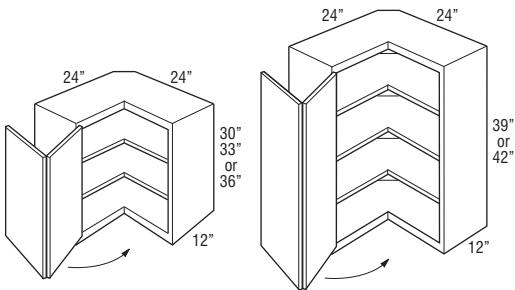

ER30 L or R	12.5
ER33 L or R	13.9
ER36 L or R	14.9
ER39 L or R	16.0
ER42 L or R	17.2

- Requires 24" x 24" of corner wall space.
- Decorative hardware screws must be countersunk to prevent scratching of adjacent cabinets and face frame of ER.
- Adjustable shelves.
- Hinged door opens 170°.
- Integrated soft close hinge not included.

Custom Modifications

ADDTK	AUTHL AUTHR	CBO	CCO	CFNTO	CFRMO	CND	EXBKL EXBKR	EXL EXR	FB	FFDL FFDR
	•	•	•						•	
FPEB	ID	INVFRM	MIP	P	PFINBTMB	RD	TD	TVRAV TVRFV TVRVV	WLI	
•	•		•		•	•			•	

Construction Upgrades

APC	PE
•	•

Door Options

ALF	CG	CG.BTM	CG.TOP	DPSRR	MD	MD.BTM	MD.TOP	MFO
				•				•

**ASYMMETRICAL EASY REACH WALL
CORNER, 30", 33", 36", 39", or
42" HIGH**

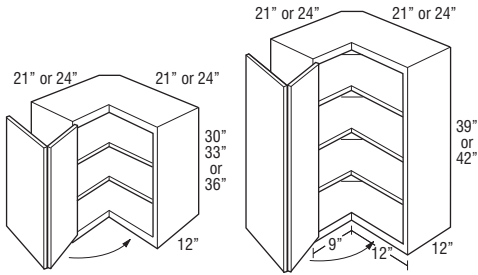

Model	Cubic Feet
ER302124 L or R	12.5
ER302421 L or R	12.5
ER332124 L or R	13.3
ER332421 L or R	13.3
ER362124 L or R	14.9
ER362421 L or R	14.9
ER392124 L or R	16.0
ER392421 L or R	16.0
ER422124 L or R	17.2
ER422421 L or R	17.2

- Hinged door opens to 170°.
- Adjustable shelves.
- Legs at the front frames are 9" on 21" leg and 12" on 24" leg.
- Nomenclature for asymmetrical cabinets reads as follows:
First set of numbers = height
Second set of numbers = left side
Third set of numbers = right side
- Decorative hardware screws must be countersunk to prevent scratching of adjacent cabinets and face frame of ER.
- ER_ _2124L shown.
- Integrated soft close hinge not included.

Custom Modifications

ADDTK	AUTHL AUTHR	CBO	CCO	CFNTO	CFRMO	CND	EXBKL EXBKR	EXL EXR	FB	FFDL FFDR
	•	•	•						•	
FPEB	ID	INVFRM	MIP	P	PFINBTMB	RD	TD	TVRAV TVRFV TVRVV	WLI	
•	•		•		•	•			•	

Construction Upgrades

APC	PE
•	•

Door Options

ALF	CG	CG.BTM	CG.TOP	DPSRR	MD	MD.BTM	MD.TOP	MFO
				•				•

135° CORNER OUTSIDE WALL, 30", 33", or 36" HIGH

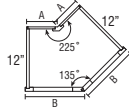
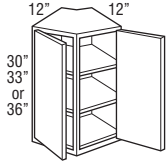

Model	A Dimension	B Dimension
W6(*)COA	6"	10 15/16"
W9(*)COA	9"	13 15/16"
W12(*)COA	12"	16 15/16"

A indicates back width of cabinet and wall space.
 (*) indicates height of cabinet.
 B indicates face frame width.

Model	Cubic Feet
W630COA	8.0
W930COA	10.6
W1230COA	13.4
W633COA	8.8
W933COA	11.5
W1233COA	14.6
W636COA	9.5
W936COA	12.5
W1236COA	15.9

- Doors are hinged on outside of frame.
- Adjustable shelves cannot be removed from cabinet.

Custom Modifications

ADDTK	AUTHL AUTHR	CBO	CCO	CFNTO	CFRMO	CND	EXBKL EXBKR	EXL EXR	FB	FFDL FFDR
		•	•						•	
FPFB	ID	INVERM	MIP	P	PFINBTMB	RD	TD	TVRAV TVRFV TVRVV	WLI	
•			•		•				•	

Construction Upgrades

APC	PE
•	•

Door Options

ALF	CG	CG.BTM	CG.TOP	DPSRR	MD	MD.BTM	MD.TOP	MFO
	•			•				•

135° CORNER OUTSIDE WALL, 39" or 42" HIGH

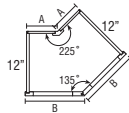
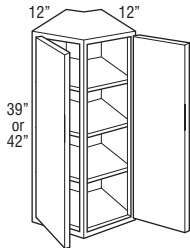

Model	A Dimension	B Dimension
W6(*)COA	6"	10 15/16"
W9(*)COA	9"	13 15/16"
W12(*)COA	12"	16 15/16"

A indicates back width of cabinet and wall space.
 (*) indicates height of cabinet.
 B indicates face frame width.

W639COA	10.2
W939COA	13.5
W1239COA	17.1
W642COA	11.0
W942COA	14.4
W1242COA	18.3

- Doors are hinged on outside of frame.
- Adjustable shelves cannot be removed from cabinet.

Custom Modifications

ADDTK	AUTHL AUTHR	CBO	CCO	CFNTO	CFRMO	CND	EXBKL EXBKR	EXL EXR	FB	FFDL FFDR
		•	•						•	
FPFB	ID	INVERM	MIP	P	PFINBTMB	RD	TD	TVRAV TVRFV TVRVV	WLI	
•			•		•				•	

Construction Upgrades

APC	PE
•	•

Door Options

ALF	CG	CG.BTM	CG.TOP	DPSRR	MD	MD.BTM	MD.TOP	MFO
	•			•				•

135° CORNER INSIDE WALL, 30", 33", or 36" HIGH

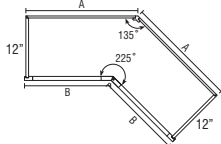
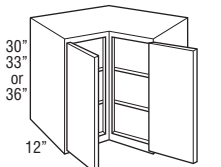

Model	A Dimension	B Dimension
W21(*)CIA	21"	16 1/16"
W24(*)CIA	24"	19 1/16"
W27(*)CIA	27"	22 1/16"

A indicates back width of cabinet and wall space.
 (*) indicates height of cabinet.
 B indicates face frame width.

Model	Cubic Feet
W2130CIA	17.5
W2430CIA	20.8
W2730CIA	24.4
W2133CIA	19.1
W2433CIA	22.7
W2733CIA	26.6
W2136CIA	20.7
W2436CIA	24.6
W2736CIA	28.8

- Doors are hinged on outside of frame.
- Adjustable shelves cannot be removed from cabinet.

Custom Modifications

ADDTK	AUTHL AUTHR	CBO	CCO	CFNTO	CFRMO	CND	EXBKL EXBKR	EXL EXR	FB	FFDL FFDR
		•	•						•	
FPFB	ID	INVFRM	MIP	P	PFINBTMB	RD	TD	TVRAV TVRFV TVRVV	WLI	
•			•		•				•	

Construction Upgrades

APC	PE
•	•

Door Options

ALF	CG	CG.BTM	CG.TOP	DPSRR	MD	MD.BTM	MD.TOP	MFO
	•			•	•†			•

†Available only on W2430CIA, W2433CIA, and W2436CIA

135° CORNER INSIDE WALL, 39" or 42" HIGH

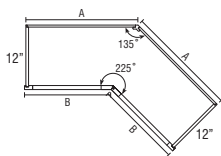
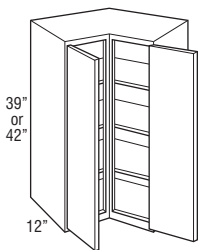

Model	A Dimension	B Dimension
W21(*)CIA	21"	16 1/16"
W24(*)CIA	24"	19 1/16"
W27(*)CIA	27"	22 1/16"

A indicates back width of cabinet and wall space.
 (*) indicates height of cabinet.
 B indicates face frame width.

W2139CIA	22.2
W2439CIA	26.5
W2739CIA	31.1
W2142CIA	23.8
W2442CIA	28.4
W2742CIA	33.3

- Doors are hinged on outside of frame.
- Adjustable shelves cannot be removed from cabinet.

Custom Modifications

ADDTK	AUTHL AUTHR	CBO	CCO	CFNTO	CFRMO	CND	EXBKL EXBKR	EXL EXR	FB	FFDL FFDR
			•	•					•	
FPFB	ID	INVFRM	MIP	P	PFINBTMB	RD	TD	TVRAV TVRFV TVRVV	WLI	
•			•		•				•	

Construction Upgrades

APC	PE
•	•

Door Options

ALF	CG	CG.BTM	CG.TOP	DPSRR	MD	MD.BTM	MD.TOP	MFO
	•			•	•†			•

†Available only on W2439CIA and W2442CIA

WALL END CABINET SINGLE DOOR, 30", 33", 36", 39", or 42" HIGH, 12" x 12"

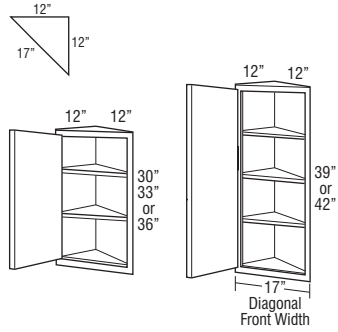

Model	Cubic Feet
WEC1230 L or R	3.7
WEC1233 L or R	4.1
WEC1236 L or R	4.4
WEC1239 L or R*	4.7
WEC1242 L or R*	4.9

- Width at wall: 12" x 12".
- Cabinet features two unfinished back panels. Must be installed with one back panel adjacent to a cabinet of equal height with the other back panel attached to the wall.

*When ordered with MD, shelves will not align with mullions.

Custom Modifications

ADDTK	AUTHL AUTHR	CBO	CCO	CFNTO	CFRMO	CND	EXBKL EXBKR	EXL EXR	FB	FFDL FFDR
		•	•	•	•					
FPFB	ID	INVERM	MIP	P	PFINBTMB	RD	TD	TVRAV TVRFV TVRVV	WLI	
			•		•				•	

Construction Upgrades

APC	PE
•	

Door Options

ALF	CG	CG.BTM	CG.TOP	DPSRR	MD	MD.BTM	MD.TOP	MFO
	•			•	•			•

STACKED WALL END CABINET SINGLE DOOR, 48", 51", 54", 57", or 60" HIGH, 12" x 12"

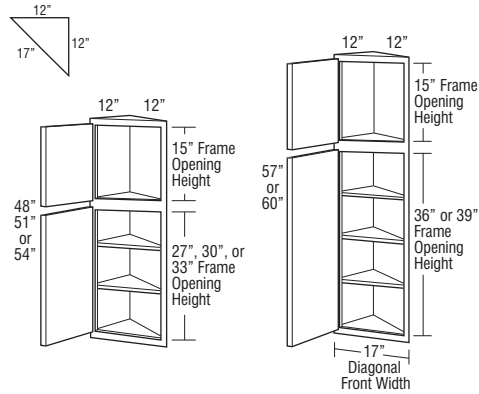

STWEC1248 L or R	5.7
STWEC1251 L or R	6.0
STWEC1254 L or R	6.4
STWEC1257 L or R	6.7
STWEC1260 L or R	7.0

- Width at wall: 12" x 12".
- Cabinet features two unfinished back panels. Must be installed with one back panel adjacent to a cabinet of equal height with the other back panel attached to the wall.

Custom Modifications

ADDTK	AUTHL AUTHR	CBO	CCO	CFNTO	CFRMO	CND	EXBKL EXBKR	EXL EXR	FB	FFDL FFDR
		•	•	•	•				STD	
FPFB	ID	INVERM	MIP	P	PFINBTMB	RD	TD	TVRAV TVRFV TVRVV	WLI	
		•	•						•	

Construction Upgrades

APC	PE
•	

Door Options

ALF	CG	CG.BTM	CG.TOP	DPSRR	MD	MD.BTM	MD.TOP	MFO
		•	•	•				•

**WALL END CABINET DOUBLE DOOR,
30", 33", 36", 39", or 42" HIGH,
12" x 12"**

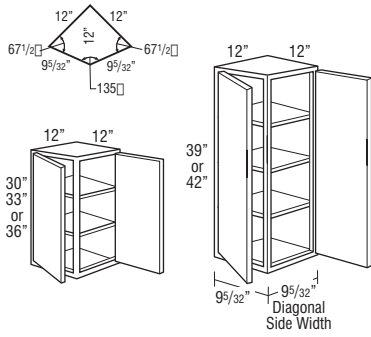

Model	Cubic Feet
WEC1230D	3.7
WEC1233D	4.1
WEC1236D	4.4
WEC1239D	4.7
WEC1242D	4.9

- Width at wall: 12" x 12".
- Cabinet features two unfinished back panels. Must be installed with one back panel adjacent to a cabinet of equal height with the other back panel attached to the wall.
- Decorative glass inserts are not available.

Custom Modifications

ADDTK	AUHL AUTHR	CBO	CCO	CFNTD	CFRMO	CND	EXBKL EXBKR	EXL EXR	FB	FFDL FFDR
		•	•							
FPEB	ID	INVFRM	MIP	P	PFINBTMB	RD	TD	TVRAV TVRFV TVRVV	WLI	
			•		•				•	

Construction Upgrades

APC	PE
•	

Door Options

ALF	CG	CG.BTM	CG.TOP	DPSRR	MD	MD.BTM	MD.TOP	MFO
	•			•				•

**STACKED WALL END CABINET DOUBLE
DOOR, 48", 51", 54", 57", or 60"
HIGH, 12" x 12"**

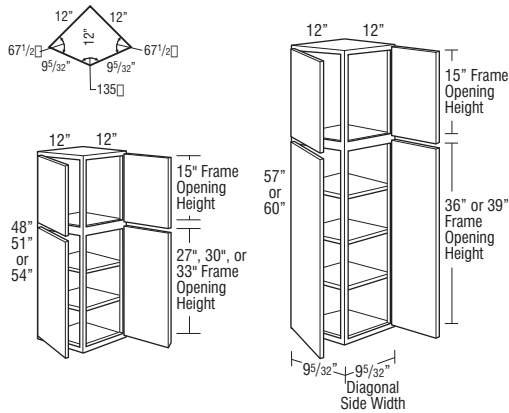

STWEC1248D	5.7
STWEC1251D	6.0
STWEC1254D	6.4
STWEC1257D	6.7
STWEC1260D	7.0

- Width at wall: 12" x 12".
- Cabinet features two unfinished back panels. Must be installed with one back panel adjacent to a cabinet of equal height with the other back panel attached to the wall.
- Decorative glass inserts are not available.

Custom Modifications

ADDTK	AUHL AUTHR	CBO	CCO	CFNTD	CFRMO	CND	EXBKL EXBKR	EXL EXR	FB	FFDL FFDR
		•	•						STD	
FPEB	ID	INVFRM	MIP	P	PFINBTMB	RD	TD	TVRAV TVRFV TVRVV	WLI	
		•	•						•	

Construction Upgrades

APC	PE
•	

Door Options

ALF	CG	CG.BTM	CG.TOP	DPSRR	MD	MD.BTM	MD.TOP	MFO
		•	•	•				•

WALL QUARTER ROUND END SHELF, 30", 33", 36", 39", or 42" HIGH

Radius Top and Bottom Panels

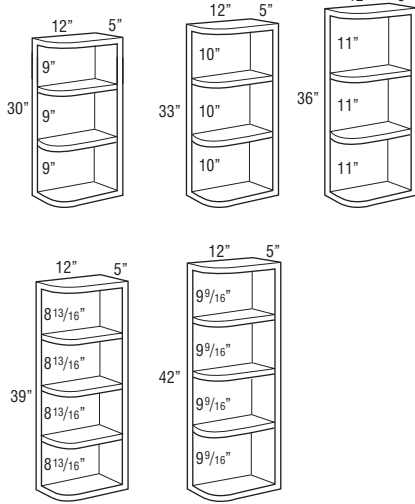
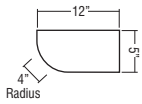

Square Top and Radius Bottom Panels

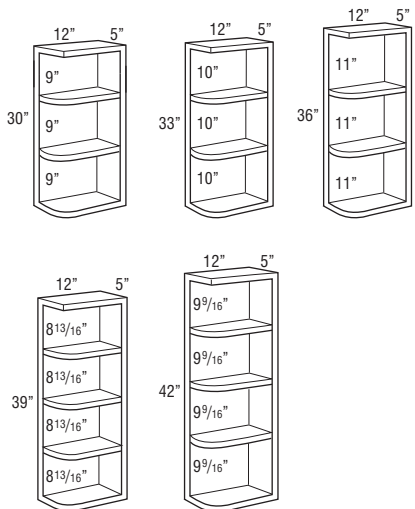
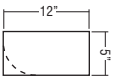

Square Top and Bottom Panels

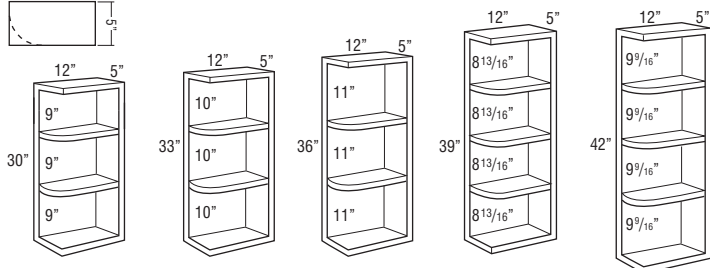
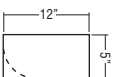

Model	Cubic Feet
WQRES630RT	1.8
WQRES633RT	1.9
WQRES636RT	2.2
WQRES639RT	2.5
WQRES642RT	2.9

- Units are reversible.
- 12" deep x 5" wide, 4" shelf radius.
- Radius moulding is not available for WQRES636RT.
- Hardwood veneer on 3/4" furniture board core.
- Matching interior.
- Veneer construction, finished to match cabinet face frame.
- If ordered with Heirlooming Technique, will not feature sand-through characteristics.
- Cabinet features two unfinished back panels. Must be installed with one back panel adjacent to a cabinet of equal height with the other back panel attached to the wall.

WQRES630ST L or R	1.8
WQRES633ST L or R	2.3
WQRES636ST L or R	2.5
WQRES639ST L or R	2.5
WQRES642ST L or R	2.9

- Specify left or right. Only top panel is square. Right shown.
- Hardwood veneer on 3/4" furniture board core.
- Matching interior.
- Veneer construction, finished to match cabinet face frame.
- If ordered with Heirlooming Technique, will not feature sand-through characteristics.
- Cabinet features two unfinished back panels. Must be installed with one back panel adjacent to a cabinet of equal height with the other back panel attached to the wall.

WQRES630STSB	1.8
WQRES633STSB	1.9
WQRES636STSB	2.2
WQRES639STSB	2.5
WQRES642STSB	2.9

- Units are reversible.
- Hardwood veneer on 3/4" furniture board core.
- Matching interior.
- Veneer construction, finished to match cabinet face frame.
- If ordered with Heirlooming Technique, will not feature sand-through characteristics.
- Cabinet features two unfinished back panels. Must be installed with one back panel adjacent to a cabinet of equal height with the other back panel attached to the wall.

MODIFICATIONS
No modifications available for these products.

Construction Upgrades

APC	PE
•	

**WALL QUARTER ROUND END SHELF,
12" RADIUS, 30", 33", 36", 39", or
42" HIGH**

Radius Top and Bottom Panels

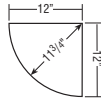

Top View

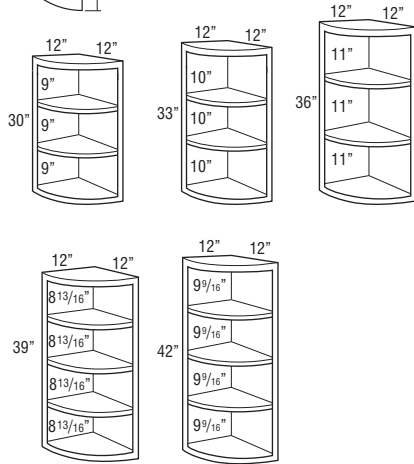

Square Top and Radius Bottom Panels

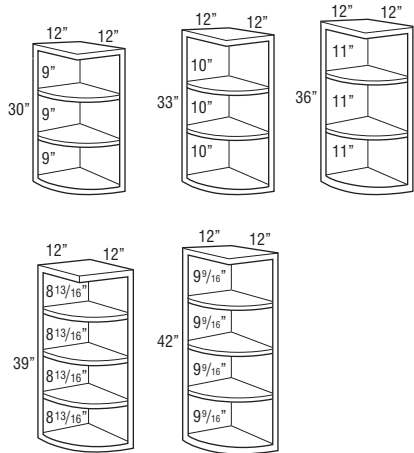

Square Top and Bottom Panels

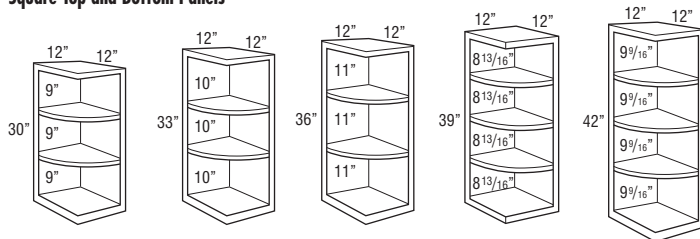

Model	Cubic Feet
WQRES1230RT	3.7
WQRES1233RT	4.0
WQRES1236RT	4.4
WQRES1239RT	4.7
WQRES1242RT	5.1

- Hardwood veneer on 3/4" furniture board core.
- Matching interior.
- Veneer construction, finished to match cabinet face frame. White Thermofoil styles are laminate.
- If ordered with Heirloom Technique, will not feature sand-through characteristics.
- Cabinet features two unfinished back panels. Must be installed with one back panel adjacent to a cabinet of equal height with the other back panel attached to the wall.

WQRES1230STRB	3.7
WQRES1233STRB	4.0
WQRES1236STRB	4.4
WQRES1239STRB	4.7
WQRES1242STRB	5.1

- Hardwood veneer on 3/4" furniture board core.
- Matching interior.
- Veneer construction, finished to match cabinet face frame. White Thermofoil styles are laminate.
- If ordered with Heirloom Technique, will not feature sand-through characteristics.
- Cabinet features two unfinished back panels. Must be installed with one back panel adjacent to a cabinet of equal height with the other back panel attached to the wall.

WQRES1230STSB	3.7
WQRES1233STSB	4.0
WQRES1236STSB	4.4
WQRES1239STSB	4.7
WQRES1242STSB	5.1

- Hardwood veneer on 3/4" furniture board core.
- Matching interior.
- Veneer construction, finished to match cabinet face frame. White thermofoil styles are laminate.
- If ordered with Heirloom Technique, will not feature sand-through characteristics.
- Cabinet features two unfinished back panels. Must be installed with one back panel adjacent to a cabinet of equal height with the other back panel attached to the wall.

MODIFICATIONS
No modifications available for these products.

Construction Upgrades

APC	PE
•	

WALL TRANSITION CABINET, 30", 33", 36", 39", or 42" HIGH

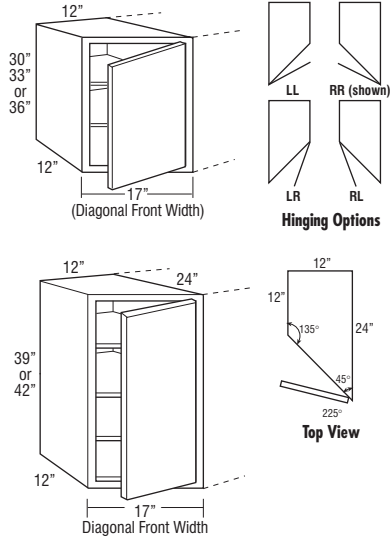

Model	Cubic Feet
WTC1230LL	6.9
WTC1230RL	6.9
WTC1230LR	6.9
WTC1230RR	6.9
WTC1233LL	7.6
WTC1233RL	7.6
WTC1233LR	7.6
WTC1233RR	7.6
WTC1236LL	8.1
WTC1236RL	8.1
WTC1236LR	8.1
WTC1236RR	8.1
WTC1239LL	8.7
WTC1239RL	8.7
WTC1239LR	8.7
WTC1239RR	8.7
WTC1242LL	9.4
WTC1242RL	9.4
WTC1242LR	9.4
WTC1242RR	9.4

- Specify door hinging. RR shown.
- Depth can be reduced to a minimum of 18".
- Full overlay styles use 38NPOHINGE, see page 418.

Custom Modifications

ADDTK	AUTHL AUTHR	CBO	CCO	CFNTO	CFRMO	CND	EXBKL EXBKR	EXL EXR	FB	FFDL FFDR
	•*	•	•	•	•				•	•*
FPEB	ID	INVERM	MIP	P	PFINBTMB	RD	TD	TVRAV TVRFV TVRVV	WLI	
•*			•		•	•			•	

*Available only on 12" deep side of cabinet

Construction Upgrades

APC	PE
•	•

Door Options

ALF	CG	CG.BTM	CG.TOP	DPSRR	MD	MD.BTM	MD.TOP	MFO
	•			•	•			•

**STACKED WALL TRANSITION CABINET,
48", 51", 54", 57", or 60" HIGH**

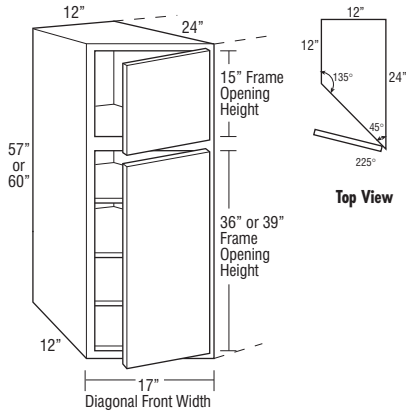
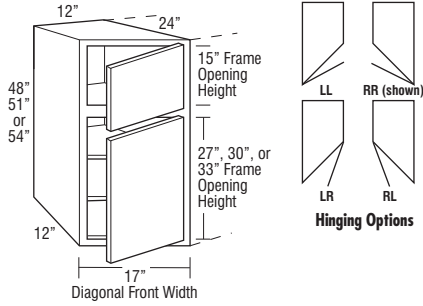

Model	Cubic Feet
STWTC1248LL	5.7
STWTC1248RL	5.7
STWTC1248LR	5.7
STWTC1248RR	5.7
STWTC1251LL	6.0
STWTC1251RL	6.0
STWTC1251LR	6.0
STWTC1251RR	6.0
STWTC1254LL	6.4
STWTC1254RL	6.4
STWTC1254LR	6.4
STWTC1254RR	6.4
STWTC1257LL	6.7
STWTC1257RL	6.7
STWTC1257LR	6.7
STWTC1257RR	6.7
STWTC1260LL	7.0
STWTC1260RL	7.0
STWTC1260LR	7.0
STWTC1260RR	7.0

- Specify door hinging. RR shown.
- Depth can be reduced to a minimum of 18".
- Full overlay styles use 38NPOHINGE, see page 418.

Custom Modifications

ADDTK	AUTHL AUTHR	CBO	CCO	CFNTO	CFRMO	CND	EXBKL EXBKR	EXL EXR	FB	FFDL FFDR
	•*	•	•	•	•				STD	•*
FPEB	ID	INVFRM	MIP	P	PFINBTMB	RD	TD	TVRAV TVRFV TVRVV	WLI	
•*		•	•			•			•	

*Available only on 12" deep side of cabinet

Construction Upgrades

APC	PE
•	•

Door Options

ALF	CG	CG.BTM	CG.TOP	DPSRR	MD	MD.BTM	MD.TOP	MFO
		•	•	•				•

**WALL MICROWAVE CABINET,
18" or 21" HIGH**

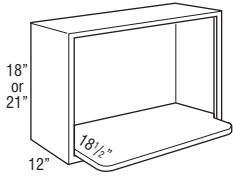

MW2718
Opening: 24" w x 14 1/4" h
Cabinet: 27" w x 18" h

MW3018
Opening: 27" w x 14 1/4" h
Cabinet: 30" w x 18" h

MW2721
Opening: 24" w x 17 1/4" h
Cabinet: 27" w x 21" h

MW3021
Opening: 27" w x 17 1/4" h
Cabinet: 30" w x 21" h

Model	Cubic Feet
MW2718	4.6
MW3018	6.9
MW2721	5.4
MW3021	8.0

- Includes one 3/4" shelf with six mounting screws. Microwave shelf extends beyond the front of the cabinet by 6 1/2", for a total shelf depth of 18 1/2".
- Microwave cabinet must be attached to wall stud and adjacent cabinets on both sides for support.
- Cabinet interior finished to match cabinet face frame.
- When ID is ordered, shelf will not be included with cabinet.
- If ordered with Heirlooming Technique, will not feature sand-through characteristics.

Custom Modifications

ADDTK	AUTHL AUTHR	CBO	CCO	CFNTO	CFRMO	CND	EXBKL EXBKR	EXL EXR	FB	FFDL FFDR
	•	STD			•		•	•	STD	
FPEB	ID	INVFRM	MIP	P	PFINBTMB	RD	TD	TVRAV TVRFV TVRVV	WLI	
•	•		STD		•					

Construction Upgrades

APC	PE
	STD

Door Options

ALF	CG	CG.BTM	CG.TOP	DPSRR	MD	MD.BTM	MD.TOP	MFO

**WALL MICROWAVE DOUBLE DOOR
CABINET, 36" HIGH**

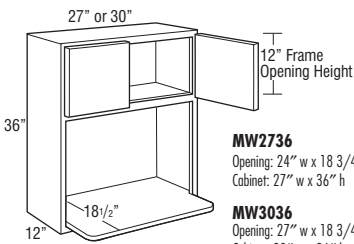

MW2736
Opening: 24" w x 18 3/4" h
Cabinet: 27" w x 36" h

MW3036
Opening: 27" w x 18 3/4" h
Cabinet: 30" w x 36" h

Model	Cubic Feet
MW2736	6.8
MW3036	10.0

- Includes one 3/4" shelf with six mounting screws. Microwave shelf extends beyond the front of the cabinet by 6 1/2", for a total shelf depth of 18 1/2".
- Microwave cabinet must be attached to wall stud and adjacent cabinets on both sides for support.
- Cabinet interior finished to match cabinet face frame.
- When ID is ordered, shelf will not be included with cabinet.

Custom Modifications

ADDTK	AUTHL AUTHR	CBO	CCO	CFNTO	CFRMO	CND	EXBKL EXBKR	EXL EXR	FB	FFDL FFDR
	•	•	•	•	•		•	•	STD	
FPEB	ID	INVFRM	MIP	P	PFINBTMB	RD	TD	TVRAV TVRFV TVRVV	WLI	
•			STD		•					

Construction Upgrades

APC	PE
	STD

Door Options

ALF	CG	CG.BTM	CG.TOP	DPSRR	MD	MD.BTM	MD.TOP	MFO
	•			•				•

**WALL BUILT-IN MICROWAVE CABINET,
18" or 21" HIGH**

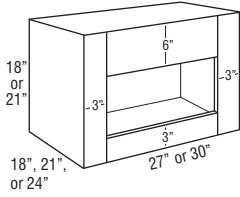

Model	Factory Opening	Maximum Cut Out
2718	21W x 9H	25 1/2W x 15H
2721	21W x 12H	25 1/2W x 18H
3018	24W x 9H	28 1/2W x 15H
3021	24W x 12H	28 1/2W x 18H

WBMW271818	4.6
WBMW301818	6.9
WBMW272118	5.4
WBMW302118	8.0
WBMW271821	6.8
WBMW301821	8.2
WBMW272121	8.4
WBMW302121	9.5
WBMW271824	8.5
WBMW301824	9.4
WBMW272124	9.8
WBMW302124	10.9

- WBMWs can be used to stack with other cabinets to create custom appliance cabinet designs.
- Microwave cabinet must be attached to wall stud and adjacent cabinets on both sides for support.
- Two 1/4" fillers included, except with FPEB, AUTHL, and AUTHR.
- If ordered with Heirlooming Technique, will not feature sand-through characteristics.

Custom Modifications

ADDTK	AUTHL AUTHR	CBO	CCO	CFNTO	CFRMO	CND	EXBKL EXBKR	EXL EXR	FB	FFDL FFDR
	•	STD			•		•	•	•	
								TVRAV TVRFV TVRVV	WLI	
FPEB	ID	INVFRM	MIP	P	PFINBTMB	RD	TD			•

Construction Upgrades

APC	PE
•	•

Door Options

ALF	CG	CG.BTM	CG.TOP	DPSRR	MD	MD.BTM	MD.TOP	MFO

WALL BUILT-IN MICROWAVE DOUBLE DOOR CABINET, 36", 39", or 42" HIGH, 18" or 21" DEEP

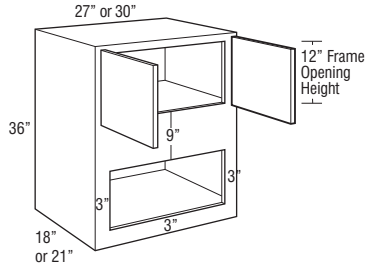

WBMW273618 WBMW273621
WBMW303618 WBMW303621

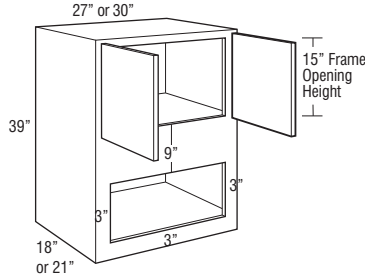

WBMW273918 WBMW273921
WBMW303918 WBMW303921

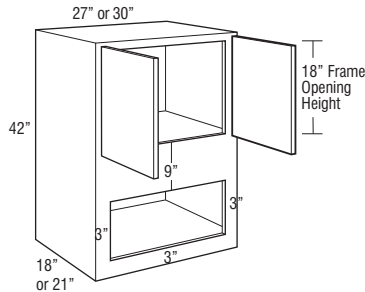

WBMW274218 WBMW274221
WBMW304218 WBMW304221

Model	Factory Opening	Maximum Cut Out
2736	21W x 10 1/2H	25 1/2W x 19 3/4H
2739	21W x 10 1/2H	25 1/2W x 19 3/4H
2742	21W x 10 1/2H	25 1/2W x 19 3/4H
3036	24W x 10 1/2H	28 1/2W x 19 3/4H
3039	24W x 10 1/2H	28 1/2W x 19 3/4H
3042	24W x 10 1/2H	28 1/2W x 19 3/4H

Model	Cubic Feet
WBMW273618	12.1
WBMW303618	13.3
WBMW273918	13.5
WBMW303918	14.9
WBMW274218	14.0
WBMW304218	15.5
WBMW273621	11.4
WBMW303621	15.8
WBMW273921	15.0
WBMW303921	18.4
WBMW274221	13.2
WBMW304221	17.1

- Two 1/4" fillers included, except with FPEB, AUTHL, and AUTHR.
- Microwave cabinet must be attached to wall stud and adjacent cabinets on both sides for support.
- All cabinets have 3" stiles on frames.
- When CG is specified, face frame will be visible through door if used with a translucent art or textured glass design.
- Uses face mount hinges on all styles.

Custom Modifications

ADDTK	AUTHL AUTHR	CBO	CCO	CFNTO	CFRMO	CND	EXBKL EXBKR	EXL EXR	FB	FFDL FFDR
	•		•		•		•	•	•	
FPEB	ID	INVERM	MIP	P	PFINBTMB	RD	TD	TVRAV TVRFV TVRVV	WLI	
•	•		•		•	•			•	

Construction Upgrades

APC	PE
•	•

Door Options

ALF	CG	CG.BTM	CG.TOP	DPSRR	MD	MD.BTM	MD.TOP	MFO
	•			•				•

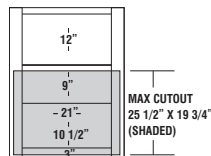

WBMW273618
WBMW273621

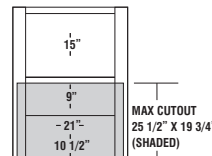

WBMW273918
WBMW273921

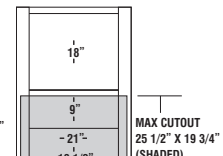

WBMW274218
WBMW274221

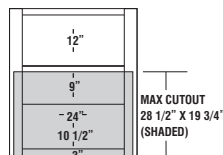

WBMW303618
WBMW303621

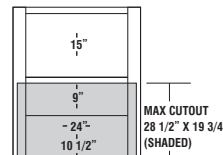

WBMW303918
WBMW303921

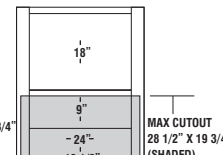

WBMW304218
WBMW304221

**STRAIGHT TAMBOUR,
18" HIGH, 12" DEEP**

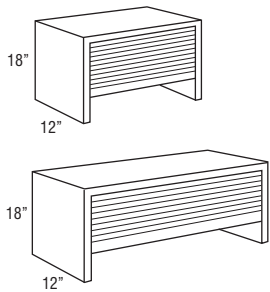

Model	Cubic Feet
ST18	3.3
ST21	3.8
ST24	4.3
ST27	4.8
ST30	5.3
ST33	5.8
ST36	6.3

- Cabinet has back and top.
- If ordered with Heirlooming Technique, will not feature sand-through characteristics.
- Trim height will be restricted when AUTHL or AUTHR is selected.

Custom Modifications

ADDTK	AUTHL AUTHR	CBO	CCO	CFNTO	CFRMO	CND	EXBKL EXBKR	EXL EXR	FB	FFDL FFDR
	•	•	•		•		•	•	•	
FPEB	ID	INVFRM	MIP	P	PFINBTMB	RD	TD	TVRAV TVRFV TVRVV	WLI	
•	•		•			•			•	

Construction Upgrades

APC	PE
•	•

Door Options

ALF	CG	CG.BTM	CG.TOP	DPSRR	MD	MD.BTM	MD.TOP	MFO

**WALL APPLIANCE GARAGE DOOR,
18" HIGH, 12" DEEP**

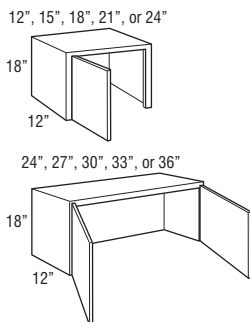

WAGD12 L or R	2.3
WAGD15 L or R	2.8
WAGD18 L or R	3.3
WAGD21 L or R	3.8
WAGD24 L or R	4.3
WAGD24	4.3
WAGD27	4.7
WAGD30	5.2
WAGD33	5.7
WAGD36	6.2

- Cabinet does not have floor.
- When ordered in Arch/Cathedral door styles, door will be Square.

Custom Modifications

ADDTK	AUTHL AUTHR	CBO	CCO	CFNTO	CFRMO	CND	EXBKL EXBKR	EXL EXR	FB	FFDL FFDR
	•		•	•	•		•	•	STD	
FPEB	ID	INVFRM	MIP	P	PFINBTMB	RD	TD	TVRAV TVRFV TVRVV	WLI	
•	•		•			•			•	

Construction Upgrades

APC	PE
•	STD

Door Options

ALF	CG	CG.BTM	CG.TOP	DPSRR	MD	MD.BTM	MD.TOP	MFO
	•			•				

WALL APPLIANCE GARAGE VERTICAL LIFT DOOR, 18" HIGH, 12" DEEP

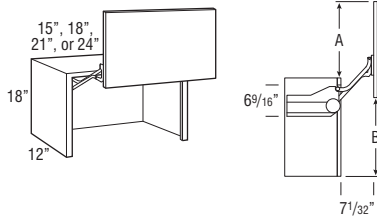

	Full Overlay	Partial Overlay
A	16 13/16"	16 1/16"
B	17 5/16"	18 1/16"

Model	Cubic Feet
WAGVLD15	2.8
WAGVLD18	3.3
WAGVLD21	3.8
WAGVLD24	4.3

- Utilizes standard doors with vertical grain on center panel and standard door configuration. Genova will have standard vertical grain pattern. Troxel will have standard horizontal grain pattern.
- When ordered in Arch/Cathedral door styles, door will be Square.
- Decorative hardware required.
- See side view drawing for required clearances.
- Lift mechanism features a single motion for up and out movement with Smart Stop, tension can be field adjusted.
- Lift mechanisms and mounting brackets will be visible if used with transparent textured glass.
- Lift mechanism not available for order for field installation, only available factory installed.
- Hardware extends 1" into opening on each side.
- Bottom edge not trimmable.

Custom Modifications

ADDTK	AUTHL AUTHR	CBO	CCO	CFNTO	CFRMO	CND	EXBKL EXBKR	EXL EXR	FB	FFDL FFDR
	•		•		•		•	•	•	
FPEB	ID	INVERM	MIP	P	PFINBTMB	RD	TD	TVRAV TVRFV TVRVV	WLI	
•	•		•						•	

Construction Upgrades

APC	PE
•	•

Door Options

ALF	CG	CG.BTM	CG.TOP	DPSRR	MD	MD.BTM	MD.TOP	MFO
	•			•				

CORNER TAMBOUR, 18" HIGH

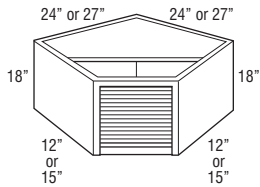

CT2424	7.8
CT2727	8.3

- CT2424 requires 24" x 24" corner wall space.
- CT2727 requires 27" x 27" corner wall space.
- Cabinet is designed to fit beneath Diagonal Wall Cabinets.
- Cabinet has partial top and no floor.
- If ordered with Heirloom Technique, will not feature sand-through characteristics.
- Trim height will be restricted when AUTHL or AUTHR is selected.

Custom Modifications

ADDTK	AUTHL AUTHR	CBO	CCO	CFNTO	CFRMO	CND	EXBKL EXBKR	EXL EXR	FB	FFDL FFDR
	•	•	•		•				•	
FPEB	ID	INVERM	MIP	P	PFINBTMB	RD	TD	TVRAV TVRFV TVRVV	WLI	
•			•						•	

Construction Upgrades

APC	PE
•	•

Door Options

ALF	CG	CG.BTM	CG.TOP	DPSRR	MD	MD.BTM	MD.TOP	MFO

CORNER DOOR, 18" HIGH

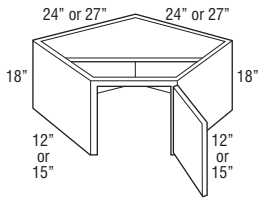

Model	Cubic Feet
CD2424 L or R	7.8
CD2727 L or R	8.3

- CD2424 L or R requires 24" x 24" corner wall space.
- CD2727 L or R requires 27" x 27" corner wall space.
- Cabinet is designed to fit beneath Diagonal Wall Cabinets.
- When ordered in Arch/Cathedral door styles, door will be Square.
- Cabinet has partial top and no floor.

Custom Modifications

ADDTK	AUTHL AUTHR	CBO	CCO	CFNTO	CFRMO	CND	EXBKL EXBKR	EXL EXR	FB	FFDL FFDR
	•		•	•	•				•	
FPEB	ID	INVRM	MIP	P	PFINBTMB	RD	TD	TVRAV TVRFV TVRVV	WLI	
•			•						•	

Construction Upgrades

APC	PE
•	•

Door Options

ALF	CG	CG.BTM	CG.TOP	DPSRR	MD	MD.BTM	MD.TOP	MFO
	•			•				

WALL BOX COLUMN PULL-OUT, PLAIN storage SOLUTIONS

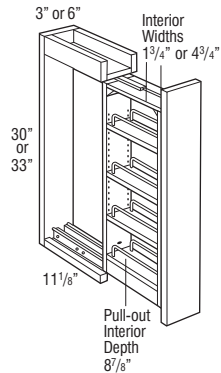

WBCPO_30
WBCPO_33

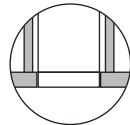

Top View

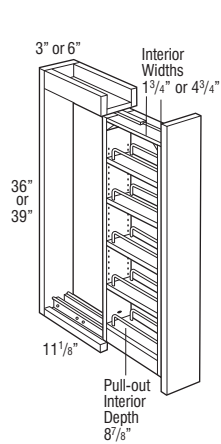

WBCPO_36
WBCPO_39

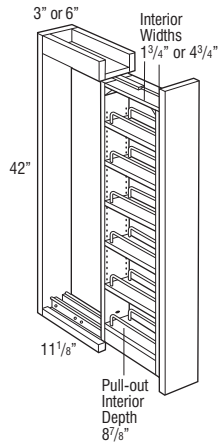

WBCPO_42

NEW WBCPO330	0.6
NEW WBCPO333	1.3
NEW WBCPO336	1.4
NEW WBCPO339	1.5
NEW WBCPO342	1.6
WBCPO630	1.3
NEW WBCPO633	2.2
NEW WBCPO636	2.4
NEW WBCPO639	2.6
NEW WBCPO642	2.7

- Recommend installation between two cabinets. Can be installed on the end of a run with the use of a 3/4" thick end panel.
- Cannot be installed between cabinets with Authentic Ends.
- All styles feature a natural finish full extension wood pull-out with adjustable shelves and chrome rail sides.
- If used at the end of a run or next to an appliance, an End Panel must be installed on the pull-out adjacent to the end of run/appliance.
- If ordered with Heirlooming Technique, will not feature sand-through characteristics.
- In order to allow proper clearance for opening and closing, allow an additional 1/8" space between adjacent cabinet face frames. The 3" wide pull-outs require 3 1/8" space and the 6" wide pull-outs require 6 1/8" space. Spacers are included with the pull-outs to allow for proper installation.
- For full access from both sides of unit, do not install against a wall or next to deeper appliances and cabinets.

MODIFICATIONS

No modifications available for these products.

Finish Techniques

Distressing	Heirloom
•	

WALL BOX COLUMN PULL-OUT, OVERLAY

storage SOLUTIONS

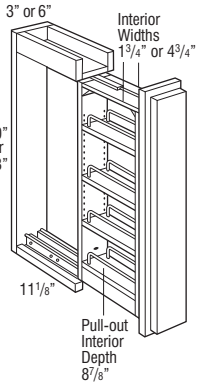

WBCPO_300L
WBCPO_330L

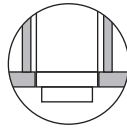

Top View

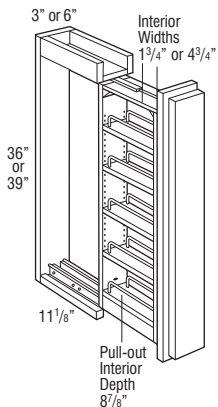

WBCPO_360L
WBCPO_390L

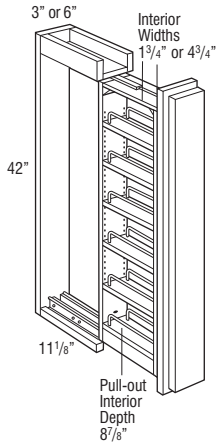

WBCPO_420L

Model	Cubic Feet
WBCPO3300L	0.6
NEW WBCPO3330L	1.3
NEW WBCPO3360L	1.4
NEW WBCPO3390L	1.5
NEW WBCPO3420L	1.6
WBCPO6300L	1.3
NEW WBCPO6330L	2.2
NEW WBCPO6360L	2.4
NEW WBCPO6390L	2.6
NEW WBCPO6420L	2.7

- Recommend installation between two cabinets. Can be installed on the end of a run with the use of a 3/4" thick end panel.
- Overlay application includes profiled full overlay filler.
- Cannot be installed between cabinets with Authentic Ends.
- All styles feature a natural finish full extension wood pull-out with adjustable shelves and chrome rail sides.
- If used at the end of a run or next to an appliance, an End Panel must be installed on the pull-out adjacent to the end of run/appliance.
- In order to allow proper clearance for opening and closing, allow an additional 1/8" space between adjacent cabinet face frames. The 3" wide pull-outs require 3 1/8" space and the 6" wide pull-outs require 6 1/8" space. Spacers are included with the pull-outs to allow for proper installation.
- For full access from both sides of unit, do not install against a wall or next to deeper appliances and cabinets.
- Not compatible with face mount moulding.

MODIFICATIONS

No modifications available for these products.

Finish Techniques

Distressing	Heirloom
•	•



**WALL BOX COLUMN PULL-OUT
with K-CUP®*, PLAIN**

storage
SOLUTIONS

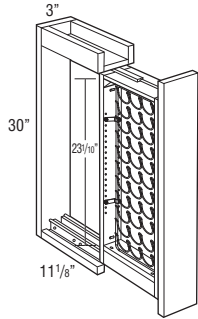

WBCPOKCUP330

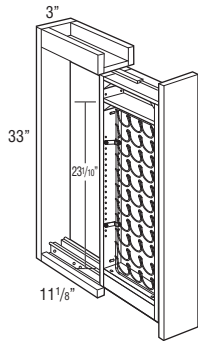
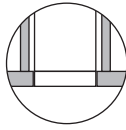

WBCPOKCUP333

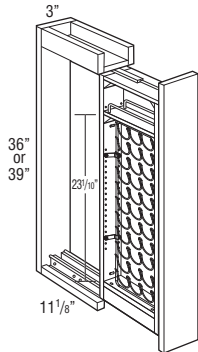

**WBCPOKCUP336
WBCPOKCUP339**

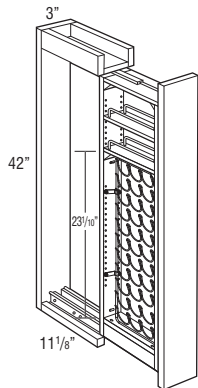

WBCPOKCUP342

Model	Cubic Feet
WBCPOKCUP330	1.2
WBCPOKCUP333	1.3
WBCPOKCUP336	1.4
WBCPOKCUP339	1.5
WBCPOKCUP342	1.6

- Holds 44 K-Cups®, compatible with K-Cup® pods only.
 - Wire K-Cup® rack included for easy field installation on either the left or right side. All units include adjustable shelves with chrome rail sides that can be used for future installation if K-Cup® insert is no longer desired. Depending on height of pull-out, shelves can be used above or below insert for additional storage:
30" & 33" high include 4 shelves, not compatible with insert.
36" & 39" high include 5 shelves, one shelf recommended for use with insert.
42" high includes 6 shelves, two shelves recommended for use with insert.
 - Recommend installation between two cabinets. Can be installed on the end of a run with the use of a 3/4" thick end panel.
 - Cannot be installed between cabinets with Authentic Ends.
 - All styles feature a natural finish full extension wood pull-out.
 - If used at the end of a run or next to an appliance, an End Panel must be installed on the pull-out adjacent to the end of run/appliance.
 - In order to allow proper clearance for opening and closing, allow an additional 1/8" space between adjacent cabinet face frames. The 3" wide pull-outs require 3 1/8" space. Spacers are included with the pull-outs to allow for proper installation.
 - For full access from both sides of unit, do not install against a wall or next to deeper appliances and cabinets.
 - Finger pull routed on bottom edge of wall unit. Hardware optional.
 - Pull-out does not have Smart Stop feature.
- *K-Cup® is a registered trademark of Keurig Green Mountain, Inc.

MODIFICATIONS
No modifications available for these products.

Finish Techniques

Distressing	Heirloom
•	

NEW WALL BOX COLUMN PULL-OUT
with K-CUP®*, OVERLAY

storage
SOLUTIONS

Model	Cubic Feet
WBCPOKCUP3300L	1.2
WBCPOKCUP3330L	1.3
WBCPOKCUP3360L	1.4
WBCPOKCUP3390L	1.5
WBCPOKCUP3420L	1.6

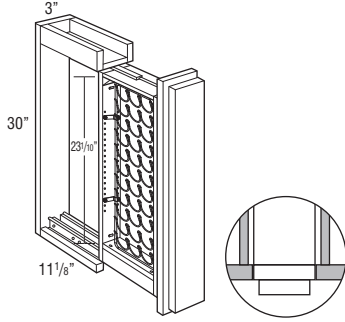

WBCPOKCUP3300L

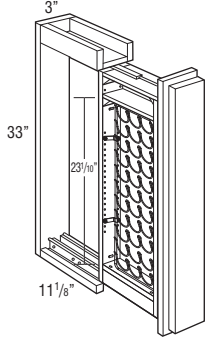

WBCPOKCUP3330L

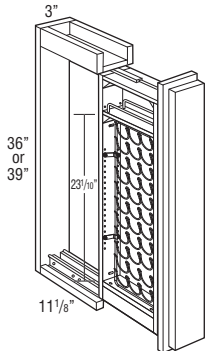

WBCPOKCUP3360L
WBCPOKCUP3390L

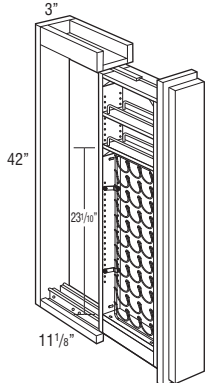

WBCPOKCUP3420L

- Holds 44 K-Cups®, compatible with K-Cup® pods only.
 - Wire K-Cup® rack included for easy field installation on either the left or right side. All units include adjustable shelves with chrome rail sides that can be used for future installation if K-Cup® insert is no longer desired. Depending on height of pull-out, shelves can be used above or below insert for additional storage:
30" & 33" high include 4 shelves, not compatible with insert.
36" & 39" high include 5 shelves, one shelf recommended for use with insert.
42" high includes 6 shelves, two shelves recommended for use with insert.
 - Overlay application includes profiled full overlay filler.
 - Recommend installation between two cabinets. Can be installed on the end of a run with the use of a 3/4" thick end panel.
 - Cannot be installed between cabinets with Authentic Ends.
 - All styles feature a natural finish full extension wood pull-out.
 - If used at the end of a run or next to an appliance, an End Panel must be installed on the pull-out adjacent to the end of run/appliance.
 - In order to allow proper clearance for opening and closing, allow an additional 1/8" space between adjacent cabinet face frames. The 3" wide pull-outs require 3 1/8" space. Spacers are included with the pull-outs to allow for proper installation.
 - For full access from both sides of unit, do not install against a wall or next to deeper appliances and cabinets.
 - Finger pull routed on bottom edge of wall unit. Hardware optional.
 - Pull-out does not have Smart Stop feature.
 - Not compatible with face mount moulding.
- *K-Cup® is a registered trademark of Keurig Green Mountain, Inc.

MODIFICATIONS

No modifications available for these products.

Finish Techniques

Distressing	Heirloom
•	•

WALL SPICE PULL-OUT, 30", 33", 36", 39", or 42" HIGH storage SOLUTIONS

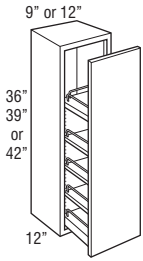
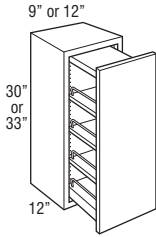

Model	Cubic Feet
WSP930	2.9
WSP1230	3.7
WSP933	3.2
WSP1233	4.1
WSP936	3.5
WSP1236	4.4
WSP939	3.7
WSP1239	4.7
WSP942	4.0
WSP1242	5.1

- 30" and 33" high units include a natural finish, full extension wood pull-out with three adjustable shelves, one fixed shelf, and chrome finish rail sides.
- Wood plugs for top of 30" high pull-out included for field installation.
- 36" to 42" high units include a natural finish, full extension wood pull-out with three adjustable shelves, two fixed shelves, and chrome finish rail sides.
- Wire for top rail on 36" to 42" high pull-out included separately for field installation.
- For full access from both sides of unit, do not install against a wall or next to deeper appliances and cabinets.
- Pull-out does not have Smart Stop feature.

Custom Modifications

ADDTK	AUTHL AUTHR	CBO	CCO	CFNTO	CFRMO	CND	EXBKL EXBKR	EXL EXR	FB	FFDL FFDR
•	•	•	•		•		•	•	•	
								TVRAV TVRFV TVRVV		
•	ID	INVFRM	MIP	P	PFINBTMB	RD	TD		WLI	•

Construction Upgrades

APC	PE
•	•

Door Options

ALF	CG	CG.BTM	CG.TOP	DPSRR	MD	MD.BTM	MD.TOP	MFO
				•				•

WALL SPICE PULL DOWN

storage SOLUTIONS

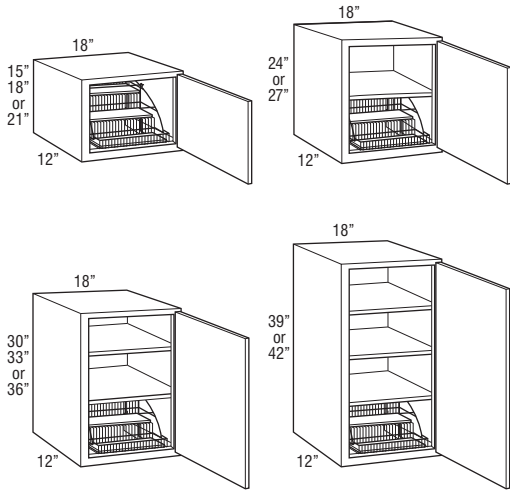

Model	Cubic Feet
W1815SPD L or R	2.8
W1818SPD L or R	3.2
W1821SPD L or R	3.7
W1824SPD L or R	4.2
W1827SPD L or R	4.7
W1830SPD L or R	5.2
W1833SPD L or R	5.7
W1836SPD L or R	6.2
W1839SPD L or R	6.6
W1842SPD L or R	7.1

- Spice Rack Pull Down dimensions: 8 15/16" high x 14 13/16" wide x 10 5/16" deep.
- Interior dimensions of pull down trays: 11 3/4" wide x 3" deep.
- Maximum Weight Capacity for Spice Rack Pull Down: 15 lbs.
- When Increased Depth (ID) is ordered, insert will not increase in size.

Custom Modifications

	AUTHL AUTHR	CBO	CCO	CFNTO	CFRMO	CND	EXBKL EXBKR	EXL EXR	FB	FFDL FFDR
	•	•*	•	•	•		•	•	•	•+
FPEB	ID	INVERM	MIP	P	PFINBTMB	RD	TD	TVRAV TVRFV TVRVV	WLI	
•	•		•		•				•	

*Not available on 15", 18", or 21" high *Not available on 15" high

Construction Upgrades

APC	PE
•	•

Door Options

ALF	CG	CG.BTM	CG.TOP	DPSRR	MD	MD.BTM	MD.TOP	MFO
	•			•	†			•

†Not available on 15", 24", or 27" high

WALL SHELF PULL DOWN

storage SOLUTIONS

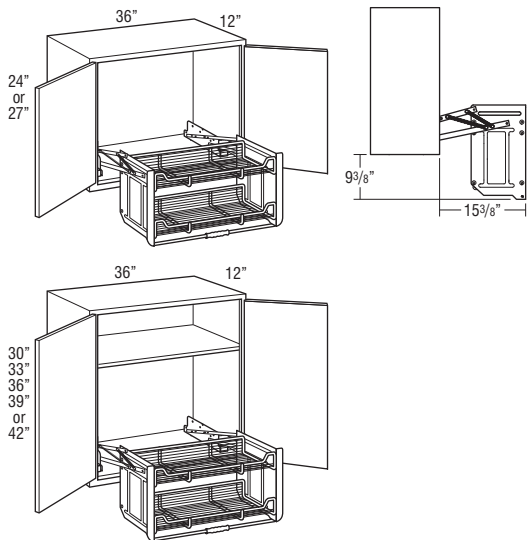

W3624SHLFPD	8.0
W3627SHLFPD	9.3
W3630SHLFPD	10.0
W3633SHLFPD	10.3
W3636SHLFPD	11.8
W3639SHLFPD	11.9
W3642SHLFPD	13.9

- Shelf Pull Down dimensions: 18 11/64" high x 28 1/4" wide x 8 1/2" deep.
- Interior dimensions of pull down trays: 28 1/4" wide x 8 1/2" deep.
- Clearance dimensions: 19 3/8" high x 15 3/8" wide.
- 30" to 42" high units will have one adjustable shelf above pull-down unit.
- Maximum Weight Capacity for Shelf Pull Down: 26 lbs.

Custom Modifications

	AUTHL AUTHR	CBO	CCO	CFNTO	CFRMO	CND	EXBKL EXBKR	EXL EXR	FB	FFDL FFDR
	•	•	•	•	•		•	•	•	
FPEB	ID	INVERM	MIP	P	PFINBTMB	RD	TD	TVRAV TVRFV TVRVV	WLI	
•			•		•				•	

Construction Upgrades

APC	PE
•	•

Door Options

ALF	CG	CG.BTM	CG.TOP	DPSRR	MD	MD.BTM	MD.TOP	MFO
	•			•	•			•

WALL SPICE RACK CABINET, 30", 33", 36", 39", or 42" HIGH storage SOLUTIONS

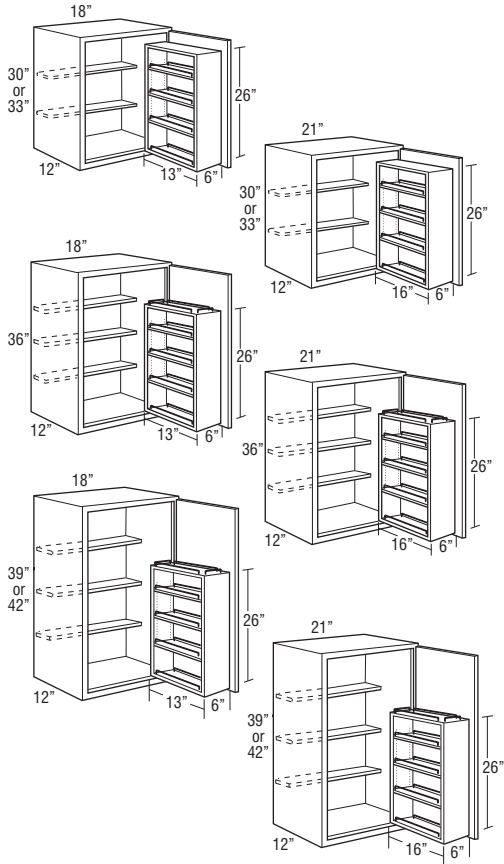

Model	Cubic Feet
WSR1830 L or R	5.3
WSR2130 L or R	6.1
WSR1833 L or R	5.9
WSR2133 L or R	6.7
WSR1836 L or R	6.3
WSR2136 L or R	7.2
WSR1839 L or R	6.8
WSR2139 L or R	7.8
WSR1842 L or R	7.3
WSR2142 L or R	8.3

- Shelves are 4 1/2" deep.
- Field installed swing-out has three adjustable and one fixed bottom shelf with chrome finish wire rail sides.
- Dimensions: WSR18 wood insert is 26" high x 13" wide x 6" deep. WSR21 wood insert is 26" high x 16" wide x 6" deep.
- When Increased Depth (ID) is ordered, wood insert will not increase in size.
- Maximum Weight Capacity for Spice Rack Shelves: 15 lbs.

Custom Modifications

ADDTK	AUTHL AUTHR	CBO	CCO	CFNTO	CFRMO	CND	EXBKL EXBKR	EXL EXR	FB	FFDL FFDR
•	•	•	•	•	•		•	•	•	
FPEB	ID	INVRM	MIP	P	PFINBTMB	RD	TD	TVRAV TVRFV TVRVV	WLI	
•	•		•		•				•	

Construction Upgrades

APC	PE
•	•

Door Options

ALF	CG	CG.BTM	CG.TOP	DPSRR	MD	MD.BTM	MD.TOP	MFO
	•			•	•			•

WALL OPEN CABINET with PLAIN BACK, 30", 33", 36", 39", or 42" HIGH

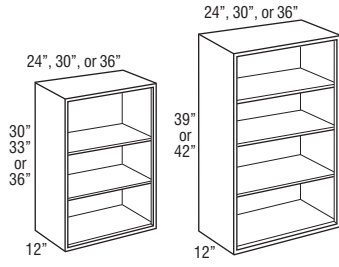

Model	Cubic Feet
WOCP2430	6.7
WOCP3030	8.3
WOCP3630	9.9
WOCP2433	7.4
WOCP3033	9.1
WOCP3633	10.8
WOCP2436	8.0
WOCP3036	9.9
WOCP3636	11.7
WOCP2439	8.6
WOCP3039	10.6
WOCP3639	12.7
WOCP2442	9.3
WOCP3042	11.4
WOCP3642	13.5

- Cabinet interior and adjustable shelves finished to match cabinet face frame.
- Hardwood veneer plywood.
- Face frame has a profiled inside edge.
- If ordered with Heirlooming Technique, will not feature sand-through characteristics.
- To change the top rail valance, specify one of the following modifications: Arch (TVRAV), Furniture (TVRFV), or Straight Valance (TVRVV).

Custom Modifications

ADDTK	AUTHL AUTHR	CBO	CCO	CFNTO	CFRMO	CND	EXBKL EXBKR	EXL EXR	FB	FFDL FFDR
•	•	STD			•		•	•	STD	
FPEB	ID	INVERM	MIP	P	PFINBTMB	RD	TD	TVRAV TVRFV TVRVV	WLI	
•	•		STD	•	•	•		•		

Construction Upgrades

APC	PE
	STD

Door Options

ALF	CG	CG.BTM	CG.TOP	DPSRR	MD	MD.BTM	MD.TOP	MFO

WALL OPEN CABINET with BEADED BACK, 30", 33", 36", 39", or 42" HIGH

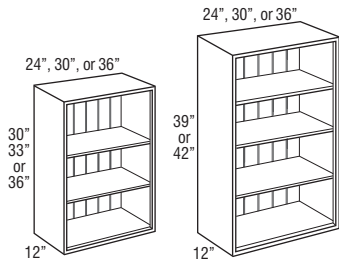

Model	Cubic Feet
WOCB2430	6.9
WOCB3030	8.5
WOCB3630	10.0
WOCB2433	7.4
WOCB3033	9.1
WOCB3633	10.8
WOCB2436	8.0
WOCB3036	9.9
WOCB3636	11.7
WOCB2439	8.6
WOCB3039	10.6
WOCB3639	12.7
WOCB2442	9.3
WOCB3042	11.4
WOCB3642	13.5

- Cabinet interior and adjustable shelves finished to match cabinet face frame.
- Hardwood veneer plywood.
- Beaded back panel is hardwood veneer on furniture board core.
- Face frame has a profiled inside edge.
- If ordered with Heirlooming Technique, will not feature sand-through characteristics.
- To change the top rail valance, specify one of the following modifications: Arch (TVRAV), Furniture (TVRFV), or Straight Valance (TVRVV).

Custom Modifications

ADDTK	AUTHL AUTHR	CBO	CCO	CFNTO	CFRMO	CND	EXBKL EXBKR	EXL EXR	FB	FFDL FFDR
•	•	STD			•		•	•	STD	
FPEB	ID	INVRM	MIP	P	PFINBTMB	RD	TD	TVRAV TVRFV TVRVV	WLI	
•	•		STD	•	•	•		•		

Construction Upgrades

APC	PE
	STD

Door Options

ALF	CG	CG.BTM	CG.TOP	DPSRR	MD	MD.BTM	MD.TOP	MFO

WALL CHINA DISPLAY, 15" HIGH

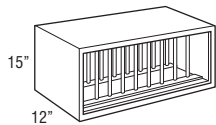

Model	# of Plates
WCD2415	10
WCD3015	13
WCD3615	16

Model	Cubic Feet
WCD2415	3.0
WCD3015	4.5
WCD3615	6.0

- Vertical dowels are 3/8" diameter, 1 1/2" apart.
- Hardwood veneer plywood.
- Matching interior.
- Individual dowels are not removable. Complete rack assembly is removable.
- If ordered with Heirlooming Technique, will not feature sand-through characteristics.

Custom Modifications

ADDTK	AUTHL AUTHR	CBO	CCO	CFNTO	CFRMO	CND	EXBKL EXBKR	EXL EXR	FB	FFDL FFDR
•		STD			•		•	•	STD	
FPEB	ID	INVRM	MIP	P	PFINBTMB	RD	TD	TVRAV TVRFV TVRVV	WLI	
•			STD		•					

Construction Upgrades

APC	PE
	STD

Door Options

ALF	CG	CG.BTM	CG.TOP	DPSRR	MD	MD.BTM	MD.TOP	MFO

**WALL CHINA DISPLAY with DOORS,
30", 33", 36", 39", or 42" HIGH**

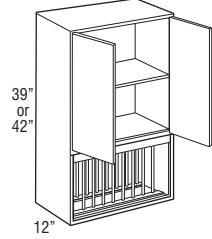
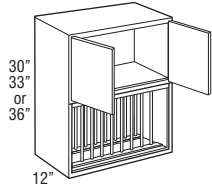

Model	# of Plates
WCD2430	10
WCD3030	13
WCD3630	16
WCD2433	10
WCD3033	13
WCD3633	16
WCD2436	10
WCD3036	13
WCD3636	16
WCD2439AH	10
WCD3039AH	13
WCD3639AH	16
WCD2442AH	10
WCD3042AH	13
WCD3642AH	16

Model	Cubic Feet
WCD2430	6.9
WCD3030	8.5
WCD3630	10.0
WCD2433	7.6
WCD3033	9.4
WCD3633	11.2
WCD2436	8.2
WCD3036	10.0
WCD3636	11.9
WCD2439AH	8.8
WCD3039AH	10.8
WCD3639AH	12.5
WCD2442AH	9.4
WCD3042AH	11.6
WCD3642AH	13.8

- Vertical dowels are 3/8" diameter, 1 1/2" apart.
- Hardwood veneer plywood.
- Matching interior.
- Individual dowels are not removable. Complete rack assembly is removable.
- China display section has 12" frame opening height.

Custom Modifications

ADDTK	AUTHL AUTHR	CBO	CCO	CFNTO	CFRMO	CND	EXBKL EXBKR	EXL EXR	FB	FFDL FFDR
•	•	•	•*	•	•		•	•	STD	
FPEB	ID	INVERM	MIP	P	PFINBTMB	RD	TD	TVRAV TVRFV TVRVV	WLI	
•			STD		•					

*Available only on 39" and 42" high

Construction Upgrades

APC	PE
	STD

Door Options

ALF	CG	CG.BTM	CG.TOP	DPSRR	MD	MD.BTM	MD.TOP	MFO
	•			•				•

WALL WINE RACK, 15", 18", or 30" HIGH

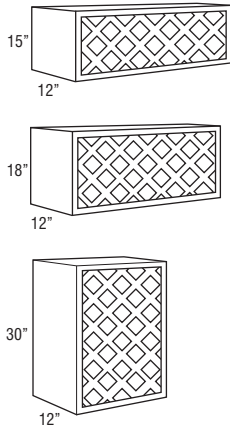

Model	# of Bottles
WNR3015	11
WNR3315	13
WNR3615	13
WNR3018	11
WNR3318	13
WNR3618	13
WNR1530	11
WNR1830	11
WNR2130	11

Model	Cubic Feet
WNR3015	4.5
WNR3315	4.9
WNR3615	5.4
WNR3018	5.3
WNR3318	5.8
WNR3618	6.3
WNR1530	4.5
WNR1830	5.3
WNR2130	6.1

- Cabinet interior finished to match cabinet face frame.
- Hardwood veneer plywood with solid wood lattice work.
- Matching interior.
- Wine bottle opening 4" x 4".
- If ordered with Heirloom Technique, will not feature sand-through characteristics.

Custom Modifications

ADDTK	AUTHL AUTHR	CBO	CCO	CFNTO	CFRMO	CND	EXBKL EXBKR	EXL EXR	FB	FFDL FFDL
•		STD			•		•	•	STD	
FPEB	ID	INVFRM	MIP	P	PFINBTMB	RD	TD	TVRAV TVRFV TVRVV	WLI	
•			STD		•					

Construction Upgrades

APC	PE
	STD

Door Options

ALF	CG	CG.BTM	CG.TOP	DPSRR	MD	MD.BTM	MD.TOP	MFO

WINE STORAGE CABINET, 12", 15", 18", 21", or 24" HIGH

storage SOLUTIONS

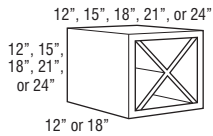

Model	# of Bottles
WSC121212	4
WSC151512	10
WSC181812	18
WSC181818	18
WSC212112	24
WSC242412	32

Model	Cubic Feet
WSC121212	1.6
WSC151512	2.3
WSC181812	3.2
WSC181818	4.3
WSC212112	4.3
WSC242412	5.5

- Must be installed between two cabinets, between a cabinet and a wall, or mounted to a horizontal surface.
- "X" shelf configuration cannot be removed.
- If ordered with Heirloom Technique, will not feature sand-through characteristics.
- Reduced depth not recommended for safe wine bottle storage.

Custom Modifications

ADDTK	AUTHL AUTHR	CBO	CCO	CFNTO	CFRMO	CND	EXBKL EXBKR	EXL EXR	FB	FFDL FFDL
							•		STD	
FPEB	ID	INVFRM	MIP	P	PFINBTMB	RD	TD	TVRAV TVRFV TVRVV	WLI	
•	•*		STD		•	•				

*ID on 12" deep models available up to 18" deep

Construction Upgrades

APC	PE
	STD

Door Options

ALF	CG	CG.BTM	CG.TOP	DPSRR	MD	MD.BTM	MD.TOP	MFO

WALL WINE CUBBY, 24", 30", 36", or 42" WIDE, 6" HIGH

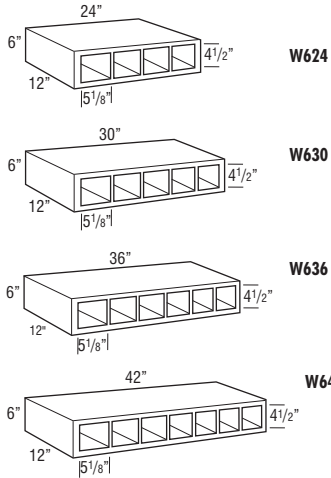

Model	Cubic Feet
W624 (4 openings)	1.8
W630 (5 openings)	2.2
W636 (6 openings)	2.7
W642 (7 openings)	3.0

- Hardwood veneer on 3/4" furniture board core.
- Matching interior.
- Frameless construction.
- If ordered with Heirlooming Technique, will not feature sand-through characteristics.
- Increased Depth only available in 3" increments.

Custom Modifications

ADDTK	AUTHL AUTHR	CBO	CCO	CFNTO	CFRMO	CND	EXBKL EXBKR	EXL EXR	FB	FFDL FFDR
									STD	
FPFB	ID	INVERM	MIP	P	PFINBTMB	RD	TD	TVRAV TVRFV TVRVV	WLI	
	•									

Construction Upgrades

APC	PE

Door Options

ALF	CG	CG.BTM	CG.TOP	DPSRR	MD	MD.BTM	MD.TOP	MFO

WALL ORGANIZER, 24", 30", or 36" WIDE, 6" HIGH

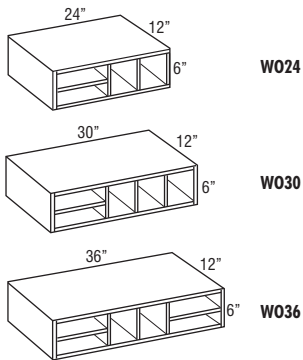

Model	Cubic Feet
W024	1.8
W030	2.2
W036	2.7

- Hardwood veneer on a 3/4" furniture board core.
- Frameless construction.
- Matching interior.
- If ordered with Heirlooming Technique, will not feature sand-through characteristics.
- Increased Depth only available in 3" increments.

Custom Modifications

ADDTK	AUTHL AUTHR	CBO	CCO	CFNTO	CFRMO	CND	EXBKL EXBKR	EXL EXR	FB	FFDL FFDR
									STD	
FPFB	ID	INVERM	MIP	P	PFINBTMB	RD	TD	TVRAV TVRFV TVRVV	WLI	
	•									

Construction Upgrades

APC	PE

Door Options

ALF	CG	CG.BTM	CG.TOP	DPSRR	MD	MD.BTM	MD.TOP	MFO

**WALL SPICE DRAWER, 24", 30", 36",
or 42" WIDE, 6" HIGH**

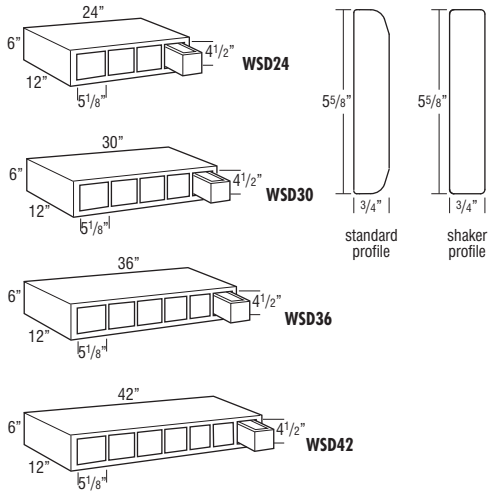

Model	Cubic Feet
WSD24 (4 drawers)	1.8
WSD30 (5 drawers)	2.2
WSD36 (6 drawers)	2.7
WSD42 (7 drawers)	3.0

- Drawer front is unique to item and will not match profile chosen.
- All styles use standard drawer front profile except Amstead, Butler, Caprice, Cotter, Darby, Hardin, Larsen, Lynnville, Northrope, Warwick, and Whitman, which use the shaker profile.
- Genova, Shafer, Taro, and Troxel drawer fronts will match doors and drawer fronts.
- Hardwood veneer on 3/4" furniture board core.
- 1/2" hardwood drawer with rabbet joint.
- Horizontal application only.
- Matching interior.
- Frameless construction.
- Increased Depth only available in 3" increments.

Custom Modifications

ADDTK	AUTHL AUTHR	CBO	CCO	CFNTO	CFRMO	CND	EXBKL EXBKR	EXL EXR	FB	FFDL FFDR
									STD	
FPEB	ID	INVRM	MIP	P	PFINBTMB	RD	TD	TVRAV TVRFV TVRVV	WLI	
	•									

Construction Upgrades

APC	PE

Door Options

ALF	CG	CG.BTM	CG.TOP	DPSRR	MD	MD.BTM	MD.TOP	MFO

FLOATING SHELVES

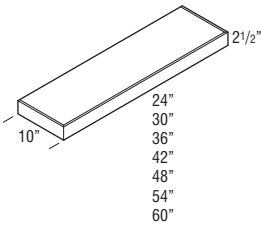

FS24	0.7
FS30	0.9
FS36	1.0
FS42	1.2
FS48	1.3
FS54	1.5
FS60	1.6

- Not available in Hickory.
- FS48, FS54, FS60 sizes are available in Maple and Cherry only.
- When ordered in Rustic Alder door styles, will not feature rustic characteristics.
- Maximum Weight Capacity per shelf:
 - 24" = 30 lbs.
 - 30" = 37.5 lbs.
 - 36" = 45 lbs.
 - 42" = 52.2 lbs.
 - 48" = 60 lbs.
 - 54" = 67.5 lbs.
 - 60" = 75 lbs.
- 3/4" thick solid wood front, back, and ends. 3/8" thick veneered plywood top and bottom. Front and ends are mitered together.

MODIFICATIONS

No modifications available for these products.

TRAY SHELVES

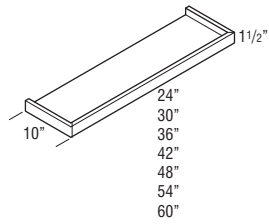

Model	Cubic Feet
TRAYSHELF2410	0.8
TRAYSHELF3010	0.9
TRAYSHELF3610	1.1
TRAYSHELF4210	1.3
TRAYSHELF4810	1.4
TRAYSHELF5410	1.6
TRAYSHELF6010	1.8

- When ordered in Rustic Alder door styles, will not feature rustic characteristics.
- Must be securely attached to wall with corbels or other shelf supports. A center support is also recommended on 42"-60" wide applications.
- 1/2" thick veneered plywood panel.

Custom Modifications

ADDTK	AUTHL AUTHR	CBO	CCO	CFNT0	CFRMO	CND	EXBKL EXBKR	EXL EXR	FB	FFDL FFDR
FPEB	ID	INVERM	MIP	P	PFINBTMB	RD	TD	TVRAV TVRFV TVRVV	WLI	
	•		STD			•				

Construction Upgrades

APC	PE
STD	

Door Options

ALF	CG	CG.BTM	CG.TOP	DPSRR	MD	MD.BTM	MD.TOP	MFO

WALL CORNER DECORATIVE SHELF

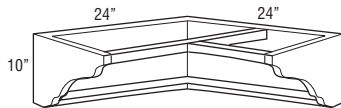

WCS2424	4.7
----------------	------------

- Bottom shelf depth is 3".
- Requires 24" x 24" corner wall space.
- Top is open; designed to mount under Easy Reach or Corner Cabinet.
- 3/4" hardwood end panel and shelf with 3/8" plywood back panel.
- Matching interior.

MODIFICATIONS

No modifications available for these products.

Finish Techniques

Distressing	Heirloom
•	

WALL DECORATIVE SHELF, 10" HIGH

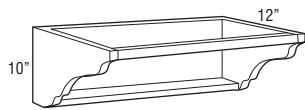

WS12	1.4
WS15	1.7
WS18	2.0
WS21	2.3
WS24	2.6
WS30	3.2
WS36	3.8

- Bottom shelf depth is 3".
- Top is open; designed to mount under wall cabinet.
- 3/4" hardwood end panel and shelf with 3/8" plywood back panel.
- Matching interior.

MODIFICATIONS

No modifications available for these products.

WALL MESSAGE CENTER, 30", 33", 36", 39", or 42" HIGH, 3" DEEP

storage
SOLUTIONS

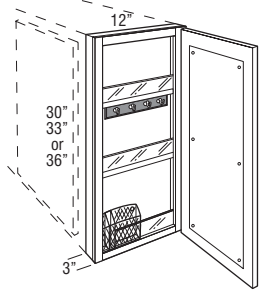

WMC1230 L or R
WMC1233 L or R
WMC1236 L or R

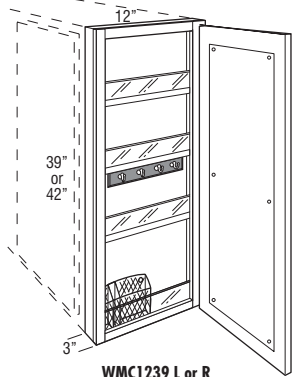

WMC1239 L or R
WMC1242 L or R

Model	Cubic Feet
WMC1230 L or R	1.8
WMC1233 L or R	1.9
WMC1236 L or R	2.2
WMC1239 L or R	2.5
WMC1242 L or R	2.9

- Includes magnetic whiteboard on back of door, key hooks, pencil holder, and fixed plexi-glass fronted shelves.
- WMC1230, WMC1233 L or R, and WMC1236 have 2 fixed shelves. WMC1239 and WMC1242 have 3 fixed shelves.
- Not available next to a Peninsula Cabinet.
- Door will open 90° without decorative hardware.
- Cabinet should be hinged on wall side.
- For proper installation, adjacent cabinet must have FPEB or 1/4" skin applied.
- Embellishments or overlay fillers can be used on side of cabinet to add a decorative touch.

Custom Modifications

	AUTHL AUTHR	CBO	CCO	CFNTO	CFRMO	CND	EXBKL EXBKR	EXL EXR	FB	FFDL FFDR
		•	•							
FPEB	ID	INVRM	MIP	P	PFINTMB	RD	TD	TVRAV TVRFV TVRVV	WLI	
STD			•						•	

Construction Upgrades

APC	PE
•	

Door Options

ALF	CG	CG.BTM	CG.TOP	DPSRR	MD	MD.BTM	MD.TOP	MFO
				•				•

WOOD HOOD ARCH, 36", 42", or 48" WIDE, 24 7/8" HIGH

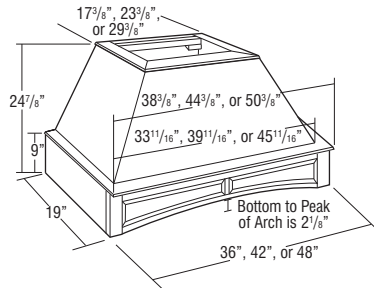

WHA36	14.0
WHA42	16.0
WHA48	18.0

- Freestanding unit (must be properly secured to wall and cannot be attached to adjacent cabinets).
- Exhaust system not included. Compatible with all Kemper blowers.
- Chimney available (WHC.). See page 156.
- Check your local building code for installation heights above the range.
- Silver metallic liner included. Assembly required.
- Arched raised panel valance front.
- Installation instructions and hardware included.
- Liner opening size: 10 1/4" deep by 19 1/2" wide.
- Wood hoods ordered in Rustic Alder will not feature Rustic characteristics.

MODIFICATIONS

No modifications available for these products.

Finish Techniques

Distressing	Heirloom
•	•

WOOD HOOD SQUARE, 36", 42", or 48" WIDE, 22 7/8" HIGH

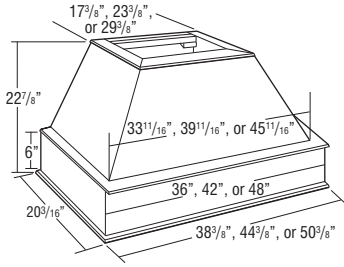

Model	Cubic Feet
WHS36	13.0
WHS42	14.0
WHS48	16.0

- Wood hoods are designed for use with decorative overlays.
- Freestanding unit (must be properly secured to wall and cannot be attached to adjacent cabinets).
- Exhaust system not included. Compatible with all Kemper blowers.
- Chimney available (WHC...). See below.
- Check your local building code for installation heights above the range.
- Silver metallic liner included. Assembly required.
- Installation instructions and hardware included.
- Liner opening size: 10 1/4" deep by 19 1/2" wide.
- Wood hoods ordered in Rustic Alder will not feature Rustic characteristics.

MODIFICATIONS
No modifications available for these products.

Finish Techniques

Distressing	Heirloom
•	•

WOOD HOOD CHIMNEY, 23 1/2" HIGH

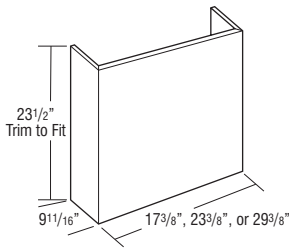

WHC36	3.0
WHC42	4.0
WHC48	5.0

- 3/4" thick plywood.
- Trimmable.
- If trimmed, moulding is recommended to conceal any cut marks.
- Optional accessory for Wood Hood Square (WHS) and Wood Hood Arch (WHA).
- Wood hoods ordered in Rustic Alder will not feature Rustic characteristics.

MODIFICATIONS
No modifications available for these products.

Finish Techniques

Distressing	Heirloom
•	•

WOOD HOOD CONTEMPORARY STRAIGHT, 30", 36", or 42" WIDE

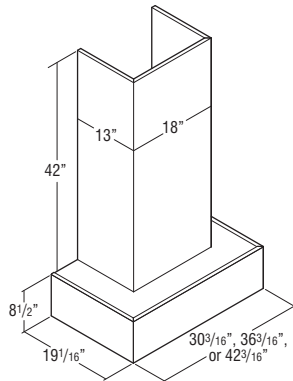

JWHCONSTR30	18.1
JWHCONSTR36	18.1
JWHCONSTR42	18.1

- Freestanding unit (must be properly secured to wall and cannot be attached to adjacent cabinets).
- Exhaust system not included. Compatible with all Kemper blowers.
- Chimney included and can be trimmed. If trimmed, moulding is recommended to cover any cut marks.
- Check your local building code for installation heights above the range.
- Silver metallic liner included. Assembly required.
- Installation instructions and hardware included.
- Liner opening size: 10 1/4" deep by 19 1/2" wide.
- Wood hoods ordered in Rustic Alder will not feature Rustic characteristics.
- Available in glaze finishes, but wood hood design does not provide detail for glaze hang-up.
- No changes or cancellations will be accepted after 24 hours from acknowledgment of order.

MODIFICATIONS
No modifications available for these products.

Finish Techniques

Distressing	Heirloom
•	•

**WOOD HOOD LINEAR, TAPERED,
30", 36", or 42" WIDE**

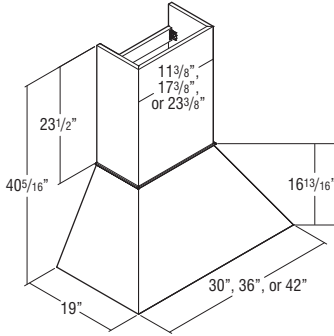

Model	Cubic Feet
JWHL30	14.0
JWHL36	16.0
JWHL42	18.0

- Freestanding unit (must be properly secured to wall and cannot be attached to adjacent cabinets).
- Exhaust system not included. Compatible with all Kemper blowers.
- Chimney included and can be trimmed.
- Check your local building code for installation heights above the range.
- Silver metallic liner included. Assembly required.
- Installation instructions and hardware included.
- Liner opening size: 10 1/4" deep by 19 1/2" wide.
- Wood hoods ordered in Rustic Alder will not feature Rustic characteristics.
- Available in glaze finishes, but wood hood design does not provide detail for glaze hang-up.
- No changes or cancellations will be accepted after 24 hours from acknowledgment of order.

MODIFICATIONS
No modifications available for these products.

**NEW WOOD HOOD SHIPLAP,
STRAIGHT, 36", 42", or
48" WIDE**

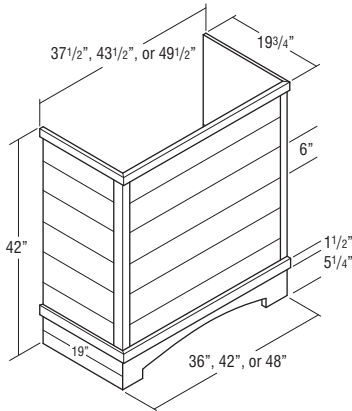

JWHSHPSTR36	22.0
JWHSHPSTR42	25.2
JWHSHPSTR48	28.4

- Freestanding unit (must be properly secured to wall and cannot be attached to adjacent cabinets).
- Constructed of 3/4" thick grooved plywood creating a shiplap appearance.
- Trimmable. If trimmed, moulding is recommended to conceal any cut marks.
- Exhaust system not included. Compatible with all Kemper blowers.
- Check local building code and appliance installation specifications for clearance requirements and installation heights above the range.
- Silver metallic liner included. Assembly required.
- Installation instructions and hardware included.
- Liner opening size: 10 1/4" deep by 19 1/2" wide.
- Wood hoods ordered in Rustic Alder will not feature Rustic characteristics.
- Not available in Hickory.
- No changes or cancellations will be accepted after 24 hours from acknowledgment of order.

MODIFICATIONS
No modifications available for these products.

Finish Techniques

Distressing	Heirloom
•	•

**NEW WOOD HOOD SHIPLAP,
STRAIGHT with CORBELS, 36",
42", or 48" WIDE**

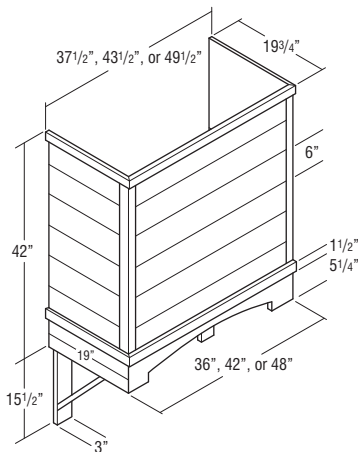

JWHSHPSTRCB36	22.0
JWHSHPSTRCB42	25.2
JWHSHPSTRCB48	28.4

- Includes a pair of decorative corbels.
- Freestanding unit (must be properly secured to wall and cannot be attached to adjacent cabinets).
- Constructed of 3/4" thick grooved plywood creating a shiplap appearance.
- Trimmable. If trimmed, moulding is recommended to conceal any cut marks.
- Exhaust system not included. Compatible with all Kemper blowers.
- Check local building code and appliance installation specifications for clearance requirements (including corbels) and installation heights above the range.
- Silver metallic liner included. Assembly required.
- Installation instructions and hardware included.
- Liner opening size: 10 1/4" deep by 19 1/2" wide.
- Wood hoods ordered in Rustic Alder will not feature Rustic characteristics.
- Not available in Hickory.
- No changes or cancellations will be accepted after 24 hours from acknowledgment of order.

MODIFICATIONS
No modifications available for these products.

Finish Techniques

Distressing	Heirloom
•	•

NEW WOOD HOOD SHIPLAP, TAPERED, 30", 36", 42", or 48" WIDE

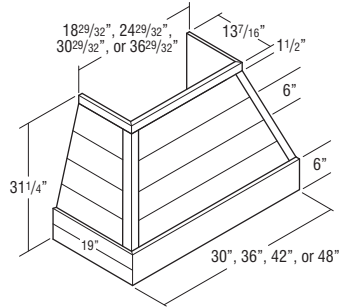

Model	Cubic Feet
JWHSIPT30	22.0
JWHSIPT36	22.0
JWHSIPT42	25.2
JWHSIPT48	28.4

- Freestanding unit (must be properly secured to wall and cannot be attached to adjacent cabinets).
- Constructed of 3/4" thick grooved plywood creating a shiplap appearance.
- Exhaust system not included. Compatible with all Kemper blowers.
- Compatible with Shiplap Chimney (JWHSIPCH__), which can be trimmed. See below.
- Check local building code and appliance installation specifications for clearance requirements and installation heights above the range.
- Silver metallic liner included. Assembly required.
- Installation instructions and hardware included.
- Liner opening size: 10 1/4" deep by 19 1/2" wide.
- Wood hoods ordered in Rustic Alder will not feature Rustic characteristics.
- Not available in Hickory.
- No changes or cancellations will be accepted after 24 hours from acknowledgment of order.

MODIFICATIONS
No modifications available for these products.

Finish Techniques

Distressing	Heirloom
•	•

NEW WOOD HOOD SHIPLAP, TAPERED with CORBELS, 36", 42", or 48" WIDE

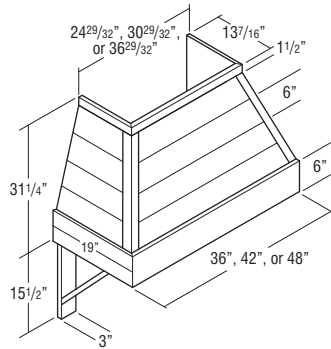

JWHSIPTCB36	22.0
JWHSIPTCB42	25.2
JWHSIPTCB48	28.4

- Includes a pair of decorative corbels.
- Freestanding unit (must be properly secured to wall and cannot be attached to adjacent cabinets).
- Constructed of 3/4" thick grooved plywood creating a shiplap appearance.
- Exhaust system not included. Compatible with all Kemper blowers.
- Compatible with Shiplap Chimney (JWHSIPCH__), which can be trimmed. See below.
- Check local building code and appliance installation specifications for clearance requirements (including corbels) and installation heights above the range.
- Silver metallic liner included. Assembly required.
- Installation instructions and hardware included.
- Liner opening size: 10 1/4" deep by 19 1/2" wide.
- Wood hoods ordered in Rustic Alder will not feature Rustic characteristics.
- Not available in Hickory.
- No changes or cancellations will be accepted after 24 hours from acknowledgment of order.

MODIFICATIONS
No modifications available for these products.

Finish Techniques

Distressing	Heirloom
•	•

NEW WOOD HOOD SHIPLAP CHIMNEY, 30", 36", 42", or 48" WIDE

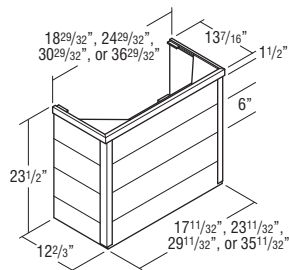

JWHSIPCH30	2.8
JWHSIPCH36	2.8
JWHSIPCH42	3.8
JWHSIPCH48	4.7

- Constructed of 3/4" thick grooved plywood creating a shiplap appearance.
- Trimable. If trimmed, moulding is recommended to conceal any cut marks.
- Optional accessory for Wood Hood Shiplap Tapered (JWHSIPT__ and JWHSIPTCB__) for an installed height of 54".
- Wood hoods ordered in Rustic Alder will not feature Rustic characteristics.
- Not available in Hickory.
- No changes or cancellations will be accepted after 24 hours from acknowledgment of order.

MODIFICATIONS
No modifications available for these products.

Finish Techniques

Distressing	Heirloom
•	•

**WOOD HOOD CANOPY ARCHED,
30" or 36" WIDE, 24" HIGH**

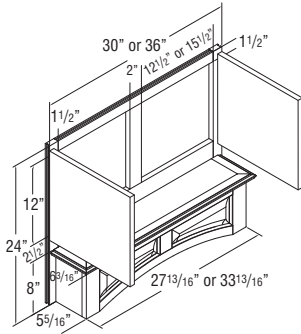

Model	Cubic Feet
WHCA30	4.7
WHCA36	5.6

- Install Wood Hoods between adjacent cabinets.
- Doors matching the style ordered will be installed on hood.
- Exhaust system not included. Compatible with all Kemper blowers.
- Check your local building code for installation heights above the range.
- Silver metallic liner included. Assembly required. Interior bottom section is finished below liner. Liner is not arched.
- Installation instructions and hardware included.
- Liner opening size: 10 1/4" deep by 19 1/2" wide.
- When ordered in Rustic Alder, only the doors will have Rustic characteristics.
- Arched raised panel valance front.

MODIFICATIONS
No modifications available for these products.

Door Options								
ALF	CG	CG.BTM	CG.TOP	DPSRR	MD	MD.BTM	MD.TOP	MFO
								•

Finish Techniques	
Distressing	Heirloom
•	•

**WOOD HOOD CANOPY ARCHED,
30" or 36" WIDE, 30" HIGH**

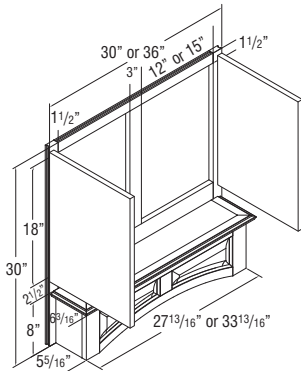

JWHCA3030	8.9
JWHCA3630	10.6

- Install Wood Hoods between adjacent cabinets.
- Doors matching the style ordered will be installed on hood.
- Exhaust system not included. Compatible with all Kemper blowers.
- Check your local building code for installation heights above the range.
- Silver metallic liner included. Assembly required. Interior bottom section is finished below liner. Liner is not arched.
- Installation instructions and hardware included.
- Liner opening size: 10 1/4" deep by 19 1/2" wide.
- When ordered in Rustic Alder, only the doors will have Rustic characteristics.
- Filter is not required unless using a ductless conversion kit. If ductless conversion kit required, see CONVERSION on page 162.
- Designed for use with FILTER250/390, see page 162.
- Arched raised panel valance front.
- No changes or cancellations will be accepted after 24 hours from acknowledgment of order.

MODIFICATIONS
No modifications available for these products.

Door Options								
ALF	CG	CG.BTM	CG.TOP	DPSRR	MD	MD.BTM	MD.TOP	MFO
								•

Finish Techniques	
Distressing	Heirloom
•	•

**WOOD HOOD CANOPY SQUARE,
30" or 36" WIDE, 24" HIGH**

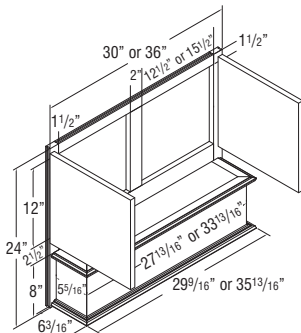

WHCS30	4.7
WHCS36	5.6

- Install Wood Hoods between adjacent cabinets.
- Doors matching the style ordered will be installed on hood.
- Exhaust system not included. Compatible with all Kemper blowers.
- Check your local building code for installation heights above the range.
- Silver metallic liner included. Assembly required. Interior bottom section is finished below liner.
- Installation instructions and hardware included.
- Liner opening size: 10 1/4" deep by 19 1/2" wide.
- When ordered in Rustic Alder, only the doors will have Rustic characteristics.

MODIFICATIONS
No modifications available for these products.

Door Options								
ALF	CG	CG.BTM	CG.TOP	DPSRR	MD	MD.BTM	MD.TOP	MFO
								•

Finish Techniques	
Distressing	Heirloom
•	•

**WOOD HOOD CANOPY SQUARE,
30" or 36" WIDE, 30" HIGH**

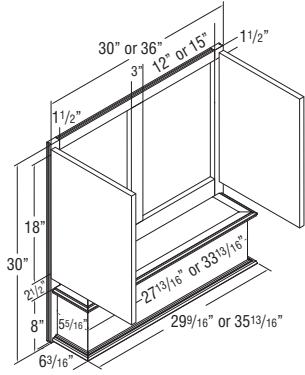

Model	Cubic Feet
JWHCS3030	8.9
JWHCS3630	10.6

- Install Wood Hoods between adjacent cabinets.
- Doors matching the style ordered will be installed on hood.
- Exhaust system not included. Compatible with all Kemper blowers.
- Check your local building code for installation heights above the range.
- Silver metallic liner included. Assembly required. Interior bottom section is finished below liner.
- Installation instructions and hardware included.
- Liner opening size: 10 1/4" deep by 19 1/2" wide.
- When ordered in Rustic Alder, only the doors will have Rustic characteristics.
- Filter is not required unless using a ductless conversion kit. If ductless conversion kit required, see CONVERSION on page 162.
- Designed for use with FILTER250/390, see page 162.
- No changes or cancellations will be accepted after 24 hours from acknowledgment of order.

MODIFICATIONS
No modifications available for these products.

Door Options								
ALF	CG	CG.BTM	CG.TOP	DPSRR	MD	MD.BTM	MD.TOP	MFO
								•

Finish Techniques	
Distressing	Heirloom
•	•

**WOOD HOOD ISLAND ARCH,
36", 42", or 48" WIDE**

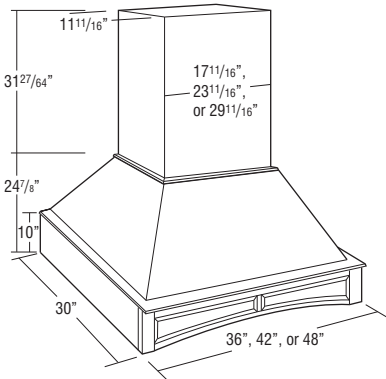

JWHIA36	19.0
JWHIA42	22.0
JWHIA48	25.0

- Check your local building codes for installation heights above the range.
- Exhaust system not included. Compatible with all Kemper blowers.
- Liner opening size: 10 1/4" D x 19 1/2" W.
- Wood hoods ordered in Rustic Alder will not feature rustic characteristics.
- Silver metallic liner included, assembly required.
- Installation kit, instructions and hardware included. Kit includes: ceiling mounting board assembly, spacers, outside corner mouldings, top trim mouldings, front, back, and end panels.
- No changes or cancellations will be accepted after 24 hours from acknowledgment of order.

MODIFICATIONS
No modifications available for these products.

Finish Techniques	
Distressing	Heirloom
•	•

**WOOD HOOD ISLAND SQUARE,
36", 42", or 48" WIDE**

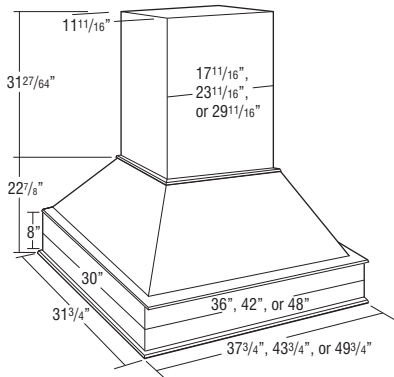

JWHIS36	19.0
JWHIS42	22.0
JWHIS48	25.0

- Check your local building codes for installation heights above the range.
- Exhaust system not included. Compatible with all Kemper blowers.
- Liner opening size: 10 1/4" D x 19 1/2" W.
- Wood hoods ordered in Rustic Alder will not feature rustic characteristics.
- Silver metallic liner included, assembly required.
- Installation kit, instructions and hardware included. Kit includes: ceiling mounting board assembly, spacers, outside corner mouldings, top trim mouldings, front, back, and end panels.
- No changes or cancellations will be accepted after 24 hours from acknowledgment of order.

MODIFICATIONS
No modifications available for these products.

Finish Techniques	
Distressing	Heirloom
•	•

**TAPERED WOOD HOOD,
30" or 36" WIDE, 24" HIGH**

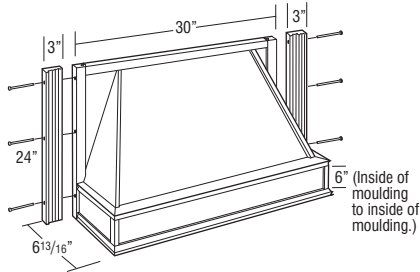
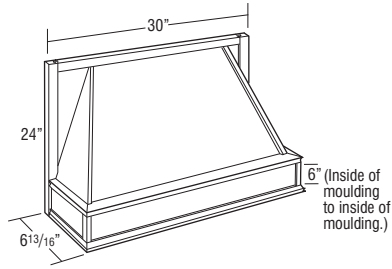

Model	Cubic Feet
TWH30	4.7
TWH36	5.6

- Wood hoods are designed for use with decorative overlays.
- Install Wood Hood between adjacent cabinets.
- Exhaust system not included. Compatible with all Kemper blowers.
- Check your local building code for installation heights above the range.
- Tapered design.
- Liner opening size: 10 1/4" deep x 19 1/2" wide.
- TWH36 has two plain/fluted fillers and metal wings included to extend hood to 36" width.
- Silver metallic liner included, not available for order separately.
- Wood hoods ordered in Rustic Alder will not feature Rustic characteristics.

MODIFICATIONS
No modifications available for these products.

Finish Techniques

Distressing	Heirloom
•	

WOOD HOOD BLOWER, 1100 CFM

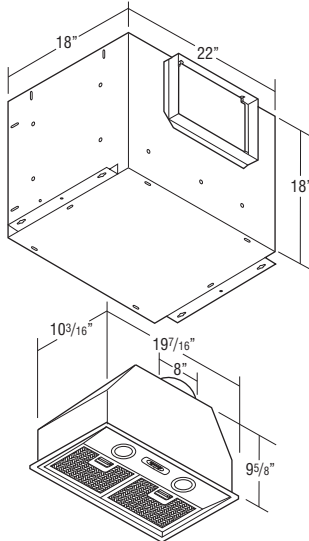

BLOWER1100	10.7
------------	------

- 1100 CFM.
- One year warranty.
- Ventilator housing unit features stainless steel finish.
- Two 50 watt (120 volt) halogen lamps included.
- Satellite blower installs remotely in the interior of the home (i.e., unfinished attic area.)
- Designed to work independently from internal blowers.
- Installation instructions, warranty, and repair information included.
- External ventilation required.
- Professional installation required.
- Compatible with all Wood Hoods and Hearths.
- Includes two in-line transitions (8" x 12" to 10" round).
- Includes two removable dishwasher safe grease filters.
- Designed for use in applications up to 110,000 BTUs.

MODIFICATIONS
No modifications available for these products.

WOOD HOOD BLOWER, 500 CFM

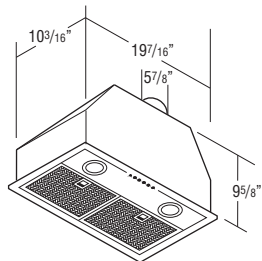

BLOWER500	4.0
-----------	-----

- 500 CFM.
- One year warranty.
- Sound rating is 8.2 sones.
- Two 20 watt (12 volt, G4 base) halogen lamps included.
- Installation instructions, warranty, and repair information included.
- Silver metallic finish.
- Three speed push button control.
- Includes two removable dishwasher safe grease filters.
- Compatible with all Wood Hoods and Hearths.
- Designed for use in applications up to 60,000 BTUs.

MODIFICATIONS
No modifications available for these products.

TAPERED WOOD HOOD BLOWER

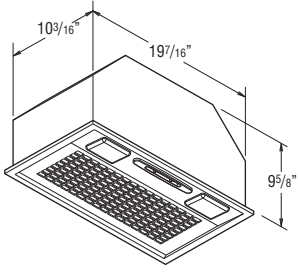

TWHBLOWER390

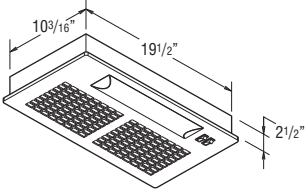

TWHBLOWER250

Model	Cubic Feet
TWHBLOWER390	2.1
TWHBLOWER250	2.1

- Range Hood Component Package has 2-speed single axial fan with lighted filter control.
- 7" diameter vent.
- 1 year warranty.
- Sound rating is 8 sones.
- Uses 2.1 amps.
- Two 40 watt candelabra lights required, but not included.
- Compatible with all Wood Hoods and Hearths.
- Silver metallic exterior finish.
- Includes removable dishwasher safe grease filter.

MODIFICATIONS
No modifications available for these products.

WOOD HOOD DUCTLESS CONVERSION KIT AND FILTER KITS

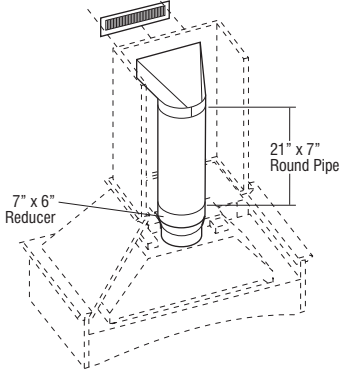

CONVERSION

CONVERSION	2.0
FILTER250/390	0.5
FILTER500	0.5

- Must order charcoal filter with CONVERSION kit for proper filtration to replace metal mesh filters included with blower unit.
- FILTER250/390 required when CONVERSION is used with TWHBLOWER250/TWHBLOWER390.
- FILTER500 required when CONVERSION is used with BLOWER500.
- CONVERSION includes: (1) 21" x 7" round pipe, (1) adjustable collar, (1) white metal soffit grille (11 3/8" x 3 5/8"), (1) adjustable boot, (1) 7" x 6" reducer, and installation instructions.

MODIFICATIONS
No modifications available for these products.

HEARTH, 48" HIGH, 21" DEEP

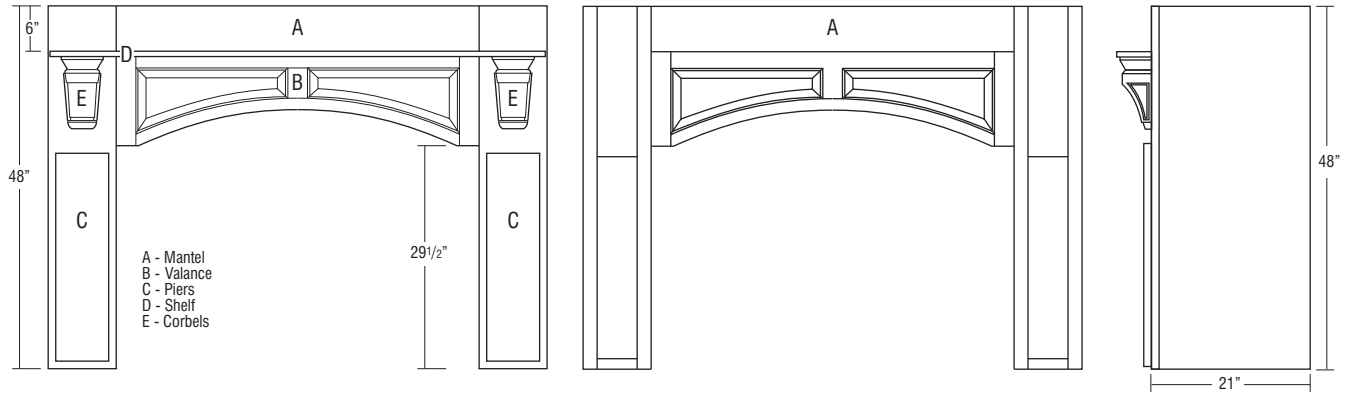

A - Mantel
B - Valance
C - Piers
D - Shelf
E - Corbels

• Recommended clearance of 7"-12" on each side of gas burner to combustible surface, 3"-6" from non-combustible surfaces including the backsplash surface and 30" from the vent. Reference local codes before installation.

		Hearth Width					
		48"	54"	60"	66"	72"	78"
48" High	Pier (left)	HP94821L or HPP94821	HP94821L or HPP94821	HP94821L or HPP94821	HP94821L or HPP94821	HP94821L or HPP94821	HP94821L or HPP94821
	Pier (right)	HP94821R or HPP94821	HP94821R or HPP94821	HP94821R or HPP94821	HP94821R or HPP94821	HP94821R or HPP94821	HP94821R or HPP94821
	Mantel	HM306	HM366	HM426	HM486	HM546	HM606
	Valance	JRPV30 or JRCPV30	JRPV36 or JRCPV36	JRPV42 or JRCPV42	JRPV48 or JRCPV48	JRPV54 or JRCPV54	JRPV60 or JRCPV60
	Corbel (2 Qty)	CORBELMIS9 or CORBELSCR9	CORBELMIS9 or CORBELSCR9	CORBELMIS9 or CORBELSCR9	CORBELMIS9 or CORBELSCR9	CORBELMIS9 or CORBELSCR9	CORBELMIS9 or CORBELSCR9
	Shelf	HS48	HS54	HS60	HS66	HS72	HS78
	Hood Liner	HL30	HL36	HL42	HL48	HL54	HL60
	Blower	All blowers are compatible					

HEARTH, 51" HIGH, 21" DEEP

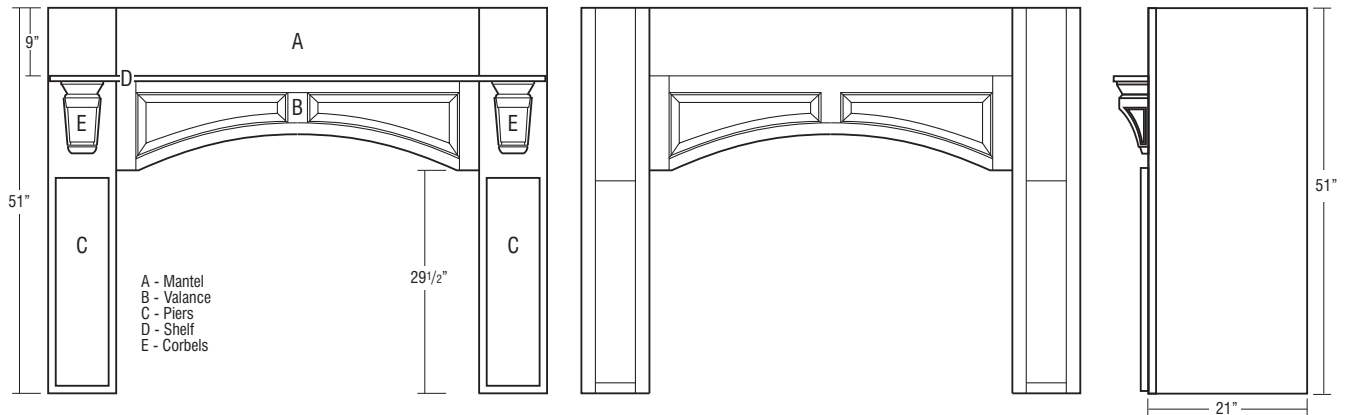

A - Mantel
B - Valance
C - Piers
D - Shelf
E - Corbels

• Recommended clearance of 7"-12" on each side of gas burner to combustible surface, 3"-6" from non-combustible surfaces including the backsplash surface and 30" from the vent. Reference local codes before installation. Side View

		Hearth Width					
		48"	54"	60"	66"	72"	78"
51" High	Pier (left)	HP95121L or HPP95121	HP95121L or HPP95121	HP95121L or HPP95121	HP95121L or HPP95121	HP95121L or HPP95121	HP95121L or HPP95121
	Pier (right)	HP95121R or HPP95121	HP95121R or HPP95121	HP95121R or HPP95121	HP95121R or HPP95121	HP95121R or HPP95121	HP95121R or HPP95121
	Mantel	HM309	HM369	HM429	HM489	HM549	HM609
	Valance	JRPV30 or JRCPV30	JRPV36 or JRCPV36	JRPV42 or JRCPV42	JRPV48 or JRCPV48	JRPV54 or JRCPV54	JRPV60 or JRCPV60
	Corbel (2 Qty)	CORBELMIS9 or CORBELSCR9	CORBELMIS9 or CORBELSCR9	CORBELMIS9 or CORBELSCR9	CORBELMIS9 or CORBELSCR9	CORBELMIS9 or CORBELSCR9	CORBELMIS9 or CORBELSCR9
	Shelf	HS48	HS54	HS60	HS66	HS72	HS78
	Hood Liner	HL30	HL36	HL42	HL48	HL54	HL60
	Blower	All blowers are compatible					

HEARTH, 54" HIGH, 21" DEEP

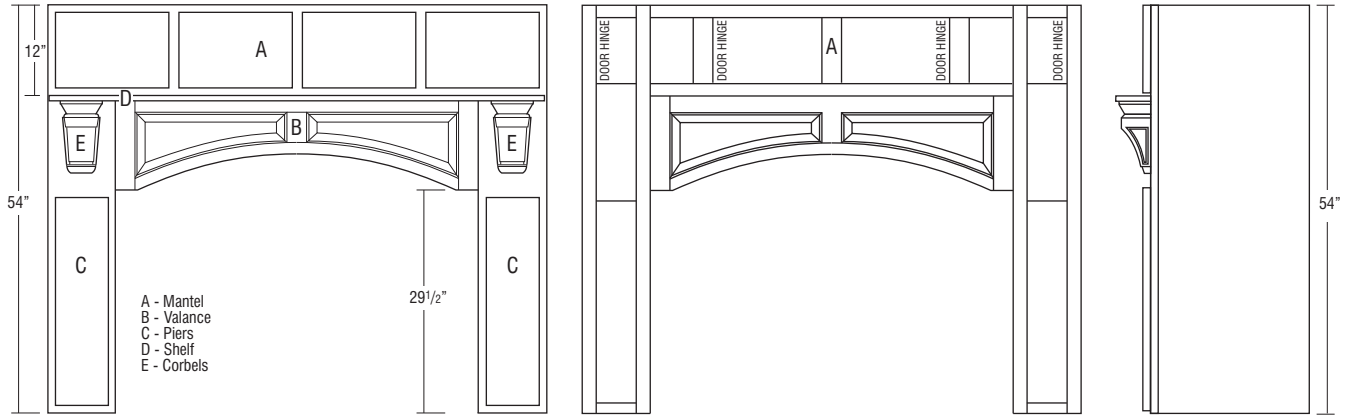

A - Mantel
 B - Valance
 C - Piers
 D - Shelf
 E - Corbels

• Recommended clearance of 7"-12" on each side of gas burner to combustible surface, 3"-6" from non-combustible surfaces including the backsplash surface and 30" from the vent. Reference local codes before installation. 21"

		Hearth Width					
		48"	54"	60"	66"	72"	78"
54" High	Pier (left)	HP95421L or HPP95421	HP95421L or HPP95421	HP95421L or HPP95421	HP95421L or HPP95421	HP95421L or HPP95421	HP95421L or HPP95421
	Pier (right)	HP95421R or HPP95421	HP95421R or HPP95421	HP95421R or HPP95421	HP95421R or HPP95421	HP95421R or HPP95421	HP95421R or HPP95421
	Mantel	HM3012	HM3612	HM4212	HM4812	HM5412	HM6012
	Valance	JRPV30 or JRCPV30	JRPV36 or JRCPV36	JRPV42 or JRCPV42	JRPV48 or JRCPV48	JRPV54 or JRCPV54	JRPV60 or JRCPV60
	Corbel (2 Qty)	CORBELMIS9 or CORBELSCR9	CORBELMIS9 or CORBELSCR9	CORBELMIS9 or CORBELSCR9	CORBELMIS9 or CORBELSCR9	CORBELMIS9 or CORBELSCR9	CORBELMIS9 or CORBELSCR9
	Shelf	HS48	HS54	HS60	HS66	HS72	HS78
	Hood Liner	HL30	HL36	HL42	HL48	HL54	HL60
	Blower	All blowers are compatible					

HEARTH, 57" HIGH, 21" DEEP

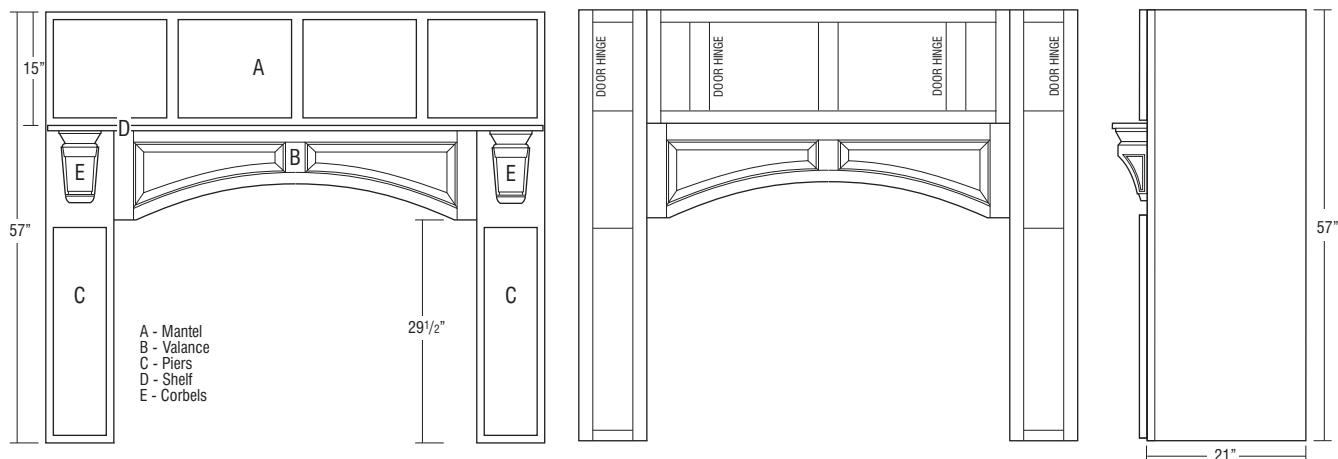

• Recommended clearance of 7"-12" on each side of gas burner to combustible surface, 3"-6" from non-combustible surfaces including the backsplash surface and 30" from the vent. Reference local codes before installation.

		Hearth Width					
		48"	54"	60"	66"	72"	78"
57" High	Pier (left)	HP95721L or HPP95721	HP95721L or HPP95721	HP95721L or HPP95721	HP95721L or HPP95721	HP95721L or HPP95721	HP95721L or HPP95721
	Pier (right)	HP95721R or HPP95721	HP95721R or HPP95721	HP95721R or HPP95721	HP95721R or HPP95721	HP95721R or HPP95721	HP95721R or HPP95721
	Mantel	HM3015	HM3615	HM4215	HM4815	HM5415	HM6015
	Valance	JRPV30 or JRCPV30	JRPV36 or JRCPV36	JRPV42 or JRCPV42	JRPV48 or JRCPV48	JRPV54 or JRCPV54	JRPV60 or JRCPV60
	Corbel (2 Qty)	CORBELMIS9 or CORBELSCR9	CORBELMIS9 or CORBELSCR9	CORBELMIS9 or CORBELSCR9	CORBELMIS9 or CORBELSCR9	CORBELMIS9 or CORBELSCR9	CORBELMIS9 or CORBELSCR9
	Shelf	HS48	HS54	HS60	HS66	HS72	HS78
	Hood Liner	HL30	HL36	HL42	HL48	HL54	HL60
	Blower	All blowers are compatible					

HEARTH, 60" HIGH, 21" DEEP

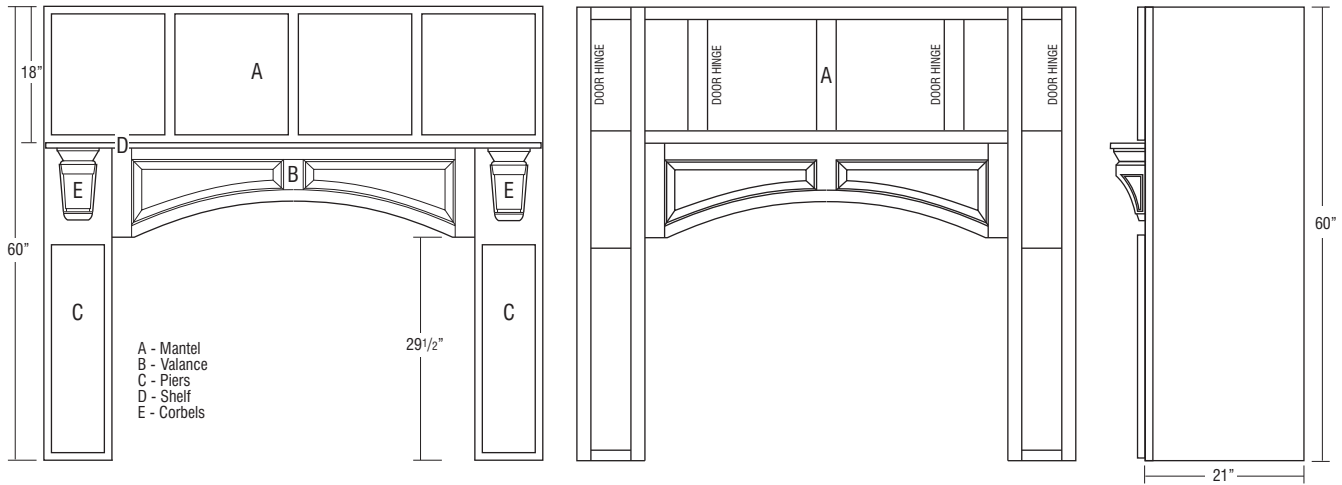

• Recommended clearance of 7"-12" on each side of gas burner to combustible surface, 3"-6" from non-combustible surfaces including the backsplash surface and 30" from the vent. Reference local codes before installation.

		Hearth Width					
		48"	54"	60"	66"	72"	78"
60" High	Pier (left)	HP96021L or HPP96021	HP96021L or HPP96021	HP96021L or HPP96021	HP96021L or HPP96021	HP96021L or HPP96021	HP96021L or HPP96021
	Pier (right)	HP96021R or HPP96021	HP96021R or HPP96021	HP96021R or HPP96021	HP96021R or HPP96021	HP96021R or HPP96021	HP96021R or HPP96021
	Mantel	HM3018	HM3618	HM4218	HM4818	HM5418	HM6018
	Valance	JRPV30 or JRCPV30	JRPV36 or JRCPV36	JRPV42 or JRCPV42	JRPV48 or JRCPV48	JRPV54 or JRCPV54	JRPV60 or JRCPV60
	Corbel (2 Qty)	CORBELMIS9 or CORBELSCR9	CORBELMIS9 or CORBELSCR9	CORBELMIS9 or CORBELSCR9	CORBELMIS9 or CORBELSCR9	CORBELMIS9 or CORBELSCR9	CORBELMIS9 or CORBELSCR9
	Shelf	HS48	HS54	HS60	HS66	HS72	HS78
	Hood Liner	HL30	HL36	HL42	HL48	HL54	HL60
	Blower	All blowers are compatible					

HEARTH (FLOATING), 36" HIGH, 21" DEEP

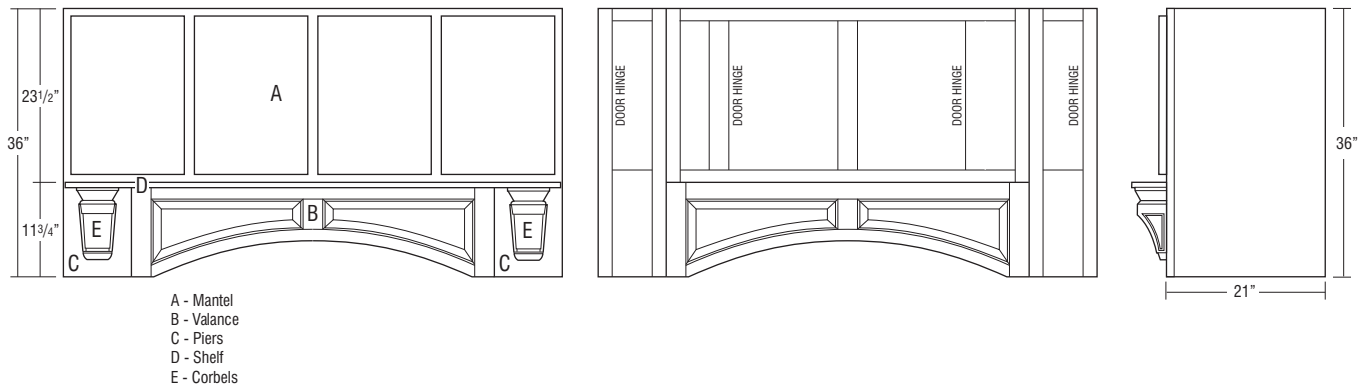

• Cabinets must be fully supported by screws in a structural member in the ceiling or soffit, and into adjacent cabinets.

		Hearth Width					
		48"	54"	60"	66"	72"	78"
36" High	Pier (left)	HP93621	HP93621	HP93621	HP93621	HP93621	HP93621
	Pier (right)	HP93621	HP93621	HP93621	HP93621	HP93621	HP93621
	Mantel	HM3023.5	HM3623.5	HM4223.5	HM4823.5	HM5423.5	HM6023.5
	Valance	JRPV30 or JRCPV30	JRPV36 or JRCPV36	JRPV42 or JRCPV42	JRPV48 or JRCPV48	JRPV54 or JRCPV54	JRPV60 or JRCPV60
	Corbel (2 Qty)	CORBELMIS9 or CORBELSCR9	CORBELMIS9 or CORBELSCR9	CORBELMIS9 or CORBELSCR9	CORBELMIS9 or CORBELSCR9	CORBELMIS9 or CORBELSCR9	CORBELMIS9 or CORBELSCR9
	Shelf	HS48	HS54	HS60	HS66	HS72	HS78
	Hood Liner	HL30	HL36	HL42	HL48	HL54	HL60
	Blower	All blowers are compatible					

Model	Cubic Feet
HP93621	5.7

HEARTH PIER, 9" WIDE, 36" HIGH

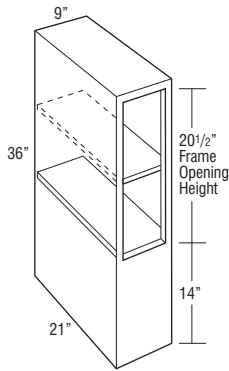

- Designed for use with a floating hearth application.
- Not available in Hickory door styles.
- Recommended for use with 24" high Mantel and 9" high Corbels.

Custom Modifications

ADDTK	AUTHL AUTHR	CBO	CCO	CFNTO	CFRMO	CND	EXBKL EXBKR	EXL EXR	FB	FFDL FFDR
		STD		•	•		•			
FPEB	ID	INVFRM	MIP	P	PFINBTMB	RD	TD	TVRAV TVRFV TVRVV	WLI	
STD	•		STD			•				

Construction Upgrades

APC	PE
STD	

Door Options

ALF	CG	CG.BTM	CG.TOP	DPSRR	MD	MD.BTM	MD.TOP	MFO

**HEARTH PIER, 9" WIDE, 21" DEEP,
48", 51", 54", 57", or 60" HIGH**

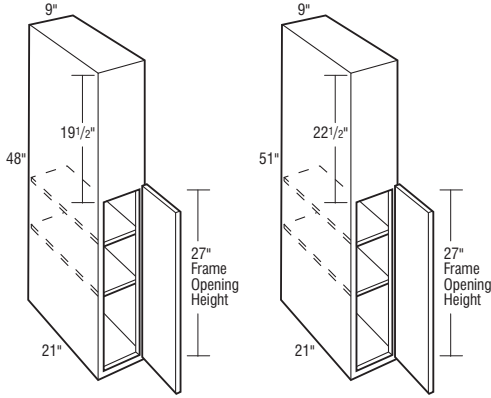

HP95121 L or R

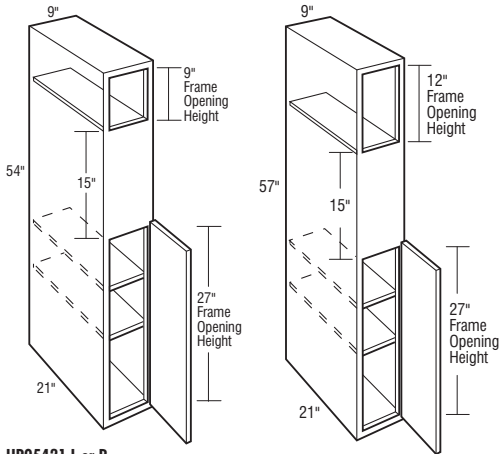

HP95421 L or R

HP95721 L or R

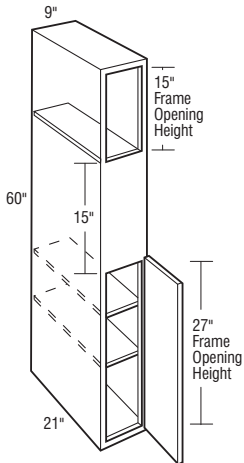

HP96021 L or R

Model	Cubic Feet
HP94821 L or R	7.7
<ul style="list-style-type: none"> • When ordered in Arch/Cathedral door styles, door will be Square. • Not available in Hickory door styles. • Recommended for use with 6" high Mantel and 9" high Corbels. 	
HP95121 L or R	7.8
<ul style="list-style-type: none"> • When ordered in Arch/Cathedral door styles, door will be Square. • Not available in Hickory door styles. • Recommended for use with 9" high Mantel and 9" high Corbels. 	
HP95421 L or R	8.6
<ul style="list-style-type: none"> • When ordered in Arch/Cathedral door styles, door will be Square. • Not available in Hickory door styles. • Recommended for use with 12" high Mantel and 9" high Corbels. 	
HP95721 L or R	8.7
<ul style="list-style-type: none"> • When ordered in Arch/Cathedral door styles, door will be Square. • Not available in Hickory door styles. • Recommended for use with 15" high Mantel and 9" high Corbels. 	
HP96021 L or R	9.5

- When ordered in Arch/Cathedral door styles, door will be Square.
- Not available in Hickory door styles.
- Recommended for use with 18" high Mantel and 9" high Corbels.

Custom Modifications

ADDTK	AUTHL AUTHR	CBO	CCO	CFNTD	CFRMO	CND	EXBKL EXBKR	EXL EXR	FB	FFDL FFDR
		•	•	•	•		•			
FPEB	ID	INVRM	MIP	P	PFINBTMB	RD	TD	TVRAV TVRFV TVRVV	WLI	
STD	•		•			•			•	

Construction Upgrades

APC	PE
•	

Door Options

ALF	CG	CG.BTM	CG.TOP	DPSRR	MD	MD.BTM	MD.TOP	MFO
				•				

**HEARTH PIER with PULL-OUT,
9" WIDE, 21" DEEP,
48", 51", 54", 57", or 60" HIGH**

storage
SOLUTIONS

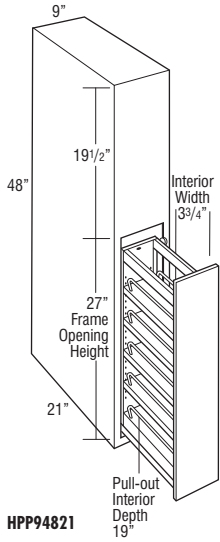

HPP94821

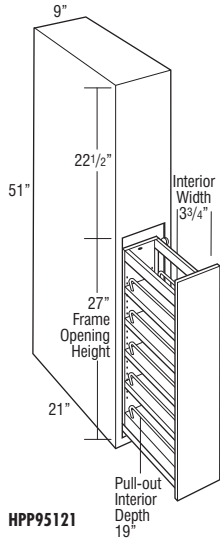

HPP95121

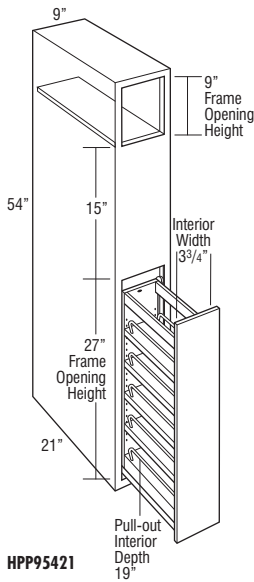

HPP95421

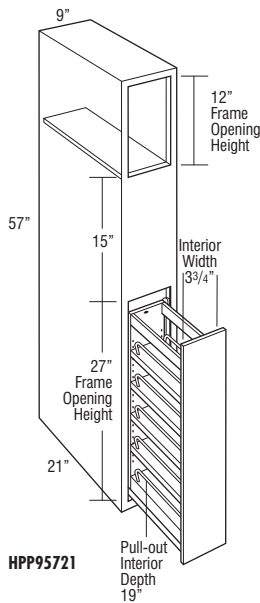

HPP95721

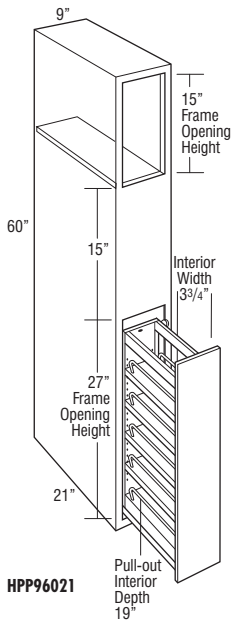

HPP96021

Model	Cubic Feet
-------	------------

HPP94821	7.7
<ul style="list-style-type: none"> Includes a natural finish full extension wood pull-out with adjustable shelves and chrome rail sides. When ordered in Arch/Cathedral door styles, door will be Square. Not available in Hickory door styles. Recommended for use with 6" high Mantel and 9" high Corbels. For full access from both sides of unit, do not install against a wall or next to deeper appliances and cabinets. 	

HPP95121	7.7
<ul style="list-style-type: none"> Includes a natural finish full extension wood pull-out with adjustable shelves and chrome rail sides. When ordered in Arch/Cathedral door styles, door will be Square. Not available in Hickory door styles. Recommended for use with 9" high Mantel and 9" high Corbels. For full access from both sides of unit, do not install against a wall or next to deeper appliances and cabinets. 	

HPP95421	7.7
<ul style="list-style-type: none"> Includes a natural finish full extension wood pull-out with adjustable shelves and chrome rail sides. When ordered in Arch/Cathedral door styles, door will be Square. Not available in Hickory door styles. Recommended for use with 12" high Mantel and 9" high Corbels. For full access from both sides of unit, do not install against a wall or next to deeper appliances and cabinets. 	

HPP95721	8.7
<ul style="list-style-type: none"> Includes a natural finish full extension wood pull-out with adjustable shelves and chrome rail sides. When ordered in Arch/Cathedral door styles, door will be Square. Not available in Hickory door styles. Recommended for use with 15" high Mantel and 9" high Corbels. For full access from both sides of unit, do not install against a wall or next to deeper appliances and cabinets. 	

HPP96021	8.6
-----------------	------------

- Includes a natural finish full extension wood pull-out with adjustable shelves and chrome rail sides.
- When ordered in Arch/Cathedral door styles, door will be Square.
- Not available in Hickory door styles.
- Recommended for use with 18" high Mantel and 9" high Corbels.
- For full access from both sides of unit, do not install against a wall or next to deeper appliances and cabinets.

Custom Modifications

	AUTHL AUTHR	CBO	CCO	CFNT0	CFRMO	CND	EXBKL EXBKR	EXL EXR	FB	FFDL FFDR
		•	•	•	•		•			
FPEB	ID	INVRM	MIP	P	PFINTMB	RD	TD	TVRAV TVRFV TVRVV	WLI	
STD	•		•						•	

Construction Upgrades

APC	PE
•	

Door Options

ALF	CG	CG.BTM	CG.TOP	DPSRR	MD	MD.BTM	MD.TOP	MFO
				•				

HEARTH MANTEL, 6" or 9" HIGH

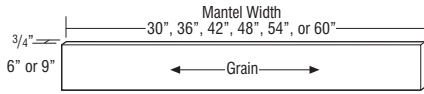

Model	Cubic Feet
HM306	2.7
HM366	2.7
HM426	2.7
HM486	2.7
HM546	2.7
HM606	2.7
HM309	5.1
HM369	5.1
HM429	5.1
HM489	5.1
HM549	5.1
HM609	5.1

- Recommended for use with 48" or 51" high Hearth Piers and same width Raised or Recessed Panel Arched Valance (see page 163).
- Not available in Hickory door styles.

MODIFICATIONS
No modifications available for these products.

Finish Techniques

Distressing	Heirloom
•	•

HEARTH MANTEL, 12" HIGH

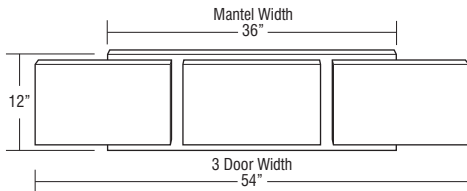
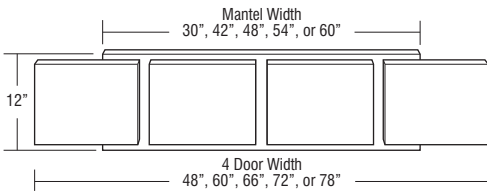

HM3012	7.5
HM3612	7.5
HM4212	7.5
HM4812	7.5
HM5412	7.5
HM6012	7.5

- Recommended for use with 54" high Hearth Piers and same width Raised or Recessed Panel Arched Valance (see page 164).
- Not available in Hickory door styles.
- Doors for Hearth Mantel are included. Field installation required for attachment of outer doors to Hearth Piers.

MODIFICATIONS
No modifications available for these products.

Door Options

ALF	CG	CG.BTM	CG.TOP	DPSRR	MD	MD.BTM	MD.TOP	MFO
				•				•

Finish Techniques

Distressing	Heirloom
•	•

HEARTH MANTEL, 15" HIGH

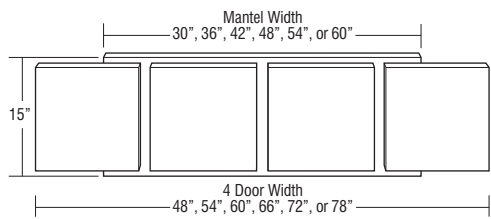

Model	Cubic Feet
HM3015	2.0
HM3615	2.3
HM4215	2.7
HM4815	3.1
HM5415	3.4
HM6015	3.8

- Recommended for use with 57" high Hearth Piers and same width Raised or Recessed Panel Arched Valance (see page 165).
- Not available in Hickory door styles.
- Doors for Hearth Mantel are included. Field installation required for attachment of outer doors to Hearth Piers.

MODIFICATIONS
No modifications available for these products.

Door Options

ALF	CG	CG.BTM	CG.TOP	DPSRR	MD	MD.BTM	MD.TOP	MFO
				•				•

Finish Techniques

Distressing	Heirloom
•	•

HEARTH MANTEL, 18" HIGH

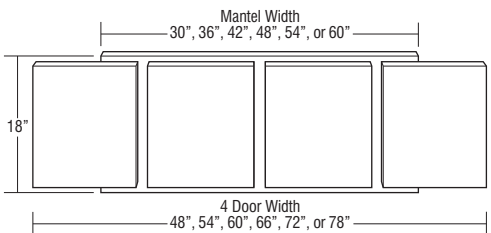

HM3018	7.5
HM3618	7.5
HM4218	7.5
HM4818	7.5
HM5418	7.5
HM6018	7.5

- Recommended for use with 60" high Hearth Piers and same width Raised or Recessed Panel Arched Valance (see page 166).
- Not available in Hickory door styles.
- Doors for Hearth Mantel are included. Field installation required for attachment of outer doors to Hearth Piers.

MODIFICATIONS
No modifications available for these products.

Door Options

ALF	CG	CG.BTM	CG.TOP	DPSRR	MD	MD.BTM	MD.TOP	MFO
				•				•

Finish Techniques

Distressing	Heirloom
•	•

HEARTH MANTEL, 23 1/2" HIGH

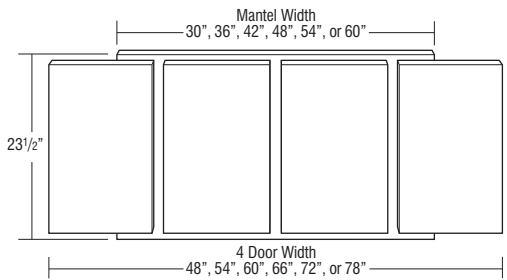

HM3023.5	1.3
HM3623.5	1.6
HM4223.5	1.8
HM4823.5	2.1
HM5423.5	2.3
HM6023.5	2.6

- Recommended for use with 36" high Hearth Piers and same width Raised or Recessed Panel Arched Valance (see page 166).
- Not available in Hickory door styles.
- Doors for Hearth Mantel are included. Field installation required for attachment of outer doors to Hearth Piers.

MODIFICATIONS
No modifications available for these products.

Door Options

ALF	CG	CG.BTM	CG.TOP	DPSRR	MD	MD.BTM	MD.TOP	MFO
				•				•

Finish Techniques

Distressing	Heirloom
•	•

HEARTH SHELF, 4 1/2" DEEP

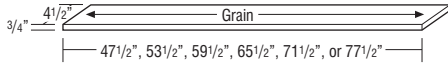

Model	Cubic Feet
HS48	2.7
HS54	2.7
HS60	2.7
HS66	2.7
HS72	2.7
HS78	2.7

- Shelves will install on top of corbels and will slightly overlay the Raised or Recessed Panel Arched Valance.
- Shelf width should match the overall hearth width (pier width + Mantel/valance width).
- Actual shelf width is 1/2" shorter than the dimension in the product code.
- Shelf finished on one long edge, two short edges, top, and bottom.
- Not available in Hickory.
- If ordered with Heirloom Technique, will not feature sand-through characteristics.

MODIFICATIONS
No modifications available for these products.

HEARTH LINER

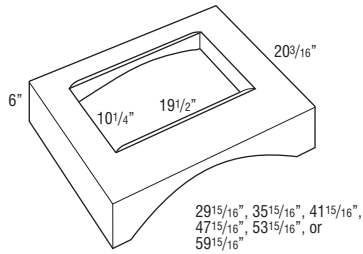

HL30	3.5
HL36	4.1
HL42	4.7
HL48	5.4
HL54	6.0
HL60	6.6

- Liner is metallic silver.
- Compatible with all blowers.
- Mounts to wall and adjoining cabinets.
- Recommended for use with Raised or Recessed Panel Arched Valance.

MODIFICATIONS
No modifications available for these products.

BASE CABINET NOMENCLATURE

All Base Cabinets are 34 1/2" high and 24" deep unless otherwise noted.

B24

Cabinet Type ← Cabinet Width

All Base Cabinets are available in Square Cabinet Styles only.

TOEKICKS

Base Cabinets are shipped with an unfinished toekick. Finished toekicks in matching wood veneer or laminate must be ordered separately and field installed.

MODIFICATIONS GRID KEY

- Available
- STD Standard on these cabinets
- storage solutions Storage Solutions Organization Cabinet
- 5 DAY** 5 Day Express Response Item

CUSTOM MODIFICATIONS

Mod.	Description	Mod.	Description	Mod.	Description
AUTHL	Authentic End - Left	FD	Full Depth Shelf	RECTBKB	Recessed Toekick - Back
AUTHR	Authentic End - Right	FFDL	Face Frame and Door on End - Left	RECTKL	Recessed Toekick - Left
CBO	Cabinet Box Only	FFDR	Face Frame and Door on End - Right	RECTKR	Recessed Toekick - Right
CCO	Cabinet Case Only			RT	Installed Roll Tray
CFNTO	Cabinet Front Only	FPEB	Furniture Finished Plywood Ends	SCPDRW	Scooped Drawer
CFP	Cabinet False Panel			TD	Tray Dividers
CFRMO	Cabinet Frame Only	FTK	Flush Toekick	TOTSS	Tilt-Out Tray, Stainless Steel
CMAT	CabMat™	FTKAV	Flush Toekick Arch	TOTSSS	Tilt-Out Tray, Stainless Steel Slim
CND	Cabinet with No Door, with Drawer	FTKFV	Flush Toekick Furniture	TVRAV	Valance Top Rail, Arch
DRT	Deep Roll Tray	ID	Increased Depth	TVRFV	Valance Top Rail, Furniture
DRWPWR	PowerGlide™ Compact Drawer Outlet	INVFRM	Inverted Frame	TVRVV	Valance Top Rail, Straight
DRWTK	Toekick Drawer	LTI	Light Installed Battery Strip	VACL	Toekick Vacuum Left End Panel
EXBKL	End Extended Back - Left	MIP	Matching Interior Plywood	VACR	Toekick Vacuum Right End Panel
EXBKR	End Extended Back - Right	P	Peninsula	VACTK	Toekick Vacuum Front
EXL	Extended Stile - Left	PTOWB	Push to Open Wastebasket	VTK	Void Toekick
EXR	Extended Stile - Right	RD	Reduced Depth	WLI	White Laminate Interior
FB	Finished Ends	RECTKALL	Recessed Island Toekick		

CONSTRUCTION UPGRADES

Mod.	Description
APC	All Plywood Construction
ET	EasyTrax™
PE	Plywood Ends

DOOR OPTIONS

Mod.	Description
CG	Cut for Glass Doors
DPSRR	Door Panel - Solid Reverse Raised

BASE SINGLE DOOR

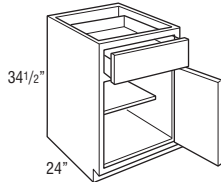

B9 L or R
B12 L or R
B15 L or R
B18 L or R
B21 L or R
B24 L or R

Model	Cubic Feet
B9 L or R	6.1
B12 L or R	7.8
B15 L or R	9.4
B18 L or R	11.1
B21 L or R	12.8
B24 L or R	14.4

- Adjustable 15" deep shelves.

Custom Modifications

AUTHL	AUTHR	CBO	CCO	CFNTO	CFP	CFRMO	CMAT	CND	DRT	DRWPWR	DRWTK	EXBKL	EXBKR	EXL	EXR	
•	•	•	•	•	•	•		•		•*	•*	•	•			
FB	FD	FFDL	FFDR	FPEB	FTK	FTKAV	ID	INVFRM	LTI	MIP	P	PTOWB	RD			
•	•	•	•	•	•	•+		•	•+	•	•▲			•		
RECTKALL	RECTBKB	RECTKL	RECTKR	RT	SCPDRW	TD	TOTSS	TOTSSS	TVRAV	TVRFV	TVRVV	VACL	VACR	VACTK	VTK	WLI
•	•	•	•▲	•								•+	•*	•	•	

*Not available on 9", 12", and 15" wide *Not available on 9" and 12" wide ▲Not available on 9" wide
†Not available on 9", 12", 15", and 18" wide

Construction Upgrades

APC	ET	PE
•		•

Door Options

CG	DPSRR
•†	•

†Not available on 9" wide

BASE PAPER TOWEL CABINET

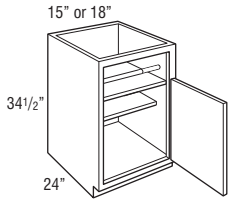

Model	Cubic Feet
BPT15 L or R	9.4
BPT18 L or R	11.1

- Upper section of cabinet features an open cubby area with veneer finished interior sides and fixed shelf, a grey tension rod for easy removal, and a storage area behind the paper towel roll for an additional three to four paper towel rolls. Maximum paper towel diameter is 6".
- Cabinet back and lower section of cabinet has standard interior.
- Adjustable 15" deep shelf.

Custom Modifications

AUTHL AUTHR	CBO	CCO	CFNTO	CFP	CFRMO	CMAT	CND	DRT	DRWPWR	DRWTK	EXBKL EXBKR	EXL EXR
•	•	•								•*	•	
FB	FD	FFDL FFDR	FPEB	FTK	FTKAV FTKFV	ID	INVFRM	LTI	MIP	P	PTOWB	RD
	•		•	•	•			•	•			•
RECTKALL RECTKBK	RECTKL RECTKR	RT	SCPDRW	TD	TOTSS TOTSSS	TVRAV TVRFV TVRVV	VACL VACR	VACTK	VTK	WLI		
•	•	•					•	•	•	•		

*Not available on 15" wide

Construction Upgrades

APC	ET	PE
•		•

Door Options

CG	DPSRR
	•

BASE DOUBLE DOOR

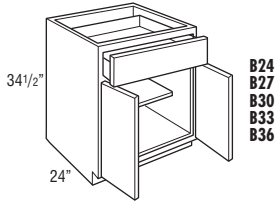

**B24
B27
B30
B33
B36**

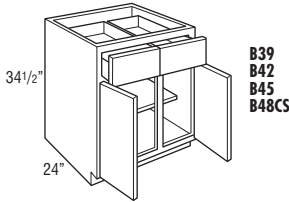

**B39
B42
B45
B48CS**

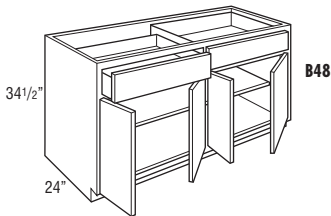

B48

B24	14.4
B27	16.1
B30	17.7
B33	19.6
B36	21.1
B39	22.7
B42	24.4
B45	25.8
B48CS	27.7
B48	27.7

- Adjustable 15" deep shelves.

Custom Modifications

AUTHL AUTHR	CBO	CCO	CFNTO	CFP	CFRMO	CMAT	CND	DRT	DRWPWR	DRWTK	EXBKL EXBKR	EXL EXR
•	•	•	•	•	•		•		•	•*	•	•
FB	FD	FFDL FFDR	FPEB	FTK	FTKAV FTKFV	ID	INVFRM	LTI	MIP	P	PTOWB	RD
•	•	•	•	•	•		•	•	•	•		•
RECTKALL RECTKBK	RECTKL RECTKR	RT	SCPDRW	TD	TOTSS TOTSSS	TVRAV TVRFV TVRVV	VACL VACR	VACTK	VTK	WLI		
•	•	•	•				•	•	•	•		

*Not available on 39", 42", 45", and 48" wide

Construction Upgrades

APC	ET	PE
•		•

Door Options

CG	DPSRR
•	•

BASE BUFFET

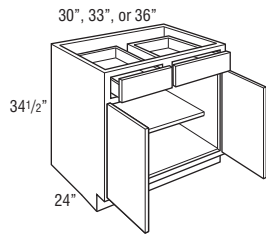

Model	Cubic Feet
B30B	17.6
B33B	19.2
B36B	20.9

- Adjustable 15" deep shelf.
- Reveal between drawers will not align with doors below.

Custom Modifications

AUTHL AUTHR	CBO	CCO	CFNTD	CFP	CFRMO	CMAT	CND	DRT	DRWPWR	DRWTK	EXBKL EXBKR	EXL EXR
•	•	•	•	•	•		•		•*	•	•	•
FB	FD	FFDL FFDR	FPEB	FTK	FTKAV FTKEV	ID	INVRM	LTI	MIP	P	PTOWB	RD
•	•	•	•	•	•			•	•	•		•
RECTKALL RECTKBK	RECTKL RECTKR	RT	SCPRW	TD	TOTSS TOTSSS	TVRAV TVRFV TVRVV	VACL VACR	VACTK	VTK	WLI		
•	•	•	•				•	•	•	•		

*Not available on 30" and 33" wide

Construction Upgrades

APC	ET	PE
•		•

Door Options

CG	DPSRR
•	•

BASE with CUTLERY INSERT WOOD ORGANIZER

storage
SOLUTIONS

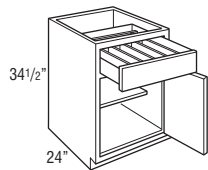

B15CIW L or R
B18CIW L or R
B21CIW L or R
B24CIW L or R

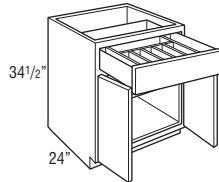

B24CIW

B15CIW L or R	9.4
B18CIW L or R	11.1
B21CIW L or R	12.8
B24CIW L or R	14.4
B24CIW	14.4

- Adjustable 15" deep shelf.
- Cutlery Insert Wood Organizer is also available as an accessory. See page 407.

Custom Modifications

AUTHL AUTHR	CBO	CCO	CFNTD	CFP	CFRMO	CMAT	CND	DRT	DRWPWR	DRWTK	EXBKL EXBKR	EXL EXR
•	•	•	•	•	•		•			•*	•	•
FB	FD	FFDL FFDR	FPEB	FTK	FTKAV FTKEV	ID	INVRM	LTI	MIP	P	PTOWB	RD
•	•	•	•	•	•			•	•	•		
RECTKALL RECTKBK	RECTKL RECTKR	RT	SCPRW	TD	TOTSS TOTSSS	TVRAV TVRFV TVRVV	VACL VACR	VACTK	VTK	WLI		
•	•	•					•+	•*	•	•		

*Not available on 15" wide +Not available on 15" and 18" wide

Construction Upgrades

APC	ET	PE
•		•

Door Options

CG	DPSRR
•	•

BASE with WOOD TIERED CUTLERY DIVIDER DRAWER

15", 18", 21", or 24"

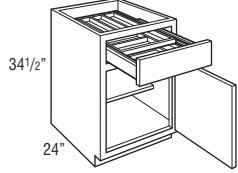

B15WTCD L or R
B18WTCD L or R
B21WTCD L or R
B24WTCD L or R

storage
SOLUTIONS

Model	Cubic Feet
B15WTCD L or R	9.4
B18WTCD L or R	11.1
B21WTCD L or R	12.8
B24WTCD L or R	14.4
B24WTCD	14.4

- Adjustable 15" deep shelf.
- Exterior WTCD drawer box height is 3 3/4", interior height of top and bottom tier is 1 3/8".
- Wood Tiered Cutlery Divider Drawer is also available as an accessory. See page 407.

Custom Modifications

AUTHL AUTHR	CBO	CCO	CFNTO	CFP	CFRMO	CMAT	CND	DRT	DRWPWR	DRWTK	EXBKL EXBKR	EXL EXR
•	•	•	•	•	•		•			•*	•	•
FB	FD	FFDL FFDR	FPEB	FTK	FTKAV FTKFV	ID	INVERM	LTI	MIP	P	PTOWB	RD
•	•	•	•	•	•			•	•	•		
RECTKALL RECTKBK	RECTKL RECTKR	RT	SCPDRW	TD	TOTSS TOTSSS	TVRAV TVRFV TVRVV	VACL VACR	VACTK	VTK	WLI		
•	•	•					•*	•*	•	•		

*Not available on 15" wide *Not available on 15" and 18" wide

Construction Upgrades

APC	ET	PE
•		•

Door Options

CG	DPSRR
•	•

NEW BASE with WOOD TIERED K-CUP®* DRAWER

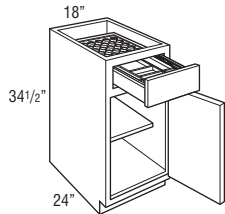

storage
SOLUTIONS

B18KUP L or R	11.1
----------------------	------

- Adjustable 15" deep shelf.
- Holds 40 K-Cups®.
- Exterior Wood Tiered K-Cup® drawer box height is 3 3/4", interior height of top tier is 1 5/8", and interior height of bottom tier is 1 3/8".
- The Wood Tiered K-Cup® Drawer is compatible with K-Cup® pods only.
- Wood Tiered K-Cup® Drawer is also available as an accessory. See page 408.

*K-Cup® is a registered trademark of Keurig Green Mountain, Inc.

Custom Modifications

AUTHL AUTHR	CBO	CCO	CFNTO	CFP	CFRMO	CMAT	CND	DRT	DRWPWR	DRWTK	EXBKL EXBKR	EXL EXR
•	•	•	•	•	•		•			•	•	•
FB	FD	FFDL FFDR	FPEB	FTK	FTKAV FTKFV	ID	INVERM	LTI	MIP	P	PTOWB	RD
•	•	•	•	•	•			•	•	•		
RECTKALL RECTKBK	RECTKL RECTKR	RT	SCPDRW	TD	TOTSS TOTSSS	TVRAV TVRFV TVRVV	VACL VACR	VACTK	VTK	WLI		
•	•	•						•	•	•		

Construction Upgrades

APC	ET	PE
•		•

Door Options

CG	DPSRR
•	•

**FULL HEIGHT BASE SINGLE DOOR,
6" WIDE**

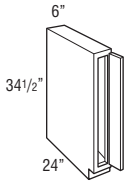

Model	Cubic Feet
B6FH L or R	4.1

- Frame opening is 3" wide.
- Cabinet has a full top panel.
- Utilizes a 5 1/2" wide overlay filler as a hinged door for full and partial overlay styles.
- When FFDL or FFDR modification is selected, the VTK modification will automatically be selected.

Custom Modifications

AUTHL AUTHR	CBO	CCO	CFNTO	CFP	CFRMO	CMAT	CND	DRT	DRWPWR	DRWTK	EXBKL EXBKR	EXL EXR
		•	•		•		•				•	•
FB	FD	FFDL FFDR	FPEB	FTK	FTKAV FTKRV	ID	INVERM	LTI	MIP	P	PTOWB	RD
•		•*	•	•		•			•	•		•
RECTKALL RECTKBK	RECTKL RECTKR	RT	SCPRW	TD	TOTSS TOTSSS	TVRAV TVRFV TVRVV	VACL VACR	VACTK	VTK	WLI		
									•	•		

*Includes VTK

Construction Upgrades

APC	ET	PE
•		•

Door Options

CG	DPSRR

FULL HEIGHT BASE SINGLE DOOR

9", 12", 15", 18", 21", or 24"

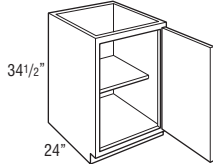

B9FH L or R
B12FH L or R
B15FH L or R
B18FH L or R
B21FH L or R
B24FH L or R

B9FH L or R	6.1
B12FH L or R	7.8
B15FH L or R	9.4
B18FH L or R	11.1
B21FH L or R	12.8
B24FH L or R	14.4

- Adjustable 15" deep shelf.

Custom Modifications

AUTHL AUTHR	CBO	CCO	CFNTO	CFP	CFRMO	CMAT	CND	DRT	DRWPWR	DRWTK	EXBKL EXBKR	EXL EXR
•	•	•	•		•					•*	•	•
FB	FD	FFDL FFDR	FPEB	FTK	FTKAV FTKRV	ID	INVERM	LTI	MIP	P	PTOWB	RD
•	•	•	•	•	•+	•		•+	•	•		•
RECTKALL RECTKBK	RECTKL RECTKR	RT	SCPRW	TD	TOTSS TOTSSS	TVRAV TVRFV TVRVV	VACL VACR	VACTK	VTK	WLI		
•▲	•▲	•▲		•			•†	•*	•	•		

*Not available on 9", 12", and 15" wide †Not available on 9" and 12" wide ▲Not available on 9" wide
†Not available on 9", 12", 15", and 18" wide

Construction Upgrades

APC	ET	PE
•		•

Door Options

CG	DPSRR
•†	•

†Not available on 9" wide

**BASE PAPER TOWEL CABINET
FULL HEIGHT**

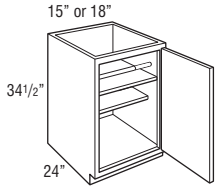

Model	Cubic Feet
BPT15FH L or R	9.4
BPT18FH L or R	11.1

- Upper section of cabinet features an open cubby area with veneer finished interior sides and fixed shelf, a grey tension rod for easy removal, and a storage area behind the paper towel roll for an additional three to four paper towel rolls. Maximum paper towel diameter is 6".
- Cabinet back and lower section of cabinet has standard interior.
- Adjustable 15" deep shelf.

Custom Modifications

AUTHL AUTHR	CBO	CCO	CFNTO	CFP	CFRMO	CMAT	CND	DRT	DRWPWR	DRWTK	EXBKL EXBKR	EXL EXR
•	•	•								•*	•	
FB	FD	FFDL FFDR	FPEB	FTK	FTKAV FTKRV	ID	INVFRM	LTI	MIP	P	PTOWB	RD
•	•	•	•	•	•	•		•	•			•
RECTKALL RECTKBL	RECTKL RECTKRL	RT	SCPDRW	TD	TOTSS TOTSSS	TVRAV TVRFV TVRVV	VACL VACR	VACTK	VTK	WLI		
•	•	•					•†	•*	•	•		

*Not available on 15" wide

Construction Upgrades

APC	ET	PE
•		•

Door Options

CG	DPSRR
	•

**FULL HEIGHT BASE SINGLE DOOR,
40 1/2" HIGH**

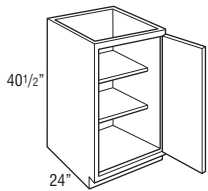

- B940FH L or R**
- B1240FH L or R**
- B1540FH L or R**
- B1840FH L or R**
- B2140FH L or R**
- B2440FH L or R**

B940FH L or R	6.7
B1240FH L or R	8.6
B1540FH L or R	10.5
B1840FH L or R	12.3
B2140FH L or R	14.2
B2440FH L or R	16.1

- Two adjustable 15" deep shelves.

Custom Modifications

AUTHL AUTHR	CBO	CCO	CFNTO	CFP	CFRMO	CMAT	CND	DRT	DRWPWR	DRWTK	EXBKL EXBKR	EXL EXR
•	•	•	•		•					•*	•	•
FB	FD	FFDL FFDR	FPEB	FTK	FTKAV FTKRV	ID	INVFRM	LTI	MIP	P	PTOWB	RD
•	•	•	•	•	•*	•		•*	•	•		•
RECTKALL RECTKBL	RECTKL RECTKRL	RT	SCPDRW	TD	TOTSS TOTSSS	TVRAV TVRFV TVRVV	VACL VACR	VACTK	VTK	WLI		
•‡	•‡	•					•†	•*	•	•		

*Not available on 9", 12", and 15" wide †Not available on 9" and 12" wide ‡Not available on 9" wide
 †Not available on 9", 12", 15", and 18" wide

Construction Upgrades

APC	ET	PE
•		•

Door Options

CG	DPSRR
•‡	•

‡Not available on 9" wide

FULL HEIGHT BASE DOUBLE DOOR

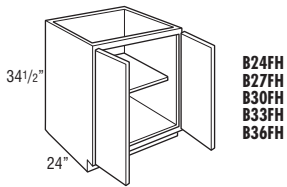

B24FH
B27FH
B30FH
B33FH
B36FH

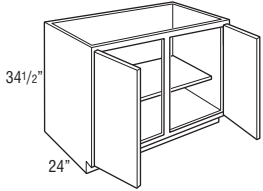

B39FH
B42FH
B45FH
B48FHCS

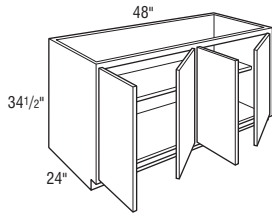

B48FH

Model	Cubic Feet
B24FH	14.4
B27FH	16.1
B30FH	17.7
B33FH	19.6
B36FH	21.1
B39FH	22.7
B42FH	24.4
B45FH	25.8
B48FHCS	27.7
B48FH	27.7

• Adjustable 15" deep shelf.

Custom Modifications

AUTHL AUTHR	CBO	CCO	CFNT0	CFP	CFRMO	CMAT	CND	DRT	DRWPWR	DRWTK	EXBKL EXBKR	EXL EXR
•	•	•	•		•					•*	•	•
FB	FD	FFDL FFDR	FPEB	FTK	FTKAV FTKEV	ID	INVERM	LTI	MIP	P	PTOWB	RD
•	•	•	•	•	•	•		•	•	•		•
RECTKALL RECTKBK	RECTKL RECTKR	RT	SCPRDW	TD	TOTSS TOTSSS	TVRAV TVRFV TVRVV	VACL VACR	VACTK	VTK	WLI		
•	•	•		•*			•	•	•	•		

*Not available on 39", 42", 45", and 48" wide

Construction Upgrades

APC	ET	PE
•		•

Door Options

CG	DPSRR
•	•

**FULL HEIGHT BASE DOUBLE DOOR,
40 1/2" HIGH**

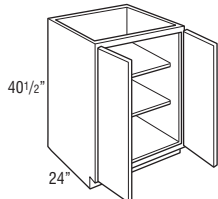

B2440FH
B2740FH
B3040FH
B3340FH
B3640FH

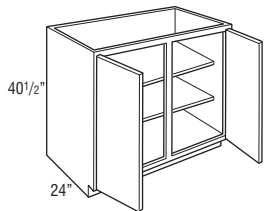

B3940FH
B4240FH
B4540FH
B4840FHCS

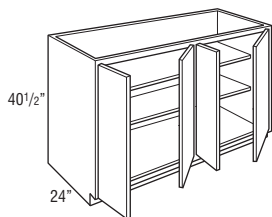

B4840FH

B2440FH	16.1
B2740FH	18.0
B3040FH	19.8
B3340FH	21.7
B3640FH	23.6
B3940FH	25.4
B4240FH	27.3
B4540FH	25.8
B4840FHCS	31.1
B4840FH	31.1

• Two adjustable 15" deep shelves.

Custom Modifications

AUTHL AUTHR	CBO	CCO	CFNT0	CFP	CFRMO	CMAT	CND	DRT	DRWPWR	DRWTK	EXBKL EXBKR	EXL EXR
•	•	•	•		•					•*	•	•
FB	FD	FFDL FFDR	FPEB	FTK	FTKAV FTKEV	ID	INVERM	LTI	MIP	P	PTOWB	RD
•	•	•	•	•	•	•		•	•	•		•
RECTKALL RECTKBK	RECTKL RECTKR	RT	SCPRDW	TD	TOTSS TOTSSS	TVRAV TVRFV TVRVV	VACL VACR	VACTK	VTK	WLI		
•	•	•					•	•	•	•		

*Not available on 39", 42", 45", and 48" wide

Construction Upgrades

APC	ET	PE
•		•

Door Options

CG	DPSRR
•	•

WALL BASE SINGLE DOOR

12", 15", 18", 21", or 24"

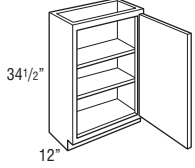

Model	Cubic Feet
WB12 L or R	4.1
WB15 L or R	5.0
WB18 L or R	5.9
WB21 L or R	6.8
WB24 L or R	7.7

- Two full depth shelves.
- Will have the same shelf hole drill pattern as a base cabinet.

Custom Modifications

AUTHL AUTHR	CBO	CCO	CFNTO	CFP	CFRMO	CMAT	CND	DRT	DRWPWR	DRWTK	EXBKL EXBKR	EXL EXR
•	•	•	•		•						•	•
FB	FD	FFDL FFDR	FPEB	FTK	FTKAV FTKFV	ID	INVFRM	LTI	MIP	P	PTOWB	RD
•		•	•	•	•*	•			•	•		•
RECTKALL RECTKBK	RECTKL RECTKR	RT	SCPDRW	TD	TOTSS TOTSSS	TVRAV TVRFV TVRVV	VACL VACR	VACTK	VTK	WLI		
•*	•			•					•	•		

*Not available on 12" wide *RECTKBK not available

Construction Upgrades

APC	ET	PE
•		•

Door Options

CG	DPSRR
•	•

WALL BASE DOUBLE DOOR

24", 27", 30", 33", or 36"

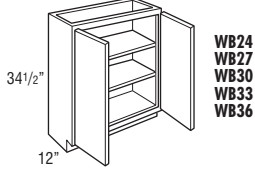

**WB24
WB27
WB30
WB33
WB36**

39", 42", 45", or 48"

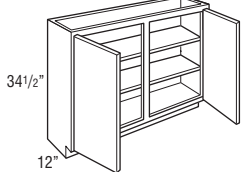

**WB39
WB42
WB45
WB48CS**

48"

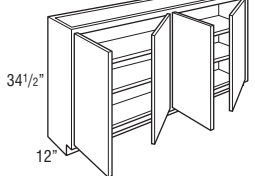

WB48

WB24	7.7
WB27	8.6
WB30	9.5
WB33	10.4
WB36	11.2
WB39	12.1
WB42	13.0
WB45	13.9
WB48CS	14.8
WB48	14.8

- Two full depth shelves.
- Will have the same shelf hole drill pattern as a base cabinet.

Custom Modifications

AUTHL AUTHR	CBO	CCO	CFNTO	CFP	CFRMO	CMAT	CND	DRT	DRWPWR	DRWTK	EXBKL EXBKR	EXL EXR
•	•	•	•		•						•	•
FB	FD	FFDL FFDR	FPEB	FTK	FTKAV FTKFV	ID	INVFRM	LTI	MIP	P	PTOWB	RD
•		•	•	•	•	•			•	•		•
RECTKALL RECTKBK	RECTKL RECTKR	RT	SCPDRW	TD	TOTSS TOTSSS	TVRAV TVRFV TVRVV	VACL VACR	VACTK	VTK	WLI		
•*	•			•*					•	•		

*Not available on 39", 42", 45", and 48" wide *RECTKBK not available

Construction Upgrades

APC	ET	PE
•		•

Door Options

CG	DPSRR
•	•

BASE EASY ACCESS STORAGE

storage
SOLUTIONS

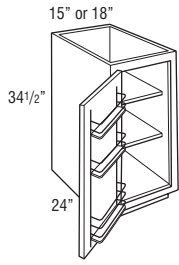

BEAS15 L or R
BEAS18 L or R

Model	Cubic Feet
BEAS15 L or R	9.4
BEAS18 L or R	11.1

- Two adjustable 20" deep shelves.
- Door features a chrome and wood three-tiered rack.
- Door rack width is 10 7/8" on 15" wide cabinet and 13 7/8" on 18" wide cabinet.
- Door rack depth is 3 1/2".

Custom Modifications

AUTHL AUTHR	CBO	CCO	CFNTD	CFP	CFRMO	CMAT	CND	DRT	DRWPWR	DRWTK	EXBKL EXBKR	EXL EXR
•	•	•	•		•					•*	•	•
FB	FD	FFDL FFDR	FPED	FTK	FTKAV FTKFV	ID	INVERM	LTI	MIP	P	PTOWB	RD
•			•	•	•				•			
RECTALL RECTBK	RECTKL RECTKR	RT	SCPDRW	TD	TOTSS TOTSSS	TVRAV TVRFV TVRVV	VACL VACR	VACTK	VTK	WLI		
•	•							•*	•	•		

*Not available on 15" wide

Construction Upgrades

APC	ET	PE
•		•

Door Options

CG	DPSRR
	•

30" SUPERCABINET™

storage SOLUTIONS

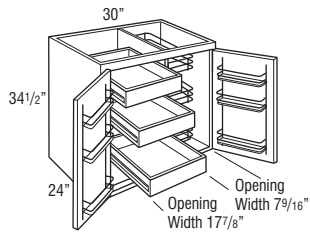

BSC30RP

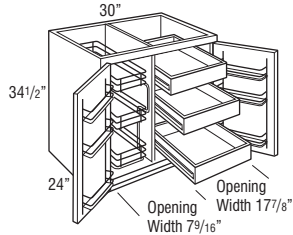

BSC30PR

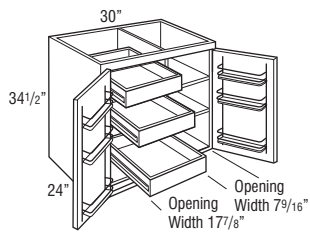

BSC30RS

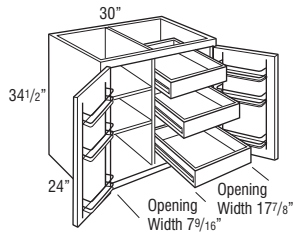

BSC30SR

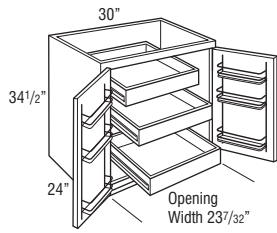

BSC30R

Model	Cubic Feet
BSC30RP	17.7
BSC30PR	17.7
BSC30RS	17.7
BSC30SR	17.7
BSC30R	17.7

- Nomenclature represents left to right order of interior components.
Example: BSC30RS = Base SuperCabinet™ 30" Roll-Out Shelves.
- Shelves are adjustable and 20" deep.
- Roll trays are Full Extension side mounted.
- Cabinets utilize 170° hinge. For sufficient pull-out clearance, 12" of adjacent space is required for door to open 170° when installed near a wall or corner.
- Each door features a chrome and wood three-tiered rack.
- Door rack width is 10 7/8".
- Door rack depth is 3 1/2".
- Integrated soft close hinge not included. Premium door mechanism installed.

Custom Modifications

AUTHL	CBO	CCO	CFNT0	CFP	CFRMO	CMAT	CND	DRT	DRWPWR	DRWTK	EXBKL	EXL
AUTHR											EXBKR	EXR
•	•		•		•					•	•	•
FB	FD	FFDL	FPEB	FTK	FTKAV	ID	INVFRM	LTI	MIP	P	PTOWB	RD
•		FFDR	•	•	FTKFV				•			
RECTALL	RECTKL	RT	SCPDRW	TD	TOTSS	TVRAV	VACL	VACTK	VTK	WLI		
RECTBK	RECTKR				TOTSS	TVRFV	VACR					
•	•					TVRVV	•	•	•	•		

Construction Upgrades

APC	ET	PE
•		•

Door Options

CG	DPSRR
	•

30" SUPERCABINET™ VERSION 2

storage
SOLUTIONS

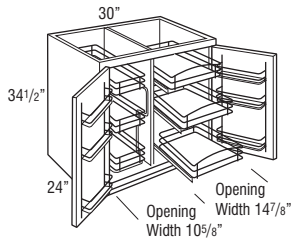

BV2SC30PR

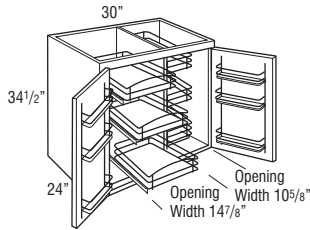

BV2SC30RP

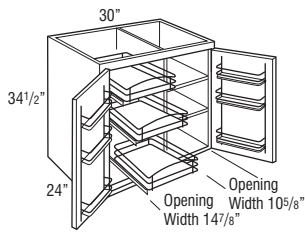

BV2SC30RS

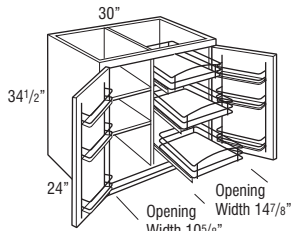

BV2SC30SR

Model	Cubic Feet
BV2SC30PR	17.7
BV2SC30RP	17.7
BV2SC30RS	17.7
BV2SC30SR	17.7

- Nomenclature represents left to right order of interior components.
Example: BV2SC30RS = Base Version 2 SuperCabinet™ 30" Roll-Out Shelves.
- Shelves are adjustable and 20" deep.
- Chrome Roll-out trays feature Smart Stop.
- Cabinets utilize 170° hinge. For sufficient pull-out clearance, 12" of adjacent space is required for door to open 170° when installed near a wall or corner.
- Each door features a chrome and wood three-tiered rack.
- Door rack width is 10 7/8".
- Door rack depth is 3 1/2".
- Side pull-outs feature 3 adjustable chrome and wood baskets on frame with Smart Stop.
- Integrated soft close hinge not included. Premium door mechanism installed.

Custom Modifications

AUTHL AUTHR	CBO	CCO	CFNTO	CFP	CFRMO	CMAT	CND	DRT	DRWPWR	DRWTK	EXBKL EXBKR	EXL EXR
•	•	•	•		•					•	•	•
FB	FD	FFDL FFDR	FPEB	FTK	FTKAV FTKFV	ID	INVFRM	LTI	MIP	P	PTOWB	RD
•			•	•	•				•			
RECTKALL RECTKBK	RECTKL RECTKR	RT	SCPRW	TD	TOTSS TOTSSS	TVRAV TVRFV TVRVV	VACL VACR	VACTK	VTK	WLI		
•	•						•	•	•	•		

Construction Upgrades

APC	ET	PE
•		•

Door Options

CG	DPSRR
	•

30" SUPERCABINET™ GOURMET

storage
SOLUTIONS

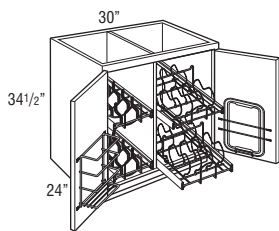

Model	Cubic Feet
BSCG30 L or R	17.7

- Cabinets utilize 170° hinge. For sufficient pull-out clearance, 12" of adjacent space is required for door to open 170° when installed near a wall or corner.
- Integrated soft close hinge not included. Premium door mechanism included.
- L or R designates lid holder side.
- Left door features wrap/foil rack.
- Right door features cutting board and cutting board storage.
- Lid pull-out capacity is 6 lids per tray. Maximum lid diameter is 8 1/2" on bottom tray and 9 3/4" on top tray.
- Pots and Pans pull-out includes 8 dividers per tray for adjustable storage.
- Cutting board is 9 3/4" x 15 3/5".

Custom Modifications

AUTHL AUTHR	CBO	CCO	CFNTO	CFP	CFRMO	CMAT	CND	DRT	DRWPWR	DRWTK	EXBKL EXBKR	EXL EXR
•	•	•	•		•					•	•	•
FB	FD	FFDL FFDR	FPEB	FTK	FTKAV FTKFV	ID	INVFRM	LTI	MIP	P	PTOWB	RD
•			•	•	•				•			
RECTKALL RECTKBK	RECTKL RECTKR	RT	SCPRW	TD	TOTSS TOTSSS	TVRAV TVRFV TVRVV	VACL VACR	VACTK	VTK	WLI		
•	•						•	•	•	•		

Construction Upgrades

APC	ET	PE
•		•

Door Options

CG	DPSRR
	•

36" SUPERCABINET™

storage SOLUTIONS

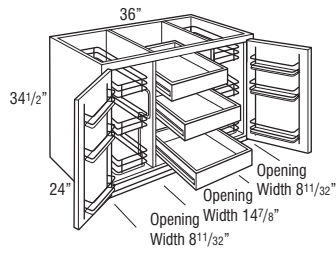

BSC36PRP

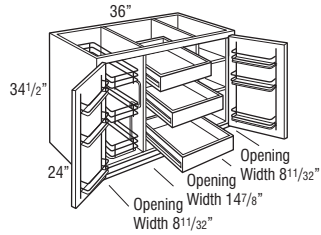

BSC36PRS

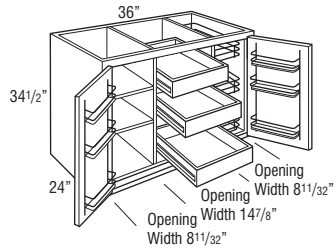

BSC36SRP

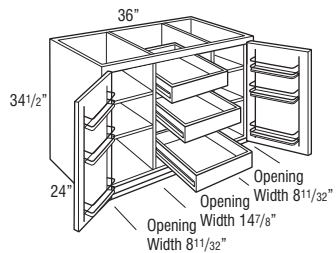

BSC36SRS

Model	Cubic Feet
BSC36PRP	21.1
BSC36PRS	21.1
BSC36SRP	21.1
BSC36SRS	21.1

- Nomenclature represents left to right order of interior components.
Example: BSC36PRS = Base SuperCabinet™ 36" Pull-Out Roll-Out Shelves.
- Shelves are adjustable and 20" deep.
- Roll trays are Full Extension side mounted.
- Cabinets utilize 170° hinge. For sufficient pull-out clearance, 12" of adjacent space is required for door to open 170° when installed near a wall or corner.
- Each door features a chrome and wood three-tiered rack.
- Door rack width is 13 7/8".
- Door rack depth is 3 1/2".
- Integrated soft close hinge not included. Premium door mechanism installed.

Custom Modifications

AUTHL	AUTHR	CBO	CCO	CFNTD	CFP	CFRMO	CMAT	CND	DRT	DRWPWR	DRWTK	EXBKL	EXBKR	EXL	EXR	
•	•	•	•	•	•	•					•	•	•	•	•	
FB	FD	FFDL	FFDR	FPEB	FTK	FTKAV	FTKRV	ID	INFRM	LTI	MIP	P	PTOWB	RD		
•				•	•	•	•				•					
RECTKLL	RECTKLBK	RECTKLL	RECTKLR	RT	SCPDRW	TD	TOTSS	TOTSSS	TVRAV	TVRFV	TVRVV	VACL	VACR	VACTK	VTK	WLI
•	•								•	•	•	•	•	•	•	•

Construction Upgrades

APC	ET	PE
•		•

Door Options

CG	DPSRR
	•

36" SUPERCABINET™ VERSION 2

storage
SOLUTIONS

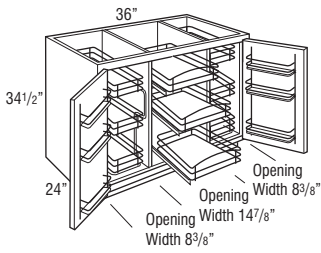

BV2SC36PRP

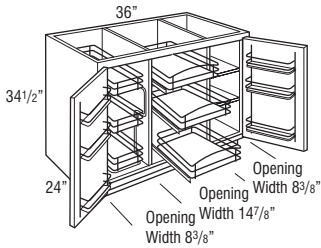

BV2SC36PRS

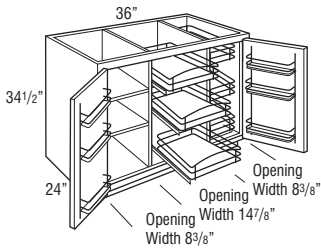

BV2SC36SRP

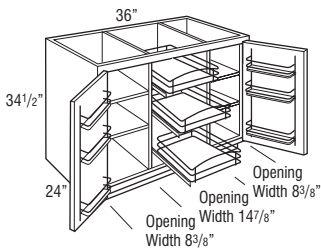

BV2SC36SRS

Model	Cubic Feet
BV2SC36PRP	21.1
BV2SC36PRS	21.1
BV2SC36SRP	21.1
BV2SC36SRS	21.1

- Nomenclature represents left to right order of interior components.
Example: BV2SC36PRS = Base Version 2 SuperCabinet™ 36" Pull-Out Roll-Out Shelves.
- Shelves are adjustable and 20" deep.
- Chrome Roll-out trays feature Smart Stop.
- Cabinets utilize 170° hinge. For sufficient pull-out clearance, 12" of adjacent space is required for door to open 170° when installed near a wall or corner.
- Each door features a chrome and wood three-tiered rack.
- Door rack width is 13 7/8".
- Door rack depth is 3 1/2".
- Side pull-outs feature 3 adjustable chrome and wood baskets on frame with Smart Stop.
- Integrated soft close hinge not included. Premium door mechanism installed.

Custom Modifications

AUTHL AUTHR	CBO	CCO	CFNTO	CFP	CFRMO	CMAT	CND	DRT	DRWPWR	DRWTK	EXBKL EXBKR	EXL EXR
•	•	•	•		•					•	•	•
FB	FD	FFDL FFDR	FPEB	FTK	FTKAV FTKFV	ID	INVFRM	LTI	MIP	P	PTOWB	RD
•			•	•	•				•			
RECTKALL RECTKBK	RECTKL RECTKR	RT	SCPRW	TD	TOTSS TOTSSS	TVRAV TVRFV TVRVV	VACL VACR	VACTK	VTK	WLI		
•	•						•	•	•	•		

Construction Upgrades

APC	ET	PE
•		•

Door Options

CG	DPSRR
	•

36" SUPERCABINET™ GOURMET

storage
SOLUTIONS

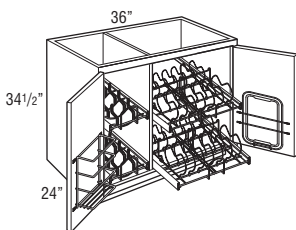

Model	Cubic Feet
BSCG36 L or R	21.1

- Cabinets utilize 170° hinge. For sufficient pull-out clearance, 12" of adjacent space is required for door to open 170° when installed near a wall or corner.
- Integrated soft close hinge not included. Premium door mechanism included.
- L or R designates lid holder side.
- Left door features wrap/foil rack.
- Right door features cutting board and cutting board storage.
- Lid pull-out capacity is 6 lids per tray. Maximum lid diameter is 8 1/2" on bottom tray and 9 3/4" on top tray.
- Pots and Pans pull-out includes 8 dividers per tray for adjustable storage.
- Cutting board is 9 3/4" x 15 3/5".

Custom Modifications

AUTHL AUTHR	CBO	CCO	CFNTO	CFP	CFRMO	CMAT	CND	DRT	DRWPWR	DRWTK	EXBKL EXBKR	EXL EXR
•	•	•	•		•					•	•	•
FB	FD	FFDL FFDR	FPEB	FTK	FTKAV FTKFV	ID	INVFRM	LTI	MIP	P	PTOWB	RD
•			•	•	•				•			
RECTKALL RECTKBK	RECTKL RECTKR	RT	SCPRW	TD	TOTSS TOTSSS	TVRAV TVRFV TVRVV	VACL VACR	VACTK	VTK	WLI		
•	•						•	•	•	•		

Construction Upgrades

APC	ET	PE
•		•

Door Options

CG	DPSRR
	•

BASE with ROLL TRAYS

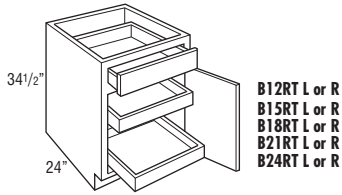

B12RT L or R
B15RT L or R
B18RT L or R
B21RT L or R
B24RT L or R

Model	Cubic Feet
B12RT L or R	7.7
B15RT L or R	9.4
B18RT L or R	11.1
B21RT L or R	12.8
B24RT L or R	14.4

- 2 roll trays standard.
- Cabinets may accommodate up to 4 roll trays, which may be purchased separately for field installation. See page 414.

Custom Modifications

AUTHL AUTHR	CBO	CCO	CFNTO	CFP	CFRMO	CMAT	CND	DRT	DRWPWR	DRWTK	EXBKL EXBKR	EXL EXR
•	•	•	•	•	•		•	•	•*	•*	•	•
FB	FD	FFDL FFDR	FPEB	FTK	FTKAV FTKRV	ID	INVFRM	LTI	MIP	P	PTOWB	RD
•			•	•	•*				•			•
RECTKALL RECTKBK	RECTKL RECTKR	RT	SCPDRW	TD	TOTSS TOTSSS	TVRAV TVRFV TVRVV	VACL VACR	VACTK	VTK	WLI		
•	•		•				•▲	•*	•	•		

*Not available on 12" and 15" wide *Not available on 12" wide ▲Not available 12", 15", and 18" wide

Construction Upgrades

APC	ET	PE
•	•	•

Door Options

CG	DPSRR
•	•

BASE DOUBLE DOOR with ROLL TRAYS

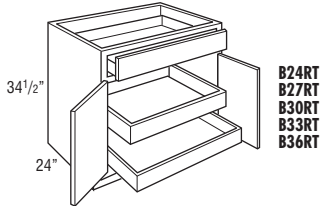

B24RT
B27RT
B30RT
B33RT
B36RT

B24RT	14.4
B27RT	16.1
B30RT	17.7
B33RT	19.6
B36RT	21.1

- 2 roll trays standard.
- Cabinet has butt doors, no center stile.
- Cabinet may accommodate up to 4 roll trays, which may be purchased separately for field installation. See page 414.

Custom Modifications

AUTHL AUTHR	CBO	CCO	CFNTO	CFP	CFRMO	CMAT	CND	DRT	DRWPWR	DRWTK	EXBKL EXBKR	EXL EXR
•	•	•	•	•	•		•	•	•	•	•	•
FB	FD	FFDL FFDR	FPEB	FTK	FTKAV FTKRV	ID	INVFRM	LTI	MIP	P	PTOWB	RD
•			•	•	•				•			•
RECTKALL RECTKBK	RECTKL RECTKR	RT	SCPDRW	TD	TOTSS TOTSSS	TVRAV TVRFV TVRVV	VACL VACR	VACTK	VTK	WLI		
•	•		•				•	•	•	•		

Construction Upgrades

APC	ET	PE
•	•	•

Door Options

CG	DPSRR
•	•

BASE DOUBLE DOOR with ROLL TRAYS

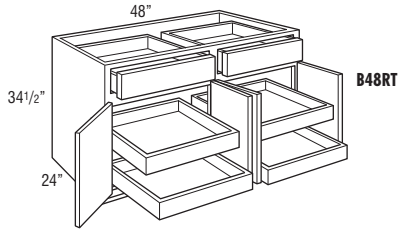
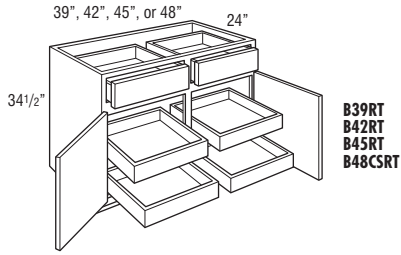

Model	Cubic Feet
B39RT	22.5
B42RT	24.2
B45RT	25.8
B48CSRT	27.5
<hr/>	
B48RT	27.5

- 4 roll trays standard.
- Cabinet may accommodate up to 8 roll trays, which may be purchased separately for field installation. See page 414.

Custom Modifications

AUTHL AUTHR	CBO	CCO	CFNT0	CFP	CFRMO	CMAT	CND	DRT	DRWPWR	DRWTK	EXBKL EXBKR	EXL EXR
•	•	•	•	•	•		•	•	•		•	•
FB	FD	FFDL FFDR	FPEB	FTK	FTKAV FTKFV	ID	INVFRM	LTI	MIP	P	PTOWB	RD
•			•	•	•				•			•
RECTKALL RECTKBK	RECTKL RECTKR	RT	SCPDRW	TD	TOTSS TOTSSS	TVRAV TVRFV TVRVV	VACL VACR	VACTK	VTK	WLI		
•	•		•				•	•	•	•		

Construction Upgrades

APC	ET	PE
•	•	•

Door Options

CG	DPSRR
•	•

BASE BUFFET with ROLL TRAYS

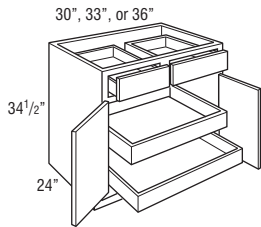

B30RTB	17.7
B33RTB	19.6
B36RTB	21.1

- Reveal between drawers will not align with doors below.
- 2 roll trays standard.
- Cabinet has butt doors, no center stile.
- Cabinet may accommodate up to 4 roll trays, which may be purchased separately for field installation. See page 414.

Custom Modifications

AUTHL AUTHR	CBO	CCO	CFNT0	CFP	CFRMO	CMAT	CND	DRT	DRWPWR	DRWTK	EXBKL EXBKR	EXL EXR
•	•	•	•	•	•		•	•	•*	•	•	•
FB	FD	FFDL FFDR	FPEB	FTK	FTKAV FTKFV	ID	INVFRM	LTI	MIP	P	PTOWB	RD
•			•	•	•				•			•
RECTKALL RECTKBK	RECTKL RECTKR	RT	SCPDRW	TD	TOTSS TOTSSS	TVRAV TVRFV TVRVV	VACL VACR	VACTK	VTK	WLI		
•	•		•				•	•	•	•		

*Not available on 30" and 33" wide

Construction Upgrades

APC	ET	PE
•	•	•

Door Options

CG	DPSRR
•	•

BASE FULL HEIGHT with ROLL TRAYS

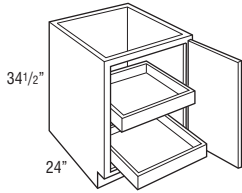

Model	Cubic Feet
B12FHRT L or R	7.7
B15FHRT L or R	9.4
B18FHRT L or R	11.1
B21FHRT L or R	12.8
B24FHRT L or R	14.4

- 2 roll trays standard.
- Cabinets may accommodate up to 5 roll trays, which may be purchased separately for field installation. See page 414.

Custom Modifications

AUTHL AUTHR	CBO	CCO	CFNT0	CFP	CFRMO	CMAT	CND	DRT	DRWPWR	DRWTK	EXBKL EXBKR	EXL EXR
•	•	•	•		•			•		•*	•	•
FB	FD	FFDL FFDR	FPEB	FTK	FTKAV FTKFV	ID	INVFRM	LTI	MIP	P	PTOWB	RD
•			•	•	•				•			•
RECTKALL RECTKBK	RECTKL RECTKR	RT	SCPDRW	TD	TOTSS TOTSSS	TVRAV TVRFV TVRVV	VACL VACR	VACTK	VTK	WLI		
•	•						•*	•*	•	•		

*Not available on 12" and 15" wide *Not available on 12", 15", and 18" wide

Construction Upgrades

APC	ET	PE
•	•	•

Door Options

CG	DPSRR
•	•

**BASE FULL HEIGHT with ROLL TRAYS,
40 1/2" HIGH**

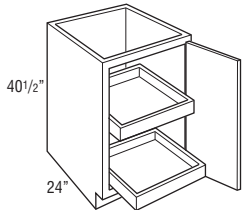

B1540FHRT L or R
B1840FHRT L or R
B2140FHRT L or R
B2440FHRT L or R

B1540FHRT L or R	10.5
B1840FHRT L or R	12.3
B2140FHRT L or R	14.2
B2440FHRT L or R	16.1
B2440FHRT	16.1
B2740FHRT	18.0

- 2 roll trays standard.
- Cabinets may accommodate up to 5 roll trays, which may be purchased separately for field installation. See page 414.

Custom Modifications

AUTHL AUTHR	CBO	CCO	CFNT0	CFP	CFRMO	CMAT	CND	DRT	DRWPWR	DRWTK	EXBKL EXBKR	EXL EXR
•	•	•	•		•			•		•*	•	•
FB	FD	FFDL FFDR	FPEB	FTK	FTKAV FTKFV	ID	INVFRM	LTI	MIP	P	PTOWB	RD
•			•	•	•				•			•
RECTKALL RECTKBK	RECTKL RECTKR	RT	SCPDRW	TD	TOTSS TOTSSS	TVRAV TVRFV TVRVV	VACL VACR	VACTK	VTK	WLI		
•	•						•*	•*	•	•		

*Not available on 15" wide *Not available on 15" and 18" wide

Construction Upgrades

APC	ET	PE
•	•	•

Door Options

CG	DPSRR
•	•

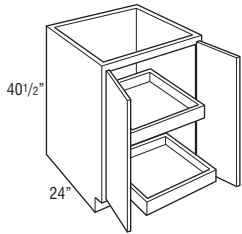

B2440FHRT
B2740FHRT

BASE FULL HEIGHT with ROLL TRAYS

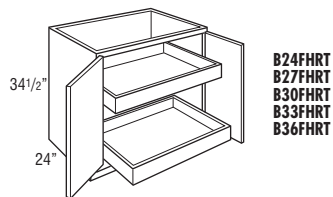

Model	Cubic Feet
B24FHRT	14.4
B27FHRT	16.1
B30FHRT	17.7
B33FHRT	19.6
B36FHRT	21.1

- 2 roll trays standard.
- Cabinet has full height butt doors, no center stile.
- Cabinet may accommodate up to 5 roll trays, which may be purchased separately. See page 414.

Custom Modifications

AUTHL AUTHR	CBO	CCO	CFNTD	CFP	CFRMO	CMAT	CND	DRT	DRWPWR	DRWTK	EXBKL EXBKR	EXL EXR
•	•	•	•		•			•		•	•	•
FB	FD	FFDL FFDR	FPED	FTK	FTKAV FTKFV	ID	INVERM	LTI	MIP	P	PTOWB	RD
•			•	•	•				•			•
RECTKALL RECTKBK	RECTKL RECTKR	RT	SCPDRW	TD	TOTSS TOTSSS	TVRAV TVRFV TVRVV	VACL VACR	VACTK	VTK	WLI		
•	•						•	•	•	•		

Construction Upgrades

APC	ET	PE
•	•	•

Door Options

CG	DPSRR
•	•

BASE FULL HEIGHT DOUBLE DOOR with ROLL TRAYS

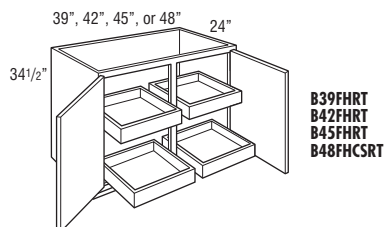

B39FHRT	22.5
B42FHRT	24.2
B45FHRT	25.8
B48FHCSRT	27.5
B48FHRT	27.5

- 4 roll trays standard.
- Cabinet may accommodate up to 10 roll trays, which may be purchased separately. See page 414.

Custom Modifications

AUTHL AUTHR	CBO	CCO	CFNTD	CFP	CFRMO	CMAT	CND	DRT	DRWPWR	DRWTK	EXBKL EXBKR	EXL EXR
•	•	•	•		•			•		•	•	•
FB	FD	FFDL FFDR	FPED	FTK	FTKAV FTKFV	ID	INVERM	LTI	MIP	P	PTOWB	RD
•			•	•	•				•			•
RECTKALL RECTKBK	RECTKL RECTKR	RT	SCPDRW	TD	TOTSS TOTSSS	TVRAV TVRFV TVRVV	VACL VACR	VACTK	VTK	WLI		
•	•						•	•	•	•		

Construction Upgrades

APC	ET	PE
•	•	•

Door Options

CG	DPSRR
•	•

BASE with CUTLERY INSERT WOOD ORGANIZER and ROLL TRAYS

storage SOLUTIONS

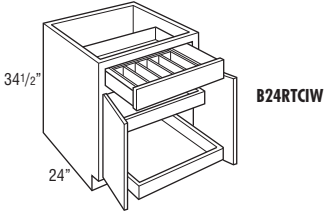
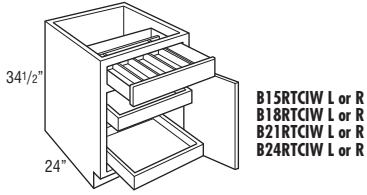

Model	Cubic Feet
B15RTCIW L or R	9.4
B18RTCIW L or R	11.1
B21RTCIW L or R	12.8
B24RTCIW L or R	14.4
B24RTCIW	14.4

- 2 roll trays standard.
- Cabinets may accommodate up to 4 roll trays, which may be purchased separately for field installation. See page 414.
- Cutlery Insert Wood Organizer is also available as an accessory. See page 407.

Custom Modifications

AUTHL AUTHR	CBO	CCO	CFNTD	CFP	CFRMO	CMAT	CND	DRT	DRWPWR	DRWTK	EXBKL EXBKR	EXL EXR
•	•	•	•	•	•		•	•		•*	•	•
FB	FD	FFDL FFDR	FPEB	FTK	FTKAV FTKRV	ID	INVFRM	LTI	MIP	P	PTOWB	RD
•			•	•	•				•			
RECTKALL RECTKBK	RECTKL RECTKR	RT	SCPDRW	TD	TOTSS TOTSSS	TVRAV TVRFV TVRVV	VACL VACR	VACTK	VTK	WLI		
•	•						•*	•*	•	•		

*Not available on 15" wide *Not available on 15" and 18" wide

Construction Upgrades

APC	ET	PE
•	•	•

Door Options

CG	DPSRR
•	•

BASE with WOOD TIERED CUTLERY DIVIDER DRAWER and ROLL TRAYS

storage SOLUTIONS

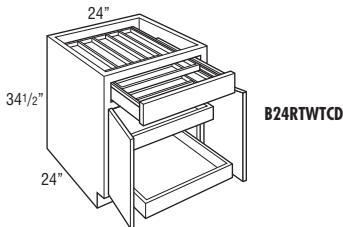
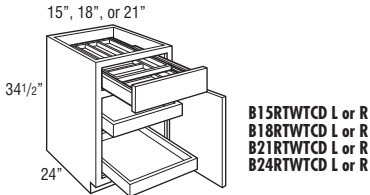

B15RTWTC D L or R	9.4
B18RTWTC D L or R	11.1
B21RTWTC D L or R	12.8
B24RTWTC D L or R	14.4
B24RTWTC D	14.4

- 2 roll trays standard.
- Cabinets may accommodate up to 4 roll trays, which may be purchased separately for field installation. See page 414.
- Exterior WTC D drawer box height is 3 3/4", interior height of top and bottom tier is 1 3/8".
- Wood Tiered Cutlery Divider Drawer is also available as an accessory. See page 407.

Custom Modifications

AUTHL AUTHR	CBO	CCO	CFNTD	CFP	CFRMO	CMAT	CND	DRT	DRWPWR	DRWTK	EXBKL EXBKR	EXL EXR
•	•	•	•	•	•		•	•		•*	•	•
FB	FD	FFDL FFDR	FPEB	FTK	FTKAV FTKRV	ID	INVFRM	LTI	MIP	P	PTOWB	RD
•			•	•	•				•			
RECTKALL RECTKBK	RECTKL RECTKR	RT	SCPDRW	TD	TOTSS TOTSSS	TVRAV TVRFV TVRVV	VACL VACR	VACTK	VTK	WLI		
•	•						•*	•*	•	•		

*Not available on 15" wide *Not available on 15" and 18" wide

Construction Upgrades

APC	ET	PE
•	•	•

Door Options

CG	DPSRR
•	•



BASE with WOOD TIERED K-CUP®* DRAWER and ROLL TRAYS

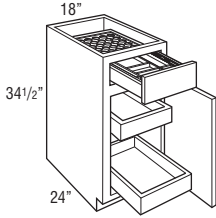

storage SOLUTIONS

Model	Cubic Feet
B18KCUPRT L or R	11.1

- 2 roll trays standard.
 - Cabinets may accommodate up to 4 roll trays, which may be purchased separately for field installation. See page 414.
 - Exterior Wood Tiered K-Cup® drawer box height is 3 3/4", interior height of top tier is 1 5/8", and interior height of bottom tier is 1 3/8".
 - The Wood Tiered K-Cup® Drawer is compatible with K-Cup® pods only.
 - Wood Tiered K-Cup® Drawer is also available as an accessory. See page 408.
- *K-Cup® is a registered trademark of Keurig Green Mountain, Inc.

Custom Modifications

AUTHL AUTHR	CBO	CCO	CFNTO	CFP	CFRMO	CMAT	CND	DRT	DRWPWR	DRWTK	EXBKL EXBKR	EXL EXR
•	•	•	•	•	•		•	•		•	•	•
FB	FD	FFDL FFDR	FPEB	FTK	FTKAV FTKFV	ID	INVERM	LTI	MIP	P	PTOWB	RD
•			•	•	•				•			
RECTKALL RECTKBK	RECTKL RECTKR	RT	SCPRW	TD	TOTSS TOTSSS	TVRAV TVRFV TVRVV	VACL VACR	VACTK	VTK	WLI		
•	•							•	•	•		

Construction Upgrades

APC	ET	PE
•	•	•

Door Options

CG	DPSRR
•	•

BASE with DRAWER and LID ORGANIZER and ROLL TRAYS

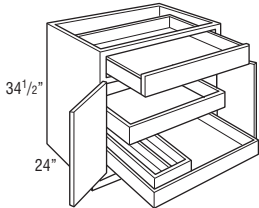

storage SOLUTIONS

B30RTLO	17.7
B33RTLO	19.6
B36RTLO	21.1

- 2 roll trays standard.
- Cabinet has butt doors, no center stile.
- Cabinet may accommodate up to 4 roll trays, which may be purchased separately for field installation. See page 414.
- Pots and Pans Lid Organizer is also available as an accessory for field installation. See page 410.
- The lid organizer is attached to the roll tray with 2 screws for shipping purposes only. Screws should be removed during installation to make the lid organizer mobile.

Custom Modifications

AUTHL AUTHR	CBO	CCO	CFNTO	CFP	CFRMO	CMAT	CND	DRT	DRWPWR	DRWTK	EXBKL EXBKR	EXL EXR
•	•	•	•	•	•		•		•	•	•	•
FB	FD	FFDL FFDR	FPEB	FTK	FTKAV FTKFV	ID	INVERM	LTI	MIP	P	PTOWB	RD
•			•	•	•				•			
RECTKALL RECTKBK	RECTKL RECTKR	RT	SCPRW	TD	TOTSS TOTSSS	TVRAV TVRFV TVRVV	VACL VACR	VACTK	VTK	WLI		
•	•							•	•	•		

Construction Upgrades

APC	ET	PE
•	•	•

Door Options

CG	DPSRR
•	•

BASE with LID ORGANIZER and ROLL TRAYS

storage SOLUTIONS

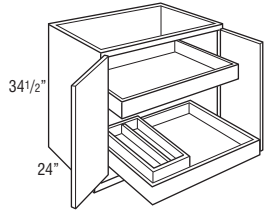

Model	Cubic Feet
B30FHRTLO	17.7
B33FHRTLO	19.6
B36FHRTLO	21.1

- 2 roll trays standard.
- Cabinet has full height butt doors, no center stile.
- Cabinet may accommodate up to 5 roll trays, which may be purchased separately for field installation. See page 414.
- Pots and Pans Lid Organizer is also available as an accessory for field installation. See page 410.
- The lid organizer is attached to the roll tray with 2 screws for shipping purposes only. Screws should be removed during installation to make the lid organizer mobile.

Custom Modifications

AUTHL AUTHR	CBO	CCO	CFNTD	CFP	CFRMO	CMAT	CND	DRT	DRWPWR	DRWTK	EXBKL EXBKR	EXL EXR
•	•	•	•	•	•					•	•	•
FB	FD	FFDL FFDR	FPEB	FTK	FTKAV FTKRV	ID	INVFRM	LTI	MIP	P	PTOWB	RD
•			•	•	•				•			
RECTKALL RECTKBK	RECTKL RECTKR	RT	SCPDRW	TD	TOTSS TOTSSS	TVRAV TVRFV TVRVV	VACL VACR	VACTK	VTK	WLI		
•	•						•	•	•	•		

Construction Upgrades

APC	ET	PE
•	•	•

Door Options

CG	DPSRR
•	•

POTS & PANS ORGANIZER BASE with DRAWER

storage SOLUTIONS

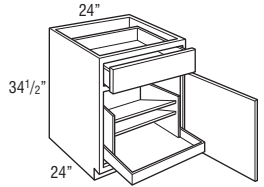

B24PS L or R

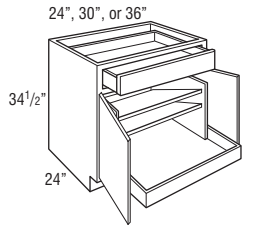

**B24PS
B30PS
B36PS**

B24PS L or R	14.4
B24PS	14.4
B30PS	17.7
B36PS	21.1

- Cabinet has butt doors, no center stile.
- Cabinet has bottom roll tray with double lid storage shelves above.
- Base Pan Storage unit is also available as an accessory for field installation. See page 406.

Custom Modifications

AUTHL AUTHR	CBO	CCO	CFNTD	CFP	CFRMO	CMAT	CND	DRT	DRWPWR	DRWTK	EXBKL EXBKR	EXL EXR
•	•	•	•	•	•					•	•	•
FB	FD	FFDL FFDR	FPEB	FTK	FTKAV FTKRV	ID	INVFRM	LTI	MIP	P	PTOWB	RD
•			•	•	•				•			
RECTKALL RECTKBK	RECTKL RECTKR	RT	SCPDRW	TD	TOTSS TOTSSS	TVRAV TVRFV TVRVV	VACL VACR	VACTK	VTK	WLI		
•	•		•				•	•	•	•		

Construction Upgrades

APC	ET	PE
•	•	•

Door Options

CG	DPSRR
•	•

BASE POTS & PANS PULL-OUT

storage
SOLUTIONS

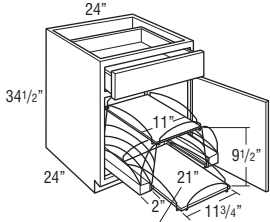

BPPP24 L or R

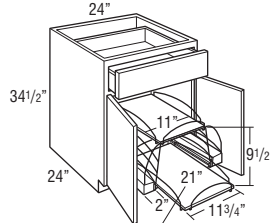

BPPP24

Model	Cubic Feet
BPPP24 L or R	14.4
BPPP24	14.4

- Full Extension slide out shelves pull out independently.
- Pots and Pans Pull-Out is also available as an accessory for field installation. See page 410.
- For full access from both sides of unit, do not install against a wall or next to deeper appliances and cabinets.

Custom Modifications

AUTHL AUTHR	CBO	CCO	CFNT0	CFP	CFRMO	CMAT	CND	DRT	DRWPWR	DRWTK	EXBKL EXBKR	EXL EXR
•	•	•	•	•	•		•		•	•	•	•
FB	FD	FFDL FFDR	FPEB	FTK	FTKAV FTKFV	ID	INVFRM	LTI	MIP	P	PTOWB	RD
•			•	•	•				•			
RECTKALL RECTKBK	RECTKL RECTKR	RT	SCPDRW	TD	TOTSS TOTSSS	TVRAV TVRFV TVRVV	VACL VACR	VACTK	VTK	WLI		
•	•		•				•	•	•	•		

Construction Upgrades

APC	ET	PE
•		•

Door Options

CG	DPSRR
•	•

BASE POTS & PANS PULL-OUT

storage
SOLUTIONS

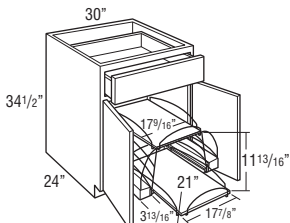

Shelf Depth
(front to back)

BPPP30	17.7
---------------	------

- Full Extension slide out shelves pull out independently.
- Pots and Pans Pull-Out is also available as an accessory for field installation. See page 410.
- For full access from both sides of unit, do not install against a wall or next to deeper appliances and cabinets.

Custom Modifications

AUTHL AUTHR	CBO	CCO	CFNT0	CFP	CFRMO	CMAT	CND	DRT	DRWPWR	DRWTK	EXBKL EXBKR	EXL EXR
•	•	•	•	•	•		•		•	•	•	•
FB	FD	FFDL FFDR	FPEB	FTK	FTKAV FTKFV	ID	INVFRM	LTI	MIP	P	PTOWB	RD
•			•	•	•				•			
RECTKALL RECTKBK	RECTKL RECTKR	RT	SCPDRW	TD	TOTSS TOTSSS	TVRAV TVRFV TVRVV	VACL VACR	VACTK	VTK	WLI		
•	•		•				•	•	•	•		

Construction Upgrades

APC	ET	PE
•		•

Door Options

CG	DPSRR
•	•

NEW BASE with FOOD STORAGE CONTAINER ORGANIZER

storage
SOLUTIONS

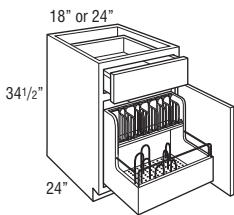

B18FSCO L or R	11.1
B24FSCO L or R	14.4

- Pull-out features natural finished hardwood dovetailed box with chrome rails on lower section with undermount Smart Stop guides.
- Includes seven chrome "U" pegs to use on the pegboard bottom to customize the fit to container sizes.
- Adjustable clip-on lid dividers included to fit with a variety of lid shapes. 18" wide includes five dividers, 24" wide includes eight dividers.
- Front of pull-out is routed for easy access.

Custom Modifications

AUTHL AUTHR	CBO	CCO	CFNT0	CFP	CFRMO	CMAT	CND	DRT	DRWPWR	DRWTK	EXBKL EXBKR	EXL EXR
•	•	•	•	•	•		•		•	•	•	•
FB	FD	FFDL FFDR	FPEB	FTK	FTKAV FTKFV	ID	INVFRM	LTI	MIP	P	PTOWB	RD
•			•	•	•				•			
RECTKALL RECTKBK	RECTKL RECTKR	RT	SCPDRW	TD	TOTSS TOTSSS	TVRAV TVRFV TVRVV	VACL VACR	VACTK	VTK	WLI		
•	•		•				•*	•	•	•		

*Not available on 18" wide

Construction Upgrades

APC	ET	PE
•		•

Door Options

CG	DPSRR
•	•

BASE with CAN and WINE BOTTLE PULL-OUTS

storage SOLUTIONS

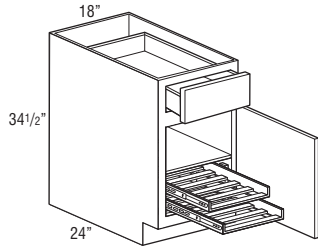

B18CWP12 L or R

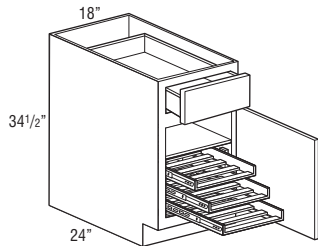
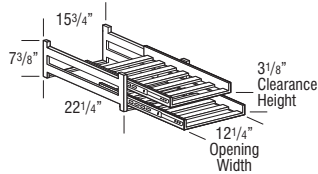

B18CWP18 L or R

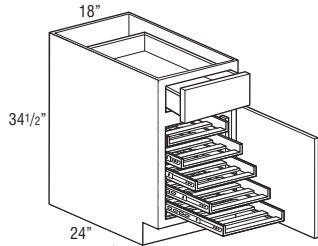
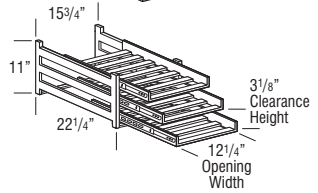

B18CWP30 L or R

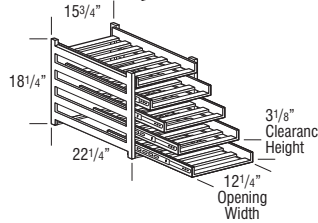

Model	Cubic Feet
B18CWP12 L or R	11.1
B18CWP18 L or R	11.1
B18CWP30 L or R	11.1

- Pull-outs feature natural finished hardwood with side mounted guides (Smart Stop not included).
- One adjustable full depth shelf on B18CWP12 and B18CWP18.
- B18CWP12 holds twelve wine bottles.
B18CWP18 holds eighteen wine bottles.
B18CWP30 holds thirty wine bottles.

Custom Modifications

AUTHL AUTHR	CBO	CCO	CFNTO	CFP	CFRMO	CMAT	CND	DRT	DRWPVR	DRWTK	EXBKL EXBKR	EXL EXR
•	•	•	•	•	•		•		•	•	•	•
FB	FD	FFDL FFDR	FPEB	FTK	FTKAV FTKRV	ID	INVFRM	LTI	MIP	P	PTOWB	RD
•	STD	•	•	•	•		•		•			
RECTKALL RECTKBK	RECTKL RECTKR	RT	SCPDRW	TD	TOTSS TOTSSS	TVRAV TVRFV TVRVV	VACL VACR	VACTK	VTK	WLI		
•	•		•					•	•	•		

Construction Upgrades

APC	ET	PE
•		•

Door Options

CG	DPSRR
•	•

BASE FULL HEIGHT with CAN and WINE BOTTLE PULL-OUTS

storage SOLUTIONS

Model	Cubic Feet
B18FHCWP12 L or R	11.1
B18FHCWP18 L or R	11.1
B18FHCWP30 L or R	11.1

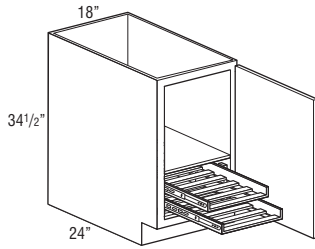

B18FHCWP12 L or R

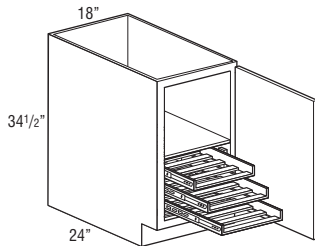
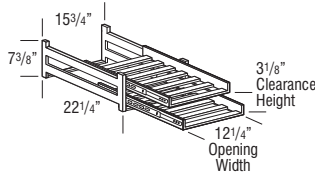

B18FHCWP18 L or R

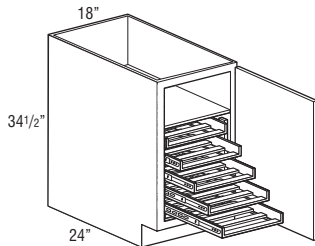
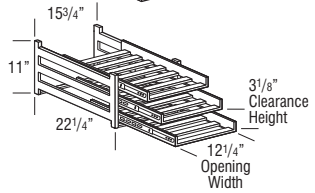

B18FHCWP30 L or R

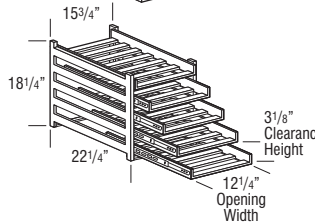

- Pull-outs feature natural finished hardwood with side mounted guides (Smart Stop not included).
- One adjustable full depth shelf.
- B18FHCWP12 holds twelve wine bottles.
- B18FHCWP18 holds eighteen wine bottles.
- B18FHCWP30 holds thirty wine bottles.

Custom Modifications

AUTHL	CBO	CCO	CFNT0	CFP	CFRMO	CMAT	CND	DRT	DRWPWR	DRWTK	EXBKL	EXL				
•	•	•	•	•	•		•			•	•	•				
FB	FD	FFDL	FPEB	FTK	FTKAV	ID	INVERM	LTI	MIP	P	PTOWB	RD				
•	STD	•	•	•	•				•							
RECTKALL	RECTKRBK	RECTKL	RECTKR	RT	SCPRW	TD	TOTSS	TOTSSS	TVRV	TVRFV	TVRVW	VACL	VACR	VACTK	VTK	WLI
•	•													•	•	•

Construction Upgrades

APC	ET	PE
•		•

Door Options

CG	DPSRR
•	•

BASE with ROLL-OUT TRAY DIVIDER storage SOLUTIONS

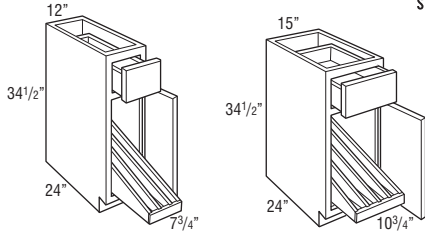

B12TDRO L or R

B15TDRO L or R

Model	Cubic Feet
B12TDRO L or R	7.8
B15TDRO L or R	9.4

- Dividers are removable.
- 12" - 3 compartments.
- 15" - 4 compartments.
- Roll-Out Tray Divider is also available as an accessory for field installation. See page 413.
- Tray divider utilizes Smart Stop undermount guides and bumpers for door protection.

Custom Modifications

AUTHL AUTHR	CBO	CCO	CFNTO	CFP	CFRMO	CMAT	CND	DRT	DRWPWR	DRWTK	EXBKL EXBKR	EXL EXR
•	•	•	•	•	•		•				•	•
FB	FD	FFDL FFDR	FPEB	FTK	FTKAV FTKFV	ID	INVFRM	LTI	MIP	P	PTOWB	RD
•			•	•	•*				•			
RECTKALL RECTKBK	RECTKL RECTKR	RT	SCPDRW	TD	TOTSS TOTSSS	TVRAV TVRFV TVRVV	VACL VACR	VACTK	VTK	WLI		
•	•		•						•	•		

*Not available on 12" wide

Construction Upgrades

APC	ET	PE
•		•

Door Options

CG	DPSRR
•	•

BASE with TRAY DIVIDER

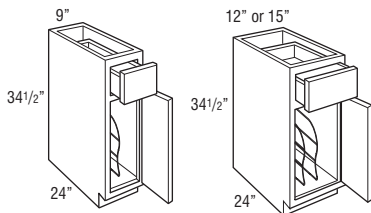

TD9 L or R

**TD12 L or R
TD15 L or R**

Model	Cubic Feet
TD9 L or R	6.1
TD12 L or R	7.8
TD15 L or R	9.4

- Tray Divider is chrome.
- Tray Divider is also available as an accessory for field installation. See page 412.

Custom Modifications

AUTHL AUTHR	CBO	CCO	CFNTO	CFP	CFRMO	CMAT	CND	DRT	DRWPWR	DRWTK	EXBKL EXBKR	EXL EXR
•	•	•	•	•	•		•				•	•
FB	FD	FFDL FFDR	FPEB	FTK	FTKAV FTKFV	ID	INVFRM	LTI	MIP	P	PTOWB	RD
•			•	•	•*			•*	•			
RECTKALL RECTKBK	RECTKL RECTKR	RT	SCPDRW	TD	TOTSS TOTSSS	TVRAV TVRFV TVRVV	VACL VACR	VACTK	VTK	WLI		
•*	•		•						•	•		

*Not available on 9" and 12" wide *Not available on 9" wide

Construction Upgrades

APC	ET	PE
•		•

Door Options

CG	DPSRR
•†	•

†Not available on 9" wide

BASE FULL HEIGHT with TRAY DIVIDER

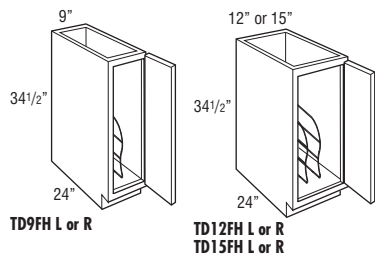

Model	Cubic Feet
TD9FH L or R	6.1
TD12FH L or R	7.8
TD15FH L or R	9.4

- Tray Divider is chrome.
- Tray Divider is also available as an accessory for field installation. See page 412.

Custom Modifications

AUTHL AUTHR	CBO	CCO	CFNTD	CFP	CFRMO	CMAT	CND	DRT	DRWPWR	DRWTK	EXBKL EXBKR	EXL EXR
•	•	•	•		•						•	•
FB	FD	FFDL FFDR	FPEB	FTK	FTKAV FTKRV	ID	INVERM	LTI	MIP	P	PTOWB	RD
•			•	•	•*			•*	•			
RECTKALL RECTKBK	RECTKL RECTKR	RT	SCPDRW	TD	TOTSS TOTSSS	TVRAV TVRFV TVRVV	VACL VACR	VACTK	VTK	WLI		
•*	•								•	•		

*Not available on 9" and 12" wide *Not available on 9" wide

Construction Upgrades

APC	ET	PE
•		•

Door Options

CG	DPSRR
•†	•

†Not available on 9" wide

NEW BASE CABINET with MIXER SHELF

storage SOLUTIONS

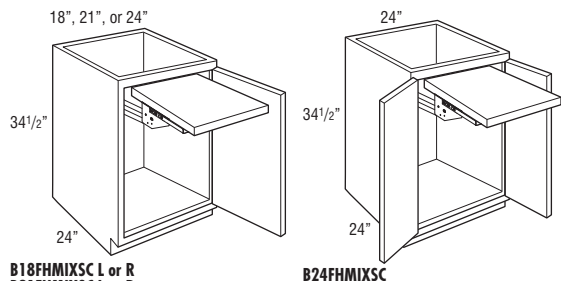

B18FHMIXSC L or R
B21FHMIXSC L or R
B24FHMIXSC L or R

B24FHMIXSC

B18FHMIXSC L or R	11.1
B21FHMIXSC L or R	12.8
B24FHMIXSC L or R	14.4
B24FHMIXSC	14.4

- Includes mixer lift with Smart Stop closing feature.
- Mixer shelf will be 3/4" thick natural finished veneer plywood, mixer shelf dimensions:
18" wide: 11 3/4" wide x 20" deep.
21" wide: 14 3/4" wide x 20" deep.
24" wide: 17 3/4" wide x 20" deep.
- Maximum Weight Capacity for Mixer Shelf: 60 lbs.
- Mixer shelf locks in the fully open position. Release brackets lower the mixer shelf back into the cabinet.
- When in closed position, clearance above shelf is 17 5/8"; clearance below shelf is 7 3/4".

Custom Modifications

AUTHL AUTHR	CBO	CCO	CFNTD	CFP	CFRMO	CMAT	CND	DRT	DRWPWR	DRWTK	EXBKL EXBKR	EXL EXR
•	•	•	•		•						•	•
FB	FD	FFDL FFDR	FPEB	FTK	FTKAV FTKRV	ID	INVERM	LTI	MIP	P	PTOWB	RD
•			•	•	•				•			
RECTKALL RECTKBK	RECTKL RECTKR	RT	SCPDRW	TD	TOTSS TOTSSS	TVRAV TVRFV TVRVV	VACL VACR	VACTK	VTK	WLI		
•	•						•*	•	•	•		

*Not available on 18" wide

Construction Upgrades

APC	ET	PE
•		•

Door Options

CG	DPSRR
•	•

SINK BASE

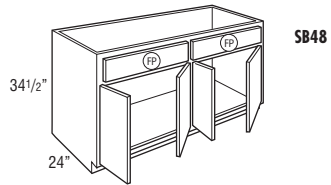
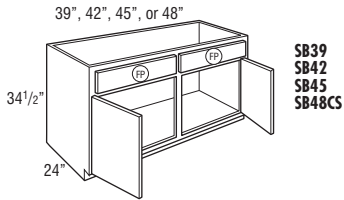
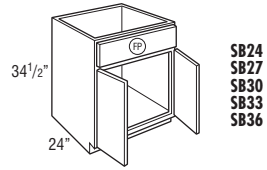
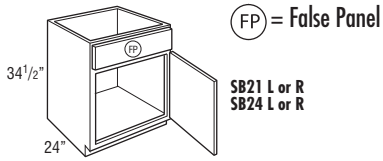

Model	Cubic Feet
SB21 L or R	12.8
SB24 L or R	14.4
SB24	14.4
SB27	16.1
SB30	17.7
SB33	19.6
SB36	21.1
SB39	22.7
SB42	24.4
SB45	25.8
SB48CS	27.7
SB48	27.7

• Mini Touch-Up Kit (MTUK) included. MTUK includes small touch-up marker and small fill stick.

Custom Modifications

AUTHL AUTHR	CBO	CCO	CFNTD	CFP	CFRMO	CMAT	CND	DRT	DRWPWR	DRWTK	EXBKL EXBKR	EXL EXR
•		•	•	STD	•	•*	•			•+	•	•
FB	FD	FFDL FFDR	FPEB	FTK	FTKAV FTKFV	ID	INVFRM	LTI	MIP	P	PTOWB	RD
•		•	•	•	•	•		•	•	•		•
RECTKAL RECTKBK	RECTKL RECTKR	RT	SCPDRW	TD	TOTSS TOTSSS	TVRAV TVRFV TVRVV	VACL VACR	VACTK	VTK	WLI		
•	•	•			•				•	•		

*Available only on 30", 33", and 36" wide *Not available on 39", 42", 45", and 48" wide

Construction Upgrades

APC	ET	PE
•		•

Door Options

CG	DPSRR
•	•

SINK BASE with CABMAT™

storage
SOLUTIONS

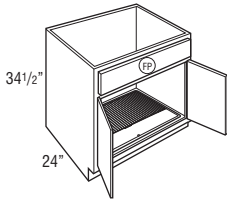

Model	Cubic Feet
SB30CM	17.7
SB33CM	19.6
SB36CM	21.1

- Mini Touch-Up Kit (MTUK) included. MTUK includes small touch-up marker and small fill stick.
- CabMat™ features a grey sloped mat to capture spills.
- CabMat™ is removable for cleaning.

Model	Liquid Capacity		Cabinet Size	
	Quarts	Liters	Width	Depth
SB30CM	4.2	3.9	30"	24"
SB33CM	4.6	4.3	33"	24"
SB36CM	5.0	4.7	36"	24"

Custom Modifications

AUTHL AUTHR	CBO	CCO	CFNT0	CFP	CFRMO	CMAT	CND	DRT	DRWPWR	DRWTK	EXBKL EXBKR	EXL EXR
•	•	•	•	STD	•		•			•	•	•
FB	FD	FFDL FFDR	FPEB	FTK	FTKAV FTKRV	ID	INVERM	LTI	MIP	P	PTOWB	RD
•		•	•	•	•			•	•	•		
RECTKALL RECTKBK	RECTKL RECTKR	RT	SCPDRW	TD	TOTSS TOTSSS	TVRAV TVRFV TVRVV	VACL VACR	VACTK	VTK	WLI		
•	•				•				•	•		

Construction Upgrades

APC	ET	PE
•		•

Door Options

CG	DPSRR
	•

SINK BASE with CADDY

storage
SOLUTIONS

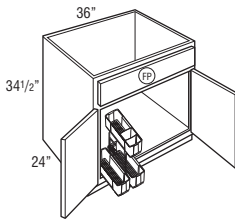

SB36CDY L or R	20.9
-----------------------	-------------

- Mini Touch-Up Kit (MTUK) included. MTUK includes small touch-up marker and small fill stick.
- L or R designates caddy location.
- Caddy is removable and portable.
- Caddy dimensions are: 9 15/16" wide x 18 5/16" tall x 18 5/8" deep.

Custom Modifications

AUTHL AUTHR	CBO	CCO	CFNT0	CFP	CFRMO	CMAT	CND	DRT	DRWPWR	DRWTK	EXBKL EXBKR	EXL EXR
•	•	•	•		•		•				•	•
FB	FD	FFDL FFDR	FPEB	FTK	FTKAV FTKRV	ID	INVERM	LTI	MIP	P	PTOWB	RD
•		•	•	•	•			•	•			
RECTKALL RECTKBK	RECTKL RECTKR	RT	SCPDRW	TD	TOTSS TOTSSS	TVRAV TVRFV TVRVV	VACL VACR	VACTK	VTK	WLI		
•	•				•				•	•		

Construction Upgrades

APC	ET	PE
•		•

Door Options

CG	DPSRR
•	•

SINK BASE, 27" DEEP, SINGLE or DOUBLE DOOR

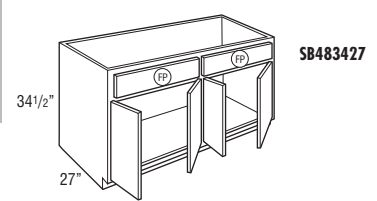
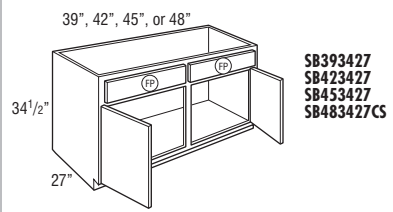
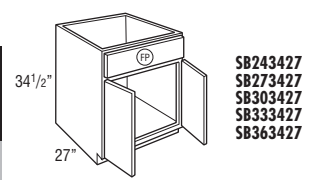
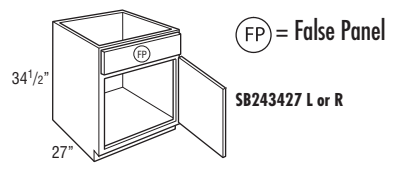

Model	Cubic Feet
SB243427 L or R	16.2
SB243427	16.2
SB273427	18.1
SB303427	19.9
SB333427	22.1
SB363427	23.7
SB393427	25.5
SB423427	27.5
SB453427	25.8
SB483427CS	31.2
SB483427	31.2

• Mini Touch-Up Kit (MTUK) included. MTUK includes small touch-up marker and small fill stick.

Custom Modifications

AUTHL	AUTHR	CBO	CCO	CFNTQ	CFP	CFRMO	CMAT	CND	DRT	DRWPWR	DRWTK	EXBKL	EXBKR	EXL	EXR	
•			•	•	STD	•		•				•		•		
FB	FD	FFDL	FFDR	FPEB	FTK	FTKAV	FTKFV	ID	INVFRM	LTI	MIP	P	PTOWB	RD		
•				•	•	•				•	•	•				
RECTKALL	RECTKLBK	RECTKLL	RECTKR	RT	SCPDRW	TD	TOTSS	TOTSSS	TVRAV	TVRFV	TVRVV	VACL	VACR	VACTK	VTK	WLI
•	•						•							•	•	

Construction Upgrades

APC	ET	PE
•		•

Door Options

CG	DPSRR
•	•

SINK BASE with TILT-OUT TRAYS

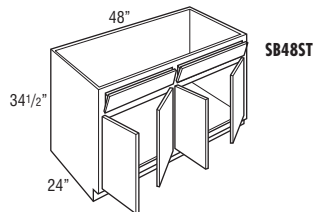
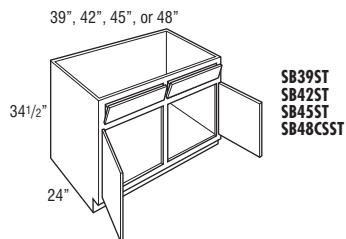
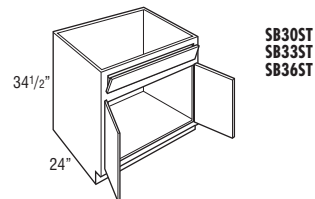
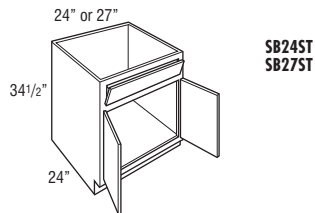
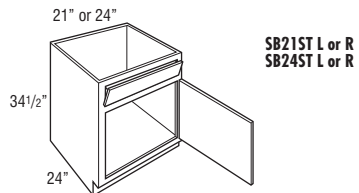

Model	Cubic Feet
SB21ST L or R	12.8
SB24ST L or R	14.4
SB24ST	14.4
SB27ST	16.1
SB30ST	17.7
SB33ST	19.6
SB36ST	21.1
SB39ST	22.7
SB42ST	24.4
SB45ST	25.7
SB48CSST	27.7
SB48ST	27.7

- Tilt-out trays are stain resistant, moisture resistant plastic to allow storage of sponges and other cleaning materials.
- Mini Touch-Up Kit (MTUK) included. MTUK includes small touch-up marker and small fill stick.
- Includes two tilt-out trays on 30"-48" wide.
- Tilt-out trays are also available as an accessory for field installation. See page 412.

Custom Modifications

AUTHL	AUTHR	CBO	CCO	CFNTO	CFP	CFRMO	CMAT	CND	DRT	DRWPWR	DRWTK	EXBKL	EXBKR	EXL	EXR	
•			•	•		•	•*	•				•*	•	•	•	
FB	FD	FFDL	FFDR	FPEB	FTK	FTKAV	FTKEV	ID	INVERM	LTI	MIP	P	PTOWB	RD		
•		•	•	•	•	•	•		•	•	•			•		
RECTKALL	RECTKLBK	RECTKL	RECTKR	RT	SCPRW	TD	TOTSS	TOTSSS	TVRAV	TVRFV	TVRVV	VACL	VACR	VACTK	VTK	WLI
•	•	•	•	•	•	•	•	•	•	•	•	•	•	•	•	•

*Available only on 30", 33", and 36" wide *Not available on 39", 42", 45", and 48" wide

Construction Upgrades

APC	ET	PE
•		•

Door Options

CG	DPSRR
•	•

SINK BASE with TILT-OUT TRAYS and CABMAT™

storage SOLUTIONS

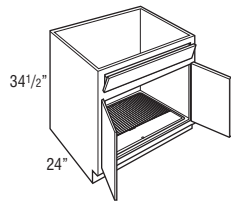

Model	Cubic Feet
SB30STCM	17.7
SB33STCM	19.6
SB36STCM	21.1

- Mini Touch-Up Kit (MTUK) included. MTUK includes small touch-up marker and small fill stick.
- CabMat™ features a grey sloped mat to capture spills.
- CabMat™ is removable for cleaning.
- Tilt-out trays are stain resistant, moisture resistant plastic to allow storage of sponges and other cleaning materials.
- Includes two tilt-out trays.
- Tilt-out trays are also available as an accessory for field installation. See page 412.

Model	Liquid Capacity		Cabinet Size	
	Quarts	Liters	Width	Depth
SB30STCM	4.2	3.9	30"	24"
SB33STCM	4.6	4.3	33"	24"
SB36STCM	5.0	4.7	36"	24"

Custom Modifications

AUTHL AUTHR	CBO	CCO	CFNTO	CFP	CFRMO	CMAT	CND	DRT	DRWPWR	DRWTK	EXBKL EXBKR	EXL EXR
•	•	•	•		•		•			•	•	•
FB	FD	FFDL FFDR	FPEB	FTK	FTKAV FTKFV	ID	INVFRM	LTI	MIP	P	PTOWB	RD
•		•	•	•	•			•	•	•		
RECTKALL RECTKBK	RECTKL RECTKR	RT	SCPDRW	TD	TOTSS TOTSSS	TVRAV TVRFV TVRVV	VACL VACR	VACTK	VTK	WLI		
•	•								•	•		

Construction Upgrades

APC	ET	PE
•		•

Door Options

CG	DPSRR
	•

SINK BASE with TILT-OUT TRAYS and CADDY

storage SOLUTIONS

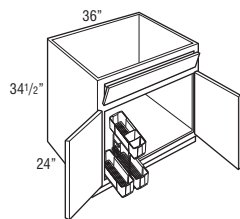

Model	Cubic Feet
SB36STCDY L or R	20.9

- Mini Touch-Up Kit (MTUK) included. MTUK includes small touch-up marker and small fill stick.
- L or R designates caddy location.
- Caddy is removable and portable.
- Tilt-out trays are stain resistant, moisture resistant plastic to allow storage of sponges and other cleaning materials.
- Includes two tilt-out trays.
- Tilt-out trays are also available as an accessory for field installation. See page 412.
- Caddy dimensions are: 9 15/16" wide x 18 5/16" tall x 18 5/8" deep.

Custom Modifications

AUTHL AUTHR	CBO	CCO	CFNTO	CFP	CFRMO	CMAT	CND	DRT	DRWPWR	DRWTK	EXBKL EXBKR	EXL EXR
•	•	•	•		•		•			•	•	•
FB	FD	FFDL FFDR	FPEB	FTK	FTKAV FTKFV	ID	INVFRM	LTI	MIP	P	PTOWB	RD
•		•	•	•	•			•	•			
RECTKALL RECTKBK	RECTKL RECTKR	RT	SCPDRW	TD	TOTSS TOTSSS	TVRAV TVRFV TVRVV	VACL VACR	VACTK	VTK	WLI		
•	•								•	•		

Construction Upgrades

APC	ET	PE
•		•

Door Options

CG	DPSRR
•	•

**SINK BASE with TILT-OUT TRAYS,
27" DEEP**

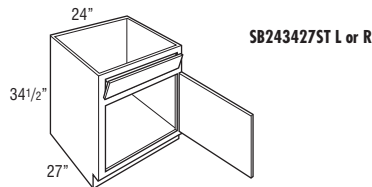

SB243427ST L or R

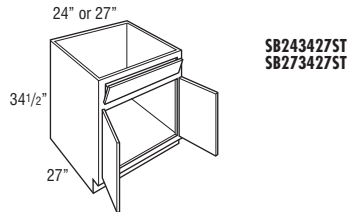

SB243427ST
SB273427ST

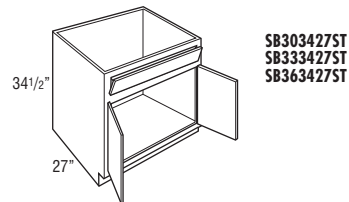

SB303427ST
SB333427ST
SB363427ST

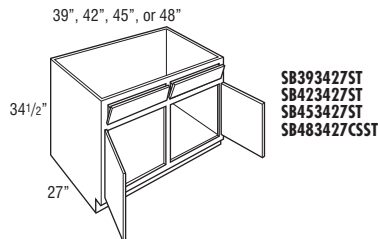

SB393427ST
SB423427ST
SB453427ST
SB483427CSST

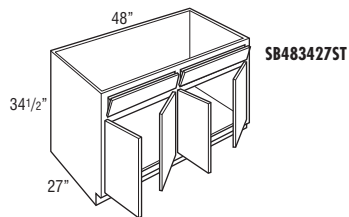

SB483427ST

Model	Cubic Feet
SB243427ST L or R	16.2
SB243427ST	16.2
SB273427ST	18.1
SB303427ST	19.9
SB333427ST	22.1
SB363427ST	23.7
SB393427ST	25.5
SB423427ST	27.5
SB453427ST	25.8
SB483427CSST	31.2
SB483427ST	31.2

- Tilt-out trays are stain resistant, moisture resistant plastic to allow storage of sponges and other cleaning materials.
- Mini Touch-up Kit (MTUK) included. MTUK includes small touch-up marker and small fill stick.
- Includes two tilt-out trays on 30"-48" wide.
- Tilt-out trays are also available as an accessory for field installation. See page 412.

Custom Modifications

AUTHL AUTHR	CBO	CCO	CFNT0	CFP	CFRMO	CMAT	CND	DRT	DRWPWR	DRWTK	EXBKL EXBKR	EXL EXR
•		•	•		•		•				•	•
FB	FD	FFDL FFDR	FPEB	FTK	FTKAV FTKFV	ID	INVFRM	LTI	MIP	P	PTOWB	RD
•			•	•	•			•	•	•		
RECTKALL RECTKBK	RECTKL RECTKR	RT	SCPDRW	TD	TOTSS TOTSSS	TVRAV TVRFV TVRVV	VACL VACR	VACTK	VTK	WLI		
•	•								•	•		

Construction Upgrades

APC	ET	PE
•		•

Door Options

CG	DPSRR
•	•

SINK BASE SUPERCABINET™

storage
SOLUTIONS

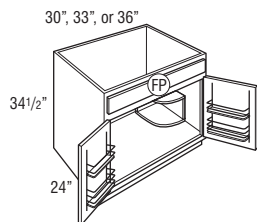

(FP) = False Panel

SB30S	17.7
SB33S	19.6
SB36S	21.1

- Quarter Round Reversible Shelf for left or right applications will be constructed from 3/4" thick laminated furniture board. When upgraded to APC, shelf will use clear coated veneer plywood. (Shelf shipped secure, can be positioned in left or right corner.)
- Mini Touch-Up Kit (MTUK) included. MTUK includes small touch-up marker and small fill stick.
- All load bearing surfaces meet KCMA standards of 15 lbs. per square foot.
- Each door features a chrome and wood two-tiered rack.
- Door rack width is 10 7/8" on 30" wide cabinet, 12 3/8" on 33" wide cabinet, and 13 7/8" on 36" wide cabinet.
- Door rack depth is 3 1/2".

Custom Modifications

AUTHL AUTHR	CBO	CCO	CFNT0	CFP	CFRMO	CMAT	CND	DRT	DRWPWR	DRWTK	EXBKL EXBKR	EXL EXR
•	•		•	STD	•		•				•	•
FB	FD	FFDL FFDR	FPEB	FTK	FTKAV FTKFV	ID	INVFRM	LTI	MIP	P	PTOWB	RD
•		•	•	•	•			•	•			
RECTKALL RECTKBK	RECTKL RECTKR	RT	SCPDRW	TD	TOTSS TOTSSS	TVRAV TVRFV TVRVV	VACL VACR	VACTK	VTK	WLI		
•	•				•				•	•		

Construction Upgrades

APC	ET	PE
•		•

Door Options

CG	DPSRR
•	•

SINK BASE SUPERCABINET™ with CABMAT™

storage SOLUTIONS

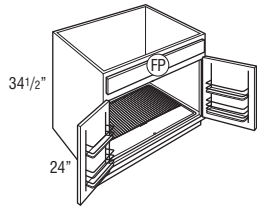

Model	Cubic Feet
SB30SCM	17.7
SB33SCM	19.6
SB36SCM	21.1

- Mini Touch-Up Kit (MTUK) included. MTUK includes small touch-up marker and small fill stick.
- CabMat™ features a grey sloped mat to capture spills.
- CabMat™ is removable for cleaning.
- All load bearing surfaces meet KCMA standards of 15 lbs. per square foot.
- Each door features a chrome and wood two-tiered rack.
- Door rack width is 10 7/8" on 30" wide cabinet, 12 3/8" on 33" wide cabinet, and 13 7/8" on 36" wide cabinet.
- Door rack depth is 3 1/2".

Model	Liquid Capacity		Cabinet Size	
	Quarts	Liters	Width	Depth
SB30SCM	4.2	3.9	30"	24"
SB33SCM	4.6	4.3	33"	24"
SB36SCM	5.0	4.7	36"	24"

Custom Modifications

AUTHL AUTHR	CBO	CCO	CFNTO	CFP	CFRMO	CMAT	CND	DRT	DRWPWR	DRWTK	EXBKL EXBKR	EXL EXR
•	•	•	•	STD	•		•			•	•	•
FB	FD	FFDL FFDR	FPEB	FTK	FTKAV FTKFV	ID	INVFRM	LTI	MIP	P	PTOWB	RD
•		•	•	•	•			•	•	•		
RECTKALL RECTKBK	RECTKL RECTKR	RT	SCPDRW	TD	TOTSS TOTSSS	TVRAV TVRFV TVRVV	VACL VACR	VACTK	VTK	WLI		
•	•				•				•	•		

Construction Upgrades

APC	ET	PE
•		•

Door Options

CG	DPSRR
	•

SINK BASE SUPERCABINET™ with CADDY

storage SOLUTIONS

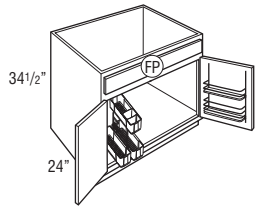

Model	Cubic Feet
SB36SCDY L or R	20.9

- Mini Touch-Up Kit (MTUK) included. MTUK includes small touch-up marker and small fill stick.
- L or R designates caddy location.
- Caddy is removable and portable.
- Caddy dimensions are: 9 15/16" wide x 18 5/16" tall x 18 5/8" deep.
- Door opposite caddy features a chrome and wood two-tiered rack.
- Door rack width is 13 7/8".
- Door rack depth is 3 1/2".

Custom Modifications

AUTHL AUTHR	CBO	CCO	CFNTO	CFP	CFRMO	CMAT	CND	DRT	DRWPWR	DRWTK	EXBKL EXBKR	EXL EXR
•	•	•	•	STD	•		•			•	•	•
FB	FD	FFDL FFDR	FPEB	FTK	FTKAV FTKFV	ID	INVFRM	LTI	MIP	P	PTOWB	RD
•		•	•	•	•			•	•	•		
RECTKALL RECTKBK	RECTKL RECTKR	RT	SCPDRW	TD	TOTSS TOTSSS	TVRAV TVRFV TVRVV	VACL VACR	VACTK	VTK	WLI		
•	•				•				•	•		

Construction Upgrades

APC	ET	PE
•		•

Door Options

CG	DPSRR
•	•

SINK BASE SUPERCABINET™ with TILT-OUT TRAYS

storage SOLUTIONS

30", 33", or 36"

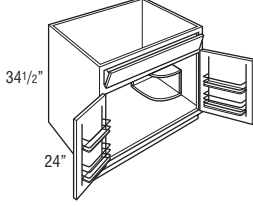

Model	Cubic Feet
SB30STS	17.7
SB33STS	19.6
SB36STS	21.1

- Quarter Round Reversible Shelf for left or right applications will be constructed from 3/4" thick laminated furniture board. When upgraded to APC, shelf will use clear coated veneer plywood. (Shelf shipped secure, can be positioned in left or right corner.)
- Mini Touch-Up Kit (MTUK) included. MTUK includes small touch-up marker and small fill stick.
- Includes two tilt-out trays.
- Tilt-out trays are stain resistant, moisture resistant plastic to allow storage of sponges and other cleaning materials.
- Tilt-out trays are also available as an accessory for field installation. See page 412.
- All load bearing surfaces meet KCMA standards of 15 lbs. per square foot.
- Each door features a chrome and wood two-tiered rack.
- Door rack width is 10 7/8" on 30" wide cabinet, 12 3/8" on 33" wide cabinet, and 13 7/8" on 36" wide cabinet.
- Door rack depth is 3 1/2".

Custom Modifications

AUTHL AUTHR	CBO	CCO	CFNTO	CFP	CFRMO	CMAT	CND	DRT	DRWPPWR	DRWTK	EXBKL EXBKR	EXL EXR
•	•	•	•		•		•			•	•	
FB	FD	FFDL FFDR	FPEB	FTK	FTKAV FTKRV	ID	INVFRM	LTI	MIP	P	PTOWB	RD
•		•	•	•	•	•		•	•			
RECTKALL RECTKBL	RECTKL RECTKR	RT	SCPDRW	TD	TOTSS TOTSSS	TVRAV TVRFV TVRVV	VACL VACR	VACTK	VTK	WLI		
•	•								•	•		

Construction Upgrades

APC	ET	PE
•		•

Door Options

CG	DPSRR
	•

SINK BASE SUPERCABINET™ with TILT-OUT TRAYS and CABMAT™

storage SOLUTIONS

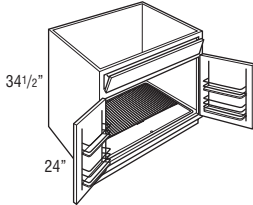

Model	Cubic Feet
SB30STSCM	17.7
SB33STSCM	19.6
SB36STSCM	21.1

- Mini Touch-Up Kit (MTUK) included. MTUK includes small touch-up marker and small fill stick.
- CabMat™ features a grey sloped mat to capture spills.
- CabMat™ is removable for cleaning.
- Includes two tilt-out trays.
- Tilt-out trays are stain resistant, moisture resistant plastic to allow storage of sponges and other cleaning materials.
- Tilt-out trays are also available as an accessory for field installation. See page 412.
- All load bearing surfaces meet KCMA standards of 15 lbs. per square foot.
- Each door features a chrome and wood two-tiered rack.
- Door rack width is 10 7/8" on 30" wide cabinet, 12 3/8" on 33" wide cabinet, and 13 7/8" on 36" wide cabinet.
- Door rack depth is 3 1/2".

Model	Liquid Capacity		Cabinet Size	
	Quarts	Liters	Width	Depth
SB30STSCM	4.2	3.9	30"	24"
SB33STSCM	4.6	4.3	33"	24"
SB36STSCM	5.0	4.7	36"	24"

Custom Modifications

AUTHL AUTHR	CBO	CCO	CFNTO	CFP	CFRMO	CMAT	CND	DRT	DRWPPWR	DRWTK	EXBKL EXBKR	EXL EXR
•	•	•	•		•		•			•	•	
FB	FD	FFDL FFDR	FPEB	FTK	FTKAV FTKRV	ID	INVFRM	LTI	MIP	P	PTOWB	RD
•		•	•	•	•	•		•	•	•		
RECTKALL RECTKBL	RECTKL RECTKR	RT	SCPDRW	TD	TOTSS TOTSSS	TVRAV TVRFV TVRVV	VACL VACR	VACTK	VTK	WLI		
•	•								•	•		

Construction Upgrades

APC	ET	PE
•		•

Door Options

CG	DPSRR
	•

SINK BASE SUPERCABINET™ with TILT-OUT TRAYS and CADDY

storage SOLUTIONS

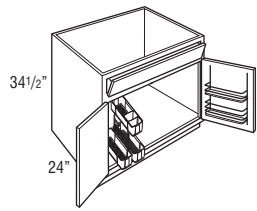

Model	Cubic Feet
SB365TSCDY L or R	20.9

- Mini Touch-Up Kit (MTUK) included. MTUK includes small touch-up marker and small fill stick.
- L or R designates caddy location.
- Caddy is removable and portable.
- Includes two tilt-out trays.
- Tilt-out trays are stain resistant, moisture resistant plastic to allow storage of sponges and other cleaning materials.
- Tilt-out trays are also available as an accessory for field installation. See page 412.
- Caddy dimensions are: 9 15/16" wide x 18 5/16" tall x 18 5/8" deep.
- Door opposite caddy features a chrome and wood two-tiered rack.
- Door rack width is 13 7/8".
- Door rack depth is 3 1/2".

Custom Modifications

AUTHL AUTHR	CBO	CCO	CFNTO	CFP	CFRMO	CMAT	CND	DRT	DRWPWR	DRWTK	EXBKL EXBKR	EXL EXR
•	•	•	•		•		•			•	•	•
FB	FD	FFDL FFDR	FPEB	FTK	FTKAV FTKRV	ID	INVFRM	LTI	MIP	P	PTOWB	RD
•		•	•	•	•	•		•	•			
RECTKALL RECTKBK	RECTKL RECTKR	RT	SCPDRW	TD	TOTSS TOTSSS	TVRAV TVRFV TVRVV	VACL VACR	VACTK	VTK	WLI		
•	•								•	•		

Construction Upgrades

APC	ET	PE
•		•

Door Options

CG	DPSRR
•	•

SINK BASE with DRAWER BELOW

storage SOLUTIONS

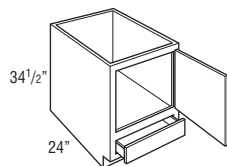

SB24D L or R

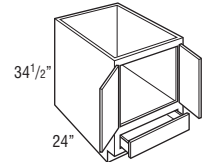

**SB24D
SB27D
SB30D
SB33D
SB36D**

39", 42", 45", or 48"

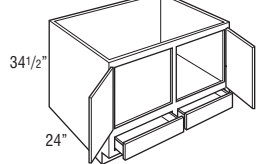

**SB39D
SB42D
SB45D
SB48DCS**

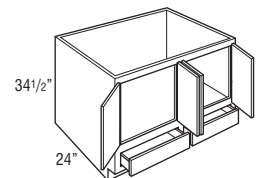

SB48D

SB24D L or R	14.4
SB24D	14.4
SB27D	16.1
SB30D	17.7
SB33D	19.6
SB36D	21.1
SB39D	22.7
SB42D	24.4
SB45D	25.8
SB48DCS	27.7
SB48D	27.7

- Drawers are below full cabinet floor.
- Mini Touch-Up Kit (MTUK) included. MTUK includes small touch-up marker and small fill stick.
- Verify that sink, garbage disposal and plumbing fit opening.
- Plumbing going through floor will interfere with drawer operation. 2 3/4" clearance from back of drawer to interior back of cabinet.
- Face frame opening height is 20 1/2".
- Face frame opening height for drawer is 4 1/2".

Custom Modifications

AUTHL AUTHR	CBO	CCO	CFNTO	CFP	CFRMO	CMAT	CND	DRT	DRWPWR	DRWTK	EXBKL EXBKR	EXL EXR
•	•	•			•	•*	•			•+	•	•
FB	FD	FFDL FFDR	FPEB	FTK	FTKAV FTKRV	ID	INVFRM	LTI	MIP	P	PTOWB	RD
•		•	•	•	•	•		•	•	•		•
RECTKALL RECTKBK	RECTKL RECTKR	RT	SCPDRW	TD	TOTSS TOTSSS	TVRAV TVRFV TVRVV	VACL VACR	VACTK	VTK	WLI		
•	•								•	•		

*Available only on 30", 33", and 36" wide *Not available on 39", 42", 45", and 48" wide

Construction Upgrades

APC	ET	PE
•		•

Door Options

CG	DPSRR
•	•

SINK FRONT BOTTOM

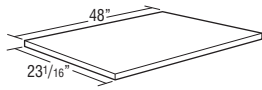

SFB48	1.0
--------------	------------

- Designed for use with Sink Bases ordered with CFNTO.
- 3/8" thick.
- Trimmable.

Custom Modifications

AUTHL AUTHR	CBO	CCO	CFNTO	CFP	CFRMO	CMAT	CND	DRT	DRWPWR	DRWTK	EXBKL EXBKR	EXL EXR
FB	FD	FFDL FFDR	FPEB	FTK	FTKAV FTKRV	ID	INVERM	LTI	MIP	P	PTOWB	RD
RECTKALL RECTKBL	RECTKL RECTKR	RT	SCPRW	TD	TOTSS TOTSSS	TVRAV TVRFV TVRVV	VACL VACR	VACTK	VTK	WLI		

Construction Upgrades

APC	ET	PE
•		

Door Options

CG	DPSRR

SQUARE CORNER SINK BASE

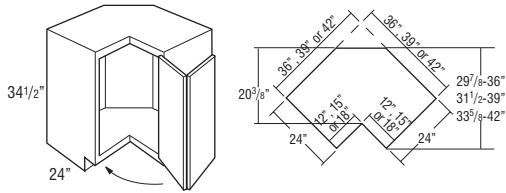

CS36 L or R	25.9
CS39 L or R	33.7
CS42 L or R	38.9

- CS36: Wall width: 36" x 36". Frame 12" x 12".
- CS39: Wall width: 39" x 39". Frame 15" x 15".
- CS42: Wall width: 42" x 42". Frame 18" x 18".
- Mini Touch-Up Kit (MTUK) included. MTUK includes small touch-up marker and small fill stick.
- For sufficient dishwasher door clearance and loading/unloading space, a 15" wide base cabinet is recommended for use between a corner sink base and dishwasher.
- Decorative hardware screws must be countersunk to prevent scratching of adjacent cabinets and face frame of CS.
- Toekick and toekick retainer shipped unattached from the face frame.
- Integrated soft close hinge not included.

Custom Modifications

AUTHL AUTHR	CBO	CCO	CFNTO	CFP	CFRMO	CMAT	CND	DRT	DRWPWR	DRWTK	EXBKL EXBKR	EXL EXR
•		•										
FB	FD	FFDL FFDR	FPEB	FTK	FTKAV FTKRV	ID	INVERM	LTI	MIP	P	PTOWB	RD
•			•						•			
RECTKALL RECTKBL	RECTKL RECTKR	RT	SCPRW	TD	TOTSS TOTSSS	TVRAV TVRFV TVRVV	VACL VACR	VACTK	VTK	WLI		
•	•								•	•		

Construction Upgrades

APC	ET	PE
•		•

Door Options

CG	DPSRR
	•

ANGLED CORNER SINK BASE

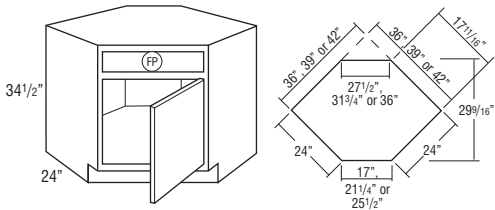

FP = False Panel

Max. Sink Widths if cut out is 4" back from face of front frame

Model	Cubic Feet
ACS36 L or R	25.9
ACS39 L or R	33.7
ACS42†	38.9

- Edges beveled at 45°.
 - Mini Touch-Up Kit (MTUK) included. MTUK includes small touch-up marker and small fill stick.
 - For sufficient dishwasher door clearance and loading/unloading space, a 15" wide base cabinet is recommended for use between a corner sink base and dishwasher.
 - Full overlay styles use 38NPOHINGE, see page 418.
- †ACS42 has butt doors.

Model	Wall Width	Frame	Maximum Sink Width	Maximum Sink Depth
ACS36	36" x 36"	17"	25 3/4"	27 11/32"
ACS39	39" x 39"	21 1/4"	30"	27 11/32"
ACS42	42" x 42"	25 1/2"	34 1/4"	27 11/32"

Custom Modifications

AUTHL AUTHR	CBO	CCO	CFNTO	CFP	CFRMO	CMAT	CND	DRT	DRWPWR	DRWTK	EXBKL EXBKR	EXL EXR
•		•	•	STD	•		•					
FB	FD	FFDL FFDR	FPEB	FTK	FTKAV FTKFV	ID	INFRM	LTI	MIP	P	PTOWB	RD
•			•	•	•			•	•			
RECTKALL RECTKBK	RECTKL RECTKR	RT	SCPDRW	TD	TOTSS TOTSSS	TVRAV TVRFV TVRVV	VACL VACR	VACTK	VTK	WLI		
•	•								•	•		

Construction Upgrades

APC	ET	PE
•		•

Door Options

CG	DPSRR
•	•

**ANGLED CORNER SINK FRONT
without SINK FLOOR**

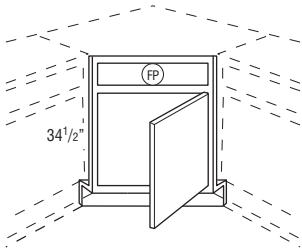

FP = False Panel

Max. Sink Widths if cut out is 4" back from face of front frame

ACSF36 L or R	3.3
ACSF39 L or R	3.3
ACSF42†	3.3

- Edges beveled at 45°.
 - Angled corner sink front bottom required for field installation. Order separately. See next item.
 - Toekick and toekick retainer shipped unattached from the face frame.
 - Full overlay styles use 38NPOHINGE, see page 418.
- †ACSF42 has butt doors.

Model	Wall Width	Frame	Maximum Sink Width	Maximum Sink Depth
ACSF36	36" x 36"	17"	25 3/4"	27 11/32"
ACSF39	39" x 39"	21 1/4"	30"	27 11/32"
ACSF42	42" x 42"	25 1/2"	34 1/4"	27 11/32"

Custom Modifications

AUTHL AUTHR	CBO	CCO	CFNTO	CFP	CFRMO	CMAT	CND	DRT	DRWPWR	DRWTK	EXBKL EXBKR	EXL EXR
			STD	STD	•		•					
FB	FD	FFDL FFDR	FPEB	FTK	FTKAV FTKFV	ID	INFRM	LTI	MIP	P	PTOWB	RD
				•	•			•				
RECTKALL RECTKBK	RECTKL RECTKR	RT	SCPDRW	TD	TOTSS TOTSSS	TVRAV TVRFV TVRVV	VACL VACR	VACTK	VTK	WLI		

Construction Upgrades

APC	ET	PE

Door Options

CG	DPSRR
	•

ANGLED CORNER SINK FRONT BOTTOM

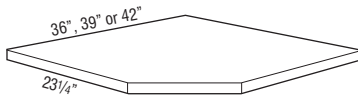

Model	Cubic Feet
ACSF36	1.0
ACSF39	1.0
ACSF42	1.0

- Designed for use with Angled Corner Sink Front.
- Cabinet bottom is sized for use next to an adjacent wall or cabinet with flush ends.
- 3/8" thick.

Custom Modifications

AUTHL AUTHR	CBO	CCO	CFNTD	CFP	CFRMO	CMAT	CND	DRT	DRWPWR	DRWTK	EXBKL EXBKR	EXL EXR
FB	FD	FFDL FFDR	FPFB	FTK	FTKAV FTKEV	ID	INVERM	LTI	MIP	P	PTOWB	RD
RECTKALL RECTKBK	RECTKL RECTKR	RT	SCPRW	TD	TOTSS TOTSSS	TVRAV TVRFV TVRVV	VACL VACR	VACTK	VTK	WLI		
												•

Construction Upgrades

APC	ET	PE
•		

Door Options

CG	DPSRR

COUNTRY SINK BASE

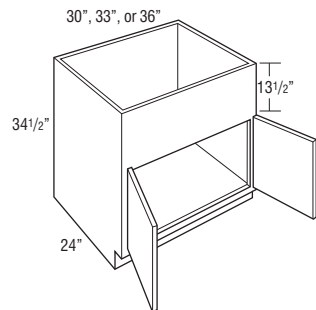

CNTYSB30
CNTYSB33
CNTYSB36

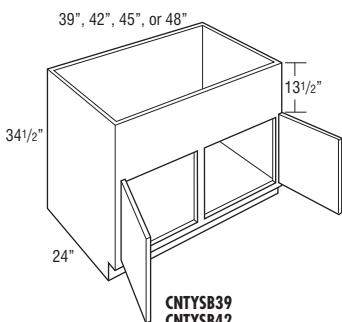

CNTYSB39
CNTYSB42
CNTYSB45
CNTYSB48CS

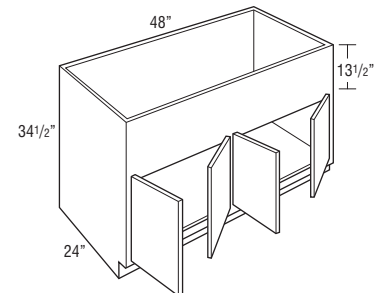

CNTYSB48

CNTYSB30	17.7
CNTYSB33	19.6
CNTYSB36	21.1
CNTYSB39	22.7
CNTYSB42	24.4
CNTYSB45	25.8
CNTYSB48CS	27.7
CNTYSB48	27.7

- 13 1/2" panel can be trimmed up to 12".
- Mini Touch-Up Kit (MTUK) included. MTUK includes small touch-up marker and small fill stick.
- For apron front sinks requiring a cut-out height of 6 1/2" or less, see Base Drop-in Range Cabinets on page 241.
- Refer to sink manufacturer's recommendations for additional support required for apron front sinks.

Custom Modifications

AUTHL AUTHR	CBO	CCO	CFNTD	CFP	CFRMO	CMAT	CND	DRT	DRWPWR	DRWTK	EXBKL EXBKR	EXL EXR
•		•	•		•	•*				•*	•	•
FB	FD	FFDL FFDR	FPFB	FTK	FTKAV FTKEV	ID	INVERM	LTI	MIP	P	PTOWB	RD
•			•	•	•			•	•			•
RECTKALL RECTKBK	RECTKL RECTKR	RT	SCPRW	TD	TOTSS TOTSSS	TVRAV TVRFV TVRVV	VACL VACR	VACTK	VTK	WLI		
•	•	•							•	•		

*Available only on 30", 33", and 36" wide *Not available on 39", 42", 45", and 48" wide

Construction Upgrades

APC	ET	PE
•		•

Door Options

CG	DPSRR
•	•

COUNTRY SINK BASE with CABMAT™

storage
SOLUTIONS

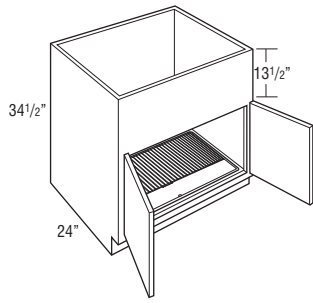

Model	Cubic Feet
CNTYSB30CM	17.7
CNTYSB33CM	19.6
CNTYSB36CM	21.1

- Mini Touch-Up Kit (MTUK) included. MTUK includes small touch-up marker and small fill stick.
- CabMat™ features a grey sloped mat to capture spills.
- CabMat™ is removable for cleaning.
- 13 1/2" panel can be trimmed to 12".
- For apron front sinks requiring a cut-out height of 6 1/2" or less, see Base Drop-in Range Cabinets on page 241.
- Refer to sink manufacturer's recommendations for additional support required for apron front sinks.

Model	Liquid Capacity		Cabinet Size	
	Quarts	Liters	Width	Depth
CNTYSB30CM	4.2	3.9	30"	24"
CNTYSB33CM	4.6	4.3	33"	24"
CNTYSB36CM	5.0	4.7	36"	24"

Custom Modifications

AUTHL AUTHR	CBO	CCO	CFNTO	CFP	CFRMO	CMAT	CND	DRT	DRWPWR	DRWTK	EXBKL EXBKR	EXL EXR
•	•	•	•		•					•	•	•
FB	FD	FFDL FFDR	FPEB	FTK	FTKAV FTKFV	ID	INVFRM	LTI	MIP	P	PTOWB	RD
•			•	•	•			•	•			
RECTKALL RECTKBK	RECTKL RECTKR	RT	SCPDRW	TD	TOTSS TOTSSS	TVRAV TVRFV TVRVV	VACL VACR	VACTK	VTK	WLI		
•	•								•	•		

Construction Upgrades

APC	ET	PE
•		•

Door Options

CG	DPSRR
	•

Base Corner Cabinets

- BCs use the wall space the nomenclature implies and may be pulled up to 3" to accommodate odd dimensions in a kitchen.
- Remember to use 3" filler on adjoining cabinets.
- The adjoining run of cabinets will cover the void.
- BCFW specifies full width blind corner base cabinet.
- The L or R in the cabinet nomenclature indicates the location of the void to ensure clearance; it is not recommended to place BC cabinets next to 27" deep appliances.

NOTE:

Full overlay styles must be pulled an additional 1 1/2" to ensure proper drawer/pull clearance. 1 1/2" pull is not included in minimum and maximum list.

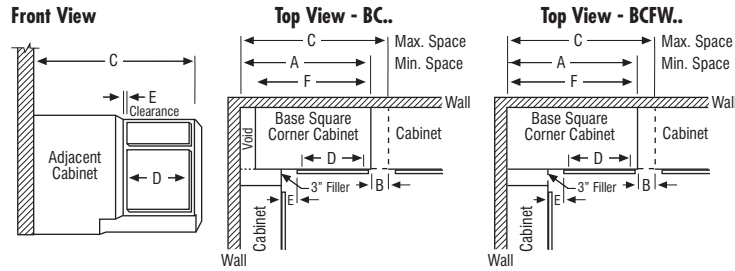

Model	A Min. Space	B Max. Pull*	C Max. Space	D Cabinet Opening	E*		E		F Actual Cabinet
					Full Overlay At Min.	At Max.	Partial Overlay At Min.	At Max.	
BC36	36"	6"	42"	7 1/2"	1 3/4"	7 3/4"	2 1/2"	8 1/2"	27"
BC39	39"	4 1/2"	43 1/2"	9"	3 1/4"	7 3/4"	4"	8 1/2"	30"
BC42	42"	6"	48"	13 1/2"	1 3/4"	7 3/4"	2 1/2"	8 1/2"	39"
BC45/BC45PO	45"	4 1/2"	49 1/2"	15"	3 1/4"	7 3/4"	4"	8 1/2"	42"
BC48/BC48PO	48"	3"	51"	16 1/2"	4 1/4"	7 3/4"	5 1/2"	8 1/2"	45"
BCFW36	36"	5"	41"	7 1/2"	1 3/4"	6 3/4"	2 1/4"	7 1/2"	36"
BCFW39	39"	3 1/2"	42 1/2"	9"	3 1/4"	6 3/4"	4"	7 1/2"	39"
BCFW42	42"	9"	51"	13 1/2"	1 3/4"	10 3/4"	2 1/2"	11 1/2"	42"
BCFW45/BCFW45PO	45"	7 1/2"	52 1/2"	15"	3 1/4"	10 3/4"	4"	11 1/2"	45"
BCFW48/BCFW48CPO/BCFW48PO	48"	4 1/2"	52 1/2"	18"	3 1/4"	7 3/4"	4"	8 1/2"	48"
BCFW48SP	48"	4 1/2"	52 1/2"	18"	3 1/4"	7 3/4"	4"	8 1/2"	48"

*Minimum/maximum space between inside edge of door and face of filler/adjoining cabinet. If cabinet is pulled to maximum stated dimension, filler will need to be cleared for proper attachment.

BASE CORNER

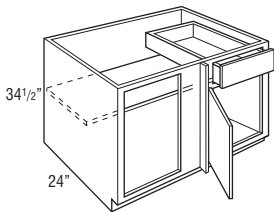

- BC36 L or R - 27" wide
- BC39 L or R - 30" wide
- BC42 L or R - 39" wide
- BC45 L or R - 42" wide
- BC48 L or R - 45" wide

Model	Cubic Feet
BC36 L or R	16.1
BC39 L or R	19.6
BC42 L or R	24.4
BC45 L or R	24.4
BC48 L or R	26.0

- Not recommended for use next to an appliance deeper than standard cabinet depth.
- Includes one 3" filler, shipped unattached.
- L or R indicates void. L (left) void shown.
- Adjustable 15" deep shelves.
- Face Frame and Door on End modification not available on the void side of the cabinet.

Custom Modifications

AUTHL AUTHR	CBO	CCO	CFNT0	CFP	CFRMO	CMAT	CND	DRT	DRWPWR	DRWTK	EXBKL EXBKR	EXL EXR
•	•	•	•	•	•		•		•*		•	•
FB	FD	FFDL FFDR	FPFB	FTK	FTKAV FTKFV	ID	INVFRM	LTI	MIP	P	PTOWB	RD
•	•	•	•	•				•+	•			•
RECTKALL RECTKBK	RECTKL RECTKR	RT	SCPRW	TD	TOTSS TOTSSS	TVRV TVRFV TVRVV	VACL VACR	VACTK	VTK	WLI		
•	•						•		•	•		

*Not available on 36", 39", and 42" wide +Not available on 36" and 39" wide

Construction Upgrades

APC	ET	PE
•		•

Door Options

CG	DPSRR
•	•

BASE CORNER with PULL-OUT

storage
SOLUTIONS

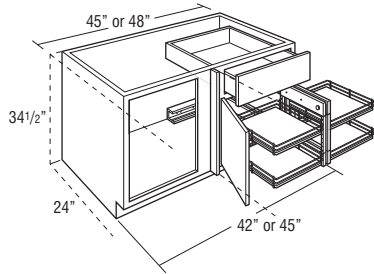

BC45PO L or R
BC48PO L or R

Model	Cubic Feet
BC45PO L or R	24.4
BC48PO L or R	26.0

- Not recommended for use next to an appliance deeper than standard cabinet depth.
- Cannot be installed next to a wall.
- Pull-out features four adjustable wood shelves with chrome surround. Smart Stop not available.
- Includes one 3" filler, shipped unattached.
- L or R indicates void. L (left) void shown.
- Adjacent cabinet hardware may interfere with adjustable shelf position or pull-out.
- Wire pull-out dimensions are 10 3/4" W x 17 1/4" D x 2 11/16" H.
- For pull-out to open, 10" of adjacent space is required with no obstruction beyond 1 3/4" in front of the cabinet face frame.
- Face Frame and Door on End modification not available on the void side of the cabinet.

Custom Modifications

AUTHL AUTHR	CBO	CCO	CFNTO	CFP	CFRMO	CMAT	CND	DRT	DRWPWR	DRWTK	EXBKL EXBKR	EXL EXR
•	•	•	•	•	•		•		•		•	•
FB	FD	FFDL FFDR	FPEB	FTK	FTKAV FTKRV	ID	INVFRM	LTI	MIP	P	PTOWB	RD
•		•	•	•					•			
RECTKALL RECTKBK	RECTKL RECTKR	RT	SCPDRW	TD	TOTSS TOTSSS	TVRAV TVRFV TVRVV	VACL VACR	VACTK	VTK	WLI		
•	•						•		•	•		

Construction Upgrades

APC	ET	PE
•		•

Door Options

CG	DPSRR
•	•

BASE CORNER FULL WIDTH

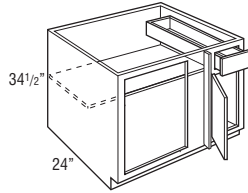

BCFW36 L or R - 36" wide
BCFW39 L or R - 39" wide

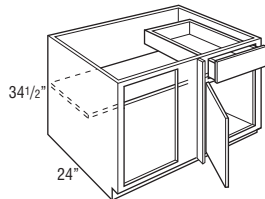

BCFW42 L or R - 42" wide
BCFW45 L or R - 45" wide
BCFW48 L or R - 48" wide

BCFW36 L or R	21.1
BCFW39 L or R	22.7
BCFW42 L or R	24.4
BCFW45 L or R	26.0
BCFW48 L or R	27.7

- Not recommended for use next to an appliance deeper than standard cabinet depth.
- Includes one 3" filler, shipped unattached.
- L or R indicates void. L (left) void shown.
- Adjustable 15" deep shelves.
- Face Frame and Door on End modification not available on the void side of the cabinet.

Custom Modifications

AUTHL AUTHR	CBO	CCO	CFNTO	CFP	CFRMO	CMAT	CND	DRT	DRWPWR	DRWTK	EXBKL EXBKR	EXL EXR
•	•	•	•	•	•		•		•*		•	•
FB	FD	FFDL FFDR	FPEB	FTK	FTKAV FTKRV	ID	INVFRM	LTI	MIP	P	PTOWB	RD
•		•	•	•					•*			•
RECTKALL RECTKBK	RECTKL RECTKR	RT	SCPDRW	TD	TOTSS TOTSSS	TVRAV TVRFV TVRVV	VACL VACR	VACTK	VTK	WLI		
•	•						•		•	•		

*Not available on 36", 39", and 42" wide *Not available on 36" and 39" wide

Construction Upgrades

APC	ET	PE
•		•

Door Options

CG	DPSRR
•	•

BASE CORNER FULL WIDTH with CURVED PULL-OUT

storage SOLUTIONS

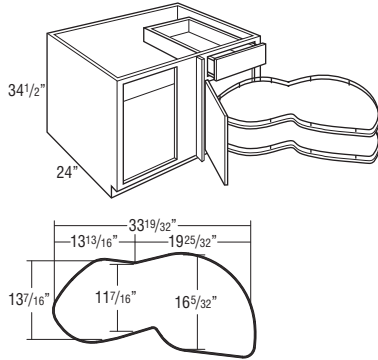

Model	Cubic Feet
BCFW48CPO L or R	27.7

- Includes one 3" filler, shipped unattached.
- L or R indicates void. L (left) void shown.
- Pull-out features 2 adjustable kidney shaped pull-outs. Smart Stop not available.
- Not recommended for use next to an appliance deeper than standard cabinet depth.
- Cannot be installed next to a wall.
- Adjacent cabinet hardware may interfere with adjustable shelf position on pull-out.
- Maximum Weight Capacity: 65 lbs. per shelf.
- For pull-out to fully open, 9 3/4" of adjacent space is required with no obstruction beyond 1 1/8" in front of the cabinet face frame.
- Face Frame and Door on End modification not available on the void side of the cabinet.

Custom Modifications

AUTHL AUTHR	CBO	CCO	CFNT0	CFP	CFRMO	CMAT	CND	DRT	DRWPWR	DRWTK	EXBKL EXBKR	EXL EXR
•	•	•	•	•	•		•		•		•	•
FB	FD	FFDL FFDR	FPEB	FTK	FTKAV FTKFV	ID	INVFRM	LTI	MIP	P	PTOWB	RD
•			•	•					•			
RECTKALL RECTKBK	RECTKL RECTKR	RT	SCPDRW	TD	TOTSS TOTSSS	TVRAV TVRFV TVRVV	VACL VACR	VACTK	VTK	WLI		
•	•						•		•	•		

Construction Upgrades

APC	ET	PE
•		•

Door Options

CG	DPSRR
	•

BASE CORNER FULL WIDTH with PULL-OUT

storage SOLUTIONS

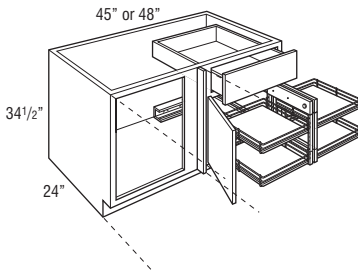

BCFW45PO L or R
BCFW48PO L or R

BCFW45PO L or R	26.0
BCFW48PO L or R	27.7

- Not recommended for use next to an appliance deeper than standard cabinet depth.
- Cannot be installed next to a wall.
- Includes one 3" filler, shipped unattached.
- L or R indicates void. L (left) void shown.
- Pull-out features four adjustable wood shelves with chrome surround. Smart Stop not available.
- Wire pull-out interior dimensions are 10 3/4" W x 17 1/4" D x 2 11/16" H.
- For pull-out to open, 10" of adjacent space is required with no obstruction beyond 1 3/4" in front of the cabinet face frame.
- Adjacent cabinet hardware may interfere with adjustable shelf position on pull-out.
- Face Frame and Door on End modification not available on the void side of the cabinet.

Custom Modifications

AUTHL AUTHR	CBO	CCO	CFNT0	CFP	CFRMO	CMAT	CND	DRT	DRWPWR	DRWTK	EXBKL EXBKR	EXL EXR
•	•	•	•	•	•		•		•		•	•
FB	FD	FFDL FFDR	FPEB	FTK	FTKAV FTKFV	ID	INVFRM	LTI	MIP	P	PTOWB	RD
•		•	•	•					•			
RECTKALL RECTKBK	RECTKL RECTKR	RT	SCPDRW	TD	TOTSS TOTSSS	TVRAV TVRFV TVRVV	VACL VACR	VACTK	VTK	WLI		
•	•						•		•	•		

Construction Upgrades

APC	ET	PE
•		•

Door Options

CG	DPSRR
•	•

BASE CORNER FULL WIDTH with ROLL TRAYS & SWING-OUT

storage SOLUTIONS

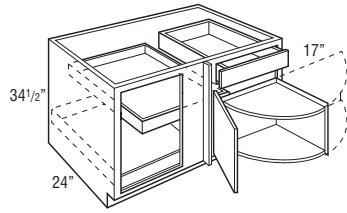

BCFW48SP L or R - 48" wide

Model	Cubic Feet
BCFW48SP L or R	27.7

- Not recommended for use next to an appliance deeper than standard cabinet depth.
- Includes one 3" filler, shipped unattached.
- L or R indicates void. L (left) void shown.
- Swing-out hinged opposite door.
- Roll trays and swing-outs installed.
- Insert swing on a base corner full width cabinet is 17"; do not install next to a wall or appliance.
- Swing-out is 3/4" laminated furniture board.

Custom Modifications

AUTHL AUTHR	CBO	CCO	CFNTO	CFP	CFRMO	CMAT	CND	DRT	DRWPWR	DRWTK	EXBKL EXBKR	EXL EXR
•	•	•	•	•	•	•	•	•	•	•	•	•
FB	FD	FFDL FFDR	FPEB	FTK	FTKAV FTKRV	ID	INVFRM	LTI	MIP	P	PTOWB	RD
•	•	•	•	•	•	•	•	•	•	•	•	•
RECTKALL RECTKBK	RECTKL RECTKR	RT	SCPDRW	TD	TOTSS TOTSSS	TVRAV TVRFV TVRVV	VACL VACR	VACTK	VTK	WLI		
•	•	•	•	•	•	•	•	•	•	•	•	•

Construction Upgrades

APC	ET	PE
•	•	•

Door Options

CG	DPSRR
•	•

BASE LAZY SUSAN CORNER (With Revolving Door) (Partial Overlay styles only)

Model	Cubic Feet
BLS36DR	20.0

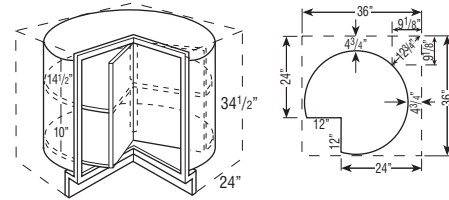

- BLS36DR wall width is 36" x 36".
- Cabinet is drum-shaped; adjoining cabinets create sides.
- BLS white plastic shelves are 28" diameter with a chrome pole.
- See Panels & Skins section for BLS BEP if used at end of cabinet run.
- Available in partial overlay styles only.
- If ordered with PE or APC, construction will not change.
- Drum diameter is 31 1/8" and composed of 1/8" thick hardboard.
- Integrated soft close hinge not included.

Custom Modifications

AUTHL AUTHR	CBO	CCO	CFNTO	CFP	CFRMO	CMAT	CND	DRT	DRWPWR	DRWTK	EXBKL EXBKR	EXL EXR
•	•	•	•	•	•	•	•	•	•	•	•	•
FB	FD	FFDL FFDR	FPEB	FTK	FTKAV FTKRV	ID	INVFRM	LTI	MIP	P	PTOWB	RD
•	•	•	•	•	•	•	•	•	•	•	•	•
RECTKALL RECTKBK	RECTKL RECTKR	RT	SCPDRW	TD	TOTSS TOTSSS	TVRAV TVRFV TVRVV	VACL VACR	VACTK	VTK	WLI		
•	•	•	•	•	•	•	•	•	•	•	•	•

Construction Upgrades

APC	ET	PE
•	•	•

Door Options

CG	DPSRR
•	•

BASE LAZY SUSAN CORNER with FULL HEIGHT DOOR and LAZY SUSAN (With Center Hinge Door)

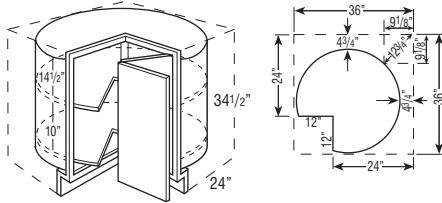

Model	Cubic Feet
BLS36 L or R	20.0

- BLS36 L or R wall width is 36" x 36".
- Cabinet is drum-shaped; adjoining cabinets create sides.
- BLS white plastic shelves are 28" diameter with a chrome pole.
- See Panels & Skins section for BLS BEP if used at end of cabinet run.
- If ordered with PE or APC, construction will not change.
- Drum diameter is 31 1/8" and composed of 1/8" thick hardboard.
- Decorative hardware screws must be countersunk to prevent scratching of adjacent cabinets and face frame of BLS.
- Integrated soft close hinge not included.

Custom Modifications

AUTHL AUTHR	CBO	CCO	CFNT0	CFP	CFRMO	CMAT	CND	DRT	DRWPWR	DRWTK	EXBKL EXBKR	EXL EXR
	•	•										
FB	FD	FFDL FFDR	FPEB	FTK	FTKAV FTKRV	ID	INVFRM	LTI	MIP	P	PTOWB	RD
RECTKALL RECTKBK	RECTKL RECTKR	RT	SCPDRW	TD	TOTSS TOTSSS	TVRAV TVRFV TVRVV	VACL VACR	VACTK	VTK	WLI		

Construction Upgrades

APC	ET	PE

Door Options

CG	DPSRR
	•

DIAGONAL BASE with FULL HEIGHT DOOR

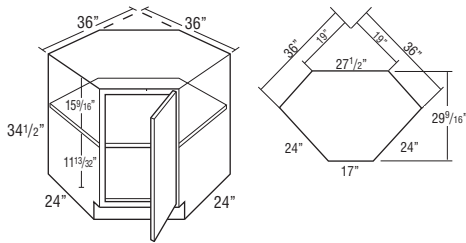

DAB36FS L or R	25.9
----------------	------

- One fixed 1/2" thick shelf.
- Full overlay styles use 38NPOHINGE, see page 418.

Custom Modifications

AUTHL AUTHR	CBO	CCO	CFNT0	CFP	CFRMO	CMAT	CND	DRT	DRWPWR	DRWTK	EXBKL EXBKR	EXL EXR
	•	•	•		•							
FB	FD	FFDL FFDR	FPEB	FTK	FTKAV FTKRV	ID	INVFRM	LTI	MIP	P	PTOWB	RD
•			•	•	•			•	•			
RECTKALL RECTKBK	RECTKL RECTKR	RT	SCPDRW	TD	TOTSS TOTSSS	TVRAV TVRFV TVRVV	VACL VACR	VACTK	VTK	WLI		
•	•								•	•		•

Construction Upgrades

APC	ET	PE
•		•

Door Options

CG	DPSRR
•	•

DIAGONAL BASE with FULL HEIGHT DOOR & LAZY SUSAN

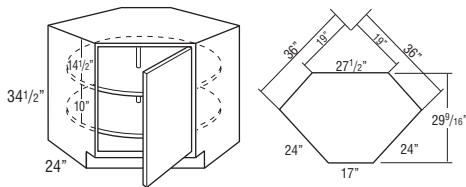

DAB36S L or R	25.9
---------------	------

- Uses two white 24" round plastic shelves on a pole for all styles.
- Full overlay styles use 38NPOHINGE, see page 418.

Custom Modifications

AUTHL AUTHR	CBO	CCO	CFNT0	CFP	CFRMO	CMAT	CND	DRT	DRWPWR	DRWTK	EXBKL EXBKR	EXL EXR
	•	•	•		•							
FB	FD	FFDL FFDR	FPEB	FTK	FTKAV FTKRV	ID	INVFRM	LTI	MIP	P	PTOWB	RD
•			•	•	•				•			
RECTKALL RECTKBK	RECTKL RECTKR	RT	SCPDRW	TD	TOTSS TOTSSS	TVRAV TVRFV TVRVV	VACL VACR	VACTK	VTK	WLI		
•	•								•	•		

Construction Upgrades

APC	ET	PE
•		•

Door Options

CG	DPSRR
•	•

DIAGONAL BASE with FULL HEIGHT DOOR & SUPER LAZY SUSAN

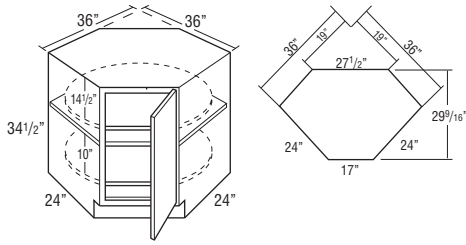

Due to fixed shelf mounting, shelves cannot be retrofitted.

Model	Cubic Feet
DAB36SLS L or R	25.9

- Features two 28" plywood revolving shelves with a 1" plywood lip. Lower shelf is mounted to floor. Upper shelf is mounted to fixed shelf. Fixed shelf is 1/2" thick laminated furniture board.
- Full overlay styles use 38NPOHINGE, see page 418.

Custom Modifications

AUTHL	CBO	CCO	CFNTD	CFP	CFRMO	CMAT	CND	DRT	DRWPWR	DRWTK	EXBKL	EXL
AUTHR	•	•	•	•	•	•	•	•	•	•	•	•
FB	FD	FFDL FFDR	FPEB	FTK	FTKAV FTKFV	ID	INVFRM	LTI	MIP	P	PTOWB	RD
•	•	•	•	•	•	•	•	•	•	•	•	•
RECTKALL RECTKBK	RECTKL RECTKR	RT	SCPDRW	TD	TOTSS TOTSSS	TVRAV TVRFV TVRVV	VACL VACR	VACTK	VTK	WLI		
•	•	•	•	•	•	•	•	•	•	•	•	•

Construction Upgrades

APC	ET	PE
•	•	•

Door Options

CG	DPSRR
•	•

BASE EASY REACH

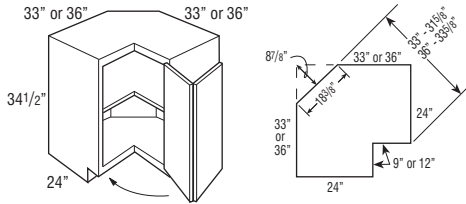

Model	Cubic Feet
BER33 L or R	24.0

Model	Cubic Feet
BER36 L or R	25.9

- BER33 L or R wall width is 33" x 33". BER36 L or R wall width is 36" x 36".
- Decorative hardware screws must be countersunk to prevent scratching of adjacent cabinets and face frame of BER.
- Fixed shelf is 1/2" thick laminated furniture board.
- Integrated soft close hinge not included.
- Cabinet top features I-beam braces with a center support brace.

Custom Modifications

AUTHL	CBO	CCO	CFNTD	CFP	CFRMO	CMAT	CND	DRT	DRWPWR	DRWTK	EXBKL	EXL
•	•	•	•	•	•	•	•	•	•	•	•	•
FB	FD	FFDL FFDR	FPEB	FTK	FTKAV FTKFV	ID	INVFRM	LTI	MIP	P	PTOWB	RD
•	•	•	•	•	•	•	•	•	•	•	•	•
RECTKALL RECTKBK	RECTKL RECTKR	RT	SCPDRW	TD	TOTSS TOTSSS	TVRAV TVRFV TVRVV	VACL VACR	VACTK	VTK	WLI		
•	•	•	•	•	•	•	•	•	•	•	•	•

Construction Upgrades

APC	ET	PE
•	•	•

Door Options

CG	DPSRR
•	•



BASE EASY REACH with ADJUSTABLE SHELVES

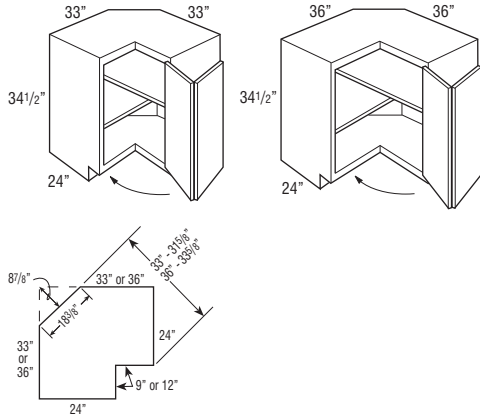

Model	Cubic Feet
BERAS33 L or R	24.0
BERAS36 L or R	25.9

- BERAS33 L or R wall width is 33" x 33". BERAS36 L or R wall width is 36" x 36".
- Decorative hardware screws must be countersunk to prevent scratching of adjacent cabinets and face frame of BERAS.
- Adjustable crisscross shelves.
- Integrated soft close hinge not included.

Custom Modifications

AUTHL AUTHR	CBO	CCO	CFNTO	CFP	CFRMO	CMAT	CND	DRT	DRWPWR	DRWTK	EXBKL EXBKR	EXL EXR
•	•	•										
FB	FD	FFDL FFDR	FPEB	FTK	FTKAV FTKFV	ID	INVERM	LTI	MIP	P	PTOWB	RD
•			•					•	•			
RECTKALL RECTKBK	RECTKL RECTKR	RT	SCPDRW	TD	TOTSS TOTSSS	TVRAV TVRFV TVRVV	VACL VACR	VACTK	VTK	WLI		
•	•								•	•		

Construction Upgrades

APC	ET	PE
•		•

Door Options

CG	DPSRR
	•

ASYMMETRICAL BASE EASY REACH

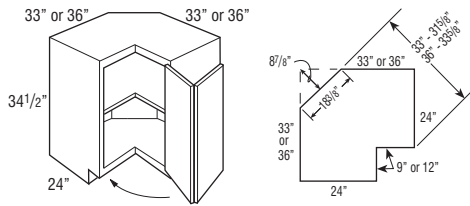

BER3336 L or R	24.5
BER3633 L or R	24.5

- BER3336 L or R wall width is 33" x 36".
- BER3633 L or R wall width is 36" x 33".
- Legs at the front frames are 9" on 33" and 12" on 36" leg.
- Nomenclature for asymmetrical cabinets reads as follows:
First set of numbers = left side of cabinet dimensions.
Second set of numbers = right side of cabinet dimensions.
- Decorative hardware screws must be countersunk to prevent scratching of adjacent cabinets and face frame of BER.
- Fixed shelf is 1/2" thick laminated furniture board.
- Integrated soft close hinge not included.
- Cabinet top features I-beam braces with a center support brace.

Custom Modifications

AUTHL AUTHR	CBO	CCO	CFNTO	CFP	CFRMO	CMAT	CND	DRT	DRWPWR	DRWTK	EXBKL EXBKR	EXL EXR
•	•	•										
FB	FD	FFDL FFDR	FPEB	FTK	FTKAV FTKFV	ID	INVERM	LTI	MIP	P	PTOWB	RD
•			•					•	•			
RECTKALL RECTKBK	RECTKL RECTKR	RT	SCPDRW	TD	TOTSS TOTSSS	TVRAV TVRFV TVRVV	VACL VACR	VACTK	VTK	WLI		
•	•								•	•		

Construction Upgrades

APC	ET	PE
•		•

Door Options

CG	DPSRR
	•

NEW ASYMMETRICAL BASE EASY REACH with ADJUSTABLE SHELVES

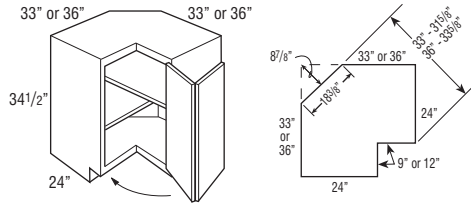

Model	Cubic Feet
BERAS3336 L or R	24.5
BERAS3633 L or R	24.5

- BERAS3336 L or R wall width is 33" x 36".
- BERAS3633 L or R wall width is 36" x 33".
- Legs at the front frames are 9" on 33" and 12" on 36" leg.
- Nomenclature for asymmetrical cabinets reads as follows:
First set of numbers = left side of cabinet dimensions.
Second set of numbers = right side of cabinet dimensions.
- Decorative hardware screws must be countersunk to prevent scratching of adjacent cabinets and face frame of BERAS.
- Adjustable crisscross shelves.
- Integrated soft close hinge not included.

Custom Modifications

AUTHL AUTHR	CBO	CCO	CFNT0	CFP	CFRMO	CMAT	CND	DRT	DRWPWR	DRWTK	EXBKL EXBKR	EXL EXR
•	•	•										
FB	FD	FFDL FFDR	FPEB	FTK	FTKAV FTKRV	ID	INVFRM	LTI	MIP	P	PTOWB	RD
•			•					•	•			
RECTKALL RECTKBK	RECTKL RECTKR	RT	SCPDRW	TD	TOTSS TOTSSS	TVRAV TVRFV TVRVV	VACL VACR	VACTK	VTK	WLI		
•	•								•	•		

Construction Upgrades

APC	ET	PE
•		•

Door Options

CG	DPSRR
	•

SEGMENTED SUPER LAZY SUSAN

storage SOLUTIONS

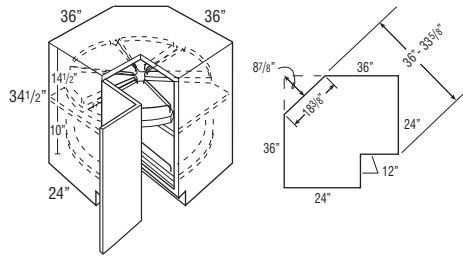

Due to fixed shelf mounting, shelves cannot be retrofitted.

SSS36 L or R	30.5
--------------	------

- SSS36 L or R wall width is 36" x 36".
- Fixed shelf is 1/2" thick laminated furniture board.
- Rotating top shelf is segmented with Full Extension hardware.
- Rotating bottom shelf is continuous.
- Chrome rail surrounds both shelves. Chrome rail height is 2 13/16".
- Segmented shelves are plywood.
- Decorative hardware screws must be countersunk to prevent scratching adjacent cabinets and face frame of SSS.
- Integrated soft close hinge not included.
- Cabinet top features I-beam braces with a center support brace.

Custom Modifications

AUTHL AUTHR	CBO	CCO	CFNT0	CFP	CFRMO	CMAT	CND	DRT	DRWPWR	DRWTK	EXBKL EXBKR	EXL EXR
	•	•										
FB	FD	FFDL FFDR	FPEB	FTK	FTKAV FTKRV	ID	INVFRM	LTI	MIP	P	PTOWB	RD
•			•						•			
RECTKALL RECTKBK	RECTKL RECTKR	RT	SCPDRW	TD	TOTSS TOTSSS	TVRAV TVRFV TVRVV	VACL VACR	VACTK	VTK	WLI		
•	•								•	•		

Construction Upgrades

APC	ET	PE
•		•

Door Options

CG	DPSRR
	•

SUPER LAZY SUSAN

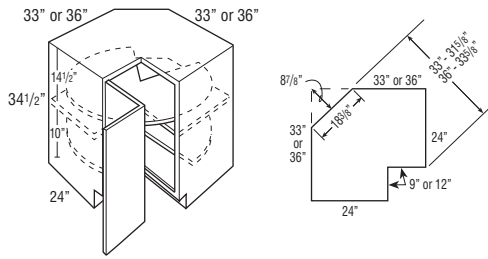

Due to fixed shelf mounting, shelves cannot be retrofitted.

Model	Cubic Feet
SLS33 L or R	24.0
SLS36 L or R	30.5

- SLS33 L or R wall width is 33" x 33".
- SLS36 L or R wall width is 36" x 36".
- SLS33 - Susans are 28" diameter.
- SLS36 - Susans are 32" diameter.
- Features two plywood revolving shelves with a 1" plywood lip. Lower shelf is mounted to floor. Upper shelf is mounted to fixed shelf. Fixed shelf is 1/2" thick laminated furniture board.
- Decorative hardware screws must be countersunk to prevent scratching adjacent cabinets and face frame of SLS.
- Integrated soft close hinge not included.
- Cabinet top features I-beam braces with a center support brace.

Custom Modifications

AUTHL AUTHR	CBO	CCO	CFNTO	CFP	CFRMO	CMAT	CND	DRT	DRWPWR	DRWTK	EXBKL EXBKR	EXL EXR
	•	•										
FB	FD	FFDL FFDR	FPEB	FTK	FTKAV FTKRV	ID	INVERM	LTI	MIP	P	PTOWB	RD
•			•					•	•			
RECTKALL RECTKBL	RECTKL RECTKR	RT	SCPRW	TD	TOTSS TOTSSS	TVRV TVRFV TVRVV	VACL VACR	VACTK	VTK	WLI		
•	•								•	•		

Construction Upgrades

APC	ET	PE
•		•

Door Options

CG	DPSRR
	•

SOLID WOOD SUPER LAZY SUSAN

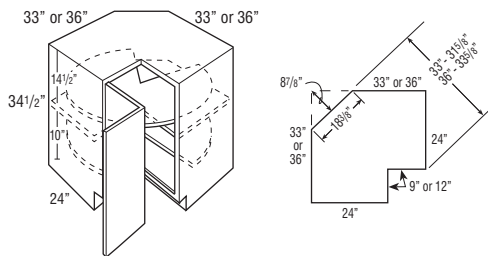

Due to fixed shelf mounting, shelves cannot be retrofitted.

Model	Cubic Feet
SLSW33 L or R	24.0
SLSW36 L or R	30.5

- SLSW33 L or R wall width is 33" x 33".
- SLSW36 L or R wall width is 36" x 36".
- SLSW33 L or R - Susans are 28" diameter.
- SLSW36 L or R - Susans are 32" diameter.
- Features two hardwood revolving shelves with a 1" lip. Lower shelf is mounted to floor. Upper shelf is mounted to fixed shelf. Fixed shelf is 1/2" thick laminated furniture board.
- Decorative hardware screws must be countersunk to prevent scratching adjacent cabinets and face frame of SLS.
- Integrated soft close hinge not included.
- Cabinet top features I-beam braces with a center support brace.

Custom Modifications

AUTHL AUTHR	CBO	CCO	CFNTO	CFP	CFRMO	CMAT	CND	DRT	DRWPWR	DRWTK	EXBKL EXBKR	EXL EXR
	•	•										
FB	FD	FFDL FFDR	FPEB	FTK	FTKAV FTKRV	ID	INVERM	LTI	MIP	P	PTOWB	RD
•			•					•	•			
RECTKALL RECTKBL	RECTKL RECTKR	RT	SCPRW	TD	TOTSS TOTSSS	TVRV TVRFV TVRVV	VACL VACR	VACTK	VTK	WLI		
•	•								•	•		

Construction Upgrades

APC	ET	PE
•		•

Door Options

CG	DPSRR
	•

SUPER LAZY SUSAN with CHROME RAIL

storage SOLUTIONS

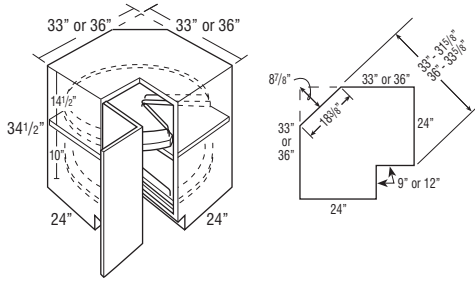

Due to fixed shelf mounting, shelves cannot be retrofitted.

Model	Cubic Feet
SLS333 L or R	30.5
SLS336 L or R	30.5

- SLS333 L or R wall width is 33" x 33". SLS336 L or R wall width is 36" x 36".
- SLS333 - Susans are 28" diameter. SLS336 - Susans are 32" diameter.
- Features two plywood revolving shelves with a 1" plywood lip. Lower shelf is mounted to floor. Upper shelf is mounted to fixed shelf. Fixed shelf is 1/2" thick laminated furniture board.
- Chrome rail surrounds both shelves. Chrome rail height is 2 13/16".
- Decorative hardware screws must be countersunk to prevent scratching adjacent cabinets and face frame of SLS333.
- Integrated soft close hinge not included.
- Cabinet top features I-beam braces with a center support brace.

Custom Modifications

AUTHL AUTHR	CBO	CCO	CFNTO	CFP	CFRMO	CMAT	CND	DRT	DRWPWR	DRWTK	EXBKL EXBKR	EXL EXR
	•	•										
FB	FD	FFDL FFDR	FPEB	FTK	FTKAV FTKRV	ID	INVFRM	LTI	MIP	P	PTOWB	RD
•			•					•	•			
RECTKALL RECTKBL	RECTKL RECTKRL	RT	SCPDRW	TD	TOTSS TOTSSS	TVRAV TVRFV TVRVV	VACL VACR	VACTK	VTK	WLI		
•	•								•	•		

Construction Upgrades

APC	ET	PE
•		•

Door Options

CG	DPSRR
	•

ASYMMETRICAL SUPER LAZY SUSAN

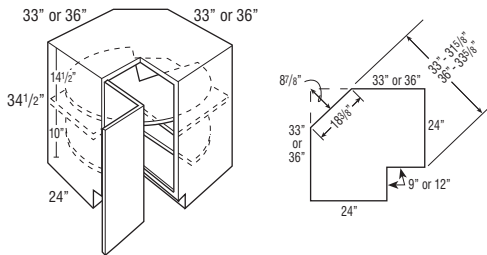

Due to fixed shelf mounting, shelves cannot be retrofitted.

SLS3336 L or R	29.1
SLS3633 L or R	29.1

- SLS3336 L or R wall width is 33" x 36".
- SLS3633 L or R wall width is 36" x 33".
- All Asymmetrical Super Susan shelves are 28" diameter.
- Features two plywood revolving shelves with a 1" plywood lip. Lower shelf is mounted to floor. Upper shelf is mounted to fixed shelf. Fixed shelf is 1/2" thick laminated furniture board.
- Nomenclature for asymmetrical cabinets reads as follows:
First set of numbers = left side of cabinet dimensions.
Second set of numbers = right side of cabinet dimensions.
- Decorative hardware screws must be countersunk to prevent scratching adjacent cabinets and face frame of SLS.
- Integrated soft close hinge not included.
- Cabinet top features I-beam braces with a center support brace.

Custom Modifications

AUTHL AUTHR	CBO	CCO	CFNTO	CFP	CFRMO	CMAT	CND	DRT	DRWPWR	DRWTK	EXBKL EXBKR	EXL EXR
	•	•										
FB	FD	FFDL FFDR	FPEB	FTK	FTKAV FTKRV	ID	INVFRM	LTI	MIP	P	PTOWB	RD
•			•					•	•			
RECTKALL RECTKBL	RECTKL RECTKRL	RT	SCPDRW	TD	TOTSS TOTSSS	TVRAV TVRFV TVRVV	VACL VACR	VACTK	VTK	WLI		
•	•								•	•		

Construction Upgrades

APC	ET	PE
•		•

Door Options

CG	DPSRR
	•

ASYMMETRICAL SOLID WOOD SUPER LAZY SUSAN

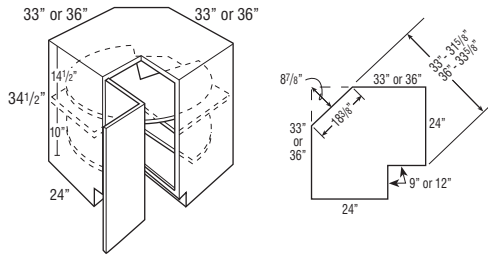

Due to fixed shelf mounting, shelves cannot be retrofitted.

Model	Cubic Feet
SLSW3336 L or R	29.1
SLSW3633 L or R	29.1

- SLSW3336 L or R wall width is 33" x 36".
- SLSW3633 L or R wall widths is 36" x 33".
- All Asymmetrical Super Susan shelves are 28" diameter.
- Features two hardwood revolving shelves with a 1" lip. Lower shelf is mounted to floor. Upper shelf is mounted to fixed shelf. Fixed shelf is 1/2" thick laminated furniture board.
- Nomenclature for asymmetrical cabinets reads as follows:
First set of numbers = left side of cabinet dimensions.
Second set of numbers = right side of cabinet dimensions.
- Decorative hardware screws must be countersunk to prevent scratching adjacent cabinets and face frame of SLS.
- Integrated soft close hinge not included.
- Cabinet top features I-beam braces with a center support brace.

Custom Modifications

AUTHL AUTHR	CBO	CCO	CFNTO	CFP	CFRMO	CMAT	CND	DRT	DRWPWR	DRWTK	EXBKL EXBKR	EXL EXR
	•	•										
FB	FD	FFDL FFDR	FPEB	FTK	FTKAV FTKRV	ID	INVFRM	LTI	MIP	P	PTOWB	RD
•			•					•	•			
RECTKALL RECTKBL	RECTKL RECTKR	RT	SCPDRW	TD	TOTSS TOTSSS	TVRAV TVRFV TVRVV	VACL VACR	VACTK	VTK	WLI		
•	•								•	•		

Construction Upgrades

APC	ET	PE
•		•

Door Options

CG	DPSRR
	•

ASYMMETRICAL SUPER LAZY SUSAN with CHROME RAIL

storage
SOLUTIONS

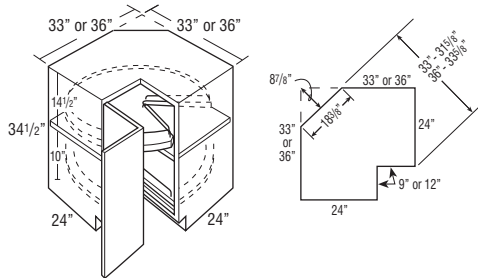

SLSCR3336 L or R	30.5
SLSCR3633 L or R	30.5

- SLSCR3336 L or R wall width is 33" x 36".
- SLSCR3633 L or R wall width is 36" x 33".
- All Asymmetrical Super Susan shelves are 28" diameter.
- Features two plywood revolving shelves with a 1" plywood lip. Lower shelf is mounted to floor. Upper shelf is mounted to fixed shelf. Fixed shelf is 1/2" thick laminated furniture board.
- Chrome rail surrounds both shelves. Chrome rail height is 2 13/16".
- Nomenclature for asymmetrical cabinets reads as follows:
First set of numbers = left side of cabinet dimensions.
Second set of numbers = right side of cabinet dimensions.
- Decorative hardware screws must be countersunk to prevent scratching adjacent cabinets and face frame of SLS.
- Integrated soft close hinge not included.
- Cabinet top features I-beam braces with a center support brace.

Custom Modifications

AUTHL AUTHR	CBO	CCO	CFNTO	CFP	CFRMO	CMAT	CND	DRT	DRWPWR	DRWTK	EXBKL EXBKR	EXL EXR
	•	•										
FB	FD	FFDL FFDR	FPEB	FTK	FTKAV FTKRV	ID	INVFRM	LTI	MIP	P	PTOWB	RD
•			•					•	•			
RECTKALL RECTKBL	RECTKL RECTKR	RT	SCPDRW	TD	TOTSS TOTSSS	TVRAV TVRFV TVRVV	VACL VACR	VACTK	VTK	WLI		
•	•								•	•		

Construction Upgrades

APC	ET	PE
•		•

Door Options

CG	DPSRR
	•

BASE ROTATING DEEP BIN

storage SOLUTIONS

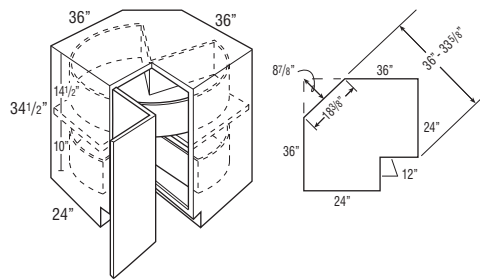

Due to fixed shelf mounting, shelves cannot be retrofitted.

Model	Cubic Feet
BRDB36 L or R	30.5

- BRDB36 wall width is 36" x 36".
- BRDB36 shelves are 30" diameter. Bins are 6" deep.
- Not available in asymmetrical applications.
- Inside bottom of lower deep susan to the fixed shelf is 10" high.
- Inside bottom of upper deep susan to the bottom of face frame cross rail is 14 1/8" high.
- Decorative hardware screws must be countersunk to prevent scratching of adjacent cabinets and face frame of BRDB.
- Integrated soft close hinge not included.
- Cabinet top features I-beam braces with a center support brace.

Custom Modifications

AUTHL AUTHR	CBO	CCO	CFNTD	CFP	CFRMO	CMAT	CND	DRT	DRWPWR	DRWTK	EXBKL EXBKR	EXL EXR
	•	•										
FB	FD	FFDL FFDR	FPEB	FTK	FTKAV FTKRV	ID	INVFRM	LTI	MIP	P	PTOWB	RD
•			•					•	•			
RECTKALL RECTBK	RECTKL RECTKR	RT	SCPRDW	TD	TOTSS TOTSSS	TVRAV TVRFV TVRVV	VACL VACR	VACTK	VTK	WLI		
•	•								•	•		

Construction Upgrades

APC	ET	PE
•		•

Door Options

CG	DPSRR
	•

LAZY SUSAN PULL-OUT

storage SOLUTIONS

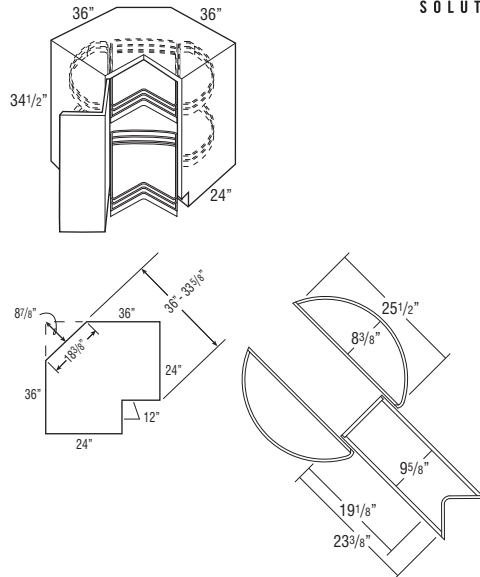

Model	Cubic Feet
LSP36 L or R	30.5

- LSP36 L or R wall width is 36" x 36".
- Features four half-moon bins (8 3/8" x 25 1/2" each) with plywood shelves and chrome rail sides.
- Center pull-outs have Smart Stop guides and operate independently. Entire unit rotates when center pull-outs are in closed position.
- Decorative hardware screws must be countersunk to prevent scratching adjacent cabinets and face frame of LSP.
- Integrated soft close hinge not included.

Custom Modifications

AUTHL AUTHR	CBO	CCO	CFNTD	CFP	CFRMO	CMAT	CND	DRT	DRWPWR	DRWTK	EXBKL EXBKR	EXL EXR
	•	•									•	
FB	FD	FFDL FFDR	FPEB	FTK	FTKAV FTKRV	ID	INVFRM	LTI	MIP	P	PTOWB	RD
•			•						•			
RECTKALL RECTBK	RECTKL RECTKR	RT	SCPRDW	TD	TOTSS TOTSSS	TVRAV TVRFV TVRVV	VACL VACR	VACTK	VTK	WLI		
•	•								•	•		

Construction Upgrades

APC	ET	PE
•		•

Door Options

CG	DPSRR
	•

THREE DRAWER CORNER CABINET

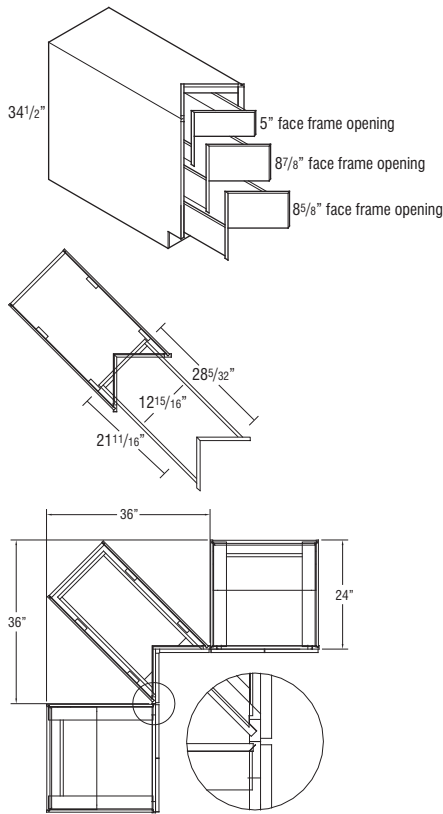

Model	Cubic Feet
3CDB36	15.0

- Must be installed between 2 cabinets.
- Allow for proper clearance of drawer head when specifying corner drawer cabinets next to appliances.
- Will have less than 3/4" overlay side reveal for clearance purposes.
- Cabinet sides will always be Natural Maple laminate. If PE or APC is specified, cabinet sides will be unfinished.
- Exterior height of bottom 2 drawer boxes is 7 3/8".
- Utilizes 110 lb. undermount Smart Stop guides on all drawers.

A Dimension	B Dimension
24"*	0"
25"	3/4"
26"	1 3/4"
27"	2 3/4"
28"	3 3/4"
29"	4 3/4"
30"	5 3/4"

A indicates depth of adjacent appliance or cabinet.
 B indicates minimum space needed between appliance/deeper cabinet and corner drawer base to insure proper operation of drawers.
 *Standard depth cabinet (24") does not require filler.

Custom Modifications

AUTHL AUTHR	CBO	CCO	CFNTD	CFP	CFRMO	CMAT	CND	DRT	DRWPWR	DRWTK	EXBKL EXBKR	EXL EXR
	•	•										
FB	FD	FFDL FFDR	FPFB	FTK	FTKAV FTKEV	ID	INVERM	LTI	MIP	P	PTOWB	RD
									•			
RECTKALL RECTKBK	RECTKL RECTKR	RT	SCPRW	TD	TOTSS TOTSSS	TVRAV TVREV TVRVV	VACL VACR	VACTK	VTK	WLI		
									•			

Construction Upgrades

APC	ET	PE
•		•

Door Options

CG	DPSRR
	•

BASE TRANSITION CABINET

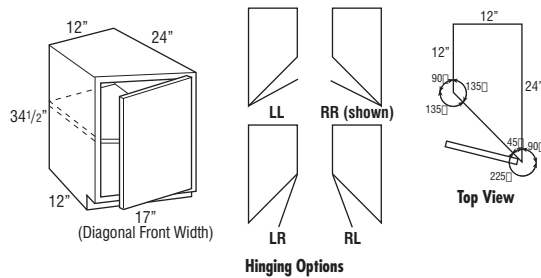

BTC12LL	14.4
BTC12RL	14.4
BTC12LR	14.4
BTC12RR	14.4

- One adjustable shelf.
- Cabinets constructed with top.
- Specify door hinging, RR shown.
- Depth can be reduced to a minimum of 18".
- RECTKBK, RECTKL and RECTKR cannot be ordered when RD is specified. RECTKL and RECTKR cannot be specified on the same cabinet.
- Full overlay styles use 38NPOHINGE, see page 418.

Custom Modifications

AUTHL AUTHR	CBO	CCO	CFNTD	CFP	CFRMO	CMAT	CND	DRT	DRWPWR	DRWTK	EXBKL EXBKR	EXL EXR
•*	•	•	•		•							
FB	FD	FFDL FFDR	FPFB	FTK	FTKAV FTKEV	ID	INVERM	LTI	MIP	P	PTOWB	RD
•		•*	•*	•				•	•			•
RECTKALL RECTKBK	RECTKL RECTKR	RT	SCPRW	TD	TOTSS TOTSSS	TVRAV TVREV TVRVV	VACL VACR	VACTK	VTK	WLI		
•+	•								•	•		

*Available only on 12" deep side of cabinet *RECTKALL not available

Construction Upgrades

APC	ET	PE
•		•

Door Options

CG	DPSRR
•	•

135° CORNER OUTSIDE BASE

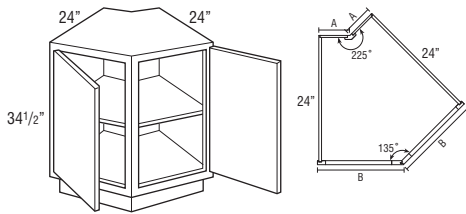

Model	A Dimension	B Dimension
BFH6COA	6"	15 15/16"
BFH9COA	9"	18 15/16"
BFH12COA	12"	21 15/16"

A indicates back width of cabinet and wall space.
B indicates face frame width.

Model	Cubic Feet
BFH6COA	21.8
BFH9COA	26.6
BFH12COA	31.6

- Doors are hinged on outside of frame.
- Adjustable shelves cannot be removed from the cabinet.

Custom Modifications

AUTHL	AUTHR	CBO	CCO	CFNTD	CFP	CFRMO	CMAT	CND	DRT	DRWPWR	DRWTK	EXBKL	EXBKR	EXL	EXR	
•	•	•	•													
FB	FD	FFDL	FFDR	FPEB	FTK	FTKAV	FTKRV	ID	INVFRM	LTI	MIP	P	PTOWB	RD		
•				•						•	•					
RECTKALL	RECTKLBK	RECTKLR	RECTKRBK	RT	SCPDRW	TD	TOTSS	TOTSSB	TVRAV	TVRFV	TVRVV	VACL	VACRBK	VACTK	VTRV	WLI
														•	•	

Construction Upgrades

APC	ET	PE
•		•

Door Options

CG	DPSRR
	•

135° CORNER INSIDE BASE

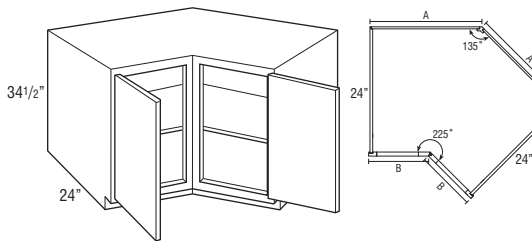

Model	A Dimension	B Dimension
BFH21CIA	21"	11 3/32"
BFH24CIA	24"	14 3/32"
BFH27CIA	27"	17 3/32"

A indicates back width of cabinet and wall space.
B indicates face frame width.

Model	Cubic Feet
BFH21CIA	29.8
BFH24CIA	34.9
BFH27CIA	40.4

- Doors are hinged on outside of frame.
- Adjustable shelves cannot be removed from the cabinet.

Custom Modifications

AUTHL	AUTHR	CBO	CCO	CFNTD	CFP	CFRMO	CMAT	CND	DRT	DRWPWR	DRWTK	EXBKL	EXBKR	EXL	EXR	
•	•	•	•													
FB	FD	FFDL	FFDR	FPEB	FTK	FTKAV	FTKRV	ID	INVFRM	LTI	MIP	P	PTOWB	RD		
•				•						•*	•					
RECTKALL	RECTKLBK	RECTKLR	RECTKRBK	RT	SCPDRW	TD	TOTSS	TOTSSB	TVRAV	TVRFV	TVRVV	VACL	VACRBK	VACTK	VTRV	WLI
														•	•	

*Not available on 21" and 24" wide

Construction Upgrades

APC	ET	PE
•		•

Door Options

CG	DPSRR
	•

BASE END CABINET

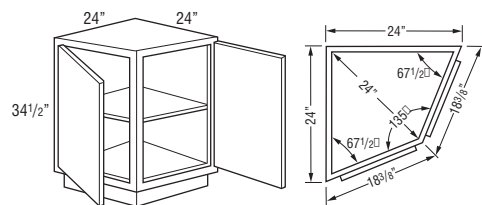

Model	Cubic Feet
BEC24	14.3

- Wall width is 24" x 24".
- 24" W x 24" D x 34 1/2" H.
- 24" from outside corner point to frame face.
- Cabinets constructed with top.
- One adjustable shelf.
- Cabinet may be installed against either end of a run.

Custom Modifications

AUTHL	AUTHR	CBO	CCO	CFNTD	CFP	CFRMO	CMAT	CND	DRT	DRWPWR	DRWTK	EXBKL	EXBKR	EXL	EXR	
		•	•													
FB	FD	FFDL	FFDR	FPEB	FTK	FTKAV	FTKRV	ID	INVFRM	LTI	MIP	P	PTOWB	RD		
					•					•	•					
RECTKALL	RECTKLBK	RECTKLR	RECTKRBK	RT	SCPDRW	TD	TOTSS	TOTSSB	TVRAV	TVRFV	TVRVV	VACL	VACRBK	VACTK	VTRV	WLI
														•	•	

Construction Upgrades

APC	ET	PE
•		

Door Options

CG	DPSRR
•	•

TWO DRAWER BASE with FILE DRAWER

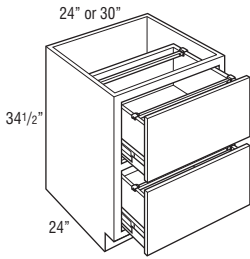

Model	Cubic Feet
2DB24FD	14.3
2DB30FD	17.6

- Includes Filing System Hardware Kit, which accommodates letter and legal filing.
- Drawers utilize 125 lb. full extension progressive sidemount guide, does not feature soft close guide.
- Depth can be reduced to a minimum of 21".
- Exterior drawer box height is 10".

Custom Modifications

AUTHL AUTHR	CBO	CCO	CFNTD	CFP	CFRMO	CMAT	CND	DRT	DRWPWR	DRWTK	EXBKL EXBKR	EXL EXR
•	•	•			•					•	•	•
FB	FD	FFDL FFDR	FPEB	FTK	FTKAV FTKRV	ID	INVERM	LTI	MIP	P	PTOWB	RD
•			•	•	•				•			•
RECTKALL RECTKBK	RECTKL RECTKR	RT	SCPRDW	TD	TOTSS TOTSSS	TVRAV TVRFV TVRVV	VACL VACR	VACTK	VTK	WLI		
•	•						•	•	•			

Construction Upgrades

APC	ET	PE
•		•

Door Options

CG	DPSRR

TWO DRAWER BASE

18", 21", 24", 27", 30", 33", 36", 42", or 48"

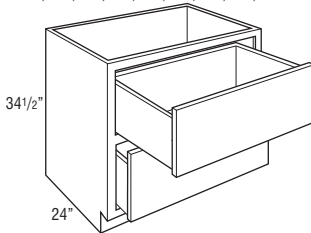

2DB18	11.1
2DB21	12.8
2DB24	14.4
2DB27	15.6
2DB30	17.7
2DB33	18.8
2DB36	21.1
2DB42	23.4
2DB48	26.6

- Exterior drawer box height is 10".
- 2DB42 and 2DB48 utilize 125 lb. full extension undermount Smart Stop guides. Depth can be reduced to a minimum of 21".
- When SCPRDW is selected, the top drawer will utilize a 6 3/8" high drawer box instead of the current 10" high drawer box, creating a clearance of 6 5/8" for the cooktop.
- When 2DB48 is ordered in Lynnville with DFF5PC, drawer fronts will have a vertical cross rail with two center panels.

Custom Modifications

AUTHL AUTHR	CBO	CCO	CFNTD	CFP	CFRMO	CMAT	CND	DRT	DRWPWR	DRWTK	EXBKL EXBKR	EXL EXR
•	•	•			•					•	•	•
FB	FD	FFDL FFDR	FPEB	FTK	FTKAV FTKRV	ID	INVERM	LTI	MIP	P	PTOWB	RD
•			•	•	•				•			•
RECTKALL RECTKBK	RECTKL RECTKR	RT	SCPRDW	TD	TOTSS TOTSSS	TVRAV TVRFV TVRVV	VACL VACR	VACTK	VTK	WLI		
•	•		•				•*	•	•			

*Not available on 18" wide

Construction Upgrades

APC	ET	PE
•		•

Door Options

CG	DPSRR

TWO DRAWER BASE with PEGGED DISH ORGANIZER

storage SOLUTIONS

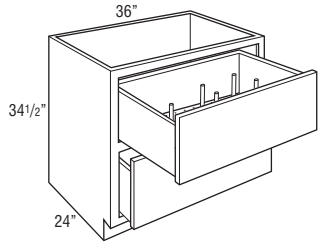

Model	Cubic Feet
2DB36PDO	21.1

- Includes 8 wooden posts.
- Includes 19/32" thick removable pegged board in top drawer.
- Exterior drawer box height is 10".
- Additional posts available as an accessory. See page 410.
- Posts and pegged board available as accessories for field installation. See page 410.
- When SCPDRW is selected, the top drawer will utilize a 6 3/8" high drawer box instead of the current 10" high drawer box, creating a clearance of 6 5/8" for the cooktop.

Custom Modifications

AUTHL AUTHR	CBO	CCO	CFNTO	CFP	CFRMO	CMAT	CND	DRT	DRWPWR	DRWTK	EXBKL EXBKR	EXL EXR
•	•				•					•	•	•
FB	FD	FFDL FFDR	FPEB	FTK	FTKAV FTKRV	ID	INVFRM	LTI	MIP	P	PTOWB	RD
•			•	•	•				•			
RECTKALL RECTKBK	RECTKL RECTKR	RT	SCPDRW	TD	TOTSS TOTSSS	TVRAV TVRFV TVRVV	VACL VACR	VACTK	VTK	WLI		
•	•		•				•	•	•			

Construction Upgrades

APC	ET	PE
•		•

Door Options

CG	DPSRR

TWO DRAWER BASE with ROLL TRAY

storage SOLUTIONS

18", 21", 24", 27", 30", 33", or 36"

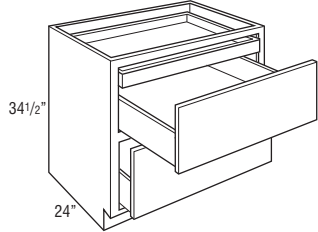

2DB18RT	11.1
2DB21RT	12.8
2DB24RT	14.4
2DB27RT	16.1
2DB30RT	17.7
2DB33RT	19.6
2DB36RT	21.1

- Includes a roll tray above the top drawer box.
- Exterior height for bottom drawer box is 6 3/8".

Custom Modifications

AUTHL AUTHR	CBO	CCO	CFNTO	CFP	CFRMO	CMAT	CND	DRT	DRWPWR	DRWTK	EXBKL EXBKR	EXL EXR
•	•	•			•					•	•	•
FB	FD	FFDL FFDR	FPEB	FTK	FTKAV FTKRV	ID	INVFRM	LTI	MIP	P	PTOWB	RD
•			•	•	•				•			•
RECTKALL RECTKBK	RECTKL RECTKR	RT	SCPDRW	TD	TOTSS TOTSSS	TVRAV TVRFV TVRVV	VACL VACR	VACTK	VTK	WLI		
•	•						•*	•	•			

*Not available on 18" wide

Construction Upgrades

APC	ET	PE
•		•

Door Options

CG	DPSRR

TWO DRAWER BASE with ROLL TRAY and PEGGED DISH ORGANIZER

storage SOLUTIONS

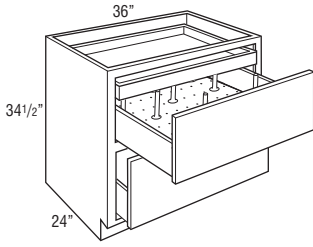

Model	Cubic Feet
2DB36RTPDO	21.1

- Includes a roll tray above the top drawer box.
- Includes 8 wooden posts.
- Includes 19/32" thick removable pegged board in top drawer.
- Additional posts available as an accessory. See page 410.
- Posts and pegged board available as accessories for field installation. See page 410.

Custom Modifications

AUTHL AUTHR	CBO	CCO	CFNT0	CFP	CFRMO	CMAT	CND	DRT	DRWPWR	DRWTK	EXBKL EXBKR	EXL EXR
•	•	•			•					•	•	•
FB	FD	FFDL FFDR	FPEB	FTK	FTKAV FTKFV	ID	INVFRM	LTI	MIP	P	PTOWB	RD
•			•	•	•				•			
RECTKALL RECTKBK	RECTKL RECTKR	RT	SCPDRW	TD	TOTSS TOTSSS	TVRAV TVRFV TVRVV	VACL VACR	VACTK	VTK	WLI		
•	•						•	•	•			

Construction Upgrades

APC	ET	PE
•		•

Door Options

CG	DPSRR

TWO DRAWER BASE, DROP-IN RANGE

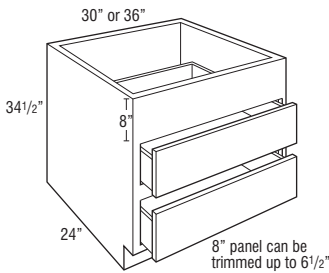

2DB30DR	17.7
2DB36DR	21.1

- Exterior height of drawer boxes is 6 3/8".

Custom Modifications

AUTHL AUTHR	CBO	CCO	CFNT0	CFP	CFRMO	CMAT	CND	DRT	DRWPWR	DRWTK	EXBKL EXBKR	EXL EXR
•	•	•	•		•					•	•	•
FB	FD	FFDL FFDR	FPEB	FTK	FTKAV FTKFV	ID	INVFRM	LTI	MIP	P	PTOWB	RD
•			•	•	•				•			•
RECTKALL RECTKBK	RECTKL RECTKR	RT	SCPDRW	TD	TOTSS TOTSSS	TVRAV TVRFV TVRVV	VACL VACR	VACTK	VTK	WLI		
•	•						•	•	•			

Construction Upgrades

APC	ET	PE
•		•

Door Options

CG	DPSRR

TWO DRAWER BASE, DROP-IN RANGE and WARMING DRAWER

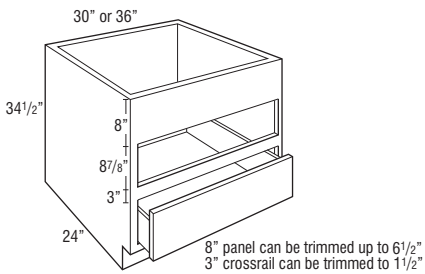

2DB30DRWD	17.7
2DB36DRWD	21.1

- Exterior height of bottom drawer box is 6 3/8".
- For built-in appliance support, OCINSTALKIT is included in 24" deep warming drawer cabinets (see page 410 for details), but will not be included when depth is modified.

Custom Modifications

AUTHL AUTHR	CBO	CCO	CFNT0	CFP	CFRMO	CMAT	CND	DRT	DRWPWR	DRWTK	EXBKL EXBKR	EXL EXR
•	•	•	•		•					•	•	•
FB	FD	FFDL FFDR	FPEB	FTK	FTKAV FTKFV	ID	INVFRM	LTI	MIP	P	PTOWB	RD
•			•	•	•				•			•
RECTKALL RECTKBK	RECTKL RECTKR	RT	SCPDRW	TD	TOTSS TOTSSS	TVRAV TVRFV TVRVV	VACL VACR	VACTK	VTK	WLI		
•	•						•	•	•			

Construction Upgrades

APC	ET	PE
•		•

Door Options

CG	DPSRR

THREE DRAWER BASE

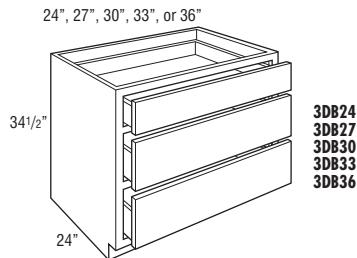
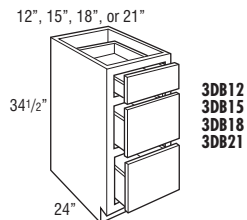

Model	Cubic Feet
3DB12	7.8
3DB15	9.4
3DB18	11.1
3DB21	12.8
3DB24	14.4
3DB27	16.1
3DB30	17.7
3DB33	19.6
3DB36	21.1

• Exterior height of bottom 2 drawer boxes is 6 3/8".

Custom Modifications

AUTHL AUTHR	CBO	CCO	CFNTO	CFP	CFRMO	CMAT	CND	DRT	DRWPWR	DRWTK	EXBKL EXBKR	EXL EXR
•	•	•		•	•				•*	•*	•	•
FB	FD	FFDL FFDR	FPEB	FTK	FTKAV FTKFV	ID	INVFRM	LTI	MIP	P	PTOWB	RD
•			•	•	•*				•			•
RECTKALL RECTKBK	RECTKL RECTKR	RT	SCPDRW	TD	TOTSS TOTSSS	TVRAV TVRFV TVRVV	VACL VACR	VACTK	VTK	WLI		
•	•		•				•▲	•*	•			

*Not available on 12" and 15" wide *Not available on 12" wide ▲Not available on 12", 15", and 18" wide

Construction Upgrades

APC	ET	PE
•		•

Door Options

CG	DPSRR

THREE DRAWER BASE BUFFET

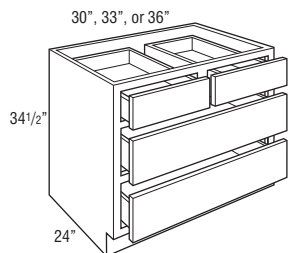

3DBB30	17.7
3DBB33	19.6
3DBB36	21.1

• Exterior height of bottom 2 drawer boxes is 6 3/8".

Custom Modifications

AUTHL AUTHR	CBO	CCO	CFNTO	CFP	CFRMO	CMAT	CND	DRT	DRWPWR	DRWTK	EXBKL EXBKR	EXL EXR
•	•	•		•	•				•*	•	•	•
FB	FD	FFDL FFDR	FPEB	FTK	FTKAV FTKFV	ID	INVFRM	LTI	MIP	P	PTOWB	RD
•			•	•	•				•			•
RECTKALL RECTKBK	RECTKL RECTKR	RT	SCPDRW	TD	TOTSS TOTSSS	TVRAV TVRFV TVRVV	VACL VACR	VACTK	VTK	WLI		
•	•		•				•	•	•			

*Not available on 30" and 33" wide

Construction Upgrades

APC	ET	PE
•		•

Door Options

CG	DPSRR

THREE DRAWER BASE with WOOD TIERED CUTLERY DIVIDER DRAWER

storage SOLUTIONS

15", 18", 21", or 24"

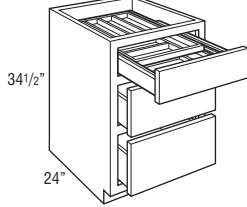

Model	Cubic Feet
3DB15WTCD	9.4
3DB18WTCD	11.1
3DB21WTCD	12.8
3DB24WTCD	14.4

- Exterior height for lower drawer boxes is 6 3/8".
- Exterior WTCD drawer box height is 3 3/4", interior height of top and bottom tier is 1 3/8".
- Wood Tiered Cutlery Divider Drawer is also available as an accessory. See page 407.

Custom Modifications

AUTHL AUTHR	CBO	CCO	CFNTO	CFP	CFRMO	CMAT	CND	DRT	DRWPPWR	DRWTK	EXBKL EXBKR	EXL EXR
•	•	•			•					•*	•	•
FB	FD	FFDL FFDR	FPEB	FTK	FTKAV FTKFV	ID	INVFRM	LTI	MIP	P	PTOWB	RD
•			•	•	•				•			
RECTKALL RECTKBK	RECTKL RECTKR	RT	SCPDRW	TD	TOTSS TOTSSS	TVRAV TVRFV TVRVV	VACL VACR	VACTK	VTK	WLI		
•	•						•+	•*	•			

*Not available on 15" wide *Not available on 15" and 18" wide

Construction Upgrades

APC	ET	PE
•		•

Door Options

CG	DPSRR

NEW THREE DRAWER BASE with WOOD TIERED K-CUP®* DRAWER

storage SOLUTIONS

18"

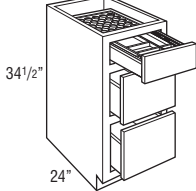

Model	Cubic Feet
3DB18KCUP	11.1

- Holds 40 K-Cups®.
 - Exterior height for lower drawer boxes is 6 3/8".
 - Exterior Wood Tiered K-Cup® drawer box height is 3 3/4", interior height of top tier is 1 5/8", and interior height of bottom tier is 1 3/8".
 - The Wood Tiered K-Cup® Drawer is compatible with K-Cup® pods only.
 - Wood Tiered K-Cup® Drawer is also available as an accessory. See page 408.
- *K-Cup® is a registered trademark of Keurig Green Mountain, Inc.

Custom Modifications

AUTHL AUTHR	CBO	CCO	CFNTO	CFP	CFRMO	CMAT	CND	DRT	DRWPPWR	DRWTK	EXBKL EXBKR	EXL EXR
•	•	•			•					•	•	•
FB	FD	FFDL FFDR	FPEB	FTK	FTKAV FTKFV	ID	INVFRM	LTI	MIP	P	PTOWB	RD
•			•	•	•				•			
RECTKALL RECTKBK	RECTKL RECTKR	RT	SCPDRW	TD	TOTSS TOTSSS	TVRAV TVRFV TVRVV	VACL VACR	VACTK	VTK	WLI		
•	•							•	•			

Construction Upgrades

APC	ET	PE
•		•

Door Options

CG	DPSRR

THREE DRAWER BASE, WARMING DRAWER

24", 27", 30", or 36"

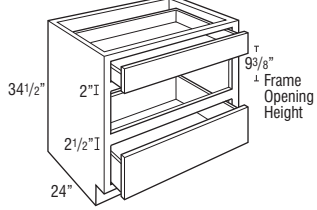

Model	Opening Width	Maximum Width	Opening Height	Maximum Height
3DB24WD	21"	22 1/2"	9 3/8"	11 3/8"
3DB27WD	24"	25 1/2"	9 3/8"	11 3/8"
3DB30WD	27"	28 1/2"	9 3/8"	11 3/8"
3DB36WD	33"	34 1/2"	9 3/8"	11 3/8"

Model	Cubic Feet
3DB24WD	14.4
3DB27WD	16.1
3DB30WD	17.7
3DB36WD	21.1

- Exterior height of bottom drawer box is 6 3/8".
- For built-in appliance support, OCINSTALLKIT is included in 24" deep warming drawer cabinets (see page 410 for details), but will not be included when depth is modified.

Custom Modifications

AUTHL AUTHR	CBO	CCO	CFNTO	CFP	CFRMO	CMAT	CND	DRT	DRWPWR	DRWTK	EXBKL EXBKR	EXL EXR
•	•	•		•	•				•	•	•	•
FB	FD	FFDL FFDR	FPEB	FTK	FTKAV FTKFV	ID	INVFRM	LTI	MIP	P	PTOWB	RD
•			•	•	•				•			•
RECTKALL RECTKBK	RECTKL RECTKR	RT	SCPRW	TD	TOTSS TOTSSS	TVRAV TVRFV TVRVV	VACL VACR	VACTK	VTK	WLI		
•	•		•				•	•	•			

Construction Upgrades

APC	ET	PE
•		•

Door Options

CG	DPSRR

THREE DRAWER BASE with DEEP DRAWER

24", 30", 33", or 36"

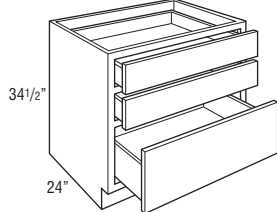

storage
SOLUTIONS

Model	Cubic Feet
3DBDD24	14.4
3DBDD30	17.7
3DBDD33	17.6
3DBDD36	20.9

- Exterior height of bottom drawer box is 10".
- Depth can be reduced to a minimum of 21".
- Bottom drawer utilizes 125 lb. full extension undermount Smart Stop guides.

Custom Modifications

AUTHL AUTHR	CBO	CCO	CFNTO	CFP	CFRMO	CMAT	CND	DRT	DRWPWR	DRWTK	EXBKL EXBKR	EXL EXR
•	•	•		•	•				•	•	•	•
FB	FD	FFDL FFDR	FPEB	FTK	FTKAV FTKFV	ID	INVFRM	LTI	MIP	P	PTOWB	RD
•			•	•	•				•			•
RECTKALL RECTKBK	RECTKL RECTKR	RT	SCPRW	TD	TOTSS TOTSSS	TVRAV TVRFV TVRVV	VACL VACR	VACTK	VTK	WLI		
•	•		•				•	•	•			

Construction Upgrades

APC	ET	PE
•		•

Door Options

CG	DPSRR

THREE DRAWER BASE BUFFET with DEEP DRAWER

storage SOLUTIONS

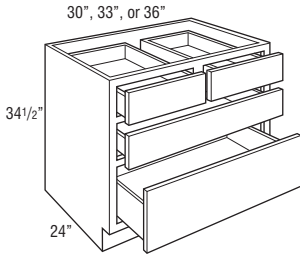

Model	Cubic Feet
3DBDD30	17.6
3DBDD33	19.2
3DBDD36	20.9

- Exterior height of bottom drawer box is 10".
- Depth can be reduced to a minimum of 21".
- Bottom drawer utilizes 125 lb. full extension undermount Smart Stop guides.

Custom Modifications

AUTHL AUTHR	CBO	CCO	CFNTD	CFP	CFRMO	CMAT	CND	DRT	DRWPWR	DRWTK	EXBKL EXBKR	EXL EXR
•	•	•		•	•				•*	•	•	•
FB	FD	FFDL FFDR	FPEB	FTK	FTKAV FTKFV	ID	INVFRM	LTI	MIP	P	PTOWB	RD
•			•	•	•				•			•
RECTKALL RECTKBK	RECTKL RECTKR	RT	SCPDRW	TD	TOTSS TOTSSS	TVRAV TVRFV TVRVV	VACL VACR	VACTK	VTK	WLI		
•	•		•				•	•	•			

*Not available on 30" and 33" wide

Construction Upgrades

APC	ET	PE
•		•

Door Options

CG	DPSRR

FOUR DRAWER BASE

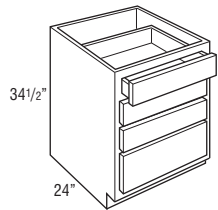

4DB12
4DB15
4DB18
4DB21

24", 27", 30", 33", or 36"

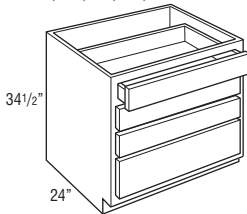

4DB24
4DB27
4DB30
4DB33
4DB36

4DB12	7.8
4DB15	9.4
4DB18	11.1
4DB21	12.8
4DB24	14.4
4DB27	15.9
4DB30	17.6
4DB33	19.2
4DB36	20.9

- Exterior height of bottom drawer box is 6 3/8".

Custom Modifications

AUTHL AUTHR	CBO	CCO	CFNTD	CFP	CFRMO	CMAT	CND	DRT	DRWPWR	DRWTK	EXBKL EXBKR	EXL EXR
•	•	•		•	•				•*	•*	•	•
FB	FD	FFDL FFDR	FPEB	FTK	FTKAV FTKFV	ID	INVFRM	LTI	MIP	P	PTOWB	RD
•			•	•	•+				•			•
RECTKALL RECTKBK	RECTKL RECTKR	RT	SCPDRW	TD	TOTSS TOTSSS	TVRAV TVRFV TVRVV	VACL VACR	VACTK	VTK	WLI		
•	•		•				•▲	•*	•			

*Not available on 12" and 15" wide *Not available on 12" wide ▲Not available on 12", 15", and 18" wide

Construction Upgrades

APC	ET	PE
•		•

Door Options

CG	DPSRR

FOUR DRAWER BASE with CUTLERY INSERT WOOD ORGANIZER

storage SOLUTIONS

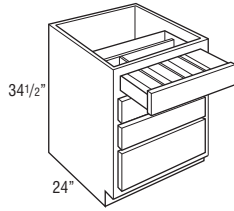

Model	Cubic Feet
4DB15CIW	9.4
4DB18CIW	11.1
4DB21CIW	12.8
4DB24CIW	14.4

- Cutlery Insert Wood Organizer is also available as an accessory. See page 407.
- Exterior height of bottom drawer box is 6 3/8".

Custom Modifications

AUTHL AUTHR	CBO	CCO	CFNTO	CFP	CFRMO	CMAT	CND	DRT	DRWPWR	DRWTK	EXBKL EXBKR	EXL EXR
•	•	•			•					•*	•	•
FB	FD	FFDL FFDR	FPEB	FTK	FTKAV FTKFV	ID	INVFRM	LTI	MIP	P	PTOWB	RD
•			•	•	•				•			
RECTKALL RECTKBK	RECTKL RECTKR	RT	SCPDRW	TD	TOTSS TOTSSS	TVRAV TVRFV TVRVV	VACL VACR	VACTK	VTK	WLI		
•	•						•*	•*	•			

*Not available on 15" wide *Not available on 15" and 18" wide

Construction Upgrades

APC	ET	PE
•		•

Door Options

CG	DPSRR

FOUR DRAWER BASE with WOOD TIERED CUTLERY DIVIDER DRAWER

storage SOLUTIONS

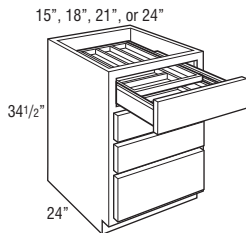

4DB15WTC	9.4
4DB18WTC	11.1
4DB21WTC	12.8
4DB24WTC	14.4

- Exterior WTC drawer box height is 3 3/4", interior height of top and bottom tier is 1 3/8".
- Wood Tiered Cutlery Divider Drawer is also available as an accessory. See page 407.
- Exterior height of bottom drawer box is 6 3/8".

Custom Modifications

AUTHL AUTHR	CBO	CCO	CFNTO	CFP	CFRMO	CMAT	CND	DRT	DRWPWR	DRWTK	EXBKL EXBKR	EXL EXR
•	•	•			•					•*	•	•
FB	FD	FFDL FFDR	FPEB	FTK	FTKAV FTKFV	ID	INVFRM	LTI	MIP	P	PTOWB	RD
•			•	•	•				•			
RECTKALL RECTKBK	RECTKL RECTKR	RT	SCPDRW	TD	TOTSS TOTSSS	TVRAV TVRFV TVRVV	VACL VACR	VACTK	VTK	WLI		
•	•						•*	•*	•			

*Not available on 15" wide *Not available on 15" and 18" wide

Construction Upgrades

APC	ET	PE
•		•

Door Options

CG	DPSRR

NEW **FOUR DRAWER BASE with WOOD TIERED K-CUP®* DRAWER**

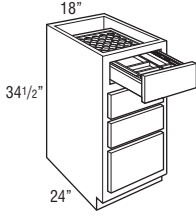

storage SOLUTIONS

Model	Cubic Feet
4DB18KUP	11.1

- Holds 40 K-Cups®.
 - Exterior height of bottom drawer box is 6 3/8".
 - Exterior Wood Tiered K-Cup® drawer box height is 3 3/4", interior height of top tier is 1 5/8", and interior height of bottom tier is 1 3/8".
 - The Wood Tiered K-Cup® Drawer is compatible with K-Cup® pods only.
 - Wood Tiered K-Cup® Drawer is also available as an accessory. See page 408.
- *K-Cup® is a registered trademark of Keurig Green Mountain, Inc.

Custom Modifications

AUTHL AUTHR	CBO	CCO	CFNTD	CFP	CFRMO	CMAT	CND	DRT	DRWPWR	DRWTK	EXBKL EXBKR	EXL EXR
•	•	•			•					•	•	•
FB	FD	FFDL FFDR	FPFB	FTK	FTKAV FTKFV	ID	INVERM	LTI	MIP	P	PTOWB	RD
•			•	•	•				•			
RECTKALL RECTKBK	RECTKL RECTKR	RT	SCPRW	TD	TOTSS TOTSSS	TVRAV TVRFV TVRVV	VACL VACR	VACTK	VTK	WLI		
•	•						•	•	•			

Construction Upgrades

APC	ET	PE
•		•

Door Options

CG	DPSRR

BASE WASTEBASKET

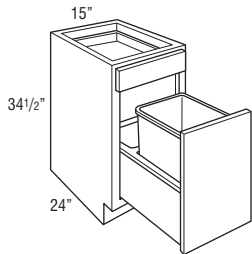

BWB15

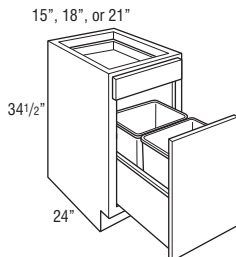

**BWB152
BWB18
BWB21**

storage SOLUTIONS **NEW**

BWB15	9.4
BWB152	9.4
BWB18	11.1
BWB21	12.8

- BWB15 includes one 35 quart grey wastebasket and one trash bag storage area.
- BWB152 includes two 27 quart grey wastebaskets.
- BWB18 and BWB21 include two 35 quart grey wastebaskets.
- BWB15 and BWB18 can be reduced in depth to 21". When reduced, BWB15 includes one wastebasket. When reduced, BWB18 includes one wastebasket and one trash bag storage area.
- Wastebasket lid available for purchase separately, see page 406. BWBLID fits 35 quart wastebaskets.
- BWBLID can only be used on the front trash can of BWB18 and BWB21.
- Pull-out features undermount Smart Stop guides.

Custom Modifications

AUTHL AUTHR	CBO	CCO	CFNTD	CFP	CFRMO	CMAT	CND	DRT	DRWPWR	DRWTK	EXBKL EXBKR	EXL EXR
•	•	•		•	•		•		•*	•*	•	•
FB	FD	FFDL FFDR	FPFB	FTK	FTKAV FTKFV	ID	INVERM	LTI	MIP	P	PTOWB	RD
•			•	•	•				•		•	•
RECTKALL RECTKBK	RECTKL RECTKR	RT	SCPRW	TD	TOTSS TOTSSS	TVRAV TVRFV TVRVV	VACL VACR	VACTK	VTK	WLI		
•	•						•+	•*	•	•		

*Not available on 15" wide *Not available on 15" and 18" wide

Construction Upgrades

APC	ET	PE
•		•

Door Options

CG	DPSRR
	•

BASE PAPER TOWEL CABINET with WASTEBASKET

storage SOLUTIONS

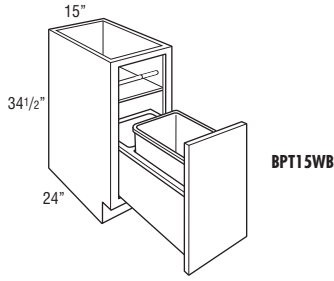

BPT15WB

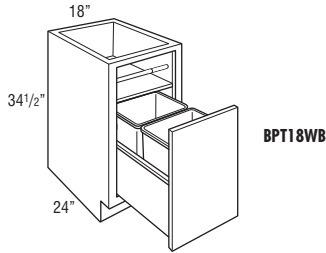

BPT18WB

Model	Cubic Feet
BPT15WB	9.4
BPT18WB	11.1

- Upper section of cabinet features an open cubby area with veneer finished interior sides and fixed shelf, a grey tension rod for easy removal, and a storage area behind the paper towel roll for an additional three to four paper towel rolls. Maximum paper towel diameter is 6".
- Cabinet back and lower section of cabinet has standard interior.
- BPT15WB includes one 35 quart grey wastebasket and one trash bag storage area.
- BPT18WB includes two 35 quart grey wastebaskets.
- Can be reduced in depth to 21". When reduced, BPT15WB includes one wastebasket. When reduced, BPT18WB includes one wastebasket and one trash bag storage area.
- Wastebasket lid available for purchase separately, see page 406. BWBLID fits 35 quart wastebaskets.
- Pull-out features undermount Smart Stop guides.

Custom Modifications

AUTHL AUTHR	CBO	CCO	CFNT0	CFP	CFRMO	CMAT	CND	DRT	DRWPWR	DRWTK	EXBKL EXBKR	EXL EXR
•	•	•								•	•	
FB	FD	FFDL FFDR	FPEB	FTK	FTKAV FTKFV	ID	INVFRM	LTI	MIP	P	PTOWB	RD
			•	•	•				•		•	•
RECTKALL RECTKBK	RECTKL RECTKR	RT	SCPDRW	TD	TOTSS TOTSSS	TVRAV TVRFV TVRVV	VACL VACR	VACTK	VTK	WLI		
•	•							•*	•	•		

*Not available on 15" wide

Construction Upgrades

APC	ET	PE
•		•

Door Options

CG	DPSRR
	•

BASE WASTEBASKET FULL HEIGHT

storage SOLUTIONS

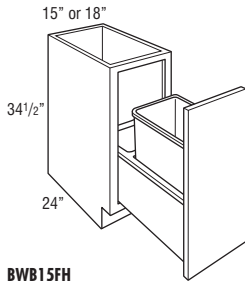

**BWB15FH
BWB18FH**

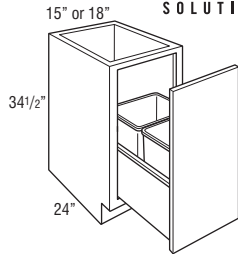

**BWB15FH2
BWB18FH2**

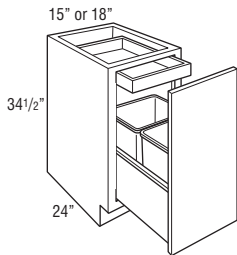

**BWB15FHRT2
BWB18FHRT2**

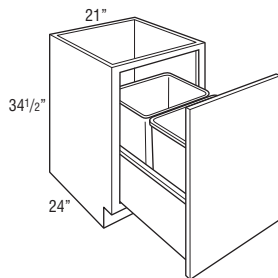

BWB21FH

BWB15FH	9.4
BWB18FH	11.1
BWB15FH2	9.4
BWB18FH2	11.1
BWB15FHRT2	9.4
BWB18FHRT2	11.1
BWB21FH	12.8

- Pull-out features undermount Smart Stop guides.
- BWB15FH and BWB18FH include one 50 quart grey wastebasket and one trash bag storage area.
- BWB15FH2 includes two 27 quart grey wastebaskets.
- BWB18FH2 includes two 35 quart grey wastebaskets.
- BWB15FHRT2 includes two 27 quart grey wastebaskets and one roll tray.
- BWB18FHRT2 includes two 35 quart grey wastebaskets and one roll tray.
- BWB21FH has two 50 quart grey wastebaskets.
- Wastebasket lid available for purchase separately, see page 406. BWBLID fits 35 quart wastebaskets. BWBFHLID fits 50 quart wastebaskets.
- BWBLID can only be used on the front trash can of BWB18FH2 and BWB18FHRT2.
- BWBFHLID can only be used on the front trash can of BWB21FH.
- Pull-out features undermount Smart Stop guides.

Custom Modifications

AUTHL AUTHR	CBO	CCO	CFNT0	CFP	CFRMO	CMAT	CND	DRT	DRWPWR	DRWTK	EXBKL EXBKR	EXL EXR
•	•	•								•*	•	•
FB	FD	FFDL FFDR	FPEB	FTK	FTKAV FTKFV	ID	INVFRM	LTI	MIP	P	PTOWB	RD
•			•	•	•				•		•	
RECTKALL RECTKBK	RECTKL RECTKR	RT	SCPDRW	TD	TOTSS TOTSSS	TVRAV TVRFV TVRVV	VACL VACR	VACTK	VTK	WLI		
•	•							•*	•	•		

*Not available on 15" wide *Available only on 21" wide

Construction Upgrades

APC	ET	PE
•		•

Door Options

CG	DPSRR
	•

BASE PAPER TOWEL CABINET with WASTEBASKET, FULL HEIGHT

storage
SOLUTIONS

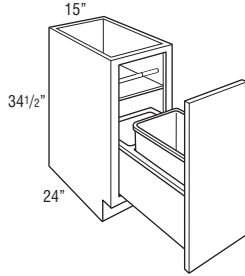

BPT15WBFH

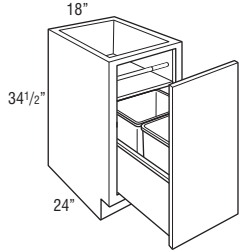

BPT18WBFH

Model	Cubic Feet
BPT15WBFH	9.4
BPT18WBFH	11.1

- Upper section of cabinet features a cubby area with veneer finished interior sides and fixed shelf, a grey tension rod for easy removal, and a storage area behind the paper towel roll for an additional three to four paper towel rolls. Maximum paper towel diameter is 6".
- Cabinet back and lower section of cabinet has standard interior.
- BPT15WBFH includes one 35 quart grey wastebasket and one trash bag storage area.
- BPT18WBFH includes two 35 quart grey wastebaskets.
- Can be reduced in depth to 21". When reduced, BPT15WBFH includes one wastebasket. When reduced, BPT18WBFH includes one wastebasket and one trash bag storage area.
- Wastebasket lid available for purchase separately, see page 406. BWBLID fits 35 quart wastebaskets.
- Pull-out features undermount Smart Stop guides.

Custom Modifications

AUTHL AUTHR	CBO	CCO	CFNT0	CFP	CFRMO	CMAT	CND	DRT	DRWPWR	DRWTK	EXBKL EXBKR	EXL EXR
•	•	•									•	
FB	FD	FFDL FFDR	FPEB	FTK	FTKAV FTKFV	ID	INVFRM	LTI	MIP	P	PTOWB	RD
			•	•	•				•		•	•
RECTKALL RECTKBK	RECTKL RECTKR	RT	SCPDRW	TD	TOTSS TOTSSS	TVRAV TVRFV TVRVV	VACL VACR	VACTK	VTK	WLJ		
•	•		•				•	•*	•	•		

*Not available on 15" wide

Construction Upgrades

APC	ET	PE
•		•

Door Options

CG	DPSRR
	•

BASE BIN TRAY PULL-OUT

storage
SOLUTIONS

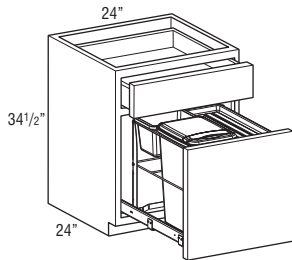

Model	Cubic Feet
BBTP24	14.4

- Door mounted pull-out features Smart Stop guides with chrome rails, grey 35 quart wastebasket with lid, grey bin, and two grey plastic trays. All items can be removed for cleaning.
- Bottom of pull-out has a removable grey plastic liner.
- Wastebasket lid available for purchase separately, see page 406. BWBLID fits 35 quart wastebaskets.

Custom Modifications

AUTHL AUTHR	CBO	CCO	CFNT0	CFP	CFRMO	CMAT	CND	DRT	DRWPWR	DRWTK	EXBKL EXBKR	EXL EXR
•		•		•	•				•	•	•	•
FB	FD	FFDL FFDR	FPEB	FTK	FTKAV FTKFV	ID	INVFRM	LTI	MIP	P	PTOWB	RD
•			•	•	•				•			
RECTKALL RECTKBK	RECTKL RECTKR	RT	SCPDRW	TD	TOTSS TOTSSS	TVRAV TVRFV TVRVV	VACL VACR	VACTK	VTK	WLJ		
•	•		•				•	•	•	•		

Construction Upgrades

APC	ET	PE
•		•

Door Options

CG	DPSRR
	•

BASE BIN TRAY PULL-OUT with PET FEEDING DRAWER

storage SOLUTIONS

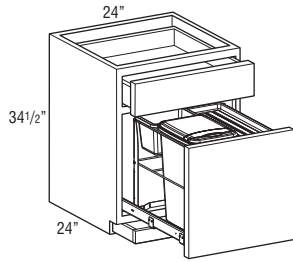

Model	Cubic Feet
BBTP24PFD	14.4

- Door mounted pull-out features Smart Stop guides with chrome rails, grey 35 quart wastebasket with lid, grey bin, and two grey plastic trays. All items can be removed for cleaning.
- Bottom of pull-out has a removable grey plastic liner.
- Pet feeding drawer in the toe-kick area features push-to-open guides with a removable grey plastic drawer insert.
- Wastebasket lid available for purchase separately, see page 406. BWBLID fits 35 quart wastebaskets.

Custom Modifications

AUTHL AUTHR	CBO	CCO	CFNTO	CFP	CFRMO	CMAT	CND	DRT	DRWPWR	DRWTK	EXBKL EXBKR	EXL EXR
•		•		•	•				•	STD	•	•
FB	FD	FFDL FFDR	FPEB	FTK	FTKAV FTKFV	ID	INVFRM	LTI	MIP	P	PTOWB	RD
•			•						•			
RECTKALL RECTKBK	RECTKL RECTKR	RT	SCPDRW	TD	TOTSS TOTSSS	TVRAV TVRFV TVRVV	VACL VACR	VACTK	VTK	WLI		
			•							•		

Construction Upgrades

APC	ET	PE
•		•

Door Options

CG	DPSRR
	•

BASE BIN TRAY PULL-OUT FULL HEIGHT

storage SOLUTIONS

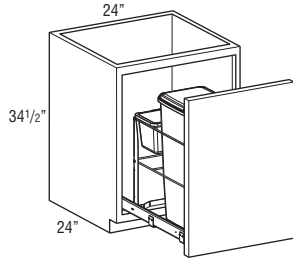

Model	Cubic Feet
BBTP24FH	14.4

- Door mounted pull-out features Smart Stop guides with chrome rails, grey 50 quart wastebasket with lid, grey bin, and two grey plastic trays. All items can be removed for cleaning.
- Bottom of pull-out has a removable grey plastic liner.
- Wastebasket lid available for purchase separately, see page 406. BWBFHLID fits 50 quart wastebaskets.

Custom Modifications

AUTHL AUTHR	CBO	CCO	CFNTO	CFP	CFRMO	CMAT	CND	DRT	DRWPWR	DRWTK	EXBKL EXBKR	EXL EXR
•		•			•					•	•	•
FB	FD	FFDL FFDR	FPEB	FTK	FTKAV FTKFV	ID	INVFRM	LTI	MIP	P	PTOWB	RD
•			•	•	•				•			
RECTKALL RECTKBK	RECTKL RECTKR	RT	SCPDRW	TD	TOTSS TOTSSS	TVRAV TVRFV TVRVV	VACL VACR	VACTK	VTK	WLI		
•	•						•	•	•	•		

Construction Upgrades

APC	ET	PE
•		•

Door Options

CG	DPSRR
	•

BASE BIN TRAY PULL-OUT FULL HEIGHT with PET FEEDING DRAWER

storage SOLUTIONS

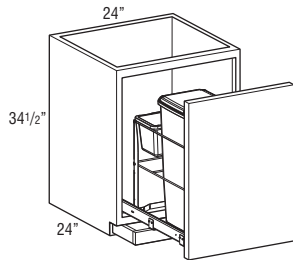

Model	Cubic Feet
BBTP24FHPFD	14.4

- Door mounted pull-out features Smart Stop guides with chrome rails, grey 50 quart wastebasket with lid, grey bin, and two grey plastic trays. All items can be removed for cleaning.
- Bottom of pull-out has a removable grey plastic liner.
- Pet feeding drawer in the toe-kick area features push-to-open guides with a removable grey plastic drawer insert.
- Wastebasket lid available for purchase separately, see page 406. BWBFHLID fits 50 quart wastebaskets.

Custom Modifications

AUTHL AUTHR	CBO	CCO	CFNTO	CFP	CFRMO	CMAT	CND	DRT	DRWPWR	DRWTK	EXBKL EXBKR	EXL EXR
•		•			•					STD	•	•
FB	FD	FFDL FFDR	FPEB	FTK	FTKAV FTKFV	ID	INVFRM	LTI	MIP	P	PTOWB	RD
•			•						•			
RECTKALL RECTKBK	RECTKL RECTKR	RT	SCPDRW	TD	TOTSS TOTSSS	TVRAV TVRFV TVRVV	VACL VACR	VACTK	VTK	WLI		
										•		

Construction Upgrades

APC	ET	PE
•		•

Door Options

CG	DPSRR
	•

BASE WINE CUBBY, 24" DEEP

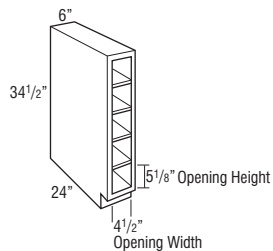

Model	Cubic Feet
BWC6	3.7

- Vertical application only.
- Matching interior.
- Frameless drilled and doweled construction.
- See BSD6 (Base Spice Cabinets with Drawers).
- Hardwood veneer on 3/4" furniture board core.
- Reduced Depth only available in 3" increments down to 12".

Custom Modifications

AUTHL AUTHR	CBO	CCO	CFNTO	CFP	CFRMO	CMAT	CND	DRT	DRWPWR	DRWTK	EXBKL EXBKR	EXL EXR
FB	FD	FFDL FFDR	FPEB	FTK	FTKAV FTKRV	ID	INVERM	LTI	MIP	P	PTOWB	RD
STD												•
RECTKALL RECTKBK	RECTKL RECTKR	RT	SCPDRW	TD	TOTSS TOTSSS	TVRAV TVRFV TVRVV	VACL VACR	VACTK	VTK	WLI		

Construction Upgrades

APC	ET	PE
-----	----	----

Door Options

CG	DPSRR
----	-------

BASE SPICE DRAWER, 24" DEEP

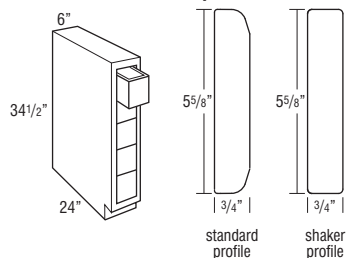

Model	Cubic Feet
BSD6	3.7

- See BWC6 (Base Wine Cubby without Drawers).
- Frameless drilled and doweled construction.
- Hardwood veneer on a 3/4" furniture board core.
- Vertical application only.
- Matching interior.
- Includes five 1/2" hardwood drawers with rabbet joint, 21 13/16" deep.
- Drawer opening is 4 1/2" wide x 5 1/8" high.
- Features flush end panels which cannot be skinned.
- If ordered with Heirloom Technique, will not feature sand-through characteristics.
- Reduced Depth only available in 3" increments down to 12".
- Drawer front is unique to item and will not match profile chosen.
- All styles use standard drawer front profile except Amstead, Butler, Caprice, Cotter, Darby, Hardin, Larsen, Lynnville, Northrope, and Warwick, Whitman, which use the shaker profile.
- Genova, Shafer, Taro, and Troxel drawer fronts will match doors and drawer fronts.

Custom Modifications

AUTHL AUTHR	CBO	CCO	CFNTO	CFP	CFRMO	CMAT	CND	DRT	DRWPWR	DRWTK	EXBKL EXBKR	EXL EXR
FB	FD	FFDL FFDR	FPEB	FTK	FTKAV FTKRV	ID	INVERM	LTI	MIP	P	PTOWB	RD
STD												•
RECTKALL RECTKBK	RECTKL RECTKR	RT	SCPDRW	TD	TOTSS TOTSSS	TVRAV TVRFV TVRVV	VACL VACR	VACTK	VTK	WLI		

Construction Upgrades

APC	ET	PE
-----	----	----

Door Options

CG	DPSRR
----	-------

FLOATING ISLAND BASE WITHOUT TOP

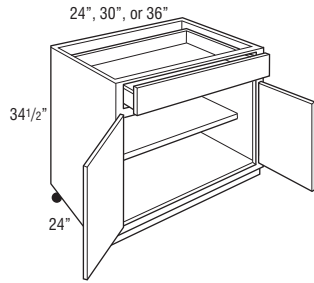

32" high without casters.

Model	Cubic Feet
FICNT24	14.4
FICNT30	17.7
FICNT36	20.9

- 1 full width drawer and 1 adjustable 15" shelf.
- 4 heavy duty locking casters.
- Cabinet sides and back are finished to match cabinet doors.
- Maximum countertop overhang of 1" on all sides.
- Not recommended for use with roll trays.

Custom Modifications

AUTHL AUTHR	CBO	CCO	CFNTO	CFP	CFRMO	CMAT	CND	DRT	DRWPWR	DRWTK	EXBKL EXBKR	EXL EXR
•	•	•	•	•	•		•					
FB	FD	FFDL FFDR	FPEB	FTK	FTKAV FTKRV	ID	INVFRM	LTI	MIP	P	PTOWB	RD
STD	•		•					•	•			
RECTKALL RECTKBK	RECTKL RECTKR	RT	SCPDRW	TD	TOTSS TOTSSS	TVRAV TVRFV TVRVV	VACL VACR	VACTK	VTK	WLI		
										•		

Construction Upgrades

APC	ET	PE
STD		

Door Options

CG	DPSRR
•	•

FLOATING ISLAND BASE

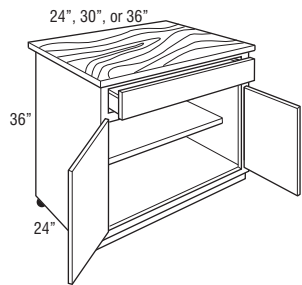

32" high without top and casters.

FIC24	15.0
FIC30	18.5
FIC36	21.9

- 1 full width drawer and 1 adjustable 15" shelf.
- 1 1/2" thick solid Maple top. Top is treated with FDA approved mineral oil.
- Top overhangs 1" on all sides. For field provided countertops, maximum overhang of 1" required on all sides.
- 4 heavy duty locking casters.
- Cabinet sides and back are finished to match cabinet doors.
- Wood tops require regular applications of mineral oil by consumers.
- Not recommended for use with roll trays.

Custom Modifications

AUTHL AUTHR	CBO	CCO	CFNTO	CFP	CFRMO	CMAT	CND	DRT	DRWPWR	DRWTK	EXBKL EXBKR	EXL EXR
•	•	•	•	•	•		•					
FB	FD	FFDL FFDR	FPEB	FTK	FTKAV FTKRV	ID	INVFRM	LTI	MIP	P	PTOWB	RD
STD	•		•					•	•			
RECTKALL RECTKBK	RECTKL RECTKR	RT	SCPDRW	TD	TOTSS TOTSSS	TVRAV TVRFV TVRVV	VACL VACR	VACTK	VTK	WLI		
										•		

Construction Upgrades

APC	ET	PE
STD		

Door Options

CG	DPSRR
•	•

BASE PANTRY PULL-OUT

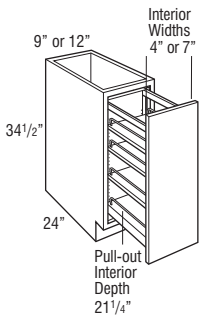

storage
SOLUTIONS

Model	Cubic Feet
BPP9	6.1
BPP12	7.8

- All styles feature a natural finish Smart Stop wood pull-out with adjustable shelves and chrome rail sides. The adjustable rear wall of the pull-out prevents items from falling behind the unit.

Custom Modifications

AUTHL AUTHR	CBO	CCO	CFNT0	CFP	CFRMO	CMAT	CND	DRT	DRWPWR	DRWTK	EXBKL EXBKR	EXL EXR
•	•	•			•						•	•
FB	FD	FFDL FFDR	FPEB	FTK	FTKAV FTKFV	ID	INVERM	LTI	MIP	P	PTOWB	RD
•			•	•					•			
RECTKALL RECTKBK	RECTKL RECTKR	RT	SCPRW	TD	TOTSS TOTSSS	TVRAV TVRFV TVRVV	VACL VACR	VACTK	VTK	WLI		
•*	•*								•	•		

*Not available on 9" wide

Construction Upgrades

APC	ET	PE
•		•

Door Options

CG	DPSRR
	•

BASE CONTAINER ORGANIZER PANTRY PULL-OUT

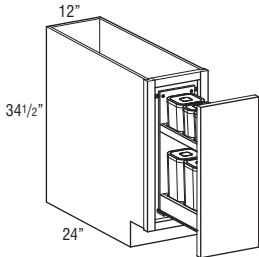

storage
SOLUTIONS

Model	Cubic Feet
BCOPP12	7.8

- Full extension, Smart Stop wood pull-out with natural finish and two fixed shelves.
- Includes seven OXO™ Good Grips POP containers (BPA Free): three 1.7 quart, three 4.3 quart, and one 2.6 quart.

Custom Modifications

AUTHL AUTHR	CBO	CCO	CFNT0	CFP	CFRMO	CMAT	CND	DRT	DRWPWR	DRWTK	EXBKL EXBKR	EXL EXR
•	•	•			•						•	•
FB	FD	FFDL FFDR	FPEB	FTK	FTKAV FTKFV	ID	INVERM	LTI	MIP	P	PTOWB	RD
•			•	•					•			
RECTKALL RECTKBK	RECTKL RECTKR	RT	SCPRW	TD	TOTSS TOTSSS	TVRAV TVRFV TVRVV	VACL VACR	VACTK	VTK	WLI		
•	•								•	•		

Construction Upgrades

APC	ET	PE
•		•

Door Options

CG	DPSRR
	•

BASE UTENSIL PANTRY PULL-OUT

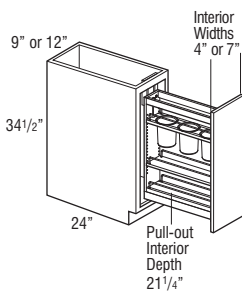

storage
SOLUTIONS

Model	Cubic Feet
BUPP9	5.8
BUPP12	7.5

- All styles feature a natural finish Smart Stop wood pull-out with two adjustable shelves (including canister shelf) and one fixed shelf with chrome rail sides. Top adjustable shelf features three stainless steel canisters for utensils. The adjustable rear wall of the pull-out prevents items from falling behind the unit.
- BUPP9 canisters are 5.85" tall and have an inside diameter of 4.3".
- BUPP12 canisters are 6.7" tall and have an inside diameter of 5".

Custom Modifications

AUTHL AUTHR	CBO	CCO	CFNT0	CFP	CFRMO	CMAT	CND	DRT	DRWPWR	DRWTK	EXBKL EXBKR	EXL EXR
•	•	•			•						•	•
FB	FD	FFDL FFDR	FPEB	FTK	FTKAV FTKFV	ID	INVERM	LTI	MIP	P	PTOWB	RD
•			•	•					•			
RECTKALL RECTKBK	RECTKL RECTKR	RT	SCPRW	TD	TOTSS TOTSSS	TVRAV TVRFV TVRVV	VACL VACR	VACTK	VTK	WLI		
•*	•*								•	•		

*Not available on 9" wide

Construction Upgrades

APC	ET	PE
•		•

Door Options

CG	DPSRR
	•

BASE UTENSIL PANTRY PULL-OUT with KNIFE BLOCK

storage SOLUTIONS

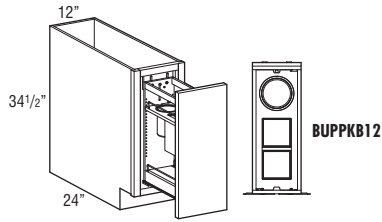

BUPPKB12

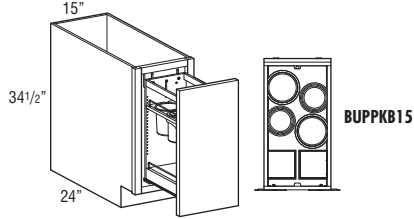

BUPPKB15

Model	Cubic Feet
BUPPKB12	7.8
BUPPKB15	9.4

- Full extension, Smart Stop wood pull-out with natural finish and one fixed shelf.
- BUPPKB12 features an adjustable shelf with knife blocks and stainless steel canister and one fixed shelf with chrome rails. Canister is 6.7" tall and has an inside diameter of 5".
- BUPPKB15 features an adjustable shelf with knife block and four stainless steel canisters and one fixed shelf with chrome rails. Two canisters are 5.85" tall and have an inside diameter of 4.3", and the other two are 6.7" tall with an inside diameter of 5".
- Knife block features movable flex rods that adjust to hold a multitude of knives.
- Includes adjustable rear wall for extra strength and stability.

Custom Modifications

AUTHL AUTHR	CBO	CCO	CFNT0	CFP	CFRMO	CMAT	CND	DRT	DRWPWR	DRWTK	EXBKL EXBKR	EXL EXR
•	•	•			•						•	•
FB	FD	FFDL FFDR	FPEB	FTK	FTKAV FTKRV	ID	INFRM	LTI	MIP	P	PTOWB	RD
•			•	•	•*				•			
RECTKALL RECTKBK	RECTKL RECTKR	RT	SCPRW	TD	TOTSS TOTSSS	TVRAV TVRFV TVRVV	VACL VACR	VACTK	VTK	WLI		
•	•								•	•		

*Not available on 12" wide

Construction Upgrades

APC	ET	PE
•		•

Door Options

CG	DPSRR
	•

BASE BOX COLUMN PULL-OUT

storage SOLUTIONS

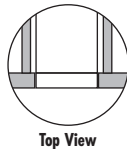
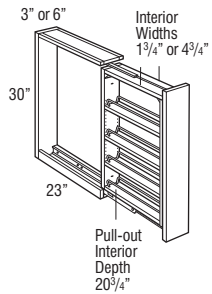

Top View

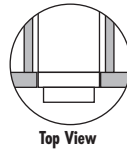
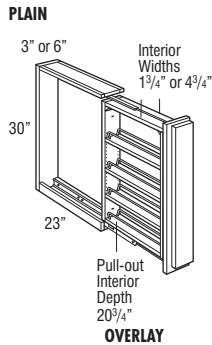

Top View

BBCPO3 (Plain)	1.3
BBCPO6 (Plain)	2.5
BBCPO3OL (Overlay)	1.3
BBCPO6OL (Overlay)	2.5

- Recommended to be installed between two cabinets. Can be installed on the end of a run with the use of an end panel (recommend BEPWD and BEPLAM).
- Can also be installed between a cabinet and a wall or between a cabinet and an end panel.
- Filler is included but unattached.
- Install unit before removing shipping brace and attaching filler.
- Overlay application includes profiled full overlay filler.
- Decorative hardware required on base units.
- Modifications not available.
- Toekick not included; must be built up in the field.
- If installed next to an appliance an End Panel must be installed onto the pull-out adjacent to the appliance.
- All styles feature a natural finish Smart Stop wood pull-out with adjustable shelves and chrome rail sides.
- BBCPO3 and BBCPO6 will not feature sand-through characteristics if ordered with Heirlooming Technique.
- In order to allow proper clearance for opening and closing, allow an additional 1/8" space between adjacent cabinet face frames. The 3" wide pull-outs require 3 1/8" space and the 6" wide pull-outs require 6 1/8" space. Spacers are included with the pull-outs to allow for proper installation.
- Cannot be installed between cabinets with furniture ends (either specified with FPEB or on opposite end panel of cabinets with AUTHL/AUTHR) or with flush ends standard. When installed next to a deeper cabinet, make sure sufficient clearance is allowed for pull-out.
- For full access from both sides of unit, do not install against a wall or next to deeper appliances and cabinets.

MODIFICATIONS

No modifications available for these products.

Finish Techniques

Distressing	Heirloom
•	•*

*Not available on Plain

BASE MESSAGE CENTER

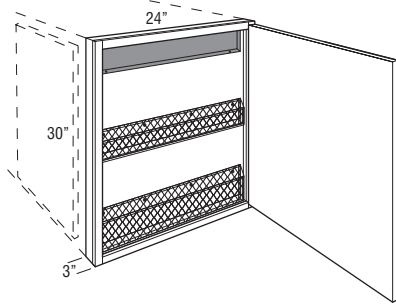

storage
SOLUTIONS

Model	Cubic Feet
BMC24 L or R	2.4

- Includes magazine holder, bulletin board, and mail holder.
- Not available next to a peninsula cabinet.
- Door will open 90° without decorative hardware.
- Cabinet should be hinged on wall side.
- For proper installation, adjacent cabinet must have FPEB or 1/4" skin applied.
- Embellishments or overlay fillers can be used on side of cabinet to add a decorative touch.

Custom Modifications

AUTHL AUTHR	CBO	CCO	CFNT0	CFP	CFRMO	CMAT	CND	DRT	DRWPWR	DRWTK	EXBKL EXBKR	EXL EXR
	•	•										
FB	FD	FFDL FFDR	FPEB	FTK	FTKAV FTKRV	ID	INVERM	LTI	MIP	P	PTOWB	RD
			STD						•			
RECTKALL RECTKBK	RECTKL RECTKR	RT	SCPDRW	TD	TOTSS TOTSSS	TVRAV TVRFV TVRVV	VACL VACR	VACTK	VTK	WLI		•

Construction Upgrades

APC	ET	PE
•		

Door Options

CG	DPSRR
	•

BASE DROP-IN RANGE CABINET

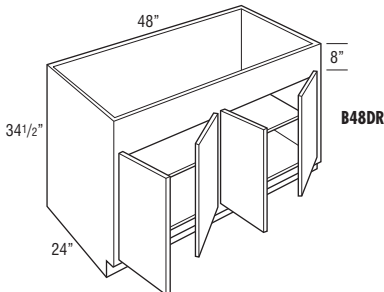
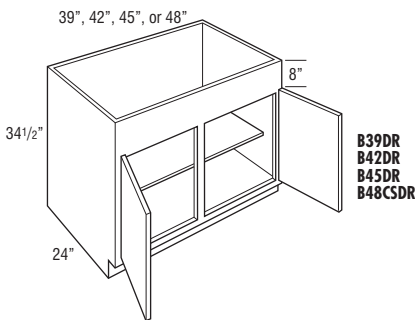
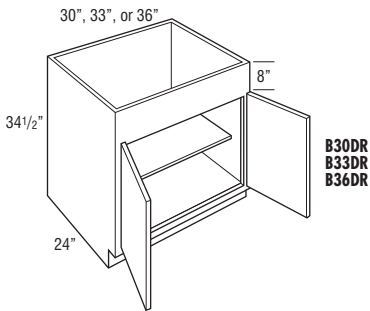

B30DR	17.4
B33DR	19.0
B36DR	20.7
B39DR	22.4
B42DR	24.0
B45DR	25.7
B48CSDR	27.3
B48DR	27.3

- 8" panel can be trimmed up to 6 1/2".
- Adjustable 15" deep shelf.
- Can also be used with apron front sinks, refer to manufacturer's dimension requirements.

Custom Modifications

AUTHL AUTHR	CBO	CCO	CFNT0	CFP	CFRMO	CMAT	CND	DRT	DRWPWR	DRWTK	EXBKL EXBKR	EXL EXR
•	•	•	•		•					•*	•	•
FB	FD	FFDL FFDR	FPEB	FTK	FTKAV FTKRV	ID	INVERM	LTI	MIP	P	PTOWB	RD
•	•		•	•	•	•		•	•			•
RECTKALL RECTKBK	RECTKL RECTKR	RT	SCPDRW	TD	TOTSS TOTSSS	TVRAV TVRFV TVRVV	VACL VACR	VACTK	VTK	WLI		
•	•	•					•	•	•	•		

*Available only on 30", 33", and 36" wide

Construction Upgrades

APC	ET	PE
•		•

Door Options

CG	DPSRR
•	•

BASE OVEN CABINET

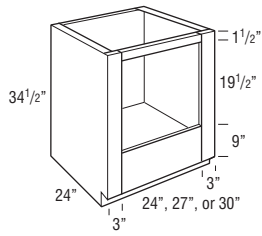

Model	Opening Width	Maximum Width	Opening Height	Maximum Height
B030	24"	28 1/2"	19 1/2"	27 1/2"
B033	27"	31 1/2"	19 1/2"	27 1/2"
B036	30"	34 1/2"	19 1/2"	27 1/2"

Model	Cubic Feet
B030	17.7
B033	19.6
B036	21.1

- Oven cabinet has laminated interior.
- May not hold cooktop and slide-in oven combination. Refer to cooktop and slide-in oven manufacturer specifications.
- If ordered with Heirloom Technique, will not feature sand-through characteristics.
- For built-in appliance support, OCINSTALLKIT is included in 24" deep oven cabinets (see page 410 for details), but will not be included when depth is modified.

Custom Modifications

AUTHL AUTHR	CBO	CCO	CFNT0	CFP	CFRMO	CMAT	CND	DRT	DRWPWR	DRWTK	EXBKL EXBKR	EXL EXR
•					•					•	•	•
FB	FD	FFDL FFDR	FPEB	FTK	FTKAV FTKRV	ID	INVFRM	LTI	MIP	P	PTOWB	RD
•			•	•	•	•			•			•
RECTKALL RECTKBK	RECTKL RECTKR	RT	SCPDRW	TD	TOTSS TOTSSS	TVRAV TVRFV TVRVV	VACL VACR	VACTK	VTK	WLI		
•	•						•	•	•			

Construction Upgrades

APC	ET	PE
•		•

Door Options

CG	DPSRR

BASE BUILT-IN MICROWAVE CABINET with DRAWER

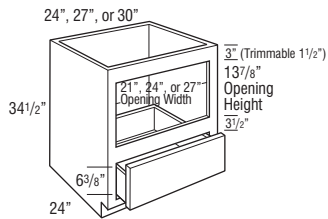

Model	Opening Width	Maximum Width	Opening Height	Maximum Height
BBMWD24	21"	22 1/2"	13 7/8"	16 7/8"
BBMWD27	24"	25 1/2"	13 7/8"	16 7/8"
BBMWD30	27"	28 1/2"	13 7/8"	16 7/8"

BBMWD24	14.4
BBMWD27	16.1
BBMWD30	17.7

- Standard interior.
- For built-in appliance support, OCINSTALLKIT is included in 24" deep cabinets (see page 410 for details), but will not be included when depth is modified.
- The usable cabinet face height between top of drawer front and top of cabinet is 19 1/8" for partial overlay and 19 3/4" for full overlay. Be sure to verify overall appliance height, gap requirements, and cut-out dimensions with cabinet specifications.

Custom Modifications

AUTHL AUTHR	CBO	CCO	CFNT0	CFP	CFRMO	CMAT	CND	DRT	DRWPWR	DRWTK	EXBKL EXBKR	EXL EXR
•	•	•			•					•	•	•
FB	FD	FFDL FFDR	FPEB	FTK	FTKAV FTKRV	ID	INVFRM	LTI	MIP	P	PTOWB	RD
•			•	•	•	•			•			•
RECTKALL RECTKBK	RECTKL RECTKR	RT	SCPDRW	TD	TOTSS TOTSSS	TVRAV TVRFV TVRVV	VACL VACR	VACTK	VTK	WLI		
•	•						•	•	•			

Construction Upgrades

APC	ET	PE
•		•

Door Options

CG	DPSRR

BASE MICROWAVE CABINET with DRAWER

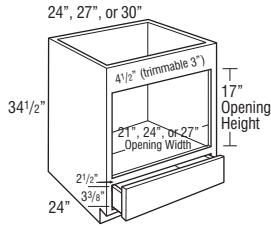

Model	Opening Width	Maximum Width	Opening Height	Maximum Height
BMWD24	21"	22 1/2"	17"	20"
BMWD27	24"	25 1/2"	17"	20"
BMWD30	27"	28 1/2"	17"	20"

Model	Cubic Feet
BMWD24	14.4
BMWD27	16.1
BMWD30	17.7

- Hardwood veneer on plywood with matching veneer interior.
- Finished interior standard.
- Reinforced plywood floor.
- The usable cabinet face height between top of drawer front and top of cabinet is 23 1/2" for partial overlay and full overlay. Be sure to verify overall appliance height, gap requirements, and cut-out dimensions with cabinet specifications.

Custom Modifications

AUTHL AUTHR	CBO	CCO	CFNTO	CFP	CFRMO	CMAT	CND	DRT	DRWPWR	DRWTK	EXBKL EXBKR	EXL EXR
•	•	•			•					•	•	•
FB	FD	FFDL FFDR	FPEB	FTK	FTKAV FTKRV	ID	INVFRM	LTI	MIP	P	PTOWB	RD
STD			•	•	•					STD		•
RECTKALL RECTKBK	RECTKL RECTKR	RT	SCPDRW	TD	TOTSS TOTSSS	TVRAV TVRFV TVRVV	VACL VACR	VACTK	VTK	WLI		
•	•						•	•	•			

Construction Upgrades

APC	ET	PE
STD		

Door Options

CG	DPSRR

BASE MICROWAVE CABINET with DEEP DRAWER

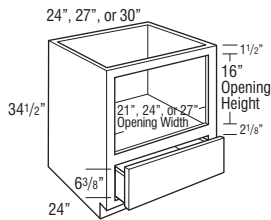

Model	Opening Width	Maximum Width	Opening Height	Maximum Height
BMWD24DD	21"	22 1/2"	16"	16"
BMWD27DD	24"	25 1/2"	16"	16"
BMWD30DD	27"	28 1/2"	16"	16"

Model	Cubic Feet
BMWD24DD	14.4
BMWD27DD	16.1
BMWD30DD	17.7

- Hardwood veneer on plywood with matching veneer interior.
- Finished interior standard.
- Reinforced plywood floor.
- The usable cabinet face height between top of drawer front and top of cabinet is 19 1/8" for partial overlay and 18 3/8" for full overlay. Be sure to verify overall appliance height, gap requirements, and cut-out dimensions with cabinet specifications.

Custom Modifications

AUTHL AUTHR	CBO	CCO	CFNTO	CFP	CFRMO	CMAT	CND	DRT	DRWPWR	DRWTK	EXBKL EXBKR	EXL EXR
•	•	•			•					•	•	•
FB	FD	FFDL FFDR	FPEB	FTK	FTKAV FTKRV	ID	INVFRM	LTI	MIP	P	PTOWB	RD
STD			•	•	•					STD		•
RECTKALL RECTKBK	RECTKL RECTKR	RT	SCPDRW	TD	TOTSS TOTSSS	TVRAV TVRFV TVRVV	VACL VACR	VACTK	VTK	WLI		
•	•						•	•	•			

Construction Upgrades

APC	ET	PE
STD		

Door Options

CG	DPSRR

BASE MICROWAVE CABINET, SINGLE or DOUBLE DOOR, 46 1/2" HIGH

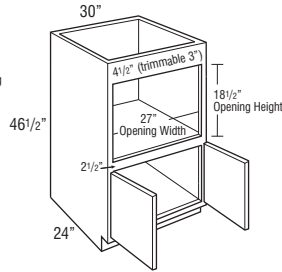
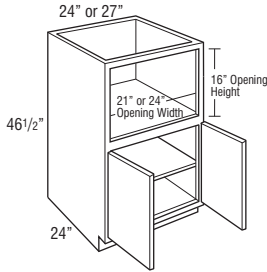
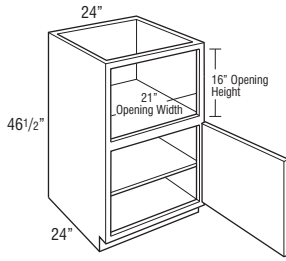

Model	Opening Width	Maximum Width	Opening Height	Maximum Height
BMW2448 L or R	21"	22 1/2"	16"	16"
BMW2448	21"	22 1/2"	16"	16"
BMW2748	24"	25 1/2"	16"	16"
BMW3048	27"	28 1/2"	18 1/2"	21 1/2"

Model	Cubic Feet
BMW2448 L or R	17.6
BMW2448	17.6
BMW2748	19.3
BMW3048	22.3

- Hardwood veneer on plywood with matching veneer interior.
- Finished interior standard.
- Reinforced plywood floor.

Custom Modifications

AUTHL	AUTHR	CBO	CCO	CFNT0	CFP	CFRMO	CMAT	CND	DRT	DRWPWR	DRWTK	EXBKL	EXBKR	EXL	EXR	
•	•	•	•	•	•	•					•	•	•	•	•	
FB	FD	FFDL	FFDR	FPEB	FTK	FTKAV	FTKRV	ID	INVFRM	LTI	MIP	P	PTOWB	RD		
STD			•	•	•	•	•	•		•	STD				•	
RECTKALL	RECTKLBK	RECTKLR	RECTKR	RT	SCPDRW	TD	TOTSS	TOTSSS	TVRAV	TVRFV	TVRVV	VACL	VACR	VACTK	VTK	WLI
•	•											•	•	•		

Construction Upgrades

APC	ET	PE
		STD

Door Options

CG	DPSRR
•	•

BASE MICROWAVE CABINET with ROLL TRAY, 46 1/2" HIGH

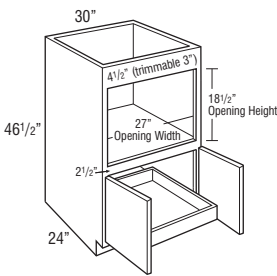
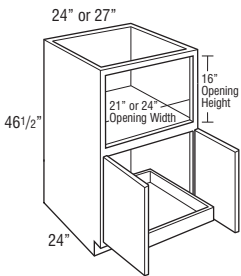
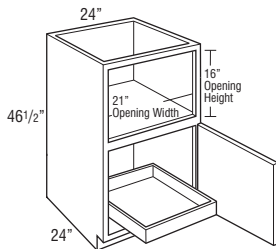

Model	Opening Width	Maximum Width	Opening Height	Maximum Height
BMW2448RT L or R	21"	22 1/2"	16"	16"
BMW2448RT	21"	22 1/2"	16"	16"
BMW2748RT	24"	25 1/2"	16"	16"
BMW3048RT	27"	28 1/2"	18 1/2"	21 1/2"

Model	Cubic Feet
BMW2448RT L or R	17.6
BMW2448RT	17.6
BMW2748RT	19.3
BMW3048RT	22.3

- Hardwood veneer on plywood with matching veneer interior.
- Finished interior standard.
- Reinforced plywood floor.

Custom Modifications

AUTHL	AUTHR	CBO	CCO	CFNT0	CFP	CFRMO	CMAT	CND	DRT	DRWPWR	DRWTK	EXBKL	EXBKR	EXL	EXR	
•	•	•	•	•	•	•					•	•	•	•	•	
FB	FD	FFDL	FFDR	FPEB	FTK	FTKAV	FTKRV	ID	INVFRM	LTI	MIP	P	PTOWB	RD		
STD			•	•	•	•	•	•		•	STD				•	
RECTKALL	RECTKLBK	RECTKLR	RECTKR	RT	SCPDRW	TD	TOTSS	TOTSSS	TVRAV	TVRFV	TVRVV	VACL	VACR	VACTK	VTK	WLI
•	•											•	•	•		

Construction Upgrades

APC	ET	PE
		STD

Door Options

CG	DPSRR
•	•

BASE CORNER PENINSULA

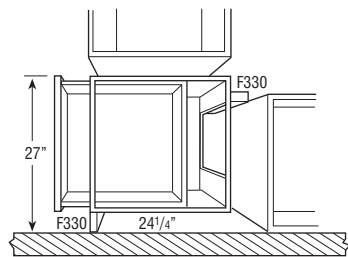

BCP24 L or R
BCP24

Model	Cubic Feet
BCP24 L or R	16.2
BCP24	14.4

- Cabinet width is 24".
- Adjustable full depth shelf.
- Includes two 3" fillers, shipped unattached. Fillers are required for drawer and door opening clearance of adjacent cabinets.
- Unfinished toekick on front (B24) and back (BCP) of cabinet.
- Will not accept roll trays.
- Peninsula base cabinets are 1/4" deeper to allow back paneling application on adjacent cabinets in a run with standard 24" deep cabinets.

Custom Modifications

AUTHL AUTHR	CBO	CCO	CFNT0	CFP	CFRMO	CMAT	CND	DRT	DRWPWR	DRWTK	EXBKL EXBKR	EXL EXR
•	•	•	•	•	•		•					•
FB	FD	FFDL FFDR	FPEB	FTK	FTKAV FTKEV	ID	INVFRM	LTI	MIP	P	PTOWB	RD
•			•	•	•			•	•		STD	•
RECTKALL RECTKBK	RECTKL RECTKR	RT	SCPRW	TD	TOTSS TOTSSS	TVRAV TVRFV TVRVV	VACL VACR	VACTK	VTK	WLI		
STD*	•							•	•	•		

*RECTKALL not available

Construction Upgrades

APC	ET	PE
•		•

Door Options

CG	DPSRR
•	•

BASE CORNER PENINSULA with FULL HEIGHT DOOR

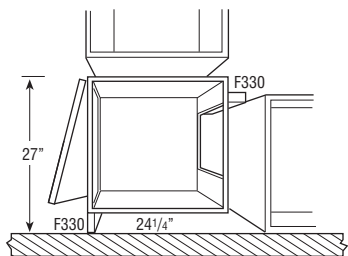

BCP24FH L or R

Model	Cubic Feet
BCP24FH L or R	16.2
BCP24FH	14.4

- Cabinet width is 24".
- Adjustable full depth shelf.
- Includes two 3" fillers, shipped unattached. Fillers are required for drawer and door opening clearance of adjacent cabinets.
- Unfinished toekick on front (B24) and back (BCP) of cabinet.
- Will not accept roll trays.
- Peninsula base cabinets are 1/4" deeper to allow back paneling application on adjacent cabinets in a run with standard 24" deep cabinets.

Custom Modifications

AUTHL AUTHR	CBO	CCO	CFNT0	CFP	CFRMO	CMAT	CND	DRT	DRWPWR	DRWTK	EXBKL EXBKR	EXL EXR
•	•	•	•	•	•		•					•
FB	FD	FFDL FFDR	FPEB	FTK	FTKAV FTKEV	ID	INVFRM	LTI	MIP	P	PTOWB	RD
•			•	•	•			•	•		STD	•
RECTKALL RECTKBK	RECTKL RECTKR	RT	SCPRW	TD	TOTSS TOTSSS	TVRAV TVRFV TVRVV	VACL VACR	VACTK	VTK	WLI		
STD*	•							•	•	•		

*RECTKALL not available

Construction Upgrades

APC	ET	PE
•		•

Door Options

CG	DPSRR
•	•

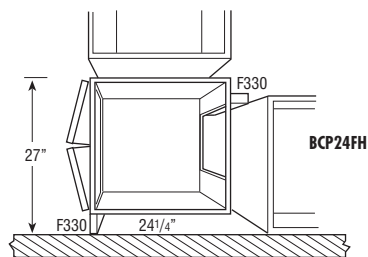

BCP24FH

BASE QUARTER ROUND END SHELF

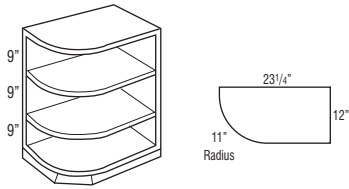

Model	Cubic Feet
BQRES	7.8

- Reversible.
- 12" wide x 23 1/4" deep x 11" radius.
- Separate pedestal base included.
- Angled pedestal design allows easier application of matching toeboard.
- Veneer construction finished to match cabinet face frame.
- Hardwood veneer on a 3/4" furniture board core.
- Matching interior.
- Cabinet is to be installed behind the face frame of the adjacent 24" deep base cabinet, features two unfinished back panels.
- If ordered with Heirloom Technique, will not feature sand-through characteristics.

MODIFICATIONS
No modifications available for these products.

Construction Upgrades

APC	ET	PE
•		

BASE OPEN CABINET with PLAIN BACK

15", 18", 24", 30", or 36"

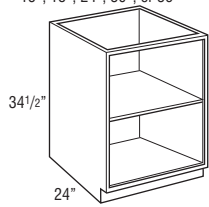

BOCP15	9.4
BOCP18	11.0
BOCP24	14.3
BOCP30	17.6
BOCP36	20.9

- Matching interior.
- Hardwood veneer plywood finished to match cabinet face frame.
- Face frame has a profiled inside edge.
- If ordered with Heirloom Technique, will not feature sand-through characteristics.
- To change the top rail valance, specify one of the following modifications: Arch (TVRAV), Furniture (TVRFV), or Straight Valance (TVRVV).

Custom Modifications

AUTHL	CBO	CCO	CFNTO	CFP	CFRMO	CMAT	CND	DRT	DRWPWR	DRWTK	EXBKL	EXL
•	STD				•					•*	•	•
FB	FD	FFDL	FPEB	FTK	FTKAV	ID	INVFRM	LTI	MIP	P	PTOWB	RD
STD	STD		•	•	•	•			STD	•		•
RECTKALL	RECTKL		SCPDRW	TD	TOTSS	TVRAV	VACL	VACTK	VTK	WLI		
RECTKBK	RECTKR	RT			TOTSSS	TVRFV	VACR					
•	•					•	•*	•*	•			

*Not available on 15" wide *Not available on 15" and 18" wide

Construction Upgrades

APC	ET	PE
		STD

Door Options

CG	DPSRR

BASE OPEN CABINET with BEADED BACK

15", 18", 24", 30", or 36"

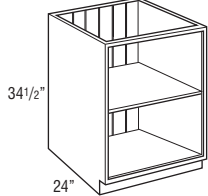

Model	Cubic Feet
BOCB15	9.4
BOCB18	11.0
BOCB24	14.3
BOCB30	17.6
BOCB36	20.9

- Matching interior.
- Beaded back panel is hardwood veneer on furniture board core.
- Hardwood veneer plywood finished to match cabinet face frame.
- Face frame has a profiled inside edge.
- If ordered with Heirlooming Technique, will not feature sand-through characteristics.
- To change the top rail valance, specify one of the following modifications: Arch (TVRAV), Furniture (TVRFV), or Straight Valance (TVRVV).

Custom Modifications

AUTHL AUTHR	CBO	CCO	CFNT0	CFP	CFRMO	CMAT	CND	DRT	DRWPPWR	DRWTK	EXBKL EXBKR	EXL EXR
•	STD				•					•*	•	•
FB	FD	FFDL FFDR	FPEB	FTK	FTKAV FTKFV	ID	INVFRM	LTI	MIP	P	PTOWB	RD
STD	STD		•	•	•	•			STD	•		•
RECTKALL RECTKBK	RECTKL RECTKR	RT	SCPDRW	TD	TOTSS TOTSSS	TVRAV TVRFV TVRVV	VACL VACR	VACTK	VTK	WLI		
•						•	•+	•*	•			

*Not available on 15" wide *Not available on 15" and 18" wide

Construction Upgrades

APC	ET	PE
		STD

Door Options

CG	DPSRR

BASE OPEN CABINET with PLAIN BACK and DRAWER

15", 18", 24", 30", or 36"

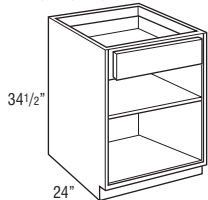

BODP15	9.4
BODP18	11.0
BODP24	14.3
BODP30	17.6
BODP36	20.9

- Matching interior.
- Hardwood veneer plywood finished to match cabinet face frame.
- If ordered with Heirlooming Technique, will not feature sand-through characteristics.
- To change the top rail valance, specify one of the following modifications: Arch (TVRAV), Furniture (TVRFV), or Straight Valance (TVRVV).

Custom Modifications

AUTHL AUTHR	CBO	CCO	CFNT0	CFP	CFRMO	CMAT	CND	DRT	DRWPPWR	DRWTK	EXBKL EXBKR	EXL EXR
•	STD				•				•*	•*	•	•
FB	FD	FFDL FFDR	FPEB	FTK	FTKAV FTKFV	ID	INVFRM	LTI	MIP	P	PTOWB	RD
STD	STD		•	•	•	•			STD	•		•
RECTKALL RECTKBK	RECTKL RECTKR	RT	SCPDRW	TD	TOTSS TOTSSS	TVRAV TVRFV TVRVV	VACL VACR	VACTK	VTK	WLI		
•	•		•			•	•+	•*	•			

*Not available on 15" wide *Not available on 15" and 18" wide

Construction Upgrades

APC	ET	PE

Door Options

CG	DPSRR

BASE OPEN CABINET with BEADED BACK and DRAWER

15", 18", 24", 30", or 36"

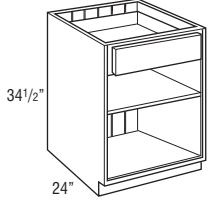

Model	Cubic Feet
BODB15	9.4
BODB18	11.0
BODB24	14.3
BODB30	17.6
BODB36	20.9

- Matching interior.
- Beaded back panel is hardwood veneer on furniture board core.
- Hardwood veneer plywood finished to match cabinet face frame.
- If ordered with Heirloom Technique, will not feature sand-through characteristics.
- To change the top rail valance, specify one of the following modifications: Arch (TVRAV), Furniture (TVRFV), or Straight Valance (TVRVV).

Custom Modifications

AUTHL AUTHR	CBO	CCO	CFNTO	CFP	CFRMO	CMAT	CND	DRT	DRWPWR	DRWTK	EXBKL EXBKR	EXL EXR
•	STD				•				•*	•*	•	•
FB	FD	FFDL FFDR	FPEB	FTK	FTKAV FTKFV	ID	INVFRM	LTI	MIP	P	PTOWB	RD
STD	STD		•	•	•	•			STD	•		•
RECTKALL RECTKBK	RECTKLL RECTKRR	RT	SCPDWR	TD	TOTSS TOTSSS	TVRAV TVRFV TVRVV	VACL VACR	VACTK	VTK	WLI		
•	•		•			•	•*	•*	•			

*Not available on 15" wide *Not available on 15" and 18" wide

Construction Upgrades

APC	ET	PE

Door Options

CG	DPSRR

All UD Cabinets are 32 1/2" high unless otherwise noted.

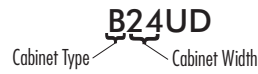

CUSTOM MODIFICATIONS			
Mod.	Description	Mod.	Description
CBO	Cabinet Box Only	EXR	Extended Shile - Right
CCO	Cabinet Case Only	FB	Finished Ends
CFNTO	Cabinet Front Only	FD	Full Depth Shelf
CFP	Cabinet False Panel	FPEB	Furniture Finished Plywood Ends
CFRMO	Cabinet Frame Only	ID	Increased Depth
CND	Cabinet with No Door, with Drawer	MIP	Matching Interior Plywood
DRT	Deep Roll Tray	RD	Reduced Depth
EXB	Extended Shiles - Both	RT	Installed Roll Tray
EXL	Extended Shile - Left	SCPDRW	Scooped Drawer
		VTK	Void Toe Kick

CONSTRUCTION UPGRADES	
Mod.	Description
APC	All Plywood Construction
3/4X	Dovetail Drawer Undermount
PE	Plywood Ends

MODIFICATIONS GRID KEY	
•	Available
STD	Standard on these cabinets
5 DAY	5 Day Express Response Item

UNIVERSAL DESIGN BASE, SINGLE DOOR

12", 15", 18", or 21"

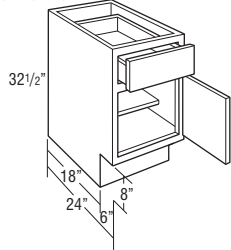

Model	Cubic Feet
B12UD L or R	6.7
B15UD L or R	8.2
B18UD L or R	9.7
B21UD L or R	12.7

- Adjustable 15" deep shelf.
- Optional roll tray kit available for field installation. Not available on B12UD.

Custom Modifications

CBO	CCO	CFNTO	CFP	CFRMO	CND	DRT	EXB	EXL	EXR
•	•	•	•	•	•		•	•	•
FB	FD	FPEB	ID	MIP	RD	RT	SCPDRW	VTK	
•	•	•		•	•	•	•	•	•

Construction Upgrades

APC	3/4X	PE
•	•	•

UNIVERSAL DESIGN BASE, DOUBLE DOOR

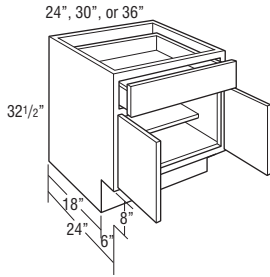

Model	Cubic Feet
B24UD	14.2
B30UD	15.8
B36UD	16.8

- Adjustable 15" deep shelf.
- Optional roll trays kit available for field installation.

Custom Modifications

CBO	CCO	CFNTO	CFP	CFRMO	CND	DRT	EXB	EXL EXR
•	•	•	•	•	•	•	•	•
FB	FD	FPEB	ID	MIP	RD	RT	SCPDRW	VTK
•	•	•	•	•	•	•	•	•

Construction Upgrades

APC	3/4X	PE
•	•	•

UNIVERSAL DESIGN BASE with ROLL TRAY, SINGLE DOOR

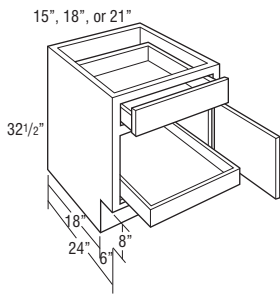

B15RTUD L or R	8.2
B18RTUD L or R	9.7
B21RTUD L or R	12.7

- 1 roll tray standard.

Custom Modifications

CBO	CCO	CFNTO	CFP	CFRMO	CND	DRT	EXB	EXL EXR
•	•	•	•	•	•	•	•	•
FB	FD	FPEB	ID	MIP	RD	RT	SCPDRW	VTK
•	•	•	•	•	•	•	•	•

Construction Upgrades

APC	3/4X	PE
•	•	•

UNIVERSAL DESIGN BASE with ROLL TRAY, DOUBLE DOOR

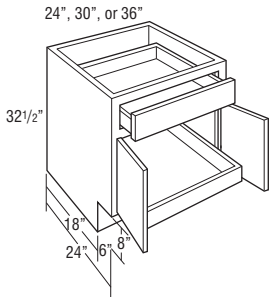

B24RTUD	14.2
B30RTUD	15.8
B36RTUD	16.8

- 1 roll tray standard.
- Top of drawer is 2" from top of cabinet to accommodate installation of a cook top.

Custom Modifications

CBO	CCO	CFNTO	CFP	CFRMO	CND	DRT	EXB	EXL EXR
•	•	•	•	•	•	•	•	•
FB	FD	FPEB	ID	MIP	RD	RT	SCPDRW	VTK
•	•	•	•	•	•	•	•	•

Construction Upgrades

APC	3/4X	PE
•	•	•

UNIVERSAL DESIGN SINK BASE

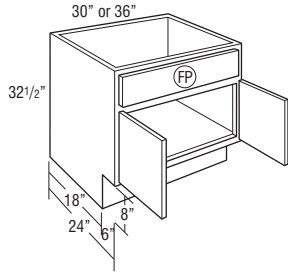

Ⓢ = False Panel

Model	Cubic Feet
SB30UD	15.8
SB36UD	16.8

- Mini Touch-Up Kit (MTUK) included. MTUK includes small touch-up marker and small fill stick.

Custom Modifications

CBO	CCO	CFNTO	CFP	CFRMO	CND	DRT	EXB	EXL EXR
•	•	•	STD	•	•		•	•
FB	FD	FPEB	ID	MIP	RD	RT	SCPDRW	VTK
•	•	•		•	•			•

Construction Upgrades

APC	3/4X	PE
•		•

UNIVERSAL DESIGN SINK BASE with TILT DOWNS

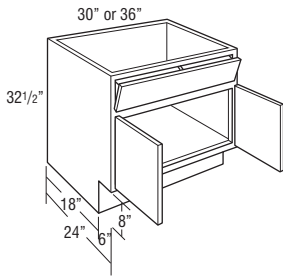

Model	Cubic Feet
SB30STUD	15.8
SB36STUD	16.8

- Tilt-out trays are stain resistant, moisture resistant plastic to allow storage of sponges and other cleaning materials.
- Mini Touch-Up Kit (MTUK) included. MTUK includes small touch-up marker and small fill stick.
- Includes two tilt-out trays.
- Tilt-out trays are also available as an accessory for field installation. See page 412.

Custom Modifications

CBO	CCO	CFNTO	CFP	CFRMO	CND	DRT	EXB	EXL EXR
	•	•		•			•	•
FB	FD	FPEB	ID	MIP	RD	RT	SCPDRW	VTK
•		•		•	•			•

Construction Upgrades

APC	3/4X	PE
•		•

UNIVERSAL DESIGN SUPER LAZY SUSAN

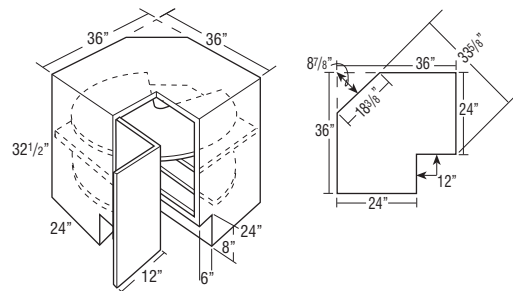

Due to fixed shelf mounting, shelves cannot be retrofitted.

Model	Cubic Feet
SLS36UD L or R	27.7

- SLS36UD L or R wall width is 36" x 36".
- Features two plywood revolving shelves with a 1" plywood lip. Lower shelf is mounted to floor. Upper shelf is mounted to fixed shelf. Fixed shelf is 3/4" thick laminated furniture board.
- Decorative hardware screws must be countersunk to prevent scratching adjacent cabinets and face frame of SLS.
- Seville door panels feature a unique raised profile due to the narrow panel width.
- Integrated soft close hinge not included.

Custom Modifications

CBO	CCO	CFNTO	CFP	CFRMO	CND	DRT	EXB	EXL EXR
•	•							
FB	FD	FPEB	ID	MIP	RD	RT	SCPDRW	VTK
•		•		•				•

Construction Upgrades

APC	3/4X	PE
•		•

UNIVERSAL DESIGN THREE DRAWER BASE

15", 18", or 24"

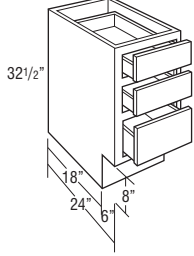

Model	Cubic Feet
3DB15UD	8.2
3DB18UD	9.7
3DB24UD	14.2

- 1 deep and 2 shallow drawers.

Custom Modifications

CBO	CCO	CFNTO	CFP	CFRMO	CND	DRT	EXB	EXL EXR
•	•		•	•			•	•
FB	FD	FPEB	ID	MIP	RD	RT	SCPDRW	VTK
•		•		•	•		•	•

Construction Upgrades

APC	3/4X	PE
•	•	•

UNIVERSAL DESIGN BASE MICROWAVE

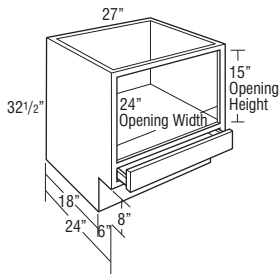

BMW27UD	15.7
----------------	------

- 1 shallow drawer below microwave.
- Microwave opening is 24" wide x 15" high.

Custom Modifications

CBO	CCO	CFNTO	CFP	CFRMO	CND	DRT	EXB	EXL EXR
•	•	•		•			•	•
FB	FD	FPEB	ID	MIP	RD	RT	SCPDRW	VTK
•	STD	•		STD	•			•

Construction Upgrades

APC	3/4X	PE
	•	

UNIVERSAL DESIGN SINGLE OVEN CABINET, 84" TALL, 24" DEEP

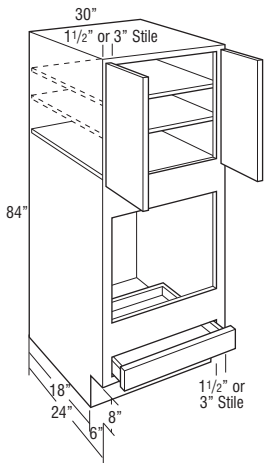

OC308424UD(N)	41.8
----------------------	------

- N represents Narrow Stile cabinets with 1 1/2" wide face frame side stiles and ACS modification availability (see page 39 for ACS specifications). Doors and drawer fronts have a consistent width reveal for full overlay (1/4") and partial overlay (1") and use standard Smart Stop hinges.
- On cabinets with 3" wide face frame side stiles, full overlay styles have a consistent 1/4" width frame reveal and use face mounted Smart Stop hinges. Partial overlay styles have a larger 2 1/2" width reveal, use standard Smart Stop hinges, and are not recommended for stacking applications due to misalignment of door width with cabinets above.
- Two full depth adjustable shelves are included.
- All top and bottom cross rails are 1 1/2" wide.
- Cabinet has 3" stiles on frame.
- Be sure to confirm a heat shield is built into your appliance.
- For built-in appliance support, OCINSTALLKIT is included in 24" deep oven cabinets (see page 410 for details). Oven install kit will not be included when depth is modified.
- Maximum cut-out dimension will allow 1/4" reveal for doors and drawer fronts on full overlay and 1" for partial overlay for trim kit face clearance.

	A Frame Opening Height	B Cut-Out Width		C Cut-Out Height		Door Height (Upper Section)	
		Min.	Max.	Min.	Max.	Partial Overlay	Full Overlay
OC308424UD	27"	24"	28 1/2"	28 1/2"	44 1/2"	28"	29 1/2"

	A Frame Opening Height	B Cut-Out Width (standard)		B Cut-Out Width (with ACS modification)			C Cut-Out Height		Door Height (Upper Section)	
		Min.	Max.	Min.	Max.	Max. w/ Field Cut	Min.	Max.	Partial Overlay	Full Overlay
OC308424UDN	27"	27"	28 1/2"	24"	27"	28 1/2"	23 1/2"	38 1/2"	28"	29 1/2"

Custom Modifications

ACS	CBO	CCO	CFNTO	CFP	CFRMO	CMAT	CND	DRT	DRWPWR	EXBKL EXBKR	EXL EXR	FB
•*	•	•			•		•			•	•	•
FD	FPEB	ID	LTI	MIP	RD	RT	SCPDRW	TOTSS TOTSSS	VTK	WLI		
•	•	•		•	•				•	•		

*Only available on Narrow Stile (N) cabinets

Construction Upgrades

APC	PE
•	•

Door Options

DPSRR	MFO
•	•

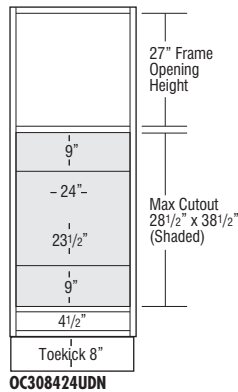
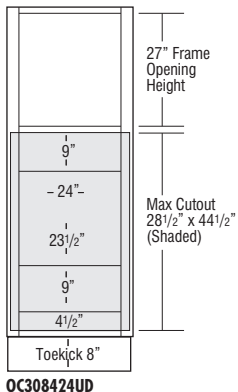

OC308424UD

OC308424UDN

UNIVERSAL DESIGN FILLER

3" and 6" Wide Fillers

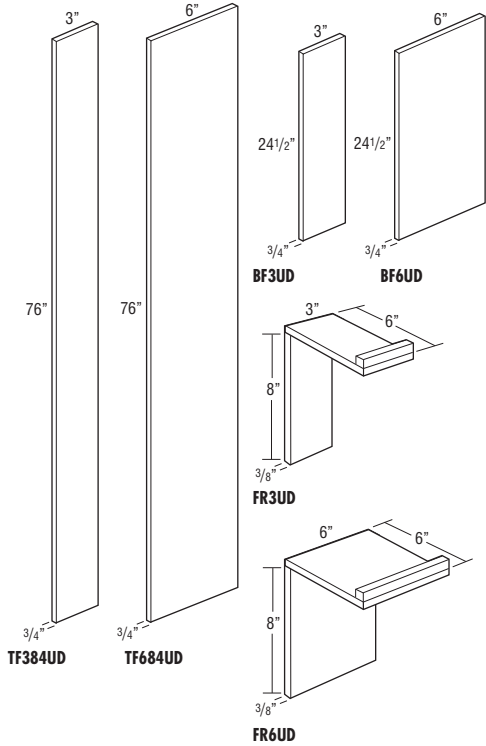

Model	Cubic Feet
BF3UD	—
TF384UD	—
FR3UD	—
BF6UD	—
TF684UD	—
FR6UD	—

- If ordered with Heirlooming Technique, will not feature sand-through characteristics.

MODIFICATIONS
No modifications available for these products.

UNIVERSAL DESIGN VANITY DESK LEG

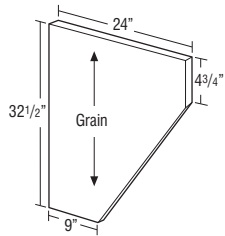

VDLUDWD	—
---------	---

- 3/4" thick veneered plywood.
- All panels are finished two sides and front edge.
- If ordered with Heirlooming Technique, will not feature sand-through characteristics.

MODIFICATIONS
No modifications available for these products.

UNIVERSAL DESIGN TOEBOARD

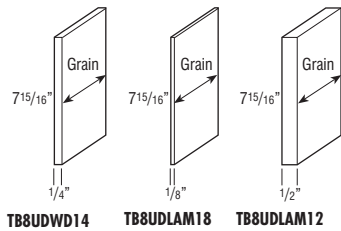

TB8UDWD14	—
TB8UDLAM18	—
TB8UDLAM12	—

- TB8UDWD14 is 1/4" plywood finished veneer, one 8" section.
- TB8UDLAM18 is 1/8" laminated hardboard, one 8" section.
- TB8UDLAM12 is 1/2" laminated hardboard, one 8" section.
- On TB8UDWD14, if ordered with Heirlooming Technique, will not feature sand-through characteristics.
- Laminate panels available only in White. Distressing not available.

MODIFICATIONS
No modifications available for these products.

TALL CABINET NOMENCLATURE

Cabinet nomenclature with AH represents upper sections with doors that align with 24" or 27" high cabinets.

U248424



MODIFICATIONS GRID KEY

- Available
- STD Standard on these cabinets
- storage SOLUTIONS Storage Solutions Organization Cabinet

NOTE:

Any included shelves on tall cabinets are packaged separately.

CUSTOM MODIFICATIONS

Mod.	Description	Mod.	Description	Mod.	Description
ACS	Appliance Cut-out, Single	EXBKL	End Extended Back - Left	FTKFV	Flush Toekick Furniture
ADDTK	Add Toekick	EXBKR	End Extended Back - Right	ID	Increased Depth
AUTHL	Authentic End - Left	EXL	Extended Shle - Left	INVFRM	Inverted Frame
AUTHR	Authentic End - Right	EXR	Extended Shle - Right	MIP	Matching Interior Plywood
CBO	Cabinet Box Only	FB	Finished Ends	RD	Reduced Depth
CCO	Cabinet Case Only	FFDL	Face Frame and Door on End - Left	RECTKL	Recessed Toekick - Left
CFNTO	Cabinet Front Only			RECTKR	Recessed Toekick - Right
CFRMO	Cabinet Frame Only	FFDR	Face Frame and Door on End - Right	RT	Installed Roll Tray
CND	Cabinet with No Door, with Drawer	FPEB	Furniture Finished Plywood Ends	TD	Tray Dividers
DRT	Deep Roll Tray	FTK	Flush Toekick	TKP	Loose Toekick
DRWTK	Toekick Drawer	FTKAV	Flush Toekick Arch	VTK	Void Toekick
				WLI	White Laminate Interior

CONSTRUCTION UPGRADES

Mod.	Description
APC	All Plywood Construction
ET	EasyTrax™
PE	Plywood Ends

DOOR OPTIONS

Mod.	Description
CG.TOP	Cut for Glass Doors
DPSRR	Door Panel - Solid Reverse Raised
MFO	Modified Full Overlay

UTILITY, 84", 87", 90", 93", or 96" TALL, 12" DEEP

9", 12", 15", 18", 21", or 24"

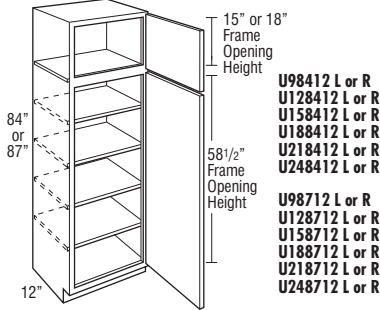

24", 27", 30", 33", or 36"

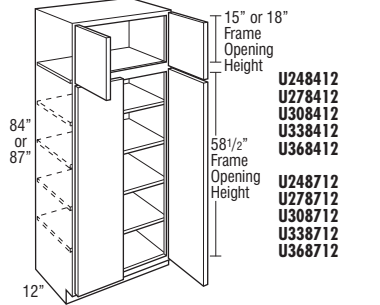

Model	Cubic Feet	Model	Cubic Feet
U98412 L or R	7.5	U98712 L or R	7.8
U128412 L or R	9.7	U128712 L or R	10.0
U158412 L or R	11.8	U158712 L or R	12.3
U188412 L or R	14.0	U188712 L or R	14.5
U218412 L or R	16.1	U218712 L or R	16.7
U248412 L or R	18.3	U248712 L or R	18.9
U248412	18.3	U248712	18.9
U278412	20.4	U278712	21.2
U308412	22.6	U308712	23.4
U338412	24.8	U338712	25.6
U368412	26.9	U368712	27.8

- Utility cabinets with depths of 12" or less must be installed to wall studs or onto the end of another tall cabinet.
- Depth can be reduced to a minimum of 6". For depths of 6"-8", cabinet will not include toekick/pedestal.
- Tall non-mitered doors will have two center panels with cross rail.
- Troxel doors greater than 48" high will be two doors doweled together.
- Utility cabinets with depths of 12" or less must be installed to wall studs or onto the end of another tall cabinet.
- Depth can be reduced to a minimum of 6". For depths of 6"-8", cabinet will not include toekick/pedestal.
- Tall non-mitered doors will have two center panels with cross rail.
- Troxel doors greater than 48" high will be two doors doweled together.

Custom Modifications

ACS	ADDTK	AUTHL	AUTHR	CBO	CCO	CFNTO	CFRMO	CND	DRT	DRWTK	EXBKL	EXBKR	EXL	EXR	FB	FFDL	FFDR
			•	•	•	•	•				•	•	•	•	•	•	•
			FTKAV	FTKFV	ID	INVFRM	MIP	RD	RECTKL	RECTKR	RT	TD	TKP	VTK	WLI		
•	•	•*				•	•	•	•	•	•	•	•	•	•	•	•

*Not available on 9" and 12" wide

Construction Upgrades

APC	ET	PE
•		•

Door Options

CG.TOP	DPSRR	MFO
•	•	•

UTILITY, 84", 87", 90", 93", or 96" TALL, 12" DEEP (cont'd)

9", 12", 15", 18", 21", or 24"

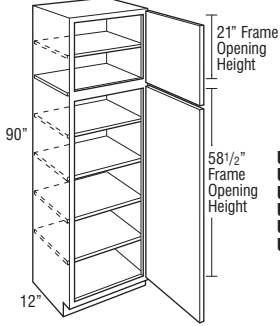

U99012AH L or R
U129012AH L or R
U159012AH L or R
U189012AH L or R
U219012AH L or R
U249012AH L or R

24", 27", 30", 33", or 36"

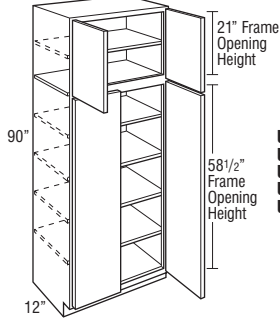

U249012AH
U279012AH
U309012AH
U339012AH
U369012AH

Model	Cubic Feet
U99012AH L or R	8.1
U129012AH L or R	10.4
U159012AH L or R	12.7
U189012AH L or R	15.0
U219012AH L or R	17.3
U249012AH L or R	19.6
U249012AH	19.6
U279012AH	21.9
U309012AH	24.2
U339012AH	26.5
U369012AH	28.8

- AH represents upper section alignment with doors on 24" or 27" high cabinets.
- Utility cabinets with depths of 12" or less must be installed to wall studs or onto the end of another tall cabinet.
- Depth can be reduced to a minimum of 6". For depths of 6"-8", cabinet will not include toekick/pedestal.
- Tall non-mitered doors will have two center panels with cross rail.
- Troxel doors greater than 48" high will be two doors doweled together.

Custom Modifications

ACS	ADDTK	AUTHL AUTHR	CBO	CCO	CFNTO	CFRMO	CND	DRT	DRWTK	EXBKL EXBKR	EXL EXR	FB	FFDL FFDR
		•	•	•	•	•				•	•	•	•
FPEB	FTK	FTKAV FTKFV	ID	INVFRM	MIP	RD	RECTKL RECTKR	RT	TD	TKP	VTK	WLI	
•	•	•*		•	•	•	•		•	•	•	•	

*Not available on 9" and 12" wide

Construction Upgrades

APC	ET	PE
•		•

Door Options

CG.TOP	DPSRR	MFO
•	•	•

UTILITY, 84", 87", 90", 93", or 96" TALL, 12" DEEP (cont'd)

9", 12", 15", 18", 21", or 24"

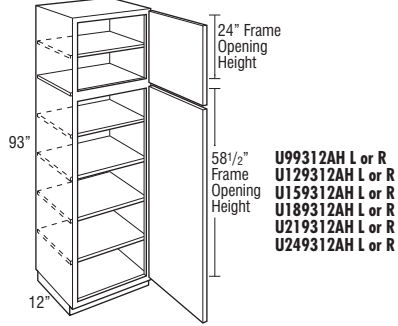

U99312AH L or R
U129312AH L or R
U159312AH L or R
U189312AH L or R
U219312AH L or R
U249312AH L or R

24", 27", 30", 33", or 36"

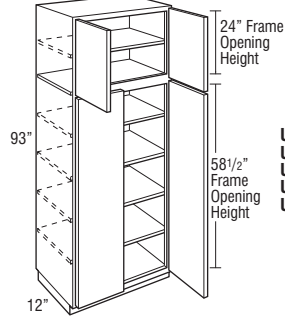

U249312AH
U279312AH
U309312AH
U339312AH
U369312AH

9", 12", 15", 18", 21", or 24"

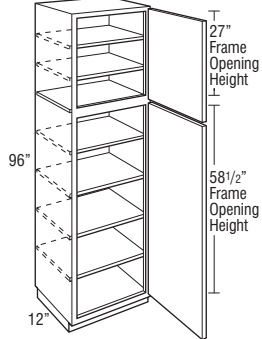

U99612 L or R
U129612 L or R
U159612 L or R
U189612 L or R
U219612 L or R
U249612 L or R

24", 27", 30", 33", or 36"

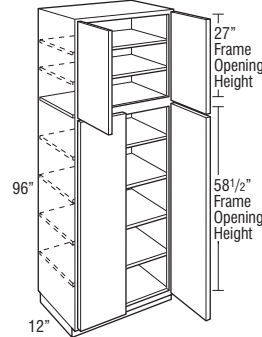

U249612
U279612
U309612
U339612
U369612

Model	Cubic Feet
U99312AH L or R	8.3
U129312AH L or R	10.7
U159312AH L or R	13.1
U189312AH L or R	15.5
U219312AH L or R	17.8
U249312AH L or R	20.2
U249312AH	20.2
U279312AH	22.6
U309312AH	25.0
U339312AH	27.4
U369312AH	29.7

Model	Cubic Feet
U99612 L or R	8.6
U129612 L or R	11.0
U159612 L or R	13.5
U189612 L or R	16.0
U219612 L or R	18.4
U249612 L or R	20.9
U249612	20.9
U279612	23.3
U309612	25.8
U339612	28.2
U369612	30.7

- AH represents upper section alignment with doors on 24" or 27" high cabinets.
- Separate pedestal base included but packaged separately on 93" tall. Pedestal is designed to create a Recessed Left or Right Toekick application during field installation, or can be centered. Pedestal must be covered with toeboard material.
- Utility cabinets with depths of 12" or less must be installed to wall studs or onto the end of another tall cabinet.
- Depth can be reduced to a minimum of 6". For depths of 6"-8", cabinet will not include toekick/pedestal.
- Tall non-mitered doors will have two center panels with cross rail.
- Troxel doors greater than 48" high will be two doors doweled together.

- Separate pedestal base included but packaged separately on 96" tall. Pedestal is designed to create a Recessed Left or Right Toekick application during field installation, or can be centered. Pedestal must be covered with toeboard material.
- Utility cabinets with depths of 12" or less must be installed to wall studs or onto the end of another tall cabinet.
- Depth can be reduced to a minimum of 6". For depths of 6"-8", cabinet will not include toekick/pedestal.
- Tall non-mitered doors will have two center panels with cross rail.
- Troxel doors greater than 48" high will be two doors doweled together.

Custom Modifications

ACS	ADDTK	AUTHL AUTHR	CBO	CCO	CFNTD	CFRMO	CND	DRT	DRWTK	EXBKL EXBKR	EXL EXR	FB	FFDL FFDR
		•	•	•	•	•				•	•	•	•
FPFB	FTK	FTKAV FTKEV	ID	INVFRM	MIP	RD	RECTKL RECTKR	RT	TD	TKP	VTK	WLI	
•				•	•	•	•		•			•	

Construction Upgrades

APC	ET	PE
•		•

Door Options

CG.TOP	DPSRR	MFO
•	•	•

UTILITY, 84", 87", 90", 93", or 96" TALL, 24" DEEP

9", 12", 15", 18", 21", or 24"

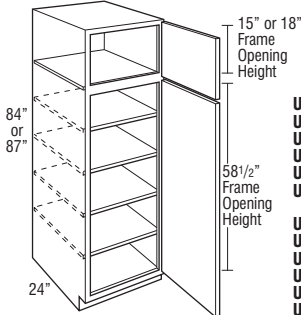

U98424 L or R
U128424 L or R
U158424 L or R
U188424 L or R
U218424 L or R
U248424 L or R

U98724 L or R
U128724 L or R
U158724 L or R
U188724 L or R
U218724 L or R
U248724 L or R

24", 27", 30", 33", or 36"

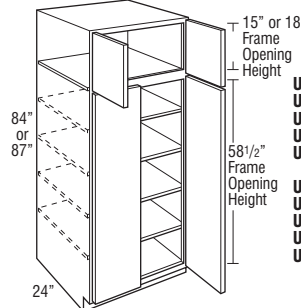

U248424
U278424
U308424
U338424
U368424

U248724
U278724
U308724
U338724
U368724

Model	Cubic Feet	Model	Cubic Feet
U98424 L or R	13.8	U98724 L or R	14.3
U128424 L or R	17.7	U128724 L or R	18.3
U158424 L or R	21.6	U158724 L or R	22.4
U188424 L or R	25.6	U188724 L or R	26.5
U218424 L or R	29.5	U218724 L or R	30.5
U248424 L or R	33.4	U248724	34.6
U248424	33.4	U248724	34.6
U278424	37.4	U278724	38.7
U308424	41.3	U308724	42.8
U338424	45.2	U338724	46.8
U368424	49.2	U368724	50.9

- Depth can be reduced to a minimum of 6". For depths of 6"-8", cabinet will not include toekick/pedestal.
- Tall non-mitered doors will have two center panels with cross rail.
- Troxel doors greater than 48" high will be two doors doweled together.

- Depth can be reduced to a minimum of 6". For depths of 6"-8", cabinet will not include toekick/pedestal.
- Tall non-mitered doors will have two center panels with cross rail.
- Troxel doors greater than 48" high will be two doors doweled together.

Custom Modifications

ACS	ADDTK	AUTHL AUTHR	CBO	CCO	CFNTO	CFRMO	CND	DRT	DRWTK	EXBKL EXBKR	EXL EXR	FB	FFDL FFDR
		•	•	•	•	•			•*	•	•	•	•
FPFB	FTK	FTKAV FTKFV	ID	INFRM	MIP	RD	RECTKL RECTKR	RT	TD	TKP	VTK	WLI	
•	•	•*	•	•	•	•	•	•▲	•	•	•	•	•

*Not available on 9", 12", and 15" wide *Not available on 9" and 12" wide ▲Not available on 9" wide

Construction Upgrades

APC	ET	PE
•		•

Door Options

CG.TOP	DPSRR	MFO
•	•	•

UTILITY, 84", 87", 90", 93", or 96" TALL, 24" DEEP (cont'd)

9", 12", 15", 18", 21", or 24"

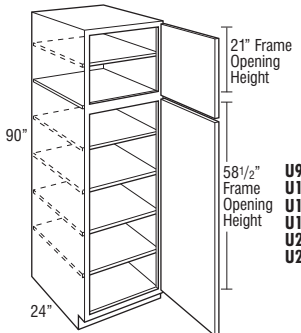

U99024AH L or R
U129024AH L or R
U159024AH L or R
U189024AH L or R
U219024AH L or R
U249024AH L or R

24", 27", 30", 33", or 36"

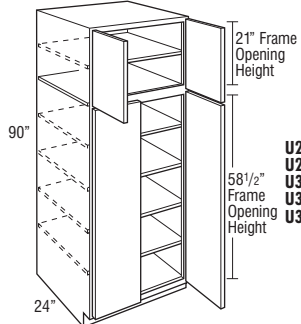

U249024AH
U279024AH
U309024AH
U339024AH
U369024AH

U99024AH L or R	14.7
U129024AH L or R	18.9
U159024AH L or R	23.2
U189024AH L or R	27.4
U219024AH L or R	31.6
U249024AH L or R	35.8
U249024AH	35.8
U279024AH	40.0
U309024AH	44.2
U339024AH	48.4
U369024AH	52.6

- AH represents upper section alignment with doors on 24" or 27" high cabinets.
- Depth can be reduced to a minimum of 6". For depths of 6"-8", cabinet will not include toekick/pedestal.
- Tall non-mitered doors will have two center panels with cross rail.
- Troxel doors greater than 48" high will be two doors doweled together.

Custom Modifications

ACS	ADDTK	AUTHL AUTHR	CBO	CCO	CFNTO	CFRMO	CND	DRT	DRWTK	EXBKL EXBKR	EXL EXR	FB	FFDL FFDR
		•	•	•	•	•			•*	•	•	•	•
FPFB	FTK	FTKAV FTKFV	ID	INFRM	MIP	RD	RECTKL RECTKR	RT	TD	TKP	VTK	WLI	
•	•	•*	•	•	•	•	•	•▲	•	•	•	•	•

*Not available on 9", 12", and 15" wide *Not available on 9" and 12" wide ▲Not available on 9" wide

Construction Upgrades

APC	ET	PE
•		•

Door Options

CG.TOP	DPSRR	MFO
•	•	•

UTILITY, 84", 87", 90", 93", or 96" TALL, 24" DEEP (cont'd)

9", 12", 15", 18", 21", or 24"

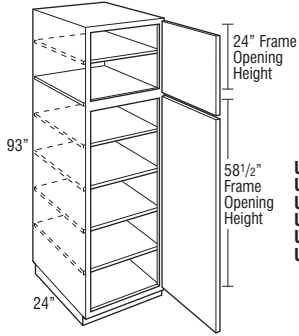

58 1/2" Frame Opening Height
U99324AH L or R
U129324AH L or R
U159324AH L or R
U189324AH L or R
U219324AH L or R
U249324AH L or R

24", 27", 30", 33", or 36"

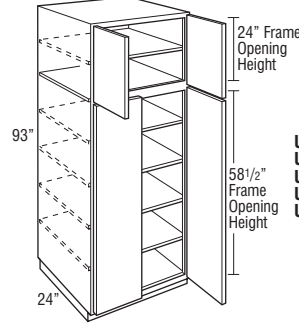

58 1/2" Frame Opening Height
U249324AH
U279324AH
U309324AH
U339324AH
U369324AH

9", 12", 15", 18", 21", or 24"

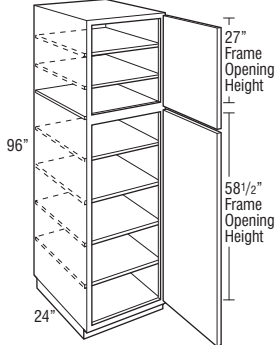

58 1/2" Frame Opening Height
U99624 L or R
U129624 L or R
U159624 L or R
U189624 L or R
U219624 L or R
U249624 L or R

24", 27", 30", 33", or 36"

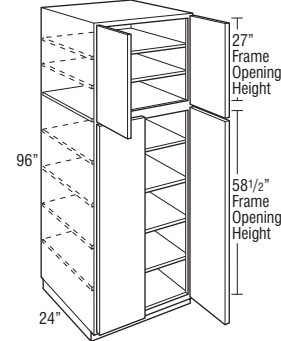

58 1/2" Frame Opening Height
U249624
U279624
U309624
U339624
U369624

Model	Cubic Feet
U99324AH L or R	15.2
U129324AH L or R	19.6
U159324AH L or R	23.9
U189324AH L or R	28.3
U219324AH L or R	32.6
U249324AH L or R	37.0
U249324AH	37.0
U279324AH	41.3
U309324AH	45.7
U339324AH	50.0
U369324AH	54.3

Model	Cubic Feet
U99624 L or R	15.7
U129624 L or R	20.2
U159624 L or R	24.7
U189624 L or R	29.2
U219624 L or R	33.6
U249624 L or R	38.1
U249624	38.1
U279624	42.6
U309624	47.1
U339624	51.6
U369624	56.1

- AH represents upper section alignment with doors on 24" or 27" high cabinets.
- Separate pedestal base included but packaged separately on 93" tall. Pedestal is designed to create a Recessed Left or Right Toekick application during field installation, or can be centered. Pedestal must be covered with toeboard material.
- Depth can be reduced to a minimum of 6". For depths of 6"-8", cabinet will not include toekick/pedestal.
- Tall non-mitered doors will have two center panels with cross rail.
- Troxel doors greater than 48" high will be two doors doweled together.

- Separate pedestal base included but packaged separately on 96" tall. Pedestal is designed to create a Recessed Left or Right Toekick application during field installation, or can be centered. Pedestal must be covered with toeboard material.
- Depth can be reduced to a minimum of 6". For depths of 6"-8", cabinet will not include toekick/pedestal.
- Tall non-mitered doors will have two center panels with cross rail.
- Troxel doors greater than 48" high will be two doors doweled together.

Custom Modifications

ACS	ADDTK	AUTHL AUTHR	CBO	CCO	CFNTO	CFRMO	CND	DRT	DRWTK	EXBKL EXBKR	EXL EXR	FB	FFDL FFDR
		•	•	•	•	•				•		•	•
FPEB	FTK	FTKAV FTKRV	ID	INVRM	MIP	RD	RECTKL RECTKR	RT	TD	TKP	VTK	WLI	
•			•	•	•	•	•	•*	•			•	

*Not available on 9" wide

Construction Upgrades

APC	ET	PE
•		•

Door Options

CG.TOP	DPSRR	MFO
•	•	•

UTILITY with ROLL TRAYS, 84", 87", 90", 93", or 96" TALL, 24" DEEP

12", 15", 18", 21", or 24"

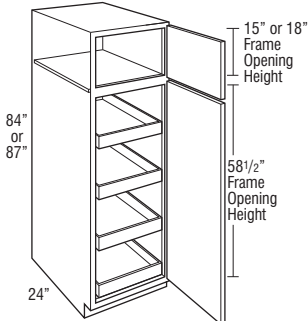

U128424RT L or R
U158424RT L or R
U188424RT L or R
U218424RT L or R
U248424RT L or R

U128724RT L or R
U158724RT L or R
U188724RT L or R
U218724RT L or R
U248724RT L or R

24", 27", 30", 33", or 36"

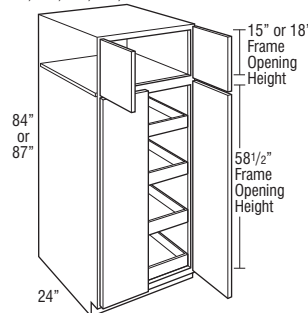

U248424RT
U278424RT
U308424RT
U338424RT
U368424RT

U248724RT
U278724RT
U308724RT
U338724RT
U368724RT

Model	Cubic Feet
U128424RT L or R	16.2
U158424RT L or R	21.6
U188424RT L or R	25.6
U218424RT L or R	29.5
U248424RT L or R	33.4
U248424RT	33.4
U278424RT	37.4
U308424RT	41.3
U338424RT	45.2
U368424RT	49.2

Model	Cubic Feet
U128724RT L or R	18.9
U158724RT L or R	22.4
U188724RT L or R	26.5
U218724RT L or R	30.5
U248724RT L or R	34.6
U248724RT	34.6
U278724RT	38.7
U308724RT	42.8
U338724RT	46.8
U368724RT	50.9

- Four roll trays are included, installed in cabinet.
- Depth can be reduced to a minimum of 12".
- Tall non-mitered doors will have two center panels with cross rail.
- Troxel doors greater than 48" high will be two doors doweled together.

- Four roll trays are included, installed in cabinet.
- Depth can be reduced to a minimum of 12".
- Tall non-mitered doors will have two center panels with cross rail.
- Troxel doors greater than 48" high will be two doors doweled together.

Custom Modifications

ACS	ADDTK	AUTHL AUTHR	CBO	CCO	CFNTO	CFRMO	CND	DRT	DRWTK	EXBKL EXBKR	EXL EXR	FB	FFDL FFDR
		•	•	•	•	•		•	•*	•	•	•	
FPFB	FTK	FTKAV FTKFV	ID	INFRM	MIP	RD	RECTKL RECTKR	RT	TD	TKP	VTK	WLI	
•	•	•			•	•	•		•	•	•	•	•

*Not available on 12" and 15" wide

Construction Upgrades

APC	ET	PE
•	•	•

Door Options

CG.TOP	DPSRR	MFO
•	•	•

UTILITY with ROLL TRAYS, 84", 87", 90", 93", or 96" TALL, 24" DEEP (cont'd)

12", 15", 18", 21", or 24"

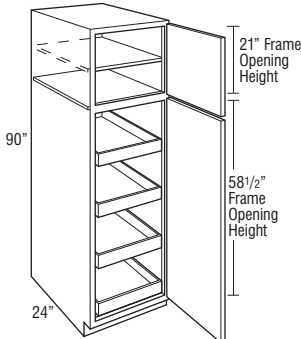

U129024RTAH L or R
U159024RTAH L or R
U189024RTAH L or R
U219024RTAH L or R
U249024RTAH L or R

24", 27", 30", 33", or 36"

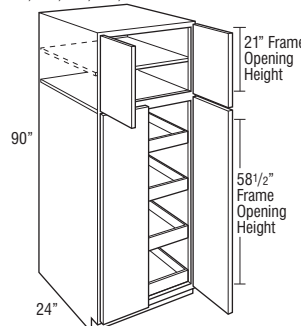

U249024RTAH
U279024RTAH
U309024RTAH
U339024RTAH
U369024RTAH

U129024RTAH L or R	17.3
U159024RTAH L or R	23.2
U189024RTAH L or R	27.4
U219024RTAH L or R	31.6
U249024RTAH L or R	35.8
U249024RTAH	35.8
U279024RTAH	40.0
U309024RTAH	44.2
U339024RTAH	48.4
U369024RTAH	52.6

- AH represents upper section alignment with doors on 24" or 27" high cabinets.
- Four roll trays are included, installed in cabinet.
- Depth can be reduced to a minimum of 12".
- Tall non-mitered doors will have two center panels with cross rail.
- Troxel doors greater than 48" high will be two doors doweled together.

Custom Modifications

ACS	ADDTK	AUTHL AUTHR	CBO	CCO	CFNTO	CFRMO	CND	DRT	DRWTK	EXBKL EXBKR	EXL EXR	FB	FFDL FFDR
		•	•	•	•	•		•	•*	•	•	•	
FPFB	FTK	FTKAV FTKFV	ID	INFRM	MIP	RD	RECTKL RECTKR	RT	TD	TKP	VTK	WLI	
•	•	•			•	•	•		•	•	•	•	•

*Not available on 12" and 15" wide

Construction Upgrades

APC	ET	PE
•	•	•

Door Options

CG.TOP	DPSRR	MFO
•	•	•

UTILITY with ROLL TRAYS, 84", 87", 90", 93", or 96" TALL, 24" DEEP (cont'd)

12", 15", 18", 21", or 24"

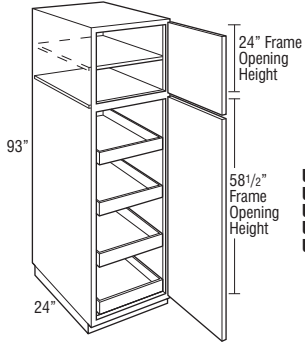

U129324RTAH L or R
U159324RTAH L or R
U189324RTAH L or R
U219324RTAH L or R
U249324RTAH L or R

24", 27", 30", 33", or 36"

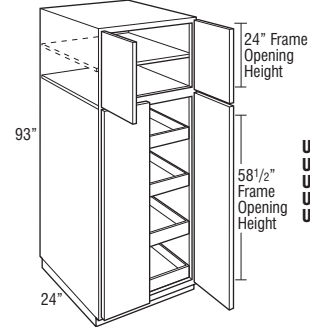

U249324RTAH
U279324RTAH
U309324RTAH
U339324RTAH
U369324RTAH

12", 15", 18", 21", or 24"

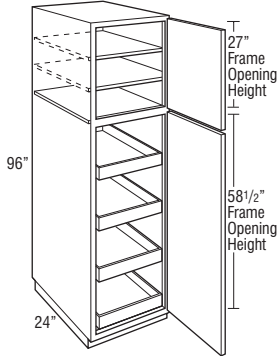

U129624RT L or R
U159624RT L or R
U189624RT L or R
U219624RT L or R
U249624RT L or R

24", 27", 30", 33", or 36"

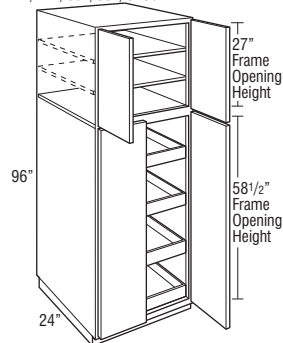

U249624RT
U279624RT
U309624RT
U339624RT
U369624RT

Model	Cubic Feet
U129324RTAH L or R	19.2
U159324RTAH L or R	23.9
U189324RTAH L or R	28.3
U219324RTAH L or R	32.6
U249324RTAH L or R	37.0
U249324RTAH	37.0
U279324RTAH	41.3
U309324RTAH	45.7
U339324RTAH	50.0
U369324RTAH	54.3

Model	Cubic Feet
U129624RT L or R	18.5
U159624RT L or R	24.7
U189624RT L or R	29.2
U219624RT L or R	33.6
U249624RT L or R	38.1
U249624RT	38.1
U279624RT	42.6
U309624RT	47.1
U339624RT	51.6
U369624RT	56.1

- AH represents upper section alignment with doors on 24" or 27" high cabinets.
- Separate pedestal base included but packaged separately on 93" tall. Pedestal is designed to create a Recessed Left or Right Toekick application during field installation, or can be centered. Pedestal must be covered with toeboard material.
- Four roll trays are included, installed in cabinet.
- Depth can be reduced to a minimum of 12".
- Tall non-mitered doors will have two center panels with cross rail.
- Troxel doors greater than 48" high will be two doors doweled together.

- Separate pedestal base included but packaged separately on 96" tall. Pedestal is designed to create a Recessed Left or Right Toekick application during field installation, or can be centered. Pedestal must be covered with toeboard material.
- Four roll trays are included, installed in cabinet.
- Depth can be reduced to a minimum of 12".
- Tall non-mitered doors will have two center panels with cross rail.
- Troxel doors greater than 48" high will be two doors doweled together.

Custom Modifications

ACS	ADDTK	AUTHL AUTHR	CBO	CCO	CFNTO	CFRMO	CND	DRT	DRWTK	EXBKL EXBKR	EXL EXR	FB	FFDL FFDR
		•	•	•	•	•		•		•	•	•	
FPEB	FTK	FTKAV FTKRV	ID	INVFRM	MIP	RD	RECTKL RECTKR	RT	TD	TKP	VTK	WLI	
•					•	•	•*		•			•	

*Not available on 12" wide

Construction Upgrades

APC	ET	PE
•	•	•

Door Options

CG.TOP	DPSRR	MFO
•	•	•

UTILITY EASY ACCESS, 84", 87", 90", 93", or 96" TALL, 12" DEEP

storage
SOLUTIONS

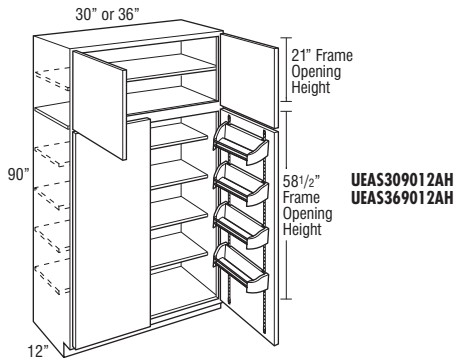
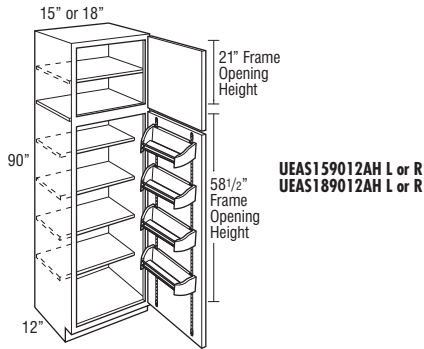
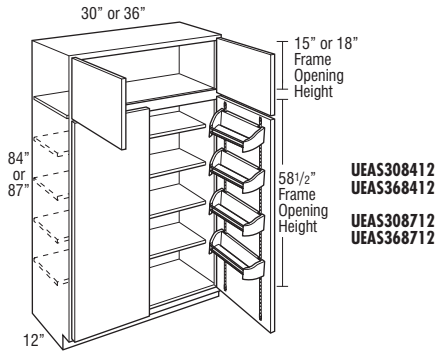
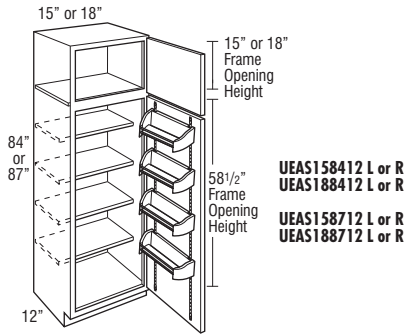

Model	Cubic Feet
UEAS158412 L or R	11.8
UEAS188412 L or R	14.0
UEAS158712 L or R	12.3
UEAS188712 L or R	14.5
UEAS308412	22.6
UEAS368412	26.9
UEAS308712	23.4
UEAS368712	27.8

Model	Cubic Feet
UEAS159012AH L or R	12.7
UEAS189012AH L or R	15.0
UEAS309012AH	24.2
UEAS369012AH	28.8

- Four chrome baskets featuring railsystem for adjustability on each lower door.
- Four 6 1/2" reduced depth adjustable shelves are included.
- Utility cabinets with depths of 12" or less must be installed to wall studs or onto the end of another tall cabinet.
- Depth can be reduced to a minimum of 10".
- Tall non-mitered doors will have two center panels with cross rail.
- Troxel doors greater than 48" high will be two doors doweled together.

Custom Modifications

ACS	ADDTK	AUTHL AUTHR	CBO	CCO	CFNT0	CFRMO	CND	DRT	DRWTK	EXBKL EXBKR	EXL EXR	FB	FFDL FFDR
		•	•	•	•	•				•	•	•	
FPFB	FTK	FTKAV FTKFV	ID	INVFRM	MIP	RD	RECTKL RECTKR	RT	TD	TKP	VTK	WLI	
•	•	•			•	•	•		•	•	•	•	

Construction Upgrades

APC	ET	PE
•		•

Door Options

CG.TOP	DPSRR	MFO
•	•	•

UTILITY EASY ACCESS, 84", 87", 90", 93", or 96" TALL, 12" DEEP (cont'd) **storage SOLUTIONS**

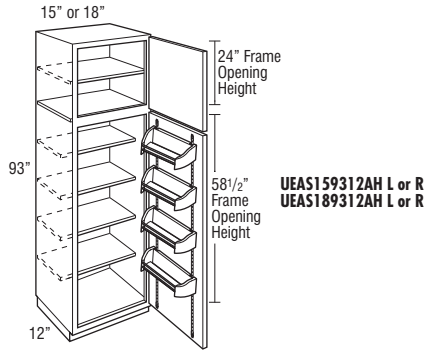

UEAS159312AH L or R
UEAS189312AH L or R

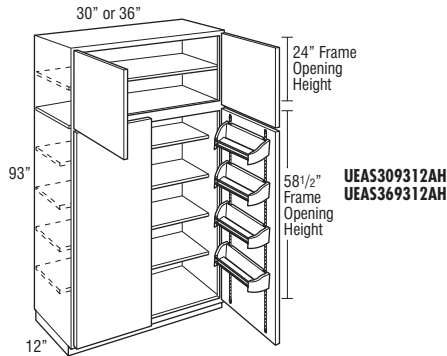

UEAS309312AH
UEAS369312AH

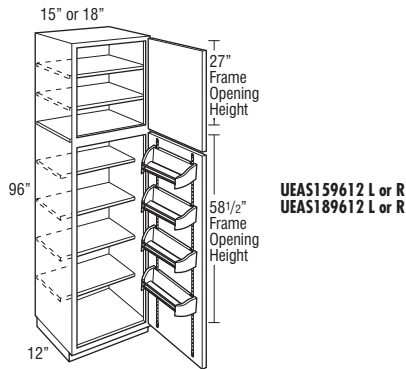

UEAS159612 L or R
UEAS189612 L or R

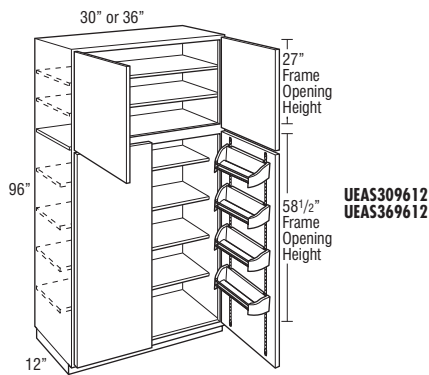

UEAS309612
UEAS369612

Model	Cubic Feet
UEAS159312AH L or R	13.1
UEAS189312AH L or R	15.5
UEAS309312AH	25.0
UEAS369312AH	29.7

Model	Cubic Feet
UEAS159612 L or R	13.5
UEAS189612 L or R	16.0
UEAS309612	25.8
UEAS369612	30.7

- AH represents upper section alignment with doors on 24" or 27" high cabinets.
- Four chrome baskets featuring railsystem for adjustability on each lower door.
- Separate pedestal base included but packaged separately on 93" tall. Pedestal is designed to create a Recessed Left or Right Toekick application during field installation, or can be centered. Pedestal must be covered with toeboard material.
- Four 6 1/2" reduced depth adjustable shelves are included.
- Utility cabinets with depths of 12" or less must be installed to wall studs or onto the end of another tall cabinet.
- Depth can be reduced to a minimum of 10".
- Tall non-mitered doors will have two center panels with cross rail.
- Troxel doors greater than 48" high will be two doors doweled together.

- Four chrome baskets featuring railsystem for adjustability on each lower door.
- Separate pedestal base included but packaged separately on 96" tall. Pedestal is designed to create a Recessed Left or Right Toekick application during field installation, or can be centered. Pedestal must be covered with toeboard material.
- Four 6 1/2" reduced depth adjustable shelves and two full depth adjustable shelves are included.
- Utility cabinets with depths of 12" or less must be installed to wall studs or onto the end of another tall cabinet.
- Depth can be reduced to a minimum of 10".
- Tall non-mitered doors will have two center panels with cross rail.
- Troxel doors greater than 48" high will be two doors doweled together.

Custom Modifications

ACS	ADDTK	AUTHL AUTHR	CBO	CCO	CFNTO	CFRMO	CND	DRT	DRWTK	EXBKL EXBKR	EXL EXR	FB	FFDL FFDR
		•	•	•	•	•				•	•	•	
FPFB	FTK	FTKAV FTKRV	ID	INVRM	MIP	RD	RECTKL RECTKR	RT	TD	TKP	VTK	WLI	
•					•	•	•		•	•		•	

Construction Upgrades

APC	ET	PE
•		•

Door Options

CG.TOP	DPSRR	MFO
•	•	•

UTILITY EASY ACCESS, 84", 87", 90", 93", or 96" TALL, 24" DEEP

storage SOLUTIONS

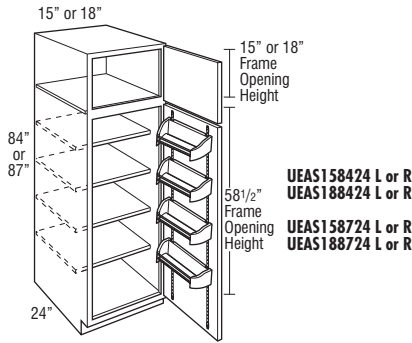

UEAS158424 L or R
UEAS188424 L or R
UEAS158724 L or R
UEAS188724 L or R

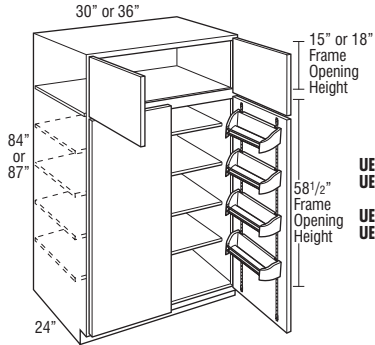

UEAS308424
UEAS368424
UEAS308724
UEAS368724

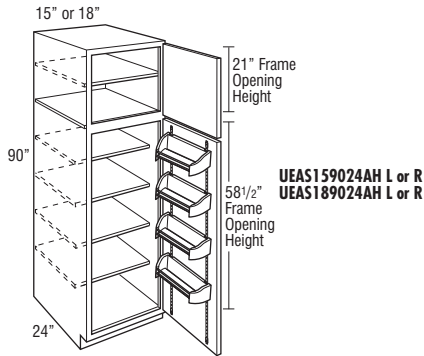

UEAS159024AH L or R
UEAS189024AH L or R

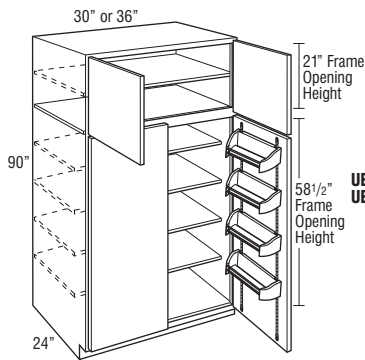

UEAS309024AH
UEAS369024AH

Model	Cubic Feet
UEAS158424 L or R	21.6
UEAS188424 L or R	25.6
UEAS158724 L or R	22.4
UEAS188724 L or R	26.5
UEAS308424	41.3
UEAS368424	49.2
UEAS308724	42.8
UEAS368724	50.9

Model	Cubic Feet
UEAS159024AH L or R	23.2
UEAS189024AH L or R	27.4
UEAS309024AH	44.2
UEAS369024AH	52.6

- Four chrome baskets featuring railsystem for adjustability on each lower door.
- Four 18 1/2" reduced depth adjustable shelves are included.
- Depth can be reduced to a minimum of 10".
- Tall non-mitered doors will have two center panels with cross rail.
- Troxel doors greater than 48" high will be two doors doweled together.

- AH represents upper section alignment with doors on 24" or 27" high cabinets.
- Four chrome baskets featuring railsystem for adjustability on each lower door.
- Four 18 1/2" reduced depth adjustable shelves and one full depth adjustable shelf are included.
- Utility cabinets with depths of 12" or less must be installed to wall studs or onto the end of another tall cabinet.
- Depth can be reduced to a minimum of 10".
- Tall non-mitered doors will have two center panels with cross rail.
- Troxel doors greater than 48" high will be two doors doweled together.

Custom Modifications

ACS	ADDTK	AUTHL AUTHR	CBO	CCO	CFNT0	CFRMO	CND	DRT	DRWTK	EXBKL EXBKR	EXL EXR	FB	FFDL FFDR
		•	•	•	•	•			•*	•	•	•	
FPEB	FTK	FTKAV FTKFV	ID	INVFRM	MIP	RD	RECTKL RECTKR	RT	TD	TKP	VTK	WLI	
•	•	•			•	•	•		•	•	•	•	

*Not available on 15" wide

Construction Upgrades

APC	ET	PE
•		•

Door Options

CG.TOP	DPSRR	MFO
•	•	•

UTILITY EASY ACCESS, 84", 87", 90", 93", or 96" TALL, 24" DEEP (cont'd)

storage
SOLUTIONS

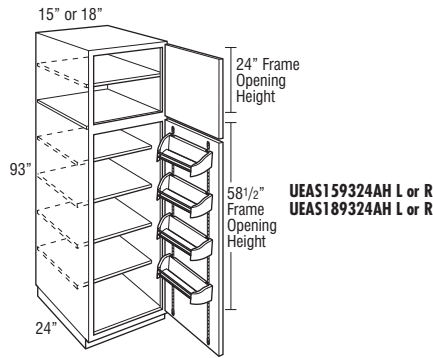

UEAS159324AH L or R
UEAS189324AH L or R

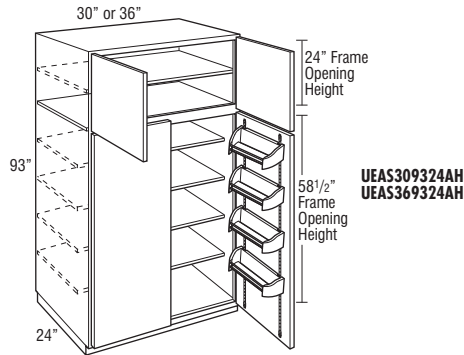

UEAS309324AH
UEAS369324AH

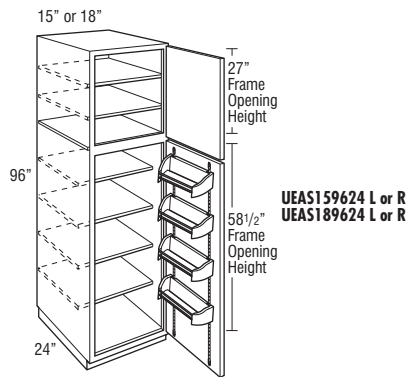

UEAS159624 L or R
UEAS189624 L or R

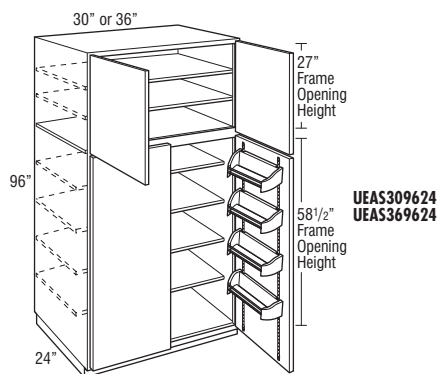

UEAS309624
UEAS369624

Model	Cubic Feet
UEAS159324AH L or R	23.9
UEAS189324AH L or R	28.3
UEAS309324AH	45.7
UEAS369324AH	54.3

Model	Cubic Feet
UEAS159624 L or R	24.7
UEAS189624 L or R	29.2
UEAS309624	47.1
UEAS369624	56.1

- AH represents upper section alignment with doors on 24" or 27" high cabinets.
- Four chrome baskets featuring railsystem for adjustability on each lower door.
- Separate pedestal base included but packaged separately on 93" tall. Pedestal is designed to create a Recessed Left or Right Toekick application during field installation, or can be centered. Pedestal must be covered with toeboard material.
- Four 18 1/2" reduced depth adjustable shelves and one full depth adjustable shelf are included.
- Utility cabinets with depths of 12" or less must be installed to wall studs or onto the end of another tall cabinet.
- Depth can be reduced to a minimum of 10".
- Tall non-mitered doors will have two center panels with cross rail.
- Troxel doors greater than 48" high will be two doors doweled together.

- Four chrome baskets featuring railsystem for adjustability on each lower door.
- Separate pedestal base included but packaged separately on 96" tall. Pedestal is designed to create a Recessed Left or Right Toekick application during field installation, or can be centered. Pedestal must be covered with toeboard material.
- Four 18 1/2" reduced depth adjustable shelves and two full depth adjustable shelves are included.
- Utility cabinets with depths of 12" or less must be installed to wall studs or onto the end of another tall cabinet.
- Depth can be reduced to a minimum of 10".
- Tall non-mitered doors will have two center panels with cross rail.
- Troxel doors greater than 48" high will be two doors doweled together.

Custom Modifications

	ACS	ADDTK	AUTHL AUTHR	CBO	CCO	CFNTO	CFRMO	CND	DRT	DRWTK	EXBKL EXBKR	EXL EXR	FB	FFDL FFDR
			•	•	•	•	•				•	•	•	
FPFB	FTK	FTKAV FTKFV	ID	INVFRM	MIP	RD	RECTKL RECTKR	RT	TD	TKP	VTK	WLI		
•					•	•	•		•				•	

Construction Upgrades

APC	ET	PE
•		•

Door Options

CG.TOP	DPSRR	MFO
•	•	•

UTILITY ORGANIZER CABINET, 84", 87", 90", 93", or 96" TALL, 6" DEEP, 24" WIDE

storage SOLUTIONS

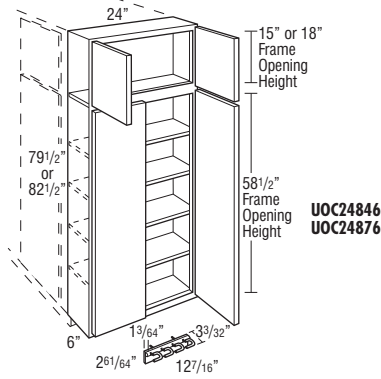

**UOC24846
UOC24876**

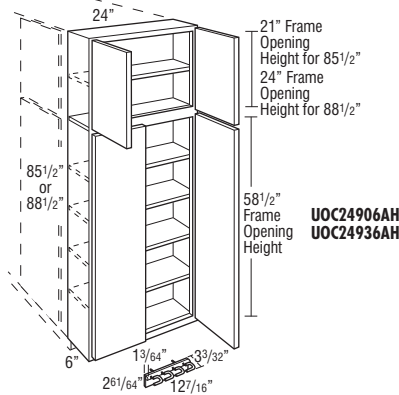

**UOC24906AH
UOC24936AH**

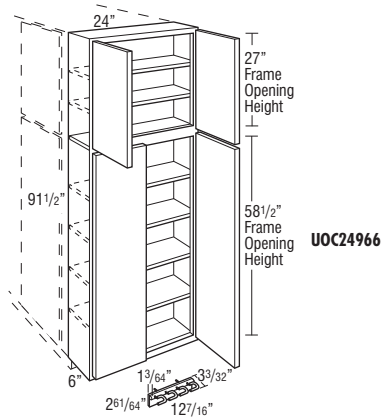

UOC24966

Model	Cubic Feet
UOC24846	10.7

- Includes four adjustable shelves and broom clip packaged separately (not installed).
- Designed to be installed onto an adjacent 24" deep tall cabinet.
- For proper installation, adjacent cabinet must have FPEB or 1/4" skin applied.
- 6" overlay fillers can be used on the side to add a decorative touch (Full overlay door styles only).
- Utility cabinets with depths of 12" or less must be installed to wall studs or onto the end of another tall cabinet.
- Does not include toeboard or pedestal.
- Tall non-mitered doors will have two center panels with cross rail.
- Troxel doors greater than 48" high will be two doors doveled together.

Model	Cubic Feet
UOC24876	11.1

- Includes four adjustable shelves and broom clip packaged separately (not installed).
- Designed to be installed onto an adjacent 24" deep tall cabinet.
- For proper installation, adjacent cabinet must have FPEB or 1/4" skin applied.
- 6" overlay fillers can be used on the side to add a decorative touch (Full overlay door styles only).
- Utility cabinets with depths of 12" or less must be installed to wall studs or onto the end of another tall cabinet.
- Does not include toeboard or pedestal.
- Tall non-mitered doors will have two center panels with cross rail.
- Troxel doors greater than 48" high will be two doors doveled together.

Model	Cubic Feet
UOC24906AH	11.5

- AH represents upper section alignment with doors on 24" or 27" high cabinets.
- Includes five adjustable shelves and broom clip packaged separately (not installed).
- Designed to be installed onto an adjacent 24" deep tall cabinet.
- For proper installation, adjacent cabinet must have FPEB or 1/4" skin applied.
- 6" overlay fillers can be used on the side to add a decorative touch (Full overlay door styles only).
- Utility cabinets with depths of 12" or less must be installed to wall studs or onto the end of another tall cabinet.
- Does not include toeboard or pedestal.
- Tall non-mitered doors will have two center panels with cross rail.
- Troxel doors greater than 48" high will be two doors doveled together.

Custom Modifications

ACS	ADDTK	AUTHL AUTHR	CBO	CCO	CFNTO	CFRMO	CND	DRT	DRWTK	EXBKL EXBKR	EXL EXR	FB	FFDL FFDR
			•	•	•	•							
FPEB	FTK	FTKAV FTKRV	ID	INVFRM	MIP	RD	RECTKL RECTKR	RT	TD	TKP	VTK	WLI	
STD				•	•							•	

Construction Upgrades

APC	ET	PE
•		

Door Options

CG.TOP	DPSRR	MFO
•	•	•

Model	Cubic Feet
UOC24936AH	11.9

- AH represents upper section alignment with doors on 24" or 27" high cabinets.
- Includes five adjustable shelves and broom clip packaged separately (not installed).
- Designed to be installed onto an adjacent 24" deep tall cabinet.
- For proper installation, adjacent cabinet must have FPEB or 1/4" skin applied.
- 6" overlay fillers can be used on the side to add a decorative touch (Full overlay door styles only).
- Utility cabinets with depths of 12" or less must be installed to wall studs or onto the end of another tall cabinet.
- Does not include toeboard or pedestal.
- Tall non-mitered doors will have two center panels with cross rail.
- Troxel doors greater than 48" high will be two doors doveled together.

Model	Cubic Feet
UOC24966	12.2

- Includes six adjustable shelves and broom clip packaged separately (not installed).
- Designed to be installed onto an adjacent 24" deep tall cabinet.
- For proper installation, adjacent cabinet must have FPEB or 1/4" skin applied.
- 6" overlay fillers can be used on the side to add a decorative touch (Full overlay door styles only).
- Utility cabinets with depths of 12" or less must be installed to wall studs or onto the end of another tall cabinet.
- Does not include toeboard or pedestal.
- Tall non-mitered doors will have two center panels with cross rail.
- Troxel doors greater than 48" high will be two doors doveled together.

UTILITY ORGANIZER DROP ZONE CABINET, 84", 87", 90", 93", or 96" HIGH, 9" DEEP, 24" WIDE

storage SOLUTIONS

Model	Cubic Feet
UOCDZ24849AEL	14.5
UOCDZ24849AER	14.5
UOCDZ24879AEL	15.0
UOCDZ24879AER	15.0
UOCDZ24909AHAL	15.5
UOCDZ24909AHAR	15.5
UOCDZ24939AHAL	16.0
UOCDZ24939AHAR	16.0
UOCDZ24969AEL	16.5
UOCDZ24969AER	16.5

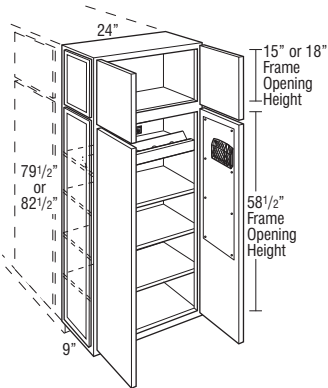
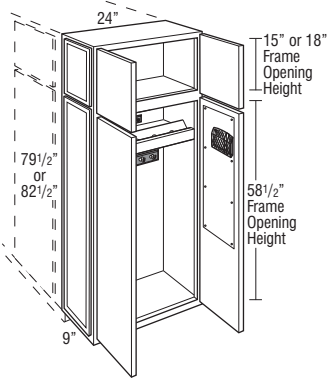

UOCDZ24849AEL
UOCDZ24849AER

UOCDZ24879AEL
UOCDZ24879AER

- AH represents upper section alignment with doors on 24" or 27" high cabinets.
- Features magnetic whiteboards on back of lower doors, one magnetic black mesh pencil holder, charging station with power strip, black plastic grommet for power cord, key hooks, and coat hooks. Accessories are field installed.
- Charging station functions as an adjustable shelf, features five cord cut-out areas and includes a UL listed power strip with three standard 110-volt plugs and one USB charging port.
- One adjustable shelf in upper section on 90" and 93", two adjustable shelves for 96", and three adjustable shelves in lower section.
- Authentic Ends are standard on one side. Specify AEL model for installation on the right side of a tall cabinet. Specify AER model for installation on the left side of a tall cabinet. Opposite end panel will feature FPEB construction (if decorative doors are desired on both sides of cabinet, order No Hinge Route doors for a Tall Pantry Pull-Out).
- Designed to be installed onto an adjacent 24" deep tall cabinet.
- For proper installation, adjacent cabinet must have FPEB or 1/4" skin applied.
- Utility cabinets with depths of 12" or less must be installed to wall studs or onto the end of another tall cabinet.
- Does not include toeboard or pedestal.
- Tall non-mitered doors will have two center panels with cross rail.
- Troxel doors greater than 48" high will be two doors doweled together.

Custom Modifications

ACS	ADDTK	AUTHL AUTHR	CBO	CCO	CFNTO	CFRMO	CND	DRT	DRWTK	EXBKL EXBKR	EXL EXR	FB	FFDL FFDR
		STD	•	•	•	•							
FPEB	FTK	FTKAV FTKVF	ID	INVFRM	MIP	RD	RECTKL RECTKR	RT	TD	TKP	VTK	WLI	
STD					•							•	

Construction Upgrades

APC	ET	PE
•		

Door Options

CG.TOP	DPSRR	MFO
•	•	•

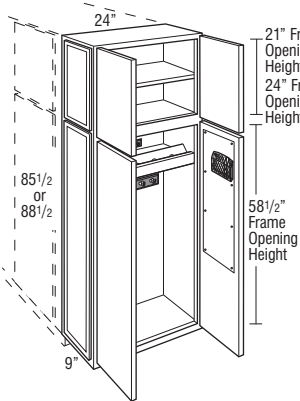

UOCDZ24909AHAL
UOCDZ24909AHAR

UOCDZ24939AHAL
UOCDZ24939AHAR

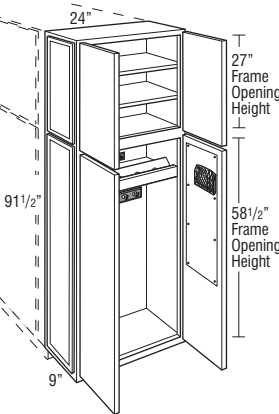
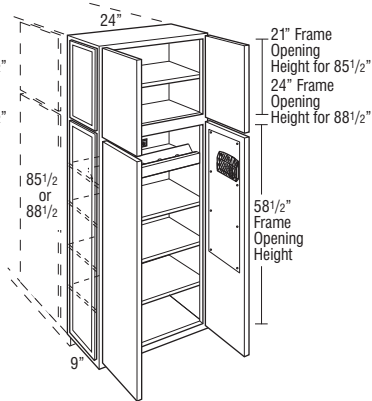

UOCDZ24969AEL
UOCDZ24969AER

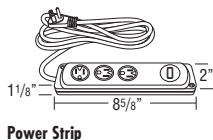
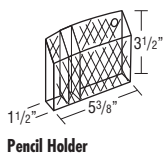

**PANTRY TOP UNIT with SHELVES,
SINGLE DOOR, 24" DEEP**

15", 18", 21", or 24"

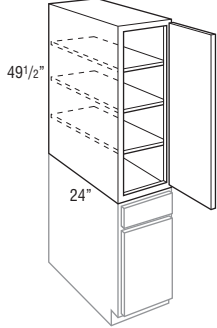

PTUS154924 L or R
PTUS184924 L or R
PTUS214924 L or R
PTUS244924 L or R

15", 18", 21", or 24"

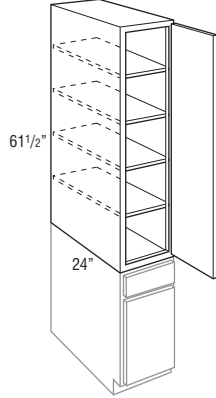

PTUS156124 L or R
PTUS186124 L or R
PTUS216124 L or R
PTUS246124 L or R

Model	Cubic Feet
PTUS154924 L or R	12.8
PTUS184924 L or R	15.1
PTUS214924 L or R	17.6
PTUS244924 L or R	19.9
PTUS156124 L or R	15.9
PTUS186124 L or R	18.8
PTUS216124 L or R	21.7
PTUS246124 L or R	24.6

- Three adjustable shelves included with 49 1/2" high, and four adjustable shelves included with 61 1/2" high.
- Sets on any 15", 18", 21", or 24" wide base (B15 shown). No countertop is needed.
- Can be reduced in depth to 6".
- Because of exposed seam when stacking, FPEB is not recommended.
- Be sure to use an end panel skin to connect the seam on the side of the stacked cabinets.
- Tall non-mitered doors will have two center panels with cross rail.
- Troxel doors will be two doors doweled together.

Custom Modifications

ACS	ADDTK	AUTHL AUTHR	CBO	CCO	CFNTO	CFRMO	CND	DRT	DRWTK	EXBKL EXBKR	EXL EXR	FB	FFDL FFDR
	•	•*	•	•	•	•				•	•	•	
FPEB	FTK	FTKAV FTKFV	ID	INFRM	MIP	RD	RECTKL RECTKR	RT	TD	TKP	VTK	WLI	
•		•			•	•*						•	

*RD12 is not compatible with AUTHL or AUTHR

Construction Upgrades

APC	ET	PE
•		•

Door Options

CG.TOP	DPSRR	MFO
	•	•

**PANTRY TOP UNIT with SHELVES,
DOUBLE DOOR, 24" DEEP**

24", 30", or 36"

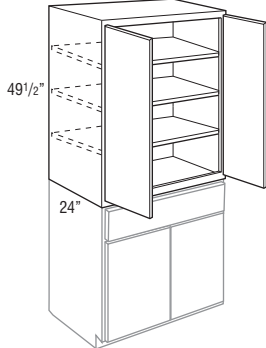

PTUS244924
PTUS304924
PTUS364924

24", 30", or 36"

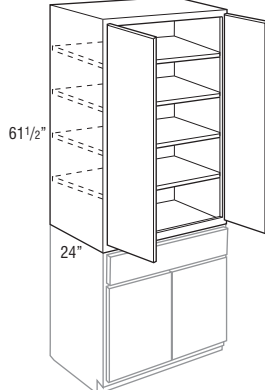

PTUS246124
PTUS306124
PTUS366124

PTUS244924	19.9
PTUS304924	24.4
PTUS364924	29.0
PTUS246124	24.6
PTUS306124	30.2
PTUS366124	35.9

- Three adjustable shelves included with 49 1/2" high, and four adjustable shelves included with 61 1/2" high.
- Sets on any 24", 30", or 36" wide base (B30 shown). No countertop is needed.
- Can be reduced in depth to 6".
- Because of exposed seam when stacking, FPEB is not recommended.
- Be sure to use an end panel skin to connect the seam on the side of the stacked cabinets.
- Tall non-mitered doors will have two center panels with cross rail.
- Troxel doors will be two doors doweled together.

Custom Modifications

ACS	ADDTK	AUTHL AUTHR	CBO	CCO	CFNTO	CFRMO	CND	DRT	DRWTK	EXBKL EXBKR	EXL EXR	FB	FFDL FFDR
	•	•*	•	•	•	•				•	•	•	
FPEB	FTK	FTKAV FTKFV	ID	INFRM	MIP	RD	RECTKL RECTKR	RT	TD	TKP	VTK	WLI	
•		•			•	•*						•	

*RD12 is not compatible with AUTHL or AUTHR

Construction Upgrades

APC	ET	PE
•		•

Door Options

CG.TOP	DPSRR	MFO
	•	•

PANTRY TOP UNIT, SINGLE DOOR, 24" DEEP storage SOLUTIONS

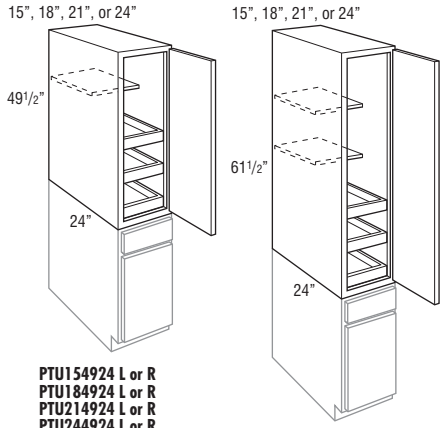

PTU154924 L or R
PTU184924 L or R
PTU214924 L or R
PTU244924 L or R

PTU156124 L or R
PTU186124 L or R
PTU216124 L or R
PTU246124 L or R

Model	Cubic Feet
PTU154924 L or R	12.8
PTU184924 L or R	15.1
PTU214924 L or R	17.6
PTU244924 L or R	19.9
PTU156124 L or R	15.9
PTU186124 L or R	18.8
PTU216124 L or R	21.7
PTU246124 L or R	24.6

- One 15" deep adjustable shelf included with 49 1/2" high, and two 15" deep adjustable shelves included with 61 1/2" high.
- Three roll trays are included, installed in cabinet.
- Sets on any 15", 18", 21", or 24" wide base (B15 shown). No countertop is needed.
- Can be reduced in depth to 12".
- Because of exposed seam when stacking, FPEB is not recommended.
- Be sure to use an end panel skin to connect the seam on side of stacked cabinets.
- Tall non-mitered doors will have two center panels with cross rail.
- Troxel doors will be two doors doweled together.

Custom Modifications

ACS	ADDTK	AUTHL AUTHR	CBO	CCO	CFNT0	CFRMO	CND	DRT	DRWTK	EXBKL EXBKR	EXL EXR	FB	FFDL FFDR
	•	•*	•	•	•	•		•		•	•	•	•
FPEB	FTK	FTKAV FTKFV	ID	INVFRM	MIP	RD	RECTKL RECTKR	RT	TD	TKP	VTK	WLI	
•					•	•*						•	

*RD12 is not compatible with AUTHL or AUTHR

Construction Upgrades

APC	ET	PE
•		•

Door Options

CG.TOP	DPSRR	MFO
	•	•

PANTRY TOP UNIT, DOUBLE DOOR, 24" DEEP storage SOLUTIONS

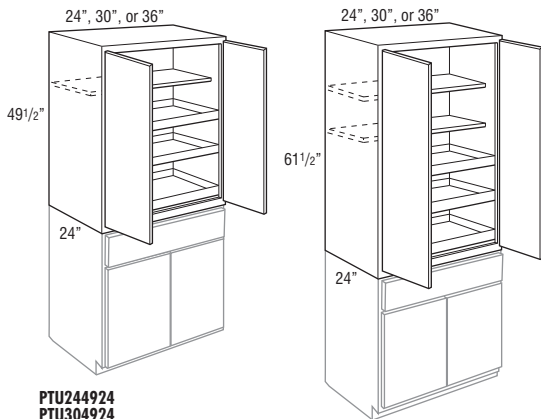

PTU244924
PTU304924
PTU364924

PTU246124
PTU306124
PTU366124

PTU244924	19.9
PTU304924	24.4
PTU364924	29.0
PTU246124	24.6
PTU306124	30.2
PTU366124	35.9

- One 15" deep adjustable shelf included with 49 1/2" high, and two 15" deep adjustable shelves included with 61 1/2" high.
- Three roll trays are included, installed in cabinet.
- Sets on any 24", 30", or 36" wide base. (B30 shown.) No countertop is needed.
- Can be reduced in depth to 12".
- Because of exposed seam when stacking, FPEB is not recommended.
- Be sure to use an end panel skin to connect the seam on side of stacked cabinets.
- Tall non-mitered doors will have two center panels with cross rail.
- Troxel doors will be two doors doweled together.

Custom Modifications

ACS	ADDTK	AUTHL AUTHR	CBO	CCO	CFNT0	CFRMO	CND	DRT	DRWTK	EXBKL EXBKR	EXL EXR	FB	FFDL FFDR
	•	•*	•	•	•	•		•		•	•	•	
FPEB	FTK	FTKAV FTKFV	ID	INVFRM	MIP	RD	RECTKL RECTKR	RT	TD	TKP	VTK	WLI	
•					•	•*						•	

*RD12 is not compatible with AUTHL or AUTHR

Construction Upgrades

APC	ET	PE
•		•

Door Options

CG.TOP	DPSRR	MFO
	•	•

**PANTRY TOP UNIT with PULL-OUT,
49 1/2" TALL, 24" DEEP**

storage
SOLUTIONS

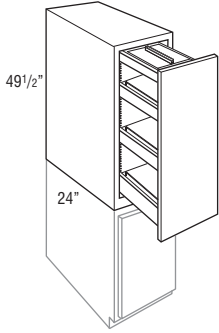

Model	Cubic Feet
PTUP154924	15.8
PTUP184924	18.7

- Two adjustable and one fixed bottom shelf with metallic finish wire rail sides. Natural finish pull-out shelves are 20 11/16" deep.
- Sets on any 15" or 18" wide base. No countertop is needed.
- Because of exposed seam when stacking, FPBE is not recommended.
- Be sure to use an end panel skin to connect the seam on side of stacked cabinets.
- Tall non-mitered doors will have two center panels with cross rail.
- Troxel doors greater than 48" high will be two doors doweled together.
- For full access from both sides of unit, do not install against a wall or next to deeper appliances and cabinets.

Custom Modifications

ACS	ADDTK	AUTHL AUTHR	CBO	CCO	CFNTO	CFRMO	CND	DRT	DRWTK	EXBKL EXBKR	EXL EXR	FB	FFDL FFDR
	•	•	•	•		•				•	•	•	
FPBE	FTK	FTKAV FTKRV	ID	INFRM	MIP	RD	RECTKL RECTKR	RT	TD	TKP	VTK	WLI	
•					•							•	

Construction Upgrades

APC	ET	PE
•		•

Door Options

CG.TOP	DPSRR	MFO
	•	•

**TALL PANTRY PULL-OUT, 84", 87", or
90" TALL, 24" DEEP**

storage
SOLUTIONS

9", 12", 15", or 18"

9", 12", 15", or 18"

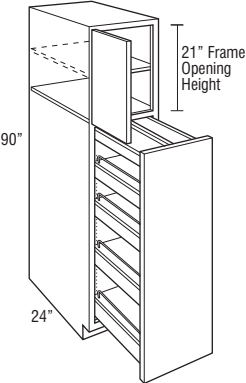
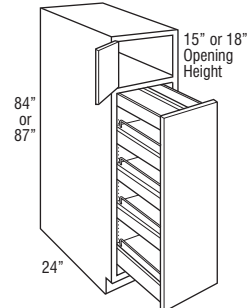

TPP98424 L or R
TPP128424 L or R
TPP158424 L or R
TPP188424 L or R

TPP98724 L or R
TPP128724 L or R
TPP158724 L or R
TPP188724 L or R

TPP99024AH L or R
TPP129024AH L or R
TPP159024AH L or R
TPP189024AH L or R

TPP98424 L or R	13.8
TPP128424 L or R	17.7
TPP158424 L or R	21.6
TPP188424 L or R	25.6
TPP98724 L or R	14.3
TPP128724 L or R	18.3
TPP158724 L or R	22.4
TPP188724 L or R	26.5
TPP99024AH L or R	14.7
TPP129024AH L or R	18.9
TPP159024AH L or R	23.2
TPP189024AH L or R	27.4

- AH represents upper section alignment with doors on 24" or 27" high cabinets.
- Three adjustable shelves and one fixed bottom shelf with metallic finish wire rail sides. Natural finish wood pull-out shelves are 20 11/16" deep. Pull-out features top/bottom mounted soft-close full extension guides.
- 84" and 87" high do not include shelves in upper section. Upper section 15" or 18".
- Tall non-mitered doors will have two center panels with cross rail.
- Troxel doors greater than 48" high will be two doors doweled together.
- For full access from both sides of unit, do not install against a wall or next to deeper appliances and cabinets.
- Pull-out mechanism not available for order for field installation, only available factory installed.

Custom Modifications

ACS	ADDTK	AUTHL AUTHR	CBO	CCO	CFNTO	CFRMO	CND	DRT	DRWTK	EXBKL EXBKR	EXL EXR	FB	FFDL FFDR
		•	•	•		•			•*	•	•	•	
FPBE	FTK	FTKAV FTKRV	ID	INFRM	MIP	RD	RECTKL RECTKR	RT	TD	TKP	VTK	WLI	
•		•*			•		•		•	•	•	•	

*Available only on 18" wide

*Not available on 9" and 12" wide

Construction Upgrades

APC	ET	PE
•		•

Door Options

CG.TOP	DPSRR	MFO
	•	•

TALL PANTRY PULL-OUT, 93" or 96" TALL, 24" DEEP storage SOLUTIONS

9", 12", 15", or 18"

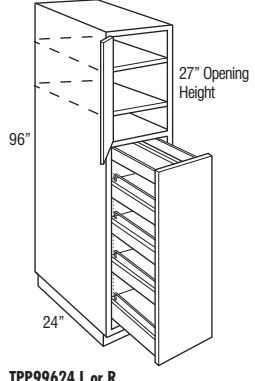
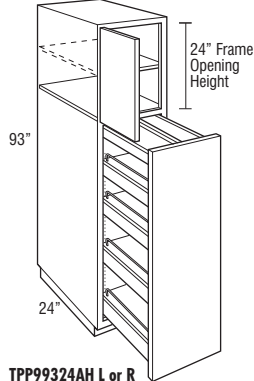

TPP99324AH L or R
 TPP129324AH L or R
 TPP159324AH L or R
 TPP189324AH L or R

TPP99624 L or R
 TPP129624 L or R
 TPP159624 L or R
 TPP189624 L or R

Model	Cubic Feet
TPP99324AH L or R	15.2
TPP129324AH L or R	19.6
TPP159324AH L or R	23.9
TPP189324AH L or R	28.3
TPP99624 L or R	15.7
TPP129624 L or R	20.2
TPP159624 L or R	24.7
TPP189624 L or R	29.2

- AH represents upper section alignment with doors on 24" or 27" high cabinets.
- Three adjustable shelves and one fixed bottom shelf with metallic finish wire rail sides. Natural finish wood pull-out shelves are 20 11/16" deep. Pull-out features top/bottom mounted soft-close full extension guides.
- Separate pedestal base included but packaged separately on 93" and 96" tall. Pedestal is designed to create a Recessed Left or Right Toekick application during field installation, or can be centered. Pedestal must be covered with toeboard material.
- Tall non-mitered doors will have two center panels with cross rail.
- Troxel doors greater than 48" high will be two doors doweled together.
- For full access from both sides of unit, do not install against a wall or next to deeper appliances and cabinets.
- Pull-out mechanism not available for order for field installation, only available factory installed.

Custom Modifications

ACS	ADDTK	AUTHL AUTHR	CBO	CCO	CFNTO	CFRMO	CND	DRT	DRWTK	EXBKL EXBKR	EXL EXR	FB	FFDL FFDR
		•	•	•		•				•	•	•	
FPFB	FTK	FTKAV FTKEV	ID	INVFRM	MIP	RD	RECTKL RECTKR	RT	TD	TKP	VTK	WLI	
•					•		•		•			•	

Construction Upgrades

APC	ET	PE
•		•

Door Options

CG.TOP	DPSRR	MFO
•	•	•

**UTILITY STORAGE with PANTRY
PULL-OUT, 84", 87", 90", 93", or
96" TALL, 24" DEEP**

storage
SOLUTIONS

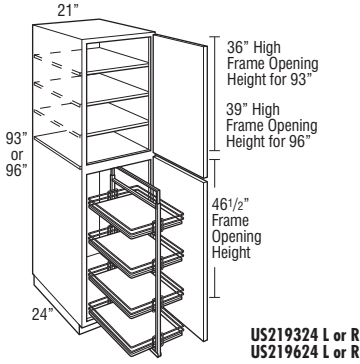
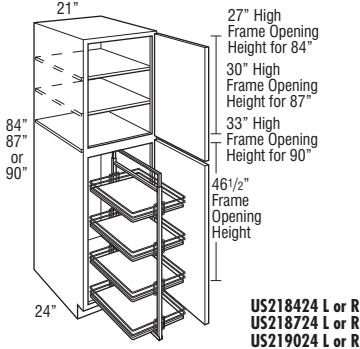

Model	Cubic Feet
US218424 L or R	29.5
US218724 L or R	30.5
US219024 L or R	31.6
US219324 L or R	32.6
US219624 L or R	33.6

- If Decorative Door End panels are desired see DADOORB and DADOORW.
- Full extension pantry pull-out with four plywood shelves and metal rails. Each shelf is 17" wide, 20 7/16" deep, and 4" high.
- Separate pedestal base included but packaged separately on 93" and 96" tall. Pedestal is designed to create a Recessed Left or Right Toekick application during field installation, or can be centered. Pedestal must be covered with toeboard material.
- Tall non-mitered doors will have two center panels with cross rail.
- Troxel doors greater than 48" high will be two doors doweled together.

Custom Modifications

ACS	ADDTK	AUTHL AUTHR	CBO	CCO	CFNTO	CFRMO	CND	DRT	DRWTK	EXBKL EXBKR	EXL EXR	FB	FFDL FFDR
			•	•	•	•			•*	•	•	•	
FPEB	FTK	FTKAV FTKFV	ID	INVFRM	MIP	RD	RECTKL RECTKR	RT	TD	TKP	VTK	WLI	
•	•*	•*			•		•			•*	•*		

*Not available on 93" and 96" tall

Construction Upgrades

APC	ET	PE
•		•

Door Options

CG.TOP	DPSRR	MFO
•	•	•

**UTILITY STORAGE with PANTRY
PULL-OUT and POT and PAN RACK,
84", 87", 90", 93", or 96" TALL,
24" DEEP**

storage
SOLUTIONS

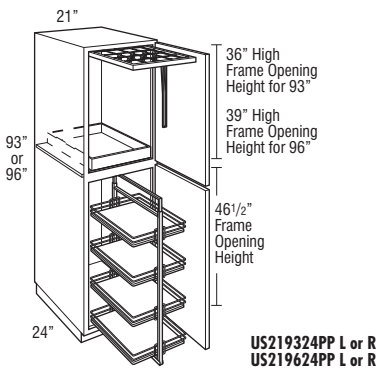
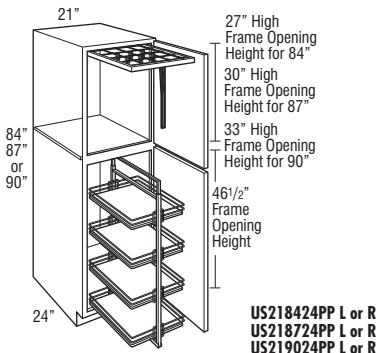

Model	Cubic Feet
US218424PP L or R	29.5
US218724PP L or R	30.5
US219024PP L or R	31.6
US219324PP L or R	32.6
US219624PP L or R	33.6

- Full extension Pot and Pan Rack features six chrome hooks and is mounted to the top of the cabinet. Maximum Weight Capacity: 47 lbs.
- Full extension pantry pull-out with four plywood shelves and metal rails. Each shelf is 17" wide, 20 7/16" deep, and 4" high.
- Separate pedestal base included but packaged separately on 93" and 96" tall. Pedestal is designed to create a Recessed Left or Right Toekick application during field installation, or can be centered. Pedestal must be covered with toeboard material.
- Tall non-mitered doors will have two center panels with cross rail.
- Troxel doors greater than 48" high will be two doors doweled together.

Custom Modifications

ACS	ADDTK	AUTHL AUTHR	CBO	CCO	CFNTO	CFRMO	CND	DRT	DRWTK	EXBKL EXBKR	EXL EXR	FB	FFDL FFDR
			•	•	•	•			•*	•	•	•	
FPEB	FTK	FTKAV FTKFV	ID	INVFRM	MIP	RD	RECTKL RECTKR	RT	TD	TKP	VTK	WLI	
•	•*	•*			•		•			•*	•*	•	

*Not available on 93" and 96" tall

Construction Upgrades

APC	ET	PE
•		•

Door Options

CG.TOP	DPSRR	MFO
•	•	•

PANTRY UNIT, 84", 87", 90", 93", or 96" TALL, 24" DEEP

storage
SOLUTIONS

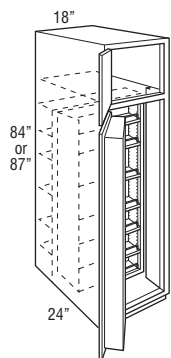

**PY188424 L or R
PY188724 L or R**

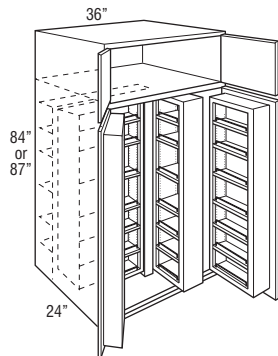

**PY368424
PY368724**

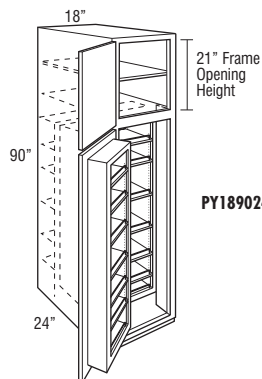

PY189024AH L or R

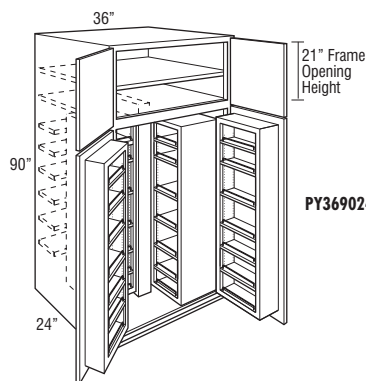

PY369024AH

Model	Cubic Feet
PY188424 L or R	25.6
PY368424	49.2
PY188724 L or R	26.5
PY368724	50.9

- Swing-out units, mounting rails, and door racks have natural finish wood adjustable shelves with metallic finish wire rail fronts and 4 1/2" deep adjustable shelves included. Door mounted rack includes 6 adjustable shelves and one fixed shelf. Swing-outs include 4 adjustable shelves and 3 fixed shelves.
- For PY18, use TF384 when installed against wall (or next to a full depth refrigerator.)
- Tall non-mitered doors will have two center panels with cross rail.
- Troxel doors greater than 48" high will be two doors doveled together.

Model	Cubic Feet
PY189024AH L or R	27.4
PY369024AH	52.6

- AH represents upper section alignment with doors on 24" or 27" high cabinets.
- Swing-out units, mounting rails, and door racks have natural finish wood adjustable shelves with metallic finish wire rail fronts and 4 1/2" deep adjustable shelves included. Door mounted rack includes 6 adjustable shelves and one fixed shelf. Swing-outs include 4 adjustable shelves and 3 fixed shelves.
- For PY18, use TF390 when installed against wall (or next to a full depth refrigerator.)
- Tall non-mitered doors will have two center panels with cross rail.
- Troxel doors greater than 48" high will be two doors doveled together.

Custom Modifications

	ACS	ADDTK	AUTHL AUTHR	CBO	CCO	CFNT0	CFRMO	CND	DRT	DRWTK	EXBKL EXBKR	EXL EXR	FB	FFDL FFDR
			•	•	•	•	•			•	•	•	•	
	FPEB	FTK	FTKAV FTKRV	ID	INVFRM	MIP	RD	RECTKL RECTKR	RT	TD	TKP	VTK	WLI	
	•	•	•					•		•	•	•	•	•

Construction Upgrades

APC	ET	PE
•		•

Door Options

CG.TOP	DPSRR	MFO
•	•	•

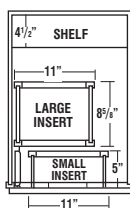

**FRONT OF CABINET
DOOR HINGED RIGHT**

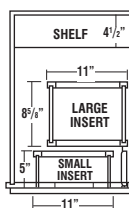

**FRONT OF CABINET
DOOR HINGED LEFT**

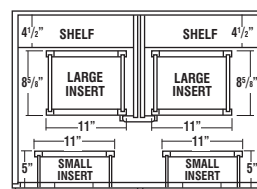

FRONT OF CABINET

PY18R

PY18L

PY36

Wood inserts for all styles:

- Top view of wood inserts positioning and size.
- Wood inserts are 56" high.

PANTRY UNIT, 84", 87", 90", 93", or 96" TALL, 24" DEEP (cont'd)

storage
SOLUTIONS

Model	Cubic Feet
PY189324AH L or R	28.3
PY369324AH	54.3

Model	Cubic Feet
PY189624 L or R	29.2
PY369624	56.1

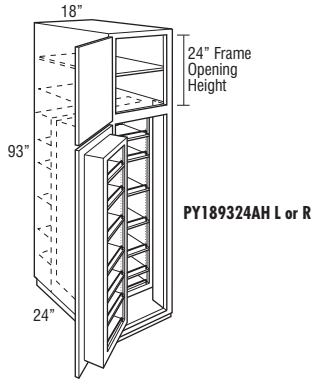

PY189324AH L or R

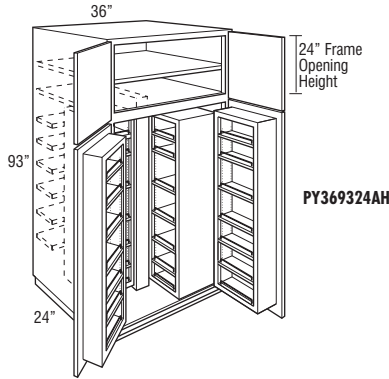

PY369324AH

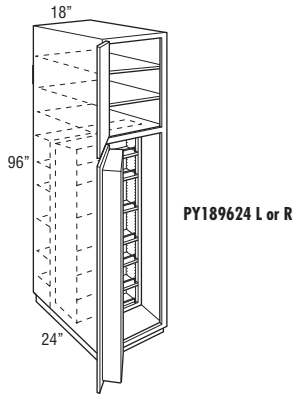

PY189624 L or R

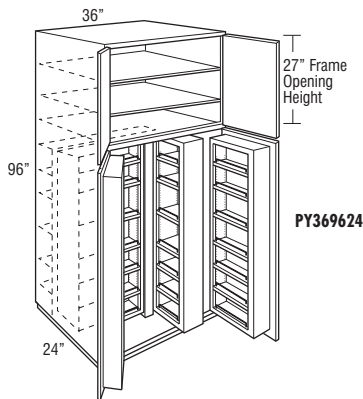

PY369624

- AH represents upper section alignment with doors on 24" or 27" high cabinets.
- Swing-out units, mounting rails, and door racks have natural finish wood adjustable shelves with metallic finish wire rail fronts and 4 1/2" deep adjustable shelves included. Door mounted rack includes 6 adjustable shelves and one fixed shelf. Swing-outs include 4 adjustable shelves and 3 fixed shelves.
- Separate pedestal base included but packaged separately on 93" tall. Pedestal is designed to create a Recessed Left or Right ToeKick application during field installation, or can be centered. Pedestal must be covered with toeboard material.
- For PY18, use TF393 when installed against wall (or next to a full depth refrigerator.)
- Tall non-mitered doors will have two center panels with cross rail.
- Troxel doors greater than 48" high will be two doors doveled together.

- Swing-out units, mounting rails, and door racks have natural finish wood adjustable shelves with metallic finish wire rail fronts and 4 1/2" deep adjustable shelves included. Door mounted rack includes 6 adjustable shelves and one fixed shelf. Swing-outs include 4 adjustable shelves and 3 fixed shelves.
- Separate pedestal base included but packaged separately on 96" tall. Pedestal is designed to create a Recessed Left or Right ToeKick application during field installation, or can be centered. Pedestal must be covered with toeboard material.
- For PY18, use TF396 when installed against wall (or next to a full depth refrigerator.)
- Tall non-mitered doors will have two center panels with cross rail.
- Troxel doors greater than 48" high will be two doors doveled together.

Custom Modifications

ACS	ADDTK	AUTHL AUTHR	CBO	CCO	CFNTD	CFRMO	CND	DRT	DRWTK	EXBKL EXBKR	EXL EXR	FB	FFDL FFDR
		•	•	•	•	•				•	•	•	
FPFB	FTK	FTKAV FTKRV	ID	INFRM	MIP	RD	RECTKL RECTKR	RT	TD	TKP	VTK	WLI	
•					•		•		•			•	

Construction Upgrades

APC	ET	PE
•		•

Door Options

CG.TOP	DPSRR	MFO
•	•	•

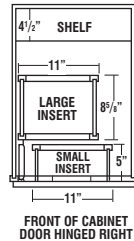

PY18R

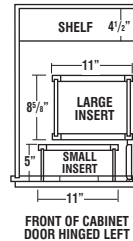

PY18L

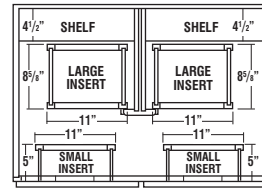

FRONT OF CABINET

PY36

Wood inserts for all styles:

- Top view of wood inserts positioning and size.
- Wood inserts are 56" high.

NEW PANTRY WALK-THROUGH, 84", 87", 90", 93", or 96" TALL, 24" DEEP

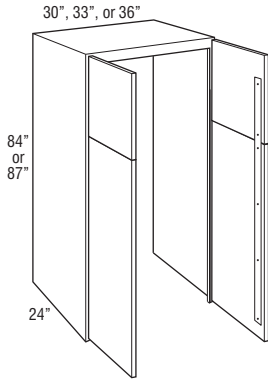

PWT308424
PWT338424
PWT368424
PWT308724
PWT338724
PWT368724

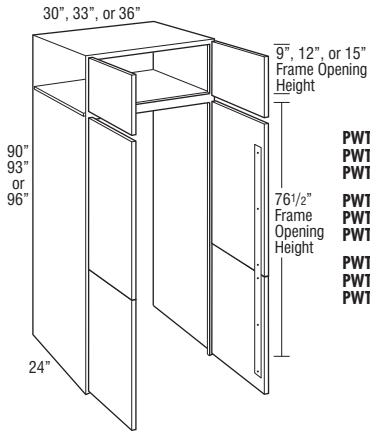

PWT309024
PWT339024
PWT369024
PWT309324
PWT339324
PWT369324
PWT309624
PWT339624
PWT369624

274

TALL CABINETS

Model	Cubic Feet
PWT308424	41.3
PWT338424	45.2
PWT368424	49.2
PWT308724	42.8
PWT338724	46.8
PWT368724	50.9
PWT309024	44.3
PWT339024	48.7
PWT369024	53.1
PWT309324	45.7
PWT339324	50.3
PWT369324	54.9
PWT309624	47.2
PWT339624	51.9
PWT369624	56.6

- Cabinet does not have a bottom or back. Doors are braced together, are 1/4" shorter than the cabinet for floor clearance, and use standard 107° Smart Stop hinges.
- Not available in Shafer, Caprice, and Vaile.
- Can be reduced in depth to 9" or increased in depth to 27".
- CG and glass inserts only available on upper doors of 90"-96" tall.
- Authentic Ends uses the standard tall door configuration by height and will not align with the front doors. A tall end panel skin can be used to conceal door attachment screws on the interior of the cabinet end panel (see TEPS_ _WD on page 355).
- Height of ceiling needs to be considered for installation, 96" high cabinet requires 99" of height for 24" deep and 100" of height for 27" deep to stand unit upright.
- Cabinet will be shipped with additional attached supports to be removed during installation.
- ICM8 (Inside Corner Moulding) can be used to conceal staples behind the face frame.
- SSM8 (Small Scribe Moulding) can be used to conceal exposed back edges of the end panels, which are not edgebanded.
- End panels will not be drilled for shelves.
- If ordered in Arch/Cathedral style on 84" and 87" tall, the top doors of 84" and 87" will feature Arch/Cathedral profile. On 90"-96" tall, only the doors on the upper section will feature Arch/Cathedral profile.

Custom Modifications

ACS	ADDTK	AUTHL AUTHR	CBO	CCO	CFNTO	CFRMO	CND	DRT	DRWTK	EXBKL EXBKR	EXL EXR	FB	FFDL FFDR
		•									•		
FPEB	FTK	FTKAV FTKFV	ID	INVFRM	MIP	RD	RECTKL RECTKR	RT	TD	TKP	VTK	WLI	
STD			•		•	•						•	

Construction Upgrades

APC	ET	PE
STD		

Door Options

CG.TOP	DPSRR	MFO
•†	•	•

†Available only on 90"-96" high

**SINGLE OVEN CABINET,
84", 87", or 90" TALL, 24" DEEP**

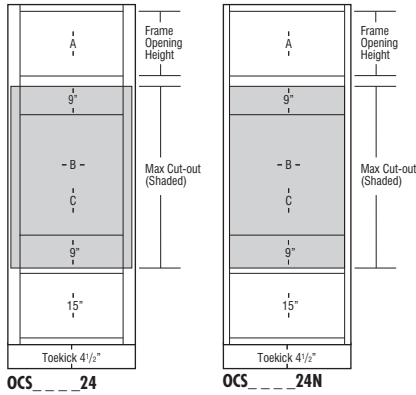
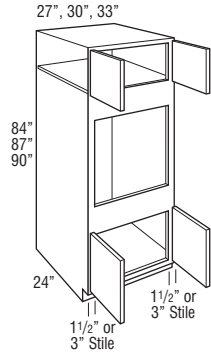

Model	Cubic Feet
OCS278424(N)	37.4
OCS308424(N)	41.3
OCS338424(N)	45.2
OCS278724(N)	38.7
OCS308724(N)	42.8
OCS338724(N)	46.8
OCS279024 (AH or N)	40.0
OCS309024 (AH or N)	44.2
OCS339024 (AH or N)	48.4

- AH represents upper section alignment with doors on 24" or 27" high cabinets.
- N represents Narrow Stile cabinets with 1 1/2" wide face frame side stiles and ACS modification availability (see page 39 for ACS specifications). Doors have a consistent width reveal for full overlay (1/4") and partial overlay (1") and use standard Smart Stop hinges.
- On cabinets with 3" wide face frame side stiles, full overlay styles have a consistent 1/4" width frame reveal and use face mounted Smart Stop hinges. Partial overlay styles have a larger 2 1/2" width reveal, use standard Smart Stop hinges, and are not recommended for stacking applications due to misalignment of door width with cabinets above.
- Upper section on 90" tall has one full depth adjustable shelf.
- All top and bottom cross rails are 1 1/2" wide.
- Be sure to confirm a heat shield is built into your appliance by the manufacturer or install the heat shield included with your appliance. Heat shields are sold separately as an accessory.
- Depth can be reduced to a minimum of 6". For depths of 6"-8", cabinet will not include toekick/pedestal.
- For built-in appliance support, OCINSTALLKIT is included in 24" deep oven cabinets (see page 410 for details). Oven install kit will not be included when depth is modified.
- Oven cabinets feature an open back in cut-out area designed to improve field appliance installation.
- Maximum cut-out dimension will allow 1/4" reveal for doors and drawer fronts on full overlay and 1" for partial overlay for trim kit face clearance.

	A Frame Opening Height	B Cut-Out Width		C Cut-Out Height		Door Height (Upper Section)	
		Min.	Max.	Min.	Max.	Partial Overlay	Full Overlay
OCS278424	15"	21"	25 1/2"	28 1/2"	43 1/2"	16"	17 1/2"
OCS308424	15"	24"	28 1/2"	28 1/2"	43 1/2"	16"	17 1/2"
OCS338424	15"	27"	31 1/2"	28 1/2"	43 1/2"	16"	17 1/2"
OCS278724	18"	21"	25 1/2"	28 1/2"	43 1/2"	19"	20 1/2"
OCS308724	18"	24"	28 1/2"	28 1/2"	43 1/2"	19"	20 1/2"
OCS338724	18"	27"	31 1/2"	28 1/2"	43 1/2"	19"	20 1/2"
OCS279024AH	21"	21"	25 1/2"	28 1/2"	43 1/2"	22"	23 1/2"
OCS309024AH	21"	24"	28 1/2"	28 1/2"	43 1/2"	22"	23 1/2"
OCS339024AH	21"	27"	31 1/2"	28 1/2"	43 1/2"	22"	23 1/2"

	A Frame Opening Height	B Cut-Out Width (standard)		B Cut-Out Width (with ACS modification)			C Cut-Out Height		Door Height (Upper Section)	
		Min.	Max.	Min.	Max.	Max. w/ Field Cut	Min.	Max.	Partial Overlay	Full Overlay
OCS278424N	15"	24"	25 1/2"	21"	24"	25 1/2"	28 1/2"	43 1/2"	16"	17 1/2"
OCS308424N	15"	27"	28 1/2"	24"	27"	28 1/2"	28 1/2"	43 1/2"	16"	17 1/2"
OCS338424N	15"	30"	31 1/2"	27"	30"	31 1/2"	28 1/2"	43 1/2"	16"	17 1/2"
OCS278724N	18"	24"	25 1/2"	21"	24"	25 1/2"	28 1/2"	43 1/2"	19"	20 1/2"
OCS308724N	18"	27"	28 1/2"	24"	27"	28 1/2"	28 1/2"	43 1/2"	19"	20 1/2"
OCS338724N	18"	30"	31 1/2"	27"	30"	31 1/2"	28 1/2"	43 1/2"	19"	20 1/2"
OCS279024N	21"	24"	25 1/2"	21"	24"	25 1/2"	28 1/2"	43 1/2"	22"	23 1/2"
OCS309024N	21"	27"	28 1/2"	24"	27"	28 1/2"	28 1/2"	43 1/2"	22"	23 1/2"
OCS339024N	21"	30"	31 1/2"	27"	30"	31 1/2"	28 1/2"	43 1/2"	22"	23 1/2"

Custom Modifications

ACS	ADDTK	AUTHL AUTHR	CBO	CCO	CFNTO	CFRMO	CND	DRT	DRWTK	EXBKL EXBKR	EXL EXR	FB	FFDL FFDR
•*		•	•*	•	•	•			•	•	•	•	
FPEB	FTK	FTKAV FTKFV	ID	INFRM	MIP	RD	RECTKL RECTKR	RT	TD	TKP	VTK	WLI	
•	•	•	•		•	•	•		•	•	•	•	

*Only available on Narrow Stile (N) cabinets *Not available on 84" and 87" tall

Construction Upgrades

APC	ET	PE
•		•

Door Options

CG.TOP	DPSRR	MFO
	•	•

**SINGLE OVEN CABINET,
93" or 96" TALL, 24" DEEP**

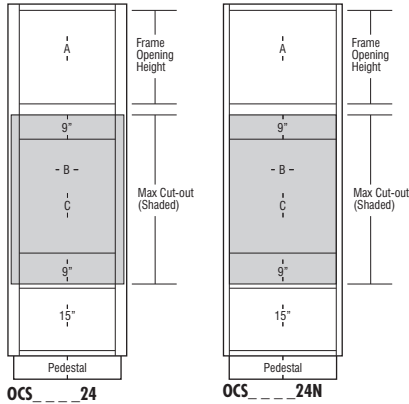
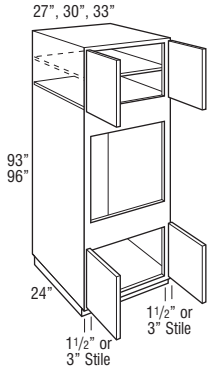

276

TALL CABINETS

Model	Cubic Feet
OCS279324 (AH or N)	41.3
OCS309324 (AH or N)	45.7
OCS339324 (AH or N)	50.0
OCS279624(N)	42.6
OCS309624(N)	47.1
OCS339624(N)	51.6

- AH represents upper section alignment with doors on 24" or 27" high cabinets.
- N represents Narrow Stile cabinets with 1 1/2" wide face frame side stiles and ACS modification availability (see page 39 for ACS specifications). Doors have a consistent width reveal for full overlay (1/4") and partial overlay (1") and use standard Smart Stop hinges.
- On cabinets with 3" wide face frame side stiles, full overlay styles have a consistent 1/4" width frame reveal and use face mounted Smart Stop hinges. Partial overlay styles have a larger 2 1/2" width reveal, use standard Smart Stop hinges, and are not recommended for stacking applications due to misalignment of door width with cabinets above.
- Includes adjustable shelves in upper section:
93" tall - one shelf
96" tall - two shelves
- All top and bottom cross rails are 1 1/2" wide.
- Be sure to confirm a heat shield is built into your appliance by the manufacturer or install the heat shield included with your appliance. Heat shields are sold separately as an accessory.
- Separate pedestal base included but packaged separately on 93" and 96" tall. Pedestal is designed to create a Recessed Left or Right Toe-kick application during field installation, or can be centered. Pedestal must be covered with toeboard material.
- Depth can be reduced to a minimum of 6". For depths of 6"-8", cabinet will not include toe-kick/pedestal.
- For built-in appliance support, OCINSTALKIT is included in 24" deep oven cabinets (see page 410 for details). Oven install kit will not be included when depth is modified.
- Oven cabinets feature an open back in cut-out area designed to improve field appliance installation.
- Maximum cut-out dimension will allow 1/4" reveal for doors and drawer fronts on full overlay and 1" for partial overlay for trim kit face clearance.

	A Frame Opening Height	B Cut-Out Width		C Cut-Out Height		Door Height (Upper Section)	
		Min.	Max.	Min.	Max.	Partial Overlay	Full Overlay
OCS279324AH	24"	21"	25 1/2"	28 1/2"	43 1/2"	25"	26 1/2"
OCS309324AH	24"	24"	28 1/2"	28 1/2"	43 1/2"	25"	26 1/2"
OCS339324AH	24"	27"	31 1/2"	28 1/2"	43 1/2"	25"	26 1/2"
OCS279624	27"	21"	25 1/2"	28 1/2"	43 1/2"	28"	29 1/2"
OCS309624	27"	24"	28 1/2"	28 1/2"	43 1/2"	28"	29 1/2"
OCS339624	27"	27"	31 1/2"	28 1/2"	43 1/2"	28"	29 1/2"

	A Frame Opening Height	B Cut-Out Width (standard)		B Cut-Out Width (with ACS modification)			C Cut-Out Height		Door Height (Upper Section)	
		Min.	Max.	Min.	Max.	Max. w/ Field Cut	Min.	Max.	Partial Overlay	Full Overlay
OCS279324N	24"	24"	25 1/2"	21"	24"	25 1/2"	28 1/2"	43 1/2"	25"	26 1/2"
OCS309324N	24"	27"	28 1/2"	24"	27"	28 1/2"	28 1/2"	43 1/2"	25"	26 1/2"
OCS339324N	24"	30"	31 1/2"	27"	30"	31 1/2"	28 1/2"	43 1/2"	25"	26 1/2"
OCS279624N	27"	24"	25 1/2"	21"	24"	25 1/2"	28 1/2"	43 1/2"	28"	29 1/2"
OCS309624N	27"	27"	28 1/2"	24"	27"	28 1/2"	28 1/2"	43 1/2"	28"	29 1/2"
OCS339624N	27"	30"	31 1/2"	27"	30"	31 1/2"	28 1/2"	43 1/2"	28"	29 1/2"

Custom Modifications

ACS	ADDTK	AUTHL AUTHR	CBO	CCO	CFNTO	CFRMO	CND	DRT	DRWTK	EXBKL EXBKR	EXL EXR	FB	FFDL FFDR
*		•	•	•	•	•				•	•	•	
FPEB	FTK	FTKAV FTKRV	ID	INVFRM	MIP	RD	RECTKL RECTKR	RT	TD	TKP	VTK	WLI	
•			•		•	•	•		•			•	

*Only available on Narrow Stile (N) cabinets

Construction Upgrades

APC	ET	PE
•		•

Door Options

CG.TOP	DPSRR	MFO
	•	•

**SINGLE OVEN CABINET, DEEP
DRAWER, 84", 87", or 90" TALL,
24" DEEP**

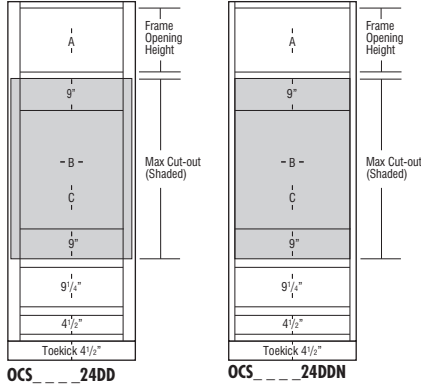
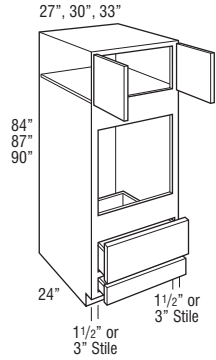

Model	Cubic Feet
OCS278424DD(N)	37.4
OCS308424DD(N)	41.3
OCS338424DD(N)	45.2
OCS278724DD(N)	38.7
OCS308724DD(N)	42.8
OCS338724DD(N)	46.8
OCS279024DD (AH or N)	40.0
OCS309024DD (AH or N)	44.2
OCS339024DD (AH or N)	48.4

- AH represents upper section alignment with doors on 24" or 27" high cabinets.
- N represents Narrow Stile cabinets with 1 1/2" wide face frame side stiles and ACS modification availability (see page 39 for ACS specifications). Doors and drawer fronts have a consistent width reveal for full overlay (1/4") and partial overlay (1") and use standard Smart Stop hinges.
- On cabinets with 3" wide face frame side stiles, full overlay styles have a consistent 1/4" width frame reveal and use face mounted Smart Stop hinges. Partial overlay styles have a larger 2 1/2" width reveal, use standard Smart Stop hinges, and are not recommended for stacking applications due to misalignment of door width with cabinets above.
- Upper section on 90" tall has one full depth adjustable shelf.
- All top and bottom cross rails are 1 1/2" wide.
- Be sure to confirm a heat shield is built into your appliance by the manufacturer or install the heat shield included with your appliance. Heat shields are sold separately as an accessory.
- Depth can be reduced to a minimum of 12".
- For built-in appliance support, OCINSTALLKIT is included in 24" deep oven cabinets (see page 410 for details). Oven install kit will not be included when depth is modified.
- Oven cabinets feature an open back in cut-out area designed to improve field appliance installation.
- Maximum cut-out dimension will allow 1/4" reveal for doors and drawer fronts on full overlay and 1" for partial overlay for trim kit face clearance.

	A Frame Opening Height	B Cut-Out Width		C Cut-Out Height		Door Height (Upper Section)	
		Min.	Max.	Min.	Max.	Partial Overlay	Full Overlay
OCS278424DD	15"	21"	25 1/2"	27 3/4"	42 3/4"	16"	17 1/2"
OCS308424DD	15"	24"	28 1/2"	27 3/4"	42 3/4"	16"	17 1/2"
OCS338424DD	15"	27"	31 1/2"	27 3/4"	42 3/4"	16"	17 1/2"
OCS278724DD	18"	21"	25 1/2"	27 3/4"	42 3/4"	19"	20 1/2"
OCS308724DD	18"	24"	28 1/2"	27 3/4"	42 3/4"	19"	20 1/2"
OCS338724DD	18"	27"	31 1/2"	27 3/4"	42 3/4"	19"	20 1/2"
OCS279024DDAH	21"	21"	25 1/2"	27 3/4"	42 3/4"	22"	23 1/2"
OCS309024DDAH	21"	24"	28 1/2"	27 3/4"	42 3/4"	22"	23 1/2"
OCS339024DDAH	21"	27"	31 1/2"	27 3/4"	42 3/4"	22"	23 1/2"

	A Frame Opening Height	B Cut-Out Width (standard)		B Cut-Out Width (with ACS modification)			C Cut-Out Height		Door Height (Upper Section)	
		Min.	Max.	Min.	Max.	Max. w/ Field Cut	Min.	Max.	Partial Overlay	Full Overlay
OCS278424DDN	15"	24"	25 1/2"	21"	24"	25 1/2"	27 3/4"	42 3/4"	16"	17 1/2"
OCS308424DDN	15"	27"	28 1/2"	24"	27"	28 1/2"	27 3/4"	42 3/4"	16"	17 1/2"
OCS338424DDN	15"	30"	31 1/2"	27"	30"	31 1/2"	27 3/4"	42 3/4"	16"	17 1/2"
OCS278724DDN	18"	24"	25 1/2"	21"	24"	25 1/2"	27 3/4"	42 3/4"	19"	20 1/2"
OCS308724DDN	18"	27"	28 1/2"	24"	27"	28 1/2"	27 3/4"	42 3/4"	19"	20 1/2"
OCS338724DDN	18"	30"	31 1/2"	27"	30"	31 1/2"	27 3/4"	42 3/4"	19"	20 1/2"
OCS279024DDN	21"	24"	25 1/2"	21"	24"	25 1/2"	27 3/4"	42 3/4"	22"	23 1/2"
OCS309024DDN	21"	27"	28 1/2"	24"	27"	28 1/2"	27 3/4"	42 3/4"	22"	23 1/2"
OCS339024DDN	21"	30"	31 1/2"	27"	30"	31 1/2"	27 3/4"	42 3/4"	22"	23 1/2"

Custom Modifications

ACS	ADDTK	AUTHL AUTHR	CBO	CCO	CFNTO	CFRMO	CND	DRT	DRWTK	EXBKL EXBKR	EXL EXR	FB	FFDL FFDR
•*		•	•	•		•	•		•	•	•	•	
FPEB	FTK	FTKAV FTKFV	ID	INFRM	MIP	RD	RECTKL RECTKR	RT	TD	TKP	VTK	WLI	
•	•	•			•	•	•		•	•	•	•	

*Only available on Narrow Stile (N) cabinets

Construction Upgrades

APC	ET	PE
•		•

Door Options

CG.TOP	DPSRR	MFO
	•	•

SINGLE OVEN CABINET, DEEP DRAWER, 93" or 96" TALL, 24" DEEP

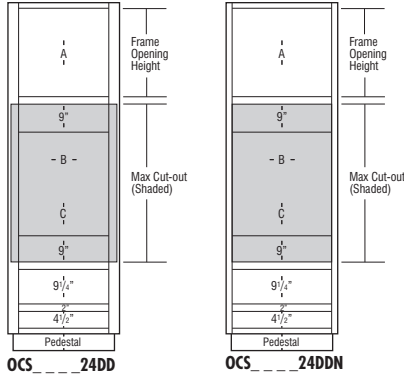
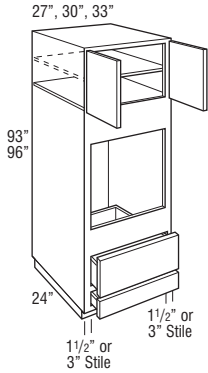

Model	Cubic Feet
OCS279324DD (AH or N)	41.3
OCS309324DD (AH or N)	45.7
OCS339324DD (AH or N)	50.0
OCS279624DD(N)	42.6
OCS309624DD(N)	47.1
OCS339624DD(N)	51.6

- AH represents upper section alignment with doors on 24" or 27" high cabinets.
- N represents Narrow Stile cabinets with 1 1/2" wide face frame side stiles and ACS modification availability (see page 39 for ACS specifications). Doors and drawer fronts have a consistent width reveal for full overlay (1/4") and partial overlay (1") and use standard Smart Stop hinges.
- On cabinets with 3" wide face frame side stiles, full overlay styles have a consistent 1/4" width frame reveal and use face mounted Smart Stop hinges. Partial overlay styles have a larger 2 1/2" width reveal, use standard Smart Stop hinges, and are not recommended for stacking applications due to misalignment of door width with cabinets above.
- Includes adjustable shelves in upper section:
93" tall - one shelf
96" tall - two shelves
- All top and bottom cross rails are 1 1/2" wide.
- Be sure to confirm a heat shield is built into your appliance by the manufacturer or install the heat shield included with your appliance. Heat shields are sold separately as an accessory.
- Separate pedestal base included but packaged separately on 93" and 96" tall. Pedestal is designed to create a Recessed Left or Right Toe Kick application during field installation, or can be centered. Pedestal must be covered with toeboard material.
- Depth can be reduced to a minimum of 12".
- For built-in appliance support, OCINSTALKIT is included in 24" deep oven cabinets (see page 410 for details). Oven install kit will not be included when depth is modified.
- Oven cabinets feature an open back in cut-out area designed to improve field appliance installation.
- Maximum cut-out dimension will allow 1/4" reveal for doors and drawer fronts on full overlay and 1" for partial overlay for trim kit face clearance.

	A Frame Opening Height	B Cut-Out Width		C Cut-Out Height		Door Height (Upper Section)	
		Min.	Max.	Min.	Max.	Partial Overlay	Full Overlay
OCS279324DDAH	24"	21"	25 1/2"	27 3/4"	42 3/4"	25"	26 1/2"
OCS309324DDAH	24"	24"	28 1/2"	27 3/4"	42 3/4"	25"	26 1/2"
OCS339324DDAH	24"	27"	31 1/2"	27 3/4"	42 3/4"	25"	26 1/2"
OCS279624DD	27"	21"	25 1/2"	27 3/4"	42 3/4"	28"	29 1/2"
OCS309624DD	27"	24"	28 1/2"	27 3/4"	42 3/4"	28"	29 1/2"
OCS339624DD	27"	27"	31 1/2"	27 3/4"	42 3/4"	28"	29 1/2"

	A Frame Opening Height	B Cut-Out Width (standard)		B Cut-Out Width (with ACS modification)			C Cut-Out Height		Door Height (Upper Section)	
		Min.	Max.	Min.	Max.	Max. w/ Field Cut	Min.	Max.	Partial Overlay	Full Overlay
OCS279324DDN	24"	24"	25 1/2"	21"	24"	25 1/2"	27 3/4"	42 3/4"	25"	26 1/2"
OCS309324DDN	24"	27"	28 1/2"	24"	27"	28 1/2"	27 3/4"	42 3/4"	25"	26 1/2"
OCS339324DDN	24"	30"	31 1/2"	27"	30"	31 1/2"	27 3/4"	42 3/4"	25"	26 1/2"
OCS279624DDN	27"	24"	25 1/2"	21"	24"	25 1/2"	27 3/4"	42 3/4"	28"	29 1/2"
OCS309624DDN	27"	27"	28 1/2"	24"	27"	28 1/2"	27 3/4"	42 3/4"	28"	29 1/2"
OCS339624DDN	27"	30"	31 1/2"	27"	30"	31 1/2"	27 3/4"	42 3/4"	28"	29 1/2"

Custom Modifications

ACS	ADDTK	AUTHL AUTHR	CBO	CCO	CFNTO	CFRMO	CND	DRT	DRWTK	EXBKL EXBKR	EXL EXR	FB	FFDL FFDR
•*		•	•	•		•	•			•	•	•	
FPEB	FTK	FTKAV FTKRV	ID	INVFRM	MIP	RD	RECTKL RECTKR	RT	TD	TKP	VTK	WLI	
•					•	•	•		•			•	

*Only available on Narrow Stile (N) cabinets

Construction Upgrades

APC	ET	PE
•		•

Door Options

CG.TOP	DPSRR	MFO
	•	•

SINGLE OVEN CABINET, WARMING DRAWER, 84", 87", or 90" TALL, 24" DEEP

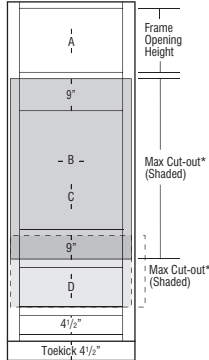
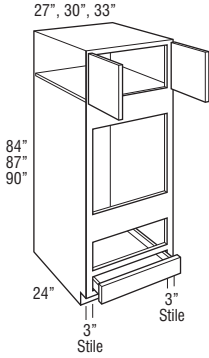

*Minimum rail height between oven and warming drawer is 1 1/2"

Model	Cubic Feet
OCS278424WD	37.4
OCS308424WD	41.3
OCS338424WD	45.2
OCS278724WD	38.7
OCS308724WD	42.8
OCS338724WD	46.8
OCS279024WDAH	40.0
OCS309024WDAH	44.2
OCS339024WDAH	48.4

- AH represents upper section alignment with doors on 24" or 27" high cabinets.
- Upper section on 90" tall has one full depth adjustable shelf.
- Full overlay styles feature concealed face mount Smart Stop hinges.
- All top and bottom cross rails are 1 1/2" wide.
- Be sure to confirm a heat shield is built into your appliance by the manufacturer or install the heat shield included with your appliance. Heat shields are sold separately as an accessory.
- Depth can be reduced to a minimum of 12".
- For built-in appliance support, OCINSTALLKIT is included in 24" deep oven cabinets (see page 410 for details). Oven install kit will not be included when depth is modified.
- Oven cabinets feature an open back in cut-out area designed to improve field appliance installation.

	A Frame Opening Height	B Cut-Out Width		C Cut-Out Height		D Warming Drawer Cut-Out Height		Door Height (Upper Section)	
		Min.	Max.	Min.	Max.	Min.	Max.	Partial Overlay	Full Overlay
OCS278424WD	15"	21"	25 1/2"	27 3/4"	42 3/4"	9 1/4"	16 3/4"	16"	17 1/2"
OCS308424WD	15"	24"	28 1/2"	27 3/4"	42 3/4"	9 1/4"	16 3/4"	16"	17 1/2"
OCS338424WD	15"	27"	31 1/2"	27 3/4"	42 3/4"	9 1/4"	16 3/4"	16"	17 1/2"
OCS278724WD	18"	21"	25 1/2"	27 3/4"	42 3/4"	9 1/4"	16 3/4"	19"	20 1/2"
OCS308724WD	18"	24"	28 1/2"	27 3/4"	42 3/4"	9 1/4"	16 3/4"	19"	20 1/2"
OCS338724WD	18"	27"	31 1/2"	27 3/4"	42 3/4"	9 1/4"	16 3/4"	19"	20 1/2"
OCS279024WDAH	21"	21"	25 1/2"	27 3/4"	42 3/4"	9 1/4"	16 3/4"	22"	23 1/2"
OCS309024WDAH	21"	24"	28 1/2"	27 3/4"	42 3/4"	9 1/4"	16 3/4"	22"	23 1/2"
OCS339024WDAH	21"	27"	31 1/2"	27 3/4"	42 3/4"	9 1/4"	16 3/4"	22"	23 1/2"

Maximum cut-out dimension will allow 1/4" reveal for doors and drawer fronts on full overlay and 1" for partial overlay for trim kit face clearance.

Custom Modifications

ACS	ADDTK	AUTHL AUTHR	CBO	CCO	CFNTO	CFRMO	CND	DRT	DRWTK	EXBKL EXBKR	EXL EXR	FB	FFDL FFDR
		•	•	•		•	•		•	•	•		
FPEB	FTK	FTKAV FTKFV	ID	INVFRM	MIP	RD	RECTKL RECTKR	RT	TD	TKP	VTK	WLI	
•	•	•	•		•	•	•		•	•	•	•	

Construction Upgrades

APC	ET	PE
•		•

Door Options

CG.TOP	DPSRR	MFO
	•	•

SINGLE OVEN CABINET, WARMING DRAWER, 93" or 96" TALL, 24" DEEP

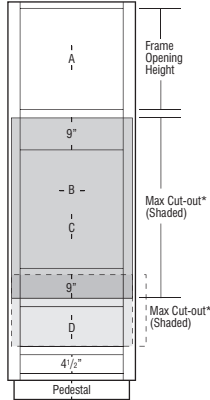
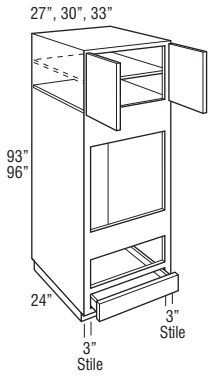

*Minimum rail height between oven and warming drawer is 1 1/2"

Model	Cubic Feet
OCS279324WDAH	41.3
OCS309324WDAH	45.7
OCS339324WDAH	50.0
OCS279624WD	42.6
OCS309624WD	47.1
OCS339624WD	51.6

- AH represents upper section alignment with doors on 24" or 27" high cabinets.
- Includes adjustable shelves in upper section:
93" tall - one shelf
96" tall - two shelves
- Full overlay styles feature concealed face mount Smart Stop hinges.
- All top and bottom cross rails are 1 1/2" wide.
- Be sure to confirm a heat shield is built into your appliance by the manufacturer or install the heat shield included with your appliance. Heat shields are sold separately as an accessory.
- Separate pedestal base included but packaged separately on 93" and 96" tall. Pedestal is designed to create a Recessed Left or Right Toe Kick application during field installation, or can be centered. Pedestal must be covered with toeboard material.
- Depth can be reduced to a minimum of 12".
- For built-in appliance support, OCINSTALLKIT is included in 24" deep oven cabinets (see page 410 for details). Oven install kit will not be included when depth is modified.
- Oven cabinets feature an open back in cut-out area designed to improve field appliance installation.

	A Frame Opening Height	B Cut-Out Width		C Cut-Out Height		D Warming Drawer Cut-Out Height		Door Height (Upper Section)	
		Min.	Max.	Min.	Max.	Min.	Max.	Partial Overlay	Full Overlay
OCS279324WDAH	24"	21"	25 1/2"	27 3/4"	42 3/4"	9 1/4"	16 3/4"	25"	26 1/2"
OCS309324WDAH	24"	24"	28 1/2"	27 3/4"	42 3/4"	9 1/4"	16 3/4"	25"	26 1/2"
OCS339324WDAH	24"	27"	31 1/2"	27 3/4"	42 3/4"	9 1/4"	16 3/4"	25"	26 1/2"
OCS279624WD	27"	21"	25 1/2"	27 3/4"	42 3/4"	9 1/4"	16 3/4"	28"	29 1/2"
OCS309624WD	27"	24"	28 1/2"	27 3/4"	42 3/4"	9 1/4"	16 3/4"	28"	29 1/2"
OCS339624WD	27"	27"	31 1/2"	27 3/4"	42 3/4"	9 1/4"	16 3/4"	28"	29 1/2"

Maximum cut-out dimension will allow 1/4" reveal for doors and drawer fronts on full overlay and 1" for partial overlay for trim kit face clearance.

Custom Modifications

ACS	ADDTK	AUTHL AUTHR	CBO	CCO	CFNTO	CFRMO	CND	DRT	DRWTK	EXBKL EXBKR	EXL EXR	FB	FFDL FFDR
		•	•	•		•	•			•	•	•	
FPFB	FTK	FTKAV FTKFV	ID	INVFRM	MIP	RD	RECTKL RECTKR	RT	TD	TKP	VTK	WLI	
•			•		•	•	•		•			•	

Construction Upgrades

APC	ET	PE
•		•

Door Options

CG.TOP	DPSRR	MFO
	•	•

DOUBLE OVEN CABINET, 84", 87", or 90" TALL, 24" DEEP

27", 30", 33"

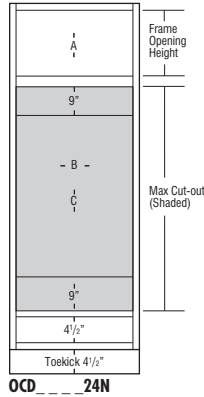
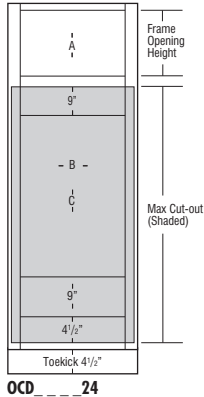
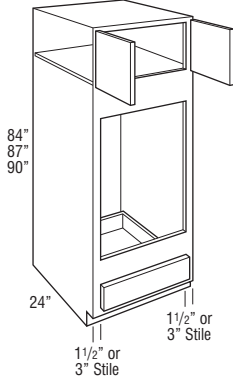

Model	Cubic Feet
OCD278424(N)	37.4
OCD308424(N)	41.3
OCD338424(N)	45.2
OCD278724(N)	38.7
OCD308724(N)	42.8
OCD338724(N)	46.8
OCD279024 (AH or N)	40.0
OCD309024 (AH or N)	44.2
OCD339024 (AH or N)	48.4

- AH represents upper section alignment with doors on 24" or 27" high cabinets.
- N represents Narrow Stile cabinets with 1 1/2" wide face frame side stiles and ACS modification availability (see page 39 for ACS specifications). Doors and drawer fronts have a consistent width reveal for full overlay (1/4") and partial overlay (1") and use standard Smart Stop hinges.
- On cabinets with 3" wide face frame side stiles, full overlay styles have a consistent 1/4" width frame reveal and use face mounted Smart Stop hinges. Partial overlay styles have a larger 2 1/2" width reveal, use standard Smart Stop hinges, and are not recommended for stacking applications due to misalignment of door width with cabinets above.
- Upper section on 90" tall has one full depth adjustable shelf.
- All top and bottom cross rails are 1 1/2" wide.
- Be sure to confirm a heat shield is built into your appliance by the manufacturer or install the heat shield included with your appliance. Heat shields are sold separately as an accessory.
- Depth can be reduced to a minimum of 12".
- For built-in appliance support, OCINSTALLKIT is included in 24" deep oven cabinets (see page 410 for details). Oven install kit will not be included when depth is modified.
- Oven cabinets feature an open back in cut-out area designed to improve field appliance installation.
- Maximum cut-out dimension will allow 1/4" reveal for doors and drawer fronts on full overlay and 1" for partial overlay for trim kit face clearance.

	A Frame Opening Height	B Cut-Out Width		C Cut-Out Height		Door Height (Upper Section)	
		Min.	Max.	Min.	Max.	Partial Overlay	Full Overlay
OCD278424	15"	21"	25 1/2"	39"	60"	16"	17 1/2"
OCD308424	15"	24"	28 1/2"	39"	60"	16"	17 1/2"
OCD338424	15"	27"	31 1/2"	39"	60"	16"	17 1/2"
OCD278724	18"	21"	25 1/2"	39"	60"	19"	20 1/2"
OCD308724	18"	24"	28 1/2"	39"	60"	19"	20 1/2"
OCD338724	18"	27"	31 1/2"	39"	60"	19"	20 1/2"
OCD279024AH	21"	21"	25 1/2"	39"	60"	22"	23 1/2"
OCD309024AH	21"	24"	28 1/2"	39"	60"	22"	23 1/2"
OCD339024AH	21"	27"	31 1/2"	39"	60"	22"	23 1/2"

	A Frame Opening Height	B Cut-Out Width (standard)		B Cut-Out Width (with ACS modification)			C Cut-Out Height		Door Height (Upper Section)	
		Min.	Max.	Min.	Max.	Max. w/ Field Cut	Min.	Max.	Partial Overlay	Full Overlay
OCD278424N	15"	24"	25 1/2"	21"	24"	25 1/2"	39"	54"	16"	17 1/2"
OCD308424N	15"	27"	28 1/2"	24"	27"	28 1/2"	39"	54"	16"	17 1/2"
OCD338424N	15"	30"	31 1/2"	27"	30"	31 1/2"	39"	54"	16"	17 1/2"
OCD278724N	18"	24"	25 1/2"	21"	24"	25 1/2"	39"	54"	19"	20 1/2"
OCD308724N	18"	27"	28 1/2"	24"	27"	28 1/2"	39"	54"	19"	20 1/2"
OCD338724N	18"	30"	31 1/2"	27"	30"	31 1/2"	39"	54"	19"	20 1/2"
OCD279024N	21"	24"	25 1/2"	21"	24"	25 1/2"	39"	54"	22"	23 1/2"
OCD309024N	21"	27"	28 1/2"	24"	27"	28 1/2"	39"	54"	22"	23 1/2"
OCD339024N	21"	30"	31 1/2"	27"	30"	31 1/2"	39"	54"	22"	23 1/2"

Custom Modifications

ACS	ADDTK	AUTHL AUTHR	CBO	CCO	CFNTO	CFRMO	CND	DRT	DRWTK	EXBKL EXBKR	EXL EXR	FB	FFDL FFDR
•*		•	•	•		•	•		•	•	•	•	
FPEB	FTK	FTKAV FTKRV	ID	INFRM	MIP	RD	RECTKL RECTKR	RT	TD	TKP	VTK	WLI	
•	•	•	•		•	•	•		•	•	•	•	

*Only available on Narrow Stile (N) cabinets

Construction Upgrades

APC	ET	PE
•		•

Door Options

CG.TOP	DPSRR	MFO
	•	•

**DOUBLE OVEN CABINET,
93" or 96" TALL, 24" DEEP**

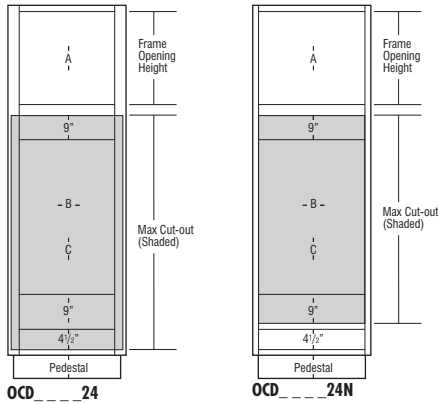
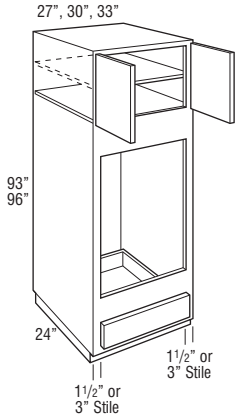

Model	Cubic Feet
OCD279324 (AH or N)	41.3
OCD309324 (AH or N)	45.7
OCD339324 (AH or N)	50.0
<hr/>	
OCD279624(N)	42.6
OCD309624(N)	47.1
OCD339624(N)	51.6

- AH represents upper section alignment with doors on 24" or 27" high cabinets.
- N represents Narrow Stile cabinets with 1 1/2" wide face frame side stiles and ACS modification availability (see page 39 for ACS specifications). Doors and drawer fronts have a consistent width reveal for full overlay (1/4") and partial overlay (1") and use standard Smart Stop hinges.
- On cabinets with 3" wide face frame side stiles, full overlay styles have a consistent 1/4" width frame reveal and use face mounted Smart Stop hinges. Partial overlay styles have a larger 2 1/2" width reveal, use standard Smart Stop hinges, and are not recommended for stacking applications due to misalignment of door width with cabinets above.
- Includes adjustable shelves in upper section:
93" tall - one shelf
96" tall - two shelves
- All top and bottom cross rails are 1 1/2" wide.
- Be sure to confirm a heat shield is built into your appliance by the manufacturer or install the heat shield included with your appliance. Heat shields are sold separately as an accessory.
- Separate pedestal base included but packaged separately on 93" and 96" tall. Pedestal is designed to create a Recessed Left or Right Toe Kick application during field installation, or can be centered. Pedestal must be covered with toeboard material.
- Depth can be reduced to a minimum of 12".
- For built-in appliance support, OCINSTALLKIT is included in 24" deep oven cabinets (see page 410 for details). Oven install kit will not be included when depth is modified.
- Oven cabinets feature an open back in cut-out area designed to improve field appliance installation.
- Maximum cut-out dimension will allow 1/4" reveal for doors and drawer fronts on full overlay and 1" for partial overlay for trim kit face clearance.

	A Frame Opening Height	B Cut-Out Width		C Cut-Out Height		Door Height (Upper Section)	
		Min.	Max.	Min.	Max.	Partial Overlay	Full Overlay
OCD279324AH	24"	21"	25 1/2"	39"	60"	25"	26 1/2"
OCD309324AH	24"	24"	28 1/2"	39"	60"	25"	26 1/2"
OCD339324AH	24"	27"	31 1/2"	39"	60"	25"	26 1/2"
OCD279624	27"	21"	25 1/2"	39"	60"	28"	29 1/2"
OCD309624	27"	24"	28 1/2"	39"	60"	28"	29 1/2"
OCD339624	27"	27"	31 1/2"	39"	60"	28"	29 1/2"

	A Frame Opening Height	B Cut-Out Width (standard)		B Cut-Out Width (with ACS modification)			C Cut-Out Height		Door Height (Upper Section)	
		Min.	Max.	Min.	Max.	Max. w/ Field Cut	Min.	Max.	Partial Overlay	Full Overlay
OCD279324N	24"	24"	25 1/2"	21"	24"	25 1/2"	39"	54"	25"	26 1/2"
OCD309324N	24"	27"	28 1/2"	24"	27"	28 1/2"	39"	54"	25"	26 1/2"
OCD339324N	24"	30"	31 1/2"	27"	30"	31 1/2"	39"	54"	25"	26 1/2"
OCD279624N	27"	24"	25 1/2"	21"	24"	25 1/2"	39"	54"	28"	29 1/2"
OCD309624N	27"	27"	28 1/2"	24"	27"	28 1/2"	39"	54"	28"	29 1/2"
OCD339624N	27"	30"	31 1/2"	27"	30"	31 1/2"	39"	54"	28"	29 1/2"

Custom Modifications

ACS	ADDTK	AUTHL AUTHR	CBO	CCO	CFNTO	CFRMO	CND	DRT	DRWTK	EXBKL EXBKR	EXL EXR	FB	FFDL FFDR
•*		•	•	•		•	•			•	•	•	
	FPEB	FTK	FTKAV FTKEV	ID	INVERM	MIP	RD	RECTKL RECTKR	RT	TD	TKP	VTK	WLI
	•		•		•	•	•	•	•			•	

*Only available on Narrow Stile (N) cabinets

Construction Upgrades

APC	ET	PE
•		•

Door Options

CG.TOP	DPSRR	MFO
	•	•

**DOUBLE OVEN CABINET, DEEP
DRAWER, 84", 87", or 90" TALL,
24" DEEP**

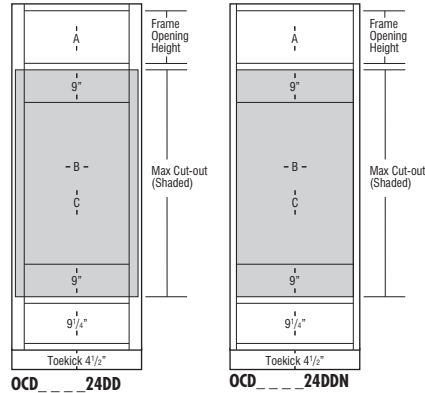
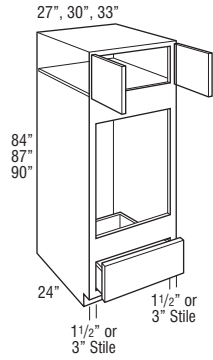

Model	Cubic Feet
OCD278424DD(N)	37.4
OCD308424DD(N)	41.3
OCD338424DD(N)	45.2
OCD278724DD(N)	38.7
OCD308724DD(N)	42.8
OCD338724DD(N)	46.8
OCD279024DD(N)	40.0
OCD309024DD(N)	44.2
OCD339024DD(N)	48.4

- N represents Narrow Stile cabinets with 1 1/2" wide face frame side stiles and ACS modification availability (see page 39 for ACS specifications). Doors and drawer fronts have a consistent width reveal for full overlay (1/4") and partial overlay (1") and use standard Smart Stop hinges.
- On cabinets with 3" wide face frame side stiles, full overlay styles have a consistent 1/4" width frame reveal and use face mounted Smart Stop hinges. Partial overlay styles have a larger 2 1/2" width reveal, use standard Smart Stop hinges, and are not recommended for stacking applications due to misalignment of door width with cabinets above.
- All top and bottom cross rails are 1 1/2" wide.
- Be sure to confirm a heat shield is built into your appliance by the manufacturer or install the heat shield included with your appliance. Heat shields are sold separately as an accessory.
- Depth can be reduced to a minimum of 12".
- For built-in appliance support, OCINSTALLKIT is included in 24" deep oven cabinets (see page 410 for details). Oven install kit will not be included when depth is modified.
- Oven cabinets feature an open back in cut-out area designed to improve field appliance installation.
- Maximum cut-out dimension will allow 1/4" reveal for doors and drawer fronts on full overlay and 1" for partial overlay for trim kit face clearance.

	A Frame Opening Height	B Cut-Out Width		C Cut-Out Height		Door Height (Upper Section)	
		Min.	Max.	Min.	Max.	Partial Overlay	Full Overlay
OCD278424DD	12"	21"	25 1/2"	37 1/4"	52 1/4"	13"	14 1/2"
OCD308424DD	12"	24"	28 1/2"	37 1/4"	52 1/4"	13"	14 1/2"
OCD338424DD	12"	27"	31 1/2"	37 1/4"	52 1/4"	13"	14 1/2"
OCD278724DD	15"	21"	25 1/2"	37 1/4"	52 1/4"	16"	17 1/2"
OCD308724DD	15"	24"	28 1/2"	37 1/4"	52 1/4"	16"	17 1/2"
OCD338724DD	15"	27"	31 1/2"	37 1/4"	52 1/4"	16"	17 1/2"
OCD279024DD	18"	21"	25 1/2"	37 1/4"	52 1/4"	19"	20 1/2"
OCD309024DD	18"	24"	28 1/2"	37 1/4"	52 1/4"	19"	20 1/2"
OCD339024DD	18"	27"	31 1/2"	37 1/4"	52 1/4"	19"	20 1/2"

	A Frame Opening Height	B Cut-Out Width (standard)		B Cut-Out Width (with ACS modification)			C Cut-Out Height		Door Height (Upper Section)	
		Min.	Max.	Min.	Max.	Max. w/ Field Cut	Min.	Max.	Partial Overlay	Full Overlay
OCD278424DDN	12"	24"	25 1/2"	21"	24"	25 1/2"	37 1/4"	52 1/4"	13"	14 1/2"
OCD308424DDN	12"	27"	28 1/2"	24"	27"	28 1/2"	37 1/4"	52 1/4"	13"	14 1/2"
OCD338424DDN	12"	30"	31 1/2"	27"	30"	31 1/2"	37 1/4"	52 1/4"	13"	14 1/2"
OCD278724DDN	15"	24"	25 1/2"	21"	24"	25 1/2"	37 1/4"	52 1/4"	16"	17 1/2"
OCD308724DDN	15"	27"	28 1/2"	24"	27"	28 1/2"	37 1/4"	52 1/4"	16"	17 1/2"
OCD338724DDN	15"	30"	31 1/2"	27"	30"	31 1/2"	37 1/4"	52 1/4"	16"	17 1/2"
OCD279024DDN	18"	24"	25 1/2"	21"	24"	25 1/2"	37 1/4"	52 1/4"	19"	20 1/2"
OCD309024DDN	18"	27"	28 1/2"	24"	27"	28 1/2"	37 1/4"	52 1/4"	19"	20 1/2"
OCD339024DDN	18"	30"	31 1/2"	27"	30"	31 1/2"	37 1/4"	52 1/4"	19"	20 1/2"

Custom Modifications

ACS	ADDTK	AUTHL AUTHR	CBO	CCO	CFNTO	CFRMO	CND	DRT	DRWTK	EXBKL EXBKR	EXL EXR	FB	FFDL FFDR
•*		•	•	•		•	•		•*	•	•	•	
FPEB	FTK	FTKAV FTKRV	ID	INFRM	MIP	RD	RECTKL RECTKR	RT	TD	TKP	VTK	WLI	
•	•	•	•		•	•	•		•▲	•	•	•	

*Only available on Narrow Stile (N) cabinets *Not available on 87" tall ▲Not available on 84" tall

Construction Upgrades

APC	ET	PE
•		•

Door Options

CG.TOP	DPSRR	MFO
	•	•

DOUBLE OVEN CABINET, DEEP DRAWER, 93" or 96" TALL, 24" DEEP

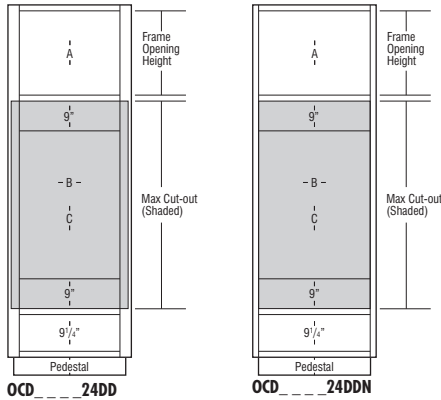
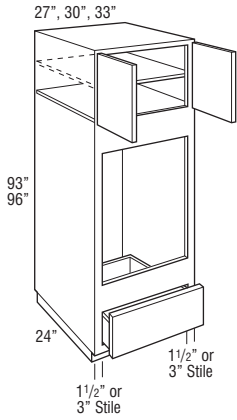

Model	Cubic Feet
OCD279324DD (AH or N)	41.3
OCD309324DD (AH or N)	45.7
OCD339324DD (AH or N)	50.0
OCD279624DD (AH or N)	42.6
OCD309624DD (AH or N)	47.1
OCD339624DD (AH or N)	51.6

- AH represents upper section alignment with doors on 24" or 27" high cabinets.
- N represents Narrow Stile cabinets with 1 1/2" wide face frame side stiles and ACS modification availability (see page 39 for ACS specifications). Doors and drawer fronts have a consistent width reveal for full overlay (1/4") and partial overlay (1") and use standard Smart Stop hinges.
- On cabinets with 3" wide face frame side stiles, full overlay styles have a consistent 1/4" width frame reveal and use face mounted Smart Stop hinges. Partial overlay styles have a larger 2 1/2" width reveal, use standard Smart Stop hinges, and are not recommended for stacking applications due to misalignment of door width with cabinets above.
- All top and bottom cross rails are 1 1/2" wide.
- Be sure to confirm a heat shield is built into your appliance by the manufacturer or install the heat shield included with your appliance. Heat shields are sold separately as an accessory.
- Separate pedestal base included but packaged separately on 93" and 96" tall. Pedestal is designed to create a Recessed Left or Right Toe-kick application during field installation, or can be centered. Pedestal must be covered with toeboard material.
- One full depth adjustable shelf included, but packaged separately.
- Depth can be reduced to a minimum of 12".
- For built-in appliance support, OCINSTALLKIT is included in 24" deep oven cabinets (see page 410 for details). Oven install kit will not be included when depth is modified.
- Oven cabinets feature an open back in cut-out area designed to improve field appliance installation.
- Maximum cut-out dimension will allow 1/4" reveal for doors and drawer fronts on full overlay and 1" for partial overlay for trim kit face clearance.

	A Frame Opening Height		B Cut-Out Width		C Cut-Out Height		Door Height (Upper Section)	
	Min.	Max.	Min.	Max.	Min.	Max.	Partial Overlay	Full Overlay
OCD279324DDAH	21"	21"	25 1/2"	37 1/4"	52 1/4"	22"	23 1/2"	
OCD309324DDAH	21"	24"	28 1/2"	37 1/4"	52 1/4"	22"	23 1/2"	
OCD339324DDAH	21"	27"	31 1/2"	37 1/4"	52 1/4"	22"	23 1/2"	
OCD279624DDAH	24"	21"	25 1/2"	37 1/4"	52 1/4"	25"	26 1/2"	
OCD309624DDAH	24"	24"	28 1/2"	37 1/4"	52 1/4"	25"	26 1/2"	
OCD339624DDAH	24"	27"	31 1/2"	37 1/4"	52 1/4"	25"	26 1/2"	

	A Frame Opening Height	B Cut-Out Width (standard)		B Cut-Out Width (with ACS modification)			C Cut-Out Height		Door Height (Upper Section)	
		Min.	Max.	Min.	Max.	Max. w/ Field Cut	Min.	Max.	Partial Overlay	Full Overlay
OCD279324DDN	21"	24"	25 1/2"	21"	24"	25 1/2"	37 1/4"	52 1/4"	22"	23 1/2"
OCD309324DDN	21"	27"	28 1/2"	24"	27"	28 1/2"	37 1/4"	52 1/4"	22"	23 1/2"
OCD339324DDN	21"	30"	31 1/2"	27"	30"	31 1/2"	37 1/4"	52 1/4"	22"	23 1/2"
OCD279624DDN	24"	24"	25 1/2"	21"	24"	25 1/2"	37 1/4"	52 1/4"	25"	26 1/2"
OCD309624DDN	24"	27"	28 1/2"	24"	27"	28 1/2"	37 1/4"	52 1/4"	25"	26 1/2"
OCD339624DDN	24"	30"	31 1/2"	27"	30"	31 1/2"	37 1/4"	52 1/4"	25"	26 1/2"

Custom Modifications

ACS	ADDTK	AUTHL AUTHR	CBO	CCO	CFNTD	CFRMO	CND	DRT	DRWTK	EXBKL EXBKR	EXL EXR	FB	FFDL FFDR
•*		•	•	•		•	•			•	•	•	
FPEB	FTK	FTKAV FTKRV	ID	INFRM	MIP	RD	RECTKL RECTKR	RT	TD	TKP	VTK	WLI	
•			•		•	•	•		•			•	

*Only available on Narrow Stile (N) cabinets

Construction Upgrades

APC	ET	PE
•		•

Door Options

CG.TOP	DPSRR	MFO
	•	•

DOUBLE OVEN CABINET, WARMING DRAWER, 84", 87", or 90" TALL, 24" DEEP

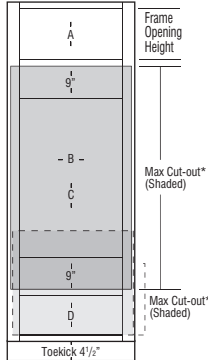
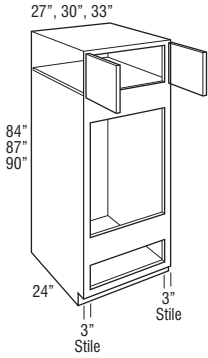

*Minimum rail height between oven and warming drawer is 1 1/2"

Model	Cubic Feet
OCD278424WD	37.4
OCD308424WD	41.3
OCD338424WD	45.2
OCD278724WD	38.7
OCD308724WD	42.8
OCD338724WD	46.8
OCD279024WD	40.0
OCD309024WD	44.2
OCD339024WD	48.4

- Full overlay styles feature concealed face mount Smart Stop hinges.
- All top and bottom cross rails are 1 1/2" wide.
- Be sure to confirm a heat shield is built into your appliance by the manufacturer or install the heat shield included with your appliance. Heat shields are sold separately as an accessory.
- Depth can be reduced to a minimum of 6". For depths of 6"-8", cabinet will not include toe kick/pedestal.
- For built-in appliance support, OCINSTALLKIT is included in 24" deep oven cabinets (see page 410 for details). Oven install kit will not be included when depth is modified.
- Oven cabinets feature an open back in cut-out area designed to improve field appliance installation.

	A Frame Opening Height	B Cut-Out Width		C Cut-Out Height		D Warming Drawer Cut-Out Height		Door Height (Upper Section)	
		Min.	Max.	Min.	Max.	Min.	Max.	Partial Overlay	Full Overlay
OCD278424WD	12"	21"	25 1/2"	37 1/4"	52 1/4"	9 1/4"	16 3/4"	13"	14 1/2"
OCD308424WD	12"	24"	28 1/2"	37 1/4"	52 1/4"	9 1/4"	16 3/4"	13"	14 1/2"
OCD338424WD	12"	27"	31 1/2"	37 1/4"	52 1/4"	9 1/4"	16 3/4"	13"	14 1/2"
OCD278724WD	15"	21"	25 1/2"	37 1/4"	52 1/4"	9 1/4"	16 3/4"	16"	17 1/2"
OCD308724WD	15"	24"	28 1/2"	37 1/4"	52 1/4"	9 1/4"	16 3/4"	16"	17 1/2"
OCD338724WD	15"	27"	31 1/2"	37 1/4"	52 1/4"	9 1/4"	16 3/4"	16"	17 1/2"
OCD279024WD	18"	21"	25 1/2"	37 1/4"	52 1/4"	9 1/4"	16 3/4"	19"	20 1/2"
OCD309024WD	18"	24"	28 1/2"	37 1/4"	52 1/4"	9 1/4"	16 3/4"	19"	20 1/2"
OCD339024WD	18"	27"	31 1/2"	37 1/4"	52 1/4"	9 1/4"	16 3/4"	19"	20 1/2"

Maximum cut-out dimension will allow 1/4" reveal for doors and drawer fronts on full overlay and 1" for partial overlay for trim kit face clearance.

Custom Modifications

ACS	ADDTK	AUTHL AUTHR	CBO	CCO	CFNTO	CFRMO	CND	DRT	DRWTK	EXBKL EXBKR	EXL EXR	FB	FFDL FFDR
		•		•		•			•	•	•	•	
FPFB	FTK	FTKAV FTKEV	ID	INFRM	MIP	RD	RECTKL RECTKR	RT	TD	TKP	VTK	WLI	
•	•	•	•		•	•	•		•*	•	•	•	

*Not available on 84" tall

Construction Upgrades

APC	ET	PE
•		•

Door Options

CG.TOP	DPSRR	MFO
	•	•

DOUBLE OVEN CABINET, WARMING DRAWER, 93" or 96" TALL, 24" DEEP

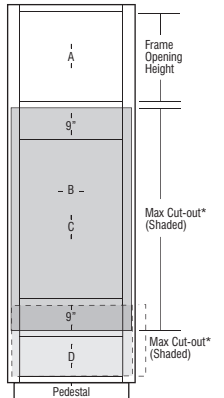
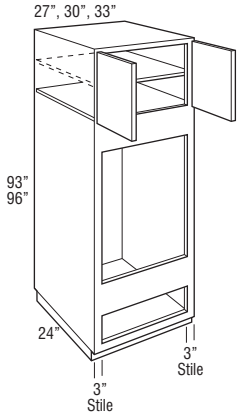

*Minimum rail height between oven and warming drawer is 1 1/2"

Model	Cubic Feet
OCD279324WDAH	41.3
OCD309324WDAH	45.7
OCD339324WDAH	50.0
OCD279624WDAH	42.6
OCD309624WDAH	47.1
OCD339624WDAH	51.6

- AH represents upper section alignment with doors on 24" or 27" high cabinets.
- Full overlay styles feature concealed face mount Smart Stop hinges.
- One adjustable shelf included but packaged separately.
- All top and bottom cross rails are 1 1/2" wide.
- Be sure to confirm a heat shield is built into your appliance by the manufacturer or install the heat shield included with your appliance. Heat shields are sold separately as an accessory.
- Separate pedestal base included but packaged separately on 93" and 96" tall. Pedestal is designed to create a Recessed Left or Right Toe Kick application during field installation, or can be centered. Pedestal must be covered with toeboard material.
- Depth can be reduced to a minimum of 6". For depths of 6"-8", cabinet will not include toe kick/pedestal.
- For built-in appliance support, OCINSTALLKIT is included in 24" deep oven cabinets (see page 410 for details). Oven install kit will not be included when depth is modified.
- Oven cabinets feature an open back in cut-out area designed to improve field appliance installation.

	A Frame Opening Height	B Cut-Out Width		C Cut-Out Height		D Warming Drawer Cut-Out Height		Door Height (Upper Section)	
		Min.	Max.	Min.	Max.	Min.	Max.	Partial Overlay	Full Overlay
OCD279324WDAH	21"	21"	25 1/2"	37 1/4"	52 1/4"	9 1/4"	16 3/4"	22"	23 1/2"
OCD309324WDAH	21"	24"	28 1/2"	37 1/4"	52 1/4"	9 1/4"	16 3/4"	22"	23 1/2"
OCD339324WDAH	21"	27"	31 1/2"	37 1/4"	52 1/4"	9 1/4"	16 3/4"	22"	23 1/2"
OCD279624WDAH	24"	21"	25 1/2"	37 1/4"	52 1/4"	9 1/4"	16 3/4"	25"	26 1/2"
OCD309624WDAH	24"	24"	28 1/2"	37 1/4"	52 1/4"	9 1/4"	16 3/4"	25"	26 1/2"
OCD339624WDAH	24"	27"	31 1/2"	37 1/4"	52 1/4"	9 1/4"	16 3/4"	25"	26 1/2"

Maximum cut-out dimension will allow 1/4" reveal for doors and drawer fronts on full overlay and 1" for partial overlay for trim kit face clearance.

Custom Modifications

ACS	ADDTK	AUTHL AUTHR	CBO	CCO	CFNTO	CFRMO	CND	DRT	DRWTK	EXBKL EXBKR	EXL EXR	FB	FFDL FFDR
		•	•	•		•				•	•	•	
FPEB	FTK	FTKAV FTKFV	ID	INVFRM	MIP	RD	RECTKL RECTKR	RT	TD	TKP	VTK	WLI	
•			•		•	•	•		•			•	

Construction Upgrades

APC	ET	PE
•		•

Door Options

CG.TOP	DPSRR	MFO
	•	•

DOUBLE OVEN CABINET, WARMING DRAWER with EXTENDED OPENING, 84", 87", or 90" TALL, 24" DEEP

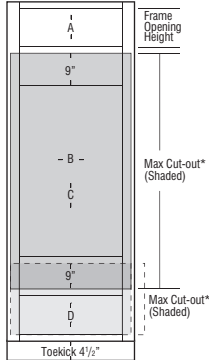
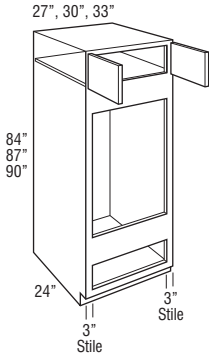

*Minimum rail height between oven and warming drawer is 1 1/2"

Model	Cubic Feet
OCD278424WDE	37.4
OCD308424WDE	41.3
OCD338424WDE	45.2
OCD278724WDE	38.7
OCD308724WDE	42.8
OCD338724WDE	46.8
OCD279024WDE	40.0
OCD309024WDE	44.2
OCD339024WDE	48.4

- Full overlay styles feature concealed face mount Smart Stop hinges.
- All top and bottom cross rails are 1 1/2" wide.
- Standard interior (matching interior not required).
- Be sure to confirm a heat shield is built into your appliance by the manufacturer or install the heat shield included with your appliance. Heat shields are sold separately as an accessory.
- Depth can be reduced to a minimum of 6". For depths of 6"-8", cabinet will not include toekick/pedestal.
- For built-in appliance support, OCINSTALLKIT is included in 24" deep oven cabinets (see page 410 for details). Oven install kit will not be included when depth is modified.
- Oven cabinets feature an open back in cut-out area designed to improve field appliance installation.

	A Frame Opening Height	B Cut-Out Width		C Cut-Out Height		D Warming Drawer Cut-Out Height		Door Height (Upper Section)	
		Min.	Max.	Min.	Max.	Min.	Max.	Partial Overlay	Full Overlay
OCD278424WDE	9"	21"	25 1/2"	40 1/4"	55 1/4"	9 1/4"	16 3/4"	10"	11 1/2"
OCD308424WDE	9"	24"	28 1/2"	40 1/4"	55 1/4"	9 1/4"	16 3/4"	10"	11 1/2"
OCD338424WDE	9"	27"	31 1/2"	40 1/4"	55 1/4"	9 1/4"	16 3/4"	10"	11 1/2"
OCD278724WDE	12"	21"	25 1/2"	40 1/4"	55 1/4"	9 1/4"	16 3/4"	13"	14 1/2"
OCD308724WDE	12"	24"	28 1/2"	40 1/4"	55 1/4"	9 1/4"	16 3/4"	13"	14 1/2"
OCD338724WDE	12"	27"	31 1/2"	40 1/4"	55 1/4"	9 1/4"	16 3/4"	13"	14 1/2"
OCD279024WDE	15"	21"	25 1/2"	40 1/4"	55 1/4"	9 1/4"	16 3/4"	16"	17 1/2"
OCD309024WDE	15"	24"	28 1/2"	40 1/4"	55 1/4"	9 1/4"	16 3/4"	16"	17 1/2"
OCD339024WDE	15"	27"	31 1/2"	40 1/4"	55 1/4"	9 1/4"	16 3/4"	16"	17 1/2"

Maximum cut-out dimension will allow 1/4" reveal for doors and drawer fronts on full overlay and 1" for partial overlay for trim kit face clearance.

Custom Modifications

ACS	ADDTK	AUTHL AUTHR	CBO	CCO	CFNTO	CFRMO	CND	DRT	DRWTK	EXBKL EXBKR	EXL EXR	FB	FFDL FFDR
		•		•	•	•			•	•	•	•	
FPEB	FTK	FTKAV FTKFV	ID	INVFRM	MIP	RD	RECTKL RECTKR	RT	TD	TKP	VTK	WLI	
•	•	•	•		•	•	•			•	•	•	

Construction Upgrades

APC	ET	PE
•		•

Door Options

CG.TOP	DPSRR	MFO
	•	•

DOUBLE OVEN CABINET, WARMING DRAWER with EXTENDED OPENING, 93" or 96" TALL, 24" DEEP

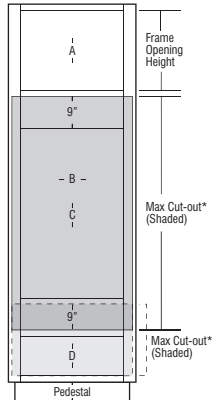
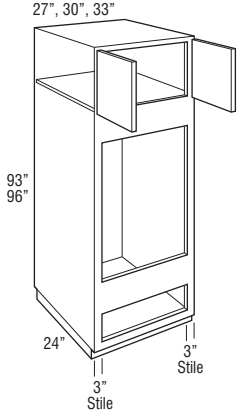

*Minimum rail height between oven and warming drawer is 1 1/2"

Model	Cubic Feet
OCD279324WDE	41.3
OCD309324WDE	45.7
OCD339324WDE	50.0
OCD279624WDEAH	42.6
OCD309624WDEAH	47.1
OCD339624WDEAH	51.6

- AH represents upper section alignment with doors on 24" or 27" high cabinets.
- Upper section on 96" tall has one full depth adjustable shelf.
- Full overlay styles feature concealed face mount Smart Stop hinges.
- All top and bottom cross rails are 1 1/2" wide.
- Standard interior (matching interior not required).
- Be sure to confirm a heat shield is built into your appliance by the manufacturer or install the heat shield included with your appliance. Heat shields are sold separately as an accessory.
- Separate pedestal base included but packaged separately on 93" and 96" tall. Pedestal is designed to create a Recessed Left or Right Toe Kick application during field installation, or can be centered. Pedestal must be covered with toeboard material.
- Depth can be reduced to a minimum of 6". For depths of 6"-8", cabinet will not include toe kick/pedestal.
- For built-in appliance support, OCINSTALLKIT is included in 24" deep oven cabinets (see page 410 for details). Oven install kit will not be included when depth is modified.
- Oven cabinets feature an open back in cut-out area designed to improve field appliance installation.

	A Frame Opening Height	B Cut-Out Width		C Cut-Out Height		D Warming Drawer Cut-Out Height		Door Height (Upper Section)	
		Min.	Max.	Min.	Max.	Min.	Max.	Partial Overlay	Full Overlay
OCD279324WDE	18"	21"	25 1/2"	40 1/4"	55 1/4"	9 1/4"	16 3/4"	19"	20 1/2"
OCD309324WDE	18"	24"	28 1/2"	40 1/4"	55 1/4"	9 1/4"	16 3/4"	19"	20 1/2"
OCD339324WDE	18"	27"	31 1/2"	40 1/4"	55 1/4"	9 1/4"	16 3/4"	19"	20 1/2"
OCD279624WDEAH	21"	21"	25 1/2"	40 1/4"	55 1/4"	9 1/4"	16 3/4"	22"	23 1/2"
OCD309624WDEAH	21"	24"	28 1/2"	40 1/4"	55 1/4"	9 1/4"	16 3/4"	22"	23 1/2"
OCD339624WDEAH	21"	27"	31 1/2"	40 1/4"	55 1/4"	9 1/4"	16 3/4"	22"	23 1/2"

Maximum cut-out dimension will allow 1/4" reveal for doors and drawer fronts on full overlay and 1" for partial overlay for trim kit face clearance.

Custom Modifications

ACS	ADDTK	AUTHL AUTHR	CBO	CCO	CFNTO	CFRMO	CND	DRT	DRWTK	EXBKL EXBKR	EXL EXR	FB	FFDL FFDR
		•		•	•	•				•	•	•	
FPFB	FTK	FTKAV FTKFV	ID	INVFRM	MIP	RD	RECTKL RECTKR	RT	TD	TKP	VTK	WLI	
•			•		•	•	•*		•+			•	

*Not available on 96" tall *Not available on 93" tall

Construction Upgrades

APC	ET	PE
•		•

Door Options

CG.TOP	DPSRR	MFO
	•	•

**TALL BUILT-IN MICROWAVE CABINET,
84", 87", or 90" TALL**

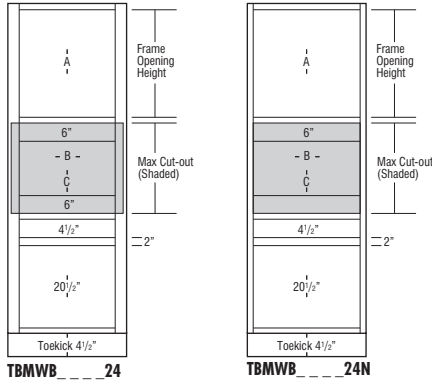
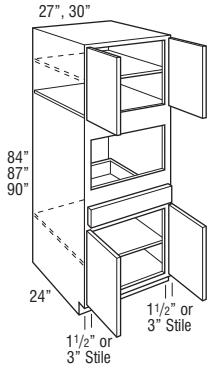

Model	Cubic Feet
TBMWB278424 (AH or N)	37.4
TBMWB308424 (AH or N)	41.3
TBMWB278724(N)	38.7
TBMWB308724(N)	42.8
TBMWB279024(N)	40.0
TBMWB309024(N)	44.2

- AH represents upper section alignment with doors on 24" or 27" high cabinets.
- N represents Narrow Stile cabinets with 1 1/2" wide face frame side stiles and ACS modification availability (see page 39 for ACS specifications). Doors and drawer fronts have a consistent width reveal for full overlay (1/4") and partial overlay (1") and use standard Smart Stop hinges.
- On cabinets with 3" wide face frame side stiles, doors and drawer fronts have a consistent width reveal for full overlay (1/4") and partial overlay (1") and use standard Smart Stop hinges. When CG is specified, face frame will be visible through door if used with a translucent art or textured glass design.
- Includes adjustable shelves in upper section:
84" tall - one shelf
87"-90" tall - two shelves
- Base section will utilize a full depth shelf.
- All top and bottom cross rails are 1 1/2" wide.
- All toe kick areas are 4 1/2" high.
- Includes OCINSTALLKIT for microwave installation.
- Maximum cut-out dimension will allow 1/4" reveal for doors and drawer fronts on full overlay and 1" for partial overlay for trim kit face clearance.

	A Frame Opening Height	B Cut-Out Width		C Cut-Out Height		Door Height (Upper Section)	
		Min.	Max.	Min.	Max.	Partial Overlay	Full Overlay
TBMWB278424AH	24"	21"	25 1/2"	13 1/2"	22 1/2"	25"	27 1/2"
TBMWB308424AH	24"	24"	28 1/2"	13 1/2"	22 1/2"	25"	27 1/2"
TBMWB278724	27"	21"	25 1/2"	13 1/2"	22 1/2"	28"	29 1/2"
TBMWB308724	27"	24"	28 1/2"	13 1/2"	22 1/2"	28"	29 1/2"
TBMWB279024	30"	21"	25 1/2"	13 1/2"	22 1/2"	31"	32 1/2"
TBMWB309024	30"	24"	28 1/2"	13 1/2"	22 1/2"	31"	32 1/2"

	A Frame Opening Height	B Cut-Out Width (standard)		B Cut-Out Width (with ACS modification)			C Cut-Out Height		Door Height (Upper Section)	
		Min.	Max.	Min.	Max.	Max. w/ Field Cut	Min.	Max.	Partial Overlay	Full Overlay
TBMWB278424N	24"	24"	25 1/2"	21"	24"	25 1/2"	13 1/2"	22 1/2"	25"	26 1/2"
TBMWB308424N	24"	27"	28 1/2"	24"	27"	28 1/2"	13 1/2"	22 1/2"	25"	26 1/2"
TBMWB278724N	27"	24"	25 1/2"	21"	24"	25 1/2"	13 1/2"	22 1/2"	28"	29 1/2"
TBMWB308724N	27"	27"	28 1/2"	24"	27"	28 1/2"	13 1/2"	22 1/2"	28"	29 1/2"
TBMWB279024N	30"	24"	25 1/2"	21"	24"	25 1/2"	13 1/2"	22 1/2"	31"	32 1/2"
TBMWB309024N	30"	27"	28 1/2"	24"	27"	28 1/2"	13 1/2"	22 1/2"	31"	32 1/2"

Custom Modifications

ACS	ADDTK	AUTHL AUTHR	CBO	CCO	CFNT0	CFRMO	CND	DRT	DRWTK	EXBKL EXBKR	EXL EXR	FB	FFDL FFDR
•*		•	•	•		•	•		•	•	•	•	
FPEB	FTK	FTKAV FTKRV	ID	INVFRM	MIP	RD	RECTKL RECTKR	RT	TD	TKP	VTK	WLI	
•	•	•			•	•	•	•	•*	•		•	

*Only available on Narrow Stile (N) cabinets *Not available on 90" tall

Construction Upgrades

APC	ET	PE
•		•

Door Options

CG.TOP	DPSRR	MFO
•	•	•

TALL BUILT-IN MICROWAVE CABINET, 93" or 96" TALL

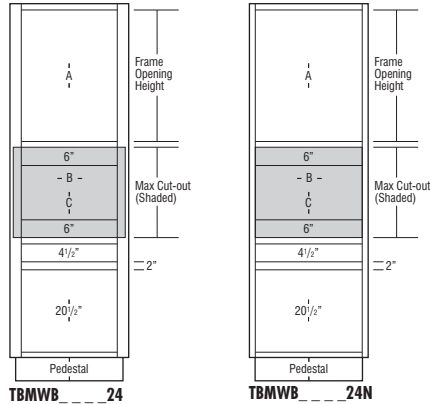
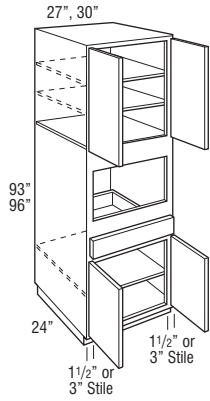

Model	Cubic Feet
TBMWB279324(N)	41.3
TBMWB309324(N)	45.7
TBMWB279624(N)	42.6
TBMWB309624(N)	47.1

- AH represents upper section alignment with doors on 24" or 27" high cabinets.
- N represents Narrow Stile cabinets with 1 1/2" wide face frame side stiles and ACS modification availability (see page 39 for ACS specifications). Doors and drawer fronts have a consistent width reveal for full overlay (1/4") and partial overlay (1") and use standard Smart Stop hinges.
- On cabinets with 3" wide face frame side stiles, doors and drawer fronts have a consistent width reveal for full overlay (1/4") and partial overlay (1") and use standard Smart Stop hinges. When CG is specified, face frame will be visible through door if used with a translucent art or textured glass design.
- Includes adjustable shelves in upper section:
93" tall - two shelves
96" tall - three shelves
- Base section will utilize a full depth shelf.
- All top and bottom cross rails are 1 1/2" wide.
- All toe kick areas are 4 1/2" high.
- Separate pedestal base included but packaged separately on 93" and 96" tall. Pedestal is designed to create a Recessed Left or Right Toe kick application during field installation, or can be centered. Pedestal must be covered with toeboard material.
- Includes OCINSTALLKIT for microwave installation.
- Maximum cut-out dimension will allow 1/4" reveal for doors and drawer fronts on full overlay and 1" for partial overlay for trim kit face clearance.

	A Frame Opening Height	B Cut-Out Width		C Cut-Out Height		Door Height (Upper Section)	
		Min.	Max.	Min.	Max.	Partial Overlay	Full Overlay
TBMWB279324	33"	21"	25 1/2"	13 1/2"	22 1/2"	34"	35 1/2"
TBMWB309324	33"	24"	28 1/2"	13 1/2"	22 1/2"	34"	35 1/2"
TBMWB279624	36"	21"	25 1/2"	13 1/2"	22 1/2"	37"	38 1/2"
TBMWB309624	36"	24"	28 1/2"	13 1/2"	22 1/2"	37"	38 1/2"

	A Frame Opening Height	B Cut-Out Width (standard)		B Cut-Out Width (with ACS modification)			C Cut-Out Height		Door Height (Upper Section)	
		Min.	Max.	Min.	Max.	Max. w/ Field Cut	Min.	Max.	Partial Overlay	Full Overlay
TBMWB279324N	33"	24"	25 1/2"	21"	24"	25 1/2"	13 1/2"	22 1/2"	34"	35 1/2"
TBMWB309324N	33"	27"	28 1/2"	24"	27"	28 1/2"	13 1/2"	22 1/2"	34"	35 1/2"
TBMWB279624N	36"	24"	25 1/2"	21"	24"	25 1/2"	13 1/2"	22 1/2"	37"	38 1/2"
TBMWB309624N	36"	27"	28 1/2"	24"	27"	28 1/2"	13 1/2"	22 1/2"	37"	38 1/2"

Custom Modifications

ACS	ADDTK	AUTHL AUTHR	CBO	CCO	CFNTO	CFRMO	CND	DRT	DRWTK	EXBKL EXBKR	EXL EXR	FB	FFDL FFDR
•*		•	•			•	•			•	•	•	
FPEB	FTK	FTKAV FTKRV	ID	INVFRM	MIP	RD	RECTKL RECTKR	RT	TD	TKP	VTK	WLI	•
•					•	•	•	•					•

*Only available on Narrow Stile (N) cabinets

Construction Upgrades

APC	ET	PE
•		•

Door Options

CG.TOP	DPSRR	MFO
•	•	•

**OVEN MICROWAVE CABINET,
84", 87", or 90" TALL, 24" DEEP**

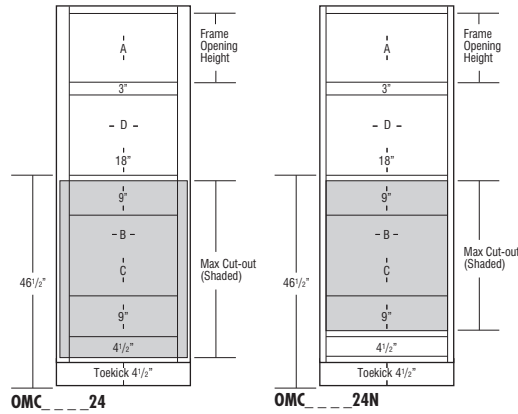
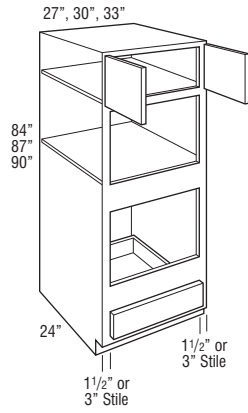

Model	Cubic Feet
OMC278424(N)	37.4
OMC308424(N)	41.3
OMC338424(N)	45.2
OMC278724(N)	38.7
OMC308724(N)	42.8
OMC338724(N)	46.8
OMC279024 (AH or N)	40.0
OMC309024 (AH or N)	44.2
OMC339024 (AH or N)	48.4

- AH represents upper section alignment with doors on 24" or 27" high cabinets.
- N represents Narrow Stile cabinets with 1 1/2" wide face frame side stiles and ACS modification availability (see page 39 for ACS specifications). Doors and drawer fronts have a consistent width reveal for full overlay (1/4") and partial overlay (1") and use standard Smart Stop hinges.
- On cabinets with 3" wide face frame side stiles, full overlay styles have a consistent 1/4" width frame reveal and use face mounted Smart Stop hinges. Partial overlay styles have a larger 2 1/2" width reveal, use standard Smart Stop hinges, and are not recommended for stacking applications due to misalignment of door width with cabinets above.
- Upper section on 90" tall has one full depth adjustable shelf.
- Designed for use with separate built-in microwave above, built-in oven below. For built-in double ovens, see pages 281-288.
- All top and bottom cross rails are 1 1/2" wide.
- All toe kick areas are 4 1/2" high.
- Be sure to confirm a heat shield is built into your appliance by the manufacturer or install the heat shield included with your appliance. Heat shields are sold separately as an accessory.
- Depth can be reduced to a minimum of 12".
- For built-in appliance support, OCINSTALLKIT is included in 24" deep oven cabinets (see page 410 for details). Oven install kit will not be included when depth is modified.
- Maximum cut-out dimension will allow 1/4" reveal for doors and drawer fronts on full overlay and 1" for partial overlay for trim kit face clearance.

	A Frame Opening Height	B Cut-Out Width		C Cut-Out Height		D Frame Opening Width	Door Height (Upper Section)	
		Min.	Max.	Min.	Max.		Partial Overlay	Full Overlay
OMC278424	15"	21"	25 1/2"	18"	39"	21"	16"	17 1/2"
OMC308424	15"	24"	28 1/2"	18"	39"	24"	16"	17 1/2"
OMC338424	15"	27"	31 1/2"	18"	39"	27"	16"	17 1/2"
OMC278724	18"	21"	25 1/2"	18"	39"	21"	19"	20 1/2"
OMC308724	18"	24"	28 1/2"	18"	39"	24"	19"	20 1/2"
OMC338724	18"	27"	31 1/2"	18"	39"	27"	19"	20 1/2"
OMC279024AH	21"	21"	25 1/2"	18"	39"	21"	22"	23 1/2"
OMC309024AH	21"	24"	28 1/2"	18"	39"	24"	22"	23 1/2"
OMC339024AH	21"	27"	31 1/2"	18"	39"	27"	22"	23 1/2"

	A Frame Opening Height	B Cut-Out Width (standard)		B Cut-Out Width (with ACS modification)			C Cut-Out Height		Door Height (Upper Section)	
		Min.	Max.	Min.	Max.	Max. w/ Field Cut	Min.	Max.	Partial Overlay	Full Overlay
OMC278424N	15"	24"	25 1/2"	21"	24"	25 1/2"	18"	33"	16"	17 1/2"
OMC308424N	15"	27"	28 1/2"	24"	27"	28 1/2"	18"	33"	16"	17 1/2"
OMC338424N	15"	30"	31 1/2"	27"	30"	31 1/2"	18"	33"	16"	17 1/2"
OMC278724N	18"	24"	25 1/2"	21"	24"	25 1/2"	18"	33"	19"	20 1/2"
OMC308724N	18"	27"	28 1/2"	24"	27"	28 1/2"	18"	33"	19"	20 1/2"
OMC338724N	18"	30"	31 1/2"	27"	30"	31 1/2"	18"	33"	19"	20 1/2"
OMC279024N	21"	24"	25 1/2"	21"	24"	25 1/2"	18"	33"	22"	23 1/2"
OMC309024N	21"	27"	28 1/2"	24"	27"	28 1/2"	18"	33"	22"	23 1/2"
OMC339024N	21"	30"	31 1/2"	27"	30"	31 1/2"	18"	33"	22"	23 1/2"

Custom Modifications

ACS	ADDTK	AUTHL AUTHR	CBO	CCO	CFNTO	CFRMO	CND	DRT	DRWTK	EXBKL EXBKR	EXL EXR	FB	FFDL FFDR
•*		•	•	•		•	•		•	•	•	•	
FPFB	FTK	FTKAV FTKFV	ID	INFRM	MIP	RD	RECTKL RECTKR	RT	TD	TKP	VTK	WLI	
•	•	•	•		•	•	•		•	•	•	•	

*Only available on Narrow Stile (N) cabinets

Construction Upgrades

APC	ET	PE
•		•

Door Options

CG.TOP	DPSRR	MFO
	•	•

**OVEN MICROWAVE CABINET,
93" or 96" TALL, 24" DEEP**

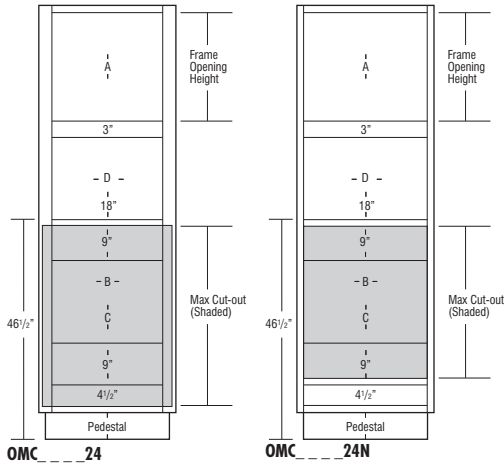
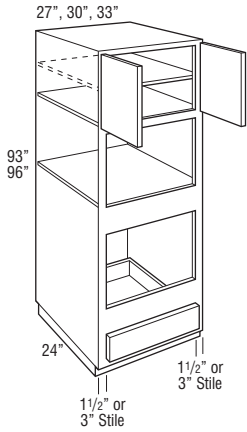

Model	Cubic Feet
OMC279324 (AH or N)	41.3
OMC309324 (AH or N)	45.7
OMC339324 (AH or N)	50.0
<hr/>	
OMC279624(N)	42.6
OMC309624(N)	47.1
OMC339624(N)	51.6

- AH represents upper section alignment with doors on 24" or 27" high cabinets.
- N represents Narrow Stile cabinets with 1 1/2" wide face frame side stiles and ACS modification availability (see page 39 for ACS specifications). Doors and drawer fronts have a consistent width reveal for full overlay (1/4") and partial overlay (1") and use standard Smart Stop hinges.
- On cabinets with 3" wide face frame side stiles, full overlay styles have a consistent 1/4" width frame reveal and use face mounted Smart Stop hinges. Partial overlay styles have a larger 2 1/2" width reveal, use standard Smart Stop hinges, and are not recommended for stacking applications due to misalignment of door width with cabinets above.
- Includes adjustable shelves in upper section:
93" tall - one shelf
96" tall - two shelves
- Designed for use with separate built-in microwave above, built-in oven below. For built-in double ovens, see pages 281-288.
- All top and bottom cross rails are 1 1/2" wide.
- All toekick areas are 4 1/2" high.
- Be sure to confirm a heat shield is built into your appliance by the manufacturer or install the heat shield included with your appliance. Heat shields are sold separately as an accessory.
- Separate pedestal base included but packaged separately on 93" and 96" tall. Pedestal is designed to create a Recessed Left or Right ToeKick application during field installation, or can be centered. Pedestal must be covered with toeboard material.
- Depth can be reduced to a minimum of 12".
- For built-in appliance support, OCINSTALLKIT is included in 24" deep oven cabinets (see page 410 for details). Oven install kit will not be included when depth is modified.
- Maximum cut-out dimension will allow 1/4" reveal for doors and drawer fronts on full overlay and 1" for partial overlay for trim kit face clearance.

	A Frame Opening Height	B Cut-Out Width		C Cut-Out Height		D Frame Opening Width	Door Height (Upper Section)	
		Min.	Max.	Min.	Max.		Partial Overlay	Full Overlay
OMC279324AH	24"	21"	25 1/2"	18"	39"	21"	25"	26 1/2"
OMC309324AH	24"	24"	28 1/2"	18"	39"	24"	25"	26 1/2"
OMC339324AH	24"	27"	31 1/2"	18"	39"	27"	25"	26 1/2"
OMC279624	27"	21"	25 1/2"	18"	39"	21"	28"	29 1/2"
OMC309624	27"	24"	28 1/2"	18"	39"	24"	28"	29 1/2"
OMC339624	27"	27"	31 1/2"	18"	39"	27"	28"	29 1/2"

	A Frame Opening Height	B Cut-Out Width (standard)		B Cut-Out Width (with ACS modification)			C Cut-Out Height		Door Height (Upper Section)	
		Min.	Max.	Min.	Max.	Max. w/ Field Cut	Min.	Max.	Partial Overlay	Full Overlay
OMC279324N	24"	24"	25 1/2"	21"	24"	25 1/2"	18"	33"	25"	26 1/2"
OMC309324N	24"	27"	28 1/2"	24"	27"	28 1/2"	18"	33"	25"	26 1/2"
OMC339324N	24"	30"	31 1/2"	27"	30"	31 1/2"	18"	33"	25"	26 1/2"
OMC279624N	27"	24"	25 1/2"	21"	24"	25 1/2"	18"	33"	28"	29 1/2"
OMC309624N	27"	27"	28 1/2"	24"	27"	28 1/2"	18"	33"	28"	29 1/2"
OMC339624N	27"	30"	31 1/2"	27"	30"	31 1/2"	18"	33"	28"	29 1/2"

Custom Modifications

	ACS	ADDTK	AUTHL AUTHR	CBO	CCO	CFNTO	CFRMO	CND	DRT	DRWTK	EXBKL EXBKR	EXL EXR	FB	FFDL FFDR
•*			•	•	•			•			•	•	•	
FPEB	FTK	FTKAV FTKFV	ID	INVFRM	MIP	RD	RECTKL RECTKR	RT	TD	TKP	VTK	WLI		
•			•		•		•		•				•	

*Only available on Narrow Stile (N) cabinets

Construction Upgrades

APC	ET	PE
•		•

Door Options

CG.TOP	DPSRR	MFO
	•	•

OVEN MICROWAVE CABINET, DEEP DRAWER, 84", 87", or 90" TALL, 24" DEEP

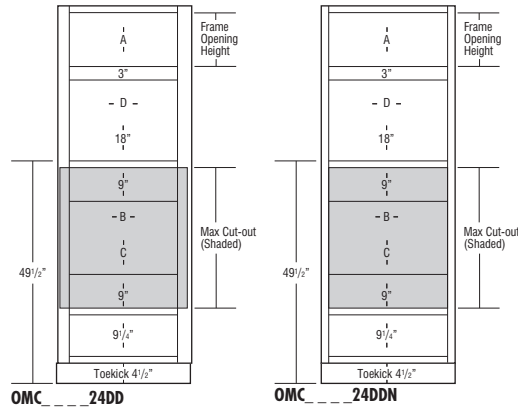
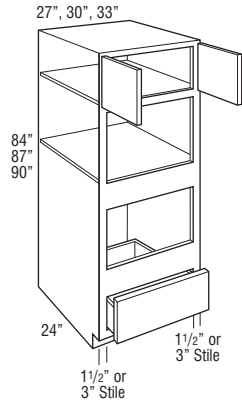

Model	Cubic Feet
OMC278424DD(N)	37.4
OMC308424DD(N)	41.3
OMC338424DD(N)	45.2
OMC278724DD(N)	38.7
OMC308724DD(N)	42.8
OMC338724DD(N)	46.8
OMC279024DD(N)	40.0
OMC309024DD(N)	44.2
OMC339024DD(N)	48.4

- N represents Narrow Stile cabinets with 1 1/2" wide face frame side stiles and ACS modification availability (see page 39 for ACS specifications). Doors and drawer fronts have a consistent width reveal for full overlay (1/4") and partial overlay (1") and use standard Smart Stop hinges.
- On cabinets with 3" wide face frame side stiles, full overlay styles have a consistent 1/4" width frame reveal and use face mounted Smart Stop hinges. Partial overlay styles have a larger 2 1/2" width reveal, use standard Smart Stop hinges, and are not recommended for stacking applications due to misalignment of door width with cabinets above.
- Designed for use with separate built-in microwave above, built-in oven below. For built-in double ovens, see pages 281-288.
- All top and bottom cross rails are 1 1/2" wide.
- All toekick areas are 4 1/2" high.
- Be sure to confirm a heat shield is built into your appliance by the manufacturer or install the heat shield included with your appliance. Heat shields are sold separately as an accessory.
- Depth can be reduced to a minimum of 12".
- For built-in appliance support, OCINSTALLKIT is included in 24" deep oven cabinets (see page 410 for details). Oven install kit will not be included when depth is modified.
- Maximum cut-out dimension will allow 1/4" reveal for doors and drawer fronts on full overlay and 1" for partial overlay for trim kit face clearance.

	A Frame Opening Height	B Cut-Out Width		C Cut-Out Height		D Frame Opening Width	Door Height (Upper Section)	
		Min.	Max.	Min.	Max.		Partial Overlay	Full Overlay
OMC278424DD	12"	21"	25 1/2"	16 1/4"	31 1/4"	21"	13"	14 1/2"
OMC308424DD	12"	24"	28 1/2"	16 1/4"	31 1/4"	24"	13"	14 1/2"
OMC338424DD	12"	27"	31 1/2"	16 1/4"	31 1/4"	27"	13"	14 1/2"
OMC278724DD	15"	21"	25 1/2"	16 1/4"	31 1/4"	21"	16"	17 1/2"
OMC308724DD	15"	24"	28 1/2"	16 1/4"	31 1/4"	24"	16"	17 1/2"
OMC338724DD	15"	27"	31 1/2"	16 1/4"	31 1/4"	27"	16"	17 1/2"
OMC279024DD	18"	21"	25 1/2"	16 1/4"	31 1/4"	21"	19"	20 1/2"
OMC309024DD	18"	24"	28 1/2"	16 1/4"	31 1/4"	24"	19"	20 1/2"
OMC339024DD	18"	27"	31 1/2"	16 1/4"	31 1/4"	27"	19"	20 1/2"

	A Frame Opening Height	B Cut-Out Width (standard)		B Cut-Out Width (with ACS modification)			C Cut-Out Height		Door Height (Upper Section)	
		Min.	Max.	Min.	Max.	Max. w/ Field Cut	Min.	Max.	Partial Overlay	Full Overlay
OMC278424DDN	12"	24"	25 1/2"	21"	24"	25 1/2"	16 1/4"	31 1/4"	13"	14 1/2"
OMC308424DDN	12"	27"	28 1/2"	24"	27"	28 1/2"	16 1/4"	31 1/4"	13"	14 1/2"
OMC338424DDN	12"	30"	31 1/2"	27"	30"	31 1/2"	16 1/4"	31 1/4"	13"	14 1/2"
OMC278724DDN	15"	24"	25 1/2"	21"	24"	25 1/2"	16 1/4"	31 1/4"	16"	17 1/2"
OMC308724DDN	15"	27"	28 1/2"	24"	27"	28 1/2"	16 1/4"	31 1/4"	16"	17 1/2"
OMC338724DDN	15"	30"	31 1/2"	27"	30"	31 1/2"	16 1/4"	31 1/4"	16"	17 1/2"
OMC279024DDN	18"	24"	25 1/2"	21"	24"	25 1/2"	16 1/4"	31 1/4"	19"	20 1/2"
OMC309024DDN	18"	27"	28 1/2"	24"	27"	28 1/2"	16 1/4"	31 1/4"	19"	20 1/2"
OMC339024DDN	18"	30"	31 1/2"	27"	30"	31 1/2"	16 1/4"	31 1/4"	19"	20 1/2"

Custom Modifications

ACS	ADDTK	AUTHL AUTHR	CBO	CCO	CFNTO	CFRMO	CND	DRT	DRWTK	EXBKL EXBKR	EXL EXR	FB	FFDL FFDR
•*		•	•	•		•	•		•	•	•	•	
	FPFB	FTK FTKFV	FTKAV FTKFV	ID	INFRM	MIP	RD	RECTKL RECTKR	RT	TD	TKP	VTK	WLI
	•	•	•	•		•	•	•		•*	•	•	•

*Only available on Narrow Stile (N) cabinets *Not available on 84" tall

Construction Upgrades

APC	ET	PE
•		•

Door Options

CG.TOP	DPSRR	MFO
	•	•

OVEN MICROWAVE CABINET, DEEP DRAWER, 93" or 96" TALL, 24" DEEP

27", 30", 33"

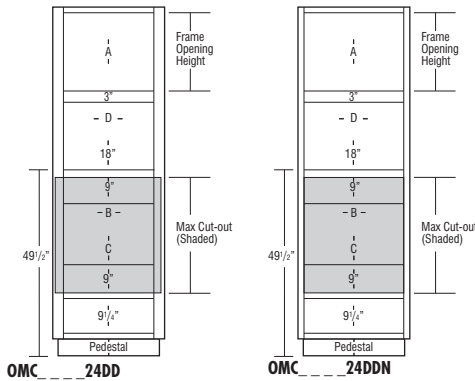
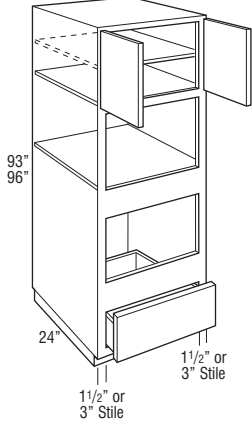

Model	Cubic Feet
OMC279324DD (AH or N)	41.3
OMC309324DD (AH or N)	45.7
OMC339324DD (AH or N)	50.0
OMC279624DD (AH or N)	42.6
OMC309624DD (AH or N)	47.1
OMC339624DD (AH or N)	51.6

- AH represents upper section alignment with doors on 24" or 27" high cabinets.
- N represents Narrow Stile cabinets with 1 1/2" wide face frame side stiles and ACS modification availability (see page 39 for ACS specifications). Doors and drawer fronts have a consistent width reveal for full overlay (1/4") and partial overlay (1") and use standard Smart Stop hinges.
- On cabinets with 3" wide face frame side stiles, full overlay styles have a consistent 1/4" width frame reveal and use face mounted Smart Stop hinges. Partial overlay styles have a larger 2 1/2" width reveal, use standard Smart Stop hinges, and are not recommended for stacking applications due to misalignment of door width with cabinets above.
- Designed for use with separate built-in microwave above, built-in oven below. For built-in double ovens, see pages 281-288.
- All top and bottom cross rails are 1 1/2" wide.
- All toekick areas are 4 1/2" high.
- Be sure to confirm a heat shield is built into your appliance by the manufacturer or install the heat shield included with your appliance. Heat shields are sold separately as an accessory.
- Separate pedestal base included but packaged separately on 93" and 96" tall. Pedestal is designed to create a Recessed Left or Right Toekick application during field installation, or can be centered. Pedestal must be covered with toeboard material.
- One full depth adjustable shelf included, but packaged separately.
- Depth can be reduced to a minimum of 12".
- For built-in appliance support, OCINSTALKIT is included in 24" deep oven cabinets (see page 410 for details). Oven install kit will not be included when depth is modified.
- Maximum cut-out dimension will allow 1/4" reveal for doors and drawer fronts on full overlay and 1" for partial overlay for trim kit face clearance.

	A Frame Opening Height	B Cut-Out Width		C Cut-Out Height		D Frame Opening Width	Door Height (Upper Section)	
		Min.	Max.	Min.	Max.		Partial Overlay	Full Overlay
OMC279324DDAH	21"	21"	25 1/2"	16 1/4"	31 1/4"	21"	22"	23 1/2"
OMC309324DDAH	21"	24"	28 1/2"	16 1/4"	31 1/4"	24"	22"	23 1/2"
OMC339324DDAH	21"	27"	31 1/2"	16 1/4"	31 1/4"	27"	22"	23 1/2"
OMC279624DDAH	24"	21"	25 1/2"	16 1/4"	31 1/4"	21"	25"	26 1/2"
OMC309624DDAH	24"	24"	28 1/2"	16 1/4"	31 1/4"	24"	25"	26 1/2"
OMC339624DDAH	24"	27"	31 1/2"	16 1/4"	31 1/4"	27"	25"	26 1/2"

	A Frame Opening Height	B Cut-Out Width (standard)		B Cut-Out Width (with ACS modification)			C Cut-Out Height		Door Height (Upper Section)	
		Min.	Max.	Min.	Max.	Max. w/ Field Cut	Min.	Max.	Partial Overlay	Full Overlay
OMC279324DDN	21"	24"	25 1/2"	21"	24"	25 1/2"	16 1/4"	31 1/4"	22"	23 1/2"
OMC309324DDN	21"	27"	28 1/2"	24"	27"	28 1/2"	16 1/4"	31 1/4"	22"	23 1/2"
OMC339324DDN	21"	30"	31 1/2"	27"	30"	31 1/2"	16 1/4"	31 1/4"	22"	23 1/2"
OMC279624DDN	24"	24"	25 1/2"	21"	24"	25 1/2"	16 1/4"	31 1/4"	25"	26 1/2"
OMC309624DDN	24"	27"	28 1/2"	24"	27"	28 1/2"	16 1/4"	31 1/4"	25"	26 1/2"
OMC339624DDN	24"	30"	31 1/2"	27"	30"	31 1/2"	16 1/4"	31 1/4"	25"	26 1/2"

Custom Modifications

ACS	ADDTK	AUTHL AUTHR	CBO	CCO	CFNTO	CFRMO	CND	DRT	DRWTK	EXBKL EXBKR	EXL EXR	FB	FFDL FFDR
•*		•	•	•		•	•			•	•	•	
FPFB	FTK	FTKAV FTKFV	ID	INVFRM	MIP	RD	RECTKL RECTKR	RT	TD	TKP	VTK	WLI	
•			•		•	•	•		•			•	

*Only available on Narrow Stile (N) cabinets

Construction Upgrades

APC	ET	PE
•		•

Door Options

CG.TOP	DPSRR	MFO
	•	•

**OVEN MICROWAVE CABINET,
WARMING DRAWER, 84", 87", or
90" TALL, 24" DEEP**

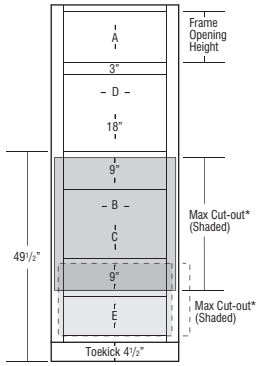
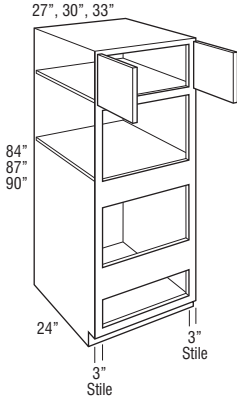

*Minimum rail height between oven and warming drawer is 1 1/2"

Model	Cubic Feet
OMC278424WD	37.4
OMC308424WD	41.3
OMC338424WD	45.2
OMC278724WD	38.7
OMC308724WD	42.8
OMC338724WD	46.8
OMC279024WD	40.0
OMC309024WD	44.2
OMC339024WD	48.4

- Designed for use with separate built-in microwave above, built-in oven below. For built-in double ovens, see pages 281-288.
- Full overlay styles feature concealed face mount Smart Stop hinges.
- All top and bottom cross rails are 1 1/2" wide.
- All toekick areas are 4 1/2" high.
- Be sure to confirm a heat shield is built into your appliance by the manufacturer or install the heat shield included with your appliance. Heat shields are sold separately as an accessory.
- Depth can be reduced to a minimum of 6". For depths of 6"-8", cabinet will not include toekick/pedestal.
- For built-in appliance support, OCINSTALLKIT is included in 24" deep oven cabinets (see page 410 for details). Oven install kit will not be included when depth is modified.

	A Frame Opening Height	B Cut-Out Width		C Cut-Out Height		D Frame Opening Width	E Warming Drawer Cut-Out Height		Door Height (Upper Section)	
		Min.	Max.	Min.	Max.		Min.	Max.	Partial Overlay	Full Overlay
OMC278424WD	12"	21"	25 1/2"	16 1/4"	31 1/4"	21"	9 1/4"	16 3/4"	13"	14 1/2"
OMC308424WD	12"	24"	28 1/2"	16 1/4"	31 1/4"	24"	9 1/4"	16 3/4"	13"	14 1/2"
OMC338424WD	12"	27"	31 1/2"	16 1/4"	31 1/4"	27"	9 1/4"	16 3/4"	13"	14 1/2"
OMC278724WD	15"	21"	25 1/2"	16 1/4"	31 1/4"	21"	9 1/4"	16 3/4"	16"	17 1/2"
OMC308724WD	15"	24"	28 1/2"	16 1/4"	31 1/4"	24"	9 1/4"	16 3/4"	16"	17 1/2"
OMC338724WD	15"	27"	31 1/2"	16 1/4"	31 1/4"	27"	9 1/4"	16 3/4"	16"	17 1/2"
OMC279024WD	18"	21"	25 1/2"	16 1/4"	31 1/4"	21"	9 1/4"	16 3/4"	19"	20 1/2"
OMC309024WD	18"	24"	28 1/2"	16 1/4"	31 1/4"	24"	9 1/4"	16 3/4"	19"	20 1/2"
OMC339024WD	18"	27"	31 1/2"	16 1/4"	31 1/4"	27"	9 1/4"	16 3/4"	19"	20 1/2"

Maximum cut-out dimension will allow 1/4" reveal for doors and drawer fronts on full overlay and 1" for partial overlay for trim kit face clearance.

Custom Modifications

ACS	ADDTK	AUTHL AUTHR	CBO	CCO	CFNTO	CFRMO	CND	DRT	DRWTK	EXBKL EXBKR	EXL EXR	FB	FFDL FFDR
		•		•	•	•			•	•	•	•	
FPFB	FTK	FTKAV FTKFV	ID	INVFRM	MIP	RD	RECTKL RECTKR	RT	TD	TKP	VTK	WLI	
•	•	•	•		•	•	•		•*	•	•	•	

*Not available on 84" tall

Construction Upgrades

APC	ET	PE
•		•

Door Options

CG.TOP	DPSRR	MFO
	•	•

**OVEN MICROWAVE CABINET,
WARMING DRAWER,
93" or 96" TALL, 24" DEEP**

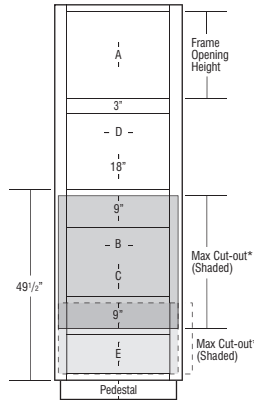
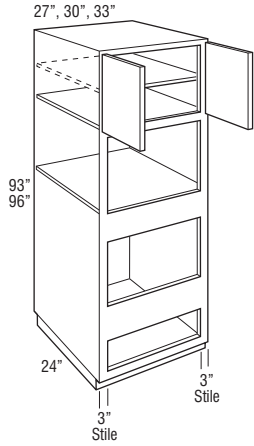

*Minimum rail height between oven and warming drawer is 1 1/2"

Model	Cubic Feet
OMC279324WDAH	41.3
OMC309324WDAH	45.7
OMC339324WDAH	50.0
OMC279624WDAH	42.6
OMC309624WDAH	47.1
OMC339624WDAH	51.6

- AH represents upper section alignment with doors on 24" or 27" high cabinets.
- Designed for use with separate built-in microwave above, built-in oven below. For built-in double ovens, see pages 281-288.
- Full overlay styles feature concealed face mount Smart Stop hinges.
- One adjustable shelf included but packaged separately.
- All top and bottom cross rails are 1 1/2" wide.
- All toekick areas are 4 1/2" high.
- Be sure to confirm a heat shield is built into your appliance by the manufacturer or install the heat shield included with your appliance. Heat shields are sold separately as an accessory.
- Separate pedestal base included but packaged separately on 93" and 96" tall. Pedestal is designed to create a Recessed Left or Right Toekick application during field installation, or can be centered. Pedestal must be covered with toeboard material.
- Depth can be reduced to a minimum of 6". For depths of 6"-8", cabinet will not include toekick/pedestal.
- For built-in appliance support, OCINSTALLKIT is included in 24" deep oven cabinets (see page 410 for details). Oven install kit will not be included when depth is modified.

	A Frame Opening Height	B Cut-Out Width		C Cut-Out Height		D Frame Opening Width	E Warming Drawer Cut-Out Height		Door Height (Upper Section)	
		Min.	Max.	Min.	Max.		Min.	Max.	Partial Overlay	Full Overlay
OMC279324WDAH	21"	21"	25 1/2"	16 1/4"	31 1/4"	21"	9 1/4"	16 3/4"	22"	23 1/2"
OMC309324WDAH	21"	24"	28 1/2"	16 1/4"	31 1/4"	24"	9 1/4"	16 3/4"	22"	23 1/2"
OMC339324WDAH	21"	27"	31 1/2"	16 1/4"	31 1/4"	27"	9 1/4"	16 3/4"	22"	23 1/2"
OMC279624WDAH	24"	21"	25 1/2"	16 1/4"	31 1/4"	21"	9 1/4"	16 3/4"	25"	26 1/2"
OMC309624WDAH	24"	24"	28 1/2"	16 1/4"	31 1/4"	24"	9 1/4"	16 3/4"	25"	26 1/2"
OMC339624WDAH	24"	27"	31 1/2"	16 1/4"	31 1/4"	27"	9 1/4"	16 3/4"	25"	26 1/2"

Maximum cut-out dimension will allow 1/4" reveal for doors and drawer fronts on full overlay and 1" for partial overlay for trim kit face clearance.

Custom Modifications

ACS	ADDTK	AUTHL AUTHR	CBO	CCO	CFNTO	CFRMO	CND	DRT	DRWTK	EXBKL EXBKR	EXL EXR	FB	FFDL FFDR
		•	•	•	•	•				•	•	•	
FPFB	FTK	FTKAV FTKFV	ID	INVFRM	MIP	RD	RECTKL RECTKR	RT	TD	TKP	VTK	WLI	
•			•		•	•	•		•			•	

Construction Upgrades

APC	ET	PE
•		•

Door Options

CG.TOP	DPSRR	MFO
	•	•

W1830BC
 Cabinet Type ← Cabinet Width

- Available
 - STD Standard on these cabinets
- 5 DAY** 5 Day Express Response Item

NOTE:

If order is placed in Arch/Cathedral door style, Office and Furniture bases will have Square doors.
 All bookcase shelves are 3/4" thick plywood with 1 1/2" tall solid wood rail attached.
 All office base cabinets are predrilled for full depth shelves or roll trays.

CUSTOM MODIFICATIONS				CONSTRUCTION UPGRADES		DOOR OPTIONS	
Mod.	Description	Mod.	Description	Mod.	Description	Mod.	Description
ADDTK	Add Toekick	EXR	Extended Stile - Right	RD	Reduced Depth	APC	All Plywood Construction
AUTHL	Authentic End - Left	FB	Finished Ends	RECTKALL	Recessed Island Toekick	PE	Plywood Ends
AUTHR	Authentic End - Right	FFDL	Face Frame and Door on End - Left	RECTKBK	Recessed Toekick - Back		
CBO	Cabinet Box Only	FFDR	Face Frame and Door on End - Right	RECTKL	Recessed Toekick - Left		
CCO	Cabinet Case Only	FPEB	Furniture Finished Plywood Ends	RECTKR	Recessed Toekick - Right		
CFNTO	Cabinet Front Only	FTK	Flush Toekick	RT	Installed Roll Tray		
CFP	Cabinet False Panel	FTKAV	Flush Toekick Arch	TVRAV	Valance Top Rail, Arch		
CFRMO	Cabinet Frame Only	FTKRV	Flush Toekick Furniture	TVRFV	Valance Top Rail, Furniture		
CND	Cabinet with No Door, with Drawer	ID	Increased Depth	TVRVV	Valance Top Rail, Straight		
DRWTK	Toekick Drawer	INVFRM	Inverted Frame	VACL	Toekick Vacuum Left End Panel		
EXBKL	End Extended Back - Left	LTI	Light Installed Battery Strip	VACR	Toekick Vacuum Right End Panel		
EXBKR	End Extended Back - Right	MIP	Matching Interior Plywood	VACTK	Toekick Vacuum Front		
EXL	Extended Stile - Left	PFINBTMB	Prepare Cabinet for Finished Bottom	VTK	Void Toekick		
		PTOWB	Push to Open Wastebasket	WLI	White Laminate Interior		

BOOKCASE, 30" HIGH, 12" DEEP

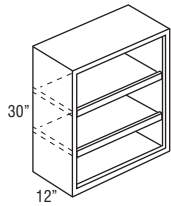

Model	Cubic Feet
W1830BC	5.3
W2430BC	6.9
W3030BC	8.5
W3630BC	10.0

- Matching Interior Plywood (MIP) standard.
- Face frame has a profiled inside edge.
- If ordered with Heirloom Technique, will not feature sand-through characteristics.
- To change the top rail valance, specify one of the following modifications: Arch (TVRAV), Furniture (TVRFV), or Straight Valance (TVRVV).

Custom Modifications

ADDTK	AUTHL AUTHR	CBO	CCO	CFNTO	CFP	CFRMO	CND	DRWTK	EXBKL EXBKR	EXL EXR	FB	FFDL FFDR	FPEB
•	•	STD				•			•	•	STD		•
	FTKAV FTKRV	ID	INVFRM	LTI	MIP	PFINBTMB	PTOWB	RD	RECTKALL RECTKBK	RECTKL RECTKR	RT	TVRAV TVRFV TVRVV	VACL VACR
		•			STD	•		•				•	
VACTK	VTK	WLI											

Construction Upgrades

APC	PE
	STD

Door Options

DPSRR

BOOKCASE, 48" HIGH, 12" DEEP

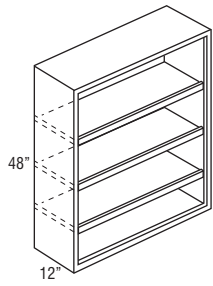

Model	Cubic Feet
W1848BC	8.2
W2448BC	10.7
W3048BC	13.2
W3648BC	15.7

- Matching Interior Plywood (MIP) standard.
- Face frame has a profiled inside edge.
- If ordered with Heirloom Technique, will not feature sand-through characteristics.
- To change the top rail valance, specify one of the following modifications: Arch (TVRAV), Furniture (TVRFV), or Straight Valance (TVRVV).

Custom Modifications

ADDTK	AUTHL AUTHR	CBO	CCO	CFNTO	CFP	CFRMO	CND	DRWTK	EXBKL EXBKR	EXL EXR	FB	FFDL FFDR	FPEB
•	•	STD				•			•	•	STD		•
FTK	FTKAV FTKFV	ID	INVFRM	LTI	MIP	PFINBTMB	PTOWB	RD	RECTKALL RECTKBR	RECTKL RECTKR	RT	TVRAV TVRFV TVRVV	VACL VACR
		•			STD	•		•				•	
VACTK	VTK	WLI											

Construction Upgrades

APC	PE
	STD

Door Options

DPSRR

WALL FURNITURE BOOKCASE, 48", 51", or 54" HIGH, 12" DEEP

18", 24", 30", or 36"

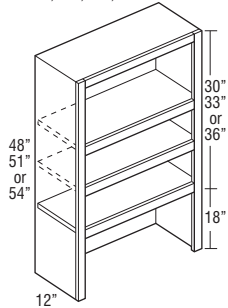

Model	Cubic Feet
WFBC1848	8.1
WFBC2448	10.5
WFBC3048	13.0
WFBC3648	15.4

Model	Cubic Feet
WFBC1851	8.6
WFBC2451	11.2
WFBC3051	13.7
WFBC3651	16.3

WFBC1854	9.1
WFBC2454	11.8
WFBC3054	14.5
WFBC3654	17.2

- 48", 51", and 54" have two adjustable shelves and one fixed shelf.
- Matching Interior Plywood (MIP) standard.
- Face frame has a profiled inside edge.
- If ordered with Heirloom Technique, will not feature sand-through characteristics.
- To change the top rail valance, specify one of the following modifications: Arch (TVRAV), Furniture (TVRFV), or Straight Valance (TVRVV).
- Bookcases can only be reduced to 9".

Custom Modifications

ADDTK	AUTHL AUTHR	CBO	CCO	CFNTO	CFP	CFRMO	CND	DRWTK	EXBKL EXBKR	EXL EXR	FB	FFDL FFDR	FPEB
	•	STD				•			•	•	STD		•
FTK	FTKAV FTKFV	ID	INVFRM	LTI	MIP	PFINBTMB	PTOWB	RD	RECTKALL RECTKBR	RECTKL RECTKR	RT	TVRAV TVRFV TVRVV	VACL VACR
		•			STD			•				•	
VACTK	VTK	WLI											

Construction Upgrades

APC	PE
	STD

Door Options

DPSRR

**WALL FURNITURE BOOKCASE, 57",
60", or 66" HIGH, 12" DEEP**

18", 24", 30", or 36"

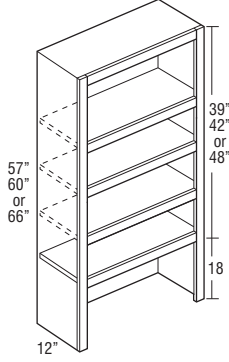

Model	Cubic Feet	Model	Cubic Feet
WFBC1857	9.6	WFBC1860	9.6
WFBC2457	12.4	WFBC2460	13.1
WFBC3057	15.3	WFBC3060	16.1
WFBC3657	18.2	WFBC3660	19.1
		WFBC1866	11.0
		WFBC2466	14.3
		WFBC3066	17.6
		WFBC3666	20.9

- 57", 60", and 66" have three adjustable shelves and one fixed shelf.
- Matching Interior Plywood (MIP) standard.
- Face frame has a profiled inside edge.
- If ordered with Heirloom Technique, will not feature sand-through characteristics.
- To change the top rail valance, specify one of the following modifications: Arch (TVRAV), Furniture (TVRFV), or Straight Valance (TVRVV).
- Bookcases can only be reduced to 9".

Custom Modifications

ADDTK	AUTHL AUTHR	CBO	CCO	CFNTO	CFP	CFRMO	CND	DRWTK	EXBKL EXBKR	EXL EXR	FB	FFDL FFDR	FPEB
	•*	STD				•			•	•	STD		•
FTK	FTKAV FTKRV	ID	INVFRM	LTI	MIP	PFINBTMB	PTOWB	RD	RECTKALL RECTKBR	RECTKL RECTKR	RT	TVRAV TVRFV TVRVV	VACL VACR
		•			STD			•				•	
VACTK	VTK	WLI											

*Not available on 66" high

Construction Upgrades

APC	PE
	STD

Door Options

DPSRR

TALL BOOKCASE, 84", 87", or 90" HIGH, 12" or 18" DEEP

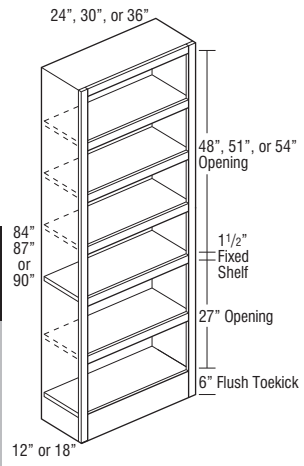

Model	Cubic Feet	Model	Cubic Feet
TBC248412	18.1	TBC248718	26.8
TBC308412	22.3	TBC308718	33.0
TBC368412	26.5	TBC368718	39.1
TBC248418	25.9	TBC249012	19.4
TBC308418	31.9	TBC309012	23.9
TBC368418	37.8	TBC369012	28.3
TBC248712	18.7	TBC249018	27.7
TBC308712	23.1	TBC309018	34.1
TBC368712	27.4	TBC369018	40.5

- 84" and 87" tall include four adjustable shelves and one fixed shelf.
- 90" tall includes five adjustable shelves and one fixed shelf.
- Matching Interior Plywood (MIP) standard.
- Face frame has a profiled inside edge.
- If ordered with Heirloom Technique, will not feature sand-through characteristics.
- To change the top rail valance, specify one of the following modifications: Arch (TVRAV), Furniture (TVRFV), or Straight Valance (TVRVV).
- Bookcases can only be reduced to 9".

Custom Modifications

ADDTK	AUTHL AUTHR	CBO	CCO	CFNTO	CFP	CFRMO	CND	DRWTK	EXBKL EXBKRR	EXL EXR	FB	FFDL FFDR	FPEB
		STD				•			•	•	STD		•
FTK	FTKAV FTKRV	ID	INVRM	LTI	MIP	PFINBTMB	PTOWB	RD	RECTKALL RECTKRR	RECTKL RECTKR	RT	TVRAV TVRFV TVRVV	VACL VACR
STD	•	•			STD			•				•	
VACTK	VTK	WLI											

Construction Upgrades

APC	PE
	STD

Door Options

DPSRR

**TALL BOOKCASE, 93" or 96" HIGH,
12" or 18" DEEP**

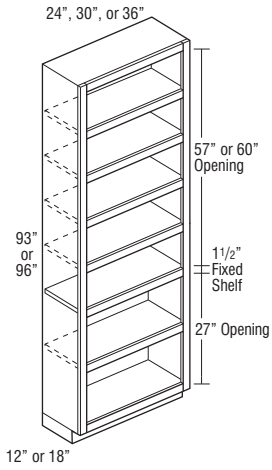

Model	Cubic Feet	Model	Cubic Feet
TBC249312	20.0	TBC249612	20.6
TBC309312	24.6	TBC309612	25.4
TBC369312	29.2	TBC369612	30.2
TBC249318	28.6	TBC249618	29.5
TBC309318	35.2	TBC309618	36.3
TBC369318	41.8	TBC369618	43.1

- 93" tall includes five adjustable shelves and one fixed shelf.
- 96" tall includes six adjustable shelves and one fixed shelf.
- Separate pedestal base included but packaged separately on 93" and 96" tall. Pedestals are the same width as the cabinet box except when specified with FPEB, in which the pedestal will be 1/4" recessed when centered.
- Matching Interior Plywood (MIP) standard.
- Face frame has a profiled inside edge.
- If ordered with Heirloom Technique, will not feature sand-through characteristics.
- To change the top rail valance, specify one of the following modifications: Arch (TVRAV), Furniture (TVRFV), or Straight Valance (TVRVV).
- Bookcases can only be reduced to 9".

Custom Modifications

ADDTK	AUTHL AUTHR	CBO	CCO	CFNTO	CFP	CFRMO	CND	DRWTK	EXBKL EXBKR	EXL EXR	FB	FFDL FFDR	FPEB
		STD				•			•	•	STD		•
FTK	FTKAV FTKRV	ID	INVRM	LTI	MIP	PFNBMB	PTOWB	RD	RECTKALL RECTBKB	RECTKL RECTKR	RT	TVRAV TVRFV TVRVV	VACL VACR
		•			STD			•		•		•	
VACTK	VTK	WLI											

Construction Upgrades

APC	PE
	STD

Door Options

DPSRR

TALL BOOKCASE with DOORS, 84", 87", or 90" HIGH, 12" or 18" DEEP

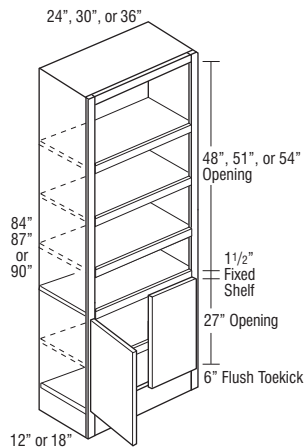

Model	Cubic Feet	Model	Cubic Feet
TBCD248412	18.1	TBCD248718	26.8
TBCD308412	22.3	TBCD308718	33.0
TBCD368412	26.5	TBCD368718	39.1
TBCD248418	25.9	TBCD249012	19.4
TBCD308418	31.9	TBCD309012	23.9
TBCD368418	37.8	TBCD369012	28.3
TBCD248712	18.7	TBCD249018	27.7
TBCD308712	23.1	TBCD309018	34.1
TBCD368712	27.4	TBCD369018	40.5

- 84" and 87" tall include four adjustable shelves and one fixed shelf.
- 90" tall includes five adjustable shelves and one fixed shelf.
- Matching Interior Plywood (MIP) standard.
- Face frame has a profiled inside edge.
- Top of doors match to a standard, full height base door, 34 1/2" high.
- To change the top rail valance, specify one of the following modifications: Arch (TVRAV), Furniture (TVRFV), or Straight Valance (TVRVV).
- Bookcases can only be reduced to 9".

Custom Modifications

ADDTK	AUTHL AUTHR	CBO	CCO	CFNTO	CFP	CFRMO	CND	DRWTK	EXBKL EXBKRR	EXL EXR	FB	FFDL FFDR	FPEB
		•	•	•		•			•	•	STD		•
FTK	FTKAV FTKRV	ID	INVFRM	LTI	MIP	PFINBTMB	PTOWB	RD	RECTKALL RECTBK	RECTKL RECTKR	RT	TVRAV TVRFV TVRVV	VACL VACR
STD	•	•			STD			•				•	
VACTK	VTK	WLI											

Construction Upgrades

APC	PE
	STD

Door Options

DPSRR
•

TALL BOOKCASE with DOORS, 93" or 96" HIGH, 12" or 18" DEEP

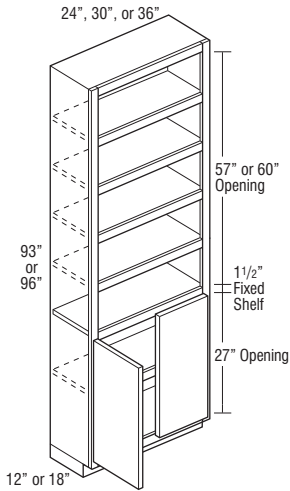

Model	Cubic Feet	Model	Cubic Feet
TBCD249312	20.0	TBCD249612	20.6
TBCD309312	24.6	TBCD309612	25.4
TBCD369312	29.2	TBCD369612	30.2
TBCD249318	28.6	TBCD249618	29.5
TBCD309318	35.2	TBCD309618	36.3
TBCD369318	41.8	TBCD369618	43.1

- 93" tall includes five adjustable shelves and one fixed shelf.
- 96" tall includes six adjustable shelves and one fixed shelf.
- Separate pedestal base included but packaged separately on 93" and 96" tall. Pedestals are the same width as the cabinet box except when specified with FPEB, in which the pedestal will be 1/4" recessed when centered.
- Matching Interior Plywood (MIP) standard.
- Face frame has a profiled inside edge.
- Top of doors match to a standard, full height base door, 34 1/2" high.
- To change the top rail valance, specify one of the following modifications: Arch (TVRAV), Furniture (TVRFV), or Straight Valance (TVRVV).
- Bookcases can only be reduced to 9".

Custom Modifications

ADDTK	AUHL AUTHR	CBO	CCO	CFNT0	CFP	CFRMO	CND	DRWTK	EXBKL EXBKR	EXL EXR	FB	FFDL FFDR	FPEB
		•	•	•		•			•	•	STD		•
FTK	FTKAV FTKRV	ID	INVFRM	LTI	MIP	PFNBAMB	PTOWB	RD	RECTKALL RECTKBR	RECTKL RECTKR	RT	TVRAV TVRFV TVRVV	VACL VACR
		•			STD			•				•	
VACTK	VTK	WLI											

Construction Upgrades

APC	PE
•	•
	STD

Door Options

DPSRR
•

DESK DOOR DRAWER BASE, 29" HIGH, 21" or 24" DEEP

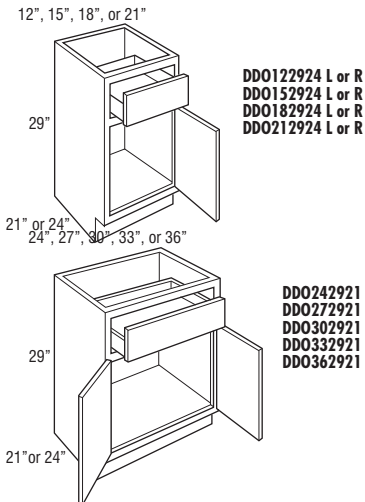

DDO122924 L or R
DDO152924 L or R
DDO182924 L or R
DDO212924 L or R

DDO242921 DDO242924
DDO272921 DDO272924
DDO302921 DDO302924
DDO332921 DDO332924
DDO362921 DDO362924

DDO122921 L or R	6.4	DDO242921	11.9
DDO152921 L or R	7.8	DDO272921	13.0
DDO182921 L or R	9.1	DDO302921	14.9
DDO212921 L or R	10.5	DDO332921	13.0
DDO122924 L or R	7.3	DDO362921	17.9
DDO152924 L or R	8.8	DDO242924	13.4
DDO182924 L or R	10.2	DDO272924	13.3
DDO212924 L or R	11.8	DDO302924	14.6
		DDO332924	16.1
		DDO362924	17.3

- Depth can be reduced to a minimum of 12".
- Depth can be increased to a maximum of 24".

Custom Modifications

ADDTK	AUHL AUTHR	CBO	CCO	CFNT0	CFP	CFRMO	CND	DRWTK	EXBKL EXBKR	EXL EXR	FB	FFDL FFDR	FPEB
	•*	•	•	•	•	•	•	•+	•	•	•	•	•
FTK	FTKAV FTKRV	ID	INVFRM	LTI	MIP	PFNBAMB	PTOWB	RD	RECTKALL RECTKBR	RECTKL RECTKR	RT	TVRAV TVRFV TVRVV	VACL VACR
•	•▲	•†	•	•▲	•			•	•	•	•		•‡
VACTK	VTK	WLI											
••+	•	•											

*Not available on 21" deep †Not available on 12" and 15" wide •+Not available on 12" wide †Not available on 24" deep ‡Available only on 21"-36" wide and 24" deep

Construction Upgrades

APC	PE
•	•

Door Options

DPSRR
•

DESK DRAWER BASE, 29" HIGH, 21" or 24" DEEP

12", 15", 18", 21", 24", 27", 30", 33", or 36"

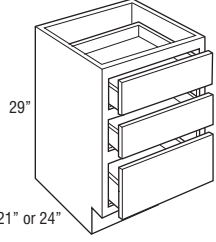

Model	Cubic Feet	Model	Cubic Feet
DDR122921	6.4	DDR242921	11.9
DDR152921	7.8	DDR272921	12.0
DDR182921	9.1	DDR302921	13.2
DDR212921	10.5	DDR332921	14.4
		DDR362921	15.7
DDR122924	7.3		
DDR152924	8.8	DDR242924	13.4
DDR182924	10.2	DDR272924	13.5
DDR212924	11.8	DDR302924	14.9
		DDR332924	16.3
		DDR362924	17.7

- Depth can be reduced to a minimum of 12".
- Depth can be increased to a maximum of 24".

Custom Modifications

ADDTK	AUTHL AUTHR	CBO	CCO	CFNTO	CFP	CFRMO	CND	DRWTK	EXBKL EXBKR	EXL EXR	FB	FFDL FFDR	FPEB
	•*	•	•		•	•		•*	•	•	•		•
FTK	FTKAV FTKFV	ID	INVERM	LTI	MIP	PFINBTMB	PTOWB	RD	RECTKALL RECTKBK	RECTKL RECTKR	RT	TVRAV TVRFV TVRVV	VACL VACR
•	•▲				•			•	•	•			•†
VACTK	VTK	WLI											
•**	•												

*Not available on 21" deep *Not available on 12" and 15" wide ▲Not available on 12" wide
†Available only on 21"-36" wide and 24" deep

Construction Upgrades

APC	PE
•	•

Door Options

DPSRR

DESK FILE DRAWER BASE, 29" HIGH, 21" or 24" DEEP

15", 18", or 21"

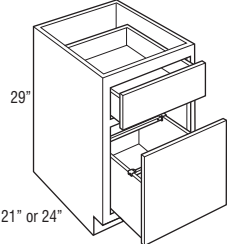

DFD152921	7.8
DFD182921	9.1
DFD212921	10.5
DFD152924	8.8
DFD182924	10.2
DFD212924	11.8

- Door is attached to file drawer.
- Includes Filing System Hardware Kit, which accommodates letter and legal filing.
- Exterior height of file drawer is 10".

Custom Modifications

ADDTK	AUTHL AUTHR	CBO	CCO	CFNTO	CFP	CFRMO	CND	DRWTK	EXBKL EXBKR	EXL EXR	FB	FFDL FFDR	FPEB
	•*	•	•			•		•*	•	•	•		•
FTK	FTKAV FTKFV	ID	INVERM	LTI	MIP	PFINBTMB	PTOWB	RD	RECTKALL RECTKBK	RECTKL RECTKR	RT	TVRAV TVRFV TVRVV	VACL VACR
•	•				•				•	•			•▲
VACTK	VTK	WLI											
•**	•												

*Not available on 21" deep *Not available on 15" wide ▲Available only on DFD212924

Construction Upgrades

APC	PE
•	•

Door Options

DPSRR

**DESK DOUBLE FILE DRAWER BASE,
29" HIGH, 21" or 24" DEEP**

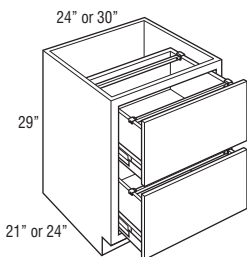

Model	Cubic Feet
DDFD242921	11.9
DDFD302921	14.9
DDFD242924	13.4
DDFD302924	17.9

- Includes Filing System Hardware Kit, which accommodates letter and legal filing.
- Drawers utilize 125 lb. full extension progressive sidemount guide, does not feature soft close guide.
- Bottom of drawer is not designed to support any weight.
- Exterior height of drawer box is 9 1/2".

Custom Modifications

ADDTK	AUTHL AUTHR	CBO	CCO	CFNT0	CFP	CFRMO	CND	DRWTK	EXBKL EXBKR	EXL EXR	FB	FFDL FFDR	FPEB
	•*	•	•			•		•	•	•	•		•
FTK	FTKAV FTKRV	ID	INVRM	LTI	MIP	PFNBMB	PTOWB	RD	RECTKALL RECTKBR	RECTKL RECTKR	RT	TVRAV TVRFV TVRVV	VACL VACR
•	•				•				•	•			
VACTK	VTK	WLI											
	•												

*Not available on 21" deep

Construction Upgrades

APC	PE
•	•

Door Options

DPSRR

**DESK WASTEBASKET FULL HEIGHT
BASE, 29" HIGH, 15" or 18" WIDE,
21" or 24" DEEP**

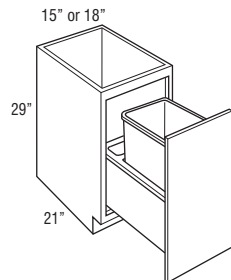

DWB152921FH
DWB182921FH

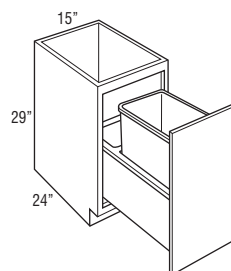

DWB152924FH

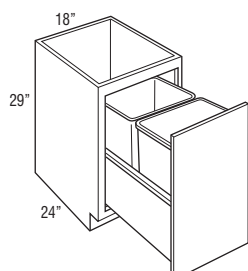

DWB182924FH

DWB152921FH	6.8
DWB182921FH	8.0
DWB152924FH	7.7
DWB182924FH	9.1

- Pull-out features undermount Smart Stop guides.
- DWB152921FH, DWB182921FH, and DWB152924FH include one 35 quart grey wastebasket and a trash bag storage area.
- DWB182924FH includes two 35 quart grey wastebaskets.
- Wastebasket lid available for purchase separately, see page 406. BWBLID fits 35 quart wastebaskets.

Custom Modifications

ADDTK	AUTHL AUTHR	CBO	CCO	CFNT0	CFP	CFRMO	CND	DRWTK	EXBKL EXBKR	EXL EXR	FB	FFDL FFDR	FPEB
	•*	•	•			•		•+	•	•	•		•
FTK	FTKAV FTKRV	ID	INVRM	LTI	MIP	PFNBMB	PTOWB	RD	RECTKALL RECTKBR	RECTKL RECTKR	RT	TVRAV TVRFV TVRVV	VACL VACR
•	•				•		•*		•	•			•*+
VACTK	VTK	WLI											
•+	•	•											

*Not available on 21" deep

*Not available on 15" wide

Construction Upgrades

APC	PE
•	•

Door Options

DPSRR
•

CPU BASE, 29" HIGH, 21" or 24" DEEP

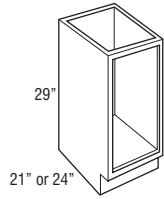

Model	Cubic Feet
CPU122921	5.0
CPU152921	6.1
CPU122924	5.6
CPU152924	6.9

- Matching interior.
- Hardwood veneer plywood.
- No door available to fit unit.
- Reduced Depth (RD) - 9" minimum.
- Face frame has a profiled inside edge.
- If ordered with Heirloom Technique, will not feature sand-through characteristics.

Custom Modifications

ADDTK	AUTHL AUTHR	CBO	CCO	CFNTO	CFP	CFRMO	CND	DRWTK	EXBKL EXBKR	EXL EXR	FB	FFDL FFDR	FPEB
	•*		STD			•			•	•	STD		•
FTK	FTKAV FTKRV	ID	INVERM	LTI	MIP	PFINBTMB	PTOWB	RD	RECTKALL RECTKBL	RECTKL RECTKR	RT	TVRAV TVRFV TVRVV	VACL VACR
•	•*				STD			•▲	•	•			
VACTK	VTK	WLI											
	•												

*Not available on 21" deep *Not available on 12" wide ▲Not available on 24" deep

Construction Upgrades

APC	PE

Door Options

DPSRR

PRINTER BASE, 29" HIGH, 21" or 24" DEEP

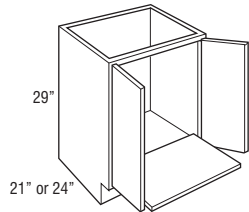

PRB242921	11.9
PRB242924	13.6

- 3/4" full depth slide out shelf with undermount full extension Smart Stop guides.
- 75 lb. maximum shelf capacity.

Custom Modifications

ADDTK	AUTHL AUTHR	CBO	CCO	CFNTO	CFP	CFRMO	CND	DRWTK	EXBKL EXBKR	EXL EXR	FB	FFDL FFDR	FPEB
	•*	•	•	•		•		•	•	•	•		•
FTK	FTKAV FTKRV	ID	INVERM	LTI	MIP	PFINBTMB	PTOWB	RD	RECTKALL RECTKBL	RECTKL RECTKR	RT	TVRAV TVRFV TVRVV	VACL VACR
•	•			•	•			•	•	•	•		•*
VACTK	VTK	WLI											
•*	•	•											

*Not available on 21" deep

Construction Upgrades

APC	PE
•	•

Door Options

DPSRR
•

DESK EASY REACH, 29" HIGH, 21" or 24" DEEP

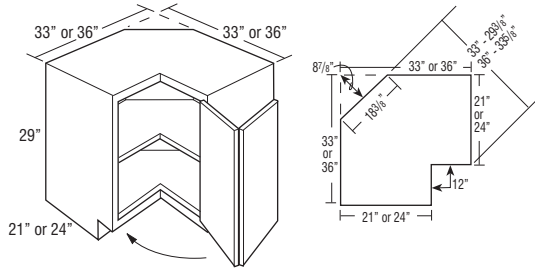

Model	Cubic Feet
DER333321 L or R	16.0
DER363624 L or R	21.3

- Features one fixed shelf in center of cabinet.
- Decorative hardware screws must be countersunk to prevent scratching of adjacent cabinets and face frame of DER.
- DER333321 L or R wall width is 33" x 33".
- DER363624 L or R wall width is 36" x 36".
- Integrated soft close hinge not included.
- Cabinet top features I-beam braces with a center support brace.

Custom Modifications

ADDTK	AUTHL AUTHR	CBO	CCO	CFNTO	CFP	CFRMO	CND	DRWTK	EXBKL EXBKR	EXL EXR	FB	FFDL FFDR	FPEB
		•	•								•		•
FTK	FTKAV FTKRV	ID	INVRM	LTI	MIP	PFINBTMB	PTOWB	RD	RECTKALL RECTKBR	RECTKL RECTKR	RT	TVRAV TVRFV TVRVV	VACL VACR
				•	•				•	•			
VACTK	VTK	WLI											
	•	•											

Construction Upgrades

APC	PE
•	•

Door Options

DPSRR
•

FURNITURE DRAWER, 6 3/4" HIGH, 24" DEEP

15", 18", 21", 24",
27", 30", or 36"

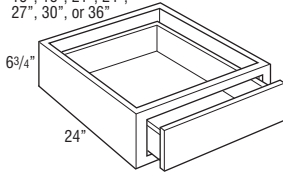

- FD1506.7524**
- FD1806.7524**
- FD2106.7524**
- FD2406.7524**
- FD2706.7524**
- FD3006.7524**
- FD3606.7524**

FD1506.7524	2.1
FD1806.7524	2.5
FD2106.7524	2.9
FD2406.7524	3.3
FD2706.7524	3.7
FD3006.7524	4.1
FD3606.7524	4.9

- On partial overlay styles, drawer front to face frame is justified to the top to be consistent with current partial overlay reveal of 1". Bottom reveal is 1/4".
- Standard with all plywood construction and wood dovetail drawer.

Custom Modifications

ADDTK	AUTHL AUTHR	CBO	CCO	CFNTO	CFP	CFRMO	CND	DRWTK	EXBKL EXBKR	EXL EXR	FB	FFDL FFDR	FPEB
•		•	•			•			•	•	•		•
FTK	FTKAV FTKRV	ID	INVRM	LTI	MIP	PFINBTMB	PTOWB	RD	RECTKALL RECTKBR	RECTKL RECTKR	RT	TVRAV TVRFV TVRVV	VACL VACR
					•			•					
VACTK	VTK	WLI											

Construction Upgrades

APC	PE
•	
STD	

Door Options

DPSRR

FURNITURE DRAWER, 12" HIGH, 24" DEEP

15", 18", 21", 24", 27", 30", or 36"

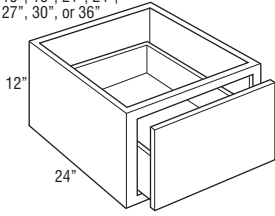

- FD151224
- FD181224
- FD211224
- FD241224
- FD271224
- FD301224
- FD361224

Model	Cubic Feet
FD151224	3.5
FD181224	4.1
FD211224	4.7
FD241224	5.4
FD271224	6.0
FD301224	6.6
FD361224	7.9

- Drawer front to face frame reveal is justified to the bottom to be consistent with both full overlay and partial overlay. Partial overlay top reveal is 1 1/8" and bottom reveal is 1". Full overlay top reveal is 3/8" and bottom reveal is 1/4".
- Standard with all plywood construction and wood dovetail drawer.
- Exterior height of drawer box is 6 3/8".

Custom Modifications

ADDTK	AUTHL AUTHR	CBO	CCO	CFNTO	CFP	CFRMO	CND	DRWTK	EXBKL EXBKR	EXL EXR	FB	FFDL FFDR	FPEB
•		•	•			•			•	•	•		•
FTK	FTKAV FTKRV	ID	INVERM	LTI	MIP	PFINBTMB	PTOWB	RD	RECTKALL RECTKBK	RECTKL RECTKR	RT	TVRAV TVRFV TVRVV	VACL VACR
					•			•					
VACTK	VTK	WLI											

Construction Upgrades

APC	PE
STD	

Door Options

DPSRR

FURNITURE DRAWER WINDOW BENCH, 18" HIGH, 24" DEEP

15", 18", 21", 24", 27", 30", or 36"

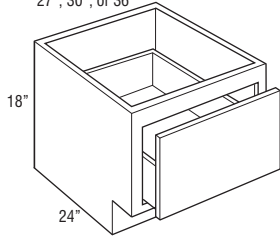

FDWB151824	4.9
FDWB181824	5.8
FDWB211824	6.7
FDWB241824	7.6
FDWB271824	8.4
FDWB301824	9.3
FDWB361824	11.1

- Drawer front to face frame reveal is justified to the bottom to be consistent with both full overlay and partial overlay. Partial overlay top reveal is 2 5/8" and bottom reveal is 1". Full overlay top reveal is 1 7/8" and bottom reveal is 1/4".
- Exterior height of drawer box is 6 3/8".

Custom Modifications

ADDTK	AUTHL AUTHR	CBO	CCO	CFNTO	CFP	CFRMO	CND	DRWTK	EXBKL EXBKR	EXL EXR	FB	FFDL FFDR	FPEB
		•	•			•		•*	•	•	•		•
FTK	FTKAV FTKRV	ID	INVERM	LTI	MIP	PFINBTMB	PTOWB	RD	RECTKALL RECTKBK	RECTKL RECTKR	RT	TVRAV TVRFV TVRVV	VACL VACR
•	•				•			•	•	•			•*
VACTK	VTK	WLI											
•*	•												

*Not available on 15" wide *Not available on 15" and 18" wide

Construction Upgrades

APC	PE
STD	

Door Options

DPSRR

WOOD TOPS, ONE SIDED, 22 1/2" or 25 1/2" DEEP

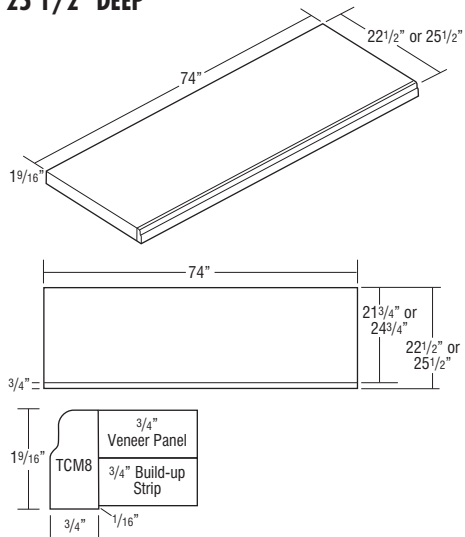

Model	Cubic Feet
1TWT7221	3.8
1TWT7224	4.2

- 3/4" thick veneer over MDF panels with build-up strips to 1 1/2" thick and Traditional Countertop Moulding (TCM8) on front edge.

MODIFICATIONS
No modifications available for these products.

Construction Upgrades

APC	PE
•	

Finish Techniques

Distressing	Heirloom
	•

WOOD TOPS, THREE SIDED, 22 1/2" or 25 1/2" DEEP

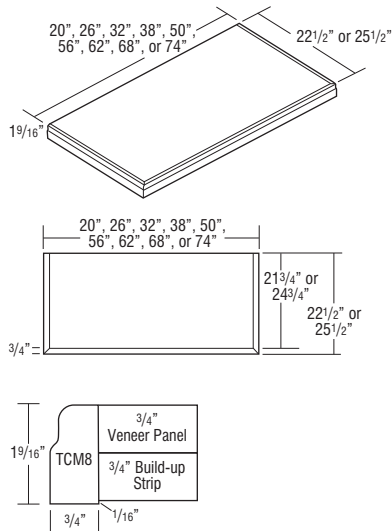

3TWT1821	1.1
3TWT2421	1.4
3TWT3021	1.7
3TWT3621	2.0
3TWT4821	2.6
3TWT5421	2.9
3TWT6021	3.2
3TWT6621	3.5
3TWT7221	3.8
3TWT1824	1.2
3TWT2424	1.6
3TWT3024	1.9
3TWT3624	2.2
3TWT4824	2.9
3TWT5424	3.2
3TWT6024	3.6
3TWT6624	3.9
3TWT7224	4.2

- 3/4" thick veneer over MDF panels with build-up strips to 1 1/2" thick and Traditional Countertop Moulding (TCM8) on front and side edges.

MODIFICATIONS
No modifications available for these products.

Construction Upgrades

APC	PE
•	

Finish Techniques

Distressing	Heirloom
	•

Model	Overall Width	Overall Depth
3TWT1821	20"	22 1/2"
3TWT2421	26"	22 1/2"
3TWT3021	32"	22 1/2"
3TWT3621	38"	22 1/2"
3TWT4821	50"	22 1/2"
3TWT5421	56"	22 1/2"
3TWT6021	62"	22 1/2"
3TWT6621	68"	22 1/2"
3TWT7221	74"	22 1/2"

Model	Overall Width	Overall Depth
3TWT1824	20"	25 1/2"
3TWT2424	26"	25 1/2"
3TWT3024	32"	25 1/2"
3TWT3624	38"	25 1/2"
3TWT4824	50"	25 1/2"
3TWT5424	56"	25 1/2"
3TWT6024	62"	25 1/2"
3TWT6624	68"	25 1/2"
3TWT7224	74"	25 1/2"

WOOD TOPS, FOUR SIDED, 27" or 33" DEEP

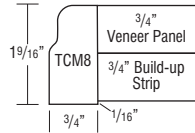
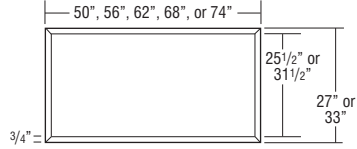
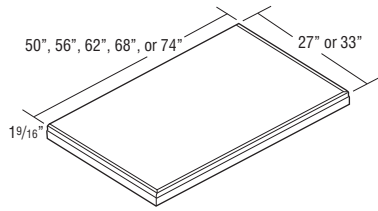

Model	Overall Width	Overall Depth
4TWT4827	50"	27"
4TWT5427	56"	27"
4TWT6027	62"	27"
4TWT6627	68"	27"
4TWT7227	74"	27"

Model	Overall Width	Overall Depth
4TWT4833	50"	33"
4TWT5433	56"	33"
4TWT6033	62"	33"
4TWT6633	68"	33"
4TWT7233	74"	33"

Model	Cubic Feet
4TWT4827	3.1
4TWT5427	3.4
4TWT6027	3.8
4TWT6627	4.1
4TWT7227	4.5
4TWT4833	3.7
4TWT5433	4.1
4TWT6033	4.5
4TWT6633	5.0
4TWT7233	5.4

- 3/4" thick veneer over MDF panels with build-up strips to 1 1/2" thick and Traditional Countertop Moulding (TCM8) on front, back, and side edges.

MODIFICATIONS
No modifications available for these products.

Construction Upgrades

APC	PE
•	

Finish Techniques

Distressing	Heirloom
	•

UNDER COUNTER DRAWER, 4 3/4" HIGH, 18" or 21" DEEP

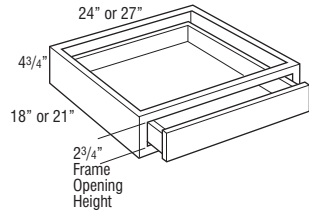

UCD2418 UCD2421
UCD2718 UCD2721

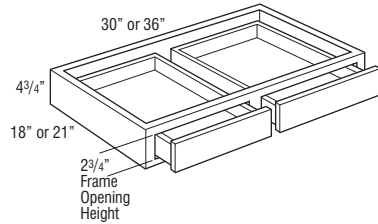

UCD3018 UCD3021
UCD3618 UCD3621

UCD2418	2.6
UCD2718	2.6
UCD2421	2.6
UCD2721	2.6
UCD3018	2.6
UCD3618	2.6
UCD3021	2.6
UCD3621	2.6

- Cabinet is 4 3/4" high. Drawer box within cabinet is 2" high (outside dimension).
- Not trimmable.
- Drawer front is 3/4" slab front.
- The frame to end panel offset is 3/4", which is designed to accommodate the vanity desk leg.
- End panels ordered in Choice will feature non-matching laminate exterior. When ordered in PE or APC, end panels will not be finished.
- Reduced depth is available in 3" increments.

Custom Modifications

ADDTK	AUTHL AUTHR	CBO	CCO	CFNTO	CFP	CFRMO	CND	DRWTK	EXBKL EXBKR	EXL EXR	FB	FFDL FFDR	FPEB
		•	•			•				•			
FTK	FTKAV FTKRV	ID	INVERM	LTI	MIP	PFINBTMB	PTOWB	RD	RECTKALL RECTKBL	RECTKL RECTKR	RT	TVRAV TVRFV TVRVV	VACL VACR
		•			•			•					
VACTK	VTK	WLI											

Construction Upgrades

APC	PE
•	•

Door Options

DPSRR

VANITY CABINET NOMENCLATURE

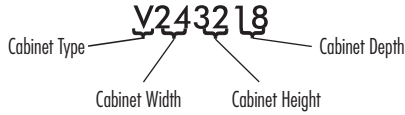

NOTE:
If order is placed in Arch/Cathedral door style, vanity bases will have Square doors and vanity utilities and linen closets will have an Arch/Cathedral top door and Square lower doors.

Distance between back of drawer box and back interior of cabinet is 2 3/4".

All vanity cabinets are predrilled for full depth shelves or roll trays.

TOEKICKS

Vanity Cabinets are shipped with an unfinished toekick. Finished toekicks in matching wood veneer or laminate must be ordered separately and field installed.

MODIFICATIONS GRID KEY

- Available
- STD Standard on these cabinets
- storage SOLUTIONS Storage Solutions Organization Cabinet
- 5 DAY** 5 Day Express Response Item

CUSTOM MODIFICATIONS

Mod.	Description	Mod.	Description	Mod.	Description
AUTHL	Authentic End - Left	EXBKR	End Extended Back - Right	LTI	Light Installed Battery Strip
AUTHR	Authentic End - Right	EXL	Extended Stile - Left	MIP	Matching Interior Plywood
CBO	Cabinet Box Only	EXR	Extended Stile - Right	RD	Reduced Depth
CCO	Cabinet Case Only	FB	Finished Ends	RECTKALL	Recessed Island Toekick
CFNTO	Cabinet Front Only	FFDL	Face Frame and Door on End - Left	RECTKBK	Recessed Toekick - Back
CFP	Cabinet False Panel	FFDR	Face Frame and Door on End - Right	RECTKL	Recessed Toekick - Left
CFRMO	Cabinet Frame Only	FFDR	Face Frame and Door on End - Right	RECTKR	Recessed Toekick - Right
CMAT	CabMat™	RT	Installed Roll Tray	RT	Installed Roll Tray
CND	Cabinet with No Door, with Drawer	FPEB	Furniture Finished Plywood Ends	TKP	Loose Toekick
DRWPWR	PowerGlide™ Compact Drawer Outlet	FTK	Flush Toekick	TOTSS	Tilt-Out Tray, Stainless Steel
DRWTK	Toekick Drawer	FTKAV	Flush Toekick Arch	TOTSSS	Tilt-Out Tray, Stainless Steel Slim
EXBKL	End Extended Back - Left	FTKRV	Flush Toekick Furniture	VTK	Void Toekick
		ID	Increased Depth	WLI	White Laminate Interior
		INVFRM	Inverted Frame		

CONSTRUCTION UPGRADES

Mod.	Description
APC	All Plywood Construction
PE	Plywood Ends

DOOR OPTIONS

Mod.	Description
ALF	Aluminum Frame Doors
CG	Cut for Glass Doors
DPSRR	Door Panel - Solid Reverse Raised
MD	Mullion Doors
MFO	Modified Full Overlay

VANITY BASE, 32" HIGH, 18" or 21" DEEP

12", 15", 18", 21", or 24"

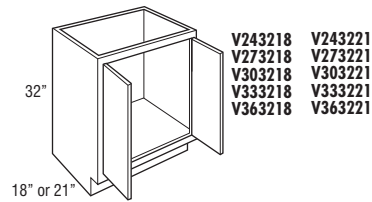
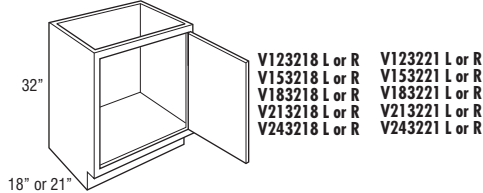

Model	Cubic Feet	Model	Cubic Feet
V123218 L or R	5.6	V243218	10.4
V153218 L or R	6.8	V273218	11.6
V183218 L or R	8.0	V303218	12.7
V213218 L or R	9.2	V333218	13.9
V243218 L or R	10.4	V363218	15.1
V123221 L or R	6.4	V243221	11.9
V153221 L or R	7.8	V273221	13.3
V183221 L or R	9.2	V303221	14.6
V213221 L or R	10.6	V333221	16.0
V243221 L or R	11.9	V363221	17.4

Custom Modifications

AUTHL	AUTHR	CBO	CCO	CFNTO	CFP	CFRMO	CMAT	CND	DRWPWR	DRWTK	EXBKL	EXBKR	EXL	EXR	FB	FFDL	FFDR	FPEB
•			•	•			•*			•*	•	•	•	•	•	•	•	•
		FTKAV	FTKRV	ID	INVFRM	LTI	MIP	RD	RECTKALL	RECTKBK	RECTKL	RECTKR	RT	TKP	TOTSS	TOTSSS	VTK	WLI
•	•▲	•	•	•▲	•	•	•	•	•	•	•	•	•	•	•	•	•	•

*Not available on 12", 15", 18", and 21" wide, or on 18" deep *Not available on 12" and 15" wide, or on 18" deep

▲Not available on 12" wide

Construction Upgrades

APC	PE
•	•

Door Options

ALF	CG	DPSRR	MD	MFO
		•		

**VANITY BASE, 32" HIGH,
18" or 21" DEEP (cont'd)**

39", 42", 45", or 48"

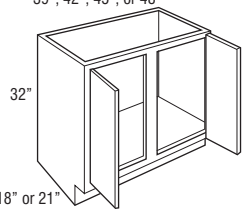

- V393218 V393221
- V423218 V423221
- V453218 V453221
- V483218CS V483221CS

48" or 60"

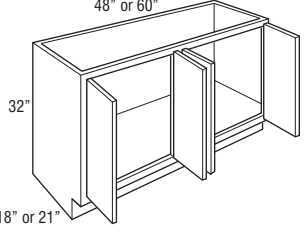

- V483218 V483221
- V603218 V603221

Model	Cubic Feet	Model	Cubic Feet
V393218	16.5	V483218	19.9
V423218	17.5	V603218	28.6
V453218	18.5	V483221	22.9
V483218CS	19.9	V603221	25.0
V393221	18.9		
V423221	20.1		
V453221	21.3		
V483221CS	22.9		

Custom Modifications

AUTHL	AUTHR	CBO	CCO	CFNTO	CFP	CFRMO	CMAT	CND	DRWPWR	DRWTK	EXBKL	EXBKR	EXL	EXR	FB	FFDL	FFDR	FPEB
•			•	•		•	•*				•	•	•	•	•	•	•	•
FTK	FTKAV	FTKFV	ID	INVFRM	LTI	MIP	RD	RECTKALL	RECTKLBK	RECTKL	RECTKR	RT	TKP	TOTSS	TOTSSS	VTK	WLI	
•	•	•	•	•	•	•	•	•	•	•	•	•	•	•	•	•	•	•

*Not available on 39", 42", and 45" wide, or on 18" deep

Construction Upgrades

APC	PE
•	•

Door Options

ALF	CG	DPSRR	MD	MFO
		•		

**VANITY BASE, 34 1/2" HIGH,
18" or 21" DEEP**

12", 15", 18", 21", or 24"

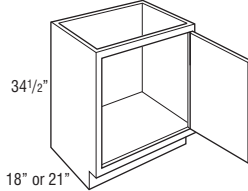

V123418 L or R V123421 L or R
V153418 L or R V153421 L or R
V183418 L or R V183421 L or R
V213418 L or R V213421 L or R
V243418 L or R V243421 L or R

18" or 21"

24", 27", 30", 33", or 36"

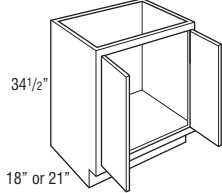

V243418 V243421
V273418 V273421
V303418 V303421
V333418 V333421
V363418 V363421

18" or 21"

39", 42", 45", or 48"

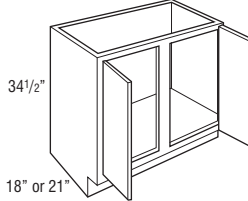

V393418 V393421
V423418 V423421
V453418 V453421
V483418CS V483421CS

18" or 21"

48" or 60"

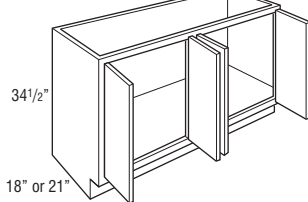

V483418 V483421
V603418 V603421

18" or 21"

Model	Cubic Feet	Model	Cubic Feet
V123418 L or R	5.8	V393418	17.3
V153418 L or R	7.1	V423418	18.6
V183418 L or R	8.3	V453418	19.9
V213418 L or R	9.6	V483418CS	21.1
V243418 L or R	10.9	V393421	22.3
V123421 L or R	6.8	V423421	24.4
V153421 L or R	8.2	V453421	25.2
V183421 L or R	9.7	V483421CS	27.7
V213421 L or R	11.2		
V243421 L or R	14.4		
		V483418	21.1
V243418	10.9	V603418	26.3
V273418	12.2	V483421	27.7
V303418	13.5	V603421	30.3
V333418	14.7		
V363418	16.0		
V243421	14.4		
V273421	16.1		
V303421	17.7		
V333421	19.6		
V363421	21.1		

Custom Modifications

AUTHL AUTHR	CBO	CCO	CFNTO	CFP	CFRMO	CMAT	CND	DRWPWR	DRWTK	EXBKL EXBKR	EXL EXR	FB	FFDL FFDR	FPEB
•		•	•		•	•*			•*	•	•	•	•	•
FTK	FTKAV FTKRV	ID	INVFRM	LTI	MIP	RD	RECTKALL RECTKBK	RECTKL RECTKR	RT	TKP	TOTSS TOTSSS	VTK	WLI	
•	•▲	•		•▲	•	•	•	•	•			•	•	

*Not available on 12", 15", 18", 21", 39", 42", and 45" wide, or on 18" deep

*Not available on 12", 15", 39", 42", 45", 48" and 60" wide, or on 18" deep ▲Not available on 12" wide

Construction Upgrades

APC	PE
•	•

Door Options

ALF	CG	DPSRR	MD	MFO
		•		

**VANITY SINK BASE with FALSE PANEL,
32" HIGH, 18" or 21" DEEP**

15", 18", 21", or 24"

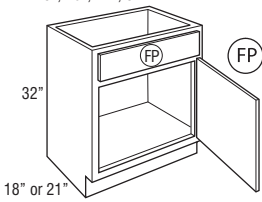

(FP) = False Panel
VSB153218 L or R
VSB183218 L or R
VSB213218 L or R
VSB243218 L or R
VSB153221 L or R
VSB183221 L or R
VSB213221 L or R
VSB243221 L or R

24", 27", 30", 33", or 36"

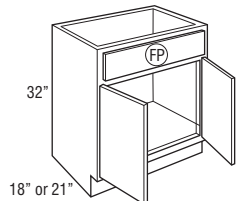

VSB243218 **VSB243221**
VSB273218 **VSB273221**
VSB303218 **VSB303221**
VSB333218 **VSB333221**
VSB363218 **VSB363221**

39", 42", 45", or 48"

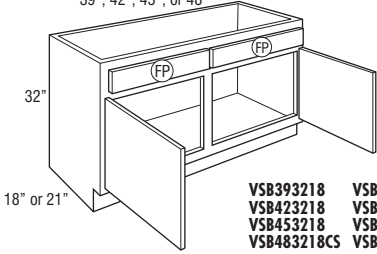

VSB393218 **VSB393221**
VSB423218 **VSB423221**
VSB453218 **VSB453221**
VSB483218CS **VSB483221CS**

48"

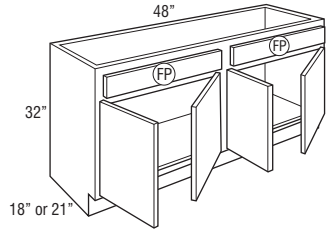

VSB483218
VSB483221

Model	Cubic Feet	Model	Cubic Feet
VSB153218 L or R	6.8	VSB393218	16.5
VSB183218 L or R	8.0	VSB423218	17.5
VSB213218 L or R	9.2	VSB453218	18.5
VSB243218 L or R	10.4	VSB483218CS	19.9
VSB153221 L or R	7.8	VSB393221	18.9
VSB183221 L or R	9.2	VSB423221	20.1
VSB213221 L or R	10.6	VSB453221	21.3
VSB243221 L or R	11.9	VSB483221CS	22.9
VSB243218	10.4	VSB483218	19.9
VSB273218	11.6	VSB483221	22.9
VSB303218	12.7		
VSB333218	13.9		
VSB363218	15.1		
VSB243221	11.9		
VSB273221	13.3		
VSB303221	14.6		
VSB333221	16.0		
VSB363221	17.4		

Custom Modifications

AUTHL	AUTHR	CBO	CCO	CFNT0	CFP	CFRMO	CMAT	CND	DRWPWR	DRWTK	EXBKL	EXBKR	EXL	EXR	FB	FFDL	FFDR	FPEB
•			•	•	STD	•	•*	•		•+	•	•	•	•	•	•	•	•
FTK	FTKAV	FTKEV	ID	INVERM	LTI	MIP	RD	RECTALL	RECTBKB	RECTKL	RECTKR	RT	TKP	TOTSS	TOTSSS	VTK	WLI	
•	•	•	•	•	•	•	•	•	•	•	•	•	•	•	•	•	•	•

*Not available on 15", 18", 21", 39", 42", and 45" wide, or on 18" deep *Not available on 15", 39", 42" and 48" wide, or on 18" deep

Construction Upgrades

APC	PE
•	•

Door Options

ALF	CG	DPSRR	MD	MFO
		•		

**VANITY SINK BASE with FALSE PANEL,
34 1/2" HIGH, 18" or 21" DEEP**

15", 18", 21", or 24"

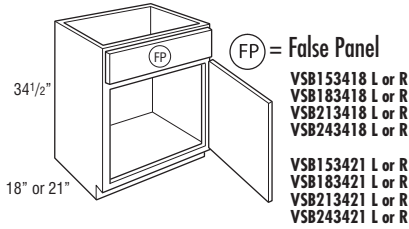

24", 27", 30", 33", or 36"

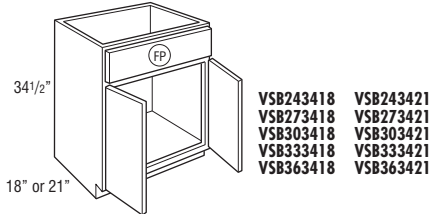

39", 42", 45", or 48"

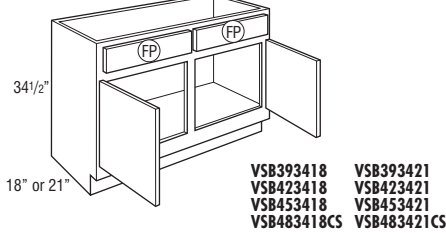

48"

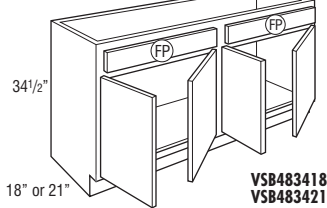

Model	Cubic Feet	Model	Cubic Feet
VSB153418 L or R	7.1	VSB393418	17.3
VSB183418 L or R	8.3	VSB423418	18.6
VSB213418 L or R	9.6	VSB453418	19.9
VSB243418 L or R	10.9	VSB483418CS	21.1
VSB153421 L or R	8.2	VSB393421	22.3
VSB183421 L or R	9.7	VSB423421	24.4
VSB213421 L or R	11.2	VSB453421	25.2
VSB243421 L or R	14.4	VSB483421CS	27.7
VSB243418	10.9	VSB483418	21.1
VSB273418	12.2	VSB483421	27.7
VSB303418	13.5		
VSB333418	14.7		
VSB363418	16.0		
VSB243421	14.4		
VSB273421	16.1		
VSB303421	17.7		
VSB333421	19.6		
VSB363421	21.1		

Custom Modifications

AUTHL	AUTHR	CBO	CCO	CFNT0	CFP	CFRMO	CMAT	CND	DRWPWR	DRWTK	EXBKL	EXBKR	EXL	EXR	FB	FFDL	FFDR	FPEB
•			•	•	•	•	•*	•		•*	•	•	•	•	•	•	•	•
FTK	FTKAV	FTKFV	ID	INVFRM	LTI	MIP	RD	RECTKALL	RECTKBK	RECTKL	RECTKR	RT	TKP	TOTSS	TOTSSS	VTK	WLI	
•	•	•	•	•	•	•	•	•	•	•	•	•	•	•	•	•	•	•

*Not available on 15", 18", 21", 39", 42", and 45" wide, or on 18" deep *Not available on 15", 39", 42" and 48" wide, or on 18" deep

Construction Upgrades

APC	PE
•	•

Door Options

ALF	CG	DPSRR	MD	MFO
		•		

**VANITY SINK BASE with U-SHAPED
ROLL-OUT TRAY, 32" HIGH, 21" DEEP**

storage
SOLUTIONS

30"

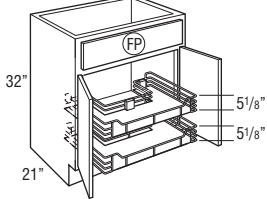

VSB303221U 14.6

- Includes two chrome U-shaped Smart Stop roll-outs with grey shelf liner.
- Cut-out for U-shape on bottom roll-out is 6 1/8" from back of cabinet.
- Cut-out for U-shape on top roll-out is 12 1/8" from back of cabinet.

Custom Modifications

AUTHL	AUTHR	CBO	CCO	CFNT0	CFP	CFRMO	CMAT	CND	DRWPWR	DRWTK	EXBKL	EXBKR	EXL	EXR	FB	FFDL	FFDR	FPEB
•			•	•	•	•		•		•	•	•	•	•	•	•	•	•
FTK	FTKAV	FTKFV	ID	INVFRM	LTI	MIP	RD	RECTKALL	RECTKBK	RECTKL	RECTKR	RT	TKP	TOTSS	TOTSSS	VTK	WLI	
•	•	•	•	•	•	•	•	•	•	•	•	•	•	•	•	•	•	•

Construction Upgrades

APC	PE
•	•

Door Options

ALF	CG	DPSRR	MD	MFO
		•		

VANITY SINK BASE with U-SHAPED ROLL-OUT TRAY, 34 1/2" HIGH, 21" DEEP

storage SOLUTIONS

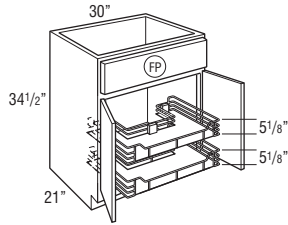

Model	Cubic Feet
VSB303421U	17.7

- Includes two chrome U-shaped Smart Stop roll-outs with grey shelf liner.
- Cut-out for U-shape on bottom roll-out is 6 1/8" from back of cabinet.
- Cut-out for U-shape on top roll-out is 12 1/8" from back of cabinet.

Custom Modifications

AUTHL AUTHR	CBO	CCO	CFNTO	CFP	CFRMO	CMAT	CND	DRWPWR	DRWTK	EXBKL EXBKR	EXL EXR	FB	FFDL FFDR	FPFB
•	•	•	•	STD	•		•		•	•	•	•		•
FTK	FTKAV FTKFV	ID	INVERM	LTI	MIP	RD	RECTKALL RECTKBK	RECTKL RECTKR	RT	TKP	TOTSS TOTSSS	VTK	WLI	
•	•	•		•	•		•	•			•	•	•	

Construction Upgrades

APC	PE
•	•

Door Options

ALF	CG	DPSRR	MD	MFO
		•		

VANITY SINK BASE with WASTEBASKET, 34 1/2" HIGH, 21" DEEP

storage SOLUTIONS

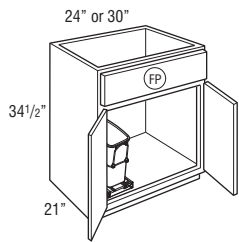

Model	Cubic Feet
VSB243421WB L or R	14.4
VSB303421WB L or R	17.7

- Bottom mounted zinc colored Smart Stop guides with 20 quart grey wastebasket inserted in chrome support. Dimensions of unit: 8.5"W x 16.7"H x 17.7"D.
- L or R designates wastebasket location.

Custom Modifications

AUTHL AUTHR	CBO	CCO	CFNTO	CFP	CFRMO	CMAT	CND	DRWPWR	DRWTK	EXBKL EXBKR	EXL EXR	FB	FFDL FFDR	FPFB
•	•	•	•	STD	•		•		•	•	•	•		•
FTK	FTKAV FTKFV	ID	INVERM	LTI	MIP	RD	RECTKALL RECTKBK	RECTKL RECTKR	RT	TKP	TOTSS TOTSSS	VTK	WLI	
•	•	•		•	•		•	•			•	•	•	

Construction Upgrades

APC	PE
•	•

Door Options

ALF	CG	DPSRR	MD	MFO
		•		

VANITY SINK BASE SUPERCABINET™ with TILT-OUT TRAYS and WASTEBASKET, 34 1/2" HIGH, 21" DEEP

storage SOLUTIONS

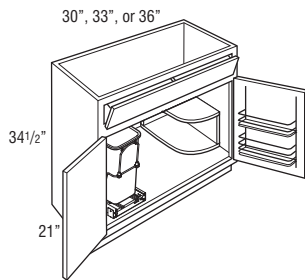

Model	Cubic Feet
VSSB303421STWB L or R	17.7
VSSB333421STWB L or R	19.6
VSSB363421STWB L or R	21.1

- Quarter Round Reversible Shelf for left or right applications will be constructed from 3/4" thick laminated furniture board. When upgraded to APC, shelf will use clear coated veneer plywood. (Shelf shipped secure, can be positioned in left or right corner.)
- Door on the side with the Quarter Round Shelf features a chrome and wood two-tiered rack.
- Door rack width is 10 7/8" on 30" wide cabinet, 12 3/8" on 33" wide cabinet, and 13 7/8" on 36" wide cabinet.
- Door rack depth is 3 1/2".
- Includes 2 installed tilt-out trays.
- Tilt-out trays are stain resistant, moisture resistant plastic to allow storage of sponges & other cleaning materials.
- Tilt-out trays are also available as an accessory for field installation. See page 412.
- All load bearing service meet KCMA standards of 15 lbs. per square foot.
- Bottom mounted zinc colored Smart Stop guides with 20 quart grey wastebasket inserted in chrome support. Dimensions of unit: 8.5"W x 16.7"H x 17.7"D.
- L or R designates wastebasket location.

Custom Modifications

AUTHL AUTHR	CBO	CCO	CFNTO	CFP	CFRMO	CMAT	CND	DRWPWR	DRWTK	EXBKL EXBKR	EXL EXR	FB	FFDL FFDR	FPFB
•	•	•	•		•		•		•	•	•	•		•
FTK	FTKAV FTKFV	ID	INVERM	LTI	MIP	RD	RECTKALL RECTKBK	RECTKL RECTKR	RT	TKP	TOTSS TOTSSS	VTK	WLI	
•	•	•		•	•		•	•			•	•	•	

Construction Upgrades

APC	PE
•	•

Door Options

ALF	CG	DPSRR	MD	MFO
		•		

VANITY SINK BASE SUPERCABINET™
with TILT-OUT TRAYS, 34 1/2" HIGH,
21" DEEP

storage
SOLUTIONS

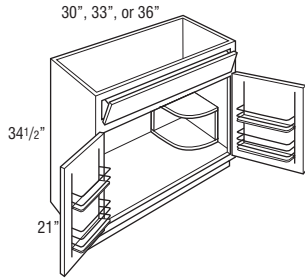

Model	Cubic Feet
VSSB303421ST	17.7
VSSB333421ST	19.6
VSSB363421ST	21.1

- Quarter Round Reversible Shelf for left or right applications will be constructed from 3/4" thick laminated furniture board. When upgraded to APC, shelf will use clear coated veneer plywood. (Shelf shipped secure, can be positioned in left or right corner.)
- Each door features a chrome and wood two-tiered rack.
- Door rack width is 10 7/8" on 30" wide cabinet, 12 3/8" on 33" wide cabinet, and 13 7/8" on 36" wide cabinet.
- Door rack depth is 3 1/2".
- Includes 2 installed tilt-out trays.
- Tilt-out trays are stain resistant, moisture resistant plastic to allow storage of sponges & other cleaning materials.
- Tilt-out trays are also available as an accessory for field installation. See page 412.
- All load bearing service meet KCMA standards of 15 lbs. per square foot.

Custom Modifications

AUTHL	AUTHR	CBO	CCO	CFNTO	CFP	CFRMO	CMAT	CND	DRWPWR	DRWTK	EXBKL	EXBKR	EXL	EXR	FB	FFDL	FFDR	FPEB
•	•	•	•	•	•	•	•	•	•	•	•	•	•	•	•	•	•	•
FTK	FTKAV	FTKRV	ID	INVFRM	LTI	MIP	RD	RECTKALL	RECTKBK	RECTKL	RECTKR	RT	TKP	TOTSS	TOTSSS	VTK	WLI	
•	•	•	•	•	•	•	•	•	•	•	•	•	•	•	•	•	•	

Construction Upgrades

APC	PE
•	•

Door Options

ALF	CG	DPSRR	MD	MFO
•	•	•	•	•

VANITY BASE, SINGLE DOOR with
DRAWER, 32" HIGH, 18" or 21" DEEP

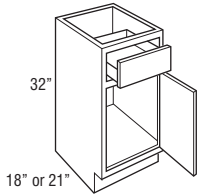

VB123218 L or R	5.6
VB153218 L or R	6.8
VB183218 L or R	8.0
VB213218 L or R	9.2
VB243218 L or R	10.5
VB123221 L or R	6.4
VB153221 L or R	7.8
VB183221 L or R	9.1
VB213221 L or R	10.8
VB243221 L or R	11.9

Custom Modifications

AUTHL	AUTHR	CBO	CCO	CFNTO	CFP	CFRMO	CMAT	CND	DRWPWR	DRWTK	EXBKL	EXBKR	EXL	EXR	FB	FFDL	FFDR	FPEB
•	•	•	•	•	•	•	•	•	•	•*	•	•	•	•	•	•	•	•
FTK	FTKAV	FTKRV	ID	INVFRM	LTI	MIP	RD	RECTKALL	RECTKBK	RECTKL	RECTKR	RT	TKP	TOTSS	TOTSSS	VTK	WLI	
•	•+	•	•	•	•+	•	•	•	•	•	•	•	•	•	•	•	•	

*Not available on 12" and 15" wide, or on 18" deep **Not available on 12" wide

Construction Upgrades

APC	PE
•	•

Door Options

ALF	CG	DPSRR	MD	MFO
•	•	•	•	•

VANITY BASE, SINGLE DOOR with DRAWER, 34 1/2" HIGH, 18" or 21" DEEP

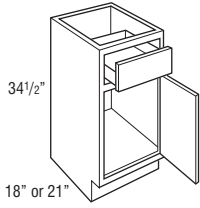

Model	Cubic Feet
VB123418 L or R	5.8
VB153418 L or R	7.1
VB183418 L or R	8.3
VB213418 L or R	9.6
VB243418 L or R	10.9
VB123421 L or R	7.8
VB153421 L or R	9.4
VB183421 L or R	11.1
VB213421 L or R	12.8
VB243421 L or R	14.4

Custom Modifications

AUTHL AUTHR	CBO	CCO	CFNTO	CFP	CFRMO	CMAT	CND	DRWPWR	DRWTK	EXBKL EXBKR	EXL EXR	FB	FFDL FFDR	FPFB
•	•	•	•	•	•		•	•*	•+	•	•	•	•	•
FTK	FTKAV FTKFV	ID	INVERM	LTI	MIP	RD	RECTKALL RECTKBK	RECTKL RECTKR	RT	TKP	TOTSS TOTSSS	VTK	WLI	
•	•^	•	•	•^	•	•	•	•	•	•	•	•	•	•

*Not available on 12" and 15" wide *Not available on 12" and 15" wide, or on 18" deep ^Not available on 12" wide

Construction Upgrades

APC	PE
•	•

Door Options

ALF	CG	DPSRR	MD	MFO
		•		

VANITY BASE, DOUBLE DOOR with DRAWER, 32" HIGH, 18" or 21" DEEP

24", 27", 30", 33", or 36"

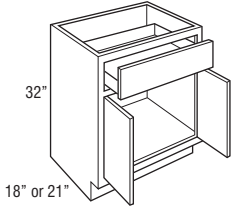

VB243218 VB243221
 VB273218 VB273221
 VB303218 VB303221
 VB333218 VB333221
 VB363218 VB363221

39", 42", 45", or 48"

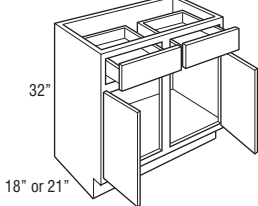

VB393218 VB393221
 VB423218 VB423221
 VB453218 VB453221
 VB483218CS VB483221CS

48"

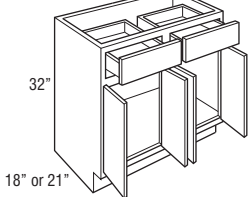

VB483218
 VB483221

VB243218	10.4
VB273218	11.7
VB303218	12.9
VB333218	14.1
VB363218	15.3
VB243221	11.9
VB273221	13.3
VB303221	14.7
VB333221	16.1
VB363221	17.5

VB393218	16.5
VB423218	17.7
VB453218	18.5
VB483218CS	20.2
VB393221	18.9
VB423221	20.3
VB453221	21.3
VB483221CS	23.1
VB483218	20.2
VB483221	23.1

Custom Modifications

AUTHL AUTHR	CBO	CCO	CFNTO	CFP	CFRMO	CMAT	CND	DRWPWR	DRWTK	EXBKL EXBKR	EXL EXR	FB	FFDL FFDR	FPFB
•	•	•	•	•	•		•	•	•*	•	•	•	•	•
FTK	FTKAV FTKFV	ID	INVERM	LTI	MIP	RD	RECTKALL RECTKBK	RECTKL RECTKR	RT	TKP	TOTSS TOTSSS	VTK	WLI	
•	•	•	•	•	•	•	•	•	•	•	•	•	•	•

*Not available on 39", 42", 45" and 48" wide, or on 18" deep

Construction Upgrades

APC	PE
•	•

Door Options

ALF	CG	DPSRR	MD	MFO
		•		

VANITY BASE, DOUBLE DOOR with DRAWER, 34 1/2" HIGH, 18" or 21" DEEP

24", 27", 30", 33", or 36"

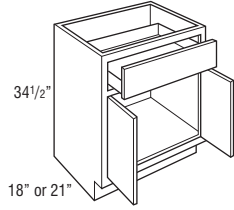

VB243418 VB243421
 VB273418 VB273421
 VB303418 VB303421
 VB333418 VB333421
 VB363418 VB363421

39", 42", 45", or 48"

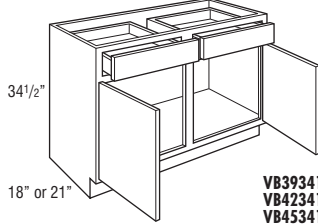

VB393418 VB393421
 VB423418 VB423421
 VB453418 VB453421
 VB483418CS VB483421CS

48"

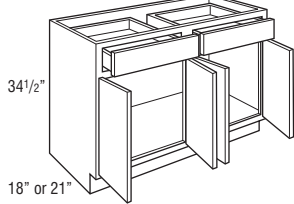

VB483418
 VB483421

Model	Cubic Feet	Model	Cubic Feet
VB243418	10.9	VB393418	17.3
VB273418	12.2	VB423418	18.6
VB303418	13.5	VB453418	19.9
VB333418	14.7	VB483418CS	21.1
VB363418	16.0	VB393421	22.3
VB243421	14.4	VB423421	24.4
VB273421	16.1	VB453421	25.2
VB303421	17.7	VB483421CS	27.7
VB333421	19.6		
VB363421	21.1	VB483418	21.1
		VB483421	27.7

Custom Modifications

AUTHL	AUTHR	CBO	CCO	CFNTO	CFP	CFRMO	CMAT	CND	DRWPWR	DRWTK	EXBKL	EXBKR	EXL	EXR	FB	FFDL	FFDR	FPFB
		•	•					•	•	•*	•	•	•	•	•	•	•	•
FTK	FTKAV	FTKVV	ID	INVRM	LTI	MIP	RD	RECTKALL	RECTKBK	RECTKL	RECTKR	RT	TKP	TOTSS	TOTSSS	VTK	WLI	
•	•	•	•	•	•	•	•	•	•	•	•	•	•	•	•	•	•	

*Not available on 39", 42", 45" and 48" wide, or on 18" deep

Construction Upgrades

APC	PE
•	•

Door Options

ALF	CG	DPSRR	MD	MFO
		•		

VANITY BASE EASY REACH, 32" HIGH, 18" or 21" DEEP

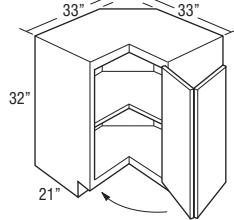
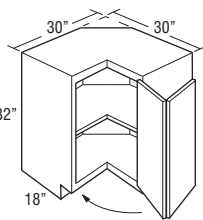

VER303218 L or R	12.9
VER333221 L or R	16.1

- Decorative hardware screws must be countersunk to prevent scratching adjacent cabinets and face frame of VER.
- Includes one 1/2" thick fixed shelf in center of cabinet.
- Integrated soft close hinge not included.
- Cabinet top features I-beam braces with a center support brace.

Custom Modifications

AUTHL	AUTHR	CBO	CCO	CFNTO	CFP	CFRMO	CMAT	CND	DRWPWR	DRWTK	EXBKL	EXBKR	EXL	EXR	FB	FFDL	FFDR	FPFB
		•	•												•			•
FTK	FTKAV	FTKVV	ID	INVRM	LTI	MIP	RD	RECTKALL	RECTKBK	RECTKL	RECTKR	RT	TKP	TOTSS	TOTSSS	VTK	WLI	
					•	•		•	•							•	•	

Construction Upgrades

APC	PE
•	•

Door Options

ALF	CG	DPSRR	MD	MFO
		•		

VANITY BASE EASY REACH, 34 1/2" HIGH, 21" DEEP

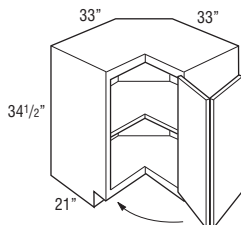

VER333421 L or R	17.1
------------------	------

- Decorative hardware screws must be countersunk to prevent scratching adjacent cabinets and face frame of VER.
- Includes one 1/2" thick fixed shelf in center of cabinet.
- Integrated soft close hinge not included.
- Cabinet top features I-beam braces with a center support brace.

Custom Modifications

AUTHL	AUTHR	CBO	CCO	CFNTO	CFP	CFRMO	CMAT	CND	DRWPWR	DRWTK	EXBKL	EXBKR	EXL	EXR	FB	FFDL	FFDR	FPFB
		•	•												•			•
FTK	FTKAV	FTKVV	ID	INVRM	LTI	MIP	RD	RECTKALL	RECTKBK	RECTKL	RECTKR	RT	TKP	TOTSS	TOTSSS	VTK	WLI	
					•	•		•	•							•	•	

Construction Upgrades

APC	PE
•	•

Door Options

ALF	CG	DPSRR	MD	MFO
		•		

**VANITY DRAWER BASE,
32" HIGH, 18" or 21" DEEP**

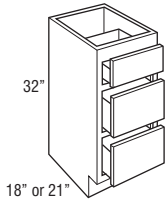

VDB123218 VDB123221
VDB153218 VDB153221
VDB183218 VDB183221
VDB213218 VDB213221

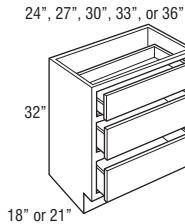

VDB243218 VDB243221
VDB273218 VDB273221
VDB303218 VDB303221
VDB333218 VDB333221
VDB363218 VDB363221

Model	Cubic Feet	Model	Cubic Feet
VDB123218	5.6	VDB243218	10.4
VDB153218	6.8	VDB273218	11.4
VDB183218	8.0	VDB303218	12.6
VDB213218	9.2	VDB333218	13.8
VDB123221	6.4	VDB363218	15.0
VDB153221	7.8	VDB243221	11.9
VDB183221	9.1	VDB273221	13.1
VDB213221	10.5	VDB303221	14.5
		VDB333221	15.8
		VDB363221	17.2

Custom Modifications

AUTHL	AUTHR	CBO	CCO	CFNTO	CFP	CFRMO	CMAT	CND	DRWPWR	DRWTK	EXBKL	EXBKR	EXL	EXR	FB	FFDL	FFDR	FPFB
•	•	•			•	•			•*	•+	•	•	•	•				•
FTK	FTKAV	FTKFV	ID	INVERM	LTI	MIP	RD	RECTKALL	RECTKLBK	RECTKL	RECTKR	RT	TKP	TOTSS	TOTSSS	VTK	WLI	
•	•^	•				•	•	•	•	•						•		

*Not available on 12" and 15" wide *Not available on 12" and 15" wide, or on 18" deep ^Not available on 12" wide

Construction Upgrades

APC	PE
•	•

Door Options

ALF	CG	DPSRR	MD	MFO

**VANITY DRAWER BASE,
34 1/2" HIGH, 18" or 21" DEEP**

12", 15", 18", or 21"

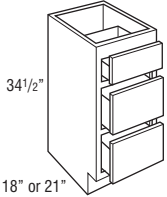

VDB123418 VDB123421
VDB153418 VDB153421
VDB183418 VDB183421
VDB213418 VDB213421

24", 27", 30", 33", or 36"

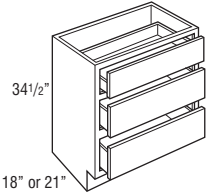

VDB243418 VDB243421
VDB273418 VDB273421
VDB303418 VDB303421
VDB333418 VDB333421
VDB363418 VDB363421

Model	Cubic Feet	Model	Cubic Feet
VDB123418	5.8	VDB243418	10.9
VDB153418	7.1	VDB273418	12.2
VDB183418	8.3	VDB303418	13.5
VDB213418	9.6	VDB333418	14.7
VDB123421	7.8	VDB363418	16.0
VDB153421	9.4	VDB243421	14.4
VDB183421	11.1	VDB273421	11.4
VDB213421	12.8	VDB303421	12.6
		VDB333421	13.8
		VDB363421	15.0

Custom Modifications

AUTHL	AUTHR	CBO	CCO	CFNTO	CFP	CFRMO	CMAT	CND	DRWPWR	DRWTK	EXBKL	EXBKR	EXL	EXR	FB	FFDL	FFDR	FPFB
•	•	•			•	•			•*	•+	•	•	•	•				•
FTK	FTKAV	FTKFV	ID	INVERM	LTI	MIP	RD	RECTKALL	RECTKLBK	RECTKL	RECTKR	RT	TKP	TOTSS	TOTSSS	VTK	WLI	
•	•^	•				•	•	•	•	•						•		

*Not available on 12" and 15" wide *Not available on 12" and 15" wide, or on 18" deep ^Not available on 12" wide

Construction Upgrades

APC	PE
•	•

Door Options

ALF	CG	DPSRR	MD	MFO

**VANITY FOUR DRAWER BASE,
34 1/2" HIGH, 18" or 21" DEEP**

12", 15", 18", or 21"

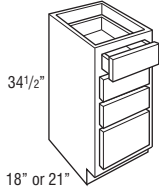

4VDB123418 4VDB123421
4VDB153418 4VDB153421
4VDB183418 4VDB183421
4VDB213418 4VDB213421

34 1/2"

18" or 21"

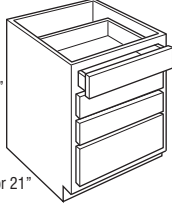

4VDB243418 4VDB243421
4VDB273418 4VDB273421
4VDB303418 4VDB303421
4VDB333418 4VDB333421
4VDB363418 4VDB363421

34 1/2"

18" or 21"

Model	Cubic Feet	Model	Cubic Feet
4VDB123418	5.8	4VDB243418	10.9
4VDB153418	7.0	4VDB273418	12.2
4VDB183418	8.3	4VDB303418	13.5
4VDB213418	9.6	4VDB333418	14.7
4VDB123421	6.8	4VDB363418	16.0
4VDB153421	8.2	4VDB243421	12.7
4VDB183421	9.7	4VDB273421	13.9
4VDB213421	11.2	4VDB303421	15.3
		4VDB333421	16.8
		4VDB363421	18.2

Custom Modifications

AUTHL	AUTHR	CBO	CCO	CFNT0	CFP	CFRMO	CMAT	CND	DRWPWR	DRWTK	EXBKL	EXBKR	EXL	EXR	FB	FFDL	FFDR	FPEB
•	•	•			•	•			•*	•*	•	•	•	•				•
FTK	FTKAV	FTKAV	ID	INVFRM	LTI	MIP	RD	RECTKALL	RECTKALL	RECTKR	RT	TKP	TOTSS	TOTSS	VTK	WLI		
•	•	•	•			•	•	•	•	•			•	•	•	•		

*Not available on 12" and 15" wide *Not available on 12" and 15" wide, or on 18" deep *Not available on 12" wide

Construction Upgrades

APC	PE
•	•

Door Options

ALF	CG	DPSRR	MD	MFO

**VANITY BASE WASTEBASKET,
34 1/2" HIGH, 21" DEEP**

storage
SOLUTIONS

VBWB153421 9.4

- Includes one 35 quart grey wastebasket and one trash bag storage area.
- Pull-out features undermount Smart Stop guides.

Custom Modifications

AUTHL	AUTHR	CBO	CCO	CFNT0	CFP	CFRMO	CMAT	CND	DRWPWR	DRWTK	EXBKL	EXBKR	EXL	EXR	FB	FFDL	FFDR	FPEB
•	•	•			•	•			•	•	•	•	•	•				•
FTK	FTKAV	FTKAV	ID	INVFRM	LTI	MIP	RD	RECTKALL	RECTKALL	RECTKR	RT	TKP	TOTSS	TOTSS	VTK	WLI		
•	•	•	•			•		•	•	•			•	•	•	•		

Construction Upgrades

APC	PE
•	•

Door Options

ALF	CG	DPSRR	MD	MFO

15"

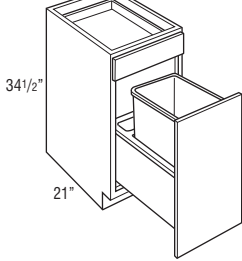

34 1/2"

21"

**VANITY WASTEBASKET FULL HEIGHT,
32" HIGH, 21" DEEP**

storage
SOLUTIONS

VWB153221 7.8

- Includes one 35 quart grey wastebasket and one trash bag storage area.
- Pull-out features undermount Smart Stop guides.

Custom Modifications

AUTHL	AUTHR	CBO	CCO	CFNT0	CFP	CFRMO	CMAT	CND	DRWPWR	DRWTK	EXBKL	EXBKR	EXL	EXR	FB	FFDL	FFDR	FPEB
•	•	•			•	•			•	•	•	•	•	•				•
FTK	FTKAV	FTKAV	ID	INVFRM	LTI	MIP	RD	RECTKALL	RECTKALL	RECTKR	RT	TKP	TOTSS	TOTSS	VTK	WLI		
•	•	•	•			•		•	•	•			•	•	•	•		

Construction Upgrades

APC	PE
•	•

Door Options

ALF	CG	DPSRR	MD	MFO

15"

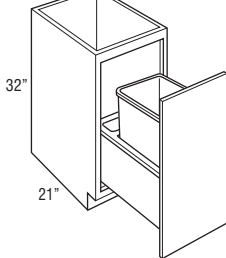

32"

21"

VANITY WASTEBASKET FULL HEIGHT with ROLL TRAY, 32" HIGH, 21" DEEP

storage SOLUTIONS

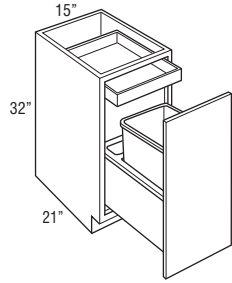

Model	Cubic Feet
VWB153221RT	7.8

- Includes one 35 quart grey wastebasket and one trash bag storage area.
- Pull-out features undermount Smart Stop guides.
- 1 roll tray standard.
- Not compatible with BWBLID due to limited height clearance.

Custom Modifications

AUTHL	AUTHR	CBO	CCO	CFNTO	CFP	CFRMO	CMAT	CND	DRWPWR	DRWTK	EXBKL	EXBKR	EXL	EXR	FB	FFDL	FFDR	FPEB
•	•	•				•					•	•	•	•				•
FTK	FTKAV	FTKFV	ID	INVFRM	LTI	MIP	RD	RECTKALL	RECTKBK	RECTKL	RECTKR	RT	TKP	TOTSS	TOTSSS	VTK	WLI	
•	•					•		•	•							•	•	

Construction Upgrades

APC	PE
•	•

Door Options

ALF	CG	DPSRR	MD	MFO

VANITY WASTEBASKET FULL HEIGHT, 34 1/2" HIGH, 21" DEEP

storage SOLUTIONS

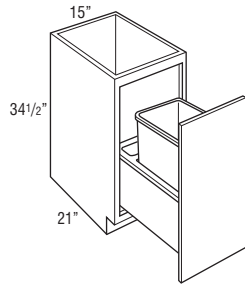

Model	Cubic Feet
VWB153421	9.4

- Includes one 35 quart grey wastebasket and one trash bag storage area.
- Pull-out features undermount Smart Stop guides.

Custom Modifications

AUTHL	AUTHR	CBO	CCO	CFNTO	CFP	CFRMO	CMAT	CND	DRWPWR	DRWTK	EXBKL	EXBKR	EXL	EXR	FB	FFDL	FFDR	FPEB
•	•	•				•					•	•	•	•				•
FTK	FTKAV	FTKFV	ID	INVFRM	LTI	MIP	RD	RECTKALL	RECTKBK	RECTKL	RECTKR	RT	TKP	TOTSS	TOTSSS	VTK	WLI	
•	•					•		•	•							•	•	

Construction Upgrades

APC	PE
•	•

Door Options

ALF	CG	DPSRR	MD	MFO

VANITY WASTEBASKET FULL HEIGHT with ROLL TRAY, 34 1/2" HIGH, 21" DEEP

storage SOLUTIONS

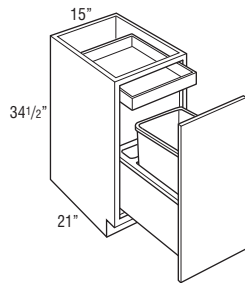

Model	Cubic Feet
VWB153421RT	9.4

- Includes one 35 quart grey wastebasket and one trash bag storage area.
- Pull-out features undermount Smart Stop guides.
- 1 roll tray standard.

Custom Modifications

AUTHL	AUTHR	CBO	CCO	CFNTO	CFP	CFRMO	CMAT	CND	DRWPWR	DRWTK	EXBKL	EXBKR	EXL	EXR	FB	FFDL	FFDR	FPEB
•	•	•				•					•	•	•	•				•
FTK	FTKAV	FTKFV	ID	INVFRM	LTI	MIP	RD	RECTKALL	RECTKBK	RECTKL	RECTKR	RT	TKP	TOTSS	TOTSSS	VTK	WLI	
•	•					•		•	•							•	•	

Construction Upgrades

APC	PE
•	•

Door Options

ALF	CG	DPSRR	MD	MFO

VANITY PULL-OUT, 34 1/2" HIGH, 21" DEEP

storage SOLUTIONS

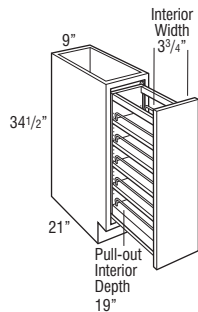

Model	Cubic Feet
VP93421	4.9

- All styles feature a natural finish full extension wood pull-out with adjustable shelves and chrome rail sides (Smart Stop not included).

Custom Modifications

AUTHL	AUTHR	CBO	CCO	CFNTO	CFP	CFRMO	CMAT	CND	DRWPWR	DRWTK	EXBKL	EXBKR	EXL	EXR	FB	FFDL	FFDR	FPEB
•	•	•				•					•	•	•	•				•
FTK	FTKAV	FTKFV	ID	INVFRM	LTI	MIP	RD	RECTKALL	RECTKBK	RECTKL	RECTKR	RT	TKP	TOTSS	TOTSSS	VTK	WLI	
•						•		•*	•							•	•	

*RECTKALL not available

Construction Upgrades

APC	PE
•	•

Door Options

ALF	CG	DPSRR	MD	MFO
		•		

**VANITY GROOMING PULL-OUT,
34 1/2" HIGH, 21" DEEP**

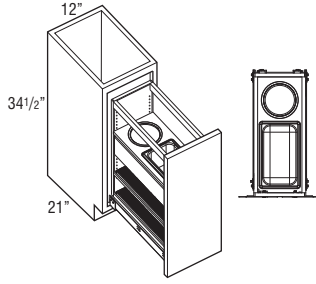

storage
SOLUTIONS

Model	Cubic Feet
VGPO123421	6.8

- Full extension, Smart Stop wood pull-out with natural finish.
- Pull-out is 19" deep.
- Features adjustable shelves with non-skid vinyl liners and clear polycarbonate rails.
- Includes two stainless steel bins (one rectangular and one round) for storing items such as curling irons and hair dryers.

Custom Modifications

AUTHL	CBO	CCO	CFNTO	CFP	CFRMO	CMAT	CND	DRWPWR	DRWTK	EXBKL	EXL	FB	FFDL	FPEB
AUTHR										EXBKR	EXR		FFDR	
•	•	•			•					•	•	•		•
FTK	FTKAV	ID	INVFRM	LTI	MIP	RD	RECTKALL	RECTKL	RT	TKP	TOTSS	VTK	WLI	
	FTKFV						RECTKBK	RECTKR			TOTSSS			
•					•		•	•				•	•	

Construction Upgrades

APC	PE
•	•

Door Options

ALF	CG	DPSRR	MD	MFO
		•		

**VANITY SINK DRAWER BASE,
32" HIGH, 18" or 21" DEEP**

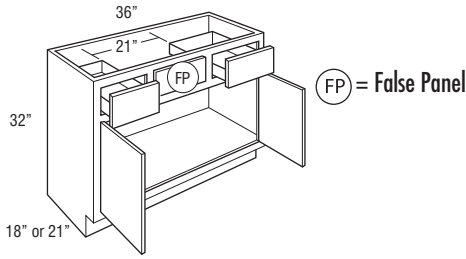

2VSD363218
2VSD363221

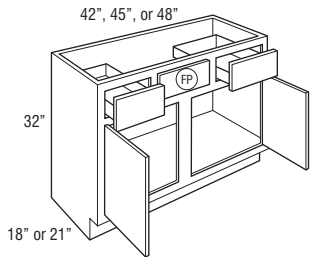

2VSD423218 2VSD423221
2VSD453218 2VSD453221
2VSD483218CS 2VSD483221CS

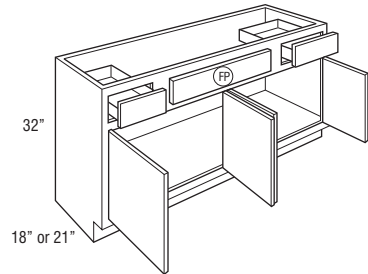

2VSD483218
2VSD483221

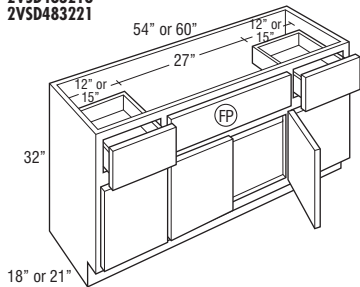

2VSD543218FP 2VSD543221FP
2VSD603218FP 2VSD603221FP

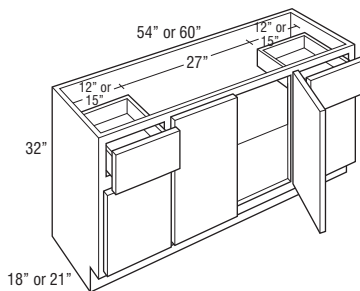

2VSD543218 2VSD543221
2VSD603218 2VSD603221

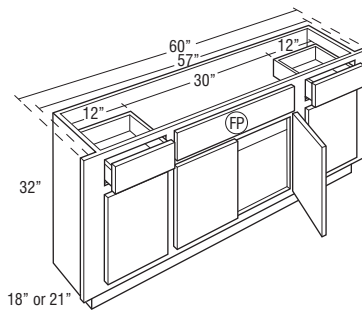

2VSD57/603218FP
2VSD57/603221FP

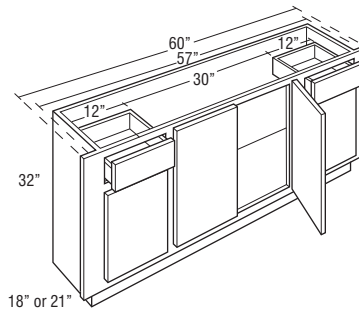

2VSD57/603218
2VSD57/603221

Model	Cubic Feet	Model	Cubic Feet
2VSD363218	15.1	2VSD543218	23.2
2VSD363221	17.4	2VSD603218	24.4
		2VSD543221	25.2
2VSD423218	17.5	2VSD603221	28.0
2VSD453218	18.5		
2VSD483218CS	19.9	2VSD57/603218FP	25.6
2VSD423221	20.1	2VSD57/603221FP	27.6
2VSD453221	21.3		
2VSD483221CS	22.9	2VSD57/603218	25.6
		2VSD57/603221	27.6
2VSD483218	19.9		
2VSD483221	22.9		
2VSD543218FP	23.2		
2VSD603218FP	24.4		
2VSD543221FP	25.2		
2VSD603221FP	28.0		

- 2VSD36/2VSD42/2VSD48 cabinets have 21" wide space between drawers for sink.
- 2VSD45 cabinets have 24" wide space between drawers for sink.
- 2VSD54/2VSD60 cabinets have 27" wide space between drawers for sink.
- 2VSD57 cabinets have 30" wide space between drawers for sink.
- 2VSD57/603221 may be trimmed 1 1/2" per side.

Custom Modifications

AUTHL	CBO	CCO	CFNTD	CFP	CFRMO	CMAT	CND	DRWPWR	DRWTK	EXBKL	EXL	FB	FFDL	FPEB
•*	•	•	•	•	•	•*	•	•▲	•†	•*	•	•	•*	•*
FTK	FTKAV	ID	INVFRM	LTI	MIP	RD	RECTKLL	RECTKLBK	RECTKL	RECTKR	RT	TKP	TOTSS	TOTSSS
•	•	•	•	•	•	•	•	•	•	•	•	•	•	•

*Not available on 2VSD57/60 and 2VSD57/60FP *Not available on 42" and 45" wide, or on 18" deep
 ▲Available only on 60" wide †Available only on 2VSD363221 ‡Available only on 36", 42", 45", and 48" wide
 †Available only on cabinets with false panels

Construction Upgrades

APC	PE
•	•

Door Options

ALF	CG	DPSRR	MD	MFO
		•		

**VANITY SINK DRAWER BASE,
34 1/2" HIGH, 18" or 21" DEEP**

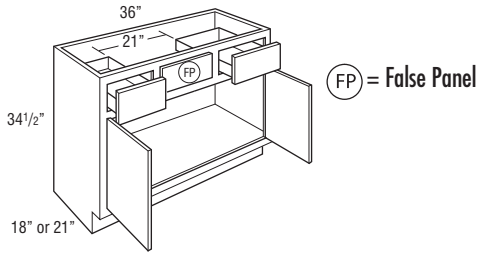

2VSD363418
2VSD363421

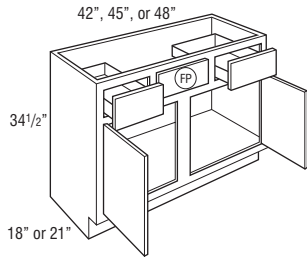

2VSD423418 2VSD423421
2VSD453418 2VSD453421
2VSD483418CS 2VSD483421CS

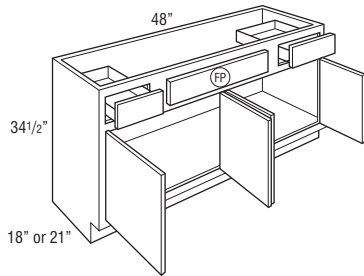

2VSD483418
2VSD483421

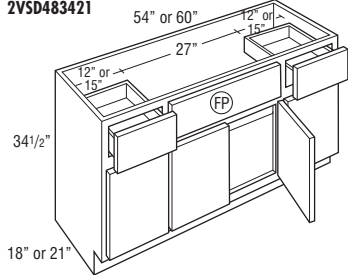

2VSD543418FP 2VSD543421FP
2VSD603418FP 2VSD603421FP

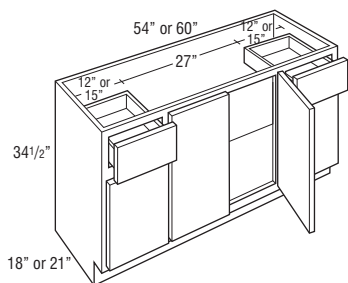

2VSD543418 2VSD543421
2VSD603418 2VSD603421

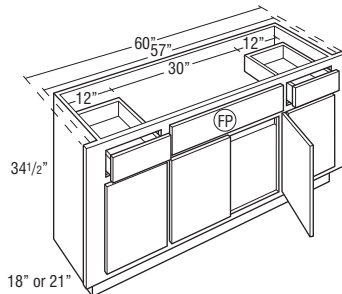

2VSD57/603418FP
2VSD57/603421FP

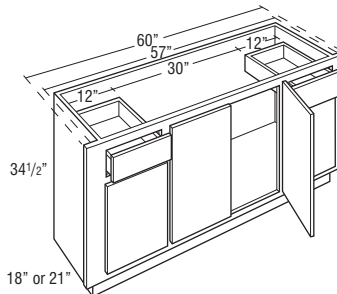

2VSD57/603418
2VSD57/603421

Model	Cubic Feet	Model	Cubic Feet
2VSD363418	16.0	2VSD543418FP	23.7
2VSD363421	16.5	2VSD603418FP	26.3
2VSD423418	18.6	2VSD543421FP	24.5
2VSD453418	19.9	2VSD603421FP	30.1
2VSD483418CS	21.1	2VSD543418	23.7
2VSD423421	19.2	2VSD603418	26.3
2VSD453421	22.8	2VSD543421	24.5
2VSD483421CS	21.9	2VSD603421	30.1
2VSD483418	21.1	2VSD57/603418FP	25.0
2VSD483421	21.9	2VSD57/603421FP	27.2
		2VSD57/603418	25.0
		2VSD57/603421	27.2

- 2VSD36/2VSD42/2VSD48 cabinets have 21" wide space between drawers for sink.
- 2VSD45 cabinets have 24" wide space between drawers for sink.
- 2VSD54/2VSD60 cabinets have 27" wide space between drawers for sink.
- 2VSD57 cabinets have 30" wide space between drawers for sink.
- 2VSD57/603421 may be trimmed 1 1/2" per side.

Custom Modifications

AUTHL	AUTHR	CBO	CCO	CFNT0	CFP	CFRMO	CMAT	CND	DRWPWR	DRWTK	EXBKL	EXBKR	EXL	EXR	FB	FFDL	FFDR	FPFB
•*	•	•	•	•	•	•	•*	•	•▲	•†	•*	•	•	•	•	•*	•	•*
FTK	FTKAV	FTKRV	ID	INVRM	LTI	MIP	RD	RECTKALL	RECTKRBK	RECTKL	RECTKR	RT	TKP	TOTSS	TOTSSS	VTK	WLI	
•	•	•	•	•	•	•	•	•	•	•	•	•	•	•	•	•	•	•

*Not available on 2VSD57/60 and 2VSD57/60FP †Not available on 42" and 45" wide, or on 18" deep
 ▲Available only on 60" wide †Available only on 2VSD363421 ‡Available only on 36", 42", 45", and 48" wide
 †Available only on cabinets with false panels

Construction Upgrades

APC	PE
•	•

Door Options

ALF	CG	DPSRR	MD	MFO
		•		

**VANITY SINK DRAWER BASE,
32" HIGH, 18" or 21" DEEP**

24", 27", 30", or 33"

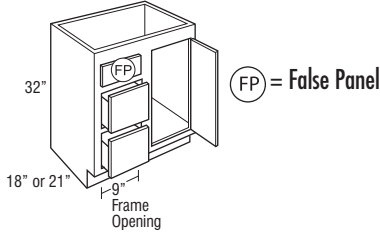

- VSD243218 DL or DR VSD243221 DL or DR
- VSD273218 DL or DR VSD273221 DL or DR
- VSD303218 DL or DR VSD303221 DL or DR
- VSD333218 DL or DR VSD333221 DL or DR

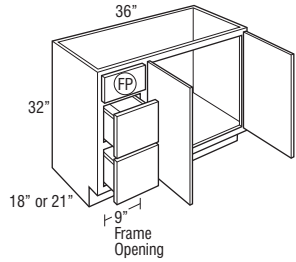

- VSD363218 DL or DR
- VSD363221 DL or DR

42", 45", or 48"

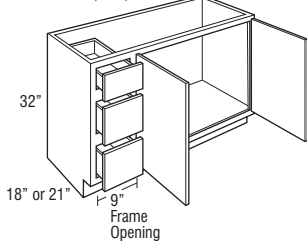

- VSD423218 DL or DR VSD423221 DL or DR
- VSD453218 DL or DR VSD453221 DL or DR
- VSD483218 DL or DR VSD483221 DL or DR

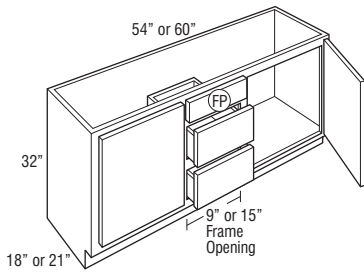

- VSD543218 VSD543221
- VSD603218 VSD603221

Model	Cubic Feet
VSD243218 DL or DR	10.4
VSD273218 DL or DR	11.7
VSD303218 DL or DR	12.7
VSD333218 DL or DR	14.1
VSD243221 DL or DR	11.9
VSD273221 DL or DR	13.3
VSD303221 DL or DR	14.6
VSD333221 DL or DR	16.1
VSD363218 DL or DR	15.1
VSD363221 DL or DR	17.4
VSD423218 DL or DR	17.5
VSD453218 DL or DR	18.5
VSD483218 DL or DR	19.9
VSD423221 DL or DR	20.1
VSD453221 DL or DR	18.5
VSD483221 DL or DR	22.9
VSD543218	22.1
VSD603218	24.7
VSD543221	25.3
VSD603221	28.4

- DL or DR indicates drawer location.
- CFP is available on 42", 45", and 48" widths, but standard on all other widths.

Custom Modifications

AUTHL	AUTHR	CBO	CCO	CFNTO	CFP	CFRMO	CMAT	CND	DRWPWR	DRWTK	EXBKL	EXBKR	EXL	EXR	FB	FFDL	FFDR	FPFB
•	•	•	•	•	STD	•	•*	•	•	•*	•	•	•	•	•	•	•	•
FTK	FTKAV FTKFV	ID	INVERM	LTI	MIP	RD	RECTKALL RECTKBK	RECTKL RECTKR	RT	TKP	TOTSS	TOTSSS	VTK	WLI				
•	•	•	•	•	•▲	•	•	•	•	•	•	•	•	•	•	•	•	•

*Not available on 24", 27", 30", 33", and 60" wide, or on 18" deep

*Not available on 42", 45", 48", 54" and 60" wide, or on 18" deep ▲Not available on 24" wide

Construction Upgrades

APC	PE
•	•

Door Options

ALF	CG	DPSRR	MD	MFO
		•		

**VANITY SINK DRAWER BASE,
34 1/2" HIGH, 18" or 21" DEEP**

24", 27", 30", or 33"

(FP) = False Panel

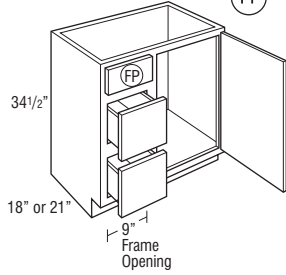

- VSD243418 DL or DR VSD243421 DL or DR
- VSD273418 DL or DR VSD273421 DL or DR
- VSD303418 DL or DR VSD303421 DL or DR
- VSD333418 DL or DR VSD333421 DL or DR

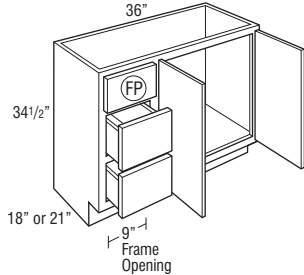

- VSD363418 DL or DR
- VSD363421 DL or DR

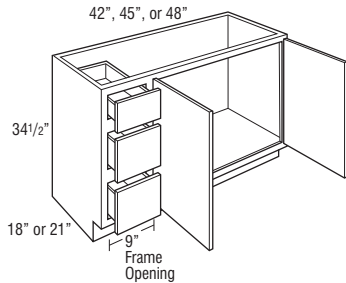

- VSD423418 DL or DR VSD423421 DL or DR
- VSD453418 DL or DR VSD453421 DL or DR
- VSD483418 DL or DR VSD483421 DL or DR

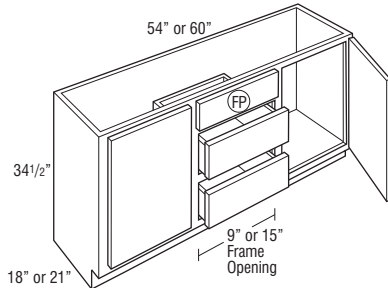

- VSD543418 VSD543421
- VSD603418 VSD603421

Model	Cubic Feet
VSD243418 DL or DR	10.9
VSD273418 DL or DR	12.2
VSD303418 DL or DR	13.5
VSD333418 DL or DR	14.7
VSD243421 DL or DR	11.1
VSD273421 DL or DR	14.1
VSD303421 DL or DR	13.8
VSD333421 DL or DR	17.1
VSD363418 DL or DR	16.0
VSD363421 DL or DR	16.5
VSD423418 DL or DR	18.6
VSD453418 DL or DR	19.9
VSD483418 DL or DR	21.1
VSD423421 DL or DR	19.2
VSD453421 DL or DR	21.3
VSD483421 DL or DR	21.9
VSD543418	23.7
VSD603418	26.3
VSD543421	27.2
VSD603421	27.2

- DL or DR indicates drawer location.
- CFP is available on 42", 45", and 48" widths, but standard on all other widths.

Custom Modifications

AUTHL AUTHR	CBO	CCO	CFNTO	CFP	CFRMO	CMAT	CND	DRWPWR	DRWTK	EXBKL EXBKR	EXL EXR	FB	FFDL FFDR	FPFB
•	•	•		STD	•	•*	•		•*	•	•	•	•	•
FTK	FTKAV FTKRV	ID	INVRM	LTI	MIP	RD	RECTKALL RECTKBK	RECTKL RECTKR	RT	TKP	TOTSS TOTSSS	VTK	WLI	
•	•	•		•▲	•	•	•	•				•	•	

*Not available on 24", 27", 30", 33", and 60" wide, or on 18" deep

*Not available on 42", 45", 48", 54" and 60" wide, or on 18" deep ▲Not available on 24" wide

Construction Upgrades

APC	PE
•	•

Door Options

ALF	CG	DPSRR	MD	MFO
		•		

VANITY SINK DRAWER BASE with FALSE PANELS, 32" HIGH, 18" or 21" DEEP

24", 27", 30", or 33"

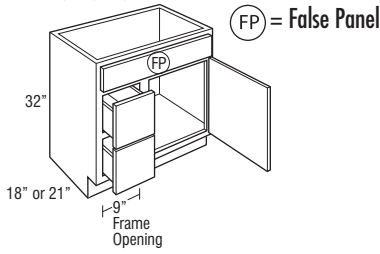

- VSD243218FP DL or DR VSD243221FP DL or DR
- VSD273218FP DL or DR VSD273221FP DL or DR
- VSD303218FP DL or DR VSD303221FP DL or DR
- VSD333218FP DL or DR VSD333221FP DL or DR

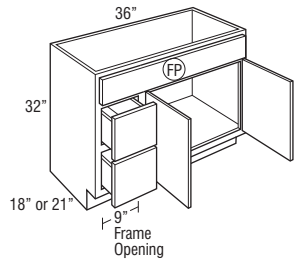

- VSD363218FP DL or DR
- VSD363221FP DL or DR

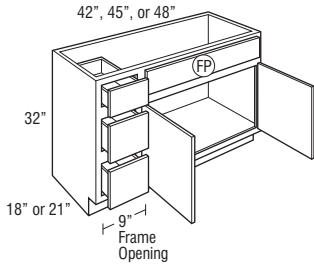

- VSD423218FP DL or DR VSD423221FP DL or DR
- VSD453218FP DL or DR VSD453221FP DL or DR
- VSD483218FP DL or DR VSD483221FP DL or DR

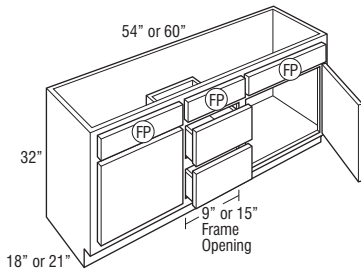

- VSD543218FP VSD543221FP
- VSD603218FP VSD603221FP

Model	Cubic Feet
VSD243218FP DL or DR	10.4
VSD273218FP DL or DR	11.7
VSD303218FP DL or DR	12.7
VSD333218FP DL or DR	14.1
VSD243221FP DL or DR	11.9
VSD273221FP DL or DR	13.3
VSD303221FP DL or DR	14.6
VSD333221FP DL or DR	16.1
VSD363218FP DL or DR	15.1
VSD363221FP DL or DR	17.4
VSD423218FP DL or DR	17.5
VSD453218FP DL or DR	18.5
VSD483218FP DL or DR	19.9
VSD423221FP DL or DR	20.1
VSD453221FP DL or DR	21.3
VSD483221FP DL or DR	22.9
VSD543218FP	22.1
VSD603218FP	24.7
VSD543221FP	25.3
VSD603221FP	28.4

- DL or DR indicates drawer location.
- CFP is available on 42", 45", and 48" widths, but standard on all other widths.

Custom Modifications

AUTHL	AUTHR	CBO	CCO	CFNTO	CFP	CFRMO	CMAT	CND	DRWPWR	DRWTK	EXBKL	EXBKR	EXL	EXR	FB	FFDL	FFDR	FPFB
•	•	•			STD	•	•*	•		•*	•	•	•	•	•	•	•	•
FTK	FTKAV	FTKFV	ID	INVERM	LTI	MIP	RD	RECTKALL	RECTKLBK	RECTKLR	RT	TKP	TOTSS	TOTSSS	VTK	WLI		
•	•	•			•▲	•	•	•	•	•			•	•	•	•		

*Not available on 24", 27", 30", 33", and 60" wide, or on 18" deep

*Not available on 42", 45", 48", 54" and 60" wide, or on 18" deep ▲Not available on 24" wide

Construction Upgrades

APC	PE
•	•

Door Options

ALF	CG	DPSRR	MD	MFO
		•		

VANITY SINK DRAWER BASE with FALSE PANEL, 34 1/2" HIGH, 18" or 21" DEEP

24", 27", 30", or 33"

(FP) = False Panel

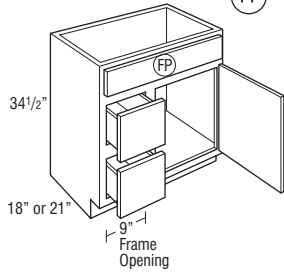

VSD243418FP DL or DR VSD243421FP DL or DR
 VSD273418FP DL or DR VSD273421FP DL or DR
 VSD303418FP DL or DR VSD303421FP DL or DR
 VSD333418FP DL or DR VSD333421FP DL or DR

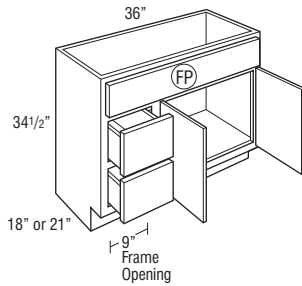

VSD363418FP DL or DR
 VSD363421FP DL or DR

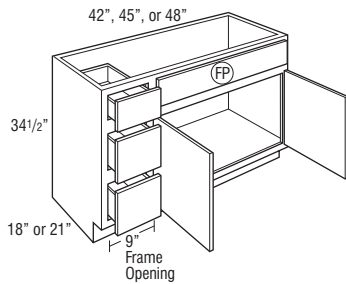

VSD423418FP DL or DR VSD423421FP DL or DR
 VSD453418FP DL or DR VSD453421FP DL or DR
 VSD483418FP DL or DR VSD483421FP DL or DR

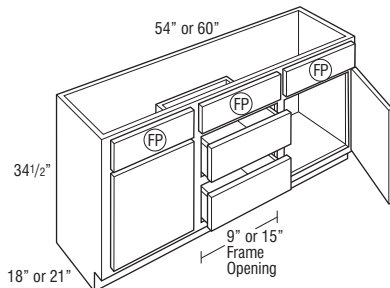

VSD543418FP VSD543421FP
 VSD603418FP VSD603421FP

Model	Cubic Feet
VSD243418FP DL or DR	10.9
VSD273418FP DL or DR	12.2
VSD303418FP DL or DR	13.5
VSD333418FP DL or DR	14.7
VSD243421FP DL or DR	11.1
VSD273421FP DL or DR	14.1
VSD303421FP DL or DR	13.8
VSD333421FP DL or DR	17.1
VSD363418FP DL or DR	16.0
VSD363421FP DL or DR	16.5
VSD423418FP DL or DR	18.6
VSD453418FP DL or DR	19.9
VSD483418FP DL or DR	21.1
VSD423421FP DL or DR	22.8
VSD453421FP DL or DR	22.8
VSD483421FP DL or DR	21.9
VSD543418FP	22.1
VSD603418FP	26.3
VSD543421FP	25.3
VSD603421FP	27.2

- DL or DR indicates drawer location.
- CFP is available on 42", 45", and 48" widths, but standard on all other widths.

Custom Modifications

AUTHL	AUTHR	CBO	CCO	CFNTO	CFP	CFRMO	CMAT	CND	DRWPWR	DRWTK	EXBKL	EXBKR	EXL	EXR	FB	FFDL	FFDR	FPFB
•	•	•	•	•	STD	•	•*	•	•	•*	•	•	•	•	•	•	•	•
FTK	FTKAV	FTKRV	ID	INVFRM	LTI	MIP	RD	RECTKALL	RECTKLBK	RECTKL	RECTKR	RT	TKP	TOTSS	TOTSSS	VTK	WLI	
•	•	•	•	•	•▲	•	•	•	•	•	•	•	•	•	•	•	•	•

*Not available on 24", 27", 30", 33", and 60" wide, or on 18" deep

*Not available on 42", 45", 48", 54" and 60" wide, or on 18" deep ▲Not available on 24" wide

Construction Upgrades

APC	PE
•	•

Door Options

ALF	CG	DPSRR	MD	MFO
		•		

**VANITY SINK THREE DRAWER BASE,
32" HIGH, 18" or 21" DEEP**

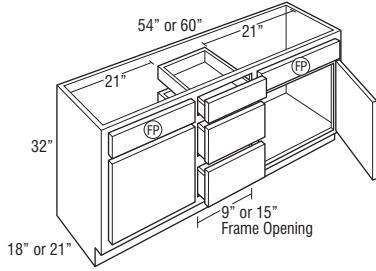

Model	Cubic Feet
VS3D543218	22.1
VS3D603218	24.4
VS3D543221	25.3
VS3D603221	28.0

Custom Modifications

AUTHL AUTHR	CBO	CCO	CFNTO	CFP	CFRMO	CMAT	CND	DRWPWR	DRWTK	EXBKL EXBKR	EXL EXR	FB	FFDL FFDR	FPFB
•	•	•		•	•	•*	•	•*		•	•	•	•	•
FTK	FTKAV FTKRV	ID	INVERM	LTI	MIP	RD	RECTKALL RECTKKB	RECTKL RECTKR	RT	TKP	TOTSS TOTSSS	VTK	WLI	
•	•	•		•	•	•	•	•			•	•	•	

*Not available on 18" deep *Available only on 60" wide

Construction Upgrades

APC	PE
•	•

Door Options

ALF	CG	DPSRR	MD	MFO
		•		

**VANITY SINK THREE DRAWER BASE,
34 1/2" HIGH, 18" or 21" DEEP**

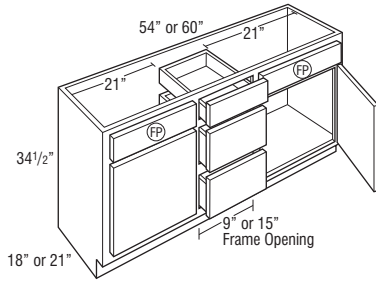

VS3D543418	23.7
VS3D603418	26.3
VS3D543421	27.2
VS3D603421	30.1

Custom Modifications

AUTHL AUTHR	CBO	CCO	CFNTO	CFP	CFRMO	CMAT	CND	DRWPWR	DRWTK	EXBKL EXBKR	EXL EXR	FB	FFDL FFDR	FPFB
•	•	•		•	•	•*	•	•*		•	•	•	•	•
FTK	FTKAV FTKRV	ID	INVERM	LTI	MIP	RD	RECTKALL RECTKKB	RECTKL RECTKR	RT	TKP	TOTSS TOTSSS	VTK	WLI	
•	•	•		•	•	•	•	•			•	•	•	

*Not available on 18" deep *Available only on 60" wide

Construction Upgrades

APC	PE
•	•

Door Options

ALF	CG	DPSRR	MD	MFO
		•		

**VANITY SINK DRAWER BASE with
SIX DRAWERS, 32" HIGH, 18" or
21" DEEP**

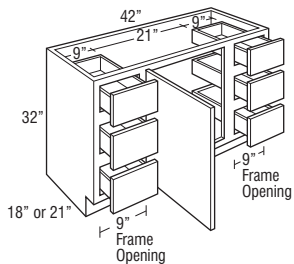

6VSD423218 L or R
6VSD423221 L or R

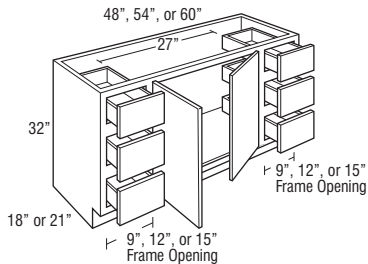

6VSD483218 6VSD543218 6VSD603218
6VSD483221 6VSD543221 6VSD603221

6VSD423218 L or R	17.3
6VSD423221 L or R	19.8
6VSD483218	19.9
6VSD483221	22.9
6VSD543218	22.1
6VSD543221	25.3
6VSD603218	24.7
6VSD603221	28.4

- 6VSD42 and 6VSD48 drawer stacks are 12" wide.
- 6VSD54 drawer stacks are 15" wide.
- 6VSD60 drawer stacks are 18" wide.
- 42" wide cabinets have a sink opening of only 21" instead of standard 27".

Custom Modifications

AUTHL AUTHR	CBO	CCO	CFNTO	CFP	CFRMO	CMAT	CND	DRWPWR	DRWTK	EXBKL EXBKR	EXL EXR	FB	FFDL FFDR	FPFB
•	•	•		•	•	•*	•	•*		•	•	•	•	•
FTK	FTKAV FTKRV	ID	INVERM	LTI	MIP	RD	RECTKALL RECTKKB	RECTKL RECTKR	RT	TKP	TOTSS TOTSSS	VTK	WLI	
•	•	•		•	•	•	•	•			•	•	•	

*Not available on 42" wide, or on 18" deep *Available only on 60" wide

Construction Upgrades

APC	PE
•	•

Door Options

ALF	CG	DPSRR	MD	MFO
		•		

VANITY SINK DRAWER BASE with SIX DRAWERS, 34 1/2" HIGH, 18" or 21" DEEP

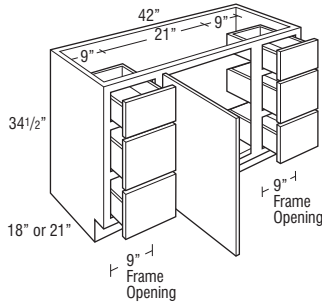

6VSD423418 L or R
6VSD423421 L or R

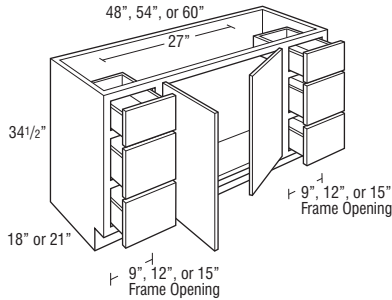

6VSD483418 6VSD543418 6VSD603418
6VSD483421 6VSD543421 6VSD603421

Model	Cubic Feet
6VSD423418 L or R	18.6
6VSD423421 L or R	21.3
6VSD483418	21.1
6VSD483421	21.9
6VSD543418	23.7
6VSD543421	27.2
6VSD603418	26.3
6VSD603421	27.2

- 6VSD42 and 6VSD48 drawer stacks are 12" wide.
- 6VSD54 drawer stacks are 15" wide.
- 6VSD60 drawer stacks are 18" wide.
- 42" wide cabinets have a sink opening of only 21" instead of standard 27".

Custom Modifications

AUTHL	AUTHR	CBO	CCO	CFNTO	CFP	CFRMO	CMAT	CND	DRWPWR	DRWTK	EXBKL	EXBKR	EXL	EXR	FB	FFDL	FFDR	FPEB
•	•	•	•	•	•	•	•*	•	•*	•	•	•	•	•	•	•	•	•
FTK	FTKAV	FTKPV	ID	INVFRM	LTI	MIP	RD	RECTKALL	RECTKBK	RECTKL	RECTKR	RT	TKP	TOTSS	TOTSSS	VTK	WLI	
•	•	•	•	•	•	•	•	•	•	•	•	•	•	•	•	•	•	•

*Not available on 42" wide, or on 18" deep *Available only on 60" wide

Construction Upgrades

APC	PE
•	•

Door Options

ALF	CG	DPSRR	MD	MFO
		•		

VANITY SINK DRAWER BASE with SIX DRAWERS & FALSE PANEL, 32" HIGH, 18" or 21" DEEP

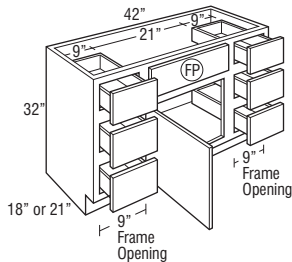

6VSD423218FP L or R
6VSD423221FP L or R

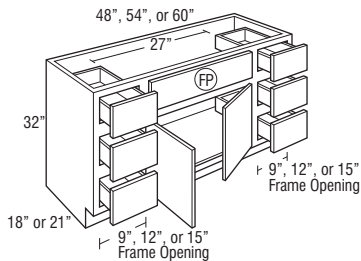

6VSD483218FP 6VSD543218FP 6VSD603218FP
6VSD483221FP 6VSD543221FP 6VSD603221FP

Model	Cubic Feet
6VSD423218FP L or R	17.3
6VSD423221FP L or R	19.8
6VSD483218FP	19.9
6VSD483221FP	22.9
6VSD543218FP	22.1
6VSD543221FP	25.3
6VSD603218FP	24.7
6VSD603221FP	28.4

- 6VSD42 and 6VSD48 drawer stacks are 12" wide.
- 6VSD54 drawer stacks are 15" wide.
- 6VSD60 drawer stacks are 18" wide.
- 42" wide cabinets have a sink opening of only 21" instead of standard 27".

Custom Modifications

AUTHL	AUTHR	CBO	CCO	CFNTO	CFP	CFRMO	CMAT	CND	DRWPWR	DRWTK	EXBKL	EXBKR	EXL	EXR	FB	FFDL	FFDR	FPEB
•	•	•	•	•	•	•	•*	•	•*	•	•	•	•	•	•	•	•	•
FTK	FTKAV	FTKPV	ID	INVFRM	LTI	MIP	RD	RECTKALL	RECTKBK	RECTKL	RECTKR	RT	TKP	TOTSS	TOTSSS	VTK	WLI	
•	•	•	•	•	•	•	•	•	•	•	•	•	•	•	•	•	•	•

*Not available on 42" wide, or on 18" deep *Available only on 60" wide

Construction Upgrades

APC	PE
•	•

Door Options

ALF	CG	DPSRR	MD	MFO
		•		

VANITY SINK DRAWER BASE with SIX DRAWERS & FALSE PANEL, 34 1/2" HIGH, 18" or 21" DEEP

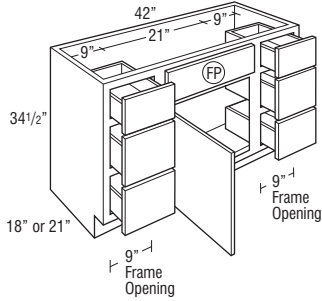

6VSD423418FP L or R
6VSD423421FP L or R

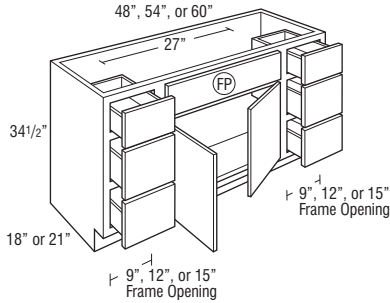

6VSD483418FP 6VSD543418FP 6VSD603418FP
6VSD483421FP 6VSD543421FP 6VSD603421FP

Model	Cubic Feet
6VSD423418FP L or R	18.6
6VSD423421FP L or R	21.3
6VSD483418FP	21.1
6VSD483421FP	21.9
6VSD543418FP	23.7
6VSD543421FP	27.2
6VSD603418FP	26.3
6VSD603421FP	27.2

- 6VSD42 and 6VSD48 drawer stacks are 12" wide.
- 6VSD54 drawer stacks are 15" wide.
- 6VSD60 drawer stacks are 18" wide.
- 42" wide cabinets have a sink opening of only 21" instead of standard 27".

Custom Modifications

AUTHL	AUTHR	CBO	CCO	CFNTO	CFP	CFRMO	CMAT	CND	DRWPWR	DRWTK	EXBKL	EXBKR	EXL	EXR	FB	FFDL	FFDR	FPEB
•	•	•	•	•	•	•	•*	•	•*	•	•	•	•	•	•	•	•	•
FTK	FTKAV	FTKFV	ID	INVFRM	LTI	MIP	RD	RECTKALL	RECTKLBK	RECTKL	RECTKR	RT	TKP	TOTSS	TOTSSS	VTK	WLI	
•	•	•	•	•	•	•	•	•	•	•	•	•	•	•	•	•	•	•

*Not available on 42" wide, or on 18" deep *Available only on 60" wide

Construction Upgrades

APC	PE
•	•

Door Options

ALF	CG	DPSRR	MD	MFO
		•		

VANITY SINK DRAWER BASE with EIGHT DRAWERS, 34 1/2" HIGH, 18" or 21" DEEP

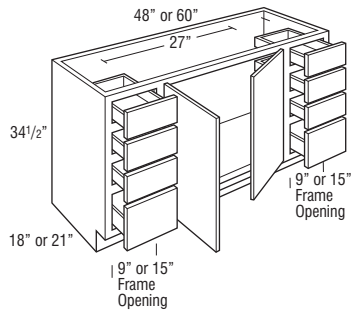

8VSD483418	21.1
8VSD603418	26.3
8VSD483421	21.9
8VSD603421	27.2

- 8VSD48 drawer stacks are 12" wide.
- 8VSD60 drawer stacks are 18" wide.
- All have 27" wide space between drawers for sink.

Custom Modifications

AUTHL	AUTHR	CBO	CCO	CFNTO	CFP	CFRMO	CMAT	CND	DRWPWR	DRWTK	EXBKL	EXBKR	EXL	EXR	FB	FFDL	FFDR	FPEB
•	•	•	•	•	•	•	•*	•	•*	•	•	•	•	•	•	•	•	•
FTK	FTKAV	FTKFV	ID	INVFRM	LTI	MIP	RD	RECTKALL	RECTKLBK	RECTKL	RECTKR	RT	TKP	TOTSS	TOTSSS	VTK	WLI	
•	•	•	•	•	•	•	•	•	•	•	•	•	•	•	•	•	•	•

*Not available on 18" deep *Available only on 60" wide

Construction Upgrades

APC	PE
•	•

Door Options

ALF	CG	DPSRR	MD	MFO
		•		

VANITY SINK DRAWER BASE with EIGHT DRAWERS & FALSE PANEL, 34 1/2" HIGH, 18 or 21" DEEP

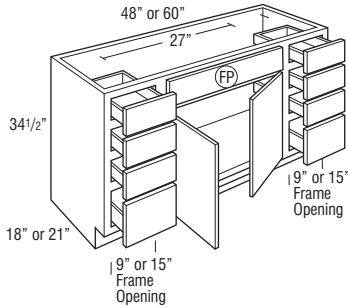

Model	Cubic Feet
8VSD483418FP	21.1
8VSD603418FP	26.3
8VSD483421FP	21.9
8VSD603421FP	27.2

- 8VSD48 drawer stacks are 12" wide.
- 8VSD60 drawer stacks are 18" wide.
- All have 27" wide space between drawers for sink.

Custom Modifications

AUTHL AUTHR	CBO	CCO	CFNT0	CFP	CFRMO	CMAT	CND	DRWPWR	DRWTK	EXBKL EXBKR	EXL EXR	FB	FFDL FFDR	FPFB
•	•	•		•	•	•*	•	•*		•	•			•
FTK	FTKAV FTKRV	ID	INVFRM	LTI	MIP	RD	RECTKALL RECTKBK	RECTKL RECTKR	RT	TKP	TOTSS TOTSSS	VTK	WLI	
•	•	•		•	•	•	•	•			•	•	•	

*Not available on 18" deep *Available only on 60" wide

Construction Upgrades

APC	PE
•	•

Door Options

ALF	CG	DPSRR	MD	MFO
		•		

VANITY ANGLE CORNER SINK FRONT, 32" HIGH

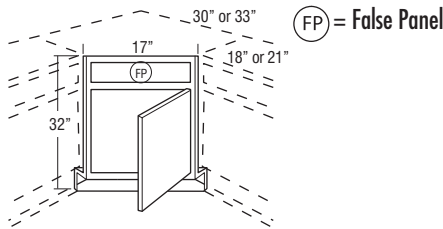

VACSF L or R	3.3
--------------	-----

- Edges are angled at 45°.
- Requires sink bottom for field installation. Order separately.
- Toekick and toekick retainer shipped unattached from the face frame.

Adjacent Cabinet Depth	Wall Width	Frame	Maximum Sink Width	Maximum Sink Depth
21"	33" x 33"	17"	25 3/4"	22 7/8"
18"	30" x 30"	17"	25 3/4"	18 5/8"

Custom Modifications

AUTHL AUTHR	CBO	CCO	CFNT0	CFP	CFRMO	CMAT	CND	DRWPWR	DRWTK	EXBKL EXBKR	EXL EXR	FB	FFDL FFDR	FPFB
				STD	•		•							
FTK	FTKAV FTKRV	ID	INVFRM	LTI	MIP	RD	RECTKALL RECTKBK	RECTKL RECTKR	RT	TKP	TOTSS TOTSSS	VTK	WLI	
				•										

Construction Upgrades

APC	PE

Door Options

ALF	CG	DPSRR	MD	MFO
		•		

VANITY ANGLE CORNER SINK FRONT BOTTOM

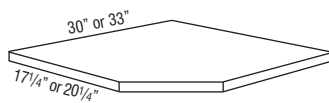

VACSF3018	1.0
VACSF3321	1.0

- Designed for use with Vanity Angle Corner Sink Front.
- 3/8" thick.
- Trimmable.

Custom Modifications

AUTHL AUTHR	CBO	CCO	CFNT0	CFP	CFRMO	CMAT	CND	DRWPWR	DRWTK	EXBKL EXBKR	EXL EXR	FB	FFDL FFDR	FPFB
FTK	FTKAV FTKRV	ID	INVFRM	LTI	MIP	RD	RECTKALL RECTKBK	RECTKL RECTKR	RT	TKP	TOTSS TOTSSS	VTK	WLI	•

Construction Upgrades

APC	PE
•	

Door Options

ALF	CG	DPSRR	MD	MFO

UNDER COUNTER DRAWER, 4 3/4" HIGH, 18" or 21" DEEP

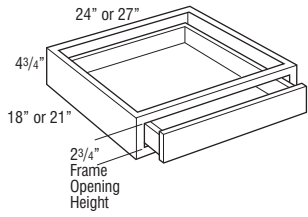

UCD2418 UCD2421
UCD2718 UCD2721

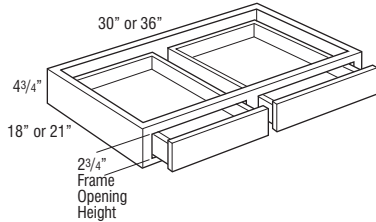

UCD3018 UCD3021
UCD3618 UCD3621

Model	Cubic Feet	Model	Cubic Feet
UCD2418	2.6	UCD3018	2.6
UCD2718	2.6	UCD3618	2.6
UCD2421	2.6	UCD3021	2.6
UCD2721	2.6	UCD3621	2.6

- Cabinet is 4 3/4" high. Drawer box within cabinet is 2" high.
- Not trimmable.
- Drawer front is 3/4" slab front.
- The frame to end panel offset is 3/4", which is designed to accommodate the vanity desk leg.
- End panels ordered in Choice will feature non-matching laminate exterior. When ordered in PE or APC, end panels will not be finished.
- Reduced depth is available in 3" increments.

Custom Modifications

AUTHL	AUTHR	CBO	CCO	CFNTO	CFP	CFRMO	CMAT	CND	DRWPWR	DRWTK	EXBKL	EXBKR	EXL	EXR	FB	FFDL	FFDR	FPFB
		•	•			•							•					
FTK	FTKAV	FTKFV	ID	INVFRM	LTI	MIP	RD	RECTKALL	RECTKLBK	RECTKLR	RT	TKP	TOTSS	TOTSSS	VTK	WLI		
•	•				•	•		•	•						•	•		

Construction Upgrades

APC	PE
•	•

Door Options

ALF	CG	DPSRR	MD	MFO

SPECIAL SIZE VANITY, 32" HIGH, 16" DEEP

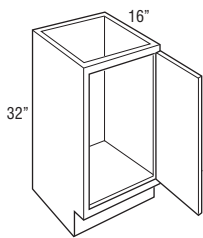

MV183216 L or R	7.2
------------------------	------------

- MV = mini-vanity.

Custom Modifications

AUTHL	AUTHR	CBO	CCO	CFNTO	CFP	CFRMO	CMAT	CND	DRWPWR	DRWTK	EXBKL	EXBKR	EXL	EXR	FB	FFDL	FFDR	FPFB
		•	•	•		•							•	•	•			•
FTK	FTKAV	FTKFV	ID	INVFRM	LTI	MIP	RD	RECTKALL	RECTKLBK	RECTKLR	RT	TKP	TOTSS	TOTSSS	VTK	WLI		
•	•				•	•		•	•						•	•		

Construction Upgrades

APC	PE
•	•

Door Options

ALF	CG	DPSRR	MD	MFO
		•		

SPECIAL SIZE VANITY, 34 1/2" HIGH, 16" DEEP

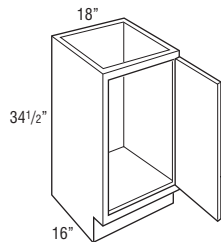

MV183416 L or R	7.7
------------------------	------------

- MV = mini vanity.

Custom Modifications

AUTHL	AUTHR	CBO	CCO	CFNTO	CFP	CFRMO	CMAT	CND	DRWPWR	DRWTK	EXBKL	EXBKR	EXL	EXR	FB	FFDL	FFDR	FPFB
		•	•	•		•							•	•	•			•
FTK	FTKAV	FTKFV	ID	INVFRM	LTI	MIP	RD	RECTKALL	RECTKLBK	RECTKLR	RT	TKP	TOTSS	TOTSSS	VTK	WLI		
•	•				•	•		•	•						•	•		

Construction Upgrades

APC	PE
•	•

Door Options

ALF	CG	DPSRR	MD	MFO
		•		

VANITY HAMPER, 32" HIGH, 21" DEEP

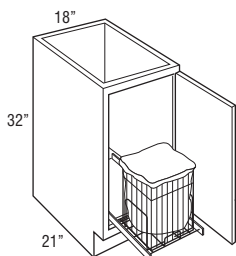

storage SOLUTIONS

VH183221FH L or R	8.9
--------------------------	------------

- Includes full-extension removable chrome pull-out hamper with removable cloth liner.
- Hamper size is 19 3/8" high x 14 3/4" wide x 18" deep.

Custom Modifications

AUTHL	AUTHR	CBO	CCO	CFNTO	CFP	CFRMO	CMAT	CND	DRWPWR	DRWTK	EXBKL	EXBKR	EXL	EXR	FB	FFDL	FFDR	FPFB
		•	•	•	•	•		•		•	•	•	•	•	•			•
FTK	FTKAV	FTKFV	ID	INVFRM	LTI	MIP	RD	RECTKALL	RECTKLBK	RECTKLR	RT	TKP	TOTSS	TOTSSS	VTK	WLI		
•	•				•	•		•	•						•	•		

Construction Upgrades

APC	PE
•	•

Door Options

ALF	CG	DPSRR	MD	MFO
		•		

**VANITY HAMPER with DRAWER,
34 1/2" HIGH, 21" DEEP**

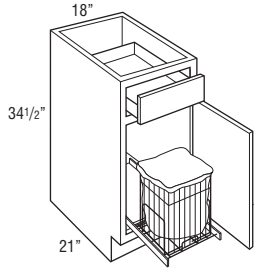

storage
SOLUTIONS

Model	Cubic Feet
VBH183421 L or R	9.5

- Includes full-extension removable chrome pull-out hamper with removable cloth liner.
- Hamper size is 19 3/8" high x 14 3/4" wide x 18" deep.

Custom Modifications

AUTHL AUTHR	CBO	CCO	CFNTO	CFP	CFRMO	CMAT	CND	DRWPWR	DRWTK	EXBKL EXBKR	EXL EXR	FB	FFDL FFDR	FPEB
•	•	•	•	•	•		•		•	•	•	•		•
FTK	FTKAV FTKRV	ID	INVFRM	LTI	MIP	RD	RECTKALL RECTKBK	RECTKL RECTKR	RT	TKP	TOTSS TOTSSS	VTK	WLI	
•	•						•	•				•	•	

Construction Upgrades

APC	PE
•	•

Door Options

ALF	CG	DPSRR	MD	MFO
		•		

LINEN CLOSET

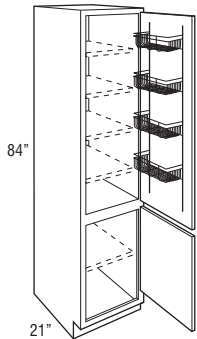

storage
SOLUTIONS

Model	Cubic Feet
LC188421 L or R	23.0

- Upper section features a 5" deep chrome door rack.
- 15" deep adjustable shelves indicated by light dotted lines are included; packaged separately.
- If ordered in Arch/Cathedral door style, top door will be Arch/Cathedral and lower door will be Square.
- Tall non-mitered doors will have two center panels with cross rail.
- Troxel doors greater than 48" high will be two doors doweled together.

Custom Modifications

AUTHL AUTHR	CBO	CCO	CFNTO	CFP	CFRMO	CMAT	CND	DRWPWR	DRWTK	EXBKL EXBKR	EXL EXR	FB	FFDL FFDR	FPEB
	•	•	•		•					•	•	•		•
FTK	FTKAV FTKRV	ID	INVFRM	LTI	MIP	RD	RECTKALL RECTKBK	RECTKL RECTKR	RT	TKP	TOTSS TOTSSS	VTK	WLI	
•	•		•		•		•	•	•	•	•	•	•	

Construction Upgrades

APC	PE
•	•

Door Options

ALF	CG	DPSRR	MD	MFO
		•		•

**LINEN CLOSET with REMOVABLE
HAMPER**

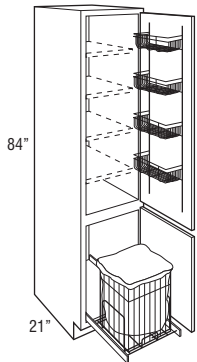

storage
SOLUTIONS

Model	Cubic Feet
LCRH188421 L or R	23.0

- Upper section features a 5" deep chrome door rack.
- 15" deep adjustable shelves indicated by light dotted lines are included; packaged separately.
- Includes full-extension removable chrome pull-out hamper with removable cloth liner.
- Hamper size is 19 3/8" high x 14 3/4" wide x 18" deep.
- If ordered in Arch/Cathedral door style, top door will be Arch/Cathedral and lower door will be Square.
- Tall non-mitered doors will have two center panels with cross rail.
- Troxel doors greater than 48" high will be two doors doweled together.

Custom Modifications

AUTHL AUTHR	CBO	CCO	CFNTO	CFP	CFRMO	CMAT	CND	DRWPWR	DRWTK	EXBKL EXBKR	EXL EXR	FB	FFDL FFDR	FPEB
	•	•	•		•					•	•	•		•
FTK	FTKAV FTKRV	ID	INVFRM	LTI	MIP	RD	RECTKALL RECTKBK	RECTKL RECTKR	RT	TKP	TOTSS TOTSSS	VTK	WLI	
•	•		•		•		•	•	•	•	•	•	•	

Construction Upgrades

APC	PE
•	•

Door Options

ALF	CG	DPSRR	MD	MFO
		•		•

LINEN STORAGE CABINET

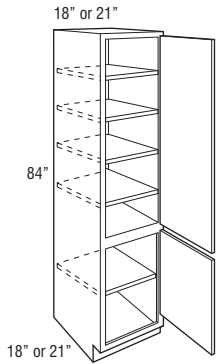

Model	Cubic Feet
LT188418 L or R	20.3
LT218418 L or R	23.4
LT188421 L or R	23.3
LT218421 L or R	26.8

- If ordered in Arch/Cathedral door style, top door will be Arch/Cathedral and lower doors will be Square.
- Tall non-mitered doors will have two center panels with cross rail.
- Troxel doors greater than 48" high will be two doors doweled together.

Custom Modifications

AUTHL AUTHR	CBO	CCO	CFNTO	CFP	CFRMO	CMAT	CND	DRWPWR	DRWTK	EXBKL EXBKR	EXL EXR	FB	FFDL FFDR	FPEB
	•	•	•		•				•*	•	•	•		•
FTK	FTKAV FTKRV	ID	INVFRM	LTI	MIP	RD	RECTKALL RECTKBK	RECTKL RECTKR	RT	TKP	TOTSS TOTSSS	VTK	WLI	
•	•	•	•		•	•		•	•	•		•	•	

*Not available on 18" deep

Construction Upgrades

APC	PE
•	•

Door Options

ALF	CG	DPSRR	MD	MFO
		•		•

**VANITY UTILITY,
84" TALL, 21" DEEP**

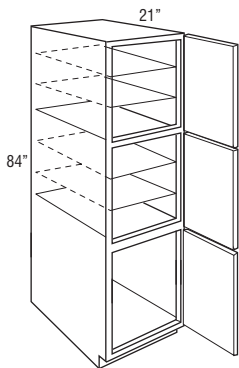

VU188421 L or R	23.0
------------------------	-------------

- Lower door section is drilled to accept adjustable shelf.
- Shelves indicated by light dotted lines are included; packaged separately.
- Shelves indicated by solid lines are fixed.
- Vanity utilities designed to be used with 32" tall vanities. Kitchen utilities should be used for 34 1/2" vanity applications.
- If ordered in Arch/Cathedral door style, top door will be Arch/Cathedral and lower doors will be Square.

Custom Modifications

AUTHL AUTHR	CBO	CCO	CFNTO	CFP	CFRMO	CMAT	CND	DRWPWR	DRWTK	EXBKL EXBKR	EXL EXR	FB	FFDL FFDR	FPEB
•	•	•	•		•				•	•	•	•		•
FTK	FTKAV FTKRV	ID	INVFRM	LTI	MIP	RD	RECTKALL RECTKBK	RECTKL RECTKR	RT	TKP	TOTSS TOTSSS	VTK	WLI	
•	•	•	•		•	•		•	•	•		•	•	

Construction Upgrades

APC	PE
•	•

Door Options

ALF	CG	DPSRR	MD	MFO
		•		•

**VANITY WALL HUNG TWO DRAWER
SINK BASE with FALSE PANEL,
23 1/2" HIGH, 21" DEEP**

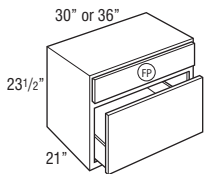

VWH2D3023.521FP	10.7
VWH2D3623.521FP	12.7

- Plumbing clearance of 15 1/16" to the top edge of the lower drawer box (6 3/8" high drawer box).
- For proper installation, cabinet must be secured on each side through both the top and bottom of the back panel into wall studs. Installation instructions and required 3 1/2" installation screws included, standard 2 1/2" installation screws are not sufficient in this application.
- 5-piece drawer front configuration will not match on door styles with unique rail widths for drawer fronts over 10" high. Check door style section on pages 8-21 for drawer rail widths by height.
- Features a full cabinet top that can be routed for sink installation.
- Approximate weight limit is 400 lbs. per cabinet (includes weight of the cabinet, countertop and contents). Proper installation is required and additional bracing may be required.
- 125 lb. full extension undermount Smart Stop guides.

Custom Modifications

AUTHL AUTHR	CBO	CCO	CFNTO	CFP	CFRMO	CMAT	CND	DRWPWR	DRWTK	EXBKL EXBKR	EXL EXR	FB	FFDL FFDR	FPEB
•	•	•			•						•			STD
FTK	FTKAV FTKRV	ID	INVFRM	LTI	MIP	RD	RECTKALL RECTKBK	RECTKL RECTKR	RT	TKP	TOTSS TOTSSS	VTK	WLI	
	•		•		•								•	

Construction Upgrades

APC	PE
STD	

Door Options

ALF	CG	DPSRR	MD	MFO

VANITY WALL HUNG TWO DRAWER BASE, 23 1/2" HIGH, 21" DEEP

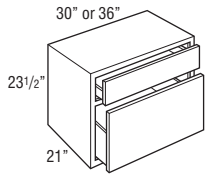

Model	Cubic Feet
VWH2D3023.521	10.7
VWH2D3623.521	12.7

- Top drawer box is 3 3/8" high, bottom drawer box is 10" high.
- Cannot be used with a sink due to drawer interference.
- For proper installation, cabinet must be secured on each side through both the top and bottom of the back panel into wall studs. Installation instructions and required 3 1/2" installation screws included, standard 2 1/2" installation screws are not sufficient in this application.
- 5-piece drawer front configuration will not match on door styles with unique rail widths for drawer fronts over 10" high. Check door style section on pages 8-21 for drawer rail widths by height.
- Approximate weight limit is 400 lbs. per cabinet (includes weight of the cabinet, countertop and contents). Proper installation is required and additional bracing may be required.
- Bottom drawer utilizes 125 lb. full extension undermount Smart Stop guides.

Custom Modifications

AUTHL	CBO	CCO	CFNT0	CFP	CFRMO	CMAT	CND	DRWPWR	DRWTK	EXBKL	EXL	FB	FFDL	FFDR	FPFB
•	•	•		•	•			•			•				STD
FTK	FTKAV FTKRV	ID	INVFRM	LTI	MIP	RD	RECTKALL RECTKBK	RECTKL RECTKR	RT	TKP	TOTSS TOTSSS	VTK	WLI		
				•	•								•		

Construction Upgrades

APC	PE
STD	

Door Options

ALF	CG	DPSRR	MD	MFO

VANITY WALL HUNG DOUBLE DOOR with U-SHAPED PULL-OUTS, 23 1/2" HIGH, 21" DEEP

storage SOLUTIONS

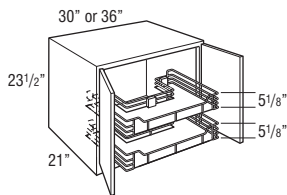

VWH3023.521U	10.7
VWH3623.521U	12.7

- Includes two chrome U-shaped Smart Stop roll-outs with non-slip grey shelf liner.
- Cut-out for U-shape on bottom roll-out is 6 1/8" from back of cabinet.
- Cut-out for U-shape on top roll-out is 12 1/8" from back of cabinet.
- For proper installation, cabinet must be secured on each side through both the top and bottom of the back panel into wall studs. Installation instructions and required 3 1/2" installation screws included, standard 2 1/2" installation screws are not sufficient in this application.
- Features a full cabinet top that can be routed for sink installation.
- Approximate weight limit is 400 lbs. per cabinet (includes weight of the cabinet, countertop and contents). Proper installation is required and additional bracing may be required.

Custom Modifications

AUTHL	CBO	CCO	CFNT0	CFP	CFRMO	CMAT	CND	DRWPWR	DRWTK	EXBKL	EXL	FB	FFDL	FFDR	FPFB
•	•	•	•		•						•				STD
FTK	FTKAV FTKRV	ID	INVFRM	LTI	MIP	RD	RECTKALL RECTKBK	RECTKL RECTKR	RT	TKP	TOTSS TOTSSS	VTK	WLI		
				•	•								•		

Construction Upgrades

APC	PE
STD	

Door Options

ALF	CG	DPSRR	MD	MFO
		•		

VANITY WALL HUNG DOUBLE DOOR, 23 1/2" HIGH, 21" DEEP

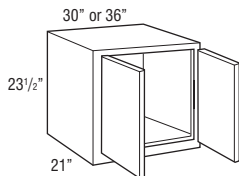

VWH3023.521
VWH3623.521

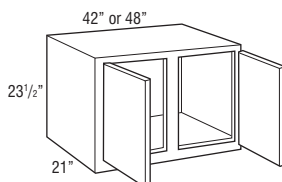

VWH4223.521
VWH4823.521CS

VWH3023.521	10.7
VWH3623.521	12.7
VWH4223.521	14.8
VWH4823.521CS	16.8

- For proper installation, cabinet must be secured on each side through both the top and bottom of the back panel into wall studs. Installation instructions and required 3 1/2" installation screws included, standard 2 1/2" installation screws are not sufficient in this application.
- Features a full cabinet top that can be routed for sink installation.
- Approximate weight limit is 400 lbs. per cabinet (includes weight of the cabinet, countertop and contents). Proper installation is required and additional bracing may be required.

Custom Modifications

AUTHL	CBO	CCO	CFNT0	CFP	CFRMO	CMAT	CND	DRWPWR	DRWTK	EXBKL	EXL	FB	FFDL	FFDR	FPFB
•	•	•	•		•						•				STD
FTK	FTKAV FTKRV	ID	INVFRM	LTI	MIP	RD	RECTKALL RECTKBK	RECTKL RECTKR	RT	TKP	TOTSS TOTSSS	VTK	WLI		
				•	•	•			•				•		

Construction Upgrades

APC	PE
STD	

Door Options

ALF	CG	DPSRR	MD	MFO
	•	•		

VANITY WALL TOWEL BAR

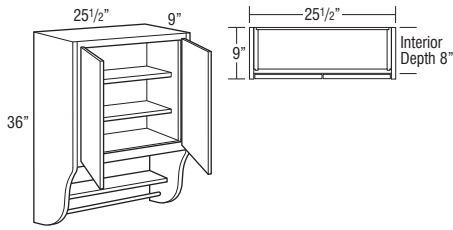

Model	Cubic Feet
VWTB24	6.8

- Includes 2 adjustable interior shelves, 1 fixed shelf, and towel rack underneath.
- Cabinet has butt doors, no center stile.
- Cabinet features factory applied 3/4" matching veneer over furniture board core end panels. Total cabinet width is 25 1/2".
- Interior cabinet case has plywood end panels.
- When ordered in APC, back, top, bottom and adjustable shelves are plywood.

Custom Modifications

AUTHL AUTHR	CBO	CCO	CFNTO	CFP	CFRMO	CMAT	CND	DRWPWR	DRWTK	EXBKL EXBKR	EXL EXR	FB	FFDL FFDR	FPFB
	•	•	•		•							STD		
FTK	FTKAV FTKFV	ID	INVFRM	LTI	MIP	RD	RECTKALL RECTKBK	RECTKL RECTKR	RT	TKP	TOTSS TOTSSS	VTK	WLI	•

Construction Upgrades

APC	PE
•	STD

Door Options

ALF	CG	DPSRR	MD	MFO
	•	•		•

VANITY WALL, 30" HIGH, 6" DEEP

12", 15", 18", or 24"

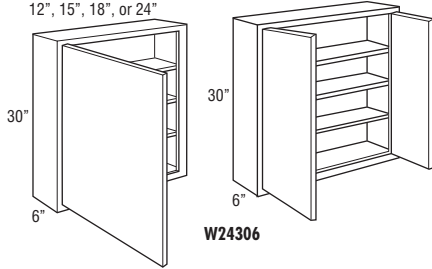

W24306

W12306 L or R
W15306 L or R
W18306 L or R
W24306 L or R

W12306 L or R	2.2
W15306 L or R	2.6
W18306 L or R	3.1
W24306 L or R	4.0
W24306	4.0

Custom Modifications

AUTHL AUTHR	CBO	CCO	CFNTO	CFP	CFRMO	CMAT	CND	DRWPWR	DRWTK	EXBKL EXBKR	EXL EXR	FB	FFDL FFDR	FPFB
	•	•	•		•					•	•	•		•
FTK	FTKAV FTKFV	ID	INVFRM	LTI	MIP	RD	RECTKALL RECTKBK	RECTKL RECTKR	RT	TKP	TOTSS TOTSSS	VTK	WLI	•

Construction Upgrades

APC	PE
•	•

Door Options

ALF	CG	DPSRR	MD	MFO
•†	•	•	•	•

†Not available on 24" wide

VANITY WALL MIRROR CABINET, 30" HIGH, 4 9/16" DEEP

18" or 24"

30" or 36"

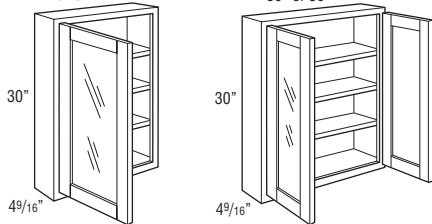

VWM1830 L or R
VWM2430 L or R

VWM3030
VWM3630

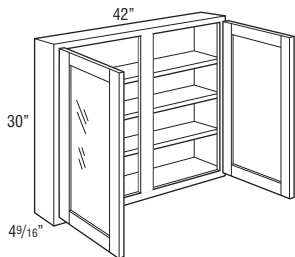

VWM4230

VWM1830 L or R	2.7
VWM2430 L or R	3.5
VWM3030	4.3
VWM3630	5.1
VWM4230	5.9

- Standard with CG doors and installed mirror glass.
- Unit intended to be surface mounted. Features standard 1/4" face frame reveal on ends.
- Not available in Caprice, Genova, Shafer, Tara, Troxel, and Vaille styles.
- Adjustable shelves.

Custom Modifications

AUTHL AUTHR	CBO	CCO	CFNTO	CFP	CFRMO	CMAT	CND	DRWPWR	DRWTK	EXBKL EXBKR	EXL EXR	FB	FFDL FFDR	FPFB
	•	•	•		•					•	•	•		•
FTK	FTKAV FTKFV	ID	INVFRM	LTI	MIP	RD	RECTKALL RECTKBK	RECTKL RECTKR	RT	TKP	TOTSS TOTSSS	VTK	WLI	•

Construction Upgrades

APC	PE
•	•

Door Options

ALF	CG	DPSRR	MD	MFO
	STD			

VANITY MIRROR with SIDE PULL-OUTS, 32 1/2" HIGH, 4 7/8" DEEP

storage SOLUTIONS

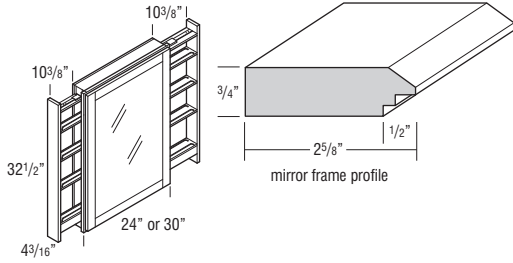

Model	Cubic Feet
VMP2432.5	3.7
VMP3032.5	4.6

- One full extension natural wood finish pull-out on each side with three adjustable shelves and chrome rail sides (Smart Stop not included).
- Pull-outs extend 10 3/8" on each side. VMP2432.5 open width is 44 3/4". VMP3032.5 open width is 50 3/4".
- Mirror frame has a shaker outside profile and a bevel inside profile with a 1/4" face frame reveal. Mirror is not removable.
- Mirror visible dimensions:
VMP2432.5 - 26 3/4" high x 18 1/4" wide
VMP3032.5 - 26 3/4" high x 24 1/4" wide
- Installation instructions included.
- When Distressing is selected, only fillers will receive treatment.
- When Heirlooming is selected, only mirror frame will receive treatment.
- Pull-outs feature plain fillers. If a more decorative look is desired, overlay fillers or embellishments may be ordered separately and field installed.

MODIFICATIONS
No modifications available for these products.

Specie Availability

Alder	Rustic Alder	Cherry	Hickory	Maple	Oak	High Gloss Laminate	Textured Laminate	Textured PureStyle™	Thermofoil
		•		•		box color	box color	box color	Maple

Finish Techniques

Distressing	Heirloom
•	•

VANITY MIRROR

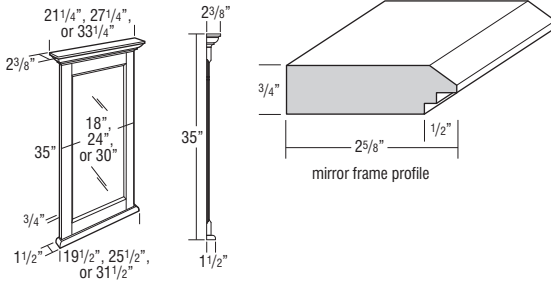

VM2135	5.4
VM2735	5.4
VM3335	5.4

- Moulding included on vanity mirror is not a standard moulding. SWLCRMB is similar.
- Mirror glass is beveled.
- Includes two installed metal hanging hooks on back.

MODIFICATIONS
No modifications available for these products.

Specie Availability

Alder	Rustic Alder	Cherry	Hickory	Maple	Oak	High Gloss Laminate	Textured Laminate	Textured PureStyle™	Thermofoil
		•		•		box color	box color	box color	Maple

Finish Techniques

Distressing	Heirloom
	•

Model	Overall Dimensions Width	Overall Dimensions Height	Mirror - Visible Dimensions Width	Mirror - Visible Dimensions Height
VM2135	21 1/4"	35"	12 15/16"	26 15/16"
VM2735	27 1/4"	35"	18 15/16"	26 15/16"
VM3335	33 1/4"	35"	24 15/16"	26 15/16"

SINGLE DOOR MEDICINE CABINET

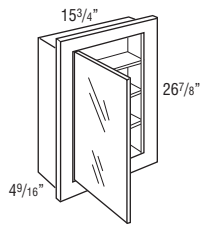

Model	Cabinet Dimensions			Cut-Out Dimensions		
	Width	Height	Depth	Width	Height	Depth
MC16	15 3/4"	26 7/8"	4 9/16"	14 7/16"	25 5/8"	4"

Model	Cubic Feet
MC16	2.5

- Unit can be surface mounted or recessed.
- Door of cabinet is glass mirror.
- Matching cabinet doors not available.
- Cabinet has wood frame.
- 1/2" plywood ends, tops, and bottoms.
- Finished exterior.
- Standard interior.
- 3/4" laminated furniture board shelves.
- Face frame has a profiled inside and outside edge.
- If ordered with Heirloom Technique, will not feature sand-through characteristics.

Custom Modifications

AUTHL	AUTHR	CBO	CCO	CFNTD	CFP	CFRMO	CMAT	CND	DRWPWR	DRWTK	EXBKL	EXBKR	EXL	EXR	FB	FFDL	FFDR	FPEB
		•	•	•		•									STD			
FTK	FTKAV	FTKEV	ID	INVERM	LTI	MIP	RD	RECTKALL	RECTKLBK	RECTKL	RECTKR	RT	TKP	TOTSS	TOTSSS	VTK	WLI	
						•											•	

Construction Upgrades

APC	PE
•	STD

Door Options

ALF	CG	DPSRR	MD	MFO

TRI-VIEW MEDICINE CABINET

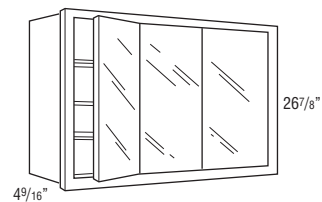

Model	Cabinet Dimensions			Cut-Out Dimensions		
	Width	Height	Depth	Width	Height	Depth
TV30	30"	26 7/8"	4 9/16"	28 11/16"	25 5/8"	4"
TV36	36"	26 7/8"	4 9/16"	34 11/16"	25 5/8"	4"
TV48	48"	26 7/8"	4 9/16"	46 11/16"	25 5/8"	4"

Model	Cubic Feet
TV30	5.4
TV36	6.5
TV48	8.5

- Cabinet has wood frame.
- Door of cabinet is glass mirror.
- Unit can be surface mounted or recessed.
- 1/2" plywood ends, tops, and bottoms.
- Finished exterior.
- Standard interior.
- 3/4" laminated furniture board shelves.
- Face frame has a profiled inside and outside edge.
- If ordered with Heirloom Technique, will not feature sand-through characteristics.

Custom Modifications

AUTHL	AUTHR	CBO	CCO	CFNTD	CFP	CFRMO	CMAT	CND	DRWPWR	DRWTK	EXBKL	EXBKR	EXL	EXR	FB	FFDL	FFDR	FPEB
		•	•			•									STD			
FTK	FTKAV	FTKEV	ID	INVERM	LTI	MIP	RD	RECTKALL	RECTKLBK	RECTKL	RECTKR	RT	TKP	TOTSS	TOTSSS	VTK	WLI	
						•											•	

Construction Upgrades

APC	PE
•	STD

Door Options

ALF	CG	DPSRR	MD	MFO

SPECIE AVAILABILITY

Specie Availability charts list the availability of each product code by specie and any substitutions that are made. Exceptions within a section are noted below the specie availability chart.

For panels with doors and/or fillers attached, specie availability is shown for the panel and filler only.

For Specie Availability, look for this chart throughout. For trim items ordered with Laminate and PureStyle™, trim items matching the cabinet box color are noted in the charts.

Specie Availability

Alder	Rustic Alder	Cherry	Hickory	Maple	Oak	High Gloss Laminate	Textured Laminate	Textured PureStyle™	Thermofoil
•	•	•	•	•	•	box color	box color	box color	Maple

DESCRIPTION

MODEL

FILLERS

3" WIDE FILLERS

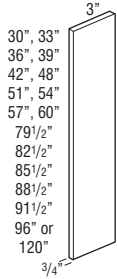

F3



F330

F333

F336

F339

F342

F348

F351

F354

F357

F360

TF384

TF387

TF390

TF393

TF396

TF396FH

TF3120FH† ♦

Finish Techniques

Distressing

Heirloom

Specie Availability

Alder	Rustic Alder	Cherry	Hickory	Maple	Oak	High Gloss Laminate	Textured Laminate	Textured PureStyle™	Thermofoil
•	•	•	•	•	•	box color	box color	box color	Maple

♦ Only available in Cherry and Maple.

3" WIDE FILLER RETURN



F3R



F3R

- Creates a toekick appearance when used with 3" wide fillers.
- 3/8" thick, Natural Maple laminated furniture board.

DESCRIPTION

MODEL

3" WIDE CORNER FILLER

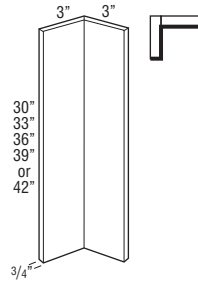

CF3



CF330

CF333

CF336

CF339

CF342

- 3/4" thick.
- Finished on front and all edges (backs are not finished).

Finish Techniques

Distressing	Heirloom
•	

Specie Availability

Alder	Rustic Alder	Cherry	Hickory	Maple	Oak	High Gloss Laminate	Textured Laminate	Textured PureStyle™	Thermofoil
•	•	•	•	•	•	box color	box color	box color	Maple

6" WIDE FILLERS

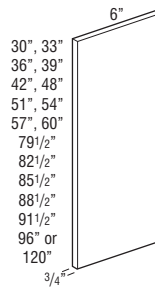

F6



F630

F633

F636

F639

F642

F648

F651

F654

F657

F660

TF684

TF687

TF690

TF693

TF696

TF696FH

TF6120FH† ♦

- 3/4" thick.
- Finished on front and all edges (backs are not finished).
- †5 day Express Response not available.

Finish Techniques

Distressing

Heirloom

Finish Techniques

Distressing	Heirloom
•	

Specie Availability

Alder	Rustic Alder	Cherry	Hickory	Maple	Oak	High Gloss Laminate	Textured Laminate	Textured PureStyle™	Thermofoil
•	•	•	•	•	•	box color	box color	box color	Maple

♦ Only available in Cherry and Maple.

6" WIDE FILLER RETURN

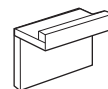

F6R



F6R

- Creates a toekick appearance when used with 6" wide fillers.
- 3/8" thick, Natural Maple laminated furniture board.

Finished edges indicated by bold lines on side view drawings.
Glazed edges indicated by arrows on side view drawings.

DESCRIPTION

MODEL

SPACE FILLERS



S96X14 (1/4" thick)
S96X12 (1/2" thick)

- S96 is 1/4" or 1/2" thick.
- Designed to fill space between adjacent cabinets; i.e. W1830 butted against side of U188424.
- Finished on front and all edges (backs are not finished).

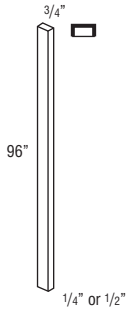

Finish Techniques

Distressing	Heirloom

Specie Availability

Alder	Rustic Alder	Cherry	Hickory	Maple	Oak	High Gloss Laminate	Textured Laminate	Textured PureStyle™	Thermofoil
•	•	•	•	•	•	box color	box color	box color	Maple

OVERLAY FILLER, 2 1/2" WIDE



- OL312** (11 1/2"H)
- OL315** (14 1/2"H)
- OL318** (17 1/2"H)
- OL321** (20 1/2"H)
- OL324** (23 1/2"H)
- OL327** (26 1/2"H)
- OL330** (28"H or 29 1/2"H)
- OL333** (31"H or 32 1/2"H)
- OL336** (34"H or 35 1/2"H)
- OL339** (37"H or 38 1/2"H)
- OL342** (40"H or 41 1/2"H)
- OL384** (79"H)
- OL387** (82"H)
- OL390** (85"H)
- OL393** (88"H)
- OL396** (91"H)
- VOL332** (27"H)
- DOL329** (24"H)

- All overlay fillers available in full overlay door styles.
- OL330, OL333, OL336, OL339, OL342 also available in partial overlay door styles. Overlays for partial overlay door styles will match partial overlay door height.
- 2 1/2" wide overlay fillers can be applied to Wall Message Centers to create custom finished look.
- Overlays match door profile and thickness.
- See page 5 for list of full overlay styles.
- Finished on front and all edges (backs are not finished).
- See OL__MFO (on right) for use with Modified Full Overlay modification.

Finish Techniques

Distressing	Heirloom
•	•

Specie Availability

Alder	Rustic Alder	Cherry	Hickory	Maple	Oak	High Gloss Laminate	Textured Laminate	Textured PureStyle™	Thermofoil
•	•	•	•	•	•				•

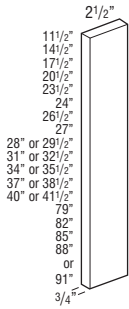

DESCRIPTION

MODEL

NEW OVERLAY FILLER for MODIFIED FULL OVERLAY, 2 1/2" WIDE



- OL312MFO** (10 3/4"H)
- OL315MFO** (13 3/4"H)
- OL318MFO** (16 3/4"H)
- OL321MFO** (19 3/4"H)
- OL324MFO** (22 3/4"H)
- OL327MFO** (25 3/4"H)
- OL330MFO** (28 3/4"H)
- OL333MFO** (31 3/4"H)
- OL336MFO** (34 3/4"H)
- OL339MFO** (37 3/4"H)
- OL342MFO** (40 3/4"H)
- OL384MFO** (78 1/4"H)
- OL387MFO** (81 1/4"H)
- OL390MFO** (84 1/4"H)
- OL393MFO** (87 1/4"H)
- OL396MFO** (90 1/4"H)

- All overlay fillers available in full overlay door styles except Tara, Troxel, Genova, Shafer, Caprice, and Vaille.
- Height will align with doors specified with Modified Full Overlay modification. See page 33 for MFO details.
- 2 1/2" wide overlay fillers can be applied to Wall Message Centers to create a custom finished look.
- Overlays match door profile and thickness.
- Finished on front and all edges (backs are not finished).

Finish Techniques

Distressing	Heirloom
•	•

Specie Availability

Alder	Rustic Alder	Cherry	Hickory	Maple	Oak	High Gloss Laminate	Textured Laminate	Textured PureStyle™	Thermofoil
•	•	•	•	•	•				

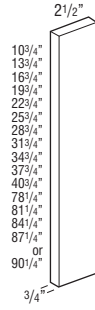

Finished edges indicated by bold lines on side view drawings.
Glazed edges indicated by arrows on side view drawings.

DESCRIPTION

**OVERLAY FILLER, PREMIUM,
2 1/2" WIDE**

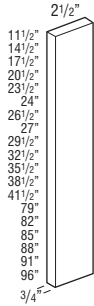

MODEL

- OL312P** (11 1/2"H)
- OL315P** (14 1/2"H)
- OL318P** (17 1/2"H)
- OL321P** (20 1/2"H)
- OL324P** (23 1/2"H)
- OL327P** (26 1/2"H)
- OL330P** (29 1/2"H)
- OL333P** (32 1/2"H)
- OL336P** (35 1/2"H)
- OL339P** (38 1/2"H)
- OL342P** (41 1/2"H)
- OL384P** (79"H)
- OL387P** (82"H)
- OL390P** (85"H)
- OL393P** (88"H)
- OL396P** (91"H)
- OL396FHP** (96"H)
- VOL332P** (27"H)
- DOL329P** (24"H)

- Overlays match door profile and thickness.
- Front, edges, and backs match door and drawer front construction.
- Taro edgebanding will match door and drawer front edgebanding selection.
- Troxel overlays feature horizontal grain. Overlays greater than 48" high will be two overlays and require field assembly (allow 3/16" gap between overlays for alignment with adjacent doors).

Finish Techniques

Distressing	Heirloom
•	•

Specie Availability

Alder	Rustic Alder	Cherry	Hickory	Maple	Oak	High Gloss Laminate	Textured Laminate	Textured PureStyle™	Thermofoil
•	•	•	•	•	•	•	•	•	•

DESCRIPTION

**OVERLAY FILLER,
5 1/2" WIDE**

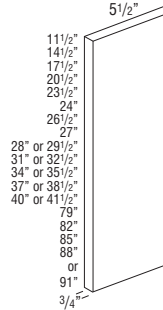

MODEL

- OL612** (11 1/2"H)
- OL615** (14 1/2"H)
- OL618** (17 1/2"H)
- OL621** (20 1/2"H)
- OL624** (23 1/2"H)
- OL627** (26 1/2"H)
- OL630** (28"H or 29 1/2"H)
- OL633** (31"H or 32 1/2"H)
- OL636** (34"H or 35 1/2"H)
- OL639** (37"H or 38 1/2"H)
- OL642** (40"H or 41 1/2"H)
- OL684** (79"H)
- OL687** (82"H)
- OL690** (85"H)
- OL693** (88"H)
- OL696** (91"H)
- VOL632** (27"H)
- DOL629** (24"H)

- All overlay fillers available in full overlay door styles.
- OL630, OL633, OL636, OL639, OL642 also available in partial overlay door styles. Overlays for partial overlay door styles will match partial overlay door height.
- Overlays match door profile and thickness.
- See page 5 for list of full overlay styles.
- Finished on front and all edges (backs are not finished).
- See OL__MFO (on page 344) for use with Modified Full Overlay modification.

Finish Techniques

Distressing	Heirloom
•	•

Specie Availability

Alder	Rustic Alder	Cherry	Hickory	Maple	Oak	High Gloss Laminate	Textured Laminate	Textured PureStyle™	Thermofoil
•	•	•	•	•	•	•	•	•	•

Finished edges indicated by bold lines on side view drawings.
Glazed edges indicated by arrows on side view drawings.

DESCRIPTION

MODEL

NEW **OVERLAY FILLER**
for **MODIFIED FULL**
OVERLAY, 5 1/2" WIDE

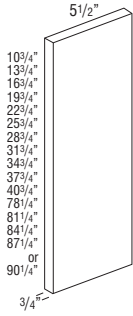

- OL612MFO** (10 3/4"H)
- OL615MFO** (13 3/4"H)
- OL618MFO** (16 3/4"H)
- OL621MFO** (19 3/4"H)
- OL624MFO** (22 3/4"H)
- OL627MFO** (25 3/4"H)
- OL630MFO** (28 3/4"H)
- OL633MFO** (31 3/4"H)
- OL636MFO** (34 3/4"H)
- OL639MFO** (37 3/4"H)
- OL642MFO** (40 3/4"H)
- OL684MFO** (78 1/4"H)
- OL687MFO** (81 1/4"H)
- OL690MFO** (84 1/4"H)
- OL693MFO** (87 1/4"H)
- OL696MFO** (90 1/4"H)

- All overlay fillers available in full overlay door styles except Tara, Troxel, Genova, Shafer, Caprice, and Vaille.
- Height will align with doors specified with Modified Full Overlay modification. See page 33 for MFO details.
- Overlays match door profile and thickness.
- Finished on front and all edges (backs are not finished).

Finish Techniques

Distressing	Heirloom
•	•

Specie Availability

Alder	Rustic Alder	Cherry	Hickory	Maple	Oak	High Gloss Laminate	Textured Laminate	Textured PureStyle™	Thermofoil
•	•	•	•	•	•				

DESCRIPTION

MODEL

OVERLAY FILLER, PREMIUM,
5 1/2" WIDE

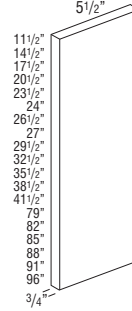

- OL612P** (11 1/2"H)
- OL615P** (14 1/2"H)
- OL618P** (17 1/2"H)
- OL621P** (20 1/2"H)
- OL624P** (23 1/2"H)
- OL627P** (26 1/2"H)
- OL630P** (29 1/2"H)
- OL633P** (32 1/2"H)
- OL636P** (35 1/2"H)
- OL639P** (38 1/2"H)
- OL642P** (41 1/2"H)
- OL684P** (79"H)
- OL687P** (82"H)
- OL690P** (85"H)
- OL693P** (88"H)
- OL696P** (91"H)
- OL696FHP** (96"H)
- VOL632P** (27"H)
- DOL629P** (24"H)

- Overlays match door profile and thickness.
- Front, edges, and backs match door and drawer front construction.
- Tara edgebanding will match door and drawer front edgebanding selection.
- Troxel overlays feature horizontal grain. Overlays greater than 48" high will be two overlays and require field assembly (allow 3/16" gap between overlays for alignment with adjacent doors).

Finish Techniques

Distressing	Heirloom
	•

Specie Availability

Alder	Rustic Alder	Cherry	Hickory	Maple	Oak	High Gloss Laminate	Textured Laminate	Textured PureStyle™	Thermofoil
						•	•	•	

FLUTED/BEADED 3" WIDE
REVERSIBLE FILLERS



FBF330 (3" x 30")

FBF336 (3" x 36")

TBF396 (3" x 96")

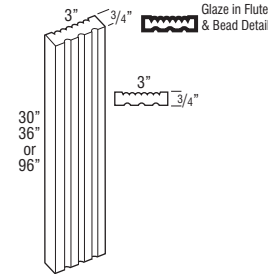

Finish Techniques

Distressing	Heirloom
	•

Specie Availability

Alder	Rustic Alder	Cherry	Hickory	Maple	Oak	High Gloss Laminate	Textured Laminate	Textured PureStyle™	Thermofoil
•	Alder	•	•	•	•	box color	box color	box color	Maple

Finished edges indicated by bold lines on side view drawings.
Glazed edges indicated by arrows on side view drawings.

DESCRIPTION

MODEL

**FLUTED/BEADED
6" WIDE
REVERSIBLE FILLERS**



FBF630 (6" x 30")

FBF636 (6" x 36")

TBF696 (6" x 96")

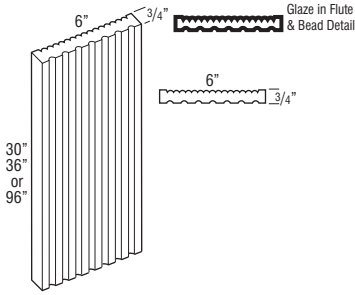

Finish Techniques

Distressing	Heirloom
	•

Specie Availability

Alder	Rustic Alder	Cherry	Hickory	Maple	Oak	High Gloss Laminate	Textured Laminate	Textured PureStyle™	Thermofoil
•	Alder	•	•	•	•	box color	box color	box color	Maple

**ANGLED FLUTED/PLAIN
3" WIDE REVERSIBLE
FILLERS**



BLVDF30 (3" x 30")

BLVDF34.5 (3" x 34 1/2")

BLVDTF96 (3" x 96")

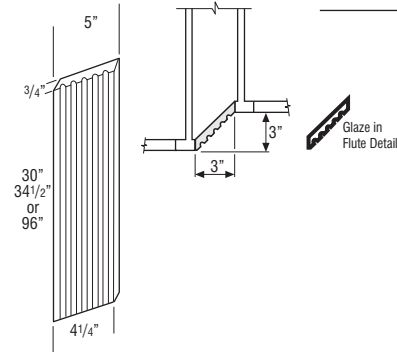

Finish Techniques

Distressing	Heirloom
	•

Specie Availability

Alder	Rustic Alder	Cherry	Hickory	Maple	Oak	High Gloss Laminate	Textured Laminate	Textured PureStyle™	Thermofoil
•	Alder	•	•	•	•	box color	box color	box color	Maple

DESCRIPTION

MODEL

**BOX COLUMN FILLERS, 3" WIDE
Wall - Plain Column
15" Deep**

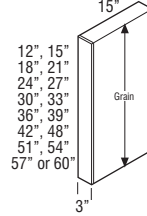

W312BCFP

W315BCFP

W318BCFP

W321BCFP

W324BCFP

W327BCFP

W330BCFP

W333BCFP

W336BCFP

W339BCFP

W342BCFP

W348BCFP

W351BCFP

W354BCFP

W357BCFP

W360BCFP

Custom Modifications

ID	RD
•	•

Finish Techniques

Distressing	Heirloom
•	

Specie Availability

Alder	Rustic Alder	Cherry	Hickory	Maple	Oak	High Gloss Laminate	Textured Laminate	Textured PureStyle™	Thermofoil
•	Alder	•	•	•	•	box color	box color	box color	Maple

**Wall - Fluted Column
15" Deep**

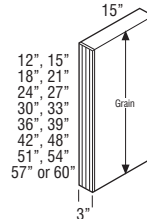

W312BCFF

W315BCFF

W318BCFF

W321BCFF

W324BCFF

W327BCFF

W330BCFF

W333BCFF

W336BCFF

W339BCFF

W342BCFF

W348BCFF

W351BCFF

W354BCFF

W357BCFF

W360BCFF

Custom Modifications

ID	RD
•	•

Finish Techniques

Distressing	Heirloom
	•

Specie Availability

Alder	Rustic Alder	Cherry	Hickory	Maple	Oak	High Gloss Laminate	Textured Laminate	Textured PureStyle™	Thermofoil
•	Alder	•	•	•	•	box color	box color	box color	Maple

Finished edges indicated by bold lines on side view drawings.
Glazed edges indicated by arrows on side view drawings.

DESCRIPTION

MODEL

**BOX COLUMN FILLERS,
3" WIDE (cont'd)
Wall - Beaded Column
15" Deep**

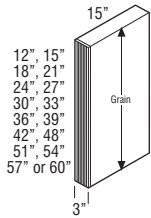

- W312BCFB
- W315BCFB
- W318BCFB
- W321BCFB
- W324BCFB
- W327BCFB
- W330BCFB
- W333BCFB
- W336BCFB
- W339BCFB
- W342BCFB
- W348BCFB
- W351BCFB
- W354BCFB
- W357BCFB
- W360BCFB

- Available in 1" depth increments from 6" to 27".
- Reversible, may be used on either left or right end.
- Front and both sides finished.
- Enclosed top and bottom.
- 1/2" plywood construction.
- Finished veneer on end panel exterior.
- No reveal on filler.

Custom Modifications		Finish Techniques	
ID	RD	Distressing	Heirloom
•	•		•

Specie Availability

Alder	Rustic Alder	Cherry	Hickory	Maple	Oak	High Gloss Laminate	Textured Laminate	Textured PureStyle™	Thermofoil
•	•	•	•	•	•	box color	box color	box color	Maple

**BOX COLUMN FILLERS, 3" WIDE
Base - Plain, Fluted, Beaded Column
27" Deep**

B334.527BCFP

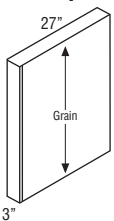

Plain

Custom Modifications		Finish Techniques	
ID	RD	Distressing	Heirloom
	•	•	

Specie Availability

Alder	Rustic Alder	Cherry	Hickory	Maple	Oak	High Gloss Laminate	Textured Laminate	Textured PureStyle™	Thermofoil
•	•	•	•	•	•	box color	box color	box color	Maple

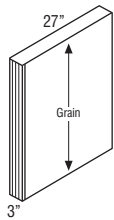

Fluted

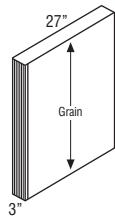

Beaded

B334.527BCFF

B334.527BCFB

- Available in 1" depth increments from 6" to 27".
- Reversible, may be used on either left or right end.
- Front and both sides finished.
- Enclosed top and bottom.
- 1/2" plywood construction.
- Finished veneer on end panel exterior.
- No reveal on filler.

Custom Modifications		Finish Techniques	
ID	RD	Distressing	Heirloom
	•		•

Specie Availability

Alder	Rustic Alder	Cherry	Hickory	Maple	Oak	High Gloss Laminate	Textured Laminate	Textured PureStyle™	Thermofoil
•	•	•	•	•	•	box color	box color	box color	Maple

DESCRIPTION

MODEL

**BOX COLUMN FILLERS, 3" WIDE
Tall - Plain Column
15" & 27" Deep**

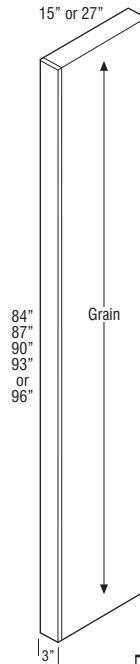

- T38415BCFP (15" Deep)
- T38715BCFP (15" Deep)
- T39015BCFP (15" Deep)
- T39315BCFP (15" Deep)
- T39615BCFP (15" Deep)
- T38427BCFP (27" Deep)
- T38727BCFP (27" Deep)
- T39027BCFP (27" Deep)
- T39327BCFP (27" Deep)
- T39627BCFP (27" Deep)

Custom Modifications		Finish Techniques	
ID	RD	Distressing	Heirloom
•*	•	•	

*ID only available on 15" deep.

Specie Availability

Alder	Rustic Alder	Cherry	Hickory	Maple	Oak	High Gloss Laminate	Textured Laminate	Textured PureStyle™	Thermofoil
•	•	•	•	•	•	box color	box color	box color	Maple

**Tall - Fluted Column
15" & 27" Deep**

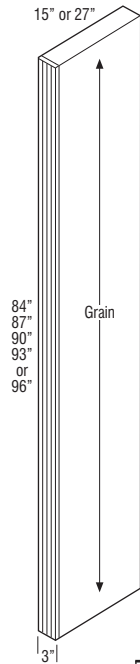

- T38415BCFF (15" Deep)
- T38715BCFF (15" Deep)
- T39015BCFF (15" Deep)
- T39315BCFF (15" Deep)
- T39615BCFF (15" Deep)
- T38427BCFF (27" Deep)
- T38727BCFF (27" Deep)
- T39027BCFF (27" Deep)
- T39327BCFF (27" Deep)
- T39627BCFF (27" Deep)

Custom Modifications		Finish Techniques	
ID	RD	Distressing	Heirloom
•*	•		•

*ID only available on 15" deep.

Specie Availability

Alder	Rustic Alder	Cherry	Hickory	Maple	Oak	High Gloss Laminate	Textured Laminate	Textured PureStyle™	Thermofoil
•	•	•	•	•	•	box color	box color	box color	Maple

DESCRIPTION

MODEL

**BOX COLUMN FILLERS,
3" WIDE (cont'd)
Tall - Beaded Column
15" & 27" Deep**

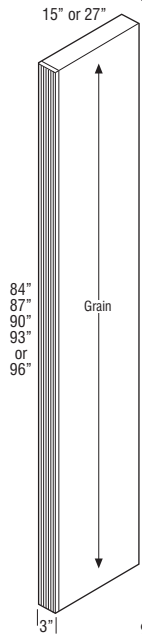

- T38415BCFB** (15" Deep)
- T38715BCFB** (15" Deep)
- T39015BCFB** (15" Deep)
- T39315BCFB** (15" Deep)
- T39615BCFB** (15" Deep)
- T38427BCFB** (27" Deep)
- T38727BCFB** (27" Deep)
- T39027BCFB** (27" Deep)
- T39327BCFB** (27" Deep)
- T39627BCFB** (27" Deep)

- Available in 1" depth increments from 6" to 27".
- Reversible, may be used on either left or right end.
- Front and both sides finished.
- Enclosed top and bottom.
- 1/2" plywood construction.
- Finished veneer on end panel exterior.
- No reveal on filler.

Custom Modifications

ID	RD
•	•

Finish Techniques

Distressing	Heirloom
	•

*ID only available on 15" deep.

Specie Availability

Alder	Rustic Alder	Cherry	Hickory	Maple	Oak	High Gloss Laminate	Textured Laminate	Textured PureStyle™	Thermofoil
•	•	•	•	•	•	box color	box color	box color	Maple

**BOX COLUMN FILLERS, 6" WIDE
Wall - Plain Column
15" Deep**

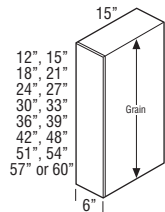

- W612BCFP**
- W615BCFP**
- W618BCFP**
- W621BCFP**
- W624BCFP**
- W627BCFP**
- W630BCFP**
- W633BCFP**
- W636BCFP**
- W639BCFP**
- W642BCFP**
- W648BCFP**
- W651BCFP**
- W654BCFP**
- W657BCFP**
- W660BCFP**

Custom Modifications

ID	RD
•	•

Finish Techniques

Distressing	Heirloom
•	

Specie Availability

Alder	Rustic Alder	Cherry	Hickory	Maple	Oak	High Gloss Laminate	Textured Laminate	Textured PureStyle™	Thermofoil
•	•	•	•	•	•	box color	box color	box color	Maple

DESCRIPTION

MODEL

**BOX COLUMN FILLERS,
6" WIDE (cont'd)
Wall - Fluted Column
15" Deep**

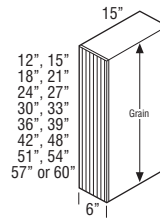

- W612BCFF**
- W615BCFF**
- W618BCFF**
- W621BCFF**
- W624BCFF**
- W627BCFF**
- W630BCFF**
- W633BCFF**
- W636BCFF**
- W639BCFF**
- W642BCFF**
- W648BCFF**
- W651BCFF**
- W654BCFF**
- W657BCFF**
- W660BCFF**

Custom Modifications

ID	RD
•	•

Finish Techniques

Distressing	Heirloom
	•

Specie Availability

Alder	Rustic Alder	Cherry	Hickory	Maple	Oak	High Gloss Laminate	Textured Laminate	Textured PureStyle™	Thermofoil
•	•	•	•	•	•	box color	box color	box color	Maple

**Wall - Beaded Column
15" Deep**

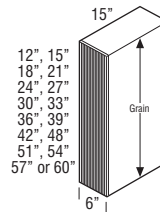

- W612BCFB**
- W615BCFB**
- W618BCFB**
- W621BCFB**
- W624BCFB**
- W627BCFB**
- W630BCFB**
- W633BCFB**
- W636BCFB**
- W639BCFB**
- W642BCFB**
- W648BCFB**
- W651BCFB**
- W654BCFB**
- W657BCFB**
- W660BCFB**

- Available in 1" depth increments from 6" to 27".
- Reversible, may be used on either left or right end.
- Front and both sides finished.
- Enclosed top and bottom.
- 1/2" plywood construction.
- Finished veneer on end panel exterior.
- No reveal on filler.

Custom Modifications

ID	RD
•	•

Finish Techniques

Distressing	Heirloom
	•

Specie Availability

Alder	Rustic Alder	Cherry	Hickory	Maple	Oak	High Gloss Laminate	Textured Laminate	Textured PureStyle™	Thermofoil
•	•	•	•	•	•	box color	box color	box color	Maple

DESCRIPTION

MODEL

BOX COLUMN FILLERS, 6" WIDE
Base - Plain, Fluted, Beaded Column
27" Deep

B634.527BCFP

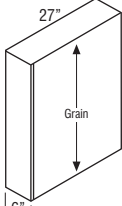

Plain

Custom Modifications		Finish Techniques	
ID	RD	Distressing	Heirloom
	•	•	

Specie Availability

Alder	Rustic Alder	Cherry	Hickory	Maple	Oak	High Gloss Laminate	Textured Laminate	Textured PureStyle™	Thermofoil
•	•	•	•	•	•	box color	box color	box color	Maple

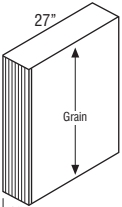

Fluted

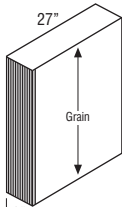

Beaded

B634.527BCFF

B634.527BCFB

- Available in 1" depth increments from 6" to 27".
- Reversible, may be used on either left or right end.
- Front and both sides finished.
- Enclosed top and bottom.
- 1/2" plywood construction.
- Finished veneer on end panel exterior.
- No reveal on filler.

Custom Modifications		Finish Techniques	
ID	RD	Distressing	Heirloom
	•		•

Specie Availability

Alder	Rustic Alder	Cherry	Hickory	Maple	Oak	High Gloss Laminate	Textured Laminate	Textured PureStyle™	Thermofoil
•	•	•	•	•	•	box color	box color	box color	Maple

BOX COLUMN FILLERS, 6" WIDE
Tall - Plain Column
15" & 27" Deep

T68415BCFP (15" Deep)

T68715BCFP (15" Deep)

T69015BCFP (15" Deep)

T69315BCFP (15" Deep)

T69615BCFP (15" Deep)

T68427BCFP (27" Deep)

T68727BCFP (27" Deep)

T69027BCFP (27" Deep)

T69327BCFP (27" Deep)

T69627BCFP (27" Deep)

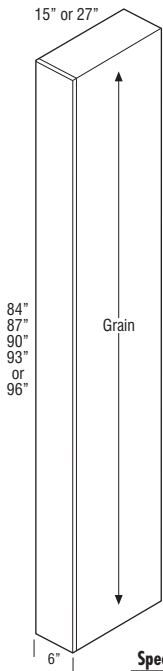

Custom Modifications		Finish Techniques	
ID	RD	Distressing	Heirloom
•*	•	•	

*ID only available on 15" deep.

Specie Availability

Alder	Rustic Alder	Cherry	Hickory	Maple	Oak	High Gloss Laminate	Textured Laminate	Textured PureStyle™	Thermofoil
•	•	•	•	•	•	box color	box color	box color	Maple

DESCRIPTION

MODEL

BOX COLUMN FILLERS,
6" WIDE (cont'd)
Tall - Fluted Column
15" & 27" Deep

T68415BCFF (15" Deep)

T68715BCFF (15" Deep)

T69015BCFF (15" Deep)

T69315BCFF (15" Deep)

T69615BCFF (15" Deep)

T68427BCFF (27" Deep)

T68727BCFF (27" Deep)

T69027BCFF (27" Deep)

T69327BCFF (27" Deep)

T69627BCFF (27" Deep)

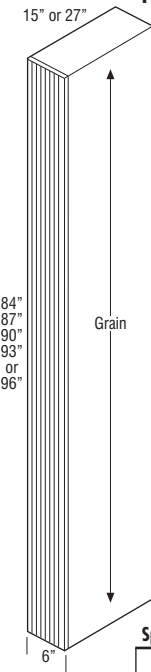

Custom Modifications		Finish Techniques	
ID	RD	Distressing	Heirloom
•*	•		•

*ID only available on 15" deep.

Specie Availability

Alder	Rustic Alder	Cherry	Hickory	Maple	Oak	High Gloss Laminate	Textured Laminate	Textured PureStyle™	Thermofoil
•	•	•	•	•	•	box color	box color	box color	Maple

Tall - Beaded Column
15" & 27" Deep

T68415BCFB (15" Deep)

T68715BCFB (15" Deep)

T69015BCFB (15" Deep)

T69315BCFB (15" Deep)

T69615BCFB (15" Deep)

T68427BCFB (27" Deep)

T68727BCFB (27" Deep)

T69027BCFB (27" Deep)

T69327BCFB (27" Deep)

T69627BCFB (27" Deep)

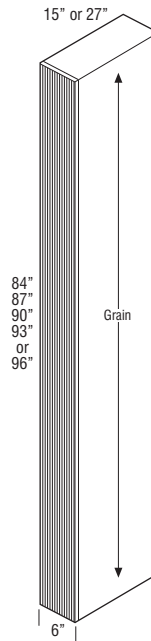

Custom Modifications		Finish Techniques	
ID	RD	Distressing	Heirloom
•*	•		•

*ID only available on 15" deep.

Specie Availability

Alder	Rustic Alder	Cherry	Hickory	Maple	Oak	High Gloss Laminate	Textured Laminate	Textured PureStyle™	Thermofoil
•	•	•	•	•	•	box color	box color	box color	Maple

WAINSCOTING, 34 1/2" or 40 1/2" HIGH

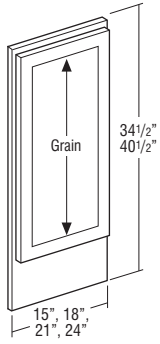

WAIN1534.5 WAIN1540.5
 WAIN1834.5 WAIN1840.5
 WAIN2134.5 WAIN2140.5
 WAIN2434.5 WAIN2440.5

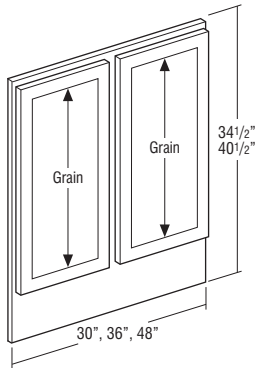

WAIN3034.5 WAIN3040.5
 WAIN3634.5 WAIN3640.5
 WAIN4834.5 WAIN4840.5

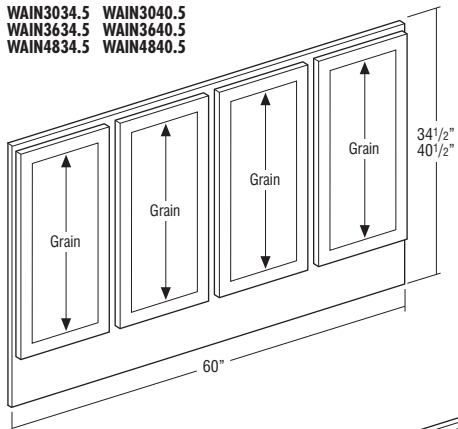

WAIN6034.5 WAIN6040.5

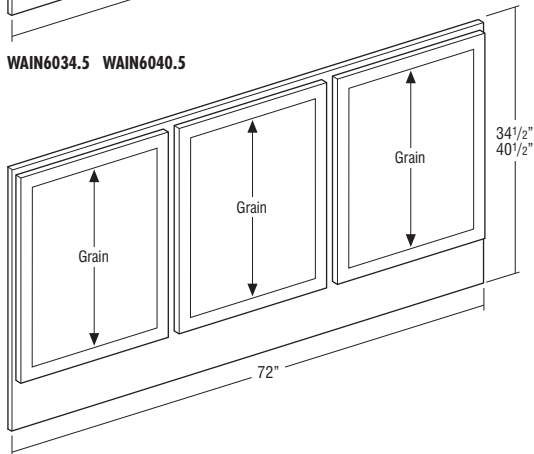

WAIN7234.5 WAIN7240.5

Model	Cubic Feet
WAIN1534.5	1.2
WAIN1834.5	1.4
WAIN2134.5	1.7
WAIN2434.5	1.9
WAIN1540.5	1.4
WAIN1840.5	1.7
WAIN2140.5	1.9
WAIN2440.5	2.2
WAIN3034.5	2.3
WAIN3634.5	2.8
WAIN4834.5	3.6
WAIN3040.5	2.7
WAIN3640.5	3.2
WAIN4840.5	7.3
WAIN6034.5	4.5
WAIN6040.5	5.3
WAIN7234.5	5.4
WAIN7240.5	6.3

- Full Overlay Styles only.
- Panel is 1 1/2" thick including doors. Non-operating doors are applied to 3/4" thick rail and stile frame.
- Flush Toe-kick standard.
- Wainscoting panel backs are not finished, but are sealed to prevent warping and cracking.
- All faces and edges will be finished.
- If order is placed in Arch/Cathedral door style, panel will have Square doors.
- For use on bars or islands, attach panel by securing the panel face frame through the inside of the applicable cabinet.
- For wall applications, the screw heads used for the panel face frame attachment to the wall can be concealed behind the doors and drawer fronts.

Product Code	Overall Width	Number of Doors	Number of Frame Center Stiles	Door Width
WAIN15..	15"	1	0	14 1/2"
WAIN18..	18"	1	0	17 1/2"
WAIN21..	21"	1	0	20 1/2"
WAIN24..	24"	1	0	23 1/2"
WAIN30..	30"	2	1	14 1/2"
WAIN36..	36"	2	1	17 1/2"
WAIN48..	48"	2	1	23 1/2"
WAIN60..	60"	4	3	14 1/2"
WAIN72..	72"	3	2	23 1/2"

Door height on 34 1/2" high panels is 29 1/2".
 Door height on 40 1/2" high panels is 35 1/2".

Custom Modifications

EXL	FTK	VTK
•	STD	•

Door Options

DPSRR
•

Finish Techniques

Distressing	Heirloom
•	•

CUSTOM HINGED DOORS

Custom Doors with Hinge Routing

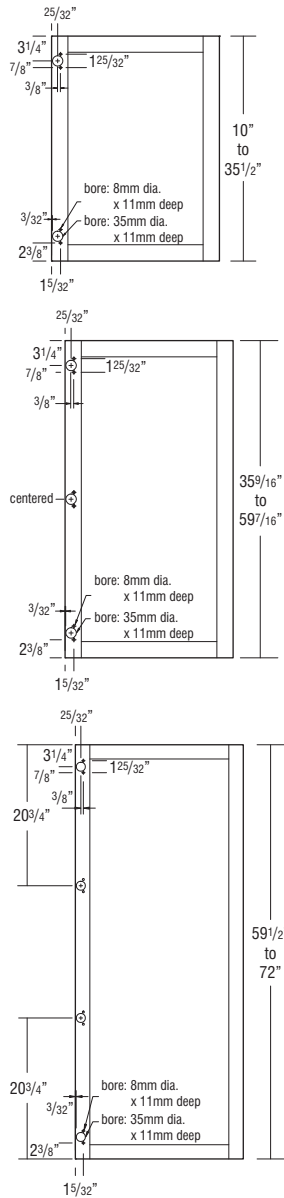

DOORB L

DOORB R

DOORW L

DOORW R

- Base doors (DOORB L and DOORB R) will always be square.
- Wall doors must specify square/cathedral/arch.
- Plastic mollies pressed in 8mm holes to accept screws to anchor the hinges to the back of these doors.
- Hinges must be ordered separately and specified full or partial overlay.
- Available in all door styles except Caprice, Genova, Shafer, Tara, Troxel, and Vaile. For Genova, Tara, and Troxel, use DOORSLAB (see page 351). For Caprice, Shafer, and Vaile, standard door sizes must be ordered.
- Doors are finished on both sides and routed for hinges.
- CG modification available, maximum size is 23 1/2" x 43".
- Custom dimensions are required when placing order and can be specified in 20/20 or on the order form.

Finish Techniques

Distressing	Heirloom
•	•

	Model	Door Style Type	Available Width Range*	Available Height Range
	DOORB.. and DOORW..	Non-Miter Square, Arch, or Cathedral Styles	7 1/2" to 23 3/4" (<3" wide rails/stiles) 8 1/2" to 23 3/4" (3" wide rails/stiles)	10" to 47 1/2" (<3" wide rails/stiles) 10" to 47 1/2" (3" wide rails/stiles)
	DOORB.. and DOORW..	Non-Miter Square, Arch, or Cathedral Styles	7 1/2" to 23 3/4" (<3" wide rails/stiles) 8 1/2" to 23 3/4" (3" wide rails/stiles)	47 9/16" to 72" (<3" wide rails/stiles) 47 9/16" to 72" (3" wide rails/stiles)
	DOORB.. and DOORW..	Non-Miter Square Styles	23 13/16" to 24" (<3" wide rails/stiles) 23 13/16" to 24" (3" wide rails/stiles)	10" to 47 1/2" (<3" wide rails/stiles) 10" to 47 1/2" (3" wide rails/stiles)
	DOORB.. and DOORW..	Non-Miter Square Styles	23 13/16" to 24" (<3" wide rails/stiles) 23 13/16" to 24" (3" wide rails/stiles)	47 9/16" to 72" (<3" wide rails/stiles) 47 9/16" to 72" (3" wide rails/stiles)
	DOORB.. and DOORW..	Miter Styles	8" to 24"	10" to 61"

*Any door with a minimum width dimension less than 10" will receive a flat center panel.

DESCRIPTION

MODEL

NEW Custom Doors with Hinge Routing, Slab Styles

DOORSLAB

- Available in slab door styles: Taro, Troxel, and Genova.
- Doors are finished on both sides and routed for hinges.
- Hinges must be ordered separately and specified full overlay.
- Plastic mollies pressed in 8mm holes to accept screws to anchor the hinges to the back of these doors.
- Custom dimensions are required when placing order and can be specified in 20/20 or on the order form.

Finish Techniques

Distressing	Heirloom
-------------	----------

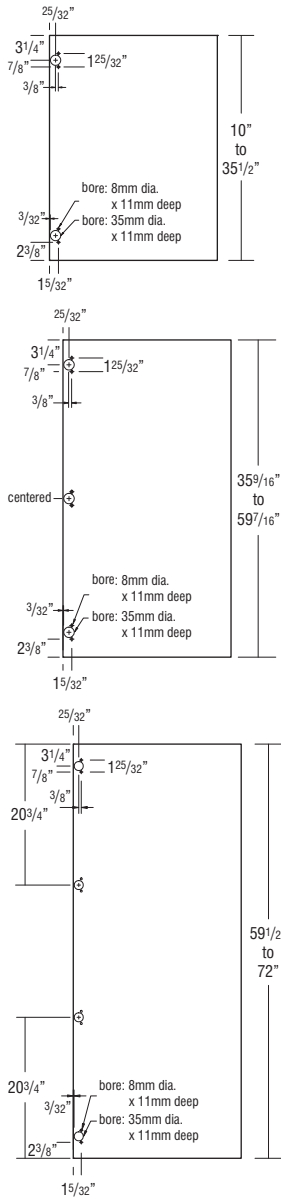

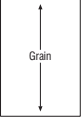
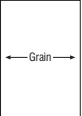
	Model	Door Style Type	Available Width Range	Available Height Range
	DOORSLAB	Vertical Grain or High Gloss	5" to 24"	10" to 72"
	DOORSLAB	Horizontal Grain	5" to 24"	10" to 48"

DESCRIPTION MODEL
DECORATIVE APPLIANCE PANELS

All custom panels and doors can be ordered through 20/20. For manual orders, please fax the order form to customer service. See page 354.
Due to customized ordering, Decorative Appliance Panels may not be returned.

Custom Panels & Doors (DAPNL.. and DADOOR..) square footage requirements are calculated by multiplying the height and width for each panel and door (square footage = width x height (in inches)/144).

Custom Panels

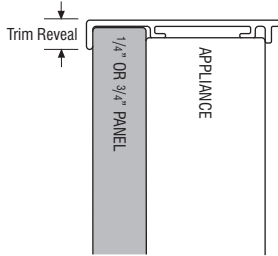

DAPNL1/4
DAPNL3/4

- DAPNL1/4 includes 1/4" finished veneer on MDF core, panel cut to fit appliance doors. Panels mount to the appliance using trim kits provided by the appliance supplier.
- DAPNL1/4 is finished on face only, edges are not finished.
- DAPNL3/4 kit includes 3/4" furniture board core veneer panel finished on both sides, and all four edges. Panel is cut to fit appliance doors, and mounts to the appliance using trim kits provided by the appliance supplier.
- Custom sizes available in 1/16" increments.
- DAPNL3/4 can be ordered in APC.

	Maximum Width	Minimum Width	Maximum Height	Minimum Height
DAPNL1/4	48"	5"	96"	5"
DAPNL3/4*	48"	5"	48"	5"
DAPNL3/4**	30"	5"	96"	5"

*If DAPNL3/4 is 48" high or less
**If DAPNL3/4 is greater than 48" high
Grain on panels will follow the height dimension (vertical)

Finish Techniques

Distressing	Heirloom

Specie Availability

Alder	Rustic Alder	Cherry	Hickory	Maple	Oak	High Gloss Laminate	Textured Laminate	Textured PureStyle™	Thermofoil
•	•	•	•	•	•	box color	box color	box color	Maple

DESCRIPTION MODEL
Custom Panels, Premium

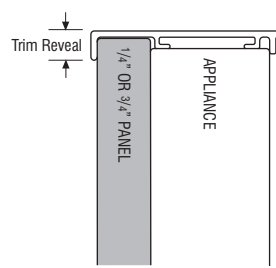

DAPNL1/4P
DAPNL3/4P
DAPNL1/4HGP
DAPNL3/4HGP

- DAPNL1/4P and DAPNL1/4HGP are 1/4" thick laminated MDF panels cut to fit appliance doors. Laminated on face only, edges are not finished.
- DAPNL3/4P and DAPNL3/4HGP are 3/4" thick laminated MDF panels. Vertical and horizontal grain panels are laminated on both sides with edgebanding on all four edges. High Gloss panels have high gloss on front of panel, back of panel is white melamine. Edgebanding on all four edges will match door and drawer front edgebanding selection.
- DAPNL1/4P and DAPNL3/4P are available for use with Genova or Shafer featuring vertical grain or with Taro featuring high gloss.
- DAPNL1/4HGP and DAPNL3/4HGP are available for use with Troxel featuring horizontal grain.
- Panel is cut to fit appliance doors, and mounts to the appliance using trim kits provided by the appliance supplier.
- Custom sizes available in 1/16" increments.

Model	Panel Type	Maximum Width	Minimum Width	Maximum Height	Minimum Height
DAPNL1/4P	Vertical Grain or High Gloss	48"	5"	96"	5"
DAPNL3/4P (48" high or less)	Vertical Grain or High Gloss	48"	5"	48"	5"
DAPNL3/4P (>48" high)	Vertical Grain or High Gloss	30"	5"	96"	5"
DAPNL1/4HGP	Horizontal Grain	96"	5"	48"	5"
DAPNL3/4HGP	Horizontal Grain	48"	5"	48"	5"
DAPNL3/4HGP (>48" wide)	Horizontal Grain	96"	5"	30"	5"

Finish Techniques

Distressing	Heirloom

Specie Availability

Alder	Rustic Alder	Cherry	Hickory	Maple	Oak	High Gloss Laminate	Textured Laminate	Textured PureStyle™	Thermofoil
						•	•	•	

Custom Doors

Overlay Application (with Backer Panel)

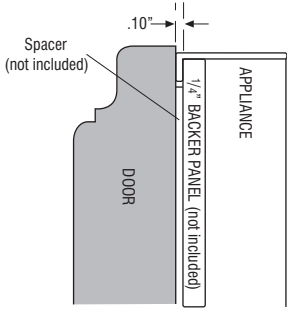

Overlay Application (no Backer Panel)

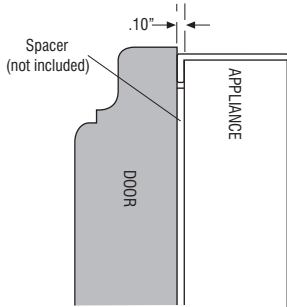

Framed Application

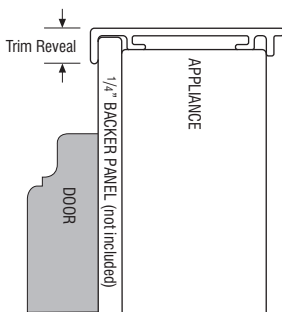

**Square Profile:
DADOORB**

**Arch/Cathedral Profile:
DADOORW**

**Horizontal Grain, Square Profile:
DADOORHG**

- DADOORB is a custom sized door with a square door profile (Arch & Cathedral styles will always be square).
- DADOORW is a custom sized door with the door profile matching the selected door style profile (Arch & Cathedral styles will be Arch/Cathedral)
- DADOORHG is a custom sized door with a square door profile (even when ordered in an Arch or Cathedral style). Stiles and rails are built as doors with a single center panel.
- DADOORHG center panel grain runs horizontal.
- DADOORHG will utilize a flat panel on raised panel styles when width or height is less than 10".
- Includes a 3/4" thick door made to a custom size for the appliance front. No backer panel included.
 - Some appliances require a .10" spacer and/or a 1/4" backer panel.
 - The 1/4" backer panel may be ordered separately (see DAPNL1/4).
- All doors will be specified "NO HINGE ROUTE". Backs may have identification marks, be unfinished, and have 3/16" diameter holes used during finish processing. For these reasons, these doors are not suitable for use as cabinet doors.
- DADOORB and DADOORW not available in Caprice, Genova, Shafer, Taro, Troxel, and Vaile. DADOORHG not available in Caprice, Genova, Lynnville, Shafer, Taro, Troxel, and Vaile. For Decorative Appliance Panels, standard door sizes must be ordered.
- Custom sizes available in 1/16" increments.
- CG modification available, maximum size is 23 1/2" x 43" for DADOORB and DADOORW, and 43" x 23 1/2" for DADOORHG.

Finish Techniques

Distressing	Heirloom
•	•

	Model	Door Style Type	Available Width Range*	Available Height Range*
	DADOORB and DADOORW	Non-Miter Square, Arch, or Cathedral Styles	7 1/2" to 23 3/4" (<3" wide rails/stiles) 8 1/2" to 23 3/4" (3" wide rails/stiles)	7 1/2" to 47 1/2" (<3" wide rails/stiles) 8 1/2" to 47 1/2" (3" wide rails/stiles)
	DADOORB and DADOORW	Non-Miter Square, Arch, or Cathedral Styles	7 1/2" to 23 3/4" (<3" wide rails/stiles) 8 1/2" to 23 3/4" (3" wide rails/stiles)	47 9/16" to 72" (<3" wide rails/stiles) 47 9/16" to 72" (3" wide rails/stiles)
	DADOORB and DADOORW	Non-Miter Square Styles	23 13/16" to 35 3/4" (<3" wide rails/stiles) 23 13/16" to 35 3/4" (3" wide rails/stiles)	7 1/2" to 47 1/2" (<3" wide rails/stiles) 8 1/2" to 47 1/2" (3" wide rails/stiles)
	DADOORB and DADOORW	Non-Miter Square Styles	23 13/16" to 35 3/4" (<3" wide rails/stiles) 23 13/16" to 35 3/4" (3" wide rails/stiles)	47 9/16" to 72" (<3" wide rails/stiles) 47 9/16" to 72" (3" wide rails/stiles)
	DADOORB and DADOORW	Miter Styles	8" to 24"	8" to 61"
	DADOORHG	Non-Miter Square Styles	7 1/2" to 42 1/4" (<3" wide rails/stiles) 8 1/2" to 42 1/4" (3" wide rails/stiles)	7 1/2" to 23 3/4" (<3" wide rails/stiles) 8 1/2" to 23 3/4" (3" wide rails/stiles)
	DADOORHG	Miter Styles	8" to 61"	8" to 24"

*Any door with a minimum width or height dimension less than 10" will receive a flat center panel.

DECORATIVE APPLIANCE PANEL ORDER FORM

Use one order form per appliance.

Refer to Spec Book for door style availability, door style limitations and center panel configurations.

STEP 1: Provide Order Information*

Account #: _____
 Date: _____
 Bill To: _____

PO #: _____
 Order #: _____
 Ship To: _____

STEP 2: Appliance Application or No Appliance* — Circle Choice (For appliance applications, circle one appliance type below per order form)

Appliance Brand Name and Model Number _____

Refrigerator/Freezer

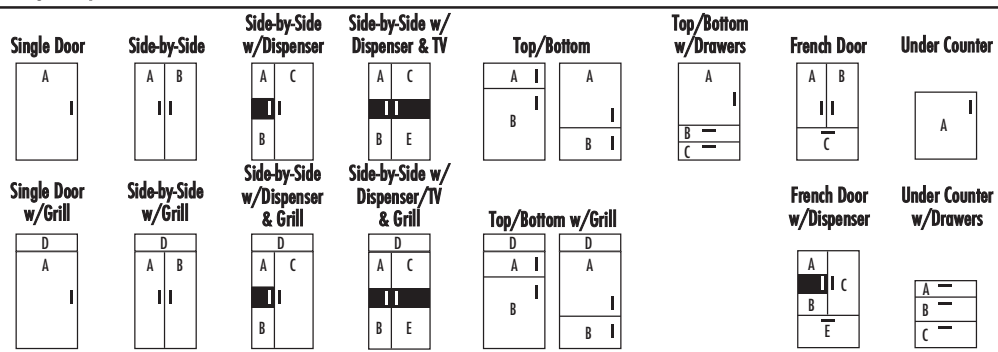

Dishwasher/Trash Compactor/
Ice Maker/Wine Cooler

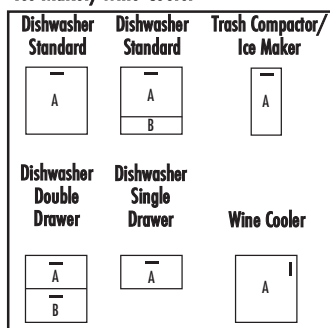

STEP 3: Provide Dimensions in Inches for Panels and/or Doors Needed as Listed Above*

Custom Panels — Dimensions for Custom Size Panel(s) and/or Door(s)

DAPNL1/4, DAPNL1/4P, DAPNL3/4, DAPNL3/4P, DAPNL1/4HGP, or DAPNL3/4HGP — Circle Choice

A _____ in. width x _____ in. height = _____ square inches
 B _____ in. width x _____ in. height = _____ square inches
 C _____ in. width x _____ in. height = _____ square inches
 D _____ in. width x _____ in. height = _____ square inches
 E _____ in. width x _____ in. height = _____ square inches

} total square inches

Standard or Custom Doors — Circle Choice

Standard Door Sizes — Dimensions for Panels with Standard Door Sizes (Chosen by Manufacturer)

*Supply overall dimensions (width and height for each panel only). Doors will be selected by manufacturer to best fit panel dimensions.

DADOORB (Square Profile) and/or DADOORW (Arch/Cathedral Profile) and/or DADOORHG (Horizontal Grain, Square Profile) — Circle Door Choice Below For Each Door

DADOORB or DADOORW or DADOORHG _____ in. width x _____ in. height = _____ square inches
 DADOORB or DADOORW or DADOORHG _____ in. width x _____ in. height = _____ square inches
 DADOORB or DADOORW or DADOORHG _____ in. width x _____ in. height = _____ square inches
 DADOORB or DADOORW or DADOORHG _____ in. width x _____ in. height = _____ square inches
 DADOORB or DADOORW or DADOORHG _____ in. width x _____ in. height = _____ square inches

} total square inches

*ALL FIELDS REQUIRED TO PROCESS ORDER.

DESCRIPTION
PANELS & SKINS

MODEL

END PANEL SKINS, BASE

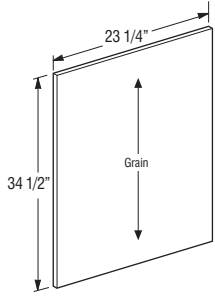

1/4" Finished

BEPS34.5WD

1/8" White Laminate

BEPS34.5LAM18 ♦

- Stains: 1/4" thick veneered furniture board.
- Opaques: 1/4" thick veneered or solid furniture board.
- 1/8" thick laminated furniture board.
- 1/4" (WD) skins recommended for use with PFINBTMB modification.

Custom Modifications

ID	RD
•	•

Finish Techniques

Distressing	Heirloom

Specie Availability

Alder	Rustic Alder	Cherry	Hickory	Maple	Oak	High Gloss Laminate	Textured Laminate	Textured PureStyle™	Thermofoil
•	•	•	•	•	•	box color	box color	box color	Maple

♦ Only available in White laminate.

END PANEL SKINS, PREMIUM - BASE

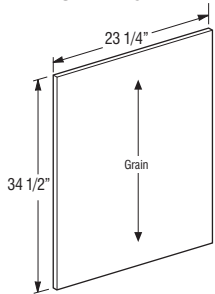

BEPS34.5P

- 1/4" thick laminated MDF.
- Not compatible with FPEB.
- High Gloss panels do not have grain.
- 1/4" skins recommended for use with PFINBTMB modification.

Custom Modifications

ID	RD
•	•

Finish Techniques

Distressing	Heirloom

Specie Availability

Alder	Rustic Alder	Cherry	Hickory	Maple	Oak	High Gloss Laminate	Textured Laminate	Textured PureStyle™	Thermofoil
						•		•	

DESCRIPTION

MODEL

END PANEL SKINS, TALL



1/4" Finished

TEPS1248WD

TEPS1296WD†

TEPS12102WD† ♦♦

TEPS12108WD† ♦♦

TEPS12120WD† ♦♦

1/8" White Laminate

TEPS1248LAM18 ♦

TEPS1296LAM18† ♦

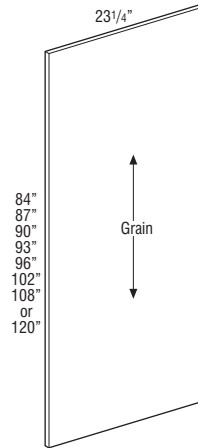
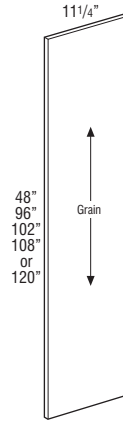

1/4" Finished

TEPS84WD†

TEPS87WD†

TEPS90WD†

TEPS93WD†

TEPS96WD†

TEPS102WD† ♦♦

TEPS108WD† ♦♦

TEPS120WD† ♦♦

1/8" White Laminate

TEPS84LAM18† ♦

TEPS87LAM18† ♦

TEPS90LAM18† ♦

TEPS93LAM18† ♦

TEPS96LAM18† ♦

- Stains: 1/4" thick veneered furniture board.
- Opaques: 1/4" thick veneered or solid furniture board.
- 1/8" thick laminated furniture board.
- 1/4" (WD) skins recommended for use with PFINBTMB modification.

†5 day Express Response not available on items greater than 48".

Custom Modifications

ID	RD
•	•

Finish Techniques

Distressing	Heirloom

Specie Availability

Alder	Rustic Alder	Cherry	Hickory	Maple	Oak	High Gloss Laminate	Textured Laminate	Textured PureStyle™	Thermofoil
•	•	•	•	•	•	box color	box color	box color	Maple

♦ Only available in White laminate.

♦♦ Only available in Cherry and Maple.

DESCRIPTION

END PANEL SKINS, PREMIUM - TALL

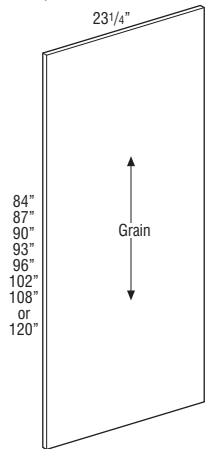
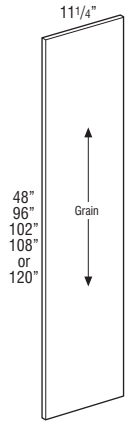

MODEL

- TEPS1248P
- TEPS1296P[†]
- TEPS12102P[†]
- TEPS12108P[†]
- TEPS12120P[†]

- TEPS84P[†]
- TEPS87P[†]
- TEPS90P[†]
- TEPS93P[†]
- TEPS96P[†]
- TEPS102P[†]
- TEPS108P[†]
- TEPS120P[†]

- 1/4" thick laminated MDF.
- Not compatible with FPEB.
- High Gloss panels do not have grain.
- 15 day Express Response not available on items greater than 48"
- 1/4" skins recommended for use with PFINBTMB modification.

Custom Modifications		Finish Techniques	
ID	RD	Distressing	Heirloom
•	•		

Specie Availability

Alder	Rustic Alder	Cherry	Hickory	Maple	Oak	High Gloss Laminate	Textured Laminate	Textured PureStyle™	Thermofoil
•						•		•	

END PANEL SKINS, WALL

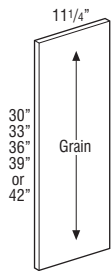

- 1/4" Finished
- WEPS30WD
- WEPS33WD
- WEPS36WD
- WEPS39WD
- WEPS42WD
- 1/8" White Laminate
- WEPS30LAM18 ♦
- WEPS33LAM18 ♦
- WEPS36LAM18 ♦
- WEPS39LAM18 ♦
- WEPS42LAM18 ♦

- Stains: 1/4" thick veneered furniture board.
- Opaques: 1/4" thick veneered or solid furniture board.
- 1/8" thick laminated furniture board.
- Not compatible with Furniture Ends (FPEB).
- 1/4" (WD) skins recommended for use with PFINBTMB modification.

Custom Modifications		Finish Techniques	
ID	RD	Distressing	Heirloom
•	•		

Specie Availability

Alder	Rustic Alder	Cherry	Hickory	Maple	Oak	High Gloss Laminate	Textured Laminate	Textured PureStyle™	Thermofoil
•	•	•	•	•	•	•	•	•	•

♦ Only available in White laminate.

DESCRIPTION

END PANEL SKINS, PREMIUM - WALL

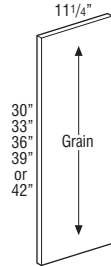

MODEL

- WEPS30P
- WEPS33P
- WEPS36P
- WEPS39P
- WEPS42P

- 1/4" thick laminated MDF.
- Not compatible with FPEB.
- High Gloss panels do not have grain.
- 1/4" skins recommended for use with PFINBTMB modification.

Custom Modifications		Finish Techniques	
ID	RD	Distressing	Heirloom
•	•		

Specie Availability

Alder	Rustic Alder	Cherry	Hickory	Maple	Oak	High Gloss Laminate	Textured Laminate	Textured PureStyle™	Thermofoil
						•		•	

FINISHED BACK SKINS

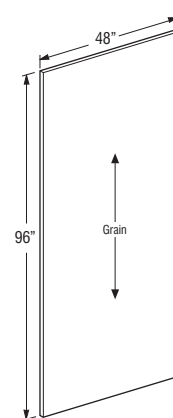
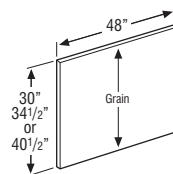

1/4" Finished

- BP4830WD
- BP4834.5WD
- BP4840.5WD
- 1/8" White Laminate
- BP4830LAM18 ♦
- BP4834.5LAM18 ♦
- BP4840.5LAM18 ♦

1/4" Finished

- BP4896WD[†]
- 1/4" Natural Maple Laminate
- BP4896LAM18 ♦ ♦
- 1/8" White Laminate
- BP4896LAM18[†] ♦

- Stains: 1/4" thick veneered furniture board.
- Opaques: 1/4" thick veneered or solid furniture board.
- 1/4" or 1/8" thick laminated furniture board.
- For custom sizes refer to DAPNL 1/4.
- 15 day Express Response not available on items greater than 48".

Custom Modifications		Finish Techniques	
ID	RD	Distressing	Heirloom

Specie Availability

Alder	Rustic Alder	Cherry	Hickory	Maple	Oak	High Gloss Laminate	Textured Laminate	Textured PureStyle™	Thermofoil
•	•	•	•	•	•	•	•	•	•

- ♦ Only available in White laminate.
- ♦♦ Only available in Natural Maple laminate.

DESCRIPTION

MODEL

FINISHED BACK SKINS, PREMIUM



BP4830P
BP4834.5P
BP4840.5P

BP4896P†

- 1/4" thick laminated MDF.
 - High Gloss panels do not have grain.
 - Not compatible with FPFB.
- †5 day Express Response not available on items greater than 48"

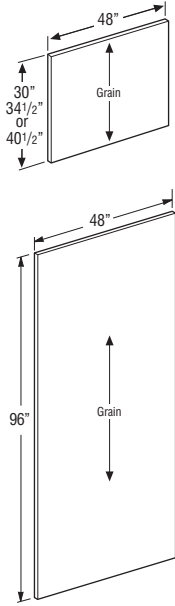

Custom Modifications

ID	RD

Finish Techniques

Distressing	Heirloom

Specie Availability

Alder	Rustic Alder	Cherry	Hickory	Maple	Oak	High Gloss Laminate	Textured Laminate	Textured PureStyle™	Thermofoil
						•		•	

CROSS GRAIN VENEER BACK SKIN 1/4" PANELS

BP9634.5CRSGR
BP9640.5CRSGR
BP9648CRSGR

- Veneer on MDF core.
- When ordered in opaque finishes, panels will use vertical grain as grain will not be visible.

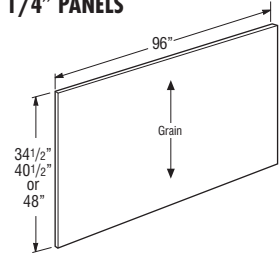

Custom Modifications

ID	RD

Finish Techniques

Distressing	Heirloom

Specie Availability

Alder	Rustic Alder	Cherry	Hickory	Maple	Oak	High Gloss Laminate	Textured Laminate	Textured PureStyle™	Thermofoil
•	Alder	•	•	•	•	box color	box color	box color	Maple

WOOD V-GROOVED BEADED SKIN 1/4" PANELS



BP4830VG
BP4834.5VG
BP4896VG†

- Veneer on MDF core.
 - V-groove on 3" centers.
 - When used as a skin, not compatible in conjunction with Furniture Ends (FPFB) or Authentic Ends (AUTHL/AUTHR).
- †5 day Express Response not available on items greater than 48"

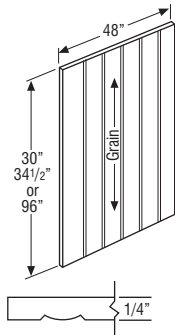

Custom Modifications

ID	RD

Finish Techniques

Distressing	Heirloom
	•

Specie Availability

Alder	Rustic Alder	Cherry	Hickory	Maple	Oak	High Gloss Laminate	Textured Laminate	Textured PureStyle™	Thermofoil
•	Alder	•	•	•	•	box color	box color	box color	Maple

DESCRIPTION

MODEL

HORIZONTAL GRAIN 1/4" SKIN, PREMIUM



14PANEL11.2530P
14PANEL11.2548P

14PANEL2334.5P

14PANEL4830P
14PANEL4834.5P
14PANEL4848P

14PANEL9634.5P†
14PANEL9648P†

- 1/4" thick laminated MDF.
 - Not compatible with FPFB.
- †5 day Express Response not available on items greater than 48"

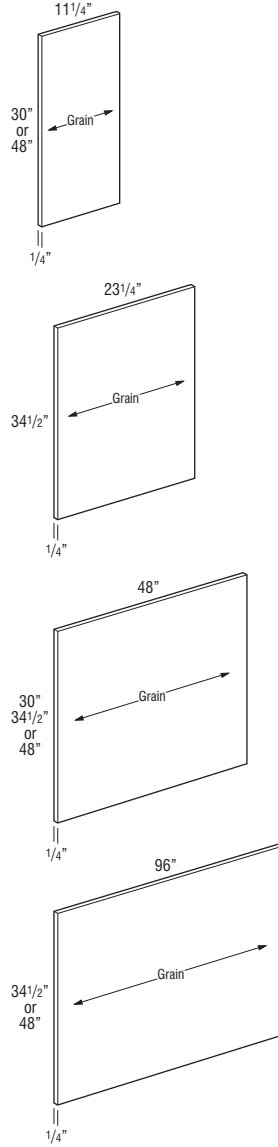

Custom Modifications

ID	RD

Finish Techniques

Distressing	Heirloom

Specie Availability

Alder	Rustic Alder	Cherry	Hickory	Maple	Oak	High Gloss Laminate	Textured Laminate	Textured PureStyle™	Thermofoil
							•		

DESCRIPTION

**HORIZONTAL GRAIN
3/4" PANEL, PREMIUM**



MODEL

34PANEL1230P

34PANEL1248P

34PANEL2434.5P

34PANEL4812P

34PANEL4834.5P

34PANEL4848P

34PANEL9612P†

34PANEL9624P†

34PANEL9630P†

- 3/4" thick laminated MDF.
 - Not compatible with FPFB.
 - 34PANEL4812P and 34PANEL9612P recommended for exterior shelf material.
 - Edgebanded on one short side and one long side only. Other edges will require moulding if exposed.
- †5 day Express Response not available on items greater than 48"

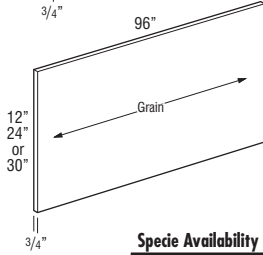
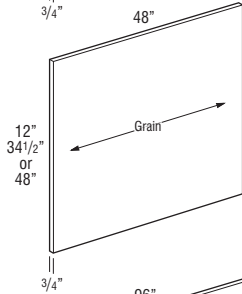
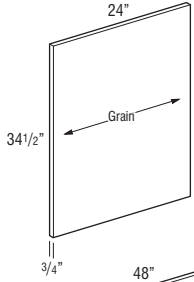
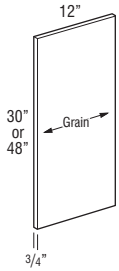

Custom Modifications

ID	RD

Finish Techniques

Distressing	Heirloom

Specie Availability

Alder	Rustic Alder	Cherry	Hickory	Maple	Oak	High Gloss Laminate	Textured Laminate	Textured PureStyle™	Thermofoil
							•		

END PANELS, WALL



3/4" Finished

WEP1230WD

3/4" White Laminate

WEP1230LAM ♦

- WEP1230WD in Stains: 3/4" thick veneered furniture board.
- WEP1230WD in Opaques: 3/4" thick veneered or solid furniture board.
- WEP1230LAM is 3/4" thick laminated furniture board (white only).
- Panels are finished on two sides and front edge.

Custom Modifications

ID	RD	APC	MIP
Laminate	•	•	
Wood	•	•	

Finish Techniques

Distressing	Heirloom

Specie Availability

Alder	Rustic Alder	Cherry	Hickory	Maple	Oak	High Gloss Laminate	Textured Laminate	Textured PureStyle™	Thermofoil
• Alder		•	•	•	•	box color	box color	box color	Maple

♦ Only available in White laminate.

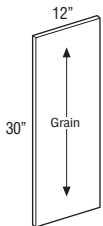

DESCRIPTION

**END PANELS,
PREMIUM - WALL**



WEP1230P

- 3/4" thick laminated MDF.
- High Gloss panels will have high gloss on front of panel and back of panel will be white melamine. Panels are finished on two sides and front edge.
- High Gloss panels do not have grain.

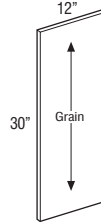

Custom Modifications

ID	RD	APC	MIP
•	•		

Finish Techniques

Distressing	Heirloom

Specie Availability

Alder	Rustic Alder	Cherry	Hickory	Maple	Oak	High Gloss Laminate	Textured Laminate	Textured PureStyle™	Thermofoil
						•		•	

END PANELS, BASE



3/4" Finished

BEPWD

3/4" White Laminate

BEPLAM ♦

- BEPWD in Stains: 3/4" thick veneered furniture board.
- BEPWD in Opaques: 3/4" thick veneered or solid furniture board.
- BEPLAM is 3/4" thick laminated furniture board (white only).
- Panels are finished on two sides and front edge.

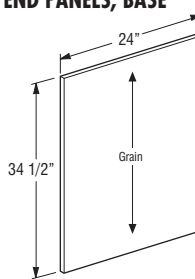

Custom Modifications

ID	RD	APC	MIP
Laminate	•	•	
Wood	•	•	

Finish Techniques

Distressing	Heirloom

Specie Availability

Alder	Rustic Alder	Cherry	Hickory	Maple	Oak	High Gloss Laminate	Textured Laminate	Textured PureStyle™	Thermofoil
• Alder		•	•	•	•	box color	box color	box color	Maple

♦ Only available in White laminate.

**END PANELS,
PREMIUM - BASE**



BEPP

- 3/4" thick laminated MDF.
- High Gloss panels will have high gloss on front of panel and back of panel will be white melamine. Edgebanding on front edge will match door and drawer front edgebanding selection.
- High Gloss panels do not have grain.

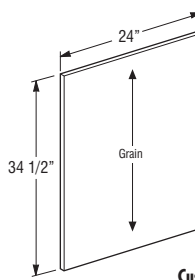

Custom Modifications

ID	RD	APC	MIP
•	•		

Finish Techniques

Distressing	Heirloom

Specie Availability

Alder	Rustic Alder	Cherry	Hickory	Maple	Oak	High Gloss Laminate	Textured Laminate	Textured PureStyle™	Thermofoil
						•		•	

DESCRIPTION

END PANELS, LAZY SUSAN

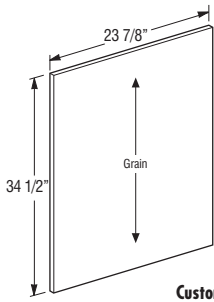

MODEL

1/2" Finished

BLSBEPWD

1/2" White Laminate

BLSBEPLAM ♦

- BLSBEPWD panels have veneer finished exterior and Natural Maple laminate interior. Specify MIP for veneered interior or APC for clear coated hardwood veneer.
- BLSBEPLAM panels have White laminated exterior and interior.

Custom Modifications

	ID	RD	APC	MIP
Laminate	•	•		
Wood	•	•	•	•

Finish Techniques

Distressing	Heirloom

Specie Availability

Alder	Rustic Alder	Cherry	Hickory	Maple	Oak	High Gloss Laminate	Textured Laminate	Textured PureStyle™	Thermofoil
•	•	•	•	•	•	box color	box color	box color	Maple

♦ Only available in White laminate.

DESCRIPTION

END PANELS, TALL

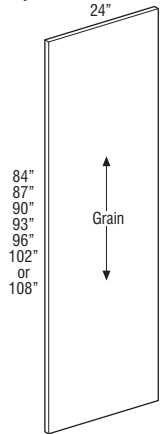
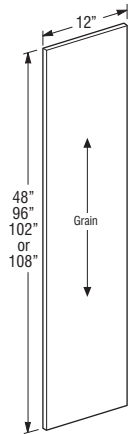

MODEL

3/4" Finished

TEP1248WD

TEP1296WD†

TEP12102WD† ♦♦

TEP12108WD† ♦♦

3/4" White Laminate

TEP1248LAM ♦

TEP1296LAM† ♦

3/4" Finished

TEP2484WD†▲

TEP2487WD†▲

TEP2490WD†▲

TEP2493WD†▲

TEP2496WD†▲

TEP24102WD† ♦♦

TEP24108WD† ♦♦

3/4" White Laminate

TEP2484LAM† ♦

TEP2487LAM† ♦

TEP2490LAM† ♦

TEP2493LAM† ♦

TEP2496LAM† ♦

- TEP_ _WD in Stains: 3/4" thick veneered furniture board.
- TEP_ _WD in Opaques: 3/4" thick veneered or solid furniture board.
- TEP_ _LAM is 3/4" thick laminated furniture board (white only).
- Panels are finished on two sides and front edge.
- 102" and 108" will have APC and MIP standard.
- †5 day Express Response not available on items greater than 48".

Custom Modifications

	ID	RD	APC	MIP
Laminate	•	•		
Wood	•▲	•	•	

Finish Techniques

Distressing	Heirloom

▲Tall wood panels will be plywood when ID31-ID36 is specified.

Specie Availability

Alder	Rustic Alder	Cherry	Hickory	Maple	Oak	High Gloss Laminate	Textured Laminate	Textured PureStyle™	Thermofoil
•	•	•	•	•	•	box color	box color	box color	Maple

♦ Only available in White laminate.

♦♦ Only available in Cherry and Maple.

DESCRIPTION

MODEL

END PANELS, PREMIUM - TALL



- TEP1248P
- TEP1296P†
- TEP12102P†
- TEP12108P†

- TEP2484P†
- TEP2487P†
- TEP2490P†
- TEP2493P†
- TEP2496P†
- TEP24102P†
- TEP24108P†

- 3/4" thick laminated MDF.
 - High Gloss panels will have high gloss on front of panel and back of panel will be white melamine. Edgebanding on front edge will match door and drawer front edgebanding selection.
 - High Gloss panels do not have grain.
- †5 day Express Response not available on items greater than 48"

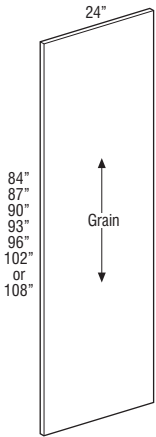
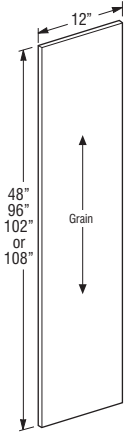

Custom Modifications

ID	RD	APC	MIP
•*	•		

Finish Techniques

Distressing	Heirloom

*ID available on TEP2484P-TEP2496P up to 30".
ID not available on TEP24102P and TEP24108P.

Specie Availability

	Rustic Alder	Cherry	Hickory	Maple	Oak	High Gloss Laminate	Textured Laminate	Textured PureStyle™	Thermofoil
	•					•		•	

END PANELS, VANITY

3/4" Finished

- VBEP2129WD
- VBEP2132WD

3/4" White Laminate

- VBEP2129LAM ♦
- VBEP2132LAM ♦

- VBEP_ _WD in Stains: 3/4" thick veneered furniture board.
- VBEP_ _WD in Opaques: 3/4" thick veneered or solid furniture board.
- VBEP_ _LAM is 3/4" thick laminated furniture board (white only).
- Panels are finished on two sides and front edge.

Custom Modifications

	ID	RD	APC	MIP
Laminate	•	•		
Wood	•	•	•	

Finish Techniques

Distressing	Heirloom

Specie Availability

	Rustic Alder	Cherry	Hickory	Maple	Oak	High Gloss Laminate	Textured Laminate	Textured PureStyle™	Thermofoil
•	•	•	•	•	•	box color	box color	box color	Maple

♦ Only available in White laminate.

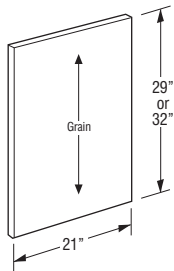

DESCRIPTION

MODEL

WALL PANEL with FILLER ATTACHED



1/2" Finished

- WEP1230F1.5WD
- WEP1230F3WD
- WEP1233F1.5WD
- WEP1233F3WD
- WEP1236F1.5WD
- WEP1236F3WD
- WEP1239F1.5WD
- WEP1239F3WD
- WEP1242F1.5WD
- WEP1242F3WD

1/2" White Laminate

- WEP1230F1.5LAM ♦
- WEP1230F3LAM ♦
- WEP1233F1.5LAM ♦
- WEP1233F3LAM ♦
- WEP1236F1.5LAM ♦
- WEP1236F3LAM ♦
- WEP1239F1.5LAM ♦
- WEP1239F3LAM ♦
- WEP1242F1.5LAM ♦
- WEP1242F3LAM ♦

- WEP_ _F_WD in Stains: 1/2" thick veneered furniture board.
- WEP_ _F_WD in Opaques: 1/2" thick veneered or solid furniture board.
- WD panels have Natural Maple laminate interior. **Specify MIP for veneered interior or APC for clear coated hardwood veneer.**
- WEP_ _F_LAM is 1/2" thick laminated furniture board (white only, exterior and interior).

Custom Modifications

	ID	RD	APC	MIP	WLI
Laminate	•	•			•
Wood	•	•	•	•	•

Finish Techniques

Distressing	Heirloom
•*	

*Distressing on filler only, not on panel. Not available on laminate panels.

Specie Availability

	Rustic Alder	Cherry	Hickory	Maple	Oak	High Gloss Laminate	Textured Laminate	Textured PureStyle™	Thermofoil
•	•	•	•	•	•	box color	box color	box color	Maple

♦ Only available in White laminate.

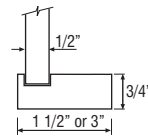
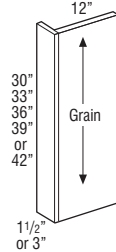

DESCRIPTION

BASE and TALL PANELS with FILLER ATTACHED

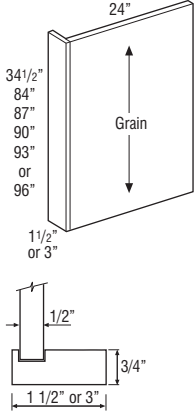

MODEL



1/2" Finished
BEPF1.5WD
BEPF3WD
 1/2" White Laminate
BEPF1.5LAM ♦
BEPF3LAM ♦

1/2" Finished
TEP2484F1.5WD †
TEP2484F3WD †
TEP2487F1.5WD †
TEP2487F3WD †
TEP2490F1.5WD †
TEP2490F3WD †
TEP2493F1.5WD †
TEP2493F3WD †
TEP2496F1.5WD †
TEP2496F3WD †

1/2" White Laminate
TEP2484F1.5LAM † ♦
TEP2484F3LAM † ♦
TEP2487F1.5LAM † ♦
TEP2487F3LAM † ♦
TEP2490F1.5LAM † ♦
TEP2490F3LAM † ♦
TEP2493F1.5LAM † ♦
TEP2493F3LAM † ♦
TEP2496F1.5LAM † ♦
TEP2496F3LAM † ♦

- BEP_ _F_WD and TEP_ _F_WD in Stains: 1/2" thick veneered furniture board.
- BEP_ _F_WD and TEP_ _F_WD in Opaques: 1/2" thick veneered or solid furniture board.
- WD panels have Natural Maple laminate interior. **Specify MIP for veneered interior or APC for clear coated hardwood veneer.**
- BEP_ _F_LAM and TEP_ _F_LAM is 1/2" thick laminated furniture board (white only, exterior and interior).

†5 day Express Response not available on items greater than 48".

Custom Modifications

	ID	RD	APC	MIP	WLI
Laminate	•	•			•
Wood	•	•	•	•	•

Finish Techniques

Distressing	Heirloom
•*	

*Distressing on filler only, not on panel. Not available on laminate panels.

Specie Availability

Alder	Rustic Alder	Cherry	Hickory	Maple	Oak	High Gloss Laminate	Textured Laminate	Textured PureStyle™	Thermofoil
•	•	•	•	•	•	box color	box color	box color	Maple

♦ Only available in White laminate.

DESCRIPTION

WALL PANEL with FILLER ATTACHED and FURNITURE ENDS

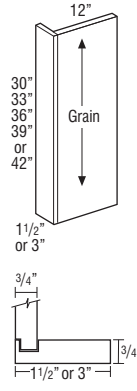

MODEL

WEP1230F1.5FPE
WEP1230F3FPE
WEP1233F1.5FPE
WEP1233F3FPE
WEP1236F1.5FPE
WEP1236F3FPE
WEP1239F1.5FPE
WEP1239F3FPE
WEP1242F1.5FPE
WEP1242F3FPE

- 3/4" thick veneered plywood with doors attached.
- Panel will have veneered exterior and Natural Maple laminated interior standard. For veneered interior, specify MIP.

Custom Modifications

	ID	RD	APC	MIP
Wood	•	•		•

Finish Techniques

Distressing	Heirloom
•	

Specie Availability

Alder	Rustic Alder	Cherry	Hickory	Maple	Oak	High Gloss Laminate	Textured Laminate	Textured PureStyle™	Thermofoil
•	•	•	•	•	•	box color	box color	box color	Maple

BASE and TALL PANELS with FILLER ATTACHED and FURNITURE ENDS

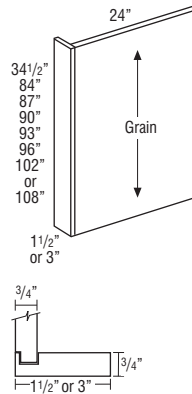

BEPF1.5FPE
BEPF3FPE

TEP2484F1.5FPE †
TEP2484F3FPE †
TEP2487F1.5FPE †
TEP2487F3FPE †
TEP2490F1.5FPE †
TEP2490F3FPE †
TEP2493F1.5FPE †
TEP2493F3FPE †
TEP2496F1.5FPE †
TEP2496F3FPE †
TEP24102F1.5FPE † ♦
TEP24102F3FPE † ♦
TEP24108F1.5FPE † ♦
TEP24108F3FPE † ♦

- 3/4" thick veneered plywood.
- Panel will have veneered exterior and Natural Maple laminated interior standard. For veneered interior, specify MIP.
- 102" and 108" are MIP standard.
- †5 day Express Response not available on items greater than 48".

Custom Modifications

	ID	RD	APC	MIP
Wood	•	•		•

Finish Techniques

Distressing	Heirloom
•	

Specie Availability

Alder	Rustic Alder	Cherry	Hickory	Maple	Oak	High Gloss Laminate	Textured Laminate	Textured PureStyle™	Thermofoil
•	•	•	•	•	•	box color	box color	box color	Maple

♦ Only available in Cherry and Maple.

DESCRIPTION

WALL PANEL with FILLER ATTACHED and AUTHENTIC ENDS



MODEL

- WEP1230F1.5AEL
- WEP1230F1.5AER
- WEP1230F3AEL
- WEP1230F3AER
- WEP1233F1.5AEL
- WEP1233F1.5AER
- WEP1233F3AEL
- WEP1233F3AER
- WEP1236F1.5AEL
- WEP1236F1.5AER
- WEP1236F3AEL
- WEP1236F3AER
- WEP1239F1.5AEL
- WEP1239F1.5AER
- WEP1239F3AEL
- WEP1239F3AER
- WEP1242F1.5AEL
- WEP1242F1.5AER
- WEP1242F3AEL
- WEP1242F3AER

- 3/4" thick veneered plywood with doors attached.
- Depth can be increased in 3" increments up to 24" deep.
- Panel will have veneered exterior and Natural Maple laminated interior standard. For veneered interior, specify MIP.
- Taro doors will be high gloss and match edgebanding selection.
- Troxel doors will have horizontal grain with matching edgebanding.
- Genova doors will have vertical grain with matching edgebanding.

Custom Modifications

	ID	RD	APC	MFO	MIP
Wood	•	•		•	•

Finish Techniques

Distressing	Heirloom
•	•

Specie Availability

Alder	Rustic Alder	Cherry	Hickory	Maple	Oak	High Gloss Laminate	Textured Laminate	Textured PureStyle™	Thermofoil
•	•	•	•	•	•	box color	box color	box color	Maple

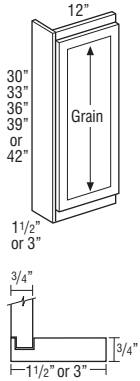

DESCRIPTION

BASE PANEL with FILLER ATTACHED and AUTHENTIC ENDS



MODEL

- BEFF1.5AEL
- BEFF1.5AER
- BEFF3AEL
- BEFF3AER

- 3/4" thick veneered plywood with doors attached.
- Depth can be increased in 3" increments up to 36" deep.
- Panel will have veneered exterior and Natural Maple laminated interior standard. For veneered interior, specify MIP.
- Taro doors will be high gloss and match edgebanding selection.
- Troxel doors will have horizontal grain with matching edgebanding.
- Genova doors will have vertical grain with matching edgebanding.

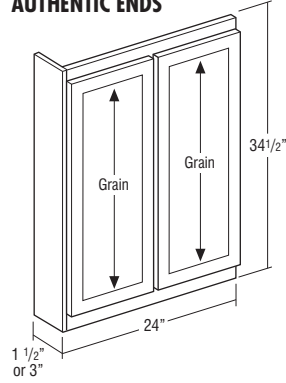

Custom Modifications

	ID	RD	APC	MFO	MIP
Wood	•				•

Finish Techniques

Distressing	Heirloom
•	•

Specie Availability

Alder	Rustic Alder	Cherry	Hickory	Maple	Oak	High Gloss Laminate	Textured Laminate	Textured PureStyle™	Thermofoil
•	•	•	•	•	•	box color	box color	box color	Maple

BASE PANEL with FILLER ATTACHED and AUTHENTIC ENDS, SINGLE DOOR



BEFF1.5AELSD

BEFF1.5AERSD

BEFF3AELSD

BEFF3AERSD

- 3/4" thick veneered plywood with doors attached.
- Depth can be reduced in 3" increments down to 9" deep.
- Panel will have veneered exterior and Natural Maple laminated interior standard. For veneered interior, specify MIP.
- Taro doors will be high gloss and match edgebanding selection.
- Troxel doors will have horizontal grain with matching edgebanding.
- Genova doors will have vertical grain with matching edgebanding.

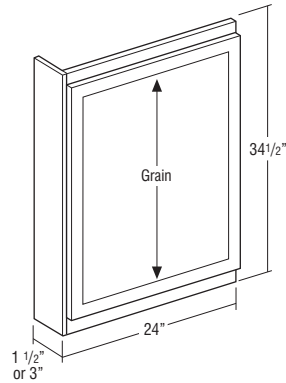

Custom Modifications

	ID	RD	APC	MFO	MIP
Wood	•				•

Finish Techniques

Distressing	Heirloom
•	•

Specie Availability

Alder	Rustic Alder	Cherry	Hickory	Maple	Oak	High Gloss Laminate	Textured Laminate	Textured PureStyle™	Thermofoil
•	•	•	•	•	•	box color	box color	box color	Maple

DESCRIPTION

MODEL

TALL PANEL with FILLER ATTACHED and AUTHENTIC ENDS

- TEP2484F1.5AEL
- TEP2484F1.5AER
- TEP2484F3AEL
- TEP2484F3AER
- TEP2487F1.5AEL
- TEP2487F1.5AER
- TEP2487F3AEL
- TEP2487F3AER
- TEP2490F1.5AHAL
- TEP2490F1.5AHAR
- TEP2490F3AHAL
- TEP2490F3AHAR
- TEP2493F1.5AHAL
- TEP2493F1.5AHAR
- TEP2493F3AHAL
- TEP2493F3AHAR
- TEP2496F1.5AEL
- TEP2496F1.5AER
- TEP2496F3AEL
- TEP2496F3AER

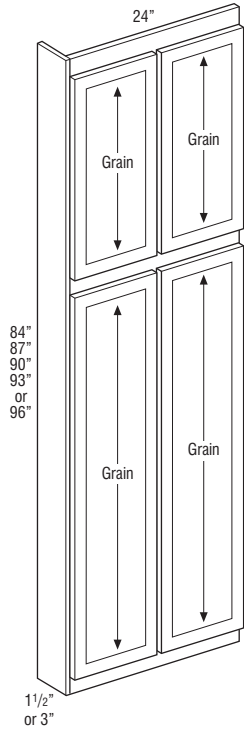

- AH represents upper section alignment with doors on 24" or 27" high cabinets.
- 3/4" thick veneered plywood with doors attached.
- Depth can be increased in 3" increments up to 36" deep.
- Panel will have veneered exterior and Natural Maple laminated interior standard. For veneered interior, specify MIP.
- Taro doors will be high gloss and match edgebanding selection.
- Troxel doors will have horizontal grain with matching edgebanding.
- Genova doors will have vertical grain with matching edgebanding.

Custom Modifications

	ID	RD	APC	MFO	MIP	INVFRM
Wood	•			•	•	•

Finish Techniques

	Distressing	Heirloom
	•	•

Specie Availability

Alder	Rustic Alder	Cherry	Hickory	Maple	Oak	High Gloss Laminate	Textured Laminate	Textured PureStyle™	Thermofoil
•	•	•	•	•	•	box color	box color	box color	Maple

DESCRIPTION

MODEL

TALL PANEL with FILLER ATTACHED and AUTHENTIC ENDS, SINGLE DOOR

- TEP84F1.5AELSD
- TEP84F1.5AERSD
- TEP84F3AELSD
- TEP84F3AERSD
- TEP87F1.5AELSD
- TEP87F1.5AERSD
- TEP87F3AELSD
- TEP87F3AERSD
- TEP90F1.5AHALSD
- TEP90F1.5AHARSD
- TEP90F3AHALSD
- TEP90F3AHARSD
- TEP93F1.5AHALSD
- TEP93F1.5AHARSD
- TEP93F3AHALSD
- TEP93F3AHARSD
- TEP96F1.5AELSD
- TEP96F1.5AERSD
- TEP96F3AELSD
- TEP96F3AERSD

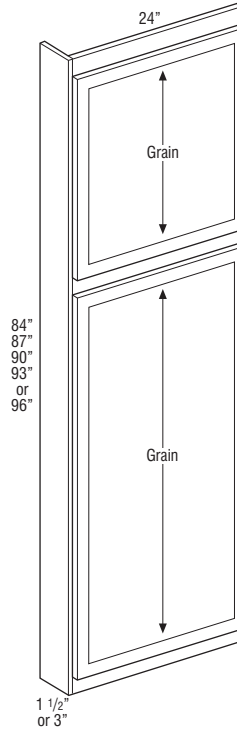

- AH represents upper section alignment with doors on 24" or 27" high cabinets.
- 3/4" thick veneered plywood with doors attached.
- Depth can be reduced in 3" increments down to 9" deep.
- On non-miter doors, the tall door on the bottom will have two vertical panels.
- Panel will have veneered exterior and Natural Maple laminated interior standard. For veneered interior, specify MIP.
- Taro doors will be high gloss and match edgebanding selection.
- Troxel doors will have horizontal grain with matching edgebanding.
- Genova doors will have vertical grain with matching edgebanding.

Custom Modifications

	ID	RD	APC	MFO	MIP	INVFRM
Wood		•		•	•	•

Finish Techniques

	Distressing	Heirloom
	•	•

Specie Availability

Alder	Rustic Alder	Cherry	Hickory	Maple	Oak	High Gloss Laminate	Textured Laminate	Textured PureStyle™	Thermofoil
•	•	•	•	•	•	box color	box color	box color	Maple

DESCRIPTION

MODEL

WOOD V-GROOVED with TRIPLE BEADED FRONT 3/4" PANELS

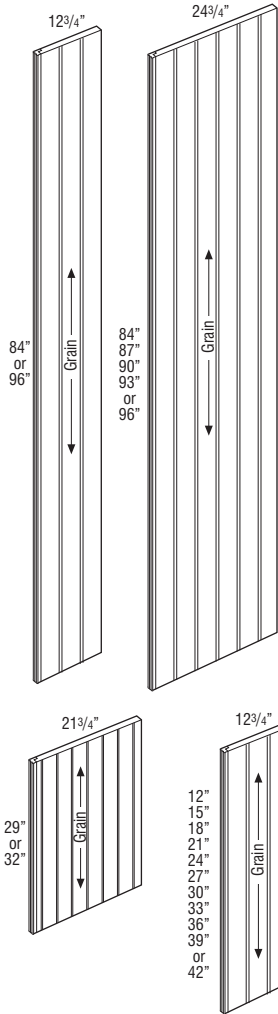

	Depth
BEPVG (34 1/2")	24 3/4" 454
BEPPVG (Peninsula)	25 1/2"
TEP1284VG†	12 3/4"
TEP1296VG†	12 3/4"
TEP84VG†	24 3/4"
TEP87VG†	24 3/4"
TEP90VG†	24 3/4"
TEP93VG†	24 3/4"
TEP96VG†	24 3/4"
VBEP29VG	21 3/4"
VBEP32VG	21 3/4"
WEP12VG	12 3/4"
WEP15VG	12 3/4"
WEP18VG	12 3/4"
WEP21VG	12 3/4"
WEP24VG	12 3/4"
WEP27VG	12 3/4"
WEP30VG	12 3/4"
WEP33VG	12 3/4"
WEP36VG	12 3/4"
WEP39VG	12 3/4"
WEP42VG	12 3/4"
WEPP42VG (Peninsula)	13 1/2"

- Veneer on MDF core.
 - V-groove on 3" centers.
- †5 day Express Response not available on items greater than 48".

Custom Modifications		Finish Techniques	
ID	RD	Distressing	Heirloom
			•

Specie Availability

Alder	Rustic Alder	Cherry	Hickory	Maple	Oak	High Gloss Laminate	Textured Laminate	Textured PureStyle™	Thermofoil
•	•	•	•	•	•	box color	box color	box color	Maple

DESCRIPTION

MODEL

DECORATIVE DOOR PANEL KITS Base End

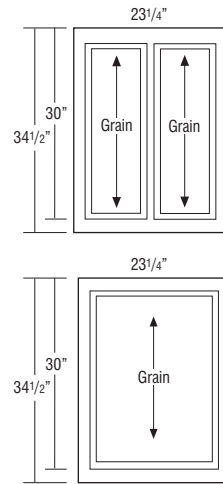

BED

BEDSD

- Door panel kits include panels and doors with attachment screws for field installation. Panels are 1/4" thick veneered furniture board for Stains and 1/4" thick veneered or solid furniture board for Opaques.
- Not compatible on cabinets specified with FPFB. Use Authentic Ends modification for decorative doors with FPFB.
- Taro doors will be high gloss and match edgebanding selection.
- Traxel doors will have horizontal grain with matching edgebanding.
- Genova doors will have vertical grain with matching edgebanding.

Custom Modifications			Finish Techniques	
ID	RD	MFO	Distressing	Heirloom
			•	•

Specie Availability

Alder	Rustic Alder	Cherry	Hickory	Maple	Oak	High Gloss Laminate	Textured Laminate	Textured PureStyle™	Thermofoil
•	•	•	•	•	•	box color	box color	box color	Maple

DESCRIPTION

**DECORATIVE DOOR
PANEL KITS
Tall End**

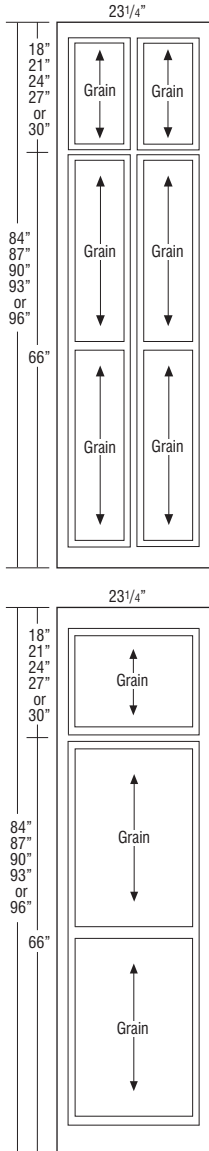

MODEL

TED2484

TED2487

TED2490AH

TED2493AH

TED2496

TED2484SD

TED2487SD

TED2490SDAH

TED2493SDAH

TED2496SD

- AH represents upper section alignment with doors on 24" or 27" high cabinets.
- Door panel kits include panels and doors with attachment screws for field installation. Panels are 1/4" thick veneered furniture board for Stains and 1/4" thick veneered or solid furniture board for Opaques.
- Not compatible on cabinets specified with FPEB. Use Authentic Ends modification for decorative doors with FPEB.
- On non-miter doors, the tall door on the bottom will have two vertical panels.
- Taro doors will be high gloss and match edgebanding selection.
- Troxel doors will have horizontal grain with matching edgebanding.
- Genova doors will have vertical grain with matching edgebanding.

Custom Modifications

ID	RD	MFO
		•

Finish Techniques

Distressing	Heirloom
•	•

Specie Availability

Alder	Rustic Alder	Cherry	Hickory	Maple	Oak	High Gloss Laminate	Textured Laminate	Textured PureStyle™	Thermofoil
•	•	•	•	•	•	box color	box color	box color	Maple

DESCRIPTION

**DECORATIVE DOOR
PANEL KITS
Wall End**

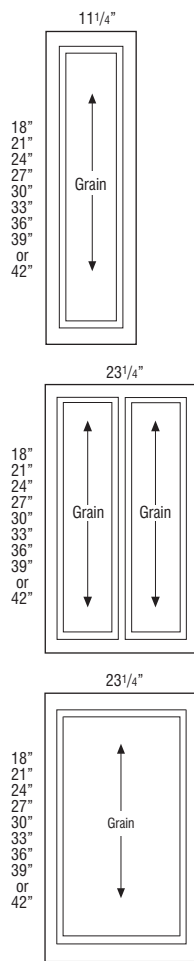

MODEL

WED1218

WED1221

WED1224

WED1227

WED1230

WED1233

WED1236

WED1239

WED1242

WED2418

WED2421

WED2424

WED2427

WED2430

WED2433

WED2436

WED2439

WED2442

WED2418SD

WED2421SD

WED2424SD

WED2427SD

WED2430SD

WED2433SD

WED2436SD

WED2439SD

WED2442SD

- Door panel kits include panels and doors with attachment screws for field installation. Panels are 1/4" thick veneered furniture board for Stains and 1/4" thick veneered or solid furniture board for Opaques.
- Custom door sizes not available.
- Not compatible on cabinets specified with FPEB. Use Authentic Ends modification for decorative doors with FPEB.
- Taro doors will be high gloss and match edgebanding selection.
- Troxel doors will have horizontal grain with matching edgebanding.
- Genova doors will have vertical grain with matching edgebanding.

Custom Modifications

ID	RD	MFO
		•

Finish Techniques

Distressing	Heirloom
•	•

Specie Availability

Alder	Rustic Alder	Cherry	Hickory	Maple	Oak	High Gloss Laminate	Textured Laminate	Textured PureStyle™	Thermofoil
•	•	•	•	•	•	box color	box color	box color	Maple

DESCRIPTION

MODEL

VANITY DESK LEGS

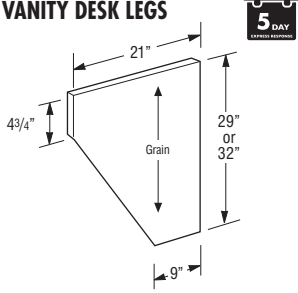

VDL2129WD

VDL2132WD

- All panels are finished 2 sides and front edge.
- VDL__WD in Stains: 3/4" thick veneered furniture board.
- VDL__WD in Opaques: 3/4" thick veneered or solid furniture board.

Custom Modifications

ID	RD

Finish Techniques

Distressing	Heirloom

Specie Availability

Alder	Rustic Alder	Cherry	Hickory	Maple	Oak	High Gloss Laminate	Textured Laminate	Textured PureStyle™	Thermofoil
•	•	•	•	•	•	box color	box color	box color	Maple



ARCHITECTURAL ACCENTS



All embellishments marked with the follow these guidelines:

Program Details

- Products are shown with availability and exceptions noted.
- Items will be shipped loose for field attachment.

Product Characteristics

- Natural characteristics of wood carved items are wider color range, irregularity of surface texture, and more noticeable variations in finish. It is imperative to understand the variations these characteristics entail and therefore will not be considered defective.

Ordering Process

- To ensure product ships with the cabinet order, include on same order. Orders not placed together may not ship together.
 - Express Response program is available for 12 day delivery.
- Must specify wood specie, finish, and technique, if different than the rest of the order.
- Since these items are ordered on an "as-required" basis, **no changes or cancellations will be accepted after 24 hours from acknowledgement of order.**

DESCRIPTION

MODEL

CROWN MOULDING

CLASSIC TALL CROWN



CLTCROWN8

CLTCROWN10 ♦

- CLTCROWN8 is one 8" section.
- CLTCROWN10 is one 10" section. 5 day Express Response not available.
- Cleat shipped unattached can be used for top mount or face frame applications.

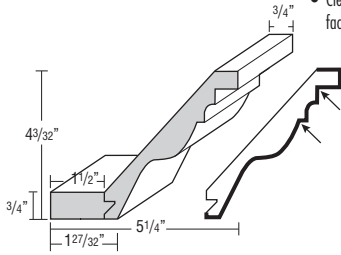

Finish Techniques

Distressing	Heirloom
•	•

Specie Availability

Alder	Rustic Alder	Cherry	Hickory	Maple	Oak	High Gloss Laminate	Textured Laminate	Textured PureStyle™	Thermofoil
•	•	•	•	•	•	box color	box color	box color	Maple

♦ Only available in Cherry and Maple.

CORNICE TALL CROWN



COTCROWN8

COTCROWN10 ♦

- COTCROWN8 is one 8" section.
- COTCROWN10 is one 10" section. 5 day Express Response not available.
- Cleat shipped unattached can be used for top mount or face frame applications.

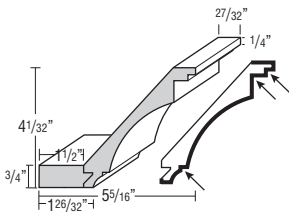

Finish Techniques

Distressing	Heirloom
•	•

Specie Availability

Alder	Rustic Alder	Cherry	Hickory	Maple	Oak	High Gloss Laminate	Textured Laminate	Textured PureStyle™	Thermofoil
•	•	•	•	•	•	box color	box color	box color	Maple

♦ Only available in Cherry and Maple.

DESCRIPTION

MODEL

COVE CROWN



COVECROWN8

COVECROWN10 ♦

- COVECROWN8 is one 8" section.
- COVECROWN10 is one 10" section. 5 day Express Response not available.
- Cleat shipped unattached can be used for top mount or face frame applications.

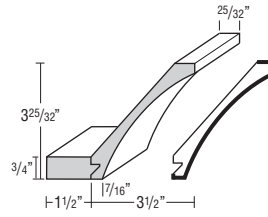

Finish Techniques

Distressing	Heirloom
•	•

Specie Availability

Alder	Rustic Alder	Cherry	Hickory	Maple	Oak	High Gloss Laminate	Textured Laminate	Textured PureStyle™	Thermofoil
•	•	•	•	•	•	box color	box color	box color	Maple

♦ Only available in Cherry and Maple.

FULL OVERLAY CROWN



FOLCROWN8

- One 8" section.

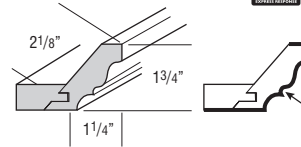

Finish Techniques

Distressing	Heirloom
	•

Specie Availability

Alder	Rustic Alder	Cherry	Hickory	Maple	Oak	High Gloss Laminate	Textured Laminate	Textured PureStyle™	Thermofoil
•	•	•	•	•	•	box color	box color	box color	Maple

INSERT CROWN



INSCROWN8

- One 8" section.
- Designed for use with all 2 1/4" insert mouldings.

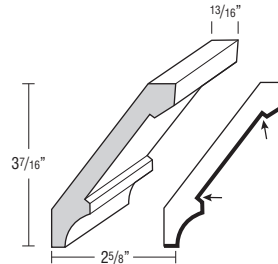

Finish Techniques

Distressing	Heirloom
	•

Specie Availability

Alder	Rustic Alder	Cherry	Hickory	Maple	Oak	High Gloss Laminate	Textured Laminate	Textured PureStyle™	Thermofoil
•	Alder	•		•	•	box color	box color	box color	Maple

LARGE STRAIGHT ANGLE CROWN



LSACROWN8

LSACROWN10 ♦

- LSACROWN8 is one 8" section.
- LSACROWN10 is one 10" section. 5 day Express Response not available.
- Cleat shipped unattached can be used for top mount or face frame applications.

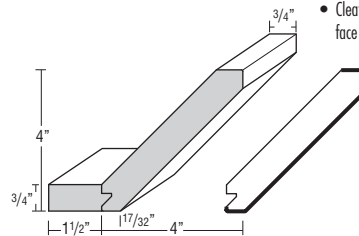

Finish Techniques

Distressing	Heirloom
•	•

Specie Availability

Alder	Rustic Alder	Cherry	Hickory	Maple	Oak	High Gloss Laminate	Textured Laminate	Textured PureStyle™	Thermofoil
•	•	•	•	•	•	box color	box color	box color	Maple

♦ Only available in Cherry and Maple.

Finished edges indicated by bold lines on side view drawings.
Glazed edges indicated by arrows on side view drawings.

DESCRIPTION

MODEL

MEDIUM STRAIGHT ANGLE CROWN



MSACROWN8
MSACROWN10 ♦

- MSACROWN8 is one 8' section.
- MSACROWN10 is one 10' section. 5 day Express Response not available.
- Cleat shipped unattached can be used for top mount or face frame applications.

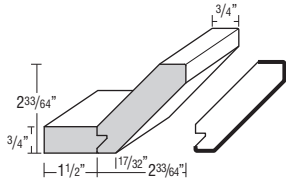

Finish Techniques

Distressing	Heirloom
•	•

Specie Availability

Alder	Rustic Alder	Cherry	Hickory	Maple	Oak	High Gloss Laminate	Textured Laminate	Textured PureStyle™	Thermofoil
•	•	•	•	•	•	box color	box color	box color	Maple

♦ Only available in Cherry and Maple.

STRAIGHT ANGLE CROWN



SACROWN8
SACROWN10 ♦

- SACROWN8 is one 8' section.
- SACROWN10 is one 10' section. 5 day Express Response not available.
- Cleat shipped unattached can be used for top mount or face frame applications.

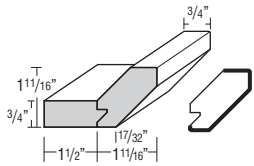

Finish Techniques

Distressing	Heirloom
•	•

Specie Availability

Alder	Rustic Alder	Cherry	Hickory	Maple	Oak	High Gloss Laminate	Textured Laminate	Textured PureStyle™	Thermofoil
•	•	•	•	•	•	box color	box color	box color	Maple

♦ Only available in Cherry and Maple.

TALL CROWN



MTCROWN8
MTCROWN10 ♦

- MTCROWN8 is one 8' section.
- MTCROWN10 is one 10' section. 5 day Express Response not available.

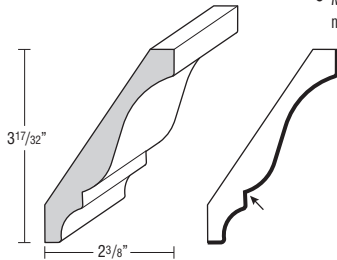

Finish Techniques

Distressing	Heirloom
•	•

Specie Availability

Alder	Rustic Alder	Cherry	Hickory	Maple	Oak	High Gloss Laminate	Textured Laminate	Textured PureStyle™	Thermofoil
•	•	•	•	•	•	box color	box color	box color	Maple

♦ Only available in Cherry and Maple.

SHAKER CROWN



SHKRCRM8

- Top mount moulding.
- One 8' section.

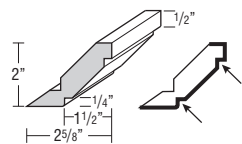

Finish Techniques

Distressing	Heirloom
•	•

Specie Availability

Alder	Rustic Alder	Cherry	Hickory	Maple	Oak	High Gloss Laminate	Textured Laminate	Textured PureStyle™	Thermofoil
•	•	•	•	•	•	box color	box color	box color	Maple

DESCRIPTION

MODEL

LARGE SHAKER CROWN



LSHAKER8
LSHAKER10 ♦

- LSHAKER8 is one 8' section.
- LSHAKER10 is one 10' section. 5 day Express Response not available.

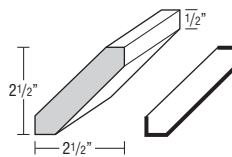

Finish Techniques

Distressing	Heirloom
•	•

Specie Availability

Alder	Rustic Alder	Cherry	Hickory	Maple	Oak	High Gloss Laminate	Textured Laminate	Textured PureStyle™	Thermofoil
•	•	•	•	•	•	box color	box color	box color	Maple

♦ Only available in Cherry and Maple.

LARGE SHAKER CROWN, PREMIUM



LSHAKER8P
LSHAKER10P

- LSHAKER8P is one 8' section.
- LSHAKER10P is one 10' section. 5 day Express Response not available.
- Horizontal grain except on High Gloss.

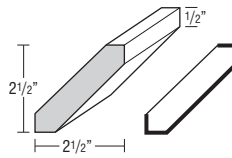

Finish Techniques

Distressing	Heirloom
•	•

Specie Availability

Alder	Rustic Alder	Cherry	Hickory	Maple	Oak	High Gloss Laminate	Textured Laminate	Textured PureStyle™	Thermofoil
•	•	•	•	•	•	•	•	•	•

SMALL COVE CROWN MOULDING



SMCOVECROWN8
SMCOVECROWN10 ♦

- SMCOVECROWN8 is one 8' section.
- SMCOVECROWN10 is one 10' section. 5 day Express Response not available.

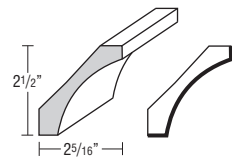

Finish Techniques

Distressing	Heirloom
•	•

Specie Availability

Alder	Rustic Alder	Cherry	Hickory	Maple	Oak	High Gloss Laminate	Textured Laminate	Textured PureStyle™	Thermofoil
•	•	•	•	•	•	box color	box color	box color	Maple

♦ Only available in Cherry and Maple.

SMALL CROWN



SCM8
SCM10 ♦

- Face mounts on Partial Overlay doors. May be face mounted on Full Overlay if used with a cleat.
- SCM8 is one 8' section.
- SCM10 is one 10' section. 5 day Express Response not available.
- Moulding can be used as standard or inverted.

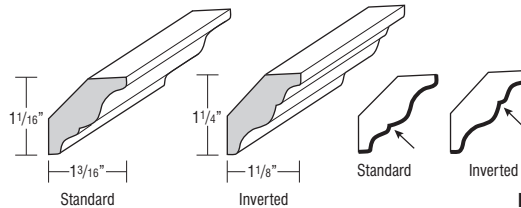

Finish Techniques

Distressing	Heirloom
•	•

Specie Availability

Alder	Rustic Alder	Cherry	Hickory	Maple	Oak	High Gloss Laminate	Textured Laminate	Textured PureStyle™	Thermofoil
•	•	•	•	•	•	box color	box color	box color	Maple

♦ Only available in Cherry and Maple.

Finished edges indicated by bold lines on side view drawings.
Glazed edges indicated by arrows on side view drawings.

DESCRIPTION

MODEL

SOLID WOOD CROWN



**SWCRM8
SWCRM10 ♦**

- Face mounts on Partial Overlay doors. May be face mounted on Full Overlay if used with a cleat.
- SWCRM8 is one 8" section.
- SWCRM10 is one 10" section. 5 day Express Response not available.
- Moulding can be used as standard or inverted.

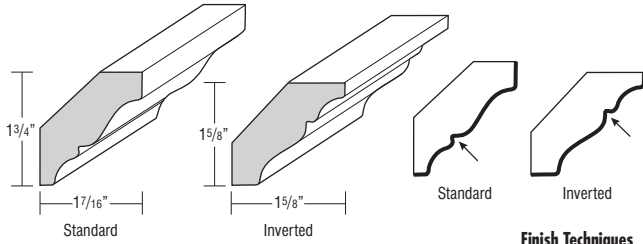

Finish Techniques

Distressing	Heirloom
•	•

Specie Availability

Alder	Rustic Alder	Cherry	Hickory	Maple	Oak	High Gloss Laminate	Textured Laminate	Textured PureStyle™	Thermofoil
•	•	•	•	•	•	box color	box color	box color	Maple

♦ Only available in Cherry and Maple.

SOLID WOOD LARGE CROWN



**SWLCRM8
SWLCRM10 ♦**

- Face mounts on Partial Overlay doors. May be face mounted on Full Overlay if used with a cleat.
- SWLCRM8 is one 8" section.
- SWLCRM10 is one 10" section. 5 day Express Response not available.
- Moulding can be used as standard or inverted.

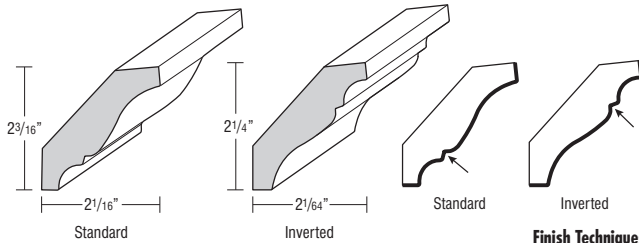

Finish Techniques

Distressing	Heirloom
•	•

Specie Availability

Alder	Rustic Alder	Cherry	Hickory	Maple	Oak	High Gloss Laminate	Textured Laminate	Textured PureStyle™	Thermofoil
•	•	•	•	•	•	box color	box color	box color	Maple

♦ Only available in Cherry and Maple.

DESCRIPTION

MODEL

SOLID WOOD TALL CROWN



**SWTCRM8
SWTCRM10 ♦**

- Face mounts on Partial Overlay doors. May be face mounted on Full Overlay if used with a cleat.
- SWTCRM8 is one 8" section.
- SWTCRM10 is one 10" section. 5 day Express Response not available.
- Moulding can be used as standard or inverted.

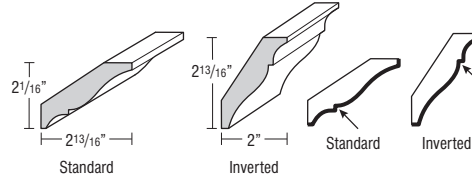

Finish Techniques

Distressing	Heirloom
•	•

Specie Availability

Alder	Rustic Alder	Cherry	Hickory	Maple	Oak	High Gloss Laminate	Textured Laminate	Textured PureStyle™	Thermofoil
•	•	•	•	•	•	box color	box color	box color	Maple

♦ Only available in Cherry and Maple.

SOLID WOOD VICTORIAN CROWN



**SWVCRM8
SWVCRM10 ♦**

- Face mounts on Partial Overlay doors. May be face mounted on Full Overlay if used with a cleat.
- Designed for braided, dentil, egg & dart, or rope moulding application.
- SWVCRM8 is one 8" section.
- SWVCRM10 is one 10" section. 5 day Express Response not available.

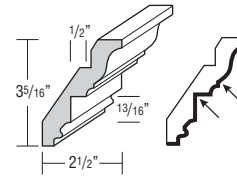

Finish Techniques

Distressing	Heirloom
•	•

Specie Availability

Alder	Rustic Alder	Cherry	Hickory	Maple	Oak	High Gloss Laminate	Textured Laminate	Textured PureStyle™	Thermofoil
•	•	•	•	•	•	box color	box color	box color	Maple

♦ Only available in Cherry and Maple.

STARTER MOULDINGS

SOFFIT FILLER MOULDING



**SFM8
SFM10 ♦**

- SFM8 is one 8" section.
- SFM10 is one 10" section. 5 day Express Response not available.
- Includes an unattached cleat.

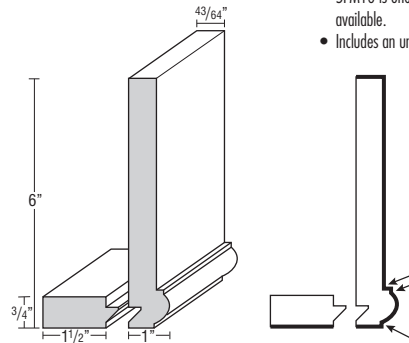

Finish Techniques

Distressing	Heirloom
	•

Specie Availability

Alder	Rustic Alder	Cherry	Hickory	Maple	Oak	High Gloss Laminate	Textured Laminate	Textured PureStyle™	Thermofoil
•	•	•	•	•	•	box color	box color	box color	Maple

♦ Only available in Cherry and Maple.

Finished edges indicated by bold lines on side view drawings.
Glazed edges indicated by arrows on side view drawings.

DESCRIPTION

MODEL

STARTER MOULDING



STR8
STR10 ♦

- STR8 is one 8' section.
- STR10 is one 10' section. 5 day Express Response not available.

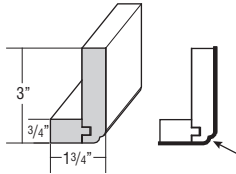

Finish Techniques

Distressing	Heirloom

Specie Availability

Alder	Rustic Alder	Cherry	Hickory	Maple	Oak	High Gloss Laminate	Textured Laminate	Textured PureStyle™	Thermofoil
•	•	•	•	•	•	box color	box color	box color	Maple

♦ Only available in Cherry and Maple.

STARTER MOULDING, SHAKER



STRS8
STRS10 ♦

- STRS8 is one 8' section.
- STRS10 is one 10' section. 5 day Express Response not available.

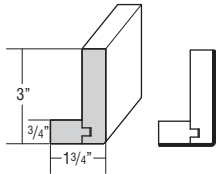

Finish Techniques

Distressing	Heirloom
•	•

Specie Availability

Alder	Rustic Alder	Cherry	Hickory	Maple	Oak	High Gloss Laminate	Textured Laminate	Textured PureStyle™	Thermofoil
•	•	•	•	•	•	box color	box color	box color	Maple

♦ Only available in Cherry and Maple.

MOULDING INSERTS

ACANTHUS INSERT



JACANINSERTM

- One 8' section.
- Pattern is 6" repeat.

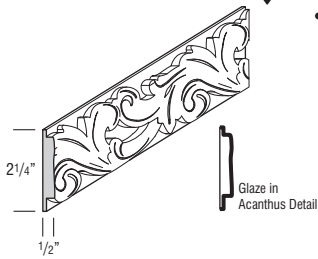

Finish Techniques

Distressing	Heirloom
	•

Specie Availability

Alder	Rustic Alder	Cherry	Hickory	Maple	Oak	High Gloss Laminate	Textured Laminate	Textured PureStyle™	Thermofoil
Cherry	Cherry	•		•		box color	box color	box color	Maple

BRAIDED



BRAIDM

- Designed to face mount on SWVCRM8.
- One 8' section.

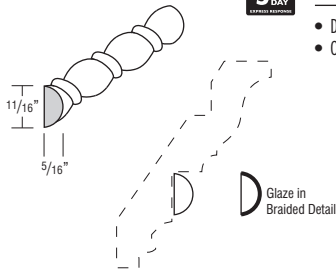

Finish Techniques

Distressing	Heirloom

Specie Availability

Alder	Rustic Alder	Cherry	Hickory	Maple	Oak	High Gloss Laminate	Textured Laminate	Textured PureStyle™	Thermofoil
•	Alder	•	Beech	•	Beech	box color	box color	box color	Maple

DESCRIPTION

MODEL

CELTIC INSERT



INSERTCELT

- One 8' section.
- Designed to be used with Insert Crown.
- Pattern is 6" repeat.

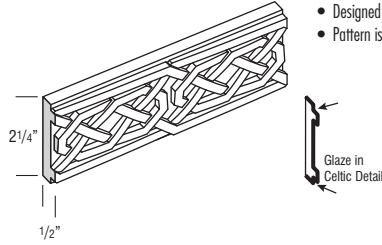

Finish Techniques

Distressing	Heirloom
	•

Specie Availability

Alder	Rustic Alder	Cherry	Hickory	Maple	Oak	High Gloss Laminate	Textured Laminate	Textured PureStyle™	Thermofoil
		•		•		box color	box color	box color	Maple

NEW DENTIL



MDENTIL8

- Designed to face mount on SWVCRM8.
- One 8' section.

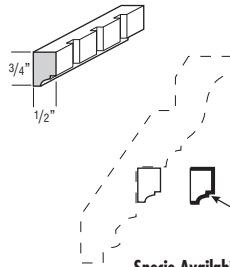

Finish Techniques

Distressing	Heirloom

Specie Availability

Alder	Rustic Alder	Cherry	Hickory	Maple	Oak	High Gloss Laminate	Textured Laminate	Textured PureStyle™	Thermofoil
•	Alder	•		•	•	box color	box color	box color	Maple

EGG & DART



EGD8

- Designed to face mount on SWVCRM8.
- One 8' section.

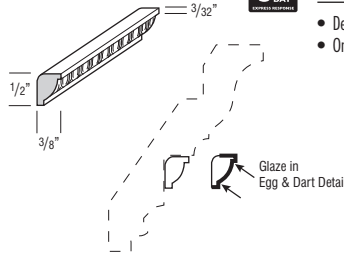

Finish Techniques

Distressing	Heirloom

Specie Availability

Alder	Rustic Alder	Cherry	Hickory	Maple	Oak	High Gloss Laminate	Textured Laminate	Textured PureStyle™	Thermofoil
				Maple		box color	box color	box color	Maple

MISSION INSERT



JMISINSERTM

- One 8' section.
- Pattern is 6" repeat.

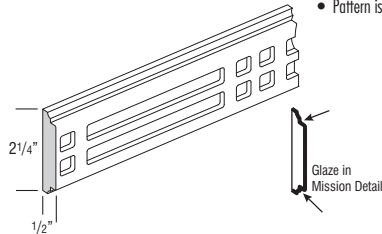

Finish Techniques

Distressing	Heirloom
	•

Specie Availability

Alder	Rustic Alder	Cherry	Hickory	Maple	Oak	High Gloss Laminate	Textured Laminate	Textured PureStyle™	Thermofoil
•	Alder	•		•		box color	box color	box color	Maple

Finished edges indicated by bold lines on side view drawings.
Glazed edges indicated by arrows on side view drawings.

DESCRIPTION

MODEL

ROPE



RPM8

- Designed to face mount on SWVCRM8.
- One 8' section.

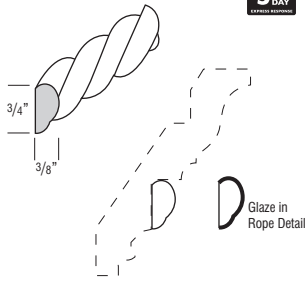

Finish Techniques

Distressing	Heirloom
	•

Specie Availability

Alder	Rustic Alder	Cherry	Hickory	Maple	Oak	High Gloss Laminate	Textured Laminate	Textured PureStyle™	Thermofoil
•	Alder	•	•	•	•	box color	box color	box color	Maple

WEAVE INSERT



JWEAVEINSERTM

- One 8' section.
- Pattern is 6" repeat.

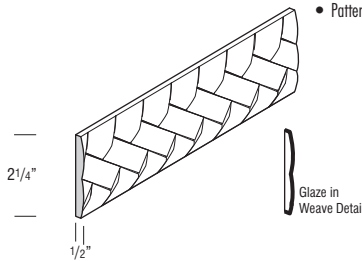

Finish Techniques

Distressing	Heirloom
	•

Specie Availability

Alder	Rustic Alder	Cherry	Hickory	Maple	Oak	High Gloss Laminate	Textured Laminate	Textured PureStyle™	Thermofoil
•	Alder	•	•	•	•	box color	box color	box color	Maple

ACCENT MOULDING

ACANTHUS



ACAM

- One 8' section.

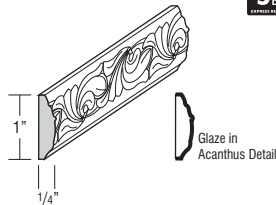

Finish Techniques

Distressing	Heirloom
	•

Specie Availability

Alder	Rustic Alder	Cherry	Hickory	Maple	Oak	High Gloss Laminate	Textured Laminate	Textured PureStyle™	Thermofoil
•	Alder	•	Beech	•	Beech	box color	box color	box color	Maple

BACK PANEL MOULDING



BPM8

- One 8' section.
- Designed to provide a decorative edge between cabinet and panel-corner seam.

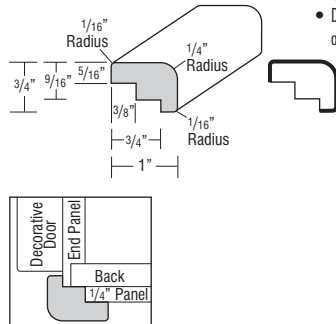

Finish Techniques

Distressing	Heirloom
	•

Specie Availability

Alder	Rustic Alder	Cherry	Hickory	Maple	Oak	High Gloss Laminate	Textured Laminate	Textured PureStyle™	Thermofoil
•	Alder	•	•	•	•	box color	box color	box color	Maple

DESCRIPTION

MODEL

CABINET PANEL EDGE



CPE8

- One 8' section.

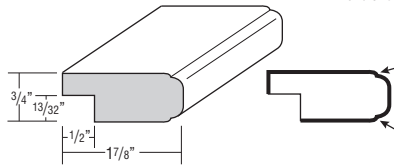

Finish Techniques

Distressing	Heirloom
	•

Specie Availability

Alder	Rustic Alder	Cherry	Hickory	Maple	Oak	High Gloss Laminate	Textured Laminate	Textured PureStyle™	Thermofoil
•	Alder	•	•	•	•	box color	box color	box color	Maple

COUNTERTOP EDGE



CCM8

Contemporary

Traditional

TCM8

- One 8' section.

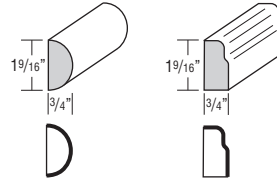

Finish Techniques

Distressing	Heirloom
	•*

*Available on TCM8 only

Specie Availability

Alder	Rustic Alder	Cherry	Hickory	Maple	Oak	High Gloss Laminate	Textured Laminate	Textured PureStyle™	Thermofoil
•	Alder	•	•	•	•	box color	box color	box color	Maple

FLAT SCRIBE



SM8

SM10 ♦

- SM8 is one 8' section.
- SM10 is one 10' section. 5 day Express Response not available.

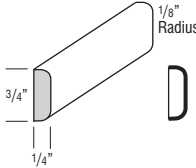

Finish Techniques

Distressing	Heirloom
	•

Specie Availability

Alder	Rustic Alder	Cherry	Hickory	Maple	Oak	High Gloss Laminate	Textured Laminate	Textured PureStyle™	Thermofoil
•	Alder	•	•	•	•	box color	box color	box color	Maple

♦ Only available in Cherry and Maple.

FLAT SCRIBE, PREMIUM



SM8P

SM10P

- SM8P is one 8' section.
- SM10P is one 10' section. 5 day Express Response not available.
- Horizontal grain except on High Gloss.

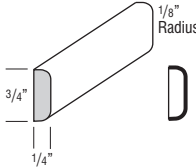

Finish Techniques

Distressing	Heirloom
	•

Specie Availability

Alder	Rustic Alder	Cherry	Hickory	Maple	Oak	High Gloss Laminate	Textured Laminate	Textured PureStyle™	Thermofoil
						•	•	•	

Finished edges indicated by bold lines on side view drawings.
Glazed edges indicated by arrows on side view drawings.

DESCRIPTION

MODEL

IVY



IVYM

- One 8' section.

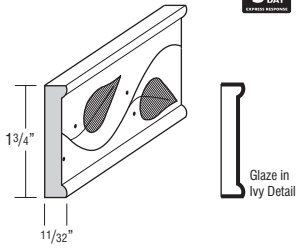

Finish Techniques

Distressing	Heirloom
	•

Specie Availability

Alder	Rustic Alder	Cherry	Hickory	Maple	Oak	High Gloss Laminate	Textured Laminate	Textured PureStyle™	Thermofoil
•	•	•	•	•	•	box color	box color	box color	Maple

LIBRARY MOULDING



LBRM

- One 8' section.

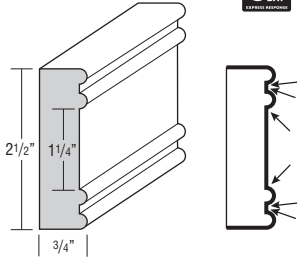

Finish Techniques

Distressing	Heirloom
•	•

Specie Availability

Alder	Rustic Alder	Cherry	Hickory	Maple	Oak	High Gloss Laminate	Textured Laminate	Textured PureStyle™	Thermofoil
•	•	•	•	•	•	box color	box color	box color	Maple

MIRROR FRAME



WMF8

- Pre-grooved.
- One 8' section.

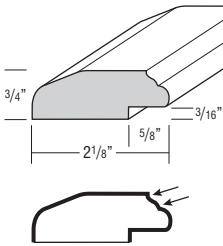

Finish Techniques

Distressing	Heirloom
•	•

Specie Availability

Alder	Rustic Alder	Cherry	Hickory	Maple	Oak	High Gloss Laminate	Textured Laminate	Textured PureStyle™	Thermofoil
•	•	•	•	•	•	box color	box color	box color	Maple

OGEE EDGE



OGEEM

- One 8' section.

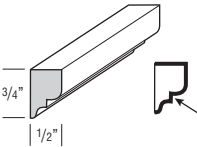

Finish Techniques

Distressing	Heirloom
	•

Specie Availability

Alder	Rustic Alder	Cherry	Hickory	Maple	Oak	High Gloss Laminate	Textured Laminate	Textured PureStyle™	Thermofoil
•	•	•	•	•	•	box color	box color	box color	Maple

DESCRIPTION

MODEL

SINGLE BEAD EDGE



SBE8

- One 8' section.

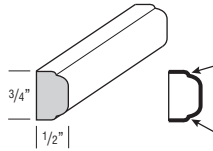

Finish Techniques

Distressing	Heirloom
	•

Specie Availability

Alder	Rustic Alder	Cherry	Hickory	Maple	Oak	High Gloss Laminate	Textured Laminate	Textured PureStyle™	Thermofoil
•	•	•	•	•	•	box color	box color	box color	Maple

SINGLE BEAD MOULDING



SBM8

- One 8' section.

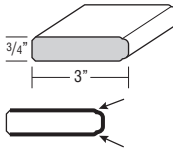

Finish Techniques

Distressing	Heirloom
	•

Specie Availability

Alder	Rustic Alder	Cherry	Hickory	Maple	Oak	High Gloss Laminate	Textured Laminate	Textured PureStyle™	Thermofoil
•	•	•	•	•	•	box color	box color	box color	Maple

SINGLE BEAD PILASTER



SBP8

- One 8' section.
- Can be used vertically between cabinets for an inset look.

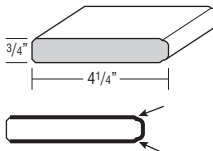

Finish Techniques

Distressing	Heirloom
	•

Specie Availability

Alder	Rustic Alder	Cherry	Hickory	Maple	Oak	High Gloss Laminate	Textured Laminate	Textured PureStyle™	Thermofoil
•	•	•	•	•	•	box color	box color	box color	Maple

SMALL SCRIBE



SSM8

SSM10 ♦

- SSM8 is one 8' section.
- SSM10 is one 10' section. 5 day Express Response not available.

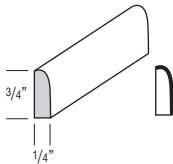

Finish Techniques

Distressing	Heirloom
	•

Specie Availability

Alder	Rustic Alder	Cherry	Hickory	Maple	Oak	High Gloss Laminate	Textured Laminate	Textured PureStyle™	Thermofoil
•	•	•	•	•	•	box color	box color	box color	Maple

♦ Only available in Cherry and Maple.

SMALL SCRIBE, PREMIUM



SSM8P

SSM10P

- SSM8P is one 8' section.
- SSM10P is one 10' section. 5 day Express Response not available.
- Horizontal grain except on High Gloss.

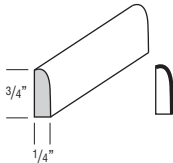

Finish Techniques

Distressing	Heirloom
	•

Specie Availability

Alder	Rustic Alder	Cherry	Hickory	Maple	Oak	High Gloss Laminate	Textured Laminate	Textured PureStyle™	Thermofoil
						•	•	•	

Finished edges indicated by bold lines on side view drawings.
Glazed edges indicated by arrows on side view drawings.

DESCRIPTION

MODEL

SOFFIT TRIM MOULDING



TSTM8
TSTM10 ♦

- TSTM8 is one 8' section.
- TSTM10 is one 10' section. 5 day Express Response not available.

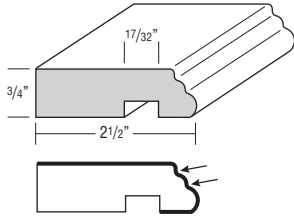

Finish Techniques

Distressing	Heirloom
	•

Specie Availability

Alder	Rustic Alder	Cherry	Hickory	Maple	Oak	High Gloss Laminate	Textured Laminate	Textured PureStyle™	Thermofoil
•	•	•	•	•	•	box color	box color	box color	Maple

♦ Only available in Cherry and Maple.

SPINDLE RAIL



SR8

- One 8' section.

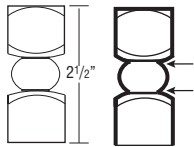
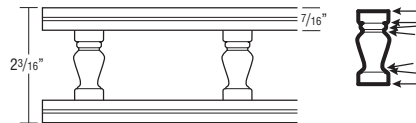

CORNERPOST*

*Use with Spindle Rail.

Finish Techniques

Distressing	Heirloom
	•

Specie Availability

Alder	Rustic Alder	Cherry	Hickory	Maple	Oak	High Gloss Laminate	Textured Laminate	Textured PureStyle™	Thermofoil
•	•	•	•	•	•	box color	box color	box color	Maple

TRIPLE BEAD EDGE



TBEM

- One 8' section.

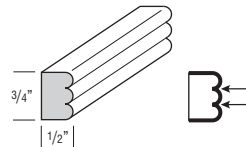

Finish Techniques

Distressing	Heirloom
	•

Specie Availability

Alder	Rustic Alder	Cherry	Hickory	Maple	Oak	High Gloss Laminate	Textured Laminate	Textured PureStyle™	Thermofoil
•	•	•	•	•	•	box color	box color	box color	Maple

TRIPLE BEAD PILASTER



TBP8

- Finished beaded front and two 4 1/2" sides.
- Can be used vertically between cabinets for an inset look.
- One 8' section.

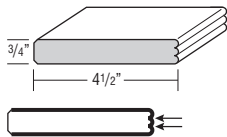

Finish Techniques

Distressing	Heirloom
	•

Specie Availability

Alder	Rustic Alder	Cherry	Hickory	Maple	Oak	High Gloss Laminate	Textured Laminate	Textured PureStyle™	Thermofoil
•	•	•	•	•	•	box color	box color	box color	Maple

DESCRIPTION

MODEL

WIDE SCRIBE



WSCRIBE

- One 8' section.

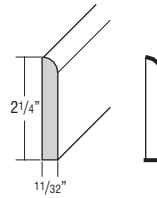

Finish Techniques

Distressing	Heirloom
	•

Specie Availability

Alder	Rustic Alder	Cherry	Hickory	Maple	Oak	High Gloss Laminate	Textured Laminate	Textured PureStyle™	Thermofoil
•	•	•	•	•	•	box color	box color	box color	Maple

TOE MOULDING

BASEBOARD



BBM8

BBM10 ♦

- BBM8 is one 8' section.
- BBM10 is one 10' section. 5 day Express Response not available.
- BBM8 can be used in place of standard toekick to provide a surface for glaze hang-up on premium finishes.

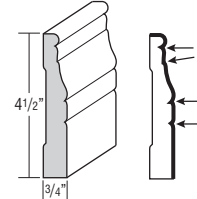

Finish Techniques

Distressing	Heirloom
•	•

Specie Availability

Alder	Rustic Alder	Cherry	Hickory	Maple	Oak	High Gloss Laminate	Textured Laminate	Textured PureStyle™	Thermofoil
•	•	•	•	•	•	box color	box color	box color	Maple

♦ Only available in Cherry and Maple.

BASEBOARD - SCULPTED



BBMSC

- One 8' section.
- BBMSC can be used in place of standard toekick to provide a surface for glaze hang-up on premium finishes.

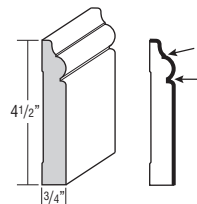

Finish Techniques

Distressing	Heirloom
	•

Specie Availability

Alder	Rustic Alder	Cherry	Hickory	Maple	Oak	High Gloss Laminate	Textured Laminate	Textured PureStyle™	Thermofoil
•	•	•	•	•	•	box color	box color	box color	Maple

BASEBOARD - SHAKER



BBMSH8

BBMSH10 ♦

- BBMSH8 is one 8' section.
- BBMSH10 is one 10' section. 5 day Express Response not available.

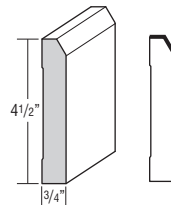

Finish Techniques

Distressing	Heirloom
•	•

Specie Availability

Alder	Rustic Alder	Cherry	Hickory	Maple	Oak	High Gloss Laminate	Textured Laminate	Textured PureStyle™	Thermofoil
•	•	•	•	•	•	box color	box color	box color	Maple

♦ Only available in Cherry and Maple.

Finished edges indicated by bold lines on side view drawings.
Glazed edges indicated by arrows on side view drawings.

DESCRIPTION

MODEL

BASEBOARD - SWOOPED



BBMSW

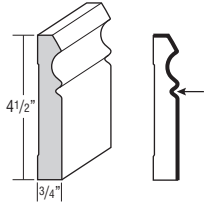

- One 8' section.
- BBMSW can be used in place of standard toekick to provide a surface for glaze hang-up on premium finishes.

Finish Techniques

Distressing	Heirloom
	•

Specie Availability

Alder	Rustic Alder	Cherry	Hickory	Maple	Oak	High Gloss Laminate	Textured Laminate	Textured PureStyle™	Thermofoil
•	•	•	•	•	•	box color	box color	box color	Maple

TOEBOARDS



TB8LAM18 ♦

TB8WD14

TB8LAM12 ♦

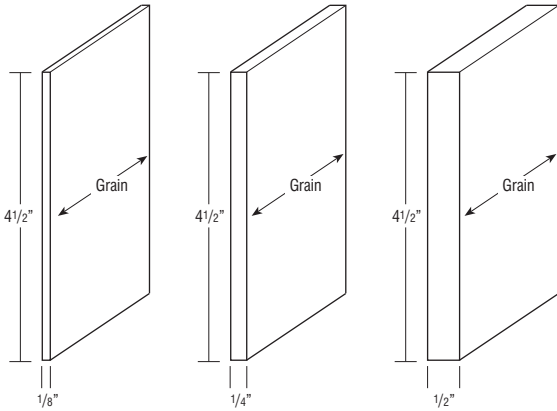

- TB8LAM18 is 1/8" Laminated Hardboard, 1 piece.
- TB8WD14 is 1/4" Plywood Finished Veneer, 1 piece.
- TB8LAM12 is 1/2" Laminated Furniture Board, 1 piece.
- One 8' section.

Finish Techniques

Distressing	Heirloom
	•

Specie Availability

Alder	Rustic Alder	Cherry	Hickory	Maple	Oak	High Gloss Laminate	Textured Laminate	Textured PureStyle™	Thermofoil
•	Alder	•	•	•	•	box color	box color	box color	Maple

♦ Only available in White Laminate.

TOEBOARDS, PREMIUM



TB8P14

- 1/4" thick laminated MDF.
- One 8' section.
- Horizontal grain except on High Gloss.

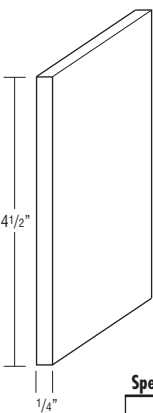

Finish Techniques

Distressing	Heirloom
	•

Specie Availability

Alder	Rustic Alder	Cherry	Hickory	Maple	Oak	High Gloss Laminate	Textured Laminate	Textured PureStyle™	Thermofoil
•	Alder	•	•	•	•	•	•	•	•

DESCRIPTION

MODEL

TOEKICK CAP



TKC

32/pair

- Sold in pairs.

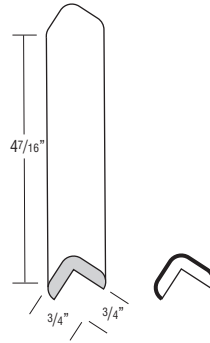

Finish Techniques

Distressing	Heirloom
	•

Specie Availability

Alder	Rustic Alder	Cherry	Hickory	Maple	Oak	High Gloss Laminate	Textured Laminate	Textured PureStyle™	Thermofoil
Maple	Maple	Maple	Oak	•	•	box color	box color	box color	Maple

WINDOW CASING

WINDOW CASING - TRADITIONAL



WCT7 (7')

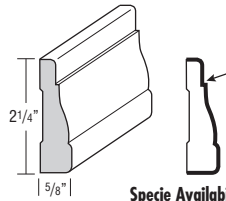

Finish Techniques

Distressing	Heirloom
	•

Specie Availability

Alder	Rustic Alder	Cherry	Hickory	Maple	Oak	High Gloss Laminate	Textured Laminate	Textured PureStyle™	Thermofoil
•	Alder	•	•	•	•	box color	box color	box color	Maple

LIGHT RAILS

CAP MOULDING



CAPM

- One 8' section.

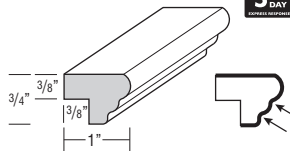

Finish Techniques

Distressing	Heirloom
	•

Specie Availability

Alder	Rustic Alder	Cherry	Hickory	Maple	Oak	High Gloss Laminate	Textured Laminate	Textured PureStyle™	Thermofoil
•	Alder	•	•	•	•	box color	box color	box color	Maple

LIGHT BAFFLE



LB2 (Square)

- One 8' section.

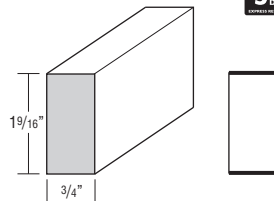

Finish Techniques

Distressing	Heirloom
	•

Specie Availability

Alder	Rustic Alder	Cherry	Hickory	Maple	Oak	High Gloss Laminate	Textured Laminate	Textured PureStyle™	Thermofoil
•	Alder	•	•	•	•	box color	box color	box color	Maple

Square Baffle

Finished edges indicated by bold lines on side view drawings.
Glazed edges indicated by arrows on side view drawings.

DESCRIPTION

MODEL

SMALL LIGHT RAIL MOULDING



SMLR

- One 8" section.

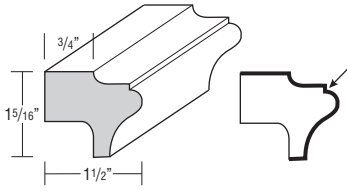

Finish Techniques

Distressing	Heirloom
•	•

Specie Availability

Alder	Rustic Alder	Cherry	Hickory	Maple	Oak	High Gloss Laminate	Textured Laminate	Textured PureStyle™	Thermofoil
•	•	•		•	•	box color	box color	box color	Maple

LIGHT RAIL MOULDING



LRM

- One 8" section.

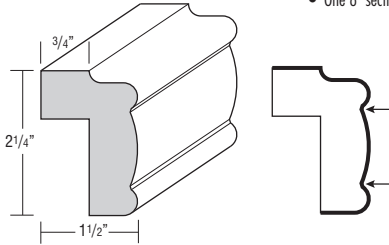

Finish Techniques

Distressing	Heirloom
•	•

Specie Availability

Alder	Rustic Alder	Cherry	Hickory	Maple	Oak	High Gloss Laminate	Textured Laminate	Textured PureStyle™	Thermofoil
•	•	•	•	•	•	box color	box color	box color	Maple

VALLEY FORGE



VFR8

- Must be shimmed at shaded area if used with full overlay styles.
- One 8" section.

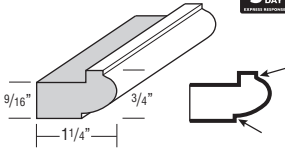

Finish Techniques

Distressing	Heirloom
	•

Specie Availability

Alder	Rustic Alder	Cherry	Hickory	Maple	Oak	High Gloss Laminate	Textured Laminate	Textured PureStyle™	Thermofoil
•	•	•	•	•	•	box color	box color	box color	Maple

TRADITIONAL LIGHT RAIL



JINSERTLRT

- One 8" section.
- Designed for use with all 3/4" insert mouldings.

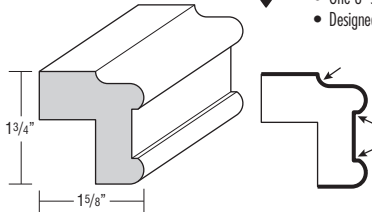

Finish Techniques

Distressing	Heirloom
	•

Specie Availability

Alder	Rustic Alder	Cherry	Hickory	Maple	Oak	High Gloss Laminate	Textured Laminate	Textured PureStyle™	Thermofoil
•	•	•		•	•	box color	box color	box color	Maple

DESCRIPTION

MODEL

CONTEMPORARY LIGHT RAIL



JINSERTLRC

- One 8" section.
- Designed for use with all 3/4" insert mouldings.

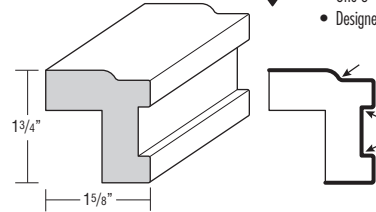

Finish Techniques

Distressing	Heirloom
	•

Specie Availability

Alder	Rustic Alder	Cherry	Hickory	Maple	Oak	High Gloss Laminate	Textured Laminate	Textured PureStyle™	Thermofoil
•	•	•		•	•	box color	box color	box color	Maple

LIGHT RAIL INSERTS

ACANTHUS LIGHT RAIL INSERT



JLRINSACAN

- One 8" section.
- Pattern is 6" repeat.

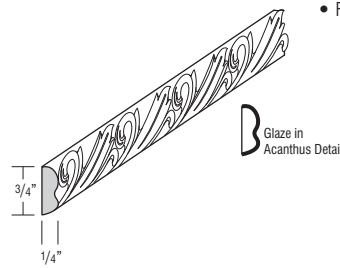

Finish Techniques

Distressing	Heirloom
	•

Specie Availability

Alder	Rustic Alder	Cherry	Hickory	Maple	Oak	High Gloss Laminate	Textured Laminate	Textured PureStyle™	Thermofoil
•	•	•		•	•	box color	box color	box color	Maple

CELTIC LIGHT RAIL INSERT



JLRINSCFLT

- One 8" section.
- Pattern is 6" repeat.

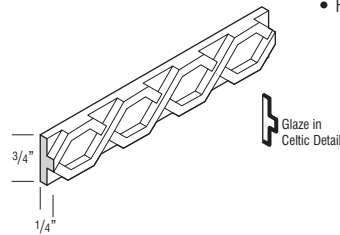

Finish Techniques

Distressing	Heirloom
	•

Specie Availability

Alder	Rustic Alder	Cherry	Hickory	Maple	Oak	High Gloss Laminate	Textured Laminate	Textured PureStyle™	Thermofoil
•	•	•		•	•	box color	box color	box color	Maple

MISSION LIGHT RAIL INSERT



JLRINSMIS

- One 8" section.
- Pattern is 6" repeat.

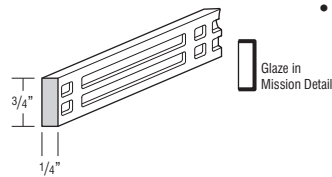

Finish Techniques

Distressing	Heirloom
	•

Specie Availability

Alder	Rustic Alder	Cherry	Hickory	Maple	Oak	High Gloss Laminate	Textured Laminate	Textured PureStyle™	Thermofoil
•	•	•		•	•	box color	box color	box color	Maple

Finished edges indicated by bold lines on side view drawings.
Glazed edges indicated by arrows on side view drawings.

DESCRIPTION

MODEL

WEAVE LIGHT RAIL INSERT



JLRINSWEAVE

- One 8' section.
- Pattern is 6" repeat.

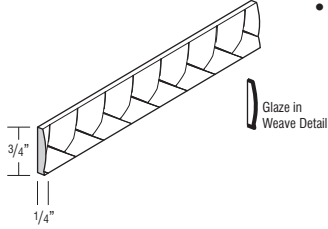

Finish Techniques

Distressing	Heirloom
	•

Specie Availability

Alder	Rustic Alder	Cherry	Hickory	Maple	Oak	High Gloss Laminate	Textured Laminate	Textured PureStyle™	Thermofoil
•	Alder	•		•		box color	box color	box color	Maple

CORNER MOULDINGS

DIAGONAL CORNER



DCM8

- Designed to set cabinets at a 45° corner application using 3/4" end panels.
- One 8' section.
- Not compatible on cabinets with Furniture Ends (FPEB) or Authentic Ends (AUTHL/AUTHR).

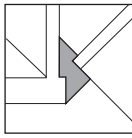
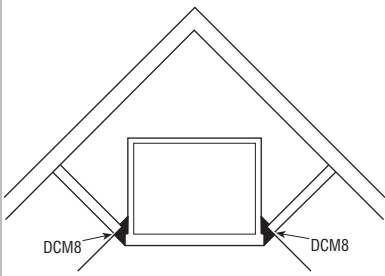
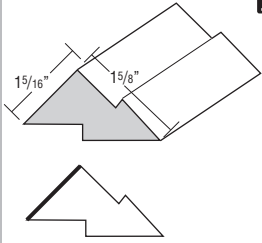

Finish Techniques

Distressing	Heirloom

Specie Availability

Alder	Rustic Alder	Cherry	Hickory	Maple	Oak	High Gloss Laminate	Textured Laminate	Textured PureStyle™	Thermofoil
•	Alder	•	•	•	•	box color	box color	box color	Maple

INSIDE CORNER



ICM8

- One 8' section.

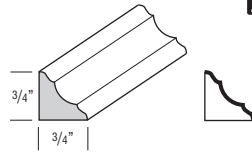

Finish Techniques

Distressing	Heirloom

Specie Availability

Alder	Rustic Alder	Cherry	Hickory	Maple	Oak	High Gloss Laminate	Textured Laminate	Textured PureStyle™	Thermofoil
•	Alder	•	•	•	•	box color	box color	box color	Maple

DESCRIPTION

MODEL

INSIDE CORNER, PREMIUM



ICM8P

- One 8' section.
- Horizontal grain except on High Gloss.

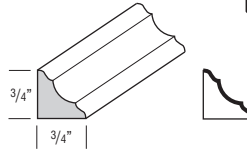

Finish Techniques

Distressing	Heirloom

Specie Availability

Alder	Rustic Alder	Cherry	Hickory	Maple	Oak	High Gloss Laminate	Textured Laminate	Textured PureStyle™	Thermofoil
						•	•	•	

LARGE OUTSIDE CORNER



LOSC8

- One 8' section.

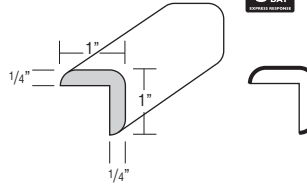

Finish Techniques

Distressing	Heirloom

Specie Availability

Alder	Rustic Alder	Cherry	Hickory	Maple	Oak	High Gloss Laminate	Textured Laminate	Textured PureStyle™	Thermofoil
•	Alder	•	•	•	•	box color	box color	box color	Maple

OUTSIDE CORNER



OCM8

- One 8' section.

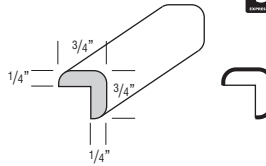

Finish Techniques

Distressing	Heirloom

Specie Availability

Alder	Rustic Alder	Cherry	Hickory	Maple	Oak	High Gloss Laminate	Textured Laminate	Textured PureStyle™	Thermofoil
•	Alder	•	•	•	•	box color	box color	box color	Maple

OUTSIDE CORNER, PREMIUM



OCM8P

- One 8' section.
- Horizontal grain except on High Gloss.

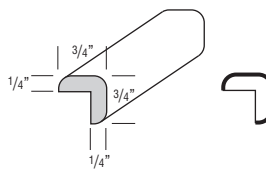

Finish Techniques

Distressing	Heirloom

Specie Availability

Alder	Rustic Alder	Cherry	Hickory	Maple	Oak	High Gloss Laminate	Textured Laminate	Textured PureStyle™	Thermofoil
						•	•	•	

OUTSIDE CORNER 135°



OC135

- One 8' section.

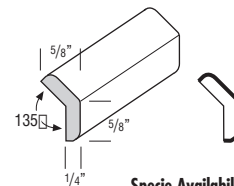

Finish Techniques

Distressing	Heirloom

Specie Availability

Alder	Rustic Alder	Cherry	Hickory	Maple	Oak	High Gloss Laminate	Textured Laminate	Textured PureStyle™	Thermofoil
•	Alder	•	•	•	•	box color	box color	box color	Maple

Finished edges indicated by bold lines on side view drawings.
Glazed edges indicated by arrows on side view drawings.

DESCRIPTION

MODEL

QUARTER ROUND MOULDING



QRM

- One 8" section.

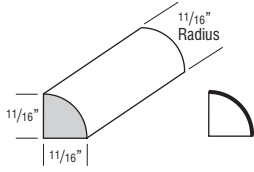

Finish Techniques

Distressing	Heirloom
•	•

Specie Availability

Alder	Rustic Alder	Cherry	Hickory	Maple	Oak	High Gloss Laminate	Textured Laminate	Textured PureStyle™	Thermofoil
•	•	•	•	•	•	box color	box color	box color	Maple

SHOE - CONVEX INSIDE CORNER



SHM8

- One 8" section.

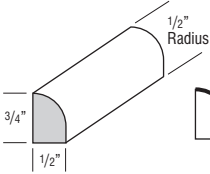

Finish Techniques

Distressing	Heirloom
•	•

Specie Availability

Alder	Rustic Alder	Cherry	Hickory	Maple	Oak	High Gloss Laminate	Textured Laminate	Textured PureStyle™	Thermofoil
•	•	•	•	•	•	box color	box color	box color	Maple

VALANCES

ARCHED VALANCE



AV36

AV48

AV60

AV72

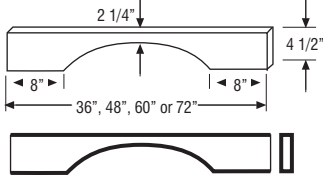

- Side shoulders are 8" wide (6" trimmable each end).
- Bottom edge has 3/16" radius.
- 3/4" thick.

Finish Techniques

Distressing	Heirloom
•	•

Specie Availability

Alder	Rustic Alder	Cherry	Hickory	Maple	Oak	High Gloss Laminate	Textured Laminate	Textured PureStyle™	Thermofoil
•	•	•	•	•	•	box color	box color	box color	Maple

FURNITURE VALANCE



FV36

FV48

FV60

FV72

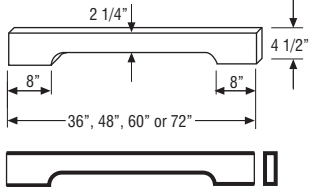

- Side shoulders are 8" wide (6" trimmable each end).
- Bottom edge has 3/16" radius profile on face.
- 3/4" thick.

Finish Techniques

Distressing	Heirloom
•	•

Specie Availability

Alder	Rustic Alder	Cherry	Hickory	Maple	Oak	High Gloss Laminate	Textured Laminate	Textured PureStyle™	Thermofoil
•	•	•	•	•	•	box color	box color	box color	Maple

DESCRIPTION

MODEL

RAISED PANEL ARCH VALANCE



JRPV30

JRPV36

JRPV42

JRPV48

JRPV54

JRPV60

JRPV72

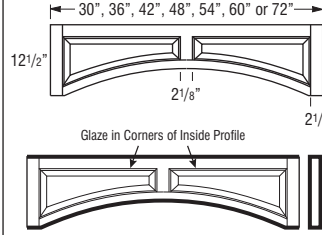

- Trimmable up to 1 3/4" per side.
- Recommended for use with hearths, see page 163.
- Center height 8".
- Raised panel profile is unique to this item and does not match any door style.
- Ends are pocket drilled for installation to adjacent cabinet frames.

Finish Techniques

Distressing	Heirloom
•	•

Specie Availability

Alder	Rustic Alder	Cherry	Hickory	Maple	Oak	High Gloss Laminate	Textured Laminate	Textured PureStyle™	Thermofoil
•	•	•	•	•	•	box color	box color	box color	Maple

RECESSED PANEL ARCH VALANCE



JRCPV30

JRCPV36

JRCPV42

JRCPV48

JRCPV54

JRCPV60

JRCPV72

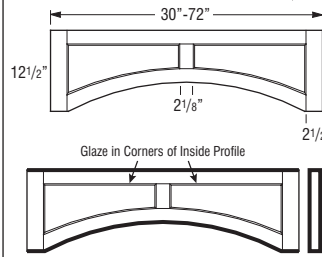

- Trimmable up to 1 3/4" per side.
- Recommended for use with hearths, see page 163.
- Center height 8".
- Ends are pocket drilled for installation to adjacent cabinet frames.

Finish Techniques

Distressing	Heirloom
•	•

Specie Availability

Alder	Rustic Alder	Cherry	Hickory	Maple	Oak	High Gloss Laminate	Textured Laminate	Textured PureStyle™	Thermofoil
•	•	•	•	•	•	box color	box color	box color	Maple

SCALLOPED VALANCE



SV48

- Trimmable.
- 3/4" thick.

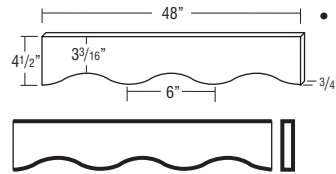

Finish Techniques

Distressing	Heirloom
•	•

Specie Availability

Alder	Rustic Alder	Cherry	Hickory	Maple	Oak	High Gloss Laminate	Textured Laminate	Textured PureStyle™	Thermofoil
•	•	•	•	•	•	box color	box color	box color	Maple

Finished edges indicated by bold lines on side view drawings.
Glazed edges indicated by arrows on side view drawings.

DESCRIPTION STRAIGHT VALANCE

MODEL VV48
VV72
VV96
VV120 ♦

4 1/2\"

• Trimmable.
• 3/4\" thick.

Finish Techniques

Distressing	Heirloom
•	•

Specie Availability

Alder	Rustic Alder	Cherry	Hickory	Maple	Oak	High Gloss Laminate	Textured Laminate	Textured PureStyle™	Thermofoil
•	•	•	•	•	•	box color	box color	box color	Maple

♦ Only available in Cherry and Maple.

DECORATIVE OVERLAYS

ACANTHUS OVERLAY

ACOVLV

4 1/2\"

5/8\"

Glaze in Acanthus Detail

Finish Techniques

Distressing	Heirloom
	•

Specie Availability

Alder	Rustic Alder	Cherry	Hickory	Maple	Oak	High Gloss Laminate	Textured Laminate	Textured PureStyle™	Thermofoil
•	Alder	•		•		box color	box color	box color	Maple

CELTIC OVERLAY

JCELOVLY

43/4\"

5/8\"

Glaze in Celtic Detail

Finish Techniques

Distressing	Heirloom
	•

Specie Availability

Alder	Rustic Alder	Cherry	Hickory	Maple	Oak	High Gloss Laminate	Textured Laminate	Textured PureStyle™	Thermofoil
		•		•	•	box color	box color	box color	Maple

DECORATIVE ORNAMENTS

ACANTHUS ORNAMENT

ACO

5\"

1 9/16\"

Glaze in Acanthus Detail

Finish Techniques

Distressing	Heirloom
	•

Specie Availability

Alder	Rustic Alder	Cherry	Hickory	Maple	Oak	High Gloss Laminate	Textured Laminate	Textured PureStyle™	Thermofoil
		•		•		box color	box color	box color	Maple

DESCRIPTION MISSION ROSETTE

MODEL ROSETTEMIS

5/16\"

7/8\"

Glaze in Mission Detail

• Apply with small brad.

Finish Techniques

Distressing	Heirloom
	•

Specie Availability

Alder	Rustic Alder	Cherry	Hickory	Maple	Oak	High Gloss Laminate	Textured Laminate	Textured PureStyle™	Thermofoil
•	Alder	•		•	•	box color	box color	box color	Maple

SCROLL ROSETTE

ROSETTESCR

9/16\"

Glaze in Rosette Detail

Finish Techniques

Distressing	Heirloom
	•

Specie Availability

Alder	Rustic Alder	Cherry	Hickory	Maple	Oak	High Gloss Laminate	Textured Laminate	Textured PureStyle™	Thermofoil
•	Alder	•		•	•	box color	box color	box color	Maple

TRADITIONAL ROSETTE

TROSETTE

3/8\"

Glaze in Rosette Detail

Finish Techniques

Distressing	Heirloom
	•

Specie Availability

Alder	Rustic Alder	Cherry	Hickory	Maple	Oak	High Gloss Laminate	Textured Laminate	Textured PureStyle™	Thermofoil
Cherry	Cherry	•	Beech	•	Beech	box color	box color	box color	Maple

Finished edges indicated by bold lines on side view drawings.
Glazed edges indicated by arrows on side view drawings.

DESCRIPTION

MODEL

CORNER ROSETTE, 3"



FFRC3X3 (Fluted)
BFRC3X3 (Beaded)

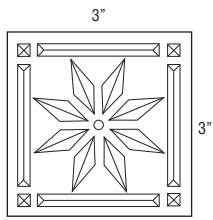

Back Views of Rosette

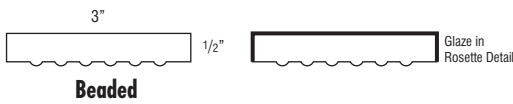
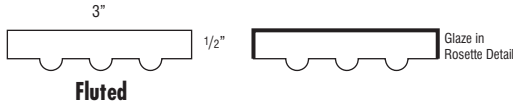

Finish Techniques

Distressing	Heirloom

Specie Availability

Alder	Rustic Alder	Cherry	Hickory	Maple	Oak	High Gloss Laminate	Textured Laminate	Textured PureStyle™	Thermofoil
• Alder	• Alder	•	•	•	•	box color	box color	box color	Maple

CELTIC ROSETTE



ROSETTCELT

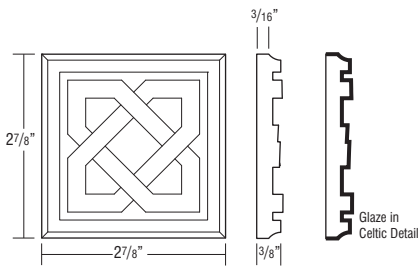

Finish Techniques

Distressing	Heirloom
	•

Specie Availability

Alder	Rustic Alder	Cherry	Hickory	Maple	Oak	High Gloss Laminate	Textured Laminate	Textured PureStyle™	Thermofoil
		•		•	•	box color	box color	box color	Maple

PLINTH BLOCK FILLER, 3"



FFP3X8 (Fluted)
BFPC3X8 (Beaded)

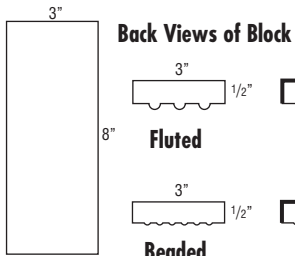

Back Views of Block

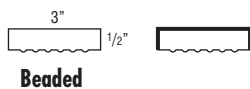
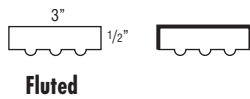

Finish Techniques

Distressing	Heirloom
	•

Specie Availability

Alder	Rustic Alder	Cherry	Hickory	Maple	Oak	High Gloss Laminate	Textured Laminate	Textured PureStyle™	Thermofoil
• Alder	• Alder	•		•	•	box color	box color	box color	Maple

DESCRIPTION

MODEL

CORNER ROSETTE, 6"



FFRC6X6 (Fluted)

• Available only as fluted.

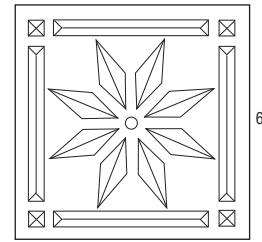

Back View of Rosette



Finish Techniques

Distressing	Heirloom

Specie Availability

Alder	Rustic Alder	Cherry	Hickory	Maple	Oak	High Gloss Laminate	Textured Laminate	Textured PureStyle™	Thermofoil
• Alder	• Alder	•	•	•	•	box color	box color	box color	Maple

ACANTHUS TILE



JTILEACAN

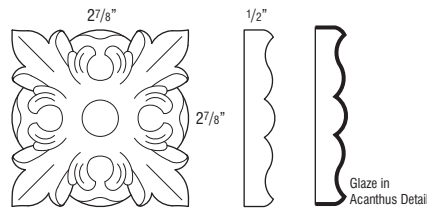

Finish Techniques

Distressing	Heirloom
	•

Specie Availability

Alder	Rustic Alder	Cherry	Hickory	Maple	Oak	High Gloss Laminate	Textured Laminate	Textured PureStyle™	Thermofoil
• Alder	• Alder	•		•	•	box color	box color	box color	Maple

MISSION TILE



JTILEMISSION

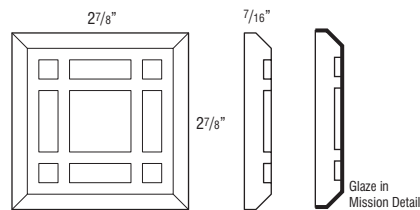

Finish Techniques

Distressing	Heirloom
	•

Specie Availability

Alder	Rustic Alder	Cherry	Hickory	Maple	Oak	High Gloss Laminate	Textured Laminate	Textured PureStyle™	Thermofoil
• Alder	• Alder	•		•	•	box color	box color	box color	Maple

Finished edges indicated by bold lines on side view drawings.
Glazed edges indicated by arrows on side view drawings.

DESCRIPTION

MODEL

PLINTH BLOCK FILLER, 6"



FFP6X8 (Fluted)

- Available only as fluted.

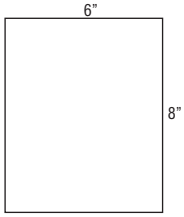

Back View of Block

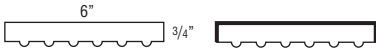

Finish Techniques

Distressing	Heirloom
	•

Specie Availability

Alder	Rustic Alder	Cherry	Hickory	Maple	Oak	High Gloss Laminate	Textured Laminate	Textured PureStyle™	Thermofoil
•	Alder	•	•	•	•	box color	box color	box color	Maple

DECORATIVE SUPPORTS

ACANTHUS LEG, 35 1/4" HIGH



JACANTHUSLEG

- Trimmable.

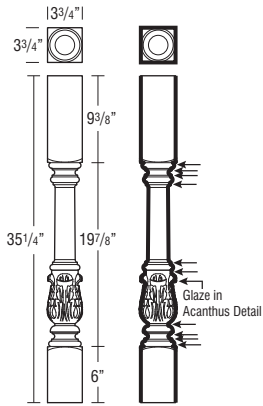

Finish Techniques

Distressing	Heirloom
	•

Specie Availability

Alder	Rustic Alder	Cherry	Hickory	Maple	Oak	High Gloss Laminate	Textured Laminate	Textured PureStyle™	Thermofoil
•	Alder	•	•	•	•	box color	box color	box color	Maple

DESCRIPTION

MODEL

BAR LEG, 2-SIDED, 42 1/4" HIGH



2SBARLEG

- Trimmable.

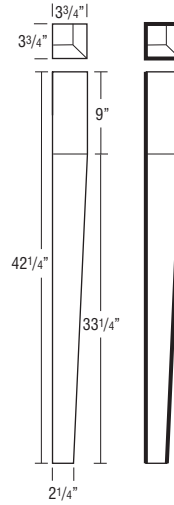

Finish Techniques

Distressing	Heirloom
	•

Specie Availability

Alder	Rustic Alder	Cherry	Hickory	Maple	Oak	High Gloss Laminate	Textured Laminate	Textured PureStyle™	Thermofoil
•	Alder	•	•	•	•	box color	box color	box color	Maple

BAR LEG, 4-SIDED, 42 1/4" HIGH



4SBARLEG

- Trimmable.

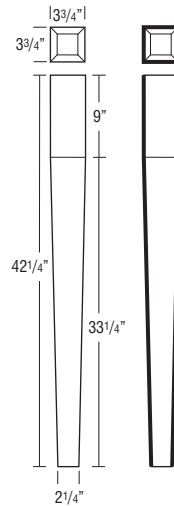

Finish Techniques

Distressing	Heirloom
	•

Specie Availability

Alder	Rustic Alder	Cherry	Hickory	Maple	Oak	High Gloss Laminate	Textured Laminate	Textured PureStyle™	Thermofoil
•	Alder	•	•	•	•	box color	box color	box color	Maple

Finished edges indicated by bold lines on side view drawings.
Glazed edges indicated by arrows on side view drawings.

DESCRIPTION

MODEL

**BAROQUE LEG,
34 1/2" HIGH**



JBAROQUELEG

- Trimmable.
- Leg is designed with three pieces. Field assembly required.

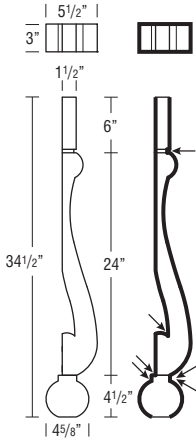

Finish Techniques

Distressing	Heirloom
	•

Specie Availability

Alder	Rustic Alder	Cherry	Hickory	Maple	Oak	High Glass Laminate	Textured Laminate	Textured PureStyle™	Thermofoil
•	Alder	•		•		box color	box color	box color	Maple

**BUFFET LEG,
34 1/2" HIGH**



JBUFFETLEG

- Trimmable.

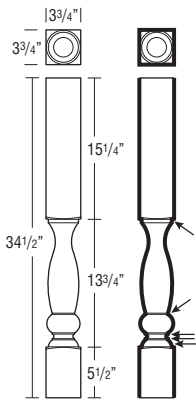

Finish Techniques

Distressing	Heirloom
	•

Specie Availability

Alder	Rustic Alder	Cherry	Hickory	Maple	Oak	High Glass Laminate	Textured Laminate	Textured PureStyle™	Thermofoil
•	Alder	•		•	•	box color	box color	box color	Maple

DESCRIPTION

MODEL

**COSMO LEG,
35 1/4" HIGH**



JCOSMOLEG

- Trimmable.
- Leg is designed with three pieces joined together.

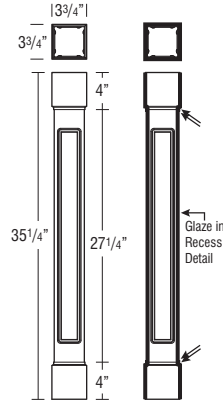

Finish Techniques

Distressing	Heirloom
	•

Specie Availability

Alder	Rustic Alder	Cherry	Hickory	Maple	Oak	High Glass Laminate	Textured Laminate	Textured PureStyle™	Thermofoil
•	Alder	•		•	•	box color	box color	box color	Maple

**ENGLISH COUNTRY
LEG, 35 1/4" HIGH**



JENGNTYLEG

- Trimmable.

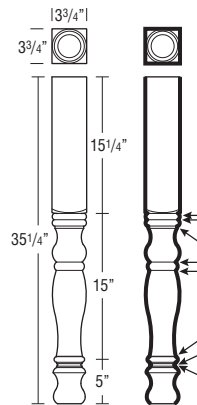

Finish Techniques

Distressing	Heirloom
	•

Specie Availability

Alder	Rustic Alder	Cherry	Hickory	Maple	Oak	High Glass Laminate	Textured Laminate	Textured PureStyle™	Thermofoil
•	Alder	•		•	•	box color	box color	box color	Maple

Finished edges indicated by bold lines on side view drawings.
Glazed edges indicated by arrows on side view drawings.

DESCRIPTION

MODEL

**ENGLISH BAR COLUMN,
42 1/4" HIGH**



ENGBARCOLUMN

- Trimmable.

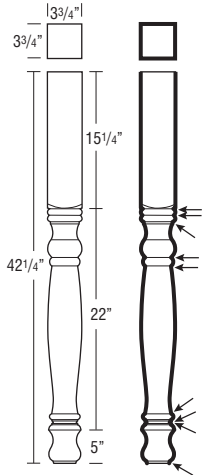

Finish Techniques

Distressing	Heirloom
	•

Specie Availability

Alder	Rustic Alder	Cherry	Hickory	Maple	Oak	High Gloss Laminate	Textured Laminate	Textured PureStyle™	Thermofoil
•	Alder	•		•	•	box color	box color	box color	Maple

**ENGLISH ISLAND COLUMN,
5" WIDE, 35 1/4" HIGH**



ENGLISHCOLUMN

- Trimmable.

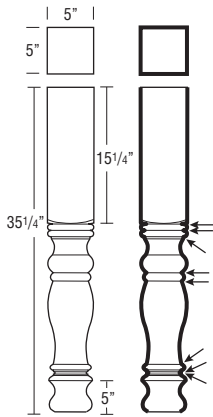

Finish Techniques

Distressing	Heirloom
	•

Specie Availability

Alder	Rustic Alder	Cherry	Hickory	Maple	Oak	High Gloss Laminate	Textured Laminate	Textured PureStyle™	Thermofoil
•	Alder	•		•	•	box color	box color	box color	Maple

DESCRIPTION

MODEL

**SMALL ESTATE LEG,
2 3/4" WIDE,
35 1/4" HIGH**



JESTATELEGS

- Trimmable.

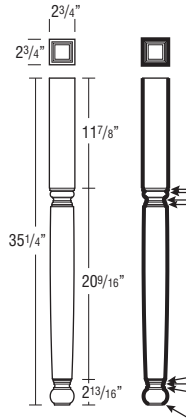

Finish Techniques

Distressing	Heirloom
	•

Specie Availability

Alder	Rustic Alder	Cherry	Hickory	Maple	Oak	High Gloss Laminate	Textured Laminate	Textured PureStyle™	Thermofoil
•	Alder	•		•	•	box color	box color	box color	Maple

**SMALL ESTATE LEG
SPLIT, 2 3/4" WIDE,
35 1/4" HIGH**



JESTATELEGSS

- Trimmable.

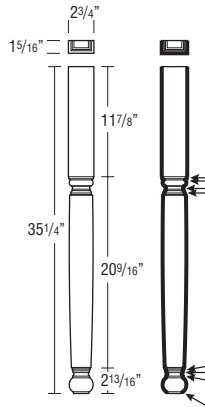

Finish Techniques

Distressing	Heirloom
	•

Specie Availability

Alder	Rustic Alder	Cherry	Hickory	Maple	Oak	High Gloss Laminate	Textured Laminate	Textured PureStyle™	Thermofoil
•	Alder	•		•	•	box color	box color	box color	Maple

Finished edges indicated by bold lines on side view drawings.
Glazed edges indicated by arrows on side view drawings.

DESCRIPTION

MODEL

**ESTATE LEG,
35 1/4" HIGH**



JESTATELEG

- Trimmable.

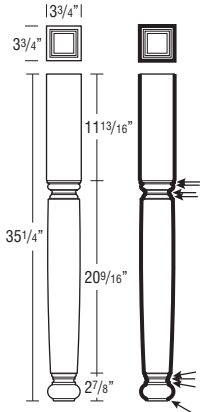

Finish Techniques

Distressing	Heirloom
	•

Specie Availability

Alder	Rustic Alder	Cherry	Hickory	Maple	Oak	High Glass Laminate	Textured Laminate	Textured PureStyle™	Thermofoil
•	Alder	•		•	•	box color	box color	box color	Maple

DESCRIPTION

MODEL

**SMALL CLASSIC FLUTED
LEG SPLIT,
2 3/4" WIDE,
35 1/4" HIGH**



JFLUTELEGSS

- Trimmable.

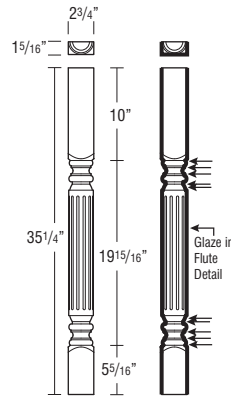

Finish Techniques

Distressing	Heirloom
	•

Specie Availability

Alder	Rustic Alder	Cherry	Hickory	Maple	Oak	High Glass Laminate	Textured Laminate	Textured PureStyle™	Thermofoil
•	Alder	•		•	•	box color	box color	box color	Maple

**SMALL CLASSIC FLUTED
LEG, 2 3/4" WIDE,
35 1/4" HIGH**



JFLUTELEGS

- Trimmable.

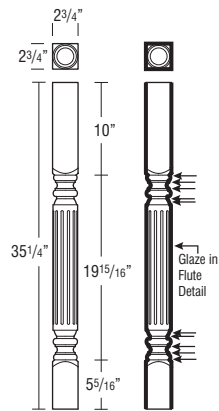

Finish Techniques

Distressing	Heirloom
	•

Specie Availability

Alder	Rustic Alder	Cherry	Hickory	Maple	Oak	High Glass Laminate	Textured Laminate	Textured PureStyle™	Thermofoil
•	Alder	•		•	•	box color	box color	box color	Maple

**CLASSIC FLUTED LEG,
35 1/4" HIGH**



JFLUTELEG

- Trimmable.

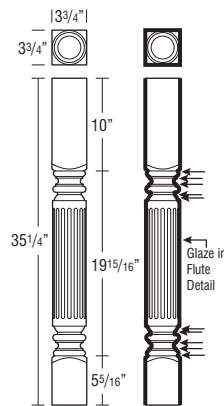

Finish Techniques

Distressing	Heirloom
	•

Specie Availability

Alder	Rustic Alder	Cherry	Hickory	Maple	Oak	High Glass Laminate	Textured Laminate	Textured PureStyle™	Thermofoil
•	Alder	•		•	•	box color	box color	box color	Maple

Finished edges indicated by bold lines on side view drawings.
Glazed edges indicated by arrows on side view drawings.

DESCRIPTION

MODEL

CLASSIC FLUTED LEG,
42 1/4" HIGH



JFLUTELEG

- Trimmable.

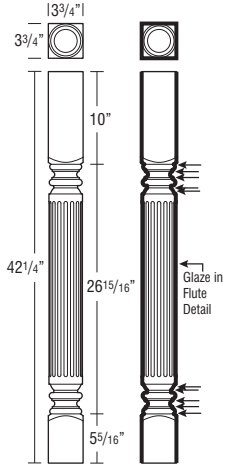

Finish Techniques

Distressing	Heirloom
	•

Specie Availability

Alder	Rustic Alder	Cherry	Hickory	Maple	Oak	High Gloss Laminate	Textured Laminate	Textured PureStyle™	Thermofoil
•	Alder	•		•	•	box color	box color	box color	Maple

CLASSIC FLUTED LEG,
5" WIDE, 35 1/4" HIGH



JFLUTELEG

- Trimmable.

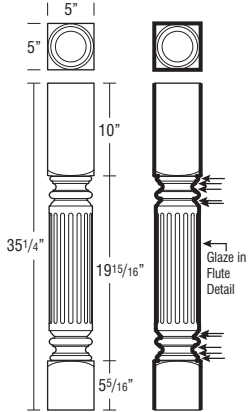

Finish Techniques

Distressing	Heirloom
	•

Specie Availability

Alder	Rustic Alder	Cherry	Hickory	Maple	Oak	High Gloss Laminate	Textured Laminate	Textured PureStyle™	Thermofoil
•	Alder	•		•	•	box color	box color	box color	Maple

DESCRIPTION

MODEL

FRENCH COUNTRY LEG,
35 1/4" HIGH



JFRNCNTYLEG

- Trimmable.

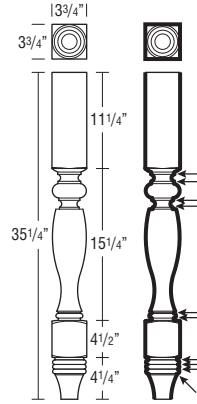

Finish Techniques

Distressing	Heirloom
	•

Specie Availability

Alder	Rustic Alder	Cherry	Hickory	Maple	Oak	High Gloss Laminate	Textured Laminate	Textured PureStyle™	Thermofoil
•	Alder	•		•	•	box color	box color	box color	Maple

FRENCH COUNTRY LEG,
42 1/4" HIGH



JFRNCNTYLEG

- Trimmable.

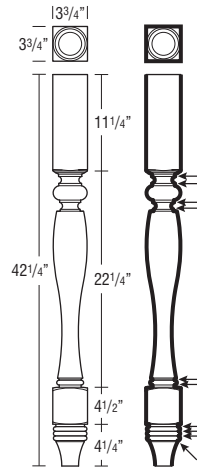

Finish Techniques

Distressing	Heirloom
	•

Specie Availability

Alder	Rustic Alder	Cherry	Hickory	Maple	Oak	High Gloss Laminate	Textured Laminate	Textured PureStyle™	Thermofoil
•	Alder	•		•	•	box color	box color	box color	Maple

Finished edges indicated by bold lines on side view drawings.
Glazed edges indicated by arrows on side view drawings.

DESCRIPTION

MODEL

FRENCH COUNTRY LEG, 5" WIDE, 35 1/4" HIGH



JFRNCNTYLEGL

- Trimable.

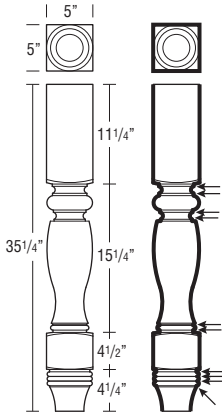

Finish Techniques

Distressing	Heirloom
	•

Specie Availability

Alder	Rustic Alder	Cherry	Hickory	Maple	Oak	High Gloss Laminate	Textured Laminate	Textured PureStyle™	Thermofoil
•	Alder	•		•	•	box color	box color	box color	Maple

DESCRIPTION

MODEL

ISLAND LEG, 4-SIDED, 35 1/4" HIGH



4SISLEG

- Trimable.

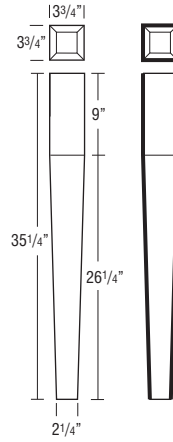

Finish Techniques

Distressing	Heirloom
	•

Specie Availability

Alder	Rustic Alder	Cherry	Hickory	Maple	Oak	High Gloss Laminate	Textured Laminate	Textured PureStyle™	Thermofoil
•	Alder	•		•	•	box color	box color	box color	Maple

ISLAND LEG, 2-SIDED, 35 1/4" HIGH



2SISLEG

- Trimable.

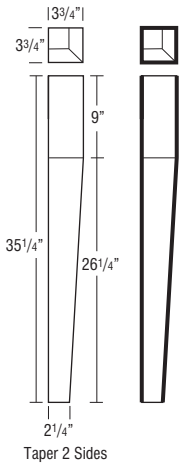

Finish Techniques

Distressing	Heirloom
	•

Specie Availability

Alder	Rustic Alder	Cherry	Hickory	Maple	Oak	High Gloss Laminate	Textured Laminate	Textured PureStyle™	Thermofoil
•	Alder	•		•	•	box color	box color	box color	Maple

METRO BAR COLUMN, 40 5/8" HIGH



METBARCOLUMN

- Trimable.
- Leg is designed with three pieces joined together.

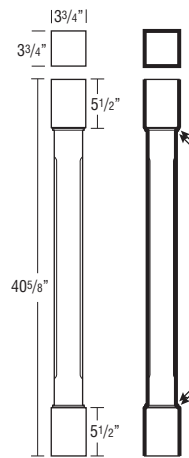

Finish Techniques

Distressing	Heirloom
	•

Specie Availability

Alder	Rustic Alder	Cherry	Hickory	Maple	Oak	High Gloss Laminate	Textured Laminate	Textured PureStyle™	Thermofoil
•	Alder	•		•	•	box color	box color	box color	Maple

Finished edges indicated by bold lines on side view drawings.
Glazed edges indicated by arrows on side view drawings.

DESCRIPTION

MODEL

**METRO ISLAND COLUMN,
34 5/8" HIGH**



METISLCOLUMN

- Trimmable.
- Leg is designed with three pieces joined together.

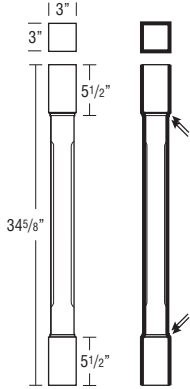

Finish Techniques

Distressing	Heirloom
	•

Specie Availability

Alder	Rustic Alder	Cherry	Hickory	Maple	Oak	High Gloss Laminate	Textured Laminate	Textured PureStyle™	Thermofoil
•	Alder	•		•	•	box color	box color	box color	Maple

**MISSION LEG,
34 1/2" HIGH**



DLEGMSSION

- Trimmable.

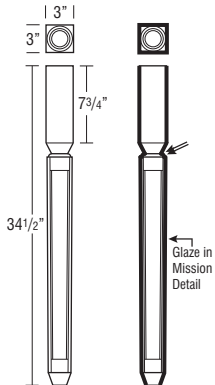

Finish Techniques

Distressing	Heirloom
	•

Specie Availability

Alder	Rustic Alder	Cherry	Hickory	Maple	Oak	High Gloss Laminate	Textured Laminate	Textured PureStyle™	Thermofoil
•	Alder	•		•	•	box color	box color	box color	Maple

DESCRIPTION

MODEL

**QUEEN ANNE LEG,
42 1/4" HIGH**



JQUNANNELEG

- Trimmable.

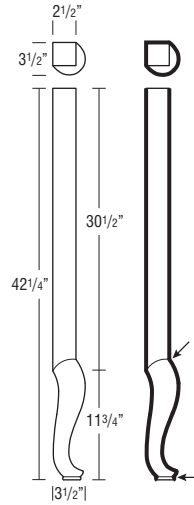

Finish Techniques

Distressing	Heirloom
	•

Specie Availability

Alder	Rustic Alder	Cherry	Hickory	Maple	Oak	High Gloss Laminate	Textured Laminate	Textured PureStyle™	Thermofoil
•	Alder	•		•	•	box color	box color	box color	Maple

REED LEG, 34 1/2" HIGH



RDLEG

- Trimmable.

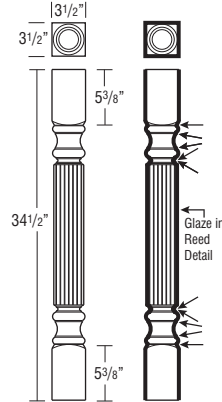

Finish Techniques

Distressing	Heirloom
	•

Specie Availability

Alder	Rustic Alder	Cherry	Hickory	Maple	Oak	High Gloss Laminate	Textured Laminate	Textured PureStyle™	Thermofoil
•	Alder	•		•	•	box color	box color	box color	Maple

Finished edges indicated by bold lines on side view drawings.
Glazed edges indicated by arrows on side view drawings.

DESCRIPTION

MODEL

REED LEG, 40 1/2" HIGH



JRDLEGT

- Trimable.

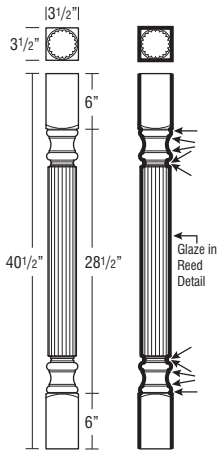

Finish Techniques

Distressing	Heirloom
	•

Specie Availability

Alder	Rustic Alder	Cherry	Hickory	Maple	Oak	High Gloss Laminate	Textured Laminate	Textured PureStyle™	Thermofoil
•	Alder	•		•	•	box color	box color	box color	Maple

DESCRIPTION

MODEL

ROMAN WEAVE LEG, 35 1/4" HIGH



JWEAVELEG

- Trimable.

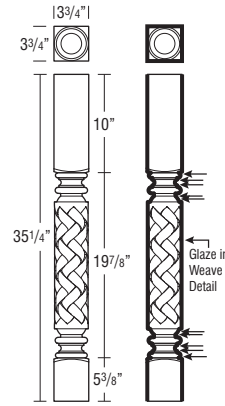

Finish Techniques

Distressing	Heirloom
	•

Specie Availability

Alder	Rustic Alder	Cherry	Hickory	Maple	Oak	High Gloss Laminate	Textured Laminate	Textured PureStyle™	Thermofoil
•	Alder	•		•	•	box color	box color	box color	Maple

REED LEG, 5" WIDE, 34 1/2" HIGH



JRDLEGL

- Trimable.

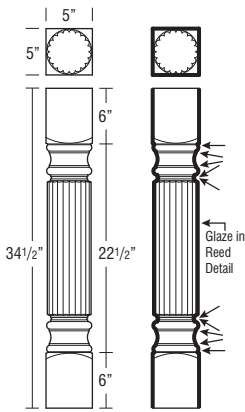

Finish Techniques

Distressing	Heirloom
	•

Specie Availability

Alder	Rustic Alder	Cherry	Hickory	Maple	Oak	High Gloss Laminate	Textured Laminate	Textured PureStyle™	Thermofoil
•	Alder	•		•	•	box color	box color	box color	Maple

ROMAN WEAVE LEG, 42 1/4" HIGH



JWEAVELEGT

- Trimable.

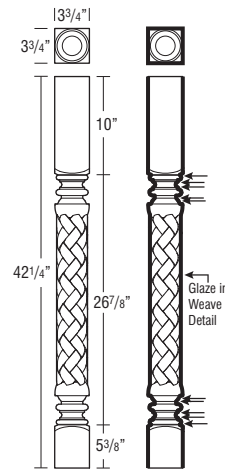

Finish Techniques

Distressing	Heirloom
	•

Specie Availability

Alder	Rustic Alder	Cherry	Hickory	Maple	Oak	High Gloss Laminate	Textured Laminate	Textured PureStyle™	Thermofoil
•	Alder	•		•	•	box color	box color	box color	Maple

Finished edges indicated by bold lines on side view drawings.
Glazed edges indicated by arrows on side view drawings.

DESCRIPTION

MODEL

**ROMAN WEAVE LEG,
5" WIDE, 35 1/4" HIGH**



JWEAVEGL

- Trimmable.

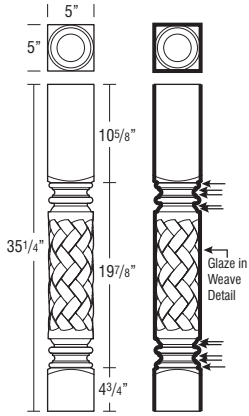

Finish Techniques

Distressing	Heirloom
	•

Specie Availability

Alder	Rustic Alder	Cherry	Hickory	Maple	Oak	High Gloss Laminate	Textured Laminate	Textured PureStyle™	Thermofoil
•	Alder	•		•	•	box color	box color	box color	Maple

**SMALL CLASSIC ROPE LEG,
2 3/4" WIDE,
35 1/4" HIGH**



JROPELGS

- Trimmable.

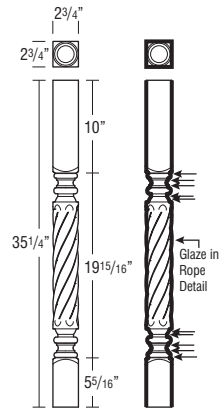

Finish Techniques

Distressing	Heirloom
	•

Specie Availability

Alder	Rustic Alder	Cherry	Hickory	Maple	Oak	High Gloss Laminate	Textured Laminate	Textured PureStyle™	Thermofoil
•	Alder	•		•	•	box color	box color	box color	Maple

DESCRIPTION

MODEL

**SMALL CLASSIC ROPE LEG SPLIT,
2 3/4" WIDE,
35 1/4" HIGH**



JROPELGSS

- Trimmable.

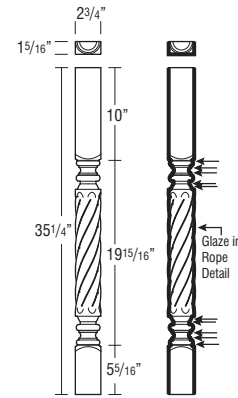

Finish Techniques

Distressing	Heirloom
	•

Specie Availability

Alder	Rustic Alder	Cherry	Hickory	Maple	Oak	High Gloss Laminate	Textured Laminate	Textured PureStyle™	Thermofoil
•	Alder	•		•	•	box color	box color	box color	Maple

**CLASSIC ROPE LEG,
35 1/4" HIGH**



JROPELEG

- Trimmable.

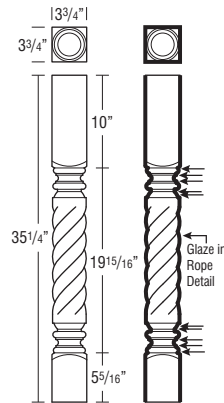

Finish Techniques

Distressing	Heirloom
	•

Specie Availability

Alder	Rustic Alder	Cherry	Hickory	Maple	Oak	High Gloss Laminate	Textured Laminate	Textured PureStyle™	Thermofoil
•	Alder	•		•	•	box color	box color	box color	Maple

Finished edges indicated by bold lines on side view drawings.
Glazed edges indicated by arrows on side view drawings.

DESCRIPTION

MODEL

**CLASSIC ROPE LEG,
42 1/4" HIGH**



JROPELEGT

- Trimmable.

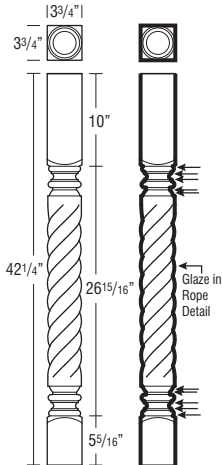

Finish Techniques

Distressing	Heirloom
	•

Specie Availability

Alder	Rustic Alder	Cherry	Hickory	Maple	Oak	High Gloss Laminate	Textured Laminate	Textured PureStyle™	Thermofoil
•	Alder	•		•	•	box color	box color	box color	Maple

DESCRIPTION

MODEL

**SMALL SPOOL LEG,
2 3/4" WIDE,
35 1/4" HIGH**



JSPLEGS

- Trimmable.

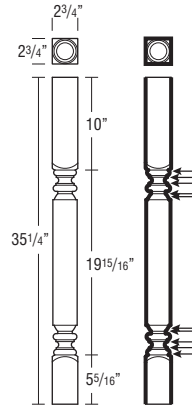

Finish Techniques

Distressing	Heirloom
	•

Specie Availability

Alder	Rustic Alder	Cherry	Hickory	Maple	Oak	High Gloss Laminate	Textured Laminate	Textured PureStyle™	Thermofoil
•	Alder	•		•	•	box color	box color	box color	Maple

**CLASSIC ROPE LEG,
5" WIDE, 35 1/4" HIGH**



JROPELEGL

- Trimmable.

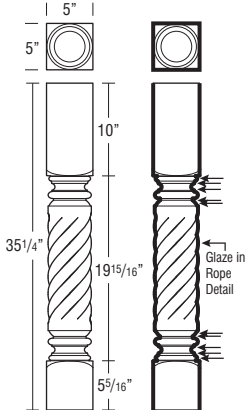

Finish Techniques

Distressing	Heirloom
	•

Specie Availability

Alder	Rustic Alder	Cherry	Hickory	Maple	Oak	High Gloss Laminate	Textured Laminate	Textured PureStyle™	Thermofoil
•	Alder	•		•	•	box color	box color	box color	Maple

**SMALL SPOOL LEG
SPLIT, 2 3/4" WIDE,
35 1/4" HIGH**



JSPLEGS

- Trimmable.

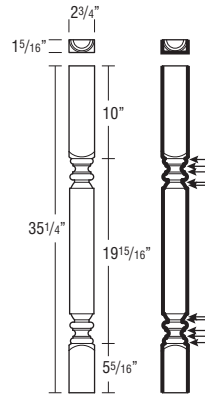

Finish Techniques

Distressing	Heirloom
	•

Specie Availability

Alder	Rustic Alder	Cherry	Hickory	Maple	Oak	High Gloss Laminate	Textured Laminate	Textured PureStyle™	Thermofoil
•	Alder	•		•	•	box color	box color	box color	Maple

Finished edges indicated by bold lines on side view drawings.
Glazed edges indicated by arrows on side view drawings.

DESCRIPTION

MODEL

**SPOOL LEG,
34 1/2" HIGH**



SPLLEG

- Trimmable.

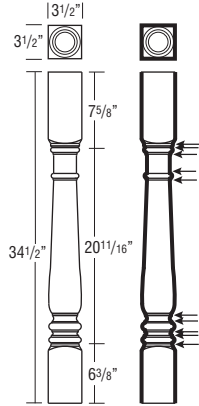

Finish Techniques

Distressing	Heirloom
	•

Specie Availability

Alder	Rustic Alder	Cherry	Hickory	Maple	Oak	High Gloss Laminate	Textured Laminate	Textured PureStyle™	Thermofoil
•	Alder	•		•	•	box color	box color	box color	Maple

**SPOOL LEG,
40 1/2" HIGH**



JSPLEGT

- Trimmable.

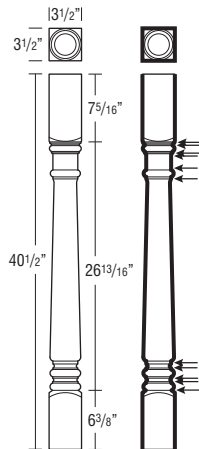

Finish Techniques

Distressing	Heirloom
	•

Specie Availability

Alder	Rustic Alder	Cherry	Hickory	Maple	Oak	High Gloss Laminate	Textured Laminate	Textured PureStyle™	Thermofoil
•	Alder	•		•	•	box color	box color	box color	Maple

**SQUARE ISLAND LEG SPLIT,
35 1/4" HIGH**



JSQISLLEG3S

- Trimmable.

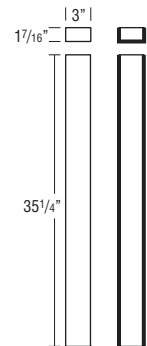

Finish Techniques

Distressing	Heirloom
	•

Specie Availability

Alder	Rustic Alder	Cherry	Hickory	Maple	Oak	High Gloss Laminate	Textured Laminate	Textured PureStyle™	Thermofoil
•	Alder	•		•	•	box color	box color	box color	Maple

DESCRIPTION

MODEL

**SQUARE ISLAND LEG,
3" x 3", 35 1/4" HIGH**



JSQISLLEG3

- Trimmable.

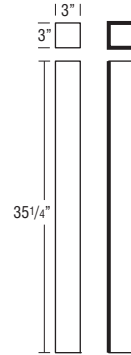

Finish Techniques

Distressing	Heirloom
	•

Specie Availability

Alder	Rustic Alder	Cherry	Hickory	Maple	Oak	High Gloss Laminate	Textured Laminate	Textured PureStyle™	Thermofoil
•	Alder	•		•	•	box color	box color	box color	Maple

**SQUARE ISLAND LEG,
4" x 4", 35 1/4" HIGH**



JSQISLLEG4

- Trimmable.

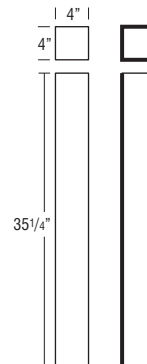

Finish Techniques

Distressing	Heirloom
	•

Specie Availability

Alder	Rustic Alder	Cherry	Hickory	Maple	Oak	High Gloss Laminate	Textured Laminate	Textured PureStyle™	Thermofoil
•	Alder	•		•	•	box color	box color	box color	Maple

**SQUARE ISLAND LEG,
6" x 6", 35 1/4" HIGH**



JSQISLLEG6

- Trimmable.

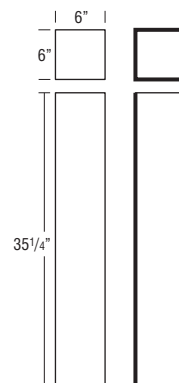

Finish Techniques

Distressing	Heirloom
	•

Specie Availability

Alder	Rustic Alder	Cherry	Hickory	Maple	Oak	High Gloss Laminate	Textured Laminate	Textured PureStyle™	Thermofoil
•	Alder	•		•	•	box color	box color	box color	Maple

Finished edges indicated by bold lines on side view drawings.
Glazed edges indicated by arrows on side view drawings.

DESCRIPTION

MODEL

**SQUARE BAR LEG
SPLIT, 42 1/4" HIGH**



JSQBARLEG3S

- Trimmable.

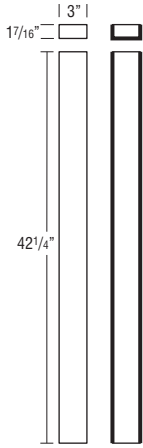

Finish Techniques

Distressing	Heirloom
	•

Specie Availability

Alder	Rustic Alder	Cherry	Hickory	Maple	Oak	High Gloss Laminate	Textured Laminate	Textured PureStyle™	Thermofoil
•	Alder	•		•	•	box color	box color	box color	Maple

DESCRIPTION

MODEL

**SQUARE BAR LEG,
4" x 4", 42 1/4" HIGH**



JSQBARLEG4

- Trimmable.

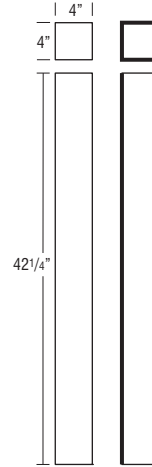

Finish Techniques

Distressing	Heirloom
	•

Specie Availability

Alder	Rustic Alder	Cherry	Hickory	Maple	Oak	High Gloss Laminate	Textured Laminate	Textured PureStyle™	Thermofoil
•	Alder	•		•	•	box color	box color	box color	Maple

**SQUARE BAR LEG,
3" x 3", 42 1/4" HIGH**



JSQBARLEG3

- Trimmable.



Finish Techniques

Distressing	Heirloom
	•

Specie Availability

Alder	Rustic Alder	Cherry	Hickory	Maple	Oak	High Gloss Laminate	Textured Laminate	Textured PureStyle™	Thermofoil
•	Alder	•		•	•	box color	box color	box color	Maple

**SQUARE BAR LEG,
6" x 6", 42 1/4" HIGH**



JSQBARLEG6

- Trimmable.

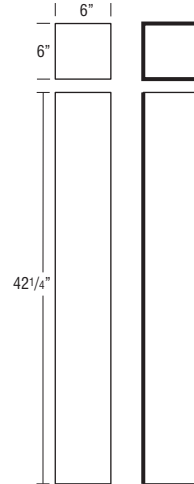

Finish Techniques

Distressing	Heirloom
	•

Specie Availability

Alder	Rustic Alder	Cherry	Hickory	Maple	Oak	High Gloss Laminate	Textured Laminate	Textured PureStyle™	Thermofoil
•	Alder	•		•	•	box color	box color	box color	Maple

Finished edges indicated by bold lines on side view drawings.
Glazed edges indicated by arrows on side view drawings.

DESCRIPTION

MODEL

TULIP LEG,
34 1/2" HIGH



JTULIPEG

- Trimmable.

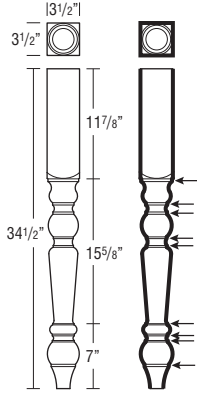

Finish Techniques

Distressing	Heirloom
	•

Specie Availability

Alder	Rustic Alder	Cherry	Hickory	Maple	Oak	High Gloss Laminate	Textured Laminate	Textured PureStyle™	Thermofoil
•	Alder	•		•	•	box color	box color	box color	Maple

TULIP LEG,
40 1/2" HIGH



JTULIPEGT

- Trimmable.

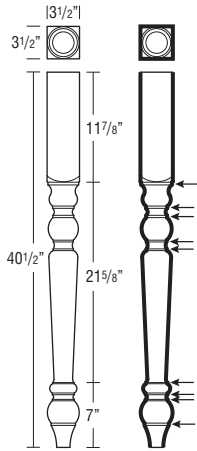

Finish Techniques

Distressing	Heirloom
	•

Specie Availability

Alder	Rustic Alder	Cherry	Hickory	Maple	Oak	High Gloss Laminate	Textured Laminate	Textured PureStyle™	Thermofoil
•	Alder	•		•	•	box color	box color	box color	Maple

DESCRIPTION

MODEL

URN LEG,
35 1/4" HIGH



JURNLEG

- Trimmable.

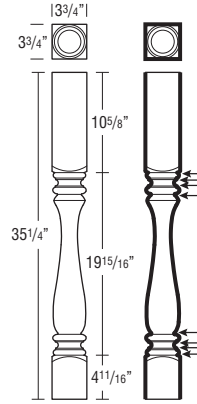

Finish Techniques

Distressing	Heirloom
	•

Specie Availability

Alder	Rustic Alder	Cherry	Hickory	Maple	Oak	High Gloss Laminate	Textured Laminate	Textured PureStyle™	Thermofoil
•	Alder	•		•	•	box color	box color	box color	Maple

URN LEG,
42 1/4" HIGH



JURNLEGT

- Trimmable.

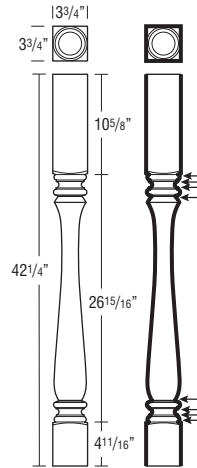

Finish Techniques

Distressing	Heirloom
	•

Specie Availability

Alder	Rustic Alder	Cherry	Hickory	Maple	Oak	High Gloss Laminate	Textured Laminate	Textured PureStyle™	Thermofoil
•	Alder	•		•	•	box color	box color	box color	Maple

Finished edges indicated by bold lines on side view drawings.
Glazed edges indicated by arrows on side view drawings.

DESCRIPTION

MODEL

**URN LEG, 5" WIDE,
35 1/4" HIGH**



JURNLEGL

- Trimable.

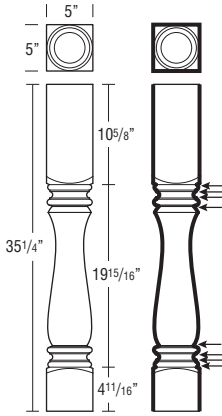

Finish Techniques

Distressing	Heirloom
	•

Specie Availability

Alder	Rustic Alder	Cherry	Hickory	Maple	Oak	High Gloss Laminate	Textured Laminate	Textured PureStyle™	Thermofoil
•	Alder	•		•	•	box color	box color	box color	Maple

ABBE FOOT, 4" HIGH



ABFOOT

- Recommended for applications without toekicks.

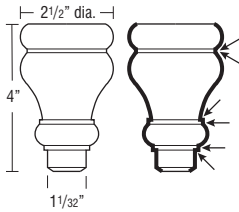

Finish Techniques

Distressing	Heirloom
	•

Specie Availability

Alder	Rustic Alder	Cherry	Hickory	Maple	Oak	High Gloss Laminate	Textured Laminate	Textured PureStyle™	Thermofoil
•	Alder	•		•	•	box color	box color	box color	Maple

FRENCH LEG, 6" HIGH



FRNLG

- Trimable.

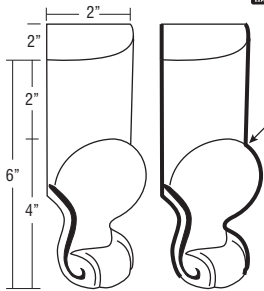

Finish Techniques

Distressing	Heirloom
	•

Specie Availability

Alder	Rustic Alder	Cherry	Hickory	Maple	Oak	High Gloss Laminate	Textured Laminate	Textured PureStyle™	Thermofoil
Cherry	Cherry	•		•		box color	box color	box color	Maple

DESCRIPTION

MODEL

**ACANTHUS FOOT,
4 1/2" HIGH**



JACANFOOT

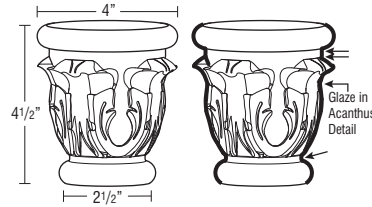

Finish Techniques

Distressing	Heirloom
	•

Specie Availability

Alder	Rustic Alder	Cherry	Hickory	Maple	Oak	High Gloss Laminate	Textured Laminate	Textured PureStyle™	Thermofoil
•	Alder	•		•	•	box color	box color	box color	Maple

**COSMO FOOT,
4" HIGH**



JCOSFOOT

- Recommended for applications without toekicks.

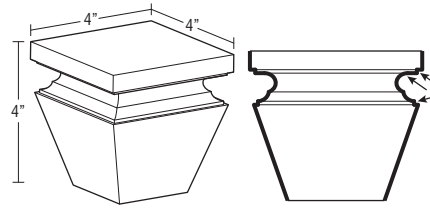

Finish Techniques

Distressing	Heirloom
	•

Specie Availability

Alder	Rustic Alder	Cherry	Hickory	Maple	Oak	High Gloss Laminate	Textured Laminate	Textured PureStyle™	Thermofoil
•	Alder	•		•	•	box color	box color	box color	Maple

**CRAFTSMAN FOOT,
4 1/2" HIGH**



JCRAFTFOOT

- Trimable.

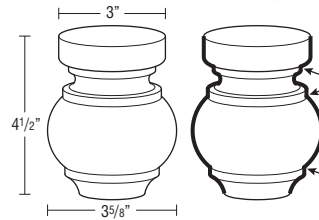

Finish Techniques

Distressing	Heirloom
	•

Specie Availability

Alder	Rustic Alder	Cherry	Hickory	Maple	Oak	High Gloss Laminate	Textured Laminate	Textured PureStyle™	Thermofoil
•	Alder	•		•	•	box color	box color	box color	Maple

**FRENCH COUNTRY
FOOT, 6" HIGH**



JFRNCNTYFOOT

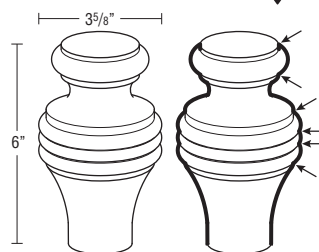

Finish Techniques

Distressing	Heirloom
	•

Specie Availability

Alder	Rustic Alder	Cherry	Hickory	Maple	Oak	High Gloss Laminate	Textured Laminate	Textured PureStyle™	Thermofoil
•	Alder	•		•	•	box color	box color	box color	Maple

Finished edges indicated by bold lines on side view drawings.
Glazed edges indicated by arrows on side view drawings.

DESCRIPTION

MODEL

**MADLINE FOOT,
4 1/2" HIGH**



JMADEFOOT

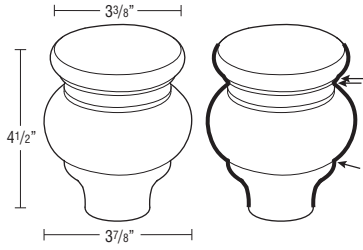

Finish Techniques

Distressing	Heirloom
	•

Specie Availability

Alder	Rustic Alder	Cherry	Hickory	Maple	Oak	High Gloss Laminate	Textured Laminate	Textured PureStyle™	Thermofoil
•	Alder	•		•	•	box color	box color	box color	Maple

**MADISON FOOT,
6 1/8" HIGH**



JMADFOOT

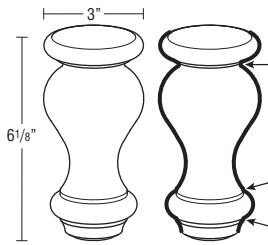

Finish Techniques

Distressing	Heirloom
	•

Specie Availability

Alder	Rustic Alder	Cherry	Hickory	Maple	Oak	High Gloss Laminate	Textured Laminate	Textured PureStyle™	Thermofoil
•	Alder	•		•	•	box color	box color	box color	Maple

**METROPOLITAN FOOT,
4 5/8" HIGH**



JMETROFOOT

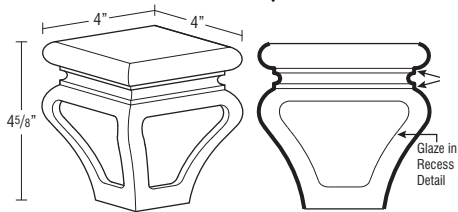

Finish Techniques

Distressing	Heirloom
	•

Specie Availability

Alder	Rustic Alder	Cherry	Hickory	Maple	Oak	High Gloss Laminate	Textured Laminate	Textured PureStyle™	Thermofoil
•	Alder	•		•	•	box color	box color	box color	Maple

DESCRIPTION

MODEL

**WEAVE FOOT,
4 1/2" HIGH**



JWEAVEFOOT

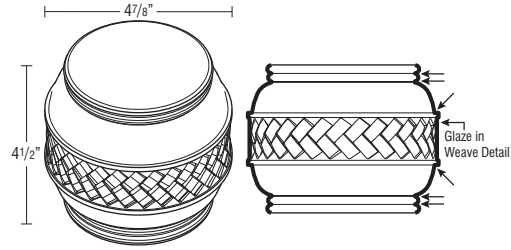

Finish Techniques

Distressing	Heirloom
	•

Specie Availability

Alder	Rustic Alder	Cherry	Hickory	Maple	Oak	High Gloss Laminate	Textured Laminate	Textured PureStyle™	Thermofoil
•	Alder	•		•	•	box color	box color	box color	Maple

**LARGE SQUARE FOOT,
5" HIGH**



LGSQFOOT

- Trimmable.

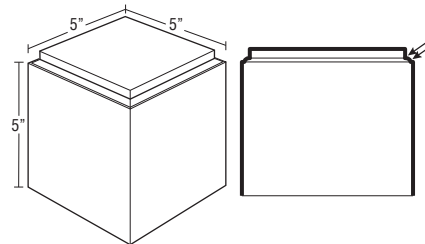

Finish Techniques

Distressing	Heirloom
	•

Specie Availability

Alder	Rustic Alder	Cherry	Hickory	Maple	Oak	High Gloss Laminate	Textured Laminate	Textured PureStyle™	Thermofoil
•	Alder	•		•	•	box color	box color	box color	Maple

**SQUARE FOOT,
4 1/2" HIGH**



JSQFOOT

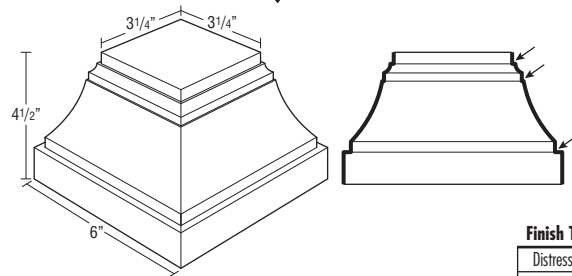

Finish Techniques

Distressing	Heirloom
	•

Specie Availability

Alder	Rustic Alder	Cherry	Hickory	Maple	Oak	High Gloss Laminate	Textured Laminate	Textured PureStyle™	Thermofoil
•	Alder	•		•	•	box color	box color	box color	Maple

Finished edges indicated by bold lines on side view drawings.
Glazed edges indicated by arrows on side view drawings.

DESCRIPTION

MODEL

**SQUARE FOOT, SPLIT,
4 1/2" HIGH**



JSQFOOTS

- Trimmable.

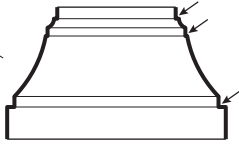
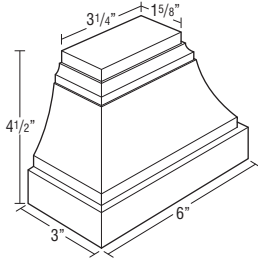

Finish Techniques

Distressing	Heirloom
	•

Specie Availability

Alder	Rustic Alder	Cherry	Hickory	Maple	Oak	High Gloss Laminate	Textured Laminate	Textured PureStyle™	Thermofoil
•	Alder	•		•	•	box color	box color	box color	Maple

LILLE FOOT, 4 1/2" HIGH



LIFOOT

- LIFOOT is designed to work with Void Toekick Modification (VTK).

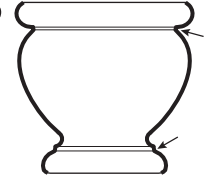
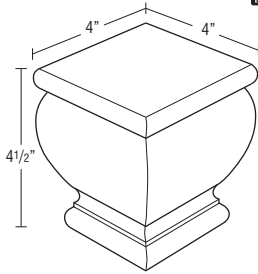

Finish Techniques

Distressing	Heirloom
	•

Specie Availability

Alder	Rustic Alder	Cherry	Hickory	Maple	Oak	High Gloss Laminate	Textured Laminate	Textured PureStyle™	Thermofoil
•	Alder	•		•	•	box color	box color	box color	Maple

**PLINTH BLOCK,
4 1/2" HIGH**



PLBLOCK

- Trimmable.

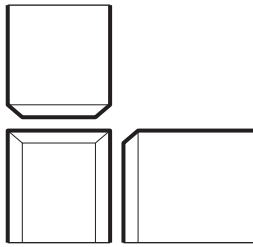
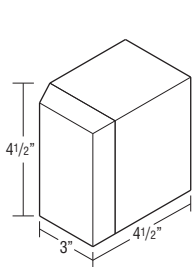

Finish Techniques

Distressing	Heirloom
	•

Specie Availability

Alder	Rustic Alder	Cherry	Hickory	Maple	Oak	High Gloss Laminate	Textured Laminate	Textured PureStyle™	Thermofoil
•	Alder	•	•	•	•	box color	box color	box color	Maple

DESCRIPTION

MODEL

TAPERED LEG, 6" HIGH



TAPLG

- Trimmable.

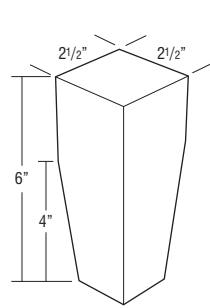

Finish Techniques

Distressing	Heirloom
	•

Specie Availability

Alder	Rustic Alder	Cherry	Hickory	Maple	Oak	High Gloss Laminate	Textured Laminate	Textured PureStyle™	Thermofoil
•	Alder	•		•		box color	box color	box color	Maple

**TOEKICK TULIP FOOT,
4 5/8" HIGH**



TKTLFOOT

- Trimmable.

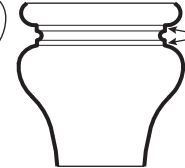
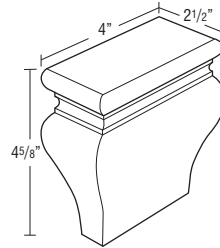

Finish Techniques

Distressing	Heirloom
	•

Specie Availability

Alder	Rustic Alder	Cherry	Hickory	Maple	Oak	High Gloss Laminate	Textured Laminate	Textured PureStyle™	Thermofoil
•	Alder	•		•	•	box color	box color	box color	Maple

TULIP FOOT, 4 5/8" HIGH



TLFOOT

- Trimmable.

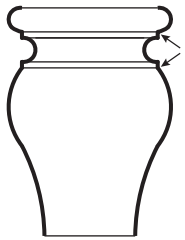
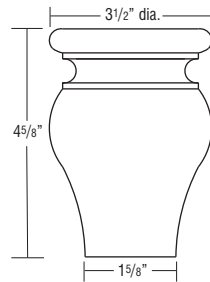

Finish Techniques

Distressing	Heirloom
	•

Specie Availability

Alder	Rustic Alder	Cherry	Hickory	Maple	Oak	High Gloss Laminate	Textured Laminate	Textured PureStyle™	Thermofoil
•	Alder	•		•	•	box color	box color	box color	Maple

Finished edges indicated by bold lines on side view drawings.
Glazed edges indicated by arrows on side view drawings.

DESCRIPTION

2" DECORATIVE SPLIT TURNINGS

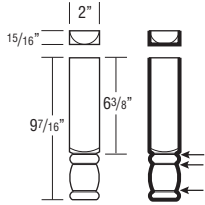

SPRINGEND

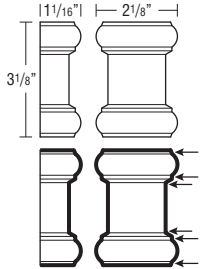

JSPRINGCTR

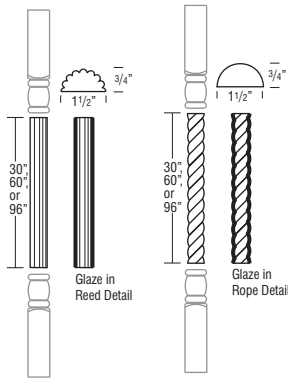

SPRINGREED

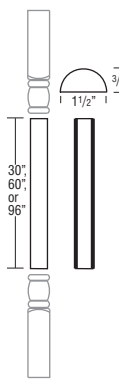

SPRINGROPE

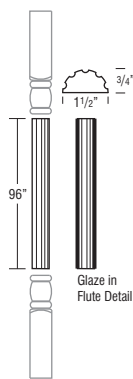

SPRINGSPPOOL

JSPRINGFLT96

Specie Availability

Alder	Rustic Alder	Cherry	Hickory	Maple	Oak	High Gloss Laminate	Textured Laminate	Textured PureStyle™	Thermofoil
•	•	•	•	•	•	box color	box color	box color	Maple

♦ Not available in Hickory.

MODEL

SPRINGEND (Sold in Pairs) /pair

✦ **JSPRINGCTR**

SPRINGREED30

(Reeded Half Round)

SPRINGREED60

(Reeded Half Round)

SPRINGREED96

(Reeded Half Round)

SPRINGROPE30

(Rope Right Twist Half Round)

SPRINGROPE60

(Rope Right Twist Half Round)

SPRINGROPE96

(Rope Right Twist Half Round)

SPRINGSPPOOL30 (Half Round)

SPRINGSPPOOL60 (Half Round)

SPRINGSPPOOL96 (Half Round)

✦ **JSPRINGFLT96**

(Half Round)

- Ends sold separately from split turnings.
- 5 day Express Response not available on Architectural Accents.

Finish Techniques

Distressing	Heirloom
	•

DESCRIPTION

3" DECORATIVE SPLIT TURNINGS

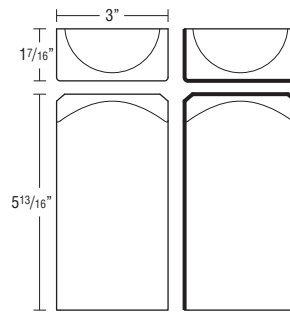

J3SPRINGBLK

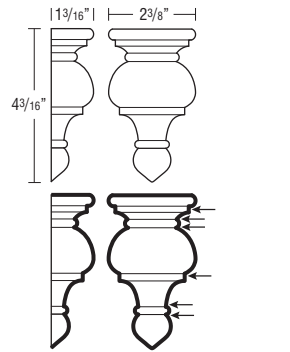

J3SPRINGFIN

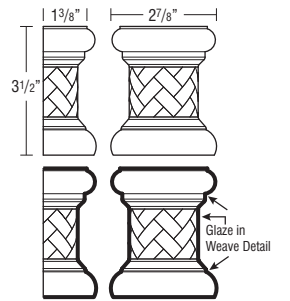

J3SPRINGWV

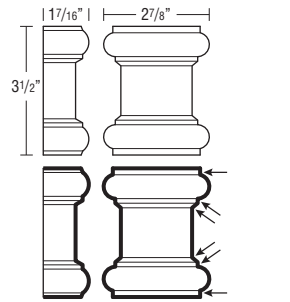

J3SPRINGCTR

MODEL

J3SPRINGBLK

J3SPRINGFIN

J3SPRINGWV

J3SPRINGCTR

J3SPTRINGS96

J3SPTRINGRP96

J3SPTRINGRD96

J3SPTRINGFL96

- Ends sold separately.

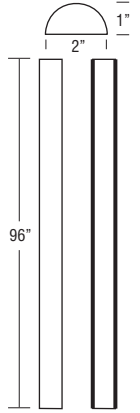

J3SPTRINGS96

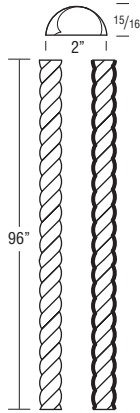

J3SPTRINGRP96

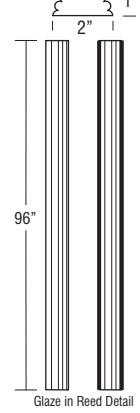

J3SPTRINGRD96

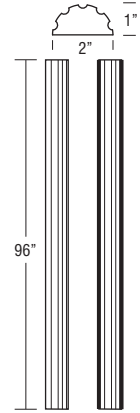

J3SPTRINGFL96

Finish Techniques

Distressing	Heirloom
	•

Specie Availability

Alder	Rustic Alder	Cherry	Hickory	Maple	Oak	High Gloss Laminate	Textured Laminate	Textured PureStyle™	Thermofoil
•	•	•	•	•	•	box color	box color	box color	Maple

Finished edges indicated by bold lines on side view drawings.
Glazed edges indicated by arrows on side view drawings.

DESCRIPTION

MODEL

9" SMALL CORBEL



SMCORBEL

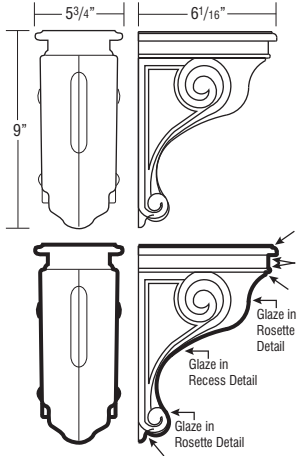

- Not intended for cabinet or freestanding countertop support. For substantial weight support, use a floor mounted support such as a Decorative Leg.

Finish Techniques

Distressing	Heirloom
	•

Specie Availability

Alder	Rustic Alder	Cherry	Hickory	Maple	Oak	High Gloss Laminate	Textured Laminate	Textured PureStyle™	Thermofoil
•	Alder	•		•	•	box color	box color	box color	Maple

13" LARGE CORBEL



LCORBEL

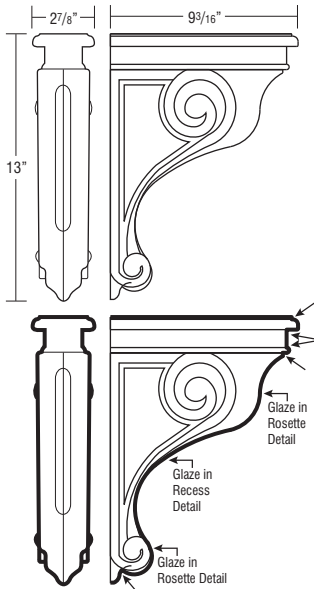

- Not intended for cabinet or freestanding countertop support. For substantial weight support, use a floor mounted support such as a Decorative Leg.

Finish Techniques

Distressing	Heirloom
	•

Specie Availability

Alder	Rustic Alder	Cherry	Hickory	Maple	Oak	High Gloss Laminate	Textured Laminate	Textured PureStyle™	Thermofoil
•	Alder	•		•	•	box color	box color	box color	Maple

DESCRIPTION

MODEL

9" ART CORBEL



CORBELART9

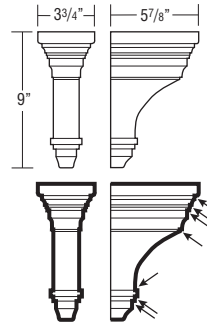

- Not intended for cabinet or freestanding countertop support. For substantial weight support, use a floor mounted support such as a Decorative Leg.

Finish Techniques

Distressing	Heirloom
	•

Specie Availability

Alder	Rustic Alder	Cherry	Hickory	Maple	Oak	High Gloss Laminate	Textured Laminate	Textured PureStyle™	Thermofoil
•	Alder	•		•	•	box color	box color	box color	Maple

7" CELTIC CORBEL



CORBELCELT

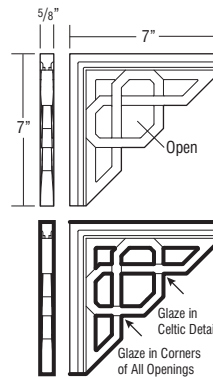

- Not intended for cabinet or freestanding countertop support. For substantial weight support, use a floor mounted support such as a Decorative Leg.

Finish Techniques

Distressing	Heirloom
	•

Specie Availability

Alder	Rustic Alder	Cherry	Hickory	Maple	Oak	High Gloss Laminate	Textured Laminate	Textured PureStyle™	Thermofoil
		•		•	•	box color	box color	box color	Maple

7" SMALL COSMO CORBEL



JCORBELCOS7

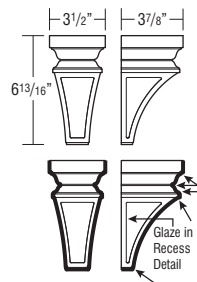

- Not intended for cabinet or freestanding countertop support. For substantial weight support, use a floor mounted support such as a Decorative Leg.

Finish Techniques

Distressing	Heirloom
	•

Specie Availability

Alder	Rustic Alder	Cherry	Hickory	Maple	Oak	High Gloss Laminate	Textured Laminate	Textured PureStyle™	Thermofoil
•	Alder	•		•	•	box color	box color	box color	Maple

Finished edges indicated by bold lines on side view drawings.
Glazed edges indicated by arrows on side view drawings.

DESCRIPTION

MODEL

13" LARGE COSMO CORBEL



JCORBELCOS13

- Not intended for cabinet or freestanding countertop support. For substantial weight support, use a floor mounted support such as a Decorative Leg.

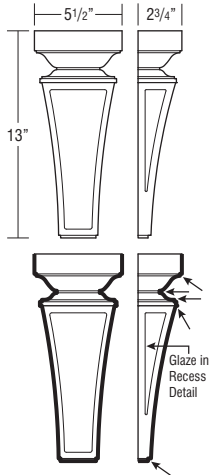

Finish Techniques

Distressing	Heirloom
	•

Specie Availability

Alder	Rustic Alder	Cherry	Hickory	Maple	Oak	High Gloss Laminate	Textured Laminate	Textured PureStyle™	Thermofoil
•	Alder	•		•	•	box color	box color	box color	Maple

13" LARGE COSMO CORBEL DEEP



JCORBELCOS13D

- Not intended for cabinet or freestanding countertop support. For substantial weight support, use a floor mounted support such as a Decorative Leg.

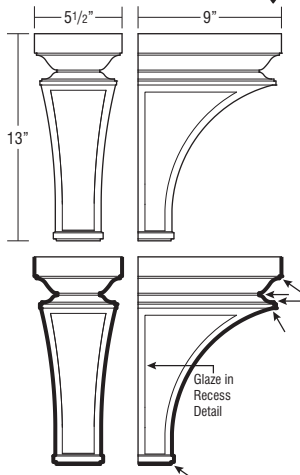

Finish Techniques

Distressing	Heirloom
	•

Specie Availability

Alder	Rustic Alder	Cherry	Hickory	Maple	Oak	High Gloss Laminate	Textured Laminate	Textured PureStyle™	Thermofoil
•	Alder	•		•	•	box color	box color	box color	Maple

NEW 7" COVE CORBEL



CORBELCOVE7

- Not intended for cabinet or freestanding countertop support. For substantial weight support, use a floor mounted support such as a Decorative Leg.

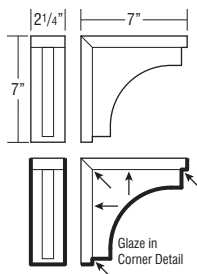

Finish Techniques

Distressing	Heirloom
	•

Specie Availability

Alder	Rustic Alder	Cherry	Hickory	Maple	Oak	High Gloss Laminate	Textured Laminate	Textured PureStyle™	Thermofoil
•	Alder	•		•	•	box color	box color	box color	Maple

DESCRIPTION

MODEL

NEW 11 1/4" COVE CORBEL



CORBELCOVE11

- Not intended for cabinet or freestanding countertop support. For substantial weight support, use a floor mounted support such as a Decorative Leg.

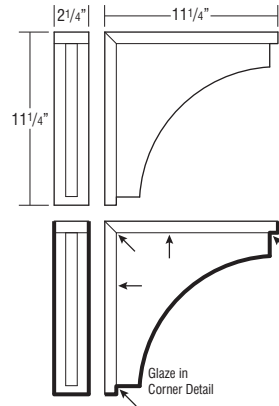

Finish Techniques

Distressing	Heirloom
	•

Specie Availability

Alder	Rustic Alder	Cherry	Hickory	Maple	Oak	High Gloss Laminate	Textured Laminate	Textured PureStyle™	Thermofoil
•	Alder	•		•	•	box color	box color	box color	Maple

6" MISSION CORBEL



CORBELMIS6

- Not intended for cabinet or freestanding countertop support. For substantial weight support, use a floor mounted support such as a Decorative Leg.

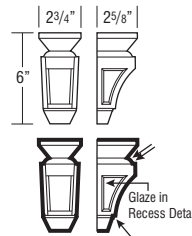

Finish Techniques

Distressing	Heirloom
	•

Specie Availability

Alder	Rustic Alder	Cherry	Hickory	Maple	Oak	High Gloss Laminate	Textured Laminate	Textured PureStyle™	Thermofoil
•	Alder	•		•	•	box color	box color	box color	Maple

9" MISSION CORBEL



CORBELMIS9

- Not intended for cabinet or freestanding countertop support. For substantial weight support, use a floor mounted support such as a Decorative Leg.

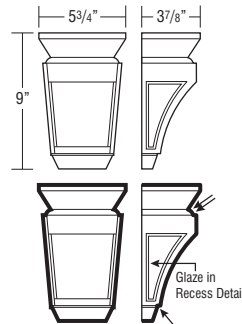

Finish Techniques

Distressing	Heirloom
	•

Specie Availability

Alder	Rustic Alder	Cherry	Hickory	Maple	Oak	High Gloss Laminate	Textured Laminate	Textured PureStyle™	Thermofoil
•	Alder	•		•	•	box color	box color	box color	Maple

Finished edges indicated by bold lines on side view drawings.
Glazed edges indicated by arrows on side view drawings.

DESCRIPTION

MODEL

4" OLDE WORLD CORBEL



JCORBELOWD4

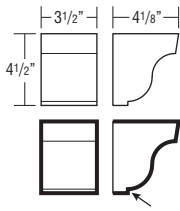

- Not intended for cabinet or freestanding countertop support. For substantial weight support, use a floor mounted support such as a Decorative Leg.

Finish Techniques

Distressing	Heirloom
	•

Specie Availability

Alder	Rustic Alder	Cherry	Hickory	Maple	Oak	High Gloss Laminate	Textured Laminate	Textured PureStyle™	Thermofoil
•	Alder	•		•	•	box color	box color	box color	Maple

5" OLDE WORLD CORBEL



CORBELOWD5

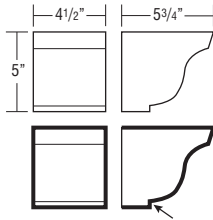

- Not intended for cabinet or freestanding countertop support. For substantial weight support, use a floor mounted support such as a Decorative Leg.

Finish Techniques

Distressing	Heirloom
	•

Specie Availability

Alder	Rustic Alder	Cherry	Hickory	Maple	Oak	High Gloss Laminate	Textured Laminate	Textured PureStyle™	Thermofoil
•	Alder	•		•	•	box color	box color	box color	Maple

7" OLDE WORLD CORBEL



JCORBELOWD7

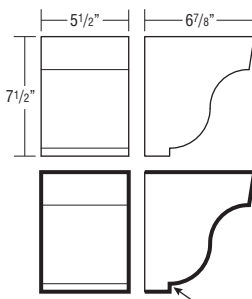

- Not intended for cabinet or freestanding countertop support. For substantial weight support, use a floor mounted support such as a Decorative Leg.

Finish Techniques

Distressing	Heirloom
	•

Specie Availability

Alder	Rustic Alder	Cherry	Hickory	Maple	Oak	High Gloss Laminate	Textured Laminate	Textured PureStyle™	Thermofoil
•	Alder	•		•	•	box color	box color	box color	Maple

6" SCROLL CORBEL



CORBELSCR6

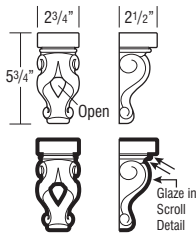

- Not intended for cabinet or freestanding countertop support. For substantial weight support, use a floor mounted support such as a Decorative Leg.

Finish Techniques

Distressing	Heirloom
	•

Specie Availability

Alder	Rustic Alder	Cherry	Hickory	Maple	Oak	High Gloss Laminate	Textured Laminate	Textured PureStyle™	Thermofoil
•	Alder	•		•	•	box color	box color	box color	Maple

DESCRIPTION

MODEL

9" SCROLL CORBEL



CORBELSCR9

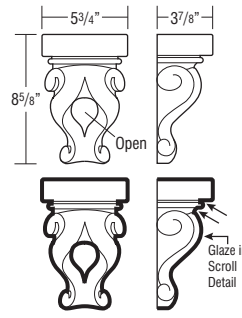

- Not intended for cabinet or freestanding countertop support. For substantial weight support, use a floor mounted support such as a Decorative Leg.

Finish Techniques

Distressing	Heirloom
	•

Specie Availability

Alder	Rustic Alder	Cherry	Hickory	Maple	Oak	High Gloss Laminate	Textured Laminate	Textured PureStyle™	Thermofoil
•	Alder	•		•	•	box color	box color	box color	Maple

SNACK BAR SUPPORT



SBS

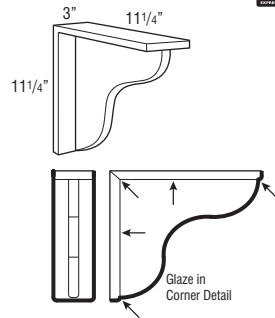

- Not intended for cabinet or freestanding countertop support. For substantial weight support, use a floor mounted support such as a Decorative Leg.

Finish Techniques

Distressing	Heirloom
	•

Specie Availability

Alder	Rustic Alder	Cherry	Hickory	Maple	Oak	High Gloss Laminate	Textured Laminate	Textured PureStyle™	Thermofoil
•	Alder	•		•	•	box color	box color	box color	Maple

10" ACANTHUS CORBEL



JCORBELACANT10

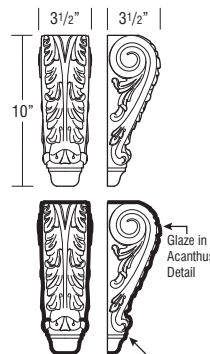

- Not intended for cabinet or freestanding countertop support. For substantial weight support, use a floor mounted support such as a Decorative Leg.

Finish Techniques

Distressing	Heirloom
	•

Specie Availability

Alder	Rustic Alder	Cherry	Hickory	Maple	Oak	High Gloss Laminate	Textured Laminate	Textured PureStyle™	Thermofoil
•	Alder	•		•	•	box color	box color	box color	Maple

Finished edges indicated by bold lines on side view drawings.
Glazed edges indicated by arrows on side view drawings.

DESCRIPTION

11 1/2" ARTS & CRAFTS BRACKET

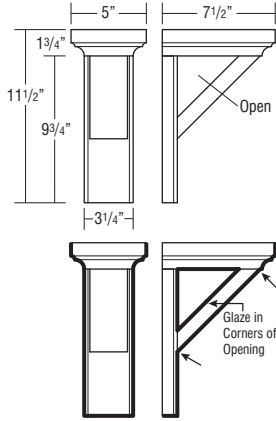

Specie Availability

Alder	Rustic Alder	Cherry	Hickory	Maple	Oak	High Gloss Laminate	Textured Laminate	Textured PureStyle™	Thermofoil
•	Alder	•		•	•	box color	box color	box color	Maple

MODEL

JBRACKETART

- Not intended for cabinet or freestanding countertop support. For substantial weight support, use a floor mounted support such as a Decorative Leg.

Finish Techniques

Distressing	Heirloom
	•

14" ARTS & CRAFTS OPEN CORBEL

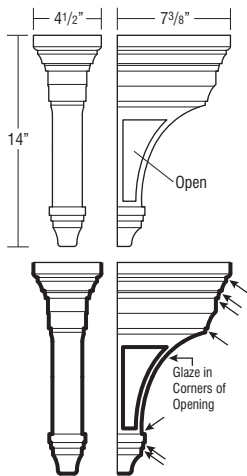

Specie Availability

Alder	Rustic Alder	Cherry	Hickory	Maple	Oak	High Gloss Laminate	Textured Laminate	Textured PureStyle™	Thermofoil
•	Alder	•		•	•	box color	box color	box color	Maple

JCORBELARTO

- Not intended for cabinet or freestanding countertop support. For substantial weight support, use a floor mounted support such as a Decorative Leg.

Finish Techniques

Distressing	Heirloom
	•

DESCRIPTION

12" CRAFTSMAN OPEN BRACKET

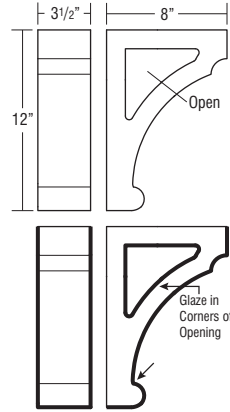

Specie Availability

Alder	Rustic Alder	Cherry	Hickory	Maple	Oak	High Gloss Laminate	Textured Laminate	Textured PureStyle™	Thermofoil
•	Alder	•		•	•	box color	box color	box color	Maple

MODEL

JCORBELCRAFTO

- Not intended for cabinet or freestanding countertop support. For substantial weight support, use a floor mounted support such as a Decorative Leg.

Finish Techniques

Distressing	Heirloom
	•

3" MINI SHAKER CORBEL

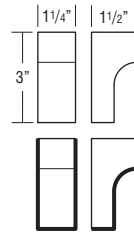

Specie Availability

Alder	Rustic Alder	Cherry	Hickory	Maple	Oak	High Gloss Laminate	Textured Laminate	Textured PureStyle™	Thermofoil
•	Alder	•		•	•	box color	box color	box color	Maple

JCORBELSHKR3

- Not intended for cabinet or freestanding countertop support. For substantial weight support, use a floor mounted support such as a Decorative Leg.

Finish Techniques

Distressing	Heirloom
	•

6 1/2" SMALL SHAKER CORBEL

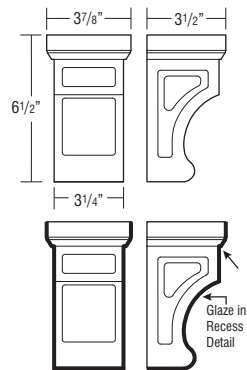

Specie Availability

Alder	Rustic Alder	Cherry	Hickory	Maple	Oak	High Gloss Laminate	Textured Laminate	Textured PureStyle™	Thermofoil
•	Alder	•		•	•	box color	box color	box color	Maple

JCORBELSHKR7

- Not intended for cabinet or freestanding countertop support. For substantial weight support, use a floor mounted support such as a Decorative Leg.

Finish Techniques

Distressing	Heirloom
	•

Finished edges indicated by bold lines on side view drawings.
Glazed edges indicated by arrows on side view drawings.

DESCRIPTION

13 3/8" MEDIUM SHAKER CORBEL

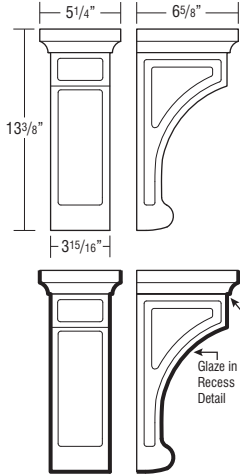

MODEL

JCORBELSHKR14

- Not intended for cabinet or freestanding countertop support. For substantial weight support, use a floor mounted support such as a Decorative Leg.

Finish Techniques

Distressing	Heirloom
	•

Specie Availability

Alder	Rustic Alder	Cherry	Hickory	Maple	Oak	High Gloss Laminate	Textured Laminate	Textured PureStyle™	Thermofoil
•	Alder	•		•	•	box color	box color	box color	Maple

16" LARGE SHAKER CORBEL

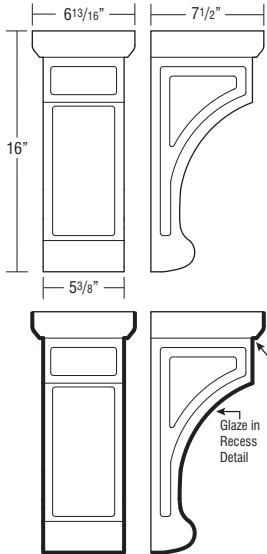

JCORBELSHKR16

- Not intended for cabinet or freestanding countertop support. For substantial weight support, use a floor mounted support such as a Decorative Leg.

Finish Techniques

Distressing	Heirloom
	•

Specie Availability

Alder	Rustic Alder	Cherry	Hickory	Maple	Oak	High Gloss Laminate	Textured Laminate	Textured PureStyle™	Thermofoil
•	Alder	•		•	•	box color	box color	box color	Maple

DESCRIPTION

14" TRADITIONAL OPEN CORBEL

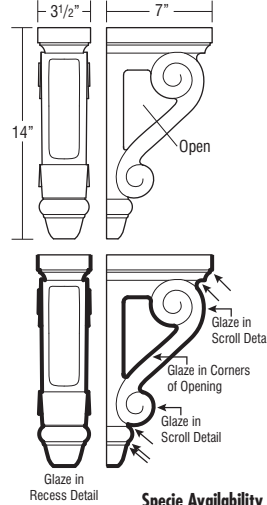

MODEL

JCORBELTRADO

- Not intended for cabinet or freestanding countertop support. For substantial weight support, use a floor mounted support such as a Decorative Leg.

Finish Techniques

Distressing	Heirloom
	•

Specie Availability

Alder	Rustic Alder	Cherry	Hickory	Maple	Oak	High Gloss Laminate	Textured Laminate	Textured PureStyle™	Thermofoil
•	Alder	•		•	•	box color	box color	box color	Maple

SINGLE OUTLET COVER

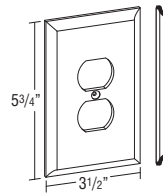

JSOC

Finish Techniques

Distressing	Heirloom

Specie Availability

Alder	Rustic Alder	Cherry	Hickory	Maple	Oak	High Gloss Laminate	Textured Laminate	Textured PureStyle™	Thermofoil
•	Alder	•		•	•	box color	box color	box color	Maple

SINGLE ROCKER PLATE

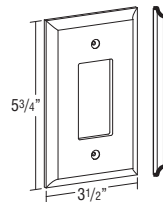

JSRC

Finish Techniques

Distressing	Heirloom

Specie Availability

Alder	Rustic Alder	Cherry	Hickory	Maple	Oak	High Gloss Laminate	Textured Laminate	Textured PureStyle™	Thermofoil
•	Alder	•		•	•	box color	box color	box color	Maple

Finished edges indicated by bold lines on side view drawings.
Glazed edges indicated by arrows on side view drawings.

DESCRIPTION **MODEL**
CONTEMPORARY EMBELLISHMENTS

METAL FEET, ANGLED

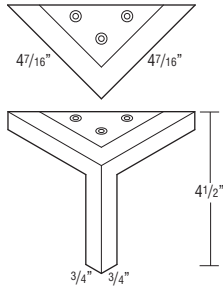

FOOTMETALANGBN
FOOTMETALANGPC

- BN = Brushed Nickel
- PC = Polished Chrome
- Maximum weight capacity is 160 lbs.

METAL FEET, ROUND

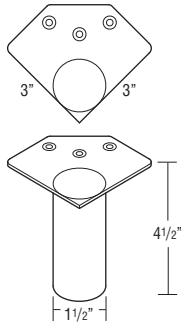

FOOTMETALRDBS
FOOTMETALRDPS

- BS = Brushed Stainless
- PS = Polished Stainless
- Maximum weight capacity is 160 lbs.

METAL FEET, SQUARE

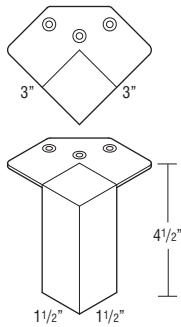

FOOTMETALSQBS
FOOTMETALSQPS

- BS = Brushed Stainless
- PS = Polished Stainless

METAL FEET, TEE

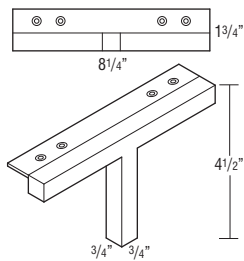

FOOTMETALANGBTN
FOOTMETALANGPC

- BN = Brushed Nickel
- PC = Polished Chrome

TOUCH LATCH

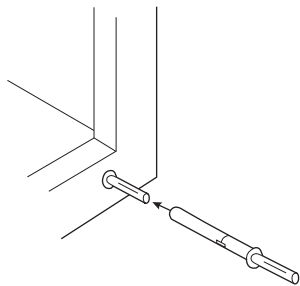

TOUCHLATCH

- Nylon grey mechanism with bumper tip.
- Face frame will need to be field drilled for insertion of the TOUCHLATCH, requires 25/64" (10mm) drill bit.
- Can be field adjusted for door gap depth, no tools required.
- For use on full overlay door styles only.
- Requires a soft touch to open the door, and door must be pushed closed to reset the TOUCHLATCH mechanism.
- Only for use on hinged doors, and can be used without decorative hardware. Not compatible with non-hinged doors such as pull-outs, Wall Vertical Lift (WVL.). For drawers, pull-outs, and other non-compatible cabinets, PULLH70 and PULLH71 are recommended (see below).

DESCRIPTION **MODEL**

FINGER PULL, BRUSHED NICKEL

PULLH70

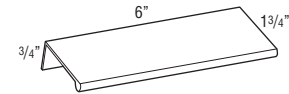

PULLH71

PULLH70

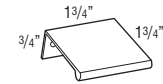

PULLH71

TRUSS METAL CORBEL, STAINLESS STEEL

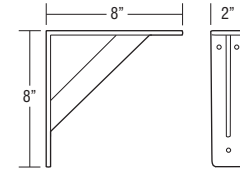

CORBELTRSS

- Pre-drilled mounting holes for easy installation.
- 1/4" material thickness.
- Not intended for cabinet or freestanding countertop support. For substantial weight support, use a floor mounted support such as a Decorative Leg.
- Must be properly installed into a structural member of the wall.

CRESCENT METAL CORBEL, BRUSHED NICKEL

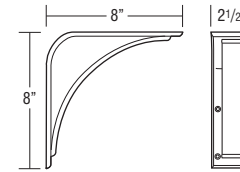

CORBELCRBN

- Matching screw caps included to hide the installation screws.
- Pre-drilled mounting holes for easy installation.
- 1/4" material thickness.
- Not intended for cabinet or freestanding countertop support. For substantial weight support, use a floor mounted support such as a Decorative Leg.
- Must be properly installed into a structural member of the wall.

SHELF SUPPORT BRACKET, SATIN NICKEL

SHELFBRKTSN

- Sold in pairs.
- Can be used with glass shelves 0.28"-0.75" (7-19mm) thick, or wood shelves 0.5"-1.61" (12-41mm) thick.
- Must be properly installed into a structural member of the wall.
- Maximum shelf load varies with shelf depth. For a 12" deep shelf, maximum shelf load is 50 lbs. each including shelf weight.

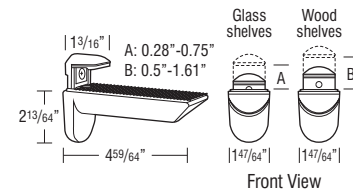

CLEAR CASTER

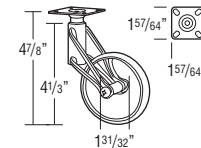

CASTERCLR

- Wheel diameter: 3 5/32".
- Fastening type: Swivel.
- Dynamic load rating is 110 lbs. per caster maximum. Not intended for heavy load applications such as islands with high storage capacity and heavy countertops.
- Does not have a locking feature.
- Sold in pairs.

DESCRIPTION

MODEL

LIGHTING

- LEDs are a solid state lighting source. LEDs are more efficient, durable, and safer than older light sources.
- CW = Cool White (Kelvin rating: 5000)
- WW = Warm White (Kelvin rating: 3200)

LED PUCK LIGHTING, STANDARD



PUCK18CW
PUCK18WW

- Contains 18 LED diodes with a life span of 50,000 hours.
- Measures less than 1/4" for low profile surface mounting.
- 65° beam angle.
- Compatible with Dimmable Driver (DIMM241512) and Power Extension Cable (CABL2500).
- Available in: warm or cool white in plastic housing with an aluminum color finish.
- Puck dimension is 2.56" x 2.56" (65mm x 65mm).
- Power usage: 1.25 watts.
- Voltage: 24V Compatibility.

LED PUCK LIGHTING, HIGH DEFINITION

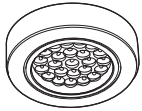

surface mount

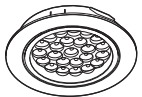

flush mount



PUCK24CW
PUCK24WW

- Contains 24 LED diodes with a life span of 50,000 hours.
- Surface or flush mounted (remove ring for flush mounting).
- 50° beam angle.
- Compatible with Dimmable Driver (DIMM241512) and Power Extension Cable (CABL2500).
- Available in: warm or cool white light in aluminum housing.
- Puck diameter is 2.58" (65.5mm) and height is 0.41" (10.5mm).
- Power usage: 1.65 watts.
- Voltage: 24V Compatibility.

LED FLEXIBLE STRIP

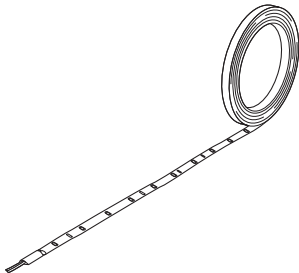

FLEX12CW
FLEX12WW
FLEX36CW
FLEX36WW

- Linkable and trimmable in increments of either 3" (FLEX12..) or 3 1/4" (FLEX36..), not to exceed a total of 18'.
- Adhesive back.
- Compatible with Dimmable Driver (DIMM121512) and Flex Driver Connection Lead (LEADDFLX2500).
- Suggested use: installed over cabinet, under cabinet, in cabinet, and on the toe kick.
- Available in: warm or cool white.
- FLEX12.. Dimensions: Length 11.81" (300mm), Width 0.31" (8mm), and Depth 0.1" (2.5mm).
- FLEX36.. Dimensions: Length: 39.37" (1000mm), Width 0.31" (8mm), and Depth 0.1" (2.5mm).
- Power usage: 0.8 watts (FLEX12..) and 2.5 watts (FLEX36..).
- Voltage: 12V Compatibility.

DESCRIPTION

MODEL

LED RIGID STRIP



RIGID12CW
RIGID12WW
RIGID24CW
RIGID24WW

- Linkable.
- Suggested use: straight runs (use link wires for corners).
- Available in 12 or 24 diodes per stick.
- Easy-to-clean, protective shell.
- Compatible with Dimmable Driver (DIMM121512) and Rigid Driver Connection Cable (CABLRIDG2500).
- Available in: warm or cool white.
- Includes brackets and screws for easy installation.
- 50,000 hour life span.
- Dimensions (12 Diodes): Length 11.81" (300mm), Width 0.31" (8mm), and Depth 0.24" (6mm).
- Dimensions (24 Diodes): Length 11.22" (285mm), Width 0.31" (8mm), and Depth 0.24" (6mm).
- Power usage: 0.8 watts (RIGID12..) and 1.5 watts (RIGID24..).
- Voltage: 12V Compatibility.

BATTERY STRIP LIGHT



BATTLTI

- Battery operated – (4) AAA batteries (not included).
- Motion activated.
- Low power usage (0.3W).
- Plastic aluminum finish.
- Dimensions: Length 11.93" (303mm), Width 0.67" (17mm), and Depth 0.55" (14mm).
- Easy adhesive install.

STANDARD DRIVERS

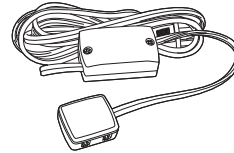

STAND1264
STAND2464

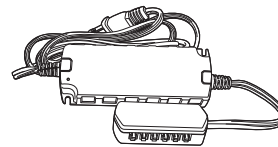

STAND121512

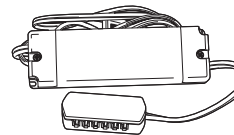

STAND123012
STAND243012

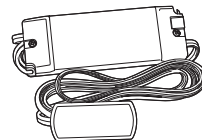

STAND242012

STAND1264

STAND2464

STAND121512

STAND123012

STAND243012

STAND242012

- Product Codes list the driver voltage, watts, and connector ports, such as STAND123012 is 12V, 30W, and 12 connector ports.

	Voltage	Wattage (Max Load)	Connector Ports
STAND1264	12	6	4
STAND2464	24	6	4
STAND121512	12	15	12
STAND123012	12	30	12
STAND243012	24	30	12
STAND242012	24	20	12

DESCRIPTION

MODEL

AC DIMMABLE DRIVERS (DAYBREAK)



**DIMM121512
DIMM241512**

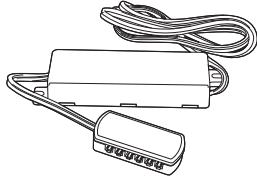

- Compatible with most standard wall dimmers.
- Drivers can be hard wired or used with included plug head. Multiple drivers can be used with a single wall dimmer switch and voltages can be mixed.

	Voltage	Wattage (Max Load)	Connector Ports
DIMM121512	12	15	12
DIMM241512	24	15	12

INFRARED LIGHT SWITCH



IR1224

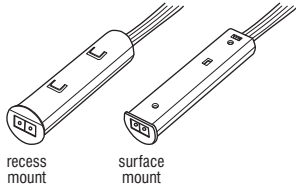

recess mount

surface mount

- Compatible with both 12V and 24V products.
- Can be installed inside or under a cabinet or recessed into moulding, turns on and off by passing hand in front of it or when cabinet door is opened or closed.

LIGHTING ACCESSORIES

- LEDs are a solid state lighting source. LEDs are more efficient, durable, and safer than older light sources.

POWER EXTENSION CABLE



CABL2500

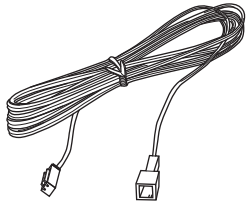

- Provides an additional 98.43" to reach those fixtures which are out of reach with the standard power leads.
- Features a male connector on one end and a female connector on the other.
- Compatible with PUCK18__ and PUCK24__.

FLEX DRIVER CONNECTION LEAD



LEADFLX2500

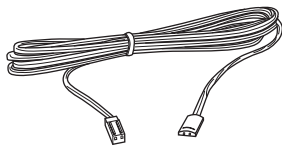

- Required part for each LED flexible strip series, connects the first LED flexible strip in the series to the driver.
- Lead length is 98".
- Compatible with FLEX12__ and FLEX36__.

FLEX INTER CONNECTIONS



CONNFLXCRN50

LEADFLXIC500

LEADFLXIC1500

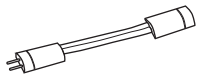

LEADFLXIC500
LEADFLXIC1500

- Used with the LED flexible strips to connect strips together while allowing a gap between sections.
- CONNFLXCRN50 is 1.97" (50mm) and is recommended for the connection of two flexible strips around a corner.
- LEADFLXIC500 is 19.69" (500mm), suggested use is around small obstructions.
- LEADFLXIC1500 is 59" (1500mm), suggested use is around large appliances such as microwaves and refrigerators.
- Compatible with FLEX12__ and FLEX36__.

DESCRIPTION

MODEL

RIGID DRIVER CONNECTION CABLE



CABLRIGD2500

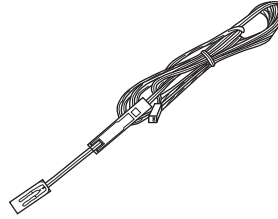

- Required to connect the first LED strip in a series to the driver.
- Cable length is 98".
- Compatible with RIGID12__ and RIGID24__.

RIGID INTER CONNECTIONS



CABLRIGCRN30

CABLRIGIC300

LEADRIC1500

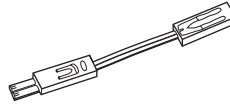

CABLRIGCRN30

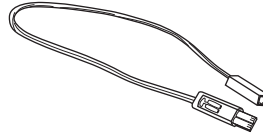

CABLRIGIC300

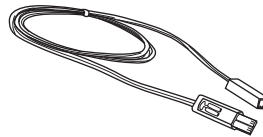

LEADRIC1500

- Used with the LED rigid strips to connect strips together while allowing a gap between sections.
- CABLRIGCRN30 is 1.18" (30mm) and is recommended for the connection of two rigid strips around a corner.
- CABLRIGIC300 is 11.81" (300mm).
- LEADRIC1500 is 59" (1500mm), suggested use is around large appliances such as microwaves and refrigerators.
- Compatible with RIGID12__ and RIGID24__.

RIGID STRIP END CAP



ENDRIG

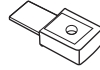

- Used to provide a clean and professional termination of the rigid strip light series.
- Compatible with RIGID12__ and RIGID24__.

QUATRO DIMMING RECEIVER



QDIMREC



- Wireless RF control for an easy, no wire installation.
- Unlimited receiver locations per zone.
- Up to 100' of wireless operation even through obstacles like walls.
- 256 levels of extra smooth dimming.
- Soft start On/Off for gradual dimming.

QUATRO WALL CONTROLLER



Q4ZONECON

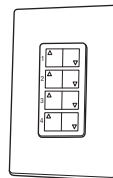



























- Wireless RF control for an easy, no wire installation.
- Unlimited receiver locations per zone with Quattro Dimming Receiver.
- Up to 100' of wireless operation.
- Detachable face for easy handheld remote operation and battery changing.
- Up to 100' of wireless operation even through obstacles like walls.
- Multiple switches per zone for easy 2, 3, or 4 way control.
- Can be ganged (grouped) with wall switches or outlets behind a single cover plate.
- Includes low cost, long life lithium 3V battery for up to 10 years of operation.

DESCRIPTION

MODEL

DECORATIVE HARDWARE

















HARDWARE - DECORATIVE PULLS AND KNOBS

	KNOBH06 - Copper Antique Highlight (1 1/4"W x 1 1/8"L)
	KNOBH07 - Copper Antique Highlight (2 1/4"W x 1 1/16"L)
	PULLH08 - Copper Antique Highlight - 128mm C/C (15/16"W x 5 1/2"L x 1 1/16"H)
	KNOBH10 - Nickel Antique Highlight (1 5/16"W x 3/4"H)
	PULLH11 - Nickel Antique Highlight - 96mm C/C (3/8"W x 4 3/4"L x 1 3/8"H)
	KNOBH20 - Red Rust Antique (1 1/4"W x 1"H)
	KNOBH23 - Ultra Brush Nickel (1 1/4"W x 1"H)
	PULLH30 - Ultra Brush Nickel - 128mm C/C (3/16"W x 6 1/2"L x 1 1/8"H)
	KNOBH31 - Ultra Brush Nickel (1"W x 3/4"H)
	KNOBH32 - Ultra Brush Nickel (1"W x 1/2"H)
	PULLH34 - Rust Pewter (1/4"W x 1.28"L)
	KNOBH35 - Rust Pewter (1.27"W x 1.03"L)
	PULLH36 - Red Rust Antique - 6" C/C (3/4"W x 7 1/2"L x 1 1/4"H)
	KNOBH37 - Red Rust Antique (1.38"W x 1 1/4"H)
	PULLH38 - Vibra Black Nickel - 128mm C/C (1 1/4"W x 5 1/8"L x 1 3/8"H)
	PULLH39 - Vibra Black Nickel - 96mm C/C (1 1/8"W x 3 7/8"L x 1 1/8"H)
	KNOBH40 - Black (1 1/8"W x 1 1/4"L x 1/2"H)
	PULLH41 - Black - 5 1/2" C/C (1 1/16"W x 7 1/8"L)
	PULLH42 - Black - 96mm C/C (1 1/8"W x 4 1/4"L x 1 1/8"H)
	KNOBH43 - Windsor Antique (1.88"W x 1.08"L)
	PULLH44 - Vibra Black Nickel (2 1/8"W x 1 1/2"L x 5/8"H)
	PULLH45 - Vibra Black Nickel - 3" C/C (4 1/4"W x 1 1/2"L x 5/8"H)
	KNOBH46 - Vibra Black Nickel (1"W x 1 1/4"L x 7/8"H)
	PULLH47 - Vibra Black Nickel - 2 1/2" C/C (3"W x 1/2"L x 5/8"H)
	PULLH50 - Satin Nickel - 5" C/C (5/16"W x 5"L x 1 1/4"H)
	PULLH51 - Stainless Steel - 1" C/C (5/16"W x 2"L x 7/16"H)

DESCRIPTION

MODEL

HARDWARE - DECORATIVE PULLS AND KNOBS (cont'd)

	PULLH52 - Stainless Steel - 7.38" C/C (3/8"W x 8 1/16"L x 7/8"H)
	PULLH53 - Satin Nickel - 96mm C/C (5/8"W x 5"L x 1 7/16"H)
	KNOBH54 - Black Nickel with Brown Glaze (1 1/4"W x 1 1/8"H)
	PULLH55 - Black Nickel with Brown Glaze - 4 1/2" C/C (7/16"W x 5 1/8"L)
	PULLH56 - South Haven Antique - 128mm C/C (5 3/8"L)
	KNOBH57 - South Haven Antique (1 1/4")
	KNOBH58 - Oil Rubbed Bronze (1 1/4"W x 1"H)
	PULLH59 - Oil Rubbed Bronze - 128mm C/C (1 1/4"W x 6 1/8"L x 1/3"H)
	PULLH60 - Oil Rubbed Bronze - 96mm C/C (4 7/8"W x 2"L x 7/8"H)
	PULLH61 - Black - 96mm C/C (7/16" x 4 15/16"L)
	KNOBH62 - Black (2 1/8"W x 2"L x 5/8"H)
	PULLH63 - Satin Nickel - 96mm C/C (1/2"W x 4 1/8"L x 1 1/6"H)
	PULLH64 - Satin Nickel - 3" C/C (1/2"W x 4 9/16"L x 15/16"H)
	KNOBH65 - Stainless Steel (0.088")
	PULLH66 - Black Nickel - 9" C/C (7/8"W x 9 1/4"L)
	PULLH70 - Brushed Nickel - 113mm C/C (1 3/4"W x 6"L x 3/4"H)
	PULLH71 - Brushed Nickel - 32mm C/C (1 3/4"W x 1 3/4"L x 3/4"H)

- Larger pulls may not be compatible with raised profile or 5-piece drawer fronts on face frame openings of 9" wide or less.
- Screws included with each hardware piece.
- See page 70 for 5-piece drawer front dimensions when specifying decorative hardware.

HARDWARE - FAUX HINGES



HINGEFH1 - Antique Brass Faux Barrel Hinge

HINGEFH2 - Pewter Faux Barrel Hinge

HINGEFH3 - Black Faux Strap Hinge

- Faux Strap Hinge: All 12" - 30" high doors use 2 hinges. All 36" high and above use 3 hinges.
- Faux Barrel Hinge: All 12" - 30" high doors use 2 hinges. All 42" high and above use 3 hinges.
- Requires field installation.
- For use with Warwick door style.

DESCRIPTION
ACCESSORIES

NEW BASE MIXER KIT

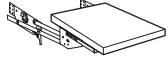

storage
SOLUTIONS



MODEL

- MIXKITFHSC18**
- MIXKITFHSC21**
- MIXKITFHSC24**

- Smart Stop closing feature.
- Mixer shelf will be 3/4" thick natural finished veneer plywood, mixer shelf dimensions:
18" wide: 11 3/4" wide x 20" deep.
21" wide: 14 3/4" wide x 20" deep.
24" wide: 17 3/4" wide x 20" deep.
- Maximum Weight Capacity for Mixer Shelf: 60 lbs.
- Mixer shelf locks in the fully open position. Release brackets lower the mixer shelf back into the cabinet.
- When in closed position, clearance above shelf is 17 5/8"; clearance below shelf is 7 3/4".

BASE PAN STORAGE

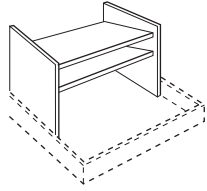

storage
SOLUTIONS

- BPS24**
- BPS30**
- BPS36**

Model	Application
BPS24	24" Base
BPS30	30" Base
BPS36	36" Base

- Roll tray not included.
- Insert consists of solid Maple sides and shelves. Back is edgebanded plywood.

BASE WASTEBASKET LIDS



- BWBLLID**
- BWBFHLID**

- Designed to be used with the BWB trash units.
- Sold individually.
- BWBLLID fits 35 quart wastebaskets. BWBFHLID fits 50 quart wastebaskets.

BROOM CLIP

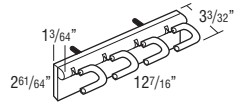

storage
SOLUTIONS



- BRMCLP**

DESCRIPTION

CABMAT™

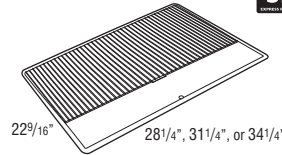

storage
SOLUTIONS

MODEL

- CABMAT30**
- CABMAT33**
- CABMAT36**

- Designed with a slope to capture spills and is removable for cleaning.
- See CabMat™ modification for easy size selection by cabinet model.
- Not trimmable. Can also be used in wider cabinets but will create a small void of unprotected area along the end panels.

Model	Liquid Capacity		Cabinet Size	
	Quarts	Liters	Width	Depth
CABMAT30	4.2	3.9	30"	24"
CABMAT33	4.6	4.3	33"	24"
CABMAT36	5.0	4.7	36"	24"

CABMAT™ VANITY

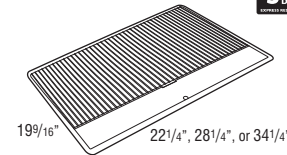

storage
SOLUTIONS

- CABMATV24**
- CABMATV30**
- CABMATV36**

- Designed with a slope to capture spills and is removable for cleaning.
- See CabMat™ modification for easy size selection by cabinet model.
- Not trimmable. Can also be used in wider cabinets but will create a small void of unprotected area along the end panels.

Model	Liquid Capacity		Cabinet Size	
	Quarts	Liters	Face Frame Opening	Depth
CABMATV24	2.5	2.4	21"-24"	21"
CABMATV30	3.3	3.1	27"-30"	21"
CABMATV36	3.9	3.7	33"	21"

DESCRIPTION

MODEL

COOKING UTENSIL DIVIDER



- CUDD24**
- CUDD30**
- CUDD36**

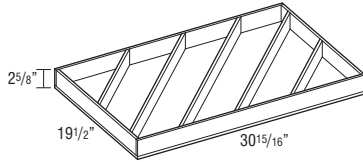
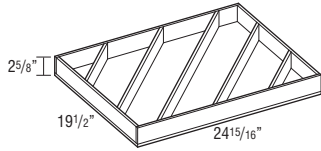
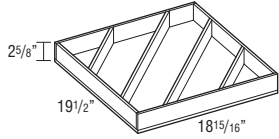

- Pre-assembled natural wood drawer insert (does not fit roll trays).

storage SOLUTIONS

CUTLERY INSERT WOOD ORGANIZER



- CIW15**
- CIW18**
- CIW21**
- CIW24**

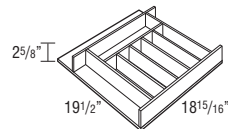
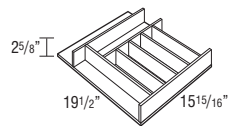
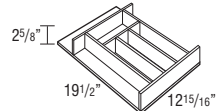
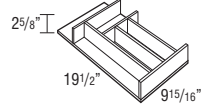

Model	Application
CIW15	15" Base
CIW18	18" Base
CIW21	21" Base
CIW24	24" Base

- Pre-assembled natural wood drawer insert.
- CIW also available installed in B__CIW, B__RTCW, and 4DB__CIW. See pages 175, 190, and 232.
- Place a cabinet with a CIW next to the dishwasher for convenience.

storage SOLUTIONS

DESCRIPTION

MODEL

WOOD TIERED CUTLERY DIVIDER DRAWER, 15", 18", 21", and 24"



- WTCD15**
- WTCD18**
- WTCD21**
- WTCD24**

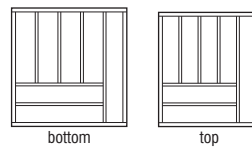
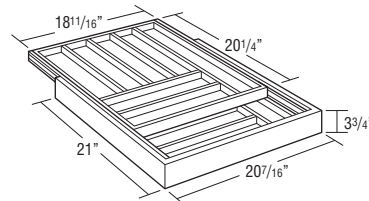
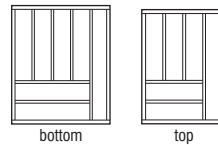
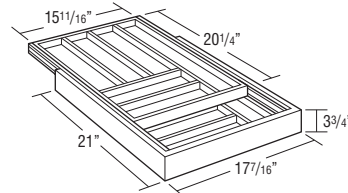
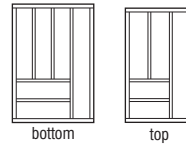
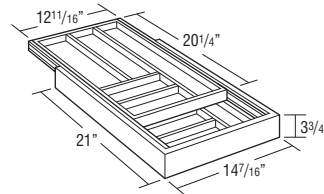
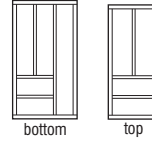
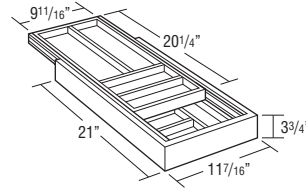

Model	Application
WTCD15	15" Base
WTCD18	18" Base
WTCD21	21" Base
WTCD24	24" Base

- Replaces standard drawer. Uses existing cabinet member drawer hardware.
- Requires field installation of drawer front.
- For use with 24" deep cabinets only.
- Exterior WTCD drawer box height is 3 3/4", interior height of top and bottom tier is 1 3/8".
- Top divider slides front-to-back.

storage SOLUTIONS

DESCRIPTION

NEW WOOD TIERED K-CUP®* DRAWER

MODEL

KCUP18

- Holds 40 K-Cups®.
- Exterior Wood Tiered K-Cup® drawer box height is 3 3/4", interior height of top tier is 1 5/8", and interior height of bottom tier is 1 3/8".
- The Wood Tiered K-Cup® Drawer is compatible with K-Cup® pods only.
- Replaces standard drawer. Uses existing cabinet member drawer hardware.
- Requires field installation of drawer front.
- Only for use with 24" deep cabinets that are 18" wide or have a 15" wide frame opening for the drawer.
- Top divider slides front-to-back.

*K-Cup® is a registered trademark of Keurig Green Mountain, Inc.

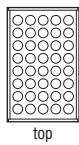
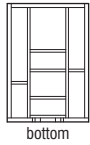
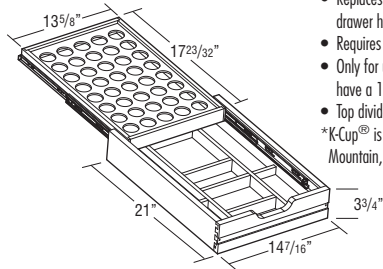

EDGEBANDING



EDGEBAND 10WD

EDGEBAND 10P

EDGEBAND 10NML

EDGEBAND 10NIP

EDGEBAND 10WHL

- Edgebanding will come in a 10' length.
- Finger joints may be visible on unfinished veneer and clear coated edgebanding.
- Edgebanding does not come pre-glued.
- EDGEBAND10WD is unfinished veneer, available in Alder, Cherry, Hickory, Maple, Oak, and Rustic Alder.
- EDGEBAND10P is available in Arctic, Antler, Elk, High Gloss White, High Gloss White with Metallic, Obsidian, and Wharf.
- EDGEBAND10NML is Natural Maple Laminate.
- EDGEBAND10NIP is clear coated veneer for use with APC natural interiors.
- EDGEBAND10WHL is White Laminate.

EXTERIOR SHELVES, 12" DEEP

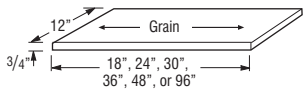

ES1218

ES1224

ES1230

ES1236

ES1248

ES1296†

- Wood 3/4" panels are veneered furniture board finished both sides, and front and side edges (back edge is not finished).
- Not available in wood grain laminates.
- Shelves can be ordered in APC.

†5 day Express Response not available on items over 48".

Custom Modifications				Finish Techniques	
ID	RD	Distressing	Heirloom		
•	•				

Specie Availability

Alder	Rustic Alder	Cherry	Hickory	Maple	Oak	High Gloss Laminate	Textured Laminate	Textured PureStyle™	Thermofoil
•	•	•	•	•	•	box color	box color	box color	Maple

DESCRIPTION

EXTERIOR SHELVES, 18" DEEP



ES1818

ES1824

ES1830

ES1836

ES1848

ES1896†

- Wood 3/4" panels are veneered furniture board finished both sides, and front and side edges (back edge is not finished).
- Not available in wood grain laminates.
- Shelves can be ordered in APC.

†5 day Express Response not available on items over 48".

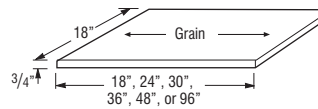

Custom Modifications

ID	RD
•	•

Finish Techniques

Distressing	Heirloom

Specie Availability

Alder	Rustic Alder	Cherry	Hickory	Maple	Oak	High Gloss Laminate	Textured Laminate	Textured PureStyle™	Thermofoil
•	•	•	•	•	•	box color	box color	box color	Maple

EXTERIOR SHELVES, 21" DEEP



ES2118

ES2124

ES2130

ES2136

ES2148

ES2196†

- Wood 3/4" panels are veneered furniture board finished both sides, and front and side edges (back edge is not finished).
- Not available in wood grain laminates.
- Shelves can be ordered in APC.

†5 day Express Response not available on items over 48".

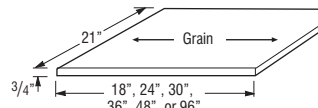

Custom Modifications

ID	RD
•	•

Finish Techniques

Distressing	Heirloom

Specie Availability

Alder	Rustic Alder	Cherry	Hickory	Maple	Oak	High Gloss Laminate	Textured Laminate	Textured PureStyle™	Thermofoil
•	•	•	•	•	•	box color	box color	box color	Maple

EXTERIOR SHELVES, 24" DEEP



ES2418

ES2424

ES2430

ES2436

ES2448

ES2496†

- Wood 3/4" panels are veneered furniture board finished both sides, and front and side edges (back edge is not finished).
- Not available in wood grain laminates.
- Shelves can be ordered in APC.

†5 day Express Response not available on items over 48".

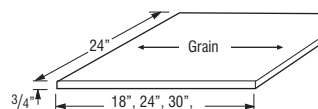

Custom Modifications

ID	RD
•	•

Finish Techniques

Distressing	Heirloom

Specie Availability

Alder	Rustic Alder	Cherry	Hickory	Maple	Oak	High Gloss Laminate	Textured Laminate	Textured PureStyle™	Thermofoil
•	•	•	•	•	•	box color	box color	box color	Maple

DESCRIPTION

FULL DEPTH SHELVING
To Fit 12" Deep Cabinets

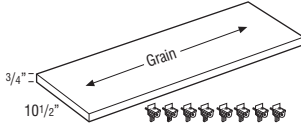

MODEL

- SK912
- SK1212
- SK1512
- SK1812
- SK2112
- SK2412
- SK2712
- SK3012
- SK3312
- SK3612
- SK3912
- SK4212
- SK4812

- One shelf, 10 1/2" deep.
- Each kit includes 8 shelf pegs.
- Shelving material specific to construction option. See page 29 for construction details.
- Specify material when ordering.
- Full Depth Shelves will be shipped separate from the cabinet.
- If matching interior is desired, order shelf kit (SK _____) with Matching Interior Plywood (MIP) modification.

Custom Modifications				Construction Upgrades
ID	MIP	RD	WLI	APC
•	•	•	•	•

FULL DEPTH SHELVING
To Fit 24" Deep Cabinets

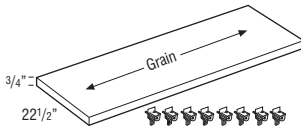

- SK924
- SK1224
- SK1524
- SK1824
- SK2124
- SK2424
- SK2724
- SK3024
- SK3324
- SK3624
- SK3924
- SK4224
- SK4824

- One shelf, 22 1/2" deep.
- Each kit includes 8 shelf pegs.
- Shelving material specific to construction option. See page 29 for construction details.
- Specify material when ordering.
- Full Depth Shelves will be shipped separate from the cabinet.
- If matching interior is desired, order shelf kit (SK _____) with Matching Interior Plywood (MIP) modification.

Custom Modifications				Construction Upgrades
ID	MIP	RD	WLI	APC
•	•	•	•	•

DESCRIPTION

GLASS SHELF KIT,
6" & 9" DEEP

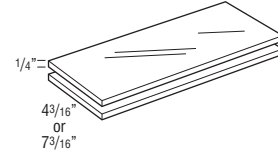

MODEL

- JGSK1206
- JGSK1506
- JGSK1806
- JGSK2106
- JGSK2406
- JGSK2706
- JGSK3006
- JGSK3306
- JGSK3606
- JGSK1209
- JGSK1509
- JGSK1809
- JGSK2109
- JGSK2409
- JGSK2709
- JGSK3009
- JGSK3309
- JGSK3609

- JGSK cannot be trimmed.
- Kit includes two 1/4" tempered shelves.
- Example: JGSK1206 = 10 9/32" x 4 3/16" to fit W1230x6 cabinet.
- Not compatible with the FFD modification.

GLASS SHELF KIT,
12" DEEP

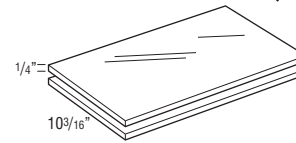

- JGSK912
- JGSK1212
- JGSK1512
- JGSK1812
- JGSK2112
- JGSK2412
- JGSK2712
- JGSK3012
- JGSK3312
- JGSK3612

- JGSK cannot be trimmed.
- Kit includes two 1/4" tempered shelves.
- Example: JGSK1512 = 13 9/32" wide x 10 3/16" deep fits in W1530x12 Deep Cabinet.

Custom Modifications	
ID	RD
•	

GLASS SHELF KIT,
DIAGONAL

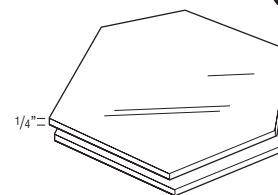

- JGSKDW24 (Fits DW..2424)
- JGSKDW27 (Fits DW..2727)

- JGSK cannot be trimmed.
- Kit includes two 1/4" tempered shelves.
- Not available for 24" and 27" high Diagonal Wall cabinets. Shelf will not fit through door opening.
- Not available for Diagonal Wall cabinets specified with Peninsula modification.

DESCRIPTION

ANGLED HEAT SHIELDS

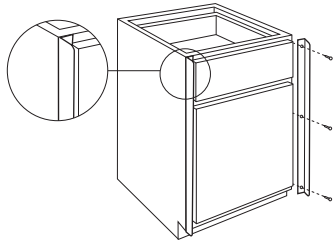
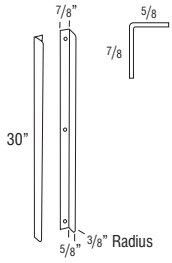

MODEL

**ANGLHEATSHIELD
ANGLHSHIELDSS**

- ANGLHEATSHIELD is a pair of 1/16" thick, white powder coated metal shields.
- ANGLHSHIELDSS is a pair of 1/16" thick, stainless steel metal shields.
- Heat Shield is used to deflect heat from self-cleaning ovens away from cabinet doors and drawer fronts.
- For use when additional 1/8" cannot be added to the oven manufacturer's recommended space requirement.
- Cabinet door cannot be hinged on the same side as the angled heat shield, not compatible with double door cabinets. Installs on the front of the face frame of each cabinet adjacent to the oven.



STRAIGHT HEAT SHIELDS

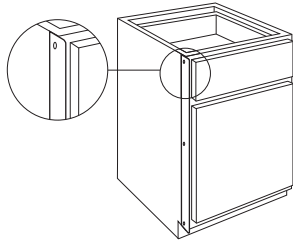
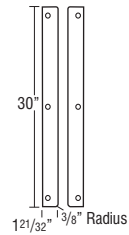

**STRTHEATSHIELD
STRTHSHIELDSS**

- STRTHEATSHIELD is a pair of 1/16" thick, white powder coated metal shields.
- STRTHSHIELDSS is a pair of 1/16" thick, stainless steel metal shields.
- Heat Shield is used to deflect heat from self-cleaning ovens away from cabinet doors and drawer fronts.
- For use when additional 1/8" can be added to the oven manufacturer's recommended space requirement.
- Installs on the side of the face frame of each cabinet adjacent to the oven.



NEW K-CUP®* INSERT

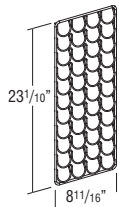

WBCPOKUP

- Holds 44 K-Cups®, compatible with K-Cup® pods only.
- Wire K-Cup® rack for easy field installation on either the left or right side. Compatible with all heights of 3" wide box column pull-outs (WBCPO., see pages 141 and 142). Depending on height of pull-out, shelves can be used above or below insert for additional storage: 30" and 33" high include 4 shelves, not compatible with insert. 36" and 39" high include 5 shelves, one shelf recommended for use with insert. 42" high includes 6 shelves, two shelves recommended for use with insert.

*K-Cup® is a registered trademark of Keurig Green Mountain, Inc.

DESCRIPTION

LID ORGANIZERS

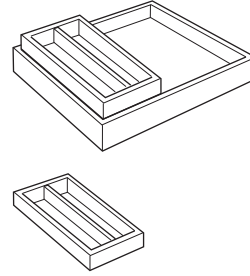

**storage
SOLUTIONS**

MODEL

**LO24DPRT30
LO24DPRT33
LO24DPRT36**

LO

- LO24DPRT30, LO24DPRT33, and LO24DPRT36 include roll tray and installation hardware.



**LINEN CLOSET HAMPER
LINER**

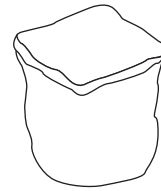

LCHAMPERLNR

- Replacement cloth liner for use with LCRH188421, see page 335.



OVEN INSTALLATION KIT

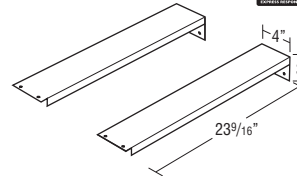

OCINSTALLKIT

- Recommended for supporting built-in appliances such as ovens, microwaves, and warming drawers. Refer to appliance manufacturer specifications for installation requirements.



PEGGED DISH ORGANIZER

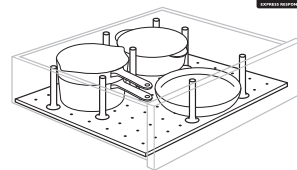

**storage
SOLUTIONS**

**PDO (8 Posts & Board)
PDOPOSTS (4 Posts)**

- For use in 36" wide drawer base cabinets in 6 3/8" or 10" deep drawers, trimmable for cabinets less than 36" wide. Not recommended for use in roll trays.
- Pegged Board is 19 3/32" thick.
- 29 15/16" x 19 1/2".
- Posts are 6" high.



POTS & PANS PULL-OUT

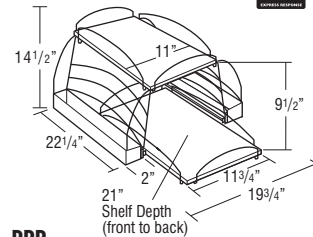

PPP

PPP

- For use in 24" wide cabinets.

PPP30

- For use in 30" wide cabinets.

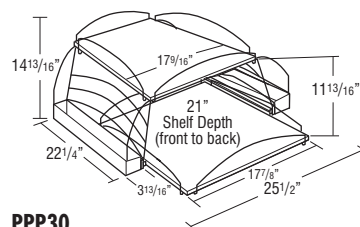

PPP30

**storage
SOLUTIONS**

DESCRIPTION

POWERGLIDE™ COMPACT DRAWER OUTLET

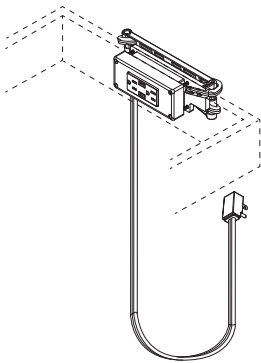
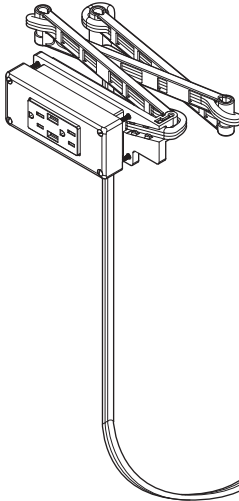

MODEL

DRWPWR1

- Outlet has a total rated capacity of 15 amps.
- Includes two 120V electrical plug-ins and two 2.1 amp rated USB charging ports.
- Cord has 3 ft. of length hanging freely from back mounting bracket. The cord is 14 gauge wire and features a standard 3-prong plug and is required to be plugged into an approved AFCI/GFCI dual function outlet for all applications.
- Outlet is ETL approved-compliant for electrical and other safety standards to U.S. and Canadian safety including UL standards.
- Requires field installation including a 4.25" x 2.13" square hole to be cut into the back of the drawer box.
- Outlet face plate measures 5.22" x 2.3" and will extend 3/4" into drawer box.
- A minimum drawer box height of 2 5/8" is required for installation.
- For use in base cabinet widths of 18" to 36".
- For use in cabinet depths of 15", 18", 21", and 24".
- Also available as an installed modification, see DRWPWR on page 43.

POWER POD

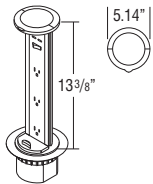

storage
SOLUTIONS

JPWRPODBK (Black)

JPWRPODSS (Stainless Steel)

JPWRPODGM (Gun Metal Black)

- Includes: independent power switch, three electrical sockets, and two USB ports (located above power switch).
- 18" of clearance required below surface mount location; and 3 9/16" diameter hole is required in countertop to install.
- This item requires field installation. This accessory cannot be installed above drawers.
- Safe for countertop installation: rated IP54-splash proof from splashing water and water jets per IPX waterproof specifications; and is ETL approved-compliant for electrical and other safety standards to North America safety including: UL, ANSI, CSA, ASTM, and NFPA standards.
- When installed, top lip of strip sits on top of countertop with a pivoting handle. Handle is pulled up to bring bottom of power strip to countertop.
- Cord is 8 ft. long and features a standard 3-prong plug for use in any household outlet. 10 amps.

SINK BASE CADDY

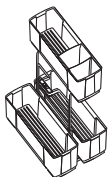

storage
SOLUTIONS



SBCADDY

- Caddy is removable and portable.
- Recommended for use in cabinets 18" and wider.
- Caddy dimensions are: 9 15/16" wide x 18 5/16" tall x 18 5/8" deep.
- Caddy fits in cabinets with a **minimum**: 12" wide x 20 1/2" high frame opening x 21" deep cabinet.

KEMPER
DESIGNING LEADERSHIP

DESCRIPTION

SLIDING TOWEL RACK

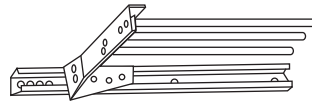

MODEL

STR

- Metal.
- 5" wide x 17 3/4" long x 1 1/2" high.
- Fits in any sink cabinet.

SPICE RACKS

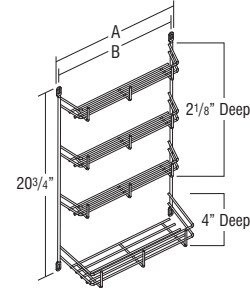

SRCH12

SRCH15

SRCH18

Model	A	B	Fits
SRCH12	7 7/8"	8 13/50"	B15, B30, B33
SRCH15	10 5/8"	11"	B18, B36
SRCH18	13 5/8"	14"	B21, B24 L or R

A = Hole Centers Width

B = Outside Overall Widths

- Designed for Base cabinets only. Mounts to door top and bottom rails.
- Spice Rack is chrome.

SPICE RACK PULL DOWN



SPD18

- Spice Rack Pull Down dimensions: 8 15/16" high x 14 13/16" wide x 10 5/16" deep.
- Maximum Weight Capacity: 15 lbs.
- Must be installed on the floor of the cabinet. Cannot be installed on an adjustable shelf.

storage
SOLUTIONS

SHELF PULL DOWN

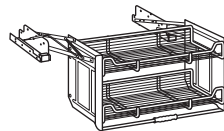

SHLFPD36

- Shelf Pull Down dimensions: 18 11/64" high x 28 1/4" wide x 8 1/2" deep.
- Clearance dimensions: 19 3/8" high x 15 3/8" wide.
- Maximum Weight Capacity: 26 lbs.
- Must be installed on the floor of the cabinet. Cannot be installed on an adjustable shelf.

storage
SOLUTIONS

TABLET HOLDER

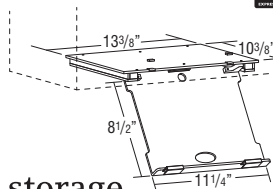

TABLEHLDR

- Mounts under 15" wide cabinet or wider.
- Designed for cabinets 12" deep or deeper.
- Features an acrylic mounting base and pull-down tablet holder tray.
- Tray is movable forward and backward with a slight side to side rotation, and can be utilized at any position.
- Tray has side cut-outs for a charging cord and can be used to store most tablets when closed, depending on overall thickness, width, height, and weight of the tablet.
- Maximum dimensions for tablet: 11 1/4" x 8 1/2" x 1 1/8" thick. Maximum tablet weight is 3 1/2 lbs.
- Tablet Holder has an overall height of 1 17/32" when installed and in closed position (measured from the bottom panel of the cabinet), 0.78" visible from front of cabinet when closed.
- Installation instructions included.

storage
SOLUTIONS

DESCRIPTION

TOEKICK VACUUM and BAGS

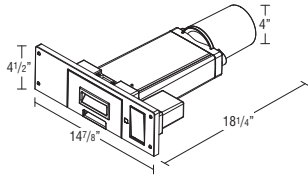

MODEL

CABVAC VACBAG

- 120V compact vacuum cleaner for field installation into the toekick area of base cabinets. Toekick area must be routed for vacuum to be inserted and screwed into place.
- Flooring installation must be compatible with the vacuum by ensuring the bottom of the cabinet is flush with the top of the flooring to allow clearance for the tray to open for changing the bag. The flooring should either be installed under the cabinets or the cabinets can be raised to the flooring level.
- Vacuum is 120V-60Hz, rated current of 5 amps, and rated input power is 650W.
- Cord is 10 ft. from the right side of the unit and features a standard 3-prong plug for use in any household outlet.
- Built-in switch can be gently tapped to turn the unit on, a 10 second timer will automatically turn the unit off.
- Should not be installed in a sink base, bathroom, outdoors, or in other wet environments. Do not expose to moisture, rain, or snow. Do not pick up water or sweep water into the vacuum.
- For installation in the front toekick, cabinet must have a minimum depth of 22" and a minimum width of 18". For installation in an end panel, cabinet must have a minimum depth of 21" and a minimum width of 21".
- CABVAC includes a 0.5 gallon vacuum bag and filter installed along with five replacement bags and one replacement filter. Also includes two plastic covers for field installation (stainless steel look and white).
- VACBAG includes five replacement bags and one replacement filter.
- CABVAC is available included with modifications VACTK, VACL, and VACR which prepares the cabinet for the CABVAC installation by routing the toekick area in the center of the front toekick or end panel (see page 48).

TILT-OUT TRAYS, PLASTIC

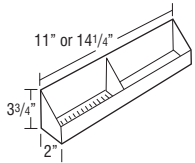

TOT15

TOT18

- Kit includes two white plastic trays and one pair of tilt-out hinges that attaches to the inside of the false panel.
- One tilt-out tray per false panel on cabinets less than 30" wide and greater than 36" wide, two tilt-out trays attached to one false panel on 30"-36" wide cabinets.
- Clean using a mild soap and water. Avoid scalding water.

Model	Width	Application
TOT15	11"	SB30, SB33
TOT18	14 1/4"	SB36, SB39, SB42, SB24, SB27, SB48

DESCRIPTION

TILT-OUT TRAYS, STAINLESS STEEL

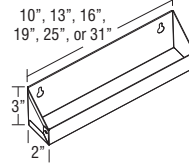

TOTSS

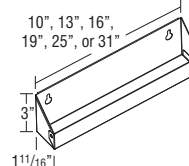

TOTSSS

MODEL

TOTSS10

TOTSS13

TOTSS16

TOTSS19

TOTSS25

TOTSS31

TOTSSS10

TOTSSS13

TOTSSS16

TOTSSS19

TOTSSS25

TOTSSS31

- Attaches to the inside of the false panel.
- One tilt-out tray per false panel.
- TOTSS is available in standard depth (2" deep) and TOTSSS is a slim version (1 1/16" deep) to be used in narrow spaces.
- Standard trays protrude 1 1/16" into cabinet. Slim trays protrude 3/4" into cabinet.
- Kit includes one stainless steel tray and one pair of tilt-out hinges.

Model	Width	Application
TOTSS10 TOTSSS10	10"	ACS36, VSB15, VACSF
TOTSS13 TOTSSS13	13"	SB39, SB45(CC), ACS39, VSB18, VSB39, 2VSD36, 2VSD42, 2VSD48, VSD60, 6VSD42FP
TOTSS16 TOTSSS16	16"	SB21, SB42, SB45, SB48(CC), VSB21, VSB42, VSB45, 2VSD45, VSD54FP, VSD60FP, VS3D54, VS3D60
TOTSS19 TOTSSS19	19"	SB24, SB27, SB30(CC), SB33(CC), SB48, ACS42, VSB24, VSB27, VSB48, VSB54, 2VSD54, 2VSD60, 2VSD57/60, VSD24FP, VSD27FP, 6VSD48FP, 6VSD54FP, 6VSD57FP, 6VSD60FP, 8VSD48FP, 8VSD60FP
TOTSS25 TOTSSS25	25"	SB30, SB33, SB36(CC), SB39(CC), VSB30, VSB33, VSB60, VSD30FP, VSD33FP, VSD42FP, VSD45FP
TOTSS31 TOTSSS31	31"	SB36, SB42(CC), VSB36, VSD36FP, VSD48FP

TRAY DIVIDER, CHROME



CTDK

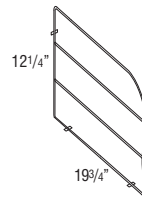

- CTDK: Includes 1 divider, 3 clips, and 3 screws.
- Tray divider is chrome wire.

DESCRIPTION

NEW TRAY DIVIDER KIT

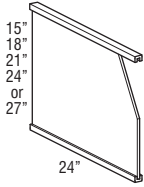

MODEL

- TDKIT15**
- TDKIT18**
- TDKIT21**
- TDKIT24**
- TDKIT27**

- Cabinets need full top and bottom for field installation of tray divider kits.
- Dividers are sized for a 24" deep cabinet, depth can be modified during field installation. Installation screws included.
- Tray dividers are Natural Maple laminated plywood. When specified with APC, tray dividers are clear coated hardwood veneer plywood. When specified with APC and WLI, dividers are white laminated plywood. Rails are always Natural Maple.

Model	Application	Wall Cabinets	Tall Cabinets – Upper Section
TDKIT15	Fits 15" high frame opening	Most 18" high wall cabinets	Upper section of 84" high utility, oven cabinets with 15" high frame opening
TDKIT18	Fits 18" high frame opening	Most 21" high wall cabinets	Upper section of 87" high utility, oven cabinets with 18" high frame opening
TDKIT21	Fits 21" high frame opening	Most 24" high wall cabinets	Upper section of 90" high utility, oven cabinets with 21" high frame opening
TDKIT24	Fits 24" high frame opening	Most 27" high wall cabinets	Upper section of 93" high utility, oven cabinets with 24" high frame opening
TDKIT27	Fits 27" high frame opening	Most 30" high wall cabinets	Upper section of 96" high utility, oven cabinets with 27" high frame opening

TRAY DIVIDER ROLL-OUT KIT

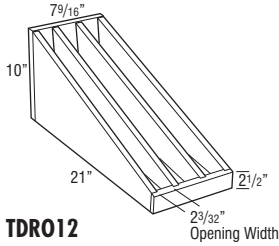

TDRO12
TDRO15

- TDRO12: 2 removable dividers (3 compartments).
- TDRO15: 3 removable dividers (4 compartments).
- Utilizes Smart Stop undermount guides and bumpers for door protection.
- Installation hardware included.

TDRO12

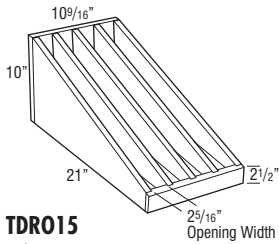

TDRO15
storage SOLUTIONS

UTILITY EASY ACCESS BASKETS

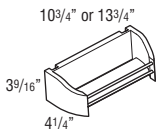

UEASBSK15
UEASBSK18

- Only for use to add baskets to a UEAS cabinet.
- Mounting hardware not included.

storage SOLUTIONS

DESCRIPTION

VANITY CHROME ROLL-OUT RACK

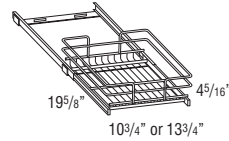

MODEL

- VCRR1521**
- VCRR1821**

- Requires installation to fixed shelf or cabinet bottom in a 21" or 24" deep cabinet.
- VCRR1521 recommended for use in VB153221, VB153421, DDD152921, CPU152921 (rack will be exposed—no door).
- VCRR1821 recommended for use in VB183421, 2VSD363221, 2VSD363421, VSD303121, VSD303421, LC188421 (lower section), VU188421, VU188421H, DDD182921.
- Roll-out is full extension.

storage SOLUTIONS

VANITY WASTEBASKET KIT



VWB

- Bottom mount zinc colored Smart Stop guide with 20 quart grey wastebasket inserted in chrome support.
- Dimension of insert: 8.5" wide x 16.7" tall x 17.7" deep.

storage SOLUTIONS

WALL SUSAN KITS

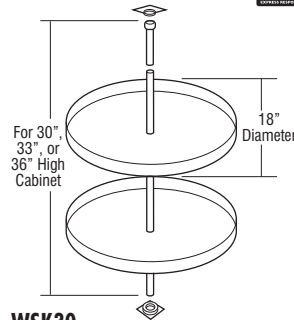

- WSK30**
- WSK33**
- WSK36**
- WSK39**
- WSK42**

- 30"-36" kits include pole and two 18" diameter plywood shelves. 39" and 42" kits include pole and three 18" diameter plywood shelves.

WSK30
WSK33
WSK36

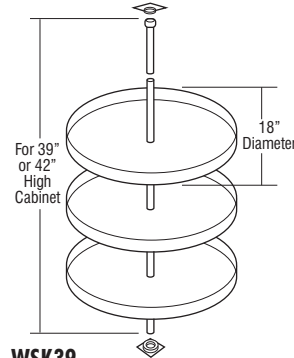

WSK39
WSK42

WINE GLASS HOLDERS

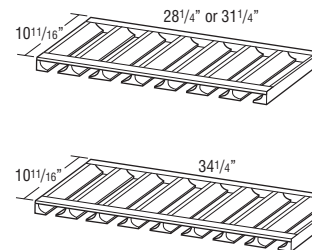

- WGH30 (7 slots)**
- WGH33 (7 slots)**
- WGH36 (8 slots)**

- Maximum wine glass base is 3 1/4" diameter.
- Wine Glass Holder is finished.
- May be trimmed to fit smaller cabinets.
- Designed for installation under a wall cabinet (between end panels and behind face frame).

Specie Availability

Alder	Rustic Alder	Cherry	Hickory	Maple	Oak	High Gloss Laminate	Textured Laminate	Textured PureStyle™	Thermofoil
•	• Alder	•	•	•	•	box color	box color	box color	Maple

DESCRIPTION
ROLL TRAY KITS

MODEL

ROLL TRAY KIT

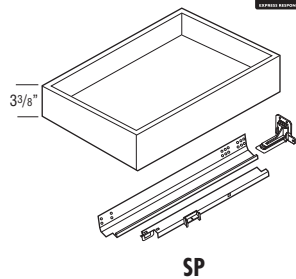

For 18" Deep Cabinets

- RT1218SP
- RT1518SP
- RT1818SP
- RT2118SP
- RT2418SP
- RT2718SP
- RT3018SP
- RT3318SP
- RT3618SP
- RT3918SP
- RT4218SP
- RT4518SP
- RT4818SP

For 21" Deep Cabinets

- RT1221SP
- RT1521SP
- RT1821SP
- RT2121SP
- RT2421SP
- RT2721SP
- RT3021SP
- RT3321SP
- RT3621SP
- RT3921SP
- RT4221SP
- RT4521SP
- RT4821SP

For 24" Deep Cabinets

- RT12SP
- RT15SP
- RT18SP
- RT21SP
- RT24SP
- RT27SP
- RT30SP
- RT33SP
- RT36SP
- RT39SP
- RT42SP
- RT45SP
- RT48SP

- RT_ _SP's include roll tray, roll tray brackets, hardware, screws, and installation instructions.
- 39"-48" wide Roll Tray Kits will contain 1 roll tray. QTY of 2 must be ordered to achieve a roll tray in both cabinet openings.

Custom Modifications

ID	RD
	•

DESCRIPTION

MODEL

DEEP ROLL TRAY KIT

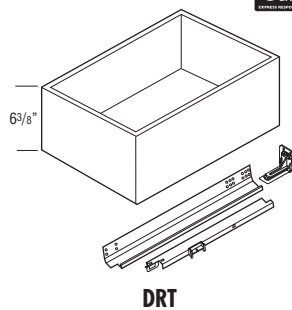

For 18" Deep Cabinets

- DRT1218
- DRT1518
- DRT1818
- DRT2118
- DRT2418
- DRT2718
- DRT3018
- DRT3318
- DRT3618
- DRT3918
- DRT4218
- DRT4518
- DRT4818

For 21" Deep Cabinets

- DRT1221
- DRT1521
- DRT1821
- DRT2121
- DRT2421
- DRT2721
- DRT3021
- DRT3321
- DRT3621
- DRT3921
- DRT4221
- DRT4521
- DRT4821

For 24" Deep Cabinets

- DRT12
- DRT15
- DRT18
- DRT21
- DRT24
- DRT27
- DRT30
- DRT33
- DRT36
- DRT39
- DRT42
- DRT45
- DRT48

- DRT_ _'s include deep roll tray, deep roll tray brackets, hardware, screws, and installation instructions.
- 39"-48" wide Deep Roll Tray Kits will contain 1 roll tray. QTY of 2 must be ordered to achieve a roll tray in both cabinet openings.

Custom Modifications

ID	RD
	•

DESCRIPTION

ROLL TRAY KIT – EASYTRAX™

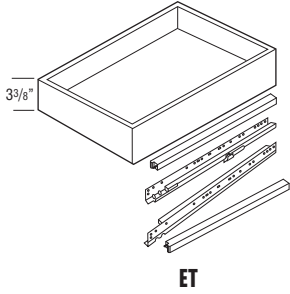

MODEL

For 18" Deep Cabinets

- RT1518ET
- RT1818ET
- RT2118ET
- RT2418ET
- RT2718ET
- RT3018ET
- RT3318ET
- RT3618ET
- RT3918ET
- RT4218ET
- RT4518ET
- RT4818ET

For 21" Deep Cabinets

- RT1521ET
- RT1821ET
- RT2121ET
- RT2421ET
- RT2721ET
- RT3021ET
- RT3321ET
- RT3621ET
- RT3921ET
- RT4221ET
- RT4521ET
- RT4821ET

For 24" Deep Cabinets

- RT15ET
- RT18ET
- RT21ET
- RT24ET
- RT27ET
- RT30ET
- RT33ET
- RT36ET
- RT39ET
- RT42ET
- RT45ET
- RT48ET

- EasyTrax™ uprights are required, must be purchased separately (see page 416).
- RT-ET's contain roll tray, hardware, wooden hardware mounting bracket, screws and installation instructions.
- 39"-48" wide Roll Tray Kits will contain 1 roll tray. QTY of 2 must be ordered to achieve a roll tray in both cabinet openings.

Custom Modifications

ID	RD
	•

DESCRIPTION

DEEP ROLL TRAY KIT – EASYTRAX™

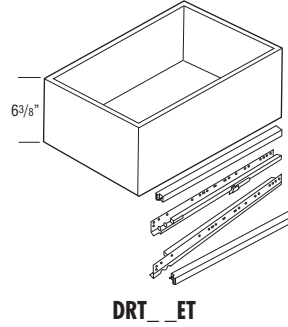

MODEL

For 18" Deep Cabinets

- DRT1218ET
- DRT1518ET
- DRT1818ET
- DRT2118ET
- DRT2418ET
- DRT2718ET
- DRT3018ET
- DRT3318ET
- DRT3618ET
- DRT3918ET
- DRT4218ET
- DRT4518ET
- DRT4818ET

For 21" Deep Cabinets

- DRT1221ET
- DRT1521ET
- DRT1821ET
- DRT2121ET
- DRT2421ET
- DRT2721ET
- DRT3021ET
- DRT3321ET
- DRT3621ET
- DRT3921ET
- DRT4221ET
- DRT4521ET
- DRT4821ET

For 24" Deep Cabinets

- DRT12ET
- DRT15ET
- DRT18ET
- DRT21ET
- DRT24ET
- DRT27ET
- DRT30ET
- DRT33ET
- DRT36ET
- DRT39ET
- DRT42ET
- DRT45ET
- DRT48ET

- EasyTrax™ uprights are required, must be purchased separately (see page 416).
- DRT-ET's contain roll tray, hardware, wooden hardware mounting bracket, screws and installation instructions.
- 39"-48" wide Deep Roll Tray Kits will contain 1 roll tray. QTY of 2 must be ordered to achieve a roll tray in both cabinet openings.

Custom Modifications

ID	RD
	•

DESCRIPTION

MODEL

EASYTRAX™ UPRIGHTS



ETUPRIGHT

ETUPRIGHTOV

ETUPRIGHT40.5

ETUPRCS

ETUPR40.5CS

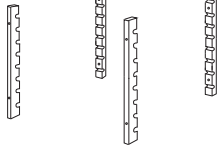

ETUPRIGHT

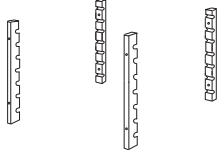

ETUPRIGHTOV

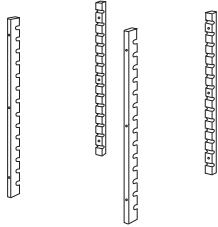

ETUPRIGHT40.5



ETUPRCS
ETUPR40.5CS

- EasyTrax™ system allows quick field installation of adjustable height roll trays with front and rear uprights to support roll tray guides.
- ETUPRIGHT contains 2 front and 2 rear uprights. QTY required: Base, Base Full Height, and 34 1/2" high Vanities = 1
Utility Cabinets = 3
42" and 48" wide cabinets = 2.
- ETUPRIGHTOV contains 2 front and 2 rear uprights. QTY required: Desk and 32" high Vanity = 1.
- ETUPRIGHT40.5 contains 2 front and 2 rear uprights. QTY required: 40 1/2" high Base cabinets = 1.
- ETUPRCS and ETUPR40.5CS recommended for DRT39ET-DRT48ET kits to secure drawer guide in ET system on cabinets with center stiles.

DESCRIPTION

MODEL

GUIDE KITS AND PARTS

DRAWER GUIDE KITS
DGK__DDFX



DGK21DDFX

DGK24DDFX

21" or 24"

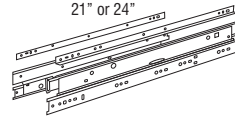

- Side mount progressive full extension guide utilized on all drawers of DDFD__ cabinets.
- Maximum Weight Capacity: 125 lbs. per pair.
- Kit includes guide hardware for one drawer box (cabinets, drawer members wood vertical mounting rails and screws)
Dimension refers to cabinet depth.

DGKIT__PG



DGKIT12PG



DGKIT15PG



DGKIT18PG



DGKIT21PG



DGKIT24PG

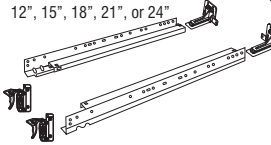

12", 15", 18", 21", or 24"

- Undermount full extension Smart Stop Premium Guide (PG).
- Maximum Weight Capacity: 90 lbs. per pair.
- Kit includes guide hardware for one drawer box (cabinets and drawer members, sockets and screws)
Dimension refers to cabinet depth.

DGKIT__RTSP



DGKIT15RTSP



DGKIT18RTSP



DGKIT21RTSP



DGKIT24RTSP

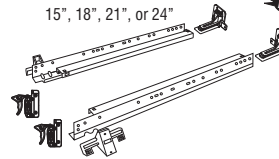

15", 18", 21", or 24"

- Undermount full extension Smart Stop Premium Guide utilized on roll trays.
- Maximum Weight Capacity: 90 lbs. per pair.
- Kit includes guide hardware for one drawer box (cabinets and drawer members, sockets and screws)
Dimension refers to cabinet depth.

DRAWER GUIDE
BACK SOCKETS



BKSOCKET-PG

BKSOCKET-SP

DGK-BKSOCKET-HD

- BKSOCKET-PG used with Smart Stop drawer guides (12"-24" deep).
- BKSOCKET-SP used with Smart Stop roll tray guides.
- DGK-BKSOCKET-HD used on deep drawers in 42" and 48" wide 2DB__, 3DBDD__, and 3DBBDD__ cabinets, and on all VWH2D__ cabinets.
- Sold in pairs.

DRAWER GUIDE
SPACER BLOCK



SPACERBLK

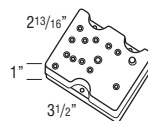

- Sold in pairs.
- For use with DGKIT..PG kits when RD is used for depths other than 3" increments.
- One SPACERBLK required for each inch of depth.
- Not required for use with 23", 20", 17", 14" depth.

FALSE PANEL CLIPS



FALSEPNLCLIP50

PFALSEPNLCLIP50

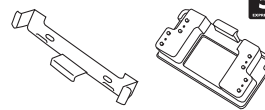

- Use to secure false front on sink base.
- Sold in pairs.

ROLL TRAY PLUG IN
BRACKET



RTBKXSP

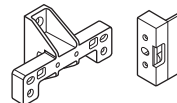

- For use with roll tray hardware to prevent interference with door hinges. Also included in roll tray hardware kit.

DESCRIPTION

MODEL

STAIN, PAINT, & TOUCH-UP TOOLS

STAIN & PAINT



STAINSTANDARD

STAINPREMIUM

PAINTQUART

PAINTPREMIUM

SSC

SSCCLEAR

- Wiping stains can be sprayed at low pressure.
- Specify finish name and wood type when ordering.
- STAINSTANDARD, STAINPREMIUM, PAINTQUART, and PAINTPREMIUM sold in quarts.
- SSC is a 384 mL aerosol can available in Opaque colors.
- SSCCLEAR is a 384 mL aerosol can in clear.
- Not available in Arctic, Antler, Elk, High Glass White, Obsidian, or Wharf.
- For Touch-Up Kits and Glaze Pens, see below.

TOUCH-UP TOOLS



TUK

MTUK

GLAZEPEN

- Touch-Up Kit includes touch up marker and a fill stick.
- MTUK not available in Black.
- MTUK ordered in opaques with glaze will only contain the base color.
- Mini Touch-Up Kit includes small touch up marker and a small fill stick.
- GLAZEPEN available in glaze colors only.
- GLAZEPEN works on finished doors and does not require a separate top coat.

Finish	Product Code
Amaretto Crème on Cloud	PAINTPREMIUM
Amaretto Crème on Coconut	PAINTPREMIUM
Amaretto Crème on Dover	PAINTPREMIUM
Amaretto Crème on Egret	PAINTPREMIUM
Amaretto Crème on Maritime	PAINTPREMIUM
Amaretto Crème on Pearl	PAINTPREMIUM
Black	PAINTQUART
Black Forest	STAINPREMIUM
Brierwood	STAINSTANDARD
Cattail	STAINSTANDARD
Chocolate	STAINSTANDARD
Cloud	PAINTQUART
Coconut	PAINTQUART
Coffee	STAINPREMIUM
Cranberry	STAINSTANDARD
Dover	PAINTQUART
Egret	PAINTQUART
Forest Floor	PAINTQUART
Grey Stone on Cloud	PAINTPREMIUM
Grey Stone on Coconut	PAINTPREMIUM
Grey Stone on Dover	PAINTPREMIUM
Grey Stone on Egret	PAINTPREMIUM
Grey Stone on Maritime	PAINTPREMIUM
Grey Stone on Pearl	PAINTPREMIUM
Grizzly	STAINPREMIUM
Havana	STAINSTANDARD
Henna	STAINSTANDARD
Juniper Berry	PAINTQUART
Kodiak	STAINPREMIUM
Lambswool	PAINTQUART
Lambswool with Amaretto Crème	PAINTPREMIUM
Lambswool with Grey Stone	PAINTPREMIUM
Lambswool with Toasted Almond	PAINTPREMIUM
Light	STAINSTANDARD
Maritime	PAINTQUART
Moonstone	PAINTQUART
Moonstone with Amaretto Crème	PAINTPREMIUM
Moonstone with Toasted Almond	PAINTPREMIUM
Oasis	PAINTPREMIUM
Palomino	STAINPREMIUM
Pearl	PAINTQUART
Sahara	STAINSTANDARD
Seal	STAINSTANDARD
Seaside	PAINTQUART
Storm	STAINSTANDARD
Thatch	STAINSTANDARD
Tidal Mist	PAINTPREMIUM
Toasted Almond on Cloud	PAINTPREMIUM
Toasted Almond on Coconut	PAINTPREMIUM
Toasted Almond on Dover	PAINTPREMIUM
Toasted Almond on Egret	PAINTPREMIUM
Toasted Almond on Maritime	PAINTPREMIUM
Toasted Almond on Pearl	PAINTPREMIUM
Tundra	STAINSTANDARD
Whiskey Black	STAINPREMIUM
White	PAINTQUART

DESCRIPTION

MODEL

HINGES

HINGES



38NPOHINGE Integrated Soft Close, 6-way Adjustable, 1/2" Partial-overlay, 107° Hinge

All cabinets not specified by other hinges. For use on full overlay styles: Base Transition Cabinets (BTC), Wall Transition Cabinets (WTC), Stacked Wall Transition Cabinets (STWTC), Diagonal Wall (DW) and Base (DAB) Cabinets, Angled Corner Sink Bases (ACS) & Fronts (ACSF), and Wall Top Hinge (WTH) Cabinets with Modified Full Overlay (MFO).

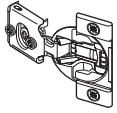

38CFOHINGE Integrated Soft Close, 6-way Adjustable, Full-overlay, 107° Hinge

All cabinets not specified by other hinges

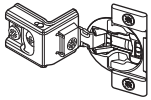

38BFOVHINGE Integrated Soft Close, 4-way Adjustable, Full-overlay, Face-mount 107° Hinge

OCD, OMC, and OCS cabinets
36" and 42" high WBMW, full and partial overlay

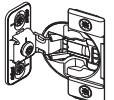

32049HINGE 90° Corner Self-Closing Center Hinge

Center Hinge for ER, BLS, SLS, BER, BERAS, and CS

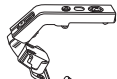

942HINGE 170° Hinge

BSC, BLS, SLS, BER, BERAS, CS, and ER



7299HINGE Mirror Hinge

TV and MC cabinets



• Sold in pairs.

HINGE ANGLE RESTRICTION CLIP



HINGERESCLIP

- For use in applications with cabinets installed at varying depths to prevent the door damage caused by opening into an adjacent cabinet.
- Restricts hinges to 86° opening capability.
- Works only with the 38NPOHINGE and 38CFOHINGE.
- Not recommended for cabinets with roll trays specified in partial overlay styles.
- Sold in pairs.



HINGE SHIM



HINGESHIMS

- Install between the face frame and hinge to allow additional adjustment of doors. Can be used to reduce gap between butt doors.
- Pack of 5 metal shims.
- Compatible with all hinges except face-mount.



LIDSTAY



LIDSTAY

- Sold in pairs.
- Recommended for field installed wall top hinge applications up to 18" high.

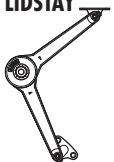

LIDSTAY - HEAVY DUTY



LIDSTAYHD

- One heavy duty lid stay hinge required per cabinet.
- Recommended for field installed wall top hinge applications of 21" high cabinets.



DESCRIPTION

MODEL

PARTS

DOORS & DRAWER FRONTS



Door for Any Cabinet 18" High or Less

Door for Any Cabinet 21" to 30" High

Door for Any Cabinet 33" or Higher

No Hinge Route Doors 18" High or Less

No Hinge Route Doors 21" to 30" High

No Hinge Route Doors 33" or Higher

Any Drawer Front

- Backs of "NO HINGE ROUTE" doors may have identification marks, be unfinished, and have 3/16" diameter holes used during finish processing. For these reasons, these doors are not suitable for use as cabinet doors.

DRAWERS



Complete Drawer

Drawer Box Only

- Complete Drawer and Drawer Box Only do not include drawer guides. They must be ordered separately.

Specie Availability

Alder	Rustic Alder	Cherry	Hickory	Maple	Oak	High Gloss Laminate	Textured Laminate	Textured PureStyle™	Thermofoil
•	•	•	•	•	•	•	•	•	•

MISCELLANEOUS PARTS



BRKOFFSCREW (pkg. 25)

INSTALLSCR24 (pkg. 24)

INSTALLSCREWS (pkg. 100)

TVHDW/WCATCH

MC16HDW/WCATCH

RETCLIP250BAG

BUMPERPADS (pkg. 25)

PDM

SHELFPEGS (pkg. 24)

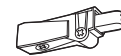

PDM

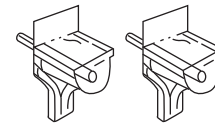

SHELFPEGS

- BRKOFFSCREW is a pack of 25 breakaway screws for use with decorative hardware pulls and knobs.
- INSTALLSCR24 and INSTALLSCREWS are screws for cabinet installation through the cabinet back to the wall studs (includes a pack of 24 or 100).
- TVHDW/WCATCH is one set of the magnetic catch hardware and handle used on mirrors on Tri-View Mirrors (TV..).
- MC16HDW/WCATCH is one set of the magnetic catch hardware, handle, and one pair of hinges used on Single Door Medicine Cabinets (MC16).
- RETCLIP250BAG: 6 retainer clips for use with glass inserts in mullion and cut for glass doors.
- PDM creates a smooth and silent self-closing motion and includes all installation hardware.
- SHELFPEGS are 3mm steel pins with clear plastic shoulders.

DESCRIPTION	MODEL
-------------	-------

SALES SUPPORT TOOLS

HARDWARE BOARD



SLCHDWBD

- 16" x 40".

SAMPLE FRAME & DOORS

DOORSAMPLEW

DOORSAMPLEB

- Specify door style and finish.
- DOORSAMPLEW features a wall door on a face frame. Overall size is 15"W x 22"H. If ordered in Arch/Cathedral, the door will be Arch/Cathedral.
- DOORSAMPLEB will have a base door and drawer front on the face frame. Overall size is 15"W x 24 1/2"H. All doors are Square.
- See door style finish chart on pages 24-27 for availability.

DESCRIPTION

MODEL

STACK MOULDING KITS

- Moulding stacks do not ship assembled; field assembly is required. Assembly instructions can be viewed in 20/20 spec pages and will also ship with moulding kits.
- When ordered as a kit, only one finish can be specified. To order with more than one finish, moulding pieces must be ordered separately.
- Moulding stacks include Assembly Instructions. Cleats and finish nails not included.

- How to place a stack moulding in 20/20:
 - Moulding
 - Top Mouldings or Bottom Mouldings
 - Stacked Mouldings
 - Drag and drop desired moulding stack onto wall cabinets

420

MOULDING STACK 1



STKMLD1

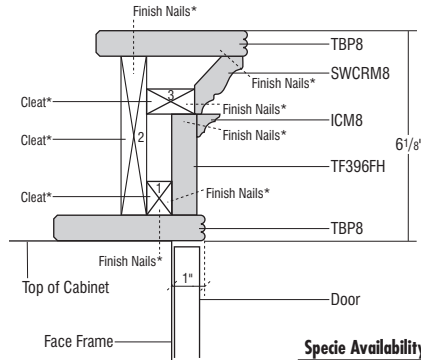
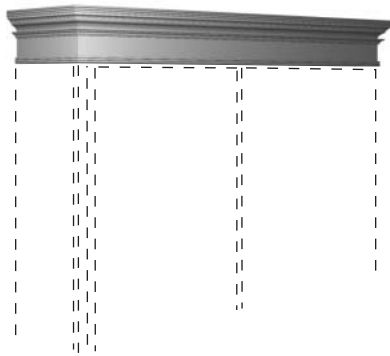

Finish Techniques

	Distressing	Heirloom
TBP8		•
SWCRM8	•	•
ICM8		
TF396FH	•	

Specie Availability

	Alder	Rustic Alder	Cherry	Hickory	Maple	Oak	High Gloss Laminate	Textured Laminate	Textured PureStyle™	Thermofoil
TBP8	•	Alder	•	•	•	•	box color	box color	box color	Maple
SWCRM8	•	•	•	•	•	•	box color	box color	box color	Maple
ICM8	•	Alder	•	•	•	•	box color	box color	box color	Maple
TF396FH	•	Alder	•	•	•	•	box color	box color	box color	Maple

*Cleats and finish nails not included.

MOULDING STACK 2



STKMLD2

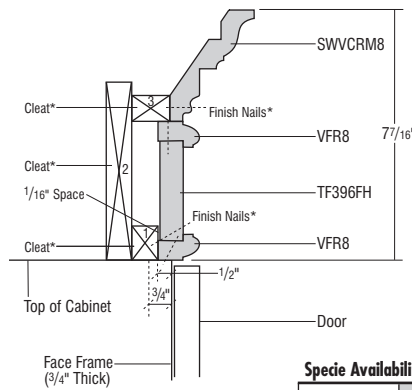
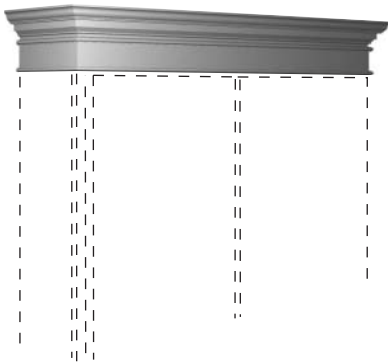

Finish Techniques

	Distressing	Heirloom
SWVCRM8	•	•
VFR8		•
TF396FH	•	

Specie Availability

	Alder	Rustic Alder	Cherry	Hickory	Maple	Oak	High Gloss Laminate	Textured Laminate	Textured PureStyle™	Thermofoil
SWVCRM8	•	•	•	•	•	•	box color	box color	box color	Maple
VFR8	•	Alder	•	•	•	•	box color	box color	box color	Maple
TF396FH	•	Alder	•	•	•	•	box color	box color	box color	Maple

*Cleats and finish nails not included.

DESCRIPTION

MODEL

STACK MOULDING KITS

- Moulding stacks do not ship assembled; field assembly is required. Assembly instructions can be viewed in 20/20 spec pages and will also ship with moulding kits.
- When ordered as a kit, only one finish can be specified. To order with more than one finish, moulding pieces must be ordered separately.
- Moulding stacks include Assembly Instructions. Cleats and finish nails not included.

- How to place a stack moulding in 20/20:
 - Moulding
 - Top Mouldings or Bottom Mouldings
 - Stacked Mouldings
 - Drag and drop desired moulding stack onto wall cabinets

MOULDING STACK 3

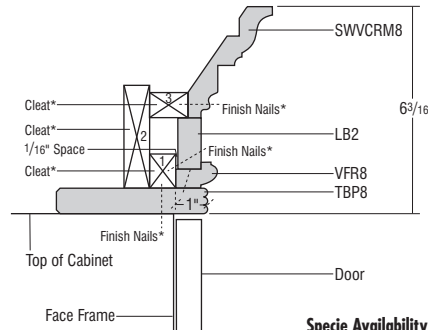
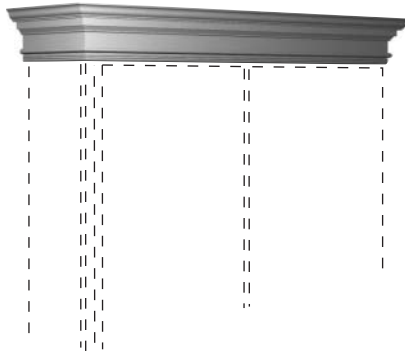

STKMLD3

- Not recommended for use when taking application to the ceiling.

Finish Techniques

	Distressing	Heirloom
SWVCRM8	•	•
LB2		
VFR8		•
TBP8		•

Specie Availability

	Alder	Rustic Alder	Cherry	Hickory	Maple	Oak	High Gloss Laminate	Textured Laminate	Textured PureStyle™	Thermofoil
SWVCRM8	•	•	•	•	•	•	box color	box color	box color	Maple
LB2	•	Alder	•	•	•	•	box color	box color	box color	Maple
VFR8	•	Alder	•	•	•	•	box color	box color	box color	Maple
TBP8	•	Alder	•	•	•	•	box color	box color	box color	Maple

*Cleats and finish nails not included.

MOULDING STACK 5

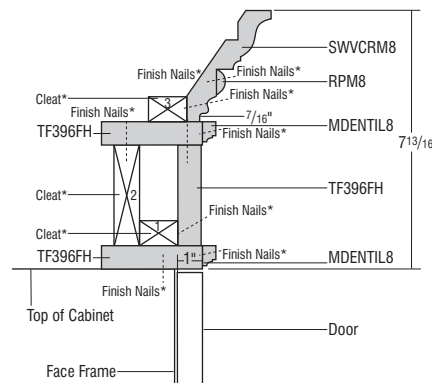
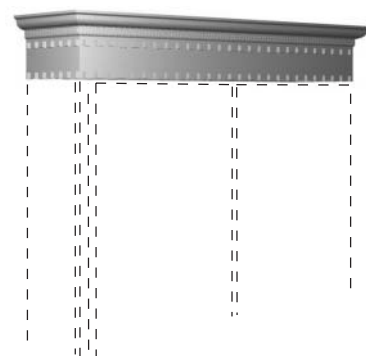

STKMLD5

Finish Techniques

	Distressing	Heirloom
SWVCRM8	•	•
RPM8		
MDENTIL8		
TF396FH	•	

Specie Availability

	Alder	Rustic Alder	Cherry	Hickory	Maple	Oak	High Gloss Laminate	Textured Laminate	Textured PureStyle™	Thermofoil
SWVCRM8	•	•	•	•	•	•	box color	box color	box color	Maple
RPM8	•	Alder	•	•	•	•	box color	box color	box color	Maple
MDENTIL8	•	Alder	•	•	•	•	box color	box color	box color	Maple
TF396FH	•	Alder	•	•	•	•	box color	box color	box color	Maple

*Cleats and finish nails not included.

MOULDING STACK 6

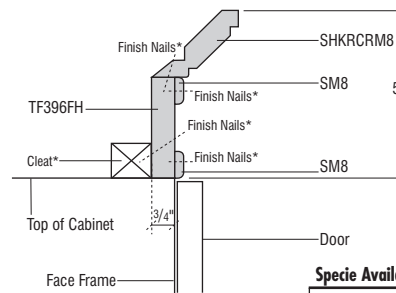
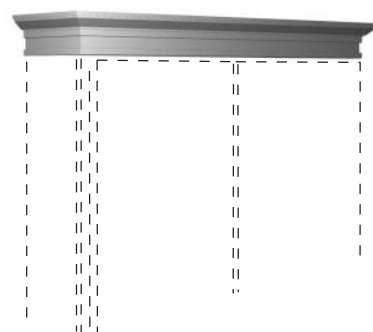

STKMLD6

- Not recommended for use when taking application to the ceiling.

Finish Techniques

	Distressing	Heirloom
SHKRCRM8	•	•
SM8		
TF396FH	•	

Specie Availability

	Alder	Rustic Alder	Cherry	Hickory	Maple	Oak	High Gloss Laminate	Textured Laminate	Textured PureStyle™	Thermofoil
SHKRCRM8	•	•	•	•	•	•	box color	box color	box color	Maple
SM8	•	Alder	•	•	•	•	box color	box color	box color	Maple
TF396FH	•	Alder	•	•	•	•	box color	box color	box color	Maple

*Cleats and finish nails not included.

DESCRIPTION

MODEL

STACK MOULDING KITS

- Moulding stacks do not ship assembled; field assembly is required. Assembly instructions can be viewed in 20/20 spec pages and will also ship with moulding kits.
- When ordered as a kit, only one finish can be specified. To order with more than one finish, moulding pieces must be ordered separately.
- Moulding stacks include Assembly Instructions. Cleats and finish nails not included.

- How to place a stack moulding in 20/20:
 - Moulding
 - Top Mouldings or Bottom Mouldings
 - Stacked Mouldings
 - Drag and drop desired moulding stack onto wall cabinets

422

MOULDING STACK 7

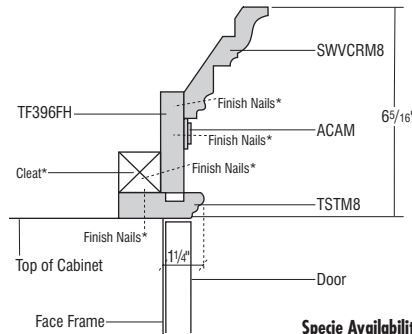
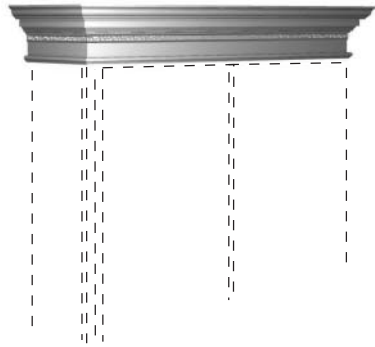

STKMLD7

- Not recommended for use when taking application to the ceiling.

Finish Techniques

	Distressing	Heirloom
SWVCRM8	•	•
ACAM		
TF396FH	•	
TSTM8		

Specie Availability

	Alder	Rustic Alder	Cherry	Hickory	Maple	Oak	High Glass Laminate	Textured Laminate	Textured PureStyle™	Thermofoil
SWVCRM8	•	•	•	•	•	•	box color	box color	box color	Maple
ACAM	•	Alder	•	•	•	•	box color	box color	box color	Maple
TF396FH	•	Alder	•	•	•	•	box color	box color	box color	Maple
TSTM8	•	Alder	•	•	•	•	box color	box color	box color	Maple

*Cleats and finish nails not included.

MOULDING STACK 8

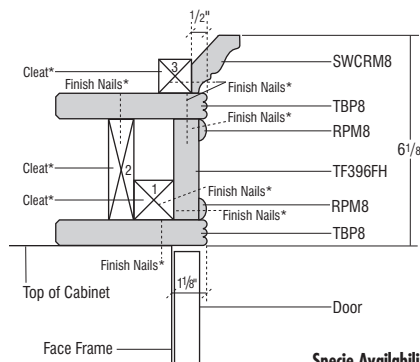
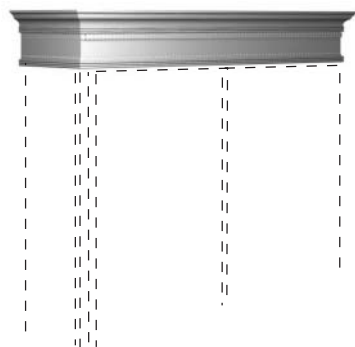

STKMLD8

- Not recommended for use when taking application to the ceiling.

Finish Techniques

	Distressing	Heirloom
SWCRM8	•	•
RPM8		
TBP8		•
TF396FH	•	

Specie Availability

	Alder	Rustic Alder	Cherry	Hickory	Maple	Oak	High Glass Laminate	Textured Laminate	Textured PureStyle™	Thermofoil
SWCRM8	•	•	•	•	•	•	box color	box color	box color	Maple
RPM8	•	Alder	•	•	•	•	box color	box color	box color	Maple
TBP8	•	Alder	•	•	•	•	box color	box color	box color	Maple
TF396FH	•	Alder	•	•	•	•	box color	box color	box color	Maple

*Cleats and finish nails not included.

MOULDING STACK 10

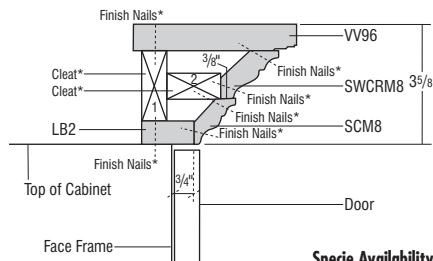
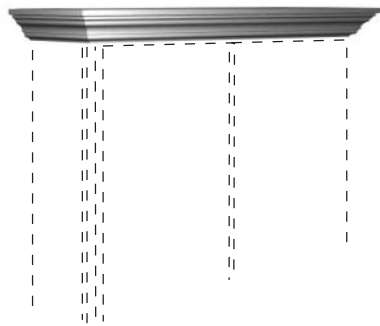

STKMLD10

- Not recommended for use when taking application to the ceiling.

Finish Techniques

	Distressing	Heirloom
VV96	•	•
SWCRM8	•	•
SCM8	•	•
LB2		

Specie Availability

	Alder	Rustic Alder	Cherry	Hickory	Maple	Oak	High Glass Laminate	Textured Laminate	Textured PureStyle™	Thermofoil
VV96	•	•	•	•	•	•	box color	box color	box color	Maple
SWCRM8	•	•	•	•	•	•	box color	box color	box color	Maple
SCM8	•	•	•	•	•	•	box color	box color	box color	Maple
LB2	•	Alder	•	•	•	•	box color	box color	box color	Maple

*Cleats and finish nails not included.

DESCRIPTION

MODEL

STACK MOULDING KITS

- Moulding stacks do not ship assembled; field assembly is required. Assembly instructions can be viewed in 20/20 spec pages and will also ship with moulding kits.
- When ordered as a kit, only one finish can be specified. To order with more than one finish, moulding pieces must be ordered separately.
- Moulding stacks include Assembly Instructions. Cleats and finish nails not included.
- How to place a stack moulding in 20/20:
 - Moulding
 - Top Mouldings or Bottom Mouldings
 - Stacked Mouldings
 - Drag and drop desired moulding stack onto wall cabinets

MOULDING STACK 11



STKMLD11

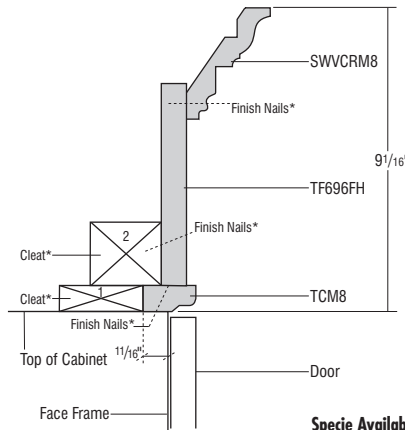
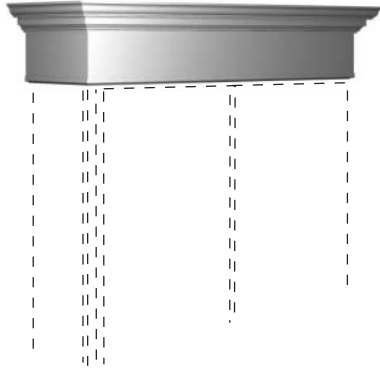

Finish Techniques

	Distressing	Heirloom
SWVCRM8	•	•
TF696FH	•	
TCM8		•

Specie Availability

	Alder	Rustic Alder	Cherry	Hickory	Maple	Oak	High Gloss Laminate	Textured Laminate	Textured PureStyle™	Thermofoil
SWVCRM8	•	•	•	•	•	•	box color	box color	box color	Maple
TF696FH	•	Alder	•	•	•	•	box color	box color	box color	Maple
TCM8	•	Alder	•	•	•	•	box color	box color	box color	Maple

*Cleats and finish nails not included.

MOULDING STACK 13



STKMLD13

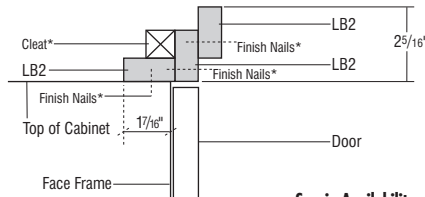
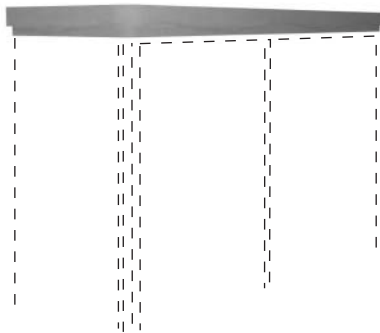

Finish Techniques

	Distressing	Heirloom
LB2		

Specie Availability

	Alder	Rustic Alder	Cherry	Hickory	Maple	Oak	High Gloss Laminate	Textured Laminate	Textured PureStyle™	Thermofoil
LB2	•	Alder	•	•	•	•	box color	box color	box color	Maple

*Cleats and finish nails not included.

MOULDING STACK 14



STKMLD14

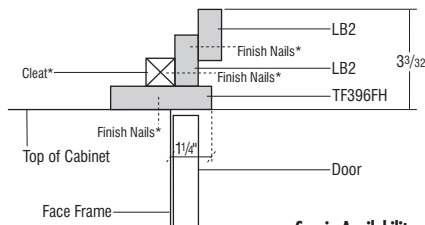
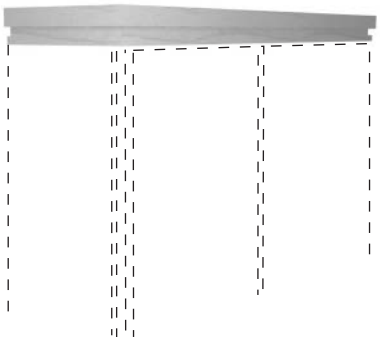

Finish Techniques

	Distressing	Heirloom
LB2		
TF396FH	•	

Specie Availability

	Alder	Rustic Alder	Cherry	Hickory	Maple	Oak	High Gloss Laminate	Textured Laminate	Textured PureStyle™	Thermofoil
LB2	•	Alder	•	•	•	•	box color	box color	box color	Maple
TF396FH	•	Alder	•	•	•	•	box color	box color	box color	Maple

*Cleats and finish nails not included.

DESCRIPTION

MODEL

STACK MOULDING KITS

- Moulding stacks do not ship assembled; field assembly is required. Assembly instructions can be viewed in 20/20 spec pages and will also ship with moulding kits.
- When ordered as a kit, only one finish can be specified. To order with more than one finish, moulding pieces must be ordered separately.
- Moulding stacks include Assembly Instructions. Cleats and finish nails not included.

- How to place a stack moulding in 20/20:
 - Moulding
 - Top Mouldings or Bottom Mouldings
 - Stacked Mouldings
 - Drag and drop desired moulding stack onto wall cabinets

424

MOULDING STACK 16

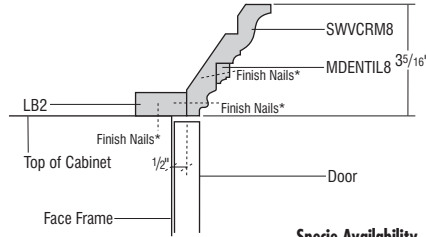
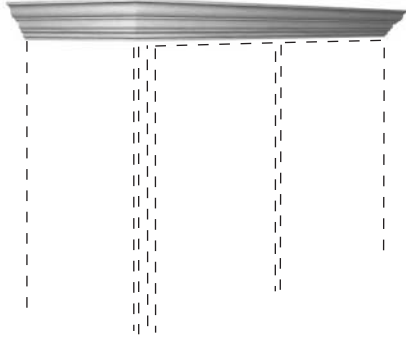

STKMLD16

- Not recommended for use when taking application to the ceiling.

Finish Techniques

	Distressing	Heirloom
SWVCRM8	•	•
MDENTIL8		
LB2		

Specie Availability

	Alder	Rustic Alder	Cherry	Hickory	Maple	Oak	High Gloss Laminate	Textured Laminate	Textured PureStyle™	Thermofoil
SWVCRM8	•	•	•	•	•	•	box color	box color	box color	Maple
MDENTIL8	•	Alder	•	•	•	•	box color	box color	box color	Maple
LB2	•	Alder	•	•	•	•	box color	box color	box color	Maple

*Cleats and finish nails not included.

MOULDING STACK 17

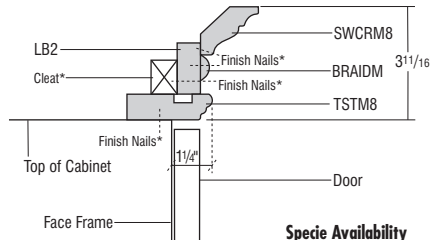
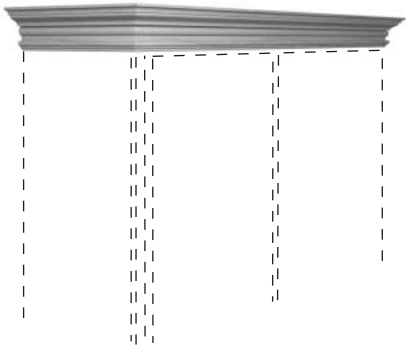

STKMLD17

- Not recommended for use when taking application to the ceiling.

Finish Techniques

	Distressing	Heirloom
SWCRM8	•	•
LB2		
BRAIDM		
TSTM8		

Specie Availability

	Alder	Rustic Alder	Cherry	Hickory	Maple	Oak	High Gloss Laminate	Textured Laminate	Textured PureStyle™	Thermofoil
SWCRM8	•	•	•	•	•	•	box color	box color	box color	Maple
LB2	•	Alder	•	•	•	•	box color	box color	box color	Maple
BRAIDM	•	Alder	•	Beech	•	Beech	box color	box color	box color	Maple
TSTM8	•	Alder	•	•	•	•	box color	box color	box color	Maple

*Cleats and finish nails not included.

MOULDING STACK 18

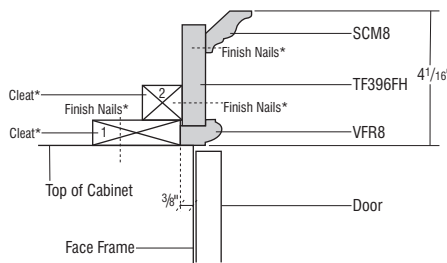
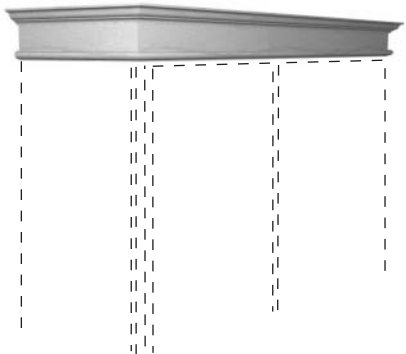

STKMLD18

Finish Techniques

	Distressing	Heirloom
SCM8	•	•
TF396FH	•	
VFR8		•

Specie Availability

	Alder	Rustic Alder	Cherry	Hickory	Maple	Oak	High Gloss Laminate	Textured Laminate	Textured PureStyle™	Thermofoil
SCM8	•	•	•	•	•	•	box color	box color	box color	Maple
TF396FH	•	Alder	•	•	•	•	box color	box color	box color	Maple
VFR8	•	Alder	•	•	•	•	box color	box color	box color	Maple

*Cleats and finish nails not included.

DESCRIPTION

MODEL

STACK MOULDING KITS

- Moulding stacks do not ship assembled; field assembly is required. Assembly instructions can be viewed in 20/20 spec pages and will also ship with moulding kits.
- When ordered as a kit, only one finish can be specified. To order with more than one finish, moulding pieces must be ordered separately.
- Moulding stacks include Assembly Instructions. Cleats and finish nails not included.

- How to place a stack moulding in 20/20:
 - Moulding
 - Top Mouldings or Bottom Mouldings
 - Stacked Mouldings
 - Drag and drop desired moulding stack onto wall cabinets

MOULDING STACK 19

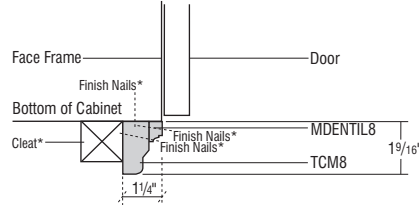
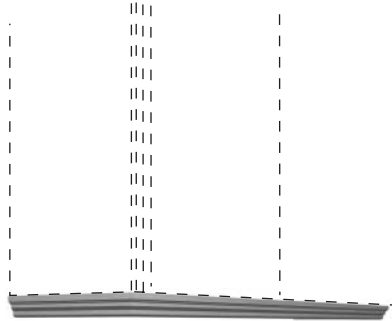

STKMLD19

Finish Techniques

	Distressing	Heirloom
MDENTIL8		
TCM8		•

Specie Availability

	Alder	Rustic Alder	Cherry	Hickory	Maple	Oak	High Gloss Laminate	Textured Laminate	Textured PureStyle™	Thermofoil
MDENTIL8	•	•	•	•	•	•	box color	box color	box color	Maple
TCM8	•	Alder	•	•	•	•	box color	box color	box color	Maple

*Cleats and finish nails not included.

MOULDING STACK 20

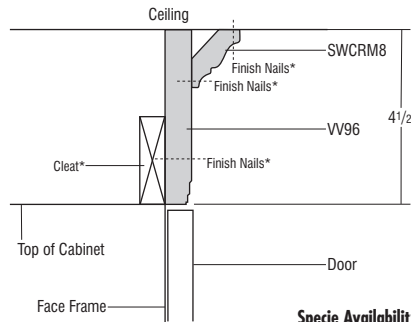
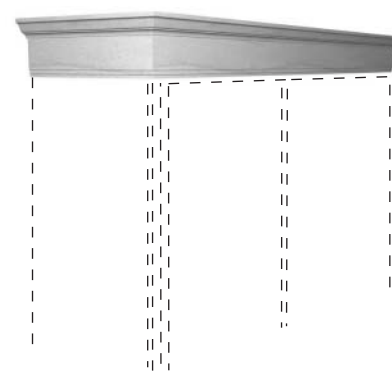

STKMLD20

Finish Techniques

	Distressing	Heirloom
SWCRM8	•	•
VV96	•	•

Specie Availability

	Alder	Rustic Alder	Cherry	Hickory	Maple	Oak	High Gloss Laminate	Textured Laminate	Textured PureStyle™	Thermofoil
SWCRM8	•	•	•	•	•	•	box color	box color	box color	Maple
VV96	•	•	•	•	•	•	box color	box color	box color	Maple

*Cleats and finish nails not included.

MOULDING STACK 21

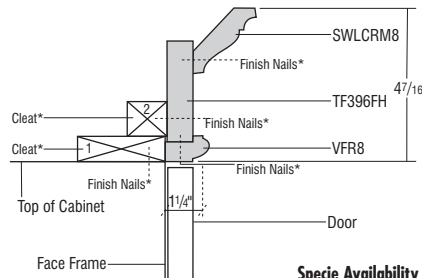
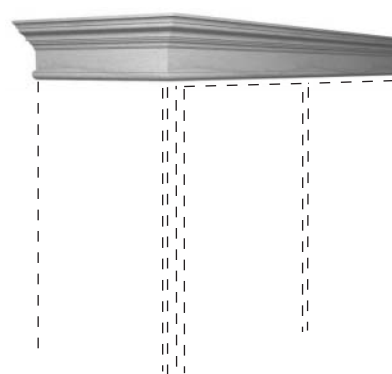

STKMLD21

Finish Techniques

	Distressing	Heirloom
SWLCRM8	•	•
TF396FH	•	
VFR8		•

Specie Availability

	Alder	Rustic Alder	Cherry	Hickory	Maple	Oak	High Gloss Laminate	Textured Laminate	Textured PureStyle™	Thermofoil
SWLCRM8	•	•	•	•	•	•	box color	box color	box color	Maple
TF396FH	•	Alder	•	•	•	•	box color	box color	box color	Maple
VFR8	•	Alder	•	•	•	•	box color	box color	box color	Maple

*Cleats and finish nails not included.

DESCRIPTION

MODEL

STACK MOULDING KITS

- Moulding stacks do not ship assembled; field assembly is required. Assembly instructions can be viewed in 20/20 spec pages and will also ship with moulding kits.
- When ordered as a kit, only one finish can be specified. To order with more than one finish, moulding pieces must be ordered separately.
- Moulding stacks include Assembly Instructions. Cleats and finish nails not included.

- How to place a stack moulding in 20/20:
 - Moulding
 - Top Mouldings or Bottom Mouldings
 - Stacked Mouldings
 - Drag and drop desired moulding stack onto wall cabinets

426

MOULDING STACK 22



STKMLD22

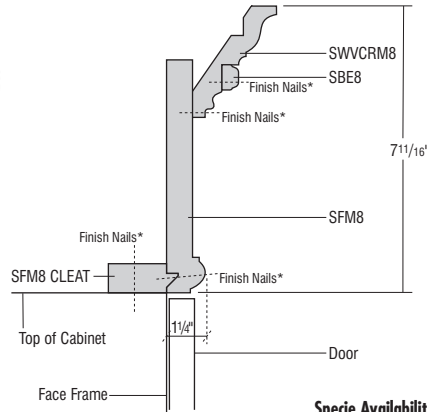
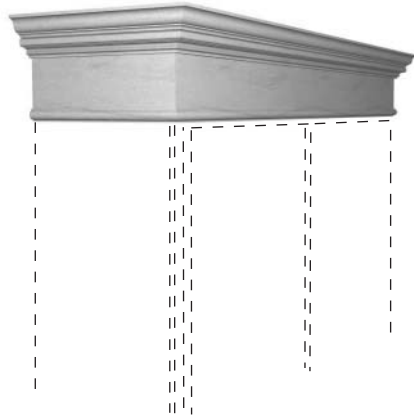

Finish Techniques

	Distressing	Heirloom
SWVCRM8	•	•
SBE8		•
SFM8		•

Specie Availability

	Alder	Rustic Alder	Cherry	Hickory	Maple	Oak	High Gloss Laminate	Textured Laminate	Textured PureStyle™	Thermofoil
SWVCRM8	•	•	•	•	•	•	box color	box color	box color	Maple
SBE8	•	Alder	•	•	•	•	box color	box color	box color	Maple
SFM8	•	•	•	•	•	•	box color	box color	box color	Maple

*Cleats and finish nails not included.

MOULDING STACK 23



STKMLD23

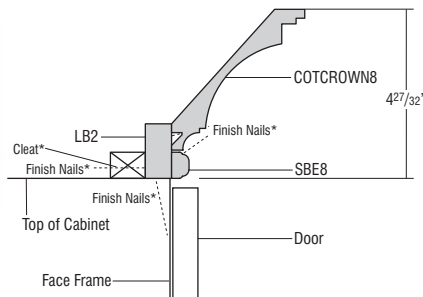
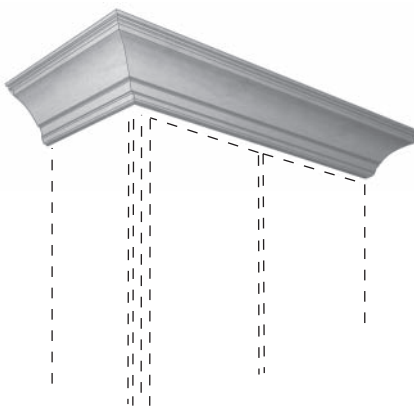

- Not recommended for use when taking application to the ceiling.

Finish Techniques

	Distressing	Heirloom
COTCROWN8	•	•
LB2		
SBE8		•

Specie Availability

	Alder	Rustic Alder	Cherry	Hickory	Maple	Oak	High Gloss Laminate	Textured Laminate	Textured PureStyle™	Thermofoil
COTCROWN8	•	•	•	•	•	•	box color	box color	box color	Maple
LB2	•	Alder	•	•	•	•	box color	box color	box color	Maple
SBE8	•	Alder	•	•	•	•	box color	box color	box color	Maple

*Cleats and finish nails not included.

MOULDING STACK 24



STKMLD24

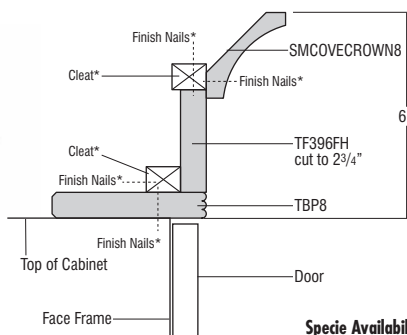
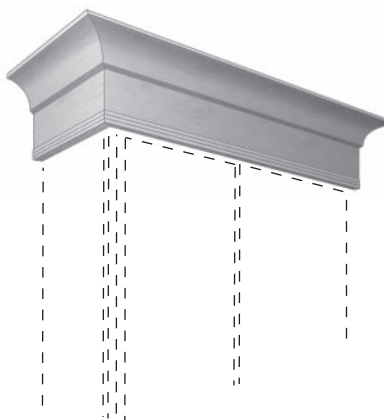

Finish Techniques

	Distressing	Heirloom
SMCOVECROWN8	•	•
TF396FH	•	
TBP8		•

Specie Availability

	Alder	Rustic Alder	Cherry	Hickory	Maple	Oak	High Gloss Laminate	Textured Laminate	Textured PureStyle™	Thermofoil
SMCOVECROWN8	•	•	•	•	•	•	box color	box color	box color	Maple
TF396FH	•	Alder	•	•	•	•	box color	box color	box color	Maple
TBP8	•	Alder	•	•	•	•	box color	box color	box color	Maple

*Cleats and finish nails not included.

STACK MOULDING KITS



DESCRIPTION

MODEL

STACK MOULDING KITS

- Moulding stacks do not ship assembled; field assembly is required. Assembly instructions can be viewed in 20/20 spec pages and will also ship with moulding kits.
- When ordered as a kit, only one finish can be specified. To order with more than one finish, moulding pieces must be ordered separately.
- Moulding stacks include Assembly Instructions. Cleats and finish nails not included.

- How to place a stack moulding in 20/20:
 - Moulding
 - Top Mouldings or Bottom Mouldings
 - Stacked Mouldings
 - Drag and drop desired moulding stack onto wall cabinets

MOULDING STACK 25

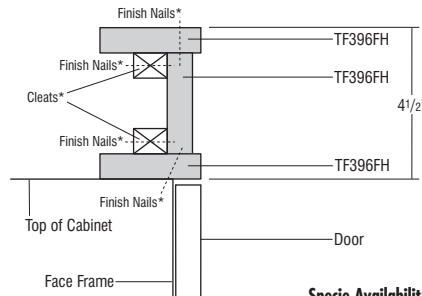
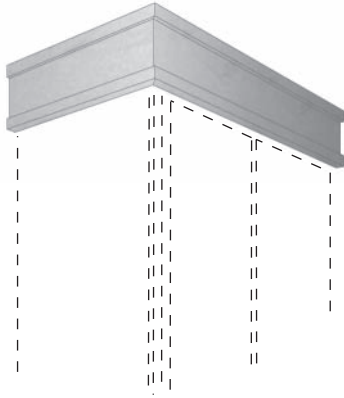

STKMULD25

Finish Techniques

	Distressing	Heirloom
TF396FH	•	

Specie Availability

	Alder	Rustic Alder	Cherry	Hickory	Maple	Oak	High Gloss Laminate	Textured Laminate	Textured PureStyle™	Thermofoil
TF396FH	•	Alder	•	•	•	•	box color	box color	box color	Maple

*Cleats and finish nails not included.

MOULDING STACK 26

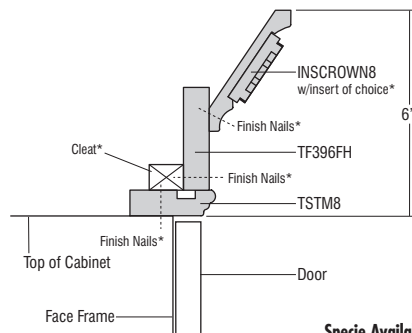

STKMULD26

Finish Techniques

	Distressing	Heirloom
INSCROWN8		•
TF396FH	•	
TSTM8		

Specie Availability

	Alder	Rustic Alder	Cherry	Hickory	Maple	Oak	High Gloss Laminate	Textured Laminate	Textured PureStyle™	Thermofoil
INSCROWN8	•	Alder	•		•	•	box color	box color	box color	Maple
TF396FH	•	Alder	•	•	•	•	box color	box color	box color	Maple
TSTM8	•	Alder	•	•	•	•	box color	box color	box color	Maple

*Cleats and finish nails not included.

MOULDING STACK 27

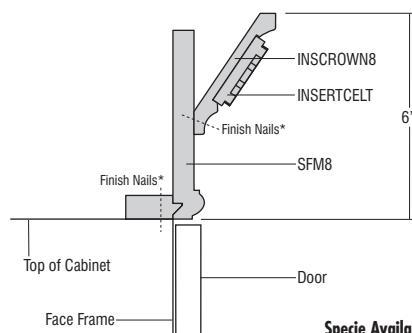
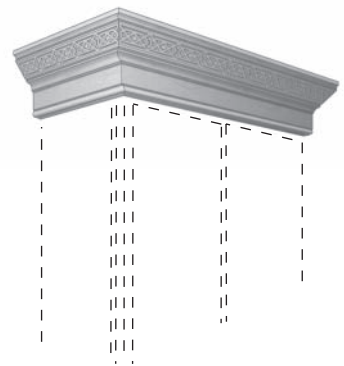

STKMULD27

Finish Techniques

	Distressing	Heirloom
INSCROWN8		•
INSERTCELT		•
SFM8		•

Specie Availability

	Alder	Rustic Alder	Cherry	Hickory	Maple	Oak	High Gloss Laminate	Textured Laminate	Textured PureStyle™	Thermofoil
INSCROWN8	•	Alder	•		•	•	box color	box color	box color	Maple
INSERTCELT	•	Alder	•		•	•	box color	box color	box color	Maple
SFM8	•	•	•	•	•	•	box color	box color	box color	Maple

*Cleats and finish nails not included.

DESCRIPTION

MODEL

STACK MOULDING KITS

- Moulding stacks do not ship assembled; field assembly is required. Assembly instructions can be viewed in 20/20 spec pages and will also ship with moulding kits.
 - When ordered as a kit, only one finish can be specified. To order with more than one finish, moulding pieces must be ordered separately.
 - Moulding stacks include Assembly Instructions. Cleats and finish nails not included.
- How to place a stack moulding in 20/20:
 - Moulding
 - Top Mouldings or Bottom Mouldings
 - Stacked Mouldings
 - Drag and drop desired moulding stack onto wall cabinets

MOULDING STACK 28

428

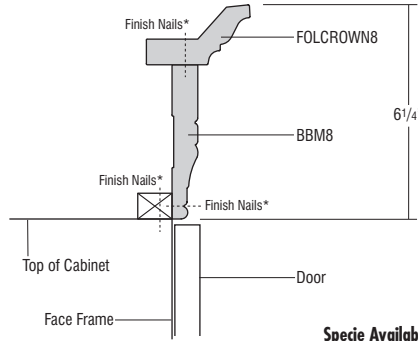
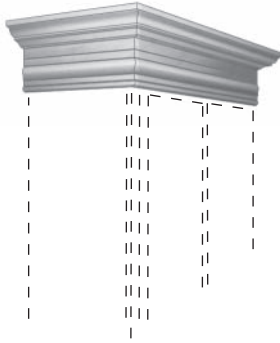

STKMLD28

- Not recommended for use when taking application to the ceiling.

Finish Techniques

	Distressing	Heirloom
FOLCROWN8		•
BBM8	•	•

Specie Availability

	Alder	Rustic Alder	Cherry	Hickory	Maple	Oak	High Gloss Laminate	Textured Laminate	Textured PureStyle™	Thermofoil
FOLCROWN8	•	•	•	•	•	•	box color	box color	box color	Maple
BBM8	•	•	•	•	•	•	box color	box color	box color	Maple

*Cleats and finish nails not included.



Dear Kemper Customer,

Congratulations on your selection of Kemper cabinetry with an Heirloom finish. Because of its unique characteristics, this finish is quite different from other cabinetry finishes you may be familiar with. Your satisfaction is important to Kemper, and we want you to fully understand the characteristics that make an Heirloom Finish unique.

Our heirloom technique is available on the following finishes: Black, Forest Floor, Juniper Berry, Maritime, Moonstone, Oasis, Seaside, Storm, and Tidal Mist. The finish will be sanded through the base coat to expose the surface of the wood. This type of sand through on the edges and profiles creates a naturally worn appearance. If a finish is chosen with a glaze, the glaze will be applied after sanding has been done. This will enhance those areas of exposed wood to take on the darker characteristics of the applied glaze.

Normal Characteristics of Painted, Sand-Through Finishes include:

- Hairline Cracking
- Visible textures of natural grain patterns
- Variation in rub through and wear techniques

Accordingly, we ask that the following agreement be signed for Heirloom Finish orders.

I have read the foregoing and find the characteristic variations of wood with Heirloom finish are desirable. As such, I agree not to hold Kemper and/or the Kemper dealer listed below responsible in the event that these characteristics are later found by me to be less desirable than I had expected.

Customer Signature

Dealer Signature

Customer Name (please print)

Dealer Name (please print)

Dealer Purchase Order Number



Dear Kemper Customer,

Congratulations on your selection of Kemper cabinetry in an Opaque or Opaque with Glaze finish. Because of its unique characteristics, this finish is quite different from other cabinetry finishes you may be familiar with. Your satisfaction is important to Kemper, and we want you to fully understand the characteristics that make painted finishes so distinctive.

It is important to realize that the beauty of wood cabinetry comes from the natural qualities of wood itself. Kemper utilizes only select solid hardwoods and hardwood veneers. The beauty of these genuine woods lies in the variation of the grain. The textures of those natural grain patterns often remain visible with paint finish and should be accepted as inherent characteristics when selecting painted cabinetry.

Seam lines and hairline cracking at stile, rail and panel joints are a normal characteristic of painted/opaque finishes and should not be considered a reason for product replacement. When ordering painted Maple 5-piece styles, the door's center panel will be constructed of MDF material. Over time, there may be a slight color shift in the paint finish due to the continued exposure to natural and artificial light sources. We mention these characteristics because neither Kemper nor your Kemper dealer can be responsible for these conditions and variations.



Example of front joint separation



Example of front joint separation



Example of end joint separation

Accordingly, we ask that the following agreement be signed for Paint Finish orders.

I have read the foregoing and find the characteristic variations of wood with painted finish are desirable. As such, I agree not to hold Kemper and/or the Kemper dealer listed below responsible in the event that these characteristics are later found by me to be less desirable than I had expected.

Customer Signature

Dealer Signature

Customer Name (please print)

Dealer Name (please print)

Dealer Purchase Order Number





Dear Kemper Customer,

Congratulations on your selection of Kemper cabinetry in Rustic Alder. Because of its unique characteristics Rustic Alder is quite different from other wood types you may be familiar with. Your satisfaction is important to Kemper, and we want you to fully understand the characteristics that make Rustic Alder so distinctive.

It is important to realize that the beauty of wood cabinetry comes from the natural qualities of wood itself. Rustic Alder is characterized by its light brown and reddish undertones and may contain a variety of pin holes, open and closed knots of various sizes and colors, small cracks, bird pecks, mineral streaks, and grain variation. Some knots may have small holes through the panel. Larger holes will not be filled. In addition, the wood will contain color difference caused by variations in minerals found in the soil, creating visible mineral tracks. However, those characteristics that might compromise the structural integrity of the door will not be included.

Sound Closed Knot (not moveable) – Expected in Rustic Alder up to approximately 3” diameter.

Sound Knot with Cracks – Expect sound knots with open cracks up to approximately 1” in length.

Open Knot (through door) – Expected in Rustic Alder with open area up to approximately 3/4” diameter.

Note: 3/4” diameter is about the size of a penny. Holes created by open knots pass completely through the door and are desirable for this rustic look.

Unsound Knot (moveable core) – Not to be expected.

Knot Cluster (cluster of tight sound knots) – To be expected in Rustic Alder.

Worm Holes/Pin Holes (can go through door) – Can be expected on Rustic Alder up to approximately 1/4” diameter.

Worm Tracks – Can be expected on Rustic Alder in sizes up to approximately 1/8” wide by 8” long.

Rustic Alder as described is featured for doors, drawer fronts, and selected mouldings. Other areas of the product will utilize standard hard Alder. Customers should expect a much lower occurrence of rustic characteristics in these other areas. Also, the natural characteristics mentioned occur randomly in Rustic Alder. All doors, drawer fronts, and selected mouldings will contain some combination of the common Rustic Alder markings; however, it will be uncommon to find all markings on any single piece.

The natural characteristics of wood described above and variations in grain patterns and color are not considered reasons for product replacement. We mention these characteristics because neither Kemper nor your Kemper dealer can be responsible for these conditions and variations.

Accordingly, we ask that the following agreement be signed for Rustic Alder orders.

I have read the foregoing and find the characteristic variations of wood with Rustic Alder are desirable.

As such, I agree not to hold Kemper and/or the Kemper dealer listed below responsible in the event that these characteristics are later found by me to be less desirable than I had expected.

Customer Signature

Dealer Signature

Customer Name (please print)

Dealer Name (please print)

Dealer Purchase Order Number

NOTES

NOTES

NOTES



OUR COMMITMENT TO CHANNEL PARTNERS, DESIGNERS AND CUSTOMERS

Kemper's Express Response™ program is designed to expedite orders when customers need product faster than normal lead times to correct problems with an existing order.

Below is an overview of the program and what you can expect from Kemper's commitment to superior service.

GUIDELINES

- Order must be associated with a previous order number.
- All orders received by 12 NOON E.T. Monday-Friday will be automatically scheduled for Express Response that same day. Orders received after the cutoff time will be processed on the next business day.
- Lead time calculation is based on receipt of a clean order on a credit-worthy account. Clean orders are orders in which all information is provided and accurate.
- There are no cancellations or returns once order is received.
- Due to the special nature of Special Orders and Appliance Panels, they are excluded from the Express Response program and will be processed as a standard lead time order.
- Express Response is available within the continental United States. Should Alaska, Hawaii or international shipments be required, customer service representatives are ready to assist by providing shipping information and determining lead times.

LEAD TIMES

12 WORKING DAYS OR LESS FROM ORDER TO DELIVERY (channel partner or home delivery agent):

- Items shipped via LTL (via SuperPAC™) or truckload.
- Includes all catalog items except those that can be expedited through the 5-day program listed below.

5 WORKING DAYS FROM ORDER TO DELIVERY:

- Qualified items are designated in the Pricing/Specification Guide with an icon
- Items will ship via parcel ground.
 - Lead time calculation allows for 2 days parcel ground shipping time. Some geographic areas may require additional shipping time.
- For orders containing both 12 day and 5 day items, the longer lead time applies.



QUESTIONS? If you have questions that aren't answered here,
contact your Customer Service team.

Everything you need to turn your dreams into reality.

You can begin designing your new kitchen, bath, or family room right away at kempercabinets.com. Find inspiration in the photo design gallery. View, search, and learn about our door and design styles, finishes, decorative accents, and storage solutions. In short, the perfect room—the one that's right for you—is just a mouse click away.



Customer Service Operating Hours:
Mon-Fri, 7:30AM – 8:00PM EDT

Customer Service Phone: (800) 730-0171
Customer Service Fax: (877) 333-7122

Please reference Service Policies at
www.mbc1touch.com

Designer ID #: _____

Customer Account #: _____

Sales Rep: _____

KEMPER®

LIMITED
LIFETIME
WARRANTY

FourEver™
QUALITY ASSURANCE
BEAUTY. FUNCTION. STRENGTH. PERFORMANCE.

 Kitchen Cabinet Manufacturers Association
Environmental Stewardship Program
All Products Impact the Environment
For ESR Program Criteria, Visit kema.org

kempercabinets.com

Styles, product availability and construction may vary slightly from those shown in this book due to material availability and/or design evolution. Specifications are subject to change without notice. Customer service is available if your design requires verification of product availability and specifications.

Product photography and illustrations have been reproduced as accurately as printing technologies permit. To ensure highest satisfaction, we strongly recommend you view an actual sample for best color, wood grain and finish representation.

© 2018 MasterBrand Cabinets, Inc.
Kemper®, a division of MasterBrand Cabinets, Inc.