



FULL ACCESS CONSTRUCTION

West Specification Guide

FEBRUARY 2019

KEMPER®

Deep Roots. High Expectations.™

Welcome to the new year and to a brand new look and feel for Kemper! With the advent of our new Full Access construction platform, we decided now was the perfect time to put a new face with our name. Offering the same ease of design, extensive offering, and expertise you know and love with our framed product line, our brand has grown!

One brand. Two platforms. Epic opportunity.

Kemper is committed to delivering on the high expectations we set for ourselves, which is why we are one of the nation's oldest cabinet companies. Trust Kemper for the design flexibility you want, the price breadth you need and the service you deserve in one complete brand experience.

Wishing you a prosperous and fulfilling 2019!

We can't wait to see what you create.



TABLE OF CONTENTS

Index by Description A-E

Characteristics 1-3

12-Step Finishing Process 4

Humidification 5

Door Styles 6-22

Premium Color Palette 23

Unfinished 24

Finish Techniques 24

Finish Availability Chart 25-30

Specifications 31

Construction Features 32

Cabinet Construction 33-36

Modification/Upgrade Compatibility Chart 37

Construction and Finish Upgrades 38

Drawer Front Upgrades 39

Drawer and Door Options 40

Custom Modifications 41-53

Door Modification/Specialty Doors 54-58

Glass Inserts 59-68

Cabinet Dimensions 69-73

Design Checklist 74

NKBA Guidelines 75-76

Storage Solutions Reference Chart 77-78

Wall Cabinets 79-148

Hearths 149-157

Base Cabinets 158-205

Universal Design Cabinets 206-210

Tall Cabinets 211-240

Office & Furniture Cabinets 241-251

Vanity Cabinets 252-279

Fillers 280-288

Wainscoting 289

Custom Hinged Doors 290-291

Decorative Appliance Panels 292-294

Panels & Skins 295-303

Moulding 304-315

Valances 316

Embellishments 317-340

Contemporary Embellishments 341

Decorative Hardware 342

Accessories 343-351

Roll Tray Kits 352

Guide Kits and Parts 353

Stain, Paint, & Touch-up Tools 353

Hinges 354

Parts 355

Stacked Moulding Kits 356-364

Agreements 365-368

Index by Code 369-370

Description	Code	Page Number
Abbe Foot	ABFOOT	331
Acanthus Foot	JACANFOOT	332
Acanthus Insert	JACANINSERTM	308
Acanthus Leg	JACANTHUSLEG	319
Acanthus Light Rail Insert	JLRINSACAN	314
Acanthus Moulding	ACAM	309
Acanthus Ornament	ACO	317
Acanthus Overlay	ACOVLY	317
Acanthus Tile	JTILEACAN	319
Add Toekick	ADDTK	49
All-plywood Construction	APC	38
Aluminum Frame Doors w/Frost Glass	ALF	54
Angled Corner Sinks	ACS	180
Angled Fluted/Plain Fillers	BLVDF	284
Arched Valance	AV	316
Art Corbel 9"	CORBELART9	336
Arts & Crafts Bracket	JBRACKETART	338
Arts & Crafts Open Corbel	JCORBELARTO	339
Asymmetrical Base Easy Reach	BER	186
Asymmetrical Base Easy Reach w/Adjustable Shelves	BERAS	186
Asymmetrical Easy Reach Wall Corners	ER	119
Asymmetrical Solid-wood Super Lazy Susan	SLSW	188
Asymmetrical Super Lazy Susan w/Chrome Rail	SLSCR	187-188
Asymmetrical Super Susans	SLS	188
Back Panel Moulding	BPM	309
Back Skin, Interior	BP.LAM, BP.NIP	295
Back Sockets	BKSOCKET	353
Bar Leg	BARLEG	319
Baroque Leg	JBAROQUELEG	320
Base Bin Tray Pull-out Cabinets	BBTP	197
Base Box Column Pull-outs (Plain, Overlay)	BBCPO	201
Base Buffet Three Drawer	3DBB	192
Base Buffet Three Drawer w/Deep Drawer	3DBDD	194
Base Built-in Microwave Cabinet w/Deep Drawer	BBMWD..DD	203
Base Built-in Microwave Cabinet w/Standard Drawer	BBMWD..SD	203
Base Cabinets	B	158-209
Base Cabinets Four Drawer	4DB	194
Base Cabinets Four Drawer w/Cutlery Insert		
Wood Organizer	4DB..WTCD	195
Base Cabinets Four Drawer w/Wood Tiered Cutlery		
Divider Drawer	4DB..WTCD	195
Base Cabinets Four Drawer w/Wood Tiered K-Cup		
Drawer	4DB..KCUP	195
Base Cabinets Three Drawer	3DB	192
Base Cabinets Three Drawer w/Deep Drawer	3DBDD	193
Base Cabinets Three Drawer w/Warming Drawer	3DB..WD	193
Base Cabinets Three Drawer w/Wood Tiered Cutlery		
Divider Drawer	3DB..WTCD	192
Base Cabinets Three Drawer w/Wood Tiered K-Cup		
Drawer	3DB..KCUP	193
Base Cabinets Two Drawer	2DB	190
Base Cabinets Two Drawer w/Drop-in Range	2DB..DR	191
Base Cabinets Two Drawer w/Pegged Dish Organizer	2DB..PDO	190
Base Cabinets Two Drawer w/Roll Tray	2DB..RT	191
Base Cabinets Two Drawer w/Roll Tray &		
Pegged Dish Organizer	2DB..RTPDO	191
Base Cabinets w/Full Height Doors	B..FH	161, 162
Base Cabinets w/Mixer Shelf	B..FHMIXSC	172
Base Container Organizer Pantry Pull-out	BCOPP	199
Base Corner Cabinets	BC	183
Base Corner Full Width Cabinets	BCFW	184
Base Corner Full Width Cabinets w/Curved Pull-out	BCFW..CPO	184
Base Drawer Cabinets	DB	190-194
Base Drop-in Range Cabinet	B..DR	202
Base Easy Access Cabinets	BEAS	163

Description	Code	Page Number
Base Easy Reach	BER	185
Base Easy Reach w/Adjustable Shelves	BERAS	185
Base End Cabinet	BEC	190
Base Full Height w/Tray Divider	TD..FH	172
Base Lazy Susan Corner	BLS	184
Base Message Center	BMC	201
Base Microwave Cabinets w/Deep Drawer	BMWD..DD	203
Base Mixer Kit	MIXKITFHSC	343
Base Open Cabinets	BOC	204
Base Open Cabinets w/Drawer	BOD	204
Base Ovens	BO	202
Base Pan Storage	BPS	343
Base Panel w/Filler Attached & Authentic End	BEP.AEL, AER	300
Base Pantry Pull-outs	BPP	199
Base Paper Towel Cabinet w/Wastebasket Full Height	BPT..WBFH	197
Base Pots & Pans Pull-out	BPPP	170
Base Rotating Deep Bin	BRDB	189
Base Spice Drawer	BSD	198
Base Transition Cabinets	BTC	189
Base Utensil Pantry Pull-out	BUPP	200
Base Utensil Pantry Pull-out w/Knife Block	BUPPKB	200
Base Wastebasket	BWB	195
Base Wastebasket Full Height	BWB..FH	196
Base Wastebasket Lids	BWBFHLID, BWBLID	343
Base Wine Cubby	BWC	198
Base w/Food Storage Container Organizer	B..FSCO	171
Baseboard Moulding	BBM	311
Baseboard - Sculpted	BBMSC	312
Baseboard - Shaker	BBMSH	312
Baseboard - Swooped	BBMSW	312
Bases w/Cutlery Insert	B..CIW	159
Bases w/Drawer & Lid Organizer & Roll Trays	B..RTLO	169
Bases w/Full Height Doors & Roll Trays	B..FHRT	167
Bases w/Lid Organizer & Roll Trays	B..FHRTLO	170
Bases w/Roll Trays	B..RT	166
Bases w/Roll-out Tray Divider	B..TDRO	171
Bases w/Tray Dividers	TD	172
Bases w/Wood Cutlery Insert & Roll Trays	B..RTCW	168
Bases w/Wood Tiered Cutlery Divider Drawer	B..WTCD	160
Bases w/Wood Tiered Cutlery Divider Drawer & Roll		
Trays	B..RTWTCD	169
Bases w/Wood Tiered K-Cup Drawer	B..KCUP	160
Bases w/Wood Tiered K-Cup Drawer & Roll Trays	B..KCUPRT	169
Battery Strip Light	BATTLTI	343
Bookcases Tall	TBC	243-243
Bookcases Tall w/Doors	TBCD	244-244
Bookcases Wall Furniture	WFBC	242
Box Column Fillers (Wall, Base, Tall)	BCF	284-286
Braided Moulding	BRAIDM	308
Broom Clip	BRMCLP	343
Buffet Leg	JBUFFETLEG	320
Bumper Pads	BUMPERPADS	355
Cabinet Box Only	CBO	41
Cabinet Case Only	CCO	41
Cabinet False Panel	CFP	41
Cabinet Panel Edge Moulding	CPE	309
Cabinet w/No Door, w/Drawer	CND	41
CabMat™	CABMAT	343
CabMat™	CMAT	45
CabMat™ Vanity	CABMATV	343
Cap Moulding	CAPM	313
Celtic Corbel	CORBELCELT	336
Celtic Insert	INSERTCELT	308
Celtic Light Rail Insert	JLRINSCFLT	314
Celtic Overlay	JCELOVLY	317

Description	Code	Page Number
Celtic Rosette	ROSETTCELT	318
Classic Fluted Leg	JFLUTELEG	323
Classic Fluted Leg, Small	JFLUTELEGS	322
Classic Fluted Leg, Small Split	JFLUTELEGSS	322
Classic Rope Leg	JROPELEG	328
Classic Rope Leg, Small	JROPELEGS	327
Classic Rope Leg, Small Split	JROPELEGSS	327
Classic Tall Crown Moulding	CLTCROWN	304
Contemporary Light Rail	JINSERTLRC	314
Cooking Utensil Divider	CUDD	343
Corner Fillers	CF	280
Cornice Tall Crown Moulding	COTCROWN	304
Cosmo Corbel, 7" Small	JCORBELCOS7	336
Cosmo Corbel, 13" Large	JCORBELCOS13	336
Cosmo Corbel, 13" Large Deep	JCORBELCOS13D	337
Cosmo Foot	JCOSFOOT	332
Cosmo Leg	JCOSMOLEG	320
Countertop Edge Moulding (Contemporary & Traditional)	CCM, TCM	309
Country Sink Base w/CabMat™	CNTYSB..CM	181
Country Sink Bases	CNTYSB	180
Country Sink Bases w/Short Apron	CNTYSB..SA	181
Cove Corbel	CORBELCOVE	337
Cove Crown Moulding	COVECROWN	304
Craftsman Foot	JCRAFTFOOT	332
Craftsman Open Bracket	JCORBELCRAFTO	339
Crescent Metal Corbel	CORBELCRBN	341
Cross Grain Veneer Back Skin 1/4" Panels	BP..CRSGR	296
Custom Doors w/Hinge Routing	DOOR	290
Custom Doors w/Hinge Routing, Slab Styles	DOORSLAB	291
Cut-for-glass Doors	CG, CG.BTM, CG.TOP	55
Cutlery Dividers	CIW, WTCO	344
Decorative Appliance Panels	DAPNL	292
Decorative Split Turnings 3"	J3SPTRING	335
Decorative Split Turning End	SPTRINGEND	335
Decorative Split Turning Reed	SPTRINGREED	335
Decorative Split Turning Rope	SPTRINGROPE	335
Decorative Split Turning Spool	SPTRINGSPPOOL	335
Deep Roll Tray	DRT	46
Dentil Moulding	MDENTIL	308
Desk Door Drawer Bases	DDO	245
Desk Double File Drawer Bases	DDFD	246
Desk Drawer Bases	DDR	245
Desk Easy Reach	DER	247
Desk File Drawer Bases	DFD	246
Desk Wastebasket Full Height Bases	DWB..FH	247
Diagonal Base Cabinet w/Full Height Door	DAB..FS	185
Diagonal Base Cabinet w/Full Height Door & Super Lazy Susan	DAB..SLS	185
Diagonal Wall Cabinets	DW	113-115
Diagonal Wall Cabinets w/Lazy Susan	DW..S	114
Diagonal Wall Cabinets w/Lower Door	DW..D	115
Diagonal Wall Cabinets w/Lower Door & Lazy Susan	DW..DS	116
Door Panel - Solid Reverse Raised	DPSRR	40
Drawer Front Flat 5-piece	DF5PC	39
Drawer Front Raised 5-piece	DFR5PC	39
Drawer Front Slab	DFSLB	39
Drawer Guide Kits	DGK	353
Drawer Guide Spacer Block	SPACERBLK	353
Ductless Conversion Kit	CONVERSION	148
Easy Reach Wall Corner Cabinets	ER	118
Edgebanding	EDGEBAND	345
Egg & Dart Moulding	EGD	308
End Extended Back	EXBKL, EXBKR	43
End Panel/Base	BEP	297
End Panel/Tall	TEP	297

Description	Code	Page Number
End Panel/Vanity Base	VBEP	298
English Bar Column	ENGBARCOLUMN	321
English Country Leg	JENGNTYLEG	321
English Island Column	ENGISLCOLUMN	321
Estate Leg	JESTATELEG	322
Estate Leg, Small	JESTATELEGS	321
Estate Leg, Small Split	JESTATELEGSS	322
Exterior Shelves	ES	345
EZ-Org™ Modular Pull-out Racks	EZORG	349
False Panel Clips	FALSEPNLCLIPFA	353
Filler Return	F..R	280
Fillers	F	280
Finger Pull	PULLH	341, 342
Finished Back Skins	BP	295
Finished Ends	FB	38
Flat Scribe Moulding	SM	309
Floating Island Bases	FIC	199
Floating Island Bases without Top	FICNT	198
Floating Shelves	FS	139
Flush Toekick	FTK, FTK.FNT.P, FTK.P	49
Flush Toekick Arch	FTKAV, FTKAV.FNT.P, FTKAV.P	49
Flush Toekick Furniture	FTKFV, FTKFV.FNT.P, FTKFV.P	49
Fluted/Beaded Fillers	FBF	284
French Country Foot	JFRNCNTYFOOT	332
French Country Leg	JFRNCNTYLEG	323
French Leg	FRNLG	332
Full Depth Shelf	FD	45
Full Depth Shelving	SK	346
Full Overlay Crown	FOLCROWN	304
Furniture Drawer Window Bench	FDWB	249
Furniture Drawers	FD	248-249
Furniture Valance	FV	316
Glass Shelf Kits	JGSK	347
Hardware Decorative Pulls and Knobs	KNOBH, PULLH	342
Hearth Liner	HL	157
Hearth Mantels	HM	155-156
Hearth Piers	HP..21	153
Hearth Piers w/Pull-out	HPP..21	154
Hearth Shelf	HS	157
Heat Shields	STRTHEATSHIELD, STRTHSHIELDSS	347
Hinge Angle Restriction Clip, Framed	HINGERESCLIP, RESCLIPQR	354
Hinge Angle Restriction Clip, Full Access	RESCLIPFA	354
Hinge Shim	HINGESHIMFA	354
Hinges	HINGE	342
Increased Depth	ID	42
Insert Crown	INSCROWN	304
Inside Corner Moulding	ICM	314
Installed Roll Tray	RT	46
Inverted Opening	INVFRM	43
Island Leg	ISLEG	324
K-Cup Insert	WBCPOKCUP	347
Large Corbel	LGCORBEL	336
Large Outside Corner Moulding	LOSC	315
Large Shaker Crown	LSHAKER	305
Large Square Foot	LGSQFOOT	333
Large Straight Angle Crown Moulding	LSACROWN	305
Lazy Susan Pull-out	LSP	189
Library Moulding	LBRM	310
Lid Organizers	LO, LO24DP	348
Lidstay	LIDSTAY, LIDSTAYHD	354
Light Baffle Moulding	LB	313

Description	Code	Page Number
Light Installed Battery Strip	LTI	46
Light Rail Moulding	LRM	313
Lille Foot	LIFOOT	333
Linen Closet	LC	275
Linen Closet Hamper Liner	LCHAMPERLNR	348
Linen Closet w/Removable Hamper	LCRH	275
Linen Storage Cabinets	LT	276
Loose Toekick	TKP	51
Madeline Foot	JMADEFOOT	332
Madison Foot	JMADFOOT	332
Matching Interior Plywood	MIP	38
Matching Specialty Laminate Furniture Board	MSLFB	38
Medicine Cabinets (Single & Tri-View)	MC, TV	279
Medium Straight Angle Crown Moulding	MSACROWN	305
Metal Feet	FOOTMETAL	341
Metro Bar Column	METBARCOLUMN	325
Metro Island Column	METISLCOLUMN	325
Metropolitan Foot	JMETROFOOT	333
Mirror Frame Moulding	WMF	310
Miscellaneous Parts	BRKOFFSCREW, BUMPERPADS, CONBOLTCH, DFBRACKET.P INSTALLSCR, INSTALLSCREWS, MC16HDW/WCATCH, OCINSTALLFA, RETCLIP.BAG, SHELFPEGS, TVHDW/WCATCH	355
Mission Corbel 6"	CORBELMIS6	337
Mission Corbel 9"	CORBELMIS9	337
Mission Insert	JMISINSERTM	308
Mission Leg	DLEMISSION	325
Mission Light Rail Insert	JLRNSMIS	314
Mission Rosette	ROSETTEMIS	317
Mission Tile	JTILEMISSION	319
Mullion Doors	MD, MD.BTM, MD.TOP	56
Mullion Doors, Prairie	PRMD	58
Mullion Doors, Shaker	SHMD	57
Ogee Edge Moulding	OGEEM	310
Old World Corbel 4"	JCORBELOWD4	337
Old World Corbel 5"	CORBELWD5	337
Old World Corbel 7"	JCORBELOWD7	338
Outside Corner 135° Moulding	OC135	315
Outside Corner Moulding	OCM	315
Oven Cabinets Double	OCD	233
Oven Cabinets Double w/Drawer	OCD..DD, WD	234-235
Oven Cabinets Double w/Drawer & Extended Opening	OCD..WDE	236
Oven Cabinets Single	OCS	230
Oven Cabinets Single w/Drawer	OCS..DD, WD	231-232
Oven Microwave Cabinets	OMC	238
Oven Microwave Cabinets w/Drawer	OMC..DD, WD	239-240
Overlay Fillers	OL	282
Panel Doors	PD	302-303
Panel Skins/Tall	TEPS	295
Panels w/Filler Attached	BEPF, TEP, WEP	298-301
Pantry Top Units	PTU	227
Pantry Top Units w/Pull-out	PTUP	227
Pantry Top Units w/Shelves	PTUS	225
Pegged Dish Organizer	PDO, PDOPOSTS	348
Peninsula	P	53
Plinth Block	PLBLOCK	334
Plinth Block Filler 3"	FFP, BFPC	318
Plinth Block Filler 6"	FFP	319

Description	Code	Page Number
Pots & Pans Organizer Bases w/Drawer	B..PS	170
Pots & Pans Pull-out	PPP	348
Power Pads	JPWRPOD	348
PowerGlide™ Compact Drawer Outlet	DRWPWR	47, 348
Printer Bases	PRB	247
Push to Open Wastebasket	PTOWB	47
Quarter Round Moulding	QRM	315
Queen Anne Leg	JQUNANNELEG	325
Raised Panel Arch Valance	JRPV	316
Recessed Bottom	RECBTM	44
Recessed Island Toekick	RECTKALL	51
Recessed Panel Arch Valance	JRCPV	316
Recessed Toekick on Back or Side	RECTKBK, RECTKL, RECTKR	51
Reduced Depth	RD	42
Reed Leg	JRDLLEG, RDLEG	326
Roll Tray Kits	RT	352
Roll Tray Kits Deep	DRT	352
Roll Tray Plug In Bracket	RTPSPACERFA	353
Roman Weave Leg	JWEAVELEG	326
Rope Moulding	RPM	308
Rosette (Traditional)	TROSETTE	317
Rosette 3"	FFRC, BFRC	318
Rosette 6"	FFRC	318
Scalloped Valance	SV	316
Scooped Drawer	SCPDRW	40
Scroll Corbel 6"	CORBELSCR6	338
Scroll Corbel 9"	CORBELSCR9	338
Scroll Rosette	ROSETTESCR	317
Segmented Super Susan	SSS	186
Shaker Corbels	JCORBELSHKR	339
Shaker Crown Moulding	SHKRCRM	305
Shelf Pull-down	SHLFPD	349
Shelf Support Bracket	SHELFBRKTSN	341
Shoe Moulding—Convex Inside Corner	SHM	315
Single Bead Edge Moulding	SBE	310
Single Bead Moulding	SBM	310
Single Bead Pilaster	SBP	310
Single Door Medicine Cabinet	MC	279
Single Outlet Cover	JSOC	340
Single Rocker Plate	JSRC	340
Sink Base Blind Corner	SBC	182
Sink Base Caddy	SBCADDY	348
Sink Base SuperCabinet™	SB..S	177
Sink Base SuperCabinet™ w/CabMat™	SB..SCM	177
Sink Base SuperCabinet™ w/Caddy	SB..SCDY	177
Sink Base SuperCabinet™ w/Tilt-out Trays	SB..STS	178
Sink Base SuperCabinet™ w/Tilt-out Trays & CabMat™	SB..STSCM	178
Sink Base SuperCabinet™ w/Tilt-out Trays & Caddy	SB..STSCDY	179
Sink Base w/CabMat™	SB..CM	173
Sink Base w/Caddy	SB..CDY	174
Sink Base w/Tilt-out Trays & CabMat™	SB..STCM	175
Sink Base w/Tilt-out Trays & Caddy	SB..STCDY	176
Sink Bases	SB	173-175
Sink Bases w/Drawers Below	SB..D	179
Sink Bases w/Tilt-out Trays	SB..ST, SB..CSST	175, 176
Sliding Towel Rack	STR	349
Small Corbel	SMCORBEL	336
Small Cove Crown Moulding	SMCOVECROWN	306
Small Crown Moulding	SCM	306
Small Light Rail Moulding	SMLR	313
Small Scribe Moulding	SSM	310
Snack Bar Support	SBS	338
Soffit Filler Moulding	SFM	307
Soffit Trim Moulding	TSTM	311

Description	Code	Page Number
Solid-wood Crown Moulding	SWCRM	306
Solid-wood Large Crown Moulding	SWLCRM	306
Solid-wood Super Lazy Susan	SLSW	187
Solid-wood Tall Crown Moulding	SWTCRM	307
Solid-wood Victorian Crown Moulding	SWVCRM	307
Space Fillers	S96	281
Spice Rack Pull-down	SPD	349
Spice Racks	SRCH	349
Spool Decorative Leg	SPLEG	329
Spool Leg	JSPLEGT	329
Spool Leg, Small	JSPLEGS	328
Spool Leg, Small Split	JSPLEGSS	329
Square Bar Leg	JSQBARLEG	330
Square Bar Leg, Split	JSQBARLEG3S	330
Square Corner Sinks	CS	179
Square Foot	JSQFOOT	333
Square Foot, Split	JSQFOOTS	333
Square Island Leg	JSQISLLEG	330
Square Island Leg, Split	JSQISLLEG3S	329
Stacked Diagonal Wall Cabinets	STDW	116
Stacked Wall	STW	106-108
Stacked Wall Appliance Garage	STWDAG	102-103
Stacked Wall Appliance Garage Vertical-Hift	STWVLDAG	104-105
Stacked Wall End Cabinets Double Door	STWEC..D	121
Stacked Wall End Cabinets Single Door	STWEC	120
Stacked Wall Transition Cabinets	STWTC	124
Stain & Paint	QUARTCOLOR, SSC	353
Starter Moulding	STR8	307
Starter Moulding, Shaker	STRS	307
Straight Angle Crown Moulding	SACROWN	305
Straight Valance	VV	316
Super Susans	SLS	187
Super Susans w/Chrome Rail	SLSR	187
SuperCabinet™, 30"	BSC30PR, R, RP, RS, SR	164
SuperCabinet™, 36"	BSC36PRP, PRS, SRP, SRS	165
SuperCabinet™ Version 2, 30"	BV2SC30PR, RP, RS, SR	164
SuperCabinet™ Version 2, 36"	BV2SC36PRP, PRS, SRP, SRS	165
Super Lazy Susans w/Chrome Rail	SLSR	187
Tablet Holder	TABLEHLDR	349
Tall Built-in Microwave Cabinet	TBMWB	237
Tall Crown Moulding	MTCROWN	305
Tall Panel w/Filler Attached & Authentic End	TEP.AEL, AER	301
Tall Pantry Pull-outs	TPP	228
Tapered Leg	TAPLG	334
Tapered Wood Hood Blower	TWHBLOWER	147
Tapered Wood Hoods	TWH	146
Tilt-out Trays, Plastic	TOT	350
Tilt-out Trays, Stainless Steel	TOTSS	47, 350
Tilt-out Trays, Stainless Steel Slim	TOTSSS	47, 350
Toeboards	TB	312
Toekick Cap	TKC	312
Toekick Drawer	DRWTK	52
Toekick Vacuum	TOEKICKVAC	349
Toekick Tulip Foot	TKTLFOOT	334
Touch Latch and Adapter	TOUHLATCHFA	341
Touch-up Tools	GLAZEPEN, MTUK, TUK	353
Traditional Light Rail	JINSERTLRT	314
Traditional Open Corbel	JCORBELTRADO	340
Tray Divider, Chrome	CTDK	350
Tray Divider Kit	TDKIT	350
Tray Divider Roll-out Kit	TDRO	350
Tray Dividers	TD	48
Tray Shelves	TRAYSHLF	139

Description	Code	Page Number
Triple Bead Edge Moulding	TBEM	311
Triple Bead Pilaster Moulding	TBP	311
Tri-View Medicine Cabinets	TV	279
Truss Metal Corbel	CORBELTRSS	341
Tulip Foot	TLFOOT	334
Tulip Leg	JTULIPLEG	331
Under Counter Drawers	UCD	251, 274
Under Panel Moulding	UPM	311
Universal Design Base Built-in Microwave Cabinets	BBMW..UD	209
Universal Design Base Cabinets	B..UD	206
Universal Design Base Cabinets w/Roll Tray	B..RTUD	207
Universal Design Base Microwave Cabinets	BMW..UD	209
Universal Design Fillers	BF, TF, FR..UD	210
Universal Design Single Oven Cabinet	OC..UD	209
Universal Design Sink Base Cabinets	SB..UD	207
Universal Design Sink Base Cabinets w/Tilt-out Trays	SB..STUD	207
Universal Design Super Susan	SLS..UD	208
Universal Design Three Drawer Base Cabinets	3DB..UD	208
Universal Design Toeboards	TB8UD	210
Universal Design Vanity Desk Leg	VDLUD	210
Urn Leg	JURNLEG	331
Utility Cabinets	U	211-215
Utility Cabinets w/Roll Trays	U..RT	216-218
Utility Easy Access Cabinets	UEAS	219-222
Utility Organizer Cabinets	UOC	223
Utility Organizer Drop Zone Cabinet	UOCDZ	224
Valance Top Rail	TVRAV, TVRFV, TVRVV	44
Valley Forge Moulding	VFR	313
Vanity Base Easy Reach	VER	261
Vanity Base Wastebasket	VBWB	264
Vanity Bases	V	252-254
Vanity Chrome Roll-out Rack	VCRR	351
Vanity Desk Legs	VDL	301
Vanity Door Drawer Bases	VB	260
Vanity Drawer Bases	VDB	262
Vanity Four Drawer Bases	4VDB	264
Vanity Grooming Pull-out	VGPO	265
Vanity Hamper	VH..FH	275
Vanity Hamper w/Drawer	VBH	275
Vanity Mirror	VM	279
Vanity Mirror w/Side Pull-outs	VMP	278
Vanity Pull-out	VP	265
Vanity Sink Bases w/False Drawer Fronts	VSB	255-256
Vanity Sink Bases w/U-shaped Roll-out Tray	VSB.....U	257
Vanity Sink Bases w/Wastebasket	VSB.....WB	257
Vanity Sink Bases SuperCabinet™ w/Tilt-out Trays	VSSB.....ST	258
Vanity Sink Bases SuperCabinet™ w/Tilt-out Trays & Wastebasket	VSSB.....STWB	258
Vanity Sink Drawer Bases	VSD	266-271
Vanity Sink Drawer Bases w/Eight Drawers	VSD	273
Vanity Sink Drawer Bases w/Eight Drawers & False Panel	VSD..FP	274
Vanity Sink Drawer Bases w/Six Drawers	VSD	272
Vanity Sink Drawer Bases w/Six Drawers & False Panel	VSD..FP	273
Vanity Sink Three Drawer Bases	VS3D	272
Vanity Utility Cabinets	VU	276
Vanity Wall Cabinets	W	278
Vanity Wall Hung Cabinets	VWH	276
Vanity Wall Mirror Cabinets	VWM	278
Vanity Wastebasket	VWB	265
Void Toekick	VTK	52
Wainscoting	WAIN	289
Wall Base Double Door Cabinets	WB	163
Wall Base Single Door Cabinets	WB	163
Wall Box Column Pull-outs (Plain, Overlay)	WBCPO	129

Description	Code	Page Number
Wall Box Column Pull-outs w/K-Cup (Plain, Overlay)	WBCPOKCUP	131
Wall Built-in Microwave	WBMW	126
Wall Corner Cabinets	WC	109-112
Wall Corner Decorative Shelf	WCS	140
Wall Decorative Shelves	WS	140
Wall Double Door Cabinets	W	80-97
Wall Easy Access Storage	WEAS	97
Wall Message Center	WMC	140
Wall Microwave	MW	125
Wall Open Cabinets	WOC	135
Wall Organizers	WO	138
Wall Quarter Round End Shelves	WQRES	122-123
Wall Refrigerator Cabinets	W	93
Wall Refrigerator Pull-out	W..PO	87, 90, 92
Wall Refrigerator Vertical-Lift	WVL	86, 90
Wall Shelf Pull-down	W..SHLFPD	134
Wall Single Door Cabinets	W	79-96
Wall Spice Drawers	WSD	138
Wall Spice Pull-down	W..SPD	133
Wall Spice Pull-out	WSP	133
Wall Spice Rack	WSR	134
Wall Susan Kits	WSK	351
Wall Three Drawer	W3D	100
Wall Top Hinge Cabinets	WTH	80-89
Wall Transition Cabinets	WTC	124
Wall Two Drawer	W2D	98-99
Wall Vertical-lift	WVL	85-90
Wall Wine Cubbies	W	138
Wall Wine Racks	WNR	137
Weave Foot	JWEAVEFOOT	333
Weave Insert	JWEAVEINSERTM	309
Weave Light Rail Insert	JLRINSWEAVE	314
White Laminate Interior	WLI	38
Wide Scribe	WSCRIBE	311
Window Casing — Traditional	WCT	313
Wine Glass Holders	WGH	351
Wine Storage Cabinet	WSC	137
Wood Hood Arch	WHA	141
Wood Hood Blower	BLOWER	147
Wood Hood Canopy Arched	WHCA, JWHCA	144
Wood Hood Canopy Square	WHCS, JWHCS	145
Wood Hood Chimney	WHC	141
Wood Hood Contemporary Straight	JWHCONSTR	142
Wood Hood Island Arch	JWHIA	146
Wood Hood Island Square	JWHIS	146
Wood Hood Linear, Tapered	JWHL	142
Wood Hood Shiplap Chimney	JWHSHPCH	143
Wood Hood Shiplap, Straight	JWHSHPSTR	142
Wood Hood Shiplap, Straight w/Corbels	JWHSHPSTRCB	143
Wood Hood Shiplap, Tapered	JWHSHIPT	143
Wood Hood Shiplap, Tapered w/Corbels	JWHSHIPTCB	144
Wood Hood Square	WHS	141
Wood Tiered K-Cup Drawer	KCUP	345
Wood Tops, Four Sided	4TWT	251
Wood Tops, One Sided	1TWT	249
Wood Tops, Three Sided	3TWT	250
Wood V-grooved Beaded Skin 1/4" Panels	BP..VG	296
Wood V-grooved w/Triple Beaded Front 3/4" Panels (Base, Tall, Wall)	BEP, TEP, WEP..VG	301

CHARACTERISTICS OF WOOD TYPES

No matter which species you choose for your new kitchen or bath cabinetry, please keep in mind that no two pieces of wood are exactly the same. Stains are likely to exaggerate the difference between open and closed grains and other markings in wood. Grain variation and color change should be expected. As hardwood ages, it will darken when exposed to different types of light. Color differences or changes in wood can also be caused by exposure to harsh chemicals, extreme heat or moisture. Additionally, wood species exhibit other defining characteristics, such as mineral deposits/streaks, knots, sap runs, pin holes and wormholes. These markings make the wood unique and contribute to its enduring beauty.



Alder has a straight fine textured grain similar to Cherry and Maple. Although classified as a hardwood, it is moderately light in weight and considerably softer than other species. Therefore, care must be taken as it will dent and mar easily. Alder may exhibit grain and color variations, sapwood can be distinguishable from the heartwood, tight pin knots are sometimes present.



Cherry is characterized by its red undertones, but may vary in color from white to a deep, rich brown. Cherry is a close-grained wood with fairly uniform texture, revealing pin knots and curly graining. All wood will age with time and the finish will darken. This is especially true for Cherry. This is a sought-after quality in Cherry cabinetry, and those who select it expect this evolution.



Hickory is a strong, heavy hardwood known for distinctive graining patterns. Contributing to its dramatic appearance is a wide variation in color and streaking, ranging from white to dark brown. This contrast in color can appear in a single door panel. Hickory also contains random knots and wormholes that further contribute to a varied appearance. These exaggerated characteristics are to be expected and are considered desirable in Hickory cabinetry.



Maple is a close-grained hardwood that is predominately white to creamy-white in color, with occasional reddish-brown tones. While Maple typically features uniform graining as compared to other wood species, characteristic markings may include fine brown lines, wavy or curly graining, bird pecks and mineral streaks. These traits are natural and serve to enhance Maple's natural beauty.



Oak is a strong, open-grained hardwood that ranges in color from white to pink and reddish tones. Streaks of green, yellow and even black may appear due to mineral deposits. Oak may also contain wormholes and wild, varying grain patterns. This distinct graining is considered a desirable quality.

CHARACTERISTICS OF WOOD TYPES (cont'd)



Rustic Alder is characterized by its light brown and reddish undertones and may contain a variety of pin holes, open and closed knots of various sizes and colors, small cracks, bird pecks, mineral streaks, and grain variation. Some knots may have small holes through the panel. Larger holes will not be filled. In addition, the wood will contain color difference caused by variations in minerals found in the soil, creating visible mineral tracks.

Sound Closed Knot (not moveable) – Expected in Rustic Alder up to approximately 3" diameter.

Sound Knot with Cracks – Expect sound knots with open cracks up to approximately 1" in length.

Open Knot (through door) – Expected in Rustic Alder with open area up to approximately 3/4" diameter. Note: 3/4" diameter is about the size of a penny. Holes created by open knots pass completely through the door and are desirable for this rustic look.

Unsound Knot (moveable core) – Not to be expected.

Knot Cluster (cluster of tight sound knots) – To be expected in Rustic Alder.

Worm Holes/Pin Holes (can go through door) – Can be expected on Rustic Alder up to approximately 1/4" diameter.

Worm Tracks – Can be expected on Rustic Alder in sizes up to approximately 1/8" wide by 8" long.



Rustic Hickory is a strong, heavy hardwood known for distinctive graining patterns. Color will vary from nearly white to dark brown, with wild flowing grain patterns and dramatic color variations. Rustic Hickory can have a fine uniform grain to large knots appearing black and brown in color of various shapes and sizes, sapwood, mineral and some checking. Doors, drawer fronts, and selected trim items will feature rustic characteristics. Other areas of the product will utilize standard Hickory.

Sound Closed Knot (not moveable) – Expected up to approximately 3" in diameter

Sound Knot with Cracks – Expect sound knots with open cracks up to approximately 1" in length

Open Knot (through door) – Expected with open area up to approximately 3/4" in diameter

Note: 3/4" diameter is about the size of a penny. Holes created by open knots pass completely through the door and are desirable for this rustic look.

Unsound Knot (moveable core) – Not to be expected

Worm Holes/Pin Holes (can go through the door) – Can be expected up to 1/4" diameter

Worm Tracks – Can be expected in sizes up to approximately 1/8" wide by 8" long

CHARACTERISTICS OF GLAZING/PAINT

Characteristics of Glazing

A professional layer of glaze can add another layer of beauty to your cabinets. First, our craftsmen apply a wood toner, which accentuates the grain's natural attributes. We then add the glaze, by hand, adding depth, dimension and an understated sheen that's guaranteed to endure.

What to expect from glazed cabinetry...

- Glazing will range from a consistent, even appearance to varied coverage.
- You should expect the result to yield a subtle to dramatic look based on the complexity of a cabinet door's design, as glaze may collect in the corners and grooves.
- Printed materials and online, electronic presentations can only do so much. It's important to both see and touch actual finished samples to ensure your satisfaction.

Penned Glazes

A professional layer of glaze can add another layer of beauty to your cabinets. Kemper's hand-detailed penned glaze application adds depth and dimension to your cabinet's appearance by highlighting the profile of your door style choice.

What to expect from penned glazed cabinetry...

- Hand-detailed penned glazing will leave a consistent, "penned" appearance around the door profile, and will not change the overall stain or paint base color.
- You should expect the result to yield a subtle to dramatic look based on the complexity of a cabinet door's design.
- Printed materials and online, electronic presentations can only do so much. It's important to both see and touch actual finished samples to ensure your satisfaction.

Characteristics of Paint Finish

Paint may develop hairline cracks in the finish, most notable around the joints. This is a result of natural expansion and contraction of the genuine hardwoods used in the manufacturing of this product. Hairline cracks are not considered a defect in the cabinetry or finish.

CHARACTERISTICS OF SPECIALTY LAMINATES

Specialty Laminates feature design leading, high definition wood grain or high gloss laminates on doors, drawer fronts, overlay fillers, and Premium trim items. The surfaces are laminate based materials with an integrated top coat that provides superior beauty, durability, and performance while meeting or exceeding all of the KCMA performance standards. The core panel material is made of MDF to ensure a consistent and stable product. Additional coordinating trim items in the cabinet box color are also available.

A heat shield is required to separate all laminate products from heat producing units to be in compliance with cabinet warranty.

CHARACTERISTICS OF THERMOFOIL

Thermofoil doors and drawer fronts feature a shaped MDF core covered with a seamless vinyl material on the face and edges, and a melamine layer on the back. The vinyl material is applied to the MDF with an adhesive, and heat and pressure are used to create a product with excellent wear and heat resistance properties.

KEMPER CABINETRY'S 12-STEP FINISHING PROCESS

- 1. Wood Selection** – The selection of the finest woods including Alder, Cherry, Hickory, Maple, Oak, and Rustic Alder is the essential first step of Kemper's 12-step finishing process.
- 2. Sanded to Perfection** – Our sanding utilizes a fine grit paper, both with and against the wood grain. This process is completed on a vacuum table, allowing for a wood surface that is free of dust particles.
- 3. Achieving Natural Wood Tone** – Toner is applied to selected finishes, enhancing the naturalistic wood appearance.
- 4. Stain Application** – A hand-sprayed deep penetrating stain is evenly applied to all surfaces for even coverage on all profiles.
- 5. Removal of Excess Stain** – The wood is hand-wiped to remove excess stain, emphasizing the cabinet's natural wood grain.
- 6. Catalyzed Sealer** – A tough, clear, catalyzed sealer is hand-sprayed on to protect the grain from moisture.
- 7. Drying Process** – For added durability, the sealed wood is oven cured to lock in the beauty of wood.
- 8. Hand-Sanded** – To achieve an ultra-smooth finish, we hand-sand the material one last time.
- 9. Dust Removal** – The resulting loose dust particles are removed from the surface of the wood.
- 10. Catalyzed Top Coat** – A premium quality catalyzed clear top coat is applied to protect the wood from environmental elements.
- 11. Final Top Coat Cure** – The top coat is cured to guarantee the strongest, most beautiful finish.
- 12. Final Inspection** – This last inspection is very thorough, ensuring quality and beauty. Our gift to you is that every cabinet is crafted with care.

HUMIDIFICATION

The natural response of wood to changes in humidity is much more dramatic than most people realize. Here is a table showing (a) how much a cabinet door panel is likely to shrink in a low humidity environment, (b) how much a cabinet door is likely to expand in excess humidity, and (c) the total potential range of dimension changes from a muggy summer to a cold dry winter.

Total Potential Movement (inches) of solid-wood panels

Species	Panel Dimension (inches)	(a) Winter	(b) Summer	(c) Annual Range
Alder/Rustic Alder	19.75	-0.27	0.25	0.52
Cherry	19.75	-0.26	0.25	0.51
Hickory	19.75	-0.34	0.31	0.65
Maple	19.75	-0.49	0.10	0.59
Oak	19.75	-0.32	0.31	0.63

Notice the annual dimension change for a solid-wood panel can approach three-quarters of an inch! For this reason, cabinet doors are typically manufactured at a targeted range of 40% – 50% relative humidity. This usually works very well because even low humidity environments stay between 20% and 70% in normal years with typical cooking and washing activities.

In extremely cold, dry winters, some doors can be exposed to conditions that are below 20% relative humidity for weeks at a time. Exposure to sustained conditions such as these would cause panels to shrink and will not be considered defective. New construction intensifies this issue since the heat is on but no one is living in the home to raise the humidity levels. Conversely, where in-home humidity exceeds 70% relative humidity for extended periods of time, panels will swell and this will not be considered defective.

Steps Consumers Can Take To Protect Real Wood Furnishings

- **Keep an eye on the humidity inside the home.** Reasonably accurate digital thermometers-hygrometer units are available to measure humidity.
- **Maintain the humidity at or above 20% when the temperature is below 20°F and over 35% when the temperature is above 20°F.** Some ways this may be accomplished are installing a whole-house humidifier on the furnace, running a portable humidifier in key rooms, or placing pans of water near the heat registers.
- **Don't over-do it.** Significant condensation on windows is a sign the humidity levels are too high for outside temperature conditions.
- **Recognize that finished wood responds to humidity over several days to several weeks.** It takes time before the wood returns to normal after any correction to the environment.

WOOD DUST WARNING:

When cutting, sanding, sawing, or shaping cabinets or wood products, you are likely to generate wood dust. For your own safety, we recommend that you wear a protective mask to prevent breathing wood dust. We also recommend eye protection to avoid injury by flying wood chips or sawdust during cabinet installation.

CARB COMPLIANCE:

Kemper is committed to offering solutions that meet or exceed air emissions rules and regulations. All composite wood products used in the construction of our cabinets for end panels, shelves, tops, bottoms, backs, toekicks, and corner blocks are compliant with the California Air Resources Board (CARB) regulations for formaldehyde emissions.

KEMPER®

Door Style Reference Chart

DOOR STYLES

6

	Alder	Cherry	Hickory	Maple	Melamine	Oak	Rustic Alder	Rustic Hickory	Specialty Laminates	Thermofoil
Amstead		✓		✓						
Ashridge		✓		✓						
Baxter		✓		✓						
Bellmont		✓		✓						
Butler		✓		✓						
Caprice		✓		✓						
Cotter		✓		✓						
Darby				✓						
Dutton		✓		✓						
Ellerby		✓	✓	✓		✓				
Gallatin	✓						✓	✓		
Genova					✓				✓	
Hardin		✓		✓						
Herrington		✓		✓						
Hurson	✓	✓	✓	✓		✓	✓	✓		
Justin		✓		✓						
Kingston	✓	✓		✓						
Larsen	✓	✓		✓		✓	✓	✓		
Lawton	✓	✓		✓			✓	✓		
Lynnville		✓		✓						
Northrope	✓	✓		✓		✓	✓	✓		
Painter		✓	✓	✓		✓				
Rennie		✓		✓						
Taro					✓				✓	
Troxel									✓	
Vaille										✓
Warwick		✓		✓						
Whitman	✓	✓	✓	✓			✓	✓		

DOOR STYLES

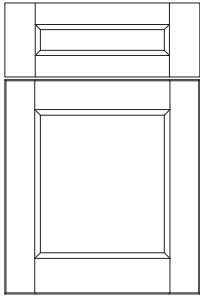

Amstead
(page 9)

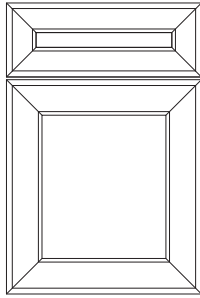

Ashridge
(page 9)

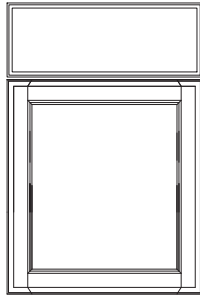

Baxter
(page 10)

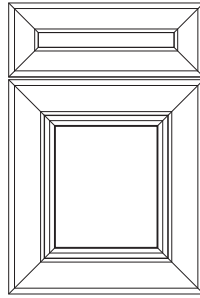

Bellmont
(page 10)

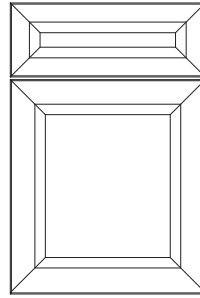

Butler
(page 11)

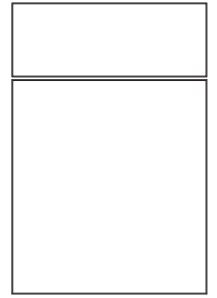

Caprice
(page 11)

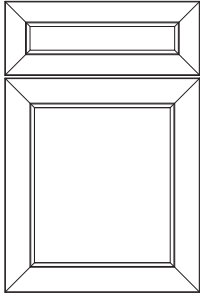

Cotter
(page 12)

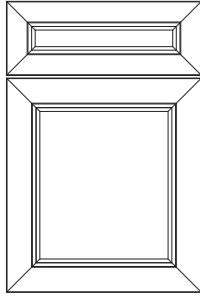

Darby
(page 12)

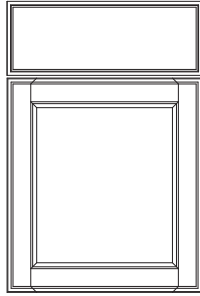

Dutton
(page 13)

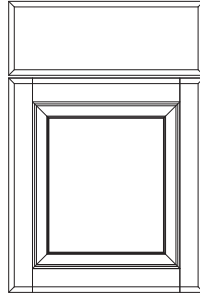

Ellerby
(page 13)

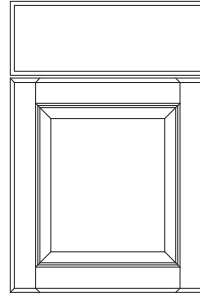

Gallatin
(page 14)

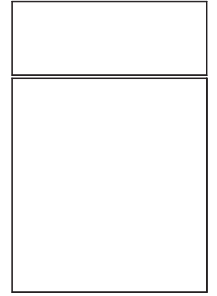

Genova
(page 14)

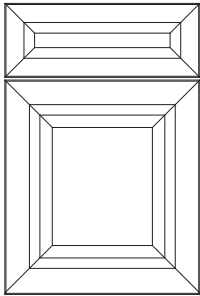

Hardin
(page 15)

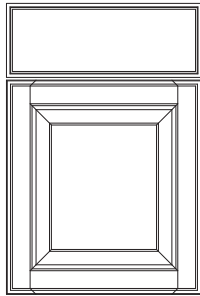

Herrington
(page 15)

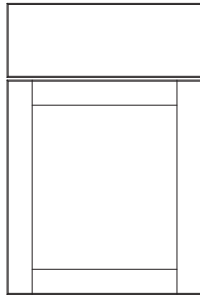

Hurson
(page 16)

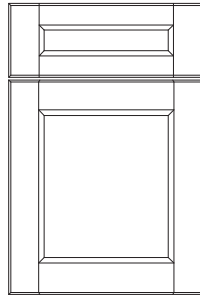

Justin
(page 16)

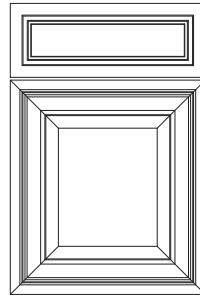

Kingston
(page 17)

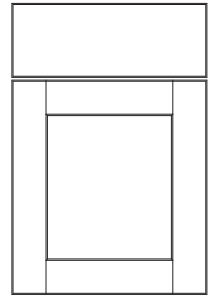

Larsen
(page 17)

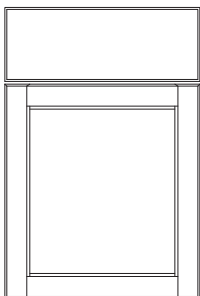

Lawton
(page 18)

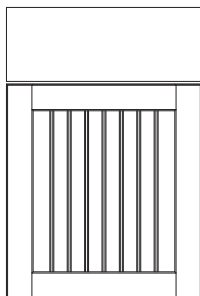

Lynnville
(page 18)

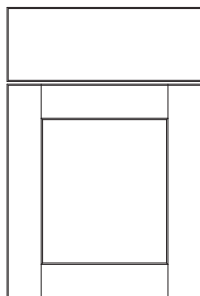

Northrope
(page 19)

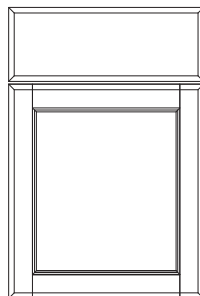

Painter
(page 19)

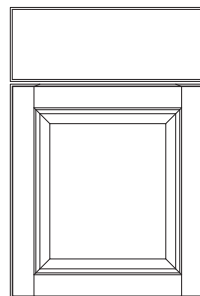

Rennie
(page 20)

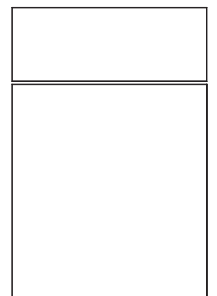

Taro
(page 20)

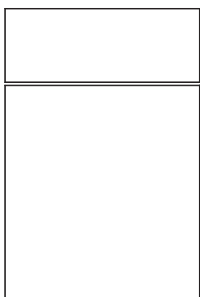

Troxel
(page 21)

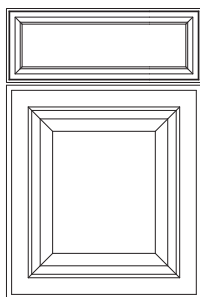

Vaille
(page 21)

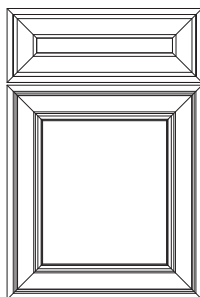

Warwick
(page 22)

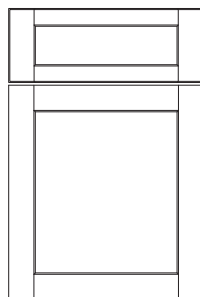

Whitman
(page 22)

DOOR STYLE SPECIFICATIONS

Cherry

- When Cherry door styles are ordered, it is recommended to specify a finished end option for exposed ends due to the natural aging of Cherry.

Maple

- When a Paint or Paint with Glaze finish is specified, the door and/or drawer front center panel may be constructed of Medium Density Fiberboard (MDF), except when Lynnville door style or when Distressing or Heirlooming are specified. MDF provides a smoother finish when painted, and is more resistant to warping, expansion, and contraction.

Rustic Alder & Rustic Hickory

- See trim section for availability of Rustic characteristics on trim items.

8

All Door Styles

- All doors and drawer fronts are 3/4" thick unless otherwise noted.

Door and Drawer Front Side Profiles

- Veneer and MDF components are shown with gray shading on side profiles. Solid-wood components do not have shading.

Wood Grain

- Shaker door styles (Lynnville and Whitman) have a vertical grain direction on the drawer front center panel.
- Genova drawer fronts have vertical grain.
- See reference images for wood grain direction on all other door styles.

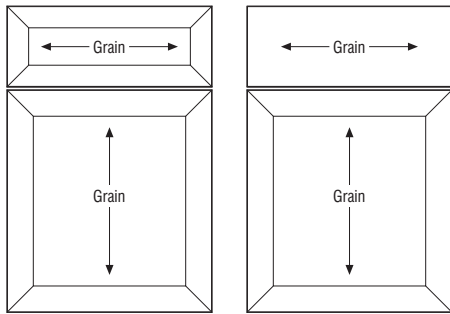

DOOR STYLES

Amstead	Alder	Cherry	Hickory	Maple*	Melamine	Oak	Rustic Alder	Rustic Hickory	Specialty Laminates	Thermofoil
	Availability	—	✓	—	✓	—	—	—	—	—

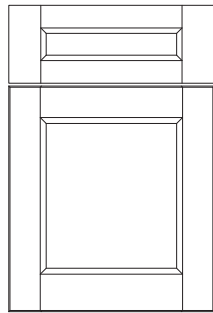

Base

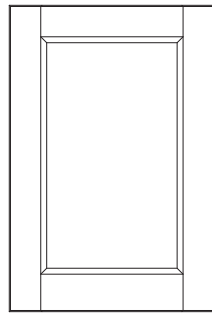

Wall



Optional Drawer Front:
Slab (DFS)

Door Options

ALF	CG	DPSRR	MD	SHMD	PRMD
•	•		•		

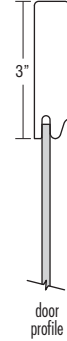
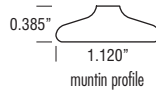

door profile

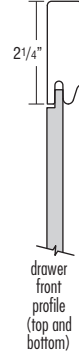

drawer front profile (top and bottom)

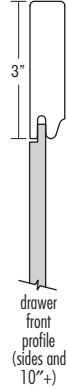

drawer front profile (sides and 10"++)



optional drawer front profile

- Veneer Flat Panel
- 5-piece Drawer Front
- See page 72 for 5-piece drawer front dimensions when specifying decorative hardware.

*When a Paint or Paint with Glaze finish is specified, the door and/or drawer front center panel may be constructed of Medium Density Fiberboard (MDF), except when Heirlooming is specified. MDF provides a smoother finish when painted, and is more resistant to warping, expansion, and contraction.

Ashridge	Alder	Cherry	Hickory	Maple*	Melamine	Oak	Rustic Alder	Rustic Hickory	Specialty Laminates	Thermofoil
	Availability	—	✓	—	✓	—	—	—	—	—

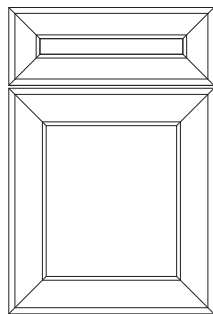

Base

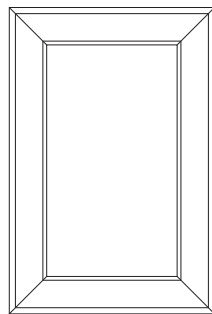

Wall

Door Options

ALF	CG	DPSRR	MD	SHMD	PRMD
•	•		•		

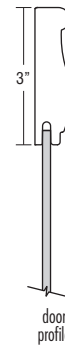
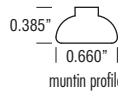

door profile

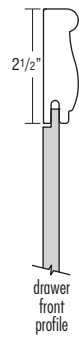

drawer front profile

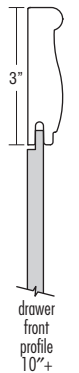

drawer front profile 10"++

- Miter Doors
- Veneer Flat Panel
- 5-piece Drawer Front Mitered to Match Door

• See page 72 for 5-piece drawer front dimensions when specifying decorative hardware.
 *When a Paint or Paint with Glaze finish is specified, the door and/or drawer front center panel may be constructed of Medium Density Fiberboard (MDF), except when Heirlooming is specified. MDF provides a smoother finish when painted, and is more resistant to warping, expansion, and contraction.

DOOR STYLES

Baxter	Alder	Cherry	Hickory	Maple*	Melamine	Oak	Rustic Alder	Rustic Hickory	Specialty Laminates	Thermofoil
	Availability	—	✓	—	✓	—	—	—	—	—

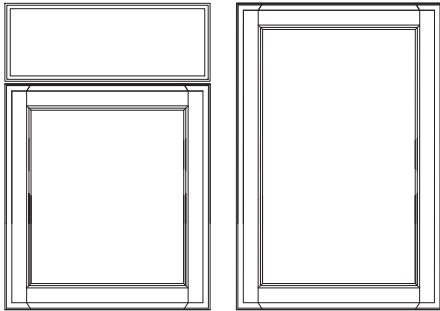

Base Wall

Door Options

ALF	CG	DPSRR	MD	SHMD	PRMD
•	•		•		

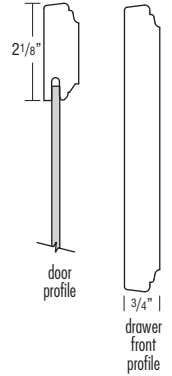
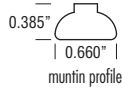

- Veneer Flat Panel
- Profiled Slab Drawer Front
- Reverse Bevel Profile, Decorative Hardware Not Required

*When a Paint or Paint with Glaze finish is specified, the door and/or drawer front center panel may be constructed of Medium Density Fiberboard (MDF), except when Heirlooming is specified. MDF provides a smoother finish when painted, and is more resistant to warping, expansion, and contraction.

Bellmont	Alder	Cherry	Hickory	Maple*	Melamine	Oak	Rustic Alder	Rustic Hickory	Specialty Laminates	Thermofoil
	Availability	—	✓	—	✓	—	—	—	—	—

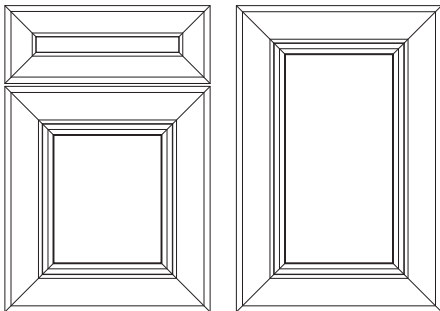

Base Wall

Door Options

ALF	CG	DPSRR	MD	SHMD	PRMD
•	•		•		

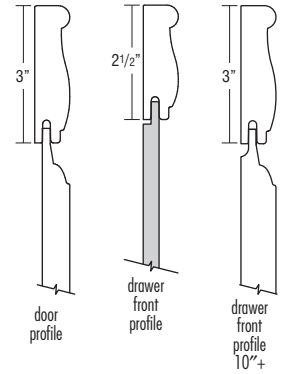
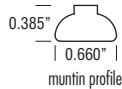

- Miter Doors
- Solid Raised Panel on Door and Large Drawer Fronts
- 5-piece Drawer Front Mitered to Match Door
- Distressing Available

• See page 72 for 5-piece drawer front dimensions when specifying decorative hardware.
 *When a Paint or Paint with Glaze finish is specified, the door and/or drawer front center panel may be constructed of Medium Density Fiberboard (MDF), except when Distressing or Heirlooming are specified. MDF provides a smoother finish when painted, and is more resistant to warping, expansion, and contraction.

DOOR STYLES

Butler	Alder	Cherry	Hickory	Maple*	Melamine	Oak	Rustic Alder	Rustic Hickory	Specialty Laminates	Thermofoil
	Availability	—	✓	—	✓	—	—	—	—	—

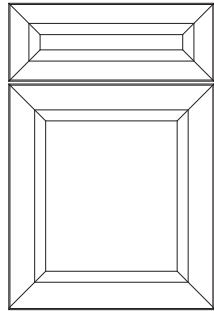

Base

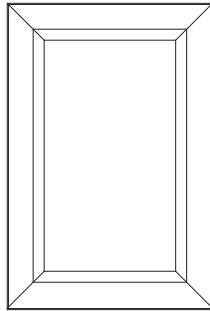

Wall



Optional Drawer Front:
Slab (DFSLSB)

Door Options

ALF	CG	DPSRR	MD	SHMD	PRMD
•					

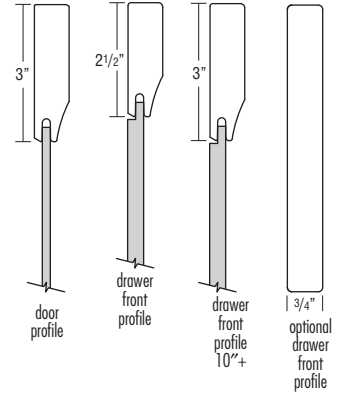

- Veneer Flat Panel Mitered Door
- 5-piece Drawer Front Mitered to Match Door
- See page 72 for 5-piece drawer front dimensions when specifying decorative hardware.

*When a Paint or Paint with Glaze finish is specified, the door and/or drawer front center panel may be constructed of Medium Density Fiberboard (MDF), except when Heirlooming is specified. MDF provides a smoother finish when painted, and is more resistant to warping, expansion, and contraction.

Caprice	Alder	Cherry	Hickory	Maple	Melamine	Oak	Rustic Alder	Rustic Hickory	Specialty Laminates	Thermofoil
	Availability	—	✓	—	✓	—	—	—	—	—

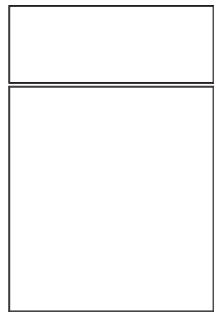

Slab Base



Slab Wall

Door Options

ALF	CG	DPSRR	MD	SHMD	PRMD
•					

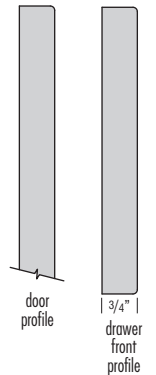

- Veneer Slab Doors and Drawer Fronts
- Veneer Face and Back
- Wood Edging on All Edges

- Furniture Board Core
- Grain direction is vertical on doors and horizontal on drawer fronts.

DOOR STYLES

Cotter

	Alder	Cherry	Hickory	Maple*	Melamine	Oak	Rustic Alder	Rustic Hickory	Specialty Laminates	Thermofoil
Availability	—	✓	—	✓	—	—	—	—	—	—

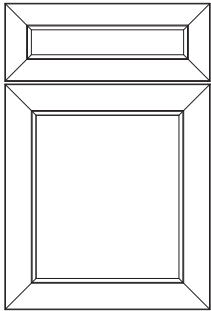

Base

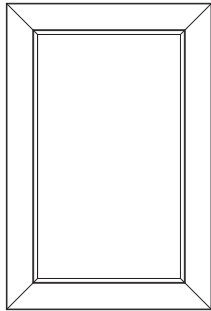

Wall



Optional Drawer Front: Slab (DFS LB)

Door Options

ALF	CG	DPSRR	MD	SHMD	PRMD
•	•		•		

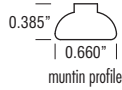

muntin profile

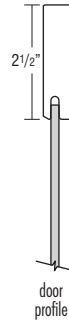

door profile

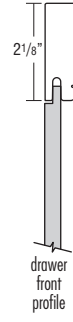

drawer front profile

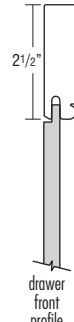

drawer front profile 10"+



optional drawer front profile

- Miter Doors
- Veneer Flat Panel
- 5-piece Drawer Front Mitered to Match Door
- See page 72 for 5-piece drawer front dimensions when specifying decorative hardware.

*When a Paint or Paint with Glaze finish is specified, the door and/or drawer front center panel may be constructed of Medium Density Fiberboard (MDF), except when Heirlooming is specified. MDF provides a smoother finish when painted, and is more resistant to warping, expansion, and contraction.

Darby

	Alder	Cherry	Hickory	Maple*	Melamine	Oak	Rustic Alder	Rustic Hickory	Specialty Laminates	Thermofoil
Availability	—	—	—	✓	—	—	—	—	—	—

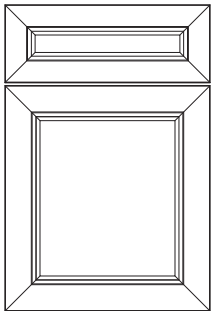

Base

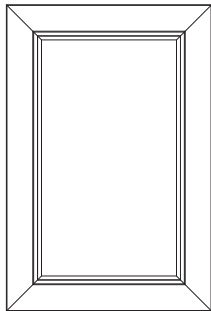

Wall



Optional Drawer Front: Slab (DFS LB)

Door Options

ALF	CG	DPSRR	MD	SHMD	PRMD
•	•		•		

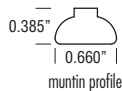

muntin profile

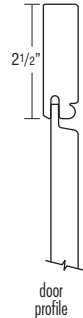

door profile

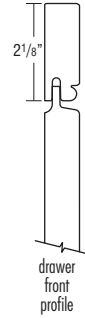

drawer front profile

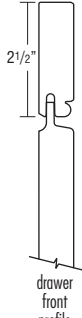

drawer front profile 10"+



optional drawer front profile

- Miter Doors
- Solid Raised Panel
- 5-piece Drawer Front Mitered to Match Door
- Distressing Available

• See page 72 for 5-piece drawer front dimensions when specifying decorative hardware.
 *When a Paint or Paint with Glaze finish is specified, the door and/or drawer front center panel may be constructed of Medium Density Fiberboard (MDF), except when Distressing or Heirlooming are specified. MDF provides a smoother finish when painted, and is more resistant to warping, expansion, and contraction.

DOOR STYLES

Dutton		Alder	Cherry	Hickory	Maple*	Melamine	Oak	Rustic Alder	Rustic Hickory	Specialty Laminates	Thermofoil
Availability		—	✓	—	✓	—	—	—	—	—	—

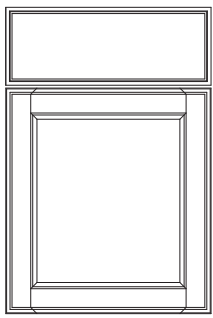

Base

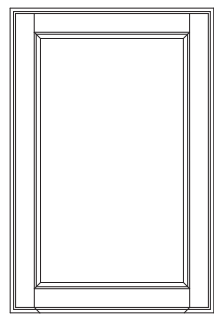

Wall

Door Options

ALF	CG	DPSRR	MD	SHMD	PRMD
•			•		



0.385"
0.660"
muntin profile

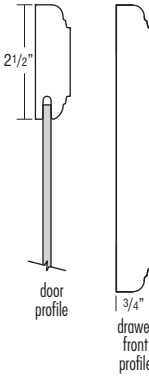

2 1/2"
door profile
3/4"
drawer front profile

- Veneer Flat Panel
- Profiled Slab Drawer Front

*When a Paint or Paint with Glaze finish is specified, the door and/or drawer front center panel may be constructed of Medium Density Fiberboard (MDF), except when Heirlooming is specified. MDF provides a smoother finish when painted, and is more resistant to warping, expansion, and contraction.



Base



Wall

Door Options

ALF	CG	DPSRR	MD	SHMD	PRMD
•			•		



0.385"
0.660"
muntin profile



2 1/2"
door profile
3/4"
drawer front profile

DOOR STYLES

Gallatin

	Alder	Cherry	Hickory	Maple	Melamine	Oak	Rustic Alder	Rustic Hickory	Specialty Laminates	Thermofoil
Availability	✓	—	—	—	—	—	✓	✓	—	—

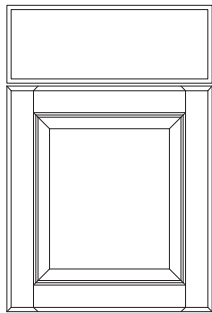

Base

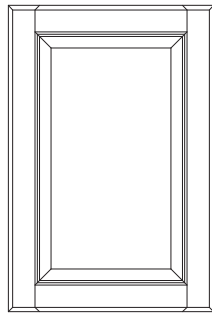

Wall



Optional Drawer Front:
Raised 5-piece (DFR5PC)

Door Options

ALF	CG	DPSRR	MD	SHMD	PRMD
•	•		•		

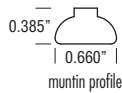

muntin profile



door profile



3/4" |
drawer front profile

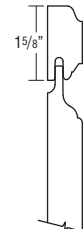

optional drawer front profile (top and bottom)



optional drawer front profile (sides and 10"+)

- Solid Raised Panel
- Profiled Slab Drawer Front

- Distressing Available
- See page 72 for 5-piece drawer front dimensions when specifying decorative hardware.

Genova

	Alder	Cherry	Hickory	Maple	Melamine	Oak	Rustic Alder	Rustic Hickory	Specialty Laminates	Thermofoil
Availability	—	—	—	—	✓	—	—	—	✓	—

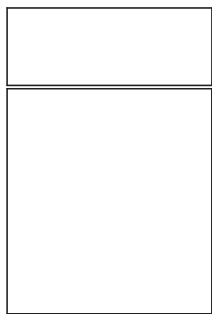

Slab Base



Slab Wall

Door Options

ALF	CG	DPSRR	MD	SHMD	PRMD
•					

Finishes Cabinet Box Color Options

	Cloud	Coconut	Dover	Icy Avalanche	Lambswool	Morel	Seal	Thatch	White
Antler	•		•		•	•			•
Elk							•	•	
Squall	•	•	•	•					•
Wharf			•		•				•



3/4" |
door profile



3/4" |
drawer front profile

- Slab Door and Drawer Front with Matching Edgebanding
- Vertical Grain Pattern
- Elk and Wharf feature a textured surface, Antler and Squall are non-textured.

- Doors, drawer fronts, overlay fillers, and selected premium trim items will be in the selected laminate or melamine. **All other cabinet components and trim items will be in the selected cabinet box color.**
- A heat shield is required to separate Genova doors, drawer fronts, overlay fillers, and all laminate or melamine products from heat producing units to be in compliance with cabinet warranty.
- For complementing Contemporary Embellishments, see page 341.
- Wood Tone Stain box colors will have visible vertical grain matching end panels.

DOOR STYLES

Hardin

	Alder	Cherry	Hickory	Maple*	Melamine	Oak	Rustic Alder	Rustic Hickory	Specialty Laminates	Thermofoil
Availability	—	✓	—	✓	—	—	—	—	—	—

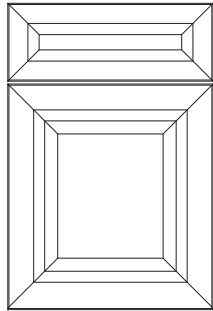

Base

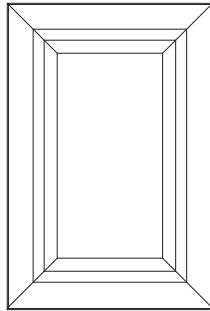

Wall



Optional Drawer Front:
Slab (DFSLB)

Door Options

ALF	CG	DPSRR	MD	SHMD	PRMD
•					

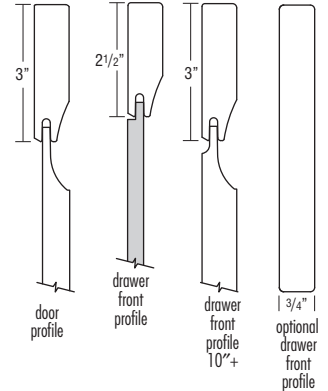

- Solid Raised Panel Mitered Door
- 5-piece Drawer Front Mitered to Match Door
- Distressing Available

- See page 72 for 5-piece drawer front dimensions when specifying decorative hardware.

*When a Paint or Paint with Glaze finish is specified, the door and/or drawer front center panel may be constructed of Medium Density Fiberboard (MDF), except when Distressing or Heirlooming are specified. MDF provides a smoother finish when painted, and is more resistant to warping, expansion, and contraction.

Herrington

	Alder	Cherry	Hickory	Maple*	Melamine	Oak	Rustic Alder	Rustic Hickory	Specialty Laminates	Thermofoil
Availability	—	✓	—	✓	—	—	—	—	—	—

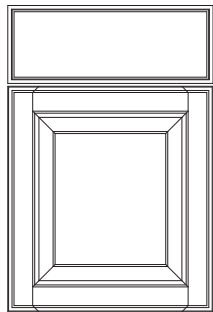

Base

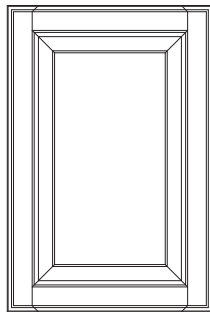

Wall



Optional Drawer Front:
Raised 5-piece (DFR5PC)

Door Options

ALF	CG	DPSRR	MD	SHMD	PRMD
•					

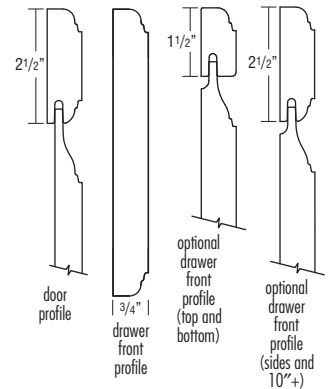
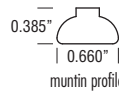

- Solid Raised Panel
- Profiled Slab Drawer Front
- Distressing Available
- See page 72 for 5-piece drawer front dimensions when specifying decorative hardware.

*When a Paint or Paint with Glaze finish is specified, the door and/or drawer front center panel may be constructed of Medium Density Fiberboard (MDF), except when Distressing or Heirlooming are specified. MDF provides a smoother finish when painted, and is more resistant to warping, expansion, and contraction.

DOOR STYLES

Hurson

	Alder	Cherry	Hickory	Maple*	Melamine	Oak	Rustic Alder	Rustic Hickory	Specialty Laminates	Thermofoil
Availability	✓	✓	✓	✓	—	✓	✓	✓	—	—

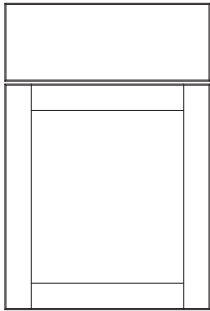

Base

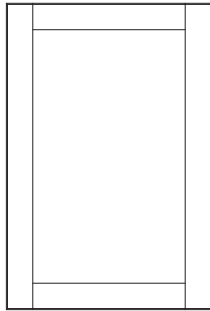

Wall

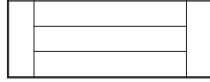

Optional Drawer Front:
Flat 5-piece (DFF5PC)

Door Options

ALF	CG	DPSRR	MD	SHMD	PRMD
•	•		•		

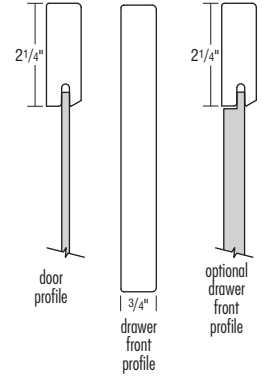
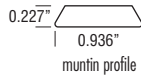

- Shaker Style Doors
- Recessed Panel
- Slab Drawer Front

- See page 72 for 5-piece drawer front dimensions when specifying decorative hardware.
- *When a Paint or Paint with Glaze finish is specified, the door and/or drawer front center panel may be constructed of Medium Density Fiberboard (MDF), except when Heirlooming is specified. MDF provides a smoother finish when painted, and is more resistant to warping, expansion, and contraction.

Justin

	Alder	Cherry	Hickory	Maple*	Melamine	Oak	Rustic Alder	Rustic Hickory	Specialty Laminates	Thermofoil
Availability	—	✓	—	✓	—	—	—	—	—	—

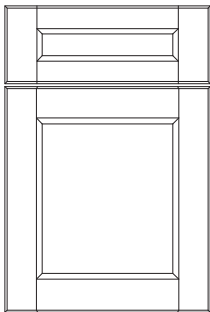

Base

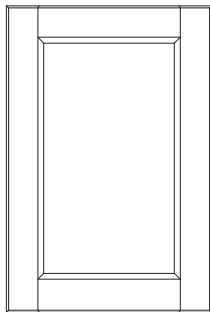

Wall



Optional Drawer Front:
Slab (DFS LB)

Door Options

ALF	CG	DPSRR	MD	SHMD	PRMD
•	•		•		

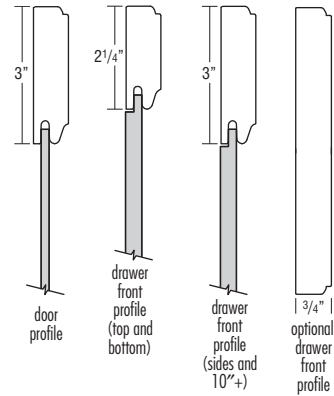
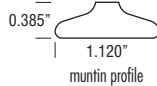

- Veneer Flat Panel
- 5-piece Drawer Front
- See page 72 for 5-piece drawer front dimensions when specifying decorative hardware.

- *When a Paint or Paint with Glaze finish is specified, the door and/or drawer front center panel may be constructed of Medium Density Fiberboard (MDF), except when Heirlooming is specified. MDF provides a smoother finish when painted, and is more resistant to warping, expansion, and contraction.

DOOR STYLES

Kingston

	Alder	Cherry	Hickory	Maple*	Melamine	Oak	Rustic Alder	Rustic Hickory	Specialty Laminates	Thermofoil
Availability	✓	✓	—	✓	—	—	—	—	—	—

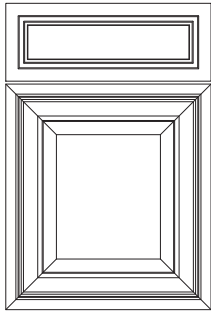

Base

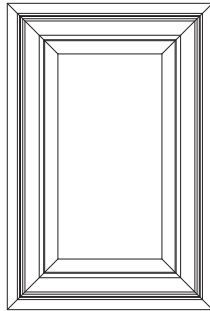

Wall

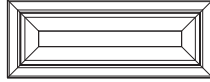

Optional Drawer Front:
Flat 5-piece (DFF5PC)

Door Options

ALF	CG	DPSRR	MD	SHMD	PRMD
•			•		



door profile



3/4" |
drawer front profile

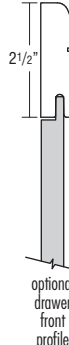

optional drawer front profile

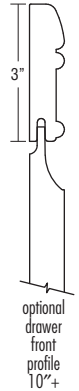

optional drawer front profile 10"+

- Miter Doors
- Solid Raised Panel on Door and Large 5-piece Drawer Fronts
- Solid Routed Drawer Front
- 5-piece drawer fronts less than 10" high have a flat center panel, drawer fronts 10" high and taller have a raised center panel.

- Distressing Available
- See page 72 for 5-piece drawer front dimensions when specifying decorative hardware.

*When a Paint or Paint with Glaze finish is specified, the door and/or drawer front center panel may be constructed of Medium Density Fiberboard (MDF), except when Distressing or Heirlooming are specified. MDF provides a smoother finish when painted, and is more resistant to warping, expansion, and contraction.

Larsen

	Alder	Cherry	Hickory	Maple*	Melamine	Oak	Rustic Alder	Rustic Hickory	Specialty Laminates	Thermofoil
Availability	✓	✓	—	✓	—	✓	✓	✓	—	—

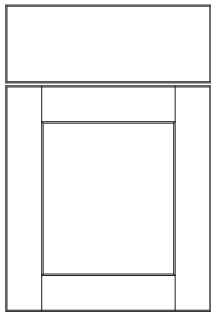

Base

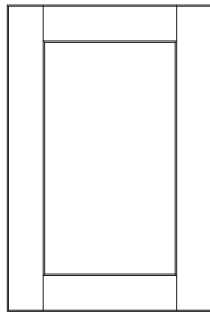

Wall

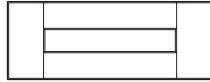

Optional Drawer Front:
Flat 5-piece (DFF5PC)

Door Options

ALF	CG	DPSRR	MD	SHMD	PRMD
•			•		•

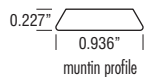

door profile



3/4" |
drawer front profile



optional drawer front profile (top and bottom)

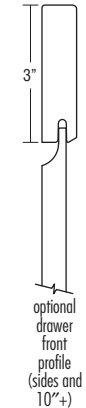

optional drawer front profile (sides and 10"+)

- Veneer Flat Panel
- Slab Drawer Front
- See page 72 for 5-piece drawer front dimensions when specifying decorative hardware.

*When a Paint or Paint with Glaze finish is specified, the door and/or drawer front center panel may be constructed of Medium Density Fiberboard (MDF), except when Heirlooming is specified. MDF provides a smoother finish when painted, and is more resistant to warping, expansion, and contraction.

DOOR STYLES

Lawton

	Alder	Cherry	Hickory	Maple*	Melamine	Oak	Rustic Alder	Rustic Hickory	Specialty Laminates	Thermofoil
Availability	✓	✓	—	✓	—	—	✓	✓	—	—

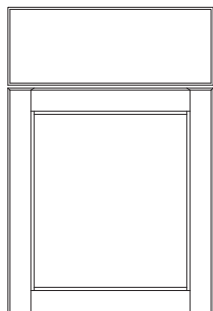

Base

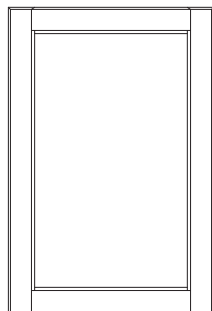

Wall

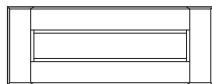

Optional Drawer Front:
Flat 5-piece (DFF5PC)

Door Options

ALF	CG	DPSRR	MD	SHMD	PRMD
•	•		•	•	•

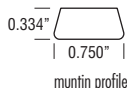

muntin profile

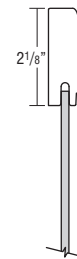

door profile



drawer front profile

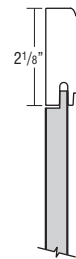

optional drawer front profile

- Veneer Flat Panel
- Profiled Slab Drawer Front
- See page 72 for 5-piece drawer front dimensions when specifying decorative hardware.

*When a Paint or Paint with Glaze finish is specified, the door and/or drawer front center panel may be constructed of Medium Density Fiberboard (MDF), except when Heirlooming is specified. MDF provides a smoother finish when painted, and is more resistant to warping, expansion, and contraction.

Lynnville

	Alder	Cherry	Hickory	Maple	Melamine	Oak	Rustic Alder	Rustic Hickory	Specialty Laminates	Thermofoil
Availability	—	✓	—	✓	—	—	—	—	—	—

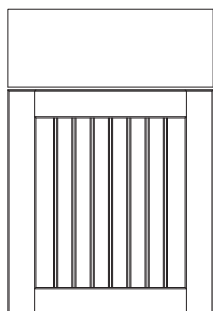

Base

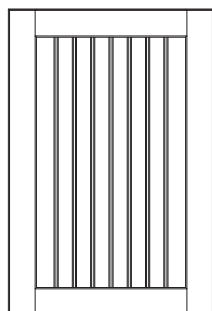

Wall

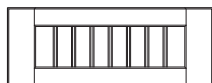

Optional Drawer Front:
Flat 5-piece (DFF5PC)

Door Options

ALF	CG	DPSRR	MD	SHMD	PRMD
•	•		•	•	•

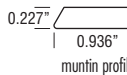

muntin profile

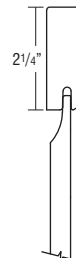

door profile

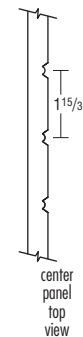

center panel top view



drawer front profile





optional drawer front profile

- Shaker Style Doors
- Solid Reverse Raised Beaded Panel
- Slab Drawer Front
- When DFF5PC is selected on a 2DB48, drawer front will have a vertical cross rail with two center panels.

- Will not use MDF center panel on Paint or Paint with Glaze finishes. See page 8 for more details.
- Beaded center panel on 5-piece drawer fronts will not align with doors when used on cabinets with double doors and a full width drawer.
- See page 72 for 5-piece drawer front dimensions when specifying decorative hardware.

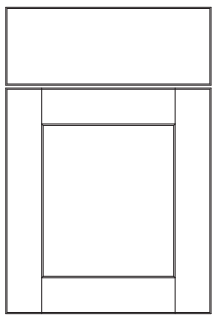
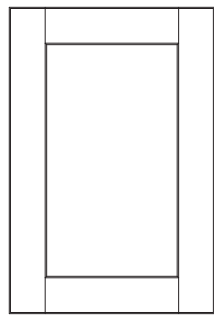
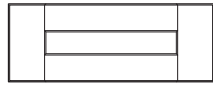
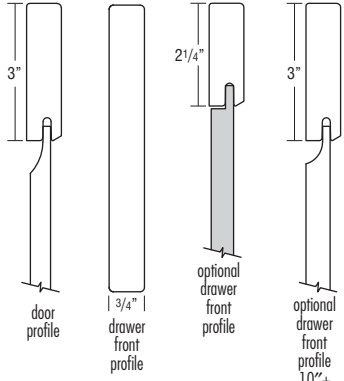
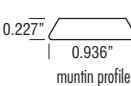
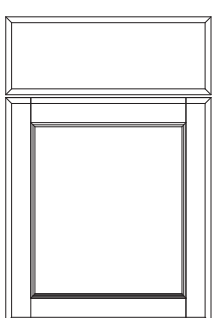
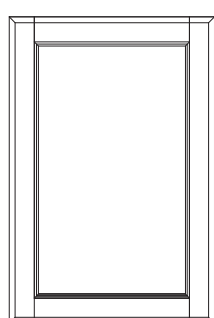
DOOR STYLES

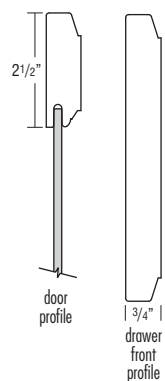
Northrope		Alder	Cherry	Hickory	Maple*	Melamine	Oak	Rustic Alder	Rustic Hickory	Specialty Laminates	Thermofoil																					
	Availability	✓	✓	—	✓	—	✓	✓	✓	—	—																					
 Base	 Wall	 Optional Drawer Front: Flat 5-piece (DFF5PC)																														
		<table border="1" style="font-size: 8px; border-collapse: collapse;"> <thead> <tr> <th colspan="6" style="text-align: left;">Door Options</th> </tr> <tr> <th>ALF</th> <th>CG</th> <th>DPSRR</th> <th>MD</th> <th>SHMD</th> <th>PRMD</th> </tr> </thead> <tbody> <tr> <td style="text-align: center;">•</td> <td style="text-align: center;">•</td> <td style="text-align: center;">•</td> <td style="text-align: center;">•</td> <td style="text-align: center;">•</td> <td style="text-align: center;">•</td> </tr> </tbody> </table>					Door Options						ALF	CG	DPSRR	MD	SHMD	PRMD	•	•	•	•	•	•	 muntin profile							
Door Options																																
ALF	CG	DPSRR	MD	SHMD	PRMD																											
•	•	•	•	•	•																											
<ul style="list-style-type: none"> Solid Reverse Raised Panel Door Slab Drawer Front See page 72 for 5-piece drawer front dimensions when specifying decorative hardware. 		<p>*When a Paint or Paint with Glaze finish is specified, the door and/or drawer front center panel may be constructed of Medium Density Fiberboard (MDF), except when Heirlooming is specified. MDF provides a smoother finish when painted, and is more resistant to warping, expansion, and contraction.</p>																														
Painter		Alder	Cherry	Hickory	Maple*	Melamine	Oak	Rustic Alder	Rustic Hickory	Specialty Laminates	Thermofoil																					
	Availability	—	✓	✓	✓	—	✓	—	—	—	—																					
 Base	 Wall	<table border="1" style="font-size: 8px; border-collapse: collapse;"> <thead> <tr> <th colspan="6" style="text-align: left;">Door Options</th> </tr> <tr> <th>ALF</th> <th>CG</th> <th>DPSRR</th> <th>MD</th> <th>SHMD</th> <th>PRMD</th> </tr> </thead> <tbody> <tr> <td style="text-align: center;">•</td> <td style="text-align: center;">•</td> <td style="text-align: center;">•</td> <td style="text-align: center;">•</td> <td style="text-align: center;">•</td> <td style="text-align: center;">•</td> </tr> </tbody> </table>					Door Options						ALF	CG	DPSRR	MD	SHMD	PRMD	•	•	•	•	•	•	 muntin profile							
Door Options																																
ALF	CG	DPSRR	MD	SHMD	PRMD																											
•	•	•	•	•	•																											
<ul style="list-style-type: none"> Veneer Flat Panel Profiled Slab Drawer Front 		<p>*When a Paint or Paint with Glaze finish is specified, the door may be constructed of Medium Density Fiberboard (MDF), except when Heirlooming is specified. MDF provides a smoother finish when painted, and is more resistant to warping, expansion, and contraction.</p>																														

DOOR STYLES

Rennie

Availability	Alder	Cherry	Hickory	Maple*	Melamine	Oak	Rustic Alder	Rustic Hickory	Specialty Laminates	Thermofoil
—	—	✓	—	✓	—	—	—	—	—	—

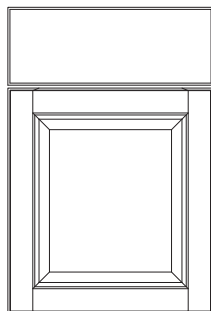

Base

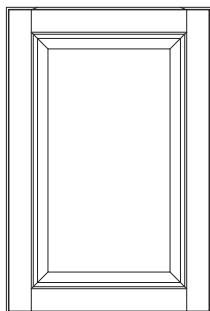

Wall

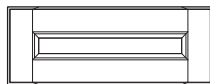

Optional Drawer Front:
Flat 5-piece (DFF5PC)

Door Options

ALF	CG	DPSRR	MD	SHMD	PRMD
•	•		•		

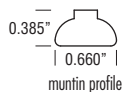

muntin profile

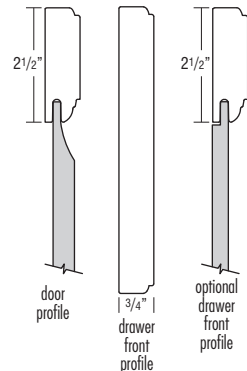

door profile

3/4" drawer front profile

optional drawer front profile

- Veneer Raised Panel
- Profiled Slab Drawer Front
- See page 72 for 5-piece drawer front dimensions when specifying decorative hardware.

*When a Paint or Paint with Glaze finish is specified, the door and/or drawer front center panel may be constructed of Medium Density Fiberboard (MDF). MDF provides a smoother finish when painted, and is more resistant to warping, expansion, and contraction.

Taro

Availability	Alder	Cherry	Hickory	Maple	Melamine	Oak	Rustic Alder	Rustic Hickory	Specialty Laminates	Thermofoil
—	—	—	—	—	✓	—	—	—	✓	—

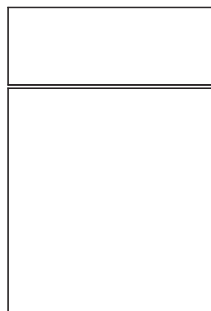

Slab Base



Slab Wall

Door Options

ALF	CG	DPSRR	MD	SHMD	PRMD
•					

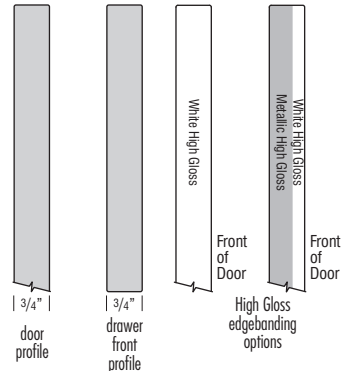

3/4" door profile

3/4" drawer front profile

White High Gloss Front of Door

White High Gloss Metallic High Gloss Front of Door

High Gloss edging options

- Slab Doors and Drawer Fronts
- High Gloss Laminate has Two Edgebanding Options
- Matching Specialty Laminate Furniture Board (MSLFB) not available on Taro Melamine.

- In High Gloss, doors, drawer fronts, overlay fillers, and selected premium trim items will be in White High Gloss (see Trim section for availability of premium trim items). Backs of doors, drawer fronts, and Premium panels will be white melamine. **All other cabinet components and embellishments will be Painted White.**
- A heat shield is required to separate Taro doors, drawer fronts, overlay fillers, and all laminate and melamine products from heat producing units to be in compliance with cabinet warranty.
- For complementing Contemporary Embellishments, see page 341.

DOOR STYLES

Troxel											
	Availability	Alder	Cherry	Hickory	Maple	Melamine	Oak	Rustic Alder	Rustic Hickory	Specialty Laminates	Thermofoil
	—	—	—	—	—	—	—	—	—	✓	—

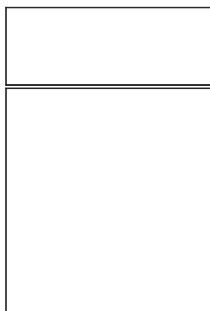

Slab Base



Slab Wall

Door Options

ALF	CG	DPSRR	MD	SHMD	PRMD
•					

Finishes Cabinet Box Color Options

	Black†	Cloud	Dover	Storm*	White
Arctic		•	•		•
Obsidian	•			•	

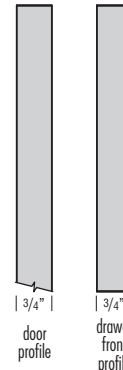

- Slab Door and Drawer Front with Matching Edgebanding
- Horizontal Grain Pattern for Contemporary Styling
- Arctic and Obsidian feature a textured surface.
- Doors, drawer fronts, overlay fillers, and selected premium trim items will be in the selected laminate. **All other cabinet components and trim items will be in the selected cabinet box color.**

- Doors and overlay fillers greater than 48" high will be two pieces. Doors will be doweled together with zinc connector pins and black plastic spacers. Replacement doors will be drilled and doweled but require field assembly.
- A heat shield is required to separate Troxel doors, drawer fronts, overlay fillers, and all textured laminate products from heat producing units to be in compliance with cabinet warranty.
- For complementing Contemporary Embellishments, see page 341.

†Standard construction is not available in Black, requires APC, MIP, or MSLFB upgrade.
 *Storm box color will have visible vertical grain matching end panels.

Vaile											
	Availability	Alder	Cherry	Hickory	Maple	Melamine	Oak	Rustic Alder	Rustic Hickory	Specialty Laminates	Thermofoil
	—	—	—	—	—	—	—	—	—	—	✓

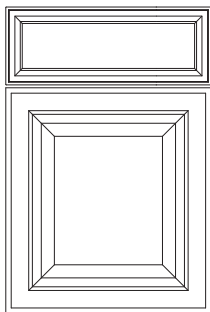

Base

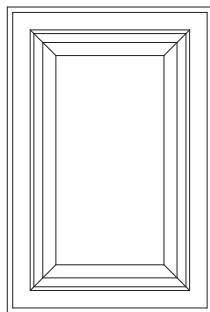

Wall

Door Options

ALF	CG	DPSRR	MD	SHMD	PRMD
•			•		

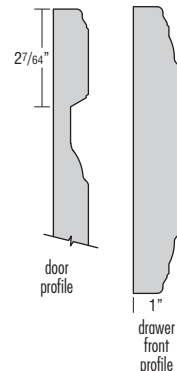
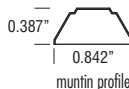

- Thermofoil MDF Raised Panel
- 1" MDF Raised Profile Drawer Front

- Thermofoil will not withstand sustained temperatures in excess of 170°F. A 3" filler or heat shield is required between any thermofoil surface and any heat source to be in compliance with cabinet warranty. Failure to use a 3" filler or heat shield will void the cabinet warranty.

DOOR STYLES

Warwick	Alder	Cherry	Hickory	Maple*	Melamine	Oak	Rustic Alder	Rustic Hickory	Specialty Laminates	Thermofoil
	Availability	—	✓	—	✓	—	—	—	—	—

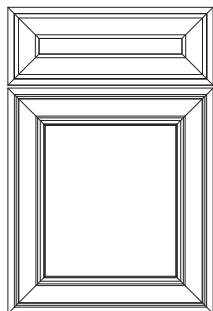

Base

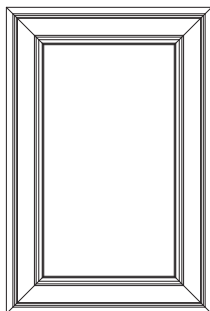

Wall

Door Options

ALF	CG	DPSRR	MD	SHMD	PRMD
•	•		•		

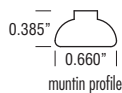

muntin profile

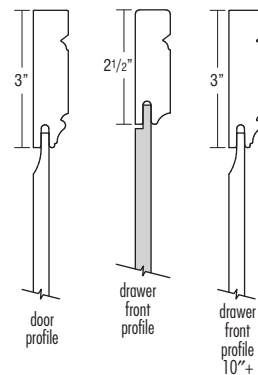

- Miter Doors
- Solid Reverse Raised Panel Door
- 5-piece Drawer Front Mitered to Match Door
- Faux Inset Design. Recommended for use with Faux Hinges (see page 342).

- 1/4" space filler is necessary when applying faux hinge (strap or barrel) on varying depth cabinet or next to an appliance to allow for full door swing clearance.
 - See page 72 for 5-piece drawer front dimensions when specifying decorative hardware.
- *When a Paint or Paint with Glaze finish is specified, the door and/or drawer front center panel may be constructed of Medium Density Fiberboard (MDF), except when Heirlooming is specified. MDF provides a smoother finish when painted, and is more resistant to warping, expansion, and contraction.

Whitman	Alder	Cherry	Hickory	Maple*	Melamine	Oak	Rustic Alder	Rustic Hickory	Specialty Laminates	Thermofoil
	Availability	✓	✓	✓	✓	—	✓	✓	—	—

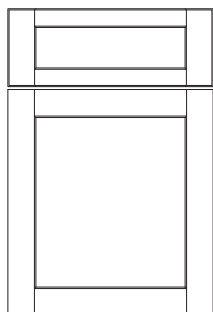

Base

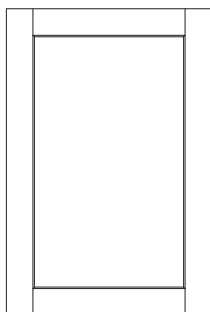

Wall



Optional Drawer Front: Slab (DFSLB)

Door Options

ALF	CG	DPSRR	MD	SHMD	PRMD
•	•	•	•	•	•

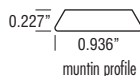

muntin profile

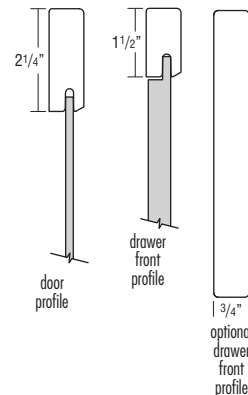

- Shaker Style Doors
- Veneer Flat Panel (Solid reverse raised door center panel is available as a modification, see DPSRR on page 40.)
- 5-piece Drawer Front

- See page 72 for 5-piece drawer front dimensions when specifying decorative hardware.
- *When a Paint or Paint with Glaze finish is specified, the door and/or drawer front center panel may be constructed of Medium Density Fiberboard (MDF), except when Heirlooming is specified. MDF provides a smoother finish when painted, and is more resistant to warping, expansion, and contraction.

PREMIUM COLOR PALETTE

	OPTION NAME	DESCRIPTION/LIMITATIONS	MATCHING LAMINATE ENDS [▲]	DISTRESSING AVAILABILITY	HEIRLOOMING AVAILABILITY
Stains	Grizzly	A deep brown finish with gray undertones and beautiful depth.	✓	✓	N/A
	Kodiak	A dark brown finish with gray and yellow undertones and a deep, rich hue.	✓	✓	N/A
	Storm	A semi translucent stone gray finish that allows the natural tones and characteristics of the wood to show through.	Maple ✓ Cherry N/A	✓	✓
Stains with Flooded Glazes	Black Forest	A two tone finish. A medium toned finish that is highlighted with a dark glaze.	✓	✓	N/A
	Coffee	A two tone finish. Dark glaze over a warmer toner that emulates a soft, Old World look and enhances the door profiles.	✓	✓	N/A
	Palomino	A two tone finish. A light toned finish that is highlighted with a dark espresso glaze. The glaze is meant to be seen primarily in the profiled areas and has minimal affect to the overall color.	✓	✓	N/A
	Whiskey Black	A warm finish with a rich dark patina to create a true reproduction of a period style antique.	✓	✓	N/A
Stains with Penned Glazes	Cattail w/Whiskey Black	A dark patina penned glaze on Cattail.	✓	✓	N/A
	Sahara w/Palomino	A dark espresso penned glaze on Sahara.	✓	✓	N/A
	Tundra w/Black Forest	A deep brown penned glaze on Tundra.	✓	✓	N/A
Paints*	Black	True black	N/A	✓	✓
	Cloud	Medium gray	✓	✓	N/A
	Coconut	Creamy off white	✓	N/A	N/A
	Dover	White with a taupe undertone	✓	N/A	N/A
	Egret	Light taupe with gray/green undertones	✓	✓	N/A
	Icy Avalanche	Cool white with gray undertones	✓	N/A	N/A
	Lambswool	Medium taupe	✓	✓	N/A
	Limestone	Light gray	✓	✓	N/A
	Maritime	Dark navy with gray/green undertones	✓	✓	✓
	Moonstone	Cool dark gray	✓	✓	✓
	Seaside	Turquoise blue	N/A	✓	✓
	White	Bright, pure white	✓	N/A	N/A
Paints with Flooded Glazes*	Seaside w/Oasis	A two toned finish, applying a turquoise blue paint finish enhanced with a coffee colored glaze.	N/A	✓	✓
Flooded and Penned Glazes for Paints*	Amaretto Crème	Dark brown glaze available on Cloud, Coconut, Dover, Egret, Icy Avalanche, Lambswool, Limestone, Maritime, Moonstone, and White (Penned Glaze only).	✓	✓	✓**
	Grey Stone	Gray glaze available on Cloud, Coconut, Dover, Egret, Icy Avalanche, Lambswool, Limestone, Maritime, and White (Penned Glaze only).	✓	✓	✓**
	Toasted Almond	Medium brown glaze available on Cloud, Coconut, Dover, Egret, Icy Avalanche, Lambswool, Limestone, Maritime, Moonstone, and White (Penned Glaze only).	✓	✓	✓**

[▲]Standard construction is not available in Black, Seaside, Seaside with Oasis, Storm Cherry, and Unfinished. An upgrade to All-plywood Construction, MIP, or MSLFB is required on these finishes.

*On wood products, normal movement is typical due to change in climatic conditions. This will cause hairline cracks at stile, rail and panel joints. This hairline cracking is a normal characteristic of painted finishes and will not be considered a reason for product replacement. Finish agreement required, see page 366.

**Available on Maritime and Moonstone only.

UNFINISHED

	OPTION NAME	DESCRIPTION/LIMITATIONS	DISTRESSING AVAILABILITY	HEIRLOOMING AVAILABILITY
Standard Finish	Unfinished	Must upgrade to APC. When cabinets are finished by an outside source, finish is not covered under warranty. Interiors of cabinets will be clear coated veneer for APC. For finishable interiors, MIP must be specified.	✓	N/A

FINISH TECHNIQUES

	OPTION NAME	DESCRIPTION
Techniques	Distressing	Provides a rustic look through the carefully crafted application of distressing characteristics such as dents, wormholes, chisel marks, and other signs of wear on solid-wood doors, drawer fronts, face frames (where applicable), and selected trim items (veneer parts will not be distressed). The distressing technique creates a finish with unique and appealing imperfections, similar to those of time-worn antiques. Distressing characteristics are more visible with glaze finishes (face frames, where applicable, and trim items without detailed profiles will not feature glaze hang-up on distressed areas). Not available to order with Coconut, Dover, Icy Avalanche, and White.
	Heirlooming	Available on select finishes. The finish will be sanded through the base coat to expose the surface of the wood. This type of sand through on the edges and profiles creates a naturally worn appearance. If a finish is chosen with a glaze, the glaze will be applied after the sanding has been done. This will enhance those areas of exposed wood to take on the darker characteristic of the applied glaze. Not available on Caprice and Rennie. Select trim pieces will feature Heirlooming characteristics. See Trim section for availability.
	Matte Sheen	Available on Stains, Stains with Flooded Glazes, and Stains with Penned Glazes. Replaces standard top coat with a low sheen, non-pigmented top coat on doors, drawer fronts, face frames, trim items, and veneer finished cabinet components in selected finish. Does not affect laminate or clear finished components.

FINISH AVAILABILITY

		MAPLE																										
		Matching Laminate Ends [▲]	Heirloom ^{* Ⓢ}	Matte Sheen	Amstead	Ashridge	Baxter	Bellmont	Butler	Caprice	Coffer	Darby	Dutton	Ellerby	Hardin	Herrington	Hurson	Justin	Kingston	Larsen	Lawton	Lynnville	Northrope	Painter	Rennie	Warwick	Whitman	
Stains	Brierwood	✓		✓	✓	✓	✓	✓	✓	✓	✓	✓	✓	✓	✓	✓	✓	✓	✓	✓	✓	✓	✓	✓	✓	✓	✓	
	Buckskin	✓		✓	✓	✓	✓	✓	✓	✓	✓	✓	✓	✓	✓	✓	✓	✓	✓	✓	✓	✓	✓	✓	✓	✓	✓	
	Cattail	✓		✓	✓	✓	✓	✓	✓	✓	✓	✓	✓	✓	✓	✓	✓	✓	✓	✓	✓	✓	✓	✓	✓	✓	✓	
	Chocolate	✓		✓	✓	✓	✓	✓	✓	✓	✓	✓	✓	✓	✓	✓	✓	✓	✓	✓	✓	✓	✓	✓	✓	✓	✓	
	Cranberry	✓		✓	✓	✓	✓	✓	✓	✓	✓	✓	✓	✓	✓	✓	✓	✓	✓	✓	✓	✓	✓	✓	✓	✓	✓	
	Grizzly	✓		✓	✓	✓	✓	✓	✓	✓	✓	✓	✓	✓	✓	✓	✓	✓	✓	✓	✓	✓	✓	✓	✓	✓	✓	✓
	Havana	✓		✓	✓	✓	✓	✓	✓	✓	✓	✓	✓	✓	✓	✓	✓	✓	✓	✓	✓	✓	✓	✓	✓	✓	✓	
	Henna	✓		✓	✓	✓	✓	✓	✓	✓	✓	✓	✓	✓	✓	✓	✓	✓	✓	✓	✓	✓	✓	✓	✓	✓	✓	✓
	Kodiak	✓		✓	✓	✓	✓	✓	✓	✓	✓	✓	✓	✓	✓	✓	✓	✓	✓	✓	✓	✓	✓	✓	✓	✓	✓	✓
	Morel	✓		✓	✓	✓	✓	✓	✓	✓	✓	✓	✓	✓	✓	✓	✓	✓	✓	✓	✓	✓	✓	✓	✓	✓	✓	✓
	Natural	✓		✓	✓	✓	✓	✓	✓	✓	✓	✓	✓	✓	✓	✓	✓	✓	✓	✓	✓	✓	✓	✓	✓	✓	✓	✓
	Sahara	✓		✓	✓	✓	✓	✓	✓	✓	✓	✓	✓	✓	✓	✓	✓	✓	✓	✓	✓	✓	✓	✓	✓	✓	✓	✓
	Seal	✓		✓	✓	✓	✓	✓	✓	✓	✓	✓	✓	✓	✓	✓	✓	✓	✓	✓	✓	✓	✓	✓	✓	✓	✓	✓
	Storm	✓	✓	✓	✓	✓	✓	✓	✓	✓	✓	✓	✓	✓	✓	✓	✓	✓	✓	✓	✓	✓	✓	✓	✓	✓	✓	✓
	Thatch	✓		✓	✓	✓	✓	✓	✓	✓	✓	✓	✓	✓	✓	✓	✓	✓	✓	✓	✓	✓	✓	✓	✓	✓	✓	✓
	Tundra	✓		✓	✓	✓	✓	✓	✓	✓	✓	✓	✓	✓	✓	✓	✓	✓	✓	✓	✓	✓	✓	✓	✓	✓	✓	✓
Unfinished	✓			✓	✓	✓	✓	✓	✓	✓	✓	✓	✓	✓	✓	✓	✓	✓	✓	✓	✓	✓	✓	✓	✓	✓	✓	
Stains with Flooded Glazes	Black Forest	✓		✓	✓	✓	✓	✓	✓	✓	✓	✓	✓	✓	✓	✓	✓	✓	✓	✓	✓	✓	✓	✓	✓	✓	✓	
	Coffee	✓		✓	✓	✓	✓	✓	✓	✓	✓	✓	✓	✓	✓	✓	✓	✓	✓	✓	✓	✓	✓	✓	✓	✓	✓	
	Palomino	✓		✓	✓	✓	✓	✓	✓	✓	✓	✓	✓	✓	✓	✓	✓	✓	✓	✓	✓	✓	✓	✓	✓	✓	✓	
	Whiskey Black	✓		✓	✓	✓	✓	✓	✓	✓	✓	✓	✓	✓	✓	✓	✓	✓	✓	✓	✓	✓	✓	✓	✓	✓	✓	
Stains with Penned Glazes	Cattail w/Whiskey Black	✓		✓	✓	✓	✓	✓	✓	✓	✓	✓	✓	✓	✓	✓	✓	✓	✓	✓	✓	✓	✓	✓	✓	✓	✓	
	Sahara w/Palomino	✓		✓	✓	✓	✓	✓	✓	✓	✓	✓	✓	✓	✓	✓	✓	✓	✓	✓	✓	✓	✓	✓	✓	✓	✓	
	Tundra w/Black Forest	✓		✓	✓	✓	✓	✓	✓	✓	✓	✓	✓	✓	✓	✓	✓	✓	✓	✓	✓	✓	✓	✓	✓	✓	✓	
Paints Ⓢ	Black		✓		✓	✓	✓	✓	✓	✓	✓	✓	✓	✓	✓	✓	✓	✓	✓	✓	✓	✓	✓	✓	✓	✓	✓	
	Cloud	✓			✓	✓	✓	✓	✓	✓	✓	✓	✓	✓	✓	✓	✓	✓	✓	✓	✓	✓	✓	✓	✓	✓	✓	
	Coconut	✓			✓	✓	✓	✓	✓	✓	✓	✓	✓	✓	✓	✓	✓	✓	✓	✓	✓	✓	✓	✓	✓	✓	✓	
	Dover	✓			✓	✓	✓	✓	✓	✓	✓	✓	✓	✓	✓	✓	✓	✓	✓	✓	✓	✓	✓	✓	✓	✓	✓	
	Egret	✓			✓	✓	✓	✓	✓	✓	✓	✓	✓	✓	✓	✓	✓	✓	✓	✓	✓	✓	✓	✓	✓	✓	✓	
	Icy Avalanche	✓			✓	✓	✓	✓	✓	✓	✓	✓	✓	✓	✓	✓	✓	✓	✓	✓	✓	✓	✓	✓	✓	✓	✓	
	Lambswool	✓			✓	✓	✓	✓	✓	✓	✓	✓	✓	✓	✓	✓	✓	✓	✓	✓	✓	✓	✓	✓	✓	✓	✓	
	Limestone	✓			✓	✓	✓	✓	✓	✓	✓	✓	✓	✓	✓	✓	✓	✓	✓	✓	✓	✓	✓	✓	✓	✓	✓	
	Maritime	✓	✓		✓	✓	✓	✓	✓	✓	✓	✓	✓	✓	✓	✓	✓	✓	✓	✓	✓	✓	✓	✓	✓	✓	✓	✓
	Moonstone	✓	✓		✓	✓	✓	✓	✓	✓	✓	✓	✓	✓	✓	✓	✓	✓	✓	✓	✓	✓	✓	✓	✓	✓	✓	✓
	Seaside		✓		✓	✓	✓	✓	✓	✓	✓	✓	✓	✓	✓	✓	✓	✓	✓	✓	✓	✓	✓	✓	✓	✓	✓	✓
	White	✓			✓	✓	✓	✓	✓	✓	✓	✓	✓	✓	✓	✓	✓	✓	✓	✓	✓	✓	✓	✓	✓	✓	✓	✓

*Heirloom not available on Caprice and Rennie.

▲Standard construction is not available in Black, Seaside, Seaside with Oasis, Storm Cherry, and Unfinished. An upgrade to All-plywood Construction, MIP, or MSLFB is required on these finishes.

†Distressing not available on Coconut, Dover, Icy Avalanche, or White.

Ⓢ Signed finish agreement required, see pages 365-368.

FINISH AVAILABILITY

					GLAZE TYPE		MAPLE																						
		Matching Laminate Ends [▲]	Heirloom [Ⓢ]	Matte Sheen	Flooded	Penned	Amstead	Ashridge	Baxter	Bellmont	Burler	Caprice	Cotter	Darby	Dutton	Ellerby	Hardin	Herrington	Hurson	Justin	Kingston	Larsen	Lawton	Lynnville	Northrope	Painter	Rennie	Warwick	Whitman
Paints with Glazes [Ⓢ]	Cloud w/Amaretto Crème	✓			✓	✓	F	✓	✓	✓	✓		✓	✓	✓	✓	✓	✓	✓	✓	F	✓	✓	✓	F	✓	✓	✓	✓
	Cloud w/Grey Stone	✓			✓	✓	F	✓	✓	✓	✓		✓	✓	✓	✓	✓	✓	✓	✓	F	✓	✓	✓	F	✓	✓	✓	✓
	Cloud w/Toasted Almond	✓			✓	✓	F	✓	✓	✓	✓		✓	✓	✓	✓	✓	✓	✓	✓	F	✓	✓	✓	F	✓	✓	✓	✓
	Coconut w/Amaretto Crème	✓			✓	✓	F	✓	✓	✓	✓		✓	✓	✓	✓	✓	✓	✓	✓	F	✓	✓	✓	F	✓	✓	✓	✓
	Coconut w/Grey Stone	✓			✓	✓	F	✓	✓	✓	✓		✓	✓	✓	✓	✓	✓	✓	✓	F	✓	✓	✓	F	✓	✓	✓	✓
	Coconut w/Toasted Almond	✓			✓	✓	F	✓	✓	✓	✓		✓	✓	✓	✓	✓	✓	✓	✓	F	✓	✓	✓	F	✓	✓	✓	✓
	Dover w/Amaretto Crème	✓			✓	✓	F	✓	✓	✓	✓		✓	✓	✓	✓	✓	✓	✓	✓	F	✓	✓	✓	F	✓	✓	✓	✓
	Dover w/Grey Stone	✓			✓	✓	F	✓	✓	✓	✓		✓	✓	✓	✓	✓	✓	✓	✓	F	✓	✓	✓	F	✓	✓	✓	✓
	Dover w/Toasted Almond	✓			✓	✓	F	✓	✓	✓	✓		✓	✓	✓	✓	✓	✓	✓	✓	F	✓	✓	✓	F	✓	✓	✓	✓
	Egret w/Amaretto Crème	✓			✓	✓	F	✓	✓	✓	✓		✓	✓	✓	✓	✓	✓	✓	✓	F	✓	✓	✓	F	✓	✓	✓	✓
	Egret w/Grey Stone	✓			✓	✓	F	✓	✓	✓	✓		✓	✓	✓	✓	✓	✓	✓	✓	F	✓	✓	✓	F	✓	✓	✓	✓
	Egret w/Toasted Almond	✓			✓	✓	F	✓	✓	✓	✓		✓	✓	✓	✓	✓	✓	✓	✓	F	✓	✓	✓	F	✓	✓	✓	✓
	Icy Avalanche w/Amaretto Crème	✓			✓	✓	F	✓	✓	✓	✓		✓	✓	✓	✓	✓	✓	✓	✓	F	✓	✓	✓	F	✓	✓	✓	✓
	Icy Avalanche w/Grey Stone	✓			✓	✓	F	✓	✓	✓	✓		✓	✓	✓	✓	✓	✓	✓	✓	F	✓	✓	✓	F	✓	✓	✓	✓
	Icy Avalanche w/Toasted Almond	✓			✓	✓	F	✓	✓	✓	✓		✓	✓	✓	✓	✓	✓	✓	✓	F	✓	✓	✓	F	✓	✓	✓	✓
	Lambswool w/Amaretto Crème	✓			✓	✓	F	✓	✓	✓	✓		✓	✓	✓	✓	✓	✓	✓	✓	F	✓	✓	✓	F	✓	✓	✓	✓
	Lambswool w/Grey Stone	✓			✓	✓	F	✓	✓	✓	✓		✓	✓	✓	✓	✓	✓	✓	✓	F	✓	✓	✓	F	✓	✓	✓	✓
	Lambswool w/Toasted Almond	✓			✓	✓	F	✓	✓	✓	✓		✓	✓	✓	✓	✓	✓	✓	✓	F	✓	✓	✓	F	✓	✓	✓	✓
	Limestone w/Amaretto Crème	✓			✓	✓	F	✓	✓	✓	✓		✓	✓	✓	✓	✓	✓	✓	✓	F	✓	✓	✓	F	✓	✓	✓	✓
	Limestone w/Grey Stone	✓			✓	✓	F	✓	✓	✓	✓		✓	✓	✓	✓	✓	✓	✓	✓	F	✓	✓	✓	F	✓	✓	✓	✓
	Limestone w/Toasted Almond	✓			✓	✓	F	✓	✓	✓	✓		✓	✓	✓	✓	✓	✓	✓	✓	F	✓	✓	✓	F	✓	✓	✓	✓
	Maritime w/Amaretto Crème	✓	✓		✓	✓	F	✓	✓	✓	✓		✓	✓	✓	✓	✓	✓	✓	✓	F	✓	✓	✓	F	✓	✓	✓	✓
	Maritime w/Grey Stone	✓	✓		✓	✓	F	✓	✓	✓	✓		✓	✓	✓	✓	✓	✓	✓	✓	F	✓	✓	✓	F	✓	✓	✓	✓
	Maritime w/Toasted Almond	✓	✓		✓	✓	F	✓	✓	✓	✓		✓	✓	✓	✓	✓	✓	✓	✓	F	✓	✓	✓	F	✓	✓	✓	✓
Moonstone w/Amaretto Crème	✓	✓		✓	✓	F	✓	✓	✓	✓		✓	✓	✓	✓	✓	✓	✓	✓	F	✓	✓	✓	F	✓	✓	✓	✓	
Moonstone w/Toasted Almond	✓	✓		✓	✓	F	✓	✓	✓	✓		✓	✓	✓	✓	✓	✓	✓	✓	F	✓	✓	✓	F	✓	✓	✓	✓	
Seaside with Oasis		✓		✓			✓	✓	✓	✓		✓	✓	✓	✓	✓	✓	✓	✓	✓	✓	✓	✓	✓	✓	✓	✓	✓	
White w/Amaretto Crème	✓				✓	F	✓	✓	✓	✓		✓	✓	✓	✓	✓	✓	✓	✓	F	✓	✓	✓	F	✓	✓	✓	✓	
White w/Grey Stone	✓				✓	F	✓	✓	✓	✓		✓	✓	✓	✓	✓	✓	✓	✓	F	✓	✓	✓	F	✓	✓	✓	✓	
White w/Toasted Almond	✓				✓	F	✓	✓	✓	✓		✓	✓	✓	✓	✓	✓	✓	✓	F	✓	✓	✓	F	✓	✓	✓	✓	
Distressing Technique	Distressing									✓ [†]					✓ [†]		✓ [†]	✓ [†]	✓ [†]		✓ [†]								

*Heirlooming not available on Caprice and Rennie.

▲Standard construction is not available in Black, Seaside, Seaside with Oasis, Storm Cherry, and Unfinished. An upgrade to All-plywood Construction, MIP, or MSLFB is required on these finishes.

†Distressing not available on Coconut, Dover, Icy Avalanche, or White.

Ⓢ Signed finish agreement required, see pages 365-368.

F: Available with Flooded Glaze Type only.

FINISH AVAILABILITY

		CHERRY																									
		Matching Laminate Ends [▲]	Heirloom [*] 	Matte Sheen	Amstead	Ashridge	Baxter	Bellmont	Butler	Caprice	Cotter	Dutton	Ellerby	Hardin	Herrington	Hurson	Justin	Kingston	Larsen	Lawton	Lynnvile	Northrope	Painter	Rennie	Warwick	Whitman	
Stains	Brierwood	✓			✓	✓	✓	✓	✓	✓	✓	✓	✓	✓	✓	✓	✓	✓	✓	✓	✓	✓	✓	✓	✓	✓	
	Buckskin	✓		✓	✓	✓	✓	✓	✓	✓	✓	✓	✓	✓	✓	✓	✓	✓	✓	✓	✓	✓	✓	✓	✓	✓	
	Cattail	✓		✓	✓	✓	✓	✓	✓	✓	✓	✓	✓	✓	✓	✓	✓	✓	✓	✓	✓	✓	✓	✓	✓	✓	
	Chocolate	✓		✓	✓	✓	✓	✓	✓	✓	✓	✓	✓	✓	✓	✓	✓	✓	✓	✓	✓	✓	✓	✓	✓	✓	
	Cranberry	✓		✓	✓	✓	✓	✓	✓	✓	✓	✓	✓	✓	✓	✓	✓	✓	✓	✓	✓	✓	✓	✓	✓	✓	
	Grizzly	✓		✓	✓	✓	✓	✓	✓	✓	✓	✓	✓	✓	✓	✓	✓	✓	✓	✓	✓	✓	✓	✓	✓	✓	
	Havana	✓		✓	✓	✓	✓	✓	✓	✓	✓	✓	✓	✓	✓	✓	✓	✓	✓	✓	✓	✓	✓	✓	✓	✓	
	Henna	✓		✓	✓	✓	✓	✓	✓	✓	✓	✓	✓	✓	✓	✓	✓	✓	✓	✓	✓	✓	✓	✓	✓	✓	✓
	Kodiak	✓		✓	✓	✓	✓	✓	✓	✓	✓	✓	✓	✓	✓	✓	✓	✓	✓	✓	✓	✓	✓	✓	✓	✓	✓
	Light	✓		✓	✓	✓	✓	✓	✓	✓	✓	✓	✓	✓	✓	✓	✓	✓	✓	✓	✓	✓	✓	✓	✓	✓	✓
	Morel	✓		✓	✓	✓	✓	✓	✓	✓	✓	✓	✓	✓	✓	✓	✓	✓	✓	✓	✓	✓	✓	✓	✓	✓	✓
	Natural	✓		✓	✓	✓	✓	✓	✓	✓	✓	✓	✓	✓	✓	✓	✓	✓	✓	✓	✓	✓	✓	✓	✓	✓	✓
	Sahara	✓		✓	✓	✓	✓	✓	✓	✓	✓	✓	✓	✓	✓	✓	✓	✓	✓	✓	✓	✓	✓	✓	✓	✓	✓
	Seal	✓		✓	✓	✓	✓	✓	✓	✓	✓	✓	✓	✓	✓	✓	✓	✓	✓	✓	✓	✓	✓	✓	✓	✓	✓
	Storm		✓	✓	✓	✓	✓	✓	✓	✓	✓	✓	✓	✓	✓	✓	✓	✓	✓	✓	✓	✓	✓	✓	✓	✓	✓
	Thatch	✓		✓	✓	✓	✓	✓	✓	✓	✓	✓	✓	✓	✓	✓	✓	✓	✓	✓	✓	✓	✓	✓	✓	✓	✓
	Tundra	✓		✓	✓	✓	✓	✓	✓	✓	✓	✓	✓	✓	✓	✓	✓	✓	✓	✓	✓	✓	✓	✓	✓	✓	✓
Unfinished	✓			✓	✓	✓	✓	✓	✓	✓	✓	✓	✓	✓	✓	✓	✓	✓	✓	✓	✓	✓	✓	✓	✓	✓	
Stains with Flooded Glazes	Black Forest	✓		✓	✓	✓	✓	✓	✓		✓	✓	✓	✓	✓	✓	✓	✓	✓	✓	✓	✓	✓	✓	✓	✓	
	Coffee	✓		✓	✓	✓	✓	✓	✓		✓	✓	✓	✓	✓	✓	✓	✓	✓	✓	✓	✓	✓	✓	✓	✓	
	Palomino	✓		✓	✓	✓	✓	✓	✓		✓	✓	✓	✓	✓	✓	✓	✓	✓	✓	✓	✓	✓	✓	✓	✓	
	Whiskey Black	✓		✓	✓	✓	✓	✓	✓		✓	✓	✓	✓	✓	✓	✓	✓	✓	✓	✓	✓	✓	✓	✓	✓	
Stains with Penned Glazes	Cattail w/Whiskey Black	✓		✓		✓	✓	✓	✓		✓	✓	✓	✓	✓	✓		✓	✓	✓		✓	✓	✓	✓	✓	
	Sahara w/Palomino	✓		✓		✓	✓	✓	✓		✓	✓	✓	✓	✓	✓		✓	✓	✓		✓	✓	✓	✓	✓	
	Tundra w/Black Forest	✓		✓		✓	✓	✓	✓		✓	✓	✓	✓	✓	✓		✓	✓	✓		✓	✓	✓	✓	✓	
Distressing Technique	Distressing						✓						✓	✓	✓			✓									



*Heirloom not available on Caprice and Rennie.

▲Standard construction is not available in Black, Seaside, Seaside with Oasis, Storm Cherry, and Unfinished. An upgrade to All-plywood Construction, MIP, or MSLFB is required on these finishes.

 Signed finish agreement required, see pages 365-368.



Cherry laminate sides are intentionally 15-20% darker at the time of manufacture to compensate for the expected darkening of doors, drawer fronts, and other finished wood products as they are exposed to natural sunlight.

FINISH AVAILABILITY

					ALDER						RUSTIC ALDER 								
		Matching Laminate Ends [▲]	Heirlooming 	Matte Sheen	Gallatin	Hurson	Kingston	Larsen	Lawton	Northrope	Whitman	Gallatin	Hurson	Larsen	Lawton	Northrope	Whitman		
Stains	Brierwood	✓		✓	✓	✓	✓	✓	✓	✓	✓	✓	✓	✓	✓	✓	✓	✓	
	Buckskin	✓		✓	✓	✓	✓	✓	✓	✓	✓	✓	✓	✓	✓	✓	✓	✓	
	Cattail	✓		✓	✓	✓	✓	✓	✓	✓	✓	✓	✓	✓	✓	✓	✓	✓	
	Chocolate	✓		✓	✓	✓	✓	✓	✓	✓	✓	✓	✓	✓	✓	✓	✓	✓	
	Cranberry	✓		✓	✓	✓	✓	✓	✓	✓	✓	✓	✓	✓	✓	✓	✓	✓	
	Grizzly	✓		✓	✓	✓	✓	✓	✓	✓	✓	✓	✓	✓	✓	✓	✓	✓	✓
	Havana	✓		✓	✓	✓	✓	✓	✓	✓	✓	✓	✓	✓	✓	✓	✓	✓	✓
	Kodiak	✓		✓	✓	✓	✓	✓	✓	✓	✓	✓	✓	✓	✓	✓	✓	✓	✓
	Morel	✓		✓	✓	✓	✓	✓	✓	✓	✓	✓	✓	✓	✓	✓	✓	✓	✓
	Natural	✓		✓	✓	✓	✓	✓	✓	✓	✓	✓	✓	✓	✓	✓	✓	✓	✓
	Sahara	✓		✓	✓	✓	✓	✓	✓	✓	✓	✓	✓	✓	✓	✓	✓	✓	✓
	Seal	✓		✓	✓	✓	✓	✓	✓	✓	✓	✓	✓	✓	✓	✓	✓	✓	✓
	Thatch	✓		✓	✓	✓	✓	✓	✓	✓	✓	✓	✓	✓	✓	✓	✓	✓	✓
	Tundra	✓		✓	✓	✓	✓	✓	✓	✓	✓	✓	✓	✓	✓	✓	✓	✓	✓
	Unfinished	✓			✓	✓	✓	✓	✓	✓	✓	✓	✓	✓	✓	✓	✓	✓	✓
Stains with Flooded Glazes	Black Forest	✓		✓	✓	✓	✓	✓	✓	✓	✓	✓	✓	✓	✓	✓	✓	✓	
	Coffee	✓		✓	✓	✓	✓	✓	✓	✓	✓	✓	✓	✓	✓	✓	✓	✓	
	Palomino	✓		✓	✓	✓	✓	✓	✓	✓	✓	✓	✓	✓	✓	✓	✓	✓	
	Whiskey Black	✓		✓	✓	✓	✓	✓	✓	✓	✓	✓	✓	✓	✓	✓	✓	✓	
Distressing Technique	Distressing				✓		✓					✓							

[▲]Standard construction is not available in Black, Seaside, Seaside with Oasis, Storm Cherry, and Unfinished. An upgrade to All-plywood Construction, MIP, or MSLFB is required on these finishes.
 Signed finish agreement required, see pages 365-368.

FINISH AVAILABILITY

					HICKORY				RUSTIC HICKORY 					OAK					
		Matching Laminate Ends [▲]	Heirloom [*] 	Matte Sheen	Ellerby	Hurson	Painter	Whitman	Gallatin	Hurson	Larsen	Lawton	Northrope	Whitman	Ellerby	Hurson	Larsen	Northrope	Painter
Stains	Brierwood	✓		✓	✓	✓	✓	✓	✓	✓	✓	✓	✓	✓	✓	✓	✓	✓	✓
	Buckskin	✓		✓	✓	✓	✓	✓	✓	✓	✓	✓	✓	✓	✓	✓	✓	✓	✓
	Chocolate	✓		✓											✓	✓	✓	✓	✓
	Grizzly	✓		✓	✓	✓	✓	✓	✓	✓	✓	✓	✓	✓	✓	✓	✓	✓	✓
	Havana	✓		✓	✓	✓	✓	✓	✓	✓	✓	✓	✓	✓	✓	✓	✓	✓	✓
	Kodiak	✓		✓	✓	✓	✓	✓	✓	✓	✓	✓	✓	✓	✓	✓	✓	✓	✓
	Light	✓		✓	✓	✓	✓	✓	✓	✓	✓	✓	✓	✓	✓	✓	✓	✓	✓
	Morel	✓		✓	✓	✓	✓	✓	✓	✓	✓	✓	✓	✓	✓	✓	✓	✓	✓
	Natural	✓		✓	✓	✓	✓	✓	✓	✓	✓	✓	✓	✓	✓	✓	✓	✓	✓
	Sahara	✓		✓	✓	✓	✓	✓	✓	✓	✓	✓	✓	✓	✓	✓	✓	✓	✓
	Seal	✓		✓	✓	✓	✓	✓	✓	✓	✓	✓	✓	✓	✓	✓	✓	✓	✓
	Thatch	✓		✓	✓	✓	✓	✓	✓	✓	✓	✓	✓	✓	✓	✓	✓	✓	✓
	Tundra	✓		✓	✓	✓	✓	✓	✓	✓	✓	✓	✓	✓	✓	✓	✓	✓	✓
Unfinished	✓			✓	✓	✓	✓	✓	✓	✓	✓	✓	✓	✓	✓	✓	✓	✓	
Stains with Flooded Glazes	Black Forest	✓		✓											✓	✓	✓	✓	✓
	Coffee	✓		✓	✓	✓	✓	✓	✓	✓	✓	✓	✓	✓					
	Palomino	✓		✓											✓	✓	✓	✓	✓
Paints	Black 		✓											✓	✓	✓	✓	✓	
Distressing Technique	Distressing				✓				✓						✓				

*Available on Oak only.

▲Standard construction is not available in Black, Seaside, Seaside with Oasis, Storm Cherry, and Unfinished. An upgrade to All-plywood Construction, MIP, or MSLFB is required on these finishes.

 Signed finish agreement required, see pages 365-368.

FINISH AVAILABILITY

DOOR COLOR AVAILABILITY		MELAMINE		SPECIALTY LAMINATES			THERMOFOIL
		Genova	Taro	Genova	Taro	Troxel	Vaille
Non-Textured	Antler			✓			
	Squall	✓					
	White		✓				✓
Textured	Arctic					✓	
	Elk			✓			
	Obsidian					✓	
	Wharf			✓			
High Gloss	White w/Matching Edgebanding				✓		
	White w/Metallic Edgebanding				✓		

CABINET COLOR AVAILABILITY		Matching Laminate Ends [▲]	DOOR COLOR AVAILABILITY							
			Antler	Arctic	Elk	High Gloss White	Obsidian	Squall	Wharf	White
Stains	Morel Cherry	✓	✓							
	Morel Hickory	✓	✓							
	Morel Maple	✓	✓							
	Morel Oak	✓	✓							
	Seal Hickory	✓		✓						
	Seal Maple	✓		✓						
	Seal Oak	✓		✓						
	Storm Maple	✓				✓				
	Thatch Hickory	✓		✓						
	Thatch Maple	✓		✓						
	Thatch Oak	✓		✓						
Paints	Black					✓				
	Cloud	✓	✓	✓			✓			
	Coconut	✓					✓			
	Dover	✓	✓	✓			✓	✓		
	Icy Avalanche	✓		✓			✓			
	Lambswool	✓	✓					✓		
	Limestone	✓	✓					✓		
	White	✓	✓	✓		✓	✓	✓	✓	✓

[▲]Standard construction is not available in Black, Seaside, Seaside with Oasis, Storm Cherry, and Unfinished. An upgrade to All-plywood Construction, MIP, or MSLFB is required on these finishes.

THINGS TO REMEMBER ABOUT FINISHED ENDS AND CABINET INTERIOR FINISHES

On cabinets with ALL-PLYWOOD CONSTRUCTION (APC) modifications, cabinet sides are plywood with an unfinished veneer exterior. You can finish the exposed ends in your kitchen with one of several decorative options, as follows:

1. Leave the ends UNFINISHED if the cabinets are installed against each other or against the wall.
2. Specify cabinets with FINISHED ENDS (FB), factory installed. Both ends of the cabinet use 5/8" plywood veneer panel that is factory finished on the exterior to match the door and frame.
3. Specify Matching Specialty Laminate Furniture Board (MSLFB) for door matching specialty laminate furniture board exterior and interior (including shelves). See page 38 for details.
4. Order Panel Doors (PD) to cover matching laminate ends or veneer finished ends for a field installed, decorative furniture look. See pages 302-303 for details.
5. Order a 3/4" finished panel to be field applied to the cabinet side.
6. Purchase a Wall MESSAGE CENTER.
7. Cabinets specified with MIP have matching veneer interior and exterior.

CONSTRUCTION FEATURES	
Drawer Box and Roll Tray Construction	Four-sided clear coated hardwood. Corners are dovetailed and glued. Drawer bottom is 5.2mm laminated plywood fully captured in box sides, front and back.
Drawer and Roll Tray Guide	Double fully concealed, ball bearing, self-aligning, full extension guide with Smart Stop™ self-closing mechanism and fast clip removal system. Smart Stop engages when the drawer or roll tray is approximately 2" from closing, applying resistance to the self-closing mechanism. All guides have a maximum weight capacity of 90 lbs. Drawers and roll trays have a maximum weight capacity of 15 lbs. per square foot.
Hinges	Smart Stop™ self closing feature, fully concealed integrated cup hinge with Quick Release™ feature for easy removal; 6-way adjustable. Hinge features deactivation option. Some cabinets utilize specialized hinges. See page 354 for details.
Stretcher Rails	Front and rear full width stretcher rails doweled into end panels provide solid support and mounting surface for countertops.
Toekick	Unfinished toekick to allow application of finished toeboard materials. A variety of laminate and wood toeboard skins and baseboard mouldings available in 8' lengths; see ACCESSORIES section.
Plywood	All-plywood components meet ANSI/HPVA HP-1 standards and may contain MDF or particleboard.
Warranty	Kemper Full Access has a Limited Lifetime Warranty. For terms and conditions, please visit: https://www.kempercabinets.com/warranty .

CABINET CONSTRUCTION

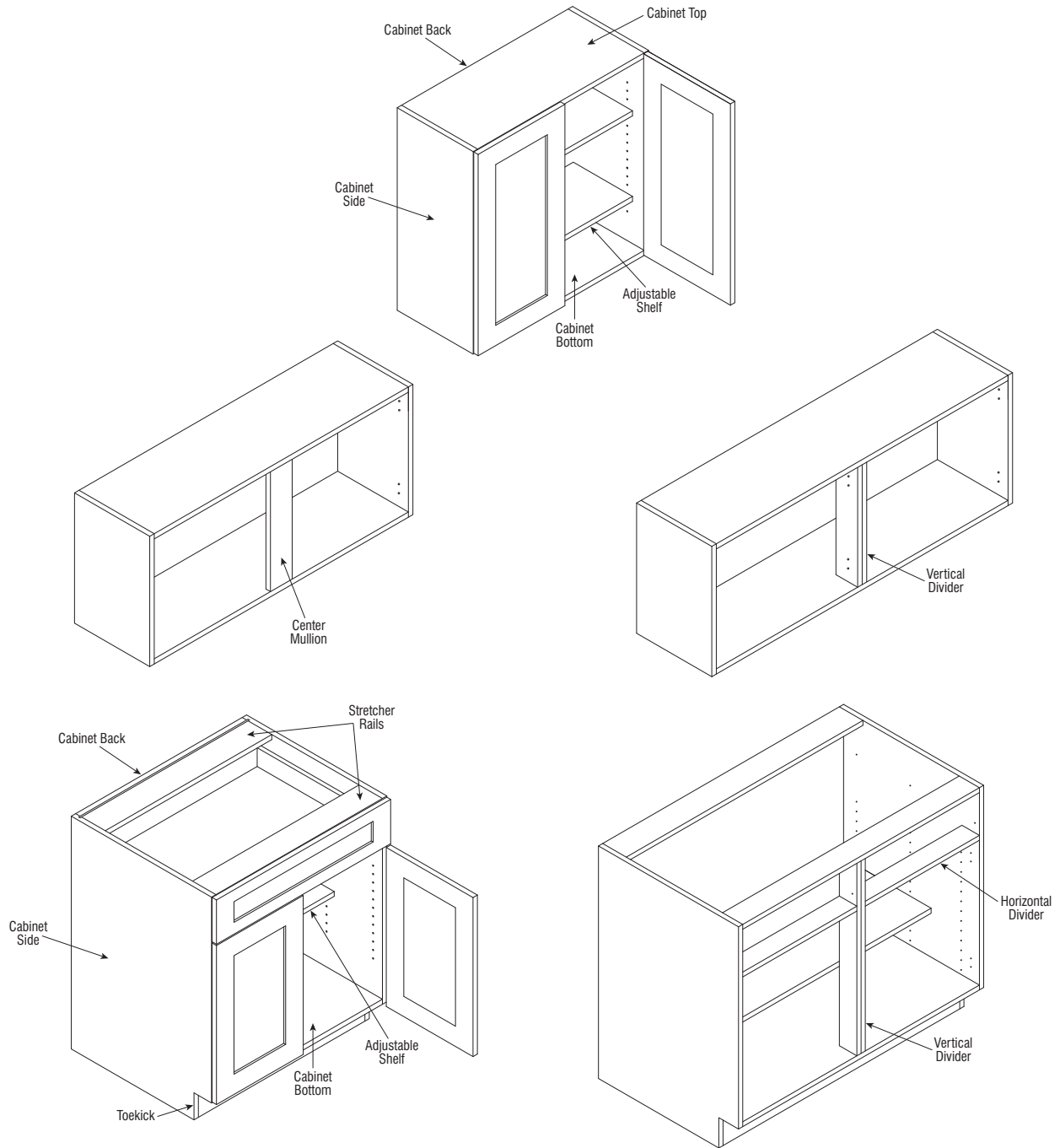

CABINET CONSTRUCTION		
	STANDARD CONSTRUCTION (KFS)*	ALL-PLYWOOD CONSTRUCTION (KFA)*†
Cabinet Bottom and Top (Wall)	5/8" thick furniture board – Natural maple laminate interior – Natural maple laminate exterior	5/8" thick plywood – Clear coated wood veneer interior – Clear coated wood veneer exterior
Cabinet Bottom (Base/Tall) and Top (Tall)	5/8" thick furniture board – Natural maple laminate interior – Unfinished exterior	5/8" thick plywood – Clear coated wood veneer interior – Unfinished veneer exterior
Stretcher Rails	5/8" thick furniture board – Natural maple laminate interior – Unfinished exterior	5/8" thick plywood – Clear coated wood veneer interior – Unfinished veneer exterior
Cabinet Sides	5/8" thick furniture board – Natural maple laminate interior – Matching laminate exterior	5/8" thick plywood – Clear coated wood veneer interior – Unfinished veneer exterior – Finished Both (FB) - Cabinet box matching finished veneer exterior (see page 38)
Cabinet Back	5/8" thick furniture board – Natural maple laminate interior – Unfinished exterior	5/8" thick plywood – Clear coated wood veneer interior – Unfinished veneer exterior
Adjustable Shelf	3/4" thick furniture board – Natural maple laminate with PVC edgebanding	3/4" thick plywood – Clear coated wood veneer with clear coated veneer edgebanding
Center Mullion	5/8" thick furniture board All Styles except Taro, Troxel, and Genova: – Natural maple laminate interior – Matching laminate exterior Troxel and Genova: – Door matching interior – Door matching exterior Taro High Gloss: – White interior (not high gloss) – Door matching exterior	5/8" thick All Styles except Taro, Troxel, and Genova (plywood): – Clear coated wood veneer interior – Cabinet box matching finished veneer exterior Troxel and Genova (furniture board): – Door matching interior (not plywood) – Door matching exterior (not plywood) Taro High Gloss (furniture board): – White interior (not high gloss, not plywood) – Door matching exterior (not plywood)
Horizontal Dividers	5/8" thick furniture board – Natural maple laminate	5/8" thick plywood – Clear coated wood veneer
Vertical Dividers	5/8" thick furniture board (2-piece) – Natural maple laminate	5/8" thick plywood (2-piece) – Clear coated wood veneer
Toe kick	5/8" thick furniture board – Unfinished (requires field applied Toeboard moulding)	5/8" thick plywood – Unfinished (requires field applied Toeboard moulding)
Edgebanding	On Cabinet Face of End Panels, Tops, Bottoms, Fixed Shelves, and Horizontal and Vertical Dividers: – Complementary door matching PVC**	On Cabinet Face of End Panels, Tops, Bottoms, Fixed Shelves, and Horizontal and Vertical Dividers: – Complementary door matching PVC**
	On End Panel Tops and Bottoms (Wall): – Complementary door matching PVC**	On End Panel Tops and Bottoms (Wall): – Complementary door matching PVC**
	On Center Mullion: – Complementary door matching PVC**	On Center Mullion: – Complementary door matching PVC**
	*Standard construction is not available in Black, Seaside, Seaside with Oasis, Storm Cherry, and Unfinished. An upgrade to All-plywood Construction, MIP, or MSLFB is required on these finishes. **Taro High Gloss PVC edgebanding is White High Gloss, Metallic High Gloss not available on cabinet box components.	*All-plywood components meet ANSI/HPVA HP-1 standards and may contain MDF or particleboard. **Taro High Gloss PVC edgebanding is White High Gloss, Metallic High Gloss not available on cabinet box components. †Order acknowledgment will list APC as KFA.

CABINET CONSTRUCTION

	MATCHING INTERIOR PLYWOOD (MIP)*	WHITE LAMINATE INTERIOR (WLI)*
Cabinet Bottom and Top (Wall)	5/8" thick plywood – Matching finished veneer interior – Matching finished veneer exterior	5/8" thick plywood – White laminate interior – White laminate exterior
Cabinet Bottom (Base/Tall) and Top (Tall)	5/8" thick plywood – Matching finished veneer interior – Unfinished veneer exterior	5/8" thick plywood – White laminate interior – Unfinished veneer exterior
Stretcher Rails	5/8" thick plywood – Matching finished veneer interior – Unfinished veneer exterior	5/8" thick plywood – White laminate interior – Unfinished veneer exterior
Cabinet Sides	5/8" thick plywood – Matching finished veneer interior – Matching finished veneer exterior	5/8" thick plywood – White laminate interior – Unfinished veneer exterior – Finished Both (FB) - Cabinet box matching finished veneer exterior (see page 38)
Cabinet Back	5/8" thick plywood – Matching finished veneer interior – Unfinished veneer exterior	5/8" thick plywood – White laminate interior – Unfinished veneer exterior
Adjustable Shelf	3/4" thick plywood, full depth – Matching finished veneer with matching finished veneer edgbanding	3/4" thick plywood – White with white PVC edgbanding
Center Mullion	5/8" thick All Styles except Taro, Troxel, and Genova (plywood): – Matching finished veneer interior – Matching finished veneer exterior Troxel and Genova (furniture board): – Door matching interior (not plywood) – Door matching exterior (not plywood) Taro High Gloss: – White interior (not high gloss, not plywood) – Door matching exterior (not plywood)	5/8" thick All Styles except Taro (plywood): – White laminate interior – White laminate exterior Taro High Gloss (not plywood): – White interior (not high gloss) – Door matching exterior
Horizontal Dividers	5/8" thick plywood – Matching finished veneer	5/8" thick plywood – White laminate
Vertical Dividers	5/8" thick plywood (2-piece) – Matching finished veneer	5/8" thick plywood (2-piece) – White laminate
Toekick	5/8" thick plywood – Unfinished (requires field applied Toeboard moulding)	5/8" thick plywood – Unfinished (requires field applied Toeboard moulding)
Edgbanding	On Cabinet Face of End Panels, Tops, Bottoms, Fixed Shelves, and Horizontal and Vertical Dividers: All styles except Taro High Gloss, Troxel, and Genova: – Matching finished veneer Taro High Gloss, Troxel, and Genova: – Complementary door matching PVC**	On Cabinet Face of End Panels, Tops, Bottoms, Fixed Shelves, and Horizontal and Vertical Dividers: – Complementary door matching PVC**
	On End Panel Tops and Bottoms (Wall): – Matching finished veneer	On End Panel Tops and Bottoms (Wall): – White PVC
	On Center Mullion: All styles except Taro High Gloss, Troxel, and Genova: – Matching finished veneer Taro High Gloss, Troxel, and Genova: – Complementary door matching PVC**	On Center Mullion: – Complementary door matching PVC**
	*All-plywood components meet ANSI/HPVA HP-1 standards and may contain MDF or particleboard. **Taro High Gloss PVC edgbanding is White High Gloss, Metallic High Gloss not available on cabinet box components.	*Only available on cabinets in White (painted Maple, Laminate, or Melamine) that are specified with APC. All-plywood components meet ANSI/HPVA HP-1 standards and may contain MDF or particleboard. **Taro High Gloss PVC edgbanding is White High Gloss, Metallic High Gloss not available on cabinet box components.

CABINET CONSTRUCTION		
MATCHING SPECIALTY LAMINATE FURNITURE BOARD (MSLFB)		
	Taro High Gloss*	Genova and Troxel
Cabinet Bottom and Top (Wall)	5/8" thick furniture board – White interior (not high gloss) – Door matching exterior	5/8" thick furniture board – Door matching interior, side-to-side grain direction – Door matching exterior, side-to-side grain direction
Cabinet Bottom (Base/Tall) and Top (Tall)	5/8" thick furniture board – White interior (not high gloss) – White exterior	5/8" thick furniture board – Door matching interior, side-to-side grain direction – Door matching exterior, side-to-side grain direction
Stretcher Rails	5/8" thick furniture board – White interior (not high gloss) – White exterior	5/8" thick furniture board – Door matching interior, side-to-side grain direction – Door matching exterior, side-to-side grain direction
Cabinet Sides	5/8" thick furniture board – White interior (not high gloss) – Door matching exterior	5/8" thick furniture board – Door matching interior, vertical grain direction – Door matching exterior, vertical grain direction
Cabinet Back	5/8" thick furniture board – White interior (not high gloss) – White exterior	5/8" thick furniture board – Door matching interior, vertical grain direction – Door matching exterior, vertical grain direction
Adjustable Shelf	3/4" thick furniture board, full depth – White with white PVC edgebanding (not high gloss)	3/4" thick furniture board, full depth – Door matching with side-to-side grain direction and matching PVC edgebanding
Center Mullion	5/8" thick furniture board – White interior (not high gloss) – Door matching exterior	5/8" thick furniture board – Door matching interior, vertical grain direction – Door matching exterior, vertical grain direction
Horizontal Dividers	5/8" thick furniture board – White (not high gloss)	5/8" thick furniture board – Door matching
Vertical Dividers	5/8" thick furniture board (2-piece) – White (not high gloss)	5/8" thick furniture board (2-piece) – Door matching
Toekick	5/8" thick furniture board – Unfinished (requires field applied Toeboard moulding)	5/8" thick furniture board – Unfinished (requires field applied Toeboard moulding)
Edgebanding	On Cabinet Face of End Panels, Tops, Bottoms, Fixed Shelves, and Horizontal and Vertical Dividers: – White high gloss	On Cabinet Face of End Panels, Tops, Bottoms, Fixed Shelves, and Horizontal and Vertical Dividers: – Complementary door matching PVC
	On End Panel Tops and Bottoms (Wall): – White high gloss	On End Panel Tops and Bottoms (Wall): – Complementary door matching PVC
	On Center Mullion: – White high gloss	On Center Mullion: – Complementary door matching PVC
	*Taro High Gloss PVC edgebanding is White High Gloss, Metallic High Gloss not available on cabinet box components.	

CONSTRUCTION AND FINISH UPGRADES

See page 37 for modification compatibility. Requests for non-published modifications may be treated as a Special Sales Order which will require feasibility, leadtime review and approval. Please check with your customer service representative before placing your order.

OPTION NAME	APPLICABLE CABINET GROUP	DESCRIPTION/LIMITATIONS
All-plywood Construction (APC)*	Most cabinets with sides	Replaces standard cabinet construction with plywood for 5/8" ends, top, bottom, and back, and 3/4" shelves. Exterior of cabinet ends are unfinished. Cabinet interior and exterior of top and bottom are clear coated wood veneer. See page 34 for more details. White Laminate Interior (WLI) modification available on White cabinets (painted White, Melamine, or Laminate) in APC.
	Selected trim panels	Replaces standard panel material with plywood. Exterior side is finished. Interior side is clear coated wood veneer.
Finished Ends (FB)	Cabinets with APC modification; both ends will be finished	Creates matching finished 5/8" veneer plywood exterior end panels.
Matching Interior Plywood (MIP)	Most cabinets	Finishes the interior and exterior of the cabinet. Cabinet construction features All-plywood Construction* with 5/8" plywood ends, top, bottom, and back. Shelves are upgraded to full depth 3/4" veneered plywood. See page 35 for more details. Interior wood accessories feature a natural finish and will not match cabinet exterior. When a decorative door option is chosen in 20/20, Matching Interior Plywood (MIP) is a preselected option. If MIP is not desired, it can be deselected by choosing NOTMIP.
	Most end panels with fillers attached	Replaces standard panel material with veneer plywood finished on both sides.
White Laminate Interior (WLI)	White cabinets with APC	Replaces clear coated wood veneer plywood interior with White laminate plywood interior. Only available on cabinets in White (painted Maple, Laminate, or Melamine) that are specified with APC. See page 35 for more details. WLI only affects the cabinet box interior and shelves, interior accessories will not change.
Matching Specialty Laminate Furniture Board (MSLFB)	Most cabinets	Replaces standard laminate cabinet components with door matching specialty laminate furniture board cabinet components. Both the exterior and interior (including shelves) of the cabinet will be constructed with a door matching specialty laminate and have matching edgebanding. Shelves are upgraded to full depth. See page 36 for more details. Available on Taro High Gloss White, Troxel, and Genova. Interior wood accessories feature a natural finish and will not have specialty laminate.

*All-plywood components meet ANSI/HPVA HP-1 standards and may contain MDF or particleboard.

DRAWER FRONT UPGRADES

See page 37 for modification compatibility. Requests for non-published modifications may be treated as a Special Sales Order which will require feasibility, leadtime review and approval. Please check with your customer service representative before placing your order.

OPTION NAME	APPLICABLE CABINET GROUP	DESCRIPTION/LIMITATIONS
Drawer Front Flat 5-piece (DFF5PC)	Base, tall, and vanity cabinets on Hurson, Kingston, Larsen, Lawton, Lynnville, Northrope, and Rennie	Replaces the standard drawer front with a 5-piece drawer front (see images with applicable door styles). Must upgrade all drawer fronts on a cabinet where applicable. See page 70 for 5-piece drawer front dimensions when specifying decorative hardware.
Drawer Front Raised 5-piece (DFR5PC)	Base, tall, and vanity cabinets on Gallatin and Herrington	Replaces the standard drawer front with a 5-piece drawer front (see images with applicable door styles). Must upgrade all drawer fronts on a cabinet where applicable. See page 70 for 5-piece drawer front dimensions when specifying decorative hardware.
Drawer Front Slab (DFS LB)	Base, tall, and vanity cabinets on Amstead, Butler, Cotter, Darby, Hardin, Justin, and Whitman	Replaces standard drawer front with slab drawer front. Must upgrade all drawer fronts on cabinet where applicable.

DRAWER FRONT FLAT 5-PIECE (DFF5PC)

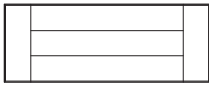

Hurson

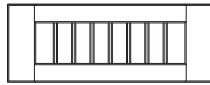

Lynnville

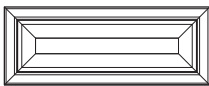

Kingston*



Northrope

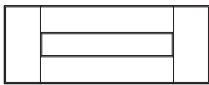

Larsen

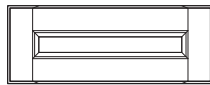

Rennie

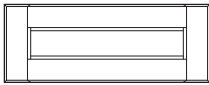

Lawton

*Kingston 5-piece drawer fronts less than 10" high have a flat center panel, drawer fronts 10" high and taller have a raised center panel.

DRAWER FRONT RAISED 5-PIECE (DFR5PC)

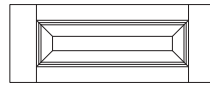

Gallatin



Herrington

DRAWER FRONT SLAB (DFS LB)



Amstead
Butler
Cotter



Justin

DRAWER AND DOOR OPTIONS

See page 37 for modification compatibility. Requests for non-published modifications may be treated as a Special Sales Order which will require feasibility, leadtime review and approval. Please check with your customer service representative before placing your order.

OPTION NAME	APPLICABLE CABINET GROUP	DESCRIPTION/LIMITATIONS
Door Panel - Solid Reverse Raised (DPSRR)	Most cabinets; available on Whitman only.	Replaces Whitman veneer flat door center panel with a solid reverse raised center panel. Drawer fronts are not affected by this door option. Center panels in Paint and Paint with Glaze finishes will be reverse raised MDF.
Scooped Drawer (SCPDRW) (SCPDRWB) (SCPDRWL) (SCPDRWR)	Most base cabinets	Replaces top drawer box with a scooped 2" high drawer box to allow for clearance of cooktops, etc. Only top drawer will be modified when specified on drawer bases. On base cabinets with two top drawers, L, R, or B must be specified. Increases clearance for cooktops from 2 1/8" to 3 1/2". Drawer box features a scooped design transitioning from 3 3/8" to 2" high at 2 5/8" deep. When SCPDRW is selected on 2DB18-2DB42, top drawer will utilize a 6 3/8" high drawer box, clearance for the cooktop of 6 3/4" from the top of drawer box to the cross rail, and 7 1/2" to the cabinet top.

DOOR PANEL - SOLID REVERSE RAISED (DPSRR)

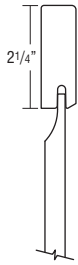

Available only on Whitman.

SCOOPED DRAWER (SCPDRW/SCPDRWB/SCPDRWL/SCPDRWR)

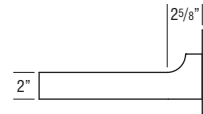

BOX MODIFICATIONS

See page 37 for modification compatibility. Requests for non-published modifications may be treated as a Special Sales Order which will require feasibility, leadtime review and approval. Please check with your customer service representative before placing your order.

OPTION NAME	APPLICABLE CABINET GROUP	DESCRIPTION/LIMITATIONS
Cabinet Box Only (CBO)	Most wall, base, tall, and vanity cabinets	Removes doors, drawer fronts, and any accessory items attached to a door or drawer front. Drawer box and any interior components attached to the cabinet box will be included. Cabinet will have standard drilling for applicable hinges, shelves, and drawer guides. Case components such as dividers and mullions are included.
Cabinet Case Only (CCO)	Most wall, base, tall, and vanity cabinets	Removes doors, drawer fronts, drawer boxes, interior components, and mini touch-up kits. Cabinet will have standard drilling for applicable hinges, shelves, and drawer guides. Case components such as dividers and mullions are included.
Cabinet False Panel (CFP)	Most base and vanity cabinets with a top drawer	Replaces top drawer with false panel. Not available with deep drawers.
Cabinet with No Door, with Drawer (CND)	Most wall, base, tall, and vanity cabinets with door(s) and drawer(s)	Removes door(s). Complete drawer(s) with drawer front(s) and interior components remain in cabinet. Cabinet will have drilling for applicable shelves and drawer guides, but will not be drilled for hinges. Case components such as dividers and mullions are included.

CABINET BOX ONLY (CBO)

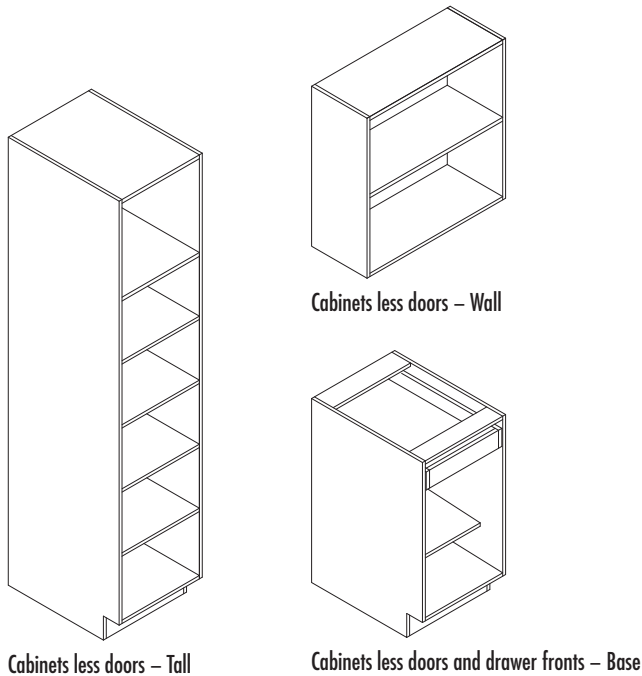

CABINET CASE ONLY (CCO)

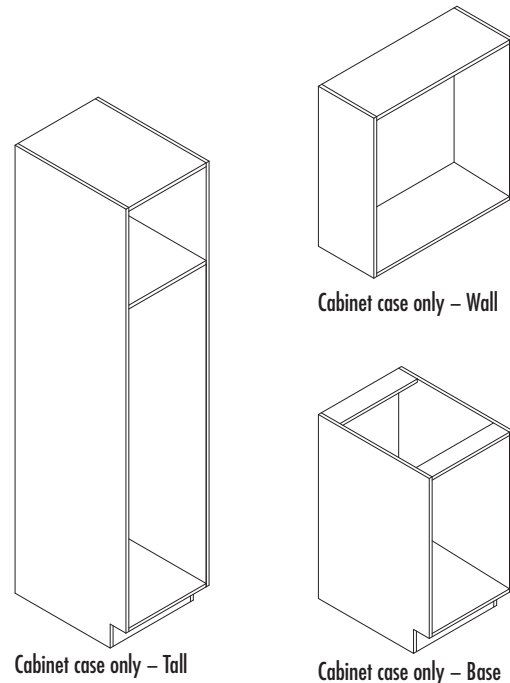

CABINET FALSE PANEL (CFP)

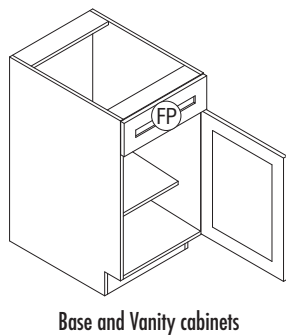

CABINET WITH NO DOOR, WITH DRAWER (CND)

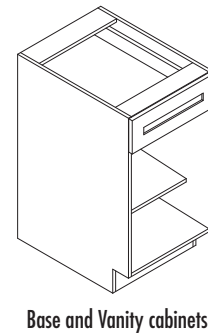

BOX MODIFICATIONS (cont'd)

See page 37 for modification compatibility. Requests for non-published modifications may be treated as a Special Sales Order which will require feasibility, leadtime review and approval. Please check with your customer service representative before placing your order.

OPTION NAME	APPLICABLE CABINET GROUP	DESCRIPTION/LIMITATIONS
Increased Depth (ID)	Most wall and vanity cabinets	Increases the depth of wall and vanity cabinets in 1" increments to a maximum depth of 24". Increased depth wall cabinets should be either floor mounted or stacked to maintain stability. Any specified shelving is included and is always full depth. Wall peninsula cabinets may be increased in 1" increments to 18" maximum. Depth restrictions may apply where depths are available as a standard cabinet.
	Most base, tall, and vanity cabinets without drawers or roll trays	Increases the depth of base, tall, and vanity cabinets without drawers or roll trays in 1" increments to 27". When depth beyond 24" is desired on tall cabinets, the 24" deep cabinet must be modified. Any specified shelving is included and is always full depth. Depth restrictions may apply where depths are available as a standard cabinet.
	Oven Cabinets	Increases the depth of oven cabinets in 1" increments to a maximum depth of 27". When oven cabinets with drawers are increased, drawer depth will not change. Any specified shelving is included and is always full depth.
	End panels	Increases the depth of end panels in 1" increments to a maximum depth of 36". 31"-36" depths available on plywood panels only. AEL/AER panels are only available in 3" increments up to a maximum depth of 36".
Reduced Depth (RD)	Most base, tall, and vanity cabinets with drawers or roll trays	Reduces the depth in 1" increments to a minimum depth of 12". Any specified shelving is included and is always full depth. The dimension is specified as the distance from the front of the face frame to the back of the cabinet.
	Most base, tall, and vanity cabinets without drawers or roll trays	Reduces the depth in 1" increments to a minimum depth of 6". If reduced depth to 8" or less, toekick will not be included. Any specified shelving is included and is always full depth. The dimension is specified as the distance from the front of the face frame to the back of the cabinet.
	Most wall cabinets	Reduces the depth in 1" increments to a minimum depth of 6". Any specified shelving is included and is always full depth. The dimension is specified as the distance from the front of the face frame to the back of the cabinet. Wall top hinge cabinets can only be reduced to 9" depth minimum.
	End panels	Reduces the depth in 1" increments to a minimum depth of 6".
	Roll tray kits	Reduces the depth in 1" increments to fit a minimum cabinet depth of 12".

Cabinet Depth	Drawer Box Depth	Clearance Behind Drawer Box
24	21	2 3/8
23	21	1 3/8
22	18	3 3/8
21	18	2 3/8
20	18	1 3/8
19	15	3 3/8
18	15	2 3/8
17	15	1 3/8
16	12	3 3/8
15	12	2 3/8
14	12	1 3/8
13	9	3 3/8
12	9	2 3/8

INCREASED DEPTH (ID)

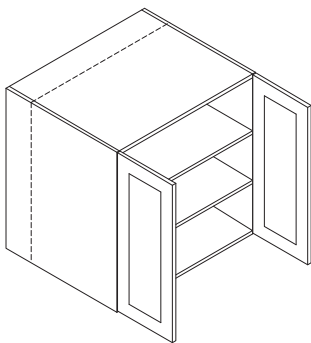

Wall cabinets

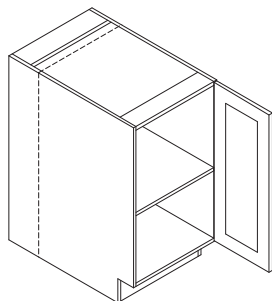

Base cabinets

REDUCED DEPTH (RD)

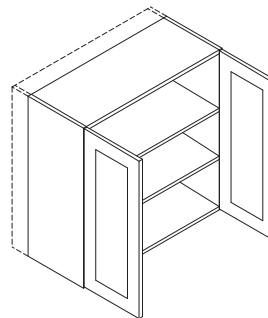

Wall cabinets

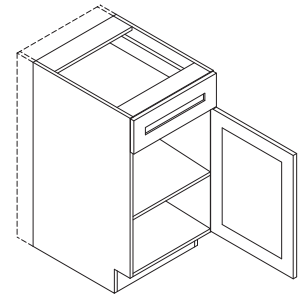

Base cabinets

BOX MODIFICATIONS (cont'd)

See page 37 for modification compatibility. Requests for non-published modifications may be treated as a Special Sales Order which will require feasibility, leadtime review and approval. Please check with your customer service representative before placing your order.

OPTION NAME	APPLICABLE CABINET GROUP	DESCRIPTION/LIMITATIONS
End Extended Back (EXBKL) (EXBKR)	Most cabinets	Extends cabinet end panel back in 1" increments, available up to 6" per side. End panel will match construction selection, can be upgraded to APC with Finished Ends if end is exposed. EXBKL and EXBKR are compatible with each other and can be specified with either the same dimension per side or unique dimensions if desired.
Inverted Opening (INVFRM)	Most cabinets with an upper and lower section Tall Panels with Filler Attached and Authentic Ends	Inverts upper and lower cabinet sections. Drawer openings relocated to the bottom of a base cabinet must always be a working drawer. Opening sizes for doors and drawer fronts do not change. On tall and stacked walls, when INVFRM is ordered in conjunction with CG (cut-for-glass), top and bottom locations should be specified after sections are inverted. Glass only available on doors for 41 7/8" high or less. Doors on inverted cabinets may not align with adjacent cabinet doors. On Tall Panels with Filler Attached and Authentic Ends, when INVFRM is selected, doors will be inverted to align with tall cabinets with the modification.

END EXTENDED BACK LEFT (EXBKL)

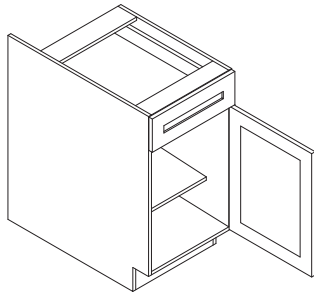

END EXTENDED BACK RIGHT (EXBKR)

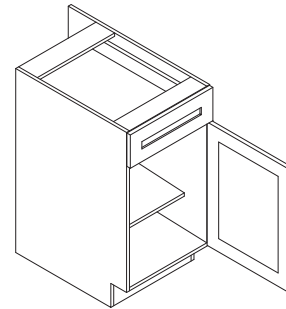

INVERTED OPENING (INVFRM)

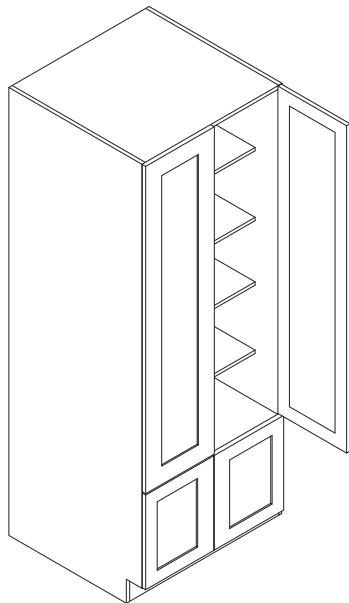

Tall cabinets

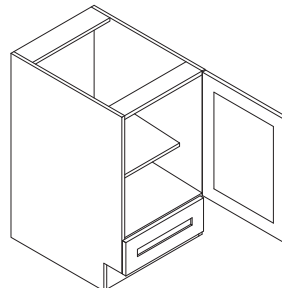

Base cabinets

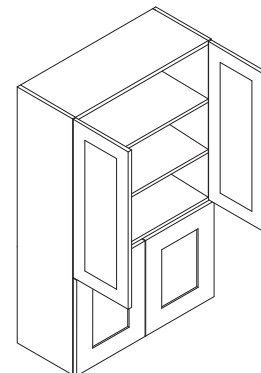

Wall cabinets

BOX MODIFICATIONS (cont'd)

See page 37 for modification compatibility. Requests for non-published modifications may be treated as a Special Sales Order which will require feasibility, leadtime review and approval. Please check with your customer service representative before placing your order.

OPTION NAME	APPLICABLE CABINET GROUP	DESCRIPTION/LIMITATIONS
Recessed Bottom (RECBTM) (RECBTMB) (RECBTML) (RECBTMR)	Most wall cabinets	<p>Creates a recessed bottom in the cabinet by moving the bottom panel and back up 1 9/16" to create a space for lighting or other under-cabinet accessories, such as a Tablet Holder (TABLETHLDR, see page 349).</p> <p>Door hinge location will not change. Door height will not change and will conceal the recessed bottom when the door is closed. Back of cabinet will also be 1 9/16" shorter to align with the cabinet bottom.</p> <p>For a stand-alone cabinet (RECBTM), the bottom and back are recessed 1 9/16" and both end panels are full height.</p> <p>For Left (RECBTML), the left end panel and back are 1 9/16" shorter to be flush with the recessed bottom.</p> <p>For Right (RECBTMR), the right end panel and back are 1 9/16" shorter to be flush with the recessed bottom.</p> <p>For Both (RECBTMB), both end panels and back are 1 9/16" shorter to be flush with the recessed bottom, door will be lower than both end panels, back, and bottom.</p> <p>If lighting is used under cabinet, Light Rail Moulding (LB2 or LB2P) is recommended to conceal lighting when door is opened. Moulding can be installed flush with end panels or recessed to allow clearance for doors. Mouldings and skins sold separately.</p> <p>On doors with rails less than 2 1/4" (Baxter and Lawton), when Mullion Doors or Cut-for-glass doors are used with transparent glass, the cabinet bottom may be visible when the door is closed.</p>
Valance Top Rail (TVRAV) (TVRFV) (TVRVV)	Base Open Cabinets, Bookcases, Wall Open Cabinets	<p>Modifies the cabinet top with an added arch, furniture, or straight valance. Cabinet top is reduced in depth behind the valance.</p> <p>All Styles except Genova, Taro High Gloss, and Troxel: Valance is matching finished veneer edgebanded plywood (horizontal grain).</p> <p>Genova: Valance is door matching (vertical grain), does not use plywood.</p> <p>Taro High Gloss: Valance is door matching high gloss, does not use plywood.</p> <p>Troxel: Valance is door matching (horizontal grain), does not use plywood.</p> <p>Valance on framed cabinets (Wall and Tall Bookcases) is solid wood with horizontal grain.</p>

RECESSED BOTTOM (RECBTM/RECBTMB/RECBTML/RECBTMR)

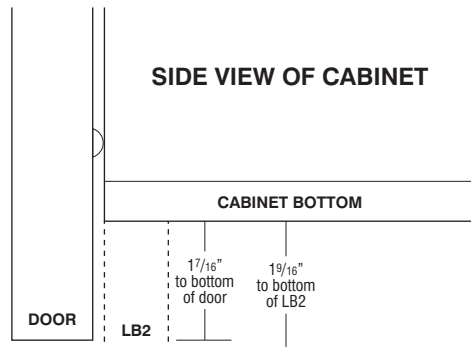
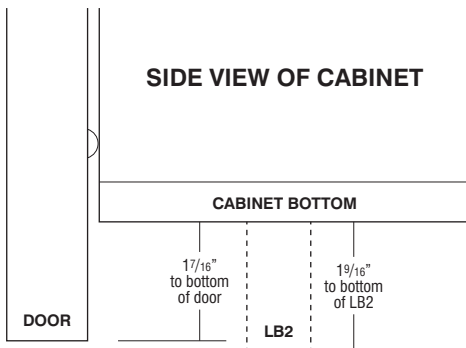

VALANCE TOP RAIL, ARCH (TVRAV)

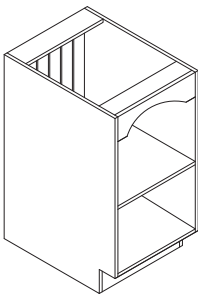

VALANCE TOP RAIL, FURNITURE (TVRFV)

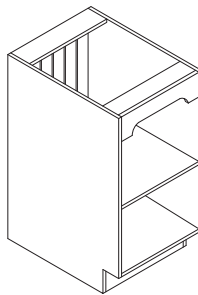

VALANCE TOP RAIL, STRAIGHT (TVRVV)

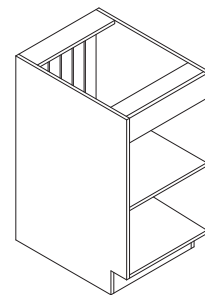

INSTALLED INTERIOR MODIFICATIONS

See page 37 for modification compatibility. Requests for non-published modifications may be treated as a Special Sales Order which will require feasibility, leadtime review and approval. Please check with your customer service representative before placing your order.

OPTION NAME	APPLICABLE CABINET GROUP	DESCRIPTION/LIMITATIONS
CabMat™ (CMAT1) (CMAT2)	Most sink base and vanity cabinets	Installs removable CabMat™, size is determined by cabinet opening width and depth. CMAT2 is only available on vanity cabinets designed for double bowl applications. Not available with Reduced Depth modification. When ordered with Increased Depth modification, CabMat™ size does not change. Vanity cabinets with cabinet openings of 24" and 30" will utilize CabMat™ sized for 21" and 27" openings.
Full Depth Shelf (FD)	Base cabinets with standard half depth shelves	Replaces standard shelf with full depth shelf. Available on cabinets up to 36" wide.

CABMAT™ (CMAT1/CMAT2)

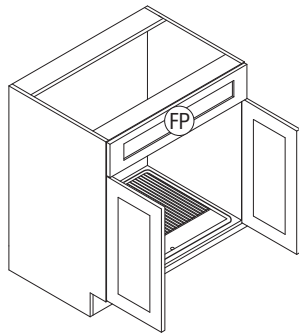

Base cabinets (CMAT1)

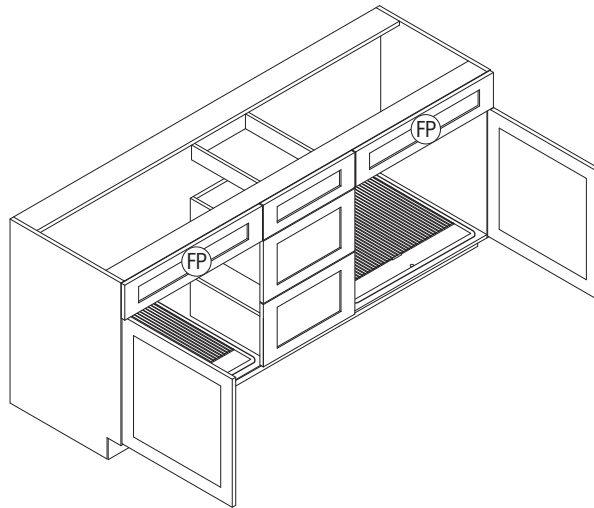

Vanity cabinets with double bowl (CMAT2)

FULL DEPTH SHELF (FD)

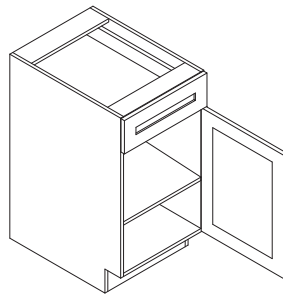

INSTALLED INTERIOR MODIFICATIONS (cont'd)

See page 37 for modification compatibility. Requests for non-published modifications may be treated as a Special Sales Order which will require feasibility, leadtime review and approval. Please check with your customer service representative before placing your order.

OPTION NAME	APPLICABLE CABINET GROUP	DESCRIPTION/LIMITATIONS
Deep Roll Tray (DRT)	Most cabinets with roll trays	Replaces standard roll trays with a 6 3/8" high deep roll tray. Replaces bottom roll tray only on base cabinets and bottom 2 roll trays on utility cabinets.
Installed Roll Tray (RT)	Select base, tall, office, and vanity cabinets	Installs specified number of roll trays (1-5). Example, for two roll trays, specify 2RT. When 1RT is specified on a base cabinet, the roll tray is installed in the lowest position and one half depth adjustable shelf is included. On utility cabinets for lower section, 1RT includes three shelves, 2RT includes two shelves, and 3RT includes 1 shelf. No shelves for lower section are included with 4RT or 5RT. See page 71 for RT positions and clearances.
Light Installed Battery Strip (LTI.BS) (LTI.BSB) (LTI.BSL) (LTI.BSR)	Select base, office, and vanity cabinets	Installs a battery operated LED light inside the cabinet door opening(s). LTI.BS installs one LED light inside the cabinet door opening. LTI.BSB installs two LED lights inside both left and right cabinet door openings. On corner cabinets, installs one LED light for the top section and one LED light below fixed shelf for bottom section. LTI.BSL installs one LED light in the left door opening. LTI.BSR installs one LED light in the right door opening. Battery operated - (4) AAA batteries (not included). Motion activated. Low power usage (0.3W). Plastic aluminum finish. Dimensions: Length 11.93" (303mm), Width 0.67" (17mm), and Depth 0.55" (14mm).

DEEP ROLL TRAY (DRT)

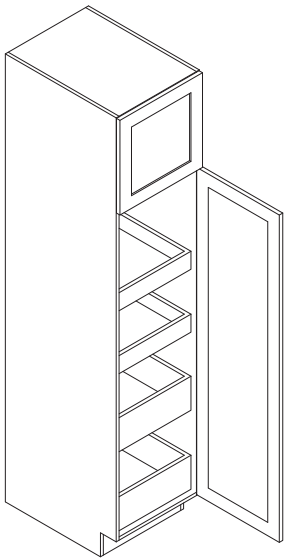

Tall cabinets

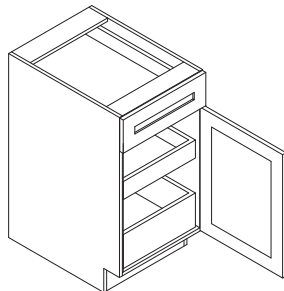

Base cabinets

INSTALLED ROLL TRAY (RT)

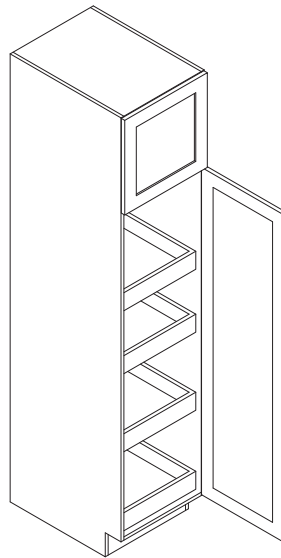

Tall cabinets

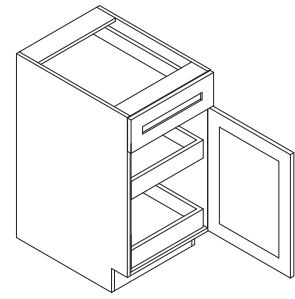

Base, Office, and Vanity cabinets

LIGHT INSTALLED BATTERY STRIP (LTI.BS/LTI.BSB/LTI.BSL/LTI.BSR)

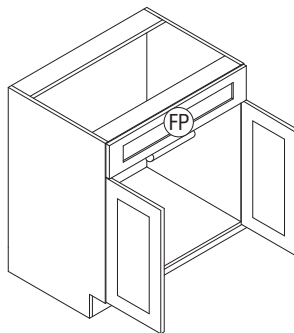

Base cabinet (LTI.BS)

INSTALLED INTERIOR MODIFICATIONS (cont'd)

See page 37 for modification compatibility. Requests for non-published modifications may be treated as a Special Sales Order which will require feasibility, leadtime review and approval. Please check with your customer service representative before placing your order.

OPTION NAME	APPLICABLE CABINET GROUP	DESCRIPTION/LIMITATIONS
PowerGlide™ Compact Drawer Outlet (DRWPWR) (DRWPWRB) (DRWPWRL) (DRWPWRR)	Most base cabinets with a top drawer	Installs PowerGlide™ Compact Drawer Outlet into the drawer box. Includes two 120V electrical plug-ins and two 2.1 amp rated USB charging ports with a total rated capacity of 15 amps. Cord has 3 ft. of length hanging freely from back mounting bracket. The cord is 14 gauge wire and features a standard 3-prong plug and is required to be plugged into an approved GFCI outlet for all applications. Outlet is ETL approved-compliant for electrical and other safety standards to U.S. and Canadian safety including UL standards. Outlet face plate measures 5.22" x 2.3" and will extend 3/4" into drawer box. Available on base cabinet widths of 18"-36". For use in cabinet depths of 13", 15", 16", 18", 19", 21", 22", and 24". Not compatible with 14", 17", 20", and 23" depths. Only compatible with RD in 3" increments. Also available as a field installed accessory, see DRWPWR1 on page 348.
Push to Open Wastebasket (PTOWB)	Base cabinets with door mounted wastebasket pull-outs	Changes the guide mechanism on wastebasket pull-outs to a mechanical push to open guide with Smart Stop. Available on 24" deep cabinets only. Does not change other drawer guides on the cabinet.
Tilt-out Tray, Stainless Steel (TOTSS) Stainless Steel Slim (TOTSSS)	Cabinets with false panels	Installs one stainless steel tilt-out tray inside of each false panel. Available as standard depth (2" deep) or a slim version (1 11/16" deep) to be used in narrow spaces. Standard trays protrude 1 1/16" into cabinet. Slim trays protrude 3/4" into cabinet.

POWERGLIDE™ COMPACT DRAWER OUTLET (DRWPWR/DRWPWRB/DRWPWRL/DRWPWRR)

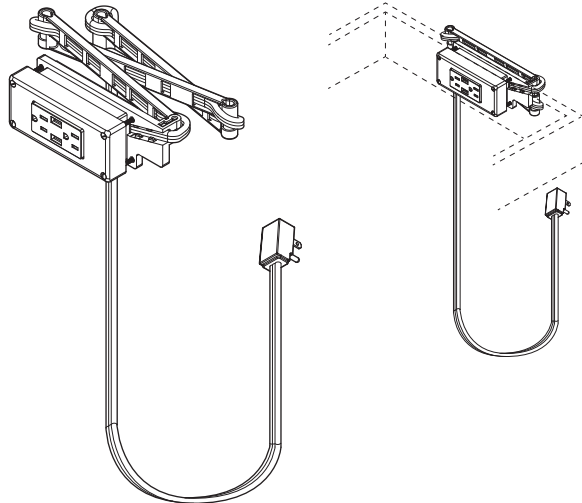

TILT-OUT TRAY, STAINLESS STEEL (TOTSS) & STAINLESS STEEL SLIM (TOTSSS)

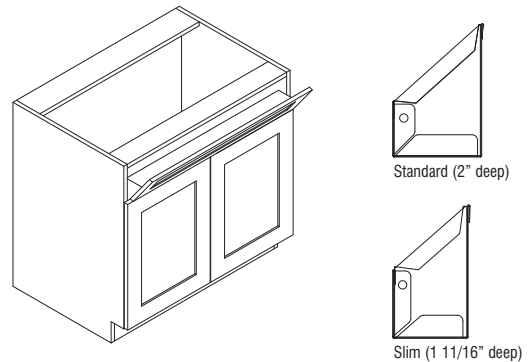

PUSH TO OPEN WASTEBASKET (PTOWB)

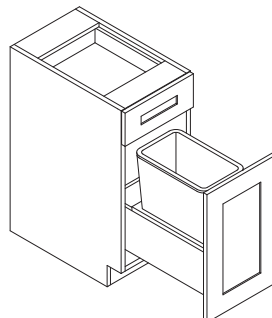

INSTALLED INTERIOR MODIFICATIONS (cont'd)

See page 37 for modification compatibility. Requests for non-published modifications may be treated as a Special Sales Order which will require feasibility, leadtime review and approval. Please check with your customer service representative before placing your order.

OPTION NAME	APPLICABLE CABINET GROUP	DESCRIPTION/LIMITATIONS																		
Tray Dividers (TD)	Most wall, full height base, and tall cabinets	<p>Installs removable Tray Dividers. Plywood dividers match the interior of the cabinet. Rails for dividers are Natural Maple regardless of the color of the interior of the cabinet.</p> <p>Number of dividers is predetermined based on cabinet width. See chart below.</p> <p>On Stacked Walls and Tall Cabinets, only available in top section.</p> <p>Available with Reduced Depth modification (12" minimum) and Increased Depth modification (27" maximum). When cabinet is increased to 27", tray dividers will be 24" deep set back 3" into the cabinet.</p> <p>Not available with Peninsula modification.</p> <p>Available on cabinets 18"-30" high and on equivalent Stacked Wall and Tall openings.</p> <table border="1" style="margin: 10px auto; border-collapse: collapse;"> <thead> <tr> <th style="text-align: center;">Cabinet Width</th> <th style="text-align: center;"># of Dividers</th> <th style="text-align: center;">Mod Name</th> </tr> </thead> <tbody> <tr> <td style="text-align: center;">9"-12"</td> <td style="text-align: center;">1</td> <td style="text-align: center;">1TD</td> </tr> <tr> <td style="text-align: center;">15"-18"</td> <td style="text-align: center;">2</td> <td style="text-align: center;">2TD</td> </tr> <tr> <td style="text-align: center;">21"-24"</td> <td style="text-align: center;">3</td> <td style="text-align: center;">3TD</td> </tr> <tr> <td style="text-align: center;">27"-30"</td> <td style="text-align: center;">4</td> <td style="text-align: center;">4TD</td> </tr> <tr> <td style="text-align: center;">33"-37"</td> <td style="text-align: center;">5</td> <td style="text-align: center;">5TD</td> </tr> </tbody> </table>	Cabinet Width	# of Dividers	Mod Name	9"-12"	1	1TD	15"-18"	2	2TD	21"-24"	3	3TD	27"-30"	4	4TD	33"-37"	5	5TD
Cabinet Width	# of Dividers	Mod Name																		
9"-12"	1	1TD																		
15"-18"	2	2TD																		
21"-24"	3	3TD																		
27"-30"	4	4TD																		
33"-37"	5	5TD																		

TRAY DIVIDERS (TD)

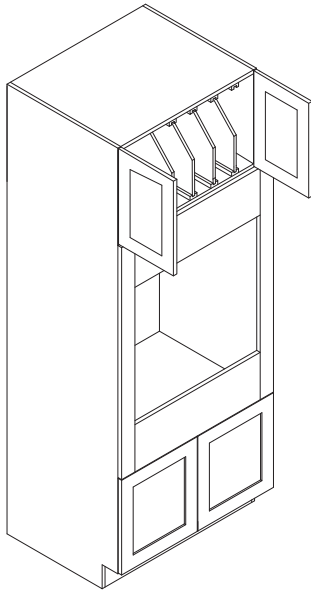

Tall cabinets

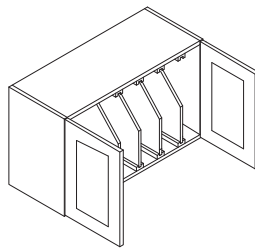

Wall cabinets

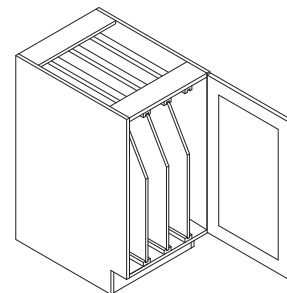

Base cabinets

TOEKICK MODIFICATIONS

See page 37 for modification compatibility. Requests for non-published modifications may be treated as a Special Sales Order which will require feasibility, leadtime review and approval. Please check with your customer service representative before placing your order.

OPTION NAME	APPLICABLE CABINET GROUP	DESCRIPTION/LIMITATIONS
Add Toekick (ADDTK)	Most wall cabinets	<p>Creates a 4 1/2" high and 3 3/8" deep toekick on the front of cabinet. Cabinet top changes to use stretcher rail construction when ADDTK is selected. ADDTK with reduced depth is available on cabinets 9" deep or larger.</p> <p>Peninsula cabinets are available with ADDTK 15" deep and larger. Depths of 14" and less will not have ADDTK available.</p> <p>Furniture drawers will be available with ADDTK option down to a reduced depth of 12".</p> <p>Available with compatible toekick modifications. See the Modification/Upgrade Compatibility Chart on page 37 for details.</p>
Flush Toekick (FTK) (FTK.FNT.P) (FTK.P)	Most base, tall, and vanity cabinets, and wall cabinets with ADDTK	<p>Creates a flush appearance with a valance installed below the cabinet bottom, eliminating the toe space area. Cabinet bottom will be standard depth with end panel. Not available when either RECTKL or RECTKR modifications are used. Not available on 93" or 96" tall cabinets due to separate pedestal base toekick.</p> <p>When FTK is ordered with the Peninsula modification, only the working drawer side will receive a flush toekick.</p> <p>When FTK.FNT.P is ordered with the Peninsula modification, both sides will receive a flush toekick.</p> <p>When FTK.P is ordered with the Peninsula modification, only the peninsula side will receive a flush toekick.</p> <p>All Styles except Genova, Taro High Gloss, and Troxel: Standard construction: Valance is matching laminated furniture board (horizontal grain). APC, MIP, and WLI: Valance is matching finished veneer edgebanded plywood (horizontal grain). Genova: Valance is door matching (vertical grain), does not use plywood. Taro High Gloss: Valance is door matching high gloss, does not use plywood. Troxel: Valance is door matching (horizontal grain), does not use plywood.</p>

ADD TOEKICK (ADDTK)

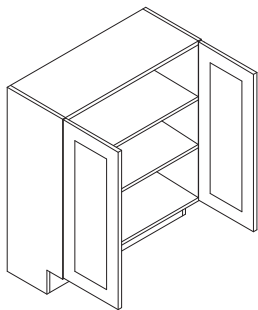

Wall cabinets

FLUSH TOEKICK (FTK)

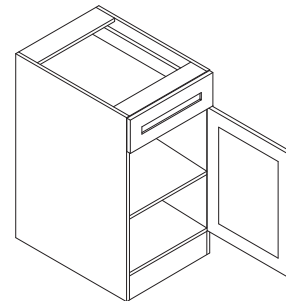

Base cabinets

FLUSH TOEKICK FRONT & PENINSULA (FTK.FNT.P)

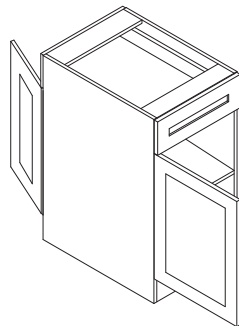

Base cabinets

FLUSH TOEKICK PENINSULA (FTK.P)

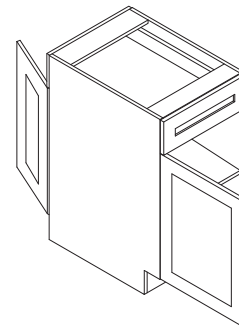

Base cabinets

TOEKICK MODIFICATIONS (cont'd)

See page 37 for modification compatibility. Requests for non-published modifications may be treated as a Special Sales Order which will require feasibility, leadtime review and approval. Please check with your customer service representative before placing your order.

OPTION NAME	APPLICABLE CABINET GROUP	DESCRIPTION/LIMITATIONS
Flush Toekick Arch (FTKAV) (FTKAV.P) (FTKAV.FNT.P)	Most base, tall, and vanity cabinets, and wall cabinets with ADDTK	Creates a flush appearance with an arched valance installed below the cabinet bottom, eliminating the toe space area. Cabinet bottom will be standard depth with end panel. Valance replaces standard toekick creating a full open area beneath cabinet floor. When FTKAV.FNT.P is ordered with the Peninsula modification, both sides will receive an arch flush toekick. When FTKAV.P is ordered with the Peninsula modification, only the peninsula side will receive an arch flush toekick. Not available on 93" or 96" tall cabinets due to separate pedestal base toekick. All Styles except Genova, Taro High Gloss, and Troxel: Standard construction: Valance is matching laminated furniture board (horizontal grain). APC, MIP, and WLI: Valance is matching finished veneer edgebanded plywood (horizontal grain). Genova: Valance is door matching (vertical grain), does not use plywood. Taro High Gloss: Valance is door matching high gloss, does not use plywood. Troxel: Valance is door matching (horizontal grain), does not use plywood.
Flush Toekick Furniture (FTKFBV) (FTKFBV.P) (FTKFBV.FNT.P)	Most base, tall, and vanity cabinets, and wall cabinets with ADDTK	Creates a flush appearance with a furniture valance installed below the cabinet bottom, eliminating the toe space area. Cabinet bottom will be standard depth with end panel. Valance replaces standard toekick creating a full open area beneath cabinet floor. When FTKFBV.FNT.P is ordered with the Peninsula modification, both sides will receive a furniture flush toekick. When FTKFBV.P is ordered with the Peninsula modification, only the peninsula side will receive a furniture flush toekick. Not available on 93" or 96" tall cabinets due to separate pedestal base toekick. All Styles except Genova, Taro High Gloss, and Troxel: Standard construction: Valance is matching laminated furniture board (horizontal grain). APC, MIP, and WLI: Valance is matching finished veneer edgebanded plywood (horizontal grain). Genova: Valance is door matching (vertical grain), does not use plywood. Taro High Gloss: Valance is door matching high gloss, does not use plywood. Troxel: Valance is door matching (horizontal grain), does not use plywood.

FLUSH TOEKICK ARCH (FTKAV)

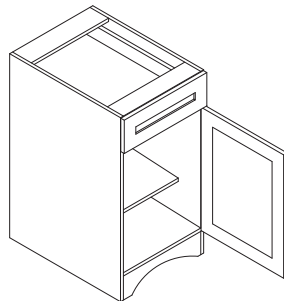

Base cabinets

FLUSH TOEKICK FURNITURE (FTKFBV)

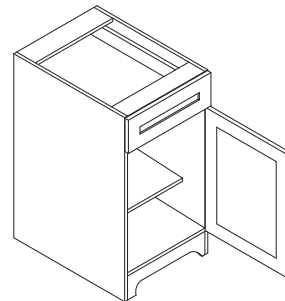

Base cabinets

TOEKICK MODIFICATIONS (cont'd)

See page 37 for modification compatibility. Requests for non-published modifications may be treated as a Special Sales Order which will require feasibility, leadtime review and approval. Please check with your customer service representative before placing your order.

OPTION NAME	APPLICABLE CABINET GROUP	DESCRIPTION/LIMITATIONS
Loose Toekick (TKP)	Most tall cabinets	Available on 84", 87", and 90" tall cabinets. Removes and ships the toekick separately. Not compatible with other toekick modifications. Pedestal is designed to create a Recessed Left or Right Toekick (RECTKL or RECTKR) application during field installation, or can be centered. Pedestal width is 3 3/8" less than cabinet width.
Recessed Island Toekick (RECTKALL)	Most base and vanity cabinets, and wall cabinets with ADDTK	Creates a 3 3/8" recessed toekick on the right, left, and back of cabinet. The entire toekick area will have non-matching material and requires any exposed toekick area to be covered.
Recessed Toekick on Back or Side (RECTKBK) (RECTKL) (RECTKR)	Most base and vanity cabinets, and wall cabinets with ADDTK	Creates a 3 3/8" recessed toekick on the back (RECTKBK), left (RECTKL), or right (RECTKR). When either the RECTKR or RECTKL are used, FTK is NOT available. The entire toekick will have non-matching material and requires any exposed toekick area to be covered. 93" and 96" tall cabinets have RECTKL or RECTKR standard on loose pedestal. For recess toekick applications of both left and right, order RECTKL.R. On 9" wide cabinets, only one side can be recessed. RECTKBK only available on cabinets at least 15" deep.

LOOSE TOEKICK (TKP)

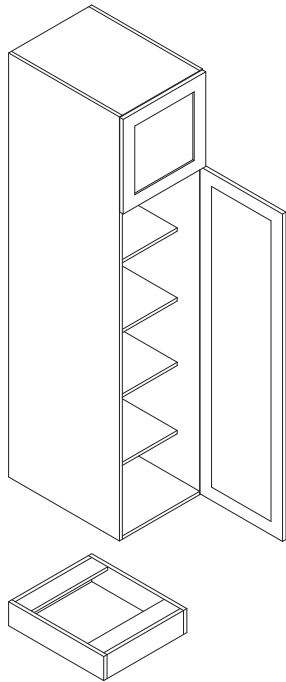

Tall cabinets

Pedestal is reduced in width for RECTKL or RECTKR during field installation.

RECESSED ISLAND TOEKICK (RECTKALL)

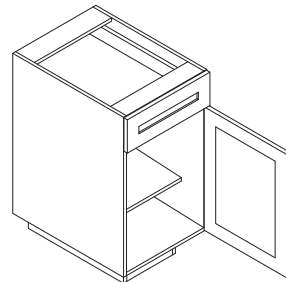

Base cabinets

RECESSED TOEKICK - BACK (RECTKBK)

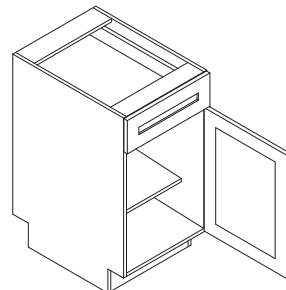

Base cabinets

RECESSED TOEKICK - LEFT (RECTKL)

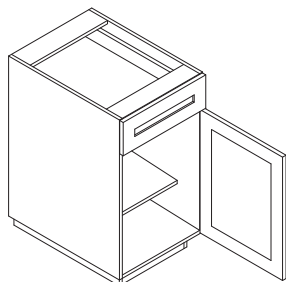

Base cabinets

RECESSED TOEKICK - RIGHT (RECTKR)

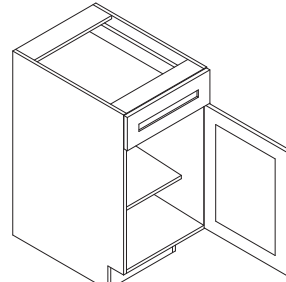

Base cabinets

TOEKICK MODIFICATIONS (cont'd)

See page 37 for modification compatibility. Requests for non-published modifications may be treated as a Special Sales Order which will require feasibility, leadtime review and approval. Please check with your customer service representative before placing your order.

OPTION NAME	APPLICABLE CABINET GROUP	DESCRIPTION/LIMITATIONS
Toekick Drawer (DRWTK)	Most cabinets with a standard toekick, and wall cabinets with ADDTK	Replaces standard toekick with a toekick drawer. Available on most 21"-24" deep cabinets in 18", 21", 24", 27", 30", 33", and 36" widths that have standard toekick construction. Front of toekick drawer is unfinished, allow enough toeboard to cover. 1" clearance below toekick drawer. Exterior dimensions of drawer are 3 3/8" tall and 15" or 18" deep. Toekick drawer uses a push to open full extension guide, does not have soft-close feature.
Void Toekick (VTK)	Most base, tall, and vanity cabinets	Removes the toekick. Only available when the cabinet has a standard toekick (not available when flush toekick is standard or when cabinet has a separate pedestal base). When VTK is specified on cabinets to be used with a countertop, cabinets must also be supported from the floor, not just attached to the wall. Failure to properly install cabinets in this situation will void the warranty.

TOEKICK DRAWER (DRWTK)

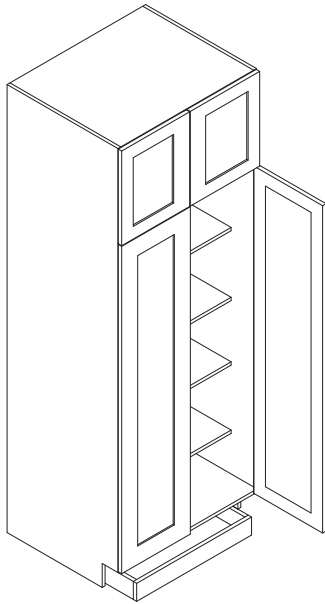

Tall cabinets

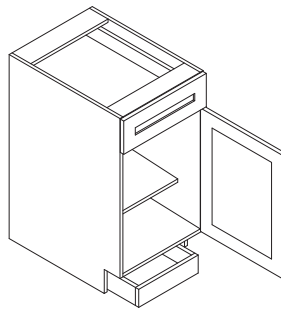

Base cabinets

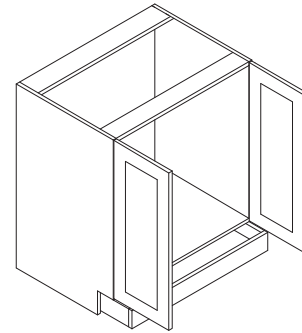

Vanity cabinets

VOID TOEKICK (VTK)

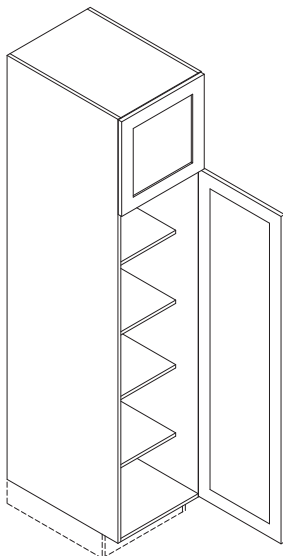

Tall cabinets

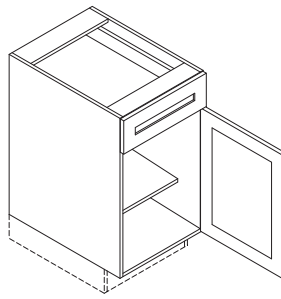

Base cabinets

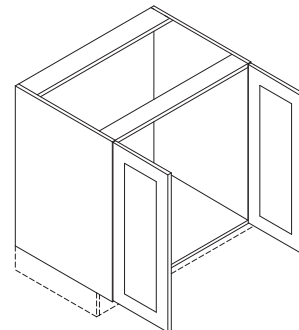

Vanity cabinets

CONFIGURATION MODIFICATIONS

See page 37 for modification compatibility. Requests for non-published modifications may be treated as a Special Sales Order which will require feasibility, leadtime review and approval. Please check with your customer service representative before placing your order.

OPTION NAME	APPLICABLE CABINET GROUP	DESCRIPTION/LIMITATIONS
Peninsula (P)	Most wall and base cabinets up to 24" wide	<p>Creates a peninsula cabinet that is 1/4" deeper than the standard cabinet depth. If ID or RD is specified, cabinet will be 1/4" deeper than specified cabinet depth.</p> <p>Any cabinet with a toekick must be at least 15" deep (either standard with a toekick or when ADDTK is specified).</p> <p>Single door cabinets are hinged on the same cabinet end, for example a W1230L will feature a Left hinge on the front side and a Right hinge on the peninsula side.</p> <p>Not available on tall cabinets (oven, utility, and pantry) or multi-drawer base cabinets.</p> <p>Cabinets with drawers can only be reduced in 3" increments.</p> <p>On wall cabinets, a 3" high support strip is installed between the end panels at top of cabinet.</p>

PENINSULA (P)

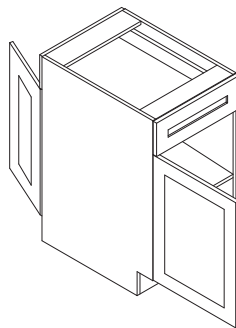

Base cabinets

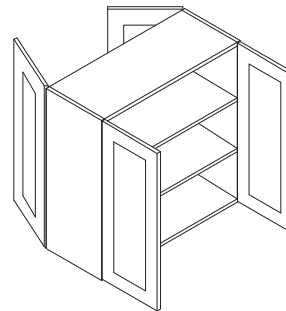

Wall cabinets

ALUMINUM FRAME DOOR OPTIONS

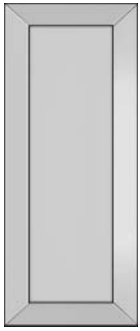

ALF
Aluminum Frame Door
in Aluminum finish
with Frost glass

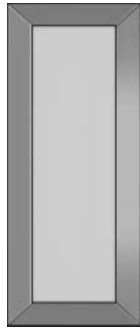

ALFBS
Aluminum Frame Door
with a Brushed Stainless
Steel look with Frost glass

AVAILABILITY						
Cabinet Width	Cabinet Height					
	12"	15"	18"	21"	30"	36"
W12	-	-	-	-	✓	✓
W15	✓	✓	-	-	✓	✓
W18	✓	✓	-	-	✓	✓
W21	-	-	-	-	✓	✓
WTH30 & WTH30..24	✓	✓	✓	✓	-	-
WVL30 & WVL30..24	-	-	✓	✓	-	-
WTH36 & WTH36..24	✓	✓	✓	✓	-	-
WVL36 & WVL36..24	-	-	✓	✓	-	-

- All aluminum doors have miter construction.
- Cabinet face frame and end panels will be matched to the finish specified.
- Aluminum and Brushed Stainless doors have an anodized finish.
- Frost glass is installed in door. Removal of glass or matching panel will void warranty.
- Door rails are 2 1/4" wide.
- Cabinet will have standard interior or can be ordered with MIP or MSLFB option.
When a decorative door option is chosen in 20/20, Matching Interior Plywood (MIP) is a preselected option. If MIP is not desired, it can be deselected by choosing NOTMIP.

CUT-FOR-GLASS DOORS (CG)

Glass not included

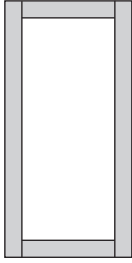

Cut-for-glass

- Not available in Caprice, Genova, Taro, Troxel, and Vaille.
- If desired for use with Caprice, using a shaker style such as Larsen, Northrope, or Whitman is recommended.
- Not available on bifold doors.
- Custom door sizes available. See pages 290-293.
- Glass clips included with door.
- For cabinet availability, please see modification grids.
- CG.TOP and CG.BTM are specified on cabinets with upper and lower doors to designate which doors should be Cut-for-glass. See Door Options grid for SKU availability.
- When a decorative door option is chosen in 20/20, Matching Interior Plywood (MIP) is a preselected option. If MIP is not desired, it can be deselected by choosing NOTMIP.

MULLION DOORS (MD)

Tempered glass included

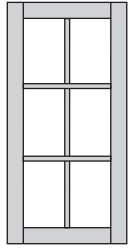

Mullion

- Available in all door styles except Butler, Caprice, Genova, Hardin, Taro, and Troxel.
- Custom Door Sizes not available.
- For Mullion Door availability, please see modification grids in wall section.
- Includes Mullion Door and fully tempered clear glass for safety.
- Textured glass may be ordered to replace clear glass, except Bevel.
- On acknowledgment, textured glass will be listed with MDI modification.
- MD.TOP and MD.BTM are specified on cabinets with upper and lower doors to designate which doors should be Mullion Doors. See Door Options grid for SKU availability.
- Shelves will not align with mullions.
- When a decorative door option is chosen in 20/20, Matching Interior Plywood (MIP) is a preselected option. If MIP is not desired, it can be deselected by choosing NOTMIP.

MULLION LITES GRID

Cabinet Width	Cabinet Height						
	18"	24"	30"	33"	36"	39"	42"
W15	G		D	D	D	A	A
W18	G		D	D	D	A	A
W21			E	E	E	B	B
W24			E	E	E	B	B
W24 (butt)			D	D	D	A	A
W27 (butt)			D	D	D	A	A
W30 (butt)	G	G	D	D	D	A	A
W33 (butt)			D	D	D	A	A
W36 (butt)	G	G	D	D	D	A	A
W42			E	E	E	B	B
W45			E	E	E	B	B
W48 (butt)			D	D	D	A	A
WC33			D	D	D	A	A
WC36			D	D	D	A	A
WC39			D	D	D	A	A
WC42			D	D	D	A	A
WC45			D	D	D	A	A
WC48			D	D	D	A	A
DW30/DW30T			D				
DW33/DW33T				D			
DW36/DW36T					D		
DW39/DW39T						A	
DW42/DW42T							A

Mullion Door Configurations

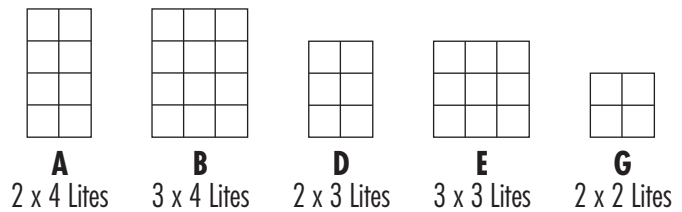

SHAKER MULLION DOORS (SHMD)

Tempered glass included

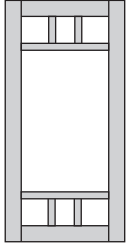

- Available in Larsen, Lawton, and Lynnville, Northrope, and Whitman.
- Custom Door Sizes not available.
- Shelves will not align with mullions.
- For Mullion Door availability, please see modification grids in wall section.
- Includes Mullion Door and fully tempered clear glass for safety.
- Textured glass may be ordered to replace clear glass, except Bevel.
- On acknowledgment, textured glass will be listed with SHMDI modification.
- When a decorative door option is chosen in 20/20, Matching Interior Plywood (MIP) is a preselected option. If MIP is not desired, it can be deselected by choosing NOTMIP.

MULLION SHAKER LITES GRID

Cabinet Width	Cabinet Height						
	18"	24"	30"	33"	36"	39"	42"
W15†	H		H	H	H	H	H
W18	H		H	H	H	H	H
W21			H	H	H	H	H
W24			H	H	H	H	H
W24 (butt)			J	J	J	J	J
W27 (butt)			J	J	J	J	J
W30 (butt)†	H	H	H	H	H	H	H
W33 (butt)			H	H	H	H	H
W36 (butt)	H	H	H	H	H	H	H
W42			H	H	H	H	H
W45			H	H	H	H	H
W48 (butt)			J	J	J	J	J
WC33			H	H	H	H	H
WC36			H	H	H	H	H
WC39			J	H	H	H	H
WC42			J	H	H	H	H
WC45			J	H	H	H	H
WC48			H	H	H	H	H
DW30/DW30T			H				
DW33/DW33T				H			
DW36/DW36T					H		
DW39/DW39T						H	
DW42/DW42T							H

†Larsen and Northrope will have "J Configuration" for 15" and 30" wide cabinets and all DW cabinets.

Shaker Mullion Door Configurations

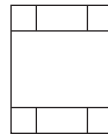

H
3 x 3 Lites

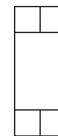

J
2 x 3 Lites

PRAIRIE MULLION DOORS (PRMD)

Tempered glass included

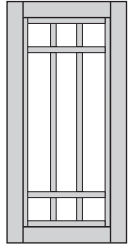

58

DOOR MODIFICATION/SPECIALTY DOORS

- Available in Larsen, Lawton, Lynnville, Northrope, and Whitman.
- Custom Door Sizes not available.
- Shelves will not align with mullions.
- For Mullion Door availability, please see modification grids in wall section.
- Includes Mullion Door and fully tempered clear glass for safety.
- Textured glass may be ordered to replace clear glass, except Bevel.
- On acknowledgment, textured glass will be listed with PRMDI modification.
- When a decorative door option is chosen in 20/20, Matching Interior Plywood (MIP) is a preselected option. If MIP is not desired, it can be deselected by choosing NOTMIP.

MULLION PRAIRIE LITES GRID

Cabinet Width	Cabinet Height						
	18"	24"	30"	33"	36"	39"	42"
W15 [†]	K		K	K	K	K	K
W18	K		K	K	K	K	K
W21			K	K	K	K	K
W24			K	K	K	K	K
W24 (butt)			L	L	L	L	L
W27 (butt)			L	L	L	L	L
W30 (butt) [†]	K	K	K	K	K	K	K
W33 (butt)			K	K	K	K	K
W36 (butt)	K	K	K	K	K	K	K
W42			K	K	K	K	K
W45			K	K	K	K	K
W48 (butt)			L	L	L	L	L
WC33			K	K	K	K	K
WC36			K	K	K	K	K
WC39			L	K	K	K	K
WC42			L	K	K	K	K
WC45			L	K	K	K	K
WC48			K	K	K	K	K
DW30/DW30T			K				
DW33/DW33T				K			
DW36/DW36T					K		
DW39/DW39T						K	
DW42/DW42T							K

Prairie Mullion Door Configurations

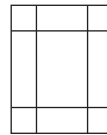

K
3 x 3 Lites



L
2 x 3 Lites

[†]Larsen and Northrope will have "L Configuration" for 15" and 30" wide cabinets and all DW cabinets.

ART GLASS PANELS



Anson



Avondale

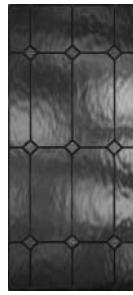

Cambridge



Charlotte

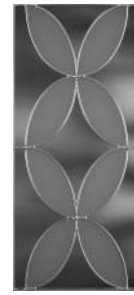

Ellington



Lanai



Lonsdale

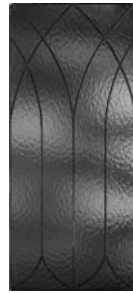

Lyndhurst

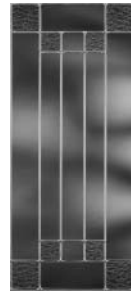

Pavillion

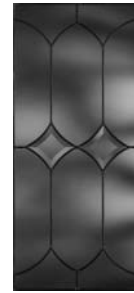

Portico

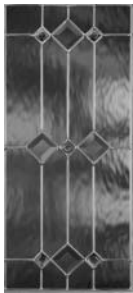

Quincy



Waterbury



Wickford

- Cut-for-glass door must be ordered separately. See page 55 for door style availability.
- For glass shelf kits, see page 347.
- Door frame may reduce amount of glass shown.
- No changes or cancellations will be accepted after 24 hours from acknowledgment of order.
- Art glass will be packaged separately from applicable cabinet(s) and shipped with cabinet order for field installation.

ART GLASS PANELS

Anson

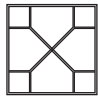
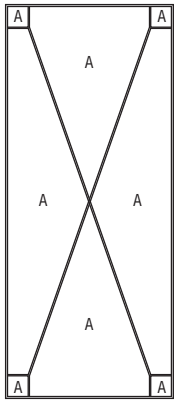

Minimum Size
6" x 6"

1 3/8"
1 3/8"

Glass Type:
A) Clear Seedy 100SDY

Metal Type:
3/16" H-Ch Zinc Proglaze2 (all)
Black Patina Finish

Cambridge

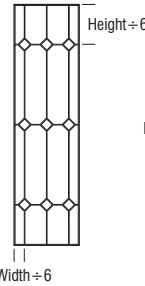
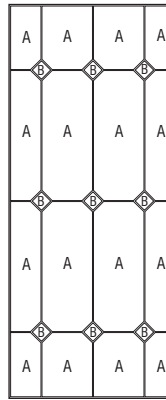

Minimum Size 6" x 10"

7/8" Sq.

Glass Types:
A) Clear Waterglass 100W
B) Clear Sparkolite

Metal Type:
3/16" H-Ch Zinc Proglaze2 (all)
Black Patina Finish

Avondale

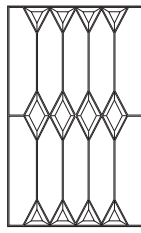
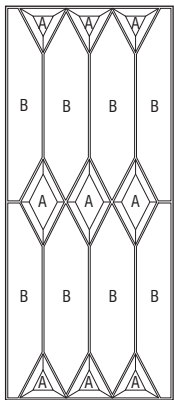

Widths > 13"
4 Vertical Columns

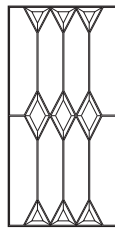

Widths > 10" to 13"
3 Vertical Columns



Widths > 7" to 10"
2 Vertical Columns

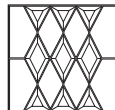

Heights > 13"
Full Design

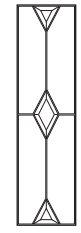

Widths 6" to 7"
1 Vertical Column

Glass Types:
A) 3/16" Clear with 1/2" Bevel
B) Clear Vecchio 100V

Metal Type:
3/16" H-Ch Zinc Proglaze2 (all)

Heights < 13"
Diamond(s) Only

Minimum Size
6" x 6 1/4"

Charlotte

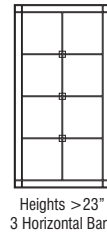
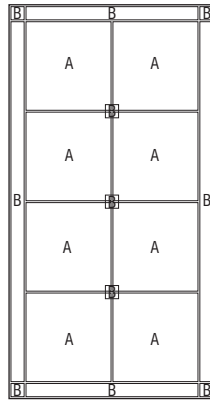

Heights > 23"
3 Horizontal Bars

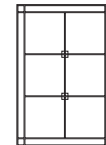

Heights > 14" to 23"
2 Horizontal Bars

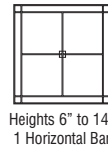

Heights 6" to 14"
1 Horizontal Bar

Overlay
1 5/16" x 1 5/16"

Minimum Size
10" x 6"

Glass Types:
A) 1/8" Clear
B) Frost Etch 100

Metal Types:
3/16" H-Ch Zinc Proglaze2 (all)
1/8" U-Ch Zinc (overlays)

ART GLASS PANELS

Ellington

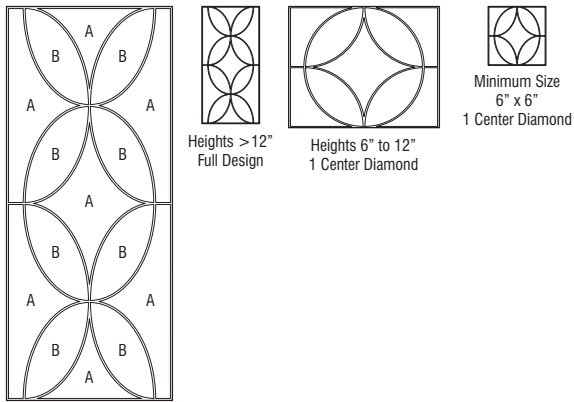

Glass Types:
A) 1/8" Clear
B) Frost Etch 100

Metal Type:
3/16" H-Ch Zinc Proglaze2 (all)

Lonsdale

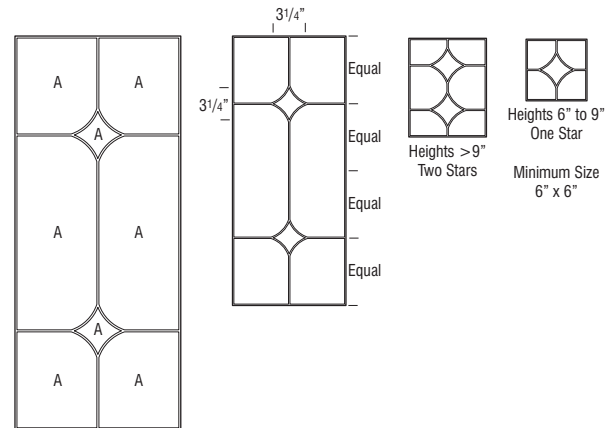

Glass Type:
A) Seedy Clear 100Sdy

Metal Type:
3/16" H-Ch Zinc Proglaze2 (all)

Lanai

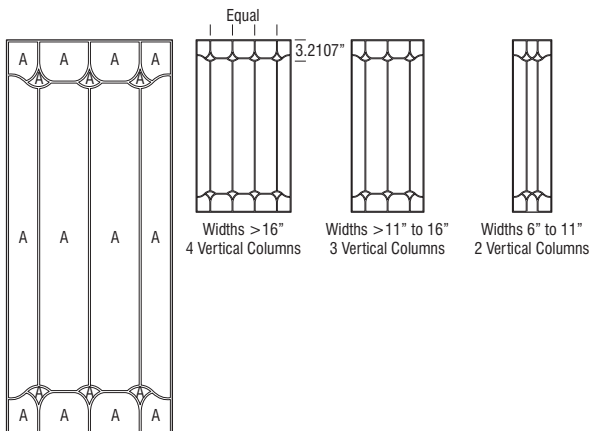

Glass Type:
A) 1/8" Clear

Metal Type:
3/16" H-Ch Zinc Proglaze2 (all)

Lyndhurst

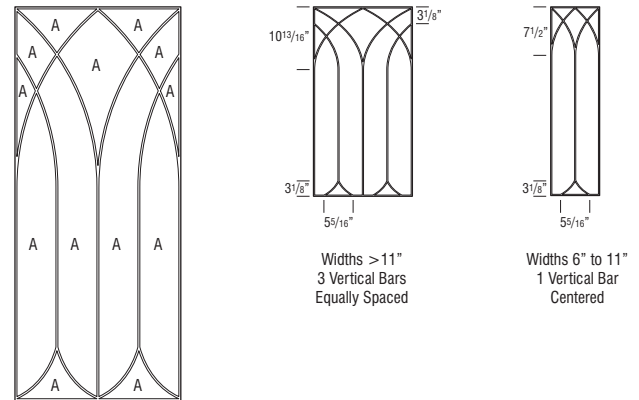

Glass Type:
A) Clear Rough Rolled 100RR

Metal Type:
3/16" H-Ch Zinc Proglaze2 (all)
Black Patina Finish

Minimum Size 6" x 12"

Pavillion

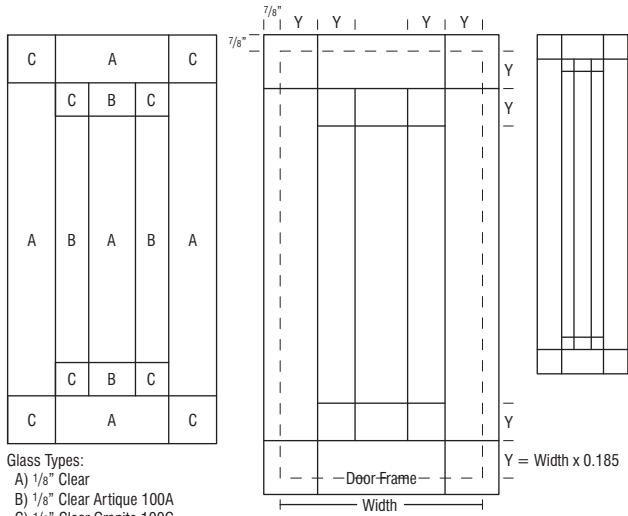

Glass Types:
 A) 1/8" Clear
 B) 1/8" Clear Artique 100A
 C) 1/8" Clear Granite 100G

Metal Type:
 3/16" H-Ch Round Zinc Proglaze2 (all)

Quincy

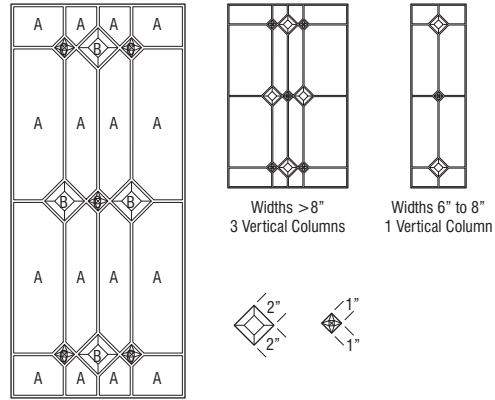

Glass Types:
 A) Clear Waterglass 100W
 B) 3/16" Clear with 1/2" Bevel
 C) Clear Faceted Jewel

Metal Type:
 3/16" H-Ch Zinc Proglaze2 (all)
 Minimum Size 6" x 10"

Portico

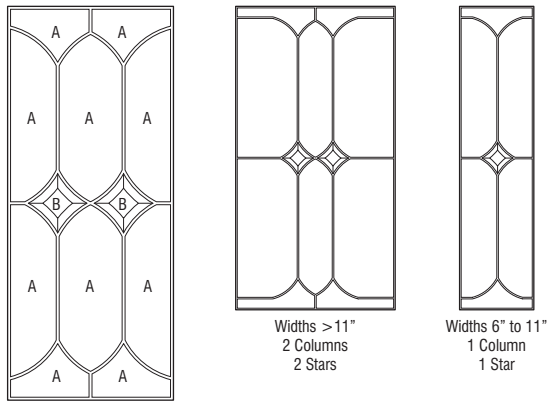

Glass Types:
 A) 1/8" Clear
 B) 3/16" Clear with 1/2" Bevel

Metal Type:
 3/16" H-Ch Zinc Proglaze2 (all)
 Black Patina Finish

Minimum Size 6" x 12"

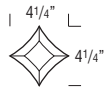

Waterbury

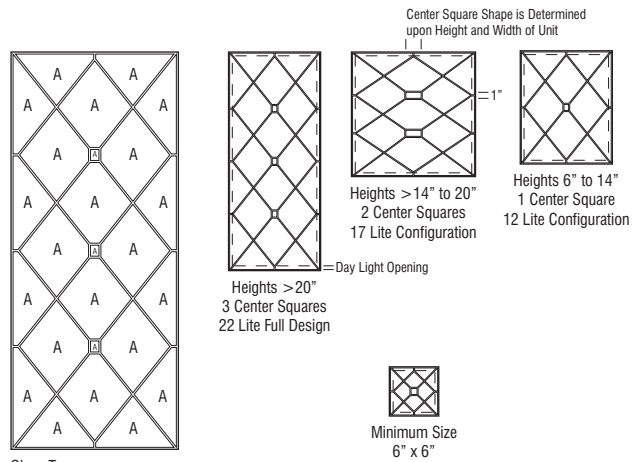

Glass Type:
 A) Clear Waterglass 100W

Metal Type:
 3/16" H-Ch Zinc Proglaze2 (all)
 Black Patina Finish

ART GLASS PANELS

Wickford

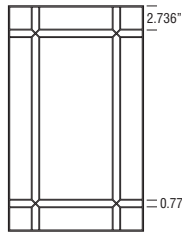
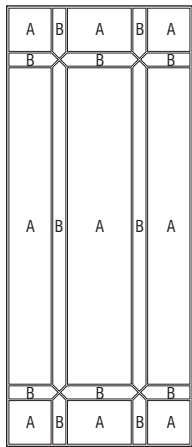

Widths > 9"
2 Vertical Columns



Widths 6 1/2" to 9"
1 Vertical Column
Centered



Minimum Size
6 1/2" x 10"

Glass Types:

- A) Clear Artique 100A
- B) Clear Granite 100G

Metal Type:

- 3/16" H-Ch Round Zinc Proglaze2 (all)

INSTALLED TEXTURED GLASS PANELS

64



Antique



Bevel



Centurian



Clear



Cocoa Rice Paper



Cross Reeded



Frost



Hammered

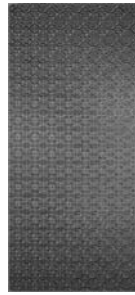

Morisco

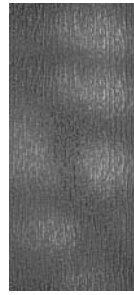

Rain



Reeded



Rice Paper



Seeded



Silhouette

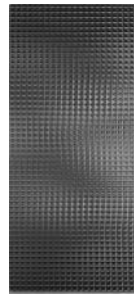

Strelli

- Textured glass panels available in Vaille only when Mullion Door is ordered because Cut-for-glass Door is not available.
- Cut-for-glass door must be ordered separately. See page 55.
- For glass shelf kits, see page 347.
- On order acknowledgment, decorative glass selection will be shown with selected CG modification.
- When textured glass is ordered for use in wall top hinge (WTH) or wall vertical-lift (WVL) cabinets, glass design will be turned horizontally and may not match desired pattern.
- All glass is fully tempered or has a safety lamination.
- Textured glass panels will be factory installed when ordered with a CG door.
- Door frame may reduce amount of glass shown.
- No changes or cancellations will be accepted after 24 hours from acknowledgment of order.

GLASS INSERTS

INSTALLED TEXTURED GLASS PANELS

Antique



- Glass type: Antique
- Panel thickness: 1/8"

Centurian

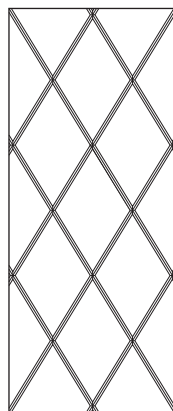

Maximum Size 24" x 48"

- Glass type: Frost Etch
- Panel thickness: 1/8"

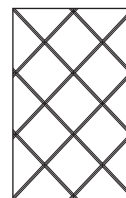

All Sizes Configured
to 17 Lite



Minimum Size
7 1/2" x 8"

Bevel

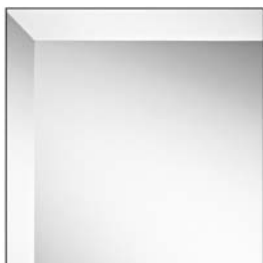

- Glass type: Clear
- Panel thickness: 1/4"
- Not compatible with Mullion Doors.

Clear



- Glass type: Clear
- Panel thickness: 1/8"

Cocoa Rice Paper

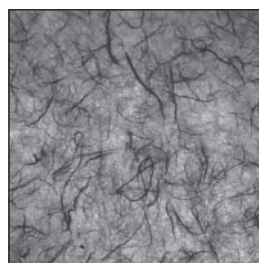

- Glass type: Cocoa Rice Paper
- Panel thickness: 9/32"

INSTALLED TEXTURED GLASS PANELS

Cross Reeded

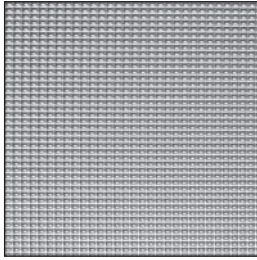

- Glass type: Cross Reeded
- Panel thickness: 5/32"

Morisco

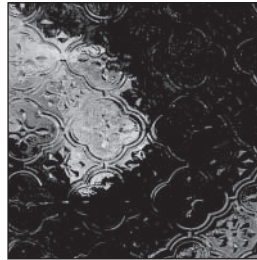

- Glass type: Morisco
- Panel thickness: 1/8"

Frost

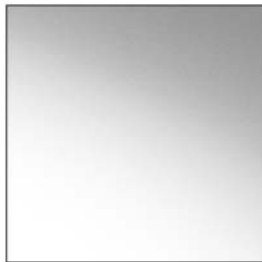

- Glass type: Frost
- Panel thickness: 5/32"

Rain

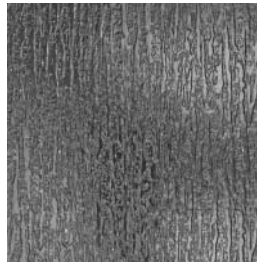

- Glass type: Rain
- Panel thickness: 5/32"

Hammered

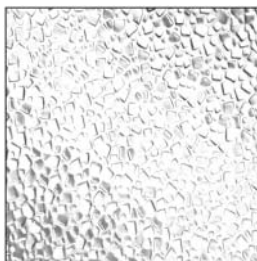

- Glass type: Hammered
- Panel thickness: 5/32"

Reeded

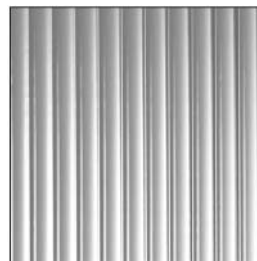

- Glass type: Reeded
- Panel thickness: 5/32"

INSTALLED TEXTURED GLASS PANELS

Rice Paper

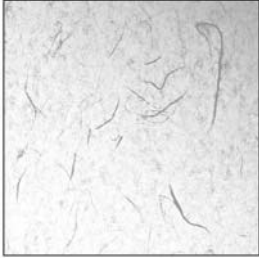

- Glass type: Rice Paper
- Panel thickness: 9/32"

Silhouette

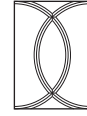
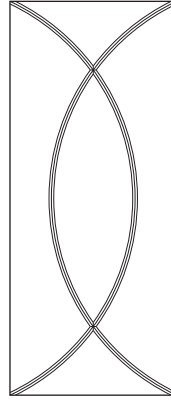

Minimum Size
6" x 8 1/2"

- Glass type: Frost Etch
- Panel thickness: 1/8"

Seeded

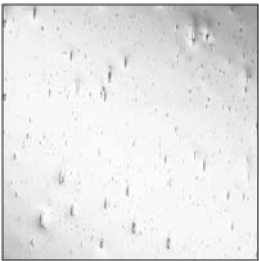

- Glass type: Seeded
- Panel thickness: 9/32"

Strelli

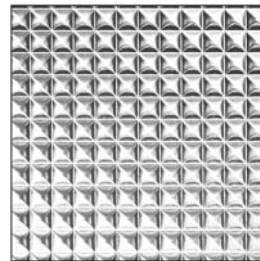

- Glass type: Strelli
- Panel thickness: 5/32"

ART & TEXTURED GLASS PANELS

ART GLASS PANELS

STYLE	PANEL THICKNESS	CAMING MATERIAL
Anson	1/4"	Zinc Black Patina
Avondale	1/4"	Zinc
Cambridge	1/4"	Zinc Black Patina
Charlotte	1/4"	Zinc
Ellington	1/4"	Zinc
Lanai	1/4"	Zinc
Lonsdale	1/4"	Zinc
Lyndhurst	1/4"	Zinc Black Patina
Pavillion	1/4"	Zinc
Portico	1/4"	Zinc Black Patina
Quincy	1/4"	Zinc
Waterbury	1/4"	Zinc Black Patina
Wickford	1/4"	Zinc

TEXTURED GLASS PANELS

STYLE	PANEL THICKNESS
Antique	1/8"
Bevel	1/4"
Centurian	1/8"
Clear	1/8"
Cocoa Rice Paper	9/32"
Cross Reeded	5/32"
Frost	5/32"
Hammered	5/32"
Morisco	1/8"
Rain	5/32"
Reeded	5/32"
Rice Paper	9/32"
Seeded	9/32"
Silhouette	1/8"
Strelli	5/32"

CABINET DIMENSIONS

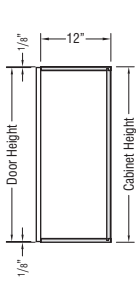

WALL CABINET

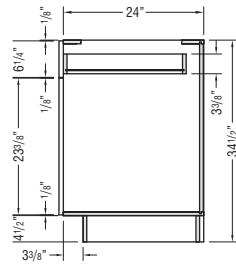

BASE CABINET

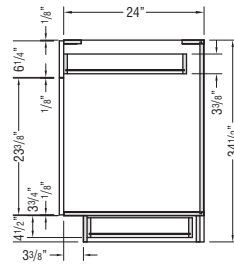

**BASE CABINET
with TOEKICK DRAWER**

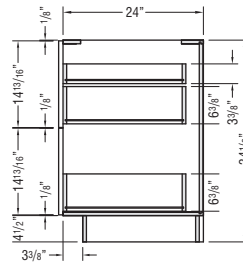

**TWO-DRAWER
BASE CABINET
with ROLL TRAY**

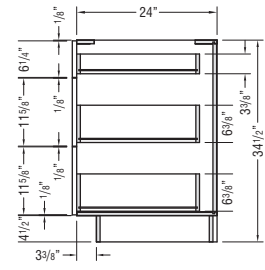

**THREE-DRAWER
BASE CABINET**

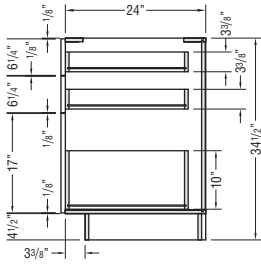

**THREE-DRAWER
BASE CABINET
with DEEP DRAWER**

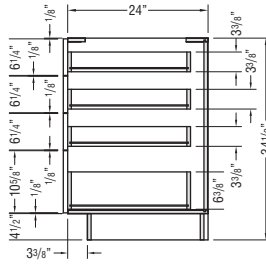

**FOUR-DRAWER
BASE CABINET**

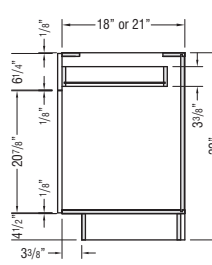

**32" HIGH
VANITY CABINET**

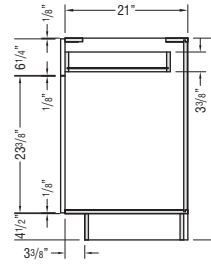

**34 1/2" HIGH
VANITY CABINET**

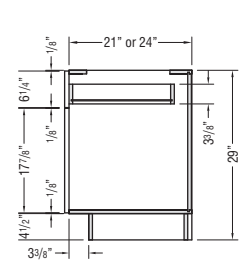

DESK BASE CABINET

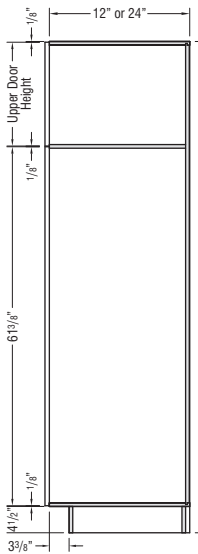

UTILITY CABINET

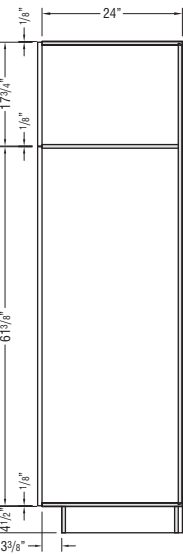

PANTRY CABINET

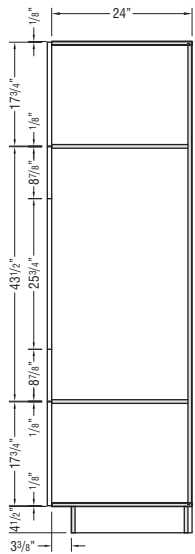

SINGLE OVEN CABINET

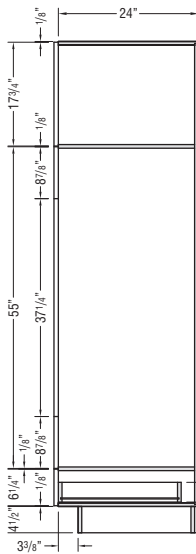

DOUBLE OVEN CABINET

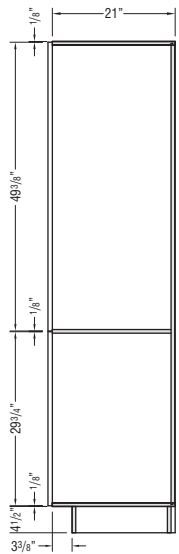

LC/LCRH CABINET

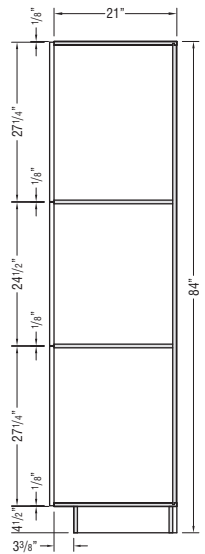

**VANITY UTILITY
CABINET**

Wall Cabinet Height	Door Height
12"	11 3/4"
15"	14 3/4"
18"	17 3/4"
21"	20 3/4"
24"	23 3/4"
27"	26 3/4"
30"	29 3/4"
33"	32 3/4"
36"	35 3/4"
39"	38 3/4"
42"	41 3/4"

Utility Cabinet Height	Upper Door Height
84"	17 3/4"
87"	20 3/4"
90"	23 3/4"
93"	26 3/4"
96"	29 3/4"

Cabinet Type	Adjustable Shelves Depth
Wall Cabinets - Standard 12" Deep	10 7/32" (9"-36" wide cabinets)
Base Cabinets - Standard 24" Deep	15"
Base Cabinets w/Full Depth Shelves	22 1/2"
Base Cabinets w/Vertical Divider and Full Depth Shelves	19 7/32"
Tall Cabinets - 24" Deep	22 1/2"

FULL ACCESS REVEAL SPECIFICATIONS

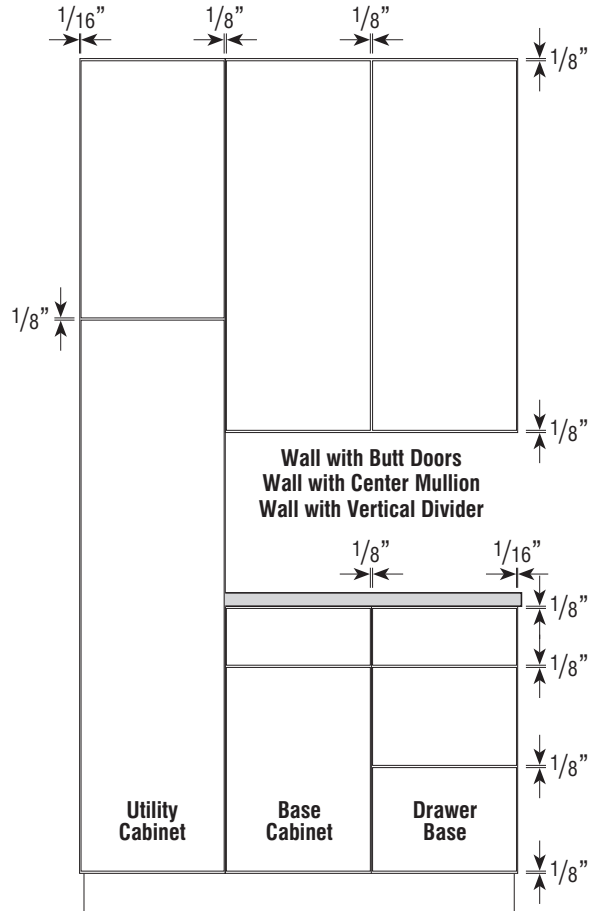

One double door cabinet has the same reveal as two single door cabinets.

5-PIECE DRAWER FRONT DIMENSIONS CHART

5-PIECE DRAWER FRONTS	DRAWER FRONT WIDTH	DRAWER FRONT HEIGHT	PANEL FLAT WIDTH	PANEL FLAT HEIGHT
Amstead	8 7/8"	6 1/4"	2 7/8"	1 3/4"
Ashridge	8 7/8"	6 1/4"	3 7/8"	1 1/4"
Bellmont	8 7/8"	6 1/4"	3 7/8"	1 1/4"
Butler	8 7/8"	6 1/4"	3 7/8"	1 1/4"
Cotter	8 7/8"	6 1/4"	4 5/8"	2"
Darby	8 7/8"	6 1/4"	4"	1 3/8"
Gallatin DFR5PC	8 7/8"	6 1/4"	2"	1 1/8"
Hardin	8 7/8"	6 1/4"	3 7/8"	1 1/4"
Herrington DFR5PC	8 7/8"	6 1/4"	1 5/8"	1"
Hurson DFF5PC	8 7/8"	6 1/4"	4 3/8"	1 3/4"
Justin	8 7/8"	6 1/4"	2 7/8"	1 3/4"
Kingston DFF5PC	8 7/8"	6 1/4"	3 7/8"	1 1/4"
Larsen DFF5PC	8 7/8"	6 1/4"	2 7/8"	1 3/4"
Lawton DFF5PC	8 7/8"	6 1/4"	2 1/2"	2 1/8"
Lynnville DFF5PC	8 7/8"	6 1/4"	4 3/8"	3 1/4"
Northrope DFF5PC	8 7/8"	6 1/4"	2 7/8"	1 3/4"
Rennie DFF5PC	8 7/8"	6 1/4"	3 7/8"	1 1/4"
Warwick	8 7/8"	6 1/4"	3 7/8"	1 1/4"
Whitman	8 7/8"	6 1/4"	4 3/8"	3 1/4"

Drawer sizes are representative of a 9" wide base cabinet.

ROLL TRAY POSITIONS

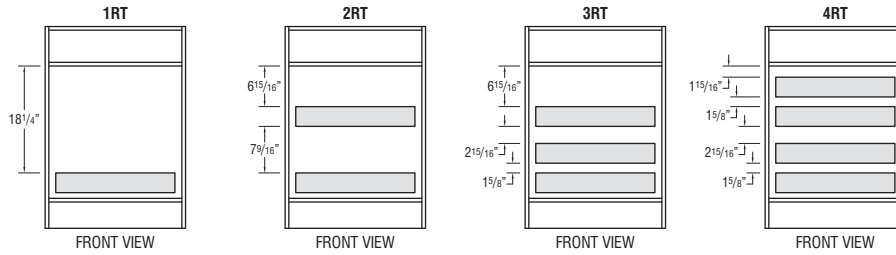

BASE CABINETS AND 34 1/2" HIGH VANITY CABINETS

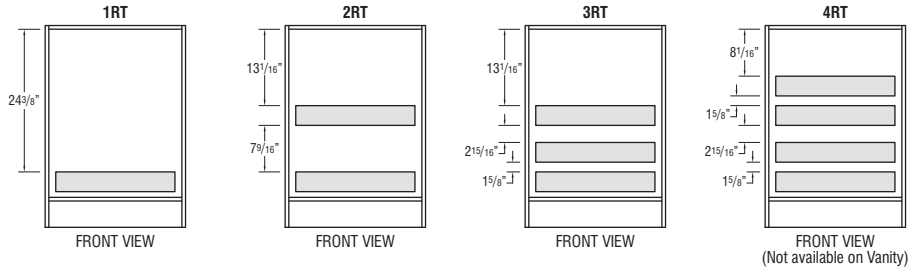

FULL HEIGHT BASE CABINETS AND 34 1/2" HIGH VANITY CABINETS

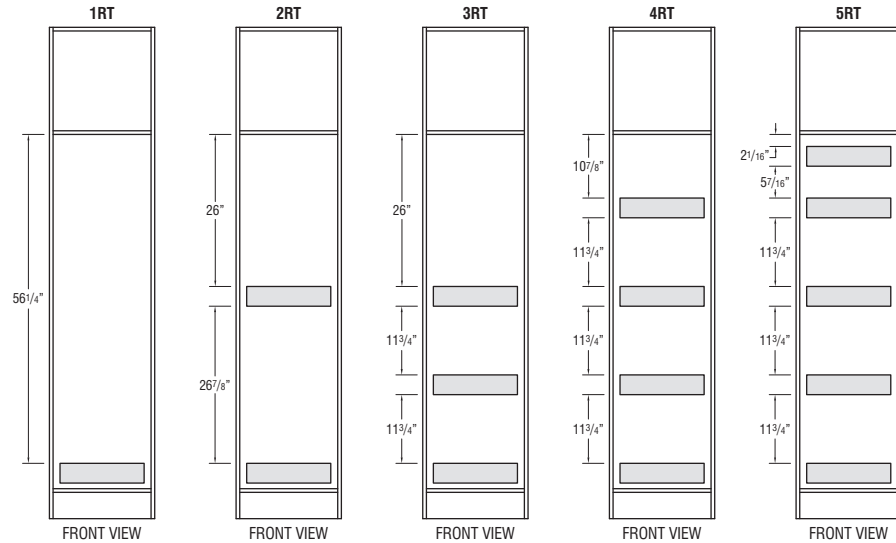

UTILITY CABINETS

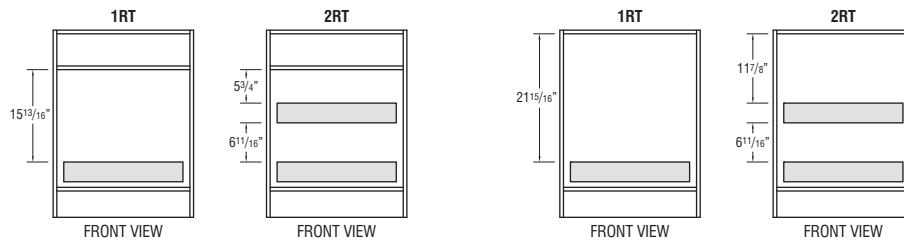

32" HIGH VANITY CABINETS

FULL HEIGHT 32" HIGH VANITY CABINETS

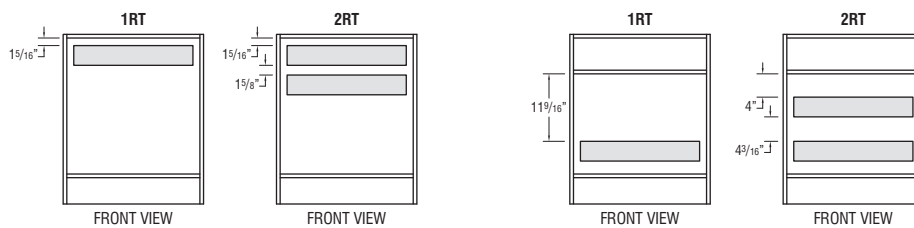

PRINTER BASE CABINETS

DESK DOOR DRAWER BASE CABINETS

DIMENSIONS FOR CORNER INSTALLATIONS (45° DIAGONAL)

12" DEEP CABINETS

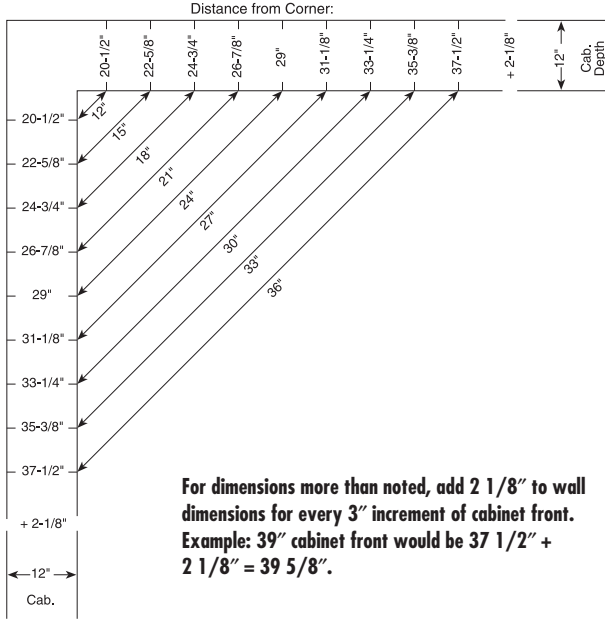

24" DEEP CABINETS

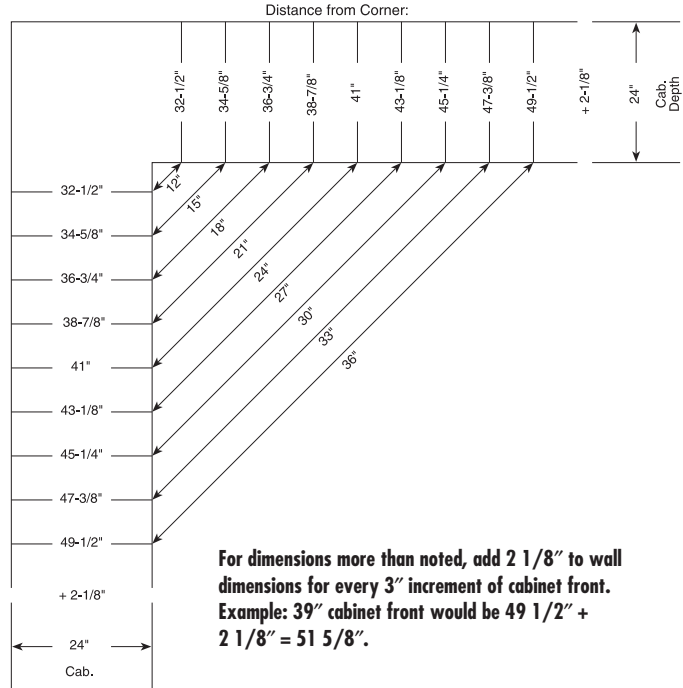

INSTALLATION HEIGHT REQUIREMENTS

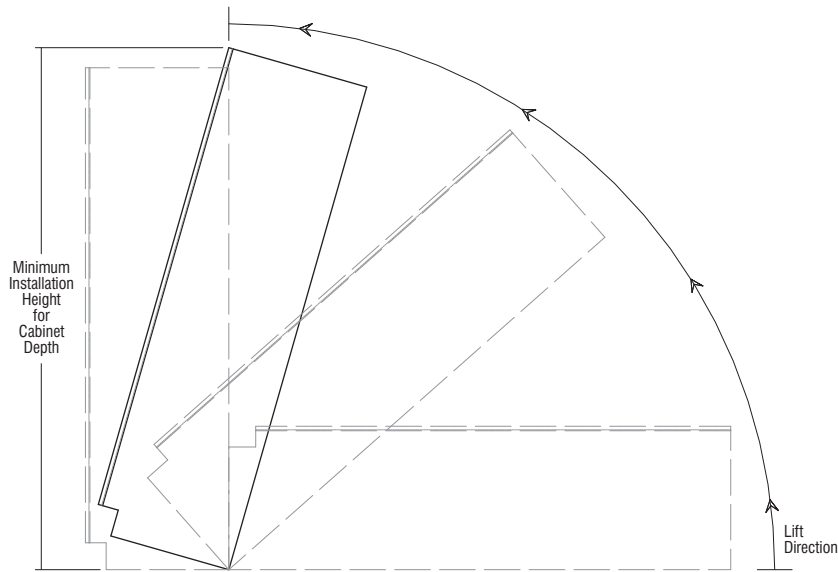

Height of ceiling needs to be considered for installation of tall cabinets. Cabinet height below includes toekick area:

Cabinet Height	Minimum Installation Height for Cabinet Depth					
	12"	15"	18"	21"	24"	27"
84"	84 7/8"	85 11/32"	85 15/16"	86 19/32"	87 3/8"	88 1/4"
87"	87 27/32"	88 5/16"	88 27/32"	89 1/2"	90 1/4"	91 3/32"
90"	90 13/16"	91 1/4"	91 13/16"	92 7/16"	93 5/32"	93 31/32"
93" *	89 5/16"	89 25/32"	90 5/16"	90 31/32"	91 23/32"	92 17/32"
96" *	92 5/16"	92 3/4"	93 9/32"	93 29/32"	94 5/8"	95 13/32"

*Separate pedestal base included with cabinet to be installed after cabinet is in an upright position.

APPLIANCE CABINET TRIM PANELS

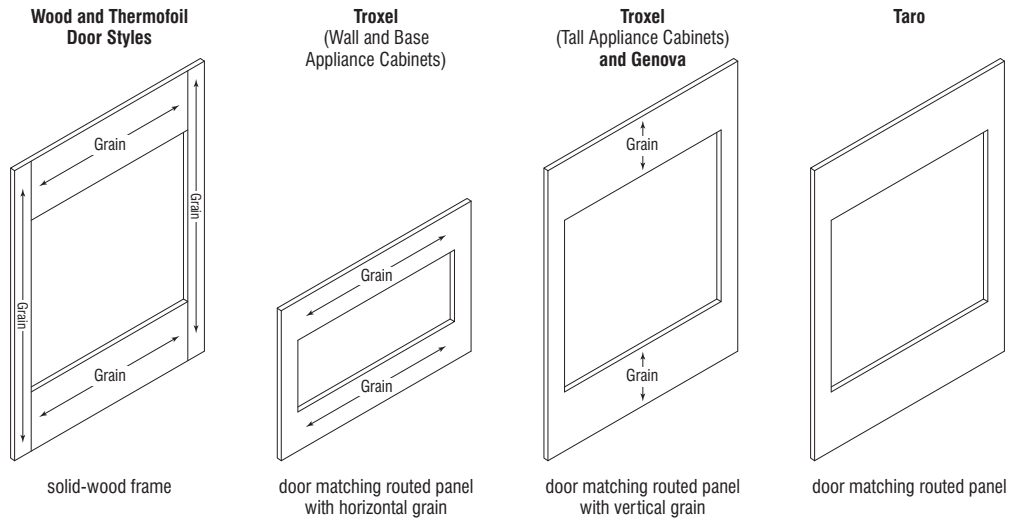

- All appliance cabinet trim panels are 3/4" thick.
- Edgebanding on Genova, Taro, and Troxel will match door edgebanding.
- Trim panel is attached to the front of cabinet end panels with clips, panel can be removed for field cut-out and appliance installation. Cut-out dimensions in charts allow width for clips on back of trim panel.
- Trim panel is installed onto the front of the cabinet face, adding 3/4" to installation cut-out depth. Panel depth will be slightly inset from the cabinet door and drawer front depth due to the bumper thickness.

Outside Profiles of Solid-wood Frames



Shaker:

Amstead Hurson
Butler Larsen
Caprice Lynnville
Cotter Northrope
Darby Warwick
Hardin Whitman

Shaped:

Ashridge
Bellmont
Kingston
Vaille

Door Matching:

Baxter Justin
Dutton Lawton
Ellerby Painter
Gallatin Rennie
Herrington

COUNTRY SINK BASE AND DROP-IN RANGE CUT-OUT PANELS

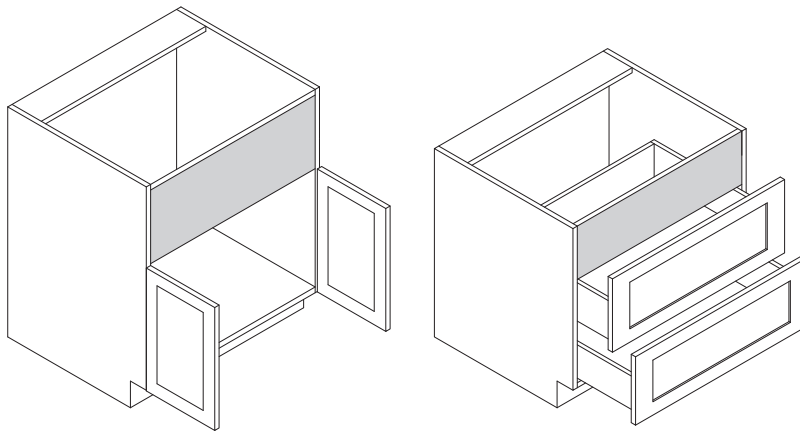

- Front cut-out panel is doweled into the cabinet end panels becoming flush with the cabinet face. Does not add 3/4" depth to the cabinet.
- All Styles except Genova, Taro High Gloss, and Troxel:
Standard construction: Panel is matching laminated furniture board (horizontal grain).
APC, MIP, and WLI: Panel is matching finished veneer edgebanded plywood (horizontal grain).
Genova: Panel is door matching (vertical grain), does not use plywood.
Taro High Gloss: Panel is door matching high gloss, does not use plywood.
Troxel: Panel is door matching (horizontal grain), does not use plywood.

KEMPER CABINETRY'S DESIGN CHECKLIST

CONSTRUCTION OPTIONS

Consider exposed end options:

- Modify exposed cabinet ends to APC.
- Adding a veneer finished end (FB) will age uniformly with the rest of the kitchen.

WOOD AND FINISH CHARACTERISTICS

Review specific details with the customer:

- Mineral Streaks, Birdseye Dots, Grain Variations (especially Hickory and Rustic Alder).
- Color Variations/Darkening (especially Natural/Light Cherry).
- Finish Variations (Glazes are "consistently inconsistent"), hairline cracks may develop at joints.
- Underside of cabinets are Natural Maple. Use light rail or cabinet panel edge and skin to hide, especially when designing with peninsula wall cabinets.

STORAGE SOLUTIONS

Review storage and usage needs with Customer. See chart on pages 77-78 for more Storage Solutions.

- Cooking Solutions:
 - Wall Spice Rack Cabinet
- Storage Solutions:
 - SuperCabinet™
 - Base Rotating Deep Bin
 - Pegged Dish Organizer
 - Wall Message Center
- Clean-up Center:
 - Base Wastebasket

CLEARANCES

- Add fillers between end cabinets and walls when hardware may interfere with door opening fully.
- Allow space between door/window trim and end cabinets for countertop and top moulding overhang.
- Include refrigerator door hinges in overall refrigerator height when placing cabinets above it.

Maintain a minimum clearance of 3" by pulling blind corners according to chart dimensions provided:

- Allow sufficient clearance (3") on each side of accessory cabinets (such as roll-out trays, swing-out units, etc.). Doors on these cabinets must open fully for accessories to be functional.

Qualify customer carefully on upper cabinet/microwave advantages/disadvantages as follows:

- Minimum of 18" from cooktop to upper cabinet/above the range microwave which allows for easy access to either, but less room over back burner.
- Minimum of 21" from cooktop to upper cabinet/microwave which allows for access to large pots on back burner of cooktop, but longer reach to microwave.

FILLERS

- Place fillers toward end of run where least conspicuous if needed.
- Attach overlay fillers on top of the base, wall, or tall fillers to maintain a consistent reveal. Don't forget to include blind corner fillers.
- Add a filler at least 6" wide to accommodate a decorative onlay when the filler is used as valance.
- When installing framed cabinets adjacent to full access cabinets, the framed cabinet requires a space filler, 1/4" skin, or FPEB modification to maintain proper alignment between cabinets.

VARYING HEIGHTS AND DEPTHS

- Also increase the depth of a wall cabinet run when you increase the height (so moulding on adjacent cabinet will return into the side of the taller cabinet).
- Add increased depth on tall end panels for a built-in look for deep refrigerators.
- Account for the additional support needed for wall cabinets with a depth of 18" or greater. This can be achieved by installing a soffit or end panels.

MATCHING INTERIOR CABINETS/GLASS OPTIONS

- Verify cut-for-glass or mullion door option is available on desired cabinet size. (See pages 55-58 for available cut-for-glass/mullion door sizes.)
- Verify glass insert option is available for desired cut-for-glass door size chosen.
- Verify matching interior option has been selected for all open or glass cabinets.
- Verify mullion door lite grid matches customer expectations.

MOULDINGS

- Order rosettes and plinths in beaded or fluted styles to match fillers.
- Verify correct amount of crown moulding has been ordered.
- Order toekick caps.
- Order extra scribe.

ISLANDS AND PENINSULAS

- Consider standard height bars are 34 1/2" tall and require 19" knee space. Raised bars are 42" tall.
- Consider base peninsula cabinets (P) are 24 1/4" deep and require 12" of knee space. Use back panels/doors to flush non-P cabinets with P cabinets.
- Use recess toe on sides and back or BBM8 when using multiple base cabinets to create an island.
- Use outside corner moulding if a skin is exposed on the back of the island.

APPLIANCES

- Note for all consumers, appliances are not included with any cabinetry product.
- Do not place dishwashers next to diagonal front cabinet (interference) or next to a range (no countertop support).
- Verify refrigerator door has enough clearance to open beyond 90° so refrigerator drawers can be utilized. Refer to appliance manufacturer's specs.
- Verify clearances meet the installation requirements by the appliance manufacturers.
- Add TF696FH, as it may be required to frame around built-in microwave ovens and other built-in items. Refer to appliance manufacturer's specs.
- Order appliance panels.

SPECIAL CONSIDERATIONS

- Consider V-groove skins and/or decorative doors on exposed cabinet sides in glazed kitchen.

MISCELLANEOUS

- Order full size touch-up kit (mini touch-up kit included with standard sink base).

TIPS TO THE INSTALLER

#10 x 2 1/2" installation screws are furnished and packaged inside all cabinets. Proper wall stud or ceiling joist installation is essential for Wall and Peninsula cabinets to support weight. Whenever possible, cabinets should be attached to each other for additional strength using connection bolts (CONBOLTCH10, see page 355) to hold cabinet end panels together. Excessive weight should not be put on cabinets hung by themselves. Shimming may be required to ensure proper alignment. Wallboard alone is not strong enough to support the cabinets.

Our Warranty does not cover damage caused by improper installation. Please be sure to install cabinets properly. If you have questions, please contact your representative or customer service.

kitchen planning guidelines

DOOR/ENTRY

- Door opening should be at least 32" wide, requiring a minimum 2' 10" wide door.

DOOR INTERFERENCE

- Entry door should not interfere with safe appliance operation or appliance doors.

DISTANCE BETWEEN WORK CENTERS

- With three work centers, the total distance traveled should not be more than 26' with no single leg of the triangle less than 4' or more than 9'.
- With more than three work centers, each additional travel distance to another work center should be no less than 4' or more than 9'. Each leg is measured from the center-front of the appliance/sink. No work triangle leg should intersect an island/peninsula by more than 12".

SEPARATING WORK CENTERS

- A tall obstacle should not separate two primary work centers. A properly recessed tall corner unit is acceptable.

WORK TRIANGLE TRAFFIC

- Major traffic patterns should not cross through the basic work triangle.

WORK AISLE

- The work aisle should be at least 42" for one cook and at least 48" for multiple cooks.

WALKWAY

- The walkway width should be at least 36".

TRAFFIC CLEARANCE AT SEATING

- Allow 32" of clearance from the table to wall/obstacle if no traffic passes behind a seated diner. If traffic passes behind the diner, allow at least 36" to edge past or 44" to walk past.

SEATING CLEARANCE

- 30" high tables/counters should allow a 24" wide by 18" deep space for each seated diner and at least 18" knee space.
- 36" high counters should allow a 24" wide by 15" deep space for each seated diner and at least 15" kneespace.
- 42" high counters should allow a 24" wide by 12" deep space for each seated diner and at least 12" kneespace.

CLEAN-UP/PREP SINK PLACEMENT

- With only one sink, locate it adjacent to or across from the cooking surface and refrigerator.

CLEAN-UP/PREP SINK LANDING AREA

- Include at least a 24" wide landing space on one side of the sink and 18" on the other.
- If all the countertop at the sink is not the same height, plan a 24" landing space on one side of the sink and 3" of countertop frontage on the other, both at the same height of the sink.

PREPARATION/WORK AREA

- Include a section of countertop at least 36" wide x 24" deep next to the sink for a work area.

DISHWASHER PLACEMENT

- Nearest edge of dishwasher should be within 36" of nearest edge of sink. Provide at least 21" of standing space between the edge of the dishwasher and countertop frontage/appliances/cabinets which are placed at a right angle to the dishwasher.

WASTE RECEPTACLES

- Include at least 2 waste receptacles, one near the sink and the other nearby for recycling.

AUXILIARY SINK

- Provide at least 3" of countertop frontage on one side of the auxiliary sink and 18" on the other side, both at the same height as the sink.

REFRIGERATOR LANDING AREA

- Include at least 15" of landing area on the handle side of the refrigerator, 15" on either side of a side-by-side refrigerator, 15" of landing space which is no more than 48" across from the front of the refrigerator, and 15" above or adjacent to any under-counter style refrigerator.

COOKING SURFACE LANDING AREA

- Include a minimum of 12" of landing area on one side of the cooking surface and 15" on the other.
- If cooking surface is at a different countertop height than the rest of the kitchen, then the 12" and 15" landing areas must be the same height as the cooking surface.
- For safety reasons, in an island or peninsula situation, the countertop should extend a minimum of 9" behind the cooking surface if the counter height is the same height as the cooking surface.

COOKING SURFACE CLEARANCE

- Allow 24" between the cooking surface and a protected noncombustible surface above it.
- At least 30" of clearance is required between the cooking surface and an unprotected/combustible surface above it.
- If a microwave/hood combination is used, then the manufacturer's specifications should be followed.

COOKING SURFACE VENTILATION

- A correctly sized, ducted ventilation system is recommended for all cooking surface appliances. The recommended minimum is 150 CFM.
- Code requires that the manufacturer's specifications be followed. Minimum exhaust rate for a ducted hood is 100 CFM and must be ducted to the outside.
- Make-up air may need to be provided. Refer to local codes.

COOKING SURFACE SAFETY

- Do not locate cooking surface under an operable window.
- Window treatments above cooking surface should not use flammable materials.
- Place a fire extinguisher near the kitchen exit away from cooking equipment.

MICROWAVE OVEN PLACEMENT

- The ideal location for the bottom of the microwave is 3" below the principle user's shoulder, but no more than 54" above the floor.

MICROWAVE LANDING AREA

- Provide at least 15" above, below, or adjacent to the handle side of a microwave oven.

OVEN LANDING AREA

- Include at least 15" next to or above the oven.
- A 15" landing area that is not more than 48" away is also acceptable as long as the oven does not open into a walkway.

COMBINING LANDING AREAS

- If two landing areas are adjacent to one another, determine a new minimum for the two by taking the longer of the two and adding 12".

continued

kitchen planning guidelines (continued)

COUNTERTOP SPACE

- A total of 158" of countertop frontage, 24" deep, with at least 15" clearance above is needed to accommodate all landing, preparation, work, and storage areas.

COUNTERTOP EDGES

- Clipped or round corners, rather than sharp edges, are recommended on all counters.

STORAGE

- The recommended total shelf/drawer frontage for a small kitchen (less than 150 square feet) is 1400", for a medium kitchen (151 to 350 square feet) is 1700", and for a large kitchen (greater than 350 square feet) is 2000".

Sizes:	S	M	L
Wall	300"	360"	360"
Base	520"	615"	660"
Drawer	360"	400"	525"
Pantry	180"	230"	310"
Misc.	40"	95"	145"

- The totals for wall, base, drawer, and pantry shelf/drawer frontage can be adjusted upward or downward as long as the recommended total stays the same.

STORAGE AT CLEAN-UP/PREP SINK

- The recommended total for a small kitchen is 400", a medium kitchen is 480", a large kitchen is 560", and should be located within 72" of the centerline of the main clean-up/prep sink.

CORNER CABINET STORAGE

- At least one corner cabinet should include a functional storage device.

ELECTRICAL RECEPTACLES

- GFCI (Ground-Fault-Circuit-Interrupter) protection is required on all receptacles servicing countertop surfaces within the kitchen.

LIGHTING

- Every work surface should be well illuminated. At least one wall switch-controlled light must be placed at the entrance.
- Window/skylight area, equal to at least 8% of the total square footage of the kitchen, or a total living space which includes a kitchen, is required.

bathroom planning guidelines

DOOR/ENTRY

- Doorway opening should be at least 32", requiring a minimum 2' 10" wide door.

DOOR INTERFERENCE

- The door area should include clear floor space for maneuvering which varies according to the type of door and the direction of the approach.

CEILING HEIGHT

- Bathroom floor to ceiling minimum height is 80". A shower or tub with a shower head shall have a minimum floor to ceiling height of 80" above a minimum area 30" x 30" at the shower head.

CLEAR SPACE

- Plan a clear space of 30" from the front edge of all fixtures to any opposite bath fixture, wall, or obstacle.
- A minimum space of at least 21" is required in front of a lavatory, toilet, bidet, and tub, with a 24" minimum space in front of a shower entry.

SINGLE LAVATORY PLACEMENT

- The distance from the centerline of the lavatory to the sidewall/tall obstacle should be at least 20".
- The minimum distance required is 15". The minimum distance required between a wall and the edge of a lavatory is 4".

DOUBLE LAVATORY PLACEMENT

- The distance between the centerlines of two lavatories should be at least 36".
- The minimum distance required is 30".
- The minimum distance required between the edges of two lavatories is 4".

LAVATORY/VANITY HEIGHT

- The height for a lavatory varies from 32" to 43" to fit the user.

COUNTERTOP EDGES

- Clipped or round corners, rather than sharp edges, are recommended on all counters.

SHOWER SIZE

- The interior shower size should be at least 36" x 36". The minimum interior shower size required is 30" x 30".

STORAGE

- Provide adequate, accessible storage for toiletries, bath linens, grooming and general bathroom supplies.
- Storage of frequently used items should be 15" to 48" above floor.

ELECTRICAL RECEPTACLES

- All GFCI receptacles should be located at electrical appliance points of use.

Load bearing floors and shelves meet KCMA standards of 15 lbs. per square foot. Warranty does not cover overloading beyond this point.

To view a complete and updated list of the NKBA Guidelines, visit <http://www.nkba.org/guidelines/default.aspx>

© Copyright 2010 National Kitchen & Bath Association

STORAGE SOLUTIONS REFERENCE CHART

Wall Cabinets	Description	3"	6"	9"	12"	15"	18"	21"	24"	27"	30"	33"	36"	39"	42"	45"	48"	Page
W18__SPD	Wall Spice Pull-down						•											133
W36__SHLFPD	Wall Shelf Pull-down												•					134
WBCPO__OL	Wall Box Column Pull-outs (Plain, Overlay)	•	•															129
WBCPOKUP3__OL	Wall Box Column Pull-outs w/K-Cup (Plain, Overlay)	•																131, 132
WEAS__	Wall Easy Access Storage Cabinets					•	•				•		•					97
WMC__	Wall Message Center	•																140
WSC__	Wine Storage Cabinet				•	•	•	•	•									137
WSP__	Wall Spice Pull-outs			•	•													133
WSR__	Wall Spice Rack Cabinets						•	•										134
Hearths																		
HPP9__21	Hearth Pier w/Pull-out			•														154
Base Cabinets																		
2DB__RT	Two Drawer Bases w/Roll Tray						•	•	•	•	•	•	•					191
2DB36PDO	Two Drawer Base w/Pegged Dish Organizer																•	190
2DB36RTPDO	Two Drawer Base w/Roll Tray & Pegged Dish Organizer																•	191
3DB__WTCO	Three Drawer Bases w/Wood Tiered Cutlery Divider Drawer					•	•	•	•									192
3DB18KCUP	Three Drawer Base w/Wood Tiered K-Cup Drawer					•												193
3DBBDD__	Three Drawer Base Buffet w/Deep Drawer										•	•	•					193
3DBDD__	Three Drawer Bases w/Deep Drawer								•		•	•	•					193
4DB__CIW	Four Drawer Bases w/Cutlery Insert Wood Organizer					•	•	•	•									194
4DB__WTCO	Four Drawer Bases w/Wood Tiered Cutlery Divider Drawer					•	•	•	•									195
4DB18KCUP	Four Drawer Base w/Wood Tiered K-Cup Drawer					•												195
B__CIW	Bases w/Cutlery Insert Wood Organizer					•	•	•	•									159
B__FHMIWSC	Base Cabinets w/Mixer Shelf						•	•	•									172
B__FHRTLO	Bases w/Lid Organizer & Roll Tray										•	•	•					170
B__FSCO	Base w/Food Storage Container Organizer						•		•									171
B__PS	Pots & Pans Organizer Bases w/Drawer								•		•		•					170
B__RTCIW	Bases w/Cutlery Insert Wood Organizer & Roll Tray					•	•	•	•									168
B__RTLO	Bases w/Drawer & Lid Organizer & Roll Tray										•	•	•					169
B__RTWTCO	Bases w/Wood Tiered Cutlery Divider Drawer & Roll Tray					•	•	•	•									169
B__TDRO	Bases with Roll-out Tray Divider				•	•												171
B__WTCO	Bases w/Wood Tiered Cutlery Divider Drawer					•	•	•	•									160
B18KCUP	Base w/Wood Tiered K-Cup Drawer					•												160
B18KUPRT	Base w/Wood Tiered K-Cup Drawer and Roll Trays					•												169
BBCPO__OL	Base Box Column Pull-outs (Plain, Overlay)	•	•															201
BBTP24	Base Bin Tray Pull-out								•									197
BBTP24FH	Base Bin Tray Pull-out Full Height								•									197
BCFW48CPO	Base Corner Full Width w/Curved Pull-out																•	184
BCOPP12	Base Container Organizer Pantry Pull-out				•													199
BEAS__	Base Easy Access Storage Cabinets					•	•											163
BMC24	Base Message Center	•																201
BPP__	Base Pantry Pull-outs			•	•													199
BPPP__	Base Pots & Pans Pull-outs								•		•							170
BPT__WBFH	Base Paper Towel Cabinet w/Wastebasket Full Height					•	•											197
BRDB36	Base Rotating Deep Bin																•	189
BSC30PR, R, RP, RS, SR	SuperCabinet™										•							164
BSC36PRP, PRS, SRP, SRS	SuperCabinet™												•					165
BUPP__	Base Utensil Pantry Pull-out			•	•													200
BUPPKB__	Base Utensil Pantry Pull-out w/Knife Block			•	•													200
BV2SC30PR, RP, RS, SR	SuperCabinet™ Version 2										•							164
BV2SC36PRP, PRS, SRP, SRS	SuperCabinet™ Version 2												•					165
BWB__	Base Wastebaskets				•	•	•											195
BWB__FH	Base Wastebaskets Full Height				•	•	•											196
CNTYSB__CM	Country Sink Base w/CabMat™										•	•	•					180
LSP36	Lazy Susan Pull-out																•	189
SB__CM, SCM, STCM, STSCM	Sink Base w/CabMat™										•	•	•					173, 175, 177, 178
SB__D	Sink Bases w/Drawers Below								•	•	•	•	•	•	•	•	•	179
SB__S	Sink Base SuperCabinet™										•	•	•					177
SB__STS	Sink Base SuperCabinet™ w/Tilt-out Trays										•	•	•					178
SB36CDY	Sink Base w/Caddy																•	174
SB36SCDY	Sink Base SuperCabinet™ w/Caddy																•	177
SB36STCDY	Sink Base w/Tilt-out Trays & Caddy																•	176
SB36STSCDY	Sink Base SuperCabinet™ w/Tilt-out Trays & Caddy																•	179
SLSCR__	Super Lazy Susans w/Chrome Rail											•	•					187
SLSCR__	Asymmetrical Super Lazy Susans w/Chrome Rail											•	•					188
SSS36	Segmented Super Lazy Susan																•	186

• Available widths

continued

STORAGE SOLUTIONS REFERENCE CHART

Tall Cabinets	Description	3"	6"	9"	12"	15"	18"	21"	24"	27"	30"	33"	36"	39"	42"	45"	48"	Page
PTU___24	Pantry Top Units					•	•	•	•		•		•					227
PTUP__4924	Pantry Top Units w/Pull-out					•	•											227
TPP___24	Tall Pantry Pull-outs			•	•	•	•											228, 229
UEAS___12, 24	Utility Easy Access					•	•				•		•					219-222
UOC24__6	Utility Organizer Cabinet		•															223
UOCD24__9	Utility Organizer Drop Zone Cabinet								•									224
Vanity Cabinets																		
LC188421	Linen Closet						•											275
LCRH188421	Linen Closet w/Removable Hamper						•											275
VBH183421	Vanity Hamper w/Drawer						•											275
VBWB153421	Vanity Base Wastebasket					•												264
VGPO123421	Vanity Grooming Pull-out				•													265
VH183221FH	Vanity Hamper						•											275
VMP___32.5	Vanity Mirror w/Side Pull-outs								•		•							278
VP93421	Vanity Pull-out			•														265
VSB__3421WB	Vanity Sink Bases w/Wastebasket								•		•							257
VSB30__21U	Vanity Sink Bases w/U-shaped Roll-out Tray										•							257
VSSB__3421ST	Vanity Sink Base SuperCabinet™ w/Tilt-out Trays										•	•	•					258
VSSB__3421STWB	Vanity Sink Base SuperCabinet™ w/Tilt-out Trays and Wastebasket										•	•	•					258
VWB15__21	Vanity Wastebasket Full Height					•												265
VWB15__21RT	Vanity Wastebasket Full Height w/Roll Tray					•												265
VWH__23.521U	Vanity Wall Hung Double Door w/U-shaped Pull-outs										•		•					277
Modifications																		
CMAT1 (Base, Universal)	CabMat™										•	•	•					45
CMAT2 (Vanity)	CabMat™							•	•	•	•	•						45
DRWTK	Toekick Drawer						•	•	•	•	•	•	•					52

• Available widths

WALL CABINET NOMENCLATURE

All Wall Cabinets are 12" deep unless otherwise noted.

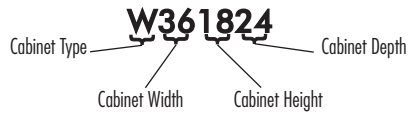

NOTE:

A fixed shelf separates upper and lower sections, all fixed and adjustable shelves in wall cabinets are shown with dotted lines. Number of adjustable shelves vary based on cabinet height (see drawings and notes for details).

MODIFICATIONS GRID KEY

- Available
- STD Standard on these cabinets
- storage SOLUTIONS Storage Solutions Organization Cabinet
- 5 DAY** 5 Day Express Response Item

CUSTOM MODIFICATIONS

Mod.	Description	Mod.	Description
ADDTK*	Add Toekick	INVRM	Inverted Opening
CBO	Cabinet Box Only	P	Peninsula
CCO	Cabinet Case Only	RD	Reduced Depth
CND	Cabinet with No Door, with Drawer	RECBTM	Recessed Bottom
EXBK	End Extended Back	TD	Tray Dividers
ID	Increased Depth	TVR_V	Valance Top Rail

CONSTRUCTION AND FINISH UPGRADES

Mod.	Description
APC	All-plywood Construction
FB	Finished Ends
MIP	Matching Interior Plywood
MSLFB	Matching Specialty Laminate Furniture Board
WLI	White Laminate Interior

DOOR OPTIONS

Mod.	Description
ALF	Aluminum Frame Doors
CG, CG.BTM, CG.TOP	Cut-for-glass Doors
DPSRR	Door Panel - Solid Reverse Raised
MD, MD.BTM, MD.TOP	Mullion Doors

*ADDTK available with compatible toekick modifications. See the Modification/Upgrade Compatibility Chart on page 37 for details.

WALL SINGLE DOOR, 12" HIGH

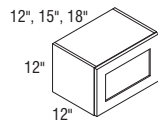

Model	Cubic Feet
W1212 L or R	1.5
W1512 L or R	1.9
W1812 L or R	2.2

Custom Modifications

ADDTK	CBO	CCO	CND	EXBK	ID	INVRM	P	RD	RECBTM	TD	TVR_V
•		•		•	•		•	•	•		

Construction and Finish Upgrades

APC	FB	MIP	MSLFB	WLI
•	•	•	•	•

Door Options

ALF	CG	CG.BTM	CG.TOP	DPSRR	MD	MD.BTM	MD.TOP
•*	•			•			

*Not available on 12" wide

WALL DOUBLE DOOR, 12" HIGH

21", 24", 27", 30",
33", 34", 36", 37", 39"

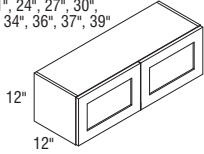

W2112-W3712 Butt doors
W3912 Center mullion

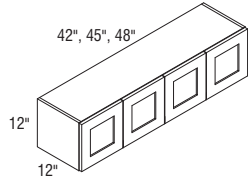

W4212-W4812 Vertical divider

Model	Cubic Feet
W2112	2.6
W2412	3.0
W2712	3.3
W3012	3.7
W3312	4.1
W3412	4.0
W3612	4.4
W3712	4.4
W3912	4.8
W4212	5.1
W4512	5.3
W4812	5.7

Custom Modifications

ADDTK	CBO	CCO	CND	EXBK	ID	INVFRM	P	RD	RECBTM	TD	TVR_V
•		•		•	•		•*	•	•		

*Available only on 21" and 24" wide

Construction and Finish Upgrades

APC	FB	MIP	MSLFB	WLI
•	•	•	•	•

Door Options

ALF	CG	CG.BTM	CG.TOP	DPSRR	MD	MD.BTM	MD.TOP
	•			•			

WALL TOP HINGE, 12" HIGH

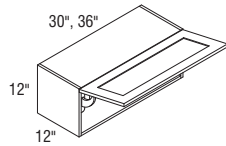

WTH3012	3.7
WTH3612	4.4

- Utilizes doors from 30" and 36" high wall cabinets. Grain on center panels and slab doors will run horizontally and door rail configuration on non-miter doors will be unique from adjacent cabinet doors. Genova will have standard vertical grain pattern. Troxel will have standard horizontal grain pattern.
- Not available on Lynnville.
- Art Glass not available.
- Cabinet may utilize one or two lift mechanisms depending on door size and weight. Door lift mechanism tension can be field adjusted.
- Depth can be reduced to a minimum of 9".
- Door will open a maximum of 107° due to hinges. For applications close to a ceiling, door angle can be restricted to 86° with a Hinge Angle Restriction Clip (HINGERESCLIP, see page 354).
- Lift mechanisms and mounting brackets will be visible if used with transparent textured glass.
- Lift mechanism not available for order for field installation, only available factory installed.

Custom Modifications

ADDTK	CBO	CCO	CND	EXBK	ID	INVFRM	P	RD	RECBTM	TD	TVR_V
		•		•	•			•	•		

Construction and Finish Upgrades

APC	FB	MIP	MSLFB	WLI
•	•	•	•	•

Door Options

ALF	CG	CG.BTM	CG.TOP	DPSRR	MD	MD.BTM	MD.TOP
•	•			•			

WALL REFRIGERATOR DOUBLE DOOR, 12" HIGH, 24" DEEP

24", 27", 30", 33",
34", 36", 37", 39"

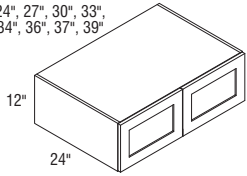

W241224-W371224 Butt doors
W391224 Center mullion

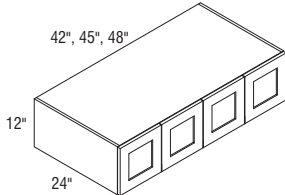

W421224-W481224 Vertical divider

Model	Cubic Feet
W241224	5.5
W271224	5.9
W301224	6.8
W331224	7.4
W341224	7.3
W361224	8.1
W371224	8.0
W391224	8.7
W421224	9.4
W451224	9.9
W481224	10.5

- 24" deep cabinets must be fully supported by screws installed in a structural member in the ceiling or soffit, and into adjacent cabinets.
- Load limit is 15 lbs. per square foot of load bearing surface.
- 42" or wider will feature four doors.

Custom Modifications

ADDTK	CBO	CCO	CND	EXBK	ID	INVFRM	P	RD	RECBTM	TD	TVR_V
•		•		•				•	•		

Construction and Finish Upgrades

APC	FB	MIP	MSLFB	WLI
•	•	•	•	•

Door Options

ALF	CG	CG.BTM	CG.TOP	DPSRR	MD	MD.BTM	MD.TOP
	•			•			

WALL TOP HINGE REFRIGERATOR, 12" HIGH, 24" DEEP

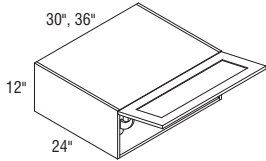

WTH301224	6.8
WTH361224	8.1

- Utilizes doors from 30" and 36" high wall cabinets. Grain on center panels and slab doors will run horizontally and door rail configuration on non-miter doors will be unique from adjacent cabinet doors. Genova will have standard vertical grain pattern. Troxel will have standard horizontal grain pattern.
- Not available on Lynnvile.
- 24" deep cabinets must be fully supported by screws installed in a structural member in the ceiling or soffit, and into adjacent cabinets.
- Load limit is 15 lbs. per square foot of load bearing surface.
- Art Glass not available.
- Cabinet may utilize one or two lift mechanisms depending on door size and weight. Door lift mechanism tension can be field adjusted.
- Depth can be reduced to a minimum of 9".
- Door will open a maximum of 107° due to hinges. For applications close to a ceiling, door angle can be restricted to 86° with a Hinge Angle Restriction Clip (HINGERESCLIP, see page 354).
- Lift mechanisms and mounting brackets will be visible if used with transparent textured glass.
- Lift mechanism not available for order for field installation, only available factory installed.

Custom Modifications

ADDTK	CBO	CCO	CND	EXBK	ID	INVFRM	P	RD	RECBTM	TD	TVR_V
		•		•				•	•		

Construction and Finish Upgrades

APC	FB	MIP	MSLFB	WLI
•	•	•	•	•

Door Options

ALF	CG	CG.BTM	CG.TOP	DPSRR	MD	MD.BTM	MD.TOP
•	•			•			

WALL SINGLE DOOR, 15" HIGH

12", 15", 18"

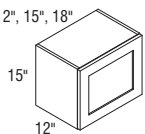

W1215 L or R	1.8
W1515 L or R	2.3
W1815 L or R	2.7

Custom Modifications

ADDTK	CBO	CCO	CND	EXBK	ID	INVFRM	P	RD	RECBTM	TD	TVR_V
•		•		•	•			•	•		

Construction and Finish Upgrades

APC	FB	MIP	MSLFB	WLI
•	•	•	•	•

Door Options

ALF	CG	CG.BTM	CG.TOP	DPSRR	MD	MD.BTM	MD.TOP
•*	•			•			

*Not available on 12" wide

WALL DOUBLE DOOR, 15" HIGH

21", 24", 27", 30",
33", 34", 36", 37", 39"

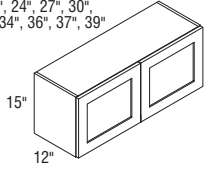

W2115-W3715 Butt doors
W3915 Center mullion

42", 45", 48"

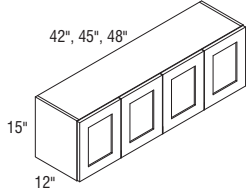

W4215-W4815 Vertical divider

Model	Cubic Feet
W2115	3.2
W2415	3.6
W2715	4.0
W3015	4.5
W3315	4.9
W3415	4.9
W3615	5.4
W3715	5.3
W3915	5.8
W4215	6.1
W4515	6.5
W4815	6.9

Custom Modifications

ADDTK	CBO	CCO	CND	EXBK	ID	INVFRM	P	RD	RECBTM	TD	TVR_V
•		•		•	•		•*	•	•		

*Available only on 21" and 24" wide

Construction and Finish Upgrades

APC	FB	MIP	MSLFB	WLI
•	•	•	•	•

Door Options

ALF	CG	CG.BTM	CG.TOP	DPSRR	MD	MD.BTM	MD.TOP
	•			•			

WALL TOP HINGE, 15" HIGH

30", 36"

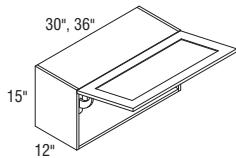

WTH3015	4.5
WTH3615	5.4

- Utilizes doors from 30" and 36" high wall cabinets. Grain on center panels and slab doors will run horizontally and door rail configuration on non-miter doors will be unique from adjacent cabinet doors. Genova will have standard vertical grain pattern. Troxel will have standard horizontal grain pattern.
- Not available on Lynnville.
- Art Glass not available.
- Cabinet may utilize one or two lift mechanisms depending on door size and weight. Door lift mechanism tension can be field adjusted.
- Depth can be reduced to a minimum of 9".
- Door will open a maximum of 107° due to hinges. For applications close to a ceiling, door angle can be restricted to 86° with a Hinge Angle Restriction Clip (HINGERESCLIP, see page 354).
- Lift mechanisms and mounting brackets will be visible if used with transparent textured glass.
- Lift mechanism not available for order for field installation, only available factory installed.

Custom Modifications

ADDTK	CBO	CCO	CND	EXBK	ID	INVFRM	P	RD	RECBTM	TD	TVR_V
		•		•	•			•	•		

Construction and Finish Upgrades

APC	FB	MIP	MSLFB	WLI
•	•	•	•	•

Door Options

ALF	CG	CG.BTM	CG.TOP	DPSRR	MD	MD.BTM	MD.TOP
•	•			•			

WALL REFRIGERATOR DOUBLE DOOR, 15" HIGH, 24" DEEP

24", 27", 30", 33", 34", 36", 37", 39"

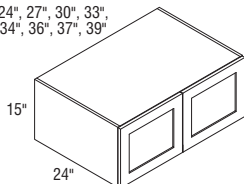

W241524-W371524 Butt doors
W391524 Center mullion

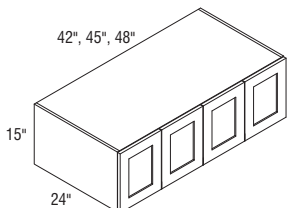

W421524-W481524 Vertical divider

Model	Cubic Feet
W241524	6.7
W271524	7.2
W301524	8.3
W331524	9.1
W341524	9.0
W361524	9.8
W371524	9.7
W391524	10.6
W421524	11.3
W451524	12.0
W481524	12.8

- 24" deep cabinets must be fully supported by screws installed in a structural member in the ceiling or soffit, and into adjacent cabinets.
- Load limit is 15 lbs. per square foot of load bearing surface.
- 42" or wider will feature four doors.

Custom Modifications

ADDTK	CBO	CCO	CND	EXBK	ID	INVFRM	P	RD	RECBTM	TD	TVR_V
•		•		•				•	•		

Construction and Finish Upgrades

APC	FB	MIP	MSLFB	WLI
•	•	•	•	•

Door Options

ALF	CG	CG.BTM	CG.TOP	DPSRR	MD	MD.BTM	MD.TOP
	•			•			

WALL TOP HINGE REFRIGERATOR, 15" HIGH, 24" DEEP

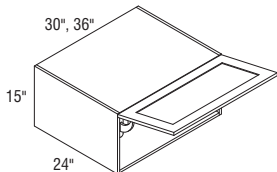

WTH301524	8.3
WTH361524	9.8

- Utilizes doors from 30" and 36" high wall cabinets. Grain on center panels and slab doors will run horizontally and door rail configuration on non-miter doors will be unique from adjacent cabinet doors. Genova will have standard vertical grain pattern. Troxel will have standard horizontal grain pattern.
- Not available on Lynnville.
- 24" deep cabinets must be fully supported by screws installed in a structural member in the ceiling or soffit, and into adjacent cabinets.
- Load limit is 15 lbs. per square foot of load bearing surface.
- Art Glass not available.
- Cabinet may utilize one or two lift mechanisms depending on door size and weight. Door lift mechanism tension can be field adjusted.
- Depth can be reduced to a minimum of 9".
- Door will open a maximum of 107° due to hinges. For applications close to a ceiling, door angle can be restricted to 86° with Hinge Angle Restriction Clip (HINGERESCLIP, see page 354).
- Lift mechanisms and mounting brackets will be visible if used with transparent textured glass.
- Lift mechanism not available for order for field installation, only available factory installed.

Custom Modifications

ADDTK	CBO	CCO	CND	EXBK	ID	INVFRM	P	RD	RECBTM	TD	TVR_V
		•		•				•	•		

Construction and Finish Upgrades

APC	FB	MIP	MSLFB	WLI
•	•	•	•	•

Door Options

ALF	CG	CG.BTM	CG.TOP	DPSRR	MD	MD.BTM	MD.TOP
•	•			•			

WALL SINGLE DOOR, 18" HIGH

12", 15", 18", 21", 24"

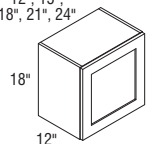

W1218 L or R	2.2
W1518 L or R	2.7
W1818 L or R	3.2
W2118 L or R	3.8
W2418 L or R	4.3

Custom Modifications

ADDTK	CBO	CCO	CND	EXBK	ID	INVFRM	P	RD	RECBTM	TD	TVR_V
•		•		•	•		•	•	•	•	

Construction and Finish Upgrades

APC	FB	MIP	MSLFB	WLI
•	•	•	•	•

Door Options

ALF	CG	CG.BTM	CG.TOP	DPSRR	MD	MD.BTM	MD.TOP
	•			•	•*		

*Not available on 12", 21", and 24" wide

WALL DOUBLE DOOR, 18" HIGH

24", 27", 30", 33", 34",
36", 37", 39", 42", 45", 48"

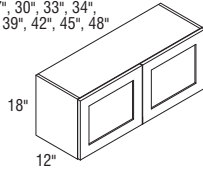

W2418-W3718 Butt doors
W3918-W4818CS Center mullion

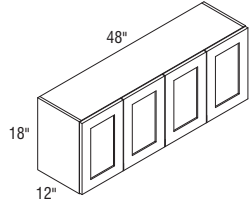

W4818 Vertical divider

Model	Cubic Feet
W2418	4.3
W2718	4.8
W3018	5.3
W3318	5.4
W3418	5.8
W3618	6.3
W3718	6.3
W3918	6.8
W4218	7.3
W4518	7.6
W4818CS	8.3
W4818	8.3

Custom Modifications

ADDTK	CBO	CCO	CND	EXBK	ID	INVERM	P	RD	RECBTM	TD	TVR_V
•		•		•	•		•*	•	•	•*	

*Available only on 24" wide *Not available on 39", 42", 45", and 48" wide

Construction and Finish Upgrades

APC	FB	MIP	MSLFB	WLI
•	•	•	•	•

Door Options

ALF	CG	CG.BTM	CG.TOP	DPSRR	MD	MD.BTM	MD.TOP
	•			•	•▲		

▲Available only on 30" and 36" wide

WALL TOP HINGE, 18" HIGH

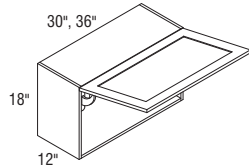

WTH3018	5.3
WTH3618	6.3

- Utilizes doors from 30" and 36" high wall cabinets. Grain on center panels and slab doors will run horizontally and door rail configuration on non-miter doors will be unique from adjacent cabinet doors. Genova will have standard vertical grain pattern. Troxel will have standard horizontal grain pattern.
- Not available on Lynnville.
- Art Glass not available.
- Cabinet may utilize one or two lift mechanisms depending on door size and weight. Door lift mechanism tension can be field adjusted.
- Depth can be reduced to a minimum of 9".
- Door will open a maximum of 107° due to hinges. For applications close to a ceiling, door angle can be restricted to 86° with a Hinge Angle Restriction Clip (HINGERESCLIP, see page 354).
- Lift mechanisms and mounting brackets will be visible if used with transparent textured glass.
- Lift mechanism not available for order for field installation, only available factory installed.

Custom Modifications

ADDTK	CBO	CCO	CND	EXBK	ID	INVERM	P	RD	RECBTM	TD	TVR_V
		•		•	•			•	•	•	

Construction and Finish Upgrades

APC	FB	MIP	MSLFB	WLI
•	•	•	•	•

Door Options

ALF	CG	CG.BTM	CG.TOP	DPSRR	MD	MD.BTM	MD.TOP
•	•			•			

WALL VERTICAL-LIFT, 18" HIGH, 12" DEEP

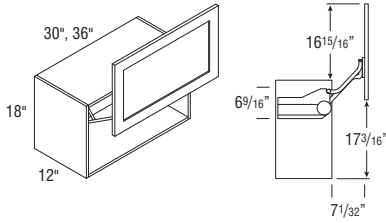

Model	Cubic Feet
WVL3018	5.2
WVL3618	6.1

- Utilizes doors from 30" and 36" high wall cabinets. Grain on center panels and slab doors will run horizontally and door rail configuration on non-miter doors will be unique from adjacent cabinet doors. Genova will have standard vertical grain pattern. Troxel will have standard horizontal grain pattern.
- Decorative hardware required.
- See side view drawing for required clearances.
- Lift mechanism features a single motion for up and out movement with Smart Stop, tension can be field adjusted.
- Lift mechanisms and mounting brackets will be visible if used with transparent textured glass.
- Lift mechanism not available for order for field installation, only available factory installed.
- Hardware extends 1" into opening on each side.
- Art Glass not available.
- Not available on Lynnville.

Custom Modifications

ADDTK	CBO	CCO	CND	EXBK	ID	INVFRM	P	RD	RECBTM	TD	TVR_V
		•		•					•		

Construction and Finish Upgrades

APC	FB	MIP	MSLFB	WLI
•	•	•	•	•

Door Options

ALF	CG	CG.BTM	CG.TOP	DPSRR	MD	MD.BTM	MD.TOP
•	•			•			

WALL REFRIGERATOR SINGLE or DOUBLE DOOR, 18" HIGH, 24" DEEP

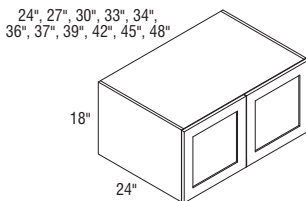
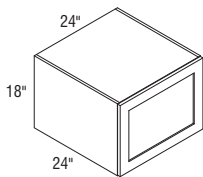

W241824-W371824 Butt doors
W391824-W481824CS Center mullion

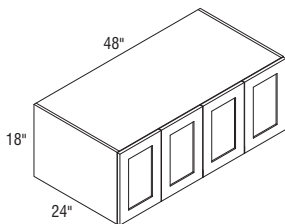

W481824 Vertical divider

W241824 L or R	7.8
W241824	7.8
W271824	8.5
W301824	9.7
W331824	10.6
W341824	10.6
W361824	11.6
W371824	11.5
W391824	12.6
W421824	13.4
W451824	14.1
W481824CS	15.2
W481824	15.2

- 24" deep cabinets must be fully supported by screws installed in a structural member in the ceiling or soffit, and into adjacent cabinets.
- Load limit is 15 lbs. per square foot of load bearing surface.

Custom Modifications

ADDTK	CBO	CCO	CND	EXBK	ID	INVFRM	P	RD	RECBTM	TD	TVR_V
•		•		•				•	•	•*	

*Not available on 39", 42", 45", and 48" wide

Construction and Finish Upgrades

APC	FB	MIP	MSLFB	WLI
•	•	•	•	•

Door Options

ALF	CG	CG.BTM	CG.TOP	DPSRR	MD	MD.BTM	MD.TOP
	•			•	•*		

*Available only on 30" and 36" wide

**WALL TOP HINGE REFRIGERATOR,
18" HIGH, 24" DEEP**

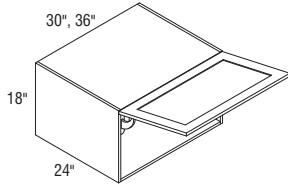

Model	Cubic Feet
WTH301824	9.7
WTH361824	10.6

- Utilizes doors from 30" and 36" high wall cabinets. Grain on center panels and slab doors will run horizontally and door rail configuration on non-miter doors will be unique from adjacent cabinet doors. Genova will have standard vertical grain pattern. Troxel will have standard horizontal grain pattern.
- Not available on Lynnville.
- 24" deep cabinets must be fully supported by screws installed in a structural member in the ceiling or soffit, and into adjacent cabinets.
- Load limit is 15 lbs. per square foot of load bearing surface.
- Art Glass not available.
- Cabinet may utilize one or two lift mechanisms depending on door size and weight. Door lift mechanism tension can be field adjusted.
- Depth can be reduced to a minimum of 9".
- Door will open a maximum of 107° due to hinges. For applications close to a ceiling, door angle can be restricted to 86° with a Hinge Angle Restriction Clip (HINGERESCLIP, see page 354).
- Lift mechanisms and mounting brackets will be visible if used with transparent textured glass.
- Lift mechanism not available for order for field installation, only available factory installed.

Custom Modifications

ADDTK	CBO	CCO	CND	EXBK	ID	INVFRM	P	RD	RECBTM	TD	TVR_V
		•		•				•	•	•	

Construction and Finish Upgrades

APC	FB	MIP	MSLFB	WLI
•	•	•	•	•

Door Options

ALF	CG	CG.BTM	CG.TOP	DPSRR	MD	MD.BTM	MD.TOP
•	•			•			

**WALL REFRIGERATOR VERTICAL-LIFT,
18" HIGH, 24" DEEP**

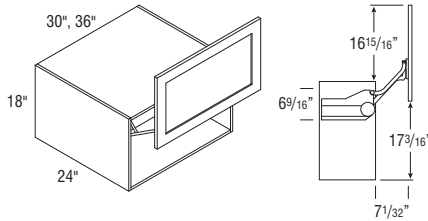

Model	Cubic Feet
WVL301824	9.4
WVL361824	11.2

- Utilizes doors from 30" and 36" high wall cabinets. Grain on center panels and slab doors will run horizontally and door rail configuration on non-miter doors will be unique from adjacent cabinet doors. Genova will have standard vertical grain pattern. Troxel will have standard horizontal grain pattern.
- Decorative hardware required.
- See side view drawing for required clearances.
- Lift mechanism features a single motion for up and out movement with Smart Stop, tension can be field adjusted.
- Lift mechanisms and mounting brackets will be visible if used with transparent textured glass.
- Lift mechanism not available for order for field installation, only available factory installed.
- Hardware extends 1" into opening on each side.
- Art Glass not available.
- Not available on Lynnville.
- Depth can be reduced to a minimum of 12".

Custom Modifications

ADDTK	CBO	CCO	CND	EXBK	ID	INVFRM	P	RD	RECBTM	TD	TVR_V
		•		•				•	•		

Construction and Finish Upgrades

APC	FB	MIP	MSLFB	WLI
•	•	•	•	•

Door Options

ALF	CG	CG.BTM	CG.TOP	DPSRR	MD	MD.BTM	MD.TOP
•	•			•			

**WALL REFRIGERATOR PULL-OUT,
18" HIGH, 24" DEEP**

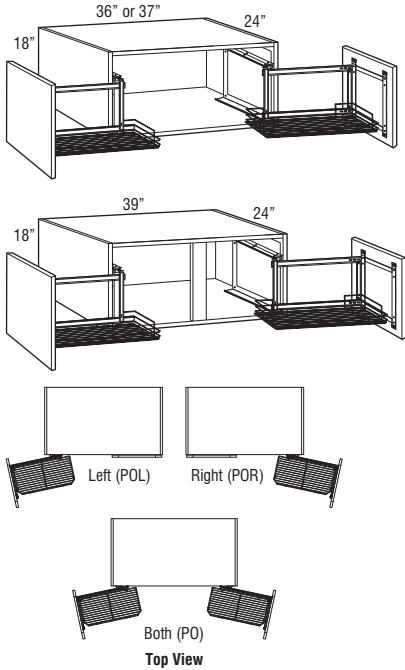

Model	Cubic Feet
W361824PO L or R	11.2
W371824PO L or R	11.5
W361824PO	11.2
W371824PO	11.5
W391824PO L or R	12.6
W391824PO	12.6

- Door-mounted pull-out with a chrome wire rack that extends fully to the front of the cabinet then opens to the side for easy accessibility to contents. Designed for use above refrigerators or other high applications. Smart Stop not included.
- Available installed in either the left side, right side, or both sides.
- For sufficient pull-out clearance, 13 1/8" of adjacent space is required for door to open fully when installed near a wall or corner.
- Chrome rack is 10" wide and 20 13/16" deep.
- 24" deep cabinets must be fully supported by screws installed in a structural member in the ceiling or soffit, and into adjacent cabinets.
- Load limit is 15 lbs. per square foot of load bearing surface.

Custom Modifications

ADDTK	CBO	CCO	CND	EXBK	ID	INVFRM	P	RD	RECBTM	TD	TVR_V
•	•			•							

Construction and Finish Upgrades

APC	FB	MIP	MSLFB	WLI
•	•	•	•	•

Door Options

ALF	CG	CG.BTM	CG.TOP	DPSRR	MD	MD.BTM	MD.TOP
				•			

WALL SINGLE DOOR, 21" HIGH

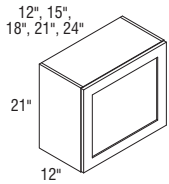

W1221 L or R	2.7
W1521 L or R	3.3
W1821 L or R	3.8
W2121 L or R	4.4
W2421 L or R	5.0

Custom Modifications

ADDTK	CBO	CCO	CND	EXBK	ID	INVFRM	P	RD	RECBTM	TD	TVR_V
•		•		•	•		•	•	•	•	

Construction and Finish Upgrades

APC	FB	MIP	MSLFB	WLI
•	•	•	•	•

Door Options

ALF	CG	CG.BTM	CG.TOP	DPSRR	MD	MD.BTM	MD.TOP
	•			•			

WALL DOUBLE DOOR, 21" HIGH

24", 27", 30", 33", 34",
36", 37", 39", 42", 45", 48"

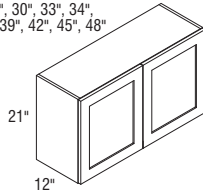

W2421-W3721 Butt doors
W3921-W4821CS Center mullion

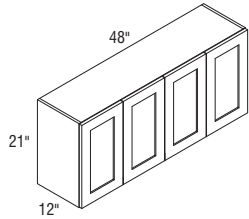

W4821 Vertical divider

Model	Cubic Feet
W2421	5.0
W2721	5.6
W3021	5.6
W3321	6.7
W3421	6.7
W3621	7.2
W3721	7.3
W3921	7.8
W4221	8.5
W4521	8.8
W4821CS	9.7
W4821	9.7

Custom Modifications

ADDTK	CBO	CCO	CND	EXBK	ID	INVFRM	P	RD	RECBTM	TD	TVR_V
•		•		•	•		•*	•	•	•*	

*Available only on 24" wide *Not available on 39", 42", 45", and 48" wide

Construction and Finish Upgrades

APC	FB	MIP	MSLFB	WLI
•	•	•	•	•

Door Options

ALF	CG	CG.BTM	CG.TOP	DPSRR	MD	MD.BTM	MD.TOP
	•			•			

WALL TOP HINGE, 21" HIGH

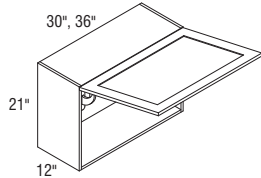

WTH3021	5.6
WTH3621	7.2

- Utilizes doors from 30" and 36" high wall cabinets. Grain on center panels and slab doors will run horizontally and door rail configuration on non-miter doors will be unique from adjacent cabinet doors. Genova will have standard vertical grain pattern. Troxel will have standard horizontal grain pattern.
- Not available on Lynnville.
- Art Glass not available.
- Cabinet may utilize one or two lift mechanisms depending on door size and weight. Door lift mechanism tension can be field adjusted.
- Depth can be reduced to a minimum of 9".
- Door will open a maximum of 107° due to hinges. For applications close to a ceiling, door angle can be restricted to 86° with a Hinge Angle Restriction Clip (HINGERESCLIP, see page 354).
- Lift mechanisms and mounting brackets will be visible if used with transparent textured glass.
- Lift mechanism not available for order for field installation, only available factory installed.

Custom Modifications

ADDTK	CBO	CCO	CND	EXBK	ID	INVFRM	P	RD	RECBTM	TD	TVR_V
		•		•	•			•	•	•	

Construction and Finish Upgrades

APC	FB	MIP	MSLFB	WLI
•	•	•	•	•

Door Options

ALF	CG	CG.BTM	CG.TOP	DPSRR	MD	MD.BTM	MD.TOP
•	•			•			

**WALL VERTICAL-LIFT, 21" HIGH,
12" DEEP**

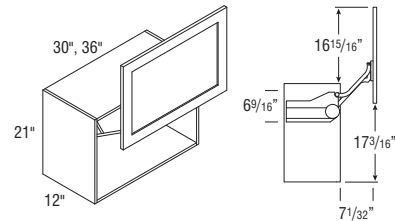

WVL3021	5.9
WVL3621	7.1

- Utilizes doors from 30" and 36" high wall cabinets. Grain on center panels and slab doors will run horizontally and door rail configuration on non-miter doors will be unique from adjacent cabinet doors. Genova will have standard vertical grain pattern. Troxel will have standard horizontal grain pattern.
- Decorative hardware required.
- See side view drawing for required clearances.
- Lift mechanism features a single motion for up and out movement with Smart Stop, tension can be field adjusted.
- Lift mechanisms and mounting brackets will be visible if used with transparent textured glass.
- Lift mechanism not available for order for field installation, only available factory installed.
- Hardware extends 1" into opening on each side.
- Art Glass not available.
- Not available on Lynnville.

Custom Modifications

ADDTK	CBO	CCO	CND	EXBK	ID	INVFRM	P	RD	RECBTM	TD	TVR_V
		•		•	•				•		

Construction and Finish Upgrades

APC	FB	MIP	MSLFB	WLI
•	•	•	•	•

Door Options

ALF	CG	CG.BTM	CG.TOP	DPSRR	MD	MD.BTM	MD.TOP
•	•			•			

WALL REFRIGERATOR SINGLE or DOUBLE DOOR, 21" HIGH, 24" DEEP

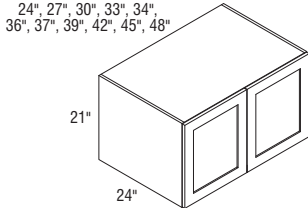
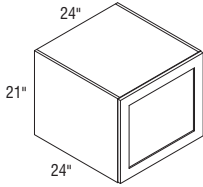

W242124-W372124 Butt doors
W392124-W482124CS Center mullion

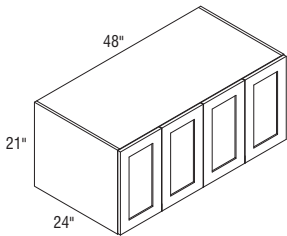

W482124 Vertical divider

Model	Cubic Feet
W242124 L or R	9.0
W242124	9.0
W272124	9.8
W302124	11.1
W332124	12.2
W342124	12.2
W362124	13.3
W372124	13.3
W392124	14.3
W422124	15.2
W452124	16.3
W482124CS	17.3
W482124	17.3

- 24" deep cabinets must be fully supported by screws installed in a structural member in the ceiling or soffit, and into adjacent cabinets.
- Load limit is 15 lbs. per square foot of load bearing surface.

Custom Modifications

ADDTK	CBO	CCO	CND	EXBK	ID	INVFRM	P	RD	RECBTM	TD	TVR_V
•		•		•				•	•	•*	

*Not available on 39", 42", 45", and 48" wide

Construction and Finish Upgrades

APC	FB	MIP	MSLFB	WLI
•	•	•	•	•

Door Options

ALF	CG	CG.BTM	CG.TOP	DPSRR	MD	MD.BTM	MD.TOP
	•			•			

WALL TOP HINGE REFRIGERATOR, 21" HIGH, 24" DEEP

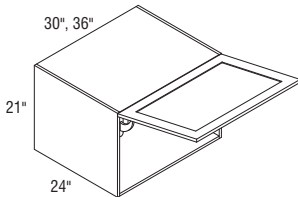

WTH302124	11.1
WTH362124	13.3

- Utilizes doors from 30" and 36" high wall cabinets. Grain on center panels and slab doors will run horizontally and door rail configuration on non-miter doors will be unique from adjacent cabinet doors. Genova will have standard vertical grain pattern. Troxel will have standard horizontal grain pattern.
- Not available on Lynnville.
- 24" deep cabinets must be fully supported by screws installed in a structural member in the ceiling or soffit, and into adjacent cabinets.
- Load limit is 15 lbs. per square foot of load bearing surface.
- Art Glass not available.
- Cabinet may utilize one or two lift mechanisms depending on door size and weight. Door lift mechanism tension can be field adjusted.
- Depth can be reduced to a minimum of 9".
- Door will open a maximum of 107° due to hinges. For applications close to a ceiling, door angle can be restricted to 86° with a Hinge Angle Restriction Clip (HINGERESCLIP, see page 354).
- Lift mechanisms and mounting brackets will be visible if used with transparent textured glass.
- Lift mechanism not available for order for field installation, only available factory installed.

Custom Modifications

ADDTK	CBO	CCO	CND	EXBK	ID	INVFRM	P	RD	RECBTM	TD	TVR_V
		•		•				•	•	•	

Construction and Finish Upgrades

APC	FB	MIP	MSLFB	WLI
•	•	•	•	•

Door Options

ALF	CG	CG.BTM	CG.TOP	DPSRR	MD	MD.BTM	MD.TOP
•	•			•			

**WALL REFRIGERATOR VERTICAL-LIFT,
21" HIGH, 24" DEEP**

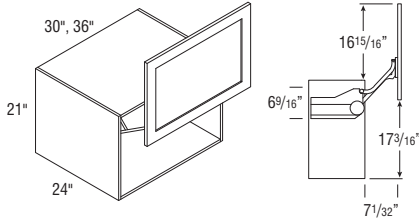

Model	Cubic Feet
WVL302124	10.9
WVL362124	12.9

- Utilizes doors from 30" and 36" high wall cabinets. Grain on center panels and slab doors will run horizontally and door rail configuration on non-miter doors will be unique from adjacent cabinet doors. Genova will have standard vertical grain pattern. Troxel will have standard horizontal grain pattern.
- Decorative hardware required.
- See side view drawing for required clearances.
- Lift mechanism features a single motion for up and out movement with Smart Stop, tension can be field adjusted.
- Lift mechanisms and mounting brackets will be visible if used with transparent textured glass.
- Lift mechanism not available for order for field installation, only available factory installed.
- Hardware extends 1" into opening on each side.
- Art Glass not available.
- Not available on Lynnville.
- Depth can be reduced to a minimum of 12".

Custom Modifications

ADDTK	CBO	CCO	CND	EXBK	ID	INVFRM	P	RD	RECBTM	TD	TVR_V
		•		•	•			•	•		

Construction and Finish Upgrades

APC	FB	MIP	MSLFB	WLI
•	•	•	•	•

Door Options

ALF	CG	CG.BTM	CG.TOP	DPSRR	MD	MD.BTM	MD.TOP
•	•			•			

**WALL REFRIGERATOR PULL-OUT,
21" HIGH, 24" DEEP**

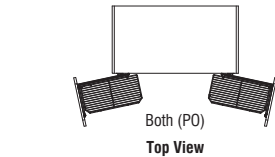
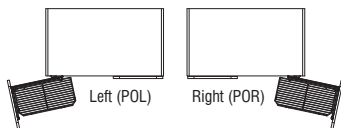
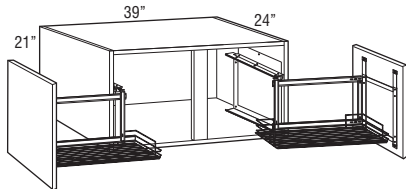
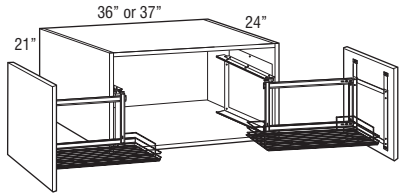

W362124PO L or R	13.3
W372124PO L or R	13.3
W362124PO	13.3
W372124PO	13.3
W392124PO L or R	14.3
W392124PO	14.3

- Door-mounted pull-out with a chrome wire rack that extends fully to the front of the cabinet then opens to the side for easy accessibility to contents. Designed for use above refrigerators or other high applications. Smart Stop not included.
- Available installed in either the left side, right side, or both sides.
- For sufficient pull-out clearance, 13 1/8" of adjacent space is required for door to open fully when installed near a wall or corner.
- Chrome rack is 10" wide and 20 13/16" deep.
- 24" deep cabinets must be fully supported by screws installed in a structural member in the ceiling or soffit, and into adjacent cabinets.
- Load limit is 15 lbs. per square foot of load bearing surface.

Custom Modifications

ADDTK	CBO	CCO	CND	EXBK	ID	INVFRM	P	RD	RECBTM	TD	TVR_V
•		•		•							

Construction and Finish Upgrades

APC	FB	MIP	MSLFB	WLI
•	•	•	•	•

Door Options

ALF	CG	CG.BTM	CG.TOP	DPSRR	MD	MD.BTM	MD.TOP
				•			

WALL SINGLE DOOR, 24" HIGH

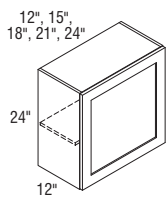

W1224 L or R	3.0
W1524 L or R	3.6
W1824 L or R	4.2
W2124 L or R	4.3
W2424 L or R	5.5

Custom Modifications

ADDTK	CBO	CCO	CND	EXBK	ID	INVFRM	P	RD	RECBTM	TD	TVR_V
•	•	•		•	•			•	•	•	

Construction and Finish Upgrades

APC	FB	MIP	MSLFB	WLI
•	•	•	•	•

Door Options

ALF	CG	CG.BTM	CG.TOP	DPSRR	MD	MD.BTM	MD.TOP
	•			•			

WALL DOUBLE DOOR, 24" HIGH

24", 27", 30", 33", 34",
36", 37", 39", 42", 45", 48"

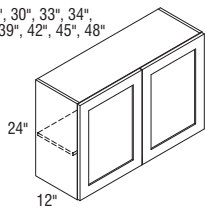

W2424-W3724 Butt doors
W3924-W4824CS Center mullion

Model	Cubic Feet
W2424	5.5
W2724	6.1
W3024	6.8
W3324	7.4
W3424	7.6
W3624	8.0
W3724	8.2
W3924	8.6
W4224	9.3
W4524	9.9
W4824CS	10.5

Custom Modifications

ADDTK	CBO	CCO	CND	EXBK	ID	INFRM	P	RD	RECBTM	TD	TVR_V
•	•	•		•	•		•*	•	•	•*	

*Available only on 24" wide *Not available on 39", 42", 45", and 48" wide

Construction and Finish Upgrades

APC	FB	MIP	MSLFB	WLI
•	•	•	•	•

Door Options

ALF	CG	CG.BTM	CG.TOP	DPSRR	MD	MD.BTM	MD.TOP
	•			•	•▲		

*Available only on 30" and 36" wide

WALL REFRIGERATOR SINGLE or DOUBLE DOOR, 24" HIGH, 24" DEEP

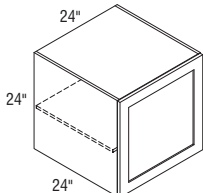

24", 27", 30", 33", 34",
36", 37", 39", 42", 45", 48"

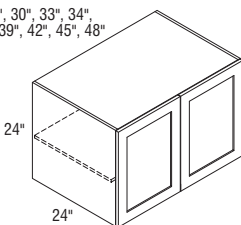

W242424-W372424 Butt doors
W392424-W482424CS Center mullion

W242424 L or R	10.5
W242424	10.5
W272424	10.9
W302424	12.4
W332424	13.6
W342424	13.9
W362424	14.7
W372424	15.1
W392424	15.9
W422424	17.1
W452424	18.4
W482424CS	19.6

- 24" deep cabinets must be fully supported by screws installed in a structural member in the ceiling or soffit, and into adjacent cabinets.
- Load limit is 15 lbs. per square foot of load bearing surface.

Custom Modifications

ADDTK	CBO	CCO	CND	EXBK	ID	INFRM	P	RD	RECBTM	TD	TVR_V
•	•	•		•				•	•	•*	

*Not available on 39", 42", 45", and 48" wide

Construction and Finish Upgrades

APC	FB	MIP	MSLFB	WLI
•	•	•	•	•

Door Options

ALF	CG	CG.BTM	CG.TOP	DPSRR	MD	MD.BTM	MD.TOP
	•			•	•*		

*Available only on 30" and 36" wide

**WALL REFRIGERATOR PULL-OUT,
24" HIGH, 24" DEEP**

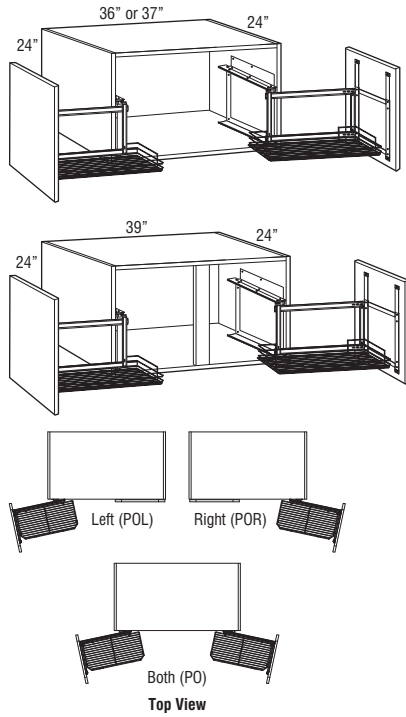

Model	Cubic Feet
W362424PO L or R	14.7
W372424PO L or R	15.1
W362424PO	14.7
W372424PO	15.1
W392424PO L or R	
W392424PO	15.9

- Door-mounted pull-out with a chrome wire rack that extends fully to the front of the cabinet then opens to the side for easy accessibility to contents. Designed for use above refrigerators or other high applications. Smart Stop not included.
- Available installed in either the left side, right side, or both sides.
- For sufficient pull-out clearance, 13 1/8" of adjacent space is required for door to open fully when installed near a wall or corner.
- Chrome rack is 10" wide and 20 13/16" deep.
- 24" deep cabinets must be fully supported by screws installed in a structural member in the ceiling or soffit, and into adjacent cabinets.
- Load limit is 15 lbs. per square foot of load bearing surface.

Custom Modifications

ADDTK	CBO	CCO	CND	EXBK	ID	INVFRM	P	RD	RECBTM	TD	TVR_V
•		•		•							

Construction and Finish Upgrades

APC	FB	MIP	MSLFB	WLI
•	•	•	•	•

Door Options

ALF	CG	CG.BTM	CG.TOP	DPSRR	MD	MD.BTM	MD.TOP
				•			

WALL SINGLE DOOR, 27" HIGH

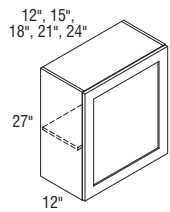

W1227 L or R	3.4
W1527 L or R	4.1
W1827 L or R	4.9
W2127 L or R	5.6
W2427 L or R	6.3

Custom Modifications

ADDTK	CBO	CCO	CND	EXBK	ID	INVFRM	P	RD	RECBTM	TD	TVR_V
•	•	•		•	•		•	•	•	•	

Construction and Finish Upgrades

APC	FB	MIP	MSLFB	WLI
•	•	•	•	•

Door Options

ALF	CG	CG.BTM	CG.TOP	DPSRR	MD	MD.BTM	MD.TOP
	•			•			

WALL DOUBLE DOOR, 27" HIGH

24", 27", 30", 33", 34",
36", 37", 39", 42", 45", 48"

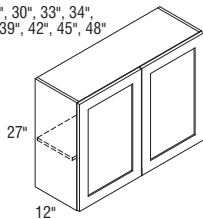

W2427-W3727 Butt doors
W3927-W4827CS Center mullion

Model	Cubic Feet
W2427	6.3
W2727	7.1
W3027	7.8
W3327	8.5
W3427	8.5
W3627	9.3
W3727	9.2
W3927	10.0
W4227	10.7
W4527	11.0
W4827CS	12.2

Custom Modifications

ADDTK	CBO	CCO	CND	EXBK	ID	INFRM	P	RD	RECBTM	TD	TVR_V
•	•	•		•	•		•*	•	•	•*	

*Available only on 24" wide *Not available on 39", 42", 45", and 48" wide

Construction and Finish Upgrades

APC	FB	MIP	MSLFB	WLI
•	•	•	•	•

Door Options

ALF	CG	CG.BTM	CG.TOP	DPSRR	MD	MD.BTM	MD.TOP
	•			•			

WALL REFRIGERATOR SINGLE or DOUBLE DOOR, 27" HIGH, 24" DEEP

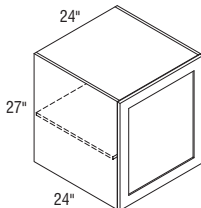

24", 27", 30", 33", 34",
36", 37", 39", 42", 45", 48"

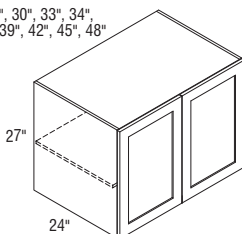

W242724-W372724 Butt doors
W392724-W482724CS Center mullion

Model	Cubic Feet
W242724 L or R	11.3
W242724	11.3
W272724	12.7
W302724	14.4
W332724	15.7
W342724	15.5
W362724	17.0
W372724	16.8
W392724	18.4
W422724	19.2
W452724	21.3
W482724CS	22.6

- 24" deep cabinets must be fully supported by screws installed in a structural member in the ceiling or soffit, and into adjacent cabinets.
- Load limit is 15 lbs. per square foot of load bearing surface.

Custom Modifications

ADDTK	CBO	CCO	CND	EXBK	ID	INFRM	P	RD	RECBTM	TD	TVR_V
•	•	•		•				•	•	•*	

*Not available on 39", 42", 45", and 48" wide

Construction and Finish Upgrades

APC	FB	MIP	MSLFB	WLI
•	•	•	•	•

Door Options

ALF	CG	CG.BTM	CG.TOP	DPSRR	MD	MD.BTM	MD.TOP
	•			•			

WALL SINGLE DOOR, 30" HIGH

9", 12", 15",
18", 21", 24"

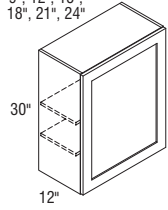

Model	Cubic Feet
W930 L or R	2.9
W1230 L or R	3.7
W1530 L or R	4.5
W1830 L or R	5.3
W2130 L or R	6.1
W2430 L or R	6.9

Custom Modifications

ADDTK	CBO	CCO	CND	EXBK	ID	INVFRM	P	RD	RECBTM	TD	TVR_V
•	•	•		•	•		•	•	•	•	

Construction and Finish Upgrades

APC	FB	MIP	MSLFB	WLI
•	•	•	•	•

Door Options

ALF	CG	CG.BTM	CG.TOP	DPSRR	MD	MD.BTM	MD.TOP
•*	•			•	•*		

*Not available on 9" and 24" wide *Not available on 9" and 12" wide

WALL DOUBLE DOOR, 30" HIGH

24", 27", 30", 33",
36", 39", 42", 45", 48"

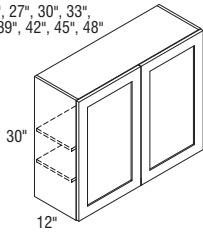

W2430-W3630 Butt doors
W3930-W4830CS Center mullion

W2430	6.9
W2730	7.7
W3030	8.5
W3330	9.3
W3630	10.0
W3930	10.8
W4230	11.6
W4530	12.2
W4830CS	13.2

Custom Modifications

ADDTK	CBO	CCO	CND	EXBK	ID	INVFRM	P	RD	RECBTM	TD	TVR_V
•	•	•		•	•		•*	•	•	•*	

*Available only on 24" wide *Not available on 39", 42", 45", and 48" wide

Construction and Finish Upgrades

APC	FB	MIP	MSLFB	WLI
•	•	•	•	•

Door Options

ALF	CG	CG.BTM	CG.TOP	DPSRR	MD	MD.BTM	MD.TOP
	•			•	•^		

^Not available on 39" wide

WALL SINGLE DOOR, 33" HIGH

9", 12", 15",
18", 21", 24"

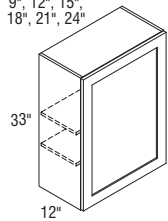

W933 L or R	3.2
W1233 L or R	4.1
W1533 L or R	5.0
W1833 L or R	5.9
W2133 L or R	6.7
W2433 L or R	7.6

Custom Modifications

ADDTK	CBO	CCO	CND	EXBK	ID	INVFRM	P	RD	RECBTM	TD	TVR_V
•	•	•		•	•		•	•	•		

Construction and Finish Upgrades

APC	FB	MIP	MSLFB	WLI
•	•	•	•	•

Door Options

ALF	CG	CG.BTM	CG.TOP	DPSRR	MD	MD.BTM	MD.TOP
	•			•	•*		

*Not available on 9" and 12" wide

WALL DOUBLE DOOR, 33" HIGH

24", 27", 30", 33",
36", 39", 42", 45", 48"

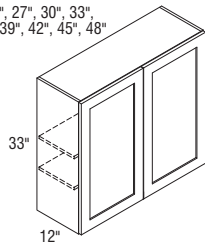

W2433-W3633 Butt doors
W3933-W4833CS Center mullion

Model	Cubic Feet
W2433	7.6
W2733	8.5
W3033	9.4
W3333	10.3
W3633	11.2
W3933	12.1
W4233	13.0
W4533	13.3
W4833CS	14.8

Custom Modifications

ADDTK	CBO	CCO	CND	EXBK	ID	INVFRM	P	RD	RECBTM	TD	TVR_V
•	•	•		•	•		•*	•	•		

*Available only on 24" wide

Construction and Finish Upgrades

APC	FB	MIP	MSLFB	WLI
•	•	•	•	•

Door Options

ALF	CG	CG.BTM	CG.TOP	DPSRR	MD	MD.BTM	MD.TOP
	•			•	•*		

*Not available on 39" wide

WALL SINGLE DOOR, 36" HIGH

9", 12", 15",
18", 21", 24"

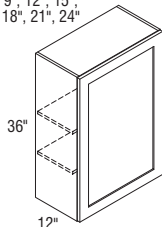

W936 L or R	3.5
W1236 L or R	4.4
W1536 L or R	5.3
W1836 L or R	6.3
W2136 L or R	7.2
W2436 L or R	8.2

Custom Modifications

ADDTK	CBO	CCO	CND	EXBK	ID	INVFRM	P	RD	RECBTM	TD	TVR_V
•	•	•		•	•		•	•	•		

Construction and Finish Upgrades

APC	FB	MIP	MSLFB	WLI
•	•	•	•	•

Door Options

ALF	CG	CG.BTM	CG.TOP	DPSRR	MD	MD.BTM	MD.TOP
•*	•			•	•*		

*Not available on 9" and 24" wide *Not available on 9" and 12" wide

WALL DOUBLE DOOR, 36" HIGH

24", 27", 30", 33",
36", 39", 42", 45", 48"

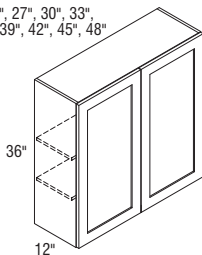

W2436-W3636 Butt doors
W3936-W4836CS Center mullion

W2436	8.2
W2736	9.1
W3036	10.0
W3336	11.0
W3636	11.8
W3936	11.8
W4236	13.8
W4536	14.5
W4836CS	14.5

Custom Modifications

ADDTK	CBO	CCO	CND	EXBK	ID	INVFRM	P	RD	RECBTM	TD	TVR_V
•	•	•		•	•		•*	•	•		

*Available only on 24" wide

Construction and Finish Upgrades

APC	FB	MIP	MSLFB	WLI
•	•	•	•	•

Door Options

ALF	CG	CG.BTM	CG.TOP	DPSRR	MD	MD.BTM	MD.TOP
	•			•	•*		

*Not available on 39" wide

WALL SINGLE DOOR, 39" HIGH

9", 12", 15",
18", 21", 24"

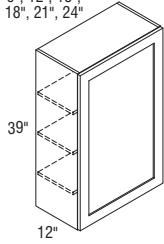

Model	Cubic Feet
W939 L or R	3.7
W1239 L or R	4.7
W1539 L or R	5.7
W1839 L or R	6.8
W2139 L or R	7.8
W2439 L or R	8.8

Custom Modifications

ADDTK	CBO	CCO	CND	EXBK	ID	INVFRM	P	RD	RECBTM	TD	TVR_V
•	•	•		•	•		•	•	•		

Construction and Finish Upgrades

APC	FB	MIP	MSLFB	WLI
•	•	•	•	•

Door Options

ALF	CG	CG.BTM	CG.TOP	DPSRR	MD	MD.BTM	MD.TOP
	•			•	•*		

*Not available on 9" and 12" wide

WALL DOUBLE DOOR, 39" HIGH

24", 27", 30", 33",
36", 39", 42", 45", 48"

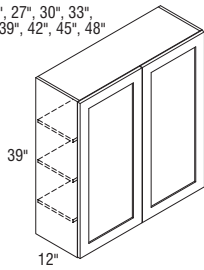

W2439-W3639 Butt doors
W3939-W4839CS Center mullion

W2439	8.2
W2739	9.1
W3039	10.0
W3339	11.0
W3639	11.9
W3939	11.8
W4239	13.8
W4539	15.6
W4839CS	16.9

Custom Modifications

ADDTK	CBO	CCO	CND	EXBK	ID	INVFRM	P	RD	RECBTM	TD	TVR_V
•	•	•		•	•		•*	•	•		

*Available only on 24" wide

Construction and Finish Upgrades

APC	FB	MIP	MSLFB	WLI
•	•	•	•	•

Door Options

ALF	CG	CG.BTM	CG.TOP	DPSRR	MD	MD.BTM	MD.TOP
	•			•	•+		

*Not available on 39" wide

WALL SINGLE DOOR, 42" HIGH

9", 12", 15",
18", 21", 24"

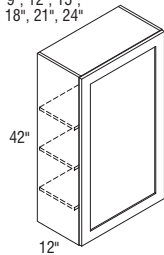

W942 L or R	4.0
W1242 L or R	5.1
W1542 L or R	6.2
W1842 L or R	7.3
W2142 L or R	8.3
W2442 L or R	9.4

Custom Modifications

ADDTK	CBO	CCO	CND	EXBK	ID	INVFRM	P	RD	RECBTM	TD	TVR_V
•	•	•		•	•		•	•	•		

Construction and Finish Upgrades

APC	FB	MIP	MSLFB	WLI
•	•	•	•	•

Door Options

ALF	CG	CG.BTM	CG.TOP	DPSRR	MD	MD.BTM	MD.TOP
	•			•	•*		

*Not available on 9" and 12" wide

WALL DOUBLE DOOR, 42" HIGH

24", 27", 30", 33",
36", 39", 42", 45", 48"

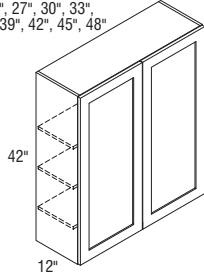

W2442-W3642 Butt doors
W3942-W4842CS Center mullion

Model	Cubic Feet
W2442	9.4
W2742	10.4
W3042	11.5
W3342	12.6
W3642	13.7
W3942	14.8
W4242	15.9
W4542	17.0
W4842CS	18.1

Custom Modifications

ADDTK	CBO	CCO	CND	EXBK	ID	INVFRM	P	RD	RECBTM	TD	TVR_V
•	•	•		•	•		•*	•	•		

*Available only on 24" wide

Construction and Finish Upgrades

APC	FB	MIP	MSLFB	WLI
•	•	•	•	•

Door Options

ALF	CG	CG.BTM	CG.TOP	DPSRR	MD	MD.BTM	MD.TOP
	•			•	•*		

*Not available on 39" wide

WALL EASY ACCESS STORAGE, 30" HIGH

storage
SOLUTIONS

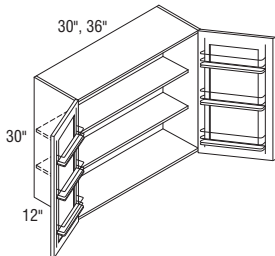
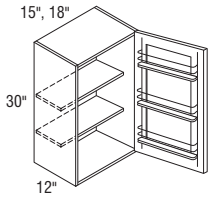

WEAS1530 L or R	4.5
WEAS1830 L or R	5.3
WEAS3030	8.5
WEAS3630	10.0

- Adjustable shelves are 7 1/2" deep.
- Each door features a chrome and wood three-tiered rack.
- Door rack width is 9 3/8" on 15" and 30" wide cabinets.
- Door rack width is 12 3/8" on 18" and 36" wide cabinets.
- Door rack depth is 3 1/2".

Custom Modifications

ADDTK	CBO	CCO	CND	EXBK	ID	INVFRM	P	RD	RECBTM	TD	TVR_V
•	•	•		•					•		

Construction and Finish Upgrades

APC	FB	MIP	MSLFB	WLI
•	•	•	•	•

Door Options

ALF	CG	CG.BTM	CG.TOP	DPSRR	MD	MD.BTM	MD.TOP
				•			

**WALL TWO DRAWER SINGLE DOOR,
48", 51", 54", 57", or 60" HIGH,
12" DEEP**

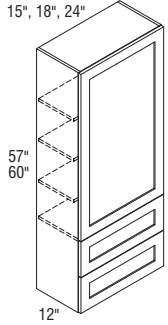
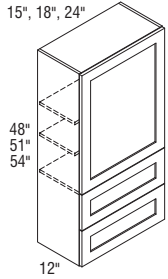

Model	Cubic Feet
W2D1548 L or R	6.5
W2D1848 L or R	7.8
W2D2448 L or R	10.4
W2D1551 L or R	7.5
W2D1851 L or R	8.9
W2D2451 L or R	11.6
W2D1554 L or R	7.2
W2D1854 L or R	8.5
W2D2454 L or R	11.1
W2D1557 L or R	7.5
W2D1857 L or R	8.9
W2D2457 L or R	11.7
W2D1560 L or R	7.9
W2D1860 L or R	9.4
W2D2460 L or R	12.3

• Reveal between door and drawer front is 1/8", door will align with adjacent cabinets in equivalent height.

Cabinet Height	Door Height	Drawer Fronts Height	Drawer Boxes Height
48"	29 3/4"	8 7/8"	3 3/8"
51"	32 3/4"	8 7/8"	3 3/8"
54"	35 3/4"	8 7/8"	3 3/8"
57"	38 3/4"	8 7/8"	3 3/8"
60"	41 3/4"	8 7/8"	3 3/8"

Custom Modifications

ADDTK	CBO	CCO	CND	EXBK	ID	INVFRM	P	RD	RECBTM	TD	TVR_V
•	•	•	•	•	•						

Construction and Finish Upgrades

APC	FB	MIP	MFLFB	WLI
•	•	•	•	•

Door Options

ALF	CG	CG.BTM	CG.TOP	DPSRR	MD	MD.BTM	MD.TOP
	•			•	•		

**WALL TWO DRAWER DOUBLE DOOR,
48", 51", 54", 57", or 60" HIGH,
12" DEEP**

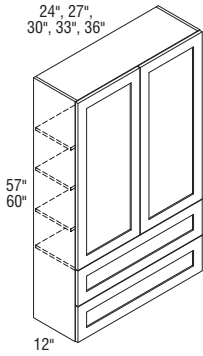
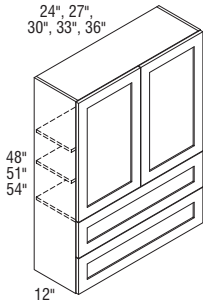

Model	Cubic Feet
W2D2448	10.4
W2D2748	11.8
W2D3048	13.1
W2D3348	14.3
W2D3648	15.6
W2D2451	11.6
W2D2751	12.6
W2D3051	13.9
W2D3351	15.2
W2D3651	16.5
W2D2454	11.1
W2D2754	13.3
W2D3054	14.7
W2D3354	16.1
W2D3654	17.5
W2D2457	11.7
W2D2757	14.0
W2D3057	15.5
W2D3357	16.9
W2D3657	18.4
W2D2460	12.3
W2D2760	14.7
W2D3060	16.3
W2D3360	17.8
W2D3660	19.4

• Reveal between door and drawer front is 1/8", door will align with adjacent cabinets in equivalent height.

Cabinet Height	Door Height	Drawer Fronts Height	Drawer Boxes Height
48"	29 3/4"	8 7/8"	3 3/8"
51"	32 3/4"	8 7/8"	3 3/8"
54"	35 3/4"	8 7/8"	3 3/8"
57"	38 3/4"	8 7/8"	3 3/8"
60"	41 3/4"	8 7/8"	3 3/8"

Custom Modifications

ADDTK	CBO	CCO	CND	EXBK	ID	INVRM	P	RD	RECBTM	TD	TVR_V
•	•	•	•	•	•						

Construction and Finish Upgrades

APC	FB	MIP	MSLFB	WLI
•	•	•	•	•

Door Options

ALF	CG	CG.BTM	CG.TOP	DPSRR	MD	MD.BTM	MD.TOP
	•			•	•		

WALL THREE DRAWER SINGLE DOOR, 48", 51", 54", 57", or 60" HIGH

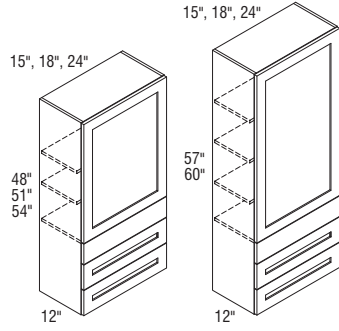

Model	Cubic Feet
W3D1548 L or R	6.5
W3D1848 L or R	7.8
W3D2448 L or R	10.4
W3D1551 L or R	7.5
W3D1851 L or R	8.9
W3D2451 L or R	11.6
W3D1554 L or R	7.2
W3D1854 L or R	8.5
W3D2454 L or R	11.1
W3D1557 L or R	8.3
W3D1857 L or R	9.7
W3D2457 L or R	12.7
W3D1560 L or R	7.9
W3D1860 L or R	9.4
W3D2460 L or R	12.3

- Top drawer will be slab drawer front for all 5-piece drawer front applications.
- Reveal between door and drawer front is 1/8", door will align with adjacent cabinets in equivalent height.

Cabinet Height	Door Height	Upper Drawer Front Height	Upper Drawer Box Height	Lower Drawer Fronts Height	Lower Drawer Boxes Height
48"	29 3/4"	5 1/8"	2"	6 1/4"	3 3/8"
51"	32 3/4"	5 1/8"	2"	6 1/4"	3 3/8"
54"	35 3/4"	5 1/8"	2"	6 1/4"	3 3/8"
57"	38 3/4"	5 1/8"	2"	6 1/4"	3 3/8"
60"	41 3/4"	5 1/8"	2"	6 1/4"	3 3/8"

Custom Modifications

ADDTK	CBO	CCO	CND	EXBK	ID	INVFRM	P	RD	RECBTM	TD	TVR_V
•	•	•	•	•	•						

Construction and Finish Upgrades

APC	FB	MIP	MSLFB	WLI
•	•	•	•	•

Door Options

ALF	CG	CG.BTM	CG.TOP	DPSRR	MD	MD.BTM	MD.TOP
	•			•	•		

**WALL THREE DRAWER DOUBLE DOOR,
48", 51", 54", 57", or 60" HIGH**

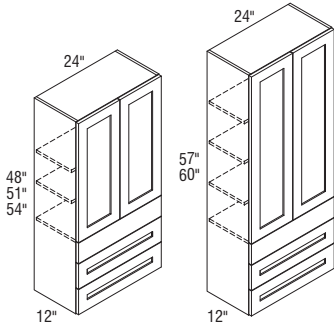

Model	Cubic Feet
W3D2448	10.4
W3D2451	11.6
W3D2454	11.1
W3D2457	12.7
W3D2460	12.3

- Top drawer will be slab drawer front for all 5-piece drawer front applications.
- Reveal between door and drawer front is 1/8", door will align with adjacent cabinets in equivalent height.

Cabinet Height	Door Height	Upper Drawer Front Height	Upper Drawer Box Height	Lower Drawer Fronts Height	Lower Drawer Boxes Height
48"	29 3/4"	5 1/8"	2"	6 1/4"	3 3/8"
51"	32 3/4"	5 1/8"	2"	6 1/4"	3 3/8"
54"	35 3/4"	5 1/8"	2"	6 1/4"	3 3/8"
57"	38 3/4"	5 1/8"	2"	6 1/4"	3 3/8"
60"	41 3/4"	5 1/8"	2"	6 1/4"	3 3/8"

Custom Modifications

ADDTK	CBO	CCO	CND	EXBK	ID	INVFRM	P	RD	RECBTM	TD	TVR_V
•	•	•	•	•	•						

Construction and Finish Upgrades

APC	FB	MIP	MSLFB	WLI
•	•	•	•	•

Door Options

ALF	CG	CG.BTM	CG.TOP	DPSRR	MD	MD.BTM	MD.TOP
	•			•	•		

**STACKED WALL APPLIANCE GARAGE,
SINGLE DOOR, 48", 51", 54", 57", or
60" HIGH**

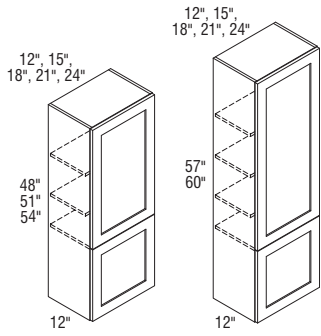

Model	Cubic Feet
STWDAG1248 L or R	5.8
STWDAG1548 L or R	7.0
STWDAG1848 L or R	8.3
STWDAG2148 L or R	9.5
STWDAG2448 L or R	10.7
STWDAG1251 L or R	6.2
STWDAG1551 L or R	7.5
STWDAG1851 L or R	8.9
STWDAG2151 L or R	10.2
STWDAG2451 L or R	11.6
STWDAG1254 L or R	6.5
STWDAG1554 L or R	7.9
STWDAG1854 L or R	9.3
STWDAG2154 L or R	10.6
STWDAG2454 L or R	12.0
STWDAG1257 L or R	6.8
STWDAG1557 L or R	8.3
STWDAG1857 L or R	9.4
STWDAG2157 L or R	11.2
STWDAG2457 L or R	12.7
STWDAG1260 L or R	7.2
STWDAG1560 L or R	8.7
STWDAG1860 L or R	10.2
STWDAG2160 L or R	11.8
STWDAG2460 L or R	13.3

- Lower section of cabinet does not have a bottom.
- Upper door aligns with doors on adjacent cabinets with equivalent heights (i.e., upper door on STWDAG2448 L/R aligns with a 30" high wall cabinet). Upper edge of lower door will not align with an adjacent 18" high wall cabinet. Reveal between upper and lower doors is 1/8".

Cabinet Height	Upper Door Height	Lower Door Height
48"	29 3/4"	17 7/8"
51"	32 3/4"	17 7/8"
54"	35 3/4"	17 7/8"
57"	38 3/4"	17 7/8"
60"	41 3/4"	17 7/8"

Custom Modifications

ADDTK	CBO	CCO	CND	EXBK	ID	INFRM	P	RD	RECBTM	TD	TVR_V
	•	•		•	•			•			

Construction and Finish Upgrades

APC	FB	MIP	MSLFB	WLI
•	•	•	•	•

Door Options

ALF	CG	CG.BTM	CG.TOP	DPSRR	MD	MD.BTM	MD.TOP
		•	•	•		•*	•*

*Not available on 12" wide

**STACKED WALL APPLIANCE GARAGE,
DOUBLE DOOR, 48", 51", 54", 57",
or 60" HIGH**

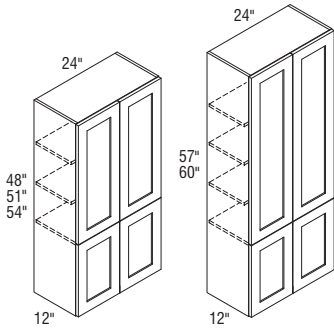

Model	Cubic Feet
STWDAG2448	10.7
STWDAG2451	11.6
STWDAG2454	12.0
STWDAG2457	12.7
STWDAG2460	13.3

- Lower section of cabinet does not have a bottom.
- Upper door aligns with doors on adjacent cabinets with equivalent heights (i.e., upper door on STWDAG2448 aligns with a 30" high wall cabinet). Upper edge of lower door will not align with an adjacent 18" high wall cabinet. Reveal between upper and lower doors is 1/8".

Cabinet Height	Upper Door Height	Lower Door Height
48"	29 3/4"	17 7/8"
51"	32 3/4"	17 7/8"
54"	35 3/4"	17 7/8"
57"	38 3/4"	17 7/8"
60"	41 3/4"	17 7/8"

Custom Modifications

ADDTK	CBO	CCO	CND	EXBK	ID	INVFRM	P	RD	RECBTM	TD	TVR_V
	•	•		•	•			•			

Construction and Finish Upgrades

APC	FB	MIP	MSLFB	WLI
•	•	•	•	•

Door Options

ALF	CG	CG.BTM	CG.TOP	DPSRR	MD	MD.BTM	MD.TOP
		•	•	•		•	•

**STACKED WALL APPLIANCE GARAGE
VERTICAL-LIFT, SINGLE DOOR, 48",
51", 54", 57", or 60" HIGH**

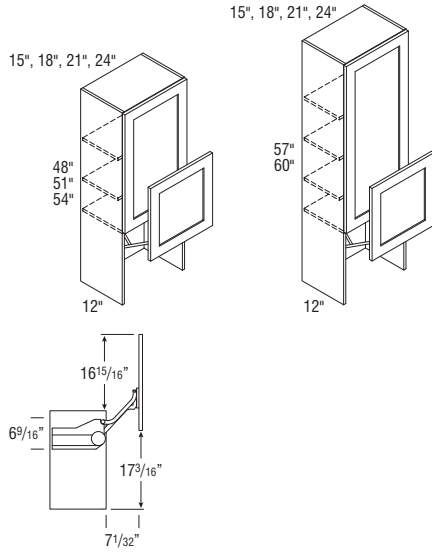

Model	Cubic Feet
STWVLDAG1548 L or R	7.0
STWVLDAG1848 L or R	8.3
STWVLDAG2148 L or R	9.5
STWVLDAG2448 L or R	10.7
STWVLDAG1551 L or R	7.5
STWVLDAG1851 L or R	8.9
STWVLDAG2151 L or R	10.2
STWVLDAG2451 L or R	11.6
STWVLDAG1554 L or R	7.9
STWVLDAG1854 L or R	9.3
STWVLDAG2154 L or R	10.6
STWVLDAG2454 L or R	12.0
STWVLDAG1557 L or R	8.3
STWVLDAG1857 L or R	9.4
STWVLDAG2157 L or R	11.2
STWVLDAG2457 L or R	12.7
STWVLDAG1560 L or R	8.7
STWVLDAG1860 L or R	10.2
STWVLDAG2160 L or R	11.8
STWVLDAG2460 L or R	13.3

- Lower section of cabinet does not have a bottom.
- Utilizes standard doors with vertical grain on center panel and standard door configuration. Genova will have standard vertical grain pattern. Troxel will have standard horizontal grain pattern.
- Decorative hardware required.
- See side view drawing for required clearances.
- Lift mechanism features a single motion for up and out movement with Smart Stop, tension can be field adjusted.
- Lift mechanisms and mounting brackets will be visible if used with transparent textured glass.
- Lift mechanism not available for order for field installation, only available factory installed.
- Hardware extends 1" into opening on each side.
- Upper door aligns with doors on adjacent cabinets with equivalent heights (i.e., upper door on STWVLDAG2448 L/R aligns with a 30" high wall cabinet). Upper edge of lower door will not align with an adjacent 18" high wall cabinet. Reveal between upper and lower doors is 1/8".

Cabinet Height	Upper Door Height	Lower Door Height
48"	29 3/4"	17 7/8"
51"	32 3/4"	17 7/8"
54"	35 3/4"	17 7/8"
57"	38 3/4"	17 7/8"
60"	41 3/4"	17 7/8"

Custom Modifications

ADDTK	CBO	CCO	CND	EXBK	ID	INFRM	P	RD	RECBTM	TD	TVR_V
	•	•		•	•			•			

Construction and Finish Upgrades

APC	FB	MIP	MSLFB	WLI
•	•	•	•	•

Door Options

ALF	CG	CG.BTM	CG.TOP	DPSRR	MD	MD.BTM	MD.TOP
		•	•	•		•	•

**STACKED WALL APPLIANCE GARAGE
VERTICAL-LIFT, DOUBLE DOOR, 48",
51", 54", 57", or 60" HIGH**

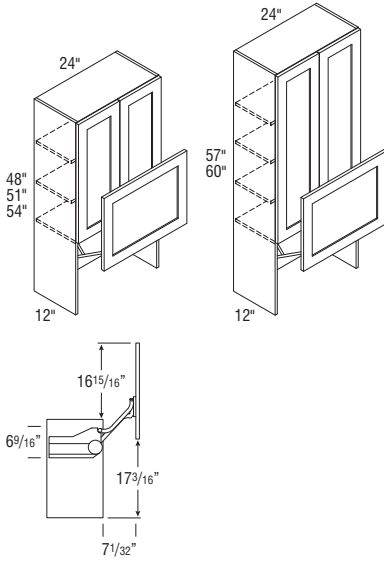

Model	Cubic Feet
STWVLDAG2448	10.7
STWVLDAG2451	11.6
STWVLDAG2454	12.0
STWVLDAG2457	12.7
STWVLDAG2460	13.3

- Lower section of cabinet does not have a bottom.
- Utilizes standard doors with vertical grain on center panel and standard door configuration. Genova will have standard vertical grain pattern. Troxel will have standard horizontal grain pattern.
- Decorative hardware required.
- See side view drawing for required clearances.
- Lift mechanism features a single motion for up and out movement with Smart Stop, tension can be field adjusted.
- Lift mechanisms and mounting brackets will be visible if used with transparent textured glass.
- Lift mechanism not available for order for field installation, only available factory installed.
- Hardware extends 1" into opening on each side.
- Upper door aligns with doors on adjacent cabinets with equivalent heights (i.e., upper door on STWVLDAG2448 aligns with a 30" high wall cabinet). Upper edge of lower door will not align with an adjacent 18" high wall cabinet. Reveal between upper and lower doors is 1/8".

Cabinet Height	Upper Door Height	Lower Door Height
48"	29 3/4"	17 7/8"
51"	32 3/4"	17 7/8"
54"	35 3/4"	17 7/8"
57"	38 3/4"	17 7/8"
60"	41 3/4"	17 7/8"

Custom Modifications

ADDTK	CBO	CCO	CND	EXBK	ID	INVFRM	P	RD	RECBTM	TD	TVR_V
	•	•		•	•			•			

Construction and Finish Upgrades

APC	FB	MIP	MSLFB	WLI
•	•	•	•	•

Door Options

ALF	CG	CG.BTM	CG.TOP	DPSRR	MD	MD.BTM	MD.TOP
		•	•	•		•	•

**STACKED WALL SINGLE DOOR,
48", 51", 54", 57", or 60" HIGH**

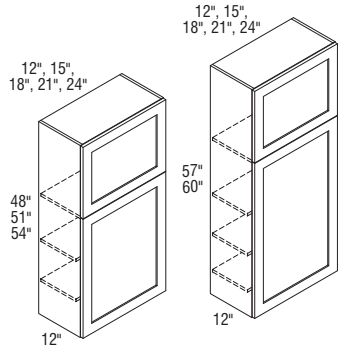

Model	Cubic Feet
STW1248 L or R	5.8
STW1548 L or R	7.0
STW1848 L or R	8.3
STW2148 L or R	9.5
STW2448 L or R	10.7
STW1251 L or R	6.2
STW1551 L or R	7.5
STW1851 L or R	8.9
STW2151 L or R	10.2
STW2451 L or R	11.6
STW1254 L or R	6.5
STW1554 L or R	7.9
STW1854 L or R	9.3
STW2154 L or R	10.6
STW2454 L or R	12.0
STW1257 L or R	6.8
STW1557 L or R	8.3
STW1857 L or R	9.4
STW2157 L or R	11.2
STW2457 L or R	12.7
STW1260 L or R	7.2
STW1560 L or R	8.7
STW1860 L or R	10.2
STW2160 L or R	11.8
STW2460 L or R	13.3

- Lower door aligns with doors on adjacent cabinets with equivalent heights (i.e., lower door on STW2448 L/R aligns with a 30" high wall cabinet). Bottom edge of upper door will not align with an adjacent 18" high cabinet. Reveal between upper and lower doors is 1/8".

Cabinet Height	Upper Door Height	Lower Door Height
48"	17 7/8"	29 3/4"
51"	17 7/8"	32 3/4"
54"	17 7/8"	35 3/4"
57"	17 7/8"	38 3/4"
60"	17 7/8"	41 3/4"

Custom Modifications

ADDTK	CBO	CCO	CND	EXBK	ID	INFRM	P	RD	RECBTM	TD	TVR_V
•	•	•		•	•	•	•	•		•	

Construction and Finish Upgrades

APC	FB	MIP	MSLFB	WLI
•	•	•	•	•

Door Options

ALF	CG	CG.BTM	CG.TOP	DPSRR	MD	MD.BTM	MD.TOP
		•	•	•		•*	•*

*Not available on 12", 21", and 24" wide

**STACKED WALL DOUBLE DOOR,
48", 51", 54", 57", or 60" HIGH**

24", 27", 30", 33",
36", 39", 42", 45", 48"

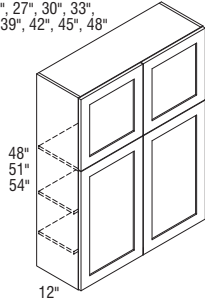

STW24 _ _STW36 _ _Butt doors
STW39 _ _STW48 _ _CS Center mullion

Model	Cubic Feet
STW2448	10.7
STW2748	12.0
STW3048	13.2
STW3348	14.4
STW3648	15.7
STW3948	16.9
STW4248	18.1
STW4548	19.0
STW4848CS	20.6
STW2451	11.6
STW2751	12.9
STW3051	14.3
STW3351	15.6
STW3651	17.0
STW3951	18.3
STW4251	19.7
STW4551	20.2
STW4851CS	22.4
STW2454	12.0
STW2754	13.4
STW3054	14.8
STW3354	16.2
STW3654	17.5
STW3954	18.9
STW4254	20.4
STW4554	21.3
STW4854CS	25.9

- Lower door aligns with doors on adjacent cabinets with equivalent heights (i.e., lower door on STW2448 aligns with a 30" high wall cabinet). Bottom edge of upper door will not align with an adjacent 18" high cabinet. Reveal between upper and lower doors is 1/8".

Cabinet Height	Upper Door Height	Lower Door Height
48"	17 7/8"	29 3/4"
51"	17 7/8"	32 3/4"
54"	17 7/8"	35 3/4"
57"	17 7/8"	38 3/4"
60"	17 7/8"	41 3/4"

Custom Modifications

ADDTK	CBO	CCO	CND	EXBK	ID	INVFRM	P	RD	RECBTM	TD	TVR_V
•	•	•		•	•	•	•*	•		•*	

*Available only on 24" wide *Not available on 39", 42", 45", and 48" wide

Construction and Finish Upgrades

APC	FB	MIP	MSLFB	WLI
•	•	•	•	•

Door Options

ALF	CG	CG.BTM	CG.TOP	DPSRR	MD	MD.BTM	MD.TOP
		•	•	•		•▲	•▲

*Available only on 30" and 36" wide

**STACKED WALL DOUBLE DOOR,
48", 51", 54", 57", or 60" HIGH
(cont'd)**

24", 27", 30", 33",
36", 39", 42", 45", 48"

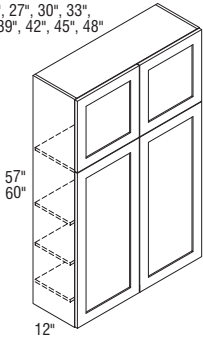

STW24 _-STW36 _ Butt doors
STW39 _-STW48 _ CS Center mullion

Model	Cubic Feet
STW2457	12.7
STW2757	14.2
STW3057	15.6
STW3357	17.1
STW3657	18.5
STW3957	20.0
STW4257	21.4
STW4557	22.5
STW4857CS	24.3
STW2460	13.3
STW2760	14.9
STW3060	16.4
STW3360	17.9
STW3660	19.4
STW3960	21.0
STW4260	22.5
STW4560	23.6
STW4860CS	31.7

• Lower door aligns with doors on adjacent cabinets with equivalent heights (i.e., lower door on STW2460 aligns with a 42" high wall cabinet). Bottom edge of upper door will not align with an adjacent 18" high cabinet. Reveal between upper and lower doors is 1/8".

Cabinet Height	Upper Door Height	Lower Door Height
48"	17 7/8"	29 3/4"
51"	17 7/8"	32 3/4"
54"	17 7/8"	35 3/4"
57"	17 7/8"	38 3/4"
60"	17 7/8"	41 3/4"

Custom Modifications

ADDTK	CBO	CCO	CND	EXBK	ID	INVFRM	P	RD	RECBTM	TD	TVR_V
•	•	•		•	•	•	•*	•		•+	

*Available only on 24" wide +Not available on 39", 42", 45", and 48" wide

Construction and Finish Upgrades

APC	FB	MIP	MJSLFB	WLI
•	•	•	•	•

Door Options

ALF	CG	CG.BTM	CG.TOP	DPSRR	MD	MD.BTM	MD.TOP
		•	•	•		•▲	•▲

▲Available only on 30" and 36" wide

Wall Corner Cabinets

- Wall corner cabinets may be installed flush to the wall (left) or pulled up to 3" away from wall (right) to accommodate odd dimensions in a kitchen design. In either case, the adjoining run of 12" wall cabinets plus a 3" filler will butt against the solid-wood panel.
- When a cabinet is "pulled" it will use proportionally more wall space, for example, a 30" wide WC pulled 2" will use 32" of space.
- The L or R in the cabinet's nomenclature indicates the location of cabinet void.
- Blind side of wall corner cabinets cannot be installed next to a range hood or microwave shelf unit due to door interference.

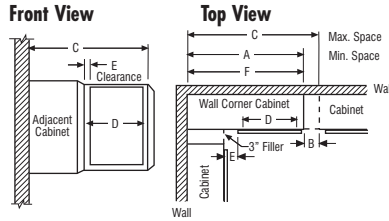

Model	A Min. Space	B Max. Pull*	C Max. Space	D Cabinet Opening	E* Clearance		F Actual Cabinet
					At Min.	At Max.	
WC24..	24"	5 1/8"	29 1/8"	9 1/4"	1 5/8"	6 3/4"	24"
WC27..	27"	4 5/8"	31 5/8"	10 3/4"	3 1/8"	7 3/4"	27"
WC30..	30"	5 1/8"	35 1/8"	15 1/4"	1 5/8"	6 3/4"	30"
WC33..	33"	4 5/8"	37 5/8"	16 3/4"	3 1/8"	7 3/4"	33"
WC36..	36"	5 1/8"	41 1/8"	21 1/4"	1 5/8"	6 3/4"	36"
WC39..	39"	4 5/8"	43 5/8"	22 3/4"	3 1/16"	7 11/16"	39"
WC42..	42"	4 5/8"	46 5/8"	25 3/4"	3 1/16"	7 11/16"	42"
WC45..	45"	4 5/8"	49 5/8"	28 3/4"	3 1/16"	7 11/16"	45"
WC48..	48"	4 5/8"	52 5/8"	31 3/4"	3 1/16"	7 11/16"	48"

*Minimum/maximum space between inside edge of door and face of filler/adjoining cabinet. Dimensions provided allow for proper filler attachment and do not require cleating.

WALL CORNER SINGLE DOOR, 24" HIGH

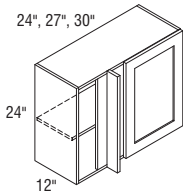

Model	Cubic Feet
WC2424 L or R	5.5
WC2724 L or R	6.1
WC3024 L or R	6.8

- Includes one 3" filler, shipped unattached.
- L or R indicates void. R (right) void shown.
- Door will attach to front panel using a hinge plate.
- Genova, Taro High Gloss, and Troxel and use door matching furniture board blind panels and fillers on standard and APC construction.

Custom Modifications

ADDTK	CBO	CCO	CND	EXBK	ID	INVFRM	P	RD	RECBTM	TD	TVR_V
•	•	•		•	•		•*	•	•		

*Available only on 24" wide

Construction and Finish Upgrades

APC	FB	MIP	MSLFB	WLI
•	•	•	•	•

Door Options

ALF	CG	CG.BTM	CG.TOP	DPSRR	MD	MD.BTM	MD.TOP
	•			•			

**WALL CORNER SINGLE DOOR,
30", 33", or 36" HIGH**

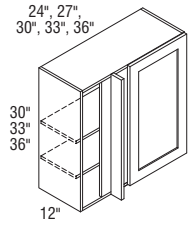

Model	Cubic Feet
WC2430 L or R	6.9
WC2730 L or R	7.7
WC3030 L or R	8.5
WC3330 L or R	9.5
WC3630 L or R	10.0
WC2433 L or R	7.6
WC2733 L or R	8.5
WC3033 L or R	9.4
WC3333 L or R	10.3
WC3633 L or R	11.2
WC2436 L or R	8.2
WC2736 L or R	9.1
WC3036 L or R	10.0
WC3336 L or R	11.1
WC3636 L or R	11.9

- Includes one 3" filler, shipped unattached.
- L or R indicates void. R (right) void shown.
- Door will attach to front panel using a hinge plate.
- Genova, Taro High Gloss, and Troxel use door matching furniture board blind panels and fillers on standard and APC construction.

Custom Modifications

ADDTK	CBO	CCO	CND	EXBK	ID	INVFRM	P	RD	RECBTM	TD	TVR_V
•	•	•		•	•		•*	•	•		

*Available only on 24" wide

Construction and Finish Upgrades

APC	FB	MIP	MJSLFB	WLI
•	•	•	•	•

Door Options

ALF	CG	CG.BTM	CG.TOP	DPSRR	MD	MD.BTM	MD.TOP
	•			•	•+		

*Available only on 33" and 36" wide

**WALL CORNER DOUBLE DOOR,
30", 33", or 36" HIGH**

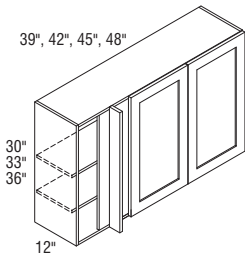

Model	Cubic Feet
WC3930 L or R	10.3
WC4230 L or R	11.6
WC4530 L or R	12.2
WC4830 L or R	13.2
WC3933 L or R	11.7
WC4233 L or R	12.6
WC4533 L or R	13.5
WC4833 L or R	14.3
WC3936 L or R	12.7
WC4236 L or R	13.7
WC4536 L or R	14.6
WC4836 L or R	15.6

- Includes one 3" filler, shipped unattached.
- L or R indicates void. R (right) void shown.
- On 39" wide cabinets, Peninsula and Mullion Door options cannot be ordered together due to the unavailability of Mullion Doors for the Peninsula side.
- Door on blind side will attach to front panel using a hinge plate.
- Genova, Taro High Gloss, and Troxel use door matching furniture board blind panels and fillers on standard and APC construction.

Custom Modifications

ADDTK	CBO	CCO	CND	EXBK	ID	INVFRM	P	RD	RECBTM	TD	TVR_V
•	•	•		•	•			•			

Construction and Finish Upgrades

APC	FB	MIP	MSLFB	WLI
•	•	•	•	•

Door Options

ALF	CG	CG.BTM	CG.TOP	DPSRR	MD	MD.BTM	MD.TOP
	•			•	•		

**WALL CORNER SINGLE DOOR,
39" or 42" HIGH**

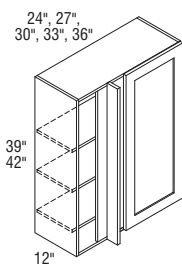

WC2439 L or R	8.8
WC2739 L or R	9.8
WC3039 L or R	10.8
WC3339 L or R	11.8
WC3639 L or R	12.5
WC2442 L or R	9.4
WC2742 L or R	10.5
WC3042 L or R	11.6
WC3342 L or R	12.7
WC3642 L or R	13.8

- Includes one 3" filler, shipped unattached.
- L or R indicates void. R (right) void shown.
- Door will attach to front panel using a hinge plate.
- Genova, Taro High Gloss, and Troxel use door matching furniture board blind panels and fillers on standard and APC construction.

Custom Modifications

ADDTK	CBO	CCO	CND	EXBK	ID	INVFRM	P	RD	RECBTM	TD	TVR_V
•	•	•		•	•		•*	•	•		

*Available only on 24" wide

Construction and Finish Upgrades

APC	FB	MIP	MSLFB	WLI
•	•	•	•	•

Door Options

ALF	CG	CG.BTM	CG.TOP	DPSRR	MD	MD.BTM	MD.TOP
	•			•	•*		

*Available only on 33" and 36" wide

**WALL CORNER DOUBLE DOOR,
39" or 42" HIGH**

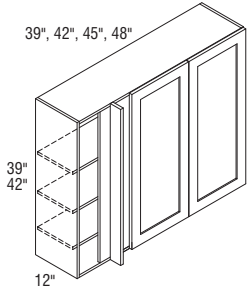

Model	Cubic Feet
WC3939 L or R	13.8
WC4239 L or R	14.8
WC4539 L or R	15.8
WC4839 L or R	16.8
WC3942 L or R	14.8
WC4242 L or R	15.9
WC4542 L or R	17.0
WC4842 L or R	18.1

- Includes one 3" filler, shipped unattached.
- L or R indicates void. R (right) void shown.
- On 39" wide cabinets, Peninsula and Mullion Door options cannot be ordered together due to the unavailability of Mullion Doors for the Peninsula side.
- Door on blind side will attach to front panel using a hinge plate.
- Genova, Taro High Gloss, and Troxel use door matching furniture board blind panels and fillers on standard and APC construction.

Custom Modifications

ADDTK	CBO	CCO	CND	EXBK	ID	INVERM	P	RD	RECBTM	TD	TVR_V
•	•	•		•	•			•	•		

Construction and Finish Upgrades

APC	FB	MIP	MSLFB	WLI
•	•	•	•	•

Door Options

ALF	CG	CG.BTM	CG.TOP	DPSRR	MD	MD.BTM	MD.TOP
	•			•	•		

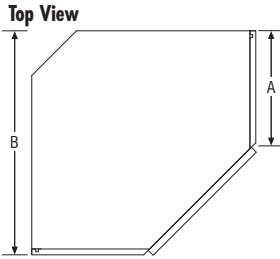

Diagonal Wall Cabinets with Increased or Reduced Depth

	RD9	RD10	RD11	STD	ID13	ID14	ID15*	ID16	ID17	ID18	ID19	ID20	ID21	ID22	ID23	ID24
Cabinet Depth (DW_2424) A	9"	10"	11"	12"	13"	14"	15"	16"	17"	18"	19"	20"	21"	22"	23"	24"
Wall Space (DW_2424) B	21"	22"	23"	24"	25"	26"	27"	28"	29"	30"	31"	32"	33"	34"	35"	36"

*ID15 dimensions are standard on DW_2727

DIAGONAL WALL, 12", 15", or 18" HIGH, 24" x 24"

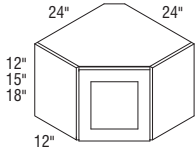

Model	Cubic Feet
DW122424 L or R	5.5
DW152424 L or R	6.7
DW182424 L or R	7.8

- Cabinets require 24" x 24" of corner wall space.

Custom Modifications

ADDTK	CBO	CCO	CND	EXBK	ID	INFRM	P	RD	RECBTM	TD	TVR_V
		•			•			•	•		

Construction and Finish Upgrades

APC	FB	MIP	MSLFB	WLI
•	•	•	•	•

Door Options

ALF	CG	CG.BTM	CG.TOP	DPSRR	MD	MD.BTM	MD.TOP
	•			•			

DIAGONAL WALL, 24" or 27" HIGH, 24" x 24"

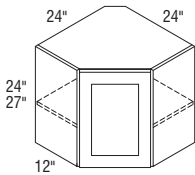

DW242424 L or R	10.2
DW272424 L or R	11.3

- Cabinets require 24" x 24" of corner wall space.
- Adjustable shelf cannot be removed/retrofitted.

Custom Modifications

ADDTK	CBO	CCO	CND	EXBK	ID	INFRM	P	RD	RECBTM	TD	TVR_V
	•	•			•			•	•		

Construction and Finish Upgrades

APC	FB	MIP	MSLFB	WLI
•	•	•	•	•

Door Options

ALF	CG	CG.BTM	CG.TOP	DPSRR	MD	MD.BTM	MD.TOP
	•			•			

DIAGONAL WALL, 30", 33", 36", 39", or 42" HIGH, 24" x 24"

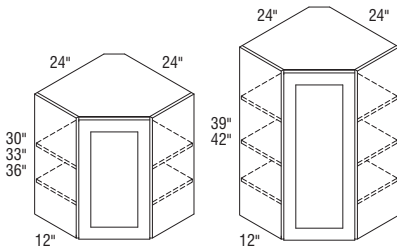

DW302424 L or R	12.5
DW332424 L or R	13.9
DW362424 L or R	14.9
DW392424 L or R	16.0
DW422424 L or R	17.2

- Cabinets require 24" x 24" of corner wall space.
- Adjustable shelves.

Custom Modifications

ADDTK	CBO	CCO	CND	EXBK	ID	INFRM	P	RD	RECBTM	TD	TVR_V
	•	•			•			•	•		

Construction and Finish Upgrades

APC	FB	MIP	MSLFB	WLI
•	•	•	•	•

Door Options

ALF	CG	CG.BTM	CG.TOP	DPSRR	MD	MD.BTM	MD.TOP
	•			•	•		

DIAGONAL WALL, 12", 15", or 18" HIGH, 27" x 27"

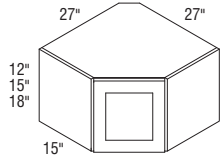

Model	Cubic Feet
DW122727 L or R	6.8
DW152727 L or R	8.3
DW182727 L or R	9.7

• Cabinets require 27" x 27" of corner wall space.

Custom Modifications

ADDTK	CBO	CCO	CND	EXBK	ID	INVFRM	P	RD	RECBTM	TD	TVR_V
		•			•			•	•		

Construction and Finish Upgrades

APC	FB	MIP	MSLFB	WLI
•	•	•	•	•

Door Options

ALF	CG	CG.BTM	CG.TOP	DPSRR	MD	MD.BTM	MD.TOP
	•			•			

DIAGONAL WALL, 24" or 27" HIGH, 27" x 27"

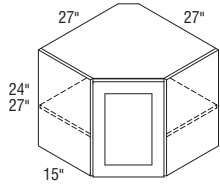

DW242727 L or R	12.7
DW272727 L or R	14.1

• Cabinets require 27" x 27" of corner wall space.
• Adjustable shelf cannot be removed/retrofitted.

Custom Modifications

ADDTK	CBO	CCO	CND	EXBK	ID	INVFRM	P	RD	RECBTM	TD	TVR_V
	•	•			•			•	•		

Construction and Finish Upgrades

APC	FB	MIP	MSLFB	WLI
•	•	•	•	•

Door Options

ALF	CG	CG.BTM	CG.TOP	DPSRR	MD	MD.BTM	MD.TOP
	•			•			

DIAGONAL WALL, 30", 33", 36", 39", or 42" HIGH, 27" x 27"

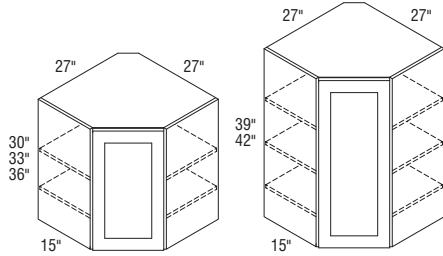

DW302727 L or R	14.7
DW332727 L or R	16.1
DW362727 L or R	17.6
DW392727 L or R	20.0
DW422727 L or R	20.5

• Cabinets require 27" x 27" of corner wall space.

Custom Modifications

ADDTK	CBO	CCO	CND	EXBK	ID	INVFRM	P	RD	RECBTM	TD	TVR_V
	•	•			•			•	•		

Construction and Finish Upgrades

APC	FB	MIP	MSLFB	WLI
•	•	•	•	•

Door Options

ALF	CG	CG.BTM	CG.TOP	DPSRR	MD	MD.BTM	MD.TOP
	•			•	•		

DIAGONAL WALL with LAZY SUSAN, 30", 33", 36", 39", or 42" HIGH, 24" x 24"

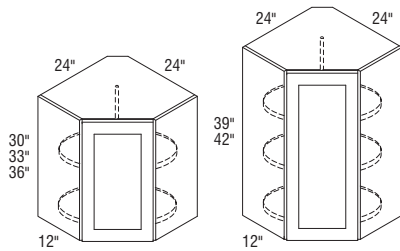

DW302424S L or R	12.5
DW332424S L or R	13.9
DW362424S L or R	14.9
DW392424S L or R	16.0
DW422424S L or R	17.2

• Cabinets require 24" x 24" of corner wall space.
• Plywood shelves are 18" in overall diameter with a 17" interior diameter and 1" high lip.
• Shelves rotate independently.

Custom Modifications

ADDTK	CBO	CCO	CND	EXBK	ID	INVFRM	P	RD	RECBTM	TD	TVR_V
	•	•							•		

Construction and Finish Upgrades

APC	FB	MIP	MSLFB	WLI
•	•	•	•	•

Door Options

ALF	CG	CG.BTM	CG.TOP	DPSRR	MD	MD.BTM	MD.TOP
	•			•	•		

**DIAGONAL WALL with LOWER DOOR,
48", 51", 54", 57", or 60" HIGH,
24" x 24"**

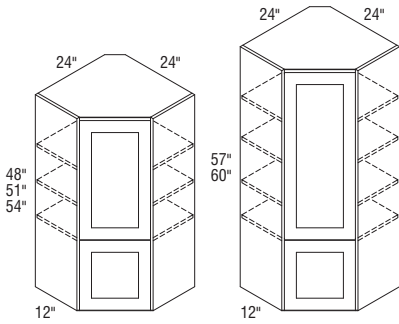

Model	Cubic Feet
DW302424D L or R	19.6
DW332424D L or R	21.0
DW362424D L or R	21.9
DW392424D L or R	23.9
DW422424D L or R	24.3

- Lower section of cabinet does not have a bottom.
- Cabinets require 24" x 24" of corner wall space.
- Bottom section does not have floor.
- Mullion Doors not available on bottom door.
- Upper door aligns with doors on adjacent cabinets with equivalent heights (i.e., upper door on DW302424D L/R aligns with a 30" high wall cabinet). Upper edge of lower door will not align with an adjacent 18" high wall cabinet. Reveal between upper and lower doors is 1/8".

Cabinet Height	Upper Door Height	Lower Door Height
48"	29 3/4"	17 7/8"
51"	32 3/4"	17 7/8"
54"	35 3/4"	17 7/8"
57"	38 3/4"	17 7/8"
60"	41 3/4"	17 7/8"

Custom Modifications

ADDTK	CBO	CCO	CND	EXBK	ID	INVFRM	P	RD	RECBTM	TD	TVR_V
	•	•			•			•			

Construction and Finish Upgrades

APC	FB	MIP	MSLFB	WLI
•	•	•	•	•

Door Options

ALF	CG	CG.BTM	CG.TOP	DPSRR	MD	MD.BTM	MD.TOP
		•	•	•			•

**DIAGONAL WALL with LOWER DOOR,
48", 51", 54", 57", or 60" HIGH,
27" x 27"**

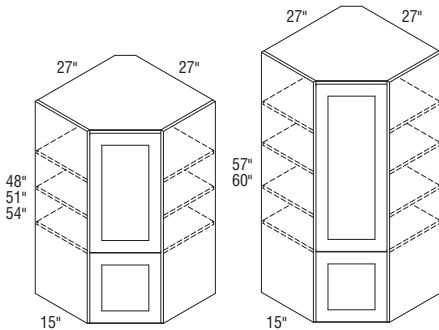

DW302727D L or R	22.2
DW332727D L or R	23.1
DW362727D L or R	24.9
DW392727D L or R	25.7
DW422727D L or R	27.7

- Lower section of cabinet does not have a bottom.
- Cabinets require 27" x 27" of corner wall space.
- Bottom section does not have floor.
- Mullion Doors not available on bottom door.
- Upper door aligns with doors on adjacent cabinets with equivalent heights (i.e., upper door on DW302727D L/R aligns with a 30" high wall cabinet). Upper edge of lower door will not align with an adjacent 18" high wall cabinet. Reveal between upper and lower doors is 1/8".

Cabinet Height	Upper Door Height	Lower Door Height
48"	29 3/4"	17 7/8"
51"	32 3/4"	17 7/8"
54"	35 3/4"	17 7/8"
57"	38 3/4"	17 7/8"
60"	41 3/4"	17 7/8"

Custom Modifications

ADDTK	CBO	CCO	CND	EXBK	ID	INVFRM	P	RD	RECBTM	TD	TVR_V
	•	•			•			•			

Construction and Finish Upgrades

APC	FB	MIP	MSLFB	WLI
•	•	•	•	•

Door Options

ALF	CG	CG.BTM	CG.TOP	DPSRR	MD	MD.BTM	MD.TOP
		•	•	•			•

DIAGONAL WALL with LOWER DOOR and LAZY SUSAN, 48", 51", 54", 57", or 60" HIGH, 24" x 24"

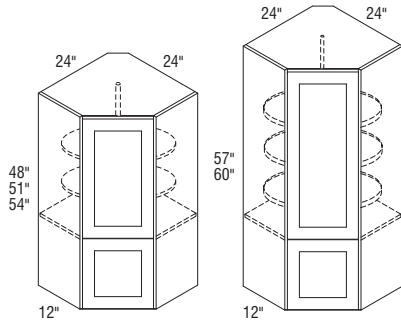

Model	Cubic Feet
DW302424DS L or R	19.6
DW332424DS L or R	21.0
DW362424DS L or R	21.9
DW392424DS L or R	23.9
DW422424DS L or R	24.3

- Lower section of cabinet does not have a bottom.
- Cabinets require 24" x 24" of corner wall space.
- Bottom section does not have floor.
- Mullion Doors not available on bottom door.
- Plywood shelves are 18" in overall diameter with a 17" interior diameter and 1" high lip.
- Shelves rotate independently.
- Upper door aligns with doors on adjacent cabinets with equivalent heights (i.e., upper door on DW302424DS L/R aligns with a 30" high wall cabinet). Upper edge of lower door will not align with an adjacent 18" high wall cabinet. Reveal between upper and lower doors is 1/8".

Cabinet Height	Upper Door Height	Lower Door Height
48"	29 3/4"	17 7/8"
51"	32 3/4"	17 7/8"
54"	35 3/4"	17 7/8"
57"	38 3/4"	17 7/8"
60"	41 3/4"	17 7/8"

Custom Modifications

ADDTK	CBO	CCO	CND	EXBK	ID	INFRM	P	RD	RECBTM	TD	TVR_V
	•	•									

Construction and Finish Upgrades

APC	FB	MIP	MSLFB	WLI
•	•	•	•	•

Door Options

ALF	CG	CG.BTM	CG.TOP	DPSRR	MD	MD.BTM	MD.TOP
		•	•	•			•

STACKED DIAGONAL WALL, 48", 51", 54", 57", or 60" HIGH, 24" x 24"

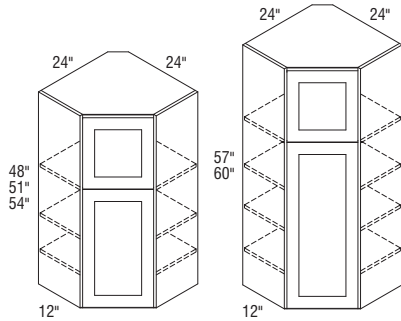

STDW482424 L or R	19.6
STDW512424 L or R	21.0
STDW542424 L or R	21.6
STDW572424 L or R	21.9
STDW602424 L or R	24.3

- Cabinet requires 24" x 24" of corner wall space.
- Lower door aligns with doors on adjacent cabinets with equivalent heights (i.e., lower door on STDW482424 L/R aligns with a 30" high wall cabinet). Bottom edge of upper door will not align with an adjacent 18" high cabinet. Reveal between upper and lower doors is 1/8".

Cabinet Height	Upper Door Height	Lower Door Height
48"	17 7/8"	29 3/4"
51"	17 7/8"	32 3/4"
54"	17 7/8"	35 3/4"
57"	17 7/8"	38 3/4"
60"	17 7/8"	41 3/4"

Custom Modifications

ADDTK	CBO	CCO	CND	EXBK	ID	INFRM	P	RD	RECBTM	TD	TVR_V
	•	•			•	•		•			

Construction and Finish Upgrades

APC	FB	MIP	MSLFB	WLI
•	•	•	•	•

Door Options

ALF	CG	CG.BTM	CG.TOP	DPSRR	MD	MD.BTM	MD.TOP
		•	•	•			

STACKED DIAGONAL WALL, 48", 51", 54", 57", or 60" HIGH, 27" x 27"

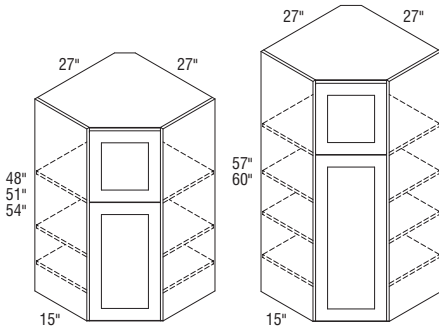

Model	Cubic Feet
STDW482727 L or R	23.4
STDW512727 L or R	26.1
STDW542727 L or R	24.1
STDW572727 L or R	26.4
STDW602727 L or R	29.3

- Cabinet requires 27" x 27" of corner wall space.
- Lower door aligns with doors on adjacent cabinets with equivalent heights (i.e., lower door on STDW482727 L/R aligns with a 30" high wall cabinet). Bottom edge of upper door will not align with an adjacent 18" high cabinet. Reveal between upper and lower doors is 1/8".

Cabinet Height	Upper Door Height	Lower Door Height
48"	17 7/8"	29 3/4"
51"	17 7/8"	32 3/4"
54"	17 7/8"	35 3/4"
57"	17 7/8"	38 3/4"
60"	17 7/8"	41 3/4"

Custom Modifications

ADDTK	CBO	CCO	CND	EXBK	ID	INVFRM	P	RD	RECBTM	TD	TVR_V
	•	•			•	•		•			

Construction and Finish Upgrades

APC	FB	MIP	MSLFB	WLI
•	•	•	•	•

Door Options

ALF	CG	CG.BTM	CG.TOP	DPSRR	MD	MD.BTM	MD.TOP
		•	•	•			

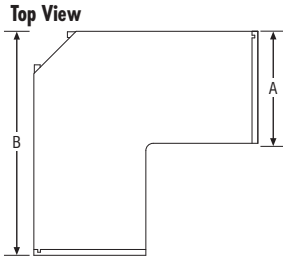

Easy Reach Wall Corner Cabinets with Increased or Reduced Depth

		RD9	RD10	RD11	STD	ID13	ID14	ID15	ID16	ID17	ID18	ID19	ID20	ID21	ID22	ID23	ID24
Cabinet Depth (ER_2424)	A	9"	10"	11"	12"	13"	14"	15"	16"	17"	18"	19"	20"	21"	22"	23"	24"
Wall Space (ER_2424)	B	21"	22"	23"	24"	25"	26"	27"	28"	29"	30"	31"	32"	33"	34"	35"	36"
Cabinet Depth (ER_2121)	A	9"	10"	11"	12"	13"	14"	15"	16"	17"	18"	19"	20"	21"	22"	23"	24"
Wall Space (ER_2121)	B	18"	19"	20"	21"	22"	23"	24"	25"	26"	27"	28"	29"	30"	31"	32"	33"

EASY REACH WALL CORNER, 30", 33", 36", 39", or 42" HIGH, 21" x 21"

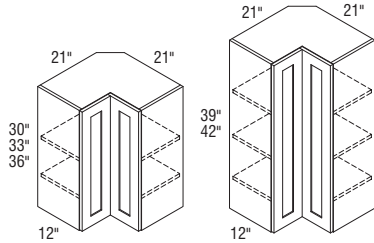

Model	Cubic Feet
ER302121 L or R	9.9
ER332121 L or R	10.3
ER362121 L or R	11.8
ER392121 L or R	12.7
ER422121 L or R	13.7

- Requires 21" x 21" of corner wall space.
- Decorative hardware screws must be countersunk to prevent scratching of adjacent cabinets.
- Adjustable shelves.
- Hinged door opens 170°.
- Integrated soft-close hinge not included.

Custom Modifications

ADDTK	CBO	CCO	CND	EXBK	ID	INVFRM	P	RD	RECBTM	TD	TVR_V
	•	•			•			•	•		

Construction and Finish Upgrades

APC	FB	MIP	MSLFB	WLI
•	•	•	•	•

Door Options

ALF	CG	CG.BTM	CG.TOP	DPSRR	MD	MD.BTM	MD.TOP
				•			

EASY REACH WALL CORNER, 30", 33", 36", 39", or 42" HIGH, 24" x 24"

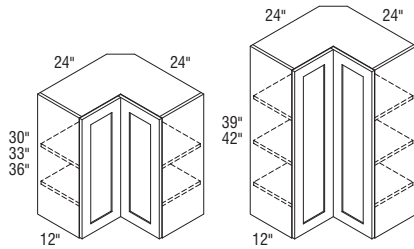

ER30 L or R	12.5
ER33 L or R	13.9
ER36 L or R	14.9
ER39 L or R	16.0
ER42 L or R	17.2

- Requires 24" x 24" of corner wall space.
- Decorative hardware screws must be countersunk to prevent scratching of adjacent cabinets.
- Adjustable shelves.
- Hinged door opens 170°.
- Integrated soft-close hinge not included.

Custom Modifications

ADDTK	CBO	CCO	CND	EXBK	ID	INVFRM	P	RD	RECBTM	TD	TVR_V
	•	•			•			•	•		

Construction and Finish Upgrades

APC	FB	MIP	MSLFB	WLI
•	•	•	•	•

Door Options

ALF	CG	CG.BTM	CG.TOP	DPSRR	MD	MD.BTM	MD.TOP
				•			

ASYMMETRICAL EASY REACH WALL CORNER, 30", 33", 36", 39", or 42" HIGH

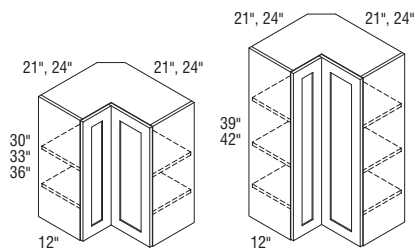

Model	Cubic Feet
ER302124 L or R	12.5
ER302421 L or R	12.5
ER332124 L or R	13.3
ER332421 L or R	13.3
ER362124 L or R	14.9
ER362421 L or R	14.9
ER392124 L or R	16.0
ER392421 L or R	16.0
ER422124 L or R	17.2
ER422421 L or R	17.2

- Hinged door opens to 170°.
- Adjustable shelves.
- Legs at the front frames are 9" on 21" leg and 12" on 24" leg.
- Nomenclature for asymmetrical cabinets reads as follows:
 First set of numbers = height
 Second set of numbers = left side
 Third set of numbers = right side
- Decorative hardware screws must be countersunk to prevent scratching of adjacent cabinets.
- ER_2124L shown.
- Integrated soft-close hinge not included.

Custom Modifications

ADDTK	CBO	CCO	CND	EXBK	ID	INVFRM	P	RD	RECBTM	TD	TVR_V
	•	•			•			•			

Construction and Finish Upgrades

APC	FB	MIP	MSLFB	WLI
•	•	•	•	•

Door Options

ALF	CG	CG.BTM	CG.TOP	DPSRR	MD	MD.BTM	MD.TOP
				•			

WALL END CABINET SINGLE DOOR, 30", 33", 36", 39", or 42" HIGH, 12" x 12"

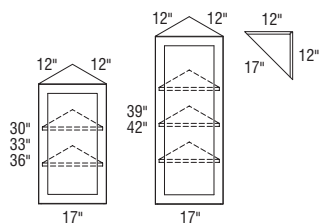

WEC1230 L or R	3.7
WEC1233 L or R	4.1
WEC1236 L or R	4.4
WEC1239 L or R*	4.7
WEC1242 L or R*	4.9

- Width at wall: 12" x 12".
 - Cabinet features two unfinished back panels. Must be installed with one back panel adjacent to a cabinet of equal height with the other back panel attached to the wall.
- *When ordered with MD, shelves will not align with mullions.

Custom Modifications

ADDTK	CBO	CCO	CND	EXBK	ID	INVFRM	P	RD	RECBTM	TD	TVR_V
	•	•							•		

Construction and Finish Upgrades

APC	FB	MIP	MSLFB	WLI
•		•	•	•

Door Options

ALF	CG	CG.BTM	CG.TOP	DPSRR	MD	MD.BTM	MD.TOP
	•			•	•		

STACKED WALL END CABINET SINGLE DOOR, 48", 51", 54", 57", or 60" HIGH, 12" x 12"

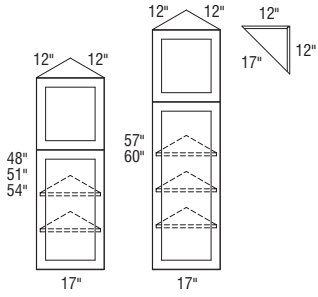

Model	Cubic Feet
STWEC1248 L or R	5.7
STWEC1251 L or R	6.0
STWEC1254 L or R	6.4
STWEC1257 L or R	6.7
STWEC1260 L or R	7.0

- Width at wall: 12" x 12".
- Cabinet features two unfinished back panels. Must be installed with one back panel adjacent to a cabinet of equal height with the other back panel attached to the wall.
- Lower door aligns with doors on adjacent cabinets with equivalent heights (i.e., lower door on STWEC1248 L/R aligns with a 30" high wall cabinet). Bottom edge of upper door will not align with an adjacent 18" high cabinet. Reveal between upper and lower doors is 1/8".

Cabinet Height	Upper Door Height	Lower Door Height
48"	17 7/8"	29 3/4"
51"	17 7/8"	32 3/4"
54"	17 7/8"	35 3/4"
57"	17 7/8"	38 3/4"
60"	17 7/8"	41 3/4"

Custom Modifications

ADDTK	CBO	CCO	CND	EXBK	ID	INVFRM	P	RD	RECBTM	TD	TVR_V
	•	•				•					

Construction and Finish Upgrades

APC	FB	MIP	MSLFB	WLI
•	STD	•	•	•

Door Options

ALF	CG	CG.BTM	CG.TOP	DPSRR	MD	MD.BTM	MD.TOP
		•	•	•			

WALL END CABINET DOUBLE DOOR, 30", 33", 36", 39", or 42" HIGH, 12" x 12"

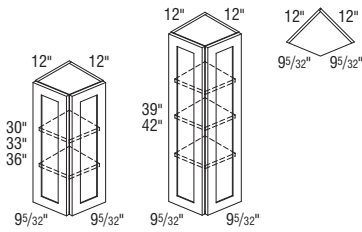

WEC1230D	3.7
WEC1233D	4.1
WEC1236D	4.4
WEC1239D	4.7
WEC1242D	4.9

- Width at wall: 12" x 12".
- Cabinet features two unfinished back panels. Must be installed with one back panel adjacent to a cabinet of equal height with the other back panel attached to the wall.
- Decorative glass inserts are not available.
- Reveal between upper and lower doors is 1/8".

Custom Modifications

ADDTK	CBO	CCO	CND	EXBK	ID	INVFRM	P	RD	RECBTM	TD	TVR_V
	•	•							•		

Construction and Finish Upgrades

APC	FB	MIP	MSLFB	WLI
•		•	•	•

Door Options

ALF	CG	CG.BTM	CG.TOP	DPSRR	MD	MD.BTM	MD.TOP
	•			•			

STACKED WALL END CABINET DOUBLE DOOR, 48", 51", 54", 57", or 60" HIGH, 12" x 12"

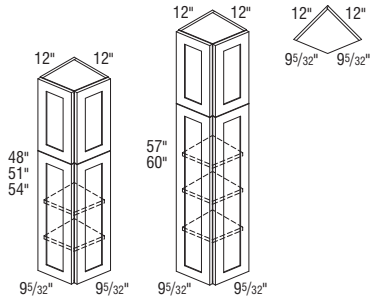

Model	Cubic Feet
STWEC1248D	5.7
STWEC1251D	6.0
STWEC1254D	6.4
STWEC1257D	6.7
STWEC1260D	7.0

- Width at wall: 12" x 12".
- Cabinet features two unfinished back panels. Must be installed with one back panel adjacent to a cabinet of equal height with the other back panel attached to the wall.
- Decorative glass inserts are not available.
- Lower door aligns with doors on adjacent cabinets with equivalent heights (i.e., lower door on STWEC1248D aligns with a 30" high wall cabinet). Bottom edge of upper door will not align with an adjacent 18" high cabinet. Reveal between upper and lower doors is 1/8".

Cabinet Height	Upper Door Height	Lower Door Height
48"	17 7/8"	29 3/4"
51"	17 7/8"	32 3/4"
54"	17 7/8"	35 3/4"
57"	17 7/8"	38 3/4"
60"	17 7/8"	41 3/4"

Custom Modifications

ADDTK	CBO	CCO	CND	EXBK	ID	INVFRM	P	RD	RECBTM	TD	TVR_V
	•	•				•					

Construction and Finish Upgrades

APC	FB	MIP	MSLFB	WLI
•	STD	•	•	•

Door Options

ALF	CG	CG.BTM	CG.TOP	DPSRR	MD	MD.BTM	MD.TOP
		•	•	•			

**WALL QUARTER ROUND END SHELF,
30", 33", 36", 39", or 42" HIGH**

Radius Top and Bottom Panels

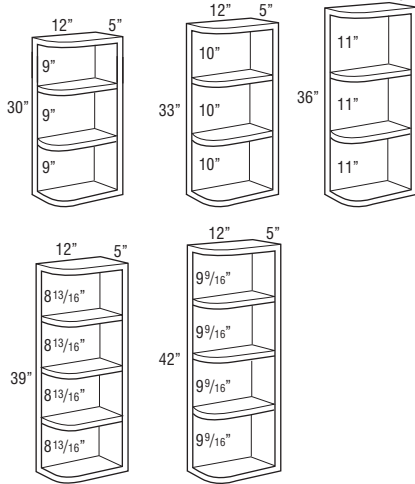
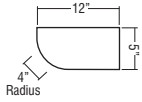

Square Top and Radius Bottom Panels

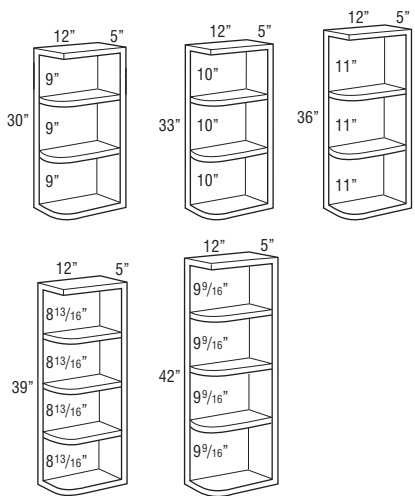
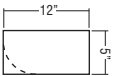

Square Top and Bottom Panels

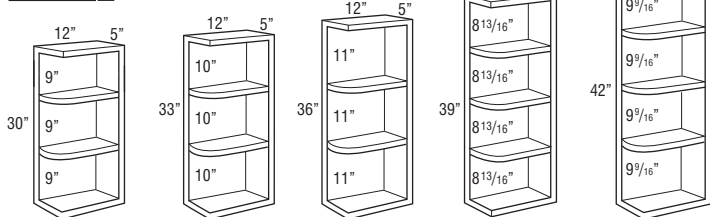
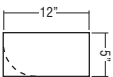

Model	Cubic Feet
WQRES630RT	1.8
WQRES633RT	1.9
WQRES636RT	2.2
WQRES639RT	2.5
WQRES642RT	2.9

- Units are reversible.
- 12" deep x 5" wide, 4" shelf radius.
- Radius moulding is not available for WQRES636RT.
- Veneer on 3/4" furniture board core.
- Matching interior.
- If ordered with Heirlooming Technique, will not feature sand-through characteristics.
- Cabinet features two unfinished back panels. Must be installed with one back panel adjacent to a cabinet of equal height with the other back panel attached to the wall.

WQRES630ST L or R	1.8
WQRES633ST L or R	2.3
WQRES636ST L or R	2.5
WQRES639ST L or R	2.5
WQRES642ST L or R	2.9

- Specify left or right. Only top panel is square. Right shown.
- Veneer on 3/4" furniture board core.
- Matching interior.
- If ordered with Heirlooming Technique, will not feature sand-through characteristics.
- Cabinet features two unfinished back panels. Must be installed with one back panel adjacent to a cabinet of equal height with the other back panel attached to the wall.

WQRES630STSB	1.8
WQRES633STSB	1.9
WQRES636STSB	2.2
WQRES639STSB	2.5
WQRES642STSB	2.9

- Units are reversible.
- Veneer on 3/4" furniture board core.
- Matching interior.
- If ordered with Heirlooming Technique, will not feature sand-through characteristics.
- Cabinet features two unfinished back panels. Must be installed with one back panel adjacent to a cabinet of equal height with the other back panel attached to the wall.

MODIFICATIONS

No modifications available for these products.

Construction and Finish Upgrades

APC	FB	MIP	MSLFB	WLI
•				

**WALL QUARTER ROUND END SHELF,
12" RADIUS, 30", 33", 36", 39", or
42" HIGH**

Radius Top and Bottom Panels

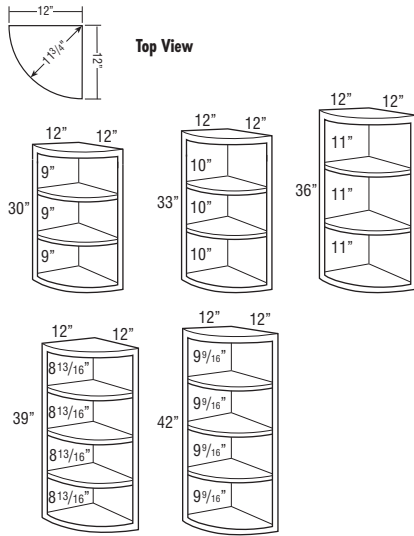

Square Top and Radius Bottom Panels

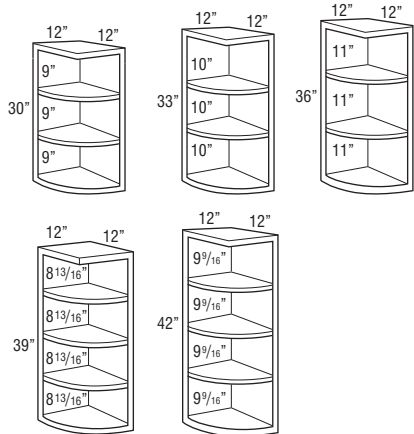

Square Top and Bottom Panels

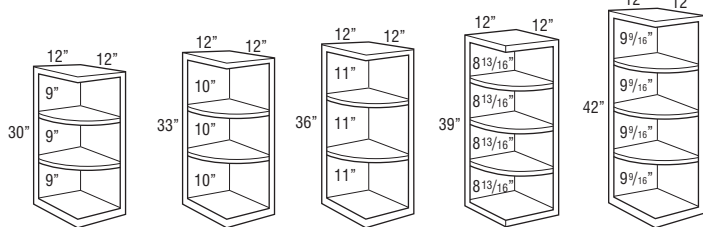

Model	Cubic Feet
WQRES1230RT	3.7
WQRES1233RT	4.0
WQRES1236RT	4.4
WQRES1239RT	4.7
WQRES1242RT	5.1
<ul style="list-style-type: none"> Veneer on 3/4" furniture board core. Matching interior. If ordered with Heirloom Technique, will not feature sand-through characteristics. Cabinet features two unfinished back panels. Must be installed with one back panel adjacent to a cabinet of equal height with the other back panel attached to the wall. 	
WQRES1230STRB	3.7
WQRES1233STRB	4.0
WQRES1236STRB	4.4
WQRES1239STRB	4.7
WQRES1242STRB	5.1
<ul style="list-style-type: none"> Veneer on 3/4" furniture board core. Matching interior. If ordered with Heirloom Technique, will not feature sand-through characteristics. Cabinet features two unfinished back panels. Must be installed with one back panel adjacent to a cabinet of equal height with the other back panel attached to the wall. 	
WQRES1230STSB	3.7
WQRES1233STSB	4.0
WQRES1236STSB	4.4
WQRES1239STSB	4.7
WQRES1242STSB	5.1

MODIFICATIONS	
No modifications available for these products.	

Construction and Finish Upgrades

APC	FB	MIP	MSLFB	WLI
•				

WALL TRANSITION CABINET, 30", 33", 36", 39", or 42" HIGH

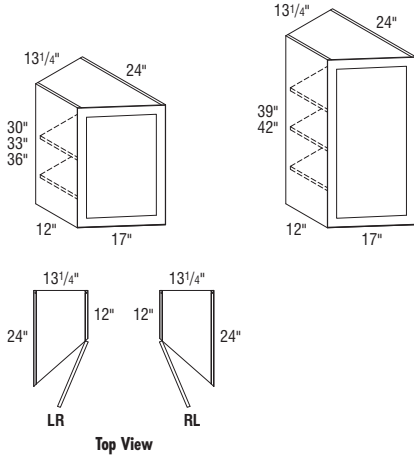

Model	Cubic Feet
WTC1230RL	6.9
WTC1230LR	6.9
WTC1233RL	7.6
WTC1233LR	7.6
WTC1236RL	8.1
WTC1236LR	8.1
WTC1239RL	8.7
WTC1239LR	8.7
WTC1242RL	9.4
WTC1242LR	9.4

- Door is always hinged on short side.
- Depth can be reduced to a minimum of 18".
- Cabinet width is 13 1/4".

Custom Modifications

ADDTK	CBO	CCO	CND	EXBK	ID	INVFRM	P	RD	RECBTM	TD	TVR_V
	•	•						•	•		

Construction and Finish Upgrades

APC	FB	MIP	MSLFB	WLI
•	•	•	•	•

Door Options

ALF	CG	CG.BTM	CG.TOP	DPSRR	MD	MD.BTM	MD.TOP
	•			•	•		

STACKED WALL TRANSITION CABINET, 48", 51", 54", 57", or 60" HIGH

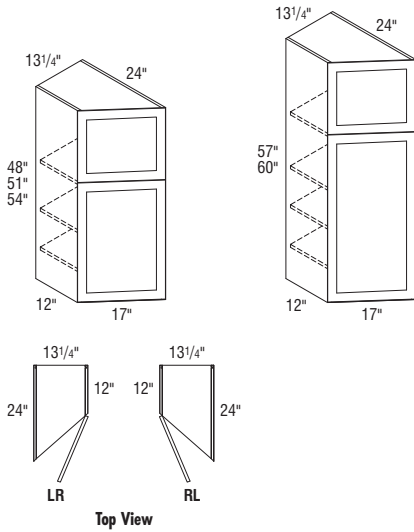

STWTC1248RL	5.7
STWTC1248LR	5.7
STWTC1251RL	6.0
STWTC1251LR	6.0
STWTC1254RL	6.4
STWTC1254LR	6.4
STWTC1257RL	6.7
STWTC1257LR	6.7
STWTC1260RL	7.0
STWTC1260LR	7.0

- Door is always hinged on short side.
- Depth can be reduced to a minimum of 18".
- Cabinet width is 13 1/4".
- Lower door aligns with doors on adjacent cabinets with equivalent heights (i.e., lower door on STWTC1248RL aligns with a 30" high wall cabinet). Bottom edge of upper door will not align with an adjacent 18" high cabinet. Reveal between upper and lower doors is 1/8".

Cabinet Height	Upper Door Height	Lower Door Height
48"	17 7/8"	29 3/4"
51"	17 7/8"	32 3/4"
54"	17 7/8"	35 3/4"
57"	17 7/8"	38 3/4"
60"	17 7/8"	41 3/4"

Custom Modifications

ADDTK	CBO	CCO	CND	EXBK	ID	INVFRM	P	RD	RECBTM	TD	TVR_V
	•	•				•		•			

Construction and Finish Upgrades

APC	FB	MIP	MSLFB	WLI
•	STD	•	•	•

Door Options

ALF	CG	CG.BTM	CG.TOP	DPSRR	MD	MD.BTM	MD.TOP
		•	•	•			

**WALL MICROWAVE,
18" or 21" HIGH**

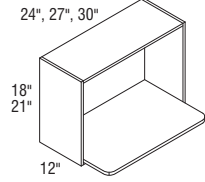

Model	Cubic Feet
MW2418	4.3
MW2718	4.6
MW3018	6.9
MW2421	5.0
MW2721	5.4
MW3021	8.0

- Includes one 3/4" shelf with six mounting screws. Microwave shelf extends beyond the front of the cabinet by 6 1/2", and is trimmable.
- Microwave cabinet must be attached to wall stud and adjacent cabinets on both sides for support.
- If ordered with Heirlooming Technique, will not feature sand-through characteristics.
- Matching Interior Plywood (MIP) standard.

Custom Modifications

ADDTK	CBO	CCO	CND	EXBK	ID	INVFRM	P	RD	RECBTM	TD	TVR_V
	STD			•	•						

Construction and Finish Upgrades

APC	FB	MIP	MSLFB	WLI
		STD	•	

Door Options

ALF	CG	CG.BTM	CG.TOP	DPSRR	MD	MD.BTM	MD.TOP

**WALL MICROWAVE DOUBLE DOOR,
36" HIGH**

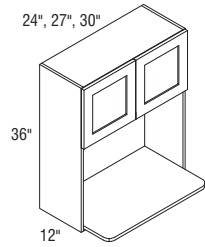

MW2436	5.5
MW2736	6.8
MW3036	10.0

- Includes one 3/4" shelf with six mounting screws. Microwave shelf extends beyond the front of the cabinet by 6 1/2", and is trimmable.
- Microwave cabinet must be attached to wall stud and adjacent cabinets on both sides for support.
- Matching Interior Plywood (MIP) standard.

Custom Modifications

ADDTK	CBO	CCO	CND	EXBK	ID	INVFRM	P	RD	RECBTM	TD	TVR_V
	•	•		•							

Construction and Finish Upgrades

APC	FB	MIP	MSLFB	WLI
		STD	•	

Door Options

ALF	CG	CG.BTM	CG.TOP	DPSRR	MD	MD.BTM	MD.TOP
	•			•			

**WALL BUILT-IN MICROWAVE,
18" HIGH, 18", 21", or 24" DEEP**

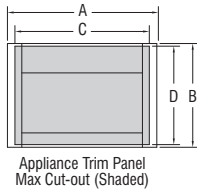
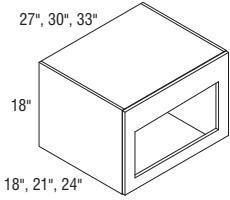

Appliance Trim Panel
Max Cut-out (Shaded)

Model	Cubic Feet
WBMW271818	4.6
WBMW301818	6.9
WBMW331818	8.0
WBMW271821	6.8
WBMW301821	8.2
WBMW331821	9.1
WBMW271824	8.5
WBMW301824	9.4
WBMW331824	10.3

- WBMWs can be used to stack with other cabinets to create custom appliance cabinet designs.
- Microwave cabinet must be attached to wall stud and adjacent cabinets on both sides for support.
- If ordered with Heirlooming Technique, will not feature sand-through characteristics.
- See page 73 for specifications on appliance cabinet trim panels.
- Nomenclature is listed in order of width, height, then depth (WBMW301821 is 30" wide, 18" high, and 21" deep).

	A Panel Width	B Panel Height	C Cut-out Width		D Cut-out Height	
			Min.	Max.	Min.	Max.
WBMW271818	26 27/32"	17 3/4"	21 3/32"	23 27/32"	6"	16 11/16"
WBMW301818	29 27/32"	17 3/4"	24 3/32"	26 27/32"	6"	16 11/16"
WBMW331818	32 27/32"	17 3/4"	27 3/32"	29 27/32"	6"	16 11/16"
WBMW271821	26 27/32"	17 3/4"	21 3/32"	23 27/32"	6"	16 11/16"
WBMW301821	29 27/32"	17 3/4"	24 3/32"	26 27/32"	6"	16 11/16"
WBMW331821	32 27/32"	17 3/4"	27 3/32"	29 27/32"	6"	16 11/16"
WBMW271824	26 27/32"	17 3/4"	21 3/32"	23 27/32"	6"	16 11/16"
WBMW301824	29 27/32"	17 3/4"	24 3/32"	26 27/32"	6"	16 11/16"
WBMW331824	32 27/32"	17 3/4"	27 3/32"	29 27/32"	6"	16 11/16"

Custom Modifications

ADDTK	CBO	CCO	CND	EXBK	ID	INVFRM	P	RD	RECBTM	TD	TVR_V
	STD			•	•			•			

Construction and Finish Upgrades

APC	FB	MIP	MSLFB	WLI
•	•	•	•	•

Door Options

ALF	CG	CG.BTM	CG.TOP	DPSRR	MD	MD.BTM	MD.TOP

**WALL BUILT-IN MICROWAVE,
21" HIGH, 18", 21", or 24" DEEP**

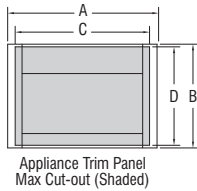
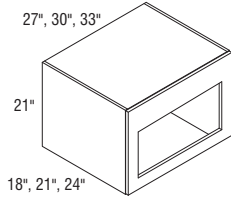

Model	Cubic Feet
WBMW272118	5.4
WBMW302118	8.0
WBMW332118	9.2
WBMW272121	8.4
WBMW302121	9.5
WBMW332121	10.6
WBMW272124	9.8
WBMW302124	10.9
WBMW332124	11.9

- WBMWs can be used to stack with other cabinets to create custom appliance cabinet designs.
- Microwave cabinet must be attached to wall stud and adjacent cabinets on both sides for support.
- If ordered with Heirloom Technique, will not feature sand-through characteristics.
- See page 73 for specifications on appliance cabinet trim panels.
- Nomenclature is listed in order of width, height, then depth (WBMW302121 is 30" wide, 21" high, and 21" deep).

	A Panel Width	B Panel Height	C Cut-out Width		D Cut-out Height	
			Min.	Max.	Min.	Max.
WBMW272118	26 27/32"	20 3/4"	21 3/32"	23 27/32"	9"	19 11/16"
WBMW302118	29 27/32"	20 3/4"	24 3/32"	26 27/32"	9"	19 11/16"
WBMW332118	32 27/32"	20 3/4"	27 3/32"	29 27/32"	9"	19 11/16"
WBMW272121	26 27/32"	20 3/4"	21 3/32"	23 27/32"	9"	19 11/16"
WBMW302121	29 27/32"	20 3/4"	24 3/32"	26 27/32"	9"	19 11/16"
WBMW332121	32 27/32"	20 3/4"	27 3/32"	29 27/32"	9"	19 11/16"
WBMW272124	26 27/32"	20 3/4"	21 3/32"	23 27/32"	9"	19 11/16"
WBMW302124	29 27/32"	20 3/4"	24 3/32"	26 27/32"	9"	19 11/16"
WBMW332124	32 27/32"	20 3/4"	27 3/32"	29 27/32"	9"	19 11/16"

Custom Modifications

ADDTK	CBO	CCO	CND	EXBK	ID	INVFRM	P	RD	RECBTM	TD	TVR_V
	STD			•	•			•			

Construction and Finish Upgrades

APC	FB	MIP	MSLFB	WLI
•	•	•	•	•

Door Options

ALF	CG	CG.BTM	CG.TOP	DPSRR	MD	MD.BTM	MD.TOP

WALL BUILT-IN MICROWAVE DOUBLE DOOR, 36", 39", or 42" HIGH, 18" or 21" DEEP

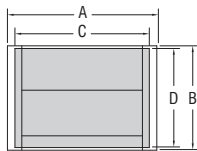
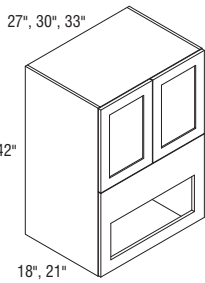
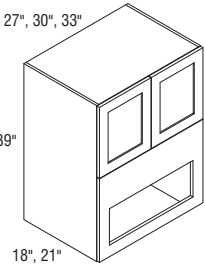
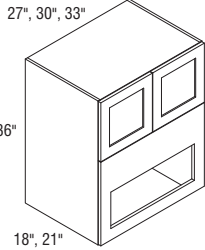

Appliance Trim Panel
Max Cut-out (Shaded)

Model	Cubic Feet
WBMW273618	12.1
WBMW303618	13.3
WBMW333618	15.3
WBMW273621	11.4
WBMW303621	15.8
WBMW333621	17.6
WBMW273918	13.5
WBMW303918	14.9
WBMW333918	16.6
WBMW273921	15.0
WBMW303921	18.4
WBMW333921	19.0
WBMW274218	14.0
WBMW304218	15.5
WBMW334218	17.8
WBMW274221	13.2
WBMW304221	17.1
WBMW334221	20.4

- Microwave cabinet must be attached to wall stud and adjacent cabinets on both sides for support.
- All cabinets have 3" stiles on frames.
- When CG is specified, face frame will be visible through door if used with a translucent art or textured glass design.
- Uses face mount hinges on all styles.
- See page 73 for specifications on appliance cabinet trim panels.
- Nomenclature is listed in order of width, height, then depth (WBMW303621 is 30" wide, 36" high, and 21" deep).

	A Panel Width	B Panel Height	C Cut-out Width		D Cut-out Height		Door Height
			Min.	Max.	Min.	Max.	
WBMW273618	26 27/32"	20 7/8"	21 3/32"	23 27/32"	9 1/8"	19 13/16"	14 3/4"
WBMW303618	29 27/32"	20 7/8"	24 3/32"	26 27/32"	9 1/8"	19 13/16"	14 3/4"
WBMW333618	32 27/32"	20 7/8"	27 3/32"	29 27/32"	9 1/8"	19 13/16"	14 3/4"
WBMW273621	26 27/32"	20 7/8"	21 3/32"	23 27/32"	9 1/8"	19 13/16"	14 3/4"
WBMW303621	29 27/32"	20 7/8"	24 3/32"	26 27/32"	9 1/8"	19 13/16"	14 3/4"
WBMW333621	32 27/32"	20 7/8"	27 3/32"	29 27/32"	9 1/8"	19 13/16"	14 3/4"
WBMW273918	26 27/32"	20 7/8"	21 3/32"	23 27/32"	9 1/8"	19 13/16"	17 3/4"
WBMW303918	29 27/32"	20 7/8"	24 3/32"	26 27/32"	9 1/8"	19 13/16"	17 3/4"
WBMW333918	32 27/32"	20 7/8"	27 3/32"	29 27/32"	9 1/8"	19 13/16"	17 3/4"
WBMW273921	26 27/32"	20 7/8"	21 3/32"	23 27/32"	9 1/8"	19 13/16"	17 3/4"
WBMW303921	29 27/32"	20 7/8"	24 3/32"	26 27/32"	9 1/8"	19 13/16"	17 3/4"
WBMW333921	32 27/32"	20 7/8"	27 3/32"	29 27/32"	9 1/8"	19 13/16"	17 3/4"
WBMW274218	26 27/32"	20 7/8"	21 3/32"	23 27/32"	9 1/8"	19 13/16"	20 3/4"
WBMW304218	29 27/32"	20 7/8"	24 3/32"	26 27/32"	9 1/8"	19 13/16"	20 3/4"
WBMW334218	32 27/32"	20 7/8"	27 3/32"	29 27/32"	9 1/8"	19 13/16"	20 3/4"
WBMW274221	26 27/32"	20 7/8"	21 3/32"	23 27/32"	9 1/8"	19 13/16"	20 3/4"
WBMW304221	29 27/32"	20 7/8"	24 3/32"	26 27/32"	9 1/8"	19 13/16"	20 3/4"
WBMW334221	32 27/32"	20 7/8"	27 3/32"	29 27/32"	9 1/8"	19 13/16"	20 3/4"

Custom Modifications

ADDTK	CBO	CCO	CND	EXBK	ID	INFRM	P	RD	RECBTM	TD	TVR_V
		•		•	•			•			

Construction and Finish Upgrades

APC	FB	MIP	MSLFB	WLI
•	•	•	•	•

Door Options

ALF	CG	CG.BTM	CG.TOP	DPSRR	MD	MD.BTM	MD.TOP
	•			•			

WALL BOX COLUMN PULL-OUT, PLAIN storage SOLUTIONS

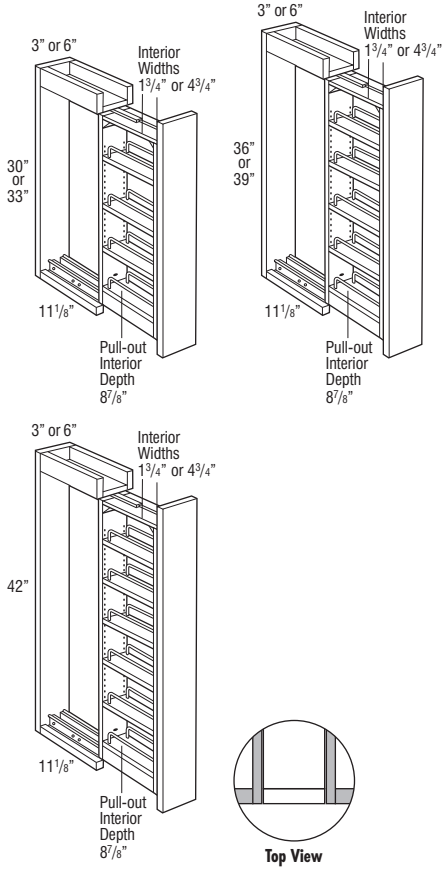

Model	Cubic Feet
WBCPO330	0.6
WBCPO630	1.3
WBCPO333	1.3
WBCPO633	2.2
WBCPO336	1.4
WBCPO636	2.4
WBCPO339	1.5
WBCPO639	2.6
WBCPO342	1.6
WBCPO642	2.7

- Recommend installation between two cabinets. Can be installed on the end of a run or adjacent to an appliance with a 3/4" thick end panel.
- All styles feature a natural finish full extension wood pull-out with adjustable shelves and chrome rail sides.
- If ordered with Heirlooming Technique, will not feature sand-through characteristics.
- In order to allow proper clearance for opening and closing, allow an additional 1/8" space between adjacent cabinets. The 3" wide pull-outs require 3 1/8" space and the 6" wide pull-outs require 6 1/8" space. Spacers are included with the pull-outs to allow for proper installation.
- For full access from both sides of unit, do not install against a wall or next to deeper appliances and cabinets.

MODIFICATIONS
No modifications available for these products.

Finish Techniques

Distressing	Heirlooming
•	

WALL BOX COLUMN PULL-OUT, OVERLAY

storage SOLUTIONS

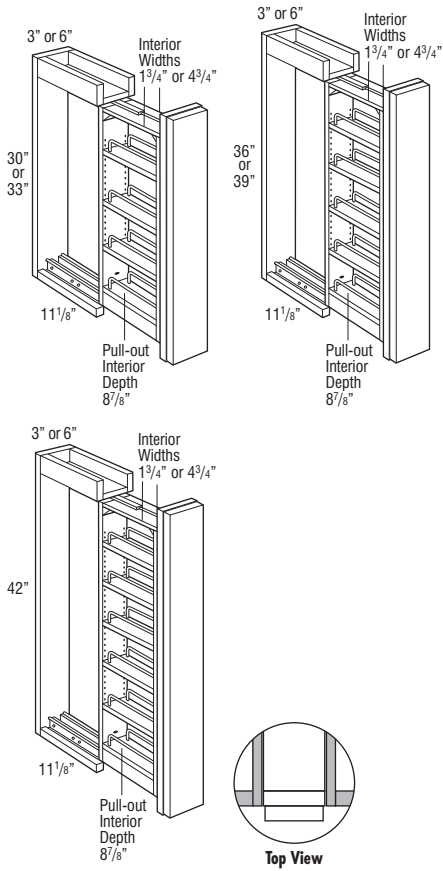

Model	Cubic Feet
WBCP03300L	0.6
WBCP06300L	1.3
WBCP03330L	1.3
WBCP06330L	2.2
WBCP03360L	1.4
WBCP06360L	2.4
WBCP03390L	1.5
WBCP06390L	2.6
WBCP03420L	1.6
WBCP06420L	2.7

- Recommend installation between two cabinets. Can be installed on the end of a run or adjacent to an appliance with a 3/4" thick end panel.
- Overlay application includes profiled full overlay filler.
- All styles feature a natural finish full extension wood pull-out with adjustable shelves and chrome rail sides.
- In order to allow proper clearance for opening and closing, allow an additional 1/8" space between adjacent cabinets. The 3" wide pull-outs require 3 1/8" space and the 6" wide pull-outs require 6 1/8" space. Spacers are included with the pull-outs to allow for proper installation.
- For full access from both sides of unit, do not install against a wall or next to deeper appliances and cabinets.

MODIFICATIONS
No modifications available for these products.

Finish Techniques

Distressing	Reirloom
•	•

WALL BOX COLUMN PULL-OUT with K-CUP*, PLAIN

storage SOLUTIONS

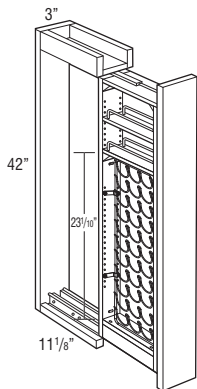
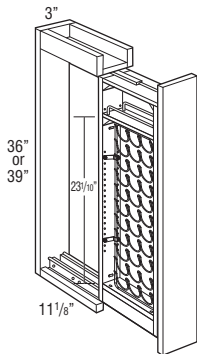
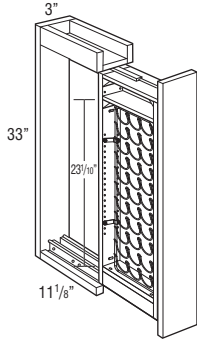
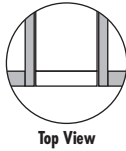
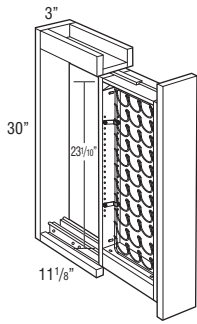

Model	Cubic Feet
WBCPOKCUP330	1.2
WBCPOKCUP333	1.3
WBCPOKCUP336	1.4
WBCPOKCUP339	1.5
WBCPOKCUP342	1.6

- Holds 44 K-Cups, compatible with K-Cup pods only.
 - Wire K-Cup rack included for easy field installation on either the left or right side (K-Cups are only accessible from one side). All units include adjustable shelves with chrome rail sides that can be used for future installation if K-Cup insert is no longer desired. Depending on height of pull-out, shelves can be used above or below insert for additional storage:
 - 30" & 33" high include 4 shelves, not compatible with insert.
 - 36" & 39" high include 5 shelves, one shelf recommended for use with insert.
 - 42" high includes 6 shelves, two shelves recommended for use with insert.
 - Recommend installation between two cabinets. Can be installed on the end of a run or adjacent to an appliance with a 3/4" thick end panel.
 - All styles feature a natural finish full extension wood pull-out.
 - In order to allow proper clearance for opening and closing, allow an additional 1/8" space between adjacent cabinets. The 3" wide pull-outs require 3 1/8" space. Spacers are included with the pull-outs to allow for proper installation.
 - For full access of upper shelves from both sides of unit, do not install against a wall or next to deeper appliances and cabinets.
 - Finger pull routed on bottom edge of wall unit. Hardware optional.
 - Pull-out does not have Smart Stop feature.
- *K-Cup is a registered trademark of Keurig Green Mountain, Inc.

MODIFICATIONS
No modifications available for these products.

Finish Techniques

Distressing	Heirlooming
•	

WALL BOX COLUMN PULL-OUT with K-CUP*, OVERLAY

storage SOLUTIONS

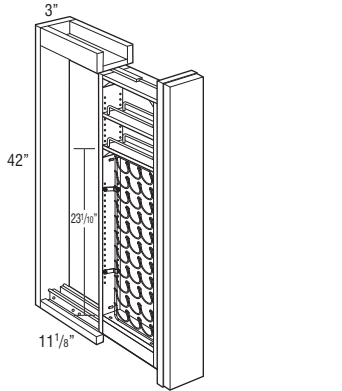
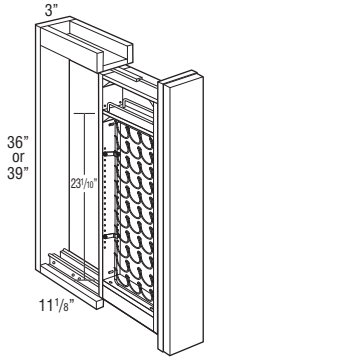
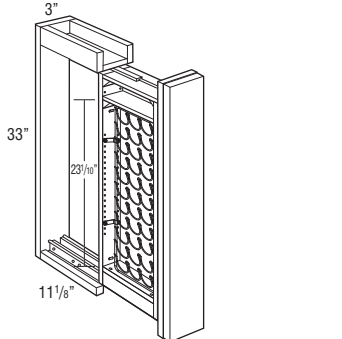
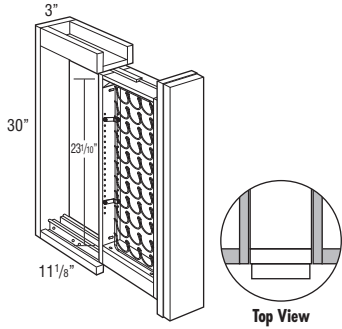

Model	Cubic Feet
WBCPOKCUP3300L	1.2
WBCPOKCUP3330L	1.3
WBCPOKCUP3360L	1.4
WBCPOKCUP3390L	1.5
WBCPOKCUP3420L	1.6

- Holds 44 K-Cups, compatible with K-Cup pods only.
 - Wire K-Cup rack included for easy field installation on either the left or right side (K-Cups are only accessible from one side). All units include adjustable shelves with chrome rail sides that can be used for future installation if K-Cup insert is no longer desired. Depending on height of pull-out, shelves can be used above or below insert for additional storage:
 30" & 33" high include 4 shelves, not compatible with insert.
 36" & 39" high include 5 shelves, one shelf recommended for use with insert.
 42" high includes 6 shelves, two shelves recommended for use with insert.
 - Overlay application includes profiled full overlay filler.
 - Recommend installation between two cabinets. Can be installed on the end of a run or adjacent to an appliance with a 3/4" thick end panel.
 - All styles feature a natural finish full extension wood pull-out.
 - In order to allow proper clearance for opening and closing, allow an additional 1/8" space between adjacent cabinets. The 3" wide pull-outs require 3 1/8" space. Spacers are included with the pull-outs to allow for proper installation.
 - For full access of upper shelves from both sides of unit, do not install against a wall or next to deeper appliances and cabinets.
 - Finger pull routed on bottom edge of wall unit. Hardware optional.
 - Pull-out does not have Smart Stop feature.
- *K-Cup is a registered trademark of Keurig Green Mountain, Inc.

MODIFICATIONS
No modifications available for these products.

Finish Techniques

Distressing	Heirlooming
•	•

WALL SPICE PULL-OUT, 30", 33", 36", 39", or 42" HIGH storage SOLUTIONS

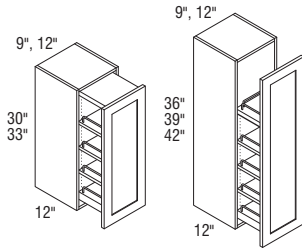

Model	Cubic Feet
WSP930	2.9
WSP1230	3.7
WSP933	3.2
WSP1233	4.1
WSP936	3.5
WSP1236	4.4
WSP939	3.7
WSP1239	4.7
WSP942	4.0
WSP1242	5.1

- 30" and 33" high units include a natural finish, full extension wood pull-out with three adjustable shelves, one fixed shelf, and chrome finish rail sides.
- Wood plugs for top of 30" high pull-out included for field installation.
- 36" to 42" high units include a natural finish, full extension wood pull-out with three adjustable shelves, two fixed shelves, and chrome finish rail sides.
- Wire for top rail on 36" to 42" high pull-out included separately for field installation.
- For full access from both sides of unit, do not install against a wall or next to deeper appliances and cabinets.
- Pull-out does not have Smart Stop feature.

Custom Modifications

ADDTK	CBO	CCO	CND	EXBK	ID	INFRM	P	RD	RECBTM	TD	TVR_V
•	•	•		•							

Construction and Finish Upgrades

APC	FB	MIP	MSLFB	WLI
•	•	•	•	•

Door Options

ALF	CG	CG.BTM	CG.TOP	DPSRR	MD	MD.BTM	MD.TOP
				•			

WALL SPICE PULL-DOWN storage SOLUTIONS

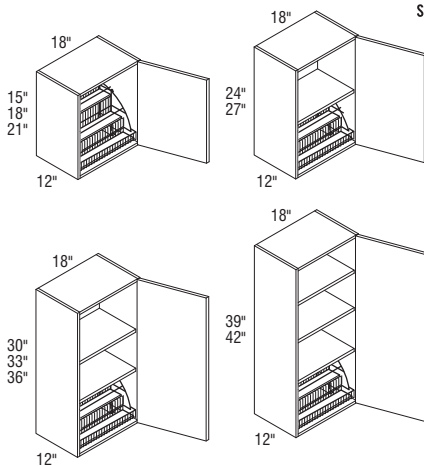

W1815SPD L or R	2.8
W1818SPD L or R	3.2
W1821SPD L or R	3.7
W1824SPD L or R	4.2
W1827SPD L or R	4.7
W1830SPD L or R	5.2
W1833SPD L or R	5.7
W1836SPD L or R	6.2
W1839SPD L or R	6.6
W1842SPD L or R	7.1

- Spice Rack Pull-down dimensions: 8 15/16" high x 14 13/16" wide x 10 5/16" deep.
- Interior dimensions of pull-down trays: 11 3/4" wide x 3" deep.
- Maximum Weight Capacity for Spice Rack Pull-down: 15 lbs.
- When Increased Depth (ID) is ordered, insert will not increase in size.

Custom Modifications

ADDTK	CBO	CCO	CND	EXBK	ID	INFRM	P	RD	RECBTM	TD	TVR_V
	•*	•		•	•				•*		

*Not available on 15", 18", or 21" high *Not available on 15" high

Construction and Finish Upgrades

APC	FB	MIP	MSLFB	WLI
•	•	•	•	•

Door Options

ALF	CG	CG.BTM	CG.TOP	DPSRR	MD	MD.BTM	MD.TOP
	•			•	•*		

*Not available on 15", 24", or 27" high

WALL SHELF PULL-DOWN

storage
SOLUTIONS

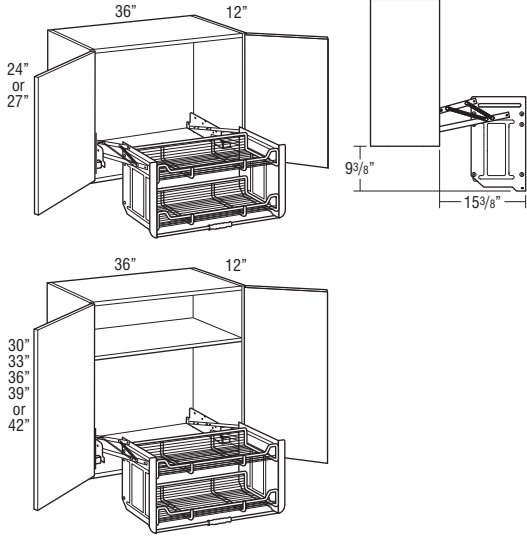

Model	Cubic Feet
W3624SHLFPD	8.0
W3627SHLFPD	9.3
W3630SHLFPD	10.0
W3633SHLFPD	10.3
W3636SHLFPD	11.8
W3639SHLFPD	11.9
W3642SHLFPD	13.9

- Shelf Pull-down dimensions: 18 11/64" high x 28 1/4" wide x 8 1/2" deep.
- Interior dimensions of pull-down trays: 28 1/4" wide x 8 1/2" deep.
- Clearance dimensions: 19 3/8" high x 15 3/8" wide.
- 30" to 42" high units will have one adjustable shelf above pull-down unit.
- Maximum Weight Capacity for Shelf Pull-down: 26 lbs.

Custom Modifications

ADDTK	CBO	CCO	CND	EXBK	ID	INVRM	P	RD	RECBTM	TD	TVR_V
	•	•		•					•*		

*Not available on 24" or 27" high

Construction and Finish Upgrades

APC	FB	MIP	MSLFB	WLI
•	•	•	•	•

Door Options

ALF	CG	CG.BTM	CG.TOP	DPSRR	MD	MD.BTM	MD.TOP
	•			•	•		

WALL SPICE RACK, 30", 33", 36", 39", or 42" HIGH

storage
SOLUTIONS

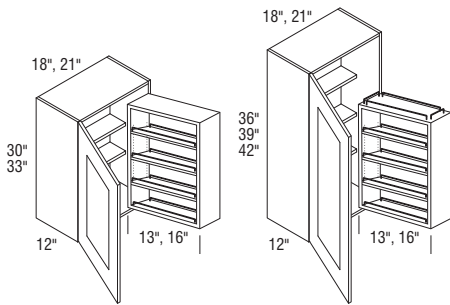

WSR1830 L or R	5.3
WSR2130 L or R	6.1
WSR1833 L or R	5.9
WSR2133 L or R	6.7
WSR1836 L or R	6.3
WSR2136 L or R	7.2
WSR1839 L or R	6.8
WSR2139 L or R	7.8
WSR1842 L or R	7.3
WSR2142 L or R	8.3

- Shelves are 4 1/2" deep.
- Field installed swing-out has three adjustable and one fixed bottom shelf with chrome finish wire rail sides.
- Dimensions: WSR18 wood insert is 26" high x 13" wide x 6" deep. WSR21 wood insert is 26" high x 16" wide x 6" deep.
- When Increased Depth (ID) is ordered, wood insert will not increase in size.
- Maximum Weight Capacity for Spice Rack Shelves: 15 lbs.

Custom Modifications

ADDTK	CBO	CCO	CND	EXBK	ID	INVRM	P	RD	RECBTM	TD	TVR_V
•	•	•		•	•						

Construction and Finish Upgrades

APC	FB	MIP	MSLFB	WLI
•	•	•	•	•

Door Options

ALF	CG	CG.BTM	CG.TOP	DPSRR	MD	MD.BTM	MD.TOP
	•			•	•		

WALL OPEN CABINET with PLAIN BACK, 30", 33", 36", 39", or 42" HIGH

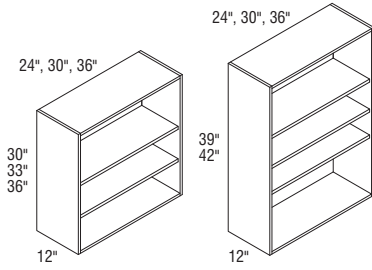

Model	Cubic Feet
WOCP2430	6.7
WOCP3030	8.3
WOCP3630	9.9
WOCP2433	7.4
WOCP3033	9.1
WOCP3633	10.8
WOCP2436	8.0
WOCP3036	9.9
WOCP3636	11.7
WOCP2439	8.6
WOCP3039	10.6
WOCP3639	12.7
WOCP2442	9.3
WOCP3042	11.4
WOCP3642	13.5

- Matching Interior Plywood (MIP) standard.
- If ordered with Heirloom Technique, will not feature sand-through characteristics.
- To change the top rail valance, specify one of the following modifications: Arch (TVRAV), Furniture (TVRFV), or Straight Valance (TVRVV).

Custom Modifications

ADDTK	CBO	CCO	CND	EXBK	ID	INVFRM	P	RD	RECBTM	TD	TVR_V
•	STD			•	•		•*	•	•		•

*Available only on 24" wide

Construction and Finish Upgrades

APC	FB	MIP	MSLFB	WLI
		STD	•	

Door Options

ALF	CG	CG.BTM	CG.TOP	DPSRR	MD	MD.BTM	MD.TOP

WALL OPEN CABINET with BEADED BACK, 30", 33", 36", 39", or 42" HIGH

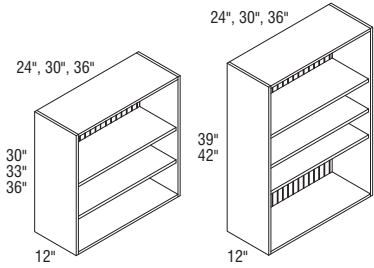

Model	Cubic Feet
WOCB2430	6.9
WOCB3030	8.5
WOCB3630	10.0
WOCB2433	7.4
WOCB3033	9.1
WOCB3633	10.8
WOCB2436	8.0
WOCB3036	9.9
WOCB3636	11.7
WOCB2439	8.6
WOCB3039	10.6
WOCB3639	12.7
WOCB2442	9.3
WOCB3042	11.4
WOCB3642	13.5

- Matching Interior Plywood (MIP) standard.
- Beaded back panel is veneer on furniture board core.
- If ordered with Heirloom Technique, will not feature sand-through characteristics.
- To change the top rail valance, specify one of the following modifications: Arch (TVRAV), Furniture (TVRFV), or Straight Valance (TVRVV).

Custom Modifications

ADDTK	CBO	CCO	CND	EXBK	ID	INVFRM	P	RD	RECBTM	TD	TVR_V
•	STD			•	•		•*	•	•		•

*Available only on 24" wide

Construction and Finish Upgrades

APC	FB	MIP	MSLFB	WLI
		STD		

Door Options

ALF	CG	CG.BTM	CG.TOP	DPSRR	MD	MD.BTM	MD.TOP

WALL WINE RACK, 15", 18", or 30" HIGH

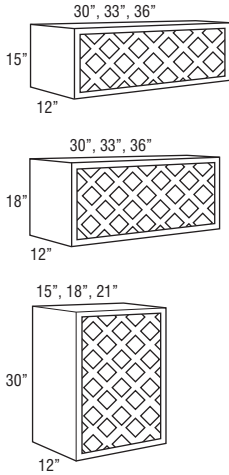

Model	# of Bottles
WNR3015	11
WNR3315	13
WNR3615	13
WNR3018	11
WNR3318	13
WNR3618	13
WNR1530	11
WNR1830	11
WNR2130	11

Model	Cubic Feet
WNR3015	4.5
WNR3315	4.9
WNR3615	5.4
WNR3018	5.3
WNR3318	5.8
WNR3618	6.3
WNR1530	4.5
WNR1830	5.3
WNR2130	6.1

- Matching Interior Plywood (MIP) standard with solid-wood lattice work.
- Wine bottle opening 4" x 4".
- If ordered with Heirloom Technique, will not feature sand-through characteristics.
- Features framed cabinet construction.

Custom Modifications

ADDTK	CBO	CCO	CND	EXBK	ID	INVFRM	P	RD	RECBTM	TD	TVR_V
•	STD			•							

Construction and Finish Upgrades

APC	FB	MIP	MSLFB	WLI
		STD		

Door Options

ALF	CG	CG.BTM	CG.TOP	DPSRR	MD	MD.BTM	MD.TOP

WINE STORAGE CABINET, 12", 15", 18", 21", or 24" HIGH

storage SOLUTIONS

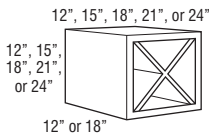

Model	# of Bottles
WSC121212	4
WSC151512	10
WSC181812	18
WSC181818	18
WSC212112	24
WSC242412	32

Model	Cubic Feet
WSC121212	1.6
WSC151512	2.3
WSC181812	3.2
WSC181818	4.3
WSC212112	4.3
WSC242412	5.5

- Matching Interior Plywood (MIP) standard.
- Must be installed between two cabinets, between a cabinet and a wall, or mounted to a horizontal surface.
- "X" shelf configuration cannot be removed.
- If ordered with Heirloom Technique, will not feature sand-through characteristics.
- Reduced depth not recommended for safe wine bottle storage.
- Features framed cabinet construction.

Custom Modifications

ADDTK	CBO	CCO	CND	EXBK	ID	INVFRM	P	RD	RECBTM	TD	TVR_V
				•	•*			•			

*ID on 12" deep models available up to 18" deep

Construction and Finish Upgrades

APC	FB	MIP	MSLFB	WLI
		STD		

Door Options

ALF	CG	CG.BTM	CG.TOP	DPSRR	MD	MD.BTM	MD.TOP

WALL WINE CUBBY, 24", 30", 36", or 42" WIDE, 6" HIGH

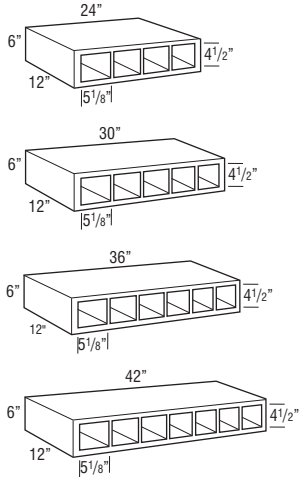

Model	Cubic Feet
W624 (4 openings)	1.8
W630 (5 openings)	2.2
W636 (6 openings)	2.7
W642 (7 openings)	3.0

- Veneer on 3/4" furniture board core.
- If ordered with Heirloom Technique, will not feature sand-through characteristics.
- Increased Depth only available in 3" increments.

Custom Modifications

ADDTK	CBO	CCO	CND	EXBK	ID	INVFRM	P	RD	RECBTM	TD	TVR_V
					•						

Construction and Finish Upgrades

APC	FB	MIP	MSLFB	WLI
	STD			

Door Options

ALF	CG	CG.BTM	CG.TOP	DPSRR	MD	MD.BTM	MD.TOP

WALL ORGANIZER, 24", 30", or 36" WIDE, 6" HIGH

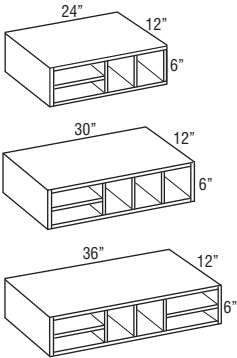

W024	1.8
W030	2.2
W036	2.7

- Veneer on a 3/4" furniture board core.
- If ordered with Heirloom Technique, will not feature sand-through characteristics.
- Increased Depth only available in 3" increments.

Custom Modifications

ADDTK	CBO	CCO	CND	EXBK	ID	INVFRM	P	RD	RECBTM	TD	TVR_V
					•						

Construction and Finish Upgrades

APC	FB	MIP	MSLFB	WLI
	STD			

Door Options

ALF	CG	CG.BTM	CG.TOP	DPSRR	MD	MD.BTM	MD.TOP

WALL SPICE DRAWER, 24", 30", 36", or 42" WIDE, 6" HIGH

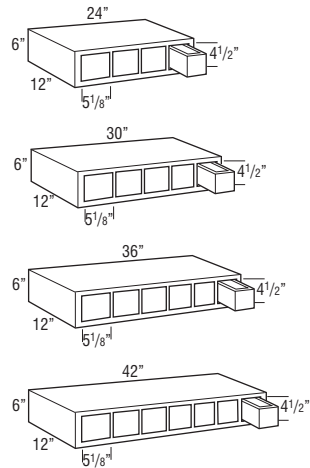

WSD24 (4 drawers)	1.8
WSD30 (5 drawers)	2.2
WSD36 (6 drawers)	2.7
WSD42 (7 drawers)	3.0

- Drawer front is unique to item and will not match profile chosen.
- All styles use standard drawer front profile except Amstead, Butler, Caprice, Cotter, Darby, Hardin, Larsen, Lynnville, Northrope, Warwick, and Whitman, which use the shaker profile.
- Genova, Taro, and Troxel drawer fronts will match doors and drawer fronts.
- Veneer on 3/4" furniture board core.
- 1/2" hardwood drawer with rabbet joint.
- Horizontal application only.
- Increased Depth only available in 3" increments.

Custom Modifications

ADDTK	CBO	CCO	CND	EXBK	ID	INVFRM	P	RD	RECBTM	TD	TVR_V
					•						

Construction and Finish Upgrades

APC	FB	MIP	MSLFB	WLI
	STD			

Door Options

ALF	CG	CG.BTM	CG.TOP	DPSRR	MD	MD.BTM	MD.TOP

FLOATING SHELVES

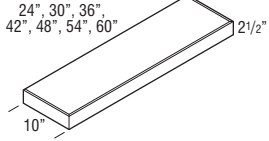

Model	Cubic Feet
FS24	0.7
FS30	0.9
FS36	1.0
FS42	1.2
FS48	1.3
FS54	1.5
FS60	1.6

- Not available in Hickory.
- FS48, FS54, FS60 sizes are available in Maple and Cherry only.
- When ordered in Rustic Alder door styles, will not feature rustic characteristics.
- Maximum Weight Capacity per shelf:
 - 24" = 30 lbs.
 - 30" = 37.5 lbs.
 - 36" = 45 lbs.
 - 42" = 52.2 lbs.
 - 48" = 60 lbs.
 - 54" = 67.5 lbs.
 - 60" = 75 lbs.
- 3/4" thick solid-wood front, back, and ends. 3/8" thick veneered plywood top and bottom. Front and ends are mitered together.

MODIFICATIONS
No modifications available for these products.

TRAY SHELVES

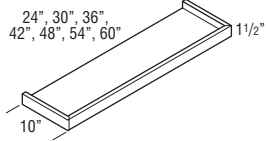

TRAYSHELF2410	0.8
TRAYSHELF3010	0.9
TRAYSHELF3610	1.1
TRAYSHELF4210	1.3
TRAYSHELF4810	1.4
TRAYSHELF5410	1.6
TRAYSHELF6010	1.8

- When ordered in Rustic Alder door styles, will not feature rustic characteristics.
- Must be securely attached to wall with corbels or other shelf supports. A center support is also recommended on 42"-60" wide applications.
- 1/2" thick veneered plywood panel.

Custom Modifications

ADDTK	CBO	CCO	CND	EXBK	ID	INFRM	P	RD	RECBTM	TD	TVR_V
					•			•			

Construction and Finish Upgrades

APC	FB	MIP	MSLFB	WLI
		STD		

Door Options

ALF	CG	CG.BTM	CG.TOP	DPSRR	MD	MD.BTM	MD.TOP

WALL CORNER DECORATIVE SHELF

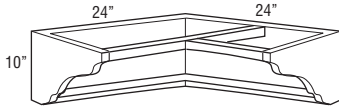

Model	Cubic Feet
WCS2424	4.7

- Bottom shelf depth is 3".
- Requires 24" x 24" corner wall space.
- Top is open; designed to mount under Easy Reach or Corner Cabinet.
- 3/4" hardwood end panel and shelf with 3/8" plywood back panel.

MODIFICATIONS
No modifications available for these products.

Finish Techniques

Distressing	Heirlooming
•	

WALL DECORATIVE SHELF, 10" HIGH

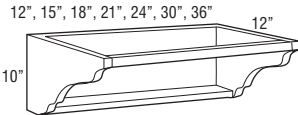

WS12	1.4
WS15	1.7
WS18	2.0
WS21	2.3
WS24	2.6
WS30	3.2
WS36	3.8

- Bottom shelf depth is 3".
- Top is open; designed to mount under wall cabinet.
- 3/4" hardwood end panel and shelf with 3/8" plywood back panel.

MODIFICATIONS
No modifications available for these products.

WALL MESSAGE CENTER, 30", 33", 36", 39", or 42" HIGH, 3" DEEP

storage SOLUTIONS

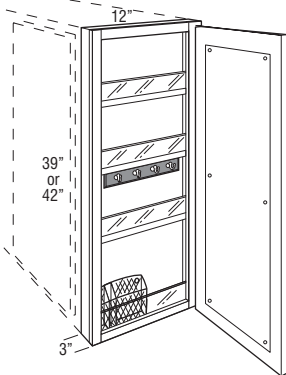
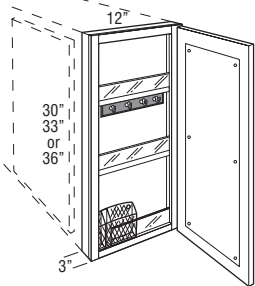

WMC1230 L or R	1.8
WMC1233 L or R	1.9
WMC1236 L or R	2.2
WMC1239 L or R	2.5
WMC1242 L or R	2.9

- Features framed construction with 1/4" reveal on sides and standard 1/16" reveal on top and bottom.
- Includes magnetic whiteboard on back of door, key hooks, pencil holder, and fixed plexi-glass fronted shelves.
- WMC1230, WMC1233 L or R, and WMC1236 have 2 fixed shelves. WMC1239 and WMC1242 have 3 fixed shelves.
- Not recommended for use next to a Peninsula cabinet due to the additional 1/4" cabinet depth.
- Door will open 90° without decorative hardware.
- Cabinet should be hinged on wall side.
- Embellishments or overlay fillers can be used on side of cabinet to add a decorative touch.

Custom Modifications

ADDTK	CBO	CCO	CND	EXBK	ID	INVFRM	P	RD	RECBTM	TD	TVR_V
	•	•									

Construction and Finish Upgrades

APC	FB	MIP	MSLFB	WLI
•		•		•

Door Options

ALF	CG	CG.BTM	CG.TOP	DPSRR	MD	MD.BTM	MD.TOP
				•			

WOOD HOOD ARCH, 36", 42", or 48" WIDE, 24 7/8" HIGH

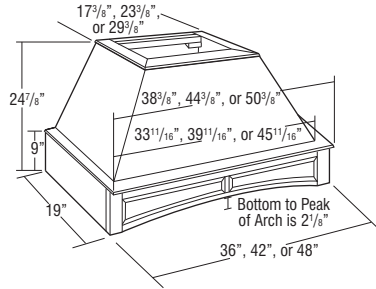

Model	Cubic Feet
WHA36	14.0
WHA42	16.0
WHA48	18.0

- Freestanding unit (must be properly secured to wall and cannot be attached to adjacent cabinets).
- Exhaust system not included. Compatible with all Kemper blowers.
- Chimney available (WHC.). See page 141.
- Check your local building code for installation heights above the range.
- Silver metallic liner included. Assembly required.
- Arched raised panel valance front.
- Installation instructions and hardware included.
- Liner opening size: 10 1/4" deep by 19 1/2" wide.
- Wood hoods ordered in Rustic Alder will not feature Rustic characteristics.

MODIFICATIONS
No modifications available for these products.

Finish Techniques

Distressing	Heirlooming
•	•

WOOD HOOD SQUARE, 36", 42", or 48" WIDE, 22 7/8" HIGH

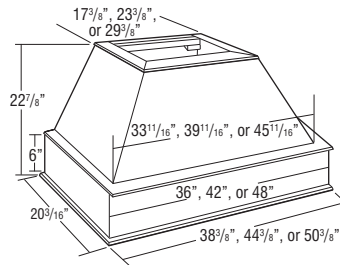

WHS36	13.0
WHS42	14.0
WHS48	16.0

- Wood hoods are designed for use with decorative overlays.
- Freestanding unit (must be properly secured to wall and cannot be attached to adjacent cabinets).
- Exhaust system not included. Compatible with all Kemper blowers.
- Chimney available (WHC.). See page 141.
- Check your local building code for installation heights above the range.
- Silver metallic liner included. Assembly required.
- Installation instructions and hardware included.
- Liner opening size: 10 1/4" deep by 19 1/2" wide.
- Wood hoods ordered in Rustic Alder will not feature Rustic characteristics.

MODIFICATIONS
No modifications available for these products.

Finish Techniques

Distressing	Heirlooming
•	•

WOOD HOOD CHIMNEY, 23 1/2" HIGH

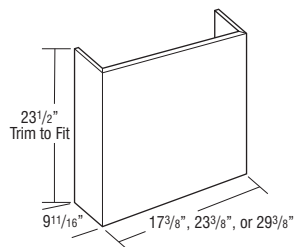

WHC36	3.0
WHC42	4.0
WHC48	5.0

- 3/4" thick plywood.
- Trimable.
- If trimmed, moulding is recommended to conceal any cut marks.
- Optional accessory for Wood Hood Square (WHS) and Wood Hood Arch (WHA).
- Wood hoods ordered in Rustic Alder will not feature Rustic characteristics.

MODIFICATIONS
No modifications available for these products.

Finish Techniques

Distressing	Heirlooming
•	•

**WOOD HOOD CONTEMPORARY
STRAIGHT, 30", 36", or 42" WIDE**

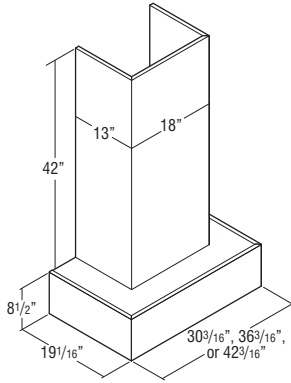

Model	Cubic Feet
JWHCONSTR30	18.1
JWHCONSTR36	18.1
JWHCONSTR42	18.1

- Freestanding unit (must be properly secured to wall and cannot be attached to adjacent cabinets).
- Exhaust system not included. Compatible with all Kemper blowers.
- Chimney included and can be trimmed. If trimmed, moulding is recommended to cover any cut marks.
- Check your local building code for installation heights above the range.
- Silver metallic liner included. Assembly required.
- Installation instructions and hardware included.
- Liner opening size: 10 1/4" deep by 19 1/2" wide.
- Wood hoods ordered in Rustic Alder will not feature Rustic characteristics.
- Available in glaze finishes, but wood hood design does not provide detail for glaze hang-up.
- No changes or cancellations will be accepted after 24 hours from acknowledgment of order.

MODIFICATIONS
No modifications available for these products.

Finish Techniques

Distressing	Heirlooming
•	•

**WOOD HOOD LINEAR, TAPERED,
30", 36", or 42" WIDE**

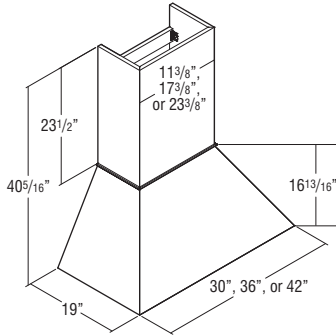

JWHL30	14.0
JWHL36	16.0
JWHL42	18.0

- Freestanding unit (must be properly secured to wall and cannot be attached to adjacent cabinets).
- Exhaust system not included. Compatible with all Kemper blowers.
- Chimney included and can be trimmed.
- Check your local building code for installation heights above the range.
- Silver metallic liner included. Assembly required.
- Installation instructions and hardware included.
- Liner opening size: 10 1/4" deep by 19 1/2" wide.
- Wood hoods ordered in Rustic Alder will not feature Rustic characteristics.
- Available in glaze finishes, but wood hood design does not provide detail for glaze hang-up.
- No changes or cancellations will be accepted after 24 hours from acknowledgment of order.

MODIFICATIONS
No modifications available for these products.

**WOOD HOOD SHIPLAP, STRAIGHT,
36", 42", or 48" WIDE**

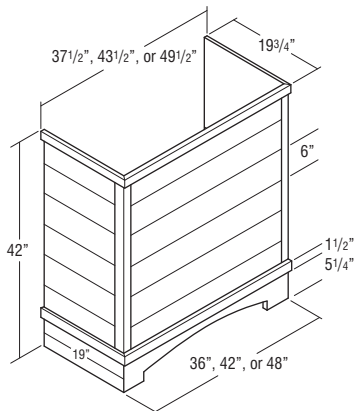

JWHSHIPSTR36	22.0
JWHSHIPSTR42	25.2
JWHSHIPSTR48	28.4

- Freestanding unit (must be properly secured to wall and cannot be attached to adjacent cabinets).
- Constructed of 3/4" thick grooved plywood creating a shiplap appearance.
- Trimmable. If trimmed, moulding is recommended to conceal any cut marks.
- Exhaust system not included. Compatible with all Kemper blowers.
- Check local building code and appliance installation specifications for clearance requirements and installation heights above the range.
- Silver metallic liner included. Assembly required.
- Installation instructions and hardware included.
- Liner opening size: 10 1/4" deep by 19 1/2" wide.
- Wood hoods ordered in Rustic Alder will not feature Rustic characteristics.
- Not available in Hickory.
- No changes or cancellations will be accepted after 24 hours from acknowledgment of order.

MODIFICATIONS
No modifications available for these products.

Finish Techniques

Distressing	Heirlooming
•	•

**WOOD HOOD SHIPLAP, STRAIGHT
with CORBELS, 36", 42", or 48" WIDE**

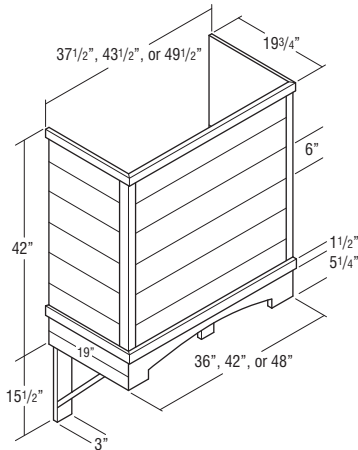

Model	Cubic Feet
JWHSHPSTRCB36	22.0
JWHSHPSTRCB42	25.2
JWHSHPSTRCB48	28.4

- Includes a pair of decorative corbels.
- Freestanding unit (must be properly secured to wall and cannot be attached to adjacent cabinets).
- Constructed of 3/4" thick grooved plywood creating a shiplap appearance.
- Trimmable. If trimmed, moulding is recommended to conceal any cut marks.
- Exhaust system not included. Compatible with all Kemper blowers.
- Check local building code and appliance installation specifications for clearance requirements (including corbels) and installation heights above the range.
- Silver metallic liner included. Assembly required.
- Installation instructions and hardware included.
- Liner opening size: 10 1/4" deep by 19 1/2" wide.
- Wood hoods ordered in Rustic Alder will not feature Rustic characteristics.
- Not available in Hickory.
- No changes or cancellations will be accepted after 24 hours from acknowledgment of order.

MODIFICATIONS
No modifications available for these products.

Finish Techniques

Distressing	Heirlooming
•	•

**WOOD HOOD SHIPLAP, TAPERED,
30", 36", 42", or 48" WIDE**

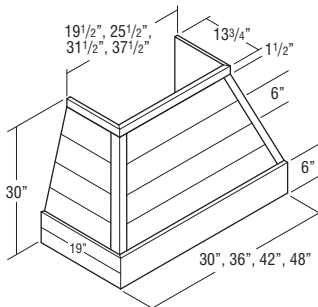

JWHSIPT30	22.0
JWHSIPT36	22.0
JWHSIPT42	25.2
JWHSIPT48	28.4

- Freestanding unit (must be properly secured to wall and cannot be attached to adjacent cabinets).
- Constructed of 3/4" thick grooved plywood creating a shiplap appearance.
- Exhaust system not included. Compatible with all Kemper blowers.
- Compatible with Shiplap Chimney (JWHSHPCH_ _), which can be trimmed. See below.
- Check local building code and appliance installation specifications for clearance requirements and installation heights above the range.
- Silver metallic liner included. Assembly required.
- Installation instructions and hardware included.
- Liner opening size: 10 1/4" deep by 19 1/2" wide.
- Wood hoods ordered in Rustic Alder will not feature Rustic characteristics.
- Not available in Hickory.
- No changes or cancellations will be accepted after 24 hours from acknowledgment of order.

MODIFICATIONS
No modifications available for these products.

Finish Techniques

Distressing	Heirlooming
•	•

WOOD HOOD SHIPLAP, TAPERED with CORBELS, 36", 42", or 48" WIDE

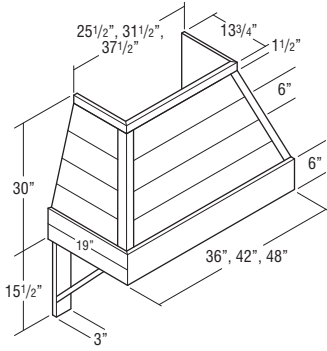

Model	Cubic Feet
JWHSIPTCB36	22.0
JWHSIPTCB42	25.2
JWHSIPTCB48	28.4

- Includes a pair of decorative corbels.
- Freestanding unit (must be properly secured to wall and cannot be attached to adjacent cabinets).
- Constructed of 3/4" thick grooved plywood creating a shiplap appearance.
- Exhaust system not included. Compatible with all Kemper blowers.
- Compatible with Shiplap Chimney (JWHSIPCH_ _), which can be trimmed. See below.
- Check local building code and appliance installation specifications for clearance requirements (including corbels) and installation heights above the range.
- Silver metallic liner included. Assembly required.
- Installation instructions and hardware included.
- Liner opening size: 10 1/4" deep by 19 1/2" wide.
- Wood hoods ordered in Rustic Alder will not feature Rustic characteristics.
- Not available in Hickory.
- No changes or cancellations will be accepted after 24 hours from acknowledgment of order.

MODIFICATIONS
No modifications available for these products.

Finish Techniques

Distressing	Heirlooming
•	•

WOOD HOOD SHIPLAP CHIMNEY, 30", 36", 42", or 48" WIDE

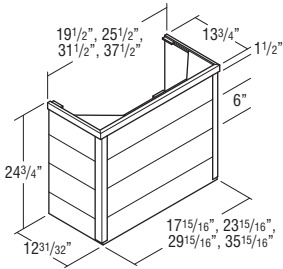

JWHSIPCH30	2.8
JWHSIPCH36	2.8
JWHSIPCH42	3.8
JWHSIPCH48	4.7

- Constructed of 3/4" thick grooved plywood creating a shiplap appearance.
- Trimmable. If trimmed, moulding is recommended to conceal any cut marks.
- Optional accessory for Wood Hood Shiplap Tapered (JWHSIPT_ _ and JWHSIPTCB_ _) for an installed height of 54".
- Wood hoods ordered in Rustic Alder will not feature Rustic characteristics.
- Not available in Hickory.
- No changes or cancellations will be accepted after 24 hours from acknowledgment of order.

MODIFICATIONS
No modifications available for these products.

Finish Techniques

Distressing	Heirlooming
•	•

WOOD HOOD CANOPY ARCHED, 30" or 36" WIDE, 24" HIGH

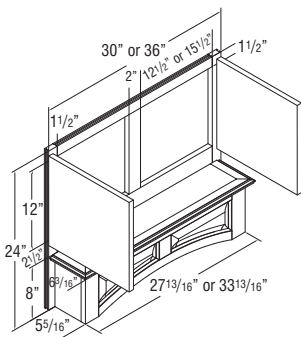

WHCA30	4.7
WHCA36	5.6

- Features framed construction with 1/4" reveal on sides and standard 1/8" reveal on top, and 1 1/8" reveal on bottom. Door height is 14 3/4".
- Install Wood Hoods between adjacent cabinets.
- Doors matching the style ordered will be installed on hood.
- Exhaust system not included. Compatible with all Kemper blowers.
- Check your local building code for installation heights above the range.
- Silver metallic liner included. Assembly required. Interior bottom section is finished below liner. Liner is not arched.
- Installation instructions and hardware included.
- Liner opening size: 10 1/4" deep by 19 1/2" wide.
- When ordered in Rustic Alder, only the doors will have Rustic characteristics.
- Arched raised panel valance front.

MODIFICATIONS
No modifications available for these products.

Finish Techniques

Distressing	Heirlooming
•	•

**WOOD HOOD CANOPY ARCHED,
30" or 36" WIDE, 30" HIGH**

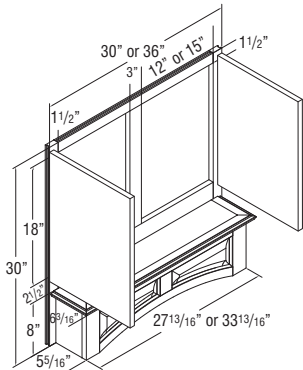

Model	Cubic Feet
JWHCA3030	8.9
JWHCA3630	10.6

- Features framed construction with 1/4" reveal on sides and standard 1/8" reveal on top, and 1 1/8" reveal on bottom. Door height is 20 3/4".
- Install Wood Hoods between adjacent cabinets.
- Doors matching the style ordered will be installed on hood.
- Exhaust system not included. Compatible with all Kemper blowers.
- Check your local building code for installation heights above the range.
- Silver metallic liner included. Assembly required. Interior bottom section is finished below liner. Liner is not arched.
- Installation instructions and hardware included.
- Liner opening size: 10 1/4" deep by 19 1/2" wide.
- When ordered in Rustic Alder, only the doors will have Rustic characteristics.
- Filter is not required unless using a ductless conversion kit. If ductless conversion kit required, see CONVERSION on page 148.
- Designed for use with FILTER250/390, see page 148.
- Arched raised panel valance front.
- No changes or cancellations will be accepted after 24 hours from acknowledgment of order.

MODIFICATIONS
No modifications available for these products.

Finish Techniques

Distressing	Heirlooming
•	•

**WOOD HOOD CANOPY SQUARE,
30" or 36" WIDE, 24" HIGH**

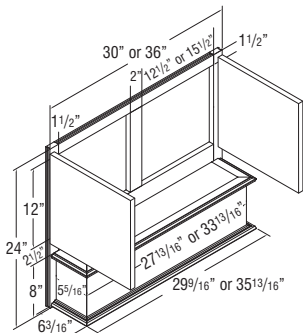

WHCS30	4.7
WHCS36	5.6

- Features framed construction with 1/4" reveal on sides and standard 1/8" reveal on top, and 1 1/8" reveal on bottom. Door height is 14 3/4".
- Install Wood Hoods between adjacent cabinets.
- Doors matching the style ordered will be installed on hood.
- Exhaust system not included. Compatible with all Kemper blowers.
- Check your local building code for installation heights above the range.
- Silver metallic liner included. Assembly required. Interior bottom section is finished below liner.
- Installation instructions and hardware included.
- Liner opening size: 10 1/4" deep by 19 1/2" wide.
- When ordered in Rustic Alder, only the doors will have Rustic characteristics.

MODIFICATIONS
No modifications available for these products.

Finish Techniques

Distressing	Heirlooming
•	•

**WOOD HOOD CANOPY SQUARE,
30" or 36" WIDE, 30" HIGH**

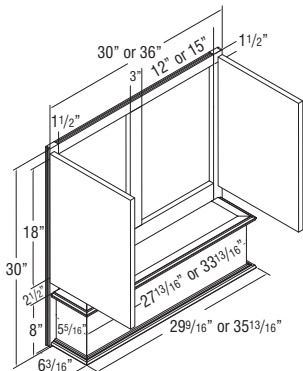

JWHCS3030	8.9
JWHCS3630	10.6

- Features framed construction with 1/4" reveal on sides and standard 1/8" reveal on top, and 1 1/8" reveal on bottom. Door height is 20 3/4".
- Install Wood Hoods between adjacent cabinets.
- Doors matching the style ordered will be installed on hood.
- Exhaust system not included. Compatible with all Kemper blowers.
- Check your local building code for installation heights above the range.
- Silver metallic liner included. Assembly required. Interior bottom section is finished below liner.
- Installation instructions and hardware included.
- Liner opening size: 10 1/4" deep by 19 1/2" wide.
- When ordered in Rustic Alder, only the doors will have Rustic characteristics.
- Filter is not required unless using a ductless conversion kit. If ductless conversion kit required, see CONVERSION on page 148.
- Designed for use with FILTER250/390, see page 148.
- No changes or cancellations will be accepted after 24 hours from acknowledgment of order.

MODIFICATIONS
No modifications available for these products.

Finish Techniques

Distressing	Heirlooming
•	•

**WOOD HOOD ISLAND ARCH,
36", 42", or 48" WIDE**

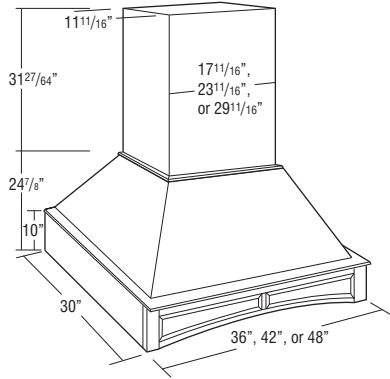

Model	Cubic Feet
JWHIA36	19.0
JWHIA42	22.0
JWHIA48	25.0

- Check your local building codes for installation heights above the range.
- Exhaust system not included. Compatible with all Kemper blowers.
- Liner opening size: 10 1/4" D x 19 1/2" W.
- Wood hoods ordered in Rustic Alder will not feature rustic characteristics.
- Silver metallic liner included, assembly required.
- Installation kit, instructions and hardware included. Kit includes: ceiling mounting board assembly, spacers, outside corner mouldings, top trim mouldings, front, back, and end panels.
- No changes or cancellations will be accepted after 24 hours from acknowledgment of order.

MODIFICATIONS
No modifications available for these products.

Finish Techniques

Distressing	Heirlooming
•	•

**WOOD HOOD ISLAND SQUARE,
36", 42", or 48" WIDE**

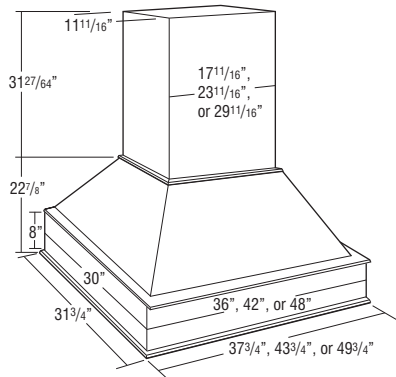

JWHIS36	19.0
JWHIS42	22.0
JWHIS48	25.0

- Check your local building codes for installation heights above the range.
- Exhaust system not included. Compatible with all Kemper blowers.
- Liner opening size: 10 1/4" D x 19 1/2" W.
- Wood hoods ordered in Rustic Alder will not feature rustic characteristics.
- Silver metallic liner included, assembly required.
- Installation kit, instructions and hardware included. Kit includes: ceiling mounting board assembly, spacers, outside corner mouldings, top trim mouldings, front, back, and end panels.
- No changes or cancellations will be accepted after 24 hours from acknowledgment of order.

MODIFICATIONS
No modifications available for these products.

Finish Techniques

Distressing	Heirlooming
•	•

**TAPERED WOOD HOOD,
30" or 36" WIDE, 24" HIGH**

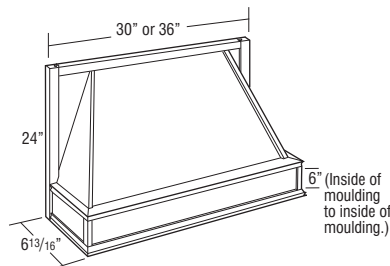

TWH30	6.9
TWH36FW	8.6

- Features framed construction.
- Wood hoods are designed for use with decorative overlays.
- Install Wood Hood between adjacent cabinets.
- Exhaust system not included. Compatible with all Kemper blowers.
- Check your local building code for installation heights above the range.
- Tapered design.
- Liner opening size: 10 1/4" deep x 19 1/2" wide.
- Silver metallic liner included, not available for order separately.
- Wood hoods ordered in Rustic Alder will not feature Rustic characteristics.

MODIFICATIONS
No modifications available for these products.

Finish Techniques

Distressing	Heirlooming
•	

WOOD HOOD BLOWER, 1100 CFM

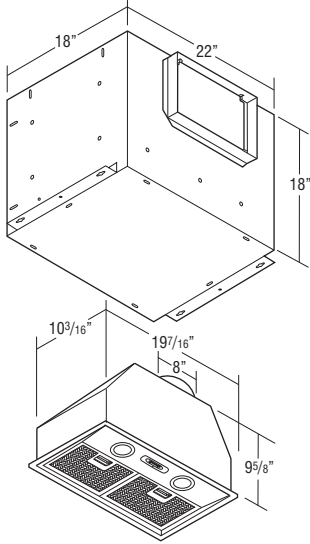

Model	Cubic Feet
BLOWER1100	10.7



- 1100 CFM.
- One year warranty.
- Ventilator housing unit features stainless steel finish.
- Two 50 watt (120 volt) halogen lamps included.
- Satellite blower installs remotely in the interior of the home (i.e., unfinished attic area.)
- Designed to work independently from internal blowers.
- Installation instructions, warranty, and repair information included.
- External ventilation required.
- Professional installation required.
- Compatible with all Wood Hoods and Hearths.
- Includes two in-line transitions (8" x 12" to 10" round).
- Includes two removable dishwasher safe grease filters.
- Designed for use in applications up to 110,000 BTUs.

MODIFICATIONS
No modifications available for these products.

WOOD HOOD BLOWER, 500 CFM

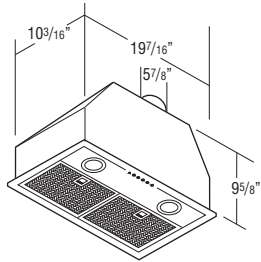

Model	Cubic Feet
BLOWER500	4.0



- 500 CFM.
- One year warranty.
- Sound rating is 8.2 sones.
- Two 20 watt (12 volt, G4 base) halogen lamps included.
- Installation instructions, warranty, and repair information included.
- Silver metallic finish.
- Three speed push button control.
- Includes two removable dishwasher safe grease filters.
- Compatible with all Wood Hoods and Hearths.
- Designed for use in applications up to 60,000 BTUs.

MODIFICATIONS
No modifications available for these products.

TAPERED WOOD HOOD BLOWER

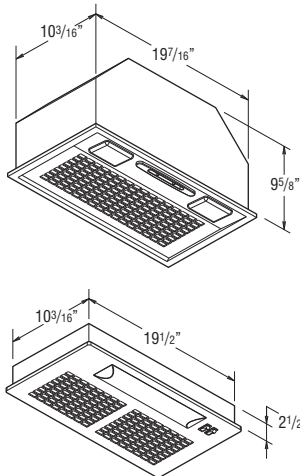

Model	Cubic Feet
TWHBLOWER390	2.1



- Range Hood Component Package has 3-speed centrifugal fan and lighted filter control.
- 6" diameter vent.
- 1 year warranty.
- Sound rating is 6 sones.
- Uses 3.2 amps.
- Two 40 watt candelabra lights required, but not included.
- Compatible with all Wood Hoods and Hearths.
- Silver metallic exterior finish.
- Includes removable dishwasher safe grease filter.

Model	Cubic Feet
TWHBLOWER250	2.1

- Range Hood Component Package has 2-speed single axial fan with lighted filter control.
- 7" diameter vent.
- 1 year warranty.
- Sound rating is 8 sones.
- Uses 2.1 amps.
- Two 40 watt candelabra lights required, but not included.
- Compatible with all Wood Hoods and Hearths.
- Silver metallic exterior finish.
- Includes removable dishwasher safe grease filter.

MODIFICATIONS
No modifications available for these products.

WOOD HOOD DUCTLESS CONVERSION KIT AND FILTER KITS

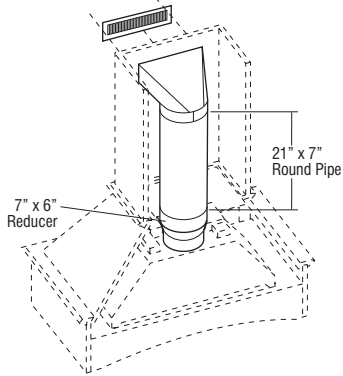

Model	Cubic Feet
CONVERSION	2.0
FILTER250/390	0.5
FILTER500	0.5

- Must order charcoal filter with CONVERSION kit for proper filtration to replace metal mesh filters included with blower unit.
- FILTER250/390 required when CONVERSION is used with TWHBLOWER250/TWHBLOWER390.
- FILTER500 required when CONVERSION is used with BLOWER500.
- CONVERSION includes: (1) 21" x 7" round pipe, (1) adjustable collar, (1) white metal soffit grille (11 3/8" x 3 5/8"), (1) adjustable boot, (1) 7" x 6" reducer, and installation instructions.

MODIFICATIONS

No modifications available for these products.

HEARTH, 48" HIGH, 21" DEEP

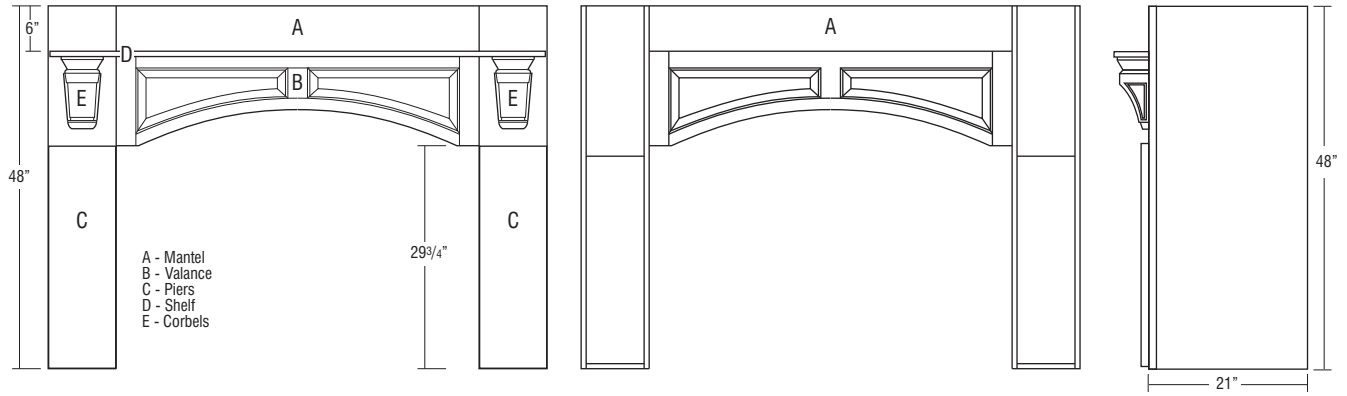

• Recommended clearance of 7"-12" on each side of gas burner to combustible surface, 3"-6" from non-combustible surfaces including the backsplash surface and 30" from the vent. Reference local codes before installation.

		Hearth Width					
		48"	54"	60"	66"	72"	78"
48" High	Pier (left)	HP94821L or HPP94821	HP94821L or HPP94821	HP94821L or HPP94821	HP94821L or HPP94821	HP94821L or HPP94821	HP94821L or HPP94821
	Pier (right)	HP94821R or HPP94821	HP94821R or HPP94821	HP94821R or HPP94821	HP94821R or HPP94821	HP94821R or HPP94821	HP94821R or HPP94821
	Mantel	HM306	HM366	HM426	HM486	HM546	HM606
	Valance	JRPV30 or JRCPV30	JRPV36 or JRCPV36	JRPV42 or JRCPV42	JRPV48 or JRCPV48	JRPV54 or JRCPV54	JRPV60 or JRCPV60
	Corbel (2 Qty)	CORBELMIS9 or CORBELSCR9	CORBELMIS9 or CORBELSCR9	CORBELMIS9 or CORBELSCR9	CORBELMIS9 or CORBELSCR9	CORBELMIS9 or CORBELSCR9	CORBELMIS9 or CORBELSCR9
	Shelf	HS48	HS54	HS60	HS66	HS72	HS78
	Hood Liner	HL30	HL36	HL42	HL48	HL54	HL60
	Blower	All blowers are compatible					

HEARTH, 51" HIGH, 21" DEEP

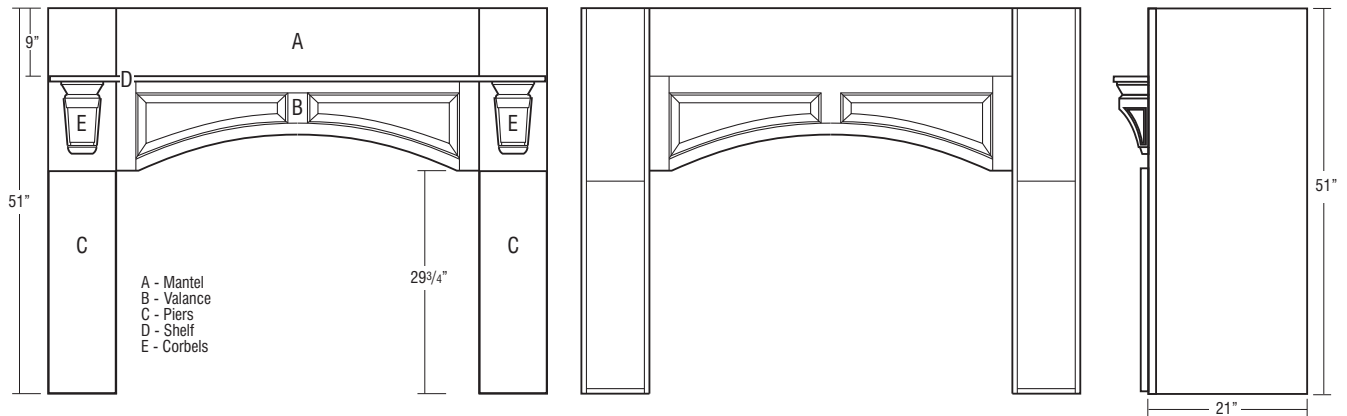

• Recommended clearance of 7"-12" on each side of gas burner to combustible surface, 3"-6" from non-combustible surfaces including the backsplash surface and 30" from the vent. Reference local codes before installation. Side View

		Hearth Width					
		48"	54"	60"	66"	72"	78"
51" High	Pier (left)	HP95121L or HPP95121	HP95121L or HPP95121	HP95121L or HPP95121	HP95121L or HPP95121	HP95121L or HPP95121	HP95121L or HPP95121
	Pier (right)	HP95121R or HPP95121	HP95121R or HPP95121	HP95121R or HPP95121	HP95121R or HPP95121	HP95121R or HPP95121	HP95121R or HPP95121
	Mantel	HM309	HM369	HM429	HM489	HM549	HM609
	Valance	JRPV30 or JRCPV30	JRPV36 or JRCPV36	JRPV42 or JRCPV42	JRPV48 or JRCPV48	JRPV54 or JRCPV54	JRPV60 or JRCPV60
	Corbel (2 Qty)	CORBELMIS9 or CORBELSCR9	CORBELMIS9 or CORBELSCR9	CORBELMIS9 or CORBELSCR9	CORBELMIS9 or CORBELSCR9	CORBELMIS9 or CORBELSCR9	CORBELMIS9 or CORBELSCR9
	Shelf	HS48	HS54	HS60	HS66	HS72	HS78
	Hood Liner	HL30	HL36	HL42	HL48	HL54	HL60
	Blower	All blowers are compatible					

HEARTH, 54" HIGH, 21" DEEP

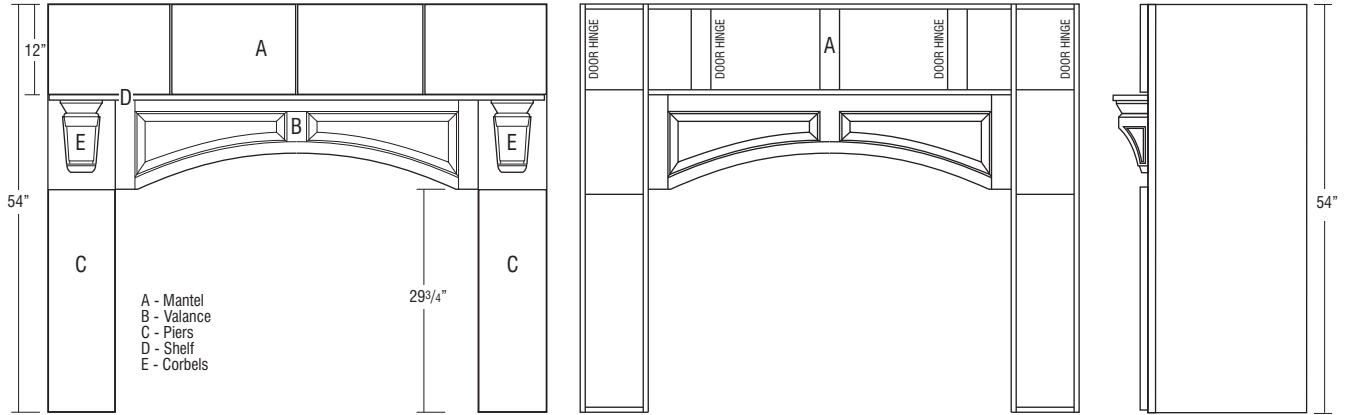

• Recommended clearance of 7"-12" on each side of gas burner to combustible surface, 3"-6" from non-combustible surfaces including the backsplash surface and 30" from the vent. Reference local codes before installation. 21"

		Hearth Width					
		48"	54"	60"	66"	72"	78"
54" High	Pier (left)	HP95421L or HPP95421	HP95421L or HPP95421	HP95421L or HPP95421	HP95421L or HPP95421	HP95421L or HPP95421	HP95421L or HPP95421
	Pier (right)	HP95421R or HPP95421	HP95421R or HPP95421	HP95421R or HPP95421	HP95421R or HPP95421	HP95421R or HPP95421	HP95421R or HPP95421
	Mantel	HM3012	HM3612	HM4212	HM4812	HM5412	HM6012
	Valance	JRPV30 or JRCPV30	JRPV36 or JRCPV36	JRPV42 or JRCPV42	JRPV48 or JRCPV48	JRPV54 or JRCPV54	JRPV60 or JRCPV60
	Corbel (2 Qty)	CORBELMIS9 or CORBELSCR9	CORBELMIS9 or CORBELSCR9	CORBELMIS9 or CORBELSCR9	CORBELMIS9 or CORBELSCR9	CORBELMIS9 or CORBELSCR9	CORBELMIS9 or CORBELSCR9
	Shelf	HS48	HS54	HS60	HS66	HS72	HS78
	Hood Liner	HL30	HL36	HL42	HL48	HL54	HL60
	Blower	All blowers are compatible					

HEARTH, 57" HIGH, 21" DEEP

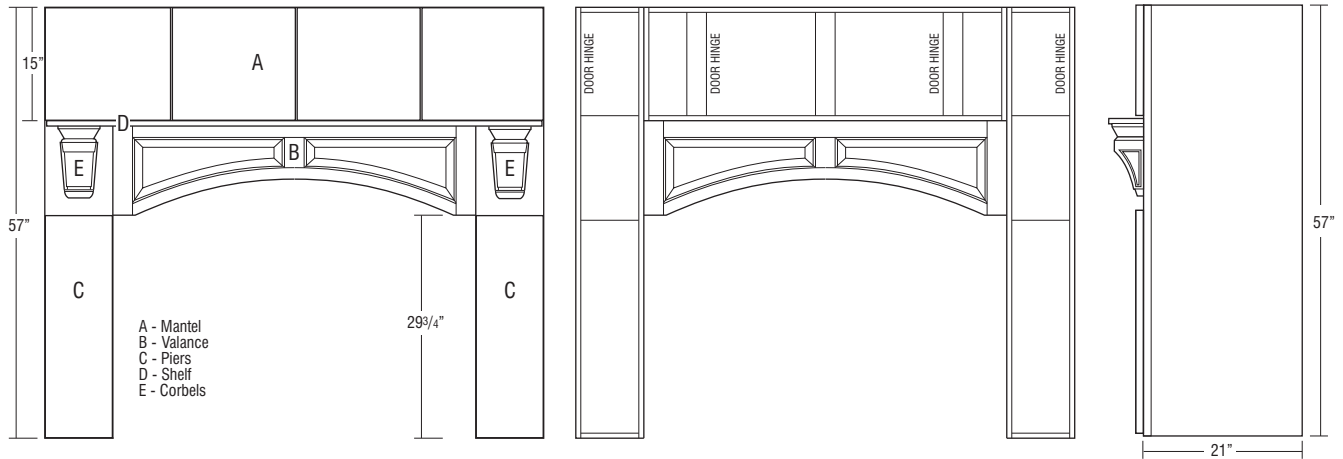

• Recommended clearance of 7"-12" on each side of gas burner to combustible surface, 3"-6" from non-combustible surfaces including the backsplash surface and 30" from the vent. Reference local codes before installation.

		Hearth Width					
		48"	54"	60"	66"	72"	78"
57" High	Pier (left)	HP95721L or HPP95721	HP95721L or HPP95721	HP95721L or HPP95721	HP95721L or HPP95721	HP95721L or HPP95721	HP95721L or HPP95721
	Pier (right)	HP95721R or HPP95721	HP95721R or HPP95721	HP95721R or HPP95721	HP95721R or HPP95721	HP95721R or HPP95721	HP95721R or HPP95721
	Mantel	HM3015	HM3615	HM4215	HM4815	HM5415	HM6015
	Valance	JRPV30 or JRCPV30	JRPV36 or JRCPV36	JRPV42 or JRCPV42	JRPV48 or JRCPV48	JRPV54 or JRCPV54	JRPV60 or JRCPV60
	Corbel (2 Qty)	CORBELMIS9 or CORBELSCR9	CORBELMIS9 or CORBELSCR9	CORBELMIS9 or CORBELSCR9	CORBELMIS9 or CORBELSCR9	CORBELMIS9 or CORBELSCR9	CORBELMIS9 or CORBELSCR9
	Shelf	HS48	HS54	HS60	HS66	HS72	HS78
	Hood Liner	HL30	HL36	HL42	HL48	HL54	HL60
	Blower	All blowers are compatible					

HEARTH, 60" HIGH, 21" DEEP

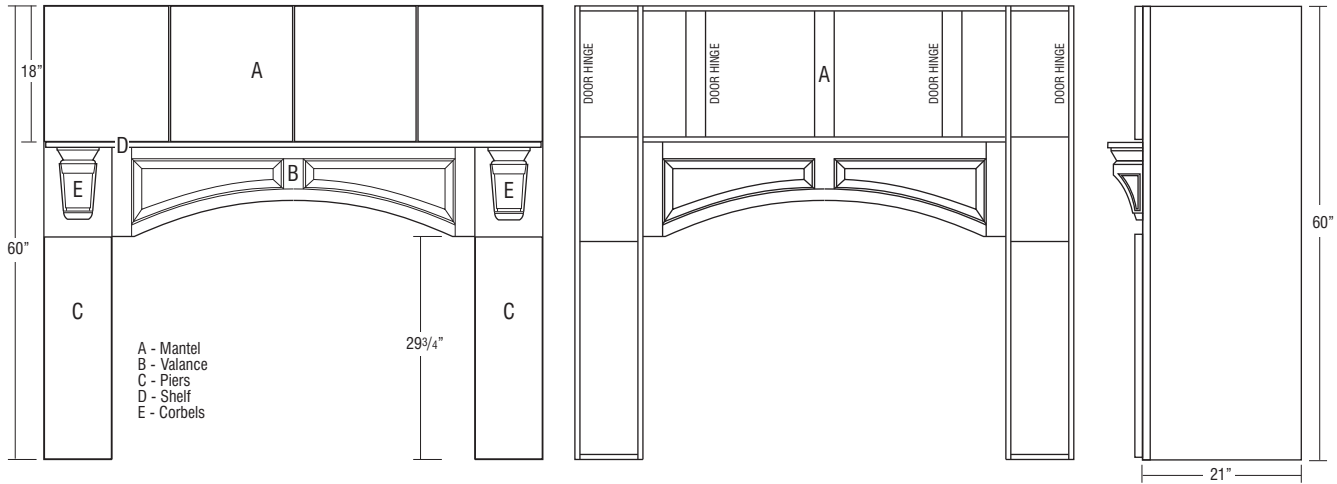

• Recommended clearance of 7"-12" on each side of gas burner to combustible surface, 3"-6" from non-combustible surfaces including the backsplash surface and 30" from the vent. Reference local codes before installation.

		Hearth Width					
		48"	54"	60"	66"	72"	78"
60" High	Pier (left)	HP96021L or HPP96021	HP96021L or HPP96021	HP96021L or HPP96021	HP96021L or HPP96021	HP96021L or HPP96021	HP96021L or HPP96021
	Pier (right)	HP96021R or HPP96021	HP96021R or HPP96021	HP96021R or HPP96021	HP96021R or HPP96021	HP96021R or HPP96021	HP96021R or HPP96021
	Mantel	HM3018	HM3618	HM4218	HM4818	HM5418	HM6018
	Valance	JRPV30 or JRCPV30	JRPV36 or JRCPV36	JRPV42 or JRCPV42	JRPV48 or JRCPV48	JRPV54 or JRCPV54	JRPV60 or JRCPV60
	Corbel (2 Qty)	CORBELMIS9 or CORBELSCR9	CORBELMIS9 or CORBELSCR9	CORBELMIS9 or CORBELSCR9	CORBELMIS9 or CORBELSCR9	CORBELMIS9 or CORBELSCR9	CORBELMIS9 or CORBELSCR9
	Shelf	HS48	HS54	HS60	HS66	HS72	HS78
	Hood Liner	HL30	HL36	HL42	HL48	HL54	HL60
	Blower	All blowers are compatible					

HEARTH (FLOATING), 36" HIGH, 21" DEEP

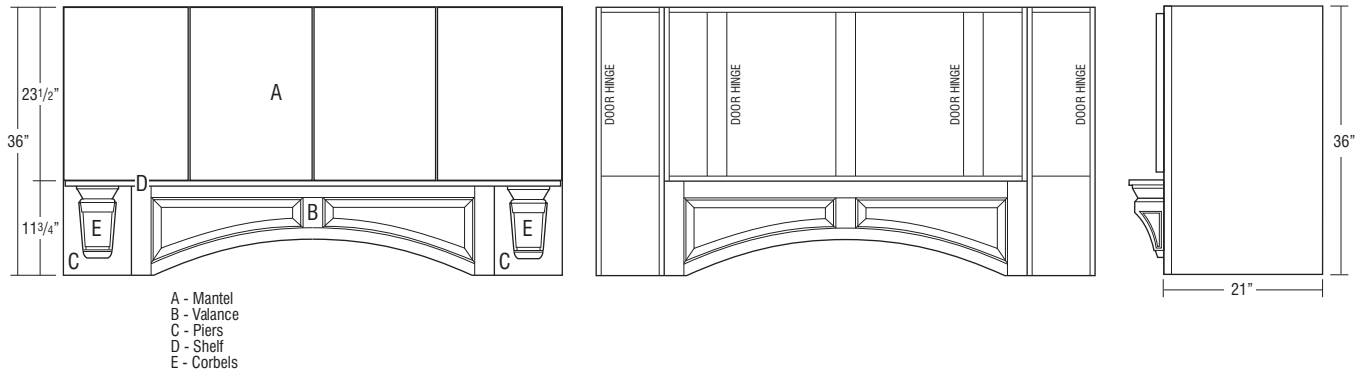

• Cabinets must be fully supported by screws in a structural member in the ceiling or soffit, and into adjacent cabinets.

		Hearth Width					
		48"	54"	60"	66"	72"	78"
36" High	Pier (left)	HP93621	HP93621	HP93621	HP93621	HP93621	HP93621
	Pier (right)	HP93621	HP93621	HP93621	HP93621	HP93621	HP93621
	Mantel	HM3023.5	HM3623.5	HM4223.5	HM4823.5	HM5423.5	HM6023.5
	Valance	JRPV30 or JRCPV30	JRPV36 or JRCPV36	JRPV42 or JRCPV42	JRPV48 or JRCPV48	JRPV54 or JRCPV54	JRPV60 or JRCPV60
	Corbel (2 Qty)	CORBELMIS9 or CORBELSCR9	CORBELMIS9 or CORBELSCR9	CORBELMIS9 or CORBELSCR9	CORBELMIS9 or CORBELSCR9	CORBELMIS9 or CORBELSCR9	CORBELMIS9 or CORBELSCR9
	Shelf	HS48	HS54	HS60	HS66	HS72	HS78
	Hood Liner	HL30	HL36	HL42	HL48	HL54	HL60
	Blower	All blowers are compatible					

HEARTH PIER, 9" WIDE, 36" HIGH

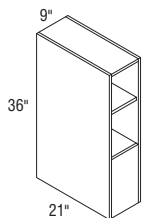

Model	Cubic Feet
HP93621	5.7

- Designed for use with a floating hearth application.
- Not available in Hickory door styles.
- Recommended for use with 24" high Mantel and 9" high Corbels.
- Front panel material varies by door style:
 - All Styles except Genova, Taro High Gloss, and Troxel: Panel is matching finished veneer edgebanded plywood (horizontal grain).
 - Genova: Panel is door matching (vertical grain), does not use plywood.
 - Taro High Gloss: Panel is door matching high gloss, does not use plywood.
 - Troxel: Panel is door matching (horizontal grain), does not use plywood.

Custom Modifications

ADDTK	CBO	CCO	CND	EXBK	ID	INVFRM	P	RD	RECBTM	TD	TVR_V
	STD			•	•			•			

Construction and Finish Upgrades

APC	FB	MIP	MSLFB	WLI
		STD		

Door Options

ALF	CG	CG.BTM	CG.TOP	DPSRR	MD	MD.BTM	MD.TOP

HEARTH PIER, 9" WIDE, 21" DEEP, 48", 51", 54", 57", or 60" HIGH

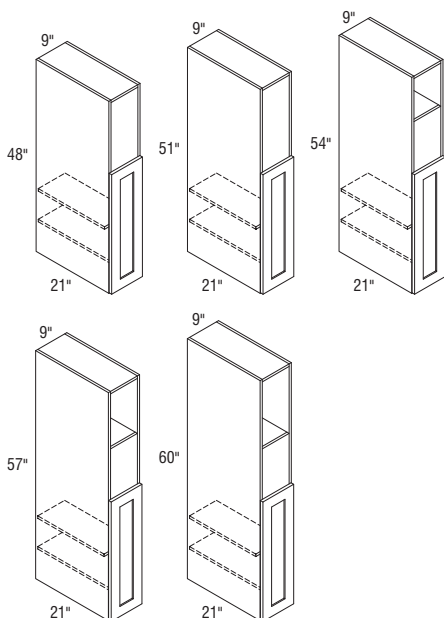

HP94821 L or R	7.7
HP95121 L or R	7.8
HP95421 L or R	8.6
HP95721 L or R	8.7
HP96021 L or R	9.5

- Not available in Hickory door styles.
- Recommended for use with hearth mantels and 9" high corbels, see pages 149-152 for mantel height recommendation.
- Front panel material varies by door style:
 - All Styles except Genova, Taro High Gloss, and Troxel: Panel is matching finished veneer edgebanded plywood (horizontal grain).
 - Genova: Panel is door matching (vertical grain), does not use plywood.
 - Taro High Gloss: Panel is door matching high gloss, does not use plywood.
 - Troxel: Panel is door matching (horizontal grain), does not use plywood.

Custom Modifications

ADDTK	CBO	CCO	CND	EXBK	ID	INVFRM	P	RD	RECBTM	TD	TVR_V
	•	•		•	•			•			

Construction and Finish Upgrades

APC	FB	MIP	MSLFB	WLI
STD	STD	•		•

Door Options

ALF	CG	CG.BTM	CG.TOP	DPSRR	MD	MD.BTM	MD.TOP
				•			

**HEARTH PIER with PULL-OUT,
9" WIDE, 21" DEEP,
48", 51", 54", 57", or 60" HIGH**

storage
SOLUTIONS

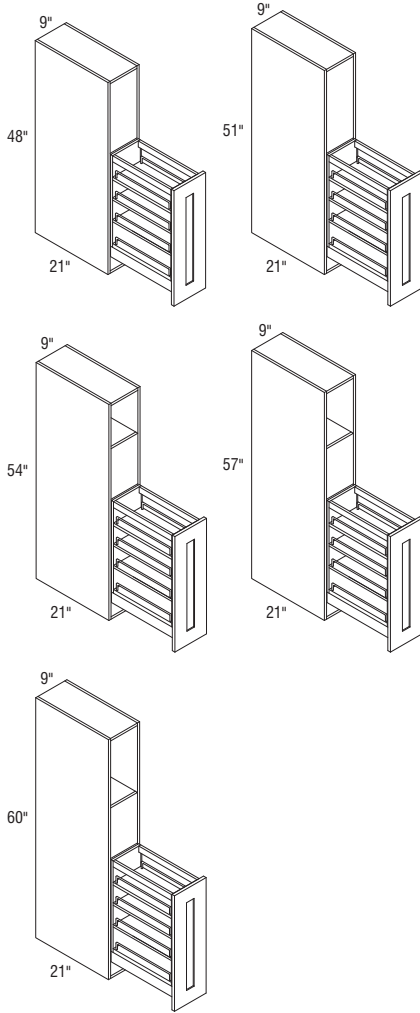

Model	Cubic Feet
HPP94821	7.7
HPP95121	7.7
HPP95421	7.7
HPP95721	8.7
HPP96021	8.6

- Not available in Hickory door styles.
- Includes a natural finish full extension wood pull-out with adjustable shelves and chrome rail sides.
- For full access from both sides of unit, do not install against a wall or next to deeper appliances and cabinets.
- Recommended for use with hearth mantels and 9" high corbels, see pages 149-152 for mantel height recommendation.
- Front panel material varies by door style:
 - All Styles except Genova, Taro High Gloss, and Troxel: Panel is matching finished veneer edgebanded plywood (horizontal grain).
 - Genova: Panel is door matching (vertical grain), does not use plywood.
 - Taro High Gloss: Panel is door matching high gloss, does not use plywood.
 - Troxel: Panel is door matching (horizontal grain), does not use plywood.

Custom Modifications

ADDTK	CBO	CCO	CND	EXBK	ID	INVFRM	P	RD	RECBTM	TD	TVR_V
	•	•		•	•						

Construction and Finish Upgrades

APC	FB	MIP	MSLFB	WLI
STD	STD	•		•

Door Options

ALF	CG	CG.BTM	CG.TOP	DPSRR	MD	MD.BTM	MD.TOP
				•			

HEARTH MANTEL, 6" or 9" HIGH

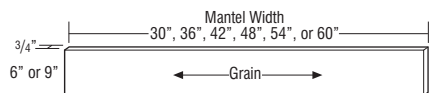

Model	Cubic Feet
HM306	2.7
HM366	2.7
HM426	2.7
HM486	2.7
HM546	2.7
HM606	2.7
HM309	5.1
HM369	5.1
HM429	5.1
HM489	5.1
HM549	5.1
HM609	5.1

- Recommended for use with 48" or 51" high Hearth Piers and same width Raised or Recessed Panel Arched Valance (see page 149).
- Not available in Hickory door styles.

MODIFICATIONS
No modifications available for these products.

Finish Techniques

Distressing	Heirlooming
•	•

HEARTH MANTEL, 12" HIGH

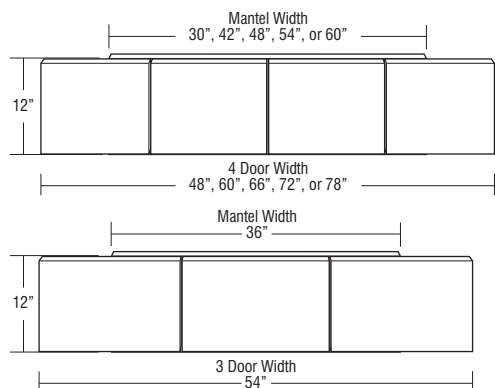

HM3012	7.5
HM3612	7.5
HM4212	7.5
HM4812	7.5
HM5412	7.5
HM6012	7.5

- Recommended for use with 54" high Hearth Piers and same width Raised or Recessed Panel Arched Valance (see page 150).
- Not available in Hickory door styles.
- Doors for Hearth Mantel are included. Field installation required for attachment of outer doors to Hearth Piers.
- Hearth Mantels use full access door heights on a face frame and have a 1/4" side reveal.

MODIFICATIONS
No modifications available for these products.

Door Options

ALF	CG	CG.BTM	CG.TOP	DPSRR	MD	MD.BTM	MD.TOP
				•			

Finish Techniques

Distressing	Heirlooming
•	•

HEARTH MANTEL, 15" HIGH

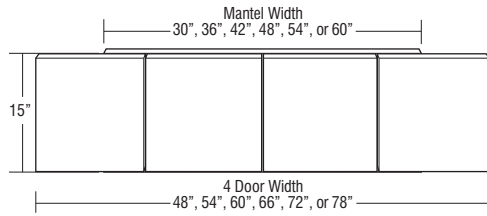

Model	Cubic Feet
HM3015	2.0
HM3615	2.3
HM4215	2.7
HM4815	3.1
HM5415	3.4
HM6015	3.8

- Recommended for use with 57" high Hearth Piers and same width Raised or Recessed Panel Arched Valance (see page 151).
- Not available in Hickory door styles.
- Doors for Hearth Mantel are included. Field installation required for attachment of outer doors to Hearth Piers.
- Hearth Mantels use full access door heights on a face frame and have a 1/4" side reveal.

MODIFICATIONS
No modifications available for these products.

Door Options

ALF	CG	CG.BTM	CG.TOP	DPSRR	MD	MD.BTM	MD.TOP
				•			

Finish Techniques

Distressing	Heirlooming
•	•

HEARTH MANTEL, 18" HIGH

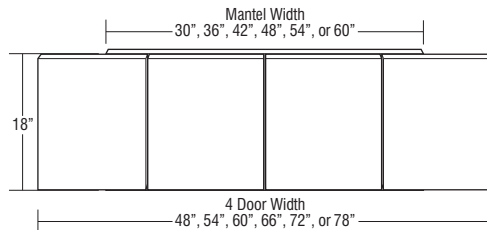

HM3018	7.5
HM3618	7.5
HM4218	7.5
HM4818	7.5
HM5418	7.5
HM6018	7.5

- Recommended for use with 60" high Hearth Piers and same width Raised or Recessed Panel Arched Valance (see page 152).
- Not available in Hickory door styles.
- Doors for Hearth Mantel are included. Field installation required for attachment of outer doors to Hearth Piers.
- Hearth Mantels use full access door heights on a face frame and have a 1/4" side reveal.

MODIFICATIONS
No modifications available for these products.

Door Options

ALF	CG	CG.BTM	CG.TOP	DPSRR	MD	MD.BTM	MD.TOP
				•			

Finish Techniques

Distressing	Heirlooming
•	•

HEARTH MANTEL, 23 1/2" HIGH

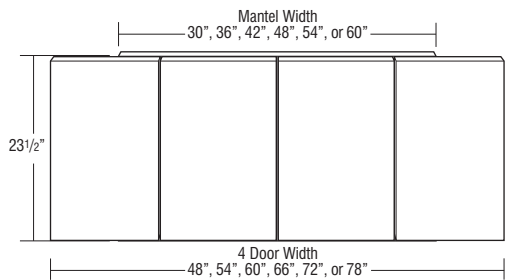

HM3023.5	1.3
HM3623.5	1.6
HM4223.5	1.8
HM4823.5	2.1
HM5423.5	2.3
HM6023.5	2.6

- Recommended for use with 36" high Hearth Piers and same width Raised or Recessed Panel Arched Valance (see page 152).
- Not available in Hickory door styles.
- Doors for Hearth Mantel are included. Field installation required for attachment of outer doors to Hearth Piers.
- Hearth Mantels use full access door heights on a face frame and have a 1/4" side reveal.

MODIFICATIONS
No modifications available for these products.

Door Options

ALF	CG	CG.BTM	CG.TOP	DPSRR	MD	MD.BTM	MD.TOP
				•			

Finish Techniques

Distressing	Heirlooming
•	•

HEARTH SHELF, 4 1/2" DEEP

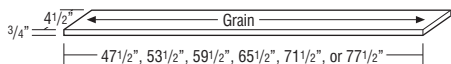

Model	Cubic Feet
HS48	2.7
HS54	2.7
HS60	2.7
HS66	2.7
HS72	2.7
HS78	2.7

- Shelves will install on top of corbels and will slightly overlay the Raised or Recessed Panel Arched Valance.
- Shelf width should match the overall hearth width (pier width + Mantel/valance width).
- Actual shelf width is 1/2" shorter than the dimension in the product code.
- Shelf finished on one long edge, two short edges, top, and bottom.
- Not available in Hickory.
- If ordered with Heirlooming Technique, will not feature sand-through characteristics.

MODIFICATIONS
No modifications available for these products.

HEARTH LINER

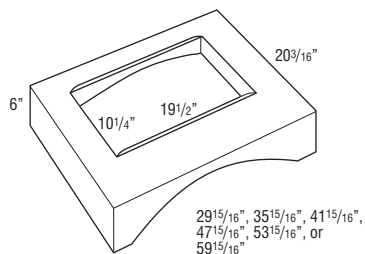

HL30	3.5
HL36	4.1
HL42	4.7
HL48	5.4
HL54	6.0
HL60	6.6

- Liner is metallic silver.
- Compatible with all blowers.
- Mounts to wall and adjoining cabinets.
- Recommended for use with Raised or Recessed Panel Arched Valance.

MODIFICATIONS
No modifications available for these products.

KEMPER®

BASE CABINET NOMENCLATURE

All Base Cabinets are 34 1/2" high and 24" deep unless otherwise noted.



TOEKICKS

Base Cabinets are shipped with an unfinished toekick. Finished toekicks in matching wood veneer or laminate must be ordered separately and field installed.

MODIFICATIONS GRID KEY

- Available
- STD Standard on these cabinets
- storage SOLUTIONS Storage Solutions Organization Cabinet
- 5 DAY** 5 Day Express Response Item

CUSTOM MODIFICATIONS

Mod.	Description	Mod.	Description	Mod.	Description
CBO	Cabinet Box Only	DRWTK	Toekick Drawer	PTOWB	Push to Open Wastebasket
CCO	Cabinet Case Only	EXBK	End Extended Back	RD	Reduced Depth
CFP	Cabinet False Panel	FD	Full Depth Shelf	RECTK	Recessed Toekick
CMAT	CabMat™	FTK	Flush Toekick	RT	Installed Roll Tray
CND	Cabinet with No Door, with Drawer	FTK_V	Flush Toekick w/Valance	SCPDRW	Scooped Drawer
DRT	Deep Roll Tray	ID	Increased Depth	TD	Tray Dividers
DRWPWR	PowerGlide™ Compact Drawer Outlet	INVFRM	Inverted Opening	TOTSS	Tilt-out Tray, Stainless Steel
		LTI	Light Installed Battery Strip	TVR_V	Valance Top Rail
		P	Peninsula	VTK	Void Toekick

CONSTRUCTION AND FINISH UPGRADES

Mod.	Description
APC	All-plywood Construction
FB	Finished Ends
MIP	Matching Interior Plywood
MSLFB	Matching Specialty Laminate Furniture Board
WLI	White Laminate Interior

DOOR OPTIONS

Mod.	Description
CG	Cut-for-glass Doors
DPSRR	Door Panel - Solid Reverse Raised

BASE CABINETS

158

BASE SINGLE DOOR

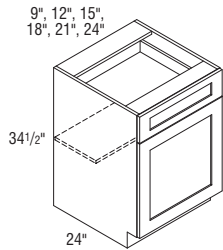

Model	Cubic Feet
B9 L or R	6.1
B12 L or R	7.8
B15 L or R	9.4
B18 L or R	11.1
B21 L or R	12.8
B24 L or R	14.4

- Adjustable 15" deep shelves.

Custom Modifications

CBO	CCO	CFP	CMAT	CND	DRT	DRWPWR	DRWTK	EXBK	FD	FTK	FTK_V	ID
•	•	•		•		•*	•*	•	•	•	•†	
	INVFRM	LTI	P	PTOWB	RD	RECTK	RT	SCPDRW	TD	TOTSS	TVR_V	VTK
	•	•*	••		•	•†	••	•				•

*Not available on 9", 12", and 15" wide †Not available on 9" and 12" wide •†Not available on 9" wide

†RECTKALL not available on 9" wide

Construction and Finish Upgrades

APC	FB	MIP	MSLFB	WLI
•	•	•	•	•

Door Options

CG	DPSRR
•†	•

†Not available on 9" wide

BASE DOUBLE DOOR

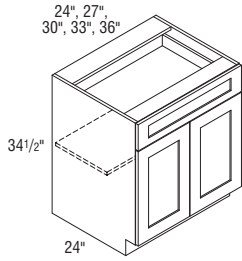

B24-B36 Butt doors

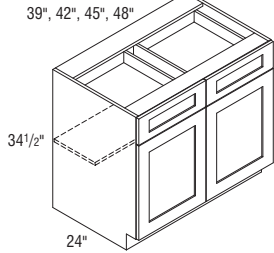

B39-B48CS Vertical divider

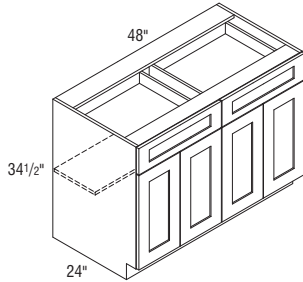

B48 Vertical divider

Model	Cubic Feet
B24	14.4
B27	16.1
B30	17.7
B33	19.6
B36	21.1
B39	22.7
B42	24.4
B45	25.8
B48CS	27.7
B48	27.7

- Adjustable 15" deep shelves.
- On B39-B48, no shelves are included when RD6-RD8 is specified.
- On B39-B48, when specified with FD or RD, full depth shelves are 15" deep instead of 19 1/2" deep due to vertical divider.

Custom Modifications

CBO	CCO	CFP	CMAT	CND	DRT	DRWPWR	DRWTK	EXBK	FD	FTK	FTK_V	ID
•	•	•				•	•*	•	•	•		
INVERM	LTI	P	PTOWB	RD	RECTK	RT	SCPDRW	TD	TOTSS	TVR_V	VTK	
•*	•	•*		•	•	•*	•				•	

*Not available on 39", 42", 45", and 48" wide *Available only on 24" wide

Construction and Finish Upgrades

APC	FB	MIP	MSLFB	WLI
•	•	•	•	•

Door Options

CG	DPSRR
•	•

BASE with CUTLERY INSERT WOOD ORGANIZER

storage SOLUTIONS

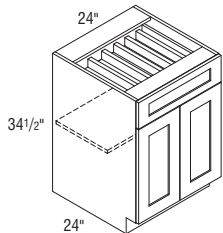
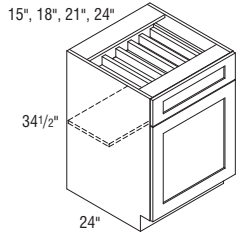

B15CIW L or R	9.4
B18CIW L or R	11.1
B21CIW L or R	12.8
B24CIW L or R	14.4
B24CIW	14.4

- Adjustable 15" deep shelf.
- Cutlery Insert Wood Organizer is also available as an accessory. See page 344.

Custom Modifications

CBO	CCO	CFP	CMAT	CND	DRT	DRWPWR	DRWTK	EXBK	FD	FTK	FTK_V	ID
•	•	•		•			•*	•	•	•	•	
INVERM	LTI	P	PTOWB	RD	RECTK	RT	SCPDRW	TD	TOTSS	TVR_V	VTK	
	•+	•			•	•					•	

*Not available on 15" wide *Available only on 24" wide

Construction and Finish Upgrades

APC	FB	MIP	MSLFB	WLI
•	•	•	•	•

Door Options

CG	DPSRR
•	•

BASE with WOOD TIERED CUTLERY DIVIDER DRAWER

storage SOLUTIONS

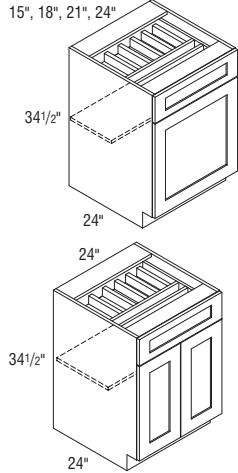

Model	Cubic Feet
B15WTC D L or R	9.4
B18WTC D L or R	11.1
B21WTC D L or R	12.8
B24WTC D L or R	14.4
B24WTC D	14.4

- Adjustable 15" deep shelf.
- Exterior WTC D drawer box height is 3 3/4", interior height of top and bottom tier is 1 3/8".
- Wood Tiered Cutlery Divider Drawer is also available as an accessory. See page 344.

Custom Modifications

CBO	CCO	CFP	CMAT	CND	DRT	DRWPWR	DRWTK	EXBK	FD	FTK	FTK_V	ID
•	•	•	•	•	•	•*	•*	•	•	•	•	•
INVFRM	LTI	P	PTOWB	RD	RECTK	RT	SCPRW	TD	TOTSS	TVR_V	VTK	
	•*	•			•	•					•	

*Not available on 15" wide *Available only on 24" wide

Construction and Finish Upgrades

APC	FB	MIP	MSLFB	WLI
•	•	•	•	•

Door Options

CG	DPSRR
•	•

BASE with WOOD TIERED K-CUP* DRAWER

storage SOLUTIONS

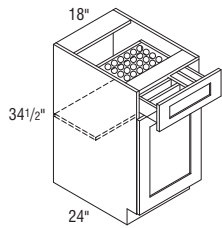

Model	Cubic Feet
B18KCUP L or R	11.1

- Adjustable 15" deep shelf.
 - Holds 40 K-Cups.
 - Exterior Wood Tiered K-Cup drawer box height is 3 3/4", interior height of top tier is 1 5/8", and interior height of bottom tier is 1 3/8".
 - The Wood Tiered K-Cup Drawer is compatible with K-Cup pods only.
 - Wood Tiered K-Cup Drawer is also available as an accessory. See page 345.
- *K-Cup is a registered trademark of Keurig Green Mountain, Inc.

Custom Modifications

CBO	CCO	CFP	CMAT	CND	DRT	DRWPWR	DRWTK	EXBK	FD	FTK	FTK_V	ID
•	•	•	•	•	•	•	•	•	•	•	•	•
INVFRM	LTI	P	PTOWB	RD	RECTK	RT	SCPRW	TD	TOTSS	TVR_V	VTK	
		•			•	•					•	

Construction and Finish Upgrades

APC	FB	MIP	MSLFB	WLI
•	•	•	•	•

Door Options

CG	DPSRR
•	•

FULL HEIGHT BASE SINGLE DOOR, 6" WIDE

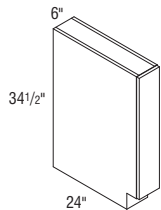

Model	Cubic Feet
B6FH L or R	4.1

- Cabinet has a full top panel.
- Utilizes a 5 7/8" wide overlay filler as a hinged door.

Custom Modifications

CBO	CCO	CFP	CMAT	CND	DRT	DRWPWR	DRWTK	EXBK	FD	FTK	FTK_V	ID
•	•	•	•	•	•	•	•	•	•	•	•	•
INVFRM	LTI	P	PTOWB	RD	RECTK	RT	SCPRW	TD	TOTSS	TVR_V	VTK	
		•		•							•	

Construction and Finish Upgrades

APC	FB	MIP	MSLFB	WLI
•	•	•	•	•

Door Options

CG	DPSRR

FULL HEIGHT BASE SINGLE DOOR

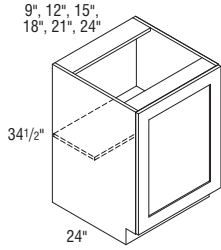

Model	Cubic Feet
B9FH L or R	6.1
B12FH L or R	7.8
B15FH L or R	9.4
B18FH L or R	11.1
B21FH L or R	12.8
B24FH L or R	14.4

- Adjustable 15" deep shelf.

Custom Modifications

CBO	CCO	CFP	CMAT	CND	DRT	DRWPWR	DRWTK	EXBK	FD	FTK	FTK_V	ID
•	•						•*	•	•	•	•+	•
INVFRM	LTI	P	PTOWB	RD	RECTK	RT	SCPDRW	TD	TOTSS	TVR_V	VTK	
	•+	•		•	•▲	•†		•			•	

*Not available on 9", 12", and 15" wide †Not available on 9" and 12" wide

▲RECTKALL not available on 9" wide †Not available on 9" wide

Construction and Finish Upgrades

APC	FB	MIP	MSLFB	WLI
•	•	•	•	•

Door Options

CG	DPSRR
•‡	•

‡Not available on 9" wide

FULL HEIGHT BASE SINGLE DOOR, 40 1/2" HIGH

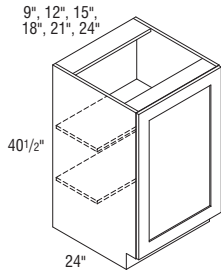

B940FH L or R	6.7
B1240FH L or R	8.6
B1540FH L or R	10.5
B1840FH L or R	12.3
B2140FH L or R	14.2
B2440FH L or R	16.1

- Two adjustable 15" deep shelves.

Custom Modifications

CBO	CCO	CFP	CMAT	CND	DRT	DRWPWR	DRWTK	EXBK	FD	FTK	FTK_V	ID
•	•						•*	•	•	•	•+	•
INVFRM	LTI	P	PTOWB	RD	RECTK	RT	SCPDRW	TD	TOTSS	TVR_V	VTK	
		•		•	•▲	•†					•	

*Not available on 9", 12", and 15" wide †Not available on 9" and 12" wide

▲RECTKALL not available on 9" wide †Not available on 9" wide

Construction and Finish Upgrades

APC	FB	MIP	MSLFB	WLI
•	•	•	•	•

Door Options

CG	DPSRR
•‡	•

‡Not available on 9" wide

FULL HEIGHT BASE DOUBLE DOOR

24", 27", 30", 33",
36", 39", 42", 45", 48"

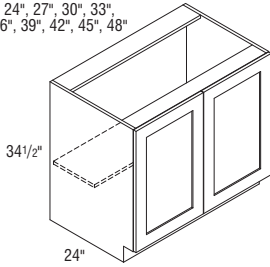

B24FH-B36FH Butt doors
B39FH-B48FHCS Center mullion

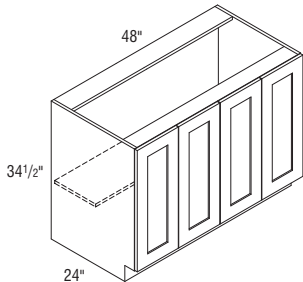

B48FH Vertical divider

Model	Cubic Feet
B24FH	14.4
B27FH	16.1
B30FH	17.7
B33FH	19.6
B36FH	21.1
B39FH	22.7
B42FH	24.4
B45FH	25.8
B48FHCS	27.7
B48FH	27.7

- Adjustable 15" deep shelf.
- On B48FH, no shelves are included when RD6-RD8 is specified.
- On B48FH when specified with FD or RD, full depth shelves are 15" deep instead of 19 1/2" deep due to vertical divider.

Custom Modifications

CBO	CCO	CFP	CMAT	CND	DRT	DRWPWR	DRWTK	EXBK	FD	FTK	FTK_V	ID
•	•						•*	•	•	•	•	•
INVFRM	LTI	P	PTOWB	RD	RECTK	RT	SCPDRW	TD	TOTSS	TVR_V	VTK	
		•+		•	•	•*		•*			•	

*Not available on 39", 42", 45", and 48" wide *Available only on 24" wide

Construction and Finish Upgrades

APC	FB	MIP	MJSLFB	WLI
•	•	•	•	•

Door Options

CG	DPSRR
•	•

FULL HEIGHT BASE DOUBLE DOOR, 40 1/2" HIGH

24", 27", 30", 33",
36", 39", 42", 45", 48"

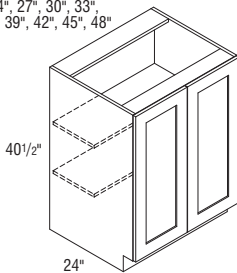

B2440FH-B3640FH Butt doors
B3940FH-B4840FHCS Center mullion

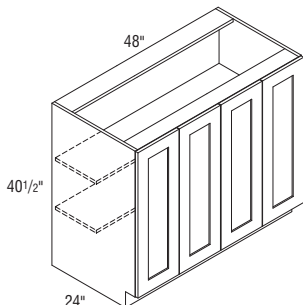

B4840FH Vertical divider

B2440FH	16.1
B2740FH	18.0
B3040FH	19.8
B3340FH	21.7
B3640FH	23.6
B3940FH	25.4
B4240FH	27.3
B4540FH	25.8
B4840FHCS	31.1
B4840FH	31.1

- Two adjustable 15" deep shelves.
- On B4840FH when specified with FD or RD, full depth shelves are 15" deep instead of 22 1/2" deep due to vertical divider.

Custom Modifications

CBO	CCO	CFP	CMAT	CND	DRT	DRWPWR	DRWTK	EXBK	FD	FTK	FTK_V	ID
•	•						•*	•	•	•	•	•
INVFRM	LTI	P	PTOWB	RD	RECTK	RT	SCPDRW	TD	TOTSS	TVR_V	VTK	
		•+		•	•	•*					•	

*Not available on 39", 42", 45", and 48" wide *Available only on 24" wide

Construction and Finish Upgrades

APC	FB	MIP	MJSLFB	WLI
•	•	•	•	•

Door Options

CG	DPSRR
•	•

WALL BASE SINGLE DOOR

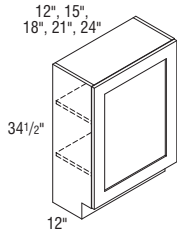

Model	Cubic Feet
WB12 L or R	4.1
WB15 L or R	5.0
WB18 L or R	5.9
WB21 L or R	6.8
WB24 L or R	7.7

- Two full depth shelves.
- Will have the same shelf hole drill pattern as a wall cabinet.

Custom Modifications

CBO	CCO	CFP	CMAT	CND	DRT	DRWPWR	DRWTK	EXBK	FD	FTK	FTK_V	ID
•	•							•		•	•*	•
INVFRM	LTI	P	PTOWB	RD	RECTK	RT	SCPDRW	TD	TOTSS	TVR_V	VTK	
		•		•	•+			•			•	

*Not available on 12" wide *RECTKBK not available

Construction and Finish Upgrades

APC	FB	MIP	MSLFB	WLI
•	•	•	•	•

Door Options

CG	DPSRR
•	•

WALL BASE DOUBLE DOOR

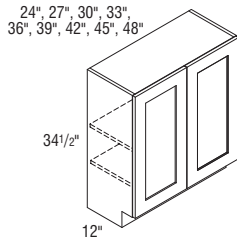

WB24-WB36 Butt doors
WB39-WB48CS Center mullion

WB24	7.7
WB27	8.6
WB30	9.5
WB33	10.4
WB36	11.2
WB39	12.1
WB42	13.0
WB45	13.9
WB48CS	14.8

- Two full depth shelves.
- Will have the same shelf hole drill pattern as a wall cabinet.

Custom Modifications

CBO	CCO	CFP	CMAT	CND	DRT	DRWPWR	DRWTK	EXBK	FD	FTK	FTK_V	ID
•	•							•		•	•	•
INVFRM	LTI	P	PTOWB	RD	RECTK	RT	SCPDRW	TD	TOTSS	TVR_V	VTK	
		•*		•	•+			•▲			•	

*Available only on 24" wide *RECTKBK not available ▲Not available on 39", 42", 45", and 48" wide

Construction and Finish Upgrades

APC	FB	MIP	MSLFB	WLI
•	•	•	•	•

Door Options

CG	DPSRR
•	•

BASE EASY ACCESS STORAGE

storage SOLUTIONS

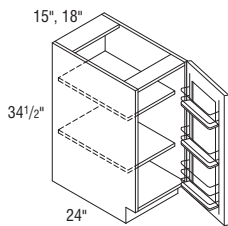

BEAS15 L or R	9.4
BEAS18 L or R	11.1

- Two adjustable 20" deep shelves.
- Door features a chrome and wood three-tiered rack.
- Door rack width is 9 3/8" on 15" wide cabinet and 12 3/8" on 18" wide cabinet.
- Door rack depth is 3".

Custom Modifications

CBO	CCO	CFP	CMAT	CND	DRT	DRWPWR	DRWTK	EXBK	FD	FTK	FTK_V	ID
•	•						•*	•		•	•	
INVFRM	LTI	P	PTOWB	RD	RECTK	RT	SCPDRW	TD	TOTSS	TVR_V	VTK	
					•						•	

*Not available on 15" wide

Construction and Finish Upgrades

APC	FB	MIP	MSLFB	WLI
•	•	•	•	•

Door Options

CG	DPSRR
	•

30" SUPERCABINET™

storage
SOLUTIONS

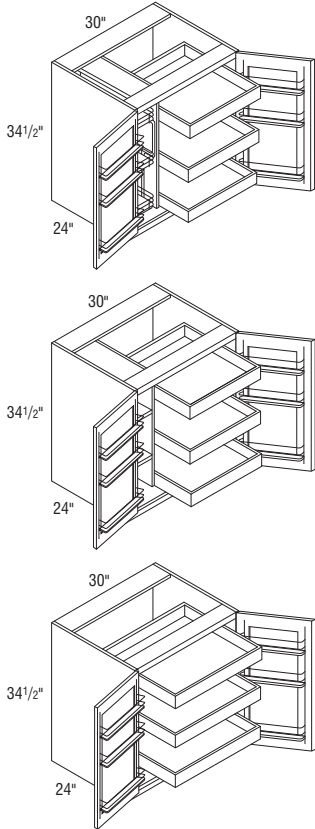

Model	Cubic Feet
BSC30RP	17.7
BSC30PR	17.7
BSC30RS	17.7
BSC30SR	17.7
BSC30R	17.7

- Nomenclature represents left to right order of interior components.
Example: BSC30RS = Base SuperCabinet™ 30" Roll-out Shelves.
- Shelves are adjustable and 20" deep.
- Cabinets utilize 170° hinge. For sufficient pull-out clearance, 12" of adjacent space is required for door to open 170° when installed near a wall or corner.
- Each door features a chrome and wood three-tiered rack.
- Door rack width is 9 3/8".
- Door rack depth is 3".
- Integrated soft-close hinge not included. Premium door mechanism installed.

Custom Modifications

CBO	CCO	CFP	CMAT	CND	DRT	DRWPWR	DRWTK	EXBK	FD	FTK	FTK_V	ID
•	•						•	•		•	•	
INVFRM	LTI	P	PTOWB	RD	RECTK	RT	SCPRW	TD	TOTSS	TVR_V	VTK	
					•						•	

Construction and Finish Upgrades

APC	FB	MIP	MSLFB	WLI
•	•	•	•	•

Door Options

CG	DPSRR
	•

30" SUPERCABINET™ VERSION 2

storage
SOLUTIONS

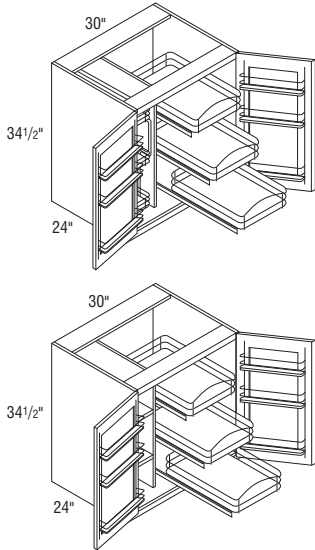

BV2SC30PR	17.7
BV2SC30RP	17.7
BV2SC30RS	17.7
BV2SC30SR	17.7

- Nomenclature represents left to right order of interior components.
Example: BV2SC30RS = Base Version 2 SuperCabinet™ 30" Roll-out Shelves.
- Shelves are adjustable and 20" deep.
- Chrome Roll-out trays feature Smart Stop.
- Cabinets utilize 170° hinge. For sufficient pull-out clearance, 12" of adjacent space is required for door to open 170° when installed near a wall or corner.
- Each door features a chrome and wood three-tiered rack.
- Door rack width is 9 3/8".
- Door rack depth is 3".
- Side pull-outs feature 3 adjustable chrome and wood baskets on frame with Smart Stop.
- Integrated soft-close hinge not included. Premium door mechanism installed.

Custom Modifications

CBO	CCO	CFP	CMAT	CND	DRT	DRWPWR	DRWTK	EXBK	FD	FTK	FTK_V	ID
•	•						•	•		•	•	
INVFRM	LTI	P	PTOWB	RD	RECTK	RT	SCPRW	TD	TOTSS	TVR_V	VTK	
					•						•	

Construction and Finish Upgrades

APC	FB	MIP	MSLFB	WLI
•	•	•	•	•

Door Options

CG	DPSRR
	•

36" SUPERCABINET™

storage
SOLUTIONS

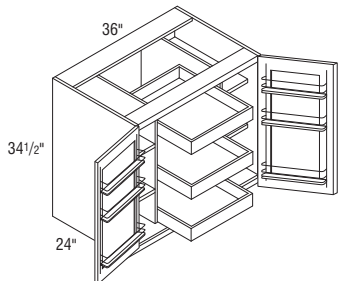
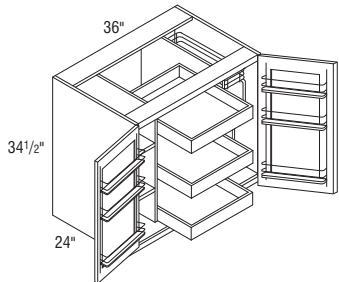
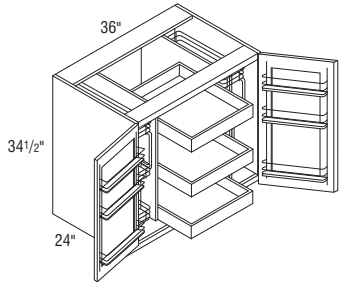

Model	Cubic Feet
BSC36PRP	21.1
BSC36PRS	21.1
BSC36SRP	21.1
BSC36SRS	21.1

- Nomenclature represents left to right order of interior components.
Example: BSC36PRS = Base SuperCabinet™ 36" Pull-out Roll-out Shelves.
- Shelves are adjustable and 20" deep.
- Cabinets utilize 170° hinge. For sufficient pull-out clearance, 12" of adjacent space is required for door to open 170° when installed near a wall or corner.
- Each door features a chrome and wood three-tiered rack.
- Door rack width is 12 3/8".
- Door rack depth is 3".
- Integrated soft-close hinge not included. Premium door mechanism installed.

Custom Modifications

CBO	CCO	CFP	CMAT	CND	DRT	DRWPWR	DRWTK	EXBK	FD	FTK	FTK_V	ID
•	•						•	•		•	•	
INVFRM	LTI	P	PTOWB	RD	RECTK	RT	SCPDRW	TD	TOTSS	TVR_V	VTK	
					•						•	

Construction and Finish Upgrades

APC	FB	MIP	MSLFB	WLI
•	•	•	•	•

Door Options

CG	DPSRR
	•

36" SUPERCABINET™ VERSION 2

storage
SOLUTIONS

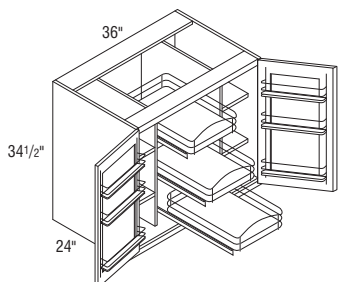
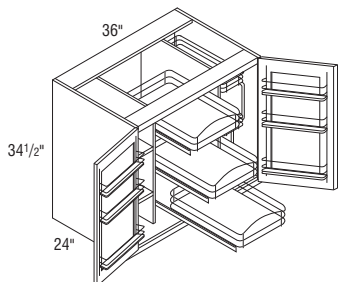
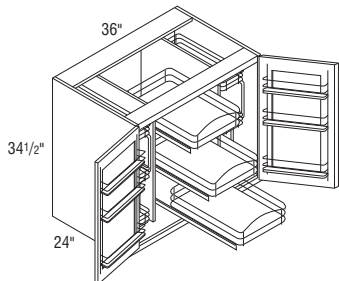

BV2SC36PRP	21.1
BV2SC36PRS	21.1
BV2SC36SRP	21.1
BV2SC36SRS	21.1

- Nomenclature represents left to right order of interior components.
Example: BV2SC36PRS = Base Version 2 SuperCabinet™ 36" Pull-out Roll-out Shelves.
- Shelves are adjustable and 20" deep.
- Chrome Roll-out trays feature Smart Stop.
- Cabinets utilize 170° hinge. For sufficient pull-out clearance, 12" of adjacent space is required for door to open 170° when installed near a wall or corner.
- Each door features a chrome and wood three-tiered rack.
- Door rack width is 12 3/8".
- Door rack depth is 3".
- Side pull-outs feature 3 adjustable chrome and wood baskets on frame with Smart Stop.
- Integrated soft-close hinge not included. Premium door mechanism installed.

Custom Modifications

CBO	CCO	CFP	CMAT	CND	DRT	DRWPWR	DRWTK	EXBK	FD	FTK	FTK_V	ID
•	•						•	•		•	•	
INVFRM	LTI	P	PTOWB	RD	RECTK	RT	SCPDRW	TD	TOTSS	TVR_V	VTK	
					•						•	

Construction and Finish Upgrades

APC	FB	MIP	MSLFB	WLI
•	•	•	•	•

Door Options

CG	DPSRR
	•

BASE with ROLL TRAYS

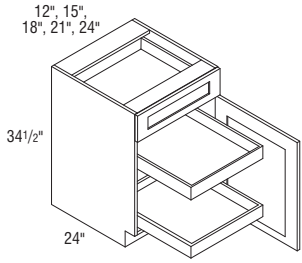

Model	Cubic Feet
B12RT L or R	7.7
B15RT L or R	9.4
B18RT L or R	11.1
B21RT L or R	12.8
B24RT L or R	14.4

- 2 roll trays standard.
- Cabinets may accommodate up to 4 roll trays, which may be purchased separately for field installation. See page 352.

Custom Modifications

CBO	CCO	CFP	CMAT	CND	DRT	DRWPWR	DRWTK	EXBK	FD	FTK	FTK_V	ID
•	•	•			•	•*	•*	•		•	•*	
INVFRM	LTI	P	PTOWB	RD	RECTK	RT	SCPRW	TD	TOTSS	TVR_V	VTK	
				•	•		•				•	

*Not available on 12" and 15" wide *Not available on 12" wide

Construction and Finish Upgrades

APC	FB	MIP	MSLFB	WLI
•	•	•	•	•

Door Options

CG	DPSRR
•	•

BASE DOUBLE DOOR with ROLL TRAYS

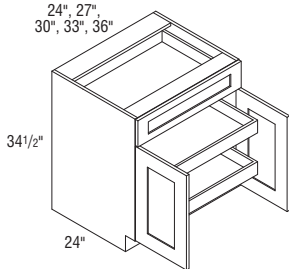

B24RT	14.4
B27RT	16.1
B30RT	17.7
B33RT	19.6
B36RT	21.1

- 2 roll trays standard.
- Cabinet has butt doors, no center stile.
- Cabinet may accommodate up to 4 roll trays, which may be purchased separately for field installation. See page 352.

Custom Modifications

CBO	CCO	CFP	CMAT	CND	DRT	DRWPWR	DRWTK	EXBK	FD	FTK	FTK_V	ID
•	•	•			•	•	•	•		•	•	
INVFRM	LTI	P	PTOWB	RD	RECTK	RT	SCPRW	TD	TOTSS	TVR_V	VTK	
				•	•		•				•	

Construction and Finish Upgrades

APC	FB	MIP	MSLFB	WLI
•	•	•	•	•

Door Options

CG	DPSRR
•	•

BASE DOUBLE DOOR with ROLL TRAYS

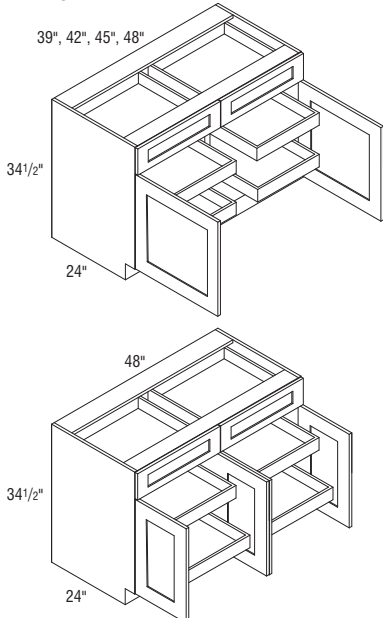

B39RT	22.5
B42RT	24.2
B45RT	25.8
B48CSRT	27.5
B48RT	27.5

- 4 roll trays standard.

Custom Modifications

CBO	CCO	CFP	CMAT	CND	DRT	DRWPWR	DRWTK	EXBK	FD	FTK	FTK_V	ID
•	•	•			•	•		•		•	•	
INVFRM	LTI	P	PTOWB	RD	RECTK	RT	SCPRW	TD	TOTSS	TVR_V	VTK	
				•	•		•				•	

Construction and Finish Upgrades

APC	FB	MIP	MSLFB	WLI
•	•	•	•	•

Door Options

CG	DPSRR
•	•

BASE FULL HEIGHT with ROLL TRAYS

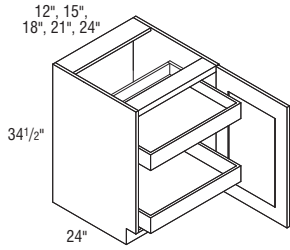

Model	Cubic Feet
B12FHRT L or R	7.7
B15FHRT L or R	9.4
B18FHRT L or R	11.1
B21FHRT L or R	12.8
B24FHRT L or R	14.4

- 2 roll trays standard.
- Cabinets may accommodate up to 4 roll trays, which may be purchased separately for field installation. See page 352.

Custom Modifications

CBO	CCO	CFP	CMAT	CND	DRT	DRWPWR	DRWTK	EXBK	FD	FTK	FTK_V	ID
•	•				•		•*	•		•	•	
INVERM	LTI	P	PTOWB	RD	RECTK	RT	SCPDRW	TD	TOTSS	TVR_V	VTK	
				•	•							•

*Not available on 12" and 15" wide

Construction and Finish Upgrades

APC	FB	MIP	MSLFB	WLI
•	•	•	•	•

Door Options

CG	DPSRR
•	•

BASE FULL HEIGHT with ROLL TRAYS, 40 1/2" HIGH

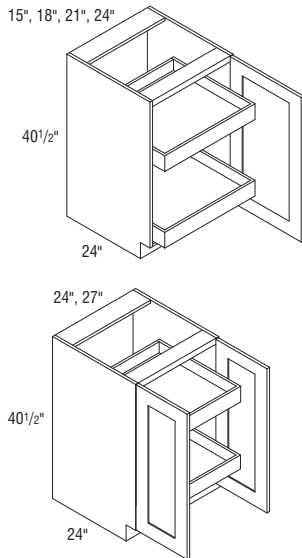

B1540FHRT L or R	10.5
B1840FHRT L or R	12.3
B2140FHRT L or R	14.2
B2440FHRT L or R	16.1
B2440FHRT	16.1
B2740FHRT	18.0

- 2 roll trays standard.
- Cabinets may accommodate up to 5 roll trays, which may be purchased separately for field installation. See page 352.

Custom Modifications

CBO	CCO	CFP	CMAT	CND	DRT	DRWPWR	DRWTK	EXBK	FD	FTK	FTK_V	ID
•	•				•		•*	•		•	•	
INVERM	LTI	P	PTOWB	RD	RECTK	RT	SCPDRW	TD	TOTSS	TVR_V	VTK	
				•	•							•

*Not available on 15" wide

Construction and Finish Upgrades

APC	FB	MIP	MSLFB	WLI
•	•	•	•	•

Door Options

CG	DPSRR
•	•

BASE FULL HEIGHT with ROLL TRAYS

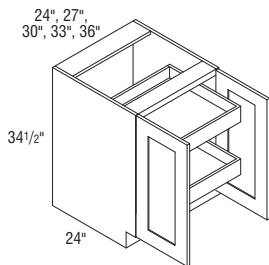

B24FHRT	14.4
B27FHRT	16.1
B30FHRT	17.7
B33FHRT	19.6
B36FHRT	21.1

- 2 roll trays standard.
- Cabinet may accommodate up to 4 roll trays, which may be purchased separately. See page 352.

Custom Modifications

CBO	CCO	CFP	CMAT	CND	DRT	DRWPWR	DRWTK	EXBK	FD	FTK	FTK_V	ID
•	•				•		•	•		•	•	
INVERM	LTI	P	PTOWB	RD	RECTK	RT	SCPDRW	TD	TOTSS	TVR_V	VTK	
				•	•							•

Construction and Finish Upgrades

APC	FB	MIP	MSLFB	WLI
•	•	•	•	•

Door Options

CG	DPSRR
•	•

BASE FULL HEIGHT DOUBLE DOOR with ROLL TRAYS

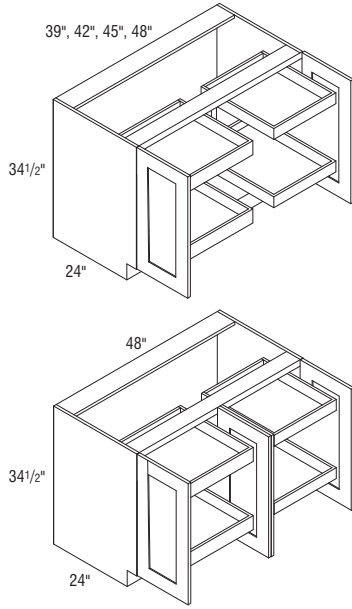

Model	Cubic Feet
B39FHRT	22.5
B42FHRT	24.2
B45FHRT	25.8
B48FHCSRT	27.5
B48FHRT	27.5

• 4 roll trays standard.

Custom Modifications

CBO	CCO	CFP	CMAT	CND	DRT	DRWPWR	DRWTK	EXBK	FD	FTK	FTK_V	ID
•	•				•			•		•	•	
INVFRM	LTI	P	PTOWB	RD	RECTK	RT	SCPDRW	TD	TOTSS	TVR_V	VTK	
				•	•						•	

Construction and Finish Upgrades

APC	FB	MIP	MSLFB	WLI
•	•	•	•	•

Door Options

CG	DPSRR
•	•

BASE with CUTLERY INSERT WOOD ORGANIZER and ROLL TRAYS

storage SOLUTIONS

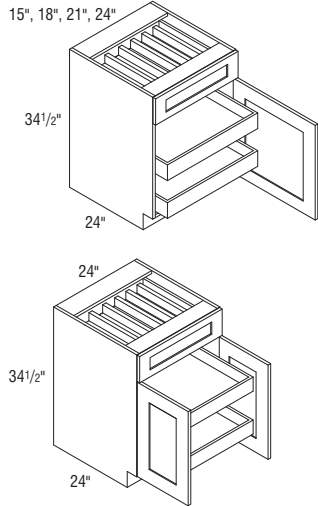

B15RTCW L or R	9.4
B18RTCW L or R	11.1
B21RTCW L or R	12.8
B24RTCW L or R	14.4
B24RTCW	14.4

- 2 roll trays standard.
- Cabinets may accommodate up to 4 roll trays, which may be purchased separately for field installation. See page 352.
- Cutlery Insert Wood Organizer is also available as an accessory. See page 344.

Custom Modifications

CBO	CCO	CFP	CMAT	CND	DRT	DRWPWR	DRWTK	EXBK	FD	FTK	FTK_V	ID
•	•	•		•	•		•*	•		•	•	
INVFRM	LTI	P	PTOWB	RD	RECTK	RT	SCPDRW	TD	TOTSS	TVR_V	VTK	
					•						•	

*Not available on 15" wide

Construction and Finish Upgrades

APC	FB	MIP	MSLFB	WLI
•	•	•	•	•

Door Options

CG	DPSRR
•	•

BASE with WOOD TIERED CUTLERY DIVIDER DRAWER and ROLL TRAYS

15", 18", 21", 24"

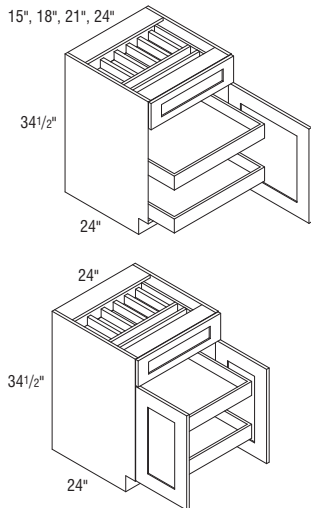

storage
SOLUTIONS

Model	Cubic Feet
B15RTWCD L or R	9.4
B18RTWCD L or R	11.1
B21RTWCD L or R	12.8
B24RTWCD L or R	14.4
B24RTWCD	14.4

- 2 roll trays standard.
- Cabinets may accommodate up to 4 roll trays, which may be purchased separately for field installation. See page 352.
- Exterior WTCDDrawer box height is 3 3/4", interior height of top and bottom tier is 1 3/8".
- Wood Tiered Cutlery Divider Drawer is also available as an accessory. See page 344.

Custom Modifications

CBO	CCO	CFP	CMAT	CND	DRT	DRWPWR	DRWTK	EXBK	FD	FTK	FTK_V	ID
•	•	•		•	•		•*	•		•	•	
INVFRM	LTI	P	PTOWB	RD	RECTK	RT	SCPDRW	TD	TOTSS	TVR_V	VTK	
					•						•	

*Not available on 15" wide

Construction and Finish Upgrades

APC	FB	MIP	MSLFB	WLI
•	•	•	•	•

Door Options

CG	DPSRR
•	•

BASE with WOOD TIERED K-CUP* DRAWER and ROLL TRAYS

18"
34 1/2"
24"

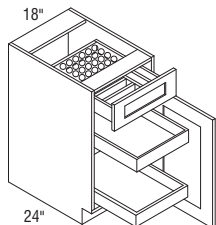

storage
SOLUTIONS

B18KCUPRT L or R	11.1
-------------------------	------

- 2 roll trays standard.
- Cabinets may accommodate up to 4 roll trays, which may be purchased separately for field installation. See page 352.
- Exterior Wood Tiered K-Cup drawer box height is 3 3/4", interior height of top tier is 1 5/8", and interior height of bottom tier is 1 3/8".
- The Wood Tiered K-Cup Drawer is compatible with K-Cup pods only.
- Wood Tiered K-Cup Drawer is also available as an accessory. See page 345.

*K-Cup is a registered trademark of Keurig Green Mountain, Inc.

Custom Modifications

CBO	CCO	CFP	CMAT	CND	DRT	DRWPWR	DRWTK	EXBK	FD	FTK	FTK_V	ID
•	•	•		•	•		•	•		•	•	
INVFRM	LTI	P	PTOWB	RD	RECTK	RT	SCPDRW	TD	TOTSS	TVR_V	VTK	
					•						•	

Construction and Finish Upgrades

APC	FB	MIP	MSLFB	WLI
•	•	•	•	•

Door Options

CG	DPSRR
•	•

BASE with DRAWER and LID ORGANIZER and ROLL TRAYS

30", 33", 36"
34 1/2"
24"

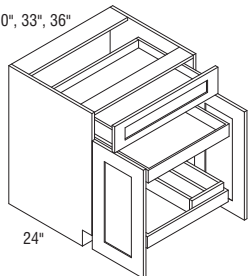

storage
SOLUTIONS

B30RTLO	17.7
B33RTLO	19.6
B36RTLO	21.1

- 2 roll trays standard.
- Pots and Pans Lid Organizer is also available as an accessory for field installation. See page 348.
- The lid organizer is attached to the roll tray with 2 screws for shipping purposes only. Screws should be removed during installation to make the lid organizer mobile.

Custom Modifications

CBO	CCO	CFP	CMAT	CND	DRT	DRWPWR	DRWTK	EXBK	FD	FTK	FTK_V	ID
•	•	•		•	•		•	•		•	•	
INVFRM	LTI	P	PTOWB	RD	RECTK	RT	SCPDRW	TD	TOTSS	TVR_V	VTK	
					•		•				•	

Construction and Finish Upgrades

APC	FB	MIP	MSLFB	WLI
•	•	•	•	•

Door Options

CG	DPSRR
•	•

BASE with LID ORGANIZER and ROLL TRAYS

storage SOLUTIONS

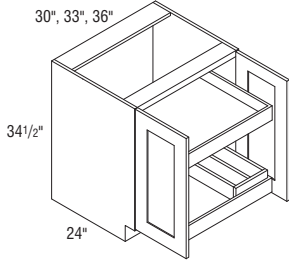

Model	Cubic Feet
B30FHRTLO	17.7
B33FHRTLO	19.6
B36FHRTLO	21.1

- 2 roll trays standard.
- Pots and Pans Lid Organizer is also available as an accessory for field installation. See page 348.
- The lid organizer is attached to the roll tray with 2 screws for shipping purposes only. Screws should be removed during installation to make the lid organizer mobile.

Custom Modifications

CBO	CCO	CFP	CMAT	CND	DRT	DRWPWR	DRWTK	EXBK	FD	FTK	FTK_V	ID
•	•						•	•		•	•	
INVFRM	LTI	P	PTOWB	RD	RECTK	RT	SCPRW	TD	TOTSS	TVR_V	VTK	
					•						•	

Construction and Finish Upgrades

APC	FB	MIP	MSLFB	WLI
•	•	•	•	•

Door Options

CG	DPSRR
•	•

POTS & PANS ORGANIZER BASE with DRAWER

storage SOLUTIONS

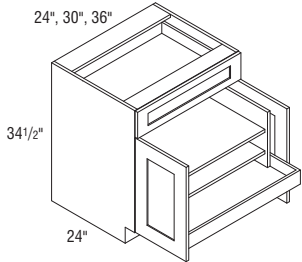
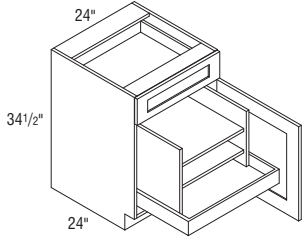

Model	Cubic Feet
B24PS L or R	14.4
B24PS	14.4
B30PS	17.7
B36PS	21.1

- Cabinet has bottom roll tray with double lid storage shelves above.
- Base Pan Storage unit is also available as an accessory for field installation. See page 343.

Custom Modifications

CBO	CCO	CFP	CMAT	CND	DRT	DRWPWR	DRWTK	EXBK	FD	FTK	FTK_V	ID
•	•	•		•		•	•	•		•	•	
INVFRM	LTI	P	PTOWB	RD	RECTK	RT	SCPRW	TD	TOTSS	TVR_V	VTK	
					•		•				•	

Construction and Finish Upgrades

APC	FB	MIP	MSLFB	WLI
•	•	•	•	•

Door Options

CG	DPSRR
•	•

BASE POTS & PANS PULL-OUT

storage SOLUTIONS

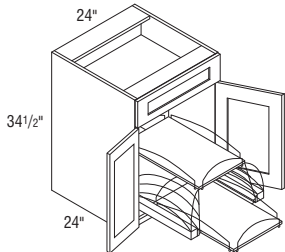
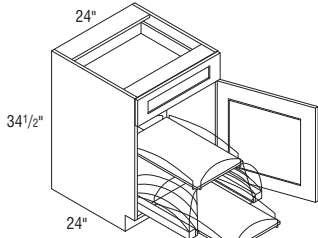

Model	Cubic Feet
BPPP24 L or R	14.4
BPPP24	14.4

- Full Extension slide-out shelves pull out independently.
- Pots and Pans Pull-out is also available as an accessory for field installation. See page 348.
- For full access from both sides of unit, do not install against a wall or next to deeper appliances and cabinets.
- Pull-out interior depth is 21", interior width is 11" on top rack and 11 3/4" on bottom rack. Height clearance on bottom rack is 9 1/2", and each side basket is 2" wide.

Custom Modifications

CBO	CCO	CFP	CMAT	CND	DRT	DRWPWR	DRWTK	EXBK	FD	FTK	FTK_V	ID
•	•			•		•	•	•		•	•	
INVFRM	LTI	P	PTOWB	RD	RECTK	RT	SCPRW	TD	TOTSS	TVR_V	VTK	
					•		•				•	

Construction and Finish Upgrades

APC	FB	MIP	MSLFB	WLI
•	•	•	•	•

Door Options

CG	DPSRR
•	•

BASE POTS & PANS PULL-OUT

storage
SOLUTIONS

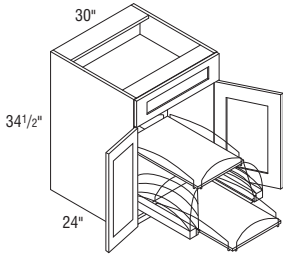

Model	Cubic Feet
BPPP30	17.7

- Full Extension slide-out shelves pull out independently.
- Pots and Pans Pull-out is also available as an accessory for field installation. See page 348.
- For full access from both sides of unit, do not install against a wall or next to deeper appliances and cabinets.
- Pull-out interior depth is 21", interior width is 17 9/16" on top rack and 17 7/8" on bottom rack. Height clearance on bottom rack is 9 1/2", and each side basket is 3 13/16" wide.

Custom Modifications

CBO	CCO	CFP	CMAT	CND	DRT	DRWPWR	DRWTK	EXBK	FD	FTK	FTK_V	ID
•	•	•		•		•	•	•		•	•	
INVFRM	LTI	P	PTOWB	RD	RECTK	RT	SCPDRW	TD	TOTSS	TVR_V	VTK	
					•		•				•	

Construction and Finish Upgrades

APC	FB	MIP	MSLFB	WLI
•	•	•	•	•

Door Options

CG	DPSRR
•	•

BASE with FOOD STORAGE CONTAINER ORGANIZER

storage
SOLUTIONS

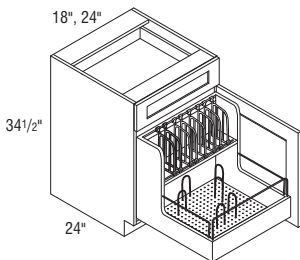

B18FSCO L or R	11.1
B24FSCO L or R	14.4

- Pull-out features natural finished hardwood dovetailed box with chrome rails on lower section with undermount Smart Stop guides.
- Includes seven chrome "U" pegs to use on the pegboard bottom to customize the fit to container sizes.
- Adjustable clip-on lid dividers included to fit with a variety of lid shapes. 18" wide includes five dividers, 24" wide includes eight dividers.
- Front of pull-out is routed for easy access.

Custom Modifications

CBO	CCO	CFP	CMAT	CND	DRT	DRWPWR	DRWTK	EXBK	FD	FTK	FTK_V	ID
•	•	•		•		•	•	•		•	•	
INVFRM	LTI	P	PTOWB	RD	RECTK	RT	SCPDRW	TD	TOTSS	TVR_V	VTK	
					•		•				•	

Construction and Finish Upgrades

APC	FB	MIP	MSLFB	WLI
•	•	•	•	•

Door Options

CG	DPSRR
•	•

BASE with ROLL-OUT TRAY DIVIDER

storage
SOLUTIONS

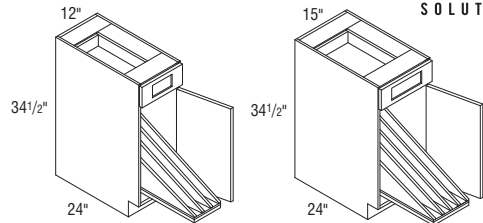

B12DRO L or R	7.8
B15DRO L or R	9.4

- Dividers are removable.
- B12DRO L/R tray divider is 7 3/4" wide and has three compartments.
- B15DRO L/R tray divider is 10 3/4" wide and has four compartments.
- Roll-out Tray Divider is also available as an accessory for field installation. See page 350.
- Tray divider utilizes Smart Stop undermount guides and bumpers for door protection.

Custom Modifications

CBO	CCO	CFP	CMAT	CND	DRT	DRWPWR	DRWTK	EXBK	FD	FTK	FTK_V	ID
•	•	•		•				•		•	•*	
INVFRM	LTI	P	PTOWB	RD	RECTK	RT	SCPDRW	TD	TOTSS	TVR_V	VTK	
					•		•				•	

*Not available on 12" wide

Construction and Finish Upgrades

APC	FB	MIP	MSLFB	WLI
•	•	•	•	•

Door Options

CG	DPSRR
•	•

BASE with TRAY DIVIDER

9", 12", 15"

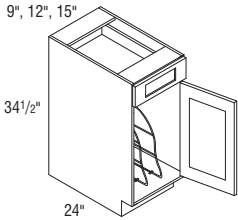

Model	Cubic Feet
TD9 L or R	6.1
TD12 L or R	7.8
TD15 L or R	9.4

- Tray Divider is chrome.
- Tray Divider is also available as an accessory for field installation. See page 350.
- TD9 L/R has one divider, TD12 L/R and TD15 L/R have two dividers.

Custom Modifications

CBO	CCO	CFP	CMAT	CND	DRT	DRWPWR	DRWTK	EXBK	FD	FTK	FTK_V	ID
•	•	•		•				•		•	•*	
INVFRM	LTI	P	PTOWB	RD	RECTK	RT	SCPRW	TD	TOTSS	TVR_V	VTK	
					•*		•				•	

*Not available on 9" and 12" wide *RECTKALL not available on 9" wide

Construction and Finish Upgrades

APC	FB	MIP	MSLFB	WLI
•	•	•	•	•

Door Options

CG	DPSRR
•†	•

†Not available on 9" wide

BASE FULL HEIGHT with TRAY DIVIDER

9", 12", 15"

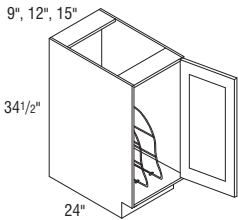

TD9FH L or R	6.1
TD12FH L or R	7.8
TD15FH L or R	9.4

- Tray Divider is chrome.
- Tray Divider is also available as an accessory for field installation. See page 350.
- TD9FH L/R has one divider, TD12FH L/R and TD15FH L/R have two dividers.

Custom Modifications

CBO	CCO	CFP	CMAT	CND	DRT	DRWPWR	DRWTK	EXBK	FD	FTK	FTK_V	ID
•	•	•		•				•		•	•*	
INVFRM	LTI	P	PTOWB	RD	RECTK	RT	SCPRW	TD	TOTSS	TVR_V	VTK	
					•*		•				•	

*Not available on 9" and 12" wide *RECTKALL not available on 9" wide

Construction and Finish Upgrades

APC	FB	MIP	MSLFB	WLI
•	•	•	•	•

Door Options

CG	DPSRR
•†	•

†Not available on 9" wide

BASE CABINET with MIXER SHELF

storage SOLUTIONS

18", 21", 24"

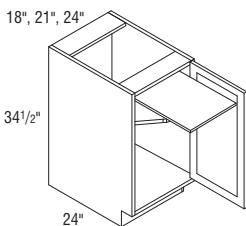

24"

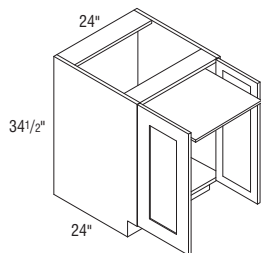

B18FHMIXSC L or R	11.1
B21FHMIXSC L or R	12.8
B24FHMIXSC L or R	14.4
B24FHMIXSC	14.4

- Includes mixer lift with Smart Stop closing feature.
- Mixer shelf will be 3/4" thick natural finished veneer plywood, mixer shelf dimensions:
18" wide: 13 7/16" wide x 20" deep.
21" wide: 16 7/16" wide x 20" deep.
24" wide: 19 7/16" wide x 20" deep.
- Maximum Weight Capacity for Mixer Shelf: 60 lbs.
- Mixer shelf locks in the fully open position. Release brackets lower the mixer shelf back into the cabinet.
- When in closed position, clearance above shelf is 19 1/2"; clearance below shelf is 8 7/16".

Custom Modifications

CBO	CCO	CFP	CMAT	CND	DRT	DRWPWR	DRWTK	EXBK	FD	FTK	FTK_V	ID
•	•	•		•				•		•	•	
INVFRM	LTI	P	PTOWB	RD	RECTK	RT	SCPRW	TD	TOTSS	TVR_V	VTK	
					•		•				•	

Construction and Finish Upgrades

APC	FB	MIP	MSLFB	WLI
•	•	•	•	•

Door Options

CG	DPSRR
•	•

SINK BASE

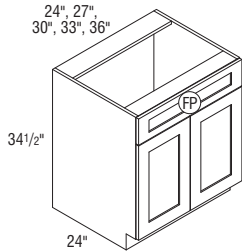
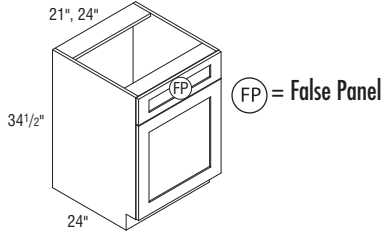

SB24-SB36 Butt doors

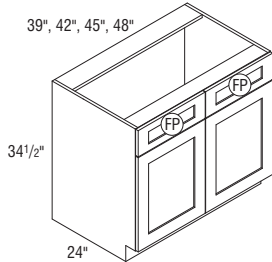

SB39-SB48CS Vertical divider

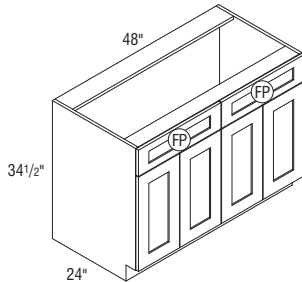

SB48 Vertical divider

Model	Cubic Feet
SB21 L or R	12.8
SB24 L or R	14.4
SB24	14.4
SB27	16.1
SB30	17.7
SB33	19.6
SB36	21.1
SB39	22.7
SB42	24.4
SB45	25.8
SB48CS	27.7
SB48	27.7

- Mini Touch-up Kit (MTUK) included. MTUK includes small touch-up marker and small fill stick.

Custom Modifications

CBO	CCO	CFP	CMAT	CND	DRT	DRWPWR	DRWTK	EXBK	FD	FTK	FTK_V	ID
	•	STD	•*	•			•*	•		•	•	•
INVERM	LTI	P	PTOWB	RD	RECTK	RT	SCPDRW	TD	TOTSS	TVR_V	VTK	
	•▲	•†		•	•	•*			•		•	

*Available only on 30", 33", and 36" wide *Not available on 39", 42", 45", and 48" wide
 †Available only on 24", 27", 30", 33", and 36" wide †Available only on 21" and 24" wide

Construction and Finish Upgrades

APC	FB	MIP	MSLFB	WLI
•	•	•	•	•

Door Options

CG	DPSRR
•	•

SINK BASE with CABMAT™

storage SOLUTIONS

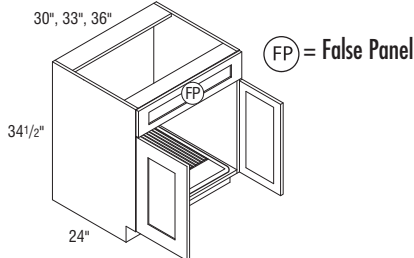

SB30CM	17.7
SB33CM	19.6
SB36CM	21.1

- Mini Touch-up Kit (MTUK) included. MTUK includes small touch-up marker and small fill stick.
- CabMat™ features a gray sloped mat to capture spills.
- CabMat™ is removable for cleaning.

Model	Liquid Capacity		Cabinet Size	
	Quarts	Liters	Width	Depth
SB30CM	4.2	3.9	30"	24"
SB33CM	4.6	4.3	33"	24"
SB36CM	5.0	4.7	36"	24"

Custom Modifications

CBO	CCO	CFP	CMAT	CND	DRT	DRWPWR	DRWTK	EXBK	FD	FTK	FTK_V	ID
•	•	STD	•	•			•	•		•	•	
INVERM	LTI	P	PTOWB	RD	RECTK	RT	SCPDRW	TD	TOTSS	TVR_V	VTK	
	•			•	•				•		•	

Construction and Finish Upgrades

APC	FB	MIP	MSLFB	WLI
•	•	•	•	•

Door Options

CG	DPSRR
	•

SINK BASE with CADDY

storage
SOLUTIONS

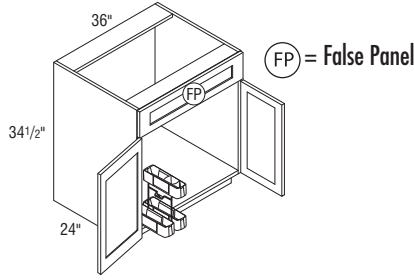

Model	Cubic Feet
SB36CDY L or R	20.9

- Mini Touch-up Kit (MTUK) included. MTUK includes small touch-up marker and small fill stick.
- L or R designates caddy location.
- Caddy is removable and portable.
- Caddy dimensions are: 9 15/16" wide x 18 5/16" tall x 18 5/8" deep.

Custom Modifications

CBO	CCO	CFP	CMAT	CND	DRT	DRWPWR	DRWTK	EXBK	FD	FTK	FTK_V	ID
•	•			•				•		•	•	•
INVERM	LTI	P	PTOWB	RD	RECTK	RT	SCPDRW	TD	TOTSS	TVR_V	VTK	
	•				•				•		•	

Construction and Finish Upgrades

APC	FB	MIP	MSLFB	WLI
•	•	•	•	•

Door Options

CG	DPSRR
•	•

SINK BASE, 27" DEEP, SINGLE or DOUBLE DOOR

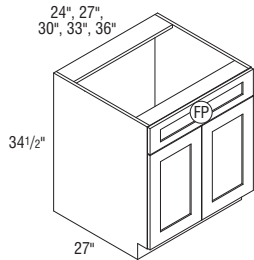
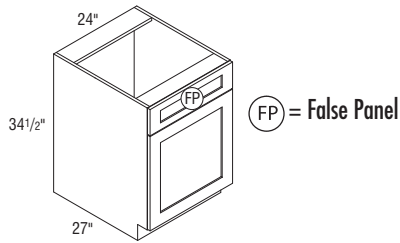

SB243427-SB363427 Butt doors

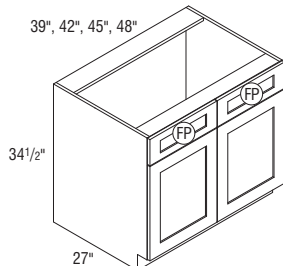

SB393427-SB483427CS Vertical divider

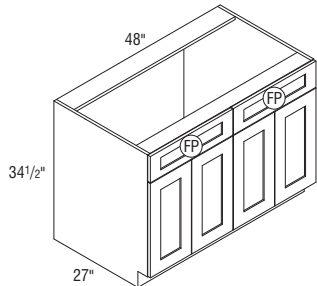

SB483427 Vertical divider

SB243427 L or R	16.2
SB243427	16.2
SB273427	18.1
SB303427	19.9
SB333427	22.1
SB363427	23.7
SB393427	25.5
SB423427	27.5
SB453427	25.8
SB483427CS	31.2
SB483427	31.2

- Mini Touch-up Kit (MTUK) included. MTUK includes small touch-up marker and small fill stick.

Custom Modifications

CBO	CCO	CFP	CMAT	CND	DRT	DRWPWR	DRWTK	EXBK	FD	FTK	FTK_V	ID
	•	STD		•				•		•	•	
INVERM	LTI	P	PTOWB	RD	RECTK	RT	SCPDRW	TD	TOTSS	TVR_V	VTK	
	•	•*			•				•		•	

*Available only on 24" wide

Construction and Finish Upgrades

APC	FB	MIP	MSLFB	WLI
•	•	•	•	•

Door Options

CG	DPSRR
•	•

SINK BASE with TILT-OUT TRAYS

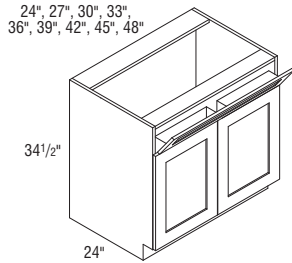
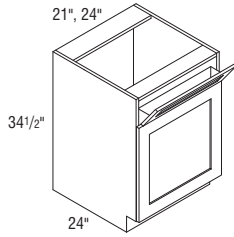

SB24ST-SB36ST Butt doors
SB39ST-SB48CSST Vertical divider, two drawer fronts

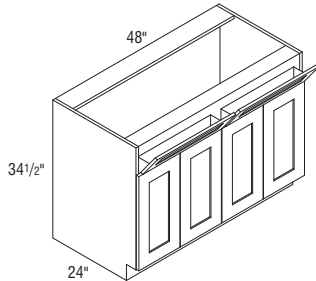

SB48ST Vertical divider

Model	Cubic Feet
SB21ST L or R	12.8
SB24ST L or R	14.4
SB24ST	14.4
SB27ST	16.1
SB30ST	17.7
SB33ST	19.6
SB36ST	21.1
SB39ST	22.7
SB42ST	24.4
SB45ST	25.7
SB48CSST	27.7
SB48ST	27.7

- Tilt-out trays are stain resistant, moisture resistant plastic to allow storage of sponges and other cleaning materials.
- Mini Touch-up Kit (MTUK) included. MTUK includes small touch-up marker and small fill stick.
- Includes two tilt-out trays on 30"-48" wide.
- Tilt-out trays are also available as an accessory for field installation. See page 350.

Custom Modifications

CBO	CCO	CFP	CMAT	CND	DRT	DRWPWR	DRWTK	EXBK	FD	FTK	FTK_V	ID
	•		•*	•			•*	•		•	•	•
INVERM	LTI	P	PTOWB	RD	RECTK	RT	SCPDRW	TD	TOTSS	TVR_V	VTK	
	•^	•†		•	•	•*					•	

*Available only on 30", 33", and 36" wide *Not available on 39", 42", 45", and 48" wide
 ^Available only on 24", 27", 30", 33", and 36" wide †Available only on 21" and 24" wide

Construction and Finish Upgrades

APC	FB	MIP	MSLFB	WLI
•	•	•	•	•

Door Options

CG	DPSRR
•	•

SINK BASE with TILT-OUT TRAYS and CABMAT™

storage SOLUTIONS

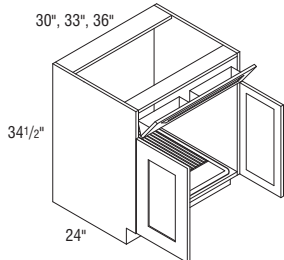

SB30STCM	17.7
SB33STCM	19.6
SB36STCM	21.1

- Mini Touch-up Kit (MTUK) included. MTUK includes small touch-up marker and small fill stick.
- CabMat™ features a gray sloped mat to capture spills.
- CabMat™ is removable for cleaning.
- Tilt-out trays are stain resistant, moisture resistant plastic to allow storage of sponges and other cleaning materials.
- Includes two tilt-out trays.
- Tilt-out trays are also available as an accessory for field installation. See page 350.

Model	Liquid Capacity		Cabinet Size	
	Quarts	Liters	Width	Depth
SB30STCM	4.2	3.9	30"	24"
SB33STCM	4.6	4.3	33"	24"
SB36STCM	5.0	4.7	36"	24"

Custom Modifications

CBO	CCO	CFP	CMAT	CND	DRT	DRWPWR	DRWTK	EXBK	FD	FTK	FTK_V	ID
•	•			•			•	•		•	•	
INVERM	LTI	P	PTOWB	RD	RECTK	RT	SCPDRW	TD	TOTSS	TVR_V	VTK	
	•				•		•				•	

Construction and Finish Upgrades

APC	FB	MIP	MSLFB	WLI
•	•	•	•	•

Door Options

CG	DPSRR
	•

SINK BASE with TILT-OUT TRAYS and CADDY

storage SOLUTIONS

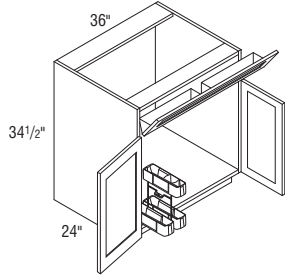

Model	Cubic Feet
SB36STCDY L or R	20.9

- Mini Touch-up Kit (MTUK) included. MTUK includes small touch-up marker and small fill stick.
- L or R designates caddy location.
- Caddy is removable and portable.
- Tilt-out trays are stain resistant, moisture resistant plastic to allow storage of sponges and other cleaning materials.
- Includes two tilt-out trays.
- Tilt-out trays are also available as an accessory for field installation. See page 350.
- Caddy dimensions are: 9 15/16" wide x 18 5/16" tall x 18 5/8" deep.

Custom Modifications

CBO	CCO	CFP	CMAT	CND	DRT	DRWPWR	DRWTK	EXBK	FD	FTK	FTK_V	ID
•	•			•			•	•		•	•	•
INVFRM	LTI	P	PTOWB	RD	RECTK	RT	SCPDRW	TD	TOTSS	TVR_V	VTK	
	•				•						•	

Construction and Finish Upgrades

APC	FB	MIP	MSLFB	WLI
•	•	•	•	•

Door Options

CG	DPSRR
•	•

SINK BASE with TILT-OUT TRAYS, 27" DEEP

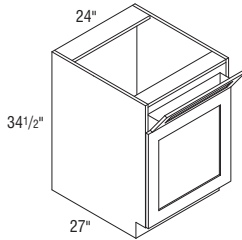

24", 27", 30", 33", 36", 39", 42", 45", 48"

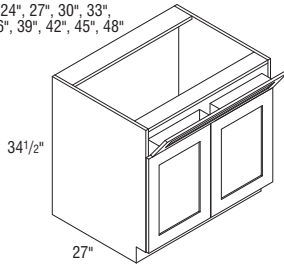

SB243427ST-SB363427ST Butt doors
SB393427ST-SB483427CSST Vertical divider, two drawer fronts

SB243427ST L or R	16.2
SB243427ST	16.2
SB273427ST	18.1
SB303427ST	19.9
SB333427ST	22.1
SB363427ST	23.7
SB393427ST	25.5
SB423427ST	27.5
SB453427ST	25.8
SB483427CSST	31.2
SB483427ST	31.2

- Tilt-out trays are stain resistant, moisture resistant plastic to allow storage of sponges and other cleaning materials.
- Mini Touch-up Kit (MTUK) included. MTUK includes small touch-up marker and small fill stick.
- Includes two tilt-out trays on 30"-48" wide.
- Tilt-out trays are also available as an accessory for field installation. See page 350.

Custom Modifications

CBO	CCO	CFP	CMAT	CND	DRT	DRWPWR	DRWTK	EXBK	FD	FTK	FTK_V	ID
	•			•				•		•	•	
INVFRM	LTI	P	PTOWB	RD	RECTK	RT	SCPDRW	TD	TOTSS	TVR_V	VTK	
	•	•*			•						•	

*Available only on 24" wide

Construction and Finish Upgrades

APC	FB	MIP	MSLFB	WLI
•	•	•	•	•

Door Options

CG	DPSRR
•	•

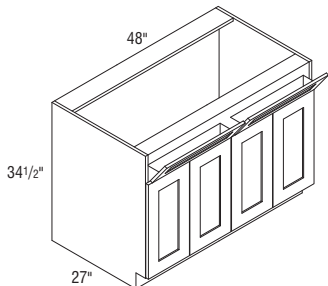

SB483427ST Vertical divider

SINK BASE SUPERCABINET™

storage SOLUTIONS

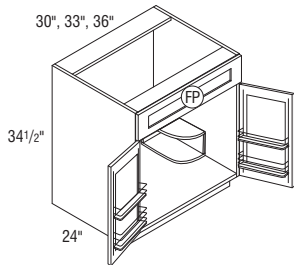

FP = False Panel

Model	Cubic Feet
SB30S	17.7
SB33S	19.6
SB36S	21.1

- Quarter Round Reversible Shelf for left or right applications will be constructed from 3/4" thick laminated furniture board. When upgraded to APC, shelf will use clear coated veneer plywood. (Shelf shipped secure, can be positioned in left or right corner.)
- Mini Touch-up Kit (MTUK) included. MTUK includes small touch-up marker and small fill stick.
- All load bearing surfaces meet KCMA standards of 15 lbs. per square foot.
- Each door features a chrome and wood two-tiered rack.
- Door rack width is 11 3/8" on 30" and 33" wide cabinets and 14 3/8" on 36" wide cabinet.
- Door rack depth is 3 1/2".

Custom Modifications

CBO	CCO	CFP	CMAT	CND	DRT	DRWPWR	DRWTK	EXBK	FD	FTK	FTK_V	ID
•	•	STD		•			•	•		•	•	•
INVFRM	LTI	P	PTOWB	RD	RECTK	RT	SCPDRW	TD	TOTSS	TVR_V	VTK	
	•				•				•		•	

Construction and Finish Upgrades

APC	FB	MIP	MSLFB	WLI
•	•	•	•	•

Door Options

CG	DPSRR
	•

SINK BASE SUPERCABINET™ with CABMAT™

storage SOLUTIONS

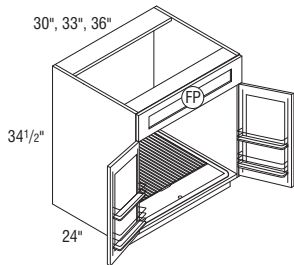

FP = False Panel

SB30SCM	17.7
SB33SCM	19.6
SB36SCM	21.1

- Mini Touch-up Kit (MTUK) included. MTUK includes small touch-up marker and small fill stick.
- CabMat™ features a gray sloped mat to capture spills.
- CabMat™ is removable for cleaning.
- All load bearing surfaces meet KCMA standards of 15 lbs. per square foot.
- Each door features a chrome and wood two-tiered rack.
- Door rack width is 11 3/8" on 30" and 33" wide cabinets and 14 3/8" on 36" wide cabinet.
- Door rack depth is 3 1/2".

Model	Liquid Capacity		Cabinet Size	
	Quarts	Liters	Width	Depth
SB30SCM	4.2	3.9	30"	24"
SB33SCM	4.6	4.3	33"	24"
SB36SCM	5.0	4.7	36"	24"

Custom Modifications

CBO	CCO	CFP	CMAT	CND	DRT	DRWPWR	DRWTK	EXBK	FD	FTK	FTK_V	ID
•	•	STD		•			•	•		•	•	
INVFRM	LTI	P	PTOWB	RD	RECTK	RT	SCPDRW	TD	TOTSS	TVR_V	VTK	
	•				•				•		•	

Construction and Finish Upgrades

APC	FB	MIP	MSLFB	WLI
•	•	•	•	•

Door Options

CG	DPSRR
	•

SINK BASE SUPERCABINET™ with CADDY

storage SOLUTIONS

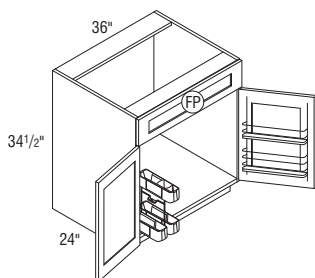

FP = False Panel

SB36SCDY L or R	20.9
------------------------	------

- Mini Touch-up Kit (MTUK) included. MTUK includes small touch-up marker and small fill stick.
- L or R designates caddy location.
- Caddy is removable and portable.
- Caddy dimensions are: 9 15/16" wide x 18 5/16" tall x 18 5/8" deep.
- Door opposite caddy features a chrome and wood two-tiered rack.
- Door rack width is 14 3/8".
- Door rack depth is 3 1/2".

Custom Modifications

CBO	CCO	CFP	CMAT	CND	DRT	DRWPWR	DRWTK	EXBK	FD	FTK	FTK_V	ID
•	•	STD		•			•	•		•	•	•
INVFRM	LTI	P	PTOWB	RD	RECTK	RT	SCPDRW	TD	TOTSS	TVR_V	VTK	
	•				•				•		•	

Construction and Finish Upgrades

APC	FB	MIP	MSLFB	WLI
•	•	•	•	•

Door Options

CG	DPSRR
•	•

SINK BASE SUPERCABINET™ with TILT-OUT TRAYS

storage SOLUTIONS

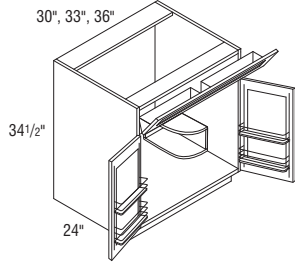

Model	Cubic Feet
SB30STS	17.7
SB33STS	19.6
SB36STS	21.1

- Quarter Round Reversible Shelf for left or right applications will be constructed from 3/4" thick laminated furniture board. When upgraded to APC, shelf will use clear coated veneer plywood. (Shelf shipped secure, can be positioned in left or right corner.)
- Mini Touch-up Kit (MTUK) included. MTUK includes small touch-up marker and small fill stick.
- Includes two tilt-out trays.
- Tilt-out trays are stain resistant, moisture resistant plastic to allow storage of sponges and other cleaning materials.
- Tilt-out trays are also available as an accessory for field installation. See page 350.
- All load bearing surfaces meet KCMA standards of 15 lbs. per square foot.
- Each door features a chrome and wood two-tiered rack.
- Door rack width is 11 3/8" on 30" and 33" wide cabinets and 14 3/8" on 36" wide cabinet.
- Door rack depth is 3 1/2".

Custom Modifications

CBO	CCO	CFP	CMAT	CND	DRT	DRWPWR	DRWTK	EXBK	FD	FTK	FTK_V	ID
•	•			•			•	•		•	•	•
INVRM	LTI	P	PTOWB	RD	RECTK	RT	SCPDRW	TD	TOTSS	TVR_V	VTK	
	•				•						•	

Construction and Finish Upgrades

APC	FB	MIP	MSLFB	WLI
•	•	•	•	•

Door Options

CG	DPSRR
	•

SINK BASE SUPERCABINET™ with TILT-OUT TRAYS and CABMAT™

storage SOLUTIONS

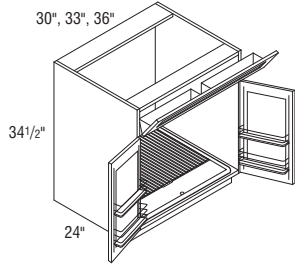

SB30STSCM	17.7
SB33STSCM	19.6
SB36STSCM	21.1

- Mini Touch-up Kit (MTUK) included. MTUK includes small touch-up marker and small fill stick.
- CabMat™ features a gray sloped mat to capture spills.
- CabMat™ is removable for cleaning.
- Includes two tilt-out trays.
- Tilt-out trays are stain resistant, moisture resistant plastic to allow storage of sponges and other cleaning materials.
- Tilt-out trays are also available as an accessory for field installation. See page 350.
- All load bearing surfaces meet KCMA standards of 15 lbs. per square foot.
- Each door features a chrome and wood two-tiered rack.
- Door rack width is 11 3/8" on 30" and 33" wide cabinets and 14 3/8" on 36" wide cabinet.
- Door rack depth is 3 1/2".

Model	Liquid Capacity		Cabinet Size	
	Quarts	Liters	Width	Depth
SB30STSCM	4.2	3.9	30"	24"
SB33STSCM	4.6	4.3	33"	24"
SB36STSCM	5.0	4.7	36"	24"

Custom Modifications

CBO	CCO	CFP	CMAT	CND	DRT	DRWPWR	DRWTK	EXBK	FD	FTK	FTK_V	ID
•	•			•			•	•		•	•	
INVRM	LTI	P	PTOWB	RD	RECTK	RT	SCPDRW	TD	TOTSS	TVR_V	VTK	
	•				•						•	

Construction and Finish Upgrades

APC	FB	MIP	MSLFB	WLI
•	•	•	•	•

Door Options

CG	DPSRR
	•

SINK BASE SUPERCABINET™ with TILT-OUT TRAYS and CADDY

storage SOLUTIONS

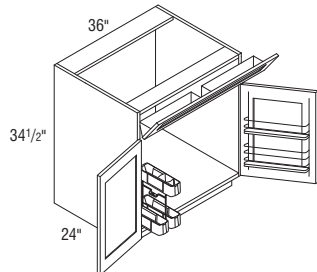

Model	Cubic Feet
SB36STSCDY L or R	20.9

- Mini Touch-up Kit (MTUK) included. MTUK includes small touch-up marker and small fill stick.
- L or R designates caddy location.
- Caddy is removable and portable.
- Includes two tilt-out trays.
- Tilt-out trays are stain resistant, moisture resistant plastic to allow storage of sponges and other cleaning materials.
- Tilt-out trays are also available as an accessory for field installation. See page 350.
- Caddy dimensions are: 9 15/16" wide x 18 5/16" tall x 18 5/8" deep.
- Door opposite caddy features a chrome and wood two-tiered rack.
- Door rack width is 14 3/8".
- Door rack depth is 3 1/2".

Custom Modifications

CBO	CCO	CFP	CMAT	CND	DRT	DRWPWR	DRWTK	EXBK	FD	FTK	FTK_V	ID
•	•			•			•	•		•	•	•
INVFRM	LTI	P	PTOWB	RD	RECTK	RT	SCPDRW	TD	TOTSS	TVR_V	VTK	
	•				•						•	

Construction and Finish Upgrades

APC	FB	MIP	MSLFB	WLI
•	•	•	•	•

Door Options

CG	DPSRR
•	•

SINK BASE with DRAWER BELOW

storage SOLUTIONS

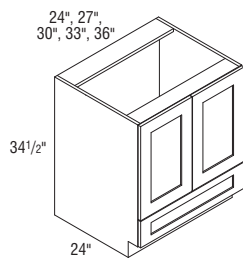
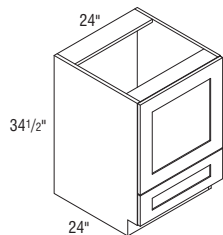

SB24D L or R	14.4
SB24D	14.4
SB27D	16.1
SB30D	17.7
SB33D	19.6
SB36D	21.1

- Drawers are below full cabinet floor.
- Mini Touch-up Kit (MTUK) included. MTUK includes small touch-up marker and small fill stick.
- Verify that sink, garbage disposal and plumbing fit opening.
- Plumbing going through floor will interfere with drawer operation. 2 3/8" clearance from back of drawer to interior back of cabinet.
- Opening height of upper section is 22 5/8".

Custom Modifications

CBO	CCO	CFP	CMAT	CND	DRT	DRWPWR	DRWTK	EXBK	FD	FTK	FTK_V	ID
•	•		•*	•			•	•		•	•	
INVFRM	LTI	P	PTOWB	RD	RECTK	RT	SCPDRW	TD	TOTSS	TVR_V	VTK	
	•	•*		•	•						•	

*Available only on 30", 33", and 36" wide

*Available only on 24" wide

Construction and Finish Upgrades

APC	FB	MIP	MSLFB	WLI
•	•	•	•	•

Door Options

CG	DPSRR
•	•

SQUARE CORNER SINK BASE

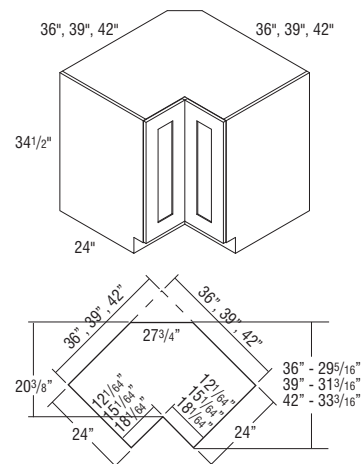

CS36 L or R	25.9
CS39 L or R	33.7
CS42 L or R	38.9

- Mini Touch-up Kit (MTUK) included. MTUK includes small touch-up marker and small fill stick.
- For sufficient dishwasher door clearance and loading/unloading space, a 15" wide base cabinet is recommended for use between a corner sink base and dishwasher.
- Decorative hardware screws must be countersunk to prevent scratching of adjacent cabinets.
- Integrated soft-close hinge not included.

Custom Modifications

CBO	CCO	CFP	CMAT	CND	DRT	DRWPWR	DRWTK	EXBK	FD	FTK	FTK_V	ID
	•											
INVFRM	LTI	P	PTOWB	RD	RECTK	RT	SCPDRW	TD	TOTSS	TVR_V	VTK	
					•						•	

Construction and Finish Upgrades

APC	FB	MIP	MSLFB	WLI
•	•	•	•	•

Door Options

CG	DPSRR
	•

ANGLED CORNER SINK BASE

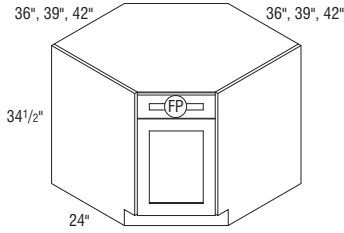

FP = False Panel

Max. Sink Widths if cut-out is 4" back from face of cabinet

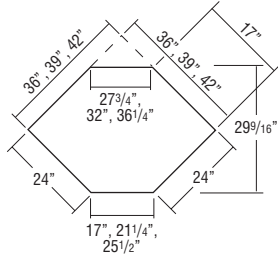

COUNTRY SINK BASE

30", 33", 36", 39", 42", 45", 48"

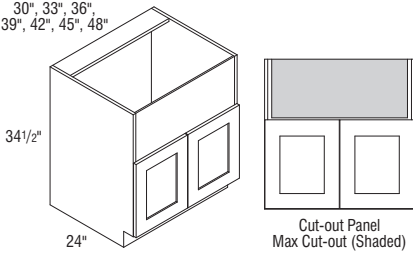

CNTYSB30-CNTYSB36 Butt doors
CNTYSB39-CNTYSB48CS Center mullion

Model	Cubic Feet
ACS36 L or R	25.9
ACS39 L or R	33.7
ACS42 [†]	38.9

- Edges beveled at 45°.
 - Mini Touch-up Kit (MTUK) included. MTUK includes small touch-up marker and small fill stick.
 - For sufficient dishwasher door clearance and loading/unloading space, a 15" wide base cabinet is recommended for use between a corner sink base and dishwasher.
- [†]ACS42 has butt doors.

Model	Wall Width	Cabinet Front Width	Maximum Sink Width	Maximum Sink Depth
ACS36	36" x 36"	17"	25 3/4"	27 11/32"
ACS39	39" x 39"	21 1/4"	30"	27 11/32"
ACS42	42" x 42"	25 1/2"	34 1/4"	27 11/32"

Custom Modifications

CBO	CCO	CFP	CMAT	CND	DRT	DRWPWR	DRWTK	EXBK	FD	FTK	FTK_V	ID
	•	STD		•						•	•	
INVFRM	LTI	P	PTOWB	RD	RECTK	RT	SCPDRW	TD	TOTSS	TVR_V	VTK	
	•				•						•	

Construction and Finish Upgrades

APC	FB	MIP	MSLFB	WLI
•	•	•	•	•

Door Options

CG	DPSRR
•	•

CNTYSB30	17.7
CNTYSB33	19.6
CNTYSB36	21.1
CNTYSB39	22.7
CNTYSB42	24.4
CNTYSB45	25.8
CNTYSB48CS	27.7

- See page 73 for cut-out panel details.
- Mini Touch-up Kit (MTUK) included. MTUK includes small touch-up marker and small fill stick.
- For apron front sinks requiring a smaller cut-out height see Country Sink Base Cabinets with Short Apron or Base Drop-in Range Cabinets on page 202.
- Refer to sink manufacturer's recommendations for additional support required for apron front sinks.
- Maximum cut-out height will leave a 1/8" reveal above doors.

Model	Maximum Cut-out	
	Width	Height
CNTYSB30	27"	12"
CNTYSB33	30"	12"
CNTYSB36	33"	12"
CNTYSB39	36"	12"
CNTYSB42	39"	12"
CNTYSB45	42"	12"
CNTYSB48CS	45"	12"

Custom Modifications

CBO	CCO	CFP	CMAT	CND	DRT	DRWPWR	DRWTK	EXBK	FD	FTK	FTK_V	ID
	•		•*				•*	•		•	•	•
INVFRM	LTI	P	PTOWB	RD	RECTK	RT	SCPDRW	TD	TOTSS	TVR_V	VTK	
	•			•	•	•*					•	

*Available only on 30", 33", and 36" wide *Not available on 39", 42", 45", and 48" wide

Construction and Finish Upgrades

APC	FB	MIP	MSLFB	WLI
•	•	•	•	•

Door Options

CG	DPSRR
•	•

COUNTRY SINK BASE with CABMAT™

storage
SOLUTIONS

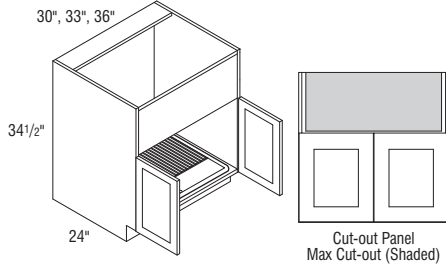

Model	Cubic Feet
CNTYSB30CM	17.7
CNTYSB33CM	19.6
CNTYSB36CM	21.1

- See page 73 for cut-out panel details.
- Mini Touch-up Kit (MTUK) included. MTUK includes small touch-up marker and small fill stick.
- CabMat™ features a gray sloped mat to capture spills.
- CabMat™ is removable for cleaning.
- For apron front sinks requiring a smaller cut-out height see Country Sink Base Cabinets with Short Apron or Base Drop-in Range Cabinets on page 202.
- Refer to sink manufacturer's recommendations for additional support required for apron front sinks.
- Maximum cut-out height will leave a 1/8" reveal above doors.

Model	Maximum Cut-out		Liquid Capacity		Cabinet Size	
	Width	Height	Quarts	Liters	Width	Depth
CNTYSB30CM	27"	12"	4.2	3.9	30"	24"
CNTYSB33CM	30"	12"	4.6	4.3	33"	24"
CNTYSB36CM	33"	12"	5.0	4.7	36"	24"

Custom Modifications

CBO	CCO	CFP	CMAT	CND	DRT	DRWPWR	DRWTK	EXBK	FD	FTK	FTK_V	ID
•	•						•	•		•	•	
INVFRM	LTI	P	PTOWB	RD	RECTK	RT	SCPDRW	TD	TOTSS	TVR_V	VTK	
	•				•						•	

Construction and Finish Upgrades

APC	FB	MIP	MSLFB	WLI
•	•	•	•	•

Door Options

CG	DPSRR
	•

COUNTRY SINK BASE with SHORT APRON

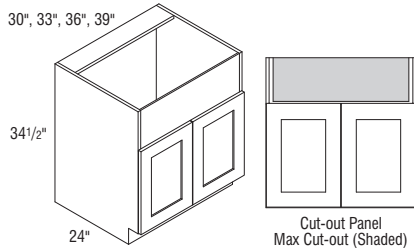

CNTYSB30SA-CNTYSB36SA Butt doors
CNTYSB39SA Center mullion

CNTYSB30SA	17.7
CNTYSB33SA	19.6
CNTYSB36SA	21.1
CNTYSB39SA	22.7

- See page 73 for cut-out panel details.
- Mini Touch-up Kit (MTUK) included. MTUK includes small touch-up marker and small fill stick.
- For apron front sinks requiring a cut-out height of 6 1/2" or less, see Base Drop-in Range Cabinets on page 202.
- Refer to sink manufacturer's recommendations for additional support required for apron front sinks.
- Maximum cut-out height will leave a 1/8" reveal above doors.

Model	Maximum Cut-out	
	Width	Height
CNTYSB30SA	27"	9"
CNTYSB33SA	30"	9"
CNTYSB36SA	33"	9"
CNTYSB39SA	36"	9"

Custom Modifications

CBO	CCO	CFP	CMAT	CND	DRT	DRWPWR	DRWTK	EXBK	FD	FTK	FTK_V	ID
	•						•*	•		•	•	•
INVFRM	LTI	P	PTOWB	RD	RECTK	RT	SCPDRW	TD	TOTSS	TVR_V	VTK	
	•			•	•	•*					•	

*Not available on 39" wide

Construction and Finish Upgrades

APC	FB	MIP	MSLFB	WLI
•	•	•	•	•

Door Options

CG	DPSRR
•	•

Sink Base Corner Cabinets

- SBCs use the wall space the nomenclature implies.
- Remember to use 3" filler on adjoining cabinets.
- The adjoining run of cabinets will cover the void.
- The L or R in the cabinet nomenclature indicates the location of the void to ensure clearance; it is not recommended to place SBC cabinets next to 27" deep appliances.
- Genova, Taro High Gloss, and Troxel use door matching furniture board blind panels and fillers on standard and APC construction.

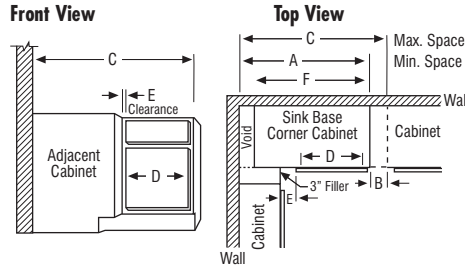

Model	A Min. Space	B Max. Pull*	C Max. Space	D Cabinet Opening	E* Clearance Between Drawer Front to Face of Adjacent Cabinet At Min. At Max.		F Actual Cabinet	Minimum Void	Maximum Void
SBC51	51"	4 5/8"	55 5/8"	22 3/4"	3 1/16"	7 11/16"	48"	0"	7 5/8"
SBC54	54"	4 5/8"	58 5/8"	25 3/4"	3 1/16"	7 11/16"	51"	0"	7 5/8"
SBC57	57"	4 5/8"	61 5/8"	28 3/4"	3 1/16"	7 11/16"	54"	0"	7 5/8"
SBC60	60"	4 5/8"	64 5/8"	31 3/4"	3 1/16"	7 11/16"	57"	0"	7 5/8"
SBC63	63"	4 5/8"	67 5/8"	34 3/4"	3 1/16"	7 11/16"	60"	0"	7 5/8"

*Minimum/maximum space between inside edge of door and face of filler/adjoining cabinet. Dimensions provided allow for proper filler attachment and do not require cleating.

SINK BASE BLIND CORNER

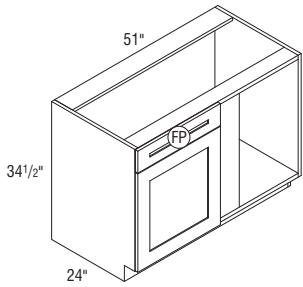

FP = False Panel

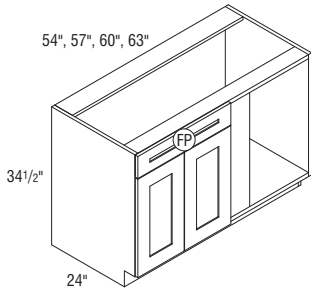

Model	Cubic Feet
SBC51 L or R	27.3
SBC54 L or R	29.0
SBC57 L or R	30.6
SBC60 L or R	32.3
SBC63 L or R	34.0

- Not recommended for use next to an appliance deeper than standard cabinet depth.
- Includes one 3" filler, shipped unattached.
- L or R indicates void. R (right) void shown.
- Mini Touch-up Kit (MTUK) included. MTUK includes small touch-up marker and small fill stick.
- Genova, Taro High Gloss, and Troxel use door matching furniture board blind panels and fillers on standard and APC construction.

Custom Modifications

CBO	CCO	CFP	CMAT	CND	DRT	DRWPWR	DRWTK	EXBK	FD	FTK	FTK_V	ID
•	•	STD		•				•				
INVERM	LTI	P	PTOWB	RD	RECTK	RT	SCPRW	TD	TOTSS	TVR_V	VTK	
	•			•	•						•	

Construction and Finish Upgrades

APC	FB	MIP	MSLFB	WLI
•	•	•	•	•

Door Options

CG	DPSRR
•	•

Base Corner Cabinets

- BCs use the wall space the nomenclature implies.
- Remember to use 3" filler on adjoining cabinets.
- The adjoining run of cabinets will cover the void.
- BCFW specifies full width blind corner base cabinet.
- The L or R in the cabinet nomenclature indicates the location of the void to ensure clearance; it is not recommended to place BC cabinets next to 27" deep appliances.
- Genova, Taro High Gloss, and Troxel use door matching furniture board blind panels and fillers on standard and APC construction.

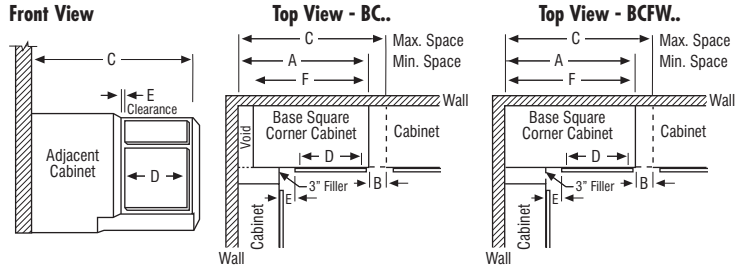

Model	A Min. Space	B Max. Pull*	C Max. Space	D Cabinet Opening	E* Clearance Between Drawer Front to Face of Adjacent Cabinet		F Actual Cabinet	Minimum Void	Maximum Void
					At Min.	At Max.			
BC36	36"	6 1/8"	42 1/8"	9 1/4"	1 9/16"	7 11/16"	27"	9"	15 1/8"
BC39	39"	4 5/8"	43 5/8"	10 3/4"	3 1/16"	7 11/16"	30"	9"	13 5/8"
BC42	42"	6 1/8"	48 1/8"	15 1/4"	1 9/16"	7 11/16"	39"	3"	9 1/8"
BC45	45"	4 5/8"	49 5/8"	16 3/4"	3 1/16"	7 11/16"	42"	3"	7 5/8"
BC48	48"	3 1/8"	51 1/8"	18 1/4"	4 9/16"	7 11/16"	45"	3"	6 1/8"
BCFW36	36"	6 1/8"	42 1/8"	9 1/4"	1 9/16"	7 11/16"	36"	0"	6 1/8"
BCFW39	39"	4 5/8"	43 5/8"	10 3/4"	3 1/16"	7 11/16"	39"	0"	4 5/8"
BCFW42	42"	6 1/8"	48 1/8"	15 1/4"	1 9/16"	7 11/16"	42"	0"	6 1/8"
BCFW45	45"	4 5/8"	49 5/8"	16 3/4"	3 1/16"	7 11/16"	45"	0"	4 5/8"
BCFW48/BCFW48CPO	48"	4 5/8"	52 5/8"	16 3/4"	3 1/16"	7 11/16"	48"	0"	4 5/8"

*Minimum/maximum space between inside edge of door and face of filler/adjointing cabinet. Dimensions provided allow for proper filler attachment and do not require cleating.

BASE CORNER

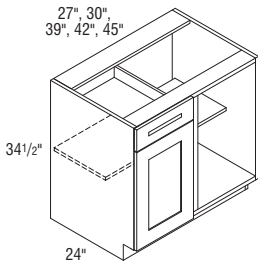

Model	Width
BC36 L or R	27"
BC39 L or R	30"
BC42 L or R	39"
BC45 L or R	42"
BC48 L or R	45"

Model	Cubic Feet
BC36 L or R	16.1
BC39 L or R	19.6
BC42 L or R	24.4
BC45 L or R	24.4
BC48 L or R	26.0

- Not recommended for use next to an appliance deeper than standard cabinet depth.
- Includes one 3" filler, shipped unattached.
- L or R indicates void. R (right) void shown.
- Adjustable 15" deep shelves.
- 9" wide front panel using end panel material, 6" wide overlay will be shipped loose for field installation allowing 3" to pull.
- Door will attach to front panel using a hinge plate.
- Genova, Taro High Gloss, and Troxel use door matching furniture board blind panels and fillers on standard and APC construction.

Custom Modifications

	CBO	CCO	CFP	CMAT	CND	DRT	DRWPWR	DRWTK	EXBK	FD	FTK	FTK_V	ID
	•	•	•		•		•*		•	•			
INVFRM	LTI	P	PTOWB	RD	RECTK	RT	SCPDRW	TD	TOTSS	TVR_V	VTK		
	•*			•	•							•	

*Not available on 36", 39", and 42" wide *Not available on 36" and 39" wide

Construction and Finish Upgrades

APC	FB	MIP	MSLFB	WLI
•	•	•	•	•

Door Options

CG	DPSRR
•	•

BASE CORNER FULL WIDTH

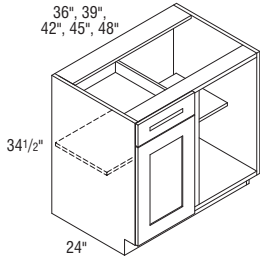

Model	Width
BCFW36 L or R	36"
BCFW39 L or R	39"
BCFW42 L or R	42"
BCFW45 L or R	45"
BCFW48 L or R	48"

Model	Cubic Feet
BCFW36 L or R	21.1
BCFW39 L or R	22.7
BCFW42 L or R	24.4
BCFW45 L or R	26.0
BCFW48 L or R	27.7

- Not recommended for use next to an appliance deeper than standard cabinet depth.
- Includes one 3" filler, shipped unattached.
- L or R indicates void. R (right) void shown.
- Adjustable 15" deep shelves.
- Genova, Taro High Gloss, and Troxel use door matching furniture board blind panels and fillers on standard and APC construction.

Custom Modifications

CBO	CCO	CFP	CMAT	CND	DRT	DRWPWR	DRWTK	EXBK	FD	FTK	FTK_V	ID
•	•	•		•		•*		•		•		
INVRM	LTI	P	PTOWB	RD	RECTK	RT	SCPDRW	TD	TOTSS	TVR_V	VTK	
	•*			•	•						•	

*Not available on 36", 39", and 42" wide *Not available on 36" and 39" wide

Construction and Finish Upgrades

APC	FB	MIP	MSLFB	WLI
•	•	•	•	•

Door Options

CG	DPSRR
•	•

BASE CORNER FULL WIDTH with CURVED PULL-OUT

storage SOLUTIONS

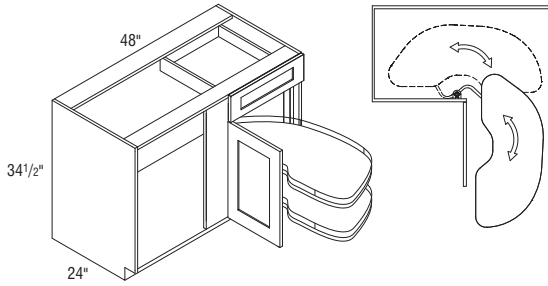

Model	Cubic Feet
BCFW48CPO L or R	27.7

- Includes one 3" filler, shipped unattached.
- L or R indicates void. L (left) void shown.
- Includes two pull-out shelves with chrome wire surround and Smart Stop closing mechanism. Shelf height can be adjusted in the field.
- When shelf is fully opened, it extends 27 3/4" from front edge of the face frame. Unit pulls out to the front only and can be installed next to a wall or appliance without side interference.
- Distance from surface of shelf to top edge of wire surround is 1 11/16".
- Maximum Weight Capacity: 44 lbs. per shelf.
- Genova, Taro High Gloss, and Troxel use door matching furniture board blind panels and fillers on standard and APC construction.

Custom Modifications

CBO	CCO	CFP	CMAT	CND	DRT	DRWPWR	DRWTK	EXBK	FD	FTK	FTK_V	ID
•	•	•		•		•		•		•		
INVRM	LTI	P	PTOWB	RD	RECTK	RT	SCPDRW	TD	TOTSS	TVR_V	VTK	
					•						•	

Construction and Finish Upgrades

APC	FB	MIP	MSLFB	WLI
•	•	•	•	•

Door Options

CG	DPSRR
	•

BASE LAZY SUSAN CORNER with FULL HEIGHT DOOR and LAZY SUSAN

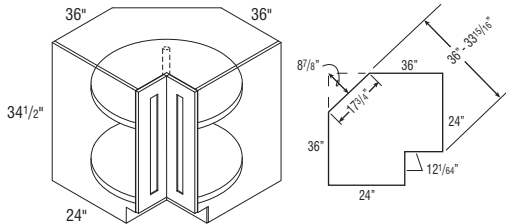

Model	Cubic Feet
BLS36 L or R	20.0

- BLS36 L or R wall width is 36" x 36".
- BLS white plastic shelves are 28" diameter with a chrome pole.
- Decorative hardware screws must be countersunk to prevent scratching of adjacent cabinets.
- Integrated soft-close hinge not included.

Custom Modifications

CBO	CCO	CFP	CMAT	CND	DRT	DRWPWR	DRWTK	EXBK	FD	FTK	FTK_V	ID
•	•											
INVRM	LTI	P	PTOWB	RD	RECTK	RT	SCPDRW	TD	TOTSS	TVR_V	VTK	

Construction and Finish Upgrades

APC	FB	MIP	MSLFB	WLI

Door Options

CG	DPSRR
	•

DIAGONAL BASE with FULL HEIGHT DOOR

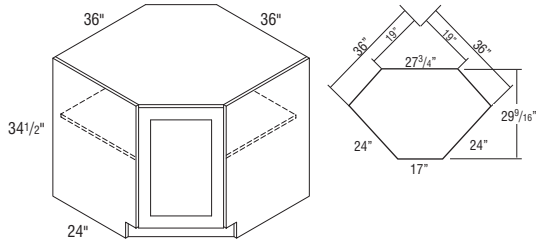

Model	Cubic Feet
DAB36FS L or R	25.9

- One fixed 5/8" thick shelf.

Custom Modifications

CBO	CCO	CFP	CMAT	CND	DRT	DRWPWR	DRWTK	EXBK	FD	FTK	FTK_V	ID
•	•									•	•	
INVERM	LTI	P	PTOWB	RD	RECTK	RT	SCPDRW	TD	TOTSS	TVR_V	VTK	
	•				•						•	

Construction and Finish Upgrades

APC	FB	MIP	MSLFB	WLI
•	•	•	•	•

Door Options

CG	DPSRR
•	•

DIAGONAL BASE with FULL HEIGHT DOOR & SUPER LAZY SUSAN

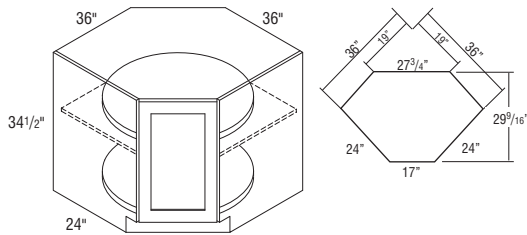

Due to fixed shelf mounting, shelves cannot be retrofitted.

Model	Cubic Feet
DAB36SLS L or R	25.9

- Features two 28" plywood revolving shelves with a 1" plywood lip. Lower shelf is mounted to floor. Upper shelf is mounted to fixed shelf. Fixed shelf is 5/8" thick.

Custom Modifications

CBO	CCO	CFP	CMAT	CND	DRT	DRWPWR	DRWTK	EXBK	FD	FTK	FTK_V	ID
•	•									•	•	
INVERM	LTI	P	PTOWB	RD	RECTK	RT	SCPDRW	TD	TOTSS	TVR_V	VTK	
	•				•						•	

Construction and Finish Upgrades

APC	FB	MIP	MSLFB	WLI
•	•	•	•	•

Door Options

CG	DPSRR
•	•

BASE EASY REACH

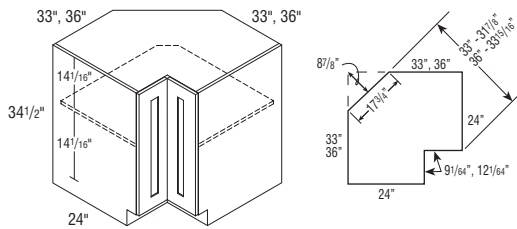

Model	Cubic Feet
BER33 L or R	24.0

Model	Cubic Feet
BER36 L or R	25.9

- BER33 L or R wall width is 33" x 33". BER36 L or R wall width is 36" x 36".
- Decorative hardware screws must be countersunk to prevent scratching of adjacent cabinets.
- Fixed shelf is 5/8" thick.
- Integrated soft-close hinge not included.

Custom Modifications

CBO	CCO	CFP	CMAT	CND	DRT	DRWPWR	DRWTK	EXBK	FD	FTK	FTK_V	ID
•	•											
INVERM	LTI	P	PTOWB	RD	RECTK	RT	SCPDRW	TD	TOTSS	TVR_V	VTK	
	•				•						•	

Construction and Finish Upgrades

APC	FB	MIP	MSLFB	WLI
•	•	•	•	•

Door Options

CG	DPSRR
	•

BASE EASY REACH with ADJUSTABLE SHELVES

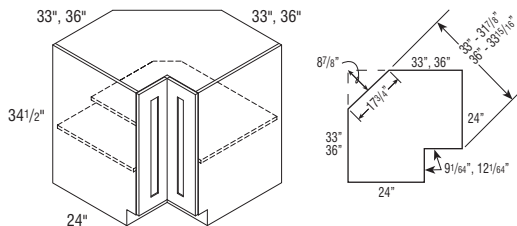

Model	Cubic Feet
BERAS33 L or R	24.0

Model	Cubic Feet
BERAS36 L or R	25.9

- BERAS33 L or R wall width is 33" x 33". BERAS36 L or R wall width is 36" x 36".
- Decorative hardware screws must be countersunk to prevent scratching of adjacent cabinets.
- Adjustable crisscross shelves.
- Integrated soft-close hinge not included.

Custom Modifications

CBO	CCO	CFP	CMAT	CND	DRT	DRWPWR	DRWTK	EXBK	FD	FTK	FTK_V	ID
•	•											
INVERM	LTI	P	PTOWB	RD	RECTK	RT	SCPDRW	TD	TOTSS	TVR_V	VTK	
	•				•						•	

Construction and Finish Upgrades

APC	FB	MIP	MSLFB	WLI
•	•	•	•	•

Door Options

CG	DPSRR
	•

ASYMMETRICAL BASE EASY REACH

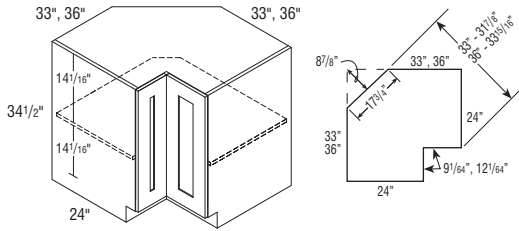

Model	Cubic Feet
BER3336 L or R	24.5
BER3633 L or R	24.5

- BER3336 L or R wall width is 33" x 36".
- BER3633 L or R wall width is 36" x 33".
- Legs at the front frames are 9" on 33" and 12" on 36" leg.
- Nomenclature for asymmetrical cabinets reads as follows:
First set of numbers = left side of cabinet dimensions.
Second set of numbers = right side of cabinet dimensions.
- Decorative hardware screws must be countersunk to prevent scratching of adjacent cabinets.
- Fixed shelf is 5/8" thick.
- Integrated soft-close hinge not included.

Custom Modifications

CBO	CCO	CFP	CMAT	CND	DRT	DRWPWR	DRWTK	EXBK	FD	FTK	FTK_V	ID
•	•											
INVFRM	LTI	P	PTOWB	RD	RECTK	RT	SCPDRW	TD	TOTSS	TVR_V	VTK	
	•				•						•	

Construction and Finish Upgrades

APC	FB	MIP	MSLFB	WLI
•	•	•	•	•

Door Options

CG	DPSRR
	•

ASYMMETRICAL BASE EASY REACH with ADJUSTABLE SHELVES

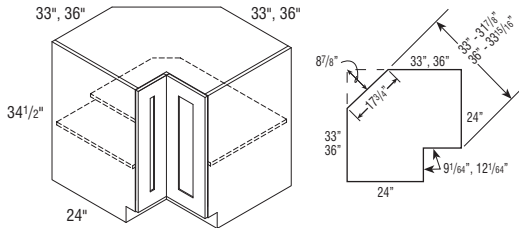

BERAS3336 L or R	24.5
BERAS3633 L or R	24.5

- BERAS3336 L or R wall width is 33" x 36".
- BERAS3633 L or R wall width is 36" x 33".
- Legs at the front frames are 9" on 33" and 12" on 36" leg.
- Nomenclature for asymmetrical cabinets reads as follows:
First set of numbers = left side of cabinet dimensions.
Second set of numbers = right side of cabinet dimensions.
- Decorative hardware screws must be countersunk to prevent scratching of adjacent cabinets.
- Adjustable crisscross shelves.
- Integrated soft-close hinge not included.

Custom Modifications

CBO	CCO	CFP	CMAT	CND	DRT	DRWPWR	DRWTK	EXBK	FD	FTK	FTK_V	ID
•	•							•				
INVFRM	LTI	P	PTOWB	RD	RECTK	RT	SCPDRW	TD	TOTSS	TVR_V	VTK	
	•				•						•	

Construction and Finish Upgrades

APC	FB	MIP	MSLFB	WLI
•	•	•	•	•

Door Options

CG	DPSRR
	•

SEGMENTED SUPER LAZY SUSAN

storage SOLUTIONS

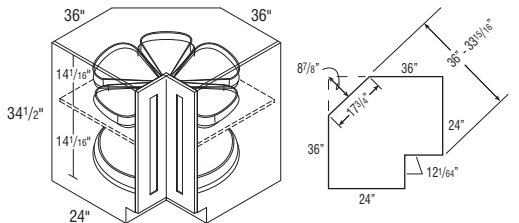

Due to fixed shelf mounting, shelves cannot be retrofitted.

SSS36 L or R	30.5
---------------------	------

- SSS36 L or R wall width is 36" x 36".
- Fixed shelf is 5/8" thick.
- Rotating top shelf is segmented with Full Extension hardware.
- Rotating bottom shelf is continuous.
- Chrome rail surrounds both shelves. Chrome rail height is 2 13/16".
- Segmented shelves are plywood.
- Decorative hardware screws must be countersunk to prevent scratching adjacent cabinets.
- Integrated soft-close hinge not included.

Custom Modifications

CBO	CCO	CFP	CMAT	CND	DRT	DRWPWR	DRWTK	EXBK	FD	FTK	FTK_V	ID
•	•											
INVFRM	LTI	P	PTOWB	RD	RECTK	RT	SCPDRW	TD	TOTSS	TVR_V	VTK	
					•						•	

Construction and Finish Upgrades

APC	FB	MIP	MSLFB	WLI
•	•	•	•	•

Door Options

CG	DPSRR
	•

SUPER LAZY SUSAN

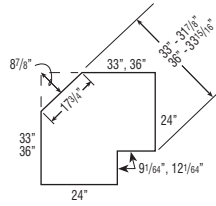
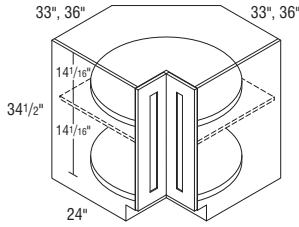

Due to fixed shelf mounting, shelves cannot be retrofitted.

Model	Cubic Feet
SLS33 L or R	24.0
SLS36 L or R	30.5

- SLS33 L or R wall width is 33" x 33".
- SLS36 L or R wall width is 36" x 36".
- SLS33 - Susans are 28" diameter.
- SLS36 - Susans are 32" diameter.
- Features two plywood revolving shelves with a 1" plywood lip. Lower shelf is mounted to floor. Upper shelf is mounted to fixed shelf. Fixed shelf is 5/8" thick.
- Decorative hardware screws must be countersunk to prevent scratching adjacent cabinets.
- Integrated soft-close hinge not included.

Custom Modifications

CBO	CCO	CFP	CMAT	CND	DRT	DRWPWR	DRWTK	EXBK	FD	FTK	FTK_V	ID
•	•											
INVFRM	LTI	P	PTOWB	RD	RECTK	RT	SCPDRW	TD	TOTSS	TVR_V	VTK	
	•				•						•	

Construction and Finish Upgrades

APC	FB	MIP	MSLFB	WLI
•	•	•	•	•

Door Options

CG	DPSRR
	•

SOLID-WOOD SUPER LAZY SUSAN

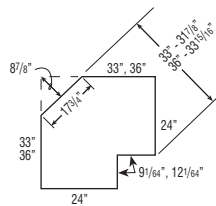
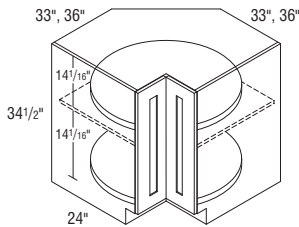

Due to fixed shelf mounting, shelves cannot be retrofitted.

Model	Cubic Feet
SLSW33 L or R	24.0
SLSW36 L or R	30.5

- SLSW33 L or R wall width is 33" x 33".
- SLSW36 L or R wall width is 36" x 36".
- SLSW33 L or R - Susans are 28" diameter.
- SLSW36 L or R - Susans are 32" diameter.
- Features two hardwood revolving shelves with a 3/16" lip. Lower shelf is mounted to floor. Upper shelf is mounted to fixed shelf. Fixed shelf is 5/8" thick.
- Decorative hardware screws must be countersunk to prevent scratching adjacent cabinets.
- Integrated soft-close hinge not included.

Custom Modifications

CBO	CCO	CFP	CMAT	CND	DRT	DRWPWR	DRWTK	EXBK	FD	FTK	FTK_V	ID
•	•											
INVFRM	LTI	P	PTOWB	RD	RECTK	RT	SCPDRW	TD	TOTSS	TVR_V	VTK	
	•				•						•	

Construction and Finish Upgrades

APC	FB	MIP	MSLFB	WLI
•	•	•	•	•

Door Options

CG	DPSRR
	•

SUPER LAZY SUSAN with CHROME RAIL

storage SOLUTIONS

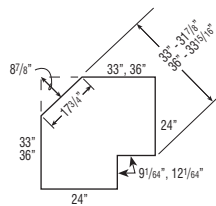
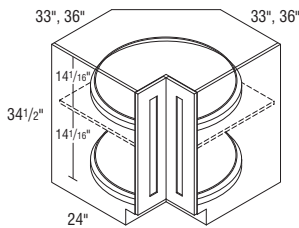

Due to fixed shelf mounting, shelves cannot be retrofitted.

Model	Cubic Feet
SLSCR33 L or R	30.5
SLSCR36 L or R	30.5

- SLSCR33 L or R wall width is 33" x 33". SLSCR36 L or R wall width is 36" x 36".
- SLSCR33 - Susans are 28" diameter. SLSCR36 - Susans are 32" diameter.
- Features two plywood revolving shelves with a 1" plywood lip. Lower shelf is mounted to floor. Upper shelf is mounted to fixed shelf. Fixed shelf is 5/8" thick.
- Chrome rail surrounds both shelves. Chrome rail height is 2 13/16".
- Decorative hardware screws must be countersunk to prevent scratching adjacent cabinets.
- Integrated soft-close hinge not included.

Custom Modifications

CBO	CCO	CFP	CMAT	CND	DRT	DRWPWR	DRWTK	EXBK	FD	FTK	FTK_V	ID
•	•											
INVFRM	LTI	P	PTOWB	RD	RECTK	RT	SCPDRW	TD	TOTSS	TVR_V	VTK	
	•				•						•	

Construction and Finish Upgrades

APC	FB	MIP	MSLFB	WLI
•	•	•	•	•

Door Options

CG	DPSRR
	•

ASYMMETRICAL SUPER LAZY SUSAN

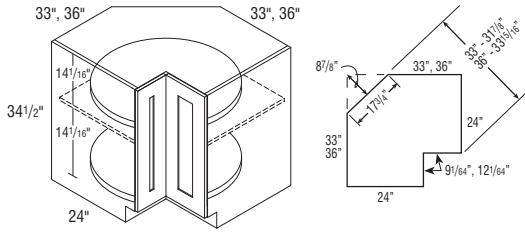

Due to fixed shelf mounting, shelves cannot be retrofitted.

Model	Cubic Feet
SLS3336 L or R	29.1
SLS3633 L or R	29.1

- SLS3336 L or R wall width is 33" x 36".
- SLS3633 L or R wall width is 36" x 33".
- All Asymmetrical Super Susan shelves are 28" diameter.
- Features two plywood revolving shelves with a 1" plywood lip. Lower shelf is mounted to floor. Upper shelf is mounted to fixed shelf. Fixed shelf is 5/8" thick.
- Nomenclature for asymmetrical cabinets reads as follows:
First set of numbers = left side of cabinet dimensions.
Second set of numbers = right side of cabinet dimensions.
- Decorative hardware screws must be countersunk to prevent scratching adjacent cabinets.
- Integrated soft-close hinge not included.

Custom Modifications

CBO	CCO	CFP	CMAT	CND	DRT	DRWPWR	DRWTK	EXBK	FD	FTK	FTK_V	ID
•	•											
INVFRM	LTI	P	PTOWB	RD	RECTK	RT	SCPRW	TD	TOTSS	TVR_V	VTK	
	•				•						•	

Construction and Finish Upgrades

APC	FB	MIP	MSLFB	WLI
•	•	•	•	•

Door Options

CG	DPSRR
	•

ASYMMETRICAL SOLID-WOOD SUPER LAZY SUSAN

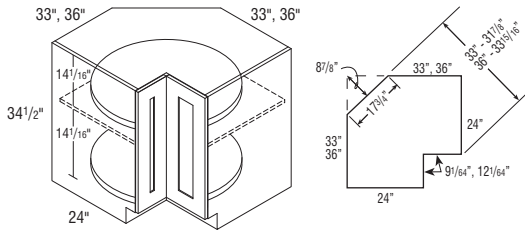

Due to fixed shelf mounting, shelves cannot be retrofitted.

SLSW3336 L or R	29.1
SLSW3633 L or R	29.1

- SLSW3336 L or R wall width is 33" x 36".
- SLSW3633 L or R wall widths is 36" x 33".
- All Asymmetrical Super Susan shelves are 28" diameter.
- Features two hardwood revolving shelves with a 3/16" lip. Lower shelf is mounted to floor. Upper shelf is mounted to fixed shelf. Fixed shelf is 5/8" thick.
- Nomenclature for asymmetrical cabinets reads as follows:
First set of numbers = left side of cabinet dimensions.
Second set of numbers = right side of cabinet dimensions.
- Decorative hardware screws must be countersunk to prevent scratching adjacent cabinets.
- Integrated soft-close hinge not included.

Custom Modifications

CBO	CCO	CFP	CMAT	CND	DRT	DRWPWR	DRWTK	EXBK	FD	FTK	FTK_V	ID
•	•											
INVFRM	LTI	P	PTOWB	RD	RECTK	RT	SCPRW	TD	TOTSS	TVR_V	VTK	
	•				•						•	

Construction and Finish Upgrades

APC	FB	MIP	MSLFB	WLI
•	•	•	•	•

Door Options

CG	DPSRR
	•

ASYMMETRICAL SUPER LAZY SUSAN with CHROME RAIL

storage SOLUTIONS

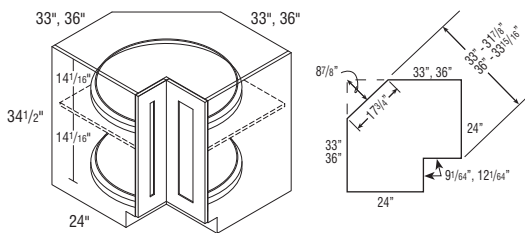

SLSCR3336 L or R	30.5
SLSCR3633 L or R	30.5

- SLSCR3336 L or R wall width is 33" x 36".
- SLSCR3633 L or R wall width is 36" x 33".
- All Asymmetrical Super Susan shelves are 28" diameter.
- Features two plywood revolving shelves with a 1" plywood lip. Lower shelf is mounted to floor. Upper shelf is mounted to fixed shelf. Fixed shelf is 5/8" thick.
- Chrome rail surrounds both shelves. Chrome rail height is 2 13/16".
- Nomenclature for asymmetrical cabinets reads as follows:
First set of numbers = left side of cabinet dimensions.
Second set of numbers = right side of cabinet dimensions.
- Decorative hardware screws must be countersunk to prevent scratching adjacent cabinets.
- Integrated soft-close hinge not included.

Custom Modifications

CBO	CCO	CFP	CMAT	CND	DRT	DRWPWR	DRWTK	EXBK	FD	FTK	FTK_V	ID
•	•											
INVFRM	LTI	P	PTOWB	RD	RECTK	RT	SCPRW	TD	TOTSS	TVR_V	VTK	
	•				•						•	

Construction and Finish Upgrades

APC	FB	MIP	MSLFB	WLI
•	•	•	•	•

Door Options

CG	DPSRR
	•

BASE ROTATING DEEP BIN

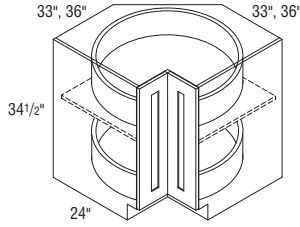

storage SOLUTIONS

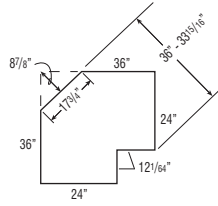

Due to fixed shelf mounting, shelves cannot be retrofitted.

Model	Cubic Feet
BRDB36 L or R	30.5

- BRDB36 wall width is 36" x 36".
- BRDB36 shelves are 30" diameter. Bins are 6" deep.
- Not available in asymmetrical applications.
- Decorative hardware screws must be countersunk to prevent scratching of adjacent cabinets.
- Integrated soft-close hinge not included.

Custom Modifications

CBO	CCO	CFP	CMAT	CND	DRT	DRWPWR	DRWTK	EXBK	FD	FTK	FTK_V	ID
•	•											
INVERM	LTI	P	PTOWB	RD	RECTK	RT	SCPDRW	TD	TOTSS	TVR_V	VTK	
	•				•						•	

Construction and Finish Upgrades

APC	FB	MIP	MSLFB	WLI
•	•	•	•	•

Door Options

CG	DPSRR
	•

LAZY SUSAN PULL-OUT

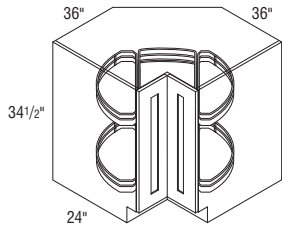

storage SOLUTIONS

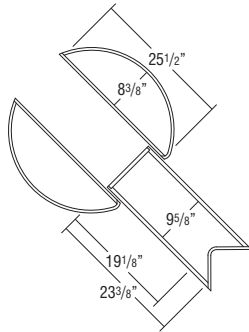
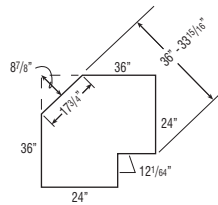

Model	Cubic Feet
LSP36 L or R	30.5

- LSP36 L or R wall width is 36" x 36".
- Features four half-moon bins (8 3/8" x 25 1/2" each) with plywood shelves and chrome rail sides.
- Center pull-outs have Smart Stop guides and operate independently. Entire unit rotates when center pull-outs are in closed position.
- Decorative hardware screws must be countersunk to prevent scratching adjacent cabinets.
- Integrated soft-close hinge not included.

Custom Modifications

CBO	CCO	CFP	CMAT	CND	DRT	DRWPWR	DRWTK	EXBK	FD	FTK	FTK_V	ID
•	•							•				
INVERM	LTI	P	PTOWB	RD	RECTK	RT	SCPDRW	TD	TOTSS	TVR_V	VTK	
					•						•	

Construction and Finish Upgrades

APC	FB	MIP	MSLFB	WLI
•	•	•	•	•

Door Options

CG	DPSRR
	•

BASE TRANSITION CABINET

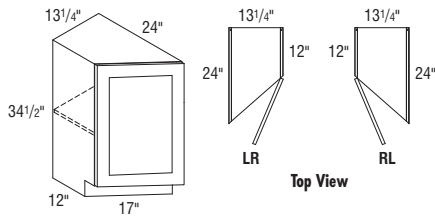

Model	Cubic Feet
BTC12RL	14.4
BTC12LR	14.4

- Cabinet width is 13 1/4".
- One adjustable shelf.
- Cabinets constructed with top.
- Door is always hinged on short side, with a recessed toekick on the short side.
- Depth can be reduced to a minimum of 18".
- RECTKBK, RECTKL and RECTKR cannot be ordered when RD is specified. RECTKL and RECTKR cannot be specified on the same cabinet.

Custom Modifications

CBO	CCO	CFP	CMAT	CND	DRT	DRWPWR	DRWTK	EXBK	FD	FTK	FTK_V	ID
•	•									•		
INVERM	LTI	P	PTOWB	RD	RECTK	RT	SCPDRW	TD	TOTSS	TVR_V	VTK	
					•*						•	

*RECTKALL not available

Construction and Finish Upgrades

APC	FB	MIP	MSLFB	WLI
•	•	•	•	•

Door Options

CG	DPSRR
•	•

BASE END CABINET

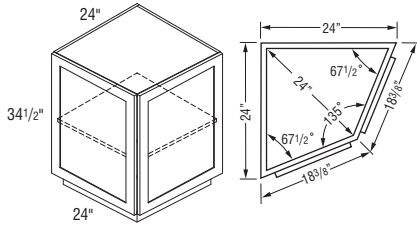

Model	Cubic Feet
BEC24	14.3

- Wall width is 24" x 24".
- 24" W x 24" D x 34 1/2" H.
- 24" from outside corner point to frame face.
- Cabinets constructed with top.
- One adjustable shelf.
- Cabinet may be installed against either end of a run.

Custom Modifications

CBO	CCO	CFP	CMAT	CND	DRT	DRWPWR	DRWTK	EXBK	FD	FTK	FTK_V	ID
•	•											
INVFRM	LTI	P	PTOWB	RD	RECTK	RT	SCPDRW	TD	TOTSS	TVR_V	VTK	
	•										•	

Construction and Finish Upgrades

APC	FB	MIP	MSLFB	WLI
•		•	•	•

Door Options

CG	DPSRR
•	•

TWO DRAWER BASE

18", 21", 24", 27",
30", 33", 36", 42", 48"

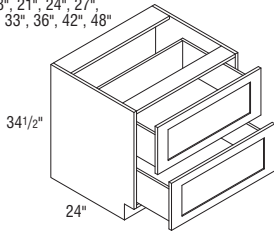

2DB18	11.1
2DB21	12.8
2DB24	14.4
2DB27	15.6
2DB30	17.7
2DB33	18.8
2DB36	21.1
2DB42	23.4
2DB48	26.6

- Exterior drawer box height is 10".
- Depth can be reduced to a minimum of 21".
- When SCPDRW is selected, the top drawer will utilize a 6 3/8" high drawer box instead of the current 10" high drawer box, creating a clearance for the cooktop of 6 3/4" from the top of drawer box to the cross rail, and 7 1/2" to the cabinet top.
- When 2DB48 is ordered in Lynnville with DFF5PC, drawer fronts will have a vertical cross rail with two center panels.

Custom Modifications

CBO	CCO	CFP	CMAT	CND	DRT	DRWPWR	DRWTK	EXBK	FD	FTK	FTK_V	ID
•	•						•*	•		•	•	
INVFRM	LTI	P	PTOWB	RD	RECTK	RT	SCPDRW	TD	TOTSS	TVR_V	VTK	
				•	•						•	

*Not available on 42" and 48" wide

Construction and Finish Upgrades

APC	FB	MIP	MSLFB	WLI
•	•	•	•	

Door Options

CG	DPSRR

TWO DRAWER BASE with PEGGED DISH ORGANIZER

storage
SOLUTIONS

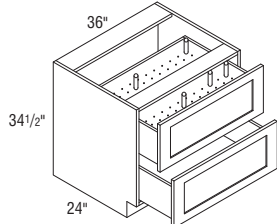

2DB36PDO	21.1
-----------------	------

- Includes 8 wooden posts.
- Includes 19/32" thick removable pegged board in top drawer.
- Exterior drawer box height is 10".
- Additional posts available as an accessory. See page 348.
- Posts and pegged board available as accessories for field installation. See page 348.
- When SCPDRW is selected, the top drawer will utilize a 6 3/8" high drawer box instead of the current 10" high drawer box, creating a clearance for the cooktop of 6 3/4" from the top of drawer box to the cross rail, and 7 1/2" to the cabinet top.

Custom Modifications

CBO	CCO	CFP	CMAT	CND	DRT	DRWPWR	DRWTK	EXBK	FD	FTK	FTK_V	ID
•	•						•	•		•	•	
INVFRM	LTI	P	PTOWB	RD	RECTK	RT	SCPDRW	TD	TOTSS	TVR_V	VTK	
					•		•				•	

Construction and Finish Upgrades

APC	FB	MIP	MSLFB	WLI
•	•	•	•	

Door Options

CG	DPSRR

TWO DRAWER BASE with ROLL TRAY

storage
SOLUTIONS

18", 21", 24",
27", 30", 33", 36"

34 1/2"

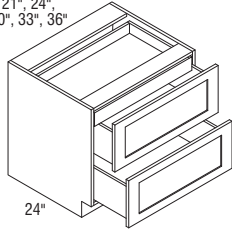

Model	Cubic Feet
2DB18RT	11.1
2DB21RT	12.8
2DB24RT	14.4
2DB27RT	16.1
2DB30RT	17.7
2DB33RT	19.6
2DB36RT	21.1

- Includes a roll tray above the top drawer box.
- Exterior height for bottom drawer box is 6 3/8".

Custom Modifications

CBO	CCO	CFP	CMAT	CND	DRT	DRWPWR	DRWTK	EXBK	FD	FTK	FTK_V	ID
•	•						•	•		•	•	
INVERM	LTI	P	PTOWB	RD	RECTK	RT	SCPDRW	TD	TOTSS	TVR_V	VTK	
				•	•						•	

Construction and Finish Upgrades

APC	FB	MIP	MSLFB	WLI
•	•	•	•	

Door Options

CG	DPSRR

TWO DRAWER BASE with ROLL TRAY and PEGGED DISH ORGANIZER

storage
SOLUTIONS

34 1/2"

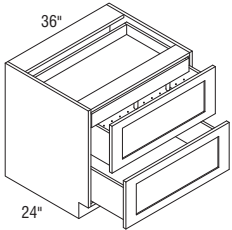

2DB36RTPDO	21.1
------------	------

- Includes a roll tray above the top drawer box.
- Includes 8 wooden posts.
- Includes 19/32" thick removable pegged board in top drawer.
- Additional posts available as an accessory. See page 348.
- Posts and pegged board available as accessories for field installation. See page 348.

Custom Modifications

CBO	CCO	CFP	CMAT	CND	DRT	DRWPWR	DRWTK	EXBK	FD	FTK	FTK_V	ID
•	•						•	•		•	•	
INVERM	LTI	P	PTOWB	RD	RECTK	RT	SCPDRW	TD	TOTSS	TVR_V	VTK	
				•	•						•	

Construction and Finish Upgrades

APC	FB	MIP	MSLFB	WLI
•	•	•	•	

Door Options

CG	DPSRR

TWO DRAWER BASE, DROP-IN RANGE

34 1/2"

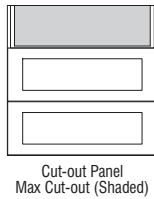
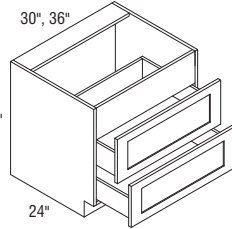

2DB30DR	17.7
2DB36DR	21.1

- Exterior height of drawer boxes is 6 3/8".
- See page 73 for cut-out panel details.
- Maximum cut-out height will leave a 1/8" reveal above doors.

Custom Modifications

CBO	CCO	CFP	CMAT	CND	DRT	DRWPWR	DRWTK	EXBK	FD	FTK	FTK_V	ID
•	•						•	•		•	•	
INVERM	LTI	P	PTOWB	RD	RECTK	RT	SCPDRW	TD	TOTSS	TVR_V	VTK	
				•	•		•				•	

Construction and Finish Upgrades

APC	FB	MIP	MSLFB	WLI
•	•	•	•	

Door Options

CG	DPSRR

THREE DRAWER BASE

12", 15", 18", 21",
24", 27", 30", 33", 36"

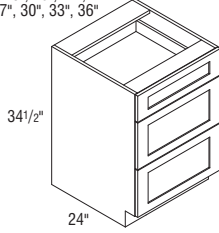

Model	Cubic Feet
3DB12	7.8
3DB15	9.4
3DB18	11.1
3DB21	12.8
3DB24	14.4
3DB27	16.1
3DB30	17.7
3DB33	19.6
3DB36	21.1

• Exterior height of bottom 2 drawer boxes is 6 3/8".

Custom Modifications

CBO	CCO	CFP	CMAT	CND	DRT	DRWPWR	DRWTK	EXBK	FD	FTK	FTK_V	ID
•	•	•				•*	•*	•		•	•*	
INVFRM	LTI	P	PTOWB	RD	RECTK	RT	SCPDRW	TD	TOTSS	TVR_V	VTK	
				•	•		•				•	

*Not available on 12" and 15" wide *Not available on 12" wide

Construction and Finish Upgrades

APC	FB	MIP	MSLFB	WLI
•	•	•	•	

Door Options

CG	DPSRR

THREE DRAWER BASE BUFFET

30", 33", 36"

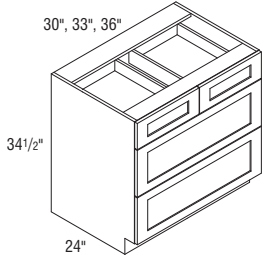

3DBB30	17.7
3DBB33	19.6
3DBB36	21.1

• Exterior height of bottom 2 drawer boxes is 6 3/8".

Custom Modifications

CBO	CCO	CFP	CMAT	CND	DRT	DRWPWR	DRWTK	EXBK	FD	FTK	FTK_V	ID
•	•	•				•*	•	•		•	•	
INVFRM	LTI	P	PTOWB	RD	RECTK	RT	SCPDRW	TD	TOTSS	TVR_V	VTK	
				•	•		•				•	

*Not available on 30" and 33" wide

Construction and Finish Upgrades

APC	FB	MIP	MSLFB	WLI
•	•	•	•	

Door Options

CG	DPSRR

THREE DRAWER BASE with WOOD TIERED CUTLERY DIVIDER DRAWER

storage SOLUTIONS

15", 18", 21", 24"

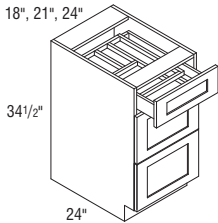

3DB15WTCD	9.4
3DB18WTCD	11.1
3DB21WTCD	12.8
3DB24WTCD	14.4

- Exterior height for lower drawer boxes is 6 3/8".
- Exterior WTCD drawer box height is 3 3/4", interior height of top and bottom tier is 1 3/8".
- Wood Tiered Cutlery Divider Drawer is also available as an accessory. See page 344.

Custom Modifications

CBO	CCO	CFP	CMAT	CND	DRT	DRWPWR	DRWTK	EXBK	FD	FTK	FTK_V	ID
•	•						•*	•		•	•	
INVFRM	LTI	P	PTOWB	RD	RECTK	RT	SCPDRW	TD	TOTSS	TVR_V	VTK	
					•						•	

*Not available on 15" wide

Construction and Finish Upgrades

APC	FB	MIP	MSLFB	WLI
•	•	•	•	

Door Options

CG	DPSRR

THREE DRAWER BASE with WOOD TIERED K-CUP* DRAWER

storage SOLUTIONS

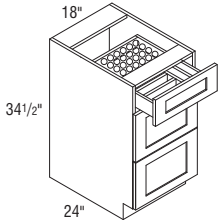

Model	Cubic Feet
3DB18KUP	11.1

- Holds 40 K-Cups.
 - Exterior height for lower drawer boxes is 6 3/8".
 - Exterior Wood Tiered K-Cup drawer box height is 3 3/4", interior height of top tier is 1 5/8", and interior height of bottom tier is 1 3/8".
 - The Wood Tiered K-Cup Drawer is compatible with K-Cup pods only.
 - Wood Tiered K-Cup Drawer is also available as an accessory. See page 345.
- *K-Cup is a registered trademark of Keurig Green Mountain, Inc.

Custom Modifications

CBO	CCO	CFP	CMAT	CND	DRT	DRWPWR	DRWTK	EXBK	FD	FTK	FTK_V	ID
•	•						•	•		•	•	
INVERM	LTI	P	PTOWB	RD	RECTK	RT	SCPDRW	TD	TOTSS	TVR_V	VTK	
					•						•	

Construction and Finish Upgrades

APC	FB	MIP	MSLFB	WLI
•	•	•	•	

Door Options

CG	DPSRR

THREE DRAWER BASE, WARMING DRAWER

24", 27", 30", 33", 36"

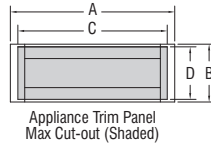
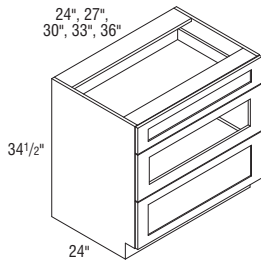

3DB24WD	14.4
3DB27WD	16.1
3DB30WD	17.7
3DB33WD	19.6
3DB36WD	21.1

- Exterior height of bottom drawer box is 6 3/8".
- For built-in appliance support in 24" deep cabinets, a kit is included (not factory installed) with a support shelf, unfinished plywood strips, and mounting screws for field mounting installation. Kit can be trimmed for when cabinet depth is modified.
- See page 73 for specifications on appliance cabinet trim panels.

	A Panel Width	B Panel Height	C Cut-out Width		D Cut-out Height		Drawer Front Height (Upper Drawer)	Drawer Front Height (Lower Drawer)
			Min.	Max.	Min.	Max.		
3DB24WD	23 27/32"	12 5/8"	18 3/32"	20 27/32"	6 7/8"	11 9/16"	6 1/4"	10 5/8"
3DB27WD	26 27/32"	12 5/8"	21 3/32"	23 27/32"	6 7/8"	11 9/16"	6 1/4"	10 5/8"
3DB30WD	29 27/32"	12 5/8"	24 3/32"	26 27/32"	6 7/8"	11 9/16"	6 1/4"	10 5/8"
3DB33WD	32 27/32"	12 5/8"	27 3/32"	29 27/32"	6 7/8"	11 9/16"	6 1/4"	10 5/8"
3DB36WD	35 27/32"	12 5/8"	30 3/32"	32 27/32"	6 7/8"	11 9/16"	6 1/4"	10 5/8"

Custom Modifications

CBO	CCO	CFP	CMAT	CND	DRT	DRWPWR	DRWTK	EXBK	FD	FTK	FTK_V	ID
•	•	•					•	•		•	•	
INVERM	LTI	P	PTOWB	RD	RECTK	RT	SCPDRW	TD	TOTSS	TVR_V	VTK	
				•	•		•				•	

Construction and Finish Upgrades

APC	FB	MIP	MSLFB	WLI
•	•	•	•	

Door Options

CG	DPSRR

THREE DRAWER BASE with DEEP DRAWER

storage SOLUTIONS

24", 30", 33", 36"

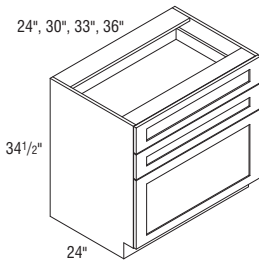

3DBDD24	14.4
3DBDD30	17.7
3DBDD33	17.6
3DBDD36	20.9

- Exterior height of bottom drawer box is 10".

Custom Modifications

CBO	CCO	CFP	CMAT	CND	DRT	DRWPWR	DRWTK	EXBK	FD	FTK	FTK_V	ID
•	•	•					•	•		•	•	
INVERM	LTI	P	PTOWB	RD	RECTK	RT	SCPDRW	TD	TOTSS	TVR_V	VTK	
				•	•		•				•	

Construction and Finish Upgrades

APC	FB	MIP	MSLFB	WLI
•	•	•	•	

Door Options

CG	DPSRR

THREE DRAWER BASE BUFFET with DEEP DRAWER

storage SOLUTIONS

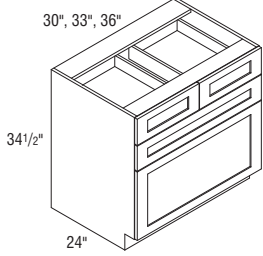

Model	Cubic Feet
3DBBDD30	17.6
3DBBDD33	19.2
3DBBDD36	20.9

• Exterior height of bottom drawer box is 10".

Custom Modifications

CBO	CCO	CFP	CMAT	CND	DRT	DRWPWR	DRWTK	EXBK	FD	FTK	FTK_V	ID
•	•	•				•*	•	•		•	•	
INVFRM	LTI	P	PTOWB	RD	RECTK	RT	SCPDRW	TD	TOTSS	TVR_V	VTK	
				•	•		•				•	

*Not available on 30" and 33" wide

Construction and Finish Upgrades

APC	FB	MIP	MSLFB	WLI
•	•	•	•	

Door Options

CG	DPSRR

FOUR DRAWER BASE

12", 15", 18", 21", 24", 27", 30", 33", 36"

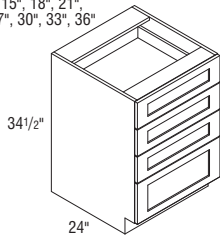

4DB12	7.8
4DB15	9.4
4DB18	11.1
4DB21	12.8
4DB24	14.4
4DB27	15.9
4DB30	17.6
4DB33	19.2
4DB36	20.9

• Exterior height of bottom drawer box is 6 3/8".

Custom Modifications

CBO	CCO	CFP	CMAT	CND	DRT	DRWPWR	DRWTK	EXBK	FD	FTK	FTK_V	ID
•	•	•				•*	•*	•		•	•*	
INVFRM	LTI	P	PTOWB	RD	RECTK	RT	SCPDRW	TD	TOTSS	TVR_V	VTK	
				•	•		•				•	

*Not available on 12" and 15" wide

*Not available on 12" wide

Construction and Finish Upgrades

APC	FB	MIP	MSLFB	WLI
•	•	•	•	

Door Options

CG	DPSRR

FOUR DRAWER BASE with CUTLERY INSERT WOOD ORGANIZER

storage SOLUTIONS

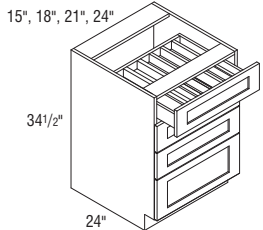

4DB15CIW	9.4
4DB18CIW	11.1
4DB21CIW	12.8
4DB24CIW	14.4

• Cutlery Insert Wood Organizer is also available as an accessory. See page 344.

• Exterior height of bottom drawer box is 6 3/8".

Custom Modifications

CBO	CCO	CFP	CMAT	CND	DRT	DRWPWR	DRWTK	EXBK	FD	FTK	FTK_V	ID
•	•	•					•*	•		•	•	
INVFRM	LTI	P	PTOWB	RD	RECTK	RT	SCPDRW	TD	TOTSS	TVR_V	VTK	
				•	•		•				•	

*Not available on 15" wide

Construction and Finish Upgrades

APC	FB	MIP	MSLFB	WLI
•	•	•	•	

Door Options

CG	DPSRR

FOUR DRAWER BASE with WOOD TIERED CUTLERY DIVIDER DRAWER

storage SOLUTIONS

15", 18", 21", 24"

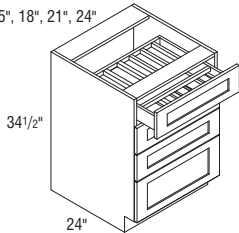

Model	Cubic Feet
4DB15WTCD	9.4
4DB18WTCD	11.1
4DB21WTCD	12.8
4DB24WTCD	14.4

- Exterior WTCD drawer box height is 3 3/4", interior height of top and bottom tier is 1 3/8".
- Wood Tiered Cutlery Divider Drawer is also available as an accessory. See page 344.
- Exterior height of bottom drawer box is 6 3/8".

Custom Modifications

CBO	CCO	CFP	CMAT	CND	DRT	DRWPWR	DRWTK	EXBK	FD	FTK	FTK_V	ID
•	•						•*	•		•	•	
INVFRM	LTI	P	PTOWB	RD	RECTK	RT	SCPDRW	TD	TOTSS	TVR_V	VTK	
					•						•	

*Not available on 15" wide

Construction and Finish Upgrades

APC	FB	MIP	MSLFB	WLI
•	•	•	•	

Door Options

CG	DPSRR

FOUR DRAWER BASE with WOOD TIERED K-CUP* DRAWER

storage SOLUTIONS

18"

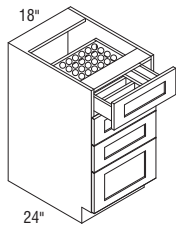

4DB18KCUP	11.1
-----------	------

- Holds 40 K-Cups.
- Exterior height of bottom drawer box is 6 3/8".
- Exterior Wood Tiered K-Cup drawer box height is 3 3/4", interior height of top tier is 1 5/8", and interior height of bottom tier is 1 3/8".
- The Wood Tiered K-Cup Drawer is compatible with K-Cup pods only.
- Wood Tiered K-Cup Drawer is also available as an accessory. See page 345.
- *K-Cup is a registered trademark of Keurig Green Mountain, Inc.

Custom Modifications

CBO	CCO	CFP	CMAT	CND	DRT	DRWPWR	DRWTK	EXBK	FD	FTK	FTK_V	ID
•	•						•	•		•	•	
INVFRM	LTI	P	PTOWB	RD	RECTK	RT	SCPDRW	TD	TOTSS	TVR_V	VTK	
					•						•	

Construction and Finish Upgrades

APC	FB	MIP	MSLFB	WLI
•	•	•	•	

Door Options

CG	DPSRR

BASE WASTEBASKET

storage SOLUTIONS

15"

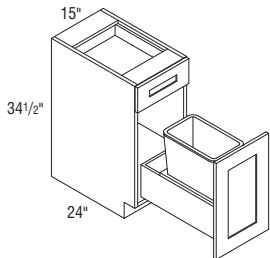

15", 18", 21"

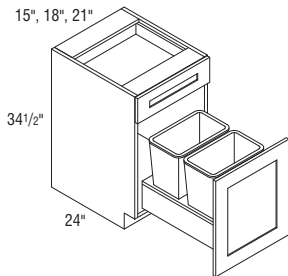

BWB15	9.4
BWB152	9.4
BWB18	11.1
BWB21	12.8

- BWB15 includes one 35 quart gray wastebasket and one trash bag storage area.
- BWB152 includes two 27 quart gray wastebaskets.
- BWB18 and BWB21 include two 35 quart gray wastebaskets.
- BWB15 and BWB18 can be reduced in depth to 21". When reduced, BWB15 includes one wastebasket. When reduced, BWB18 includes one wastebasket and one trash bag storage area.
- Wastebasket lid available for purchase separately, see page 343. BWBLID fits 35 quart wastebaskets.
- BWBLID can only be used on the front trash can of BWB18 and BWB21.
- Pull-out features undermount Smart Stop guides.

Custom Modifications

CBO	CCO	CFP	CMAT	CND	DRT	DRWPWR	DRWTK	EXBK	FD	FTK	FTK_V	ID
•	•	•		•		•*	•*	•		•	•	
INVFRM	LTI	P	PTOWB	RD	RECTK	RT	SCPDRW	TD	TOTSS	TVR_V	VTK	
				•*	•						•	

*Not available on 15" wide *Not available on BWB152 and BWB21

Construction and Finish Upgrades

APC	FB	MIP	MSLFB	WLI
•	•	•	•	•

Door Options

CG	DPSRR
	•

BASE WASTEBASKET FULL HEIGHT

storage
SOLUTIONS

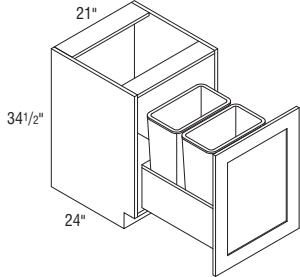
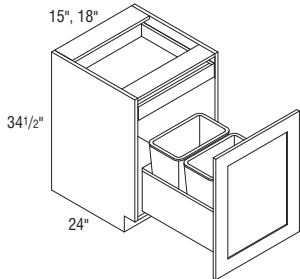
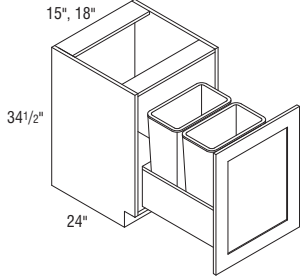
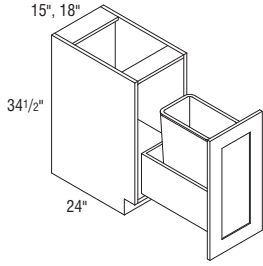

Model	Cubic Feet
BWB15FH	9.4
BWB18FH	11.1
BWB15FH2	9.4
BWB18FH2	11.1
BWB15FHRT2	9.4
BWB18FHRT2	11.1
BWB21FH	12.8

- BWB15FH and BWB18FH include one 50 quart gray wastebasket and one trash bag storage area.
- BWB15FH2 includes two 27 quart gray wastebaskets.
- BWB18FH2 includes two 35 quart gray wastebaskets.
- BWB15FHRT2 includes two 27 quart gray wastebaskets and one roll tray.
- BWB18FHRT2 includes two 35 quart gray wastebaskets and one roll tray.
- BWB21FH has two 50 quart gray wastebaskets.
- Wastebasket lid available for purchase separately, see page 343. BWBLID fits 35 quart wastebaskets. BWBFHLID fits 50 quart wastebaskets.
- BWBLID can only be used on the front trash can of BWB18FH2 and BWB18FHRT2.
- BWBFHLID can only be used on the front trash can of BWB21FH.
- Pull-out features undermount Smart Stop guides.

Custom Modifications

CBO	CCO	CFP	CMAT	CND	DRT	DRWPWR	DRWTK	EXBK	FD	FTK	FTK_V	ID
•	•						•*	•		•	•	
INVFRA	LTI	P	PTOWB	RD	RECTK	RT	SCPDRW	TD	TOTSS	TVR_V	VTK	
			•		•						•	

*Not available on 15" wide

Construction and Finish Upgrades

APC	FB	MIP	MSLFB	WLI
•	•	•	•	•

Door Options

CG	DPSRR
	•

BASE PAPER TOWEL CABINET with WASTEBASKET, FULL HEIGHT

storage SOLUTIONS

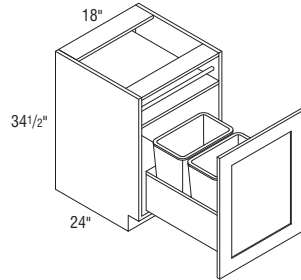
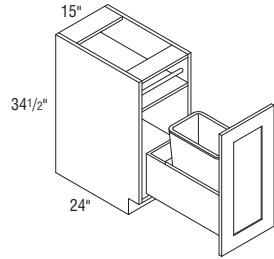

Model	Cubic Feet
BPT15WBFH	9.4
BPT18WBFH	11.1

- Upper section of cabinet features a cubby area with veneer finished interior sides and fixed shelf, a gray tension rod for easy removal, and a storage area behind the paper towel roll for an additional three to four paper towel rolls. Maximum paper towel diameter is 6".
- Cabinet back and lower section of cabinet has standard interior.
- BPT15WBFH includes one 35 quart gray wastebasket and one trash bag storage area.
- BPT18WBFH includes two 35 quart gray wastebaskets.
- Can be reduced in depth to 21". When reduced, BPT15WBFH includes one wastebasket. When reduced, BPT18WBFH includes one wastebasket and one trash bag storage area.
- Wastebasket lid available for purchase separately, see page 343. BWBLID fits 35 quart wastebaskets. BWBLID can only be used on the front trash can of BPT18WBFH.
- Pull-out features undermount Smart Stop guides.

Custom Modifications

CBO	CCO	CFP	CMAT	CND	DRT	DRWPWR	DRWTK	EXBK	FD	FTK	FTK_V	ID
•	•						•	•		•	•	
INVFRM	LTI	P	PTOWB	RD	RECTK	RT	SCPDRW	TD	TOTSS	TVR_V	VTK	
			•	•	•						•	

Construction and Finish Upgrades

APC	FB	MIP	MSLFB	WLI
•		•	•	•

Door Options

CG	DPSRR
	•

BASE BIN TRAY PULL-OUT

storage SOLUTIONS

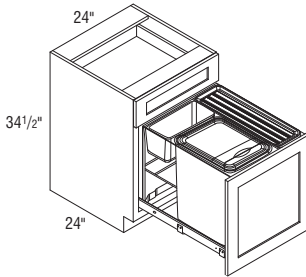

Model	Cubic Feet
BBTP24	14.4

- Door mounted pull-out features Smart Stop guides with chrome rails, gray 35 quart wastebasket with lid, gray bin, and two gray plastic trays. All items can be removed for cleaning.
- Bottom of pull-out has a removable gray plastic liner.
- Wastebasket lid available for purchase separately, see page 343. BWBLID fits 35 quart wastebaskets.

Custom Modifications

CBO	CCO	CFP	CMAT	CND	DRT	DRWPWR	DRWTK	EXBK	FD	FTK	FTK_V	ID
	•	•				•	•	•		•	•	
INVFRM	LTI	P	PTOWB	RD	RECTK	RT	SCPDRW	TD	TOTSS	TVR_V	VTK	
					•		•				•	

Construction and Finish Upgrades

APC	FB	MIP	MSLFB	WLI
•	•	•	•	•

Door Options

CG	DPSRR
	•

BASE BIN TRAY PULL-OUT FULL HEIGHT

storage SOLUTIONS

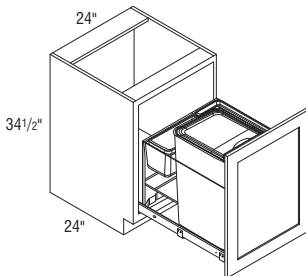

Model	Cubic Feet
BBTP24FH	14.4

- Door mounted pull-out features Smart Stop guides with chrome rails, gray 50 quart wastebasket with lid, gray bin, and two gray plastic trays. All items can be removed for cleaning.
- Bottom of pull-out has a removable gray plastic liner.
- Wastebasket lid available for purchase separately, see page 343. BWBFHLID fits 50 quart wastebaskets.

Custom Modifications

CBO	CCO	CFP	CMAT	CND	DRT	DRWPWR	DRWTK	EXBK	FD	FTK	FTK_V	ID
	•						•	•		•	•	
INVFRM	LTI	P	PTOWB	RD	RECTK	RT	SCPDRW	TD	TOTSS	TVR_V	VTK	
					•						•	

Construction and Finish Upgrades

APC	FB	MIP	MSLFB	WLI
•	•	•		•

Door Options

CG	DPSRR
	•

BASE WINE CUBBY, 24" DEEP

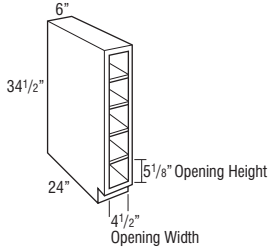

Model	Cubic Feet
BWC6	3.7

- Matching finished veneer interior and exterior with matching finished veneer edgebanding.
- Vertical application only.
- Reduced Depth only available in 3" increments down to 12".

Custom Modifications

CBO	CCO	CFP	CMAT	CND	DRT	DRWPWR	DRWTK	EXBK	FD	FTK	FTK_V	ID
INVFRM	LTI	P	PTOWB	RD	RECTK	RT	SCPDRW	TD	TOTSS	TVR_V	VTK	
				•							•	

Construction and Finish Upgrades

APC	FB	MIP	MSLFB	WLI
	STD			

Door Options

CG	DPSRR

BASE SPICE DRAWER, 24" DEEP

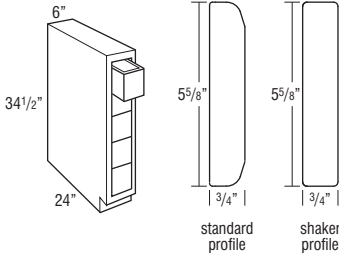

Model	Cubic Feet
BSD6	3.7

- Matching finished veneer interior and exterior with matching finished veneer edgebanding.
- See BWC6 (Base Wine Cubby without Drawers).
- Vertical application only.
- Includes five 1/2" hardwood drawers with rabbet joint, 21 13/16" deep.
- Drawer opening is 4 1/2" wide x 5 1/8" high.
- If ordered with Heirloom Technique, will not feature sand-through characteristics.
- Reduced Depth only available in 3" increments down to 12".
- Drawer front is unique to item and will not match profile chosen.
- All styles use standard drawer front profile except Amstead, Butler, Caprice, Cotter, Darby, Hardin, Larsen, Lynnville, Northrope, Warwick, and Whitman, which use the shaker profile.
- Genova, Taro, and Troxel drawer fronts will match doors and drawer fronts.

Custom Modifications

CBO	CCO	CFP	CMAT	CND	DRT	DRWPWR	DRWTK	EXBK	FD	FTK	FTK_V	ID
INVFRM	LTI	P	PTOWB	RD	RECTK	RT	SCPDRW	TD	TOTSS	TVR_V	VTK	
				•							•	

Construction and Finish Upgrades

APC	FB	MIP	MSLFB	WLI
	STD			

Door Options

CG	DPSRR

FLOATING ISLAND BASE WITHOUT TOP

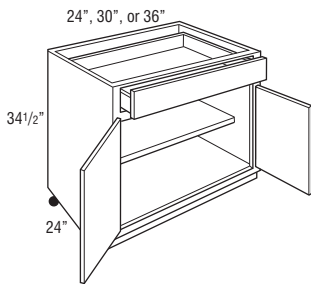

32" high without casters.

Model	Cubic Feet
FICNT24	14.4
FICNT30	17.7
FICNT36	20.9

- Features framed construction with Full Overlay door and drawer front sizes.
- 1 full width drawer and 1 adjustable 15" shelf.
- 4 heavy duty locking casters.
- Cabinet back is finished to match cabinet box color.
- Maximum countertop overhang of 1" on all sides.
- Not recommended for use with roll trays.

Custom Modifications

CBO	CCO	CFP	CMAT	CND	DRT	DRWPWR	DRWTK	EXBK	FD	FTK	FTK_V	ID
•	•	•		•					•			
INVFRM	LTI	P	PTOWB	RD	RECTK	RT	SCPDRW	TD	TOTSS	TVR_V	VTK	
	•											

Construction and Finish Upgrades

APC	FB	MIP	MSLFB	WLI
STD	STD	•		•

Door Options

CG	DPSRR
•	•

FLOATING ISLAND BASE

24", 30", or 36"

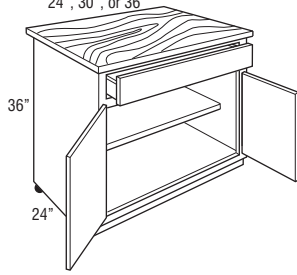

32" high without top and casters.

Model	Cubic Feet
FIC24	15.0
FIC30	18.5
FIC36	21.9

- Features framed construction with Full Overlay door and drawer front sizes.
- 1 full width drawer and 1 adjustable 15" shelf.
- 1 1/2" thick solid Maple top. Top is treated with FDA approved mineral oil.
- Top overhangs 1" on all sides. For field provided countertops, maximum overhang of 1" required on all sides.
- 4 heavy duty locking casters.
- Cabinet back is finished to match cabinet box color.
- Wood tops require regular applications of mineral oil by consumers.
- Not recommended for use with roll trays.

Custom Modifications

CBO	CCO	CFP	CMAT	CND	DRT	DRWPWR	DRWTK	EXBK	FD	FTK	FTK_V	ID
•	•	•		•					•			
INVFRM	LTI	P	PTOWB	RD	RECTK	RT	SCPDRW	TD	TOTSS	TVR_V	VTK	
	•											

Construction and Finish Upgrades

APC	FB	MIP	MSLFB	WLI
APC	FB	MIP	MSLFB	WLI
STD	STD	•		•

Door Options

CG	DPSRR
CG	DPSRR
•	•

BASE PANTRY PULL-OUT

9", 12"

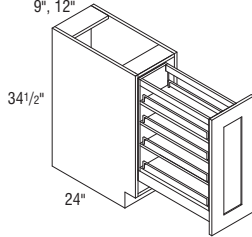

storage SOLUTIONS

BPP9	6.1
BPP12	7.8

- All styles feature a natural finish Smart Stop wood pull-out with adjustable shelves and chrome rail sides. The adjustable rear wall of the pull-out prevents items from falling behind the unit.

Custom Modifications

CBO	CCO	CFP	CMAT	CND	DRT	DRWPWR	DRWTK	EXBK	FD	FTK	FTK_V	ID
•	•							•		•		
INVFRM	LTI	P	PTOWB	RD	RECTK	RT	SCPDRW	TD	TOTSS	TVR_V	VTK	
					•*							•

*RECTKALL not available on 9" wide

Construction and Finish Upgrades

APC	FB	MIP	MSLFB	WLI
APC	FB	MIP	MSLFB	WLI
•	•	•	•	•

Door Options

CG	DPSRR
CG	DPSRR
	•

BASE CONTAINER ORGANIZER PANTRY PULL-OUT

12"

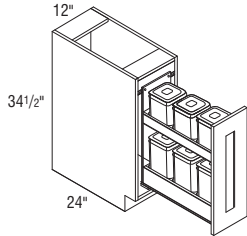

storage SOLUTIONS

BCOPP12	7.8
----------------	-----

- Full extension, Smart Stop wood pull-out with natural finish and two fixed shelves.
- Includes seven OXO™ Good Grips POP containers (BPA Free): three 1.7 quart, three 4.3 quart, and one 2.6 quart.

Custom Modifications

CBO	CCO	CFP	CMAT	CND	DRT	DRWPWR	DRWTK	EXBK	FD	FTK	FTK_V	ID
•	•							•		•		
INVFRM	LTI	P	PTOWB	RD	RECTK	RT	SCPDRW	TD	TOTSS	TVR_V	VTK	
					•							•

Construction and Finish Upgrades

APC	FB	MIP	MSLFB	WLI
APC	FB	MIP	MSLFB	WLI
•	•	•	•	•

Door Options

CG	DPSRR
CG	DPSRR
	•

BASE UTENSIL PANTRY PULL-OUT

storage
SOLUTIONS

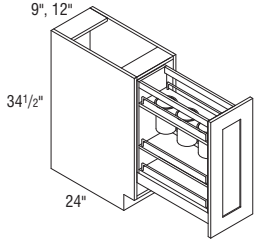

Model	Cubic Feet
BUPP9	5.8
BUPP12	7.5

- All styles feature a natural finish Smart Stop wood pull-out with two adjustable shelves (including canister shelf) and one fixed shelf with chrome rail sides. Top adjustable shelf features three stainless steel canisters for utensils. The adjustable rear wall of the pull-out prevents items from falling behind the unit.
- BUPP9 canisters are 5.85" tall and have an inside diameter of 4.3".
- BUPP12 canisters are 6.7" tall and have an inside diameter of 5".

Custom Modifications

CBO	CCO	CFP	CMAT	CND	DRT	DRWPWR	DRWTK	EXBK	FD	FTK	FTK_V	ID
•	•							•		•		
INVRM	LTI	P	PTOWB	RD	RECTK	RT	SCPDRW	TD	TOTSS	TVR_V	VTK	
					•*						•	

*RECTKALL not available on 9" wide

Construction and Finish Upgrades

APC	FB	MIP	MSLFB	WLI
•	•	•	•	•

Door Options

CG	DPSRR
	•

BASE UTENSIL PANTRY PULL-OUT with KNIFE BLOCK

storage
SOLUTIONS

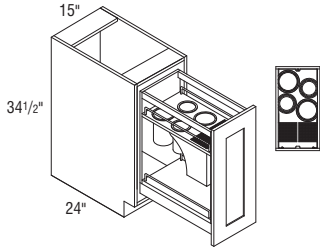
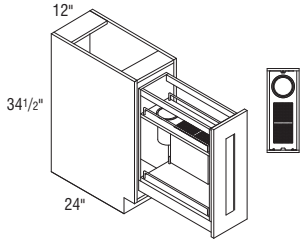

Model	Cubic Feet
BUPPKB12	7.8
BUPPKB15	9.4

- Full extension, Smart Stop wood pull-out with natural finish and one fixed shelf.
- BUPPKB12 features an adjustable shelf with two knife blocks, one stainless steel canister, and one fixed shelf with chrome rails. Canister is 6.7" tall and has an inside diameter of 5".
- BUPPKB15 features an adjustable shelf with two knife blocks, four stainless steel canisters, and one fixed shelf with chrome rails. Two canisters are 5.85" tall and have an inside diameter of 4.3", and the other two are 6.7" tall with an inside diameter of 5".
- Knife block features movable flex rods that adjust to hold a multitude of knives.
- Includes adjustable rear wall for extra strength and stability.
- Adjustable shelf is easily reversible for placement of knife blocks in the front or rear.

Custom Modifications

CBO	CCO	CFP	CMAT	CND	DRT	DRWPWR	DRWTK	EXBK	FD	FTK	FTK_V	ID
•	•							•		•	•*	
INVRM	LTI	P	PTOWB	RD	RECTK	RT	SCPDRW	TD	TOTSS	TVR_V	VTK	
					•						•	

*Not available on 12" wide

Construction and Finish Upgrades

APC	FB	MIP	MSLFB	WLI
•	•	•	•	•

Door Options

CG	DPSRR
	•

BASE BOX COLUMN PULL-OUT

storage
SOLUTIONS

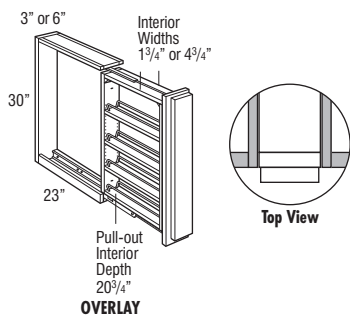
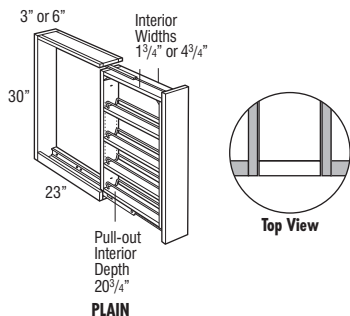

Model	Cubic Feet
BBCP03 (Plain)	1.3
BBCP06 (Plain)	2.5
BBCP03OL (Overlay)	1.3
BBCP06OL (Overlay)	2.5

- Recommended to be installed between two cabinets. Can be installed on the end of a run or adjacent to an appliance with a 3/4" thick end panel.
- Filler is included but unattached.
- Install unit before removing shipping brace and attaching filler.
- Overlay application includes profiled overlay filler.
- Decorative hardware required on base units.
- Modifications not available.
- Toekick not included; must be built up in the field.
- All styles feature a natural finish Smart Stop wood pull-out with adjustable shelves and chrome rail sides.
- BBCP03 and BBCP06 will not feature sand-through characteristics if ordered with Heirlooming Technique.
- In order to allow proper clearance for opening and closing, allow an additional 1/8" space between adjacent cabinets. The 3" wide pull-outs require 3 1/8" space and the 6" wide pull-outs require 6 1/8" space. Spacers are included with the pull-outs to allow for proper installation.
- For full access from both sides of unit, do not install against a wall or next to deeper appliances and cabinets.

MODIFICATIONS
No modifications available for these products.

Finish Techniques

Distressing	Heirlooming
•	•*

*Not available on Plain

BASE MESSAGE CENTER

storage
SOLUTIONS

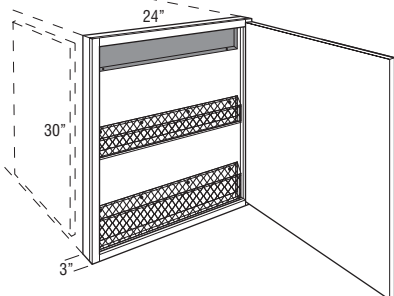

Model	Cubic Feet
BMC24 L or R	2.4

- Features framed construction with Full Access door height and Full Overlay door width.
- Includes magazine holder, bulletin board, and mail holder.
- Not recommended for use next to a Peninsula cabinet due to the additional 1/4" cabinet depth.
- Door will open 90° without decorative hardware.
- Cabinet should be hinged on wall side.
- Embellishments or overlay fillers can be used on side of cabinet to add a decorative touch.

Custom Modifications

	CBO	CCO	CFP	CMAT	CND	DRT	DRWPWR	DRWTK	EXBK	FD	FTK	FTK_V	ID
	•	•											
INVERM		LTI	P	PTOWB	RD	RECTK	RT	SCPDRW	TD	TOTSS	TVR_V	VTK	

Construction and Finish Upgrades

APC	FB	MIP	MSLFB	WLI
•		•	•	•

Door Options

CG	DPSRR
	•

BASE DROP-IN RANGE CABINET

30", 33", 36",
39", 42", 45", 48"

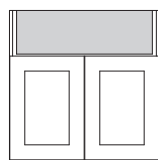
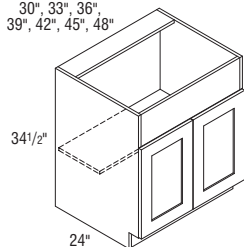

Cut-out Panel
Max Cut-out (Shaded)

B30DR-B36DR Butt doors
B39DR-B48CSDR Center mullion

Model	Cubic Feet
B30DR	17.4
B33DR	19.0
B36DR	20.7
B39DR	22.4
B42DR	24.0
B45DR	25.7
B48CSDR	27.3

- See page 73 for cut-out panel details.
- Adjustable 15" deep shelf.
- Can also be used with apron front sinks, refer to manufacturer's dimension requirements and recommendations for additional support required for apron front sinks.
- Maximum cut-out height will leave a 1/8" reveal above doors.

Model	Maximum Cut-out	
	Width	Height
B30DR	27"	9"
B33DR	30"	9"
B36DR	33"	9"
B39DR	36"	9"
B42DR	39"	9"
B45DR	42"	9"
B48CSDR	45"	9"

Custom Modifications

CBO	CCO	CFP	CMAT	CND	DRT	DRWPWR	DRWTK	EXBK	FD	FTK	FTK_V	ID
•	•						•*	•	•	•	•	•
INVFRM	LTI	P	PTOWB	RD	RECTK	RT	SCPDRW	TD	TOTSS	TVR_V	VTK	
	•			•	•	•+					•	

*Available only on 30", 33", and 36" wide *Not available on 39", 42", 45", and 48" wide

Construction and Finish Upgrades

APC	FB	MIP	MSLFB	WLI
•	•	•	•	•

Door Options

CG	DPSRR
•	•

BASE OVEN CABINET

30", 33", 36"

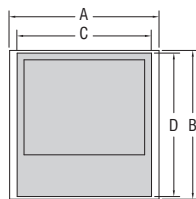
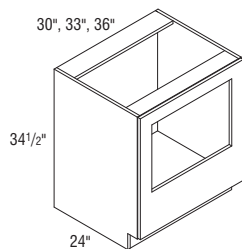

Appliance Trim Panel
Max Cut-out (Shaded)

Model	Cubic Feet
B030	17.7
B033	19.6
B036	21.1

- Standard interior.
- May not hold cooktop and slide-in oven combination. Refer to cooktop and slide-in oven manufacturer specifications.
- If ordered with Heirloom Technique, will not feature sand-through characteristics.
- For built-in appliance support in 24" deep cabinets, a kit is included (not factory installed) with a support shelf, unfinished plywood strips, and mounting screws for field mounting installation. Kit can be trimmed for when cabinet depth is modified.
- See page 73 for specifications on appliance cabinet trim panels.

	A Panel Width	B Panel Height	C Cut-out Width		D Cut-out Height	
			Min.	Max.	Min.	Max.
B030	29 27/32"	29 3/4"	24 3/32"	26 27/32"	18"	28 11/16"
B033	32 27/32"	29 3/4"	27 3/32"	29 27/32"	18"	28 11/16"
B036	35 27/32"	29 3/4"	30 3/32"	32 27/32"	18"	28 11/16"

Custom Modifications

CBO	CCO	CFP	CMAT	CND	DRT	DRWPWR	DRWTK	EXBK	FD	FTK	FTK_V	ID
							•	•		•	•	•
INVFRM	LTI	P	PTOWB	RD	RECTK	RT	SCPDRW	TD	TOTSS	TVR_V	VTK	
				•	•						•	

Construction and Finish Upgrades

APC	FB	MIP	MSLFB	WLI
•	•	•	•	

Door Options

CG	DPSRR

BASE BUILT-IN MICROWAVE CABINET with STANDARD DRAWER

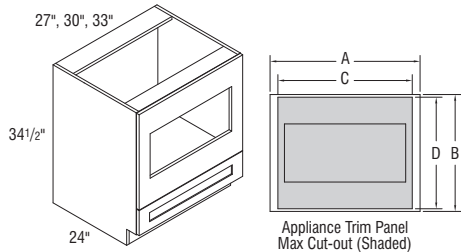

Model	Cubic Feet
BBMWD27SD	16.1
BBMWD30SD	17.7
BBMWD33SD	19.6

- Standard interior.
- Drawer box is 3 3/8" high with a 6 1/4" high drawer front.
- For built-in appliance support in 24" deep cabinets, a kit is included (not factory installed) with a support shelf, unfinished plywood strips, and mounting screws for field mounting installation. Kit can be trimmed for when cabinet depth is modified.
- See page 73 for specifications on appliance cabinet trim panels.

	A Panel Width	B Panel Height	C Cut-out Width		D Cut-out Height		Drawer Front Height
			Min.	Max.	Min.	Max.	
BBMWD27SD	26 27/32"	23 3/8"	23 3/32"	23 27/32"	11 5/8"	22 5/16"	6 1/4"
BBMWD30SD	29 27/32"	23 3/8"	26 3/32"	26 27/32"	11 5/8"	22 5/16"	6 1/4"
BBMWD33SD	32 27/32"	23 3/8"	29 3/32"	29 27/32"	11 5/8"	22 5/16"	6 1/4"

Custom Modifications

CBO	CCO	CFP	CMAT	CND	DRT	DRWPWR	DRWTK	EXBK	FD	FTK	FTK_V	ID
•	•						•	•		•	•	
INVFRM	LTI	P	PTOWB	RD	RECTK	RT	SCPDRW	TD	TOTSS	TVR_V	VTK	
				•	•						•	

Construction and Finish Upgrades

APC	FB	MIP	MSLFB	WLI
•	•	•	•	•

Door Options

CG	DPSRR

BASE BUILT-IN MICROWAVE CABINET with DEEP DRAWER

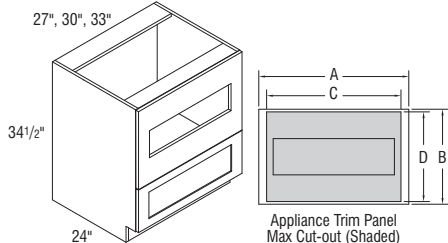

BBMWD27DD	16.1
BBMWD30DD	17.7
BBMWD33DD	19.6

- Standard interior.
- Drawer box is 6 3/8" high with a 10 5/8" high drawer front.
- For built-in appliance support in 24" deep cabinets, a kit is included (not factory installed) with a support shelf, unfinished plywood strips, and mounting screws for field mounting installation. Kit can be trimmed for when cabinet depth is modified.
- See page 73 for specifications on appliance cabinet trim panels.

	A Panel Width	B Panel Height	C Cut-out Width		D Cut-out Height		Drawer Front Height
			Min.	Max.	Min.	Max.	
BBMWD27DD	26 27/32"	19"	21 3/32"	23 27/32"	7 1/4"	17 15/16"	10 5/8"
BBMWD30DD	29 27/32"	19"	24 3/32"	26 27/32"	7 1/4"	17 15/16"	10 5/8"
BBMWD33DD	32 27/32"	19"	27 3/32"	29 27/32"	7 1/4"	17 15/16"	10 5/8"

Custom Modifications

CBO	CCO	CFP	CMAT	CND	DRT	DRWPWR	DRWTK	EXBK	FD	FTK	FTK_V	ID
•	•						•	•		•	•	
INVFRM	LTI	P	PTOWB	RD	RECTK	RT	SCPDRW	TD	TOTSS	TVR_V	VTK	
				•	•						•	

Construction and Finish Upgrades

APC	FB	MIP	MSLFB	WLI
•	•	•	•	•

Door Options

CG	DPSRR

BASE MICROWAVE CABINET with DEEP DRAWER

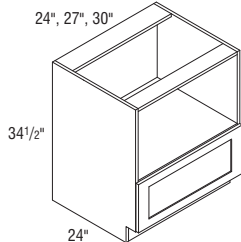

BMWD24DD	14.4
BMWD27DD	16.1
BMWD30DD	17.7

- Matching Interior Plywood (MIP) standard.
- Designed for use with stand-alone/countertop microwaves.
- Drawer box is 6 3/8" high with an 11 5/8" high drawer front.

Custom Modifications

CBO	CCO	CFP	CMAT	CND	DRT	DRWPWR	DRWTK	EXBK	FD	FTK	FTK_V	ID
•	•						•	•		•	•	
INVFRM	LTI	P	PTOWB	RD	RECTK	RT	SCPDRW	TD	TOTSS	TVR_V	VTK	
				•	•						•	

Construction and Finish Upgrades

APC	FB	MIP	MSLFB	WLI
		STD	•	

Door Options

CG	DPSRR

BASE OPEN CABINET with PLAIN BACK

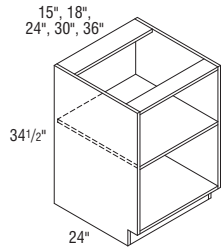

Model	Cubic Feet
BOCP15	9.4
BOCP18	11.0
BOCP24	14.3
BOCP30	17.6
BOCP36	20.9

- Matching Interior Plywood (MIP) standard.
- If ordered with Heirloom Technique, will not feature sand-through characteristics.
- To change the top rail valance, specify one of the following modifications: Arch (TVRAV), Furniture (TVRFV), or Straight Valance (TVRVV).

Custom Modifications

CBO	CCO	CFP	CMAT	CND	DRT	DRWPWR	DRWTK	EXBK	FD	FTK	FTK_V	ID
STD							•*	•	STD	•	•	•
INVFRM	LTI	P	PTOWB	RD	RECTK	RT	SCPDRW	TD	TOTSS	TVR_V	VTK	
		•+		•	•					•	•	

*Not available on 15" wide *Not available on 30" and 36" wide

Construction and Finish Upgrades

APC	FB	MIP	MSLFB	WLI
		STD	•	

Door Options

CG	DPSRR

BASE OPEN CABINET with BEADED BACK

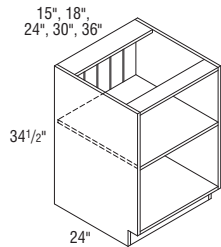

BOCB15	9.4
BOCB18	11.0
BOCB24	14.3
BOCB30	17.6
BOCB36	20.9

- Matching Interior Plywood (MIP) standard.
- Beaded back panel is veneer on furniture board core.
- If ordered with Heirloom Technique, will not feature sand-through characteristics.
- To change the top rail valance, specify one of the following modifications: Arch (TVRAV), Furniture (TVRFV), or Straight Valance (TVRVV).

Custom Modifications

CBO	CCO	CFP	CMAT	CND	DRT	DRWPWR	DRWTK	EXBK	FD	FTK	FTK_V	ID
STD							•*	•	STD	•	•	•
INVFRM	LTI	P	PTOWB	RD	RECTK	RT	SCPDRW	TD	TOTSS	TVR_V	VTK	
		•+		•	•					•	•	

*Not available on 15" wide *Not available on 30" and 36" wide

Construction and Finish Upgrades

APC	FB	MIP	MSLFB	WLI
		STD	•	

Door Options

CG	DPSRR

BASE OPEN CABINET with PLAIN BACK and DRAWER

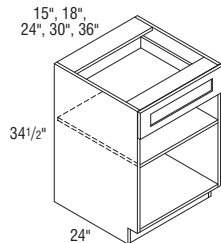

BODP15	9.4
BODP18	11.0
BODP24	14.3
BODP30	17.6
BODP36	20.9

- Matching Interior Plywood (MIP) standard.
- If ordered with Heirloom Technique, will not feature sand-through characteristics.
- To change the top rail valance, specify one of the following modifications: Arch (TVRAV), Furniture (TVRFV), or Straight Valance (TVRVV).

Custom Modifications

CBO	CCO	CFP	CMAT	CND	DRT	DRWPWR	DRWTK	EXBK	FD	FTK	FTK_V	ID
STD							•*	•*	•	STD	•	•
INVFRM	LTI	P	PTOWB	RD	RECTK	RT	SCPDRW	TD	TOTSS	TVR_V	VTK	
		•+		•	•		•			•	•	

*Not available on 15" wide *Not available on 30" and 36" wide

Construction and Finish Upgrades

APC	FB	MIP	MSLFB	WLI
		STD	•	

Door Options

CG	DPSRR

BASE OPEN CABINET with BEADED BACK and DRAWER

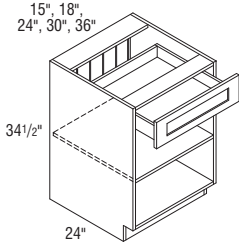

Model	Cubic Feet
BODB15	9.4
BODB18	11.0
BODB24	14.3
BODB30	17.6
BODB36	20.9

- Matching Interior Plywood (MIP) standard.
- Beaded back panel is veneer on furniture board core.
- If ordered with Heirloom Technique, will not feature sand-through characteristics.
- To change the top rail valance, specify one of the following modifications: Arch (TVRAV), Furniture (TVRFV), or Straight Valance (TVRVV).

Custom Modifications

CBO	CCO	CFP	CMAT	CND	DRT	DRWPWR	DRWTK	EXBK	FD	FTK	FTK_V	ID
STD						•*	•*	•	STD	•	•	•
INVERM	LTI	P	PTOWB	RD	RECTK	RT	SCPDRW	TD	TOTSS	TVR_V	VTK	
		•*		•	•		•			•	•	

*Not available on 15" wide *Not available on 30" and 36" wide

Construction and Finish Upgrades

APC	FB	MIP	MSLFB	WLI
		STD		

Door Options

CG	DPSRR

KEMPER®

UNIVERSAL DESIGN NOMENCLATURE

All UD Cabinets are 32 1/2" high unless otherwise noted.
All UD Cabinets have an 8" high x 6" deep toekick.

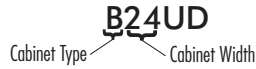

MODIFICATIONS GRID KEY

- Available Standard on these cabinets
- 5 Day Express Response Item

206

UNIVERSAL DESIGN CABINETS

CUSTOM MODIFICATIONS

Mod.	Description	Mod.	Description
CBO	Cabinet Box Only	EXBK	End Extended Back
CCO	Cabinet Case Only	FD	Full Depth Shelf
CFP	Cabinet False Panel	ID	Increased Depth
CMAT	CabMat™	LTI	Light Installed Battery Strip
CND	Cabinet with No Door, with Drawer	RD	Reduced Depth
DRT	Deep Roll Tray	RT	Installed Roll Tray
DRWPWR	PowerGlide™ Compact Drawer Outlet	SCPDRW	Scooped Drawer
		TOTSS	Tilt-out Tray, Stainless Steel
		VTK	Void Toekick

CONSTRUCTION AND FINISH UPGRADES

Mod.	Description
APC	All-plywood Construction
FB	Finished Ends
MIP	Matching Interior Plywood
MSLFB	Matching Specialty Laminate Furniture Board
WLI	White Laminate Interior

DOOR OPTIONS

Mod.	Description
DPSRR	Door Panel - Solid Reverse Raised

UNIVERSAL DESIGN BASE, SINGLE DOOR

12", 15", 18", 21"

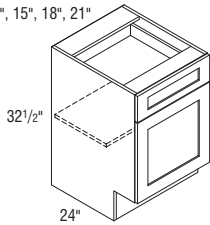

Model	Cubic Feet
B12UD L or R	6.7
B15UD L or R	8.2
B18UD L or R	9.7
B21UD L or R	12.7

- Adjustable 15" deep shelf.

Custom Modifications

CBO	CCO	CFP	CMAT	CND	DRT	DRWPWR	EXBK	FD	ID	LTI	RD	RT
•	•	•		•		•*	•	•			•	•
SCPDRW	TOTSS	VTK										
•		•										

*Not available on 12" and 15" wide

Construction and Finish Upgrades

APC	FB	MIP	MSLFB	WLI
•	•	•	•	•

Door Options

DPSRR
•

UNIVERSAL DESIGN BASE, DOUBLE DOOR

24", 30", 36"

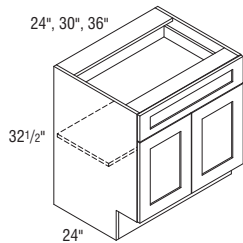

B24UD	14.2
B30UD	15.8
B36UD	16.8

- Adjustable 15" deep shelf.

Custom Modifications

CBO	CCO	CFP	CMAT	CND	DRT	DRWPWR	EXBK	FD	ID	LTI	RD	RT
•	•	•		•		•	•	•		•	•	•
SCPDRW	TOTSS	VTK										
•		•										

Construction and Finish Upgrades

APC	FB	MIP	MSLFB	WLI
•	•	•	•	•

Door Options

DPSRR
•

UNIVERSAL DESIGN BASE with ROLL TRAY, SINGLE DOOR

15", 18", 21"

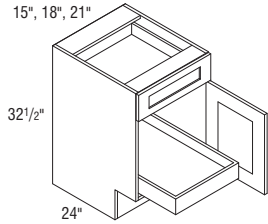

Model	Cubic Feet
B15RTUD L or R	8.2
B18RTUD L or R	9.7
B21RTUD L or R	12.7

- 1 roll tray standard.

Custom Modifications

CBO	CCO	CFP	CMAT	CND	DRT	DRWPWR	EXBK	FD	ID	LTI	RD	RT
•	•	•		•	•	•*	•				•	
SCPDRW	TOTSS	VTK										
•		•										

*Not available on 15" wide

Construction and Finish Upgrades

APC	FB	MIP	MSLFB	WLI
•	•	•	•	•

Door Options

DPSRR
•

UNIVERSAL DESIGN BASE with ROLL TRAY, DOUBLE DOOR

24", 30", 36"

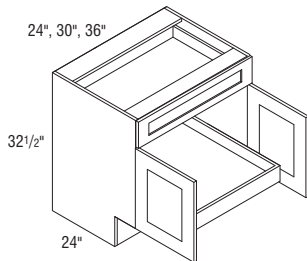

B24RTUD	14.2
B30RTUD	15.8
B36RTUD	16.8

- 1 roll tray standard.
- Top of drawer box is 2 1/8" from top of cabinet to accommodate installation of a cook top.

Custom Modifications

CBO	CCO	CFP	CMAT	CND	DRT	DRWPWR	EXBK	FD	ID	LTI	RD	RT
•	•	•		•	•	•	•				•	
SCPDRW	TOTSS	VTK										
•		•										

Construction and Finish Upgrades

APC	FB	MIP	MSLFB	WLI
•	•	•	•	•

Door Options

DPSRR
•

UNIVERSAL DESIGN SINK BASE

30", 36"

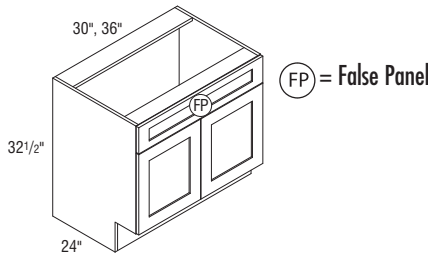

FP = False Panel

SB30UD	15.8
SB36UD	16.8

- Mini Touch-up Kit (MTUK) included. MTUK includes small touch-up marker and small fill stick.

Custom Modifications

CBO	CCO	CFP	CMAT	CND	DRT	DRWPWR	EXBK	FD	ID	LTI	RD	RT
•	•	STD	•	•			•	•		•	•	•
SCPDRW	TOTSS	VTK										
	•	•										

Construction and Finish Upgrades

APC	FB	MIP	MSLFB	WLI
•	•	•	•	•

Door Options

DPSRR
•

UNIVERSAL DESIGN SINK BASE with TILT-OUT TRAYS

30", 36"

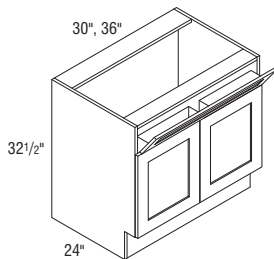

SB30STUD	15.8
SB36STUD	16.8

- Tilt-out trays are stain resistant, moisture resistant plastic to allow storage of sponges and other cleaning materials.
- Mini Touch-up Kit (MTUK) included. MTUK includes small touch-up marker and small fill stick.
- Includes two tilt-out trays.
- Tilt-out trays are also available as an accessory for field installation. See page 350.

Custom Modifications

CBO	CCO	CFP	CMAT	CND	DRT	DRWPWR	EXBK	FD	ID	LTI	RD	RT
	•		•				•			•	•	•
SCPDRW	TOTSS	VTK										
		•										

Construction and Finish Upgrades

APC	FB	MIP	MSLFB	WLI
•	•	•	•	•

Door Options

DPSRR
•

UNIVERSAL DESIGN SUPER LAZY SUSAN

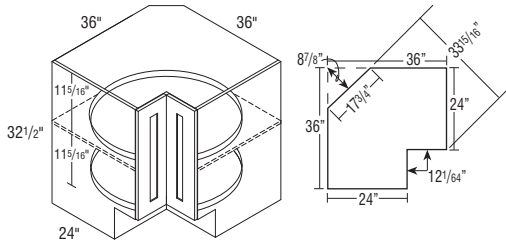

Due to fixed shelf mounting, shelves cannot be retrofitted.

Model	Cubic Feet
SLS36UD L or R	27.7

- SLS36UD L or R wall width is 36" x 36".
- Features two plywood revolving shelves with a 1" plywood lip. Lower shelf is mounted to floor. Upper shelf is mounted to fixed shelf. Fixed shelf is 5/8" thick.
- Decorative hardware screws must be countersunk to prevent scratching adjacent cabinets.
- Integrated soft-close hinge not included.

Custom Modifications

CBO	CCO	CFP	CMAT	CND	DRT	DRWPWR	EXBK	FD	ID	LTI	RD	RT
•	•									•		
SCPDRW	TOTSS	VTK										
		•										

Construction and Finish Upgrades

APC	FB	MIP	MSLFB	WLI
•	•	•	•	•

Door Options

DPSRR
•

UNIVERSAL DESIGN THREE DRAWER BASE

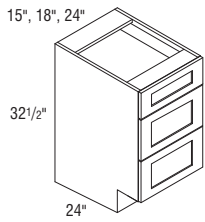

3DB15UD	8.2
3DB18UD	9.7
3DB24UD	14.2

- Exterior height of bottom 2 drawer boxes is 6 3/8".

Custom Modifications

CBO	CCO	CFP	CMAT	CND	DRT	DRWPWR	EXBK	FD	ID	LTI	RD	RT
•	•					•*	•				•	
SCPDRW	TOTSS	VTK										
•		•										

*Not available on 15" wide

Construction and Finish Upgrades

APC	FB	MIP	MSLFB	WLI
•	•	•	•	

Door Options

DPSRR

UNIVERSAL DESIGN BASE MICROWAVE

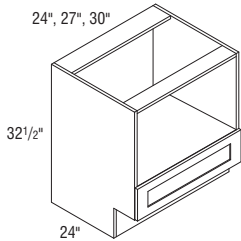

BMW24UD	14.2
BMW27UD	15.7
BMW30UD	15.8

- Drawer box is 3 3/8" high with a 6 1/4" high drawer front.
- Matching Interior Plywood (MIP) standard.
- Designed for use with stand-alone/countertop microwaves.

Custom Modifications

CBO	CCO	CFP	CMAT	CND	DRT	DRWPWR	EXBK	FD	ID	LTI	RD	RT
•	•						•				•	
SCPDRW	TOTSS	VTK										
		•										

Construction and Finish Upgrades

APC	FB	MIP	MSLFB	WLI
		STD	•	

Door Options

DPSRR

UNIVERSAL DESIGN BASE BUILT-IN MICROWAVE

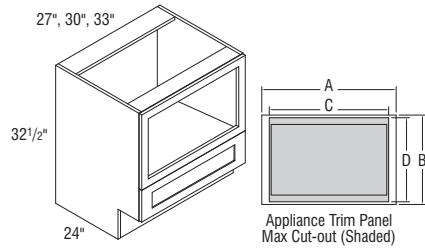

Model	Cubic Feet
BBMW27UD	15.0
BBMW30UD	15.8
BBMW33UD	16.8

- Standard interior.
- Drawer box is 3 3/8" high with a 6 1/4" high drawer front.
- For built-in appliance support in 24" deep cabinets, a kit is included (not factory installed) with a support shelf, unfinished plywood strips, and mounting screws for field mounting installation. Kit can be trimmed for when cabinet depth is modified.
- See page 73 for specifications on appliance cabinet trim panels.

	A Panel Width	B Panel Height	C Cut-out Width		D Cut-out Height		Drawer Front Height
			Min.	Max.	Min.	Max.	
BBMW27UD	26 27/32"	17 7/8"	21 3/32"	23 27/32"	6 1/8"	16 13/16"	6 1/4"
BBMW30UD	29 27/32"	17 7/8"	24 3/32"	26 27/32"	6 1/8"	16 13/16"	6 1/4"
BBMW33UD	32 27/32"	17 7/8"	27 3/32"	29 27/32"	6 1/8"	16 13/16"	6 1/4"

Custom Modifications

CBO	CCO	CFP	CMAT	CND	DRT	DRWPWR	EXBK	FD	ID	LTI	RD	RT
•	•						•				•	
SCPDRW	TOTSS	VTK										
		•										

Construction and Finish Upgrades

APC	FB	MIP	MSLFB	WLI
•	•	•	•	

Door Options

DPSRR

UNIVERSAL DESIGN SINGLE OVEN CABINET, 84" TALL, 24" DEEP

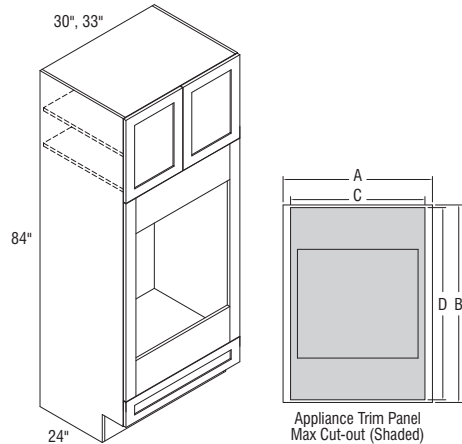

OC308424UD	41.8
OC338424UD	45.2

- Two full depth adjustable shelves are included.
- Be sure to confirm a heat shield is built into your appliance by the manufacturer or install the heat shield included with your appliance. Heat shields are sold separately as an accessory.
- For built-in appliance support in 24" deep cabinets, a kit is included (not factory installed) with a support shelf, unfinished plywood strips, and mounting screws for field mounting installation. Kit can be trimmed for when cabinet depth is modified.
- See page 73 for specifications on appliance cabinet trim panels.

	A Panel Width	B Panel Height	C Cut-out Width		D Cut-out Height		Door Height	Door Front Height
			Min.	Max.	Min.	Max.		
OC308424UD	29 27/32"	39 1/2"	24 3/32"	26 27/32"	21 3/4"	38 7/16"	29 3/4"	6 1/4"
OC338424UD	32 27/32"	39 1/2"	27 3/32"	29 27/32"	21 3/4"	38 7/16"	29 3/4"	6 1/4"

Custom Modifications

CBO	CCO	CFP	CMAT	CND	DRT	DRWPWR	EXBK	FD	ID	LTI	RD	RT
•	•			•			•		•		•	
SCPDRW	TOTSS	VTK										
		•										

Construction and Finish Upgrades

APC	FB	MIP	MSLFB	WLI
•	•	•	•	•

Door Options

DPSRR
•

UNIVERSAL DESIGN FILLER

3" and 6" Wide Fillers

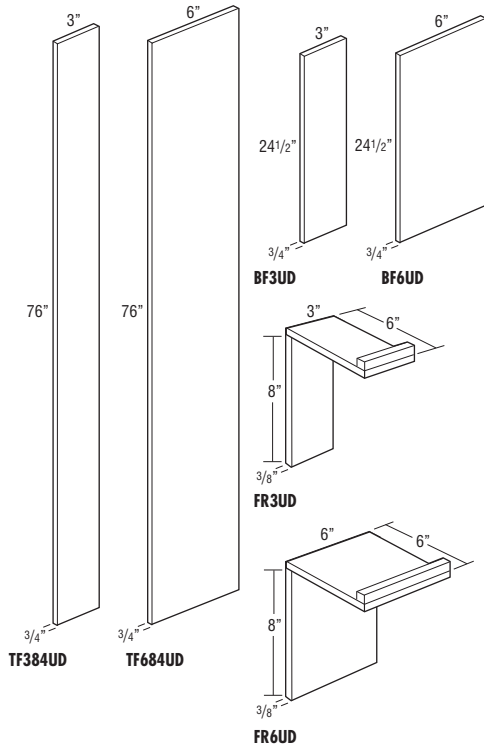

Model	Cubic Feet
BF3UD	—
TF384UD	—
FR3UD	—
BF6UD	—
TF684UD	—
FR6UD	—

• FR3UD and FR6UD are 3/8" thick, Natural Maple laminated furniture board, used to create a toekick appearance when used with fillers.

MODIFICATIONS
No modifications available for these products.

Finish Techniques	
Distressing	Heirlooming
•▲	

*Not available on FR3UD and FR6UD

Species Availability (Wood)

Alder	Rustic Alder	Cherry	Hickory	Rustic Hickory	Maple	Oak
•*	•*	•*	•*	•*	•*	•*

*FR3UD and FR6UD only available in Natural Maple laminate

Species Availability (All Laminates)

High Gloss box color	Horiz. Grain on Maple box color	Vert. Grain on Maple box color	Vert. Grain on Cherry box color	Vert. Grain on Hickory box color	Vert. Grain on Oak box color	Thermofoil box color

UNIVERSAL DESIGN VANITY DESK LEG

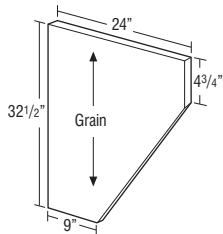

Model	Cubic Feet
VDLUDWD	—

- VDLUDWD in Stains: 3/4" thick veneered furniture board.
- VDLUDWD in Paints: 3/4" thick veneered or solid furniture board.
- All panels are finished two sides and front edge.

MODIFICATIONS
No modifications available for these products.

Finish Techniques	
Distressing	Heirlooming

Species Availability (Wood)

Alder	Rustic Alder	Cherry	Hickory	Rustic Hickory	Maple	Oak
•	•	•	•	•	•	•

Species Availability (All Laminates)

High Gloss box color	Horiz. Grain on Maple box color	Vert. Grain on Maple box color	Vert. Grain on Cherry box color	Vert. Grain on Hickory box color	Vert. Grain on Oak box color	Thermofoil box color

UNIVERSAL DESIGN TOEBOARD

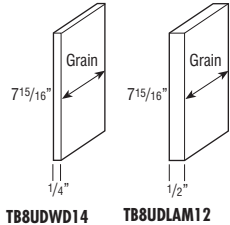

Model	Cubic Feet
TB8UDWD14	—
TB8UDLAM12	—

- TB8UDWD14 in Stains: 1/4" thick veneered furniture board, one 8' section.
- TB8UDWD14 in Paints: 1/4" thick veneered or solid furniture board, one 8' section.
- TB8UDLAM12 is 1/2" White laminated hardboard, one 8' section.

MODIFICATIONS
No modifications available for these products.

Finish Techniques	
Distressing	Heirlooming

Species Availability (Wood)

Alder	Rustic Alder	Cherry	Hickory	Rustic Hickory	Maple	Oak
•*	•*	•*	•*	•*	•*	•*

*Laminate panels only available in White

Species Availability (All Laminates)

High Gloss box color	Horiz. Grain on Maple box color	Vert. Grain on Maple box color	Vert. Grain on Cherry box color	Vert. Grain on Hickory box color	Vert. Grain on Oak box color	Thermofoil box color

TALL CABINET NOMENCLATURE

Cabinet nomenclature with AH represents upper sections with doors that align with 24" or 27" high cabinets.

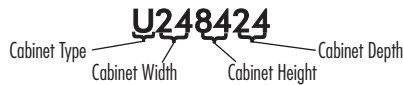

NOTE:

Any included shelves in tall cabinets are packaged separately. A fixed shelf separates upper and lower sections (not shown on drawings). Adjustable shelves vary based on cabinet height (see drawings and notes for details).

MODIFICATIONS GRID KEY

- Available
- STD Standard on these cabinets
- storage Storage Solutions Organization Cabinet

CUSTOM MODIFICATIONS

Mod.	Description	Mod.	Description
ADDTK	Add Toekick	ID	Increased Depth
CBO	Cabinet Box Only	INVERM	Inverted Opening
CCO	Cabinet Case Only	RD	Reduced Depth
CND	Cabinet with No Door, with Drawer	RECTK	Recessed Toekick
DRT	Deep Roll Tray	RT	Installed Roll Tray
DRWTK	Toekick Drawer	TD	Tray Dividers
EXBK	End Extended Back	TKP	Loose Toekick
FTK	Flush Toekick	VTK	Void Toekick
FTK_V	Flush Toekick w/Valance		

CONSTRUCTION AND FINISH UPGRADES

Mod.	Description
APC	All-plywood Construction
FB	Finished Ends
MIP	Matching Interior Plywood
MSLFB	Matching Specialty Laminate Furniture Board
WLI	White Laminate Interior

DOOR OPTIONS

Mod.	Description
CG.TOP	Cur-For-glass Doors
DPSRR	Door Panel - Solid Reverse Raised

UTILITY, 84", 87", 90", 93", or 96" TALL, 12" DEEP

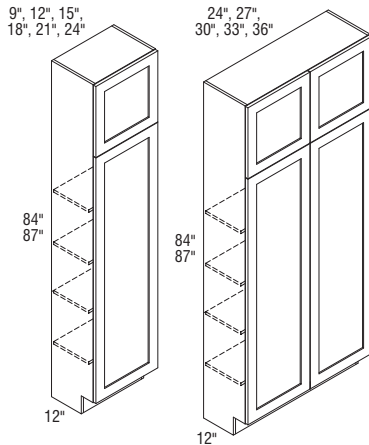

Model	Cubic Feet
U98412 L or R	7.5
U128412 L or R	9.7
U158412 L or R	11.8
U188412 L or R	14.0
U218412 L or R	16.1
U248412 L or R	18.3
U248412	18.3
U278412	20.4
U308412	22.6
U338412	24.8
U368412	26.9

Model	Cubic Feet
U98712 L or R	7.8
U128712 L or R	10.0
U158712 L or R	12.3
U188712 L or R	14.5
U218712 L or R	16.7
U248712 L or R	18.9
U248712	18.9
U278712	21.2
U308712	23.4
U338712	25.6
U368712	27.8

- Utility cabinets with depths of 12" or less must be installed to wall studs or onto the end of another tall cabinet.
- Depth can be reduced to a minimum of 6". For depths of 6"-8", cabinet will not include toekick/pedestal.
- Tall non-mitered doors will have two center panels with cross rail.
- Troxel doors greater than 48" high will be two doors doweled together.

- Utility cabinets with depths of 12" or less must be installed to wall studs or onto the end of another tall cabinet.
- Depth can be reduced to a minimum of 6". For depths of 6"-8", cabinet will not include toekick/pedestal.
- Tall non-mitered doors will have two center panels with cross rail.
- Troxel doors greater than 48" high will be two doors doweled together.

Custom Modifications

ADDTK	CBO	CCO	CND	DRT	DRWTK	EXBK	FTK	FTK_V
	•	•				•	•	•*
ID	INVERM	RD	RECTK	RT	TD	TKP	VTK	
	•	•	•		•	•	•	

*Not available on 9" and 12" wide

Construction and Finish Upgrades

APC	FB	MIP	MSLFB	WLI
•	•	•	•	•

Door Options

CG.TOP	DPSRR
•	•

UTILITY, 84", 87", 90", 93", or 96" TALL, 12" DEEP (cont'd)

9", 12", 15",
18", 21", 24"

24", 27",
30", 33", 36"

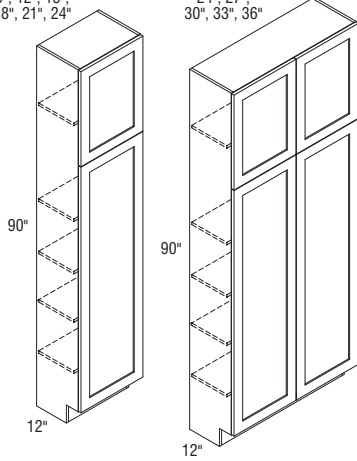

Model	Cubic Feet
U99012AH L or R	8.1
U129012AH L or R	10.4
U159012AH L or R	12.7
U189012AH L or R	15.0
U219012AH L or R	17.3
U249012AH L or R	19.6
U249012AH	19.6
U279012AH	21.9
U309012AH	24.2
U339012AH	26.5
U369012AH	28.8

- AH represents upper section alignment with doors on 24" or 27" high cabinets.
- Utility cabinets with depths of 12" or less must be installed to wall studs or onto the end of another tall cabinet.
- Depth can be reduced to a minimum of 6". For depths of 6"-8", cabinet will not include toekick/pedestal.
- Tall non-mitered doors will have two center panels with cross rail.
- Troxel doors greater than 48" high will be two doors doweled together.

Custom Modifications

ADDTK	CBO	CCO	CND	DRT	DRWTK	EXBK	FTK	FTK_V
	•	•				•	•	•*
ID	INVFRM	RD	RECTK	RT	TD	TKP	VTK	
	•	•	•		•	•	•	

*Not available on 9" and 12" wide

Construction and Finish Upgrades

APC	FB	MIP	MSLFB	WLI
•	•	•	•	•

Door Options

CG.TOP	DPSRR
•	•

UTILITY, 84", 87", 90", 93", or 96" TALL, 12" DEEP (cont'd)

9", 12", 15",
18", 21", 24"

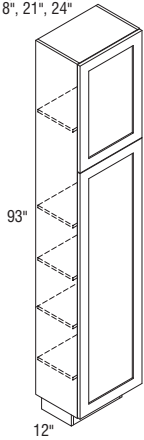

24", 27",
30", 33", 36"

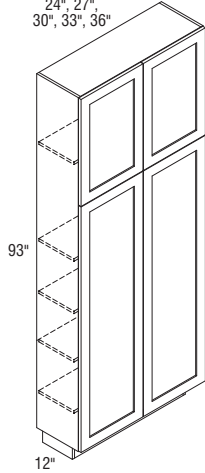

9", 12", 15",
18", 21", 24"

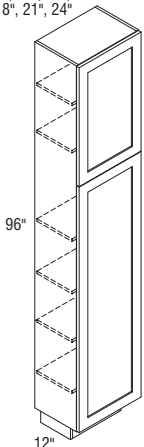

24", 27",
30", 33", 36"

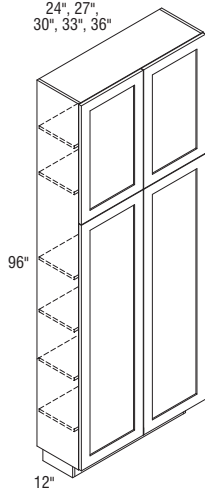

Model	Cubic Feet
U99312AH L or R	8.3
U129312AH L or R	10.7
U159312AH L or R	13.1
U189312AH L or R	15.5
U219312AH L or R	17.8
U249312AH L or R	20.2
U249312AH	20.2
U279312AH	22.6
U309312AH	25.0
U339312AH	27.4
U369312AH	29.7

Model	Cubic Feet
U99612 L or R	8.6
U129612 L or R	11.0
U159612 L or R	13.5
U189612 L or R	16.0
U219612 L or R	18.4
U249612 L or R	20.9
U249612	20.9
U279612	23.3
U309612	25.8
U339612	28.2
U369612	30.7

- AH represents upper section alignment with doors on 24" or 27" high cabinets.
- Separate pedestal base included but packaged separately on 93" tall. Pedestal is designed to create a Recessed Left or Right Toekick application during field installation, or can be centered. Pedestal must be covered with toeboard material.
- Utility cabinets with depths of 12" or less must be installed to wall studs or onto the end of another tall cabinet.
- Depth can be reduced to a minimum of 6". For depths of 6"-8", cabinet will not include toekick/pedestal.
- Tall non-mitered doors will have two center panels with cross rail.
- Troxel doors greater than 48" high will be two doors doweled together.

- Separate pedestal base included but packaged separately on 96" tall. Pedestal is designed to create a Recessed Left or Right Toekick application during field installation, or can be centered. Pedestal must be covered with toeboard material.
- Utility cabinets with depths of 12" or less must be installed to wall studs or onto the end of another tall cabinet.
- Depth can be reduced to a minimum of 6". For depths of 6"-8", cabinet will not include toekick/pedestal.
- Tall non-mitered doors will have two center panels with cross rail.
- Troxel doors greater than 48" high will be two doors doweled together.

Custom Modifications

ADDTK	CBO	CCO	CND	DRT	DRWTK	EXBK	FTK	FTK_V
	•	•				•		
ID	INVERM	RD	RECTK	RT	TD	TKP	VTK	
	•	•	•		•			

Construction and Finish Upgrades

APC	FB	MIP	MSLFB	WLI
•	•	•	•	•

Door Options

CG.TOP	DPSRR
•	•

UTILITY, 84", 87", 90", 93", or 96" TALL, 24" DEEP

9", 12", 15", 18", 21", 24"

24", 27", 30", 33", 36"

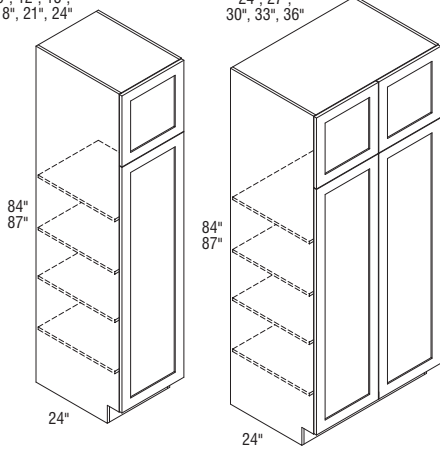

Model	Cubic Feet
U98424 L or R	13.8
U128424 L or R	17.7
U158424 L or R	21.6
U188424 L or R	25.6
U218424 L or R	29.5
U248424 L or R	33.4
U248424	33.4
U278424	37.4
U308424	41.3
U338424	45.2
U368424	49.2

Model	Cubic Feet
U98724 L or R	14.3
U128724 L or R	18.3
U158724 L or R	22.4
U188724 L or R	26.5
U218724 L or R	30.5
U248724 L or R	34.6
U248724	34.6
U278724	38.7
U308724	42.8
U338724	46.8
U368724	50.9

- Depth can be reduced to a minimum of 6". For depths of 6"-8", cabinet will not include toekick/pedestal.
- Tall non-mitered doors will have two center panels with cross rail.
- Troxel doors greater than 48" high will be two doors doweled together.

- Depth can be reduced to a minimum of 6". For depths of 6"-8", cabinet will not include toekick/pedestal.
- Tall non-mitered doors will have two center panels with cross rail.
- Troxel doors greater than 48" high will be two doors doweled together.

Custom Modifications

ADDTK	CBO	CCO	CND	DRT	DRWTK	EXBK	FTK	FTK_V
	•	•			•*		•	•*
ID	INVFRM	RD	RECTK	RT	TD	TKP	VTK	
•	•	•	•	•▲	•	•	•	

*Not available on 9", 12", and 15" wide *Not available on 9" and 12" wide
▲Not available on 9" wide

Construction and Finish Upgrades

APC	FB	MIP	MSLFB	WLI
•	•	•	•	•

Door Options

CG.TOP	DPSRR
•	•

UTILITY, 84", 87", 90", 93", or 96" TALL, 24" DEEP (cont'd)

9", 12", 15", 18", 21", 24"

24", 27", 30", 33", 36"

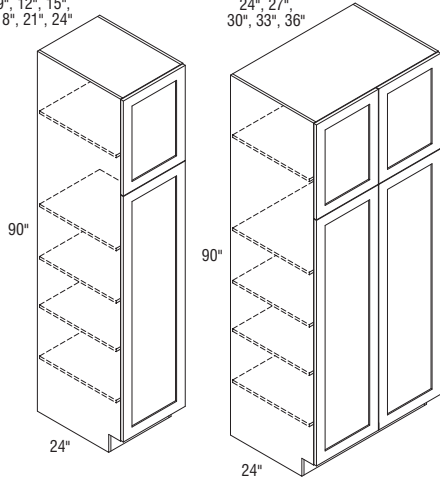

U99024AH L or R	14.7
U129024AH L or R	18.9
U159024AH L or R	23.2
U189024AH L or R	27.4
U219024AH L or R	31.6
U249024AH L or R	35.8
U249024AH	35.8
U279024AH	40.0
U309024AH	44.2
U339024AH	48.4
U369024AH	52.6

- AH represents upper section alignment with doors on 24" or 27" high cabinets.
- Depth can be reduced to a minimum of 6". For depths of 6"-8", cabinet will not include toekick/pedestal.
- Tall non-mitered doors will have two center panels with cross rail.
- Troxel doors greater than 48" high will be two doors doweled together.

Custom Modifications

ADDTK	CBO	CCO	CND	DRT	DRWTK	EXBK	FTK	FTK_V
	•	•			•*		•	•*
ID	INVFRM	RD	RECTK	RT	TD	TKP	VTK	
•	•	•	•	•▲	•	•	•	

*Not available on 9", 12", and 15" wide *Not available on 9" and 12" wide
▲Not available on 9" wide

Construction and Finish Upgrades

APC	FB	MIP	MSLFB	WLI
•	•	•	•	•

Door Options

CG.TOP	DPSRR
•	•

UTILITY, 84", 87", 90", 93", or 96" TALL, 24" DEEP (cont'd)

9", 12", 15", 18", 21", 24"

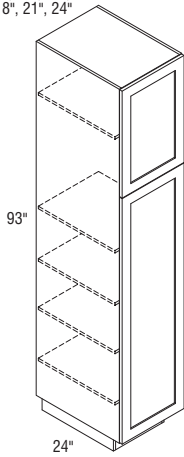

24", 27", 30", 33", 36"

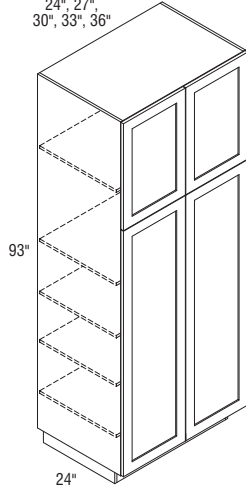

9", 12", 15", 18", 21", 24"

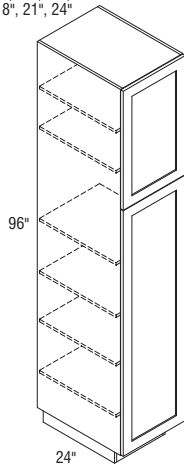

24", 27", 30", 33", 36"

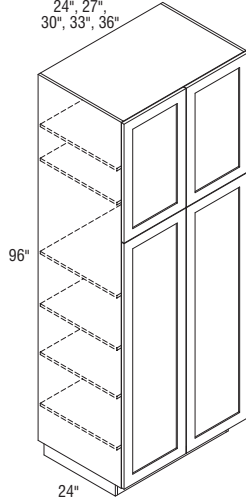

Model	Cubic Feet	Model	Cubic Feet
U99324AH L or R	15.2	U99624 L or R	15.7
U129324AH L or R	19.6	U129624 L or R	20.2
U159324AH L or R	23.9	U159624 L or R	24.7
U189324AH L or R	28.3	U189624 L or R	29.2
U219324AH L or R	32.6	U219624 L or R	33.6
U249324AH L or R	37.0	U249624 L or R	38.1
U249324AH	37.0	U249624	38.1
U279324AH	41.3	U279624	42.6
U309324AH	45.7	U309624	47.1
U339324AH	50.0	U339624	51.6
U369324AH	54.3	U369624	56.1

- AH represents upper section alignment with doors on 24" or 27" high cabinets.
- Separate pedestal base included but packaged separately on 93" tall. Pedestal is designed to create a Recessed Left or Right Toe Kick application during field installation, or can be centered. Pedestal must be covered with toeboard material.
- Depth can be reduced to a minimum of 6". For depths of 6"-8", cabinet will not include toe kick/pedestal.
- Tall non-mitered doors will have two center panels with cross rail.
- Troxel doors greater than 48" high will be two doors doweled together.

- Separate pedestal base included but packaged separately on 96" tall. Pedestal is designed to create a Recessed Left or Right Toe Kick application during field installation, or can be centered. Pedestal must be covered with toeboard material.
- Depth can be reduced to a minimum of 6". For depths of 6"-8", cabinet will not include toe kick/pedestal.
- Tall non-mitered doors will have two center panels with cross rail.
- Troxel doors greater than 48" high will be two doors doweled together.

Custom Modifications

ADDTK	CBO	CCO	CND	DRT	DRWTK	EXBK	FTK	FTK_V
	•	•				•		
ID	INVFRM	RD	RECTK	RT	TD	TKP	VTK	
•	•	•	•	•*	•			

*Not available on 9" wide

Construction and Finish Upgrades

APC	FB	MIP	MSLFB	WLI
•	•	•	•	•

Door Options

CG.TOP	DPSRR
•	•

UTILITY with ROLL TRAYS, 84", 87", 90", 93", or 96" TALL, 24" DEEP

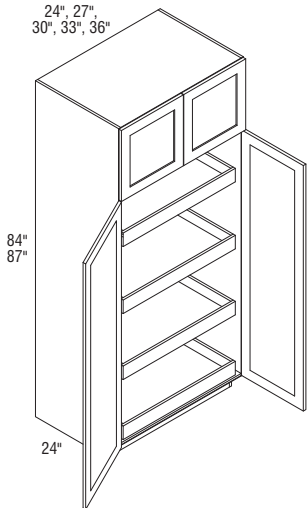
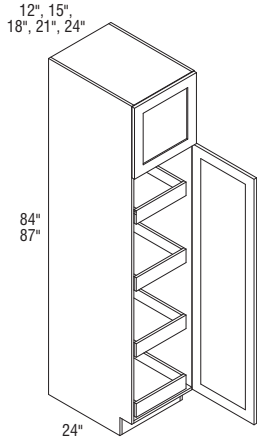

Model	Cubic Feet	Model	Cubic Feet
U128424RT L or R	16.2	U128724RT L or R	18.9
U158424RT L or R	21.6	U158724RT L or R	22.4
U188424RT L or R	25.6	U188724RT L or R	26.5
U218424RT L or R	29.5	U218724RT L or R	30.5
U248424RT L or R	33.4	U248724RT L or R	34.6
U248424RT	33.4	U248724RT	34.6
U278424RT	37.4	U278724RT	38.7
U308424RT	41.3	U308724RT	42.8
U338424RT	45.2	U338724RT	46.8
U368424RT	49.2	U368724RT	50.9

- Four roll trays are included, installed in cabinet.
- Depth can be reduced to a minimum of 12".
- Tall non-mitered doors will have two center panels with cross rail.
- Troxel doors greater than 48" high will be two doors doweled together.

- Four roll trays are included, installed in cabinet.
- Depth can be reduced to a minimum of 12".
- Tall non-mitered doors will have two center panels with cross rail.
- Troxel doors greater than 48" high will be two doors doweled together.

Custom Modifications

ADDTK	CBO	CCO	CND	DRT	DRWTK	EXBK	FTK	FTK_V
	•	•		•	•*	•	•	•
ID	INVFRM	RD	RECTK	RT	TD	TKP	VTK	
		•	•		•	•	•	

*Not available on 12" and 15" wide

Construction and Finish Upgrades

APC	FB	MIP	MSLFB	WLI
•	•	•	•	•

Door Options

CG.TOP	DPSRR
•	•

UTILITY with ROLL TRAYS, 84", 87", 90", 93", or 96" TALL, 24" DEEP (cont'd)

12", 15", 18", 21", 24"

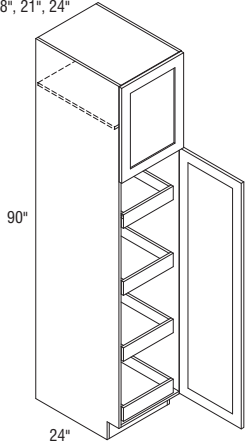

24"

24", 27", 30", 33", 36"

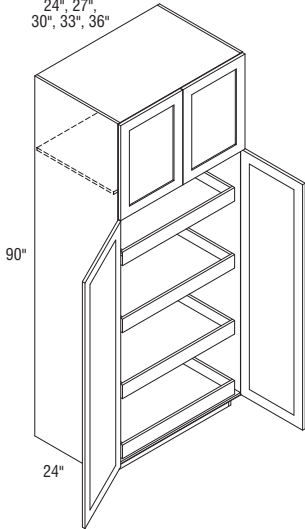

24"

Model	Cubic Feet
U129024RTAH L or R	17.3
U159024RTAH L or R	23.2
U189024RTAH L or R	27.4
U219024RTAH L or R	31.6
U249024RTAH L or R	35.8
U249024RTAH	35.8
U279024RTAH	40.0
U309024RTAH	44.2
U339024RTAH	48.4
U369024RTAH	52.6

- AH represents upper section alignment with doors on 24" or 27" high cabinets.
- Four roll trays are included, installed in cabinet.
- Depth can be reduced to a minimum of 12".
- Tall non-mitered doors will have two center panels with cross rail.
- Troxel doors greater than 48" high will be two doors doweled together.

Custom Modifications

ADDTK	CBO	CCO	CND	DRT	DRWTK	EXBK	FTK	FTK_V
	•	•		•	•*	•	•	•
ID	INVERM	RD	RECTK	RT	TD	TKP	VTK	
		•	•		•	•	•	

*Not available on 12" and 15" wide

Construction and Finish Upgrades

APC	FB	MIP	MSLFB	WLI
•	•	•	•	•

Door Options

CG.TOP	DPSRR
•	•

UTILITY with ROLL TRAYS, 84", 87", 90", 93", or 96" TALL, 24" DEEP (cont'd)

12", 15", 18", 21", 24"

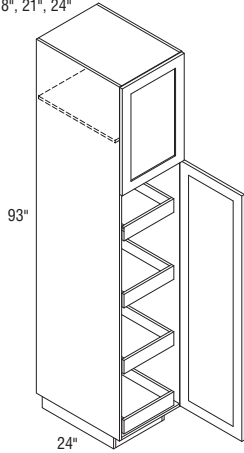

24", 27", 30", 33", 36"

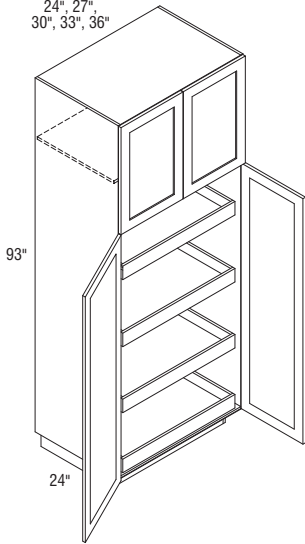

12", 15", 18", 21", 24"

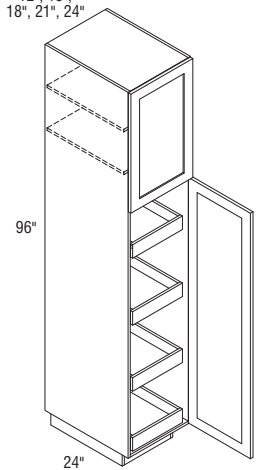

24", 27", 30", 33", 36"

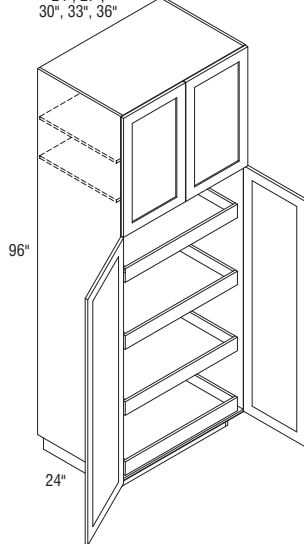

Model	Cubic Feet
U129324RTAH L or R	19.2
U159324RTAH L or R	23.9
U189324RTAH L or R	28.3
U219324RTAH L or R	32.6
U249324RTAH L or R	37.0
U249324RTAH	37.0
U279324RTAH	41.3
U309324RTAH	45.7
U339324RTAH	50.0
U369324RTAH	54.3

Model	Cubic Feet
U129624RT L or R	18.5
U159624RT L or R	24.7
U189624RT L or R	29.2
U219624RT L or R	33.6
U249624RT L or R	38.1
U249624RT	38.1
U279624RT	42.6
U309624RT	47.1
U339624RT	51.6
U369624RT	56.1

- AH represents upper section alignment with doors on 24" or 27" high cabinets.
- Separate pedestal base included but packaged separately on 93" tall. Pedestal is designed to create a Recessed Left or Right Toekick application during field installation, or can be centered. Pedestal must be covered with toeboard material.
- Four roll trays are included, installed in cabinet.
- Depth can be reduced to a minimum of 12".
- Tall non-mitered doors will have two center panels with cross rail.
- Troxel doors greater than 48" high will be two doors doweled together.

- Separate pedestal base included but packaged separately on 96" tall. Pedestal is designed to create a Recessed Left or Right Toekick application during field installation, or can be centered. Pedestal must be covered with toeboard material.
- Four roll trays are included, installed in cabinet.
- Depth can be reduced to a minimum of 12".
- Tall non-mitered doors will have two center panels with cross rail.
- Troxel doors greater than 48" high will be two doors doweled together.

Custom Modifications

ADDTK	CBO	CCO	CND	DRT	DRWTK	EXBK	FTK	FTK_V
	•	•		•		•		
ID	INVFRM	RD	RECTK	RT	TD	TKP	VTK	
		•	•*		•			

*Not available on 12" wide

Construction and Finish Upgrades

APC	FB	MIP	MSLFB	WLI
•	•	•	•	•

Door Options

CG.TOP	DPSRR
•	•

UTILITY EASY ACCESS, 84", 87", 90", 93", or 96" TALL, 12" DEEP

storage
SOLUTIONS

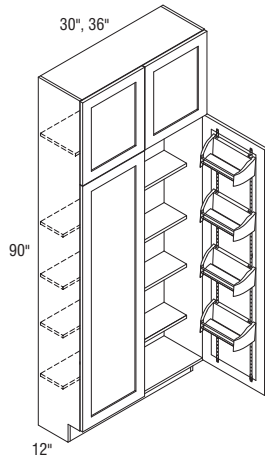
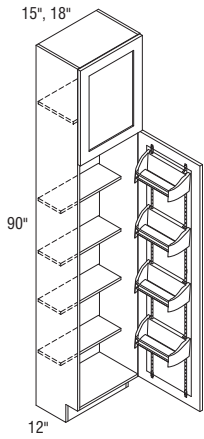
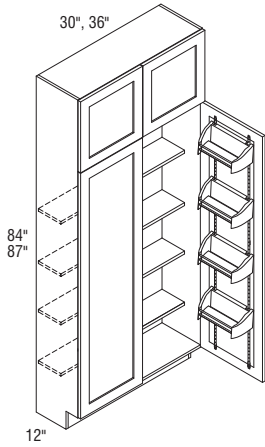
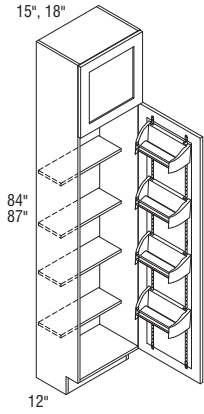

Model	Cubic Feet
UEAS158412 L or R	11.8
UEAS188412 L or R	14.0
UEAS158712 L or R	12.3
UEAS188712 L or R	14.5
UEAS308412	22.6
UEAS368412	26.9
UEAS308712	23.4
UEAS368712	27.8

Model	Cubic Feet
UEAS159012AH L or R	12.7
UEAS189012AH L or R	15.0
UEAS309012AH	24.2
UEAS369012AH	28.8

- Four chrome baskets featuring rail system for adjustability on each lower door.
- Four 6 1/2" reduced depth adjustable shelves are included.
- Utility cabinets with depths of 12" or less must be installed to wall studs or onto the end of another tall cabinet.
- Depth can be reduced to a minimum of 10".
- Tall non-mitered doors will have two center panels with cross rail.
- Troxel doors greater than 48" high will be two doors doweled together.

- AH represents upper section alignment with doors on 24" or 27" high cabinets.
- Four chrome baskets featuring rail system for adjustability on each lower door.
- Four 6 1/2" reduced depth adjustable shelves and one full depth adjustable shelf are included.
- Utility cabinets with depths of 12" or less must be installed to wall studs or onto the end of another tall cabinet.
- Depth can be reduced to a minimum of 10".
- Tall non-mitered doors will have two center panels with cross rail.
- Troxel doors greater than 48" high will be two doors doweled together.

Custom Modifications

ADDTK	CBO	CCO	CND	DRT	DRWTK	EXBK	FTK	FTK_V
	•	•				•	•	•
ID	INVERM	RD	RECTK	RT	TD	TKP	VTK	
		•	•		•	•	•	

Construction and Finish Upgrades

APC	FB	MIP	MSLFB	WLI
•	•	•	•	•

Door Options

CG.TOP	DPSRR
•	•

UTILITY EASY ACCESS, 84", 87", 90", 93", or 96" TALL, 12" DEEP (cont'd)

storage SOLUTIONS

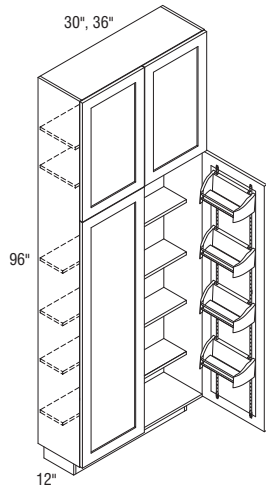
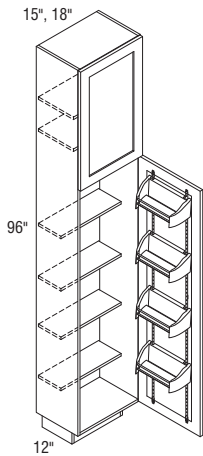
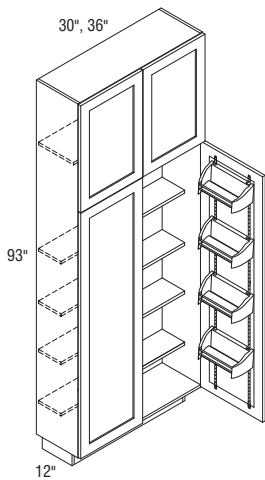
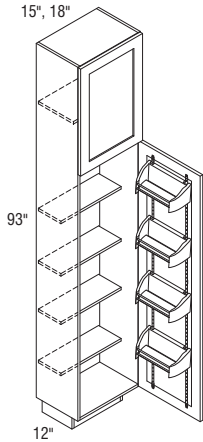

Model	Cubic Feet
UEAS159312AH L or R	13.1
UEAS189312AH L or R	15.5
UEAS309312AH	25.0
UEAS369312AH	29.7

- AH represents upper section alignment with doors on 24" or 27" high cabinets.
- Four chrome baskets featuring rail system for adjustability on each lower door.
- Separate pedestal base included but packaged separately on 93" tall. Pedestal is designed to create a Recessed Left or Right Toekick application during field installation, or can be centered. Pedestal must be covered with toeboard material.
- Four 6 1/2" reduced depth adjustable shelves are included.
- Utility cabinets with depths of 12" or less must be installed to wall studs or onto the end of another tall cabinet.
- Depth can be reduced to a minimum of 10".
- Tall non-mitered doors will have two center panels with cross rail.
- Troxel doors greater than 48" high will be two doors doweled together.

Model	Cubic Feet
UEAS159612 L or R	13.5
UEAS189612 L or R	16.0
UEAS309612	25.8
UEAS369612	30.7

- Four chrome baskets featuring rail system for adjustability on each lower door.
- Separate pedestal base included but packaged separately on 96" tall. Pedestal is designed to create a Recessed Left or Right Toekick application during field installation, or can be centered. Pedestal must be covered with toeboard material.
- Four 6 1/2" reduced depth adjustable shelves and two full depth adjustable shelves are included.
- Utility cabinets with depths of 12" or less must be installed to wall studs or onto the end of another tall cabinet.
- Depth can be reduced to a minimum of 10".
- Tall non-mitered doors will have two center panels with cross rail.
- Troxel doors greater than 48" high will be two doors doweled together.

Custom Modifications

ADDTK	CBO	CCO	CND	DRT	DRWTK	EXBK	FTK	FTK_V
	•	•				•		
ID	INVFRM	RD	RECTK	RT	TD	TKP	VTK	
		•	•		•			

Construction and Finish Upgrades

APC	FB	MIP	MSLFB	WLI
•	•	•	•	•

Door Options

CG.TOP	DPSRR
•	•

UTILITY EASY ACCESS, 84", 87", 90", 93", or 96" TALL, 24" DEEP

storage SOLUTIONS

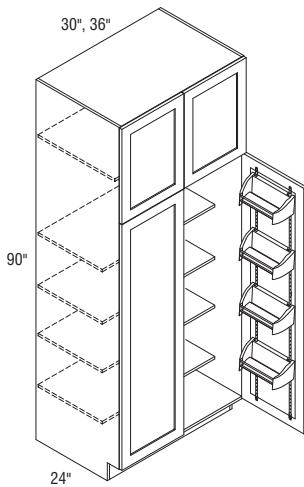
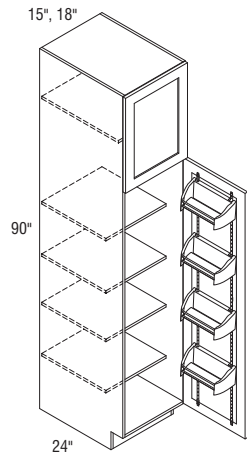
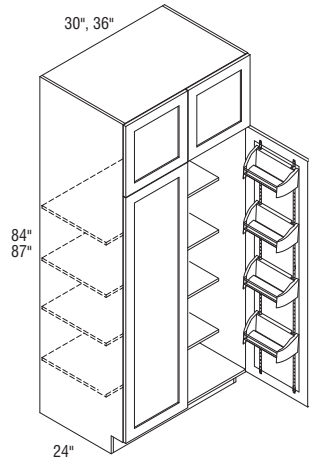
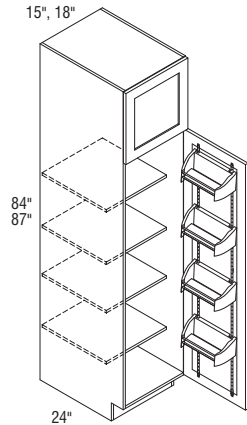

Model	Cubic Feet
UEAS158424 L or R	21.6
UEAS188424 L or R	25.6
UEAS158724 L or R	22.4
UEAS188724 L or R	26.5
UEAS308424	41.3
UEAS368424	49.2
UEAS308724	42.8
UEAS368724	50.9

- Four chrome baskets featuring rail system for adjustability on each lower door.
- Four 18 1/2" reduced depth adjustable shelves are included.
- Depth can be reduced to a minimum of 10".
- Tall non-mitered doors will have two center panels with cross rail.
- Troxel doors greater than 48" high will be two doors doweled together.

Custom Modifications

ADDTK	CBO	CCO	CND	DRT	DRWTK	EXBK	FTK	FTK_V
	•	•			•*	•	•	•
ID	INVFRM	RD	RECTK	RT	TD	TKP	VTK	
		•	•		•	•	•	

*Not available on 15" wide

Construction and Finish Upgrades

APC	FB	MIP	MSLFB	WLI
•	•	•	•	•

Door Options

CG.TOP	DPSRR
•	•

Model	Cubic Feet
UEAS159024AH L or R	23.2
UEAS189024AH L or R	27.4
UEAS309024AH	44.2
UEAS369024AH	52.6

- AH represents upper section alignment with doors on 24" or 27" high cabinets.
- Four chrome baskets featuring rail system for adjustability on each lower door.
- Four 18 1/2" reduced depth adjustable shelves and one full depth adjustable shelf are included.
- Utility cabinets with depths of 12" or less must be installed to wall studs or onto the end of another tall cabinet.
- Depth can be reduced to a minimum of 10".
- Tall non-mitered doors will have two center panels with cross rail.
- Troxel doors greater than 48" high will be two doors doweled together.

UTILITY EASY ACCESS, 84", 87", 90", 93", or 96" TALL, 24" DEEP (cont'd)

storage SOLUTIONS

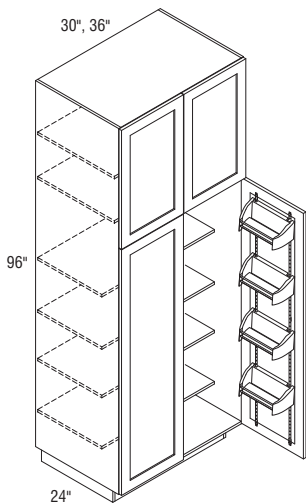
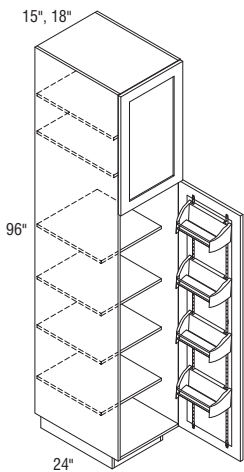
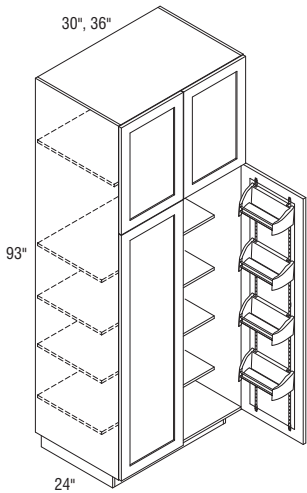
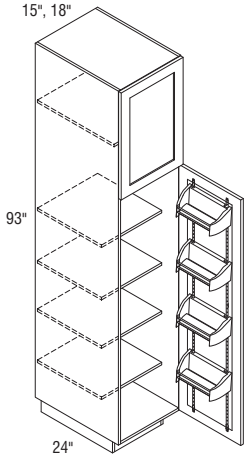

Model	Cubic Feet
UEAS159324AH L or R	23.9
UEAS189324AH L or R	28.3
UEAS309324AH	45.7
UEAS369324AH	54.3

Model	Cubic Feet
UEAS159624 L or R	24.7
UEAS189624 L or R	29.2
UEAS309624	47.1
UEAS369624	56.1

- AH represents upper section alignment with doors on 24" or 27" high cabinets.
- Four chrome baskets featuring rail system for adjustability on each lower door.
- Separate pedestal base included but packaged separately on 93" tall. Pedestal is designed to create a Recessed Left or Right Toekick application during field installation, or can be centered. Pedestal must be covered with toeboard material.
- Four 18 1/2" reduced depth adjustable shelves and one full depth adjustable shelf are included.
- Utility cabinets with depths of 12" or less must be installed to wall studs or onto the end of another tall cabinet.
- Depth can be reduced to a minimum of 10".
- Tall non-mitered doors will have two center panels with cross rail.
- Troxel doors greater than 48" high will be two doors doweled together.

- Four chrome baskets featuring rail system for adjustability on each lower door.
- Separate pedestal base included but packaged separately on 96" tall. Pedestal is designed to create a Recessed Left or Right Toekick application during field installation, or can be centered. Pedestal must be covered with toeboard material.
- Four 18 1/2" reduced depth adjustable shelves and two full depth adjustable shelves are included.
- Utility cabinets with depths of 12" or less must be installed to wall studs or onto the end of another tall cabinet.
- Depth can be reduced to a minimum of 10".
- Tall non-mitered doors will have two center panels with cross rail.
- Troxel doors greater than 48" high will be two doors doweled together.

Custom Modifications

ADDTK	CBO	CCO	CND	DRT	DRWTK	EXBK	FTK	FTK_V
	•	•				•		
ID	INVFRM	RD	RECTK	RT	TD	TKP	VTK	
		•	•		•			

Construction and Finish Upgrades

APC	FB	MIP	MSLFB	WLI
•	•	•	•	•

Door Options

CG.TOP	DPSRR
•	•

UTILITY ORGANIZER CABINET, 84", 87", 90", 93", or 96" TALL, 6" DEEP, 24" WIDE

storage SOLUTIONS

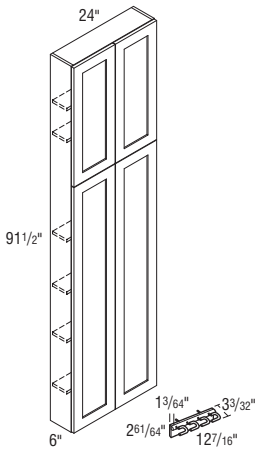
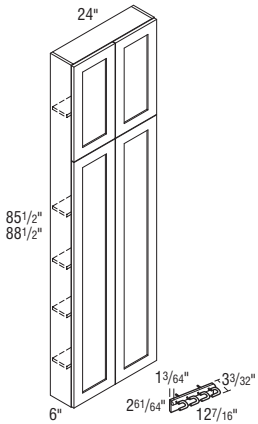
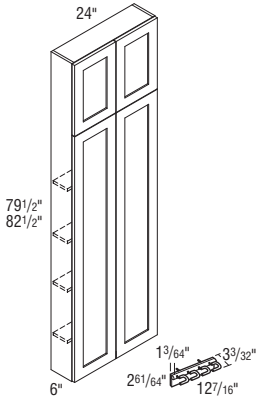

Model	Cubic Feet	Model	Cubic Feet
-------	------------	-------	------------

UOC24846	10.7
<ul style="list-style-type: none"> Includes four adjustable shelves and broom clip packaged separately (not installed). Designed to be installed onto an adjacent 24" deep tall cabinet. 6" overlay fillers can be used on the side to add a decorative touch. Utility cabinets with depths of 12" or less must be installed to wall studs or onto the end of another tall cabinet. Does not include toeboard or pedestal. Tall non-mitered doors will have two center panels with cross rail. Troxel doors greater than 48" high will be two doors doveled together. 	

UOC24876	11.1
<ul style="list-style-type: none"> Includes four adjustable shelves and broom clip packaged separately (not installed). Designed to be installed onto an adjacent 24" deep tall cabinet. 6" overlay fillers can be used on the side to add a decorative touch. Utility cabinets with depths of 12" or less must be installed to wall studs or onto the end of another tall cabinet. Does not include toeboard or pedestal. Tall non-mitered doors will have two center panels with cross rail. Troxel doors greater than 48" high will be two doors doveled together. 	

UOC24906AH	11.5
<ul style="list-style-type: none"> AH represents upper section alignment with doors on 24" or 27" high cabinets. Includes five adjustable shelves and broom clip packaged separately (not installed). Designed to be installed onto an adjacent 24" deep tall cabinet. 6" overlay fillers can be used on the side to add a decorative touch. Utility cabinets with depths of 12" or less must be installed to wall studs or onto the end of another tall cabinet. Does not include toeboard or pedestal. Tall non-mitered doors will have two center panels with cross rail. Troxel doors greater than 48" high will be two doors doveled together. 	

UOC24936AH	11.9
<ul style="list-style-type: none"> AH represents upper section alignment with doors on 24" or 27" high cabinets. Includes five adjustable shelves and broom clip packaged separately (not installed). Designed to be installed onto an adjacent 24" deep tall cabinet. 6" overlay fillers can be used on the side to add a decorative touch. Utility cabinets with depths of 12" or less must be installed to wall studs or onto the end of another tall cabinet. Does not include toeboard or pedestal. Tall non-mitered doors will have two center panels with cross rail. Troxel doors greater than 48" high will be two doors doveled together. 	

UOC24966	12.2
<ul style="list-style-type: none"> Includes six adjustable shelves and broom clip packaged separately (not installed). Designed to be installed onto an adjacent 24" deep tall cabinet. 6" overlay fillers can be used on the side to add a decorative touch. Utility cabinets with depths of 12" or less must be installed to wall studs or onto the end of another tall cabinet. Does not include toeboard or pedestal. Tall non-mitered doors will have two center panels with cross rail. Troxel doors greater than 48" high will be two doors doveled together. 	

Custom Modifications

ADDTK	CBO	CCO	CND	DRT	DRWTK	EXBK	FTK	FTK_V
	•	•						
ID	INVRM	RD	RECTK	RT	TD	TKP	VTK	
	•							

Construction and Finish Upgrades

APC	FB	MIP	MSLFB	WLI
•		•	•	•

Door Options

CG.TOP	DPSRR
•	•

UTILITY ORGANIZER DROP ZONE CABINET, 84", 87", 90", 93", or 96" HIGH, 9" DEEP, 24" WIDE

storage SOLUTIONS

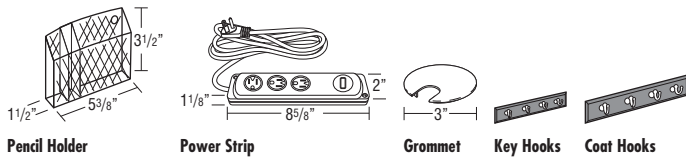
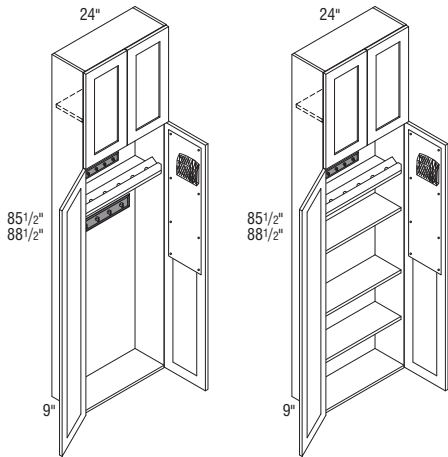
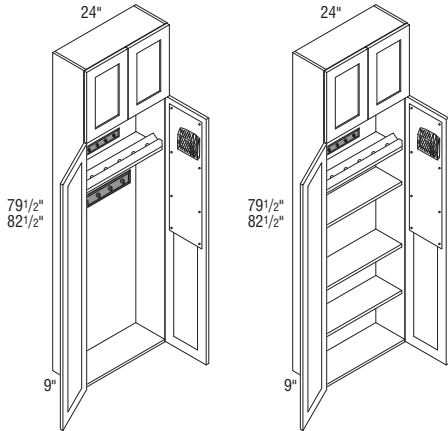

Model	Cubic Feet
UOCDZ24849	14.5
UOCDZ24879	15.0
UOCDZ24909	15.5
UOCDZ24939	16.0
UOCDZ24969	16.5

- Features magnetic whiteboards on back of lower doors, one magnetic black mesh pencil holder, charging station with power strip, black plastic grommet for power cord, key hooks, and coat hooks. Accessories are field installed.
- Charging station functions as an adjustable shelf, features five cord cut-out areas and includes a UL listed power strip with three standard 110-volt plug-ins and one USB charging port.
- One adjustable shelf in upper section on 90" and 93", two adjustable shelves for 96", and three adjustable shelves in lower section.
- Designed to be installed onto an adjacent 24" deep tall cabinet.
- Utility cabinets with depths of 12" or less must be installed to wall studs or onto the end of another tall cabinet.
- Does not include toeboard or pedestal.
- Tall non-mitered doors will have two center panels with cross rail.
- Troxel doors greater than 48" high will be two doors doweled together.

Custom Modifications

ADDTK	CBO	CCO	CND	DRT	DRWTK	EXBK	FTK	FTK_V
	•	•						
ID	INVFRM	RD	RECTK	RT	TD	TKP	VTK	

Construction and Finish Upgrades

APC	FB	MIP	MSLFB	WLI
•		•	•	•

Door Options

CG.TOP	DPSRR
•	•

**PANTRY TOP UNIT with SHELVES,
SINGLE DOOR, 24" DEEP**

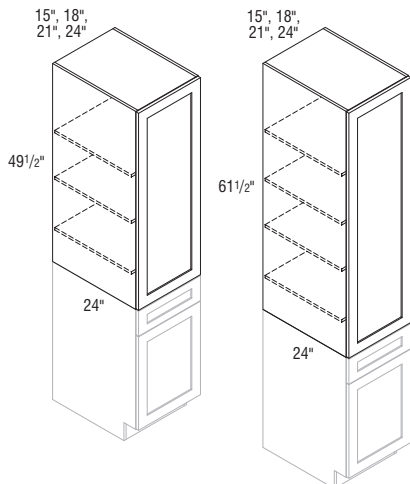

Model	Cubic Feet
PTUS154924 L or R	12.8
PTUS184924 L or R	15.1
PTUS214924 L or R	17.6
PTUS244924 L or R	19.9
PTUS156124 L or R	15.9
PTUS186124 L or R	18.8
PTUS216124 L or R	21.7
PTUS246124 L or R	24.6

- Three adjustable shelves included with 49 1/2" high, and four adjustable shelves included with 61 1/2" high.
- Sets on any 15", 18", 21", or 24" wide base (B15 shown). No countertop is needed.
- Can be reduced in depth to 6".
- If used on the end of a run, seam will be visible between stacked cabinets. A tall panel can be applied to the sides of the cabinets to hide seams.
- Tall non-mitered doors will have two center panels with cross rail.
- Troxel doors will be two doors doweled together.

Cabinet Height	Door Height
49 1/2"	49 1/4"
61 1/2"	61 1/4"

Custom Modifications

ADDTK	CBO	CCO	CND	DRT	DRWTK	EXBK	FTK	FTK_V
•	•	•				•		•
ID	INVFRM	RD	RECTK	RT	TD	TKP	VTK	
		•						

Construction and Finish Upgrades

APC	FB	MIP	MSLFB	WLI
•	•	•	•	•

Door Options

CG.TOP	DPSRR
	•

**PANTRY TOP UNIT with SHELVES,
DOUBLE DOOR, 24" DEEP**

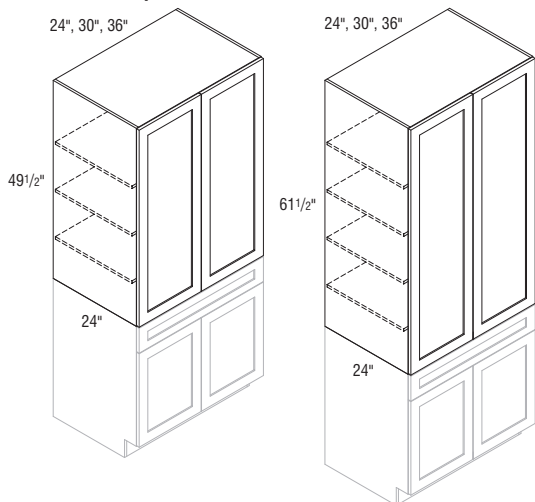

PTUS244924	19.9
PTUS304924	24.4
PTUS364924	29.0
PTUS246124	24.6
PTUS306124	30.2
PTUS366124	35.9

- Three adjustable shelves included with 49 1/2" high, and four adjustable shelves included with 61 1/2" high.
- Sets on any 24", 30", or 36" wide base (B30 shown). No countertop is needed.
- Can be reduced in depth to 6".
- If used on the end of a run, seam will be visible between stacked cabinets. A tall panel can be applied to the sides of the cabinets to hide seams.
- Tall non-mitered doors will have two center panels with cross rail.
- Troxel doors will be two doors doweled together.

Cabinet Height	Door Height
49 1/2"	49 1/4"
61 1/2"	61 1/4"

Custom Modifications

ADDTK	CBO	CCO	CND	DRT	DRWTK	EXBK	FTK	FTK_V
•	•	•				•		•
ID	INVFRM	RD	RECTK	RT	TD	TKP	VTK	
		•						

Construction and Finish Upgrades

APC	FB	MIP	MSLFB	WLI
•	•	•	•	•

Door Options

CG.TOP	DPSRR
	•

**PANTRY TOP UNIT, SINGLE DOOR,
24" DEEP**

storage
SOLUTIONS

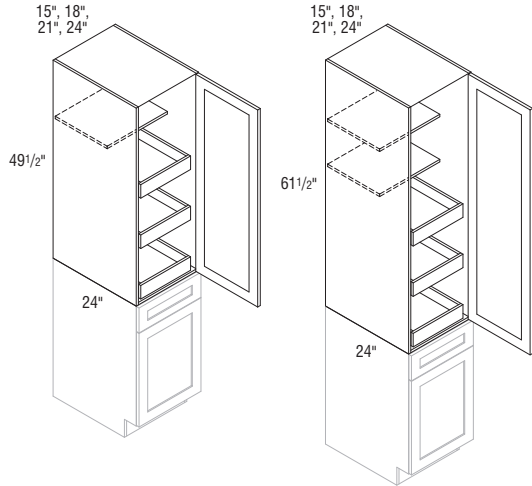

Model	Cubic Feet
PTU154924 L or R	12.8
PTU184924 L or R	15.1
PTU214924 L or R	17.6
PTU244924 L or R	19.9
PTU156124 L or R	15.9
PTU186124 L or R	18.8
PTU216124 L or R	21.7
PTU246124 L or R	24.6

- One 15" deep adjustable shelf included with 49 1/2" high, and two 15" deep adjustable shelves included with 61 1/2" high.
- Three roll trays are included, installed in cabinet.
- Sets on any 15", 18", 21", or 24" wide base (B15 shown). No countertop is needed.
- Can be reduced in depth to 12".
- If used on the end of a run, seam will be visible between stacked cabinets. A tall panel can be applied to the cabinet sides to conceal the seam.
- Tall non-mitered doors will have two center panels with cross rail.
- Troxel doors will be two doors doweled together.

Cabinet Height	Door Height
49 1/2"	49 1/4"
61 1/2"	61 1/4"

Custom Modifications

ADDTK	CBO	CCO	CND	DRT	DRWTK	EXBK	FTK	FTK_V
•	•	•		•		•		
ID	INVFRM	RD	RECTK	RT	TD	TKP	VTK	
		•						

Construction and Finish Upgrades

APC	FB	MIP	MSLFB	WLI
•	•	•	•	•

Door Options

CG.TOP	DPSRR
	•

PANTRY TOP UNIT, DOUBLE DOOR, 24" DEEP

storage SOLUTIONS

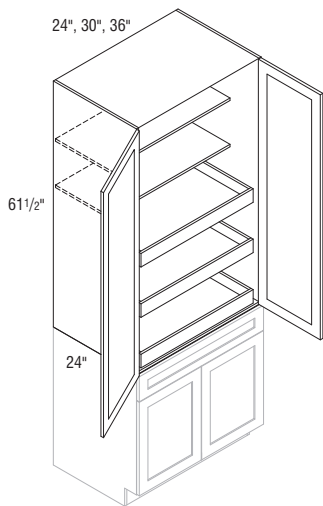
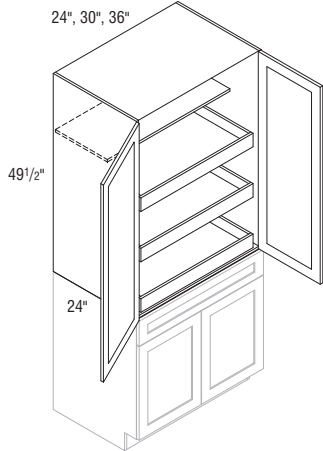

Model	Cubic Feet
PTU244924	19.9
PTU304924	24.4
PTU364924	29.0
PTU246124	24.6
PTU306124	30.2
PTU366124	35.9

- One 15" deep adjustable shelf included with 49 1/2" high, and two 15" deep adjustable shelves included with 61 1/2" high.
- Three roll trays are included, installed in cabinet.
- Sets on any 24", 30", or 36" wide base. (B30 shown.) No countertop is needed.
- Can be reduced in depth to 12".
- If used on the end of a run, seam will be visible between stacked cabinets. A tall panel can be applied to the cabinet sides to conceal the seam.
- Tall non-mitered doors will have two center panels with cross rail.
- Troxel doors will be two doors doweled together.

Cabinet Height	Door Height
49 1/2"	49 1/4"
61 1/2"	61 1/4"

Custom Modifications

ADDTK	CBO	CCO	CND	DRT	DRWTK	EXBK	FTK	FTK_V
•	•	•		•		•		
ID	INVFRM	RD	RECTK	RT	TD	TKP	VTK	
		•						

Construction and Finish Upgrades

APC	FB	MIP	MSLFB	WLI
•	•	•	•	•

Door Options

CG.TOP	DPSRR
	•

PANTRY TOP UNIT with PULL-OUT, 49 1/2" TALL, 24" DEEP

storage SOLUTIONS

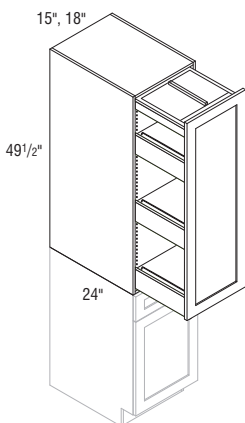

PTUP154924	15.8
PTUP184924	18.7

- Two adjustable and one fixed bottom shelf with metallic finish wire rail sides. Natural finish pull-out shelves are 20 11/16" deep.
- Sets on any 15" or 18" wide base. No countertop is needed.
- If used on the end of a run, seam will be visible between stacked cabinets. A tall panel can be applied to the cabinet sides to conceal the seam.
- Tall non-mitered doors will have two center panels with cross rail.
- Troxel doors greater than 48" high will be two doors doweled together.
- For full access from both sides of unit, do not install against a wall or next to deeper appliances and cabinets.

Cabinet Height	Door Height
49 1/2"	49 1/4"

Custom Modifications

ADDTK	CBO	CCO	CND	DRT	DRWTK	EXBK	FTK	FTK_V
•	•	•				•		
ID	INVFRM	RD	RECTK	RT	TD	TKP	VTK	

Construction and Finish Upgrades

APC	FB	MIP	MSLFB	WLI
•	•	•	•	•

Door Options

CG.TOP	DPSRR
	•

TALL PANTRY PULL-OUT, 84", 87", or 90" TALL, 24" DEEP

storage SOLUTIONS

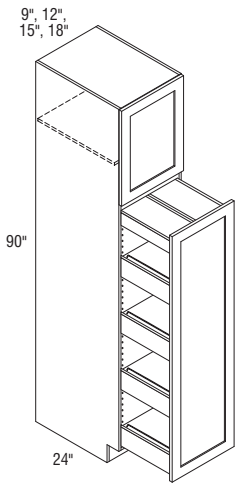
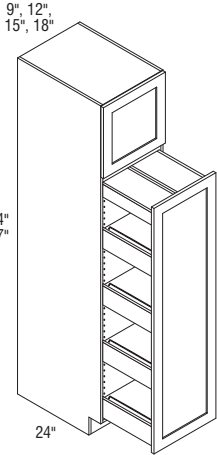

Model	Cubic Feet
TPP98424 L or R	13.8
TPP128424 L or R	17.7
TPP158424 L or R	21.6
TPP188424 L or R	25.6
TPP98724 L or R	14.3
TPP128724 L or R	18.3
TPP158724 L or R	22.4
TPP188724 L or R	26.5
TPP99024AH L or R	14.7
TPP129024AH L or R	18.9
TPP159024AH L or R	23.2
TPP189024AH L or R	27.4

- AH represents upper section alignment with doors on 24" or 27" high cabinets.
- Three adjustable shelves and one fixed bottom shelf with metallic finish wire rail sides. Natural finish wood pull-out shelves are 20 11/16" deep. Pull-out features top/bottom mounted soft-close full extension guides.
- 84" and 87" high do not include shelves in upper section. Upper section 15" or 18".
- Tall non-mitered doors will have two center panels with cross rail.
- Troxel doors greater than 48" high will be two doors doweled together.
- For full access from both sides of unit, do not install against a wall or next to deeper appliances and cabinets.
- Pull-out mechanism not available for order for field installation, only available factory installed.

Cabinet Height	Door Height (Upper Section)	Door Height (Lower Section)
84"	17 3/4"	61 3/8"
87"	20 3/4"	61 3/8"
90"	23 3/4"	61 3/8"
93"	26 3/4"	61 3/8"
96"	29 3/4"	61 3/8"

Custom Modifications

ADDTK	CBO	CCO	CND	DRT	DRWTK	EXBK	FTK	FTK_V
	•	•			•*	•	•	•*
ID	INFRM	RD	RECTK	RT	TD	TKP	VTK	
			•		•	•	•	

*Available only on 18" wide *Not available on 9" and 12" wide

Construction and Finish Upgrades

APC	FB	MIP	MSLFB	WLI
•	•	•	•	•

Door Options

CG.TOP	DPSRR
•	•

**TALL PANTRY PULL-OUT, 93" or 96"
TALL, 24" DEEP**

9", 12",
15", 18"

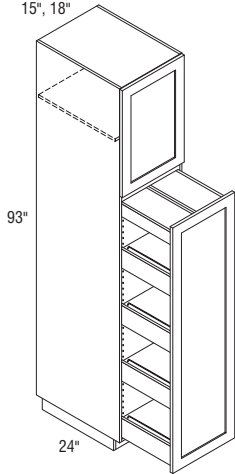

9", 12",
15", 18"

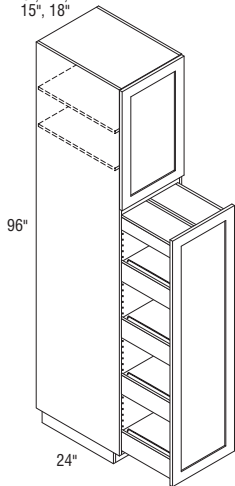

storage
SOLUTIONS

Model	Cubic Feet
TPP99324AH L or R	15.2
TPP129324AH L or R	19.6
TPP159324AH L or R	23.9
TPP189324AH L or R	28.3
TPP99624 L or R	15.7
TPP129624 L or R	20.2
TPP159624 L or R	24.7
TPP189624 L or R	29.2

- AH represents upper section alignment with doors on 24" or 27" high cabinets.
- Three adjustable shelves and one fixed bottom shelf with metallic finish wire rail sides. Natural finish wood pull-out shelves are 20 11/16" deep. Pull-out features top/bottom mounted soft-close full extension guides.
- Separate pedestal base included but packaged separately on 93" and 96" tall. Pedestal is designed to create a Recessed Left or Right Toekick application during field installation, or can be centered. Pedestal must be covered with toeboard material.
- Tall non-mitered doors will have two center panels with cross rail.
- Troxel doors greater than 48" high will be two doors doweled together.
- For full access from both sides of unit, do not install against a wall or next to deeper appliances and cabinets.
- Pull-out mechanism not available for order for field installation, only available factory installed.

Cabinet Height	Door Height (Upper Section)	Door Height (Lower Section)
84"	17 3/4"	61 3/8"
87"	20 3/4"	61 3/8"
90"	23 3/4"	61 3/8"
93"	26 3/4"	61 3/8"
96"	29 3/4"	61 3/8"

Custom Modifications

ADDTK	CBO	CCO	CND	DRT	DRWTK	EXBK	FTK	FTK_V
	•	•				•		
ID	INVFRM	RD	RECTK	RT	TD	TKP	VTK	
			•		•			

Construction and Finish Upgrades

APC	FB	MIP	MSLFB	WLI
•	•	•	•	•

Door Options

CG.TOP	DPSRR
•	•

**SINGLE OVEN CABINET,
84", 87", 90", 93", or 96" TALL,
24" DEEP**

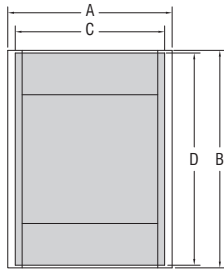
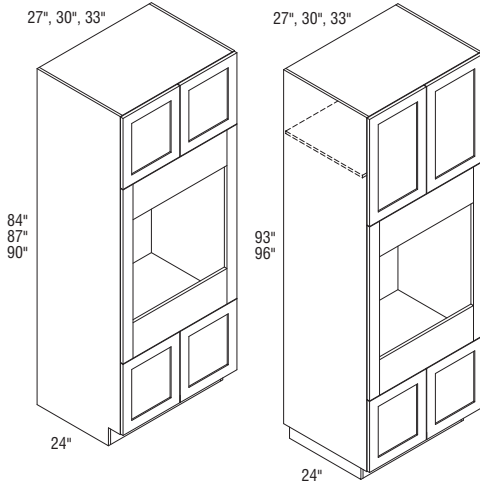

Appliance Trim Panel
Max Cut-out (Shaded)

Model	Cubic Feet
OCS278424	37.4
OCS308424	41.3
OCS338424	45.2
OCS278724	38.7
OCS308724	42.8
OCS338724	46.8
OCS279024AH	40.0
OCS309024AH	44.2
OCS339024AH	48.4
OCS279324AH	41.3
OCS309324AH	45.7
OCS339324AH	50.0
OCS279624	42.6
OCS309624	47.1
OCS339624	51.6

- AH represents upper section alignment with doors on 24" or 27" high cabinets.
- Includes adjustable shelves in upper section:
90" and 93" tall - one shelf
96" tall - two shelves
- Be sure to confirm a heat shield is built into your appliance by the manufacturer or install the heat shield included with your appliance. Heat shields are sold separately as an accessory.
- Separate pedestal base included but packaged separately on 93" and 96" tall. Pedestal is designed to create a Recessed Left or Right Toe-kick application during field installation, or can be centered. Pedestal must be covered with toeboard material.
- Depth can be reduced to a minimum of 6". For depths of 6"-8", cabinet will not include toe-kick/pedestal.
- For built-in appliance support in 24" deep cabinets, a kit is included (not factory installed) with a support shelf, unfinished plywood strips, and mounting screws for field mounting installation. Kit can be trimmed for when cabinet depth is modified.
- See page 73 for specifications on appliance cabinet trim panels.

	A Panel Width	B Panel Height	C Cut-out Width		D Cut-out Height		Door Height (Upper Section)	Door Height (Lower Section)
			Min.	Max.	Min.	Max.		
OCS278424	26 27/32"	43 1/2"	21 3/32"	23 27/32"	25 3/4"	42 7/16"	17 3/4"	17 3/4"
OCS308424	29 27/32"	43 1/2"	24 3/32"	26 27/32"	25 3/4"	42 7/16"	17 3/4"	17 3/4"
OCS338424	32 27/32"	43 1/2"	27 3/32"	29 27/32"	25 3/4"	42 7/16"	17 3/4"	17 3/4"
OCS278724	26 27/32"	43 1/2"	21 3/32"	23 27/32"	25 3/4"	42 7/16"	20 3/4"	17 3/4"
OCS308724	29 27/32"	43 1/2"	24 3/32"	26 27/32"	25 3/4"	42 7/16"	20 3/4"	17 3/4"
OCS338724	32 27/32"	43 1/2"	27 3/32"	29 27/32"	25 3/4"	42 7/16"	20 3/4"	17 3/4"
OCS279024AH	26 27/32"	43 1/2"	21 3/32"	23 27/32"	25 3/4"	42 7/16"	23 3/4"	17 3/4"
OCS309024AH	29 27/32"	43 1/2"	24 3/32"	26 27/32"	25 3/4"	42 7/16"	23 3/4"	17 3/4"
OCS339024AH	32 27/32"	43 1/2"	27 3/32"	29 27/32"	25 3/4"	42 7/16"	23 3/4"	17 3/4"
OCS279324AH	26 27/32"	43 1/2"	21 3/32"	23 27/32"	25 3/4"	42 7/16"	26 3/4"	17 3/4"
OCS309324AH	29 27/32"	43 1/2"	24 3/32"	26 27/32"	25 3/4"	42 7/16"	26 3/4"	17 3/4"
OCS339324AH	32 27/32"	43 1/2"	27 3/32"	29 27/32"	25 3/4"	42 7/16"	26 3/4"	17 3/4"
OCS279624	26 27/32"	43 1/2"	21 3/32"	23 27/32"	25 3/4"	42 7/16"	29 3/4"	17 3/4"
OCS309624	29 27/32"	43 1/2"	24 3/32"	26 27/32"	25 3/4"	42 7/16"	29 3/4"	17 3/4"
OCS339624	32 27/32"	43 1/2"	27 3/32"	29 27/32"	25 3/4"	42 7/16"	29 3/4"	17 3/4"

Custom Modifications

ADDTK	CBO	CCO	CND	DRT	DRWTK	EXBK	FTK	FTK_V
	•*	•			•*	•	•*	•*
ID	INVFRM	RD	RECTK	RT	TD	TKP	VTK	
•	•	•			•	•*	•*	

*Not available on 84" and 87" tall *Not available on 93" and 96" tall

Construction and Finish Upgrades

APC	FB	MIP	MSLFB	WLI
•	•	•	•	•

Door Options

CG.TOP	DPSRR
	•

**SINGLE OVEN CABINET, DEEP
DRAWER, 84", 87", 90", 93", or 96"
TALL, 24" DEEP**

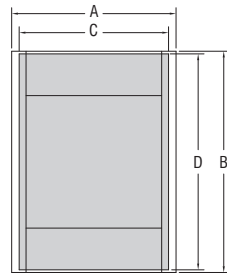
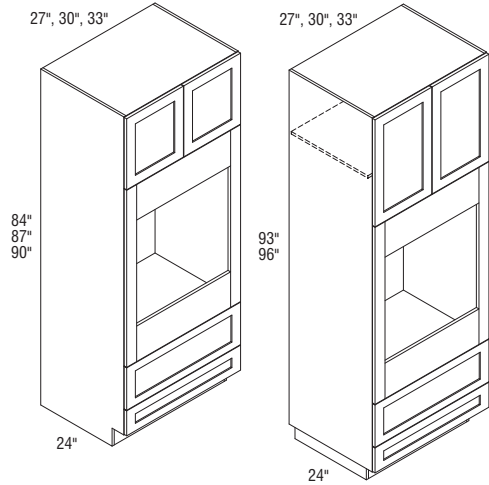

Appliance Trim Panel
Max Cut-out (Shaded)

Model	Cubic Feet
OCS278424DD	37.4
OCS308424DD	41.3
OCS338424DD	45.2
OCS278724DD	38.7
OCS308724DD	42.8
OCS338724DD	46.8
OCS279024DDAH	40.0
OCS309024DDAH	44.2
OCS339024DDAH	48.4
OCS279324DDAH	41.3
OCS309324DDAH	45.7
OCS339324DDAH	50.0
OCS279624DD	42.6
OCS309624DD	47.1
OCS339624DD	51.6

- AH represents upper section alignment with doors on 24" or 27" high cabinets.
- Includes adjustable shelves in upper section:
90" and 93" tall - one shelf
96" tall - two shelves
- Be sure to confirm a heat shield is built into your appliance by the manufacturer or install the heat shield included with your appliance. Heat shields are sold separately as an accessory.
- Separate pedestal base included but packaged separately on 93" and 96" tall. Pedestal is designed to create a Recessed Left or Right Toe-kick application during field installation, or can be centered. Pedestal must be covered with toeboard material.
- Depth can be reduced to a minimum of 12".
- For built-in appliance support in 24" deep cabinets, a kit is included (not factory installed) with a support shelf, unfinished plywood strips, and mounting screws for field mounting installation. Kit can be trimmed for when cabinet depth is modified.
- See page 73 for specifications on appliance cabinet trim panels.

	A Panel Width	B Panel Height	C Cut-out Width		D Cut-out Height		Door Height	Drawer Front Height (Upper Drawer)	Drawer Front Height (Lower Drawer)
			Min.	Max.	Min.	Max.			
OCS278424DD	26 27/32"	44 1/4"	21 3/32"	23 27/32"	26 1/2"	43 3/16"	17 3/4"	10 5/8"	6 1/4"
OCS308424DD	29 27/32"	44 1/4"	24 3/32"	26 27/32"	26 1/2"	43 3/16"	17 3/4"	10 5/8"	6 1/4"
OCS338424DD	32 27/32"	44 1/4"	27 3/32"	29 27/32"	26 1/2"	43 3/16"	17 3/4"	10 5/8"	6 1/4"
OCS278724DD	26 27/32"	44 1/4"	21 3/32"	23 27/32"	26 1/2"	43 3/16"	20 3/4"	10 5/8"	6 1/4"
OCS308724DD	29 27/32"	44 1/4"	24 3/32"	26 27/32"	26 1/2"	43 3/16"	20 3/4"	10 5/8"	6 1/4"
OCS338724DD	32 27/32"	44 1/4"	27 3/32"	29 27/32"	26 1/2"	43 3/16"	20 3/4"	10 5/8"	6 1/4"
OCS279024DDAH	26 27/32"	44 1/4"	21 3/32"	23 27/32"	26 1/2"	43 3/16"	23 3/4"	10 5/8"	6 1/4"
OCS309024DDAH	29 27/32"	44 1/4"	24 3/32"	26 27/32"	26 1/2"	43 3/16"	23 3/4"	10 5/8"	6 1/4"
OCS339024DDAH	32 27/32"	44 1/4"	27 3/32"	29 27/32"	26 1/2"	43 3/16"	23 3/4"	10 5/8"	6 1/4"
OCS279324DDAH	26 27/32"	44 1/4"	21 3/32"	23 27/32"	26 1/2"	43 3/16"	26 3/4"	10 5/8"	6 1/4"
OCS309324DDAH	29 27/32"	44 1/4"	24 3/32"	26 27/32"	26 1/2"	43 3/16"	26 3/4"	10 5/8"	6 1/4"
OCS339324DDAH	32 27/32"	44 1/4"	27 3/32"	29 27/32"	26 1/2"	43 3/16"	26 3/4"	10 5/8"	6 1/4"
OCS279624DD	26 27/32"	44 1/4"	21 3/32"	23 27/32"	26 1/2"	43 3/16"	29 3/4"	10 5/8"	6 1/4"
OCS309624DD	29 27/32"	44 1/4"	24 3/32"	26 27/32"	26 1/2"	43 3/16"	29 3/4"	10 5/8"	6 1/4"
OCS339624DD	32 27/32"	44 1/4"	27 3/32"	29 27/32"	26 1/2"	43 3/16"	29 3/4"	10 5/8"	6 1/4"

Custom Modifications

ADDTK	CBO	CCO	CND	DRT	DRWTK	EXBK	FTK	FTK_V
	•	•	•		•*	•	•*	•*
ID	INFRM	RD	RECTK	RT	TD	TKP	VTK	
		•	•		•	•*	•*	

*Not available on 93" and 96" tall

Construction and Finish Upgrades

APC	FB	MIP	MSLFB	WLI
•	•	•	•	•

Door Options

CG.TOP	DPSRR
	•

SINGLE OVEN CABINET, WARMING DRAWER, 84", 87", 90", 93", or 96" TALL, 24" DEEP

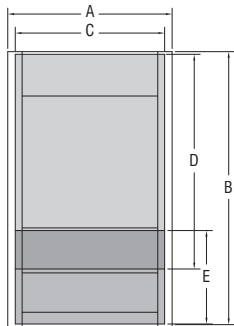
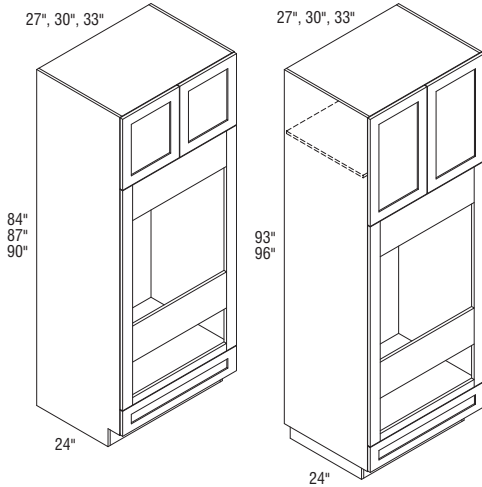

Appliance Trim Panel
Max Cut-out (Shaded)

Model	Cubic Feet
OCS278424WD	37.4
OCS308424WD	41.3
OCS338424WD	45.2
OCS278724WD	38.7
OCS308724WD	42.8
OCS338724WD	46.8
OCS279024WDAH	40.0
OCS309024WDAH	44.2
OCS339024WDAH	48.4
OCS279324WDAH	41.3
OCS309324WDAH	45.7
OCS339324WDAH	50.0
OCS279624WD	42.6
OCS309624WD	47.1
OCS339624WD	51.6

- AH represents upper section alignment with doors on 24" or 27" high cabinets.
- Includes adjustable shelves in upper section:
90" and 93" tall - one shelf
96" tall - two shelves
- Be sure to confirm a heat shield is built into your appliance by the manufacturer or install the heat shield included with your appliance. Heat shields are sold separately as an accessory.
- Separate pedestal base included but packaged separately on 93" and 96" tall. Pedestal is designed to create a Recessed Left or Right Toe Kick application during field installation, or can be centered. Pedestal must be covered with toeboard material.
- Depth can be reduced to a minimum of 12".
- For built-in appliance support in 24" deep cabinets, a kit is included (not factory installed) with a support shelf, unfinished plywood strips, and mounting screws for field mounting installation. Kit can be trimmed for when cabinet depth is modified.
- See page 73 for specifications on appliance cabinet trim panels.

	A Panel Width	B Panel Height	C Cut-out Width		D Cut-out Height		E Warming Drawer Cut-out Height		Door Height	Drawer Front Height
			Min.	Max.	Min.	Max.	Min.	Max.		
OCS278424WD	26 27/32"	55"	21 3/32"	23 27/32"	26 3/8"	42 15/16"	7 7/8"	18 11/16"	17 3/4"	6 1/4"
OCS308424WD	29 27/32"	55"	24 3/32"	26 27/32"	26 3/8"	42 15/16"	7 7/8"	18 11/16"	17 3/4"	6 1/4"
OCS338424WD	32 27/32"	55"	27 3/32"	29 27/32"	26 3/8"	42 15/16"	7 7/8"	18 11/16"	17 3/4"	6 1/4"
OCS278724WD	26 27/32"	55"	21 3/32"	23 27/32"	26 3/8"	42 15/16"	7 7/8"	18 11/16"	20 3/4"	6 1/4"
OCS308724WD	29 27/32"	55"	24 3/32"	26 27/32"	26 3/8"	42 15/16"	7 7/8"	18 11/16"	20 3/4"	6 1/4"
OCS338724WD	32 27/32"	55"	27 3/32"	29 27/32"	26 3/8"	42 15/16"	7 7/8"	18 11/16"	20 3/4"	6 1/4"
OCS279024WDAH	26 27/32"	55"	21 3/32"	23 27/32"	26 3/8"	42 15/16"	7 7/8"	18 11/16"	23 3/4"	6 1/4"
OCS309024WDAH	29 27/32"	55"	24 3/32"	26 27/32"	26 3/8"	42 15/16"	7 7/8"	18 11/16"	23 3/4"	6 1/4"
OCS339024WDAH	32 27/32"	55"	27 3/32"	29 27/32"	26 3/8"	42 15/16"	7 7/8"	18 11/16"	23 3/4"	6 1/4"
OCS279324WDAH	26 27/32"	55"	21 3/32"	23 27/32"	26 3/8"	42 15/16"	7 7/8"	18 11/16"	26 3/4"	6 1/4"
OCS309324WDAH	29 27/32"	55"	24 3/32"	26 27/32"	26 3/8"	42 15/16"	7 7/8"	18 11/16"	26 3/4"	6 1/4"
OCS339324WDAH	32 27/32"	55"	27 3/32"	29 27/32"	26 3/8"	42 15/16"	7 7/8"	18 11/16"	26 3/4"	6 1/4"
OCS279624WD	26 27/32"	55"	21 3/32"	23 27/32"	26 3/8"	42 15/16"	7 7/8"	18 11/16"	29 3/4"	6 1/4"
OCS309624WD	29 27/32"	55"	24 3/32"	26 27/32"	26 3/8"	42 15/16"	7 7/8"	18 11/16"	29 3/4"	6 1/4"
OCS339624WD	32 27/32"	55"	27 3/32"	29 27/32"	26 3/8"	42 15/16"	7 7/8"	18 11/16"	29 3/4"	6 1/4"

Custom Modifications

ADDTK	CBO	CCO	CND	DRT	DRWTK	EXBK	FTK	FTK_V
	•	•	•		•*	•	•*	•*
ID	INVFRM	RD	RECTK	RT	TD	TKP	VTK	
•		•			•	•*	•*	

*Not available on 93" and 96" tall

Construction and Finish Upgrades

APC	FB	MIP	MSLFB	WLI
•	•	•	•	•

Door Options

CG.TOP	DPSRR
	•

**DOUBLE OVEN CABINET,
84", 87", 90", 93", or 96" TALL,
24" DEEP**

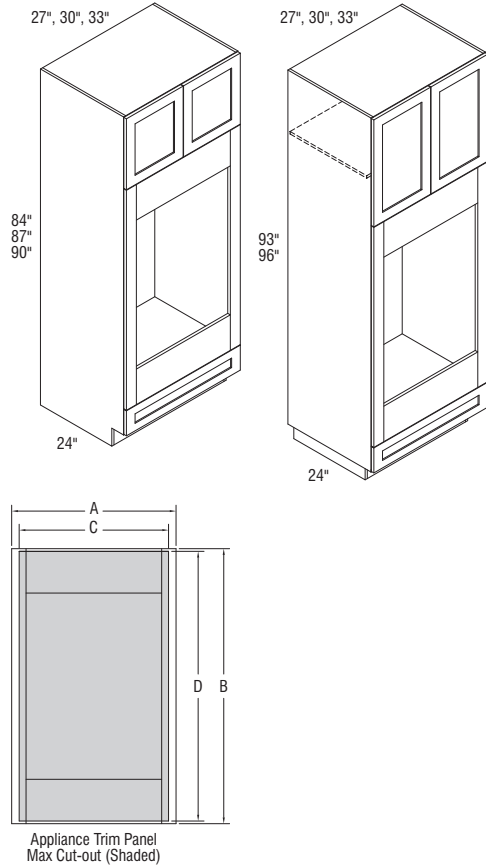

Model	Cubic Feet
OCD278424	37.4
OCD308424	41.3
OCD338424	45.2
OCD278724	38.7
OCD308724	42.8
OCD338724	46.8
OCD279024AH	40.0
OCD309024AH	44.2
OCD339024AH	48.4
OCD279324AH	41.3
OCD309324AH	45.7
OCD339324AH	50.0
OCD279624	42.6
OCD309624	47.1
OCD339624	51.6

- AH represents upper section alignment with doors on 24" or 27" high cabinets.
- Includes adjustable shelves in upper section:
90" and 93" tall - one shelf
96" tall - two shelves
- Be sure to confirm a heat shield is built into your appliance by the manufacturer or install the heat shield included with your appliance. Heat shields are sold separately as an accessory.
- Separate pedestal base included but packaged separately on 93" and 96" tall. Pedestal is designed to create a Recessed Left or Right ToeKick application during field installation, or can be centered. Pedestal must be covered with toeboard material.
- Depth can be reduced to a minimum of 12".
- For built-in appliance support in 24" deep cabinets, a kit is included (not factory installed) with a support shelf, unfinished plywood strips, and mounting screws for field mounting installation. Kit can be trimmed for when cabinet depth is modified.
- See page 73 for specifications on appliance cabinet trim panels.

	A Panel Width	B Panel Height	C Cut-out Width		D Cut-out Height		Door Height	Drawer Front Height
			Min.	Max.	Min.	Max.		
OCD278424	26 27/32"	55"	21 3/32"	23 27/32"	37 1/4"	53 15/16"	17 3/4"	6 1/4"
OCD308424	29 27/32"	55"	24 3/32"	26 27/32"	37 1/4"	53 15/16"	17 3/4"	6 1/4"
OCD338424	32 27/32"	55"	27 3/32"	29 27/32"	37 1/4"	53 15/16"	17 3/4"	6 1/4"
OCD278724	26 27/32"	55"	21 3/32"	23 27/32"	37 1/4"	53 15/16"	20 3/4"	6 1/4"
OCD308724	29 27/32"	55"	24 3/32"	26 27/32"	37 1/4"	53 15/16"	20 3/4"	6 1/4"
OCD338724	32 27/32"	55"	27 3/32"	29 27/32"	37 1/4"	53 15/16"	20 3/4"	6 1/4"
OCD279024AH	26 27/32"	55"	21 3/32"	23 27/32"	37 1/4"	53 15/16"	23 3/4"	6 1/4"
OCD309024AH	29 27/32"	55"	24 3/32"	26 27/32"	37 1/4"	53 15/16"	23 3/4"	6 1/4"
OCD339024AH	32 27/32"	55"	27 3/32"	29 27/32"	37 1/4"	53 15/16"	23 3/4"	6 1/4"
OCD279324AH	26 27/32"	55"	21 3/32"	23 27/32"	37 1/4"	53 15/16"	26 3/4"	6 1/4"
OCD309324AH	29 27/32"	55"	24 3/32"	26 27/32"	37 1/4"	53 15/16"	26 3/4"	6 1/4"
OCD339324AH	32 27/32"	55"	27 3/32"	29 27/32"	37 1/4"	53 15/16"	26 3/4"	6 1/4"
OCD279624	26 27/32"	55"	21 3/32"	23 27/32"	37 1/4"	53 15/16"	29 3/4"	6 1/4"
OCD309624	29 27/32"	55"	24 3/32"	26 27/32"	37 1/4"	53 15/16"	29 3/4"	6 1/4"
OCD339624	32 27/32"	55"	27 3/32"	29 27/32"	37 1/4"	53 15/16"	29 3/4"	6 1/4"

Custom Modifications

ADDTK	CBO	CCO	CND	DRT	DRWTK	EXBK	FTK	FTK_V
	•	•	•		•*	•	•*	•*
ID	INVFRM	RD	RECTK	RT	TD	TKP	VTK	
•		•	•		•	•*	•*	

*Not available on 93" and 96" tall

Construction and Finish Upgrades

APC	FB	MIP	MSLFB	WLI
•	•	•	•	•

Door Options

CG.TOP	DPSRR
	•

DOUBLE OVEN CABINET, DEEP DRAWER, 84", 87", 90", 93", or 96" TALL, 24" DEEP

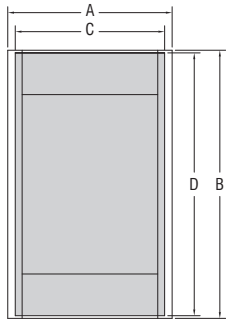
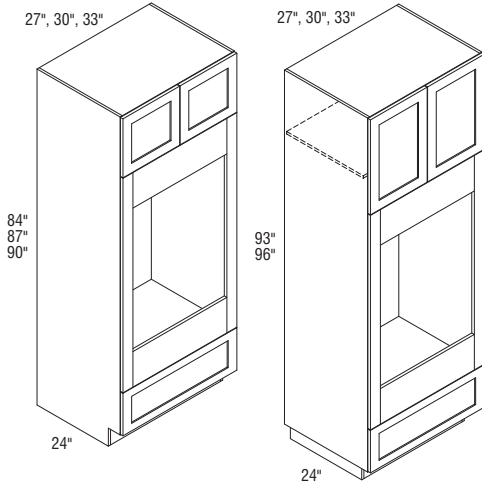

Appliance Trim Panel Max Cut-out (Shaded)

Model	Cubic Feet
OCD278424DD	37.4
OCD308424DD	41.3
OCD338424DD	45.2
OCD278724DD	38.7
OCD308724DD	42.8
OCD338724DD	46.8
OCD279024DD	40.0
OCD309024DD	44.2
OCD339024DD	48.4
OCD279324DDAH	41.3
OCD309324DDAH	45.7
OCD339324DDAH	50.0
OCD279624DDAH	42.6
OCD309624DDAH	47.1
OCD339624DDAH	51.6

- AH represents upper section alignment with doors on 24" or 27" high cabinets.
- Includes one adjustable shelf in upper section of 93" and 96" tall.
- Be sure to confirm a heat shield is built into your appliance by the manufacturer or install the heat shield included with your appliance. Heat shields are sold separately as an accessory.
- Separate pedestal base included but packaged separately on 93" and 96" tall. Pedestal is designed to create a Recessed Left or Right Toe Kick application during field installation, or can be centered. Pedestal must be covered with toeboard material.
- Depth can be reduced to a minimum of 12".
- For built-in appliance support in 24" deep cabinets, a kit is included (not factory installed) with a support shelf, unfinished plywood strips, and mounting screws for field mounting installation. Kit can be trimmed for when cabinet depth is modified.
- See page 73 for specifications on appliance cabinet trim panels.

	A Panel Width	B Panel Height	C Cut-out Width		D Cut-out Height		Door Height	Drawer Front Height
			Min.	Max.	Min.	Max.		
OCD278424DD	26 27/32"	53 5/8"	21 3/32"	23 27/32"	35 7/8"	52 9/16"	14 3/4"	10 5/8"
OCD308424DD	29 27/32"	53 5/8"	24 3/32"	26 27/32"	35 7/8"	52 9/16"	14 3/4"	10 5/8"
OCD338424DD	32 27/32"	53 5/8"	27 3/32"	29 27/32"	35 7/8"	52 9/16"	14 3/4"	10 5/8"
OCD278724DD	26 27/32"	53 5/8"	21 3/32"	23 27/32"	35 7/8"	52 9/16"	17 3/4"	10 5/8"
OCD308724DD	29 27/32"	53 5/8"	24 3/32"	26 27/32"	35 7/8"	52 9/16"	17 3/4"	10 5/8"
OCD338724DD	32 27/32"	53 5/8"	27 3/32"	29 27/32"	35 7/8"	52 9/16"	17 3/4"	10 5/8"
OCD279024DD	26 27/32"	53 5/8"	21 3/32"	23 27/32"	35 7/8"	52 9/16"	20 3/4"	10 5/8"
OCD309024DD	29 27/32"	53 5/8"	24 3/32"	26 27/32"	35 7/8"	52 9/16"	20 3/4"	10 5/8"
OCD339024DD	32 27/32"	53 5/8"	27 3/32"	29 27/32"	35 7/8"	52 9/16"	20 3/4"	10 5/8"
OCD279324DDAH	26 27/32"	53 5/8"	21 3/32"	23 27/32"	35 7/8"	52 9/16"	23 3/4"	10 5/8"
OCD309324DDAH	29 27/32"	53 5/8"	24 3/32"	26 27/32"	35 7/8"	52 9/16"	23 3/4"	10 5/8"
OCD339324DDAH	32 27/32"	53 5/8"	27 3/32"	29 27/32"	35 7/8"	52 9/16"	23 3/4"	10 5/8"
OCD279624DDAH	26 27/32"	53 5/8"	21 3/32"	23 27/32"	35 7/8"	52 9/16"	26 3/4"	10 5/8"
OCD309624DDAH	29 27/32"	53 5/8"	24 3/32"	26 27/32"	35 7/8"	52 9/16"	26 3/4"	10 5/8"
OCD339624DDAH	32 27/32"	53 5/8"	27 3/32"	29 27/32"	35 7/8"	52 9/16"	26 3/4"	10 5/8"

Custom Modifications

ADDTK	CBO	CCO	CND	DRT	DRWTK	EXBK	FTK	FTK_V
	•	•	•		•**	•	•*	•*
ID	INVFRM	RD	RECTK	RT	TD	TKP	VTK	
•		•	•		•▲	•+	•*	

*Not available on 87" tall **Not available on 93" and 96" tall ▲Not available on 84" tall

Construction and Finish Upgrades

APC	FB	MIP	MSLFB	WLI
•	•	•	•	•

Door Options

CG.TOP	DPSRR
	•

DOUBLE OVEN CABINET, WARMING DRAWER, 84", 87", 90", 93", or 96" TALL, 24" DEEP

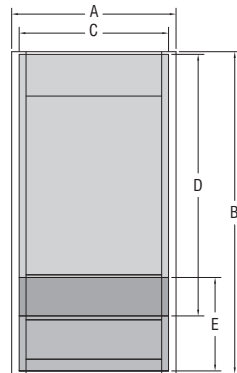
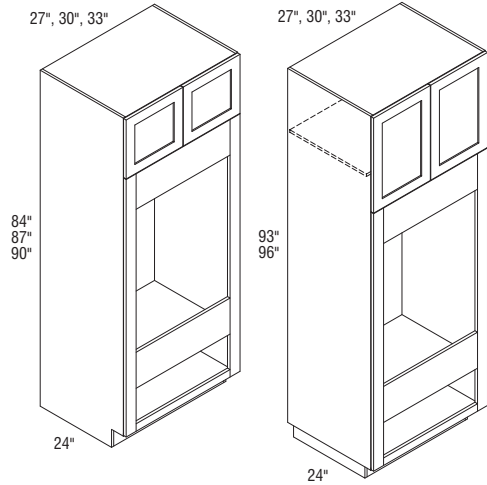

Appliance Trim Panel Max Cut-out (Shaded)

Model	Cubic Feet
OCD278424WD	37.4
OCD308424WD	41.3
OCD338424WD	45.2
OCD278724WD	38.7
OCD308724WD	42.8
OCD338724WD	46.8
OCD279024WD	40.0
OCD309024WD	44.2
OCD339024WD	48.4
OCD279324WDAH	41.3
OCD309324WDAH	45.7
OCD339324WDAH	50.0
OCD279624WDAH	42.6
OCD309624WDAH	47.1
OCD339624WDAH	51.6

- AH represents upper section alignment with doors on 24" or 27" high cabinets.
- Includes one adjustable shelf in upper section of 93" and 96" tall.
- Be sure to confirm a heat shield is built into your appliance by the manufacturer or install the heat shield included with your appliance. Heat shields are sold separately as an accessory.
- Separate pedestal base included but packaged separately on 93" and 96" tall. Pedestal is designed to create a Recessed Left or Right Toe Kick application during field installation, or can be centered. Pedestal must be covered with toeboard material.
- Depth can be reduced to a minimum of 6". For depths of 6"-8", cabinet will not include toe kick/pedestal.
- For built-in appliance support in 24" deep cabinets, a kit is included (not factory installed) with a support shelf, unfinished plywood strips, and mounting screws for field mounting installation. Kit can be trimmed for when cabinet depth is modified.
- See page 73 for specifications on appliance cabinet trim panels.

	A Panel Width	B Panel Height	C Cut-out Width		D Cut-out Height		E Warming Drawer Cut-out Height		Door Height
			Min.	Max.	Min.	Max.	Min.	Max.	
OCD278424WD	26 27/32"	64 3/8"	21 3/32"	23 27/32"	35 3/4"	52 5/16"	7 7/8"	18 11/16"	14 3/4"
OCD308424WD	29 27/32"	64 3/8"	24 3/32"	26 27/32"	35 3/4"	52 5/16"	7 7/8"	18 11/16"	14 3/4"
OCD338424WD	32 27/32"	64 3/8"	27 3/32"	29 27/32"	35 3/4"	52 5/16"	7 7/8"	18 11/16"	14 3/4"
OCD278724WD	26 27/32"	64 3/8"	21 3/32"	23 27/32"	35 3/4"	52 5/16"	7 7/8"	18 11/16"	17 3/4"
OCD308724WD	29 27/32"	64 3/8"	24 3/32"	26 27/32"	35 3/4"	52 5/16"	7 7/8"	18 11/16"	17 3/4"
OCD338724WD	32 27/32"	64 3/8"	27 3/32"	29 27/32"	35 3/4"	52 5/16"	7 7/8"	18 11/16"	17 3/4"
OCD279024WD	26 27/32"	64 3/8"	21 3/32"	23 27/32"	35 3/4"	52 5/16"	7 7/8"	18 11/16"	20 3/4"
OCD309024WD	29 27/32"	64 3/8"	24 3/32"	26 27/32"	35 3/4"	52 5/16"	7 7/8"	18 11/16"	20 3/4"
OCD339024WD	32 27/32"	64 3/8"	27 3/32"	29 27/32"	35 3/4"	52 5/16"	7 7/8"	18 11/16"	20 3/4"
OCD279324WDAH	26 27/32"	64 3/8"	21 3/32"	23 27/32"	35 3/4"	52 5/16"	7 7/8"	18 11/16"	23 3/4"
OCD309324WDAH	29 27/32"	64 3/8"	24 3/32"	26 27/32"	35 3/4"	52 5/16"	7 7/8"	18 11/16"	23 3/4"
OCD339324WDAH	32 27/32"	64 3/8"	27 3/32"	29 27/32"	35 3/4"	52 5/16"	7 7/8"	18 11/16"	23 3/4"
OCD279624WDAH	26 27/32"	64 3/8"	21 3/32"	23 27/32"	35 3/4"	52 5/16"	7 7/8"	18 11/16"	26 3/4"
OCD309624WDAH	29 27/32"	64 3/8"	24 3/32"	26 27/32"	35 3/4"	52 5/16"	7 7/8"	18 11/16"	26 3/4"
OCD339624WDAH	32 27/32"	64 3/8"	27 3/32"	29 27/32"	35 3/4"	52 5/16"	7 7/8"	18 11/16"	26 3/4"

Custom Modifications

ADDTK	CBO	CCO	CND	DRT	DRWTK	EXBK	FTK	FTK_V
	•*	•			•+	•	•+	•+
ID	INVFRM	RD	RECTK	RT	TD	TKP	VTK	
•		•	•		••	•+	•+	

*Not available on 84", 87", and 90" tall *Not available on 93" and 96" tall

•Not available on 84" tall

Construction and Finish Upgrades

APC	FB	MIP	MSLFB	WLI
•	•	•	•	•

Door Options

CG.TOP	DPSRR
	•

DOUBLE OVEN CABINET, WARMING DRAWER with EXTENDED OPENING, 84", 87", 90", 93", or 96" TALL, 24" DEEP

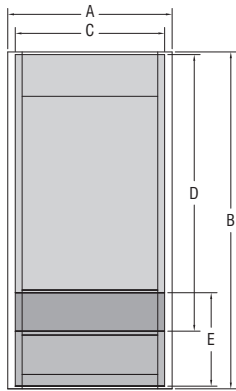
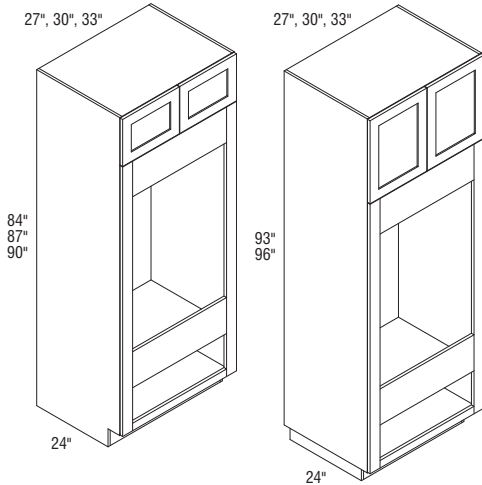

Appliance Trim Panel Max Cut-out (Shaded)

Model	Cubic Feet
OCD278424WDE	37.4
OCD308424WDE	41.3
OCD338424WDE	45.2
OCD278724WDE	38.7
OCD308724WDE	42.8
OCD338724WDE	46.8
OCD279024WDE	40.0
OCD309024WDE	44.2
OCD339024WDE	48.4
OCD279324WDE	41.3
OCD309324WDE	45.7
OCD339324WDE	50.0
OCD279624WDEAH	42.6
OCD309624WDEAH	47.1
OCD339624WDEAH	51.6

- AH represents upper section alignment with doors on 24" or 27" high cabinets.
- Includes one adjustable shelf in upper section of 96" tall.
- Be sure to confirm a heat shield is built into your appliance by the manufacturer or install the heat shield included with your appliance. Heat shields are sold separately as an accessory.
- Separate pedestal base included but packaged separately on 93" and 96" tall. Pedestal is designed to create a Recessed Left or Right Toe Kick application during field installation, or can be centered. Pedestal must be covered with toeboard material.
- Depth can be reduced to a minimum of 6". For depths of 6"-8", cabinet will not include toe kick/pedestal.
- For built-in appliance support in 24" deep cabinets, a kit is included (not factory installed) with a support shelf, unfinished plywood strips, and mounting screws for field mounting installation. Kit can be trimmed for when cabinet depth is modified.
- See page 73 for specifications on appliance cabinet trim panels.

	A Panel Width	B Panel Height	C Cut-out Width		D Cut-out Height		E Warming Drawer Cut-out Height		Door Height
			Min.	Max.	Min.	Max.	Min.	Max.	
OCD278424WDE	26 27/32"	67 3/8"	21 3/32"	23 27/32"	38 3/4"	55 5/16"	7 7/8"	18 11/16"	11 3/4"
OCD308424WDE	29 27/32"	67 3/8"	24 3/32"	26 27/32"	38 3/4"	55 5/16"	7 7/8"	18 11/16"	11 3/4"
OCD338424WDE	32 27/32"	67 3/8"	27 3/32"	29 27/32"	38 3/4"	55 5/16"	7 7/8"	18 11/16"	11 3/4"
OCD278724WDE	26 27/32"	67 3/8"	21 3/32"	23 27/32"	38 3/4"	55 5/16"	7 7/8"	18 11/16"	14 3/4"
OCD308724WDE	29 27/32"	67 3/8"	24 3/32"	26 27/32"	38 3/4"	55 5/16"	7 7/8"	18 11/16"	14 3/4"
OCD338724WDE	32 27/32"	67 3/8"	27 3/32"	29 27/32"	38 3/4"	55 5/16"	7 7/8"	18 11/16"	14 3/4"
OCD279024WDE	26 27/32"	67 3/8"	21 3/32"	23 27/32"	38 3/4"	55 5/16"	7 7/8"	18 11/16"	17 3/4"
OCD309024WDE	29 27/32"	67 3/8"	24 3/32"	26 27/32"	38 3/4"	55 5/16"	7 7/8"	18 11/16"	17 3/4"
OCD339024WDE	32 27/32"	67 3/8"	27 3/32"	29 27/32"	38 3/4"	55 5/16"	7 7/8"	18 11/16"	17 3/4"
OCD279324WDE	26 27/32"	67 3/8"	21 3/32"	23 27/32"	38 3/4"	55 5/16"	7 7/8"	18 11/16"	20 3/4"
OCD309324WDE	29 27/32"	67 3/8"	24 3/32"	26 27/32"	38 3/4"	55 5/16"	7 7/8"	18 11/16"	20 3/4"
OCD339324WDE	32 27/32"	67 3/8"	27 3/32"	29 27/32"	38 3/4"	55 5/16"	7 7/8"	18 11/16"	20 3/4"
OCD279624WDEAH	26 27/32"	67 3/8"	21 3/32"	23 27/32"	38 3/4"	55 5/16"	7 7/8"	18 11/16"	23 3/4"
OCD309624WDEAH	29 27/32"	67 3/8"	24 3/32"	26 27/32"	38 3/4"	55 5/16"	7 7/8"	18 11/16"	23 3/4"
OCD339624WDEAH	32 27/32"	67 3/8"	27 3/32"	29 27/32"	38 3/4"	55 5/16"	7 7/8"	18 11/16"	23 3/4"

Custom Modifications

ADDTK	CBO	CCO	CND	DRT	DRWTK	EXBK	FTK	FTK_V
		•			•*	•	•*	•*
ID	INVERM	RD	RECTK	RT	TD	TKP	VTK	
•		•	•+		•▲	•*	•*	

*Not available on 93" and 96" tall *Not available on 96" tall

▲Not available on 84", 87", 90", and 93" tall

Construction and Finish Upgrades

APC	FB	MIP	MSLFB	WLI
•	•	•	•	•

Door Options

CG.TOP	DPSRR
	•

**TALL BUILT-IN MICROWAVE CABINET,
84", 87", 90", 93", or 96" TALL**

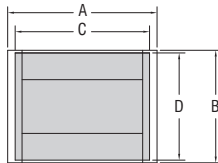
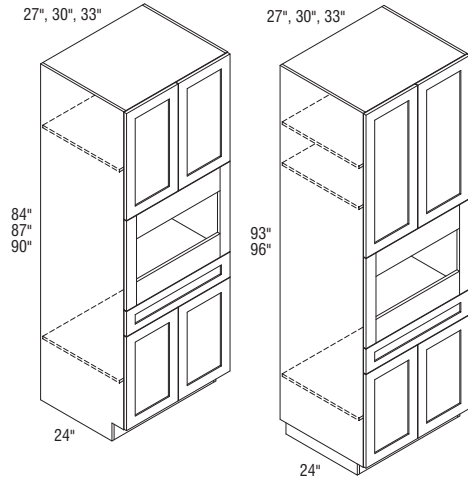

Appliance Trim Panel
Max Cut-out (Shaded)

Model	Cubic Feet
TBMWB278424AH	37.4
TBMWB308424AH	41.3
TBMWB338424AH	45.2
TBMWB278724	38.7
TBMWB308724	42.8
TBMWB338724	46.8
TBMWB279024	40.0
TBMWB309024	44.2
TBMWB339024	48.4
TBMWB279324	41.3
TBMWB309324	45.7
TBMWB339324	50.0
TBMWB279624	42.6
TBMWB309624	47.1
TBMWB339624	51.6

- AH represents upper section alignment with doors on 24" or 27" high cabinets.
- Includes adjustable shelves in upper section:
87"-90" tall - one shelf
93" tall - two shelves
96" tall - three shelves
- Base section will utilize a full depth shelf.
- Be sure to confirm a heat shield is built into your appliance by the manufacturer or install the heat shield included with your appliance. Heat shields are sold separately as an accessory.
- Separate pedestal base included but packaged separately on 93" and 96" tall. Pedestal is designed to create a Recessed Left or Right Toe Kick application during field installation, or can be centered. Pedestal must be covered with toeboard material.
- Depth can be reduced to a minimum of 12".
- For built-in appliance support in 24" deep cabinets, a kit is included (not factory installed) with a support shelf, unfinished plywood strips, and mounting screws for field mounting installation. Kit can be trimmed for when cabinet depth is modified.
- See page 73 for specifications on appliance cabinet trim panels.

	A Panel Width	B Panel Height	C Cut-out Width		D Cut-out Height		Door Height (Upper Section)	Door Height (Lower Section)	Drawer Front Height
			Min.	Max.	Min.	Max.			
TBMWB278424AH	26 27/32"	22 1/2"	21 3/32"	23 27/32"	10 3/4"	21 7/16"	26 3/4"	23 3/8"	6 1/4"
TBMWB308424AH	29 27/32"	22 1/2"	24 3/32"	26 27/32"	10 3/4"	21 7/16"	26 3/4"	23 3/8"	6 1/4"
TBMWB338424AH	32 27/32"	22 1/2"	27 3/32"	29 27/32"	10 3/4"	21 7/16"	26 3/4"	23 3/8"	6 1/4"
TBMWB278724	26 27/32"	22 1/2"	21 3/32"	23 27/32"	10 3/4"	21 7/16"	29 3/4"	23 3/8"	6 1/4"
TBMWB308724	29 27/32"	22 1/2"	24 3/32"	26 27/32"	10 3/4"	21 7/16"	29 3/4"	23 3/8"	6 1/4"
TBMWB338724	32 27/32"	22 1/2"	27 3/32"	29 27/32"	10 3/4"	21 7/16"	29 3/4"	23 3/8"	6 1/4"
TBMWB279024	26 27/32"	22 1/2"	21 3/32"	23 27/32"	10 3/4"	21 7/16"	32 3/4"	23 3/8"	6 1/4"
TBMWB309024	29 27/32"	22 1/2"	24 3/32"	26 27/32"	10 3/4"	21 7/16"	32 3/4"	23 3/8"	6 1/4"
TBMWB339024	32 27/32"	22 1/2"	27 3/32"	29 27/32"	10 3/4"	21 7/16"	32 3/4"	23 3/8"	6 1/4"
TBMWB279324	26 27/32"	22 1/2"	21 3/32"	23 27/32"	10 3/4"	21 7/16"	35 3/4"	23 3/8"	6 1/4"
TBMWB309324	29 27/32"	22 1/2"	24 3/32"	26 27/32"	10 3/4"	21 7/16"	35 3/4"	23 3/8"	6 1/4"
TBMWB339324	32 27/32"	22 1/2"	27 3/32"	29 27/32"	10 3/4"	21 7/16"	35 3/4"	23 3/8"	6 1/4"
TBMWB279624	26 27/32"	22 1/2"	21 3/32"	23 27/32"	10 3/4"	21 7/16"	38 3/4"	23 3/8"	6 1/4"
TBMWB309624	29 27/32"	22 1/2"	24 3/32"	26 27/32"	10 3/4"	21 7/16"	38 3/4"	23 3/8"	6 1/4"
TBMWB339624	32 27/32"	22 1/2"	27 3/32"	29 27/32"	10 3/4"	21 7/16"	38 3/4"	23 3/8"	6 1/4"

Custom Modifications

ADDTK	CBO	CCO	CND	DRT	DRWTK	EXBK	FTK	FTK_V
	•	•	•		•*	•	•*	•*
ID	INVFRM	RD	RECTK	RT	TD	TKP	VTK	
		•	•	•	•*	•*		

*Not available on 93" and 96" tall *Not available on 90", 93", and 96" tall

Construction and Finish Upgrades

APC	FB	MIP	MSLFB	WLI
•	•	•	•	•

Door Options

CG.TOP	DPSRR
•	•

**OVEN MICROWAVE CABINET,
84", 87", 90", 93", or 96" TALL,
24" DEEP**

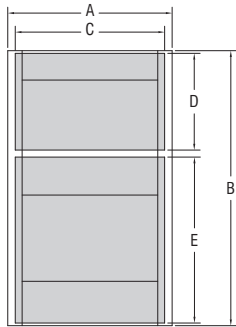
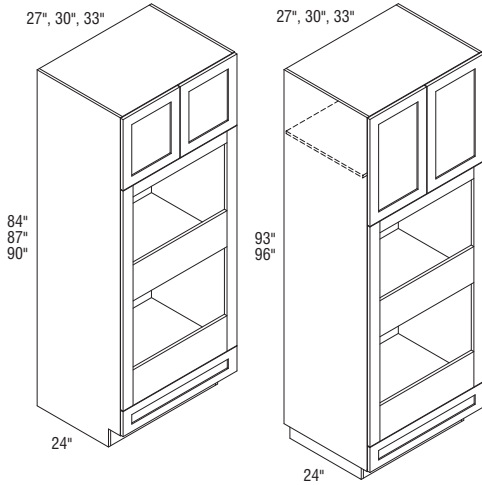

Appliance Trim Panel
Max Cut-out (Shaded)

Model	Cubic Feet
OMC278424	37.4
OMC308424	41.3
OMC338424	45.2
OMC278724	38.7
OMC308724	42.8
OMC338724	46.8
OMC279024AH	40.0
OMC309024AH	44.2
OMC339024AH	48.4
OMC279324AH	41.3
OMC309324AH	45.7
OMC339324AH	50.0
OMC279624	42.6
OMC309624	47.1
OMC339624	51.6

- AH represents upper section alignment with doors on 24" or 27" high cabinets.
- Includes adjustable shelves in upper section:
90" and 93" tall - one shelf
96" tall - two shelves
- Designed for use with separate built-in microwave above, built-in oven below. For built-in double ovens, see pages 233-236.
- Be sure to confirm a heat shield is built into your appliance by the manufacturer or install the heat shield included with your appliance. Heat shields are sold separately as an accessory.
- Separate pedestal base included but packaged separately on 93" and 96" tall. Pedestal is designed to create a Recessed Left or Right Toe-kick application during field installation, or can be centered. Pedestal must be covered with toeboard material.
- Depth can be reduced to a minimum of 12".
- For built-in appliance support in 24" deep cabinets, a kit is included (not factory installed) with a support shelf, unfinished plywood strips, and mounting screws for field mounting installation. Kit can be trimmed for when cabinet depth is modified.
- See page 73 for specifications on appliance cabinet trim panels.

	A Panel Width	B Panel Height	C Cut-out Width		D Microwave Opening Height		E Oven Cut-out Height		Door Height	Drawer Front Height
			Min.	Max.	Min.	Max.	Min.	Max.		
OMC278424	26 27/32"	55"	21 3/32"	23 27/32"	14"	19 11/32"	17 1/4"	33 3/16"	17 3/4"	6 1/4"
OMC308424	29 27/32"	55"	24 3/32"	26 27/32"	14"	19 11/32"	17 1/4"	33 3/16"	17 3/4"	6 1/4"
OMC338424	32 27/32"	55"	27 3/32"	29 27/32"	14"	19 11/32"	17 1/4"	33 3/16"	17 3/4"	6 1/4"
OMC278724	26 27/32"	55"	21 3/32"	23 27/32"	14"	19 11/32"	17 1/4"	33 3/16"	20 3/4"	6 1/4"
OMC308724	29 27/32"	55"	24 3/32"	26 27/32"	14"	19 11/32"	17 1/4"	33 3/16"	20 3/4"	6 1/4"
OMC338724	32 27/32"	55"	27 3/32"	29 27/32"	14"	19 11/32"	17 1/4"	33 3/16"	20 3/4"	6 1/4"
OMC279024AH	26 27/32"	55"	21 3/32"	23 27/32"	14"	19 11/32"	17 1/4"	33 3/16"	23 3/4"	6 1/4"
OMC309024AH	29 27/32"	55"	24 3/32"	26 27/32"	14"	19 11/32"	17 1/4"	33 3/16"	23 3/4"	6 1/4"
OMC339024AH	32 27/32"	55"	27 3/32"	29 27/32"	14"	19 11/32"	17 1/4"	33 3/16"	23 3/4"	6 1/4"
OMC279324AH	26 27/32"	55"	21 3/32"	23 27/32"	14"	19 11/32"	17 1/4"	33 3/16"	26 3/4"	6 1/4"
OMC309324AH	29 27/32"	55"	24 3/32"	26 27/32"	14"	19 11/32"	17 1/4"	33 3/16"	26 3/4"	6 1/4"
OMC339324AH	32 27/32"	55"	27 3/32"	29 27/32"	14"	19 11/32"	17 1/4"	33 3/16"	26 3/4"	6 1/4"
OMC279624	26 27/32"	55"	21 3/32"	23 27/32"	14"	19 11/32"	17 1/4"	33 3/16"	29 3/4"	6 1/4"
OMC309624	29 27/32"	55"	24 3/32"	26 27/32"	14"	19 11/32"	17 1/4"	33 3/16"	29 3/4"	6 1/4"
OMC339624	32 27/32"	55"	27 3/32"	29 27/32"	14"	19 11/32"	17 1/4"	33 3/16"	29 3/4"	6 1/4"

Custom Modifications

ADDTK	CBO	CCO	CND	DRT	DRWTK	EXBK	FTK	FTK_V
	•	•	•		•*	•	•*	•*
ID	INVFRM	RD	RECTK	RT	TD	TKP	VTK	
•		•	•		•	•*	•*	

*Not available on 93" and 96" tall

Construction and Finish Upgrades

APC	FB	MIP	MFLFB	WLI
•	•	•	•	•

Door Options

CG.TOP	DPSRR
	•

**OVEN MICROWAVE CABINET, DEEP
DRAWER, 84", 87", 90", 93", or 96"
TALL, 24" DEEP**

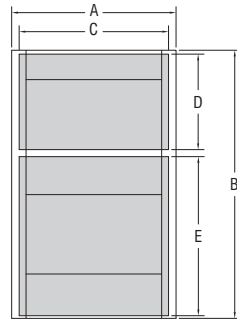
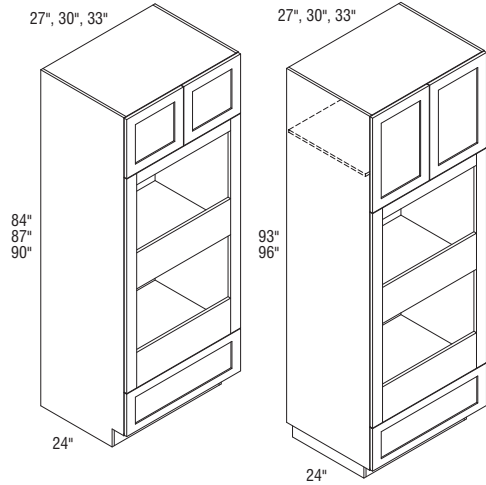

Appliance Trim Panel
Max Cut-out (Shaded)

Model	Cubic Feet
OMC278424DD	37.4
OMC308424DD	41.3
OMC338424DD	45.2
OMC278724DD	38.7
OMC308724DD	42.8
OMC338724DD	46.8
OMC279024DD	40.0
OMC309024DD	44.2
OMC339024DD	48.4
OMC279324DDAH	41.3
OMC309324DDAH	45.7
OMC339324DDAH	50.0
OMC279624DDAH	42.6
OMC309624DDAH	47.1
OMC339624DDAH	51.6

- AH represents upper section alignment with doors on 24" or 27" high cabinets.
- Includes one adjustable shelf in upper section of 93" and 96" tall.
- Designed for use with separate built-in microwave above, built-in oven below. For built-in double ovens, see pages 233-236.
- Be sure to confirm a heat shield is built into your appliance by the manufacturer or install the heat shield included with your appliance. Heat shields are sold separately as an accessory.
- Separate pedestal base included but packaged separately on 93" and 96" tall. Pedestal is designed to create a Recessed Left or Right Toe-kick application during field installation, or can be centered. Pedestal must be covered with toeboard material.
- Depth can be reduced to a minimum of 12".
- For built-in appliance support in 24" deep cabinets, a kit is included (not factory installed) with a support shelf, unfinished plywood strips, and mounting screws for field mounting installation. Kit can be trimmed for when cabinet depth is modified.
- See page 73 for specifications on appliance cabinet trim panels.

	A Panel Width	B Panel Height	C Cut-out Width		D Microwave Opening Height		E Oven Cut-out Height		Door Height	Drawer Front Height
			Min.	Max.	Min.	Max.	Min.	Max.		
OMC278424DD	26 27/32"	53 5/8"	21 3/32"	23 27/32"	14"	19 3/32"	15 7/8"	31 13/16"	14 3/4"	10 5/8"
OMC308424DD	29 27/32"	53 5/8"	24 3/32"	26 27/32"	14"	19 3/32"	15 7/8"	31 13/16"	14 3/4"	10 5/8"
OMC338424DD	32 27/32"	53 5/8"	27 3/32"	29 27/32"	14"	19 3/32"	15 7/8"	31 13/16"	14 3/4"	10 5/8"
OMC278724DD	26 27/32"	53 5/8"	21 3/32"	23 27/32"	14"	19 3/32"	15 7/8"	31 13/16"	17 3/4"	10 5/8"
OMC308724DD	29 27/32"	53 5/8"	24 3/32"	26 27/32"	14"	19 3/32"	15 7/8"	31 13/16"	17 3/4"	10 5/8"
OMC338724DD	32 27/32"	53 5/8"	27 3/32"	29 27/32"	14"	19 3/32"	15 7/8"	31 13/16"	17 3/4"	10 5/8"
OMC279024DD	26 27/32"	53 5/8"	21 3/32"	23 27/32"	14"	19 3/32"	15 7/8"	31 13/16"	20 3/4"	10 5/8"
OMC309024DD	29 27/32"	53 5/8"	24 3/32"	26 27/32"	14"	19 3/32"	15 7/8"	31 13/16"	20 3/4"	10 5/8"
OMC339024DD	32 27/32"	53 5/8"	27 3/32"	29 27/32"	14"	19 3/32"	15 7/8"	31 13/16"	20 3/4"	10 5/8"
OMC279324DDAH	26 27/32"	53 5/8"	21 3/32"	23 27/32"	14"	19 3/32"	15 7/8"	31 13/16"	23 3/4"	10 5/8"
OMC309324DDAH	29 27/32"	53 5/8"	24 3/32"	26 27/32"	14"	19 3/32"	15 7/8"	31 13/16"	23 3/4"	10 5/8"
OMC339324DDAH	32 27/32"	53 5/8"	27 3/32"	29 27/32"	14"	19 3/32"	15 7/8"	31 13/16"	23 3/4"	10 5/8"
OMC279624DDAH	26 27/32"	53 5/8"	21 3/32"	23 27/32"	14"	19 3/32"	15 7/8"	31 13/16"	26 3/4"	10 5/8"
OMC309624DDAH	29 27/32"	53 5/8"	24 3/32"	26 27/32"	14"	19 3/32"	15 7/8"	31 13/16"	26 3/4"	10 5/8"
OMC339624DDAH	32 27/32"	53 5/8"	27 3/32"	29 27/32"	14"	19 3/32"	15 7/8"	31 13/16"	26 3/4"	10 5/8"

Custom Modifications

ADDTK	CBO	CCO	CND	DRT	DRWTK	EXBK	FTK	FTK_V
	•	•	•		•*	•	•*	•*
ID	INVERM	RD	RECTK	RT	TD	TKP	VTK	
•		•	•		•+	•*	•*	

*Not available on 93" and 96" tall

*Not available on 84" tall

Construction and Finish Upgrades

APC	FB	MIP	MSLFB	WLI
•	•	•	•	•

Door Options

CG.TOP	DPSRR
	•

**OVEN MICROWAVE CABINET,
WARMING DRAWER, 84", 87", 90",
93", or 96" TALL, 24" DEEP**

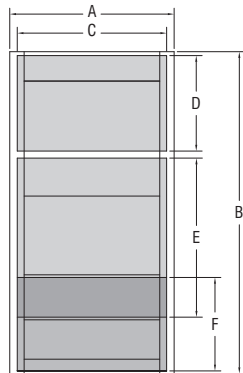
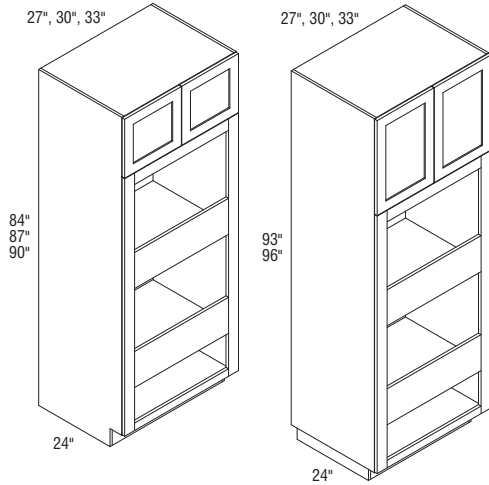

Appliance Trim Panel
Max Cut-out (Shaded)

Model	Cubic Feet
OMC278424WD	37.4
OMC308424WD	41.3
OMC338424WD	45.2
OMC278724WD	38.7
OMC308724WD	42.8
OMC338724WD	46.8
OMC279024WD	40.0
OMC309024WD	44.2
OMC339024WD	48.4
OMC279324WDAH	41.3
OMC309324WDAH	45.7
OMC339324WDAH	50.0
OMC279624WDAH	42.6
OMC309624WDAH	47.1
OMC339624WDAH	51.6

- AH represents upper section alignment with doors on 24" or 27" high cabinets.
- Includes one adjustable shelf in upper section of 93" and 96" tall.
- Designed for use with separate built-in microwave above, built-in oven below. For built-in double ovens, see pages 233-236.
- Be sure to confirm a heat shield is built into your appliance by the manufacturer or install the heat shield included with your appliance. Heat shields are sold separately as an accessory.
- Separate pedestal base included but packaged separately on 93" and 96" tall. Pedestal is designed to create a Recessed Left or Right Toe-kick application during field installation, or can be centered. Pedestal must be covered with toeboard material.
- Depth can be reduced to a minimum of 6". For depths of 6"-8", cabinet will not include toe-kick/pedestal.
- For built-in appliance support in 24" deep cabinets, a kit is included (not factory installed) with a support shelf, unfinished plywood strips, and mounting screws for field mounting installation. Kit can be trimmed for when cabinet depth is modified.
- See page 73 for specifications on appliance cabinet trim panels.

	A		B		C		D		E		F		Door Height
	Panel Width		Panel Height		Cut-out Width		Microwave Opening Height		Oven Cut-out Height		Warming Drawer Cut-out Height		
	Min.	Max.	Min.	Max.	Min.	Max.	Min.	Max.	Min.	Max.	Min.	Max.	
OMC278424WD	26 27/32"	64 3/8"	21 3/32"	23 27/32"	14"	19 3/16"	15 3/4"	31 13/16"	7 7/8"	18 11/16"	14 3/4"		
OMC308424WD	29 27/32"	64 3/8"	24 3/32"	26 27/32"	14"	19 3/16"	15 3/4"	31 13/16"	7 7/8"	18 11/16"	14 3/4"		
OMC338424WD	32 27/32"	64 3/8"	27 3/32"	29 27/32"	14"	19 3/16"	15 3/4"	31 13/16"	7 7/8"	18 11/16"	14 3/4"		
OMC278724WD	26 27/32"	64 3/8"	21 3/32"	23 27/32"	14"	19 3/16"	15 3/4"	31 13/16"	7 7/8"	18 11/16"	17 3/4"		
OMC308724WD	29 27/32"	64 3/8"	24 3/32"	26 27/32"	14"	19 3/16"	15 3/4"	31 13/16"	7 7/8"	18 11/16"	17 3/4"		
OMC338724WD	32 27/32"	64 3/8"	27 3/32"	29 27/32"	14"	19 3/16"	15 3/4"	31 13/16"	7 7/8"	18 11/16"	17 3/4"		
OMC279024WD	26 27/32"	64 3/8"	21 3/32"	23 27/32"	14"	19 3/16"	15 3/4"	31 13/16"	7 7/8"	18 11/16"	20 3/4"		
OMC309024WD	29 27/32"	64 3/8"	24 3/32"	26 27/32"	14"	19 3/16"	15 3/4"	31 13/16"	7 7/8"	18 11/16"	20 3/4"		
OMC339024WD	32 27/32"	64 3/8"	27 3/32"	29 27/32"	14"	19 3/16"	15 3/4"	31 13/16"	7 7/8"	18 11/16"	20 3/4"		
OMC279324WDAH	26 27/32"	64 3/8"	21 3/32"	23 27/32"	14"	19 3/16"	15 3/4"	31 13/16"	7 7/8"	18 11/16"	23 3/4"		
OMC309324WDAH	29 27/32"	64 3/8"	24 3/32"	26 27/32"	14"	19 3/16"	15 3/4"	31 13/16"	7 7/8"	18 11/16"	23 3/4"		
OMC339324WDAH	32 27/32"	64 3/8"	27 3/32"	29 27/32"	14"	19 3/16"	15 3/4"	31 13/16"	7 7/8"	18 11/16"	23 3/4"		
OMC279624WDAH	26 27/32"	64 3/8"	21 3/32"	23 27/32"	14"	19 3/16"	15 3/4"	31 13/16"	7 7/8"	18 11/16"	26 3/4"		
OMC309624WDAH	29 27/32"	64 3/8"	24 3/32"	26 27/32"	14"	19 3/16"	15 3/4"	31 13/16"	7 7/8"	18 11/16"	26 3/4"		
OMC339624WDAH	32 27/32"	64 3/8"	27 3/32"	29 27/32"	14"	19 3/16"	15 3/4"	31 13/16"	7 7/8"	18 11/16"	26 3/4"		

Custom Modifications

ADDTK	CBO	CCO	CND	DRT	DRWTK	EXBK	FTK	FTK_V
	•*	•			•+	•	•+	•+
ID	INVFRM	RD	RECTK	RT	TD	TKP	VTK	
•		•	•		•▲	•+	•+	

*Not available on 84", 87", and 90" tall *Not available on 93" and 96" tall ▲Not available on 84" tall

Construction and Finish Upgrades

APC	FB	MIP	MSLFB	WLI
•	•	•	•	•

Door Options

CG.TOP	DPSRR
	•

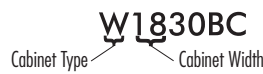

NOTE:

All bookcase shelves are 3/4" thick plywood with 1 1/2" tall solid-wood rail attached.

All office base cabinets are predrilled for full depth shelves or roll trays.

- Available
- STD Standard on these cabinets



5 Day Express Response Item

CUSTOM MODIFICATIONS	
Mod.	Description
ADDTK	Add Toekick
CBO	Cabinet Box Only
CCO	Cabinet Case Only
CFP	Cabinet False Panel
CND	Cabinet with No Door, with Drawer
DRWTK	Toekick Drawer
EXBK	End Extended Back
FTK	Flush Toekick
FTK_V	Flush Toekick w/Valance

CONSTRUCTION AND FINISH UPGRADES	
Mod.	Description
APC	All-plywood Construction
FB	Finished Ends
MIP	Matching Interior Plywood
MSLFB	Matching Specialty Laminate Furniture Board
WLI	White Laminate Interior

DOOR OPTIONS	
Mod.	Description
DPSRR	Door Panel - Solid Reverse Raised

BOOKCASE, 30" HIGH, 12" DEEP

18", 24", 30", 36"

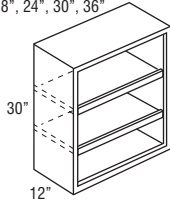

Model	Cubic Feet
W1830BC	5.3
W2430BC	6.9
W3030BC	8.5
W3630BC	10.0

- Features framed construction, face frame has a profiled inside edge.
- Matching Interior Plywood (MIP) standard.
- If ordered with Heirloom Technique, will not feature sand-through characteristics.
- To change the top rail valance, specify one of the following modifications: Arch (TVRAV), Furniture (TVRFV), or Straight Valance (TVRVV).

Custom Modifications

ADDTK	CBO	CCO	CFP	CND	DRWTK	EXBK	FTK	FTK_V	ID	INFRM	LTI
•	STD					•			•		

Construction and Finish Upgrades

APC	FB	MIP	MSLFB	WLI
		STD		

Door Options

DPSRR

BOOKCASE, 48" HIGH, 12" DEEP

18", 24", 30", 36"

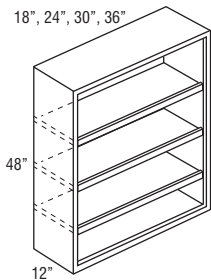

Model	Cubic Feet
W1848BC	8.2
W2448BC	10.7
W3048BC	13.2
W3648BC	15.7

- Features framed construction, face frame has a profiled inside edge.
- Matching Interior Plywood (MIP) standard.
- If ordered with Heirloom Technique, will not feature sand-through characteristics.
- To change the top rail valance, specify one of the following modifications: Arch (TVRAV), Furniture (TVRFV), or Straight Valance (TVRVV).

Custom Modifications

ADDTK	CBO	CCO	CFP	CND	DRWTK	EXBK	FTK	FTK_V	ID	INFRM	LTI
•	STD					•			•		

Construction and Finish Upgrades

APC	FB	MIP	MSLFB	WLI
		STD		

Door Options

DPSRR

WALL FURNITURE BOOKCASE, 48", 51", or 54" HIGH, 12" DEEP

18", 24", 30", or 36"

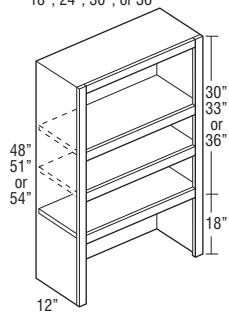

Model	Cubic Feet	Model	Cubic Feet
WFBC1848	8.1	WFBC1851	8.6
WFBC2448	10.5	WFBC2451	11.2
WFBC3048	13.0	WFBC3051	13.7
WFBC3648	15.4	WFBC3651	16.3

WFBC1854	9.1
WFBC2454	11.8
WFBC3054	14.5
WFBC3654	17.2

- Features framed construction, face frame has a profiled inside edge.
- 48", 51", and 54" have two adjustable shelves and one fixed shelf.
- Matching Interior Plywood (MIP) standard.
- If ordered with Heirloom Technique, will not feature sand-through characteristics.
- To change the top rail valance, specify one of the following modifications: Arch (TVRAV), Furniture (TVRFV), or Straight Valance (TVRVV).
- Bookcases can only be reduced to 9".

Custom Modifications

ADDTK	CBO	CCO	CFP	CND	DRWTK	EXBK	FTK	FTK_V	ID	INVERM	LTI
	STD					•			•		
PTOWB	RD	RECTK	RT	TVR_V	VTK						
	•			•							

Construction and Finish Upgrades

APC	FB	MIP	MSLFB	WLI
		STD		

Door Options

DPSRR

WALL FURNITURE BOOKCASE, 57", 60", or 66" HIGH, 12" DEEP

18", 24", 30", or 36"

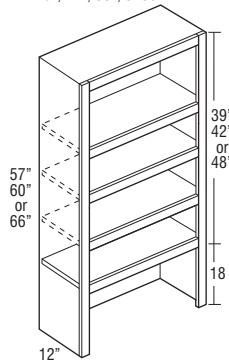

WFBC1857	9.6	WFBC1860	9.6
WFBC2457	12.4	WFBC2460	13.1
WFBC3057	15.3	WFBC3060	16.1
WFBC3657	18.2	WFBC3660	19.1

WFBC1866	11.0
WFBC2466	14.3
WFBC3066	17.6
WFBC3666	20.9

- Features framed construction, face frame has a profiled inside edge.
- 57", 60", and 66" have three adjustable shelves and one fixed shelf.
- Matching Interior Plywood (MIP) standard.
- If ordered with Heirloom Technique, will not feature sand-through characteristics.
- To change the top rail valance, specify one of the following modifications: Arch (TVRAV), Furniture (TVRFV), or Straight Valance (TVRVV).
- Bookcases can only be reduced to 9".

Custom Modifications

ADDTK	CBO	CCO	CFP	CND	DRWTK	EXBK	FTK	FTK_V	ID	INVERM	LTI
	STD					•			•		
PTOWB	RD	RECTK	RT	TVR_V	VTK						
	•			•							

Construction and Finish Upgrades

APC	FB	MIP	MSLFB	WLI
		STD		

Door Options

DPSRR

TALL BOOKCASE, 84", 87", or 90" HIGH, 12" or 18" DEEP

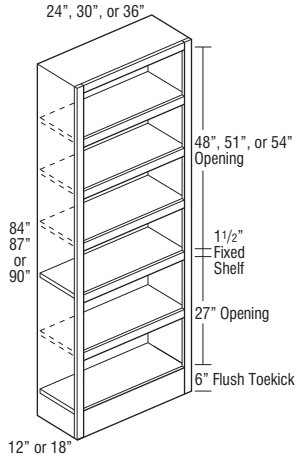

Model	Cubic Feet	Model	Cubic Feet
TBC248412	18.1	TBC248718	26.8
TBC308412	22.3	TBC308718	33.0
TBC368412	26.5	TBC368718	39.1
TBC248418	25.9	TBC249012	19.4
TBC308418	31.9	TBC309012	23.9
TBC368418	37.8	TBC369012	28.3
TBC248712	18.7	TBC249018	27.7
TBC308712	23.1	TBC309018	34.1
TBC368712	27.4	TBC369018	40.5

- Features framed construction, face frame has a profiled inside edge.
- 84" and 87" tall include four adjustable shelves and one fixed shelf.
- 90" tall includes five adjustable shelves and one fixed shelf.
- Matching Interior Plywood (MIP) standard.
- If ordered with Heirloom Technique, will not feature sand-through characteristics.
- To change the top rail valance, specify one of the following modifications: Arch (TVRAV), Furniture (TVRFV), or Straight Valance (TVRVV).
- Bookcases can only be reduced to 9".

Custom Modifications

ADDTK	CBO	CCO	CFP	CND	DRWTK	EXBK	FTK	FTK_V	ID	INFRM	LTI
	STD					•	STD	•	•		
PTOWB	RD	RECTK	RT	TVR_V	VTK						
	•			•							

Construction and Finish Upgrades

APC	FB	MIP	MSLFB	WLI
		STD		

Door Options

DPSRR

TALL BOOKCASE, 93" or 96" HIGH, 12" or 18" DEEP

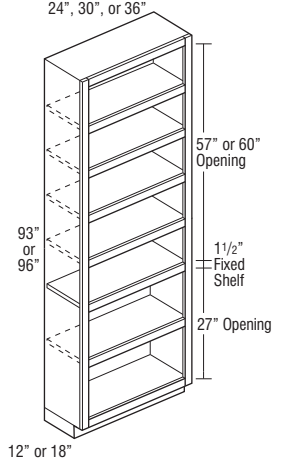

TBC249312	20.0	TBC249612	20.6
TBC309312	24.6	TBC309612	25.4
TBC369312	29.2	TBC369612	30.2
TBC249318	28.6	TBC249618	29.5
TBC309318	35.2	TBC309618	36.3
TBC369318	41.8	TBC369618	43.1

- Features framed construction, face frame has a profiled inside edge.
- 93" tall includes five adjustable shelves and one fixed shelf.
- 96" tall includes six adjustable shelves and one fixed shelf.
- Separate pedestal base included but packaged separately on 93" and 96" tall. Pedestals are the same width as the cabinet box.
- Matching Interior Plywood (MIP) standard.
- If ordered with Heirloom Technique, will not feature sand-through characteristics.
- To change the top rail valance, specify one of the following modifications: Arch (TVRAV), Furniture (TVRFV), or Straight Valance (TVRVV).
- Bookcases can only be reduced to 9".

Custom Modifications

ADDTK	CBO	CCO	CFP	CND	DRWTK	EXBK	FTK	FTK_V	ID	INFRM	LTI
	STD					•			•		
PTOWB	RD	RECTK	RT	TVR_V	VTK						
	•			•							

Construction and Finish Upgrades

APC	FB	MIP	MSLFB	WLI
		STD		

Door Options

DPSRR

TALL BOOKCASE with DOORS, 84", 87", or 90" HIGH, 12" or 18" DEEP

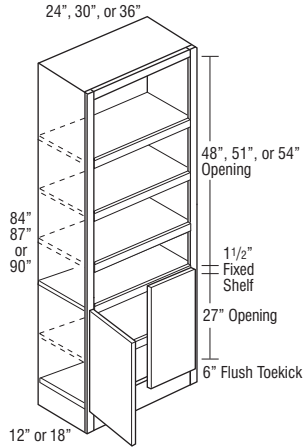

Model	Cubic Feet	Model	Cubic Feet
TBCD248412	18.1	TBCD248718	26.8
TBCD308412	22.3	TBCD308718	33.0
TBCD368412	26.5	TBCD368718	39.1
TBCD248418	25.9	TBCD249012	19.4
TBCD308418	31.9	TBCD309012	23.9
TBCD368418	37.8	TBCD369012	28.3
TBCD248712	18.7	TBCD249018	27.7
TBCD308712	23.1	TBCD309018	34.1
TBCD368712	27.4	TBCD369018	40.5

- Features framed construction, face frame has a profiled inside edge.
- Top of doors align with a standard 34 1/2" high full height base cabinet. Reveal on sides is 1/4".
- 84" and 87" tall include four adjustable shelves and one fixed shelf.
- 90" tall includes five adjustable shelves and one fixed shelf.
- Matching Interior Plywood (MIP) standard.
- To change the top rail valance, specify one of the following modifications: Arch (TVRAV), Furniture (TVRFV), or Straight Valance (TVRVV).
- Bookcases can only be reduced to 9".

Custom Modifications

ADDTK	CBO	CCO	CFP	CND	DRWTK	EXBK	FTK	FTK_V	ID	INFRM	LTI
	•	•				•	STD	•	•		
PTOWB	RD	RECTK	RT	TVR_V	VTK						
	•			•							

Construction and Finish Upgrades

APC	FB	MIP	MSLFB	WLI
		STD		

Door Options

DPSRR
•

TALL BOOKCASE with DOORS, 93" or 96" HIGH, 12" or 18" DEEP

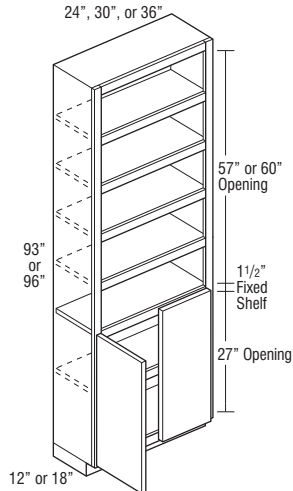

TBCD249312	20.0	TBCD249612	20.6
TBCD309312	24.6	TBCD309612	25.4
TBCD369312	29.2	TBCD369612	30.2
TBCD249318	28.6	TBCD249618	29.5
TBCD309318	35.2	TBCD309618	36.3
TBCD369318	41.8	TBCD369618	43.1

- Features framed construction, face frame has a profiled inside edge.
- Top of doors align with a standard 34 1/2" high full height base cabinet. Reveal on sides is 1/4".
- 93" tall includes five adjustable shelves and one fixed shelf.
- 96" tall includes six adjustable shelves and one fixed shelf.
- Separate pedestal base included but packaged separately on 93" and 96" tall. Pedestals are the same width as the cabinet box.
- Matching Interior Plywood (MIP) standard.
- To change the top rail valance, specify one of the following modifications: Arch (TVRAV), Furniture (TVRFV), or Straight Valance (TVRVV).
- Bookcases can only be reduced to 9".

Custom Modifications

ADDTK	CBO	CCO	CFP	CND	DRWTK	EXBK	FTK	FTK_V	ID	INFRM	LTI
	•	•				•			•		
PTOWB	RD	RECTK	RT	TVR_V	VTK						
	•			•							

Construction and Finish Upgrades

APC	FB	MIP	MSLFB	WLI
		STD		

Door Options

DPSRR
•

**DESK DOOR DRAWER BASE,
29" HIGH, 21" or 24" DEEP**

12", 15", 18", 21"

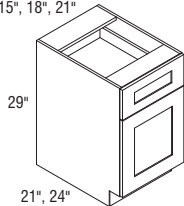

24", 27", 30", 33", 36"

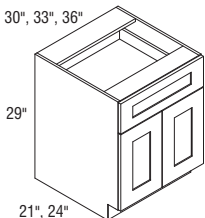

Model	Cubic Feet	Model	Cubic Feet
DDO122921 L or R	6.4	DDO242921	11.9
DDO152921 L or R	7.8	DDO272921	13.0
DDO182921 L or R	9.1	DDO302921	14.9
DDO212921 L or R	10.5	DDO332921	13.0
DDO122924 L or R	7.3	DDO362921	17.9
DDO152924 L or R	8.8	DDO242924	13.4
DDO182924 L or R	10.2	DDO272924	13.3
DDO212924 L or R	11.8	DDO302924	14.6
		DDO332924	16.1
		DDO362924	17.3

- Depth can be reduced to a minimum of 12".
- Depth can be increased to a maximum of 24".

Custom Modifications

ADDTK	CBO	CCO	CFP	CND	DRWTK	EXBK	FTK	FTK_V	ID	INVFRM	LTI
	•	•	•	•	•*	•	•	•+	•*	•	•†
PTOWB	RD	RECTK	RT	TVR_V	VTK						
	•	•	•		•						

*Not available on 12" and 15" wide *Not available on 12" wide *Not available on 24" deep
†Not available on 12", 15", 18", or 21" wide

Construction and Finish Upgrades

APC	FB	MIP	MSLFB	WLI
•	•	•	•	•

Door Options

DPSRR
•

**DESK DRAWER BASE, 29" HIGH,
21" or 24" DEEP**

12", 15", 18", 21",
24", 27", 30", 33", 36"

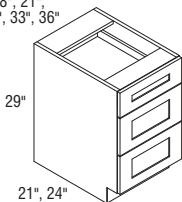

Model	Cubic Feet	Model	Cubic Feet
DDR122921	6.4	DDR122924	7.3
DDR152921	7.8	DDR152924	8.8
DDR182921	9.1	DDR182924	10.2
DDR212921	10.5	DDR212924	11.8
DDR242921	11.9	DDR242924	13.4
DDR272921	12.0	DDR272924	13.5
DDR302921	13.2	DDR302924	14.9
DDR332921	14.4	DDR332924	16.3
DDR362921	15.7	DDR362924	17.7

- Depth can be reduced to a minimum of 12".
- Depth can be increased to a maximum of 24".
- Top drawer front is 6 1/4" high and lower drawer fronts are 8 7/8" high.

Custom Modifications

ADDTK	CBO	CCO	CFP	CND	DRWTK	EXBK	FTK	FTK_V	ID	INVFRM	LTI
	•	•	•	•	•*	•	•	•+			
PTOWB	RD	RECTK	RT	TVR_V	VTK						
	•	•			•						

*Not available on 12" and 15" wide *Not available on 12" wide

Construction and Finish Upgrades

APC	FB	MIP	MSLFB	WLI
•	•	•	•	

Door Options

DPSRR

DESK FILE DRAWER BASE, 29" HIGH, 21" or 24" DEEP

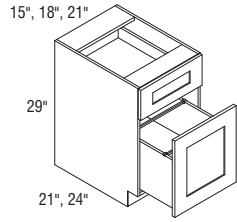

Model	Cubic Feet
DFD152921	7.8
DFD182921	9.1
DFD212921	10.5
DFD152924	8.8
DFD182924	10.2
DFD212924	11.8

- Door is attached to file drawer.
- Includes Filing System Hardware Kit, which accommodates letter and legal filing.
- Exterior height of file drawer is 10".

Custom Modifications

ADDTK	CBO	CCO	CFP	CND	DRWTK	EXBK	FTK	FTK_V	ID	INVERM	LTI
	•	•			•*	•	•	•			
PTOWB	RD	RECTK	RT	TVR_V	VTK						
		•			•						

*Not available on 15" wide

Construction and Finish Upgrades

APC	FB	MIP	MSLFB	WLI
•	•	•	•	

Door Options

DPSRR

DESK DOUBLE FILE DRAWER BASE, 29" HIGH, 21" or 24" DEEP

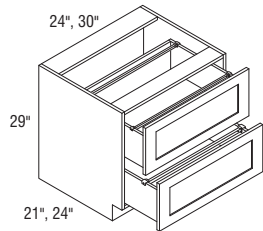

DDFD242921	11.9
DDFD302921	14.9
DDFD242924	13.4
DDFD302924	17.9

- Includes Filing System Hardware Kit, which accommodates letter and legal filing.
- Exterior height of file drawer is 10".
- Drawer fronts are 12 1/16" high.

Custom Modifications

ADDTK	CBO	CCO	CFP	CND	DRWTK	EXBK	FTK	FTK_V	ID	INVERM	LTI
	•	•			•	•	•	•			
PTOWB	RD	RECTK	RT	TVR_V	VTK						
		•			•						

Construction and Finish Upgrades

APC	FB	MIP	MSLFB	WLI
•	•	•	•	

Door Options

DPSRR

**DESK WASTEBASKET FULL HEIGHT
BASE, 29" HIGH, 15" or 18" WIDE,
21" or 24" DEEP**

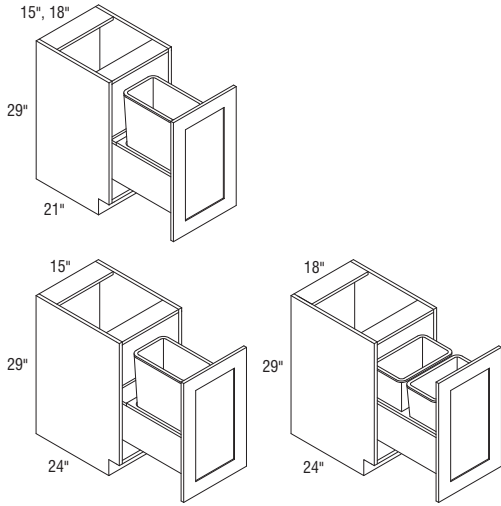

Model	Cubic Feet
DWB152921FH	6.8
DWB182921FH	8.0
DWB152924FH	7.7
DWB182924FH	9.1

- Pull-out features undermount Smart Stop guides.
- DWB152921FH, DWB182921FH, and DWB152924FH include one 35 quart gray wastebasket and a trash bag storage area.
- DWB182924FH includes two 35 quart gray wastebaskets.
- Wastebasket lid available for purchase separately, see page 343. BWBLID fits 35 quart wastebaskets.

Custom Modifications

ADDTK	CBO	CCO	CFP	CND	DRWTK	EXBK	FTK	FTK_V	ID	INFRM	LTI
	•	•			•*	•	•	•			
PTOWB	RD	RECTK	RT	TVR_V	VTK						
•*		•			•						

*Not available on 15" wide *Not available on 21" deep

Construction and Finish Upgrades

APC	FB	MIP	MSLFB	WLI
•	•	•	•	•

Door Options

DPSRR
•

**PRINTER BASE, 29" HIGH, 21" or
24" DEEP**

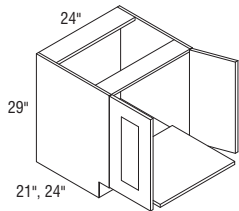

PRB242921	11.9
PRB242924	13.6

- 3/4" full depth slide-out shelf with undermount full extension Smart Stop guides.
- 75 lb. maximum shelf capacity.

Custom Modifications

ADDTK	CBO	CCO	CFP	CND	DRWTK	EXBK	FTK	FTK_V	ID	INFRM	LTI
	•	•			•	•	•	•	•		•
PTOWB	RD	RECTK	RT	TVR_V	VTK						
	•	•	•		•						

Construction and Finish Upgrades

APC	FB	MIP	MSLFB	WLI
•	•	•	•	•

Door Options

DPSRR
•

**DESK EASY REACH, 29" HIGH, 21" or
24" DEEP**

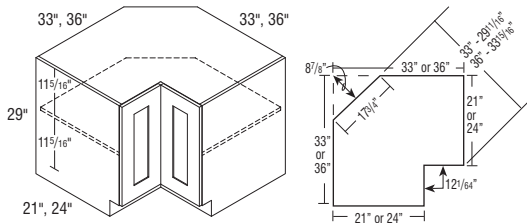

DER333321 L or R	16.0
DER363624 L or R	21.3

- Features one fixed shelf in center of cabinet.
- Decorative hardware screws must be countersunk to prevent scratching of adjacent cabinets.
- DER333321 L or R wall width is 33" x 33".
- DER363624 L or R wall width is 36" x 36".
- Integrated soft-close hinge not included.

Custom Modifications

ADDTK	CBO	CCO	CFP	CND	DRWTK	EXBK	FTK	FTK_V	ID	INFRM	LTI
	•	•									•
PTOWB	RD	RECTK	RT	TVR_V	VTK						
		•			•						

Construction and Finish Upgrades

APC	FB	MIP	MSLFB	WLI
•	•	•	•	•

Door Options

DPSRR
•

FURNITURE DRAWER, 6 1/2" HIGH, 24" DEEP

15", 18", 21",
24", 27", 30", 36"

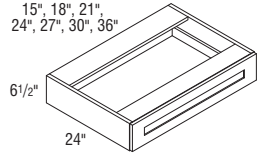

Model	Cubic Feet
FD1506.524	2.1
FD1806.524	2.5
FD2106.524	2.9
FD2406.524	3.3
FD2706.524	3.7
FD3006.524	4.1
FD3606.524	4.9

• Exterior height of drawer box is 3 3/8", drawer front is 6 1/4" high.

Custom Modifications

ADDTK	CBO	CCO	CFP	CND	DRWTK	EXBK	FTK	FTK_V	ID	INVRM	LTI
•	•	•				•					
PTOWB	RD	RECTK	RT	TVR_V	VTK						
	•										

Construction and Finish Upgrades

APC	FB	MIP	MSLFB	WLI
STD	•	•		

Door Options

DPSRR

FURNITURE DRAWER, 12" HIGH, 24" DEEP

15", 18", 21",
24", 27", 30", 36"

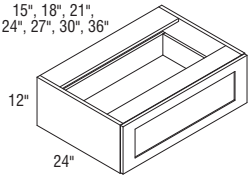

FD151224	3.5
FD181224	4.1
FD211224	4.7
FD241224	5.4
FD271224	6.0
FD301224	6.6
FD361224	7.9

• Exterior height of drawer box is 6 3/8", drawer front is 11 3/4" high.

Custom Modifications

ADDTK	CBO	CCO	CFP	CND	DRWTK	EXBK	FTK	FTK_V	ID	INVRM	LTI
•	•	•				•					
PTOWB	RD	RECTK	RT	TVR_V	VTK						
	•										

Construction and Finish Upgrades

APC	FB	MIP	MSLFB	WLI
STD	•	•		

Door Options

DPSRR

**FURNITURE DRAWER WINDOW
BENCH, 18" HIGH, 24" DEEP**

15", 18", 21",
24", 27", 30", 36"

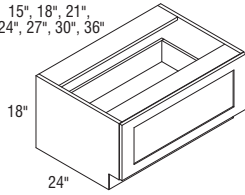

Model	Cubic Feet
FDWB151824	4.9
FDWB181824	5.8
FDWB211824	6.7
FDWB241824	7.6
FDWB271824	8.4
FDWB301824	9.3
FDWB361824	11.1

• Exterior height of drawer box is 6 3/8", drawer front is 13 1/4" high.

Custom Modifications

ADDTK	CBO	CCO	CFP	CND	DRWTK	EXBK	FTK	FTK_V	ID	INFRM	LTI
	•	•			•*	•	•	•			
PTOWB	RD	RECTK	RT	TVR_V	VTK						
	•	•			•						

*Not available on 15" wide

Construction and Finish Upgrades

APC	FB	MIP	MSLFB	WLI
	•	•		
STD				

Door Options

DPSRR
•

**WOOD TOPS, ONE SIDED, 22 1/2" or
25 1/2" DEEP**

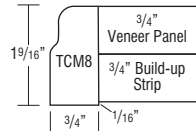
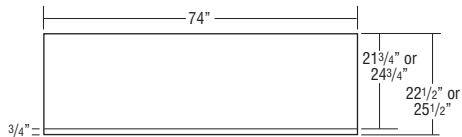
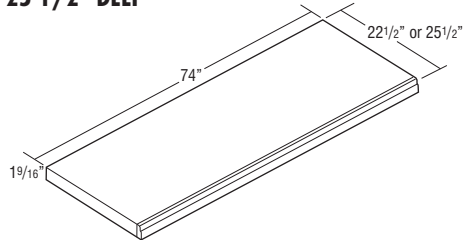

1TWT7221	3.8
1TWT7224	4.2

• 3/4" thick veneer over MDF panels with build-up strips to 1 1/2" thick and Traditional Countertop Moulding (TCM8) on front edge.

MODIFICATIONS

No modifications available for these products.

Construction and Finish Upgrades

APC	FB	MIP	MSLFB	WLI
•				

Finish Techniques

Distressing	Heirlooming
	•

WOOD TOPS, THREE SIDED, 22 1/2" or 25 1/2" DEEP

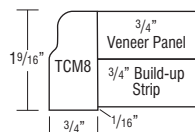
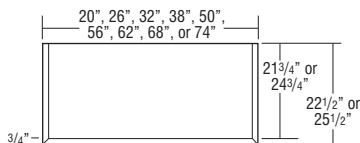
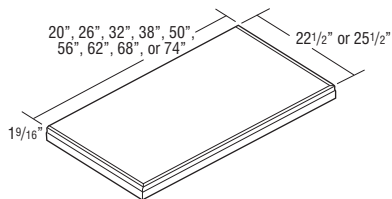

Model	Overall Width	Overall Depth
3TWT1821	20"	22 1/2"
3TWT2421	26"	22 1/2"
3TWT3021	32"	22 1/2"
3TWT3621	38"	22 1/2"
3TWT4821	50"	22 1/2"
3TWT5421	56"	22 1/2"
3TWT6021	62"	22 1/2"
3TWT6621	68"	22 1/2"
3TWT7221	74"	22 1/2"

Model	Overall Width	Overall Depth
3TWT1824	20"	25 1/2"
3TWT2424	26"	25 1/2"
3TWT3024	32"	25 1/2"
3TWT3624	38"	25 1/2"
3TWT4824	50"	25 1/2"
3TWT5424	56"	25 1/2"
3TWT6024	62"	25 1/2"
3TWT6624	68"	25 1/2"
3TWT7224	74"	25 1/2"

Model	Cubic Feet
3TWT1821	1.1
3TWT2421	1.4
3TWT3021	1.7
3TWT3621	2.0
3TWT4821	2.6
3TWT5421	2.9
3TWT6021	3.2
3TWT6621	3.5
3TWT7221	3.8
3TWT1824	1.2
3TWT2424	1.6
3TWT3024	1.9
3TWT3624	2.2
3TWT4824	2.9
3TWT5424	3.2
3TWT6024	3.6
3TWT6624	3.9
3TWT7224	4.2

- 3/4" thick veneer over MDF panels with build-up strips to 1 1/2" thick and Traditional Countertop Moulding (TCM8) on front and side edges.

MODIFICATIONS

No modifications available for these products.

Construction and Finish Upgrades

APC	FB	MIP	MSLFB	WLI
•				

Finish Techniques

Distressing	Heirlooming
	•

WOOD TOPS, FOUR SIDED, 27" or 33" DEEP

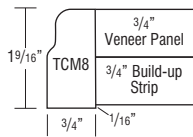
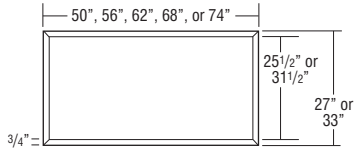
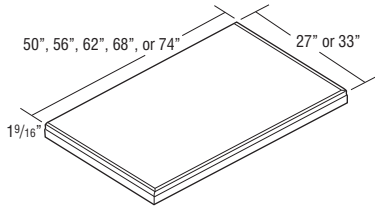

Model	Overall Width	Overall Depth
4TWT4827	50"	27"
4TWT5427	56"	27"
4TWT6027	62"	27"
4TWT6627	68"	27"
4TWT7227	74"	27"

Model	Overall Width	Overall Depth
4TWT4833	50"	33"
4TWT5433	56"	33"
4TWT6033	62"	33"
4TWT6633	68"	33"
4TWT7233	74"	33"

Model	Cubic Feet
4TWT4827	3.1
4TWT5427	3.4
4TWT6027	3.8
4TWT6627	4.1
4TWT7227	4.5
4TWT4833	3.7
4TWT5433	4.1
4TWT6033	4.5
4TWT6633	5.0
4TWT7233	5.4

- 3/4" thick veneer over MDF panels with build-up strips to 1 1/2" thick and Traditional Countertop Moulding (TCM8) on front, back, and side edges.

MODIFICATIONS
No modifications available for these products.

Construction and Finish Upgrades

APC	FB	MIP	MSLFB	WLI
•				

Finish Techniques

Distressing	Heirlooming
	•

UNDER COUNTER DRAWER, 4 3/4" HIGH, 18" or 21" DEEP

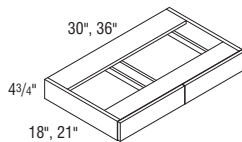
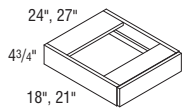

UCD2418	2.6
UCD2718	2.6
UCD2421	2.6
UCD2721	2.6
UCD3018	2.6
UCD3618	2.6
UCD3021	2.6
UCD3621	2.6

- Cabinet is 4 3/4" high. Drawer box within cabinet is 2" high (outside dimension), drawer front is 4 1/2" high.
- Top and bottom reveal is 1/8".
- Not trimmable.
- Drawer front is 3/4" slab front.
- When ordered in APC, end panels will be finished.
- Reduced depth is available in 3" increments.

Custom Modifications

ADDTK	CBO	CCO	CFP	CND	DRWTK	EXBK	FTK	FTK_V	ID	INFRM	LTI
	•	•							•		
PTOWB	RD	RECTK	RT	TVR_V	VTK						
	•										

Construction and Finish Upgrades

APC	FB	MIP	MSLFB	WLI
•		•	•	

Door Options

DPSRR

VANITY CABINET NOMENCLATURE

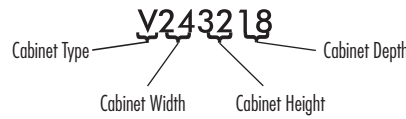

NOTE:
Distance between back of drawer box and back interior of cabinet is 2 3/8".
All vanity cabinets are predrilled for full depth shelves or roll trays.

TOEKICKS

Vanity Cabinets are shipped with an unfinished toekick. Finished toekicks in matching wood veneer or laminate must be ordered separately and field installed.

MODIFICATIONS GRID KEY

- Available
- STD Standard on these cabinets
- storage Storage Solutions Organization Cabinet
- 5 DAY** 5 Day Express Response Item

CUSTOM MODIFICATIONS

Mod.	Description	Mod.	Description
CBO	Cabinet Box Only	ID	Increased Depth
CCO	Cabinet Case Only	INVERM	Inverted Opening
CFP	Cabinet False Panel	LTI	Light Installed Battery Strip
CMAT	CabMat™	RD	Reduced Depth
CND	Cabinet with No Door, with Drawer	RECTK	Recessed Toekick
DRWPWR	PowerGlide™ Compact Drawer Outlet	RT	Installed Roll Tray
DRWTK	Toekick Drawer	TKP	Loose Toekick
EXBK	End Extended Back	TOTSS	Tilt-out Tray, Stainless Steel
FTK	Flush Toekick	VTK	Void Toekick
FTK_V	Flush Toekick w/Valance		

CONSTRUCTION AND FINISH UPGRADES

Mod.	Description
APC	All-plywood Construction
FB	Finished Ends
MIP	Matching Interior Plywood
MSLFB	Matching Specialty Laminate Furniture Board
WLI	White Laminate Interior

DOOR OPTIONS

Mod.	Description
ALF	Aluminum Frame Doors
CG	Cut-For-glass Doors
DPSRR	Door Panel - Solid Reverse Raised
MD	Mullion Doors

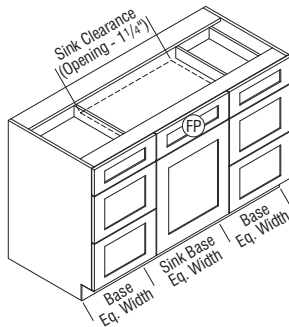

VANITY BASE, 32" HIGH, 18" or 21" DEEP

12", 15", 18", 21", 24"

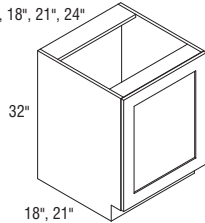

24", 27", 30", 33", 36"

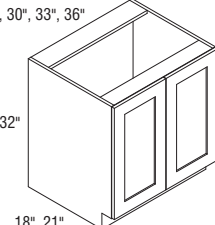

V2432_ _V3632_ _ Butt doors

Model	Cubic Feet	Model	Cubic Feet
V123218 L or R	5.6	V243218	10.4
V153218 L or R	6.8	V273218	11.6
V183218 L or R	8.0	V303218	12.7
V213218 L or R	9.2	V333218	13.9
V243218 L or R	10.4	V363218	15.1
V123221 L or R	6.4	V243221	11.9
V153221 L or R	7.8	V273221	13.3
V183221 L or R	9.2	V303221	14.6
V213221 L or R	10.6	V333221	16.0
V243221 L or R	11.9	V363221	17.4

Custom Modifications

CBO	CCO	CFP	CMAT	CND	DRWPWR	DRWTK	EXBK	FTK	FTK_V	ID	INVERM
	•		•*			•+	•	•	•▲	•	
		RD	RECTK	RT	TKP	TOTSS	VTK				
•?	•	•	•				•				

*Not available on 12", 15", 18", and 21" wide, or on 18" deep *Not available on 12" and 15" wide, or on 18" deep

▲Not available on 12" wide †Not available on 12", 15", 18", and 21" wide

Construction and Finish Upgrades

APC	FB	MIP	MSLFB	WLI
•	•	•	•	•

Door Options

ALF	CG	DPSRR	MD
		•	

**VANITY BASE, 32" HIGH,
18" or 21" DEEP (cont'd)**

39", 42", 45", 48"

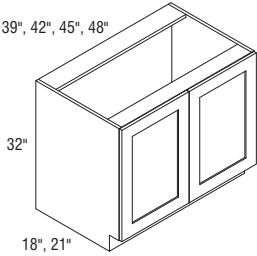

V3932 _ -V4832 _ CS Center mullion

48", 60"

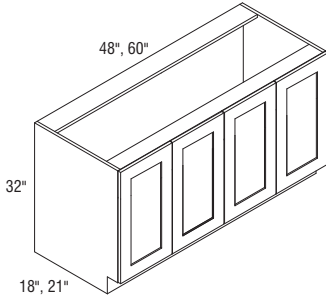

V4832 _ -V6032 _ Vertical divider

Model	Cubic Feet	Model	Cubic Feet
V393218	16.5	V483218	19.9
V423218	17.5	V603218	28.6
V453218	18.5	V483221	22.9
V483218CS	19.9	V603221	25.0
V393221	18.9		
V423221	20.1		
V453221	21.3		
V483221CS	22.9		

Custom Modifications

CBO	CCO	CFP	CMAT	CND	DRWPVR	DRWTK	EXBK	FTK	FTK_V	ID	INVFRM
	•		•*				•	•†	•†	•	
LTI	RD	RECTK	RT	TKP	TOTSS	VTK					
•	•	•				•					

*Not available on 39", 42", and 45" wide, or on 18" deep †Not available on 60" wide

Construction and Finish Upgrades

APC	FB	MIP	MSLFB	WLI
•	•	•	•	•

Door Options

ALF	CG	DPSRR	MD
		•	

**VANITY BASE, 34 1/2" HIGH,
18" or 21" DEEP**

12", 15", 18", 21", 24"

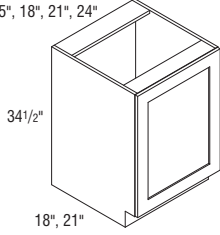

24", 27", 30", 33",
36", 39", 42", 45", 48"

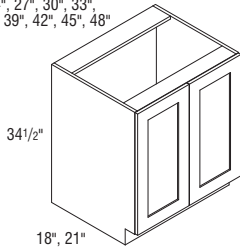

V2434 -V3634 Butt doors
V3934 -V4834 CS Vertical divider

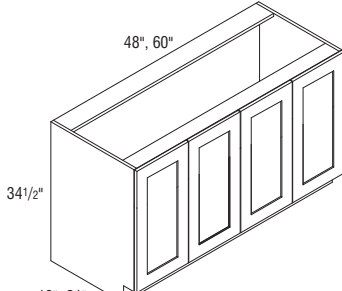

V4834 -V6034 Vertical divider

Model	Cubic Feet	Model	Cubic Feet
V123418 L or R	5.8	V393418	17.3
V153418 L or R	7.1	V423418	18.6
V183418 L or R	8.3	V453418	19.9
V213418 L or R	9.6	V483418CS	21.1
V243418 L or R	10.9	V393421	22.3
V123421 L or R	6.8	V423421	24.4
V153421 L or R	8.2	V453421	25.2
V183421 L or R	9.7	V483421CS	27.7
V213421 L or R	11.2		
V243421 L or R	14.4	V483418	21.1
		V603418	26.3
V243418	10.9	V483421	27.7
V273418	12.2	V603421	30.3
V303418	13.5		
V333418	14.7		
V363418	16.0		
V243421	14.4		
V273421	16.1		
V303421	17.7		
V333421	19.6		
V363421	21.1		

Custom Modifications

CBO	CCO	CFP	CMAT	CND	DRWPWR	DRWTK	EXBK	FTK	FTK_V	ID	INVFRM
	•		•*			•+	•	•▲	•†	•	
LTI	RD	RECTK	RT	TKP	TOTSS	VTK					
•‡	•	•	•^			•					

*Not available on 12", 15", 18", 21", 39", 42", and 45" wide, or on 18" deep

†Not available on 12", 15", 39", 42", 45", 48" and 60" wide, or on 18" deep

▲Not available on 60" wide †Not available on 12" and 60" wide

‡Not available on 12", 15", 18", and 21" wide

^Not available on 39", 42", 45", 48", and 60" wide

Construction and Finish Upgrades

APC	FB	MIP	MSLFB	WLI
•	•	•	•	•

Door Options

ALF	CG	DPSRR	MD
		•	

**VANITY SINK BASE with FALSE PANEL,
32" HIGH, 18" or 21" DEEP**

15", 18", 21", 24"

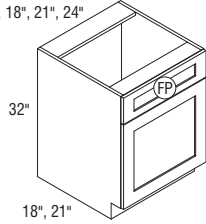

(FP) = False Panel

24", 27", 30", 33", 36"

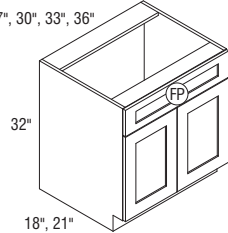

VSB2432 __ -VSB3632 __ Butt doors

39", 42", 45", 48"

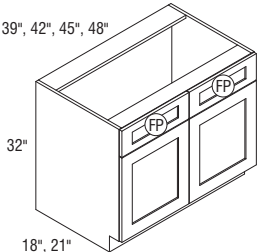

VSB3932 __ -VSB4832 __ CS Vertical divider

48"

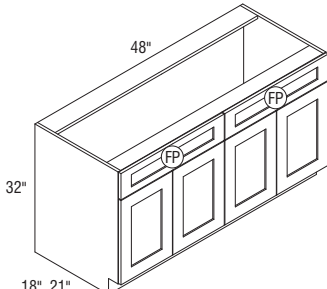

VSB4832 __ Vertical divider

Model	Cubic Feet	Model	Cubic Feet
VSB153218 L or R	6.8	VSB393218	16.5
VSB183218 L or R	8.0	VSB423218	17.5
VSB213218 L or R	9.2	VSB453218	18.5
VSB243218 L or R	10.4	VSB483218CS	19.9
VSB153221 L or R	7.8	VSB393221	18.9
VSB183221 L or R	9.2	VSB423221	20.1
VSB213221 L or R	10.6	VSB453221	21.3
VSB243221 L or R	11.9	VSB483221CS	22.9
VSB243218	10.4	VSB483218	19.9
VSB273218	11.6	VSB483221	22.9
VSB303218	12.7		
VSB333218	13.9		
VSB363218	15.1		
VSB243221	11.9		
VSB273221	13.3		
VSB303221	14.6		
VSB333221	16.0		
VSB363221	17.4		

Custom Modifications

CBO	CCO	CFP	CMAT	CND	DRWPWR	DRWTK	EXBK	FTK	FTK_V	ID	INVFRM
	•	STD	•*	•		•*	•	•	•	•	
LTI	RD	RECTK	RT	TKP	TOTSS	VTK					
•▲	•	•	•†		•	•					

*Not available on 15", 18", 21", 39", 42", and 45" wide, or on 18" deep

•Not available on 15", 39", 42" and 48" wide, or on 18" deep

▲Not available on 15", 18", and 21" deep

†Not available on 39", 42", 45", and 48" wide

Construction and Finish Upgrades

APC	FB	MIP	MSLFB	WLI
•	•	•	•	•

Door Options

ALF	CG	DPSRR	MD
		•	

**VANITY SINK BASE with FALSE PANEL,
34 1/2" HIGH, 18" or 21" DEEP**

15", 18", 21", 24"

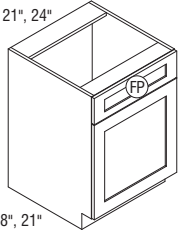

(FP) = False Panel

24", 27", 30", 33", 36"

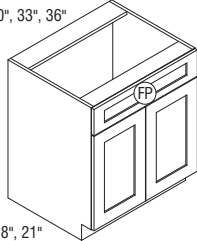

VSB2434 _-**VSB3634** _- Butt doors

39", 42", 45", 48"

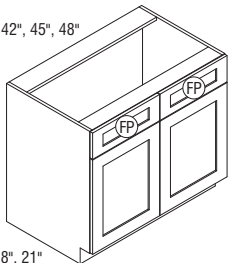

VSB3934 _-**VSB4834** _- CS Vertical divider

48"

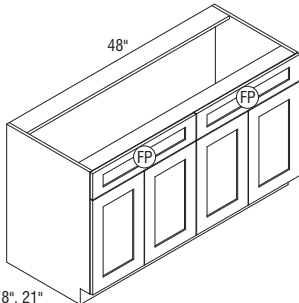

VSB4834 _- Vertical divider

Model	Cubic Feet	Model	Cubic Feet
VSB153418 L or R	7.1	VSB393418	17.3
VSB183418 L or R	8.3	VSB423418	18.6
VSB213418 L or R	9.6	VSB453418	19.9
VSB243418 L or R	10.9	VSB483418CS	21.1
VSB153421 L or R	8.2	VSB393421	22.3
VSB183421 L or R	9.7	VSB423421	24.4
VSB213421 L or R	11.2	VSB453421	25.2
VSB243421 L or R	14.4	VSB483421CS	27.7
VSB243418	10.9	VSB483418	21.1
VSB273418	12.2	VSB483421	27.7
VSB303418	13.5		
VSB333418	14.7		
VSB363418	16.0		
VSB243421	14.4		
VSB273421	16.1		
VSB303421	17.7		
VSB333421	19.6		
VSB363421	21.1		

Custom Modifications

CBO	CCO	CFP	CMAT	CND	DRWPWR	DRWTK	EXBK	FTK	FTK_V	ID	INVERM
	•	STD	•*	•		•*	•	•	•	•	
LTI	RD	RECTK	RT	TKP	TOTSS	VTK					
•^	•	•	•†		•	•					

*Not available on 15", 18", 21", 39", 42", and 45" wide, or on 18" deep

†Not available on 15", 39", 42" and 48" wide, or on 18" deep

^Not available on 15", 18", and 21" deep

†Not available on 39", 42", 45", and 48" wide

Construction and Finish Upgrades

APC	FB	MIP	MSLFB	WLI
•	•	•	•	•

Door Options

ALF	CG	DPSRR	MD
		•	

VANITY SINK BASE with U-SHAPED ROLL-OUT TRAY, 32" HIGH, 21" DEEP

storage SOLUTIONS

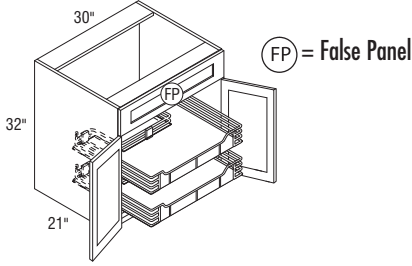

Model	Cubic Feet
VSB303221U	14.6

- Includes two chrome U-shaped Smart Stop roll-outs with gray shelf liner.
- Cut-out for U-shape on bottom roll-out is 6 1/8" from back of cabinet.
- Cut-out for U-shape on top roll-out is 12 1/8" from back of cabinet.
- Trays are 25 21/32" wide and 17 23/32" deep.

Custom Modifications

CBO	CCO	CFP	CMAT	CND	DRWPWR	DRWTK	EXBK	FTK	FTK_V	ID	INVFRM
•	•	STD		•		•	•	•	•	•	
LTI	RD	RECTK	RT	TKP	TOTSS	VTK					
•		•				•					

Construction and Finish Upgrades

APC	FB	MIP	MSLFB	WLI
•	•	•	•	•

Door Options

ALF	CG	DPSRR	MD
		•	

VANITY SINK BASE with U-SHAPED ROLL-OUT TRAY, 34 1/2" HIGH, 21" DEEP

storage SOLUTIONS

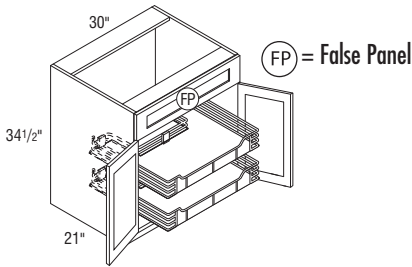

Model	Cubic Feet
VSB303421U	17.7

- Includes two chrome U-shaped Smart Stop roll-outs with gray shelf liner.
- Cut-out for U-shape on bottom roll-out is 6 1/8" from back of cabinet.
- Cut-out for U-shape on top roll-out is 12 1/8" from back of cabinet.
- Trays are 25 21/32" wide and 17 23/32" deep.

Custom Modifications

CBO	CCO	CFP	CMAT	CND	DRWPWR	DRWTK	EXBK	FTK	FTK_V	ID	INVFRM
•	•	STD		•		•	•	•	•	•	
LTI	RD	RECTK	RT	TKP	TOTSS	VTK					
•		•				•					

Construction and Finish Upgrades

APC	FB	MIP	MSLFB	WLI
•	•	•	•	•

Door Options

ALF	CG	DPSRR	MD
		•	

VANITY SINK BASE with WASTEBASKET, 34 1/2" HIGH, 21" DEEP

storage SOLUTIONS

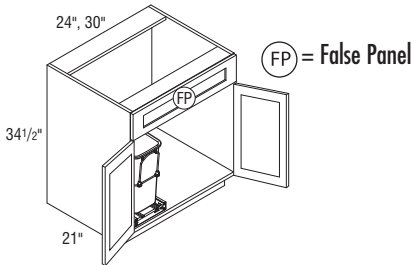

Model	Cubic Feet
VSB243421WB L or R	14.4

Model	Cubic Feet
VSB303421WB L or R	17.7

- Bottom mounted zinc colored Smart Stop guides with 20 quart gray wastebasket inserted in chrome support. Dimensions of unit: 8.5"W x 16.7"H x 17.7"D.
- L or R designates wastebasket location.

Custom Modifications

CBO	CCO	CFP	CMAT	CND	DRWPWR	DRWTK	EXBK	FTK	FTK_V	ID	INVFRM
•	•	STD		•		•	•	•	•	•	
LTI	RD	RECTK	RT	TKP	TOTSS	VTK					
•		•				•					

Construction and Finish Upgrades

APC	FB	MIP	MSLFB	WLI
•	•	•	•	•

Door Options

ALF	CG	DPSRR	MD
		•	

VANITY SINK BASE SUPERCABINET™
with TILT-OUT TRAYS and
WASTEBASKET, 34 1/2" HIGH,
21" DEEP

storage
SOLUTIONS

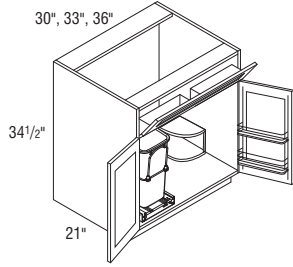

Model	Cubic Feet
VSSB303421STWB L or R	17.7
VSSB333421STWB L or R	19.6
VSSB363421STWB L or R	21.1

- Quarter Round Reversible Shelf for left or right applications will be constructed from 3/4" thick laminated furniture board. When upgraded to APC, shelf will use clear coated veneer plywood. (Shelf shipped secure, can be positioned in left or right corner.)
- Door on the side with the Quarter Round Shelf features a chrome and wood two-tiered rack.
- Door rack width is 11 3/8" on 30" and 33" wide cabinets and 14 3/8" on 36" wide cabinet.
- Door rack depth is 3 1/2".
- Includes 2 installed tilt-out trays.
- Tilt-out trays are stain resistant, moisture resistant plastic to allow storage of sponges & other cleaning materials.
- Tilt-out trays are also available as an accessory for field installation. See page 350.
- All load bearing service meet KCMA standards of 15 lbs. per square foot.
- Bottom mounted zinc colored Smart Stop guides with 20 quart gray wastebasket inserted in chrome support. Dimensions of unit: 8.5"W x 16.7"H x 17.7"D.
- L or R designates wastebasket location.

Custom Modifications

CBO	CCO	CFP	CMAT	CND	DRWPWR	DRWTK	EXBK	FTK	FTK_V	ID	INVERM
•	•			•		•	•	•	•	•	
LTI	RD	RECTK	RT	TKP	TOTSS	VTK					
•		•				•					

Construction and Finish Upgrades

APC	FB	MIP	MSLFB	WLI
•	•	•	•	•

Door Options

ALF	CG	DPSRR	MD
		•	

VANITY SINK BASE SUPERCABINET™
with TILT-OUT TRAYS, 34 1/2" HIGH,
21" DEEP

storage
SOLUTIONS

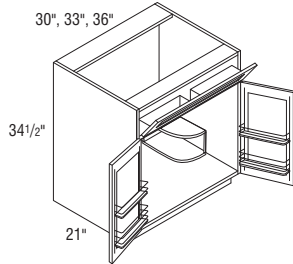

VSSB303421ST	17.7
VSSB333421ST	19.6
VSSB363421ST	21.1

- Quarter Round Reversible Shelf for left or right applications will be constructed from 3/4" thick laminated furniture board. When upgraded to APC, shelf will use clear coated veneer plywood. (Shelf shipped secure, can be positioned in left or right corner.)
- Each door features a chrome and wood two-tiered rack.
- Door rack width is 11 3/8" on 30" and 33" wide cabinets and 14 3/8" on 36" wide cabinet.
- Door rack depth is 3 1/2".
- Includes 2 installed tilt-out trays.
- Tilt-out trays are stain resistant, moisture resistant plastic to allow storage of sponges & other cleaning materials.
- Tilt-out trays are also available as an accessory for field installation. See page 350.
- All load bearing service meet KCMA standards of 15 lbs. per square foot.

Custom Modifications

CBO	CCO	CFP	CMAT	CND	DRWPWR	DRWTK	EXBK	FTK	FTK_V	ID	INVERM
•	•			•		•	•	•	•	•	
LTI	RD	RECTK	RT	TKP	TOTSS	VTK					
•		•				•					

Construction and Finish Upgrades

APC	FB	MIP	MSLFB	WLI
•	•	•	•	•

Door Options

ALF	CG	DPSRR	MD
		•	

VANITY BASE, SINGLE DOOR with DRAWER, 32" HIGH, 18" or 21" DEEP

12", 15", 18", 21", 24"

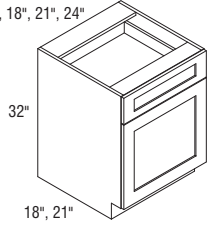

Model	Cubic Feet
VB123218 L or R	5.6
VB153218 L or R	6.8
VB183218 L or R	8.0
VB213218 L or R	9.2
VB243218 L or R	10.5
VB123221 L or R	6.4
VB153221 L or R	7.8
VB183221 L or R	9.1
VB213221 L or R	10.8
VB243221 L or R	11.9

Custom Modifications

CBO	CCO	CFP	CMAT	CND	DRWPVR	DRWTK	EXBK	FTK	FTK_V	ID	INVFRM
•	•	•		•		•*	•	•	•*	•	•
LTI	RD	RECTK	RT	TKP	TOTSS	VTK					
•*	•	•	•			•					

*Not available on 12" and 15" wide, or on 18" deep *Available only on 24" wide

Construction and Finish Upgrades

APC	FB	MIP	MSLFB	WLI
•	•	•	•	•

Door Options

ALF	CG	DPSRR	MD
		•	

VANITY BASE, SINGLE DOOR with DRAWER, 34 1/2" HIGH, 18" or 21" DEEP

12", 15", 18", 21", 24"

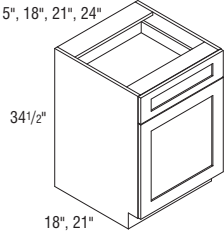

VB123418 L or R	5.8
VB153418 L or R	7.1
VB183418 L or R	8.3
VB213418 L or R	9.6
VB243418 L or R	10.9
VB123421 L or R	7.8
VB153421 L or R	9.4
VB183421 L or R	11.1
VB213421 L or R	12.8
VB243421 L or R	14.4

Custom Modifications

CBO	CCO	CFP	CMAT	CND	DRWPVR	DRWTK	EXBK	FTK	FTK_V	ID	INVFRM
•	•	•		•		•*	•	•	•▲	•	•
LTI	RD	RECTK	RT	TKP	TOTSS	VTK					
•▲	•	•	•			•					

*Not available on 12" and 15" wide *Not available on 12" and 15" wide, or on 18" deep ▲Available only on 24" wide

Construction and Finish Upgrades

APC	FB	MIP	MSLFB	WLI
•	•	•	•	•

Door Options

ALF	CG	DPSRR	MD
		•	

VANITY BASE, DOUBLE DOOR with DRAWER, 32" HIGH, 18" or 21" DEEP

24", 27", 30", 33", 36"

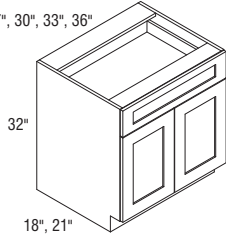

VB2432 __-VB3632 __ Butt doors

39", 42", 45", 48"

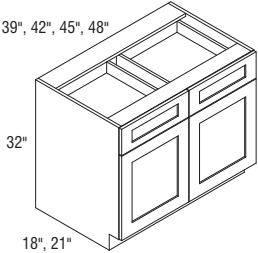

VB3932 __-VB4832 __ CS Center mullion

48"

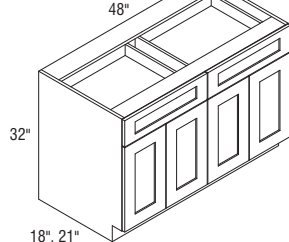

VB4832 __ Vertical divider

Model	Cubic Feet	Model	Cubic Feet
VB243218	10.4	VB393218	16.5
VB273218	11.7	VB423218	17.7
VB303218	12.9	VB453218	18.5
VB333218	14.1	VB483218CS	20.2
VB363218	15.3	VB393221	18.9
VB243221	11.9	VB423221	20.3
VB273221	13.3	VB453221	21.3
VB303221	14.7	VB483221CS	23.1
VB333221	16.1		
VB363221	17.5	VB483218	20.2
		VB483221	23.1

Custom Modifications

CBO	CCO	CFP	CMAT	CND	DRWPWR	DRWTK	EXBK	FTK	FTK_V	ID	INVFRM
•	•	•		•	•	•*	•	•	•	•	•
LTI	RD	RECTK	RT	TKP	TOTSS	VTK					
•*	•	•	•+			•					

*Not available on 39", 42", 45" and 48" wide, or on 18" deep *Not available on 39", 42", 45", and 48" wide

Construction and Finish Upgrades

APC	FB	MIP	MSLFB	WLI
•	•	•	•	•

Door Options

ALF	CG	DPSRR	MD
		•	

VANITY BASE, DOUBLE DOOR with DRAWER, 34 1/2" HIGH, 18" or 21" DEEP

24", 27", 30", 33", 36"

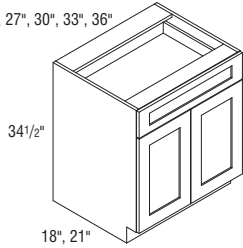

VB2434 -VB3634 - Butt doors

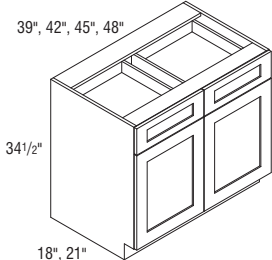

VB3934 -VB4834 - CS Center mullion

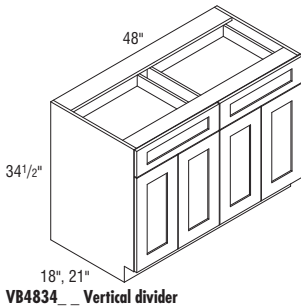

VB4834 - Vertical divider

Model	Cubic Feet	Model	Cubic Feet
VB243418	10.9	VB393418	17.3
VB273418	12.2	VB423418	18.6
VB303418	13.5	VB453418	19.9
VB333418	14.7	VB483418CS	21.1
VB363418	16.0	VB393421	22.3
VB243421	14.4	VB423421	24.4
VB273421	16.1	VB453421	25.2
VB303421	17.7	VB483421CS	27.7
VB333421	19.6		
VB363421	21.1	VB483418	21.1
		VB483421	27.7

Custom Modifications

CBO	CCO	CFP	CMAT	CND	DRWPVR	DRWTK	EXBK	FTK	FTK_V	ID	INVFRM
•	•	•		•	•	•*	•	•	•	•	•
LTI	RD	RECTK	RT	TKP	TOTSS	VTK					
•+	•	•	•*			•					

*Not available on 39", 42", 45" and 48" wide, or on 18" deep *Not available on 39", 42", 45", and 48" wide

Construction and Finish Upgrades

APC	FB	MIP	MSLFB	WLI
•	•	•	•	•

Door Options

ALF	CG	DPSRR	MD
		•	

VANITY BASE EASY REACH, 32" HIGH, 18" or 21" DEEP

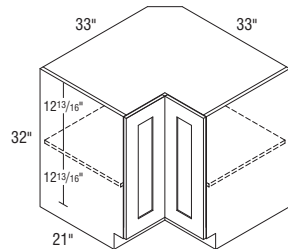
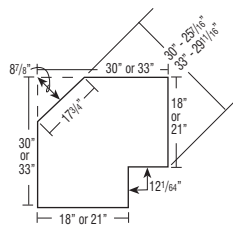
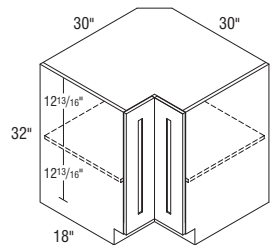

VER303218 L or R	12.9
VER333221 L or R	16.1

- Decorative hardware screws must be countersunk to prevent scratching adjacent cabinets.
- Includes one 5/8" thick fixed shelf in center of cabinet.
- Integrated soft-close hinge not included.

Custom Modifications

CBO	CCO	CFP	CMAT	CND	DRWPVR	DRWTK	EXBK	FTK	FTK_V	ID	INVFRM
•											
LTI	RD	RECTK	RT	TKP	TOTSS	VTK					
•		•				•					

Construction and Finish Upgrades

APC	FB	MIP	MSLFB	WLI
•	•	•	•	•

Door Options

ALF	CG	DPSRR	MD
		•	

**VANITY BASE EASY REACH,
34 1/2" HIGH, 21" DEEP**

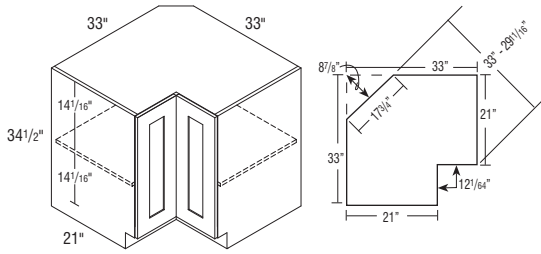

Model	Cubic Feet
VER333421 L or R	17.1

- Decorative hardware screws must be countersunk to prevent scratching adjacent cabinets.
- Includes one 5/8" thick fixed shelf in center of cabinet.
- Integrated soft-close hinge not included.

Custom Modifications

CBO	CCO	CFP	CMAT	CND	DRWPWR	DRWTK	EXBK	FTK	FTK_V	ID	INVERM
•	•										
LTI	RD	RECTK	RT	TKP	TOTSS	VTK					
•		•				•					

Construction and Finish Upgrades

APC	FB	MIP	MSLFB	WLI
•	•	•	•	•

Door Options

ALF	CG	DPSRR	MD
		•	

**VANITY DRAWER BASE,
32" HIGH, 18" or 21" DEEP**

12", 15", 18", 21",
24", 27", 30", 33", 36"

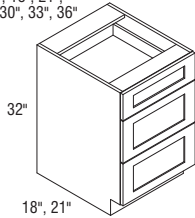

VDB123218	5.6
VDB153218	6.8
VDB183218	8.0
VDB213218	9.2
VDB243218	10.4
VDB273218	11.4
VDB303218	12.6
VDB333218	13.8
VDB363218	15.0
VDB123221	6.4
VDB153221	7.8
VDB183221	9.1
VDB213221	10.5
VDB243221	11.9
VDB273221	13.1
VDB303221	14.5
VDB333221	15.8
VDB363221	17.2

- Top drawer front is 6 1/4" high and lower drawer fronts are 10 3/8" high.

Custom Modifications

CBO	CCO	CFP	CMAT	CND	DRWPWR	DRWTK	EXBK	FTK	FTK_V	ID	INVERM
•	•	•			•*	•*	•	•	•▲	•	
LTI	RD	RECTK	RT	TKP	TOTSS	VTK					
	•	•				•					

*Not available on 12" and 15" wide *Not available on 12" and 15" wide, or on 18" deep ▲Not available on 12" wide

Construction and Finish Upgrades

APC	FB	MIP	MSLFB	WLI
•	•	•	•	

Door Options

ALF	CG	DPSRR	MD

**VANITY DRAWER BASE,
34 1/2" HIGH, 18" or 21" DEEP**

12", 15", 18", 21",
24", 27", 30", 33", 36"

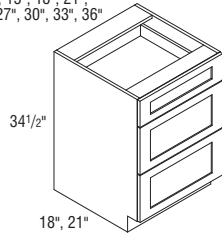

Model	Cubic Feet
VDB123418	5.8
VDB153418	7.1
VDB183418	8.3
VDB213418	9.6
VDB243418	10.9
VDB273418	12.2
VDB303418	13.5
VDB333418	14.7
VDB363418	16.0
VDB123421	7.8
VDB153421	9.4
VDB183421	11.1
VDB213421	12.8
VDB243421	14.4
VDB273421	11.4
VDB303421	12.6
VDB333421	13.8
VDB363421	15.0

• Top drawer front is 6 1/4" high and lower drawer fronts are 11 5/8" high.

Custom Modifications

CBO	CCO	CFP	CMAT	CND	DRWPWR	DRWTK	EXBK	FTK	FTK_V	ID	INVFRM
•	•	•			•*	•*	•	•	•▲	•	
LTI	RD	RECTK	RT	TKP	TOTSS	VTK					
	•	•				•					

*Not available on 12" and 15" wide *Not available on 12" and 15" wide, or on 18" deep ▲Not available on 12" wide

Construction and Finish Upgrades

APC	FB	MIP	MSLFB	WLI
•	•	•	•	

Door Options

ALF	CG	DPSRR	MD

**VANITY FOUR DRAWER BASE,
34 1/2" HIGH, 18" or 21" DEEP**

12", 15", 18", 21",
24", 27", 30", 33", 36"

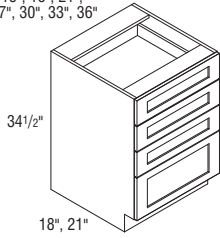

Model	Cubic Feet
4VDB123418	5.8
4VDB153418	7.0
4VDB183418	8.3
4VDB213418	9.6
4VDB243418	10.9
4VDB273418	12.2
4VDB303418	13.5
4VDB333418	14.7
4VDB363418	16.0
4VDB123421	6.8
4VDB153421	8.2
4VDB183421	9.7
4VDB213421	11.2
4VDB243421	12.7
4VDB273421	13.9
4VDB303421	15.3
4VDB333421	16.8
4VDB363421	18.2

• Upper three drawer fronts are 6 1/4" high and bottom drawer front is 10 5/8" high.

Custom Modifications

CBO	CCO	CFP	CMAT	CND	DRWPWR	DRWTK	EXBK	FTK	FTK_V	ID	INVERM
•	•	•			•*	•+	•	•	•▲	•	
LTI	RD	RECTK	RT	TKP	TOTSS	VTK					
	•	•				•					

*Not available on 12" and 15" wide *Not available on 12" and 15" wide, or on 18" deep ▲Not available on 12" wide

Construction and Finish Upgrades

APC	FB	MIP	MSLFB	WLI
•	•	•	•	

Door Options

ALF	CG	DPSRR	MD

**VANITY BASE WASTEBASKET,
34 1/2" HIGH, 21" DEEP**

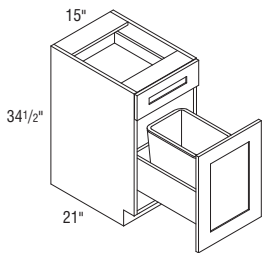

storage
SOLUTIONS

VBWB153421	9.4
-------------------	------------

- Includes one 35 quart gray wastebasket and one trash bag storage area.
- Pull-out features undermount Smart Stop guides.

Custom Modifications

CBO	CCO	CFP	CMAT	CND	DRWPWR	DRWTK	EXBK	FTK	FTK_V	ID	INVERM
•	•	•			•	•	•	•	•		
LTI	RD	RECTK	RT	TKP	TOTSS	VTK					
		•				•					

Construction and Finish Upgrades

APC	FB	MIP	MSLFB	WLI
•	•	•	•	•

Door Options

ALF	CG	DPSRR	MD

**VANITY WASTEBASKET FULL HEIGHT,
32" or 34 1/2" HIGH, 21" DEEP**

storage
SOLUTIONS

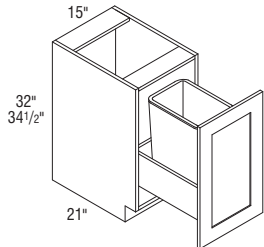

Model	Cubic Feet
VWB153221	7.8
VWB153421	9.4

- Includes one 35 quart gray wastebasket and one trash bag storage area.
- Pull-out features undermount Smart Stop guides.

Custom Modifications

CBO	CCO	CFP	CMAT	CND	DRWPWR	DRWTK	EXBK	FTK	FTK_V	ID	INVFRM
•	•						•	•	•		
LTI	RD	RECTK	RT	TKP	TOTSS	VTK					
		•				•					

Construction and Finish Upgrades

APC	FB	MIP	MSLFB	WLI
•	•	•	•	•

Door Options

ALF	CG	DPSRR	MD

**VANITY WASTEBASKET FULL HEIGHT
with ROLL TRAY,
32" or 34 1/2" HIGH, 21" DEEP**

storage
SOLUTIONS

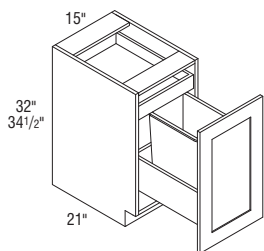

Model	Cubic Feet
VWB153221RT	7.8
VWB153421RT	9.4

- Includes one 35 quart gray wastebasket and one trash bag storage area.
- Pull-out features undermount Smart Stop guides.
- 1 roll tray standard.
- VWB153221RT not compatible with BWBLID due to limited height clearance.

Custom Modifications

CBO	CCO	CFP	CMAT	CND	DRWPWR	DRWTK	EXBK	FTK	FTK_V	ID	INVFRM
•	•						•	•	•		
LTI	RD	RECTK	RT	TKP	TOTSS	VTK					
		•				•					

Construction and Finish Upgrades

APC	FB	MIP	MSLFB	WLI
•	•	•	•	•

Door Options

ALF	CG	DPSRR	MD

**VANITY PULL-OUT,
34 1/2" HIGH, 21" DEEP**

storage
SOLUTIONS

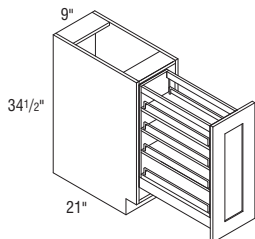

Model	Cubic Feet
VP93421	4.9

- All styles feature a natural finish full extension wood pull-out with adjustable shelves and chrome rail sides (Smart Stop not included).

Custom Modifications

CBO	CCO	CFP	CMAT	CND	DRWPWR	DRWTK	EXBK	FTK	FTK_V	ID	INVFRM
•	•						•	•			
LTI	RD	RECTK	RT	TKP	TOTSS	VTK					
		•*				•					

*RECTKALL not available

Construction and Finish Upgrades

APC	FB	MIP	MSLFB	WLI
•	•	•	•	•

Door Options

ALF	CG	DPSRR	MD
		•	

**VANITY GROOMING PULL-OUT,
34 1/2" HIGH, 21" DEEP**

storage
SOLUTIONS

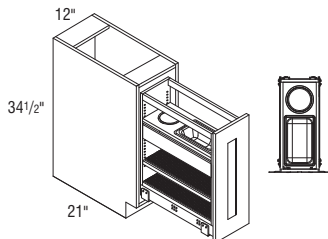

Model	Cubic Feet
VGPO123421	6.8

- Full extension, Smart Stop wood pull-out with natural finish.
- Pull-out is 19" deep.
- Features adjustable shelves with non-skid vinyl liners and clear polycarbonate rails.
- Includes two stainless steel bins (one rectangular and one round) for storing items such as curling irons and hair dryers.

Custom Modifications

CBO	CCO	CFP	CMAT	CND	DRWPWR	DRWTK	EXBK	FTK	FTK_V	ID	INVFRM
•	•						•	•			
LTI	RD	RECTK	RT	TKP	TOTSS	VTK					
		•				•					

Construction and Finish Upgrades

APC	FB	MIP	MSLFB	WLI
•	•	•	•	•

Door Options

ALF	CG	DPSRR	MD
		•	

**VANITY SINK DRAWER BASE,
32" HIGH, 18" or 21" DEEP**

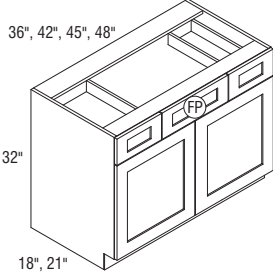

FP = False Panel

2VSD3632... Butt doors
2VSD4232...-2VSD4832... CS Center mullion

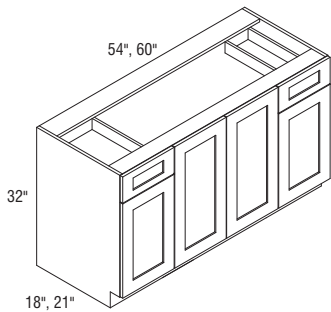
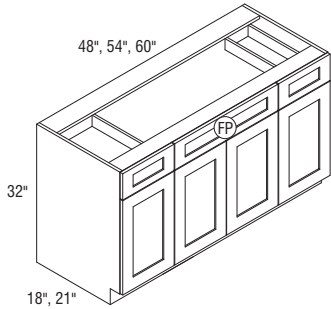

Model	Cubic Feet	Model	Cubic Feet
2VSD363218	15.1	2VSD483218	19.9
2VSD363221	17.4	2VSD543218FP	23.2
2VSD423218	17.5	2VSD603218FP	24.4
2VSD453218	18.5	2VSD483221	22.9
2VSD483218CS	19.9	2VSD543221FP	25.2
2VSD423221	20.1	2VSD603221FP	28.0
2VSD453221	21.3	2VSD543218	23.2
2VSD483221CS	22.9	2VSD603218	24.4
		2VSD543221	25.2
		2VSD603221	28.0

Model	Drawer Base Equivalent Width	Sink Base Equivalent Width	Available Sink Clearance Width
2VSD36...	9"	18"	16 3/4"
2VSD42...	12"	18"	16 3/4"
2VSD45...	12"	21"	19 3/4"
2VSD48...	15"	18"	16 3/4"
2VSD54...	15"	24"	22 3/4"
2VSD60...	18"	24"	22 3/4"

Custom Modifications

CBO	CCO	CFP	CMAT	CND	DRWPWR	DRWTK	EXBK	FTK	FTK_V	ID	INVERM
•	•	•	•*	•	•*	•▲	•†	•‡	•‡	•	
LTI	RD	RECTK	RT	TKP	TOTSS	VTK					
•	•	•	•^		•**	•					

*Not available on 42" and 45" wide, or on 18" deep †Available only on 60" wide ‡Available only on 2VSD363221
 †Available only on 36" wide ‡Not available on 54" and 60" wide ^Available only on 36", 42", 45", and 48" wide
 **Available only on cabinets with false panels

Construction and Finish Upgrades

APC	FB	MIP	MSLFB	WLI
•	•	•	•	•

Door Options

ALF	CG	DPSRR	MD
		•	

**VANITY SINK DRAWER BASE,
34 1/2" HIGH, 18" or 21" DEEP**

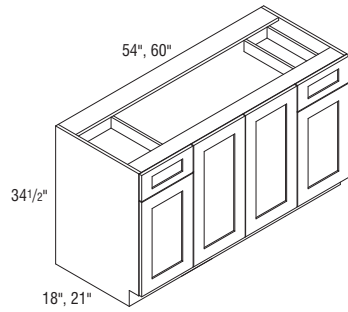
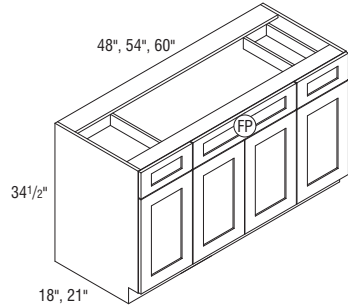
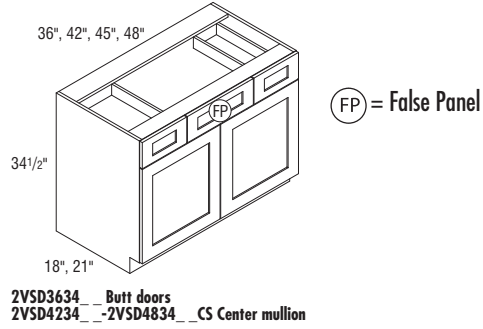

(FP) = False Panel

Model	Cubic Feet	Model	Cubic Feet
2VSD363418	16.0	2VSD543418	23.7
2VSD363421	16.5	2VSD603418	26.3
2VSD423418	18.6	2VSD543421	24.5
2VSD453418	19.9	2VSD603421	30.1
2VSD483418CS	21.1		
2VSD423421	19.2		
2VSD453421	22.8		
2VSD483421CS	21.9		
2VSD483418	21.1		
2VSD543418FP	23.7		
2VSD603418FP	26.3		
2VSD483421	21.9		
2VSD543421FP	24.5		
2VSD603421FP	30.1		

Model	Drawer Base Equivalent Width	Sink Base Equivalent Width	Available Sink Clearance Width
2VSD36...	9"	18"	16 3/4"
2VSD42...	12"	18"	16 3/4"
2VSD45...	12"	21"	19 3/4"
2VSD48...	15"	18"	16 3/4"
2VSD54...	15"	24"	22 3/4"
2VSD60...	18"	24"	22 3/4"

Custom Modifications

CBO	CCO	CFP	CMAT	CND	DRWPWR	DRWTK	EXBK	FTK	FTK_V	ID	INVFRM
•	•	•	•*	•	•†	•‡	•†	•†	•†	•	
LTI	RD	RECTK	RT	TKP	TOTSS	VTK					
•	•	•	•^		•**	•					

*Not available on 42" and 45" wide, or on 18" deep †Available only on 60" wide ‡Available only on 2VSD363421
 †Available only on 36" wide ‡Not available on 54" and 60" wide †Available only on 36", 42", 45", and 48" wide
 **Available only on cabinets with false panels

Construction and Finish Upgrades

APC	FB	MIP	MSLFB	WLI
•	•	•	•	•

Door Options

ALF	CG	DPSRR	MD
		•	

**VANITY SINK DRAWER BASE,
32" HIGH, 18" or 21" DEEP**

24", 27", 30", 33"

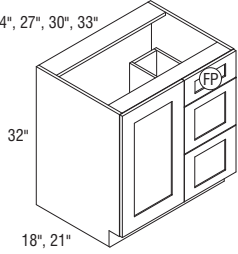

FP = False Panel

36"

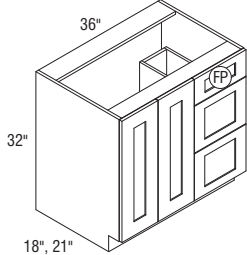

42", 45", 48"

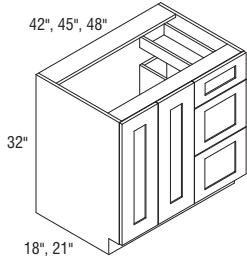

54", 60"

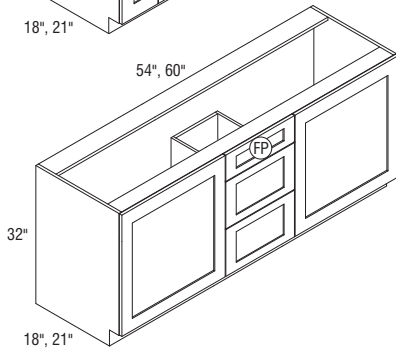

Model	Cubic Feet	Model	Cubic Feet
VSD243218 DL or DR	10.4	VSD423218 DL or DR	17.5
VSD273218 DL or DR	11.7	VSD453218 DL or DR	18.5
VSD303218 DL or DR	12.7	VSD483218 DL or DR	19.9
VSD333218 DL or DR	14.1	VSD423221 DL or DR	20.1
VSD243221 DL or DR	11.9	VSD453221 DL or DR	18.5
VSD273221 DL or DR	13.3	VSD483221 DL or DR	22.9
VSD303221 DL or DR	14.6		
VSD333221 DL or DR	16.1	VSD543218	22.1
		VSD603218	24.7
VSD363218 DL or DR	15.1	VSD543221	25.3
VSD363221 DL or DR	17.4	VSD603221	28.4

- DL or DR indicates drawer location.
- CFP is available on 42", 45", and 48" widths, but standard on all other widths.
- Top drawer front is 6 1/4" high and lower drawer fronts are 10 3/8" high.

Model	Drawer Base Equivalent Width	Sink Base Equivalent Width	Available Sink Clearance Width
VSD24..	12"	12"	22 3/4"
VSD27..	12"	15"	25 3/4"
VSD30..	12"	18"	28 3/4"
VSD33..	12"	21"	31 3/4"
VSD36..	12"	24"	34 3/4"
VSD42...	12"	30"	28 3/4"
VSD45...	12"	33"	31 3/4"
VSD48...	12"	36"	34 3/4"
VSD54..	12"	21"	19 3/4"
VSD60..	18"	21"	19 3/4"

Custom Modifications

CBO	CCO	CFP	CMAT	CND	DRWPWR	DRWTK	EXBK	FTK	FTK_V	ID	INVFRM
•	•	STD	•*	•		•+	•	•▲	•▲	•	
LTI	RD	RECTK	RT	TKP	TOTSS	VTK					
•†	•	•				•					

*Not available on 24", 27", 30", 33", and 60" wide, or on 18" deep

†Not available on 42", 45", 48", 54" and 60" wide, or on 18" deep

▲Not available on 54" and 60" wide

†Not available on 24" wide

Construction and Finish Upgrades

APC	FB	MIP	MSLFB	WLI
•	•	•	•	•

Door Options

ALF	CG	DPSRR	MD
		•	

**VANITY SINK DRAWER BASE,
34 1/2" HIGH, 18" or 21" DEEP**

24", 27", 30", 33"

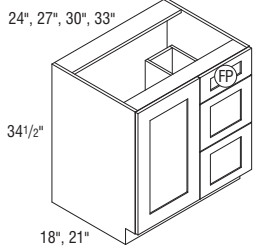

(FP) = False Panel

36"

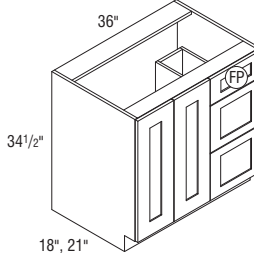

42", 45", 48"

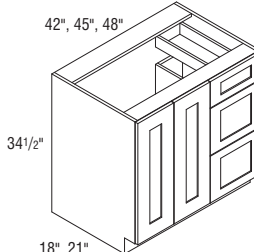

54", 60"

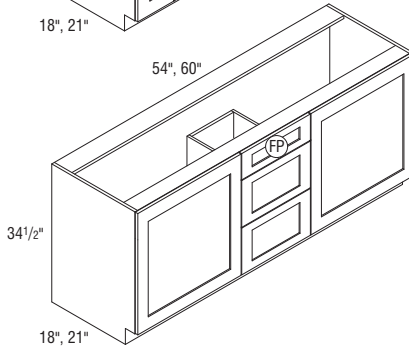

Model	Cubic Feet	Model	Cubic Feet
VSD243418 DL or DR	10.9	VSD423418 DL or DR	18.6
VSD273418 DL or DR	12.2	VSD453418 DL or DR	19.9
VSD303418 DL or DR	13.5	VSD483418 DL or DR	21.1
VSD333418 DL or DR	14.7	VSD423421 DL or DR	19.2
VSD243421 DL or DR	11.1	VSD453421 DL or DR	21.3
VSD273421 DL or DR	14.1	VSD483421 DL or DR	21.9
VSD303421 DL or DR	13.8		
VSD333421 DL or DR	17.1	VSD543418	23.7
		VSD603418	26.3
VSD363418 DL or DR	16.0	VSD543421	27.2
VSD363421 DL or DR	16.5	VSD603421	27.2

- DL or DR indicates drawer location.
- CFP is available on 42", 45", and 48" widths, but standard on all other widths.
- Top drawer front is 6 1/4" high and lower drawer fronts are 11 5/8" high.

Model	Drawer Base Equivalent Width	Sink Base Equivalent Width	Available Sink Clearance Width
VSD24..	12"	12"	22 3/4"
VSD27..	12"	15"	25 3/4"
VSD30..	12"	18"	28 3/4"
VSD33..	12"	21"	31 3/4"
VSD36..	12"	24"	34 3/4"
VSD42...	12"	30"	28 3/4"
VSD45...	12"	33"	31 3/4"
VSD48...	12"	36"	34 3/4"
VSD54..	12"	21"	19 3/4"
VSD60..	18"	21"	19 3/4"

Custom Modifications

CBO	CCO	CFP	CMAT	CND	DRWPWR	DRWTK	EXBK	FTK	FTK_V	ID	INVFRM
•	•	STD	•*	•		•*	•	•▲	•▲	•	
LTI	RD	RECTK	RT	TKP	TOTSS	VTK					
•†	•	•				•					

*Not available on 24", 27", 30", 33", and 60" wide, or on 18" deep

*Not available on 42", 45", 48", 54" and 60" wide, or on 18" deep

▲Not available on 54" and 60" wide

†Not available on 24" wide

Construction and Finish Upgrades

APC	FB	MIP	MSLFB	WLI
•	•	•	•	•

Door Options

ALF	CG	DPSRR	MD
		•	

VANITY SINK DRAWER BASE with FALSE PANELS, 32" HIGH, 18" or 21" DEEP

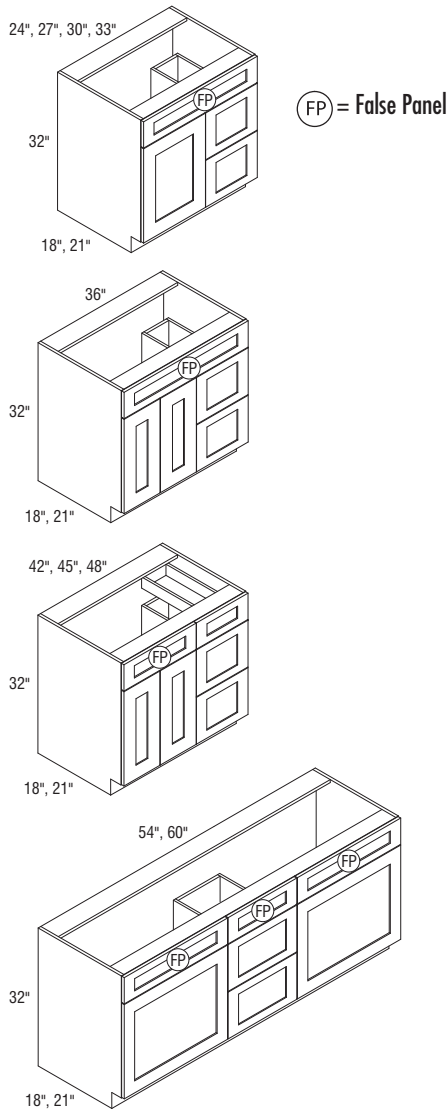

Model	Cubic Feet	Model	Cubic Feet
VSD243218FP DL or DR	10.4	VSD423218FP DL or DR	17.5
VSD273218FP DL or DR	11.7	VSD453218FP DL or DR	18.5
VSD303218FP DL or DR	12.7	VSD483218FP DL or DR	19.9
VSD333218FP DL or DR	14.1	VSD423221FP DL or DR	20.1
VSD243221FP DL or DR	11.9	VSD453221FP DL or DR	21.3
VSD273221FP DL or DR	13.3	VSD483221FP DL or DR	22.9
VSD303221FP DL or DR	14.6		
VSD333221FP DL or DR	16.1	VSD543218FP	22.1
		VSD603218FP	24.7
VSD363218FP DL or DR	15.1	VSD543221FP	25.3
VSD363221FP DL or DR	17.4	VSD603221FP	28.4

- DL or DR indicates drawer location.
- CFP is available on 42", 45", and 48" widths, but standard on all other widths.
- Top drawer front is 6 1/4" high and lower drawer fronts are 10 3/8" high.

Model	Drawer Base Equivalent Width	Sink Base Equivalent Width	Available Sink Clearance Width
VSD24..FP	12"	12"	22 3/4"
VSD27..FP	12"	15"	25 3/4"
VSD30..FP	12"	18"	28 3/4"
VSD33..FP	12"	21"	31 3/4"
VSD36..FP	12"	24"	34 3/4"
VSD42...FP	12"	30"	28 3/4"
VSD45...FP	12"	33"	31 3/4"
VSD48...FP	12"	36"	34 3/4"
VSD54..FP	12"	21"	19 3/4"
VSD60..FP	18"	21"	19 3/4"

Custom Modifications

CBO	CCO	CFP	CMAT	CND	DRWPWR	DRWTK	EXBK	FTK	FTK_V	ID	INVFRM
•	•	STD	•*	•		•+	•	•▲	•▲	•	
LTI	RD	RECTK	RT	TKP	TOTSS	VTK					
•†	•	•			•	•					

*Not available on 24", 27", 30", 33", and 60" wide, or on 18" deep

*Not available on 42", 45", 48", 54" and 60" wide, or on 18" deep

†Not available on 54" and 60" wide

†Not available on 24" wide

Construction and Finish Upgrades

APC	FB	MIP	MSLFB	WLI
•	•	•	•	•

Door Options

ALF	CG	DPSRR	MD
		•	

VANITY SINK DRAWER BASE with FALSE PANEL, 34 1/2" HIGH, 18" or 21" DEEP

24", 27", 30", 33"

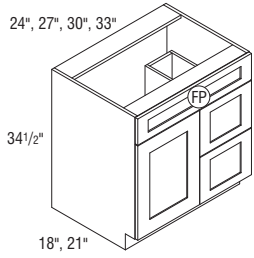

(FP) = False Panel

36"

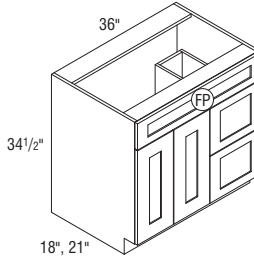

42", 45", 48"

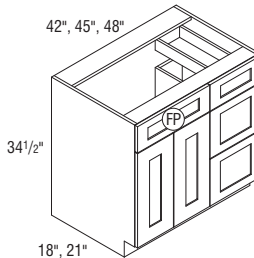

54", 60"

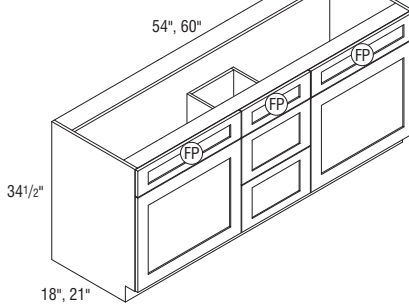

Model	Cubic Feet	Model	Cubic Feet
VSD243418FP DL or DR	10.9	VSD423418FP DL or DR	18.6
VSD273418FP DL or DR	12.2	VSD453418FP DL or DR	19.9
VSD303418FP DL or DR	13.5	VSD483418FP DL or DR	21.1
VSD333418FP DL or DR	14.7	VSD423421FP DL or DR	22.8
VSD243421FP DL or DR	11.1	VSD453421FP DL or DR	22.8
VSD273421FP DL or DR	14.1	VSD483421FP DL or DR	21.9
VSD303421FP DL or DR	13.8		
VSD333421FP DL or DR	17.1	VSD543418FP	22.1
		VSD603418FP	26.3
VSD363418FP DL or DR	16.0	VSD543421FP	25.3
VSD363421FP DL or DR	16.5	VSD603421FP	27.2

- DL or DR indicates drawer location.
- CFP is available on 42", 45", and 48" widths, but standard on all other widths.
- Top drawer front is 6 1/4" high and lower drawer fronts are 11 5/8" high.

Model	Drawer Base Equivalent Width	Sink Base Equivalent Width	Available Sink Clearance Width
VSD24..FP	12"	12"	22 3/4"
VSD27..FP	12"	15"	25 3/4"
VSD30..FP	12"	18"	28 3/4"
VSD33..FP	12"	21"	31 3/4"
VSD36..FP	12"	24"	34 3/4"
VSD42...FP	12"	30"	28 3/4"
VSD45...FP	12"	33"	31 3/4"
VSD48...FP	12"	36"	34 3/4"
VSD54..FP	12"	21"	19 3/4"
VSD60..FP	18"	21"	19 3/4"

Custom Modifications

CBO	CCO	CFP	CMAT	CND	DRWPWR	DRWTK	EXBK	FTK	FTK_V	ID	INVFRM
•	•	STD	•*	•		•*	•	•▲	•▲	•	
LTI	RD	RECTK	RT	TKP	TOTSS	VTK					
•†	•	•			•	•					

*Not available on 24", 27", 30", 33", and 60" wide, or on 18" deep

*Not available on 42", 45", 48", 54" and 60" wide, or on 18" deep

▲Not available on 54" and 60" wide

†Not available on 24" wide

Construction and Finish Upgrades

APC	FB	MIP	MSLFB	WLI
•	•	•	•	•

Door Options

ALF	CG	DPSRR	MD
		•	

**VANITY SINK THREE DRAWER BASE,
32" or 34 1/2" HIGH, 18" or 21"
DEEP**

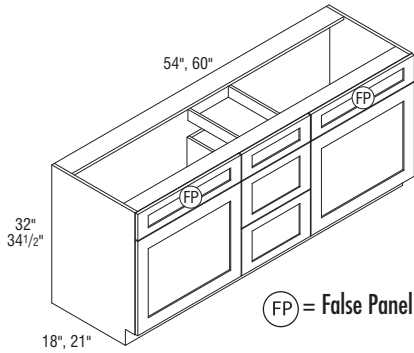

FP = False Panel

Model	Cubic Feet
VS3D543218	22.1
VS3D603218	24.4
VS3D543221	25.3
VS3D603221	28.0
VS3D543418	23.7
VS3D603418	26.3
VS3D543421	27.2
VS3D603421	30.1

Model	Drawer Base Equivalent Width	Sink Base Equivalent Width	Available Sink Clearance Width
VS3D54...	12"	21"	19 3/4"
VS3D60...	18"	21"	19 3/4"

Custom Modifications

CBO	CCO	CFP	CMAT	CND	DRWPWR	DRWTK	EXBK	FTK	FTK_V	ID	INVERM
•	•	•	•*	•	•†		•	•▲	•▲	•†	
LTI	RD	RECTK	RT	TKP	TOTSS	VTK					
•	•	•			•	•					

*Not available on 18" deep †Available only on 60" wide ▲Not available on 54" and 60" wide
†Not available on 34 1/2" high

Construction and Finish Upgrades

APC	FB	MIP	MSLFB	WLI
•	•	•	•	•

Door Options

ALF	CG	DPSRR	MD
		•	

**VANITY SINK DRAWER BASE with
SIX DRAWERS, 32" or 34 1/2" HIGH,
18" or 21" DEEP**

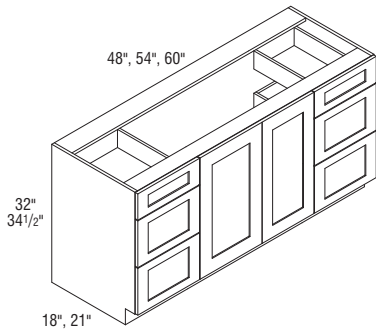
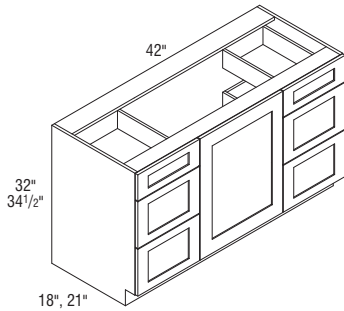

6VSD423218 L or R	17.3
6VSD423221 L or R	19.8
6VSD423418 L or R	18.6
6VSD423421 L or R	21.3

6VSD483218	19.9
6VSD483221	22.9
6VSD543218	22.1
6VSD543221	25.3
6VSD603218	24.7
6VSD603221	28.4
6VSD483418	21.1
6VSD483421	21.9
6VSD543418	23.7
6VSD543421	27.2
6VSD603418	26.3
6VSD603421	27.2

Model	Drawer Base Equivalent Width	Sink Base Equivalent Width	Available Sink Clearance Width
6VSD42...	12"	18"	16 3/4"
6VSD48...	12"	24"	22 3/4"
6VSD54...	15"	24"	22 3/4"
6VSD60...	18"	24"	22 3/4"

Custom Modifications

CBO	CCO	CFP	CMAT	CND	DRWPWR	DRWTK	EXBK	FTK	FTK_V	ID	INVERM
•	•	•	•*	•	•†		•	•▲	•▲	•	
LTI	RD	RECTK	RT	TKP	TOTSS	VTK					
•	•	•				•					

*Not available on 42" wide, or on 18" deep †Available only on 60" wide ▲Not available on 54" and 60" wide

Construction and Finish Upgrades

APC	FB	MIP	MSLFB	WLI
•	•	•	•	•

Door Options

ALF	CG	DPSRR	MD
		•	

VANITY SINK DRAWER BASE with SIX DRAWERS & FALSE PANEL, 32" or 34 1/2" HIGH, 18" or 21" DEEP

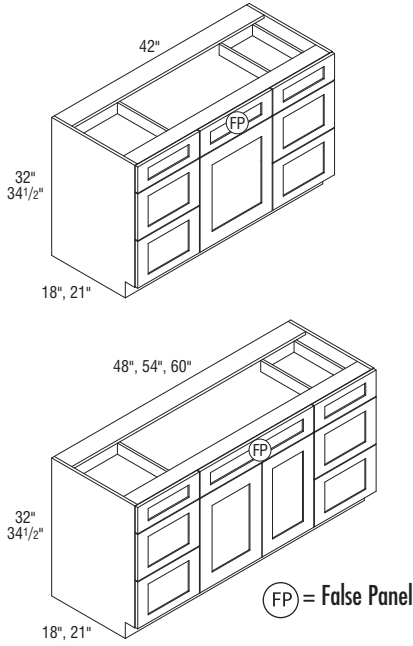

Model	Cubic Feet
6VSD423218FP L or R	17.3
6VSD423221FP L or R	19.8
6VSD423418FP L or R	18.6
6VSD423421FP L or R	21.3
6VSD483218FP	19.9
6VSD483221FP	22.9
6VSD543218FP	22.1
6VSD543221FP	25.3
6VSD603218FP	24.7
6VSD603221FP	28.4
6VSD483418FP	21.1
6VSD483421FP	21.9
6VSD543418FP	23.7
6VSD543421FP	27.2
6VSD603418FP	26.3
6VSD603421FP	27.2

Model	Drawer Base Equivalent Width	Sink Base Equivalent Width	Available Sink Clearance Width
6VSD42...FP	12"	18"	16 3/4"
6VSD48...FP	12"	24"	22 3/4"
6VSD54...FP	15"	24"	22 3/4"
6VSD60...FP	18"	24"	22 3/4"

Custom Modifications

CBO	CCO	CFP	CMAT	CND	DRWPWR	DRWTK	EXBK	FTK	FTK_V	ID	INVFRM
•	•	•	•*	•	•+		•	•▲	•▲	•	
LTI	RD	RECTK	RT	TKP	TOTSS	VTK					
•	•	•				•					

*Not available on 42" wide, or on 18" deep *Available only on 60" wide *Not available on 54" and 60" wide

Construction and Finish Upgrades

APC	FB	MIP	MSLFB	WLI
•	•	•	•	•

Door Options

ALF	CG	DPSRR	MD
		•	

VANITY SINK DRAWER BASE with EIGHT DRAWERS, 34 1/2" HIGH, 18" or 21" DEEP

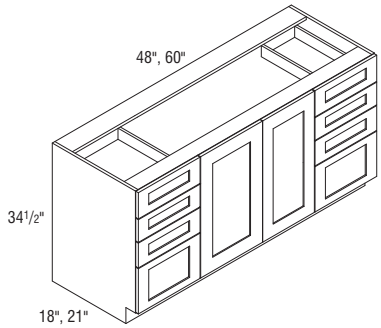

8VSD483418	21.1
8VSD603418	26.3
8VSD483421	21.9
8VSD603421	27.2

• Upper three drawer fronts are 6 1/4" high and bottom drawer front is 10 5/8" high.

Model	Drawer Base Equivalent Width	Sink Base Equivalent Width	Available Sink Clearance Width
8VSD48...	12"	24"	22 3/4"
8VSD60...	18"	24"	22 3/4"

Custom Modifications

CBO	CCO	CFP	CMAT	CND	DRWPWR	DRWTK	EXBK	FTK	FTK_V	ID	INVFRM
•	•	•	•*	•	•+		•	•▲	•▲	•	
LTI	RD	RECTK	RT	TKP	TOTSS	VTK					
•	•	•				•					

*Not available on 18" deep *Available only on 60" wide *Not available on 60" wide

Construction and Finish Upgrades

APC	FB	MIP	MSLFB	WLI
•	•	•	•	•

Door Options

ALF	CG	DPSRR	MD
		•	

VANITY SINK DRAWER BASE with EIGHT DRAWERS & FALSE PANEL, 34 1/2" HIGH, 18 or 21" DEEP

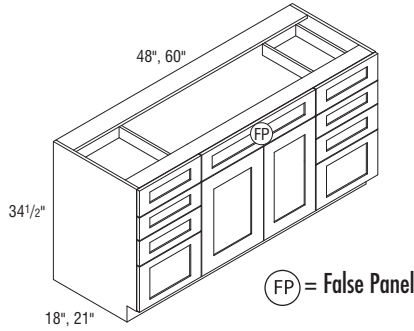

Model	Cubic Feet
8VSD483418FP	21.1
8VSD603418FP	26.3
8VSD483421FP	21.9
8VSD603421FP	27.2

- Upper three drawer fronts are 6 1/4" high and bottom drawer front is 10 5/8" high.

Model	Drawer Base Equivalent Width	Sink Base Equivalent Width	Available Sink Clearance Width
8VSD48...FP	12"	24"	22 3/4"
8VSD60...FP	18"	24"	22 3/4"

Custom Modifications

CBO	CCO	CFP	CMAT	CND	DRWPWR	DRWTK	EXBK	FTK	FTK_V	ID	INVFRM
•	•	•	•*	•	•*		•	•▲	•▲	•	
LTI	RD	RECTK	RT	TKP	TOTSS	VTK					
•	•	•			•	•					

*Not available on 18" deep *Available only on 60" wide ▲Not available on 60" wide

Construction and Finish Upgrades

APC	FB	MIP	MSLFB	WLI
•	•	•	•	•

Door Options

ALF	CG	DPSRR	MD
		•	

UNDER COUNTER DRAWER, 4 3/4" HIGH, 18" or 21" DEEP

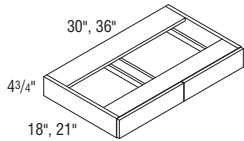
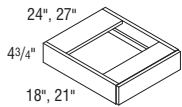

UCD2418	2.6
UCD2718	2.6
UCD2421	2.6
UCD2721	2.6
UCD3018	2.6
UCD3618	2.6
UCD3021	2.6
UCD3621	2.6

- Cabinet is 4 3/4" high. Drawer box within cabinet is 2" high, drawer front is 4 1/2" high.
- Top and bottom reveal is 1/8".
- Not trimmable.
- Drawer front is 3/4" slab front.
- When ordered in APC, end panels will be finished.
- Reduced depth is available in 3" increments.

Custom Modifications

CBO	CCO	CFP	CMAT	CND	DRWPWR	DRWTK	EXBK	FTK	FTK_V	ID	INVFRM
•	•									•	
LTI	RD	RECTK	RT	TKP	TOTSS	VTK					
	•										

Construction and Finish Upgrades

APC	FB	MIP	MSLFB	WLI
•		•	•	

Door Options

ALF	CG	DPSRR	MD

VANITY HAMPER, 32" HIGH, 21" DEEP

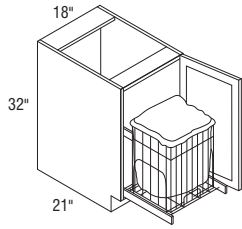

storage SOLUTIONS

Model	Cubic Feet
VH183221FH L or R	8.9

- Includes full extension removable chrome pull-out hamper with removable cloth liner.
- Hamper size is 19 3/8" high x 14 3/4" wide x 18" deep.

Custom Modifications

CBO	CCO	CFP	CMAT	CND	DRWPWR	DRWTK	EXBK	FTK	FTK_V	ID	INVFRM
•	•	•		•		•	•	•			
LTI	RD	RECTK	RT	TKP	TOTSS	VTK					
		•				•					

Construction and Finish Upgrades

APC	FB	MIP	MSLFB	WLI
•	•	•	•	•

Door Options

ALF	CG	DPSRR	MD
		•	

VANITY HAMPER with DRAWER, 34 1/2" HIGH, 21" DEEP

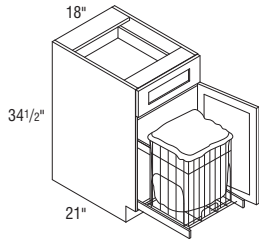

storage SOLUTIONS

Model	Cubic Feet
VBH183421 L or R	9.5

- Includes full extension removable chrome pull-out hamper with removable cloth liner.
- Hamper size is 19 3/8" high x 14 3/4" wide x 18" deep.

Custom Modifications

CBO	CCO	CFP	CMAT	CND	DRWPWR	DRWTK	EXBK	FTK	FTK_V	ID	INVFRM
•	•	•		•		•	•	•			
LTI	RD	RECTK	RT	TKP	TOTSS	VTK					
		•				•					

Construction and Finish Upgrades

APC	FB	MIP	MSLFB	WLI
•	•	•	•	•

Door Options

ALF	CG	DPSRR	MD
		•	

LINEN CLOSET

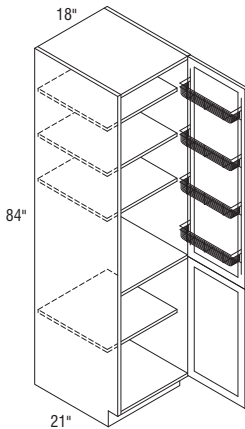

storage SOLUTIONS

Model	Cubic Feet
LC188421 L or R	23.0

- Upper section features a 5" deep chrome door rack.
- Adjustable shelves are 15" deep and are packaged separately.
- A fixed shelf separates upper and lower sections.
- Tall non-mitered doors will have two center panels with cross rail.
- Troxel doors greater than 48" high will be two doors doweled together.
- Recommended for use with 34 1/2" high cabinets (bottom door will align with top of drawer front). See page 69 for more details.

Custom Modifications

CBO	CCO	CFP	CMAT	CND	DRWPWR	DRWTK	EXBK	FTK	FTK_V	ID	INVFRM
•	•						•	•	•		•
LTI	RD	RECTK	RT	TKP	TOTSS	VTK					
		•*	•	•		•					

*RECTKALL and RECTKBK not available

Construction and Finish Upgrades

APC	FB	MIP	MSLFB	WLI
•	•	•	•	•

Door Options

ALF	CG	DPSRR	MD
		•	

LINEN CLOSET with REMOVABLE HAMPER

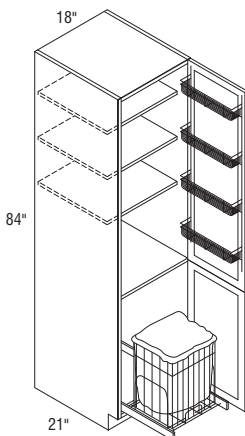

storage SOLUTIONS

Model	Cubic Feet
LCRH188421 L or R	23.0

- Upper section features a 5" deep chrome door rack.
- Adjustable shelves are 15" deep and are packaged separately.
- A fixed shelf separates upper and lower sections.
- Includes full extension removable chrome pull-out hamper with removable cloth liner.
- Hamper size is 19 3/8" high x 14 3/4" wide x 18" deep.
- Tall non-mitered doors will have two center panels with cross rail.
- Troxel doors greater than 48" high will be two doors doweled together.
- Recommended for use with 34 1/2" high cabinets (bottom door will align with top of drawer front). See page 69 for more details.

Custom Modifications

CBO	CCO	CFP	CMAT	CND	DRWPWR	DRWTK	EXBK	FTK	FTK_V	ID	INVFRM
•	•						•	•	•		
LTI	RD	RECTK	RT	TKP	TOTSS	VTK					
		•*	•	•		•					

*RECTKALL and RECTKBK not available

Construction and Finish Upgrades

APC	FB	MIP	MSLFB	WLI
•	•	•	•	•

Door Options

ALF	CG	DPSRR	MD
		•	

LINEN STORAGE CABINET

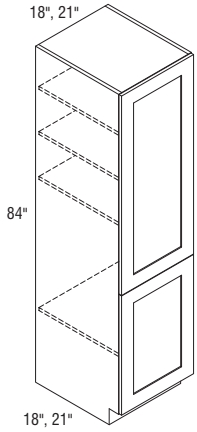

Model	Cubic Feet
LT188418 L or R	20.3
LT218418 L or R	23.4
LT188421 L or R	23.3
LT218421 L or R	26.8

- Tall non-mitered doors will have two center panels with cross rail.
- Troxel doors greater than 48" high will be two doors doweled together.
- Recommended for use with 34 1/2" high cabinets (bottom door will align with top of drawer front). See page 69 for more details.
- Shelves are packaged separately.
- A fixed shelf separates upper and lower sections (not shown on drawing). Adjustable shelves are shown.

Custom Modifications

CBO	CCO	CFP	CMAT	CND	DRWPWR	DRWTK	EXBK	FTK	FTK_V	ID	INVFRM
•	•					•*	•	•	•	•	•
LTI	RD	RECTK	RT	TKP	TOTSS	VTK					
	•	•*	•	•		•					

*Not available on 18" deep *RECTKALL and RECTKBK not available

Construction and Finish Upgrades

APC	FB	MIP	MSLFB	WLI
•	•	•	•	•

Door Options

ALF	CG	DPSRR	MD
		•	

VANITY UTILITY, 84" TALL, 21" DEEP

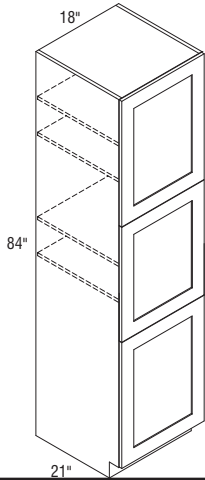

VU188421 L or R	23.0
-----------------	------

- Lower door section is drilled to accept adjustable shelf.
- Shelves are packaged separately.
- A fixed shelf separates upper, middle, and lower sections (not shown on drawing). Adjustable shelves are shown.
- Vanity utilities designed to be used with 32" tall vanities. See page 69 for more details.

Custom Modifications

CBO	CCO	CFP	CMAT	CND	DRWPWR	DRWTK	EXBK	FTK	FTK_V	ID	INVFRM
•	•					•	•	•	•	•	
LTI	RD	RECTK	RT	TKP	TOTSS	VTK					
	•	•*	•	•		•					

*RECTKALL and RECTKBK not available

Construction and Finish Upgrades

APC	FB	MIP	MSLFB	WLI
•	•	•	•	•

Door Options

ALF	CG	DPSRR	MD
		•	

VANITY WALL HUNG TWO DRAWER SINK BASE with FALSE PANEL, 23 1/2" HIGH, 21" DEEP

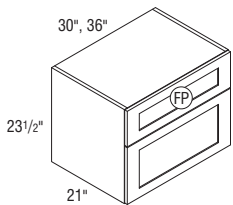

FP = False Panel

VWH2D3023.521FP	10.7
VWH2D3623.521FP	12.7

- Plumbing clearance of 15 15/16" to the top edge of the lower drawer box (6 3/8" high drawer box).
- For proper installation, cabinet must be secured on each side through both the top and bottom of the back panel into wall studs. Installation instructions and required 3 1/2" installation screws included, standard installation screws are not sufficient in this application.
- 5-piece drawer front configuration will not match on door styles with unique rail widths for drawer fronts over 10" high. Check door style section on pages 12-18 for drawer rail widths by height.
- Features a full cabinet top that can be routed for sink installation.
- Approximate weight limit is 400 lbs. per cabinet (includes weight of the cabinet, countertop and contents). Proper installation is required and additional bracing may be required.

Custom Modifications

CBO	CCO	CFP	CMAT	CND	DRWPWR	DRWTK	EXBK	FTK	FTK_V	ID	INVFRM
•	•										
LTI	RD	RECTK	RT	TKP	TOTSS	VTK					

Construction and Finish Upgrades

APC	FB	MIP	MSLFB	WLI
STD		•		•

Door Options

ALF	CG	DPSRR	MD

**VANITY WALL HUNG TWO DRAWER
BASE, 23 1/2" HIGH, 21" DEEP**

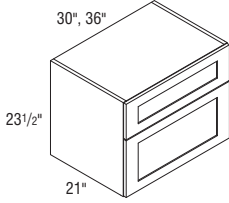

Model	Cubic Feet
VWH2D3023.521	10.7
VWH2D3623.521	12.7

- Top drawer box is 3 3/8" high, bottom drawer box is 10" high.
- Cannot be used with a sink due to drawer interference.
- For proper installation, cabinet must be secured on each side through both the top and bottom of the back panel into wall studs. Installation instructions and required 3 1/2" installation screws included, standard installation screws are not sufficient in this application.
- 5-piece drawer front configuration will not match on door styles with unique rail widths for drawer fronts over 10" high. Check door style section on pages 12-18 for drawer rail widths by height.
- Approximate weight limit is 400 lbs. per cabinet (includes weight of the cabinet, countertop and contents). Proper installation is required and additional bracing may be required.

Custom Modifications

CBO	CCO	CFP	CMAT	CND	DRWPWR	DRWTK	EXBK	FTK	FTK_V	ID	INVFRM
•	•	•			•						
LTI	RD	RECTK	RT	TKP	TOTSS	VTK					

Construction and Finish Upgrades

APC	FB	MIP	MSLFB	WLI
STD		•		•

Door Options

ALF	CG	DPSRR	MD

**VANITY WALL HUNG DOUBLE DOOR
with U-SHAPED PULL-OUTS,
23 1/2" HIGH, 21" DEEP**

storage
SOLUTIONS

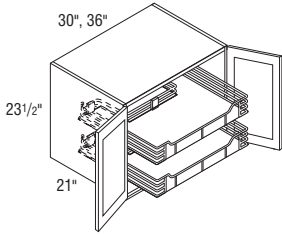

VWH3023.521U	10.7
VWH3623.521U	12.7

- Includes two chrome U-shaped Smart Stop roll-outs with non-slip gray shelf liner.
- Cut-out for U-shape on bottom roll-out is 6 1/8" from back of cabinet.
- Cut-out for U-shape on top roll-out is 12 1/8" from back of cabinet.
- For proper installation, cabinet must be secured on each side through both the top and bottom of the back panel into wall studs. Installation instructions and required 3 1/2" installation screws included, standard installation screws are not sufficient in this application.
- Features a full cabinet top that can be routed for sink installation.
- Approximate weight limit is 400 lbs. per cabinet (includes weight of the cabinet, countertop and contents). Proper installation is required and additional bracing may be required.

Custom Modifications

CBO	CCO	CFP	CMAT	CND	DRWPWR	DRWTK	EXBK	FTK	FTK_V	ID	INVFRM
•	•										
LTI	RD	RECTK	RT	TKP	TOTSS	VTK					
•											

Construction and Finish Upgrades

APC	FB	MIP	MSLFB	WLI
STD		•		•

Door Options

ALF	CG	DPSRR	MD
		•	

**VANITY WALL HUNG DOUBLE DOOR,
23 1/2" HIGH, 21" DEEP**

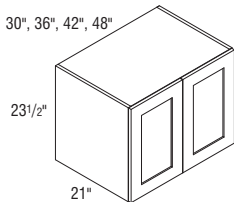

VWH3023.521	10.7
VWH3623.521	12.7
VWH4223.521	14.8
VWH4823.521CS	16.8

- For proper installation, cabinet must be secured on each side through both the top and bottom of the back panel into wall studs. Installation instructions and required 3 1/2" installation screws included, standard installation screws are not sufficient in this application.
- Features a full cabinet top that can be routed for sink installation.
- Approximate weight limit is 400 lbs. per cabinet (includes weight of the cabinet, countertop and contents). Proper installation is required and additional bracing may be required.

Custom Modifications

CBO	CCO	CFP	CMAT	CND	DRWPWR	DRWTK	EXBK	FTK	FTK_V	ID	INVFRM
	•										
LTI	RD	RECTK	RT	TKP	TOTSS	VTK					
•	•		•*								

*Not available on 42" and 48" wide

Construction and Finish Upgrades

APC	FB	MIP	MSLFB	WLI
STD		•		•

Door Options

ALF	CG	DPSRR	MD
	•	•	

VANITY WALL, 30" HIGH, 6" DEEP

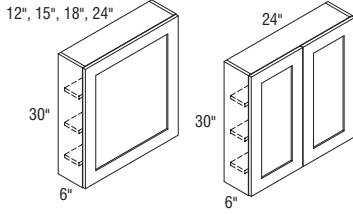

Model	Cubic Feet
W12306 L or R	2.2
W15306 L or R	2.6
W18306 L or R	3.1
W24306 L or R	4.0
W24306	4.0

Custom Modifications

CBO	CCO	CFP	CMAT	CND	DRWPWR	DRWTK	EXBK	FTK	FTK_V	ID	INVERM
•	•						•				
LTI	RD	RECTK	RT	TKP	TOTSS	VTK					

Construction and Finish Upgrades

APC	FB	MIP	MSLFB	WLI
•	•	•	•	•

Door Options

ALF	CG	DPSRR	MD
•*	•	•	•

*Not available on 24" wide

VANITY WALL MIRROR CABINET, 30" HIGH, 4 7/8" DEEP

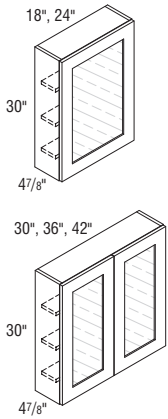

VWM3030-VWM3630 Butt doors
VWM4230 Center mullion

VWM1830 L or R	2.7
VWM2430 L or R	3.5
VWM3030	4.3
VWM3630	5.1
VWM4230	5.9

- Standard with CG doors and installed mirror glass.
- Unit intended to be surface mounted.
- Not available in Caprice, Genova, Tara, Troxel, and Vaile styles.
- Adjustable shelves.

Custom Modifications

CBO	CCO	CFP	CMAT	CND	DRWPWR	DRWTK	EXBK	FTK	FTK_V	ID	INVERM
•	•						•				
LTI	RD	RECTK	RT	TKP	TOTSS	VTK					

Construction and Finish Upgrades

APC	FB	MIP	MSLFB	WLI
•	•	•	•	•

Door Options

ALF	CG	DPSRR	MD
	STD		

VANITY MIRROR with SIDE PULL-OUTS, 32 1/2" HIGH, 4 7/8" DEEP

storage SOLUTIONS

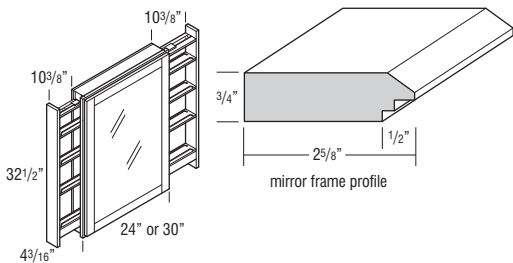

VMP2432.5	3.7
VMP3032.5	4.6

- One full extension natural wood finish pull-out on each side with three adjustable shelves and chrome rail sides (Smart Stop not included).
- Pull-outs extend 10 3/8" on each side. VMP2432.5 open width is 44 3/4". VMP3032.5 open width is 50 3/4".
- Mirror frame has a shaker outside profile and a bevel inside profile with a 1/4" face frame reveal. Mirror is not removable.
- Mirror visible dimensions:
VMP2432.5 - 26 3/4" high x 18 1/4" wide
VMP3032.5 - 26 3/4" high x 24 1/4" wide
- Installation instructions included.
- When Distressing is selected, only fillers will receive treatment.
- When Heirlooming is selected, only mirror frame will receive treatment.
- Pull-outs feature plain fillers. If a more decorative look is desired, overlay fillers or embellishments may be ordered separately and field installed.

MODIFICATIONS

No modifications available for these products.

Finish Techniques

Distressing	Heirlooming
•	•

Species Availability (Wood)

Alder	Rustic Alder	Cherry	Hickory	Rustic Hickory	Maple	Oak
		•			•	

Species Availability (All Laminates)

High Gloss box color	Horiz. Grain on Maple box color	Vert. Grain on Maple box color	Vert. Grain on Cherry box color	Vert. Grain on Hickory	Vert. Grain on Oak	Thermofoil box color

VANITY MIRROR

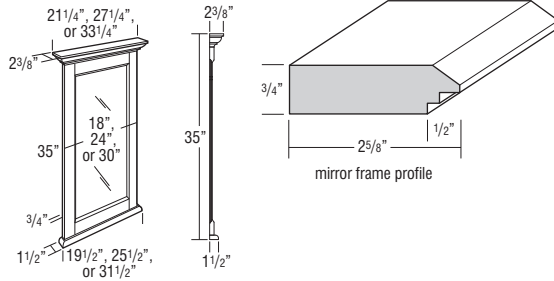

Model	Overall Dimensions Width	Overall Dimensions Height	Mirror - Visible Dimensions Width	Mirror - Visible Dimensions Height
VM2135	21 1/4"	35"	12 15/16"	26 15/16"
VM2735	27 1/4"	35"	18 15/16"	26 15/16"
VM3335	33 1/4"	35"	24 15/16"	26 15/16"

Model	Cubic Feet
VM2135	5.4
VM2735	5.4
VM3335	5.4

- Moulding included on vanity mirror is not a standard moulding. SWLCRM8 is similar.
- Mirror glass is beveled.
- Includes two installed metal hanging hooks on back.

MODIFICATIONS

No modifications available for these products.

Finish Techniques

Distressing	Heirlooming
	•

Species Availability (Wood)

	Rustic Alder	Cherry	Hickory	Rustic Hickory	Maple	Oak
		•				

Species Availability (All Laminates)

	High Gloss box color	Horiz. Grain on Maple box color	Vert. Grain on Maple box color	Vert. Grain on Cherry box color	Vert. Grain on Hickory	Vert. Grain on Oak	Thermofoil box color

SINGLE DOOR MEDICINE CABINET

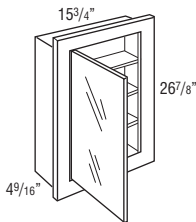

Model	Cabinet Dimensions			Cut-out Dimensions		
	Width	Height	Depth	Width	Height	Depth
MC16	15 3/4"	26 7/8"	4 9/16"	14 7/16"	25 5/8"	4"

MC16	2.5
------	-----

- Features framed construction, face frame has a profiled inside and outside edge.
- Unit can be surface mounted or recessed.
- Door of cabinet is glass mirror.
- Matching cabinet doors not available.
- 1/2" plywood ends, tops, and bottoms.
- Finished exterior.
- Standard interior.
- 3/4" laminated furniture board shelves.
- If ordered with Heirlooming Technique, will not feature sand-through characteristics.

Custom Modifications

CBO	CCO	CFP	CMAT	CND	DRWPWR	DRWTK	EXBK	FTK	FTK_V	ID	INVFRM
•	•										
LTl	RD	RECTK	RT	TKP	TOTSS	VTK					

Construction and Finish Upgrades

APC	FB	MIP	MSLFB	WLI
STD	STD	•		•

Door Options

ALF	CG	DPSRR	MD

TRI-VIEW MEDICINE CABINET

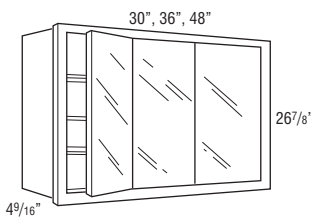

Model	Cabinet Dimensions			Cut-out Dimensions		
	Width	Height	Depth	Width	Height	Depth
TV30	30"	26 7/8"	4 9/16"	28 11/16"	25 5/8"	4"
TV36	36"	26 7/8"	4 9/16"	34 11/16"	25 5/8"	4"
TV48	48"	26 7/8"	4 9/16"	46 11/16"	25 5/8"	4"

TV30	5.4
------	-----

TV36	6.5
------	-----

TV48	8.5
------	-----

- Features framed construction, face frame has a profiled inside and outside edge.
- Door of cabinet is glass mirror.
- Unit can be surface mounted or recessed.
- 1/2" plywood ends, tops, and bottoms.
- Finished exterior.
- Standard interior.
- 3/4" laminated furniture board shelves.
- If ordered with Heirlooming Technique, will not feature sand-through characteristics.

Custom Modifications

CBO	CCO	CFP	CMAT	CND	DRWPWR	DRWTK	EXBK	FTK	FTK_V	ID	INVFRM
•	•										
LTl	RD	RECTK	RT	TKP	TOTSS	VTK					

Construction and Finish Upgrades

APC	FB	MIP	MSLFB	WLI
STD	STD	•		•

Door Options

ALF	CG	DPSRR	MD

SPECIES AVAILABILITY

Species Availability charts list the availability of each product code by species and any substitutions that are made. Exceptions within a section are noted below the species availability chart.

For panels with doors and/or fillers attached, species availability is shown for the panel and filler only.

For Species Availability, look for this chart throughout. For trim items ordered with Laminates, trim items matching the cabinet box color are noted in the charts.

Taro Melamine will use Maple for trim and panels, refer to Maple in the Species Availability charts.

Species Availability (Wood)

Alder	Rustic Alder	Cherry	Hickory	Rustic Hickory	Maple	Oak
•	Alder	•	•	Hickory	•	•

Species Availability (All Laminates)

High Gloss	Horiz. Grain on Maple	Vert. Grain on Maple	Vert. Grain on Cherry	Vert. Grain on Hickory	Vert. Grain on Oak	Thermofoil
box color	box color	box color	box color	box color	box color	box color

DESCRIPTION

MODEL

FILLERS

3" WIDE FILLERS

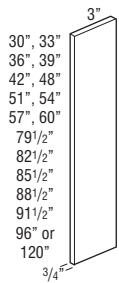

F330
F333
F336
F339
F342
F348
F351
F354
F357
F360
TF384
TF387
TF390
TF393
TF396
TF396FH
TF3120FH† ♦

- 3/4" thick.
- Finished on front and all edges (backs are not finished).
- †5 day Express Response not available.

Finish Techniques

Distressing	Heirlooming
•	

Species Availability (Wood)

Alder	Rustic Alder	Cherry	Hickory	Rustic Hickory	Maple	Oak
•	Alder	•	•	Hickory	•	•

♦ Only available in Cherry and Maple.

Species Availability (All Laminates)

High Gloss	Horiz. Grain on Maple	Vert. Grain on Maple	Vert. Grain on Cherry	Vert. Grain on Hickory	Vert. Grain on Oak	Thermofoil
box color	box color	box color	box color	box color	box color	box color

♦ Only available in Cherry and Maple box colors.

DESCRIPTION

MODEL

3" WIDE FILLERS, PREMIUM

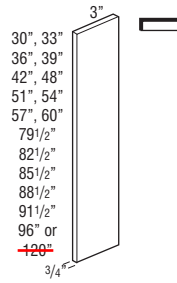

F330P
F333P
F336P
F339P
F342P
F348P
F351P
F354P
F357P
F360P
TF384P
TF387P
TF390P
TF393P
TF396P
TF396FHP
TF3120FHP not available

- All grain will be vertical (including Troxel).
- 3/4" thick.
- Edgebanded on all edges.

Finish Techniques

Distressing	Heirlooming

Species Availability (Wood)

Alder	Rustic Alder	Cherry	Hickory	Rustic Hickory	Maple	Oak

Species Availability (All Laminates)

High Gloss	Horiz. Grain on Maple	Vert. Grain on Maple	Vert. Grain on Cherry	Vert. Grain on Hickory	Vert. Grain on Oak	Thermofoil
•	•	•*	•	•	•	

*TF3120FHP not available in Squall.

3" WIDE FILLER RETURN



F3R
• Creates a toekick appearance when used with 3" wide fillers.
• 3/8" thick, Natural Maple laminated furniture board.

3" WIDE CORNER FILLER

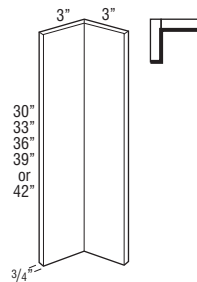

CF330
CF333
CF336
CF339
CF342

- 3/4" thick.
- Finished on front and all edges (backs are not finished).

Finish Techniques

Distressing	Heirlooming
•	

Species Availability (Wood)

Alder	Rustic Alder	Cherry	Hickory	Rustic Hickory	Maple	Oak
•	Alder	•	•	Hickory	•	•

Species Availability (All Laminates)

High Gloss	Horiz. Grain on Maple	Vert. Grain on Maple	Vert. Grain on Cherry	Vert. Grain on Hickory	Vert. Grain on Oak	Thermofoil
box color	box color	box color	box color	box color	box color	box color

Finished edges indicated by bold lines on side view drawings.
Glazed edges indicated by arrows on side view drawings.

DESCRIPTION

MODEL

3" WIDE CORNER FILLER, PREMIUM

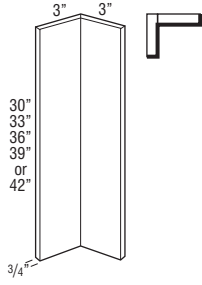

- CF330P
- CF333P
- CF336P
- CF339P
- CF342P

- All grain will be vertical (including Troxel).
- 3/4" thick.
- Edgebanded on all edges.

Finish Techniques

Distressing	Heirlooming

Species Availability (Wood)

Alder	Rustic Alder	Cherry	Hickory	Rustic Hickory	Maple	Oak

Species Availability (All Laminates)

High Gloss	Horiz. Grain on Maple	Vert. Grain on Maple	Vert. Grain on Cherry	Vert. Grain on Hickory	Vert. Grain on Oak	Thermofoil
•	•	•	•	•	•	

6" WIDE FILLERS

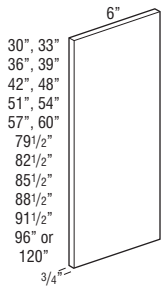

- F630
- F633
- F636
- F639
- F642
- F648
- F651
- F654
- F657
- F660
- TF684
- TF687
- TF690
- TF693
- TF696
- TF696FH
- TF6120FH† ♦

- 3/4" thick.
- Finished on front and all edges (backs are not finished).
- †5 day Express Response not available.

Finish Techniques

Distressing	Heirlooming
•	

Species Availability (Wood)

Alder	Rustic Alder	Cherry	Hickory	Rustic Hickory	Maple	Oak
•	Alder	•	•	Hickory	•	•

♦ Only available in Cherry and Maple.

Species Availability (All Laminates)

High Gloss	Horiz. Grain on Maple	Vert. Grain on Maple	Vert. Grain on Cherry	Vert. Grain on Hickory	Vert. Grain on Oak	Thermofoil
box color	box color	box color	box color	box color	box color	box color

♦ Only available in Cherry and Maple box colors.

DESCRIPTION

MODEL

6" WIDE FILLERS, PREMIUM

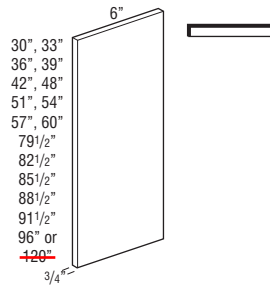

- F630P
- F633P
- F636P
- F639P
- F642P
- F648P
- F651P
- F654P
- F657P
- F660P
- TF684P
- TF687P
- TF690P
- TF693P
- TF696P
- TF696FHP
- ~~TF6120FHP~~ not available

- All grain will be vertical (including Troxel).
- 3/4" thick.
- Edgebanded on all edges.

Finish Techniques

Distressing	Heirlooming

Species Availability (Wood)

Alder	Rustic Alder	Cherry	Hickory	Rustic Hickory	Maple	Oak

Species Availability (All Laminates)

High Gloss	Horiz. Grain on Maple	Vert. Grain on Maple	Vert. Grain on Cherry	Vert. Grain on Hickory	Vert. Grain on Oak	Thermofoil
•	•	•*	•	•	•	

*TF6120FHP not available in Squall.

6" WIDE FILLER RETURN

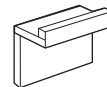

- F6R
- Creates a toekick appearance when used with 6" wide fillers.
- 3/8" thick, Natural Maple laminated furniture board.

SPACE FILLERS

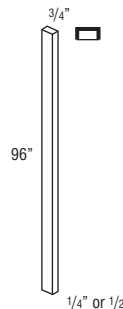

- S96X14 (1/4" thick)
- S96X12 (1/2" thick)

- S96 is 1/4" or 1/2" thick.
- Designed to fill space between adjacent cabinets; i.e. W1830 butted against side of U188424.
- Finished on front and all edges (backs are not finished).

Finish Techniques

Distressing	Heirlooming

Species Availability (Wood)

Alder	Rustic Alder	Cherry	Hickory	Rustic Hickory	Maple	Oak
•	Alder	•	•	Hickory	•	•

Species Availability (All Laminates)

High Gloss	Horiz. Grain on Maple	Vert. Grain on Maple	Vert. Grain on Cherry	Vert. Grain on Hickory	Vert. Grain on Oak	Thermofoil
box color	box color	box color	box color	box color	box color	box color

Finished edges indicated by bold lines on side view drawings.
Glazed edges indicated by arrows on side view drawings.

DESCRIPTION

OVERLAY FILLER, 2 25/32 WIDE

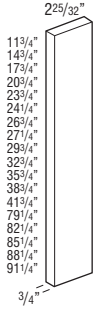

MODEL

- OL312** (11 3/4"H)
- OL315** (14 3/4"H)
- OL318** (17 3/4"H)
- OL321** (20 3/4"H)
- OL324** (23 3/4"H)
- OL327** (26 3/4"H)
- OL330** (29 3/4"H)
- OL333** (32 3/4"H)
- OL336** (35 3/4"H)
- OL339** (38 3/4"H)
- OL342** (41 3/4"H)
- OL384** (79 1/4"H)
- OL387** (82 1/4"H)
- OL390** (85 1/4"H)
- OL393** (88 1/4"H)
- OL396** (91 1/4"H)
- VOL332** (27 1/4"H)
- DOL329** (24 1/4"H)

- 2 25/32" wide overlay fillers can be applied to Wall Message Centers to create custom finished look.
- Overlays match door profile and thickness.
- Finished on front and all edges (backs are not finished).
- Overlays in Taro Melamine will be door matching with edgebanding.

Finish Techniques

Distressing	Heirlooming
•	•

Species Availability (Wood)

Alder	Rustic Alder	Cherry	Hickory	Rustic Hickory	Maple	Oak
•	•	•	•	•	•	•

Species Availability (All Laminates)

High Gloss	Horiz. Grain on Maple	Vert. Grain on Maple	Vert. Grain on Cherry	Vert. Grain on Hickory	Vert. Grain on Oak	Thermofoil
•	•	•	•	•	•	•

DESCRIPTION

OVERLAY FILLER, PREMIUM, 2 25/32" WIDE

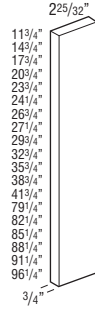

MODEL

- OL312P** (11 3/4"H)
- OL315P** (14 3/4"H)
- OL318P** (17 3/4"H)
- OL321P** (20 3/4"H)
- OL324P** (23 3/4"H)
- OL327P** (26 3/4"H)
- OL330P** (29 3/4"H)
- OL333P** (32 3/4"H)
- OL336P** (35 3/4"H)
- OL339P** (38 3/4"H)
- OL342P** (41 3/4"H)
- OL384P** (79 1/4"H)
- OL387P** (82 1/4"H)
- OL390P** (85 1/4"H)
- OL393P** (88 1/4"H)
- OL396P** (91 1/4"H)
- OL396FHP** (96 1/4"H)
- VOL332P** (27 1/4"H)
- DOL329P** (24 1/4"H)

- 2 25/32" wide overlay fillers can be applied to Wall Message Centers to create custom finished look.
- Overlays match door profile and thickness (3/4").
- Front, edges, and backs match door and drawer front construction. Edgebanded on all edges.
- Taro edgebanding will match door and drawer front edgebanding selection.
- Troxel overlays feature horizontal grain. Overlays greater than 48" high will be two overlays and require field assembly (allow 1/8" gap between overlays for alignment with adjacent doors).

Finish Techniques

Distressing	Heirlooming
•	•

Species Availability (Wood)

Alder	Rustic Alder	Cherry	Hickory	Rustic Hickory	Maple	Oak
•	•	•	•	•	•	•

Species Availability (All Laminates)

High Gloss	Horiz. Grain on Maple	Vert. Grain on Maple	Vert. Grain on Cherry	Vert. Grain on Hickory	Vert. Grain on Oak	Thermofoil
•	•	•	•	•	•	•

Finished edges indicated by bold lines on side view drawings.
Glazed edges indicated by arrows on side view drawings.

DESCRIPTION

OVERLAY FILLER, 5 25/32" WIDE

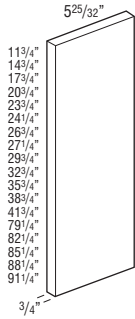

MODEL



- OL612** (11 3/4"H)
- OL615** (14 3/4"H)
- OL618** (17 3/4"H)
- OL621** (20 3/4"H)
- OL624** (23 3/4"H)
- OL627** (26 3/4"H)
- OL630** (29 3/4"H)
- OL633** (32 3/4"H)
- OL636** (35 3/4"H)
- OL639** (38 3/4"H)
- OL642** (41 3/4"H)
- OL684** (79 1/4"H)
- OL687** (82 1/4"H)
- OL690** (85 1/4"H)
- OL693** (88 1/4"H)
- OL696** (91 1/4"H)
- VOL632** (27 1/4"H)
- DOL629** (24 1/4"H)

- Overlays match door profile and thickness.
- Finished on front and all edges (backs are not finished).
- Overlays in Taro Melamine will be door matching with edgebanding.

Finish Techniques

Distressing	Heirlooming
•	•

Species Availability (Wood)

Alder	Rustic Alder	Cherry	Hickory	Rustic Hickory	Maple	Oak
•	•	•	•	•	•	•

Species Availability (All Laminates)

High Gloss	Horiz. Grain on Maple	Vert. Grain on Maple	Vert. Grain on Cherry	Vert. Grain on Hickory	Vert. Grain on Oak	Thermofoil
•	•	•	•	•	•	•

DESCRIPTION

OVERLAY FILLER, PREMIUM, 5 25/32" WIDE

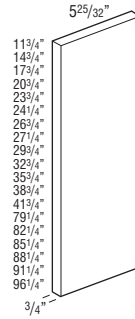

MODEL

- OL612P** (11 3/4"H)
- OL615P** (14 3/4"H)
- OL618P** (17 3/4"H)
- OL621P** (20 3/4"H)
- OL624P** (23 3/4"H)
- OL627P** (26 3/4"H)
- OL630P** (29 3/4"H)
- OL633P** (32 3/4"H)
- OL636P** (35 3/4"H)
- OL639P** (38 3/4"H)
- OL642P** (41 3/4"H)
- OL684P** (79 1/4"H)
- OL687P** (82 1/4"H)
- OL690P** (85 1/4"H)
- OL693P** (88 1/4"H)
- OL696P** (91 1/4"H)
- OL696FHP** (96 1/4"H)
- VOL632P** (27 1/4"H)
- DOL629P** (24 1/4"H)

- Overlays match door profile and thickness (3/4").
- Front, edges, and backs match door and drawer front construction. Edgebanded on all edges.
- Taro edgebanding will match door and drawer front edgebanding selection.
- Troxel overlays feature horizontal grain. Overlays greater than 48" high will be two overlays and require field assembly (allow 1/8" gap between overlays for alignment with adjacent doors).

Finish Techniques

Distressing	Heirlooming
•	•

Species Availability (Wood)

Alder	Rustic Alder	Cherry	Hickory	Rustic Hickory	Maple	Oak
•	•	•	•	•	•	•

Species Availability (All Laminates)

High Gloss	Horiz. Grain on Maple	Vert. Grain on Maple	Vert. Grain on Cherry	Vert. Grain on Hickory	Vert. Grain on Oak	Thermofoil
•	•	•	•	•	•	•

Finished edges indicated by bold lines on side view drawings.
Glazed edges indicated by arrows on side view drawings.

DESCRIPTION

MODEL

FLUTED/BEADED 3" WIDE REVERSIBLE FILLERS



FBF330 (3" x 30")

FBF336 (3" x 36")

TFBF396 (3" x 96")

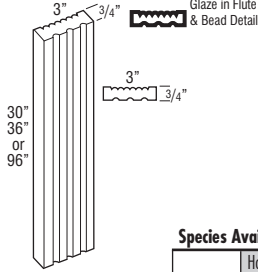

Finish Techniques

Distressing	Heirlooming
	•

Species Availability (Wood)

Alder	Rustic Alder	Cherry	Hickory	Rustic Hickory	Maple	Oak
•	•	•	•	•	•	•

Species Availability (All Laminates)

High Gloss box color	Horiz. Grain on Maple box color	Vert. Grain on Maple box color	Vert. Grain on Cherry box color	Vert. Grain on Hickory box color	Vert. Grain on Oak box color	Thermofoil box color
----------------------	---------------------------------	--------------------------------	---------------------------------	----------------------------------	------------------------------	----------------------

FLUTED/BEADED 6" WIDE REVERSIBLE FILLERS



FBF630 (6" x 30")

FBF636 (6" x 36")

TFBF696 (6" x 96")

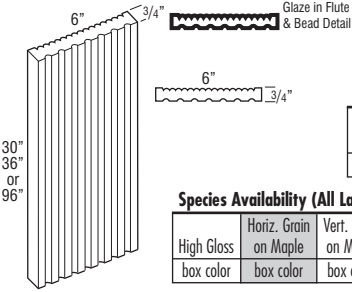

Finish Techniques

Distressing	Heirlooming
	•

Species Availability (Wood)

Alder	Rustic Alder	Cherry	Hickory	Rustic Hickory	Maple	Oak
•	•	•	•	•	•	•

Species Availability (All Laminates)

High Gloss box color	Horiz. Grain on Maple box color	Vert. Grain on Maple box color	Vert. Grain on Cherry box color	Vert. Grain on Hickory box color	Vert. Grain on Oak box color	Thermofoil box color
----------------------	---------------------------------	--------------------------------	---------------------------------	----------------------------------	------------------------------	----------------------

ANGLED FLUTED/PLAIN 3" WIDE REVERSIBLE FILLERS



BLVDF30 (3" x 30")

BLVDF34.5 (3" x 34 1/2")

BLVDTF96 (3" x 96")

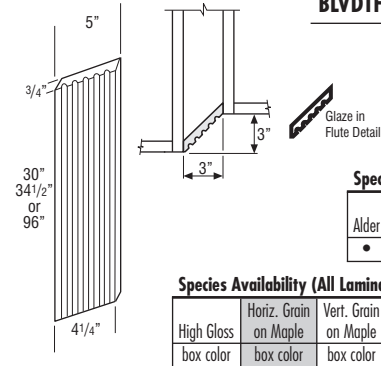

Finish Techniques

Distressing	Heirlooming
	•

Species Availability (Wood)

Alder	Rustic Alder	Cherry	Hickory	Rustic Hickory	Maple	Oak
•	•	•	•	•	•	•

Species Availability (All Laminates)

High Gloss box color	Horiz. Grain on Maple box color	Vert. Grain on Maple box color	Vert. Grain on Cherry box color	Vert. Grain on Hickory box color	Vert. Grain on Oak box color	Thermofoil box color
----------------------	---------------------------------	--------------------------------	---------------------------------	----------------------------------	------------------------------	----------------------

DESCRIPTION

MODEL

BOX COLUMN FILLERS, 3" WIDE Wall - Plain Column 15" Deep

W312BCFP

W315BCFP

W318BCFP

W321BCFP

W324BCFP

W327BCFP

W330BCFP

W333BCFP

W336BCFP

W339BCFP

W342BCFP

W348BCFP

W351BCFP

W354BCFP

W357BCFP

W360BCFP

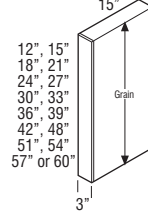

Custom Modifications

ID	RD
•	•

Finish Techniques

Distressing	Heirlooming
•	•

Species Availability (Wood)

Alder	Rustic Alder	Cherry	Hickory	Rustic Hickory	Maple	Oak
•	•	•	•	•	•	•

Species Availability (All Laminates)

High Gloss box color	Horiz. Grain on Maple box color	Vert. Grain on Maple box color	Vert. Grain on Cherry box color	Vert. Grain on Hickory box color	Vert. Grain on Oak box color	Thermofoil box color
----------------------	---------------------------------	--------------------------------	---------------------------------	----------------------------------	------------------------------	----------------------

Wall - Fluted Column 15" Deep

W312BCFF

W315BCFF

W318BCFF

W321BCFF

W324BCFF

W327BCFF

W330BCFF

W333BCFF

W336BCFF

W339BCFF

W342BCFF

W348BCFF

W351BCFF

W354BCFF

W357BCFF

W360BCFF

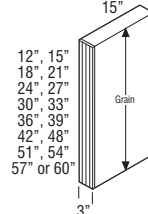

Custom Modifications

ID	RD
•	•

Finish Techniques

Distressing	Heirlooming
•	•

Species Availability (Wood)

Alder	Rustic Alder	Cherry	Hickory	Rustic Hickory	Maple	Oak
•	•	•	•	•	•	•

Species Availability (All Laminates)

High Gloss box color	Horiz. Grain on Maple box color	Vert. Grain on Maple box color	Vert. Grain on Cherry box color	Vert. Grain on Hickory box color	Vert. Grain on Oak box color	Thermofoil box color
----------------------	---------------------------------	--------------------------------	---------------------------------	----------------------------------	------------------------------	----------------------

Finished edges indicated by bold lines on side view drawings.
Glazed edges indicated by arrows on side view drawings.

DESCRIPTION

MODEL

**BOX COLUMN FILLERS,
3" WIDE (cont'd)
Wall - Beaded Column
15" Deep**

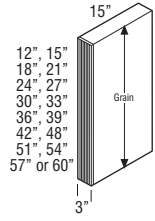

- W312BCFB
- W315BCFB
- W318BCFB
- W321BCFB
- W324BCFB
- W327BCFB
- W330BCFB
- W333BCFB
- W336BCFB
- W339BCFB
- W342BCFB
- W348BCFB
- W351BCFB
- W354BCFB
- W357BCFB
- W360BCFB

- Available in 1" depth increments from 6" to 27".
- Reversible, may be used on either left or right end.
- Front and both sides finished.
- Enclosed top and bottom.
- 1/2" plywood construction.
- Finished veneer on end panel exterior.
- No reveal on filler.

Custom Modifications		Finish Techniques	
ID	RD	Distressing	Heirlooming
•	•		•

Species Availability (Wood)						
Alder	Rustic Alder	Cherry	Hickory	Rustic Hickory	Maple	Oak
•	Alder	•	•	Hickory	•	•

Species Availability (All Laminates)						
High Gloss	Horiz. Grain on Maple	Vert. Grain on Maple	Vert. Grain on Cherry	Vert. Grain on Hickory	Vert. Grain on Oak	Thermofoil
box color	box color	box color	box color	box color	box color	box color

DESCRIPTION

MODEL

**BOX COLUMN FILLERS, 3" WIDE
Base - Plain, Fluted, Beaded Column
27" Deep**

B334.527BCFP

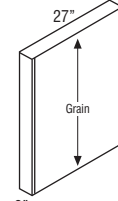

3" Plain

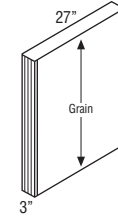

3" Fluted

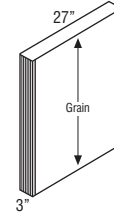

3" Beaded

Custom Modifications		Finish Techniques	
ID	RD	Distressing	Heirlooming
	•	•	

Species Availability (Wood)						
Alder	Rustic Alder	Cherry	Hickory	Rustic Hickory	Maple	Oak
•	Alder	•	•	Hickory	•	•

Species Availability (All Laminates)						
High Gloss	Horiz. Grain on Maple	Vert. Grain on Maple	Vert. Grain on Cherry	Vert. Grain on Hickory	Vert. Grain on Oak	Thermofoil
box color	box color	box color	box color	box color	box color	box color

B334.527BCFF

B334.527BCFB

- Available in 1" depth increments from 6" to 27".
- Reversible, may be used on either left or right end.
- Front and both sides finished.
- Enclosed top and bottom.
- 1/2" plywood construction.
- Finished veneer on end panel exterior.
- No reveal on filler.

Custom Modifications		Finish Techniques	
ID	RD	Distressing	Heirlooming
	•		•

Species Availability (Wood)						
Alder	Rustic Alder	Cherry	Hickory	Rustic Hickory	Maple	Oak
•	Alder	•	•	Hickory	•	•

Species Availability (All Laminates)						
High Gloss	Horiz. Grain on Maple	Vert. Grain on Maple	Vert. Grain on Cherry	Vert. Grain on Hickory	Vert. Grain on Oak	Thermofoil
box color	box color	box color	box color	box color	box color	box color

DESCRIPTION

BOX COLUMN FILLERS, 3" WIDE
Tall - Plain Column
15" & 27" Deep

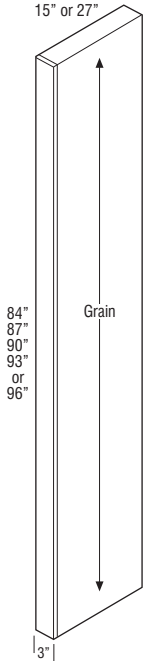

MODEL

- T38415BCFP (15" Deep)
- T38715BCFP (15" Deep)
- T39015BCFP (15" Deep)
- T39315BCFP (15" Deep)
- T39615BCFP (15" Deep)
- T38427BCFP (27" Deep)
- T38727BCFP (27" Deep)
- T39027BCFP (27" Deep)
- T39327BCFP (27" Deep)
- T39627BCFP (27" Deep)

Custom Modifications		Finish Techniques	
ID	RD	Distressing	Heirlooming
•*	•	•	•

*ID only available on 15" deep.

Species Availability (Wood)

Alder	Rustic Alder	Cherry	Hickory	Rustic Hickory	Maple	Oak
•	Alder	•	•	Hickory	•	•

Species Availability (All Laminates)

High Gloss	Horiz. Grain on Maple	Vert. Grain on Maple	Vert. Grain on Cherry	Vert. Grain on Hickory	Vert. Grain on Oak	Thermofoil
box color	box color	box color	box color	box color	box color	box color

Tall - Fluted Column
15" & 27" Deep

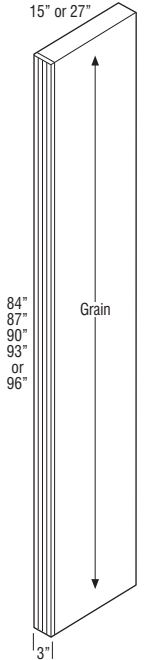

- T38415BCFF (15" Deep)
- T38715BCFF (15" Deep)
- T39015BCFF (15" Deep)
- T39315BCFF (15" Deep)
- T39615BCFF (15" Deep)
- T38427BCFF (27" Deep)
- T38727BCFF (27" Deep)
- T39027BCFF (27" Deep)
- T39327BCFF (27" Deep)
- T39627BCFF (27" Deep)

Custom Modifications		Finish Techniques	
ID	RD	Distressing	Heirlooming
•*	•	•	•

*ID only available on 15" deep.

Species Availability (Wood)

Alder	Rustic Alder	Cherry	Hickory	Rustic Hickory	Maple	Oak
•	Alder	•	•	Hickory	•	•

Species Availability (All Laminates)

High Gloss	Horiz. Grain on Maple	Vert. Grain on Maple	Vert. Grain on Cherry	Vert. Grain on Hickory	Vert. Grain on Oak	Thermofoil
box color	box color	box color	box color	box color	box color	box color

DESCRIPTION

BOX COLUMN FILLERS, 3" WIDE (cont'd)
Tall - Beaded Column
15" & 27" Deep

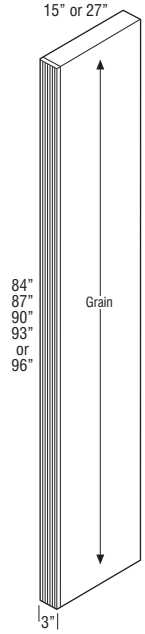

MODEL

- T38415BCFB (15" Deep)
- T38715BCFB (15" Deep)
- T39015BCFB (15" Deep)
- T39315BCFB (15" Deep)
- T39615BCFB (15" Deep)
- T38427BCFB (27" Deep)
- T38727BCFB (27" Deep)
- T39027BCFB (27" Deep)
- T39327BCFB (27" Deep)
- T39627BCFB (27" Deep)

- Available in 1" depth increments from 6" to 27".
- Reversible, may be used on either left or right end.
- Front and both sides finished.
- Enclosed top and bottom.
- 1/2" plywood construction.
- Finished veneer on end panel exterior.
- No reveal on filler.

Custom Modifications		Finish Techniques	
ID	RD	Distressing	Heirlooming
•*	•	•	•

*ID only available on 15" deep.

Species Availability (Wood)

Alder	Rustic Alder	Cherry	Hickory	Rustic Hickory	Maple	Oak
•	Alder	•	•	Hickory	•	•

Species Availability (All Laminates)

High Gloss	Horiz. Grain on Maple	Vert. Grain on Maple	Vert. Grain on Cherry	Vert. Grain on Hickory	Vert. Grain on Oak	Thermofoil
box color	box color	box color	box color	box color	box color	box color

BOX COLUMN FILLERS, 6" WIDE
Wall - Plain Column
15" Deep

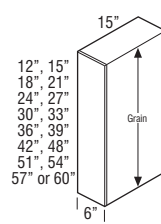

- W612BCFP
- W615BCFP
- W618BCFP
- W621BCFP
- W624BCFP
- W627BCFP
- W630BCFP
- W633BCFP
- W636BCFP
- W639BCFP
- W642BCFP
- W648BCFP
- W651BCFP
- W654BCFP
- W657BCFP
- W660BCFP

Custom Modifications		Finish Techniques	
ID	RD	Distressing	Heirlooming
•	•	•	•

Species Availability (Wood)

Alder	Rustic Alder	Cherry	Hickory	Rustic Hickory	Maple	Oak
•	Alder	•	•	Hickory	•	•

Species Availability (All Laminates)

High Gloss	Horiz. Grain on Maple	Vert. Grain on Maple	Vert. Grain on Cherry	Vert. Grain on Hickory	Vert. Grain on Oak	Thermofoil
box color	box color	box color	box color	box color	box color	box color

DESCRIPTION

**BOX COLUMN FILLERS,
6" WIDE (cont'd)
Wall - Fluted Column
15" Deep**

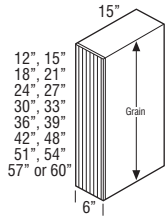

MODEL

- W612BCFF
- W615BCFF
- W618BCFF
- W621BCFF
- W624BCFF
- W627BCFF
- W630BCFF
- W633BCFF
- W636BCFF
- W639BCFF
- W642BCFF
- W648BCFF
- W651BCFF
- W654BCFF
- W657BCFF
- W660BCFF

Custom Modifications

ID	RD
•	•

Finish Techniques

Distressing	Heirlooming
	•

Species Availability (Wood)

Alder	Rustic Alder	Cherry	Hickory	Rustic Hickory	Maple	Oak
•	•	•	•	•	•	•

Species Availability (All Laminates)

High Gloss	Horiz. Grain on Maple	Vert. Grain on Maple	Vert. Grain on Cherry	Vert. Grain on Hickory	Vert. Grain on Oak	Thermofoil
box color	box color	box color	box color	box color	box color	box color

DESCRIPTION

**BOX COLUMN FILLERS,
6" WIDE (cont'd)
Wall - Beaded Column
15" Deep**

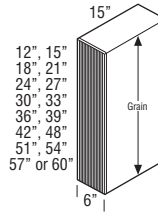

MODEL

- W612BCFB
- W615BCFB
- W618BCFB
- W621BCFB
- W624BCFB
- W627BCFB
- W630BCFB
- W633BCFB
- W636BCFB
- W639BCFB
- W642BCFB
- W648BCFB
- W651BCFB
- W654BCFB
- W657BCFB
- W660BCFB

- Available in 1" depth increments from 6" to 27".
- Reversible, may be used on either left or right end.
- Front and both sides finished.
- Enclosed top and bottom.
- 1/2" plywood construction.
- Finished veneer on end panel exterior.
- No reveal on filler.

Custom Modifications

ID	RD
•	•

Finish Techniques

Distressing	Heirlooming
	•

Species Availability (Wood)

Alder	Rustic Alder	Cherry	Hickory	Rustic Hickory	Maple	Oak
•	•	•	•	•	•	•

Species Availability (All Laminates)

High Gloss	Horiz. Grain on Maple	Vert. Grain on Maple	Vert. Grain on Cherry	Vert. Grain on Hickory	Vert. Grain on Oak	Thermofoil
box color	box color	box color	box color	box color	box color	box color

DESCRIPTION

MODEL

BOX COLUMN FILLERS, 6" WIDE
Base - Plain, Fluted, Beaded Column
27" Deep

B634.527BCFP

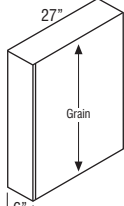

Plain

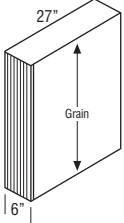

Fluted

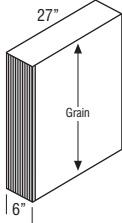

Beaded

Custom Modifications

ID	RD
	•

Finish Techniques

Distressing	Heirlooming
•	

Species Availability (Wood)

Alder	Rustic Alder	Cherry	Hickory	Rustic Hickory	Maple	Oak
•	Alder	•	•	Hickory	•	•

Species Availability (All Laminates)

High Gloss box color	Horiz. Grain on Maple box color	Vert. Grain on Maple box color	Vert. Grain on Cherry box color	Vert. Grain on Hickory box color	Vert. Grain on Oak box color	Thermofoil box color
----------------------	---------------------------------	--------------------------------	---------------------------------	----------------------------------	------------------------------	----------------------

B634.527BCFF

B634.527BCFB

- Available in 1" depth increments from 6" to 27".
- Reversible, may be used on either left or right end.
- Front and both sides finished.
- Enclosed top and bottom.
- 1/2" plywood construction.
- Finished veneer on end panel exterior.
- No reveal on filler.

Custom Modifications

ID	RD
	•

Finish Techniques

Distressing	Heirlooming
	•

Species Availability (Wood)

Alder	Rustic Alder	Cherry	Hickory	Rustic Hickory	Maple	Oak
•	Alder	•	•	Hickory	•	•

Species Availability (All Laminates)

High Gloss box color	Horiz. Grain on Maple box color	Vert. Grain on Maple box color	Vert. Grain on Cherry box color	Vert. Grain on Hickory box color	Vert. Grain on Oak box color	Thermofoil box color
----------------------	---------------------------------	--------------------------------	---------------------------------	----------------------------------	------------------------------	----------------------

BOX COLUMN FILLERS, 6" WIDE
Tall - Plain Column
15" & 27" Deep

T68415BCFP (15" Deep)

T68715BCFP (15" Deep)

T69015BCFP (15" Deep)

T69315BCFP (15" Deep)

T69615BCFP (15" Deep)

T68427BCFP (27" Deep)

T68727BCFP (27" Deep)

T69027BCFP (27" Deep)

T69327BCFP (27" Deep)

T69627BCFP (27" Deep)

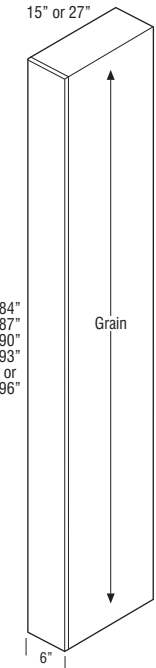

Custom Modifications

ID	RD
•*	•

Finish Techniques

Distressing	Heirlooming
•	

*ID only available on 15" deep.

Species Availability (Wood)

Alder	Rustic Alder	Cherry	Hickory	Rustic Hickory	Maple	Oak
•	Alder	•	•	Hickory	•	•

Species Availability (All Laminates)

High Gloss box color	Horiz. Grain on Maple box color	Vert. Grain on Maple box color	Vert. Grain on Cherry box color	Vert. Grain on Hickory box color	Vert. Grain on Oak box color	Thermofoil box color
----------------------	---------------------------------	--------------------------------	---------------------------------	----------------------------------	------------------------------	----------------------

DESCRIPTION

MODEL

BOX COLUMN FILLERS, 6" WIDE (cont'd)
Tall - Fluted Column
15" & 27" Deep

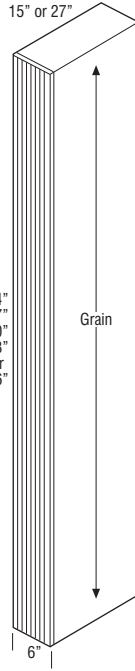

84"
87"
90"
93"
or
96"

T68415BCFF (15" Deep)

T68715BCFF (15" Deep)

T69015BCFF (15" Deep)

T69315BCFF (15" Deep)

T69615BCFF (15" Deep)

T68427BCFF (27" Deep)

T68727BCFF (27" Deep)

T69027BCFF (27" Deep)

T69327BCFF (27" Deep)

T69627BCFF (27" Deep)

Custom Modifications

ID	RD
•*	•

Finish Techniques

Distressing	Heirlooming
	•

*ID only available on 15" deep.

Species Availability (Wood)

Alder	Rustic Alder	Cherry	Hickory	Rustic Hickory	Maple	Oak
•	Alder	•	•	Hickory	•	•

Species Availability (All Laminates)

High Gloss box color	Horiz. Grain on Maple box color	Vert. Grain on Maple box color	Vert. Grain on Cherry box color	Vert. Grain on Hickory box color	Vert. Grain on Oak box color	Thermofoil box color
----------------------	---------------------------------	--------------------------------	---------------------------------	----------------------------------	------------------------------	----------------------

Tall - Beaded Column
15" & 27" Deep

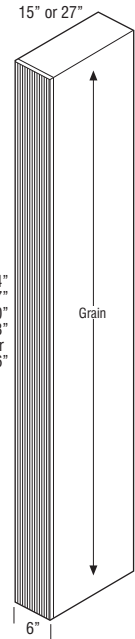

84"
87"
90"
93"
or
96"

T68415BCFB (15" Deep)

T68715BCFB (15" Deep)

T69015BCFB (15" Deep)

T69315BCFB (15" Deep)

T69615BCFB (15" Deep)

T68427BCFB (27" Deep)

T68727BCFB (27" Deep)

T69027BCFB (27" Deep)

T69327BCFB (27" Deep)

T69627BCFB (27" Deep)

- Available in 1" depth increments from 6" to 27".
- Reversible, may be used on either left or right end.
- Front and both sides finished.
- Enclosed top and bottom.
- 1/2" plywood construction.
- Finished veneer on end panel exterior.
- No reveal on filler.

Custom Modifications

ID	RD
•*	•

Finish Techniques

Distressing	Heirlooming
	•

*ID only available on 15" deep.

Species Availability (Wood)

Alder	Rustic Alder	Cherry	Hickory	Rustic Hickory	Maple	Oak
•	Alder	•	•	Hickory	•	•

Species Availability (All Laminates)

High Gloss box color	Horiz. Grain on Maple box color	Vert. Grain on Maple box color	Vert. Grain on Cherry box color	Vert. Grain on Hickory box color	Vert. Grain on Oak box color	Thermofoil box color
----------------------	---------------------------------	--------------------------------	---------------------------------	----------------------------------	------------------------------	----------------------

WAINSCOTING, 34 1/2" or 40 1/2" HIGH

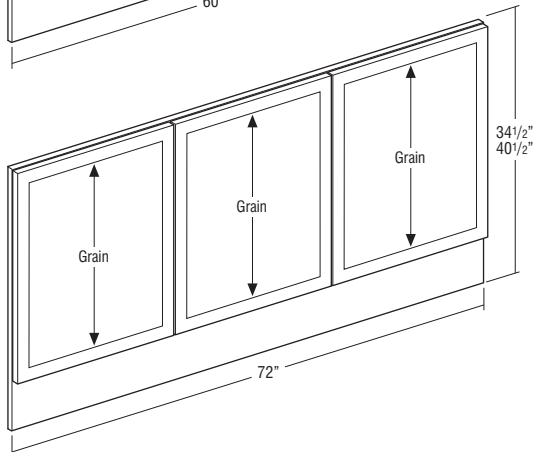
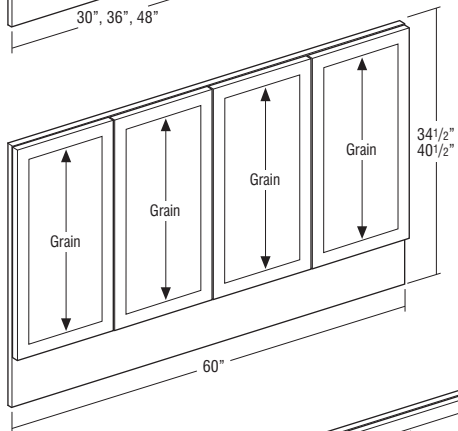
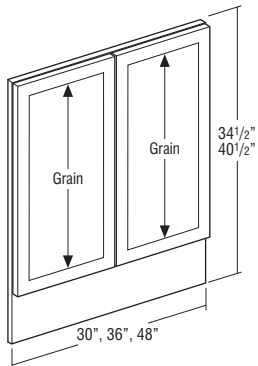
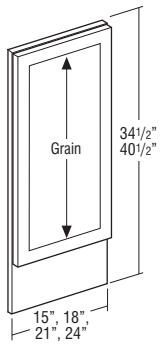

Model	Cubic Feet
WAIN1534.5	1.2
WAIN1834.5	1.4
WAIN2134.5	1.7
WAIN2434.5	1.9
WAIN1540.5	1.4
WAIN1840.5	1.7
WAIN2140.5	1.9
WAIN2440.5	2.2
WAIN3034.5	2.3
WAIN3634.5	2.8
WAIN4834.5	3.6
WAIN3040.5	2.7
WAIN3640.5	3.2
WAIN4840.5	7.3
WAIN6034.5	4.5
WAIN6040.5	5.3
WAIN7234.5	5.4
WAIN7240.5	6.3

- Panel is 1 1/2" thick including doors. Non-operating doors are applied to 3/4" thick rail and stile frame with full access door sizes and reveals.
- Flush ToeKick standard.
- Wainscoting panel backs are not finished, but are sealed to prevent warping and cracking.
- All faces and edges will be finished.
- For use on bars or islands, attach panel by securing the panel face frame through the inside of the applicable cabinet.
- For wall applications, the screw heads used for the panel face frame attachment to the wall can be concealed behind the doors and drawer fronts.

Product Code	Overall Width	Number of Doors	Number of Frame Center Stiles	Door Width
WAIN15..	15"	1	0	14 27/32"
WAIN18..	18"	1	0	17 27/32"
WAIN21..	21"	1	0	20 27/32"
WAIN24..	24"	1	0	23 27/32"
WAIN30..	30"	2	1	14 27/32"
WAIN36..	36"	2	1	17 27/32"
WAIN48..	48"	2	1	23 27/32"
WAIN60..	60"	4	3	14 27/32"
WAIN72..	72"	3	2	23 27/32"

Door height on 34 1/2" high panels is 29 3/4".
 Door height on 40 1/2" high panels is 35 3/4".

Custom Modifications		Door Options	Finish Techniques	
FTK	VTK	DPSRR	Distressing	Heirlooming
STD	•	•	•	•

CUSTOM HINGED DOORS

Custom Doors with Hinge Routing

DOORB1

DOORB2

DOORW1

DOORW2

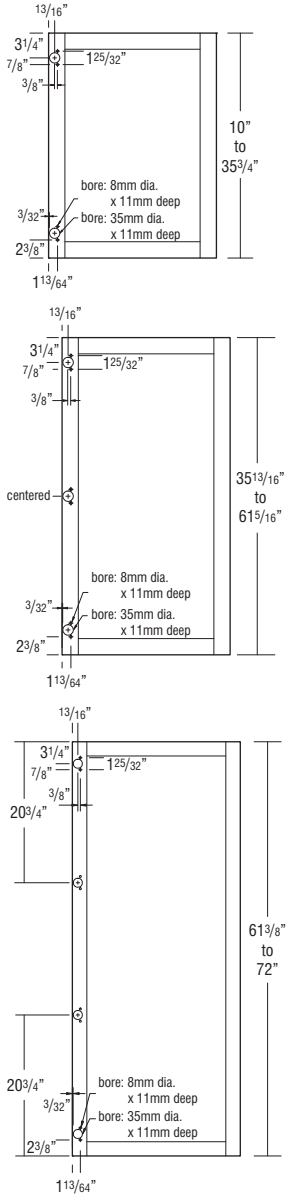

- Plastic mollies pressed in 8mm holes to accept screws to anchor the hinges to the back of these doors.
- Hinges must be ordered separately.
- Available in all door styles except Caprice, Genova, Tara, Troxel, and Vaile. For Genova, Tara, and Troxel use DOORSLAB (see page 291). For Caprice and Vaile, standard door sizes must be ordered.
- Doors are finished on both sides and routed for hinges.
- CG modification available, maximum size is 23 1/2" x 43".
- Custom dimensions are required when placing order and can be specified in 20/20 or on the order form.

Finish Techniques

Distressing	Heirlooming
•	•

	Model	Door Style Type	Available Width Range*	Available Height Range
	DOORB.. and DOORW..	Non-Miter Styles	7 1/2" to 24" (<3" wide rails/stiles) 8 1/2" to 24" (3" wide rails/stiles)	10" to 47 7/16" (<3" wide rails/stiles) 10" to 47 7/16" (3" wide rails/stiles)
	DOORB.. and DOORW..	Non-Miter Styles	7 1/2" to 24" (<3" wide rails/stiles) 8 1/2" to 24" (3" wide rails/stiles)	47 1/2" to 72" (<3" wide rails/stiles) 47 1/2" to 72" (3" wide rails/stiles)
	DOORB.. and DOORW..	Miter Styles	8" to 24"	10" to 61"

*Any door with a minimum width dimension less than 10" will receive a flat center panel.

Custom Doors with Hinge Routing, Slab Styles



DOORSLAB

- Available in slab door styles: Genova, Taro, and Troxel.
- Doors are finished on both sides and routed for hinges.
- Hinges must be ordered separately.
- Plastic mollies pressed in 8mm holes to accept screws to anchor the hinges to the back of these doors.
- Custom dimensions are required when placing order and can be specified in 20/20 or on the order form.

Finish Techniques

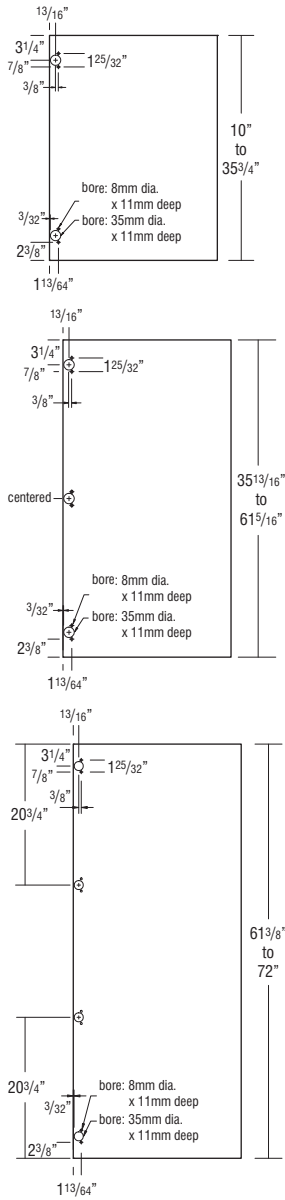
Distressing	Heirlooming
-------------	-------------

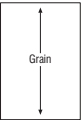

	Model	Door Style Type	Available Width Range	Available Height Range
	DOORSLAB	Vertical Grain or High Gloss	5" to 24"	10" to 72"
	DOORSLAB	Horizontal Grain	5" to 24"	10" to 48"

DESCRIPTION MODEL
DECORATIVE APPLIANCE PANELS

All custom panels and doors can be ordered through 20/20. For manual orders, please fax the order form to customer service. See page 294.

Due to customized ordering, Decorative Appliance Panels may not be returned.

Custom Panels & Doors (DAPNL.. and DADOOR..) square footage requirements are calculated by multiplying the height and width for each panel and door (square footage = width x height (in inches)/144).

Custom Panels

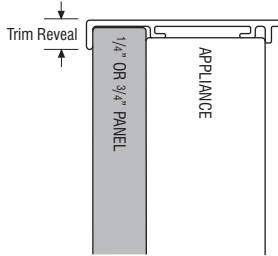

DAPNL1/4
DAPNL3/4

- DAPNL1/4 includes 1/4" finished veneer on MDF core, panel cut to fit appliance doors. Panels mount to the appliance using trim kits provided by the appliance supplier.
- DAPNL1/4 is finished on face only, edges are not finished.
- DAPNL3/4 kit includes 3/4" furniture board core veneer panel finished on both sides, and all four edges. Panel is cut to fit appliance doors, and mounts to the appliance using trim kits provided by the appliance supplier.
- Custom sizes available in 1/16" increments.
- DAPNL3/4 can be ordered in APC.

	Maximum Width	Minimum Width	Maximum Height	Minimum Height
DAPNL1/4	48"	5"	96"	5"
DAPNL3/4*	48"	5"	48"	5"
DAPNL3/4**	30"	5"	96"	5"

*If DAPNL3/4 is 48" high or less
**If DAPNL3/4 is greater than 48" high
Grain on panels will follow the height dimension (vertical)

Finish Techniques

Distressing	Heirlooming

Species Availability (Wood)

Alder	Rustic Alder	Cherry	Hickory	Rustic Hickory	Maple	Oak
•		•	•	Hickory	•	•

Species Availability (All Laminates)

High Gloss	Horiz. Grain on Maple	Vert. Grain on Maple	Vert. Grain on Cherry	Vert. Grain on Hickory	Vert. Grain on Oak	Thermofoil
box color	box color	box color	box color	box color	box color	box color

DESCRIPTION MODEL
Custom Panels, Premium

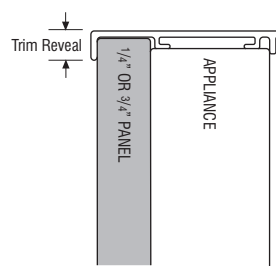

DAPNL1/4P
DAPNL3/4P
DAPNL1/4HGP
DAPNL3/4HGP

- DAPNL1/4P and DAPNL1/4HGP are 1/4" thick laminated MDF panels cut to fit appliance doors. Laminated on face only, edges are not finished.
- DAPNL3/4P and DAPNL3/4HGP are 3/4" thick laminated MDF panels. Vertical and horizontal grain panels are laminated on both sides with edgebanding on all four edges. High Gloss panels have high gloss on front of panel, back of panel is white melamine. Edgebanding on all four edges will match door and drawer front edgebanding selection.
- DAPNL1/4P and DAPNL3/4P are available for use with Genova featuring vertical grain or with Taro featuring high gloss or melamine.
- DAPNL1/4HGP and DAPNL3/4HGP are available for use with Troxel featuring horizontal grain.
- Panel is cut to fit appliance doors, and mounts to the appliance using trim kits provided by the appliance supplier.
- Custom sizes available in 1/16" increments.

Model	Panel Type	Maximum Width	Minimum Width	Maximum Height	Minimum Height
DAPNL1/4P	Vertical Grain or High Gloss	48"	5"	96"	5"
DAPNL3/4P (48" high or less)	Vertical Grain or High Gloss	48"	5"	48"	5"
DAPNL3/4P (>48" high)	Vertical Grain or High Gloss	30"	5"	96"	5"
DAPNL1/4HGP	Horizontal Grain	96"	5"	48"	5"
DAPNL3/4HGP	Horizontal Grain	48"	5"	48"	5"
DAPNL3/4HGP (>48" wide)	Horizontal Grain	96"	5"	30"	5"

Finish Techniques

Distressing	Heirlooming

Species Availability (Wood)

Alder	Rustic Alder	Cherry	Hickory	Rustic Hickory	Maple	Oak

Species Availability (All Laminates)

High Gloss	Horiz. Grain on Maple	Vert. Grain on Maple	Vert. Grain on Cherry	Vert. Grain on Hickory	Vert. Grain on Oak	Thermofoil
•	•*	•	•	•	•	

*Only available on DAPNL1/4HGP and DAPNL3/4HGP.

Custom Doors

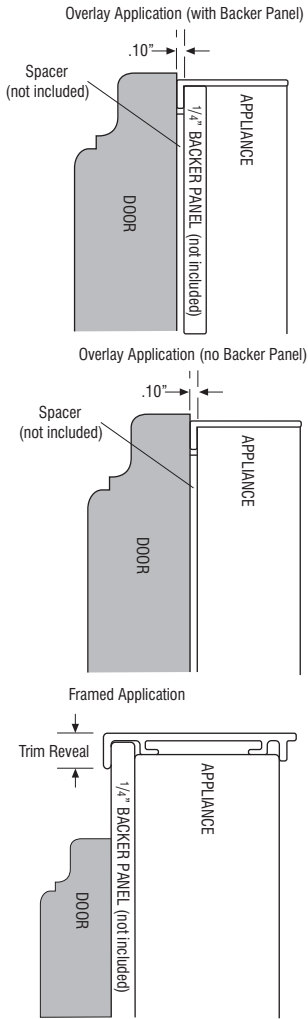

DADOORB

DADOORW

DADOORHG

- DADOORB is a custom sized door with vertical center panel grain.
- DADOORW is a custom sized door with vertical center panel grain.
- DADOORHG is a custom sized door with horizontal center panel grain.
- DADOORHG will utilize a flat panel on raised panel styles when width or height is less than 10".
- Includes a 3/4" thick door made to a custom size for the appliance front. No backer panel included.
 - Some appliances require a .10" spacer and/or a 1/4" backer panel.
 - The 1/4" backer panel may be ordered separately (see DAPNL1/4).
- All doors will be specified "NO HINGE ROUTE". Backs may have identification marks, be unfinished, and have 3/16" diameter holes used during finish processing. For these reasons, these doors are not suitable for use as cabinet doors.
- DADOORB and DADOORW not available in Caprice, Genova, Tara, Troxel, and Vaille. DADOORHG not available in Caprice, Genova, Lynnville, Tara, Troxel, and Vaille. For Decorative Appliance Panels, standard door sizes must be ordered.
- Custom sizes available in 1/16" increments.
- CG modification available, maximum size is 23 1/2" x 43" for DADOORB and DADOORW, and 43" x 23 1/2" for DADOORHG.

Finish Techniques

Distressing	Heirlooming
•	•

	Model	Door Style Type	Available Width Range*	Available Height Range*
	DADOORB and DADOORW	Non-Miter Styles	7 1/2" to 25 7/8" (<3" wide rails/stiles) 8 1/2" to 25 7/8" (3" wide rails/stiles)	7 1/2" to 47 7/16" (<3" wide rails/stiles) 8 1/2" to 47 7/16" (3" wide rails/stiles)
	DADOORB and DADOORW	Non-Miter Styles	7 1/2" to 25 7/8" (<3" wide rails/stiles) 8 1/2" to 25 7/8" (3" wide rails/stiles)	47 1/2" to 72" (<3" wide rails/stiles) 47 1/2" to 72" (3" wide rails/stiles)
	DADOORB and DADOORW	Non-Miter Styles	25 15/16" to 35 3/4" (<3" wide rails/stiles) 25 15/16" to 35 3/4" (3" wide rails/stiles)	7 1/2" to 47 7/16" (<3" wide rails/stiles) 8 1/2" to 47 7/16" (3" wide rails/stiles)
	DADOORB and DADOORW	Non-Miter Styles	25 15/16" to 35 3/4" (<3" wide rails/stiles) 25 15/16" to 35 3/4" (3" wide rails/stiles)	47 1/2" to 72" (<3" wide rails/stiles) 47 1/2" to 72" (3" wide rails/stiles)
	DADOORB and DADOORW	Miter Styles	8" to 25 7/8"	8" to 61"
	DADOORHG	Non-Miter Styles	7 1/2" to 42 1/4" (<3" wide rails/stiles) 8 1/2" to 42 1/4" (3" wide rails/stiles)	7 1/2" to 23 3/4" (<3" wide rails/stiles) 8 1/2" to 23 3/4" (3" wide rails/stiles)
	DADOORHG	Miter Styles	8" to 61"	8" to 24"

*Any door with a minimum width or height dimension less than 10" will receive a flat center panel.

DECORATIVE APPLIANCE PANEL ORDER FORM

Use one order form per appliance.
Refer to Spec Book for door style availability, door style limitations and center panel configurations.

STEP 1: Provide Order Information*

Account #: _____ PO #: _____
 Date: _____ Order #: _____
 Bill To: _____ Ship To: _____

STEP 2: Appliance Application or No Appliance* — Circle Choice (For appliance applications, circle one appliance type below per order form)

Appliance Brand Name and Model Number _____

Refrigerator/Freezer

Dishwasher/Trash Compactor/
Ice Maker/Wine Cooler

Single Door 	Side-by-Side 	Side-by-Side w/Dispenser 	Side-by-Side w/Dispenser & TV 	Top/Bottom 	Top/Bottom w/Drawers 	French Door 	Under Counter
Single Door w/Grill 	Side-by-Side w/Grill 	Side-by-Side w/Dispenser & Grill 	Side-by-Side w/Dispenser/TV & Grill 	Top/Bottom w/Grill 		French Door w/Dispenser 	Under Counter w/Drawers

Dishwasher Standard 	Dishwasher Standard 	Trash Compactor/ Ice Maker
Dishwasher Double Drawer 	Dishwasher Single Drawer 	Wine Cooler

STEP 3: Provide Dimensions in Inches for Panels and/or Doors Needed as Listed Above*

Custom Panels — Dimensions for Custom Size Panel(s) and/or Door(s)

DAPNL1/4, DAPNL1/4P, DAPNL3/4, DAPNL3/4P, DAPNL1/4HGP, or DAPNL3/4HGP — Circle Choice

A _____ in. width x _____ in. height = _____ square inches
 B _____ in. width x _____ in. height = _____ square inches
 C _____ in. width x _____ in. height = _____ square inches
 D _____ in. width x _____ in. height = _____ square inches
 E _____ in. width x _____ in. height = _____ square inches

} total square inches

Standard or Custom Doors — Circle Choice

Standard Door Sizes — Dimensions for Panels with Standard Door Sizes (Chosen by Manufacturer)

*Supply overall dimensions (width and height for each panel only). Doors will be selected by manufacturer to best fit panel dimensions.

DADOORB, DADOORW, and DADOORHG — Circle Door Choice Below For Each Door

DADOORB or DADOORW or DADOORHG _____ in. width x _____ in. height = _____ square inches
 DADOORB or DADOORW or DADOORHG _____ in. width x _____ in. height = _____ square inches
 DADOORB or DADOORW or DADOORHG _____ in. width x _____ in. height = _____ square inches
 DADOORB or DADOORW or DADOORHG _____ in. width x _____ in. height = _____ square inches
 DADOORB or DADOORW or DADOORHG _____ in. width x _____ in. height = _____ square inches

} total square inches

*ALL FIELDS REQUIRED TO PROCESS ORDER.

DESCRIPTION

MODEL

PANELS & SKINS

PANEL SKINS, TALL

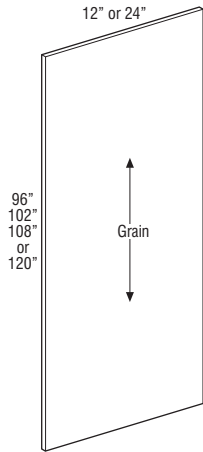

TEPS1296WD

TEPS12102WD ♦

TEPS12108WD ♦

TEPS12120WD ♦

TEPS96WD

TEPS102WD ♦

TEPS108WD ♦

TEPS120WD ♦

- TEPS_ _WD in Stains: 1/4" thick veneered furniture board.
- TEPS_ _WD in Paints: 1/4" thick veneered or solid furniture board.
- Can be used with Small Scribe Moulding (SSM8 or SSM10) or Under Panel Moulding (UPM8) to conceal raw edge.

Custom Modifications

ID	RD
•*	•

Finish Techniques

Distressing	Heirlooming

*ID not available on 12" deep.

Species Availability (Wood)

Alder	Rustic Alder	Cherry	Hickory	Rustic Hickory	Maple	Oak
•	•	•	•	•	•	•

♦ Only available in Cherry and Maple.

Species Availability (All Laminates)

High Gloss box color	Horiz. Grain on Maple box color	Vert. Grain on Maple box color	Vert. Grain on Cherry box color	Vert. Grain on Hickory box color	Vert. Grain on Oak box color	Thermofoil box color

♦ Only available in Cherry and Maple box colors.

PANEL SKINS, PREMIUM - TALL

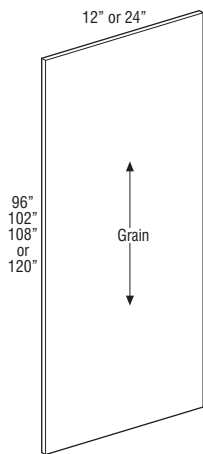

TEPS1296P

TEPS12102P

TEPS12108P

TEPS12120P

TEPS96P

TEPS102P

TEPS108P

TEPS120P

- 1/4" thick laminated MDF.
- High Gloss panels do not have grain.
- Can be used with Small Scribe Moulding (SSM8P or SSM10P) or Under Panel Moulding (UPM8P) to conceal raw edge.

Custom Modifications

ID	RD
•	•

Finish Techniques

Distressing	Heirlooming

Species Availability (Wood)

Alder	Rustic Alder	Cherry	Hickory	Rustic Hickory	Maple	Oak

Species Availability (All Laminates)

High Gloss	Horiz. Grain on Maple	Vert. Grain on Maple	Vert. Grain on Cherry	Vert. Grain on Hickory	Vert. Grain on Oak	Thermofoil
•		•*	•	•	•	

*TEPS12102P, TEPS12108P, TEPS12120P, TEPS102P, TEPS108P, and TEPS120P not available in Squall.

DESCRIPTION

MODEL

FINISHED BACK SKINS

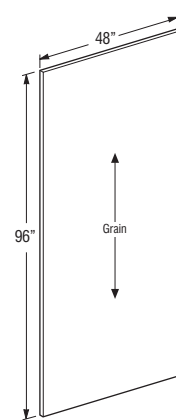

BP4896WD

- BP4896WD in Stains: 1/4" thick veneered furniture board.
- BP4896WD in Paints: 1/4" thick veneered or solid furniture board.
- For custom sizes refer to DAPNL 1/4.
- Can be used with Small Scribe Moulding (SSM8 or SSM10) or Under Panel Moulding (UPM8) to conceal raw edge.

Custom Modifications

ID	RD

Finish Techniques

Distressing	Heirlooming

Species Availability (Wood)

Alder	Rustic Alder	Cherry	Hickory	Rustic Hickory	Maple	Oak
•	•	•	•	•	•	•

Species Availability (All Laminates)

High Gloss box color	Horiz. Grain on Maple box color	Vert. Grain on Maple box color	Vert. Grain on Cherry box color	Vert. Grain on Hickory box color	Vert. Grain on Oak box color	Thermofoil box color

FINISHED BACK SKINS, PREMIUM

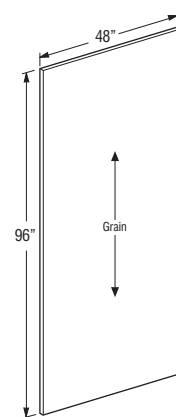

BP4896P

- 1/4" thick laminated MDF.
- High Gloss panels do not have grain.
- Can be used with Small Scribe Moulding (SSM8P or SSM10P) or Under Panel Moulding (UPM8P) to conceal raw edge.

Custom Modifications

ID	RD

Finish Techniques

Distressing	Heirlooming

Species Availability (Wood)

Alder	Rustic Alder	Cherry	Hickory	Rustic Hickory	Maple	Oak

Species Availability (All Laminates)

High Gloss	Horiz. Grain on Maple	Vert. Grain on Maple	Vert. Grain on Cherry	Vert. Grain on Hickory	Vert. Grain on Oak	Thermofoil
•		•	•	•	•	

BACK SKIN, INTERIOR

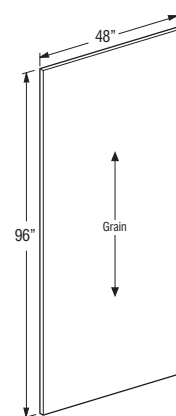

BP4896NIP

BP4896LAM

- BP4896LAM is 1/4" thick furniture board with Natural Maple laminate to match standard cabinet interior.
- BP4896NIP is 1/4" thick plywood with clear coated veneer to match APC cabinet interior.

DESCRIPTION

MODEL

CROSS GRAIN VENEER BACK SKIN
1/4" PANELS

BP9634.5CRSGR

BP9640.5CRSGR

BP9648CRSGR

- BP96___CRSGR is a 1/4" thick veneered panel with an MDF core.
- When ordered in Paint finishes, panels will use vertical grain as grain will not be visible.
- Can be used with Small Scribe Moulding (SSM8 or SSM10) or Under Panel Moulding (UPM8) to conceal raw edge.

Custom Modifications		Finish Techniques	
ID	RD	Distressing	Heirlooming

Species Availability (Wood)

Alder	Rustic Alder	Cherry	Hickory	Rustic Hickory	Maple	Oak
•		•	•	•	•	•

Species Availability (All Laminates)

High Gloss box color	Horiz. Grain on Maple box color	Vert. Grain on Maple box color	Vert. Grain on Cherry box color	Vert. Grain on Hickory box color	Vert. Grain on Oak box color	Thermofoil box color

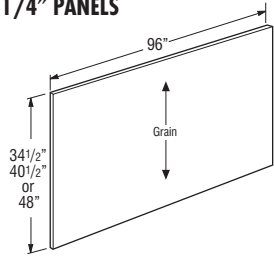

WOOD V-GROOVED
BEADED SKIN
1/4" PANELS



BP4830VG

BP4834.5VG

BP4896VG†

- BP48__VG is a 1/4" thick veneered panel with an MDF core.
- V-groove on 3" centers.
- Can be used with Small Scribe Moulding (SSM8 or SSM10) or Under Panel Moulding (UPM8) to conceal raw edge.

†5 day Express Response not available on items greater than 48".

Custom Modifications		Finish Techniques	
ID	RD	Distressing	Heirlooming
			•

Species Availability (Wood)

Alder	Rustic Alder	Cherry	Hickory	Rustic Hickory	Maple	Oak
•		•	•	•	•	•

Species Availability (All Laminates)

High Gloss box color	Horiz. Grain on Maple box color	Vert. Grain on Maple box color	Vert. Grain on Cherry box color	Vert. Grain on Hickory box color	Vert. Grain on Oak box color	Thermofoil box color

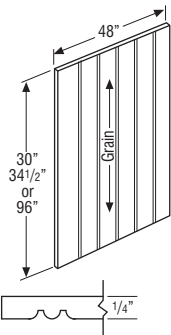

HORIZONTAL GRAIN
1/4" SKIN, PREMIUM



14PANEL4834.5P

14PANEL4848P

14PANEL9634.5P†

14PANEL9648P†

- 1/4" thick laminated MDF.
- Can be used with Small Scribe Moulding (SSM8P or SSM10P) or Under Panel Moulding (UPM8P) to conceal raw edge.

†5 day Express Response not available on items greater than 48".

Custom Modifications		Finish Techniques	
ID	RD	Distressing	Heirlooming

Species Availability (Wood)

Alder	Rustic Alder	Cherry	Hickory	Rustic Hickory	Maple	Oak
•		•	•	•	•	•

Species Availability (All Laminates)

High Gloss box color	Horiz. Grain on Maple box color	Vert. Grain on Maple box color	Vert. Grain on Cherry box color	Vert. Grain on Hickory box color	Vert. Grain on Oak box color	Thermofoil box color
	•					

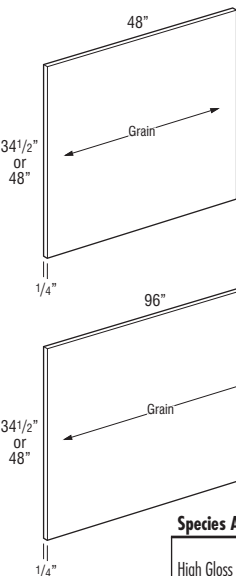

KEMPER®

DESCRIPTION

MODEL

HORIZONTAL GRAIN
3/4" PANEL, PREMIUM



34PANEL1230P

34PANEL1248P

34PANEL2434.5P

34PANEL4812P

34PANEL4834.5P

34PANEL4848P

34PANEL9612P†

34PANEL9624P†

34PANEL9630P†

- 3/4" thick laminated MDF.
 - 34PANEL4812P and 34PANEL9612P recommended for exterior shelf material.
 - Edgembanded on one short side and one long side only. Other edges will require moulding if exposed.
- †5 day Express Response not available on items greater than 48".

Custom Modifications		Finish Techniques	
ID	RD	Distressing	Heirlooming

Species Availability (Wood)

Alder	Rustic Alder	Cherry	Hickory	Rustic Hickory	Maple	Oak
•		•	•	•	•	•

Species Availability (All Laminates)

High Gloss box color	Horiz. Grain on Maple box color	Vert. Grain on Maple box color	Vert. Grain on Cherry box color	Vert. Grain on Hickory box color	Vert. Grain on Oak box color	Thermofoil box color
	•					

END PANELS, WALL



WEP1230WD

WEP1230LAM ♦

- WEP1230WD in Stains: 3/4" thick veneered furniture board.
- WEP1230WD in Paints: 3/4" thick veneered or solid furniture board.
- WEP1230LAM is 3/4" thick laminated furniture board (white only).
- Panels are finished on two sides and front edge.

Custom Modifications				Finish Techniques	
ID	RD	APC	MIP	Distressing	Heirlooming
•	•	•	•		
•	•	•	•		

Species Availability (Wood)

Alder	Rustic Alder	Cherry	Hickory	Rustic Hickory	Maple	Oak
•		•	•	•	•	•

♦ Only available in White laminate.

Species Availability (All Laminates)

High Gloss box color	Horiz. Grain on Maple box color	Vert. Grain on Maple box color	Vert. Grain on Cherry box color	Vert. Grain on Hickory box color	Vert. Grain on Oak box color	Thermofoil box color

♦ Only available in White laminate.

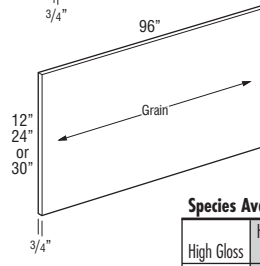
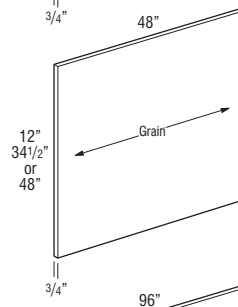
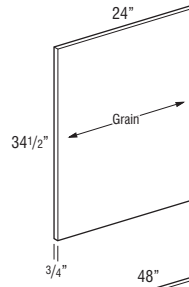
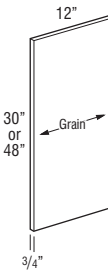

DESCRIPTION

END PANELS, PREMIUM - WALL

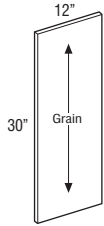

MODEL

WEP1230P

- 3/4" thick laminated MDF.
- High Gloss panels will have high gloss on front of panel and back of panel will be white melamine. Edgebanding will match door and drawer front edgebanding selection.
- High Gloss panels do not have grain.
- Edgebanded on front edge, top, and bottom.

Custom Modifications				Finish Techniques	
ID	RD	APC	MIP	Distressing	Heirlooming
•	•				

Species Availability (Wood)

Alder	Rustic Alder	Cherry	Hickory	Rustic Hickory	Maple	Oak

Species Availability (All Laminates)

High Gloss	Horiz. Grain on Maple	Vert. Grain on Maple	Vert. Grain on Cherry	Vert. Grain on Hickory	Vert. Grain on Oak	Thermofoil
•		•	•	•	•	

END PANELS, BASE

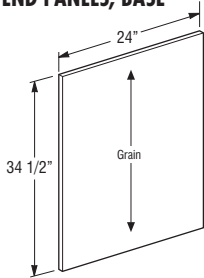

BEPWD

BEPLAM ♦

- BEPWD in Stains: 3/4" thick veneered furniture board.
- BEPWD in Paints: 3/4" thick veneered or solid furniture board.
- BEPLAM is 3/4" thick laminated furniture board (white only).
- Panels are finished on two sides and front edge.

Custom Modifications				Finish Techniques	
ID	RD	APC	MIP	Distressing	Heirlooming
Laminate	•	•			
Wood	•	•	•		

Species Availability (Wood)

Alder	Rustic Alder	Cherry	Hickory	Rustic Hickory	Maple	Oak
• Alder		•	•	Hickory	•	•

♦ Only available in White laminate.

Species Availability (All Laminates)

High Gloss	Horiz. Grain on Maple	Vert. Grain on Maple	Vert. Grain on Cherry	Vert. Grain on Hickory	Vert. Grain on Oak	Thermofoil
box color	box color	box color	box color	box color	box color	box color

♦ Only available in White laminate.

END PANELS, PREMIUM - BASE

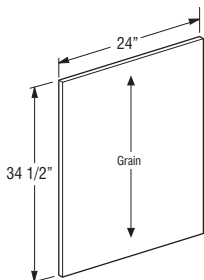

BEPP

- 3/4" thick laminated MDF.
- High Gloss panels will have high gloss on front of panel and back of panel will be white melamine. Edgebanding on front edge will match door and drawer front edgebanding selection.
- High Gloss panels do not have grain.

Custom Modifications				Finish Techniques	
ID	RD	APC	MIP	Distressing	Heirlooming
•	•				

Species Availability (Wood)

Alder	Rustic Alder	Cherry	Hickory	Rustic Hickory	Maple	Oak

Species Availability (All Laminates)

High Gloss	Horiz. Grain on Maple	Vert. Grain on Maple	Vert. Grain on Cherry	Vert. Grain on Hickory	Vert. Grain on Oak	Thermofoil
•		•	•	•	•	

DESCRIPTION

END PANELS, TALL

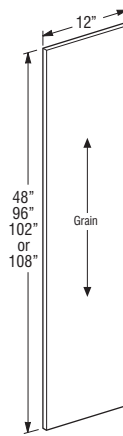

MODEL

TEP1248WD

TEP1296WD†

TEP12102WD† ♦♦

TEP12108WD† ♦♦

TEP1248LAM ♦

TEP1296LAM† ♦

TEP2484WD†^

TEP2487WD†^

TEP2490WD†^

TEP2493WD†^

TEP2496WD†^

TEP24102WD† ♦♦

TEP24108WD† ♦♦

TEP2484LAM† ♦

TEP2487LAM† ♦

TEP2490LAM† ♦

TEP2493LAM† ♦

TEP2496LAM† ♦

- TEP__WD in Stains: 3/4" thick veneered furniture board.
 - TEP__WD in Paints: 3/4" thick veneered or solid furniture board.
 - TEP__LAM is 3/4" thick laminated furniture board (white only).
 - Panels are finished on two sides and front edge.
 - 102" and 108" will have APC and MIP standard.
- †5 day Express Response not available on items greater than 48".

Custom Modifications

	ID	RD	APC	MIP	Finish Techniques	
Laminate	•	•			Distressing	Heirlooming
Wood	•▲	•	•			

▲Tall wood panels will be plywood when ID31-ID36 is specified.

Species Availability (Wood)

Alder	Rustic Alder	Cherry	Hickory	Rustic Hickory	Maple	Oak
• Alder		•	•	Hickory	•	•

♦ Only available in White laminate.

♦♦ Only available in Cherry and Maple.

Species Availability (All Laminates)

High Gloss	Horiz. Grain on Maple	Vert. Grain on Maple	Vert. Grain on Cherry	Vert. Grain on Hickory	Vert. Grain on Oak	Thermofoil
box color	box color	box color	box color	box color	box color	box color

♦ Only available in White laminate.

♦♦ Only available in Cherry and Maple box colors.

DESCRIPTION

END PANELS, PREMIUM - TALL



MODEL

TEP1248P

TEP1296P†

TEP12102P†

TEP12108P†

TEP2484P†

TEP2487P†

TEP2490P†

TEP2493P†

TEP2496P†

TEP24102P†

TEP24108P†

- 3/4" thick laminated MDF.
 - High Gloss panels will have high gloss on front of panel and back of panel will be white melamine. Edgebanding on front edge will match door and drawer front edgebanding selection.
 - High Gloss panels do not have grain.
- †5 day Express Response not available on items greater than 48"

Custom Modifications

ID	RD	APC	MIP
•*	•		

*ID available on TEP2484P-TEP2496P up to 30".
ID not available on TEP24102P and TEP24108P.

Finish Techniques

Distressing	Heirlooming

Species Availability (Wood)

Alder	Rustic Alder	Cherry	Hickory	Rustic Hickory	Maple	Oak

Species Availability (All Laminates)

High Gloss	Horiz. Grain on Maple	Vert. Grain on Maple	Vert. Grain on Cherry	Vert. Grain on Hickory	Vert. Grain on Oak	Thermofoil
•		•*	•	•	•	

*TEP12102P, TEP12108P, TEP24102P, and TEP24108P not available in Squall.

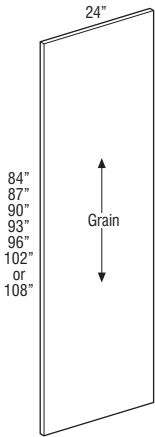
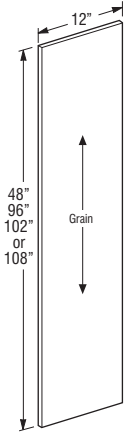

DESCRIPTION

WALL PANEL with FILLER ATTACHED and FURNITURE ENDS



MODEL

WEP1230F1.5FPE

WEP1230F3FPE

WEP1233F1.5FPE

WEP1233F3FPE

WEP1236F1.5FPE

WEP1236F3FPE

WEP1239F1.5FPE

WEP1239F3FPE

WEP1242F1.5FPE

WEP1242F3FPE

- 3/4" thick veneered plywood with solid-wood filler.
- Panel will have veneered exterior and Natural Maple laminated interior standard. For veneered interior, specify MIP.

Custom Modifications

ID	RD	APC	MIP
•	•		•

Finish Techniques

Distressing	Heirlooming
•	

Species Availability (Wood)

Alder	Rustic Alder	Cherry	Hickory	Rustic Hickory	Maple	Oak
•	Alder	•	•	Hickory	•	•

Species Availability (All Laminates)

High Gloss	Horiz. Grain on Maple	Vert. Grain on Maple	Vert. Grain on Cherry	Vert. Grain on Hickory	Vert. Grain on Oak	Thermofoil
box color	box color	box color	box color	box color	box color	box color

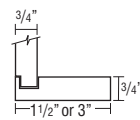
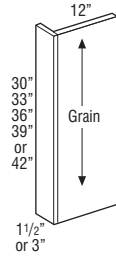

END PANELS, VANITY

VBEP2129WD

VBEP2132WD

VBEP2129LAM ♦

VBEP2132LAM ♦

- VBEP_ _WD in Stains: 3/4" thick veneered furniture board.
- VBEP_ _WD in Paints: 3/4" thick veneered or solid furniture board.
- VBEP_ _LAM is 3/4" thick laminated furniture board (white only).
- Panels are finished on two sides and front edge.

Custom Modifications

Laminate	ID	RD	APC	MIP
•	•	•		

Finish Techniques

Distressing	Heirlooming

Species Availability (Wood)

Alder	Rustic Alder	Cherry	Hickory	Rustic Hickory	Maple	Oak
•	Alder	•	•	Hickory	•	•

♦ Only available in White laminate.

Species Availability (All Laminates)

High Gloss	Horiz. Grain on Maple	Vert. Grain on Maple	Vert. Grain on Cherry	Vert. Grain on Hickory	Vert. Grain on Oak	Thermofoil
box color	box color	box color	box color	box color	box color	box color

♦ Only available in White laminate.

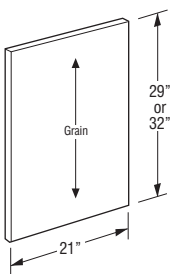

DESCRIPTION

BASE and TALL PANELS with FILLER ATTACHED and FURNITURE ENDS

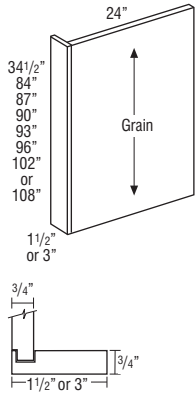

MODEL

BEPF1.5FPE
BEPF3FPE

- TEP2484F1.5FPE†
- TEP2484F3FPE†
- TEP2487F1.5FPE†
- TEP2487F3FPE†
- TEP2490F1.5FPE†
- TEP2490F3FPE†
- TEP2493F1.5FPE†
- TEP2493F3FPE†
- TEP2496F1.5FPE†
- TEP2496F3FPE†
- TEP24102F1.5FPE† ♦
- TEP24102F3FPE† ♦
- TEP24108F1.5FPE† ♦
- TEP24108F3FPE† ♦

- 3/4" thick veneered plywood with solid-wood filler.
 - Panel will have veneered exterior and Natural Maple laminated interior standard. For veneered interior, specify MIP.
 - 102" and 108" are MIP standard.
- †5 day Express Response not available on items greater than 48".

Custom Modifications

	ID	RD	APC	MIP
Wood	•	•	•	•

Finish Techniques

	Distressing	Heirlooming
	•	

Species Availability (Wood)

	Rustic Alder	Cherry	Hickory	Rustic Hickory	Maple	Oak
• Alder	•	•	•	•	•	•

♦ Only available in Cherry and Maple.

Species Availability (All Laminates)

High Gloss	Horiz. Grain on Maple	Vert. Grain on Maple	Vert. Grain on Cherry	Vert. Grain on Hickory	Vert. Grain on Oak	Thermofoil
box color	box color	box color	box color	box color	box color	box color

♦ Only available in Cherry and Maple box colors.

DESCRIPTION

WALL PANEL with FILLER ATTACHED and AUTHENTIC ENDS

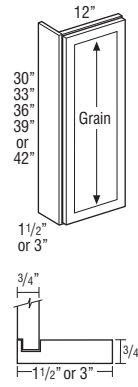

MODEL

- WEP1230F1.5AEL
- WEP1230F1.5AER
- WEP1230F3AEL
- WEP1230F3AER
- WEP1233F1.5AEL
- WEP1233F1.5AER
- WEP1233F3AEL
- WEP1233F3AER
- WEP1236F1.5AEL
- WEP1236F1.5AER
- WEP1236F3AEL
- WEP1236F3AER
- WEP1239F1.5AEL
- WEP1239F1.5AER
- WEP1239F3AEL
- WEP1239F3AER
- WEP1242F1.5AEL
- WEP1242F1.5AER
- WEP1242F3AEL
- WEP1242F3AER

- 3/4" thick veneered plywood with doors attached and solid-wood filler.
- Depth can be increased in 3" increments up to 24" deep.
- Panel will have veneered exterior and Natural Maple laminated interior standard. For veneered interior, specify MIP.
- Taro doors will be high gloss or melamine and match edgebanding selection.
- Troxel doors will have horizontal grain with matching edgebanding.
- Genova doors will have vertical grain with matching edgebanding.

Custom Modifications

	ID	RD	APC	MIP
Wood	•	•	•	•

Finish Techniques

	Distressing	Heirlooming
	•	

Species Availability (Wood)

	Rustic Alder	Cherry	Hickory	Rustic Hickory	Maple	Oak
• Alder	•	•	•	•	•	•

Species Availability (All Laminates)

High Gloss	Horiz. Grain on Maple	Vert. Grain on Maple	Vert. Grain on Cherry	Vert. Grain on Hickory	Vert. Grain on Oak	Thermofoil
box color	box color	box color	box color	box color	box color	box color

DESCRIPTION

BASE PANEL with FILLER ATTACHED and AUTHENTIC ENDS



MODEL

- BEPF1.5AEL**
- BEPF1.5AER**
- BEPF3AEL**
- BEPF3AER**

- 3/4" thick veneered plywood with doors attached and solid-wood filler.
- Depth can be increased in 3" increments up to 36" deep.
- Panel will have veneered exterior and Natural Maple laminated interior standard. For veneered interior, specify MIP.
- Taro doors will be high glass or melamine and match edgebanding selection.
- Troxel doors will have horizontal grain with matching edgebanding.
- Genova doors will have vertical grain with matching edgebanding.

Custom Modifications				Finish Techniques	
ID	RD	APC	MIP	Distressing	Heirlooming
Wood	•	•	•	•	•

Species Availability (Wood)

Alder	Rustic Alder	Cherry	Hickory	Rustic Hickory	Maple	Oak
•	•	•	•	•	•	•

Species Availability (All Laminates)

High Gloss box color	Horiz. Grain on Maple box color	Vert. Grain on Maple box color	Vert. Grain on Cherry box color	Vert. Grain on Hickory box color	Vert. Grain on Oak box color	Thermofoil box color

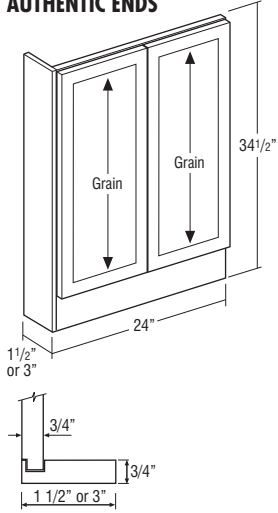

BASE PANEL with FILLER ATTACHED and AUTHENTIC ENDS, SINGLE DOOR



- BEPF1.5AELSD**
- BEPF1.5AERSD**
- BEPF3AELSD**
- BEPF3AERSD**

- 3/4" thick veneered plywood with doors attached and solid-wood filler.
- Depth can be reduced in 3" increments down to 9" deep.
- Panel will have veneered exterior and Natural Maple laminated interior standard. For veneered interior, specify MIP.
- Taro doors will be high glass or melamine and match edgebanding selection.
- Troxel doors will have horizontal grain with matching edgebanding.
- Genova doors will have vertical grain with matching edgebanding.

Custom Modifications				Finish Techniques	
ID	RD	APC	MIP	Distressing	Heirlooming
Wood	•	•	•	•	•

Species Availability (Wood)

Alder	Rustic Alder	Cherry	Hickory	Rustic Hickory	Maple	Oak
•	•	•	•	•	•	•

Species Availability (All Laminates)

High Gloss box color	Horiz. Grain on Maple box color	Vert. Grain on Maple box color	Vert. Grain on Cherry box color	Vert. Grain on Hickory box color	Vert. Grain on Oak box color	Thermofoil box color

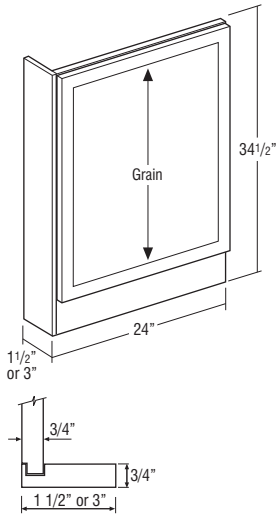

DESCRIPTION

TALL PANEL with FILLER ATTACHED and AUTHENTIC ENDS

MODEL

- TEP2484F1.5AEL**
- TEP2484F1.5AER**
- TEP2484F3AEL**
- TEP2484F3AER**
- TEP2487F1.5AEL**
- TEP2487F1.5AER**
- TEP2487F3AEL**
- TEP2487F3AER**
- TEP2490F1.5SAHAL**
- TEP2490F1.5SAHAR**
- TEP2490F3AHAL**
- TEP2490F3AHAR**
- TEP2493F1.5SAHAL**
- TEP2493F1.5SAHAR**
- TEP2493F3AHAL**
- TEP2493F3AHAR**
- TEP2496F1.5AEL**
- TEP2496F1.5AER**
- TEP2496F3AEL**
- TEP2496F3AER**

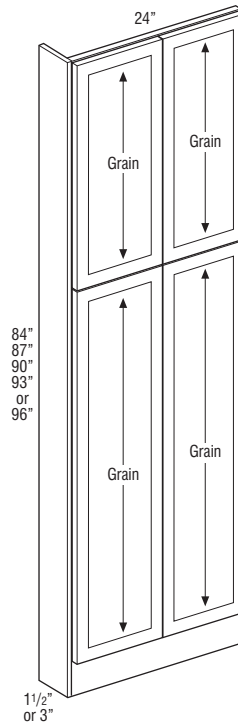

- AH represents upper section alignment with doors on 24" or 27" high cabinets.
- 3/4" thick veneered plywood with doors attached and solid-wood filler.
- Depth can be increased in 3" increments up to 36" deep.
- Panel will have veneered exterior and Natural Maple laminated interior standard. For veneered interior, specify MIP.
- Taro doors will be high glass or melamine and match edgebanding selection.
- Troxel doors will have horizontal grain with matching edgebanding.
- Genova doors will have vertical grain with matching edgebanding.

Custom Modifications					Finish Techniques	
ID	RD	APC	MIP	INVFRM	Distressing	Heirlooming
Wood	•	•	•	•	•	•

Species Availability (Wood)

Alder	Rustic Alder	Cherry	Hickory	Rustic Hickory	Maple	Oak
•	•	•	•	•	•	•

Species Availability (All Laminates)

High Gloss box color	Horiz. Grain on Maple box color	Vert. Grain on Maple box color	Vert. Grain on Cherry box color	Vert. Grain on Hickory box color	Vert. Grain on Oak box color	Thermofoil box color

DESCRIPTION

MODEL

TALL PANEL with FILLER ATTACHED and AUTHENTIC ENDS, SINGLE DOOR

- TEP84F1.5AELSD
- TEP84F1.5AERSD
- TEP84F3AELSD
- TEP84F3AERSD
- TEP87F1.5AELSD
- TEP87F1.5AERSD
- TEP87F3AELSD
- TEP87F3AERSD
- TEP90F1.5AHALSD
- TEP90F1.5AHARSD
- TEP90F3AHALSD
- TEP90F3AHARSD
- TEP93F1.5AHALSD
- TEP93F1.5AHARSD
- TEP93F3AHALSD
- TEP93F3AHARSD
- TEP96F1.5AELSD
- TEP96F1.5AERSD
- TEP96F3AELSD
- TEP96F3AERSD

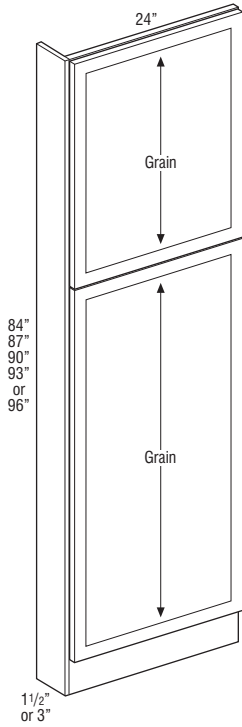

- AH represents upper section alignment with doors on 24" or 27" high cabinets.
- 3/4" thick veneered plywood with doors attached and solid-wood filler.
- Depth can be reduced in 3" increments down to 9" deep.
- On non-miter doors, the tall door on the bottom will have two vertical panels.
- Panel will have veneered exterior and Natural Maple laminated interior standard. For veneered interior, specify MIP.
- Taro doors will be high gloss or melamine and match edgebanding selection.
- Troxel doors will have horizontal grain with matching edgebanding.
- Genova doors will have vertical grain with matching edgebanding.

Custom Modifications					Finish Techniques	
ID	RD	APC	MIP	INVERM	Distressing	Heirlooming
Wood		•	•	•	•	•

Species Availability (Wood)

Alder	Rustic Alder	Cherry	Hickory	Rustic Hickory	Maple	Oak
•	•	•	•	•	•	•

Species Availability (All Laminates)

High Gloss	Horiz. Grain on Maple	Vert. Grain on Maple	Vert. Grain on Cherry	Vert. Grain on Hickory	Vert. Grain on Oak	Thermofoil
box color	box color	box color	box color	box color	box color	box color

DESCRIPTION

MODEL

WOOD V-GROOVED with TRIPLE BEADED FRONT 3/4" PANELS

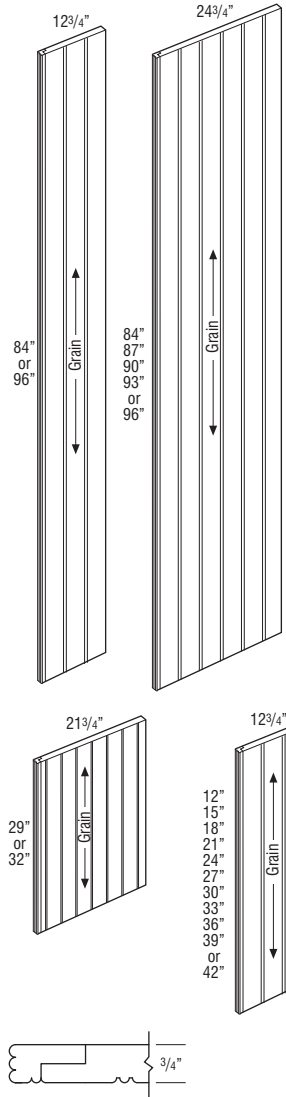

	Depth	
BEPVG (34 1/2")	24 3/4"	454
BEPPVG (Peninsula)	25 1/2"	
TEP1284VG†	12 3/4"	
TEP1296VG†	12 3/4"	
TEP84VG†	24 3/4"	
TEP87VG†	24 3/4"	
TEP90VG†	24 3/4"	
TEP93VG†	24 3/4"	
TEP96VG†	24 3/4"	
VBEP29VG	21 3/4"	
VBEP32VG	21 3/4"	
WEP12VG	12 3/4"	
WEP15VG	12 3/4"	
WEP18VG	12 3/4"	
WEP21VG	12 3/4"	
WEP24VG	12 3/4"	
WEP27VG	12 3/4"	
WEP30VG	12 3/4"	
WEP33VG	12 3/4"	
WEP36VG	12 3/4"	
WEP39VG	12 3/4"	
WEP42VG	12 3/4"	
WEPP42VG (Peninsula)	13 1/2"	

- Veneer on MDF core.
- V-groove on 3" centers.
- 15 day Express Response not available on items greater than 48".

Custom Modifications		Finish Techniques	
ID	RD	Distressing	Heirlooming
			•

Species Availability (Wood)

Alder	Rustic Alder	Cherry	Hickory	Rustic Hickory	Maple	Oak
					•	

Species Availability (All Laminates)

High Gloss	Horiz. Grain on Maple	Vert. Grain on Maple	Vert. Grain on Cherry	Vert. Grain on Hickory	Vert. Grain on Oak	Thermofoil
box color	box color	box color				box color

VANITY DESK LEGS

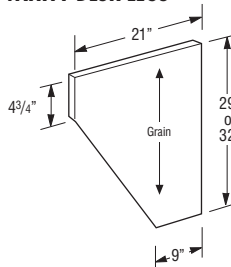

VDL2129WD

VDL2132WD

- All panels are finished 2 sides and front edge.
- VDL_ _WD in Stains: 3/4" thick veneered furniture board.
- VDL_ _WD in Paints: 3/4" thick veneered or solid furniture board.

Custom Modifications		Finish Techniques	
ID	RD	Distressing	Heirlooming

Species Availability (Wood)

Alder	Rustic Alder	Cherry	Hickory	Rustic Hickory	Maple	Oak
•	Alder	•	•	Hickory	•	•

Species Availability (All Laminates)

High Gloss	Horiz. Grain on Maple	Vert. Grain on Maple	Vert. Grain on Cherry	Vert. Grain on Hickory	Vert. Grain on Oak	Thermofoil
box color	box color	box color	box color	box color	box color	box color

DESCRIPTION

MODEL

PANEL DOOR, WALL

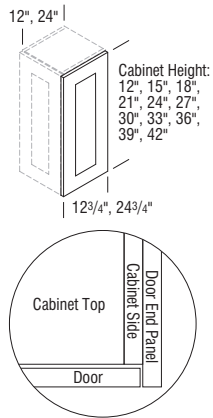

- PDW1212
- PDW1215
- PDW1218
- PDW1221
- PDW1224
- PDW1227
- PDW1230
- PDW1233
- PDW1236
- PDW1239
- PDW1242

- PDW2412
- PDW2415
- PDW2418
- PDW2421
- PDW2424
- PDW2427
- PDW2430
- PDW2433
- PDW2436
- PDW2439
- PDW2442

- Field installation required.
- Requires a matching laminate or finished end panel.
- Depth can be reduced in 3" increments to a minimum of 9". For other door sizes, use Custom Doors (DADOOR_).
- Panel is installed 1/8" from the back edge of cabinet box and flush with front of door.
- Not available in Caprice and Vaile door styles. Standard door sizes can be applied to cabinet side, but will not be flush with the cabinet door as shown for Panel Doors.

Custom Modifications		Finish Techniques	
DPSRR	RD	Distressing	Heirlooming
•	•	•	•

DESCRIPTION

MODEL

PANEL DOOR, STACKED WALL

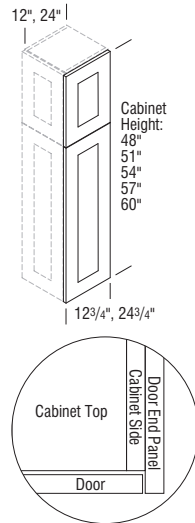

- PDSTW1248
- PDSTW1251
- PDSTW1254
- PDSTW1257
- PDSTW1260

- PDSTW2448
- PDSTW2451
- PDSTW2454
- PDSTW2457
- PDSTW2460

- Field installation required.
- Requires a matching laminate or finished end panel.
- Depth can be reduced in 3" increments to a minimum of 9". For other door sizes, use Custom Doors (DADOOR_).
- Panel is 1/8" from back edge of cabinet box and flush with front of door.
- Troxel doors greater than 48" high will be two doors dove-tailed together.
- Not available in Caprice and Vaile door styles. Standard door sizes can be applied to cabinet side, but will not be flush with the cabinet door as shown for Panel Doors.

Custom Modifications		Finish Techniques	
DPSRR	RD	Distressing	Heirlooming
•	•	•	•

PANEL DOOR, BASE

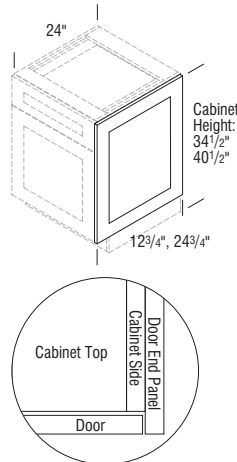

- PDB1234.5
- PDB2434.5
- PDB2440.5

- Field installation required.
- Requires a matching laminate or finished end panel.
- Depth can be reduced in 3" increments to a minimum of 9". For other door sizes, use Custom Doors (DADOOR_).
- Panel is 1/8" from back edge of cabinet box and flush with front of door.
- Not available in Caprice and Vaile door styles. Standard door sizes can be applied to cabinet side, but will not be flush with the cabinet door as shown for Panel Doors.

Custom Modifications		Finish Techniques	
DPSRR	RD	Distressing	Heirlooming
•	•	•	•

PANEL DOOR, BASE PENINSULA

PDBP2434.5

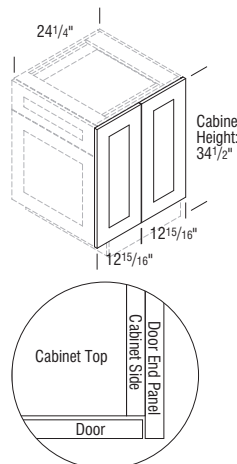

- Field installation required.
- Requires a matching laminate or finished end panel.
- Reduced depth not available, for other door sizes, use Custom Doors (DADOOR_).
- PDBP2434.5 includes two 12 15/16" wide panel doors to cover the end of a base peninsula cabinet. Outside edges are flush with faces of working doors.
- Not available in Caprice and Vaile door styles. Standard door sizes can be applied to cabinet side, but will not be flush with the cabinet door as shown for Panel Doors.

Custom Modifications		Finish Techniques	
DPSRR	RD	Distressing	Heirlooming
•	•	•	•

DESCRIPTION

PANEL DOOR, TALL

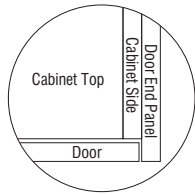
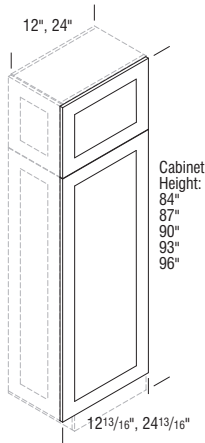

MODEL

- PDT1284
- PDT1287
- PDT1290
- PDT1293
- PDT1296
- PDT2449.5
- PDT2461.5
- PDT2484
- PDT2487
- PDT2490
- PDT2493
- PDT2496

- Field installation required.
- Requires a matching laminate or finished end panel.
- Depth can be reduced in 3" increments to a minimum of 9". For other door sizes, use Custom Doors (DADOOR__).
- Panel is 1/8" from back edge of cabinet box and flush with front of door.
- Troxel doors greater than 48" high will be two doors doweled together.
- PDT2449.5 and PDT2461.5 are for use with Pantry Top Units (PTU__S, PTU__P) and have one door to align with cabinet door.
- Not available in Caprice and Vaile door styles. Standard door sizes can be applied to cabinet side, but will not be flush with the cabinet door as shown for Panel Doors.

Custom Modifications		Finish Techniques	
DPSRR	RD	Distressing	Heirlooming
•	•	•	•

PANEL DOOR, OFFICE

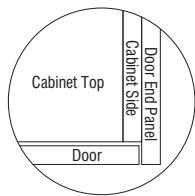
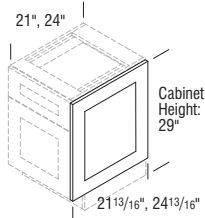

PDB2129
PDB2429

- Field installation required.
- Requires a matching laminate or finished end panel.
- Depth can be reduced in 3" increments to a minimum of 9". For other door sizes, use Custom Doors (DADOOR__).
- Panel is 1/8" from back edge of cabinet box and flush with front of door.
- Not available in Caprice and Vaile door styles. Standard door sizes can be applied to cabinet side, but will not be flush with the cabinet door as shown for Panel Doors.

Custom Modifications		Finish Techniques	
DPSRR	RD	Distressing	Heirlooming
•	•	•	•

DESCRIPTION

PANEL DOOR, UNIVERSAL DESIGN

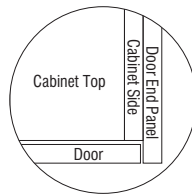
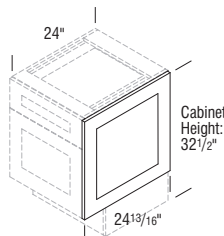

MODEL

PDUD2432.5

- Field installation required.
- Requires a matching laminate or finished end panel.
- Depth can be reduced in 3" increments to a minimum of 9". For other door sizes, use Custom Doors (DADOOR__).
- Panel is 1/8" from back edge of cabinet box and flush with front of door.
- Not available in Caprice and Vaile door styles. Standard door sizes can be applied to cabinet side, but will not be flush with the cabinet door as shown for Panel Doors.

Custom Modifications		Finish Techniques	
DPSRR	RD	Distressing	Heirlooming
•	•	•	•

PANEL DOOR, VANITY

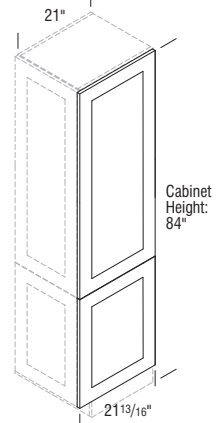
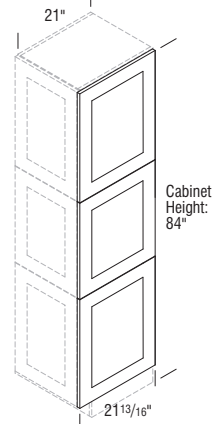
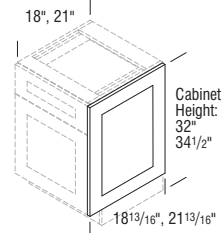

PDV1832

PDV1834.5
PDV2132
PDV2134.5

PDVU2184

PDLC2184

- Field installation required.
- Requires a matching laminate or finished end panel.
- Depth can be reduced in 3" increments to a minimum of 9". For other door sizes, use Custom Doors (DADOOR__).
- Panel is 1/8" from back edge of cabinet box and flush with front of door.
- Troxel doors greater than 48" high will be two doors doweled together.
- Not available in Caprice and Vaile door styles. Standard door sizes can be applied to cabinet side, but will not be flush with the cabinet door as shown for Panel Doors.

Custom Modifications		Finish Techniques	
DPSRR	RD	Distressing	Heirlooming
•	•	•	•



All embellishments marked with the follow these guidelines:

Program Details

- Products are shown with availability and exceptions noted.
- Items will be shipped loose for field attachment.

Product Characteristics

- Natural characteristics of wood carved items are wider color range, irregularity of surface texture, and more noticeable variations in finish. It is imperative to understand the variations these characteristics entail and therefore will not be considered defective.

Ordering Process

- To ensure product ships with the cabinet order, include on same order. Orders not placed together may not ship together.
- Express Response program is available for 12 day delivery.
- Must specify wood species, finish, and technique, if different than the rest of the order.
- Since these items are ordered on an "as-required" basis, **no changes or cancellations will be accepted after 24 hours from acknowledgment of order.**

MOULDING SPECIFICATIONS

Mouldings specified as 8' nominal length have a usable length range of 93" up to 99". Mouldings specified as 10' nominal length have a usable length range of 117" up to 123". Be sure to order the correct amount of moulding length to work around required cuts with minimal butt joints.

DESCRIPTION **MODEL**
CROWN MOULDING

CLASSIC TALL CROWN



CLTCROWN8

CLTCROWN10 ♦

- CLTCROWN8 is one 8' section.
- CLTCROWN10 is one 10' section. 5 day Express Response not available.
- Cleat shipped unattached.

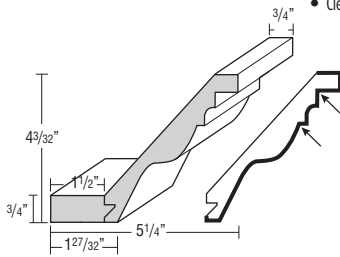

Finish Techniques

Distressing	Heirlooming
•	•

Species Availability (Wood)

Alder	Rustic Alder	Cherry	Hickory	Rustic Hickory	Maple	Oak
•	•	•	•	•	•	•

♦ Only available in Cherry and Maple.

Species Availability (All Laminates)

High Gloss box color	Horiz. Grain on Maple box color	Vert. Grain on Maple box color	Vert. Grain on Cherry box color	Vert. Grain on Hickory box color	Vert. Grain on Oak box color	Thermofoil box color
----------------------	---------------------------------	--------------------------------	---------------------------------	----------------------------------	------------------------------	----------------------

♦ Only available in Cherry and Maple box colors.

CORNICE TALL CROWN



COTCROWN8

COTCROWN10 ♦

- COTCROWN8 is one 8' section.
- COTCROWN10 is one 10' section. 5 day Express Response not available.
- Cleat shipped unattached.

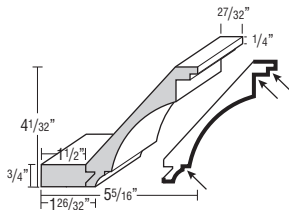

Finish Techniques

Distressing	Heirlooming
•	•

Species Availability (Wood)

Alder	Rustic Alder	Cherry	Hickory	Rustic Hickory	Maple	Oak
•	•	•	•	•	•	•

♦ Only available in Cherry and Maple.

Species Availability (All Laminates)

High Gloss box color	Horiz. Grain on Maple box color	Vert. Grain on Maple box color	Vert. Grain on Cherry box color	Vert. Grain on Hickory box color	Vert. Grain on Oak box color	Thermofoil box color
----------------------	---------------------------------	--------------------------------	---------------------------------	----------------------------------	------------------------------	----------------------

♦ Only available in Cherry and Maple box colors.

DESCRIPTION

COVE CROWN

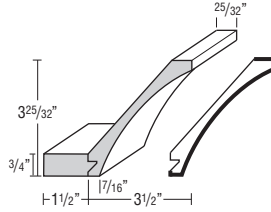

MODEL

COVECROWN8

COVECROWN10 ♦

- COVECROWN8 is one 8' section.
- COVECROWN10 is one 10' section. 5 day Express Response not available.
- Cleat shipped unattached.

Finish Techniques

Distressing	Heirlooming
•	•

Species Availability (Wood)

Alder	Rustic Alder	Cherry	Hickory	Rustic Hickory	Maple	Oak
•	•	•	•	•	•	•

♦ Only available in Cherry and Maple.

Species Availability (All Laminates)

High Gloss box color	Horiz. Grain on Maple box color	Vert. Grain on Maple box color	Vert. Grain on Cherry box color	Vert. Grain on Hickory box color	Vert. Grain on Oak box color	Thermofoil box color
----------------------	---------------------------------	--------------------------------	---------------------------------	----------------------------------	------------------------------	----------------------

♦ Only available in Cherry and Maple box colors.

FULL OVERLAY CROWN

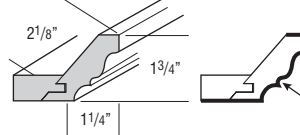

FOLCROWN8

- One 8' section.

Finish Techniques

Distressing	Heirlooming
	•

Species Availability (Wood)

Alder	Rustic Alder	Cherry	Hickory	Rustic Hickory	Maple	Oak
•	•	•	•	•	•	•

Species Availability (All Laminates)

High Gloss box color	Horiz. Grain on Maple box color	Vert. Grain on Maple box color	Vert. Grain on Cherry box color	Vert. Grain on Hickory box color	Vert. Grain on Oak box color	Thermofoil box color
----------------------	---------------------------------	--------------------------------	---------------------------------	----------------------------------	------------------------------	----------------------

INSERT CROWN

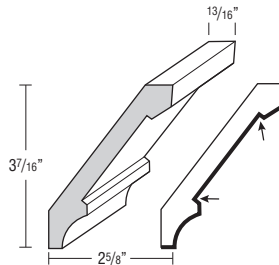

INSCROWN8

- One 8' section.
- Designed for use with all 2 1/4" insert mouldings.
- Use with Starter Crown (STRS_) or use a Filler (F3_) or Light Baffle (LB2) for a species matching cleat.

Finish Techniques

Distressing	Heirlooming
	•

Species Availability (Wood)

Alder	Rustic Alder	Cherry	Hickory	Rustic Hickory	Maple	Oak
•	•	•	•	•	•	•

Species Availability (All Laminates)

High Gloss box color	Horiz. Grain on Maple box color	Vert. Grain on Maple box color	Vert. Grain on Cherry box color	Vert. Grain on Hickory box color	Vert. Grain on Oak box color	Thermofoil box color
----------------------	---------------------------------	--------------------------------	---------------------------------	----------------------------------	------------------------------	----------------------

Finished edges indicated by bold lines on side view drawings.
Glazed edges indicated by arrows on side view drawings.

DESCRIPTION

MODEL

LARGE STRAIGHT ANGLE CROWN



LSACROWN8

LSACROWN10 ♦

- LSACROWN8 is one 8' section.
- LSACROWN10 is one 10' section. 5 day Express Response not available.
- Cleat shipped unattached.

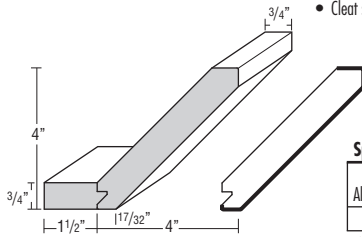

Finish Techniques

Distressing	Heirlooming
•	•

Species Availability (Wood)

Alder	Rustic Alder	Cherry	Hickory	Rustic Hickory	Maple	Oak
•	•	•	•	•	•	•

♦ Only available in Cherry and Maple.

Species Availability (All Laminates)

High Gloss box color	Horiz. Grain on Maple box color	Vert. Grain on Maple box color	Vert. Grain on Cherry box color	Vert. Grain on Hickory box color	Vert. Grain on Oak box color	Thermofoil box color
•	•	•	•	•	•	•

♦ Only available in Cherry and Maple box colors.

MEDIUM STRAIGHT ANGLE CROWN



MSACROWN8

MSACROWN10 ♦

- MSACROWN8 is one 8' section.
- MSACROWN10 is one 10' section. 5 day Express Response not available.
- Cleat shipped unattached.

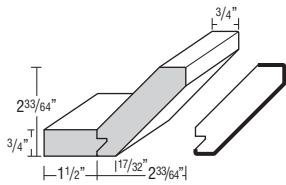

Finish Techniques

Distressing	Heirlooming
•	•

Species Availability (Wood)

Alder	Rustic Alder	Cherry	Hickory	Rustic Hickory	Maple	Oak
•	•	•	•	•	•	•

♦ Only available in Cherry and Maple.

Species Availability (All Laminates)

High Gloss box color	Horiz. Grain on Maple box color	Vert. Grain on Maple box color	Vert. Grain on Cherry box color	Vert. Grain on Hickory box color	Vert. Grain on Oak box color	Thermofoil box color
•	•	•	•	•	•	•

♦ Only available in Cherry and Maple box colors.

STRAIGHT ANGLE CROWN



SACROWN8

SACROWN10 ♦

- SACROWN8 is one 8' section.
- SACROWN10 is one 10' section. 5 day Express Response not available.
- Cleat shipped unattached.

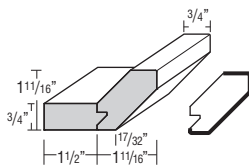

Finish Techniques

Distressing	Heirlooming
•	•

Species Availability (Wood)

Alder	Rustic Alder	Cherry	Hickory	Rustic Hickory	Maple	Oak
•	•	•	•	•	•	•

♦ Only available in Cherry and Maple.

Species Availability (All Laminates)

High Gloss box color	Horiz. Grain on Maple box color	Vert. Grain on Maple box color	Vert. Grain on Cherry box color	Vert. Grain on Hickory box color	Vert. Grain on Oak box color	Thermofoil box color
•	•	•	•	•	•	•

♦ Only available in Cherry and Maple box colors.

DESCRIPTION

MODEL

TALL CROWN



MTCROWN8

MTCROWN10 ♦

- MTCROWN8 is one 8' section.
- MTCROWN10 is one 10' section. 5 day Express Response not available.
- Use with Starter Crown (STRS_) or use a Filler (F3_) or Light Baffle (LB2) for a species matching cleat.

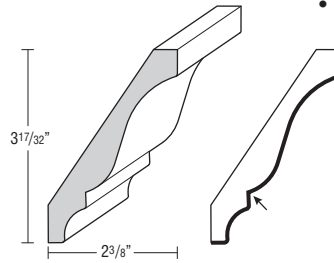

Finish Techniques

Distressing	Heirlooming
•	•

Species Availability (Wood)

Alder	Rustic Alder	Cherry	Hickory	Rustic Hickory	Maple	Oak
•	•	•	•	•	•	•

♦ Only available in Cherry and Maple.

Species Availability (All Laminates)

High Gloss box color	Horiz. Grain on Maple box color	Vert. Grain on Maple box color	Vert. Grain on Cherry box color	Vert. Grain on Hickory box color	Vert. Grain on Oak box color	Thermofoil box color
•	•	•	•	•	•	•

♦ Only available in Cherry and Maple box colors.

SHAKER CROWN



SHKCRM8

- Top mount moulding.
- One 8' section.

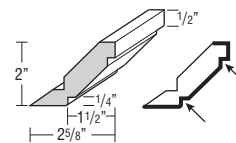

Finish Techniques

Distressing	Heirlooming
•	•

Species Availability (Wood)

Alder	Rustic Alder	Cherry	Hickory	Rustic Hickory	Maple	Oak
•	•	•	•	•	•	•

Species Availability (All Laminates)

High Gloss box color	Horiz. Grain on Maple box color	Vert. Grain on Maple box color	Vert. Grain on Cherry box color	Vert. Grain on Hickory box color	Vert. Grain on Oak box color	Thermofoil box color
•	•	•	•	•	•	•

LARGE SHAKER CROWN



LSHAKER8

LSHAKER10 ♦

- LSHAKER8 is one 8' section.
- LSHAKER10 is one 10' section. 5 day Express Response not available.
- Use with Starter Crown (STRS_) or use a Filler (F3_) or Light Baffle (LB2) for a species matching cleat.

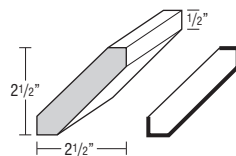

Finish Techniques

Distressing	Heirlooming
•	•

Species Availability (Wood)

Alder	Rustic Alder	Cherry	Hickory	Rustic Hickory	Maple	Oak
•	•	•	•	•	•	•

♦ Only available in Cherry and Maple.

Species Availability (All Laminates)

High Gloss box color	Horiz. Grain on Maple box color	Vert. Grain on Maple box color	Vert. Grain on Cherry box color	Vert. Grain on Hickory box color	Vert. Grain on Oak box color	Thermofoil box color
•	•	•	•	•	•	•

♦ Only available in Cherry and Maple box colors.

DESCRIPTION

LARGE SHAKER CROWN, PREMIUM

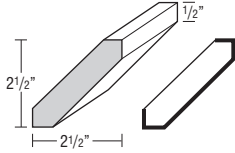

MODEL

**LSHAKER8P
LSHAKER10P**

- LSHAKER8P is one 8" section.
- LSHAKER10P is one 10" section. 5 day Express Response not available.
- Horizontal grain except on High Gloss.
- Use with Starter Crown (STRS_P) or use a Filler (F3_P) or Light Baffle (LB2P) for a species matching cleat.

Finish Techniques

Distressing	Heirlooming

Species Availability (Wood)

Alder	Rustic Alder	Cherry	Hickory	Rustic Hickory	Maple	Oak

Species Availability (All Laminates)

High Gloss	Horiz. Grain on Maple	Vert. Grain on Maple	Vert. Grain on Cherry	Vert. Grain on Hickory	Vert. Grain on Oak	Thermofoil
•	•	•*	•	•	•	

*LSHAKER10P not available in Squal.

SMALL COVE CROWN MOULDING

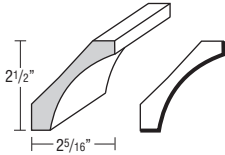

**SMCOVECROWN8
SMCOVECROWN10 ♦**

- SMCOVECROWN8 is one 8" section.
- SMCOVECROWN10 is one 10" section. 5 day Express Response not available.
- Use with Starter Crown (STRS_) or use a Filler (F3_) or Light Baffle (LB2) for a species matching cleat.

Finish Techniques

Distressing	Heirlooming
•	•

Species Availability (Wood)

Alder	Rustic Alder	Cherry	Hickory	Rustic Hickory	Maple	Oak
•	•	•			•	•

♦ Only available in Cherry and Maple.

Species Availability (All Laminates)

High Gloss	Horiz. Grain on Maple	Vert. Grain on Maple	Vert. Grain on Cherry	Vert. Grain on Hickory	Vert. Grain on Oak	Thermofoil
box color	box color	box color	box color		box color	box color

♦ Only available in Cherry and Maple box colors.

SMALL CROWN



**SCM8
SCM10 ♦**

- SCM8 is one 8" section.
- SCM10 is one 10" section. 5 day Express Response not available.
- Moulding can be used as standard or inverted.
- Use with Starter Crown (STRS_) or use a Filler (F3_) or Light Baffle (LB2) for a species matching cleat.

Finish Techniques

Distressing	Heirlooming
•	•

Species Availability (Wood)

Alder	Rustic Alder	Cherry	Hickory	Rustic Hickory	Maple	Oak
•	•	•	•	•	•	•

♦ Only available in Cherry and Maple.

Species Availability (All Laminates)

High Gloss	Horiz. Grain on Maple	Vert. Grain on Maple	Vert. Grain on Cherry	Vert. Grain on Hickory	Vert. Grain on Oak	Thermofoil
box color	box color	box color	box color	box color	box color	box color

♦ Only available in Cherry and Maple box colors.

DESCRIPTION

SOLID-WOOD CROWN



MODEL

**SWCRM8
SWCRM10 ♦**

- SWCRM8 is one 8" section.
- SWCRM10 is one 10" section. 5 day Express Response not available.
- Moulding can be used as standard or inverted.
- Use with Starter Crown (STRS_) or use a Filler (F3_) or Light Baffle (LB2) for a species matching cleat.

Finish Techniques

Distressing	Heirlooming
•	•

Species Availability (Wood)

Alder	Rustic Alder	Cherry	Hickory	Rustic Hickory	Maple	Oak
•	•	•		•	•	•

♦ Only available in Cherry and Maple.

Species Availability (All Laminates)

High Gloss	Horiz. Grain on Maple	Vert. Grain on Maple	Vert. Grain on Cherry	Vert. Grain on Hickory	Vert. Grain on Oak	Thermofoil
box color	box color	box color	box color	box color	box color	box color

♦ Only available in Cherry and Maple box colors.

SOLID-WOOD LARGE CROWN



**SWLCRM8
SWLCRM10 ♦**

- SWLCRM8 is one 8" section.
- SWLCRM10 is one 10" section. 5 day Express Response not available.
- Moulding can be used as standard or inverted.
- Use with Starter Crown (STRS_) or use a Filler (F3_) or Light Baffle (LB2) for a species matching cleat.

Finish Techniques

Distressing	Heirlooming
•	•

Species Availability (Wood)

Alder	Rustic Alder	Cherry	Hickory	Rustic Hickory	Maple	Oak
•	•	•		•	•	•

♦ Only available in Cherry and Maple.

Species Availability (All Laminates)

High Gloss	Horiz. Grain on Maple	Vert. Grain on Maple	Vert. Grain on Cherry	Vert. Grain on Hickory	Vert. Grain on Oak	Thermofoil
box color	box color	box color	box color	box color	box color	box color

♦ Only available in Cherry and Maple box colors.

Finished edges indicated by bold lines on side view drawings.
Glazed edges indicated by arrows on side view drawings.

DESCRIPTION

SOLID-WOOD TALL CROWN

MODEL

**SWTCRM8
SWTCRM10 ♦**



- SWTCRM8 is one 8" section.
- SWTCRM10 is one 10" section. 5 day Express Response not available.
- Moulding can be used as standard or inverted.
- Use with Starter Crown (STRS_) or use a Filler (F3_) or Light Baffle (LB2) for a species matching cleat.

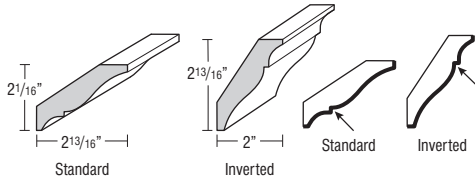

Finish Techniques

Distressing	Heirlooming
•	•

Species Availability (Wood)

Alder	Rustic Alder	Cherry	Hickory	Rustic Hickory	Maple	Oak
•	•	•	•	•	•	•

♦ Only available in Cherry and Maple.

Species Availability (All Laminates)

High Gloss box color	Horiz. Grain on Maple box color	Vert. Grain on Maple box color	Vert. Grain on Cherry box color	Vert. Grain on Hickory box color	Vert. Grain on Oak box color	Thermofoil box color
----------------------	---------------------------------	--------------------------------	---------------------------------	----------------------------------	------------------------------	----------------------

♦ Only available in Cherry and Maple box colors.

SOLID-WOOD VICTORIAN CROWN



**SWVCRM8
SWVCRM10 ♦**

- Designed for braided, dentil, egg & dart, or rope moulding application.
- SWVCRM8 is one 8" section.
- SWVCRM10 is one 10" section. 5 day Express Response not available.
- Use with Starter Crown (STRS_) or use a Filler (F3_) or Light Baffle (LB2) for a species matching cleat.

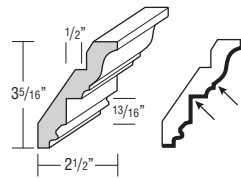

Finish Techniques

Distressing	Heirlooming
•	•

Species Availability (Wood)

Alder	Rustic Alder	Cherry	Hickory	Rustic Hickory	Maple	Oak
•	•	•	•	•	•	•

♦ Only available in Cherry and Maple.

Species Availability (All Laminates)

High Gloss box color	Horiz. Grain on Maple box color	Vert. Grain on Maple box color	Vert. Grain on Cherry box color	Vert. Grain on Hickory box color	Vert. Grain on Oak box color	Thermofoil box color
----------------------	---------------------------------	--------------------------------	---------------------------------	----------------------------------	------------------------------	----------------------

♦ Only available in Cherry and Maple box colors.

DESCRIPTION

STARTER MOULDINGS

MODEL

SOFFIT FILLER MOULDING



**SFM8
SFM10 ♦**

- SFM8 is one 8" section.
- SFM10 is one 10" section. 5 day Express Response not available.
- Includes an unattached cleat.

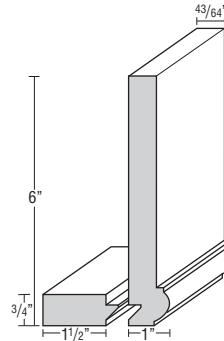

Finish Techniques

Distressing	Heirlooming
•	•

Species Availability (Wood)

Alder	Rustic Alder	Cherry	Hickory	Rustic Hickory	Maple	Oak
•	•	•	•	•	•	•

♦ Only available in Cherry and Maple.

Species Availability (All Laminates)

High Gloss box color	Horiz. Grain on Maple box color	Vert. Grain on Maple box color	Vert. Grain on Cherry box color	Vert. Grain on Hickory box color	Vert. Grain on Oak box color	Thermofoil box color
----------------------	---------------------------------	--------------------------------	---------------------------------	----------------------------------	------------------------------	----------------------

♦ Only available in Cherry and Maple box colors.

STARTER MOULDING



**STR8
STR10 ♦**

- STR8 is one 8" section.
- STR10 is one 10" section. 5 day Express Response not available.

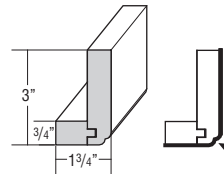

Finish Techniques

Distressing	Heirlooming
•	•

Species Availability (Wood)

Alder	Rustic Alder	Cherry	Hickory	Rustic Hickory	Maple	Oak
•	•	•	•	•	•	•

♦ Only available in Cherry and Maple.

Species Availability (All Laminates)

High Gloss box color	Horiz. Grain on Maple box color	Vert. Grain on Maple box color	Vert. Grain on Cherry box color	Vert. Grain on Hickory box color	Vert. Grain on Oak box color	Thermofoil box color
----------------------	---------------------------------	--------------------------------	---------------------------------	----------------------------------	------------------------------	----------------------

♦ Only available in Cherry and Maple box colors.

STARTER MOULDING, SHAKER



**STRS8
STRS10 ♦**

- STRS8 is one 8" section.
- STRS10 is one 10" section. 5 day Express Response not available.

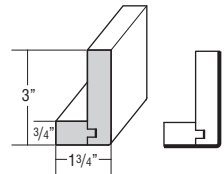

Finish Techniques

Distressing	Heirlooming
•	•

Species Availability (Wood)

Alder	Rustic Alder	Cherry	Hickory	Rustic Hickory	Maple	Oak
•	•	•	•	•	•	•

♦ Only available in Cherry and Maple.

Species Availability (All Laminates)

High Gloss box color	Horiz. Grain on Maple box color	Vert. Grain on Maple box color	Vert. Grain on Cherry box color	Vert. Grain on Hickory box color	Vert. Grain on Oak box color	Thermofoil box color
----------------------	---------------------------------	--------------------------------	---------------------------------	----------------------------------	------------------------------	----------------------

♦ Only available in Cherry and Maple box colors.

Finished edges indicated by bold lines on side view drawings.
Glazed edges indicated by arrows on side view drawings.

DESCRIPTION

MODEL

STARTER Moulding, SHAKER PREMIUM



STRS8P

- One 8' section.
- Horizontal grain except on High Gloss.

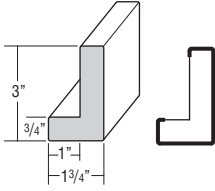

Finish Techniques

Distressing	Heirlooming

Species Availability (Wood)

Alder	Rustic Alder	Cherry	Hickory	Rustic Hickory	Maple	Oak

Species Availability (All Laminates)

High Gloss	Horiz. Grain on Maple	Vert. Grain on Maple	Vert. Grain on Cherry	Vert. Grain on Hickory	Vert. Grain on Oak	Thermofoil
•	•	•	•	•	•	

MOULDING INSERTS

ACANTHUS INSERT



JACANINSERTM

- One 8' section.
- Pattern is 6" repeat.

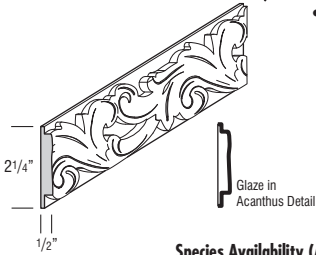

Finish Techniques

Distressing	Heirlooming
	•

Species Availability (Wood)

Alder	Rustic Alder	Cherry	Hickory	Rustic Hickory	Maple	Oak
		•			•	

Species Availability (All Laminates)

High Gloss	Horiz. Grain on Maple	Vert. Grain on Maple	Vert. Grain on Cherry	Vert. Grain on Hickory	Vert. Grain on Oak	Thermofoil
box color	box color	box color	box color			box color

BRAIDED



BRAIDM

- Designed to face mount on SWVCRM8.
- One 8' section.

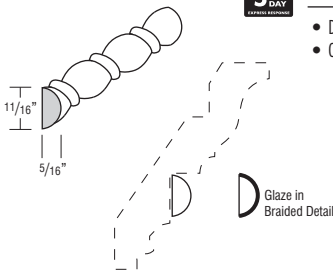

Finish Techniques

Distressing	Heirlooming

Species Availability (Wood)

Alder	Rustic Alder	Cherry	Hickory	Rustic Hickory	Maple	Oak
•	Alder	•	Beech	Beech	•	Beech

Species Availability (All Laminates)

High Gloss	Horiz. Grain on Maple	Vert. Grain on Maple	Vert. Grain on Cherry	Vert. Grain on Hickory	Vert. Grain on Oak	Thermofoil
box color	box color	box color	box color	Beech	Beech	box color

CELTIC INSERT



INSERTCELT

- One 8' section.
- Designed to be used with Insert Crown.
- Pattern is 6" repeat.

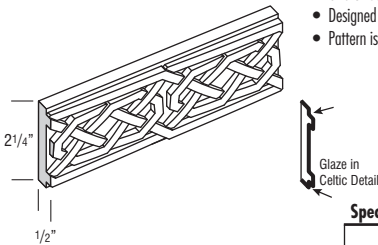

Finish Techniques

Distressing	Heirlooming
	•

Species Availability (Wood)

Alder	Rustic Alder	Cherry	Hickory	Rustic Hickory	Maple	Oak
		•			•	

Species Availability (All Laminates)

High Gloss	Horiz. Grain on Maple	Vert. Grain on Maple	Vert. Grain on Cherry	Vert. Grain on Hickory	Vert. Grain on Oak	Thermofoil
box color	box color	box color	box color			box color

DESCRIPTION

MODEL

DENTIL



MDENTIL8

- Designed to face mount on SWVCRM8.
- One 8' section.

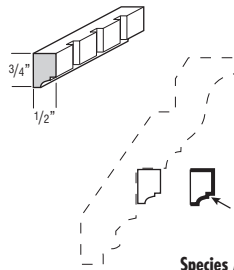

Finish Techniques

Distressing	Heirlooming

Species Availability (Wood)

Alder	Rustic Alder	Cherry	Hickory	Rustic Hickory	Maple	Oak
•	Alder	•			•	•

Species Availability (All Laminates)

High Gloss	Horiz. Grain on Maple	Vert. Grain on Maple	Vert. Grain on Cherry	Vert. Grain on Hickory	Vert. Grain on Oak	Thermofoil
box color	box color	box color	box color		box color	box color

EGG & DART



EGD8

- Designed to face mount on SWVCRM8.
- One 8' section.

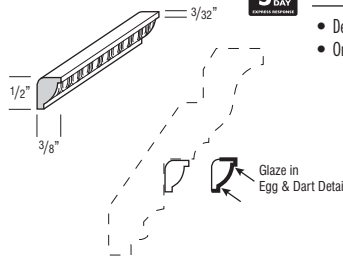

Finish Techniques

Distressing	Heirlooming

Species Availability (Wood)

Alder	Rustic Alder	Cherry	Hickory	Rustic Hickory	Maple	Oak
					Maple	

Species Availability (All Laminates)

High Gloss	Horiz. Grain on Maple	Vert. Grain on Maple	Vert. Grain on Cherry	Vert. Grain on Hickory	Vert. Grain on Oak	Thermofoil
box color	box color	box color				box color

MISSION INSERT



JMISINSERTM

- One 8' section.
- Pattern is 6" repeat.

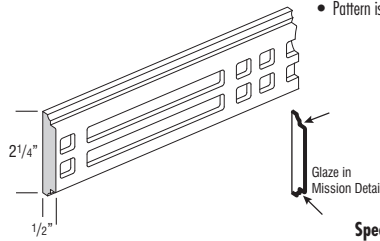

Finish Techniques

Distressing	Heirlooming
	•

Species Availability (Wood)

Alder	Rustic Alder	Cherry	Hickory	Rustic Hickory	Maple	Oak
•	Alder	•			•	

Species Availability (All Laminates)

High Gloss	Horiz. Grain on Maple	Vert. Grain on Maple	Vert. Grain on Cherry	Vert. Grain on Hickory	Vert. Grain on Oak	Thermofoil
box color	box color	box color	box color			box color

ROPE



RPM8

- Designed to face mount on SWVCRM8.
- One 8' section.

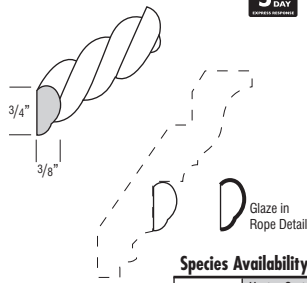

Finish Techniques

Distressing	Heirlooming

Species Availability (Wood)

Alder	Rustic Alder	Cherry	Hickory	Rustic Hickory	Maple	Oak
•	Alder	•	•	Hickory	•	•

Species Availability (All Laminates)

High Gloss	Horiz. Grain on Maple	Vert. Grain on Maple	Vert. Grain on Cherry	Vert. Grain on Hickory	Vert. Grain on Oak	Thermofoil
box color	box color	box color	box color	box color	box color	box color

Finished edges indicated by bold lines on side view drawings.
Glazed edges indicated by arrows on side view drawings.

DESCRIPTION

MODEL

WEAVE INSERT



JWEAVEINSERTM

- One 8" section.
- Pattern is 6" repeat.

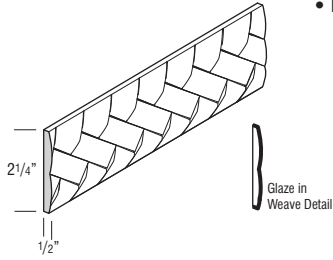

Finish Techniques

Distressing	Heirloom
	•

Species Availability (Wood)

Alder	Rustic Alder	Cherry	Hickory	Rustic Hickory	Maple	Oak
•	Alder	•			•	

Species Availability (All Laminates)

High Gloss box color	Horiz. Grain on Maple box color	Vert. Grain on Maple box color	Vert. Grain on Cherry box color	Vert. Grain on Hickory	Vert. Grain on Oak	Thermofoil box color
----------------------	---------------------------------	--------------------------------	---------------------------------	------------------------	--------------------	----------------------

ACCENT MOULDING

ACANTHUS



ACAM

- One 8" section.

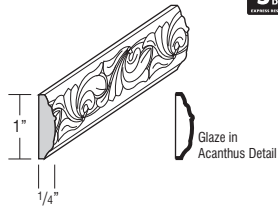

Finish Techniques

Distressing	Heirloom

Species Availability (Wood)

Alder	Rustic Alder	Cherry	Hickory	Rustic Hickory	Maple	Oak
•	Alder	•	Beech	Beech	•	Beech

Species Availability (All Laminates)

High Gloss box color	Horiz. Grain on Maple box color	Vert. Grain on Maple box color	Vert. Grain on Cherry box color	Vert. Grain on Hickory	Vert. Grain on Oak	Thermofoil box color
----------------------	---------------------------------	--------------------------------	---------------------------------	------------------------	--------------------	----------------------

BACK PANEL MOULDING



BPM8

- One 8" section.
- Designed to provide a decorative edge between cabinet and panel-corner seam.
- Not compatible with Panel Doors.

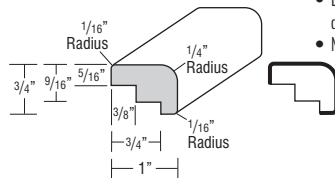

Finish Techniques

Distressing	Heirloom

Species Availability (Wood)

Alder	Rustic Alder	Cherry	Hickory	Rustic Hickory	Maple	Oak
•	Alder	•	•	Hickory	•	•

Species Availability (All Laminates)

High Gloss box color	Horiz. Grain on Maple box color	Vert. Grain on Maple box color	Vert. Grain on Cherry box color	Vert. Grain on Hickory	Vert. Grain on Oak	Thermofoil box color
----------------------	---------------------------------	--------------------------------	---------------------------------	------------------------	--------------------	----------------------

CABINET PANEL EDGE



CPE8

- One 8" section.

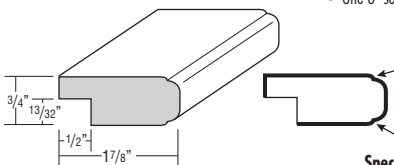

Finish Techniques

Distressing	Heirloom
	•

Species Availability (Wood)

Alder	Rustic Alder	Cherry	Hickory	Rustic Hickory	Maple	Oak
•	Alder	•	•	Hickory	•	•

Species Availability (All Laminates)

High Gloss box color	Horiz. Grain on Maple box color	Vert. Grain on Maple box color	Vert. Grain on Cherry box color	Vert. Grain on Hickory	Vert. Grain on Oak	Thermofoil box color
----------------------	---------------------------------	--------------------------------	---------------------------------	------------------------	--------------------	----------------------

DESCRIPTION

MODEL

COUNTERTOP EDGE



CCM8

Contemporary

Traditional

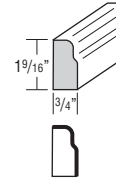
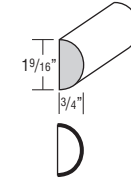

TCM8

- One 8" section.

Finish Techniques

Distressing	Heirloom
	•*

*Available on TCM8 only

Species Availability (Wood)

Alder	Rustic Alder	Cherry	Hickory	Rustic Hickory	Maple	Oak
•	Alder	•	•	Hickory	•	•

Species Availability (All Laminates)

High Gloss box color	Horiz. Grain on Maple box color	Vert. Grain on Maple box color	Vert. Grain on Cherry box color	Vert. Grain on Hickory	Vert. Grain on Oak	Thermofoil box color
----------------------	---------------------------------	--------------------------------	---------------------------------	------------------------	--------------------	----------------------

FLAT SCRIBE



SM8

SM10 ♦

- SM8 is one 8" section.
- SM10 is one 10" section. 5 day Express Response not available.

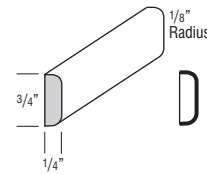

Finish Techniques

Distressing	Heirloom

Species Availability (Wood)

Alder	Rustic Alder	Cherry	Hickory	Rustic Hickory	Maple	Oak
•	Alder	•	•	Hickory	•	•

♦ Only available in Cherry and Maple.

Species Availability (All Laminates)

High Gloss box color	Horiz. Grain on Maple box color	Vert. Grain on Maple box color	Vert. Grain on Cherry box color	Vert. Grain on Hickory	Vert. Grain on Oak	Thermofoil box color
----------------------	---------------------------------	--------------------------------	---------------------------------	------------------------	--------------------	----------------------

♦ Only available in Cherry and Maple box colors.

FLAT SCRIBE, PREMIUM



SM8P

SM10P

- SM8P is one 8" section.
- SM10P is one 10" section. 5 day Express Response not available.
- Horizontal grain except on High Gloss.

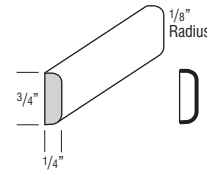

Finish Techniques

Distressing	Heirloom

Species Availability (Wood)

Alder	Rustic Alder	Cherry	Hickory	Rustic Hickory	Maple	Oak

Species Availability (All Laminates)

High Gloss	Horiz. Grain on Maple	Vert. Grain on Maple	Vert. Grain on Cherry	Vert. Grain on Hickory	Vert. Grain on Oak	Thermofoil
•	•	•*	•	•	•	

*SM10P not available in Squal.

DESCRIPTION

MODEL

LIBRARY MOULDING



LBRM

- One 8' section.

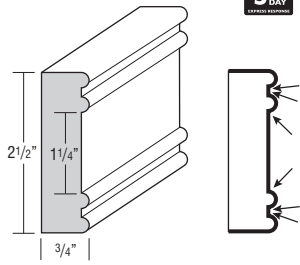

Finish Techniques

Distressing	Heirlooming
•	•

Species Availability (Wood)

Alder	Rustic Alder	Cherry	Hickory	Rustic Hickory	Maple	Oak
•	•	•	•	•	•	•

Species Availability (All Laminates)

High Gloss box color	Horiz. Grain on Maple box color	Vert. Grain on Maple box color	Vert. Grain on Cherry box color	Vert. Grain on Hickory box color	Vert. Grain on Oak box color	Thermofoil box color
----------------------	---------------------------------	--------------------------------	---------------------------------	----------------------------------	------------------------------	----------------------

MIRROR FRAME



WMF8

- Pre-grooved.
- One 8' section.

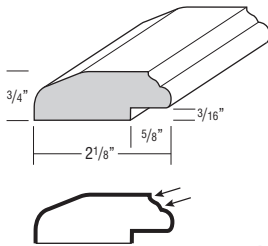

Finish Techniques

Distressing	Heirlooming
•	•

Species Availability (Wood)

Alder	Rustic Alder	Cherry	Hickory	Rustic Hickory	Maple	Oak
•	•	•	•	•	•	•

Species Availability (All Laminates)

High Gloss box color	Horiz. Grain on Maple box color	Vert. Grain on Maple box color	Vert. Grain on Cherry box color	Vert. Grain on Hickory box color	Vert. Grain on Oak box color	Thermofoil box color
----------------------	---------------------------------	--------------------------------	---------------------------------	----------------------------------	------------------------------	----------------------

OGEE EDGE



OGEEM

- One 8' section.

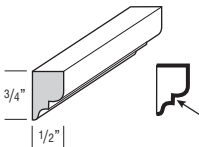

Finish Techniques

Distressing	Heirlooming
	•

Species Availability (Wood)

Alder	Rustic Alder	Cherry	Hickory	Rustic Hickory	Maple	Oak
•	•	•	•	•	•	•

Species Availability (All Laminates)

High Gloss box color	Horiz. Grain on Maple box color	Vert. Grain on Maple box color	Vert. Grain on Cherry box color	Vert. Grain on Hickory box color	Vert. Grain on Oak box color	Thermofoil box color
----------------------	---------------------------------	--------------------------------	---------------------------------	----------------------------------	------------------------------	----------------------

SINGLE BEAD EDGE



SBE8

- One 8' section.

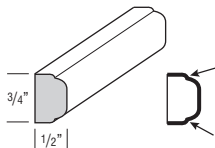

Finish Techniques

Distressing	Heirlooming
	•

Species Availability (Wood)

Alder	Rustic Alder	Cherry	Hickory	Rustic Hickory	Maple	Oak
•	•	•	•	•	•	•

Species Availability (All Laminates)

High Gloss box color	Horiz. Grain on Maple box color	Vert. Grain on Maple box color	Vert. Grain on Cherry box color	Vert. Grain on Hickory box color	Vert. Grain on Oak box color	Thermofoil box color
----------------------	---------------------------------	--------------------------------	---------------------------------	----------------------------------	------------------------------	----------------------

DESCRIPTION

MODEL

SINGLE BEAD MOULDING



SBM8

- One 8' section.

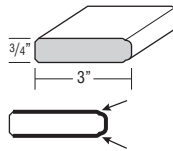

Finish Techniques

Distressing	Heirlooming
	•

Species Availability (Wood)

Alder	Rustic Alder	Cherry	Hickory	Rustic Hickory	Maple	Oak
•	•	•	•	•	•	•

Species Availability (All Laminates)

High Gloss box color	Horiz. Grain on Maple box color	Vert. Grain on Maple box color	Vert. Grain on Cherry box color	Vert. Grain on Hickory box color	Vert. Grain on Oak box color	Thermofoil box color
----------------------	---------------------------------	--------------------------------	---------------------------------	----------------------------------	------------------------------	----------------------

SINGLE BEAD PILASTER



SBP8

- One 8' section.
- Can be used vertically between cabinets for an inset look.

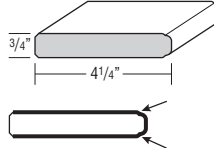

Finish Techniques

Distressing	Heirlooming
•	•

Species Availability (Wood)

Alder	Rustic Alder	Cherry	Hickory	Rustic Hickory	Maple	Oak
•	•	•	•	•	•	•

Species Availability (All Laminates)

High Gloss box color	Horiz. Grain on Maple box color	Vert. Grain on Maple box color	Vert. Grain on Cherry box color	Vert. Grain on Hickory box color	Vert. Grain on Oak box color	Thermofoil box color
----------------------	---------------------------------	--------------------------------	---------------------------------	----------------------------------	------------------------------	----------------------

SMALL SCRIBE



SSM8

SSM10 ♦

- SSM8 is one 8' section.
- SSM10 is one 10' section. 5 day Express Response not available.

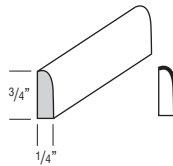

Finish Techniques

Distressing	Heirlooming
	•

Species Availability (Wood)

Alder	Rustic Alder	Cherry	Hickory	Rustic Hickory	Maple	Oak
•	•	•	•	•	•	•

♦ Only available in Cherry and Maple.

Species Availability (All Laminates)

High Gloss box color	Horiz. Grain on Maple box color	Vert. Grain on Maple box color	Vert. Grain on Cherry box color	Vert. Grain on Hickory box color	Vert. Grain on Oak box color	Thermofoil box color
----------------------	---------------------------------	--------------------------------	---------------------------------	----------------------------------	------------------------------	----------------------

♦ Only available in Cherry and Maple box colors.

SMALL SCRIBE, PREMIUM



SSM8P

SSM10P

- SSM8P is one 8' section.
- SSM10P is one 10' section. 5 day Express Response not available.
- Horizontal grain except on High Gloss.
- Can be used with premium skins to conceal raw edge.

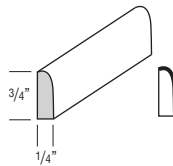

Finish Techniques

Distressing	Heirlooming
	•

Species Availability (Wood)

Alder	Rustic Alder	Cherry	Hickory	Rustic Hickory	Maple	Oak

Species Availability (All Laminates)

High Gloss	Horiz. Grain on Maple	Vert. Grain on Maple	Vert. Grain on Cherry	Vert. Grain on Hickory	Vert. Grain on Oak	Thermofoil
•	•	•*	•	•	•	

*SSM10P not available in Squal.

Finished edges indicated by bold lines on side view drawings.
Glazed edges indicated by arrows on side view drawings.

DESCRIPTION

MODEL

SOFFIT TRIM MOULDING



TSTM8
TSTM10 ♦

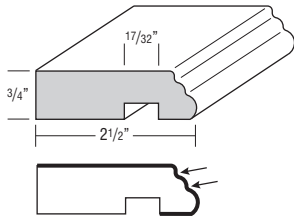

- TSTM8 is one 8' section.
- TSTM10 is one 10' section. 5 day Express Response not available.

Finish Techniques

Distressing	Heirlooming

Species Availability (Wood)

Alder	Rustic Alder	Cherry	Hickory	Rustic Hickory	Maple	Oak
•	•	•	•	•	•	•

♦ Only available in Cherry and Maple.

Species Availability (All Laminates)

High Gloss box color	Horiz. Grain on Maple box color	Vert. Grain on Maple box color	Vert. Grain on Cherry box color	Vert. Grain on Hickory box color	Vert. Grain on Oak box color	Thermofoil box color
----------------------	---------------------------------	--------------------------------	---------------------------------	----------------------------------	------------------------------	----------------------

♦ Only available in Cherry and Maple box colors.

TRIPLE BEAD EDGE



TBEM

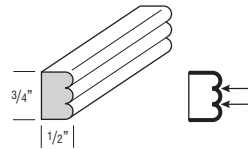

- One 8' section.

Finish Techniques

Distressing	Heirlooming
	•

Species Availability (Wood)

Alder	Rustic Alder	Cherry	Hickory	Rustic Hickory	Maple	Oak
•	•	•	•	•	•	•

Species Availability (All Laminates)

High Gloss box color	Horiz. Grain on Maple box color	Vert. Grain on Maple box color	Vert. Grain on Cherry box color	Vert. Grain on Hickory box color	Vert. Grain on Oak box color	Thermofoil box color
----------------------	---------------------------------	--------------------------------	---------------------------------	----------------------------------	------------------------------	----------------------

TRIPLE BEAD PILASTER



TBP8

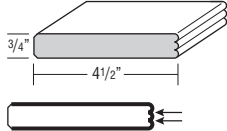

- Finished beaded front and two 4 1/2" sides.
- Can be used vertically between cabinets for an inset look.
- One 8' section.

Finish Techniques

Distressing	Heirlooming
	•

Species Availability (Wood)

Alder	Rustic Alder	Cherry	Hickory	Rustic Hickory	Maple	Oak
•	•	•	•	•	•	•

Species Availability (All Laminates)

High Gloss box color	Horiz. Grain on Maple box color	Vert. Grain on Maple box color	Vert. Grain on Cherry box color	Vert. Grain on Hickory box color	Vert. Grain on Oak box color	Thermofoil box color
----------------------	---------------------------------	--------------------------------	---------------------------------	----------------------------------	------------------------------	----------------------

WIDE SCRIBE



WSCRIBE

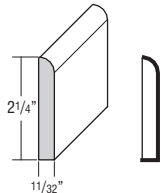

- One 8' section.

Finish Techniques

Distressing	Heirlooming
	•

Species Availability (Wood)

Alder	Rustic Alder	Cherry	Hickory	Rustic Hickory	Maple	Oak
•	•	•	•	•	•	•

Species Availability (All Laminates)

High Gloss box color	Horiz. Grain on Maple box color	Vert. Grain on Maple box color	Vert. Grain on Cherry box color	Vert. Grain on Hickory box color	Vert. Grain on Oak box color	Thermofoil box color
----------------------	---------------------------------	--------------------------------	---------------------------------	----------------------------------	------------------------------	----------------------

DESCRIPTION

MODEL

UNDER PANEL MOULDING



UPM8

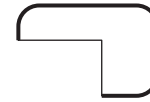
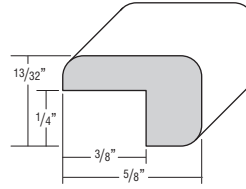

- One 8' section.
- Can be used on edges of 1/4" thick panels to conceal end grain.

Finish Techniques

Distressing	Heirlooming

Species Availability (Wood)

Alder	Rustic Alder	Cherry	Hickory	Rustic Hickory	Maple	Oak
		•			•	

Species Availability (All Laminates)

High Gloss box color	Horiz. Grain on Maple box color	Vert. Grain on Maple box color	Vert. Grain on Cherry box color	Vert. Grain on Hickory box color	Vert. Grain on Oak box color	Thermofoil box color
----------------------	---------------------------------	--------------------------------	---------------------------------	----------------------------------	------------------------------	----------------------

UNDER PANEL MOULDING, PREMIUM



UPM8P

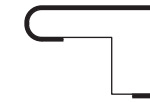
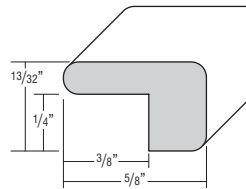

- One 8' section.
- Horizontal grain except on High Gloss.
- Can be used on edges of 1/4" thick panels to conceal end grain.

Finish Techniques

Distressing	Heirlooming

Species Availability (Wood)

Alder	Rustic Alder	Cherry	Hickory	Rustic Hickory	Maple	Oak

Species Availability (All Laminates)

High Gloss box color	Horiz. Grain on Maple box color	Vert. Grain on Maple box color	Vert. Grain on Cherry box color	Vert. Grain on Hickory box color	Vert. Grain on Oak box color	Thermofoil box color
•	•	•	•	•	•	•

TOE MOULDING

BASEBOARD



BBM8

BBM10 ♦

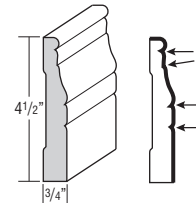

- BBM8 is one 8' section.
- BBM10 is one 10' section. 5 day Express Response not available.
- BBM8 can be used in place of standard toekick to provide a surface for glaze hang-up on premium finishes.

Finish Techniques

Distressing	Heirlooming
•	•

Species Availability (Wood)

Alder	Rustic Alder	Cherry	Hickory	Rustic Hickory	Maple	Oak
•	•	•	•	•	•	•

♦ Only available in Cherry and Maple.

Species Availability (All Laminates)

High Gloss box color	Horiz. Grain on Maple box color	Vert. Grain on Maple box color	Vert. Grain on Cherry box color	Vert. Grain on Hickory box color	Vert. Grain on Oak box color	Thermofoil box color
----------------------	---------------------------------	--------------------------------	---------------------------------	----------------------------------	------------------------------	----------------------

♦ Only available in Cherry and Maple box colors.

DESCRIPTION

MODEL

BASEBOARD - SCULPTED



BBMSC

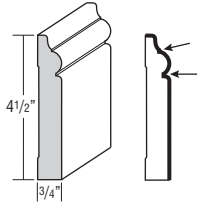

- One 8" section.
- BBMSC can be used in place of standard toekick to provide a surface for glaze hang-up on premium finishes.

Finish Techniques

Distressing	Heirlooming
	•

Species Availability (Wood)

Alder	Rustic Alder	Cherry	Hickory	Rustic Hickory	Maple	Oak
•	•	•	•	•	•	•

Species Availability (All Laminates)

High Gloss box color	Horiz. Grain on Maple box color	Vert. Grain on Maple box color	Vert. Grain on Cherry box color	Vert. Grain on Hickory box color	Vert. Grain on Oak box color	Thermofoil box color

BASEBOARD - SHAKER



BBMSH8

BBMSH10 ♦

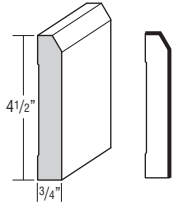

- BBMSH8 is one 8" section.
- BBMSH10 is one 10" section. 5 day Express Response not available.

Finish Techniques

Distressing	Heirlooming
•	•

Species Availability (Wood)

Alder	Rustic Alder	Cherry	Hickory	Rustic Hickory	Maple	Oak
•	•	•	•	•	•	•

♦ Only available in Cherry and Maple.

Species Availability (All Laminates)

High Gloss box color	Horiz. Grain on Maple box color	Vert. Grain on Maple box color	Vert. Grain on Cherry box color	Vert. Grain on Hickory box color	Vert. Grain on Oak box color	Thermofoil box color

♦ Only available in Cherry and Maple box colors.

BASEBOARD - SWOOPED



BBMSW

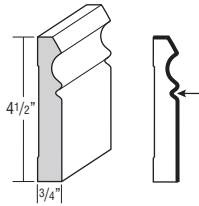

- One 8" section.
- BBMSW can be used in place of standard toekick to provide a surface for glaze hang-up on premium finishes.

Finish Techniques

Distressing	Heirlooming
	•

Species Availability (Wood)

Alder	Rustic Alder	Cherry	Hickory	Rustic Hickory	Maple	Oak
•	•	•	•	•	•	•

Species Availability (All Laminates)

High Gloss box color	Horiz. Grain on Maple box color	Vert. Grain on Maple box color	Vert. Grain on Cherry box color	Vert. Grain on Hickory box color	Vert. Grain on Oak box color	Thermofoil box color

DESCRIPTION

MODEL

TOEBOARDS



TB8WD14

TB8LAM12 ♦

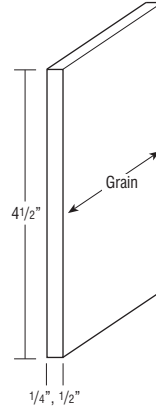

- TB8WD14 in Stains: 1/4" thick veneered furniture board.
- TB8WD14 in Paints: 1/4" thick veneered or solid furniture board.
- TB8LAM12 is 1/2" laminated furniture board.
- One 8" section.

Finish Techniques

Distressing	Heirlooming

Species Availability (Wood)

Alder	Rustic Alder	Cherry	Hickory	Rustic Hickory	Maple	Oak
•	•	•	•	•	•	•

♦ Only available in White Laminate.

Species Availability (All Laminates)

High Gloss box color	Horiz. Grain on Maple box color	Vert. Grain on Maple box color	Vert. Grain on Cherry box color	Vert. Grain on Hickory box color	Vert. Grain on Oak box color	Thermofoil box color

♦ Only available in White Laminate.

TOEBOARDS, PREMIUM



TB8P14

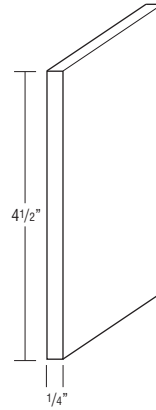

- 1/4" thick laminated MDF.
- One 8" section.
- Horizontal grain except on High Gloss.

Finish Techniques

Distressing	Heirlooming

Species Availability (Wood)

Alder	Rustic Alder	Cherry	Hickory	Rustic Hickory	Maple	Oak

Species Availability (All Laminates)

High Gloss	Horiz. Grain on Maple	Vert. Grain on Maple	Vert. Grain on Cherry	Vert. Grain on Hickory	Vert. Grain on Oak	Thermofoil
•	•	•	•	•	•	

TOEKICK CAP



TKC

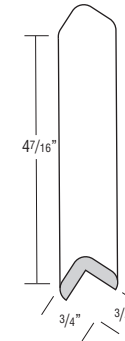

- Sold in pairs.

Finish Techniques

Distressing	Heirlooming

Species Availability (Wood)

Alder	Rustic Alder	Cherry	Hickory	Rustic Hickory	Maple	Oak
•	•	•	•	•	•	•

Species Availability (All Laminates)

High Gloss box color	Horiz. Grain on Maple box color	Vert. Grain on Maple box color	Vert. Grain on Cherry box color	Vert. Grain on Hickory box color	Vert. Grain on Oak box color	Thermofoil box color

Finished edges indicated by bold lines on side view drawings.
Glazed edges indicated by arrows on side view drawings.

DESCRIPTION
WINDOW CASING

MODEL

WINDOW CASING - TRADITIONAL



WCT8

- One 8' section.

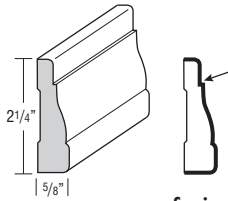

Finish Techniques

Distressing	Heirlooming
	•

Species Availability (Wood)

Alder	Rustic Alder	Cherry	Hickory	Rustic Hickory	Maple	Oak
•	Alder	•	•	Hickory	•	•

Species Availability (All Laminates)

High Gloss box color	Horiz. Grain on Maple box color	Vert. Grain on Maple box color	Vert. Grain on Cherry box color	Vert. Grain on Hickory box color	Vert. Grain on Oak box color	Thermofoil box color
----------------------	---------------------------------	--------------------------------	---------------------------------	----------------------------------	------------------------------	----------------------

LIGHT RAILS

CAP MOULDING



CAPM

- One 8' section.

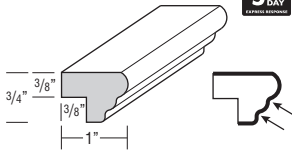

Finish Techniques

Distressing	Heirlooming
	•

Species Availability (Wood)

Alder	Rustic Alder	Cherry	Hickory	Rustic Hickory	Maple	Oak
•	Alder	•	•	Hickory	•	•

Species Availability (All Laminates)

High Gloss box color	Horiz. Grain on Maple box color	Vert. Grain on Maple box color	Vert. Grain on Cherry box color	Vert. Grain on Hickory box color	Vert. Grain on Oak box color	Thermofoil box color
----------------------	---------------------------------	--------------------------------	---------------------------------	----------------------------------	------------------------------	----------------------

LIGHT BAFFLE



LB2

- One 8' section.

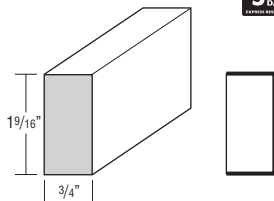

Finish Techniques

Distressing	Heirlooming

Species Availability (Wood)

Alder	Rustic Alder	Cherry	Hickory	Rustic Hickory	Maple	Oak
•	Alder	•	•	Hickory	•	•

Species Availability (All Laminates)

High Gloss box color	Horiz. Grain on Maple box color	Vert. Grain on Maple box color	Vert. Grain on Cherry box color	Vert. Grain on Hickory box color	Vert. Grain on Oak box color	Thermofoil box color
----------------------	---------------------------------	--------------------------------	---------------------------------	----------------------------------	------------------------------	----------------------

LIGHT BAFFLE, PREMIUM



LB2P

- One 8' section.
- Horizontal grain except on High Gloss.

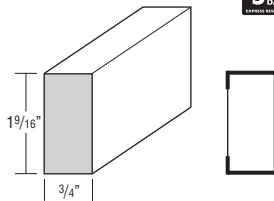

Finish Techniques

Distressing	Heirlooming

Species Availability (Wood)

Alder	Rustic Alder	Cherry	Hickory	Rustic Hickory	Maple	Oak

Species Availability (All Laminates)

High Gloss	Horiz. Grain on Maple	Vert. Grain on Maple	Vert. Grain on Cherry	Vert. Grain on Hickory	Vert. Grain on Oak	Thermofoil
•	•	•	•	•	•	

DESCRIPTION

MODEL

SMALL LIGHT RAIL MOULDING



SMLR

- One 8' section.

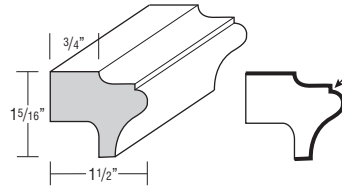

Finish Techniques

Distressing	Heirlooming
•	•

Species Availability (Wood)

Alder	Rustic Alder	Cherry	Hickory	Rustic Hickory	Maple	Oak
•	•	•			•	•

Species Availability (All Laminates)

High Gloss box color	Horiz. Grain on Maple box color	Vert. Grain on Maple box color	Vert. Grain on Cherry box color	Vert. Grain on Hickory	Vert. Grain on Oak box color	Thermofoil box color
----------------------	---------------------------------	--------------------------------	---------------------------------	------------------------	------------------------------	----------------------

LIGHT RAIL MOULDING



LRM

- One 8' section.

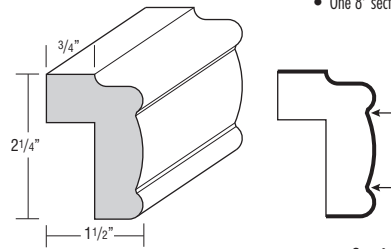

Finish Techniques

Distressing	Heirlooming
•	•

Species Availability (Wood)

Alder	Rustic Alder	Cherry	Hickory	Rustic Hickory	Maple	Oak
•	•	•	•	•	•	•

Species Availability (All Laminates)

High Gloss box color	Horiz. Grain on Maple box color	Vert. Grain on Maple box color	Vert. Grain on Cherry box color	Vert. Grain on Hickory box color	Vert. Grain on Oak box color	Thermofoil box color
----------------------	---------------------------------	--------------------------------	---------------------------------	----------------------------------	------------------------------	----------------------

VALLEY FORGE



VFR8

- Must be shimmed at shaded area if used with full overlay styles.
- One 8' section.

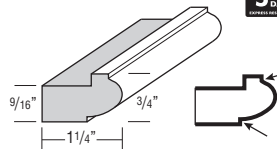

Finish Techniques

Distressing	Heirlooming
	•

Species Availability (Wood)

Alder	Rustic Alder	Cherry	Hickory	Rustic Hickory	Maple	Oak
•	Alder	•	•	Hickory	•	•

Species Availability (All Laminates)

High Gloss box color	Horiz. Grain on Maple box color	Vert. Grain on Maple box color	Vert. Grain on Cherry box color	Vert. Grain on Hickory box color	Vert. Grain on Oak box color	Thermofoil box color
----------------------	---------------------------------	--------------------------------	---------------------------------	----------------------------------	------------------------------	----------------------

DESCRIPTION

MODEL

TRADITIONAL LIGHT RAIL



JINSERLRT

- One 8' section.
- Designed for use with all 3/4" insert mouldings.

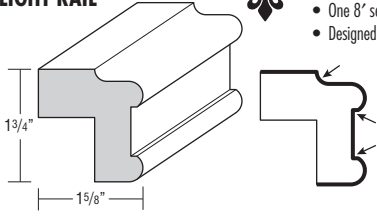

Finish Techniques

Distressing	Heirloom
	•

Species Availability (Wood)

Alder	Rustic Alder	Cherry	Hickory	Rustic Hickory	Maple	Oak
•	Alder	•			•	•

Species Availability (All Laminates)

High Gloss box color	Horiz. Grain on Maple box color	Vert. Grain on Maple box color	Vert. Grain on Cherry box color	Vert. Grain on Hickory	Vert. Grain on Oak box color	Thermofoil box color
----------------------	---------------------------------	--------------------------------	---------------------------------	------------------------	------------------------------	----------------------

CONTEMPORARY LIGHT RAIL



JINSERLRC

- One 8' section.
- Designed for use with all 3/4" insert mouldings.

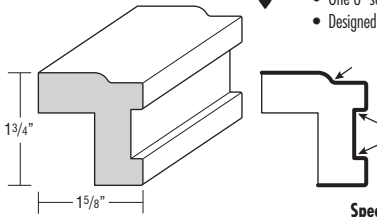

Finish Techniques

Distressing	Heirloom
	•

Species Availability (Wood)

Alder	Rustic Alder	Cherry	Hickory	Rustic Hickory	Maple	Oak
•	Alder	•			•	•

Species Availability (All Laminates)

High Gloss box color	Horiz. Grain on Maple box color	Vert. Grain on Maple box color	Vert. Grain on Cherry box color	Vert. Grain on Hickory	Vert. Grain on Oak box color	Thermofoil box color
----------------------	---------------------------------	--------------------------------	---------------------------------	------------------------	------------------------------	----------------------

LIGHT RAIL INSERTS

ACANTHUS LIGHT RAIL INSERT



JLRINSACAN

- One 8' section.
- Pattern is 6" repeat.

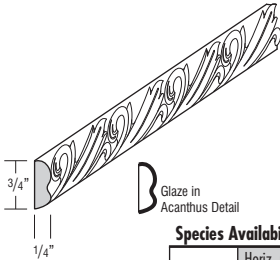

Finish Techniques

Distressing	Heirloom
	•

Species Availability (Wood)

Alder	Rustic Alder	Cherry	Hickory	Rustic Hickory	Maple	Oak
•	Alder	•			•	

Species Availability (All Laminates)

High Gloss box color	Horiz. Grain on Maple box color	Vert. Grain on Maple box color	Vert. Grain on Cherry box color	Vert. Grain on Hickory	Vert. Grain on Oak box color	Thermofoil box color
----------------------	---------------------------------	--------------------------------	---------------------------------	------------------------	------------------------------	----------------------

CELTIC LIGHT RAIL INSERT



JLRINSCELT

- One 8' section.
- Pattern is 6" repeat.

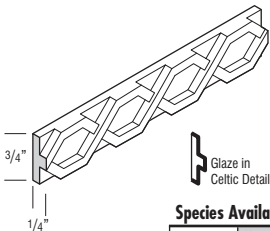

Finish Techniques

Distressing	Heirloom
	•

Species Availability (Wood)

Alder	Rustic Alder	Cherry	Hickory	Rustic Hickory	Maple	Oak
•	Alder	•			•	

Species Availability (All Laminates)

High Gloss box color	Horiz. Grain on Maple box color	Vert. Grain on Maple box color	Vert. Grain on Cherry box color	Vert. Grain on Hickory	Vert. Grain on Oak box color	Thermofoil box color
----------------------	---------------------------------	--------------------------------	---------------------------------	------------------------	------------------------------	----------------------

DESCRIPTION

MODEL

MISSION LIGHT RAIL INSERT



JLRINSMIS

- One 8' section.
- Pattern is 6" repeat.

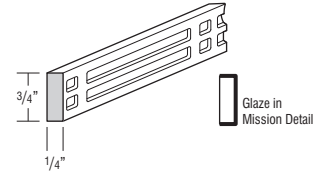

Finish Techniques

Distressing	Heirloom
	•

Species Availability (Wood)

Alder	Rustic Alder	Cherry	Hickory	Rustic Hickory	Maple	Oak
•	Alder	•			•	

Species Availability (All Laminates)

High Gloss box color	Horiz. Grain on Maple box color	Vert. Grain on Maple box color	Vert. Grain on Cherry box color	Vert. Grain on Hickory	Vert. Grain on Oak	Thermofoil box color
----------------------	---------------------------------	--------------------------------	---------------------------------	------------------------	--------------------	----------------------

WEAVE LIGHT RAIL INSERT



JLRINSWEAVE

- One 8' section.
- Pattern is 6" repeat.

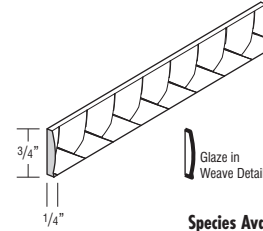

Finish Techniques

Distressing	Heirloom
	•

Species Availability (Wood)

Alder	Rustic Alder	Cherry	Hickory	Rustic Hickory	Maple	Oak
•	Alder	•			•	

Species Availability (All Laminates)

High Gloss box color	Horiz. Grain on Maple box color	Vert. Grain on Maple box color	Vert. Grain on Cherry box color	Vert. Grain on Hickory	Vert. Grain on Oak	Thermofoil box color
----------------------	---------------------------------	--------------------------------	---------------------------------	------------------------	--------------------	----------------------

CORNER MOULDINGS

INSIDE CORNER



ICM8

- One 8' section.

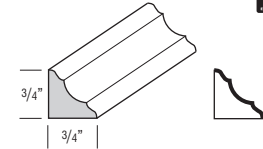

Finish Techniques

Distressing	Heirloom

Species Availability (Wood)

Alder	Rustic Alder	Cherry	Hickory	Rustic Hickory	Maple	Oak
•	Alder	•	•	Hickory	•	•

Species Availability (All Laminates)

High Gloss box color	Horiz. Grain on Maple box color	Vert. Grain on Maple box color	Vert. Grain on Cherry box color	Vert. Grain on Hickory box color	Vert. Grain on Oak box color	Thermofoil box color
----------------------	---------------------------------	--------------------------------	---------------------------------	----------------------------------	------------------------------	----------------------

INSIDE CORNER, PREMIUM



ICM8P

- One 8' section.
- Horizontal grain except on High Gloss.

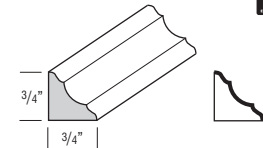

Finish Techniques

Distressing	Heirloom

Species Availability (Wood)

Alder	Rustic Alder	Cherry	Hickory	Rustic Hickory	Maple	Oak

Species Availability (All Laminates)

High Gloss	Horiz. Grain on Maple	Vert. Grain on Maple	Vert. Grain on Cherry	Vert. Grain on Hickory	Vert. Grain on Oak	Thermofoil
•	•	•	•	•	•	

Finished edges indicated by bold lines on side view drawings.
Glazed edges indicated by arrows on side view drawings.

DESCRIPTION

MODEL

LARGE OUTSIDE CORNER



LOSC8

- One 8' section.

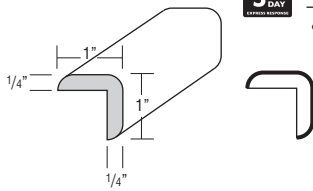

Finish Techniques

Distressing	Heirlooming
-------------	-------------

Species Availability (Wood)

Alder	Rustic Alder	Cherry	Hickory	Rustic Hickory	Maple	Oak
•	Alder	•	•	Hickory	•	•

Species Availability (All Laminates)

High Gloss	Horiz. Grain on Maple	Vert. Grain on Maple	Vert. Grain on Cherry	Vert. Grain on Hickory	Vert. Grain on Oak	Thermofoil
box color	box color	box color	box color	box color	box color	box color

OUTSIDE CORNER



OCM8

- One 8' section.

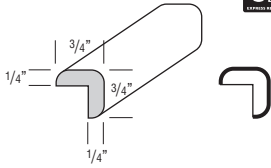

Finish Techniques

Distressing	Heirlooming
-------------	-------------

Species Availability (Wood)

Alder	Rustic Alder	Cherry	Hickory	Rustic Hickory	Maple	Oak
•	Alder	•	•	Hickory	•	•

Species Availability (All Laminates)

High Gloss	Horiz. Grain on Maple	Vert. Grain on Maple	Vert. Grain on Cherry	Vert. Grain on Hickory	Vert. Grain on Oak	Thermofoil
box color	box color	box color	box color	box color	box color	box color

OUTSIDE CORNER, PREMIUM



OCM8P

- One 8' section.
- Horizontal grain except on High Gloss.

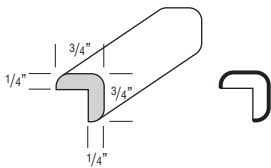

Finish Techniques

Distressing	Heirlooming
-------------	-------------

Species Availability (Wood)

Alder	Rustic Alder	Cherry	Hickory	Rustic Hickory	Maple	Oak

Species Availability (All Laminates)

High Gloss	Horiz. Grain on Maple	Vert. Grain on Maple	Vert. Grain on Cherry	Vert. Grain on Hickory	Vert. Grain on Oak	Thermofoil
•	•	•	•	•	•	

OUTSIDE CORNER 135°



OC135

- One 8' section.

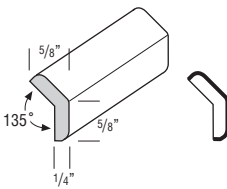

Finish Techniques

Distressing	Heirlooming
-------------	-------------

Species Availability (Wood)

Alder	Rustic Alder	Cherry	Hickory	Rustic Hickory	Maple	Oak
•	Alder	•	•	Hickory	•	•

Species Availability (All Laminates)

High Gloss	Horiz. Grain on Maple	Vert. Grain on Maple	Vert. Grain on Cherry	Vert. Grain on Hickory	Vert. Grain on Oak	Thermofoil
box color	box color	box color	box color	box color	box color	box color

DESCRIPTION

MODEL

QUARTER ROUND Moulding



QRM

- One 8' section.

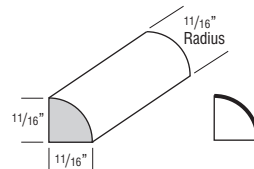

Finish Techniques

Distressing	Heirlooming
-------------	-------------

Species Availability (Wood)

Alder	Rustic Alder	Cherry	Hickory	Rustic Hickory	Maple	Oak
•	Alder	•	•	Hickory	•	•

Species Availability (All Laminates)

High Gloss	Horiz. Grain on Maple	Vert. Grain on Maple	Vert. Grain on Cherry	Vert. Grain on Hickory	Vert. Grain on Oak	Thermofoil
box color	box color	box color	box color	box color	box color	box color

SHOE - CONVEX INSIDE CORNER



SHM8

- One 8' section.

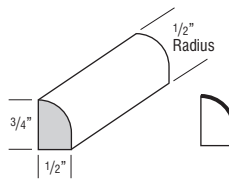

Finish Techniques

Distressing	Heirlooming
-------------	-------------

Species Availability (Wood)

Alder	Rustic Alder	Cherry	Hickory	Rustic Hickory	Maple	Oak
•	Alder	•	•	Hickory	•	•

Species Availability (All Laminates)

High Gloss	Horiz. Grain on Maple	Vert. Grain on Maple	Vert. Grain on Cherry	Vert. Grain on Hickory	Vert. Grain on Oak	Thermofoil
box color	box color	box color	box color	box color	box color	box color

DESCRIPTION MODEL
VALANCES

ARCHED VALANCE

5 DAY **AV36**
AV48
AV60
AV72

- Side shoulders are 8" wide (6" trimmable each end).
- Bottom edge has 3/16" radius.
- 3/4" thick.

Finish Techniques

Distressing	Heirlooming
•	•

Species Availability (Wood)

Alder	Rustic Alder	Cherry	Hickory	Rustic Hickory	Maple	Oak
•	•	•	•	•	•	•

Species Availability (All Laminates)

High Gloss box color	Horiz. Grain on Maple box color	Vert. Grain on Maple box color	Vert. Grain on Cherry box color	Vert. Grain on Hickory box color	Vert. Grain on Oak box color	Thermofoil box color
----------------------	---------------------------------	--------------------------------	---------------------------------	----------------------------------	------------------------------	----------------------

FURNITURE VALANCE

5 DAY **FV36**
FV48
FV60
FV72

- Side shoulders are 8" wide (6" trimmable each end).
- Bottom edge has 3/16" radius profile on face.
- 3/4" thick.

Finish Techniques

Distressing	Heirlooming
•	•

Species Availability (Wood)

Alder	Rustic Alder	Cherry	Hickory	Rustic Hickory	Maple	Oak
•	•	•	•	•	•	•

Species Availability (All Laminates)

High Gloss box color	Horiz. Grain on Maple box color	Vert. Grain on Maple box color	Vert. Grain on Cherry box color	Vert. Grain on Hickory box color	Vert. Grain on Oak box color	Thermofoil box color
----------------------	---------------------------------	--------------------------------	---------------------------------	----------------------------------	------------------------------	----------------------

RAISED PANEL ARCH VALANCE

JRPV30
JRPV36
JRPV42
JRPV48
JRPV54
JRPV60
JRPV72

Glaze in Corners of Inside Profile

- Trimmable up to 1 3/4" per side.
- Recommended for use with hearths, see page 149.
- Center height 8".
- Raised panel profile is unique to this item and does not match any door style.
- Ends are pocket drilled for installation to adjacent cabinets.

Finish Techniques

Distressing	Heirlooming
•	•

Species Availability (Wood)

Alder	Rustic Alder	Cherry	Hickory	Rustic Hickory	Maple	Oak
•	•	•	•	•	•	•

Species Availability (All Laminates)

High Gloss box color	Horiz. Grain on Maple box color	Vert. Grain on Maple box color	Vert. Grain on Cherry box color	Vert. Grain on Hickory box color	Vert. Grain on Oak box color	Thermofoil box color
----------------------	---------------------------------	--------------------------------	---------------------------------	----------------------------------	------------------------------	----------------------

DESCRIPTION MODEL

RECESSED PANEL ARCH VALANCE

JRCPV30
JRCPV36
JRCPV42
JRCPV48
JRCPV54
JRCPV60
JRCPV72

Glaze in Corners of Inside Profile

- Trimmable up to 1 3/4" per side.
- Recommended for use with hearths, see page 149.
- Center height 8".
- Ends are pocket drilled for installation to adjacent cabinets.

Finish Techniques

Distressing	Heirlooming
•	•

Species Availability (Wood)

Alder	Rustic Alder	Cherry	Hickory	Rustic Hickory	Maple	Oak
•	•	•	•	•	•	•

Species Availability (All Laminates)

High Gloss box color	Horiz. Grain on Maple box color	Vert. Grain on Maple box color	Vert. Grain on Cherry box color	Vert. Grain on Hickory box color	Vert. Grain on Oak box color	Thermofoil box color
----------------------	---------------------------------	--------------------------------	---------------------------------	----------------------------------	------------------------------	----------------------

SCALLOPED VALANCE

5 DAY **SV48**

- Trimmable.
- 3/4" thick.

Finish Techniques

Distressing	Heirlooming
•	•

Species Availability (Wood)

Alder	Rustic Alder	Cherry	Hickory	Rustic Hickory	Maple	Oak
•	•	•	•	•	•	•

Species Availability (All Laminates)

High Gloss box color	Horiz. Grain on Maple box color	Vert. Grain on Maple box color	Vert. Grain on Cherry box color	Vert. Grain on Hickory box color	Vert. Grain on Oak box color	Thermofoil box color
----------------------	---------------------------------	--------------------------------	---------------------------------	----------------------------------	------------------------------	----------------------

STRAIGHT VALANCE

5 DAY **VV48**
VV72
VV96
VV120 ♦

- Trimmable.
- 3/4" thick.

Finish Techniques

Distressing	Heirlooming
•	•

Species Availability (Wood)

Alder	Rustic Alder	Cherry	Hickory	Rustic Hickory	Maple	Oak
•	•	•	•	•	•	•

♦ Only available in Cherry and Maple.

Species Availability (All Laminates)

High Gloss box color	Horiz. Grain on Maple box color	Vert. Grain on Maple box color	Vert. Grain on Cherry box color	Vert. Grain on Hickory box color	Vert. Grain on Oak box color	Thermofoil box color
----------------------	---------------------------------	--------------------------------	---------------------------------	----------------------------------	------------------------------	----------------------

♦ Only available in Cherry and Maple box colors.

Finished edges indicated by bold lines on side view drawings.
Glazed edges indicated by arrows in side view drawings.

DESCRIPTION MODEL
DECORATIVE OVERLAYS

ACANTHUS OVERLAY



ACOVLV

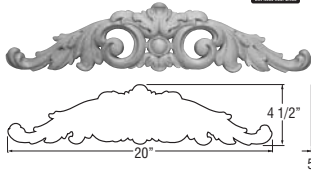

- Apply with small brad.
- Cannot be installed on valances.



Finish Techniques	
Distressing	Heirlooming
	•

Species Availability (Wood)

Alder	Rustic Alder	Cherry	Hickory	Rustic Hickory	Maple	Oak
•	Alder	•			•	

Species Availability (All Laminates)

High Gloss box color	Horiz. Grain on Maple box color	Vert. Grain on Maple box color	Vert. Grain on Cherry box color	Vert. Grain on Hickory	Vert. Grain on Oak	Thermofoil box color

CELTIC OVERLAY



JCELOVLY

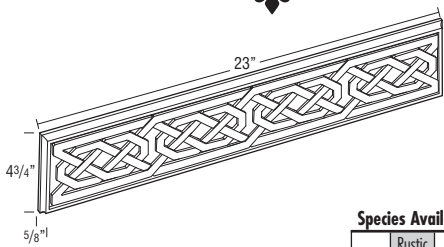

Finish Techniques	
Distressing	Heirlooming
	•

Species Availability (Wood)

Alder	Rustic Alder	Cherry	Hickory	Rustic Hickory	Maple	Oak
		•			•	•

Species Availability (All Laminates)

High Gloss box color	Horiz. Grain on Maple box color	Vert. Grain on Maple box color	Vert. Grain on Cherry box color	Vert. Grain on Hickory	Vert. Grain on Oak	Thermofoil box color

DECORATIVE ORNAMENTS

ACANTHUS ORNAMENT



ACO

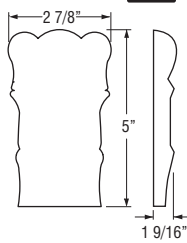

- Apply with small brad.

Finish Techniques	
Distressing	Heirlooming
	•

Species Availability (Wood)

Alder	Rustic Alder	Cherry	Hickory	Rustic Hickory	Maple	Oak
		•			•	

Species Availability (All Laminates)

High Gloss box color	Horiz. Grain on Maple box color	Vert. Grain on Maple box color	Vert. Grain on Cherry box color	Vert. Grain on Hickory	Vert. Grain on Oak	Thermofoil box color

DESCRIPTION MODEL

MISSION ROSETTE



ROSETTEMIS

- Apply with small brad.

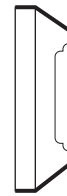
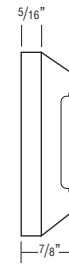
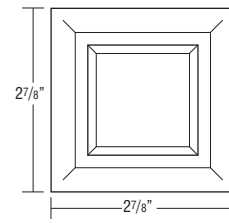

Finish Techniques	
Distressing	Heirlooming
	•

Species Availability (Wood)

Alder	Rustic Alder	Cherry	Hickory	Rustic Hickory	Maple	Oak
•	Alder	•			•	•

Species Availability (All Laminates)

High Gloss box color	Horiz. Grain on Maple box color	Vert. Grain on Maple box color	Vert. Grain on Cherry box color	Vert. Grain on Hickory	Vert. Grain on Oak	Thermofoil box color

SCROLL ROSETTE



ROSETTESCR

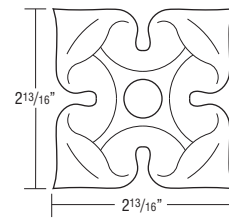

Finish Techniques	
Distressing	Heirlooming
	•

Species Availability (Wood)

Alder	Rustic Alder	Cherry	Hickory	Rustic Hickory	Maple	Oak
•	Alder	•			•	•

Species Availability (All Laminates)

High Gloss box color	Horiz. Grain on Maple box color	Vert. Grain on Maple box color	Vert. Grain on Cherry box color	Vert. Grain on Hickory	Vert. Grain on Oak	Thermofoil box color

TRADITIONAL ROSETTE



TROSETTE

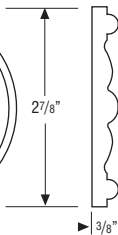
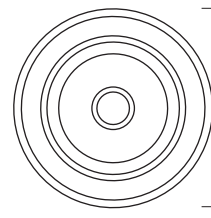

Finish Techniques	
Distressing	Heirlooming
	•

Species Availability (Wood)

Alder	Rustic Alder	Cherry	Hickory	Rustic Hickory	Maple	Oak
Cherry	Cherry	•	Beech	Beech	•	Beech

Species Availability (All Laminates)

High Gloss box color	Horiz. Grain on Maple box color	Vert. Grain on Maple box color	Vert. Grain on Cherry box color	Vert. Grain on Hickory	Vert. Grain on Oak	Thermofoil box color

Finished edges indicated by bold lines on side view drawings.
Glazed edges indicated by arrows on side view drawings.

DESCRIPTION

MODEL

CORNER ROSETTE, 3"



FFRC3X3 (Fluted)
BFRC3X3 (Beaded)

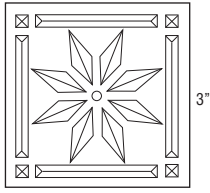

Back Views of Rosette

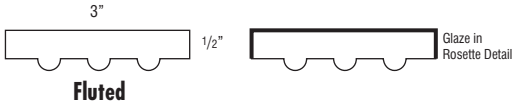

Fluted

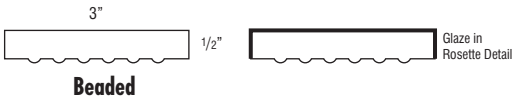

Beaded

Finish Techniques

Distressing	Heirlooming
	•

Species Availability (Wood)

Alder	Rustic Alder	Cherry	Hickory	Rustic Hickory	Maple	Oak
•	Alder	•	•	Hickory	•	•

Species Availability (All Laminates)

High Gloss box color	Horiz. Grain on Maple box color	Vert. Grain on Maple box color	Vert. Grain on Cherry box color	Vert. Grain on Hickory box color	Vert. Grain on Oak box color	Thermofoil box color
----------------------	---------------------------------	--------------------------------	---------------------------------	----------------------------------	------------------------------	----------------------

CELTIC ROSETTE



ROSETTCEL

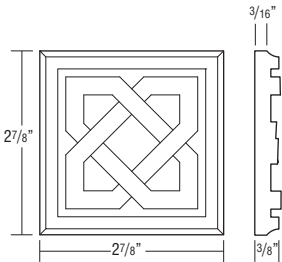

Glaze in Celtic Detail

Finish Techniques

Distressing	Heirlooming
	•

Species Availability (Wood)

Alder	Rustic Alder	Cherry	Hickory	Rustic Hickory	Maple	Oak
		•			•	•

Species Availability (All Laminates)

High Gloss box color	Horiz. Grain on Maple box color	Vert. Grain on Maple box color	Vert. Grain on Cherry box color	Vert. Grain on Hickory box color	Vert. Grain on Oak box color	Thermofoil box color
----------------------	---------------------------------	--------------------------------	---------------------------------	----------------------------------	------------------------------	----------------------

DESCRIPTION

MODEL

PLINTH BLOCK FILLER, 3"



FFP3X8 (Fluted)
BFPC3X8 (Beaded)

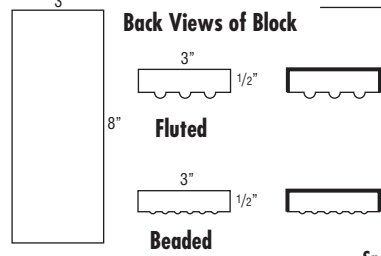

Back Views of Block

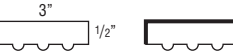

Fluted

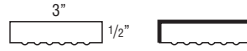

Beaded

Finish Techniques

Distressing	Heirlooming
	•

Species Availability (Wood)

Alder	Rustic Alder	Cherry	Hickory	Rustic Hickory	Maple	Oak
•	Alder	•			•	•

Species Availability (All Laminates)

High Gloss box color	Horiz. Grain on Maple box color	Vert. Grain on Maple box color	Vert. Grain on Cherry box color	Vert. Grain on Hickory box color	Vert. Grain on Oak box color	Thermofoil box color
----------------------	---------------------------------	--------------------------------	---------------------------------	----------------------------------	------------------------------	----------------------

CORNER ROSETTE, 6"



FFRC6X6 (Fluted)

- Available only as fluted.

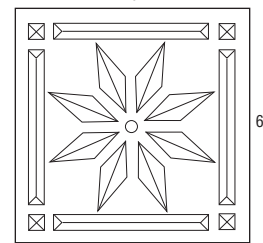

Back View of Rosette



Glaze in Rosette Detail

Finish Techniques

Distressing	Heirlooming
	•

Species Availability (Wood)

Alder	Rustic Alder	Cherry	Hickory	Rustic Hickory	Maple	Oak
•	Alder	•	•	Hickory	•	•

Species Availability (All Laminates)

High Gloss box color	Horiz. Grain on Maple box color	Vert. Grain on Maple box color	Vert. Grain on Cherry box color	Vert. Grain on Hickory box color	Vert. Grain on Oak box color	Thermofoil box color
----------------------	---------------------------------	--------------------------------	---------------------------------	----------------------------------	------------------------------	----------------------

Finished edges indicated by bold lines on side view drawings.
Glazed edges indicated by arrows on side view drawings.

DESCRIPTION

MODEL

ACANTHUS TILE

JTILEACAN

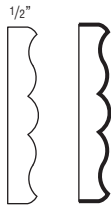
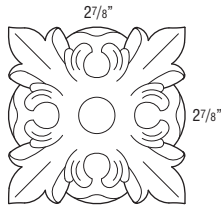

Glaze in Acanthus Detail

Finish Techniques

Distressing	Heirloom
	•

Species Availability (Wood)

Alder	Rustic Alder	Cherry	Hickory	Rustic Hickory	Maple	Oak
•	Alder	•			•	•

Species Availability (All Laminates)

High Gloss box color	Horiz. Grain on Maple box color	Vert. Grain on Maple box color	Vert. Grain on Cherry box color	Vert. Grain on Hickory	Vert. Grain on Oak box color	Thermofoil box color
----------------------	---------------------------------	--------------------------------	---------------------------------	------------------------	------------------------------	----------------------

MISSION TILE

JTILEMISSION

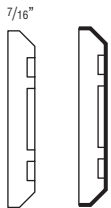
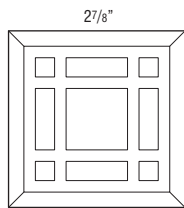

Glaze in Mission Detail

Finish Techniques

Distressing	Heirloom
	•

Species Availability (Wood)

Alder	Rustic Alder	Cherry	Hickory	Rustic Hickory	Maple	Oak
•	Alder	•			•	•

Species Availability (All Laminates)

High Gloss box color	Horiz. Grain on Maple box color	Vert. Grain on Maple box color	Vert. Grain on Cherry box color	Vert. Grain on Hickory	Vert. Grain on Oak box color	Thermofoil box color
----------------------	---------------------------------	--------------------------------	---------------------------------	------------------------	------------------------------	----------------------

PLINTH BLOCK FILLER, 6"



FFP6X8 (Fluted)

• Available only as fluted.

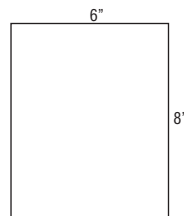

Back View of Block

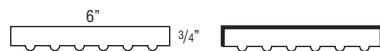

Finish Techniques

Distressing	Heirloom
	•

Species Availability (Wood)

Alder	Rustic Alder	Cherry	Hickory	Rustic Hickory	Maple	Oak
•	Alder	•	•	Hickory	•	•

Species Availability (All Laminates)

High Gloss box color	Horiz. Grain on Maple box color	Vert. Grain on Maple box color	Vert. Grain on Cherry box color	Vert. Grain on Hickory box color	Vert. Grain on Oak box color	Thermofoil box color
----------------------	---------------------------------	--------------------------------	---------------------------------	----------------------------------	------------------------------	----------------------

DESCRIPTION

MODEL

DECORATIVE SUPPORTS

ACANTHUS LEG, 35 1/4" HIGH



JACANTHUSLEG

• Trimmable.

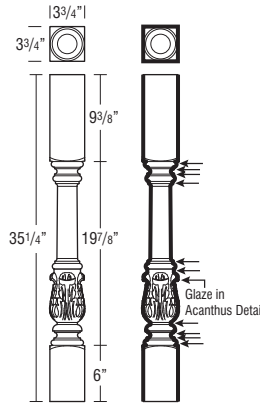

Finish Techniques

Distressing	Heirloom
	•

Species Availability (Wood)

Alder	Rustic Alder	Cherry	Hickory	Rustic Hickory	Maple	Oak
•	Alder	•			•	•

Species Availability (All Laminates)

High Gloss box color	Horiz. Grain on Maple box color	Vert. Grain on Maple box color	Vert. Grain on Cherry box color	Vert. Grain on Hickory	Vert. Grain on Oak box color	Thermofoil box color
----------------------	---------------------------------	--------------------------------	---------------------------------	------------------------	------------------------------	----------------------

BAR LEG, 2-SIDED, 42 1/4" HIGH



2SBARLEG

• Trimmable.

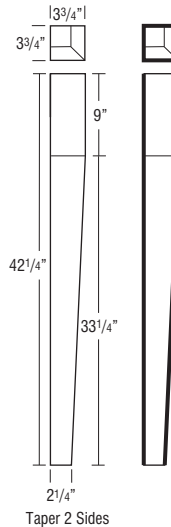

Finish Techniques

Distressing	Heirloom
	•

Species Availability (Wood)

Alder	Rustic Alder	Cherry	Hickory	Rustic Hickory	Maple	Oak
•	Alder	•			•	•

Species Availability (All Laminates)

High Gloss box color	Horiz. Grain on Maple box color	Vert. Grain on Maple box color	Vert. Grain on Cherry box color	Vert. Grain on Hickory	Vert. Grain on Oak box color	Thermofoil box color
----------------------	---------------------------------	--------------------------------	---------------------------------	------------------------	------------------------------	----------------------

Taper 2 Sides

Finished edges indicated by bold lines on side view drawings.
Glazed edges indicated by arrows on side view drawings.

DESCRIPTION

MODEL

**BAR LEG, 4-SIDED,
42 1/4" HIGH**



4SBARLEG

- Trimmable.

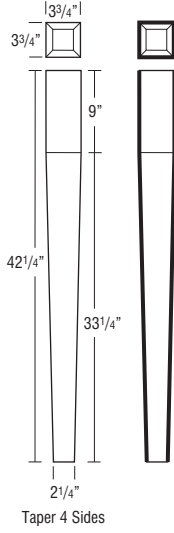

Finish Techniques

Distressing	Heirlooming
	•

Species Availability (Wood)

Alder	Rustic Alder	Cherry	Hickory	Rustic Hickory	Maple	Oak
•	Alder	•			•	•

Species Availability (All Laminates)

High Gloss	Horiz. Grain on Maple	Vert. Grain on Maple	Vert. Grain on Cherry	Vert. Grain on Hickory	Vert. Grain on Oak	Thermofoil
box color	box color	box color	box color		box color	box color

**BAROQUE LEG,
34 1/2" HIGH**



JBAROQUELEG

- Trimmable.
- Leg is designed with three pieces. Field assembly required.

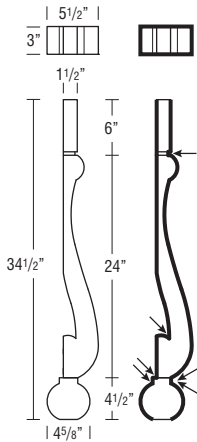

Finish Techniques

Distressing	Heirlooming
	•

Species Availability (Wood)

Alder	Rustic Alder	Cherry	Hickory	Rustic Hickory	Maple	Oak
•	Alder	•			•	•

Species Availability (All Laminates)

High Gloss	Horiz. Grain on Maple	Vert. Grain on Maple	Vert. Grain on Cherry	Vert. Grain on Hickory	Vert. Grain on Oak	Thermofoil
box color	box color	box color	box color			box color

DESCRIPTION

MODEL

**BUFFET LEG,
34 1/2" HIGH**



JBUFFETLEG

- Trimmable.

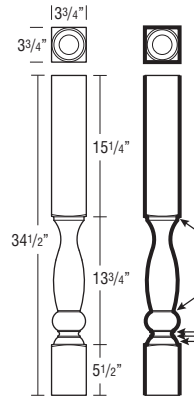

Finish Techniques

Distressing	Heirlooming
	•

Species Availability (Wood)

Alder	Rustic Alder	Cherry	Hickory	Rustic Hickory	Maple	Oak
•	Alder	•			•	•

Species Availability (All Laminates)

High Gloss	Horiz. Grain on Maple	Vert. Grain on Maple	Vert. Grain on Cherry	Vert. Grain on Hickory	Vert. Grain on Oak	Thermofoil
box color	box color	box color	box color		box color	box color

**COSMO LEG,
35 1/4" HIGH**



JCOSMOLEG

- Trimmable.
- Leg is designed with three pieces joined together.

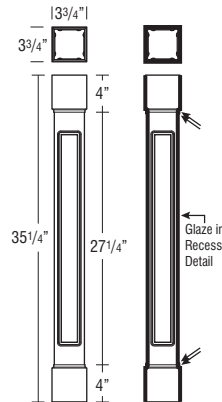

Finish Techniques

Distressing	Heirlooming
	•

Species Availability (Wood)

Alder	Rustic Alder	Cherry	Hickory	Rustic Hickory	Maple	Oak
•	Alder	•			•	•

Species Availability (All Laminates)

High Gloss	Horiz. Grain on Maple	Vert. Grain on Maple	Vert. Grain on Cherry	Vert. Grain on Hickory	Vert. Grain on Oak	Thermofoil
box color	box color	box color	box color		box color	box color

Finished edges indicated by bold lines on side view drawings.
Glazed edges indicated by arrows on side view drawings.

DESCRIPTION

MODEL

ENGLISH COUNTRY LEG, 35 1/4" HIGH



JENGNTYLEG

- Trimable.

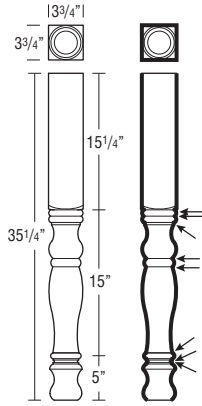

Finish Techniques

Distressing	Heirlooming
	•

Species Availability (Wood)

Alder	Rustic Alder	Cherry	Hickory	Rustic Hickory	Maple	Oak
•	Alder	•			•	•

Species Availability (All Laminates)

High Gloss	Horiz. Grain on Maple	Vert. Grain on Maple	Vert. Grain on Cherry	Vert. Grain on Hickory	Vert. Grain on Oak	Thermofoil
box color	box color	box color	box color		box color	box color

DESCRIPTION

MODEL

ENGLISH ISLAND COLUMN, 5" WIDE, 35 1/4" HIGH



ENGLISCOLUMN

- Trimable.

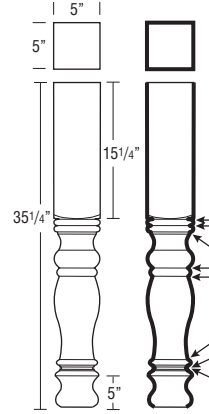

Finish Techniques

Distressing	Heirlooming
	•

Species Availability (Wood)

Alder	Rustic Alder	Cherry	Hickory	Rustic Hickory	Maple	Oak
•	Alder	•			•	•

Species Availability (All Laminates)

High Gloss	Horiz. Grain on Maple	Vert. Grain on Maple	Vert. Grain on Cherry	Vert. Grain on Hickory	Vert. Grain on Oak	Thermofoil
box color	box color	box color	box color		box color	box color

ENGLISH BAR COLUMN, 42 1/4" HIGH



ENGBARCOLUMN

- Trimable.

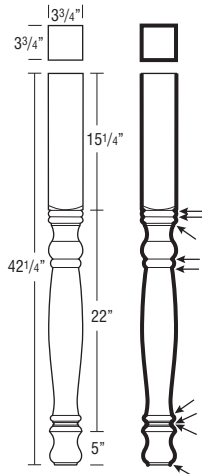

Finish Techniques

Distressing	Heirlooming
	•

Species Availability (Wood)

Alder	Rustic Alder	Cherry	Hickory	Rustic Hickory	Maple	Oak
•	Alder	•			•	•

Species Availability (All Laminates)

High Gloss	Horiz. Grain on Maple	Vert. Grain on Maple	Vert. Grain on Cherry	Vert. Grain on Hickory	Vert. Grain on Oak	Thermofoil
box color	box color	box color	box color		box color	box color

SMALL ESTATE LEG, 2 3/4" WIDE, 35 1/4" HIGH



JESTATELEGS

- Trimable.

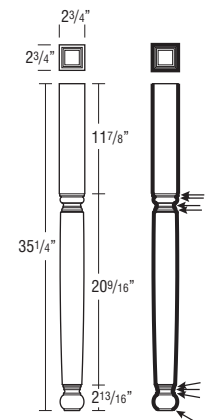

Finish Techniques

Distressing	Heirlooming
	•

Species Availability (Wood)

Alder	Rustic Alder	Cherry	Hickory	Rustic Hickory	Maple	Oak
•	Alder	•			•	•

Species Availability (All Laminates)

High Gloss	Horiz. Grain on Maple	Vert. Grain on Maple	Vert. Grain on Cherry	Vert. Grain on Hickory	Vert. Grain on Oak	Thermofoil
box color	box color	box color	box color		box color	box color

Finished edges indicated by bold lines on side view drawings.
Glazed edges indicated by arrows on side view drawings.

DESCRIPTION

MODEL

SMALL ESTATE LEG SPLIT, 2 3/4" WIDE, 35 1/4" HIGH



JESTATELEGSS

- Trimmable.

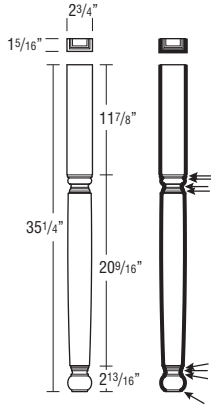

Finish Techniques

Distressing	Heirlooming
	•

Species Availability (Wood)

Alder	Rustic Alder	Cherry	Hickory	Rustic Hickory	Maple	Oak
•	Alder	•			•	•

Species Availability (All Laminates)

High Gloss box color	Horiz. Grain on Maple box color	Vert. Grain on Maple box color	Vert. Grain on Cherry box color	Vert. Grain on Hickory	Vert. Grain on Oak box color	Thermofoil box color
----------------------	---------------------------------	--------------------------------	---------------------------------	------------------------	------------------------------	----------------------

ESTATE LEG, 35 1/4" HIGH



JESTATELEG

- Trimmable.

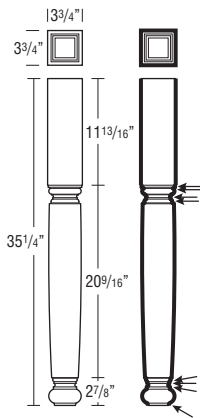

Finish Techniques

Distressing	Heirlooming
	•

Species Availability (Wood)

Alder	Rustic Alder	Cherry	Hickory	Rustic Hickory	Maple	Oak
•	Alder	•			•	•

Species Availability (All Laminates)

High Gloss box color	Horiz. Grain on Maple box color	Vert. Grain on Maple box color	Vert. Grain on Cherry box color	Vert. Grain on Hickory	Vert. Grain on Oak box color	Thermofoil box color
----------------------	---------------------------------	--------------------------------	---------------------------------	------------------------	------------------------------	----------------------

DESCRIPTION

MODEL

SMALL CLASSIC FLUTED LEG, 2 3/4" WIDE, 35 1/4" HIGH



JFLUTELEGS

- Trimmable.

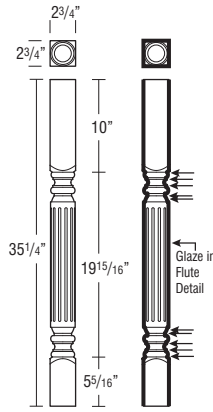

Finish Techniques

Distressing	Heirlooming
	•

Species Availability (Wood)

Alder	Rustic Alder	Cherry	Hickory	Rustic Hickory	Maple	Oak
•	Alder	•			•	•

Species Availability (All Laminates)

High Gloss box color	Horiz. Grain on Maple box color	Vert. Grain on Maple box color	Vert. Grain on Cherry box color	Vert. Grain on Hickory	Vert. Grain on Oak box color	Thermofoil box color
----------------------	---------------------------------	--------------------------------	---------------------------------	------------------------	------------------------------	----------------------

SMALL CLASSIC FLUTED LEG SPLIT, 2 3/4" WIDE, 35 1/4" HIGH



JFLUTELEGSS

- Trimmable.

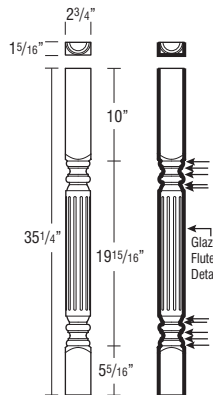

Finish Techniques

Distressing	Heirlooming
	•

Species Availability (Wood)

Alder	Rustic Alder	Cherry	Hickory	Rustic Hickory	Maple	Oak
•	Alder	•			•	•

Species Availability (All Laminates)

High Gloss box color	Horiz. Grain on Maple box color	Vert. Grain on Maple box color	Vert. Grain on Cherry box color	Vert. Grain on Hickory	Vert. Grain on Oak box color	Thermofoil box color
----------------------	---------------------------------	--------------------------------	---------------------------------	------------------------	------------------------------	----------------------

Finished edges indicated by bold lines on side view drawings.
Glazed edges indicated by arrows on side view drawings.

DESCRIPTION

MODEL

**CLASSIC FLUTED LEG,
35 1/4" HIGH**



JFLUTELEG

- Trimable.

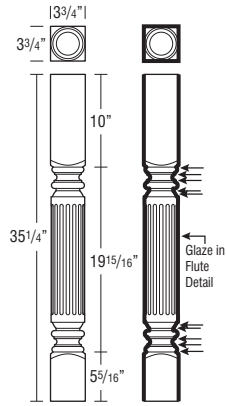

Finish Techniques

Distressing	Heirlooming
	•

Species Availability (Wood)

Alder	Rustic Alder	Cherry	Hickory	Rustic Hickory	Maple	Oak
•	Alder	•			•	•

Species Availability (All Laminates)

High Gloss box color	Horiz. Grain on Maple box color	Vert. Grain on Maple box color	Vert. Grain on Cherry box color	Vert. Grain on Hickory	Vert. Grain on Oak box color	Thermofoil box color
-------------------------	---------------------------------------	--------------------------------------	---------------------------------------	---------------------------	------------------------------------	-------------------------

DESCRIPTION

MODEL

**CLASSIC FLUTED LEG,
5" WIDE, 35 1/4" HIGH**



JFLUTEGL

- Trimable.

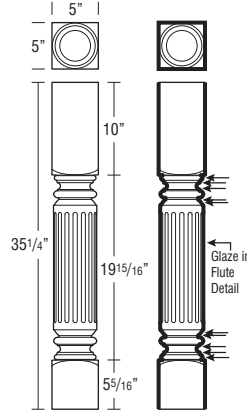

Finish Techniques

Distressing	Heirlooming
	•

Species Availability (Wood)

Alder	Rustic Alder	Cherry	Hickory	Rustic Hickory	Maple	Oak
•	Alder	•			•	•

Species Availability (All Laminates)

High Gloss box color	Horiz. Grain on Maple box color	Vert. Grain on Maple box color	Vert. Grain on Cherry box color	Vert. Grain on Hickory	Vert. Grain on Oak box color	Thermofoil box color
-------------------------	---------------------------------------	--------------------------------------	---------------------------------------	---------------------------	------------------------------------	-------------------------

**CLASSIC FLUTED LEG,
42 1/4" HIGH**



JFLUTELEG

- Trimable.

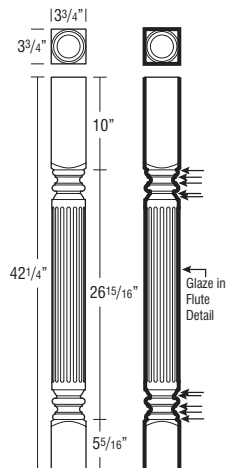

Finish Techniques

Distressing	Heirlooming
	•

Species Availability (Wood)

Alder	Rustic Alder	Cherry	Hickory	Rustic Hickory	Maple	Oak
•	Alder	•			•	•

Species Availability (All Laminates)

High Gloss box color	Horiz. Grain on Maple box color	Vert. Grain on Maple box color	Vert. Grain on Cherry box color	Vert. Grain on Hickory	Vert. Grain on Oak box color	Thermofoil box color
-------------------------	---------------------------------------	--------------------------------------	---------------------------------------	---------------------------	------------------------------------	-------------------------

**FRENCH COUNTRY LEG,
35 1/4" HIGH**



JFRNCNTLEG

- Trimable.

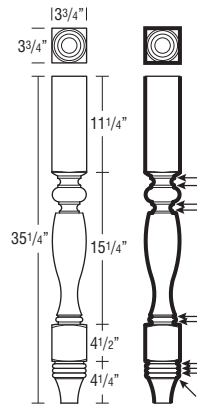

Finish Techniques

Distressing	Heirlooming
	•

Species Availability (Wood)

Alder	Rustic Alder	Cherry	Hickory	Rustic Hickory	Maple	Oak
•	Alder	•			•	•

Species Availability (All Laminates)

High Gloss box color	Horiz. Grain on Maple box color	Vert. Grain on Maple box color	Vert. Grain on Cherry box color	Vert. Grain on Hickory	Vert. Grain on Oak box color	Thermofoil box color
-------------------------	---------------------------------------	--------------------------------------	---------------------------------------	---------------------------	------------------------------------	-------------------------

Finished edges indicated by bold lines on side view drawings.
Glazed edges indicated by arrows on side view drawings.

DESCRIPTION

MODEL

FRENCH COUNTRY LEG, 42 1/4" HIGH



JFRNCNTYLEGT

- Trimmable.

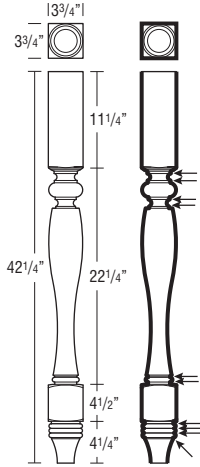

Finish Techniques

Distressing	Heirlooming
	•

Species Availability (Wood)

Alder	Rustic Alder	Cherry	Hickory	Rustic Hickory	Maple	Oak
•	Alder	•			•	•

Species Availability (All Laminates)

High Gloss box color	Horiz. Grain on Maple box color	Vert. Grain on Maple box color	Vert. Grain on Cherry box color	Vert. Grain on Hickory	Vert. Grain on Oak box color	Thermofoil box color
----------------------	---------------------------------	--------------------------------	---------------------------------	------------------------	------------------------------	----------------------

FRENCH COUNTRY LEG, 5" WIDE, 35 1/4" HIGH



JFRNCNTYLEGL

- Trimmable.

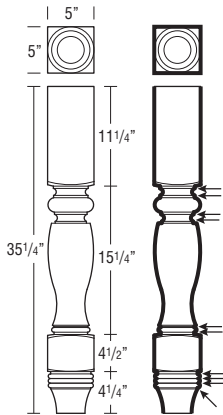

Finish Techniques

Distressing	Heirlooming
	•

Species Availability (Wood)

Alder	Rustic Alder	Cherry	Hickory	Rustic Hickory	Maple	Oak
•	Alder	•			•	•

Species Availability (All Laminates)

High Gloss box color	Horiz. Grain on Maple box color	Vert. Grain on Maple box color	Vert. Grain on Cherry box color	Vert. Grain on Hickory	Vert. Grain on Oak box color	Thermofoil box color
----------------------	---------------------------------	--------------------------------	---------------------------------	------------------------	------------------------------	----------------------

DESCRIPTION

MODEL

ISLAND LEG, 2-SIDED, 35 1/4" HIGH



2SISLEGT

- Trimmable.

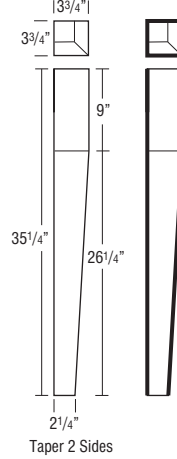

Finish Techniques

Distressing	Heirlooming
	•

Species Availability (Wood)

Alder	Rustic Alder	Cherry	Hickory	Rustic Hickory	Maple	Oak
•	Alder	•			•	•

Species Availability (All Laminates)

High Gloss box color	Horiz. Grain on Maple box color	Vert. Grain on Maple box color	Vert. Grain on Cherry box color	Vert. Grain on Hickory	Vert. Grain on Oak box color	Thermofoil box color
----------------------	---------------------------------	--------------------------------	---------------------------------	------------------------	------------------------------	----------------------

ISLAND LEG, 4-SIDED, 35 1/4" HIGH



4SISLEGT

- Trimmable.

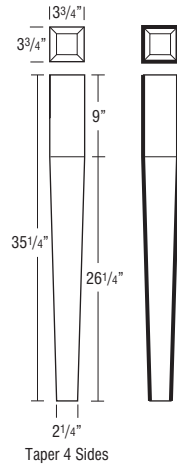

Finish Techniques

Distressing	Heirlooming
	•

Species Availability (Wood)

Alder	Rustic Alder	Cherry	Hickory	Rustic Hickory	Maple	Oak
•	Alder	•			•	•

Species Availability (All Laminates)

High Gloss box color	Horiz. Grain on Maple box color	Vert. Grain on Maple box color	Vert. Grain on Cherry box color	Vert. Grain on Hickory	Vert. Grain on Oak box color	Thermofoil box color
----------------------	---------------------------------	--------------------------------	---------------------------------	------------------------	------------------------------	----------------------

Finished edges indicated by bold lines on side view drawings.
Glazed edges indicated by arrows on side view drawings.

DESCRIPTION

MODEL

**METRO BAR COLUMN,
42 1/4" HIGH**



METBARCOLUMN

- Trimmable.
- Leg is designed with three pieces joined together.

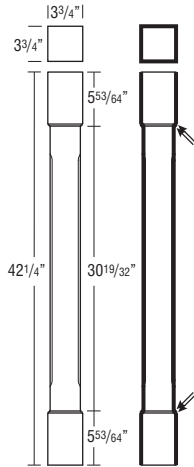

Finish Techniques

Distressing	Heirlooming
	•

Species Availability (Wood)

Alder	Rustic Alder	Cherry	Hickory	Rustic Hickory	Maple	Oak
•	Alder	•			•	•

Species Availability (All Laminates)

High Gloss box color	Horiz. Grain on Maple box color	Vert. Grain on Maple box color	Vert. Grain on Cherry box color	Vert. Grain on Hickory	Vert. Grain on Oak box color	Thermofoil box color
-------------------------	---------------------------------------	--------------------------------------	---------------------------------------	---------------------------	------------------------------------	-------------------------

**METRO ISLAND COLUMN,
34 5/8" HIGH**



METISLCOLUMN

- Trimmable.
- Leg is designed with three pieces joined together.

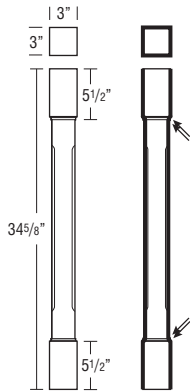

Finish Techniques

Distressing	Heirlooming
	•

Species Availability (Wood)

Alder	Rustic Alder	Cherry	Hickory	Rustic Hickory	Maple	Oak
•	Alder	•			•	•

Species Availability (All Laminates)

High Gloss box color	Horiz. Grain on Maple box color	Vert. Grain on Maple box color	Vert. Grain on Cherry box color	Vert. Grain on Hickory	Vert. Grain on Oak box color	Thermofoil box color
-------------------------	---------------------------------------	--------------------------------------	---------------------------------------	---------------------------	------------------------------------	-------------------------

DESCRIPTION

MODEL

**MISSION LEG,
34 1/2" HIGH**



DLEMISSION

- Trimmable.

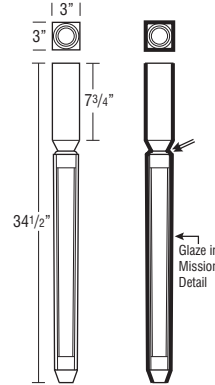

Finish Techniques

Distressing	Heirlooming
	•

Species Availability (Wood)

Alder	Rustic Alder	Cherry	Hickory	Rustic Hickory	Maple	Oak
•	Alder	•			•	•

Species Availability (All Laminates)

High Gloss box color	Horiz. Grain on Maple box color	Vert. Grain on Maple box color	Vert. Grain on Cherry box color	Vert. Grain on Hickory	Vert. Grain on Oak box color	Thermofoil box color
-------------------------	---------------------------------------	--------------------------------------	---------------------------------------	---------------------------	------------------------------------	-------------------------

**QUEEN ANNE LEG,
42 1/4" HIGH**



JQUNANNELEG

- Trimmable.

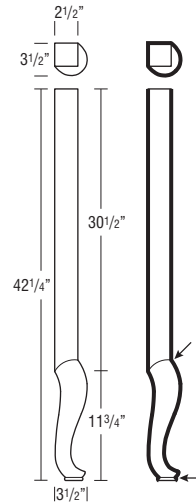

Finish Techniques

Distressing	Heirlooming
	•

Species Availability (Wood)

Alder	Rustic Alder	Cherry	Hickory	Rustic Hickory	Maple	Oak
•	Alder	•			•	•

Species Availability (All Laminates)

High Gloss box color	Horiz. Grain on Maple box color	Vert. Grain on Maple box color	Vert. Grain on Cherry box color	Vert. Grain on Hickory	Vert. Grain on Oak box color	Thermofoil box color
-------------------------	---------------------------------------	--------------------------------------	---------------------------------------	---------------------------	------------------------------------	-------------------------

Finished edges indicated by bold lines on side view drawings.
Glazed edges indicated by arrows on side view drawings.

DESCRIPTION

MODEL

REED LEG, 34 1/2" HIGH



RDLEG

• Trimmable.

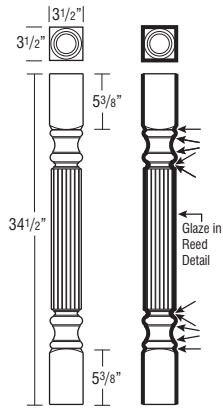

Finish Techniques

Distressing	Heirlooming
	•

Species Availability (Wood)

Alder	Rustic Alder	Cherry	Hickory	Rustic Hickory	Maple	Oak
•	Alder	•			•	•

Species Availability (All Laminates)

High Gloss box color	Horiz. Grain on Maple box color	Vert. Grain on Maple box color	Vert. Grain on Cherry box color	Vert. Grain on Hickory	Vert. Grain on Oak box color	Thermofoil box color
----------------------	---------------------------------	--------------------------------	---------------------------------	------------------------	------------------------------	----------------------

REED LEG, 40 1/2" HIGH



JRDLEGT

• Trimmable.

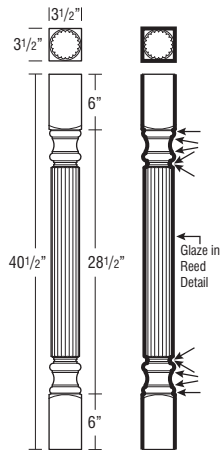

Finish Techniques

Distressing	Heirlooming
	•

Species Availability (Wood)

Alder	Rustic Alder	Cherry	Hickory	Rustic Hickory	Maple	Oak
•	Alder	•			•	•

Species Availability (All Laminates)

High Gloss box color	Horiz. Grain on Maple box color	Vert. Grain on Maple box color	Vert. Grain on Cherry box color	Vert. Grain on Hickory	Vert. Grain on Oak box color	Thermofoil box color
----------------------	---------------------------------	--------------------------------	---------------------------------	------------------------	------------------------------	----------------------

DESCRIPTION

MODEL

REED LEG, 5" WIDE, 34 1/2" HIGH



JRDLEGL

• Trimmable.

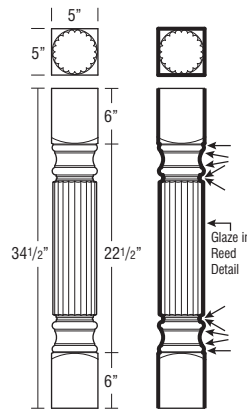

Finish Techniques

Distressing	Heirlooming
	•

Species Availability (Wood)

Alder	Rustic Alder	Cherry	Hickory	Rustic Hickory	Maple	Oak
•	Alder	•			•	•

Species Availability (All Laminates)

High Gloss box color	Horiz. Grain on Maple box color	Vert. Grain on Maple box color	Vert. Grain on Cherry box color	Vert. Grain on Hickory	Vert. Grain on Oak box color	Thermofoil box color
----------------------	---------------------------------	--------------------------------	---------------------------------	------------------------	------------------------------	----------------------

ROMAN WEAVE LEG, 35 1/4" HIGH



JWEAVEGL

• Trimmable.

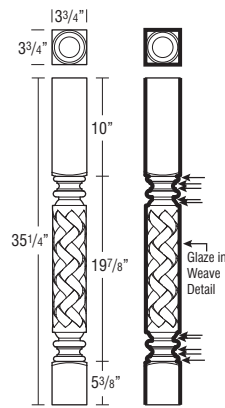

Finish Techniques

Distressing	Heirlooming
	•

Species Availability (Wood)

Alder	Rustic Alder	Cherry	Hickory	Rustic Hickory	Maple	Oak
•	Alder	•			•	•

Species Availability (All Laminates)

High Gloss box color	Horiz. Grain on Maple box color	Vert. Grain on Maple box color	Vert. Grain on Cherry box color	Vert. Grain on Hickory	Vert. Grain on Oak box color	Thermofoil box color
----------------------	---------------------------------	--------------------------------	---------------------------------	------------------------	------------------------------	----------------------

Finished edges indicated by bold lines on side view drawings.
Glazed edges indicated by arrows on side view drawings.

DESCRIPTION

MODEL

**ROMAN WEAVE LEG,
42 1/4" HIGH**



JWEAVELEGT

- Trimable.

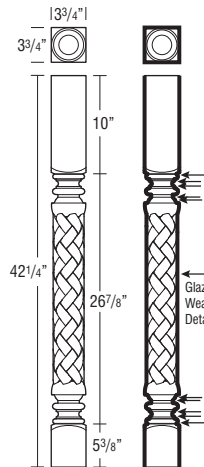

Finish Techniques

Distressing	Heirlooming
	•

Species Availability (Wood)

Alder	Rustic Alder	Cherry	Hickory	Rustic Hickory	Maple	Oak
•	Alder	•			•	•

Species Availability (All Laminates)

High Gloss box color	Horiz. Grain on Maple box color	Vert. Grain on Maple box color	Vert. Grain on Cherry box color	Vert. Grain on Hickory	Vert. Grain on Oak box color	Thermofoil box color
-------------------------	---------------------------------------	--------------------------------------	---------------------------------------	---------------------------	------------------------------------	-------------------------

DESCRIPTION

MODEL

**SMALL CLASSIC ROPE
LEG, 2 3/4" WIDE,
35 1/4" HIGH**



JROPELEGS

- Trimable.

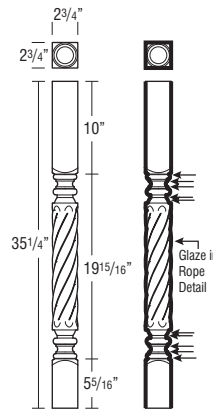

Finish Techniques

Distressing	Heirlooming
	•

Species Availability (Wood)

Alder	Rustic Alder	Cherry	Hickory	Rustic Hickory	Maple	Oak
•	Alder	•			•	•

Species Availability (All Laminates)

High Gloss box color	Horiz. Grain on Maple box color	Vert. Grain on Maple box color	Vert. Grain on Cherry box color	Vert. Grain on Hickory	Vert. Grain on Oak box color	Thermofoil box color
-------------------------	---------------------------------------	--------------------------------------	---------------------------------------	---------------------------	------------------------------------	-------------------------

**ROMAN WEAVE LEG,
5" WIDE, 35 1/4" HIGH**



JWEAVELEGL

- Trimable.

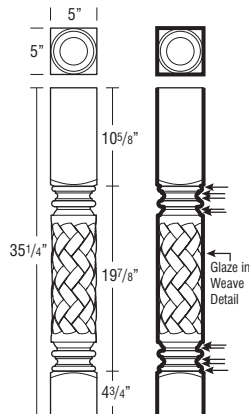

Finish Techniques

Distressing	Heirlooming
	•

Species Availability (Wood)

Alder	Rustic Alder	Cherry	Hickory	Rustic Hickory	Maple	Oak
•	Alder	•			•	•

Species Availability (All Laminates)

High Gloss box color	Horiz. Grain on Maple box color	Vert. Grain on Maple box color	Vert. Grain on Cherry box color	Vert. Grain on Hickory	Vert. Grain on Oak box color	Thermofoil box color
-------------------------	---------------------------------------	--------------------------------------	---------------------------------------	---------------------------	------------------------------------	-------------------------

**SMALL CLASSIC ROPE
LEG SPLIT,
2 3/4" WIDE,
35 1/4" HIGH**



JROPELEGS

- Trimable.

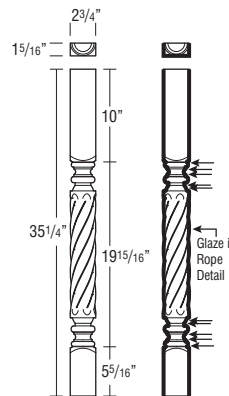

Finish Techniques

Distressing	Heirlooming
	•

Species Availability (Wood)

Alder	Rustic Alder	Cherry	Hickory	Rustic Hickory	Maple	Oak
•	Alder	•			•	•

Species Availability (All Laminates)

High Gloss box color	Horiz. Grain on Maple box color	Vert. Grain on Maple box color	Vert. Grain on Cherry box color	Vert. Grain on Hickory	Vert. Grain on Oak box color	Thermofoil box color
-------------------------	---------------------------------------	--------------------------------------	---------------------------------------	---------------------------	------------------------------------	-------------------------

Finished edges indicated by bold lines on side view drawings.
Glazed edges indicated by arrows on side view drawings.

DESCRIPTION

MODEL

**CLASSIC ROPE LEG,
35 1/4" HIGH**



JROPELEG

• Trimmable.

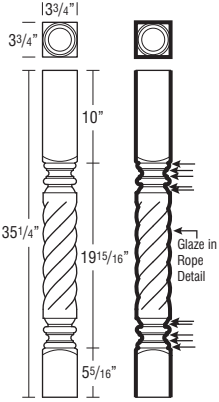

Finish Techniques

Distressing	Heirlooming
	•

Species Availability (Wood)

Alder	Rustic Alder	Cherry	Hickory	Rustic Hickory	Maple	Oak
•	Alder	•			•	•

Species Availability (All Laminates)

High Gloss box color	Horiz. Grain on Maple box color	Vert. Grain on Maple box color	Vert. Grain on Cherry box color	Vert. Grain on Hickory	Vert. Grain on Oak box color	Thermofoil box color
----------------------	---------------------------------	--------------------------------	---------------------------------	------------------------	------------------------------	----------------------

DESCRIPTION

MODEL

**CLASSIC ROPE LEG,
5" WIDE, 35 1/4" HIGH**



JROPEGL

• Trimmable.

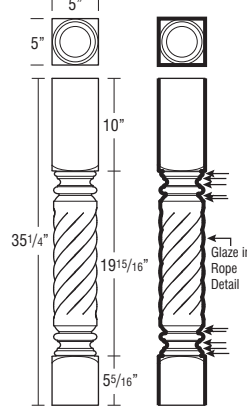

Finish Techniques

Distressing	Heirlooming
	•

Species Availability (Wood)

Alder	Rustic Alder	Cherry	Hickory	Rustic Hickory	Maple	Oak
•	Alder	•			•	•

Species Availability (All Laminates)

High Gloss box color	Horiz. Grain on Maple box color	Vert. Grain on Maple box color	Vert. Grain on Cherry box color	Vert. Grain on Hickory	Vert. Grain on Oak box color	Thermofoil box color
----------------------	---------------------------------	--------------------------------	---------------------------------	------------------------	------------------------------	----------------------

**CLASSIC ROPE LEG,
42 1/4" HIGH**



JROPELEG

• Trimmable.

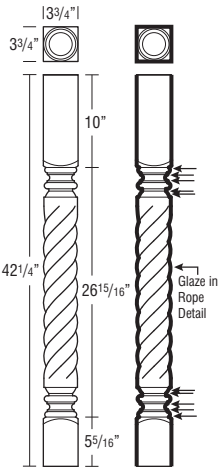

Finish Techniques

Distressing	Heirlooming
	•

Species Availability (Wood)

Alder	Rustic Alder	Cherry	Hickory	Rustic Hickory	Maple	Oak
•	Alder	•			•	•

Species Availability (All Laminates)

High Gloss box color	Horiz. Grain on Maple box color	Vert. Grain on Maple box color	Vert. Grain on Cherry box color	Vert. Grain on Hickory	Vert. Grain on Oak box color	Thermofoil box color
----------------------	---------------------------------	--------------------------------	---------------------------------	------------------------	------------------------------	----------------------

**SMALL SPOOL LEG,
2 3/4" WIDE,
35 1/4" HIGH**



JSPLEGS

• Trimmable.

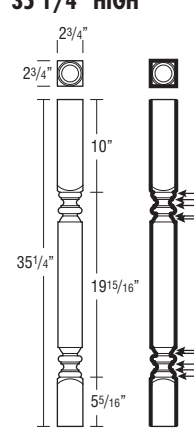

Finish Techniques

Distressing	Heirlooming
	•

Species Availability (Wood)

Alder	Rustic Alder	Cherry	Hickory	Rustic Hickory	Maple	Oak
•	Alder	•			•	•

Species Availability (All Laminates)

High Gloss box color	Horiz. Grain on Maple box color	Vert. Grain on Maple box color	Vert. Grain on Cherry box color	Vert. Grain on Hickory	Vert. Grain on Oak box color	Thermofoil box color
----------------------	---------------------------------	--------------------------------	---------------------------------	------------------------	------------------------------	----------------------

Finished edges indicated by bold lines on side view drawings.
Glazed edges indicated by arrows on side view drawings.

DESCRIPTION

SMALL SPOOL LEG SPLIT, 2 3/4" WIDE, 35 1/4" HIGH



MODEL

JSPLEGSS

- Trimable.

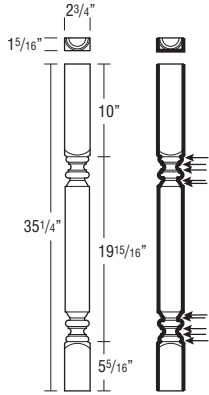

Finish Techniques

Distressing	Heirloom
	•

Species Availability (Wood)

Alder	Rustic Alder	Cherry	Hickory	Rustic Hickory	Maple	Oak
•	Alder	•			•	•

Species Availability (All Laminates)

High Gloss box color	Horiz. Grain on Maple box color	Vert. Grain on Maple box color	Vert. Grain on Cherry box color	Vert. Grain on Hickory	Vert. Grain on Oak box color	Thermofoil box color
-------------------------	---------------------------------------	--------------------------------------	---------------------------------------	---------------------------	------------------------------------	-------------------------

SPOOL LEG, 34 1/2" HIGH



SPLEG

- Trimable.

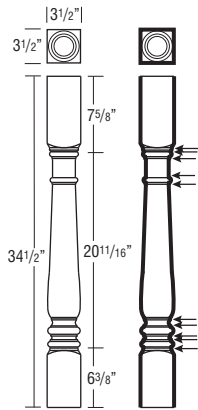

Finish Techniques

Distressing	Heirloom
	•

Species Availability (Wood)

Alder	Rustic Alder	Cherry	Hickory	Rustic Hickory	Maple	Oak
•	Alder	•			•	•

Species Availability (All Laminates)

High Gloss box color	Horiz. Grain on Maple box color	Vert. Grain on Maple box color	Vert. Grain on Cherry box color	Vert. Grain on Hickory	Vert. Grain on Oak box color	Thermofoil box color
-------------------------	---------------------------------------	--------------------------------------	---------------------------------------	---------------------------	------------------------------------	-------------------------

DESCRIPTION

SPOOL LEG, 40 1/2" HIGH



MODEL

JSPLEGT

- Trimable.

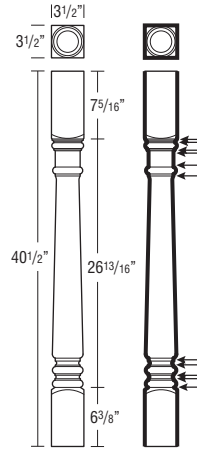

Finish Techniques

Distressing	Heirloom
	•

Species Availability (Wood)

Alder	Rustic Alder	Cherry	Hickory	Rustic Hickory	Maple	Oak
•	Alder	•			•	•

Species Availability (All Laminates)

High Gloss box color	Horiz. Grain on Maple box color	Vert. Grain on Maple box color	Vert. Grain on Cherry box color	Vert. Grain on Hickory	Vert. Grain on Oak box color	Thermofoil box color
-------------------------	---------------------------------------	--------------------------------------	---------------------------------------	---------------------------	------------------------------------	-------------------------

SQUARE ISLAND LEG SPLIT, 35 1/4" HIGH



JSQISLEG3S

- Trimable.

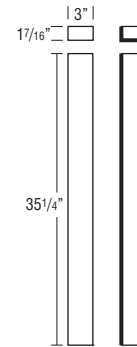

Finish Techniques

Distressing	Heirloom
	•

Species Availability (Wood)

Alder	Rustic Alder	Cherry	Hickory	Rustic Hickory	Maple	Oak
•	Alder	•			•	•

Species Availability (All Laminates)

High Gloss box color	Horiz. Grain on Maple box color	Vert. Grain on Maple box color	Vert. Grain on Cherry box color	Vert. Grain on Hickory	Vert. Grain on Oak box color	Thermofoil box color
-------------------------	---------------------------------------	--------------------------------------	---------------------------------------	---------------------------	------------------------------------	-------------------------

SQUARE ISLAND LEG, 3" x 3", 35 1/4" HIGH



JSQISLEG3

- Trimable.

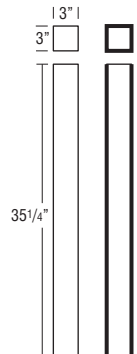

Finish Techniques

Distressing	Heirloom
	•

Species Availability (Wood)

Alder	Rustic Alder	Cherry	Hickory	Rustic Hickory	Maple	Oak
•	Alder	•			•	•

Species Availability (All Laminates)

High Gloss box color	Horiz. Grain on Maple box color	Vert. Grain on Maple box color	Vert. Grain on Cherry box color	Vert. Grain on Hickory	Vert. Grain on Oak box color	Thermofoil box color
-------------------------	---------------------------------------	--------------------------------------	---------------------------------------	---------------------------	------------------------------------	-------------------------

Finished edges indicated by bold lines on side view drawings.
Glazed edges indicated by arrows on side view drawings.

DESCRIPTION

MODEL

**SQUARE ISLAND LEG,
4" x 4", 35 1/4" HIGH**



JSQISLEG4

• Trimmable.



Finish Techniques

Distressing	Heirlooming
	•

Species Availability (Wood)

Alder	Rustic Alder	Cherry	Hickory	Rustic Hickory	Maple	Oak
•	Alder	•			•	•

Species Availability (All Laminates)

High Gloss box color	Horiz. Grain on Maple box color	Vert. Grain on Maple box color	Vert. Grain on Cherry box color	Vert. Grain on Hickory	Vert. Grain on Oak box color	Thermofoil box color
-------------------------	---------------------------------------	--------------------------------------	---------------------------------------	---------------------------	------------------------------------	-------------------------

DESCRIPTION

MODEL

**SQUARE BAR LEG,
3" x 3", 42 1/4" HIGH**



JSQBARLEG3

• Trimmable.

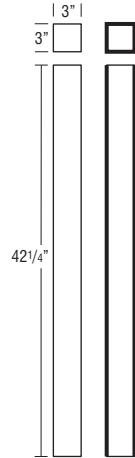

Finish Techniques

Distressing	Heirlooming
	•

Species Availability (Wood)

Alder	Rustic Alder	Cherry	Hickory	Rustic Hickory	Maple	Oak
•	Alder	•			•	•

Species Availability (All Laminates)

High Gloss box color	Horiz. Grain on Maple box color	Vert. Grain on Maple box color	Vert. Grain on Cherry box color	Vert. Grain on Hickory	Vert. Grain on Oak box color	Thermofoil box color
-------------------------	---------------------------------------	--------------------------------------	---------------------------------------	---------------------------	------------------------------------	-------------------------

**SQUARE ISLAND LEG,
6" x 6", 35 1/4" HIGH**



JSQISLEG6

• Trimmable.

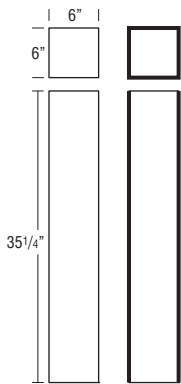

Finish Techniques

Distressing	Heirlooming
	•

Species Availability (Wood)

Alder	Rustic Alder	Cherry	Hickory	Rustic Hickory	Maple	Oak
•	Alder	•			•	•

Species Availability (All Laminates)

High Gloss box color	Horiz. Grain on Maple box color	Vert. Grain on Maple box color	Vert. Grain on Cherry box color	Vert. Grain on Hickory	Vert. Grain on Oak box color	Thermofoil box color
-------------------------	---------------------------------------	--------------------------------------	---------------------------------------	---------------------------	------------------------------------	-------------------------

**SQUARE BAR LEG,
4" x 4", 42 1/4" HIGH**



JSQBARLEG4

• Trimmable.

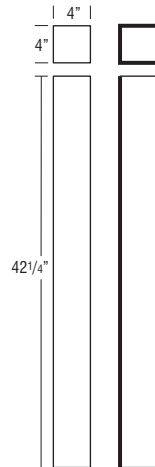

Finish Techniques

Distressing	Heirlooming
	•

Species Availability (Wood)

Alder	Rustic Alder	Cherry	Hickory	Rustic Hickory	Maple	Oak
•	Alder	•			•	•

Species Availability (All Laminates)

High Gloss box color	Horiz. Grain on Maple box color	Vert. Grain on Maple box color	Vert. Grain on Cherry box color	Vert. Grain on Hickory	Vert. Grain on Oak box color	Thermofoil box color
-------------------------	---------------------------------------	--------------------------------------	---------------------------------------	---------------------------	------------------------------------	-------------------------

**SQUARE BAR LEG
SPLIT, 42 1/4" HIGH**



JSQBARLEG3S

• Trimmable.

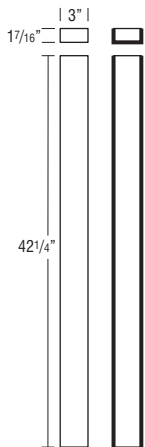

Finish Techniques

Distressing	Heirlooming
	•

Species Availability (Wood)

Alder	Rustic Alder	Cherry	Hickory	Rustic Hickory	Maple	Oak
•	Alder	•			•	•

Species Availability (All Laminates)

High Gloss box color	Horiz. Grain on Maple box color	Vert. Grain on Maple box color	Vert. Grain on Cherry box color	Vert. Grain on Hickory	Vert. Grain on Oak box color	Thermofoil box color
-------------------------	---------------------------------------	--------------------------------------	---------------------------------------	---------------------------	------------------------------------	-------------------------

**SQUARE BAR LEG,
6" x 6", 42 1/4" HIGH**



JSQBARLEG6

• Trimmable.

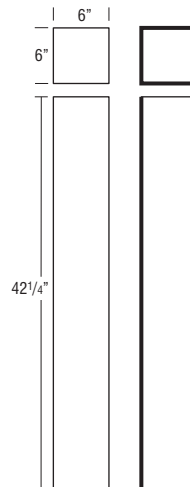

Finish Techniques

Distressing	Heirlooming
	•

Species Availability (Wood)

Alder	Rustic Alder	Cherry	Hickory	Rustic Hickory	Maple	Oak
•	Alder	•			•	•

Species Availability (All Laminates)

High Gloss box color	Horiz. Grain on Maple box color	Vert. Grain on Maple box color	Vert. Grain on Cherry box color	Vert. Grain on Hickory	Vert. Grain on Oak box color	Thermofoil box color
-------------------------	---------------------------------------	--------------------------------------	---------------------------------------	---------------------------	------------------------------------	-------------------------

Finished edges indicated by bold lines on side view drawings.
Glazed edges indicated by arrows on side view drawings.

DESCRIPTION

MODEL

**TULIP LEG,
34 1/2" HIGH**



JTULIPLG

- Trimable.

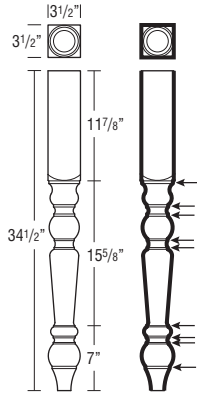

Finish Techniques

Distressing	Heirloom
	•

Species Availability (Wood)

Alder	Rustic Alder	Cherry	Hickory	Rustic Hickory	Maple	Oak
•	Alder	•			•	•

Species Availability (All Laminates)

High Gloss box color	Horiz. Grain on Maple box color	Vert. Grain on Maple box color	Vert. Grain on Cherry box color	Vert. Grain on Hickory	Vert. Grain on Oak box color	Thermofoil box color
-------------------------	---------------------------------------	--------------------------------------	---------------------------------------	---------------------------	------------------------------------	-------------------------

**TULIP LEG,
40 1/2" HIGH**



JTULIPLGT

- Trimable.

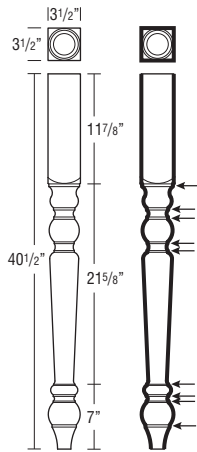

Finish Techniques

Distressing	Heirloom
	•

Species Availability (Wood)

Alder	Rustic Alder	Cherry	Hickory	Rustic Hickory	Maple	Oak
•	Alder	•			•	•

Species Availability (All Laminates)

High Gloss box color	Horiz. Grain on Maple box color	Vert. Grain on Maple box color	Vert. Grain on Cherry box color	Vert. Grain on Hickory	Vert. Grain on Oak box color	Thermofoil box color
-------------------------	---------------------------------------	--------------------------------------	---------------------------------------	---------------------------	------------------------------------	-------------------------

**URN LEG,
35 1/4" HIGH**



JURNLEG

- Trimable.

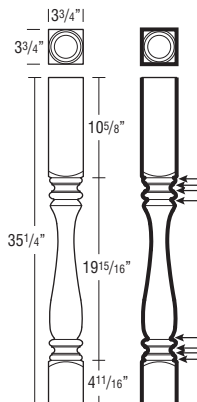

Finish Techniques

Distressing	Heirloom
	•

Species Availability (Wood)

Alder	Rustic Alder	Cherry	Hickory	Rustic Hickory	Maple	Oak
•	Alder	•			•	•

Species Availability (All Laminates)

High Gloss box color	Horiz. Grain on Maple box color	Vert. Grain on Maple box color	Vert. Grain on Cherry box color	Vert. Grain on Hickory	Vert. Grain on Oak box color	Thermofoil box color
-------------------------	---------------------------------------	--------------------------------------	---------------------------------------	---------------------------	------------------------------------	-------------------------

DESCRIPTION

MODEL

**URN LEG,
42 1/4" HIGH**



JURNLEGT

- Trimable.

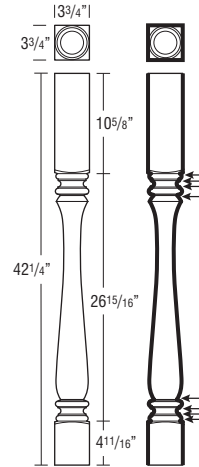

Finish Techniques

Distressing	Heirloom
	•

Species Availability (Wood)

Alder	Rustic Alder	Cherry	Hickory	Rustic Hickory	Maple	Oak
•	Alder	•			•	•

Species Availability (All Laminates)

High Gloss box color	Horiz. Grain on Maple box color	Vert. Grain on Maple box color	Vert. Grain on Cherry box color	Vert. Grain on Hickory	Vert. Grain on Oak box color	Thermofoil box color
-------------------------	---------------------------------------	--------------------------------------	---------------------------------------	---------------------------	------------------------------------	-------------------------

**URN LEG, 5" WIDE,
35 1/4" HIGH**



JURNLEGL

- Trimable.

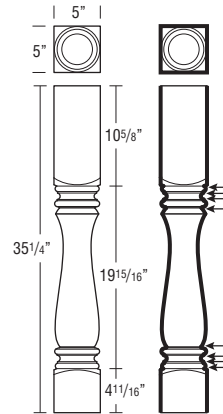

Finish Techniques

Distressing	Heirloom
	•

Species Availability (Wood)

Alder	Rustic Alder	Cherry	Hickory	Rustic Hickory	Maple	Oak
•	Alder	•			•	•

Species Availability (All Laminates)

High Gloss box color	Horiz. Grain on Maple box color	Vert. Grain on Maple box color	Vert. Grain on Cherry box color	Vert. Grain on Hickory	Vert. Grain on Oak box color	Thermofoil box color
-------------------------	---------------------------------------	--------------------------------------	---------------------------------------	---------------------------	------------------------------------	-------------------------

ABBE FOOT, 4" HIGH



ABFOOT

- Recommended for applications without toekicks.

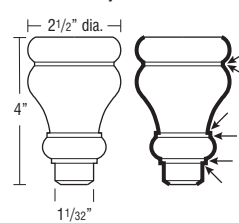

Finish Techniques

Distressing	Heirloom
	•

Species Availability (Wood)

Alder	Rustic Alder	Cherry	Hickory	Rustic Hickory	Maple	Oak
•	Alder	•			•	•

Species Availability (All Laminates)

High Gloss box color	Horiz. Grain on Maple box color	Vert. Grain on Maple box color	Vert. Grain on Cherry box color	Vert. Grain on Hickory	Vert. Grain on Oak box color	Thermofoil box color
-------------------------	---------------------------------------	--------------------------------------	---------------------------------------	---------------------------	------------------------------------	-------------------------

Finished edges indicated by bold lines on side view drawings.
Glazed edges indicated by arrows on side view drawings.

DESCRIPTION

MODEL

FRENCH LEG, 6" HIGH



FRNLG

- Trimmable.

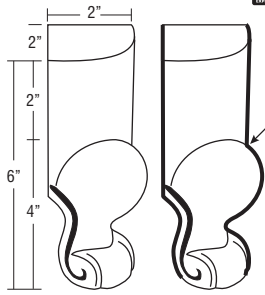

Finish Techniques

Distressing	Heirlooming
	•

Species Availability (Wood)

Alder	Rustic Alder	Cherry	Hickory	Rustic Hickory	Maple	Oak
•	•	•			•	

Species Availability (All Laminates)

High Gloss	Horiz. Grain on Maple	Vert. Grain on Maple	Vert. Grain on Cherry	Vert. Grain on Hickory	Vert. Grain on Oak	Thermofoil
box color	box color	box color	box color		box color	box color

ACANTHUS FOOT, 4 1/2" HIGH



JACANFOOT

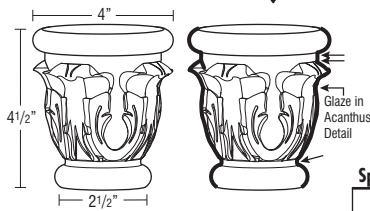

Finish Techniques

Distressing	Heirlooming
	•

Species Availability (Wood)

Alder	Rustic Alder	Cherry	Hickory	Rustic Hickory	Maple	Oak
•	•	•			•	•

Species Availability (All Laminates)

High Gloss	Horiz. Grain on Maple	Vert. Grain on Maple	Vert. Grain on Cherry	Vert. Grain on Hickory	Vert. Grain on Oak	Thermofoil
box color	box color	box color	box color		box color	box color

COSMO FOOT, 4" HIGH



JCOSFOOT

- Recommended for applications without toeicks.

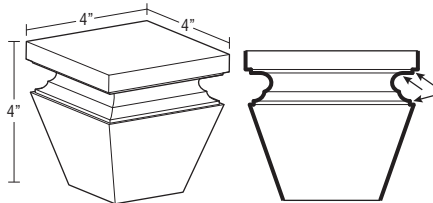

Finish Techniques

Distressing	Heirlooming
	•

Species Availability (Wood)

Alder	Rustic Alder	Cherry	Hickory	Rustic Hickory	Maple	Oak
•	•	•			•	•

Species Availability (All Laminates)

High Gloss	Horiz. Grain on Maple	Vert. Grain on Maple	Vert. Grain on Cherry	Vert. Grain on Hickory	Vert. Grain on Oak	Thermofoil
box color	box color	box color	box color		box color	box color

DESCRIPTION

MODEL

CRAFTSMAN FOOT, 4 1/2" HIGH



JCRAFTFOOT

- Trimmable.

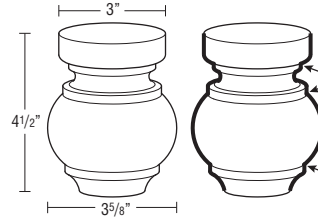

Finish Techniques

Distressing	Heirlooming
	•

Species Availability (Wood)

Alder	Rustic Alder	Cherry	Hickory	Rustic Hickory	Maple	Oak
•	•	•			•	•

Species Availability (All Laminates)

High Gloss	Horiz. Grain on Maple	Vert. Grain on Maple	Vert. Grain on Cherry	Vert. Grain on Hickory	Vert. Grain on Oak	Thermofoil
box color	box color	box color	box color		box color	box color

FRENCH COUNTRY FOOT, 6" HIGH



JFRNCNTYFOOT

- Recommended for applications without toeicks.

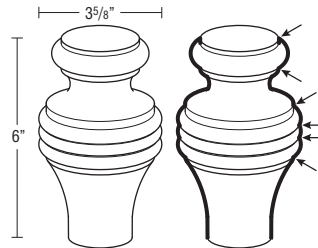

Finish Techniques

Distressing	Heirlooming
	•

Species Availability (Wood)

Alder	Rustic Alder	Cherry	Hickory	Rustic Hickory	Maple	Oak
•	•	•			•	•

Species Availability (All Laminates)

High Gloss	Horiz. Grain on Maple	Vert. Grain on Maple	Vert. Grain on Cherry	Vert. Grain on Hickory	Vert. Grain on Oak	Thermofoil
box color	box color	box color	box color		box color	box color

MADELINE FOOT, 4 1/2" HIGH



JMADEFOOT

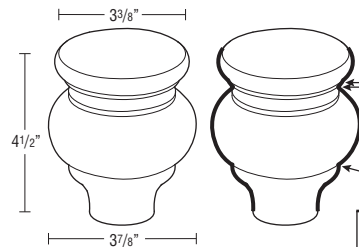

Finish Techniques

Distressing	Heirlooming
	•

Species Availability (Wood)

Alder	Rustic Alder	Cherry	Hickory	Rustic Hickory	Maple	Oak
•	•	•			•	•

Species Availability (All Laminates)

High Gloss	Horiz. Grain on Maple	Vert. Grain on Maple	Vert. Grain on Cherry	Vert. Grain on Hickory	Vert. Grain on Oak	Thermofoil
box color	box color	box color	box color		box color	box color

MADISON FOOT, 6 1/8" HIGH



JMADFOOT

- Recommended for applications without toeicks.

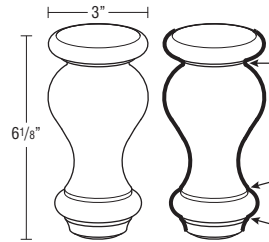

Finish Techniques

Distressing	Heirlooming
	•

Species Availability (Wood)

Alder	Rustic Alder	Cherry	Hickory	Rustic Hickory	Maple	Oak
•	•	•			•	•

Species Availability (All Laminates)

High Gloss	Horiz. Grain on Maple	Vert. Grain on Maple	Vert. Grain on Cherry	Vert. Grain on Hickory	Vert. Grain on Oak	Thermofoil
box color	box color	box color	box color		box color	box color

Finished edges indicated by bold lines on side view drawings.
Glazed edges indicated by arrows on side view drawings.

DESCRIPTION

MODEL

METROPOLITAN FOOT, 4 5/8" HIGH



JMETROFOOT

- Recommended for applications without toekicks.

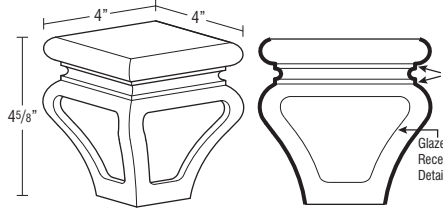

Finish Techniques

Distressing	Heirlooming
	•

Species Availability (Wood)

Alder	Rustic Alder	Cherry	Hickory	Rustic Hickory	Maple	Oak
•	Alder	•			•	•

Species Availability (All Laminates)

High Gloss box color	Horiz. Grain on Maple box color	Vert. Grain on Maple box color	Vert. Grain on Cherry box color	Vert. Grain on Hickory	Vert. Grain on Oak box color	Thermofoil box color
----------------------	---------------------------------	--------------------------------	---------------------------------	------------------------	------------------------------	----------------------

WEAVE FOOT, 4 1/2" HIGH



JWEAVEFOOT

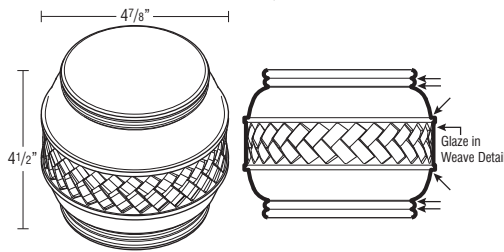

Finish Techniques

Distressing	Heirlooming
	•

Species Availability (Wood)

Alder	Rustic Alder	Cherry	Hickory	Rustic Hickory	Maple	Oak
•	Alder	•			•	•

Species Availability (All Laminates)

High Gloss box color	Horiz. Grain on Maple box color	Vert. Grain on Maple box color	Vert. Grain on Cherry box color	Vert. Grain on Hickory	Vert. Grain on Oak box color	Thermofoil box color
----------------------	---------------------------------	--------------------------------	---------------------------------	------------------------	------------------------------	----------------------

LARGE SQUARE FOOT, 5" HIGH



LGSQFOOT

- Trimmable.

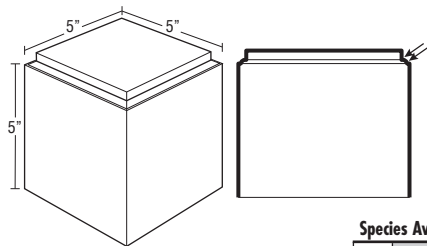

Finish Techniques

Distressing	Heirlooming
	•

Species Availability (Wood)

Alder	Rustic Alder	Cherry	Hickory	Rustic Hickory	Maple	Oak
•	Alder	•			•	•

Species Availability (All Laminates)

High Gloss box color	Horiz. Grain on Maple box color	Vert. Grain on Maple box color	Vert. Grain on Cherry box color	Vert. Grain on Hickory	Vert. Grain on Oak box color	Thermofoil box color
----------------------	---------------------------------	--------------------------------	---------------------------------	------------------------	------------------------------	----------------------

DESCRIPTION

MODEL

SQUARE FOOT, 4 1/2" HIGH



JSQFOOT

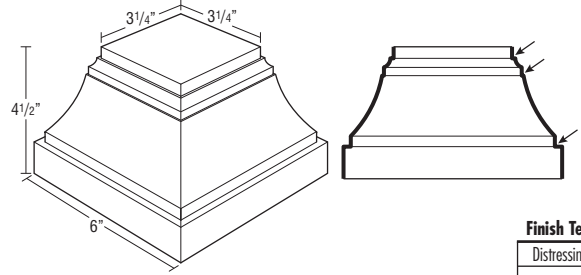

Finish Techniques

Distressing	Heirlooming
	•

Species Availability (Wood)

Alder	Rustic Alder	Cherry	Hickory	Rustic Hickory	Maple	Oak
•	Alder	•			•	•

Species Availability (All Laminates)

High Gloss box color	Horiz. Grain on Maple box color	Vert. Grain on Maple box color	Vert. Grain on Cherry box color	Vert. Grain on Hickory	Vert. Grain on Oak box color	Thermofoil box color
----------------------	---------------------------------	--------------------------------	---------------------------------	------------------------	------------------------------	----------------------

SQUARE FOOT, SPLIT, 4 1/2" HIGH



JSQFOOTS

- Trimmable.

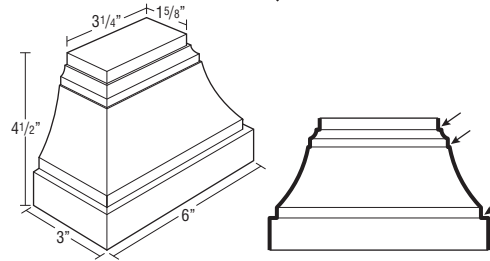

Finish Techniques

Distressing	Heirlooming
	•

Species Availability (Wood)

Alder	Rustic Alder	Cherry	Hickory	Rustic Hickory	Maple	Oak
•	Alder	•			•	•

Species Availability (All Laminates)

High Gloss box color	Horiz. Grain on Maple box color	Vert. Grain on Maple box color	Vert. Grain on Cherry box color	Vert. Grain on Hickory	Vert. Grain on Oak box color	Thermofoil box color
----------------------	---------------------------------	--------------------------------	---------------------------------	------------------------	------------------------------	----------------------

LILLE FOOT, 4 1/2" HIGH



LIFOOT

- Recommended for applications without toekicks.

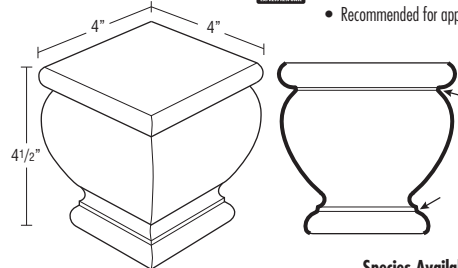

Finish Techniques

Distressing	Heirlooming
	•

Species Availability (Wood)

Alder	Rustic Alder	Cherry	Hickory	Rustic Hickory	Maple	Oak
•	Alder	•			•	•

Species Availability (All Laminates)

High Gloss box color	Horiz. Grain on Maple box color	Vert. Grain on Maple box color	Vert. Grain on Cherry box color	Vert. Grain on Hickory	Vert. Grain on Oak box color	Thermofoil box color
----------------------	---------------------------------	--------------------------------	---------------------------------	------------------------	------------------------------	----------------------

Finished edges indicated by bold lines on side view drawings.
Glazed edges indicated by arrows on side view drawings.

DESCRIPTION

PLINTH BLOCK,
4 1/2" HIGH

MODEL



PLBLOCK

- Trimmable.

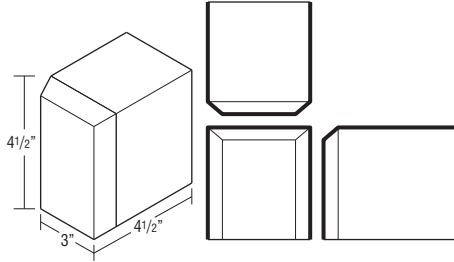

Finish Techniques

Distressing	Heirlooming
	•

Species Availability (Wood)

Alder	Rustic Alder	Cherry	Hickory	Rustic Hickory	Maple	Oak
•	Alder	•	•	Hickory	•	•

Species Availability (All Laminates)

High Gloss	Horiz. Grain on Maple	Vert. Grain on Maple	Vert. Grain on Cherry	Vert. Grain on Hickory	Vert. Grain on Oak	Thermofoil
box color	box color	box color	box color	box color	box color	box color

TAPERED LEG, 6" HIGH



TAPLG

- Trimmable.

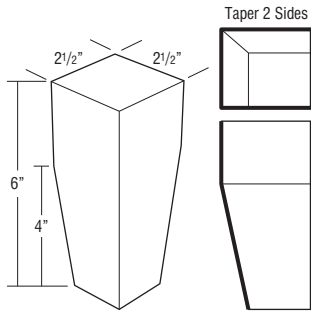

Finish Techniques

Distressing	Heirlooming
	•

Species Availability (Wood)

Alder	Rustic Alder	Cherry	Hickory	Rustic Hickory	Maple	Oak
•	Alder	•			•	

Species Availability (All Laminates)

High Gloss	Horiz. Grain on Maple	Vert. Grain on Maple	Vert. Grain on Cherry	Vert. Grain on Hickory	Vert. Grain on Oak	Thermofoil
box color	box color	box color	box color			box color

DESCRIPTION

TOEKICK TULIP FOOT,
4 5/8" HIGH

MODEL



TKTLFOOT

- Trimmable.

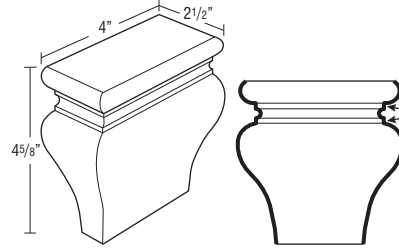

Finish Techniques

Distressing	Heirlooming
	•

Species Availability (Wood)

Alder	Rustic Alder	Cherry	Hickory	Rustic Hickory	Maple	Oak
•	Alder	•			•	•

Species Availability (All Laminates)

High Gloss	Horiz. Grain on Maple	Vert. Grain on Maple	Vert. Grain on Cherry	Vert. Grain on Hickory	Vert. Grain on Oak	Thermofoil
box color	box color	box color	box color		box color	box color

TULIP FOOT, 4 5/8" HIGH



TLFOOT

- Trimmable.

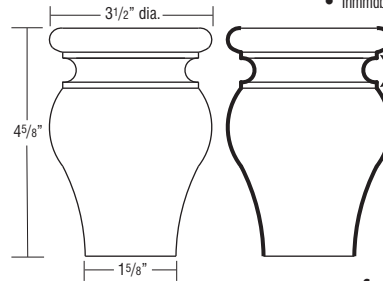

Finish Techniques

Distressing	Heirlooming
	•

Species Availability (Wood)

Alder	Rustic Alder	Cherry	Hickory	Rustic Hickory	Maple	Oak
•	Alder	•			•	•

Species Availability (All Laminates)

High Gloss	Horiz. Grain on Maple	Vert. Grain on Maple	Vert. Grain on Cherry	Vert. Grain on Hickory	Vert. Grain on Oak	Thermofoil
box color	box color	box color	box color		box color	box color

Finished edges indicated by bold lines on side view drawings.
Glazed edges indicated by arrows on side view drawings.

DESCRIPTION

2" DECORATIVE SPLIT TURNINGS



MODEL

SPRINGEND (Sold in Pairs)

JSPRINGCTR ♦

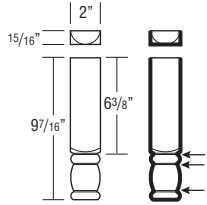

SPRINGEND

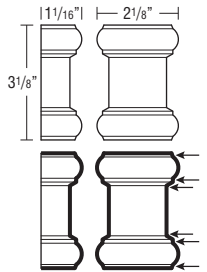

JSPRINGCTR

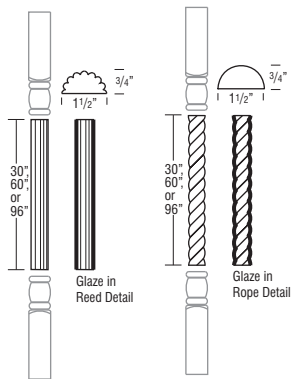

SPRINGREED

SPRINGROPE

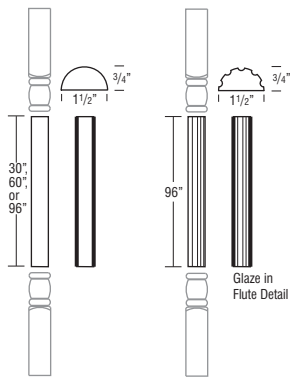

SPRINGSPPOOL

JSPRINGFLT96

SPRINGREED30

(Reeded Half Round)

SPRINGREED60

(Reeded Half Round)

SPRINGREED96

(Reeded Half Round)

SPRINGROPE30

(Rope Right Twist Half Round)

SPRINGROPE60

(Rope Right Twist Half Round)

SPRINGROPE96

(Rope Right Twist Half Round)

SPRINGSPPOOL30 (Half Round)

SPRINGSPPOOL60 (Half Round)

SPRINGSPPOOL96 (Half Round)

JSPRINGFLT96 ♦

(Half Round)

- Ends sold separately from split turnings.
- 5 day Express Response not available on Architectural Accents.

Finish Techniques

Distressing	Heirlooming
	•

Species Availability (Wood)

Alder	Rustic Alder	Cherry	Hickory	Rustic Hickory	Maple	Oak
•	•	•	•	•	•	•

♦ Not available in Hickory.

Species Availability (All Laminates)

High Gloss box color	Horiz. Grain on Maple box color	Vert. Grain on Maple box color	Vert. Grain on Cherry box color	Vert. Grain on Hickory box color	Vert. Grain on Oak box color	Thermofoil box color

♦ Not available in Hickory box color.

DESCRIPTION

3" DECORATIVE SPLIT TURNINGS



MODEL

J3SPTRINGBLK

J3SPTRINGFIN

J3SPTRINGWV

J3SPTRINGCTR

J3SPTRINGSP96

J3SPTRINGRP96

J3SPTRINGRD96

J3SPTRINGFL96

- Ends sold separately.

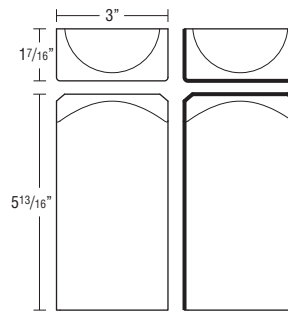

J3SPTRINGBLK

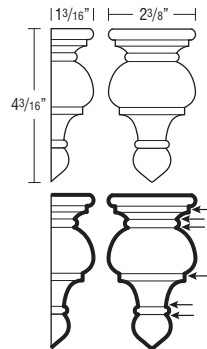

J3SPTRINGFIN

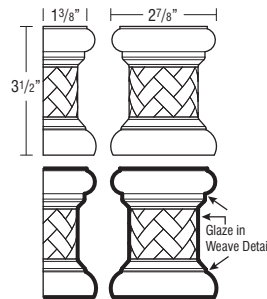

J3SPTRINGWV

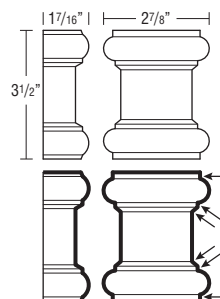

J3SPTRINGCTR

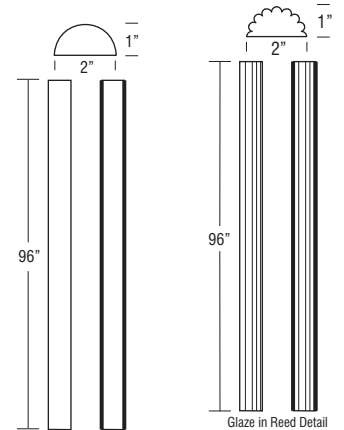

J3SPTRINGSP96

J3SPTRINGRD96

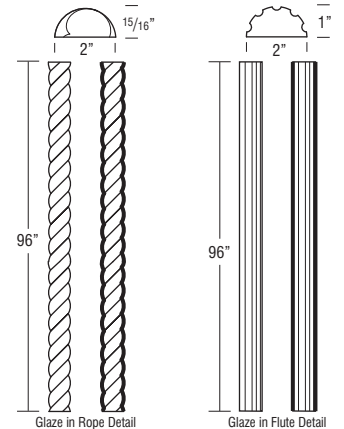

J3SPTRINGRP96

J3SPTRINGFL96

Finish Techniques

Distressing	Heirlooming
	•

Species Availability (Wood)

Alder	Rustic Alder	Cherry	Hickory	Rustic Hickory	Maple	Oak
•	•	•			•	•

Species Availability (All Laminates)

High Gloss box color	Horiz. Grain on Maple box color	Vert. Grain on Maple box color	Vert. Grain on Cherry box color	Vert. Grain on Hickory box color	Vert. Grain on Oak box color	Thermofoil box color

Finished edges indicated by bold lines on side view drawings.
Glazed edges indicated by arrows on side view drawings.

DESCRIPTION

9" SMALL CORBEL



MODEL

SMCORBEL

- Not intended for cabinet or freestanding countertop support. For substantial weight support, use a floor mounted support such as a Decorative Leg.

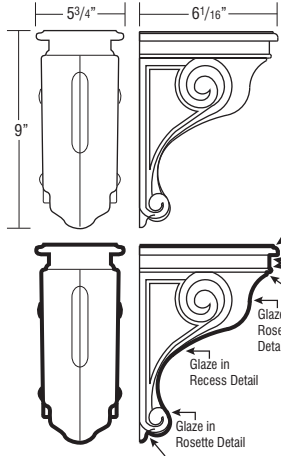

Finish Techniques

Distressing	Heirloom
	•

Species Availability (Wood)

Alder	Rustic Alder	Cherry	Hickory	Rustic Hickory	Maple	Oak
•	Alder	•			•	•

Species Availability (All Laminates)

High Gloss box color	Horiz. Grain on Maple box color	Vert. Grain on Maple box color	Vert. Grain on Cherry box color	Vert. Grain on Hickory	Vert. Grain on Oak box color	Thermofoil box color
----------------------	---------------------------------	--------------------------------	---------------------------------	------------------------	------------------------------	----------------------

13" LARGE CORBEL



LGCORBEL

- Not intended for cabinet or freestanding countertop support. For substantial weight support, use a floor mounted support such as a Decorative Leg.

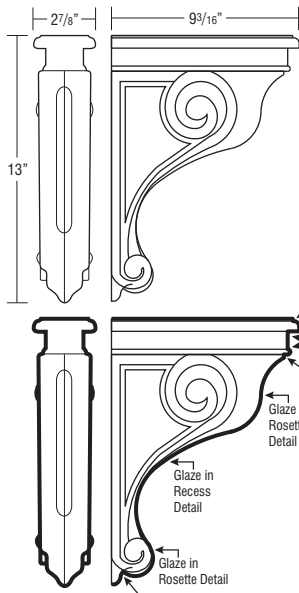

Finish Techniques

Distressing	Heirloom
	•

Species Availability (Wood)

Alder	Rustic Alder	Cherry	Hickory	Rustic Hickory	Maple	Oak
•	Alder	•			•	•

Species Availability (All Laminates)

High Gloss box color	Horiz. Grain on Maple box color	Vert. Grain on Maple box color	Vert. Grain on Cherry box color	Vert. Grain on Hickory	Vert. Grain on Oak box color	Thermofoil box color
----------------------	---------------------------------	--------------------------------	---------------------------------	------------------------	------------------------------	----------------------

9" ART CORBEL



CORBELART9

- Not intended for cabinet or freestanding countertop support. For substantial weight support, use a floor mounted support such as a Decorative Leg.

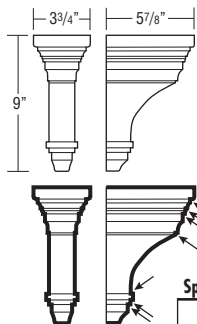

Finish Techniques

Distressing	Heirloom
	•

Species Availability (Wood)

Alder	Rustic Alder	Cherry	Hickory	Rustic Hickory	Maple	Oak
•	Alder	•			•	•

Species Availability (All Laminates)

High Gloss box color	Horiz. Grain on Maple box color	Vert. Grain on Maple box color	Vert. Grain on Cherry box color	Vert. Grain on Hickory	Vert. Grain on Oak box color	Thermofoil box color
----------------------	---------------------------------	--------------------------------	---------------------------------	------------------------	------------------------------	----------------------

DESCRIPTION

7" CELTIC CORBEL



MODEL

CORBELCELT

- Not intended for cabinet or freestanding countertop support. For substantial weight support, use a floor mounted support such as a Decorative Leg.

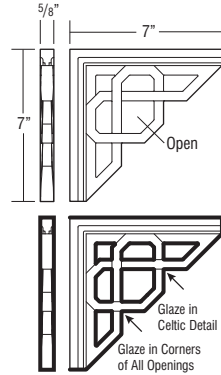

Finish Techniques

Distressing	Heirloom
	•

Species Availability (Wood)

Alder	Rustic Alder	Cherry	Hickory	Rustic Hickory	Maple	Oak
		•			•	•

Species Availability (All Laminates)

High Gloss box color	Horiz. Grain on Maple box color	Vert. Grain on Maple box color	Vert. Grain on Cherry box color	Vert. Grain on Hickory	Vert. Grain on Oak box color	Thermofoil box color
----------------------	---------------------------------	--------------------------------	---------------------------------	------------------------	------------------------------	----------------------

7" SMALL COSMO CORBEL



JCORBELCOS7

- Not intended for cabinet or freestanding countertop support. For substantial weight support, use a floor mounted support such as a Decorative Leg.

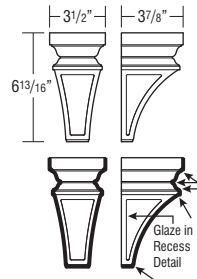

Finish Techniques

Distressing	Heirloom
	•

Species Availability (Wood)

Alder	Rustic Alder	Cherry	Hickory	Rustic Hickory	Maple	Oak
•	Alder	•			•	•

Species Availability (All Laminates)

High Gloss box color	Horiz. Grain on Maple box color	Vert. Grain on Maple box color	Vert. Grain on Cherry box color	Vert. Grain on Hickory	Vert. Grain on Oak box color	Thermofoil box color
----------------------	---------------------------------	--------------------------------	---------------------------------	------------------------	------------------------------	----------------------

13" LARGE COSMO CORBEL



JCORBELCOS13

- Not intended for cabinet or freestanding countertop support. For substantial weight support, use a floor mounted support such as a Decorative Leg.

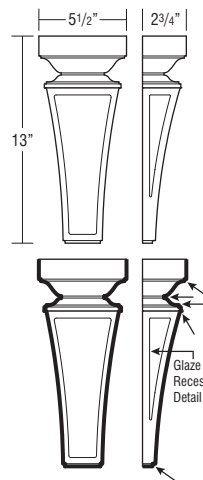

Finish Techniques

Distressing	Heirloom
	•

Species Availability (Wood)

Alder	Rustic Alder	Cherry	Hickory	Rustic Hickory	Maple	Oak
•	Alder	•			•	•

Species Availability (All Laminates)

High Gloss box color	Horiz. Grain on Maple box color	Vert. Grain on Maple box color	Vert. Grain on Cherry box color	Vert. Grain on Hickory	Vert. Grain on Oak box color	Thermofoil box color
----------------------	---------------------------------	--------------------------------	---------------------------------	------------------------	------------------------------	----------------------

Finished edges indicated by bold lines on side view drawings.
Glazed edges indicated by arrows on side view drawings.

DESCRIPTION

13" LARGE COSMO CORBEL DEEP

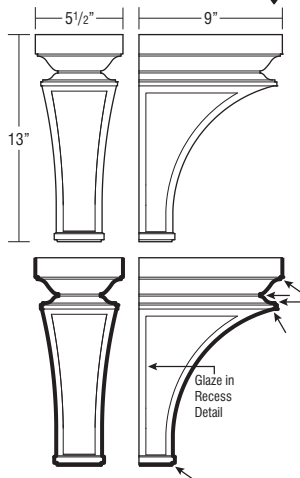

MODEL

JCORBELCOS13D

- Not intended for cabinet or freestanding countertop support. For substantial weight support, use a floor mounted support such as a Decorative Leg.

Finish Techniques

Distressing	Heirloom
	•

Species Availability (Wood)

Alder	Rustic Alder	Cherry	Hickory	Rustic Hickory	Maple	Oak
•	Alder	•			•	•

Species Availability (All Laminates)

High Gloss box color	Horiz. Grain on Maple box color	Vert. Grain on Maple box color	Vert. Grain on Cherry box color	Vert. Grain on Hickory	Vert. Grain on Oak box color	Thermofoil box color
----------------------	---------------------------------	--------------------------------	---------------------------------	------------------------	------------------------------	----------------------

7" COVE CORBEL

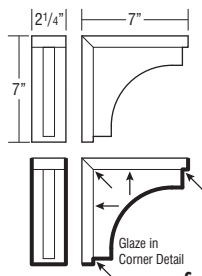

CORBELCOVE7

- Not intended for cabinet or freestanding countertop support. For substantial weight support, use a floor mounted support such as a Decorative Leg.

Finish Techniques

Distressing	Heirloom
	•

Species Availability (Wood)

Alder	Rustic Alder	Cherry	Hickory	Rustic Hickory	Maple	Oak
•	Alder	•			•	•

Species Availability (All Laminates)

High Gloss box color	Horiz. Grain on Maple box color	Vert. Grain on Maple box color	Vert. Grain on Cherry box color	Vert. Grain on Hickory	Vert. Grain on Oak box color	Thermofoil box color
----------------------	---------------------------------	--------------------------------	---------------------------------	------------------------	------------------------------	----------------------

11 1/4" COVE CORBEL

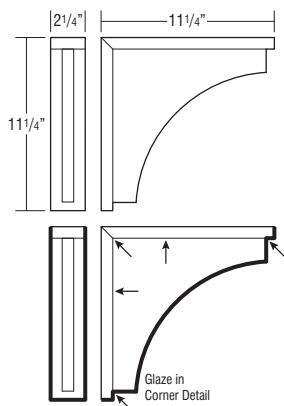

CORBELCOVE11

- Not intended for cabinet or freestanding countertop support. For substantial weight support, use a floor mounted support such as a Decorative Leg.

Finish Techniques

Distressing	Heirloom
	•

Species Availability (Wood)

Alder	Rustic Alder	Cherry	Hickory	Rustic Hickory	Maple	Oak
•	Alder	•		Hickory	•	•

Species Availability (All Laminates)

High Gloss box color	Horiz. Grain on Maple box color	Vert. Grain on Maple box color	Vert. Grain on Cherry box color	Vert. Grain on Hickory	Vert. Grain on Oak box color	Thermofoil box color
----------------------	---------------------------------	--------------------------------	---------------------------------	------------------------	------------------------------	----------------------

DESCRIPTION

6" MISSION CORBEL

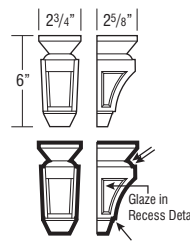

MODEL

CORBELMIS6

- Not intended for cabinet or freestanding countertop support. For substantial weight support, use a floor mounted support such as a Decorative Leg.

Finish Techniques

Distressing	Heirloom
	•

Species Availability (Wood)

Alder	Rustic Alder	Cherry	Hickory	Rustic Hickory	Maple	Oak
•	Alder	•			•	•

Species Availability (All Laminates)

High Gloss box color	Horiz. Grain on Maple box color	Vert. Grain on Maple box color	Vert. Grain on Cherry box color	Vert. Grain on Hickory	Vert. Grain on Oak box color	Thermofoil box color
----------------------	---------------------------------	--------------------------------	---------------------------------	------------------------	------------------------------	----------------------

9" MISSION CORBEL

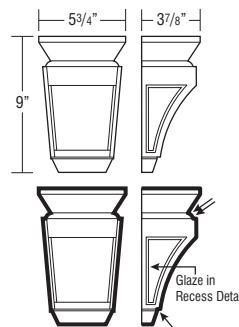

CORBELMIS9

- Not intended for cabinet or freestanding countertop support. For substantial weight support, use a floor mounted support such as a Decorative Leg.

Finish Techniques

Distressing	Heirloom
	•

Species Availability (Wood)

Alder	Rustic Alder	Cherry	Hickory	Rustic Hickory	Maple	Oak
•	Alder	•			•	•

Species Availability (All Laminates)

High Gloss box color	Horiz. Grain on Maple box color	Vert. Grain on Maple box color	Vert. Grain on Cherry box color	Vert. Grain on Hickory	Vert. Grain on Oak box color	Thermofoil box color
----------------------	---------------------------------	--------------------------------	---------------------------------	------------------------	------------------------------	----------------------

4" OLD WORLD CORBEL

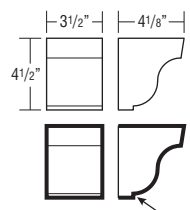

JCORBELOWD4

- Not intended for cabinet or freestanding countertop support. For substantial weight support, use a floor mounted support such as a Decorative Leg.

Finish Techniques

Distressing	Heirloom
	•

Species Availability (Wood)

Alder	Rustic Alder	Cherry	Hickory	Rustic Hickory	Maple	Oak
•	Alder	•			•	•

Species Availability (All Laminates)

High Gloss box color	Horiz. Grain on Maple box color	Vert. Grain on Maple box color	Vert. Grain on Cherry box color	Vert. Grain on Hickory	Vert. Grain on Oak box color	Thermofoil box color
----------------------	---------------------------------	--------------------------------	---------------------------------	------------------------	------------------------------	----------------------

5" OLD WORLD CORBEL

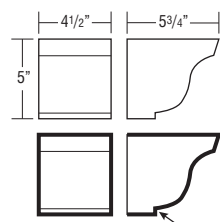

CORBELOWD5

- Not intended for cabinet or freestanding countertop support. For substantial weight support, use a floor mounted support such as a Decorative Leg.

Finish Techniques

Distressing	Heirloom
	•

Species Availability (Wood)

Alder	Rustic Alder	Cherry	Hickory	Rustic Hickory	Maple	Oak
•	Alder	•			•	•

Species Availability (All Laminates)

High Gloss box color	Horiz. Grain on Maple box color	Vert. Grain on Maple box color	Vert. Grain on Cherry box color	Vert. Grain on Hickory	Vert. Grain on Oak box color	Thermofoil box color
----------------------	---------------------------------	--------------------------------	---------------------------------	------------------------	------------------------------	----------------------

Finished edges indicated by bold lines on side view drawings.
Glazed edges indicated by arrows on side view drawings.

DESCRIPTION

MODEL

7" OLD WORLD CORBEL



JCORBELOWD7

- Not intended for cabinet or freestanding countertop support. For substantial weight support, use a floor mounted support such as a Decorative Leg.

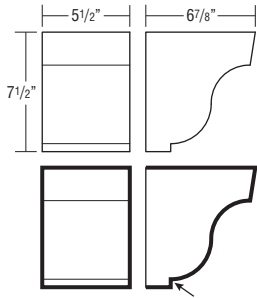

Finish Techniques

Distressing	Heirlooming
	•

Species Availability (Wood)

Alder	Rustic Alder	Cherry	Hickory	Rustic Hickory	Maple	Oak
•	Alder	•			•	•

Species Availability (All Laminates)

High Gloss box color	Horiz. Grain on Maple box color	Vert. Grain on Maple box color	Vert. Grain on Cherry box color	Vert. Grain on Hickory	Vert. Grain on Oak box color	Thermofoil box color
----------------------	---------------------------------	--------------------------------	---------------------------------	------------------------	------------------------------	----------------------

6" SCROLL CORBEL



CORBELSCR6

- Not intended for cabinet or freestanding countertop support. For substantial weight support, use a floor mounted support such as a Decorative Leg.

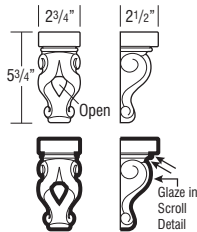

Finish Techniques

Distressing	Heirlooming
	•

Species Availability (Wood)

Alder	Rustic Alder	Cherry	Hickory	Rustic Hickory	Maple	Oak
•	Alder	•			•	•

Species Availability (All Laminates)

High Gloss box color	Horiz. Grain on Maple box color	Vert. Grain on Maple box color	Vert. Grain on Cherry box color	Vert. Grain on Hickory	Vert. Grain on Oak box color	Thermofoil box color
----------------------	---------------------------------	--------------------------------	---------------------------------	------------------------	------------------------------	----------------------

9" SCROLL CORBEL



CORBELSCR9

- Not intended for cabinet or freestanding countertop support. For substantial weight support, use a floor mounted support such as a Decorative Leg.

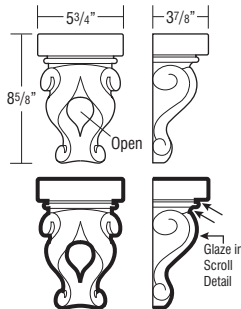

Finish Techniques

Distressing	Heirlooming
	•

Species Availability (Wood)

Alder	Rustic Alder	Cherry	Hickory	Rustic Hickory	Maple	Oak
•	Alder	•			•	•

Species Availability (All Laminates)

High Gloss box color	Horiz. Grain on Maple box color	Vert. Grain on Maple box color	Vert. Grain on Cherry box color	Vert. Grain on Hickory	Vert. Grain on Oak box color	Thermofoil box color
----------------------	---------------------------------	--------------------------------	---------------------------------	------------------------	------------------------------	----------------------

DESCRIPTION

MODEL

SNACK BAR SUPPORT



SBS

- Not intended for cabinet or freestanding countertop support. For substantial weight support, use a floor mounted support such as a Decorative Leg.

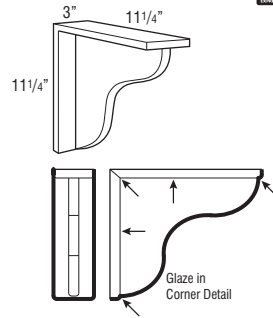

Finish Techniques

Distressing	Heirlooming
	•

Species Availability (Wood)

Alder	Rustic Alder	Cherry	Hickory	Rustic Hickory	Maple	Oak
•	Alder	•	•	Hickory	•	•

Species Availability (All Laminates)

High Gloss box color	Horiz. Grain on Maple box color	Vert. Grain on Maple box color	Vert. Grain on Cherry box color	Vert. Grain on Hickory box color	Vert. Grain on Oak box color	Thermofoil box color
----------------------	---------------------------------	--------------------------------	---------------------------------	----------------------------------	------------------------------	----------------------

10" ACANTHUS CORBEL



JCORBELACANT10

- Not intended for cabinet or freestanding countertop support. For substantial weight support, use a floor mounted support such as a Decorative Leg.

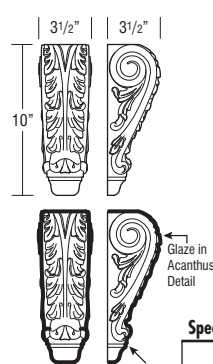

Finish Techniques

Distressing	Heirlooming
	•

Species Availability (Wood)

Alder	Rustic Alder	Cherry	Hickory	Rustic Hickory	Maple	Oak
•	Alder	•			•	•

Species Availability (All Laminates)

High Gloss box color	Horiz. Grain on Maple box color	Vert. Grain on Maple box color	Vert. Grain on Cherry box color	Vert. Grain on Hickory	Vert. Grain on Oak box color	Thermofoil box color
----------------------	---------------------------------	--------------------------------	---------------------------------	------------------------	------------------------------	----------------------

11 1/2" ARTS & CRAFTS BRACKET



JBRACKETART

- Not intended for cabinet or freestanding countertop support. For substantial weight support, use a floor mounted support such as a Decorative Leg.

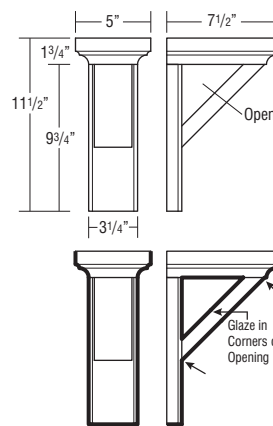

Finish Techniques

Distressing	Heirlooming
	•

Species Availability (Wood)

Alder	Rustic Alder	Cherry	Hickory	Rustic Hickory	Maple	Oak
•	Alder	•			•	•

Species Availability (All Laminates)

High Gloss box color	Horiz. Grain on Maple box color	Vert. Grain on Maple box color	Vert. Grain on Cherry box color	Vert. Grain on Hickory	Vert. Grain on Oak box color	Thermofoil box color
----------------------	---------------------------------	--------------------------------	---------------------------------	------------------------	------------------------------	----------------------

Finished edges indicated by bold lines on side view drawings.
Glazed edges indicated by arrows on side view drawings.

DESCRIPTION

14" ARTS & CRAFTS OPEN CORBEL

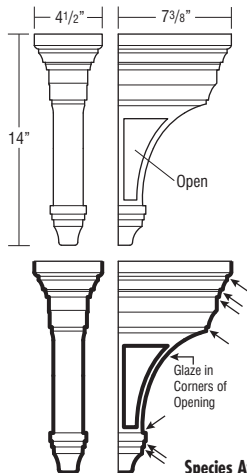

MODEL

JCORBELARTO

- Not intended for cabinet or freestanding countertop support. For substantial weight support, use a floor mounted support such as a Decorative Leg.

Finish Techniques

Distressing	Heirlooming
	•

Species Availability (Wood)

Alder	Rustic Alder	Cherry	Hickory	Rustic Hickory	Maple	Oak
•	Alder	•			•	•

Species Availability (All Laminates)

High Gloss box color	Horiz. Grain on Maple box color	Vert. Grain on Maple box color	Vert. Grain on Cherry box color	Vert. Grain on Hickory	Vert. Grain on Oak box color	Thermofoil box color
----------------------	---------------------------------	--------------------------------	---------------------------------	------------------------	------------------------------	----------------------

12" CRAFTSMAN OPEN BRACKET

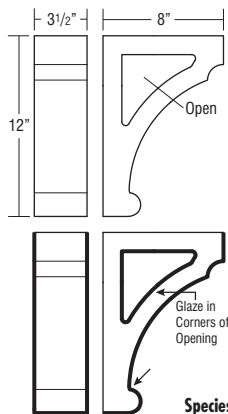

JCORBELCRAFTO

- Not intended for cabinet or freestanding countertop support. For substantial weight support, use a floor mounted support such as a Decorative Leg.

Finish Techniques

Distressing	Heirlooming
	•

Species Availability (Wood)

Alder	Rustic Alder	Cherry	Hickory	Rustic Hickory	Maple	Oak
•	Alder	•			•	•

Species Availability (All Laminates)

High Gloss box color	Horiz. Grain on Maple box color	Vert. Grain on Maple box color	Vert. Grain on Cherry box color	Vert. Grain on Hickory	Vert. Grain on Oak box color	Thermofoil box color
----------------------	---------------------------------	--------------------------------	---------------------------------	------------------------	------------------------------	----------------------

3" MINI SHAKER CORBEL

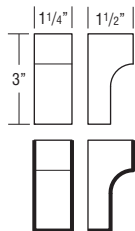

JCORBELSHKR3

- Not intended for cabinet or freestanding countertop support. For substantial weight support, use a floor mounted support such as a Decorative Leg.

Finish Techniques

Distressing	Heirlooming
	•

Species Availability (Wood)

Alder	Rustic Alder	Cherry	Hickory	Rustic Hickory	Maple	Oak
•	Alder	•			•	•

Species Availability (All Laminates)

High Gloss box color	Horiz. Grain on Maple box color	Vert. Grain on Maple box color	Vert. Grain on Cherry box color	Vert. Grain on Hickory	Vert. Grain on Oak box color	Thermofoil box color
----------------------	---------------------------------	--------------------------------	---------------------------------	------------------------	------------------------------	----------------------

DESCRIPTION

6 1/2" SMALL SHAKER CORBEL

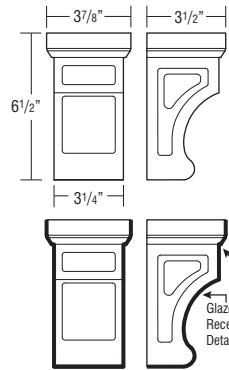

MODEL

JCORBELSHKR7

- Not intended for cabinet or freestanding countertop support. For substantial weight support, use a floor mounted support such as a Decorative Leg.

Finish Techniques

Distressing	Heirlooming
	•

Species Availability (Wood)

Alder	Rustic Alder	Cherry	Hickory	Rustic Hickory	Maple	Oak
•	Alder	•			•	•

Species Availability (All Laminates)

High Gloss box color	Horiz. Grain on Maple box color	Vert. Grain on Maple box color	Vert. Grain on Cherry box color	Vert. Grain on Hickory	Vert. Grain on Oak box color	Thermofoil box color
----------------------	---------------------------------	--------------------------------	---------------------------------	------------------------	------------------------------	----------------------

13 3/8" MEDIUM SHAKER CORBEL

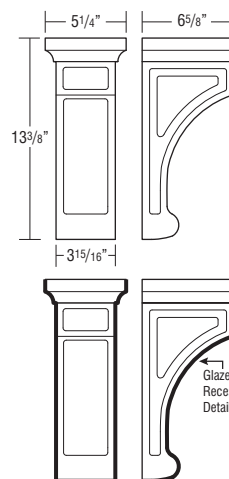

JCORBELSHKR14

- Not intended for cabinet or freestanding countertop support. For substantial weight support, use a floor mounted support such as a Decorative Leg.

Finish Techniques

Distressing	Heirlooming
	•

Species Availability (Wood)

Alder	Rustic Alder	Cherry	Hickory	Rustic Hickory	Maple	Oak
•	Alder	•			•	•

Species Availability (All Laminates)

High Gloss box color	Horiz. Grain on Maple box color	Vert. Grain on Maple box color	Vert. Grain on Cherry box color	Vert. Grain on Hickory	Vert. Grain on Oak box color	Thermofoil box color
----------------------	---------------------------------	--------------------------------	---------------------------------	------------------------	------------------------------	----------------------

Finished edges indicated by bold lines on side view drawings.
Glazed edges indicated by arrows on side view drawings.

DESCRIPTION

MODEL

16" LARGE SHAKER CORBEL



JCORBELSHKR16

- Not intended for cabinet or freestanding countertop support. For substantial weight support, use a floor mounted support such as a Decorative Leg.

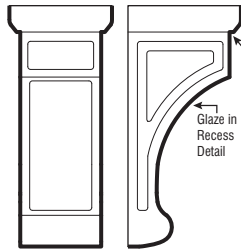
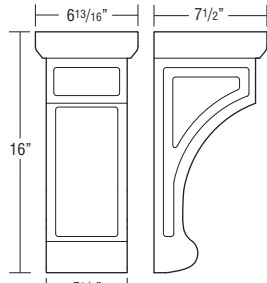

Finish Techniques

Distressing	Heirlooming
	•

Species Availability (Wood)

Alder	Rustic Alder	Cherry	Hickory	Rustic Hickory	Maple	Oak
•	Alder	•			•	•

Species Availability (All Laminates)

High Gloss box color	Horiz. Grain on Maple box color	Vert. Grain on Maple box color	Vert. Grain on Cherry box color	Vert. Grain on Hickory	Vert. Grain on Oak box color	Thermofoil box color
----------------------	---------------------------------	--------------------------------	---------------------------------	------------------------	------------------------------	----------------------

14" TRADITIONAL OPEN CORBEL



JCORBELTRADO

- Not intended for cabinet or freestanding countertop support. For substantial weight support, use a floor mounted support such as a Decorative Leg.

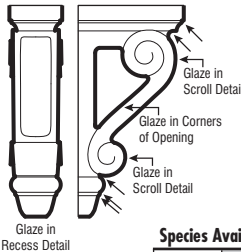
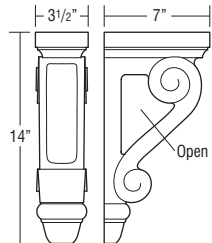

Finish Techniques

Distressing	Heirlooming
	•

Species Availability (Wood)

Alder	Rustic Alder	Cherry	Hickory	Rustic Hickory	Maple	Oak
•	Alder	•			•	•

Species Availability (All Laminates)

High Gloss box color	Horiz. Grain on Maple box color	Vert. Grain on Maple box color	Vert. Grain on Cherry box color	Vert. Grain on Hickory	Vert. Grain on Oak box color	Thermofoil box color
----------------------	---------------------------------	--------------------------------	---------------------------------	------------------------	------------------------------	----------------------

DESCRIPTION

MODEL

SINGLE OUTLET COVER



JSOC

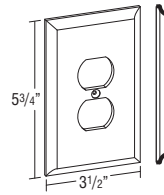

Finish Techniques

Distressing	Heirlooming

Species Availability (Wood)

Alder	Rustic Alder	Cherry	Hickory	Rustic Hickory	Maple	Oak
•	Alder	•			•	•

Species Availability (All Laminates)

High Gloss box color	Horiz. Grain on Maple box color	Vert. Grain on Maple box color	Vert. Grain on Cherry box color	Vert. Grain on Hickory	Vert. Grain on Oak box color	Thermofoil box color
----------------------	---------------------------------	--------------------------------	---------------------------------	------------------------	------------------------------	----------------------

SINGLE ROCKER PLATE



JSRC

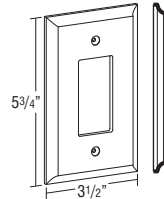

Finish Techniques

Distressing	Heirlooming

Species Availability (Wood)

Alder	Rustic Alder	Cherry	Hickory	Rustic Hickory	Maple	Oak
•	Alder	•			•	•

Species Availability (All Laminates)

High Gloss box color	Horiz. Grain on Maple box color	Vert. Grain on Maple box color	Vert. Grain on Cherry box color	Vert. Grain on Hickory	Vert. Grain on Oak box color	Thermofoil box color
----------------------	---------------------------------	--------------------------------	---------------------------------	------------------------	------------------------------	----------------------

Finished edges indicated by bold lines on side view drawings. Glazed edges indicated by arrows on side view drawings.

DESCRIPTION

MODEL

CONTEMPORARY EMBELLISHMENTS

METAL FEET, ANGLED

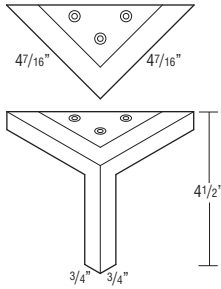

FOOTMETALANBN

FOOTMETALANGPC

- BN = Brushed Nickel
- PC = Polished Chrome
- Maximum weight capacity is 160 lbs.

METAL FEET, ROUND

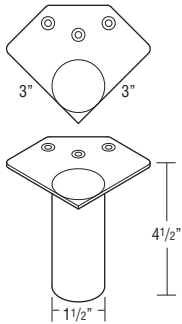

FOOTMETALRDBS

FOOTMETALRDPS

- BS = Brushed Stainless
- PS = Polished Stainless
- Maximum weight capacity is 150 lbs.

METAL FEET, SQUARE

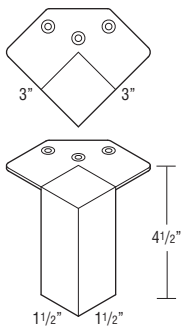

FOOTMETALSQBS

FOOTMETALSQPS

- BS = Brushed Stainless
- PS = Polished Stainless

METAL FEET, TEE

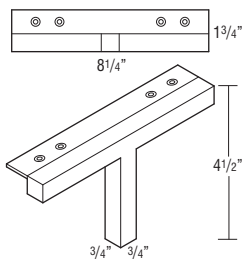

FOOTMETALANGTBN

FOOTMETALANGTPC

- BN = Brushed Nickel
- PC = Polished Chrome

DESCRIPTION

MODEL

TOUCH LATCH AND ADAPTER

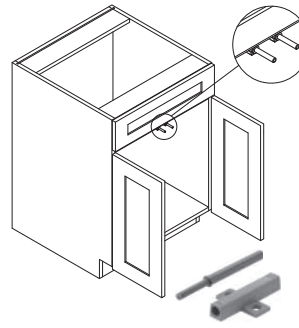

TOUCHLATCHFA

- Nylon gray mechanism with bumper tip with adapter plate.
- Can be field adjusted for door gap depth, no tools required.
- Requires a soft touch to open the door, and door must be pushed closed to reset the TOUCHLATCHFA mechanism.
- Only for use on hinged doors, and can be used without decorative hardware. Not compatible with non-hinged doors such as pull-outs, Wall Vertical-lift (WVL.). For drawers, pull-outs, and other non-compatible cabinets, PULLH70 and PULLH71 are recommended.

FINGER PULL, BRUSHED NICKEL

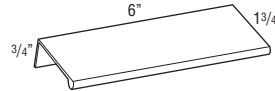

PULLH70

PULLH71

PULLH70

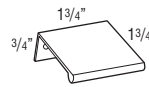

PULLH71

TRUSS METAL CORBEL, STAINLESS STEEL

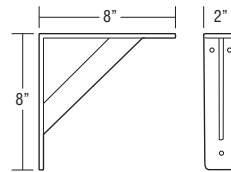

CORBELTRSS

- Pre-drilled mounting holes for easy installation.
- 1/4" material thickness.
- Not intended for cabinet or freestanding countertop support. For substantial weight support, use a floor mounted support such as a Decorative Leg.
- Must be properly installed into a structural member of the wall.

CRESCENT METAL CORBEL, BRUSHED NICKEL

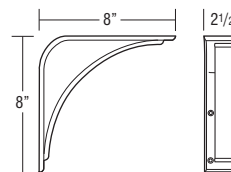

CORBELCRBN

- Matching screw caps included to hide the installation screws.
- Pre-drilled mounting holes for easy installation.
- 1/4" material thickness.
- Not intended for cabinet or freestanding countertop support. For substantial weight support, use a floor mounted support such as a Decorative Leg.
- Must be properly installed into a structural member of the wall.

SHELF SUPPORT BRACKET, SATIN NICKEL

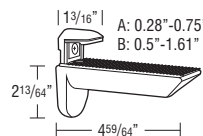





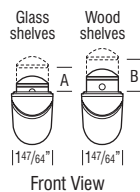





















SHELFBRKTSN

- Sold in pairs.
- Can be used with glass shelves 0.28"-0.75" (7-19mm) thick, or wood shelves 0.5"-1.61" (12-41mm) thick.
- Must be properly installed into a structural member of the wall.
- Maximum shelf load varies with shelf depth. For a 12" deep shelf, maximum shelf load is 50 lbs. each including shelf weight.



DESCRIPTION MODEL
DECORATIVE HARDWARE

HARDWARE - DECORATIVE PULLS AND KNOBS

	KNOBH06 - Copper Antique Highlight (1 1/4"W x 1 1/8"L)
	KNOBH07 - Copper Antique Highlight (2 1/4"W x 1 1/16"L)
	PULLH08 - Copper Antique Highlight - 128mm C/C (15/16"W x 5 1/2"L x 1 1/16"H)
	KNOBH10 - Nickel Antique Highlight (1 5/16"W x 3/4"H)
	PULLH11 - Nickel Antique Highlight - 96mm C/C (3/8"W x 4 3/4"L x 1 3/8"H)
	KNOBH20 - Red Rust Antique (1 1/4"W x 1"H)
	KNOBH23 - Ultra Brush Nickel (1 1/4"W x 1"H)
	PULLH30 - Ultra Brush Nickel - 128mm C/C (3/16"W x 6 1/2"L x 1 1/8"H)
	KNOBH31 - Ultra Brush Nickel (1"W x 3/4"H)
	KNOBH32 - Ultra Brush Nickel (1"W x 1/2"H)
	PULLH34 - Rust Pewter (1/4"W x 1.28"L)
	KNOBH35 - Rust Pewter (1.27"W x 1.03"L)
	PULLH36 - Red Rust Antique - 6" C/C (3/4"W x 7 1/2"L x 1 1/4"H)
	KNOBH37 - Red Rust Antique (1.38"W x 1 1/4"H)
	PULLH38 - Vibra Black Nickel - 128mm C/C (1 1/4"W x 5 1/8"L x 1 3/8"H)
	PULLH39 - Vibra Black Nickel - 96mm C/C (1 1/8"W x 3 7/8"L x 1 1/8"H)
	KNOBH40 - Black (1 1/8"W x 1 1/4"L x 1/2"H)
	PULLH41 - Black - 5 1/2" C/C (1 1/16"W x 7 1/8"L)
	PULLH42 - Black - 96mm C/C (1 1/8"W x 4 1/4"L x 1 1/8"H)
	KNOBH43 - Windsor Antique (1.88"W x 1.08"L)
	PULLH44 - Vibra Black Nickel (2 1/8"W x 1 1/2"L x 5/8"H)
	PULLH45 - Vibra Black Nickel - 3" C/C (4 1/4"W x 1 1/2"L x 5/8"H)
	KNOBH46 - Vibra Black Nickel (1"W x 1 1/4"L x 7/8"H)
	PULLH47 - Vibra Black Nickel - 2 1/2" C/C (3"W x 1/2"L x 5/8"H)
	PULLH50 - Satin Nickel - 5" C/C (5/16"W x 5"L x 1 1/4"H)
	PULLH51 - Stainless Steel - 1" C/C (5/16"W x 2"L x 7/16"H)

KEMPER®

DESCRIPTION MODEL

HARDWARE - DECORATIVE PULLS AND KNOBS (cont'd)

	PULLH52 - Stainless Steel - 7.38" C/C (3/8"W x 8 1/16"L x 7/8"H)
	PULLH53 - Satin Nickel - 96mm C/C (5/8"W x 5"L x 1 7/16"H)
	KNOBH54 - Black Nickel with Brown Glaze (1 1/4"W x 1 1/8"H)
	PULLH55 - Black Nickel with Brown Glaze - 4 1/2" C/C (7/16"W x 5 1/8"L)
	PULLH56 - South Haven Antique - 128mm C/C (5 3/8"L)
	KNOBH57 - South Haven Antique (1 1/4")
	KNOBH58 - Oil Rubbed Bronze (1 1/4"W x 1"H)
	PULLH59 - Oil Rubbed Bronze - 128mm C/C (1 1/4"W x 6 1/8"L x 1 3/8"H)
	PULLH60 - Oil Rubbed Bronze - 96mm C/C (4 7/8"W x 2"L x 7/8"H)
	PULLH61 - Black - 96mm C/C (7/16" x 4 15/16"L)
	KNOBH62 - Black (2 1/8"W x 2"L x 5/8"H)
	PULLH63 - Satin Nickel - 96mm C/C (1/2"W x 4 1/8"L x 1 1/6"H)
	PULLH64 - Satin Nickel - 3" C/C (1/2"W x 4 9/16"L x 15/16"H)
	KNOBH65 - Stainless Steel (0.088")
	PULLH66 - Black Nickel - 9" C/C (7/8"W x 9 1/4"L)
	PULLH70 - Brushed Nickel - 113mm C/C (1 3/4"W x 6"L x 3/4"H)
	PULLH71 - Brushed Nickel - 32mm C/C (1 3/4"W x 1 3/4"L x 3/4"H)

- Screws included with each hardware piece.
- Larger pulls may not be compatible with raised profile or 5-piece drawer fronts less than 12" wide.
- See page 70 for 5-piece drawer front dimensions when specifying decorative hardware.

HARDWARE — FAUX HINGES



HINGEFH1
HINGEFH2

HINGEFH3

HINGEFH1 - Antique Brass Faux Barrel Hinge

HINGEFH2 - Pewter Faux Barrel Hinge

HINGEFH3 - Black Faux Strap Hinge

- Faux Strap Hinge: All 12" - 30" high doors use 2 hinges. All 36" high and above use 3 hinges.
- Faux Barrel Hinge: All 12" - 30" high doors use 2 hinges. All 42" high and above use 3 hinges.
- Requires field installation.
- For use with Warwick door style.

DESCRIPTION
ACCESSORIES

MODEL

BASE MIXER KIT

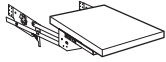

MIXKITFHSC18
MIXKITFHSC21
MIXKITFHSC24

- Smart Stop closing feature.
- Mixer shelf will be 3/4" thick natural finished veneer plywood, mixer shelf dimensions:
18" wide: 13 7/16" wide x 20" deep.
21" wide: 16 7/16" wide x 20" deep.
24" wide: 19 7/16" wide x 20" deep.
- Maximum Weight Capacity for Mixer Shelf: 60 lbs.
- Mixer shelf locks in the fully open position. Release brackets lower the mixer shelf back into the cabinet.
- When in closed position, clearance above shelf is 19 1/2"; clearance below shelf is 8 7/16".

storage
SOLUTIONS

BASE PAN STORAGE

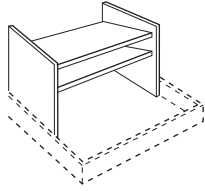

BPS24
BPS30
BPS36

Model	Application
BPS24	24" Base
BPS30	30" Base
BPS36	36" Base

- Roll tray not included.
- Insert consists of solid Maple sides and shelves. Back is edgebanded plywood.

storage
SOLUTIONS

BASE WASTEBASKET LIDS

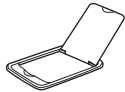

BWBLID
BWBFLID

- Designed to be used with the BWB trash units.
- Sold individually.
- BWBLID fits 35 quart wastebaskets. BWBFLID fits 50 quart wastebaskets.

BATTERY STRIP LIGHT



BATTLTI

- Battery operated – (4) AAA batteries (not included).
- Motion activated.
- Low power usage (0.3W).
- Plastic aluminum finish.
- Dimensions: Length 11.93" (303mm), Width 0.67" (17mm), and Depth 0.55" (14mm).
- Easy adhesive install.

BROOM CLIP

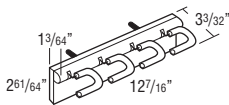

BRMCLP

storage
SOLUTIONS

DESCRIPTION

MODEL

CABMAT™

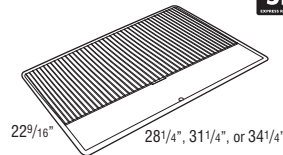

CABMAT30
CABMAT33
CABMAT36

- Designed with a slope to capture spills and is removable for cleaning.
- See CabMat™ modification for easy size selection by cabinet model.
- Not trimmable. Can also be used in wider cabinets but will create a small void of unprotected area along the end panels.

storage
SOLUTIONS

Model	Liquid Capacity		Cabinet Size	
	Quarts	Liters	Width	Depth
CABMAT30	4.2	3.9	30"	24"
CABMAT33	4.6	4.3	33"	24"
CABMAT36	5.0	4.7	36"	24"

CABMAT™ VANITY

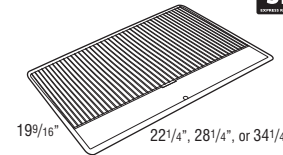

CABMATV24
CABMATV30
CABMATV36

- Designed with a slope to capture spills and is removable for cleaning.
- See CabMat™ modification for easy size selection by cabinet model.
- Not trimmable. Can also be used in wider cabinets but will create a small void of unprotected area along the end panels.

storage
SOLUTIONS

Model	Liquid Capacity		Cabinet Size	
	Quarts	Liters	Equivalent Cabinet Width	Depth
CABMATV24	2.5	2.4	24"-27"	21"
CABMATV30	3.3	3.1	30"-33"	21"
CABMATV36	3.9	3.7	36"	21"

COOKING UTENSIL DIVIDER

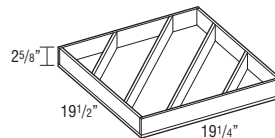

CUDD24
CUDD30
CUDD36

- Pre-assembled natural wood drawer insert (does not fit roll trays).

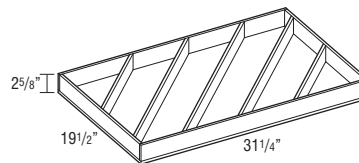
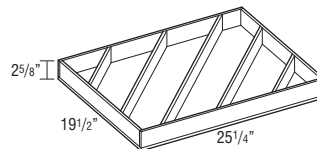

storage
SOLUTIONS

DESCRIPTION

MODEL

CUTLERY INSERT WOOD ORGANIZER



- CIW15
- CIW18
- CIW21
- CIW24

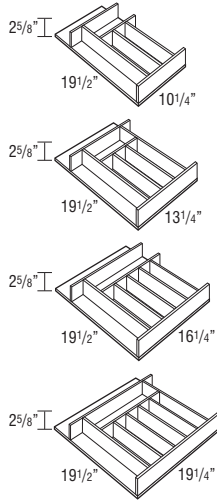

Model	Application
CIW15	15" Base
CIW18	18" Base
CIW21	21" Base
CIW24	24" Base

- Pre-assembled natural wood drawer insert.
- CIW also available installed in B__CIW, B__RTCIW, and 4DB__CIW. See pages 159, 168, and 194.
- Place a cabinet with a CIW next to the dishwasher for convenience.

storage SOLUTIONS

DESCRIPTION

MODEL

WOOD TIERED CUTLERY DIVIDER DRAWER, 15", 18", 21", and 24"



- WTCD15
- WTCD18
- WTCD21
- WTCD24

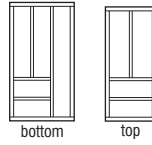
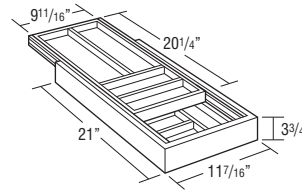

Model	Application
WTCD15	15" Base
WTCD18	18" Base
WTCD21	21" Base
WTCD24	24" Base

- Replaces standard drawer. Uses existing cabinet member drawer hardware.
- Requires field installation of drawer front.
- For use with 24" deep cabinets only.
- Exterior WTCD drawer box height is 3 3/4", interior height of top and bottom tier is 1 3/8".
- Top divider slides front-to-back.

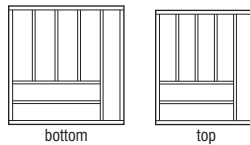
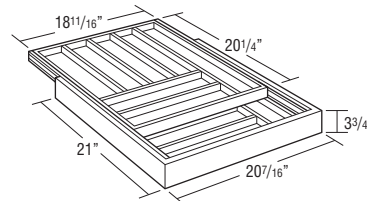
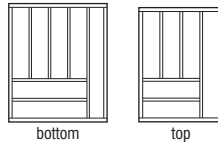
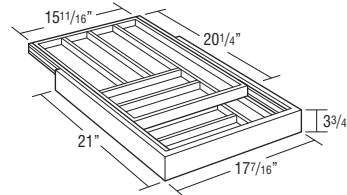
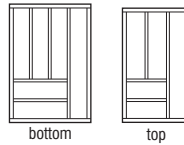
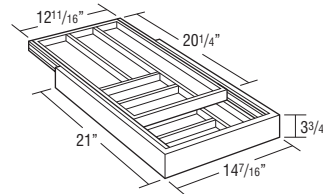

storage SOLUTIONS

DESCRIPTION

WOOD TIERED K-CUP* DRAWER

MODEL

KCUP18

- Holds 40 K-Cups.
 - Exterior Wood Tiered K-Cup drawer box height is 3 3/4", interior height of top tier is 1 5/8", and interior height of bottom tier is 1 3/8".
 - The Wood Tiered K-Cup Drawer is compatible with K-Cup pods only.
 - Replaces standard drawer. Uses existing cabinet member drawer hardware.
 - Requires field installation of drawer front.
 - Only for use with 24" deep cabinets that are 18" wide or have an equivalent size drawer.
 - Top divider slides front-to-back.
- *K-Cup is a registered trademark of Keurig Green Mountain, Inc.

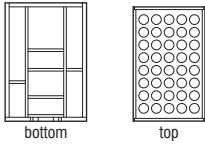
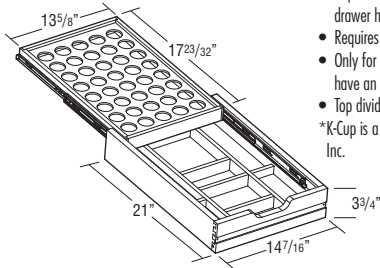

EDGE BANDING



EDGE BANDING

EDGE BANDING

EDGE BANDING

EDGE BANDING

EDGE BANDING

- Edgebanding will come in a 10' length.
- Finger joints may be visible on unfinished veneer and clear coated edgebanding.
- Edgebanding does not come pre-glued.
- EDGE BANDING 10WD is unfinished veneer, available in Alder, Cherry, Hickory, Maple, Oak, Rustic Alder, and Rustic Hickory.
- EDGE BANDING 10P is available in Arctic, Antler, Elk, High Gloss White, High Gloss White with Metallic, Obsidian, and Wharf.
- EDGE BANDING 10NML is Natural Maple Laminated.
- EDGE BANDING 10NIP is clear coated veneer for use with APC natural interiors.
- EDGE BANDING 10WHL is White Laminated.
- EDGE BANDING 10WD and EDGE BANDING 10WHL can be used for White Melamine.

DESCRIPTION

EXTERIOR SHELVES, 12" DEEP



ES1218

ES1224

ES1230

ES1236

ES1248

ES1296†

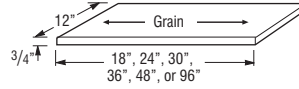

- Wood 3/4" panels are veneered furniture board finished both sides, and front and side edges (back edge is not finished).
 - Not available in wood grain laminates.
 - Shelves can be ordered in APC.
- †5 day Express Response not available on items over 48".

Custom Modifications		Finish Techniques	
ID	RD	Distressing	Heirlooming
•	•		

Species Availability (Wood)

Alder	Rustic Alder	Cherry	Hickory	Rustic Hickory	Maple	Oak
•	Alder	•	•	Hickory	•	•

Species Availability (All Laminates)

High Gloss box color	Horiz. Grain on Maple box color	Vert. Grain on Maple box color	Vert. Grain on Cherry box color	Vert. Grain on Hickory box color	Vert. Grain on Oak box color	Thermofoil box color

EXTERIOR SHELVES, 18" DEEP



ES1818

ES1824

ES1830

ES1836

ES1848

ES1896†

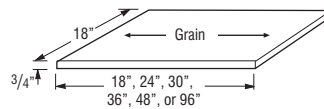

- Wood 3/4" panels are veneered furniture board finished both sides, and front and side edges (back edge is not finished).
 - Not available in wood grain laminates.
 - Shelves can be ordered in APC.
- †5 day Express Response not available on items over 48".

Custom Modifications		Finish Techniques	
ID	RD	Distressing	Heirlooming
•	•		

Species Availability (Wood)

Alder	Rustic Alder	Cherry	Hickory	Rustic Hickory	Maple	Oak
•	Alder	•	•	Hickory	•	•

Species Availability (All Laminates)

High Gloss box color	Horiz. Grain on Maple box color	Vert. Grain on Maple box color	Vert. Grain on Cherry box color	Vert. Grain on Hickory box color	Vert. Grain on Oak box color	Thermofoil box color

DESCRIPTION

**EXTERIOR SHELVES,
21" DEEP**



MODEL

- ES2118
- ES2124
- ES2130
- ES2136
- ES2148
- ES2196†

- Wood 3/4" panels are veneered furniture board finished both sides, and front and side edges (back edge is not finished).
 - Not available in wood grain laminates.
 - Shelves can be ordered in APC.
- †5 day Express Response not available on items over 48".

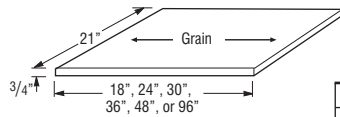

Custom Modifications		Finish Techniques	
ID	RD	Distressing	Heirlooming
•	•		

Species Availability (Wood)						
Alder	Rustic Alder	Cherry	Hickory	Rustic Hickory	Maple	Oak
•	•	•	•	•	•	•

Species Availability (All Laminates)						
High Gloss box color	Horiz. Grain on Maple box color	Vert. Grain on Maple box color	Vert. Grain on Cherry box color	Vert. Grain on Hickory box color	Vert. Grain on Oak box color	Thermofoil box color

**EXTERIOR SHELVES,
24" DEEP**



- ES2418
- ES2424
- ES2430
- ES2436
- ES2448
- ES2496†

- Wood 3/4" panels are veneered furniture board finished both sides, and front and side edges (back edge is not finished).
 - Not available in wood grain laminates.
 - Shelves can be ordered in APC.
- †5 day Express Response not available on items over 48".

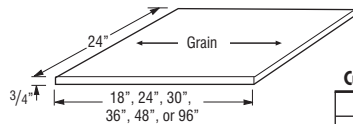

Custom Modifications		Finish Techniques	
ID	RD	Distressing	Heirlooming
•	•		

Species Availability (Wood)						
Alder	Rustic Alder	Cherry	Hickory	Rustic Hickory	Maple	Oak
•	•	•	•	•	•	•

Species Availability (All Laminates)						
High Gloss box color	Horiz. Grain on Maple box color	Vert. Grain on Maple box color	Vert. Grain on Cherry box color	Vert. Grain on Hickory box color	Vert. Grain on Oak box color	Thermofoil box color

DESCRIPTION

FULL DEPTH SHELVING
To Fit 12" Deep Cabinets



MODEL

- SK912
- SK1212
- SK1512
- SK1812
- SK2112
- SK2412
- SK2712
- SK3012
- SK3312
- SK3612
- SK3912
- SK4212
- SK4812

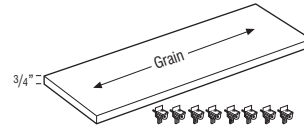

- One shelf, 10 15/32" deep, may require field trimming based on cabinet configuration.
- Each kit includes 8 shelf pegs.
- Shelving material specific to construction option. See pages 34-35 for construction details.
- Specify material when ordering.
- Full Depth Shelves will be shipped separate from the cabinet.
- If matching interior is desired, order shelf kit (SK____) with Matching Interior Plywood (MIP) modification.

Custom Modifications				Construction Upgrades
ID	MIP	RD	WLI	APC
•	•	•	•	•

FULL DEPTH SHELVING
To Fit 24" Deep Cabinets



- SK924
- SK1224
- SK1524
- SK1824
- SK2124
- SK2424
- SK2724
- SK3024
- SK3324
- SK3624
- SK3924
- SK4224
- SK4824

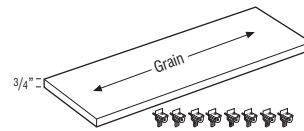

- One shelf, 22 15/32" deep, may require field trimming based on cabinet configuration.
- Each kit includes 8 shelf pegs.
- Shelving material specific to construction option. See pages 34-35 for construction details.
- Specify material when ordering.
- Full Depth Shelves will be shipped separate from the cabinet.
- If matching interior is desired, order shelf kit (SK____) with Matching Interior Plywood (MIP) modification.

Custom Modifications				Construction Upgrades
ID	MIP	RD	WLI	APC
•	•	•	•	•

DESCRIPTION

**GLASS SHELF KIT,
6", 9", & 12" DEEP
(FULL ACCESS)**

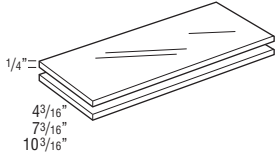

MODEL

JGSK1206FA
JGSK1506FA
JGSK1806FA
JGSK2106FA
JGSK2406FA
JGSK2706FA
JGSK3006FA
JGSK3306FA
JGSK3606FA

JGSK1209FA
JGSK1509FA
JGSK1809FA
JGSK2109FA
JGSK2409FA
JGSK2709FA
JGSK3009FA
JGSK3309FA
JGSK3609FA

JGSK912FA
JGSK1212FA
JGSK1512FA
JGSK1812FA
JGSK2112FA
JGSK2412FA
JGSK2712FA
JGSK3012FA
JGSK3312FA
JGSK3612FA

- For use in full access cabinets.
- JGSK__FA cannot be trimmed.
- Kit includes two 1/4" tempered shelves.
- Example: JGSK1512FA = 13 17/32" wide x 10 3/16" deep fits in W1530 (12" deep cabinet).
- ID13-ID18 available on JGSK1212FA-JGSK3612FA.

**GLASS SHELF KIT,
DIAGONAL
(FULL ACCESS)**

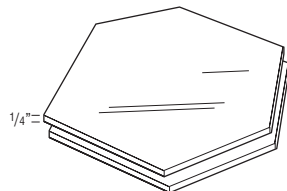

JGSKDW24FA
JGSKDW27FA

- For use in full access cabinets.
- JGSKDW__FA cannot be trimmed.
- Kit includes two 1/4" tempered shelves.
- Not available for 24" and 27" high Diagonal Wall cabinets. Shelf will not fit through door opening.
- JGSKDW24FA fits 24" Deep Diagonal Wall cabinets (DW__2424).
- JGSKDW27FA fits 27" Deep Diagonal Wall cabinets (DW__2727).

DESCRIPTION

**GLASS SHELF KIT,
6", 9", & 12" DEEP
(FRAMED)**

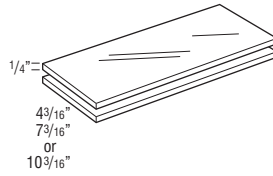

MODEL

JGSK1806
JGSK2406
JGSK3006
JGSK3606

JGSK1809
JGSK2409
JGSK3009
JGSK3609

- For use in framed cabinets such as Wall Bookcase (W__BC and WFBC__) and Tall Bookcase (TBC__ and TBCD__).
- JGSK__ cannot be trimmed.
- Kit includes two 1/4" tempered shelves.
- Example: JGSK1812 = 16 9/32" wide x 10 3/16" deep fits in WFBC1848 (12" deep cabinet).
- ID13-ID18 available on JGSK1812-JGSK3612.

STRAIGHT HEAT SHIELDS

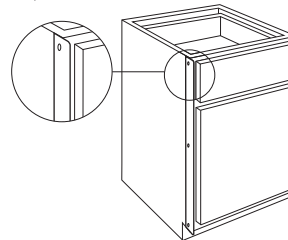
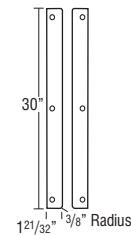

**STRTHEATSHIELD
STRTHSHIELDSS**

- STRTHEATSHIELD is a pair of 1/16" thick, white powder coated metal shields.
- STRTHSHIELDSS is a pair of 1/16" thick, stainless steel metal shields.
- Heat Shield is used to deflect heat from self-cleaning ovens away from cabinet doors and drawer fronts.
- For use when additional 1/8" can be added to the oven manufacturer's recommended space requirement.
- Installs on the cabinet end panel of each cabinet adjacent to the oven.

K-CUP* INSERT

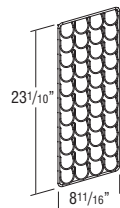

WBCPOKCUP

- Holds 44 K-Cups, compatible with K-Cup pods only.
- Wire K-Cup rack for easy field installation on either the left or right side. Compatible with all heights of 3" wide box column pull-outs (WBCPO., see page 130). Depending on height of pull-out, shelves can be used above or below insert for additional storage:
30" and 33" high include 4 shelves, not compatible with insert.
36" and 39" high include 5 shelves, one shelf recommended for use with insert.
42" high includes 6 shelves, two shelves recommended for use with insert.

*K-Cup is a registered trademark of Keurig Green Mountain, Inc.

DESCRIPTION

MODEL

LID ORGANIZERS



LO24DPRT30

LO24DPRT33

LO24DPRT36

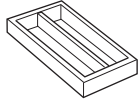
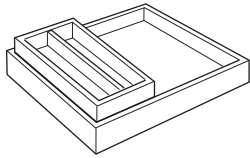

storage
SOLUTIONS

LO

- LO24DPRT30, LO24DPRT33, and LO24DPRT36 include roll tray and installation hardware.

LINEN CLOSET HAMPER LINER



LCHAMPERLNR

- Replacement cloth liner for use with LCRH188421, see page 275.

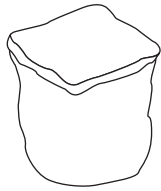

PEGGED DISH ORGANIZER



PDO (8 Posts & Board)

PDOPOSTS (4 Posts)

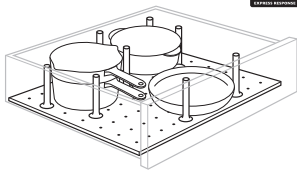

- For use in 36" wide drawer base cabinets in 6 3/8" or 10" deep drawers, trimmable for cabinets less than 36" wide. Not recommended for use in roll trays.
- Pegged Board is 19/32" thick.
- 33" x 19 5/8".
- Posts are 6" high.

storage
SOLUTIONS

POTS & PANS PULL-OUT



PPP

- For use in 24" wide cabinets.

PPP30

- For use in 30" wide cabinets.

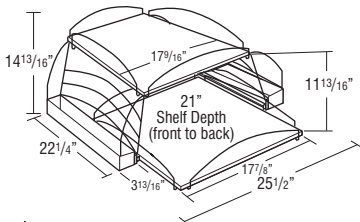
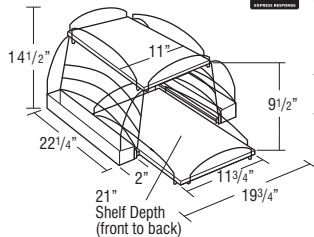

storage
SOLUTIONS

DESCRIPTION

MODEL

POWERGLIDE™ COMPACT DRAWER OUTLET

DRWPWR1

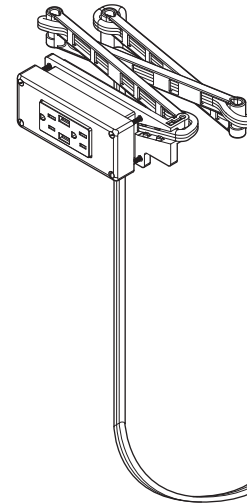

- Outlet has a total rated capacity of 15 amps.
- Includes two 120V electrical plug-ins and two 2.1 amp rated USB charging ports.
- Cord has 3 ft. of length hanging freely from back mounting bracket. The cord is 14 gauge wire and features a standard 3-prong plug and is required to be plugged into an approved AFCI/GFCI dual function outlet for all applications.
- Outlet is ETL approved-compliant for electrical and other safety standards to U.S. and Canadian safety including UL standards.
- Requires field installation including a 4.25" x 2.13" square hole to be cut into the back of the drawer box.
- Outlet face plate measures 5.22" x 2.3" and will extend 3/4" into drawer box.
- A minimum drawer box height of 2 5/8" is required for installation.
- For use in base cabinet widths of 18" to 36".
- For use in cabinet depths of 13", 15", 16", 18", 19", 21", 22", and 24". Not compatible with 14", 17", 20", and 23" depths..
- Also available as an installed modification, see DRWPWR on page 47.

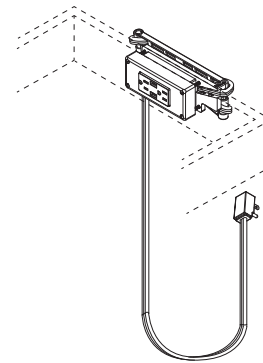

POWER POD

JPWRPODBK (Black)

JPWRPODSS (Stainless Steel)

JPWRPODGM (Gun Metal Black)

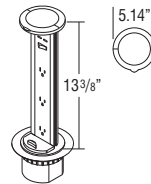

storage
SOLUTIONS

- Includes: independent power switch, three electrical sockets, and two USB ports (located above power switch).
- 18" of clearance required below surface mount location; and 3 9/16" diameter hole is required in countertop to install.
- This item requires field installation. This accessory cannot be installed above drawers.
- Safe for countertop installation: rated IP54-splash proof from splashing water and water jets per IPX waterproof specifications; and is ETL approved-compliant for electrical and other safety standards to North America safety including: UL, ANSI, CSA, ASTM, and NFPA standards.
- When installed, top lip of strip sits on top of countertop with a pivoting handle. Handle is pulled up to bring bottom of power strip to countertop.
- Cord is 8 ft. long and features a standard 3-prong plug for use in any household outlet. 10 amps.

SINK BASE CADDY



SBCADDY

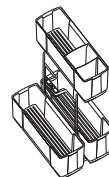

- Caddy is removable and portable.
- Recommended for use in cabinets 18" and wider.
- Caddy dimensions are: 9 15/16" wide x 18 5/16" tall x 18 5/8" deep.
- Caddy fits in cabinets with a minimum: 12" wide x 20 1/2" high opening x 21" deep cabinet.

storage
SOLUTIONS

DESCRIPTION

SLIDING TOWEL RACK

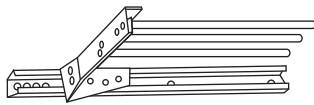

MODEL

STR

- Metal.
- 5" wide x 17 3/4" long x 1 1/2" high.
- Fits in any sink cabinet.

EZ-ORG™ MODULAR PULL-OUT RACKS

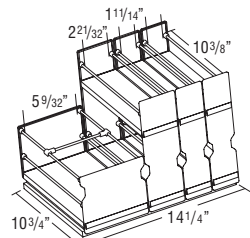

EZORG18

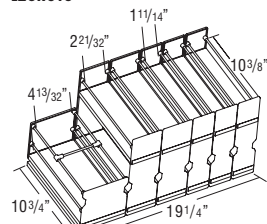

EZORG24

EZORG18

EZORG24

- EZORG18 includes four pull-out racks installed onto a wood base for use in an 18" wide or wider cabinet. Outside rack dimensions: one 5 7/8" wide x 5 3/4" high one 3 1/4" wide x 10 3/4" high two 2 3/8" wide x 10 3/8" high
- EZORG24 includes six pull-out racks installed onto a wood base for use in a 24" wide or wider cabinet. Outside rack dimensions: one 5" wide x 5 3/8" high two 3 1/4" wide x 10 3/4" high three 2 3/8" wide x 10 3/8" high
- Entire pull-out must be installed as one unit, cannot remove racks from wood base for individual installation.
- Racks feature natural finish wood shelves with wire racks and frosted front and back panels. Guides are full extension and do not feature Smart Stop.
- Maximum Weight Capacity: 2 3/8" and 3 1/4" wide racks: 7 lbs. 5" and 5 7/8" wide racks: 20 lbs.
- Must be installed on the floor of the cabinet. Cannot be installed on an adjustable shelf.
- Field installation requires attaching wood base to cabinet bottom with pre-drilled mounting holes, includes 4 screws and instructions.
- Installation height clearance of 12" minimum is recommended.

SPICE RACKS

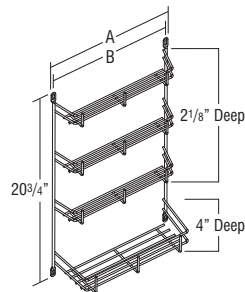

SRCH12

SRCH15

SRCH18

Model	A	B	Fits
SRCH12	7 7/8"	8 13/50"	B15, B30, B33
SRCH15	10 5/8"	11"	B18, B36
SRCH18	13 5/8"	14"	B21, B24 L or R

A = Hole Centers Width

B = Outside Overall Widths

- Designed for Base cabinets only. Mounts to door top and bottom rails.
- Spice Rack is chrome.

SPICE RACK PULL-DOWN



storage SOLUTIONS

SPD18

- Spice Rack Pull-down dimensions: 8 15/16" high x 14 13/16" wide x 10 5/16" deep.
- Maximum Weight Capacity: 15 lbs.
- Must be installed on the floor of the cabinet. Cannot be installed on an adjustable shelf.

DESCRIPTION

SHELF PULL-DOWN

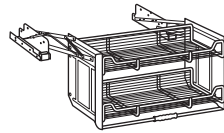

storage SOLUTIONS

MODEL

SHLFPD36

- Shelf Pull-down dimensions: 18 11/64" high x 28 1/4" wide x 8 1/2" deep.
- Clearance dimensions: 19 3/8" high x 15 3/8" wide.
- Maximum Weight Capacity: 26 lbs.
- Must be installed on the floor of the cabinet. Cannot be installed on an adjustable shelf.

TABLET HOLDER

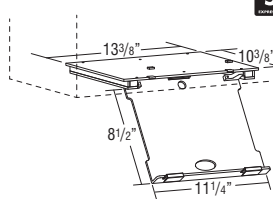

storage SOLUTIONS

TABLEHLDR

- Mounts under 15" wide cabinet or wider.
- Designed for cabinets 12" deep or deeper.
- Features an acrylic mounting base and pull-down tablet holder tray.
- Tray is movable forward and backward with a slight side to side rotation, and can be utilized at any position.
- Tray has side cut-outs for a charging card and can be used to store most tablets when closed, depending on overall thickness, width, height, and weight of the tablet.
- Maximum dimensions for tablet: 11 1/4" x 8 1/2" x 1 1/8" thick. Maximum tablet weight is 3 1/2 lbs.
- Tablet Holder has an overall height of 1 17/32" when installed and in closed position (measured from the bottom panel of the cabinet), 0.78" visible from front of cabinet when closed.
- Installation instructions included.

TOEKICK VACUUM

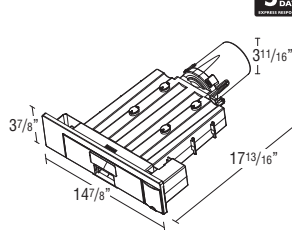

TOEKICKVAC

- 120V compact vacuum cleaner for field installation into the toekick area of base cabinets. Toekick area must be routed for vacuum to be inserted and screwed into place.
- Flooring installation must be compatible with the vacuum by ensuring the bottom of the cabinet is flush with the top of the flooring to allow clearance for the tray to open to access the bag and filter. The flooring should either be installed under the cabinets or the cabinets can be raised to the flooring level.
- Vacuum is 120V-60Hz, rated current of 5 amps, and rated input power is 650W.
- Cord is 10 ft. from the right side of the unit and features a standard 3-prong plug for use in any household outlet.
- Built-in switch can be gently tapped to turn the unit on, a 10 second timer will automatically turn the unit off.
- Should not be installed in a sink base, bathroom, outdoors, or in other wet environments. Do not expose to moisture, rain, or snow. Do not pick up water or sweep water into the vacuum.
- For installation in the front toekick, cabinet must have a minimum depth of 22" and a minimum width of 18". For installation in an end panel, cabinet must have a minimum depth of 21" and a minimum width of 21".
- TOEKICKVAC includes one reusable 0.5 gallon vacuum bag, one HEPA filter, and 4 disposable bags.
- Plastic faceplate features a stainless steel look.
- An air exhaust opening equal to 8" sq (50 cm sq) is required in an area adjacent to the TOEKICKVAC at the rear or side of the cabinet, where cabinets are tight to the floor.

DESCRIPTION

TILT-OUT TRAYS, PLASTIC

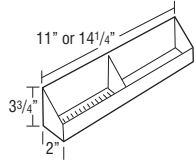

MODEL

TOT15
TOT18

- Kit includes two white plastic trays and one pair of tilt-out hinges that attaches to the inside of the false panel.
- One tilt-out tray per false panel on cabinets less than 30" wide and greater than 36" wide, two tilt-out trays attached to one false panel on 30"-36" wide cabinets.
- Clean using a mild soap and water. Avoid scalding water.

Model	Width	Application
TOT15	11"	SB30, SB33
TOT18	14 1/4"	SB36, SB39, SB42, SB24, SB27, SB48

TILT-OUT TRAYS, STAINLESS STEEL

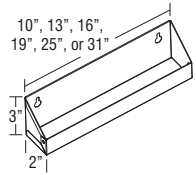

TOTSS

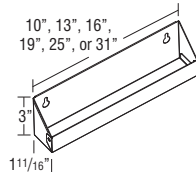

TOTSSS



TOTSS10
TOTSS13
TOTSS16
TOTSS19
TOTSS25
TOTSS31

TOTSSS10
TOTSSS13
TOTSSS16
TOTSSS19
TOTSSS25
TOTSSS31

- Kit contains one tray and one pair of tilt-out hinges that attaches to the inside of the false panel.
- One tilt-out tray per false panel.
- TOTSS is available in standard depth (2" deep) and TOTSSS is a slim version (1 1/16" deep) to be used in narrow spaces.
- Standard trays protrude 1 1/16" into cabinet. Slim trays protrude 3/4" into cabinet.

Model	Width	Application
TOTSS10	10"	VS815
TOTSSS10		
TOTSS13	13"	SB39, SB45, VSB18, VSB39, 2VSD36, 2VSD42, 2VSD48, VSD60, 6VSD42FP
TOTSSS13		
TOTSS16	16"	SB21, SB42, SB45, SB48, VSB21, VSB42, VSB45, 2VSD45, VSD54FP, VSD60FP, VS3D54, VS3D60
TOTSSS16		
TOTSS19	19"	SB24, SB27, SB30, SB33, SB48, VSB24, VSB27, VSB48, 2VSD54, 2VSD60, VSD24FP, VSD27FP, 6VSD48FP, 6VSD54FP, 6VSD60FP, 8VSD48FP, 8VSD60FP
TOTSSS19		
TOTSS25	25"	SB30, SB33, SB36, SB39, VSB30, VSB33, VSD30FP, VSD33FP, VSD42FP, VSD45FP
TOTSSS25		
TOTSS31	31"	SB36, SB42, VSB36, VSD36FP, VSD48FP
TOTSSS31		

DESCRIPTION

TRAY DIVIDER, CHROME

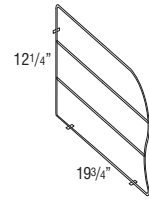

MODEL

CTDK

- CTDK: Includes 1 divider, 3 clips, and 3 screws.
- Tray divider is chrome wire.

TRAY DIVIDER KIT

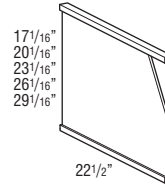

TDKIT15
TDKIT18
TDKIT21
TDKIT24
TDKIT27

- Dividers are sized for a 24" deep cabinet, Depth and height can be trimmed during field installation. Installation screws included.
- Tray dividers are Natural Maple laminated plywood. When specified with APC, tray dividers are clear coated veneer plywood. When specified with APC and WLI, dividers are white laminated plywood. Rails are always Natural Maple.

Model	Wall Cabinets	Tall Cabinets – Upper Section
TDKIT15	Most 18" high wall cabinets	Upper section of 84" high utility, oven cabinets with 17 3/4" high doors
TDKIT18	Most 21" high wall cabinets	Upper section of 87" high utility, oven cabinets with 20 3/4" high doors
TDKIT21	Most 24" high wall cabinets	Upper section of 90" high utility, oven cabinets with 23 3/4" high doors
TDKIT24	Most 27" high wall cabinets	Upper section of 93" high utility, oven cabinets with 26 3/4" high doors
TDKIT27	Most 30" high wall cabinets	Upper section of 96" high utility, oven cabinets with 29 3/4" high doors

TRAY DIVIDER ROLL-OUT KIT

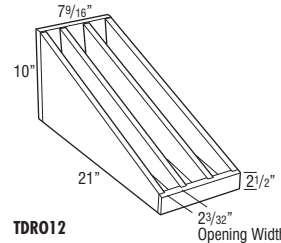

TDRO12

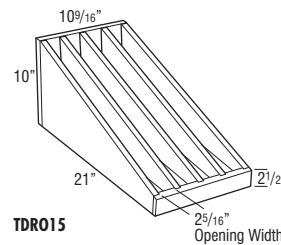

TDRO15



TDRO12
TDRO15

- TDRO12: 2 removable dividers (3 compartments).
- TDRO15: 3 removable dividers (4 compartments).
- Utilizes Smart Stop undermount guides and bumpers for door protection.
- Installation hardware included.

storage SOLUTIONS

DESCRIPTION

MODEL

UTILITY EASY ACCESS BASKETS



UEASBSK15
UEASBSK18

10³/₄" or 13³/₄"

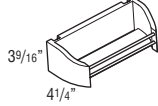

- Only for use to add baskets to a UEAS cabinet.
- Mounting hardware not included.

storage
SOLUTIONS

VANITY CHROME ROLL-OUT RACK



VCRR1521
VCRR1821

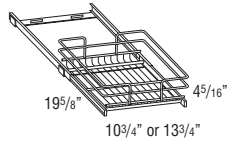

- Requires installation to fixed shelf or cabinet bottom in a 21" or 24" deep cabinet.
- VCRR1521 recommended for use in VB153221, VB153421, DDD152921, CPU152921 (rack will be exposed—no door).
- VCRR1821 recommended for use in VB183421, 2VSD363221, 2VSD363421, VSD303121, VSD303421, LC188421 (lower section), VU188421, VU188421H, DDD182921.
- Roll-out is full extension.

storage
SOLUTIONS

VANITY WASTEBASKET KIT



VWB



- Bottom mount zinc colored Smart Stop guide with 20 quart gray wastebasket inserted in chrome support.
- Dimension of insert: 8.5" wide x 16.7" tall x 17.7" deep.

storage
SOLUTIONS

WALL SUSAN KITS



WSK30
WSK33
WSK36
WSK39
WSK42

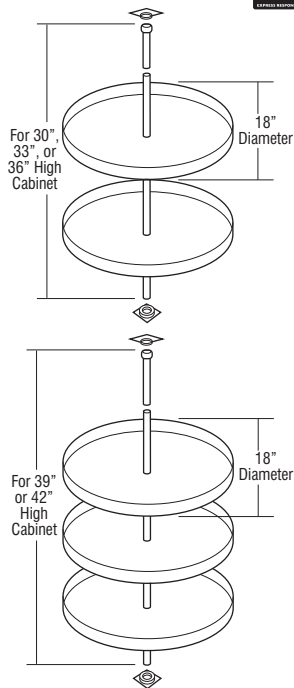

- 30"-36" kits include pole and two 18" diameter plywood shelves. 39" and 42" kits include pole and three 18" diameter plywood shelves.

DESCRIPTION

MODEL

WINE GLASS HOLDERS

WGH30 (7 slots)
WGH33 (7 slots)
WGH36 (8 slots)

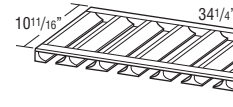
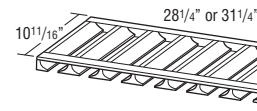

- Maximum wine glass base is 3" diameter.
- Wine Glass Holder is finished.
- May be trimmed to fit smaller cabinets.
- Designed for installation under a wall cabinet recommended for use with Recessed Bottom (RECBTM) modification.

Species Availability (Wood)

Alder	Rustic Alder	Cherry	Hickory	Rustic Hickory	Maple	Oak
•	Alder	•	•	Hickory	•	•

Species Availability (All Laminates)

High Glass	Horiz. Grain on Maple	Vert. Grain on Maple	Vert. Grain on Cherry	Vert. Grain on Hickory	Vert. Grain on Oak	Thermofoil
box color	box color	box color	box color	box color	box color	box color

DESCRIPTION
ROLL TRAY KITS

MODEL

ROLL TRAY KIT

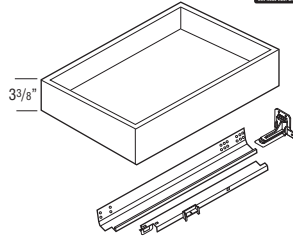

For 18" Deep Cabinets

- RT1218SP
- RT1518SP
- RT1818SP
- RT2118SP
- RT2418SP
- RT2718SP
- RT3018SP
- RT3318SP
- RT3618SP

For 21" Deep Cabinets

- RT1221SP
- RT1521SP
- RT1821SP
- RT2121SP
- RT2421SP
- RT2721SP
- RT3021SP
- RT3321SP
- RT3621SP

For 24" Deep Cabinets

- RT12SP
- RT15SP
- RT18SP
- RT21SP
- RT24SP
- RT27SP
- RT30SP
- RT33SP
- RT36SP

- RT_ _SP's include roll tray, roll tray brackets, hardware, screws, and installation instructions.
- Kits can only be used on the cabinet width specified for proper field installation. For installed roll trays in wider cabinets, specify the RT modification.

Custom Modifications

ID	RD
	•

DESCRIPTION

MODEL

DEEP ROLL TRAY KIT

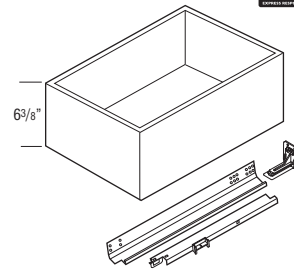

For 18" Deep Cabinets

- DRT1218
- DRT1518
- DRT1818
- DRT2118
- DRT2418
- DRT2718
- DRT3018
- DRT3318
- DRT3618

For 21" Deep Cabinets

- DRT1221
- DRT1521
- DRT1821
- DRT2121
- DRT2421
- DRT2721
- DRT3021
- DRT3321
- DRT3621

For 24" Deep Cabinets

- DRT12
- DRT15
- DRT18
- DRT21
- DRT24
- DRT27
- DRT30
- DRT33
- DRT36

- DRT_ _'s include deep roll tray, deep roll tray brackets, hardware, screws, and installation instructions.
- Kits can only be used on the cabinet width specified for proper field installation. For installed roll trays in wider cabinets, specify the RT modification.

Custom Modifications

ID	RD
	•

DESCRIPTION

MODEL

GUIDE KITS AND PARTS

DRAWER GUIDE KITS

12", 15", 18", 21", or 24"

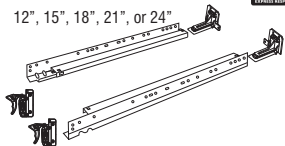

DGKIT12FA

DGKIT15FA

DGKIT18FA

DGKIT21FA

DGKIT24FA

- Undermount full extension Smart Stop Premium Guide (PG).
- Maximum Weight Capacity: 90 lbs. per pair.
- Kit includes guide hardware for one drawer box (cabinets and drawer members, sockets and screws)
- Dimension refers to cabinet depth.

12", 15", 18", 21", or 24"

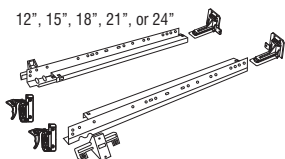

DGKIT12RTFA

DGKIT15RTFA

DGKIT18RTFA

DGKIT21RTFA

DGKIT24RTFA

- Undermount full extension Smart Stop Premium Guide utilized on roll trays.
- Maximum Weight Capacity: 90 lbs. per pair.
- Kit includes guide hardware for one drawer box (cabinets and drawer members, sockets and screws)
- Dimension refers to cabinet depth.

DRAWER GUIDE BACK SOCKETS



BKSOCKET-PG

BKSOCKET-SP

- BKSOCKET-PG used with Smart Stop drawer guides (12"-24" deep).
- BKSOCKET-SP used with Smart Stop roll tray guides.
- Sold in pairs.

DRAWER GUIDE SPACER BLOCK



SPACERBLK

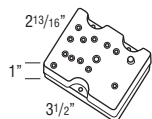

- Sold in pairs.
- For use with DGKIT..FA kits when RD is used for depths other than in 3" increments.
- One SPACERBLK required for each inch of depth. For 14", 17", 20", and 23" depths order (2)SPACERBLK (pair). For 13", 16", 19", and 22" depths order (1)SPACERBLK (pair).

FALSE PANEL CLIPS



FALSEPNLCLIPFA

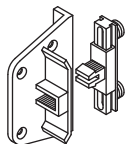

- Use to secure false front on sink base.
- Sold in pairs.

ROLL TRAY PLUG IN BRACKET



RTSPACERFA

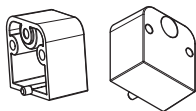

- For use with roll tray hardware to prevent interference with door hinges. Also included in roll tray hardware kit.

DESCRIPTION

MODEL

STAIN, PAINT, & TOUCH-UP TOOLS

STAIN & PAINT



QUARTCOLOR

SSC

SSCCLEAR

SSCMATTESH

- Wiping stains can be sprayed at low pressure.
- Specify finish name and wood type when ordering.
- QUARTCOLOR sold in quarts.
- SSC is a 384 mL aerosol can available in Paint colors.
- SSCCLEAR is a 384 mL aerosol can in clear.
- SSCMATTESH is a 384 mL aerosol can in clear with a matte sheen.
- Not available in Arctic, Antler, Elk, High Gloss White, Obsidian, or Wharf.
- For Touch-up Kits and Glaze Pens, see below.

TOUCH-UP TOOLS



TUK

MTUK

GLAZEPEN

- Touch-up Kit includes touch-up marker and a fill stick.
- MTUK ordered in Paints with glaze will only contain the base color.
- Mini Touch-up Kit includes small touch-up marker and a small fill stick.
- GLAZEPEN available in glaze colors only.
- GLAZEPEN works on finished doors and does not require a separate top coat.

DESCRIPTION

MODEL

HINGES

HINGES - FULL ACCESS



HINGEFASTD

- 107° Full Access hinge and mounting plate used on all cabinets not specified by other hinges.
- Sold in pairs.



HINGEFABC

- 95° Full Access hinge and mounting plate used on: Blind Corner Cabinets (WC, BC, BCFW).
- Sold in pairs.



HINGEFANEG30

- 30° Full Access hinge and mounting plate used on: Wall End Double Door Cabinets (WEC__D, STWEC__D).
- Sold in pairs.



HINGEFA45

- 45° Full Access hinge used on Wall Transition Cabinets (WTC__, STWTC__), Diagonal Wall Cabinets (DW__), Angle Corner Sink Base (ACS__), and Diagonal Base Cabinets (DAB__).
- Sold in pairs.



HINGEFANEG45

- 45° Full Access hinge and mounting plate used on: Wall End Single Door Cabinets (WEC, STWEC).
- Sold in pairs.



HINGEFAWTH

- 107° Full Access hinge and mounting plate used on: Wall Top Hinge Cabinets (WTH).
- Sold in pairs.



HINGEFA170

- 170° Full Access hinge and mounting plate used on: Corner/Angle Base Cabinets (CS, BER, BERAS, BLS, SLS), Base SuperCabinets™ (BSC).
- Sold in pairs.



32049HINGE

- 90° Corner Self-closing Center Hinge.
- Center Hinge for Corner/Angle Base Cabinets (ER, BLS, SLS, BER, BERAS, and CS).
- Sold in pairs.

HINGES - OTHER

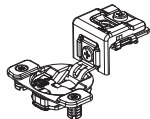

HINGEQRFO

- Quick-Release™ with Integrated Smart Stop, 6-way Adjustable, Full Overlay, 107° Hinge for use on framed construction cabinets: Floating Island Cabinets (FICNT and FIC) and Tall Bookcase Cabinets with Doors (TB CD).
- Sold in pairs.

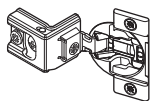

38CFOHINGE

- Integrated Soft-close, 6-way Adjustable, Full Overlay, 107° Hinge for use on framed construction cabinets: Wall Message Center (WMC) and Base Message Center (BMC).
- Sold in pairs.

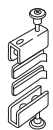

7299HINGE

- Mirror Hinge.
- TV and MC cabinets.
- Sold in pairs.

KEMPER®

DESCRIPTION

MODEL

HINGE ANGLE RESTRICTION CLIP, FULL ACCESS



RESCLIPFA

- For use in applications with cabinets installed at varying depths to prevent the door damage caused by opening into an adjacent cabinet.
- Restricts hinges to 86° opening capability.
- Works only with the HINGEFASTD.
- Sold in pairs.

HINGE ANGLE RESTRICTION CLIP, FRAMED



RESCLIPQR



HINGERESCLIP



RESCLIPQR

HINGERESCLIP

- For use in framed applications only with cabinets installed at varying depths to prevent the door damage caused by opening into an adjacent cabinet.
- Restricts hinges to 86° opening capability.
- RESCLIPQR is only compatible with HINGEQRFO for use on framed construction cabinets: Floating Island Cabinets (FICNT and FIC) and Tall Bookcase Cabinets with Doors (TB CD).
- HINGERESCLIP is only compatible with 38CFOHINGE for use on framed construction cabinets: Wall Message Center (WMC) and Base Message Center (BMC).
- Sold in pairs.

HINGE SHIM



HINGESHIMFA

- Installs between the hinge and hinge cup bore of the door. Used on cabinets requiring a 13mm hinge cup depth such as Wall End Cabinets (WEC, STWEC, WEC__D, STWEC__D), Diagonal Walls (DW), Wall Transition (WTC, STWTC), Wall Blind Corner (WC__), Base Blind Corner (BC), Base Transition (BTC), Diagonal Angle Base (DAB), and Angle Corner Sink (ACS).
- Pack of 5 metal shims.

LIDSTAY

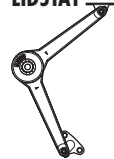

LIDSTAY

- Sold in pairs.
- Recommended for field installed wall top hinge applications up to 18" high.

LIDSTAY - HEAVY DUTY

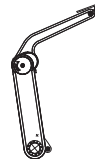

LIDSTAYHD

- One heavy duty lid stay hinge required per cabinet.
- Recommended for field installed wall top hinge applications of 21" high cabinets.

DESCRIPTION

MODEL

PARTS

DOORS & DRAWER FRONTS



Standard Door Size, 18" High or Less

Standard Door Size, 21" to 30" High

Standard Door Size, 33" or Higher

Standard Door Size, No Hinge Route, 18" High or Less

Standard Door Size, No Hinge Route, 21" to 30" High

Standard Door Size, No Hinge Route, 33" or Higher

Any Drawer Front

- Backs of "NO HINGE ROUTE" doors may have identification marks, be unfinished, and have 3/16" diameter holes used during finish processing. For these reasons, these doors are not suitable for use as cabinet doors.

DRAWERS



Complete Drawer

Drawer Box Only

- Complete Drawer and Drawer Box Only do not include drawer guides. They must be ordered separately.

Species Availability (Wood)

Alder	Rustic Alder	Cherry	Hickory	Rustic Hickory	Maple	Oak
•	•	•	•	•	•	•

Species Availability (All Laminates)

High Gloss	Horiz. Grain on Maple	Vert. Grain on Maple	Vert. Grain on Cherry	Vert. Grain on Hickory	Vert. Grain on Oak	Thermofoil
•	•	•	•	•	•	•

DESCRIPTION

MODEL

MISCELLANEOUS PARTS



BRKOFFSCREW (pkg. 25)

CONBOLTCH10

DFBRACKET5P

INSTALLSCR24 (pkg. 24)

INSTALLSCREWS (pkg. 100)

TVHDW/WCATCH

MC16HDW/WCATCH

RETCLIP250BAG

BUMPERPADS (pkg. 25)

SHELFPEGSFA (pkg. 20)

SHELFPEGS (pkg. 24)

OCINSTALLFA27

OCINSTALLFA30

OCINSTALLFA33

- BRKOFFSCREW is a pack of 25 breakaway screws for use with decorative hardware pulls and knobs.
- CONBOLTCH10 is a package of 10 bolt and sleeve sets that allow adjacent cabinets to be connected to one another by bolting cabinet end panels together.
- DFBRACKET5P is a pair of brackets and screws used to attach 5-piece drawer fronts to drawer boxes.
- INSTALLSCR24 and INSTALLSCREWS are screws for cabinet installation through the cabinet back to the wall studs (includes a pack of 24 or 100).
- TVHDW/WCATCH is one set of the magnetic catch hardware and handle used on mirrors on Tri-View Mirrors (TV..).
- MC16HDW/WCATCH is one set of the magnetic catch hardware, handle, and one pair of hinges used on Single Door Medicine Cabinets (MC16).
- RETCLIP250BAG: 6 retainer clips for use with glass inserts in mullion and cut-for-glass doors.
- SHELFPEGSFA are 5mm steel pins with clear plastic shoulders.
- SHELFPEGS are 3mm steel pins with clear plastic shoulders, for use on framed cabinets only.
- OCINSTALLFA_ _ are recommended for supporting built-in appliances such as ovens, microwaves, and warming drawers. Refer to appliance manufacturer specifications for installation requirements.

DESCRIPTION

MODEL

STACK MOULDING KITS

- Moulding stacks do not ship assembled; field assembly is required. Assembly instructions can be viewed in 20/20 spec pages and will also ship with moulding kits.
- When ordered as a kit, only one finish can be specified. To order with more than one finish, moulding pieces must be ordered separately.
- Moulding stacks include Assembly Instructions. Cleats and finish nails not included.

- How to place a stack moulding in 20/20:
 - Moulding
 - Top Mouldings or Bottom Mouldings
 - Stacked Mouldings
 - Drag and drop desired moulding stack onto wall cabinets
- Mouldings specified as 8' nominal length have a usable length range of 93" up to 99". Mouldings specified as 10' nominal length have a usable length range of 117" up to 123". Be sure to order the correct amount of moulding length to work around required cuts with minimal butt joints.

356

MOULDING STACK 1

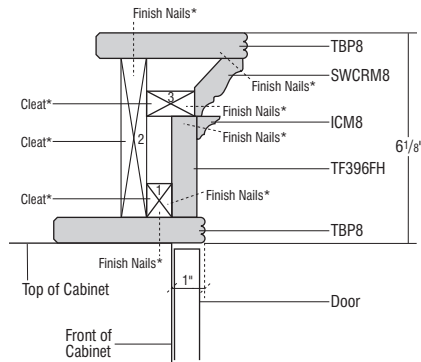
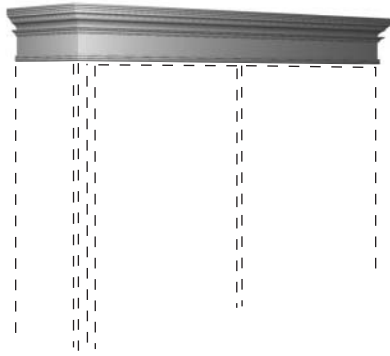

*Cleats and finish nails not included.



STKMLD1

Finish Techniques

	Distressing	Heirlooming
TBP8		•
SWCRM8	•	•
ICM8		
TF396FH	•	

Species Availability (Wood)

	Alder	Rustic Alder	Cherry	Hickory	Rustic Hickory	Maple	Oak
TBP8	•	Alder	•	•	Hickory	•	•
SWCRM8	•	•	•	•	•	•	•
ICM8	•	Alder	•	•	Hickory	•	•
TF396FH	•	Alder	•	•	Hickory	•	•

Species Availability (All Laminates)

	High Gloss	Horiz. Grain on Maple	Vert. Grain on Maple	Vert. Grain on Cherry	Vert. Grain on Hickory	Vert. Grain on Oak	Thermofoil
TBP8	box color	box color	box color	box color	box color	box color	box color
SWCRM8	box color	box color	box color	box color	box color	box color	box color
ICM8	box color	box color	box color	box color	box color	box color	box color
TF396FH	box color	box color	box color	box color	box color	box color	box color

MOULDING STACK 2

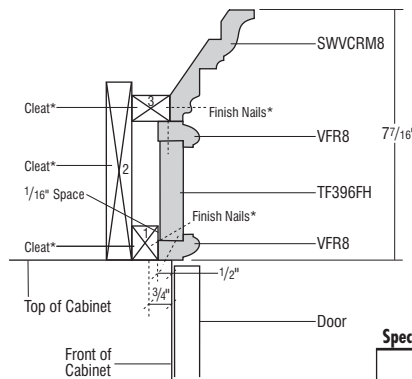
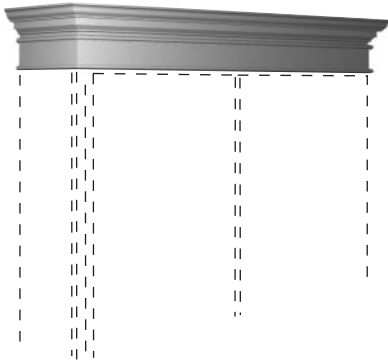

*Cleats and finish nails not included.



STKMLD2

Finish Techniques

	Distressing	Heirlooming
SWVCRM8	•	•
VFR8		•
TF396FH	•	

Species Availability (Wood)

	Alder	Rustic Alder	Cherry	Hickory	Rustic Hickory	Maple	Oak
SWVCRM8	•	•	•	•	•	•	•
VFR8	•	Alder	•	•	Hickory	•	•
TF396FH	•	Alder	•	•	Hickory	•	•

Species Availability (All Laminates)

	High Gloss	Horiz. Grain on Maple	Vert. Grain on Maple	Vert. Grain on Cherry	Vert. Grain on Hickory	Vert. Grain on Oak	Thermofoil
SWVCRM8	box color	box color	box color	box color	box color	box color	box color
VFR8	box color	box color	box color	box color	box color	box color	box color
TF396FH	box color	box color	box color	box color	box color	box color	box color

DESCRIPTION

MODEL

MOULDING STACK 3

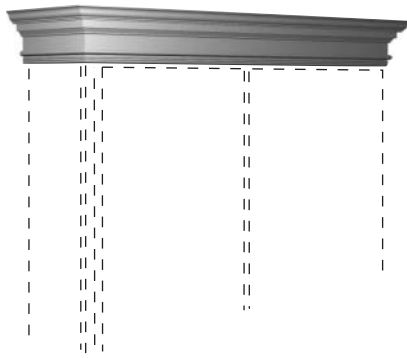

*Cleats and finish nails not included.

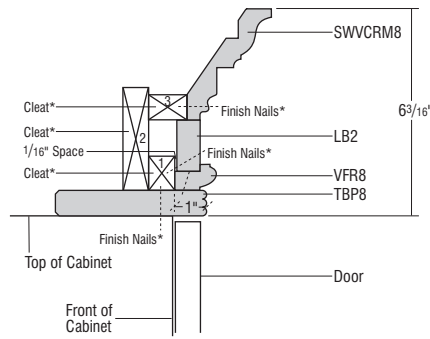

STKMLD3

- Not recommended for use when taking application to the ceiling.

Finish Techniques

	Distressing	Heirlooming
SWVCRM8	•	•
LB2		
VFR8		•
TBP8		•

Species Availability (Wood)

	Alder	Rustic Alder	Cherry	Hickory	Rustic Hickory	Maple	Oak
SWVCRM8	•	•	•	•	•	•	•
LB2	•	Alder	•	•	Hickory	•	•
VFR8	•	Alder	•	•	Hickory	•	•
TBP8	•	Alder	•	•	Hickory	•	•

Species Availability (All Laminates)

	High Gloss	Horz. Grain on Maple	Vert. Grain on Maple	Vert. Grain on Cherry	Vert. Grain on Hickory	Vert. Grain on Oak	Thermofoil
SWVCRM8	box color	box color	box color	box color	box color	box color	box color
LB2	box color	box color	box color	box color	box color	box color	box color
VFR8	box color	box color	box color	box color	box color	box color	box color
TBP8	box color	box color	box color	box color	box color	box color	box color

MOULDING STACK 5

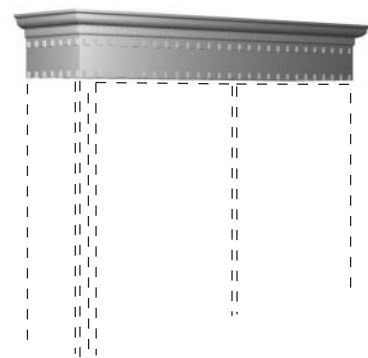

*Cleats and finish nails not included.

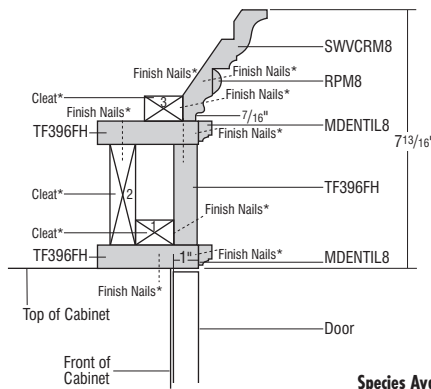

STKMLD5

Finish Techniques

	Distressing	Heirlooming
SWVCRM8	•	•
RPM8		
MDENTIL8		
TF396FH	•	

Species Availability (Wood)

	Alder	Rustic Alder	Cherry	Hickory	Rustic Hickory	Maple	Oak
SWVCRM8	•	•	•	•	•	•	•
RPM8	•	Alder	•	•		•	•
MDENTIL8	•	Alder	•			•	•
TF396FH	•	Alder	•	•		•	•

Species Availability (All Laminates)

	High Gloss	Horz. Grain on Maple	Vert. Grain on Maple	Vert. Grain on Cherry	Vert. Grain on Hickory	Vert. Grain on Oak	Thermofoil
SWVCRM8	box color	box color	box color	box color	box color	box color	box color
RPM8	box color	box color	box color	box color	box color	box color	box color
MDENTIL8	box color	box color	box color	box color	box color	box color	box color
TF396FH	box color	box color	box color	box color	box color	box color	box color

MOULDING STACK 6

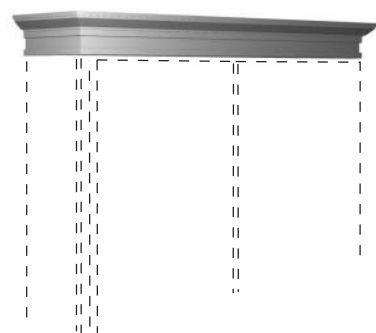

*Cleats and finish nails not included.

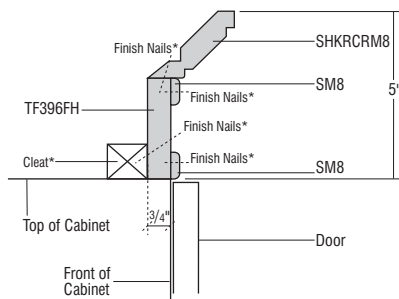

STKMLD6

- Not recommended for use when taking application to the ceiling.

Finish Techniques

	Distressing	Heirlooming
SHKRCRM8	•	•
SM8		
TF396FH	•	

Species Availability (Wood)

	Alder	Rustic Alder	Cherry	Hickory	Rustic Hickory	Maple	Oak
SHKRCRM8	•	•	•	•	•	•	•
SM8	•	Alder	•	•	Hickory	•	•
TF396FH	•	Alder	•	•	Hickory	•	•

Species Availability (All Laminates)

	High Gloss	Horz. Grain on Maple	Vert. Grain on Maple	Vert. Grain on Cherry	Vert. Grain on Hickory	Vert. Grain on Oak	Thermofoil
SHKRCRM8	box color	box color	box color	box color	box color	box color	box color
SM8	box color	box color	box color	box color	box color	box color	box color
TF396FH	box color	box color	box color	box color	box color	box color	box color

DESCRIPTION

MODEL

MOULDING STACK 7

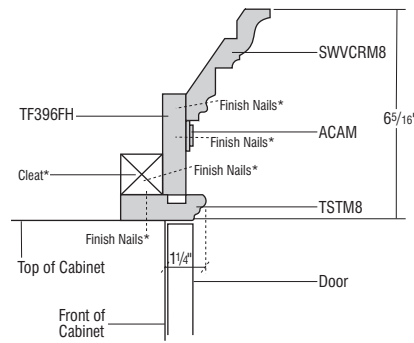
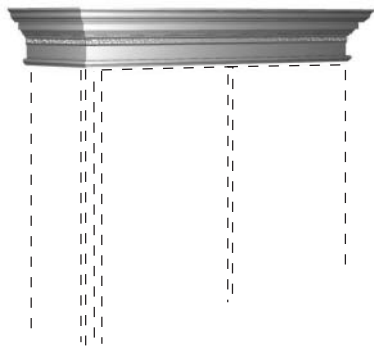

*Cleats and finish nails not included.



STKMLD7

- Not recommended for use when taking application to the ceiling.

Finish Techniques

	Distressing	Heirlooming
SWVCRM8	•	•
ACAM		
TF396FH	•	
TSTM8		

Species Availability (Wood)

	Alder	Rustic Alder	Cherry	Hickory	Rustic Hickory	Maple	Oak
SWVCRM8	•	•	•	•	•	•	•
ACAM	•	Alder	•	Beech	Beech	•	Beech
TF396FH	•	Alder	•	•	Hickory	•	•
TSTM8	•	Alder	•	•	Hickory	•	•

Species Availability (All Laminates)

	High Gloss	Horiz. Grain on Maple	Vert. Grain on Maple	Vert. Grain on Cherry	Vert. Grain on Hickory	Vert. Grain on Oak	Thermofoil
SWVCRM8	box color	box color	box color	box color	box color	box color	box color
ACAM	box color	box color	box color	box color	Beech	Beech	box color
TF396FH	box color	box color	box color	box color	box color	box color	box color
TSTM8	box color	box color	box color	box color	box color	box color	box color

MOULDING STACK 8

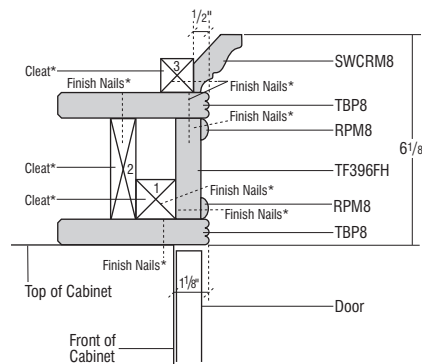
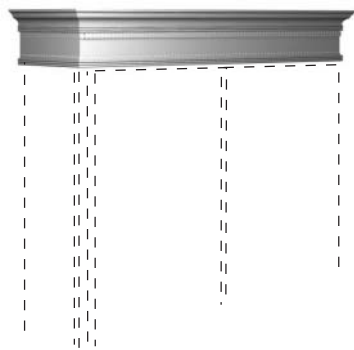

*Cleats and finish nails not included.



STKMLD8

- Not recommended for use when taking application to the ceiling.

Finish Techniques

	Distressing	Heirlooming
SWCRM8	•	•
RPM8		
TBP8		•
TF396FH	•	

Species Availability (Wood)

	Alder	Rustic Alder	Cherry	Hickory	Rustic Hickory	Maple	Oak
SWCRM8	•	•	•	•	•	•	•
RPM8	•	Alder	•	•	Hickory	•	•
TBP8	•	Alder	•	•	Hickory	•	•
TF396FH	•	Alder	•	•	Hickory	•	•

Species Availability (All Laminates)

	High Gloss	Horiz. Grain on Maple	Vert. Grain on Maple	Vert. Grain on Cherry	Vert. Grain on Hickory	Vert. Grain on Oak	Thermofoil
SWCRM8	box color	box color	box color	box color	box color	box color	box color
RPM8	box color	box color	box color	box color	box color	box color	box color
TBP8	box color	box color	box color	box color	box color	box color	box color
TF396FH	box color	box color	box color	box color	box color	box color	box color

MOULDING STACK 10

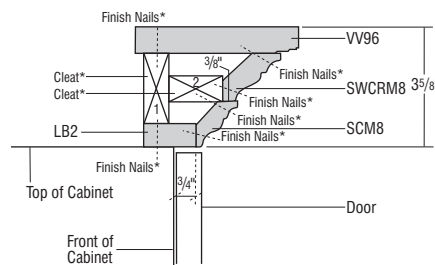
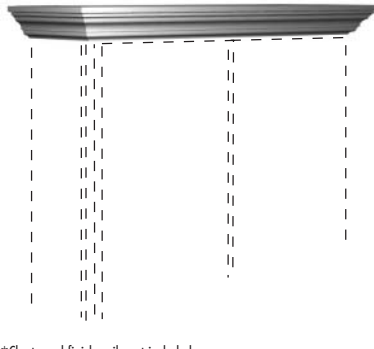

*Cleats and finish nails not included.



STKMLD10

- Not recommended for use when taking application to the ceiling.

Finish Techniques

	Distressing	Heirlooming
VV96	•	•
SWCRM8	•	•
SCM8	•	•
LB2		

Species Availability (Wood)

	Alder	Rustic Alder	Cherry	Hickory	Rustic Hickory	Maple	Oak
VV96	•	•	•	•	•	•	•
SWCRM8	•	•	•	•	•	•	•
SCM8	•	•	•	•	•	•	•
LB2	•	Alder	•	•	Hickory	•	•

Species Availability (All Laminates)

	High Gloss	Horiz. Grain on Maple	Vert. Grain on Maple	Vert. Grain on Cherry	Vert. Grain on Hickory	Vert. Grain on Oak	Thermofoil
VV96	box color	box color	box color	box color	box color	box color	box color
SWCRM8	box color	box color	box color	box color	box color	box color	box color
SCM8	box color	box color	box color	box color	box color	box color	box color
LB2	box color	box color	box color	box color	box color	box color	box color

DESCRIPTION

MODEL

MOULDING STACK 11

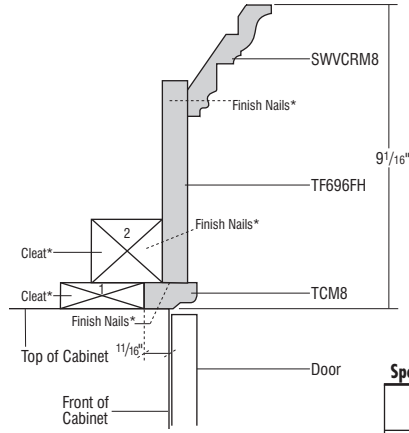
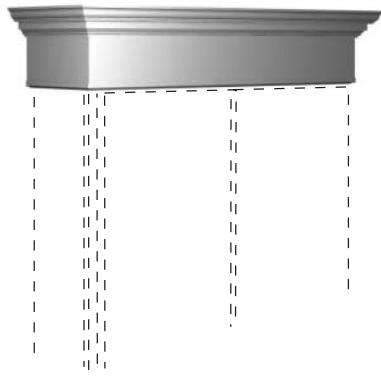

*Cleats and finish nails not included.



STKMLD11

Finish Techniques

	Distressing	Heirlooming
SWVCRM8	•	•
TF696FH	•	•
TCM8	•	•

Species Availability (Wood)

	Alder	Rustic Alder	Cherry	Hickory	Rustic Hickory	Maple	Oak
SWVCRM8	•	•	•	•	•	•	•
TF696FH	•	Alder	•	•	Hickory	•	•
TCM8	•	Alder	•	•	Hickory	•	•

Species Availability (All Laminates)

	High Gloss	Horiz. Grain on Maple	Vert. Grain on Maple	Vert. Grain on Cherry	Vert. Grain on Hickory	Vert. Grain on Oak	Thermofoil
SWVCRM8	box color	box color	box color	box color	box color	box color	box color
TF696FH	box color	box color	box color	box color	box color	box color	box color
TCM8	box color	box color	box color	box color	box color	box color	box color

MOULDING STACK 13

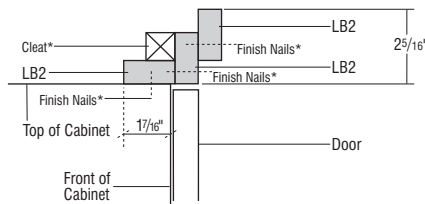
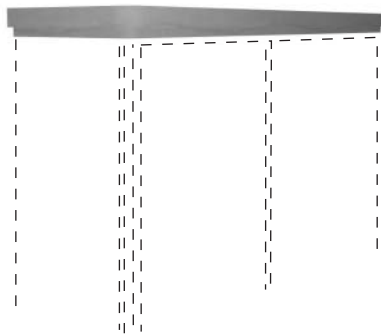

*Cleats and finish nails not included.



STKMLD13

Finish Techniques

	Distressing	Heirlooming
LB2	•	•

Species Availability (Wood)

	Alder	Rustic Alder	Cherry	Hickory	Rustic Hickory	Maple	Oak
LB2	•	Alder	•	•	Hickory	•	•

Species Availability (All Laminates)

	High Gloss	Horiz. Grain on Maple	Vert. Grain on Maple	Vert. Grain on Cherry	Vert. Grain on Hickory	Vert. Grain on Oak	Thermofoil
LB2	box color	box color	box color	box color	box color	box color	box color

MOULDING STACK 14

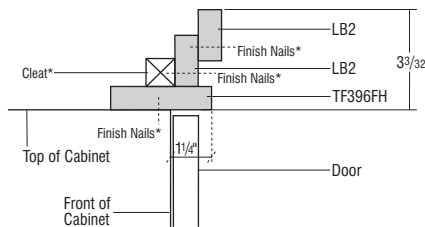
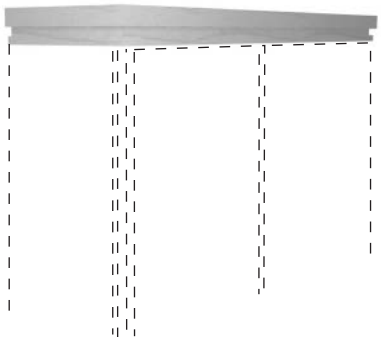

*Cleats and finish nails not included.



STKMLD14

Finish Techniques

	Distressing	Heirlooming
LB2	•	•
TF396FH	•	•

Species Availability (Wood)

	Alder	Rustic Alder	Cherry	Hickory	Rustic Hickory	Maple	Oak
LB2	•	Alder	•	•	Hickory	•	•
TF396FH	•	Alder	•	•	Hickory	•	•

Species Availability (All Laminates)

	High Gloss	Horiz. Grain on Maple	Vert. Grain on Maple	Vert. Grain on Cherry	Vert. Grain on Hickory	Vert. Grain on Oak	Thermofoil
LB2	box color	box color	box color	box color	box color	box color	box color
TF396FH	box color	box color	box color	box color	box color	box color	box color

DESCRIPTION

MODEL

MOULDING STACK 16

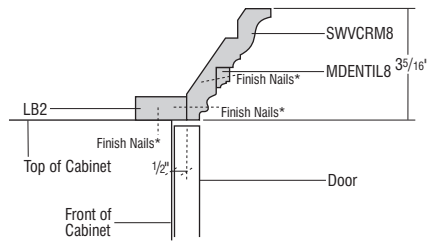
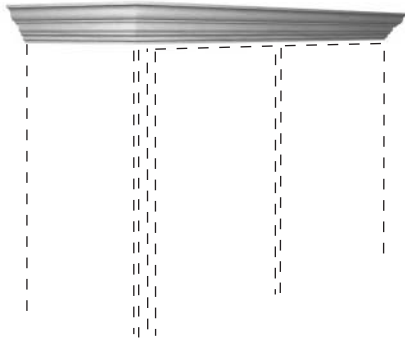

STKMLD16

- Not recommended for use when taking application to the ceiling.

Finish Techniques

	Distressing	Heirlooming
SWVCRM8	•	•
MDENTIL8		
LB2		

Species Availability (Wood)

	Alder	Rustic Alder	Cherry	Hickory	Rustic Hickory	Maple	Oak
SWVCRM8	•	•	•	•		•	•
MDENTIL8	•	Alder	•			•	•
LB2	•	Alder	•	•		•	•

Species Availability (All Laminates)

	High Gloss	Horiz. Grain on Maple	Vert. Grain on Maple	Vert. Grain on Cherry	Vert. Grain on Hickory	Vert. Grain on Oak	Thermofoil
SWVCRM8	box color	box color	box color	box color	box color	box color	box color
MDENTIL8	box color	box color	box color	box color		box color	box color
LB2	box color	box color	box color	box color	box color	box color	box color

*Cleats and finish nails not included.

MOULDING STACK 17

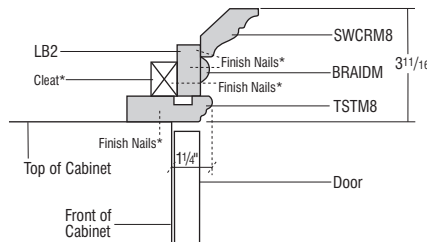
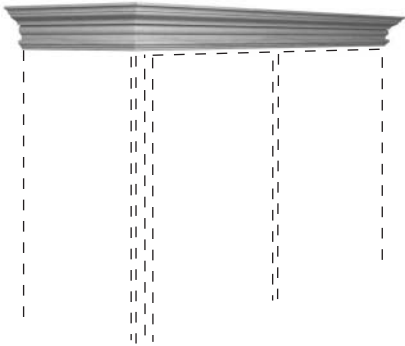

STKMLD17

- Not recommended for use when taking application to the ceiling.

Finish Techniques

	Distressing	Heirlooming
SWCRM8	•	•
LB2		
BRAIDM		
TSTM8		

Species Availability (Wood)

	Alder	Rustic Alder	Cherry	Hickory	Rustic Hickory	Maple	Oak
SWCRM8	•	•	•	•	•	•	•
LB2	•	Alder	•	•	Hickory	•	•
BRAIDM	•	Alder	•	Beech	Beech	•	Beech
TSTM8	•	Alder	•	•	Hickory	•	•

Species Availability (All Laminates)

	High Gloss	Horiz. Grain on Maple	Vert. Grain on Maple	Vert. Grain on Cherry	Vert. Grain on Hickory	Vert. Grain on Oak	Thermofoil
SWCRM8	box color	box color	box color	box color	box color	box color	box color
LB2	box color	box color	box color	box color	box color	box color	box color
BRAIDM	box color	box color	box color	box color	Beech	Beech	box color
TSTM8	box color	box color	box color	box color	box color	box color	box color

*Cleats and finish nails not included.

MOULDING STACK 18

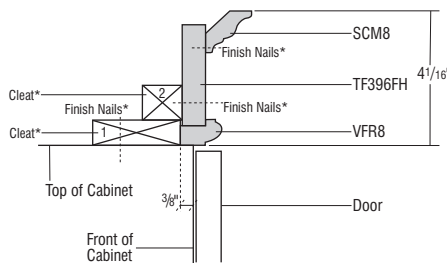
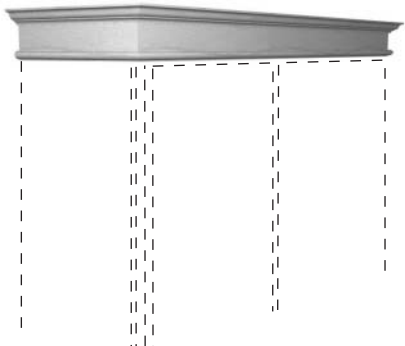

STKMLD18

Finish Techniques

	Distressing	Heirlooming
SCM8	•	•
TF396FH	•	
VFR8		•

Species Availability (Wood)

	Alder	Rustic Alder	Cherry	Hickory	Rustic Hickory	Maple	Oak
SCM8	•	•	•	•	•	•	•
TF396FH	•	Alder	•	•	Hickory	•	•
VFR8	•	Alder	•	•	Hickory	•	•

Species Availability (All Laminates)

	High Gloss	Horiz. Grain on Maple	Vert. Grain on Maple	Vert. Grain on Cherry	Vert. Grain on Hickory	Vert. Grain on Oak	Thermofoil
SCM8	box color	box color	box color	box color	box color	box color	box color
TF396FH	box color	box color	box color	box color	box color	box color	box color
VFR8	box color	box color	box color	box color	box color	box color	box color

*Cleats and finish nails not included.

DESCRIPTION

MODEL

MOULDING STACK 19

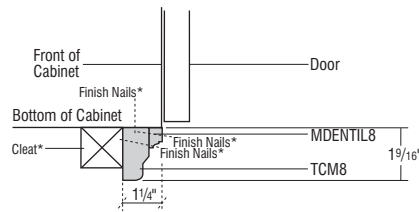
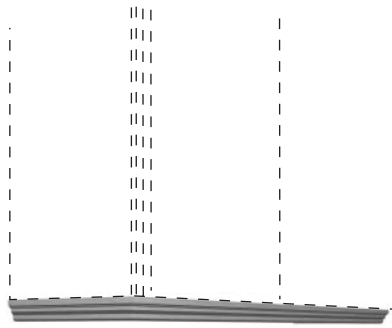

*Cleats and finish nails not included.



STKMLD19

Finish Techniques

	Distressing	Heirlooming
MDENTIL8		
TCM8		•

Species Availability (Wood)

	Alder	Rustic Alder	Cherry	Hickory	Rustic Hickory	Maple	Oak
MDENTIL8	•	Alder	•			•	•
TCM8	•	Alder	•	•		•	•

Species Availability (All Laminates)

	High Gloss	Horiz. Grain on Maple	Vert. Grain on Maple	Vert. Grain on Cherry	Vert. Grain on Hickory	Vert. Grain on Oak	Thermofoil
MDENTIL8	box color	box color	box color	box color		box color	box color
TCM8	box color	box color	box color	box color	box color	box color	box color

MOULDING STACK 20

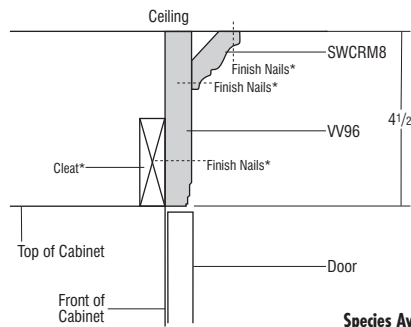
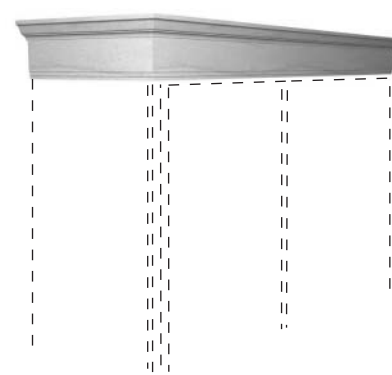

*Cleats and finish nails not included.



STKMLD20

Finish Techniques

	Distressing	Heirlooming
SWCRM8	•	•
VV96	•	•

Species Availability (Wood)

	Alder	Rustic Alder	Cherry	Hickory	Rustic Hickory	Maple	Oak
SWCRM8	•	•	•	•	•	•	•
VV96	•	•	•	•	•	•	•

Species Availability (All Laminates)

	High Gloss	Horiz. Grain on Maple	Vert. Grain on Maple	Vert. Grain on Cherry	Vert. Grain on Hickory	Vert. Grain on Oak	Thermofoil
SWCRM8	box color	box color	box color	box color	box color	box color	box color
VV96	box color	box color	box color	box color	box color	box color	box color

MOULDING STACK 21

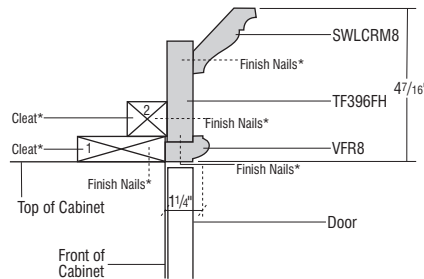
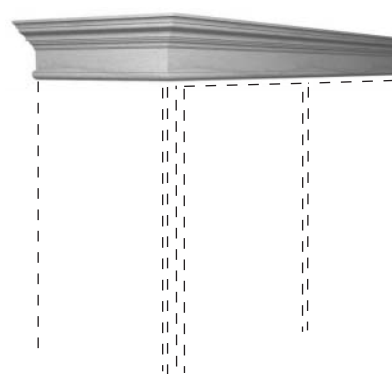

*Cleats and finish nails not included.



STKMLD21

Finish Techniques

	Distressing	Heirlooming
SWLCRM8	•	•
TF396FH	•	
VFR8		•

Species Availability (Wood)

	Alder	Rustic Alder	Cherry	Hickory	Rustic Hickory	Maple	Oak
SWLCRM8	•	•	•	•	•	•	•
TF396FH	•	Alder	•	•	Hickory	•	•
VFR8	•	Alder	•	•	Hickory	•	•

Species Availability (All Laminates)

	High Gloss	Horiz. Grain on Maple	Vert. Grain on Maple	Vert. Grain on Cherry	Vert. Grain on Hickory	Vert. Grain on Oak	Thermofoil
SWLCRM8	box color	box color	box color	box color	box color	box color	box color
TF396FH	box color	box color	box color	box color	box color	box color	box color
VFR8	box color	box color	box color	box color	box color	box color	box color

DESCRIPTION

MODEL

MOULDING STACK 22

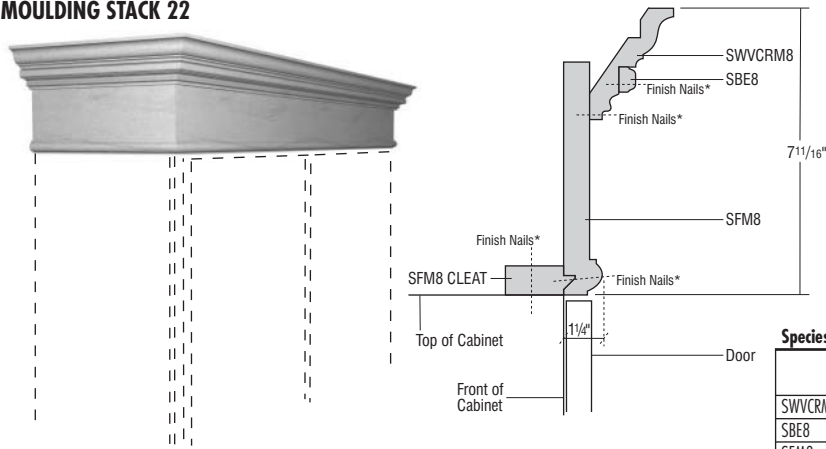

STKMLD22

Finish Techniques

	Distressing	Heirlooming
SWVCRM8	•	•
SBE8		•
SFM8		•

Species Availability (Wood)

	Alder	Rustic Alder	Cherry	Hickory	Rustic Hickory	Maple	Oak
SWVCRM8	•	•	•	•	•	•	•
SBE8	•	Alder	•	•	Hickory	•	•
SFM8	•	•	•	•	•	•	•

Species Availability (All Laminates)

	High Gloss	Horiz. Grain on Maple	Vert. Grain on Maple	Vert. Grain on Cherry	Vert. Grain on Hickory	Vert. Grain on Oak	Thermofoil
SWVCRM8	box color	box color	box color	box color	box color	box color	box color
SBE8	box color	box color	box color	box color	box color	box color	box color
SFM8	box color	box color	box color	box color	box color	box color	box color

*Cleats and finish nails not included.

MOULDING STACK 23

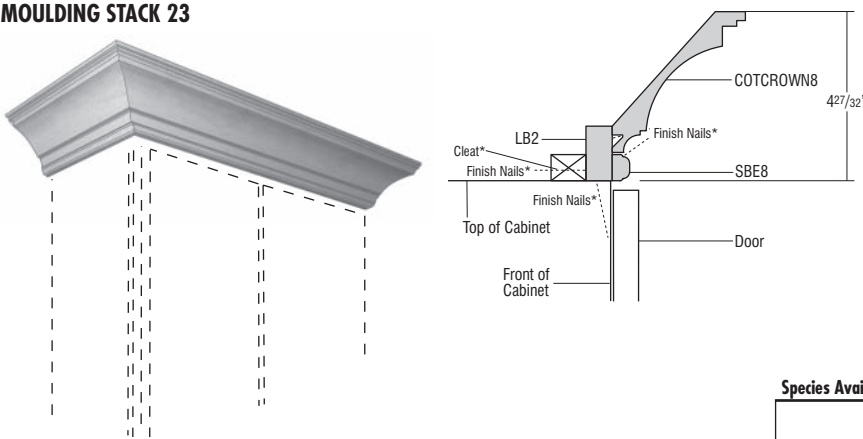

STKMLD23

• Not recommended for use when taking application to the ceiling.

Finish Techniques

	Distressing	Heirlooming
COTCROWN8	•	•
LB2		
SBE8		•

Species Availability (Wood)

	Alder	Rustic Alder	Cherry	Hickory	Rustic Hickory	Maple	Oak
COTCROWN8	•	•	•	•	•	•	•
LB2	•	Alder	•	•	Hickory	•	•
SBE8	•	Alder	•	•	Hickory	•	•

Species Availability (All Laminates)

	High Gloss	Horiz. Grain on Maple	Vert. Grain on Maple	Vert. Grain on Cherry	Vert. Grain on Hickory	Vert. Grain on Oak	Thermofoil
COTCROWN8	box color	box color	box color	box color	box color	box color	box color
LB2	box color	box color	box color	box color	box color	box color	box color
SBE8	box color	box color	box color	box color	box color	box color	box color

*Cleats and finish nails not included.

MOULDING STACK 24

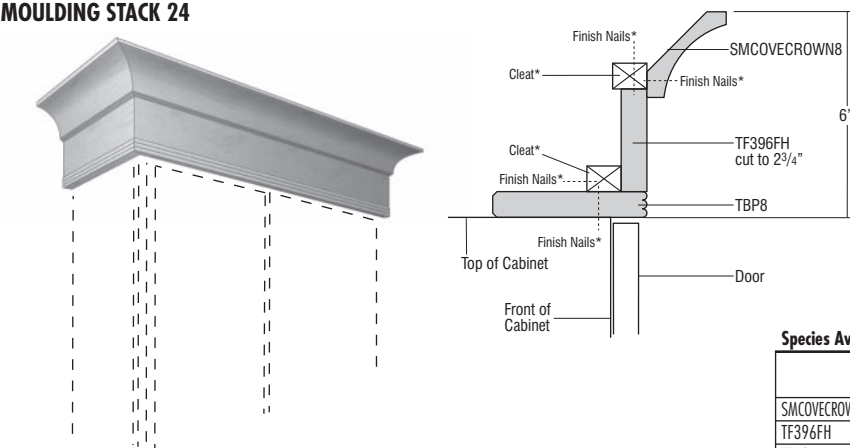

STKMLD24

Finish Techniques

	Distressing	Heirlooming
SMCOVECROWN8	•	•
TF396FH	•	
TBP8		•

Species Availability (Wood)

	Alder	Rustic Alder	Cherry	Hickory	Rustic Hickory	Maple	Oak
SMCOVECROWN8	•	•	•			•	•
TF396FH	•	Alder	•	•		•	•
TBP8	•	Alder	•	•		•	•

Species Availability (All Laminates)

	High Gloss	Horiz. Grain on Maple	Vert. Grain on Maple	Vert. Grain on Cherry	Vert. Grain on Hickory	Vert. Grain on Oak	Thermofoil
SMCOVECROWN8	box color	box color	box color	box color		box color	box color
TF396FH	box color	box color	box color	box color	box color	box color	box color
TBP8	box color	box color	box color	box color	box color	box color	box color

*Cleats and finish nails not included.

DESCRIPTION

MODEL

MOULDING STACK 25

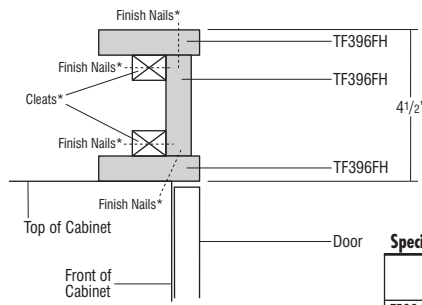
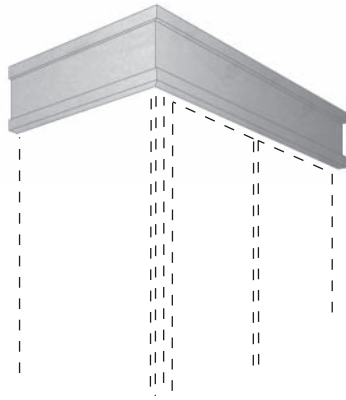

*Cleats and finish nails not included.



STKMLD25

Finish Techniques

	Distressing	Heirlooming
TF396FH	•	

Species Availability (Wood)

	Alder	Rustic Alder	Cherry	Hickory	Rustic Hickory	Maple	Oak
TF396FH	•	Alder	•	•	Hickory	•	•

Species Availability (All Laminates)

	High Gloss	Horiz. Grain on Maple	Vert. Grain on Maple	Vert. Grain on Cherry	Vert. Grain on Hickory	Vert. Grain on Oak	Thermofoil
TF396FH	box color	box color	box color	box color	box color	box color	box color

MOULDING STACK 26

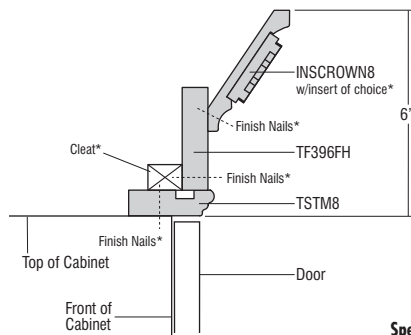

*Cleats and finish nails not included.



STKMLD26

Finish Techniques

	Distressing	Heirlooming
INSCROWN8		•
TF396FH	•	
TSTM8		

Species Availability (Wood)

	Alder	Rustic Alder	Cherry	Hickory	Rustic Hickory	Maple	Oak
INSCROWN8	•	Alder	•			•	•
TF396FH	•	Alder	•	•		•	•
TSTM8	•	Alder	•	•		•	•

Species Availability (All Laminates)

	High Gloss	Horiz. Grain on Maple	Vert. Grain on Maple	Vert. Grain on Cherry	Vert. Grain on Hickory	Vert. Grain on Oak	Thermofoil
INSCROWN8	box color	box color	box color	box color	box color	box color	box color
TF396FH	box color	box color	box color	box color	box color	box color	box color
TSTM8	box color	box color	box color	box color	box color	box color	box color

MOULDING STACK 27

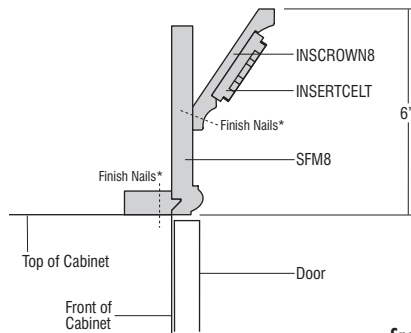
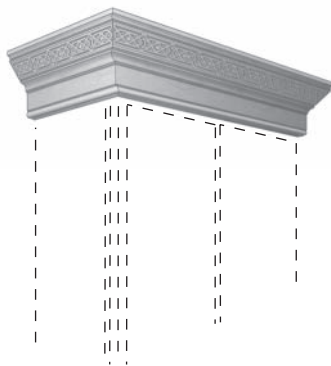

*Cleats and finish nails not included.



STKMLD27

Finish Techniques

	Distressing	Heirlooming
INSCROWN8		•
INSERTCELT		•
SFM8		•

Species Availability (Wood)

	Alder	Rustic Alder	Cherry	Hickory	Rustic Hickory	Maple	Oak
INSCROWN8	•	Alder	•			•	•
INSERTCELT			•				
SFM8	•	•	•	•		•	•

Species Availability (All Laminates)

	High Gloss	Horiz. Grain on Maple	Vert. Grain on Maple	Vert. Grain on Cherry	Vert. Grain on Hickory	Vert. Grain on Oak	Thermofoil
INSCROWN8	box color	box color	box color	box color		box color	box color
INSERTCELT	box color	box color	box color	box color			box color
SFM8	box color	box color	box color	box color	box color	box color	box color

DESCRIPTION

MODEL

MOULDING STACK 28



STKMLD28

- Not recommended for use when taking application to the ceiling.

Finish Techniques

	Distressing	Heirlooming
FOLCROWN8		•
BBM8	•	•

Species Availability (Wood)

	Alder	Rustic Alder	Cherry	Hickory	Rustic Hickory	Maple	Oak
FOLCROWN8	•	•	•	•	•	•	•
BBM8	•	•	•	•	•	•	•

Species Availability (All Laminates)

	High Gloss	Horiz. Grain on Maple	Vert. Grain on Maple	Vert. Grain on Cherry	Vert. Grain on Hickory	Vert. Grain on Oak	Thermofoil
FOLCROWN8	box color	box color	box color	box color	box color	box color	box color
BBM8	box color	box color	box color	box color	box color	box color	box color

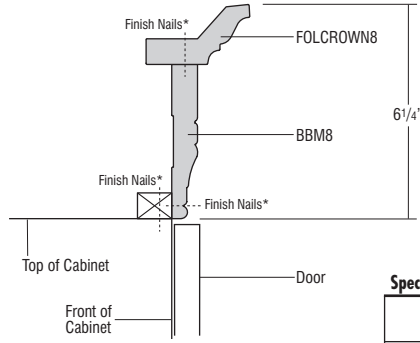
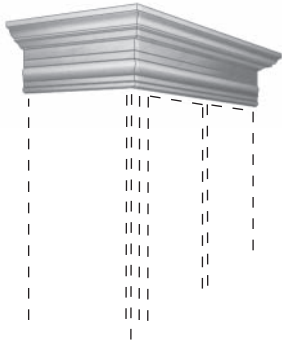

*Cleats and finish nails not included.

KEMPER®

Dear Kemper Customer,

Congratulations on your selection of Kemper cabinetry with an Heirlooming finish. Because of its unique characteristics, this finish is quite different from other cabinetry finishes you may be familiar with. Your satisfaction is important to Kemper, and we want you to fully understand the characteristics that make an Heirlooming Finish unique.

Our heirlooming technique is available on the following finishes: Black, Maritime, Moonstone, Seaside, Seaside w/Oasis, and Storm. The finish will be sanded through the base coat to expose the surface of the wood. This type of sand through on the edges and profiles creates a naturally worn appearance. If a finish is chosen with a glaze, the glaze will be applied after sanding has been done. This will enhance those areas of exposed wood to take on the darker characteristics of the applied glaze.

Normal Characteristics of Painted, Sand-Through Finishes include:

- Hairline Cracking
- Visible textures of natural grain patterns
- Variation in rub through and wear techniques

Accordingly, we ask that the following agreement be signed for Heirlooming Finish orders.

I have read the foregoing and find the characteristic variations of wood with Heirlooming finish are desirable. As such, I agree not to hold Kemper and/or the Kemper dealer listed below responsible in the event that these characteristics are later found by me to be less desirable than I had expected.

Customer Signature

Dealer Signature

Customer Name (please print)

Dealer Name (please print)

Dealer Purchase Order Number



KEMPER®

Dear Kemper Customer,

Congratulations on your selection of Kemper cabinetry in a Paint or Paint with Glaze finish. Because of its unique characteristics, this finish is quite different from other cabinetry finishes you may be familiar with. Your satisfaction is important to Kemper, and we want you to fully understand the characteristics that make painted finishes so distinctive.

It is important to realize that the beauty of wood cabinetry comes from the natural qualities of wood itself. Kemper utilizes only select solid hardwoods and veneers. The beauty of these genuine woods lies in the variation of the grain. The textures of those natural grain patterns often remain visible with paint finish and should be accepted as inherent characteristics when selecting painted cabinetry.

Seam lines and hairline cracking at stile, rail and panel joints are a normal characteristic of painted finishes and should not be considered a reason for product replacement. When ordering painted Maple 5-piece styles (except Lynnville), the door's center panel will be constructed of MDF material. Over time, there may be a slight color shift in the paint finish due to the continued exposure to natural and artificial light sources. We mention these characteristics because neither Kemper nor your Kemper dealer can be responsible for these conditions and variations.



Example of front joint separation



Example of front joint separation



Example of end joint separation

Accordingly, we ask that the following agreement be signed for Paint Finish orders.

I have read the foregoing and find the characteristic variations of wood with painted finish are desirable. As such, I agree not to hold Kemper and/or the Kemper dealer listed below responsible in the event that these characteristics are later found by me to be less desirable than I had expected.

Customer Signature

Dealer Signature

Customer Name (please print)

Dealer Name (please print)

Dealer Purchase Order Number

KEMPER®

Dear Kemper Customer,

Congratulations on your selection of Kemper cabinetry in Rustic Alder. Because of its unique characteristics Rustic Alder is quite different from other wood types you may be familiar with. Your satisfaction is important to Kemper, and we want you to fully understand the characteristics that make Rustic Alder so distinctive.

It is important to realize that the beauty of wood cabinetry comes from the natural qualities of wood itself. Rustic Alder is characterized by its light brown and reddish undertones and may contain a variety of pin holes, open and closed knots of various sizes and colors, small cracks, bird pecks, mineral streaks, and grain variation. Some knots may have small holes through the panel. Larger holes will not be filled. In addition, the wood will contain color difference caused by variations in minerals found in the soil, creating visible mineral tracks. However, those characteristics that might compromise the structural integrity of the door will not be included.

Sound Closed Knot (not moveable) – Expected in Rustic Alder up to approximately 3” diameter.

Sound Knot with Cracks – Expect sound knots with open cracks up to approximately 1” in length.

Open Knot (through door) – Expected in Rustic Alder with open area up to approximately 3/4” diameter.

Note: 3/4” diameter is about the size of a penny. Holes created by open knots pass completely through the door and are desirable for this rustic look.

Unsound Knot (moveable core) – Not to be expected.

Knot Cluster (cluster of tight sound knots) – To be expected in Rustic Alder.

Worm Holes/Pin Holes (can go through door) – Can be expected on Rustic Alder up to approximately 1/4” diameter.

Worm Tracks – Can be expected on Rustic Alder in sizes up to approximately 1/8” wide by 8” long.

Rustic Alder as described is featured for doors, drawer fronts, and selected mouldings. Other areas of the product will utilize standard hard Alder. Customers should expect a much lower occurrence of rustic characteristics in these other areas. Also, the natural characteristics mentioned occur randomly in Rustic Alder. All doors, drawer fronts, and selected mouldings will contain some combination of the common Rustic Alder markings; however, it will be uncommon to find all markings on any single piece.

The natural characteristics of wood described above and variations in grain patterns and color are not considered reasons for product replacement. We mention these characteristics because neither Kemper nor your Kemper dealer can be responsible for these conditions and variations.

Accordingly, we ask that the following agreement be signed for Rustic Alder orders.

I have read the foregoing and find the characteristic variations of wood with Rustic Alder are desirable.

As such, I agree not to hold Kemper and/or the Kemper dealer listed below responsible in the event that these characteristics are later found by me to be less desirable than I had expected.

Customer Signature

Dealer Signature

Customer Name (please print)

Dealer Name (please print)

Dealer Purchase Order Number

KEMPER®

Dear Kemper Customer,

Congratulations on your selection of Kemper cabinetry in Rustic Hickory. Because of its unique characteristics Rustic Hickory is quite different from other wood types you may be familiar with. Your satisfaction is important to Kemper, and we want you to fully understand the characteristics that make Rustic Hickory so distinctive.

Rustic Hickory is a strong, heavy hardwood known for distinctive graining patterns. Color will vary from nearly white to dark brown, with wild, flowing grain patterns and dramatic color variations. Rustic Hickory can have a fine uniform grain to large knots appearing black and brown in color of various shapes and sizes, sapwood, mineral and some checking.

Sound Closed Knot (not moveable) – Expected up to approximately 3” diameter.

Sound Knot with Cracks – Expect sound knots with open cracks up to approximately 1” length.

Open Knot (through door) – Expected with open area up to approximately 3/4” diameter.

Unsound Knot (moveable core) – Not to be expected.

Worm Holes/Pin Holes (can go through the door) – Can be expected up to 1/4” diameter.

Worm Tracks – Can be expected in sizes up to approximately 1/8” wide by 8” long.

Note: 3/4” diameter is about the size of a penny. Holes created by open knots pass completely through the door and are desirable for this rustic look.

Doors, drawer fronts, and selected trim items will feature rustic characteristics. Other areas of the product will utilize standard Hickory.

The natural characteristics of wood described above and variations in grain patterns and color are not considered reasons for product replacement. We mention these characteristics because neither Kemper nor your Kemper dealer can be responsible for these conditions and variations.

Accordingly, we ask that the following agreement be signed for Rustic Hickory orders.

I have read the foregoing and find the characteristic variations of wood with Rustic Hickory are desirable.

As such, I agree not to hold Kemper and/or the Kemper dealer listed below responsible in the event that these characteristics are later found by me to be less desirable than I had expected.

Customer Signature

Dealer Signature

Customer Name (please print)

Dealer Name (please print)

Dealer Purchase Order Number

Code	Page Number
1TWT	249
2DB	190
2DB..DR	191
2DB..PDO	190
2DB..RT	191
2DB..RTPDO	191
3DB	192
3DB..KCUP	193
3DB..UD	208
3DB..WD	193
3DB..WTCD	192
3DBB	192
3DBBDD	194
3DBDD	193
3TWT	250
4DB	194
4DB..CIW	194
4DB..KCUP	195
4DB..WTCD	195
4TWT	251
4VDB	264
ABFOOT	331
ACAM	309
ACO	317
ACOVLY	317
ACS	180
ADDTK	49
ALF	54
APC	38
AV	316
B	158-209
B..CIW	159
B..DR	202
B..FH	161, 162
B..FHMIXSC	172
B..FHRT	167
B..FHRTLO	170
B..FSCO	171
B..KCUP	160
B..KCUPRT	169
B..PS	170
B..RT	166
B..RTCIW	168
B..RTLO	169
B..RTUD	207
B..RTWTCD	169
B..TDRO	171
B..UD	206
B..WTCD	160
BARLEG	319
BATTLI	343
BBCPO	201
BBM	311
BBMSC	312
BBMSH	312
BBMSW	312
BBMW..UD	209
BBMW..DD	203
BBMW..SD	203
BBTP	197
BC	183
BCF	284-288
BCFW	184
BCFW..CPO	184
BCOPP	199
BEAS	163
BEC	190
BEP	297
BEP..AEL, AER	300
BEP..VG	301
BEPF	299-300
BER	186
BERAS	185
BF	210
BFPC	318
BFRC	318
BKSOCKET	353
BLOWER	147
BLS	184
BLVDF	284

Code	Page Number
BMC	201
BMW..UD	209
BMW..DD	203
BO	202
BOC	204
BOD	204
BP	295
BP..CRSGR	296
BP..LAM, BP..NIP	295
BP..VG	296
BPM	309
BPP	199
BPPP	170
BPS	343
BPT..WBFH	197
BRAIDM	308
BRDB	189
BRKOFFSCREW	355
BRMCLP	343
BSC3OPR, R, RP, RS, SR	164
BSC36PRP, PRS, SRP, SRS	165
BSD	198
BTC	189
BUMPERPADS	355
BUPP	200
BUPPKB	200
BV2SC3OPR, RP, RS, SR	164
BV2SC36PRP, PRS, SRP, SRS	165
BWB	195
BWB..FH	196
BWBFLID, BWBLID	343
BWC	198
CABMAT	343
CABMATV	343
CAPM	313
CBO	41
CCM	309
CCO	41
CF	280
CFP	41
CG, CG..BTM, CG..TOP	55
CIW	344
CLTCROWN	304
CMAT	45
CND	41
CNTYSB	180
CNTYSB..CM	181
CNTYSB..SA	181
CONBOLTCH	355
CONVERSION	148
CORBELART9	336
CORBELCELT	336
CORBELCOVE	337
CORBELCRBN	341
CORBELMIS6	337
CORBELMIS9	337
CORBELOWD5	337
CORBELSCR6	338
CORBELSCR9	338
CORBELTRSS	341
COTCROWN	304
COVECROWN	304
CPE	309
CS	179
CTDK	350
CUDD	343
DAB..FS	185
DAB..SLS	185
DAPNL	292
DB	190-194
DDFD	246
DDO	245
DDR	245
DER	247
DFBRACKET..P	355
DFD	246
DF5PC	39
DFR5PC	39
DFSLB	39
DGK	353

Code	Page Number
DLEMISSION	325
DOOR	290
DOORSLAB	291
DPSRR	40
DRT	46, 352
DRWPWR	47, 348
DRWTK	52
DW	113-115
DW..D	115
DW..DS	116
DW..S	114
DWB..FH	247
EDGE BAND	345
EGD	308
ENGBARCOLUMN	321
ENGLSCOLUMN	321
ER	118
ES	345
EXBKL, EXBKR	43
EZORG	349
F	280
F..R	280
FALSEPNLCLIPFA	353
FB	38
FBF	284
FD	45, 248-249
FDWB	249
FFP	318
FFRC	318
FIC	199
FICNT	198
FOLCROWN	304
FOOTMETAL	341
FR..UD	210
FRNLG	332
FS	139
FTK, FTK..FNT.P, FTK.P	49
FTKAV, FTKAV..FNT.P, FTKAV.P	49
FTKFV, FTKFV..FNT.P, FTKFV.P	49
FV	316
GLAZEPEN	353
HINGE	342
HINGERESCLIP	354
HINGESHIMFA	354
HL	157
HM	155-156
HP..21	153
HPP..21	154
HS	157
ICM	314
ID	42
INSCROWN	304
INSERTCELT	308
INSTALLSCR, INSTALLSCREWS	355
INVFRM	43
ISLLEG	324
J3SPTRING	335
JACANFOOT	332
JACANINSERTM	308
JACANTHUSLEG	319
JBAROQUELEG	320
JBRACKETART	338
JBUFFTELEG	320
JCELOVLY	317
JCORBELARTO	339
JCORBELCOS7	336
JCORBELCOS13	336
JCORBELCOS13D	337
JCORBELCRAFTO	339
JCORBELOWD4	337
JCORBELOWD7	338
JCORBELSHKR	339
JCORBELTRADO	340
JCOSFOOT	332
JCOSMOLEG	320
JCRAFTFOOT	332
JENG CNTYLEG	321
JESTATELEG	322
JESTATELEGS	321

Code	Page Number
JESTATELEGS	322
JFLUTELEG	323
JFLUTELEGS	322
JFLUTELEGS	322
JFRNCNTYFOOT	332
JFRNCNTYLEG	323
JGSK	347
JINSERTLRC	314
JINSERTLRT	314
JLRINSACAN	314
JLRINSCFLT	314
JLRINSMIS	314
JLRINSWEAVE	314
JMADEFOOT	332
JMAFOOT	332
JMETROFOOT	333
JMISINSERTM	308
JPWRPOD	348
JQUNANNELEG	325
JRCVP	316
JRDLEG	326
JROPELEG	328
JROPELEGS	327
JROPELEGS	327
JRPV	316
JSOC	340
JSPLEGS	328
JSPLEGSS	329
JSPLEGT	329
JSQBARLEG	330
JSQBARLEG3S	330
JSQFOOT	333
JSQFOOTS	333
JSQSILLEG	329
JSQSILLEG3S	329
JSRC	340
JTILECAN	319
JTILEMISSION	319
JTULIPLEG	331
JURNLEG	331
JWEAVEFOOT	333
JWEAVEINSERTM	309
JWEAVELEG	326
JWHCA	145
JWHCONSTR	142
JWHCS	145
JWHIA	146
JWHIS	146
JWHL	142
JWHSHIPCH	143
JWHSHIPSTR	142
JWHSHIPSTRCB	143
JWHSHIPT	143
JWHSHIPTCB	144
KCUP	345
KNOBH	342
LB	313
LBRM	310
LC	275
LCHAMPERLNR	348
LCRH	275
LGCORBEL	336
LGSQFOOT	333
LIDSTAY, LIDSTAYHD	354
LIFOOT	333
LO, LO24DP	348
LOSC	315
LRM	313
LSACROWN	305
LSHAKER	305
LSP	189
LT	276
LTI	46
MC	279
MC16HDW/WCATCH	355
MD, MD..BTM, MD..TOP	56
MDENTIL	308
METBARCOLUMN	325
METISLSCOLUMN	325
MIP	38

Code	Page Number
MIXKITFHSC	343
MSACROWN	305
MSLFB	38
MTCROWN	305
MTUK	353
MW	125
OC..UD	209
OCT35	315
OCD, OCD..DD, OCD..WD, OCD..WDE	233-236
OCINSTALLFA	355
OCM	315
OCS, OCS..DD, OCS..WD	230-232
OGEEEM	310
OL	282
OMC, OMC..DD, OMC..WD	238-240
P	53
PD	302-303
PDO, PDOPOSTS	348
PLBLOCK	334
PPP	348
PRB	247
PRMD	58
PTOWB	47
PTU	227
PTUP	227
PTUS	225
PULLH	341, 342
QRM	315
QUARTCOLOR	353
RD	42
RDLEG	326
RECBTM	44
RECTKALL	51
RECTKBK	51
RECTKL	51
RECTKR	51
RESCLIPIFA	354
RESCLIPIQR	354
RETCIPI..BAG	355
ROSETTCELT	318
ROSETTEMIS	317
ROSETTESCR	317
RPM	308
RT	46, 352
RTSPACERFA	353
S96	281
SACROWN	305
SB	173-175
SB..CDY	174
SB..CM	173
SB..D	179
SB..S	177
SB..SCDY	177
SB..SCM	177
SB..ST	175
SB..STCDY	176
SB..STCM	175
SB..STS	178
SB..STSCDY	179
SB..STSCM	178
SB..STUD	207
SB..UD	207
SBC	182
SBCADDY	348
SBE	310
SBM	310
SBP	310
SBS	338
SCM	306
SCPDRW	40
SFM	307
SHELFBRKTSN	341
SHELFPEGS	355
SHKRCRM	305
SHLFPD	349
SHM	315
SHMD	57
SK	346
SLS	187, 188

Code	Page Number
SLS..UD	208
SLSCLR	187
SLSW	187, 188
SM	309
SMCORBEL	336
SMCOVECROWN	306
SMLR	313
SPACERBLK	353
SPD	349
SPLEG	329
SPRINGEND	335
SPRINGREED	335
SPRINGROPE	335
SPRINGSPPOOL	335
SRCH	349
SSC	353
SSM	310
SSS	186
STDW	116
STR8	307
STRS	307
STRTHEATSHIELD	347
STRTHSHIELDSS	347
STW	106-108
STWDAG	102-103
STWEC	120
STWEC..D	121
STWTC	124
STWVLDAG	104-105
SV	316
SWCRM	306
SWLCRM	306
SWTCRM	307
SWVCRM	307
TABLETHLDR	349
TAPLG	334
TB	312
TB8UD	210
TBC	243-243
TBCD	244-244
TBEM	311
TBMWB	237
TBP	311
TCM	309
TD	48, 172
TD..FH	172
TDKIT	350
TDRO	350
TEP, TEP..AEL, TEP..AER	297, 301
TEP..VG	301
TEP	301
TEPS	295
TF	210
TKC	312
TKP	51
TKTLFOOT	334
TLFOOT	334
TOEKICKVAC	349
TOT	350
TOTSS	47, 350
TOTSSS	47, 350
TOUCHLATCHFA	341
TPP	228
TRAYSHLF	139
TROSETTE	317
TSTM	311
TUK	353
TV	279
TVHDW/WCATCH	355
TVRAV, TVRFV, TVRVV	44
TWH	146
TWHBLOWER	147
U	211-215
U..RT	216-218
UCD	251, 274
UEAS	219-222
UOC	223
UOCDZ	224
UPM	311
V	252-254

Code	Page Number
VB	260
VBEP	298
VBH	275
VBWB	264
VCCR	351
VDB	262
VDL	301
VDLUD	210
VER	261
VFR	313
VGPO	265
VH..FH	275
VM	279
VMP	278
VP	265
VS3D	272
VSU	255-256
VSU.....U	257
VSU.....WB	257
VSD	266-272, 273
VSD..FP	273
VSSB.....ST	258
VSSB.....STWB	258
VTK	52
VU	276
VV	316
VWB	265
VWH	276
VWM	278
W	79-97, 138, 278
W..BC	241
W..PO	87, 90 92
W..SHLFPD	134
W..SPD	133
W2D	99
W3D	100
WAIN	289
WB	163
WBCPO	129
WBCPOKUP	131, 347
WBMW	126
WC	109-112
WCS	140
WCT	313
WEAS	97
WEC	119
WER.VG	301
WEP	301
WFBC	242
WGH	351
WHA	141
WHC	141
WHCA	144
WHCS	145
WHS	141
WLI	38
WMC	140
WMF	310
WNR	137
WO	138
WOC	135
WQRES	122-123
WS	140
WSC	137
WSCRIBE	311
WSD	138
WSK	351
WSP	133
WSR	134
WTC	124
WTCU	344
WTH	80-89
WVL	85-90



OUR COMMITMENT TO CHANNEL PARTNERS, DESIGNERS AND CUSTOMERS

Kemper's Express Response™ program is designed to expedite orders when customers need product faster than normal lead times to correct problems with an existing order.

Below is an overview of the program and what you can expect from Kemper's commitment to superior service.

GUIDELINES

- Order must be associated with a previous order number.
- All orders received by 12 NOON E.T. Monday-Friday will be automatically scheduled for Express Response that same day. Orders received after the cutoff time will be processed on the next business day.
- Lead time calculation is based on receipt of a clean order on a credit-worthy account. Clean orders are orders in which all information is provided and accurate.
- There are no cancellations or returns once order is received.
- Due to the special nature of Special Orders and Appliance Panels, they are excluded from the Express Response program and will be processed as a standard lead time order.
- Express Response is available within the continental United States. Should Alaska, Hawaii or international shipments be required, customer service representatives are ready to assist by providing shipping information and determining lead times.

LEAD TIMES

12 WORKING DAYS OR LESS FROM ORDER TO DELIVERY (channel partner or home delivery agent):

- Items shipped via LTL (via SuperPAC™) or truckload.
- Includes all catalog items except those that can be expedited through the 5-day program listed below.

5 WORKING DAYS FROM ORDER TO DELIVERY:

- Qualified items are designated in the Pricing/Specification Guide with an icon
- Items will ship via parcel ground.
 - Lead time calculation allows for 2 days parcel ground shipping time. Some geographic areas may require additional shipping time.
- For orders containing both 12 day and 5 day items, the longer lead time applies.



QUESTIONS? If you have questions that aren't answered here,
contact your Customer Service team.



KEMPER DOOR STYLE PRICING REFERENCE

★ New ★ Available Soon

Price Point Order

4 Baxter Maple	12 Gallatin Alder
4 Genova Melamine	12 Gallatin Rustic Alder
4 Hurson Alder	12 Gallatin Rustic Hickory
4 Hurson Hickory	12 Herrington Maple
4 Hurson Maple	12 Larsen Alder
4 Hurson Oak	12 Larsen Maple
4 Hurson Rustic Alder	12 Larsen Rustic Alder
4 Hurson Rustic Hickory	12 Larsen Rustic Hickory
4 Lawton Alder	12 Lynnville Maple
4 Lawton Maple	13 Caprice Maple
4 Lawton Rustic Alder	14 Darby Maple
4 Lawton Rustic Hickory	14 Ellerby Cherry
4 Painter Oak	14 Herrington Cherry
4 Taro Melamine	14 Larsen Cherry
5 Dutton Maple	14 Lynnville Cherry
5 Painter Hickory	15 Amstead Cherry
5 Painter Maple	15 Ashridge Maple
7 Baxter Cherry	15 Cotter Cherry
7 Lawton Cherry	15 Justin Cherry
7 Vaille Thermofoil	15 Kingston Alder
8 Dutton Cherry	15 Kingston Maple
8 Hurson Cherry	15 Northrope Alder
8 Larsen Oak	15 Northrope Maple
8 Painter Cherry	15 Northrope Rustic Alder
8 Rennie Maple	15 Northrope Rustic Hickory
9 Whitman Alder	16 Ashridge Cherry
9 Whitman Hickory	16 Butler Cherry
9 Whitman Maple	16 Caprice Cherry
9 Whitman Rustic Alder	16 Hardin Maple
9 Whitman Rustic Hickory	16 Genova Laminate
10 Amstead Maple	16 Taro Laminate
10 Butler Maple	16 Troxel Laminate
10 Cotter Maple	17 Belmont Maple
10 Ellerby Oak	17 Kingston Cherry
10 Justin Maple	17 Northrope Cherry
10 Northrope Oak	17 Warwick Maple
10 Whitman Cherry	18 Belmont Cherry
11 Rennie Cherry	18 Hardin Cherry
12 Ellerby Hickory	18 Warwick Cherry
12 Ellerby Maple	

Alphabetical Order

15 Amstead Cherry	17 Kingston Cherry
10 Amstead Maple	15 Kingston Maple
16 Ashridge Cherry	12 Larsen Alder
15 Ashridge Maple	14 Larsen Cherry
7 Baxter Cherry	12 Larsen Maple
4 Baxter Maple	8 Larsen Oak
18 Belmont Cherry	12 Larsen Rustic Alder
17 Belmont Maple	12 Larsen Rustic Hickory
16 Butler Cherry	4 Lawton Alder
10 Butler Maple	7 Lawton Cherry
16 Caprice Cherry	4 Lawton Maple
13 Caprice Maple	4 Lawton Rustic Alder
15 Cotter Cherry	4 Lawton Rustic Hickory
10 Cotter Maple	14 Lynnville Cherry
14 Darby Maple	12 Lynnville Maple
8 Dutton Cherry	15 Northrope Alder
5 Dutton Maple	17 Northrope Cherry
14 Ellerby Cherry	15 Northrope Maple
12 Ellerby Hickory	10 Northrope Oak
12 Ellerby Maple	15 Northrope Rustic Alder
10 Ellerby Oak	15 Northrope Rustic Hickory
12 Gallatin Alder	8 Painter Cherry
12 Gallatin Rustic Alder	5 Painter Hickory
12 Gallatin Rustic Hickory	5 Painter Maple
4 Genova Melamine	4 Painter Oak
16 Genova Laminate	11 Rennie Cherry
18 Hardin Cherry	8 Rennie Maple
16 Hardin Maple	16 Taro Laminate
14 Herrington Cherry	4 Taro Melamine
12 Herrington Maple	16 Troxel Laminate
4 Hurson Alder	7 Vaille Thermofoil
8 Hurson Cherry	18 Warwick Cherry
4 Hurson Hickory	17 Warwick Maple
4 Hurson Maple	9 Whitman Alder
4 Hurson Oak	10 Whitman Cherry
4 Hurson Rustic Alder	9 Whitman Hickory
4 Hurson Rustic Hickory	9 Whitman Maple
15 Justin Cherry	9 Whitman Rustic Alder
10 Justin Maple	9 Whitman Rustic Hickory
15 Kingston Alder	

KEMPER®

Deep Roots. High Expectations.™

 **FRAMED
CONSTRUCTION**

 **FULL ACCESS
CONSTRUCTION**

Styles, product availability and construction may vary slightly from those shown in this book due to material availability and/or design evolution. Specifications are subject to change without notice. Customer service is available if your design requires verification of product availability and specifications.

Product photography and illustrations have been reproduced as accurately as printing technologies permit. To ensure highest satisfaction, we strongly recommend you view an actual sample for best color, wood grain and finish representation.

Kemper® is a certified brand in the Kitchen Cabinet Manufacturers Association (KCMA) Environmental Stewardship Program. The program recognizes companies that demonstrate an ongoing commitment to environmental practices and sustainability.



KITCHEN CABINET MANUFACTURERS ASSOCIATION
ENVIRONMENTAL STEWARDSHIP PROGRAM
ALL PRODUCTS MEET THE ENVIRONMENTAL
AND SOCIAL RESPONSIBILITY REQUIREMENTS



kempercabinets.com
#KemperCabinets
© 2019 MasterBrand Cabinets, Inc.

Kemper® has a Limited Lifetime Warranty.

For terms and conditions, please visit: <https://www.kempercabinets.com/warranty>

Cabinet Care and Cleaning Instructions: <https://www.masterbrand.com/care-and-cleaning>

Front cover image: CAPRICE Full Access Maple Limestone

Customer Service

Hours: Mon - Fri, 7:30 AM - 8:00 PM EST

Phone: (800) 730-0171

Fax: (877) 333-7122

Please reference Service Policies at www.mbc1touch.com

Designer ID #: _____

Customer Account #: _____

Sales Rep: _____