Keysight Technologies

85054B 50 Ω Type-N with Sliding Load Calibration Kit

This is the User's and Service Guide for the 85054B 50 Ω Type-N with Sliding Load Calibration Kit.

Notices

© Keysight Technologies, Inc.
1993-2023

No part of this manual may be reproduced in any form or by any means (including electronic storage and retrieval or translation into a foreign language) without prior agreement and written consent from Keysight Technologies, Inc. as governed by United States and international copyright laws.

Trademark Acknowledgments

Manual Part Number

85054-90049

Edition

Edition 1, October 2023

Printed in USA/Malaysia

Published by:

Keysight Technologies
1400 Fountaingrove Parkway
Santa Rosa, CA 95403

Warranty

THE MATERIAL CONTAINED IN THIS DOCUMENT IS PROVIDED "AS IS," AND IS SUBJECT TO BEING CHANGED, WITHOUT NOTICE, IN FUTURE EDITIONS. FURTHER, TO THE MAXIMUM EXTENT PERMITTED BY APPLICABLE LAW, KEYSIGHT DISCLAIMS ALL WARRANTIES, EITHER EXPRESS OR IMPLIED WITH REGARD TO THIS MANUAL AND ANY INFORMATION CONTAINED HEREIN, INCLUDING BUT NOT LIMITED TO THE IMPLIED WARRANTIES OF MERCHANTABILITY AND FITNESS FOR A PARTICULAR PURPOSE. KEYSIGHT SHALL NOT BE LIABLE FOR ERRORS OR FOR INCIDENTAL OR CONSEQUENTIAL DAMAGES IN CONNECTION WITH THE FURNISHING, USE, OR PERFORMANCE OF THIS DOCUMENT OR ANY INFORMATION CONTAINED HEREIN. SHOULD KEYSIGHT AND THE USER HAVE A SEPARATE WRITTEN AGREEMENT WITH WARRANTY TERMS COVERING THE MATERIAL IN THIS

DOCUMENT THAT CONFLICT WITH THESE TERMS, THE WARRANTY TERMS IN THE SEPARATE AGREEMENT WILL CONTROL.

Technology Licenses

The hardware and/or software described in this document are furnished under a license and may be used or copied only in accordance with the terms of such license.

U.S. Government Rights

The Software is "commercial computer software," as defined by Federal Acquisition Regulation ("FAR") 2.101. Pursuant to FAR 12.212 and 27.405-3 and Department of Defense FAR Supplement ("DFARS") 227.7202, the U.S. government acquires commercial computer software under the same terms by which the software is customarily provided to the public.

Accordingly, Keysight provides the Software to U.S. government customers under its standard commercial license, which is embodied in its End User License Agreement (EULA), a copy of which can be found at

<http://www.keysight.com/find/sweula>

The license set forth in the EULA represents the exclusive authority by which the U.S. government may use, modify, distribute, or disclose the Software. The EULA and the license set forth therein, does not require or permit, among other things, that Keysight: (1) Furnish technical information related to commercial computer software or commercial computer software documentation that is not customarily provided to the public; or (2) Relinquish to, or otherwise provide, the government rights in excess of these rights customarily provided to the public to use, modify, reproduce, release, perform, display, or disclose commercial computer software or commercial computer software documentation. No additional

government requirements beyond those set forth in the EULA shall apply, except to the extent that those terms, rights, or licenses are explicitly required from all providers of commercial computer software pursuant to the FAR and the DFARS and are set forth specifically in writing elsewhere in the EULA. Keysight shall be under no obligation to update, revise or otherwise modify the Software. With respect to any technical data as defined by FAR 2.101, pursuant to FAR 12.211 and 27.404.2 and DFARS 227.7102, the U.S. government acquires no greater than Limited Rights as defined in FAR 27.401 or DFAR 227.7103-5 (c), as applicable in any technical data.

Safety Notices

CAUTION

A **CAUTION** notice denotes a hazard. It calls attention to an operating procedure, practice, or the like that, if not correctly performed or adhered to, could result in damage to the product or loss of important data. Do not proceed beyond a CAUTION notice until the indicated conditions are fully understood and met.

WARNING

A **WARNING** notice denotes a hazard. It calls attention to an operating procedure, practice, or the like that, if not correctly performed or adhered to, could result in personal injury or death. Do not proceed beyond a WARNING notice until the indicated conditions are fully understood and met.

- 1. **General Information**
 - Calibration Kit Overview 1-1
 - Kit Contents 1-1
 - Calibration Definitions 1-2
 - Equipment Required but Not Supplied 1-4
 - Incoming Inspection 1-4
 - Serial Numbers 1-5
 - Recording the Device Serial Numbers 1-5
 - Precision Slotless Connectors 1-6
 - Clarifying the Terminology of a Connector Interface 1-7
 - Preventive Maintenance 1-7
 - When to Calibrate 1-8

- 2. **Specifications**
 - Environmental Requirements 2-1
 - Temperature—What to Watch Out For 2-1
 - Mechanical Characteristics 2-2
 - Pin Depth 2-2
 - Electrical Specifications 2-5
 - Certification 2-5

- 3. **Use, Maintenance, and Care of the Devices**
 - Electrostatic Discharge 3-1
 - Visual Inspection 3-3
 - Look for Obvious Defects and Damage First 3-3
 - Inspect the Mating Plane Surfaces 3-3
 - Inspect the Precision Slotless Connectors (female) 3-5
 - Cleaning Connectors 3-6
 - Gaging Connectors 3-8
 - Connector Gage Accuracy 3-8
 - When to Gage Connectors 3-8
 - Reading the Connector Gage 3-9
 - Gaging Procedures 3-10
 - Connections 3-20
 - How to Make a Connection 3-20
 - How to Separate a Connection 3-24
 - Using the Sliding Load 3-25

Contents

Handling and Storage	3-27
4. Performance Verification	
Introduction	4-1
How Keysight Verifies the Devices in This Kit	4-1
Recertification	4-2
How Often to Recertify	4-2
Where to Send a Kit for Recertification	4-2
5. Troubleshooting	
Troubleshooting Process	5-1
Where to Look for More Information	5-3
Returning a Kit or Device to Keysight	5-4
Contacting Keysight	5-5
6. Replaceable Parts	
Introduction	6-1
A: Standard Definitions	
Class Assignments and Standard Definitions Values are Available on the Web	A-1

1 General Information

Calibration Kit Overview

The Keysight 85054B type-N calibration kit is used to calibrate Keysight network analyzers up to 18 GHz for measurements of components with 50Ω type-N connectors.

The standards in this calibration kit allow you to perform simple 1- or 2-port and TRM (thru-reflect-match) calibrations.

This manual describes the 85054B calibration kit and provides replacement part numbers, specifications, and procedures for using, maintaining, and troubleshooting the kit.

Kit Contents

The 85054B calibration kit contains the following:

- offset opens and shorts, and lowband and sliding load terminations
- four type-N to 7 mm adapters
- two type-N to type-N adapters
- a type-N connector gage set
- a 3/4 inch, 135 N-cm (12 in-lb) torque wrench for use on the type-N connectors
- a spanner wrench

Refer to [Table 6-1](#), [Figure 6-1](#), and [Figure 6-2](#) for a complete list of kit contents and their associated part numbers.

Offset Opens and Shorts

The offset opens and shorts are built from parts that are machined to the current state-of-the-art in precision machining.

The offset short's inner conductors have a one-piece construction, common with the shorting plane. The construction provides for extremely repeatable connections.

The offset opens have inner conductors that are supported by a strong, low-dielectric constant plastic to minimize compensation values.

Both the opens and shorts are constructed so that the pin depth can be controlled very tightly, thereby minimizing phase errors. The lengths of the offsets in the opens and shorts are designed so that the difference in phase of their reflection coefficients is approximately 180 degrees at all frequencies.

Lowband Loads

The lowband loads are metrology-grade, 50 ohm terminations which have been optimized for lowband performance up to 2 GHz. The rugged internal structure provides for highly repeatable connections. A distributed resistive element on sapphire provides excellent stability and return loss.

Sliding Loads

The sliding loads in this kit are designed to provide excellent performance from 3 GHz to 18 GHz. The inner and outer conductors of the airline portion are precision machined to state-of-the-art tolerances. Although the sliding load has exceptional return loss, its superior load stability qualifies it as a high-performance device.

The sliding load was designed with the ability to extend the inner conductor for connection purposes and then pull it back to a preset pin depth. This feature is critical since it minimizes the possibility of damage during the connection, while maintaining a minimum pin depth to optimize performance.

Adapters

Like the other devices in the kit, the adapters are built to very tight tolerances to provide good broadband performance. The adapters utilize a dual-beaded connector structure to ensure stable, repeatable connections. The beads are designed to minimize return loss and are separated far enough so that interaction between the beads is minimized.

Calibration Definitions

The calibration kit must be selected and the calibration definitions for the devices in the kit installed in the network analyzer prior to performing a calibration. Refer to your network analyzer user's guide for instructions on selecting the calibration kit and performing a calibration.

The calibration definitions can be:

- resident within the analyzer
- entered from the front panel

Class assignments and standard definitions may change as more accurate model and calibration methods are developed. You can download the most recent class assignments and standard definitions from Keysight's Calibration

Kit Definitions Web page at
<https://www.keysight.com/us/en/assets/9922-01521/technical-specifications/Calibration-Kit-Definitions.pdf>.

NOTE

The 8510 network analyzer is no longer being sold or supported by Keysight. However, you can download the 8510 class assignments and standard definitions from Keysight's Calibration Kit Definitions Web page at
<https://www.keysight.com/us/en/assets/9922-01521/technical-specifications/Calibration-Kit-Definitions.pdf>.

Installation of the Calibration Definitions

The calibration definitions for the kit may be permanently installed in the internal memory or hard disk of the network analyzer.

If the calibration definitions for the kit are not permanently installed in the network analyzer, they must be manually entered. Refer to your network analyzer user's guide for instructions.

Equipment Required but Not Supplied

Connector cleaning supplies and various electrostatic discharge (ESD) protection devices are not supplied with the calibration kit but are required to ensure successful operation of the kit. Refer to **Table 6-2 on page 6-2** for ordering information.

Incoming Inspection

Refer to **“Kit Contents” on page 1-1** to verify a complete shipment. Use **Table 1-1 on page 1-5** to record the serial numbers of all serialized devices in your kit.

Check for damage. The foam-lined storage case provides protection during shipping. If the case or any device appears damaged, or if the shipment is incomplete, refer to **“Contacting Keysight” on page 5-5**. Keysight will arrange for repair or replacement of incomplete or damaged shipments without waiting for a settlement from the transportation company. See **“Returning a Kit or Device to Keysight” on page 5-4**.

Serial Numbers

A serial number is attached to this calibration kit. The first four digits followed by a letter comprise the serial number prefix; the last five digits are the suffix, unique to each calibration kit.

Recording the Device Serial Numbers

In addition to the kit serial number, the devices in the kit are individually serialized (serial numbers are labeled onto the body of each device). Record these serial numbers in

Table 1-1. Recording the serial numbers will prevent confusing the devices in this kit with similar devices from other kits.

Table 1-1 Serial Number Record for the 85054B

Device	Serial Number
Calibration kit	_____
Calibration Devices	
Lowband load -m-	_____
Lowband load -f-	_____
Open-m-	_____
Open -f-	_____
Short -m-	_____
Short -f-	_____
Sliding load -f-	_____
Sliding load -m-	_____
Gages	
Gage Master-m-	_____
Gage Master -f-	_____
Connector gage -m-	_____
Connector gage -f-	_____
Adapters	
Type-N -m- to Type-N -m-	_____
Type-N -f- to Type-N -f-	_____
Type-N -f- to 7 mm	_____
Type-N -m- to 7 mm	_____

Precision Slotless Connectors

The female type-N connectors in this calibration kit are metrology-grade, precision slotless connectors (PSC). A characteristic of metrology-grade connectors is direct traceability to national measurement standards through their well-defined mechanical dimensions.

Conventional female center conductors are slotted. When mated, the female center conductor is flared by the male pin. Because physical dimensions determine connector impedance, electrical characteristics of the female connector (and connection pair) are dependent upon the mechanical dimensions of the male pin. While connectors are used in pairs, their male and female halves are always specified separately as part of a standard, instrument, or device under test. Because of these facts, making precision measurements with the conventional slotted connector is very difficult, and establishing a direct traceability path to primary dimensional standards is nearly impossible.

The precision slotless connector was developed to eliminate these problems. All PSCs are female. A PSC incorporates a center conductor with a solid cylindrical shell that defines the outside diameter of the female center pin. Its outside diameter and, therefore, the impedance in its region does not change. The inner part provides an internal contact that flexes to accept the allowed range of male pin diameters.

The calibration of a network analyzer having a conventional slotted female connector on the test port remains valid only when the device under test and all calibration standards have identical male pin diameters. For this reason PSC test port adapters are supplied in most calibration kits.

Precision slotless connectors have the following characteristics:

- There is no loss of traceable calibration on test ports when the male pin diameter of the connector on the device under test is different from the male pin diameter of the calibration standard.
- The female PSC and its mating male connector can be measured and specified separately as part of the device either is attached to.
- All female connectors can have a known, stable impedance based only on the diameters of their inner and outer conductors.
- Female calibration standards can be fully specified. Their specifications and traceability are unaffected by the diameter of the male mating pin.
- A fully traceable performance verification is made using a precision 50 ohm airline having a PSC.
- Measurement repeatability is enhanced due to non-changing connector characteristics with various pin diameters.

With PSCs on test ports and standards, the percentage of accuracy achieved when measuring at 50 dB return loss levels is comparable to using conventional slotted connectors measuring devices having only 30 dB return loss. This represents an accuracy improvement of about 10 times.

Clarifying the Terminology of a Connector Interface

In this document and in the prompts of the PNA calibration wizard, the sex of cable connectors and adapters is referred to in terms of the center conductor. For example, a connector or device designated as 1.85 mm –f– has a 1.85 mm female center conductor.

A connector gage is referred to in terms of the connector that it measures. For instance, a male connector gage has a female connector on the gage so that it can measure male devices.

Preventive Maintenance

The best techniques for maintaining the integrity of the devices in this kit include:

- routine visual inspection
- cleaning
- proper gaging
- proper connection techniques

All of the above are described in **Chapter 3, “Use, Maintenance, and Care of the Devices.”** Failure to detect and remove dirt or metallic particles on a mating plane surface can degrade repeatability and accuracy and can damage any connector mated to it. Improper connections, resulting from pin depth values being out of the **observed** limits (see **Table 2-2 on page 2-4**), or from bad connections, can also damage these devices.

When to Calibrate

A network analyzer calibration remains valid as long as the changes in the systematic error are insignificant. This means that changes to the uncorrected leakages (directivity and isolation), mismatches (source match and load match), and frequency response of the system are small (<10%) relative to accuracy specifications.

Change in the environment (especially temperature) between calibration and measurement is the major cause in calibration accuracy degradation. The major effect is a change in the physical length of external and internal cables. Other important causes are dirty and damaged test port connectors and calibration standards. If the connectors become dirty or damaged, measurement repeatability and accuracy is affected. Fortunately, it is relatively easy to evaluate the general validity of the calibration. To test repeatability, remeasure one of the calibration standards. If you can not obtain repeatable measurements from your calibration standards, maintenance needs to be performed on the test port connectors, cables and calibration standards. Also, maintain at least one sample of the device under test or some known device as your reference device. A verification kit may be used for this purpose. After calibration, measure the reference device and note its responses. Periodically remeasure the device and note any changes in its corrected response which can be attributed to the test system. With experience you will be able to see changes in the reference responses that indicate a need to perform the measurement calibration again.

2 Specifications

Environmental Requirements

Table 2-1 Environmental Requirements

Parameter	Limits
Temperature	
Operating ^a	+20 °C to +26 °C
Storage	−40 °C to +75 °C
Error-corrected range ^b	± 1 °C of measurement calibration temperature
Relative humidity	Type tested, 0% to 95% at 40 °C, non-condensing

- a. The temperature range over which the calibration standards maintain conformance to their specifications.
- b. The allowable network analyzer ambient temperature drift during measurement calibration and during measurements when the network analyzer error correction is turned on. Also, the range over which the network analyzer maintains its specified performance while correction is turned on.

Temperature—What to Watch Out For

Changes in temperature can affect electrical characteristics. Therefore, the operating temperature is a critical factor in performance. During a measurement calibration, the temperature of the calibration devices must be stable and within the range specified in [Table 2-1](#).

NOTE

Avoid unnecessary handling of the devices during calibration because your fingers are a heat source.

Mechanical Characteristics

Mechanical characteristics such as center conductor protrusion and pin depth are not performance specifications. They are, however, important supplemental characteristics related to the electrical performance of devices. Keysight Technologies verifies the mechanical characteristics of the devices in this kit with special gaging processes and electrical testing. This ensures that the device connectors do not exhibit any excess center conductor protrusion or improper pin depth when the kit leaves the factory.

“Gaging Connectors” on page 3- 8 explains how to use gages to determine if the kit devices have maintained their mechanical integrity. (Refer to **Table 2-2 on page 2-4** for typical and observed pin depth limits.)

Pin Depth

Pin depth is the distance the center conductor mating plane differs from being flush with the outer conductor mating plane. Refer to **Figure 2-1**. Some coaxial connectors, such as 2.4 mm and 3.5 mm, are designed to have these planes nearly flush. Type-N connectors, however, are designed with a pin depth offset of approximately 5.26 mm (0.207 inch), not permitting these planes to be flush. The male center conductors are recessed by the offset value while the female center conductors compensate by protruding the same amount. This offset necessitates the redefining of pin depth with regard to protrusion and recession.

Protrusion refers to a male type-N connector center conductor having a pin depth value less than 5.26 mm (0.207 inch), or a female type-N connector center conductor having a pin depth value greater than 5.26 mm (0.207 inch).

Recession refers to a male type-N connector center conductor having a pin depth value greater than 5.26 mm (0.207 in), or a female type-N connector center conductor having a pin depth value less than 5.26 mm (0.207 inch).

Figure 2-1

Connector Pin Depth

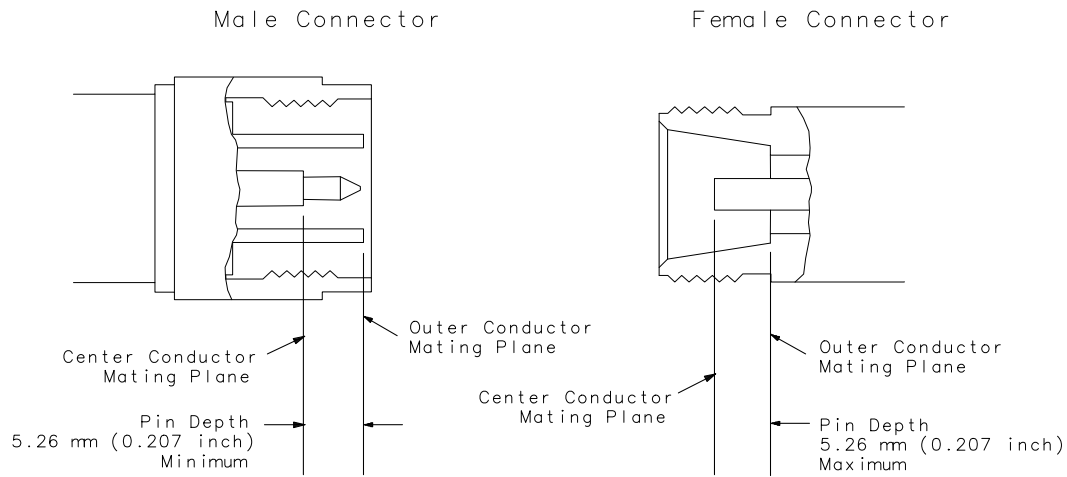

wj53b

NOTE

The gages for measuring type-N connectors compensate for the designed offset of 5.26 mm (0.207 inch), therefore, protrusion and recession readings are in relation to a zero reference plane (as if the inner and outer conductor planes were intended to be flush). Gage readings can be directly compared with the **observed** values listed in [Table 2-2](#).

The pin depth value of each calibration device in this kit is not specified, but is an important mechanical parameter. The electrical performance of the device depends, to some extent, on its pin depth. The electrical specifications for each device in this kit take into account the effect of pin depth on the device's performance. [Table 2-2](#) lists the typical pin depths and measurement uncertainties, and provides observed pin depth limits for the devices in the kit. If the pin depth of a device does not measure within the **observed** pin depth limits, it may be an indication that the device fails to meet electrical specifications. Refer to [Figure 2-1](#) for an illustration of pin depth in type-N connectors.

Table 2-2 Pin Depth Limits

Device	Typical Pin Depth micrometers (10 ⁻⁴ inches)	Measurement Uncertainty ^a micrometers (10 ⁻⁴ inches)	Observed Pin Depth Limits ^b micrometers (10 ⁻⁴ inches)
Opens	0 to -12.7 (0 to -5.0)	+3.8 to -3.8 (+ 1.5 to -1.5)	+3.8 to -16.5 (+ 1.5 to -6.5)
Shorts	0 to -12.7 (0 to -5.0)	+3.8 to -3.8 (+ 1.5 to -1.5)	+3.8 to -16.5 (+ 1.5 to -6.5)
Lowband loads	0 to -50.8 (0 to -20.0)	+3.8 to -3.8 (+ 1.5 to -1.5)	+3.8 to -54.6 (+ 1.5 to -21.5)
Sliding loads	0 to -7.6 (0 to -3.0)	+3.8 to -3.8 (+ 1.5 to -1.5)	+3.8 to -11.4 (+ 1.5 to -4.5)
Adapters ^c (7 mm end) 85054-60031 85054-60032	0 to -50.8 (0 to -20.0)	+3.8 to -3.8 (+ 1.5 to -1.5)	+3.8 to -54.6 (+ 1.5 to -21.5)
Adapters (type-N end) 85054-60037 85054-60038	0 to -12.7 (0 to -5.0)	+3.8 to -3.8 (+ 1.5 to -1.5)	+3.8 to -16.5 (+ 1.5 to -6.5)
Adapters ^{c, d} (type-N end) 85054-60031 85054-60032	-12.7 to -22.86 (-5.0 to -9.0)	+3.8 to -3.8 (+ 1.5 to -1.5)	-8.9 to -26.66 (-3.5 to -10.5)

- a. Approximately +2 sigma to -2 sigma of gage uncertainty based on studies done at the factory according to recommended procedures.
- b. Observed pin depth limits are the range of observation limits seen on the gage reading due to measurement uncertainty. The depth could still be within specifications.
- c. For a description of these adapters, refer to [Table 6-1 on page 6-1](#).
- d. In May 2015, this specification was changed from "0 to -12.7 um (0 to -0.0005 inch)" to "-12.7 to -22.8 um (-0.0005 to -0.0009 inch)". The Keysight factory began manufacturing adapters to this new specification a few months earlier. This change was made to improve the electrical transmission performance and repeatability of the adapter. On incoming inspection, Keysight will pass all devices which meet either specification and will ensure all devices meet the new specification when they are returned.

NOTE

When measuring pin depth, the measured value (resultant average of three or more measurements) is **not** the true value. Always compare the measured value with the observed pin depth limits in [Table 2-2](#) to evaluate the condition of device connectors.

Electrical Specifications

The electrical specifications in **Table 2-3** apply to the devices in your calibration kit when connected with a Keysight precision interface.

Table 2-3 Electrical Specifications

Device	Frequency (GHz)	Parameter	Specification
Lowband loads	DC to ≤ 2	Return Loss	≥ 48 dB ($\leq 0.00398\rho$)
Sliding loads ^a	> 2 to ≤ 18	Return Loss	≥ 42 dB ($\leq 0.00794\rho$)
Adapters (both styles)	DC to ≤ 8	Return Loss	≥ 34 dB ($\leq 0.0200\rho$)
	> 8 to ≤ 18	Return Loss	≥ 28 dB ($\leq 0.0398\rho$)
Offset Opens ^b	at 18	Deviation from Nominal Phase	$\pm 1.5^\circ$
Offset Shorts ^b	at 18	Deviation from Nominal Phase	$\pm 1.0^\circ$

a. Assuming proper usage, the specifications for the residual return loss after calibration for the sliding load termination include:

- the quality of the airline portions within the sliding load, combined with
- the effective stability of the sliding element.

Proper usage includes the following practices:

- Connector mating surfaces are clean.
- The changes in slide positioning are NOT done in equal steps since this results in very poor calibration for some portions of the frequency range.
- The center conductor of test port connectors are nominally set back from the outer conductor.

Sliding loads are designed to allow the center conductor to be moved. The position of the sliding load center conductor should be set by a reference block and not positioned flush against the center conductor of the test port.

b. The specifications for the opens and shorts are given as allowed deviation from the nominal model as defined in the standard definitions (see **“Class Assignments and Standard Definitions Values are Available on the Web”** on page A-1).

Certification

Keysight Technologies certifies that this product met its published specifications at the time of shipment from the factory. Keysight further certifies that its calibration measurements are traceable to the United States National Institute of Standards and Technology (NIST) to the extent allowed by the Institute's calibration facility, and to the calibration facilities of other International Standards Organization members. See **“How Keysight Verifies the Devices in This Kit”** on page 4- 1 for more information.

Specifications
Electrical Specifications

3 Use, Maintenance, and Care of the Devices

Electrostatic Discharge

Protection against ESD (electrostatic discharge) is essential while connecting, inspecting, or cleaning connectors attached to a static-sensitive circuit (such as those found in test sets).

Static electricity can build up on your body and can easily damage sensitive internal circuit elements when discharged. Static discharges too small to be felt can cause permanent damage. Devices such as calibration components and devices under test (DUTs), can also carry an electrostatic charge. To prevent damage to the test set, components, and devices:

- **always** wear a grounded wrist strap having a 1 MΩ resistor in series with it when handling components and devices or when making connections to the test set.
- **always** use a grounded, conductive table mat while making connections.
- **always** wear a heel strap when working in an area with a conductive floor. If you are uncertain about the conductivity of your floor, wear a heel strap.
- **always** ground yourself before you clean, inspect, or make a connection to a static-sensitive device or test port. You can, for example, grasp the grounded outer shell of the test port or cable connector briefly.
- **always** ground the center conductor of a test cable before making a connection to the analyzer test port or other static-sensitive device. This can be done as follows:
 1. Connect a short (from your calibration kit) to one end of the cable to short the center conductor to the outer conductor.
 2. While wearing a grounded wrist strap, grasp the outer shell of the cable connector.
 3. Connect the other end of the cable to the test port.
 4. Remove the short from the cable.

Refer to **Chapter 6, “Replaceable Parts.”** for part numbers and instructions for ordering ESD protection devices.

Figure 3-1 ESD Protection Setup

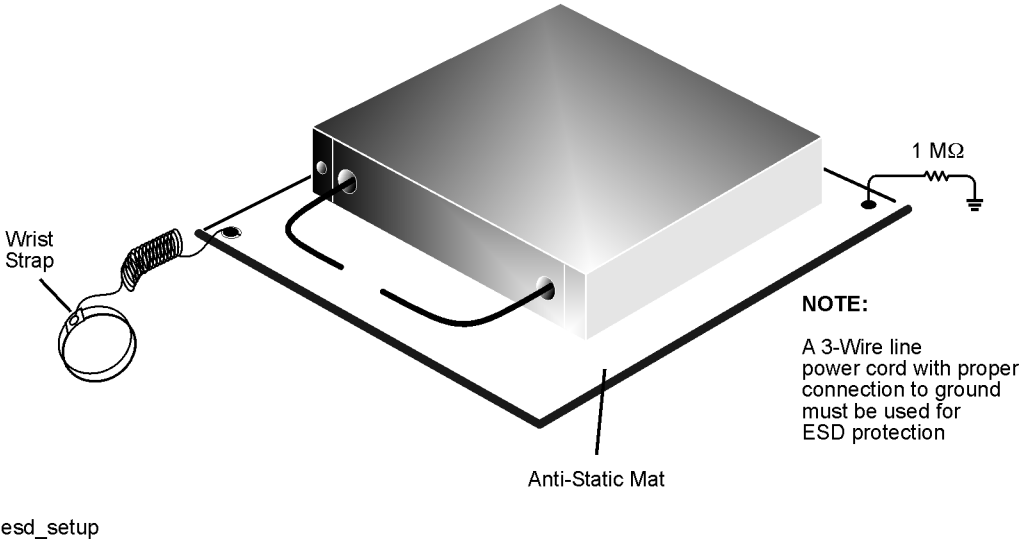

Visual Inspection

Visual inspection and, if necessary, cleaning should be done every time a connection is made. Metal particles from the connector threads may fall into the connector when it is disconnected. One connection made with a dirty or damaged connector can damage both connectors beyond repair.

Magnification is helpful when inspecting connectors, but it is not required and may actually be misleading. Defects and damage that cannot be seen without magnification generally have no effect on electrical or mechanical performance. Magnification is of great use in analyzing the nature and cause of damage and in cleaning connectors, but it is not required for inspection.

Look for Obvious Defects and Damage First

Examine the connectors first for obvious defects and damage: badly worn plating on the connector interface, deformed threads, or bent, broken, or misaligned center conductors. Connector nuts should move smoothly and be free of burrs, loose metal particles, and rough spots.

What Causes Connector Wear?

Connector wear is caused by connecting and disconnecting the devices. The more use a connector gets, the faster it wears and degrades. The wear is greatly accelerated when connectors are not kept clean, or are connected incorrectly.

Connector wear eventually degrades performance of the device. Calibration devices should have a long life if their use is on the order of a few times per week. Replace devices with worn connectors.

The test port connectors on the network analyzer test set may have many connections each day, and are therefore more subject to wear. It is recommended that an adapter be used as a test port saver to minimize the wear on the test set's test port connectors.

Inspect the Mating Plane Surfaces

Flat contact between the connectors at all points on their mating plane surfaces is required for a good connection. See **Figure 2-1 on page 2-3**. Look especially for deep scratches or dents, and for dirt and metal particles on the connector mating plane surfaces. Also look for signs of damage due to excessive or uneven wear or misalignment.

Light burnishing of the mating plane surfaces is normal, and is evident as light scratches or shallow circular marks distributed more or less uniformly over the mating plane surface. Other small defects and cosmetic imperfections are also normal. None of these affect electrical or mechanical performance.

Use, Maintenance, and Care of the Devices
Visual Inspection

If a connector shows deep scratches or dents, particles clinging to the mating plane surfaces, or uneven wear, clean and inspect it again. Devices with damaged connectors should be discarded. Determine the cause of damage before connecting a new, undamaged connector in the same configuration.

Inspect the Precision Slotless Connectors (female)

Precision slotless female connectors are used to improve accuracy. The slotless contacts are not affected by the slight variations in male contact pin diameter. However, it is still advisable to inspect them regularly for damage.

NOTE

This is particularly important when mating nonprecision to precision devices.

Cleaning Connectors

Clean connectors are essential for ensuring the integrity of RF and microwave coaxial connections.

1. Use Compressed Air or Nitrogen

WARNING

Always use protective eyewear when using compressed air or nitrogen.

Use compressed air (or nitrogen) to loosen particles on the connector mating plane surfaces.

You can use any source of clean, dry, low-pressure compressed air or nitrogen that has an effective oil-vapor filter and liquid condensation trap placed just before the outlet hose.

Ground the hose nozzle to prevent electrostatic discharge, and set the air pressure to less than 414 kPa (60 psi) to control the velocity of the air stream. High-velocity streams of compressed air can cause electrostatic effects when directed into a connector. These electrostatic effects can damage the device. Refer to “[Electrostatic Discharge](#)” earlier in this chapter for additional information.

2. Clean the Connector Threads

WARNING

Keep isopropyl alcohol away from heat, sparks, and flame. Store in a tightly closed container. It is extremely flammable. In case of fire, use alcohol foam, dry chemical, or carbon dioxide; water may be ineffective.

Use isopropyl alcohol with adequate ventilation and avoid contact with eyes, skin, and clothing. It causes skin irritation, may cause eye damage, and is harmful if swallowed or inhaled. It may be harmful if absorbed through the skin. Wash thoroughly after handling.

In case of spill, soak up with sand or earth. Flush spill area with water.

Dispose of isopropyl alcohol in accordance with all applicable federal, state, and local environmental regulations.

Use a lint-free swab or cleaning cloth moistened with isopropyl alcohol to remove any dirt or stubborn contaminants on a connector that cannot be removed with compressed air or nitrogen. Refer to [Table 6-2 on page 6-2](#) for a part number for cleaning swabs.

- a. Apply a small amount of isopropyl alcohol to a lint-free cleaning swab.
- b. Clean the connector threads.

- c. Let the alcohol evaporate, then blow the threads dry with a gentle stream of clean, low-pressure compressed air or nitrogen. Always completely dry a connector before you reassemble or use it.

3. Clean the Mating Plane Surfaces

- a. Apply a small amount of isopropyl alcohol to a lint-free cleaning swab.
- b. Clean the center and outer conductor mating plane surfaces. Refer to [Figure 2-1 on page 2-3](#). When cleaning a female connector, avoid snagging the swab on the center conductor contact fingers by using short strokes.
- c. Let the alcohol evaporate, then blow the connector dry with a gentle stream of clean, low-pressure compressed air or nitrogen. Always completely dry a connector before you reassemble or use it.

4. Inspect

Inspect the connector again to make sure that no particles or residue are present.

Gaging Connectors

The gages available from Keysight Technologies are intended for preventive maintenance and troubleshooting purposes only. (See [Table 6-1 on page 6-1](#) for part number information.) They are effective in detecting excessive center conductor protrusion or recession, and conductor damage on DUTs, test accessories, and the calibration kit devices. **Do not use the gages for precise pin depth measurements.**

Connector Gage Accuracy

The connector gages are only capable of performing coarse measurements. They do not provide the degree of accuracy necessary to precisely measure the pin depth of the kit devices. This is partially due to the repeatability uncertainties that are associated with the measurement. Only the factory—through special gaging processes and electrical testing— can accurately verify the mechanical characteristics of the devices.

With proper technique, however, the gages are useful in detecting gross pin depth errors on device connectors. To achieve maximum accuracy, random errors must be reduced by taking the average of at least three measurements having different gage orientations on the connector. Even the resultant average can be in error by as much as ± 0.0001 inch due to systematic (biasing) errors usually resulting from worn gages and gage masters. The information in [Table 2-2 on page 2-4](#) assumes new gages and gage masters. Therefore, these systematic errors were not included in the uncertainty analysis. As the gages undergo more use, the systematic errors can become more significant in the accuracy of the measurement.

The measurement uncertainties (see [Table 2-2 on page 2-4](#)) are primarily a function of the assembly materials and design, and the unique interaction each device type has with the gage. Therefore, these uncertainties can vary among the different devices. For example, note the difference between the uncertainties of the opens and shorts in [Table 2-2](#).

The observed pin depth limits in [Table 2-2](#) add these uncertainties to the typical factory pin depth values to provide practical limits that can be referenced when using the gages. See [“Pin Depth” on page 2-2](#). Refer to [“Kit Contents” on page 1-1](#) for more information on the design of the calibration devices in this kit.

NOTE

When measuring pin depth, the measured value (resultant average of three or more measurements) contains measurement uncertainty and is not necessarily the true value. Always compare the measured value with the observed pin depth limits (which account for measurement uncertainties) in [Table 2-2 on page 2-4](#) to evaluate the condition of device connectors.

When to Gage Connectors

Gage a connector at the following times:

Use, Maintenance, and Care of the Devices Gaging Connectors

- Prior to using a device for the first time: record the pin depth measurement so that it can be compared with future readings. (It will serve as a good troubleshooting tool when you suspect damage may have occurred to the device.)
- If either visual inspection or electrical performance suggests that the connector interface may be out of typical range (due to wear or damage, for example).
- If a calibration device is used by someone else or on another system or piece of equipment.
- Initially after every 100 connections, and after that as often as experience indicates.

Reading the Connector Gage

The gage dial is divided into increments of 0.0001 inch and major divisions of 0.001 inch (see **Figure 3-2**). For each revolution of the large dial, the smaller dial indicates a change of 0.01 inch. Use the small dial as the indicator of multiples of 0.01 inch. In most connector measuring applications, this value will be zero.

When making a measurement, the gage dial indicator will travel in one of two directions. If the center conductor is recessed from the zero reference plane, the indicator will move counterclockwise to indicate the amount of **recession**, which is read as a negative value. If the center conductor protrudes, the indicator will move clockwise to indicate the amount of **protrusion**, which is read as a positive value. Refer to **“Pin Depth” on page 2-2** for definitions of protrusion and recession.

Figure 3-2 Reading the Connector Gage

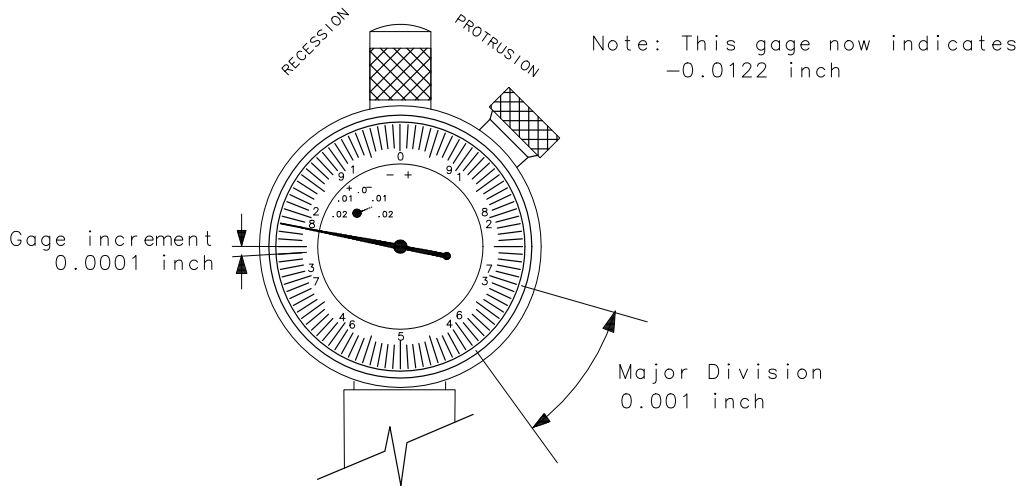

wj57f

Gaging Procedures

Gaging Male Type-N Connectors

NOTE

Always hold a connector gage by the gage barrel, below the dial indicator. This gives the best stability, and improves measurement accuracy.

1. Select the proper gage for your connector. (Refer to [Table 6-2](#) for the gage set part number).
2. Inspect and clean the gage, gage master, and device to be gaged. Refer to [“Visual Inspection”](#) and [“Cleaning Connectors”](#) earlier in this chapter.
3. Zero the connector gage (refer to [Figure 3-3](#)):
 - a. While holding the gage by the barrel, and without turning the gage or the gage master, screw the gage master connecting nut onto the male gage, just until you meet resistance. Connect the nut finger tight. Do not overtighten.
 - b. Use the torque wrench recommended for use with this kit to tighten the connecting nut to 135 N-cm (12 in-lb). Refer to [“Connections” on page 3-20](#) for more information.

- c. Loosen the dial lock screw on the gage and rotate the gage dial so that the pointer corresponds to the correction value noted on the gage master. Do not adjust the gage dial to zero, unless the correction value on the gage master is zero.
 - d. Tighten the dial lock screw and remove the gage master.
 - e. Attach and torque the gage master to the gage once again to verify that the setting is repeatable. Remove the gage master.
4. Gage the device connector (refer to **Figure 3-3**):
 - a. While holding the gage by the barrel, and without turning the gage or the device, screw the connecting nut of the device being measured onto the gage, just until you meet resistance. Connect the nut finger-tight. Do not overtighten.
 - b. Use the torque wrench recommended for use with this kit to tighten the connecting nut to 135 N-cm (12 in-lb). Refer to **“Connections” on page 3-20** for more information.
 - c. Gently tap the barrel of the gage with your finger to settle the gage reading.
 - d. Read the gage indicator dial. If the needle has moved clockwise, the center conductor is **protruding** by an amount indicated by the black numbers. If the needle has moved counterclockwise, the center conductor is **recessed** by an amount indicated by the red numbers.

For maximum accuracy, measure the connector a minimum of three times and take an average of the readings. After each measurement, rotate the gage a quarter-turn to reduce measurement variations that result from the gage or the connector face not being exactly perpendicular to the center axis.
 - e. Compare the average reading with the observed pin depth limits in **Table 2-2 on page 2-4**.

Figure 3-3 Gaging Male Type-N Connectors

Zero the Connector Gage

- Screw the male gage master connecting nut onto the male gage.
- Torque the connecting nut.
- Loosen the dial lock screw.
- Adjust the gage to the correction value noted on the gage master.
- Tighten the dial lock screw.
- Remove the gage master.

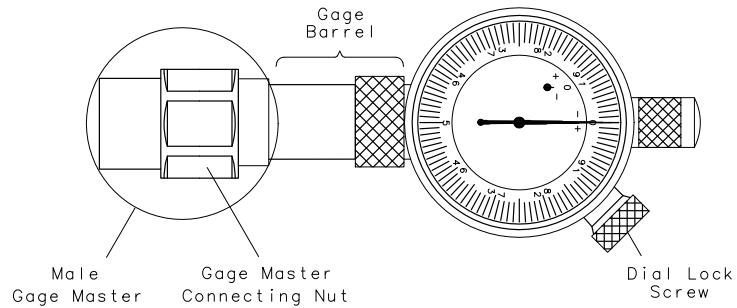

Gage the Device Connector

- Screw the male device connecting nut onto the male gage.
- Torque the connecting nut.
- Gently tap the gage barrel to settle the reading.
- Read recession or protrusion from the gage.
- Remove the device.

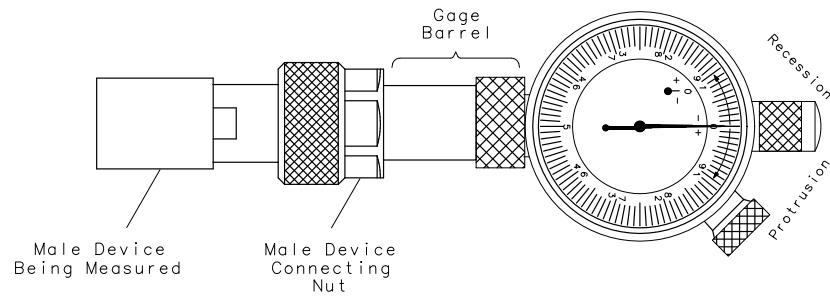

wj55f

Gaging Female Type-N Connectors

NOTE

Always hold a connector gage by the gage barrel, below the dial indicator. This gives the best stability, and improves measurement accuracy.

1. Select the proper gage for your connector. (Refer to [Table 6-2](#) for the gage set part number).
2. Inspect and clean the gage, gage master, and device to be gaged. Refer to [“Visual Inspection”](#) and [“Cleaning Connectors”](#) earlier in this chapter.
3. Zero the connector gage (refer to [Figure 3-4](#)):
 - a. While holding the gage by the barrel, and without turning the gage or the gage master, screw the gage connecting nut onto the female gage master, just until you meet resistance. Connect the nut finger-tight. Do not overtighten.
 - b. Use the torque wrench recommended for use with this kit to tighten the connecting nut to 135 N-cm (12 in-lb). Refer to [“Connections” on page 3-20](#) for more information.
 - c. Loosen the dial lock screw on the gage and rotate the gage dial so that the pointer corresponds to the correction value noted on the gage master. Do not adjust the gage dial to zero, unless the correction value on the gage master is zero.
 - d. Tighten the dial lock screw and remove the gage master.
 - e. Attach and torque the gage master to the gage once again to verify that the setting is repeatable. Remove the gage master.
4. Gage the device connector (refer to [Figure 3-3 on page 3-12](#)):
 - a. While holding the gage by the barrel, and without turning the gage or the device, screw the gage connecting nut onto the device being measured, just until you meet resistance. Connect the nut finger-tight. Do not overtighten.
 - b. Use the torque wrench recommended for use with this kit to tighten the connecting nut to 135 N-cm (12 in-lb). Refer to [“Connections” on page 3-20](#) for more information.
 - c. Gently tap the barrel of the gage with your finger to settle the gage reading.
 - d. Read the gage indicator dial. If the needle has moved clockwise, the center conductor is **protruding** by an amount indicated by the black numbers. If the needle has moved counterclockwise, the center conductor is **recessed** by an amount indicated by the red numbers.

For maximum accuracy, measure the connector a minimum of three times and take an average of the readings. After each measurement, rotate the gage a quarter-turn to reduce measurement variations that result from the gage or the connector face not being exactly perpendicular to the center axis.

- e. Compare the average reading with the observed pin depth limits in [Table 2-2 on page 2-4](#).

Figure 3-4 Gaging Female Type-N Connectors

Zero the Connector Gage

- Screw the female gage connecting nut onto the female gage master.
- Torque the connecting nut.
- Loosen the dial lock screw.
- Adjust the gage to the correction value noted on the gage master.
- Tighten the dial lock screw.
- Remove the gage master.

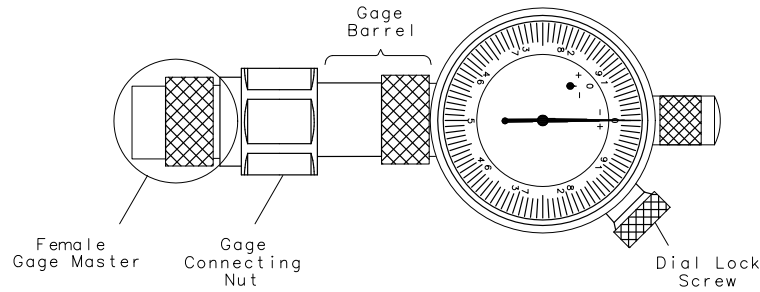

Gage the Device Connector

- Screw the female gage connecting nut onto the female device.
- Torque the connecting nut.
- Gently tap the gage barrel to settle the reading.
- Read recession or protrusion from the gage.
- Remove the device.

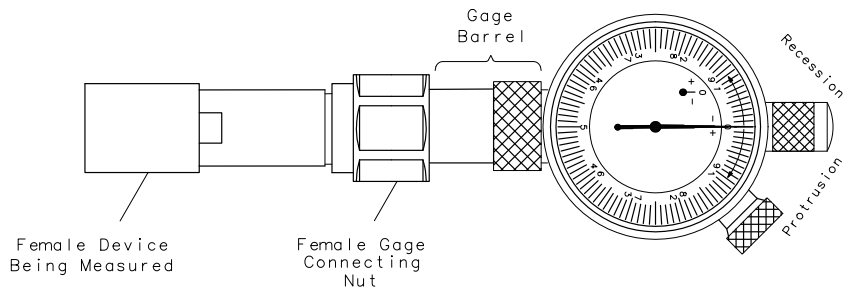

wj54f

Gaging the Sliding Loads

Gage a sliding load before each use. If the sliding load pin depth is out of the observed pin depth limits listed in [Table 2-2 on page 2-4](#), refer to [“Adjusting the Sliding Load Pin Depth” on page 3-18](#).

NOTE

Always hold a connector gage by the gage barrel, below the dial indicator. This gives the best stability, and improves measurement accuracy. (Cradling the gage in your hand or holding it by the dial applies stress to the gage plunger mechanism through the dial indicator housing.)

NOTE

The sliding load uses a plastic centering bead to support its center conductor when pin depth is adjusted and gaged and when the load is stored. Remove this support bead from the sliding load before you connect the load for an electrical calibration. Reinsert this support bead when you've finished using the sliding load.

1. Select the proper gage for your connector. Refer to [Table 6-1 on page 6-1](#) for gage part numbers.
2. Inspect and clean the gage, gage master, and device to be gaged. Refer to [“Visual Inspection” on page 3-3](#) and [“Cleaning Connectors” on page 3-6](#) earlier in this chapter.
3. Zero the connector gage as described in either (for a male gage) or (for a female gage).
4. Remove the center conductor protective cap from the sliding load.
5. Loosen the center conductor pull-back nut completely, and press the center-conductor cap to extend the center conductor beyond the end of the connector. With the sliding ring pulled back approximately 0.5 inch, install a centering bead (if not already installed) in the connector end of the sliding load.
6. Continue to press the center conductor cap and mate the center conductor of the sliding load with the gage's center conductor.

CAUTION

The sliding load center conductor can be damaged if the sliding load is not in line when mating the load to a connector. Always line-up the sliding load when connecting or removing it from a connector.

7. Mate the outer conductor of the sliding load with the outer conductor of the gage. Torque the connection with a 3/4 inch torque wrench to approximately 135 N-cm (12 in-lb). Re-tighten the center conductor pull-back nut. It will “click” when it is tight.
8. Gently tap the barrel of the gage with your finger to settle the gage reading.

9. Read the gage indicator dial. If the needle had moved clockwise, the center conductor is protruding and the value is determined by the **black** numbers. If the needle had moved counterclockwise, the center conductor is recessed by an amount determined by the **red** numbers.
10. For maximum accuracy, measure the connector a minimum of three times and take an average of the readings.

NOTE

When performing pin depth measurements, use different orientations of the gage within the connector. Averaging a minimum of three readings, each taken after a quarter-turn rotation of the gage, reduces measurement variations that result from the gage or the connector face not being exactly perpendicular to the center axis.

11. Compare the average reading with the **observed** pin depth limits in [Table 2-2 on page 2-4](#). If the pin depth is outside the limits, it must be adjusted before proceeding. Refer to [“Adjusting the Sliding Load Pin Depth” on page 3-18](#).
12. Loosen the connection between the gage and sliding load, and remove the sliding load from the gage.
13. Leave the centering bead installed on the sliding load if you are going to adjust the pin depth. Carefully remove the centering bead from the sliding load if you’re going to use it for an electrical calibration. If the centering bead does not come out of the sliding load easily, loosen the center conductor pull-back nut, and press the center conductor cap to extend the center conductor. This should expose the centering bead so that it may be removed. Retract the center conductor and retighten the pull-back nut.

If the centering bead still will not come out, hold the sliding load with the connector end pointed down. Move the sliding element up, then quickly down. The trapped air behind the centering bead helps eject it.

CAUTION

Damage can occur to the sliding load during the removal of a centering bead that has slipped too far into the sliding load. If you’re going to perform an electrical calibration, prevent damage by removing the centering bead immediately after aligning the sliding load pin depth. The sliding load will not perform to its specifications if the centering bead is not removed from the sliding load before an electrical calibration.

Figure 3-5 Gaging the Sliding Loads

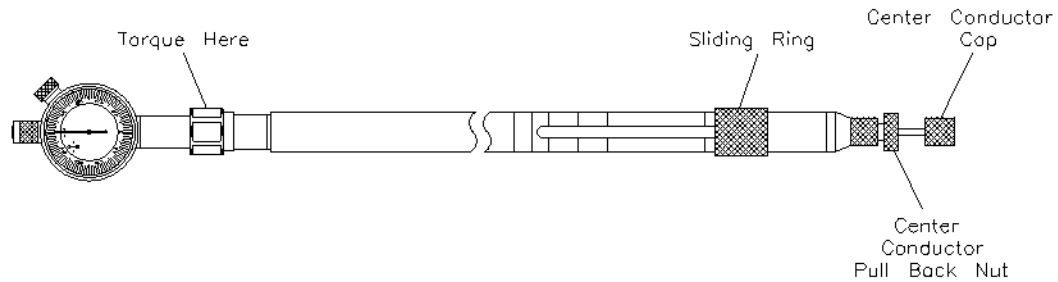

Adjusting the Sliding Load Pin Depth

The sliding loads in this kit have a setback mechanism that allows the pin depth to be set to any desired value. The pin depth of the sliding load is preset at the factory. **The pin depth should not have to be reset each time the sliding load is used**, but it should be checked before each use.

If the pin depth is outside the **observed** limits listed in [Table 2-2 on page 2-4](#), use the following procedure to reset it. Always measure the sliding load pin depth before attaching it to any connector.

This procedure assumes that you were directed here from [“Gaging the Sliding Loads” on page 3-16](#). If not, perform the steps in that procedure before performing this procedure.

1. The gage should be attached to the sliding load. The sliding load should have its centering bead installed. Refer to [“Gaging the Sliding Loads” on page 3-16](#) if necessary.
2. With a 0.050 inch hex key, loosen the **two largest** hex screws by turning them 1/4 turn clockwise. Refer to [Figure 3-6](#).

CAUTION

Do not loosen any hex screws other than the two largest hex screws pointed out in [Figure 3-6](#).

3. Gently turn the center conductor pin depth adjustment knob on the sliding load until the gage pointer reads -3.81 micrometers (-1.5×10^{-4} inches). Refer to [Figure 3-6](#).
4. Tighten the two hex screws just until they are finger tight (do not overtighten).
5. Wait approximately five minutes to allow the temperature to stabilize. Do not touch either the gage or the sliding load during this time.

6. Note the gage reading. If it is no longer within the allowable range, perform steps 2–5 again.
7. Loosen the connecting nut and remove the gage from the sliding load. If you're going to store the sliding load, leave the centering bead installed. If you're going to use the sliding load for an electrical calibration, remove the centering bead.

NOTE

When performing pin depth measurements, use different orientations of the gage within the connector. Averaging a minimum of three readings, each taken after a quarter-turn rotation of the gage, reduces measurement variations that result from the gage or the connector face not being exactly perpendicular to the center axis.

The sliding load pin depth is now in specification and the load is ready to use. Once the sliding load pin depth is set it rarely needs to be adjusted. However, the pin depth should be rechecked before each use. Replace the protective plastic caps on the sliding load and gage connectors when these devices are not in use.

Figure 3-6 Adjusting the Sliding Load Pin Depth

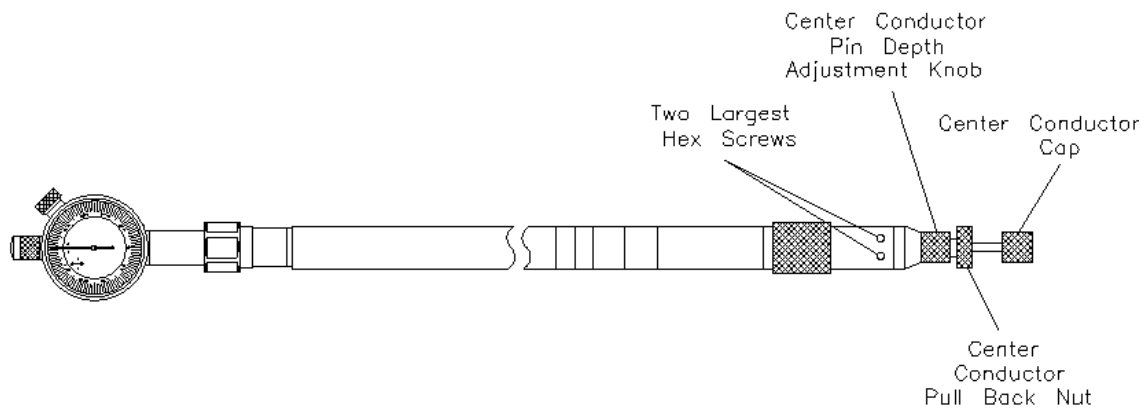

Connections

Good connections require a skilled operator. **The most common cause of measurement error is bad connections.** The following procedures illustrate how to make good connections.

How to Make a Connection

Preliminary Connection

1. Ground yourself and all devices. Wear a grounded wrist strap and work on a grounded, conductive table mat. Refer to **“Electrostatic Discharge” on page 3-1** for ESD precautions.
2. Visually inspect the connectors. Refer to **“Visual Inspection” on page 3-3**.
3. If necessary, clean the connectors. Refer to **“Cleaning Connectors” on page 3-6**.
4. Use a connector gage to verify that all center conductors are within the observed pin depth values in **Table 2-2 on page 2-4**. Refer to **“Gaging Connectors” on page 3-8**.
5. Carefully align the connectors. The male connector center pin must slip concentrically into the contact finger of the female connector.
6. Push the connectors straight together.

CAUTION

Do not turn the device body. Only turn the connector nut. Damage to the center conductor can occur if the device body is twisted.

Do **not** twist or screw the connectors together. As the center conductors mate, there is usually a slight resistance.

7. The preliminary connection is tight enough when the mating plane surfaces make uniform, light contact. Do not overtighten this connection.

A connection in which the outer conductors make gentle contact at all points on both mating surfaces is sufficient. Very light finger pressure is enough to accomplish this.

8. Make sure the connectors are properly supported. Relieve any side pressure on the connection from long or heavy devices or cables.

Final Connection Using a Torque Wrench

Use a torque wrench to make a final connection. **Table 3-1** provides information about the torque wrench recommended for use with this calibration kit. A torque wrench is **not** included in the calibration kit. Refer to **Chapter 6** for part number and ordering information.

Table 3-1 Torque Wrench Information

Connector Type	Torque Setting	Torque Tolerance
Type-N	135 N-cm (12 in-lb)	± 13.5 N-cm (± 1.2 in-lb)

Using a torque wrench guarantees that the connection is not too tight, preventing possible connector damage. It also guarantees that all connections are equally tight each time.

Prevent the rotation of anything other than the connector nut that you are tightening. It may be possible to do this by hand if one of the connectors is fixed (as on a test port). In all situations, however, it is recommended that you use an open-end wrench to keep the body of the device from turning. Refer to **Chapter 6** for part number and ordering information.

1. Position both wrenches within 90 degrees of each other before applying force. See **Figure 3-7**. Wrenches opposing each other (greater than 90 degrees apart) will cause a lifting action which can misalign and stress the connections of the devices involved. This is especially true when several devices are connected together.

Figure 3-7 Wrench Positions

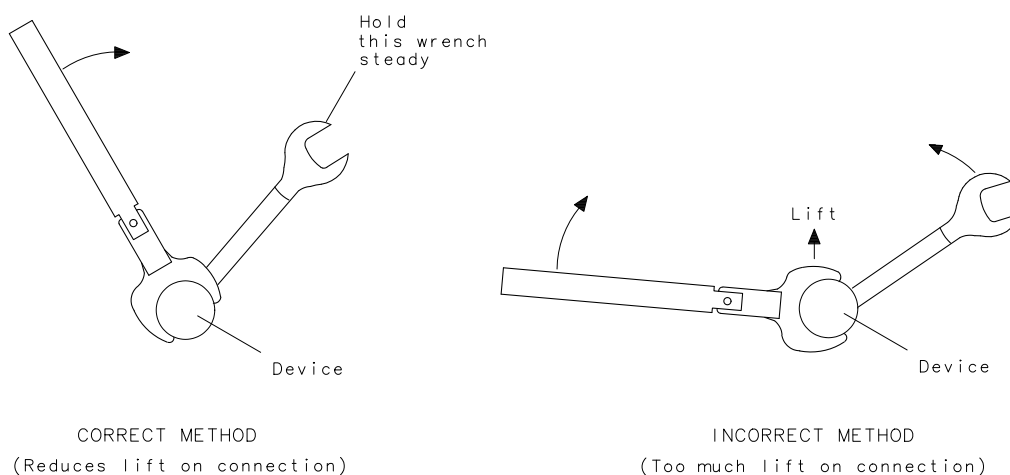

wj56f

2. Hold the torque wrench lightly, at the end of the handle only (beyond the groove). See **Figure 3-8**.

Figure 3-8 Using the Torque Wrench

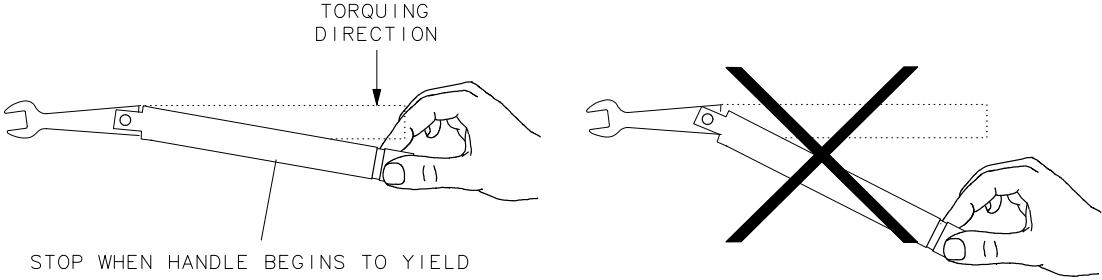

wj68d

3. Apply downward force perpendicular to the wrench handle. See **Figure 3-8**. This applies torque to the connection through the wrench.

Do not hold the wrench so tightly that you push the handle straight down along its length rather than pivoting it, otherwise you apply an unknown amount of torque.

4. Tighten the connection just to the torque wrench break point. The wrench handle gives way at its internal pivot point. See **Figure 3-8**. Do not tighten the connection further.

CAUTION

You don't have to fully break the handle of the torque wrench to reach the specified torque; doing so can cause the handle to kick back and loosen the connection. Any give at all in the handle is sufficient torque.

Do not pivot the wrench handle on your thumb or other fingers, otherwise you apply an unknown amount of torque to the connection when the wrench reaches its break point.

Do not twist the head of the wrench relative to the outer conductor mating plane. If you do, you apply more than the recommended torque.

Connecting the Sliding Load

Use this procedure to connect the sliding load to a test port or a type-N cable connector.

NOTE

The sliding load uses a plastic centering bead to support its center conductor when pin depth is adjusted and gaged and when the load is stored. Remove this support bead from the sliding load before you connect the load for an electrical calibration. Reinsert this support bead when you've finished using the sliding load.

CAUTION

Circuitry inside the test set at the test ports may be destroyed if precautions are not taken to avoid electrostatic discharge (ESD). During this procedure, the center conductor of the sliding load is connected to the exposed center conductor of the test port. Ground yourself to prevent electrostatic discharge.

CAUTION

The sliding load center conductor can be damaged if the sliding load is not in line when mating the load to a connector. Always line-up the sliding load when connecting or removing it from a connector.

1. Refer to **Figure 3-9**. Loosen the center conductor pull-back nut completely. Press the center conductor cap to extend the center conductor of the sliding load beyond the end of the connector.

2. Continue to press the center conductor cap and mate the center conductor of the sliding load with the cable/test port connector's center conductor.
3. Release pressure on the center conductor and mate the outer conductor of the sliding load with the outer conductor of the cable/test port connector. Torque the connection with a 3/4 inch torque wrench to approximately 135 N-cm (12 in-lb). Refer to **“Final Connection Using a Torque Wrench”** on page 3-21 for additional information.
4. Retighten the center conductor pull-back nut. It will “click” when it is tight.

Figure 3-9 Connecting the Sliding Load

1. ALIGN CENTER CONDUCTORS.

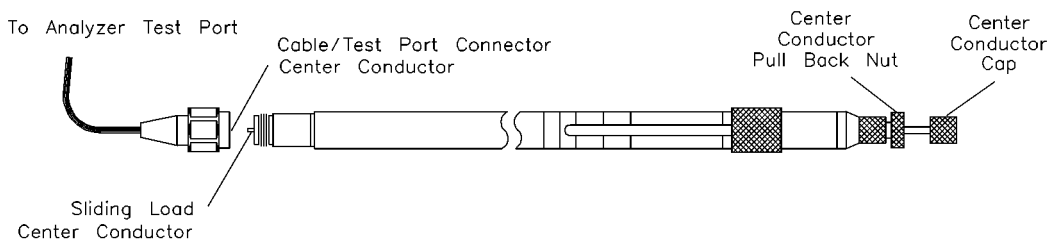

2. THEN MATE OUTER CONDUCTORS.

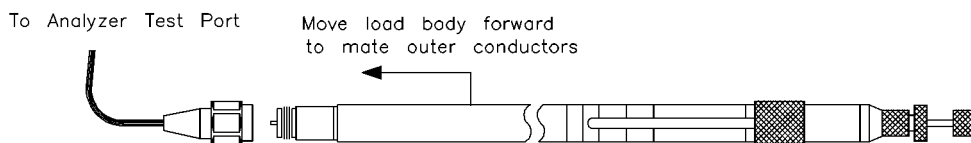

How to Separate a Connection

To avoid lateral (bending) force on the connector mating plane surfaces, always support the devices and connections.

CAUTION

Turn the connector nut, not the device body. Major damage to the center conductor can occur if the device body is twisted.

1. Use an open-end wrench to prevent the device body from turning.
2. Use the torque wrench to loosen the connector nut.
3. Complete the separation by hand, turning only the connector nut.
4. Pull the connectors straight apart without twisting, rocking, or bending either of the connectors.

Using the Sliding Load

When performing a sliding load calibration, it is recommended that the sliding ring be set at the marked positions (rings) along the sliding load body. Using the set marks ensures that a broad distribution of phase angles is selected, thereby optimizing the calibration.

The set marks function as detents so that the internal center of the sliding ring can mate with them. Because of this, the set mark being used cannot be seen but is felt as the sliding ring is moved from mark to mark during a calibration. Moving the sliding ring with only the index fingers of both hands will increase your ability to detect the sliding ring detent at each position.

NOTE

The sliding load uses a plastic bead to support its center conductor when it is stored. Remove this support bead from the sliding load before you connect the load for use. Reinsert this support bead when you are finished using the sliding load.

Preferred Method:

1. Move the sliding ring forward as far as possible toward the connector end of the load.
2. Move the sliding ring back until you feel it detent at the first set mark.
3. Follow the network analyzer instructions to measure the sliding load at each detent position.

NOTE

After a calibration has begun, always move the sliding ring toward the center conductor pullback end of the sliding load. If you slightly overshoot the desired mark by less than 0.5 mm (0.02 inch), do not move the sliding ring, but continue with the calibration as if the sliding ring is set to the proper position. If the sliding ring is moved toward the connector end of the load during the calibration sequence, the calibration may be unstable and poor measurements may result. If the desired position is overshoot by more than 0.5 mm (0.02 inch), restart the calibration sequence from step 1.

It does not matter if you start with the slide at the front and move it backwards, or start at the back and move it forward. To minimize stability errors, it is important to start at one end and move it in the same direction for each of the measurement steps.

This manual contains limited information about a sliding load calibration. For detailed information on this calibration using a VNA, ENA or PNA series network analyzer, refer to the appropriate user guide or online Help.

- To view the ENA or PNA online Help, press the Help key on the front panel of the network analyzer.
- To view an online VNA user guide, use the following steps:

Use, Maintenance, and Care of the Devices
Using the Sliding Load

1. Go to www.keysight.com.
2. Enter your VNA model number (Ex: N5242A) in the Search box and click Search.
3. Under the heading Manuals & Guides, click on the title/hyperlink for the document PDF you want to view.

If you need additional information, see [“Where to Look for More Information”](#) on page 5-3.

Figure 3-10 Using the Sliding Load (Preferred Method)

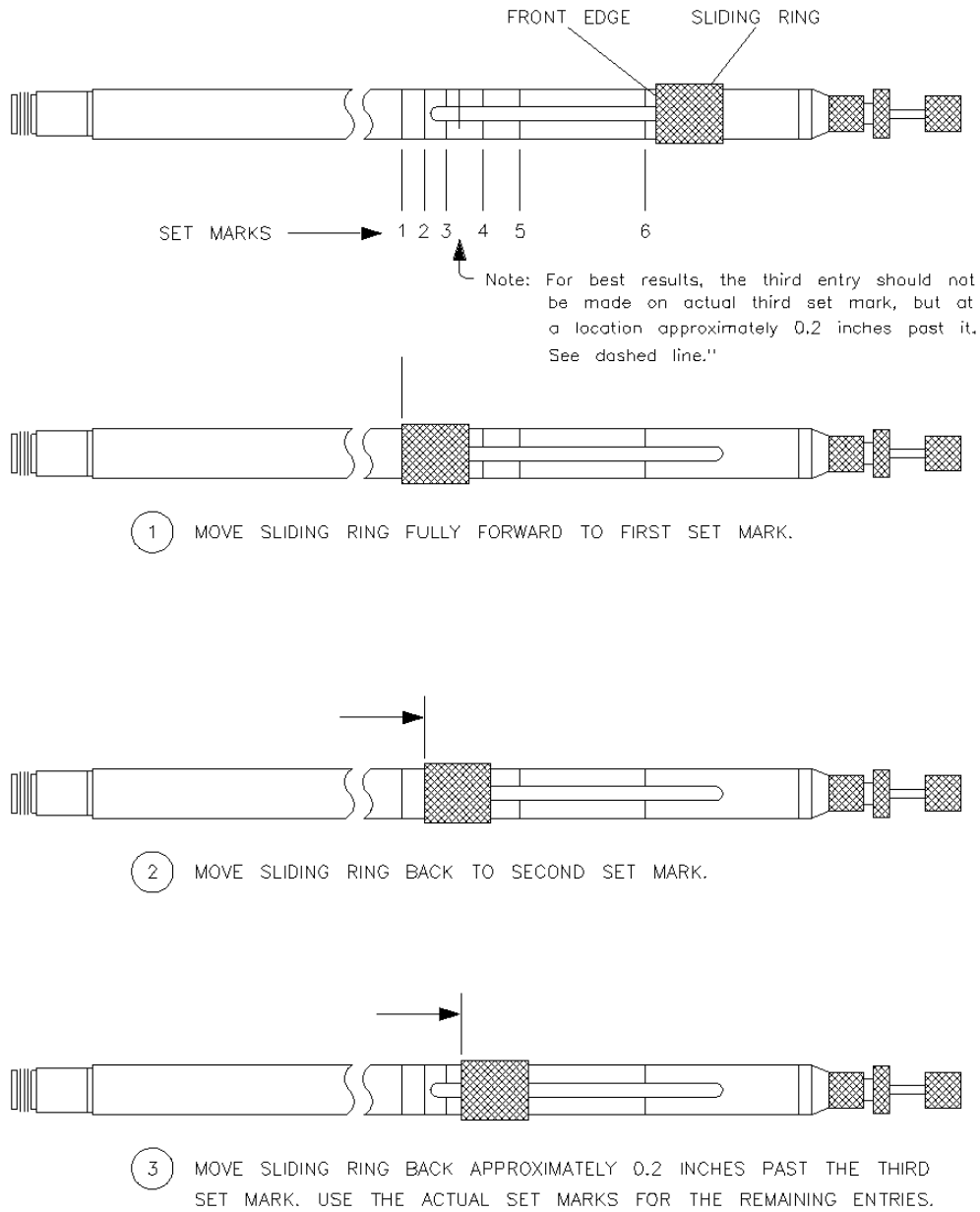

Handling and Storage

- Install the protective end caps and store the calibration devices in the foam-lined storage case when not in use.

Use, Maintenance, and Care of the Devices
Handling and Storage

- Never store connectors loose in a box, desk, or bench drawer. This is the most common cause of connector damage during storage.
- Keep connectors clean.
- Do not touch mating plane surfaces. Natural skin oils and microscopic particles of dirt are easily transferred to a connector interface and are very difficult to remove.
- Do not set connectors contact-end down on a hard surface. The plating and the mating plane surfaces can be damaged if the interface comes in contact with any hard surface.

4 Performance Verification

Introduction

The performance of your calibration kit can only be verified by returning the kit to Keysight Technologies for recertification. The equipment required to verify the specifications of the devices in the kit has been specially manufactured and is not commercially available.

How Keysight Verifies the Devices in This Kit

Keysight verifies the specifications of these devices as follows:

- 1. The residual microwave error terms of the test system are verified with precision airlines and shorts that are directly traced to NIST (National Institute of Standards and Technology). The airline and short characteristics are developed from mechanical measurements. The mechanical measurements and material properties are carefully modeled to give very accurate electrical representation. The mechanical measurements are then traced to NIST through various plug and ring gages and other mechanical measurements.**
- 2. Each calibration device is electrically tested on this system. For the initial (before sale) testing of the calibration devices, Keysight includes the test measurement uncertainty as a guardband to guarantee each device meets the published specification. For recertifications (after sale), no guardband is used and the measured data is compared directly with the specification to determine the pass or fail status. The measurement uncertainty for each device is, however, recorded in the calibration report that accompanies recertified kits.**

These two steps establish a traceable link to NIST for Keysight to the extent allowed by the Institute's calibration facility. The specifications data provided for the devices in this kit is traceable to NIST through Keysight Technologies.

Recertification

The following will be provided with a recertified kit:

- a new calibration sticker affixed to the case
- a certificate of calibration
- a calibration report for each device in the kit listing measured values, specifications, and uncertainties

NOTE

A list of NIST traceable numbers may be purchased upon request to be included in the calibration report.

Keysight Technologies offers a **Standard** calibration for the recertification of this kit. For more information, contact Keysight Technologies. For contact information, see [page 5-5](#).

How Often to Recertify

The suggested initial interval for recertification is 12 months or sooner. The actual need for recertification depends on the use of the kit. After reviewing the results of the initial recertification, you may establish a different recertification interval that reflects the usage and wear of the kit.

NOTE

The recertification interval should begin on the date the kit is first used after the recertification date.

Where to Send a Kit for Recertification

Contact Keysight Technologies for information on where to send your kit for recertification. For contact information, refer to [page 5-5](#).

When you return the kit, complete and attach a service tag. Refer to [“Returning a Kit or Device to Keysight” on page 5-4](#) for details.

5 Troubleshooting

Troubleshooting Process

If you suspect a bad calibration, or if your network analyzer does not pass performance verification, follow the steps in [Figure 5-1](#).

Figure 5-1 Troubleshooting Flowchart

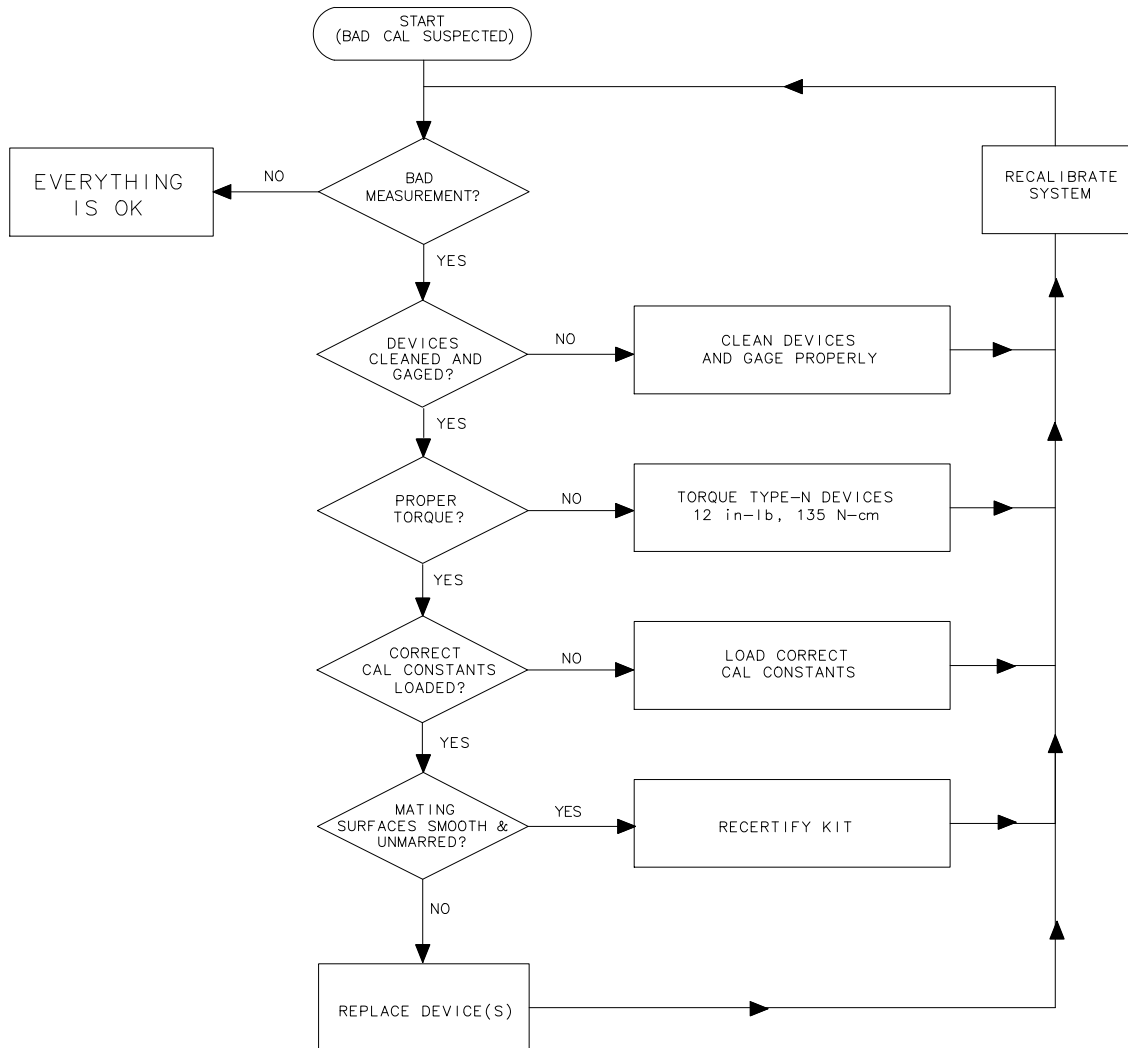

wj53f

Where to Look for More Information

This manual contains limited information about network analyzer system operation. For detailed information on using a VNA, ENA or PNA series network analyzer, refer to the appropriate user guide or online Help.

- To view the ENA or PNA online Help, press the Help key on the front panel of the network analyzer.
- To view an online VNA user guide, use the following steps:
 1. Go to www.keysight.com.
 2. Enter your VNA model number (Ex: N5242A) in the Search box and click Search.
 3. Under the heading Manuals & Guides, click on the title/hyperlink for the document PDF you want to view.

If you need additional information, see [“Contacting Keysight” on page 5-5](#).

Returning a Kit or Device to Keysight

If your kit or device requires service, contact Keysight Technologies for information on where to send it. See **“Contacting Keysight” on page 5-5** for contact information. Include a service tag (located near the end of this manual) on which you provide the following information:

- your company name and address
- a technical contact person within your company, and the person's complete telephone number
- the model number and serial number of the kit
- the part number and serial number of each device
- the type of service required
- a **detailed** description of the problem and how the device was being used when the problem occurred (such as calibration or measurement)

Contacting Keysight

Assistance with test and measurements needs and information on finding a local Keysight office are available on the Web at:

www.keysight.com/find/assist

If you do not have access to the Internet, please contact your Keysight field engineer.

NOTE

In any correspondence or telephone conversation, refer to the Keysight product by its model number and full serial number. With this information, the Keysight representative can determine whether your product is still within its warranty period.

Troubleshooting
Contacting Keysight

6 Replaceable Parts

Introduction

Table 6-1 lists the replacement part numbers for items included in the 85054B calibration kit and **Figure 6-1** illustrates each of these items.

Table 6-2 lists the replacement part numbers for items recommended or required for successful operation but not included in the calibration kit.

To order a listed part, note the description, the part number, and the quantity desired. Refer to **“Contacting Keysight” on page 5-5**.

Table 6-1 Replaceable Parts for the 85054B Calibration Kit^a

Description	Qty Per Kit	Keysight Part Number
Calibration Devices (50Ω Type-N)		
Type-N -m- sliding load	1	85054-60043
Type-N -f- sliding load	1	85054-60044
Type-N -m- lowband load	1	00909-60011
Type-N -f- lowband load	1	00909-60012
Type-N -m- offset short	1	85054-60025
Type-N -f- offset short	1	85054-60026
Type-N -m- offset open	1	85054-60027
Type-N -f- offset open	1	85054-60028
Adapters		
Type-N -m- to Type-N -m-	1	85054-60038
Type-N -f- to Type-N -f-	1	85054-60037
Type-N -f- to 7 mm	2	85054-60031
Type-N -m- to 7 mm	2	85054-60032
Wrenches		
3/4 in., 135 N-cm (12 in-lb) Torque	1	8710-1766

Table 6-1 Replaceable Parts for the 85054B Calibration Kit^a

Description	Qty Per Kit	Keysight Part Number
Spanner	1	08513-20014
Calibration Kit Storage Kit		
Storage case assembly (includes items listed below)	1	85054-60039
Storage Box	1	5180-7900
Foam pad (bottom)	1	85054-80023
Foam pad (lid)	1	5181-5543
Gages		
Type-N gage set (includes items listed below)	1	85054-60049
Type-N gage -f-	1	85054-60050
Type-N gage master -f-	1	85054-60052
Type-N gage -m-	1	85054-60051
Type-N gage master -m-	1	85054-60053
Centering beads	1	85054-80028
Miscellaneous Items		
User's and service guide	1	85054-90049
Protective End Cap, 0.812-ID, Black	as required	1401-0214
Protective End Cap, 0.625-ID, Black	as required	1401-0225

a. Refer to [“Clarifying the Terminology of a Connector Interface” on page 1-7](#).

Table 6-2 Replaceable Parts—Items Not Included in the Calibration Kit^a

Description	Qty	Keysight Part Number
1/2 in and 9/16 in open-end wrench	1	8710-1770
Adapter: Type-N to 7 mm 50 ohm -m- (extendable/retractable sleeve)	1	85054-60009
Adapter: Type-N to 7 mm 50 ohm -f- (extendable/retractable sleeve)	1	85054-60001
Grounding wrist strap	1	9300-1367
5 ft grounding cord for wrist strap	1	9300-0980
2 ft by 4 ft conductive table mat with 15 ft grounding wire	1	9300-0797
Anhydrous isopropyl alcohol (>92% pure) ^b	--	--

Table 6-2 Replaceable Parts—Items Not Included in the Calibration Kit^a

Description	Qty	Keysight Part Number
Cleaning swabs	100	9301-1243

- a. Refer to **“Clarifying the Terminology of a Connector Interface”** on page 1-7.
- b. Keysight can no longer safely ship isopropyl alcohol, so customers should purchase it locally.

Figure 6-1 Replaceable Parts for the 85054B Calibration Kit

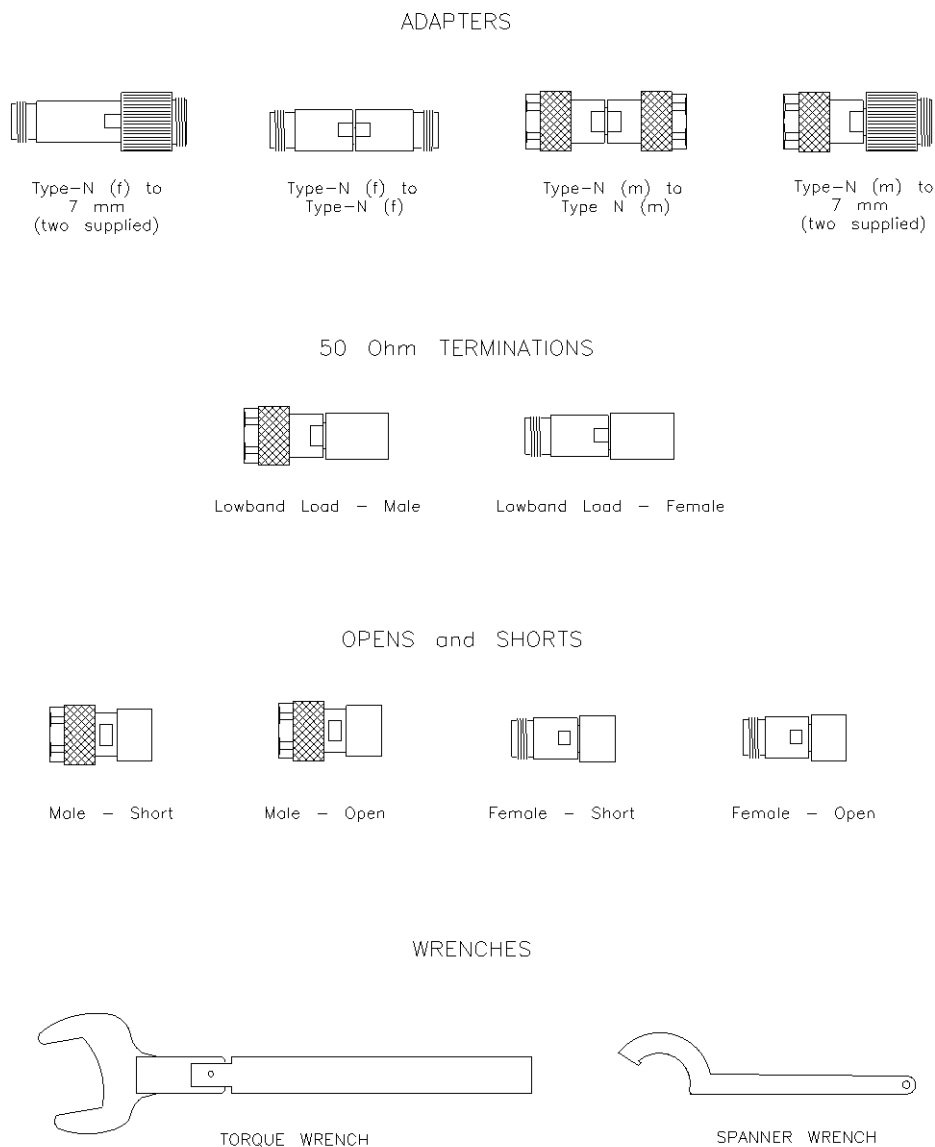
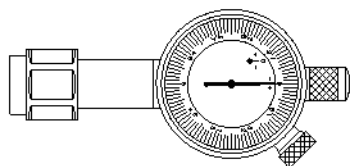
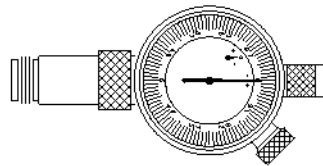

Figure 6-2 More Replaceable Parts for the 85054B Calibration Kit



Type-N Connector Gage (f)



Type-N Connector Gage (m)



Gage Master (f)



Centering Beads

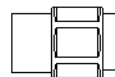

Gage Master (m)

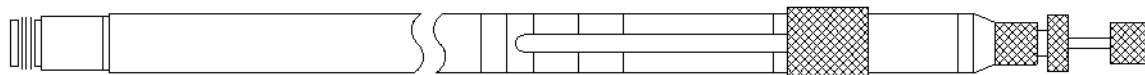

Sliding Load (f)

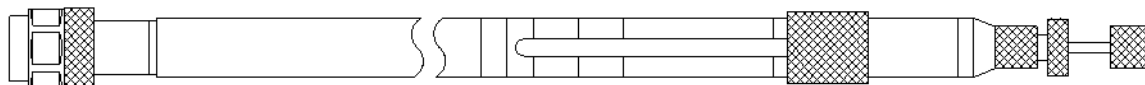

Sliding Load (m)

Not Shown:

- Storage Case
- Protective End Caps

parts2

A: Standard Definitions

Class Assignments and Standard Definitions Values are Available on the Web

Class assignments and standard definitions may change as more accurate model and calibration methods are developed. You can download the most recent class assignments and standard definitions from Keysight's Calibration Kit Definitions Web page at

<https://www.keysight.com/us/en/assets/9922-01521/technical-specifications/Calibration-Kit-Definitions.pdf>.

For a detailed discussion of calibration kits, refer to the Keysight Application Note, "Specifying Calibration Standards and Kits for Keysight Vector Network Analyzers." This application note covers calibration standard definitions, calibration kit content and its structure requirements for Keysight vector network analyzers. It also provides some examples of how to set up a new calibration kit and how to modify an existing calibration kit definition file. To download a free copy, go to www.keysight.com and enter literature number 5989-4840EN in the Search window.

Standard Definitions

Class Assignments and Standard Definitions Values are Available on the Web

Index

A

- adapters, 1-2
 - part numbers, 6-1
- alcohol
 - isopropyl
 - as cleaning solvent, 3-6
- altitude, 2-1

C

- cal kit
 - contents, 1-1
 - overview, 1-1
- calibration
 - bad, 5-1
 - certificate of, 4-1
 - constants, *See* calibration definitions
 - definitions
 - entering, 1-2
 - permanently stored, 1-2
 - frequency, 1-8
 - report, 4-1
 - standards, 2-5
 - sticker, 4-2
 - temperature, 2-1
 - when to perform, 1-8
- calibration kit
 - contents, 1-1
 - Keysight Application Note, A-1
 - modifying definition files, A-1
 - overview, 1-1
- center conductor
 - protrusion, 3-9
 - recession, 3-9
- certificate of calibration, 4-1
- certification
 - specifications, 2-5
- characteristics
 - mechanical, 2-2
 - supplemental, 2-2
- class assignments
 - downloading from Keysight Web site, A-1

- cleaning connectors, 3-6
- cleaning supplies, 1-4
 - part numbers, 6-1
- compressed air or nitrogen, 3-6
- conductor
 - mating plane, 2-2
 - protrusion, 2-2
 - recession, 2-2
- connections, 3-1, 3-20, 3-24
 - cautions in making, 3-20
 - disconnecting, 3-24
 - ESD concerns, 3-20
 - final, 3-21
 - how to make, 3-20
 - preliminary, 3-20
 - sliding load, 3-23
 - undoing, 3-24
 - using a torque wrench, 3-21
- connector
 - cleaning, 3-6
 - cleaning supplies, 6-1
 - damage, 3-3
 - female, 3-5, 3-13
 - gage
 - dial, 3-9
 - handling, 3-16
 - zeroing, 3-16
 - gaging, 3-8
 - when to do, 3-8
 - life, 3-3
 - male, 3-10
 - mating plane, 3-7
 - precision slotless (female), 1-6, 3-5
 - terminology, 1-7
 - threads, 3-6
 - visual inspection, 3-3
 - wear, 3-3
- connector gage
 - accuracy, 3-8
 - handling, 3-10, 3-13
 - master, 3-10, 3-13
 - reading, 3-9
 - zeroing, 3-10, 3-13

- constants, calibration, *See* calibration definitions
- contacting Keysight Technologies, 5-4
- contents
 - incomplete
 - what to do, 1-4
 - kit, 1-1

D

- damage
 - to connectors, 3-3
 - damaged connectors, 3-3
 - data, recertification, 4-1
 - defective connectors, 3-3
 - definitions
 - calibration, 1-2
 - deviation from nominal phase, 2-5
 - device
 - conductor
 - mating plane, 2-2
 - connecting, 3-20
 - disconnecting, 3-24
 - handling, 3-27
 - maintenance, 1-7
 - part numbers, 6-1
 - pin depth, 2-2
 - storage, 3-27
 - temperature, 2-1
 - visual inspection, 3-3
- devices
 - how Keysight verifies, 4-1
- dial
 - connector gage, 3-9
- dimensions
 - device
 - center conductor, 2-2
 - outer conductor, 2-2
- disconnections, 3-24
- downloading class assignments & std definitions from the Web, A-1

E

electrical specifications, 2-5
 electrostatic discharge, 3-1
 supplies
 part numbers, 6-1
 when making
 connections, 3-20
 environmental
 requirements, 2-1
 equipment
 required
 but not supplied, 6-1
 supplied, 1-1, 6-1
 equipment required, 1-4
 ESD, 3-1
 precautions, 3-1, 3-6
 supplies
 part numbers, 6-1
 when making
 connections, 3-20

F

frequency
 range, 2-5
 specifications, 2-5
 frequency of calibration, 1-8

G

gage
 connector, 1-4
 dial, 3-9
 handling, 3-10, 3-13, 3-16
 master, 3-10, 3-13
 reading, 3-9
 zeroing, 3-10, 3-13
 gage master
 using, 3-10, 3-13
 gaging
 connectors, 3-8
 when to do, 3-8
 female connectors, 3-13
 male connectors, 3-10
 procedures, 3-10
 sliding loads, 3-16

H

handling, 3-27
 how often to calibrate, 1-8

humidity, 2-1

I

incoming inspection, 1-4
 inspection
 damage, 3-3
 defects, 3-3
 incoming, 1-4
 mating plane, 3-3
 visual, 3-3
 isopropyl alcohol
 as cleaning solvent, 3-6

K

Keysight Technologies
 application note, A-1
 contacting, 5-4
 kit
 contents, 1-1
 overview, 1-1

L

label
 calibration, 4-2
 limits
 pin depth, 2-4
 load
 lowband, 1-2
 sliding
 connections, 3-23

M

maintenance, 3-1
 of devices, 1-7
 preventive, 1-7
 making connections, 3-20
 manual
 part number, 6-1
 mating plane
 conductor, 2-2
 connector, 3-7
 inspection, 3-3
 surfaces, 3-7
 mechanical characteristics, 2-2
 mechanical integrity, 2-2
 modifying calibration kit
 definition files, A-1

N

nitrogen, 3-6
 numbers
 serial, 1-5

O

observed limits
 pin depth, 2-4
 offset opens and shorts, 1-1
 open-end wrench, 3-24
 part number, 6-1
 opens, 1-1
 ordering parts, 6-1

P

part numbers, 6-1
 parts
 ordering, 6-1
 replaceable, 6-1
 required but not supplied, 6-1
 performance verification, 4-1
 fail, 5-1
 permanently stored calibration
 definitions, 1-3
 pin depth, 2-2
 adjusting sliding load, 3-18
 definition of, 2-2
 effect on electrical
 specifications, 2-3
 importance of, 2-3
 observed limits, 2-3, 2-4
 typical values, 2-3, 2-4
 precision slotless
 connectors, 1-6, 3-5
 preventive maintenance, 1-7
 protrusion
 center conductor, 3-9
 conductor, 2-2

R

reading connector gage, 3-9
 recertification, 4-2
 how often?, 4-2
 interval, 4-2
 what's included, 4-2
 where to send your kit, 4-2
 recession
 center conductor, 3-9
 conductor, 2-2

- regulations
 - environmental, 3-7
- replaceable parts, 6-1
- requirements
 - environmental, 2-1
- return kit or device to
 - Keysight, 1-4, 5-4
- return loss specifications, 2-5

S

- serial numbers, 1-5
 - devices, 1-5
 - recording, 1-5
- service, 5-2, 5-4
- service tag, 4-2, 5-4
- set marks
 - sliding load, 3-25
- shorts, 1-1
- sliding load
 - calibration, 3-25
 - connections, 3-23
 - gaging, 3-16
 - in kit contents, 1-2
 - pin depth
 - adjusting, 3-18
 - set marks, 3-25
 - sliding ring, 3-25
 - using, 3-25
- specifications, 2-1
 - certification, 2-5
 - electrical, 2-5
 - environmental, 2-1
 - frequency, 2-5
 - humidity, 2-1
 - pin depth, 2-3
 - return loss, 2-5
 - temperature, 2-1
 - verifying, 4-1
- standard definitions
 - downloading from Keysight
 - Web site, A-1
- standards
 - calibration, 2-5
 - NIST, 2-5, 4-2
- static discharge, 3-1
- sticker
 - calibration, 4-2
- storage, 3-27
 - humidity, 2-1
 - temperature, 2-1

- supplemental
 - characteristics, 2-2
- supplies
 - cleaning, 1-4

T

- tag
 - service, 4-2, 5-4
- temperature
 - calibration, 2-1
 - device, 2-1
 - error-corrected temperature
 - range, 2-1
 - measurement, 2-1
 - operating range, 2-1
 - verification and
 - measurement, 2-1
- terminology, connector, 1-7
- test data, 4-1
- threads
 - connector, 3-6
- torque wrench, 1-4, 3-21
 - part number, 6-1
 - specifications, 3-21
- traceability, 4-1
- troubleshooting, 5-1

V

- verification
 - performance, 4-1
 - temperature, 2-1
- visual inspection, 3-3

W

- when to calibrate, 1-8
- wrench
 - open-end, 1-4, 3-24
 - part number, 6-1
 - undoing
 - connections, 3-2
 - 4
 - part numbers, 6-1
 - torque, 1-4
 - part number, 6-1

Z

- zeroing

- connector gage, 3-10, 3-13, 3-16



This information is subject to change without notice.

© Keysight Technologies 1993-2023

Edition 1, October



85054-90049

www.keysight.com