

HX426C16FB3K2/16

16GB (8GB 1G x 64-Bit x 2 pcs.)

DDR4-2666 CL16 288-Pin DIMM Kit



SPECIFICATIONS

CL(IDD)	16 cycles
Row Cycle Time (tRCmin)	45.75ns(min.)
Refresh to Active/Refresh Command Time (tRFCmin)	350ns(min.)
Row Active Time (tRASmin)	29.25ns(min.)
UL Rating	94 V - 0
Operating Temperature	0° C to +85° C
Storage Temperature	-55° C to +100° C

DESCRIPTION

HyperX HX426C16FB3K2/16 is a kit of two 1G x 64-bit (8GB) DDR4-2666 CL16 SDRAM (Synchronous DRAM) 1Rx8, memory module, based on eight 1G x 8-bit FBGA components per module. Each module kit supports Intel® Extreme Memory Profiles (Intel® XMP) 2.0. Total kit capacity is 16GB. Each module has been tested to run at DDR4-2666 at a low latency timing of 16-18-18 at 1.2V. Additional timing parameters are shown in the Plug-N-Play (PnP) Timing Parameters section below. The JEDEC standard electrical and mechanical specifications are as follows:

Note: The PnP feature offers a range of speed and timing options to support the widest variety of processors and chipsets. Your maximum speed will be determined by your BIOS.

FEATURES

- Power Supply: VDD = 1.2V Typical
- VDDQ = 1.2V Typical
- VPP = 2.5V Typical
- VDDSPD = 2.2V to 3.6V
- On-Die termination (ODT)
- 16 internal banks; 4 groups of 4 banks each
- Bi-Directional Differential Data Strobe
- 8 bit pre-fetch
- Burst Length (BL) switch on-the-fly BL8 or BC4(Burst Chop)
- Height 1.3425" (34.1mm), w/heatsink

FACTORY TIMING PARAMETERS

- Default (Plug N Play): DDR4-2666 CL16-18-18 @1.2V
- XMP Profile #1: DDR4-2666 CL16-18-18 @1.2V

Continued >>

MODULE WITH HEAT SPREADER

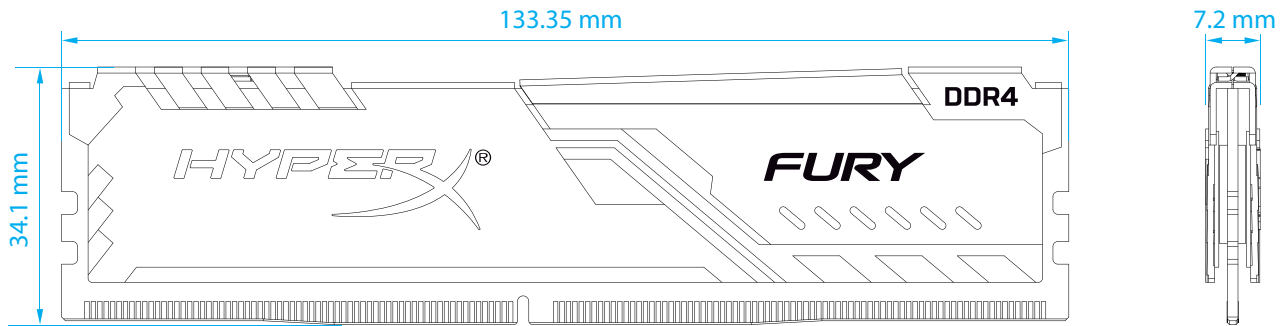

MODULE DIMENSIONS

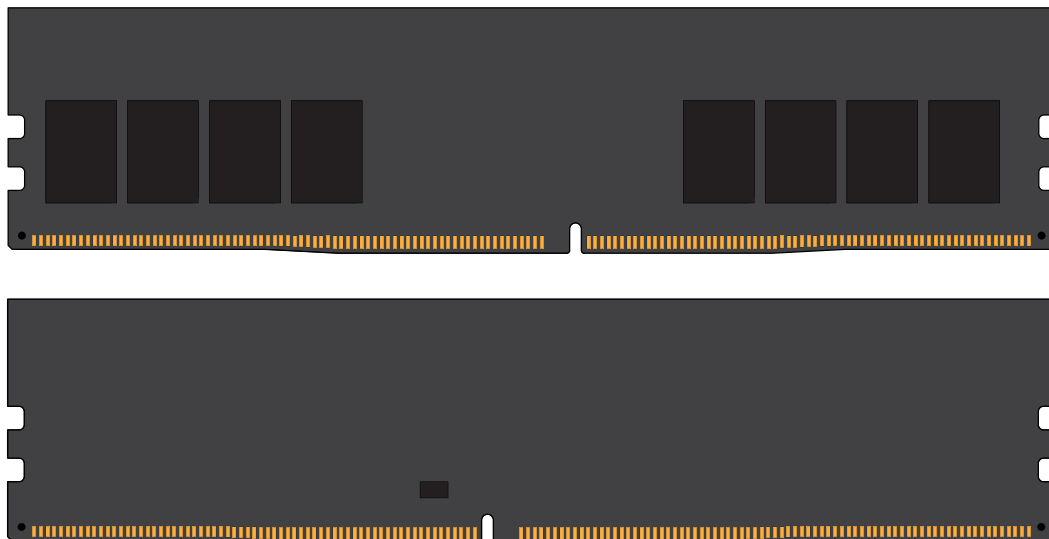

All measurements are in millimeters.
(Tolerances on all dimensions are ± 0.12 unless otherwise specified)

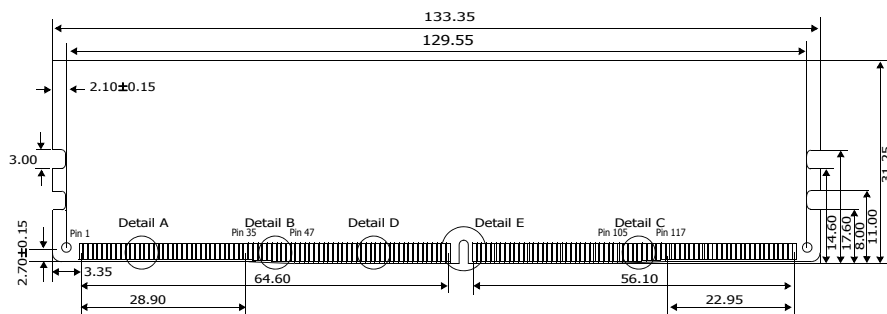

The product images shown are for illustration purposes only and may not be an exact representation of the product. Kingston reserves the right to change any information at anytime without notice.

FOR MORE INFORMATION, GO TO HYPERXGAMING.COM

All Kingston products are tested to meet our published specifications. Some motherboards or system configurations may not operate at the published HyperX memory speeds and timing settings. Kingston does not recommend that any user attempt to run their computers faster than the published speed. Overclocking or modifying your system timing may result in damage to computer components.