

Kodak ESP 5

All-in-One Printer
print copy scan



User Guide

Kodak

Eastman Kodak Company

Rochester, New York 14650

© Eastman Kodak Company, 2008

Kodak is a trademark of Eastman Kodak Company.

The Bluetooth® word mark and logos are owned by the Bluetooth SIG, Inc., and any use of such marks is under license.

©1989-2007 I.R.I.S. (Image Recognition Integrated Systems), All Rights Reserved

P/N 1K3269 Rev D

January 2009



Table of Contents

1. Printer Overview	1
All-in-One Features	1
Main Components of the ESP All-in-One Printer	1
Memory Card Slots	2
Memory Cards Supported	3
Control Panel Layout	3
USB Port	5
Status Lights	5
Control Panel Screen	7
Using Menus	7
Using 4-Way Navigation Buttons	8
All-in-One Home Center (Windows)	8
All-in-One Home Center (Macintosh)	8
2. Setting Up Your Printer	11
Selecting a Printer Location	11
Configuring Printer Settings	11
Configuring Basic Settings	11
Printer Settings Options	12
3. Handling and Loading Paper	13
Handling Paper	13
Loading the Paper Tray	13
Loading Plain Paper	14
Loading 4 x 6 Photo Paper	14
Things to Keep in Mind	15
Loading Plain Paper	15
Loading Photo Paper	15
Loading Envelopes	16
Loading Originals	16
Loading an Original for Copying or Scanning	16
4. Viewing and Printing Photos	17
Viewing Photos	17
Configuring Photo Print Settings	18
Print Photos Options	19
Printing Photos	19

Printing Photos from a PictBridge Camera	19
Printing Photos from Other Cameras, Memory Cards, and Portable Storage Devices	20
Printing Tagged Images	20
Printing from a Bluetooth Device	21
Range	21
Bluetooth Security Pin	21
Printing Multiple Photos	21
Printing Panoramic Photos	21
Zooming and Cropping Photos	22
Transferring Images From the Printer to a Computer	22
Transferring Images to a Windows Computer	23
Transferring Images to a Macintosh Computer	23
5. Copying Pictures or Documents	25
Simple Copying	25
Adjusting Copy Settings	25
Copy Document Options	26
Copy Photo Options	27
6. Scanning Your Pictures	29
Before You Start	29
Simple Scanning	29
Scanning Multiple Originals	30
Adjusting Scan Settings	30
Scan Options	30
7. Maintaining Your Printer	33
General Care	33
Cleaning the Scanner Glass	34
Cleaning the Scanner Lid	34
Monitoring and Adjusting the Printer's Performance	34
Maintenance Options	35
Replacing Ink Cartridges	36
Replacing the Printhead	38
8. All-in-One Troubleshooting	41
General Troubleshooting	41
Printer Fails to Power On	41
Device Not Recognized	42
Ink Cartridge Not Recognized	42
Multiple Paper Feed	43
Multiple Pictures Not Scanned Properly	43
No Communication With Computer	44
No Paper Feed	44
One Or More Of The Colors On The Calibration Sheet Is Missing	45
Paper Jam	45

Printer Not Responding	45
Transfer Pictures Failure	46
User Guide on the CD Is Obsolete	46
Wrong Paper Size	46
Macintosh OS 10 Troubleshooting	47
Non-Intel Mac Only: Black Screen or Screen Freeze Occurs When Applying Printer Settings Via Home Center Software	47
Windows Vista Troubleshooting	47
WIA (Windows Image Acquisition) Error: Service Has Stopped Working	47
Home Center Software Works Incorrectly Following Software Upgrade	47
Print Troubleshooting	48
Envelope Printing Incorrect	48
Multiple-Page Document in Reverse Order	48
PictBridge Camera Not Detected	48
Picture Cropped	49
Picture Print Smudged	49
Picture Will Not Print	49
Poor Print Quality	50
Print Skewed or Slanted	50
Print Spotted	51
Print Too Dark	51
Print Too Light	51
Printing Slow	51
Printing Stops	52
White Edges on Borderless Prints	52
Copy Troubleshooting	53
Copy Cut Off	53
Scan Troubleshooting	53
Scan Fails	53
Scanned Image Blank	54
9. Customer Support	55
All-in-One Support Options	55
Printer Help	55
Help Options	55
Home Center Help	55
Troubleshooting Frequently-Asked-Questions	56
Resources on the All-in-One Setup CD-ROM	56
Contacting Customer Support at Kodak	56
Support on the Kodak Web Site	56

A. Glossary	57
B. Product and Safety Specifications	61
Print Performance.....	61
Photo Printing Features.....	61
Copy Document Features.....	62
Copy Photo Features.....	62
Scanning Features.....	62
Paper Tray Features.....	62
Ink Tanks.....	63
Connectivity.....	63
Software Support.....	63
Physical Specifications.....	63
Warranty.....	64
System Requirements.....	64
Windows PC.....	64
Macintosh.....	64
Papers Supported.....	65
Paper Types.....	65
Paper Sizes.....	65
Safety Specifications.....	65
Parts.....	66
Power.....	66
Location.....	67
Environment.....	67
Regulatory Compliance.....	68
FCC Compliance and Advisory.....	68
FCC and Industry Canada.....	68
IC Radiation Exposure Statement.....	69
Canadian DOC Statement.....	69
German Compliance Statement.....	69
Waste Electrical and Electronic Equipment Labeling.....	70
Index	71

1 Printer Overview

The Kodak ESP 5 All-in-One printer allows you to print, copy, and scan digital images and documents. Although many functions can be operated directly from the control panel, you may also print, store, and manage digital images from a Windows or Macintosh computer connected to the printer via Kodak's All-in-One Home Center software, which installs during the printer setup process

All-in-One Features

This printer includes:

- A printhead system with two Kodak high-quality pigmented ink cartridges (full black and five-ink color)
- A paper tray that supports multiple media, including A4, Letter, Legal, 8x10, 5x7 4x6, and 4x12 paper, transparencies, and envelopes
- A scanner capable of scanning up to A4 (length) and Letter-width originals
- Multi-format memory card support
- A host Universal Serial Bus (USB) port on the front of the printer for connecting a variety of external plug-and-play devices to the printer. These include Picture Transfer Protocol (PTP) image transfer cameras, mass storage cameras, portable flash-memory drives, and Kodak Bluetooth dongles
- A client Universal Serial Bus port on the back of the printer, for connecting the printer to host Windows or Macintosh computers
- A control panel with push buttons, light indicators, and a 3-inch LCD screen
- Kodak's All-in-One Home Center software that can be used to configure your printer as well as scan, copy, or print your documents. See Home Center Help for more information

Main Components of the ESP All-in-One Printer

The graphics below show the printer scanner glass control panel, screen, and the door to the paper trays. The legend describing the parts shown in the images is in the table below.

Printer Overview

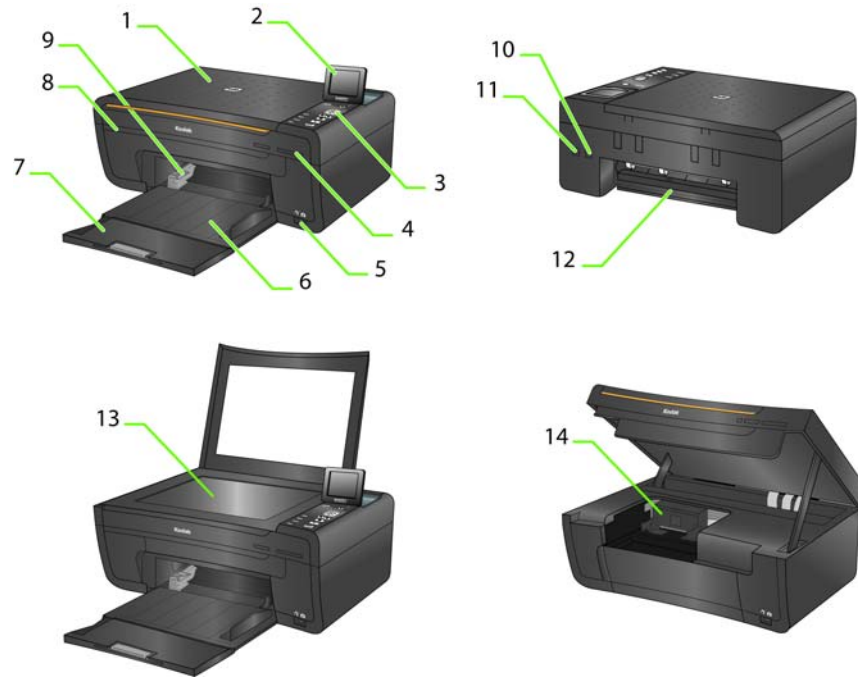

Number	Name
1	Scanner lid
2	Screen
3	Control panel
4	Memory card slots and memory card status light
5	Universal serial bus host port (for connecting image-transfer cameras, and plug-and-play mass storage devices)
6	Paper tray
7	Output tray extender
8	Printer access door
9	Paper width guide
10	Power connector
11	Universal serial bus device port (for connecting the printer to a computer)
12	Rear cleanout area
13	Scanner glass
14	Carriage (where Printhead is installed)

Memory Card Slots

Although this All-in-One printer has two card slots, insert only one memory card into the slot at a time.

A green light, located to the left of the memory card slots, blinks while the card is being accessed and stays lit while the card remains in the slot and the printer is on.





Warning: Do NOT remove the memory card while the light is blinking, or you may damage it.

Memory Cards Supported

The Kodak ESP 5 All-in-One printer supports the following memory cards, used in most digital cameras:

XD xD-Picture Card

MS Memory Stick, Memory Stick Pro

SD Secure Digital Card/Multi-Media Card

CF Compact Flash type I and type II, including micro drives

SDHC Secure Digital High Capacity cards

Additionally, the printer supports the following memory cards used with Memory Stick and SD/MMC card slot adapters, which you will need to purchase separately:

- Memory Stick Duo and Duo Pro
- miniSD
- MicroSD (TransFlash)

Control Panel Layout

The legend describing the numbered parts of the control panel is in the table below.

Printer Overview

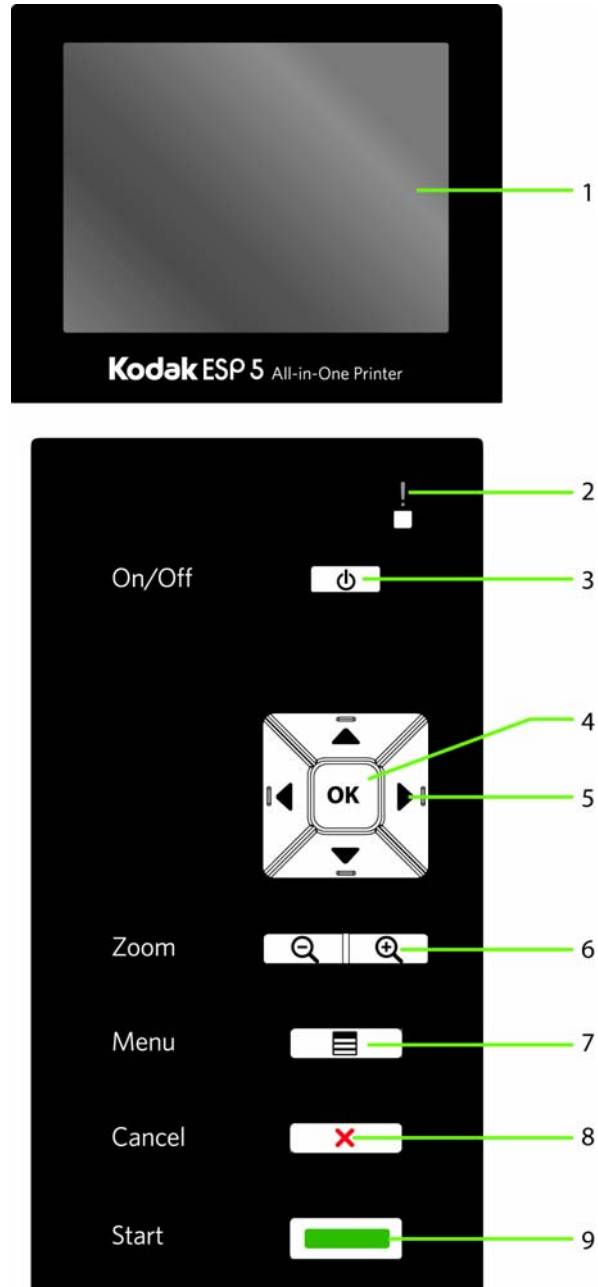

Number	Name	Description
1	Screen	Displays photos, messages, status, and menus.
2	Attention Light	Blinks or flashes when an error occurs.
3	On/Off button	Powers the printer ON or OFF.
4	OK button	Enables you to complete a menu selection or photo print command, or allows you to continue with the current operation.
5	4-way Navigation buttons	Enables you to navigate menus and photos, and pan around a zoomed photo.
6	Zoom buttons	Allows you to zoom in and out of the photo.

Number	Name	Description
7	Menu button	Displays the menu, and toggles between the parameters and preview screens.
8	Cancel button	Cancels the current operation and control panel navigation, and returns you to the menu.
9	Start button	Allows you to start the following operations: copy, scan, print, and transfer.

USB Port

This All-in-One printer works with most digital cameras. Using the USB port located on the front of the printer (see figure), you can connect the following devices to the printer:



- PTP camera
- USB flash drive
- Kodak Bluetooth dongle
- Image-transfer cameras
- mass storage cameras

Status Lights

The tables below describe the meaning of each light and condition, and offer tips on what action to take.

On/Off Light		
Light Status	Cause	Action/Solution
Off	The printer is turned off.	Press On/Off to turn the printer on.
	The printer does not have power applied.	Ensure that the power cord is properly plugged into the back of the printer.
Blinking	The printer is initializing or busy.	None. Allow the printer to finish the initialization process.
On	The printer is ready.	None.

Printer Power Cord Light		
Light Status	Cause	Action/Solution
Off	The printer power cord is not properly connected to the printer.	Reconnect the printer power cord plug to the printer.
	The electrical power cord is not properly connected to your electrical outlet.	Reconnect the cord to the electrical outlet. Ensure that the electrical power cord is fully connected to the alternating current (AC) adapter at the end of the printer power cord.
	Your wall outlet has no power.	Plug a working device into you wall outlet to test it, or have it checked by an electrician.
	The problem may lie with the power supply.	Visit Kodak.com for additional troubleshooting steps, or contact your local Kodak call center.
On	The power supply is supplying power to the printer.	None.

Memory Card Slot Slight		
Light Status	Cause	Action/Solution
Off	Either the SD/MMC card is not inserted or is improperly inserted in the card slot.	Remove and reinsert the SD/MMC card.
Blinking	The internal card reader is initializing or communicating with a memory card.	None.
On	An SD/MMC card is properly inserted in the card slot.	None.

Attention Light	
Light Status	Error
Off	None.
Blinking (slow)	Paper jam. Paper tray empty. Paper carriage stall. Paper size or type mismatch. Change ink cartridge. Ink cartridge not readable. Printhead not calibrated. Unit open. Too many image sources. Printhead not installed. Unable to read device.
Blinking (fast)	Ink cartridge(s) inserted incorrectly. Ink cartridge(s) not installed.
On	Media sensor failure. Printhead failure. Scanner failure.

Control Panel Screen

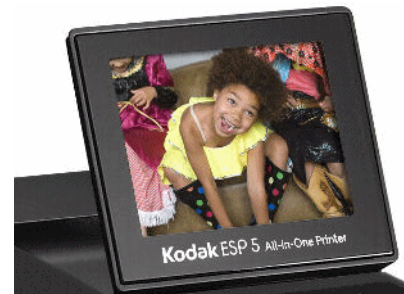

The display screen can be adjusted to any position between upright and flush with the printer cover. It displays photos, messages, instructions, and menu items. You control the items displayed on the screen by pressing the 4-way navigation buttons on the control panel.

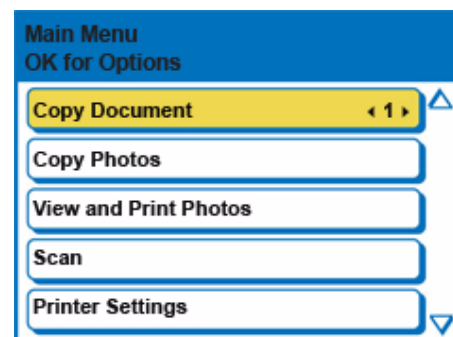

Using Menus

Use the menus displayed on the screen to select stand-alone tasks (that is, tasks that can be performed without your computer) such as copying documents or photos, or printing photos stored on memory cards or digital cameras plugged into the printer. You can also select tasks that will be completed on a computer connected to the printer, such as transferring photos from a memory card or connected camera to the computer.



The next page symbol , located in the lower right corner, allows you to access the next page, while the previous page symbol , located in the top right corner, allows you to access the previous page.

Using 4-Way Navigation Buttons

Pressing Down (▼) highlights the next row down in the visible menu. When the last row is highlighted, pressing ▼ causes page 1 to be replaced with page 2, with the top row highlighted. Pressing Up (▲) returns you to the previous page. Holding down any of the 4-way navigation buttons causes them to repeat the action until you release it.

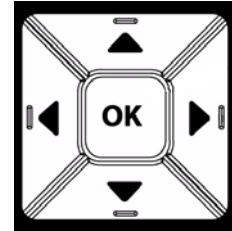

When a menu is displayed on the control panel screen, the selected row is highlighted. Instructions displayed at the top of the screen describe how to perform the task shown in the row by pressing either **Start** or **OK**. When there are two or more options for the setting shown on the selected row, each option is displayed between the Left (◀) and Right (▶) symbols. Pressing ◀ or ▶ on the control panel displays the active choice.

All-in-One Home Center (Windows)

Kodak All-in-One Home Center software allows you to print, copy, scan, and configure your All-in-One printer from your Windows XP or Vista computer.

From the All-in-One Home Center main menu, selecting one of the six menu items enables you to:

- Scan images and documents
- Copy images
- Enhance and print images
- Configure settings for printing, copying, and scanning from the control panel
- Access My Resource Center at Kodak
- Order supplies

The functions of the three small icons located in the upper-right corner of the Home Center window are shown below:



Returns you to the main Home Center window



Displays the Status Monitor



Displays a Help and Maintenance panel for the Home Center software

All-in-One Home Center (Macintosh)

After installing the software on your Macintosh OS X computer, you can run Home Center from the System Preference's **Print & Fax** pane by selecting your All-in-One in the Printer List, clicking the **Print Queue** button, and clicking the **Utility** icon.

Selecting the **Setup** and **Maintenance** tabs allows you to:

- Print a test page
- Align the printhead
- Run a printhead nozzle health check
- Choosing any of the following commands allows you to select a printer, order supplies online, or check the status of your printer:

Select: This option lets you select a printer from a list of connected printers.

Order Supplies: Selecting this option allows you to order supplies online from a Kodak web site.

View/Hide Status: Opens a drawer displaying the configuration status of your printer.

2 Setting Up Your Printer

Use this chapter to set up and start using your Kodak All-in-One printer.

Selecting a Printer Location

Place your printer on a clean, flat surface in a dry, well-ventilated location, away from direct sunlight. Avoid areas with high levels of dust and debris: Don't expose the printer and paper to ventilation ducts, open doors, or high traffic, as airborne particles can affect picture quality.

Allow enough space on all sides of the printer to comfortably connect and disconnect cables, change ink cartridges, and remove and load paper.

Configuring Printer Settings

Printer settings can be adjusted in two ways, via the control panel or the Home Center software that comes with your printer (see Home Center Help for more details).

Configuring Basic Settings

- 1 Press **Menu** on the control panel to display the main menu.
- 2 Press **▼** until **Printer Settings** is selected, and then press **OK**.
- 3 Press **▼** until the parameter you want to configure is selected, and then press **OK**.
- 4 As needed, press **▲** or **▼** to set the desired sub-setting, as in configuring the current date and time.
- 5 As needed, Press **◀** or **▶** to change the setting.
- 6 Press **OK** to save the setting(s).

Printer Settings Options

Menu Options	Settings
Date and Time (see Note below)	Year
	Month
	Day
	Hour
	Minute
Tagged Image Printing	On
	Off
Language	English (U.S.)
	English (International)
	Deutsch
	Français
	Français (Canada)
	Italiano
	Español
	Castellano
	Português
	Nederlands
Reset All Settings	OK



Note: Setting date and time via the control panel is a separate task from stamping the date and time on photo prints. Also, using the Home Center software (see Home Center Help), you can synchronize the printer's date and time with that of the connected computer.

Restoring the factory defaults from the **Reset All Settings** option will not change the date and time information you set.

3 Handling and Loading Paper

Your Kodak All-in-One printer accepts print stock of various types and sizes, including letter and legal-size plain paper, photo paper, transparencies, T-shirt transfers, envelopes, cards, and labels. It automatically detects the size and type of photo paper loaded into the paper tray, thus producing the highest quality output for that paper.

The paper tray accepts media from 4 to 8.5 inches wide, and up to 14 inches long; its capacity is 100 sheets of 20 lb. plain paper. You can load up to 30 sheets of 4 x 6 inch (101 x 150 mm) photo paper into the paper tray.

For best results, use Kodak paper with your Kodak All-in-One printer. Kodak photo paper has embedded watermarks that are read by your printer. This allows the printer to detect the paper type, automatically make adjustments to optimize the final output.

Handling Paper

Follow the precautions below when handling paper:

- Hold the paper by the edges; avoid placing your fingerprints on it
- Do not touch the glossy side of photo paper
- Store paper flat, away from direct sunlight and heat (such as in a car parked in the sun)

Loading the Paper Tray

Your printer accepts A4, Letter, Legal, 8x 10, 5 x 7, and 4 x 6 paper, as well as envelopes, transparencies, and labels. The paper tray capacity is 100 sheets of 20lb. plain paper.

Loading Plain Paper

- 1** Pull the paper tray all the way out until the paper guide flips up on the right side.
- 2** Slide the paper-width guide to its left-most position.
- 3** Align the edges of a stack of paper.
- 4** Insert the stack of paper into the paper tray with the print-side down.
- 5** For paper less than 8.5 inches wide, squeeze the paper-width guide and slide it to the right until it lightly touches the stack of paper.
- 6** Leave the paper tray open when paper is loaded.
- 7** Pull the output tray extender all the way out.
- 8** Lift the small gray paper stop (at the near edge of the output tray extender) until it is perpendicular to the tray.

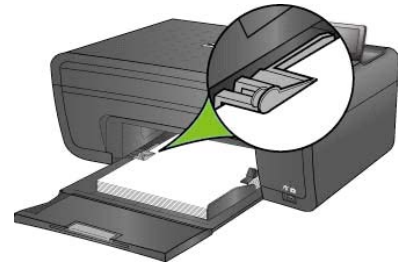

Loading 4 x 6 Photo Paper

You can load up to 30 sheets of 4 x 6 inch (101 x 150 mm) photo paper into the paper tray. Photo paper must be loaded coated side facing down.

- 1** Remove all other paper from the paper tray.
- 2** Insert photo paper into the right side of the paper tray print-side down, with the short edge forward. Do not overload the paper tray.
- 3** Slide the paper forward until it stops.
- 4** Squeeze the paper-width guide and slide it to the right until it touches the loaded paper.
- 5** Leave the paper tray open while the paper is loaded.

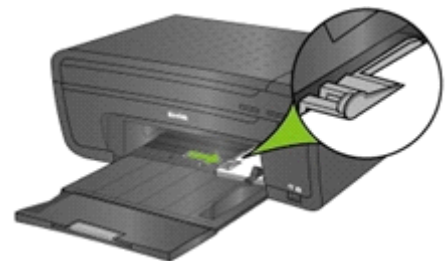

Things to Keep in Mind

- After you finish loading paper into the paper tray, leave the paper tray open during all print, copy, and scan jobs.
- Lift the small gray paper stop (at the edge of the output tray extender) until it is perpendicular to the tray. This prevents the printed paper from sliding off of the paper tray as it exits the printer. This step is especially important when paper more than 11 inches (279 mm) long is loaded in the paper tray.

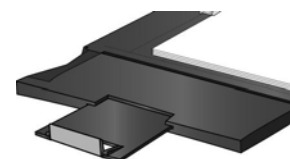

Warning: The hinged section of the paper tray serves as the paper tray door when the ESP 5 All-in-One is closed. Avoid lifting it perpendicular to the paper tray, even when it is extended out. When paper is held against the paper tray door, the printer may pull it into the printer after it has been printed, causing a paper jam.

Loading Plain Paper

- 1 Pull the paper tray toward you until the paper guide flips up on the right side.
- 2 As needed, squeeze and slide the paper-width guide on the tray to its left-most position.
- 3 Insert the media into the paper tray with the print side down.
- 4 As needed, squeeze and slide the paper-width guide to the right and align it to the left edge of the media.
- 5 Leave the paper tray open.

Loading Photo Paper

- 1 Remove all other paper from the paper tray.
- 2 Insert photo paper into the right side of the paper tray print-side down, with the short edge forward. Do not overload the tray.
- 3 Slide the paper forward until it stops.
- 4 Squeeze the paper-width guide and slide it to the right until it just touches the loaded paper.
- 5 Leave the paper tray open.

Loading Envelopes



Warning: Do not load envelopes with cutouts or cellophane windows in this printer.

- 1 Remove all other paper from the paper tray.
- 2 Place one or more envelopes along the right edge of the paper tray, with the print side down and the envelope flaps pointing toward the left side of the tray.
- 3 Squeeze the paper-width guide and move it to the right until it just touches the loaded envelope(s).
- 4 Leave the paper tray open.

Loading Originals

Loading an Original for Copying or Scanning

To copy or scan a document or photo, place your original directly on the scanner glass, face down, against the silver arrow on the right front corner, as shown here.

To copy or scan oversized originals, completely remove the lid from the printer, which will continue to function even with the lid removed.



To remove the lid:

Lift the lid to the open position, grasp the sides of the lid, and then gently pull it upward, as shown here.



To replace the lid:

Insert the tabs on the hinge back into the appropriate slots.



4 Viewing and Printing Photos

You can print images directly from PictBridge, image-transfer digital cameras, mass storage cameras, thumbdrives, and memory cards. You can also print photos and most types of files that can be printed from a computer program from a portable storage (“flash”) drive, or from any computer connected to your All-in-One printer.



Note: For assistance on printing from a connected computer to this All-in-One, refer to the instructions from the software application (such as a word-processing or image-editing program) used to send the file to the printer; or, review your computer’s operating system instructions.

Although this All-in-One printer is compatible with the Kodak 8-in-1 USB card reader (sold separately) as well as other Kodak USB card readers, it is not compatible with other manufacturers’ card readers. An 8-in-1 card reader can be plugged into the front USB port on your Kodak All-in-One printer.



Warning: Do not remove a storage device (memory card, portable storage drive, or image-transfer camera) from the printer while it is being accessed, or you may damage the files on it. Safely remove the device only after the green status light, located next to the memory card slots, stops blinking.

Viewing Photos

Insert one of the following plug-and-play devices into the appropriate slot:



Note: Always use the USB port on the front of the printer. To avoid an error, use only one slot or port at a time.

Device Type	Printer Slot
Memory Card	Memory Card Reader
Portable Storage Drive	USB port

Device Type	Printer Slot
Image-storing Digital Camera	USB port
Kodak Bluetooth dongle	USB port



Note: If Tagged Image Printing is enabled on this printer (see “Configuring Printer Settings” on page 11), it detects a Digital Print Order Format (DPOF) file when you insert a memory card. The printer screen prompts you to verify that you want to print tagged images. See “Printing Tagged Images” on page 20.

Most memory cards (see “” on page 3) will work with this printer. When you insert a memory card into the card slot of the printer, connect a camera, or portable flash drive to it, the last photo taken is displayed first.



Caution: Do not insert more than one memory device, such as a portable storage drive (USB) or memory card, into the printer at a time. An error message will display when a second device is connected to your printer unless you are already printing a job. The error message will only display after the print job is complete.



Note: Photos stored on a PictBridge camera are displayed on the camera screen.

Configuring Photo Print Settings

You can change the factory default print settings for your printer using the control panel. Windows users may adjust some settings using the All-in-One Home Center software (see Home Center Help for information on using Home Center).

- 1 Insert a memory card into the appropriate slot, or plug a portable storage device or an image transfer digital camera to the front panel USB port. The last photo is displayed first.
- 2 Press **Menu** on the control panel to display the main menu.
- 3 Press **▼** until **View and Print Photos** is selected, and then press **OK**.
- 4 To view one photo at a time, press **◀** or **▶** on the control panel; to scroll up or down, press and hold the **▲** or **▼** arrow.
- 5 Press **▼** until the parameter you want to configure is selected, and then press **OK**.
- 6 As needed, press **◀** or **▶** to change the setting.
- 7 Press **OK** to save the setting for the current print job.
- 8 To save the setting as the default value, select **Save as Default** and press **OK**.

Print Photos Options

Menu Options	View Settings / Select	Settings
View Photos	OK	Display last photo
Transfer All to PC	OK	
Rotate This Photo	OK	
Quantity	◀ or ▶	1- 99
Print Size	◀ or ▶	4x6
		4x12 (Panoramic)
		5x7
		8x10
		8.5x11
		(2x3) Wallet
Quality »	◀ or ▶	Best
		Normal
		Draft
Color	◀ or ▶	Color
		Black & White
Scene Balance »»	◀ or ▶	On
		Off
Add Date to Prints »»»	◀ or ▶	No
		Yes
Save as Defaults	OK	

» This All-in-One printer automatically adjusts the print output to the best available quality for images printed on photo paper. You can set the **Quality** to Draft, Normal or Best only when printing images or documents on plain printer paper. The default setting for printing on plain paper is Normal.

»» This printer is capable of automatically adjusting scene balance improvements (or the brightness) of photos printed from camera cards and USB connected devices. The default is Scene Balance selected (On).

»»» The default setting does not print the date on the photo print.

Printing Photos

Printing Photos from a PictBridge Camera

You can print photos directly from a PictBridge camera, which controls photo selection and printing.

- 1 Load the paper tray with photo paper, print side down.
- 2 Connect a PictBridge camera to the USB port located on the front panel of your printer.

- 3 Use your PictBridge camera to select and print the photos.

Printing Photos from Other Cameras, Memory Cards, and Portable Storage Devices



Caution: This printer does not support portable storage “flash” drives that require third party access software, are encrypted, or contain multiple partitions. If this type of device is plugged into the USB port on the front panel, the printer does not recognize or display photos, and displays an error message on the control panel screen.

- 1 Connect an image-transfer digital camera, or portable storage drive to the front panel USB port; or insert a memory card to the appropriate card reader on the front panel. The last photo is displayed first.
- 2 Load the paper tray with photo paper, print side down.
- 3 Press or ◀ or ▶ until a photo you want to print is displayed in the screen.
- 4 Press **OK** to select the photo.



Tip: To select and print all the photos on a memory card or portable storage device, hold down the **OK** button for 2 seconds. Holding down the **OK** button again for 2 seconds de-selects all the photos

- 5 Press **Menu** to display the **Print Photos Options** menu.
- 6 Press ▼ until **Quantity** is selected, and then press ▶ to select the number of prints.
- 7 Press **Start** to print the selected photo, or press ▲ until **View Photos** is selected. Press **OK**.
- 8 Press ◀ or ▶ until you view another photo you want to print.
- 9 Repeat Steps 3-8 until you have finished selecting photos.



Note: The photo is automatically deselected after it has been printed.

Printing Tagged Images

Many digital cameras allow you to create a Digital Print Order Format (DPOF) file, an industry standard, for printing tagged photos. When you use your camera to select photos, a file is created identifying the photos tagged for printing. The DPOF file is stored by the digital camera on a memory card and specifies which photos to print.

This All-in-One printer can read the DPOF file from a memory card, and you do not have to reselect the photos you wish to print.



Note: Not all digital cameras support tagging or the creation of tagged image files. Refer to your camera’s user guide to ensure it supports this functionality.

When you print tagged photos, the selected layout is applied unless your camera allows selection of sizes.

Printing from a Bluetooth Device

Your printer allows you to print from a Bluetooth device, using an optional Kodak USB Bluetooth dongle, which you can purchase from Kodak at www.kodak.com/go/accessories. Bluetooth allows wireless connectivity between compatible electronic devices.

To enable Bluetooth wireless connectivity, plug the Kodak Bluetooth dongle into the USB port located on the front panel of your printer. When the device and the printer are connected, you can send photos from your Bluetooth device to the printer. The All-in-One supports connectivity to one Bluetooth device at a time.

The Kodak dongle (shown below) supports receiving print jobs from the following Bluetooth-enabled devices:



- Mobile camera phones
- Personal Digital Assistants (PDAs)
- Digital still cameras
- Computers

Range

For the highest transfer speed, Kodak recommends keeping a maximum distance of 10 meters or 33 feet between Bluetooth devices, as they may not work reliably beyond this range.

Bluetooth Security Pin

The printer's bluetooth security pin is 1111. This is entered on the image source and is only needed if the image source requires a security exchange. The printer does not require a security pin.

Printing Multiple Photos

When the you select a print size smaller than the paper size, this printer automatically lays out multiple photos using the least amount of space, minimizing paper waste when cutting out the photos.

Printing Panoramic Photos

You can print a panoramic photo on 4 x 12 paper, or two panoramic photos on U.S. letter or A4 paper; some cropping will occur.

Zooming and Cropping Photos

Your printer enables you to zoom in or out on a specific area of a photo. When you print the photo, the photo is cropped so only the area shown on the display is printed.



Note: The changes you make to the photo apply only to viewing and printing the photo and will not be saved on the memory card or storage device.

- 1 Select an image from the display. As needed, see “Printing Photos from a PictBridge Camera” on page 19, or “Printing Photos from Other Cameras, Memory Cards, and Portable Storage Devices” on page 20.
- 2 Press **Zoom +** to enlarge the photo in .25X increments, up to a 5X magnification. Press **Zoom –** to decrease the magnification in .25X increments, to 1X.
- 3 Use the ▲, ▼, ◀ and ▶ navigation buttons on the control panel to display the part of the picture you want to print.
- 4 Press **OK** when finished. The photo is displayed with a border (“crop box”) around the magnification and position you selected.
- 5 Press **Menu** and press ▼ to select the **Print Photos Options** menu; then press **OK**.
- 6 Press ▼ and select **Quantity**, and then press ▶ to select the number of prints.
- 7 Press **Start** to print the area displayed in the crop box.



Tip: You can make more precise zoom and crop adjustments to your photos on your computer using photo editing software. To send a photo from the All-in-One to your computer, see “Transferring Images From the Printer to a Computer” below.

Transferring Images From the Printer to a Computer

You can transfer .jpg, .mov, and .wav files to your Windows or Macintosh computer from a PictBridge camera, digital image-transfer (PTP) camera, memory card, Kodak Bluetooth dongle, and portable (USB) storage drive connected to this All-in-One printer.



Note: To transfer large files, such as video files, from a memory card to a computer, Kodak recommends using a card reader attached directly to the computer instead of transferring the file(s) via the All-in-One printer.

Likewise, Kodak recommends transferring large (400 or more) groups of image files stored on a memory card to a computer via a card reader connected to the computer.

Transferring Images to a Windows Computer

- 1 Connect the plug-and-play device to the appropriate slot on the front panel of your printer.
- 2 Press **Menu** to display the Print Photos Options menu in the screen.
- 3 Press **▼** until **Transfer All to PC** is selected, and click **OK**.
- 4 At the prompt, click **Start**. The Kodak All-in-One Printer Software dialog opens on the PC monitor.
- 5 In the Kodak All-in-One Printer Software dialog on your PC, click an option to select it:
 - Browse and print my pictures
 - Transfer my pictures
 - Both

Then click **OK**.

- 6 If the Kodak Home Center software opens on the desktop, follow the instructions in the to complete the transfer.
- 7 If the Select Device dialog displays on the PC monitor, select the All-in-One printer as the location of the image file(s), and then click **OK**. Follow the instructions in the Windows Scanner and Camera wizard to complete the transfer.
- 8 From the dialog, select **Transfer my pictures** and click **OK**.
- 9 Follow the instructions in the Windows Scanner and Camera wizard to complete the transfer.

Transferring Images to a Macintosh Computer

- 1 Connect the plug-and-play device to the appropriate slot on the front panel of your printer.
- 2 Press **Menu** to display the options on the computer monitor (for a PictBridge camera) or the printer screen (all other devices).
- 3 Press **▼** until **Transfer All to PC** is selected.
- 4 Press **OK**.
- 5 When a transfer or connection message appears on the monitor, click **Yes**.
- 6 Press **Start**.
- 7 Use iPhoto or Image Capture to complete the transfer.

Viewing and Printing Photos

5 Copying Pictures or Documents

You can copy both photos and documents directly from the control panel of your Kodak ESP All-in-One printer. The printer produces high-quality color or black-and-white copies on a variety of paper types, including transparencies.



Note: Before using your All-in-One printer to copy a document or photo for the first time, review the procedures for loading paper and originals in Chapter 3 on page 13.

Simple Copying

- 1 Place the original (document or photo) at the right front corner of the scanner glass.
- 2 Press **Menu** to display the main menu.
- 3 **Copy Document** is the first option. As needed, press ▼ to select **Copy Photo**.
- 4 Press **Start**.

Adjusting Copy Settings

You can change the factory default copy document settings for your printer using the control panel. Depending on whether you are copying a photo or a document, select the appropriate option submenu from the main menu.

- 1 Press **Menu** to display the main menu.
- 2 **Copy Document** is the first option. As needed, press ▼ to select **Copy Photo**.
- 3 Press **OK** to display the submenu.
- 4 Press ▼ until the desired option is selected.
- 5 Press ◀ or ▶ to select the desired setting.
- 6 Press **OK** to continue making selections, as needed.



Note: Any changes you make to the copy document settings apply only to the current copy operation.

Copying Pictures or Documents

- 7 To keep the settings as permanent, press ▼ until **Save as Defaults** is selected; press **OK**, and then press Yes to save the change(s) as the new default settings.
- 8 Press **Start** to initiate copying the document.

The available copy settings are shown in the tables below:

Copy Document Options

Menu Options	View Settings / Select	Settings
Quantity	◀ or ▶	1- 99
Copy Size »	◀ or ▶	Same Size
		20% to 500%
Quality »»	◀ or ▶	Best
		Normal
		Draft
Color	◀ or ▶	Color
		Black & White
Brightness	◀ or ▶	-3 to +3
		-3 to +3
Save As Defaults	OK	

»Scaling is anchored to the upper left corner of the original.

Same Size The copy is the same size as the original. Cropping occurs if the original is larger than the paper size. The copy will contain white space if the original is smaller than the paper size. **Same Size** is the default copy setting.

Scaling Press ◀ from **Same Size** to scale copies smaller than the original, from 99% to 20%, in 1% increments. Scale copies larger than the original from 101% to 200%, in 1% increments; 200% - 500% in 5% increments.

»»Plain paper quality output:

Draft Produces the fastest print speed, but the lowest quality.

Normal Delivers high-quality output and is the default setting. **Normal** prints faster than **Best**.

Best Produces the highest quality for all paper and eliminates the banding (striping) effect that sometimes occurs in **Draft** and **Normal** modes. **Best** is the slowest print speed. If Kodak photo paper is loaded in the paper tray, this setting is used.

Copy Photo Options

Menu Options	View Settings / Select	Settings
Quantity	◀ or ▶	1- 99
Copy Size	◀ or ▶	4x6
		4x12 (Panoramic)
		5x7
		8x10
		8.5x11
		(Wallet) 2x3
		3.5x5
Quality	◀ or ▶	Best
		Normal
		Draft
Color	◀ or ▶	Color
		Black & White
Brightness	◀ or ▶	-3 to +3
Preview	◀ or ▶	No
		Yes
Save As Defaults	OK	

Copying Pictures or Documents

6 Scanning Your Pictures

Scanning converts text and images from documents and pictures placed on the scanner glass into electronic data, and then sends the data to your computer. To scan using the ESP 5 All-in-One, the printer must be connected to a computer. You can scan to Kodak Home Center, a memory card, scanner software, or save the scanned image to a new file on your computer.

Before You Start

Before you start scanning with this All-in-One, Kodak recommends that you use Home Center software to configure the default scan settings. This way, you can easily manage the scan in your computer.

Using Home Center, you can adjust the following default settings for scanned photos and documents:

- Applications used for file destination(s)
- File type used to save the scan
- File storage location for saved scans
- Rule for naming scan files
- Default scan resolution and photo enhancement preferences
- Color or black-and-white

Before initiating a scan, you can also preview the scan in Home Center, and crop the output as desired. When you are satisfied with the intended results, you can initiate the scan directly from Home Center. See Home Center Help for instructions.



Note: Before using your All-in-One printer to copy a document or photo for the first time, review the procedures for loading paper and originals in Chapter 3 on page 13.

Simple Scanning

- 1 Place the original (document or photo) at the right front corner of the scanner glass.
- 2 Press **Menu** to display the main menu.

Scanning Your Pictures

- 3 Press ▼ until **Scan** is selected.
- 4 Press **Start**.
- 5 When the Scanner dialog window displays on your computer, follow the prompts to finish the scanning process.

Scanning Multiple Originals

Kodak's Home Center software can detect multiple photos when placed on the All-in-One scanner glass. Allow some space on the scanner glass between each item, and use Home Center to save each photo a separate file. Home Center interprets any originals with touching or overlapping edges as a single image.

Home Center cannot interpret two or more documents, or a combination of documents and photos, as separate scanned items.

Adjusting Scan Settings

You can change the factory default scan settings for your printer using the control panel. When you change scan settings from the control panel, the settings apply only to the current scan job. To apply scan settings to all future scan jobs, you can save your changes.

- 1 Press **Menu** to display the main menu.
- 2 Press ▼ until **Scan** is selected.
- 3 Press **OK** to display the Scan menu.
- 4 As needed, press ▼ to change the scan settings for **Scan What** and **Scan To**.



Note: Any changes you make to the scan settings apply only to the current scan operation.

- 5 To keep the settings as permanent, press ▼ until **Save as Defaults** is selected, and then press **OK**.
- 6 Press **Start** to initiate the scan.

The available scan settings are in the table below:

Scan Options

Menu Options	View Settings / Select	Settings
Scan What ▶	◀ or ▶	Document
		Photo
Scan To	◀ or ▶	Computer
		Memory Card

Menu Options	View Settings / Select	Settings
Scan Destination »»	◀ or ▶	File
		[Application Name]
Save As Defaults	OK	

» If you select **Document**, the scan is saved as a document file, even if the original is a photo. If you select **Photo**, a text document will be scanned as an image file, and cannot be read by optical character recognition software.

»» You must create a list of one or more applications using Home Center software for any to display by name in the **Scan Destination** settings. Each application will appear as a separate setting in the display. In addition, before using a **Scan Destination** setting of **File**, familiarize yourself with the location where the file will be saved, and with the file naming setting. This will prevent problems later in finding the scan file on your computer. For more information, see the Home Center help.

Scanning Your Pictures

7

Maintaining Your Printer

The Kodak ESP 5 All-in-One printer requires little maintenance. However, you should regularly clean the scanner glass and lid backing to remove dust and fingerprints. Fingerprints and other debris on the glass or lid backing could slow down performance and affect the quality and accuracy of scanning.

Service agreements are available in some countries. Contact dealers for Kodak products for more information.

For recycling and or disposal information, contact your local authorities. In the U.S., visit the Electronics Industry Alliance Web site at www.eiae.org.

General Care



Caution: Always disconnect the power on the this All-in-One printer before cleaning it. Do not use harsh or abrasive cleaners or organic solvents on the printer or any of its parts.

- To clean the printer, wipe the outside with a clean, dry cloth
- Keep the surrounding area vacuumed and litter-free
- Protect the printer from tobacco smoke, dust, sand, other small particles (such as crumbs), and liquid spills
- Avoid placing objects on the printer
- Keep the printer supplies away from direct sunlight and out of high-temperature environments
- Do not allow chemicals, such as suntan lotion, to come into contact with the painted surface of the printer
- If the printer has been exposed to bad weather or has water inside it, turn it off and let it dry completely. If this does not solve the problem, contact customer support (see “Telephone Customer Support” on page 57)

Cleaning the Scanner Glass

For good copies and scans, ensure the printer's scanner glass and lid backing are clean; dust the exterior as needed.



Warning: Do not use abrasives, acetone, benzene, or carbon tetrachloride on the glass, as they can damage it. Do not place or spray liquid directly on the glass. The liquid might seep under the glass and damage the device.

- 1 Unplug the printer and raise the lid.
- 2 Clean the glass with a soft cloth or sponge slightly moistened with a nonabrasive glass cleaner.
- 3 Dry the glass with a lint-free cloth.
- 4 When finished cleaning, plug in the printer.

Cleaning the Scanner Lid

Minor debris can accumulate on the document backing located underneath the scanner lid of the Kodak printer.



Warning: Do not use paper-based wipes, as these might scratch the underside of the scanner lid. Do not use harsh or abrasive cleaners or organic solvents on the printer or any of its parts.

- 1 Unplug the printer and raise the lid.
- 2 Clean the underside with a soft cloth or sponge, slightly moistened with a mild soap and warm water.
- 3 Wipe the underside gently to loosen debris. Do not scrub.
- 4 Dry the underside with a chamois or soft cloth.
- 5 If further cleaning is needed, repeat the previous steps using isopropyl (rubbing) alcohol, and wipe the underside thoroughly with a damp cloth to remove any residual alcohol.
- 6 When finished cleaning, plug in the printer.

Monitoring and Adjusting the Printer's Performance

From the Control Panel, you can perform many tasks to keep this printer in good working order. For example, you can check the status of the printer's inkjet nozzle to ensure high-quality prints. Kodak recommends that you run a nozzle check if you are experiencing changes in image quality. You can also use the **Printhead Alignment** function if you see degradation in print quality.

- 1 Make sure that there are 5 - 10 sheets of plain paper loaded in the paper tray.
- 2 Press **Menu** to display the main menu.
- 3 Press ▼ until Maintenance is selected.
- 4 As needed, press ▼ until the desired option is selected.
- 5 Press **OK**.
- 6 Follow the prompts in the display screen to initiate or cancel the task.



Tip: A printhead alignment and a check of the inkjet nozzle can also be initiated from the Home Center software.

Windows: Open the Home Center Help panel by clicking Help  on the Home Center window, as needed. Click **Maintenance**, and then click **Nozzle Check** or **Printhead Alignment**.

Macintosh: Open the Home Center window and click **Maintenance**, and then click **Nozzle Correction** or **Printhead Alignment**.

These available maintenance options are shown in the table below:

Maintenance Options

Menu Options	Select
Check Ink Levels	OK
Nozzle Check	OK
Printhead Alignment	OK
Clean Printhead	OK
Print Demo Sheet	OK
Print Test Page	OK
Format Memory Card	OK



Warning: Formatting will erase all the data on a memory card.

Replacing Ink Cartridges

Your Kodak printer uses separate black and color ink cartridges. The ink levels are shown on the control panel and in the printer software.



Caution: For the best quality prints, store ink cartridges in locations where the temperature does not exceed 85°F (30°C).



Warning: Use genuine Kodak ink cartridges to ensure best results and avoid printhead damage not covered under warranty. Third-party ink cartridges may not contain the necessary information to notify you before the ink cartridge is empty, which could cause damage to the printhead.

- 1 Make sure the printer is turned on.
- 2 Open the printer access door by lifting from the front center of the unit. The printhead moves to an accessible position for handling the ink cartridges. The ink cartridges are seated in the printhead.

1 Printhead

2 Color Ink cartridge

3 Black ink cartridge

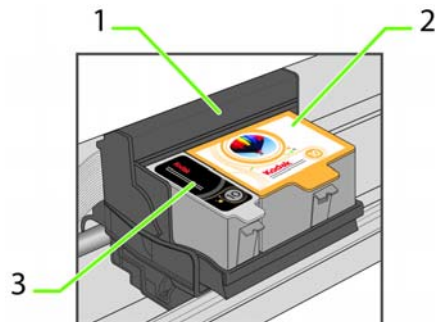

- 3 Wait until the printhead stops moving, then pinch the latch on the old ink cartridge with your thumb and forefinger and lift it out of the printhead.



Note: You can take your used ink cartridges to most office supply or electronics stores for safe disposal.

- 4 Open the box containing the new ink cartridge.

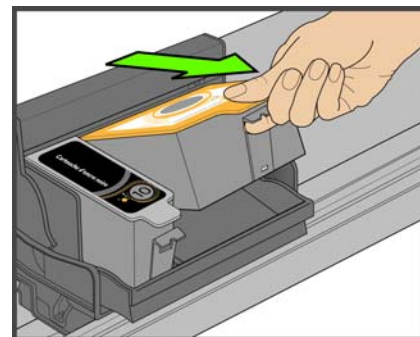

- 5 Remove the bagged ink cartridge from the box, tear open the bag at the notch, and remove the ink cartridge.



Caution: Insert the ink cartridge immediately to prevent any drying of the ink.

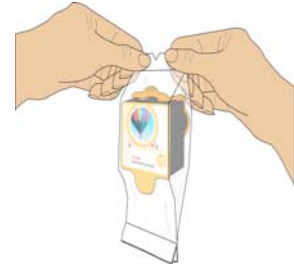

- 6 Remove the orange cap from the cartridge by grasping the top edge and pulling/rotating it off the ink cartridge. Discard the orange cap.

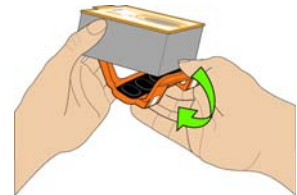

- 7 Insert the ink cartridge into the printhead.

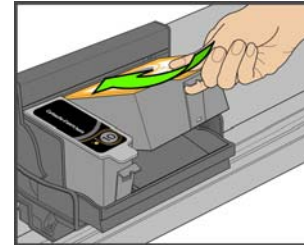

- 8 Press down on the tab until you hear a click and feel the latch snap into position.
- 9 Close the printer access door. The printhead moves to its ready position and prepares the new ink cartridge for use (this could take up to a minute).

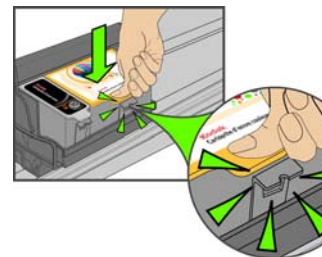

Replacing the Printhead

If your printhead is damaged or broken, you may replace it yourself. You will need to get a replacement printhead from Service and Support prior to executing this task.

- 1 Make sure your printer is turned on.
- 2 Pinch the latch on the ink cartridge with your thumb and forefinger and lift it out of the print head. Remove both ink cartridges. .



Caution: Insert the ink cartridges into the newly installed printhead as soon as possible to prevent any drying of the ink.

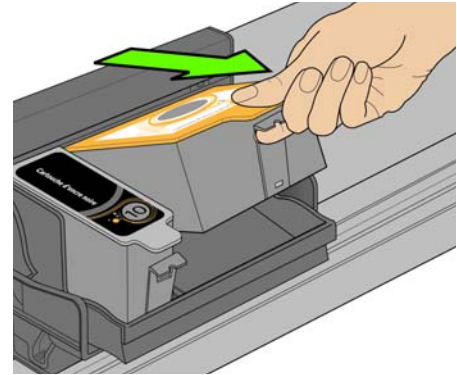

- 3 Unlatch the printhead by pressing the release on the top of the carriage.

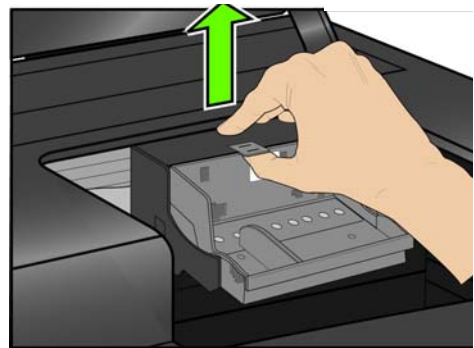

- 4 Remove the old printhead from the carriage.

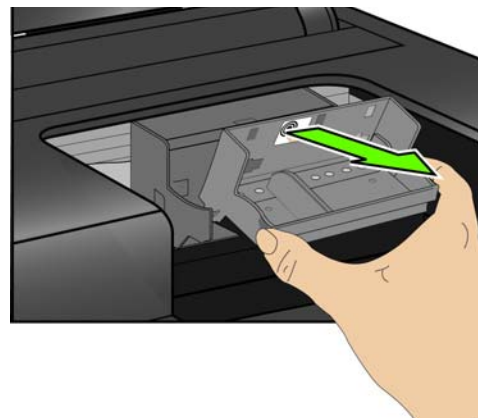

5 Remove the new printhead from its bag.



6 Remove and discard the black plastic casing and the orange protective cap.

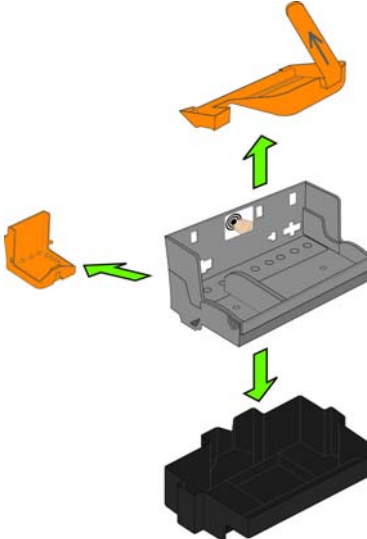

7 Place the new printhead into the carriage.

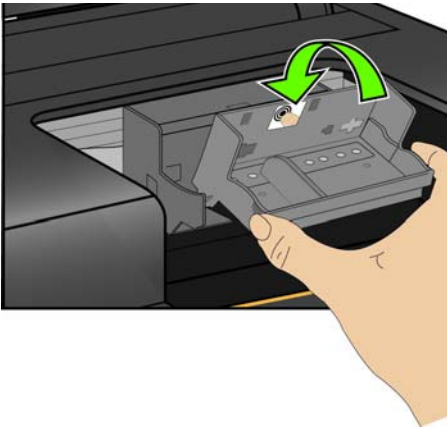

8 Push firmly against the target label on the printhead until it clicks into place.

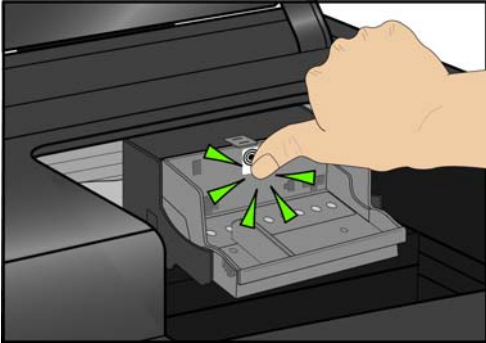

Maintaining Your Printer

- 9** Reinstall the ink cartridges.
- 10** Close the printer access door.
- 11** The printer will require a calibration after installing a new printhead. Follow the prompts on your printer's display screen.

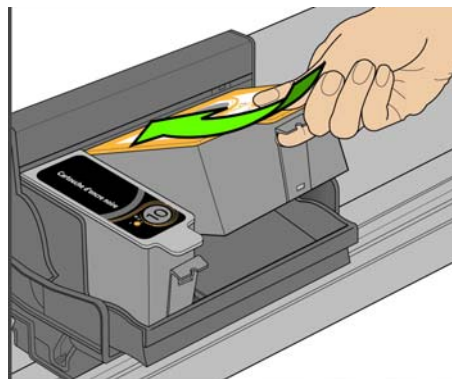

8

All-in-One Troubleshooting

The information in this chapter is designed to help you solve on your own many problems that may occur with your printer.



Note: Many issues with degradation in performance or print quality can be resolved by meeting or exceeding the recommended system requirements. See “Product and Safety Specifications” on page 61.

General Troubleshooting

Printer Fails to Power On

Probable Cause

The power supply is not properly connected.

Corrective Action

- Make sure the electrical power cord is connected to the alternating current power adapter, and is plugged into a grounded power outlet or power strip
- If using a power strip, make sure it is turned on
- If using a switched power outlet, make sure the switch is on
- Make sure the power outlet is supplying power
- Verify the light on the Kodak printer power cord plug is lit

Probable Cause 2

The USB cable was unplugged from the printer and then reconnected; or, power to the printer is interrupted.

Corrective Action

Restart the computer.

Probable Cause 3

The USB cable is not 2.0 compliant.

Corrective Action

- Replace the USB cable with a USB 2.0 compliant cable



Note: For optimal quality and performance, use a good-quality high speed USB 2.0 cable. When connecting to the Kodak All-in-One printer, use the USB ports located in the back of the computer. Any USB 2.0 hubs that are used should be self-powered.

- Restart the computer

If none of the above corrects the problem, contact Kodak support.

Device Not Recognized

Probable Cause

Any of the following can prevent your Kodak printer from reading a connected digital camera, USB mass storage device, or memory card.

- The camera is turned OFF
- The USB connector from the camera is not fully inserted into the port
- The memory card is not completely inserted
- The memory card file system is corrupt
- More than one memory card is inserted
- The USB device is not supported

Corrective Action

- Correct any connection problems and try again
- If the memory card file system is corrupt, reformat it in your camera
- Disconnect the unsupported device

Ink Cartridge Not Recognized

Probable Cause 1

The color or black ink cartridge installed was not recognized.



Warning: Generic or non-Kodak ink cartridges may not function in All-in-One printer. Kodak recommends using genuine Kodak ink cartridges.

Corrective Action

Install a genuine Kodak ink cartridge.

Probable Cause 2

One of the ink cartridges needs to be replaced.

Corrective Action

Replace the ink cartridge.

Multiple Paper Feed

Probable Cause

Multiple sheets of paper were pulled through printer.

Corrective Action

Caution: Kodak Inkjet paper is recommended for your Kodak All-in-One printer.

- 1 Remove the paper from the paper tray.
- 2 Carefully “fan” the paper to keep the sheets from sticking together.
- 3 Reload the paper tray. Do not overfill.
- 4 Press **OK**.

Multiple Pictures Not Scanned Properly

When scanning or copying, the Kodak printer can detect multiple images on the scanner glass, straighten them, and create individual files. If you are having trouble with this feature, check the following:

Probable Cause 1

Your photos are not placed optimally on the scanner glass.

Corrective Action

- Make sure that your photos do not overlap
- Place photos away from the edges of the scanner glass
- Some images do not scan well. Light-colored images may not be detected as separate images
- You may need to make adjustments to the scanning area using the Preview feature in the Kodak Home Center

Probable Cause 2

The scanner glass is dirty.

Corrective Action

Make sure the scanner glass is completely clean or the photos might not scan properly (see “Cleaning the Scanner Glass” on page 34).

Probable Cause 3

The scanner lid is dirty.

Corrective Action

Clean the scanner lid (see“Cleaning the Scanner Lid” on page 34

No Communication With Computer

Probable Cause

Your Kodak printer is not connected to your computer.

Corrective Action

- Make sure your printer is plugged in and turned on
- Make sure you are using the proper USB cable (USB 2.0)
- Check the connection from your computer to your printer. Ensure that the square end of the USB cable is plugged in to the USB port on the back of your printer, and the flat end into a USB port on your computer
- You may need to disconnect other printers or scanners from your computer
- After checking connections, restart your computer
- Make sure your computer meets the minimum system requirements, otherwise upgrade your system if necessary

For more information on connecting your printer to your computer, see the Setup Guide that came with your printer.

No Paper Feed

Probable Cause

The paper tray may be empty, or there may be a problem with the paper in the tray.



Caution: Kodak Inkjet paper is recommended for your Kodak All-in-One printer.

Corrective Action

If the tray is empty, load paper into the paper tray, then resume printing. Check for a message on the printer status monitor (Windows) on your computer. Check for a problem with the paper in the tray.

To check the paper

- 1 Inspect the paper and make sure no paper sheets are damaged in any way. Reload with new paper, if necessary.
- 2 Carefully “fan” the paper to keep the sheets from sticking together.
- 3 Reload the paper tray. Do not overfill.
- 4 Press **OK**.

One Or More Of The Colors On The Calibration Sheet Is Missing

Probable Cause

The printhead is not installed correctly. If the printhead has been working properly, it may have come loose.

Corrective Action

If the printhead has come loose:

- 1 Open the printer access door, and then remove the black and color ink cartridges.
- 2 Press the printhead release button.
- 3 Lift the printhead out.
- 4 Reinsert the printhead and ink cartridges.



Note: See “Replacing the Printhead” on page 38 for illustrated instructions for performing this procedure.

If this does not resolve your printing issue, contact Kodak Service and Support.

Paper Jam

Probable Cause

The paper did not advance, was not picked up properly from the paper tray, or is lodged inside the printer.



Caution: Kodak Inkjet paper is recommended for your Kodak All-in-One printer.

Corrective Action

- 1 Remove the paper from the tray.
- 2 Turn off the printer.
- 3 Open the rear access area and pull the paper out from the rollers without tearing it..



Caution: If the paper tears while removing it, make sure you remove all the torn pieces. More jams are likely to occur when torn pieces are left in the printer.

- 4 Reload the paper tray, but do not overfill it.
- 5 Turn the printer on.
- 6 Press **OK**.

Printer Not Responding

Probable Cause

The firmware or software is not in a ready state.

Corrective Action

- Turn the printer off and turn it back on
- If the problem persists, unplug the power cord from the power supply and plug it back in
- If the problem continues to persist, restart your computer

Transfer Pictures Failure

Problem

Nothing happens when you try to transfer photos to the computer.

Corrective Action

- Remove the memory card or USB device and reinsert it
- Check the power connection to the computer
- If you are trying to transfer photos from a memory card and a PictBridge camera is connected, disconnect the camera
- Close unnecessary software applications, and minimize remaining application windows. Follow any messages on the screen that may have been hidden by other windows
- Disconnect then reconnect the USB cable from the printer to the computer
- Make sure you are using a high-quality USB cable (See “No Communication With Computer” on page 44)
- Make sure your computer meets the minimum system requirements for using your printer (see “General Troubleshooting” on page 41). Upgrade your system if necessary

User Guide on the CD Is Obsolete

Probable Cause

The User Guide has been updated since the software CD was released.

Corrective Action

Download the most recent version of the User Guide from Kodak.com.

Wrong Paper Size

Probable Cause

The print size or paper size you selected may be larger or smaller than the paper found in the paper tray.

Corrective Action

- 1 Replace the paper in the paper tray with the correct size.
- 2 Press **OK**.

If the situation continues, contact Kodak support.

Macintosh OS 10 Troubleshooting

Non-Intel Mac Only: Black Screen or Screen Freeze Occurs When Applying Printer Settings Via Home Center Software

Probable Cause

This error only occurs with non-Intel Macintoshes running Leopard OS version 10.5. Apple has confirmed that there are problems running the latest version (Leopard) on G5 processors.

Corrective Action

Upgrade to Macintosh OS 10.5.2.

Windows Vista Troubleshooting

WIA (Windows Image Acquisition) Error: Service Has Stopped Working

Probable Cause 1

The USB cable is unplugged and reconnected to the printer or when the printer terminated error

Probable Cause 2

Power is interrupted. This results in the inability to connect a camera and transfer pictures from the camera. Neither the camera nor the printer is visible through the **Transfer All to My PC** option on the Print Photo Options menu.

Corrective Action

Restart the computer and printer.

Home Center Software Works Incorrectly Following Software Upgrade

Probable Cause

Some changes in the Home Center software may have been affected by enabled Security and/or User Account Control settings.

Corrective Action

- 1 Right-click on the Home Center icon (shortcut) on the Desktop.
- 2 Select **Properties**.
- 3 Select the Compatibility tab.
- 4 Check the box that says "Run the program as an administrator."

Print Troubleshooting

Use this section to resolve print problems.

Envelope Printing Incorrect

Probable Cause

The envelopes are not loaded correctly.

Corrective Action

- 1 Remove the envelopes from the paper tray.
- 2 Straighten the stack of envelopes against a flat surface. Reload the stack into the paper tray print side down, with the envelope flap aligned to the left.
- 3 Squeeze the paper guide and slide it to the right until it touches the edge of the envelopes.

Multiple-Page Document in Reverse Order

Probable Cause

The print settings in the printer driver are set to print the first page of your document first.

Corrective Action

Configure the printer driver to print the document in reverse order, so the pages are in the correct order when printing is complete.

To set a Windows PC to print in reverse order:

- 1 On the Windows Desktop, click **Start > Settings > Control Panel**.
- 2 In the Control Panel window, open Printers or Printers and Faxes.
- 3 In the Windows Explorer window, Right-click on the Kodak All-in-One printer in the **Name** column, and then select **Printing Preferences**.
- 4 On the Printing Preferences window, select **Print last page first** on the General tab.

To set a Macintosh to print in reverse order:

- 1 On the File menu, select **Print**.
- 2 On the Print dialog, select **Paper Handling**.
- 3 Select the **Reverse Page Order** option.

PictBridge Camera Not Detected

Probable Cause

The camera is not communicating with the printer.

Corrective Action

- Make sure the camera is turned ON
- Check the USB connections from the PictBridge camera to the printer
- If disconnected, reconnect the USB cable from the PictBridge camera to the printer
- Make sure the connected camera is PictBridge-compatible. See your camera or device user's guide for details
- Check the camera batteries

Picture Cropped

- Change the picture quality setting (or resolution) on your digital camera to 3:2. See your camera user's guide for details
- Adjust cropped photos using the Kodak Home Center or other image editing software on your computer
- If you are printing from an application on your computer, select the proper paper size from the printer options



Note: Cropping may vary, depending on the selected picture size and size of the output paper. The dimensions of the photo on the camera are slightly different from each paper size so a portion will be cropped to fit perfectly on whatever paper size was selected.

Picture Print Smudged

Probable Cause

Fingerprints may be on glossy side of paper.

Corrective Action

Handle paper by the edges.

Picture Will Not Print

A selected picture does not print.

Probable Cause 1

The image file may be corrupt.

Corrective Action

Review the picture on the camera or computer and delete it if necessary.

Probable Cause 2

The image file may not be in JPEG format.

Corrective Action

The Kodak printer can print only JPEG files in stand-alone mode. Connect the printer to a computer and use software to print other image formats.

Poor Print Quality

Probable Cause

Low resolution image file or the printer may need maintenance.

Corrective Action

- Align the printhead (see “Monitoring and Adjusting the Printer's Performance” on page 34)
- Perform a nozzle check with the Home Center software
- Clean the printhead from Home Center or from the **Maintenance** menu on the printer control panel. If the printhead is clogged, the printouts should begin to improve with two or three cleanings. Repeat the cleaning cycle until the printout stops improving
- If the problem still persists, you may need to replace the printhead

Print Skewed or Slanted

Probable Cause 1

The paper is not properly loaded in the tray.



Caution: Kodak Inkjet paper is recommended for your Kodak All-in-One printer.

Corrective Action

Realign the paper in the paper tray.

- 1** Remove paper and check for wrinkles and tears.
- 2** Slide the paper-width guide away from the paper.
- 3** Straighten the stack of paper against a flat surface, and reload it into the paper tray.
- 4** Slide the paper-width guide up against the edge of the paper.

Probable Cause 2

More than one type or size of paper is loaded.

Corrective Action

Load only one type or size of paper at a time.

Print Spotted

Probable Cause

Paper may be dirty.

Corrective Action

Use a dry, lint-free cloth to wipe clean. For excessive dirt or debris, thoroughly clean the paper tray, and load new paper.



Note: When you are not using the printer, keep paper tray cover closed to keep dust and debris from collecting on the paper or inside the printer.

Print Too Dark

- Try retaking the picture with the flash on, or move within the flash range of the camera. Refer to your camera user's guide for details
- Adjust the exposure compensation on your camera, and try taking the picture again. Refer to your camera user's guide for details
- Edit the picture using Kodak Home Center or other image editing software
- Make sure the printer is not placed in direct sunlight or is not operating in a high-temperature environment

Print Too Light.



Caution: For best results, use Kodak paper and ink cartridges for your Kodak All-in-One printer.

- Make sure the paper is loaded with the print side face down. Reload it if necessary
- Try taking the picture again with the flash off. Refer to your camera user's guide for details
- Adjust the exposure compensation on your camera and try taking the picture again. Refer to your camera user's guide for details
- Edit the picture on your computer

Printing Slow



Note: When printing a large number of prints, printing may slow down to prevent the printhead from overheating.

- Make sure the printer is not placed in direct sunlight or is not operating in a high-temperature environment (higher than 95° F., or 35° C)
- Close unnecessary software applications

- Make sure your computer meets the minimum system requirements. Upgrade your system if necessary

Printing Stops

Printing stops during mid-print. Paper stops feeding, and status light may blink.



Caution: For best results, use Kodak paper and ink cartridges for your Kodak All-in-One printer.

To check the paper:

- 1 Remove any loose paper from the printer. Check the paper access door in the rear of the printer.
- 2 Inspect the paper supplies and reload with new paper, if necessary.
- 3 Carefully “fan” the paper to keep the sheets from sticking together.
- 4 Reload the paper tray. Do not overload.
- 5 Press **Start** to continue

White Edges on Borderless Prints

Probable Cause 1

White edges can appear when there are slight misalignments between the printer and paper. Some software applications are able to “hide” these small misalignments so that the prints look borderless.

Corrective Action

- Realign the paper in the tray
- Use the application's Fill Page option or resize the picture so it is slightly larger than the paper size

Probable Cause 2

If the image's proportions or dimensions are not compatible with the selected paper size, the print usually will not be borderless. For example, if a square image is printed on 4 x 6-inch paper, it will often print as a 4 x 4 inch image, with white edges on each side of the print.

Corrective Action 2

Crop the image so it is compatible with the selected paper size.

Copy Troubleshooting

Copy Cut Off

Probable Cause

The original is larger than the paper loaded.

Corrective Action

When the original is larger than the paper loaded, reduce copy size to fit the size of the paper loaded.

Scan Troubleshooting

Scan Fails

Probable Cause 1

Your computer is not turned ON.

Corrective Action

Turn on your computer.

Probable Cause 2

Your Kodak printer is not connected to your computer.

Corrective Action

Connect your Kodak printer to your computer with a standard USB cable.

Probable Cause 3

The Kodak Home Center software is not installed.

Corrective Action

Insert the Kodak printer installation CD and install the software.

Probable Cause 4

Your computer system resources may be low.

Corrective Action

- Turn off your computer and the printer, and then turn them back on
- If the problem still persists, try scanning at a lower resolution

Probable Cause 5

The memory card you are scanning to does not have enough free space to save the scanned photo.

Corrective Action

Free up some space on your memory card or use another memory card to save the scanned photo.

Scanned Image Blank

Probable Cause

Your original is not placed correctly on the scanner glass.

Corrective Action

Place your original face down in the proper corner of the scanner glass.

9 Customer Support

All-in-One Support Options

Before contacting Customer Support, Kodak encourages you to determine if the resources in the ESP 5 All-in-One, in this user guide, or in Home Center software can address your concern right away. The following types of assistance came with your printer:

Printer Help

- 1 Press **Menu** to display the main menu.
- 2 Press **▼** until **Help** is selected.
- 3 As needed, press **▼** until the desired option is selected.
- 4 Press **OK**.
- 5 Follow the prompts in the display screen to view the available information.

The options in the Help menu are shown in the table below:

Help Options

Menu Options	Select
Install Ink Cartridges	OK
Copy a Document	OK
Copy a Photo	OK
Print a Photo	OK
Scan a Document	OK
Scan a Photo	OK

Home Center Help

In both Windows and Macintosh, Kodak All-in-One Home Center software provides online Help for using with your printer. Remember that Home Center must be open on your computer to access Help.

Troubleshooting Frequently-Asked-Questions

See “All-in-One Troubleshooting” on page 41 for solutions to many specific All-in-One problems.

Resources on the All-in-One Setup CD-ROM

In addition to this user guide, the CD-ROM used as part of the setup contains additional technical information in the ReadMe file.

Contacting Customer Support at Kodak

Should you need more assistance than is available from Home Center, this guide, the Readme file, or the All-in-One control panel Help, Kodak provides several resources, listed below, to help you solve your printer problems.

- Support from the Kodak Web site (www.kodak.com/go/aiosupport). See the table below for useful Web addresses

Support on the Kodak Web Site

Support	Description	Internet Address
General	Resource Center.	www.kodak.com/go/resourcecenter
Printer	Get support for your product (FAQs, troubleshooting information, etc.).	www.kodak.com/go/faqs
	Purchase a full range of digital camera and printer accessories.	www.kodak.com/go/accessories
	Download latest printer software, firmware, and drivers.	www.kodak.com/go/downloads
	Online tutorials.	www.kodak.com/go/howto
Software	Get information on Kodak EasyShare software.	www.kodak.com/go/easysharesw
	Get help with the Windows operating system and working with digital images.	www.kodak.com/go/pcbasics
Other	Get support for Kodak printers, cameras, software, accessories, and more. Print a Test Page before contacting Kodak support (see “All-in-One Support Options” on page 55).	www.kodak.com/go/support
	Register your printer.	www.kodak.com/go/register

A Glossary

A

All-in-One All-in-One

B

Bluetooth An industrial specification for wireless personal area networks (PANs). Bluetooth provides a way to connect and exchange information between devices such as mobile phones, laptops, PCs, printers, digital cameras, and video game consoles over a secure, globally unlicensed short-range radio frequency. The Bluetooth specifications are developed and licensed by the Bluetooth Special Interest Group.

D

DPI dots per inch

DPOF Digital Print Order File. This file allows the user of a digital camera to define which captured images on the storage card are to be printed, together with information on the number of copies or other image information such as paper size, image title text, image orientation, contact information, and more.

E

ESP EasyShare Printer

EXIF Exchangeable Image File Format. A standard for storing interchange information in image files, especially those using JPEG compression. Most digital cameras now use the EXIF format.

J

JPEG Joint Photographic Experts Group. The name of the committee that developed the image file format. JPEG is a compressed image file format. JPEG is a "lossy" format, which means some quality is lost when the image is compressed.

K

Kodak Perfect Touch Automatically corrects for common image flaws and “mistakes,” such as shadows, and backlighting. Kodak Perfect Touch technology also enhances the desirable qualities of pictures, for vibrant color and richer detail. This feature is available when scanning or copying pictures. Color restoration and Kodak Perfect Touch can be used together to enhance pictures. This feature is not available when scanning black and white pictures.

KPT Kodak Perfect Touch.

O

OCR Optical character recognition.

P

PictBridge A Camera and Imaging Products Association standardized technology that allows printing of images between any PictBridge compliant digital camera and any PictBridge compliant printer. Thus, you can print from a memory card in a digital camera directly to a printer, regardless of brand. No computer is necessary. Each device is automatically recognized by the other. The camera compares its PictBridge functions to the functions of the printer. The camera then displays the supported functions on menus on the LCD screen or in the viewfinder. Once a PictBridge digital camera is connected to a compliant printer, print options appear on the camera monitor (LCD). The camera menu system is used to select settings such as print size, layout, media type, and date. You can print a single image displayed on the camera, print two or more images, or print all of the images on the memory card. You can print part of an image by first cropping it within the camera and even create index prints (contact sheets). To find out if a camera or printer is PictBridge compatible, look for the PictBridge logo on the packaging or check the manual for specifications.

PTP Picture Transfer Protocol. A standard for transferring pictures from a digital camera.

R

Red Eye The red-eye effect in flash photography is caused by the light from the flash reflecting off the blood vessels and interior eye tissue in humans. Animal eye glow from reflections is caused by a different internal eye structure, which is much like a mirror. When not enough time elapses between the flash and exposure (as with most compact cameras), the light of the flash occurs too fast for the iris of the eye to close the pupil. The flash of light is focused by the lens of the eye onto the blood-rich retina at the back of the eye. The image of the illuminated retina is then focused by the lens of the eye back to the camera, resulting in a red appearance of the eye on the picture.

T

Tagged Images See [DPOF](#).

U

USB Universal Serial Bus. A connection protocol between a peripheral device and a computer, allowing electronic data/signals to be transmitted back and forth. It is used commonly to connect a portable storage device such, as a “thumb” or “flash” drive, to a PC or Macintosh desktop or laptop computer. The Kodak All-in-One printer has a USB port on the front panel for external USB devices to plug into, and another one on the back panel to connect the printer to a computer via a USB cable.

B Product and Safety Specifications

Specifications for this Kodak ESP 5 All-in-One printer are described in the tables below.

Print Performance

Print Performance	
Black print speed	Up to 30 pages per minute on plain paper
Color print speed	Up to 29 pages per minute on plain paper
Print technology	Continuous-tone thermal ink jet
Print quality modes	Draft, Normal, and Best on plain paper Photo quality mode on photo paper

Photo Printing Features

Photo Printing Features	
Quantity	1 - 99
Print Sizes	2 x 3 inch (5 x 7.6 cm) 3.5 x 5 inch (9 x 12.7 cm) 4 x 6 inch (10 x 15 cm) 4 x 12 (Panoramic) 4 x 12 inch. (10 x 30 cm) 5 x 7 inch (13 x 18 cm) 8 x 10 inch (20 x 25 cm) US Letter (8.5 x 11 inch) (22 x 28 cm) A4 (21 x 30 cm)
Quality	Normal, Best, and Draft
Auto-detect media	Auto-detect plain paper, photo paper, and transparency Optimize image quality for Kodak Photo Papers with barcode
Image enhancement	Kodak Perfect Touch Technology with Home Center software
Add Dates to Prints	Yes, No
Color	Color, Black-and-White
Scene Balance	On, Off

Copy Document Features

Copy Document Features	
Color	Black & white or color
Quantity	1 to 99 copies per job
Copy size	Same Size, 20% to 500%
Quality	Normal, Best, and Draft
Brightness	- 3 to + 3

Copy Photo Features

Copy Photo Features	
Color	Black & white or color
Quantity	1 to 99 copies
Copy size	2 x 3 inch (5 x 7.6 cm) 3.5 x 5 inch (9 x 12.7 cm) 4 x 6 inch (10 x 15 cm) 4 x 12 (Panoramic) 4 x 12 inch, (10 x 30 cm) 5 x 7 inch (13 x 18 cm) 8 x 10 inch (20 x 25 cm) US Letter (8.5 x 11 inch) (22 x 28 cm) A4 (21 x 30 cm)
Quality	Normal, Best, and Draft
Brightness	- 3 to + 3

Scanning Features

Scanning Features	
Scanner type	Contact Image Sensor (CIS) type scanner
Maximum scan size	8.5 x 11.7 inch, (21.6 x 29.7 cm)
Functions	Segmentation scanning Auto-destination OCR

Paper Tray Features

Paper Tray	
Paper capacity:	100 sheets of 20 lb plain paper or 30 sheets of 10 mil photo paper
Paper size supported	4 x 6 inches to 8.5 x 14 inches (10 x 15 cm to 21.6 x 36 cm)

Ink Tanks

Ink Tanks	
Ink handling	2-cartridge, 6-ink system
Ink life	1-year warranty from date of purchase

Connectivity

Connectivity	
Protocols supported	USB 2.0 (Mass Storage & PTP), USB PTP, BLUETOOTH® 2.0, PictBridge, DPOF, MIPC (Mobile Image and Printing Consortium), SDHC (Secure Digital High Capacity) memory cards.
Devices supported	Windows and Macintosh computers, USB mass storage devices, memory cards (MS, XD, SD, and CF), PictBridge-enabled digital still cameras, and BLUETOOTH® Technology-enabled imaging devices
Image formats supported	JPEG (EXIF V2.2) (progressive JPEG format not supported) AVI and WAV (transfer only)
Number of USB ports	One front host port (full speed), one rear device port (high speed)

Software Support

Software Support	
Application support	Third-party image management applications or Kodak EasyShare Software for photos; optical character reader (OCR) support for documents
Media support	Plain paper, photo paper, envelopes, greeting cards, transparencies, labels, t-shirt transfers
Scanner support	TWAIN and WIA import, including EasyShare Software, segmentation scanning
File transfer support	Automatic color, contrast, sharpness improvements upon transfer to PC
Update support	Software and firmware updates available through web support

Physical Specifications

Physical Specifications	
Power	US: 110–120 V AC, 60 Hz at ~2 A WW: 110–240 V AC, 50–60 Hz Output: 36 V AC at 3 A (120 watt) 24V AC adapter (100–240 VAC 50/60 Hz)
Dimensions	16.6 x 7.0 x 11.8 inches (422 x 178 x 299 mm) [W x H x D]
Weight	13.1 lbs (5.9 kg)

Product and Safety Specifications

Physical Specifications	
Operating range	5°C (41°F) to 35°C (95°F), 15 to 85 % RH (non-condensing), and atmospheric pressure of no less than 15 PSI (approximately 10,000 ft ASL)
Full IQ environmental range	15°C (59°F) to 30°C (86°F), and 20 to 80 % RH

Warranty

Warranty	
Product	One year from purchase (with proof of purchase)
Printhead	One year from purchase (with proof of purchase)

System Requirements

The following specifications are subject to change without notice.

Windows PC

Windows PC	Minimum	Recommended
Operating System	Microsoft Windows XP SP2	Microsoft Windows Vista
CPU	Celeron	32 or 64-bit processor
Clock Speed	1.2 GHz	2 GHz
Memory	512 MB RAM	1024 MB RAM
Available Disk Space	1.8 GB ROM	40 GB with 15 GB free
Interface	USB 2.0	USB 2.0
Removable Drive	CD-ROM	DVD-ROM
Other	Internet access capability	Internet access capability

Macintosh

Macintosh	Minimum	Recommended
Operating System	Macintosh OS X 10.4.8	10.4.9 or greater
Computer	PowerMac or Powerbook G3, G4; iMac; eMac; or iBook	Intel Mac
Clock Speed	2 GHz	2 GHz
Memory	512 MB RAM	1024 MB RAM
Available Disk Space	200 MB	200 MB
Interface	USB 2.0	USB 2.0
Removable Drive	CD-ROM	DVD-ROM
Other	Internet access capability	Internet access capability

Papers Supported

Paper Types

Paper Types Supported	
Plain paper	20 to 24 lb (60 to 90 gsm)
Photo paper	5 to 10 mils
Card stock	110 lb index max (200 gsm)
Envelopes	20 to 24 lb (75 to 90 gsm)
Transparencies	All commercially available inkjet varieties (with or without a white stripe)
Labels	All commercially available inkjet varieties on 8.5 x 11 and A4 size sheets
Iron-on transfers	All commercially available inkjet varieties on 8.5 x 11 and A4 size sheets

Paper Sizes

Paper Sizes Supported	
Usage	Size
Document page sizes Labels	A4 (8.27 x 11.69 in.) (210 x 297 mm) A5 (5.87 x 8.27 in.) (148 x 210 mm) A6 (4.13 x 5.83 in.) (105 x 148 mm) B5 (6.93 x 9.84 in.) (176 x 250 mm) US Executive (7.25 x 10.5 in.) (184 x 266 mm) US Letter (8.5 x 11 in.) (216 x 280 mm) US Legal (8.5 x 14 in.) (216 x 356 mm) Custom sizes
Index card stock	4 x 6 in. index cards (101 x 152 mm) 5 x 7 in. index cards (127 x 178 mm)
Transparency Iron-on transfers	A4 (210 x 297 mm) US Letter (8.5 x 11 in.) (216 x 280 mm)
Envelopes	C5 (6.38 x 9 in.) (162 x 299 mm) C6 (4.49 x 6.38 in.) (114 x 162 mm) A2 (4.37 x 5.75 in.) (111 x 146 mm) DL (designated long) (4.33 x 8.66 in.) (110 x 220 mm) US #10 (4.12 x 9.5 in.) (105 x 241 mm)
Photo	4 x 6 in. (102 x 152 mm) 4 x 7 in. (102 x 178 mm) 4 x 12 in. (102 x 305 mm) 5 x 7 in. (127 x 178 mm) 8 x 10 in. (203 x 254 mm) US Letter (8.5 x 11 in.) (216 x 280 mm) A4 (210 x 297 mm)

Safety Specifications

- Read and follow these cautions and warnings before using Kodak products
- Always follow basic safety procedures
- Follow all warnings and instructions marked on the Kodak ESP 5 All-in-One printer

Parts



Caution: Do not disassemble this product; there are no user-serviceable part(s) inside. Refer servicing to Kodak's qualified service personnel.



Warning: Keep out of reach of children. Ink may be harmful if swallowed.

Power



Caution: If the power cord or plug is frayed or damaged, the equipment gets wet, or the equipment does not operate normally when the operating instructions are followed, unplug your printer from the power outlet and have qualified service personnel service your printer.



Caution: The alternating current (AC) adapter power supply is equipped with a three-wire grounding type plug. If you cannot insert the plug into the power outlet, contact an electrician to check or replace the power outlet.



Caution: For added protection from damage during a lightning storm, or when your printer and its associated alternating current (AC) adapter are unused for long periods of time, unplug the AC adapter from the power outlet.



Warning: Pushing objects through the equipment openings can result in an electric shock or fire.



Caution: Do not plug the alternating current (AC) adapter into a household extension cord.



Warning: The use of an accessory not recommended by Kodak could cause fire, an electric shock, or injury.

Location



Caution: To prevent your printer from overheating, do not block or cover the slots and openings in the equipment, place it near a heat register, or install it in a cabinet without proper ventilation.



Caution: Do not use your printer near water, or spill liquid on it.



Warning: Do not place your printer on an unstable cart, stand, bracket, or table; this risks damaging the equipment and injuring people.

Environment



Caution: Excessive dust levels may damage internal parts.



Caution: Unplug the equipment from the electrical outlet before cleaning.



Caution: Dropping your printer may damage the housing and result in extensive damage that will require replacement or repair by a qualified technician to restore normal operation.



Warning: Do not expose this product to liquid, moisture, or extreme temperatures. Kodak alternating current (AC) adapters are intended for indoor use only. The use of controls, adjustments, or procedures other than those specified herein may result in exposure to shock and/or electrical or mechanical hazards.



Caution: Adjust only those controls covered in the user guide or setup instructions.

For more information, go to www.Kodak.com/go/MSDS.

Regulatory Compliance



FCC Compliance and Advisory

This equipment has been tested and found to comply with the limits for a Class B digital device, pursuant to Part 15 of the FCC Rules. These limits are designed to provide reasonable protection against harmful interference in a residential installation.

This equipment generates, uses, and can radiate radio frequency energy and, if not installed or used in accordance with the instructions, may cause harmful interference to radio communications. However, there is no guarantee that interference will not occur in a particular installation.

If this equipment does cause harmful interference to radio or television reception, which can be determined by turning the equipment off and on, you are encouraged to try to correct the interference by one or more of the following measures: 1) reorient or relocate the receiving antenna; 2) increase the separation between the equipment and the receiver; 3) connect the equipment to a different outlet (on a circuit) than the one the receiver is connected to; 4) consult the dealer or an experienced radio/TV technician for additional suggestions.

Any changes or modifications not expressly approved by the party responsible for compliance could void the user's authority to operate the equipment.

Any changes or modifications not expressly approved by the party responsible for compliance could void the user's authority to operate the equipment. To ensure compliance with FCC regulations, use only the shielded interface cables provided with the product, or additional specified components or accessories that can be used with the installation of the product.



Caution: When using the Bluetooth interface with a Kodak printer, the transmitter must not be collocated or operated in conjunction with any other antenna or transmitter.

FCC and Industry Canada

This device complies with RSS-210 of the Industry Canada Rules. Operation is subject to the following two conditions:

- 1 This device may not cause interference and
- 2 This device must accept any interference, including interference that may cause undesired operation of the device

This device has been designed to operate with an antenna having a maximum gain of 1.8dB.

Antenna having a higher gain is strictly prohibited per regulations of Industry Canada. The required antenna impedance is 50 ohms.

To reduce potential radio interference to other users, the antenna type and its gain should be so chosen that the EIRP is not more than required for successful communication.

IC Radiation Exposure Statement

IMPORTANT NOTE: This equipment complies with IC radiation exposure limits set forth for an uncontrolled environment. This equipment should be installed and operated with minimum distance 20cm between the radiator and your body.

Canadian DOC Statement

DOC Class B Compliance—This Class B digital apparatus complies with Canadian ICES-003.

Observation des normes-Class B—Cet appareil numérique de la classe B est conforme à la norme NMB-003 du Canada.

German Compliance Statement

Noise emissions for this equipment do not exceed 70 dBa.

This equipment is not intended for use in the work place in accordance with BildscharbV regulations.

"Das Gerät ist nicht für die Benutzung am Bildschirmarbeitsplatz gemäß BildscharbV vorgesehen."



Caution: There is risk of explosion if the battery is replaced by an incorrect type. Dispose of used batteries according to the instructions. Contact your local Kodak representative or refer to www.kodak.com/go/recycle for additional information on the collection and recovery programs for batteries.

Achtung

Explosionsrisiko wenn die Batterie durch einen inkorrekten Typen ersetzt wird. Entsorgung der Batterie gemäss der Gebrauchsanweisung. Bitte kontaktieren Sie Ihren lokalen Kodak Repräsentanten oder www.kodak.com/go/recycle für mehr Informationen über das Sammeln und Wiederverwerten von Batterien.

Waste Electrical and Electronic Equipment Labeling



In the European Union, this symbol indicates that when the last user wishes to discard this product, it must be sent to appropriate facilities for recovery and recycling. Contact your local Kodak representative or refer to www.kodak.com/go/recycle for additional information on the collection and recovery programs available for this product.

Index

A

- Adjusting
 - Copy settings 25
 - Printer performance 50, 56
- Adjusting scan settings 30

B

- Bluetooth 21
 - Range 21
- Borderless 52

C

- Camera 42
- Communication 44
- Computer 44
- Control Panel 3
- Control Panel 19
- Copy Problems 53
- Copy settings
 - Adjusting 25
- Copying 25
- Cropped Pictures 49
- Customer Support See Support

D

- Dark Print 51
- DPOF ERGEFORMAT 20

E

- Envelopes 16

F

- FCC Compliance 68

H

- Help
 - Control Panel options 55
 - Home Center software 55
- Home Center 8
 - Stops working 47

I

- Ink Cartridge 42

J

- Jammed Paper 45

L

- LCD Screen 7
- Light Print 51

M

- Macintosh Troubleshooting
 - Black screen or screen freeze 47
- Maintenance 33
- Media 65
- Memory Cards 2, 3, 42
- Modifying See Adjusting
- Multiple originals
 - Scanning 30
- Multiple photo printing 21

P

- Panoramic photo paper, using 21
- Paper 46, 65
- Paper Feed 43, 44
- Paper Jam 45
- Paper Tray 13
- Photo Paper 16
- Photos
 - Cropping 22
 - Zooming 22
- PictBridge 48

PictBridge camera		
Printing photos from	19
Power	41
Print Order	20
Print Problems	48, 49, 50, 52
Print Quality	50
Print Smudged	49
Print Spotted	51
print troubleshooting	48
Printer not Responding	45
Printing		
from Bluetooth	21
Multiple photos	21
Panoramic photos	21
Photos		
PictBridge	19
PTP Camera	20
Tagged image photos	20
Q		
Quality Settings		
CityNormal	26
Quality settings		
Best	26
Draft	26
R		
Regulatory Compliance	68
S		
Safety	65
Same Size	26
Scale Percent	26
Scan Problems	53, 54
Scan settings		
Adjusting	30
Scanning	29
Multiple originals	30
Slow Printing	51
Support	55
System Requirements	64
T		
Tagged Images	20
Technical Support See Support		
Transfer	19, 46
Troubleshooting	41
Maintenance options	50, 56
U		
USB Port	5, 42
User Guide		
Outdated	46
V		
Vista troubleshooting	47
W		
Waste Labeling	68
White Edges	52
WIA error	47
Windows Vista troubleshooting		
WIA error	47
Z		
Zooming	22



1K3269

Rev D