

KODAK EASYSHARE MD41 Digital Camera

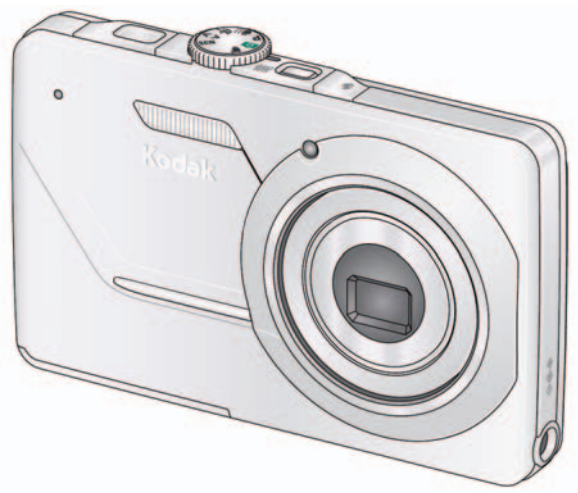

Extended user guide

www.kodak.com

For interactive tutorials:

www.kodak.com/go/howto

For help with your camera:

www.kodak.com/go/md41support

Kodak

Eastman Kodak Company
Rochester, New York 14650

© Kodak, 2009

All screen images are simulated.

Kodak, EasyShare, and Perfect Touch are trademarks of Eastman Kodak Company.

4H6612_en

Front view

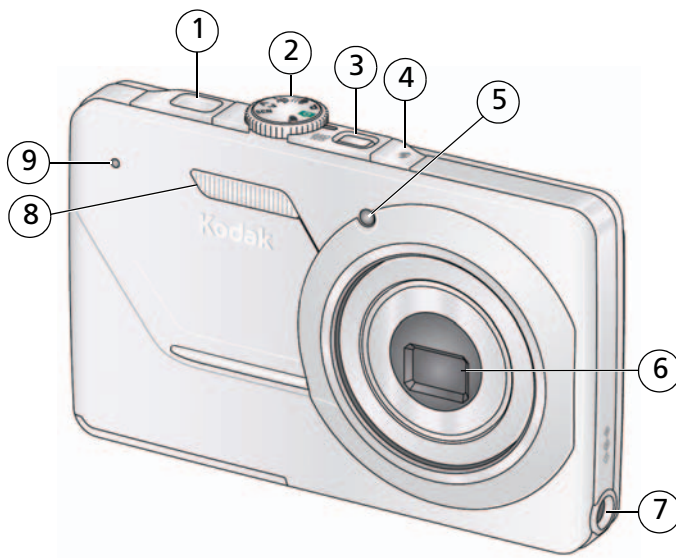

- | | | | |
|---|------------------|---|-----------------|
| 1 | Shutter button | 6 | Lens/Lens cover |
| 2 | Mode dial | 7 | DC-In (5V) |
| 3 | Power button | 8 | Flash |
| 4 | Flash button | 9 | Microphone |
| 5 | Self-timer light | | |

Back view

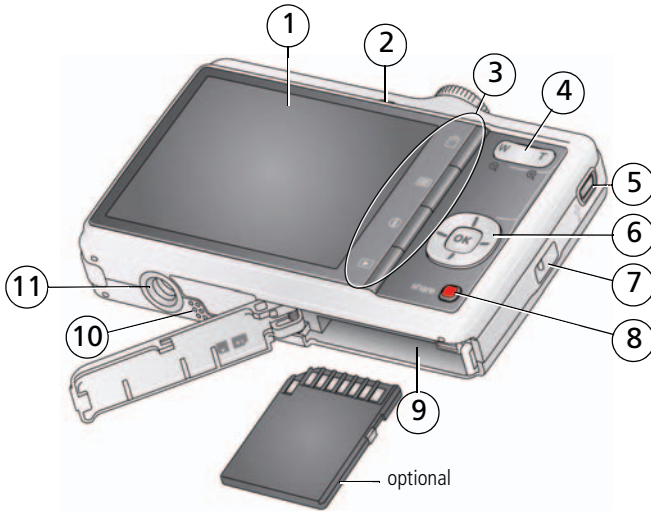

- | | | | |
|---|--|----|-----------------------------------|
| 1 | LCD | 7 | Strap post |
| 2 | Ready/Battery Charging light | 8 | Share button |
| 3 | Delete, Menu, Info, Review buttons | 9 | Battery, SD/SDHC Card compartment |
| 4 | Zoom (Telephoto/Wide Angle) button | 10 | Speaker |
| 5 | USB/AV Out | 11 | Tripod socket |
| 6 | 
OK button | | |

Table of contents

1	Setting up your camera	1
	Attaching the strap	1
	Loading the KLIC-7001 battery	1
	Charging the battery	2
	Turning on the camera	3
	Setting the language and date/time	3
	Storing pictures on an optional SD or SDHC Card	4
2	Taking pictures/videos	5
	Taking pictures	5
	Using the optical zoom	6
	Using the flash	7
	Using different modes	8
	Taking a video	10
	Using shortcuts	11
	Taking self-timer pictures	12
	Taking burst pictures	12
	Taking panoramic pictures	13
	Understanding the picture-taking icons	14
3	Working with pictures/videos	15
	Reviewing pictures/videos	15
	Deleting pictures/videos	16
	Viewing pictures/videos in different ways	17
	Selecting multiple pictures/videos	17
	Play a multimedia slide show	18
	Displaying pictures/videos on a television	19
	Using the menu button in review	20
	Understanding the review icons	25

4 Doing more with your camera	26
Using the menu button to change settings.....	26
Using the Setup menu	30
5 Transferring, printing, tagging	33
Installing the software.....	33
Transferring pictures/videos with the USB cable	34
Printing pictures.....	35
Marking/tagging your pictures.....	37
6 Getting help	41
Getting help from your camera	41
Troubleshooting	42
Getting help on the Web.....	46
7 Appendix	47
Camera specifications	47
Care and maintenance	49
Upgrading your software and firmware.....	49
Storage capacities.....	50
Important safety instructions	50
Battery replacement, battery life.....	51
Limited warranty.....	52
Regulatory compliance	54

1

Setting up your camera

IMPORTANT: *For package contents, see your product package.*

Attaching the strap



Loading the KLIC-7001 battery

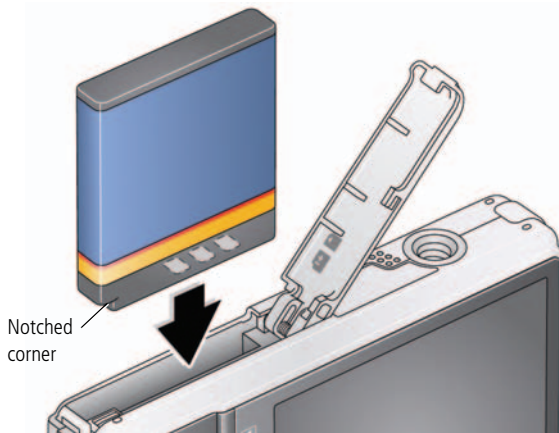

For information on replacing the battery and extending battery life, see [page 51](#).

Charging the battery

- 1 Turn off the camera.
- 2 Connect KODAK USB Cable, Model U-8 and adapter.

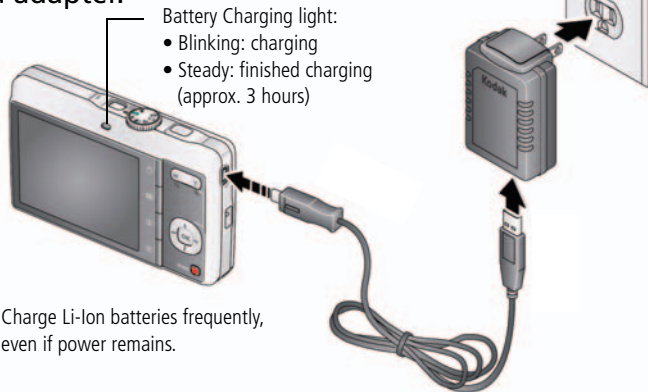

Using an optional KODAK 5V AC Adapter

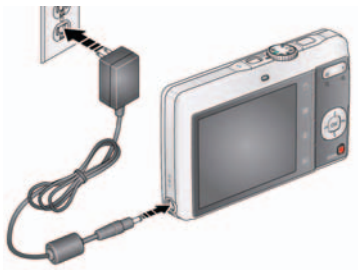

Learn more about batteries

See [page 51](#)

Purchase accessories

www.kodak.com/go/md41accessories

Turning on the camera

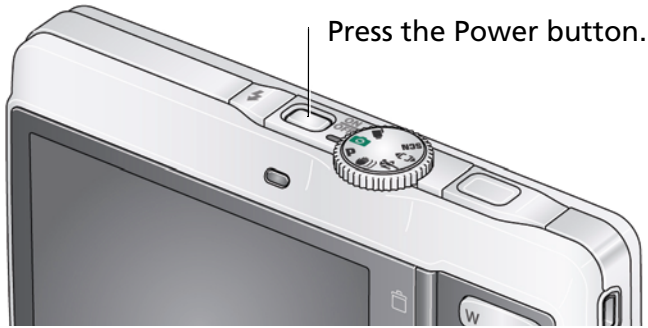

Setting the language and date/time

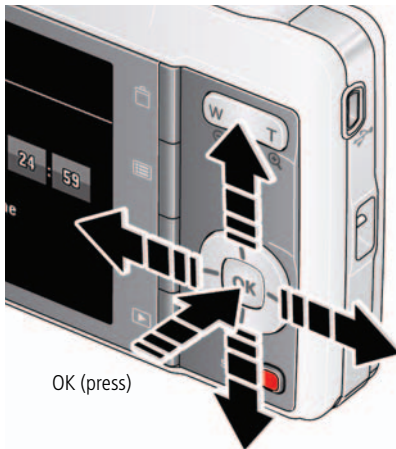

Language:
▲/▼ to change.
OK to accept.

Date/Time:
At the prompt, press OK.
▲/▼ to change current field.
◀/▶ for previous/next field.
OK to accept.

NOTE: To change language in the future, use the Setup Menu ([see page 30](#)).

Storing pictures on an optional SD or SDHC Card

Your camera has internal memory. You can purchase an SD or SDHC Card to conveniently store more pictures/videos.



CAUTION:

A card can only be inserted one way; forcing it may cause damage. Inserting or removing a card while the camera is on may damage the pictures, the card, or the camera.

- 1 Turn off the camera.
- 2 Insert or remove the optional card.
- 3 Turn on the camera.

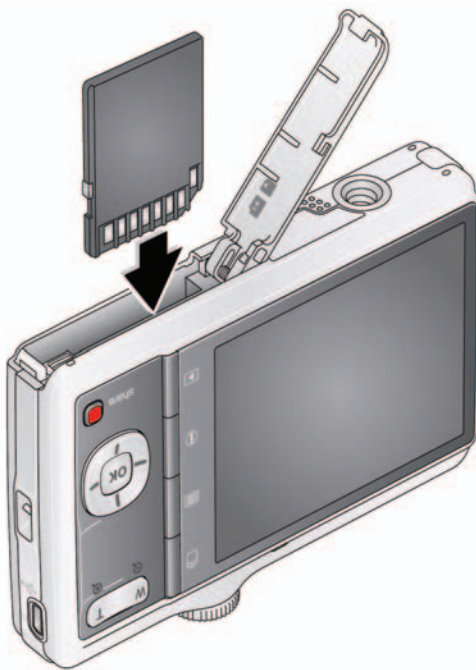

Purchase accessories www.kodak.com/go/md41accessories

2

Taking pictures/videos

Taking pictures

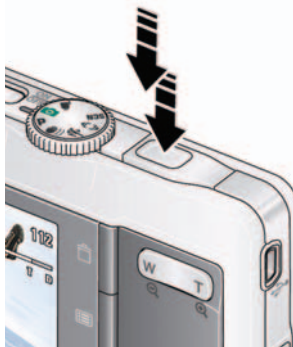

To get clear, focused pictures:

- 1 Turn the Mode dial to Smart Capture . Then press the Power button to turn on the camera.
- 2 Compose the picture.
- 3 Press the Shutter button **halfway** to focus and set exposure. When the framing marks turn green, press the Shutter button **completely down**.

Using the framing marks to ensure focused pictures

Framing marks indicate the camera focus area. In Smart Capture mode (and in SCN modes designed for pictures of people), the camera attempts to focus on faces.



- 1 Press the Shutter button **halfway**.
If the camera is not focusing on the desired subject, release the Shutter button and recompose the scene.
- 2 Press the Shutter button **completely down** to take the picture.

NOTE: Framing marks do not appear in all modes.

Reviewing the picture/video just taken

After you take a picture/video, the LCD briefly displays a quickview. (To exit the quickview sooner, press the Shutter button halfway.)



To review pictures/videos anytime, see [page 15](#).

Using the optical zoom

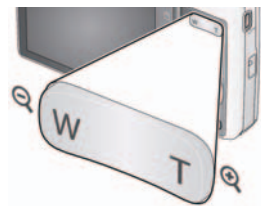

- 1 Use the LCD to frame your subject.
- 2 To zoom in, press Telephoto (T).
To zoom out, press Wide Angle (W).
- 3 Take the picture.

NOTE: For focus distances, see Specifications starting on [page 47](#).

Using digital zoom

Use digital zoom to get up to 5X magnification beyond optical zoom. (Digital zoom is not available in Smart Capture mode.) Press Telephoto (T) until the slider is at the end of the optical zoom range. Release Telephoto (T), then press it again.

NOTE: You may notice decreased image quality when using digital zoom. The slider pauses and turns red when the picture quality reaches the limit for an acceptable 4 x 6 in. (10 x 15 cm) print.

Using the flash

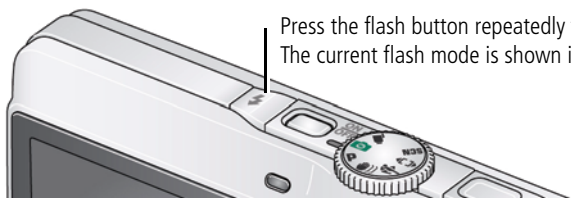





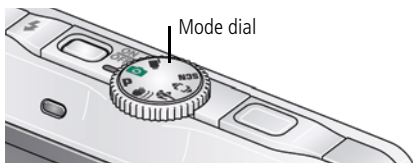

Press the flash button repeatedly to scroll through flash modes. The current flash mode is shown in the LCD status area.

Flash modes		Flash fires
Auto		When the lighting conditions require it.
Fill (Flash On)		Every time you take a picture, regardless of the lighting conditions. Use when the subject is in shadow or is "backlit" (when the light is behind the subject). NOTE: (Not available in Smart Capture mode.)
Red Eye Your camera can correct red-eye using 2 methods. To choose a red eye setting, see page 30 .	Preflash 	A preflash fires, shrinking the eye pupil, before the picture is taken.
	Digital Correction 	A preflash does not fire; the camera corrects red eye.
Off		Never

Using different modes

Turn the Mode dial to the mode that best suits your subjects and surroundings.



Use this mode	For
 Smart Capture	General picture taking—it offers excellent image quality and ease of use. <ul style="list-style-type: none">■ Faces are detected.■ The scene is analyzed for other content and for lighting. You can choose the best picture size and aspect ratio for your needs—just press the Menu  button and choose Picture Size. <ul style="list-style-type: none">■ 3:2 (the best choice when making 4 x 6 prints)■ 16:9 (wide screen)■ 4:3 (the default setting)
P Program	Advanced picture taking—allows more access to manual settings than Smart Capture.
 Blur Reduction	Reducing blur caused by camera shake or subject motion.
 Sport	Action pictures.
 Panorama	“Stitching” up to 3 pictures into a panoramic scene. (See page 13.)
SCN Scene	Point-and-shoot simplicity when taking pictures in practically any situation. (See page 9.)
 Video	Capturing video with sound. (See page 10.)

Using Scene (SCN) modes

Choose a Scene mode—for great pictures in practically any situation.

- 1 Turn the Mode dial to SCN.
- 2 Press to view scene mode descriptions.
If the mode description turns off before you finish reading it, press OK.
- 3 Press OK to choose a Scene mode.

SCN mode	For
Portrait	Full-frame portraits of people.
Landscape	Distant scenes.
Close-up	Close range (see Camera specifications, page 47).
Flower	Close-ups of flowers or other small subjects in bright light.
Sunset	Subjects at dusk.
Backlight	Subjects that are in shadow or “backlit” (when light is behind the subject).
Candle Light	Subjects illuminated by candle light.
Children	Action pictures of children in bright light.
Manner/ Museum	Quiet occasions, like a wedding or lecture. Flash and sound are disabled. Place the camera on a steady surface or tripod.
Text	Documents. Place the camera on a steady surface or tripod.
Beach	Bright beach scenes.
Snow	Bright snow scenes.
Fireworks	Fireworks. Place the camera on a steady surface or tripod.
Self-Portrait	Close-ups of yourself. Assures proper focus and minimizes red eye.
Night Portrait	Reduces red eye of people in night scenes or low-light conditions.
Night Landscape	Distant scenery at night. Flash does not fire.
Panning Shot	Emphasizing horizontal motion, keeping the foreground sharp.

SCN mode	For
High ISO	People indoors, in low-light scenes.

Taking a video



- 1 Turn the Mode dial to Video .
- 2 Press the Shutter button **completely down**, then release it. To stop recording, press and release the Shutter button again.

To review and work with videos, see [page 15](#).

Using shortcuts

Your camera has a clean, uncluttered interface. For quick access to the most popular capture and review functions:

- 1 Press the Info **i** button.

The shortcuts appear.

- 2 Press **◀/▶** to access functions like Exposure Compensation, Self-timer, and Auto focus. (You'll see different functions in different modes.)
- 3 Press **▲/▼** to choose a setting.

To hide the shortcuts again, press **i**.



Taking self-timer pictures

Use the self-timer when you want to be included in a picture, or to ensure a steady Shutter button press.



- 1 In any picture-taking mode, press the Info **i** button to show shortcuts.
- 2 Press **◀/▶** to highlight the Self-timer/Burst **🕒** icon. Press **▲/▼** to choose a setting:
 - 10 seconds**—A picture is taken after a 10-second delay (so you have time to get into the scene).
 - 2 seconds**—A picture is taken after a 2-second delay (for a steady, shutter release on a tripod).
 - 2 shot**—The first picture is taken after a 10-second delay. A second picture is taken 8 seconds later.

- 3 Compose the scene. Press the Shutter button **halfway**, then **completely down**.

The camera takes the picture/pictures after the delay.

NOTE: In Panoramic modes (page 13), only the 2- and 10-second options are available.

Use the same procedure to take a 2- or 10-second self-timer video.

Taking burst pictures

Use the Burst feature to take up to 4 pictures in quick succession.

NOTE: Burst is not available in all modes.

- 1 In any picture-taking mode, press the Info **i** button to show shortcuts.
- 2 Press **◀/▶** to highlight the Self-timer/Burst **🕒** icon. Press **▲/▼** to highlight Burst **📷**.
- 3 Compose the scene. Press the Shutter button **halfway**, then **hold completely down** while the camera takes up to 3 pictures.

Taking panoramic pictures

Use panorama to “stitch” up to 3 pictures into a panoramic scene.

NOTE: Only the panoramic picture is saved; individual pictures are not. (Exposure and white balance are set with the first picture. The flash is set to Off.)

- 1 Turn the Mode dial to **[P]**.
- 2 Press **◀/▶** **▲/▼** to highlight Panorama Left-Right or Panorama Right-Left (depending on the direction you want to pan), then press OK.
- 3 Take the first picture.

After a quickview, the LCD displays the liveview and an “overlay” from the first picture.

- 4 Compose the second picture. Make the overlay from the first picture cover the same portion in the new picture. (You can press the Delete button to re-take a picture.)
- 5 If you are taking only 2 pictures, press OK to stitch them together.

After you take 3 pictures, the pictures are automatically stitched together.

Take 2 or 3 pictures.



Get 1 panoramic picture.



NOTE: To use the self-timer 10-second or 2-second setting, see [page 12](#).

Understanding the picture-taking icons

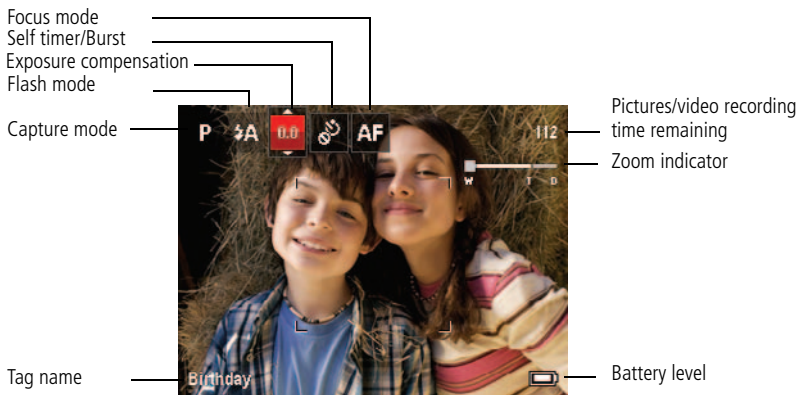

3

Working with pictures/videos



Reviewing pictures/videos

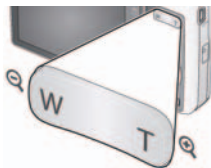

- 1 Press the Review  button.
- 2 Press  for previous/next picture/video.
 - To exit, press the Review button.
 - To view pictures/videos as thumbnails, press the Wide Angle (W) button. (For more, see [page 17.](#))

Magnifying a picture





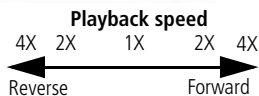

- 1 Press T to magnify 1X–8X.
- 2 Press    to view other parts of a picture.
 - Press OK to return to 1X.



Playing a video



Press OK to play a video. Press OK to pause/resume. During playback:

- Press  to adjust the volume.
 - Press  to play at 2X speed; press again for 4X.
 - Press  to reverse at 2X speed; press again for 4X.
- Press  while paused to play in slow motion.

Deleting pictures/videos





- 1 Press the Review  button.
- 2 Press  for previous/next picture/video.
- 3 Press the Delete button.
- 4 Follow the screen prompts.

NOTE: To delete protected pictures/videos, remove protection before deleting. (See [Protecting pictures/videos from deletion](#), below.)

Using the undo delete feature

If you accidentally delete a picture, you may be able to use Undo Delete to retrieve it. This feature is only available immediately after you delete a picture.

Protecting pictures/videos from deletion

- 1 Press the Review  button.
- 2 Press  for previous/next picture/video.
- 3 Press the Menu  button.
- 4 Press  to highlight Protect, then press OK.

The picture/video is protected and cannot be deleted. The Protect icon  appears with the protected picture/video.

- Press the Menu  button to exit the menu.

IMPORTANT: Your camera offers a built-in Help system. See [page 41](#).

CAUTION:

Formatting internal memory or an SD or SDHC Card deletes all (including protected) pictures/videos. (Formatting internal memory also deletes email addresses and tag names. To restore them, see KODAK EASYSHARE Software Help.)

Viewing pictures/videos in different ways

Viewing as thumbnails (multi-up)

- 1 Press the Review  button.

The camera shows the last picture that was taken.

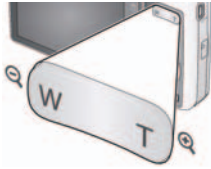

- 2 Press the Wide Angle (W) button to view pictures/videos as thumbnails. (Press it again to see more, smaller thumbnails.)

To view all pictures/videos, highlight the All tab.

To sort by favorites, date, or tagged pictures/videos, press  and highlight the appropriate tab.

- 3 To see a single picture/video, press  to highlight it. Then press the Telephoto (T) button.

- To select multiple pictures/videos, see [Selecting multiple pictures/videos](#).
- Press the Review button to exit Review.

Selecting multiple pictures/videos

Use the multi-select feature when you have two or more pictures/videos to print, transfer, delete, etc. Multi-select is used most effectively in Multi-Up mode, [Viewing as thumbnails \(multi-up\)](#).

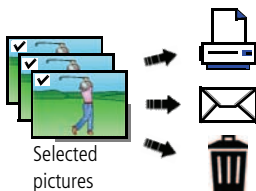





- 1 Press the Review  button, then  to find a picture/video.
- 2 Press OK to select pictures/videos.

A check mark appears on the picture. You can now print, transfer, delete, etc. the selected pictures. You can press OK again to remove a check mark.

Play a multimedia slide show







To show all pictures/videos

- 1 Press the Review  button.
- 2 Press the Menu  button, then  to highlight the Review tab.
- 3 Press  to highlight Multimedia Slide Show, then press OK.
- 4 Press  to highlight Preview Slide Show, then press OK.



All pictures/videos are displayed. To interrupt the slide show, press OK. After the slide show plays, you may save or modify it.

IMPORTANT: Your camera offers a built-in Help system. See [page 41](#).

To show selected pictures/videos

- 1 Press the Review  button.
- 2 Press the Menu  button, then  to highlight the Review tab.
- 3 Press  to highlight Multimedia Slide Show, then press OK.
- 4 Press  to highlight Select Images, then press OK.
- 5 Press  to locate a picture/video, then press OK.

A checkmark appears.

Press  to and OK to add more pictures/videos. When finished, press  to highlight Done, then press OK.

- 6 Press  to highlight Preview Slide Show, then press OK.

Selected pictures/videos are displayed. To interrupt the slide show, press OK. After the slide show plays, you may save or modify it.

Displaying pictures/videos on a television



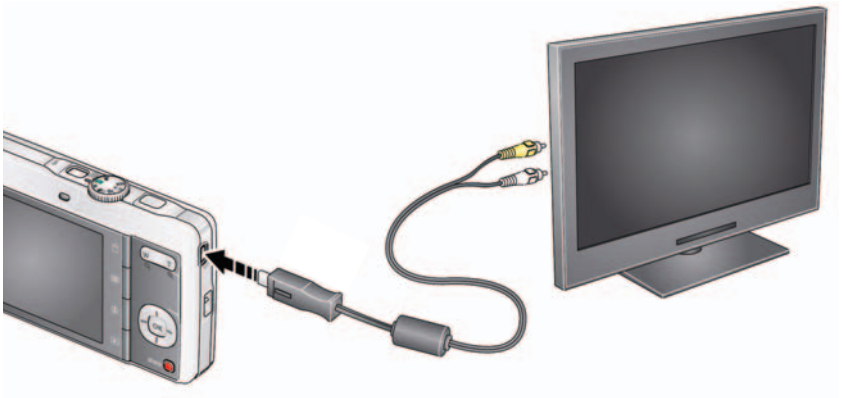

You can display pictures/videos on a television, computer monitor, or any device equipped with a video input. To connect the camera directly to a television, use an A/V cable (may be sold separately).



Purchase accessories www.kodak.com/go/md41accessories

NOTE: Ensure that the Video Out setting (NTSC or PAL) is correct (see page 31). The slide show stops if you connect or disconnect the cable while the slide show is running. (Image quality on a television screen may not be as good as on a computer monitor or when printed.)





Using the menu button in review

- 1 Press the Review  button, then the Menu  button.
- 2 Press  to highlight a tab:
 - **Review**
 - **Edit**
 - **Setup**
- 3 Press  to highlight a setting, then press OK.
- 4 Highlight an option, then press OK.

IMPORTANT: *Your camera offers a built-in Help system. See page 41.*

Adding a date stamp to pictures

You can imprint a date stamp on pictures.





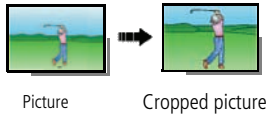

- 1 Press the Review  button.
- 2 Press  to locate a picture.
- 3 Press the Menu  button, then  to highlight the Edit tab.
- 4 Press  to highlight Add Date Stamp, then press OK.
- 5 Follow the prompts to save the stamped picture.

NOTE: To remove a date stamp, crop it or use an image editing program. You cannot add a date stamp to Panoramic pictures or videos. To set the camera's date/time, see page 3.

Cropping pictures

You can crop a picture so that only the desired portion of the picture remains.



- 1 Press the Review  button, then  to find a picture to crop.
- 2 Press the Menu  button, then  to highlight the Edit tab. Highlight Crop, then press OK.
- 3 Press Telephoto (T) to zoom in, or   to move the crop box. Press OK.
- 4 Follow the screen prompts.







The picture is cropped. (The original is saved.) Cropped pictures cannot be cropped again on the camera.

- Press the Review  button to exit review.

IMPORTANT: *Your camera offers a built-in Help system. See page 41.*

Using KODAK PERFECT TOUCH Technology







KODAK PERFECT TOUCH Technology helps ensure better, brighter pictures. PERFECT TOUCH Technology is automatically applied to pictures taken in Smart Capture mode. (You cannot apply PERFECT TOUCH Technology to videos, panoramic pictures, or pictures to which PERFECT TOUCH Technology is already applied.)

- 1 Press the Review  button, then  for previous/next picture.
 - 2 Press the Menu  button, then  to highlight the Edit tab. Highlight PERFECT TOUCH Tech, then press OK.
The enhancement is previewed. Press   to view other parts of the picture.
 - 3 Press OK. Follow the screen prompts to replace the original picture or to save the enhanced picture as a new one.
- Press the Review  button to exit review.

Copying pictures/videos

You can copy pictures/videos from a card to internal memory or from internal memory to a card.

Copy pictures/videos:

- 1 Press the Review  button.
- 2 Press the Menu  button, then   to highlight the Edit tab.
- 3 Press   to highlight Copy, then press OK. Highlight a choice, then press OK.

NOTE: Pictures/videos are copied, not moved. To remove pictures/videos from the original location after copying, delete them (see [page 16](#)).

IMPORTANT: *Your camera offers a built-in Help system. See [page 41](#).*





Editing videos

You can do incredible things with your videos.

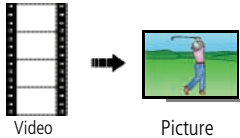
Making a picture from a video

You can choose a single frame from a video, then make a picture suitable for a 4 x 6-inch (10 x 15 cm) print.







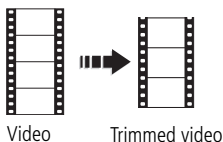

- 1 Press the Review  button, then  to find a video.
- 2 Press the Menu  button, then  to highlight the Edit tab. Highlight Make Picture, then press OK.
- 3 Follow the screen prompts.
A picture is created. (The original video is saved.)
 - Press the Review  button to exit review.

IMPORTANT: Your camera offers a built-in Help system. See [page 41](#).

Trimming a video

You can remove an unwanted start or end from a video, saving only the desired portion.





- 1 Press the Review  button, then  to find a video.
- 2 Press the Menu  button, then  to highlight the Edit tab. Highlight Trim, then press OK.
- 3 Follow the screen prompts.
The video is trimmed. (You can save it as a new video or replace the original.)
 - Press the Review  button to exit review.

Making a video action print

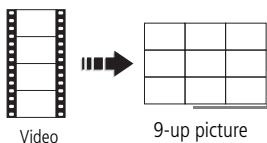
From a video, you can make a 9-up picture, suitable for a 4 x 6-inch (10 x 15 cm) print.



- 1 Press the Review  button, then  to find a video.
- 2 Press the Menu  button, then  to highlight the Edit tab. Highlight Action Print, then press OK.
- 3 Highlight an option, then press OK.

Auto—The camera includes the first and last frames, then 7 equally spaced frames.

Manual—Choose the first and last frames; the camera chooses 7 frames.

A 9-up picture is created.

- Press the Review  button to exit review.

IMPORTANT: *Your camera offers a built-in Help system. See page 41.*

Understanding the review icons

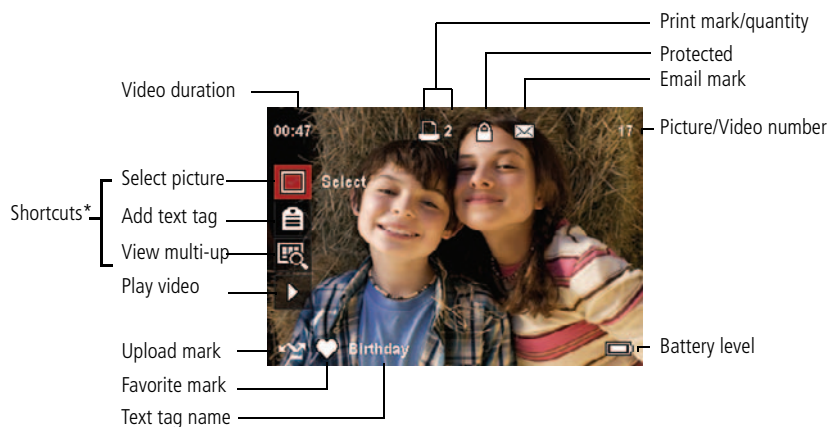

* For more about shortcuts, see [page 11](#).

4





Doing more with your camera

IMPORTANT: *Your camera offers a built-in Help system. To get the most from your camera, [See page 41](#).*

Using the menu button to change settings

You can change settings to get the best results from your camera.

NOTE: Some modes offer limited settings. Some settings remain until you change them; others, until you change modes or turn off the camera.

- 1 Press the Menu  button.
- 2 Press   to highlight a tab:
 - **Capture/Video** for the most common picture- and video-taking settings
 - **Setup** for other camera settings
- 3 Press   to highlight a setting, then press OK.
- 4 Highlight an option, then press OK.

Using the capture tab

Press Menu,  ,  , **Picture-taking Options** and OK to access settings

IMPORTANT: *Your camera offers a built-in Help system. [See page 41](#).*

Exposure Compensation 0.0, +/-0.3, +/-0.7, +/-1.0, +/-1.3, +/-1.7, +/-2.0

Make a picture lighter or darker. (Available in Program and Panorama modes.) To use a shortcut, see [page 11](#).

Press Menu, , , , , and OK to access settings

Picture-taking Options

IMPORTANT: *Your camera offers a built-in Help system. See page 41.*

Picture Size

Choose a picture resolution and aspect ratio.

See [Camera specifications, page 47](#).

Focus Mode

Choose a focus mode that matches your subject's distance.

Auto—For general picture-taking.

Macro—For sharpness and detail in pictures at close range. Use available light instead of flash, if possible. The camera automatically sets the focus distance depending on the zoom position.

Infinity—For distant subjects; auto-focus framing marks are unavailable.

Long Time Exposure

Choose how long the shutter stays open.

Off

0.5, 1.0, 2.0, 4.0, 8.0 seconds

Color Mode

Choose color tones.

Unavailable in Video mode.

High Color

Natural Color

Low Color

Black & White

Sepia—For a reddish-brown, antique look.

NOTE: EASYSHARE Software also lets you change a color picture to black-and-white or sepia.

AF Control (Still)

Choose an auto-focus setting.

Continuous AF—Because the camera is always focusing, there is no need to press the Shutter button halfway down to focus.

Single AF—Camera focuses when the Shutter button is pressed halfway down.

Press Menu, , , , , and OK to access settings

Picture-taking Options

IMPORTANT: *Your camera offers a built-in Help system. See page 41.*

White Balance

Choose your lighting condition. (Available only in Program and Panorama modes.)

Auto—Automatically corrects white balance. Ideal for general picture taking.

Daylight—For pictures in natural lighting.

Tungsten—Corrects the orange cast of incandescent light bulbs. Ideal for indoor pictures under tungsten or halogen lighting without flash.

Fluorescent—Corrects the green cast of fluorescent lighting. Ideal for indoor pictures under fluorescent lighting without flash.

Open Shade—For pictures in shade in natural lighting.

Face Detect Capture

Choose if faces get focus priority.

On—In P mode (and in SCN modes designed for pictures of people), the camera attempts to focus on faces.

Off

NOTE: Not available in Smart Capture mode (because face detection is always on).

Exposure Metering

Evaluate light levels at specific areas of a scene.

Multi-Pattern—Evaluates lighting conditions throughout the image to give an optimum picture exposure. Ideal for general picture taking.

Center-Weight—Evaluates the lighting conditions of the subject centered in the lens. Ideal for backlit subjects.





Center-Spot—Similar to Center-weight, except the metering is concentrated on a smaller area of the subject centered in the LCD.

AF Zone





Select a large or concentrated area of focus.

Multi-Zone—Evaluates 5 zones to give an even picture focus. Ideal for general picture taking.

Center-Zone—Evaluates the small area centered in the lens. Ideal when you need precise focus.







Press Menu, , , , , and OK to access settings		Picture-taking Options IMPORTANT: <i>Your camera offers a built-in Help system. See page 41.</i>
ISO Speed Control the sensitivity of the camera sensor.	Auto —For general picture taking (ISO 80–320). ISO 80, 100, 200, 400, 800, 1000	
Sharpness Control picture sharpness or softness.	Sharp Normal Soft	
Self-timer/Burst See page 12.	10-second 2-second 2-shot Burst	





Using the Video tab (while in Video mode)





Press Menu, , , , , and OK to access settings		Video-taking Options IMPORTANT: <i>Your camera offers a built-in Help system. See page 41.</i>
Video Size Choose a video resolution.	See Camera specifications, page 47.	
AF Control Choose an auto-focus setting.	Continuous AF —Camera is always focusing. Single AF —Camera focuses once, when the Shutter button is pressed.	
Self-timer See page 12.	10-second 2-second	

Using the Setup menu

Use Setup to customize other camera settings.

Press Menu,   to highlight Setup, then   to access settings	Setup Options IMPORTANT: <i>Your camera offers a built-in Help system. See page 41.</i>
LCD Brightness Choose LCD brightness.	High Power Power Save
Share button Choose how pictures/videos are handled when you press the Share button. NOTE: Some online services limit video file sizes. Use EASYSHARE Software to choose a preferred online service.	Favorite and Upload —Pictures/videos are marked as Favorites and uploaded to your preferred online service when you connect to your computer or network. Favorite —Pictures/videos are marked as Favorites (5-star in EASYSHARE Software, on your computer). Upload —Pictures/videos are uploaded to your preferred online service when you connect to your computer or network.
Set Tag Create tag names and assign them to pictures/videos. See page 39 .	On —Create a tag. Off
Red Eye Reduction Choose how you want to reduce red eye.	Preflash —Red eye preflash fires before the picture is taken.  Digital Correction —Red eye preflash does not fire; the camera digitally corrects red eye. 
Orientation Sensor Orient pictures/videos so that they are displayed with the correct side up.	On —The camera rotates pictures to their correct orientation. On Transfer —Pictures are rotated when transferred to EASYSHARE Software. Off —Pictures are not rotated.

<p>Press Menu,   to highlight Setup, then   to access settings</p>	<p>Setup Options IMPORTANT: <i>Your camera offers a built-in Help system. See page 41.</i></p>
<p>Camera Sounds Choose sound volume and on/off for each function.</p>	<p>Volume (High, Medium, Low) Power On (On/Off) Focus Lock (On/Off) Shutter (On/Off) Error (On/Off) Self-timer (On/Off)</p>
<p>Date & Time</p>	<p>Set date and time.</p>
<p>Video Out Choose the regional setting that lets you connect the camera to a television or other external device.</p>	<p>NTSC—Used in North America and Japan; most common format. PAL—Used in Europe and China.</p>
<p>Image Storage Choose a storage location for pictures/videos.</p>	<p>Auto—The camera uses the card if one is in the camera. If not, the camera uses internal memory. Internal Memory—The camera always uses internal memory, even if a card is installed.</p>
<p>Language</p>	<p>Choose your language.</p>
<p>Reset Camera Reset settings to their default.</p>	
<p>Format</p> <p> CAUTION: Formatting deletes all pictures/videos, including those that are protected. Removing a card during formatting may damage the card.</p>	<p>Memory Card—Deletes everything on the card; formats the card. Cancel—Exits without making a change. Internal Memory—Deletes everything in internal memory including email addresses, and tag names; formats the internal memory.</p>

Press Menu,   to highlight
Setup, then   to access settings

Setup Options

IMPORTANT: *Your camera offers a built-in Help system. [See page 41.](#)*

About

View camera information.

5

Transferring, printing, tagging



CAUTION:

Before connecting any cables, install the software that was included with your camera. Failure to do so may cause the software to load incorrectly.

Installing the software

- 1 Close all open software applications before starting the installation.

NOTE: If running WINDOWS OS and installing EASYSHARE Software from the Kodak Web site, do not close the WinZip application. If prompted, allow EASYSHARE Software to access the Internet.

- 2 Place the KODAK EASYSHARE Software CD into the CD-ROM drive.

- 3 Load the software:

WINDOWS OS—if the install window does not appear, choose Run from the Start menu and type **d:\setup.exe** where **d** is the drive letter that contains the CD.

MAC OS X—double-click the CD icon on the desktop, then click the Install icon.

- 4 Follow the on-screen instructions to install the software.

NOTE: When prompted, register your camera and software. Registering lets you sign up for information that keeps your system up-to-date. To register later, visit www.kodak.com/go/register.

- 5 If prompted, restart the computer.

Software help

Click the Help button in EASYSHARE Software

Transferring pictures/videos with the USB cable

Using the USB cable

- ① Turn off the camera.
- ② Connect a KODAK USB Cable, Model U-8.
- ③ Turn on the camera.

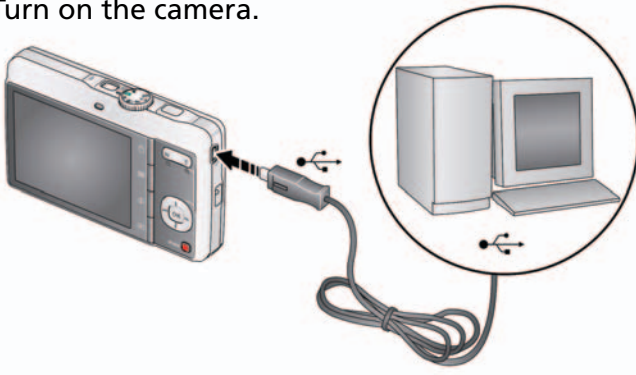

Using other options

You can also use a card reader to transfer your pictures/videos.

Purchase accessories www.kodak.com/go/md41accessories

Learn more about connecting www.kodak.com/go/howto

Printing pictures

Direct printing with a KODAK All-in-One Printer

Your camera is compatible with PICTBRIDGE Technology, so you can print directly to PICTBRIDGE enabled printers. You need a camera with fully charged battery, a PICTBRIDGE enabled printer, and a USB cable.

Connecting the camera to a KODAK All-in-One Printer

- 1 Turn **off** the printer. Turn **on** the camera.
- 2 Connect the appropriate USB cable from the camera to the printer. Turn on the printer.

The PICTBRIDGE logo is displayed, followed by the current picture and menu. (If no pictures are found, a message is displayed.) If the menu turns off, press any button to redisplay it.

- 3 Highlight a printing option, then press OK.

Current Picture—Press ◀/▶ to choose a picture. Choose the number of copies.

Marked Pictures—Print pictures that you marked for printing and choose a print size.

Index Print—Print thumbnails of all pictures. (This option requires one or more sheets of paper.) If the printer is capable, choose a print size.

All Pictures—Print all pictures in internal memory or on a card. Choose the number of copies.

Image Storage—Access Auto or Internal Memory.

NOTE: During direct printing, pictures are not permanently transferred or saved to the printer. To transfer pictures to your computer, see [page 34](#).

Purchase cables, accessories www.kodak.com/go/md41accessories

Disconnecting the camera from a KODAK All-in-One Printer

- 1 Turn off the camera and printer.
- 2 Disconnect the USB cable from the camera and the printer.

Using a printer that is not PICTBRIDGE enabled

After you transfer pictures from the camera to your computer, you can print them from EASYSHARE Software. For details, see Help in EASYSHARE Software.

Ordering prints online

KODAK Gallery (www.kodakgallery.com) is one of the many online print services offered in EASYSHARE Software. You can easily:

- Upload your pictures.
- Edit, enhance, and add borders to your pictures.
- Store pictures, and share them with family and friends.
- Have prints, photo greeting cards, frames, and albums delivered to your door.

Printing from an optional SD or SDHC Card







- Automatically print marked pictures when you insert your card into a printer with an SD/SDHC Card slot. See your printer user's guide for details.
- Make prints at an SD/SDHC Card-capable KODAK Picture Kiosk. Visit www.kodak.com/go/picturemaker.
- Take the card to your local photo retailer for professional printing.





Marking/tagging your pictures

You can mark your pictures so they are easy to:

- Print
- Email
- Organize with a favorite mark
- Organize with a tag name that you create

Marking pictures for printing

- 1 Press the Review  button. Press   to locate a picture.
- 2 Press the Menu  button.
- 3 Press   to highlight Print, then press OK.
- 4 Press   to select the number of copies.

Optional: You can apply a print quantity to other pictures. Press   for previous/next. Keep the print quantity as is, or press   to change it. Repeat this step until the desired print quantity is applied to each picture.

- 5 Press OK.

The Print icon appears in the status area.

- Press the Review  button to exit review.









IMPORTANT: *Your camera offers a built-in Help system. See page 41.*

Printing marked pictures

When you transfer the marked pictures to your computer, the EASYSHARE Software print screen opens. For details on printing, see Help in EASYSHARE Software.

Marking pictures/videos for emailing

First, create a new email address: highlight Add Email, press OK, then use the on-camera keyboard.

- 1 Press the Review  button. Press   to locate a picture.
- 2 Press the Menu  button.
- 3 Press   to highlight Email, then press OK.
- 4 Press   to locate an email address, then press OK.

To mark other pictures/videos with the same address, scroll through them. When the picture you want is displayed, press OK.

To send the pictures/videos to more than one address, repeat step 3.

- To remove a selection, highlight a checked address and press OK. To remove all email selections, highlight Clear All, then press OK.
- Press the Review  button to exit review.

The Email icon appears in the status area.

When you transfer the marked pictures/videos to your computer, EASYSHARE Software prompts you to send the pictures/videos. For details, see Help in EASYSHARE Software.

IMPORTANT: *Your camera offers a built-in Help system. See page 41.*

Assigning the favorite mark to pictures/videos



To make your favorite pictures/videos easier to locate in EASYSHARE Software, you can assign the favorite mark.

- 1 Press the Share button, then locate a picture/video.
- 2 Highlight Favorite, then press OK.

The favorite icon appears with the picture. When you transfer the marked pictures/videos to your computer, EASYSHARE Software opens and categorizes your favorite pictures/videos.

Assigning text tags to pictures/videos

First, create a new tag name: highlight New Tag, press OK, then use the on-camera keyboard.

- 1 Press the Review  button, then locate a picture/video.
- 2 Press the Menu  button.
- 3 Highlight Tag, then press OK.
- 4 Highlight a tag name, then press OK.

To assign the tag to other pictures, press  to locate a picture, then press OK.

The tag name appears with the picture.

To remove a selection, highlight a tag name and press OK. To remove all tag selections, highlight Clear All, then press OK.

When you transfer the tagged pictures/videos to your computer, EASYSHARE Software opens and categorizes your pictures/videos with the appropriate tag.

IMPORTANT: *Your camera offers a built-in Help system. See page 41.*

Assigning a tag to pictures/videos you take next

Use the Set Tag feature to assign a tag name to the next pictures/videos you take. First, create a new tag name: highlight New Tag, press OK, then use the on-camera keyboard.

- 1 Press the Menu  button.
- 2 Highlight the Setup tab.
- 3 Highlight Set Tag, then press OK.
- 4 Highlight a tag name, then press OK.
- 5 Press the Menu button to exit the menu.

The selected tag is displayed on the LCD.

When you transfer the tagged pictures/videos to your computer, EASYSHARE Software opens and categorizes your pictures/videos with the appropriate tag.

IMPORTANT: *Your camera offers a built-in Help system. See [page 41](#).*

6

Getting help

Getting help from your camera

You want the most from your camera. You want to understand:

- What it can do for you
- And how to take the best possible pictures and videos

Great news!

Your camera offers a built-in Help system. It describes every setting for every menu choice. If you learn nothing else about your camera, learn how to use on-camera Help. Because the more you know your camera, the more confident you become.

Turning on camera Help

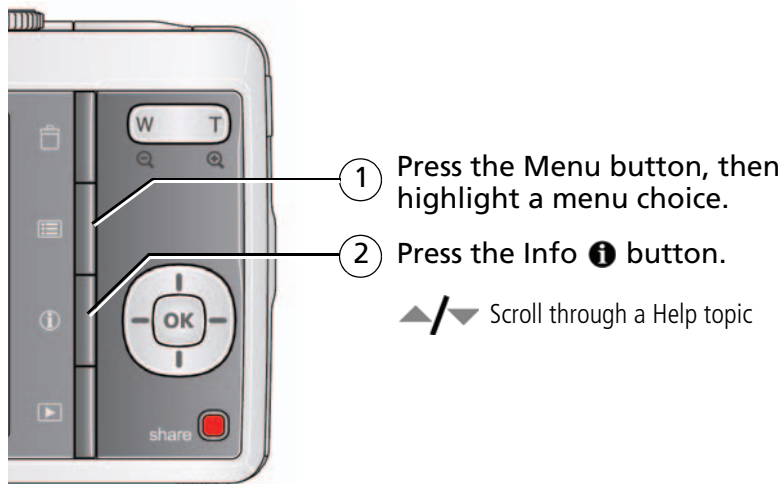

Troubleshooting

Camera problems

Status	Solution
Camera does not turn on	■ Make sure the battery is charged and installed correctly (see page 1).
Camera does not turn off	
Camera buttons and controls do not function	
In Review, a blue or black screen is displayed instead of a picture	■ Transfer <i>all</i> pictures to the computer (see page 34). ■ Take another picture.
Pictures remaining number does not decrease after taking a picture	■ Continue taking pictures. The camera is operating normally. (The camera estimates the number of pictures remaining after each picture is taken, based on picture size and content.)
Flash does not fire	■ Check the flash setting, and change as needed (see page 7). NOTE: The flash does not fire in all modes.
Memory card is almost or entirely full	■ Transfer the pictures to the computer (see page 34). ■ Delete pictures from the card (see page 16) or insert a new card.
Battery life is short	■ Make sure the correct battery type is installed (see page 51). ■ Wipe the contacts with a clean, dry cloth before inserting a battery in the camera. ■ Insert a new or charged battery (see page 1).

Status	Solution
You cannot take a picture	<ul style="list-style-type: none"> ■ Turn the camera off, then on again. ■ Depress the Shutter button all the way (see page 5). ■ Insert a new or charged battery (see page 1). ■ Memory is full. Transfer pictures to the computer (see page 34), delete pictures (see page 16), or insert another card.
Memory card not recognized or camera freezes with card	<ul style="list-style-type: none"> ■ Card may be corrupted. Format the card in the camera (see page 31). ■ Use another memory card. Only SD or SDHC Cards are supported.
Cannot find the desired picture/video	<ul style="list-style-type: none"> ■ To view pictures on a card or in internal memory, see page 15.

Computer/connectivity problems

Status	Solution
Pictures do not transfer to computer	<ul style="list-style-type: none"> ■ See Help in EASYSHARE Software.
Slide Show does not run on an external video device	<ul style="list-style-type: none"> ■ Adjust the camera Video Out setting to NTSC or PAL (see page 31). ■ Make sure the external device settings are correct. (See the device's user's guide).
Computer does not communicate with the camera	<ul style="list-style-type: none"> ■ Make sure the battery is charged and installed correctly (see page 1). ■ Turn on the camera. ■ Make sure the USB cable model U-8 is connected to the camera and the computer (see page 34). ■ Make sure EASYSHARE Software is installed (see page 33).

Picture quality problems

Status	Solution
Picture is not clear	<ul style="list-style-type: none">■ To automatically set exposure and focus, press the Shutter button halfway. When the framing marks turn green, press the Shutter button completely down to take the picture.■ Clean the lens (see page 49).■ Make sure the camera is not in Macro focus if you are more than 27.6 in. (70 cm) from your subject (see page 27).■ Place the camera on a flat, steady surface or use a tripod (especially in high-zoom settings or in low light).■ Use a larger picture size (see page 27).■ If you're manually adjusting the ISO speed, realize that high ISO setting may cause grainy pictures (see page 29).
Picture is too dark	<ul style="list-style-type: none">■ Reposition the camera for more available light.■ Use Fill flash (see page 7) or change your position so light is not behind the subject.■ Move so that the distance between you and the subject is within the effective flash range. (See camera specifications starting on page 47.)■ To automatically set exposure and focus, press the Shutter button halfway. When the framing marks turn green, press the Shutter button completely down to take the picture.
Picture is too light	<ul style="list-style-type: none">■ Reposition the camera to reduce the amount of available light.■ Turn the flash off (see page 7).■ Move so that the distance between you and the subject is within the effective flash range. (See camera specifications starting on page 47.)■ To automatically set exposure and focus, press the Shutter button halfway. When the framing marks turn green, press the Shutter button completely down to take the picture.■ In Program and Panorama modes, adjust the Exposure Compensation (see page 26).

Direct printing (PICTBRIDGE enabled printer) problems

Status	Solution
Cannot find the desired picture	■ Use the Direct printing menu to change the image storage location (see page 35).
The Direct printing menu interface turns off	■ Press any camera button to redisplay the menu.
Cannot print pictures	■ Make sure there is a connection between the camera and the printer (see page 34). ■ Make sure the printer and the camera have power.
Camera or printer display an error message	■ Follow the prompts to resolve the issue.

Getting help on the Web

Camera

Email, write, or phone Kodak	www.kodak.com/go/contact
Get support for your product (FAQs, troubleshooting information, arrange for repairs, etc.)	www.kodak.com/go/md41support
Purchase camera accessories (lenses, cards, etc.)	www.kodak.com/go/md41accessories
Download the latest camera firmware and software	www.kodak.com/go/md41downloads
See online demonstrations of your camera	www.kodak.com/go/howto
Register your camera	www.kodak.com/go/register

Software

Get information on EASYSHARE Software	www.kodak.com/go/easysharesw (or see Help in EASYSHARE Software)
Get help with the WINDOWS OS and working with digital pictures	www.kodak.com/go/pcbasics

Other

Get support for cameras, software, accessories, more	www.kodak.com/go/support
Get information on KODAK Inkjet Products	www.kodak.com/go/inkjet
Optimize your printer for truer, more vibrant colors	www.kodak.com/go/onetouch

Camera specifications

CCD—1/2.33-type

Effective pixels—12.2 MP (4024 x 3022)

LCD—2.7 in. (6.9 cm) LCD; 230K pixels

Image storage—Optional SD/SDHC Card  (The SD logo is a trademark of the SD Card Association.) Maximum supported card size: 32 GB

Internal storage capacity—32 MB internal memory (24 MB available for image storage. 1 MB equals one million bytes.)

Taking lens—3X optical zoom; f/3.1–f/5.7; 35 mm equivalent: 35–105 mm

Lens protection—Built-in

Digital zoom—5X continuous

Focus system—TTL-AF (through-the-lens auto focus); Auto: Multi-Zone, Center-Zone. Working range:

60 cm (23.6 in.)–infinity @ wide, normal

10–70 cm (3.9–27.6 in.) @ wide, Macro mode

60 cm (23.6 in.)–infinity @ telephoto, Normal

60–70 cm (23.6–27.6 in.) @ telephoto, Macro mode

10 m (32.8 ft)–infinity @ wide, Landscape mode

Auto focus control—Continuous and Single AF

Face detection—Up to 5 faces

Shutter speed—1/1400–8 seconds (Long Time Exposure up to 8 seconds)

ISO speed—Auto (in Smart Capture): 80–250; Manual: 80, 100, 200, 400, 800, 1000

Exposure metering—TTL-AE; Multi-Pattern, Center-Weight, Center-Spot

Exposure compensation—+/-2.0 EV with 1/3 EV step

White Balance—Auto, Daylight, Tungsten, Fluorescent, Open Shade

Electronic Flash—Auto flash; Auto, Fill, Red Eye, Off; Guide No.7; working range @ ISO 250: 0.6–3.5 m (2–11.5 ft) @ wide; 0.6–2.0 m (2–6.6 ft) @ telephoto

Burst mode—Maximum 4 pictures @ 1.5 fps; Auto Exposure, Auto Focus, Auto White Balance executed for first shot only

Capture modes—Smart Capture, Program, Blur Reduction, Sport, Panorama, Scene modes, Video

Image file format—

Still: EXIF 2.21 (JPEG compression); file organization DCF

Video: QUICKTIME (CODEC Motion JPEG; audio: G.711)

Picture size—12.0 MP (4:3): 4000 x 3000 pixels

10.7 MP (3:2): 4000 x 2666 pixels

9.0 MP (16:9): 4000 x 2250 pixels

6.2 MP (4:3): 2888 x 2160 pixels

3.1 MP (4:3): 2048 x 1536 pixels

2.2 MP (3:2): 1800 x 1200 pixels

2.1 MP (16:9): 1920 x 1080 pixels

1.2 MP (4:3): 1280 x 960 pixels

Color modes—High Color, Natural Color, Low Color, Black & White, Sepia

Sharpness modes—High, Normal, Low

Video capture—80 minutes maximum

VGA (640 x 480 @ 30 fps)

QVGA (320 x 240 @ 30 fps)

Video blur reduction—Yes

Communication with computer—USB 2.0 high speed (PIMA 15740 protocol); via KODAK USB Cable, Model U-8

Video output—NTSC or PAL

Microphone—Yes

Speaker—Yes

PICTBRIDGE support—Yes

Power—KODAK Li-Ion Rechargeable Digital Camera Battery KLIC-7001; KODAK 5-Volt AC adapter

Tripod mount—1/4 inch

Size—95.5 x 58.5 x 19.2 mm (3.8 x 2.3 x 0.8 in.) @ power off

Weight—115 g (4.1 oz) without card or battery

Operating temperature—0–40 degrees C (32–104 degrees F)

Care and maintenance

- If you suspect water has gotten inside the camera, remove the battery and card. Allow all components to air-dry for at least 24 hours before using the camera.
- Blow gently on the lens or LCD to remove dust and dirt. Wipe gently with a soft, lint-free cloth or an untreated lens-cleaning tissue. Do not use cleaning solutions unless designed specifically for camera lenses. Do not allow chemicals, such as suntan lotion, to contact painted surfaces.
- Service agreements may be available in your country. Contact a dealer of KODAK Products for more information.
- For digital camera disposal or recycling information, contact your local authorities. In the US, visit the Electronics Industry Alliance Web site at www.eiae.org or www.kodak.com/go/md41support.

Upgrading your software and firmware

Download the latest versions of the software included on the KODAK EASYSHARE Software CD and the camera firmware (the software that runs on the camera). Visit www.kodak.com/go/md41downloads.

Storage capacities

The LCD displays the approximate number of pictures (or minutes/seconds of video) remaining. For average SD Card capacities, visit www.kodak.com/go/SDcapacities. Actual storage capacity varies depending on subject composition, card size, and other factors. You may be able to store more or fewer pictures and videos.

Important safety instructions



CAUTION:

Do not disassemble this product; there are no user-serviceable parts inside. Refer servicing to qualified service personnel. KODAK AC Adapters and Battery Chargers are intended for indoor use only. The use of controls, adjustments, or procedures other than those specified herein may result in exposure to shock and/or electrical or mechanical hazards. If the LCD breaks, do not touch the glass or liquid. Contact Kodak customer support.

- The use of an accessory that is not recommended by Kodak may cause fire, electric shock, or injury. For approved accessories, visit www.kodak.com/go/accessories.
- Use only a USB-certified computer equipped with a current-limiting motherboard. Contact your computer manufacturer if you have questions.
- If using this product in an airplane, observe all instructions of the airline.
- When removing the battery, allow it to cool; it may be hot.
- Follow all warnings and instructions supplied by the battery manufacturer.
- Use only batteries approved for this product to avoid risk of explosion.
- Keep batteries out of the reach of children.
- Do not allow batteries to touch metal objects, including coins. Otherwise, a battery may short circuit, discharge energy, become hot, or leak.
- Do not disassemble, install backward, or expose batteries to liquid, moisture, fire, or extreme temperature.

- Remove the battery when the product is stored for an extended period of time. In the unlikely event that battery fluid leaks inside the product, contact Kodak customer support.
- In the unlikely event that battery fluid leaks onto your skin, wash immediately with water and contact your local health provider. For additional health-related information, contact your local Kodak customer support.
- Dispose of batteries according to local and national regulations. Visit www.kodak.com/go/kes.
- Do not charge non-rechargeable batteries. For more information, see www.kodak.com/go/batteries.

Battery replacement, battery life

KODAK Li-Ion Rechargeable Digital Camera Battery KLIC-7001 (720 mAh): 250–280 pictures per charge.

KODAK Li-Ion Rechargeable Digital Camera Battery KLIC-7001 (770 mAh): 260–290 pictures per charge.

Battery life per CIPA testing method. (Approximate number of pictures in Smart Capture mode.) Actual life may vary based on usage.

Extending battery life

- Use power-saving features. (Example: lower the LCD Brightness setting, [see page 30](#).) Use the Review and Slide Show features sparingly.
- Keep battery contacts/terminals clean. Wipe with a dry cloth.
- Charge Li-Ion batteries frequently, even if power remains.
- Battery performance is reduced at low temperatures. When using your camera in cold weather, keep spare batteries warm. Do not discard cold batteries that do not work; when they return to room temperature, they may be usable.

Limited warranty

Kodak warrants its digital cameras and accessories (excluding batteries) to be free from malfunctions and defects in both materials and workmanship for the warranty period specified on your Kodak Product packaging. Retain the original dated sales receipt. Proof of purchase date is required with any request for warranty repair.

Limited warranty coverage

Warranty service is only available from within the country where the Products were originally purchased. You may be required to ship Products, at your expense, to the authorized service facility for the country where the Products were purchased. Kodak will repair or replace Products if they fail to function properly during the warranty period, subject to any conditions and/or limitations stated herein. Warranty service will include all labor as well as any necessary adjustments and/or replacement parts. If Kodak is unable to repair or replace a Product, Kodak will, at its option, refund the purchase price paid for the Product provided the Product has been returned to Kodak along with proof of the purchase price paid. Repair, replacement, or refund of the purchase price are the sole remedies under the warranty. If replacement parts are used in making repairs, those parts may be remanufactured, or may contain remanufactured materials. If it is necessary to replace the entire Product, it may be replaced with a remanufactured Product. Remanufactured Products, parts and materials are warranted for the remaining warranty term of the original Product, or 90 days after the date of repair or replacement, whichever is longer.

Limitations

This warranty does not cover circumstances beyond Kodak's control. This warranty does not apply when failure is due to shipping damage, accident, alteration, modification, unauthorized service, misuse, abuse, use with incompatible accessories or attachments (such as third party ink or ink tanks), failure to follow Kodak's operation, maintenance or repacking instructions, failure to use items supplied by Kodak (such as adapters and cables), or claims made after the duration of this warranty. Kodak makes no other express or implied warranty for this product. In the event that the exclusion of any implied warranty is ineffective under the law, the duration of the implied warranty will be the length of the express warranty period

specified on your Kodak product packaging. The option of repair, replacement, or refund is Kodak's only obligation. Kodak will not be responsible for any special, consequential or incidental damages resulting from the sale, purchase, or use of this product regardless of the cause. Liability for any special, consequential or incidental damages (including but not limited to loss of revenue or profit, downtime costs, loss of the use of the equipment, cost of substitute equipment, facilities or services, or claims of your customers for such damages resulting from the purchase, use, or failure of the Product), regardless of cause or for breach of any written or implied warranty is expressly disclaimed.

Your rights

Some states or jurisdictions do not allow exclusion or limitation of incidental or consequential damages, so the above limitation or exclusion may not apply to you. Some states or jurisdictions do not allow limitations on how long an implied warranty lasts, so the above limitation may not apply to you. This warranty gives you specific rights, and you may have other rights which vary from state to state or by jurisdiction.

Outside the United States and Canada

In countries other than the United States and Canada, the terms and conditions of this warranty may be different. Unless a specific Kodak warranty is communicated to the purchaser in writing by a Kodak company, no warranty or liability exists beyond any minimum requirements imposed by law, even though defect, damage, or loss may be by negligence or other act.

Regulatory compliance

FCC compliance and advisory

This equipment has been tested and found to comply with the limits for a Class B digital device, pursuant to Part 15 of the FCC Rules. These limits are designed to provide reasonable protection against harmful interference in a residential installation. This equipment generates, uses, and can radiate radio frequency energy and, if not installed or used in accordance with the instructions, may cause harmful interference to radio communications. However, there is no guarantee that interference will not occur in a particular installation. If this equipment does cause harmful interference to radio or television reception, which can be determined by turning the equipment off and on, the user is encouraged to try to correct the interference by one or more of the following measures: 1) reorient or relocate the receiving antenna; 2) increase the separation between the equipment and the receiver; 3) connect the equipment to an outlet on a circuit different from that to which the receiver is connected; 4) consult the dealer or an experienced radio/TV technician for additional suggestions. Any changes or modifications not expressly approved by the party responsible for compliance could void the user's authority to operate the equipment. Where shielded interface cables have been provided with the product or specified additional components or accessories elsewhere defined to be used with the installation of the product, they must be used in order to ensure compliance with FCC regulation.

CE

Hereby, Eastman Kodak Company declares that this KODAK Product is in compliance with the essential requirements and other relevant provisions of Directive 1999/5/E.

Waste Electrical and Electronic Equipment/Battery disposal



In Europe: For human/environmental protection, it is your responsibility to dispose of this equipment and batteries at a collection facility established for this purpose (separate from municipal waste.) For more information, contact your retailer, collection facility, or appropriate local authorities; or visit www.kodak.com/go/recycle. Product weight: 115 g (4.1 oz)



Australian C-Tick



N137

VCCI Class B ITE

この装置は、情報処理装置等電波障害自主規制協議会（VCCI）の基準に基づくクラスB情報技術装置です。この装置は、家庭環境で使用することを目的としていますが、この装置がラジオやテレビジョン受信機に近接して使用されると、受信障害を引き起こすことがあります。
取扱説明書に従って正しい取り扱いをして下さい。

Korean Class B ITE

B급 기기
(가정용 방송통신기기)

이 기기는 가정용(B급)으로 전자파적합등록을
한 기기로서 주로 가정에서 사용하는 것을 목적
으로 하며, 모든 지역에서 사용할 수 있습니다.

Russian GOST-R



Eastman Kodak Company
Rochester, NY 14650

Фотокамера изготовлена в Китае, остальные элементы -
АЮ-40 в соответствии с маркировкой.

China RoHS

环保使用期限 (EPUP)

在中国大陆, 该值表示产品中存在的任何危险物质不得释放, 以免危及人身健康、财产或环境的时间期限(以年计)。该值根据操作说明中所规定的产品正常使用而定。

有毒有害物质或元素名称及含量标识表						
部件名称	有毒有害物质或元素					
	铅	汞	镉	六价铬	多溴联苯	多溴二苯醚
数码相机电路板元件	×	○	○	○	○	○
锂电池	×	○	○	○	○	○
交流变压器	×	○	○	○	○	○

○: 表示该有毒有害物质在该部件所有均质材料中的含量均在SJ/T 11363-2006规定的限量要求以下。
 ×: 表示该有毒有害物质至少在该部件的某一均质材料中的含量超出SJ/T 11363-2006规定的限量要求。



Canadian DOC statement

DOC Class B Compliance—This Class B digital apparatus complies with Canadian ICES-003.

Observation des normes-Classe B—Cet appareil numérique de la classe B est conforme à la norme NMB-003 du Canada.

Index

A

- A/V out, 19
- about this camera, 32
- accessories, 34
 - battery, 51
 - buying, 46
 - SD/SDHC Card, 4
- AF control (Still), 27
- AF zone, 28
- auto, 8
 - enhancement, 21
 - focus control, 27, 28, 29
 - focus framing marks, 5
- auto focus (AF)
 - zone, 28

B

- backlight, 9
- battery
 - charging, 2
 - expected life, 51
 - loading, 1
 - types, 51
- battery compartment, ii
- beach, 9
- burst, using, 12
- button
 - burst, 12
 - delete, 6
 - review, ii
 - telephoto/zoom, 6

C

- cable
 - audio/video, 19
 - USB, 34
- camera sounds, 31
- Canadian compliance, 56
- care and maintenance, 49
- charging the battery, 2
- children, 9
- clock, setting, 3
- color mode, 27
- computer
 - connecting camera, 33
 - transfer to, 33
- connector, USB / A/V, 19, 34
- copy pictures
 - card to memory, 22
 - memory to card, 22
 - to computer via USB cable, 33
- cropping pictures, 21
- customize camera, 30

D

- date setting, 3
- date stamp, 20
- DC-in, i
- delete button, ii
- deleting
 - during quickview, 6
 - from internal memory, 16
 - from SD/SDHC Card, 16
 - protecting pictures, videos, 16

digital zoom, 6
displaying slide show, 18
disposal, recycling, 49
downloading pictures, 33

E

EASYSHARE Software, 33
edit videos, 23
emailing pictures, videos, 38
expected battery life, 51
exposure
 long time, 27, 30
 metering, 28
exposure compensation, 26
exposure metering, 28
external video device
 viewing pictures, videos, 19

F

face detect capture, 28
favorites, marking, 39
FCC compliance, 54
fireworks, 9
firmware, upgrading, 49
flash, i
flash button, i
flash, using, 7
flower, 9
focus framing marks, 5
focus mode, 27
format, 31
framing marks, 5

G

guidelines, battery, 51

H

help
 camera help, 41
 Web links, 41
high ISO, 9, 10

I

icons, modes, 8
image storage, 31
installing
 battery, 1
 SD/SDHC Card, 4
 software, 33
ISO speed, 29

J

joystick, ii

K

KODAK EASYSHARE Software
 installing, 33
 upgrading, 49
KODAK PERFECT TOUCH
 Technology, 21
Kodak Web sites, 41

L

language, 31
LCD, ii
 brightness, 30
 reviewing pictures, 15
 reviewing videos, 15
LCD brightness, 30
lens
 cleaning lens, 49

light, self-timer, i
loading
 battery, 1
 SD/SDHC Card, 4
 software, 33
long time exposure, 27, 30

M

MAC OS, installing software, 33
magnify a picture, 15
maintenance, camera, 49
make picture from video, 23
manner/museum, 9
marking
 favorites, 39
 for email, 38
 for print, 37
memory card, inserting, 4
menu button, ii
menu settings, 26
mode dial, i
modes, 8
 auto, 8
 backlight, 9
 beach, 9
 children, 9
 fireworks, 9
 flower, 9
 high ISO, 9, 10
 manner/museum, 9
 night landscape, 9
 night portrait, 9
 scene (SCN), 9
 self-portrait, 9

 snow, 9
 text, 9
modes, capture
 smart capture, 8
multiple selections, 17
multi-up, 17

N

night landscape, 9
night portrait, 9

O

OK button, ii
online prints, ordering, 36
optical zoom, 6
orientation sensor, 30

P

panoramic pictures, 13
PERFECT TOUCH Technology, 21
PICTBRIDGE enabled printer, 35
picture size, 26, 27
pictures
 copying, 22
 cropping, 21
 email marked, 38
 marking, tagging, 37
 PERFECT TOUCH, 21
 print marked, 37
 printing, 36
 protecting, 16
 review icons, 25
 reviewing, 15
 taking, modes, 8
 transfer via USB cable, 33

- pictures/video
 - deleting, 16
 - playing a video, 15
- power
 - camera, 3
- pre-tagging, 40
- printing
 - from a card, 36
 - from computer, 36
 - marked pictures, 36
 - optimizing printer, 41
 - order online, 36
 - PICTBRIDGE, 35
- protecting pictures, videos, 16

Q

- quickview, using, 6

R

- recycling, disposal, 49
- regulatory information, 54
- repair, 46
- reset camera, 31
- review button, ii
- reviewing pictures/video
 - as you take them, 6
 - deleting, 16
 - LCD, 15
 - protecting, 16
 - slide show, 18
- running slide show, 18

S

- safety, 50
- scene modes (SCN), 9

- SD/SDHC Card
 - inserting, 4
 - printing from, 36
- select multiple pictures/videos, 17
- self-portrait, 9
- self-timer, 12
- self-timer light, i
- set tag, 30
- setting
 - AF zone, 28
 - auto-focus, 27, 28, 29
 - camera sounds, 31
 - color mode, 27
 - date and time, 3
 - exposure metering, 28
 - image storage, 31
 - ISO, 29
 - language, 31
 - LCD brightness, 30
 - long time exposure, 27, 30
 - orientation sensor, 30
 - picture size, 26, 27
 - picture-taking mode, 8
 - self-timer, 12
 - sharpness, 29
 - video out, 31
 - video size, 29
 - white balance, 28
- setting up the camera, 1
- setup menu, 30
- Share button, 30
- sharpness, 29
- shutter
 - problems, 43

- self-timer delay, 12
- shutter button, i
- slide show
 - running, 18
- smart capture, 8
- snow, 9
- software
 - installing, 33
 - upgrading, 49
- sounds, 31
- specifications, camera, 47
- strap, 1
- strap post, ii

T

- tagging
 - creating tags, 39
 - pre-tagging, 40
- taking pictures, videos, 5
- television, slide show, 19
- text, 9
- time, setting, 3
- timer, shutter delay, 12
- tips
 - care & maintenance, 49
- transfer, via USB cable, 33
- trash can, deleting, 6
- trimming a video, 23
- tripod socket, ii
- turning camera on and off, 3

U

- undelete, undo, 16
- upgrading software, firmware, 49

- URLs, Kodak Web sites, 41
- USB
 - transferring pictures, 33
- USB/AV Out, ii

V

- VCCI compliance, 55
- video
 - action print, 24
 - copying, 22
 - edit, 23
 - emailing marked, 38
 - out, 31
 - playback, 15
 - protecting, 16
 - review icons, 25
 - size, 29
 - transfer to computer, 33
 - viewing, 15
- video out, 31
- video size, 29
- viewing
 - by multi-up, 17
 - picture, after taking, 6, 15

W

- warranty, 52
- white balance, 28
- WINDOWS OS, installing software, 33

Z

- zoom
 - digital, 6
 - optical, 6
- zoom button, ii