

FLORISTIK

Floristics



DER UMWELT ZULIEBE GO GREEN

Als Papier- und Kunststoffarbeiter nehmen wir die Herausforderung und die Verantwortung für die Herstellung möglichst nachhaltiger Produkte an.

- Unsere Produkte sind langlebig und mehrfach verwendbar
- Die von uns verwendeten Kunststoffe sind sortenrein und zu 100 % recycelbar
- Für die Herstellung unserer Floristenbedarfsartikel verwenden wir bis zu 80 % Recyclingmaterial, unsere eigenen Produktionsabfälle werden schon seit Jahren im eigenen Haus recycelt und anschließend dem Produktionsprozess wieder zugeführt.

As paper and plastic workers, we accept the challenge and responsibility for producing products that are as sustainable as possible.

- Our products are durable and can be used multiple times
- The plastics used are unmixed (variety purity) and 100 % recyclable
- We use up to 80 % recycled material to manufacture our florist's supplies, our own production waste has been recycled in-house for years and then returned to the production process.



Biologisch abbaubar
Biodegradable



Gut wiederverwertbar
Well reusable



Aus Recyclingmaterial
Made from recycled material

UMWELTFREUNDLICH EINKAUFEN,
ACHTEN SIE AUF DIESE SYMBOLE!

SHOP ENVIRONMENTALLY FRIENDLY,
PAY ATTENTION TO THESE SYMBOLS!



wer wir sind

**Goertz – Hersteller und Dienstleister für die Floristik.
Made in Germany – seit 1972.**

Ob nassfeste Dekorblumentöpfe oder buntes Floristenkrepppapier, klassische Biedermeiermanschetten oder filigrane Stanz- oder Spritzgussartikel: Die Marke Goertz steht für hochwertige und breit gefächerte Papier- und Kunststoffprodukte für den Floristikbedarf. Die Spitzenqualität „Made in Germany“ unseres Traditionsunternehmens überzeugt die deutsche und internationale Floristik- und PBS-Branche seit über 45 Jahren. Wir sind der führende Hersteller von nicht ausblutendem Floristenkrepp in Premiumqualität.

Gegründet 1972, fertigen und produzieren wir bis heute in unserem Werk in Bad Harzburg. Ausgestattet mit modernster Fertigungstechnik und einer eigenen Spritzgussabteilung, stellen wir hier einen Großteil unserer rund 1.000 Floristenbedarfs- und Dekorationsartikel her. Hohen Wert legen wir dabei auf beste Rohstoffe und Farben sowie auf die besondere Sorgfalt bei der Veredelung zum Endprodukt. Unsere Farben und Rohstoffe sind im Sinne der Nachhaltigkeit ausgesucht und recyclingfähig. Komplettiert wird unser selbst gefertigtes Sortiment durch Handelsware.

Von unserem modernen Logistik- und Verwaltungszentrum aus beliefern wir Großhändler in Deutschland und Europa. Die gute Verfügbarkeit und schnelle Lieferung unserer vielfältigen Produkte machen uns zu einem bestens eingebundenen Dienstleister der Floristik.



Fast 50 Jahre Tradition

who we are

**Goertz – manufacturer and supplier for floristry.
Made in Germany – since 1972.**

Whether wet-proof decorative flower pots or colorful florist crepe paper, classic Biedermeier cuffs, filigree stamped or injection-molded articles: The brand Goertz stands for high-quality and broad-based paper and plastic products for florists' supplies.

The top quality "Made in Germany" of our long-established company has been convincing the German and international floristry markets as well as the stationery industry for over 45 years. We are the leading manufacturer of premium quality non-bleeding florist's crepe.

Founded in 1972, we manufacture and produce in our factory in Bad Harzburg to this day. Equipped with state-of-the-art production technology and our own injection molding department, we produce a large part of our over 1,000 florist supplies and decorative items here. In doing so, we attach great importance to the best raw materials and colors as well as the special care in the finishing of the end product. Colors and raw materials needless to say are selected in terms of sustainability and recyclable. Furthermore our self-made assortment is completed by articles of merchandise.

We supply wholesalers in Germany and Europe from our modern logistics and administrative center. The good availability and fast delivery of our wide range of products make us one of the best integrated suppliers of floristry.



INHALT TABLE OF CONTENT

KREPPPAPIER CREPE PAPER

- 10 Premium Floristenkrepp
(Premium florist crepe paper)
- 16 Floristenkrepp Bänder
(Florist crepe ribbons)
- 18 Aquarola Floristenkrepp
(Aquarola florist crepe)
- 19 Krepp Wickelmaschine
(Crepe winding machine)

MANSCHETTEN SLEEVES

- 22 Krepp Topfmanschetten
(Crepe paper flowerpot sleeves)
- 24 Plisseemanschetten
(Pleated flowerpot sleeves)
- 26 Biedermeiermanschetten
(Biedermeier-cuffs)
- 32 Brautmanschetten
(Bridal cuffs)
- 32 Krepp Blumenmanschetten
(Crepe bouquet cuffs)
- 33 Straußmanschetten
(Rondellas)

FOLIEN UND TÜTEN FOIL AND BAGS

- 38 Blumentüten
(Flower bags)
- 39 Transparente Dekofolie
(Transparent decoration foil)
- 40 Metallisierte Verpackungsfolie
(Metallic foil)
- 42 Papiertragetaschen mit
gedrehter Kordel
(Paper bags with twisted cord)
- 43 Papiertragetaschen mit
flach gelegtem Henkel
(Paper bags)
- 44 Kreuzbodensack
(Cross-bottom bag)
- 45 Jute Sack /Laub Sack
(Jute bag / Leaf bag)
- 46 Deko Jute Säckchen
(Decorative jute bag)
- 48 Weinverpackung aus Jute
(Wine jute packaging)
- 49 Packpapier
(Wrapping paper)
- 49 Hemdchentragetaschen
(Plastic bags)



SCHMUCKBÄNDER RIBBONS

- 52 Polyband
(Polyribbon)
- 58 Polybandsplitter
(Ribbon splicer)
- 58 Polyband-Abroller
(Ribbon unwinder)
- 59 Tüllband
(Tulle ribbon)
- 60 Jute Band
(Jute band)

BINDEREIBEDARF BINDERY SUPPLY

- 64 Bindfaden
(Cord)
- 65 Bindestreifen
(Florist wire)
- 68 Gummibänder
(Rubber band)
- 69 Gärtnerbast
(Poly raffia)
- 70 Perlonschnur
(Nylon string)
- 71 Saugnäpfe
(Sucker)
- 71 Stecknadeln
(Pins)
- 72 Blumenklebeband
(Stem wind)
- 73 Römerwickelband
(Fleece rayon)

GESTECKHALTER PLASTIC HOLDER

- 76 Gesteckhalter
(Pinholder)
- 77 Blumenclips
(Synthetic flower clips)
- 78 Steckringe
(Plastic ring)
- 78 Wursthälter
(Sausage holder)
- 79 Flaschendekohalter
(Decoration holder for bottles)
- 79 Brautstraußhalter
(Bouquet holder)
- 80 Orchideenröhrchen
(Flower tubes)
- 81 Reagenzgläser
(Glas tubes)
- 82 Kunststoff Blumen
(Plastic flowers)
- 83 Stütz- und Falzgitter
(Support and folding grille)



INHALT TABLE OF CONTENT

WERKZEUGE UND KLEBTECHNIK TOOLS AND HOT MELT

- 86 Rosenentdorn
(Thorn stripper)
- 86 Floristik Messer
(Florist knives)
- 87 Klebesticks
(Hot glue sticks)
- 87 Klebepistolen
(Hot glue gun)
- 88 Heftzange und Klammern
(Stapler and staples)
- 88 Tacker und Tackerklammern
(Melt pen)
- 89 Drillapparat und Ösen
(Drilling tool)
- 90 Klebetechnik
(Adhesive technology)
- 92 Multifunktions Organizer
(Organizer)
- 93 Tischabroller
(Tape stand)
- 93 Klebeband
(Adhesive film)

DEKORATION DECORATION

- 96 Einzelzahlen
(Single figures)
- 98 Jahreszahlen
(Annual numbers)
- 99 Jubiläumszahlen und Kränze
(Jubilee figures and wreath)
- 104 Tauben
(Decoration doves)
- 106 Hochzeitsdekoration
(Wedding decoration)
- 107 Valentins- und
Muttertagsdekoration
(Valentins- and mothers day)
- 108 Schiefertafeln
(Slate, non-punched)
- 109 Selbstklebetiketten
(Self-adhesive labels)
- 110 Grußschilder
(Greeting labels)
- 111 Silvesterdekoration
(Happy New Year decoration)

DEKORATIONSGEFÄSSE UND DEKOFORMEN PLASTIC SHAPES

- 114 Kunststoff Zylinder
(Plastic top-hat)
- 117 Kunststoff Fliegenpilz Topf
(Plastic decoration pot)
- 117 Kunststoff Sektkühler
(Champagne ice bucket)
- 119 Kunststoff Geschenksack
(Giftbag)
- 120 Pflanz-, Blumen- und Kräu-
terbox Display
(Plant, flower and herb box
display)
- 122 Pflanz-, Blumen- und Kräu-
terbox
(Plant, flower and herb box)
- 124 Kunststoff Übertöpfe
(Plastic planters)
- 136 Eierbecher
(Eggcups)
- 136 Eierschale
(Eggshell bowl)
- 137 Dekoformen
(Deco shapes)



PREISAUZEICHNUNG UND DRUCKSACHEN PRICING AND PRINTED MATTER

- 142 Allzweckreiniger
(Detergent)
- 143 Marker und Stifte
(Marker and Pencils)
- 146 Stecker und Schilder
(Plugs and Labels)
- 152 Etiketten
(Labels)
- 158 Werbesymbole
(Advertising signs)
- 159 Vordrucke
(Preprinted form)
- 160 Kranzanhänger
(Wreath label)
- 160 Pergaminhüllen
(Glassine envelope)
- 161 Etui Geschenkkarte
(Etui gift card)
- 161 Weihnachts-Geschenkbbox
(Christmas Giftbox)
- 162 Grußkarten
(Greeting cards)

BESTELLEN ORDER

- 164 So kaufen Sie bei uns ein
(Directly purchase from us)
- 166 Stichwortverzeichnis
(Alphabetical index)

KREPPPAPIERE

CREPE PAPER



- 10 Premium Floristenkrepp
(Premium florist crepe paper)
- 16 Floristenkrepp Bänder
(Florist crepe ribbons)
- 18 Aquarola Floristenkrepp
(Aquarola florist crepe)
- 19 Krepp Wickelmaschine
(Crepe winding machine)



Premium Floristenkrepp

PREMIUM FLORIST CREPE PAPER



170500



170555



170502



170540



170566



170504



170514



170513



170515

Premium Floristenkrepp

Premium florist crepe paper



ARTIKELNUMMER	FARBE	DEKOR	Ø GRÖSSE/CM	STK/PACK	VPE	KARTONMENGE	PRODUKTEIGENSCHAFTEN
ART.-NO.	COLOR	DESIGN	Ø SIZE/CM	CONTENT	PU	BOX AMOUNT	PRODUCT CHARACTERISTICS
170500	Weiss White	Standard Standard	50 x 250	Rll.	5	50	Nicht ausblutende Qualität, 160 g/Rolle Non bleeding pigment, 160 g/roll
170555	Antikweiss Antique white	Standard Standard	50 x 250	Rll.	5	50	
170502	Champagner Champagne	Standard Standard	50 x 250	Rll.	5	50	
170540	Creme Cream	Standard Standard	50 x 250	Rll.	5	50	
170566	Hellgelb Light yellow	Standard Standard	50 x 250	Rll.	5	50	
170504	Gelb Yellow	Standard Standard	50 x 250	Rll.	5	50	
170514	Sonnengelb Sun yellow	Standard Standard	50 x 250	Rll.	5	50	
170513	Mandarine Tangerine	Standard Standard	50 x 250	Rll.	5	50	
170515	Hellorange Light orange	Standard Standard	50 x 250	Rll.	5	50	

Premium Floristenkrepp

PREMIUM FLORIST CREPE PAPER



170503



170510



170511



170536



170530



170506



170509



170553

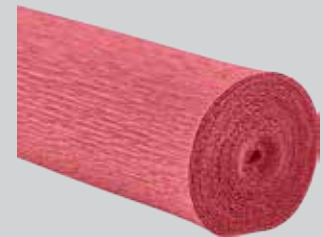

170531

Premium Floristenkrepp

Premium florist crepe paper



ARTIKELNUMMER	FARBE	DEKOR	Ø GRÖSSE/CM	STK/PACK	VPE	KARTONMENGE	PRODUKTEIGENSCHAFTEN
ART.-NO.	COLOR	DESIGN	Ø SIZE/CM	CONTENT	PU	BOXAMOUNT	PRODUCT CHARACTERISTICS
170503	Orange Orange	Standard Standard	50 x 250	Rll.	5	50	Nicht ausblutende Qualität, 160 g/Rolle Non bleeding pigment, 160 g/roll
170510	Rot Red	Standard Standard	50 x 250	Rll.	5	50	
170511	Dunkelrot Dark red	Standard Standard	50 x 250	Rll.	5	50	
170536	Lachs Salomon	Standard Standard	50 x 250	Rll.	5	50	
170530	Rosa getönt Rose tinted	Standard Standard	50 x 250	Rll.	5	50	
170506	Hellpink Light pink	Standard Standard	50 x 250	Rll.	5	50	
170509	Pink Pink	Standard Standard	50 x 250	Rll.	5	50	
170553	Dunkelpink Dark pink	Standard Standard	50 x 250	Rll.	5	50	
170531	Pastellrosa Pastel rose	Standard Standard	50 x 250	Rll.	5	50	

Premium Floristenkrepp

PREMIUM FLORIST CREPE PAPER



170532



170537



170535



170583



170582



170539



170538



170527



170565

Premium Floristenkrepp

Premium florist crepe paper



ARTIKELNUMMER	FARBE	DEKOR	Ø GRÖSSE/CM	STK/PACK	VPE	KARTONMENGE	PRODUKTEIGENSCHAFTEN
ART.-NO.	COLOR	DESIGN	Ø SIZE/CM	CONTENT	PU	BOXAMOUNT	PRODUCT CHARACTERISTICS
170532	Hellrosa Light rose	Standard Standard	50 x 250	Rll.	5	50	Nicht ausblutende Qualität, 160 g/Rolle Non bleeding pigment, 160 g/roll
170537	Altrosa Antique pink	Standard Standard	50 x 250	Rll.	5	50	
170535	Bordeaux Bordeaux	Standard Standard	50 x 250	Rll.	5	50	
170583	Nougat Nougat	Standard Standard	50 x 250	Rll.	5	50	
170582	Terrakotta Terra cotta	Standard Standard	50 x 250	Rll.	5	50	
170539	Braun Brown	Standard Standard	50 x 250	Rll.	5	50	
170538	Schokobraun Chocolate	Standard Standard	50 x 250	Rll.	5	50	
170527	Erika Erica	Standard Standard	50 x 250	Rll.	5	50	
170565	Pastellflieder Pastel lilac	Standard Standard	50 x 250	Rll.	5	50	

Premium Floristenkrepp

PREMIUM FLORIST CREPE PAPER



170529



170550



170526



170524



170525



170528



170517



170518



170501

Premium Floristenkrepp

Premium florist crepe paper



ARTIKELNUMMER	FARBE	DEKOR	Ø GRÖSSE/CM	STK/PACK	VPE	KARTONMENGE	PRODUKTEIGENSCHAFTEN
ART.-NO.	COLOR	DESIGN	Ø SIZE/CM	CONTENT	PU	BOX AMOUNT	PRODUCT CHARACTERISTICS
170529	Dunkellila Dark violet	Standard Standard	50 x 250	Rll.	5	50	Nicht ausblutende Qualität, 160 g/Rolle Non bleeding pigment, 160 g/roll
170550	Türkis Turquoise	Standard Standard	50 x 250	Rll.	5	50	
170526	Hellblau Lightblue	Standard Standard	50 x 250	Rll.	5	50	
170524	Blau Blue	Standard Standard	50 x 250	Rll.	5	50	
170525	Mittelblau Middle blue	Standard Standard	50 x 250	Rll.	5	50	
170528	Königsblau Royal blue	Standard Standard	50 x 250	Rll.	5	50	
170517	Maigrün May green	Standard Standard	50 x 250	Rll.	5	50	
170518	Grasgrün Grass green	Standard Standard	50 x 250	Rll.	5	50	
170501	Hellgrün Light green	Standard Standard	50 x 250	Rll.	5	50	

Premium Floristenkrepp

PREMIUM FLORIST CREPE PAPER

NEU
NEW



170522



170516



170519



170541



170545



171520



171521



NEU
NEW

170991

Premium Floristenkrepp

Premium florist crepe paper



ARTIKELNUMMER	FARBE	DEKOR	Ø GRÖSSE/CM	STK/PACK	VPE	KARTONMENGE	PRODUKTEIGENSCHAFTEN
ART.-NO.	COLOR	DESIGN	Ø SIZE/CM	CONTENT	PU	BOX AMOUNT	PRODUCT CHARACTERISTICS
170522	Tropicgrün Tropic green	Standard Standard	50 x 250	Rll.	5	50	Nicht ausblutende Qualität, 160 g/Rolle Non bleeding pigment, 160 g/roll
170516	Apfelgrün Apple green	Standard Standard	50 x 250	Rll.	5	50	
170519	Dunkelgrün Dark green	Standard Standard	50 x 250	Rll.	5	50	
170541	Grau Grey	Standard Standard	50 x 250	Rll.	5	50	
170545	Schwarz Black	Standard Standard	50 x 250	Rll.	5	50	
171520	Silber Silver	Gestrichen Painted	50 x 250	Rll.	5	50	
171521	Gold Gold	Gestrichen Painted	50 x 250	Rll.	5	50	
NEU NEW 170991	Weiss mit roten Herzen White with red hearts	Bedruckt Printed	50 x 250	Rll.	5	50	

Premium Floristenkrepp

PREMIUM FLORIST CREPE PAPER

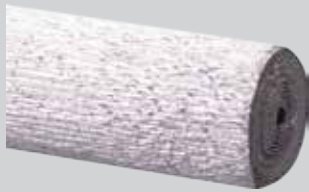

170700



170701



170710

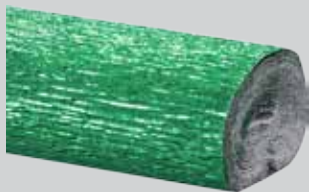

170719



170720



170736

Premium Floristenkrepp

Premium florist crepe paper

ARTIKELNUMMER	FARBE	DEKOR	Ø GRÖSSE/CM	STK/PACK	VPE	KARTONMENGE	PRODUKTEIGENSCHAFTEN
ART.-NO.	COLOR	DESIGN	Ø SIZE/CM	CONTENT	PU	BOX AMOUNT	PRODUCT CHARACTERISTICS
170700	Silber Aluminum silver	Aluminium Aluminum	50 x 250	Rll.	5	50	Nicht ausblutende Qualität, 160 g/Rolle Non bleeding pigment, 160 g/roll
170701	Gold Aluminum gold	Aluminium Aluminum	50 x 250	Rll.	5	50	Nicht ausblutende Qualität, 160 g/Rolle Non bleeding pigment, 160 g/roll
170710	Rot Aluminum red	Aluminium Aluminum	50 x 250	Rll.	5	50	Nicht ausblutende Qualität, 160 g/Rolle Non bleeding pigment, 160 g/roll
170719	Grün Aluminum green	Aluminium Aluminum	50 x 250	Rll.	5	50	Nicht ausblutende Qualität, 160 g/Rolle Non bleeding pigment, 160 g/roll
170720	Blau Aluminum blue	Aluminium Aluminum	50 x 250	Rll.	5	50	Nicht ausblutende Qualität, 160 g/Rolle Non bleeding pigment, 160 g/roll
170736	Kupfer Aluminum copper	Aluminium Aluminum	50 x 250	Rll.	5	50	Nicht ausblutende Qualität, 160 g/Rolle Non bleeding pigment, 160 g/roll

Floristenkrepp Bänder

FLORIST CREPE RIBBONS

Floristenkrepp Bänder

Florist crepe ribbons

Nicht ausblutende Qualität
Non bleeding pigment



	5 cm x 25 m		7cm x 25 m		10 cm x 25 m		12 cm x 25 m		14 cm x 25 m	
FARBE	ARTIKELNR.	VPE	ARTIKELNR.	VPE	ARTIKELNR.	VPE	ARTIKELNR.	VPE	ARTIKELNR.	VPE
COLOR	ART.-NO.	PU	ART.-NO.	PU	ART.-NO.	PU	ART.-NO.	PU	ART.-NO.	PU
Weiss White	160500	4/24	160700	4/24	161000	2/12	161200	2/12	161400	2/12

Floristenkrepp Bänder

Florist crepe ribbons

Nicht ausblutende Qualität
Non bleeding pigment



	10 cm x 25 m		12 cm x 25 m		14 cm x 25 m	
FARBE	ARTIKELNR.	VPE	ARTIKELNR.	VPE	ARTIKELNR.	VPE
COLOR	ART.-NO.	PU	ART.-NO.	PU	ART.-NO.	PU
NEU Antikweiss Antique white	161055	2/12				
Champagner Champagne	161002	2/12				
Hellgrün Light green	161001	2/12	161201	2/12	161401	2/12
Orange Orange	161003	2/12	161203	2/12	161403	2/12
Gelb Yellow	161004	2/12	161204	2/12	161404	2/12
Rot Red	161010	2/12	161210	2/12	161410	2/12
Dunkelrot Dark red	161011	2/12				
Sonnengelb Sun yellow	161014	2/12				
Hellorange Light orange	161015	2/12				
Grün Green	161016	2/12				
Dunkelgrün Dark green	161019	2/12	161219	2/12	161419	2/12
Silber Silver	161020	2/12				
Gold Gold	161021	2/12				
Blau Blue	161024	2/12				
Mittelblau Middle blue	161025	2/12				
Königsblau Royal blue	161028	2/12				
Rosa getönt Rose tinted	161030	2/12	161230	2/12	161430	2/12
Bordeaux Bordeaux	161035	2/12				
Alu-Silber Aluminium silver	161090	2/12				
Alu-Gold Aluminium gold	161091	2/12				

Floristenkrepp Bänder

FLORIST CREPE RIBBONS



Weiss White



Weiss White



Weiss White



NEU
NEW

Antikweiss Antique white



Champagner Champagne



Gelb Yellow



Sonnengelb Sun yellow



Hellorange Light orange



Orange Orange



Rot Red



Dunkelrot Dark red



Bordeaux Bordeaux



Hellgrün Light green



Grün Green



Dunkelgrün Dark green



Blau Blue



Mittelblau Middle blue



Königsblau Royal blue



Rosa getönt Rose tinted



Alu-Silber Aluminium silver



Alu-Gold Aluminium gold



Silber Silver



Gold Gold

Aquarola® Floristenkrepp

AQUAROLA® FLORIST CREPE PAPER



151000



151003



151004



151010



151019



151028

Aquarola® Floristenkrepp

Aquarola® florist crepe paper



ARTIKELNUMMER	FARBE	DEKOR	Ø GRÖSSE/M	STK/PACK	VPE	KARTONMENGE	PRODUKTEIGENSCHAFTEN
ART.-NO.	COLOR	DESIGN	Ø SIZE/M	CONTENT	PU	BOX AMOUNT	PRODUCT CHARACTERISTICS
151000	Weiss White	nicht färbende Qualität Non-dyeing quality	0,1 x 25	Rll.	2	12	<p>Aquarola Floristenkrepp, Nicht färbend! Ideal geeignet zur Anwendung im Außenbereich z. Bsp. zur Herstellung von Maiherzen und Kreppröschen.</p> <p>Aquarola florist crepe ribbons, does not bleed or stain! Ideal suitable for using outdoor for example manufacturing mayhearts or crepe roses</p>
151003	Orange Orange	nicht färbende Qualität Non-dyeing quality	0,1 x 25	Rll.	2	12	
151004	Gelb Yellow	nicht färbende Qualität Non-dyeing quality	0,1 x 25	Rll.	2	12	
151010	Rot Red	nicht färbende Qualität Non-dyeing quality	0,1 x 25	Rll.	2	12	
151019	Grün Green	nicht färbende Qualität Non-dyeing quality	0,1 x 25	Rll.	2	12	
151028	Blau Blue	nicht färbende Qualität Non-dyeing quality	0,1 x 25	Rll.	2	12	



170100

Kreppwickelmaschine

Crepe winding machine

ARTIKELNUMMER	FARBE	DEKOR	Ø GRÖSSE/CM	STK/PACK	VPE	KARTONMENGE	PRODUKTEIGENSCHAFTEN
ART.-NO.	COLOR	DESIGN	Ø SIZE/CM	CONTENT	PU	BOX AMOUNT	PRODUCT CHARACTERISTICS
170100				Stck	1	15	Krepp-Wickelmaschine, handbetrieben Crepe winding machine, hand-operated

MANSCHETTEN

SLEEVES



- 22 Krepp Topfmanschetten
(Crepe paper flowerpot sleeves)
- 24 Plisseemanschetten
(Pleated flowerpot sleeves)
- 26 Biedermeiermanschetten
(Biedermeier-cuffs)
- 32 Brautmanschetten
(Bridal cuffs)
- 32 Krepp Blumenmanschetten
(Crepe bouquet cuffs)
- 33 Straußmanschetten
(Rondellas)

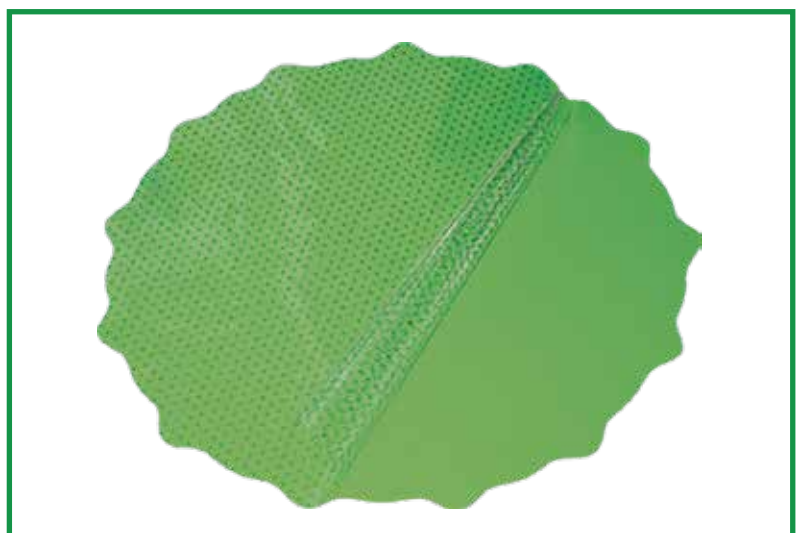
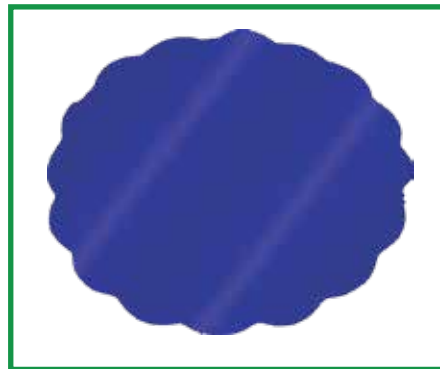

Krepptopfmanschetten

CREPE PAPER FLOWERPOT SLEEVES

Krepptopfmanschetten

Crepe paper flowerpot sleeves



ARTIKELNUMMER	FARBE	DEKOR	Ø GRÖSSE/MM	STK/PACK	VPE	KARTONMENGE	PRODUKTEIGENSCHAFTEN
ART.-NO.	COLOR	DESIGN	Ø SIZE/MM	CONTENT	PU	BOX AMOUNT	PRODUCT CHARACTERISTICS
270100	5-Farbig sortiert Assorted colors		85 /95 105 /115 125 /135	Sort	1	12	Topf-Manschetten Sortiment 150 Stück/Sortiment Flowerpot sleeves, non bleeding pigment, water repellent, recyclable, assortment 150 pieces/assortment

Krepptopfmanschetten

Crepe paper flowerpot sleeves



Farbe Colour	85 mm		105 mm		125 mm		145 mm		165 mm	
	ART.-NR.	VPE	ART.-NR.	VPE	ART.-NR.	VPE	ART.-NR.	VPE	ART.-NR.	VPE
	Art.-No.	PU	Art.-No.	PU	Art.-No.	PU	Art.-No.	PU	Art.-No.	PU
Weiss White	270800	100/2000	271000	100/2000	271200	100/2000	271400	100/1500	271600	100/1000
Hellgrün Light green	270801	100/2000	271001	100/2000	271201	100/2000	271401	100/1500	271601	100/1000
Champagner Champagne	270802	100/2000	271002	100/2000	271202	100/2000	271402	100/1500		
Orange Orange	270803	100/2000	271003	100/2000	271203	100/2000	271403	100/1500	271603	100/1000
Gelb Yellow	270804	100/2000	271004	100/2000	271204	100/2000	271404	100/1500	271604	100/1000
Pink Pink	270809	100/2000	271009	100/2000	271209	100/2000	271409	100/1500		
Rot Red	270811	100/2000	271011	100/2000	271211	100/2000	271411	100/1500	271611	100/1000
Apfelgrün Apple green	270816	100/2000	271016	100/2000	271216	100/2000	271416	100/1500	271616	100/1000
Maigrün May green	270817	100/2000	271017	100/2000	271217	100/2000	271417	100/1500		
Dunkelgrün Dark green	270819	100/2000	271019	100/2000	271219	100/2000	271419	100/1500	271619	100/1000
Blau Blue	270825	100/2000	271025	100/2000	271225	100/2000	271425	100/1500		
Erika Erica	270827	100/2000	271027	100/2000	271227	100/2000	271427	100/1500		
Rosa Rose	270831	100/2000	271031	100/2000	271231	100/2000	271431	100/1500	271631	100/1000
Grau Grey	270841	100/2000	271041	100/2000	271241	100/2000	271441	100/1500		
Türkis Turquoise	270850	100/2000	271050	100/2000	271250	100/2000	271450	100/1500		
Nougat Nougat	270883	100/2000	271083	100/2000	271283	100/2000	271483	100/1500		

Krepptopfmanschetten

CREPE PAPER FLOWERPOT SLEEVES



270100



Weiss White



Hellgrün Light green



Champagner Champagne



Orange Orange



Gelb Yellow



Pink Pink



Rot Red



Apfelgrün Apple green



Maigrün May green



Dunkelgrün Dark green



Blau Blue



Erika Erica



Rosa Rose



Grau Grey



Türkis Turquoise



Nougat Nougat

Plissee Manschetten

PLEATED FLOWERPOT SLEEVES

Plissee Manschetten

Pleated flowerpot sleeves

ARTIKELNUMMER	FARBE	DEKOR	Ø GRÖSSE/MM	STK/PACK	VPE	KARTONMENGE	PRODUKTEIGENSCHAFTEN
ART.-NR.	COLOR	DESIGN	Ø SIZE/MM	CONTENT	PU	BOX AMOUNT	PRODUCT CHARACTERISTICS
280100	5-farbig sortiert 5-color assorted		100, 125, 140	Sort	1	14	Plissee-Manschetten Sortiment, 150 Stück Inhalt Pleated cuffs, assortment, 150 pieces

Plissee Manschetten

Pleated flowerpot sleeves

Farbe Colour	80 mm		100 mm		125 mm		140 mm	
	ART.-NR.	VPE	ART.-NR.	VPE	ART.-NR.	VPE	ART.-NR.	VPE
	Art.-No.	PU	Art.-No.	PU	Art.-No.	PU	Art.-No.	PU
Weiss White	280800	100/4000	281000	100/3000	281200	100/2400	281400	100/1800
Gelb Yellow			281004	100/3000	281204	100/2400	281404	100/1800
Orange Orange			281003	100/3000	281203	100/2400	281403	100/1800
Maigrün May green			281017	100/3000	281217	100/2400	281417	100/1800
Signalrot Signal red	280810	100/4000	281010	100/3000	281210	100/2400	281410	100/1800
Dunkelgrün Dark green	280819	100/4000	281019	100/3000	281219	100/2400	281419	100/1800
NEU Metallic silber Metallic silver			281011	100/3000	281211	100/2400	281411	100/1800
NEU Metallic gold Metallic gold			281012	100/3000	281212	100/2400	281412	100/1800
NEU Metallic rot Metallic red			281013	100/3000	281213	100/2400	281413	100/1800

Plissee Manschetten

Pleated flowerpot sleeves

Farbe Colour	165 mm		180 mm		200 mm	
	ART.-NR.	VPE	ART.-NR.	VPE	ART.-NR.	VPE
	Art.-No.	PU	Art.-No.	PU	Art.-No.	PU
Weiss White	281600	100/1400	281800	100/1200		
Dunkelgrün Dark green	281619	100/1400	281819	100/1200	282019	100/1200

Plisse Manschetten

PLEATED FLOWERPOT SLEEVES



280100



Weiss White



Gelb Yellow

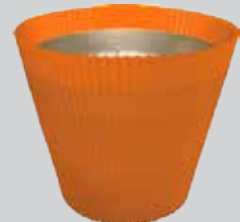

Orange Orange



Maigrün May green



Signalrot Signal red

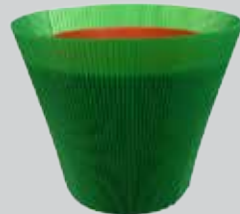

Dunkelgrün Dark green



NEU
NEW

Metallic gold Metallic gold



NEU
NEW

Metallic silber Metallic silver



NEU
NEW

Metallic rot Metallic red

Biedermeiermanschetten

BIEDERMEIER-CUFFS



020300



020400



020500



020600



020700



020800

Biedermeiermanschetten

Biedermeier-cuffs



ARTIKELNUMMER	FARBE	Ø AUSSEN/CM	Ø INNEN/CM	STK/PACK	VPE	KARTONMENGE	PRODUKTEIGENSCHAFTEN
ART.-NO.	COLOR	Ø OUTSIDE/CM	Ø INSIDE/CM	CONTENT	PU	BOX AMOUNT	PRODUCT CHARACTERISTICS
020300	Weiss White	8	3,5	Stck	25	200	Biedermeier Manschetten aus nassfestem Papier Biedermeier cuffs, wet-strength paper
020400	Weiss White	10	4,5	Stck	25	200	
020500	Weiss White	12	5	Stck	25	200	
020600	Weiss White	13	6	Stck	25	200	
020700	Weiss White	16	7	Stck	25	200	
020800	Weiss White	18	8	Stck	25	200	

Biedermeiermanschetten

BIEDERMEIER-CUFFS



020900



021000

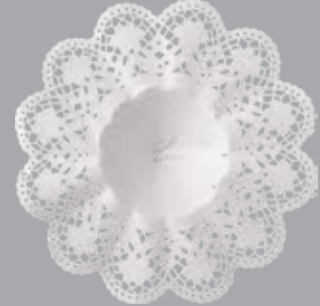

021100



021200



021400

Biedermeiermanschetten

Biedermeier-cuffs



ARTIKELNUMMER	FARBE	Ø AUSSEN/CM	Ø INNEN/CM	STK/PACK	VPE	KARTONMENGE	PRODUKTEIGENSCHAFTEN
ART.-NO.	COLOR	Ø OUTSIDE/CM	Ø INSIDE/CM	CONTENT	PU	BOX AMOUNT	PRODUCT CHARACTERISTICS
020900	Weiss White	22	9,5	Stck	25	200	Biedermeier Manschetten aus nassfestem Papier Biedermeier cuffs, wet-strength paper
021000	Weiss White	23	10	Stck	25	200	
021100	Weiss White	26	11	Stck	25	200	
021200	Weiss White	27	12	Stck	25	200	
021400	Weiss White	30	14,5	Stck	25	200	

Biedermeiermanschetten

BIEDERMEIER-CUFFS



020705



020714



020718



020805



020814



020818



021005



021014



021018

Biedermeiermanschetten beidseitig farbig

Biedermeier-cuffs, double sided coloured paper



ARTIKELNUMMER	FARBE	Ø AUSSEN/CM	Ø INNEN/CM	STK/PACK	VPE	KARTONMENGE	PRODUKTEIGENSCHAFTEN
ART.-NO.	COLOR	Ø OUTSIDE/CM	Ø INSIDE/CM	CONTENT	PU	BOX AMOUNT	PRODUCT CHARACTERISTICS
020705	Dunkelblau Darkblue	16	7	Stck	25	200	Biedermeier Manschetten aus nassfestem, beidseitig gefärbtem Papier Biedermeier cuffs, double sided coloured wet-strength paper
020714	Dunkelgrün Darkgreen	16	7	Stck	25	200	
020718	Rot Red	16	7	Stck	25	200	
020805	Dunkelblau Darkblue	18	8	Stck	25	200	
020814	Dunkelgrün Darkgreen	18	8	Stck	25	200	
020818	Rot Red	18	8	Stck	25	200	
021005	Dunkelblau Darkblue	23	10	Stck	25	200	
021014	Dunkelgrün Darkgreen	23	10	Stck	25	200	
021018	Rot Red	23	10	Stck	25	200	

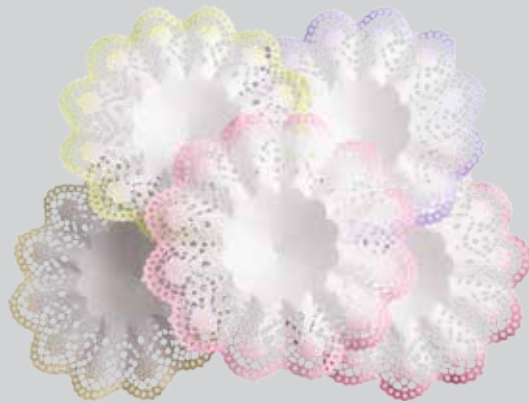

081000

Biedermeiermanschetten Batik

Biedermeier-cuffs, paper batik coloured



ARTIKELNUMMER	FARBE	Ø AUSSEN/CM	Ø INNEN/CM	STK/PACK	VPE	KARTONMENGE	PRODUKTEIGENSCHAFTEN
ART.-NO.	COLOR	Ø OUTSIDE/CM	Ø INSIDE/CM	CONTENT	PU	BOX AMOUNT	PRODUCT CHARACTERISTICS
080700	Batik sortiert	16	7	Stck	25	200	Biedermeiermanschetten aus nassfestem Papier, mit Batik gefärbtem Rand, 5 Farben sortiert Biedermeier cuffs, wet-strength paper, batik coloured, 5 colors assorted
080800	Batik sortiert	18	8	Stck	25	200	
080900	Batik sortiert	22	9	Stck	25	200	
081000	Batik sortiert	23	10	Stck	25	200	
081200	Batik sortiert	27	12	Stck	25	200	

Biedermeiermanschetten

BIEDERMEIER-CUFFS



Silber Silver



Gold Gold

Biedermeiermanschetten metallic

Biedermeier-cuffs, paper metallic

ARTIKELNUMMER	FARBE	Ø AUSSEN/CM	Ø INNEN/CM	STK/PACK	VPE	KARTONMENGE	PRODUKTEIGENSCHAFTEN
ART.-NO.	COLOR	Ø OUTSIDE/CM	Ø INSIDE/CM	CONTENT	PU	BOX AMOUNT	PRODUCT CHARACTERISTICS
070611	Silber Silver	13	6	Stck	25	200	
070612	Gold Gold	13	6	Stck	25	200	
070711	Silber Silver	16	7	Stck	25	200	
070712	Gold Gold	16	7	Stck	25	200	
070811	Silber Silver	18	8	Stck	25	200	



Silber Silver



Gold Gold

Biedermeiermanschetten metallic

Biedermeier-cuffs, paper metallic

ARTIKELNUMMER	FARBE	Ø AUSSEN/CM	Ø INNEN/CM	STK/PACK	VPE	KARTONMENGE	PRODUKTEIGENSCHAFTEN
ART.-NO.	COLOR	Ø OUTSIDE/CM	Ø INSIDE/CM	CONTENT	PU	BOX AMOUNT	PRODUCT CHARACTERISTICS
070812	Gold Gold	18	8	Stck	25	200	
070911	Silber Silver	22	9,5	Stck	25	200	
070912	Gold Gold	22	9,5	Stck	25	200	
071011	Silber Silver	23	10	Stck	25	200	
071012	Gold Gold	23	10	Stck	25	200	

Krepp Blumenmanschetten

CREPE BOUQUET CUFFS



260201



260203



260210



260214



260228



142200

Krepp Blumenmanschetten

Crepe bouquet cuffs



ARTIKELNUMMER	FARBE	Ø AUSSEN/CM	Ø INNEN/CM	STK/PACK	VPE	KARTONMENGE	PRODUKTEIGENSCHAFTEN
ART.-NO.	COLOR	Ø OUTSIDE/CM	Ø INSIDE/CM	CONTENT	PU	BOX AMOUNT	PRODUCT CHARACTERISTICS
260201	Hellgrün Light green	25	7,5	Stck	10	100	Hergestellt aus nicht ausblutendem Krepp, mit Kunststoffrichter Made of non bleeding crepe paper with plastic funnel
260203	Orange Orange	25	7,5	Stck	10	100	
260210	Rot Red	25	7,5	Stck	10	100	
260214	Sonnengelb Sun yellow	25	7,5	Stck	10	100	
260228	Königsblau Royal blue	25	7,5	Stck	10	100	

Braut Manschetten aus Tüll

Bridal cuffs, standard tulle

ARTIKELNUMMER	FARBE	Ø AUSSEN/CM	Ø INNEN/CM	STK/PACK	VPE	KARTONMENGE	PRODUKTEIGENSCHAFTEN
ART.-NO.	COLOR	Ø OUTSIDE/CM	Ø INSIDE/CM	CONTENT	PU	BOX AMOUNT	PRODUCT CHARACTERISTICS
142200	Weiss White	22	7,5	Stck	12	48	Hergestellt aus Tüll mit Spitzenrand, sortiert Made of tulle with lace top, assorted
142500	Weiss White	25	7,5	Stck	12	48	
143000	Weiss White	30	7,5	Stck	12	48	

Die Abbildungen können in Größenproportionen und Farbe vom Original abweichen. Änderungen behalten wir uns vor.
Size proportions and colors of items presented may vary from original. Subject to change without further notice.



590431



590433



590435



590438



590631



590633



590635



590638

Straußmanschetten, zweilagig mit Punkten

Rondellas two ply with dots

ARTIKELNUMMER	FARBE	DEKOR	Ø GRÖSSE/CM	STK/PACK	VPE	KARTONMENGE	PRODUKTEIGENSCHAFTEN
ART.-NO.	COLOR	DESIGN	Ø SIZE/CM	CONTENT	PU	BOX AMOUNT	PRODUCT CHARACTERISTICS
590431	Gelb Yellow	Zweilagig mit Punkten Two ply with dots	44	Stck	25		Zu 25 Stück gerollt Rolled by 25 pcs
590433	Rot Red	Zweilagig mit Punkten Two ply with dots	44	Stck	25		
590435	Apfelgrün Apple green	Zweilagig mit Punkten Two ply with dots	44	Stck	25		
590438	Orange Orange	Zweilagig mit Punkten Two ply with dots	44	Stck	25		
590631	Gelb Yellow	Zweilagig mit Punkten Two ply with dots	64	Stck	25		
590633	Rot Red	Zweilagig mit Punkten Two ply with dots	64	Stck	25		
590635	Apfelgrün Apple green	Zweilagig mit Punkten Two ply with dots	64	Stck	25		
590638	Orange Orange	Zweilagig mit Punkten Two ply with dots	64	Stck	25		

Straußmanschetten

RONDELLAS



580420



580426



580430



580620



580626



580630

Straußmanschetten, metallic glänzend

Rondellas metallic

ARTIKELNUMMER	FARBE	DEKOR	Ø GRÖSSE/CM	STK/PACK	VPE	KARTONMENGE	PRODUKTEIGENSCHAFTEN
ART.-NO.	COLOR	DESIGN	Ø SIZE/CM	CONTENT	PU	BOX AMOUNT	PRODUCT CHARACTERISTICS
580420	Königsblau Royal blue	Metallic glänzend Metallic	44	Stck	25		Rückseite silber, zu 25 Stück gerollt Backside in silver, rolled by 25 pcs
580426	Rot Red	Metallic glänzend Metallic	44	Stck	25		
580430	Gold Gold	Metallic glänzend Metallic	44	Stck	25		
580620	Königsblau Royal blue	Metallic glänzend Metallic	64	Stck	25		
580626	Rot Red	Metallic glänzend Metallic	64	Stck	25		
580630	Gold Gold	Metallic glänzend Metallic	64	Stck	25		



560405



560421



560428



560426



560429



560423

Straußmanschetten, Kraftmuster

Craft structure decor

ARTIKELNUMMER	FARBE	DEKOR	Ø GRÖSSE/CM	STK/PACK	VPE	KARTONMENGE	PRODUKTEIGENSCHAFTEN
ART.-NO.	COLOR	DESIGN	Ø SIZE/CM	CONTENT	PU	BOX AMOUNT	PRODUCT CHARACTERISTICS
560405	Weiss White	Kraftmuster Craft decor	44	Stck	25		Zu 25 Stück gerollt Rolled by 25 pcs
560421	Gelb Yellow	Kraftmuster Craft decor	44	Stck	25		
560428	Orange Orange	Kraftmuster Craft decor	44	Stck	25		
560426	Lavendel Lavender	Kraftmuster Craft decor	44	Stck	25		
560429	Fuchsia Fuchsia	Kraftmuster Craft decor	44	Stck	25		
560423	Rot Red	Kraftmuster Craft decor	44	Stck	25		
560605	Weiss White	Kraftmuster Craft decor	64	Stck	25		
560621	Gelb Yellow	Kraftmuster Craft decor	64	Stck	25		
560628	Orange Orange	Kraftmuster Craft decor	64	Stck	25		
560626	Lavendel Lavender	Kraftmuster Craft decor	64	Stck	25		
560629	Fuchsia Fuchsia	Kraftmuster Craft decor	64	Stck	25		
560623	Rot Red	Kraftmuster Craft decor	64	Stck	25		

FOLIEN UND TÜTEN

FOIL AND BAGS



- | | | | |
|----|--|----|--|
| 38 | Blumentüten
(Flower bags) | 44 | Kreuzbodensack
(Cross bottom bag) |
| 39 | Transparente Dekofolie
(Transparent decoration foil) | 45 | Jute Sack / Laub Sack
(Jute bag / Leaf bag) |
| 40 | Metallisierte Verpackungsfolie
(Metallic foil) | 46 | Deko Jute Sack
(Decorative jute bag) |
| 42 | Papiertragetaschen mit
gedrehter Kordel
(Paper bags with twisted cord) | 48 | Weinverpackungen aus Jute
(Wine jute packaging) |
| 43 | Papiertragetaschen mit
flach gelegtem Henkel
(Paper bags) | 49 | Packpapier
(Wrapping paper) |
| | | 49 | Hemdchentragetaschen
(Plastic bags) |



Blumentüten

FLOWER BAGS



610203



611100



611121



618000



619000



610103

Blumentüten

Flower bags

ARTIKELNUMMER	FARBE	DEKOR	Ø GRÖSSE/CM	STK/PACK	VPE	KARTONMENGE	PRODUKTEIGENSCHAFTEN
ART.-NO.	COLOR	DESIGN	Ø SIZE/CM	CONTENT	PU	BOX AMOUNT	PRODUCT CHARACTERISTICS
610203	Transparent Transparent	Mit gelben Schmetterlingen With yellow butterflies	50 x 44 x 9	Stck	50	1000	
611100	Transparent Transparent	Mit weissen Wellen With white waves	50 x 44 x 9	Stck	50	1000	
611121	Transparent Transparent	Mit grünen Wellen With green waves	50 x 44 x 9	Stck	50	1000	
618000	Transparent Transparent	Mit weisser Blumenranke With white lace, for one single flower	60 x 14 x 3,5	Stck	100	2000	Blumentüte für die einzelne Blume Flower bag for the single flower
619000	Transparent Transparent	Neutral mit Perlmuttrückseite With nacre backside, for one single flower	65 x 14 x 3	Stck	50	3000	Blumentüte für die einzelne Blume Flower bag for the single flower
610103	Transparent Transparent	Mit gelben Schmetterlingen With yellow butterflies	50 x 35 x 9	Stck	50	1000	



96351



561110



560501



561120

Transparente Dekofolie

Transparent decoration foil

ARTIKELNUMMER	FARBE	DEKOR	Ø GRÖSSE/M	STK/PACK	VPE	KARTONMENGE	PRODUKTEIGENSCHAFTEN
ART.-NO.	COLOR	DESIGN	Ø SIZE/M	CONTENT	PU	BOX AMOUNT	PRODUCT CHARACTERISTICS
96351	Transparent, unbedruckt Transparent, unprinted		1,0 x 10	Rll.	1	20	Stärke 28 MY Thickness 28 MY
561110	Transparent, unbedruckt Transparent, unprinted		0,7 x 50	Rll.	1	10	
560501	Transparent, unbedruckt Transparent, unprinted		0,5 x 120	Rll.	1	10	Stärke 30 MY Thickness 30 MY
561120	Transparent, unbedruckt Transparent, unprinted		0,7 x 200	Rll.	1	4	Stärke 28 MY Thickness 28 MY
NEU NEW 561121	Transparent, unbedruckt Transparent, unprinted		40 cm x 50 cm	Packung	1	1	Stärke 30 MY, 1000 Stk/Pkg, 30 Pkg/Palette Thickness 30 MY, 1000 pcs / pack, 30 packs / pallet

Metallisierte Verpackungsfolie

SINGLE AND DOUBLE SIDED METALLIC FOIL



561101



561102

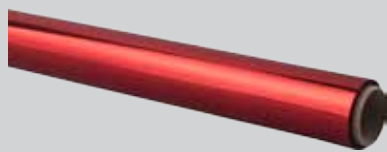

561107



561136

Metallisierte Verpackungsfolie

Single and double sided metallic foil

ARTIKELNUMMER	FARBE	DEKOR	Ø GRÖSSE/M	STK/PACK	VPE	KARTONMENGE	PRODUKTEIGENSCHAFTEN
ART.-NO.	COLOR	DESIGN	Ø SIZE/M	CONTENT	PU	BOX AMOUNT	PRODUCT CHARACTERISTICS
561101	Silber Silver	Beidseitig Double sided	0,7 x 10	Rll.	1	30	
561102	Gold Gold	Beidseitig Double sided	0,7 x 10	Rll.	1	30	
561107	Rot Red	Beidseitig Double sided	0,7 x 10	Rll.	1	30	
561136	Kupfer Copper	Beidseitig Double sided	0,7 x 10	Rll.	1	30	

Metallisierte Verpackungsfolie

SINGLE AND DOUBLE SIDED METALLIC FOIL



563001



563002

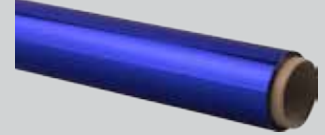

563003

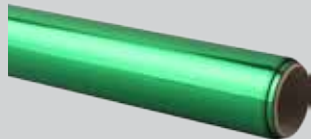

563004



563007

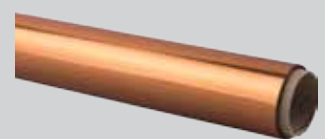

563036

Metallisierte Verpackungsfolie

Single and double sided metallic foil

ARTIKELNUMMER	FARBE	DEKOR	Ø GRÖSSE/M	STK/PACK	VPE	KARTONMENGE	PRODUKTEIGENSCHAFTEN
ART.-NO.	COLOR	DESIGN	Ø SIZE/M	CONTENT	PU	BOX AMOUNT	PRODUCT CHARACTERISTICS
563001	Silber Silver	Rückseite Silber Backside Silver	1,0 x 10	Rll.	1	25	
563002	Gold Gold	Rückseite Silber Backside Silver	1,0 x 10	Rll.	1	25	
563003	Blau Blue	Rückseite Silber Backside Silver	1,0 x 10	Rll.	1	25	
563004	Grün Green	Rückseite Silber Backside Silver	1,0 x 10	Rll.	1	25	
563007	Rot Red	Rückseite Silber Backside Silver	1,0 x 10	Rll.	1	25	
563036	Kupfer Copper	Rückseite Silber Backside Silver	1,0 x 10	Rll.	1	25	

Papiertragetaschen

PAPER BAGS



668300



668301



668303



668304



668306



668310



668312



668313



668314

Papiertragetasche mit gedrehter Kordel

Paper bags with twisted cord



ARTIKELNUMMER	FARBE	DEKOR	Ø GRÖSSE/CM	STK/PACK	VPE	KARTONMENGE	PRODUKTEIGENSCHAFTEN
ART.-NO.	COLOR	DESIGN	Ø SIZE/CM	CONTENT	PU	BOX AMOUNT	PRODUCT CHARACTERISTICS
668300	Weiss White		18 x 8 x 24	Pack	1	20	Papiertragetasche mit gedrehter Kordel, 20 Stück/Packung, hergestellt aus 100 g/qm Kraftpapier Paper bag with twisted cord, 20 pieces/pack, made of 100 g/qm craft paper
668301	Natur Nature		18 x 8 x 24	Pack	1	20	
668303	Gelb Yellow		18 x 8 x 24	Pack	1	20	
668304	Orange Orange		18 x 8 x 24	Pack	1	20	
668306	Hellgrün Light green		18 x 8 x 24	Pack	1	20	
668310	Rot Red		18 x 8 x 24	Pack	1	20	
668312	Fuchsia Fuchsia		18 x 8 x 24	Pack	1	20	
668313	Violett Lilac		18 x 8 x 24	Pack	1	20	
668314	Türkis Turquoise		18 x 8 x 24	Pack	1	20	

**NEU
NEW**

Papiertragetaschen

PAPER BAGS



Dunkelrot Darkred



Apfelgrün Apple green



Altrosa Rose



**NEU
NEW**

Papiertragetaschen Paper bags

Papiertragetasche mit flach gelegtem Henkel

Paper bags



ARTIKELNUMMER	FARBE	DEKOR	Ø GRÖSSE/CM	STK/PACK	VPE	KARTONMENGE	PRODUKTEIGENSCHAFTEN
ART.-NO.	COLOR	DESIGN	Ø SIZE/CM	CONTENT	PU	BOX AMOUNT	PRODUCT CHARACTERISTICS
668002	Altrosa Rose	Kraftpapier Craft paper	22 x 11 x 36	Stck	25	200	Hergestellt aus 90 g/qm Kraftpapier Made of 90 g/qm craft paper
668005	Dunkelrot Darkred	Kraftpapier Craft paper	22 x 11 x 36	Stck	25	200	
668006	Apfelgrün Apple green	Kraftpapier Craft paper	22 x 11 x 36	Stck	25	200	
668102	Altrosa Rose	Kraftpapier Craft paper	32 x 17 x 41	Stck	25	250	
668105	Dunkelrot Darkred	Kraftpapier Craft paper	32 x 17 x 41	Stck	25	250	
668106	Apfelgrün Apple green	Kraftpapier Craft paper	32 x 17 x 41	Stck	25	250	

Papiertragetasche mit flach gelegtem Henkel

Paper bags with flattened handle



ARTIKELNUMMER	FARBE	DEKOR	Ø GRÖSSE/CM	STK/PACK	VPE	KARTONMENGE	PRODUKTEIGENSCHAFTEN
ART.-NO.	COLOR	DESIGN	Ø SIZE/CM	CONTENT	PU	BOX AMOUNT	PRODUCT CHARACTERISTICS
668001	Natur Nature	Kraftpapier Craft paper	22 x 11 x 36	Stück	25	250	Papiertragetasche mit flach gelegtem Henkel, hergestellt aus 70 g/qm Kraftpapier Paper bag with flattened handle, made of 70 g/qm craft paper
NEU NEW 668003	Natur Nature	Kraftpapier Craft paper	32 + 17 x 27	Stück	25	250	
NEU NEW 668008	Natur Nature	Kraftpapier Craft paper	22 + 10 x 28	Stück	25	250	
NEU NEW 668009	Natur Nature	Kraftpapier Craft paper	18 + 8 x 22	Stück	25	250	
NEU NEW 668010	Natur Nature	Kraftpapier Craft paper	26 + 17 x 25	Stück	25	250	
668101	Natur Nature	Kraftpapier Craft paper	32 x 17 x 41	Stück	25	250	Hergestellt aus 90 g/qm Kraftpapier Made of 90 g/qm craft paper

Kreuzbodensack

CROSS BOTTOM BAG

NEU
NEW

infobox

Unsere Abfallsäcke sind vollständig kompostierbar und daher für die Entsorgung von Bio-Müll ideal einsetzbar.



NEU
NEW

690005

690004

Kreuzbodensack

Cross-bottom bag



ARTIKELNUMMER	FARBE	DEKOR	FASSUNGS- VERMÖGEN/L	Ø GRÖSSE/CM	STK/PACK	VPE	KARTONMENGE	PRODUKTEIGENSCHAFTEN
ART.-NO.	COLOR	DESIGN	CAPACITY/L	Ø SIZE/CM	CONTENT	PU	BOX AMOUNT	PRODUCT CHARACTERISTICS
NEU NEW 690004	Natur Nature	Kraftpapier Craft paper	70 Liter	55 x 85	Pack	1	16	Zu 5 Stück/Pack gebündelt, geklebt, 2-lagig aus 70g Kraftpapier, Standboden 20cm, mit Daumenausschlag und verklebtem Füllrand, unbedruckt. Unsere Abfallsäcke sind vollständig kompostierbar und daher für die Entsorgung von Bio Müll ideal einsetzbar.
NEU NEW 690005	Natur Nature	Kraftpapier Craft paper	120 Liter	70 x 95	Pack	1	14	Crossbottom sack, bundled to 5 pieces / pack, glued, 2-ply 70g kraft paper, floor 20cm, with thumb rash and glued rim, unprinted. Our waste bags are fully compostable and therefore ideal for the disposal of organic waste.

**NEU
NEW**

Jute Sack / Laub Sack

JUTE BAG / LEAF BAG



**NEU
NEW**

90405



**NEU
NEW**

90285



**NEU
NEW**

90170

Jute Sack Jute bag



ARTIKELNUMMER	FARBE	MATERIAL	FASSUNGS- VERMÖGEN/KG	Ø GRÖSSE/CM	STK/PACK	VPE	KARTONMENGE	PRODUKTEIGENSCHAFTEN
ART.-NO.	COLOR	MATERIAL	CAPACITY/KG	Ø SIZE/CM	CONTENT	PU	BOX AMOUNT	PRODUCT CHARACTERISTICS
NEU NEW 90170	Natur Nature	Jute Jute	40 kg	80 x 50	Stück	50	1	Dichte des Jutegewebes: 230 g/qm, mit Außennaht Density of jute fabric: 230 gsm, with outside seam.
NEU NEW 90285	Natur Nature	Jute Jute	50 kg	110 x 60	Stück	50	1	

Laub Sack Leaf bag



ARTIKELNUMMER	FARBE	MATERIAL	FASSUNGS- VERMÖGEN/L	Ø GRÖSSE/CM	STK/PACK	VPE	KARTONMENGE	PRODUKTEIGENSCHAFTEN
ART.-NO.	COLOR	MATERIAL	CAPACITY/L	Ø SIZE/CM	CONTENT	PU	BOX AMOUNT	PRODUCT CHARACTERISTICS
NEU NEW 90405	Natur Nature	Jute und Baumwolle Jute and cotton	~250 Liter	102 x 71	Stück	50	1	Laub Sack besteht aus 100% Naturfaser (Jute und Baumwolle). Leaf bag is made of 100% natural fiber (Jute and cotton)

Deko Jute Sack

DECORATIVE JUTE BAG

NEU
NEW



NEU
NEW 90401



NEU
NEW 90402



NEU
NEW 90403



NEU
NEW 90406



NEU
NEW 90407



NEU
NEW 90404

Deko Jute Säckchen

Decorative jute bag



ARTIKELNUMMER	FARBE	DEKOR	Ø GRÖSSE/CM	STK/PACK	VPE	KARTONMENGE	PRODUKTEIGENSCHAFTEN
ART.-NO.	COLOR	DESIGN	Ø SIZE/CM	CONTENT	PU	BOX AMOUNT	PRODUCT CHARACTERISTICS
NEU NEW 90401	Gelb Yellow	Uni, mit Knopf und Juteband Uni, with button and jute ribbon	25 x 20	Pack	1	20	25 Stück/Packung 25 pieces/pack
NEU NEW 90402	Rot Red		25 x 20	Pack	1	20	
NEU NEW 90403	Grün Green		25 x 20	Pack	1	20	
NEU NEW 90406	Weiss White		25 x 20	Pack	1	20	
NEU NEW 90407	Natur Nature	Blumen- mädchen Flowers girl	25 x 18	Pack	1	20	
NEU NEW 90404	Natur Nature	Nikolaus Nicolas	25 x 18	Pack	1	20	



Weinverpackung aus Jute

WINE JUTE PACKAGING

NEU
NEW



NEU
NEW

95012-1



NEU
NEW

95024-1



NEU
NEW

95021-1

Weinverpackung aus Jute mit Bambusgriffen

Wine jute packaging with bamboo handles



ARTIKELNUMMER	FARBE	DEKOR	Ø GRÖSSE/CM	STK/PACK	VPE	KARTONMENGE	PRODUKTEIGENSCHAFTEN
ART.-NO.	COLOR	DESIGN	Ø SIZE/CM	CONTENT	PU	BOX AMOUNT	PRODUCT CHARACTERISTICS
NEU NEW 95021-1	Natur Nature	Jute Jute	35 x 11 x 11	Stück	1	200	Für eine einzelne Flasche mit Sichtfenster For a single bottle with viewing window
NEU NEW 95012-1	Natur Nature	Jute Jute	35 x 11 x 11	Stück	1	200	Für eine einzelne Flasche ohne Sichtfenster For a single bottle without viewing window
NEU NEW 95024-1	Natur Nature	Jute Jute	40 x 20 x 13	Stück	1	100	Für zwei Flaschen mit Sichtfenster For two bottles with viewing window

**NEU
NEW**

Plastiktüte

PLASTIC BAGS



668200



668210



880101

**NEU
NEW**



880102

**NEU
NEW**

Hemdchentragetaschen

Plastic bags

ARTIKELNUMMER	FARBE	DEKOR	Ø GRÖSSE/CM	STK/PACK	VPE	KARTONMENGE	PRODUKTEIGENSCHAFTEN
ART.-NO.	COLOR	DESIGN	Ø SIZE/CM	CONTENT	PU	BOX AMOUNT	PRODUCT CHARACTERISTICS
668200	Weiss White		25 x 12 x 45	Stck	2000		Stärke 10 MY Thickness 10 MY
668210	Weiss White		30 x 18 x 55	Stck	2000		Stärke 13 MY Thickness 13 MY

Packpapier

Wrapping paper



ARTIKELNUMMER	FARBE	DEKOR	Ø GRÖSSE/CM	STK/PACK	VPE	PLATTENMENGE	PRODUKTEIGENSCHAFTEN
ART.-NO.	COLOR	DESIGN	Ø SIZE/CM	CONTENT	PU	BOX AMOUNT	PRODUCT CHARACTERISTICS
NEU NEW 880101	Natur Nature	Engerippt braun ribbed brown	50cm x 300m x Ø21cm	Rolle	1	40	Natronmischpapier 80g/m ² Mixed sodium paper 80g / sqm
NEU NEW 880102	Natur Nature	Engerippt braun ribbed brown	75cm x 300m x Ø21cm	Rolle	1	20	

Die Abbildungen können in Größenproportionen und Farbe vom Original abweichen. Änderungen behalten wir uns vor.
Size proportions and colors of items presented may vary from original. Subject to change without further notice.

SCHMUCKBÄNDER

RIBBONS



- 52 Polyband
(Polyribbon)
- 58 Polybandsplitter
(Ribbon splicer)
- 58 Polyband-Abroller
(Ribbon unwinder)
- 59 Tüllband
(Tulle ribbon)
- 60 Jute Band
(Jute band)



Polyband
Poly ribbon

	5 mm x 500 m		10 mm x 250 m		19 mm x 100 m (Standard)		19 mm x 100 m (ohne Seitenscheibe)	
FARBE	ARTIKELNR.	VPE	ARTIKELNR.	VPE	ARTIKELNR.	VPE	ARTIKELNR.	VPE
COLOR	ART.-NO.	PU	ART.-NO.	PU	ART.-NO.	PU	ART.-NO.	PU
Weiß White	410105	5/30	430105	5/30	460105	1/15	461005	1/15
Creme Cream	410140	5/30	430140	5/30	460140	1/15	461040	1/15
Hellorange Light orange	410107	5/30	430107	5/30				
Gelb Yellow	410103	5/30	430103	5/30	460103	1/15	461003	1/15
Gold Gold	410104	5/30	430104	5/30				
Orange Orange	410109	5/30	430109	5/30	460109	1/15	461009	1/15
Braun Brown	410125	5/30	430125	5/30				
Kolonialbraun Colonial brown	410122	5/30	430122	5/30				
Schwarz Black	410123	5/30	430123	5/30	460123	1/15	461023	1/15
Silber Silver	410101	5/30	430101	5/30				
Lachsrosa Salmon rose	410108	5/30	430108	5/30				
Rosa Rose	410112	5/30	430112	5/30				
Pink Pink	410117	5/30	430117	5/30	460117	1/15	461017	1/15
Hellflieder Light lilac	410114	5/30	430114	5/30	460114	1/15	461014	1/15
Flieder Lilac	410116	5/30	430116	5/30				
Dunkellila Dark lilac	410132	5/30	430132	5/30				
Rot Red	410111	5/30	430111	5/30	460111	1/15	461011	1/15
Burgunder Burgundy	410118	5/30	430118	5/30				
Blau Blue	410120	5/30	430120	5/30	460120	1/15	461020	1/15
Hellblau Light blue	410124	5/30	430124	5/30				
Maigrün May green	410138	5/30	430138	5/30	460138	1/15	461038	1/15
Moos Moss	410121	5/30	430121	5/30				
Dunkelgrün Dark green	410127	5/30	430127	5/30	460127	1/15	461027	1/15
Hellgrün Light green	410126	5/30	430126	5/30				
Tannengrün Fir tree green	410137	5/30	430137	5/30				



410105



410104

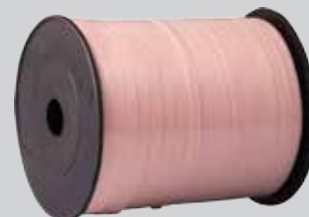

410107



Weiß White



Crème Cream



Hellorange Light orange



Gelb Yellow



Gold Gold



Orange Orange



Braun Brown



Kolonialbraun Colonial brown



Schwarz Black



Silber Silver



Lachsrosa Salmon rose



Rosa Rose



Pink Pink



Hellflieder Light lilac



Flieder Lilac



Dunkellila Dark lilac

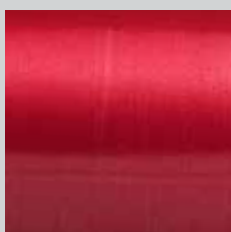

Rot Red



Burgunder Burgundy



Blau Blue



Hellblau Light blue



Maigrün May green



Moos Moss



Dunkelgrün Dark green



Hellgrün Light green



Tannengrün Fir tree green



Weiß White



Creme Cream



Gelb Yellow



Orange Orange



Schwarz Black



Pink Pink



Hellflieder Light lilac

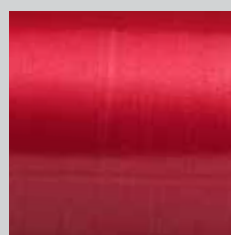

Rot Red



Blau Blue



Maigrün May green



Dunkelgrün Dark green

Polyband

Poly ribbon

	31 mm x 100 m		31 mm x 100 m (ohne Seitenscheibe)		50 mm x 100 m		50 mm x 100 m (ohne Seitenscheibe)	
FARBE	ARTIKELNR.	VPE	ARTIKELNR.	VPE	ARTIKELNR.	VPE	ARTIKELNR.	VPE
COLOR	ART.-NO.	PU	ART.-NO.	PU	ART.-NO.	PU	ART.-NO.	PU
Weiß White	480105	1/11	481005	1/10	500105	1/7	501005	1/6
Creme Cream	480140	1/11	481040	1/10	500140	1/7	501040	1/6
Gelb Yellow	480103	1/11	481003	1/10	500103	1/7	501003	1/6
Orange Orange	480109	1/11	481009	1/10	500109	1/7	501009	1/6
Schwarz Black	480123	1/11	481023	1/10	500123	1/7	501023	1/6
Pink Pink	480117	1/11	481017	1/10	500117	1/7	501017	1/6
Hellflieder Light lilac	480114	1/11	481014	1/10	500114	1/7	501014	1/6
Rot Red	480111	1/11	481011	1/10	500111	1/7	501011	1/6
Blau Blue	480120	1/11	481020	1/10	500120	1/7	501020	1/6
Maigrün May green	480138	1/11	481038	1/10	500138	1/7	501038	1/6
Dunkelgrün Dark green	480127	1/11	481027	1/10	500127	1/7	501027	1/6



430301



430304



430311



430336

Polyband metallic

Poly ribbon metallic

ARTIKELNUMMER	FARBE	DEKOR	Ø GRÖSSE/MM/M	STK/PACK	VPE	KARTONMENGE	PRODUKTEIGENSCHAFTEN
ART.-NO.	COLOR	DESIGN	Ø SIZE/CM	CONTENT	PU	BOX AMOUNT	PRODUCT CHARACTERISTICS
410301	Silber Silver	Metallic Metallic	5 mm x 250 m	Stck	5	30	
410304	Gold Gold	Metallic Metallic	5 mm x 250 m	Stck	5	30	
410311	Rot Red	Metallic Metallic	5 mm x 250 m	Stck	5	30	
410336	Kupfer Copper	Metallic Metallic	5 mm x 250 m	Stck	5	30	
430301	Silber Silver	Metallic Metallic	10 mm x 250 m	Stck	5	30	
430304	Gold Gold	Metallic Metallic	10 mm x 250 m	Stck	5	30	
430311	Rot Red	Metallic Metallic	10 mm x 250 m	Stck	5	30	
430336	Kupfer Copper	Metallic Metallic	10 mm x 250 m	Stck	5	30	



480301



480304

Polyband metallic

Poly ribbon metallic

ARTIKELNUMMER	FARBE	DEKOR	Ø GRÖSSE/MM/M	STK/PACK	VPE	KARTONMENGE	PRODUKTEIGENSCHAFTEN
ART.-NO.	COLOR	DESIGN	Ø SIZE/CM	CONTENT	PU	BOX AMOUNT	PRODUCT CHARACTERISTICS
460301	Silber Silver	Metallic Metallic	19 mm x 100 m	Stck	1	15	
460304	Gold Gold	Metallic Metallic	19 mm x 100 m	Stck	1	15	
480301	Silber Silver	Metallic Metallic	31 mm x 100 m	Stck	1	11	
480304	Gold Gold	Metallic Metallic	31 mm x 100 m	Stck	1	11	
500301	Silber Silver	Metallic Metallic	50 mm x 100 m	Stck	1	7	
500304	Gold Gold	Metallic Metallic	50 mm x 100 m	Stck	1	7	

NEU
NEW

Polyband bedruckt

POLY RIBBONS



430512



410510



430511



NEU
NEW

45013



NEU
NEW

45014

Polyband bedruckt

Printed polyribbon

ARTIKELNUMMER	FARBE	DEKOR	Ø GRÖSSE/MM/Y	STK/PACK	VPE	KARTONMENGE	PRODUKTEIGENSCHAFTEN
ART.-NO.	COLOR	DESIGN	Ø SIZE/CM	CONTENT	PU	BOX AMOUNT	PRODUCT CHARACTERISTICS
430512	Weiss White	Glückskele Four-leafed clover tape Green on White	10 mm x 250 m	Stck	1	20	
410510	Weiss White	Weiss mit roten Herzen Heart tape, Red on White	4,8 mm x 500 yards	Stck	1	15	
430511	Weiss White	Weiss mit roten Herzen Heart tape, Red on White	10 mm x 250 yards	Stck	1	15	
NEU NEW 45013	Grün Green	Aspa Polyband Aspa polyribbon	30 mm x 40 mm	Stck	10	70	
NEU NEW 45014	Grün Green	Aspa Polyband Aspa polyribbon	90 mm x 40 mm	Stck	4	40	

Polybandsplitter

RIBBON SPLICER



520001

Made in Germany
Mit Metallzähnen With metal teeth



520002



520010



520011

Polybandsplitter

Ribbon splicer



ARTIKELNUMMER	FARBE	DEKOR	Ø GRÖSSE/CM	STK/PACK	VPE	KARTONMENGE	PRODUKTEIGENSCHAFTEN
ART.-NO.	COLOR	DESIGN	Ø SIZE/CM	CONTENT	PU	BOX AMOUNT	PRODUCT CHARACTERISTICS
520001	Farbig sortiert Assorted colors			Stck	25	300	Polybandsplitter ECO, mit 1 Splittbreite, mit Metallzähnen, Made in Germany Polybandsplitter ECO, with 1 split width, with metal teeth, Made in Germany
520002	Farbig sortiert Assorted colors			Stck	1	25	Polybandsplitter Favorit, mit 2 Splittbreiten, geblistert, mit Metallzähnen, Made in Germany Polybandsplitter Favorit, with 2 split widths, in blister pack, with metal teeth, Made in Germany

Polyband-Abroller

Ribbon unwinder

ARTIKELNUMMER	FARBE	DEKOR	Ø GRÖSSE/CM	STK/PACK	VPE	KARTONMENGE	PRODUKTEIGENSCHAFTEN
ART.-NO.	COLOR	DESIGN	Ø SIZE/CM	CONTENT	PU	BOX AMOUNT	PRODUCT CHARACTERISTICS
520010				Stck	1		Polybandabroller, Standhalter für 6 Rollen Ribbon unwinder, stand holder for 6 rolls
520011				Stck	1		Polybandabroller, Standhalter für 8 Rollen Ribbon unwinder, stand holder for 8 rolls

Die Abbildungen können in Größenproportionen und Farbe vom Original abweichen. Änderungen behalten wir uns vor.
Size proportions and colors of items presented may vary from original. Subject to change without further notice.



Champagner Champagner



Weiss White



Rot Red



Schwarz Black



Silber Silver



Gold Gold

Tüllband

Tulle ribbon

	5 cm x 50 m		7,5 cm x 50 m		10 cm x 50 m		12,5 cm x 50 m	
FARBE	ARTIKELNR.	VPE	ARTIKELNR.	VPE	ARTIKELNR.	VPE	ARTIKELNR.	VPE
COLOR	ART.-NO.	PU	ART.-NO.	PU	ART.-NO.	PU	ART.-NO.	PU
Champagner Champagne	400502	1/18	400702	1/12	401002	1/9	401202	1/6
Weiss White	400505	1/18	400705	1/12	401005	1/9	401205	1/6
Rot Red	400511	1/18	400711	1/12	401011	1/9	401211	1/6
Schwarz Black	400523	1/18	400723	1/12	401023	1/9	401223	1/6

Tüllband

Tulle ribbon

	5 cm x 20 m		7,5 cm x 20 m		10 cm x 20 m		12,5 cm x 20 m	
FARBE	ARTIKELNR.	VPE	ARTIKELNR.	VPE	ARTIKELNR.	VPE	ARTIKELNR.	VPE
COLOR	ART.-NO.	PU	ART.-NO.	PU	ART.-NO.	PU	ART.-NO.	PU
Silber Silver	400551	1/18	400751	1/12	401051	1/9	401251	1/6
Gold Gold	400552	1/18	400752	1/12	401052	1/9	401252	1/6

Jute Band / Jute Wickelstreifen

JUTE BAND / JUTE WRAPPER

NEU
NEW



NEU
NEW

Natur Nature



NEU
NEW

Gelb Yellow



NEU
NEW

Rot Red



NEU
NEW

Braun Brown



NEU
NEW

Dunkelgrün Dark green



NEU
NEW

Hellgrün Light green



NEU
NEW

Dunkelblau Dark blue



NEU
NEW

Hellblau Light blue



NEU
NEW

Weiss White

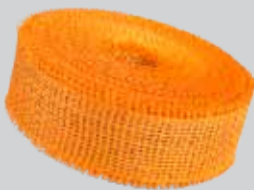

NEU
NEW

Orange Orange



NEU
NEW

Natur Nature

Jute Wickelstreifen
Jute Wrapper



Jute Wickelstreifen

Jute wrapper

ARTIKELNUMMER	FARBE	Ø GRÖSSE/CM	STK/PACK	VPE	KARTONMENGE	PRODUKTEIGENSCHAFTEN
ART.-NO.	COLOR	Ø SIZE/CM	CONTENT	PU	BOX AMOUNT	PRODUCT CHARACTERISTICS
NEU NEW 80051	Natur Nature	15 cm x 25 m	Rll.	1	30	Jutegewebe 185g/qm , aus 100% Jutefaser, biologisch abbaubar Jute fabric 185g / sqm , made of 100% jute, biodegradable

Jute Band

Jute band



ARTIKELNUMMER	FARBE	Ø GRÖSSE/CM	STK/PACK	VPE	KARTONMENGE	PRODUKTEIGENSCHAFTEN
ART.-NO.	COLOR	Ø SIZE/CM	CONTENT	PU	BOX AMOUNT	PRODUCT CHARACTERISTICS
NEU NEW 35015	Natur Nature	4 cm x 25 m	Rll.	1	100	Aus 100% Jutefaser , biologisch abbaubar, 180g/qm . leicht gestärkt , mit Lino Rand Made of 100% jute, biodegradable, 180g / sqm . slightly strengthened, with Lino edge
NEU NEW 35016	Gelb Yellow	4 cm x 25 m	Rll.	1	100	
NEU NEW 35017	Rot Red	4 cm x 25 m	Rll.	1	100	
NEU NEW 35018	Braun Brown	4 cm x 25 m	Rll.	1	100	
NEU NEW 35019	Dunkelgrün Dark green	4 cm x 25 m	Rll.	1	100	
NEU NEW 35020	Hellgrün Light green	4 cm x 25 m	Rll.	1	100	
NEU NEW 35021	Dunkelblau Dark blue	4 cm x 25 m	Rll.	1	100	
NEU NEW 35022	Hellblau Light blue	4 cm x 25 m	Rll.	1	100	
NEU NEW 35023	Weiss White	4 cm x 25 m	Rll.	1	100	
NEU NEW 35024	Orange Orange	4 cm x 25 m	Rll.	1	100	

BINDEREIBEDARF

BINDERY SUPPLY



- 64 Bindfaden
(Cord)
- 65 Bindestreifen
(Florist wire)
- 68 Gummibänder
(Rubber band)
- 69 Gärtnerbast
(Poly raffia)
- 70 Perlonschnur
(Nylon string)
- 71 Saugnäpfe
(Sucker)
- 71 Stecknadeln
(Pins)
- 72 Blumenklebeband
(Stem wind)
- 73 Römerwickelband
(Fleece rayon)



Bindfaden

TWINE



606060



607060



608060



609060

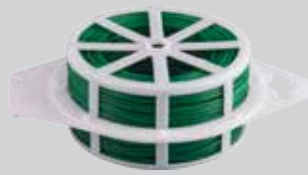

110004

Bindfäden aus Naturfaser

Nature fibre string



ARTIKELNUMMER	FARBE	DEKOR	Ø GRÖSSE/M	STK/PACK	VPE	KARTONMENGE	PRODUKTEIGENSCHAFTEN
ART.-NO.	COLOR	DESIGN	Ø SIZE/M	CONTENT	PU	BOX AMOUNT	PRODUCT CHARACTERISTICS
606060	Natur Nature	Fein Fine	160	Stck	10	150	
607060	Natur Nature	Mittelstark Moderately	80	Stck	10	150	
608060	Natur Nature	Stark Strong	40	Stck	10	150	
609060	Natur Nature	Superstark Super strong	40	Stck	6	60	

Bindestreifen Spule 100 m, mit Abschneider

Bobbin with 100 m plastic florist wire and cutter

ARTIKELNUMMER	FARBE	DEKOR	LÄNGE/M	STK/PACK	VPE	KARTONMENGE	PRODUKTEIGENSCHAFTEN
ART.-NO.	COLOR	DESIGN	LENGTH/M	CONTENT	PU	BOX AMOUNT	PRODUCT CHARACTERISTICS
110004	Grün Green	Kunststoff Plastic	100	Stck	1	10	



113004



114004



111001



112001

Bindestreifen Kunststoff mit 1 Drahteinlage

Plastic florist wire I-wire

ARTIKELNUMMER	FARBE	DEKOR	Ø GRÖSSE/CM	STK/PACK	VPE	KARTONMENGE	PRODUKTEIGENSCHAFTEN
ART.-NO.	COLOR	DESIGN	Ø SIZE/CM	CONTENT	PU	BOX AMOUNT	PRODUCT CHARACTERISTICS
111004	Grün Green	Kunststoff Plastic	10cm	Stck	1000	25000	
111504	Grün Green	Kunststoff Plastic	15cm	Stck	1000	25000	
112004	Grün Green	Kunststoff Plastic	20cm	Stck	1000	25000	
112504	Grün Green	Kunststoff Plastic	25cm	Stck	1000	25000	
113004	Grün Green	Kunststoff Plastic	30cm	Stck	1000	25000	
114004	Grün Green	Kunststoff Plastic	40cm	Stck	1000	20000	

Bindestreifen Papier mit 1 Drahteinlage

Paper florist wire I-wire

ARTIKELNUMMER	FARBE	DEKOR	Ø GRÖSSE/CM	STK/PACK	VPE	KARTONMENGE	PRODUKTEIGENSCHAFTEN
ART.-NO.	COLOR	DESIGN	Ø SIZE/CM	CONTENT	PU	BOX AMOUNT	PRODUCT CHARACTERISTICS
111001	Grün Green	Papier Paper	10	Stck	1000	30000	
112001	Grün Green	Papier Paper	20	Stck	1000	25000	

Bindestreifen

FLORIST WIRE



111002



111202



111502



111802



112002



112202

Bindestreifen Papier 2-Draht, Grün

Paper florist wire 2-wire, Green

ARTIKELNUMMER	FARBE	DEKOR	Ø GRÖSSE/CM	STK/PACK	VPE	KARTONMENGE	PRODUKTEIGENSCHAFTEN
ART.-NO.	COLOR	DESIGN	Ø SIZE/CM	CONTENT	PU	BOX AMOUNT	PRODUCT CHARACTERISTICS
111002	Grün Green	Papier Paper	10	Stck	1000	30000	
111202	Grün Green	Papier Paper	12	Stck	1000	30000	
111502	Grün Green	Papier Paper	15	Stck	1000	25000	
111802	Grün Green	Papier Paper	18	Stck	1000	25000	
112002	Grün Green	Papier Paper	20	Stck	1000	20000	
112202	Grün Green	Papier Paper	22	Stck	1000	20000	
112502	Grün Green	Papier Paper	25	Stck	1000	15000	
112802	Grün Green	Papier Paper	28	Stck	1000	15000	
113002	Grün Green	Papier Paper	30	Stck	1000	15000	
113502	Grün Green	Papier Paper	35	Stck	1000	10000	
114002	Grün Green	Papier Paper	40	Stck	1000	10000	

Die Abbildungen können in Größenproportionen und Farbe vom Original abweichen. Änderungen behalten wir uns vor.
Size proportions and colors of items presented may vary from original. Subject to change without further notice.

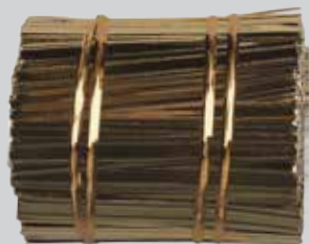

111003



111203



111503



112003



112503

Bindestreifen Papier 2-Draht Gold

Paper florist wire, 2-wire, Gold

ARTIKELNUMMER	FARBE	DEKOR	Ø GRÖSSE/CM	STK/PACK	VPE	KARTONMENGE	PRODUKTEIGENSCHAFTEN
ART.-NO.	COLOR	DESIGN	Ø SIZE/CM	CONTENT	PU	BOX AMOUNT	PRODUCT CHARACTERISTICS
111003	Gold Gold	Papier Papier	10	Stck	1000	30000	
111203	Gold Gold	Papier Papier	12	Stck	1000	30000	
111503	Gold Gold	Papier Papier	15	Stck	1000	25000	
112003	Gold Gold	Papier Papier	20	Stck	1000	25000	
112503	Gold Gold	Papier Papier	25	Stck	1000	20000	

Gummibänder

RUBBER BAND



115010



115011

Gummibänder

Rubber band

ARTIKELNUMMER	FARBE	DEKOR	Ø GRÖSSE/CM	STK/PACK	VPE	KARTONMENGE	PRODUKTEIGENSCHAFTEN
ART.-NO.	COLOR	DESIGN	Ø SIZE/CM	CONTENT	PU	BOX AMOUNT	PRODUCT CHARACTERISTICS
115010	Rot Red		6	Beutel	1	10	Gummibänder 1 kg/Beutel, ca. 60 % Kautschukanteil Rubber bands 1 kg/bag, app. 60 % proportion of rubber
115011	Natur Nature		6	Beutel	1	10	Gummibänder 1 kg/Beutel, ca. 90 % Kautschukanteil Rubber bands 1 kg/bag, app. 90 % proportion of rubber



114500



114501



114502



114503

Gärtnerbast Poly raffia

ARTIKELNUMMER	FARBE	DEKOR	Ø GRÖSSE/M	STK/PACK	VPE	KARTONMENGE	PRODUKTEIGENSCHAFTEN
ART.-NO.	COLOR	DESIGN	Ø SIZE/M	CONTENT	PU	BOX AMOUNT	PRODUCT CHARACTERISTICS
114500	Grün Green	Im Netz In net	500	Stck	5	50	
114501	Grün Green	In Dose In can	700	Stck	1	12	
114502	Grün Green	Nachfüllrolle Refiller	700	Stck	5	50	
114503	Grün Green	Standstecher stand cutter		Stck	1	2	Ohne Nachfüllrolle Without refill roll

Perlonschnur

NYLON STRING



320015



320020



320030



320035

Perlonschnur

Nylon string

ARTIKELNUMMER	FARBE	DEKOR	Ø GRÖSSE/MM/M	STK/PACK	VPE	KARTONMENGE	PRODUKTEIGENSCHAFTEN
ART.-NO.	COLOR	DESIGN	Ø SIZE/CM	CONTENT	PU	BOX AMOUNT	PRODUCT CHARACTERISTICS
320015	Transparent/Weiss Transparent/White	Hängerspule hanging spool	0,3 mm x 100 m	Rll.	1	10	Reissfestigkeit 5,7 kg Tear strength 5,7 kg
320020	Transparent/Weiss Transparent/White	Hängerspule hanging spool	0,5 mm x 100 m	Rll.	1	10	Reissfestigkeit 14,5 kg Tear strength 5,7 kg
320030	Transparent/Weiss Transparent/White	Arm-/Klemmspule Arm/coil terminal	0,3 mm x 100 m	Rll.	1	10	
320035	Transparent/Weiss Transparent/White	Arm-/Klemmspule Arm/coil terminal	0,5 mm x 100 m	Rll.	1	10	



402000



405000



401208



501208



502004



300901

Saugnapfe

Sucker

ARTIKELNUMMER	FARBE	DEKOR	Ø GRÖSSE/CM	STK/PACK	VPE	KARTONMENGE	PRODUKTEIGENSCHAFTEN
ART.-NO.	COLOR	DESIGN	Ø SIZE/CM	CONTENT	PU	BOX AMOUNT	PRODUCT CHARACTERISTICS
402000	Transparent Transparent	Mit transparentem Haken With transparent hook	4	Beutel	1	24	10 Stück/Beutel 10 pcs/bag
405000	Transparent Transparent	Mit Metallhaken With metal hook	4	Beutel	1	24	10 Stück/Beutel 10 pcs/bag
401208	Transparent Transparent	Knopfsauger Button sucker	4	Beutel	1	24	10 Stück/Beutel 10 pcs/bag
501208	Transparent Transparent	Knopfsauger Button sucker	5	Beutel	1	24	10 Stück/Beutel 10 pcs/bag
502004	Transparent Transparent	Lochsauger mit 4 mm Querloch Vacuum cleaner with 4 mm cross hole	5	Beutel	1	24	10 Stück/Beutel 10 pcs/bag

Stecknadeln

Pins, nickel-plated, 30mm

ARTIKELNUMMER	FARBE	DEKOR	Ø GRÖSSE/CM	STK/PACK	VPE	KARTONMENGE	PRODUKTEIGENSCHAFTEN
ART.-NO.	COLOR	DESIGN	Ø SIZE/CM	CONTENT	PU	BOX AMOUNT	PRODUCT CHARACTERISTICS
300901	Vernickelt Nickel plated		0,07 x 3	Pack	1	30	500 g/Packung 500 g/pack

Blumenklebeband

STEM WIND

NEU
NEW

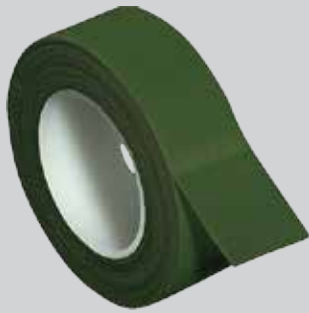

161371

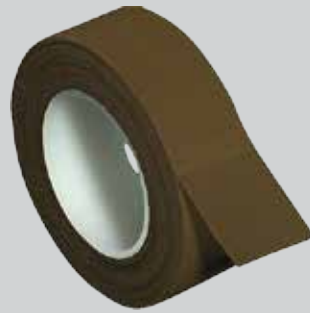

161372

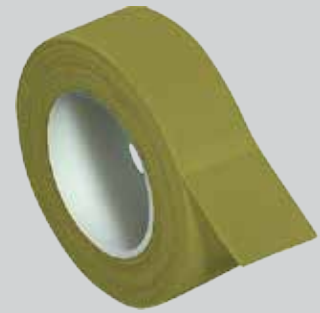

161376



162650



162671



NEU
NEW

161301



NEU
NEW

161304

Floraltape

Floral tape

ARTIKELNUMMER	FARBE	DEKOR	Ø GRÖSSE/MM/M	STK/PACK	VPE	KARTONMENGE	PRODUKTEIGENSCHAFTEN
ART.-NO.	COLOR	DESIGN	Ø SIZE/CM	CONTENT	PU	BOX AMOUNT	PRODUCT CHARACTERISTICS
NEU NEW 161301	Silber Silver	Metallic Metallic	12 mm x 20 yards	Rll.	12	288	Wasserabweisendes, kreppähnliches Band zum Umwickeln von Blumenstielen oder -draht Water-repellent, crepe-like tape for wrapping flower stalks or wire
NEU NEW 161304	Gold Gold	Metallic Metallic	12 mm x 20 yards	Rll.	12	288	
161350	Weiss White	Floraltape floral tape	13 mm x 28 m	Rll.	12	288	
161371	Dunkelgrün Dark green	Floraltape floral tape	13 mm x 28 m	Rll.	12	288	
161372	Braun Brown	Floraltape floral tape	13 mm x 28 m	Rll.	12	288	
161376	Hellgrün Light green	Floraltape floral tape	13 mm x 28 m	Rll.	12	288	
162650	Weiss White	Floraltape floral tape	26 mm x 28 m	Rll.	6	144	
162671	Dunkelgrün Dark green	Floraltape floral tape	26 mm x 28 m	Rll.	6	144	
162672	Braun Brown	Floraltape floral tape	26 mm x 28 m	Rll.	6	144	
162676	Hellgrün Light green	Floraltape floral tape	26 mm x 28 m	Rll.	6	144	

Die Abbildungen können in Größenproportionen und Farbe vom Original abweichen. Änderungen behalten wir uns vor.
Size proportions and colors of items presented may vary from original. Subject to change without further notice.



161390



162690



171518



171519

Blumenklebeband

Stem wind

ARTIKELNUMMER	FARBE	DEKOR	Ø GRÖSSE/MM/M	STK/PACK	VPE	KARTONMENGE	PRODUKTEIGENSCHAFTEN
ART.-NO.	COLOR	DESIGN	Ø SIZE/CM	CONTENT	PU	BOX AMOUNT	PRODUCT CHARACTERISTICS
161390	Mittelgrün Middle green	Parafilm parafilm	13x23m	Rll.	12	144	
162690	Mittelgrün Middle green	Parafilm parafilm	26x23m	Rll.	6	72	

Römerwickelband Viskosevlies

Fleece rayon



ARTIKELNUMMER	FARBE	DEKOR	Ø GRÖSSE/CM/M	STK/PACK	VPE	KARTONMENGE	PRODUKTEIGENSCHAFTEN
ART.-NO.	COLOR	DESIGN	Ø SIZE/CM	CONTENT	PU	BOX AMOUNT	PRODUCT CHARACTERISTICS
171518	Dunkelgrün Dark green		6 cm x 100 m	Rll.	5	60	24 g/qm

Römerwickelband Floristenkrepp

Florist crepe paper



ARTIKELNUMMER	FARBE	DEKOR	Ø GRÖSSE/CM/M	STK/PACK	VPE	KARTONMENGE	PRODUKTEIGENSCHAFTEN
ART.-NO.	COLOR	DESIGN	Ø SIZE/CM	CONTENT	PU	BOX AMOUNT	PRODUCT CHARACTERISTICS
171519	Dunkelgrün Dark green		6 cm x 20 m	Rll.	5	70	65 g/qm

GESTECKHALTER

PLASTIC HOLDER

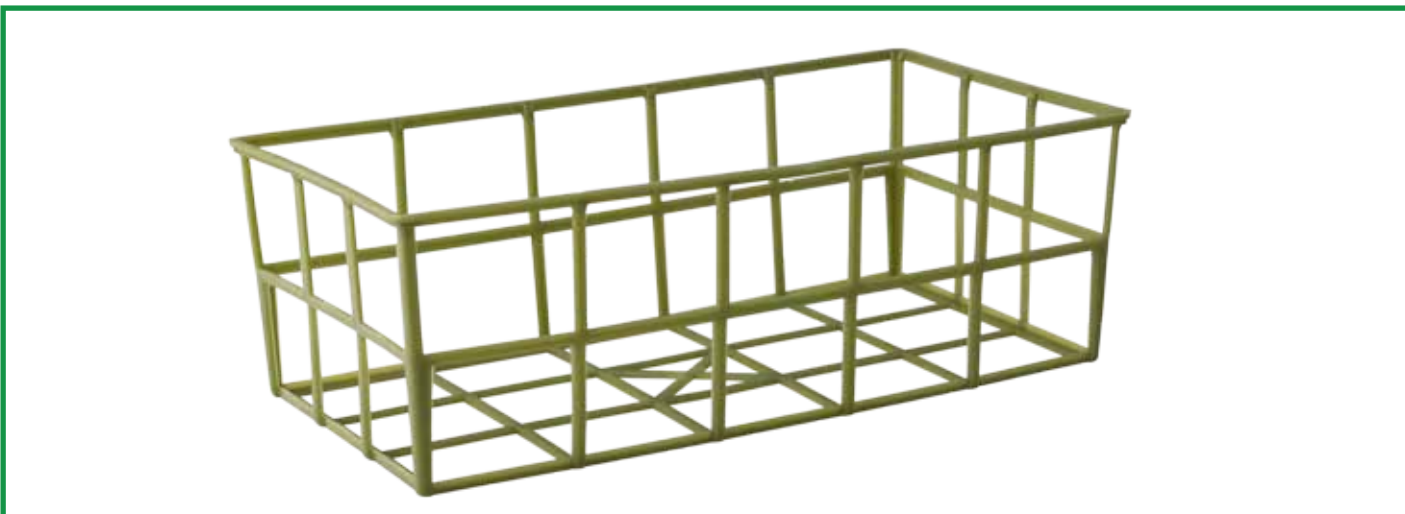

76 Gesteckhalter
(Pinholder)

77 Blumenclips
(Synthetic flower clips)

78 Steckringe
(Plastic ring)

78 Wursthalter
(Sausage holder)

79 Flaschendekohalter
(Decoration holder for bottles)

79 Brautstraußhalter
(Bouquet holder)

80 Orchideenröhrchen
(Flower tubes)

81 Reagenzgläser
(Glas tubes)

82 Kunststoff Blumen
(Plastic flowers)

83 Stütz- und Faltgitter
(Support and folding grille)

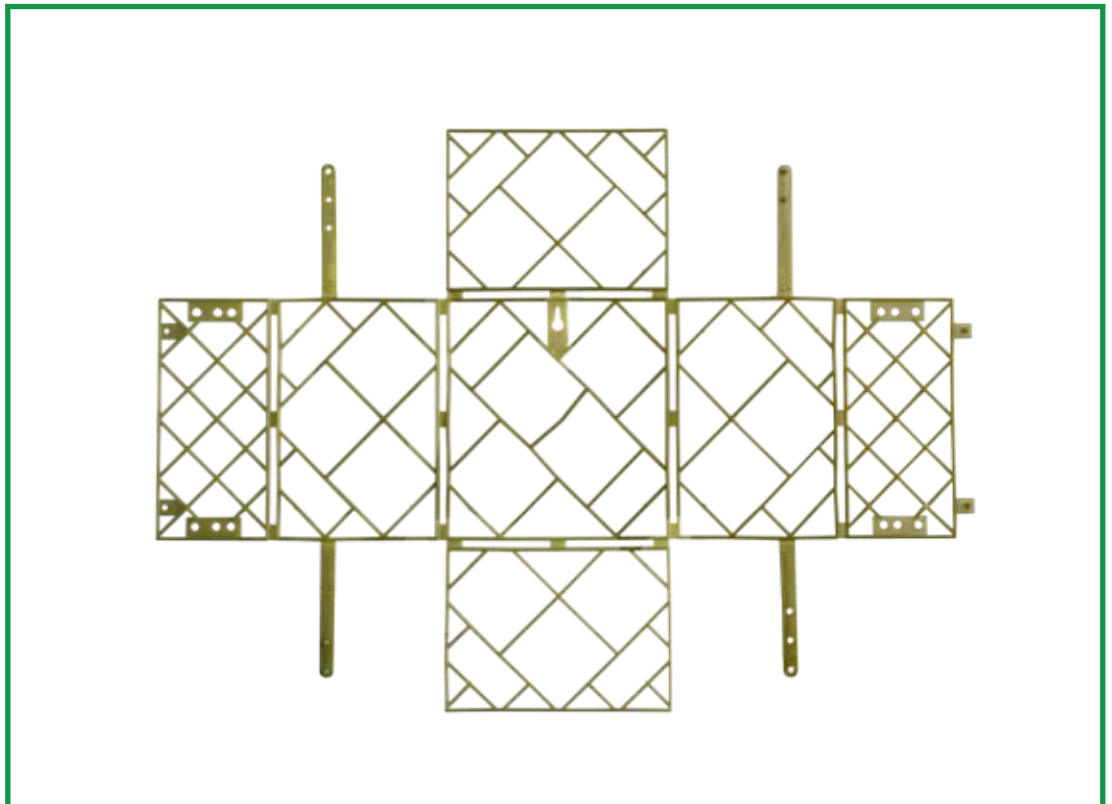
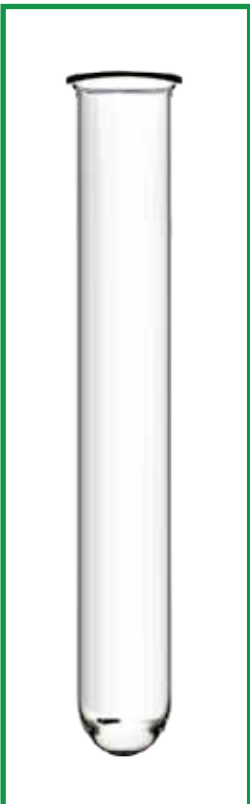

Gesteckhalter

PIN HOLDER



147100

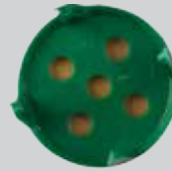

147101

Gesteckhalter

Pin holder



ARTIKELNUMMER	FARBE	DEKOR	Ø GRÖSSE/CM	STK/PACK	VPE	KARTONMENGE	PRODUKTEIGENSCHAFTEN
ART.-NO.	COLOR	DESIGN	Ø SIZE/CM	CONTENT	PU	BOX AMOUNT	PRODUCT CHARACTERISTICS
147100	Grün Green		3 x 3	Stck	100	2600	
147101	Grün Green	mit Selbst- klebeetikett with self adhesive label	3 x 3	Stck	100	2600	

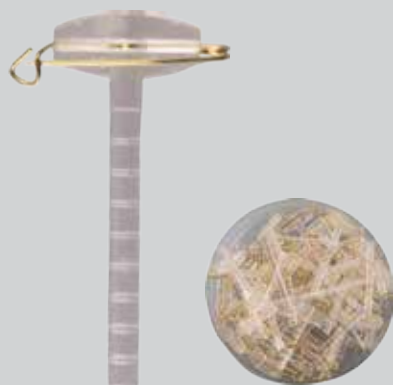

305191



305193



305195

Blumenclips

Synthetic flower clips

ARTIKELNUMMER	FARBE	DEKOR	Ø GRÖSSE/CM	STK/PACK	VPE	KARTONMENGE	PRODUKTEIGENSCHAFTEN
ART.-NO.	COLOR	DESIGN	Ø SIZE/CM	CONTENT	PU	BOX AMOUNT	PRODUCT CHARACTERISTICS
305191	Transparent Transparent	Blumenclips mit Anstecknadel	5	Dose	1	50	50 Stück/Dose 50 pcs/box
305192	Transparent Transparent	Blumenclips mit Anstecknadel	5	Dose	1	50	100 Stück/Dose 100 pcs/box
305193	Transparent Transparent	Blumenclips mit Magnet	5	Dose	1	50	10 Stück/Dose 10 pcs/box
305195	Silber Silver	Scheibenmagnet	1 x 0,3	Pack	1	20	10 Stück/Pack 10 pcs/pack

Steckringe

PLASTIC RINGS



353000



305101

Steckringe

Plastic rings



ARTIKELNUMMER	FARBE	DEKOR	Ø GRÖSSE/CM	STK/PACK	VPE	KARTONMENGE	PRODUKTEIGENSCHAFTEN
ART.-NO.	COLOR	DESIGN	Ø SIZE/CM	CONTENT	PU	BOX AMOUNT	PRODUCT CHARACTERISTICS
351400	Grün Green		14	Stck	50	1000	
351700	Grün Green		17	Stck	50	600	
352000	Grün Green		20	Stck	50	300	
352500	Grün Green		25	Stck	25	150	
353000	Grün Green		30	Stck	25	100	

Wursthalter

Sausage holder



ARTIKELNUMMER	FARBE	DEKOR	Ø GRÖSSE/CM	STK/PACK	VPE	KARTONMENGE	PRODUKTEIGENSCHAFTEN
ART.-NO.	COLOR	DESIGN	Ø SIZE/CM	CONTENT	PU	BOX AMOUNT	PRODUCT CHARACTERISTICS
305101	Transparent Transparent		9	Stck	200	4800	

Die Abbildungen können in Größenproportionen und Farbe vom Original abweichen. Änderungen behalten wir uns vor.
Size proportions and colors of items presented may vary from original. Subject to change without further notice.

Flaschendekhalter

DECORATION HOLDER FOR BOTTLES



305001



146401



146404

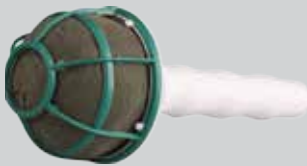

146405

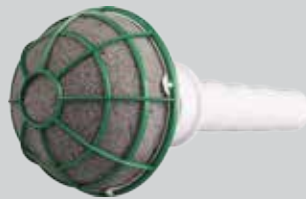

146501

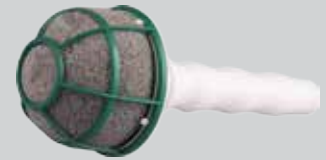

146505

Flaschendekhalter

Decoration holder for bottles



ARTIKELNUMMER	FARBE	DEKOR	Ø GRÖSSE/CM	STK/PACK	VPE	KARTONMENGE	PRODUKTEIGENSCHAFTEN
ART.-NO.	COLOR	DESIGN	Ø SIZE/CM	CONTENT	PU	BOX AMOUNT	PRODUCT CHARACTERISTICS
305001	Grün Green		6	Stck	6	48	Mit Trockenschaum With dry foam

Brautstraußhalter

Bouquet holder



ARTIKELNUMMER	FARBE	DEKOR	Ø GRÖSSE/CM	STK/PACK	VPE	KARTONMENGE	PRODUKTEIGENSCHAFTEN
ART.-NO.	COLOR	DESIGN	Ø SIZE/CM	CONTENT	PU	BOX AMOUNT	PRODUCT CHARACTERISTICS
146401		Favorit 1 Favorit 1		Stck	6	48	Mit Naßschaum With humid foam
146404		Favorit 4 Favorit 4		Stck	6	48	
146405		Piccolo Piccolo		Stck	6	48	
146501		Favorit 1 Favorit 1		Stck	6	48	Mit Trockenschaum With dry foam
146505		Piccolo Piccolo		Stck	6	48	

Orchideenröhrchen

FLOWER TUBES



311198



311100



311101



311102



311105



311107



311199



311180



311181

Orchideenröhrchen

Flower tubes



ARTIKELNUMMER	FARBE	DEKOR	Ø GRÖSSE/CM	STK/PACK	VPE	KARTONMENGE	PRODUKTEIGENSCHAFTEN
ART.-NO.	COLOR	DESIGN	Ø SIZE/CM	CONTENT	PU	BOX AMOUNT	PRODUCT CHARACTERISTICS
311198	Transparent Transparent	6 cc	1,4 x 5,8	Stck	100	2500	
311100	Transparent Transparent	7,5 cc	1,3 x 8,0	Stck	100	3000	
311101	Transparent Transparent	10 cc	1,0 x 8,0	Stck	100	2000	
311102	Transparent Transparent	16 cc	1,4 x 10,7	Stck	100	1800	
311105	Transparent Transparent	24 cc	1,8 x 10,7	Stck	100	1200	
311107	Transparent Transparent	35 cc	2,5 x 11,0	Stck	100	1000	
311199	Transparent Transparent	60 cc	3,0 x 11,0	Stck	100	600	
311180	Grün Green		1,3 x 15	Stck	100	2000	
311181	Grün Green		1,3 x 30	Stck	100	1000	

NEU
NEW

Reagenzgläser
GLASS TUBES



Rundboden



Bördelrand



NEU
NEW

301030



NEU
NEW

301020



NEU
NEW

301010

Reagenzgläser Glass tubes



ARTIKELNUMMER	FARBE	DEKOR	Ø GRÖSSE/CM	STK/PACK	VPE	KARTONMENGE	PRODUKTEIGENSCHAFTEN
ART.-NO.	COLOR	DESIGN	Ø SIZE/CM	CONTENT	PU	BOX AMOUNT	PRODUCT CHARACTERISTICS
NEU NEW 301010	Transparent Transparent	Reagenzglas	1,2 x 10	Stck	200	-	Rundboden Reagenzgläser in Klarglasausführung mit Bördelrand Round bottom test tubes in clear glass version with crimp rim
NEU NEW 301020	Transparent Transparent	Reagenzglas	1,6 x 15	Stck	200	-	
NEU NEW 301030	Transparent Transparent	Reagenzglas	2,0 x 15	Stck	140	-	

Reagenzgläser Glass tubes



ARTIKELNUMMER	FARBE	DEKOR	Ø GRÖSSE/CM	STK/PACK	VPE	KARTONMENGE	PRODUKTEIGENSCHAFTEN
ART.-NO.	COLOR	DESIGN	Ø SIZE/CM	CONTENT	PU	BOX AMOUNT	PRODUCT CHARACTERISTICS
NEU NEW 301010-1	Transparent Transparent	Reagenzglas	1,2 x 10	Pack	1	1	10 Stück/Packung, Rundboden Reagenzgläser in Klarglasausführung mit Bördelrand 10 pieces / pack, Round bottom test tubes in clear glass version with crimp rim
NEU NEW 301020-1	Transparent Transparent	Reagenzglas	1,6 x 15	Pack	1	1	
NEU NEW 301030-1	Transparent Transparent	Reagenzglas	2,0 x 15	Pack	1	1	

Die Abbildungen können in Größenproportionen und Farbe vom Original abweichen. Änderungen behalten wir uns vor.
Size proportions and colors of items presented may vary from original. Subject to change without further notice.

Kunststoff Blumen

PLASTIC FLOWERS



82806



82807



82808



82883

Kunststoff Blumen

Plastic flowers



ARTIKELNUMMER	FARBE	DEKOR	Ø GRÖSSE/CM	STK/PACK	VPE	KARTONMENGE	PRODUKTEIGENSCHAFTEN
ART.-NO.	COLOR	DESIGN	Ø SIZE/CM	CONTENT	PU	BOX AMOUNT	PRODUCT CHARACTERISTICS
82806	Weiss White	Kunststoff Blume Calla Plastic flower Calla	12,5 x 8	Stck	50	1000	Am 30 cm Stab On the 30 cm stick
82807	Weiss White	Kunststoff Blume Calla Plastic flower Calla	10,5 x 7	Stck	50	1400	Am 30 cm Stab On the 30 cm stick
82808	Weiss White	Kunststoff Blume Lilie Plastic flower Lily	11 x 6,5	Stck	25	700	Am 30 cm Stab On the 30 cm stick
82883	Weiss White	Kunststoff Blume Christrose Plastic flower Christmas rose	5 x 3	Stck	50	1000	Am 30 cm Stab On the 30 cm stick

NEU
NEW

Stütz- und Falzgitter

PLASTIC GRID FOR HUMID AND DRY FOAM

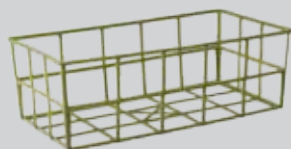

80800

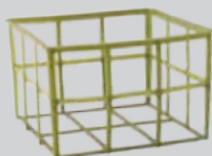

80801

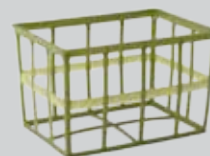

NEU
NEW

80806

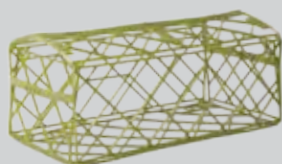

80802

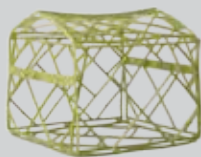

80803

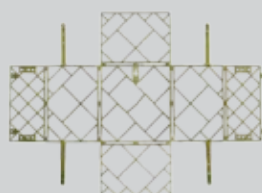
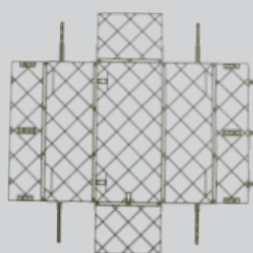

infobox

Unsere Stütz- und Falzgitter werden ressourcenschonend aus Recyclingmaterial (PET Altplastik) hergestellt und können immer wieder recycelt werden!

Stütz- und Falzgitter

Plastic grid for humid and dry foam



ARTIKELNUMMER	FARBE	DEKOR	Ø GRÖSSE/CM	STK/PACK	VPE	KARTONMENGE	PRODUKTEIGENSCHAFTEN
ART.-NO.	COLOR	DESIGN	Ø SIZE/CM	CONTENT	PU	BOX AMOUNT	PRODUCT CHARACTERISTICS
80800	Grün Green		24,5 x 11,5 x 8,0	Stck	20	320	Lieferung erfolgt ungefalted für 1 Steckschaumziegel Delivery is unfolded for 1 Floral Foam Brick
80801	Grün Green		11,5 x 11,5 x 7,5	Stck	30	540	Lieferung erfolgt ungefalted für ½ Steckschaumziegel Delivery is unfolded for half Floral Foam Brick
80802	Grün Green		23,0 x 11,5 x 8,0	Stck	20	200	Lieferung erfolgt ungefalted für 1 Steckschaumziegel Delivery is unfolded for 1 Floral Foam Brick
80803	Grün Green		11,5 x 11,5 x 7,5	Stck	20	300	Lieferung erfolgt ungefalted für ½ Steckschaumziegel Delivery is unfolded for half Floral Foam Brick
80806	Grün Green		11,5 x 7,5 x 7,5	Stck	30	360	Geeignet für ⅓ Steckschaumziegel Suitable for ⅓ foam tiles

WERKZEUGE UND KLEBTECHNIK

TOOLS AND HOT MELT



- 86 Rosenentdorn
(Thorn stripper)
- 86 Floristik Messer
(Florist knives)
- 87 Klebesticks
(Hot glue sticks)
- 87 Klebepistolen
(Hot glue gun)
- 88 Heftzange und Klammern
(Stapler and staples)
- 88 Tacker und Tackerklammern
(Melt pen)
- 89 Drillapparat und Ösen
(Drilling tool)
- 90 Klebetechnik
(Adhesive technology)
- 92 Multifunktions Organizer
(Organizer)
- 93 Tischabroller
(Tape stand)
- 93 Klebeband
(Adhesive film)



Rosenentdorner

THORN STRIPPER



643025



643030



643040

Rosenentdorner

Thorn stripper

ARTIKELNUMMER	FARBE	DEKOR	Ø GRÖSSE/CM	STK/PACK	VPE	KARTONMENGE	PRODUKTEIGENSCHAFTEN
ART.-NO.	COLOR	DESIGN	Ø SIZE/CM	CONTENT	PU	BOX AMOUNT	PRODUCT CHARACTERISTICS
643025	Aus Metall Metal rustic	Rustikal Rustic		Pack	1	6	Rosenentdorner 2 Stck geblistert. Einfach in der Handhabung, entfernt Blätter und Dornen bei Rosenstielen. Es geht ganz einfach. Thorn stripper 2 pieces, in blister pack. Easy to use, removes leaves and thorns on rose stalks.
643030	Rostfrei, aufklappbar Stainless, hinged	Mit rotem Griff With red handle		Stck	1	20	

Messer und Werkzeuge

Floristic knife and tools

ARTIKELNUMMER	FARBE	DEKOR	Ø GRÖSSE/CM	STK/PACK	VPE	KARTONMENGE	PRODUKTEIGENSCHAFTEN	
ART.-NO.	COLOR	DESIGN	Ø SIZE/CM	CONTENT	PU	BOX AMOUNT	PRODUCT CHARACTERISTICS	
643040	10 Stck/Skinkarte 10 pcs/skinkarte	Rot/gelber Griff sortiert Red/yellow handle sorted		16	Pack	1	15	Floristenmesser Florists knife

Die Abbildungen können in Größenproportionen und Farbe vom Original abweichen. Änderungen behalten wir uns vor.
Size proportions and colors of items presented may vary from original. Subject to change without further notice.



642207



642208



640020

Klebepistolen

Hot glue gun

ARTIKELNUMMER	FARBE	DEKOR	Ø GRÖSSE/CM	STK/PACK	VPE	KARTONMENGE	PRODUKTEIGENSCHAFTEN
ART.-NO.	COLOR	DESIGN	Ø SIZE/CM	CONTENT	PU	BOX AMOUNT	PRODUCT CHARACTERISTICS
642207	Grau Grey			Stck	1	12	Automatik-Heißklebepistole, 80 Watt, geblistert Automatic glue gun, 80 Watt, in blister pack
642208	Grau Grey			Stck	1	12	Profiklebepistole, 100 Watt, geblistert Professional glue gun, 100 Watt, in blister pack

Klebesticks

Glue sticks

ARTIKELNUMMER	FARBE	DEKOR	Ø GRÖSSE/CM	STK/PACK	VPE	KARTONMENGE	PRODUKTEIGENSCHAFTEN
ART.-NO.	COLOR	DESIGN	Ø SIZE/CM	CONTENT	PU	BOX AMOUNT	PRODUCT CHARACTERISTICS
640020	Transparent Transparent		11,3 x 200 mm	Kg	2	10	Klebesticks 200 mm Adhesive sticks 200 mm

Heftzangen und Klammern

STAPLER AND STAPLES

NEU
NEW



643050

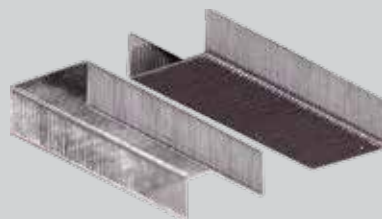

643051



NEU
NEW

643054

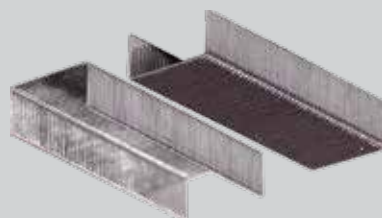

NEU
NEW

643055

Heftzange und Klammern

Stapler and staples

ARTIKELNUMMER	FARBE	DEKOR	Ø GRÖSSE/CM	STK/PACK	VPE	KARTONMENGE	PRODUKTEIGENSCHAFTEN
ART.-NO.	COLOR	DESIGN	Ø SIZE/CM	CONTENT	PU	BOX AMOUNT	PRODUCT CHARACTERISTICS
643050				Stck	1	10	Heftzange HP-10, für Heftklammern Nr. 10 Stapler HP-10, for Staples No. 10
643051				Pack	20	800	Hand-Heftklammern Nr. 10, 1000 Stck/Pack Hand Staples No. 10, 1000 pcs/pack

Tacker

Stapler and staples

ARTIKELNUMMER	FARBE	DEKOR	Ø GRÖSSE/CM	STK/PACK	VPE	KARTONMENGE	PRODUKTEIGENSCHAFTEN
ART.-NO.	COLOR	DESIGN	Ø SIZE/CM	CONTENT	PU	BOX AMOUNT	PRODUCT CHARACTERISTICS
NEU NEW 643054				Stück	1	40	Handtacker TS-610 aus Metall Hand stapler TS-610 made of metal
NEU NEW 643055				Pack	20	300	Tacker Klammern 24/6-1M 1000 Stück/Pack Tacker staples 24 / 6-1M 1000 pieces / pack



100600



100601

Drillapparat

Drilling tool

ARTIKELNUMMER	FARBE	DEKOR	Ø GRÖSSE/CM	STK/PACK	VPE	KARTONMENGE	PRODUKTEIGENSCHAFTEN
ART.-NO.	COLOR	DESIGN	Ø SIZE/CM	CONTENT	PU	BOX AMOUNT	PRODUCT CHARACTERISTICS
100600			31	Stck	1	6	Drillapparat Drilling Tools
100601			0,01 x 14	Pack	1	1	Ösendrähte, 1000 Stck/Pack Hanging Wire, 1000 pcs/pack

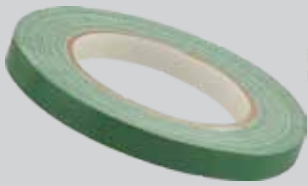

NEU
NEW 161250



NEU
NEW 162525



NEU
NEW 165025



NEU
NEW 18002

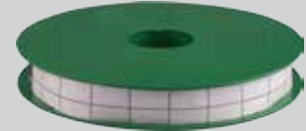

147102

Anchor Tape

Anchor tape

ARTIKELNUMMER	FARBE	DEKOR	Ø GRÖSSE/CM	STK/PACK	VPE	KARTONMENGE	PRODUKTEIGENSCHAFTEN
ART.-NO.	COLOR	DESIGN	Ø SIZE/CM	CONTENT	PU	BOX AMOUNT	PRODUCT CHARACTERISTICS
NEU NEW 161250	Dunkelgrün Dark green	Anchor Tape Anchor tape	1,2 x 5	Stck	1	72	Wasserfestes, stark haftendes Gewebband Waterproof, strong adhesive tape

Doppelseitiges Klebeband

Double sided adhesive tape

ARTIKELNUMMER	FARBE	DEKOR	Ø GRÖSSE/CM	STK/PACK	VPE	KARTONMENGE	PRODUKTEIGENSCHAFTEN
ART.-NO.	COLOR	DESIGN	Ø SIZE/CM	CONTENT	PU	BOX AMOUNT	PRODUCT CHARACTERISTICS
NEU NEW 162525	Transparent Transparent	-	2,5 x 25m	Stck	1	40	
NEU NEW 165025	Transparent Transparent	-	5 x 25m	Stck	1	20	

Klebepen

Melt pen

ARTIKELNUMMER	FARBE	DEKOR	GRÖSSE	STK/PACK	VPE	KARTONMENGE	PRODUKTEIGENSCHAFTEN
ART.-NO.	COLOR	DESIGN	SIZE	CONTENT	PU	BOX AMOUNT	PRODUCT CHARACTERISTICS
NEU NEW 18002	Transparent Transparent	-	35 x 4,0 x 1,0	Stck	30	150	Geeignet zum Kleben von Papier, Stoff, Holz, Kork und Filz, tropffreie, saubere Verarbeitung und schnelle Trocknung Suitable for gluing paper, fabric, wood, cork and felt, drip-free, clean processing and fast drying

Goertz Fix Klebeband

Goertz Fix Adhesive tape

ARTIKELNUMMER	FARBE	DEKOR	Ø GRÖSSE/MM/M	STK/PACK	VPE	KARTONMENGE	PRODUKTEIGENSCHAFTEN
ART.-NO.	COLOR	DESIGN	Ø SIZE/MM/M	CONTENT	PU	BOX AMOUNT	PRODUCT CHARACTERISTICS
147102	Grün Green		15 x 5	Stck	1	24	Wasserfest Waterproof



Biedermeiermanschetten, ab Seite 26
Biedermeier-cuffs, from page 26

Multifunktions Organizer

ORGANIZER

NEU
NEW

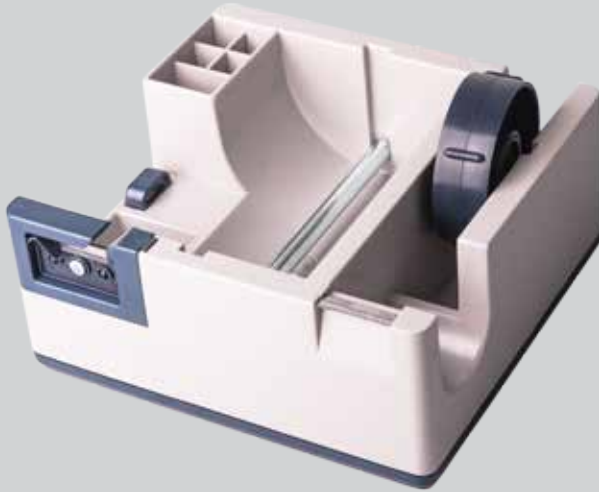

Abbildungsbeispiel

NEU
NEW

338503

Multifunktions Organizer

Organizer

ARTIKELNUMMER	FARBE	DEKOR	Ø GRÖSSE/CM	STK/PACK	VPE	KARTONMENGE	PRODUKTEIGENSCHAFTEN
ART.-NO.	COLOR	DESIGN	Ø SIZE/CM	CONTENT	PU	BOX AMOUNT	PRODUCT CHARACTERISTICS
NEU NEW 338503	Grau Grey		20 x 8,5 x 9	Stck	1		



338501



338502



338304



338303

Tischabroller

Tape stand

ARTIKELNUMMER	FARBE	DEKOR	Ø GRÖSSE/CM	STK/PACK	VPE	KARTONMENGE	PRODUKTEIGENSCHAFTEN
ART.-NO.	COLOR	DESIGN	Ø SIZE/CM	CONTENT	PU	BOX AMOUNT	PRODUCT CHARACTERISTICS
338501				Stck	1	20	Tischabroller B1, für 33 m Rollen geeignet Table dispenser B1, suitable for 33 m rolls
338502				Stck	1	8	Tischabroller Nova, für 66 m Rollen geeignet Table dispenser Nova, suitable for 66 m rolls

Klebeband

Adhesive film

ARTIKELNUMMER	FARBE	DEKOR	Ø GRÖSSE/MM/M	STK/PACK	VPE	KARTONMENGE	PRODUKTEIGENSCHAFTEN
ART.-NO.	COLOR	DESIGN	Ø SIZE/MM/M	CONTENT	PU	BOX AMOUNT	PRODUCT CHARACTERISTICS
338303	Transparent Transparent		12 x 66	Rll.	24	144	geeignet für den Tischabroller Nova Suitable for tape stand Nova
338304	Transparent Transparent		12 x 33	Pack	1	20	PVC Klebefilm, 12 Stück/Pack, geeignet für Tischabroller B1 PVC adhesive film, 12 pcs/pack, suitable for Tape stand B1

DEKORATION

DECORATION

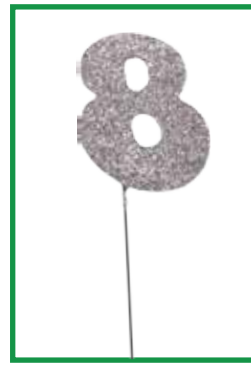

- 96 Einzelzahlen
(Single figures)
- 98 Jahreszahlen
(Annual numbers)
- 99 Jubiläumszahlen und Kränze
(Jubilee figures and wreath)
- 104 Tauben
(Decoration doves)
- 106 Hochzeitsdekoration
(Wedding decoration)
- 107 Valentins- und
Muttertagsdekoration
(Valentins- and mothers day)
- 108 Schiefertafeln
(Slate, non-punched)
- 109 Selbstklebetiketten
(Self-adhesive labels)
- 110 Grußschilder
(Greeting labels)
- 111 Silvesterdekoration
(Happy New Year decoration)



Einzelzahlen

SINGLE FIGURES



180041



180042



180043



180044



180045



180046



180047



180048



180049

Einzelzahlen, beglimmert

Single figures with glitter

ARTIKELNUMMER	FARBE	DEKOR	Ø GRÖSSE/CM	STK/PACK	VPE	KARTONMENGE	PRODUKTEIGENSCHAFTEN
ART.-NO.	COLOR	DESIGN	Ø SIZE/CM	CONTENT	PU	BOX AMOUNT	PRODUCT CHARACTERISTICS
180040	Gold Gold	Zahl 0 Number 0	7 x 5	Stck	20	200	Glimmer Einzelzahl am Draht Mica single number on the wire
180041	Gold Gold	Zahl 1 Number 1	7 x 5	Stck	20	200	
180042	Gold Gold	Zahl 2 Number 2	7 x 5	Stck	20	200	
180043	Gold Gold	Zahl 3 Number 3	7 x 5	Stck	20	200	
180044	Gold Gold	Zahl 4 Number 4	7 x 5	Stck	20	200	
180045	Gold Gold	Zahl 5 Number 5	7 x 5	Stck	20	200	
180046	Gold Gold	Zahl 6 Number 6	7 x 5	Stck	20	200	
180047	Gold Gold	Zahl 7 Number 7	7 x 5	Stck	20	200	
180048	Gold Gold	Zahl 8 Number 8	7 x 5	Stck	20	200	
180049	Gold Gold	Zahl 9 Number 9	7 x 5	Stck	20	200	

Die Abbildungen können in Größenproportionen und Farbe vom Original abweichen. Änderungen behalten wir uns vor.
Size proportions and colors of items presented may vary from original. Subject to change without further notice.



180050



180051



180052



180053



180054



180055



180056



180057



180058

Einzelzahlen, beglimmert

Single figures with glitter

ARTIKELNUMMER	FARBE	DEKOR	Ø GRÖSSE/CM	STK/PACK	VPE	KARTONMENGE	PRODUKTEIGENSCHAFTEN
ART.-NO.	COLOR	DESIGN	Ø SIZE/CM	CONTENT	PU	BOX AMOUNT	PRODUCT CHARACTERISTICS
180050	Silber Silver	Zahl 0 Number 0	7 x 5	Stck	20	200	Glimmer Einzelzahl am Draht Mica single number on the wire
180051	Silber Silver	Zahl 1 Number 1	7 x 5	Stck	20	200	
180052	Silber Silver	Zahl 2 Number 2	7 x 5	Stck	20	200	
180053	Silber Silver	Zahl 3 Number 3	7 x 5	Stck	20	200	
180054	Silber Silver	Zahl 4 Number 4	7 x 5	Stck	20	200	
180055	Silber Silver	Zahl 5 Number 5	7 x 5	Stck	20	200	
180056	Silber Silver	Zahl 6 Number 6	7 x 5	Stck	20	200	
180057	Silber Silver	Zahl 7 Number 7	7 x 5	Stck	20	200	
180058	Silber Silver	Zahl 8 Number 8	7 x 5	Stck	20	200	
180059	Silber Silver	Zahl 9 Number 9	7 x 5	Stck	20	200	



180125



180150



180191



180192

infobox

Bitte beachten, Abbildung kann vom gelieferten Produkt abweichen.

Please note, Illustration may differ from the delivered product.

Moderne Jubiläumszahl am Draht Modern jubilee figures

ARTIKELNUMMER	FARBE	DEKOR	Ø GRÖSSE/CM	STK/PACK	VPE	KARTONMENGE	PRODUKTEIGENSCHAFTEN
ART.-NO.	COLOR	DESIGN	Ø SIZE/CM	CONTENT	PU	BOX AMOUNT	PRODUCT CHARACTERISTICS
180125	Silber Silver	Zahl 25 Number 25	6,5 x 9,5	Stck	10	1000	Moderne Jubiläumszahl am Draht, bestehend aus Glimmerkarton Modern anniversary number on the wire consisting of mica cardboard
180150	Gold Gold	Zahl 50 Number 50	6,5 x 9,5	Stck	10	1000	

Jahreszahl am Draht Annual figure

ARTIKELNUMMER	FARBE	DEKOR	Ø GRÖSSE/CM	STK/PACK	VPE	KARTONMENGE	PRODUKTEIGENSCHAFTEN
ART.-NO.	COLOR	DESIGN	Ø SIZE/CM	CONTENT	PU	BOX AMOUNT	PRODUCT CHARACTERISTICS
180191	Gold Gold	Zahl 2021 Number 2021	6 x 3	Stck	10		Jahreszahl 2021 am Draht, aus Glimmerkarton Annual figure, Year 2021 on wire, made of mica cardboard
180192	Silber Silver	Zahl 2021 Number 2021	6 x 3	Stck	10		
180092	Silber Silver	Zahl 2021 Number 2021	6 x 13	Stck	10		
180096	Gold Gold	Zahl 2021 Number 2021	6 x 13	Stck	10		



182400



182725



182750



184025



184050



184060



184070



184080



184090

Jubiläumskränze

Jubilee wreath

ARTIKELNUMMER	FARBE	DEKOR	Ø GRÖSSE/CM	STK/PACK	VPE	KARTONMENGE	PRODUKTEIGENSCHAFTEN
ART.-NO.	COLOR	DESIGN	Ø SIZE/CM	CONTENT	PU	BOX AMOUNT	PRODUCT CHARACTERISTICS
182400	Gold Gold	100 Number 100	24	Stck	1	25	Zahlenkranz Number wreath
182725	Silber Silver	25 Number 25	27	Stck	1	5	
182750	Gold Gold	50 Number 50	27	Stck	1	5	
184025	Silber Silver	25 Number 25	40	Stck	1	5	
184050	Gold Gold	50 Number 50	40	Stck	1	5	
184060	Gold Gold	60 Number 60	40	Stck	1	5	
184070	Gold Gold	70 Number 70	40	Stck	1	5	
184080	Gold Gold	80 Number 80	40	Stck	1	5	
184090	Gold Gold	90 Number 90	40	Stck	1	5	

Jubiläumszahlen

JUBILEE FIGURES



180810



180820



180825



180830



180835



180840



180845



180850



180855

Jubiläumszahl am Draht

Jubilee figureres

ARTIKELNUMMER	FARBE	DEKOR	Ø GRÖSSE/CM	STK/PACK	VPE	KARTONMENGE	PRODUKTEIGENSCHAFTEN
ART.-NO.	COLOR	DESIGN	Ø SIZE/CM	CONTENT	PU	BOX AMOUNT	PRODUCT CHARACTERISTICS
180810	Silber Silver	10 Number 10	8 x 12	Stck	10	100	8 x 12 cm mit Draht 8 x 12 cm with wire
180820	Gold Gold	20 Number 20	8 x 12	Stck	10	100	
180825	Silber Silver	25 Number 25	8 x 12	Stck	10	100	
180830	Gold Gold	30 Number 30	8 x 12	Stck	10	100	
180835	Gold Gold	35 Number 35	8 x 12	Stck	10	100	
180840	Gold Gold	40 Number 40	8 x 12	Stck	10	100	
180845	Gold Gold	45 Number 45	8 x 12	Stck	10	100	
180850	Gold Gold	50 Number 50	8 x 12	Stck	10	100	
180855	Gold Gold	55 Number 55	8 x 12	Stck	10	100	



180860



180865



180870



180875



180880



180885



180890



180895



180800

Jubiläumsszahl am Draht

Jubilee figureres

ARTIKELNUMMER	FARBE	DEKOR	Ø GRÖSSE/CM	STK/PACK	VPE	KARTONMENGE	PRODUKTEIGENSCHAFTEN
ART.-NO.	COLOR	DESIGN	Ø SIZE/CM	CONTENT	PU	BOX AMOUNT	PRODUCT CHARACTERISTICS
180860	Gold Gold	60 Number 60	8 x 12	Stck	10	100	8 x 12 cm mit Draht 8 x 12 cm with wire
180865	Gold Gold	65 Number 65	8 x 12	Stck	10	100	
180870	Gold Gold	70 Number 70	8 x 12	Stck	10	100	
180875	Gold Gold	75 Number 75	8 x 12	Stck	10	100	
180880	Gold Gold	80 Number 80	8 x 12	Stck	10	100	
180885	Gold Gold	85 Number 85	8 x 12	Stck	10	100	
180890	Gold Gold	90 Number 90	8 x 12	Stck	10	100	
180895	Gold Gold	95 Number 95	8 x 12	Stck	10	100	
180800	Gold Gold	100 Number 100	8 x 12	Stck	10	100	

Jubiläumskränze

JUBILEE WREATH



181825



181850



181860



181870



181880



182410



182425



182430

Jubiläumskränze

Jubilee wreath

ARTIKELNUMMER	FARBE	DEKOR	Ø GRÖSSE/CM	STK/PACK	VPE	KARTONMENGE	PRODUKTEIGENSCHAFTEN
ART.-NO.	COLOR	DESIGN	Ø SIZE/CM	CONTENT	PU	BOX AMOUNT	PRODUCT CHARACTERISTICS
181825	Silber Silver	25 Number 25	18	Stck	25		Zahlenkranz Number wreath
181850	Gold Gold	50 Number 50	18	Stck	25		
181860	Gold Gold	60 Number 60	18	Stck	25		
181870	Gold Gold	70 Number 70	18	Stck	25		
181880	Gold Gold	80 Number 80	18	Stck	25		
182410	Silber Silver	10 Number 10	24	Stck	1	25	
182425	Silber Silver	25 Number 25	24	Stck	1	25	
182430	Gold Gold	30 Number 30	24	Stck	1	25	



182440



182450



182460



182465



182470



182475



182480



182485



182490

Jubiläumskränze

Jubilee wreath

ARTIKELNUMMER	FARBE	DEKOR	Ø GRÖSSE/CM	STK/PACK	VPE	KARTONMENGE	PRODUKTEIGENSCHAFTEN
ART.-NO.	COLOR	DESIGN	Ø SIZE/CM	CONTENT	PU	BOX AMOUNT	PRODUCT CHARACTERISTICS
182440	Gold Gold	40 Number 40	24	Stck	1	25	Zahlenkranz Number wreath
182450	Gold Gold	50 Number 50	24	Stck	1	25	
182460	Gold Gold	60 Number 60	24	Stck	1	25	
182465	Gold Gold	65 Number 65	24	Stck	1	25	
182470	Gold Gold	70 Number 70	24	Stck	1	25	
182475	Gold Gold	75 Number 75	24	Stck	1	25	
182480	Gold Gold	80 Number 80	24	Stck	1	25	
182485	Gold Gold	85 Number 85	24	Stck	1	25	
182490	Gold Gold	90 Number 90	24	Stck	1	25	

Tauben

DECORATION DOVES



980000389



980000390



980000682



980000683



980000685



980000686



980006643



980006644



980006645

Tauben

Doves

ARTIKELNUMMER	FARBE	DEKOR	Ø GRÖSSE/CM	STK/PACK	VPE	KARTONMENGE	PRODUKTEIGENSCHAFTEN
ART.-NO.	COLOR	DESIGN	Ø SIZE/CM	CONTENT	PU	BOX AMOUNT	PRODUCT CHARACTERISTICS
980000389	Weiss White		22	Stck	12	216	Weiße fliegende Taube mit Perlen am Draht White flying dove with pearls on the wire
980000390	Weiss White		26	Stck	12	144	Weiße fliegende Taube mit Perlen am Draht White flying dove with pearls on the wire
980000682	Weiss White		18	Stck	6	144	Hochzeitstaubenpaar mit Hut und Schleier am Draht Wedding dove couple with hat and veil
980000683	Weiss White		18	Stck	6	144	Hochzeitstaubenpaar mit Ringen am Draht Wedding dove couple with rings on the wire
980000685	Weiss White		32	Stck	2	36	Hochzeitstaubenpaar mit Ringen Wedding dove couple with rings
980000686	Weiss White		32	Stck	2	36	Hochzeitstaubenpaar mit Hut und Schleier Wedding dove couple with hat and veil
980006643	Weiss White		7,5	Stck	12	864	Kleines Taubenpärchen mit Ringen am Draht Little pigeon couple with ring on the wire
980006644	Weiss White		7,5	Stck	12	864	Kleines Taubenpärchen mit Hut und Schleier am Draht Little dove couple with hat and veil on the wire
980006645	Weiss White		11	Stck	12	288	Taubenpaar auf Ringen am Draht Dove pair on rings on wire



980006646



980006647



980006650



980006652



980022279



980022280

Tauben

Doves

ARTIKELNUMMER	FARBE	DEKOR	Ø GRÖSSE/CM	STK/PACK	VPE	KARTONMENGE	PRODUKTEIGENSCHAFTEN
ART.-NO.	COLOR	DESIGN	Ø SIZE/CM	CONTENT	PU	BOX AMOUNT	PRODUCT CHARACTERISTICS
980006646	Weiss White		17	Stck	12	432	Feder Taube am Draht, sitzend Feather pigeon on wire, sitting
980006647	Weiss White		17	Stck	12	288	Feder Taube am Draht, fliegend Feather dove on the wire, flying
980006650	Weiss White		8	Stck	24	1728	Feder Taube am Draht, sitzend Feather pigeon on wire, sitting
980006652	Weiss White		8	Stck	24	1728	Feder Taube am Draht, fliegend Feather dove on the wire, flying
980022279	Weiss White		11	Stck	6	288	Hochzeitstauenpärchen mit Hut und Schleier, am Draht Wedding dove couple with hat and veil, on wire
980022280	Weiss White		11	Stck	6	288	Hochzeitstauenpärchen mit Ringen am Draht Wedding dove couple with rings on the wire

Hochzeitdekoration

WEDDING DECORATION



2262191010



301502



Hochzeitsdekoration

Wedding decoration

ARTIKELNUMMER	FARBE	DEKOR	Ø GRÖSSE/CM	STK/PACK	VPE	KARTONMENGE	PRODUKTEIGENSCHAFTEN
ART.-NO.	COLOR	DESIGN	Ø SIZE/CM	CONTENT	PU	BOX AMOUNT	PRODUCT CHARACTERISTICS
2262191010	Silber Silver		4 x 2,7	Pack	10	100	Deko Streu Eheringe Silber 10 g Decoration stray wedding bands silver 10 g
301502	Rosa/Blau sortiert rose/blue sorted		8	Stck	24	600	Kunststoff Babyflasche am Draht Plastic baby bottle on the wire



Valentins-und Muttertagsdekoration

VALENTINES- AND MOTHERS DAY



980000101



980000142



980000201



980006250



980000559



980000600



980000610



980000620



980000625

Valentins-und Muttertagsdekoration

Valentines- and mothers day

ARTIKELNUMMER	FARBE	DEKOR	Ø GRÖSSE/CM	STK/PACK	VPE	KARTONMENGE	PRODUKTEIGENSCHAFTEN
ART.-NO.	COLOR	DESIGN	Ø SIZE/CM	CONTENT	PU	BOX AMOUNT	PRODUCT CHARACTERISTICS
980000101	Rot Red	Zum Muttertag For Mother's Day	3,7	Beut	1	100	Miniherz am Draht, 25 Stück/Beutel Mini heart on the wire, 25 pcs/bag
980000142	Rot Red	14. Februar Valentinstag February 14 Valentine's Day	3,7	Beut	1	100	
980000201	Rot Red	Neutral Neutral	3,7	Beut	1	100	
980006250	Rot Red	Neutral mit Goldrand Neutral with gold rim	6	Beut	1	120	Herz mit Goldrand am Draht, 25 Stück/Beutel Heart with gold border on the wire, 25 pcs/bag
980000559	Rot Red	Zum Muttertag For Mother's Day	6	Beut	1	100	Muttertagsherzen mit Loch, 100 Stück//Beutel Mother's Day hearts with hole, 100 pcs/bag
980000600	Rot Red	14. Februar Valentinstag February 14 Valentine's Day	6	Beut	1	100	Valentinsherz mit Loch, 100 Stück/Beutel Valentine's heart with hole, 100 pcs/bag
980000610	Rot Red	Zum Muttertag For Mother's Day	6	Beut	1	120	Herz am Draht, 25 Stück/Beutel Heart on the wire, 25 pcs/bag
980000620	Rot Red	14. Februar Valentinstag February 14 Valentine's Day	6	Beut	1	120	Herz am Draht, 25 Stück/Beutel Heart on the wire, 25 pcs/bag
980000625	Rot Red	Neutral Neutral	6	Beut	1	120	Herz am Draht, 25 Stück/Beutel Heart on the wire, 25 pcs/bag

Die Abbildungen können in Größenproportionen und Farbe vom Original abweichen. Änderungen behalten wir uns vor.
Size proportions and colors of items presented may vary from original. Subject to change without further notice.

Valentins- und Muttertagsdekoration

VALENTINES- AND MOTHERS DAY



980000719



980003511



980000244



980094280



190010

infobox

Reines Naturprodukt ohne schädliche Substanzen. Die energiearme Gewinnung und schonende Weiterverarbeitung schont unsere Umwelt. Mit der Entsorgung schließt sich der ökologische Kreislauf durch problemlose Rückführung des Materials in die Natur.

Pure natural product without harmful substances. The low-energy extraction and gentle further processing protect our environment. Disposal closes the ecological cycle by easily returning the material to nature.

Valentins- und Muttertagsdekoration

Valentines- and mothers day

ARTIKELNUMMER	FARBE	DEKOR	Ø GRÖSSE/CM	STK/PACK	VPE	KARTONMENGE	PRODUKTEIGENSCHAFTEN
ART.-NO.	COLOR	DESIGN	Ø SIZE/CM	CONTENT	PU	BOX AMOUNT	PRODUCT CHARACTERISTICS
980000719	Rot Red	Neutral mit Goldrand Neutral with gold rim	4,5	Stck	25	500	Holz Herz am Draht Wooden heart on the wire
980000720	Rot Red	Neutral mit Goldrand Neutral with gold rim	6	Stck	36	432	Holz Herz am Draht Wooden heart on the wire
980003511	Junge/Mädchen sortiert Assorted	Zum Schulanfang To the beginning of school	7	Stck	1	120	Schulanfangsstecker am Draht, 25 Stück/Beutel School start plug on wire, 25 pcs/bag
980000244	Rot Red	Herzform Heart shaped		Beut	1	25	Luftballons Herzform 10 Stück/Beutel Balloons heart shape, 10 pcs/bag
980094280	Rot Red	Neutral mit Marienkäfer Neutral with ladybug	4	Stck	48	1920	Holz Herz am Stab Wood heart on the bar

Schiefertafeln

Slate, non-punched

ARTIKELNUMMER	FARBE	DEKOR	Ø GRÖSSE/CM	STK/PACK	VPE	KARTONMENGE	PRODUKTEIGENSCHAFTEN
ART.-NO.	COLOR	DESIGN	Ø SIZE/CM	CONTENT	PU	BOX AMOUNT	PRODUCT CHARACTERISTICS
190010	Schwarz Black		22 x 16	Stck	20	20	Schiefertafeln, ungelocht - Slates, Non punched
190013	Schwarz Black		25 x 35	Stck	5	5	Schiefertafeln, ungelocht Slates, Non punched

Die Abbildungen können in Größenproportionen und Farbe vom Original abweichen. Änderungen behalten wir uns vor.
Size proportions and colors of items presented may vary from original. Subject to change without further notice.



998401500



998401501

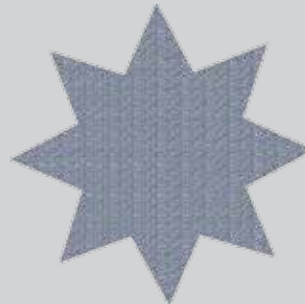

998601500



Selbstklebeetiketten

Self-adhesive labels

ARTIKELNUMMER	FARBE	DEKOR	Ø GRÖSSE/CM	STK/PACK	VPE	KARTONMENGE	PRODUKTEIGENSCHAFTEN
ART.-NO.	COLOR	DESIGN	Ø SIZE/CM	CONTENT	PU	BOX AMOUNT	PRODUCT CHARACTERISTICS
998401500	Gold Gold	Goldstern Gold star	3,5	Stck	1	1	Etikettenspender, Inhalt 500 Stück Etiketten Label dispenser, content 500 pcs labels
998401501	Silber Silver	Silberstern Silver star	3,5	Stck	1	1	
998601500	Natur Nature	Herzlichen Glückwunsch Congratulations	4,5 x 3,3	Stck	1	50	

Grußschilder

GREETING LABELS



1290000592



1290010592



1290060592



1290080592



1292000592



1292010592



1292020592



1292060592

Grußschilder Greeting labels



ARTIKELNUMMER	FARBE	DEKOR	Ø GRÖSSE/CM	STK/PACK	VPE	KARTONMENGE	PRODUKTEIGENSCHAFTEN
ART.-NO.	COLOR	DESIGN	Ø SIZE/CM	CONTENT	PU	BOX AMOUNT	PRODUCT CHARACTERISTICS
1290000592	Rot/Grün Red/Green	Neutral Neutral	43 x 30	Stück	5		Grußschild Eichenkranz Greeting card oak wreath
1290010592	Rot/Grün Red/Green	Herzlich willkommen Welcome	43 x 30	Stück	5		Grußschild Eichenkranz Greeting card oak wreath
1290060592	Rot/Grün Red/Green	Hoch lebe das Brautpaar High live to the bride and groom	43 x 30	Stück	5		Grußschild Eichenkranz Greeting card oak wreath
1290080592	Rot/Grün Red/Green	Glück und Segen zum Einzug Fortune and blessings	40 x 29	Stück	5		Grußschild Eichenkranz Greeting card oak wreath
1292000592	Weiß/Grün White/Green	Neutral Neutral	40 x 29	Stück	5		Grußschild Blütenkranz Greeting card flower wreath
1292010592	Weiß/Grün White/Green	Herzlich willkommen Welcome	40 x 29	Stück	5		Grußschild Blütenkranz Greeting card flower wreath
1292020592	Weiß/Grün White/Green	Herzlich Glückwunsch Congratulations	40 x 29	Stück	5		Grußschild Blütenkranz Greeting card flower wreath
1292060592	Weiß/Grün White/Green	Hoch lebe das Brautpaar High live to the bride and groom	40 x 29	Stück	5		Grußschild Blütenkranz Greeting card flower wreath

Silvesterdekoration

HAPPY NEW YEAR DECORATION



980021305



980021341



980021348



980021352



980021353



980021354



980021356



301503



301504



Silvesterdekoration

Happy New Year decoration

ARTIKELNUMMER	FARBE	DEKOR	Ø GRÖSSE/CM	STK/PACK	VPE	KARTONMENGE	PRODUKTEIGENSCHAFTEN
ART.-NO.	COLOR	DESIGN	Ø SIZE/CM	CONTENT	PU	BOX AMOUNT	PRODUCT CHARACTERISTICS
980021305	Schwarz Black	Mit Pilz und Holzleiter With mushroom and wooden ladder	8,5	Pack	1	60	Chenille Kaminfeger am Stab, 48 Stk/Beutel Chenille chimney sweep on the bar, 48 pcs/bag
980021341	Schwarz Black	Mit Kulleraugen, Besen und Leiter With googly eyes, broom and ladder	12,5	Beut	1	35	Chenille Kaminfeger am Stab, 24 Stk/Beutel Chenille chimney sweep on the bar, 24 pcs/bag
980021348	Schwarz Black	Mit goldenem Schwein und goldener Leiter With golden pig and golden ladder	16	Beut	1	7	Chenille Kaminfeger am Stab, 48 Stk/Beutel Chenille chimney sweep on the bar, 48 pcs/bag
980021352	Schwarz Black	Mit Kulleraugen, Glücksschwein und Leiter With googly eyes, lucky pig and ladder	9	Beut	1	35	
980021353	Schwarz Black	Mit Pilz und goldener Leiter With mushroom and golden ladder	9	Beut	1	60	Chenille Kaminfeger am Stab, 24 Stk/Beutel Chenille chimney sweep on the bar, 24 pcs/bag
980021354	Schwarz Black	Mit Fliege und goldener Leiter With bow tie and golden ladder	8	Beut	1	60	
980021356	Schwarz Black	Mit Kulleraugen und Holzleiter With googly eyes and wooden ladder	12	Beut	1	35	
301503	Grün Green	Mit goldenem eloxiertem Kopf With golden anodised head	5,5	Stck	28	728	Sektflasche am Draht Champagne bottle on the wire
301504	Grün Green	Mit goldenem eloxiertem Kopf With golden anodised head	8	Stck	24	600	Sektflasche am Draht Champagne bottle on the wire

Die Abbildungen können in Größenproportionen und Farbe vom Original abweichen. Änderungen behalten wir uns vor.
Size proportions and colors of items presented may vary from original. Subject to change without further notice.



DEKORATIONSGEFÄSSE

PLASTIC SHAPES



- | | |
|---|---|
| 114 Kunststoff Zylinder
(Plastic top-hat) | 122 Pflanz-, Blumen- und Kräuterbox
(Plant, flower and herb box) |
| 117 Kunststoff Fliegenpilz Topf
(Plastic decoration pot) | 124 Kunststoff Übertöpfe
(Plastic planters) |
| 117 Kunststoff Sektkühler
(Champagne ice bucket) | 136 Eierbecher
(Eggcups) |
| 119 Kunststoff Geschenksack
(Giftbag) | 136 Eierschale
(Eggshell bowl) |
| 120 Display Pflanz-, Blumen-
und Kräuterbox
(Display Plant, flower and herb
box) | 137 Dekoformen
(Deco shapes) |



Kunststoff Zylinder

PLASTIC TOP-HAT



300505



300505



300731



300792

Kunststoff Zylinder

Plastic top-hat



ARTIKELNUMMER	FARBE	DEKOR	Ø GRÖSSE/CM	STK/PACK	VPE	KARTONMENGE	PRODUKTEIGENSCHAFTEN
ART.-NO.	COLOR	DESIGN	Ø SIZE/CM	CONTENT	PU	BOX AMOUNT	PRODUCT CHARACTERISTICS
300505	Weiss White		5	Stck	20	280	Kunststoff Zylinder Plastic cylinder
300523	Schwarz Black		5	Stck	20	280	Kunststoff Zylinder Plastic cylinder
300705	Weiss White		7	Stck	9	108	Kunststoff Zylinder Plastic cylinder
300723	Schwarz Black		7	Stck	9	108	Kunststoff Zylinder Plastic cylinder
300731	Silber glänzend Silver anodized		7	Stck	9	144	Kunststoff Zylinder Plastic cylinder
300792	Neon Farbig sortiert Neon color assorted		7	Stck	9	108	Kunststoff Zylinder Plastic cylinder



300799



300823



302505



302505



Kunststoff Zylinder

Plastic top-hat



ARTIKELNUMMER	FARBE	DEKOR	Ø GRÖSSE/CM	STK/PACK	VPE	KARTONMENGE	PRODUKTEIGENSCHAFTEN
ART.-NO.	COLOR	DESIGN	Ø SIZE/CM	CONTENT	PU	BOX AMOUNT	PRODUCT CHARACTERISTICS
300799	Transparent Farbig sortiert Transparent color assorted		7	Stck	9	108	Kunststoff Zylinder Plastic cylinder
300823	Schwarz Black		8	Stck	8	80	Kunststoff Zylinder Plastic cylinder
302505	Weiss White		12	Stck	1	36	Kunststoff Zylinder Plastic cylinder
302523	Schwarz Black		12	Stck	1	36	Kunststoff Zylinder Plastic cylinder
302623	Schwarz Black		15	Stck	1	15	Kunststoff Zylinder Plastic cylinder



Kunststoff Sektkühler + Fliegenpilz Topf

CHAMPAGNE ICE BUCKET + PLASTIC DECORATION POT



301401



301404



301411



301436



301490



301306



301305

Kunststoff Sektkühler

Champagne ice bucket



ARTIKELNUMMER	FARBE	DEKOR	Ø GRÖSSE/CM	STK/PACK	VPE	KARTONMENGE	PRODUKTEIGENSCHAFTEN
ART.-NO.	COLOR	DESIGN	Ø SIZE/CM	CONTENT	PU	BOX AMOUNT	PRODUCT CHARACTERISTICS
301401	Silber eloxiert Silver anodized		6/7	Stck	15	240	Kunststoff Sektkühler Plastic champagne cooler
301404	Gold eloxiert Gold anodized		6/7	Stck	15	240	Kunststoff Sektkühler Plastic champagne cooler
301411	Rot eloxiert Red anodized		6/7	Stck	15	240	Kunststoff Sektkühler Plastic champagne cooler
301436	Kupfer eloxiert Copper anodized		6/7	Stck	15	240	Kunststoff Sektkühler Plastic champagne cooler
301490	Transparent Farbig sortiert Transparent color assorted		6/7	Stck	15	240	Kunststoff Sektkühler Plastic champagne cooler

Kunststoff Fliegenpilz Topf

Plastic decoration pot



ARTIKELNUMMER	FARBE	DEKOR	Ø GRÖSSE/CM	STK/PACK	VPE	KARTONMENGE	PRODUKTEIGENSCHAFTEN
ART.-NO.	COLOR	DESIGN	Ø SIZE/CM	CONTENT	PU	BOX AMOUNT	PRODUCT CHARACTERISTICS
301305	Weiss/Rot White/Red		5,5	Stck	11	275	Kunststoff Fliegenpilz Plastic fly agaric
301306	Weiss/Rot White/Red		6	Stck	11	275	Kunststoff Fliegenpilz Plastic fly agaric

Kunststoff Sektkühler

CHAMPAGNE ICE BUCKET



301492



301801



301804



301931



301934

Kunststoff Sektkühler

Champagne ice bucket



ARTIKELNUMMER	FARBE	DEKOR	Ø GRÖSSE/CM	STK/PACK	VPE	KARTONMENGE	PRODUKTEIGENSCHAFTEN
ART.-NO.	COLOR	DESIGN	Ø SIZE/CM	CONTENT	PU	BOX AMOUNT	PRODUCT CHARACTERISTICS
301492	Neon Farbig sortiert Neon color assorted		6/7	Stck	15	240	Kunststoff Sektkühler Plastic champagne cooler
301801	Silber matt Silver		6/7	Stck	15	240	Kunststoff Sektkühler Plastic champagne cooler
301804	Gold matt Gold		6/7	Stck	15	240	Kunststoff Sektkühler Plastic champagne cooler
301931	Silber glänzend Silver anodized		5,5	Stck	30	360	Kunststoff Sektkühler Plastic champagne cooler
301934	Gold glänzend Gold anodized		5,5	Stck	30	360	Kunststoff Sektkühler Plastic champagne cooler



302090



302091



302092

Geschenksack

Giftbag



ARTIKELNUMMER	FARBE	DEKOR	Ø GRÖSSE/CM	STK/PACK	VPE	KARTONMENGE	PRODUKTEIGENSCHAFTEN
ART.-NO.	COLOR	DESIGN	Ø SIZE/CM	CONTENT	PU	BOX AMOUNT	PRODUCT CHARACTERISTICS
302090	Transparent, farbig sortiert Transparent, assorted colors		8	Stck	6	72	Geschenksack Giftbag
302091	Nicht Transparent, farbig sortiert Assorted colors		8	Stck	6	72	Geschenksack Giftbag
302092	Neon, farbig sortiert Neon color assorted		8	Stck	6	72	Geschenksack Giftbag

Display Pflanz-, Blumen- und Kräuterbox

DISPLAY PLANT, FLOWER AND HERB BOX



6062019101G



Display Floristik Detail
Display Floristic Detail



Display Floristik

Display floristic



ARTIKELNUMMER	FARBE	DEKOR	Ø GRÖSSE/M	STK/PACK	VPE	KARTONMENGE	PRODUKTEIGENSCHAFTEN
ART.-NO.	COLOR	DESIGN	Ø SIZE/M	CONTENT	PU	BOX AMOUNT	PRODUCT CHARACTERISTICS
6062019101G	Grau Grey			91	1	1	Display-Floristik Display-Floristic

Display Floristik - Inhalt

Display floristic - Content

ARTIKELNUMMER	FARBE	FÜLLMENGE/ML	Ø GRÖSSE/CM	STK/PACK	VPE	MENGE/DISPLAY	INHALT/ARTIKEL
ART.-NO.	COLOR	CAPACITY/ML	Ø SIZE/CM	CONTENT	PU	Amount/Display	Content/Article
9202000100G	Grün Green		12	1		12	Kräuterschere Herbs scissors
9201000100G	Schwarz permanent Black permanent			1		12	Folienstift Foil pen
8501101200G	Weiß White		3 x 6	12		6	Geschenkanhänger mit Öse und Faden Gift pendant with eye and thread
8501481200G	Nature Nature		3 x 6	12		6	Geschenkanhänger mit Öse und Faden Gift pendant with eye and thread
1906001200G	Weiß White		6	12		12	Pflanzenstecker Plant plug
1910000300G	Weiß White		10	6		6	Pflanzenstecker Plant plug
7046481212AG	Nature Nature		5 x 5 x 6	12		3	Mini Pflanz-, Blumen-, Kräuterbox: Pflanz-, Blumen- und Kräuterbox Mini aus beschichtetem Karton, nassfest mit Bogenkante, aufgestellt Plant, flower and herbs mini box made of coated cardboard, wet-proof with bow edge, set up
7046821212AG	Weißer Pünktchen auf Rot White Dots on Red	200	5 x 5 x 6	12		3	
7046661212AG	Vichy grün Vichy green	200	5 x 5 x 6	12		3	
7046781212AG	Kaktus mint Cactus mint	200	5 x 5 x 6	12		3	
7046771212AG	Kaktus rosa Cactus rose	200	5 x 5 x 6	12		3	
7045480310AG	Nature Nature	620	6 x 6 x 10	3		4	
7045820310AG	Weißer Pünktchen auf Rot White Dots on Red	620	6 x 6 x 10	3		4	XL Pflanz-, Blumen- und Kräuterbox: Pflanz-, Blumen- und Kräuterbox XL aus beschichtetem Karton, nassfest mit Bogenkante, aufgestellt Plant, flower and herbs box xl made of coated cardboard, wet-proof with bow edge, set up
7045780310AG	Kaktus mint Cactus mint	620	6 x 6 x 10	3		4	
7045770310AG	Kaktus rosa Cactus rose	620	6 x 6 x 10	3		4	
7045770310AG	Kaktus rosa Cactus rose	620	6 x 6 x 10	3		4	



Display Pflanz-, Blumen- und Kräuterbox

DISPLAY PLANT, FLOWER AND HERB BOX



Pflanz-, Blumen- und Kräuterbox

PLANT, FLOWER AND HERB BOX

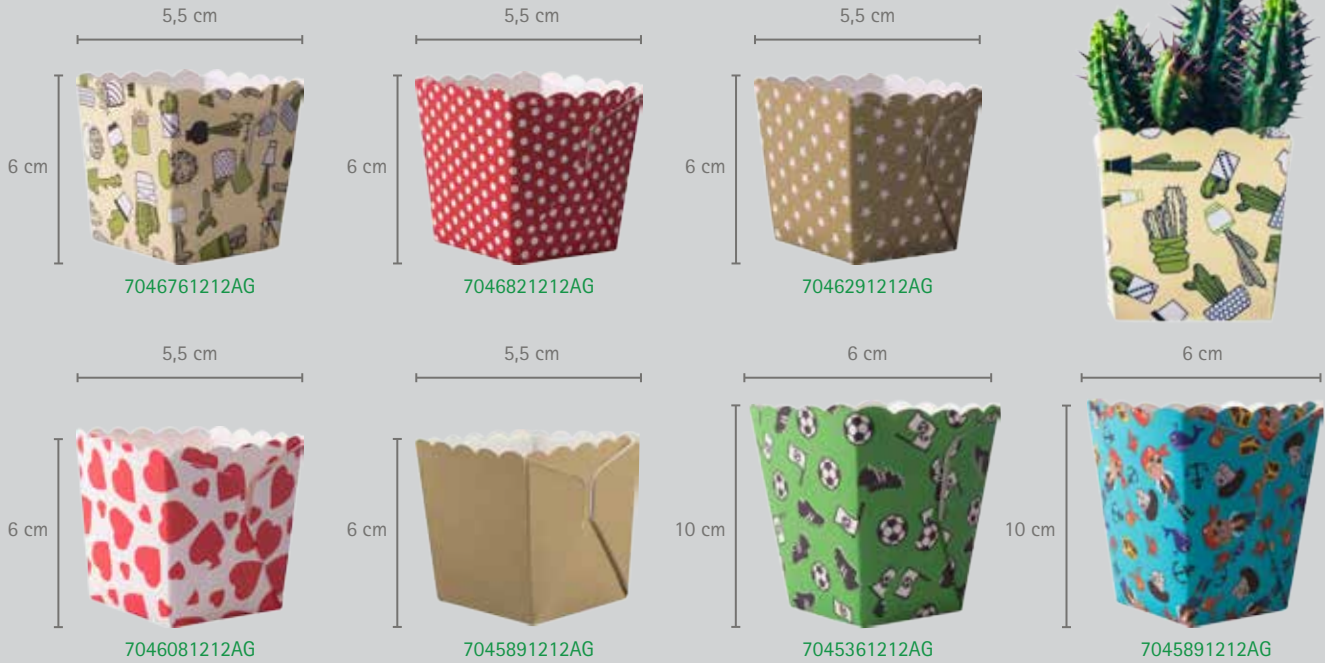

Pflanz-, Blumen- und Kräuterbox

Plant, flower and herb box

ARTIKELNUMMER	FARBE	DEKOR	Ø GRÖSSE/CM	STK/PACK	VPE	KARTONMENGE	PRODUKTEIGENSCHAFTEN
ART.-NO.	COLOR	DESIGN	Ø SIZE/CM	CONTENT	PU	BOX AMOUNT	PRODUCT CHARACTERISTICS
7045761212AG	Gelb Yellow	Kaktus Cactus	6 x 6 x 10	Pack	1	12	Pflanz-, Blumen- und Kräuterbox aus beschichtetem Karton, nassfest mit Bogenkante, aufgestellt, 12 Stück/Packung Plant, flower and herbs box made of coated cardboard, wet-proof with bow edge, set up, 12 pcs/pack
7045821212AG	Rot Red	Mit weissen Punkten With white dots	6 x 6 x 10	Pack	1	12	
7045291212AG	Gold Gold	Mit weissen Sternchen With white starlets	6 x 6 x 10	Pack	1	12	
7045081212AG	Weiss White	Rote Herzen Red hearts	6 x 6 x 10	Pack	1	12	
7045361212AG	Grün/weiss Green/white	Fußball Soccer	6 x 6 x 10	Pack	1	12	
7045891212AG	Blau Blue	Pirat Pirate	6 x 6 x 10	Pack	1	12	
7045481212AG	Natur Nature	Nature Nature	6 x 6 x 10	Pack	1	12	
7046761212AG	Gelb Yellow	Kaktus Cactus	5,5 x 5,5 x 6	Pack	1	12	
7046821212AG	Rot Red	Mit weissen Punkten With white dots	5,5 x 5,5 x 6	Pack	1	12	
7046291212AG	Gold Gold	Mit weissen Sternchen With white starlets	5,5 x 5,5 x 6	Pack	1	12	
7046081212AG	Weiss White	Rote Herzen Red hearts	5,5 x 5,5 x 6	Pack	1	12	
7046361212AG	Grün/weiss Green/white	Fußball Soccer	5,5 x 5,5 x 6	Pack	1	12	
7046891212AG	Blau Blue	Pirat Pirate	5,5 x 5,5 x 6	Pack	1	12	
7046481212AG	Natur Nature	Nature Nature	5,5 x 5,5 x 6	Pack	1	12	



Pflanz-, Blumen- und Kräuterbox

PLANT, FLOWER AND HERB BOX



7041021010AG



7041341010AG



7041321010AG



7041821010AG



7041191010AG



7041921010AG



Pflanz-, Blumen- und Kräuterschale

Plant, flower and herb bowl

ARTIKELNUMMER	FARBE	DEKOR	Ø GRÖSSE/CM	STK/PACK	VPE	KARTONMENGE	PRODUKTEIGENSCHAFTEN
ART.-NO.	COLOR	DESIGN	Ø SIZE/CM	CONTENT	PU	BOX AMOUNT	PRODUCT CHARACTERISTICS
7041021010AG	Farbig sortiert Color assorted	Kaktus Cactus	7 x 4 x 4	Pack	1	10	Pflanz-, Blumen- und Kräuterschale aus beschichtetem Karton, nassfest mit Bogenkante, aufgestellt, 10 Stück/Packung Plant, flower and herbs bowl made of coated cardboard, wet-proof with bow edge, set up, 10 pcs/pack
7041341010AG	Grün/rot Green/red	Erdbeere Strawberry	7 x 4 x 4	Pack	1	10	
7041321010AG	Blau Blue	Einhorn Unicorn	7 x 4 x 4	Pack	1	10	
7041821010AG	Rot Red	Mit weissen Punkten With white dots	7 x 4 x 4	Pack	1	10	
7041191010AG	Grau Grey	Mit weissen Sternen With white stars	7 x 4 x 4	Pack	1	10	
7041921010AG	Weiss White	Mit rosa Sternen With pink stars	7 x 4 x 4	Pack	1	10	

Kunststoff Übertöpfe

PLASTIC PLANTER



201001-1



201003-1



201004-1



201006-1



201008-1



201010-1



201011-1



201024-1



201025-1

Kunststoff Übertöpfe Corona

Plastic planter corona



ARTIKELNUMMER	FARBE	DEKOR	Ø GRÖSSE/CM	STK/PACK	VPE	KARTONMENGE	PRODUKTEIGENSCHAFTEN
ART.-NO.	COLOR	DESIGN	Ø SIZE/CM	CONTENT	PU	BOX AMOUNT	PRODUCT CHARACTERISTICS
201001-1	Weiss White	Modell Corona	Ø 7/11 cm, Höhe 10,5 cm	Pack	1	20	Kunststoff Übertopf 10 Stück/Pack Plastic planter 10 pcs/pack
201003-1	Gelb Yellow	Modell Corona	Ø 7/11 cm, Höhe 10,5 cm	Pack	1	20	
201004-1	Grün Green	Modell Corona	Ø 7/11 cm, Höhe 10,5 cm	Pack	1	20	
201006-1	Rosa Rose	Modell Corona	Ø 7/11 cm, Höhe 10,5 cm	Pack	1	20	
201008-1	Rot Red	Modell Corona	Ø 7/11 cm, Höhe 10,5 cm	Pack	1	20	
201010-1	Violett Purple	Modell Corona	Ø 7/11 cm, Höhe 10,5 cm	Pack	1	20	
201011-1	Lila Lilac	Modell Corona	Ø 7/11 cm, Höhe 10,5 cm	Pack	1	20	
201024-1	Cappuchino Cappuchino	Modell Corona	Ø 7/11 cm, Höhe 10,5 cm	Pack	1	20	
201025-1	Hellblau Lightblue	Modell Corona	Ø 7/11 cm, Höhe 10,5 cm	Pack	1	20	



201026-1



211201-1



211203-1



211204-1



211205-1



211207-1



211209-1



211208-1



211215-1

Kunststoff Übertöpfe Corona

Plastic planter corona



ARTIKELNUMMER	FARBE	DEKOR	Ø GRÖSSE/CM	STK/PACK	VPE	KARTONMENGE	PRODUKTEIGENSCHAFTEN
ART.-NO.	COLOR	DESIGN	Ø SIZE/CM	CONTENT	PU	BOX AMOUNT	PRODUCT CHARACTERISTICS
201026-1	Grau Grey	Modell Corona	Ø 7/11 cm, Höhe 10,5 cm	Pack	1	20	Kunststoff Übertopf 10 Stück/Pack Plastic planter 10 pcs/pack
211201-1	Weiss White	Modell Corona	Ø 8/11,5 cm, Höhe 15 cm	Pack	1	12	
211203-1	Gelb Yellow	Modell Corona	Ø 8/11,5 cm, Höhe 15 cm	Pack	1	12	
211204-1	Grün Green	Modell Corona	Ø 8/11,5 cm, Höhe 15 cm	Pack	1	12	
211205-1	Rosa Rose	Modell Corona	Ø 8/11,5 cm, Höhe 15 cm	Pack	1	12	
211207-1	Rot Red	Modell Corona	Ø 8/11,5 cm, Höhe 15 cm	Pack	1	12	
211208-1	Violett Purple	Modell Corona	Ø 8/11,5 cm, Höhe 15 cm	Pack	1	12	
211209-1	Lila Lilac	Modell Corona	Ø 8/11,5 cm, Höhe 15 cm	Pack	1	12	
211215-1	Cappuchino Cappuchino	Modell Corona	Ø 8/11,5 cm, Höhe 15 cm	Pack	1	12	

Kunststoff Übertöpfe

PLASTIC PLANTER

NEU
NEW



NEU
NEW

211216-1



NEU
NEW

211217-1



NEU
NEW

221505-1



NEU
NEW

221516-1



NEU
NEW

221501-1



NEU
NEW

221517-1



NEU
NEW

221504-1

Kunststoff Übertöpfe Corona

Plastic planter corona



ARTIKELNUMMER	FARBE	DEKOR	Ø GRÖSSE/CM	STK/PACK	VPE	KARTONMENGE	PRODUKTEIGENSCHAFTEN
ART.-NO.	COLOR	DESIGN	Ø SIZE/CM	CONTENT	PU	BOX AMOUNT	PRODUCT CHARACTERISTICS
NEU NEW 211216-1	Hellblau Lightblue	Modell Corona	Ø 8/11,5 cm, Höhe 15 cm	Pack	1	12	Kunststoff Übertopf 10 Stück/Pack Plastic planter 10 pcs/pack
NEU NEW 211217-1	Grau Grey	Modell Corona	Ø 8/11,5 cm, Höhe 15 cm	Pack	1	12	Kunststoff Übertopf 10 Stück/Pack Plastic planter 10 pcs/pack
NEU NEW 221501-1	Weiss White	Modell Corona	Ø 9/14 cm, Höhe 18,5 cm	Pack	1	20	Kunststoff Übertopf 10 Stück/Pack Plastic planter 10 pcs/pack
NEU NEW 221504-1	Grün Green	Modell Corona	Ø 9/14 cm, Höhe 18,5 cm	Pack	1	20	
NEU NEW 221505-1	Rosa Rose	Modell Corona	Ø 9/14 cm, Höhe 18,5 cm	Pack	1	20	
NEU NEW 221516-1	Hellblau Lightblu	Modell Corona	Ø 9/14 cm, Höhe 18,5 cm	Pack	1	20	
NEU NEW 221517-1	Grau Grey	Modell Corona	Ø 9/14 cm, Höhe 18,5 cm	Pack	1	20	

NEU
NEW

Kunststoff Übertöpfe

PLASTIC PLANTER



NEU
NEW

752301



NEU
NEW

752316



NEU
NEW

752320



NEU
NEW

752326



NEU
NEW

762301



NEU
NEW

762316



NEU
NEW

762320



NEU
NEW

762326

Kunststoff Übertöpfe Modena

Plastic planter modena



ARTIKELNUMMER	FARBE	DEKOR	Ø GRÖSSE/CM	STK/PACK	VPE	KARTONMENGE	PRODUKTEIGENSCHAFTEN
ART.-NO.	COLOR	DESIGN	Ø SIZE/CM	CONTENT	PU	BOX AMOUNT	PRODUCT CHARACTERISTICS
NEU NEW 752301	Weiss White	Modell Modena mit hohem Untersetzer	Ø 23x12,5 cm, Höhe 20 cm	Pack	1	4	Kunststoff Pflanzschale 5 Schalen und 5 hohe Untersetzer/Pack Plastic planter 5 bowls and 5 high coasters/pack
NEU NEW 752316	Gold Gold		Ø 23x12,5 cm, Höhe 20 cm	Pack	1	4	
NEU NEW 752320	Grau Grey		Ø 23x12,5 cm, Höhe 20 cm	Pack	1	4	
NEU NEW 752326	Anthrazit Anthracite		Ø 23x12,5 cm, Höhe 20 cm	Pack	1	4	
NEU NEW 762301	Weiss White	Modell Modena mit flachem Untersetzer	Ø 23x12,5 cm, Höhe 16 cm	Pack	1	4	Kunststoff Pflanzschale 5 Schalen und 5 flache Untersetzer/Pack Plastic planter 5 bowls and 5 flat coasters/pack
NEU NEW 762316	Gold Gold		Ø 23x12,5 cm, Höhe 16 cm	Pack	1	4	
NEU NEW 762320	Grau Grey		Ø 23x12,5 cm, Höhe 16 cm	Pack	1	4	
NEU NEW 762326	Anthrazit Anthracite		Ø 23x12,5 cm, Höhe 16 cm	Pack	1	4	



Kunststoff Übertöpfe Luna

Plastic planter luna

ARTIKELNUMMER	FARBE	DEKOR	Ø GRÖSSE/MM	STK/PACK	VPE	KARTONMENGE	PRODUKTEIGENSCHAFTEN	
ART.-NO.	COLOR	DESIGN	Ø SIZE/MM	CONTENT	PU	BOX AMOUNT	PRODUCT CHARACTERISTICS	
NEU NEW 707001	Weiss White	Modell Luna 1	25x10 x12	Pack	1	21	Kunststoff Dekoschale 10 Stück/Pack Plastic planter 10 pieces / pack	
NEU NEW 707002	Ecreu Ecreu	Modell Luna 1	25x10 x12	Pack	1	21		
NEU NEW 707003	Gelb Yellow	Modell Luna 1	25x10 x12	Pack	1	21		
NEU NEW 707004	Grün Green	Modell Luna 1	25x10 x12	Pack	1	21		
NEU NEW 707010	Violett Violet	Modell Luna 1	25x10 x12	Pack	1	21		
NEU NEW 707016	Gold Gold	Modell Luna 1	25x10 x12	Pack	1	21		
NEU NEW 707017	Silber Silver	Modell Luna 1	25x10 x12	Pack	1	21		
NEU NEW 707024	Capuccino Capuccino	Modell Luna 1	25x10 x12	Pack	1	21		
NEU NEW 707025	Hellblau Lightblue	Modell Luna 1	25x10 x12	Pack	1	21		
NEU NEW 707026	Grau Gray	Modell Luna 1	25x10 x12	Pack	1	21		
NEU NEW 707028	Anthrazit Anthracite	Modell Luna 1	25x10 x12	Pack	1	21		
NEU NEW 717101	Weiss White	Modell Luna 2	30x11 x13	Pack	1	10		Kunststoff Dekoschale 10 Stück/Pack Plastic planter 10 pieces / pack
NEU NEW 717102	Ecreu Ecreu	Modell Luna 2	30x11 x13	Pack	1	10		
NEU NEW 717103	Gelb Yellow	Modell Luna 2	30x11 x13	Pack	1	10		
NEU NEW 717104	Grün Green	Modell Luna 2	30x11 x13	Pack	1	10		
NEU NEW 717110	Violett Violet	Modell Luna 2	30x11 x13	Pack	1	10		
NEU NEW 717116	Gold Gold	Modell Luna 2	30x11 x13	Pack	1	10		
NEU NEW 717117	Silber Silver	Modell Luna 2	30x11 x13	Pack	1	10		
NEU NEW 717124	Capuccino Capuccino	Modell Luna 2	30x11 x13	Pack	1	10		
NEU NEW 717125	Hellblau Lightblue	Modell Luna 2	30x11 x13	Pack	1	10		
NEU NEW 717126	Grau Gray	Modell Luna 2	30x11 x13	Pack	1	10		
NEU NEW 717128	Anthrazit Anthracite	Modell Luna 2	30x11 x13	Pack	1	10		

NEU
NEW

Kunststoff Übertöpfe

PLASTIC PLANTERS



NEU
NEW

Weiss White



NEU
NEW

Ecreu Ecreu



NEU
NEW

Geld Yellow



NEU
NEW

Grün Green



NEU
NEW

Violett Violet



NEU
NEW

Gold Gold



NEU
NEW

Silber Silver



NEU
NEW

Capuccino Capuccino



NEU
NEW

Hellblau Lightblue



NEU
NEW

Grau Gray



NEU
NEW

Anthrazit Anthracite



Kunststoff Übertöpfe Porto

Plastic planter porto

ARTIKELNUMMER	FARBE	DEKOR	Ø GRÖSSE/MM	STK/PACK	VPE	KARTONMENGE	PRODUKTEIGENSCHAFTEN
ART.-NO.	COLOR	DESIGN	Ø SIZE/MM	CONTENT	PU	BOX AMOUNT	PRODUCT CHARACTERISTICS
NEU NEW 721101	Weiss White	Modell Porto	Ø 8,5/11,5 cm, Höhe 10,5 cm	Pack	1	36	Kunststoff Dekoschale 10 Stück/Pack Plastic planter 10 pieces / pack
NEU NEW 721104	Grün Green	Modell Porto	Ø 8,5/11,5 cm, Höhe 10,5 cm	Pack	1	36	
NEU NEW 721106	Rosa Pink	Modell Porto	Ø 8,5/11,5 cm, Höhe 10,5 cm2	Pack	1	36	
NEU NEW 721110	Violett Violet	Modell Porto	Ø 8,5/11,5 cm, Höhe 10,5 cm	Pack	1	36	
NEU NEW 721120	Grau Gray	Modell Porto	Ø 8,5/11,5 cm, Höhe 10,5 cm	Pack	1	36	
NEU NEW 721124	Capuccino Capuccino	Modell Porto	Ø 8,5/11,5 cm, Höhe 10,5 cm	Pack	1	36	
NEU NEW 731301	Weiss White	Modell Porto	Ø 8,5/12,5 cm, Höhe 11 cm	Pack	1	19	Kunststoff Dekoschale 10 Stück/Pack Plastic planter 10 pieces / pack
NEU NEW 731304	Grün Green	Modell Porto	Ø 8,5/12,5 cm, Höhe 11 cm	Pack	1	19	
NEU NEW 731306	Rosa Pink	Modell Porto	Ø 8,5/12,5 cm, Höhe 11 cm2	Pack	1	19	
NEU NEW 731310	Violett Violet	Modell Porto	Ø 8,5/12,5 cm, Höhe 11 cm	Pack	1	19	
NEU NEW 731320	Grau Gray	Modell Porto	Ø 8,5/12,5 cm, Höhe 11 cm2	Pack	1	19	
NEU NEW 731324	Capuccino Capuccino	Modell Porto	Ø 8,5/12,5 cm, Höhe 11 cm	Pack	1	19	
NEU NEW 741501	Weiss White	Modell Porto	Ø 10,5/15,5 cm, Höhe 13,5 cm	Pack	1	10	Kunststoff Dekoschale 10 Stück/Pack Plastic planter 10 pieces / pack
NEU NEW 741504	Grün Green	Modell Porto	Ø 10,5/15,5 cm, Höhe 13,5 cm	Pack	1	16	
NEU NEW 741506	Rosa Pink	Modell Porto	Ø 10,5/15,5 cm, Höhe 13,5 cm	Pack	1	16	
NEU NEW 741510	Violett Violet	Modell Porto	Ø 10,5/15,5 cm, Höhe 13,5 cm	Pack	1	16	
NEU NEW 741520	Grau Gray	Modell Porto	Ø 10,5/15,5 cm, Höhe 13,5 cm	Pack	1	16	
NEU NEW 741524	Capuccino Capuccino	Modell Porto	Ø 10,5/15,5 cm, Höhe 13,5 cm	Pack	1	16	

NEU
NEW

Kunststoff Übertöpfe

PLASTIC PLANTERS



NEU
NEW

Weiss White



NEU
NEW

Rosa Pink



NEU
NEW

Grün Green



NEU
NEW

Violett Violet



NEU
NEW

Grau Gray



NEU
NEW

Capuccino Capuccino

Kunststoff Übertöpfe

PLASTIC PLANTER



090801



090804



090806



090807



090818



090910

Kunststoff Übertöpfe Primula

Plastic planter primula



ARTIKELNUMMER	FARBE	DEKOR	Ø GRÖSSE/CM	STK/PACK	VPE	KARTONMENGE	PRODUKTEIGENSCHAFTEN
ART.-NO.	COLOR	DESIGN	Ø SIZE/CM	CONTENT	PU	BOX AMOUNT	PRODUCT CHARACTERISTICS
090801	Weiss White	Modell Primula	Ø 5,5/9,5 cm, Höhe 9 cm	Pack	1	20	Kunststoff Übertopf 50 Stück/Pack Plastic planter 50 pcs/pack
090818	Banane Banana	Modell Primula	Ø 5,5/9,5 cm, Höhe 9 cm	Pack	1	20	Kunststoff Übertopf 50 Stück/Pack Plastic planter 50 pcs/pack
090807	Mandarine Tangerine	Modell Primula	Ø 5,5/9,5 cm, Höhe 9 cm	Pack	1	20	Kunststoff Übertopf 50 Stück/Pack Plastic planter 50 pcs/pack
090806	Rosa Rose	Modell Primula	Ø 5,5/9,5 cm, Höhe 9 cm	Pack	1	20	Kunststoff Übertopf 50 Stück/Pack Plastic planter 50 pcs/pack
090810	Violett Purple	Modell Primula	Ø 5,5/9,5 cm, Höhe 9 cm	Pack	1	20	Kunststoff Übertopf 50 Stück/Pack Plastic planter 50 pcs/pack
090804	Grün Green	Modell Primula	Ø 5,5/9,5 cm, Höhe 9 cm	Pack	1	20	Kunststoff Übertopf 50 Stück/Pack Plastic planter 50 pcs/pack



100801



100818



100807



100806



100810



100804

Kunststoff Übertöpfe Primula

Plastic planter primula



ARTIKELNUMMER	FARBE	DEKOR	Ø GRÖSSE/CM	STK/PACK	VPE	KARTONMENGE	PRODUKTEIGENSCHAFTEN
ART.-NO.	COLOR	DESIGN	Ø SIZE/CM	CONTENT	PU	BOX AMOUNT	PRODUCT CHARACTERISTICS
100801	Weiss White	Modell Primula	Ø 7 / 10,5 cm, Höhe 9,5 cm	Pack	1	16	Kunststoff Übertopf 25 Stück/Pack Plastic planter 25 pcs/pack
100818	Banane Banana	Modell Primula	Ø 7 / 10,5 cm, Höhe 9,5 cm	Pack	1	16	Kunststoff Übertopf 25 Stück/Pack Plastic planter 25 pcs/pack
100807	Mandarine Tangerine	Modell Primula	Ø 7 / 10,5 cm, Höhe 9,5 cm	Pack	1	16	Kunststoff Übertopf 25 Stück/Pack Plastic planter 25 pcs/pack
100806	Rosa Rose	Modell Primula	Ø 7 / 10,5 cm, Höhe 9,5 cm	Pack	1	16	Kunststoff Übertopf 25 Stück/Pack Plastic planter 25 pcs/pack
100810	Violett Purple	Modell Primula	Ø 7 / 10,5 cm, Höhe 9,5 cm	Pack	1	16	Kunststoff Übertopf 25 Stück/Pack Plastic planter 25 pcs/pack
100804	Grün Green	Modell Primula	Ø 7 / 10,5 cm, Höhe 9,5 cm	Pack	1	16	Kunststoff Übertopf 25 Stück/Pack Plastic planter 25 pcs/pack

Kunststoff Übertöpfe

PLASTIC PLANTER

NEU
NEW



NEU
NEW

Gold Gold



NEU
NEW

Grafit Graphit

Kunststoff Pflanzschale Misa

Plastic planter misa



ARTIKELNUMMER	FARBE	DEKOR	Ø GRÖSSE/CM	STK/PACK	VPE	KARTONMENGE	PRODUKTEIGENSCHAFTEN
ART.-NO.	COLOR	DESIGN	Ø SIZE/CM	CONTENT	PU	BOX AMOUNT	PRODUCT CHARACTERISTICS
NEU NEW 1042316	Gold Gold	Modell Misa	Ø oben 22 cm, Höhe 10 cm, Ø unten 17,5 cm	Pack	1	15	Kunststoff Pflanzschale 10 Stück/Pack Plastic planter 10 pcs/pack
NEU NEW 1042326	Grafit Graphit	Modell Misa	Ø oben 22 cm, Höhe 10 cm, Ø unten 17,5 cm	Pack	1	15	
NEU NEW 1042016	Gold Gold	Modell Misa	Ø oben 20 cm, Höhe 9,8 cm, Ø unten 14,5 cm	Pack	1	20	
NEU NEW 1042026	Grafit Graphit	Modell Misa	Ø oben 20 cm, Höhe 9,8 cm, Ø unten 14,5 cm	Pack	1	20	
NEU NEW 1041816	Gold Gold	Modell Misa	Ø oben 18 cm, Höhe 8 cm, Ø unten 13,5 cm	Pack	1	30	
NEU NEW 1041826	Grafit Graphit	Modell Misa	Ø oben 18 cm, Höhe 8 cm, Ø unten 13,5 cm	Pack	1	30	
NEU NEW 1041616	Gold Gold	Modell Misa	Ø oben 16 cm, Höhe 8 cm, Ø unten 11,5 cm	Pack	1	40	
NEU NEW 1041626	Grafit Graphit	Modell Misa	Ø oben 16 cm, Höhe 8 cm, Ø unten 11,5 cm	Pack	1	40	
NEU NEW 1041316	Gold Gold	Modell Misa	Ø oben 13,5 cm, Höhe 6,5 cm, Ø unten 10 cm	Pack	1	48	
NEU NEW 1041326	Grafit Graphit	Modell Misa	Ø oben 13,5 cm, Höhe 6,5 cm, Ø unten 10 cm	Pack	1	48	

NEU
NEW

Kunststoff Übertöpfe

PLASTIC PLANTER



NEU
NEW

Gold Gold

NEU
NEW

Kupfer Copper

NEU
NEW

Weiss White

NEU
NEW

Schwarz Black

Kunststoff Pflanzschale Elipsa

Plastic planter elipsa



ARTIKELNUMMER	FARBE	DEKOR	Ø GRÖSSE/CM	STK/PACK	VPE	KARTONMENGE	PRODUKTEIGENSCHAFTEN
ART.-NO.	COLOR	DESIGN	Ø SIZE/CM	CONTENT	PU	BOX AMOUNT	PRODUCT CHARACTERISTICS
NEU NEW 1063301	Weiss White	Modell Elipsa	Innenmaß: 33x15 cm	Pack	1	9	Kunststoff Pflanzschale 10 Stück/Pack Plastic planter 10 pcs/pack
NEU NEW 1063316	Gold Gold	Modell Elipsa	Innenmaß: 33x15 cm	Pack	1	9	
NEU NEW 1063326	Grafit Graphit	Modell Elipsa	Innenmaß: 33x15 cm	Pack	1	9	
NEU NEW 1063332	Kupfer Copper	Modell Elipsa	Innenmaß: 33x15 cm	Pack	1	9	
NEU NEW 1062601	Weiss White	Modell Elipsa	Innenmaß: 26x15 cm	Pack	1	10	
NEU NEW 1062616	Gold Gold	Modell Elipsa	Innenmaß: 26x15 cm	Pack	1	10	
NEU NEW 1062626	Grafit Graphit	Modell Elipsa	Innenmaß: 26x15 cm	Pack	1	10	
NEU NEW 1062632	Kupfer Copper	Modell Elipsa	Innenmaß: 26x15 cm	Pack	1	10	

Eierbecher

EGGCUPS



301001



301201



301203



532101



532103

Eierbecher

Eggcups



ARTIKELNUMMER	FARBE	DEKOR	Ø GRÖSSE/CM	STK/PACK	VPE	KARTONMENGE	PRODUKTEIGENSCHAFTEN
ART.-NO.	COLOR	DESIGN	Ø SIZE/CM	CONTENT	PU	BOX AMOUNT	PRODUCT CHARACTERISTICS
301001	5 Farbig sortiert Assorted colors		7cm	Stck	20	240	Eierbecher Eggcup
301003	Gelb Yellow		7cm	Stck	20	240	
301201	5 Farbig sortiert Assorted colors		13cm	Stck	12	108	
301203	Gelb Yellow		13cm	Stck	12	108	

Eierschale

Eggshell bowl



ARTIKELNUMMER	FARBE	DEKOR	Ø GRÖSSE/CM	STK/PACK	VPE	KARTONMENGE	PRODUKTEIGENSCHAFTEN
ART.-NO.	COLOR	DESIGN	Ø SIZE/CM	CONTENT	PU	BOX AMOUNT	PRODUCT CHARACTERISTICS
532101	Weiss White		21 x 11,5 x 7,5 cm	Pack	1		Eierschale, 25 Stück/Pack Eggshell, 25 pcs/pack
532103	Gelb Yellow		21 x 11,5 x 7,5 cm	Pack	1		

Die Abbildungen können in Größenproportionen und Farbe vom Original abweichen. Änderungen behalten wir uns vor.
Size proportions and colors of items presented may vary from original. Subject to change without further notice.



Transparent Transparent

Dekorationskugeln mit Loch für Lichterkette

Plastic balls with hole for light string



ARTIKELNUMMER	FARBE	DEKOR	Ø GRÖSSE/CM	STK/PACK	VPE	KARTONMENGE	PRODUKTEIGENSCHAFTEN
ART.-NO.	COLOR	DESIGN	Ø SIZE/CM	CONTENT	PU	BOX AMOUNT	PRODUCT CHARACTERISTICS
320600L	Transparent Transparent	Zweiteilig Two-part	6	Stck	10	250	Dekorationskugeln mit Loch für Lichterkette Decoration balls with hole for fairy lights
320800L	Transparent Transparent	Zweiteilig Two-part	8	Stck	14	112	
321000L	Transparent Transparent	Zweiteilig Two-part	10	Stck	8	112	
321200L	Transparent Transparent	Zweiteilig Two-part	12	Stck	7	105	
321400L	Transparent Transparent	Zweiteilig Two-part	14	Stck	6	66	
321600L	Transparent Transparent	Zweiteilig Two-part	16	Stck	4	32	

Dekoformen

PLASTIC SHAPES



320600



Dekorationskugeln

Plastic balls



ARTIKELNUMMER	FARBE	DEKOR	Ø GRÖSSE/CM	STK/PACK	VPE	KARTONMENGE	PRODUKTEIGENSCHAFTEN
ART.-NO.	COLOR	DESIGN	Ø SIZE/CM	CONTENT	PU	BOX AMOUNT	PRODUCT CHARACTERISTICS
320600	Transparent Transparent	Zweiteilig Two-part	6	Stck	10	250	
320800	Transparent Transparent	Zweiteilig Two-part	8	Stck	14	112	
321000	Transparent Transparent	Zweiteilig Two-part	10	Stck	8	112	
321200	Transparent Transparent	Zweiteilig Two-part	12	Stck	7	105	
321205	Transparent Transparent	Zweiteilig Two-piece	12	Stck	7	105	Dekorationskugeln, zweiteilig, mit einseitiger Öffnung Decoration balls, two-piece, with one-sided opening
321400	Transparent Transparent	Zweiteilig Two-part	14	Stck	6	66	
321600	Transparent Transparent	Zweiteilig Two-part	16	Stck	4	32	
321800	Transparent Transparent	Zweiteilig Two-part	18	Stck	4	24	
322000	Transparent Transparent	Zweiteilig Two-part	20	Stck	4	16	



322400



323800



324700

Dekorationstropfen

Plastic drops



ARTIKELNUMMER	FARBE	DEKOR	Ø GRÖSSE/CM	STK/PACK	VPE	KARTONMENGE	PRODUKTEIGENSCHAFTEN
ART.-NO.	COLOR	DESIGN	Ø SIZE/CM	CONTENT	PU	BOX AMOUNT	PRODUCT CHARACTERISTICS
322100	Transparent Transparent	Zweiteilig Two-part	11	Stck	9	72	Dekorationstropfen Decoration drops
322400	Transparent Transparent	Zweiteilig Two-part	14	Stck	8	88	
322700	Transparent Transparent	Zweiteilig Two-part	17	Stck	10	80	

Dekorationsherzen

Plastic hearts



ARTIKELNUMMER	FARBE	DEKOR	Ø GRÖSSE/CM	STK/PACK	VPE	KARTONMENGE	PRODUKTEIGENSCHAFTEN
ART.-NO.	COLOR	DESIGN	Ø SIZE/CM	CONTENT	PU	BOX AMOUNT	PRODUCT CHARACTERISTICS
323600	Transparent Transparent	Zweiteilig Two-part	6	Stck	5	50	Dekorationsherzen Decoration heart
323800	Transparent Transparent	Zweiteilig Two-part	8	Stck	5	60	
324000	Transparent Transparent	Zweiteilig Two-part	10	Stck	12	216	

Dekorationseier

Plastic eggs



ARTIKELNUMMER	FARBE	DEKOR	Ø GRÖSSE/CM	STK/PACK	VPE	KARTONMENGE	PRODUKTEIGENSCHAFTEN
ART.-NO.	COLOR	DESIGN	Ø SIZE/CM	CONTENT	PU	BOX AMOUNT	PRODUCT CHARACTERISTICS
324600	Transparent Transparent	Zweiteilig Two-part	6	Stck	10	100	Dekorationseier Decoration eggs
324700	Transparent Transparent	Zweiteilig Two-part	10	Stck	5	40	
324900	Transparent Transparent	Zweiteilig Two-part	12	Stck	9	72	
324800	Transparent Transparent	Zweiteilig Two-part	14	Stck	4	72	

PREIS AUSZEICHNUNG UND DRUCKSACHEN

PRICING AND PRINTED MATTER

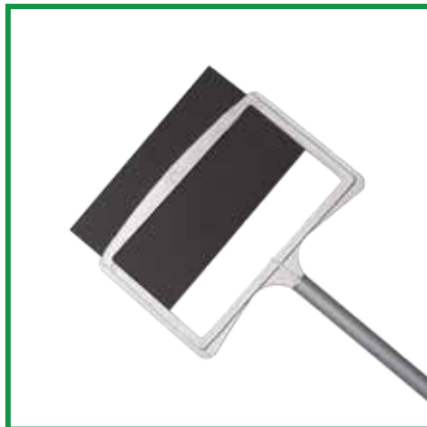

- 142 Allzweckreiniger
(Detergent)
- 143 Marker und Stifte
(Marker and Pencils)
- 146 Stecker und Schilder
(Plugs and Labels)
- 152 Etiketten
(Labels)
- 158 Werbesymbole
(Advertising signs)
- 159 Vordrucke
(Preprinted form)

- 160 Kranzanhänger
(Wreath label)
- 160 Pergaminhüllen
(Glassine envelope)
- 161 Etui Geschenkkarte
(Etui gift card)
- 161 Weihnachts-Geschenkbbox
(Christmas Giftbox)
- 162 Grußkarten
(Greeting cards)



Allzweckreiniger

DETERGENT



250000



250001

Allzweckreiniger

Detergent

ARTIKELNUMMER	FARBE	DEKOR	Ø GRÖSSE/CM	STK/PACK	VPE	KARTONMENGE	PRODUKTEIGENSCHAFTEN
ART.-NO.	COLOR	DESIGN	Ø SIZE/CM	CONTENT	PU	BOX AMOUNT	PRODUCT CHARACTERISTICS
250000				Stck	1	12	Allzweckreiniger 250 ml All Purpose cleaner 250 ml
250001				Pack	12	1	Sprühkopf für Allzweckreiniger Flasch, 12 Stück/Pack Spray head for all-purpose cleaner bottle, 12 pieces/pack

Marker und Stifte

MARKER UND PENCILS



100100



100102

NEU
NEW

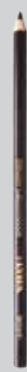

2940099



100200



100300

Allzweckstifte

All surface pen



ARTIKELNUMMER	FARBE	DEKOR	Ø GRÖSSE/CM	STK/PACK	VPE	KARTONMENGE	PRODUKTEIGENSCHAFTEN
ART.-NO.	COLOR	DESIGN	Ø SIZE/CM	CONTENT	PU	BOX AMOUNT	PRODUCT CHARACTERISTICS
100100	Schwarz Black			Stck	12	144	Gardenpen, wetterfeste Markierungen Gardenpen, weatherproof markings
100102	Weiss White			Stck	12	144	Fettstift, wasserfeste Markierungen Grease stick, waterproof marks
NEU NEW 2940099	Schwarz Black			Stck	12	144	Universalstift schreibt auf Glas, Plastik, Metall und Papier All surface pen writes on glass, plastic, metal and paper

Faserstifte

Permanent marker

ARTIKELNUMMER	FARBE	DEKOR	Ø GRÖSSE/CM	STK/PACK	VPE	KARTONMENGE	PRODUKTEIGENSCHAFTEN
ART.-NO.	COLOR	DESIGN	Ø SIZE/CM	CONTENT	PU	BOX AMOUNT	PRODUCT CHARACTERISTICS
100200	Schwarz Black	Schmal Narrow		Stck	10	200	Faserschreiber, wasserfest, permanent Felt-tip pen, Permanent Marker, waterproof, permanent
100300	Schwarz Black	Breit Wide		Stck	10	100	Faserschreiber, wasserfest, permanent Felt-tip pen, Permanent Marker, waterproof, permanent

Kreide Marker / Faserstifte

PERMANENT / CHALK MARKER

NEU
NEW



NEU 219018
NEW 219019



NEU 210007
NEW 210008



NEU 712010
NEW



NEU 712520
NEW

Faserstifte

Permanent marker

ARTIKELNUMMER	FARBE	DEKOR	STRICHSTÄRKE	STK/PACK	VPE	KARTONMENGE	PRODUKTEIGENSCHAFTEN
ART.-NO.	COLOR	DESIGN	LINE WIDTH	CONTENT	PU	BOX AMOUNT	PRODUCT CHARACTERISTICS
NEU NEW 712010	Weiss White	Schmal Narrow	1-3 mm	Stck	10	60	Permanentmarker Strichstärke 1-3 mm Permanent marker Line width 1-3 mm
NEU NEW 219018	Silber Silver	Breit Wide	2-4 mm	Stck	10	120	Paintmarker Strichstärke 2-4 mm Paint marker Line width 2-4 mm
NEU NEW 219019	Gold Gold	Breit Wide	2-4 mm	Stck	10	120	Paintmarker Strichstärke 2-4 mm Paint marker Line width 2-4 mm
NEU NEW 210007	Silber Silver	Schmal Narrow	1-2 mm	Stck	10	120	Paintmarker Strichstärke 1-2 mm Paint marker Line width 1-2 mm
NEU NEW 210008	Gold Gold	Schmal Narrow	1-2 mm	Stck	10	120	Paintmarker Strichstärke 1-2 mm Paint marker Line width 1-2 mm
NEU NEW 712520	Schwarz Black	Schmal und breit Narrow and wide	1 mm 1-4 mm	Stck	8	96	Permanentmarker mit 2 Strichstärken 1mm und 1-4mm Permanent marker with 2 Line width 1mm and 1-4mm

NEU
NEW

Kreide Marker

CHALK MARKER



100500



100520



NEU
NEW

620010
620020
620025



NEU
NEW

620055
620065
620070



Kreide Marker

Chalk marker

ARTIKELNUMMER	FARBE	DEKOR	Ø GRÖSSE/CM	STK/PACK	VPE	KARTONMENGE	PRODUKTEIGENSCHAFTEN
ART.-NO.	COLOR	DESIGN	Ø SIZE/CM	CONTENT	PU	BOX AMOUNT	PRODUCT CHARACTERISTICS
100500	Weiss White		1 - 4 mm	Stck	4	24	Deko Marker mit Flüssigkreide Decorative marker with liquid chalk
100520	Weiss White		5 - 15 mm	Stck	4	16	
NEU NEW 620010	Gelb Yellow	Schmal Narrow	2-4 mm	Stck	4	24	
NEU NEW 620020	Pink Pink	Schmal Narrow	2-4 mm	Stck	4	24	
NEU NEW 620025	Blau Blue	Schmal Narrow	2-4 mm	Stck	4	24	
NEU NEW 620055	Gelb Yellow	Breit Wide	5-15 mm	Stck	4	16	
NEU NEW 620065	Pink Pink	Breit Wide	5-15 mm	Stck	4	16	
NEU NEW 620070	Blau Blue	Breit Wide	5-15 mm	Stck	4	16	

Steckschilder

STICK LABELS

NEU
NEW



NEU
NEW

Pastell rosa Pastel rosa
Reseda grün Reseda green



Pastell flieder Pastel lilac
Anthrazit Anthracite



Steckschilder Stick Labels



ARTIKELNUMMER	FARBE	STABLÄNGE/CM	SCHILDGRÖSSE/CM	STK/PACK	VPE	KARTONMENGE	PRODUKTEIGENSCHAFTEN
ART.-NO.	COLOR	BAR LENGTH/CM	LABEL SIZE/CM	CONTENT	PU	BOX AMOUNT	PRODUCT CHARACTERISTICS
NEU NEW 190852	Reseda grün Reseda green	8	2,5 x 3,0	Stck	100	5000	Pflanzensteckschild Stick label
NEU NEW 190853	Pastell rosa Pastel rosa	8	2,5 x 3,0	Stck	100	5000	
NEU NEW 190854	Pastell flieder Pastel lilac	8	2,5 x 3,0	Stck	100	5000	
NEU NEW 190855	Anthrazit Anthracite	8	2,5 x 3,0	Stck	100	5000	
NEU NEW 191052	Reseda grün Reseda green	10	4,2 x 3,5	Stck	100	5000	
NEU NEW 191053	Pastell rosa Pastel rosa	10	4,2 x 3,5	Stck	100	5000	
NEU NEW 191054	Pastell flieder Pastel lilac	10	4,2 x 3,5	Stck	100	5000	
NEU NEW 191055	Anthrazit Anthracite	10	4,2 x 3,5	Stck	100	5000	
NEU NEW 191252	Reseda grün Reseda green	12	4,6 x 4,0	Stck	100	2000	
NEU NEW 191253	Pastell rosa Pastel rosa	12	4,6 x 4,0	Stck	100	2000	
NEU NEW 191254	Pastell flieder Pastel lilac	12	4,6 x 4,0	Stck	100	2000	
NEU NEW 191255	Anthrazit Anthracite	12	4,6 x 4,0	Stck	100	2000	
NEU NEW 192452	Reseda grün Reseda green	24	5 x 4,5	Stck	10	1440	
NEU NEW 192453	Pastell rosa Pastel rosa	24	5 x 4,5	Stck	10	1440	
NEU NEW 192454	Pastell flieder Pastel lilac	24	5 x 4,5	Stck	10	1440	
NEU NEW 192455	Anthrazit Anthracite	24	5 x 4,5	Stck	10	1440	

NEU
NEW

Stecker und Schilder

PLUGS AND LABELS



Weiss/Schwarz White/Black



Weiss White

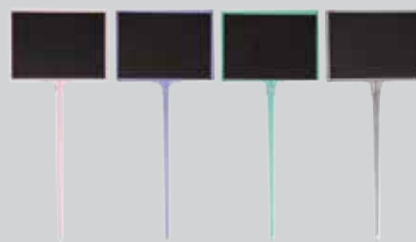

NEU
NEW

Pastell rosa Pastel rosa
Reseda grün Reseda green

Pastell flieder Pastel lilac
Anthrazit Anthracite

Steckschilder

Stick-labels



ARTIKELNUMMER	FARBE	STABLÄNGE/CM	SCHILDGRÖSSE/CM	STK/PACK	VPE	KARTONMENGE	PRODUKTEIGENSCHAFTEN
ART.-NO.	COLOR	LENGTH/CM	LABEL SIZE/CM	CONTENT	PU	BOX AMOUNT	PRODUCT CHARACTERISTICS
190600	Weiss White	6	2,5 x 3	Stck	100	5000	Pflanzensteckschild Plant cutting plate
190800	Weiss White	8	2,5 x 3	Stck	100	5000	Pflanzensteckschild Plant cutting plate
191000	Weiss White	10	4,2 x 3,5	Stck	100	5000	Pflanzensteckschild Plant cutting plate
191200	Weiss White	12	4,6 x 4,0	Stck	100	2000	Pflanzensteckschild Plant cutting plate
191600	Weiss White	16	5,0 x 4,0	Stck	10	2650	Pflanzensteckschild Plant cutting plate
191650	Weiss mit schwarzer Tafelfolie White, label area Black	17	11 x 8	Stck	10	500	Tafelstecker zum Beschriften Table plug for labeling
NEU NEW 191652	Reseda grün mit schwarzer Tafelfolie Reseda green, label area Black	17	11x 8	Stck	10	500	Tafelstecker zum Beschriften Table plug for labeling
NEU NEW 191653	Pastell rosa mit schwarzer Tafelfolie Pastel rose, label area Black	17	11 x 8	Stck	10	500	Tafelstecker zum Beschriften Table plug for labeling
NEU NEW 191654	Pastell flieder mit schwarzer Tafelfolie Pastel lilac, label area Black	17	11 x 8	Stck	10	500	Tafelstecker zum Beschriften Table plug for labeling
NEU NEW 191655	Anthrazit mit schwarzer Tafelfolie Anthracite, label area Black	17	11 x 8	Stck	10	500	Tafelstecker zum Beschriften Table plug for labelingzz
192400	Weiss White	24	5 x 4,5	Stck	10	1440	Pflanzensteckschild Plant cutting plate
193200	Weiss White	32	5,6 x 4,5	Stck	10	900	Pflanzensteckschild Plant cutting plate
193600	Weiss White	36	8 x 6	Stck	10	560	Pflanzensteckschild Plant cutting plate
194000	Weiss White	40	8 x 6,5	Stck	10	450	Pflanzensteckschild Plant cutting plate
195000	Weiss White	50	8,5 x 7	Stck	10	350	Pflanzensteckschild Plant cutting plate
195600	Weiss White	56	12 x 8	Stck	10	220	Pflanzensteckschild Plant cutting plate

Stecker und Schilder

PLUGS AND LABELS



190050



190050



190055



190055

Varioschilder

Variable labels



ARTIKELNUMMER	FARBE	DEKOR	Ø GRÖSSE/CM	STK/PACK	VPE	KARTONMENGE	PRODUKTEIGENSCHAFTEN
ART.-NO.	COLOR	DESIGN	Ø SIZE/CM	CONTENT	PU	BOX AMOUNT	PRODUCT CHARACTERISTICS
190050				Sort	1	22	Vario-Schild-Sortiment besteht aus: 10 Stück Grundstab 32 cm, 10 Stück Verlängerung 20 cm, 10 Stück Schildhalter und 10 Stück Ersatzschilder 110 x 65 mm Vario Shield assortment consists of: 10 pieces basic stick 32 cm, 10 pieces extension 20 cm, 10 pieces shield holders and 10 pieces replacement labels 110 x 65 mm
190055				Stck	10	1000	Vario-Schild-Halter Vario-plate holder
192451			24	Stck	10	900	Vario Grundstab Vario base bar
193251			32	Stck	10	700	Vario Grundstab Vario base bar
194051			40	Stck	10	700	Vario Grundstab Vario base bar
192052			20	Stck	10	900	Vario Schild Verlängerung Vario shield extension
192852			28	Stck	10	700	Vario Schild Verlängerung Vario shield extension

NEU
NEW

Stecker und Schilder

PLUGS AND LABELS



NEU
NEW

190138



NEU
NEW

Ersatzschild im Stecker



NEU
NEW

194042 - 04587



NEU
NEW

195042 - 04587



NEU
NEW

196042 - 04587

Wechselschilder, gerade

Clip-on labels, straight



NEU
NEW

ARTIKELNUMMER	FARBE	STABLÄNGE/CM	SCHILDGRÖSSE/CM	STK/PACK	VPE	KARTONMENGE	PRODUKTEIGENSCHAFTEN
ART.-NO.	COLOR	LENGTH/CM	LABEL SIZE/CM	CONTENT	PU	BOX AMOUNT	PRODUCT CHARACTERISTICS
194042 - 04587	Anthrazit Anthracite	34	12 x 7,5	Stck	10	240	Beidseitig mit schwarzer Tafelfarbe bedruckt Printed on both sides with black board color
195042 - 04587		44	12 x 7,5	Stck	10	240	
196042 - 04587		54	12 x 7,5	Stck	10	200	

Ersatzschilder

Spare labels



NEU
NEW

ARTIKELNUMMER	FARBE	MATERIAL-STÄRKE/MY	GRÖSSE/CM	STK/PACK	VPE	KARTONMENGE	PRODUKTEIGENSCHAFTEN
ART.-NO.	COLOR	THICKNESS/MY	SIZE/CM	CONTENT	PU	BOX AMOUNT	PRODUCT CHARACTERISTICS
190138	Beidseitig schwarz Black on both sides	380	8 x 4,8	Stck	100	4000	Beidseitig mit schwarzer Tafelfarbe bedruckt Printed on both sides with black board color
190142		380	11 x 6,5	Stck	100	2000	

Stecker und Schilder

PLUGS AND LABELS



192020 - 196020



190042

190252

190253

190254

190255

190257

Metalstecker

Metal labels

ARTIKELNUMMER	FARBE	STABLÄNGE/CM	Ø ÖSE/CM	STK/PACK	VPE	KARTONMENGE	PRODUKTEIGENSCHAFTEN
ART.-NO.	COLOR	LENGTH/CM	Ø BAIL/CM	CONTENT	PU	BOX AMOUNT	PRODUCT CHARACTERISTICS
192020	Metall, verzinkt Galvanized	20	1,8	Stck	25	500	
193020	Metall, verzinkt Galvanized	30	2	Stck	25	500	
194020	Metall, verzinkt Galvanized	40	2,5	Stck	25	500	
196020	Metall, verzinkt Galvanized	60	2,5	Stck	25	500	

Ersatzschilder

Spare labels

ARTIKELNUMMER	FARBE	MATERIALSTÄRKE/MY	Ø GRÖSSE/CM	STK/PACK	VPE	KARTONMENGE	PRODUKTEIGENSCHAFTEN
ART.-NO.	COLOR	MATERIAL THICKNESS/MY	Ø SIZE/CM	CONTENT	PU	BOX AMOUNT	PRODUCT CHARACTERISTICS
190038	Weiss White	380	8 x 4,8	Stck	100	4000	Ersatzschilder aus Hart PVC Folie Replacement labels made of hard PVC film
190042	Weiss White	380	11 x 6,5	Stck	100	2000	
190252	Gelb Yellow	400	11 x 6,5	Stck	100	2000	
190253	Rot Red	400	11 x 6,5	Stck	100	2000	
190254	Blau Blue	400	11 x 6,5	Stck	100	2000	
190255	Grün Green	400	11 x 6,5	Stck	100	2000	
190257	Orange Orange	400	11 x 6,5	Stck	100	2000	

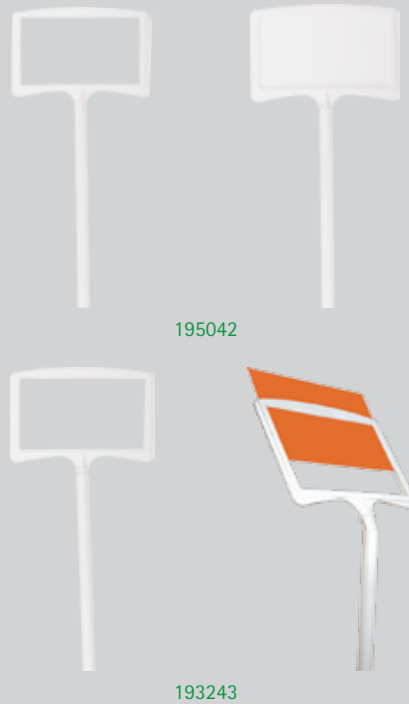

Wechselschilder, gerade

Clip-on labels, straight



ARTIKELNUMMER	FARBE	STABLÄNGE/CM	SCHILDGRÖSSE/CM	STK/PACK	VPE	KARTONMENGE	PRODUKTEIGENSCHAFTEN
ART.-NO.	COLOR	LENGTH/CM	LABEL SIZE/CM	CONTENT	PU	BOX AMOUNT	PRODUCT CHARACTERISTICS
192438	Weiss White	24	8,5 x 5,2	Stck	10	700	
193238	Weiss White	32	8,5 x 5,2	Stck	10	600	
193242	Weiss White	32	12 x 7,5	Stck	10	300	
194038	Weiss White	40	8,5 x 5,2	Stck	10	600	
194042	Weiss White	40	12 x 7,5	Stck	10	240	
195038	Weiss White	50	8,5 x 5,2	Stck	10	400	
195042	Weiss White	50	12 x 7,5	Stck	10	240	
196042	Weiss White	60	12 x 7,5	Stck	10	200	

Wechselschilder, abgeschrägt

Clip-on labels, bevelled



ARTIKELNUMMER	FARBE	STABLÄNGE/CM	SCHILDGRÖSSE/CM	STK/PACK	VPE	KARTONMENGE	PRODUKTEIGENSCHAFTEN
ART.-NO.	COLOR	LENGTH/CM	LABEL SIZE/CM	CONTENT	PU	BOX AMOUNT	PRODUCT CHARACTERISTICS
193243	Weiss White	32	12 x 7,5	Stck	10	300	
194043	Weiss White	40	12 x 7,5	Stck	10	240	
195043	Weiss White	50	12 x 7,5	Stck	10	240	

Etiketten

LABELS



191710



191712



191713



191714

Schlaufenetiketten

Labels with loops

ARTIKELNUMMER	FARBE	MATERIALSTÄRKE/MY	Ø GRÖSSE/CM	STK/PACK	VPE	KARTONMENGE	PRODUKTEIGENSCHAFTEN
ART.-NO.	COLOR	MATERIAL THICKNESS/MY	Ø SIZE/CM	CONTENT	PU	BOX AMOUNT	PRODUCT CHARACTERISTICS
191410	Weiss White	200	1,3 x 14,3	Stck	1000	26000	Schlaufenetiketten aus PVC Folie, in Lagen Loop labels made of PVC film, in layers
191510	Weiss White	200	1,3 x 14	Stck	1000	8000	Schlaufenetiketten aus PVC Folie, auf Rolle Loop labels made of PVC film, on roll
191610	Weiss White	200	1,3 x 16	Stck	1000	8000	
191612	Gelb Yellow	200	1,3 x 16	Stck	1000	8000	
191613	Rot Red	200	1,3 x 16	Stck	1000	8000	
191710	Weiss White	200	1,6 x 16	Stck	1000	48000	
191712	Gelb Yellow	200	1,6 x 16	Stck	1000	6000	
191713	Rot Red	200	1,6 x 16	Stck	1000	6000	
191714	Blau Blue	200	1,6 x 16	Stck	1000	6000	
192010	Weiss White	200	1,3 x 20	Stck	1000	8000	
192210	Weiss White	200	1,3 x 22	Stck	1000	6000	
192410	Weiss White	200	2,5 x 22	Stck	1000	3000	



Weiss White



Gelb Yellow



Rot Red



Blau Blue



Grün Green



Orange Orange

Stecketiketten

Stick labels

ARTIKELNUMMER	FARBE	MATERIALSTÄRKE/MY	Ø GRÖSSE/CM	STK/PACK	VPE	KARTONMENGE	PRODUKTEIGENSCHAFTEN
ART.-NO.	COLOR	MATERIAL THICKNESS/MY	Ø SIZE/CM	CONTENT	PU	BOX AMOUNT	PRODUCT CHARACTERISTICS
190601	Weiss White	380	1,3 x 6	Stck	250	20000	Stecketiketten aus Hart PVC Folie Insert labels made of hard PVC foil
190801	Weiss White	380	1,3 x 8	Stck	250	16000	
190901	Weiss White	380	1,7 x 8	Stck	250	10000	
191001	Weiss White	380	1,6 x 10	Stck	250	9000	
191002	Gelb Yellow	400	1,6 x 10	Stck	250	9000	
191003	Rot Red	400	1,6 x 10	Stck	250	9000	
191004	Blau Blue	400	1,6 x 10	Stck	250	9000	
191005	Grün Green	400	1,6 x 10	Stck	250	9000	
191007	Orange Orange	400	1,6 x 10	Stck	250	9000	
191201	Weiss White	400	1,6 x 12	Stck	250	8000	
191202	Gelb Yellow	400	1,6 x 12	Stck	250	8000	
191203	Rot Red	400	1,6 x 12	Stck	250	8000	
191204	Blau Blue	400	1,6 x 12	Stck	250	8000	
191205	Grün Green	400	1,6 x 12	Stck	250	8000	
191207	Orange Orange	400	1,6 x 12	Stck	250	8000	
191401	Weiss White	380	2,0 x 14	Stck	250	6000	
191601	Weiss White	380	2,0 x 16	Stck	250	4500	
191801	Weiss White	500	2,5 x 18	Stck	200	2400	
192001	Weiss White	500	2,5 x 20	Stck	200	2000	
192501	Weiss White	500 500	2,5 x 25	Stck	200	1600	

Etiketten

LABELS



190420



190620



190820



190920



191020



191220



191420

Hängeetiketten aus Kunststoff

Plastic hang tags

ARTIKELNUMMER	FARBE	MATERIALSTÄRKE/MY	Ø GRÖSSE/CM	STK/PACK	VPE	KARTONMENGE	PRODUKTEIGENSCHAFTEN
ART.-NO.	COLOR	MATERIAL STRENGTH/MY	Ø SIZE/CM	CONTENT	PU	BOX AMOUNT	PRODUCT CHARACTERISTICS
190420	Weiss White	200	4,0 x 6,0	Stck	250	5000	Hängeetiketten, geöst mit Draht gefädelt Hang tags, threaded with wire
190620	Weiss White	200	1,8 x 6,0	Stck	250	5000	
190820	Weiss White	200	2,0 x 8,0	Stck	250	5000	
190920	Weiss White	200	3,0 x 6,0	Stck	250	5000	
191020	Weiss White	200	2,0 x 10,0	Stck	250	5000	
191220	Weiss White	200	2,0 x 12,0	Stck	250	5000	
191420	Weiss White	200	2,0 x 14,0	Stck	250	5000	

NEU
NEW

Etiketten
LABELS



NEU
NEW

190500



NEU
NEW

190510



Hängeetiketten Hang tags



ARTIKELNUMMER	FARBE	MATERIALSTÄRKE/MY	Ø GRÖSSE/CM	STK/PACK	VPE	KARTONMENGE	PRODUKTEIGENSCHAFTEN
ART.-NO.	COLOR	MATERIAL STRENGTH/MY	Ø SIZE/CM	CONTENT	PU	BOX AMOUNT	PRODUCT CHARACTERISTICS
NEU NEW 190500	Natur Nature	350g/m ²	9,5 x 4,5 cm	Stück	100	5000	Geschenkanhänger aus hochwertigem 350g/m ² Recyclingkarton, neutral ohne Druck Gift tags made of high quality 350g / m ² recycling cardboard, neutral without print
NEU NEW 190510	Natur/Gold Nature/Gold	350g/m ²	9,5 x 4,5 cm	Stück	50	5000	Geschenkanhänger aus hochwertigem 350g/m ² Recyclingkarton, mit Goldprägung „Herzlichen Glückwunsch“ Gift tags made of high quality 350g / m ² recycling cardboard, with gold embossing „Herzlichen Glückwunsch“ (german only)

Etiketten

LABELS

NEU
NEW



190300



190400



190402



190401

Hängeetiketten aus Karton

Carton hang tags



ARTIKELNUMMER	FARBE	DEKOR	Ø GRÖSSE/CM	STK/PACK	VPE	KARTONMENGE	PRODUKTEIGENSCHAFTEN
ART.-NO.	COLOR	DESIGN	Ø SIZE/CM	CONTENT	PU	BOX AMOUNT	PRODUCT CHARACTERISTICS
190300	Braun Brown		3 x 6	Stck	100	5000	Hängeetikett, geöst und gefädelt, hergestellt aus 250 g/qm Karton Hanging label, loosened and threaded, Made of 250 g/qm carton
190400	Weiss White		3 x 6	Stck	100	5000	
190401	Grau Grey		3 x 6	Stck	100	5000	Hängeetikett, geöst und gefädelt, hergestellt aus 300 g/qm Karton Hanging label, loosened and threaded, Made of 300 g/qm carton
190402	Schwarz Black		3 x 6	Stck	100	5000	Hängeetikett, geöst und gefädelt, hergestellt aus 270 g/qm Karton Hanging label, loosened and threaded, Made of 270 g/qm carton
190310	Braun Brown		5 x 8	Stck	100	3000	Hängeetikett, geöst und gefädelt, hergestellt aus 250 g/qm Karton Hanging label, loosened and threaded, Made of 250 g/qm carton
190410	Weiss White		5 x 8	Stck	100	3000	
190411	Grau Grey		5 x 8	Stck	100	3000	Hängeetikett, geöst und gefädelt, hergestellt aus 300 g/qm Karton Hanging label, loosened and threaded, Made of 300 g/qm carton
190412	Schwarz Black		5 x 8	Stck	100	3000	Hängeetikett, geöst und gefädelt, hergestellt aus 270 g/qm Karton Hanging label, loosened and threaded, Made of 270 g/qm carton
NEU NEW 194073	Braun Brown		4 x 7	Stck	100	4000	Hängeetikett, geöst und gefädelt, hergestellt aus 250 g/qm Karton Hanging label, loosened and threaded, Made of 250 g/qm carton
NEU NEW 194074	Weiss White		4 x 7	Stck	100	4000	
NEU NEW 194070	Schwarz Black		4 x 7	Stck	100	4000	Hängeetikett, geöst und gefädelt, hergestellt aus 270 g/qm Karton Hanging label, loosened and threaded, Made of 270 g/qm carton
NEU NEW 194071	Grau Grey		4 x 7	Stck	100	4000	Hängeetikett, geöst und gefädelt, hergestellt aus 300 g/qm Karton Hanging label, loosened and threaded, Made of 300 g/qm carton



190301



190302



190303



190305



190307



190309



190313



190314

Hängeetiketten aus Karton

Carton hang tags



ARTIKELNUMMER	FARBE	DEKOR	Ø GRÖSSE/CM	STK/PACK	VPE	KARTONMENGE	PRODUKTEIGENSCHAFTEN
ART.-NO.	COLOR	DESIGN	Ø SIZE/CM	CONTENT	PU	BOX AMOUNT	PRODUCT CHARACTERISTICS
190301	Braun Brown	Oval Oval	6,5 x 4,5	Stck	50	1000	Hängeetikett, mit beiliegendem Bindfaden Hanging label, with attached twine
190302	Rot Red	Herz Heart	8,0 x 7,0	Stck	50	1000	
190303	Braun Brown	Herz Heart	8,0 x 7,0	Stck	50	1000	
190305	Braun Brown	Blume Flower	8,0 x 8,0	Stck	50	1000	
190307	Braun Brown	Kleeblatt Leaf	7,7 x 7,8	Stck	50	1000	
190309	Braun Brown	Baum Tree	8,5 x 7,0	Stck	50	1000	
190313	Rot Red	Stern Star	8,5 x 8,5	Stck	50	1000	
190314	Braun Brown	Stern Star	8,5 x 8,5	Stck	50	1000	

Werbesymbole

ADVERTISING SIGNS



332605



332611 - 332613



332614 - 332615

Werbesymbole

Advertising signs



ARTIKELNUMMER	FARBE	DEKOR	Ø GRÖSSE/CM	STK/PACK	VPE	KARTONMENGE	PRODUKTEIGENSCHAFTEN
ART.-NO.	COLOR	DESIGN	Ø SIZE/CM	CONTENT	PU	BOX AMOUNT	PRODUCT CHARACTERISTICS
332605	Farbig sortiert Assorted colors	Pfeil Arrow	25 x 21	Pack	1	16	Werbesymbole aus Neokarton, 50 Stück/Pack Neon cardboard advertising symbols, 50 pcs/pack, 5 colors sorted
332611	Farbig sortiert Assorted colors	Kreis Circle	7,5	Pack	1	26	
332612	Farbig sortiert Assorted colors	Kreis Circle	10	Pack	1	27	
332613	Farbig sortiert Assorted colors	Kreis Circle	19	Pack	1	21	
332614	Farbig sortiert Assorted colors	Stern Star	13 x 9	Pack	1	18	
332615	Farbig sortiert Assorted colors	Stern Star	21 x 16	Pack	1	21	
332610	Farbig sortiert Assorted colors	Sortiment Sterne Assortment stars		Pack	1	10	Werbesymbole aus Neokarton, 100 Stück/Pack, 5 Größen sortiert Neon cardboard advertising symbols, 100 pcs/pack, 5 sizes assorted

NEU
NEW

Vordrucke
PREPRINTED FORM



332650



332651



NEUES DESIGN
NEW DESIGN

332652



NEUES DESIGN
NEW DESIGN

332653



NEUES DESIGN
NEW DESIGN

332654



NEUES DESIGN
NEW DESIGN

332656

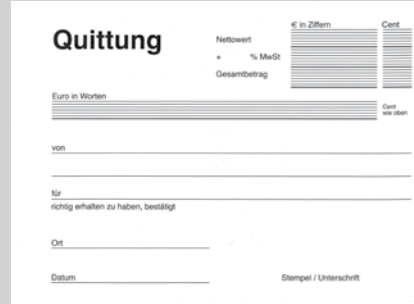

NEUES DESIGN
NEW DESIGN

332658

Vordrucke
Preprinted form



ARTIKELNUMMER	FARBE	BLATT/BLOCK	Ø GRÖSSE/CM	STK/PACK	VPE	KARTONMENGE	PRODUKTEIGENSCHAFTEN
ART.-NO.	COLOR	PAGES/PAD	Ø SIZE/CM	CONTENT	PU	BOX AMOUNT	PRODUCT CHARACTERISTICS
332650		100	A5	Pack	1	6	Auftrag/Quittung Block, 4 Blöcke/Pack, Anzahl Blatt je Block: 100 Blatt Order/Receipt Block, 4 blocks/pack, number of sheets per block: 100 sheets
332651		2 x 50	A5	Stck	1	20	Auftrag Block mit Durchschrift, Anzahl Blatt je Block: 2 x 50 Blatt Order block with copy, number of sheets per block: 2 x 50 sheets
332652		100	A6	Pack	1	8	Rechnungsblok, 5 Blöcke/Pack, Anzahl Blatt je Block: 100 Blatt Billing block, 5 blocks/pack, number of sheets per block: 100 sheets
332653		100	A6	Pack	1	8	Quittungsblok, 5 Blöcke/Pack, Anzahl Blatt je Block: 100 Blatt Receipt block, 5 blocks/pack, number of sheets per block: 100 sheets
332654		100	A5	Pack	1	4	Auftragsblock, 5 Blöcke/Pack, Anzahl Blatt je Block: 100 Blatt Order block, 5 blocks/pack, number of sheets per block: 100 sheets
332656		50	A6	Pack	1	16	Gutschein Block 5 Blöcke/Pack, Anzahl Blatt je Block: 50 Blatt Coupon Block 5 blocks/pack, number of sheets per block: 50 sheets
332658		100	A6	Pack	1	8	Quittungsblok, 5 Blöcke/Pack, Anzahl Blatt je Block: 100 Blatt Receipt block, 5 blocks/pack, number of sheets per block: 100 sheets

Die Abbildungen können in Größenproportionen und Farbe vom Original abweichen. Änderungen behalten wir uns vor.
Size proportions and colors of items presented may vary from original. Subject to change without further notice.

Kranzanhänger

WREATH LABEL

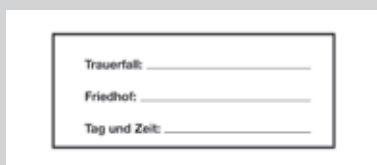

992618100



998200000



998300000

Kranzanhänger

Wreath label



ARTIKELNUMMER	FARBE	DEKOR	Ø GRÖSSE/CM	STK/PACK	VPE	KARTONMENGE	PRODUKTEIGENSCHAFTEN
ART.-NO.	COLOR	DESIGN	Ø SIZE/CM	CONTENT	PU	BOX AMOUNT	PRODUCT CHARACTERISTICS
992618100			12 x 5	Stck	1	60	Kranzanhänger Friedhofstext Block, Anzahl Blatt je Block: 100 Blatt Wreath Pendant Cemetery Text Block, number of sheets per block: 100 Sheets

Pergaminhüllen

Glassine envelope



ARTIKELNUMMER	FARBE	DEKOR	Ø GRÖSSE/CM	STK/PACK	VPE	KARTONMENGE	PRODUKTEIGENSCHAFTEN
ART.-NO.	COLOR	DESIGN	Ø SIZE/CM	CONTENT	PU	BOX AMOUNT	PRODUCT CHARACTERISTICS
998200000			12,5 x 18	Stck	1000		Pergaminhüllen Glassine cover
998300000			14 x 23	Stck	1000		Pergaminhüllen Glassine cover

NEU
NEW

Etui-Geschenkkarte

CASE GIFT CARD



NEU
NEW

Etui Gutscheinkarte



NEU
NEW

Weihnachts-Geschenkbbox „Pillow“

Etui-Gutscheinkarte

Case gift card



ARTIKELNUMMER	FARBE	DEKOR	Ø GRÖSSE/CM	STK/PACK	VPE	KARTONMENGE	PRODUKTEIGENSCHAFTEN
ART.-NO.	COLOR	DESIGN	Ø SIZE/CM	CONTENT	PU	BOX AMOUNT	PRODUCT CHARACTERISTICS
NEU NEW 91400	4 Motive sortiert 4 Motives sorted		flachliegend 19 x 26 cm	Pack	1	12	20 Stück/Pack Vorderseite mit Glanzeffekt, Innenseite, matt mit Gutscheintext, 4 Motive sortiert. Zu einem Etui faltbar. Kein Kuvert notwendig! 20 pieces / pack front with glossy effect, inside, dull with voucher text, 4 motives sorted. Foldable to a case. No envelope required!

Weihnachts-Geschenkbbox „Pillow“

Christmas gift box „Pillow“



ARTIKELNUMMER	FARBE	DEKOR	Ø GRÖSSE/CM	STK/PACK	VPE	KARTONMENGE	PRODUKTEIGENSCHAFTEN
ART.-NO.	COLOR	DESIGN	Ø SIZE/CM	CONTENT	PU	BOX AMOUNT	PRODUCT CHARACTERISTICS
NEU NEW 22-0412	5 Motive sortiert 5 Motives sorted		22 x 11 x 3,5	Pack	1	60	Weihnachts-Geschenkbbox „Pillow“, 15 Stück/Packung Christmas gift box „Pillow“, 15 pieces / pack



Grußkarten
Greeting cards



ARTIKELNUMMER	FARBE	DEKOR	Ø GRÖSSE/CM	STK/PACK	VPE	KARTONMENGE	PRODUKTEIGENSCHAFTEN
ART.-NO.	COLOR	DESIGN	Ø SIZE/CM	CONTENT	PU	BOX AMOUNT	PRODUCT CHARACTERISTICS
911177121	Silberhochzeit Silver wedding		11,5 x 17	Pack	1	25	Grußkarten, 20 Stück/Klarsichtbox, einzeln cellophaniert mit Umschlag Greeting cards, 20 pcs/clear box, individually film-laminated with envelope
911177223	Goldhochzeit Gold wedding		11,5 x 17	Pack	1	25	
911178121	Trauer Sort. 1 Mourning Sort. 1		11,5 x 17	Pack	1	14	
911178122	Trauer Sort. 2 Mourning Sort. 2		11,5 x 17	Pack	1	25	
911179121	Vermählung Marriage		11,5 x 17	Pack	1	25	
914004123	Gutschein-Allgemein Coupon-General		11,5 x 17	Pack	1	25	
914008123	Gutschein-Trauer Coupon mourning		11,5 x 17	Pack	1	25	



Grußkarten
Greeting cards



ARTIKELNUMMER	FARBE	DEKOR	Ø GRÖSSE/CM	STK/PACK	VPE	KARTONMENGE	PRODUKTEIGENSCHAFTEN
ART.-NO.	COLOR	DESIGN	Ø SIZE/CM	CONTENT	PU	BOX AMOUNT	PRODUCT CHARACTERISTICS
911171121	Konfirmation Confirmation		11,5 x 17	Pack	1	25	Grußkarten, 20 Stück/Klarsichtbox, einzeln cellophaniert mit Umschlag Greeting cards, 20 pcs/clear box, individually film-laminated with envelope
911171221	Kommunion Communion		11,5 x 17	Pack	1	25	
911172221	Weihnachten/Neujahr Christmas / New Year		11,5 x 17	Pack	1	25	
911174121	Allgemeine Wünsche General wishes		11,5 x 17	Pack	1	25	
911174923	Blanco-Motiv Blanco motive		11,5 x 17	Pack	1	25	
911175123	Geburtstag Birthday		11,5 x 17	Pack	1	25	

Stichwortverzeichnis

ALPHABETICAL INDEX

A		Einzelziffern Single digits	96	Hemdchentrageaschen Plastic bags	49
Anchortape Anchor tape	90	Ersatzschilder Spare labels	149	Hochzeitsdekoration Wedding decoration	106
Allzweckreiniger Detergent	142	Etiketten Labels	152	J	
Auftrag Assignment	159	Etui-Geschenkkarte Case gift card	161	Jahreszahl Annual figure	98
Aquarola Floristenkrepp Aquarola florist crepe	18	F		Jubiläumskränze Jubilee wreath	99 - 102
B		Faltgitter Plastic grid	83	Jubiläumsszahlen Jubilee figures	100
Babyflaschen Baby bottles	106	Faserstifte Permanent marker	143	Jutebänder Jubilee figures	60
Bänder Ribbons	52 - 60	Festliche Zahlen Festive numbers	99	Jutesack Jubilee figures	45
Beschriften Label	143 - 158	Fettstifte Grease pencils	143	Jute-Weinverpackung Jubilee figures	48
Biedermeier-Manschetten Biedermeier-cuffs	26 - 31	Flaschendeckhalter Decoration holder for bottles	79	K	
Bindestreifen Florist wire	65	Fliegenpilz Plastic decoration pot	117	Klebeband Tape	93
Bindestreifenspule Bobbin	64	Floristenkrepp Florist crepe	10 - 18	Klebebänder Tapes	93
Bindfaden Nature fibre string	64	Floraltape Floral tape	72	Klebepen Glue pen	90
Blumenclips Synthetic flower clips	77	Folien Foil	39 - 41	Klebepistole Glue gun	87
Blumenklebebänder Flowers tapes	72	Folien, metallic Florist knife	40 - 41	Klebesticks Glue sticks	87
Blumentüten Flower bags	38	G		Klebetchnik Hot melt	90
Brautmanschetten Bridal cuffs	32	Gärtnerbast Poly raffia	69	Kranzanhänger Wreath label	160
Brautstraußhalter Bouquet holder	79	Geschenksack Giftbag	119	Kreidemaker Chalk marker	145
D		Gesteckhalter Pinholder	76	Krepp Bänder Crepe paper ribbons	16 - 19
Deko Marker mit Flüssigkreide Chalk marker	145	Gesteckhalter mit Selbstklebe- etikett Pinholder self-adhesive label	76	Krepp Blumenmanschetten Crepe bouquet cuffs	32
Dekofolie Decoration foil	39	Goertz Fix Klebeband Goertz Fix adhesive tape	90	Krepp Topfmanschetten Crepe paper flowerpot sleeves	22 - 23
Dekoformen Deco shapes	137	Grußkarten Greeting cards	162	Krepp-Wickelmaschine Crepe winding machine	19
Display Pflanz-, Blumen- und Kräuterbox Display Plant, flower and herb box	120	Grußschilder Greeting labels	110	Kreuzbodensack Cross-bottom bag	44
Doppelseitiges Klebeband Double sided adhesive tape	90	Gummibänder Rubber band	78	Kunststoff Blumen Plastic flowers	82
Drillapparat Drilling tool	89	Gutscheinblock Coupon block	159	Kunststoff Übertöpfe Plastic planter	124
Drillösen Hanging wire	89	H		L	
Drucksachen Printed matter	159	Hängeetiketten Hangtags	155	Laubsack Leaves bag	45
E		Heftklammer Staple	88	Luftballons Balloons	108
Eierbecher Eggcups	136	Heftzange Stapler	88	M	
Eierschale Eggshell bowl	136	Heißkleben Heat sealing	87	Messer Knife	86
				Metallstecker Metal labels	150

Metallisierte Verpackungsfolie Metallic foil	40 - 41
Multifunktions- Organizer Organizer	92
O	
Orchideenröhrchen Flower tubes	80
P	
Packpapier Wrapping paper	49
Papierdeko Topf Paper cover pot	122
Papiertragetaschen Paper bags	42
Pergaminhüllen Glassine envelope	170
Permanent Marker Permanent marker	143
Perlonschnur Nylon string	70
Pflanzenstecker Plants plug	146
Pflanz-, Blumen Et Kräuterbox Plant, flower Et herb box	122
Plissee Topfmanschetten Pleated cup cuffs	24 - 25
Polyband Ribbon	52
Polybandabroller Ribbon unwinder	58
Polyband, beduckt Ribbon, printed	57
Polyband, metallic Ribbon, metallic	55
Polybandsplitter Ribbon splicer	58
Q	
Quittungblock Receipt book	159
R	
Reagenzgläser Glas tubes	81
Rechnungsblock Bill block	159
Römerwickelband Florist crepe ribbon	73
Rosenentdornen Thorn stripper	86
S	
Saugnäpfe Sucker	71
Schiefertafeln Slate, non-punched	108
Schlaufenetiketten Labels with loops	152
Sektkühler Champagne ice bucket	117
Selbstklebe-Etiketten Self-adhesive labels	109

Silvesterdekoration Happy new year decoration	111
Sprühkopf für Allzweckreiniger- flasche Spray head for all-purpose cleaner bottle	142
Stand Schneider Stand cutter	69
Stecketiketten Stick labels	153
Stecknadeln Pins	71
Steckringe Plastic ring	78
Steckschilder Stick-labels	146
Stifte Pen	143
Straußmanschetten Rondellas	33 - 35
Stützgitter Plastic grid	83
T	
Tacker Tacker	88
Tafelstecker Panel plug	147
Tauben Decoration doves	104
Tischabroller Tape stand	93
Topfmanschetten Crepe paper flowerpot sleeves	22 - 23
Transparente Folie Transparent foil	39
Tüllband, standard Tulle ribbon, standard	59
Tüten mit gedrehter Kordel Paper bags with twisted cord	42
V	
Valentin- und Muttertagsstecker Valentins- and mothers day plug	107
Varioschilder Variable labels	148
Viskosevlies Fleece rayon	73
Vordrucke Preprinted form	159
W	
Weihnachts-Geschenkbox Christmas gift box	163
Wechselschilder Clip-on labels	149
Weinverpackung Vine packaging	48
Werbesymbole Advertising sign	158
Wursthalter Sausage holder	78

Z	
Zahlen Numbers	96
Zylinder Top hat	114

DER UMWELT ZULIEBE GO GREEN

Als Papier- und Kunststoffarbeiter nehmen wir die Herausforderung und die Verantwortung für die Herstellung möglichst nachhaltiger Produkte an.

- Unsere Produkte sind langlebig und mehrfach verwendbar
- Die von uns verwendeten Kunststoffe sind sortenrein und zu 100 % recycelbar
- Für die Herstellung unserer Floristenbedarfsartikel verwenden wir bis zu 80 % Recyclingmaterial, unsere eigenen Produktionsabfälle werden schon seit Jahren im eigenen Haus recycelt und anschließend dem Produktionsprozess wieder zugeführt.

As paper and plastic workers, we accept the challenge and responsibility for producing products that are as sustainable as possible.

- Our products are durable and can be used multiple times
- The plastics used are unmixed (variety purity) and 100 % recyclable
- We use up to 80 % recycled material to manufacture our florist's supplies, our own production waste has been recycled in-house for years and then returned to the production process.



Biologisch abbaubar
Biodegradable



Gut wiederverwertbar
Well reusable



Aus Recyclingmaterial
Made from recycled material

UMWELTFREUNDLICH EINKAUFEN,
ACHTEN SIE AUF DIESE SYMBOLE!

SHOP ENVIRONMENTALLY FRIENDLY,
PAY ATTENTION TO THESE SYMBOLS!



krepppapier.de
Großhandel & Vertrieb

Bachgasse 17
D-63584 Gründau
Tel. 0049 6058 1002
Fax 0049 6058 1001
E-Mail: info@krepppapier.de