

Latitude 38

VOLUME 339 September 2005

WE GO WHERE THE WIND BLOWS



SAN FRANCISCO...

THE PEARL OF THE PACIFIC!



GRAND MARINA...

THE PEARL OF THE BAY!

It has been said by many, "there's no place like San Francisco"... it also has been said, "there is no place like Grand Marina". A truly unique, world-class marina, nestled in the tranquility of the Alameda Estuary. Come on by and we'll make a believer out of you.

- Over 400 concrete berths 30 to 53 feet
- Secured Gatehouses (key access only)
- Dockside Electrical (up to 50A - 220V)
- Cable TV & Telephone Service
- Local Marine Services
- Heated & tiled restrooms with individual showers
- Beautifully Landscaped
- Ample Parking
- Great Customer Service
- Sailboat & Powerboat Brokers on site

DIRECTORY of GRAND MARINA TENANTS

Alameda Prop & Machine	107
Bay Island Yachts	11
Mariner Boat Yard	220
Pacific Coast Canvas	109
Pacific Yacht Imports	13



Located adjacent to four active yacht clubs:
Oakland YC, Encinal YC, Alameda YC and Island YC



GRAND MARINA
ANDERSON-ENCINAL

510-865-1200

Leasing Office
Open Daily

2099 Grand Street
Alameda, CA 94501

www.grandmarina.com

Big Boat Series Special
on Musto Outerwear and
Dubarry Boots. See p. 72.

Why Are These People Smiling?

PHOTO: JOHN DAVIS



*Ralphie's crew and ground crew**

Because they won! Co-skippers Davis and Taylor Pillsbury, crew, family and friends are celebrating a nearly 10 hour victory of *Ralphie* over the next closest boat in the Cal 40 class of this year's Transpac race to Honolulu.

Davis contacted Pineapple Sails and asked for a studied proposal of the anticipated wind and sea states expected during the race. After discussions with the Pillsburys, and sharing descriptions of past races and conditions, we came to a solid agreement on the problem. We then built *Ralphie's* entire spinnaker inventory. The results are very impressive. In a class of 14 nearly identical boats, *Ralphie* was able to put time on the fleet in virtually all conditions.

Working with a sailmaker who works with you will make you smile too. Give us a call. We're happy to help.

YOUR DEALER FOR: Musto foul weather gear, Dubarry footwear and Headfoil 2

Sails in need of repair may be dropped off at: West Marine in Oakland, Alameda, Richmond or Berkeley; or Svendsen's in Alameda.



PINEAPPLE SAILS

*Powered by Pineapples

Phone (510) 522-2200
Fax (510) 522-7700
www.pineapplesails.com
2526 Blanding Ave., Alameda, California 94501

Boat Show ♦ Jack London Square ♦ Oakland ♦ Sept. 1-18

Special Boat Show Packages & Incentives

Island Packet 445



This raised deck Pilot Saloon yacht has a center cockpit with a huge owner's suite aft and many of the same attributes that have made the IP 485 a success. The 445 is an amazing bluewater liveaboard high quality yacht at a very reasonable price.



At the Show

Island Packet 370



The 370 is built for the cruising couple that wants all of the Island Packet features, quality and attributes in a boat under 40 feet. All of the attention to detail, construction integrity, storage, equipment choices and sailing characteristics are pure Island Packet.



At the Show

Wauquiez Centurion 40s



The Centurion 40 s is a swift and elegant cruiser/racer that will be the envy of experienced sailors everywhere. The workmanship, interior, layout, fit, finish, deck layout and equipment choices approach perfection for a 40-ft yacht.

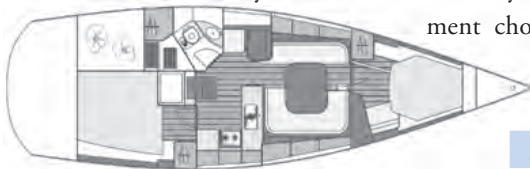

At the Show

Swift Trawler 42



The Beneteau Swift Trawler is a modern rendition of a traditional looking yacht. You can cruise at 8 or 28 knots in conditions that would keep most boats at the dock. The beautiful interior and extensive standard equipment will convince you that this boat is a bargain.

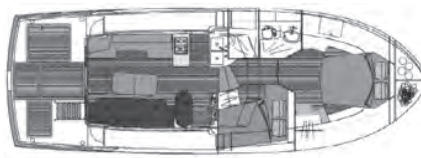

At the Show

 **PassageYachts**
INC.
1220 Brickyard Cove Rd.,
Pt. Richmond, CA
Ph: (510) 236-2633 Fx: (510) 234-0118
www.passageyachts.com

 **BENETEAU** Swift Trawler

 ISLAND PACKET

 Wauquiez

Don't Miss Our 12-Boat Display at the Show

Passage Yachts Display

The boat show layout is different this year. Don't miss our 12-boat display on the docks behind Scott's!

Passage boats at the show: Beneteau 473, 423, 393, 373, 343, 323, First 44.7, 36.7
 Island Packet 445, 370 • Wauquiez Centurion 40s • Swift Trawler 42

Beneteau 323

At the Show

Beneteau 343

At the Show

Beneteau 373

At the Show

BOAT OF THE YEAR
 CRUISING WORLD
 BEST SAILOR 2003
 BENETEAU 373

Beneteau 393

At the Show

Beneteau 423

At the Show

BOAT OF THE YEAR
 CRUISING WORLD
 BEST SAILOR 2002
 BENETEAU 423

Beneteau 473

At the Show

BOAT OF THE YEAR
 CRUISING WORLD
 BEST SAILOR 2000
 BENETEAU 473

First 36.7

At the Show

BOAT OF THE YEAR
 SAILING WORLD
 BEST SAILOR 2002
 FIRST 36.7

First 44.7

At the Show

BOAT OF THE YEAR
 SAILING WORLD
 BEST IN CATEGORY 2005
 BENETEAU FIRST 44.7

DIMEN

Marine Financial Services

"A better way to get a boat loan."

See Bill Kinstler of our
Northern California office!

Loans Starting at \$25,000

Fixed Rates

New and Used

Liveaboard

Boat Loans



Northern California

Bill Kinstler

866-486-2628

www.norcal.dimenmarine.com

CONTENTS

subscriptions	10
calendar	36
letters	52
loose lips	112
sightings	116
pyewacket donation	134
peterson interview, pt. II	138
eye on the bay	144
volvo race preview	148
moana's budget cruise	154
tall ship parade	158
baja ha-ha profiles	164
transpac wrap-up	176
max ebb: talking the talk	180
the racing sheet	184
world of chartering	198
changes in latitudes	206
classy classifieds	226
advertisers' index	241
brokerage	243

Cover: The schooner 'Seaward' sails into the Bay.

Photo: Latitude 38/JR

Copyright 2005 Latitude 38 Publishing Co., Inc.

Latitude 38 welcomes editorial contributions in the form of stories, anecdotes, photographs—anything but poems, please; we gotta draw the line somewhere. Articles with the best chance at publication must 1) pertain to a West Coast or universal sailing audience, 2) be accompanied by a variety of pertinent, in-focus digital images (preferable) or color or black and white prints with identification of all boats, situations and people therein; and 3) be legible. These days, we prefer to receive both text and photos electronically, but if you send by mail, anything you want back must be accompanied by a self-addressed, stamped envelope. **Submissions not accompanied by an SASE will not be returned.** We also advise that you not send original photographs or negatives unless we specifically request them; copies will work just fine. Notification time varies with our workload, but generally runs four to six weeks. Please don't contact us before then by phone or mail. Send all electronic submissions to editorial@latitude38.com, and all snail mail submissions to Latitude 38 editorial department, 15 Locust Ave., Mill Valley, CA 94941. For more specific information, request writers' guidelines from the above address or see www.latitude38.com/writers.htm.

Why I Own a Beneteau



John Beckley at Passage Yachts listened as I told him my story of 25 years of racing on the SF Bay. The transition of a "self-indulged sailing nut" into a "middle-aged family man with wife and kids who wanted to cruise" was the dilemma. John understood. We bought our first Beneteau with high expectations and a lot of trust in John's wisdom. Four years later, with many enjoyable family cruises and fun club racing under our belt, we thought about a new boat.

When the time came to upgrade, we knew exactly who to go to. Again, John at Passage Yachts worked with us to find the perfect fit, and now we are proud owners of a new Beneteau 423. As we begin our new adventures, we have the security of knowing that Passage Yachts, Beneteau and professionals like John will be there for the next upgrade.

*Gary and Kelly Troxel
Beneteau 423 'Tiki Blue'*



1220 Brickyard Cove Rd., Pt. Richmond, CA
Ph: (510) 236-2633 Fx: (510) 234-0118
www.passageyachts.com

The Sea Demands the Best... And so Do Our Clients!



Built by Queen Long Marine Co. Ltd., Kaohsiung, Taiwan



The design of a Hylas is exceeded only by the strength of our development program. Leading-edge thinking inspired by



A Hylas offers beamier aft sections than most other yachts (red).

modern offshore racing designs can be found throughout our line. In the 46 pictured above, a plumb bow and beamy aft sections deliver swiftness, power and stability, while maximizing space down below. There is more than ample room for a



Hylas 49
Also available,
Hylas 46, 54, 54 Raised Saloon,
and the new 66

Hylas - Elegant at Anchor, Strong and Fast Offshore.



Hylas 46

luxurious owner's suite aft, beautifully finished in hand-chosen woods. Offshore comfort is further enhanced by the way we build our hulls. We invite your closer inspection of the Frers-designed Hylas 54 and 46. You'll find that no other yachts compete. On the water. Or on the drawing board.

Hylas

Hylas Yachts, P.O. Box 583,
Marblehead, MA 01945

1-800-875-5114

Web: www.hylasyachtsusa.com
Email: hylas@hylasyachtsusa.com



Refrigeration – Easy As 1,2,3!

1. KEEL COOLED

- No Pump
- No Fan
- No Noise!



2. AIR COOLED

- Forced Air Cooling
- Extremely Compact
- Duct Kit Available



3. WATER COOLED

- 20% better cooling efficiency
- Self-priming pump
- Protected against lack of water

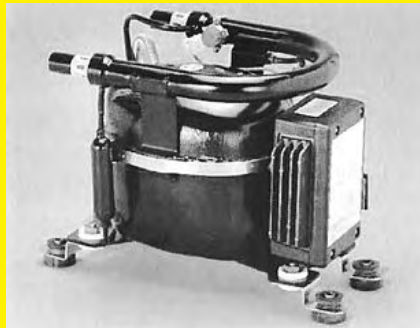

Frigoboat offers three cooling options each providing unique features to ideally fit your circumstances.

Which is best for you?

CALL TODAY TO DISCUSS THE MOST COST EFFECTIVE AND EFFICIENT SOLUTION FOR YOUR BOAT.



SWEDISH MARINE

1150 BRICKYARD COVE RD., SUITE B6
PT. RICHMOND, CA 94801 (510) 234-9566

SUBSCRIPTIONS



- Enclosed is \$30.00 for one year
Third Class Postage (Delivery time 2-3 weeks; Postal Service will not forward third class, so you must make address change with us in writing.)
- Third Class Renewal (*current subs. only!*)
- Enclosed is \$55.00 for one year
First Class Postage (Delivery Time 2 to 3 days)
(Canada & Mexico: First Class Only)
- First Class Renewal (*current subs. only!*)
- Gift Subscription – Gift Card to read from:

We regret that we cannot accept foreign subscriptions. Check, money order, or credit card info. must accompany subscription request. Please allow 4-6 wks to process changes/additions plus delivery time.

Name _____
Address _____
City _____ State _____ Zip _____

CREDIT CARD INFORMATION MASTERCARD VISA AMERICAN EXPRESS
Min. Charge \$20 Number: _____ Exp. Date: _____

INDIVIDUAL ISSUE ORDERS
Current issue = \$6.00 • With classy ad placed = \$5.00
Back Issues = \$7.00 (must indicate exact issue by month or vol. #)

- DISTRIBUTION**
- We have a marine-oriented business/yacht club in California which will distribute copies of Latitude 38. (Please fill out your name and address and mail it to the address below. Distribution will be supplied upon approval.)
 - Please send me further information for distribution outside California

Business Name _____ Type of Business _____
Address _____
City _____ State _____ Zip _____
County _____ Phone Number _____

Latitude 38

"we go where the wind blows"

- Publisher/Exec. Editor.....Richard Spindler..... richard@latitude38.comext. 111
- Managing Editor.....John Riise..... johnr@latitude38.comext. 110
- Senior Editor.....Rob Moore..... rob@latitude38.comext. 109
- Senior Editor.....Andy Turpin..... andy@latitude38.com.....ext. 112
- General Manager.....Colleen Levine..... colleen@latitude38.comext. 102
- Classifieds.....Mary Briggs..... class@latitude38.comext. 104
- Production.....Christine Weaver..... chris@latitude38.comext. 103
- Production.....Annie Bates-Winship.. annie@latitude38.comext. 106
- Advertising.....Mitch Perkins..... mitch@latitude38.comext. 107
- Advertising.....John Arndt..... john@latitude38.comext. 108
- Bookkeeping.....Helen Nichols..... helen@latitude38.comext. 101

- Directions to our officepress 4
- Subscriptions.....press 1,4
- Classifiedclass@latitude38.com.....press 1,1
- Distributiondistribution@latitude38.com.....press 1,5
- Editorial.....editorial@latitude38.compress 1,6
- Other emailgeneral@latitude38.com.....Website: www.latitude38.com

15 Locust Avenue, Mill Valley, CA 94941 • (415) 383-8200 Fax: (415) 383-5816
Please address all correspondence by person or department name



Bay Island YACHTS

(510) 814-0400

yachtsales@bayislandyachts.com
www.bayislandyachts.com

51' JEANNEAU, 1994



4 cabins, 4 heads and a great price.
Local boat too! \$169,500.

41' COLUMBIA



Very affordable and roomy cruiser/
liveaboard. Now \$38,000.

37' ENDEAVOUR, 1977



Our choice for the best Mexico cruiser
for the price. \$54,500.

33' NEWPORT



Recent reduction, she's ready for Mexico.
\$29,500.

28' HUNTER 280



Aft cabin, roomy salon makes her
a great family Bay boat.
\$37,500

51' ALEUTIAN, 1980



Solid world cruiser w/large workshop.
\$139,500.

45' CORONADO



Owner moved and needs to sell.
\$49,500.

36' ISLANDER



One of the most popular Bay boats ever.
\$34,500.

44' CUSTOM



This one has been around the world!
\$59,500.

MORE ALAMEDA LISTINGS

29' HUNTER 29.5.....	2 from \$40,000
30' O'DAY	\$17,500
31' CAL	\$29,900
33' HUNTER.....	\$19,900
33' HUNTER 33.6.....	\$65,000
35' VINDO.....	\$59,000

YACHTWORLD.com

42' PRIVILEGE, 1994

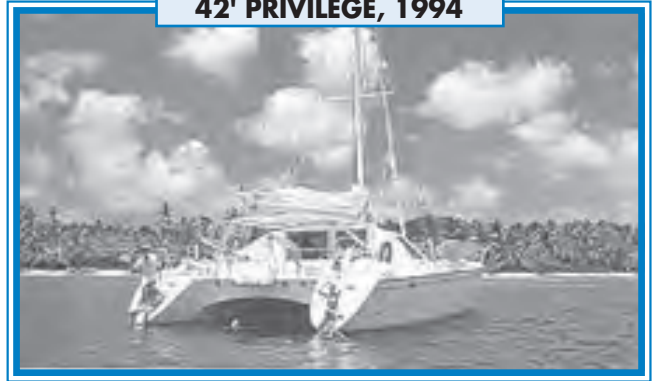

New to the market and equipped for comfortable cruising.
New engines. New mainsail. New upholstery and much more.
Asking \$289,000.

YOUR MULTIHULL BROKERAGE SPECIALIST

82' CNB.....	\$1,700,000	42' PRIVILEGE, 1994	289,000
60' YAPLUKA	€1,500,000	42' VENEZIA, 1995.....	\$209,000
60' CUSTOM CAT, 1998.....	\$350,000	42' VENEZIA, 1995.....	€180,000
56' MARQUISES, 1999.....	€520,000	39' DUFOUR NAUTITECH.....	€165,000
55' HENDRICKS CUSTOM	\$289,000	37' ANTIGUA, 1992	\$129,000
48' NEOS CUSTOM, 2004	€385,000	33' SEAWIND, 2000	\$160,000
48' PRIVILEGE	3 from \$350,000		

37' ANTIGUA



Very affordable bluewater cruising cat.
\$129,000.

44' CSY, 1980



Walk-thru model.
Now asking \$129,500.

42' VENEZIA, 1995



This is very clean, well equipped and
ready to cruise. \$219,000.

45' BREWER



Cozy and warm interior makes you
feel at home. \$99,000.

SOME OF OUR 100+ CARIBBEAN LISTINGS

60' OCEAN



Sleek, roomy and great for cruising
or charter work. \$200,000.

53' FRERS STEEL



This 2001 round bilge cruiser will take
you anywhere. \$320,000.

72' CUSTOM ALUMINUM, 1988..	\$695,000
72' SCHOONER, 2003.....	\$866,000
68' EASTWIND KETCH, 1991	\$320,000
60' JOUBERT-NIVELT.....	\$295,000
56' ARTHUR ROBB YAWL, 1996... ..	\$175,000
53' ALAN PAPE KETCH, 1984.....	\$75,000
52' JEANNEAU, 1999.....	\$210,000
52' NAUTICAT, 1984.....	\$346,000
50' BENETEAU CUST. FARR, 1996.	\$299,000
50' DUFOUR ATOLL, 1999.....	\$289,000

48' FEELING 486, 1994.....	\$191,000
48' TRINTELLA, 1980.....	\$180,000
47' CT, 1986.....	\$119,000
46' BENETEAU M463, 2000.....	\$229,000
46' OCEAN 14, 1987.....	\$375,000
45' BENETEAU FIRST 45f5, 1991 ..	\$139,000
45' C&L EXPLORER, 1981	\$215,300
44' S&S, 1980.....	\$100,000
44' BARENS SEATRADER, 1988... ..	\$119,900
40' HANSE 401, 1999	\$142,300



In Grand Marina • 2099 Grand St., Alameda, CA 94501 • Fax (510) 814-8765



EXCLUSIVE BAY AREA CATALINA DEALER

See **Catalina** Yachts at
 the Northern California
 Boat Show
 Jack London Square
 September 10-18

2005 Catalina 42 Mk II

Catalina Yachts

CatalinaMorgan 440



SEE IT TODAY!

- Larger, more comfortable aft cabin
- The most popular 42 in the world!
- Long list of standard features



- The first CatalinaMorgan production cruiser
- Raised cabin sole for deck salon views
- Rugged offshore construction
- Winner! Cruising World Boat of the Year

8th Annual Catalina Rendezvous at Angel Island • October 1-2 • Contact your fleet captain or sign up at <http://raft.c380.org>



Ocean Alexander 50, 1988



New Ocean Alexander Altus 48



Ocean Alexander Altus 42



Catalina 320, 2002



Catalina 34, 2003



Catalina 36, 2000

PREOWNED CATALINA YACHTS

Catalina 470	1999	339,000
Catalina 42 MkII	2003	210,000
Catalina 42 MkII	2005	Coming
Catalina 387	2004	199,955
Catalina 380	2001	157,000
Catalina 380	2000	149,000
Catalina 36	2002	120,000
Catalina 36	1987	63,000

Catalina 36	1987	67,000
Catalina 36	1984	57,500
Catalina 350	2004	150,000
Catalina 34	2003	125,000
Catalina 34	1986	56,000
Catalina 34	1987	57,500
Catalina 34	1989	58,000
Catalina 320	2002	109,500
Catalina 320	2000	84,500

Catalina 30	1983	29,950
Catalina 30	1982	18,000

PREOWNED SAILING YACHTS

Challenger 40	1972	57,500
Ericson 38	1986	84,500
Beneateau 345	1986	39,900
Hunter 34	1998	78,500
Hunter 326	2002	78,000

Beneateau 32	2000	89,000
Mollycat 17	1987	14,900

NEW & PREOWNED MOTOR YACHTS

New Ocean Alexander
 Altus 42 and 48 *at our docks*
 Ocean Alexander 50 1988 399,000

1070 Marina Village Pkwy., Suite 104
 Alameda, CA 94501
 T: 510.523.6730 • F: 510.523.3041

View our New Yachts Showroom
 and our Brokerage Listings at:
www.faralloneyachts.com



TAYANA SEMI-CUSTOM YACHTS

Tayana Models:

37 • 42 • 48
52 • 55/58
64 • 65



Tayana 58 Deck Salon

The Tayana 58 Deck Salon is designed and built for serious cruising. The hull is one of the most durable, safest, and best performing hulls in its class. With its 16'2" beam, it easily accommodates a three or four cabin layout and has room left over for a stand-up engine room and dedicated sail locker on deck. Base price, delivered, is \$498,000. Center cockpits start at \$474,000.



WORLD CLASS SAILING YACHTS



X-35

X-Yachts Models:

X-35
X-37 • X-40
X-43 • X-46
X-50 • X-55
IMX-70
X-73

The X-35 is the newest one design racer from X-Yachts of Denmark. The vision behind the design was to create a sporty and simple yacht with under deck comfort for both racing crew and family weekend cruising. So popular she has already presold 60 boats.

OUR BROKERAGE LISTINGS – TAKE A LOOK!



1999 TAYANA 58 CUTTER. Well equipped and well proven, this boat's in excellent condition, ready for your next adventure. **\$475,000.**



1999 TAYANA 48 CC. Just Listed! Beautiful dark blue hull, less than 250 hrs on Yanmar 88 hp. Cust. 2 cabin layout. Generator, refrig., many elect. Bristol! **\$379,500.**



2005 TAYANA 48 DECK SALON. Refrig., freezer, air/heat, genset, washer/dryer, Leisurefurl main, ProFurl headsails, electric primaries, cust. leather inter. **\$415,000**



1998 X-412. Race or cruise this beautiful X-Yacht from Denmark. Rare two stateroom version in excellent condition, all gear. **\$239,000.**



2003 TAYANA 42 CENTER COCKPIT. Popular bluewater cruiser. Furlboom mainsail, ProFurl genoa, exc. cond., like new! **\$239,000.**



1981 BABA 30. Robert Perry-designed pocket cruiser with beautiful teak interior by Ta Shing. Shows well and is in clean condition. Just listed! **\$59,900.**



ISLANDER 44. Custom center cockpit cruiser is ideal for bluewater cruising. Experienced and upgraded for just **\$97,000.**



1988 HANS CHRISTIAN 41 Molokai. In as fine a condition as one will hope to find in a yacht of this caliber. Fully equipped. **\$250,000.**



1982 SPARKMAN & STEPHENS KETCH Well equipped center cockpit cruiser. Has been cruised and is ready to go again. **\$105,000.**



1980 TAYANA 42 AFT COCKPIT Just returned from the South Pacific and loaded with gear **\$149,000.**



1979 EXPLORER 45 CC KETCH. Rugged, full keel world cruiser designed by Stan Huntingford. Full cockpit enclosure, AP, refer, solar. **\$105,000.**



1978 FORMOSA 46 CC A good example of this Doug Peterson-designed performance cruiser. **\$85,000.**



1987 SHANNON 37 KETCH Clean, well equipped bluewater cruiser from a top quality East Coast builder. **\$149,000.**



1987 HUNTER 31 Clean, well equipped Bay sailor. Yanmar diesel, radar, autopilot, refrigeration. **\$28,500.**



1983 UNION 36 CUTTER Well equipped blue water cruiser. Low hours, ready to go! **\$79,900.**



1986 TAYANA 37 Recent refit includes new electronics, dodger, new interior cushions and even a bow thruster. **\$125,000.**

Pacific Yacht Imports

We're at Grand Marina

2051 Grand Street #12, Alameda, CA 94501

Tel (510) 865-2541 Fax (510) 865-2369

www.yachtworld.com/pacificyachtimports • neil.weinberg@mindspring.com



See us at the
Northern California Fall Boat Show
 September 10-18 • Jack London Square



Here Now...
 New Tartan 3700!

**NOW STANDARD ON ALL
 TARTANS AND C&Cs**

- Carbon Spar
- Epoxy Hull
- 15-Year Hull Warranty



CALL FOR PERSONAL TOUR AND SPECIFICATIONS

TARTAN ^{NEW} 5100 • 4400 • 4100 • 3700 • 3500 • ^{NEW} 3400

NEW 2005 C&C 99
Fall Boat Show Promotion



C&C 115 Here Now!

**\$12,000
 Savings
 on Inventory
 C&C 99!
 (September only)**

- One design specs
- Novis carbon fiber mast – standard
- Epoxy hull – standard
- 15-year hull warranty – standard
- Doyle race sail package

Ready to race and cruise – Take delivery immediately

C&C 121 • C&C 115 • C&C 110 • C&C 99



New Listing

C&C 38 MkII, 1986. Swift performance racer/cruiser. Impec. cond. Well equipped. **\$87,900**



Great Boat

40' Hunter Legend, 1989. Lots of equipment and very clean. **\$79,000**



Farr 44, 1989. Performance cruiser, rounded Cape Horn twice. **\$190,000**



32' Pacific Seacraft PH, 1995. Inside steering, complete electronics. **\$160,000**



New Listing

SISTERSHIP

Tartan 4100, 2001
 Like new! Lots of equipment.
 Asking **\$295,000**



SOLD!

37' Gulfstar. Well equipped, ready to go to Baja. Go now for only **\$59,950**



Go to Mexico Now!

Beneteau 40 CC, 2001
Reduced – \$175,000



REDUCED

Downeast 41, 1981
 Pilothouse, new diesel. **\$59,000**



C&C 29, 1977
\$24,500

28' Pearson, 1975. Terrific family weekender, ready for summer fun. **\$12,750**
27' Catalina, 1979. Inboard, good condition. **\$7,300**

Tartan C&C Yachts of San Francisco

1070 Marina Village Parkway, Suite 102, Alameda, CA 94501

(510) 769-9400

www.yachtworld.com/tccsf

GOOD LISTINGS NEEDED



C&C 115, 2006. Brand new for west coast. Call for specs and prices.

Elegant Performance



315
ft

342
ft

370
ft

400
ft

461
ft

531
ft

Built in Germany | Design by Judd/Prock & Co.

Hanse Yachts US
Ph: 1-410-426-1400
hanse.yachts@comcast.net

Europe & Asia
Ph: 1-800-426-7727

See us at the
Annapolis Boat Show
Oct 6th to 10th

www.hanseyachts.com

Hanse

BALLENABAY

YACHT BROKERS



1150 Ballena Blvd. #121, Alameda, CA 94501 ♦ (510) 865-8600 ♦ Fax (510) 865-5560

2736 Shelter Island Drive, San Diego, CA 92106 ♦ (619) 523-1151

info@ballenabayyachts.com ♦ www.ballenabayyachts.com ♦ www.trawlers.com ♦ www.yachtworld.com/ballenabay

Your California Nordic Tugs Center ♦ New and Used Nordic Tugs

**Cruise Comfortably at 8 Knots/2 GPH ♦ Top Speed 16+ Knots
Safe and Reliable Diesel Power ♦ Bright, Spacious Engine Room**



*New, available at our docks
32, 37, 42*

NORDIC TUGS 37

**SNUG, WARM
PILOTHOUSE**



Hand built
in the USA

**1,000 NM
RANGE**



NEED TO SELL YOUR QUALITY SAILBOAT? OUR LISTINGS ARE SELLING *FAST*. CALL US TODAY.

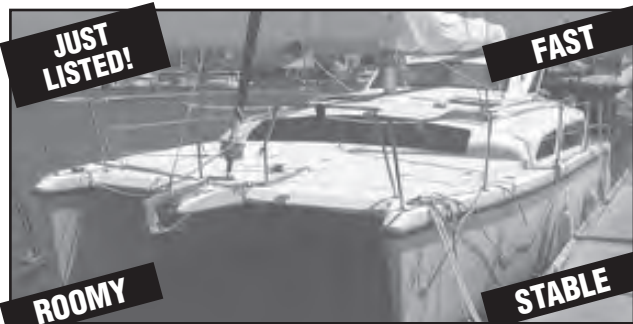

JUST LISTED!

FAST

ROOMY

STABLE

105M GEMINI, 1996
Performance cruiser. **\$109,000**



SALE PENDING

43' CAPE NORTH, 1980
None better for the price. **\$89,900**



SOLD!

36' FREEDOM, 1987
Excellent condition. **\$84,900**



SALE PENDING

45' HUNTER, 1986
Clean and spacious cruiser. **\$115,000**

Check our Web sites for other fine listings!



51' Passport
\$315,000

N
↑



40' Sabre 402
\$199,900



47' Nova CPMY
\$198,000



44' Nordic
\$119,500



39' Ocean Alexander
Sedan
\$169,000



35' Viking Express
\$149,000

Cityyachts
 San Francisco's yacht
 broker since 1969
 N 37° 48.566'
 W 122° 25.974'

← W

→ E



34' Californian
\$79,900



32' Four Winns
Vista 328 \$79,900



30' Catalina
\$29,900



27' Ericson
\$14,500



38' Hinckley
\$69,000

↓ S



30' Nonsuch
\$77,900

10 MARINA BLVD. • SAN FRANCISCO, CA 94123 • PHONE (415) 567-8880
FAX (415) 567-6725 • email sales@citysf.com • website <http://yachtworld.com/cityyachts>



PLEASE VISIT OUR FUEL DOCK AT GASHOUSE COVE MARINA • OPEN 7 DAYS A WEEK • 9AM TO 5PM

NELSON *Yachts*

Yacht Sales Redefined...

Dry Sell Your Yacht!

Simply the best way to sell your boat!

Sail and Power • Trailer Boats to 65' Yachts
Largest Inventory in One Location

- 'Dry Sell Area' at the best rates on the coast, only \$5.00 ft.
- Maintenance is minimized to an occasional wash down.
- Buyers have the advantage of seeing the entire vessel.
- Full service boat yard attached.



HUNTER 37.5, 1993
Absolutely beautiful.
\$89,000



**CUSTOM BENEteau
ONE-TONNER**
Coyote is ready to race!
Call



HUNTER 37.5, 1985
Great liveboard.
\$59,000



MAJOR REFIT PHOTO: JOSH DICK
OPEN 60, 1983
Thursday's Child
Major upgrade and refit 1998.
\$120,000



J/32, 1997
Ragtop – the ultimate J/Boat.
Ready for cruising and racing.
\$126,000



NEW LISTING
SYDNEY 38, 2005
High performance, easy to sail, sharp interior. Come see this beauty.
\$199,000



FREEDOM 39, 1985
Innovative, easy to handle schooner rig.
Great for the Bay and beyond.
\$99,500



PRISTINE
FREEDOM 38, 1992. TPI's rugged construction and Gary Mull's superior design make this a fantastic performer – crewed or shorthanded. **\$109,000**



OFFERS
MORGAN 36. Well balanced racer/cruiser. Radar arch, wind generator and more. Has just returned from Mexico and is ready to go. **All offers welcome.**



NEW LISTING
J/105, 1998
Well cared for and ready to join the hot J/105 one design fleet.
\$99,000



NEW LISTING
**ISLAND PACKET CAT 35
1994**
\$125,000



ERICSON 35 MKII, 1970
Previously cruised.
Ready to go.
\$35,000



PEARSON 34, 1985
Dodger and canvas. Great family Bay and coastal cruiser.
\$52,900



OOD 34
Jeremy Rogers-built performance racer cruiser. Come see it.
\$37,500

ADDITIONAL LISTINGS:

Open 60, 1983..... 120,000
Columbia 50, 1966 69,900
Irwin 45 CC, 1973..... 58,000
Roberts 44 CC, 1981..... 79,000
Gulfstar 43 CC, 1975..... SOLD
Choate 40, 1981 39,900
Freedom 39, 1985 99,000
Freedom 38, 1992 109,000
Sydney 38 One Dsgn, 2005 Inquire

Sydney 38, 1995..... 199,000
Hunter 37.5, 1993..... 89,000
Hunter 37.5, 1985..... 59,000
Morgan 36, 1984 Offers
Ericson 35 MkII, 1970..... 35,000
Isl. Packet Cat 35, 1984 125,000
J/105, 35', 1998..... 99,000
Jeremy Rogers 34, 1980 37,500
Pearson 34, 1985 52,900
J/32, 1997..... Reduced 126,000

Carter 30, 1976..... 19,950
Catalina 30, 1983 Pending
Hunter 30, 1980..... 15,000
Santana 30/30, 1983 15,000
Santana 30, 1976 SOLD
Cal 29, 1972 19,900
Wylie Hawkfarm 28, 1979..... Pending
Catalina 27, 1978 Pending
Hunter 25, 2005..... Inquire
Hunter 216, 2005..... 15,199

Hunter 17, 2005..... 7,199
Hunter JY 15, 2005..... 5,399
Hunter 140, 2005 4,499
Hunter 146, 2005 5,149
Hunter Liberty Row 10, 2005 1,499
Hunter Xcite 10, 2005 2,699
Hunter JY Club Trainer 8, 2005 ... 1,999
POWER
Sunseeker Manhtn 48, 1999 .. 475,000
Bavaria 29, 2003 88,000
Uniflite 28 Sport sdn, 1973 21,500

J/32
Clean, ready.
Call!

Chris Corlett • Ruth Scott • Wayne Moscow

www.yachtworld.com/nelsonyachts

www.nelsonyachts.net

Also offering
NEW
Sydney Yachts
Grand Soleil
Hunter Trailers

1500 Ferry Point, Alameda, CA 94501 • email: sales@nelsonyachts.net • 510 337-2870

The Pros Know!

Modern Master



Tom Wylie, Yacht Designer

From the 20' Mini-Transat winning American Express, to the ultra-light, ultra-fast 70' "cruising" boat *Rage*, Tom Wylie has penned the lines for countless successful boats, each of which reflects his genius for creative innovation. Tom's designs are characterized not just by their exceptional performance, but by the ease with which that performance is attained. His popular Wyliecat series of boats, for instance, use unstayed cat rigs with wishbone booms to eliminate the need for standing rigging, unruly headsails and the danger of a flailing boom. Tom relies on West Marine to supply the products and equipment that give Wyliecat owners Cheshire cat grins.

www.wyliecat.com

1-800-BOATING
westmarine.com or
BoatUS-store.com

West Marine®

and  **BoatU.S.®**
Marine Centers

SAVE 30%

146⁹⁹
West Marine
**West Marine
200SS Propane
Kettle Barbecue**



- 100% marine-grade, mirror-polished, stainless-steel grill with a large 200sq.in. grilling area
- Model 7042039** Reg. 209.99

SAVE 20%

83⁹⁹
Speedtech Instruments
Skymate Windmeter



- Lightweight, pocket-sized windmeter with a Fahrenheit/Celsius temperature gauge
 - Mph, kph, knots, meters-per-second, and feet-per-second wind measurements
 - Lithium battery and lanyard included; 1 3/4"W x 5 1/2"H (closed) x 3/4"D
- Model 2803864** Reg. 104.99

SAVE \$30

69⁹⁹
Lifesling
Lifesling2



- Combination horseshoe buoy and lifting sling gets your crewmate back onboard fast!
- Model 357634** Reg. 99.99

SAVE \$18

39⁹⁹
West Marine
**10" Aluminum
Winch Handle**



- Lightweight yet rugged winch handle makes sail trim quick and easy
 - Ball bearing assures fast, efficient cranking
 - Special grip for two-handed use gives you more grinding power; locking
- Model 5531348** Reg. 57.99

NEW

349⁹⁸/set
West Marine
**Explorer Breathable
Coastal Foul Weather
Gear**



- Breathable gear keeps you dry in the roughest coastal weather!
- Jacket: Red/Navy, Yellow/Navy—
Model 7215916S 199.99
Bibs: Red, Yellow—
Model 7217409S 149.99

SAVE 40%

59⁹⁹
West Marine
High-Back Go-Anywhere Chair



- Wider, longer and thicker than our original Go-Anywhere Chair, this seat provides more stability and comfort plus great new features
 - Pillow offers head and neck support and can easily adjust to suit a wide range of heights
 - Opened seat is 3 1/2"H x 19"W x 47"L
- Ref. Model 6465314** Reg. 99.99

MUST PRESENT THIS AD!

to get the Sale Prices* shown. Specials in this ad not combinable with any other offer.
Sale Prices good September 1–25, 2005

*Cashier please ring through as POV using item discount, reason code "Event".
Product descriptions, typographic, price or photographic mistakes are unintentional and subject to correction.



KKMI KH R

HAULOUTS - MECHANICAL - REPAIRS - YACHT SALES - DO-IT-YOURSELFERS WE



Breaking the record to Hawaii demands world-class sailors.

Hauling a yacht like this requires a world-class facility.



Servicing such clients takes world-class craftsmen.

Fortunately, you don't need to set a record to enjoy world-class service and craftsmanship.

Welcome to KKMI.

H RONICLE

530 WEST CUTTING BOULEVARD
POINT RICHMOND, CA 94804
(510) 235-KKMI • fax: 235-4664
www.kkmi.com • e-mail: yard@kkmi.com

RS WELCOME - LARGE MARINE STORE ON PREMISES STORE HOURS 7:30-4:30 MON.-FRI., 8-2 SAT.

KKMI's Acclaimed Diesel Engine Seminar



FREE!*

"The most professional, informative and enjoyable time I could have ever imagined. Are you sure we talked about diesel engines?"

"Mike Haley was great. Now I see why KKMI has been so successful. Your commitment to helping your clients goes well beyond the norm."

"My wife now wants to sign up for one of your Engine 101 classes. I guess I'm now out of a job on our boat."

Saturday, September 24, in the Boathouse.
*Call KKMI for details.



Mike Haley
35 Years of Experience
***Priceless!**



Isn't your engine due for a check up?



Sunday Sailing

BEAUTIFUL THEN: 70 years ago W. L. Stuart, Jr., the son of the founder of the Union Oil Company saw a dream of his come true. He'd hired the hotshot young designer Olin Stephens of Sparkman & Stephens (S & S) to design him a schooner that could show her heels to the best. Built of mahogany planks over white oak frames in Southern California, *Santana* was launched. At her christening the following was read:

*A hull so white, like virgin snow on Baldy,
And lines so graceful, that it is a joy,
For every sailor true, to behold her,
A gift it seems, Direct from out of the sky.*

*A fast ship she will prove, there is no question,
So clean a run no other yacht can boast,
With Aeolus, the God of wind behind her,
She soon will be Los Angeles Yacht Club toast.*

*'Santana' is the name her owner gave her,
'Big Wind' in language of the Red Skin old,
A Stewart is her captain, William Junior
A master skilled and courageous bold.*

*May you go forth, you beautiful creation,
Of Olin Stephens and shipwright's skill,
Let Wind and Fortune favor you and William,
Let Neptune and the Gods prevent all ill.*

– October, 1935, Captain Frank Jansen

**HAPPY 70th BIRTHDAY SANTANA
YOU SURE DON'T
LOOK YOUR AGE!**

(Visit thesantana.com for more info.)

YACHTFINDERS

WINDSEAKERS

(619) 224-2349 • Fax (619) 224-4692



2330 Shelter Island Dr. # 207
San Diego, CA 92106
yachtfinders@earthlink.net
www.yachtfinders.biz



44' MORGAN CC, '89 \$119,000
A roomy center cockpit sailing yacht with great lines and proportion, she's priced right to sell quickly.



43' COLUMBIA, '70 \$49,900
Reported to have been built for Bill Tripp himself, she has a highly-customized interior with many extras.



41' C&C RACER/CRUISER, '85 \$94,000
Argonaut offers generous headroom in a custom interior, KVH Quadra racing computer and 11 bags of sails.



38' HANS CHRISTIAN Mk II, '82 \$109,000
Few boats have achieved the popularity and respect of the HC-38. This one will lead to fulfilling "the dream".



37' RANGER ONE TON, '74 \$39,500
Gary Mull design with lots of zip and a very loyal following. Get on board and find out why!



40' LANGILLE SCHOONER, '62 \$59,000
Carinae has been lovingly cared for by the same owner for 41 years. Reduced price shows his motivation to move on.



37' IRWIN CC, '76 \$36,900
Her center cockpit puts you in control of all systems while keeping you dry in active weather. Sails and instruments like new.



37' PAC. SEACRAFT YAWL, '82 \$89,500
Watermaker, SSB radio, radar, wind generator, inverter, solar panels and new running rigging are just a few of her highlights.



35' ERICSON Mk III, '87 \$67,900
Wheel steering and a 21 hp diesel in one of the most popular US-built midsize cruisers around today.



34' CAL Mk III, '79 \$34,400
Excellent choice for the budget minded. With a little work, this boat will be ready to take you south in October.



33' C&C RACER/CRUISER, '85 \$39,900
With functional interior and good all-round sailing characteristics, *Amiga* is available due to a change in family circumstances.



28' S2 8.6M, '84 \$19,900
Economical coastal cruiser with enough equipment and amenities to let you really enjoy sailing in California.

**Thinking About
Selling
Your Boat?**

**Then You Should
REALLY
Call (510) 236-6633**

KKMI  **Yacht
Brokerage**
Professional Sales and Service



MONTEREY BAY CANVAS
dodgers • enclosures • custom projects
831.277.6094

MARINA FESTIVAL
 Sunday, October 23
 See our Web site for details
www.ci.brisbane.ca.us

BRISBANE MARINA

AT SIERRA POINT

BEST LOCATION

Ten minutes from downtown San Francisco and close to central bay sailing.



GOING NORTH OR SOUTH ON HWY 101, TAKE THE SIERRA PT. PARKWAY EXIT.

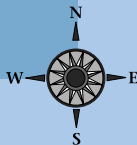

BEST RATES

According to the Bay Area Survey of Marina Rates, Brisbane Marina is among the lowest.

36-ft Berths \$212⁴⁰/month



400 Sierra Point Parkway, Brisbane, CA 94005

(650) 583-6975

www.ci.brisbane.ca.us • harbormaster@ci.brisbane.ca.us

Open 7 days a week: Monday-Saturday 8am-5pm, Sunday 8am-4:30pm

BEST STAFF

Friendly, knowledgeable and helpful.
 Open 7 days a week.



- BERTHS AVAILABLE NOW 30-66 FT.
- CONVENIENT PARKING
- ELECTRONICALLY KEYPED RESTROOMS/SHOWERS
- IMMEDIATE SAILING BEYOND CHANNEL MARKERS
- FREEWAY ENTRANCE FROM HWY 101
- DEEP, WELL MARKED ENTRANCE
- PROTECTED WATERS, NO SURGE
- ALL CONCRETE DOCKS AND BREAKWATER

BALLENA ISLE MARINA

Official
Sponsor
2005
BAJA
HA-HA

SEPTEMBER CALENDAR & SPECIALS

- **BALLENA ISLE MARINA**
Slips available 22-ft to 70-ft!
- **OPEN BOAT WEEKEND**
September 10 & 11: New and used boats open and on display.
- **BALLENA BAY YACHT CLUB**
Sanctioned racing.
Prospective members and reciprocal club members welcome.
Dinner most Saturdays, 7pm; call for details (510) 523-2292.
- **BALLENA BAY YACHT BROKERS**
The *Exclusive* California dealer of **Nordic Tugs**
Now see all the new 2005 models and many other fine yachts at our docks.
- **H&S CRUISING SPECIALISTS**
New Hunters ~ Jeanneaus ~ Calibers ~ Sabres at our docks.
- **THE TRAWLER SCHOOL**
Presenting two courses: 'Hands-on and Underway' and 'Working Radar'.
See www.trawlerschool.com.
- **NEW ENGLAND MARINE TITLE**
Full registration and titling services for state, federal
and foreign registered vessels.

BALLENA ISLE DIRECTORY

Ballena Bay Yacht Brokers
(510) 865-8600

Ballena Bay Yacht Club
(510) 523-2292

Bay Marine Diesel
(510) 435-8870

Club Nautique
(800) 343-SAIL

H&S Cruising Specialists
(888) 78-YACHT

Good & Plenty Deli
(510) 769-2132

Harbormaster
(510) 523-5528

New England Marine Title
(510) 521-4925

The Trawler School
(510) 865-8602



Propane Tank Refills Available



BALLENA ISLE MARINA

1150 Ballena Bl. #111, Alameda, CA 94501

(510) 523-5528 • 1-800-675-SLIP

www.ballenaisle.com

Home to These Fine Sailboat Lines:



And These Trawler Lines:

Nordic Tugs
Californian • Silverton
Navigator Yachts • Mainship





Flying Cloud Yachts

Hans Christian

GEMINI

Sail • BROKERS • Power

MEMBER
BoatWizard
M.L.S.
YachtWorld.com



6400 Marina Dr., Long Beach, CA 90803

Phone (562) 594-9716 Fax (562) 594-0710



50' CUSTOM COLUMBIA SLOOP, '93. Yanmar diesel, LP '01, upgraded equipment, custom interior/exterior, CLEAN & BEAUTIFUL! \$164,500.



44' LAFITTE CUTTER, '81. 2000 Yanmar 70hp diesel, new GPS map/sounder, radar, restored teak decks, full sails, '03 Caribew/OB. \$169,900.



NEW 105Mc - GEMINI
Best selling cruising catamaran in the U.S.!
\$145,500.



42' VAGABOND ketch, '82. 3 double cabins, 2 heads/showers. New upholstery, water heater, batteries, bilge pump, bottom paint. \$139,000.



44' MASON CUTTER, '88. Yanmar dsl, Max prop, B&G inst., watermaker, Technautic refrig., inverter, full batten main, Harken furling. \$225,000.



42' HUNTER 420 PASSAGE, '99.
Full batten main, new Leisure furling boom, electric winch, generator, inverter. \$179,000.



61' TEC steel sloop, '86. USCG licensed to carry 27 passengers. Perkins 4-236. 3 staterooms, hand-crafted white birch interior, full B&G, new rigging.



57' BOWMAN CC KETCH, '78. 110hp Perkins, new dark blue LP, cruise electronics, 3 staterooms, inflatable, OB, VacuFlush heads. \$249,000.



45' NOBLESTEEL SCHNR, '90. Corten steel hull and deck, Forespar masts, 50hp Perkins, inverter, solar panels, watermaker, ProFurl furling. \$250,000.

Web site: www.yachtworld.com/fcyachts • email: flyingcloud@verizon.net



41' C&C SLOOP, '84
Race/cruise. Huge sail inventory, dodger, autopilot, white LP. \$79,500.



41' CHEOY LEE OFFSHORE KETCH, '79
Well equipped for long range cruise. Vane, radar, mast steps, furling, lots of sails. \$85,000.



43' SPINDRIFT PH CUTTER, '83
Raised salon, 2 helm stations, 80hp Lehman, StackPak main, furling jib. \$99,900.



49' CUSTOM KETCH, '78. Quality FC construction, 80hp Lehman, full cruise equipment, large, traditional layout. Call to view.



43' BENETEAU SLOOP, '88. Incredible inventory, major refurb '05. New electronics, steering, sails, rigging, wiring, canvas, +++. \$124,950.



38' HANS CHRISTIAN Mk II CUTTER, '82
Radar on tower, AP, SSB, wind generator, completely equipped for cruising. \$128,000.



MORGAN 41 OUTISLAND SLOOP, '74
'99 Yanmar 50hp, generator, wind generator, solar panels, 3 inverters, new hardwood floors.



CATALINAS AVAILABLE:
30' CATALINAS, 3 available.
25' CATALINA, '91... \$28,500.



36' CATALINA sp, '03. Innovate Upgrade winner at '05 Catalina Rendezvous! Furling main, genoa, hardtop dodger/bimini, davits. \$137,000.



32' WESTSAIL CUTTER, '73. Owner's prepared for long distance cruising over last 4 years. All systems upgraded. Call for specs. \$44,900.



37' ENDEAVOUR SLOOP, '80. Major ongoing refit since '01. Upgraded electronics, standing and running rigging, headsail, +++. \$49,500.



35' ERICSON SLOOP, '73/74. New main, dodger, canvas '04. Atomic 4, FWC, rebuilt '99. Well cared for an unabused by original owner. \$22,900.



43' CAL SLOOP, '70.
Fast traditional racer/cruiser, custom interior, extensive inventory. \$93,000.



37' C&C SLOOP, '84. Performance hull, race/cruise. Quality equipment, rod rigging, spinnaker gear, self-steering vane. \$64,500.



39' ANDREWS SLOOP, '83. Race/cruise with large sail inventory, new rigging, LP, rebuilt engine, new main and jib. \$36,500.



27' PACIFIC SEACRAFT ORION, '84. Beautifully finished, maintained. Dsl, refrig, full boat cover, 2 furling headsails, spinnaker. \$72,500.

Some boats shown may be sisterships.



**INVENTORY IS
DURING OUR
DON'T MISS
CALL TODAY:**

ALL BOATS ARE IN STOCK & AVAILABLE FOR DELIVERY NOW!



Hunter 46LE #05-1943 • Save \$59,865



New 45 Hunter Center Cockpit
Arrives in September



Hunter 44DS #05-1923 • Save \$28,056



Hunter 41 #05-1915 • Save \$23,157



Hunter 38 #05-1933 • Save \$22,340



Hunter 36 #05-1931 • Save \$14,440



Hunter 33 #05-1922 • Save \$11,600



Hunter 31 Special Purchase • Save \$15,970



Hunter 27 #05-1891 • Save \$6,425

Alameda

1120 Ballena Blvd.
(510) 521-5544
www.hsyacht.com

Channel Islands

3141 South Victoria Ave., Oxnard
(805) 815-4140
www.hsyacht.com

Marina del Rey

13555-A Fiji Way
(310) 822-9814
www.hsyacht.com

Photos show sisterships. All offers limited to inventory on hand and subject to prior sale, price change, or withdrawal without notice or obligation. Savings based on comparison with current pricing. ©

SELLING FAST '05 CLEARANCE THE BOAT! 1-888-325-4353



'05 CLEARANCE SAVINGS LIMITED TO STOCK SHOWN – CALL NOW!



Jeanneau 54DS #05-1889 • Only \$652,000



Jeanneau 49 #05-1919 • Only \$415,615



Jeanneau 45 #05-1917 • Only \$339,990
First sold – Second just arrived – Must see!



Jeanneau 43DS #05-1950 • Only \$305,000



Caliber 40LRC #05-1992 • Only \$294,360



Sabre 386 #04-1712 • Save \$35,000 • Only \$275,000



Mainship 40T #05-1906 • Only \$349,995
New one arrives this month.



Mainship 34T #05-1963 • Only \$246,805
New one arrives shortly.



Mainship Pilot 30II SRR #05-1968 • \$197,029

Newport Beach
1700 West Coast Highway
(949) 642-4786
www.hsyacht.com

San Diego – Sail
1880 Harbor Island Dr.
(619) 291-6313
www.hsyacht.com

San Diego – Power
955 Harbor Island Dr.
(619) 291-2600
www.hsyacht.com

Photos show sisterships. All offers limited to inventory on hand and subject to prior sale, price change, or withdrawal without notice or obligation. Savings based on comparison with current pricing. ©

Mexico

Sail & Power

www.mazmarine.com

Your Mexico Connection



50' Gulstar CC Ketch, 1978
Reduced! \$129,000



32' Vancouver PH, 1986
\$79,000

MAZATLAN

Centro Marino  Marine Center

s.a. de c.v.

San Carlos Yachts
Puerto Vallarta Yachts

MAZATLAN
Ray Watson & Jeannette
ph/fax: 011 52 (669) 916-50-15
email: Mazmarine@aol.com

PUERTO VALLARTA
Nick Rau
ph: 011 52 (322) 297-2249
email: PVyachts@aol.com



36' Cabo Rico Tiburon Ketch
Two to choose from

FINANCIAL AND TITLING TRANSACTIONS ARE CONDUCTED BY MARINE DOCUMENTATION SERVICE, INC., IN SEATTLE, WA. TAX SAVINGS ON OFFSHORE SALE; CONTACT US FOR DETAILS.



56' Sundeer Sloop, 1995
One owner. \$450,000



43' Taswell CC Cutter Sloop, 1992
\$315,000



Ericson 35 MkIII, 1982, \$63,000
Ericson Cruising 36, 1976, \$49,900

BRITISH MARINE and INDUSTRIAL

#11 Embarcadero Cove
Oakland, CA 94606
(800) 400-2757
(510) 534-2757

Conveniently located on the Oakland Estuary - 2 blocks from West Marine

SUMMER Haulouts for Bottom Painting
Small yard offers specialized service.

Interlux
yachtpaint.com



NEW MARINE DIESELS

Perkins DIESELS

10% OFF

PERKINS PARTS

Mention this ad ~ Good until 9/30/05

Servicing California Marine and Industrial Engines
Perkins Authorized Master Service Dealer
SALES SERVICE PARTS

www.britishmarine-usa.com

We ship worldwide

FULL SERVICE BOATYARD



WoodenBoat School

2005 SAN FRANCISCO COURSES

At the Small Boat Shop

San Francisco Maritime National Historic Park

- Oct. 10-15 • **WOODEN BOAT REPAIR METHODS** with Ellis Rowe
- Oct. 17-22 • **INTRODUCTION TO BOATBUILDING** with Bill Thomas

For more information contact:

WoodenBoat School

P.O. Box 78, Brooklin, ME 04616

(207) 359-4651 (Mon.-Thurs.)

Fax: (207) 359-8920

www.woodenboat.com

The Horrible Heifer:

A thoughtless boater who dumps no matter where he is. This selfish act puts everyone in a bad moo'd.

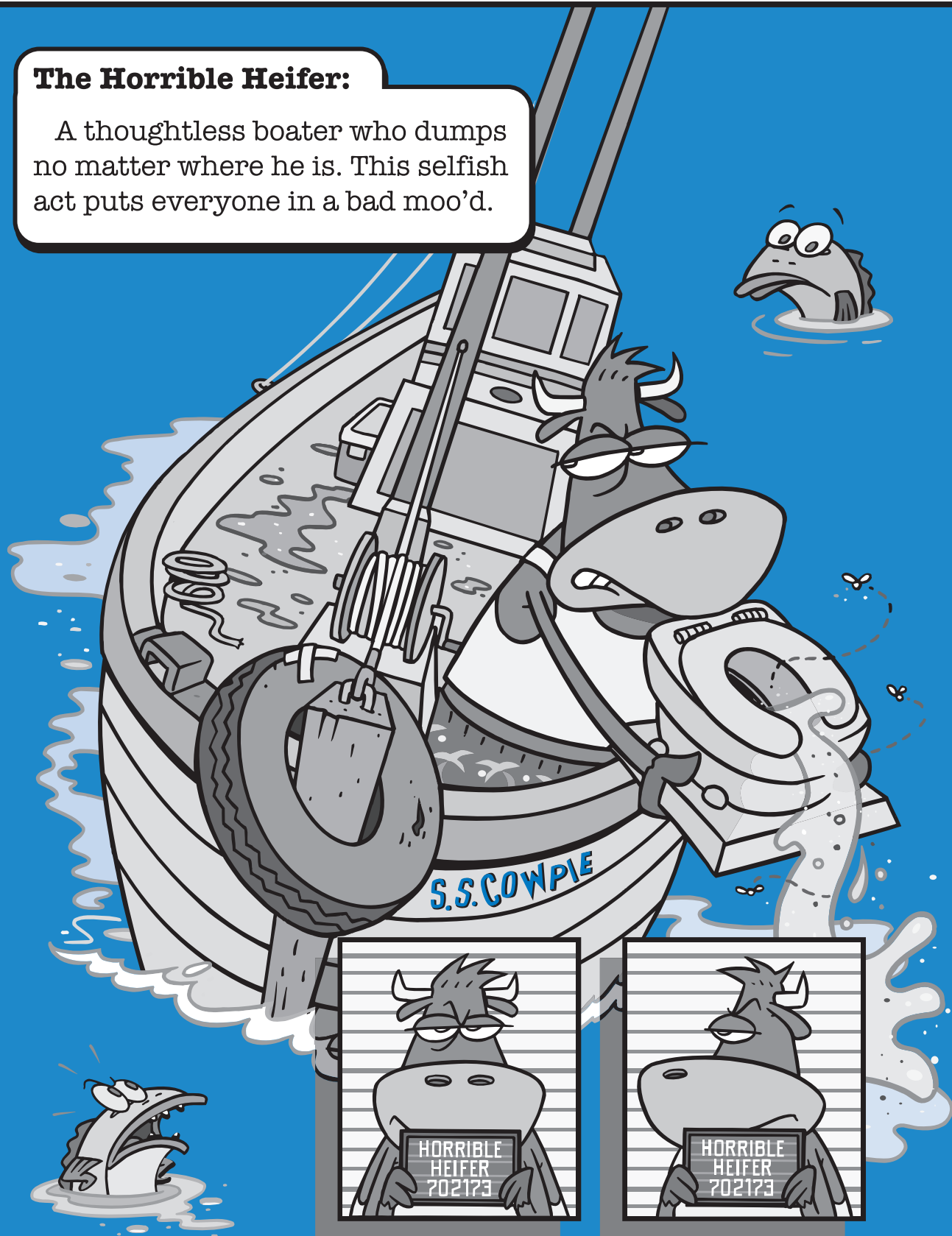

Don't be a party pooper. Dump at the pump.





**MARINA BAY
Yacht Harbor**
(510) 236-1013

1340 Marina Way South, Richmond, CA 94804

www.marinabayyachtharbor.com

Prepare to Be Surprised...

- Stunning City Views
- Modern Facilities & Concrete Docks
- Easy Access to Bay Landmarks & Delta
- 24-Hour Courtesy Patrol
- Deep Draft Harbor
- Nearby Shipyards, Boating Stores & Services
- Excellent Restaurant, Deli & General Store
- Discount Programs Available

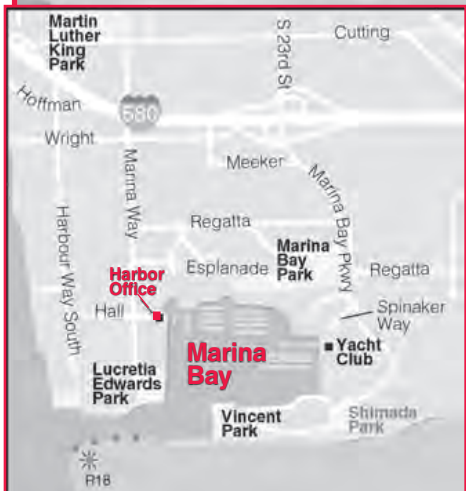

**Are You a
KKMI Client?
Are You Selling
Your Boat?**

**Then You Should
REALLY, REALLY
Call (510) 236-6633**

KKMI  **Yacht
Brokerage**
Professional Sales and Service

**LIVE
AND IN
PERSON!**

The Legends of Sailing

**August 11:
Kevin Burnham**

Oct 13: Mark Reynolds

6-9 p.m. • \$10 per person

For more information, visit
www.cyc.org/speakers or call **(415) 435-4771**

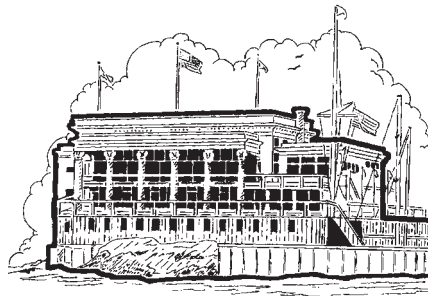

Corinthian Yacht Club

OF SAN FRANCISCO
43 MAIN, TIBURON, CA 94920 • www.cyc.org

Quality
People
Quality
Service



Why Choose West Marine Maritime Electronics?

- ✓ Courteous, certified and trained professionals get the job done right the first time
- ✓ Advice and instruction on how to select the right product for your needs and how to use it
- ✓ Installation at our docks with full boatyard services capabilities
- ✓ All our installations and services are backed by the West Marine guarantee!



West Marine®
Maritime Electronics

Reliable, Professional INSTALLATION Guaranteed!



The largest selection of marine electronics!

	Raymarine
B&G	
SIMRAD A KONGSBERG Company	
NORTHSTAR	
 <i>Look to the Leader. Look to Sea Tel.</i>	 TAILOR MADE ENERGY

Call your local Service Manager for more information!

Sausalito, CA.....(415) 332-5086
Point Richmond, CA **NEW!**.....(510) 236-2781

also available at...

Alameda, CA.....(510) 769-8425
Long Beach, CA.....(562) 598-7619
San Diego, CA.....(619) 223-7022



VALLEJO MARINA

*Gateway
To The
Bay & Delta*

A Friendly, Helpful Staff...Join Us! We love Making New Friends and Spoiling Them!

- ★ Competitive Rates!
- ★ Guest Dock
- ★ Fuel Dock and Pump Out Stations
- ★ Great Restrooms with Showers
- ★ Full Service Boat Yard and Chandlery
- ★ 2 Restaurants for Breakfast, Lunch, Cocktails and Dinner



707-648-4370

Fax 707-648-4660



website: www.ci.vallejo.ca.us



42 Harbor Way • Vallejo, CA 94590

**Do you want to save
time and money?
Are you selling
your boat?**

**Then You Should
REALLY, REALLY, REALLY
Call (510) 236-6633**

KKMI Yacht Brokerage
Professional Sales and Service

KISSINGER CANVAS

Marine Canvas & Interiors
STEVEN KISSINGER
(925) 825-6734
Covering the Entire Bay Area



- Biminis
- Boat Covers
- Cushions
- Sail Covers
- Headliners
- Awnings

DODGERS

Side handrails and window covers
included

OPTIONS

Aft handrail, dodger cover,
sailing bimini.

Free Estimates and Delivery

SailingProShop

A Division of Small Craft Advisories



CALL FOR BIG BOAT SERIES & TEAM GEAR SPECIALS

MUSTO
PERFORMANCE



MPX GORE-TEX COASTAL JACKET SM1263

- Roll-away fluorescent hood with width, height and face adjustment
- Fleece lined collar
- Adjustable double cuffs giving virtual drysuit cuff protection

MPX GORE-TEX TROUSERS SM150W1

- Wide elasticized braces for comfort
- High chest fit for extra protection
- Elasticized underarms

dubarry
of Ireland



Dubarry deck shoes and loafers are the latest in nautical fashion. If you're not wearing Dubarrys, you've been left behind.

FREE SHIPPING ANYWHERE* plus NO SALES TAX!

When you mention this ad. *UPS Ground in the contiguous U.S. August & September only.



THE DRYSHIRT™

Tired of wet T-shirts? Enter the DRYSHIRT. Short or long sleeve, the DRYSHIRT's revolutionary hydrophobic material breathes, which means sweat from the inside escapes to keep your skin dry and more comfortable. It also repels water from the outside so if you get splashed you won't get wet!



Gill

RESPECT THE ELEMENTS™

Gill products are now widely considered the most technologically advanced foul weather gear in the world. You can spend more, but you can't get better equipment than Gill.

Toll Free order line: 800-354-7245

www.sailingproshop.com

Your #1 Source for High Performance Marine Apparel

TARTAN C&C YACHTS OF SOUTHERN CALIFORNIA



Southern California  Yacht Sales



**New
San Diego
Office
Now Open
at
Sunroad
Marina**



**C&C 115
HOTTEST C&C ON THE MARKET!**

**2005 TARTAN 3700
TRUE CRUISER/RACER.**

955 Harbor Island Drive, Suite 115, San Diego, CA 92101

800-731-0201 • www.scyachtsales.com • info@scyachtsales.com

**We're Selling Yachts.
We Want Yours!
Please Visit Our
Web Site for a List
of Recent Sales.**

**To List Yours
Call (510) 236-6633**

www.kkmi.com

KKMI  **Yacht
Brokerage**
Professional Sales and Service

**26th St. Maarten
Heineken
Regatta**



March 3rd, 4th and 5th, 2006
www.heinekenregatta.com
Organized by: Sint. Maarten Yacht Club



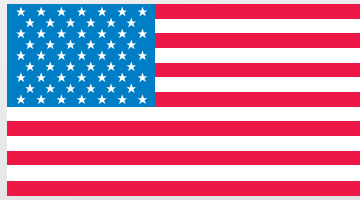

Along with a great place to berth your boat, San Leandro Marina offers you a wealth of recreational opportunities...

- **27 holes of championship golf**
- **A waterfront hotel**
- **Fine dining at 2 restaurants overlooking the water**
- **40 acres of shoreline park and picnic sites**
- **300 acres of tidal wetlands on the Bay Trail**
- **2 active yacht clubs**



(510) 357-7447

www.ci.san-leandro.ca.us/slmarina.html

ISLAND YACHT CLUB

Located in beautiful downtown Alameda's
Alameda Marina • 1853 Clement Ave.

(510) 521-2980

www.iyc.org

MEMBERSHIP SPECIAL*



\$300

Initiation Waived

Good thru March 31, 2007.

Yes, that's 18 months!

- Club Cruises Every Month
Including Half Moon Bay & Delta
- Monthly Dinners with Speakers
- Crabfeed, Pig Roast, Cinco de Mayo
- Friday Beer Can Races,
Interclub Races, Silver Eagle Race,
Sadie Hawkins Race,
Commodore's Cup, Jack & Jill + 1
- Reciprocal Privileges

Call Shirley or Rich (925) 672-2514

Visit www.iyc.org for an application

**Special good from Sept. 1 thru Dec. 31, 2005*

Don't Miss the 13th Annual WOMEN'S SAILING SEMINAR

Women teaching women to sail...

October 8-9

For more information,
contact Pam at (510) 339-9451
or see www.iyc.org

CALENDAR

Non-Race

Aug. 31, 1995 — Ten Years After, from a *Sightings* piece titled "Smoke on the Water":

"It would actually be more newsworthy if we hadn't broken the record," confessed multihuller Peter Hogg. He was referring to the recent 16-day, 17-hour, 21-minute run from Yokohama, Japan, to San Francisco by Steve Fossett's 60-ft French-designed trimaran *Lakota*. "Given the boat, the crew, and all the high-tech weather routing help we had, it was fairly easy. As long as we didn't flip or dismast, we knew we would do it."

It was still a dramatic moment when Fossett, a 51-year-old adventurer, drove *Lakota* under the Golden Gate Bridge just after noon on Thursday, August 31. While Hogg handled radio communications, the two other crewmembers — professional sailors Ben Wright of Australia and Brian Thompson of England — lit off smoke flares and popped open a bottle of champagne. The 'James Gang' (all four men had the same middle name) had beaten the previous record of 21.5 days, set 110 years ago by the clipper ship *James Stafford*, by almost five days. This despite light winds in the first half of the 4,525-mile trip that forced them to cut through the Aleutian Islands before diving south toward California. In fact, in venturing as high as 54° north latitude, *Lakota* may have been the first ocean racing multihull ever to transit the Bering Sea.

"It was a little chilly up there, about 40° air temperature," said Fossett, a securities dealer who lives in Colorado and works (mostly by phone, fax, etc. from wherever he happens to be) through a home office in Chicago. "We were a little worried about the light winds at first, especially after being bogged down for most of two days. We made up for it later, though. We averaged 393 miles a day over one four-day stretch, and hit a top day's run of 479 miles." The latter sprint — set in winds that averaged 12 knots at 90 degrees true with almost flat seas — wasn't that far off the world record of 540 miles, set last summer by solo sailor Laurent Bourgnon aboard *Lakota's* sistership, *Primagaz*. Both boats were designed by Marc van Peteghem and Lauriot Prevost. Interestingly, two other sisterships out of the same molds played the bizarre armed multihulls in the Kevin Costner sci-fi movie *Waterworld*.

This was the third world record that *Lakota* has notched in less than two months, the other two being the TransPac (6:16:07) and the Hawaii-Japan leg (13:20:09). *Lakota*, named after a Sioux Indian tribe, also holds the records for circumnavigating the Isle of Wight (the original America's Cup course), Britain and Ireland, and Ireland itself. Future record attempts may include the San Francisco-to-L.A. run and the one-mile world speed record, which is the average of two runs (each way on the course) within half an hour.

Interestingly, the *Lakota* voyages — which include a 5,000-mile solo Route de Rhum Race — are probably among the tamest of Fossett's various adventures. He's pushed the edge of the envelope in many other sports, including mountain climbing (he's summited six of the seven highest continental peaks, failing only in two attempts on Everest), car racing (24 hour Le Mans and the Paris-to-Dakar enduro through the Sahara Desert), dogsledding (three Iditarods), distance swimming (English Channel, Golden Gate, Alcatraz), running marathons and lots more. "A few hundred years ago, Steve would have been one of the great explorers," figured Hogg.

Lately, Fossett's main passion besides sailing is hot air (and gas) ballooning. Last February, he became the first person to solo across the Pacific, going from Seoul to Canada and setting the world distance record for ballooning in the process. This November, he'll undertake what may be his diciest challenge

Guest Berthing in the City



South Beach Harbor is a great way to experience San Francisco. Boats of all sizes are welcome in our protected deep water harbor. Bring your boat to South Beach and enjoy all the attractions of the City – and great sailing too!



- 650-ft. Guest Dock
- 20 Guest Berths – Cruise-ins are welcome
- 24-Hour Security
- Free Pump Out Station
- Casual and Fine Dining Nearby
- Adjacent to SBC Park
- Easy Access to Transportation
- On-Site Marine Services
 - Boat Charters
 - Boat Cleaning/Detailing
 - Diving Services
 - Marine Canvas/Upholstery
 - Rigging Services
 - Sailing School



For Guest Reservations, Contact:

**South Beach
Harbor Office**
(415) 495-4911
Fax (415) 512-1351
sb.harbor@sfgov.org
www.southbeachharbor.com

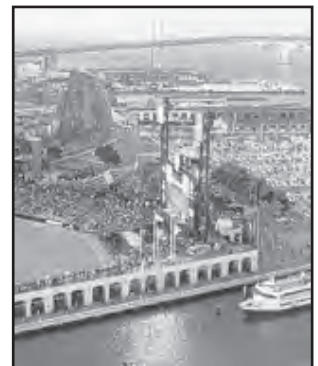

BERKELEY MARINA

**YOUR BAY
EVERY DAY**



Come Visit Us!

- New Dry Storage Area
- Renovated Launch Ramp
- Guest Berthing
- 3 Great Restaurants
- Choice Berths Available
- Sport Fishing Charters
- Chandlery & Yacht Club
- Fuel Dock & Boatyard
- Bait Shop & Deli
- Easy I-80 Access
- Beautiful Park Setting

*Always a great
downwind sail home!*

Berkeley Marina

201 University Ave., Berkeley, CA 94710

(510) 981-6740

Fax (510) 981-6745

www.ci.berkeley.ca.us/marina

Gateway to the Golden Gate

Plan an overnight or club cruise at our facility.



29th Annual
Wooden Boat Festival

September 9, 10, 11, 2005 ~ Port Townsend, WA

Celebrate the fun, the magic, the beauty of Wooden Boats.

Featuring more than 200 boat of all kinds, and more than 200 Sailors, Boatbuilders, Marine Trades Experts, Artists, Exhibitors & Educational Organizations at the Festival every day! Kids' stuff, Music, Good Food, Great Brews and On-the-Water Races

www.woodenboat.org

This year's special guest:

Nigel Calder

Author of many books, including:
The Boat Owners' Mechanical & Electrical Manual and Marine Diesel Engines

Buy Tickets Online:

Festival Thursday Symposium
with Nigel Calder on September 8

Visit us in Point Hudson, Port Townsend, WA.
Or call (360) 344-3436.

The Wooden Boat Festival is an educational fund-raising event of international acclaim. Funds support year-round youth and adult maritime education of the Wooden Boat Foundation & Northwest Maritime Center.



**DIESEL
FUEL
FILTERING**

since 1989*

*Superior equipment and years of experience
guarantee results - Don't settle for less.*

Purify Diesel Fuel & Flush Tanks.

Process scrubs; polishes; removes algae, dirt, rust and water from diesel fuel.

Includes internal tank washdown.

Save your injectors, costly engine repair and down time.

*We are in compliance with State and Federal
Specifications & pollution control.*

- "All Pleasure Yachts & Commercial Craft."
- Your berth or boat yard.
- Fully Insured

(510) 521-6797

Fax: (510) 521-3309



*Owned and operated by Bob Sherman since 1989

South Beach Sailing Center

AWARD WINNING INTERIORS

**SPECIALIZING IN:
YACHT INTERIOR DESIGN
CONSULTATION, FABRICATION
AND INSTALLATION**

DESIGNER...

- CUSHIONS
Interior, Cockpit & Lumbar
- DINETTES
- CARPET
- CURTAINS
- MATTRESSES
- DESIGN CONSULTATION

**NORTH
BEACH
MARINE
CANVAS**



Featuring
BottomSiders cockpit cushions

888•251•5455 415•543•1887
Pier 40, South Beach Harbor, San Francisco
www.northbeachmarinecanvas.com Fax (415) 543-2565

got time?

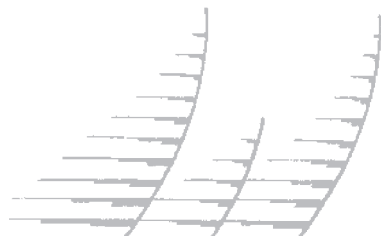

- WASHING
- WAXING
- VARNISHING

Serving the entire Bay Area for 20 years

Westwind

Complete Yacht Care

Ask us about automotive detailing



(415) 661-2205



email: westwinddetailing@sonic.net • website: boatdetailing.com

Pier 40, South Beach on the Embarcadero • San Francisco
Call Toll Free 1-888-828-6789

South Beach Riggers

Custom Solutions for your Custom Problems

Let our knowledgeable and professional rigging team manage your project.

We have the Answers to your Questions.

Winning Technology for the Hot Race or the Casual Cruise

- Expert advice, sales and splicing of Vectran, Spectra, Technora, and Dacron by our certified splicer
- Professional survey and tune for your rig
- Standing and running rigging replacement
- Sales and installation of all marine hardware
- Fabrication and hydraulics
- Insurance work
- Over 100,000 miles racing and cruising experience

TWO LOCATIONS

399 Harbor Dr. • Clipper Marina • Sausalito • 415.331.3400
Pier 40 • South Beach Harbor • San Francisco • 415.974.6063

DO IT ONCE – DO IT RIGHT... **Call Tom Today**

Pier 40 • South Beach Harbor • San Francisco

MARINER'S GENERAL INSURANCE

Since 1959

Now with five offices
offering you local
insurance service and global
insurance coverage.

SEATTLE

Scott Rohrer
(800) 823-2798
(206) 281-8144
Fax (206) 281-8036

NO. CALIFORNIA

(800) 853-6504
(650) 373-0595
Fax (650) 548-1585
email: boomeins@aol.com
Lic. # OA99058

L.A./ORANGE COUNTY

Craig Chamberlain
(800) 992-4443 • (949) 642-5174
Fax (949) 642-0252
Lic. # OD36887

SAN DIEGO

Henry Medina
(800) 639-0002
Fax (619) 226-6410
Lic. # OA96346

BRADENTON, FLORIDA

Jerry Norman
(800) 914-9928
Lic. # E051940

ATTENTION
CRUISERS!
MEXICAN
LIABILITY
INSURANCE
ONLINE

Official
Sponsor
2005
BAJA
HA-HA

We insure racers and cruisers all over
the world with prompt, reliable service.

www.marinersinsurance.com

• Sail & Power

• Fishing Boats

• Charter Boats

• Liveaboards

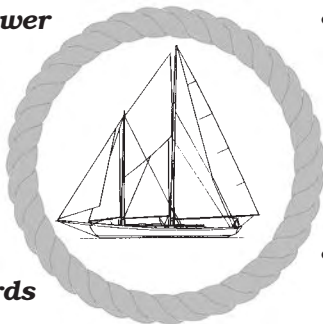

• Marine Businesses

• Tugboats

• Cargo

• Offshore Cruising

It's A Mariner's Fact:

Mariner's General Insurance insures
cruising sailboats all over the world...
are you heading out?

CALENDAR

yet — the first-ever solo round-the-world balloon attempt. Like Fossett's previous adventures, the upcoming endeavor will be self-financed. He does these things more for the personal satisfaction than any notoriety they may generate.

Sept. 5 — Avoid the office on Labor Day.

Sept. 8 — Corinthian Speaker Series, featuring Olympic 470 gold medalist/2004 Rolex Yachtsman of the Year Kevin Burnham. Doors open at 6:00 p.m.; show starts at 7:30 p.m. Info, www.cyc.org/speakers.

Sept. 8 — Single Sailors Association monthly meeting at Ballena Bay YC. Details, www.sail-ssa.org.

Sept. 9-11 — 29th Annual Wooden Boat Festival at Port Townsend, WA. Info, www.woodenboat.org.

Sept. 10 — "The East Bay's Largest Nautical Flea Market", 6 a.m. to noon at Encinal YC. Info, (510) 522-3272.

Sept. 10-11 — Open Boat Weekend in Alameda at Marina Village, (510) 521-0905, and Ballena Isle Marina, (510) 523-5528.

Sept. 10-18 — 35th NorCal Fall Boat Show at Jack London Square. See the ad in this issue to save two bucks on admission. NCMA, (800) 698-5777.

Sept. 13 — "Advanced Coastal Navigation," an 11-week class, begins at Loch Lomond YC, 7:30-9:30 p.m. USCG Auxiliary, Flotilla 14; Herb Golenpaul, (707) 996-5964.

Sept. 13-Oct. 27 — "Boating Skills & Seamanship" classes begin on Yerba Buena Island, continuing on Tuesdays and Thursdays, 7:30-9:30 p.m. To register, call USCG Auxiliary Flotilla 17 at (415) 399-3411.

Sept. 14-18 — Boats Afloat Show on Lake Union (Seattle), including the third Sailfest Northwest. Info, www.boatsafloatshow.com.

Sept. 17 — "Diesel Engines and Propulsion," a daylong session at Nelson's Marine for \$249. Info, (510) 814-1858.

Sept. 17 — Howl at the full moon.

Sept. 17 — "SSB Operation," a free two-hour seminar by Chuck von Schalscha at McGrath Pacific Yacht Sales (Sausalito), 9 a.m. RSVP, (415) 331-5020.

Sept. 19 — International Talk Like A Pirate Day. Learn the five basic words (*Ahoy! Avast! Aye! Aye aye! Arrrr!*) and more at www.talklikeapirate.com.

Sept. 22 — Celebrate the Autumnal Equinox.

Sept. 24 — Ninth Annual PICYA Wheelchair Regatta, a powerboat cruise for disabled U.S. veterans followed by a picnic at Encinal YC. Volunteers needed! Margot Brown, (510) 523-2098.

Sept. 24 — "Know Your Boat," an introductory look at your boat's major systems. Nelson's Marine; \$89. Info, (510) 814-1858.

Sept. 26 — Captain's License Classes (6-pack and 100-ton) begin in San Mateo. Details, www.usmaritime.us or Mike, (650) 298-9489.

Oct. 1-2 — 8th Annual Catalina Rendezvous at Ayala Cove, Angel Island. All size Catalina yachts welcome. For more info, call your local fleet captain or Bill, (925) 820-7370.

Oct. 5 — *Latitude 38* Mexico-Only Crew List and Baja Ha-Ha Party. Encinal YC, 6-9 p.m. Info, www.latitude38.com.

Oct. 8-9 — Fleet Week, including the return of the Blue Angels. Details, www.fleetweek.us.

Oct. 8-9 — 13th Annual Women's Sailing Seminar. Island YC; Pam Krawiec, (510) 339-9451.

Oct. 10-15 — "Wooden Boat Repair Method," a course by Ellis Rowe at the S.F. Maritime National Historic Park. WoodenBoat School, www.woodenboat.com.

Oct. 17-22 — "Introduction to Boatbuilding," with Bill Thomas. Same deal as above.

SVENDSEN'S

All Systems 'GO'!

Don't let your systems
keep you at the dock.

We specialize in:

Electrical Systems
Repairs & Installation

Fuel Systems

Bow & Stern Thrusters
Installation & Service

Engine Repairs & Repowers

Sanitation Systems
Tecma Distributor/Dealer

Windlass Installations

Spectra Watermaker
Sales & Installations

**Expert Fiberglass
& Wood Repair**

Bottom & Topside Painting

Full Service Rigging Shop

CALL TODAY
to schedule your liftoff:
510.522.2886
or schedule online at
www.svendsens.com



**SVENDSEN'S
BOAT WORKS**

**THE BAY AREA'S
ONE-STOP LOCATION
FOR MARINE PRODUCTS
AND BOAT REPAIR!**

Located in the Alameda Marina
1851 Clement Avenue • Alameda, California 94501

Want the right sailing school?

Ask yourself some simple questions:

Do I want to learn to sail on boats specifically designed for teaching (not racing)?

Do I want to learn at a school that offers a variety of locations and wind conditions?

Do I want to learn from a school that has the confidence in my training to charter me a boat after I'm certified whether I'm a member or not?

Do I want to have access to the largest (over 50 boats), newest (10 brand new boats added to fleet this year), and best equipped fleet on the bay?

If you answer yes to these questions, call, surf or stop in and let us show you around.



Visit us at the NCMA Boat Show in Jack London Square, September 10th thru the 18th for special discounts on classes.



Alameda
1-800-343-SAIL

Sausalito
1-800-559-CLUB

Call today for your free brochure with CD-rom

CALENDAR

Racing

Aug. 29-Sept. 2 — 18 Skiff International Regatta, with about 10 boats expected. Major league crashing and burning on the Cityfront. StFYC, (415) 563-6363.

Sept. 1 — Ronstan Bridge to Bridge Race, pitting 18s, boards, kites, and maybe even trifoilers against each other in a mad dash from the Golden Gate Bridge to the Bay Bridge. StFYC, (415) 563-6363.

Sept. 2 — Windjammers Race. Pop the kite and head for Santa Cruz! SCYC, (831) 425-0690.

Sept. 2-4 — J/120 North Americans on the Berkeley Circle. SFYC, (415) 789-5647.

Sept. 2-4 — Moore 24, Express 27, and Antrim 27 Nationals. StFYC, (415) 563-6363.

Sept. 3 — 17th Annual Jazz Cup, a 26-mile romp from T.I. to Benicia YC. SBYC; Sherry Nash, (650) 552-9260.

Sept. 3-4 — Labor Day Regatta. The above three national championships will share the course with Melges 24s and J/24s. StFYC, (415) 563-6363.

Sept. 3-4 — Fall Open Regatta, a Dave Wahle dinghy production. SCYC, (831) 425-0690.

Sept. 4-10 — Etchells Worlds, six races on the Berkeley Circle. RYC, (510) 237-2821, or www.sfetchells.org.

Sept. 8, 1985 — It Was Twenty Years Ago Today, from a *Racing Sheet* item called "Have All the Rowdy Racers Gone and Settled Down?":

Is the inclination to marry a communicable condition? You have to wonder given the epidemic-like number of pairings involving many of San Francisco's best young racers during the last 45 days. The following, for example, are merely six cases we learned of in one 15-minute span.

On September 8, Kenny Keefe tied the knot with Kerry Burgess. Besides being the individual responsible for getting San Francisco's 12-Meter together and to Australia in Cup-winning shape, Kenny has long been one of the most sought-after crew on boats between 20 and 80 feet. His next big racing project is winning the Star Worlds this November in Nassau with Paul Cayard.

Cayard is another former St. Francis junior sailor who has gone on to firmly establish himself in international racing. And, like Keefe, Cayard just got married. His bride is Icka Petterson, daughter of Swede Pelle Petterson. Pelle has long been a top helmsman in Stars, Six Meters and 12-Meters. Paul and Icka were married in Sweden on August 12 during a break in what's been an unbelievably hectic sailing year. Cayard drove *Nitissima* to second in class in the SORC; he won three of five races in the Star Bacardi Cup, but dropped to 8th because of an infraction; he took fourth in the Six Meter Worlds in Europe; he won the Star Spring Championship; he was second in the Italian IOR championships on *Brava*; he sailed *Sidewinder* to third in the Admiral's Cup Trials; he slipped to fifth in Stars at Kiel by virtue of another infraction; in the One Ton Worlds the boat he was driving was dismantled; he drove *Sidewinder* in the Admiral's Cup; he got married in Sweden; he drove the 72-ft *Il Moro* in the maxi championships in Mallorca, and took second in the Star North Americans. Here at the Big Boat Series he drove *High Roler* to two bullets in the first two races.

Cayard figures he's racked up 150,000 air miles since the beginning of the year. Having built up so many frequent flyer credits, he was able to give his Star crew Kenny Keefe and Kenny's bride a free trip to Europe. Are you junior sailors taking note of the opportunities available to those who excel?

Back to the altar: October 6 is the date for Steve Jeppeson, a very fine driver who works out of the Sobstad loft, to go down



ANTICIPATE THE SHIFT

**IF YOU WANT TO WIN,
WHY WOULD YOU BUY
THE SAME SAILS AS
YOUR COMPETITION?**

FUSION



QUANTUM SAIL DESIGN GROUP

510.234.4334 or sanfrancisco@quantumsails.com

WWW.QUANTUMSAILS.COM



OWL HARBOR MARINA

THE FRIENDLY MARINA

- Prepay one year, get the 12th month free!
- 30'-50' deep draft berths @\$4.75 per foot
- Showers • Laundry
- Dry and open storage
- Extra wide berths for multihulls
- Home of Martin's sailing school

Yacht Club Cruises Welcome!

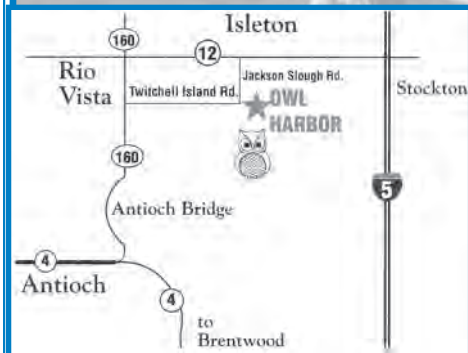

LOCATED ON SEVEN MILE SLOUGH
OFF THE SAN JOAQUIN RIVER

HARBORMASTERS:

FRANK & RHENAE DIETRICH

(800) 483-9992 OR (916) 777-6055

email: owlharbor@citlink.net

www.owlharbormarina.com

1550 W. TWITCHELL ISLAND RD.
ISLETON, CA 95641

Custom Canvas & Interiors



The Gianola Family has been designing and fabricating custom canvas and interiors since 1969. Gianola & Sons offers you the best in quality, more choices, and personal service.



360 Gate 5 Road
Sausalito, CA 94965
(415) 332-3339
www.gianolacanvas.com

MARINER'S CHOICE

THE BAY AREA'S CENTER for
CANVAS, UPHOLSTERY, HARDTOPS



HOME of
WAVESTOPPER™ HARD TOPS
for Sail & Power

Canvas Dodgers, Biminis & Enclosures
Custom Upholstery

Dealer for **BARRETT** Bonded Windows

mariners_choice@hotmail.com

(707) 257-1634

Quality
People
Quality
Service



- Running Rigging
- Standard Rigging
- Dock & Anchor Lines
- Lifelines
- Navtec Hydraulics



West Marine®
Rigging Service

Custom RIGGING by the Experts!



NAVTEC®
Rigging Solutions™
NEW ENGLAND ROPES
YALE CORDAGE
SAMSON
HARKEN®
Marlow®
SCHAEFER MARINE
RONSTAN
Hayn Marine
LEWMAR®
FORESPAR®
Hi-MOD
Made in UK

Onsite Rigging Locations

East Coast Rigging

Production Facility
860 Marine Dr. Suite 581
Rock Hill, SC, 29730
Ph 888-477-7444
Fax 803-909-6290

Annapolis

Annapolis Rigging Shop
113 Hillsmere Dr.
Annapolis, MD, 21403
Ph 410-268-0129

West Coast Rigging

Production Facility
2395 Bert Dr. Suite 502
Hollister, CA, 95023
Ph 831-761-4129

San Diego

San Diego Rigging Shop
1520 Rosecrans St.
San Diego, CA, 92106
Ph 619-255-8844

Alameda

Alameda Rigging Shop
730 Buena Vista Ave.
Alameda, CA, 94501
Ph 510-521-4865

Seattle

Seattle Rigging Shop
1000 Mercer St.
Seattle, WA, 98109
Ph 206-292-8663

Your boat deserves the Seashine touch



ONE-STOP DOCKSIDE BOAT CLEANING
AND MAINTENANCE

- Detailing and Polishing
- Washdown
- Bilge Cleaning
- NEW** • Engine Inspection
- NEW** • Boat Maintenance

SERVING SATISFIED CUSTOMERS
ON SAN FRANCISCO BAY SINCE 1986
WE COME TO YOU

"Seashine has been cleaning, polishing
and washing my boat for years.

Their service is high quality and consistent."

— Larry Fox, owner

45 foot Sabre *Sea Fox*

Contact us today for a free estimate
510 428-2522
www.seashine.net

CALENDAR

the aisle with Adele Surtees, daughter of Dennis Surtees. October 6 is also the day for Steve Enzensperger to say "I do" to Colleen McKimmie. Steve keeps *Damn Near* and a host of other boats in racing condition.

October 9 is the date for Jeff Trask and Tracy Cleveland. Jeff crewed on *Checkmate* in the last Clipper Cup and is a big J sailor — his father Don is the dealer.

And a little bit further down the road, Jeff's sister Jill will be married to Dave Hulse. Hulse, in addition to being another superb driver, builds grand prix masts at Hulse Spars in Alameda.

Congratulations to all of you. Our advice for marital bliss is simple: don't hang around with guys like Steve Baumhoff. Just kidding, just kidding.

Sept. 9-10 — Knarr Match Races, rescheduled from earlier in the summer. StFYC, (415) 563-6363.

Sept. 10 — SSS East Bay/Estuary Race, another short-handed race. Jeff Berman, (415) 302-0101.

Sept. 10 — Alameda Interclub Series #6, hosted by BAMA and the Catalina 34 fleet. Info, www.sfbama.org.

Sept. 10-11 — West Marine Fun Regatta for junior sailors. SCYC, (831) 425-0690.

Sept. 15-18 — 41st Rolex Big Boat Series, always the highlight of the local sailing season. StFYC, (415) 563-6363.

Sept. 16-18 — Flying Dutchman North Americans. BVBC, (415) 495-9500.

Sept. 17 — South Bay YRA race #6, hosted by Ballena Bay YC. Info, <http://sbyra.home.comcast.net>.

Sept. 17-18 — Multihull Championship. SCYC, (831) 425-0690.

Sept. 17-18 — Finn PCCs. CPYC, (650) 347-6730.

Sept. 17-23 — International Regatta for Nordic Folkboats. SFYC, (415) 789-5647.

Sept. 24 — Fall SCORE #2. SCYC, (831) 425-0690.

Sept. 24 — CYC/OYRA Drake's Bay Race, a nice place to visit in the fall. YRA, (415) 771-9500.

Sept. 24-25 — Melges 24 PCCs. SFYC, (415) 789-5647.

Sept. 24-25 — Totally Dinghy Regatta for, well, dinghies. RYC, (510) 237-2821.

Sept. 24-25 — Jessica Cup, fleet racing for big woodies. StFYC, (415) 563-6363.

Oct. 1-2 — Dolphin Cup, a five-race weekend in Monterey for Sydney 38s, Santana 35s, and Moore 24s. MPYC; Garth Hobson, (831) 655-4846.

Oct. 1-2 — Oktoberfest Regatta. SCYC, (831) 425-0690.

Oct. 8-9 — Santa Cruz Invitational Regatta for SC 52s and SC 50s. SCYC, (831) 425-0690.

Oct. 8-9 — El Toro Stampede. RYC, (510) 237-2821.

Oct. 8-9 — Fall One Design. SFYC, (415) 789-5647.

Oct. 8-9 — SSS Vallejo 1-2, a mellow way to end the short-handed season. Jeff Berman, (415) 302-0101.

Oct. 14-16 — International Masters Regatta, J/105 racing for senior citizens. StFYC, (415) 563-6363.

Oct. 15 — HDA Yankee Cup/ODCA Champion of Champions, hosted by IYC at GGYC. YRA, (415) 771-9500.

Oct. 22 — Joan Storer Regatta, a mostly all-women race benefitting BAYS (Bay Area Youth Sailing). One token male is allowed per boat, but he can't touch the helm. Tiburon YC; Lesa Kinney, (415) 389-8224.

Oct. 22-23 — Joe Logan (Mercuries)/Calvin Paige (Stars) regattas on the Cityfront. StFYC, (415) 563-6363.

Oct. 29 — RYC/OYRA Junior Waterhouse, the ocean racing finale. YRA, (415) 771-9500.

Oct. 29-30 — Great Pumpkin Regatta, a Bay Area Halloween tradition. RYC, (510) 237-2821.



Ownership Made Easy

**Now Open in
Monterey Bay!**

LET SAILTIME PAY FOR YOUR New Hunter Sailboat

- We'll pay all the costs and guarantee you a monthly income
- Design your sailing calendar online 24/7, on your own boat, in your local waterway
- We professionally manage, detail and maintain your boat all year round
- Your boat is only sailed by you and 7 other fully qualified SailTime Members



...for the time of your life

Call 1-877-SAILTIME
(724-5846)

www.sailtime.com

**SAN FRANCISCO • MONTEREY BAY • SAN DIEGO
CHANNEL ISLANDS • ORANGE COUNTY**

...and over 30 national and international locations

BAJA HA-HA 12

**BROUGHT TO YOU BY
THESE OFFICIAL SPONSORS**

CORTEZ CHARTS

NAVIGATION CHARTS - CRUISING GUIDES
TIDE TABLES - LIGHT LISTS
GPS COORDINATES

www.gerrycruise.com

...CONTINUE THE ADVENTURE

**"RALLY TO PARADISE 2005"
CABO TO PV**

011-52-322-22-66728
www.paradisevillage.com
marina@paradisevillage.com





Headquarters for the
3 Day Rally to Paradise
And during the month of March...
The Banderas Bay Festival Nautico

Your HOME BASE in Mexico
www.vallartayachtclub.com

RIGGING ONLY

Standing and running rigging, lifelines, furlers, winches, main slider systems, windlasses, travelers, wire terminals, blocks and more...
Expert advice for selection and installation

Our 21st Year
www.riggingonly.com



Let Marina El Cid
Welcome You to Mexico
A Cruiser's Paradise!

www.elcid.com
qcevallos@elcid.com.mx
011-52 (669) 916-3468



Self steering that includes an emergency rudder 'ready to go'
636 Clyde St. #15 • West Vancouver, BC, Canada V7T 1E1
Tel: (604) 925-2660 • Fax: (604) 925-2653
john@hydrovane.com • www.hydrovane.com

**ARE YOU READY TO
HA-HA?**

Although the September 10 entry deadline is fast approaching, there is still time for you to bite the bullet, throw practicality to the wind and sign up for the 2005 cruise to the Cape!

So what are you waiting for? Have that conversation with your boss, tell the postman to hold your mail and cut those docklines. The sunny latitudes of Mexico await.

The first leg of this year's rally begins on Halloween, October 31, so the starting line should be more festive than ever.

The Baja Ha-Ha, of course, is a 750-mile cruisers' rally from San Diego to Cabo San Lucas, with stops along the way at Turtle Bay and Bahia Santa Maria.

At this writing, nearly 200 prospective entrants have already requested entry packets. To get yours, send a 9x12, self-addressed envelope – no return postage necessary – with a check for \$18 (for postage and handling) to: Baja Ha-Ha, Inc., 21 Apollo Road, Tiburon, CA 94920. An application packet, complete with special offers from the sponsors listed in this ad, will be mailed back to you expeditiously. The event entry fee is \$299 per boat.

Prospective entrants should be clear that this offshore sailing event definitely is not a hand-holding service for those incapable of making this trip on their own. However, it is an ideal opportunity to get acquainted with hundreds of like-minded cruisers as you 'cruise-in-company' along the Baja coast. The two stops en route to Cabo give even the slowest boats a chance to catch up, and allow everyone to rest and recreate.

**VISIT
WWW.BAJA-HAHA.COM
FOR MORE DETAILS!**

**SELF-STEERING
auto-helm**
w i n d v a n e

SCANMAR Factory Direct
INTERNATIONAL

432 South 1st Street • Pt. Richmond, CA 94804
Tel: (510) 215-2010 • Fax: (510) 215-5005
email: scanmar@selfsteer.com • www.selfsteer.com

Call me to help make your journey smoother.
As a cruiser, I understand investments and asset management for the cruising lifestyle. See you at the Baja Ha Ha 2005 (KD7YID s/v Duetto)
Stuart Kaplan, CMFC, Sr VP-Investments
800 754-0692 or stuart.i.kaplan@pjc.com.

5/05 PC-05-0660 **PiperJaffray®**



Not just a marina – a cruiser's community
Your best destination across the Sea...
www.marina-mazatlan.com
011-52 (669) 916-7799
antonio@marina-mazatlan.com

San Diego **MAIL CALL** Multilingual
CRUISER'S HOMEPORT

Worldwide forwarding
(619) 222-1186
Fax: (619) 222-1185
e-mail: mailcall1@earthlink.net

OPEQUIMAR
MARINE CENTER CENTRO MARINO

A Full Service Boat Yard in Puerto Vallarta
88 ton Travelift • Parts • Service • Repairs
011-52 (322) 221-1800 www.opequimar.com
gustavo@opequimar.com

*'lectronic
Latitude* Official Electronic Host
We Go Where
the Wind Blows

See *'lectronic Latitude* at
www.latitude38.com

JOIN THE FUN!



The Rally Committee encourages you to patronize the advertisers who make this event possible.

OFFICIAL SAILMAKER



Builders of the world's lightest, fastest and most durable cruising sails.

www.northsails.com

San Francisco • San Diego

Ventura Harbor Boatyard

Full & Self Service Facility
www.venturaharborboatyard.com
(805) 654-1433

NEW! Fuel Dock: Diesel & Biodiesel

Swiss Tech America

Unique and innovative products for the blue water sailor!

(408) 298-7682

Fax (408) 298-0559
 email: gglamb@att.net
www.swisstech-america.com

TOTAL YACHT SERVICES

Yanmar Parts & Service
 Complete Marine Repair

Serving the West Coast of Mexico
totallyachtsvcs@aol.com

011-52 (669) 117-0911 (from US/Canada)
 044 (669) 932-8767 (Local - Mazatlan)



FULL SERVICE MARINA

New breakwater • New docks

Tel: 011-52 (612) 122-1646
 Fax: 011-52 (612) 125-5900
 email: marinalapaz@prodigy.net.mx
www.marinadelapaz.com



MAKING WATER DRINKING WATER

12-volt and 24-volt watermakers

(800) 787-1069

marine@katadyn.com

MARINER'S GENERAL INSURANCE

Cruise with Confidence
 43 Years of Reliable Marine Insurance for Cruisers

(800) 992-4443

see our half-page ad this issue

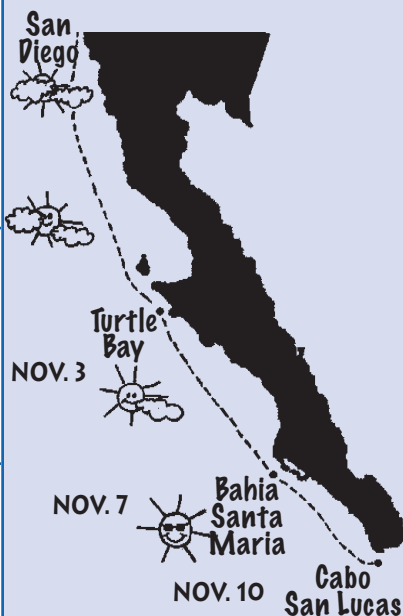
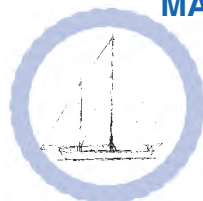

IMPORTANT DATES

- Sep 10 — Entry deadline.
- Oct 5 — Mexico Only Crew List and Baja Ha-Ha Party, Encinal YC; 6-9 p.m.
- Oct 30 — Skipper's meeting, noon, at Cabrillo Isle Marina, San Diego.
- Oct 30 — Baja Ha-Ha Halloween Costume Party and barbecue at Cabrillo Isle; co-hosted by West Marine.
- Oct 31 — Start of Leg 1
- Nov 12 — Awards presentations hosted by the Cabo Marina.

Baja Ha-Ha Inc.

21 Apollo Road
 Tiburon, CA 94920
www.baja-haha.com

There is no phone number for the Baja Ha-Ha. And please don't phone *Latitude 38* with questions, as the Ha-Ha is a completely separate operation.



Mexico Cruising Insurance Bluewater Insurance

(800) 655-9224 • (619) 226-6702

Fax: (619) 226-8513
 Mexico full or part-time • Crew of two
www.bluewaterins.com



THE CRUISER'S CHANDLERY

www.downwindmarine.com
downwind@attglobal.net

(619) 224-2733 • Fax (619) 224-7683

The southbound cruiser's source for **EVERYTHING!** Watch for our fall cruising seminar schedule.



water & power, inc.
 CALL US about Watermakers, Generators, Combos or Diesel Re-power, we will design and install a system to meet your needs in time for the BAJA HA HA.

sales@watermakerstore.com • www.watermakerstore.com

619-226-2622
 1273 Scott St., S.D.
 (Shelter Island)



yachtfinders@earthlink.net • www.yachtfinders.biz

(619) 224-2349 Fax (619) 224-4692

Professional yacht brokers specializing in offshore cruising monohull and multihull sailboats.



The best weather comes from OCENS

Contact your local marine electronics dealer or OCENS at

(800) 746-1462

www.ocens.com



We make boating more fun!

Call 1-800-BOATING

(1-800-262-8464)

for a catalog or the store nearest you.

WHALE POINT MARINE & HARDWARE CO.

A FAMILY OWNED & OPERATED BUSINESS FOR THREE GENERATIONS
ACE Hardware
MARINE PARTS & ACCESSORIES, PLUS A COMPLETE HARDWARE STORE

"DISCOUNT PRICES WITHOUT THE ATTITUDE"

WALKER 8'-10' Dinghy

Very affordable. Converts from row boat to sailboat to motorboat. Polypropylene hull. Comes with oars. Sail kit optional.



10' Dinghy: **\$899⁰⁰**

8' Special \$599⁰⁰

Z-SPAR PETIT Flagship Varnish

Highest UV protection available. Quart



Pint: List \$27¹⁵
Now \$16⁹⁵
 Quart: List \$44⁰⁰
Now \$24⁹⁹

FORCE 10 3 Burner Propane Stove

FORCE 10

Model 63351 West \$1399
Whale Pt \$1199⁰⁰
 Model 63251: 2-burners: West \$1349
Whale Pt \$1099⁰⁰



FORESPAR Mini-Galley

NOW \$119⁹⁵

Mini-Galley comes with timble cocking frame, perfect for any boat and uses standard propane cylinders.



PORTABLE HEATER Mr Heater

Indoor safe propane heater.



9,000 BTU: **NOW \$99⁹⁹**

TEMPO OIL CHANGER

5 qt container, self-priming pump, 3 sizes of hose to fit your dipstick!



NOW \$49⁹⁹

SOSPENDERS Inflatable Safety Harness

Manual inflate **\$169⁹⁹**
 Auto inflate **\$189⁹⁹**



Buy 2 • **SAVE \$10 EACH**
 Buy 4 • **SAVE \$20 EACH**
 Lanyards sold separate

S.S. BOW ROLLERS



Model Size List **NOW**
 44440 ... 3"x30" ... \$200 ... **\$159⁹⁹**
 44441 ... 3"x24" ... \$180 ... **\$109⁹⁹**
 44443 ... 2"x15" ... \$80 ... **\$49⁹⁹**
 44444 ... 2"x20" ... \$45 ... **\$32⁹⁹**

205 Cutting Blvd, Corner of 2nd, Richmond 510-233-1988 • FAX 233-1989

Mon-Fri: 8:30am - 5pm • Sat: 9am - 5pm • Sun: 10am - 4pm

www.aceretailer.com/whalepoint • Email: whalepoint@acehardware.com

CALENDAR

Jan. 16-20 — 19th Key West Race Week, the best regatta in the country. Info, www.premiere-racing.com.

Remaining Beer Can Races

BAY VIEW BC — Monday Night Madness, Fall Series: 9/5, 9/19, 9/26. John, (415) 664-0490.

BENICIA YC — Every Thursday night through 10/6. Joe Marra, (707) 746-6600.

BERKELEY YC — Every Friday night up to 9/30. Paul Kamen, (510) 540-7968.

COYOTE POINT YC — Every Wednesday night through 10/26. Jennifer Neumann, (650) 638-9496.

ENCINAL YC — Friday Nights, Summer Series: 9/16, 9/30. Tony Shaffer, (510) 522-6437.

FOLSOM LAKE YC — Every Wednesday night until 9/28. John Poimiroo, john@poimiroo.com.

FREMONT SC — Hot Dog Series: 9/11, 10/2. Chuck, (408) 263-5690.

ISLAND YC — Friday Nights: 9/9, 9/23. Joanne McFee, (925) 254-5384.

LAKE TAHOE WINDJAMMERS YC — Every Wednesday night through 10/26. Kurt Rasmussen, (530) 541-1129.

MONTEREY PENINSULA YC — Sunset Series, every Wednesday night through 9/28. Ron, (831) 626-9169.

OAKLAND YC — Sweet 16 Midweek Series. Wednesday Nights through 9/14. Ted, (510) 769-1414.

RICHMOND YC — Wednesday Nights: 8/31, 9/21. Eric Arens, (510) 841-6022.

SANTA CRUZ YC — Wet Wednesdays throughout Daylight Saving Time. Larry, (831) 423-8111, lweaver@cruzio.com.

SAUSALITO YC — Tuesday Nights. Summer Sunset Series: 9/6, 9/20. George Shea, (415) 999-9358.

SEQUOIA YC — Every Wednesday night through 10/12. Charlie Watt, (650) 361-9472.

VALLEJO YC — Every Wednesday night through 9/28. Gary Cicerello, (707) 643-1254.

Please send your calendar items by the 10th of the month to *Latitude 38* (Attn: *Calendar*), 15 Locust Avenue, Mill Valley, CA, 94941. Better yet, fax them to us at (415) 383-5816 or email them to rob@latitude38.com. But please, no phone-ins! *Calendar* listings are for marine-related events that are either free or don't cost much to attend. The *Calendar* is not meant to support commercial enterprise.

September Weekend Currents

date/day	slack	max	slack	max
9/03Sat	0131	0438/4.2E	0829	1127/3.4F
	1433	1703/2.8E	2027	2317/2.9F
9/04Sun	0211	0512/4.1E	0857	1150/3.4F
	1459	1734/3.2E	2102	2352/3.0F
9/05Mon	0251	0547/3.9E	0923	1216/3.2F
	1524	1809/3.5E	2137	
9/10Sat	0044	0344/2.5F	0718	0930/1.7E
	1203	1527/1.8F	1804	2153/3.8E
9/11Sun	0155	0455/2.4F	0837	1033/1.3E
	1308	1631/1.6F	1906	2256/3.9E
9/17Sat	0053	0359/5.0E	0743	1042/4.2F
	1348	1629/3.9E	1953	2249/4.0F
9/18Sun	0149	0447/4.8E	0825	1120/4.2F
	1423	1712/4.4E	2041	2339/4.2F
9/24Sat	0112	0420/2.7F	0746	0942/1.3E
	1308	1547/1.5F	1829	2156/3.5E
9/25Sun	0221	0539/2.5F	0857	1054/1.0E
	1425	1658/1.3F	1936	2301/3.2E

Now, the Only **Summer** Boat Show in the N.W.

BOATS AFLOAT SHOW



SAILFEST NORTHWEST
3RD ANNUAL SAILING SHOWCASE

- Free Seminars
- Free Sailboat Rides



SEPTEMBER 14-18

LAKE UNION

NEW & USED
POWER & SAIL

SEATTLE, WA

FISHING, RUNABOUTS & INFLATABLES
TRAILER BOATS TO LARGE YACHTS

WEEKDAYS: 11 AM-6 PM • WEEKENDS: 10 AM-6 PM

E-TICKETS
EXPANDED VENUE
DISCOUNTED PARKING
FREE SHUTTLE
GREAT GIVEAWAYS
GO TO...

Produced by



Supported by



Presented by

Sea

WWW.BOATSAFLOATSHOW.COM

Continuing the Tradition

We build custom sails
to suit your needs,
your boat, your plans.

CALL
ABOUT OUR
FALL
10-20%
DISCOUNT



Keep cruising with
HOGIN SAILS



Cruising Sails
High Tech Sails • Racing Sails
Repairs • Recuts

Making Sails Since 1979

In the Alameda Marina at
1801-D Clement Ave., Alameda, CA 94501

510.523.4388

Mon-Fri 8:30am to 5pm
Saturday by appointment only

sales@hoginsails.com
service@hoginsails.com
www.hoginsails.com

100%
Manufactured
in
Alameda,
CA

LETTERS

↑↓PART OF THE RICHMOND BRIDGE ALMOST HIT US!

Would you like to hear about a piece of the Richmond - San Rafael Bridge that fell and came within 30 feet of hitting our boat on the afternoon of July 19? It seemed big and heavy enough to possibly have sunk our boat. Whatever it was had been severed from the bridge by a bridge worker in a trolley working under the bridge but over the water. We suppose we should have called someone, but we didn't. We would like to find out what it was, because it looked pretty important.

Gary Storms
Skipper of *Fresh Air*, Catalina 30
San Leandro

Readers — A couple of weeks after we received this letter, we got a call from the Cal Trans supervisor of the paint crew that had been working on the Richmond Bridge that afternoon. He explained that there had been a "minor accident" on the bridge that resulted in a Racon navigation unit falling into the water. Racon units are mounted on all the bridges in the Bay Area as aids to ship navigation — and are expensive.

Anyway, the Cal Trans supervisor said that a sailboat reportedly circled the unit a couple of times, and one of the



Part of this bridge almost fell on our boat!

paint crew thought they might have even hauled the Racon unit onto their boat. Alas, the paint crew couldn't see the name of the boat or provide a more precise description of the vessel other than "a big sailboat." By the time the Coast Guard arrived, the sailboat was long gone.

Recognizing our civic duty, we put the Cal Trans paint supervisor in touch with Gary Storms, who presumably passed along the unfortunate news that the Racon unit was now on the bottom of the Bay.

↑↓A WOMAN'S 12-YEAR CIRCUMNAVIGATION

Would you please add my name to your list of West Coast circumnavigators? Although I live in Vancouver, B.C. I began my circumnavigation in Golfito, Costa Rica in March of '93, and returned to Golfito in April of this year. During the circumnavigation, I sailed to 61 countries and visited 19 others by land. It was truly a fantastic experience, and I enjoyed every minute of it. Well, almost every minute of it!

I want to thank the 16 wonderful crewmembers who helped me during various legs of the trip around. And I want to say a very special thank you to my long-suffering husband, who put up with my absences, did most of the boat maintenance, and crewed for a lot of the coastal sailing.

P.S. I've enjoyed copies of *Latitude* whenever I can get them, as they are fun to read and informative.

Gillian West, Captain
Khamsin
Vancouver, B.C.

Gillian — Congratulations on your achievement. Of course, we'll be happy to add your name to the list — but we would need to know what kind of boat Khamsin is. Our West Coast Circumnavigator's list is ongoing, so if anybody completes a



The **NEW Swan 46**. A bluewater yacht that is uncompromised in its style, outstanding interior arrangement and the ability to provide the ultimate cruising experience. A yacht of unrivalled quality, excellent craftsmanship with a beautiful interior.



The **NEW Swan 53**. Built for comfort, her hull shape is voluminous. With three spacious and luxurious cabins, she is able to accommodate up to eight people and yet she is easily managed with just two aboard.



Swan 46 Purchased new in 1986 by current owner. Extensive upgrades were completed in 2004, including new rod rigging and electronics. She shows the care and attention of a long term owner.



Swan 60 Privateer Sail around the world in comfort. Equipped with countless added features and a stunning interior. Asking **\$1,975,000**



Swan 41 Beautiful S&S design. New teak decks, extensive inventory and ready to cruise. Asking **\$139,000**



SWAN CLASS 601 Care to Join Us?

Possibly you've always admired the look of a Swan. When you were aboard one for the first time, something struck you. Was it the craftsmanship, performance, or just the experience itself?

Racing may be in your blood, but no matter what, she needs to be sweet at the helm, regardless of how she looks.

Performance is important, as is comfort. For you, sailing is more than drinking beer with the crew after a race, but spending time aboard with your family and friends.

Owning a dual purpose yacht has been a dream of yours, but so far no one has built the 'perfect yacht'.

Welcome aboard the new Swan 601. See your dream come true. The West Coast Fleet has begun. Care to join us?



Owner's Stateroom

Racing Mode



Cruising Mode



Swan 48 The most advanced and complete Swan 48 in the world. Numerous upgrades, including a new carbon fiber mast with carbon fiber Leisure Furl self-furling boom. New electric Andersen stainless steel winches and a custom aft stateroom, custom steering pod and instruments.



Swan 44 NautiDreams is an excellent example of this highly successful design and has proven herself yet again with a recent sail from San Francisco to Australia and back.

**HONDA
MARINE**

**& caribe
INFLATABLES**

IT'S ALL ABOUT POWER.



Caribe Light RIB combined with Honda 4 Strokes give you the best value on the market. Hypalon/Neoprene construction.

Light 8'	105 lbs.	\$2,031 Sale
Light 9'	110 lbs.	2,167 Sale
Light 10'	116 lbs.	2,541 Sale
Light 11'	138 lbs.	2,711 Sale



**HONDA
MARINE**

IT'S ALL ABOUT POWER.

For optimum performance and safety, read the Owner's Manual before operating your Honda Marine product. Always wear a personal flotation device while boating.

Voyager Marine

1296 State St.
P.O. Box 246, Alviso, CA 95002-0246
(408) 263-7633 • (800) 700-7633
Open Tuesday thru Saturday



- Collapsible tenders from 7 ft. to 18 ft.
- 100% Hypalon
- New inflatable floor models:

LSI 88	\$1,496 Sale
LSI 96	1,607 Sale
LSI 104	1,699 Sale



Powered by



5 HP Tohatsu \$1,149 Sale
6 HP Tohatsu \$1,229 Sale

Voyager Marine

1296 State St.
P.O. Box 246, Alviso, CA 95002-0246
(408) 263-7633 • (800) 700-7633
Open Tuesday thru Saturday



LETTERS

circumnavigation, we'd love to know about it.

↑↓ ONLY AS STRONG AS THE WEAKEST LINK . . .

Less than five years ago, we purchased what appeared to be a beautiful — but not so inexpensive — universal anchor swivel by 'XYZ' Stainless from our local chandlery. Since then, we've used the anchor swivel about 25 times, but never in strong winds.

While recently doing a casual survey of the bow of our boat, I noticed — with a bit of shock — a hairline crack in the swivel, right where the nut and anchor shank connect! Glad to have noticed the crack while at the dock — rather than discovering our boat drifting around an anchorage and into other boats — I placed a call to 'XYZ' Stainless to inform them of the unexpected problem. There was only an answering machine, so I had to leave a message.

After three weeks of not being called back by 'XYZ', I called again, as I was about to take the boat out again. Once connected with an employee, I explained the failure of the critical part. He paused and then said, "Unfortunately, there is only a one year guarantee on that part."

"Is that the best you can do?" I replied.

"Unfortunately, yes," he said.

If that's the best that 'XYZ' Stainless can do, then I plan to do better — short of a recall. I certainly expected a different



It turns out the company accused of producing this defective product had nothing to do with making it.

response/interest/concern from 'XYZ'! I work in the health care field and would never dream of shrugging off any concerns

that my patient voiced in such a casual "I'm-not-responsible-nor-concerned" manner.

The chandlery we purchased the swivel from said they no longer carry the product because of similar customer complaints. In fact, one skipper who berths his boat in our marina lost his anchor because the swivel broke.

The attached picture is a view of said item after we removed the shackle from the swivel and its frozen nut. I must admit that I loved the looks of the universal swivel — but not enough to place us, our vessel, or anybody else in jeopardy.

An Unhappy Consumer

Readers — We've changed the name of the company in the letter for reasons you'll soon understand, and of the author, to eliminate what we expect would be embarrassment. Here's the response of the president of the company to the unhappy consumer:

"We acknowledge receipt of your letter, but take great exception to the views expressed in it, as well as in your conclusions. The photo that purports to show a Suncor Stainless Swivel (S0190-X013), clearly depicts the opposite: a very poor copy of our patent pending anchor swivel! We have seen these copies before, as they are or were marketed by several importers in the USA and are widely available. In contrast to the very poor quality anchor swivel shown in the photo, Suncor's swivel is made from 17-4PH material, that is superior in strength to the (probably) 304 stainless used in the copy. This selection of material combined with far superior manufacturing techniques result in a Breaking Load of 15,000 lb for that size swivel, obviously far in excess of what the copy swivel could withstand.



BayRisk Insurance Brokers, Inc.

800-647-2025

Visit our Website www.bayrisk.com

1920 Minturn Street • Alameda, CA 94501



IN THE HEART OF THE ALAMEDA ESTUARY!

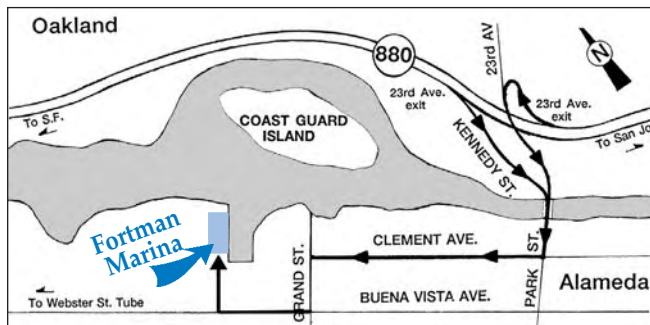

- Sheltered Alameda Location
- Competitive Rates
- Home of the Alameda Yacht Club

1535 Buena Vista Ave., Alameda, California
(510) 522-9080

For directions and rates go to:
www.fortman.com

LETTERS

"Furthermore you have accused us of having a 'one year warranty'. Again you are completely wrong with that! All our printed catalogs (on every single page!) and marketing material are clearly marked with 'Lifetime Warranty'. What you, in effect, have attempted, is to make Suncor cover a warranty for a product not produced by us.

"You could have clearly found out from our catalog or the Internet website that the Suncor swivel is materially different from what you have on your boat, but it appears to us that you did not take this very basic precaution to ensure that your story is correct in every respect."

↑↓NEGLECT OF ALA WAI REACHES TRAGIC STATE

[Editor's note: The following letter was first published in the Honolulu Advertiser and then sent to other sailing publications.]

I've been sailing across the Pacific on the TransPac Yacht Race to Honolulu since 1975. In fact, I haven't missed a race since. And I have always been a huge supporter of the race, and especially of the wondrous welcoming aloha from everyone in Hawaii to each of the competing boats as they arrive — no matter the time of day and night — at the Diamond Head finish line and Ala Wai Yacht Harbor.

And what welcomes they were! There were host families for every boat who provided mai-tais, pupus, and endless warm hospitality. And the boats were berthed in a line, in order of finish, along 'TransPac Row'. The socializing and the spirit of aloha were endless, and inevitably lured us back for the next race and the next great experience.

But what has happened to the Ala Wai Yacht Harbor? It seems to be vanishing before our very eyes! This year there was no TransPac Row. In fact, when the sailors on this year's near-record 75 boats arrived at the Ala Wai at the end of the 100th anniversary of the first race, they found that the Ala Wai had gone to seed. Some docks were condemned, and others were falling apart. For the first time, there wasn't enough room for all the arriving race boats, so they wound up having to raft in bunches. It's not the most pleasant way to berth at the end of a 2,200-mile race.

It's a sad state of affairs that the great state of Hawaii has let the single most important and prestigious marina in the North Pacific decline to such an inglorious state. What could be a great tourist draw, what could be a source of pride for all Hawaiians, what could be another feather in its crown, what could bring meaningful tourist dollars to Honolulu and to Hawaii, has been neglected to the point of tragedy.

I write as one who knows the state more than a little. I first came to the Hawaiian paradise in 1939, and always returned out of love. Sometimes I came back as a tourist, sometimes as a businessman, as the owner of a local television outlet for many years, and, of course, as a competitor in the TransPac. It pains me greatly that the government has been so remiss in recognizing the importance of the Ala Wai. I'm very much afraid that if the harbor is left to deteriorate further still, Hawaii will be diminished, and the world-renowned TransPac Race, initiated by King Kalakaua, will suffer. We would all be the poorer for it.

Please, for all of us — visiting sailors, local sailors, and all the proud citizens of Hawaii — fix the Ala Wai!!!

Roy E. Disney
Skipper of *Pyewacket*, MaxZ86
Los Angeles

Readers — Regular readers of Latitude know that we've been ranting about the shameful decline of the Ala Wai Yacht



"My watch stopped just before the start."
"My brother-in-law forgot to cleat the guy."
"We can't point with our Light No. 1."
"I didn't know they changed the course."
"We can't point with our Heavy No 1."
"The reaching mark must have drifted."
"I bent my mast on the hoist."
"My brother-in-law tore the chute."
"The guy forgot to clean our bottom this week."
"We got out of phase on the fourth leg."
"Our main looks a little funny after that recut."
"My brother-in-law had a hangover."
"Ever since I hit that rock we can't go upwind."
"We had weed on our rudder."
"My brother-in-law was steering."

It's time.



If making excuses is starting to wear thin, now is the time to put some North performance, durability and *confidence* on your boat. The timing couldn't be better, because your North representative is offering special end-of-season savings on the world's fastest sails. Call today... and put your team on the fast track.



Faster by Design

San Francisco Bay 510-522-5373

San Diego 619-224-2424

Long Beach 562-795-5488

Channel Islands 805-984-8100

Marina Del Rey 310-827-8888

Santa Barbara 805-965-4538

www.northsails.com

WET DECKS are no longer the enemy

Sailors are particular when selecting gear for their boats. On a wet, rolling deck there is no time to question the equipment. That's why sailors choose Harken—not just for blocks and winches, but for critical gear like shoes.

Two styles that look great and grip in any kind of weather.

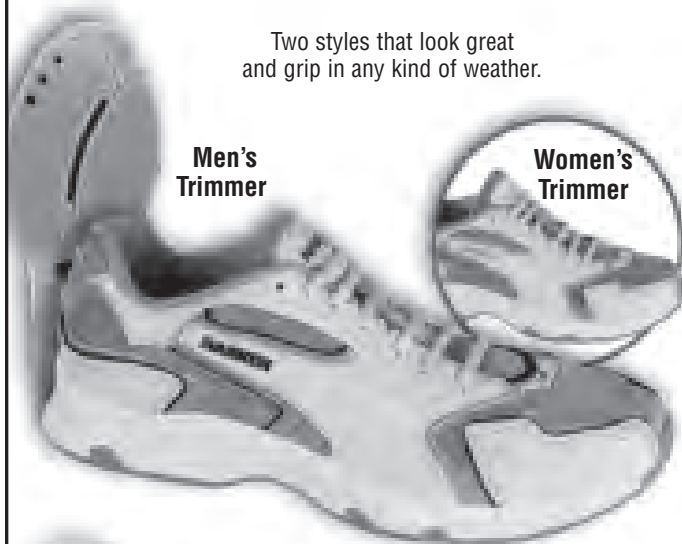

Men's
Trimmer

Women's
Trimmer

Soles designed for superior traction and support
Quick-dry materials and anti-microbial sock liner

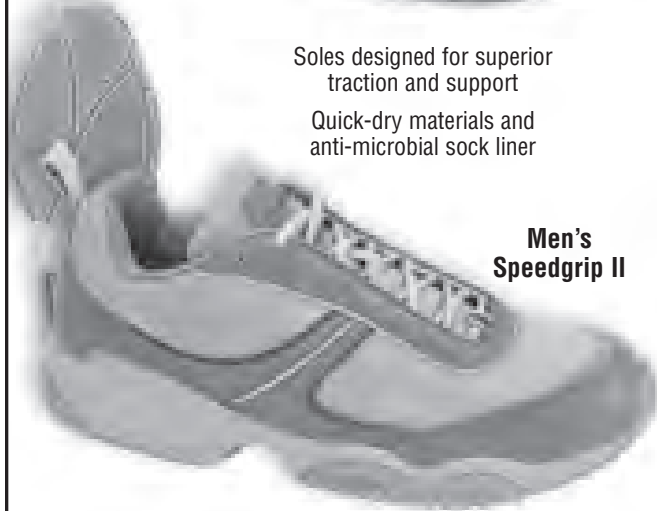

Men's
Speedgrip II

Also available:
Beachcomber Sandals

Blister-free neoprene padding
Supportive EVA midsole
Quick-drying



SAILING GEAR

www.harkensailinggear.com • 262-691-3320

LETTERS

Harbor for years. Sometimes government-owned marinas are well run, but often they aren't. For whatever reason, the Ala Wai is the worst-run major marina we've seen anywhere in the world — and it's been deteriorating at an ever-increasing rate in recent years.

The Ala Wai could and should be the gem marina of the Pacific. The yacht harbor area could be a great facility not just for sailors, but also surfers, kayakers, fishermen — and just about everyone else who has an interest in ocean access. And it should be able to pay for itself. But under current state mismanagement, the Ala Wai minimizes rather than maximizes ocean access for both residents and visitors. It's an outrage.

For decades now, the state has proven it's been unable to even break even with the harbor despite having a monopoly on a much-wanted commodity. As such, they should get out of the harbor management business by accepting the best bid to have the harbor renovated and managed by a private concern. But as you'll read in the letter after the next, the state's harbor blundering hasn't been limited to the Ala Wai.

We made numerous attempts to get a comment from the Department of Land and Natural Resources, which is in charge of the small harbors, but were unsuccessful. But even that process was a revelation. Of all the people we talked to in search of a comment, only one of them sounded as if they had a pulse. Several others were either "on vacation," "not working that day," didn't answer the phone, or put us on hold for an eternity. We hadn't experienced such bureaucratic apathy since we visited Cuba 10 years ago.

↑↓ ALA WAI'S WOES SIMILAR TO OTHERS

Mr. Disney's comments regarding the conditions at Ala Wai Yacht Harbor are indeed tragic, but far from unique. There are other marinas — such as the San Francisco Municipal Harbor — that are in similar disrepair. A common thread is that they are both owned and managed by the public sector.

The government owns many assets, from parking garages to golf courses, which are managed by concessionaires. These companies are experts in their field and offer us, the taxpayers, the highest return on *our* investment. In addition, these companies are held responsible for properly maintaining and insuring *our* property.

Unlike private marinas, government marinas don't carry insurance, so they have little worry about ever-increasing insurance premiums. More to the point, there's even less regard for getting tied up in litigation due to their negligence. If someone falls through a dilapidated dock, too bad, just get in line with all the other folks who are suing the government — and who must be prepared for a long battle. While government-owned marinas don't spend much money on dock maintenance, they seem to have plenty of funding for the attorneys. In fact, the attorneys are already on the payroll.

I applaud Mr. Disney's plea for the repair of the Ala Wai, yet I fear that until there's a wholesale change in how this and other similar marinas are managed, history will only repeat itself. The taxpayers will fund the repairs, the marina will deteriorate again, and so on.

Finally, if you're in the marine industry, you know the sport can't survive without attractive, safe, and functional marinas that can be enjoyed by all participants. If you do not make your voice heard on this issue, it will only serve to accelerate the decline of our sport.

Paul Kaplan
Keefe Kaplan Maritime, Inc.
Richmond



**34th Annual NORTHERN CALIFORNIA
FALL BOAT SHOW**

*Jack London Square
Port of Oakland*

September 10-18

**Weekdays: Noon-6
Weekends: 10:00-6
Adults: \$10 Kids: \$5
Under 6 FREE!**



**Last
Big Show
of the Season!**

**Bring this coupon for
\$2.00 OFF** adult admission

NORTHERN CALIFORNIA FALL BOAT SHOW '05
Jack London Square Port of Oakland

www.ncma.com

1(800) 698-5777

L-38

What's Right for You?

The J/124...



The J/124 is the next generation of high performance 40-ft one design racers built for competitive fleet racing. With an eye towards speed and close quarters racing, the J/124 offers more opportunity than any previous 40-ft design. With strict one design rules and class management, the J/124 will offer an unbeatable fleet at a very manageable price.

...or J/100

Our spring show boat is RED and ready to deliver to you now. See, sail and enjoy the new J/100 with Sail California. New boats are now sailing the Bay and the local fleet is rapidly growing thanks to the nationwide success of this stylish, high performance vessel. As *Sailing World's* boat tester Chuck Allen relayed, "It was entertaining to hear out-of-towners try to figure out what kind of boat it was...then someone finally said 'It's the new J/100'. All I heard was WOW." Asking \$135,000.



The performance comes standard – you just choose the boat.

SAIL California

Web Site:
www.sailcal.com
Email: info@sailcal.com

SAN DIEGO
(619) 224-6200
FAX (619) 224-6278

NEWPORT BEACH
(949) 675-8053
FAX (949) 675-0584

ALAMEDA
(510) 523-8500
FAX (510) 522-0641

LETTERS

↑↓NOTHING WOULD GET DONE WITHOUT THE FEDS

I've just read the August issue letter about the deteriorating condition of the Ala Wai Harbor in Honolulu. Well, I have an update about the state-run, 389-berth, Keehi Small Boat Harbor down by the airport.

I've recently seen changes for the better at Keehi. For instance, during the past month they have cleaned up the parking lot by getting rid of derelict vehicles, drug dealers and homeless people. So now it's easy to find a place to park. I have also noticed that quite a few of the old boats are gone and that more slips seem to be available. There are also boats with notices posted on them notifying the owner that he/she is behind in slip fees. So maybe some of those boats will be gone before long, too.

I have also seen Conservation Officers and the Sheriff deputies patrolling the parking lots in the evenings, sometimes with two officers in each vehicle. At one time the 700 Dock gate had been jammed so it couldn't be locked, allowing anybody and everybody access to the docks all night long. I'm told a lot of people who weren't slipholders used that access. The gate can now be locked.

Last month I noticed that renovations had started on the restrooms, and that new cement was being laid in the area of the phone booths. So now you won't have to stand in the mud while making a phone call.

Yesterday, I received a letter from the state saying that some of the repairs to Keehi are federally mandated for the handicapped, so walkways are being widened, parking set aside for the handicapped, and other things of that nature.

The really good news is that today I noticed that they were repairing some of the broken wooden planks on the docks.

I remember reading an article in a local newspaper last year about the poor condition of the harbors. It said that most slipholders wouldn't mind an increase in slip fees as long as the fees went back into the harbor for maintenance rather than being siphoned off for other state projects. The really sad part is that, according to a financial report, it seems the Harbors budget was cut some time ago, so I don't really expect that we'll ever get back the docks that were declared unsafe and torn down. So if we ever decide to liveaboard full time, we'll have to move into a private marina.

Tony (last name withheld)
Honolulu, Hawaii

Tony — Nobody should get their hopes up for Keehi — or any other state marina in Hawaii — because the situation is actually worse than you make it seem. Keehi Harbor Agent Kenneth Chee told Latitude that none of the improvements are being done voluntarily by the state of Hawaii, but are actually being done under threat of fines by the feds so that the facilities come into compliance with the Americans with Disabilities Act. All the money for the work, by the way, is coming from the feds — your and our tax money — because Hawaii isn't chipping in anything.

With Keehi having been overshadowed by the catastrophe that is the Ala Wai Yacht Harbor, we didn't realize how bad things were there too. Chee tells us that half of the slips on 200 dock have been condemned, all of the slips on the 100 dock are down, and there are nothing but pilings left at what once was the 600 dock. The bottom line is about 100 of the original 389 slips — or nearly 25% of the harbor — are unusable and therefore don't generate any badly needed revenue!

Of course, it's not as if these slips would generate much revenue anyway, as the slip rate — despite a 50-boat waiting list — is a ridiculous \$3.50/ft/month! This means that Hawaii,

SAIL *California*

Performance Yachts



BY APPOINTMENT

**Elliott 46
Bravado**
All the comforts of a
multihull with the
sailing performance of
a monohull.
Asking \$375,000

**Wauquiez
Centurion 45s, 2003
Angelline**

An elegant yacht:
style, grace and loads
of equipment.
**Reduced
Asking \$399,000**



NOW IN ALAMEDA

SISTERSHIP

**C&C 99, 2001
North Star**
Excellent for racing or
cruising. Priced to sell.
Asking \$110,000



NEW LISTING



**Beneteau 36.7, 2003
Summer & Smoke**
Racing or cruising,
what is your pleasure?
Summer & Smoke will give
you what you wish.
Reduced! \$139,500

SISTERSHIP



IN SAN DIEGO

NEW LISTING

J/100, 2005
A modern 33-footer,
aimed at daysailing.
\$155,000.



IN SAN DIEGO

NEW LISTING

J/109, 2003 Conundrum
Impeccably maintained and
ready to race or cruise.
\$227,000.



IN SAN DIEGO

MASON 44, 1998 Ciao Bella
This boat is very clean, ready to go and has
all of the options. The owner has spared no
expense when outfitting this boat. **\$310,000.**



IN SAN DIEGO

REDUCED

SAGA 43, 2002 Windshear
Comfortable shorthanded sailing and
comfortable cruising without compromising
performance or quality. **\$275,000.**

MARINA VILLAGE OPEN BOAT WEEKEND • SEPTEMBER 10 & 11

53' J/160, '02, *La Aventura**..... 899,000
46' Elliott Tourer (14m), '97, *Bravado* 375,000
45' Wauquiez Centurion 45s, *Angelline*..... Reduced 399,000
44' Mason, '98, *Cia Bella**..... Reduced 300,000
43' Mason ketch, '81, *Tiramisu**..... 112,000
43' Saga, '02, *Wind Shear**..... Reduced 275,000
43' Tiara, '00, *Rascal**..... 479,000
42' J/42, '99, *Fine-a-lee**..... 309,000
42' Moody, '01, *Jezebel***..... Reduced 275,000
42' Baltic, '81, *Setanta*..... Pending 114,000
40' J/120, '93 New Listing 198,000
40' J/120, '02, *Snaps**..... Pending 245,000
40' Farr, '86, *Rascal***..... 149,500
40' Wilderness 40, '87, *Falcon**..... Reduced 46,000
38' Morgan, '93, *Bonnie Lassie**..... SOLD 105,000
37' J/37, '87, *Kalimotxo**..... 60,000
36' J/36, '81, *Impetuous***..... 55,000
36' Islander, '77, *Altair* Pending 42,000

36' Beneteau 36.7, '02, *Summer & Smoke*... Reduced 139,500
35' J/109, '03, *Conundrum**..... New Listing 227,000
35' J/109, '03, hull #44, *Traveller***..... 239,000
35' J/105, '00, *Nirvana*..... New Listing 119,000
35' J/105, '01 *Trickster**..... 119,000
35' J/105, '00, *Despicable**..... 118,000
35' J/105, '00, *Pendragon**..... 127,000
35' J/35, '93, hull #323, *Raptor*..... Reduced 64,500
35' J/35, '92, *Amakua**..... SOLD 69,000
35' J/35, '84, *Cheers**..... 35,000
35' J/35, '84, *Uncle Bill***..... 49,500
35' J/35, '85, *Fast Feather***..... 54,900
35' J/35, '85, *Shaken Not Stirred***..... Reduced 45,000
35' Schock, '85, *Rivalry***..... 34,000
35' Cal MkII, '80, *Calliope***..... 45,500
35' Santana, '79, *Spirit of Bombay*..... Reduced 22,500
35' Cooper Prawler, '90, *Vida En Agua**..... 75,000
34' Express, '87, *Yeofy*..... Pending 65,000

34' Sabreline, '01 New Listing 289,000
33' J/100, '05*..... New Listing 155,000
33' J/33, '89, *Phase Loc***..... 54,500
33' Aphrodite 101, '78**..... New Listing 25,000
32' J/32, '02, *Loon**..... 168,000
32' C&C 99, '02, *North Star*..... New Listing 110,000
30' J/30, '79, *Circe***..... New Listing 21,000
30' J/30, '79, *Garuda***..... 29,900
30' J/92, '92, hull #10, *Triple Dog Dare***..... Reduced 53,500
29' J/29, '81, *Macs**..... New Listing 26,900
29' J/29, '84, *Zulu**..... 25,000
26' J/80, '01, *Running with Scissors**..... SOLD 30,000
23' Boston Whaler Conquest, '01 Reduced 49,500
22' J/22, *Joy Ride*..... 12,000

* Indicates Southern California Boats
** Indicates Pacific Northwest Boats

J
Net

YACHTWORLD.COM

SAIL *California*

Web Site: www.sailcal.com
Email: info@sailcal.com

SAN DIEGO
2330 Shelter Island Drive
#106
San Diego, CA 92106
(619) 224-6200
FAX (619) 224-6278

NEWPORT BEACH
251 Shipyard Way
Cabin A
Newport Beach, CA 92663
(949) 675-8053
FAX (949) 675-0584

ALAMEDA
1070 Marina Village Pkwy
#108
Alameda, CA 94501
(510) 523-8500
FAX (510) 522-0641



ORDER NOW
for delivery in Jan. '06!



Back Cove 29

Now at Our Sales Dock!



Back Cove 26

The Back Cove is the ultimate luxury tender. A sailor's powerboat, the Back Cove 29 and 26 are elegantly styled and meticulously crafted. Crafted in Maine, her Down East styling with traditional spoon bow and sloped transom turns heads wherever she goes. Call now to inquire on available delivery.

SAIL California

Web Site:
www.sailcal.com
Email: info@sailcal.com

NEWPORT BEACH

251 Shipyard Way
Cabin A
Newport Beach, CA 92663
(949) 675-8053
FAX (949) 675-0584

ALAMEDA

1070 Marina Village Pkwy
#108
Alameda, CA 94501
(510) 523-8500
FAX (510) 522-0641

LETTERS

which has just about the highest cost of living of any state in the Union, has about the lowest slip fees for state-run marinas. Heck, slip fees are even higher at the five marinas on the Rio Dulce in impoverished Guatemala!

Here's the thing that we've never been able to figure out about state legislators in Hawaii: Are they too dumb to recognize that there is a correlation between the amount of money charged for slip fees and what's available for maintenance? Or are they too dumb to do the obvious and raise the rates? Or is it that they just don't give a damn? If it's not one of the three, we can't imagine what it could be. But there's one thing we're sure of; for the sake of everyone, Hawaii needs to get out of the marina business.

↑↓ GREAT FUN FULL OF WATER AGAIN?

The story of the sinking of the Davidson 50 *Great Fun* sounds oddly familiar. My wife and I were driving near the Santa Cruz beaches on a cold November day in 1983 when we noticed a sailboat and two Coast Guard boats about a quarter mile from the harbor entrance. We were surprised to see any boats out there because a recent storm had left the Santa Cruz Harbor with its usual winter sandbar, and the storm swell was producing breaking waves across the harbor entrance.

At first it appeared that the sailboat had lost her rudder, because every time a wave picked up her stern, she would turn sideways. It was later, when the boat was inside the harbor, that we realized she was half full of water and that the force of the water inside the boat moving to the bow was what caused her to turn.

The Coasties got the boat under tow, and seemed to slow and wait for a lull before entering the harbor through the breaking surf. I don't know what the depth was at the sandbar, but it was obviously quite shallow because the sailboat layed over on its starboard side as the Coast Guard boat pulled her over it. When finally secured to the guest dock, she only had a foot or two of freeboard remaining. We were shocked when we realized it was *Great Fun*, which, at the time, was one of the hottest racing boats in the United States.

I don't remember the details of the skipper's story, but I believe it was that the boat was being delivered from San Francisco to Monterey. While motoring south into the storm swells she began taking on water. The course was changed and a call for help was placed. Thanks to the Coast Guard, *Great Fun* survived to have many more happy and successful years of racing.

Larry Laney
Hakuna Matata, Ranger 23
Lake Oroville



LARRY LANEY

By the time 'Great Fun' was towed in to Santa Cruz Harbor, she was almost out of freeboard.

in peculiar circumstances with only one person aboard. And second, why in the world would anybody have their IOR racing

Larry — As we recall, there were two things about the incident that struck many observers as being a little funky. First, only a short time before, *Great Fun* had nearly sunk by the Lightbucket



LEARN TO SAIL!



With the Most Experienced Sailing School on the Bay

The most patient and fun instructors anywhere!

40 years of teaching sailing



Win!

Basic Keel Boat Class

Visit us on our Web site at
www.TradewindsSailing.com
 to enter.

Tradewinds is focused on value!

Basic Keel Boat	\$495
Basic Coastal Cruising	\$595
Bareboat Chartering	\$695
Complete 3-Class Package	\$1,295



Greek Isles!
Sailing Vacation
May 2006

Members and non-members welcome.
 Check our Web site at
www.TradewindsSailing.com for details.



1230 Brickyard Cove Road, Suite #100, Point Richmond, CA 94801
 (800) 321-TWSC (510) 232-7999

www.tradewindssailing.com



41 Liberty Ship Way, Sausalito, CA 94965
(415) 331-5020
www.McGrathPacific.com



52' CUSTOM SCHUMACHER, 2002 • \$795,000
 State-of-the-art high performance vessel.
 Set up for shorthanded cruising. Ready to go!



34' SABRE, 1984 • \$77,500
 Loaded with all the latest and greatest equipment!

SAIL	78' CUSTOM HERRESHOFF, 1978.....	\$279,000
	52' CUSTOM SCHUMACHER, 2002.....	\$795,000
	50' SANTA CRUZ BOC, 1986.....	\$165,000
	47' TAYANA, 1990.....	\$280,000
	45' LEOPARD, 1998.....	\$319,000
	43' BALTIC, 1986.....	\$285,000
	42' CABO RICO, 2001.....	\$449,000
	40' COLUMBIA, 1965.....	\$38,500
	40' BENETEAU, 1997.....	\$179,950
	40' OLSON, 1983.....	\$79,500
	40' CATALINA, 1995.....	\$165,000
	38' CATALINA, 1984.....	\$54,500
	36' CATALINA, 1985.....	\$54,500
	30' ISLANDER, 1974.....	\$13,500
POWER	133' USCG CUTTER BUOY TENDER, 1943.....	\$925,000
	80' SAN LORENZO, 1993/2003.....	\$2,175,000
	61' HATTERAS, 1981.....	\$559,000
	53' HATTERAS YF, 1978.....	\$329,000
	50' NAVIGATOR, 1996.....	\$399,000
	49' DEFEVER PILOTHOUSE, 1983.....	\$279,900
	48' DEFEVER, 1981.....	\$269,000
	47' PONDEROSA, 1986.....	\$169,000
	46' SEA RANGER, 1985.....	\$199,000
	45' C&L PILOTHOUSE, 1979.....	\$179,500
	42' PROTECTOR, 1999.....	\$179,500
	42' GRAND BANKS, 1988.....	\$267,000
	42' FU HWA, 1986.....	\$115,000
	42' GRAND BANKS, 1973.....	\$175,000
	41' MMC DEFEVER, 1981.....	\$119,000
	40' BELL MARINE KHA SHING, 1982.....	\$117,000
	40' HERSHINE, 1982.....	\$126,700
	40' SEA RAY, 1995.....	\$129,000
	40' BELL, 1981.....	\$115,000
	38' HERITAGE, 1980.....	\$129,000
	36' GRAND BANKS, 1973.....	\$96,500
	34' CHB, 1980.....	\$39,000
	33' SEA RAY, 1992.....	\$49,000
	32' BAYLINER, 1987.....	\$72,000
	31' LIEN HWA SEA HORSE, 1981.....	\$49,900
	30' WILLARD, 1972.....	\$49,000
	30' MONTEREY, 2000.....	\$99,000
	22' PACIFIC, 2005, CUSTOM.....	INQUIRE
	22' GRADY WHITE, 1993.....	SOLD
	18' FLETCHER, 1994.....	\$10,000

LETTERS

machine taken to Monterey in November?

↑↓CALL THE ONES THAT ADVERTISE IN LATITUDE 38

I'm a subscriber and wonder if you might be able to solve an insurance problem for me. The only insurance I'd like to get for my boat is third party liability insurance. The Europeans don't seem to have any problem getting it, but I've been having trouble trying to find it in North America. In fact, in North America you have to pay an arm and a leg for it, since you have to buy whole-boat insurance, which is about 10 times as much as third-party only. Any ideas on how to proceed?

Isolde Nosty
 Nakusp, BC, Canada

Isolde — We think a good way to proceed would be to call the insurance companies that advertise in Latitude 38. We contacted the first one we came across paging through the last issue — Mariner's General in Newport Beach — and Craig Chamberlin told us that Mariners can get third-party coverage through Progressive Insurance for a couple of hundred dollars a year — assuming that the boat isn't wood, is in reasonably good shape, and isn't quite as old as the Nina, Pinta or Santa Maria.

For what it's worth, Peter Lewis, Progressive's founder and CEO until last year, also enjoys boats. Having made a pile of money insuring high-risk drivers that nobody else would touch in the mid-'90s, he refit a 255-ft ocean-going tug as a yacht and christened her Lone Ranger. He's taken this spectacular yacht — which comes complete with a Seaplane, an F-27 trimaran, and all the toys you can imagine — all over the world. The only scary thing is fueling up, as she holds 50,000 gallons of diesel.



LATITUDE / RICHARD

The 'Lone Ranger' is an unusual yacht for an unusual entrepreneur.

Now age 71, Lewis may not be the wild man he once was. But according to a profile in Fortune magazine from the mid-'90s, an investor told Lewis he had a great company, but knowing how important he was to it, asked how his health was. Lewis is reported to have responded, "Well, I really don't know because I don't believe in doctors. But No. 1, I feel fine. No. 2, I swim a mile every day. And No. 3, I'm single, so I get laid all the time." In addition to being an atypical CEO, Lewis has donated big money to the legalization of pot, and has said that he doesn't think car insurance should be mandatory. In terms of freethinking and free-talking, he's right up there with Ted Turner.

↑↓CAN ANYONE DELIVER CASH TO SRI LANKA?

You may remember us from the Irwin 37 *Lady Ann*, as we were boat neighbors in Schoonmaker Yacht Harbor, both before our '98-'02 circumnavigation and for a short time afterwards. I am writing with a request.

While we were in Sri Lanka, we met a lovely young family. Ekka, the father, drove a tuk-tuk, and gave us invaluable

HUGE SELECTION OF BROKERAGE BOATS

- Power & Sail -

Bay Fest

Come See
THE PACIFIC 22

Boats & More

for the Pacific Coast Mariner

October 1 & 2, 2005

McGrath Pacific Yacht Sales, Inc

Historic Liberty Ship Marina

Sausalito

McGrath Pacific

37.51.83 N

122.29.63 W

The Best of the Bay!

Vessel Safety Checks by Marin Power Squadron

Speakers - Demonstrations

Food - Music

Boats Boats Boats

415 331-5020

sales@McGrathPacific.com



The West Coast source for state-of-the-art running rigging and performance hardware

• RONSTAN • WICHARD

RACE READY RIGGING SUPPORT AT 2005 BIG BOAT SERIES

FREDERIKSEN • SCHAEFER



Visit our race trailer on site at the St. Francis Yacht Club.

LEWMAR • NAVTEC • YALE CORDAGE • SPARCRAFT • SPINLOCK

- California's largest inventory of high-tech cordage.
- Exclusive West Coast manufacturers of Yale LOUPS™. Custom models available.
- Digitally controlled test bed.
- Pre-loading and stretching of running rigging.
- Destructive testing to 60,000 lbs.
- Navtec hydraulics sales and service.
- Lewmar winch and hardware spare parts and technical support.
- NEW! Load cell testing available. (By appointment only.)

JOHNSON • ANTAL • FAGNOR • TYLASKA • PROFURL



2540 SHELTER ISLAND DR., STE. E
SAN DIEGO, CA 92106

PHONE: 619-223-3788
FAX: 619-223-3099

WWW.RIGWORKS.COM

LETTERS

help around Galle. He invited us to his home, where his wife prepared a beautiful meal, and our kids played with their small son. We were very worried about Ekka and his family after the December 26 tsunami and upon hearing about all the damage in Galle.

After making efforts to track him down, we received an email from Ekka yesterday. He and his family are safe, as they were able to run to high ground in time. But he sent us a photograph of his house — it's nothing but pieces of walls and rubble. And they now have a baby daughter, too. Ekka lost his tuk-tuk in the tsunami, so he is renting another one to make a living. He said that an Englishman helped them while they were in the refugee camp by buying him a small piece of land. He now needs help to build a modest house.

We would like to help Ekka and his family, but knowing the system in Sri Lanka, we're afraid to send anything by mail. So we wonder if there are any cruisers in that area who would be willing to receive a care package — including cash — and find Ekka to deliver it to him directly. That's the safest way we can think of that will make sure the help gets to him.

We can be reached at: ladyann_leslies@hotmail.com

Andrea, Willie, Scott (13) & Ellen (11) Leslie
ex-Lady Ann, Irwin 37

Willie and Andrea — We'll put the word out. Knowing the incredible corruption in the Third and Developing Worlds, and the terrible inefficiencies associated with traditional aid organizations, we understand your desire to find an alternative way of helping.

↑↓ CAN WE GET BY ON \$2,500 A MONTH?

I'm a longtime fan of *Latitude*, having grown up in L.A. and spent 10 years in San Francisco. Although 'they' say that the Pacific Northwest is one of the world's top cruising destinations, the holy grail for me is Mexico and beyond. After all, it rains up here. A lot. About 10 months of the year.

So I've spent about the last three years preparing our Malo 39 — the 'other Swedish boat' — for cruising, and my wife and I liveaboard. I may have an opportunity to take early retirement next year, which would allow me to leave this wonderful but very wet and very crowded place. I have two questions:

First, how much does it really cost to cruise in Mexico? I know, I know, it depends on the crew, whether you anchor out, the age and condition of the boat, etc. I already know what it costs to keep a boat up, and don't expect that will change in Mexico and points beyond. We have set our boat up for independent living, and prefer anchoring out, so we would probably spend 75% of the time on the hook. That said, we love a party and the good life, and at least one of us is fluent in Spanish, and we hope to engage the locals in a more meaningful way than we have in our past travels.

The bottom line is that we'll have about \$2,500 a month cash for daily living for the two of us. This doesn't count other money we have set aside for boat repairs and insurance — that's a separate pot. So, what kind of cruising life will that buy us in Mexico?

Our second question has to do with all those pesky hurricanes. Where do people go? Or do they just sail around and take their chances? One hopes that with a good breakwater, concrete floats, and proper preparation, a boat would be all right in a marina — but that is leaving a lot to risk. My wife insists that we head south beyond the hurricane zone by June 1 — is that what most prudent folks do?

There are a lot of 'experts' out there full of advice — and other things — but we have always enjoyed the reports and

Ask About
FORESPAR®
LEISURE FURL™
In-Boom Furling Systems
FALL DISCOUNTS IN EFFECT

Photo: GINGER,
Outbound Yachts 44,
finishes **FIRST** in class in the West
Marine Bermuda Cup.
*Congratulations
Mel and Barbara Collins!*

www.outboundyachts.com

THE FINEST SAILS BEGIN WITH THE BEST SAILCLOTH

Our patented woven Vectran® sailcloth performs like the laminates with the durability of Dacron®, especially in roller furling applications. In fact, Vectran® is lighter, lower stretch, and retains its shape over a longer life than any sailcloth we've ever offered to cruising sailors. That's because Hood Vectran® is woven, not laminated to Mylar® film. And you can be sure that each sail we roll out is built by hand, with the same care and craftsmanship that has been the Hood hallmark for 50 years.

To discuss your sailcloth needs – whether our state-of-the-art Vectran® or our soft, tight-weave Dacron® – give us a call today.

Visit our website for
Special Online Discount Pricing...
www.hoodsailmakers.com



Call Robin Sodaro
(800) 883-7245
(415) 332-4104
Fax (415) 332-0943
email: hoodsails@aol.com
466 Coloma St., Sausalito, CA 94965



Online Shopping, Tips,
Instructions
www.sailrite.com

ULTRA FEED™ MACHINES STARTING AT \$399



LS-1 Base Package
#100535A

- New Low priced Classic Model
- New PowerPlus Balance wheel standard with Base Model
- New Posi-Pin Clutch System on Base and Deluxe Models
- Walking Foot - 6mm straight & 5mm zigzag stitches
- Sew—sails, canvas, upholstery, crafts, drapery, leather, use for general sewing.
- Amazing Power

Tools



Fabric



Kits



Thread



FREE CATALOG

Includes kits for sails, dodgers, biminis, covers, bags, Sunbrella™, DACRON®, ripstop nylon, mesh fabrics, foam, headliner, snaps, slugs, slides, grommets, thread, zippers, webbing, tools, instructions and much more.

Sailrite

(800) 348-2769

www.sailrite.com

Fort Lauderdale retail store

NOW OPEN!

e-mail: sailrite@sailrite.com

Churubusco, IN (260) 693-2242

Ft. Lauderdale, FL (954) 779-2227

LETTERS

insights published in your magazine, and appreciate the straight answers you provide.

Gary
Planet Earth

Gary — If you only spend a week a month in a marina and don't overdo it in tourist bars and restaurants, you can cruise like kings in Mexico for \$2,500 a month — and still have \$1,000 to \$1,500 left in your pocket at the start of the next month. If you reread our recent interview with Blair and Joan Grinols of Capricorn Cat (May 2005 issue), you'll see that they figured they cruised on about \$600 a month in personal expenses for both Mexico and the South Pacific. And it wasn't because they were trying to live particularly inexpensively, but were just living the 'into it' cruiser life. As they noted, you can buy 30 pounds of fruit and vegetables for \$10, and there are many places you can stuff yourself for \$5 a person. You can't eat that inexpensively at the Four Seasons or Carlos 'n Charlies, of course, but you can do so in non-touristy restaurants all over Mexico, and those places tend to be much more interesting places, too. Just to be on the safe side, we'd set aside maybe \$1,500 for personal expenses, but you'd still have quite a bit left. It's certainly possible to spend more than \$2,500 a month on personal expenses in Mexico, but you'd have to work at it.

As for engaging the locals, that's as simple as pie. You just smile and start a conversation, and from there you can take it as far as you want to go. Unlike here in the States, where making money is so important and people can be cold, the people of Mexico are warm and naturally care more about personal interactions. They are very friendly and caring.

As for the "pesky hurricanes," virtually nobody cruises mainland Mexico during the summer hurricane season, but primarily because it's so rainy and humid. However, people do continue to cruise in the Sea of Cortez. In a typical summer, the waters off Mexico are hit by a number of tropical storms and hurricanes. The vast majority of them, however, start offshore and head to the northwest — which is out to the open ocean.

In the last 25 years, we can't remember a hurricane that did significant damage to boats on mainland Mexico. We say this partly because we can't remember a marina ever suffering a direct hit — other than San Blas a few years ago, but there weren't any recreational boats there at the time. The other thing is that many of the marinas along the mainland aren't right on the water, but are relatively well-protected from open water and the real danger, which is big waves. Ixtapa, Barra Navidad, Marina Vallarta, Paradise Village Marina, Nuevo Vallarta Marina, Mazatlan Marina, Marina El Cid — all of them are located up channels and around corners from the open ocean.

Unlike on the mainland, quite a number of folks cruise the Sea of Cortez or stay on their boats in La Paz or Puerto Escondido during the summer. On average, the Sea of Cortez gets hit by a hurricane every other year, but most of the time they have missed the cruising areas. But marinas have been hit. Cabo has had a couple of direct hits with 100-knot winds, but thanks to the protection, no boats were damaged. La Paz has been hit hard twice in recent years, which were the second and third times in about 25 years. There were many boats that were badly damaged in Marina de La Paz, which, at the time, didn't have the protection it has now. Others were damaged while on the hard. But there was little damage to boats in marinas with good protection. The new Costa Baja Marina just outside of La Paz looks as though it would be an excellent place to ride out hurricane force winds, as does Marina Palmira.

Puerto Escondido has always been a popular place for cruising boats in the summer. A number of boats were driven

BOAT LOANS



from
Trident Funding

*"a fresh approach from
people you can trust"*

See Us At The
35th Annual
NORTHERN CALIFORNIA FALL BOAT SHOW
Jack London Square • Port of Oakland
September 10-18
Booth 300 & 301

In Northern California call
JOAN BURLEIGH
(800) 690-7770

MAINSAIL BATTGARS

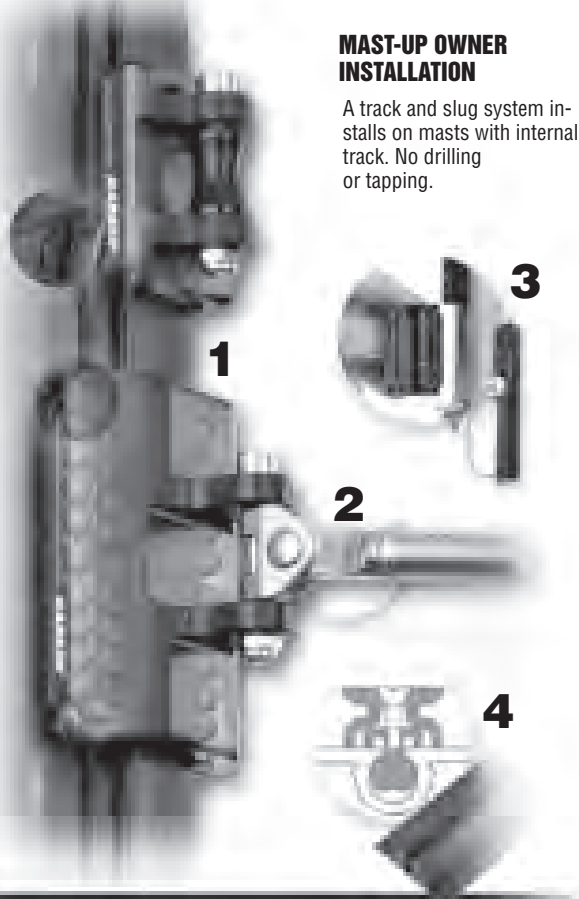

MAST-UP OWNER INSTALLATION

A track and slug system installs on masts with internal track. No drilling or tapping.

DETAILS MAKE THE DIFFERENCE

1 STRONG, LIGHT CAR BODY

One-piece solid 6061-T6 aluminum construction for strength and durability. CNC sculpted to remove excess weight.

COMPACT SLIDER CARS

Compact design reduces weight and stack height. Slider cars are low friction and cost effective.

LONG-LASTING PROTECTIVE FINISH

Car bodies are deep-saturation Hardkote-anodized for strength, with a black additive for no-fade UV-stabilization, and corrosion protection. Teflon®-impregnated for a smooth, slippery surface.

2 THREADED TOGGLE STUD

Handles twisting, angled, compression/tension loads.

3 EASY-REMOVE SCREWPIN ENDSTOP

Unscrew track endstop to remove cars and mainsail. System B CB has quick release pins on cars to remove just the mainsail.

4 TOUGH, DURABLE TRACK

Hardkote-anodized 6061-T6 aluminum track accepts both CB and Slider cars..

HARKEN[®]
INNOVATIVE SAILING SOLUTIONS

1251 E. Wisconsin Ave., Pewaukee, WI 53072, Tel: 262-691-3320
Fax: 262-691-3008, Email: harken@harken.com, Web: www.harken.com

LETTERS

aground there by hurricane-force winds a few years ago — but this didn't happen to a single boat with crew aboard. On rare occasions, hurricanes still have enough steam to make it all the way up to San Carlos on the mainland side. Usually the only boats that are damaged are the ones anchored out and unattended. By the time hurricanes get halfway up the Sea of Cortez, they've usually lost most of their steam.

We would have no qualms about leaving Profligate in any of the aforementioned marinas during hurricane season. If your wife is still worried, we suggest she contact each of the marinas and find out the last time they've been hit. Yes, there is risk, but we think it's very, very small. In fact, we'd be much more concerned about our boat being hit by lightning in one of the mainland marinas.

Our advice to you would be to enjoy the great and inexpensive cruising life in Mexico during the winter. Come May, we'd suggest putting your boat in a marina on the mainland, or heading up into the Sea of Cortez. If you went into the Sea, we'd still put the boat in a well-protected marina for at least the months of July, August and September. During those three months, we'd take a 'vacation' from cruising. With all the money you had left over from your \$2,500/month winter budget, you could take a vacation from cruising in South America, Australia, Europe — or maybe even back in the States.

The bottom line is that \$2,500 a month might seem like a pittance in the more expensive cities in the States, but in Mexico and most of the developing world, it can be a small fortune. And you can take that to the bank!

If any other veteran cruisers would like to add their two cents on how much it costs per month in personal expenses to cruise in Mexico, we'd love to hear from you.

↑↓ CHEAP DENTAL WORK SOUTH OF THE BORDER

We sailed *Dream Caper*, our 42-ft Fontaine-Pajot catamaran, in the '03 Ha-Ha and then around Mexico. For the summer of '04, we left our cat on the hard in San Carlos. Upon our return, we continued south, arriving in El Salvador in May of this year. We left *Dream Caper* afloat in Bahia Del Sol for the summer, and are now back in Marin.

A reader wrote in asking about dental work in Mexico. Unfortunately, I had to have a lot done, but fortunately, I was able to get it done in Mexico, where I found well-trained and competent dentists. Furthermore, their much lower prices allowed me to save a bundle over what the treatments would have cost here in the States. Here's my history.

In October of '04, I had a root canal done in San Carlos, and had two crowns replaced. In January of '05, I needed a root canal on another tooth, and had this and another crown done in Puerto Vallarta. After experiencing pain in the same tooth as the Puerto Vallarta root canal, I went to a dentist in Huatulco. He gave me antibiotics to relieve the swelling and pain until I returned home, and recommended that I see an endodontist.

When I got back to Marin, my endodontist advised that I needed a redo on the root canal — at a cost of \$1700, but with no guarantees as to the outcome. So I consulted with my Puerto Vallarta endodontist, who told me he'd fix the problem if I returned. So in early June, I returned to Puerto Vallarta for one night. It turned out that my tooth had cracked and needed to be pulled, and I would then need a bridge or implant. I opted for the implant.

A week later, I returned to Puerto Vallarta, where a specialist endodontist from Guadalajara, in cooperation with the Puerto Vallarta endodontist, pulled my cracked tooth and installed an implant. This took about two hours. After three

The Right Sailing School

"Best sailing school on the Bay"

SF Magazine
Best of the Bay



26
YEARS

sail with confidence

Choosing the right sailing school is about more than just taking a class. Sailing will open up a whole new world for you. New friends — New adventures. You want to find an institution that gives you the lifestyle as well as the sport. OCSC pioneered the sailing campus concept 26 years ago. Our focus is to provide you with instant access to every element of the sport without requiring boat ownership. At OCSC you will learn from the top professional instructors in the country. They know how to make learning fun and you'll be certified to sail boats anywhere in the world. You have a fleet of boats to choose from

ranging from day sailors to state of the art performance yachts. OCSC's extraordinary location, world-class waterfront facility and full calendar of social and educational activities compare with any yacht club. And most important, you'll be welcomed into a community where you'll make friends who share your passion. Please call, click or visit our campus anytime. We look forward to meeting you.



**Free
Brochure**

Please call our friendly staff
800.223.2984

one spinnaker way • berkeley ca 94710
info@ocscsailing.com

September Special

**\$100 off
Basic Keelboat
Certification Package***

Reg: \$890 Special \$790
You save \$100!

**\$200 off
OCSC Membership***

Take your class or start your
membership anytime in 2005

*offer ends 9/30/05



2004 Winner of the
**US SAILING
Prosser Award**
for Excellence in
Sailing Instruction

OCSC

san francisco bay
www.ocscsailing.com

Big Boat Series Special!

FREE Musto Amara gloves with purchase of Gore-tex smock, jacket or trousers or Dubarry boots



MPX Gore-tex Race Smock from Musto



Shamrock Stretch Boot from Dubarry

IN STOCK AT:



PINEAPPLE SAILS
 Phone (510) 522-2200
 Fax (510) 522-7700
 www.pineapplesails.com
 2526 Blanding Ave., Alameda, CA 94501

LETTERS

months, I will return to Puerto Vallarta for a crown.

The dentist I saw in Puerto Vallarta who referred me to the endodontist was Dr. Adan Noel Michel Brixon, who has an office downtown. He did the crown after the root canal. Many cruisers and other travelers go to Dr. Michel, who speaks excellent English. While in the waiting room, we had a nice visit with frequent Mexico cruisers, Blair and Joan Grinols of the then Vallejo-based 45-ft *Capricorn Cat*.

My Puerto Vallarta endodontist is Dr. Benjamin Valle Vargas (Unident Office), whose office is located very close to the airport at Marina Vallarta. He also speaks excellent English. His office is very modern, with x-rays on computers. My implant procedure was conducted in the strictest of sanitary conditions — I was very impressed. I will return to him for my crown after the implant sets. The dentists in San Carlos, Huatulco, and Dr. Michel in Puerto Vallarta have less modern offices, but also do very fine work.

I have to admit that I was concerned — even a little afraid — before my first visit to a Mexico dentist, Dr. Hiram Martinez, as he was identified as "the one behind Rosa's Cantina." But as he was very competent, I quickly relaxed. All of the endodontists also perform regular dental work, had assistants, and followed up by telephone — to my cellphone on the boat — to see how I was doing after the procedures. I was also impressed by the way these Mexican dentists used anesthetics. In each case the anesthesia was effective in eliminating the pain of the procedure, but avoided the puffy numbed lips and cheeks that lasts for hours after a visit to my dentist in the States.

Prior to my first root canal and crown in San Carlos, I called my endodontist and dentist in Marin, and found it would cost more than \$1400 for a root canal and \$1200 for a crown — a total of more than \$2600, plus the cost of airfare to return home. By having it done in Mexico, the cost was only \$500. I'm not sure of the cost of an implant in the States, but I believe they are a minimum of \$5,000 per tooth.

Cost of Dental Work in Mexico	Estimated U.S.\$
Root Canal, San Carlos.....	\$300\$1,400
Crown, San Carlos (each).....	2 @ \$200.....\$2,400
Root Canal, P.V.....	\$220.....\$1,400
Crown, P.V.....	\$230.....\$1,200
Implant, P.V.....	\$1175.....\$5,000
Airfare (RT+hotel; each trip).....	3@ \$391
Crown, P.V.....	\$230.....\$1200
Total.....	\$3,728.....\$12,600

The way I figure it, I saved \$8,872. As I said, I'm very pleased with all of the dental work I've had done in Mexico. Ever since, I have suggested to anyone who is interested that Puerto Vallarta is a great place to vacation — and get quality dental work without going broke.

My husband Steven Stecher and I will be back aboard *Dream Caper* cruising in Central America until March 2006, at which time we plan to do the Puddle Jump to the South Pacific.

Portia Igarashi
Dream Caper, F/P 42 Catamaran
 Marin County

Portia — Thanks for the excellent information. By the way, we love your name, as it looks Italian but sounds like a German sports car.

↑↓ THE SPERM WAS HERE IN THE CARIBBEAN, TOO

In a recent *Lectronic*, you wondered if readers thought

A winning formula...



**Our full-
service yard...
your starting
point for a fast
bottom &
smooth sailing!**

- Lift capacity to 25 tons
- Chandlery and Store
- Rigging Repairs and Installation
- Fiberglass and Gelcoat Repairs
- Sprayed Racing Bottoms
- Full Painting Service, Topsides and Bottoms
- Electrical Repairs and Installation
- Electric Propulsion Systems
- Engine Service and Repowering
- Propeller Tuning
- Wood Hull Repairs and Caulking
- Teak and Non-Skid Deck Repairs
- Waxing and Detailing
- Long-term Projects Accommodated

Call today for a free estimate!

**Chandlery &
Fuel Dock
Open 7 Days**

Mon – Fri
8 am to 5 pm

Sat & Sun
9 am to 5 pm



In Berkeley Marina • 510-843-8195 • www.berkeleymarine.com

Do you have your

Berkeley Marine

T-Shirt ?



\$12 Short Sleeve

\$15 Long Sleeve

**FREE
with any Haulout**

(Mention this ad for one Free
T-shirt with haulout at Berkeley
Marine Center)





Santa Cruz 52 (1993). This beautiful fast cruiser looks like new. Stunning red topsides, carbon rig, elect. main halyard, watermk, great sails. Best around only **\$490,000!**



Oyster 42 Gypsy (1999). Traditional classic Oyster design in near perfect cond. An ocean going yacht, though primarily used in S.F. Bay. Original owner. **\$475,000**



Santa Cruz 50 (1981). A lovely 50 set up for shorthanded sailing with a custom deck layout and a low draft wing keel. Never raced. Excellent cond. **\$175,000**



Andrews 72 (1998). Completed in 2000, this fast cruiser has a gorgeous maple interior. Very clean, easy to sail, large aft stateroom. Asking **\$975,000**



Passport 40 Sea Peace is a classic Robert Perry design cruiser. Solid build and very comfortable. Has been very well maintained.



Locura, a 92-ft aluminum world cruiser. Recently returned from a major refit in New Zealand, in perfect condition and ready to go again.



Farr 40 Pendragon. Incredible inventory, immaculate condition and impeccably prepared for you to take her to the starting line. Located in Marina del Rey.



53' Tollycraft A 'sailor's motor yacht'. Astounding inventory of first-class equipment, including the spares! Cruise the West Coast & beyond. Asking **\$645,000**



Crescent 96 (1998) Superb example of one of the Pacific NW finest builders. Immaculate condition with a recent refit. Priced reduced to **\$3,295,000**



Burger 72' Pilothouse Motor Yacht (1964) Lovely aluminum vessel has recently had both diesels rebuilt. USCG-certified for 62 passengers. **\$645,000**



Oyster 48 Performance cruiser as well as a comfortable liveaboard. Large center cockpit, a spacious galley and second companionway from the deck to the owner's cabin. **\$305,000.**



Oyster 53 A semi-custom yacht which includes numerous detailed appointments. Designed to be modern and coordinated, while remaining practical and durable at sea. **\$950,000.**

(510) 236-6633 • fax: (510) 231-2355
yachtsales@kkmi.com • www.kkmi.com
530 W. Cutting Blvd.
Pt. Richmond, CA 94804

LETTERS

naming a big powerboat *Lucky Sperm* was in poor taste, and what other names might be in the same category. *Lucky Sperm* was down here in the British Virgins this past season, and I thought the name was a bit much, too. As I recall, the people aboard looked like the money had been inherited recently and they were going to spend it all whether they wanted to or not.

As for other tasteless boat names, how about *Passing Wind*? There's one of those sitting here at the dock. Other provocative boat names, although funny, are: *AFTICA*, an acronym for Another F--king Thing I Can't Afford. Or, the one that always got me in trouble at Customs and Immigration for being a smart ass: *I Wonder*.

Peter Whitney, Captain
Sea Leopard, Moorings 6200 Cat
 Lake Tahoe / British Virgin Islands

Peter — Since you're in the Caribbean a lot, you've probably seen the large motoryacht named Porn Star, reportedly in honor of the owner's wife, a former star in the X-rated segment of the film industry. We suppose there are two types of men in the world, those who would be very proud to be married to a porn star, and those who would be very ashamed of the same thing.

↑↓ A NAME IS JUST A NAME

I was rather disheartened to read your caption under the photo of *Lucky Sperm*: "... more evidence that just because a person has a lot of money doesn't mean he/she also has good taste."

Could it be that *Latitude 38* has been taken over by a bunch of conservatives in Marin? Worse yet, a bunch of snobs? Ones who feel it necessary to provide negative comments on something like a boat name like *Lucky Sperm*? The same ones who have been known to occasionally publish pictures of bare-chested ladies in their good — usually — rag? Let's see. *Lucky Sperm*. Bare-chested ladies. I fail to see the problem in either case.

C'mon, guys and gals, it's a free country, but since when



The 'Sperm' lying at Schoonmaker Marina in Sausalito.

did *Latitude* start becoming the connoisseurs of good taste? It seems like you're the purveyors of nonsense in this case. So what if a person wants to celebrate the fact that perhaps they feel a bit lucky? The name of a boat is just the name of a boat, and having a

boat is about having fun and enjoying life.

And just what does *Profligate* mean that's so different from *Lucky Sperm*? Both names are conversation pieces, and both are meant in fun. Just like my boat's name — which I didn't think up, but decided it was good enough to keep! So lighten up! Criminy!

By the way, what exactly does *Profligate* mean, anyway?

Tad Sheldon
While I Can, Catalina 36MKII
 South Beach Harbor, San Francisco

Tad — To answer your questions in order. 1) Latitude/

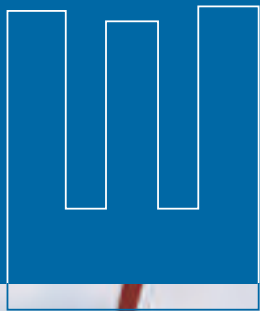

Doyle APC



- :: Doyle's Asymmetrical Power Cruiser fills the gap in your downwind inventory
- :: Easy to set and douse with a spinnaker sleeve
- :: Reaches faster than a genoa, runs like a spinnaker—without a pole or hardware
- :: Stable and easy to trim
- :: Your choice of colors

www.doylesails.com



DOYLE SAILS ▶ 2035 Clement Ave ▶ Alameda, CA 94501 ▶ 510-523-9411
San Francisco

THE SAILMAKERS WHO MAKE IT POSSIBLE.

Not Using Your Boat?



**STORE
IT**

Want To Sell Your Boat?



**STORE
IT**

Want to Dry Out Your Boat?



**STORE
IT**

Leaving the Country?



**STORE
IT**

Want to Save Money?



**STORE
IT**

**DRY
STORAGE
\$3.50/ft**



NAPA VALLEY MARINA

1200 Milton Road • Napa, CA 94559

(707) 252-8011 • Fax (707) 252-0851

www.napavalleymarina.com

Marina • Boatyard • Chandlery • Brokerage

Dealers for
YANMAR

Interlux
yachtpaint.com

Distributors for *Brownell*
Boat Stands

LETTERS

Lectronic hasn't been taken over by anybody, as evidenced by the fact that the same person — the owner — is writing editorial responses as when we started publication 28 years ago. 2) Being a snob sounds like a lot of fun, unfortunately, we can't think of anything we have reason to feel snobby about. 3) We don't see any connection between photos of women wearing 'fair weather gear' and raunchy boat names — except photos of women can also be tasteful or raunchy. 4) We probably wouldn't have bothered to comment on Lucky Sperm except that just about everybody on our boat — about a dozen — and several others were grossed out by it. 5) The name of a boat is much more than just the name of a boat, as some really can be repulsive. For example, when we were about to launch our catamaran, a tipsy powerboater tried to insist that we christen her — please skip to the next letter now if you don't want to be completely grossed out — Wet Pussy. (We warned you to skip to the next letter!) If you didn't think less of a guy who had a boat with such a name, you'd be in the minority. 6) The primary meaning of Profligate is 'ruthless spendthrift' — which we think is most appropriate.

↑↓ I'M JEALOUS!

I think the really scandalous thing about a boat named *Lucky Sperm* is that it's not bombast or bluster — but true! After all, wouldn't we all like to have been born wealthy? I'm jealous. I have images and fantasies of being able to do anything I want at any time and forever! When I see that name, I think of utter freedom. Being unfettered. Not having a care in the world.

Yes, the name shocked me the first time I saw it, but it certainly made me curious. But it's true. I think you forgot that when you criticized it, and it's significant. Maybe you're jealous as well.

Emmanuel Uren
Maltese Falcon
San Francisco

Emmanuel — When we found out the real story behind the boat being named Lucky Sperm, it changed our opinion — at least somewhat. Details to follow.

As for your assumption that everyone would like to have been born wealthy so they could do anything they wanted at any time, you've got to be kidding. While being born into great wealth might sound like fun, the reality is often quite different. For many people, being an heir to a large fortune is a burden that stunts ambition and makes it difficult for them to lead fulfilling lives. If we were to wish anything on our kids, it's not a billion dollars, but rather intelligence and passion. That way, if they really wanted a billion dollars, they could make it themselves. But at least they'd be smart enough to know that having everything you wanted all the time would only be heaven for a very short time. After that, it could be hell — especially for those who didn't earn the money themselves.

↑↓ SHE'S FROM CLIMAX, TOO

I was told that while *Lucky Sperm's* homeport is Climax, Pennsylvania, she belongs to an heir to the *San Francisco Chronicle*.

Bob Payne
Northern California

↑↓ ON THE TRAIL OF THE LUCKY SPERM

I can confirm that *Lucky Sperm* is owned by Cam Theriot, an heir to the *Chronicle* — and a neighbor of mine! I think your original comment was accurate, that just because somebody

Gotta Sail?

We'll teach you how!

*For all your
sailing needs,
we offer all levels
of instruction...
and much more!*

The best in the business!

Contact us:

IN SAN DIEGO

www.jworld-sailing.com • 1-800-666-1050

IN SAN FRANCISCO

www.jworldsf.com • 1-800-910-1101

J the
performance
sailing
WORLD school



Slip Into Someplace Comfortable

Silicon Valley's newest and most convenient marina



Discover a touch of Italy with the quickest access to South San Francisco Bay. Bair Island's new management team is committed to providing a truly excellent home for your boat.

- ★ Slips and side-ties from 30' to 75'
- ★ 30 and 50 amp power
- ★ Cable TV, DSL and phone
- ★ Calm, quiet and protected
- ★ Free parking
- ★ Heated shower and laundry facilities
- ★ Walk to shops, restaurants and movies
- ★ Office open 7 days
- ★ Dock boxes with lighting
- ★ Kids playground

BAIR ISLAND MARINA



702 Bair Island Road
Redwood City, CA 94063
650-701-0382
www.greatslips.com

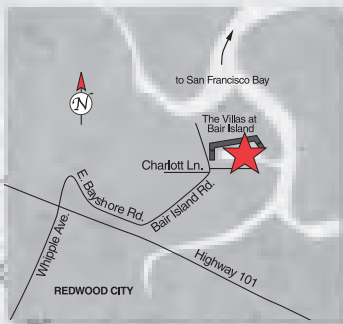

CALIFORNIA RECREATION COMPANY

LETTERS

has money doesn't mean they have good taste.

Bob Rozett
Northern California

↑↓ HIS HORSES BRED MULTIPLE CHAMPIONS

After spending about two weeks looking at *Lucky Sperm* at the guest dock at Pier 40/South Beach Harbor, I learned the following: The *Lucky Sperm* and the horseshoe logo stand for a stallion owner who has bred multiple champions. The proceeds from the 'donations' financed the boat.

The most unique and, maybe tending to the unusual side of boat names, is one I saw at San Leandro Marina on a houseboat — *We be Havin' Thangs*. I think this outranks *Seaducer*, *Knotty Gal*, *A Little After Five*, etc.

Paul Kassatkin
Northern California

Paul — *Geez, we wish you hadn't told us that because: 1) It makes perfect sense. How could we have been so stupid not to have put sperm, horseshoes and breeding together? And 2) It's actually sort of a clever name — a double-entendre and dually appropriate.*

Nonetheless, we still think it's too gross for general consumption. Something like Lucky S would have been better. Then when somebody asked what the 'S', little 'fish', and horseshoes all had in common, the owner could wait until everybody had a cocktail or two before dinner, then share the reasonably funny reason why he named his boat what he did.

↑↓ MORE JEALOUSLY?

There is a red power boat at Barnhill Marina on the Alameda Estuary named *Sailing Sucks*. I think he's jealous.

Grant Miller
Chimera

Grant — *Given the recent increases in the price of fuel, we bet he's even more jealous than ever. We were down in Catalina in August and overheard the owner of a 30-ft sportfishing boat complaining to another that it now costs him \$300 in fuel alone for a weekend trip from Newport to Catalina and back. Ouch!*

↑↓ MORE 'BAD TASTE'

My nomination for tasteless boat names is *Breaking Wind*.

P.S. Thanks for printing my inquiry about the schooner *Zaca*. You sure came up with a lot of great information.

Larry Watkins
Beneteau OC 400, *Moondance*
Long Beach

↑↓ A DUAL PURPOSE NAME

The most tasteless — and also ubiquitous — boat name: *Wet Dream*.

Steve Madden
Fort Myers, Florida

↑↓ JUST TO BE SURE, I ALWAYS STAYED TO WINDWARD

One sailboat I used to see in the Long Beach vicinity was named *Passing Wind*.

Al Reed
Gulf 32, *Ensueno*
Huntington Beach

no guts,
no glory.



The inner workings of the Lewmar winch deliver winning performance.

The Lewmar winch is an engineering marvel. At the heart of it is an all-bronze, single-piece center stem and precision-machined bronze gears that deliver smooth, **Efficient Power**. Stainless steel roller bearings are housed in a rigid cage that performs under intense loads. A screw-on cap allows for fast, convenient

access and **Easy Maintenance**, ensuring efficient operation. The Lewmar Ocean Winch (featured above) is fully **Convertible**, allowing for quick and easy transformation to an electric winch in models 40ST, 44ST and 48ST. Look into Lewmar's full line of winches at www.lewmar.com. There's definitely one that's engineered for you. **Lewmar. In Control.**



LEWMAR®

www.lewmar.com



SCHOONMAKER POINT MARINA

• IN SAUSALITO •

"Sausalito's Finest Marina"



160 Berth Marina in one of the most beautiful spots on the Bay

Visitor berths
Guest moorage able to handle yachts up to 200 ft.
Dry storage • Three-ton Hoist
Windsurfing • Rowing • Kayaking
Deli • Beach • Waterfront Offices
Yacht clubs always welcome



Call the Marina Office for more information

415•331•5550

FAX 415•331•8523

or check our web site at

www.schoonmakermarina.com

85 LIBERTY SHIP WAY, #205, SAUSALITO, CA 94965

LETTERS

↑↓THE TWO WORST

It's no surprise, but the two most tasteless boat names I've ever seen were on powerboats: *Breach Berth* and *Grandpa's Wet Dream*. Those are pretty sleazy!

Laraine Salmon

↑↓HATE IS SUCH A STRONG WORD

I hate the following names: *Wet Spot* and *Wet Dream*.

Tom Nemeth
Northern California

↑↓COOL NAMES

The coolest boat name — for a change — is *Flying Patio Furniture*.

Charlie Ruppert
Northern California

Charlie — *We like that name, too, but the one that really impresses us for being clever is Gruntled.*

↑↓THE SOUNDS OF POLYNESIA AND THE ORIENT

There was a period when many American boatowners christened their boats with Polynesian-sounding names. The names could rarely be found in any Polynesian dictionary, but the trend persisted — producing such memorable names as *Comana Wanna Lay You* and the like. In response to this trend, there was a boat in Newport named the *Lani-Ru*. It seemed like a nice name . . . until you spelled it backwards.

Timothy O'Brien
San Pedro

Timothy — *There were also a number of boats that were given Oriental-sounding names. Who, for example, could ever forget Fujimo, which, unknown to the average person, actually stood for a divorce proceeding: 'Fuck you Jane, I'm Moving Out'.*

↑↓I BELIEVE MY BOAT WAS ATTACKED BY A DOLPHIN

I have to comment on Suzanne Pew's account of our dolphin experience with *Birinci Mevki* in Mexico as reported in the July Changes. My theory is slightly different than Dr. Defran's, who says he doesn't believe we were attacked by a dolphin.

I was indeed standing at the forward end of the port side of the cockpit when this very large dolphin came up, almost touched the boat, then veered off. 'What's going on?' I wondered to myself. 'I'm glad we didn't hit it.' I know how intelligent dolphins are, that they have very good sonar, and that they usually keep a foot or two away from a moving boat — even when playing with it.

Right after being glad we didn't hit the dolphin, we did hit something very solid but soft. My Rawson 30 shuddered and almost stopped. Then John couldn't move the tiller, and we saw what turned out to be pieces of fiberglass-covered foam in a swirl behind the boat. The rudder freed up enough to get us into Sweet Pea Cove. John dove down and found a large chunk was gone from the bottom edge of the rudder, and the shaft had been bent out of the gudgeon.

My theory is that the two dolphins were mating, hence their attention was on things other than approaching boats. It is known that male dolphins get very aggressive when annoyed, and I certainly would have been annoyed had I been interrupted in 'the act'. So I think he whacked my rudder and took a chunk out of it. As I understand it, during mating the male is upside down under the female. It may be a rare occurrence, but I think my explanation of a dolphin attacking

CRUISING OR RACING, UK-HALSEY ALSO MAKES THE MOST DURABLE AND EFFECTIVE MULTIHULL SAILS.



An F-31 trimaran with Tape-Drive™ load path sails.



CHEYENNE (ex PLAY STATION) sailed hard, fast and far.

Multihulls are tough on sails because of their extra stability and their faster speeds. When PLAY STATION started her around-the-world contest, her 478-square meter Cuben Fibre mainsail was two years old. Steve Fossett had already bet-tered many records with this 38.5 meter cat whose entire sail inventory came from our group. The same mainsail on the same boat, renamed CHEYENNE, then went around again in the Oryx Quest, quite a feat for a sail that's 51 meters on the luff and pushed hard through such tough conditions. Perhaps more similar to your multihull is an F-31 trimaran; their '05 Nationals were just won using an inventory of UK-Halsey sails. If you're looking for sails with proven durability and want all the performance your multihull can deliver, call or stop in.

UK Halsey : 451 W. Atlantic, #115, Alameda, CA 94501 Tel: 510-523-3966



www.ukhalsey.com

Pre-Cruised Best Buys



Hunter 41 • \$199,995



Catalina 42 MkII • \$195,000



Beneteau 42CC • \$199,900



Hunter 420 • \$179,900



Jeanneau 40.3 • \$215,000



Beneteau 42CC • \$219,000



Hunter 30 • \$39,950



Hunter 310 • \$65,000



Hunter 326 • \$72,050



Hunter 320 • 2 from \$61,000



Silverton 34C • \$199,500



Hunter 340 • \$78,500



H&STM
YACHT SALES

1-888-325-4353 • www.hsyacht.com

Alameda • Channel Islands • Marina del Rey • Newport Beach • San Diego
Sisterships shown. Subject to prior sale, change or withdrawal without notice.

LETTERS

my boat makes the most sense.

Have any other cruisers had any physical contact with angry dolphins?

Gerry Cunningham
Birinci Mevki, Rawson 30
Patagonia, Arizona

↑↓SOUNDS LIKE SOUR GRAPES TO ME

I was shocked to read that James Moore, a so-called "professional" yacht broker, would use the tragic murder of Tom and Jackie Hawks for the self-serving purpose of selling his services. How sad. It sounds like sour grapes to me.

Every time I think of that tragedy it brings tears to my eyes. One could only imagine what went through their minds as they were allegedly being handcuffed to the anchor knowing what was coming next. I think *Latitude's* response to Moore should have been less congenial.

Joseph Poppo
Los Gatos

Readers — For an update on the five accused of murder in the deaths of cruisers Tom and Jackie Hawks, see this month's Sightings. It's a gruesome story.

↑↓BASHING UNDER SAIL FROM CABO TO VICTORIA

Having done my second Baja — and California, and Oregon, and Washington — Bash from Cabo San Lucas to Victoria, British Columbia, I don't understand what all the fuss is about. I say pick your weather and sail the windshifts.

For what it's worth, sailing my 40-ft catamaran *Pantera* north from Cabo in April of 2004 worked much better than my northbound sail in May of '02. I believe this was due to the Pacific High moving northeast in summer and 'squeezing' the continental Low that increases as the desert warms up. Although two trips is hardly much of a data base, instead of the 25-30+ knots which I had almost daily going north in 2002, 15-20 knots was more typical in 2004, except for seven days spent in Bodega Bay.

During both trips and all the way from Cabo to Victoria, it was my general experience that the day would start with a long starboard tack in predominantly northerly winds. Around midday, as the land heated up, the wind would often shift 30-40 degrees to come out of the northwest. After sailing for a half hour into this header, I would tack to port, occasionally making good 70° between tacks through the daylight hours. This was very important, because I often experienced 1-1.5 knots of adverse current. If you're only making good 7-8 knots, a knot-and-one-half is a lot to lose. The slower the boat, the more important this is — and probably explains the 'bash' in Baja Bash. After all, if your boat won't sail well upwind, you motor — often into a steep chop that is relatively more closely spaced than tacking into it. The motion under sail, as everyone knows, is much better than motoring. As my 40-ft catamaran *Pantera* only has a 9.9 hp Yamaha, motoring into strong headwinds is not an option for me.

Since my return to Victoria, I noted some debate in *Latitude* on the windward capability and comfort of multihulls. I must admit that in my entire life I have spent no more than 30-40 hours sailing monohulls. I have, however, sailed upwind in 20-25 knots of wind close alongside Santa Cruz 50s and 70s in the Swiftsure Race. My vote for a good combination of speed and comfort is long skinny hulls, high stability, low windage, an efficient rig and foils. While a lightweight multi has a lively motion, unlike a lightweight mono, it seldom pounds. When *Pantera* pounds, I slow down by pinching up — a good



BAY MARINE

BOATWORKS Inc.

(FORMERLY BAY SHIP & YACHT Co.)

HAULOUTS 20' to 80'

**HAULOUTS ON
SHORT NOTICE...
CALL US!**



NORTHERN LIGHTS

**GENERATOR
SALES & SERVICE**

**NEW!
Complete Gas
& Diesel
Engine Service
Department**

FULL SERVICE BOATYARD:

- ✓ COMPLETE PROPELLER SHOP
- ✓ ELECTRICAL REPAIR & INSTALLATION
- ✓ FIBERGLASS BLISTER WORK
- ✓ LPU PAINTING
- ✓ COMPLETE MACHINE SHOP
- ✓ SHIPWRIGHTS - CAULKING & CARPENTRY



- ✓ GAS & DIESEL ENGINE SERVICE
- ✓ MAST & RIGGING REPAIR
- ✓ SANDBLASTING & EPOXY COATINGS
- ✓ FIBERGLASS & GELCOAT REPAIRS
- ✓ USCG CERT. WELDERS - STEEL/ALUMINUM
- ✓ INSURANCE WORK WELCOME

88-TON TRAVELIFT HANDLES UP TO 23' BEAM!

**Online reservations now available at
www.baymarineboatworks.com**



1-800-900-6646
(510) 237-0140 • Fax: (510) 237-2253

STEVE TAFT, MANAGER

310 WEST CUTTING BLVD. • POINT RICHMOND, CA 94804





Whatever the conditions, we've got you covered.

Ronstan wet weather gear utilizes the latest in material technologies to provide superior performance and comfort in the challenging marine environment.

Our range includes Lightweight Inshore, Inshore, Heavy Duty and Coastal gear. The outer layer of our breathable waterproof R-Tech™ fabrics utilise a micro-porous membrane with pores large enough to allow transmission of the tiny molecules of perspiration apour but small enough to prevent the passage of the larger droplets of liquid water from the external environment.



100% Waterproof • 100% Windproof • Breathable



www.ronstan.com

Available at Svendsen's Marine

LETTERS

thing — and reducing sail to limit speed to 8-9 knots. Even so, stacks of CDs sit on my un-fiddled galley counter without falling over. With my cat, preparation from anchor to 'Bash' requires nothing more than closing the ports and hoisting the sails. Enough said.

Pantera is once again headed south — which means no windward ability will be required! I'll likely enjoy a quick trip to Central America for the winter with stops in Mexico to visit friends. But what would a trip to Mexico be without doing the Baja Ha-Ha? I only have two problems. First, I need a guarantee that there won't be another nuclear winter-type forest fire in San Diego again this year like there was in '04, and I need paying crew to help out with expenses. A couple of independently wealthy Playmates would be nice, especially if they have some sailing skills. Seriously, at the moment I have room for three and perhaps four crew, be they singles, couples, male or female. I'm thinking \$100/day plus food and drink sounds reasonable. Bahia de Tortuga. Bahia Santa Maria. Cabo. I can't wait to hook up with everybody once again.

Bob Smith

Pantera, 40-ft catamaran
Vancouver, British Columbia

Bob — That you've twice sailed your cat all the way from Cabo San Lucas to Victoria, British Columbia — nearly three times the distance of a normal Baja Bash — is something that impresses us to no end. It's genuinely a tribute to you and your cat *Pantera*. In fact, we'd love to publish more details — such as how many days it took, how much VMG you made to Victoria each day, and so forth.

As for the debate over the pointing ability, it's always been between racer/cruiser catamarans and racer/cruiser monohulls. To our thinking, *Pantera* is at the very edge of not really being a cruising catamaran. In any event, we'd be very interested in knowing how many degrees *Pantera* tacks in. We haven't seen a cruising cat that can do it in less than 105°, but suspect your nearly-racing cat might do significantly better.

For folks interested in doing a very sporting Ha-Ha — and not that interested in having lots of space or headroom — we think a ride on *Pantera* would be a blast. But far be it for us to judge what might be reasonable in a 'shared expenses' situation.

↑↓ WHERE TO HAUL

Since *Profligate* is a beamy catamaran and travels all over the place, I think you might have the answer to my question. Where on the West Coast — especially in Northern California, Oregon, Washington, and Mexico — are there boatyards that can haul catamarans with a 25-foot beam?

Stuart Kaplan

Duetto, Norseman 430
Chula Vista, CA

Stuart — *Profligate* has a 30-ft beam, which limits the number of places she can be hauled. To date, we've hauled her at Napa Valley Marina in Napa, Channel Islands Boatyard in Oxnard, Vacamonte Boatyard in Panama, and at Island Water World in Sint Maarten. We also know that David Crowe hauled his cat *Humu-Humu*, with its 34-ft beam, in Mazatlan, and that a *Lagoon 55*, which has a beam of 30 feet, was hauled at Vacamonte in Panama.

We're told that *Knight & Carver* is the place to haul bigger cats in San Diego, and we're sure there are places in the Pacific Northwest — although we don't know any names. However, since *Duetto* has five feet less beam than *Profligate*, there may

**ESSEX
CREDIT**

NEW - USED - REFINANCE

Zero Down Program*

Boat Loans Made Easy®

**Please
Visit Our
New
Website!**

Come see us at:

*Jack London Fall Power & Sail Boat Show
09/10 to 09/18*

Lake Union Boats Afloat Show -- 09/14 to 09/18

Lido Yacht Expo Show -- 09/22 - 09/25

*Newport International Sail & Power Boat Show
10/06 - 10/09*



Loans From \$15,000 to \$10 million

90 Days to First Payment*

25 & 30 Year Exclusive Terms*

Instant Loan Approvals*

866-ESSEX-4-U (866-377-3948)

Northern California

Erin Moore ext. 7953

Southern California

Bonnie Summers ext. 7977

Washington

Tom Hill ext. 7966

www.essexcredit.com

*(Subject to Program Guidelines and Credit Approval)

Reference code = MAR931

EQUAL CREDIT OPPORTUNITY LENDER

Rig solutions



DINGHIES



KEELBOATS



YACHTS

 **SELDÉN**
for sailing

Find out why: www.seldenmast.com

LETTERS

be other possibilities. We'd start by calling KKMI in Richmond, Ventura Boatyard in Ventura, Long Beach Shipyard in Long Beach and Driscoll's in San Diego.

Interestingly enough, Profligate has been lifted out three different ways. At Napa Valley she goes out on a rail that supports the bridgedeck alone. At Channel Islands, she goes out on a hydraulic lift that also supports the bridgedeck alone. In Panama she went out — against our wishes — resting on her two hulls. In St. Maarten, a crane lifted four straps around her two hulls. The latter was our favorite method.

↑↓LOOKING FOR REPUTABLE SITES FOR BOATS

Having owned — or been owned by — a few boats over the past decades, it's finally time to get that good — used — boat for bluewater cruising. We've poured over brochures, talked with brokers and boatowners, walked the docks and sailed on and read nearly everything we can get our hands on, but we still think we're missing information about boats current and past. Are there any reputable websites or bulletin boards along the line of *Consumer Reports* where we can get good information?

We've been reading *Latitude* for nearly as long as it's been around — we even subscribe first class just so we don't miss an issue — and think it's the best, and not just because you'll take off the wall questions like this one.

Steve Denison
Lafayette

Steve — Sorry, but we're not familiar with any sites or bulletin boards that we feel offer particularly good boat-buying advice. And we've seen plenty that we thought offered irresponsible advice.

One reason is that there is such a variety of boats available. We think your first job is to limit your choices. Having sailed for years and owned boats, certainly you must have developed a preference for the type of bluewater boat you want, be it a retired racer, a racer/cruiser, a more traditional moderate-to-heavy-displacement boat, or a multihull. Second, you need to determine how much money you want to spend. And finally, you need to identify what you're really going to do with the boat. Answering these 'big three' questions should narrow your search considerably, at which point we suggest you interview owners of boats that seem attractive to you. One of the best places to do this is in Cabo San Lucas at the end of the Ha-Ha, because you'll see a heck of a variety of cruising boats in one place.

The good news, it would seem to us, is that there are a tremendous number of terrific used boats available in just about every category and in just about every price range. And compared to the price of houses in California, they are dirt cheap, too. In fact, anybody who has owned a house in California for the last five years could easily use the equity that has built up to buy a great cruising boat and go cruising for the next five years. And in many cases, they could keep their house and rent it out to pay for the remaining mortgage. For a lot of Baby Boomers, this would seem to be pretty much the last best time to go cruising.

↑↓EARTH WORKS JUST LIKE A WHISKEY STILL

I know you were being humorous when, in the July 20 *Lectronic*, you reported that "researchers have found that a major source of chemical contamination in the Arctic has not been human activity after all, but bird droppings. It was found that the chemical pollution in ponds frequented by seabirds can be many times higher than in nearby regions."

JUST LAUNCHED... The new J/65 Hull #1

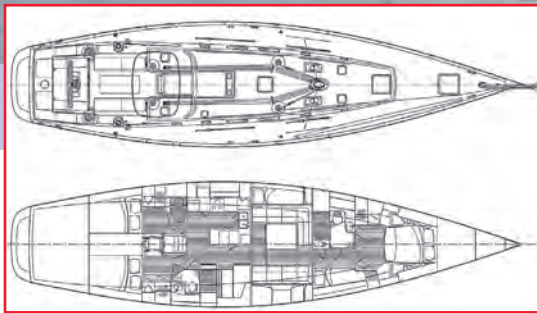

AND AVAILABLE FOR VIEWING IN SAN DIEGO

"The new 65 will be the flagship of almost any cruising fleet she joins and will be a real head-turner when she decides to strap on the racing sails and go for the silver."

– George Day, *Bluewater Sailing*

Into a luxury yacht market populated by vessels more distinguished by interior appointments and professional crew than sailing qualities, J/Boats introduces the fast new J/65 cruising/racing sloop that will be more fun for its owners to sail. The first J/65 has been delivered and is being commissioned in San Diego.

Hull #1 is optimized for 'high performance global cruising', with an extensive systems package (AC/heat/genset/inverter, etc.), bow thruster, hydraulic winches, hydraulic furler/windlass package, and a 9-ft draft all-purpose keel. Hull #2 is optimized for distance racing with all the creature comforts of elegant cruising including electric winches and heads, a full, warm, cherry-wood interior, a custom-made wine locker, and LCD video and stereo throughout. To add to performance, her ends and deck have been done in strong, lightweight carbon.

Staying true to the philosophy that comfort at sea translates into comfort at the dock, J/65's interior delivers both on style and function. There are three private cabins, a large main saloon, a large navigation station, spacious galley and an abundance of storage. This ocean-proven layout allows secure fore and aft crew movement below, even in rough conditions. Owner customization of the interior layout is contemplated within the confines of the structural/systems layout.

As with all J/Boats, the J/65 has been designed for exceptional sailing performance whether racing or cruising while offering accommodations for couples and families who want to have fun enjoying days or weeks at sea.

A J/65 will not sit still for long... call for an appointment to view the flagship of the J/Boat fleet.



A 'Cordon Bleu' galley

J/65 Hull #2 Available for December Delivery!

SAIL California
SAN DIEGO

Exclusive Agent: Jeff Brown
Web Site: www.sailca.com
Email: jboat@cts.com

2330 Shelter Island Drive #106
San Diego, CA 92106
(619) 709-0697
FAX (619) 224-6278



SVENDSEN'S MARINE

TECMA

Silence Plus Head

(38101)

LIST PRICE: **\$1152⁹⁰**
SALE PRICE: **\$864⁹⁰**



Very simple to install.
Perfectly silent operation.
Completely automatic wash cycle.
Cannot become clogged.



tacktick

Micro Compass

(T061)

LIST PRICE: **\$599⁹⁹**
SALE PRICE: **\$419⁹⁹**

No wires or connections to make.
Simple to set-up and use.
Totally waterproof (submersible to 10m).
Shock resistant. Lightweight.
Ultra wide viewing angles. Battery level indicator.
Precise to 1 degree. Easy to read large digits.

LEWMAR

Titan VIPER Carbon Winch Handle Locking 10 inch, Maxi Grip

LIST PRICE: **\$261⁰⁰**
SALE PRICE: **\$156⁹⁰**



Stronger, rigid and a massive
40% lighter than aluminum
types. The stiffness and
strength of this handle has
to be seen to be believed.
Ball bearing mounted locking spindle.

ALL SALE ITEMS LIMITED TO STOCK ON HAND.
PRICES VALID THROUGH SEPTEMBER 30, 2005.

Located in the Alameda Marina
1851 Clement Avenue, Alameda
CHANDLERY: 510.521.8454 • BOAT YARD: 510.522.2886
www.svendSENS.com

LETTERS

The full story about seabirds being the source of all that Arctic pollution is actually very interesting — and should be a concern. Because it really is we humans who are the source of that pollution through an interesting series of mechanisms.

When we humans release pollutants in temperate or tropical climates, the warm weather helps evaporate them into the atmosphere. Atmospheric circulation carries the stuff to arctic climates, where the cold temperatures cause it to precipitate out of the atmosphere and fall on land and sea. Essentially, the planet is working just like a whiskey still concentrating alcohol at high levels at the tap, except that it is concentrating pollutants in arctic regions. As such, the Arctic Sea has higher concentrations of some pollutants than temperate or tropical seas.

Once the stuff is there, especially in the sea, it enters the food chain and bioaccumulates. At every step up food webs, there are higher concentrations of pollutants in fish. Sea birds, which eat those fish, are at a very high trophic level, so they get the highest accumulation within their bodies. There are now two levels of concentration of the pollutants: the global still, and bioaccumulation in seabirds.

Now we get to the part you alluded to. Those seabirds nest in very high concentrations on cliffs above coastal plains with ponds. Those ponds gather the guano from all the nesting birds. And this is a third level of accumulation: when the contaminated seabirds congregate, they bring pollutants from broad swathes of the arctic oceans to very small local areas, and excrete them into those ponds.

So, the ponds sit at the top of a three-stage accumulation mechanism for concentrating the pollutants that we humans produce. The birds don't cause the pollution, they simply help to concentrate it at very high levels in those tiny ponds.

Why such a concern? Those ponds, teeming with life from all the bird fertilizer, are major contributors to arctic ecosystems. If the accumulation of pollutants harms the ponds, we harm ecosystems on a broader level. To my knowledge, we don't yet know if that is happening.

Lee Smith
Oakland

Lee — We were indeed being humorous about the birds being the real source of pollution in the arctic, and thank you for your complete explanation. What to do about such pollution is, of course, a much greater problem. After all, we can't realistically live without many of the things that cause pollution, yet many birds, animals and humans can't live with excessive amounts of the stuff. Unfortunately, we suspect it's not going to be all that easy for the world community to find a healthy and happy medium.

Nonetheless, there are certain places where birds and mammals really do seem to be the sole source of pollution — such as Campbell Cove State Beach, which is on Bodega Bay. According to Heal The Bay, which monitors California beaches, Campbell Cove was the fourth dirtiest beach in California last year, and in 2003 it was the second dirtiest, having 200 times the minimum safe levels of E. coli bacteria. Initially, it was thought the usual suspects — humans — were responsible. But after a \$500,000 two-year study, it was determined that the bacteria came from the poop of sea lions, seals, pelicans, raccoons, dogs, deer, seagulls — but not humans.

In addition, there are places — such as the Santa Barbara Channel — where much of the air and water pollution is natural, seeping up through the ocean floor.

Of course, when it comes to the sum total of pollution, and especially the more severely toxic stuff, we humans are signifi-



...CONTINUE THE ADVENTURE
"RALLY TO PARADISE 2005"
CABO TO PV

PARADISE VILLAGE MARINA AT:
marina@paradisevillage.com

PH/FAX:
011-52-322-22-66728

PLEASE VISIT OUR WEB SITE:
www.paradisevillage.com

Paradise Village
MARINA & YACHT CLUB

Enjoy Paradise Village Marina featuring 200 slips with maximum privacy and security. Located in Banderas Bay, one of the safest and most protected bays on the Pacific Coast of Mexico.

Come and experience the difference of our successful combination.

- Warm, friendly, personal service - Five-star facility



Contact your host:
Harbor Master Dick Markie
marina@paradisevillagegroup.com



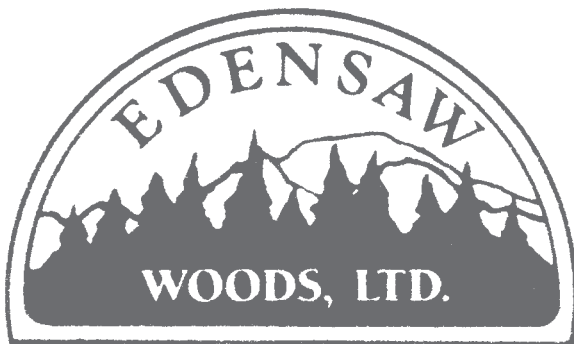

211 Seton Road
 Port Townsend, WA 98368
 Toll Free: 1-866- 583-4055
 Email: info@edensaw.com

MARINE PLY

Okoume BS 1088
 Okoume BS 6566
 Hydrotek BS 1088
 Aquatek BS 6566
 Douglas Fir Marine
 Teak and Holly
 Teak

VENEERS

(Over 150 species of
 raw & paperbacked
 in stock.)

EXOTICS

(Too many species on
 hand to list here.)

TRICEL
HONEYCOMB

LUMBER

Honduran Mahogany
 Philippine Mahogany
 African Mahogany
 Western Red Cedar
 White Bending Oak
 Sitka Spruce
 Douglas Fir
 Ironbark
 Apitong
 Teak
 Makore
 Aniegre
 Bubinga
 Over 60 species in stock.



Our Okoume products are available from
 the following distributors.

CALIFORNIA
 Sorensen Woodcraft
 13307 Avenue 221/2
 Chowchilla, CA 93610
 Toll Free: 800-891-1808

MINNESOTA
 Midwest Marine Plywood
 2259 James Street
 Eagan, MN 55122
 Phone: 651-882-9704

www.edensaw.com

LETTERS

cantly more responsible than birds, animals, and Ma Nature in general.

↑↓ **A MASS MURDERER LOOKING FOR A FREE BOAT**

It's a sorry and inaccurate cliché that the two happiest days of boat ownership are the day the craft is bought and the day she's sold. For me, the day my unfinished 26-ft catamaran lurched out of my parent's backyard in the back of a U-Haul truck brought a sense of relief. For nearly a decade my folks cajoled, coaxed, and hounded me to remove the Ed Horstman-designed hulls I had started building in 1989. So in 2004, much to my dad's delight, I placed an ad in the *Latitude Classy Classifieds* offering the foam/fiberglass hulls for a pittance of the \$7,000 I had invested.

One interested buyer was an articulate and witty man who lived near my folks' home in Clovis. He inspected the hulls, then called me in Sacramento and asked for the hulls free of charge. He might have gotten them had he intended to finish the original design. Instead, he wanted to use them as *amas* for a 26-ft monohull he planned to convert into a trimaran. Weeks later his face was splashed across the national media, for he was Fresno resident Marcus Wesson, who was arrested — and was later sentenced to death — for killing nine of his children, including some he fathered with his daughters.

The run-in with Wesson abated my dad's insistence on selling the hulls for several months. Then earlier this year, I learned he had taken my — well his — reciprocating saw during a visit to see the granddaughters. I soon got the call I expected. Either I get my hulls out of his backyard or he'd see which blades worked best on fiberglass.

So last June, my hulls reappeared in *Classy Classifieds*, this time free to the first taker. The second caller fit the bill: "My husband wants them. How soon can I get them?" Then the Willits resident added, "He's wanted to do this his whole life and can't wait to get started once he's out." Out of Soledad State Prison, that is. His crime had been running from the police. Why? "He was being stupid." I didn't press any further, as visions of Marcus Wesson and my elderly parents flashed through my mind. But everyone needs a break and a fresh start, right? So I called two of my burliest buddies and we met her at my folks. We loaded up the hulls and waved as they drove off.

My relief was multifaceted: fears / concerns were unfounded; the hulls are finally off to someone who just might see



CRAIG MOYLE

Dad was glad to see those hulls go.

the project through; and I no longer have to permanently borrow power tools capable of halving a hull. Since I never got to meet the new builder — he didn't get out until August 18 — and I know he's an avid *Latitude 38* reader, I wish to bid him fair winds and speedy construction. And if you're thinking of a name to grace the stern, I have a suggestion: *Second Chance*.

Craig Moyle
 Concordia
 Sacramento

Craig — Does it come as any surprise that sailing magazines — which celebrate a lifestyle of unusual freedom — are very

Make Your First Ocean Passage a Great One



EARN WHAT IT TAKES...

to make a major cruise under sail during our 22nd offshore sail training voyage. This summer, we're headed back to Hawaii and Tahiti, on a voyage that offers you a choice of four ocean passages, a coastal trip, or a rare exploration of remote South Pacific atolls.

Our emphasis is on helping you build skills in an environment of fun and great sailing. Many who sail with us are planning voyages of their own—there is no better way to prepare. Underway, we provide in-depth experience in vessel management, safety, provisioning, electrical and plumbing systems, celestial navigating, anchoring, sail handling, weather routing, and heavy weather.

Along with eight other crewmembers, you'll sail in all conditions, standing watches and steering as *Alaska Eagle* sails 180 to 240 miles a day. Delicious meals are prepared by the ship's cook. Everyone has a comfortable berth, and double cabins are available for couples and single women.

Alaska Eagle is owned by one of the nation's premier non-profit sailing schools. Designed by Sparkman & Stephens and strongly built of aluminum by the Royal Huisman Shipyard, *Alaska Eagle* (ex Whitbread winner *Flyer*) has logged more than 350,000 offshore miles. She has a comfortable four stateroom interior and all the latest electronics and cruising gear. She is Coast Guard certified for All Oceans.

SUMMER 2006 SKIPPERS – *Sail and Learn with the Best*



Since Rich and Sheri first sailed aboard *Alaska Eagle* from England to California in 1982, they have been aboard as skipper and mate for the majority of her voyages. Combined, they have sailed more than 550,000 miles, including three Atlantic crossings, more than 30 crossings between Hawaii and the West Coast, 13 equator crossings, and many miles through the South Pacific between Tahiti and Australia. In between, Rich and Sheri built two boats, virtually by themselves. In the first boat, a Farr 44 named *Confetti*, they circumnavigated South America. Their next boat was a 54 foot aluminum sloop named *Polar Mist*, in which they voyaged from California to Antarctica and back.

Rich and Sheri enjoy sharing their extraordinary knowledge with others. Rich can fix anything (and has) on a boat. He has taught many nautical skills, and enjoys showing sailors how easy it is to learn celestial navigation. Sheri is an expert in preparing for cruising, from provisioning to spare parts to sail selection. Rich and Sheri live life to the fullest, enjoy sharing the adventure, and always look forward to new destinations.

Licenses held: USCG Master Upon Oceans • STCW International • Yacht Master Offshore (RYA/DOT) • US Sailing Keelboat Instr.

ALASKA EAGLE 2006 SUMMER VOYAGE

Leg 1	Newport Beach-Marquesas	3000 miles	May 5-May 26	21 days
Leg 2	Marquesas-Tuamotus-Tahiti	775 miles	May 29-June 13	15 days
Leg 3	Tahiti-Fanning-Hawaii	2500 miles	June 16-July 16	20 days
Leg 4	Hawaii-San Francisco*	2400 miles	July 20-Aug. 6	17 days
Leg 5	San Francisco-Newport Beach	350 miles	Aug. 9-Aug. 13	4 days

**Our leg 4 voyage from Hawaii to San Francisco is an all-women's trip, led by a great team of experienced offshore sailors and teachers: Karen Prioleau, Barbara Marrett and Carol Hasse.*

To learn more: occsailing.com

To request a color catalog or specific info: **949-645-9412**

Or write: Alaska Eagle Voyages, 1801 W. Coast Hwy, Newport Beach, CA 92663

The School of
SAILING & SEAMANSHIP
Orange Coast College



FOR PLAY

Forespar helps make your playtime easier by providing a wide variety of quality marine products, hardware and accessories specifically designed for your boat.

Full Line Catalog Available



Downwind Poles



Plumbing



Leisure Furl



Safety



Lifts & Davits



Vangs



Ph: 949.858.8820
Fax: 949.858.0505

www.forespar.com

LETTERS

popular with people who are incarcerated?

By the way, your boat name recommendation recalls the inspired series of names used by the late Colin Case: Felony (which was destroyed on the rocks at Pt. Bonita during the deadly Doublehanded Farallones Race of '92), Second Offense, and Recidivist. The only one of Case's boats that didn't fit the series was National Biscuit, the company from whence came much of his wealth.

↑↓ THIS MONTH'S SECOND LETTER FROM IRELAND

I read the August issue *20 Years Ago This Month* item about rock star Simon Le Bon and 23 others being aboard the 77-ft *Drum* that rolled — because the 14-ton keel came off — during very windy conditions in the 1985 Fastnet Race. Despite the fact that many of the 24-person crew ended up in the water, and that Le Bon, his younger brother, and five others were trapped down below for 40 minutes, all were rescued without major injuries.

I had designed *Drum* in anticipation of the upcoming Whitbread Around The World Race.

In the original *Sightings* piece from 20 years before, *Latitude* speculated that the keel had come off because of inadequate design specification — a speculation that was repeated when you reprinted the original piece. I'd like to make it clear that it was determined that the problem wasn't with the design specification, but rather with the welding of the aluminum fabricated keel. Ron Holland Design has had complete confidence in continuing to successfully design keels following this same system.

Ron Holland
Kinsale, County Cork, Ireland

Ron — Thanks for the clarification. It's too bad that the Drum sailors who returned for the 20th anniversary Fastnet had such very light weather conditions for the reunion race aboard what is now known as Arnold Clark Drum.

As many readers know, Ron Holland spent more than a little time around San Francisco Bay some 25 years ago, and was catapulted into design fame by the 40-ft Imp he designed for Dave Allen of Belvedere, a boat that is considered a landmark design because of her incredible performances at the Admirals Cup in England and the SORC in Florida. New Zealand native Holland later moved to Ireland, where in subsequent years he has become perhaps best known for designing mega sailing yachts — such as Joe Vittoria's 247-ft Mirabella. His office is



RON HOLLAND DESIGN

Ron Holland is currently designing this 190-footer for the co-founder of Sun Microsystems.

currently at work designing the 190-ft ketch Ethereal for Bill Joy, one of the Northern California founders of Sun Microsystems. Joy intends to make her the world's most eco-friendly yacht. Check out this and other Holland projects at www.ronhollanddesign.com.

↑↓ GOLDEN GATE / FARALLON / BODEGA

I'm having a hard time getting information about the Gold-

landfallnavigation.com



**LANDFALL
NAVIGATION**

OFFSHORE OUTFITTERS

**electronic charts
paper charts
SOLAS flares
life rafts
foul weather gear
navigation software
GPS receivers
MOB equipment
inflatable PFDs
cruising guides
almanacs, pilots
tethers
jacklines
clocks, barometers
instruments
EPIRBs
watermakers
drogues
sea anchors
abandon ship gear
rigging cutters
medical packs
night vision
sextants**

See our catalog online
or call for a free print catalog

800-941-2219

VISIT OUR RETAIL STORE

Exit 6 off I95 · 151 Harvard Ave., Stamford, CT 06902



**MODERN SAILING
ACADEMY**
20+ Years
Quality Sailing Instruction

SF Weekly: "Best Sailing Instruction"
Cruising World: "Very experienced instructors"

Sausalito Headquarters
"THE BEST SAILING ADVENTURES"
School of the Year 2004

Offshore Passagemaking (ASA 108)
This six day/ five night intensive class will be taught aboard our Islander 53 "Polaris". Celestial navigation is an integral part of the class and John Connolly will give you a simple and precise way to do "Noon Sites" so you can find a fix at least once per day. Topics include daily system inspections, plotting rhumb lines on a mercator chart, shipboard routines on an extended voyage, etc. (Just 2 berths open) \$1275
October 3 to 8 (OPM) w/ John Connolly

Australia - Whitsundays 2006
The Whitsunday islands off Australia's East Coast are a mecca for cruisers, with 74 islands, consistent breeze and abundant marine life. February is summer on this side of the equator, so temperatures stay in the low 80's with lots of sunshine. (BBC & ACC) \$2250 pp \$4050 cabin
Leg 1: Feb 9 - 19 Leg 2: Feb 23 to Mar 4

Greece & Turkey 2006
The Dodecanese group of islands (14 in all) are on the eastern edge of the Greek Isles in the Aegean Sea. Both legs stop in Turkey. \$2375 pp \$4275 cabin
Leg 1: May 6 - 16 Leg 2: May 19 - 29 (BBC & ACC)

Specialty Courses & Events

- * Wednesday Night Sail - Sept 7, 21 - \$25
- * High Wind Docking - Sept 11 - \$85
- * Radar Class - Sept 18 - \$165
- * Farallones Day Trip - Sept 24 - \$185
- * 12 Volt Class - Oct 1 - \$150

"Learn To Skipper Course"

- ASA Basic Keelboat (BKB) - Sept 3-4, 17-18
- ASA Basic Coastal Cruising (BCC) Sept 10-11, 17-18
- Combo (BKB) & (BCC) 5 day Class Sept 12-16, 19-23
5 days (\$995) or 4 weekends (\$1190)

PHONE FOR EXPERT CONSULTATION
415 - 331 - 8250 / 800 - 995 - 1668
www.modernsailing.com

LETTERS

en Gate 30 — aka Bodega 30 and Farallon 29/30. I'm writing to you in particular because you mentioned this design in an editorial response about good cruising boats under \$100,000 — and it's about the only mention I could find on the web. So far, I've found out that the boat was designed by William Blains, who is also unknown on the web. How else can I find out about the boat's cruising ability?

Claude Badet
Planet Earth

Claude — If we're not mistaken, the Golden Gate / Bodega / Farallon was — like the similar-looking Nor'West 33 — designed by Chuck Burns. We're not familiar with William Blains.

Ray 'Sea Gypsy' Jason, who writes for Latitude from time to time, has been cruising his Farallon 30 for God-knows-how-many-years. You might email him at seagypsy38@aol.com for his input.

Our impression is that the 30-footer is a performance full-keel design that was built very sturdily, but is not as roomy as some boats of the same length. But don't hold us to it.

↑↓ I'VE BURNED BIODIESEL FOR TWO YEARS

Concerning Dedalus Hyde's recent article on using biodiesel in marine engines, I have about 2.5 years of experience I can share.

I have one of those 49 mpg diesel Volkswagens *Latitude's* editor mentions wanting, an '03 VW Beetle TDI that I've run on 100% biodiesel (B100) since it was new some 21,000 miles ago. (This, incidentally, was against VW of America's warranty.) Although I don't get near the 49 mpg potential of the vehicle — I mostly drive my kid's and my own butt around hilly, stop-and-go Marin County — it easily pushes over 40 mpg in freeway driving and I average about 38 around town. I pay \$3.35/gal for biodiesel from a local co-op that gets it delivered from Yokayo Biofuels (www.ybiofuels.org) in Ukiah. It's worth noting that at almost \$3/gal for gasoline these days, I'm still doing significantly better economically speaking than I did in my '98 gas-engined VW Beetle, which averaged about 22 mpg.

At about the same time in early '03, I started burning 100% biodiesel in my 40-year-old Perkins 4-108 aboard *Pearl*, my '77 Islander 36 sloop. As readers may know, biodiesel is blendable in any proportion with regular petroleum (#2) diesel. No engine conversion or modification is required.

There are, however, several important caveats to using 100% biodiesel, or even a blend greater than 20%. Indeed, if you don't take into consideration these important points, you could be very disappointed in your biodiesel experience. However, I consider the many benefits of using biodiesel in a marine environment — more on these in a moment — to be well worth it.

First and foremost, biodiesel is a much stronger solvent than petroleum diesel. As such, it eats rubber components much faster than petrodiesel. The neoprene gasket between my fuel tank sender and the tank turned to gooey mush after about a year of exposure to biodiesel. If your fuel lines are more than five or six years old, they're probably made of something that will dissolve quite rapidly with biodiesel. The most biodiesel-impervious material for this purpose is Viton, which costs \$3/ft for 5/16" hose, but will pretty much *never* have to be replaced.

Also, because it's such a strong solvent, biodiesel is going to release every bit of sludge that's accumulated in your fuel tank over the years, which will immediately clog your secondary fuel filter. My tank was a mess long before I began

DO YOU WANT TO SAVE A LOT OF MONEY REFITTING YOUR BOAT?

If you are considering an extensive refit, consider Port Townsend Shipwrights Co-op located in the Port of Port Townsend in Washington. Since 1981, employee owned PTSC has been serving the commercial and pleasure boat fleets of Puget Sound and SE Alaska. We specialize in all aspects of boat repair and construction: structural and fine woodworking, metal fabrication, ABYC electrical, repowering, plumbing and hydraulics, even wooden spar construction and traditional coatings. 70- or 330-ton travelifts, owned and operated by the Port of Port Townsend are available to safely deliver your boat to our facility.

Our basic yard rate is only \$50 per hour

Round-trip trucking for a 40-ft sailboat 12-ft beam max to Port Townsend currently is about \$5,500.*

We competently manage larger projects or simply ready your boat for the season, and you can keep those savings to the bank. Call us; we'd enjoy discussing your project.



OUR FACILITY



WATERMAKER INSTALLATION

PORT TOWNSEND SHIPWRIGHTS CO-OP INC.

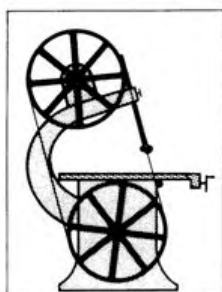

3109 JEFFERSON ST.
PT. TOWNSEND, WA 98368
(800) 567-8780 • (360) 385-6138
Fax (360) 385-5710
ptship@olypen.com
www.ptshipwrights.com

*call us for an estimate, sales tax not included



INTERIOR JOINERY



OYSTER POINT MARINA/PARK

MARINA SERVICES

BERTHING: 600 berths from 26-60 ft.

GUEST DOCK & BERTHING: Available at 60¢/ft./night

RESTROOMS & HOT SHOWERS: Public restrooms and private restrooms with showers

LAUNCH RAMP: Two-lane concrete ramp with parking for 70 boat trailers and cars

PUMP-OUT FACILITY: Located on the fuel dock

PARK/OPEN SPACE: Approximately 33 acres of park and open space with trails, promenades and swimming beach

FISHING PIER: A 300' concrete fishing pier

24-HOUR SECURITY

DRY STORAGE

CABLE TV: Available

OFFICE HOURS: Weekdays 8:30 to 4:30

Saturdays and Sundays by Appointment

Closed holidays

BOAT & MOTOR MART

New Boat Sales (Parker, Osprey)

Yacht Broker

(650) 246-1460

OYSTER POINT BAIT, TACKLE & DELI

(650) 589-3474

MARINE CENTER

Dry Storage, Fuel (Both Regular & Diesel)

(650) 872-0795

DOMINIC'S RESTAURANT

Weekday Lunch • Banquet Facilities

Dinner Nightly

(650) 589-1641

INN AT OYSTER POINT

Bed & Breakfast with Restaurant

(650) 737-7633

ANCHOR DETAILING

Complete Yacht Detailing Services

(650) 579-2776

OYSTER POINT YACHT CLUB

(650) 873-5166

Located in

SOUTH SAN FRANCISCO

Take Hwy. 101 to South San Francisco/Oyster Point Blvd. exit.

Then one mile EAST on Oyster Point Blvd.

By Water: 8.2 Nautical Miles SOUTH of Bay Bridge.

FOR INFORMATION CALL
(650) 952-0808
www.smharbor.com

LETTERS

burning biodiesel, and I had 'polished' the fuel several times before switching, so it wasn't as big a problem for me. I had also installed a dual-bowl Racor filter system with a vacuum gauge as well, which I highly recommend. You can 'see' the filters clogging by the increased vacuum pressure in the gauge, and it's a great feeling to have this feedback as well as the ability to switch filters by flopping a lever while underway.

Biodiesel is also more viscous than petroleum diesel, which isn't much of a problem here in sunny California, but could be in colder areas where gelling of the fuel can stop it from flowing much sooner than petrodiesel. I also burn a little more fuel using biodiesel than petroleum diesel — biodiesel has 5-10% fewer BTUs/gallon — but since I burn so little fuel overall in the sailboat, I hardly notice.

At one time there was a marine biodiesel fueling station on the Bay in Alameda, but because of the problems associated with its high solvency properties — and higher price — they stopped selling it. When you're out for a cruise, feeling good about burning an eco-friendly — or friendlier — fuel, and suddenly your boat stops moving, you need a tow, and the mechanic blames it on "bad fuel," you're probably not going to keep using it. It's all a matter of expectations and education.

Now for the good news — and why I burn the stuff, despite the costs and aforementioned caveats.

First of all, biodiesel is a *much* cleaner-burning fuel than petrodiesel in almost every respect. There's far less soot, which means far less cleaning of the hull by my exhaust hose thru-hull. Then there's the smell — I burn fuel made from recycled fryer oil — mostly soy oil in the U.S. — which tends to smell a little like the kitchen of the restaurant from which it came. It's not what I'd exactly call pleasant, but it's a far cry from the stinky petroleum-based stuff I used to burn. When there's a little tailwind, it makes a big difference.

Also, biodiesel has a much higher flashpoint than petrodiesel. While it's true that diesel #2 doesn't generally burn if you put a match to it, it *will* burn — very hot — if it gets ignited by something a bit hotter. Biodiesel just *doesn't*. I remember doing a little test with my 12-year-old son — nothing like setting something on fire to please a 12-year-old — in a couple of tuna fish cans. We put a small butane torch to both diesel #2 and a *very* small amount of biodiesel. The #2 caught fire immediately and burned black like kerosene — which is its neighbor on the alkane scale. But the biodiesel just smoldered and smelled like a kitchen fire. That's not to say it won't burn under enough heat, but it's much safer than diesel #2 in this respect. For me, this alone justifies using it on the boat.

Another factor is the smell of the fuel itself. Again, it's not Chanel #9, but compared to diesel #2, it's like a walk through a rose garden. Even more significantly, it has essentially zero VOCs and is thus much easier on your hands as well. Changing the primary on my 4-108 requires losing about 8 ounces of fuel into an absorbent pad — and my hands — every time, and the difference in the resulting smell in the boat and on my hands is huge.

Biodiesel also has higher lubricity than petro diesel. As such, longer term, biodiesel-burning engines have less wear — which has been routinely documented. But the amazing thing is the short-term benefit. My 4-108 is noticeably quieter at idle, and will idle at lower rpms, when burning biodiesel! It still shakes and roars like an 18-wheeler at its cruising speed of 2,000 rpm, but it's nice when coming dockside to be a few dB down. (I should note that you should be even more aware of your lubricating oil condition when burning biodiesel, as mixing of the raw fuel and the oil can cause the oil to gel — so

SAFETY WITH A TWIST

Why a Garhauer Radar Tower?

Rather than depend on high maintenance gimbals mechanisms, a large knurled knob quickly levels your radome to the tack you're on. Whether you are cruising coastal or offshore, we have the tower to meet your needs. Call us today to discuss the best solution for your boat.

All stainless steel: Not powder coated, our towers are polished stainless steel, designed with quality marine materials and built in the USA. All radar towers come with a 10 year unconditional guarantee.

Free technical/installation support: You are only a phone call away from a helpful and knowledgeable representative.

Each all stainless steel radar tower kit comes complete with:

- Polished stainless steel pole
- Radar plate matched to your radome model
- All mounting hardware
- Pivoting or fixed base and backing plate
- 6 to 1 engine hoist with yacht braid

Great price: Because Garhauer sells only direct to our customers, we are able to offer top quality gear for a lot less than elsewhere.

RT-8 2.0" surface mount

RT-8 2.5" surface mount

RT-10 2.0"below deck mount

RT-10 2.5"below deck mount

Tower shown includes the optional antenna hoop, available for mounting other antennas in one easy to access location.

GARHAUER

MARINE HARDWARE

1082 West Ninth St., Upland, CA 91786

10 Year Unconditional Guarantee

Tel: (909) 985-9993

FAX: (909) 946-3913

www.garhauermarine.com



Tower shown with optional antenna hoop (radome not included)



SPINNAKER

S A I L I N G



LEARN TO SAIL

Complete ASA Courses
7 days a week

SAILING CLUB

4 memberships to choose

CHARTERS

Boats from 22 to
47 feet - available

SAILING VACATIONS

Join us for an
unforgettable sailing
holiday or let us
help you plan yours



Upcoming Flotilla Trips

BVI - Dec. 05



\$100.00 OFF
LEARN TO SAIL
PACKAGE
with this ad
during the month
of September '05
take classes anytime
in 2005

Stop by, Call or visit our website

(650) 363-1390

Located at the Redwood City Marina
451 Seaport Ct. Redwood City

www.spinnakersailing.com

The South Bay's premier Sailing Club
Celebrating 25 years - since 1980

LETTERS

keeping it clean is still very important.)

Finally, there's the eco/biofuel/foreign-petroleum-dependency/'guilt-free' argument for using biodiesel. Frankly, given the above advantages of using the fuel, this isn't necessarily at the top of my list. But it's hard for me to feel guilty burning 20-25 gallons a year of any fuel on the boat. Of course, it still puts carbon into the atmosphere, but like any biofuel, at least it's recent carbon — carbon absorbed by the crops that produced it in the last few years, not those from a few hundred million years ago.

Alas, availability and cost are still the two factors that will prevent all but nuts like me from using biodiesel in their boats. And if you've got a dozens-or-more-gallons-per-hour powerboat, you're not going to be fueling it from jerry jugs, period. But biodiesel's popularity is increasing, and hopefully in the future we'll begin to see 10-20% (B20) blends of bio- and petrodiesel become more common (the effects of blending are nonlinear in terms of both emissions and smell, by the way, so you get a strong benefit from even a low blend).

Readers interested in contacting me about my biodiesel experience can email me at eric@gus.to.

Eric Lyons
Pearl, Islander 36
Tiburon

Eric — Terrific information, thank you very much.

↑↓ **THE COVER PHOTO MAKES YOU FEEL IT**

The July cover with the photos of *Lydia* and *Pegasus* is the best I've seen yet on *Latitude*! You can feel yourself trying to stand straight at a 45 degree angle. Many, many thanks.

Steve Morris
Half Moon Bay

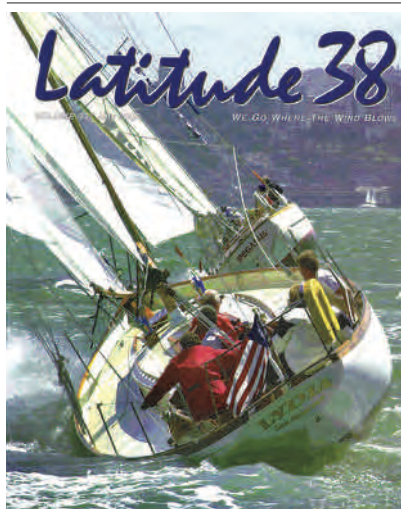

Steve — We're glad you liked it. Although we often get soaked in the process, one of our greatest pleasures while creating *Latitude 38* each month is shooting dramatic photos on the Bay. This one was taken

by Managing Editor John Riise.

↑↓ **DOESN'T GET AWAY FROM THE DOCK TOO OFTEN**

As a member of the Ha-Ha Class of '04, I find Sigmund Baardsen's negative comments about that event to be all wet. What an education I got from the Ha-Ha — followed by the Run to Paradise to Banderas Bay, Philo's at Thanksgiving, Rick's at Christmas, the Banderas Bay Regatta, and then putting two boats on the hard at Marina Seca! What experience and knowledge I gained.

I also love La Paz — but won't be influenced by someone who doesn't get away from the dock too often.

Bobby Rohrer
SunStar
Albuquerque, New Mexico



NOW THIS WAS SAILING!

and PUSSEY'S RUM, ~ or "Nelson's Blood" ~ was their rum!

The original navy rum and the father of grog as issued on board ships of Great Britain's Royal Navy for 330 years. There is nothing like the full, rich taste of PUSSEY'S - 100% pot still

like single malts. Sip it neat, or try it with cola to taste the real difference. Gold Medal Winner, London 2001 & Double Gold, San Francisco 2003.

HOW TO FIND PUSSEY'S & to learn more of its colorful history. www.pussers.com

© 2003 Pusser's Rum, Inc. All rights reserved. Pusser's Rum is a registered trademark of Pusser's Rum, Inc. Pusser's Rum is a registered trademark of Pusser's Rum, Inc. Pusser's Rum is a registered trademark of Pusser's Rum, Inc.

Oceanus Marine LLC

Marine Surveying and Consulting

- Extensive Pre-Purchase Surveys
- Valuation and Condition Appraisals
- Machinery and Systems Assessments
- Both Sail and Power

Comprehensive Experience:

- Lloyd's Surveyor (Small Craft & Engineering)
- USCG Master & Engineer Licenses
- USCG Commercial Vessel Asst. Inspector
- Mega-Yacht Construction and Engineering
- NASA Aviation Safety Research Engineer

John H. Moses, M.S. 650.267.3104
oceanusmarine@hotmail.com

LLOYD'S MARITIME
ACADEMY



MEMBER
ABYC

STARBUCK



CANVAS WORKS

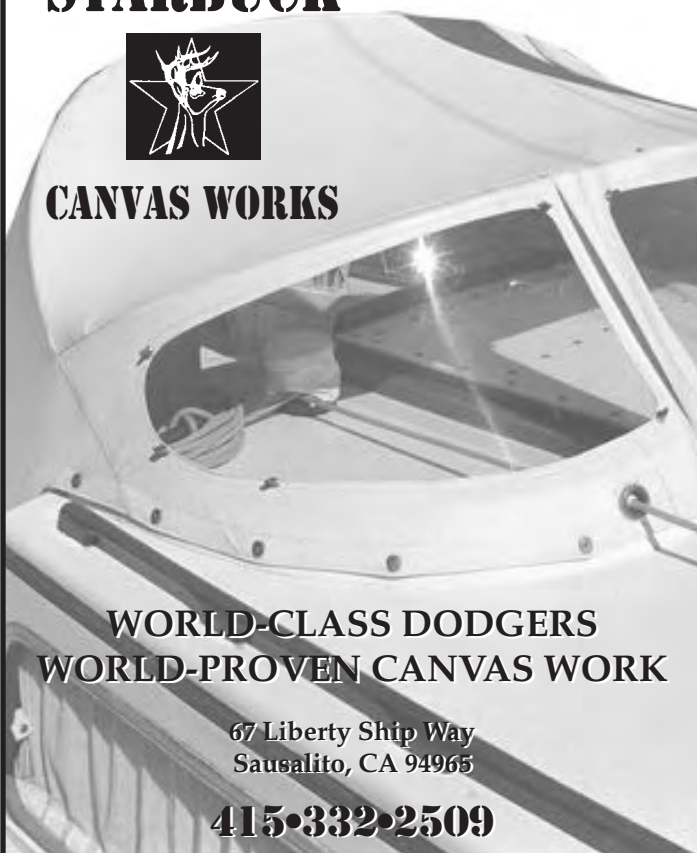

WORLD-CLASS DODGERS
WORLD-PROVEN CANVAS WORK

67 Liberty Ship Way
 Sausalito, CA 94965

415-332-2509

LETTERS

↑↓ BEACHBALLS ON BOATS — AND IN OUTER SPACE

I read with interest the letter in the July issue referring to the use of a beachball globe as a record of routes sailed. I didn't know about that back in 2000, when I furnished a Space Shuttle crew with one for their on-orbit interviews. We were mapping the world on that mission — I was the Payload Communicator, and talk about learning your radio protocol! — and the ball was useful to show the orbital paths they flew. Note the dark lines drawn on the globe with a Shuttle model floating above it. That's Kevin Kregel, our commander, and Payload Specialist Gerhard Thiele making sure the earth doesn't float out of the picture.

By the way, while the mission mapped most of the land area of the earth in 3D, a side benefit is a map of all the coastlines — accurate to about 10 meters! I'm trying to get that out to the public, as I'm well aware that coastlines and islands can be misplaced on older maps and charts. I've plotted the GPS



NASA

Shuttle astronauts used low-tech visual aids to illustrate their routes to viewers back on planet Earth.

tracks of some of our charter trips onto the Shuttle maps, and they lay down quite well.

Dr. Tom G. Farr, Deputy Project Specialist
 Jet Propulsion Laboratory and Santa Barbara YC
 Pasadena

PS: If you run the picture, please credit NASA and include the image number (s99e5259.jpg), as folks can get it directly from NASA that way.

↑↓ WHY THE ENVIRONMENTALISTS ARE SELECTIVE

Recently, the editor of *Latitude* wondered why the ecological community mounted such a big campaign to prevent a relatively benign salt plant from being permitted at Laguna San Ignacio, while for decades they've seemingly done nothing to save the Sea of Cortez, an infinitely more valuable ecological resource. I'd like to take a crack at answering that question.

The San Ignacio salt project proposal caused an uproar because it could be represented as a new threat complete with villains — Japan and the government — and things to save — whales and a United Nations-designated preserve. It also had an easy solution: Scream a lot and get it stopped.

This is the kind of high-profile target favored by ENGOs (Environmental Non-Government Organizations — to make it appear as if they are doing something for the money people give to them to do something. What I liked about it was the orchestrating by the World Wildlife Fund and others, and *Grupo de Cien* (mostly Mexican intellectuals who wouldn't know the rear end of a whale if one sat on them). Their full-

EMERY COVE YACHT HARBOR

OWN A SLIP ON SAN FRANCISCO BAY

Great Location and Great Investment



A MARINA THAT MAKES YOU FEEL LIKE A RESORT GUEST!

THE PERFECT LOCATION - IN THE HEART OF THE SAN FRANCISCO BAY!

BUY A SLIP...

SAVE MONEY & EARN EQUITY!

Save 1/3 of your rental cost when you own your own boat slip and enjoy big tax savings as a slip owner. Emery Cove Yacht Harbor is the only marina on the Bay with FEE SIMPLE dockominium ownership.

OR RENT...

COMPETITIVE RENTAL RATES!

Rental rates from \$7.50 to \$8.00.

CALL FOR A COMPLETE MARKETING PACKAGE • 510-428-0505

3300 Powell Street, Emeryville, CA 94608 • www.emerycove.com • Email: info@emerycove.com

First Time Ever, Limited Time Only MONITOR TRADE-IN PROGRAM!



TRADE IN YOUR TIRED OLD MONITOR FOR A BRAND NEW, GUARANTEED ONE.

For an old Monitor in functioning condition, we will pay up to \$1,200 depending on age and condition.

OLD MONITORS ARE GREAT BUT NEW ONES ARE EVEN BETTER!



FOR SPECIFICS, CHECK OUR WEB SITE

www.selfsteer.com

AND CLICK ON 'USED MONITORS'

FACTORY DIRECT
SCANMAR
INTERNATIONAL

432 South 1st St. • Pt. Richmond, CA 94804
Tel: 510 215-2010 • Fax: 510 215-5005
Toll Free: 888-WINDVANE (946-3826)
email: scanmar@selfsteer.com

Horizon Reverse Osmosis™

Pioneer of fresh water since 1975

New!
Energy Efficient
Escape Model

The Seafari™ Escape with its unique EfficientSea™ energy transfer technology brings efficient, compact, extraordinarily quiet watermaking to small and mid-size power or sailboats.



The ingeniously designed manifold and two-valve flow control system allows for smooth, constant, fault-free, one-touch automatic operation. The overall design of the unit, coupled with the use of the highest quality stainless steel and polymers, make it truly superior to models currently on the market.

200-600 gallons per day!

- Compact and Extraordinarily Quiet
- Electricity Consumption reduced by as much as 75% in DC & AC applications

Model pictured is Modular system. Also available in Contained system.

AC powered systems also available from 170 gpd to 1,800 gpd

Distributor:



Southern California Marine Enterprises
(619) 224-2869

1214 ROSECRANS ST, SAN DIEGO CA 92106 • FAX 619-226-0496

www.southerncalmarine.com

Reliable Marine Electronics

Northern California's most complete,
full service marine electronics specialists.

B&G[®]

C-MAP
USA

ComNav
autopilot
800.221.5005
www.comnavmarine.com

Datamarine
PRECISION MARINE INSTRUMENTS

DIRECTV[®]

Globalstar

FURUNO[®]

ICOM

INCA
CORPORATION

KIVHI

NAVIONICS[®]
THE LEADER IN ELECTRONIC CHARTS

NORTHSTAR✦

Raymarine

SEA
American Technology That Talks To The World

SeaTel[®]

SIMRAD

WESMAR

SALES • SERVICE • CUSTOM INSTALLATION

RADAR • AUTOPILOT • CHARTPLOTTERS
SATELLITE TV/PHONE • GPS
VIDEO DISTRIBUTION
ENTERTAINMENT SYSTEMS

Alameda Showroom and Service Center

1925 Lafayette Street
Alameda, CA 94501
Tel (510) 864-7141
Fax (510) 864-1233

See us before you head south!

LETTERS

page ad in the *New York Times* was a masterpiece, postulating that desalinization — i.e. taking the salt out of the water (sic), would cause the waters in the lagoon to become fresh so the baby whales would sink and drown! This amazing science, which was picked up as fact by some "science writers," and was passed on to the flat earthers by the always obliging press. Anyway, the project was killed, and the ENGO's claimed to have once again saved the whale from extinction by the ever-evil Japanese.

Saving the Sea of Cortez is a different kind of animal. As the editor of *Latitude* observed, the problem has been going on since the '60s. At that time, along with expanding big boat fisheries for sardines and shrimp, FAO and Mexico began an artisanal fishing development program. The Mexican government granted permits to private entrepreneurs, set up Fishery Cooperatives, and provided both groups with credit to obtain *pangas*, outboard motors, fishing gear and pickup trucks. Thousands of people relocated to the coastal areas of Baja and the Sea of Cortez. The result was very satisfactory in terms of production. The problem was that there was little management data collected, no quotas on catches for finfish and sharks, and little oversight or enforcement of permits.

As one might expect, the fisheries were mostly exploited at rates that were not sustainable over the long term. Over-exploitation was exacerbated by a more than doubling of the population in Mexico — and the U.S., where much of the table fish went — and the construction of the TransPeninsular Highway down the Baja. Today, the problems are to reconstruct some idea of what was removed and to develop management strategies to allow stocks to rebuild — or at least be fished on a sustainable basis — and provide some alternative employment for people in the coastal communities.

The big NGO's like World Wildlife Fund, the Packard Foundation, PEW, the Nature Conservancy, and their smaller Mexican counterparts recognize the problem — but the solution is not simple. Unlike San Ignacio, the NGO's cannot solve the problem by demanding and getting a simple prohibition. One cannot just put a stop to fishing.

Nonetheless, the NGO's have pushed for Marine Protected Areas and strict regulations — but do not seem concerned by the resultant social impact. The activist NGO's need quick solutions, and have little interest in working out long-term solutions. The private NGOs — like PEW and Packard — are better in that they are not dependent on checks from little old ladies and pennies from school children for their support. However, I was at one meeting for the *Parque Nacional Bahía de Loreto*, where a question was raised about what to do with the fishing communities. Even the private NGOs said, "They (the fishermen affected by park regulations) will just have to do something else."

Unfortunately, the thousands of fishermen and their children and grandchildren in the coastal communities have no obvious means to do "something else" to make a legal living. Retraining and creating jobs takes time, and have other attendant problems. They are not the kind of headline-grabbing, fun and spectacular activities — like stopping Mitsubishi, or saving the whales — that get donations pouring into the coffers. And that, in my cynical opinion, is why, Seawatch aside, you do not hear much about the fate of the Sea of Cortez.

Frank Hester
Ligüi
Baja California Sur, México

Frank — We hate to be cynical, but we think your explana-



Able Apogee 50' • 1993 • \$590,000

Lidgard 37' • 86 • \$179,000



Sabre 45' • 2001 • \$525,000



7

great reasons to visit Seattle.

Norseman 400 40' • 87 • \$225,000



The secret is out. Bay Area yacht buyers have discovered that the Seattle Boats Afloat show is a prime venue for finding the yacht of their dreams. Bay Area buyers have also learned that *Swiftsure Yachts of Seattle is the brokerage that delivers the expertise and range of services needed to buy (or sell) a high-quality yacht, from finding the right yacht to delivery.* So come visit Swiftsure Yachts at Boats Afloat September 14–18. Can't make it to Seattle? Take a closer look at these yachts, and all of the Swiftsure Yachts listings, at www.swiftsureyachts.com.

SEATTLE SEPTEMBER 14~18
BOATS AFLOAT SHOW
 WWW.BOATSAFLOATSHOW.COM

Hallberg-Rassy 43' • 2004 • inquire



Santa Cruz 52' 1993 • \$550,000



Taswell 43' • 1994 • \$325,000



Note: Actual lineup of yachts to be exhibited at Boats Afloat is subject to change due to factors such as sales and availability. For changes, call 206.378.1110.

MORE QUALITY LISTINGS FROM SWIFTSURE YACHTS

65 Frers	1978	SOLD	46 Hallberg Rassy	2002	SOLD
61 Nordia	1985	\$900,000	46 Hallberg-Rassy	1999	SOLD
61 Custom Perry	1998	\$699,000	46 Hallberg-Rassy	1999	\$499,000
50 Riley Jespersen			46 J Boat	2000	\$450,000
Eden 50	1998	inquire	42 Brewer PH	1992	PENDING
49 Hylas	1999	\$429,000	41 Frers	1988	\$115,000
47 Passport	2002	\$549,000	32 Pac. Seacraft PH	1994	\$129,500
47 Colin Archer	1980	\$290,000	30 Mumm	1998	\$55,000



Swiftsure Yachts, Inc.
 206.378.1110 | info@swiftsureyachts.com
 at Julie's Landing on Lake Union
 2100 Westlake Ave. N. Suite 204 Seattle WA 98109



spinlock
the experts in rope holding

Deck Organiser T-Series

Tiller Extensions EA & EJ

XX0812 Powerclutch

Give yourself the racing advantage

Specify Spinlock Ropeholding, Rope Management and Boat Control Hardware

- deck organisers
- tiller extensions
- powerclutches

MARITIME TRADING CO.LLC
T: 802.362.5258 F: 802.362.5358
E: spinlock@maritimetrading.net
Spares: www.spinlock.co.uk

LETTERS

tion hits the nail on the head.

↑↓ GET A POOPER SCOOPER AND USE IT

Don't you just love it when you're settled in some nice cove, then someone ferries their dog to the beach, and then doesn't pick up after it? I've seen this happen on numerous occasions in Cherry Cove on Catalina. The irresponsible dog owners far outnumber the responsible ones. Come on folks, get a pooper scooper and use it.

Dennis Nespor
San Clemente

Dennis — The problem isn't unique to Southern California. There's a beach in the middle of Schoonmaker Yacht Harbor in Sausalito, and several prominent signs state that dogs aren't permitted. Yet everybody in the world — and their brother — brings dogs to the beach. Either these people are all blind and have seeing-eye dogs, or, more likely, they believe that laws don't apply to them — a common Marin County state of mind. This behavior is almost as comical as the bicyclists who absolutely insist on riding in the middle of a car lane rather than the bike lane the city just spent a small fortune setting aside for their safety and pleasure.

↑↓ GOOD SERVICE GETTING PARTS TO MEXICO

I snapped the gears on my windlass in Huatulco, Mexico, in February. So I moved over to the protected paradise of Marina Chahue in the next bay and took a berth.

With the help of Mike Tosse at Svendsen's Boatyard in Alameda, I ordered replacement parts from Imtra Marine in Massachusetts. A week later, they arrived in Toluca, a suburb of Mexico City that is the site of the main clearinghouse in Mexico. Three days later, they were shipped to Crucesita where, with a little help from Enrique, Marina Chahue's fostering manager, I picked them up. DHL had acted as my clearing agent for a nominal fee. Even though I had a 10-Year Import Permit, I still had to pay a 17% Customs fee — which I may have gotten waived had I travelled all the way up to Toluca.

In any event, I want to thank DHL, Imtra, Mike and Enrique for their good service.

Harmon Heed
Truth, Gulfstar 43 ketch
San Francisco On The Way To Sarasota Bay

↑↓ DERELICT STILL FLOATING 45 DAYS LATER

On July 18, we, the crew of the Swan 53 *Incredible*, participating in the Centennial TransPac from Los Angeles to Honolulu, passed within 100 yards of the derelict Newporter 40 ketch *Kamera*. Her main mast was down, and she was drifting with nobody aboard. We snapped a few photos, noted our mid-



USCG

'Kamera', abandoned in the Pacific.

day position as 25.54N x 134.34W — which was close to the halfway point on the 2,225 mile race. We also notified the *Alaska*

Eagle, the communications vessel for the TransPac, of the abandoned boat's location so other yachts racing might watch out for her.

Having done that, we wondered what happened to the boat and her crew. We guessed that they were rescued after the

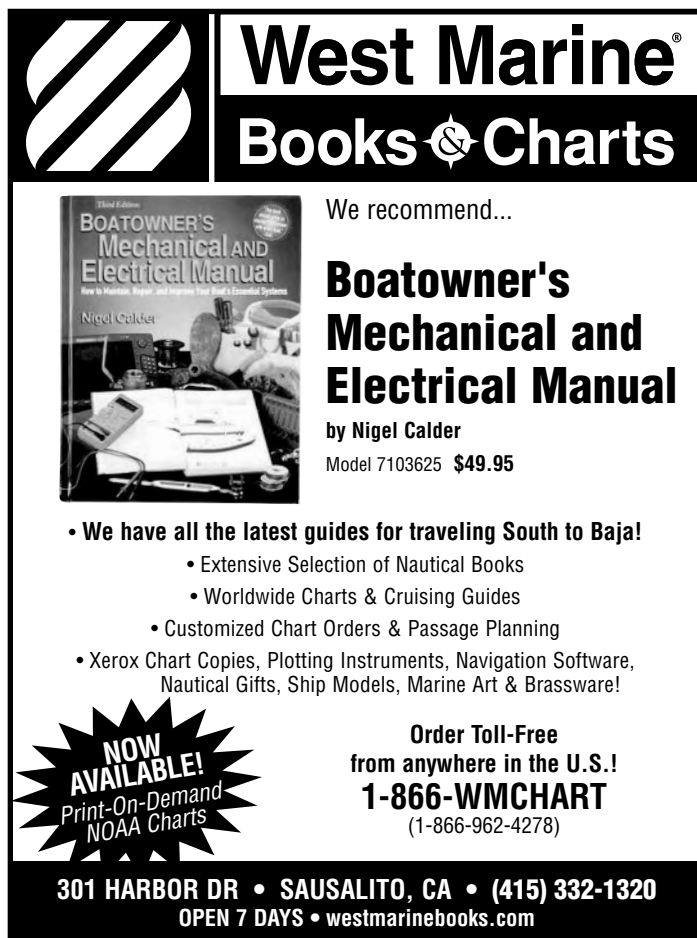

West Marine®
Books & Charts

We recommend...

Boatowner's Mechanical and Electrical Manual
by Nigel Calder
Model 7103625 \$49.95

- We have all the latest guides for traveling South to Baja!
 - Extensive Selection of Nautical Books
 - Worldwide Charts & Cruising Guides
 - Customized Chart Orders & Passage Planning
 - Xerox Chart Copies, Plotting Instruments, Navigation Software, Nautical Gifts, Ship Models, Marine Art & Brassware!

NOW AVAILABLE!
Print-On-Demand
NOAA Charts

Order Toll-Free
from anywhere in the U.S.!
1-866-WMCHART
(1-866-962-4278)

301 HARBOR DR • SAUSALITO, CA • (415) 332-1320
OPEN 7 DAYS • westmarinebooks.com



**2005
110 SPORT
IN STOCK!**

**BOSTON
WHALER**

Outboard Motor Shop



C DORY

**Rugged and Practical
Simple and Sensible**



NEW!

In Stock!

C-Dory 22 Angler & Cruiser
Fishing and cruising versions make for a rugged, comfortable weekend pleasure cruiser. Visit our display yard!

**AIR COOLED
2 hp Honda
Now in Stock!**
Optional clutch available



More Fun. Less Fuel.

- Quiet, 4-stroke technology
- No smoky 2-stroke exhaust
- Unsurpassed fuel economy
- Transistorized pointless ignition
- Ideal for sailboats, small tenders

**Take a
Honda to
Mexico**



HONDA MARINE

IT'S ALL ABOUT POWER.

*Compared to comparably sized 2-stroke outboards at trolling speed.

**Meets EPA
2006 & CARB
2008
Emissions
Standards!**

For optimum performance and safety, read the Owner's Manual before operating your Honda Marine product. Always wear a personal flotation device while boating.
© 2004 American Honda Motor Co., Inc.

Universal DIESEL MARINE ENGINES



ATOMIC 4 and UNIVERSAL DIESEL SPECIALISTS

We have everything you need to keep your engine in perfect running order.

- Tune up parts
- Water pumps
- Gasket kits
- Exhaust parts
- Carburetors
- Service manuals

ATOMIC 4



Outboards Offered



4 hp up to 275 hp



Ask about new ETec Technology
40 to 250 hp



Four strokes • 4-225 hp



VARNISH TODAY...Don't Repeat for Two-Four Years!
New stock of Bristol Finish – the most durable exterior wood finish available.



- Transparent, light amber
- 1 hour between coats
- Lasts 2-4 years
- Catalyzed acrylic urethane
- UV resistant
- No sanding

This is the solution for sunny California and fine wood finishes.

We use it ourselves!



Vacu Flush Toilets:

Increase holding tank capacity • Eliminate odors

Stay clean and sanitary • Use less electricity



www.outboardmotorshop.com • www.sea-power.com • (510) 533-9290 • 333 Kennedy St., Oakland, CA 94606 • Fax 510-533-3374

Earn Your Captain's License at California Maritime Academy

- U.S. Coast Guard Approved
- Personalized classes
- No hidden costs - all fees included
- High pass rate
- Continuing Education Units (CEU's)

Classes:

- Operator Uninspected Passenger Vessel (6-pack)
- 100 Ton Master Upgrade
- 200 Ton Master Upgrade
- Towing & Sailing Endorsement



707 654-1157 (or 1156)

www.maritime-education.com

California Maritime Academy
200 Maritime Academy Drive
Vallejo, California 94590

A Campus of the California State University

LETTERS

dismasting and the boat was set adrift. But why, where and when?

Two days further into the race, one of our crew was reading the July issue of *Latitude* — and amazingly, all our questions about the derelict boat were answered! For in the *Sightings* section, the *End Of The Line* article described how William Peterson, while singlehanded from Panama to San Francisco to complete a nine-year circumnavigation, lost his main mast in 25 knots of wind about 800 miles southwest of San Diego. Thanks to his EPIRB and the US Navy, he was rescued. The damaged but still-floating 48-year-old ketch was allowed to drift rather than be scuttled. Peterson had assumed that his boat would soon sink because she had been taking on water, and there was no way to keep bilge pumps working after the batteries ran dead. Nonetheless, 45 days after he had to leave her, she was still floating — and had drifted over 1,000 miles.

By the way, this letter to the editor is being sent by email via our Iridium sat phone while we are still four days out of Honolulu!

Michael Lawler
Incredible, Swan 53
Newport Beach

↑↓ IF I WERE SAILING FROM THE EAST COAST . . .

In a response to a letter last month, you advised readers Randy and Ellen Hasness to get to the Caribbean from the Northeast by joining the West Marine Caribbean 1500 Rally to Tortola. This, as opposed to going south on the InterCoastal Waterway.

I'm sure the West Marine Rally is a wonderful event, but having done the Intercoastal Waterway from Norfolk to Miami twice, I can tell you it's also a wonderful trip. In fact, I can recommend it to anyone who has the time, as it offers a very interesting variety of experiences.

And rather than bypassing the Bahamas as one would do on the 1500, taking the 'Thorny Path' through those islands is something that I can really recommend. You're right, it involves some upwind work, but it's not really that thorny. Having sailed both in the Bahamas and the Caribbean, I know they are both wonderful, but if I could only do one again, it would be the Bahamas.

The trip to the Caribbean through the Bahamas is similar to the trip down The Ditch in that the pace at which you travel can dictate the quality of enjoyment. But then, what sailing experience isn't like that? Also, a trip just to the Bahamas is an extremely worthwhile endeavor. If I were sailing from the East Coast to the West Coast, I wouldn't miss the Bahamas. You can visit a different anchorage every night. It's not better than offshore sailing, just different.

P.S. Thanks for forwarding to me your wonderful mag while I was in Antarctica last winter.

John DeFoe
Laurel, Maryland

John — We very much appreciate your opinion. Anybody else want to weigh in on the best way to get from the Northeast to either Florida or the Eastern Caribbean?

↑↓ PITFALLS TO CRUISING WITH A FURRY FRIEND

My girlfriend and I are planning the big cruise, with a 2007 departure date for Mexico, the South Pacific, and points beyond. We're planning on taking our (currently) four-year-old Sheltie with us. It seems like a tremendous pain in the rear to go sailing with a dog, but she's part of our family, and we

West Marine
We make boating more fun!™

West Marine Bargain Center

Blowout Sale!

Lowest Prices of the Month!

One Day Only!

Saturday, September 10

20% Off Yellow Tags

30% Off Orange Tags

40% Off Red Tags

Electronics 20% Off current clearance prices!*

*Color tag discounts not applicable.

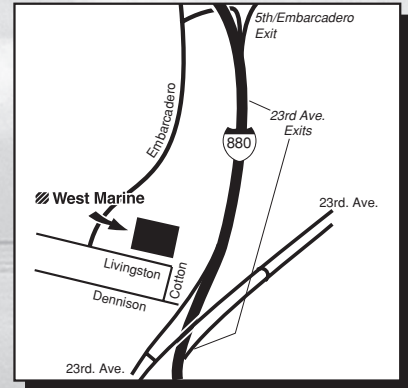

OAKLAND • 2200 Livingston St • (510) 532-5230

NEW Alameda Prop & Machine
Adds Stainless Custom Fabrication!

Expanded Facilities

Offers full range of metal fabrication services

Call now for your cruising upgrades

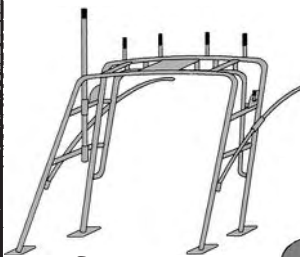

Radar
and Davits

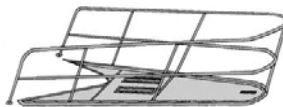

Pulpits



NEW & USED

Folding, Feathering & Fixed Props

Alameda Prop & Machine

at the Grand Marina Marine Center

(510) 522-7899 (800) 774-7899

Gori® propeller



3-Blade



2-Blade



Racing

A.B. Marine Inc.
747 Aquidneck Avenue
PO Box 6104 - Middletown
Rhode Island 02842
Phone: 401 847 0326
Fax: 401 849 0631
www.gori-propeller.com

BETA MARINE

SMOOTHER.....QUIETER!

Our engines idle smoother and quieter because of our high inertia flywheel. This is one of the many Beta Marine exclusive features that make our diesel engines easier to live with.

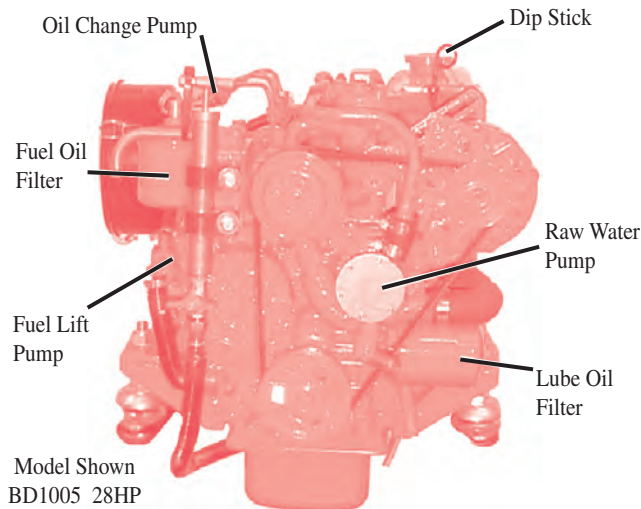

Model Shown
BD1005 28HP

What a Concept!

It is engineered to be easily serviced

Beta Marine superb propulsion engines, using Kubota diesel from 10-90HP including our famous Atomic 4 replacements.

Also available: Marine Generators up to 30Kw.

For service and sales on the West Coast, contact any of the fine establishments listed below:

- East Sound: Jay Kimball*(360) 376-2985
- Anacortes: Marine Servicer*(360) 293-8200
- Portland: Cascade Yacht Builders*.....(503) 287-5794
- Oregon Marine Industries*.....(503) 629-5370
- Sausalito: Marine Engine Company*(415) 332-3507
- Santa Barbara: Above the Waterline*(805) 455-8444
- Newport Beach: Worldcruiser Yacht Co*.....(714) 549-9331
- Los Angeles: Marine Diesel Engineering*(310) 301-9011
- San Pedro: Bill Lewis*(310) 614-8907
- San Diego: The Watermaker Store*.....(619) 226-2622

For the rest of the world, find the dealer nearest you by contacting:

BETA MARINE US, LTD.

P.O. Box 5, Arapahoe, NC 28510

800-682-8003 • 252-249-2473

sales@betamarinenc.com

www.betamarinenc.com

LETTERS

can't bear to leave her behind.

I've found no end of people to give me advice on cruising, but, sadly, none has ever cruised with a dog. Hopefully, you and/or your readership can help. Aside from the obvious hair problem associated with this particular breed, what are the great pitfalls of cruising with a small dog? Is her presence on board going to be a problem when visiting various different ports? How does one go about housebreaking (boatbreaking?) an adult dog who is used to just 'going outside'? I expect she'll get seasick, but can I expect that she'll ever get over it? Are there other major pitfalls to cruising with a furry friend?

P.S. *Latitude* is a tremendous resource.

Andrew Hartman
Belmont

Andrew — We're not the best qualified to answer your cruising-with-a-dog questions, so we'll throw it out to our readership. We can tell you, however, that once cruisers get to the South Pacific with cats or dogs, there are significant issues with them being allowed on shore — or even on boats tied up to docks. In some cases, there are lengthy quarantines required and considerable expense. We're sure we'll get some good info on the subject in the next month or two.

↑↓AN INAPPROPRIATE COMPARISON

I was very pleased to read Carole Bradfield's account of her experience selling their catamaran to the John Walton family. John was indeed a very special sort of guy, truly a class act.

Here's another story about him: I served as a pilot with the 195th Assault Helicopter Company in Vietnam (6/68-6/69). One of our primary missions was to support 5th Special Forces Group, Project Sigma, moving teams into and out of Cambodia as well as inside of Vietnam. John Walton was an A Team Green Beret. From a family of privilege, John probably could have figured out a way to stay out of anything — but instead he became a Special Forces Medic and earned the Silver Star in the battle of Ashau Valley, in August 1968.

Far less impressive is the letter from Ian Farrier, who seemed to try to capitalize on the tragedy of John's recent death and his business relationship with him in order to plug his designs. Farrier then tries to link the fatal accident rate for light airplanes to the capsize rate for his boats — which I believe is too much of a stretch for any reasonable comparison — except marketing. Based on my 38 years in aviation, Farrier's statistical analysis is UFO-grade out-there.

But wait, there's more. My wife and I attended the San Diego Boat show in the late '80s with the intent of buying a Corsair F-27 trimaran designed by Farrier. We met Ian, listened to him for a bit, and then left for dinner to talk. I remember two things from our chat over dinner. First, that we decided not to buy a F-27. Second, that my wife said, "He's a bit too full of himself."

It looks like he still is.

Mark Kovaletz
Chief Pilot, Aircraft Operations
Newport Beach

Mark — We don't know Farrier personally, but we'd hesitate to be too harsh on him, as technically inclined folks often don't have the most polished PR and sales skills.

↑↓THEY WERE A BIT ROUGH ON THE SLOW BOATS

We have some comments on Jim and Sue Corenman's comments on the loss of boats in a storm that hit the northbound

Being the industry leader for more than twenty years is what prompts more yacht owners to come to **PACIFIC COAST CANVAS**.

- **Offshore Dodger™**

Welded aft handrail
Bolt-on side handrails
Lexan windshields

- **Baja Awning™**

Lightweight and waterproof
Durable and easy to launch
Multiple side screen configurations



Our dodgers are built with strength and grace... we know you'll appreciate our quality and attention to detail.

- **Coastal Dodger™**

Affordable designs
Same high quality materials
Same superior workmanship

- **Cruiser's Awning™**

Easy setup off your dodger
Flies with no bulky frame
Comes with shade screens

Why not schedule a design appointment with the company you can trust for the best in Design, Service and Quality.

Open Monday-Friday 8:00-4:00
Saturday by appointment
(510) 521-1829



**2021 Alaska Packer Place
Alameda, CA 94501
Grand Marina**



FOLDAWAY Midship boarding ladder

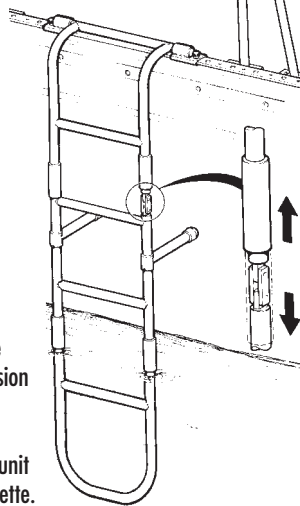

Constructed entirely of polished marine grade stainless steel for superior strength and corrosion resistance. Extended it serves as a swimming ladder as well as for dockside and dinghy boarding. It folds twice to become a compact unit which secures to lifelines or stows in the lazarette. An innovative locking system assures strength and safety.

MYSTIC
STAINLESS & ALUMINUM
(860) 572-9999 Fax (860) 536-2326

www.mysticstainless.com
Fabricators of World Class Custom Marine Hardware

Blue Water Insurance

Blue Water Insurance covers more active cruising boats than any other marine agency in the Western Hemisphere and is the leading innovator of insurance products for the offshore sailor.

Our Insurance Programs Provide

Crew of two Anywhere	World Wide Navigation
Hawaii	Europe
South Pacific	Caribbean

Low Local Coastal Rates

Local Coastal USA • Hawaii

Blue Water World Wide Health Insurance

International and USA health insurance plans at affordable prices.

West Coast Office

2730 Shelter Island Dr.
San Diego, CA 92106

East Coast Office

1016 Clemons St., Ste 404
Jupiter, FL 33477



BLUE WATER
INSURANCE
JUPITER, FLORIDA • USA

Call Toll Free:
(800) 655-9224

Visit our web site:
www.BlueWaterIns.com



**FINANCE
YOUR DREAM
THROUGH OUR
WELL-CHARTED
WATERS**



Seacoast Marine Finance offers more than the best rates, extraordinary expertise and a streamlined loan process. You can rest assured that your application is being handled by professionals who value your privacy and confidentiality. Don't drift into uncharted waters for assistance. Navigate to Seacoast Marine Finance, the premier haven for yacht buyers, dealers and brokers.

Call for your complimentary quote today.

Florida toll-free | 877-916-2326

California toll-free | 800-233-6542

Seattle | 206-784-7773

New England | 207-846-0004



www.seacoastmarine.net

*A division of First National Bank
and Trust Company of the Treasure Coast*

LETTERS

fleet from New Zealand this year. As was usual for May, there were lots of boats — 30 to 40 — sailing between New Zealand and Tonga/Fiji at the time. No lives were lost, but a couple of boats that had been anchored at Minerva Reef were lost.

As the Corenmans say, weather forecasting is now amazingly thorough, and Sailmail makes it possible for many yachts to get the best and latest weather info onboard — no matter where they are in the world. We have come to count on the grib file forecasts, and place a lot of weight on information contained in them. In fact, we'd be lost without them — although they don't always accurately predict local weather conditions, which we've found are often contrary to the predictions for the wider area.

But I thought the Corenmans were a bit rough on the slower boats, which might leave on a 12-day passage with a good forecast — and still get caught with a low cell that started to develop after the boat left port.

Nor do the Corenmans touch on the issue of peer pressure, where a rally, race, or a cruise has a set date for starting, and they want to leave on schedule — even in the face of a questionable forecast. In fact, I think this is a bigger issue, as the herding instinct tends to make people ignore what their own good sense might be telling them about an upcoming weather window. Considering the possibility that forecasters are being somewhat on the safe side — I didn't say 'alarmist' — and probably predict more low cells than actually show up, means that there is often a chance of scary weather included in the long range forecast.

However, the Corenmans are absolutely spot-on that boats should be able to withstand 50 knots of wind and 12-foot seas. Most Kiwis will tell you that on any passage to or from New Zealand, one should count on getting smacked at least once. Further, getting caught in Minerva Reef during bad weather is just bad seamanship. You only need a day or two of warning to be able to get out of an anchorage and get to sea when a storm is coming to a place of dubious protection.

I notice that the Corenmans are now living in Friday Harbor. What a wonderful place. We miss it dearly.

Fred Roswold
Wings, Serendipity 43
Hong Kong

Readers — A number of years ago, Fred made a passage from the South Pacific to New Zealand in which many boats were caught in a very bad blow. While he and Wings made it, several sailors and boats weren't as lucky.

We do have to disagree with him, however, on how badly rally and race organizers want to start their events on specific dates despite questionable forecasts. While weather delays are a great inconvenience to everyone, races and rallies are often postponed because of them. This was the case last year in a May event from New Zealand to Tonga, in last year's Caribbean 1500, and in a big transatlantic race two years ago.

We are often swamped with letters. So if yours hasn't appeared, don't give up hope. We welcome all letters that are of interest to sailors. Please include your name, your boat's name, hailing port, and, if possible, a way to contact you for clarifications.

By far the best way to send letters is to email them to richard@latitude38.com. You can also mail them to 15 Locust, Mill Valley, CA, 94941, or fax them to (415) 383-5816.

RemoteVision...

A wireless link to your instrument system and pilot controller in the palm of your hand, ideal for cruising and racing sailors alike.

Held in the palm of your hand, it enables you to do everything you can with the Pilot Display and Full Function Displays and more! View data from your system, including boat speed, wind, depth or heading. Alter course by a few degrees, or maneuver the boat in an emergency. All done simply and quickly from wherever you are on the boat...below deck, or even climbing the mast!

- View all data graphically in strip-chart format to see trends from the rail or anywhere on the boat
- Makes control & calibration of your instruments and autopilot so easy
- Take and store hand-bearings with the gimballed internal compass
- Includes a handy LED torch
- Fully waterproof to IP68 standards
- Quick and easily retrofittable to most B&G Hercules or Hydra systems
- Set and monitor alarms while resting in your bunk
- Runs on AA or rechargeable batteries

Information and control...wireless done right!



RemoteVision as used by Ellen MacArthur, fastest woman to sail single-handed around the world.

B&G USA: 13130 56th Court, Suite 602, Clearwater, FL 33760, Ph: 727-540-0229

www.BandG.com

MAXIMIZING YOUR PERFORMANCE AT SEA



Marine Energy Systems

- Specialists in Marine AC and DC Electrical Systems and Renewable Energy
- Your Source for Products and Advice on Networked Instruments
- Recognized Expertise in System Design
- Knowledgeable Technical Support
- Customized and Personalized Service
- Free Web Workshop Presentations
- Online Store with Complete Product Documentation

www.jrenergy.com
1-800-473-3981



Rigging Insulators

the **only failsafe insulator** for wire



Hi-MOD Compression Fittings

unique **crown ring** keeps wire strands in position. for detailed information visit www.hayn.com



Hayn Marine [800.346.4296] fax [800.441.4296]
email [marine@hayn.com] web [www.hayn.com]

MARK YOUR CALENDAR!

Cruisers' Fair - Fri., Nov. 11

Cruisers' Kick-Off Party - Sun., Nov. 13

You bring a side dish - we bring the rest:
Hamburgers, hot dogs, beer and soft drinks!

FALL CRUISING SEMINAR SCHEDULE

Check Web site for updates.

- Everything we stock is available online
- Fast delivery - ANYWHERE
- Secure credit card transactions
- Competitive Prices - Check their catalog, then call or visit us on the Web for knowledgeable service and great pricing



32° 43' 01" N 117° 13' 50" W

The West Coast's Most Experienced Cruising Outfitter

The Southbound Cruiser's Source for Everything:

- Marine Electronics
- Cruising Guides
- Wind Generators
- Baja Fuel Filters
- High Output Alternators and Regulators
- Solar Panels
- Dinghy Wheels

2804 Canon St., San Diego, CA (619) 224-2733

Fax (619) 224-7683

email: info@downwindmarine.com

Open: M-F 8-5 • Sat. 9-5

Cruisers' Net, Ch. 68, from 8:30 am weekdays: WHX369

NEED MORE SPEED?

Then offload 2½ TONS of unneeded weight. WATER!

No worries, that's how much water the Cape Horn Xtreme can produce in just 24 hours.

It will be the toughest 64 pound member of your crew. Should you find yourself with a problem ... We have GLOBAL, factory-trained technicians in nearly every port or path you choose to travel.

Now that's Xtreme.



SPECTRA WATERMACHINES™

The World's Fastest Watermakers.

www.spectrawatermakers.com • Phone: 415.526.2780
20 Mariposa Road, San Rafael, California 94901

LOOSE LIPS

Just when you thought it was safe. . .

We weren't in the best position to judge what kind of shark it was that Reid McNally took photos of near the entrance to



There are tons of harmless leopard sharks in the Bay, but this may be the first great white ever photographed.

the Estuary last month. For one thing, the photos aren't the clearest in the world. For another, we're hardly shark guys. For a third, we'd just finished reading Susan Casey's excellent book *The Devil's Teeth*, which is about the great white sharks at the Farallones and the people who study them. At the moment, anything bigger than a goldfish looks like Cal Ripfin to us.

But Reid had sent copies of the photos of the little shark (he estimated it was 4 to 4.5 feet) to the Pelagic Shark Research Foundation in Santa Cruz, and executive director Sean Van Sommeran thought it looked like a small great white. We forwarded copies of the photos to noted

shark expert John McCosker at Steinhart Aquarium and he thought the same thing.

"I've shared this with a couple of associates and they, like me, figure it probably is a white shark. It certainly appears to be a member of the family *Lamnidae*, which includes white sharks, mako sharks, and salmon sharks (in our area), but amongst them it sure looks most like a white shark in its proportions. But, I must caution you in saying that none of us are confident of its identity, only that it seems more like a white shark than any other that we are aware of. Its location is curious in that white sharks rarely (if ever) have been known to come so far inside the Bay. To my knowledge no one has ever captured one inside of the Golden Gate."

So much for jumping in the water anymore to clean our own boat bottom.

By the way, the photos were taken near the South trestle of the Bay Bridge, about mid-morning on, ahem, Friday the 13th (of May).

Windward's winches.

A few months ago, we ran a two-part article by Robert 'RC' Keefe about the great 83-ft M-class sloop *Windward*, which raced the Bay in the late '40s through mid-'50s. Part of her legacy to both Bay and, eventually, international sailing was that she was a testbed for the development of the two-speed winch. Prototypes designed and built by Tim Moseley eventually led to the founding of the Barient winch company.

Windward was lost when she dragged anchor and went on the beach at Yelapa in 1958. But virtually everything that could be salvaged from her was, including the winches. In our correspondence with Keefe, he mentioned that he'd been on the lookout for those winches for years. Well, it turns out that his articles may have solved the mystery of their whereabouts. In one of the many letters and emails we got about the articles, Stuart Newcomb of Southern California added a PS: "I have the two-speed winches." We put he and RC in contact and RC says that Newcomb will present the winches (at a date to be determined) to the St. Francis YC, where they will be "properly displayed as a monument to Commodores Tim Moseley and Cyril Tobin." (Tobin was *Windward's* owner.) We'll let you know when that takes place in a future issue.

When you call
Emeryville Marina Home

... Emeryville Marina

NEW SLIPS!

**40-65' Available Now
Call Today...**

ON THE BAY

Showers and Laundry Facilities • Fuel Dock • Pumpout Station
Free Members' Parking • Security • Park and Picnic Area • Restaurants
Controlled Access to Docks • Electronic Gate for Controlled Access to Park After Hours

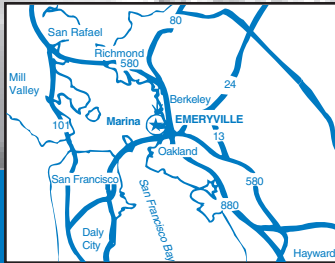

MARINAS[™]
International

(510) 654-3716

3310 Powell Street, Emeryville, CA 94608
(Exit off I-80 at Powell Street)
Visit Our Website @ emeryvillemarina.com

...call this your backyard!

SEA FROST[®]



COOL IT YOURSELF!

Refrigeration has never been easier. Sea Frost's compact and powerful, 12-volt BD refrigeration conversion kit comes pre-charged and ready for owner installation.

Sea Frost... Quality at an affordable price!

Local Dealers:

Anderson Refrigeration Co. • Alameda, CA
(510) 521-3111

Poole Refrigeration Service • Alameda, CA
(510) 523-3495

www.seafrost.com

BAY PROPELLER

**FULL SERVICE
PROPELLER AND
SHAFT REPAIR**

**Bay Propeller is the largest and
most experienced propeller shop
in Northern California**

Full service repairs on all makes and sizes. Our services include pitching, balancing, custom modifications, re-hubbing and computer analysis. Also shaft repair/replacement, rudder and lower unit skeg repair.

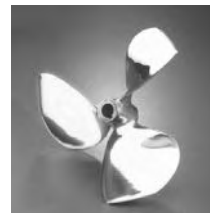

Featuring the Non-Slip Propeller Modification

- ✓ Saves fuel
- ✓ Eliminates prop walk
- ✓ Reduces slip
- ✓ Increases thrust

U.S. Patent No. 6,352,408

BAY PROPELLER • 2900 MAIN STREET • ALAMEDA, CA 94501

510-337-9122

FAX: 510-263-9827
www.bay-ship.com

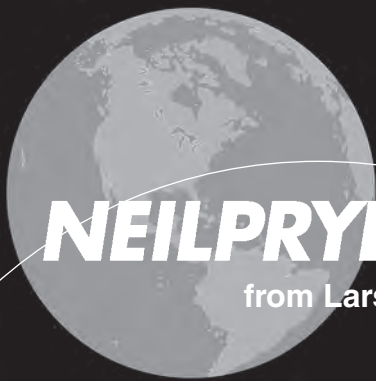

NEILPRYDESAILS

from Larsen Sailmakers

global service

www.neilprydesails.com

locally

**ORDER YOUR
BAJA HA-HA
CRUISING
SAILS NOW!**

**The global resources of Neil Pryde Sails
with local sales and service from the
most experienced hands in the business.**

San Francisco Bay Area • Jim Leech • 415-827-1177
Jack D. Scullion Yacht Services • 510-919-0001

Monterey Bay Area • Bob White • 800-347-6817

Santa Barbara • Marty Spargur • 805-451-3543

1041-A 17th Ave., Santa Cruz, CA 95062 Fax 831-479-4275
www.neilprydesails.com

LOOSE LIPS

Avast, ye scurvy lot — piratical updates.

* Forget the West Nile virus. The fastest-spreading affliction in the nation continues to be Talk Like a Pirate Day, scheduled once again for September 19. As mentioned last year in *Sightings*, TLAP Day began in 1995 when two friends, John Baur and Mark Summers, began to talk like pirates in the middle of a racquetball game in their hometown of Albany, Oregon. For years it remained an inside joke until one of them got the idea of a national Talk Like a Pirate Day. September 19 was chosen because it was Summers' ex-wife's birthday — and thus easy to remember — and because the date did not conflict with anything really important, like Superbowl. But nothing much came of it until Baur found columnist Dave Barry's email address and wrote him about the idea. Barry's September, 2002, column launched the concept like a Saturn V launches a moon mission, simultaneously rocketing Baur and Summers into their 15 minutes of fame. (Or, as Barry put it, "This thing may be big. Maybe 20 minutes.") Since then, the two have done interviews with radio and TV stations all over America, as well as the British Isles and Australia. They even put together two books, the latest of which, *Pirattitude*, is due out September 6. It has such useful information as: "how to make your own TLAP party a buccaneer ball that even Martha Stewart would be proud of"; "how to determine your true pirate moniker"; and "surefire pirate pickup lines for any occasion" ("*Prepare to be boarded, fair lassie!*"). And with the fateful date approaching once again, Baur ('Ol' Chumbucket') and Summers ('Cap'n Slappy') are once again in high demand for personal appearances.

For more on TLAP Day, links to special events in your area, and even a new 'pirate translator' feature, check out the official website at www.talklikeapirate.com.

* Unrelated to TLAP Day, but a hoot nevertheless, is Buccaneer Days at Catalina Island's Two Harbors landing, scheduled this year for Saturday, October 1 (although many attendees make a whole weekend — or more — of it). With the exception of pirate costumes, which are encouraged, this raucous celebration is actually not much different than any other summer weekend at Two Harbors, but it's great fun for all involved. Well, all adults that is. Leave the kids home for this one. See www.ecatalina.com/two_harbors_cal. cfm for more information.

* There is no Captain Jack Sparrow (Johnny Depp) pirate calendar — yet — but pirate artist Don Maitz (who drew the Captain on the Captain Morgan Rum label) is coming out with one that will be of interest to perhaps a broader audience than teenage girls. Titled simply *Pirates*, the 12-month 2006 calendar contains some of his most celebrated artwork, as well as noting appropriate historical dates such as "Talk Like A Pirate Day," (9/19) and the anniversary of Sir Francis Drake's taking of the treasure ship *Cacafuego* in 1529 (3/1). *Pirates!* calendars are available by visiting the artist's website at www.paravia.com/DonMaitz. The calendars sell for \$12.95

* Finally, for you Northern California scallywags, we mention 826 Valencia, which is both the name and address of San Francisco's very own pirate store. Among the wares available there are eye patches, glass eyes, writing quills, a skull-and-crossbones seal with red wax, hair prosthetics (sideburns, muttonchops, etc.) — and rack upon rack of pirate attire. You can walk out of this place looking more swashbuckling than John Silver — or Johnny Depp. Or smelling better than Anne Bonny with pirate scents like "Buxom" or "Siren". (And you'll be doing a good thing shopping there — proceeds from the sale of pirate booty fund writing projects and after-school writing programs for 8-18 year olds.)

NEXT

**GENERATION REFRIGERATION
with AIR CONDITIONING**



**SMALL,
LIGHT,
POWERFUL,
ENERGY-
EFFICIENT**

**micro
HYBRID-PLATE**

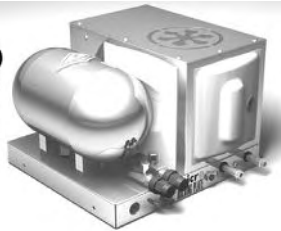

Glacier Bay, Inc, the marine industry's premier refrigeration system manufacturer, offers the award winning Micro™ HPS – a new kind of marine refrigeration system. The Micro™ HPS represents the most significant advancement in marine refrigeration technology in the past 30 years and blurs the line between small, hermetically sealed DC constant-cycle units and large, high-powered DC hybrid-plate systems. The Micro™ HPS is a compact 12" w x 12" h x 9" h and available in 12v and 24v DC as well as a high voltage AC/DC versions. Air-conditioning available off of the same condensing unit.



www.glacierbay.com

Glacier Bay, Inc. 2845 Chapman Street Oakland, CA 94601
(510) 437-9100 Fax (510) 437-9200
e-mail sales@glacierbay.com

JACK D SCULLION RIGGING • ELECTRICAL

since 1986

Battery Systems
Electrical Panels
Equipment Installation
Troubleshooting
Hardware
Rigging
Deck
Layouts



**Call for
package pricing
for main or jib
furlers with a
NEILPRYDE
sail.**

(510) 919-0001

Fax (510) 769-7659 • jdsyachts@att.net

PRECISION FORGING

Safety begins with a W



Forging steel involves heating the material to a precise temperature at which point the steel is formed using extreme force. The forging process produces steel products up to 60% stronger than cast equivalents.

WICHARD is the reference for marine forged products.



www.wichard-usa.com

ENGINEERED FOR LIFE
PROFURL FURLING AND REEFING SYSTEMS



- SEALED CARBON FIBER BACKING
- HAL YARD WHIP STOP SYSTEM
- LARGE OPEN FURLING DRUM
- MILITARY ANODIZED FINISH

www.profurl.com
1101 WICHARD USA.COM



SIGHTINGS

***seaward* — new girl in town**

In the past several years, the fleet of locally-based traditional charter vessels, especially those used for youth sailing programs, has lost several notable members. The well-known charter Brigantine *Rendezvous* was donated to a nonprofit in Santa Cruz, and last year *Hawaiian Chieftain* departed for the East Coast under new owners. Not long after, the beautiful schooner *Ka'iulani* was laid up for some extensive refitting. That left only a handful of traditional schooners, including the Maritime Museum's 1891 scow schooner *Alma*, *Rendezvous* Charter's 90-ft *Bay Lady*



Alan Olson.

continued on outside column of next sightings page

hawks murder ordered to

After a two-day hearing in Orange County, on August 17 three defendants were ordered to stand trial in the deaths of former cruisers Tom and Jackie Hawks of the Newport Beach-based 55-ft trawler *Well-Deserved*. Tom, 57, and Jackie, 47, had done a long cruise in Mexico and were well known in the cruising community. They disappeared during a 'sea trial' in November while in the process of selling the boat.

The alleged ringleader of the murder plot was Skylar DeLeon, then 26, who recruited Alonso Machain, 21, whom he met while Machain was working in



suspects stand trial

a county jail. DeLeon told Machain he needed help in killing "some bad people," for which Machain would supposedly be paid several million dollars. Prosecutors say that DeLeon and Machain originally intended to kill the Hawksees during a 'sea trial' on the boat on November 6, but didn't realize how big and strong Hawks — a former bodybuilder — would be. They decided they needed a third person.

So on November 15, DeLeon and Machain recruited the oddly-named John Fitzgerald Kennedy, 40, at a Long Beach liquor store. Kennedy, a member of the

continued middle of next sightings page

new girl — cont'd

and Billy Martinelli's scow schooner *Gas Light*, to accommodate the burgeoning youth educational sailing programs.

But thanks to Captains Alan Olson, Ken Neal-Boyd, and the or-



Left and above, 'Seaward' arrives in the Bay.



ganization Call of the Sea, that will soon change. By the time this issue is in the newsstands, Call of the Sea's 82-ft staysail schooner *Seaward* will have arrived in her new home of San Francisco Bay.

While *Seaward* is the new girl in town, Olson is no stranger to *Latitude* readers. He started the non-profit Call of the Sea in 1984 and sailed his schooner *Stone Witch* on many local and long distance sail training expeditions to Mexico. The focus, then and now, was traditional seamanship and education in youth-oriented programs. After *Stone Witch*, Olson bought and restored the 1929 54-ft schooner *Marmel* and continued Call of the Sea's mission, sailing her regularly to Mexico as well as on several North Pacific Expeditions, including a 'circumnavigation' of the Pacific Rim from San Francisco to Hawaii, Guam, Japan, Alaska and back to the Bay. Many who sailed on *Marmel* came home with a charter skipper's certificate after completing a week-long course under Olson's tutelage.

In 2004, Olson met fellow tall ship aficionado Ken Neal-Boyd. The 39-year-old Neal-Boyd was returning to the Bay Area with his family after eight years of skippering various sail training ships on the East and West coasts, and most recently working as the Marine Superintendent of the Sea Education Association in Woods Hole, Massachusetts. He had also founded an organization called Voyage Seaward whose goals were much the same as Call of the Sea. Combined with his own 15 years of education under sail and a 3,000-ton Master's license, Neal-Boyd had a lot to offer. Call of the Sea soon merged with Voyage Seaward, and it was a marriage made in maritime heaven.

One of the first orders of business for the re-chartered Call of the Sea was to secure their own training vessel. They found her chartering out of

continued on outside column of next sightings page

SIGHTINGS

new girl — cont'd

Boston. The *Edna* had been built in the late 80's as a Coast Guard-certified passenger vessel capable of ocean passages. Olson and Neal-Boyd knew that the stout, traditional schooner would fulfill their needs. With financing from their board, a deal was soon struck.

Buying the schooner was only half the job. The other half was to get her to her new home on the Bay. Olson took the first leg from Boston to Ft. Lauderdale, where the boat was loaded on a transport ship for Ensenada via the Panama Canal. (This was necessary for insurance purposes during hurricane season.) In Ensenada, the renamed *Seaward* was offloaded and started the last leg north under Captain Neal-Boyd. She arrived under the Golden Gate on August 21.

Seaward is already slated for more than 20 educational/sail-training programs for school-age kids in the next two months. For older students (14-20), she will offer five-day, four-night seagoing adventure cruises. And for those lucky enough, *Seaward* will explore Southern California and Mexico during the winter, where marine biology will be

continued on outside column of next sightings page

trial

notorious African American street gang the Crips, is known on the streets as 'Crazy John'. Improbably, Kennedy was introduced to the Hawkses as DeLeon's accountant.

As the Hawkses and the three men went out for a 'sea trial' again on the 15th, DeLeon and Kennedy allegedly overpowered Tom, while Machain did the same to Jackie. Stun guns were reportedly used to subdue the couple. According to Machain, after handcuffing the couple and duct-taping their eyes and mouths closed, the couple were made to sign off on several power of attorney papers. For about two hours after that, it's alleged that the boat was motored in the general direction of



— cont'd

Catalina, while the couple were kept in the master stateroom. According to Machain, the couple were then brought up on deck and had a 66-pound anchor attached to their waists. No doubt sensing their lives were in danger, Tom Hawks was able to kick DeLeon so hard in the groin that he was knocked over. DeLeon is said to have just laughed, then tossed the heavy anchor overboard. The couple, struggling mightily, were reportedly then thrown over also, and left to drown.

According to some observers at the August proceedings, DeLeon looked to be on the verge of breaking out laughing several times. His wife, Jennifer, 23, who

continued middle of next sightings page

Volunteer 'victim' goes overboard off the 33-ft Seawind catamaran 'Bluewater' during crew overboard trials. Fourteen other boats and 110 volunteers took part in four days of testing.



new girl — cont'd

mixed with sailing, navigation and local culture. Professional educators will join the sailing crew to enrich the teaching experience.

— john skoriak

Those interested in a closer look at *Seaward* can get one at an open house on the boat at Pier 39 on September 8 from 4 to 6 p.m. For more information on Call of the Sea, log onto www.callofthesea.org.

crew overboard symposium

It's not something you read much about, but people fall off boats with some regularity. Especially racers. You don't hear about 95% of these incidents because falling overboard is just part of the racing game, and because most racing crews are strapping young studs attuned enough to the boat that they can spin around and yank a guy back aboard in about as much time as it takes to read this paragraph.

The most dangerous crew-overboard incidents — the ones you *do* read about — most often involve cruisers or daysailors. (But not always — we've written about a number of racers who have perished in Bay waters.) The most heartbreaking of these involve husband-and-wife teams when the more experienced husband goes in the water and the wife either can't get back to him or can't get him back aboard.

"It's pretty discouraging," understated Captain Henry Marks last month. Marks founded Landfall Navigation in Connecticut, an outfit that specializes in navigation and safety equipment. He has run the local marine safety program for the last decade and teaches crew overboard recovery. But when he tossed a fender overboard while daysailing with his wife one day and said, "That's me," it was, well, pretty discouraging. "She kept saying, 'What do I do?' and I kept saying, 'I can't tell you; I'm in the water.'"

Marks's anecdote was one of a hundred conveyed over four days of intensive testing and discussion at the Crew Overboard Recovery Symposium held off Sausalito last month. The August 9-12 event was put together by John Connolly of Modern Sailing Academy and Chuck Hawley of West Marine. Rounding out the executive committee were Karen Prioleau, a US Sailing instructor at OCC, John Rousmaniere, author and North U instructor, and Ruth Wood, president of the BoatUS Foundation for Boating Safety and Clean Water. Modern Sailing and West Marine sponsored the event, with major support provided by the Bonnell Cove Foundation (part of the Cruising Club of America), and BoatUS. Additional support came from the Sailing Foundation of Seattle, Garmin International and North Sails.

Like a similar event in 1996, the 'COB' Symposium was designed to bring marine safety experts and equipment manufacturers together to test and evaluate return methods, recovery methods and both new and old products, with the long-range goal being safer products and methods for recovering sailors who have gone overboard.

The preliminary results of the seminar — which is likely the largest and most ambitious of its type held anywhere in the world — is that there is no magic bullet. There is no one best way to get back to and retrieve a person in the water. In fact, it became immediately evident on the first day that there was not even one return method that was best for all boats. Different types of boats — the seminar included multihulls, light displacement sloops and even powerboats, as well as regular keelboats — differ greatly in how efficiently they can even do the four 'standard' recovery maneuvers: figure eight, quick stop, fast return and the deep beam reach. Cats, for example, jibe easily, while tris did better tacking. Light displacement boats are easier to stop, while heavy boats have more momentum. And of course a lot depends on what point of sail you're on to begin with.

Representatives from a dozen organizations, both U.S. coasts and the countries of Canada, Japan and Iceland showed up for the seminar.

continued on outside column of next sightings page

SIGHTINGS

crew overboard — cont'd

Products ranged from the \$1,300 MOM-9 package to the 'Noodlelevator', which the developer claims can be built out of a \$4 'swim noodle' (ask your kids) and spare jibsheet. In between were odd concoctions of every type, size and description. It was easy to understand the creative thinking behind most of them as the inventors demonstrated their wares. Unfortunately, real-world application was not quite as inspiring.

Each day's program started in a big tent in Modern Sailing's parking lot. Chuck Hawley MC'd the event, and each morning brought a quick review of the previous day, a brief outline of that day's goals and any other salient information. Then it was off to the boats — six per day, with three medium to heavy-displacement keelboat 'regulars' and the remaining three a continuously changing mix which included a J/105; F24, F28 and Dragonfly 40 trimarans, a Seawing 1000 (33-ft) catamaran and various size powerboats. The largest sailboat in the test was the Islander 53 *Polaris*, whose giant stern-mounted windvane presented a whole new set of variables to the data recorders.

In addition to a skipper and volunteer crew, each boat had a recorder, who timed each recovery and jotted down notes. The boats were out on the water for five to six hours a day.

Rescues were made in flat water, rough water, lots of wind (gusts to 36 knots one day), light wind, at night (locations only, no 'live ones' in the water), by the whole crew, and by only one crew. Of the more than 400 recoveries, half were of 'live' crew, hardy wetsuited volunteers. (The other half were of dummies or just foam heads at the end of sticks.) Almost all the live recoveries were videotaped and/or photographed by organizers in chase boats, and GPS tracks were recorded for every rescue. At the end of each day, each recorder or skipper gave a rundown of what worked and what didn't. Most evenings there were also presentations by special guests. Then everybody ate dinner and basically collapsed until the following morning when it started all over again.

Noted author and safety-at-sea expert John Rousmaniere (*Annapolis Book of Sailing*, *Fastnet Force 10*, etc.) has the unenviable task of quantifying the reams of information gathered at the symposium. His report is due out in a couple of months. In the meantime, Chuck Hawley reminds boaters that, if anything, the messages are even stronger. If you truly want to prepare yourself and your boat for the eventuality of a crew overboard situation, you must:

continued on next sightings page

trial

is also charged in the murders and is the mother of the couple's two young children, wasn't as jovial.

Machain, the main prosecution witness, is being tried separately.

triumph of

On August 22, Hilary Lister set a new sailing record. No, it wasn't another blazing Atlantic crossing or staggering day's run mark. And it wasn't set aboard a bajillion dollar megayacht or a radical multihull. Lister simply sailed from Dover



— cont'd

There has also been testimony that DeLeon had badgered a scuba shop employee for tips on how to dispose of bodies at sea, and that a notary accepted \$2,000 to back date a bill of sale for the boat.

the spirit

to Calais, 21 miles across the English Channel. What made the voyage remarkable is that Hilary, 33, is a quadraplegic. She is able to move only her head, eyes and mouth. She controlled the sails

continued middle of next sightings page

crew overboard — cont'd

* Know your boat — Know not only how it best maneuvers, but how to stop it and keep it stopped.

* Whatever method you choose to return to a crew overboard and deploy recovery gear such as a Lifesling, practice the maneuver and know how to use the gear. Don't be trying to read the instructions while the guy is treading water 50 yards away.

* Be familiar with at least the basic concepts. There are three components to crew overboard recovery: returning to the victim, making contact with the victim and getting the victim back aboard. Many novices think that once you've done the first two, the 'rescue' is a success. On the contrary, getting a person out of the water — even if he can help — is by far the hardest part of the equation. Also worth noting: The goal of any return maneuver is to pull up to the person on a close reach and stop as close as you can, with him on the leeward side.

Of course, it goes without saying — we hope — that the *best* course of action is to take every precaution you can not to fall off in the first place.

She didn't go far, and she didn't go fast, but it was still great to see Ron MacAnnan's 'Pursuit' under sail again at Sail San Francisco 2005. It's the first time the lovely M-class sloop has sailed since 1978.



LATITUDE/ANDY

SIGHTINGS

the joy of no-frills cruising

To casual observers looking down from the Golden Gate Bridge, the 39-ft cutter-rigged ketch *Mindedal* appeared to be just another daysailer as she entered San Francisco Bay early last month. On the contrary, she had just completed a nonstop, doublehanded passage from Nagasaki, Japan, a voyage of over 5,000 miles.

Aboard were owner Manfred Schubert and his old friend Frank von Tevenar, both natives of Germany. The latter had 'subbed' on the crossing for Manfred's American wife, Gini. She had opted to make this particular crossing at 35,000 feet rather than at sea level, despite the fact that since she and Manfred set out from Hamburg, Germany, in 1990, they have doublehanded this classic-looking, 22-ton vessel across more miles of open ocean than they care to count.

Although their voyaging didn't start until Manfred retired at age 50 — he worked as a research chemist — they both claim to have caught the travel bug early in life. Manfred recalls setting off on a Vespa scooter to explore Western Europe almost as soon as he got his driver's license. A few years later, he met Gini on a blind date in Hamburg. Sparks flew, and before long they concocted a scheme to ship a funky Citroën Deux Chevaux — that's a car — to New York and explore North America. Not only did they successfully tour the U.S., Canada and Alaska in the 2-cylinder tin can, they then went on to explore most of South America, as Manfred explains, "often driving on old Inca roads." Amazingly, the flimsy little car never suffered a serious breakdown.

That same luck has carried the couple through 15 years of world cruising, although their Colin Archer ketch is the polar opposite of a Deux Chevaux in terms of strength and durability. Having already designed and built their own house in Germany, in the mid-'70s Manfred and Gini decided to tackle the challenge of completing their own cruising boat. They bought *Mindedal* as a bare hull after she had been professionally laid up in an English yard. As if the massively-thick fiberglass hull wasn't bulletproof enough, Manfred added eight more layers of glass just to be sure! Working on her during their spare time, it took nine years before she was ready to launch.

As most old salts know, the basic Colin Archer design dates back to the 1890s. Such vessels were first used to rescue fishermen in the often-stormy waters of the Baltic and North Seas. Although Manfred was an avid Hobbie Cat sailor in his youth, and still claims to be "a multihuller at heart," when it came time to choose a cruising boat, he figured that neither a cat nor a tri would be appropriate for the extensive voyaging they intended to do and the heavy gear they wanted to bring along. "Gini insisted on bringing 400 of her favorite books."

With her full-keel, labor-intensive teak decks and tiller steering, she's not the sort of boat that most contemporary cruisers would choose. But her strength and stability would certainly be a plus in nasty weather. Ironically, though, Manfred and Gini, who are now in their mid-60s, say they've never actually been in what *they* would call a serious storm.

Although *Mindedal* carries GPS and an HF email setup, this duo is definitely into keeping things simple. The boat has no refrigeration, no watermaker and, surprisingly, no liferaft. "I don't ever want to feel dependant on someone else for my safety," says Manfred. He's a self-proclaimed "bronze freak," so virtually every metal component aboard is solid bronze, with a dull green patina from years of exposure to the elements. A massive manual windlass sits on the foredeck, harnessing a huge bronze CQR. Various types of all-bronze winches — the likes of which we've never seen before — were collected during their travels. And how does this middle-aged couple manage that massive tiller? First of all, *Mindedal* tracks along nicely due to her full keel and balanced sailplan. But Manfred, whom we surmise is a consummate tinkerer, also devised a simple tiller locking mechanism made from a couple of lines, a double cam cleat and a bicycle brake lever. He and Gini are also huge fans of their New Zealand-built Fleming windvane.

Although they enjoy ocean crossings, they're quick to point out that 90% of their time has been spent living in one place or another rather than actually traveling under sail. After sea testing *Mindedal* in

continued on outside column of next sightings page

triumph

and rudder of the specially-equipped 26-ft sloop by sucking and blowing into tubes.

Lister, who lives in Kent, England, with her husband, completed the sail in 6 hours, 13 minutes. Not only was she the first quadraplegic to make the crossing, the sail was also the longest solo sail for anyone with a similar handicap. Famed solo sailor Emma Richards sailed next to Hilary on another boat just in case. But Lister never needed help.



— cont'd

Hilary was met on the docks in France with a champagne reception. "I'm just thrilled!" she said. "It's been a huge team effort and I'm so grateful to everyone who made it possible." Lister lived an active life until she was diagnosed with a degenerative condition called reflex sympathetic dystrophy, which slowly robbed her of control of her muscles. She took up sailing two years ago as a way to boost her self confidence.



LATITUDE/ANDY

no frills — cont'd

European waters for a few years, they headed to the Caribbean, then north along the Eastern Seaboard, eventually trucking the ketch to San Diego, where they stayed for seven years, caretaking Gini's ailing mother and fattening up their cruising kitty.

A 21-day crossing to the Marquesas began their long Pacific circuit. They lingered for almost a year in New Zealand and more than two years in Australia. "We love both of those places," says Gini, "but my favorite spot in the South Pacific was (Western) Samoa. It's truly unspoiled and the people there take from the West only things which will not change their traditional values."

After a stint in Guam, they sailed to Osaka, in southern Japan. They stayed in the southern islands for two years. Surprisingly, they say *Mindedal* was one of only three or four other cruising boats that came through the area each year — most are scared away by the threat of typhoons much of the year. They were fascinated by many aspects of Japanese culture, and were treated as honored guests by most folks they met. So it was with some reluctance that they departed, June 14, for San Francisco — he by sea and she by air. Apart from annoying headwinds, the 53-day crossing was remarkably benign, with no winds stronger than about 35 knots.

Where to now? After a visit to San Diego, they'll head south and through the Canal, eventually, they suppose, returning to Europe. But after 15 years of rambling about, Gini and Manfred still seem to have plenty of wanderlust.

Left, Gini and Manfred Schubert. Spread, the heavy cruiser 'Mindedal' was the boat of choice for this well-traveled couple.



COURTESY MANFRED AND GINI SCHUBERT

SIGHTINGS

mexico-only crew list

A few years ago, author Dominick Dunne was reviewing a new fiction book about life, wealth and power among New York's billionaire society set, when he realized one of the characters was . . . him. His interest piqued, he eagerly plowed on, only to find the character was bludgeoned to death on the orders of a rich widow who didn't like what he wrote about her. But he was pleased to read that nearly everyone who was anyone attended the funeral, and his longtime editor delivered a very moving eulogy.

"I hope to do as well in real life when my time comes," he concluded.

We bring this up because you're looking at one more chance to 'do as well' with any plans you might have entertained to head to Mexico on a boat this winter. This is the second and last month we will run forms for the Mexico-Only Crew List, and if you missed sending one in last month, we'd suggest you not procrastinate any longer. The Mexico Cruising Class of '05-06 starts taking off next month.

continued on outside column of next sightings page

hams re-enact vj day announcement

At 2:08 p.m. Hawaiian time on September 1 (5:08 p.m. PDT), from the radio room of the battleship *USS Missouri* in Pearl Harbor, Susan Meckley (W7KFI) will rebroadcast the actual message sent out from that ship 60 years ago from Tokyo Harbor: Japan has surrendered — World War II is over.

The broadcast will be on the 20 meter amateur radio band at 14.263Mhz, and should be receivable by hams on the West Coast. It will be repeated later in the evening. The message will be conveyed via Vibroplex Bug a 'speed key' used by morse code operators.



SIGHTINGS

crew list — cont'd

Here's how it works: fill out the appropriate form and send it to us with the proper fee. In the October issue, we'll run a list of all the names in two categories — *Boat Owners Looking for Crew* and *Crew Looking for Boats*. All names will be followed by information about the individual, including skill level, desires, special talents, experience, a contact number and, in the case of boat owners, the size and type of boat. All you do then is go down the appropriate list and call up the most appealing prospects.

Through the Crew List, lots of people have had lots of neat adventures. But there are risks, which is why we insist that, ultimately, you must take responsibility for your own actions. Let's face it, sailing is an inherently dangerous sport. And sailing long distances with people you haven't known that long on boats you don't know that well is a whole other can of worms. So, for the record, the *Latitude 38* Crew

continued on outside column of next sightings page



The Express 37 'Bullet' practices for the Big Boat Series. This rig test took place during last month's Summer Keelboat Regatta, Act II.



ALL PHOTOS LESLIE RICHTER

SIGHTINGS

crew list — cont'd

List is an advertising supplement intended for informational purposes only. *Latitude 38* does not make or imply any guarantee, warranty or recommendation as to the character of individuals participating in the Crew List or the conditions of the boats or equipment. You must judge

I WANT TO CREW IN MEXICO

NAME(S): _____

AGE(S): _____ SEX: _____

PHONE OR OTHER CONTACT: _____

(check as many as apply in all categories)

I WANT TO CREW:

- 1) ___ For the trip down
- 2) ___ While in Mexico
- 3) ___ For Baja Ha-Ha 12, the cruisers' rally to Cabo starting October 31.
- 4) ___ Return trip up Baja
- 5) ___ Other _____

MY EXPERIENCE IS:

- 1) ___ Little or none
- 2) ___ Some, mostly Bay sailing
- 3) ___ Moderate, some ocean cruising or racing
- 4) ___ Lots: **a)** extensive sailing; **b)** extensive cruising; **c)** foreign cruising

I CAN OFFER:

- 1) ___ Few skills, I am a novice sailor
- 2) ___ Skills of a normal hand: watch standing, reefing, changing sails
- 3) ___ Skilled and experienced sailor. I can navigate, set a spinnaker, steer and handle basic mechanical problems.
- 4) ___ Cooking, provisioning or other food-related skills
- 5) ___ 'Local knowledge': **a)** I have cruised Mexico before; **b)** I speak passable Spanish
- 6) ___ Companionship

Mail completed form and \$7 to: *Mexico Only Crew List*, 15 Locust Ave., Mill Valley, CA 94941 by **September 15, 2005**.

those things for yourself.

Still with us? *Bueno!* Here are the ground rules.

1) We must receive all Crew List forms by September 15. That doesn't mean 'postmarked by.' It means in our sweaty little palms. No exceptions.

continued on outside column of next sightings page

belle of

The largest boat signed up for this year's Baja Ha-Ha so far is also perhaps the most unusual of the many hundreds of boats that have participated in all the Ha-Ha cruisers' rallies to Mexico in the last 11 years. She is the 60-ft LOD (85-ft sparrred length) schooner *Patricia Belle*, a rugged, broad-shouldered, old-school schooner not very unlike her builder and owner, Pat Hughes.

Hughes has been a professional mariner most of his life, running everything from ferry boats in Puget Sound to Windjammer cruise ships in the Caribbean. He's skippered oil rig boats off his native Southern California, as well as the *Swift of Ipswich* and other LA-based tallships. He's run tugs and tankers, and done time ashore at Horluck Transportation, a Port Orchard, Washington, ferry company whose contracts with the Navy over the years netted them four large warehouses full of stuff dating back before the turn of the century. . . the *last* century. In other words, Pat has contacts — boy, does this guy have contacts.

Patricia Belle is the seventh boat Pat has owned and the third he's built. She's a modified George Buehler design made entirely of Douglas fir from keel to truck. When plans, a schedule and a building site were firmed up, Pat started gathering wood. Along with all his contacts, Pat is a scrounger of the first order. He actually did buy some of the wood, but much of it came from windfall trees (trees felled by storms). The masts were trees he cut down in his front yard. And at least some of the raw materials came from logs he spotted during ferryboat duty on Puget Sound. Refugees from log rafts, they'd wash up on beaches on the various islands. He'd chart their positions, and when his shift was up, he'd periodically borrow a ferry and go recover the logs, stacking them at a local boat ramp until he'd accumulated enough to hire a guy with a portable mill to come down and turn the logs into planks.

When he'd amassed about 60,000 board feet (most of it dried for a year or more), the building of the boat began. This was 1994. She was launched in 1997 and fitting out took another year. Pat's workforce consisted of himself and an ever-revolving crew of kids. Four of them were his — Steven, Joshua, Caleb and daughter Dorie. But he enlisted many of their friends too, with the promise that they would have a berth for at least a while when the boat was finished.

mystery

the ball

Of course, there's more to building a traditional schooner than just a big pile of Doug fir. Pat's many years and contacts in the Seattle waterfront made that process relatively painless, inexpensive — and creative beyond imagination. The 4-71 'Jimmy' diesel once did duty in a fishing boat. *Patricia Belle's* portholes are from an 1892 tugboat. The big Barient sheet winches were salvaged from a racing boat that foundered on a local beach. The 1 X 3 X 42-ft deadwood timber was a bridge timber saved when an old bridge was demolished. The steering gear is out of an old dumptruck. The main and foremast sheet blocks were once lifeboat davit blocks on a World War II Victory ship. And so it went. Total cost of the finished boat was \$50,000.

True to his word, Pat had a crew of 14 teenagers aboard when he exited the Strait of Juan de Fuca in 1998 and turned south. The 'shakedown cruise' took the boat 3,000 miles south to Nicaragua, where *Patricia Belle* took on her first cargo.

You read right. Yet another unusual feature built into the boat was her large central berthing area, which doubles as a hold. In cargo mode, the big main cabin roof lifts off to reveal a space big enough to lower a small car into. Her first cargo, however, was coffee. Hughes and crew loaded up with 10,000 pounds of it and headed back Stateside.

They landed in San Diego, and Pat contacted various coffee houses and other vendors. All (including Starbucks) but one small local shop turned a cold shoulder. So Pat and the boys started selling it off the boat. When word got out — and the rich beans got tasted — locals were soon clamoring for more. Pat and the boys were getting \$5 a pound for beans that had cost them \$.60/pound. Not bad. Some people were happy to hand over \$100 for 20-pound bags. It ended up being a productive if somewhat frustrating adventure. (He was in Nicaragua a month securing the proper paperwork.) He was going to try it a second time, but when he took off, "somehow we ended up in Hawaii instead," he says.

There was a significant addition to the crew on that passage. Pat had injured his foot in Nicaragua, so after the coffee was gone, he headed over to the University medical center to have it looked at. There he ran into a pretty blonde RN named

continued middle of next sightings page

rectangle

crew list — cont'd

2) All forms must be accompanied by the appropriate fee. That's \$5 apiece for everyone. And don't fax the forms to us. We have to receive the fee *with* the form.

3) One form per person, please — unless you and a friend want

I NEED CREW FOR MEXICO

NAME(S): _____

AGE(S): _____ SEX: _____

PHONE OR OTHER CONTACT: _____

BOAT SIZE/TYPE: _____

(check as many as apply in all categories)

I NEED CREW FOR:

1) ___ For the trip down

2) ___ While in Mexico

3) ___ For Baja Ha-Ha 12, the cruisers' rally to Cabo starting October 31.

4) ___ Return trip up Baja

5) ___ Other _____

MY EXPERIENCE IS:

1) ___ Bay

2) ___ Ocean

3) ___ Foreign Cruising

I AM LOOKING FOR:

1) ___ Enthusiasm — experience is not all that important

2) ___ Moderately experienced sailor to share normal crew responsibilities

3) ___ Experienced sailor who can a) share navigation and/or mechanical skills; b) who can show me the ropes

4) ___ Cooking, provisioning or other food-related skills

5) ___ 'Local knowledge': someone who has a) been to Mexico before; b) speaks passable Spanish

6) ___ Someone to help me bring the boat back up the coast

7) ___ Someone to help me trailer boat back up/down the coast

8) ___ Someone who might stick around if I decide to keep going beyond Mexico

9) ___ Other _____

Mail completed form and \$7 to: *Mexico Only Crew List*, 15 Locust Ave., Mill Valley, CA 94941 **by September 15, 2005.**

to go only if you can go together. Whether you're a couple or just friends, applying for a 'group rate' does diminish your chances of finding a boat somewhat. But holding out for a skipper who will take you

continued on outside column of next sightings page

SIGHTINGS

crew list — cont'd

both will certainly enhance the adventure. In these situations, both parties should fill out one Crew List form and send in one fee. If you think you'll need additional forms, or want to send some to friends, simply make copies of the ones on these pages.

4) Be honest. The simplest rule of all. In this case, being honest means not inflating your experience or skill level because you think it's what someone wants to hear. In sailing, perhaps more than any other sport, if you don't know what you're talking about, people who do can recognize it instantly. BSers don't get rides.

Contrary to what you might think, honest folks with little or no ex-

continued on outside column of next sightings page

patricia belle

Jeannie and — long story short — they were married in 2001. Her teenaged kids, son Elijah and daughters Mariah and Joanna, have all since done crewing stints on *Patricia Belle*.

These days, the *Belle* is homeported in Ensenada. Pat is between 'real jobs' as he prepares the boat for the Ha-Ha, while Jeannie travels back across the border to work two days a week in the neonatal unit at UCSD. Crew for the Ha-Ha will likely

Spread, 'Patricia Belle' at Two Harbors, Catalina, last month. Opposite page, top left, the current crew includes (l to r) Matt Tripp, Clark Irvin, Steven Hughes and Jerome Tripp. Top right, Jeannie Hughes in the pilothouse 'parlor' with crew John Entner. Right, Pat Hughes next to a clever combination winch pedestal/samson post.

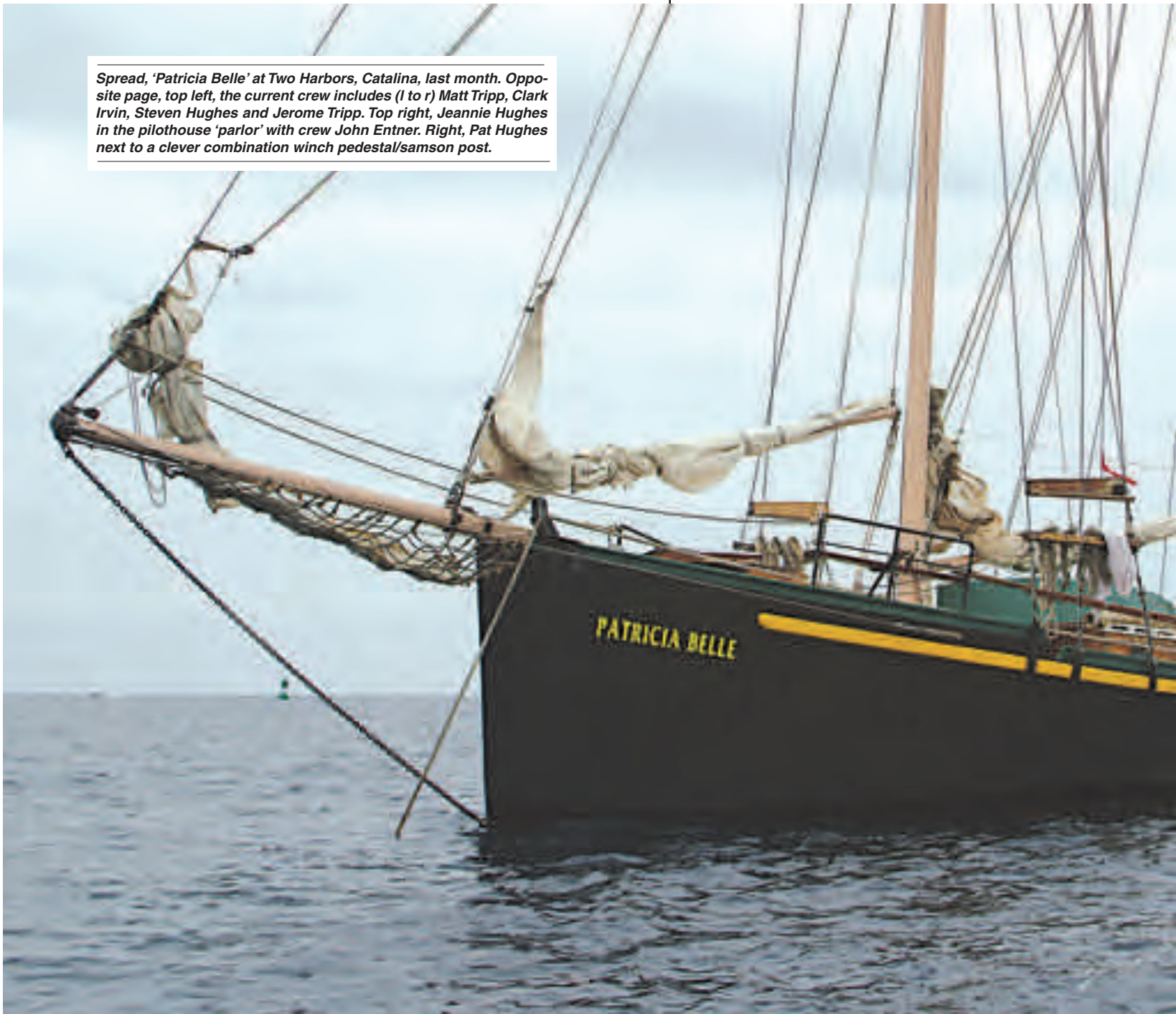

SIGHTINGS

— cont'd

include Pat's youngest son Stephen (who has been aboard for two years now) and some of his pals, as well as anyone willing to pay the always-in-effect \$25 / day crewing fee. (ibsurfqueen@yahoo.com if you're interested.)

Pat's eventual hope is to obtain a Mexican license that will allow him to day charter the boat out of Ensenada — when he's not 'ending up' in far flung Pacific ports, that is.

crew list — cont'd

perience often get rides. It has to do with some experienced skippers preferring to train people in their way of doing things.

5) Women can use first names only. If you are female, you *will* get calls. Possibly lots of them. We've talked to women who say they have gotten *hundreds* of calls, some months or even years after the Crew List is published.

For this reason, we recommend that women use first names only, and that they *not* use a home phone number as a contact. Instead, use a P.O. Box, answering service, fax number, email or other contact that insulates you a bit. It also makes screening easier. Finally — *guys and*

continued on outside column of next sightings page



ALL PHOTOS LATITUDEJR

SIGHTINGS

mexico only crew list

women — please keep the hormone thing out of the Crew List process. Once your crewing situation is worked out, if you mutually like what you see, then let nature take its course. But please, not before. Thanks.

6) If you take part in the Crew List, you get into the Crew List party free! Back in the old days, the Crew List party used to be a relatively low-key affair. It has now grown into an event of epic proportions, complete with T-shirt giveaways and all kinds of other neat stuff. And it's not just for Crew Listers anymore, but serves as a rendezvous point and reunion for Baja Ha-Ha Rally participants past and present. How big is it? This year, the entertainment lineup includes the Rolling Stones, Madonna, Jimmy Buffet and those bad boys of cruising, Aerosmith. We haven't actually asked any of them yet, but what could possibly go wrong?

This year's party will be held at the Encinal YC on Wednesday, October 5. If you haven't lined up a boat or crew by then, come on by

continued on outside column of next sightings page

ha-ha entry deadline

As of the third week in August, the number of paid entries for this fall's Baja Ha-Ha is 77 — and rising steadily. "I anticipate we'll have 120 entries by the September 10 deadline," says Ha-Ha Honcho Lauren Spindler.

The Ha-Ha is the 750-mile cruisers' rally from San Diego to Cabo San Lucas, with stops at Turtle Bay and Bahia Santa Maria. The Ha-Ha differs from a race in several important ways. First, the Ha-Ha philosophy is that everybody who participates is a winner. Second, rather than a nonstop passage as with races, the Ha-Ha fleet alternates a couple of days of sailing with a couple of days of R&R in great plac-



Action was hot and heavy at the 470 Worlds held on the Bay last month. These guys are David Hughes (hanging on wire) and skipper Mike Anderson-Mitterling, who were running near the top in the Silver Fleet. (No US teams made the Gold Fleet.) Although this maneuver doesn't look pretty, they prevented a capsize, recovered quickly and took off like a shot. Look for a report on the Worlds, which was still in progress as we went to press, next month.

CHRIS RAY

just around the corner

es. So by the time participants cross the finish near Cabo, they've usually had lots of great sailing, had fun exploring a couple of great places on the Baja coast, and made scores of new cruising friends.

October 31 is the start of the 12th annual Ha-Ha. The event is open to boats 27 feet or longer that were designed, built, and have been maintained for offshore sailing. There must be at least two crew, and at least two of the crew must have overnight sailing and navigation experience. While the event welcomes relatively inexperienced offshore sailors, it's not an offshore babysitting service. If you're not ready to sail to Cabo on your own, you're not ready to Ha-Ha.

The Ha-Ha priorities are having a safe trip to the Cape and making lots of friends. So if your main interests are insane partying and really hitting the booze, this is definitely the wrong event for you. Yes, there are a couple of beach parties with music and beer, but the Ha-Ha is all about responsible fun. "If people want to get wild and crazy," says Ms. Spindler, "the time is after the Ha-Ha is over, and the place is Squid Roe in Cabo."

The Ha-Ha previews with the West Marine Official Ha-Ha Kick-Off & Halloween Costume Party on Sunday, October 30, with the start of sailing the following day. The fleet should arrive in Cabo on the following Thursday. If you're a couple and one or the other of you can't make the trip, here's a fun solution: One of you sails down in the Ha-Ha, while the other flies to Cabo to meet the arriving sailor and spend a few romantic days together before flying home Sunday. As we all know, absence makes the heart grow fonder and the lust more intense.

If you want to do this year's Ha-Ha,

continued middle of next sightings page

crew list — cont'd

for a last chance at the party itself. (Everyone wears color-coded nametags, so spotting crew or boat owners is easy). If you already have a boat/crew spot, plan on coming by anyway for an enjoyable evening with like-minded people heading south.

Next month in the October issue, we'll run all the names of people who signed up. If you want to be one of them, don't snooze much longer or you'll lose out. Why not clip and send your Crew List form in right now?

LATEST HA-HA ENTRIES

Allegro	Catalina 42	Jim & Mary Brye	Ventura
Dawn Treader	Contest 48cs	Hal Craft	Dana Point
Island Mistress	Willington 47	Jeff & Judy Wahl	Yankton, SD
Koho	Cal 48	Hugh & Karlene Owens	Portland
Daydreams	Pearson 385	Joe & Melinda Day	Nevada City, CA
Out of Africa	Wildcat 350 cat	Richard & Kathy Cavanagh	Isleton
Jakyrhah	Island Packet 35	Tom & Chris Wakes	San Diego
Lonesome Dove	Elite 29	Britta Fjelstrom	San Francisco
Dream Ketch'r	Endeavour 43	Don Watkins	San Diego
Sonrisa	Valiant 40	John & Sylvia Parr	Corpus Christi
Catch the Wind	Cal 39	John Crabtree/Suzie Wilson	Richmond, CA
Salacia	Catalina 42	Mark & Deanna Roozendaal	Victoria, BC
Chaitanya	Tayana 37	Ian & Heidi Jarman	Alameda
Jenny	Jeanneau 43	Doug & Joan Leavitt	San Francisco
Topaz	Caliber LRC	Mark & Karen Isaacson	Alameda
The Boat	Island Packet 35	Ron & Tam Preston	Stockton
La Vie	Beneteau 405	David Kane	Seattle
Serenity	Catalina 42MKII	David Albert	Oceanside
Murray Grey	Ericson 38	Jim Sicard	Portland
De La Sol	Alberg 35	Jerry & Slater McArdle	Oceanside
Allegra	C&C 37	Alan Paul	Oxnard
Flyer	Tartan 3400	Klaus Kutz & Jennifer Rader	Alameda
Capt Geo Thomas	C&C 30	Capt Bill Thomas	Vallejo
Tiki iti	Downeast 38	Sean & Adrian Guches	N/A
Freestyle	40-ft cat	Jerry Wetzler	Dana Point
Sun Baby	Lagoon 410 cat	Daniel & Cynthia Kerns	Seattle
Sumatra	Trintella 53	Jerome Morgan	San Francisco
Tenten	Catalina 42	Cynthia Cantwell	Chico
Rock Hopper	Tartan 4400	Mark Partridge	Alameda
Ulysses	Cascade 29	Thomas Baldwin	Kalama, WA
New Horizon IV	Kelly Peterson	Wolfgang Boehle	San Diego
Rocinante	Islander 36	Dan Martone	Point Richmond

short sightings

PHUKET, THAILAND — In one of many inspiring stories to come out of tsunami-devastated Thailand, a group of boatbuilders has begun production of a fiberglass version of the traditional longtail fishing boat. Some 4,000 longtails were lost in last December's tsunami. The earthquake-generated waves also depleted the forests from which new boats could be built. In response to this problem, a group of concerned individuals and organiza-

tions headed by Phuket-based Omni Marine has developed the 'Loa Maa', a fiberglass version of the slender 30-ft craft. Besides preserving the look and feel of the traditional longtail — so named because the propeller is at the end of a long shaft — the Loa Maa helps save natural resources, and will last longer than a wooden version. Design tweaks will also make the boats more fuel efficient and seaworthy. Prototypes are currently undergoing testing, after which they will be made available to fishermen who lost boats in the tsunami. For a look at the new boats, log onto www.omnitrips.com/longtail-boats-tsunami-phuket-thailand.html.

YOUR TV — Outdoor Life Network (OLN) recently announced that it had secured rights to televise the next America's Cup and all events leading up to it. Last month, the "new home of the America's Cup" came out with a schedule for a special 'magazine' series that will follow the latest series of qualifying regattas — or 'Acts' as the AC guys call them — and will continue right on up and through the 32nd America's Cup, which will be contested off Valencia in 2007. The magazine began last month with a look back at the opening Act in Marseilles in '04. Upcoming shows — all are currently scheduled on Wednesdays — are slated for September 8 (6:30 ET), September 21 (5:30 ET) and October 19 (5:30 ET). As with everything in TV land, these times are subject to change without notice, so be sure to check your local listings. OLN's website

continued on outside column of next sightings page

SIGHTINGS

shorts — cont'd

is www.olntv.com, but we looked all over the place there and couldn't find a dang thing about this series.

THE DELTA — Last month, Billings, Montana-based Kampgrounds of America, Inc. (KOA) announced it had partnered with Westrec Marinas to take over the operation of the 400-site RV resort at Westrec's Tower Park Resort complex in the Delta. The lease agreement makes the resort one of the largest campgrounds in the 456-site KOA system, which includes sites throughout the U.S., Canada and Japan.

The Tower Park facility — henceforth to be known as the Stockton Delta/Tower Park Resort KOA — is one of several cooperative ventures between KOA and Westrec. Tower Park is a completely self-contained resort community 30 miles south of Sacramento. Along with 400 full hookup RV sites, the park has 400 boat slips, a group events pavilion, swimming pool, spa, boat sales and rentals, a restaurant, bar and banquet facilities — and even has its own post office and drinking water processing plant.

Westrec Marinas is the world's largest owner/operator of marinas and marina-related businesses. They currently operate 25 marinas offering 15,000 boat slips throughout the U.S., as well as in Brazil and Jamaica.

continued on outside column of next sightings page

ha-ha

you need to get an entry packet and then return your entry to the Ha-Ha folks by September 10. For a packet, send a check for \$18 with a self-addressed 9x12 envelope to Baja Ha-Ha, Inc., 21 Apollo Road, Tiburon, CA 94920. The Ha-Ha entry fee is \$299, for which you get all kinds of goodies, deals, and more swag than any other sailing event we know of. And this year the folks at the Baja Cantina vow to welcome all entries with a round of free drinks and finger foods.

If you're a skipper who is going to need crew, or if you're a sailor looking for a berth, check out the Mexico Only Crew List article and forms elsewhere in *Sightings* — or just show up at the Ha-Ha Reunion Kick-Off/Mexico Crew List Party to be held at the Encinal YC in Alameda on Wednesday, October 5, from 6-9 p.m. This party gives everyone a chance to meet potential shipmates face-to-face — but be



Making a splash — The Catalina 38 'Fat Bob' enjoying a nice breeze in Golden Gate Strait.



— cont'd

careful, as previous parties have resulted in a few marriages. This year the Ha-Ha folks will have a continuous slide show with photos from previous Ha-Ha's, and there will be several other displays of interest to cruisers.

This year's Ha-Ha fleet looks to be typical of years past, with almost all the boats in the 38 to 42-foot range, but with lots of variety. There's a Westsail 32 and a Santa Cruz 52; a '60s-vintage Bounty II, and some fairly new boats; there's even a few catamarans and several motoryachts.

As with the last eight years, *Profligate* will be the mothership, and the event will be run by the Grand Poobah, Banjo Andy Turpin, and Dona de Mallorca. Heading up the activities for kids will be Jerry McArdle of the Alberg 35 *Del La Sol*. Speaking as the Poobah, we can't wait to sail and socialize with all of you!

shorts — cont'd

EGDEOYA ISLAND, NORWAY — Did you hear the one about the three researchers who got shipwrecked on a remote island in Norway's Svalbard archipelago? Seems the guys were part of the crew of the Polish research ship *Horyzont*. They were headed to the island in an inflatable to pick up some equipment when the boat somehow capsized and threw the trio into the water. "They lost all their equipment and weapons," said the Associated Press report. "They swam and clambored over chunks of floating ice to get to the island of Egdeoya."

Weapons? But wait. It gets better.

The three guys made it to the beach okay, and even managed to get a fire going "using the spark plugs from their craft's outboard motor". Then they notice the polar bears. There are three of them. And the polar bears have *definitely* noticed them. The ship, meanwhile, has been trying to reach them with another inflatable, but the water is so rough that it's eventually recalled. So they go to Plan B. The *Horyzont* — which you'll recall is a 'research vessel' — fires their *harpoon cannon* at the island, and sends some food and water down the line to the stranded sailors. Then they put out a *mayday* call.

In a cliffhanger ending right out of reality TV, the three hapless sailors get plucked off the island by helicopter in the nick of time. The three polar bears were reportedly only 20 yards away. "That is dangerously close," noted a representative of the Svalbard governor's office.



SIGHTINGS

crew list — cont'd

List is an advertising supplement intended for informational purposes only. *Latitude 38* does not make or imply any guarantee, warranty or recommendation as to the character of individuals participating in the Crew List or the conditions of the boats or equipment. You must judge

I WANT TO CREW IN MEXICO

NAME(S): _____

AGE(S): _____ SEX: _____

PHONE OR OTHER CONTACT: _____

(check as many as apply in all categories)

I WANT TO CREW:

- 1) ___ For the trip down
- 2) ___ While in Mexico
- 3) ___ For Baja Ha-Ha 12, the cruisers' rally to Cabo starting October 31.
- 4) ___ Return trip up Baja
- 5) ___ Other _____

MY EXPERIENCE IS:

- 1) ___ Little or none
- 2) ___ Some, mostly Bay sailing
- 3) ___ Moderate, some ocean cruising or racing
- 4) ___ Lots: **a)** extensive sailing; **b)** extensive cruising;
c) foreign cruising

I CAN OFFER:

- 1) ___ Few skills, I am a novice sailor
- 2) ___ Skills of a normal hand: watch standing, reefing, changing sails
- 3) ___ Skilled and experienced sailor. I can navigate, set a spinnaker, steer and handle basic mechanical problems.
- 4) ___ Cooking, provisioning or other food-related skills
- 5) ___ 'Local knowledge': **a)** I have cruised Mexico before;
b) I speak passable Spanish
- 6) ___ Companionship

Mail completed form and \$7 to: *Mexico Only Crew List*, 15 Locust Ave., Mill Valley, CA 94941 by **September 15, 2005**.

belle of

The largest boat signed up for this year's Baja Ha-Ha so far is also perhaps the most unusual of the many hundreds of boats that have participated in all the Ha-Ha cruisers' rallies to Mexico in the last 11 years. She is the 60-ft LOD (85-ft sparrred length) schooner *Patricia Belle*, a rugged, broad-shouldered, old-school schooner not very unlike her builder and owner, Pat Hughes.

Hughes has been a professional mariner most of his life, running everything from ferry boats in Puget Sound to Windjammer cruise ships in the Caribbean. He's skippered oil rig boats off his native Southern California, as well as the *Swift of Ipswich* and other LA-based tallships. He's run tugs and tankers, and done time ashore at Horluck Transportation, a Port Orchard, Washington, ferry company whose contracts with the Navy over the years netted them four large warehouses full of stuff dating back before the turn of the century. . . the *last* century. In other words, Pat has contacts — boy, does this guy have contacts.

Patricia Belle is the seventh boat Pat has owned and the third he's built. She's a modified George Buehler design made entirely of Douglas fir from keel to truck. When plans, a schedule and a building site were firmed up, Pat started gathering wood. Along with all his contacts, Pat is a scrounger of the first order. He actually did buy some of the wood, but much of it came from windfall trees (trees felled by storms). The masts were trees he cut down in his front yard. And at least some of the raw materials came from logs he spotted during ferryboat duty on Puget Sound. Refugees from log rafts, they'd wash up on beaches on the various islands. He'd chart their positions, and when his shift was up, he'd periodically borrow a ferry and go recover the logs, stacking them at a local boat ramp until he'd accumulated enough to hire a guy with a portable mill to come down and turn the logs into planks.

When he'd amassed about 60,000 board feet (most of it dried for a year or more), the building of the boat began. This was 1994. She was launched in 1997 and fitting out took another year. Pat's workforce consisted of himself and an ever-revolving crew of kids. Four of them were his — Steven, Joshua, Caleb and daughter Dorie. But he enlisted many of their friends too, with the promise that they would have a berth for at least a while when the boat was finished.

those things for yourself.

Still with us? *Bueno!* Here are the ground rules.

1) **We must receive all Crew List forms by September 15.** That doesn't mean 'postmarked by.' It means in our sweaty little palms. No exceptions.

continued on outside column of next sightings page

the ball

Of course, there's more to building a traditional schooner than just a big pile of Doug fir. Pat's many years and contacts in the Seattle waterfront made that process relatively painless, inexpensive — and creative beyond imagination. The 4-71 'Jimmy' diesel once did duty in a fishing boat. *Patricia Belle's* portholes are from an 1892 tugboat. The big Barient sheet winches were salvaged from a racing boat that foundered on a local beach. The 1 X 3 X 42-ft deadwood timber was a bridge timber saved when an old bridge was demolished. The steering gear is out of an old dumptruck. The main and foremast sheet blocks were once lifeboat davit blocks on a World War II Victory ship. And so it went. Total cost of the finished boat was \$50,000.

True to his word, Pat had a crew of 14 teenagers aboard when he exited the Strait of Juan de Fuca in 1998 and turned south. The 'shakedown cruise' took the boat 3,000 miles south to Nicaragua, where *Patricia Belle* took on her first cargo.

You read right. Yet another unusual feature built into the boat was her large central berthing area, which doubles as a hold. In cargo mode, the big main cabin roof lifts off to reveal a space big enough to lower a small car into. Her first cargo, however, was coffee. Hughes and crew loaded up with 10,000 pounds of it and headed back Stateside.

They landed in San Diego, and Pat contacted various coffee houses and other vendors. All (including Starbucks) but one small local shop turned a cold shoulder. So Pat and the boys started selling it off the boat. When word got out — and the rich beans got tasted — locals were soon clamoring for more. Pat and the boys were getting \$5 a pound for beans that had cost them \$.60/pound. Not bad. Some people were happy to hand over \$100 for 20-pound bags. It ended up being a productive if somewhat frustrating adventure. (He was in Nicaragua a month securing the proper paperwork.) He was going to try it a second time, but when he took off, "somehow we ended up in Hawaii instead," he says.

There was a significant addition to the crew on that passage. Pat had injured his foot in Nicaragua, so after the coffee was gone, he headed over to the University medical center to have it looked at. There he ran into a pretty blonde RN named

continued middle of next sightings page

crew list — cont'd

2) All forms must be accompanied by the appropriate fee. That's \$5 apiece for everyone. And don't fax the forms to us. We have to receive the fee *with* the form.

3) One form per person, please — unless you and a friend want

I NEED CREW FOR MEXICO

NAME(S): _____

AGE(S): _____ SEX: _____

PHONE OR OTHER CONTACT: _____

BOAT SIZE/TYPE: _____

(check as many as apply in all categories)

I NEED CREW FOR:

1) ___ For the trip down

2) ___ While in Mexico

3) ___ For Baja Ha-Ha 12, the cruisers' rally to Cabo starting October 31.

4) ___ Return trip up Baja

5) ___ Other _____

MY EXPERIENCE IS:

1) ___ Bay

2) ___ Ocean

3) ___ Foreign Cruising

I AM LOOKING FOR:

1) ___ Enthusiasm — experience is not all that important

2) ___ Moderately experienced sailor to share normal crew responsibilities

3) ___ Experienced sailor who can a) share navigation and/or mechanical skills; b) who can show me the ropes

4) ___ Cooking, provisioning or other food-related skills

5) ___ 'Local knowledge': someone who has a) been to Mexico before; b) speaks passable Spanish

6) ___ Someone to help me bring the boat back up the coast

7) ___ Someone to help me trailer boat back up/down the coast

8) ___ Someone who might stick around if I decide to keep going beyond Mexico

9) ___ Other _____

Mail completed form and \$7 to: *Mexico Only Crew List*, 15 Locust Ave., Mill Valley, CA 94941 **by September 15, 2005.**

to go only if you can go together. Whether you're a couple or just friends, applying for a 'group rate' does diminish your chances of finding a boat somewhat. But holding out for a skipper who will take you

continued on outside column of next sightings page

SIGHTINGS

crew list — cont'd

both will certainly enhance the adventure. In these situations, both parties should fill out one Crew List form and send in one fee. If you think you'll need additional forms, or want to send some to friends, simply make copies of the ones on these pages.

4) Be honest. The simplest rule of all. In this case, being honest means not inflating your experience or skill level because you think it's what someone wants to hear. In sailing, perhaps more than any other sport, if you don't know what you're talking about, people who do can recognize it instantly. BSers don't get rides.

Contrary to what you might think, honest folks with little or no ex-

continued on outside column of next sightings page

patricia belle

Jeannie and — long story short — they were married in 2001. *Her* teenaged kids, son Elijah and daughters Mariah and Joanna, have all since done crewing stints on *Patricia Belle*.

These days, the *Belle* is homeported in Ensenada. Pat is between 'real jobs' as he prepares the boat for the Ha-Ha, while Jeannie travels back across the border to work two days a week in the neonatal unit at UCSD. Crew for the Ha-Ha will likely

Spread, 'Patricia Belle' at Two Harbors, Catalina, last month. Opposite page, top left, the current crew includes (l to r) Matt Tripp, Clark Irvin, Steven Hughes and Jerome Tripp. Top right, Jeannie Hughes in the pilothouse 'parlor' with crew John Entner. Right, Pat Hughes next to a clever combination winch pedestal/samson post.



— cont'd

include Pat's youngest son Stephen (who has been aboard for two years now) and some of his pals, as well as anyone willing to pay the always-in-effect \$25/day crewing fee. (ibsurfqueen@yahoo.com if you're interested.)

Pat's eventual hope is to obtain a Mexican license that will allow him to day charter the boat out of Ensenada — when he's not 'ending up' in far flung Pacific ports, that is.

crew list — cont'd

perience often get rides. It has to do with some experienced skippers preferring to train people in their way of doing things.

5) Women can use first names only. If you are female, you *will* get calls. Possibly lots of them. We've talked to women who say they have gotten *hundreds* of calls, some months or even years after the Crew List is published.

For this reason, we recommend that women use first names only, and that they *not* use a home phone number as a contact. Instead, use a P.O. Box, answering service, fax number, email or other contact that insulates you a bit. It also makes screening easier. Finally — *guys and*

continued on outside column of next sightings page



ALL PHOTOS LATITUDE/JR

SIGHTINGS

mexico only crew list

women — please keep the hormone thing out of the Crew List process. Once your crewing situation is worked out, if you mutually like what you see, then let nature take its course. But please, not before. Thanks.

6) If you take part in the Crew List, you get into the Crew List party free! Back in the old days, the Crew List party used to be a relatively low-key affair. It has now grown into an event of epic proportions, complete with T-shirt giveaways and all kinds of other neat stuff. And it's not just for Crew Listers anymore, but serves as a rendezvous point and reunion for Baja Ha-Ha Rally participants past and present. How big is it? This year, the entertainment lineup includes the Rolling Stones, Madonna, Jimmy Buffet and those bad boys of cruising, Aerosmith. We haven't actually asked any of them yet, but what could possibly go wrong?

This year's party will be held at the Encinal YC on Wednesday, October 5. If you haven't lined up a boat or crew by then, come on by

continued on outside column of next sightings page

ha-ha entry deadline

As of the third week in August, the number of paid entries for this fall's Baja Ha-Ha is 77 — and rising steadily. "I anticipate we'll have 120 entries by the September 10 deadline," says Ha-Ha Honcho Lauren Spindler.

The Ha-Ha is the 750-mile cruisers' rally from San Diego to Cabo San Lucas, with stops at Turtle Bay and Bahia Santa Maria. The Ha-Ha differs from a race in several important ways. First, the Ha-Ha philosophy is that everybody who participates is a winner. Second, rather than a nonstop passage as with races, the Ha-Ha fleet alternates a couple of days of sailing with a couple of days of R&R in great plac-



Action was hot and heavy at the 470 Worlds held on the Bay last month. These guys are David Hughes (hanging on wire) and skipper Mike Anderson-Mitterling, who were running near the top in the Silver Fleet. (No US teams made the Gold Fleet.) Although this maneuver doesn't look pretty, they prevented a capsize, recovered quickly and took off like a shot. Look for a report on the Worlds, which was still in progress as we went to press, next month.

CHRIS RAY

just around the corner

es. So by the time participants cross the finish near Cabo, they've usually had lots of great sailing, had fun exploring a couple of great places on the Baja coast, and made scores of new cruising friends.

October 31 is the start of the 12th annual Ha-Ha. The event is open to boats 27 feet or longer that were designed, built, and have been maintained for offshore sailing. There must be at least two crew, and at least two of the crew must have overnight sailing and navigation experience. While the event welcomes relatively inexperienced offshore sailors, it's not an off-shore babysitting service. If you're not ready to sail to Cabo on your own, you're not ready to Ha-Ha.

The Ha-Ha priorities are having a safe trip to the Cape and making lots of friends. So if your main interests are insane partying and really hitting the booze, this is definitely the wrong event for you. Yes, there are a couple of beach parties with music and beer, but the Ha-Ha is all about responsible fun. "If people want to get wild and crazy," says Ms. Spindler, "the time is after the Ha-Ha is over, and the place is Squid Roe in Cabo."

The Ha-Ha previews with the West Marine Official Ha-Ha Kick-Off & Halloween Costume Party on Sunday, October 30, with the start of sailing the following day. The fleet should arrive in Cabo on the following Thursday. If you're a couple and one or the other of you can't make the trip, here's a fun solution: One of you sails down in the Ha-Ha, while the other flies to Cabo to meet the arriving sailor and spend a few romantic days together before flying home Sunday. As we all know, absence makes the heart grow fonder and the lust more intense.

If you want to do this year's Ha-Ha,

continued middle of next sightings page

crew list — cont'd

for a last chance at the party itself. (Everyone wears color-coded nametags, so spotting crew or boat owners is easy). If you already have a boat/crew spot, plan on coming by anyway for an enjoyable evening with like-minded people heading south.

Next month in the October issue, we'll run all the names of people who signed up. If you want to be one of them, don't snooze much longer or you'll lose out. Why not clip and send your Crew List form in right now?

LATEST HA-HA ENTRIES

Allegro	Catalina 42	Jim & Mary Brye	Ventura
Dawn Treader	Contest 48cs	Hal Craft	Dana Point
Island Mistress	Willington 47	Jeff & Judy Wahl	Yankton, SD
Koho	Cal 48	Hugh & Karlene Owens	Portland
Daydreams	Pearson 385	Joe & Melinda Day	Nevada City, CA
Out of Africa	Wildcat 350 cat	Richard & Kathy Cavanagh	Isleton
Jakyrhah	Island Packet 35	Tom & Chris Wakes	San Diego
Lonesome Dove	Elite 29	Britta Fjelstrom	San Francisco
Dream Ketch'r	Endeavour 43	Don Watkins	San Diego
Sonrisa	Valiant 40	John & Sylvia Parr	Corpus Christi
Catch the Wind	Cal 39	John Crabtree/Suzie Wilson	Richmond, CA
Salacia	Catalina 42	Mark & Deanna Roozendaal	Victoria, BC
Chaitanya	Tayana 37	Ian & Heidi Jarman	Alameda
Jenny	Jeanneau 43	Doug & Joan Leavitt	San Francisco
Topaz	Caliber LRC	Mark & Karen Isaacson	Alameda
The Boat	Island Packet 35	Ron & Tam Preston	Stockton
La Vie	Beneteau 405	David Kane	Seattle
Serenity	Catalina 42MKII	David Albert	Oceanside
Murray Grey	Ericson 38	Jim Sicard	Portland
De La Sol	Alberg 35	Jerry & Slater McArdle	Oceanside
Allegra	C&C 37	Alan Paul	Oxnard
Flyer	Tartan 3400	Klaus Kutz & Jennifer Rader	Alameda
Capt Geo Thomas	C&C 30	Capt Bill Thomas	Vallejo
Tiki iti	Downeast 38	Sean & Adrian Guches	N/A
Freestyle	40-ft cat	Jerry Wetzler	Dana Point
Sun Baby	Lagoon 410 cat	Daniel & Cynthia Kerns	Seattle
Sumatra	Trintella 53	Jerome Morgan	San Francisco
Tenten	Catalina 42	Cynthia Cantwell	Chico
Rock Hopper	Tartan 4400	Mark Partridge	Alameda
Ulysses	Cascade 29	Thomas Baldwin	Kalama, WA
New Horizon IV	Kelly Peterson	Wolfgang Boehle	San Diego
Rocinante	Islander 36	Dan Martone	Point Richmond

short sightings

PHUKET, THAILAND — In one of many inspiring stories to come out of tsunami-devastated Thailand, a group of boatbuilders has begun production of a fiberglass version of the traditional longtail fishing boat. Some 4,000 longtails were lost in last December's tsunami. The earthquake-generated waves also depleted the forests from which new boats could be built. In response to this problem, a group of concerned individuals and organiza-

tions headed by Phuket-based Omni Marine has developed the 'Loa Maa', a fiberglass version of the slender 30-ft craft. Besides preserving the look and feel of the traditional longtail — so named because the propeller is at the end of a long shaft — the Loa Maa helps save natural resources, and will last longer than a wooden version. Design tweaks will also make the boats more fuel efficient and seaworthy. Prototypes are currently undergoing testing, after which they will be made available to fishermen who lost boats in the tsunami. For a look at the new boats, log onto www.omnitrips.com/longtail-boats-tsunami-phuket-thailand.html.

YOUR TV — Outdoor Life Network (OLN) recently announced that it had secured rights to televise the next America's Cup and all events leading up to it. Last month, the "new home of the America's Cup" came out with a schedule for a special 'magazine' series that will follow the latest series of qualifying regattas — or 'Acts' as the AC guys call them — and will continue right on up and through the 32nd America's Cup, which will be contested off Valencia in 2007. The magazine began last month with a look back at the opening Act in Marseilles in '04. Upcoming shows — all are currently scheduled on Wednesdays — are slated for September 8 (6:30 ET), September 21 (5:30 ET) and October 19 (5:30 ET). As with everything in TV land, these times are subject to change without notice, so be sure to check your local listings. OLN's website

continued on outside column of next sightings page

PYEWACKET GOES

The year 2005 has been one of milestones for the Disney family. Disneyland celebrated its 50th anniversary. Roy Disney, Walt's nephew and the company's former vice president, celebrated his 75th birthday in January, and his 16th and final TransPac race in July. After the race, Roy, one of the good guys of West Coast sailing for the last three decades, announced that he was retiring from the yacht racing game — and that he was donating *Pyewacket*, his state-of-the-art, 86-ft sloop, to the Orange Coast College of Sailing and Seamanship in Newport Beach.

The donation came as a shock to many. But to those who knew the magnanimous Disney — who has long supported sailing in general and youth sailing in particular — it seemed an altogether fitting and graceful 'final bow' for the veteran campaigner.

It is also a major feather in the cap for the OCC program, whose fleet of large sailing craft is unrivaled by any other sailing school (or most military academies) in the country. In addition to *Pyewacket*, that fleet includes *Alaska Eagle*, the Sparkman/Stephens 65 that (as *Flyer*) won the '77-'78 Whitbread Round-the-World Race, the Farr 58 *Lucinda May*, the TransPac 52 *Victoria V*, and the 80-ft maxi *Kialoa III*, another S&S design, which was donated to the program earlier this year by longtime owner Jim Kilroy.

But nothing at the school — in fact, with a few notable exceptions, nothing on the whole West Coast — holds a candle to *Pyewacket* in terms of speed, sophistication or complexity. The boat was designed by the San Diego firm of Reichel/Pugh, built at Cookson's Boatyard in Auckland (at a reported cost of \$7 million), and launched in November, 2003. Design innovations include fore and aft rudders, a hydraulically operated canting keel and all carbon fiber construction of both the hull and 125-ft mast. *Pyewacket* is the third, and probably final, yacht built to the maxZ86 class rule, a virtual twin sister to Hasso Plattner's *Morning Glory*, but a generation beyond the first maxZ86, the water-ballasted *Zephyrus V* (currently sailing as

Windquest).

No expense was spared in campaigning *Pyewacket* (which was named for the magic cat in John Van Druten's play/movie *Bell, Book and Candle*). What she needed, she got — gear, sails or crew. Disney has always sought out the best and brightest crews (and they, him — Roy is regarded as one of the most gracious and popular owners on the big boat circuit). And it showed. Among her many accomplishments, the newest *Pyewacket* — the third of Disney's big ultralights to wear the name — won the



Roy Disney.

2004 Caribbean Big Boat Series, Cork Race Week (Ireland) and the 2004 Rolex Maxi Yacht World Championships. In these and other competitions, the newest 'magic cat' carried on a tradition of winning that has captured Disney many of the most coveted trophies in the sport, including breaking the TransPac record twice in previous *Pyewackets*. (In this year's event, Disney and crew finished two hours behind perennial rival — and Division 1 winner — *Morning Glory*.)

In giving the boat to OCC, Disney's goal is to share *Pyewacket* with other sailors who have a passion for big, fast sailboats.

"My crew and I have so many great memories of spectacular sailing aboard *Pyewacket*," he said. "It's been a tremendous ride. There's nothing like the size and speed of this boat. It gives me great pleasure to know that *Pyewacket* will now be enjoyed by many other sailors."

"*Pyewacket* is the largest, fastest and most advanced sailboat ever given to OCC, by far," said Brad Avery, director of the School of Sailing and Seamanship. "She will give our advanced students an incredible learning experience found nowhere else."

Along with *Pyewacket*, Disney has donated the money to have the boat modified for school use, and has pledged a monthly stipend to help run her for two years.

The modifications include shortening the bowsprit to its original configuration,



TO SCHOOL

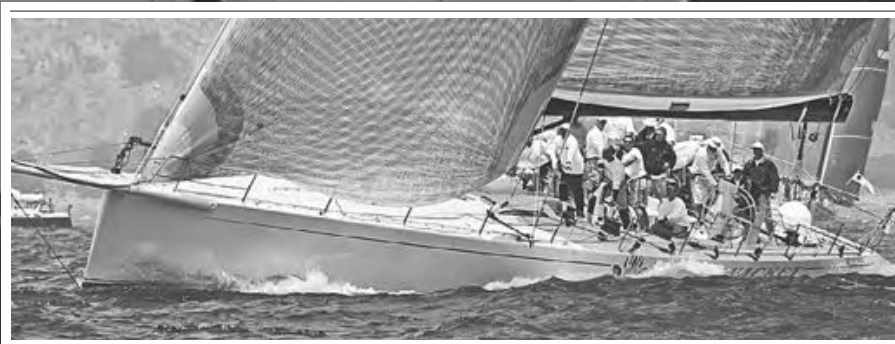

Above, 'Pyewacket' at the start of the 2005 TransPac. Below, in full-tilt-boogie mode.



and constructing a new keel that's 'only' 12 feet deep. At 15 feet, even her 'shallow' racing keel was too deep for Newport, and her 18-ft offshore keel would pretty much have kept her, well, offshore. Avery says the school will also sail the boat with her smaller main so that she can run a permanent backstay.

Plans have more or less been firmed up on the three ways OCC will use the boat. They are:

Pyewacket Sailing Team — Experienced adult racers apply, try out and are chosen for a racing team. There will probably be 40 sailors on the team, of which 18 to 20 will sail on the boat at any one time — along with boat captain Keith Kilpatrick and 3 or 4 professional crew. Planned events include Catalina races, the Ensenada Race and other "straight line" events.

Pyewacket Magic — This is an intermediate course for experienced 'average' sailors. No racing is involved. Again, interested folks must put in applications and be chosen via interviews. Those chosen will do a half-day dockside familiarization with every system on the boat, after which they'll participate in two days of sailing, returning to the dock each evening.

Pyewacket Daysails — Roy's wish was to have as many people have a chance to enjoy the boat as possible, and this program will address that desire. It is open to anyone, regardless of experience. You simply sign up at OCC's website, and when periodic daysails are announced, selectees will be notified by phone or email. The daysails will be just that — a one-day sail under the guidance of Kilpatrick and a professional crew.

Fees for these programs have not yet been determined, so keep an eye on OCC's website, www.occsailing.com.

As this was written, *Pyewacket* was in Marina del Rey undergoing the aforementioned modifications. She is due to join the rest of the fleet at the OCC docks — it is hoped — by late October. Team tryouts and daysails will start in November and December.

One could say that *Pyewacket* went from one class act to another. OCC's School of Sailing and Seamanship operates the largest public sailing program in the United States, providing nautical education in all disciplines from diesel mechanics to sailing the oceans of the world (aboard *Alaska Eagle*). More than 4,000 student and adult sailors a year take part in various programs at the school.

SPREAD, COURTESY OCC/PYEWACKET; INSET, RICH ROBERTS, WWW.UNDERTHESUNPHOTOS.COM

PYEWACKET GOES TO SCHOOL



COURTESY OCC SCHOOL OF SAILING/PYEWACKET

They also have the largest fleet of boats of any similar institution. In addition to the big boats mentioned earlier, OCC has several large powerboats between 70 and 80 feet, a dozen 30-ft Shields sloops and a couple dozen dinghies. The organization is self-supporting

On canting-keelers, the keel may be out of mind, but it's rarely out of sight.

through fees charged its customers, as well as through donations of boats or monetary gifts. They have their own enviable facility and docks right on the water at 1801 West Pacific Coast Highway in

Newport, as well as an acre's worth of storage and shop facilities up on OCC's main campus.

One more big bonus: the College rowing team shares the same dock space, so Avery says the sailing program has a ready supply of strong young grinders to shanghai for *Kialoa* — and eventually *Pyewacket* — sails.

And speaking of celebrations, and perhaps of serendipity, like Disneyland, OCC's School of Sailing and Seamanship is also observing its 50th anniversary this year. What better way to celebrate this milestone than to crown *Pyewacket* the new queen of the fleet.

— **latitude** /jr

For more information on OCC's School of Sailing and Seamanship, log onto www.occsailing.com. Anyone interested in taking part in any of the three proposed Pyewacket sailing programs (Sailing Team, Pyewacket Magic, Day Sails) should send an email with their contact information to Pyewacket@occsailing.com. OCC will respond to everyone (via email only) starting October 1.



Bilge Steam Clean Oil Changes Fuel Polishing

**BOAT SHOW
SPECIAL
10% OFF**

Expires 10/31/05

From our boat to yours

We deliver professional service to your boat, anywhere in the San Francisco Bay, Sunday thru Friday. Please call:

MarineLube, Inc. 877 744-2244

or www.MarineLube.biz

THANKS ROY!



**EASOM
ON SITE**



2005 Big Boat Series

**EASOM
ON SITE**



2005 Etchells Worlds

Easom Rigging would like to thank Roy Disney for the opportunity to participate as rigger and crew in 12 years of Grand Prix racing with the outstanding *Pyewacket* program. Roy's dedication to performance and the confidence he placed in Easom Rigging combined to give us the experience of a lifetime. Thanks, Roy, for your support, friendship, and many miles of fabulous sailing.

The Easom Rigging team will continue to prepare and rig Roy's new 65' custom cruising boat when she's ready to hit the water. And we'll continue pushing the envelope of rigging excellence as we move on to the new Dubois 90 *Genuine Risk*.

Call Easom Rigging for riggers who continue to sail at the head of the fleet with miles of leading edge experience.



1150 Brickyard Cove Rd. Suite B1, Point Richmond, CA 95801

(510) 232-SAIL (7245)

Easom Rigging – a serious advantage in serious competition

the *latitude* interview, part 2:

William Peterson

Last month, we introduced you to William Peterson, a true gypsy of the seas who has cruised his last two boats — both of which he got for free — several times to the South Pacific and once around the world. In the first installment of this interview, Will talked about finding Kama, a 34-ft ferrocement Sea Mist cutter, in a cement yard in Guerneville. It had been started years before by someone who lost interest. Will finished the boat and in 1980 took off on a cruise that would take him to Mexico, Hawaii and back home. Once back in northern California, he started a new four-year cycle: work for two, cruise for two. On the second trip, he sailed all over the South Pacific before returning home.

The third time, he was planning to go all the way around. By then he had found a steady mate — and soul mate — in Jaki, a pretty Englishwoman he'd met in New Zealand. They departed from Tonga in 1992, only to hit a reef and lose the boat and almost everything Peterson owned. Will and Jaki said goodbye and Peterson spent his last few dollars — from the sale of items he'd salvaged off the boat — for a plane ticket home to Northern California. He found work but felt directionless until an uncle told him to go look at a boat in Point Richmond. "I have no money," Will said. "Just go look," said the uncle. He looked. It was an old Newporter 40 ketch that had belonged to the present owner's cousin. The cousin had intended to fix it up and sail around the world but had died of cancer. If Will promised to do the same, he could have the boat. He promised. He didn't quite believe it would really happen until he received all the ownership papers in the mail. The first time he climbed aboard was after he'd registered the boat in his name. Above the companionway, an old, sparkly sign fluttered. It read, "Expect a miracle." You will also recall that Peterson completed a nine-year circumnavigation with the boat — 'tying the knot' off Mexico earlier this spring — only to lose her on June 10 when she dismasted some 800 miles off San Diego. We pick up this month's second and final installment of our interview as Peterson steps aboard Kamera for the first time. . .

So this fellow gave you the boat and you'd never even been aboard?

No. I'd looked at it, but I hadn't gotten on because I hadn't talked to the guy at that point. But I know what I'm looking at, and I could see through the windows that it had a diesel engine and all kinds of gear inside. And it was floating!

What kind of gear did it have?

Electronics — older stuff but most of it worked. Remember those video depthsounders? It had one of those. Commander binoculars. Sails. Engine spares. It took me three or four days to inventory all the gear. I surveyed the boat and structurally, it was pretty sound. There was some rot a foot below all the caprails where water leaked in, so I had to get all that out. All the diesel needed was a fresh fuel and filter change and it fired right up. I motored it under its own power up to Petaluma Marina. Spent two years there rebuilding the boat and getting it ready.

Were you also working at the time?

Yeah. As a field supervisor for Pinkerton — nights and weekends. On weekdays, I worked on the boat.

Were you working alone?

At first. Once I got going I phoned Jaki up in England and I said, "You want to come help me redo a boat?" So she flew over about a month after I got the boat and got a job at *Cigarettes Are Cheaper* in Petaluma, which was within walking distance of the marina. We lived in Forestville until I got the interior boat of the boat done, then we moved aboard.

When did you get done?

We took off in November, '96. Like before, Southern California, Mexico and down to the South Seas — Fatu Hiva, Samoa, Fiji. Took a whole bunch of people out as we went along. Made lots of friends. Took a whole load of schoolkids out in Fiji. There's always been lots of kids around. I let them play on the boat.

So anyway, we'd spend the sweet season in the South. Go to Micronesia for the sweet season up north, then bounce

back down again. Six months one place, six months the other, moving north and south but always, always west.

After three trips through the South Seas, did you have a favorite place?

Kosrae, in Micronesia. It's a beautiful little island, a lot like Hawaii, about 7 degrees north and all by itself in the middle of nowhere. There are three big Bays, one in the east, one in the west and one in the south. And the people are very friendly. You can't walk 100 yards down the road without somebody offering you a ride. They'll take you where you want to go, bring you back, give you things. There are ruins there — big rock walls, foundations, canals, and ancient stone walking paths through the jungle. No one knows who did them.

Australia was also nice. Spent eight months in Australia. Dived the barrier reef. Africa was also fantastic.

Did you have a least-favorite place?

The really poor places like Madagascar — which is supposed to be the poorest country in the world — can be depressing since there is so much poverty. It's amazing how much poverty there is all over the world. But still, the people are nice. They might have no shoes and their clothes are all full of holes, and they're living in a shack you wouldn't put a dog in in the States — but if they're cooking a pot of beans on a fire in front of the shack, they'll share their pot with you. Or give you half the fish they've caught. I've seen that so many times. There are good people everywhere.

Were you ever treated badly? Ever fear for your life?

In South Africa, yeah. Very dangerous there, especially if you're a small, blond-headed, white person. Politically, racially, it's horrible. I'd say that was probably my least favorite place. The rest of Africa is wonderful — Haut Bay, Mosul Bay, Port Elizabeth, Richards Bay, Simons' Bay. We spent eight terrific months in Africa. Then I took off for Brazil.

You and Jaki were still together at this point?

No, she got off the boat in Africa. Two people living together in close quarters for that long get on each other's nerves. You

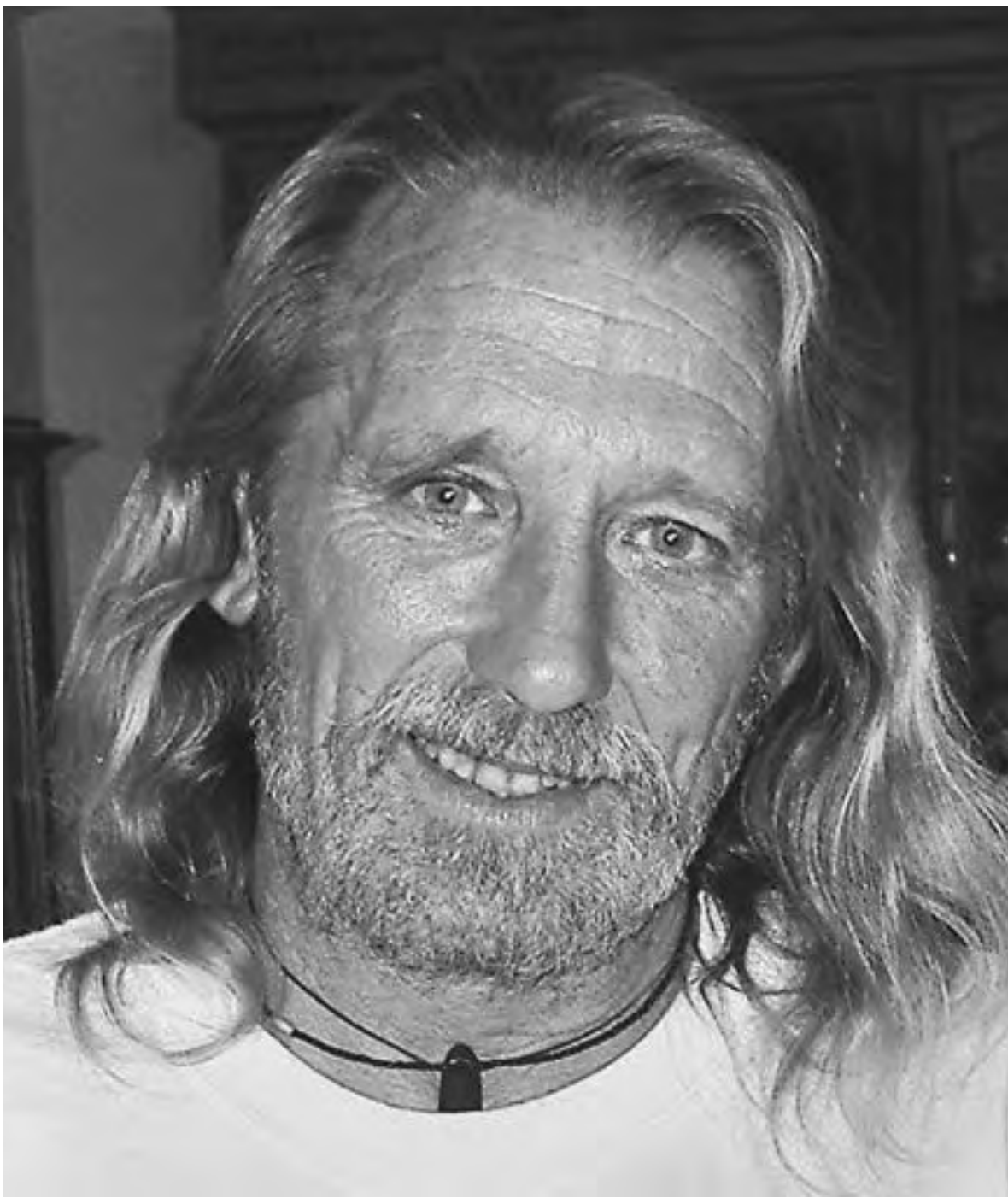

can't help it. And whether you love them or not, there comes a point when you say, either I leave or you're leaving.

Jaki is a very powerful woman. She could sail the boat, cook, adventure, everything. She's a beautiful lady that helped me a lot, but just like me she's very stubborn and opinionated and she likes to be the boss. I told her that position was already filled. So we separated when we hit Richards Bay. I did most of the Atlantic passages by myself.

So you headed straight for Brazil?

I made stops. Went to St. Helena, got to sit on Napoleon's tomb. Went to Ascension Island, an interesting place with giant sea turtles. Stopped at a beautiful island off the Brazilian coast named Fernando de Noronja. When I went to check in,

the officials told me, "We haven't seen you, and you haven't seen us! Enjoy your stay!"

Ha ha ha. Check ins are a bit different everywhere.

Yeah. In Africa, they don't stamp your passport, they give you a seaman's pass at your first port. And you can stay as long as you want. The day I left Cape Town they stamped me in and out of the country.

When did you finally make it back to the States?

2003. After Brazil, I spent some time in Tobago and Trinidad, did the Virgins, and worked my way over to Louisiana, to a place called Porgie's Duck Club at the mouth of the Mississippi. I wanted to sail up the Mississippi and get

interview 2: william peterson

reacquainted with the country that way. I phoned Customs and Immigration and told them that I was back after seven years of sailing. They said, "Welcome home." I said, "Is there anything else you want me to do?" They said, "No, we got you on the computer." And that's how I entered. I never did any paperwork. Nobody looked at my boat. I could have had anything I wanted on board.

What was the Mississippi like?

Dirty and nasty and full of shipping. I didn't like it. I sailed about 30 miles up, and it wasn't Mark Twain at all. It was also cold and kind of miserable because it was around Thanksgiving. So I turned around and sailed back out. I ran into a man and his son who wanted to sail to Pensacola, so we did that. We sailed to Florida. I put the boat at the Rod and Reel Marina on the ICW in Pensacola and started looking immediately for a job because, at that point, I had about 50 bucks to my name. And the boat needed work.

What kind of work did you find?

Truck driving. It actually worked out well. I decided *that* would be the best way to see the country. Rediscover the United States and get paid for it. So I left the boat at the marina and plugged myself into a truck driving school in Joplin, Missouri. In three weeks I had my Class A license. I got hired right out of school by Central Refrigerated. They were based in Utah, but had a yard in Connolly, Georgia, so I drove out of Georgia. I drove for a year and two months, and saw every state in the lower 48 except North and South Dakota. And I got to visit my family and bring home all my carvings and gear from around the world.

What were your impressions of the country?

It's a crazy place moving at a million miles an hour. Same as when I left except there were more people trying to kill themselves on the roads.

After fourteen months I quit truck driving and started working on the boat. I put \$5,000 into it and bounced it back up. I'd just finished the pilothouse when hurricane Ivan came through.

It hit where you were?

Oh yeah. All of us in the marina had been watching about four hurricanes go by and none of them hit us. But Ivan was headed straight at us. So I took the boat out of the marina and I went across the Alabama border up into Soldier's Creek, which is up in the bayou. Went a couple miles up the creek and put out all five anchors off the bow. That evening, the hurricane hit.

Where did you stay?

I stayed on the boat. There were about 30 other boats up Soldier's Creek, and everyone else tied up and got the hell out of there. I wanted to stay, I wanted to experience it. It wasn't the smartest decision I ever made. I'd never do it again and I'd never recommend it to anyone else, either.

What was it like?

It was like a nuclear explosion going off over the top of you. Just a horrible thing. The boat would lay over on one side, completely on its side, like a complete knockdown. Then it would come back up, and lay down on the other side.

And there's nothing you could do. You couldn't go out in it — you couldn't even look out in it. The water stings like a

bastard and there's shit flying all over the place that can hit you. I have a pilothouse with a 360-degree view, so I could hang out in the pilothouse and see it all safely.

All night long, I watched boats whistle past me and onto the beach. There were houses and big pine trees all around the anchorage. One time during the night I thought I had dragged and was ashore in the trees, because there was a tree right next to me. But it was a blown-down tree going past me that had gotten hung up in my chains.

How hard did it blow?

I don't know. I read later that it hit 120 mph. And that's after it had been downgraded from a category 5 to a category 3 or 4 when it hit us. When the eye goes over, there was a little break. Then it started up again blowing from the opposite direction. It was quite a night.

Were you afraid for your life?

No, because I was so close to shore. I figured if the boat went up on shore, I'd just get off. But I *was* worried about losing the boat, because it was humping around bad. I had mostly chain rodes so it wouldn't chafe, but there was huge pressure on everything.

How long did it last?

From about 8 o'clock at night until about 4 in the morning. Then it was gone. The water stayed high for almost a day, then it started subsiding.

When it was over, about half the 30 boats that had been in the anchorage were ashore. Some were 30 or 40 yards from the water. There were boats in the trees, boats in houses — one boat was sitting in someone's yard, perfectly upright. A 20-foot surge had come up the creek and taken everything right up to the road about 500 meters away. Trees were blown down in wind rows a mile long. Where some houses had been there were just foundations. Others were cut perfectly in half — you could look in and see clothes still hanging in the closet, lamps on the tables and nothing was disturbed, except half the house was not there. Some houses looked untouched.

The marina I had been in, Rod and Reel, when I went back, no longer existed. The docks, the bar, the restaurant where all us old farts would have our coffee club every morning — was completely gone.

Where did you go? What did you do?

I stayed where I was. The ICW was closed, with houses and boats and trash in it. You couldn't go anywhere. So I spent a month up the creek working on the boat and helping out. The neighbors and the local people let us use their yards and their cars and telephones. The Army came in with MREs and water. We were treated really good. When I could get out, I went back down and anchored off the Rod and Reel for a few days. I went to Wal-Mart, which had just opened back up, and stocked the boat. Got myself together, did my three or four days of sitting around staring at myself getting ready to go, said my final farewells — and took off for Islas Mujeres.

Was Mexico any different from when you'd been there 4-5 years before?

It cost more money. Before it was cheap. Now it cost me \$150 to enter, and I had to get an agent and do all this paperwork. And you *still* had to go check in everywhere else you went and pay everywhere. So I just didn't check in anywhere else the whole time I was there.

interview 2: william peterson

What about Panama — how much did it cost to go through and how long did it take?

Last time I'd done it in '95, I'd had to wait three weeks and it took five days to transit. This time, I also had to wait three weeks, but I had to pay triple — \$1,000 — to go through. They even want \$5 a day to park your dinghy at the Marina Flamingo in Balboa. And Colon was terrible in '95 and exactly the same in 2004. A hell of an eyesore.

Balboa's nice, though. I spent about a month and a half there getting the boat ready for the sail home.

The sail home. Tell us about that.

Well, you know how it ended up. How it started was, I had decided I'd do the old clipper route. My idea was to head west to Clipperton Island and then start making my northing from there. The time of year I was doing it, May and June, the Pacific High hadn't moved far enough north that I had to go up really high. So you can do a lower loop. At about latitude 37 you can start making your easting and wind up at San Francisco. And you can sail the whole way. You don't have to motor a lot. In theory, anyway.

Of course, there was no wind for the first two weeks. For a thousand miles around Panama in every direction it was a dead zone. So I did motor a lot during that time.

After two weeks, I finally started picking up wind and had some good sailing for a week and a half or two weeks. By day 30, it turned overcast and cold and stayed that way. The wind kept pretty steady at 20-25 with gusts into the 30s. Not storming or anything. Just uncomfortable. I was always just off the wind, never tightened right up into it, pounding to windward. That's what finally did it I think. All the pounding.

What were the circumstances of the dismasting?

It was June 10, about 9 o'clock at night. I was 38 days out of Panama and 800 miles southwest of San Diego. I'd done my evening walk-around and everything looked okay. Had a double reef in the main and a small yankee up forward. My Monitor self-steering vane was working fine. But I made a giant mistake. My little voice — the same one I heard right before my other boat, *Kama*, hit the reef — said, "Maybe you should drop down to a staysail for the evening." And I didn't. I was comfortable with the way the boat was moving. I thought, "I'll wait til it picks up, then I'll go out and shorten sail."

Here's some advice. Any time you hear your little voice, you should step right up and do whatever it says to do: reef, run off, take down a sail, look around. If you don't listen to your little voice that you've evolved over the years, you usually wind up in deep shit.

So anyway, I was down below, taking one of my short naps as I do at night. And about 9 o'clock there was this big BANG, like a cannon had gone off. I stuck my head up, looked around, and everything was doing the hootchie-coo. The mainmast had fallen backwards against the mizzen and was just hanging there. The boom was slamming around, the sheets were flogging and the sails were flapping and banging. I just thought, shit, this looks bad.

Why had the mast fallen?

One of the side stays on the bowsprit had failed and the bowsprit snapped off. When the mast fell backwards, it ripped off the fitting for the staysail stay, too, and all the stuff that was attached to it. So on the foredeck was this big, tangled mess of anchors, roller, pulpit and chain — and the bow-

sprit.

The first thing I had to do was get the sails down. If I survived that, I thought maybe I could rig a halyard forward and try to winch the mast back up. At that time, it was still attached at the tabernacle. About half of the six big bolts holding it onto the deck had ripped out, but it was still attached.

So I got my flashlight and my pliers, and my bolt cutters and axe, and headed out. It took about 45 minutes just to get the sails down. And the whole time the mast is dropping down farther and farther. And this big aluminum tabernacle is ripping up and making noises and I figure the whole thing's going to fire off into the universe like a big bow and arrow any second — and probably take me with it.

That night, for the first time, I thought I was dead. I'd been rolled a couple of times, been through a hurricane, but that night I really thought was it.

I got the sails down, but before I could do anything else, the tabernacle ripped out of the deck. The base of the mast shot forward and the top end came crashing down on deck, taking out stanchions and everything in its way. Without the sails up, the boat was rolling heavily and everything was still crashing around and the rig was crushing my dinghy. So I needed to get it off the boat.

Once it was in the water, it started smashing into the side of the boat. Whee-ha, cool — good idea, Peterson! Luckily the rigging kept it close to the boat, so it wasn't hitting very hard at first. I thought briefly about trying to snag it, and lash it tight against the side of the boat to try to save it. But it was too dark and too dangerous and it was beating the hell out of the boat. So I started undoing all the rigging.

I cut the running rigging, and on the loose stays I just pulled the pins out of the turnbuckles. For the tight stays, you had to cut those with the bolt cutters — after first making sure you're not going to be in the way if anything came whipping back. A couple times I thought I'd gotten everything, but the mast was still attached. So I had to go looking around with the flashlight in my mouth and it's darker than shit. . . . At some point, you just start cutting everything you find. Don't worry about saving anything. Get rid of it all.

When I finally cut the last line, I watched the mast disappear. All that work, all that gear, the 50-year-old bronze bow pulpit, the big bronze star on the end of the bowsprit — watched it all go away.

Then you find out that even though it was beating the crap out of the boat, the mast was also holding it steady. As soon as you cut it away, now you're *really* rolling.

When during all this did you decide you needed help?

After I went below and saw all the water. I hadn't been below since all this began at 9 o'clock. So after the mast is gone, it's now about 1 in the morning. I was assessing the situation, thinking I might be able to jury rig something off the mizzen and maybe make it to Hawaii. Then I went below and looked in the bilges and — oh, f**k — there was a lot of water there. The Newporters have two separate bilges and both of them had about 15 gallons in them. I pumped them out okay, but the water in the aft bilge had gone over the starter to the motor. So the engine's not going to start. And the mast had crushed the bottom of the dinghy. So that wasn't going to help me. And I could see the bilges starting to fill up again pretty quickly. And I'd hurt my back on deck. . . .

That's when I made my decision that if somebody would come, I'd be willing to leave. So I clicked my EPIRB on. I had no idea if it was working or not.

interview 2: william peterson

What did you do while you waited?

I looked for the leaks. The water was not coming through the stuffing gland. It was somewhere else, and I couldn't find where. I normally had to pump the boat once a week. Now I'm pumping 10 or 15 gallons out of both bilges every hour.

If the EPIRB was not working, if no one came, I figured I could probably have fixed the dinghy. And maybe I could get my wetsuit on and patch the boat. Maybe. I could tighten up all the rigging on the mizzen and maybe run a line from the top of the mizzen to the bow of the boat and put together some kind of lateen arrangement and sail downwind to Hawaii. I probably could have saved myself. But the little voice was saying, "If you spring a joint completely, you're going down, then it will be too late." And this time I was listening to everything the voice said. I even made a deal with Poseidon and Neptune: You can have it all. Just leave me. I was hoping they'd go for the deal.

As it turns out, the EPIRB was working.

Yeah. About 6:30 the next morning I heard a plane. I was a paratrooper in the 82nd Airborne back in the '60s and I recognized it instantly as a C-130. It was a Coast Guard plane. I'd lost my main antennas with the mast, but I had one of those little emergency whip antennas, so I was able to talk to them. They made sure I was okay and told me that they'd diverted a Navy ship that would be there in an hour.

And this was the destroyer *USS Chung-Hoon*?

Yes, and they were *wonderful*. For one thing, they let me get a bunch of personal effects off the boat — four big bags of carvings, swords, charts, books, my sextant, and of course my passport and what money I had left. They made me an honorary crew member, gave me all kinds of things. Gave me the captain's 'sea room' to live in on the way back to San Diego. After they ran a computer check and found out I was a veteran, they gave me complete run of ship. They were great, from Captain Williams down to the lowest crewmember. That was the best part of what happened, and it really helped bounce me back up after losing the boat.

You're back home now, healed up — and boatless. What are your plans?

What I'd really like is to be adopted by a beautiful, compassionate, loving woman, so I could do some painting and sculpting for a while (laughs).

Are you through with boats for a while?

Well, see, that was the idea — I was going to quit anyway. I was going to sell the boat when I got back and give it a break. I don't know if it would be forever. I've been doing it too long. But now, to start all over again, with nothing? (pause)

If someone offered me another boat, I'd probably go again.

Buy Quality
Sails Direct
at 25-40%
Savings!



It's the easy way to measure and order your own sails and SAVE! Premium fabrics, quality construction, unbeatable value. Order online or ask for our FREE catalog today!

www.cruisingdirect.com

Call 1-888-424-7328 for your FREE 2004 catalog Fax toll free: 1-888-237-2457

MANUFACTURED AND SERVICED BY NORTH SAILS

CD
CRUISING DIRECT
SAILS



BERTHING at OYSTER COVE

can make boating easier, more convenient and more enjoyable!

- Berths 30 feet to 60 feet
- Double Finger Concrete Slips
- Telephone Available
- Close to the Airport
- Five Minutes to SFO
- Heated Dressing Rooms & Showers
- Laundry Room
- Nightly Security Patrol
- Complimentary Ice
- Cable TV
- High Speed Internet Access
- Recently Dredged
- End Ties Available at \$5.75 per Foot!

Making boating easier – and more fun! is what a marina should be all about. That's why Oyster Cove Marina rates number one with many Bay Area mariners. It's an exclusive yet reasonable facility of 219 berths, accommodating pleasurecraft in slips 30', 32', 36', 40', 44', 50' and 60' in length.

Oyster Cove is the private Peninsula marina closest to Blue Water boating. Want to cruise to Sausalito, lunch at Tiburon, or sail to Angel Island? How about a day's fishing outside the Gate, or a weekend at the Delta? No other private Peninsula marina is better situated or offers nicer, fresher surroundings.

First Month FREE with 6-Month Lease (for 30-ft & 32-ft slips only)

OYSTER COVE MARINA

385 OYSTER POINT BOULEVARD #8A, SOUTH SAN FRANCISCO

(650) 952-5540



Portable 12/24 and 110-volt refrigerator/freezer



- * Super low amp draw
- * Will freeze or refrigerate in over 110 degree heat
- * Made for the marine environment

FridgeFreeze, Inc.
5343 Banks Street • San Diego, CA 92110
(619) 220-6003

www.fridgefreeze.com

Marina San Carlos



**SLIPS • MOORINGS • DRY STORAGE MARINA
WORK AREA • MARINE TRANSPORTATION**

Contact us for reservations...

Toll free USA: **(877) 402-4638**

Toll free Mexico: **(800) 849-2740**

marinaseca@marinasancarlos.com

www.marinasancarlos.com

EYE ON THE BAY

All the photos on the following 2.5 pages were taken on the afternoon of Sunday, August 21. In a month rife with historical dates (August 6 — Hiroshima, August 9 — Nagasaki, August 15 — VJ Day, August 14, etc.), all we could find for the 21st was that, in 1931, Babe Ruth hit his 600th home run. In 1959, Hawaii became the 50th state. It's Wilt Chamberlain's 69th birthday, and Kenny Rogers' 67th. And Benjamin Thompson died. He invented baked Alaska.

But there was still plenty to celebrate out on the Bay, in the form of sun, wind and just enough fog to shroud the City in its trademark gray suit. Lots of folks were out, too, some bashing along outside the Gate or across the Slot, others gliding serenely behind Angel Island or up Raccoon Strait. As always, there was something for everyone.

While we were out there, we got the



SUNDAY DRIVERS



Sunday sailors (clockwise from here) — 'Fan' leans into a good breeze; 'Fying Tiger' bashes a wet one; some of the best seats in the house were on 'Shindig'; soloing 'Ay Caliente' across Golden Gate Strait; the yellowest Moore 24 in existence; rippin' and shreddin' the Bay.

ALL PHOTOS LATITUDE/JR

EYE ON THE BAY



Above and right, the sailing in Raccoon Strait was warm and serene.

first sense that the seasons are starting to shift. The days have been getting shorter since June, and on September 21, the autumnal equinox, day and night will be of equal length. From there on, the days get shorter and shorter and winter's not far behind. At the end of October, we'll be turning the clock back to boring old 'standard' time.



In a bit of good news, at least one facet of this inevitable scenario will change in a couple of years. On August 8, President Bush signed into law a broad-based energy bill that will, among other things, add a month to daylight savings time. Effective in March, 2007, DST will begin three weeks earlier than in the

past, and end in early November, a week later.

Until then, folks, your best course of action is to get in as much more summer sailing as you can, before it's too late.

— **latitude** /jr

The East Bay's Largest Nautical Flea Market at Encinal Yacht Club 1251 Pacific Marina Alameda, California

Steer Your Way To Great Deals
Saturday, Sept. 10, 2005
6:00AM - 1:00PM

- Breakfast
- Lunch
- Beverages

FOR INFORMATION CALL (510) 522-3272

AQUAMARINE[®] INC.

SPARKLING FRESH WATER, POWER, AND REFRIGERATION FROM THE SEVEN SEAS



AquaGen Remote S/S Panel

AquaGen & MyT-Gen Kits combine the quality, simplicity and reliability of the AquaMarine, Inc., watermakers with the durability of Kubota marine 12 volt diesel gensets. They are compact, low fuel consumption, capable of producing up to 150 amps, and 62 GPH fresh water. Make water, refrigeration, charge batteries all within the same duty cycle. A hydraulic pump may be added to run a dive compressor, windlass, small bow thruster, or emergency bilge pump. Ideal for long-term cruisers or weekend wanderers. We custom build our systems to fit your needs. Electric, hydraulic, or belt driven modular kits are available. All AquaMarine, Inc. kits have expansibility built into them. Visit our Web site for more information.

QUALITY AT AFFORDABLE PRICES SINCE 1987

LIFETIME WARRANTY ON PUMP HEAD & PRESSURE VESSELS

58 Fawn Lane, P.O. BOX 55, Deer Har, WA 98243-0055 USA
(800) 376-3091 or (360) 376-3091 Fax (360) 376-3243

www.aquamarineinc.net

There's Always a Boat Show at Marina Village

SAILORS START HERE

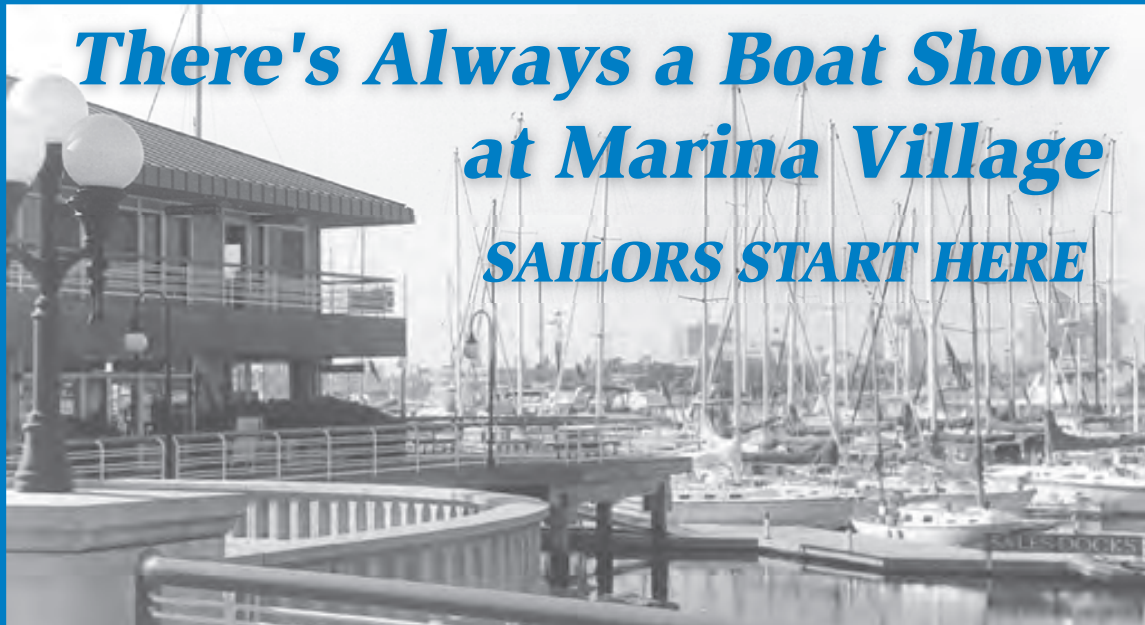

Dozens of new and brokerage boats at our sales docks, shown by the Bay's best brokers!



J/100



Catalina 42



C&C 110



J/124



Catalina 350



Tartan 4400



Catalina 47



Tartan 3400



J/65



Catalina 400



C&C 99



J/42

*J/Boats
Sail California
(510) 523-6730*

*Tartan/C&C Yachts
of San Francisco
(510) 769-9400*

*Catalina
Farallone Yachts
(510) 523-6730*

Marina Village Dealers Offer Sailboats in Every Size and Style to Fit Your Sailing Desires.

MARINA VILLAGE YACHT HARBOR

Much More Than Just a Marina

(510) 521-0905 • www.marinavillageharbor.com

Want to start sailing right? Upgrade your skills? Call J/World (510) 522-0547

VOLVO RACE PREVIEW

Fasten the seatbelts on your Barca-loungers, the Volvo Ocean Race is right around the corner! Seven hot new Volvo 70 canting-keelers are poised to start the ninth edition of this grueling eight-month marathon — which began life 32 years ago as the Whitbread Race — with an 'in-port' race in Sanxenxo, Spain, on November 5. Following that, on November 12, the real game will be afoot when the small, but high octane, fleet takes off from Vigo, Spain, bound for Cape Town.

The 33,000-mile race bears little resemblance to its predecessors, other than the obvious fact that it is still a crewed, round-the-world race. Just about everything is different about the '05-'06 Volvo Ocean Race — the course, the rules, the boats, the scoring, you name it. The massive make-over, announced midway through the race's four-year-cycle on September 8, 2003, was meant to inject new life into the struggling event, though it may have had the opposite effect — only six boats were entered initially, and it was shaping up to be a real yawner.

Fortunately, a last-minute seventh entry — the high-profile Disney boat, skippered by '97-98 Volvo Race winner Paul Cayard — was secured in March. It's no secret that Volvo is underwriting a substantial part of that project, which seems like a win-win deal for everyone — Disney will use the race as a promotional vehicle for its *Pirates of the Caribbean* sequel, *Dead Man's Chest*, while the Disney/Cayard cache will certainly garner more mainstream press for the Volvo Race than it otherwise would have enjoyed.

The *Black Pearl*, the first USA race entry since '97-98, will give American race fans a boat to get behind, though we suspect there won't be a lot of Yanks on board. Bay Area sailors will actually

have two boats to root for — another local hero, Stan Honey, will navigate the Dutch *ABN AMRO I*.

But we're getting ahead of the story. First, a little background is in order:

The New Boats

The new Volvo Open 70s are bigger, proportionally lighter, and light years more powerful than the Winnebago-like VO-60s they are replacing. VPPs suggest they are 21 days faster (18%) on the old round-the-world race track, which has also been modified for the coming race. The new 70s will sail with two less crew — ten, to be exact — which, despite more room and creature comforts below, will make the event more physically demanding than ever before. Canting keels, reducing the number of sails from 38 to 24 (with just 11 sails onboard per leg, not including mandatory storm sails), and allowing roller furler systems will supposedly make the boats easier to sail — if there's anything 'easy' about going up to 35 knots at night during a snow storm in the Southern Ocean.

The boats are all designed to a box rule which strictly limits length (70.5 feet), beam (between 15.4 and 18.7 feet), draft (14.8 feet), displacement (12.3-13.8 tons), bulb weight (4.4 tons minimum), mast height (103.3 feet max), and the sail area of the main, jib, and spinnakers. Appendages (twin rudders, canards, dagger



JON NASH

Sightseeing — The first 'ABN AMRO' boat visited Newport and New York this spring. Note the fully lifted, gigantic daggerboard.

boards) and fore-and-aft water ballast are fair game. Carbon fiber, previously banned, will be used in the hulls and decks of the new boats, and retractable prop shafts and PBO standing rigging are also allowed now. Picture a smaller, but beefier, version of *Pyewacket*, subtract half the crew, add a few more underwater appendages, and you've got the basic idea.

Five of the seven boats are sailing now, but they are training privately and the syndicates haven't lined up against each other yet. Only *Movistar* has done any real ocean sailing, and they are



Volvo Ocean Race Dates

- Nov. 5:** In-port race at Sanxenxo, Spain
- Nov. 12:** Leg 1: Vigo-Cape Town (6,400 miles)
- Dec. 26:** In-port race at Cape Town
- Jan. 2:** Leg 2: Cape Town-Melbourne (6,100 miles)
- Feb. 4:** In-port race at Melbourne
- Feb. 12:** Leg 3: Melbourne-Wellington (pit stop; 1,450 miles)
- Feb. 19:** Leg 4: Wellington-Rio de Janeiro (6,700 miles)
- Mar. 25:** In-port race at Rio de Janeiro
- April 2:** Leg 5: Rio de Janeiro-Baltimore/Annapolis (5,000 miles)
- April 29:** In-port race at Baltimore/Annapolis
- May 7:** Leg 6: Baltimore/Annapolis-New York (pit stop; 400 miles)
- May 11:** Leg 7: New York-Portsmouth (3,200 miles)
- May 29:** In-port race at Portsmouth
- June 2:** Leg 8: Portsmouth-Rotterdam (1,500 miles)
- June 11:** In-port race at Rotterdam
- June 15:** Leg 9: Rotterdam-Gothenburg (500 miles)

— ONCE MORE INTO THE BREACH



HECTOR ETCHEBASTER

generally thought to be farthest up the VO-70 learning curve. Information is still sketchy as to how each boat is configured, and which innovations and corners of the box rule the syndicates have opted for. Four of the fleet (*Movistar*, *Brasil 1*, *Ericsson*, and *The Black Pearl*) are Farr designs, a logical choice given that firm's design record in this race. They will intuitively be near-sisterships, putting a premium on subtle differences in hull shape, construction technique, sail development programs, and of course, when the race finally starts, sailing ability.

The two Dutch boats, both in the *ABN AMRO* stable, are Juan Kouyoumdjian creations, while the Aussie boat, *Premier Challenge*, was designed by Don Jones. These latter designs, from what we can tell, are more in the 'wild card' category.

The New Course & Scoring

Since the inaugural Whitbread Round the World Race — which began with 17 boats and 167 sailors on September 8, 1973 — the event has always taken off from England. This time, the race will start in Vigo, Spain, before embarking on an unprecedented nine-leg lap around the globe. Stopovers are scheduled in Cape Town, Melbourne, Wellington (a 'pit stop'), Rio de Janeiro, Baltimore/Annapolis, New York (another 'pit stop'), Portsmouth, Rotterdam, and the finish in Gothenburg.

The two 'pit stops', Wellington and the Big Apple, are modeled after the popular Hobart stopover in the last race. These are basically mini-stopovers after the

Blame it on Rio — 'Brasil 1', which sports splashy blue and yellow graphics, is currently sailing across the Atlantic to Portugal.

sprint races, with the crews barely having time for a shower and a pint or two before the race restarts between 24 and 48 hours later. The five longest legs also feature 'scoring gates' this time — Archipelago of Fernando de Noronha (Leg 1), the Kerguelen and Eclipse Islands (Leg 2), Cape Horn (Leg 4), Fernando de Noronha again (Leg 5), and Lizard Point (Leg 7).

Scoring for the race will be high-point (i.e., first in the 7-boat fleet gets 7 points), with no discards and all nine legs counting equally. Additionally, half points will be awarded as the fleet passes through the five gates, so a boat that leads wire-to-wire could pick up 10.5 points on a given leg (7 points, plus the 3.5-point gate bonus).

'In-port' racing, a new feature of the Volvo Race, will add to the merriment — and point tally — as well as provide lots of media exposure. Buoy racing is scheduled at seven of the stopovers, ending with a final heat in Rotterdam on June 11. Winners of these day outings will get half a point for every boat they beat (i.e., the top boat gets 3.5 points again), making the inshore races count for about 20% of the total race scores. That's enough to get sailors' attention, especially with regard to sail allocation — but with the 24-sail limit, specialist inshore sails will be few and

far between.

The in-port entertainment package will also include a separate exhibition series — no points! — for a new breed of grand prix catamaran, the Volvo Extreme 40s. These lightweight, transportable boats will be shipped to 'some' of the stopovers, and will be raced with four-man teams and one rider, "likely a media guest, celebrity, or VIP" (read: Johnny Depp? Orlando Bloom?). The first VE-40, the creation of Mitch Booth and Yves Loday, was launched in July, and five more are expected to follow by race time. The new cats apparently fly a hull in just 6 knots of breeze, and can reach 35 knots of boatspeed in 25 knots of wind — for sheer entertainment, this sideshow might even eclipse the VO-70 inshore racing.

The Fleet

Here's a brief scouting report on the seven boats entered in the race. Check the various websites, where available, for more.

ABN AMRO 1, Netherlands
Skipper — Mike Sanderson (NZL)
Navigator — Stan Honey (USA)
Technical Director — Roy Heiner (NED)
Designer — Juan Kouyoumdjian (ARG)
Builder — Schaap Shipcare (NED)
www.abnamro.com/team

ABN AMRO, an international banking conglomerate, is sponsoring two boats in the race, both designed by young Argentinian Juan Kouyoumdjian and constructed by Irishman Killian Busche, builder of '01-02 winner *illbruck*, in the Netherlands. As a supposed cost saving measure, the rules only allow building two boats if both will be sailed in the



COURTESY VE-40

Extreme entertainment — 'Team Holmatro', the first of the new Volvo Extreme 40s, idles along at 20 knots during her maiden voyage.

race.

ABN AMRO, a hard-chined boat with extra-long daggerboards, was the first Volvo 70 in the water back in January. The syndicate has been practicing out

VOLVO RACE PREVIEW

of its base in Portimao, Portugal, though due to some keel issues, they've lost much of the advantage of their head-start. The second *ABN AMRO*, which incorporates all that the team learned from the first boat, was just launched in mid-August. The 'varsity' team will sail the second boat, while the 'kids' get the prototype.

Skipper Moose Sanderson has assembled a talented crew, including sought-after American navigator Stan Honey, who, at 50 years old, is the oldest — and probably smartest — guy in the race. Typical of the modern-day VOR, there are no Dutch sailors aboard this 'Dutch' boat. Also somewhat typical, there are four Kiwis aboard *ABN AMRO I*, making this boat a favorite in New Zealand.

The team, minus some key players including Honey and Mark 'Crusty' Christensen, sailed over to the States and back for practice, and is currently two-boat testing every day with both *ABN AMROs* in the Netherlands. After the second *AA* boat is christened in Rotterdam on August 27, the two teams will 'race' each other back to Portugal, knocking off their 2,000-mile VOR qualifier in the process.

ABN AMRO 2, Netherlands (Youth Team)

Skipper — Sebastien Josse (FRA)
 Navigator — Simon 'SiFi' Fisher (UK)
 Manager — Roy Heiner (NED)
 Designer — Juan Kouyoumdjian (ARG)
 Builder — Schaap Shipcare (NED)
www.abnamro.com/team

This team of 21-to-30-year-old sailors was selected through a series of tryouts, kind of a nautical version of *Survivor* or *The Apprentice* ("you're fired!"). Her young crew, led by 30-year-old 'JoJo' Josse, trained on the VO-60 *Tyco* while waiting for their boat, the first *ABN AMRO*, to be turned over to them. Two of her crew are Americans, George Peet

(age 25, Newport, RI) and Laser/youth champ Andrew Lewis (23, San Diego).

ABN AMRO's corporate motto is "making more possible," which they have generously done for these up-and-coming sailors. Realistically, however, this group doesn't have the experience, let alone the best *ABN AMRO* boat, to be a factor in the race.

BRASIL 1, Brazil

Skipper — Torben Grael (BRA)
 Navigator — A. Cahalan (AUS)
 Manager — Alan Adler (BRA)
 Designer — Farr Yachts (USA)
 Builder — Marco LandiBoatworks (BRA)
www.brasil1.com.br

This Farr design was built near Sao Paulo, and was trucked to Rio de Janeiro for its mid-June launching. Five-time Olympic medalist Torben Grael has put together an international team, including four other Brazilians and Aussie navigator Adrienne Cahalan, thus far the only woman in the race. The team is presently sailing across the Atlantic to its new home base in Cascais, Portugal, satisfying their nonstop 2,000-mile race qualifier in the process.

The well-funded Brazil I syndicate — the first Brazilian effort in Volvo history — will make its presence felt at each stopover, setting up a village-sized pavilion to showcase their country's music, fashion, and culture. Unfortunately, their website is entirely in Portuguese, making it hard for the rest of the world

Artist renditions of a VO-70 cockpit (left), and the gigantic sail plan (below). The spinnakers are limited to 5,382 square feet — huge!



COURTESY MOVISTAR

to follow this team's progress.

ERICSSON RACING TEAM, Sweden

Skipper — Neal McDonald (GBR)
 Navigator — Steve Hayles (GBR)
 Advisor — Magnus Olsson (SWE)
 Designer — Farr Yacht Design (USA)
 Builder — Green Marine (GBR)
www.ericssonracingteam.com

The Ericsson boat is a sistership to *Black Pearl*, with both boats designed by Farr, built by Green, and commissioned by Atlant Ocean Racing. The boat, which sports orange and blue Howard Johnson-like graphics, was launched on June 30, and the team has been practicing out of Vigo ever since. Neal McDonald, a four-time round-the-world vet, has assembled a talented mixture of *Assa Abloy*, *Tyco* and *SEB* alumni. There are four Brits on board, as close to a 'home team' as England will get this time.

Between August 8-15, *Ericsson*, with advisor and five-time race vet Magnus Olsson aboard, sailed up to Gothenburg, Sweden, where the boat was christened with much fanfare. The trip doubled as their qualifying passage for the upcoming race. *Ericsson*, thought to be on the light side of the box, performed beautifully, with no breakages. Crewmember and construction manager Jason Carrington noted, "She certainly requires a lot of respect and there are times when you have to throttle back. The key will be to find her limit — we still have some work

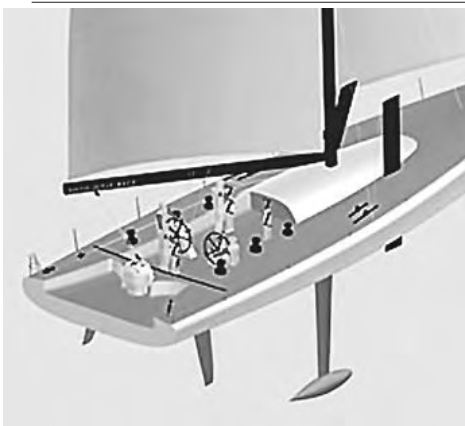

PREMIER CHALLENGE

— ONCE MORE INTO THE BREACH



PREMIER CHALLENGE

Up and running, from left — The Spanish 'Movistar'; the brand new Aussie 'Premier Challenge'; and the Swedish 'Ericsson'.

to do, but we are almost there."

MOVISTAR, Spain

Skipper — Bouwe Bekking (NED)
 Navigator — Andrew Cape (AUS)
 Manager — Pedro Campos (ESP)
 Designer — Farr Yacht Design (USA)
 Builder — Boatspeed (AUS)
www.movistar.es/vela

Funded primarily by Spanish telecom company Telefonica, this Farr design was built near Sydney, where it underwent sea trials in the spring. In April, skipper Bouwe Bekking and his veteran crew took off for Rio de Janeiro, promptly posting a bunch of 500-mile days. Along the way, they upped the 24-hour monohull speed record by five miles, knocking the 140-foot *Mari-Cha IV* out of the record book. *Movistar* topped out at 530 miles — a 22.08-knot average — and the boat was essentially right out of the box! Surely, that record will fall again during the Volvo Race.

Bekking and crew, which includes Spanish 49er Olympic gold medalist Iker Martinez and Kiwi race vet Stu Bannetyne, now have 18,000 miles of training on *Movistar*, by far the most sailing time of all the syndicates. As part of their schedule, they raced in last month's light-air Rolex Fastnet Race, where, despite the 'fastest monohull in



THIERRY MARTINEZ

the world title', they didn't seem particularly special (several Open 60s beat them boat-for-boat). They're presently hauled out near Galacia, getting a new keel bulb and a new mast.

PREMIER CHALLENGE, Australia

Skipper — Grant Wharington (AUS)
 Navigator — TBA
 Designer — Don Jones (AUS)
 Builder — Hart Marine (AUS)
www.premierchallenge.com.au
www.wildthingyachting.com.au

Skipper Grant Wharington has gone with the same designer and builder as his maxi *Skandia*, which lost its keel and subsequently flipped in the last Sydney-Hobart Race. *Skandia* was uninsured, and the financial setback contributed to *Premier Challenge's* late start and rumors about the project's demise. However, the boat was recently launched and went through the mandatory stability testing. *PC* should be shipped to Spain soon, where her as-yet unnamed crew will begin practicing.

The *Premier Challenge* website is 'under construction' and information about this mysterious project is minimal. From what we can tell, it's a darkhorse effort at best.

PIRATES OF THE CARIBBEAN, USA

Skipper — Paul Cayard (USA)
 Navigator — TBA
 Manager — Kimo Worthington (USA)

Designer — Farr (USA)
 Builder — Green (GBR)
 (currently no website)

This boat, a sister-ship to *Ericsson*, was built on spec by Atlant Ocean Racing, which is managed by a group of Swedish race veterans including Magnus Olsson. Things fell into place perfectly for everyone when Disney and then Cayard were signed, and the boat is now nearing completion under the experienced eyes of project manager Kimo Worthington. Cayard is presently in England, and the first crew announcements are imminent, including the signing of Newport, RI, Bowman Jerry Kirby. (According to the rumor mill, free agent John Kosteki will appear in the afterguard of some syndicate for the 'in-port'

racess, but it won't be with Cayard.)

This swashbuckling program has everything going for it — the Farr/Green Marine pedigree, Cayard's sailing skills and charisma, and even a literal Hollywood connection. The only downside is their late start, which means the Pirates may still be figuring out their new beast on the fly during the race. Historically, the boat that wins Leg 1 has gone on to win overall (except Chris Dickson's *Tokio*, which dismasted later in the race), so the pressure is definitely on. However, no one is counting this syndicate out, and we're quite sure of one thing — win or lose, *The Black Pearl* will reap the most press, which, from a sponsor's point of view, is the whole point of the exercise.

Pro Picks

Okay, let's cut to the chase — who's going to win the Volvo Race? We polled some industry experts and race veterans, and their opinions follow:

Gary Jobson — "*Movistar* or *Ericsson*. Time in the boat, design, past track record, and budget. . . The best things about the race are that it's coming to my hometown (Annapolis), Cayard's involvement, and the new boats. On the downside, out of the 150 or so talks I've given around this country in the past year, not one person raised their hand and asked me about the Volvo Race. There just isn't a lot of American interest this time around. I'm also disappointed that Volvo

VOLVO RACE PREVIEW

hasn't supported more TV coverage — I'm only doing one ESPN show, an hour-long wrap-up in July '06."

Peter Isler — "My bet is on *ABN AMRO I*, mainly because of Stan — but I honestly don't have a lot of insights on the teams. The new inshore component is very cool, and, of course, canting ballast is the way to go. I'll be following the race closely online — I find the website coverage of these long distance races really compelling."

Dee Smith — "*Movistar* will win, and it will be a free-for-all for second. Bouwe knows all about canting keelers from his time on *Morning Glory*, and they have been putting in the time on the water. Everyone else is starting too late, and will still be learning their boats on the first few legs."

Whitbread/Volvo Race Winners

Year	Yacht	Design	Skipper	Crew	Country
1973-74	<i>Sayula II</i>	S&S 65 ketch	Roman Carlin	12	MEX
1977-78	<i>Flyer</i>	S&S 65 ketch	C. van Rietschoten	12	NED
1981-82	<i>Flyer</i>	Frers 65 ketch	C. van Rietschoten	16	NED
1985-86	<i>L'Esprit d'Equipe</i>	Briand 58.6 sloop	Lionel Pean	8-9	FRA
1989-90	<i>Steinlager 2 (maxi A&B)</i>	Farr 84 ketch	Peter Blake	15	NZL
1989-90	<i>Equity and Law 2 (class C)</i>	J/V 63 sloop	Dirk Nautor	10	NED
1989-90	<i>L'Esprit de Liberte (class D)</i>	Briand 58.6 sloop	Patrick Tablary	8	FRA
1993-94	<i>N.Z. Endeavour (maxi)</i>	Farr 84 ketch	Grant Dalton	14	NZL
1993-94	<i>Yamaha (W60 class)</i>	Farr 64 sloop	Ross Field	12	JPN
1997-98	<i>EF Language</i>	Farr 64 sloop	Paul Cayard	12	SWE
2001-02	<i>illbruck Challenge</i>	Farr 60 sloop	John Kostecki	12	GER

John Jourdane — "I'm going with *Movistar* — most preparation and miles sailed. Second, *Brasil I*; third, *Black Pearl*. . . I like the point system instead of overall elapsed time — one breakdown before, and you were out. I don't really like all the stopovers and short races. I'm of the old school — give me 6,000-mile legs!"

Tom 'The Curmudgeon' Leweck — "What, the Volvo Race again? Well, at least it will provide lots of fodder for *Scuttlebutt* this winter."

the bottom, or even the end, of this great event — or will the sexy new boats and expanded format bring it roaring back in '08? Regardless of the size or future of this race, the upcoming edition is sure to be action-packed, with lots of broken records, broken boats, and assorted human drama.

The fun starts in just about two months, and we can't wait to see how this race unfolds. Stay tuned to www.volvo-oceanrace.org for virtually daily updates.

— **latitude** / rkm



Red Spinnaker.

deWitt

NEW WORK!

Come see Jim DeWitt's latest sailing paintings. His new work approaches the world of sailing from a more abstract point of view and reveals the artist's great passion and consummate skill in his foremost areas of expertise: sailing and painting.

Discover it for yourself at:

DeWitt Art Gallery & Framing

(510) 236-1401 (800) 758-4291

www.jimdewitt.com

121 Park Place, Point Richmond, CA 94801

Tuesday-Thursday 11:30 a.m. to 5:00 p.m.

Friday 11:00 a.m. to 3:00 p.m. • Saturday 11:00 a.m. to 4:00 p.m.

and visit the DeWitt Gallery at Keller Williams in Berkeley at 9th and Gilman

VESSEL ASSIST Goes The ...Distance

If you're a boater who likes to go the distance, make sure your towing service does too.

The Unlimited Captain's card from VESSEL ASSIST provides towing service for up to 30 miles offshore and up to 40 miles in Southern California.

- Largest Fleet on the Pacific Coast
- Applies to all recreational boats you own, borrow or charter
- Towing and soft ungroundings, parts & fuel delivery, jumpstarts
- 24-hour nationwide dispatch
- Dock to Dock Towing — Provided for 100% from restricted use docks

To join, call
800-888-4869
 or online at **BoatUS.com**

*Unlimited Service for breakdowns at sea within a VESSEL ASSIST Service Area. All Towing Services are subject to the limits and conditions of the BoatU.S. — VESSEL ASSIST Towing Service Agreement. For details, call or visit us online at BoatUS.com/Towing.



VESSEL ASSIST
 Towing You Can Trust From BoatUS

MAKE FURLING A SNAP
 SCHAEFER SNAPPFURL SYSTEMS

The new Snappfurl CF-700 Jib Furling system for boats in the 24-28 foot range brings quality and simplicity to a new level. Our computer machined aluminum drum incorporates a double race of Torton Balls for effortless furling or reefing. The efficient round foil snaps over an existing headstay for easy furling and installation.

As with all of our furling systems, the CF-700 will allow you to have a more enjoyable sailing experience. Contact us today for more information.

SCHAEFER
 LEGENDARY STRENGTH

Visit us at www.schaefermarine.com

158 Duchaine Blvd., New Bedford, MA 02745-1295
 Tel: 508.995.9511 Fax: 508.995.4282

SAL'S INFLATABLE SERVICES, INC.

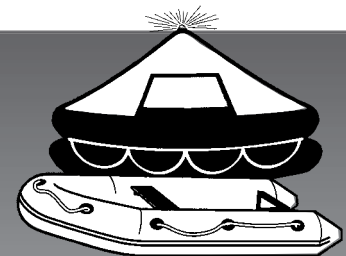

Visit our Alameda showroom for **BOAT SHOW SAVINGS!**
 Good thru Sept. 30.

OPEN SATURDAYS
 by appointment

- Sales
- Service
- Repairs
- Rentals
- Liferafts
- Inflatables
- EPIRBs
- Flares
- Survival Suits

Your safety is our business!

Just 3 miles from Jack London Square!

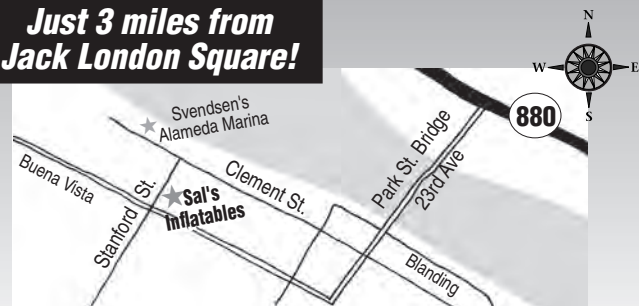

PHONE (510) 522-1824 FAX (510) 522-1064

1914 Stanford Street, Alameda, CA 94501
 email: salsinf611@cs.com • www.salsinflatableservices.com

ADVENTURES OF YOUTH

Tied up at the quay at Papeete, we're cruising young and without much money — and hope to encourage others to do the same. As for encouragement, we've



ALL PHOTOS MOANA

While still in their 20s, Sally and Sam had dreams of cruising that couldn't be held back by the lack of extensive funds.

gotten a lot of that from *Latitude*, and last year's Ha-Ha proved to be a great way to start our cruise.

Sailing has played a big part in our lives together. We met on Mission Bay in San Diego, had our first sail on Morro

Sally strikes a pose on the bow. Traveling in cramped quarters on a small budget doesn't seem to bother her at all.



Bay, got engaged on San Francisco Bay, and were married on San Diego Bay. From the beginning, we dreamed of heading south for an extended cruise. It helped that both of us agreed that age and a lack of money shouldn't prevent anyone from fulfilling their dreams.

It was in 2001, shortly after we were married, that we started seriously looking to upgrade our Ericson 26 to a larger cruising boat. In fact, my Sam had been researching a boat upgrade since the day he'd purchased the Ericson two years before. At the time, Sam was 27, and I, Sally, was 29. We had youth on our side, but unlike most cruisers, we didn't have the luxury of years of savings and retirement money to finance our cruise. With limited money, we knew it would take time and a lot of hard work to find and prepare a vessel for cruising.

In November of that year, we found *Moana*, a structurally sound DownEast 32 that had been neglected. Her owner looked ready to tow her to the ship

She was a boat calling out for someone to rescue her.

graveyard, and she was cosmetically challenged — to put it nicely. There was a layer of grime on the hull, and the exterior wood was being sapped of life. A dirty tarp was draped over the boom in either a last-ditch effort to protect her — or maybe hide her. Inside, the upholstery in the V-berth smelled like the holding tank which lay beneath it. The foam mattress had canyons that outlined the former owner's body at sleep, and iron rods held up the disintegrating curtains. The engine compartment looked as though it had been used as a fireplace year 'round. As for the head, let's just say there was a lot of crap to deal with.

But structurally the boat was sound. I liked her wide and deep cabin, and figured her heavy displacement would ease the seasickness I was susceptible to. We also liked all the wood in her interior, as it made the boat seem warm and inviting. She was a boat calling out for someone to rescue her, for someone to give her the TLC she so desperately deserved.

Despite her shortcomings, the purchase price of \$15,000 meant *Moana* was the boat we'd been searching for

to fulfill our cruising dream. We knew, of course, that the purchase price was just a start, as the engine needed to be rebuilt or replaced, and that countless hours of elbow-grease would be required. Trying to be realistic, we set our cruising schedule to pull out of San Diego in late October of '04 as part of the Ha-Ha fleet. That was three years out from our purchase date. Indeed, getting her into cruising condition cost another \$15,000 — and more hours of work than we care to calculate.

After towing *Moana* to her new berth, we gave her a thorough cleaning and disinfecting, both inside and out.



— MOANA'S LOW-BUDGET CRUISE

The engine had to be scrapped and the fireplace returned to her original purpose — that of an engine room. All interior lockers had to be painted, and the cabin sides and soles varnished. All the electrical wires and hoses, holding tank and head, faucets and ice box, curtain rods, curtains and upholstery, had to be replaced. Most of these jobs weren't completed for two or three years.

Our generation knows almost nothing about fixing things. When something breaks — say a DVD — we just go to the store and buy another one. It makes sense because you usually end

Completing her long, slow crossing from Mexico, 'Moana' made landfall at the idyllic Marquesan island of Fatu Hiva.

up with a better DVD player for less money than it would have cost to fix the new one. But it's different with boat gear. So suddenly we had a great need to learn how to take care of, fix, and even replace items that were foreign to us. For we were well aware that if the head broke 15 days into a 30-day Pacific crossing, there wouldn't be a marine superstore just a few miles away.

We also had to learn to become self-reliant be-



After an extensive refit, 'Moana', a small but sturdy DownEast 32, safely took Sam and Sally south with the Ha-Ha fleet.

cause it was beyond our budget to have a professional repair or install most items. Thus, my husband enrolled himself in what he calls Boat Handyman University. He learned the basics through trial and error, research, and talking with others who had more experience. In the latter case, dock neighbors provided lots of valuable information. He also got help from various marine magazines, the public library and the Internet.

Sam's strategy was to start on the simple projects and work up to the more complicated ones. In hindsight, it was a good idea. Nonetheless, most of the projects took three to four times as long as they should have — and some required a complete redoing later on. But by the time he was done, he had gained a wealth of knowledge from each job, and he now knows the boat inside out.

Since both of us had full-time jobs at the time — meaning more than 40 hours a week — fixing up *Moana* took up most of our spare time.

Although we knew we'd want to sail most of the time, we also knew that we'd need a reliable engine. This was to be one of the biggest and most expensive projects. When we got the boat, the engine had less than 7 pounds of oil pressure. After spending several hundred dollars rebuilding an old starter and trying to diagnose the source of the low pressure, we decided we were throwing good money after bad. Following the removal of the old engine, our mechanic instructed my husband to pick up a small shovel on his way down to the boat. Shoveling stuff out



ADVENTURES OF YOUTH

of the engine compartment was the first step in getting it ready for a new engine. Fortunately, we came across a new Westerbeke diesel at 25% off as a boat show special.

After a year of hard work and replacing the engine, we took *Moana's* identification plate to be restored by professionals. As moving-aboard day approached, we focused on the interior of the boat. The inside lockers were lined with engine oil! Evidently, one of the previous owners had drained the used engine oil into the bilge where it mixed with water. Later, when the boat heeled over, this awful 'soup' had seeped high enough to coat the lockers.

We had to remove everything from the main salon and replaced it with a hose, buckets, rags, soap and various cleaners for removing oil and goo. Yes, we literally hosed down *Moana's* interior. After letting the cabin and lockers dry out, we applied thick coats of white paint. This brightened up the lockers and eased our



One of the rewards of arriving in the Marquesas is getting ashore to experience the primeval topography. This fall is above Daniel's Bay.

task of storing and finding things. This was a significant improvement from the days when we were worried about sticking our hands down in a locker for fear that we might get bitten by something mysterious.

Of course, we couldn't move aboard until we finished varnishing the interior. My original plan was to only varnish

selected parts of the interior, saying that it would "complement" the other wood. But as soon as I finished varnishing the first big panel, I was hooked. I had to varnish all the wood. After many late nights and long weekends, I had most of the wood gleaming.

In the last months before leaving, we tackled items we wouldn't have dreamed of just a few years before. One of these was installing a Cape Horn Windvane.

Installation involved fun things such as drilling a 2.5-inch hole in the transom, cutting stainless steel tubes to length, fiberglassing pads to the inside of the hull, and fiberglassing the windvane to the inside of our hull. If we didn't cut the tubes the right length or the hole in the transom wasn't level, we would have had a tough time fixing the blunders. However, the knowledge gained through previous projects and through problem-solving with a good friend and mentor

Your Boatyard in the Heart of Paradise



Large, fenced, secure dry storage area

Tahiti Customs policy has changed!
Foreign Flag vessels can stay on dry storage in our yard for up to 12 months out of 24.



A Subsidiary of
The Moorings Yacht Charter, Ltd.

Our Services |

HAULOUT

- Marine Travelift 25 tons
- Marine railway 120 tons
- Storage in adjustable steel cradles
- Fenced Yard

PAINTING

- Topsides, hull, bottom, varnish
- Brush, roller, spray

MECHANICAL WORK

- Inboard, outboard, diesel, gas
- All brands

REPAIRS

- Electrical repairs
- Refrigeration installation & repair
- Fiberglass & woodwork
- Welding, steel, stainless, aluminum

SAIL LOFT

- Sail repairs, biminis, dodgers, covers

STORE

- International, Pettit, Epiglass, Devoe
- Spares
- Fill U.S. gas cylinders

DO-IT-YOURSELFERS WELCOME!

BoatUS Cooperating Marina



Professional boatyard in the heart of Paradise

*Raiatea Carenage will make sure
paradise is everything you expected.
Call, write, or sail in . . . we're here to serve you.*

B.P. 1111 Uturoa Raiatea 98 735 Polynésie Française

Tel: (689) 600-545 ~ Fax: (689) 600-546 ~ VHF 68

Web site: <http://raiatea.com/sailing/carenage/> ~ email: raiateacarenage@mail.pf

— MOANA'S LOW-BUDGET CRUISE

helped us work through the installation issues. It was a moment of great pride when we first engaged the vane and she steered *Moana* on a straight course. Now, having put 7,000 miles under her keel, we can say the windvane is one of the most important items on our boat.

The final steps before moving on the boat included installing a new fridge and replacing the upholstery. We figured we could complete the remaining projects while living aboard.

We moved aboard *Moana* four months before starting our cruise. Two months before setting off we both quit our jobs in order to complete mandatory projects. When we were finished, many friends congratulated us on actually living out the dream rather than just talking about it. We had inspired them.

On October 25, 2004, we pulled out of the San Diego YC to start this adventure, beginning with the Baja Ha-Ha Rally

from San Diego to Cabo San Lucas. We were the youngest captain/first mate team in that event. And after the surveys were turned in by the 145 entries, we were delighted to learn that our boat cost the least of any in the Ha-Ha.

Having now cruised Mexico and across to French Polynesia, we're amazed at how little we spent compared to other cruis-

You don't have to buy new or pay a lot of money to get a seaworthy and comfortable boat.

ers. We've been on many, many boats since the start of our cruise, and can honestly say *Moana* is one of the most comfortable and warm boats we've seen. (But hey, we may be a little biased!) Our point is that you don't have to buy new

or pay a lot of money to get a seaworthy and comfortable boat. And if you're doing the refinishing and refurbishing, you get to make all the decisions on the type of equipment, the colors and so forth. You truly get the chance to make the boat yours.

Our lesson for other young and less-than-affluent cruisers is that you don't have to be independently wealthy, retired and/or a jack-of-all-trades in order to make the cruising life a reality. With research, hard work, a willingness to learn — combined with a good dose of common sense — you too could be on your way to storied destinations such as the South Pacific.

Our motto has been that we will continue to cruise as long as we have fun and the funds. Eight months into our cruise, we are currently exploring the island of our dreams. After tackling a few projects, we'll be heading off to Moorea and then Bora Bora. We hope to continue cruising for an extended time, because it's a lot of fun. It's just the funds we're going to have to figure out.

sam & sally peterson

Buy your next boat...“on the house.”



Introducing the innovative.....

HOME OWNERSHIP ACCELERATOR™

It's a revolutionary new line of credit that "parks" all of your monthly income against your home's principal balance to save you interest while you aren't using the money. Interest saved leaves more of your funds for principal, and you pay off years earlier! Or use the savings for other things (like a new boat!). And, with unlimited checks, ATM/Visa, and bill-pay, you have 24/7 access to funds, up to 80% of your home's value -- for anything your heart desires!

This is the most powerful new financial tool in a generation! Play the 4 minute movie at www.cmghome.com and give us a call today.



Mortgage West

Office 925-820-7110
Direct 925-899-2320

Call DRE Lic. #01460724. Home Ownership Accelerator and the yellow flying house logo are trademarks of CMG Financial Services Inc.

A CELEBRATION OF SAIL

For more than 150 years, San Francisco Bay has been a haven for sailing craft of all types. During the boom years of the Gold Rush, massive clipper ships, schooners and steamers arrived from the Gulf of Panama, around the Horn and across the Pacific, loaded to the gunnels with the dreamers, adventurers and laborers who would lay the foundations of California culture. Back then, virtually every local boat afloat — from simple skiffs to flat-bottomed scow schooners — was commandeered to shuttle seekers to the gold fields of the Sacramento River Delta.



These days, of course, the Bay still bustles with nautical action, but the nature of the scene has changed a bit: in addition to long-haul freighters and tankers, multi-million-dollar yachts share Bay waters with modest cruisers, cutting-edge racing machines, weather-worn daysailers and all sorts of sailing dinghies.

Despite the region's undying enthusiasm for sail power, however, we rarely take time to celebrate our unique maritime heritage. But last month, thanks to the dedicated efforts of the Sail San Francisco organization, the Bay played host to a varied array of majestic square riggers, elegant schooners and other

'Pallada' glided past as effortlessly as a seabird riding the trade winds

vintage craft, which paraded along the Cityfront on July 28. It was a feast for the eyes enjoyed by thousand of shore-side spectators and many others who shadowed the fleet in their own boats — outside the Coast Guard's carefully controlled security perimeter, of course. In case you missed the show, we'll share a sampling of the fleet in these pages.

The two mega-stars of the parade were the Mexican Navy's three-masted

barque *Cuauhtemoc*, with a 'spared length' of 270 feet, and the 356-ft Russian merchant marine training vessel *Pallada*, termed a 'full-rigged ship', as she carries square sails on all three masts.

Above: With her stately lines and great clouds of sail, the Russian sail training ship 'Pallada' is an elegant blend of form and function. Inset: Balancing on the end of 'Cuauhtemoc's' massive bow sprit, two sailors struggle to hoist a chain of signal flags — a tall ship tradition.

ALL PHOTOS LATITUDE / ANDY



— SAIL SAN FRANCISCO 2005

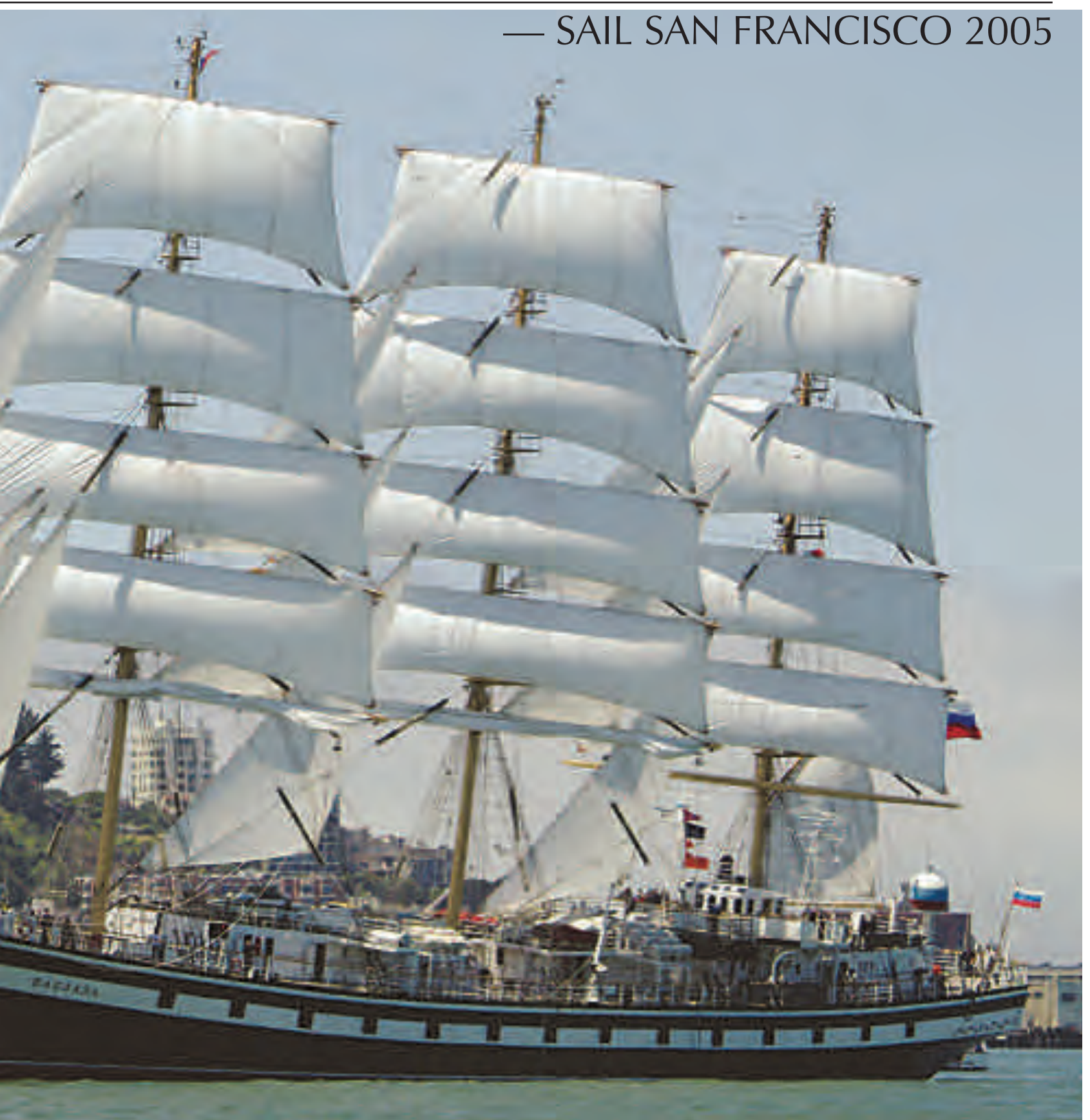

Watching these splendid ships sail beneath the Golden Gate Bridge and into the Bay was a jaw-dropping experience. Flying over 25,000 feet of sail — all but her lower 'courses' — *Pallada* glided past as effortlessly as a seabird riding

the trade winds. It's been said that no invention of man is more beautiful than a square-rigger under full sail. We would tend to agree. Gracefully harnessing the power of the wind, they are indeed a harmonious blend of form and function.

These and other globe-trotting vessels had literally come thousands of miles to participate in the Sail San Francisco 2005 event, in addition to a series of other summer tall ship festivals along the West Coast, beginning at Victoria,

A CELEBRATION OF SAIL

B.C. and ending at San Diego. Most were run in cooperation with the American Sail Training Association (ASTA), which administered races between ports.

Among the other notable foreign-flag vessels seen here on the Bay was the *R. Tucker Thompson*, an 85-ft square tops'l schooner whose design (by a former Californian) was inspired by North American fishing schooners. Built of steel and based in New Zealand, she takes sail training 'cadets' of all ages on

circuits through the South Pacific. Also in attendance was the 151-ft brigantine *Kaisei*, which, although acquired last year by Sausalito's Ocean Voyages Institute, sails internationally, promoting ocean conservation and youth sail training.

The beautiful 122-ft square tops'l schooner *Lynx*, now operated out of Newport Beach by Woods Maritime, was one of several vessels that made the long trek to

the Northwest, then harbor-hopped back down the coast with the fleet. This recently-built replica is reminiscent of naval schooners and privateers used during the era of the War of 1812. With her crew fitted out in period costume, she operates as a sail training vessel for groups of all ages, focusing also on historical, environmental and ecological

Clockwise from upper right: The 60-ft schooner 'Gold Star' sails wing-on-wing; 'Lord Jim' slides past the Exploratorium; Skipper Ron MacAnnan (white shirt and hat) and friends finally take 'Pursuit' out of moth balls; the lovely 'Elizabeth Muir'; the replica schooner 'Lynx'; 'Cuauhtemoc' carrying five headsails; the New Zealand-based 'R Tucker Thompson'; acrophobia is not an option aboard 'Cuauhtemoc'; stowing a jib.



— SAIL SAN FRANCISCO 2005

issues.

Like a nautical 'coming-out' party, the procession also provided a perfect forum for a number of newly restored local beauties to strut their stuff. Among these, the biggest surprise was the ap-

pearance of *Pursuit*, one of only two remaining M-Class sloops. She hadn't been seen out on the water in 27 years! (See also *Sightings*.) Another pleasant surprise was the famous gaff tops'l schooner *Lord Jim* — a veteran of four circumnavigations — which has been stuck at the dock in refit mode for the past three years. In the fall she'll be leaving the Bay again, this time for South America and beyond. The 97-ft schooner *Talofa* was

also here. As written up in our July issue, this 1920s cargo vessel was recently resurrected, and will soon be off to do charter work in Mexico.

There were many lovely schooners in the lineup, but probably the most exquisite was *Elizabeth Muir*, the masterwork of the late Babe Lamberdin, a well-loved local shipwright.



A CELEBRATION OF SAIL



LATITUDE / ANDY

In a spirit of inclusiveness, which is a hallmark of the Sail San Francisco organization (and its affiliate, the Pacific Rim Foundation), a smattering of other, non-sailing vessels were also invited to attend, most notably, the *USS Potomac*, formerly President F.D. Roosevelt's personal yacht, and the WWII Liberty Ship *SS Jeremiah O'Brien*.

Can anybody play? Certainly. The battered yet proud tug / fireboat 'Nokonis', carried a contingent of U.S. Navy Sea Cadets.

This grand promenade along the Cityfront was undoubtedly enjoyed by all in attendance, and several of the larger ships made themselves available for dockside tours for several days afterwards.

Unfortunately, the event was not without its frustrations for organizers. While other North American and European cities gladly back such festivals with lavish promotional budgets and genuine multi-agency support, San Francisco — for whatever reason — has been embarrassingly slow to jump on the bandwagon. Add to this two unfortunate scheduling problems which greatly diminished the field of large, Class A ships: the magnificent four-masted Japanese barque *Nippon Maru's* schedule put her here several weeks in advance of the rest of the fleet, while Ecuador's three-master, *Guayas*, could not arrive here until late October. As you can imagine, events such as this are nightmarishly complex to host, which is all the more reason to tip our hats to the Sail San Francisco staffers and their small army of volunteers.

For all of us whose hearts swell up at the sight of varnished spars, tarred rigging and billowing clouds of sail, the parade was a stellar experience. We only wish such events could happen a bit more often.

— *latitude/aet*

FOAM

Mattresses • Cushions
FREE CUTTING!



- **Custom foam** cut to any size or shape for your bows, berths, bunks and cushions
- **Largest selection** of foam in stock extra firm to pillow soft
- **Expert** custom sewing 20 years experience, lifetime warranty
- **Quality** marine fabrics, marine vinyls, Sunbrella, canvas

10% OFF WITH THIS AD



FREE ESTIMATES



FOAM CREATIONS

ALBANY ~ BERKELEY
1120 Solano Avenue
(1 block above San Pablo)

(510) 526-7186

Hours: Monday-Saturday 10-6 • Sunday 11-5

COVER CRAFT

The Bay Area's Finest
Biminis

Canvas Dodgers, Covers, Enclosures



Better materials, better workmanship

"We could not be more pleased...
Design and craftsmanship are important. Attention must be paid to every detail."

1230 Brickyard Cove Road, #106
Pt. Richmond, CA 94801
In Brickyard Cove Marina

(510) 234-4400

Quality
Yacht
Canvas



Jack London Square Marina

An Almar Marina



Location, Location, Location. Imagine your boat in one of the most desirable locations in San Francisco Bay, Jack London Square. Here you will find yourself within walking distance of several fine restaurants like Scott's Seafood, Yoshi's and El Pescadori. Enjoy the Arts and Crafts Saturdays on the promenade or the Farmers Market on Sundays. Take in a movie at the cinema two blocks from your slip and on the way browse the many specialty shops through out Jack London Square. It's all just steps from the marina. Because Jack London Square Marina is an Almar Marina, you can enjoy reciprocal privileges with all of Almar's California marinas. Call today, mention this ad and be our guest for the weekend. See for yourself the benefits of a great location. Slips are now available in Jack London Square for boat sizes 36' to 75'.

Official Sponsor

**2005
 BAJA
 HA-HA**

Almar is the largest operator of salt water marinas on the West Coast. With thirteen facilities situated in the most desirable locations, Almar Marinas provide a wide range of services and programs that few marinas can offer. Some of these programs include: monthly boating seminars, boat handling classes, navigation courses, and organized outings to beautiful local anchorages. Each marina offers wireless high speed internet access, which can be used with your reciprocal privileges at any of Almar's California marinas. To see what a difference this makes, visit one of our marinas this weekend. With thousands of slips in convenient locations, let us find one for you.

Call us at 800.675.3625 for more information about all of the Oakland Marinas. The Oakland Marinas consist of four marinas in the Oakland Estuary from Jack London Square to Coast Guard Island.

www.oaklandmarinas.com

BAJA HA-HA XII PROFILES, PT I

A few decades ago, futurists assumed that by the turn of the century average Americans would be aided in their daily lives by so many labor-saving devices that they'd have more free time than they knew what to do with. Ha!

Turns out that in our ultra-modern society the typical working stiff seems to have less time for rest and relaxation than ever before. In fact, some folks barely come up for air from one year to the next. And before they know it — poof! — their hair's gone gray, their vision's shot and they can no longer fit into their swimsuits. The late John Lennon put it best, "Life is what happens while you're busy making other plans."

Perhaps that's why, a dozen years ago, a certain magazine publisher — who has adopted the moniker The Grand Poobah — initiated the annual Baja Ha-Ha cruisers rally from San Diego to Cabo San Lucas. It seemed as though a whole lot of folks needed a good excuse to get away from the rat race and have some fun.

By design one of the most loosely organized sailing events in the world, the Ha-Ha's purpose, as most readers know, is simply to create a forum where like-minded sailors can get to know one another while cruising south along the starkly beautiful Baja coast. With a pre-Halloween kickoff party scheduled for October 30 at San Diego's Cabrillo Isle Marina (sponsored by West Marine), the start this year falls on Halloween Day, so we expect it to be even more festive than usual. As always, the fleet will have layovers at both Turtle Bay and Bahia Santa Maria, arriving at the Cape on November 10.

With that, we introduce you to the Baja Ha-Ha Class of 2005. (*Entrants are presented here in the order in which they*

Tom and Amy of 'Sandpiper' got hitched in Vegas — by Elvis! Now the Ha-Ha honeymoon.



signed up. Look for two additional installations in October and November.)

See Ya — Newport 30 Axel Heller, Temple City, CA

Axel's boat name says it all. He's outta here. Gone.

Until we met him a couple of weeks ago we couldn't understand why he was so adamant about becoming the very first Ha-Ha entry this year. But after learning that he's been itching to make the trip for over a decade, we understand his enthusiasm. "After thinking about this trip for 11 years, going through a divorce and settling for a smaller boat than planned for, I am now finally ready for my permanent vacation!"

A retired electronics ace, Axel is an active member of the Coast Guard auxiliary, and he often volunteers to instruct classes in safety and navigation. Joining him on the trip south and beyond will be Tom Church and John Gray.

Sandpiper — Yorktown 35 Tom & Amy Larson, Tiburon, CA

Having retired from a 20-year career in the Coast Guard, Tom undoubtedly has spent more time at sea than most Ha-Ha entrants. But his sailing career began even earlier.

When he was seven, his dad sold his businesses in Santa Barbara, loaded the family into a van and drove to Florida where they moved onto a home-built steel ketch. Aboard her, they vagabonded around the Caribbean and southern U.S. for several years earning money by "hand line fishing." Eventually returning to California, Tom entered the Guard immediately after graduating from high school. During his career, he has done everything from buoy tending to drug interdiction to HAZMAT cleanup — he spent a month at Ground Zero in New York after 9/11 and another month in D.C. cleaning anthrax out of the Hart Building!

"My story starts six years ago," says First Mate Amy. That's when she started dating Tom and sailing the Bay. The first time she crewed for a friend in a race, they ended up on the rocks



Sailors from the 2004 Ha-Ha give a celebratory cheer at Cabo. "Geez, that wasn't so hard after all," said one skipper.

shortly after the start. "Is this supposed to happen?" she queried.

Recently married, the couple hopes to sail around the world in their vintage Yorktown. The Ha-Ha will be the official beginning of their honeymoon.

Aquarelle — Mao Ta 42 Diane & Ken Kay, Long Beach, CA

"Bring it on!" say Diane and Ken. "Twenty-five years of middle school teaching prepares you for anything! We're ready for whatever Mother Nature cares to dish out." Who says you can't go cruising on a teacher's salary?

Within this duo, let's be clear that Diane is the captain, while Ken is her able crew. She began taking sailing lessons at Orange Coast College Sailing Center at age 24. Ken admits that prior to meeting Diane, even standing on the deck of a cruise ship made him nervous. Today, though, thanks to sailing lessons and Diane's nurturing, he's as eager as she is to circumnavigate the globe!

When we first heard that Ken is a music teacher, we looked forward to initiating him into the ever-changing Baja Ha-Ha Band. But now we're not so sure — his primary instrument is the tuba!

— RUNNING FROM THE RAT RACE



Maestra — Sunnfjord Trawler 47
John & Gaye Rodriguey
Coupeville, WA

After crewing on both the 2000 and 2004 Ha-Has, John figured it was about time he made the trip to Cabo on his own boat, "the mothership," as he likes to call her. His Whidbey Island business, Toby's Tavern, keeps him busy, and Gaye's profession as a preschool teacher

After years of NW cruising, Gaye and John of 'Maestra' are heading to sunnier climes.



undoubtedly keeps her exhausted between September and June. But for the past 15 years they've made good use of their summers, exploring much of the Northwest's prime cruising grounds, including annual cruises to places like Princess Louisa Inlet, Desolation Sound and Barkley Sound, on the rowdy west coast of Vancouver Island.

Maestra's ample speed, says John, usually allows her to be an anchor "when the stick boats arrive, and to have the appetizers and drinks ready." (Comments duly noted by the Rally Committee.) Subscribing to the 'more-the-merrier' philosophy, they'll have Robert and Linda Jones as well as Michael and Holly Peterson along as crew.

Duetto — Norseman 430
Stuart & Jean Kaplan
Chula Vista, CA

After a 'false start' last year, Stuart and Jean are back for a second attempt. Last fall they lost an engine halfway to Turtle Bay and decided to turn back for repairs. Then, right on cue, Murphy's Law of nautical activities manifested itself with gale-force winds — on the nose — near the Coronados. This year, they're

keeping their fingers crossed for better luck.

Stuart is a financial adviser whose company, PiperJaffray, became a Ha-Ha sponsor this year with the idea that folks heading off on open-ended cruises might like to have a financially savvy sailor in their corner to keep their cruising kit-ties solvent. He invites any interested



After last year's mishap, Jean and Stuart of 'Duetto' are determined to complete the course.

Ha-Ha'ers to contact him for a chat at 800-754-0692 or shoot him an email at stuart.i.kaplan@pjc.com.

Rocinante — Island Packet 38
Paul & Leslie Granger, San Diego, CA

"We're two retired airline captains with two former flight attendants, trying to find our way to Cabo," says Paul of his Ha-Ha team. Just as he did when flying for PSA, Paul plans to keep the land on his left as they head south. "The ladies have promised to feed us free peanuts en route!"

After her flying career at TWA, Leslie eventually became a district administrator for a San Diego county school system. More importantly perhaps, Paul notes that "she can cook up a great meal even when I don't think there is any food left on board."

Rounding out the crew will be Bill and Jeri Barsz, who, as mentioned, are also airline industry vets. Bill describes himself as a "wharf rat," but Paul thinks of him as a "superb sailor." Jeri's extensive sailing experience has earned her the status of "Senior ranking officer in charge of all the stuff we can't figure out."

They will bash back north in March, but plan to Ha-Ha again next year and continue on into the Pacific.

Free Spirit — Beneteau 390
The Rieber Family
Stockton, CA

"We're looking forward to getting back

BAJA HA-HA XII PROFILES, PT I

to basics with our family," say Jennifer and Russ (aka Mom and Dad). "We want our children to know that there is more to life than what they see on TV or in video games. We want them to learn self-reliance, cooperation and an appreciation of different cultures."

Hopefully the six months that the family has set aside to cruise Mexico will reward the kids, Steven, 13, Thomas, 10, and Carolyn, 8, with those things and more. The whole family has spent a lot of time around boats. In fact, they own a variety of craft including an Express 27 which Captain Russ, an aerospace engineer, often races. Jennifer is a pediatrician in 'real life', but will serve as first mate during the cruise. Naturally, she'll also be responsible for "medical decisions and doing the patching up."

**Platinum — Morgan 45
Clair & Mark Rommell
San Francisco, CA**

As if the fleet won't have enough to celebrate by the time they get to Turtle Bay, they can also help Mark celebrate his big 5-0 birthday (November 3).



Meet the 'Free Spirit'-ed Rieber clan, minus Jennifer — aka Mom.

Both Mark and Clair have been sailing since childhood. They met at an Alameda YC Lobster Fest five years ago. And,

according to Mark, it was "love at first sight." He explains, "She reached over to my plate and took my steak, and gave me her lobster. We've been together ever since."

Either by winning the lottery or careful planning, both Clair and Mark list themselves as retired — he was a general contractor and she was a paralegal. So now they're off on an open-ended cruise, first south, then into the Caribbean. Oh, and they plan to snowboard in Chile and Argentina during the hurricane season. Sheesh! These young retirees!

**Liberty Call II — Hunter 37.5
Ron Feldman & Anita Giani
San Francisco, CA**

Anita and Ron met on the docks of Pete's Harbor in '94. As they put it, "It was a match made in heaven," as he was looking for a good woman who liked to sail and she was looking for a good man — and a good boat. They tied the knot a year later.

Now retired, he from a Navy career as a tech instructor, and she from a career in P.R. consulting, they expect



MARINA DE LA PAZ

S.A. DE C.V.

**FULL
SERVICE
MARINA**

*Friendly, helpful,
fully bilingual staff*

- All new hardwood docks
- Centrally located in downtown La Paz

*Official
Sponsor*
**2005
BAJA
HA-HA**



Reserve now to hold a space for the winter season.

TEL: 01152 612 122 1646 • FAX: 01152 612 125 5900 • email: marinalapaz@prodigy.net.mx

www.marinadelapaz.com

Apdo. Postal 290, La Paz, 23000, Baja California Sur, Mexico

— RUNNING FROM THE RAT RACE

to spend a couple of years leisurely exploring Mexico, then eventually move on to the Caribbean, and perhaps later explore the Eastern Seaboard. They've owned this trusty Hunter for 13 years.

**Gypsy — Columbia 52
Steve Washburn
Long Beach, CA**

Steve is a lifelong sailor whose racing resume is a mile long. So if you see *Gypsy* coming up behind you, bear in mind that even if you're in 'rally' mode, she'll be racing you! He's done six TransPacs and countless Mexico races.

His connection to this vintage Bill Tripp-designed sloop goes back decades. As a teenager he crewed aboard her, then nearly three decades later (five years ago) he found her for sale and jumped at the chance to buy her. Since then he's done a complete refit and she's now in "better-than-new" condition.

Joining Steve on the cruise, er, ah,



'Eagle's Nest' will have a multi-generational crew: (L to R) Robin, Joseph, Patty and Jerry.

race south, will be Steve Steinberg and Jenny Paul as well as others who have yet to be announced. With three school-age boys at home, there'll be no long-term cruising this time for Steve. *Gypsy* will be delivered north after the Rally.

**Eagle's Nest — Hunter Passage 42
The Ahlering Family
Vallejo, CA**

Without giving away his age, we have to say that we're impressed that Jerry

(Dad) has been sailing for half a century. We assume he can tie a bowline blindfolded while standing on his head!

He and Patty (Mom) met in the Navy and were soon living aboard their first boat in San Diego Bay. Since then, they have lived all over the country — although both are now retired, he as a hospital administrator and she as an R.N.

They crewed in the 2001 Ha-Ha with their son Joseph and his wife, Robin, aboard *Sailmates II*. This year, Mom and Dad are in charge, and the 'kids' are crewing for them along with Jerry's brother Michael and his wife, Nancy. The more the merrier, right?

After the Rally, they'll all saunter on down to Puerto Vallarta.

**Epifania — 45-ft Steel Sloop
The Bentz Family
Albuquerque, NM**

Here's an inspiring tale. About eight years ago Tammy and Les dreamed up

Choose an Insurance Company On Price Alone and You May be Left High & Dry



When it comes to boat insurance policies, you get what you pay for. A "Total Protection" Yacht policy from BoatU.S. may not always be the least expensive, but it will be the best . . . the best coverage, the best value, and the best service.

- Agreed Value Policies
- Full Salvage Coverage
- 24-Hour Immediate Assistance
- Claims Handling by Boating Experts

For a free, no obligation quote call

800-283-2883

Priority Code 4141

or apply online at **BoatUS.com**



BAJA HA-HA XII PROFILES, PT I

the idea of someday unplugging from the workaday world and going off sailing with their young daughter. Besides the fact that they lived out in the desert, the only problem was they didn't know how to sail. Oh, and they didn't have a boat either.

No matter, they picked up a J/24 and learned to sail on local lakes, then "scrimped and saved" in order to buy this custom steel sloop in an unfinished state. They trucked her out to Albuquerque and have been laboring over her ever since. Now, however, she's all fitted out and ready to go. Tammy and Les have quit their jobs in high tech, they've signed on their athletic 13-year-old daughter Dakota as First Mate and shanghaied Les' dad, Ron, who is 74 years young, to be their "Science Officer," aka Mr. Fixit. After the Rally, they'll continue south to Central America.



'Epifania' has finally left the desert. L to R are Dakota, Tammy, Les and Ron.

**Sensei — Norseman 447
The Mellor Family, Richmond, CA**

"Our friends are envious," say Chris and Kelley, "our clients don't know yet, our parents are anxious but supportive and my daughter's teachers want to come along."

Although they both learned to sail as teenagers, they claim that it was living in the Bay Area for the past five years — and "reading *Latitude 38* cover to

cover" — that inspired them to pull up their tent stakes and head south. Just a few months ago they upgraded to this sturdy Bob Perry-designed sloop, and it's been a mad dash to get her ready ever since.

Also along for the ride will be their daughter Claire, 10, and Nellie the Weimaraner. Like all reasonable sailors, the Mellors' plans are flexible. If they like the cruising life as much as they think they will, they may eventually hang a right and head for the South Pacific.

**Shiraz — Hunter Passage 42
Phil & Nora McCaleb
Sacramento, CA**

"Most people do the Ha-Ha for 'fun in the sun'," note Phil and Nora, "but we're embarking on a search and rescue mission!" That is, they have decided to go off in search of their former dockmates, Michael and Laine of the Gemini cat *Miki-G*. It seems they've grown suspicious



**The Marina at
Ensenada
Cruiseport Village**

A First-Class Marina





**Call us today to make
your reservation**

Tel: 011 52(646) 173-4141
Fax: 011 52(646) 173-4151
reservations@ecpvmarina.com
www.ecpvmarina.com

Ensenada Cruiseport Village
Blvd. Lázaro Cárdenas s/n
Muelle de Cruceros,
C.P. 22800
Ensenada, B.C. México

31° 50' 39" N 116° 38' 03" W

Located just 70 miles from San Diego, the Marina at Ensenada Cruiseport Village offers all the amenities to make your experience in Ensenada an enjoyable one.

<ul style="list-style-type: none"> ▶ Double Breakwater protection for Safety and Comfort. ▶ Slips from 36' to 60'. ▶ Long term and guest moorage. ▶ Electricity (30 and 50 amp). 	<ul style="list-style-type: none"> ▶ Full 24-hour security. ▶ Close to retail shops/restaurants. ▶ Showers & Water. ▶ Laundry room. ▶ End-Ties available.
---	--

— RUNNING FROM THE RAT RACE

that the couple may have fallen prey to pirates, terrorists or white slavers. Their reasoning: Micheal had written an article or two for *Latitude*, but "once *Miki-G* was through the Canal, the writing changed — it got looser and more relaxed." Phil and Nora became very suspicious and felt they had to do something to save their old mates!

"We've enlisted a crack crew (Pat Patterson and Jim Dixon), disguised them as decrepit oldies, abandoned our children, our careers of 30+ years, our security, and we're ready to throw caution to the wind," say Phil and Nora. Geez, what a sacrifice. We sure hope Michael and Laine appreciate it.

**Ohana — Beneteau 45f5
The Plesons Family
Santa Barbara, CA**

"We're a 'go slow' group on a fast boat," explains Pam. She and her husband Dennis have gone to great lengths to make their dream of cruising with their kids possible. But then, love of the water seems to be in their blood. He grew up in



Pam and Dennis, and their kids, Marina and Niko, will cruise for a year aboard 'Ohana'.

Greece — where the pair also took their honeymoon — and she started sailing as a 10-year-old in New England.

According to Pam, "Captain Psyche (Dennis), a psychiatrist by profession, will be working hard to avoid mutiny." Apparently the kids, Marina, 12, and Niko, 9, were a bit reluctant to leave soccer, tennis and their friends behind. No doubt they'll cheer up once they meet other kids.

During their yearlong cruise, Pam, a travel business owner who speaks Span-

ish fluently, plans to organize inland excursions in order to enhance the overall experience.

**Yemonja — Island Packet 380
Mike Araneda & Linda Tromblay
San Francisco, CA**

Having worked for five years at Marina Village Yacht Harbor in Alameda, Linda just had to escape the bad jokes and infectious laughter of Harbormaster Alan Weaver.

Just kidding. Actually, she and her husband Mike say they've "benefited greatly from Alan's advice and experience." After all he's done the Ha-Ha a half dozen times on various boats.

After driving UPS trucks for 34 years, we'd bet that Mike is ready to embrace an alternate means of transport. The game plan is to take it slow, cruising where the wind and their whims take them. Eventually, they expect to end up on the U.S. East Coast.

**Willow — Westsail 32
BJ & Merry Loew, Pasco, WA**
Old habits die hard. For example,

NOMAR™ BUMPERS

Manufactured By:

HOLMES MARINE SPECIALTIES
HMS

Meeting Your Docking Needs



PATENT PENDING

Imagine NOT having the hassle of taking your fenders ON and OFF every time you go in and out of your slip? Are you tired of having them constantly riding up on the docks, and getting your hull marked up or worse? Paying for expensive hull rub-outs or repairs? We have great news for you. HMS is now manufacturing a new style of Dock Bumper. A bumper that uses no staples, screws, bolts or nails to attach. Not only is the new style of bumper extremely durable, it is also removable so you can take it with you if you move. Now available in three mounting formats to meet your docking needs.

For more information and a FREE Price Quote please call us at

800-501-0607

or visit www.holmesms.com

See us at the
**NORTHERN CALIFORNIA
FALL BOAT SHOW**
September 10-18
Jack London Square
Oakland

BAJA HA-HA XII PROFILES, PT I

after teaching science for 30 years, we're told that BJ "still carries a red pen in his pocket and jumps up and runs when he hears a ringing bell!"

By contrast, we understand that Merry, "has made it her mission for the past year to forget completely the 24 years she spent writing procedures for a contractor to the Federal government."

Both are avid outdoor adventurers and travelers, so they expect their transition to the cruising life will be an easy one. Plans are open-ended and may include a Pacific circuit and/or an exploration of European canals. During the Ha-Ha, David Beach will be along as crew.

Nootka — Island Packet 40 Glen Read, Edmonds, WA

Glen explains that the name Nootka was given to Vancouver Island Indians by Captain Cook. It literally means "go around," he says, "and that is likely what Nootka will be doing — going around and around trying to find the finish line."



Judging by this photo — and his profile — Capt. Glen of 'Nootka' must be quite a character.

Like Glen, his lively crew, Marty Lumsden and Jeff Quinn, are both licensed captains. But since it's Glen's boat, and he's the "old fart" among them, he "gets to shout the loudest."

Having sailed for 40 years, Glen has had more than his share of adventures already. He offers this sampling: "I've been chased by ladies of the night in Bornea (or were they Wombats?), been shelled by the Ethiopian Navy in the Red Sea, and learned to weave tapestries with

a hermit on Dunk Island while on the Great Barrier Reef."

Tranquillo — Catalina 400 Lloyd & Colleen Clauss Huntington Beach, CA

"One Ha-Ha deserves another," says Lloyd. He and Colleen are veterans of the 2003 Rally, so we assume they know their way to the Cape. The duo has owned six boats, upgrading to this beauty in 2002 when she was new. Lloyd, by the way, has been sailing since 1960.

This year the goal is to cruise south after the Rally, then eventually head north again to gunkhole through the Sea of Cortez. Bob and Sandy Snyders will serve as additional Ha-Ha crew.

Gettin' Around — Catalina 400 Doug & June Springstead Suisun City, CA

"I may be broke," says Doug, "but the boat is safe and is up to the trip." An aircraft mechanic by trade, he retired last year from "a major bankrupt airline." Doug's introduction to sailing is a bit

Survive Your Dream

Find out why...

- ★ Latest 'ARC Gear Survey' rates Hydrovane #1 in ALL categories!
- ★ Hydrovane is the leading self steering system in the UK
- ★ Hydrovane is the favorite of delivery skippers



Hydrovane is both:

- ★ Self Steering
- ★ The BEST Emergency Steering



Sponsor of the Baja Ha-Ha Cruiser Rally

www.hydrovane.com

604-925-2660 fax 604-925-2653 info@hydrovane.com

WeatherNet & GRIB Explorer

**Access more weather information
On-Demand & display it like you have
never seen it before.**



**Contact your local marine electronics dealer
or OCENS at:**

www.ocens.com - 800.746.1462

— RUNNING FROM THE RAT RACE

out of the ordinary. He learned the sport while in the Navy, stationed in Panama during the mid-'80s.

June's working life has been equally interesting. She was a "lab tech" for Anheuser Busch. Damn, is that like. . . a beer taster? Hmmm. There may be an job opening suds factory these days, as June, too, is now retired.

Darrell and Diane Huseh will be along as crew during the Rally. Afterwards Doug and June will be looking for another couple to continue the cruise with them, south to Panama and through the West Indies. Eventually they expect to end up at Titusville, Florida, their new home base.

Sea Lady — Brewer 42 Stephen & Kay Terzian, Bend, OR

We've never met Stephen or Kay, but we already like their sense of humor. They tell us that *Sea Lady's* motto is: "Semper Gumby" (always flexible). If there's one endeavor in life where you need to stay flexible, it's sailing.

Having retired early, like so many other Ha-Ha'ers, they too plan to con-



Having paid their dues, Phillip and Madelyn are 'In the Mood' for some serious R&R.

tinue south, hang a left and explore the Caribbean. Stephen, by the way, was a firefighter and Kay worked for the building department. Steve learned to sail as a kid in the Sea Scouts, while Kay is a recent inductee (2003). No doubt she's a good sport.

In the Mood — Sabre 38 Phillip & Madelyn Case, Seattle

"We're 'in the mood' for sunshine and the Mexican coast," say the Cases. Phil-

lip, a retired architect, and Madelyn, a former teacher, have both been sailing for 20 years, and they've owned this sweet Sabre sloop for seven.

We shouldn't have to worry about *In the Mood* getting lost on the trip south, especially since they'll have the help of two ol' salts, Pierson Smith and Thomas Gray. Smith is a longtime ocean master and chief engineer who has logged untold sea miles, including many Atlantic crossings and a couple of years fishing in the Bering Sea.

After the Rally, the Cases plan to spend at least a year exploring the Sea of Cortez and the Mexican coast.

Bata Mor — Island Packet 43 Timothy & Tim Harrington Phoenix, AZ

Here's a switch. Captain Timothy says that after sweltering in the Arizona desert all summer, he's "looking forward to the cool Pacific coast of Baja this fall." We hope he's not disappointed as the air and sea temps heat up on the approach to Cabo.

Actually, the skipper knows exactly

FRESH THINKING.

The PowerSurvivor 40E Watermaker is the best solution for the self-sufficient lifestyle.



Official Sponsor
2005
BAJA
HA-HA

Simplicity - Simple design and rugged construction. Easy to install, operate, and maintain.

Efficiency - Using only 4 amps, the 40E can run on alternative power alone or can be pumped manually in case of power failure.

Reliability - Built to last. The PowerSurvivor 40E is the #1 best selling watermaker for cruising sailboats.

Learn more about a great way to improve your life onboard - all for about \$3000.

www.katadyn.com

KATADYN
MAKING WATER DRINKING WATER

BAJA HA-HA XII PROFILES, PT I

what he's in for, as he is a veteran of the 2003 Ha-Ha. Joining him this time will be his son, Tim, Jr., and friends Bob Biggar and Steve Shedd. They figure the most interesting thing about their entry is "the idea of 'racing' an Island Packet that's loaded down with fixtures and provisions for months in Mexico."

**Ticket to Ride — Celestial 50
Damien McCullough
Santa Ana, CA**

According to Damien, finally cruising to Mexico will be the realization of a dream he's held for 23 years. "My attitude towards this is one of both adventure and tranquility," he explains. He looks forward to "breaking the bonds of corporate responsibilities and exchanging them for the simple thrills of life."

Now retired from a career in aerospace manufacturing, Damien plans to "continue south with no particular schedule," eventually taking his big pilot house sloop through the Canal and into



Young dudes on vacation. 'M', 'BW' and the boys are headin' out aboard 'Bingo'.

the Carib.

On the Ha-Ha, he'll have plenty of help with watch-standing. Frank and Joni Hajar, their 9-year-old daughter Kiara, and Deborah Ream are all on his crew list.

**Bingo — Choate-Fao 37
M. DeMeritt & Bryan (BW) Maher
Hermosa Beach, CA**

We get the feeling that although 'M'

and 'BW' are only 28 and 27 respectively, they've already had enough of the rat race. As they put it, "We just want to get as far away from the 405 freeway as possible." Their game plan is to keep on going. . . first south along the Central American coast, then west into the big blue Pacific.

Joining them, at least until reaching the Cape, will be Joel McFadden and Scott Cincotta. We've never met any of these young bucks, but we're impressed that each of them has already earned a Coast Guard

captain's license. Still, we imagine they'll be easy to spot on the dance floor at the famous Squid Roe.

**Beltane — Hallberg-Rassy 39
Steve Hannon & Susan Steinway
Lakewood, CO**

Steve, a longtime sailor, is a retired lawyer — or, as another Ha-Ha attorney termed his status, a "recovering lawyer." He first learned to sail on Colorado lakes many moons ago. A few years later he



las hadas
golf & resort manzanillo
GRUPO HOTELERO BRISAS

COME AND VISIT US!!!



- Spaces from 20-100' long
- Internet
- Each space comes with its own mooring
- Laundry room
- 62 private spaces available
- Showers
- Double breakwater
- Diesel & gas station
- Dry marina storage
- Parking
- Port Clearance
- 24-hour security
- Water and power supply (30 & 50 amp)
- Picnic area
- Controlled access to dock
- Restaurant (boat service)
- Private swimming beach right next to your vessel
- Launch ramp

hadas.marina@brisas.com.mx
www.brisas.com.mx
Tel: 011 52 (314) 331-0101
Tel/Fax: 011 52 (314) 331-0127
at Manzanillo 'The Sail Fish Capital'
Col. Mexico

30 Years of Charm & Magic
19° 06' N / 104° 21' W

— RUNNING FROM THE RAT RACE

crossed the Atlantic in a newly-purchased Camper-Nich 40.

Years later, after falling in love with Susan, the pair bought this German Frers-designed offshore cruiser in Europe and Steve brought her across the pond with the 2000 ARC Rally. She was then shipped to Vancouver, where the couple has done substantial cruising together. But Steve's true passion is singlehanding. Last summer, in fact, he soloed 3,600 miles up to Alaska and back, with Susan flying in a couple of times to rendezvous.

After the Ha-Ha, the couple will cruise the Sea of Cortez, eventually laying up *Beltane* in San Carlos for the summer.

Windarra — Roberts 44 Steve Bergo, San Diego, CA

"I started reading *Latitude 38* six years ago and knew after the second issue that the 400-mile range of my sportfisher wasn't going to cut it," says Steve. He learned to sail just two years ago and bought this lovely ketch in June, 2004.

Speaking about his 'Viking' heritage, Steve says, "I am 'Norske', but too old to



Like many Ha-Ha'ers, Steve of 'Windarra' intends to do plenty of fishing on the trip south.

pillage and plunder. So the "nothing serious" rally fits perfectly. In other words he and his fun-loving crew of — how many? — six guys are out to have some serious fun. By the time *Windarra* reaches the starting line, she'll be loaded to the gunnels with surfboards, kayaks and diving gear, plus massive quantities of beer and food.

On the crew roster are: Gus Larson,

Mike Montgomery, Darren Lee, Steve Fazziola and Max Davis. Look out Cabo!

Gone Again — J/42 Alex Schmid & Tina Hogan Lafayette, CA

We can't guarantee perfect weather during the Ha-Ha, but it is bound to be better than some conditions Alex and his first mate, Mitch Ward, have experienced aboard *Gone Again*. Five years ago, they brought her from Vancouver Island to San Francisco, and off the Oregon coast they "suffered 60-knot winds and 22-foot seas!" Compared to that, cruising in Mexico should be a walk in the park.

Their respective wives, Tina and Ann, claim to be "eager, but somewhat reluctant crew." If that seems like a contradiction, it's probably because, well... they're 'conflicted' after hearing the horror stories. No worries, we'll bet they'll all have a "nothin' to it" attitude by the time they reach Cabo.

After the Rally, Alex and Tina plan to cruise Mexico for a year. "After that, who knows?"

Whether you're cruising the Bay or cruising the world, first, cruise the web!

www.waypoints.com

www.hfradio.com

Nautical books, software, charts, GPS, radar, marine SSB & VHF radios, email, satellite telephones, & much more!

**Make us your Baja cruising resource--
Charts, Cruising Guides, Flags, and more!
New! PTC II USB Modem--more features, lower price!
In stock now!**



WAYPOINT

(510) 769-1547



H.F. Radio On Board

(510) 814-8881

1813 Clement Ave., Bldg. 24, Alameda, CA 94501
Prefer shopping in person? Call for an appointment!



BAJA HA-HA XII PROFILES, PT I

**Linda — Rhodes Bounty II
Steve & Linda Maggart
Elephant Butte, NM**

As longtime *Latitude* readers know, we have a special place in our hearts for Bounty IIs. It was while living aboard one that the mag's founder — aka the Ha-Ha's "Grand Poobah" — produced the first few issues, right there on the settee table.

Steve and Linda apparently have better sense. Having bought *Linda* in Seattle, and trucked her to New Mexico, they completely refurbished her inside and out, including a new teak interior. Today, they say, she's in "bristol condition."

After meeting on a blind date 13 years ago, they found they both loved watersports, which apparently helped cement their bond. Their honeymoon included a dive trip to the Caribbean. After the Ha-Ha, they plan to cruise Mexico, then eventually cross the Pacific to New Zealand.



Posing like a salty version of American Gothic, Steve and Linda of 'Linda' enjoy crabbing.

**Charissa — Liberty 458
Tom Jones & Tracy Deally
San Mateo**

If you're looking for a guy who can climb a mast without getting the jitters, Tom may be your man. He recently retired from a career with PG&E, where he worked as a crew foreman and spent untold hours hanging off power poles.

An outdoor sort of guy, he's done just about every sport that requires daring and adrenaline — most notably, motorcycle racing.

Even before his recent retirement, he

had his mind set on sailing to Mexico and soaking up its sunny climate. He shopped around, and finally found *Charissa*, a solid boat which has already circumnavigated.

Sailing with him will be his girlfriend Tracy Deally — who we know virtually nothing about — and additional crew who are yet to be determined. Although Tracy will fly home after the Rally, Tom plans to stay in

Mexico indefinitely. You might recognize him, because he apparently loves to dance. "You probably haven't heard of my style of dancing, though. I call it 'Drunken Tom' and it sure is fun!"

On that note, we'll take a breather until next month when... the profiles will continue.

If you're sitting out there toying with the idea of joining the fun this year, there's little time left to procrastinate. The entry deadline is September 10. See www.baja-haha.com for details.

— *latitude/aet*

Two... now one

Cabo

Marinas de Baja
CABO SAN LUCAS MEXICO
Tel 011 52 624 1436522
Toll Free 1 877 696 2281
www.marinadebaja.com

La Pa

Marinas de Baja
PALMIRA
Tel 011 52 612 1237000
Toll Free 1 877 217 1513
www.marinapalmira.com

SUNNY ✨ WARM ✨ FRIENDLY

LOCH LOMOND MARINA
IN SAN RAFAEL



Completely Rebuilt Marina
Recently Dredged
Gas & Diesel Fuel Dock Open 7 Days
Free Pump Out Station
24 Hour Card Key Access
Modern Launch Ramp
Guest Slips Available

Protected by Large Breakwater
Monitor Channel 16
On Site Security
Restrooms/Showers

HOME OF:
• Live Bait Shop
• Loch Lomond Yacht Club
• Marine Mechanical Boat Repair
• Windjammer Yacht Sales
• Arena Marine Supply Store
• Bobby's Fo'c'sle Cafe
• Bruno's Grocery Store
• Land or Sea Canvas



110 Loch Lomond Drive, San Rafael, CA 94901

Phone: (415) 454-7228 • Fax: (415) 454-6154
www.lochlomondmarina.com

Ensenada Bay Beach
Homes for Yachtsmen
Next to Marina Coral

The most desirable area
of the famous Ensenada Bay

Boat slip leases available
at Marina Coral
located next door

1 hour from
San Diego

Ocean Views

Southwestern YACHT CLUB
ANNOUNCE THE
42nd. Annual
San Diego to Ensenada
International Yacht Race
October 7th 2005

OFFICIAL SPONSOR

PLAYITAS CLUB DEL MAR

011 52 (646) 175-2439
(619) 944 4783
Ensenada, B.C. México

www.playitasclubdelmar.com

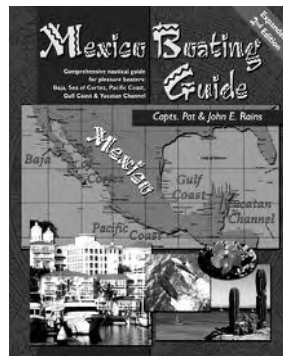

Rains' nautical guidebook
New & expanded
fall 2005

2nd
edition

Mexico Boating Guide

- More detail in **entire** Sea of Cortez!
- **350 Charts** GPS- and Satellite-accurate!
- **500 new photos**, 4-color every page.
- New **Satellite Images** in 4-color, wow!
- New port-clearance **rules & blank forms**.
- Covers all Mexico. New "Resource Guide"
- Expanded to **416 pages**, concise, no fluff.
- by **American** USCG-licensed captains.

www.MexicoBoating.com
toll-free (888) 302-2628

TRANSPAC REVISITED

July's 43rd TransPac, the 100th anniversary celebration, was so good we thought we'd take one more look at it — as well as update and expand last month's article, which was written before the race finished. This was a banner year for the race, with 75 starters (second only to the 80-boat fleet in 1979), including 14 from the Bay Area. Befitting the gala occasion, and defying the strange, unsettled weather, all sorts of records were broken, not to mention all kinds of other 'firsts'. Following are some excerpts from the 2005 TransPac highlight reel:

Fastest time — As everybody surely already knows, Hasso Plattner's R/P maxZ86 *Morning Glory* won the Barn Door, crushing *Pyewacket's* 1999 record by almost 20 hours (four other boats also broke the old record: *Pyewacket*, *Genuine Risk*, *Magnitude*, and *Windquest*). The new time to beat is 6 days, 16 hours, 4 minutes, and 11 seconds. Along the way, *MG* also set a new 24-hour TransPac record of 393 miles. Imagine if it had actually been windy!

Slowest time — Improbably, the same race also produced the slowest ever time between L.A. and Honolulu — 22 days, 11 hours, 36 minutes, set by Aloha division sailors Jim and Annie Read in their 1968 Stewart 42 *Camille*. The Reads, the first married doublehanders in the history of the race, started a day late and never caught up. They took a decidedly low-key approach to the race, even bringing along 'Sweetie Pie', their Havanese dog. The Reads finished on August 2, four days after the final festivities, and have since taken off cruising.

End of an era — Popular *Pyewacket* skipper Roy Disney, 75, hung up his seaboots after the race, his 15th TransPac. No owner has done more TransPacs or given more back to the race than Disney, and he will be sorely missed. "This race is not about the big boats," remarked Disney in his 'farewell address' to a packed house of 1,040 sailors and guests at the awards ceremony in the Ilikai Ballroom. "It's about the Cal 40s, it's about *B'Quest's* disabled sailors, it's about *Bubala* and the old geezers. Keep doing this. I've brought all four of our kids up on it. Thank you, all of you."

Disney subsequently donated his pristine maxZ86 to Orange Coast College (see *Pyewacket Goes to School* on page 134), and is already talking with the Reichel/Pugh office about building a 60-some-foot cruising boat. Hopefully, his sailing schedule will include a stopover



GERICONSER@EARTHLINK.NET

in Honolulu in July '07. Maybe by then, the Ala Wai Yacht Harbor may even be fixed (see page 56).

Bay Area boats — For a change, the Bay Area was well-represented in terms of numbers — 14 boats, including 5 Cal 40s — and podium finishes. Best of all, a Santa Cruz-based R/P TP-52, Roger Sturgeon's *Rosebud*, won the race overall! Philippe Kahn's new Farr

TP-52, *Pegasus 52*, also based out of Santa Cruz, was a close second overall. Two other NorCal boats also took home trophies: Sally Lindsay Honey's Cal 40 *Illusion* was second in class, and Bob and Rob Barton's Andrews 56 *Cipango* was third.

Ooops, sorry — Last month, in our deadline daze, we mentioned that the Grand Prix Sailing Academy's 1D-35

— STILL CRAZY AFTER ALL THESE YEARS



Grinding away — Don Grind's Cal 40 'Far Far' hit 14 knots, the top speed of their trip, as they approached the Diamond Head finish line.

Sensation took third in Division IV, which turned out to be pretty wide of the mark. They were projected to finish third with just a day to go, so it seemed like a safe assumption. Wrong! The Andrews 43 *Kahoots* (ex-It's OK!) ended up third, behind

the doublehanded 1D-35 *Two Guys on the Edge*, which had been incommunicado for several days. *Sensation* sank to sixth, 51 minutes out of third. The fourth place boat, the Santa Barbara-based J/120 *Wild Impulse*, probably felt even worse than *Sensation* — they corrected out a mere 12 seconds behind *Kahoots*!

The amazing Cal 40 revival, cont'd
— Building on the last race's 10-boat Cal

40 turnout, 14 boats showed up at the starting line on July 11, tying the all-time Cal 40 TransPac turnout set in 1967. Next time, there could even be more (between 155-160 of these '63 designs were built, many of which have been restored and are waiting in the wings).

Like the sleds of the mid-'80s, each Cal 40 was configured slightly differently — but it was still basically one design

TRANSPAC REVISITED

ocean racing. With all due respect to the rockstars on the maxis, this fleet of 'ordinary people on ordinary boats' was truly the backbone of this year's race. *Ralphie* rolled the dice early with a dive south, and went on to win the 'jalopy race' by 10 hours. They also finished fourth overall on corrected time, and probably would have won overall if the entire first start, 33 boats, hadn't been screwed by the weather getting off the coast.

More all-women crew — Prior to this year, only five all-women teams have taken on the TransPac: *Concubine* ('79), *Antara* ('93, '95), *Baywolf* ('97), and *Pegasus* ('97). This year, in a nice trend, there were two such projects: *Illusion* (Sally Lindsay Honey, Charlie 'Susan' Arms, Liz Baylis, and Melinda Erkelens) took second in the Cal 40 fleet — the best finish ever by an all-women team — and the Catalina 470 *Charmed Life* (Pat Garfield, Diane Murray) made history as the first all-women doublehanded team.

"This was a harder race than when we won in '03," noted Sally. "Our fleet was bigger and way better, and the race itself was a real head-scratcher. We dove south with *Ralphie*, but chickened out and came north again too early, covering the fleet rather than the breakaway boat. We were as low as eighth at one roll call, but clawed our way back with four good drivers and good speed. We jibed 35 times, each time getting everyone up. It was a fabulous trip — I'd go anywhere with this crew!"

Old men rule — Newport Beach skipper Lloyd Sellinger, 72, and his handpicked crew of self-proclaimed "old guys" sailed *Bubala* to 13th in the Cal 40

On the Edge — The aptly named doublehanded 1D-35 *Two Guys on the Edge* on the homestretch. They were second in Div. IV.



GERI CONSER

A taste of Honey — *'Illusion'*, sailed by Sally Lindsay Honey and three other talented women, was second in the Cal 40s.

class. Their race lasted 15 days and 21 hours — over twice as long as the maxis — but all aboard considered the voyage a huge success. "You know what, we won!" claimed Sellinger. "I hope people who are as old as we are will take on challenges. Just because you are a little older doesn't mean you have to just wait for the undertaker."

Congratulations to Sellinger and crew Mike Gass, 67; Andy Szaz, 68; Herb Huber, 68; Jim Doherty, 68; and Gordon Livingston, the youngster at 66. At an average age of 68 years, this is the oldest crew ever to sail in the TransPac — truly an inspirational accomplishment.

Disabled guys rule, too — And speaking of inspirations, The San Diego-based Challenged America gang was back for the second time in a row with their Tripp 40 *B'Quest*. This year, they sailed with just five aboard, as Jeff Reinhold had to drop out prior to the start with an infected elbow. Four of the crew are disabled in some way — Urban Miyares,

Jim Halverson, Kevin Wixom, and Scott Meide — while skipper Joshua Ross is a "TAB" ("temporarily-able bodied"). This intrepid group led Division V after three days, and hung on to finish fourth out of eight boats, a tremendous achievement. "By all accounts, it looked like an impossibility," said Miyares, a blind Vietnam vet who



GERI CONSER



RICH ROBERTS, UNDERTHE SUNPHOTOS.COM

The Bubbas — The *'Bubala'* crew, the oldest group ever to do the race, pose for a family portrait. Their T-shirts claimed, "Old Men Rule!"

co-founded Challenged America. "Just getting to the starting line has been our success."

David vs. the Goliaths — Scott Self and crew Nigel Brown scored an unprecedented double whammy with their tiny Hobie 33 *Soap Opera*, winning the eight-boat Division V by 8 hours, as well as comfortably topping the seven-boat doublehanded sub-class. "We're just Texas lake sailors. Our whole program budget was \$20,000, less than some skippers spend for a new spinnaker," commented Self, who hopes to see a fleet of Hobie 33s on the starting line in '07.

The envelopes, please — *Morning Glory* boat captain Pete Pendleton received the Don Vaughn Trophy as the outstanding crewmember of the fastest boat, an honor bestowed by his crewmates. . . Ivan Chan Wa, director of pier operations — no easy task considering the ongoing mess in the Ala Wai — earned the top volunteer award. . . 11-year-old Bernardo Guzman, who crewed for his parents on their Acapulco-based J/145 *Jeito*, was honored as the youngest person in the race.

"The TransPac is back!" concluded TPYC Commodore Jerry Montgomery. "This was a really gratifying turnout after just 33 boats in '99 and '01, and then 59 in '03. I'd say this was the best one in quite a while, with a really diverse fleet and all kinds of sub-stories. It was a great time, worthy of our Centennial celebration."

See www.transpacificyc.org for more.

— latitude/rkm

The San Diego Yacht Club Presents...

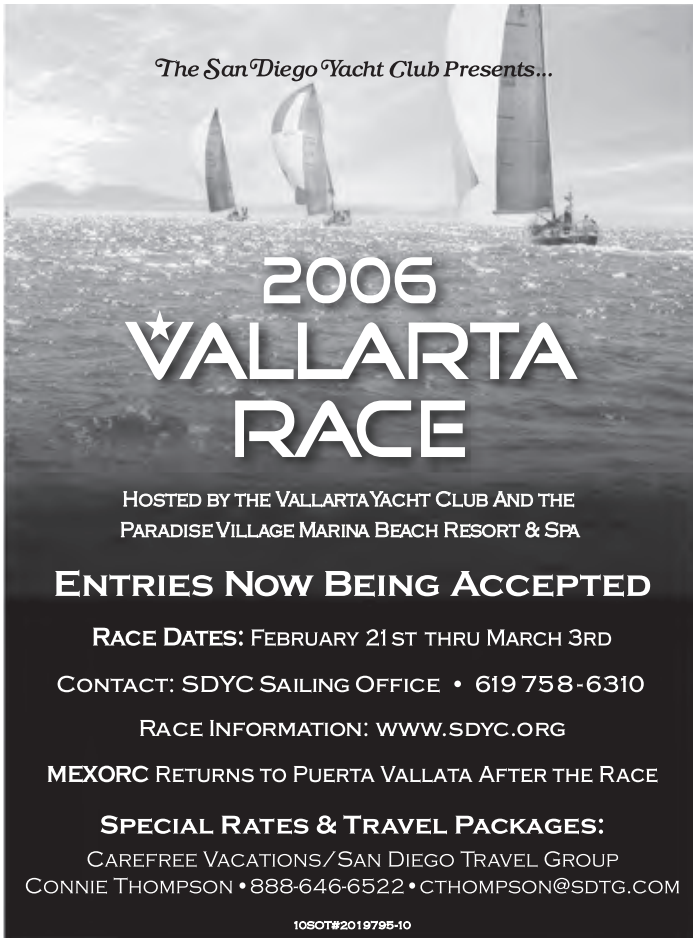

2006 ★ VALLARTA RACE

HOSTED BY THE VALLARTA YACHT CLUB AND THE
PARADISE VILLAGE MARINA BEACH RESORT & SPA

ENTRIES NOW BEING ACCEPTED

RACE DATES: FEBRUARY 21ST THRU MARCH 3RD

CONTACT: SDYC SAILING OFFICE • 619 758-6310

RACE INFORMATION: WWW.SDYC.ORG

MEXORC RETURNS TO PUERTA VALLATA AFTER THE RACE

SPECIAL RATES & TRAVEL PACKAGES:

CAREFREE VACATIONS/SAN DIEGO TRAVEL GROUP
CONNIE THOMPSON • 888-646-6522 • CTHOMPSON@SDTG.COM

1090T#2019795-10

Boat Show SPECIALS



NCMA
Fall Show
Sept. 10-18



Cadet
Fastroller

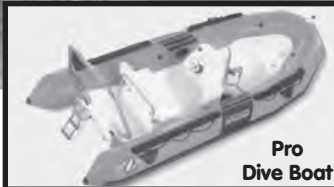

Pro
Dive Boat

- ☛ YACHT TENDERS
- ☛ PROFESSIONAL DIVE BOATS
- ☛ RIBs & ROLL-UPS
- ☛ LIFERAFTS
- ☛ SALES AND SERVICE



CALL TODAY FOR **LOWEST PRICE OF THE YEAR!**

Tim's Zodiac Marine

45570 Industrial Place #10, Fremont, CA 94538

(510) 438-9881



AVON INFLATABLES



Spinnaker Shop

a division of
Precision Technical Sewing, Inc.

Making fabric work on land and sea since 1979

Your Off-Shore Canvas Experts!



Ocean-going Kite-saving Speed Gear

In this year's TransPac, the 14-boat Cal 40 fleet enjoyed fiercely close competition with places changing radically throughout the race. Every gear set-back threatened a dropped position. In the generally light conditions, many boats reported problems with wrapped spinnakers, which destroyed primary kites and cost many miles. **Ralphie** and **Illusion**, 1st and 2nd place Cal 40's, used Spinnaker Shop nets, as did **Callisto**. Without the net, **Illusion** would have had 35 wraps.

Spinnaker Shop nets have also saved these boats: Eyrie, **Hawkfarm**, class winner, 2004 Pacific Cup Surprise, **Schumacher 46**, PacCup 2004 David Rasmussen had nets on both his **Express 27** and his **Synergy 1000**, 2-handed and fully crewed. Richard Craig's **J105**, PacCup 2004, 3-handed.

Call for a quote before your next off-shore venture.

921 E CHARLESTON RD, PALO ALTO, CA 94303

650-858-1544 FAX 856-1638

For Specific Passage-making advice,
please see our website at

www.spinnakershop.com

MAX EBB

Some boats have crew, some find crew, and some have crew thrust upon them.

The last option is what happened to me at the last beer can race. I was only down at the boat to check the bilge and air out the cabin, after which I planned to join the early seating for dinner before the racers were back. Maybe even help with the finish line, if they were short-handed. But it was not to be.

"Max! We're here!" shouted several female voices from the dock. I poked my head out the hatch to see Lee Helm with two of her friends. Without stopping to even ask if I was actually planning to race that night, they all clambered aboard and started to rig.

Lee is a naval architecture grad student, a great dinghy sailor and an accomplished big boat crew. When she wants to race she can have her pick of any boat in the harbor — so when she chooses my boat I really don't want to say no. On the other hand, there's usually an agenda.

She introduced her two friends, Lilly Pond and May Day.

"They're my students at the University Sailing Club," she explained. "And like, they're really making great progress toward their dinghy skipper rating. They'll be good crew."

"Well, okay," I said hesitantly, looking over the new recruits and evaluating their brand new foulies, the cheap faded lifejackets (with the sailing club's initials stenciled on the back), and what I suspected was just a touch of eye makeup. Their hair was perfect.

"Let's tee up the blade," said Lilly. "It's blowing like stink out in the slot."

"I'll run strings," added May. "Where's the jewelry box?"

"Sounds like they know what they're doing," I said to Lee as I directed them to the plastic milk crate full of snatch blocks and winch handles, "but you know, it takes more than four to race this boat."



TALK LIKE A RACING SAILOR — MODERN SAILING JARGON

accordion (v.) — compression or expansion of the fleet as it encounters wind or current gradients.

autotack (n.) — a tack caused by a sudden wind shift, requiring little or no alteration of course.

banana split (n.) — jibe-broach.

bang the corner (v.) — to sail all the way to one side of a race course in search of a strategic advantage.

barn door jibe (n.) — method of jibing an asymmetrical spinnaker in which the sail swings out in front of the boat.

barn door (n.) — first to finish position for any long ocean race, especially TransPac.

bent (adj.) — headed.

blackaller (n.) — kink or hockle in a sheet or halyard that prevents it from running freely through a fairlead or block. There are other names for the same thing, but this one is used with the utmost respect.

blade (n.) — heavy-air non-overlapping jib, usually full hoist.

boat bum or **boat butt** (n.) — medical condition caused by prolonged sitting in wet gear.

bogoknot (n.) — Unit of speed measurement, often applied to wind speed or boat speed. One bogoknot equals from 0.5 to 0.8 international knots.

bone (v.) — tighten or increase load on.

bounce (v.) — to tack on an opponent, causing them to tack predictably as in, "Should we bounce them again?"

brick (v.) — to tightly fold or flake a sail into a compact, heavy, rectangular shape

broach coach (n.) — boat with difficult downwind handling characteristics.

brodie (n.) — broach.

bubble boat (n.) — production cruising yacht with high freeboard and small cockpit to maximize internal volume.

bump (v.) — to pull or haul briefly but vigorously, as in "bump the topping lift at the mast."

buns up (adj.) — condition in which all available crew are using their weight to best advantage on the windward rail. Most frequently used as a command to assume this position.

burn (v.) — to completely release a heavily loaded sheet or halyard.

butt cleat (n.) — method of temporarily securing a halyard, sheet, or control line by pressing the line between one's posterior and the deck.

butting (v.) — tacking into a competitor's bad air.

caddie (n.) — a mainsheet winch grinder, or in general, a helper with any mostly-physical tasks on a boat.

Casper douse (n.) — spinnaker douse in which large portions of the spinnaker

fall on top of the crew, resembling ghost costumes.

cheap seats (n.) — crew positions on poorly performing boats.

cheat, cheat it up (v.) — to partially raise a sail in preparation for hoisting. For example, starting to raise a jib in preparation for the hoist at the leeward mark.

cheese grater (n.) — small-diameter rigging wire on trapeze dinghy.

checkbox position (n.) — 1) crew position with no function other than to pay for the boat and its operation (usually applied to the owner). 2) Orientation of two or more boats such that a serious collision appears to be unavoidable.

chicken chute (n.) — undersize spinnaker for heavy air, usually narrow and flat. Also known as a **shy kite**.

chicken jibe (n.) — the act of coming about instead of jibing in conditions where a jibe would be difficult or dangerous.

clever (n.) — Cunningham. (Also known as a **smart pig** or **ooker**.)

Clorox bottle (n.) cheaply-built fiberglass production sailboat, usually a design with emphasis on internal volume.

clubhouse reach (n.) — local Bay Area term for boats headed across the main Bay toward St. Francis YC.

code zero (n.) — largest jib. Originally a

— TALKING THE TALK



Pegging the funmeter on a Melges 24.

LATITUDE/JR

"Not to worry, Max. I invited some other people. And here are the snacks."

She handed over a bag full of designer pastries from the most expensive bakery in town. Taking that bag from her was like accepting a towline from a salvage tug — there was no way to back out now.

Just then my friend Roxanne Scholles walked by. She's owned a boat on this dock for years, and even though she's not a racer, has cruised everywhere and knows that winches go clockwise.

"Racing tonight?" she asked.

"If I get two or three more," I said. "Come aboard."

Roxanne wasn't sure she wanted to spend her evening getting cold and wet. The bag of pastries almost changed her mind, but she was last seen accepting what to her seemed like a better offer: a ride on Stan Chun's big cutter-rigged cruiser that usually comes in at the back of the fleet.

masthead jib that measures as a spinnaker, for use upwind in light air on a boat with fractional jib halyards but masthead spinnaker halyards. First popularized on Whitbread 60s.

cowboy (v.) — to flip the lazy spinnaker sheet over and around the active guy, or flip the sheet above the pole tip, as in "cowboy the sheet."

concertina effect (n.) — the tendency of ocean racing fleets to alternately bunch up and spread out as weather systems pass.

crab crusher (n.) — heavy, traditional-looking cruising yacht, often double-ended, characterized by poor performance, heavy gear, and infrequency of use.

crack off (v.) — to bear away or fall off.

crack (v.) — to ease a sheet or halyard slightly, especially one which is under heavy load.

d-1 (n.) — The first diagonal shroud on a multi-spreader rig. (Also **d-2**, **d-3**, etc. for subsequent shrouds farther up the mast.)

delaminate (v.) — 1) to remove clothing by layers; 2) any structural failure of a composite structure, regardless of whether actual delamination is involved.

DFL (adj.) — Dead f***ing last.

dangly pole (n.) — self-launching whisker pole

dillet (n.) — the opposite of a fillet (as seen on *Stars & Stripes* keel bulb in 1995).

dock potato (n.) — person who spends a lot of time at the marina or yacht club but seldom goes sailing.

dog the main (v.) — to let most or all of the mainsail flog ineffectively in strong wind.

down and dirty (adj.) — describes condition of the helm at the initiation of a tack, replacing "hard-a-lee."

downhill (adj.) — downwind.

downstairs (n.) — the cabin, or below-decks portion of a yacht.

drift set (n.) — floater set.

drop trav (v.) — to move the traveler car to leeward.

dude schooner (n.) — large vessel, often with only vestigial or decorative sails, used for group charter.

elephant ass (n.) — spinnaker with a large vertical fold or crease up the centerline.

Everest knot (n.) — any knot finished off with an excessive number of half hitches to use up the running end, simply "because it's there/"

facing (v.) — tacking directly on a competitor's wind.

fat (adv.) — "Sailing fat" is sailing slightly on the low and fast side of close-hauled, with sails often closer to stalling than

to luffing.

firehose reach (n.) — a beam reach with continuous spray on deck or in faces of sailors.

flag 'em (v.) — displaying a protest flag.

floater set (n.) — spinnaker set in which the pole is set after the sail is hoisted and filled.

floater douse (n.) — spinnaker douse in which the pole is removed before the douse.

flop (v.) — to come about or tack.

fraculator (n.) — headsail halyard or other control used to rake the rig forward for downwind sailing.

frontsail (n.) — jib.

fun meter (n.) — knotmeter. (Also, **steam gauge**.)

furniture boat (n.) — race boat with cruising accommodations.

garbage set (n.) — spinnaker set with sail rigged on wrong side, thrown into air like a bag of garbage.

gas (n.) — bad air downwind of another boat.

gauge (n.) — relative distance between two boats, distinct from bearing, as in, "Gaining gauge, losing bearing."

goose eggs (n.) — multiple zeros displayed on a knotmeter.

gravity storm (n.) — phrase indicating

continued on next page

MODERN SAILING JARGON — *cont'd*

why/how a boat dismasted.

grunt up (v.) — show some backbone!

hand sailing (v.) — describing sailing maneuvers, usually during a post-race analysis, by using palms of hands to represent courses and heel angles. (Also known as **bar karate**.)

hip (n.) — windward quarter of a boat, referring to position of competitor, as in “on our hip.”

hollywooding (v.) — overacting in some way to ‘fake’ a rival boat into doing something wrong. For example, turning to the boat next to you (which is doing nothing wrong) and shouting rules that don’t apply at top volume while throwing your hat down — causing the skipper to tack away in confusion.

hot it up (v.) — to sail higher and faster on a running or reaching leg.

hula (n.) — “hull appendage” to extend effective hull length without measuring as part of the hull.

huli (v.) — capsizes (Hawaiian).

hump (v.) — any action involving significant physical effort, as in “hump the number one up on deck” on a large boat.

hunt (v.) — to maneuver toward another boat that has to keep clear, with the intent of causing a foul.

jewelry box (n.) — container for blocks, shackles, cars, winch handles and other small expensive gear that is usually stowed below decks when not in use.

jewelry store (n.) — chandlery.

jibing simo (v.) — simultaneous jibing.

jump, jump the halyard (v.) — to raise a sail quickly by rapidly and repeatedly hanging from the halyard at the point where it exits the mast.

Kiwi clip-on (n.) — Hull appendage that extends effective waterline length. Also called hula for “hull appendage.” Used to describe appendage used on New Zealand AC defender in ‘03.

Kiwi douse (n.) — Spinnaker douse similar to Mexican Takedown, but with a symmetrical spinnaker.

knock (n.) — 1) header. 2) sudden strong gust of wind.

Koch Block (n.) — Running backstay or checkstay block positioned so that it could hit the head of the aft-most member of the afterguard when not under load. First coined during the 1992 America’s Cup defense aboard Bill Koch’s *America*³.

lead-mine (n.) — heavily ballasted yacht, often applied to early IOR designs. Used by multihull sailors to refer to all ballasted yachts.

lefty (n.) — wind shift to the left.

Letterbox douse (n.) — spinnaker douse in which the spinnaker is pulled between loose-footed mainsail and boom.

leverage (n.) — separation distance at right angles to the wind or course, producing a strategic advantage in the event of a favorable wind shift or current gradient.

made (adj.) — condition in which the spinnaker pole is re-connected to both the mast and the after guy at the conclusion of a jibe. Usually hailed by the foredeck crew to indicate that this condition has been reached.

making trees (v.) — moving sufficiently faster than another boat so that the background scenery appears to be moving forward behind them.

mastectomy (n.) — 1) the act of lowering a mast for maintenance or repair; 2) dismasting.

Maui bag (n.) — bag of disposable old clothing brought on ocean race. Each article of clothing is thrown overboard after being worn. “Here today, gone to Maui.”

meat-hook (n.) — broken strand of wire projecting a short distance from the surface of a wire rope.

Mexican take-down (n.) — Method of dousing a gennaker whereby the boat jibes first and the sail falls on deck, into the jib. Coined by Buddy Melges during the ‘92 or ‘95 America’s Cup campaign in San Diego, because the boat is usually

pointing south towards Mexico during the maneuver.

Mister Potato-Head boat (n.) — Boat with a number of unusual and replaceable appendages, especially America’s Cup Class. Used by Dawn Riley on OLN AC broadcast, Jan 12, 2003.

motor boating (v.) — severe leach flutter, especially when audible.

noodle (n.) — exceptionally thin and flexible mast.

overhaul (v.) — take up slack.

parade (n.) — reaching leg with little opportunity to pass or to be passed by another competitor.

parking it up (v.) — going slow. Used by *AmericaOne* afterguard on Jan 30, 2000.

parking lot (n.) — local region of negligible wind, usually containing several yachts. (Also know as a **hole**.) Races with several parking lots might have these areas designated “lot A”, “lot B,” etc. by competitors.

passing lanes (n.) — opportunities to pass, usually created by wind shifts.

pickle dish (n.) — trophy.

Pinocchio boat (n.) — sport boat with retractable bowsprit.

Plank sailor (n.) — windsurfer.

pointy end (n.) — the bow.

QFB (adj.) — Quite far back.

racing stripes (n.) — fenders accidentally left out during race.

rail meat (n.) — crew selected primarily for their weight.

rag the main (v.) to let the mainsail luff or flog ineffectively.

righty (n.) — wind shift to the right.

rollies (n. pl.) — symptom of marginal control while sailing downwind in heavy weather, characterized by rhythmic rolling through large angles.

room, the (n.) — protest room, protest procedure in general. As in, “Take it to The Room”

sacred wood (n.) — the tiller.

sail my boat (v.) — sail best VMG without entering bad air from competitor. as

Fortunately, just as Lee had promised, more of her friends continued to arrive.

Flo Field, an older woman whom Lee introduced as an expert in numerical hydrodynamics, climbed aboard.

“Kewel, Mark Hunter is here, too,” said Lee as a young man with very thick glasses joined us.

“This boat is trailing edge technology,”

she said apologetically to Flo and Mark, “but it can usually sail to its rating.”

“And there’s Bjorn Toulouse,” said Flo, pointing up to the parking lot.

“He’s a post-doc from Europe,” Lee explained.

The backpack that Bjorn brought aboard was partly unzipped, and as he passed it up to the boat I noticed a copy of a popular book about basic racing

strategy by Miles B. Hind.

I also noticed that they all seemed to be referring to folded-up sheets of paper whenever they asked for something or instructed each other on how to get the boat ready. Lee must have written up some rigging procedures for them. Nice touch, I thought. Lee helped them get the jib on deck and the spinnaker sheets run, then hopped off to untie the dock

in “Can I sail my boat?”

sand bag (n.) — 1) crew position, usually entry level, involving little more than positioning oneself on the correct side of the boat. See ‘rail meat.’ 2) slow down to protect PHRF rating.

sardined (v.) — caught between layline and right-of-way competitor.

sausage (n.) — 1) sailbag in shape of long tube. 2) windward-leeward course or windward-leeward segment of more complex course.

send it (v.) — to hoist or raise, as referring to a sail being set. Usually used as a command.

sewer (n.) — the below-decks space on a large racing yacht with minimal accommodations.

shrapnel (n.) — bits of metal hardware, such as blocks and shackles, normally stored in the jewelry box.

shy kite (n.) — undersize spinnaker for heavy air, usually narrow and flat. Also called a “chicken chute.”

sit on their face (v.) — to closely cover a competitor, matching them tack-for-tack and keeping them in bad air.

skirt (v.) — to flip the foot of the jib inboard of the lifelines or other obstructions.

sky, sky the pole (v.) — to inadvertently allow the spinnaker pole to rapidly swing upwards to a near-vertical position.

slam-dunk (n.) — the act of tacking on another boat’s wind in sufficiently close proximity to prevent the other boat from tacking away.

sled (n.) — large ultra-light racer with best performance “downhill.”

sleep (v.) — 1) “sleep the boat,” to heel the boat to leeward in light air 2) “put the main to sleep,” to flatten the mainsail to the point where it has almost no power, but does not luff despite very high windspeed.

snacktician (n.) — member of crew primarily responsible for food.

snout line (n.) — tack line; the line that runs from the tack of an asymmetrical

spinnaker to the stem or bowsprit end.
soak (v.) — to sail below polars for tactical advantage, probably from “soaking up” extra speed and turning some of it into a positional advantage.

soft, soft trim (adv.) — trimmed so that there is slight luffing, or luffing more often than stalling.

space case (n.) — plastic milk crate used for gear storage. (See ‘jewelry box.’)

spaghetti (n.) — disorganized sheet and halyard tails, usually piled together in a common tangle.

spaghetti patrol (n.) — the crew position responsible for, or the process of, methodically untangling and making up sheet and halyard tails.

speed bump (n.) — sailmaker’s term for unwanted wrinkle in a new sail.

spike (v.) — to release a triggerlock type shackle under heavy load using a fid, marlinspike or similar tool.

spinnaker (n.) — spinnaker.

spinnaker neck (n.) — sore or stiff neck suffered by spinnaker trimmer. Despite widespread epidemiology, spinnaker neck is not yet recognized by the American Council of Sports Medicine.

splash (v.) — to launch, especially by a boatyard, as in “no cash, no splash.”

square back (v.) — bring the pole back to a dead run position, usually immediately preceding a jibe.

square waves (n.) — very steep waves or chop.

sting or stinger (n.) — local gust of wind in light conditions.

stink, blowing like (adv.) — extremely windy.

string (n.) — line or rope.

sucking up (v.) — working up from just ahead and to leeward of a competitor to a covering position by taking advantage of lift in the “safe leeward” position.

tee up (v.) — to prepare a sail for hoisting, as in, “Tee up the #3.”

tea bagging (v.) — to lose control of one’s feet while trapezing from a dinghy and drag alongside the boat on the wire.

telephone pole (n.) — very stiff or over-built mast.

throw one (v.) — to tack or jibe, as in, “Let’s throw one.”

tiller bum or tiller butt (n.) — Medical condition caused by prolonged steering.

tractor (v.) — to assist the clew of an overlapping jib around the mast and rigging during a tack.

trans-nasally (adv.) — method of paying for marine hardware (equivalent to “through the nose”).

trip reef (n.) — flattening reef.

trip (v.) — to release the spinnaker pole from the guy and/or the mast. Often used by the driver as a command to the foredeck crew at the beginning of a jibe.

twing, tweaker (n.) — floating lead block which the spinnaker sheet is led through. Used to improve the lead angle when the sheet is functioning as an afterguy, or to keep the sheet clear of the main boom.

uphill (adj.) — upwind.

vanity jibe (n.) — an unnecessary jibe or modified jibe timing, done for the sole purpose of passing close to yacht club, committee boat, or spectators on shore.

victory roll (n.) — tight 360-degree turn performed under sail in front of the yacht club after returning from a race, to indicate a confirmed first-place finish.

VMG (n.) — velocity made good. Actual vessel speed after adjusting for such factors as current and leeway.

walk strings (v.) — to shift spinnaker gear so that the sail is ready to set on the opposite tack.

wallet-based (adj.) — driven more by money than by expertise.

wind (‘wynd’) or **wound** (v.) — progressive wind shift, usually a lift.

wind it up (v.) — to rapidly bring in a sheet or halyard which is under sufficient load to require the use of a winch.

wound, wound up (adj.) — lifted.

lines after I started the engine.

“Lines off!” I ordered.

“Clear fore and aft,” Lee shouted back from the dock.

I put the engine in gear. “Hop on,” I said as the gap between boat and dock widened.

“Have a great race,” Lee said with a wave.

“Wait a minute! Aren’t you coming

with us?”

“No way,” she answered. “I mean, like, the wind is up. I’m going windsurfing.”

That’s when I began to suspect what those pages of notes were all about. But it wasn’t until after they had all left, much later that evening, when I found a soggy copy in the chart table, that I knew for sure. It was a vocabulary list. Not the words in a nautical dictionary or the

glossary of a how-to-sail book, but a ‘secret’ list of the slang words and phrases in common usage among racers.

The race, of course, was a disaster. None of that crew had ever set foot on a boat with a keel before that evening, so I had to give sailing lessons while I single-handed the boat around the course. At least the pastries were good.

— max ebb

THE RACING

With reports this month on the SFYC-hosted Junior Olympics; the windy Waikiki Offshore Series; a six-pack of recent US Sailing championships; the Etchells Pre-Worlds; the Rolex Swan American Regatta in Newport, RI; the YRA Second Half Opener; a pair of pleasant ocean races; the Aldo Alessio Regatta; the Summer Keel Boat Regatta, Acts I and II; a bunch of national championships; the ongoing 470 Worlds; an American sweep at the IKC in Norway; and the usual mixed bag of box scores and race notes.

Junior Olympics

San Francisco YC hosted 112 youngsters on August 6-7 for the Junior Olympics, one of 24 such events around the country organized by US Sailing and presented by West Marine. Uncooperative winds in Belvedere Cove and around the corner in Richardson Bay led to an abbreviated weekend of racing in some of the classes, but everything else about the regatta was first class. The well-travelled California YC juniors fared especially well at the JOs, taking home the gold in four of the eight classes.

"This was the centerpiece of the Bay Area junior sailing season, kind of their Big Boat Series," noted Richard Feeny, director of youth sailing at SFYC. Certainly, it was the biggest and most successful Junior Olympics in the Bay Area to date, swollen by a huge 32-boat turnout in the Opti-Green class (the kinder, gentler Opti

ing down as the school year approaches, but there is one more big event on the horizon — the popular West Marine Fun Regatta in Santa Cruz on September 10-11. That's also the fifth and final regatta of the inaugural BAYS (Bay Area Youth Sailing) season championship, and newly-donated perpetual trophies, courtesy of Farr 40 sailor Chuck Parrish, will be awarded at the end of the weekend.

"Junior sailing in the Bay Area is getting better every year," concluded Feeny. "We have a long way to go to catch up with Southern California, but we're making progress."

OPTI — 1) Ben Spector, CalYC, 8 points; 2) James Moody, SFYC, 16; 3) Gregory Dair, CalYC, 19. (13 boats)

OPTI GREEN — 1) Henry Buckingham, SFYC, 28 points; 2) Michael Buhl, SFYC, 28; 3) Simone Staff, CalYC, 34; 4) Sammy Shea, SFYC, 36; 5) Natalie Urban, SFYC, 39. (32 boats)

LASER 4.7 — 1) Cody Young, EYC, 5 points. (1 boat)



PHOTOS BY LESLIE RICHTER

Optimists — SFYC members Henry Buckingham, above, and Jack Barton, right, shared the sportsmanship award at the Junior Olympics.

fleet geared toward the younger kids), and better-than-usual attendance in the 420 and Laser Radial fleets. Absent were the El Toros, which are now out of fashion with the junior league (though still popular with adults), and the 29er class, which is taking a breather after the recent Worlds.

The local junior sailing circuit is wind-



BYTE — 1) Jim Parker, OakYC, 8; 2) Max Brodie, JLAC, 12. (6 boats)

LASER — 1) Peter Wenner, CalYC, 15 points; 2) Brian Malouf, PYSF/SeqYC, 16. (6 boats)

LASER RADIAL — 1) Matt Wenner, CalYC, 15 points; 2) Dominique Bertrand, SFYC, 23; 3) Ashley Simpson, PYSF/SYC, 25; 4) Ryann Hall, CalYC, 30. (17 boats)

420 — 1) William Peterson/Kaytlin Hall, CalYC, 11 points; 2) Erik Glaser/Thomas Brook, EYC, 20; 3)



Alex Butti/Devon Lindsley, SFYC, 33. (11 boats)

CFJ — 1) Geoffrey Ruppert/Ali Gardiner, Newport Harbor YC, 10 points; 2) Tim Marymee/Mike Lazzaro, PYSF, 11. (8 boats)

Full results — www.sfyf.org

Waikiki Offshore Series

Waikiki YC's second Waikiki Offshore Series, held after the TransPac on July 31-August 8, attracted just eight boats for a windy 8-race series. To no one's surprise, Philippe Kahn's beautiful new Farr TP-52 *Pegasus 52* mopped up in Division I and overall, winning 8 of the 9 races overall. *Pegasus*, which swapped to an inshore keel after the TransPac, was expertly sailed by an all-star crew which included Adrian Stead (tactician), Adrienne Cahalan (navigator), Jeff Madrigali (strategist), Shark Kahn (grinder/back-up driver), Darren Jones, Adrian Finglas, Euan McNicol, Eric Arndt, Bob Wylie, Casey Smith, Kyle Gundersen, Justin Clougher, Peter Phelan, and Alan Nakaniishi.

"I sail everywhere around the world,



Horsing around — Philippe Kahn's new TP-52 'Pegasus 52' crushed the tiny fleet in the second Waikiki Offshore Series. Inset, 'Kaimiloa III' and 'Sensation' overlapped off Honolulu.

and conditions in Hawaii were the best — winds from 15 to 35 knots and waves from 1 to 12 feet, tropical waters and unbelievable scenery," said helmsman Kahn, an occasional resident of Honolulu. "It doesn't get any better than this!"

Kaimiloa III, Dave Nottage's local J/44, took Division II despite breaking their boom near the end of the week. Another local boat, the Farr 43 *Flash Gordon III*, was third, followed by *Sensation*, Gary Fanger's San Francisco-based 1D-35. *Sensation* started slowly — they ripped the forestay's hydraulic ram through the bulkhead on the first day and took two costly DNFs in the no-throwout series — but finished on a high note, winning the last race overall, the only boat to beat *Pegasus* all week. Not coincidentally, it wasn't until the last day that *Sensation* shook the reef out of their mainsail.

The Series, which saw winds and waves reminiscent of the legendary mid-'80s Kenwood Cups, was meant to include the overnight Molokai Race — but after polling the fleet (only *Pegasus* and *Sensation* were up for it), the race committee wisely replaced it with a 40-mile buoy race and the Bacardi Rum party. That race was the only one that all eight boats started and finished — the rest of the week was a war of attrition, with boats electing not to start some days and lots of DNFs due to gear failure.

DIV. I — 1) **Pegasus 52**, Farr TP-52, Philippe Kahn, 9 points; 2) **Braveheart**, B/W TP-52, Charles Burnett, Seattle, 22; 3) **Beecom**, R/P 72, Isao Mita, JPN, 30. (3 boats)

DIV. II — 1) **Kaimiloa III**, J/44, Dave Nottage, Kaneohe, 21 points; 2) **Flash Gordon III**, Farr 43, John Myhre & Harvey Arkin, Honolulu, 25; 3) **Sensation**, 1D-35, Gary Fanger, San Francisco, 26; 4) **Boomerang**, Sydney 41, John Spadaro, 39; 5) **Georntius**, Farr 42, Gil Budar, Honolulu, 48. (5 boats)

OVERALL — 1) **Pegasus 52**, 10 points; 2) **Kaimiloa III**, 38; 3) **Braveheart**, 39. (8 boats)

month, almost all of them in Southern California. Sailors from Area G —that's us! —participated in all six events, but only SFYC juniors Josh Leighton and Aaron Dornbrand-Lo landed on the podium. They were third out of twenty 420 teams in the Newport Harbor YC-hosted Bemis Trophy.

Complete results of all US Sailing championships can be found, as always, at www.ussailing.org.

INDEPENDENCE CUP (Chicago YC: 7/30-8/1):

FREEDOM 20 (gold) — 1) Karen Mitchell/Kerry Gruson (Deerfield Beach, FL/Miami, FL), 6 points; 2) Bob Jones/Ken Kelly (Issaquah, WA/Victoria, BC), 18. (7 boats). . . NorCal participants: 7) **Mike Strahle/Martha Hitchcock** (Redding, CA).

FREEDOM 20 (silver) — 1) Charles Rosenfield/Joe Del Vecchio (Woodstock, CT/East Providence, RI), 6 points; 2) Donna DeMarest/Paul McKenna (Waterbury, CT/Newport, RI), 12. (7 boats)

2.4 METRE (gold) — 1) Nick Scandone, Fountain Valley, CA, 7 points; 2) Rick Doerr, Clifton, NJ, 15. (6 boats)

2.4 METRE (silver) — 1) Mike Hersey, Hyannis, MA, 8 points; 2) Craig Wilson, Oakham, MA, 13; 3) **Lee Buratti**, Corte Madera, CA, 13. (6 boats)

LEITER CUP (CalYC: 7/30-8/5; Laser Radials):

1) Stephanie Roble, WI, 10 points; 2) Morgan Wilson, MD, 24; 3) Sarah Lihan, FL, 32; 4) Ann Haeger, IL, 45; 5) Allie Blecher, CA, 65; 6) Carolyn Prioleau, TX, 66; 7) Elizabeth Barry, CT, 73; 8) **Claire Dennis**, CA, 74; 9) Alaina Bussell, FL, 76; 10) Nicole Buechler, FL, 79. (60 sailors; 10 races; 2 throwouts)

SMYTHE (NHYC: Aug. 10-12; Lasers):

1) Camerson Cullman, American YC, 24 points; 2) Thomas Barrows, Pleon YC, 31; 3) Michael Easton, Portland YC, 32; 4) Austin Kana, Tred Avon YC, 38; 5) Drew Robb, Kaneohe YC, 42; 6) Jake Sorosky, Del Rey YC, 66; 7) Josh Garber, Minnetonka YC, 69; 8) Derick Vranizan, Seattle YC, 72; 9) Paige Johnston, San Diego YC, 72; 10) **Sean Kelly**, San Francisco YC, 73. . . Other NorCal participants; 18) **Brian Malouf**, Sequoia YC. (20 sailors; 10 races; 1 throwout)

BEMIS (NHYC: Aug. 10-12; 420s):

1) Cole Hatton/Blair Belling, Newport Harbor YC, 40 points; 2) Taylor Canfield/Nathan Rosenberg, St. Thomas YC, 45; 3) **Josh Leighton/Aaron Dornbrand-Lo**, San Francisco YC, 50; 4) John Kempton/Molly Lucas, Island Heights YC, 53; 5) Jonathan Bernbaum/Scott Szawiowski, Columbia YC, 53; 6) Jeff Knowles/Caila Johnson, Sail Newport, 53; 7) Willy Peterson/Kaylin Hall, Cal YC, 60; 8) Ned Turney/Sandra Williams, Chicago YC, 62; 9) Sara Watters/Franny Kupersmith, Tred Avon YC, 76; 10) Amanda Sackett/John Rogers, Mento Harbor YC,

COURTESY TEAM PEGASUS; INSET, DARIN SLADE

THE RACING

80. . . Other NorCal participants: 20) **Megan Grove/Lindsay Grove**, Encinal YC. (20 teams; 10 races; 1 throwout)

SEARS (Balboa YC; Aug. 8-12; GovCup 21s):

1) Ted Hale/Evan Aras/Joe Morris, Annapolis YC, 17 points; 2) Jackson Benvenuti/Gary Taylor/David Bolyard, Bay Waveland YC, 20; 3) Christian Emsiek/Wade Buston/Perry Emsiek, Balboa YC, 34; 4) Chad Miller/Daniel Hagan/Peter Hazelett, Mallets Bay BC, 38; 5) Carl Shorett/Patrick Layton/Garrett Linrothe, Port Madison YC, 38. . . NorCal participants: 8) **Alex Lowry/John Gray/Christina Nagatani**, Richmond YC. (10 teams; 10 races; 1 throwout)

O'DAY (Alamitos Bay YC; Aug. 18-21; Lasers):

1) Brian Taugher, Huntington Beach, 25 points; 2) Reed Johnson, Toms River, NJ, 33; 3) Thomas Barrows, St. Thomas, USVI, 53; 4) **Peter Phelan**, Santa Cruz, 57; 5) Vann Wilson, Long Beach, 62; 6) Chuck Tripp, San Pedro, 67; 7) Mark Bear, Boston, 76; 8) Daniel Falk, Seattle, 78; 9) Kurt Miller, Boulder, CO, 85; 10) Drew Robb, Honolulu, 90. . . Other NorCal participants: 13) **Tracy Usher**; 21) **Jeffrey Sloan**, Santa Rosa. (23 sailors; 9 races; no throwouts; www.abyc.org)

Etchells Pre-Worlds

Richmond YC hosted the Etchells Pre-Worlds on the Berkeley Circle on August 13-14, with 28 boats in attendance. Two races were held each day in 12-18 knots of breeze, with lots of wind shifts and general recalls. Popular Marblehead sailmaker Jud Smith mastered the challenging conditions with apparent ease, putting together a 1,2,2,1 record to win the regatta over locals Russ Silvestri and Peter Vessella.

Smith, who sailed with Henry Frazier (South Carolina) and Andrew Wills (NZL), displayed boatspeed to burn and flawless tactics. "He was on fire all weekend, and appears to be the guy to beat at the Worlds," noted Jim Gregory, who finished ninth. "Jud's been the bridesmaid four times in the Worlds, and is long overdue to win it."



DANIEL FORSTER/ROLEX

The last tune-up before the Worlds was SFYC's Eason Founder's Regatta on August 27-28, which was shaping up to be even bigger than the Pre-Worlds (see www.sfyf.org for results). The main event, the six-race Etchells Worlds, will take place on the Circle between September 5-10. About 80 boats are expected for what promises to be the most competitive regatta on the Bay this year.

Follow all the action at www.sf-etchells.org.

1) Jud Smith (Henry Frazier/Andrew Wills), 6 points; 2) Russ Silvestri (Jim Nichols/unknown), 12; 3) Peter Vessella (Scott Gordon/Matt Carter), 15; 4) Jeff Pape (Chris Busch/Rodney Hagebols), 27; 5) Vince Brun (Ben Mitchell/Brian Terhaar), 28; 6) Brian Camet (Alex Camet/ D. Camet), 30; 7) Craig Healy (Dave Gruver/Keith Stahnke), 33; 8) Peter Duncan (Bill Barton/T. Blackwell), 34; 9) Jim Gregory (Tracy Usher/Mike Ruff), 36; 10) Marvin Beckmann (L.

Ramping up — San Diegan Jeff Pape (#873) trails Craig Healy (#946) and Andrew Whittome (1283) at the Etchells Pre-Worlds.

License to kill — Jim Swartz's pretty new Swan 601 'Moneypenny' was the talk of the town at the Rolex Swan American Regatta.

Horvat/M. Curtin), 36. (28 boats)
Full results — www.richmondyc.org

Rolex Swan American Regatta

The biennial Rolex Swan Regatta attracted 39 Swans to Newport, RI, on July 25-29 for a week of fun racing and camaraderie. The races were run by New York YC, with shoreside activities revolving around their Harbor Court clubhouse and a dockside 'regatta village' at the Newport Shipyard. The 8-race, 1-throwout series was sailed under Nautor Swan's mysterious in-house rating rule, and winners of each of the four classes were awarded Rolex Steel Submariner watches.

Two NorCal boats competed in the regatta, Jim Swartz's brand-new, metallic-green Swan 601 *Moneypenny* and Peter Noonan's Swan 56 *Defiance*. *Moneypenny* had a spectacular debut, dominating Class A with a 1,1,1,(4),1,1,2,4 record. "The boat performed fantastically, beyond my expectations," claimed owner/driver Swartz, who is shipping *Moneypenny* out for the upcoming Big Boat Series.

Swartz, a venture capitalist who also owns a Mumm 30 (Q), a big Protector (*Odd Job*), and a vintage 12-Meter (*Onawa*) with friend Chuck Parrish, sailed with a talented crew including Bay Area sailors Dee Smith (tactician), Kimo Worthington, Matt Ciesicki, John Bonds, Ken Keefe, Jeff Price, and Campbell Rivers. Most of these guys also were involved in the heroics of getting *Moneypenny* off a ship in Baltimore the week before the regatta, commissioning the boat, and then basically sea-trialing it on the way to the starting line.

Defiance came in fifth in Class D, with



ELLEN M. HOKE

Bob Billingham, Charlie Griffith, and Nadine Franczyk among the crew.

CLASS A — 1) **Money Penny**, Swan 601, Jim Swartz, Edgartown, MA, 11 points; 2) **Aqua Equinox**, Swan 56, Filip Balcaen, BEL, 19; 3) **Lolita**, Swan 56, Frank Savage, Stamford, CT, 20. (10 boats)

CLASS B — 1) **Crescendo**, Swan 44, Leon Christianakis/Martin Jacobson, Greenwich, CT, 10 points; 2) **Vixen**, Swan 44, John Wyatt, Jamestown, RI, 11; 3) **Xenophon**, Swan 44, Jeffrey Rabuffo, Middletown, RI, 20. (7 boats)

CLASS C (Swan 45) — 1) **Goombay Smash**, William Douglass, Stamford, CT, 22 points; 2) **Bellicosa**, Massimo Ferragamo, New York, NY, 27; 3) **Plenty**, Alexander Roepers, New York, NY, 33. (9 boats)

CLASS D (non-spinnaker) — 1) **Reef Points**, Swan 44, Joseph Huber, Wynnewood, PA, 7 points; 2) **Amanda**, Swan 53, Roland Bathory, Weston, MA, 26; 3) **Clover III**, Swan 56, Neal Finnegan, Cohasset, MA, 29. (13 boats)

Full results — www.nyyc.org

YRA Second Half Opener

Despite an unfortunate conflict with StFYC's Aldo Alessio Regatta, the EYC/YRA Second Half still attracted 79 in 16 classes on August 6-7. On Saturday, all classes except the Santana 22s sailed a 22-mile course from T.I. out to Bonita, followed by a lively chute run back to the finish in front of Encinal YC. About 50 boats stuck around for Sunday's buoy race.

The deed for the Carl Schumacher Trophy, which honors the late, great Alameda yacht designer, was recently rewritten and now goes to the corrected time winners of both race courses. Gerard Sheridan's Elan 40 *Tupelo Honey* won offshore honors against 77 other competitors, while Pat Broderick's Santana 22 *Elaine* took inshore honors over, ahem, a two-boat fleet. Maybe it's time to reconsider that deed of gift again.

Why the Second Half Opener was a week later than usual, and how two of the biggest regattas of the year were scheduled on top of each other is a mystery to us — but the upshot of the weekend was that attendance was down at both The Aldo and the Second Half Opener. "This should never have happened," fumed an anonymous St. Francis YC member. "A group of representatives from the more powerful classes have met several times to discuss this ongoing problem, and we're seriously considering taking the scheduling into our own hands next year."

Winners of Saturday's race follow. Full results of both YRA races are posted at www.yra.org.

DIV. G (< 90) — 1) **Tupelo Honey**, Elan 40,

Gerard Sheridan; 2) **Bodacious**, Farr One Ton, Clauser/Tosse; 3) **City Lights**, SC 50, Tom Sanborn. (9 boats)

DIV. J (93-129) — 1) **Petard**, Farr 36, Keith Buck; 2) **Harp**, Catalina 38, Mike Mannix; 3) **Shenanigans**, C&C 36, David Fiorito. (9 boats)

DIV. K (132-177) — 1) **Encore**, Wylie 30, Andy Hall; 2) **Silkye**, WylieCat 30, Seal/Skinner; 3) **Chesapeake**, Merit 25, Jim Fair. (7 boats)

DIV. M (> 179) — 1) **Latin Lass**, Catalina 27, Bill Chapman; 2) **Wuvulu**, IB-30, John New. (4 boats) SPORTBOAT — 1) **Wile E. Coyote**, Express 27, Dan Pruzan; 2) **Sand Dollar**, Mumm 30, Erich Bauer. (4 boats)

SF 30 — 1) **Bay Loon**, J/29, Joe Ferrie; 2) **Shameless**, Capo 30 mod., George Ellison. (5 boats)

IOR WARHORSE — 1) **Tiger Beetle**, N/M 45, Rob Macfarlane. (3 boats)

ALERION 28 — 1) **Lazy Lightning**, Jason Freskos; 2) **Dream**, Kirk Smith. (5 boats)

ANTRIM 27 — 1) **Cascade**, Steve Reinhart. (3 boats)

CAL 29 — 1) **Bluejacket**, Bill O'Connor. (3 boats)

CATALINA 30 — 1) **Goose**, Mike Kastrop; 2) **Starkite**, Laurie Miller. (4 boats)

EXPRESS 37 — 1) **Stewball**, Caleb Everett; 2) **Golden Moon**, Richards/Bridge. (4 boats)

OLSON 30 — 1) **Family Hour**, Bilafer Family; 2) **Hoot**, Andy Macfie. (6 boats)

NEWPORT 30 — 1) **Fast Freight**, Bob Harford; 2) **Harry**, Dick Aronoff. (5 boats)

OLSON 25 — 1) **Hamburger Haus**, Jens Jensen; 2) **Vivace**, Larry Nelson. (6 boats)

SANTANA 22 — 1) **Elaine**, Pat Broderick. (2 boats)

Southern Cross outing only mustered 20 of the regular OYRA players.

Both races were won overall by Mark Halman, sailing doublehanded with Bob Fricke in the SHS class on the Hobie 33 *Sleeping Dragon*. Needless to say, Halman has essentially wrapped up the SHS season title already. Other class leaders at the moment include *Samiko* (IOR Warhorses), *Eclipse* (PHRO-1), *Green Buffalo* (PHRO-2), and *Bloom County* (MORA). PHRO-1A, the new class for 50-footers, looks like it will be a battle to the wire between *Emily Carr* and *Cipango*, which skipped some races while successfully competing in the TransPac.

There are still four ocean races left: the Farallones Race (Aug. 27), Windjammers (Sept. 2), Drakes Bay (Sept. 24-25), and the Junior Waterhouse (Oct. 22). One-time entries in any of these events, which are generally a lot mellower than their spring counterparts, is encouraged. The entry fee per race is \$55, and you must be a member of YRA (\$40). Your boat must also have a PHRF certificate (\$40 for a new one; \$30 for a renewal) and the appropriate safety gear for going out in the ocean.

LIGHTSHIP II (RYC: July 30; 25.4 miles):

PHRO-1A — 1) **Zephyra**, DK-46, Robert Youngjohns. (3 boats)

PHRO-1 — 1) **Melange**, Express 37, Jim &



Here there be dragons — The doublehanded Hobie 33 'Sleeping Dragon' is the boat to beat in the Gulf of the Farallones this year.

Two Ocean Races

The first two races of OYRA's second half, the Lightship II Race and the Southern Cross, went off without a hitch on July 30 and August 13, respectively. The 25-mile jaunt out to the Lightship was attended by 58 boats, while the 33-mile

Petra Reed; 2) **Eclipse**, Express 37, Mark Dowdy; 3) **Double Trouble**, Sydney 38, Andy Costello; 4) **Tupelo Honey**, Elan 40, Gerard Sheridan; 5) **Summer Moon**, Synergy 1000, Pohl/DeVries. (14 boats)

IOR WARHORSE — 1) **Samiko**, Serendipity 43, Dexter Bailey; 2) **Zamazaan**, Farr 52, Chuck Weghorn. (4 boats)

J/105 — 1) **Lulu**, Don Wieneke. (3 boats)

PHRO-2 — 1) **Mistral**, Beneteau 36.7, Ed Durbin; 2) **Serendipity 2**, Beneteau 36.7, Thomas Bruce; 3) **Green Buffalo**, Cal 40, Jim Quanci. (7 boats)



MORA — 1) **El Raton**, Express 27, Ray Lotto; 2) **Bloom County**, Mancebo 31, Anthony Basso; 3) **Two Scoops**, Express 34, Chris Longaker; 4) **Flexi-Flyer**, Soverel 33, Mitch Wells. (11 boats)
 SF-30 — 1) **Shameless**, Capo 30 mod., George Ellison; 2) **Abba-Zaba**, Tartan Ten, Charles Pick. (5 boats)
 SHS — 1) **Sleeping Dragon**, Hobie 33, Mark Halman; 2) **Punk Dolphin**, Wylie 39, Jonathan Livingston; 3) **Starbuck**, Black Soo, Greg Nelsen. (9 boats)
 CATALINA 30 — 1) **Goose**, Michael Kastrop. (2

Aldo Alessio Regatta, clockwise from upper left — Anonymous J/120 crew hauling in the shrimp; Cityfront pinball in the J/105 fleet; coming and going in the J/120 class; big boats coming off the starting line; 'Swiftsure' head-on; and IRC winner 'Zephyra'. All photos 'Latitude'rob.

boats)

OVERALL — 1) **Sleeping Dragon**; 2) **Punk Dolphin**; 3) **Starbuck**. (58 boats)

SOUTHERN CROSS (SRYC; Aug. 13; 33.1 miles):

PHRO-1A — 1) **Emily Carr**, SC 50, Ray Minehan. (2 boats)

PHRO-1 — 1) **Auspice**, Schumacher 40, Jim Coggan; 2) **Melange**, Express 37, Jim & Petra Reed;

3) **Eclipse**, Express 37, Mark Dowdy. (7 boats)

PHRO-2 — 1) **Green Buffalo**, Cal 40, Jim Quanci. (2 boats)

MORA — 1) **Bloom County**, Mancebo 31, Anthony Basso; 2) **Relentless**, Syndey 32, Arnold Zippel. (4 boats)

SHS — 1) **Sleeping Dragon**, Hobie 33, Mark Halman; 2) **Tivoli**, Beneteau 42, Judy & Torben Bentsen. (5 boats).



AA meeting, cont'd — The green 'Mr. Magoo' leads the J/120 pack; the winning form of the J/105 'Good Timin' (even the mainsheet trimmer hikes !); 'Irrational Again' and 'Lulu' chute the breeze; the Sydney 38 'Howl' sails up into the J/105 fleet; the venerable 'Zamazaan' on the offset leg.

OVERALL — 1) **Sleeping Dragon**; 2) **Bloom County**; 3) **Tivoli**. (20 boats)
Full results — www.yra.org

Aldo Alessio Regatta

St. Francis YC hosted its annual three-day, four-race Aldo Alessio Regatta on August 5-7, providing a range of courses

and conditions for 50 boats. The four-year-old series, which most crews used as a tune-up for next month's 41st Big Boat Series (Sept. 15-18), began with a foggy, light-air, abbreviated ocean race on Friday, followed by two moderately windy Cityfront races on Saturday, and concluded with a fun 20+ mile 'Three

Hour Tour' of the Bay on Sunday.

Phil Perkins won the big pickle dish, the Alessio Perpetual Trophy for best performance in Friday's ocean race, with his all-conquering J/105 *Good Timin'*. Perkins sailed with boat partner Dave Wilson, Thomas 'Isi' Iseler, Darren Ward, Dennis George, and Aimee LeRoy. The trophy, which was created to promote ocean racing in the Gulf of the Farallones, was established in 1992 through an endow-

THE RACING



LATITUDE/ROB EXCEPT AS NOTED



MAX FANCHER

ment by the late Aldo Alessio, a veteran offshore sailor and staff commodore at both StFYC and CYC.

Perkins went on to demolish the 24-boat J/105 class all weekend, stringing together a near-perfect 1,1,2,1 score. It was a good weekend for the Perkins brothers — while Phil was taking care of business at home, brothers Jon and Chris finished first and second, respectively, in the Knarr International Championship (IKC) in Oslo, Norway.

Chance, Barry Lewis's J/120, improved steadily over the weekend, posting a 6,3,2,1 record to nip *Mr. Magoo* by a point. Robert Youngjohns DK-46 *Zephyra*, thus far the only purpose-built IRC boat on the Bay, won the IRC division with Jeff Thorpe calling tactics. *Zephyra*'s consistent 2,2,2,3 tally was just enough to hold off *Scorpio*'s 7,1,1,1 effort. *White Dove*, Mike Garl's Beneteau 40.7, ran away with the tiny PHRF division.

J/120 — 1) **Chance**, Barry Lewis, 12 points; 2) **Mr. Magoo**, Steve Madeira, 13; 3) **Jolly Mon**, Mark Bowman, 14; 4) **Desdemona**, John Wimer, 22. (10 boats)

J/105 — 1) **Good Timin'**, Phil Perkins, 5 points; 2) **Aquavit**, Tim Russell, 8; 3) **Brick House**, Kristen & Peter Lane, 19; 4) **Orion**, Gary Kneeland, 26; 5) **Arbitrage**, Bruce Stone, 31; 6) **Larrikin**, Stuart Taylor, 34; 7) **Windance**, Littfin/Pugh, 34; 8) **Risk**, Woodley/Titchener/Whitney, 35; 9) **Jabberwocky**, Vaughan/Ryff, 40; 10) **Akula**, Doug Bailey, 42. (24 boats)

IRC — 1) **Zephyra**, DK-46, Robert Youngjohns, 9 points; 2) **Scorpio**, Wylie 42, John Siegel, 10; 3) **Double Trouble**, Sydney 38, Andy Costello, 13; 4) **Bustin' Loose**, Sydney 38, Jeff Pulford, 15; 5) **Just in Time**, Beneteau 42, Norman Olson, 22. (12 boats)

PHRF — 1) **White Dove**, Beneteau 40.7, Mike Garl, 6 points; 2) **Great Sensation**, 1D-35, Giramonit/Fanger, 11. (4 boats)

Full results — www.stfyc.com

Summer Keelboat Act I & II
San Francisco YC got its 'Acts' together

Top actors in the Summer Keel Regatta, from left — Don Jesberg (Melges 24), Buzz Blackett (Express 27), and Rich Jepsen (J/24).

on consecutive weekends last month, hosting the Summer Keelboat Regatta Act I (Express 27s, Melgi, J/24s) on Aug. 13-14, followed by Act II on Aug. 21-22 (J/120, Express 37, J/105). Both weekends were five-race, no-throwout events sailed on the Berkeley Circle in the full gamut of wind and current conditions.

Previously, the Summer Keel Regatta was a one-weekend affair, with as many as nine one design classes competing on two venues — a situation which taxed the resources of the club to the max. Ironically, after splitting the regatta into two halves, attendance plummeted this year (the Farr 40s have evaporated, the Etchells are otherwise engaged, the Moore 24 class was a no-show, etc.).

The Melges 24 class headlined Act I, with 13 boats in attendance, many of whom were gearing up for the PCCs (Sept. 24-25 at SFYC) and the Worlds in Key Largo this December. Don Jesberg, feeling the need for speed after sailing the Cal 40 *Ralphie* to Hawaii in the recent TransPac, put together a 2,3,1,2,1 record with *Ego* to win the class. Jesberg's crew was Ricky Matthews, Andy Casey, and former Melges/Farr 40 owner Zarko Draganic, back on a two-week visit from Italy.

Buzz Blackett, who has owned his Express 27 *New Wave* since 1983, dominated that class, sailing with Ralf Morgan, Sutter Schumacher, Andrew Hura, and Ellen Liebenberg. OCSC purveyor Rich Jepsen took the J/24 class with *Rail to Rail*, along with crew Tom Henneberger (owner), Larry Ledgerwood, Trena Depel, and Joaquin Chung, all of whom are OCSC graduates.

Act II, for bigger boats, went down to the wire in all classes. Steve Madeira's *Mr. Magoo* won the J/120 class again, and is

poised to win the season championship with just two events left, the Nationals (7 races) and the BBS (7 races). "The key to sailing J/120s seems to be sailing consistently and avoiding major disasters," noted Madeira, whose 10-man crew included tactician Peter Cameron, Dave Grandin, John Broadhead, Mike Bacon, Greg Meagher, and Ray Catlette.

Tim Russell overtook *Donkey Jack* on Sunday to win the 26-boat J/105 class, sailing *Aquavit* with tactician Ted Wilson, John Claude, Brent Draney, Scott Parker, and J.V. Gilmour. *Good Timin'*, which has essentially wrapped up their sixth season championship in a row, was off their usual pace due to a DNF in Saturday's second race due to a broken boom. Chris Perkins and crew borrowed the boom from Ron Anderson's *Streaker* and came roaring back on Sunday with a pair of bullets, pulling themselves up to seventh for the weekend.

Expeditious, Bartz Schneider's Express 37, won that small class on a tiebreaker with the new *Stewball*. In the process, *Expeditious* also won their season championship for the second year in a row, barely passing early leader *Elan*. "They were three points ahead of us going into the weekend," said Schneider. "Our season literally came down to the last race of 19, which we bulleted!" The victorious *Expeditious* gang included tactician Fritz Glasser, son Marshall Schneider, crew boss Rhett Smith, Jay Early, John Spencer, Chris Hackett, Doug Lee, Phil Hodgson, and Brooke Bailey.

ACT ONE (August 13-14; 5 races):

EXPRESS 27 — 1) **New Wave**, Buzz Blackett, 6 points; 2) **Moxie**, Joshua Grass, 16; 3) **Mirage**, Terry Cobb, 19; 4) **Xena**, Mark Lowry, 22. (8 boats)

MELGES 24 — 1) **Ego**, Don Jesberg, 9 points; 2) **Pareto Optimal**, Seadon Wijsen, 12; 3) **BYU**, Matt McQueen, 14; 4) **Tinseltown Rebellion**, Cam Lewis, 21; 5) **Smokin'**, Kevin Clark, 27; 6) **Go Dogs Go**, Pepe Parsons, 28. (13 boats)



J/24 — 1) **Rail to Rail**, Rich Jepsen, 8 points; 2) **Running With Scissors**, Press/Yares, 10; 3) **TMC Racing**, Michael Whitfield, 13; 4) **Small Flying Patio Furniture**, Steve Hartman, 22. (8 boats)

ACT TWO (August 20-21; 5 races):

J/120 — 1) **Mr. Magoo**, Steve Madeira, 14 points; 2) **Oui B5**, John Sylvia, 15; 3) **Dayenu**, Jermaine/Payan, 23; 4) **Jolly Mon**, Chamberlin/Bowman, 27. (10 boats)

EXPRESS 37 — 1) **Expeditious**, Bartz Schneider, 12 points; 2) **Stewball**, Caleb Everett, 12. (5 boats)

J/105 — 1) **Aquavit**, Tim Russell, 14 points; 2) **Donkey Jack**, Scott Sellers, 16; 3) **Chile Pepper**, John Downing, 21; 4) **Windance**, Littfin/Pugh, 25; 5) **Natural Blonde**, Rob Cooper, 26; 6) **Masquerade**, Tom Coates, 26; 7) **Good Timin'**, Perkins/Wilson, 31; 8) **Brick House**, Kristen Lane, 32; 9) **Jabberwocky**, Brent Vaughan, 39; 10) **Risk**, Woody/Titchner/Whitney, 44. (26 boats; 4 races)

Full results — www.sfyf.org

470s on the Bay

August was '470 Month' in Northern California, with three separate events scheduled for these lively Olympic class dinghies. The first contest was the Nationals, put on by Santa Cruz YC on August 8-10. A Japanese team, skipper Seki Kazuto and crew Yanagawa Shouichi, topped the 21-boat fleet.



Summer Keel Regatta winners, cont'd — Steve Madeira (J/120), Bartz Schneider (Express 37), and Tim Russell (J/105).

Next up was the North Americans, held in the South Bay and hosted by South Beach YC, Bay View BC, and BAADS. Forty-one boats sailed in the NAs, with Argentinian teams — Lucas Calabrese/Fernando Gwozdz (men) and Fernanda Sesto/Consuelo Monsegur (women) — walking off with the gold. The young San Diego team of Mikee Anderson-Mitterling and David Hughes was a close second in the men's competition, which, combined with their third place in the Nationals, bodes well for their chances at the Worlds.

As we go to press, the 2005 International 470 Worlds were getting underway on the Cityfront. Ninety-nine boats, representing 29 countries, just finished a 9-race, three-day qualification series to break the 65 boats in the men's fleet into a gold and silver fleet (the 34 women's boats won't be broken in half for the Worlds). The actual Worlds Championship followed

Mikee likes it — The Anderson-Mitterling/Hughes team (USA 1734) struck silver in the 470 NAs and should do well at the Worlds.



on August 25-28. Check www.stfyf.com for results.

470 NATIONALS (SCYC; Aug. 8-10):

1) Seki Kazuto/Yanagawa Shouichi, JPN, 16 points; 2) Tetsuya Matsunaga/Taro Veho, JPN, 20; 3) Mikee Anderson-Mitterling/David Hughes, USA, 24; 4) Therese Torgensson/Vendula Zachrisson, SWE, 25; 5) Stuart McNay/Graham Biehl, USA, 33; 6) Erin Maxwell/Alice Manard, USA, 44; 7) Stephane Locas/Oliver Bone, CAN, 46; 8) Jen Provan/Carol Luttmer, CAN, 55; 9) Chizuko Ijima/Sayaka Kato, JPN, 56; 10) Zachary Brown/A. Kinsolving, USA, 60. (21 boats; 8 races; 1 throwout; www.scyf.org)

470 NAs (SBYC/BVBC/BAADS; Aug. 13-16):

MEN/MIXED — 1) Lucas Calabrese/Fernando Gwozdz, ARG, 36 points; 2) Mikee Anderson-Mitterling/David Hughes, USA, 46; 3) Matthias Schmid/Florian Reichstaedter, AUT, 48; 4) Dimitry Berezkin/A. Zybin, RUS, 50; 5) Stu McNay/Graham Biehl, USA, 56; 6) Adam Roberts/N. Martin, USA, 58; 7) Justin Law/M. Miller, USA, 78; 8) Francis Proot/W. Heynink, BEL, 47; 9) M. Buhler/M. Lamas, ARG, 92; 10) Zach Brown/A. Kinsolving, USA, 94. (26 boats)

WOMEN — 1) Fernanda Sesto/Consuelo Monsegur, ARG, 20 points; 2) Amanda Clark/S. Mergenthaler, USA, 27; 3) Sylvia Vogl/C. Flatscher, AUT, 35; 4) Molly Carapiet/Whitney Besse, USA, 40; 5) Allison Jolly/Molly O'Bryan, USA, 45. (15 boats)

(41 boats; 10 races; 1 throwout; www.470class-nachampionship.org)

Nationals Round-Up

August and September are the most popular months for national championships, for all the logical reasons. Here are the results of five nationals which just occurred around the West Coast, and no doubt there were others we missed. Next month, the hits just keep coming — at least four more nationals will be held on the Bay in early September (J/120, Express 27, Antrim 27, Moore 24) and, as usual, the Big Boat Series will double as the Express 37 nationals.

EL TORO NATIONALS (StkSC; July 30-Aug. 4):

SENIOR — 1) Gordie Nash, 14 points; 2) Max Fraser, 20; 3) Fred Paxton, 21; 4) Art Lange, 28; 5) Paul Tara, 30; 6) Nancy Farnum, 33; 7) John Amen,



JANE PARADISE

THE RACING

49; 8) Chris Straub, 52; 9) Bruce Bradfute, 53; 10) Vicki Gilmour, 58. (17 boats)

JUNIOR — 1) David Liebenberg, 9 points; 2) Allen Sterling, 11. (4 boats)

Full results — www.eltoroyra.org

WABBIT NATIONALS (SCYC: Aug. 5-7):

1) **Furrari**, Pete & Angie Rowland/OJ Olson, 16 points; 2) **Jack**, Bill Erkelens, 18; 3) **The White Boat**, Andy Hamilton, 22; 4) **Keala**, Ron Tostenson, 29; 5) **Mr. McGregor**, Kim Desenberg, 32. (10 boats; 8 races)

SANTANA 20 NATIONALS (Cascade Locks, OR; Aug. 8-12):

1) **Mini Me**, Bruce Golison, ABYC, 12 points; 2) **Disaster Area**, Chris Winnard, SWYC, 12; 3) **Sea Bear**, Lance Purdy, NoYC, 13; 4) **Chubasco**, Tim Dunton, Denver SA, 34; 5) **H2O Boa**, Gordon Mattatal, Eugene YC, 37. (23 boats; 7 races; 1 throwout; www.s20.org)

Winning crew — Bruce Golison, Steve Washburn, Stevie Washburn, Anika Olsen.

KEANE STAR NAs (CalYC: Aug. 16-21):

1) George Szabo/Eric Monroe, SDYC, 16 points; 2) Rick Merriman/Rick Peters, SDYC, 16; 3) John Dane III/Austin Sperry, PCYC, 19; 4) Eric Lidecis/Michael Marzahl, BCYC, 29; 5) Iain Murray/Andrew Palfram, Royal Prince Alfred YC, AUS, 39; 6) Mark Reynolds/Hal Haanel, SDYC, 40; 7) Eric Doyle/Brian Sharp, SDYC; 8) Arthur Anosov/Dave Caesar, TSS, 41; 9) John MacCausland/Robert Schofield, Co-



LATITUDE ARCHIVES

Knarry! Jon 'JP' Perkins won the IKC for the second time, topping older brother Chris and many other good sailors in the process.

per River YC, 44; 10) Fabian McGowan/Valentin Thompson, Olivos YC, ARG, 45. (41 boats; 6 races; 1 throw-out; www.cal yachtclub.com)

MERCURY NATIONALS (CBYC: Aug. 12-14):

1) Mike & JJ Burch, 16 points; 2) Jim & Kathy Bradley, 18; 3) Pat Bradley/Mike Dick, 20; 4) Pax Davis/Dave Morris, 24; 5) Don Whelan/AI Johnson, 30; 6) Chris Messano/Chuck Clay, 40; 7) Doug Baird/Jim

Taylor, 42; 8) Greg & Steve Dair, 47; 9) Greg Clark/Bill Schoop, 50; 10) Jim & Jack Barton, 52. (20 boats; 5 races; www.merc583.addr.com/sail/)

Knarr Internationals

San Francisco restaurateur Jon Perkins led an American sweep of the 37th International Knarr Championship (IKC), held in Oslo, Norway, on July 30-August 6. Sailing with Melissa and Tom Purdy and Jeff Moseley, Perkins trounced the fleet to win this prestigious event for the second time. Older brother Chris Perkins, the defending IKC champion and also a two-time winner, was second, and fellow StFYC member Knud Wibroe was a close third. Collectively, this was the Americans' best performance abroad ever (the IKC rotates every year between San Francisco, Copenhagen, and Oslo/Bergen).

Jon won the event by 15 points, but it was closer than it looked — he used a discard in the 9-race, 2-throwout series early (an OCS in the second race), putting his back to the wall almost immediately. Chris, sailing light with Hans Baldauf and Allie Rowe, led the series until his own OCS in the fourth race. The Perkins brothers remained essentially tied until

**REPAIR
REPAIR
REPAIR**

**• CRUISERS' REPAIRS
• FAST TURNAROUND
• RACING REPAIRS**

**YOUR UV COVER
CONVERSION
SPECIALIST**

ROOSTER SAILS

451 West Atlantic Ave., Alameda Pt. (Alameda Naval Air Stn.)
(510) 523-1977
www.roostersails.com • rui@roostersails.com
Open M-Th 9-6 • Fri 9-5 • Sat by appt.
Owned and Operated by Rui Luis • Experienced Sail Repair and Fabrication

NOW OFFERING NEW CRUISING SAILS!

SAIL REPAIR SPECIALISTS • COMPETITIVE RATES • RECUTS • CONVERSIONS

The Yale Performance Advantage

"Yale lines have greatly improved the performance of *Dark Star*; the Crystalne halyards show no stretch or creep, the Yaletail runner tails play well on the winch, and the new Code Zero furls evenly and quickly with its Torque Rope luff."

—Jonathan McKee
Olympic gold-medalist and skipper of Mini Transat participant Team McLube

YALE CORDAGE

77 Industrial Park Road • Saco, ME 04072
Tel: 207-282-3396 • Fax: 207-282-4620
www.yalecordage.com

Call for a free copy of Yale's new 22-page cordage catalog and selection guide.



RICH ROBERTS/WWW.UNDERTHESUNPHOTOS.COM

the last two races, when Chris took a costly DSQ (a starting line infraction with Knud Wibroe) and a 17th, relegating himself to a distant second place finish. Wibroe, sailing with Mike Ratiani, Bernard O'Driscoll, and Bill Fredericks, rounded out the podium, just two points behind Chris.

"It was a great battle with Chris right to the last race," said Jon. "He got flagged on

Up periscope! A Laser sailor goes into stealth mode at the ABYC-hosted O'Day Trophy off Long Beach. See results on page 186.

an alleged port/starboard violation by a Dane, did a precautionary 720, and never was able to recover. I had mixed emotions about beating my brother, though my crew didn't!"

1) **Jon Perkins**, USA, 18 points; 2) **Chris Per-**

kins, 33; 3) **Knud Wibroe**, 36; 4) Erik Bergsbakk Holter, NOR, 38; 5) Jens Faber, DEN, 41; 6) **Tom Reed**, USA, 48; 7) Christian Rasmussen, DEN, 50; 8) Nils Petter Haugfos, 54; 9) Johan Gustav Hvide, NOR, 55; Peter Lerbrandt, DEN, 57... Other American participants: 19) **Mark Adams**; 22) **Mark Dahm**; 23) **Graham Green**. (25 teams; www.knarr-sf.com)

Box Scores

Ocean races, team races, boardsailing races — we've got a little of everything in *Box Scores* this month. Warning: This section of the magazine may cause drowsiness. Do not attempt to drive or operate heavy machinery while reading.

TEAM RACE PCCs (StFYC: 7/30-31; Van. 15s):

1) **Bizarre Gardening Accident**, 18-7; 2) **No Name**, 14-11; 3) **T.I. Bone Crushers**, 13-12; 4) **S.F. Sleigh Ride**, 12.5-12; 5) **Mass Occidentals**, 12-13; 6) **Treasure Island Pirates**, 5-20.

Winning team — Holt Condon/Jen Morgan; Kevin Richards/Betsy Cleveland; Nick Adamson/Avery Patton.

SANTA BABS-KING HARBOR (8/5; 81 miles):

DIV. A — 1) **Peligroso**, DenCho 70, Campbell/Williams; 2) **Horizon**, SC 50, Jack Taylor; 3) **Bay Wolf**, SC 50, Parlette/Wilson; 4) **Sorcery**, Mull 80, Jake Wood. (11 boats)



SUMMER RIGGING SPECIALS

Hansen Rigging offers the best for performance and offshore cruising sailors.

- ✓ Mast restoration and total rig replacements in aluminum and carbon
- ✓ Wire and rod standing rigging made on site
- ✓ Huge rope inventory with over 250 spools in stock
- ✓ Certified splicing
- ✓ Rigging inspections
- ✓ Deck layout and hardware design

Modernize your sail handling systems with the best the industry has to offer combined with expert installation.

Dedicated racers and world cruisers have trusted us for years. Give us a call to discuss your next rigging project.

Call for an estimate or consultation

(510) 521-7027

HANSEN RIGGING

451 W. Atlantic Ave., Suite 101, Alameda, CA 94501
hansenrig@sbcglobal.net

THE RACING

DIV. B — 1) **Groovederci**, Mumm 30, D. & J. Demourkas; 2) **Stressless**, Farr 40, Tom Parker; 3) **Shiver**, 1D-35, Yabsley/McDonough. (10 boats)

DIV. C — 1) **Magic Light**, Hobie 33, Keith Lorence; 2) **Capt. Sluggo**, Hobie 33, Michael Burke; 3) **Ono**, Olson 40, Galloway & Folkmen. (10 boats)

DIV. D — 1) **Restless**, Schock 35, Anthony Pascone; 2) **Montserrat**, SC 41, Thomas Zahiten; 3) **Fast Lane**, J/35, Doug Steele. (9 boats)

DIV. E — 1) **Cuidado**, 11:Metre, Tom Bolla; 2) **Flying Dutchman**, Hobie 33, Paul Zambriski; 3) **Mad Max**, Hobie 33, Max Rosenberg. (13 boats)

DIV. F — 1) **Day Tripper II**, Hunter 40, Andy Horning; 2) **Arc Angel**, Sonoma 30, Jack Tatum; 3) **La Diana**, Contessa 35, The Huffmans. (10 boats)

DIV. G — 1) **Comet**, Morgan 36, Don Currie; 2) **Elan**, Tartan 3500, Doug Mills; 3) **Airstream**, 'Pre 35', Michael Roach. (9 boats)

DIV. H — 1) **Midnight Run**, Catalina 320, John Dean; 2) **El Tigre**, Cal 3-30, Kari Keidser; 3) **Proper Lady**, Islander 32-2, Bob Cash. (8 boats)

SPRIT-A — 1) **Stark Raving Mad**, J/145, Jim Madden; 2) **Wildcat**, Cheeta 30, John Staff; 3) **Mad Dog**, Schock 40, Ed Feo. (7 boats)

SPRIT-B — 1) **In The Fridge**, Melges 24, Mark Golison; 2) **Cartel**, Columbia 30, David Clarke; 3) **Derivative**, Melges 24, Mark Surber. (12 boats)

ORCA — 1) **Exit**, F-31, George & Kurt Mayo; 2) **2 of 10**, Rolland 36, Edward Terchunian; 3) **After-**

burner, Custom 52-ft cat, Bill Gibbs. (14 boats)
J/105 — 1) **Escapade**, Mark Noble; 2) **Rock & Roll**, Bernard Girod; 3) **Off The Porch**, Scott McDaniel. (9 boats)
Full results — www.sbyc.org

ALAMEDA INTERCLUB #5 (TIYC: 8/6: 11 miles):
BIG SPINNY (< 174) — 1) **Uno**, WylieCat 30, Steve Wanner; 2) **Crinan II**, WylieCat 30, Bill West. (5 boats)

LITTLE SPINNY (187-up) — 1) **Lone Ranger**, Ranger 26, Ken Viaggi. (3 boats)
FAT 30 — 1) **Spindrifter**, Tartan 30, Paul Skabo;

2) **Lelo Too**, Tartan 30, Emile Carles. (4 boats)
CATALINA 34 — 1) **Mottley**, Chris Owen; 2) **Crew's Nest**, Ray Irvine. (5 boats)

NON-SPINNY — 1) **Flotsam**, Yankee OD, The Clerks; 2) **Flyer**, Peterson 33, John Diegoli; 3) **Espresso**, Hobie 33, The Williams. (10 boats)

MULTIHULL — 1) **Origami**, F-24 Mk. II, Ross Stein; 2) **Raptor**, F-27, Todd Olsen. (6 boats)
Full results — www.sfbama.org

PASSPORT REGATTA (CYC: July 13: 18 miles):
PASSPORT 40/42 — 1) **Cayenne**, Passport 40, Michael Moradzadeh; 2) **Drambuoy**, Passport 40, Rick Cooley. (5 boats)
PASSPORT 47 — 1) **Georgia J.**, Kim & Sharon Barr. (3 boats)

OVERALL — **Georgia J.** (8 boats)
For more — www.sailpoa.org

S.F. BAY CLASSIC (StFYC: Aug. 13-14):
FORMULA (overall) — 1) Bill Weir, 7 points; 2) Eric Christianson, 13; 3) Soheil Zahedi, 16; 4) Jean Rathle, 16; 5) Mike Zajicek, 18; 6) Steve Bodner, 18; 7) Al Mirel, 19; 8) Mike Percey, 21; 9) Ron Kern, 22; 10) Jim Kiriakis, 23. (23 boards)
CLASSIC — Bill Weir.
ULTRANECTAR CHALLENGE — Mike Zajicek.
COURSE — Soheil Zahedi.
Full Results — www.stfyc.com

GRACIE & GEORGE (EYC: Aug. 13: 12.4 miles):
SPORTBOAT — 1) **Kwazy**, Wylie Wabbit, Hillary Hansen/Colin Moore. (1 boat)
FLEET 2 (< 121) — 1) **Javelin**, J/100, Joan Garrett/Norman Davant; 2) **Harp**, Catalina 38, Linda Farabee/Mike Mannix. (4 boats)
FLEET 3 (121-149) — 1) **Jammin'**, Catalina 36, Mary Coleman/Jim Forest. (2 boats)
FLEET 4 (150-179) — 1) **Bewitched**, Merit 25, Lorraine & Mark Salmon. (3 boats)
FLEET 5 (>179) — 1) **Maverick**, Columbia 5.5, Heather Noel/Adam Sadeg. (3 boats)
OVERALL — 1) **Maverick**; 2) **Javelin**; 3) **Be-**

deckware®
by spinlock



NEW!
Deckware Lifejacket and harnesses. Made for performance sailing.

150 N LIFEJACKET HARNESS

- INTEGRAL HARNESS
- RAPID FIT
- COMFORTABLE ERGONOMIC SHAPE
- LIGHTWEIGHT FIBRE CONSTRUCTION
- EASY-FIND INFLATION HANDLE
- CONTOURED THIGH STRAPS
- SPRAYHOOD
- AQ98 LIFEJACKET LIGHT

NEW!
Mast harness built for the marine environment.

MAST PRO HARNESS

- STAINLESS STEEL BUCKLES
- EXTRA WIDE LEG STRAPS
- MULTI TOOL HOLDER
- SPIKE POCKET
- KEVLAR® ANTI-ABRASION COVERS
- COMFORTABLE ERGONOMIC SHAPE



...with  technology

spinlockdeckware.com
Toll-free: 877.774.6562 Outside the US: 802.362.5258

CLIPPER YACHT HARBOR

Sausalito's Only Full Service Marina

www.clipperyacht.com
310 Harbor Dr., Sausalito, CA 94965
(415) 332-3500

800 Slips 20-60 ft • Dry Storage Available

- Fuel Dock
- Bait & Tackle Shop
- Sport Fishing
- Restaurants
- West Marine
- Launch Ramp
- Pump Out
- Laundry Facility
- Private Restrooms/Showers
- Anderson's Boat Yard
- Guest Slips Available



"Your Destination for a Full Service Marina"

witched. (12 boats)

Full results — www.encinal.org

PICYA CHISPA/YOUTH (TISC; Aug. 13; 6 races):

CHISPA — 1) Brian Malouf, 7 points.; 2) Simon Bell, 8. (4 boats)

FJ — 1) Don Ryan/Ryan Anderson, 5 points. (2 boats)

OPTI-A — 1) Will Cefali, 5 points; 2) Marie de Cannart d'Hamale, 11. (6 boats)

OPTI-B — 1) Michael Grove, 6 points; 2) Lauren Cefali, 10. (6 boats)

FALL SCORE #1 (SCYC; Aug. 13):

DIV. A — 1) **Heartbeat**, Wylie 45, Lou Pambianco. (3 boats)

DIV. B — 1) **Bullet**, Olson 30, Mike Gross; 2) **Saffron**, SC 27, Noah Flores. (6 boats)

Full results — www.scyc.org

ONE DESIGN REGATTA (SCYC; Aug. 20-21):

SC 27 — 1) **Saffron**, Noah Flores, 5 points. (3 boats)

SANTANA 22 — 1) **Maybe**, Ernie Rideout, 3 points; 2) **Insanity Cruz**, Mark Langer, 7. (5 boats) (4 races; 1 throwout; www.scyc.org)

Race Notes

Cerveza circuit: It's not too early to



JILL MANTZ

Brotherly love — Mill Valley sailors Myles (left) and Morgan Gutenkunst finished on the podium at the 420 Worlds — but not with each other.

start planning for San Diego YC's 26th biennial race to Mexico, which will return to **Puerto Vallarta** this year in staggered starts from February 21-24. The 1,000-mile hopefully downwind race will mercifully end at Punta Mita, and the post-race parties will be held at Paradise Village, Nuevo Vallarta. On Sunday, March 5, the eight-race **MEXORC** series will begin

in Banderas Bay. See www.sdy.org for more information on both these fun events. . . A quicker Mexican 'fix' will be offered in late March, when, to the complete dismay of San Diego YC, Balboa YC debuts its own version of the **Cabo Race**. The new race will start on March 24, with the awards ceremony in Cabo set for March 31. See www.balboayachtclub.com for the NOR and more.

Sale boats of the month: Stan Glaros has rebounded quickly from the loss of his Davidson 50 *Great Fun*, buying a Cheeta 30 from the Seattle area. The 2,350-pound spritpoler, formerly *Fed Express*, has almost nothing in common with its IOR warhorse predecessor other than the name, **Great Fun II**. . . Probably the most successful Express 27 ever, **Swamp Donkey** (ex-*Friday*), hull #13, has a new owner, EYC member Bill Goldfoos. In case you've ever wondered where the name came from, check out www.swampdonkeysailing.com. . . SSS stalwart Greg Nelson, owner of the 'orginal sportboat', the Black Soo *Starbuck*, recently went to Long Island and towed his newest acquisition, the Azzurra 310 **Azzurra**, back to its original home of Alameda. *Azzurra*



AGAPE VILLAGES

FOSTER CHILDREN NEED YOUR HELP!



Donate your boat to support



AGAPE VILLAGES

Tax Deductible

1-800-513-6560

COAST MARINE

& INDUSTRIAL SUPPLY INC.

398 Jefferson St. San Francisco - On the Wharf.

800-433-8050

Ph (415) 673-1923
Fax (415) 673-1927



LIFE RAFT

Sales & Service

U.S.C.G. Approved Testing Facility

- ★ U.S.C.G. life raft facility for Solas commercial yacht and fisherman rafts
- ★ COMAR DEBARKATION LADDERS
- ★ COMAR PILOT LADDERS
- ★ COMAR WORK LADDERS
- ★ All U.S.C.G. approved



GUINNESS

WORLD RECORD "World's longest tested ladder 320ft."

Major Distributor for:





IN SAN DIEGO CALL OCEANS WEST 619 544-1900

THE RACING SHEET

has been mastless since Key West Race Week, and Nelson's first move will be to install a new carbon rig. "It's a bit of a project, but I couldn't resist!" he said."

More sale boats: RYC members Pete and Angie Rowland, the 2005 Wylie Wabbit national champs, have bought a cruising boat, an Irwin 39 named **Casablanca**, in Santa Cruz ("through an ad in *Latitude*, thank you!"). They plan to take off in two years, heading north to circumnavigate Vancouver Island before heading to the South Pacific. . . Another RYC member, Jeff McCord, has finally finished off his custom N/M 36 **Quiver**, which will debut at the Jazz Cup. McCord bought the bare hull, built in '99, and engine from Martin Yachts in British Columbia, and added a beefy Hall carbon rig and deeper Jim Antrim-designed keel.

Random notes: The latest entries in the '06 West Marine Pacific Cup include *Morpheus* (Schumacher 50), *Kyrnos* (Barnett 56), *Jam* (J/160), *Basic Instinct* (El-



The big boats are starting to roll into town. 'Morning Glory', on the hard at KKMI, dwarfs the guy working on her bow.

liott 10.50), and *Sonata* (Morgan 38). . . The busy **Gutenkunst brothers**, Myles and Morgan, did quite well at the International 420 Worlds in Brest, France, last month. Myles, crewing for Tyler Sinks, finished second in the silver fleet. Nineteen-year-old Morgan, a sophomore at UC Irvine, crewed for Justin Law and finished third, just 8 points back. In June, Myles and Tyler took second place in 420s at the US Youth Championship

in Westport, CT — and Myles, a 17-year-old senior at Marin Catholic, was awarded the **Dave Perry Sportsmanship Award**.

Good times: The **41st Rolex Big Boat Series**, set for Sept. 15-18, promises to be a big one, possibly even eclipsing the previous all-time-high fleet of 115 boats in 2003. Putting the 'big' back in this year's Series will be **Morning Glory**, *Genuine Risk*, *Beecom*, and *Peligroso*,

which will form the majority of IRC-A. That group, which will be docked at Pier 45 (near Aquatic Park), will sail to a weather mark outside the Gate, while everyone else will stay on the two traditional courses. About 40 IRC entries are expected, almost doubling last year's inaugural turnout of 23 boats. There will be one design classes for J/120s, Express 37s, 1D-35s, J/105s, and Sydney 38s. Social highlights will include the Rolex party (Thursday), the Mt. Gay party (Friday), and the awards ceremony on Sunday, when six engraved Rolexes will be doled out.

Coyote Point Marina

- ➔ Berths: 24' to 50'
- ➔ Concrete Double Side Ties
- ➔ Monthly Rates: \$5.96-\$8.25 per ft. – Utilities and Dockbox Included
- ➔ 22' Side Ties Available at \$80.00/month
Larger Berths Are Available

- Beautiful Mid-Peninsula Location
Easy Access from US101
- Club Nautique Charters and Instruction
for Sail and Powerboats
- Fuel Dock, Gasoline and Diesel
- Accommodating Staff and Convenient Parking
- Adjacent to Park with Playground, Shoreline Trail,
Nature Museum, Beach, Picnic and Barbecue Areas
- Adjacent to 18-Hole Golf Course
and Dominic's Restaurant

1900 Coyote Point Drive, San Mateo, CA 94401
Open 7 days a week

(650) 573-2594

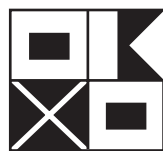

**SOCIETY OF ACCREDITED
MARINE SURVEYORS®**

Serving Northern California

Al Blair, SA
(415) 456-3154

Tom List, AMS®
(415) 332-5478

Rich Christopher,
AMS®
(650) 368-8711

Jack Mackinnon,
AMS®/SMS
(800) 501-8527

Dennis Daly, SA
(510) 849-1766

Randell Sharpe,
AMS®
(877) 337-0706

Alan Hugenot, AMS®
(415) 531-6172

**R. J. Whitfield &
Associates, AMS®**
(800) 344-1838

San Francisco Boat Works

REDEEM THIS COUPON FOR **\$100 OFF** YARD LABOR SERVICES*



And yes, there is a **FREE LUNCH** with bottom job...at our restaurant – The Ramp

AUTHORIZED DEALER
YANMAR - JOHNSON - EVINRUDE

30 & 40 Ton Travel Lift • 2 Acre Yard
Rigging • Woodworking • Metal Fabrication
Engine Installation • Outdrive Repair
Spraypainting • Fiberglass Repair
Blister Repair • Outboard Repair
The Ramp Restaurant on Site



Craig Page, Yard Manager

* Certain restrictions apply. Limited time offer.

NOW HIRING
Mechanic, System Specialist,
Equipment Operator –
Call for details.

Interlux
yachtpaint.com

835 Terry A. François St.
San Francisco, CA 94158

Convenient location 5 minutes to
downtown S.F and easy walk to PacBell Park

(415) 626-3275

Fax (415) 626-9172

Email: sfboatworks@yahoo.com • Visit our Website: www.sfboatworks.com

Latitude 38

**MEXICO-ONLY
CREW LIST
AND BAJA HA-HA
PARTY**



The 2004 Baja Ha-Ha fleet starts leg 2
Photo Latitude/Andy

ENCINAL YACHT CLUB

(Foot of Triumph Street, Pacific Marina, Alameda)

Wednesday, October 5 • 6-9 pm (no earlybirds please!)

\$7 at the Door

(FREE if Your Name Is on the Crew List Published in the October 2005 Latitude 38 and for registered 2005 Baja Ha-Ha Skippers & First Mates)

Apertivos • Name Tags • Guest Experts
Door Prizes • No Host Bebidas

Everyone welcome • No reservations required • Come as you are

For more information or directions, check our Web site at
www.latitude38.com or call us at **(415) 383-8200**

Change a life.
Donate your boat.



Support local and regional programs for children and young adults through the charitable donation of your boat.

The Pacific Marine foundation is a 501(c)(3) non-profit organization funding regional programs such as Northwest Youth Services, Sea Scouts, Boys & Girls Clubs, and local public school education foundations. A substantial tax savings and the possibility of a partial cash sale makes a charitable donation a very attractive alternative for any owner who is considering selling their well-found power or sailing yacht.



**PACIFIC
MARINE
FOUNDATION**

(888) 443-8262

www.pacificmarine.org

WORLD

With reports this month on a novel marketing concept meant to inspire **A Worldwide Sampling of Charter Destinations**, plus a frequent Caribbean charterer's foray into **The Spanish Virgins**, and miscellaneous **Charter**

Around the World Chartering: Where Do We Sign Up?

In recent years we've become reacquainted with an old buddy from our high school days named Craig. It was a pleasant surprise to learn that he, too, had become an avid sailor during the intervening years. Not only that, but he's been pipedreaming of sailing around the world in the not-too-distant future — despite the fact that he doesn't yet have a boat suited to the task.

When the conversation turned to the realistic costs of making such a trip, Craig caught us a bit off guard with an alternate concept: "What about the idea of simply flying from one prime sailing venue to the next and chartering a local bareboat?" Oddly enough, that's a scheme we've fantasized about ourselves a few years back. And it's also a concept currently being promoted by Sunsail, at last count the world's largest charter outfit, with 36 bases in 23 countries, all over the globe.

Here's the deal: For a flat rate of \$15,000, you get to do five weeklong charters aboard a 40-ft monohull at any five of their charter destinations. As far as we can tell, there are no 'blockout' dates other than "New Year's week." However, the 15 grand must be paid in advance, and all five trips must be completed within 24 months of the first departure date. The fee covers the boat rental only, so fuel, cruising taxes, provisioning, etc. are additional, as with most typical charters. Also, you may pay extra to upgrade to a larger yacht — or, presumably, to a catamaran.

As an added incentive, the first skip-

One of the benefits of escaping to the tropics periodically is exploring the wonderworld beneath the surface. This is a Seychelles reef.



SEYCHELLES TOURISM

per to complete a "Sunsail the World" charter package will win a free week at the destination of his/her choice. Pretty cool concept, eh? And, depending on where you choose to sail, and during which season, you could potentially save a good deal of cash.

Of course, you could customize your own around-the-world charter package with other large companies such as The Moorings or Kiriacoulis — or a combination of companies for that matter. But we've got to hand it to Sunsail for coming up with such a clever marketing campaign, which uniquely spotlights the diversity of their offerings with built-in money-saving incentives.

To our way of thinking, perhaps the best thing about this plan is that, by committing to five trips, you would essentially 'force' yourself to get out and have the kind of fun that you often wish you were having! Buying into this deal is somewhat analogous to sailors who



TAHITI TOURISM

One day you're chained to your desk, the next you're showering under a Tahitian waterfall.

buy a new boat and put it into charter with a big company like The Moorings or Sunsail. In terms of actual return on your money, it may not be the

most lucrative investment you would ever make, but the four to six weeks of chartering you would get as a perk of the deal would give you a bona fide impetus to get out of town and go sailing in different venues much more often than you probably would otherwise. With that in mind, you would essentially be *investing* in an incredible lifestyle that's hard to quantify in dollars and sense.

Similarly, buying into the Sunsail the World package would be an investment in your peace of mind, while also being wonderfully educational. And, if you're one of those lucky business travelers who's got frequent flyer miles to burn, you'd have it made.

Of course, the package probably would have little appeal to would-be cruisers who already have a paid-off boat that's fully fitted out for offshore voyaging. But for those of us who: A) haven't even started making payments on the ultimate world cruiser, B) haven't yet figured out how to take more than a few weeks off work at a time, or C) have a spouse who has zero interest in crossing oceans, this just might be an idea worth pursuing.

So where would we go? Hmmm. . . Well, we'd certainly want to include some of the most exotic places like Thailand and the Seychelles. Plus, we've always thought it would be cool to do two or three charters in different locations, back to back. That idea came about years ago, when we discovered that there are specialty travel agents that will sell you an around-the-world ticket for a very reasonable cost, which allows you to layover at several — perhaps even a half dozen — destinations en route (i.e. L.A. to Tahiti to Sydney to Bangkok to London to L.A.).

But we digress. . . Whether you combine destinations into a single vacation or do them separately, you'll first need to consider when the prime sailing seasons occur. Have a look at the illustration (right) and some alluring ideas will prob-

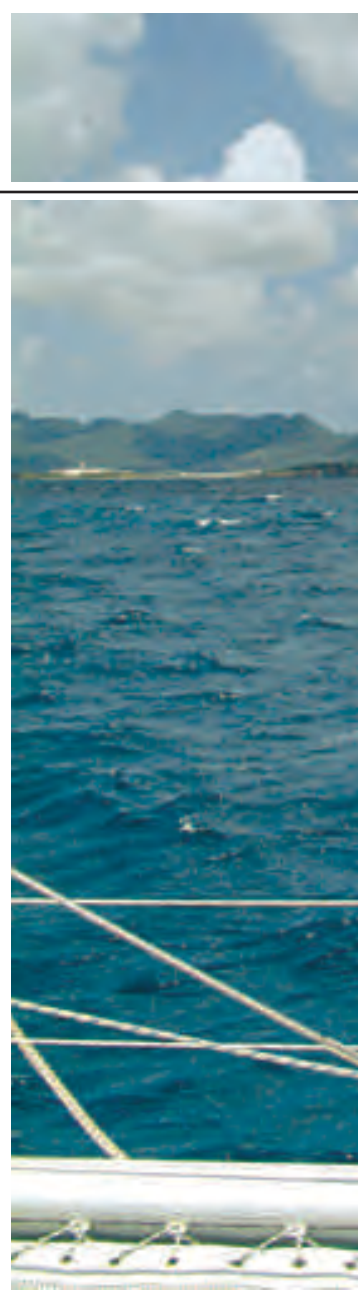



OF CHARTERING

perhaps we'd fly to Singapore and across to Malaysia's Langkawi Archipelago, an exotic array of islands that combine the extremes of duty-free shopping, deserted beaches and abundant wildlife. As such, it's a favorite with world cruisers. A short flight to the north would then take us to Phuket for a week of sailing and diving among its near-shore islands and surreal limestone pinnacles. We'd then head home in a single leg from Bangkok.

Okay, so maybe we're getting a bit carried away. A more practical idea might be to take a different trip every six months or so. For example, Greece in September, Antigua in February, Tahiti in July, Sydney in January and Guadeloupe in June. Five destinations, all within the 24-month window — pretty slick. Now you take a crack at it. Where would you choose to go given this basic outline? The possibilities are mind-boggling.

In fact, we have gotten ourselves so excited about all this that we've practically talked ourselves into signing up. Now, if we could only find those frequent flyer vouchers?

— latitude/aet

LATITUDE / ANDY

"Land ho!" If it's January, this must be St. Maarten. With charter venues around the world, the possibilities are mind-boggling.

PRIME SAILING SEASONS

* Please note: The blocks below represent the absolute best months in terms of wind and weather. However, there's good sailing in many of these locations beyond these dates also, as some venues are truly "year-round" destinations. (Data from industry sources.)

	JAN	FEB	MAR	APR	MAY	JUN	JUL	AUG	SEP	OCT	NOV	DEC
Seychelles												
Thailand												
Whitsundays												
Sydney												
New Zealand												
Fiji												
Tonga												
Tahiti												
British Isles												
Scandinavia												
Fr. Riviera												
Greece/Turkey												
Croatia												
Belize												
Caribbean												

ably come to mind. Let's see, in terms of combo trips, how about a summer 'trifecta', first to France's Côte d'Azur to hang with the beautiful people and soak in some centuries-old European culture. A flight from Paris would then take us down to the Seychelles, a remote cluster of exotic isles in the Indian Ocean with stunning turquoise waters strewn with giant boulders. After soaking up the sun and diving on the reefs, we'd jet north again, finishing off our ultimate getaway with a cruise along Croatia's Dalmatian Coast.

Or, how about this one: In the opposite season, we might escape the dreariness of winter with an overnight flight to summertime in Sydney, Australia. There we'd take in the sights under sail, wrestle a kangaroo or two and enjoy the spirited Aussie nightlife. Then,



THE MOORINGS

Remotely located in the Indian Ocean, the Seychelles offer dream-like landscapes and a unique multi-cultural heritage.

WORLD



KENNETH WOOTON

Culebrita, just to the east of Culebra, offers some of the more picturesque anchorages in the Passage Islands.

quiet and uncrowded compared to the rest of the Virgin Islands.

Our first destination was Culebrita, a small cay which is a nature preserve just east of the main island of Culebra. Leaving Frenchtown, St. Thomas, about 2:00 p.m. after the usual fuss with trying to coordinate everybody and everything — Where are the lemons? What do you mean you thought I brought them?

— we had a rapid and pleasant downwind sail, arriving in the secluded bay on the northeast side of the island at 4:00 p.m. The bay has moorings for five boats, and is well protected from most sea conditions. We were the only boat in the bay, and enjoyed the solitude, watching a lovely sunset over cocktails in the cockpit. Our usual approach to meals when cruising is to have breakfast and lunch on board, with dinner ashore each night. Otherwise, it seems less like a vacation. In this instance we made an

exception due to the beauty of the spot, and grilled a mahi-mahi which we had caught trolling on the sail over.

The next morning we dropped the mooring around 9:30 a.m. and sailed south down the channel between Culebrita and Culebra, rounding up into Ensenada Honda, the principal harbor of Culebra. Although we didn't do it this time, it is possible to anchor on the west side of Culebrita, almost due west of the lighthouse, for some very nice snorkeling along the reef.

We cleared U.S. Customs and Immigration by cell phone. In order to do so you will need about 10 minutes, everyone's passport and address, the boat's papers and an annual Customs decal. Although we didn't have this last item, Customs very nicely overlooked our lack, although you can't really count on having the same luck.

There are two principal anchorages in Ensenada Honda. The first, and by far the most scenic, is behind the reef

The Right Equipment. **The Lowest Cost.**

New South Pacific destinations in Tonga and New Zealand | **WINTER SAVINGS**
Monohulls and Catamarans ranging from 36' to 50' | **SAVE UP TO 15%***
*Call for details

BRITISH VIRGIN ISLANDS | **800-521-1198**
NEW ZEALAND • TONGA | **footloosecharters.com**

Footloose 10th Anniversary
SAILING CHARTERS

OF CHARTERING

on the southwest side of the harbor entrance. You will find other boats anchored there, but be sure to enter by going well clear of the northern tip of the reef after passing between the buoys at the harbor entrance. The other anchorage is in a small bay with brown water north of Punta Cabras, on the northeast side of the harbor. Again, you will find a number of boats anchored there, and holding is good in a muddy sand bottom. The choice of anchorage really depends on how far you wish to ride your dinghy to reach Dewey, the main town.

From WWII until 1975, Culebra was part of the U.S. Navy's practice range for gunnery and bombing. It has a beautiful long beach called Flamingo Beach on the northeast coast, complete with a few wrecked tanks that were targets. Today, Culebra is a tranquil place with friendly people, and what seems to be a more or less permanent group of resident yachters. Replenishing provisions is possible, although not in modern su-



KENNETH WOOTON

permarkets. Two days at Culebra seems to be just right.

Rental cars and taxis are both readily available. Our favorite spot for dining is Mamacita's, reached by taking your dinghy part way into the canal that cuts through the town of Dewey and tying up at their dock on the north side of the canal.

Bananas is one of several seaside watering holes in the sleepy town of Esperanza on the south side of Vieques.

Our next stop was the island of Vieques, which also had the dubious honor of being a target for the U.S. Navy until 2003. The upside of this situation is that most of the island is undeveloped. We again left about 9:00 a.m. and sailed

BVI ■ LEEWARD AND WINDWARD ISLANDS ■ MEDITERRANEAN ■ NORTH AMERICA ■ INDIAN OCEAN ■ PACIFIC OCEAN



More service than anyone else.

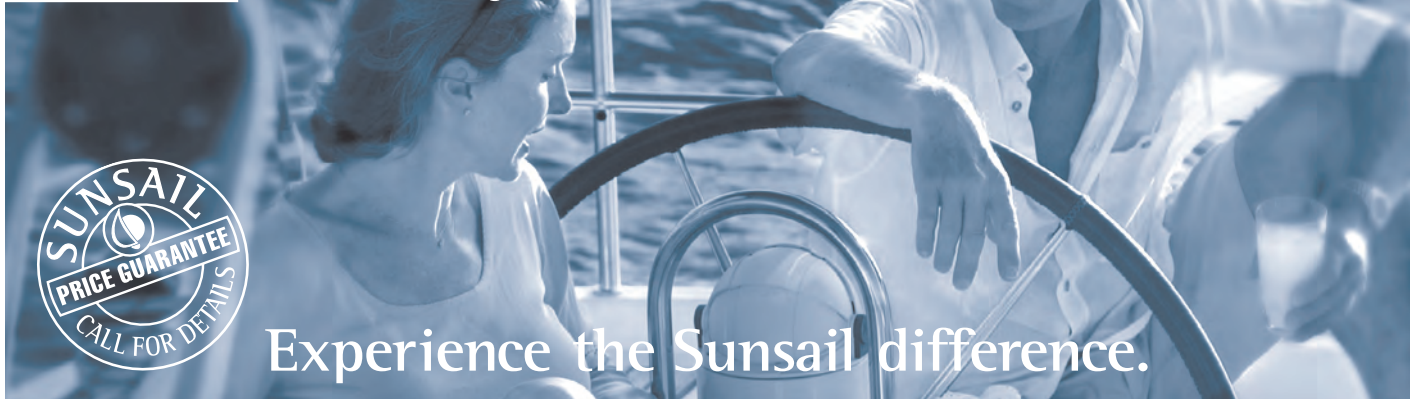

Experience the Sunsail difference.

With ■ **MORE** dedicated people to service your every need ■ **MORE** choice of yachts ■ **MORE** new yachts ■ **MORE** of a great deal with our price guarantee, it's no wonder ■ **MORE** people sail with Sunsail than anyone else.

Call 800.734.8682 Visit sunsail.com



BAREBOAT ■ LUXURY AND CREWED CHARTER ■ FLOTILLAS ■ ACTIVITY CRUISES ■ BVI SAILING SCHOOL

WORLD

due south on a beam reach, achieving an exhilarating 14 knots. Rounding the easternmost point of the island, we then headed west, up the south coast to the small town of Esperanza. Entry into the bay is easy; there is a deep (17 feet) channel between Punta de Tierra on the east and a small island called Cayo Real on the west. Four moorings were available when we arrived, and during our three-day stay only two other boats came in.

Vieques is a delightful island with many beautiful beaches such as Ensenada Sun Bay, just east of Esperanza. The town itself has a lovely esplanade and several restaurants along the shore, all of which we have found to be acceptable. Just a few miles out of town is a truly memorable restaurant called the Blue Macaw, located in



KENNETH WOOTON

The town of Dewey on Culebra is the only place to provision on the island. The lift bridge crosses a canal that bisects the island.

the Inn on the Blue Horizon. There is also a nice museum in the main town of Isabel Segundo. It is located in the middle of the island on the north coast in a restored

Spanish fort. The highlight of a visit to Vieques is a night trip to Mosquito Bay to kayak and swim in the most spectacular phosphorescent bay we have ever experienced.

If you are seeking solitude rather than diversion, there are a number of isolated bays on the southeast coast such as Bahía Salina del Sur and another Ensenada Honda. These both require careful eyeball navigation to enter, but you are almost guaranteed privacy and a sheltered anchorage, especially if you avoid weekends, when many power boaters

come over from Puerto Rico. We departed Esperanza reluctantly about 9 a.m. for the windward slog back to St. Thomas. We planned the trip to arrive in Elephant Bay around 4 p.m., then dinghy ashore to Tickle for dinner in Crown Bay or back to CYOA for one

Have we got a cat for you ...

GOCATS
Catamaran Charters Worldwide

In North America
Call for a Brochure
1-800-592-1254
WWW.GOCATS1.COM
South Pacific • Mediterranean • Caribbean • Indian Ocean

Tahiti,
is calling you

The...
magical seduction! spectacular beauty!
dazzling sunshine! turquoise lagoons!

Charter a new catamaran for a week or more
and cruise around the best palm trees in the world

TAHITI YACHT CHARTER CO.
P.O. Box 5162 • Newport Beach, CA 92662
949-675-3519 • Fax: 949-723-8512
marimktg@ix.netcom.com

For reservations Call toll free:
1-800-404-1010
anywhere in USA or Canada

OF CHARTERING

of the numerous restaurants in Frenchtown. This allowed us a leisurely morning the next day to clean up the boat, refuel, and return to the CYOA docks.

— *charles consolvo*
(reprinted with permission from CYOA)

Ed. note — CYOA is a relatively small, but long-established, bareboat charter outfit based at Frenchtown, St. Thomas, in the U.S. Virgins. For more info, see www.cyoacharters.com or call (800) 944-2962.

Charter Notes

In these troubled times, many Americans are extremely reluctant to travel anywhere in Europe, and especially in **Turkey**, because it is a Muslim nation — even though it is the most 'westernized' of all its Muslim neighbors. We're told that several **recent terrorist bombings** in resort areas along the popular southwest coast have caused the flow of tourist dollars to resorts and charter



KENNETH WOOTTON

Rented kayaks are used to explore the magnificent bioluminescence-rich Mosquito Bay on the south side of Vieques.

outfits to dry up dramatically.

Although periodic bombings or other 'disturbances' have occurred for years in the southeastern part of Turkey, such incidents had previously been virtually

nonexistent in the tourist areas along the southwest coastline — the Turquoise Coast — which has been popular with European and North American sailors for decades.

From thousands of miles away, it's difficult to put such events in perspective. True, these were two or three isolated incidents. It is impossible to say whether they harbingers of more attacks to come or simply random events which are not likely to be repeated — at least in tourist areas — anytime soon.

For a sense of perspective, we had a chat with local charter skipper **Marco Sange**, who now runs the **C&C 48 Incognito** on the Bay. He spent 19 years running charter yachts in the Aegean, principally *Serena*, a 62-ft S&S steel sloop. Marco had just returned from a month of chartering in Turkey when the most recent bombing occurred.

"I just want to tell *Latitude* readers that **the people of Turkey are wonderful, hospitable and kind**, and it is a

www.cyoacharters.com

thinking about a sailing vacation?

Since variety is the spice of life, we've added new cats to our charter fleet. Checkout our 4-cabin, air conditioned Fountaine Pajots. They're loaded with all the creature comforts you need for inland hopping and smooth sailing.

Our website provides details about these models, plus Hunter, Jeanneau and Mainship members of our fleet. Whether you are sailing with just one friend or a large group, there's a perfect boat for you.

We have been sailing the Virgins for over 20 years and we know what makes a bareboat vacation perfect... well-maintained boats, a friendly knowledgeable staff, easy travel arrangements and reasonable charter rates. Start planning your perfect vacation today.

WE'RE BETTER THAN EVER!

CYOA

YACHT CHARTERS

info@cyoacharters.com
ph: 340-777-9690 fax: 340-777-9750
st thomas, u.s. virgin islands 00802

1-800-944-CYOA

VIRGIN ISLANDS BAREBOAT CHARTERS - SAIL & POWER

HUNTER - FOUNTAINE PAJOT - JEANNEAU - MAINSHIP

WORLD OF CHARTERING

fabulous place to cruise or charter.

"During 26 days of cruising the coast with charter guests from the Bay Area aboard, I never felt a hint of hostility toward us as Americans. People would tell me, **'We love American people. Why aren't they coming anymore?'**

"They understand our political situation; of course they don't like the actions of our government, but they don't blame travelers for that."

Knowing the area from years past, he was relieved to find that most of the cruising area has developed very slowly over the years. "If there was one restaurant in a bay years ago, now there might be two. The cuisine is fantastic and incredibly inexpensive. The bays are kept clean, with no trash lying around anywhere, and everywhere, the people we met were incredibly hospitable. They



STARDUST/SUNSAIL

Turkey is a sailing venue with a seemingly boundless wealth of cultural antiquities, as well as exceedingly hospitable people.

just couldn't do enough for you."

With a wealth of ancient ruins that date back hundreds — or even thousands — of years found close to many anchorages, it is, of course, a cruising venue incredibly rich in history and culture. And while Greece, sadly, has become more and more crowded each summer, Turkey — even before 9/11, the Iraq War and the recent bombings — saw much less impact from Western tourism. These days, according to Marco, there are far fewer boats than ever.

Far be it for us to send you into harm's way when you're supposed to be on vacation, but we certainly wouldn't rule out a trip to Turkey after talking to Marco. And if you're the type who hates traveling to places that are overrun with hordes of American tourists, this could be the perfect time to explore those ancient waterways.

HEY
Enjoy total freedom and peace of mind with the charter company renowned for its customer service and quality since 1979.

ARE YOU MISSING THE BOAT?

TMM
Yacht Charters

1-800-633-0155 • charter@sailtmm.com • www.sailtmm.com
Belize • Tortola • The Grenadines
Catamarans • Monohulls • Motor Yachts • Yacht Ownership

BRITISH VIRGIN ISLANDS
"BEST DEALS ON KEELS"

Conch Charters
Est. 1986

- Most selection of sailboats 28'-51'
- "Purr" with cats 37'-42'
- Bare boat or skippered
- Best yacht management program

NEW YACHTS IN FLEET!

www.conchcharters.com
Email: sailing@conchcharters.com
Call our 'Sails' Office
(USA) (800) 521-8939
Tel (284) 494-4868 • Fax (284) 494-5793

Sail paradise with Conch Charters

CALIFORNIA'S CARIBBEAN CONNECTION

**12 Issues,
2,910 pages
each year...**



**At \$30 a year,
that's only a
penny a page!**

"I don't want to miss a single page, so sign me up now!"

Enclosed is **\$30.00** for one year
Third Class Postage (Delivery time 2-3 weeks;
Postal Service will not forward third class, so you must make
address change with us in writing.)

Enclosed is **\$55.00** for one year
First Class Postage (Delivery time 2 to 3 days)
(Canada & Mexico: First Class Only
Sorry, we cannot accept other foreign subscriptions.)

Gift Subscription – Gift Card to read from:

**PLEASE READ
CAREFULLY
BEFORE
SUBMITTING!**

*Check, money order
or credit card info
must accompany
subscription request.*

*We do not bill for
subscriptions.*

Please allow
4-6 weeks
to process new
subscriptions and
changes, plus
delivery time.

Check or Money Order Enclosed

MasterCard VISA American Express

Number: _____

Expiration Date: ____ / ____ Amount \$ _____

Name _____

Address _____

City _____

State _____

Zip _____

FILL OUT THIS FORM AND MAIL IT TO US AT:
Latitude 38, Attn: Subscriptions, 15 Locust Ave., Mill Valley, CA 94941

OR FAX IT (CREDIT CARD ORDERS ONLY) TO:
(415) 383-5816, Attn: Subscriptions

Latitude 38

**Maine Cat 30 & 41
Hope Town, Abaco, Bahamas
Bareboat Charters**



Enjoy well protected Sea of Abaco waters with their beautiful islands and beaches aboard an open bridgedeck cruising catamaran. A breeze to handle and fully equipped.

Visit: www.mecat.com

Email: mecat@gwi.net

Phone: 1-888-832-CATS

CHARTER YOUR OWN TALL SHIP!!!

**TALOFA presents...
Eco Adventure Vacations**

BAJA HA-HA Oct 30-Nov 12

SEA OF CORTEZ MARINE SANCTUARY November, April, May, June

CHANNEL ISLANDS MARINE SANCTUARY

July, August, September, October

Contact Betsy Bryan www.bajaschoonercruises.com (805) 216-6494

**Thank Your Crew For A Great Sailing Season...
Give the gift of Latitude 38 Logowear**



Check out our
Web site at: www.latitude38.com

or write to: *Latitude 38* Logowear
15 Locust Ave., Mill Valley, CA 94941



**Closest full-service
charter base to
Desolation Sound &
Princess Louisa Inlet**

Visit our Web site
for a preview of
our 25' to 44'
Power & Sail fleet

*One week bareboat charters
starting at U.S. \$700*

e-mail charter@desolationoundyachtcharters.com
<http://www.desolationoundyachtcharters.com>

#101-1819 Beaufort Ave., Comox, B.C. Canada V9M 1R9
TOLL FREE 1-877-647-5815 FAX (250) 359-9217

CHANGES

With reports this month from **Wind Trekker** on Banderas Bay; from **Gemini** on six years of cruising; from **Anduril** on a 30th anniversary cruise; from **Delphinus** on riding the Gulfstream to Key West; from **Neverland** on a short cruise in the Sea of Cortez; from **Flashgirl** on sailing to and around French Polynesia; and lots of **Cruise Notes**.

Wind Trekker — Corsair 31 Tri Tom Brown Banderas Bay Sailing Adventure (Palo Alto)

For six weeks in May and June, I enjoyed beautiful sailing on Banderas Bay, Mexico, aboard our cruising-equipped Corsair 31 trimaran *Wind Trekker*. During one 24-hour period, I sailed all around the bay from Paradise Village in Nuevo Vallarta, and then out to Corbatina Rock. A northerly evening breeze carried us along 4-6 knots, and the tip of the daggerboard was clearly visible in the phosphorescent turbulence five feet below. Need I mention the stars were spectacular on the moonless night?

When we were about 10 miles west of Cabo Corrientes at 1 a.m., the C.A.R.D. (Collision Avoidance Radar Detector) began chirping. Something was 'painting' us from our aft port quarter. Ten minutes later, the C.A.R.D. reported a stronger signal dead ahead with no lateral movement. Nonetheless, we couldn't see anything, either with our night-adapted eyes or with radar. Anyone monitoring us should have seen our radar reflector and our tricolor masthead sailing lights. Whoever it was apparently didn't wish to be seen, for they were invisible to our own small 2 kw radar. Still concerned, I finally flicked on our steaming and deck lights, identified ourselves on VHF 16, and requested that the vessel dead ahead of our position/bearing identify herself. But there was no response.

Who could it have been? Later the harbor master told me that it was probably a Mexican Navy inflatable patrolling

Tom Brown enjoyed good summer fishing in Banderas Bay from his 31-ft tri. He and his wife will be moving there with their boat in the fall.

for 'agricultural shipments'. In fact, that weekend the navy reported seizing four tons of cocaine off the coast. In retrospect, I'm glad we were forewarned that we were being watched and from what direction, as it allowed us to make it clear that we weren't out there for a midnight rendezvous with some bales of pot.

Were our sails on Banderas Bay and the freshly-caught sierras worth trailering *Wind Trekker* 1,800 miles south from the Channel Islands, down highway 15D (and back via San Blas instead of Tepic)? Except for the dangerous treks through L.A. (going) and San Diego to L.A. rush hour traffic (returning), yes it was worth it! Fortunately, I had 500 miles to practice keeping the trailer inside the white lines before I hit the no-shoulders/six-inch-vertical-dropoff segments of Highway 15D. I never drove tired or at night. Rather than drive as the locals do with my U.S. tags and boat, I obeyed every speed limit that I saw. It was a good thing, because more than once the first vehicle that passed me when I pulled off to let a long line of cars go by was a police car that had been riding sight unseen behind my trailered trimaran. Friendly smiles, a bit of Spanish, strict obedience to the law — and perhaps the Vagabundos del Mar stickers all over my Tahoe — made for a pleasant, no-hassles trip.

I'd do the trip again, but next year I think I'll sail *Wind Trekker* to Mexico as part of Baja Ha-Ha 13 next fall, and then on to Banderas Bay. You see, when my fair weather sailing partner flew down to stay at Paradise Village Hotel, we did some real estate shopping around Banderas Bay. The result is that we bought a villa in Punta Esmeralda, which is between Bucerias and La Cruz, about 15 miles

from the Puerto Vallarta Airport. If all goes well, we'll be readying our Palo Alto house for sale next year before the Ha-Ha, and then relocating our boat and ourselves to Banderas Bay.

— tom
06/15/05

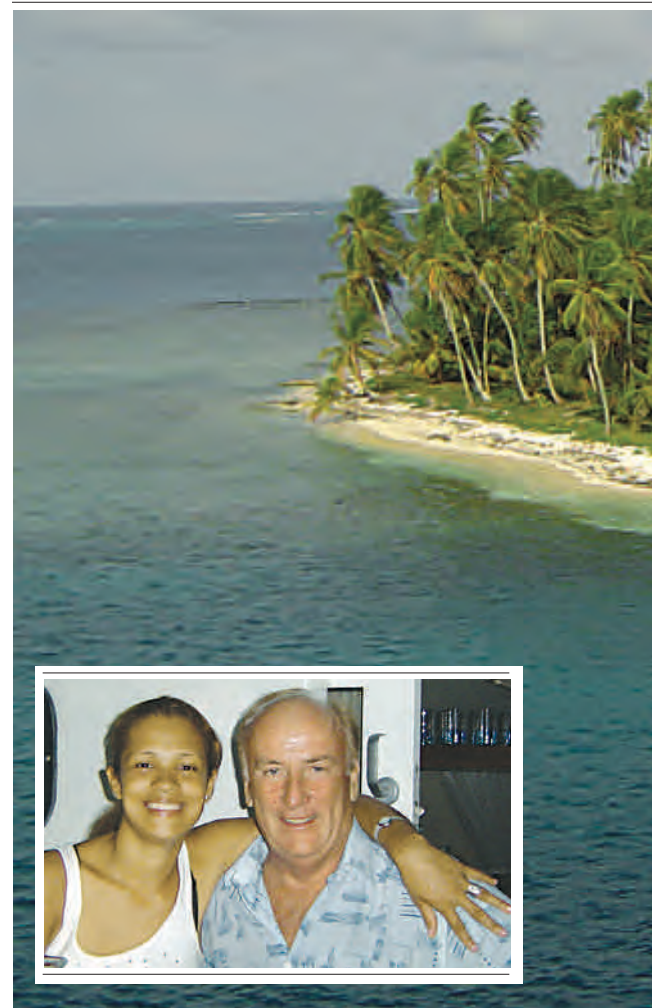

Gemini — Albin Nimbus 42 Les Sutton & Diane Grant The Sixth Year Q&A (Northern California)

A while back, Les Sutton stopped by the office, and we had a lively talk that jumped all over the place and touched on various bits of his and Diane's six years of cruising adventures. Some highlights:

The I.Q. of fish. "Fish in the Caribbean are smarter than the fish in the Pacific, because they'll swim into a hole, glance back, but swim out the other side. The dumb fish in the Pacific swim into a hole, then come back out to see who chased them — at which point you shoot them."

Unusual weather. "No matter where we've been in our six years of cruising, people have always told us they were having 'atypical' weather". For example, we had two weeks of absolute flat calm in the Western Caribbean in May and June. "Atypical," everyone said."

How to know if there will be a sailing breeze in the Sea of Cortez? "Listen to Tom Tango Papa on the Chubasco Net. At the beginning of the forecast, he gives the

TOM BROWN

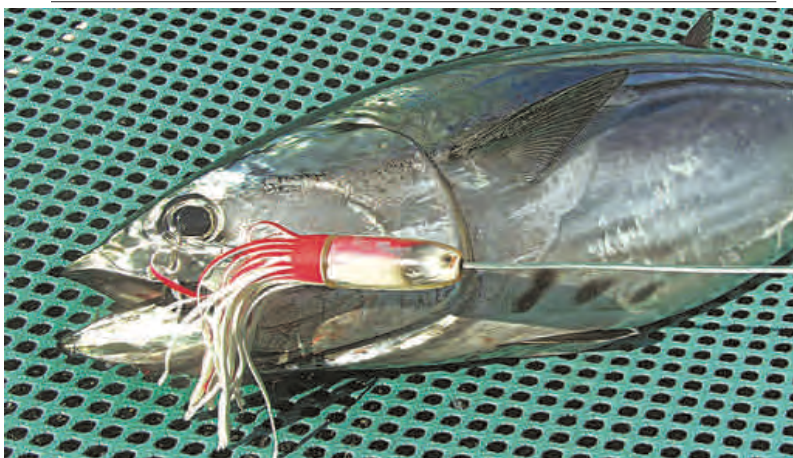

IN LATITUDES



BOTH PHOTOS COURTESY GEMINI

Spread; Some 350 islets like this make up the San Blas Islands. Inset; John and his Colombian sweetheart have returned to Cartagena.

baro pressure for San Felipe and for Cabo. If there's a lot of difference between the two, there will be a good sailing breeze. If there is little difference, there will be little or no breeze. The wind blows out of the northwest all winter in the Sea, and out of the south in the summer."

What about looking out the porthole? "Diane and I do get 90% of our weather information by looking out the porthole. Nonetheless, Don Anderson of *Summer Passage*, who provides weather forecasts for Mexico and beyond, is excellent at explaining the overall picture. We think he's gotten better over time because he no longer tries to forecast microclimates."

What indicates there will be a strong Norther blowing down the Sea of Cortez in the winter? "High pressure in the 'four corners' regions of the States."

What about *elefantes*. "Lots of people fear the *elefantes*, which are the strong night breezes blowing off the Baja coast of the Sea of Cortez in summer. These are

caused by the hot air collapsing at night and blowing offshore. They blow up to 45 knots right by shore, but five to 10 miles out they only blow at 20 knots, making for great traveling winds."

What was the sound you kept hearing when crossing the Gulf of Tehautepec? "The bow of our boat hitting turtles. There seem to be a lot more of them than before."

What are your feelings about Colon, Panama, regarded by many as the dangerous armpit of the world of cruising?

"We had to spend 40 days there after losing our engine. It's not a bad place, but you do have to be careful and don't want to flash indications of wealth. We always used cabs between the yacht club and downtown. There are certain areas — and it's obvious which ones they are — where you should not go. For \$1 a cab driver would pick up

rotisserie chicken for us and deliver it to the Panama Canal YC, which is the cruiser 'safe zone' there. There are lots of Chinese and Lebanese merchants in Colon, which makes it interesting. One guy makes great falafel bread over an open fire."

Why did it take so long to get your engine rebuilt in Colon? "It took time getting the right parts from John Schere of Montreal, who created the Pathfinder marine diesel. Once we got them, Alejandro, our mechanic, got right on it. He bid \$1,000 on the job and stuck to it."

Are the San Blas Islands of Panama as good as people say? "We spent several months there, and they really are wonderful. The locals are always coming out selling you official-looking cruising permits — \$5 for 30 days — but we didn't begrudge them. Over on Chichime, Julian Harvey, an ex-corporate guy, makes delicious 'Kuna bread' with coconut milk. He bakes the loaves in a 55-gallon drum over an open fire."

How many boats are in the San Blas during the winter 'high season'? "About 50, including the Italians, Germans, and some French. We had a great time with the Germans and Italians, but not so much with the French. We also met some really wonderful folks on a Japanese boat."

Is there a 'Club Med' for cruisers in the San Blas? "That would be Coco Bandero, which is a little south of the Hollandes Cays. They had a social activity there every single night — and they were really fun. Some cruisers stayed for months and months."

And the Monday night burn? "That would be held by Reggie and Deb of the New York City-based *Runner*. For years now, Reggie has been the self-appointed cleanup crew of an island near the 'swimming pool', and every Monday night he burns the debris he's collected. The burn

Six years into cruising from Mexico to Colombia, Les and Diane stopped to enjoy a rest during a hike up Panama's Rio Cedra.



COURTESY GEMINI

CHANGES

has become a social event during the high season."

Did you see any Kuna transvestite mola makers? "Yes, we hiked up the Rio Cedra on the mainland to see the falls and buy some molas from the transvestite mola maker. The hike — about five miles up a canyon — was a little more difficult than advertised, as Diane lost her glasses while jumping off a waterfall and Quincy of *Chewbacca* fell and needed stitches in her chin."

Do cruisers really transport backpackers and others between Cartagena and Panama? "They do. For example, Mark and Paula of the Roberts 44 *Melody* do backpacker charters. Check them out at Freshaircharters.com. They also shop and deliver groceries, gear, and fuel for cruisers out at the San Blas Islands. You get a receipt for the stuff, for which 30% is added on for their time and effort."

What's the best time of year for the San Blas Islands? "There are strong winds — to 35 knots — from December to March, with a few weather windows. Sometimes the strong winds start as early as November. The San Blas high season is from December to March, but Diane and I think it's best from March to November — even though part of that is the 'rainy season'."

What about the Bocas del Toro region on the Caribbean side of Panama? "It's getting more popular all the time. When we were there, Susie from the powerboat *Caberet* organized all the many social activities. It's a great place, and Bocas Marina is the place to stay. There are lots of surfers and surfing, too, as there are Pipeline-like waves breaking over shallow reefs.

If you're looking for some delicious warm Kuna coconut bread, you can only get it from Juliana on Chimchime.



GEMINI

Panama is known for lightning, isn't it? "Yes. You should see the horizontal lightning sizzle over a mast. We're told the mast doesn't attract lightning unless the anchor is down, but we're not sure about that. You just don't want to be in the wrong spot at the wrong time."

How far is it from the San Blas Islands to Cartagena, Colombia? "One hundred and ninety miles.

How nasty can the sailing conditions be in the Caribbean around Cartagena? "The Alaska-based Cheoy Lee 41 *Kukara* had been all over, including to the Med and back. But while sailing downwind to Cartagena, a rogue wave broke the stern pulpit, bent the wheel, took out the cockpit doors, filled the salon sole with 18 inches of water, flooded the engine, and damaged the electronics."

What's the deal with private armies in Colombia? "Oil companies have them, banana companies have them — there are five or six wandering around the countryside. Then there's the FARC rebel group. A year or two ago they kidnapped a bunch of tourists and held them for ransom, so the U.S. put out an advisory about Colombia being unsafe. Cruise ship visits — which flood Cartagena with money — tumbled from about 200 a year to 20 a year.

"Does Cartagena still have the shiva buses or whatever, which are bars with rock 'n roll bands that endlessly drive around town? "Yes, but there aren't as many as there used to be."

How safe is Cartagena? "It's safe — although it just takes one person to ruin it for you. You only want to wear the kind of jewelry you're prepared to lose."

What's the story with boatyards in Cartagena? "There are three of them: Manzanillo Marina Club, Ferrocem, and Todomar. Ferrocem is the only one that allows you to do your own work. We negotiated with all three on getting our 42-footer painted from keel to deck, and the bids were 12 to 15 million pesos — which sounds like a lot, but is only \$5,500 to \$7,000. We finally agreed on \$5,000. They do beautiful work, and it was a fraction of what it would have cost in the States. But as in any Third World country, you have to constantly supervise the work."

What about boatwork in Panama? "Labor is cheaper in Colombia, but all imported items are subject to 70% import tax. Panama is duty free, and Marco at the Marine Warehouse in Panama City is great at bringing stuff in. If you need a lot of stuff, Hal White will bring it down from the States for \$1/pound in a container. So buy your stuff in Panama and have your boat work done in Columbia."



List your favorite cruising countries in order of preference:

"Mexico is number one because the people are so friendly and because it's so convenient to the States. Panama is second, as the San Blas Islands are great and it's easy to get anything you want for your boat. Third would be El Salvador, as the people are friendly and the marinas really take care of you. Nicaragua — specifically Marina Puesto del Sol — would be fourth because Roberto Membrano, the Californian who developed the resort and marina, and his staff are wonderful. Costa Rica would be fifth, as we had to pay a lot of bribes to get stuff imported. Cartagena is worth the visit, but we don't know it well enough to rank it. One great place not many people visit is the Gulf of Fonseca on the Pacific, which is shared by El Salvador, Nicaragua, and Honduras. Tiger Island, in the gulf, used to be a CIA headquarters, and the whole gulf was deliberately mischarted for military purposes. We'd like to do the South Pacific, too, but don't want to be isolated from 85-year-old parents."

"But Mexico is the best cruising base

IN LATITUDES



HANALULA

Water shortage in Canada? Harold and Linda Anderson of Grass Valley trailered their Balboa 27 'Hanalula' to Canada's Gulf Islands for a little cruising. Based on the photos they forwarded to us, Canada's ocean's seem to be running dry. Either that, or folks can't read depthsounders.

and the best place to cruise. We love Mazatlan, La Paz, Puerto Vallarta, Manzanillo, Zihua, and up in the Sea of Cortez. In fact, our favorite place of all has been the Sea of Cortez in the summer when there aren't so many boats. People have been friendly wherever we've gone, but nowhere as friendly as Mexico. We plan to return some day."

John Haste and his San Diego-based Perry 52 cat *Little Wing* didn't make it to the Banderas Bay Regatta this year. Have you seen him? "Yes, we saw him and Suhay, his Colombian girlfriend, back in Cartagena."

— latitude 08/02/05

Anduril — Cross 40 Trimaran Joanne Sandstrom French Polynesia Revisited (Oakland)

It's July 17, so I'm writing on the 30th birthday of *Anduril*, the Cross 40 that our family built and have sailed around the world twice.

My husband Don and I are now back at latitude 38, but *Anduril* is still around latitude 21, where my son Donald and his wife Erika are spending a few weeks in Hawaii before sailing home. They sailed to Mexico last fall, then in mid-March of this year continued on to the Marquesas. Don and I joined them in Raiatea in mid-June for the passage to Hilo.

Our passage to Hawaii took 16 days and 7 hours. We didn't make as much easting early in the trip as we had planned, so we came up on Caroline Island and stopped for snorkeling. The black-tipped sharks were a little more aggressive than we liked — one clamped its teeth around the boat pole that Donald was carrying — so our stay was even shorter than we'd hoped. But the water was the clearest and warmest we'd encountered on this trip. Even if Caroline Island was on some sailing track, which it isn't, it wouldn't normally be visited because there is no passage into the lagoon and because there is no suitable place to anchor.

A word on meeting boats in the Marquesas. Don and I flew into Papeete at the

beginning of the trip — after being forced to buy return tickets in Honolulu (never mind what the French consulate in San Francisco told Don about not needing them since we were joining our own boat). We stayed at the Tiare Tahiti Hotel just across the street from the quay. The post office was across the other street, and it had a blinking neon light, which gave us fits for two nights. People aboard boats on the quay had the same complaint. Given that the post office isn't open at night or at any time on Sunday, we wondered why the neon? It's probably a French thing.

As instructed, Donald had bought us tickets on the *Vaeanu* for the passage from Papeete to Raiatea. I had told him to get us deck passage, but after the Tahitian ticket-seller asked him our ages and showed him pictures — which the ticket-seller swore were 20 years old — of the freighter, Donald got us a cabin with a shared toilet. The *Vaeanu* is best described as a 'Van Gogh ship', meaning the very thick paint mostly covers the rust — and probably helps to hold the ship together.

Bora Bora was a gigantic disappointment compared to our first visit in '77 during our '75 to '80 circumnavigation. Hotels — which I can't imagine are being filled — are going up everywhere. The construction has clouded the water and probably helped kill a lot of the coral. In any event, much of the coral is now dead. All the hotels seem to have the 'traditional' thatched roofs — no matter that no one builds such roofs on private homes. I'm assuming that there's some kind of composite roof under the thatch. Worst of all, however, are the all-too-numerous #\$\$^@&*@% motorized bugs — aka 'personal watercraft' — that buzz about everywhere, shattering the peace and 'tranquility' of the anchorages and endangering the snorkelers. Next time I'd give Bora Bora a pass!

What a difference a generation makes! Testosterone levels were down, so father ***Unhappy with the changes at Bora Bora — including all the new hotels — the Sandstroms say they'd give the fabled island a pass next time.***



INTERLUDE

CHANGES

Don and son Donald were able to coexist in the same "40-foot box" without conflict. Of course, the roles had changed. Donald and Erika are captain and admiral now; Don and I went along simply as crew. I had the 'Teveye watches' — sunrise and sunset. The 0300-0600 watches were also moon-brightened every morning. The moon was waxing when we started, then waning later on. I loved it.

Other differences from before: *Anduril* now has refrigeration, so we didn't have to make do with bilge-temperature beer and an unending diet of 'can over' rice or pasta. The wind generator and solar panels provided enough electricity that we never had to turn on the engine to charge the batteries — although we did motor into Hilo to get in before dark. The water tanks were filled at the start of the passage, but most of our daily use was supplied by the watermaker. There's a sextant on the boat — and we know how to use it — but we got our positions from GPS. The autopilot makes things a lot easier, of course, but using it still seems like cheating to me — rather like crossing the desert in an air-conditioned Volvo set on cruise control instead of driving the 1946 Hudson with the water bag hung from the grill to keep the radiator cool and the wind wings adjusted to blow air in our face. Nevertheless, it was great to be at sea again. And the 1946 Hudson is long gone!

— joanne 07/15/05

Delphinus — Mayotte 47 Cat Randy Sparks, Crew Coming Home On The Gulfstream (Santa Cruz)

[Editor's note: This Changes was written prior to hurricane Emily smashing into the Caribbean coast of Mexico.]

It was difficult for us to leave Mexico's Isla Mujeres — pronounced 'moo-HAIR-

Randy and Josanne on the beach at Isla Mujeres before he and Bruce, the owner of 'Delphinus' rode the Gulfstream to Key West.

ayz' — after only five days. The low and narrow four-mile long island that is just six miles northeast of Cancun has the finest white sand — almost powder — beaches in the world. In addition, the Mexican lifestyle is mesmerizing. I could very easily see myself getting lost in the peacefulness of the Mayan Riviera.

There are many stories of how the place became named 'Island of Women'. Among them is that drunken pirates mistook the manatees for mermaids. Whatever the reason, the idea of finding a woman at Isla Mujeres seems to be a draw for many of the hordes of male tourists at pumping Cancun. Nonetheless, Mujeres still slumbers in tranquil Mayan dreams — at least compared to her neighbors of Cancun, Isla Cozumel, and Playa Del Carmen. If your boat draws less than eight feet, there are three marinas on Isla Mujeres that can accommodate you, which makes it the cruiser capital of the Yucatan. While we were there, 47 boats arrived as part of a race from St. Pete, Florida.

Josanne, my girlfriend, and I visited Isla Mujeres for the first time during my birthday this year. Although we only stayed a day, we fell in love with the low-key atmosphere and the beautiful beaches. Our visit included Josanne's first snorkeling adventure on a coral reef. It was fun to watch her initial reaction to the tropical fish, which came so close that she could pet them.

Anyway, Bruce, the owner of the Portland-based *Delphinus* that I've been crewing on, and I ended up leaving Isla Mujeres in the company of three other sailboats on the 350-mile trip to Key West. We knew one of the boats, Charlie and Teresa's *El Rigallo*, from the Bocas del Toro area of Panama. The other two were new to us, and in any event, we lost contact with them after the first day. Thanks to the Gulfstream, we had a sleighride toward Key West. We made 105 miles in the first 12 hours, a new record for the cat.

And we could have done better had we set the sails earlier and not hit a group of whale sharks.

When I say 'hit' the whale sharks, that's just what I mean. I was asleep at the time of contact, but it was enough to wake me. Bruce and I both ran up on deck to find

What do you do if you're Arnold of the Grass Valley-based Island Packet 'Moondance', you're 15 days out of Hawaii for Monterey, still 1,000 miles from land, stuck in the middle of the windless Pacific Hgh, and are down to your last 15 gallons of fuel?

Easy, you wait for Paul Biery of the Emeryville-based Catana 431 cat 'New Focus' to show up on July 31. Although Biery and crew were on their way from Maui to Seattle, they still crossed paths with 'Moondance'. The 'New Focus' crew floated a jug of fuel — see lower left — for Arnold to pick up.

'New Focus' made it to Seattle in 17 days, a respectable 152 miles a day given the mostly light going. Her crew are interested to know when



dozens of the giant whale sharks feeding around the cat. This seemed like it might be a once-in-a-lifetime opportunity to see the giant creatures up close, for as recently as the '70s some experts believed they had become extinct. Whale sharks range in size from 20 to 40 feet, feed on plankton, but have cartilage rather than bone skeletons like sharks.

It wasn't until I got into the water with them that I began to appreciate what huge mouths they have — maybe 10 feet around. If they weren't plankton-eaters with a balleen filtering system, they could have swallowed me whole. At one point I was able to look into the gaping mouths of these giants and see how their plankton filtering mechanism works — and even the open gills behind it! Eventually, one whale shark swam close enough for me to grab onto his dorsal fin. He took me for a ride of about 30 feet before I let go and he swam away.

When I began to swim back to the cat, one of the smaller whales saw me and made a beeline in my direction. I had both hands on him when his mother noticed. Nonchalantly, she headed over toward us, gently nudged him away, and they both swam off. Bruce, who had counted



IN LATITUDES



JOHN RICHARDS

18 sharks in the group, later told me he thought I was a goner when the mother came toward me. He'd been nice enough to keep the cat pointed into the wind so she didn't sail away from me.

After a slow night, the next day started fast. I awoke to find two mahi on our fishing lines — our first double hook-up in the Caribbean. We hitched a ride on the Gulfstream going past Cuba on the second night, and got to listen to all the Cuban fishing boats talking on the radio. We also had to dodge parked ships and fishing boats — just like on the Pacific side of Mexico. When coming up the long channel to Key West at 6 a.m., someone, obviously gay, serenaded us with a rendition of *Wake Up* in falsetto. We weren't in Kansas — or Central America — anymore.

For those who slept through U.S. History, Ponce de Leon was the first to sight the Keys in 1513, but there was no permanent settlement for another 300 years. It was the Brits who came up with the name Key West for the most westerly of the Keys. The U.S. got Florida from Spain in 1819, and a couple of years later a U.S. Naval Base was established at Key West. Commodore David Porter's mission

was to rid the Keys of pirates known as the 'Brethren of the Coast'. Once all the pirates were hanged, settlers moved in from the eastern states, the Bahamas and Cuba. A combination of wreckers, converted pirates, and commercial fisherman formed the unique core of Key West society. They dubbed themselves 'Conchs' — pronounced 'Konks' — after the abundant shellfish that was a staple of their diet. The Conchs became famous — or infamous — for their lucrative marine salvage business. Local legend has it that many ships were lured onto the reefs by false lights and crooked merchant skippers. Whether the wrecks were deliberate or not, by 1830 such salvage made Key West the most prosperous city per capita in the country! And by 1890, Key West was Florida's largest city.

Today Key West is a rowdy town of 70,000 permanent residents, many of them gay, and the nightlife goes on until dawn. Ever since the Navy left, tourism has been the city's number one industry. Nobody will ever have trouble finding the action in Key West. But one informal spot popular with locals and cruisers is the Half Shell Raw Bar overhanging Key West Bight. It's not posh, just a good spot to get the flavor of Key West while sitting at picnic benches eating raw oysters.

It's great to be back in the States. For one thing, in the U.S. we don't have to worry about the water, the toilets flush with just a quick push of the lever, and the bathrooms always have toilet paper and paper towels. There are cultural niceties, too. The waitress will bring you what you thought you ordered, will fill your coffee cup as many times as you'd like, and will bring you your check without your having to ask. In addition, there are no currency exchange problems, no smog-belching buses, and my cell phone works. There are many, many reasons I'm glad to be back in the States, the number one of which is that my girlfriend is here. On the other hand, I sure will miss the adventure of exploring foreign countries by boat.

— randy 05/15/06

Neverland — Nor'Sea 27 Naftuli Furman and Larisa Sycheva Mini Cruise In The Sea (Fairfax)

It's been a few years since we did the Ha-Ha in '02 and spent some time in La Paz in '03. Since then, we've had *Neverland* at Marina de La Paz, then Marina Palmira, and most recently on the hard at Coast Marine. I've really enjoyed the professional and courteous service of Coast's manager Raul Cervantes, and recommend it as a good place to be hauled out. Raul and Sharon speak perfect English and Spanish. Of course, La Paz itself it was a wonderful place to leave my boat and return to several times a year for mini-cruises.

This year, Larisa and I decided we would sail up the coast from La Paz toward Loreto before returning to La Paz. As many others have reported, this area of Baja, along with the mainland's Gold Coast, are the two most popular cruising regions in Mexico. I flew to La Paz from Sacramento on June 10, which was a much shorter trip than Larisa's, who flew all the way from

Naftuli felt invigorated to be back sailing on the Sea of Cortez.

Ekaterinburg, Russia, on June 11. Yes, my girlfriend lives in Russia! But she speaks good English and I speak some Russian. *Gavarite parusski?* Having been born in Costa Rica, I also speak



NEVERLAND

CHANGES

NEVERLAND



After a long Russian winter, the warmth of the Sea of Cortez felt good on Larisa's pale skin.

Spanish.

Once we were both in La Paz, we went to Marina Palmira and spent three days preparing *Neverland* for sea. Small boats such as the Nor' Sea 27 are very easy to prepare, rig, and sail.

Our first passage was a very short one, about a mile to the new Marina Costa Baja at the outskirts of La Paz. We sailed all the way to a guest dock next to the front door of the Fiesta Inn — part of the Fiesta America chain — that's adjacent to the marina. The great thing about this hotel is that, if you take a room — about \$80/night, including breakfast — you get to use one of the hotel's guest docks. It's perfect for those who want to slowly ease into their cruise.

After the breakfast buffet the next day, we continued on our way to Isla Espiritu

A smiling Larisa holds up the catch of the day. If you can't live off the Sea of Cortez, you must have straight hooks.

NEVERLAND



Santo, which was only another 15 or so miles away. We planned to anchor at Ensenada El Cardonal, but there were already two other boats there, so we turned back for the larger Caleta Partida anchorage. The charts clearly indicate a reef between the two anchorages, so how was it we managed to hit the darn thing?

The sound of a fiberglass boat hitting a rocky reef is a horrible one. Fortunately, we hit at high tide, as it could have been worse. As it was, we were heeled over 35 degrees. I immediately put the engine in reverse, and with the help of some waves, was slowly able to back off the reef. Naturally, we got to the Caleta Partida anchorage as quickly as we could so I could dive on *Neverland's* hull to check for damage. Thanks to the Nor' Seas being built like tanks, there was nothing but a scratch on her bottom. I kissed my little boat so many times after that. Do I deserve such a wonderful sailboat? I don't know, I just know that I'll have to live up to her — and remember to sail around reefs!

The wind blew very hard — 25 to 30 knots — from the southwest that night. This was the well-known *coromuel* wind out of La Paz. The lines in our rigging sounded like the strings on a guitar. I set out 150 of my 200 feet of 1/4-inch chain attached to a primary Bruce anchor and also a Danforth anchor. It held well all night long.

Our third stop was The Hook at Isla San Francisco. The problem was that there were already four boats there: a sailboat from The Moorings and three motoryachts. We had a little scare that night,

too, as the depth-sounder alarm that had been set to six feet went off. Since *Neverland* draws four feet, it was time to reanchor in deeper water. Fortunately, my little boat has an electric windlass. Once I had 200 feet of chain out in deeper water, I slept soundly — even though it blew hard that night, too.

With the wind still blowing 20 knots from the south early the next morning, we



set sail north to the Evaristo anchorage on the Baja mainland. Having hit the reef at Isla Partida, I was very careful to avoid the Rocas de la Foca, which are just to the north of Isla San Francisco and not where one might expect them.

While at Evaristo, my darling beautiful Russian girlfriend decided to fish for dinner — and caught some! Meanwhile, I set up the BBQ and opened a bottle of California rosé. As far as we were concerned, life couldn't have been much better, as it seemed as though we were in paradise. Although the wind continued to blow hard out of the southwest, there was no fetch in Evaristo.

With wind out of the south the next morning, we once again took advantage of it for the sail to Agua Verde anchorage. I wish we could have stayed there for a few days — alas, we also had plans to fly to Puerto Vallarta and Mexico City before Larisa had to return to Russia. Our trip back to La Paz was all under motor, and we only took breaks to prepare the fish we'd caught for lunch and dinner.

Sometimes life can be so wonderful on just a short and simple little cruise.

IN LATITUDES



PHOTOS COURTESY FLASHGIRL

Spread; 'Flashgirl' at anchor off Bora Bora. Inset left; Commodore uses a jib to insure a PG rating; Inset right; An aerial of Cook's Bay.

Larisa and I felt we had been so lucky, and thanked God for it.

— *naftuli* 07/15/05

**Flashgirl — Wylie 38+
Commodore & Nancy Tompkins
Gendarmes & Robbers In Moorea
(Mill Valley)**

We arrived in Papeete on the wings of a very strong breeze the evening of July 7 to conclude a fantastic 22-day nonstop passage from San Diego. The passage was so wonderful that it seemed like no more than a week. In fact, when I realized that we'd be making landfall in a day or so, I got a little panicky — as I didn't want the extraordinary experience to end. I'd gotten into a rhythm with the sea, sun, and stars, and had found it quite agreeable.

Why, if we arrived on the 7th, has it taken us until the 29th to write? The truth is that I have no idea where the last 21 days have gone! The days just seem to drift by, full of swimming, rowing, walking to the market, meeting other cruisers,

doing a little boat maintenance — and taking that all-important midday nap.

So sorry for the delay, but here's the recap so far: Despite the strong winds and big seas, we managed to find the entrance to 110-meter-wide Papeete Pass — no thanks to the many lights of the nearby airport. Commodore was keen to anchor in the port of Papeete, just as he'd done aboard his family's 85-ft pilot schooner *Wander Bird* so many years before. But after getting the hook caught on the hurricane chain that runs through the harbor, we decided to find a spot along the downtown quay with the 40 or so other cruising boats.

While at the quay, it was fun to share stories with the crews of other boats, who had come from many different countries. After we cleared with customs, Commodore removed the American flag from the back of our boat and replaced it with a flag of the United Nations. We rather like the concept,

and got mostly approving comments. But about the first thing we did was hook up the hose and relish the abundance of freshwater. After such a long passage, salt crystals had caked up all over the boat, and it took a bit of encouragement to get all surfaces clean again.

I enjoyed the downtown location — except for the noise! The main drag runs right along the quay and, except for a few

Commodore and Nancy in French Polynesia looking like something Gauguin might have painted during his Impressionist period.



COURTESY FLASHGIRL

CHANGES

hours in the very early morning, it's always busy. After all, Papeete is a bustling city that is home to half of all the 250,000 residents of French Polynesia.

The people-watching and the convenient location of the quay made up for Papeete's shortcomings. The big produce market, for example, was just a few blocks away, as was Immigration and the Harbormaster. We were also able to walk to the *Heiva* (Polynesian Dance Festival), as well as simply wander the streets of this classic crossroads of the Pacific. Being tied to the quay also meant we were just a short-distance from the *roulettes*, which are the food vans that assemble in the evening to serve dinner at a third of the price of restaurants. There's a nice ambience around the 'roach coaches' in the evening.

But after a week, we'd had enough of city living, and moved to Marina Taina, about five miles away around the island to the west in the town of Puunavia. Since we anchored out about half a mile, it was the first time we had to assemble *Taxi Dancer*, the Wylie-designed nesting dinghy that Commodore had built last fall. From what I can tell, we pretty much have the only oar-powered and hard dinghy around, as most people use outboard-powered inflatables. Between the marina and the anchorage there were quite a few boats — I'd guess about 175.

There is a fabulous Costco-like super store so close to Marina Taina that you can off-load from the shopping carts directly into your dinghy. In addition, the water off Puunavia is a clear blue and just the right temperature for swimming or snorkeling — and there were plenty of tropical fish to see. However, the best part of the anchorage was the front row view of Moorea! The ever changing seascape and the sun setting behind Moorea provided us with endless viewing pleasure.

Nancy and Commodore never tired of the view of Moorea from Tahiti. Nor of the crystal clear waters of French Polynesia.

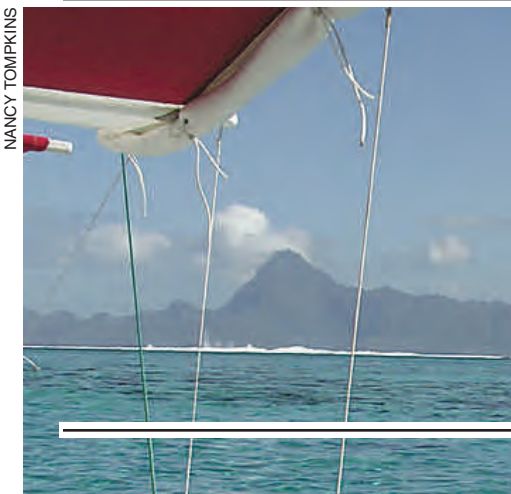

NANCY TOMPKINS

So it was with great reluctance that we weighed anchor and set sail for Moorea — which turned out to be just as fantastic in reality as it looked from a distance! Moorea is something out of a fantasy, but all the jutting and jagged ridges are real, as are all the tropical vegetation and flowers. We found Opunohu Bay to be the most beautiful and surreal place to anchor.

And now a few words from Commodore:

This morning Commodore and I rowed out into Opunohu Bay to watch the sunrise. We beached *Taxi Dancer* at the head of the bay, and walked for 30 minutes into the valley. It was beautiful. Thankfully it was also overcast, which is the best weather for hiking.

Upon our return, we visited with a Swedish boat that was anchored in the bay, then rowed to a little store. At that point, Commodore suggested that I walk into Papatoai while he rowed over. After walking a few steps, I put down my knapsack to take a photo. As I focused on *Taxi Dancer* . . . whoosh, a small green car drove by, and one of the passengers grabbed my knapsack! I ran down the road as fast as I could in pursuit, but clearly wasn't going to be fast enough. But the car behind the thieves gave chase, as did the next car, which stopped to pick me up. Both drivers got on their cell phones to call the *gendarmes*. By the time I got to Papatoai, a *gendarme* in a jeep picked me up and drove me to the *Gendarmerie* in Pao Pao — a place I would soon become familiar with.

Evidently, the car had been stolen, and the driver and a passenger had gone on a rampage. The owner of the car, a young French lady who lives on Moorea, joined me at the station. The ferry was called and the crew instructed not to allow any green cars to board. We later learned that the car had been abandoned in an industrial yard near the ferry terminal. My knapsack was in the car, but my wallet had been stripped bare — no passport, credit cards, cash, or anything!

Things seemed hopeless at that point, but the *gendarmes* asked me to wait a little longer. An hour or so later, we received word that two guys had been apprehended when the ferry docked at Papeete! How had they been found on a ferry full of people? When they dumped the car, a worker in the yard noticed them leaving and that one of them was wearing a blue Bob Marley-type hat with his long hair stuffed under it. Apparently the dummy kept his hat on, making him and his partner easy to spot.



The *gendarmes* asked me to wait until the duo could be returned to Moorea for questioning and to see if they had any of my missing items. The hours passed slowly, but ultimately two handcuffed thugs were brought into the station. The next thing I knew, the sweet young *gendarme* — in cute blue hot pants! — presented me with everything that had been stolen — except for some local currency. Amazing! Not only that, the thieves had stuffed all of my other stuff into my camera bag — including the cable that I need to download my digital photos to my computer. So I got that back, too. The *gendarmes* and people of Moorea did a great job nabbing the thieves and returning my stuff. Yes, it was even worth the seven hours I'd spent in the *Gendarmerie*.

To celebrate the fact that goodness had prevailed, we decided to go out for dinner at a place right on the water — which has its own collection of manta rays — at Cook's Bay. It was feeding time, so some of us bolder folks took turns going down the steps to the water's edge to feed and pet them. What a thrill! To make it even better, Commodore had brought *Flashgirl* around while I'd spent the afternoon in the *Gendarmerie*, anchored her right off

IN LATITUDES



MARINA DE LA PAZ

Marina de La Paz now has fixed breakwaters in place to protect against winds from the northeast and southwest. More in 'Cruise Notes'.

the restaurant, and rowed ashore in *Taxi Dancer*. It was all very lovely.

The lesson of the day was to leave one's wallet and other important papers stashed on one's boat, and to bring a minimum amount of valuables ashore. Yes, there is theft everywhere, even in paradise. So taking precautions is being careful, not paranoid.

The winds outside of the lagoon are pretty light, so we're thinking of heading to the Tuamotus before the easterlies kick in.

— nancy 08/05/05

Cruise Notes:

Interpol is combing the Baja Ha-Ha entry list for criminals?! "I got a nasty call today from Interpol," writes Jay Hall of the Punta Gorda, Florida-based Pacific Seacraft 37 **Orion**, entry #33 in this year's Ha-Ha. "I'd been listed as Joy rather than Jay Hall, and it seems Interpol has me confused with another sailor with a similar name. Apparently this individual is wanted for excessive drinking, carousing, and consorting with undesirable charac-

ters. I need to get the misunderstanding cleared up or I might not be allowed into Mexico with the Ha-Ha this year."

The Ha-Ha folks have made the name correction, but are terribly confused. For if excessive drinking, carousing, and consorting with undesirable characters were a crime, most of the people who visit tourist bars in Cabo, Mazatlan, and P.V. would be in jail.

"All of us here in **La Paz, Baja California Sur**, and especially at Marina de La Paz, are looking forward to the November arrival of the Baja Ha-Ha participants — as well as those who plan to continue south and return to the Sea of Cortez in the spring," write Neil and Mary Shroyer of **Marina de La Paz**. "La Paz now has more slips than ever, four places to haul out, increased dry storage capacity, four chandleries, skilled marine craftsmen, and locals with an especially friendly attitude. As for us at Marina de La Paz, we've completed a new fixed breakwater that provides new protection from the seasonal winds and swell out of the northeast and southwest. **Marina Don Jose** and **Marina El Palmar**, which are next door to us, have also put in additional

slips. All of us are within walking distance of downtown. Our Marina de La Paz is an 'authorized marina', which means we can handle the new simplified clearing in and out procedures that have been established for private yachts coming from and going to other Mexican ports.

"Our recommendation for West Coast boats headed to Mexico is as follows," the Shroyers continue. "If you are with the Ha-Ha, follow their recommendations for where to clear into Mexico. We recommend that all others clear into Mexico at Ensenada, which has established a 'one-stop' facility for that purpose. When done, you should come away with: 1) A 180-day Tourist Visa (from *Migracion*/Immigration) — but make sure it's for 180 days. 2) A Check-in document from the *Capitania de Puerto*/Port Captain); and 3) A Temporary Import Permit / *Permiso Temporal de Importacion* (from Customs / *Aduana*). If you are returning to Mexico and already have a Temporary Import Permit, you don't need another one.

"The major change in clearing from last year," the couple continue, "is that once you've cleared into the country, you will no longer have to check in and out with *Migracion* until your last port in Mexico. The procedure with the *Capitania de Puerto* is also much simplified — although it may vary slightly from port to port. You are required to 'inform' the port captain of arrivals and departures. But unless there is a change in crew, in most ports it can probably be done over the VHF. In addition, any 'authorized' marina can be 'informed' of your arrival or departure instead. Marina de La Paz provides this service free for its clients. Two other changes are that you can't be required to use an agent unless your vessel is over 500 tons, and the port captain can't charge for clearing. All in all, these changes should make cruising in Mexico even more pleasant and much less expensive."

Ever since the Shroyers opened up **Ma-**
When enjoying the great cruising grounds to the north of La Paz, you have to share the water with seals, whales, dolphins, and other sea life.



LATTITUDE/RICHARD

CHANGES

rina de La Paz in the early '80s — one of the first marinas in Mexico — we've found their information to be accurate and their advice excellent. When they say the new domestic clearing procedures should make cruising in Mexico even more pleasant and less expensive, we couldn't agree with them more. And for the many 'commuter cruisers', it allows for a lot more freedom of movement and the ability to meet tighter schedules. As such, for the first time in a number of years we're looking forward to calling on places such as La Paz and San Blas. As the Shroyers suggest, La Paz is one of the most-loved cruiser stops in Mexico. The only flies in the ointment are the sometimes cranky 'cruisers' who haven't weighed anchor in years and often have bad things to say about just about everyone and everything. Ignore them and you'll have a great time. As for the Shroyers' recommendation to clear into Mexico at Ensenada, we frankly don't think it makes any difference in terms of time or money whether you do it there or Cabo. So we recommend whichever is most convenient for you.

Speaking of La Paz, Naftuli Furman of



BILL TOVER

Who is this young mystery woman and why is she hoisting herself up the mast of her Cal 40? See the last page of Changes for the answer.

the Nor'Sea 27 **Neverland** — who wrote a *Changes* earlier in this section — gives a very favorable review of the **Homega Gym** in La Paz, which is located near Marina de La Paz. "I like to exercise and am happy to

report that owner Manuel Agundez runs a fine operation."

It's going to be a whole new life for Sam Crabtree and Susie Wilson, as on October 2 they will be getting married on Angel Island; on October 31 they'll be starting the Ha-Ha aboard their Cal 39 **Catch The Wind**; and from then on they'll have downsized their living situation from a three-bedroom home to a 39-ft sailboat as they pursue their dream of an open-ended cruise. If you've been reading *Latitude* since almost the beginning, you might remember that Sam did the Singlehanded TransPac to Hawaii in '81 aboard *Catch The Wind*. All friends are welcome at their *bon voyage* party at the Richmond YC on October 8 from 10 a.m. to 5 p.m.

Economic life has never been easy in the **Caribbean**, and two months ago it got worse, as the European Union announced it intended to cut the subsidized price it pays for sugar by 39% over the next five years. Even with the huge reduction in subsidies, the price the E.U. will pay for sugar from Jamaica, Guyana, Belize, Barbados, and Trinidad & Tobago, and

BottomSiders



WANTED: ATTRACTIVE ALL-WEATHER SAILING COMPANION THAT FLOATS

Solution: **BottomSiders**™ custom-made cockpit cushions are the answer to your dreams. Our cushions provide the style and comfort you demand. And, unlike some of your former sailing companions, you won't find any split seams or soggy seats.

- Closed Cell Foam
- UV Resistant
- Slide Resistant
- Waterproof

2305 BAY AVE.
HOQUIAM, WA 98550

(800) 438-0633

PHONE (360) 533-5355 FAX (360) 533-4474

www.bottomsiders.com

email cushions@bottomsiders.com

service & quality at the best price

- 75 ton travel lift
- Paint, carpentry & blister repair
- S.S. & aluminum mig & tig welding
- Mechanical & structural work
- Full service marina
- Short & long term rentals

bajanaival.com



Ensenada, México
Ph 011-52-646-174-0020
Fx 011-52-646-174-0028

Boatyard & Marina

IN LATITUDES

LATITUDE/ANNIE

other countries in Africa and the Pacific will still be twice that of the world market. The problem is that these small countries don't enjoy the economies of scale. Competitors such as Brazil and Australia can produce a pound of raw sugar for less than 7 cents, while in the Caribbean it costs from 18 cents a pound at the most efficient producers and up to 40 cents a pound at the inefficient government-run operations in Jamaica. As if this wasn't enough bad news, in August the World Trade Organization ruled against the E.U.'s plans to protect the Caribbean banana industry — which is important for Jamaica as well as tiny island-nation states such as Grenada, St. Vincent, St. Lucia, and Dominica. The irony is that this comes at a time when the United Kingdom is leading international efforts to alleviate poverty in these smaller countries. Thanks to the debt relief efforts of the Group of Eight industrial nations, Guyana will benefit to the tune of about \$9 million a year in their debt service. Alas, the loss in their sugar income is expected to be about \$40 million a year.

What economic options are left for the little island-nations? Tourism is the most legal of them, and is growing, but West Indians aren't the best natural hosts. Shady financial havens is another growth area. But for small farmers, it will be harder than ever to resist the temptation to grow ganja.

"When we last wrote, we were planning to have sailed our Spindrift 40 cat **Cheshire** from England to Panama and through the Canal by now," writes Susanne Ames of Olympia, Washington. But my husband David and I have decided to slow down a bit, and are therefore spending the hurricane season in the southern Caribbean. Currently, we're in Trinidad. We got a little smack from hurricane *Emily*, but otherwise haven't had any other weather trouble. We need to



"Yes, we have bananas," say some of the small islands of the Caribbean. "We just can't produce them as inexpensively as elsewhere."

haul — again! — in order to replace our 9.9 hp outboard with a 25 h.p. outboard, to raise our waterline, as well as to take care of the bottom paint we applied four months ago that hasn't stood up to the ravages of tropical waters. So what's the deal on Astillero Boat Yard in Panama as a place for cats to haul out?"

When it comes to hauling a 40-ft cat, you have all kinds of options long before Panama. There are several yards in the southern Caribbean islands that special-



MARITIME INSTITUTE

INCORPORATED

U.S. COAST GUARD APPROVED

Captain's License

6-Pack/100 Ton - Towing & Sailing Endorsements
Test with us on site!

Why Maritime Institute?

- Thousands of mariners trained in over 25 years.
- Professional instructors, and personal attention maintains our 96% pass rate.
- Courses in 15 Coastal Cities and **SF Bay Area**.
- POST Certified for all CA Law Enforcement.
- Professional up-grade classes for:
200 Ton, 500 Ton, 1600 Ton, and 3rd Mate
- STCW Basic Safety Training (BST) for all levels.
- Hands-on shipboard courses available.

We are an Authorized West Coast School for



CALL TOLL FREE

888-262-8020

OR visit our website for more information
www.MaritimeInstitute.com

CHANGES

ize in hauling cats, and there's Puerto La Cruz, Venezuela; Ferrocem in Cartagena; or Astillero, Flamenco, or Vacamonte in Panama. On the other hand, if you wait until Panama, and have a cat that was designed for it, you can take advantage of the extreme tides by going up on a beach. We remember that Michael Beattie and Patricia Goldman of the Santa Cruz-based Gemini 31 **Miki G.** did that with great success several years ago. By the way, we're glad to hear that you decided to slow down, as the most common mistake first-time cruisers make is trying to cruise at the speed of life in urban America.

They may have to fly in the first thousand or so copies from the printer in Asia, but captain-authors Pat and John Rains have assured us that their much-enhanced second edition of their **Mexico Boating Guide** will be available before the October 31 start of the Ha-Ha and the Mexico cruising season. At 424 glossy pages, with 300 color photos and 200 GPS charts, this second edition seems destined to be the definitive cruising guide to Mexico's 3,500-mile coastline — as well as to the coast of the Yucatan. We got an ad-



Here's a sample chartlet — with a GPS reference point — of *Espirito Santo* from the new edition of the *Mexico Boating Guide*, available soon.

vance peek at Chapter 12, *La Paz and Isla Espiritu Santos*, and were very impressed. The suggested retail is \$69.95, which isn't cheap, but to our mind the aerial photos and improved charts with GPS positions will easily make it worthwhile. We'll have

COURTESY MEXICO BOATING GUIDE

a more detailed review when the first complete copy becomes available.

"J.R. and I had an incredible two-week sail aboard our Catana 47 catamaran **Moon And Stars**," reports Lupe Dipp of Guadalajara. "Having survived hurricane *Emily* hauled out at Isla Mujeres, we headed to Guatemala. What a trip! What a sea! Oh, the places we saw and the color of the ocean! And those people of the Caribbean have music in their souls. As neither J.R. nor I wanted to stand night watches, we anchored in a different place every night. Besides, some parts of the Western Caribbean are so shallow and littered with coral that we preferred to turn in early at night and set sail again at 6 a.m. J.R. made fun of me because when in Mexico I'm up every night to midnight or later, but on our cat I'm sound asleep by 9 p.m. I thought it was going to be hard for the two of us — we're not kids anymore — to doublehand a 47-ft cat, but we're doing just fine.

"We had no trouble clearing out of Mexico from the state of Quintana Roo," Lupe continues, "and entered Belize. I

LET MARINA EL CID
WELCOME YOU TO MAZATLAN!

Cruisers -
**FIRST
NIGHT
FREE***



Official
Sponsor
2005
**BAJA
HA-HA**

A CRUISER'S PARADISE IN THE HEART OF MEXICO'S
LUSH TROPICAL COASTLINE AND BEAUTIFUL ISLANDS

A Full Service Marina Offers...

- ★ 90 slips from 25' to 120'
- ★ Electrical and water hookups
- ★ Telephone connections
- ★ Restrooms and shower facilities
- ★ Dock Boxes
- ★ Dock Carts
- ★ 24-hour security
- ★ 24-hour laundromat
- ★ Supermarket
- ★ Dry dock
- ★ Gasoline - Diesel
- ★ Pump-out station

NEW Marina-Wide High Speed Wireless Internet Connections!

www.elcid.com

011-52 (669) 916-3468 • gcevallos@elcid.com.mx

***Reserve for any multi-day stay and your first day is FREE!**

Wright Way designs

MARINE UPHOLSTERY & INTERIORS

PROFESSIONAL
DESIGN
SERVICES
INCLUDE
CUSTOM
carpeting
cushions
designer fabrics
draperies
linens
upholstery



OTHER
SERVICES
OFFERED
maid service
by **MER** Maids

Deborah Wright

510-908-3939

2900 Main Street, #67, Alameda, CA 94501 • wwdesignz@hotmail.com

IN LATITUDES

loved Belize — at least the tourist town of San Pedro which, because of the brightly painted wooden houses, was so beautiful. It was there that I found another reason to love our cat. We were anchored in the tourist zone, so all the tourist boats roared back and forth at full throttle. Had we been on my old *Moon And Stars* monohull, we would have rolled like crazy. But we didn't feel any movement at all on our cat. I love our cat — including all the space and systems like air-conditioning. The latter because it's wicked hot and humid down here in the summer, and there are thousands of mosquitos of all sizes, shapes, and colors."

"Words can't describe the scenery when we went up Guatemala's Rio Dulce," says Lupe, "as you travel up a river between cliffs covered with vegetation. The river itself has lots of Indians fishing from their wood *cayucos*. Because the Rio Dulce is a summertime haven from Caribbean hurricanes, there are now about 400 boats in the five marinas or anchored off them. I found life here to be like that in Puerto Vallarta in that it's very well organized.

Every morning they have their net, and it's made up from people from all over the world. Right now, *Moon And Stars* is berthed at Marina Tortuga next to a restaurant with great cooks. We pay 1,920 *quetzals* a month for our marina space, which comes out to be about \$220 dollars a month. Everything here is dirt cheap. A breakfast of eggs, beans, rice, sweet rolls, juice, and fruit costs about \$5, and you can hire someone to polish your entire boat for \$12. I love the Rio Dulce, I love our catamaran, I loved the trip, and I love my husband! Above all, this trip has made me realize how much I love the sea. If it was possible, I'd never get off our cat! It's been very hard for me to return to the real world of work."



MOON AND STARS

Talk about being in love! Lupe is absolutely crazy about her and JR's catamaran. If it was up to her, she says she'd never get off.

Isn't it wonderful to hear somebody having such a great time with their boat? The thing that cracks us up is that berth fees are higher in poverty-ridden Guatemala where there is lots of competition than in Honolulu where the state of Hawaii has a monopoly.

"We participated in the '03 Ha-Ha and will be sailing to Mexico again this fall," report Jeff and Stephanie Sarantopulos

www.shinyboatstuff.com

Anchors

Swivels

Snap Shackles

Chain

Dinghy Wheels

Deck & Cabin Hardware

Thimbles

Mast Steps

More!



**CLICK
AND
SAVE
ON
STAINLESS
STEEL
BOATING
HARDWARE**

**Visit Our
Web Site for
Unbelievable
Prices!**

DaNard Marine Products
350 Hearst Dr., Oxnard, CA 93030
(805) 983-8285
www.shinyboatstuff.com

GLEN COVE MARINA



*"with access to San Francisco Bay
and the Sacramento River Delta"*

Glen Cove Marina has recently been updated with extensive improvements, including channel dredging.

- Guest Dock
- Pump-out Station
- Clean Restrooms
- Showers
- 24 Hour Security Gates
- Laundry
- Water & Storage Boxes
- Yacht Brokerage Services
- Picnic & Recreational Facilities
- Waterfront Walking Trail

Open Berth to 55 Feet • Covered Berth to 44 Feet

GLEN COVE MARINA 707-552-3236

On the Carquinez Strait
2000 Glen Cove Road, Vallejo, CA 94591
www.friendlyharbors.com • friendlyharbors@msn.com

CHANGES

of the Emeryville-based Passport 47 **Mu-setta**. "But this time we have no itinerary or schedule, and we eventually hope to end up in the Med." Why is it we get the feeling the couple might eventually make it to Greece?

"In the August *Changes* there was a report on all the red-tape involved with cruising in **Croatia**," write Glenn and Dana Meyer of the San Francisco-based **Mahalo 1**, who are currently in Lefkas, Greece. "We emailed our friends who have been cruising the Med for three years now, and wintering in Turkey for the last two. They are presently cruising up the coast of Greece and plan to anchor in Croatia. Here is their response to that report:"

"Thanks for the info from *Latitude*, but fortunately it contradicts a lot of what we've been hearing from friends/acquaintances who have recently been there or are still there. Yes, they have regulations, but some of them are seldom if ever enforced — such as showing a certificate of competency. One could say the same things about Greece. Here there is no coordination between ports of entry, so one can do things like skip out of one port



CROATIA PHOTO

Croatia offers some of the most consistently beautiful cruising in Europe. This is the historic fortress city of Dubrovnik.

for whatever reason and check back into another, saying you have just come from Italy. Also, one is supposed to check-in with the Port Police in every port where they have an office. But half the time they

don't even know what to do with you, so now we never check in with them — unless specifically asked. And then we are all smiles and cooperation. What we've learned is to be aware that these rules exist, cooperate when asked, and accept that there is often a wide range of interpretation between different officials."

That report from Croatia — the gist of which appeared in several major cruising magazines — appears to at the least have been quite inaccurate. Our apologies. It turns out that Croatia and Greece sound a lot like Mexico, where flexibility and a smile tend to be the keys to happiness.

"My wife Nancy's email must not have been proofread by her," writes Peter Bennett of Knightsen, CA, "as our new **Destiny** went from 40 feet to 44 feet to 48 feet. She's actually a C&C 48. I'm putting together some thoughts on purchasing a hurricane-damaged boat 3,000 miles from home. It all worked out fine for us, but it's not for the faint of heart or someone new to boating. By the way, I tend to agree with *Latitude's* philosophy on life, as Nancy and I try to keep ours simple

MARINER BOAT YARD

"Where Service Has Meaning"

It's All Play and No Work
When You Have
MARINER BOAT YARD
Take Care of Your Boat

- Brushed on bottoms
- Fiberglass and gelcoat repairs
- Excellent equipment installations
- Bow thrusters (Side-Power)
- Rigging and commissioning
- Awlgrip specialists
- Full estimates

PETTIT
marine paint

Located at Grand Marina
2021 Alaska Packer Place, Alameda, CA

510-521-6100

www.marinerboatyard.com



Lowrie Yacht Harbor INC.

In Central Marin, Convenient to Delta & Golden Gate
Family Owned & Operated since 1948

- 25'-65' Berths Available
- Best Rates this Side of the Bay — \$6.00 per foot
- Whole Foods & Trader Joe's Nearby
- Recently Dredged (Thanks Western Dock!)
- Surge & Wind Protected, Friendly, Warm & Sunny
- Home of Neptune Yacht Sales

(415) 454-7595

40 Pt. San Pedro Rd., San Rafael, CA 94901
Harbor Office: M-F 9:15-4:15

also — but we're definitely in the minority. Nonetheless, it means when we go back to cruising, we can enjoy ourselves and not have to worry about keeping up with anybody. One of the things we really enjoyed about our previous cruising is how everybody gets along and treats each other as equals — despite the diversity of wealth and backgrounds."

We've always enjoyed sailing in the tropics — warm winds, warm water, not much clothing, surfing, that kind of stuff. As such, we've always mentally set aside a cruise to Alaska for when we're old and feeble. But having seen some of the recent photographs by Steve and Dorothy Darden of the M&M 55 cat **Adagio**, we're rapidly changing our minds. Armed with a new Canon digital SLR camera and an up-to-480MM zoom with image stabilization, the couple have been taking sensational photos of whales, bears, eagles, and other wildlife. We hope to share more of them with you in color next month. But if you can't wait, check them out at www.adagiomarine.com.

Last month, we recommended that

readers wanting to get excellent overall views of anchorages in Mexico go to **Google**, visit their 'maps' feature, and then click the 'satellite' button. The aerial perspectives are incredibly enlightening. And you're not just limited to Mexico.

In the last five minutes, for example, we've zoomed in for close-ups of such diverse places as Westhaven Marina in Auckland; Cape Town, South Africa; Cape Horn, Chile; Sydney and the Great Barrier Reef in Australia; Phuket, Thailand; and Palma de Mallorca, Spain. What a way to travel!

What's new about this feature, reports **John Pettitt** of Sausalito, is that Google



This humpback whale at Frederick Sound breached 15 times. The Dardens took so many shots they temporarily ran out of digits.

now has high-resolution images of much more of Mexico. In Cabo, for example, you can actually pick out certain of the larger boats. But this high-resolution imaging is not available everywhere. Punta Mita on Banderas Bay, for example, is still only moderate resolution. Oddly enough, Westhaven Marina in Auckland was also very clear. It's important to remember that

Make plans to visit us...

Located in a beautiful sheltered lagoon on the north Pacific coast of Nicaragua, Marina Puesta del Sol is your premier cruising destination in Central America. We offer a wide range of services and amenities for all your needs...

- 140 foot fuel dock – diesel/gasoline
- Well marked, lighted channel
- 40 slips with water, power & cable TV
- Pool, tennis courts, horseback riding
- Clubhouse with showers and laundry
- Luxurious hotel with 20 executive suites
- Yacht maintenance & pump-out station
- Easy access to marina basin, 24 hours/day
- 24 hour security patrol
- Onsite Immigration and Customs
- Full service restaurant and bar
- Iced & bottled water
- Internet & fax/copy service
- Beach house with pool & restaurant

Here you have a safe place to leave your boat for extended stays or while traveling to other parts of this fascinating country.



...in beautiful Nicaragua!

Marina Puesta del Sol

RESORT ♦ NICARAGUA

Entrance Buoy: Latitude 12° 36.55' North Longitude 087° 22.41' West

Aserradores, Nicaragua ♦ 011-505-276-0585 mpuestadelsol@yahoo.com ♦ marinapuestadelsol.com ♦ U.S.A.: 408-588-0017



CHANGES



We've anchored at Bahia Santa Maria more than a dozen times, but it wasn't until we saw this Google aerial view that we really got a sense of what the place is really like.

these aren't 'real time' photos, so what you see in the photo isn't necessarily what you get. The photos were taken over the last three years, and are continuously being updated. Pettitt also reports that

lots!"

From now on, we plan to get a Google aerial view of every anchorage we plan to enter, just to have a better feel for the 'lay of the land'. We don't know what's more mind-boggling, the ability to do this — or the fact that it's absolutely free!

you can download Google's 'earth tool' at <http://earth.google.com>, "which allows you to create custom flyovers and look at 3D views — actually 2D images mapped onto 3D terrain models — that are very cool. For example, if I look at Sausalito, I can pick out my house — and even see the lines between the spaces in the parking

"We're currently on the Rio Dulce in Guatemala, and are looking for a Mexican transport company that could truck our boat from the Caribbean coast of Mexico to the Sea of Cortez," writes Chuck Baier of the 45-ft sloop **Sea Trek**. "Otherwise, we'll have to return to the U.S. and ship the boat to the West Coast and not get to stop in the Sea of Cortez. We're hoping to do this in November or December."

We're sorry to report that we've never heard of boats being trucked from the Caribbean side of Mexico across all those mountains to the Pacific side. We suppose it might be possible, but you'd be breaking all new ground — and probably be subjecting yourself to all kinds of uncertainty and perhaps lots of 'one-time fees'. We think you'd be way better off sailing up to Houston, and then having your boat trucked to Tucson, where the folks from Marina Seca could pick her up and take her down to San Carlos, or trucked all the way to California.

"Looking for a dentist in the Puerto Vallarta area?" writes Mike Fulmor of the Channel Islands-based Swift 40 **Arabella**. "I have nothing but good to say about

SAUSALITO



LIST MARINE INC.

**California
Yanmar Dealer
of the Year!**

- We service all makes
- New, used and rebuilt engines
- Docksides facilities
- Mobile service trucks



**YANMAR
MARINE DIESEL
ENGINES**

P.O. BOX 2008 / 69 LIBERTY SHIP WAY
SAUSALITO, CA 94966
Adjacent to Schoonmaker Pt. Marina

415•332•5478

in Southern California...



*A First Class Full Service Facility Serving the Entire Pacific Coast
150 Ton & 30 Ton Travelifts*

VENTURA HARBOR BOATYARD

Open 6 Days a Week!

Competitive Rates ~ Professional Staff

*For quality and attention to detail you can count
on our commitment to your satisfaction.*

(805) 654-1433

**1415 Spinnaker Drive, Ventura, CA 93001
www.vhby.com**

IN LATITUDES

Dr. Cecilia Gamboa, who has her office in Bucerias, which is near La Cruz. She was recommended to me by Paul and Paula of **Lucky Dog**. One of their mothers comes down from the States just to see this highly skilled — and cute! — lady. Cecilia's number is 01-329-298-18-66, and her office is at #2 Morelos St., Bucerias. I'm in Oregon now, but am looking forward to seeing everyone in Puerto Valarta come November!"

High altitude racing/cruising. "In July, the northern California Corsair 24 fleet made its annual pilgrimage to the Sierras for the Trans-Tahoe race and **Harmonic Convergence**, reports Ross Stein of the Menlo Park-based Corsair 24 Origami. "The Convergence takes place on the Thursday and Friday before the race, and is hosted by Tahoe Corsair 24 sailor Kevin Gammell. The trimarans sail into beautiful Emerald Bay, and beach their boats for a BBQ, party, and overnighter. We can walk off the transoms onto the beach — no dinghy needed. The next morning, we hiked to Eagle Falls, toured the Vikingsholm, said goodbye to the gaggle of ducks, and sailed out the entrance

into Lake Tahoe and back across the lake. Beautiful breezes and warm days and nights made this one of the highlights of our season."

About a year ago, we ran a *Changes* about young Liz Clark of Santa Barbara, a former collegiate surf champ who was preparing her Cal 40 **Swell** for

a long sailing/surfing expedition down the coast of Central America and to the South Pacific. As often happens with cruising plans, Liz's trip got delayed a year. It may have been a good thing, because when we saw her last month, she seemed a lot more mature and confident. Anyway, she



Not all California cruising adventures take place on salt water. The Corsair 24 'Harmonic Convergence' is held on Lake Tahoe.

says "I'm so excited because I'll finally be leaving Santa Barbara sometime before the middle of September. After a stop at the Channel Islands, I sail to San Diego, then have to fly to Cabo for a wedding, after which my crew and I will begin our



RICHARDSON BAY MARINA

formerly Kappas Marina

MODERN FACILITIES IN A WELL-PROTECTED HARBOR

Concrete Dock System

Well Maintained Facilities

Beautiful Surroundings

- DEEP WATER BERTHS: BASIN AND CHANNEL DREDGED
- CARD KEY SECURITY SYSTEM
- DOCK CARTS
- PUMP OUT STATION
- AMPLE PARKING
- CLEAN SHOWER AND TOILET FACILITIES
- WITHIN WALKING DISTANCE: MARKET/DELI, LAUNDROMAT, RESTAURANT
- AT EACH BERTH: LARGE STORAGE BOX, METERED ELECTRICITY, WATER, PHONE HOOKUPS

BERTH YOUR BOAT IN SAUSALITO

415 • 332 • 5510

100 Gate Six Road, Sausalito • Fax (415) 332-5812

CHANGES



After an extra year of preparation for her trip, Liz is eager to get out of Santa Barbara and start riding waves — with her boat and boards.

sailing/surfing adventure down the coast of Baja."

Hot wheels! "There seems to be a cruiser version of an urban legend floating around which needs to be dispelled," writes Jerry Metheany of the Mazatlan-

groceries, propane, and fuel, and helps to alleviate the cabin fever syndrome of being too long in a small cabin. That being said, I would also like to dispel another rumor, which is that it's unsafe to drive at night in Mexico and that you should stick to toll roads. Personally, I like to drive at night,

based Hunter 46 **Rosita**. "I'm referring to the rumors that driving in Mexico is only for the foolish and brave of heart. I believe that having a car while cruising enhances the experience, and lessens the stress level of acquiring much needed

as there is less traffic and it's faster. By the way, I drive for a living, so I'm aware of the problems of driving at night."

We're going to have more on this subject from Metheany in the October 1 issue of *Latitude*.

In last month's *Changes*, a lot of veteran Mexico cruisers gave their opinions on which were the best cruising guides to Mananaland. Michael Pordes, who did the '00 Ha-Ha with the Richmond-based **Favonius**, has a slightly different take. "The best cruising guides we ever found were the ones the local cruising communities publish for arriving cruisers. These included the **Mazatlan Cruising Guide** and the **Puerto Vallarta Cruising Guide**. They cost about \$3 each, and are available in the big marinas. Updated each year, they tell you where to find everything and which are the best restaurants and such. No matter if you have a toothache or need to get a stainless bracket fabricated, these guides are a big help!"

Summer is fading, but the great **fall cruising season** — perhaps the best season of the year in California — is upon us. Enjoy!

Fall Clearance Sale

ALL INVENTORY PRICED TO MOVE!

CONSIGNMENT BOATS WANTED

- Catalina
- Capri
- Hobie
- Windrider
- Blokart

More than 40 sailboat models available!



WINDTOYS

Wind and Water Sports Center

Your Small Boat Specialist!

3019 Santa Rosa Ave, Santa Rosa
New & Used Boats!

OVER 30 NEW BOATS IN STOCK

800.499.SAIL

Authorized Sales & Service for...







COME SEE OUR FULL-LINE KAYAK SHOP!

MARINA REAL

SAN CARLOS, SONORA, MEXICO

IN THE SEA OF CORTEZ

Located on the Mexican mainland near Guaymas and San Carlos, 265 miles south of Nogales, Arizona.

- 350 slip marina • 20 & 30 amps electrical service
- 24-hour security patrol
- Fuel dock with gasoline/diesel
- Restrooms & showers
- Web email • Fax/copy service
- Port entry clearance
- Book exchange • Video loan library
- Ice & bottled water
- Wet storage for summer months (low prices)

Now Offering:

Haulouts, Dry Storage & Service Yard



marina Real

Phone/fax 011-52-622-2270011
Call on VHF #16 when in area
email: marinareal@prodigy.net.mx

Visit our website:
www.marinareal.net

**Thinking of
Repowering?**

**Then You Should
Call (510) 235-KKMI**



A 'Gold Plus' Yanmar Dealer

**Factory Trained &
Authorized Mechanics**
Professional Sales and Service



Latitude 23° 16' 14" W - Longitude 106° 28' 12" N

**NOT JUST A MARINA...
A CRUISER'S COMMUNITY!**

CALENDAR OF EVENTS

NOVEMBER

- 18 WELCOME MARGARITA PARTY**
Presented by La Costa Marinera Restaurant
FREE Margaritas, Seafood Appetizers, Music, Fun
- 24 THANKSGIVING DAY PARTY**
The Greatest in Mexico !!!
Traditional Sitdown Dinner, Casual Elegance Please
Live Music, Dancing Fireworks

DECEMBER

- 10 STONE ISLAND BEACH PARTY
TWILIGHT RACE BACK TO THE MARINA**
Food, Beer Prizes!
Horseback Riding, Water Sports, Games
- 17 MEXICAN TRADITIONAL BENEFIT POSADA**
Tamales, Beans, Hot Punch, Traditional Dessert
Catered by Ciudad de los Niños Orphanage
Humorous Play by Theater Students
Music, 'Shelter Seeking', Piñatas

AND MUCH, MUCH MORE !!!



Make reservations at:
antonio@marina-mazatlan.com
Tel. 52 (669) 916-7799
Tel. & Fax 52 (669) 916-3614

For rates, services and more information, visit:
www.marina-mazatlan.com

Perfect Companions

Our Kestrel 140 amp, 1/8 GPH
Diesel DC Generator and
an HRO Seafari Escape
R.O. Watermaker

HRO Systems
HORIZON
Seafari Escape



Kestrel
Generators by
Water & Power



Compact
Efficient
200-600
G.P.D.

The Watermaker Store™
water & power, inc.

Official
Sponsor
2005
BAJA
HA-HA

Telephone: (619) 226-2622 Fax: (619) 226-1077
www.watermakerstore.com E-Mail: sales@watermakerstore.com

Please read before submitting ad

Classy CLASSIFIEDS

- 1. Write your ad.** Describe what you're selling. Indicate category. Don't forget price and contact info. Be neat. We aren't responsible for errors due to illegible writing or unclear meaning. We make final placement determination.
- 2. Count the words.** Anything with a space before and after counts as one word (eg, phone number, email address, price). We'll spell-check, edit and abbreviate, as necessary.
- 3. Mail your ad.** Enclose check or money order, or deliver to our office with cash, or ...

Post your ad safely online with Visa, MasterCard or AmEx at: www.latitude38.com

Personal Ads	Business Ads
1-40 Words: \$40	\$70 for 40 Words Max
41-80 Words: \$65	All promotional advertising
81-120 Words: \$90	1 boat per broker per issue
Photo: \$20	Camera-ready art OK
• Personal Advertising Only •	No photos/reversals
No Business/promotional ads	No Extra Bold type
except Non-Profit, Job/Biz Op.	Not to exceed 12 pt font
	Artwork subject to editor approval.
'Trying to Locate' Ads	
Searching for People: \$10 for 20 Words Max	
All ads will be set to fit Latitude 38 standard.	
Re-Run Ads: Same price, Same deadline.	

Mail (or bring) to: **Latitude 38**
Attn: Classified Dept
15 Locust Ave, Mill Valley, CA 94941
Questions?: (415) 383-8200, ext 104 • class@latitude38.com

DEADLINE
is always the
18th at 5 pm
of the month prior to publication.
Due to our short lead time, deadlines are *very strict* and include weekends & holidays.

- No ads without payments
- No billing arrangements
- No ads accepted by phone or fax
- No verification of receipt
- We reserve the right to refuse poor quality photos or illegible ads.

DINGHIES, LIFERAFTS AND ROWBOATS

PENOBSCOT 14. New by builder. Okoume glued lapstrake, white epoxy exterior, bright oak and mahogany interior, simple sprit sail rig, two rowing stations, one pair collapsible fir balanced oars. Trailer, complete, needs nothing. \$6,800. Call (925) 937-6565 or dhgreenwood@comcast.net.

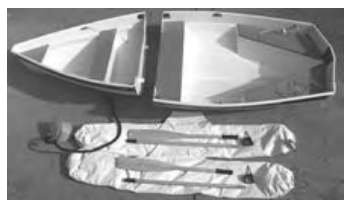

NICOLLSLITE NESTING DINGHY, 10'2" dinghy nested into a 5'8" package, with oars and cover, also installed, Dinghy Dog flotation tubes with foot pump. Plus 4 hp Mercury 4-stroke engine. Barely used. \$2,000. (650) 369-1001 or email: ragtopbrad@yahoo.com.

2002 MCLAUGHLIN RACE-READY Optimist, \$1950. Excellent condition, garage-stored. Sails standard McLaughlin blades and blade bag. Black and gold spars, bottom cover, new flotation bags, etc. (415) 860-3985.



CUSTOM 16' ALUMINUM INFLATABLE. Includes aluminum trailer and Mercury 50 hp 4-stroke engine, recently serviced. Runs well. \$6,000/obo. (415) 435-9525 or email: youth@sfdc.org.

ZODIAC Mk I, 1999 with 9.8 Nissan 2-stroke. Oars, bow bag, repair kit and anchor. All in great shape. \$2,000/obo. Email: thomaswfrith@yahoo.com.

AVON R-310 SPORTBOAT. Experienced. Full cover (Sunbrella), lifting and towing bridles, oars, 2 seats, repair kit, etc. Carson Valley. \$1,250/obo. (775) 267-0344. See ad in 'Misc' for outboards. Perfect for cruising.

9-FT LAPSTRAKE YACHT TENDER. Port Orford cedar on oak, built 2004. \$4,200. (415) 279-1081.

AVON 310 INFLATABLE. 10-feet, hard floor with inflatable keel. Very good condition. Always stored inside. Seat, oars, pump. 6 hp Johnson, low hours. Will plane with 6 hp. \$1,300. (925) 628-8352.

24 FEET & UNDER

CLIPPER MARINE 23, 1977. Good sails, Honda outboard, twin keels. Berthed Stockton Sailing Club. \$1,000/obo. (209) 668-3273.

FLICKA 20, 1979. \$19,900. Overall excellent condition. New brass portlights, Lewmar hatches, headliner, sails, ProFurl, running and standing rigging, solar panel. No blisters. 9.9 hp Honda with 100 hours, etc. Ready for the Baja Ha-Ha. Call (760) 765-1564 for details.

MOORE 24, #78. Larry Tuttle-designed keel. 4 hp outboard, carbon fiber pole. New halyards, deck hardware, many spares. Great single-axle trailer. \$9,000/obo. (760) 419-7001 or email: dhb0642@cox.net.

WEST WIGHT POTTER 19. Excellent condition with trailer. Originally purchased Sept. 1999. Paid \$16,000 plus tax. Asking \$8,500. Also, 1981 Hobie cat with trailer. Great condition. Asking \$600. (209) 538-9018.

COLUMBIA 24. Fiberglass. Converted to fishing. It's free with two month berth fee. (415) 309-0795.

RANGER 23, 1974. Strong Bay boat, sails in great condition, two mains, #1 and #2 jib. Boat in fair condition, just hauled out, good motor. Asking \$2,250. Call (408) 310-2933.

CATALINA 22, 1983. Swing keel, pop-top, forward hatch, Honda 7.5. Trailer, stern pulpit, swim ladder, Porta-Potti, galley. VHF, knotmeter, stereo, ground tackle, lines led aft, cruising spinnaker, solar, freshwater sailed. Clean, extra stuff. \$3,800. (559) 322-7938.

24-FT QUARTER-TON RACER. Ron Holland design. Yanmar inboard, VHF speed and depth, autopilot. Sleeps 4. Galley and head. Fresh bottom. Rod rigging. Lots of sails, some like new, some Kevlar. Chutes, blooper, reacher. Good condition. \$7,250. In Vallejo. (916) 600-4877.

J/24, 1981. 6 hp 4-stroke 2003 Mercury, double-axle trailer 1989, Berkeley slip, 2 sets of sails: Shore and UK. Many new Harken blocks and new lines 6/05. VHF, Danforth with rode, 2-speed mainsheet, more. \$9,500/obo. Call (707) 546-4740 or email: cmbailey@sonic.net.



12-FT BEETLE CAT, ANHAGA. New paint, coaming, varnish and new canvas plus extras. New trailer. Good condition, hull #736, cedar/oak. \$3,000/obo. (707) 822-5443 or 4doboshes@sbcglobal.net.

WEST WIGHT POTTER 15. Good condition, lots of extras. Tan bark sails, galvanized trailer. \$3,800. Call (707) 442-2496.

DOLPHIN 17. New mainsail, new electric trolling motor, sleeps two. \$1,200/obo. (916) 990-0535.

MONTGOMERY 17. Lyle Hess's famous, rugged pocketcruiser. Excellent condition. Trailer stored. Many upgrades and extras: Harken, low hours Honda 5 hp, electronics, galley, berths for four, sail covers, and more. \$6,800. (925) 229-0425.

BENETEAU 235, 1987. Great pocket cruiser for Bay or lake sailing. Also competitive racer. Fin keel, with motor. Good condition. With or without trailer. \$9,500. Call Dave (916) 933-2346.



KAMAKAI 20, 1999. Topsail gaff cutter pocket cruiser. Website pictures and details at: www.members.cox.net/dwellens/kamakai/kamakai.htm (619) 980-8704 or email: dwellens@cox.net.

WEST WIGHT POTTER 15, #1231. 4 hp Evinrude. Rare, articulating trailer. Yellow hull, roller furling, with too many goodies to list, all in first class condition. A joy to the eye, a pleasure to sail. Alameda. \$5,990. (510) 522-3957.

MONTGOMERY 17, 1982. Very nice, \$6,000/obo. Also, O'Day 25, 1976, diesel, \$6,500/obo. Both with trailers. Mike (661) 823-1091 or (661) 747-8507.

WILDERNESS 21. Trailer included. Located in Berkeley. Excellent condition, new standing rigging, new running rigging, wind/speed/depth/tictac, compass, GPS, VHF. New motor. Main #1, #3 and spinnaker all good condition. \$5,000. (707) 451-8813.

CATALINA 22, 1983. Great condition, swing keel, pop-top, main, jib, 120% genoa, 15 hp Evinrude, new cushions, new battery, ground tackle. Ready to sail. Brickyard Cove Marina, berth G-11. \$2,900. Nick (415) 706 8215.

COLUMBIA CHALLENGER 24, 1965. Freshwater boat since new. Race ready, two sets of sails, two spinnakers, new low-stretch halyards and spinnies sheets, knotmeter. Very smooth VC17 bottom, no blisters. 5 hp outboard. Excellent condition. \$4,400. (209) 465-9169.

MOORE 24 #98, COOKIE JAR. Has had a very successful singlehanded racing career. She needs to return to class racing in the best one design class. Singlehanded TransPac vet, numerous offshore victories to her credit. Includes spare Ballenger mast and spare rudder. New Honda 2 hp 4-stroke, 6 hours on it. Good sail inventory. Trailer is galvanized tandem, new in 2001. New boat project forces sale. \$13,500. (831) 724-3363 or mmadonna@ix.netcom.com.



WONDERFUL OLD GAFF-RIGGED cutter. One-of-a-kind, wood/brightwork topsides and ply/glass hull. 22-ft, 3 tons, diesel, all sails, rigging, anchor, cushions, galley, lights, etc. In Alameda Marina plus huge trailer. \$2,000. More at: <www.Home-Museum.com/boat.htm> Call (408) 986-8020 or WHHarvey 904@hotmail.com.

WESTWIGHT POTTER 15, 1999. Custom cutter rigged. 5 sails, galv. trailer, 2 furling jibs, red and white sails and trim. Lights inside and out. Anchor and chain, rope. Battery, fuse bank, electric bilge pump, lazyjack. \$3,950. (541) 469-9379.

CATALINA 22, 1971. Dinette style, swing keel, trailer (new wiring). Good condition. Main, jib, 6.5 hp Evinrude. Standing and running rigging, good order. Direct ss spreader bracket retrofit. White hull/cockpit. Keel recently painted, cushions in fair condition. \$1,950/obo. (916) 788-0997.



NZL 24. Greg Young design, Bull 7000. Ideal for the TransPac Double. 12-18 knots constant. Strong, fast and safe. Category 1, weight 2,240-lbs, 845-lbs in bulb. Draft 5'6", board down. Sails: Diax Mylar, #1 and #2 main. Battened blade, storm jib and drifter, 2 masthead kites, one fractional. More info: <www.kzboats.com> \$27,500. Call (503) 543-4734.

WESTWIGHT POTTER 15, 2004. #2667. As new, never sailed. You christen and launch her for the first time. Illness forces sale. Bluewater layup, singlehanded, tan bark sails, trailer, new motor, etc. New \$11,000. Asking \$9,000. Email: wwp15@4jp.info or (510) 390-3572.



O'DAY 240, 1988. Sleeps 4, alcohol stove, sink Porta-Potti, 1997 Honda 8 hp, running lights, battery, solar panel. Jib and main in good shape. Shoal draft keel. Boat clean, great shape. Engine runs well. \$7,500/obo. Marc (415) 328-2992.

RANGER 20, 1981. New Yamaha 4 hp ob, EZ Loader trailer. Excellent condition. Main, jib, genoa. \$3,500. Sacto. (916) 481-7067.

MacGREGOR 21, 1981. Good condition, new interior, roller furling blocks, freshwater only. Most accessories, trailer, outboard, swing keel. \$2,000/obo. (775) 853-6662.

SANTANA 22, 1969. New sails, updated rigging, 5 hp outboard, anchor, safety equipment and more. In good condition and ready to sail. \$2,200. Two available. For more info call Rich (650) 363-1390.

PEARSON 23, 1983. Cat rig, unstayed mast. Fully battened, extra mainsail, boombrake, lines aft, 8 hp Nissan 1989. Sleeps 2, galley area/sink. Enclosed head. Bilge pump, anchor, and more. Great for short-hauled sailing. \$2,900. Call (707) 815-9492 or (707) 255-5157.

25 TO 28 FEET

ERICSON 27, 1976. Race rigged, halyards led aft, headfoil, 5 winches, many sails, diesel low hours. FW boat, wheel steering, battery charger, 2 anchors, spinnaker pole, lifelines, new Porta-Potti. \$6,500/obo. (916) 721-0133.

CRUISING/RACING BALBOA 27, 1979. Clean, in great condition, complete canvas, sail covers, 2 spinnakers, 2 jibs, 1 main, spinnaker pole. Fathometer, interphase locator, tiller autopilot. Nissan 8 hp, swing keel, stove, head, water, sink, cooler, sleeps 5. \$7,000/obo. Call (510) 523-6376 or (209) 795-0650.

NEWPORT 27, 1988. Good condition inboard diesel, full batten main, roller furling jib, spinnaker, depth, knot, VHF, Loran, propane stove, head, sleeps 5. \$5,500/as is. (925) 980-0144.

ANTRIM 27, HULL #1 in excellent condition. One design sport boat ready to race with complete set of racing and practice sails and new Quantum jib. Carbon mast, trailer, Nexus instruments. \$40,000. Call Rob (415) 828-1203.

CATALINA 27, 1974. Atomic 4 inboard runs well, main, 2 jibs (100, 150), spinnaker and gear. Standing rigging 2001, new exhaust system and battery. Slip E-16, Richmond Yacht Club. John Glennon (925) 427-7107 or jglenn@aol.com.

FOLKBOAT, 1962. Woodie, moored on Lake Tahoe, winter cradle, dinghy, outboard, AM/FM/CD, VHF, more. Bristol condition. Asking \$12,000/obo. (775) 841-1730.

O'DAY 25, 1977 in great shape. New bottom and all lines in Nov, 2004. In 1995, new 15 hp Mercury OB with electric start and charging, cushions and curtains. Club foot, 100% and main. Full lifelines and stanchions. \$4,999. (925) 516-0057.

TANZER 28, \$4,500/AS IS. Brand new \$6,000 Volvo diesel. Roller furling jib, spinnaker, sleeps 4, needs bottom paint and transmission work. Santa Cruz Harbor, Q-4. Santa Cruz Sailing Foundation. Call Jim (831) 426-7797 (days) or (831) 476-0328 (eves).



ERICSON 27, 1976. Volvo diesel, North main, 3 jibs, dodger, wheel steering, autopilot, 4-channel CD, Custom double bed, 2 sinks, gorgeous interior, lots of teak and brass. LectraSan, swim ladder, anchor 300', hatch and lifeline covers, shorepower. Beautiful boat, transferable slip. Must sell. \$8,500. (650) 291-1043.

PEARSON 28-2, 1986. Excellent condition. Yanmar diesel, 570 hours, professionally tuned. Bottom painted 2004. Dodger, full batten main, 3 jibs. BBQ, new head, shower, teak and holly sole, microwave, great interior. \$26,500. Richmond. (707) 528-2458.

IRWIN 10-4, 1975. Roomy, 25-ft (plus 3-1/2' bowsprit) fiberglass sloop. 10'4" beam, headroom, shoal draft, swing keel, enclosed head, galley, much teak, brass, storage. Opening ports, wheel, furler, main, 3 jibs, spinnaker, inboard. Nice. \$6,500. Call (925) 516-2877.

CATALINA 27, 1977. Atomic 4, sink, stove, heater, icebox, head, dual battery with charger, pressurized water system, solar-powered vent, VHF, microwave, TV. \$7,900. Half Moon Bay. (408) 425-6285.

SANTA CRUZ 27. Launched in 1995. Best SC27. National Champion with winning record. Extensive sail inventory for race/cruising. Dry sailed, over-built mast support, Harken rudder bearing, extra keel bolts, custom setup for raising mast, galvanized dual-axle trailer setup for ramp launch, locking sail storage boxes, 5 hp outboard, new headstay, foil, backstay, numerous custom features. Set up for singlehanded or crewed racing. Sea foam green. Located Santa Cruz. \$13,500. Call (408) 705-7157 or (408) 345-8434.

LANCER 28, 1979. 4 sails, roller furling, tandem trailer, newer Honda 9.9, teak and holly, standing headroom interior, separate head and V-berth, BBQ, lots of storage. \$6,995. (530) 893-4757.



NEWPORT 27. Excellent Bay boat. Great condition. Many upgrades and many new items. Harken furler, 5 sails, new head, holding tank. Atomic 4 with new electronic ignition and new water pump, good storage, sleeps 5. Asking \$7,500. Call John (510) 749-0970.

CAPRI 25 BY CATALINA. 4-stroke, two-axle trailer, dinghy, porta-head. Two sets cruising sails, rigged to race comfortably. On trailer, dry sailed, freshwater only. This boat is so dry it's parched. \$6,000/obo. Call (775) 265-4235 or email: ecassells@excite.com.

ISLANDER 28, 1977. Atomic 4, tiller, good condition. \$12,000. (510) 865-6872. See at: <http://home.comcast.net/~rleber/wsb/html/view.cgi-home.html.html>



MERIT 25, 1985. Fun racer/cruiser. Water tank, sink, shower, Porta-Potti, stove, VHF radio, Autohelm, GPS, trailer, Sigma speed/depth/temp, full set of sails, two 11 gal gas tanks, 9.9 Evinrude with autostart, solar panel, covers. \$9,000. (949) 500-1973.

NEWPORT 28. Rebuilt Atomic 4, new cushions, new VHF, shore power, holding tank, new thru-hulls, new prop, whisker pole, ground tackle. 3 sails, life jackets, 2-speed winches, halyards led aft, 2 batteries, more. \$7,000. (650) 342-3361.

••• Clearance Sale On All •••
WALKER BAY BOATS
8-ft model, \$519
10-ft model, \$895
10-ft demo, \$799

Stockdale Marine
AND NAVIGATION CENTER
6850 Landis Ave., Carmichael, CA 95608
(916) 944-1606 • fax (916) 944-2214
gstockdale03@comcast.net

Yacht Repair
Design / Consulting
Custom Interiors
Exterior Joinery



STEVE'S MARINE WOODWORK
60 C Libertyship Way, Sausalito
jonessail@aol.com • (415) 332-2500



MARINE SURVEYS • Jan Van Sickle
Member: SAMS – AMS & ABYC
Ultrasound Thickness Testing of Steel & Aluminum
jtvs@post.harvard.edu • www.vintageyachts.org
(707) 939-9131 • No travel charge within Bay Area

NEW for 2005! • HIGH DEFINITION PRINTS
256 INCREDIBLE SHADES! • CHART SAVINGS UP TO 80%
Worldwide • Sample Chart \$5 • Affordable E-Chart back-ups
Bellingham Chart Printers Division, TIDES END LTD., PO Box 1728L, Friday Harbor, WA 98250
800-643-3900 • Fax 360-468-3939 • Web: www.tidesend.com

ERICSON 28, 1987. One owner, documented, well maintained, 7 sails (North, Pattison, UK), new mainsheet traveler, tiller steering, new canvas, beautiful teak interior, 6'1" headroom, 6 berths, Universal diesel, shore power, battery charger. \$21,000/obo. Tom (714) 826-3652.

MacGREGOR 25, 1985. Excellent condition. Used in freshwater only. Includes trailer. Swing keel, pop-top with cover, stereo, 2 jibs, spinnaker with pole, enclosed Porta-Potti, Honda 7.5 hp with gas tank, anchor with 100' line, BBQ. \$4,300. (775) 772-7709.

DUFOR 27, 1974. Sound fiberglass hull. Great condition, clean, fully equipped. 2 mainsails, 4 headsails. VHF. Inboard 10 hp freshwater cooled Volvo diesel. Full galley, standing headroom. Berthed Coyote Point Marina. \$15,000. Call Dick (408) 358-0384.

CATALINA 27, 1976. 6 sails, new jib and spinnaker. Autohelm, 15 hp outboard 4 years old. New AGM battery, roller furling, many extras. Excellent condition. This is a great boat for the Bay. \$8,500. Call (925) 687-8346 or catalina-27@hotmail.com.



ALBIN VEGA, 1973. Swedish built, sweet sailing pocket cruiser, bluewater capable and equipped. Sobstad 135 on ProFurl. North mainsail with 3 reefs, cruising spinnaker, spinnaker, all lines aft. Newer oversized rigging and lifelines. Twin headstays. Extensive ground tackle, sturdy bow roller. Rebuilt Volvo MD7A, 100 hours. Fuel 18 gals. Water 2 tanks 30 gals. Solar panel. Tricolor masthead. Radio, depth, speed, compass, 2 handheld GPSs. Viking valise, 4-man raft, Avon dinghy. Full canvas. Propane stove. Many custom features. Clean and ready to go now. Lots of spares. Navik vane, 3 Autohelm tillerpilots. Same owner for 12 years. \$14,850. Call for 2-page equipment and parts list. (415) 434-1451.

EXCALIBUR 26. Great Bay racer and weekender. Refurbished: New running rigging, 5 hp 4-stroke outboard, knotmeter, bulkhead compass, VHF, fathometer, battery. Stereo, solar, 6+ sails, anchor, 2-axle trailer. Moored Tahoe. Act now for sea trial. \$6,900/obo. (775) 267-0344.

BUCCANEER 28, 1976. Fiberglass hull. New: Head, sink, hot water heater, carpet, battery and fridge. 6' headroom, sleeps 4. 1 main, 1 jib. Recent haulout. Cozy live-aboard, transferable East Bay slip. Call for details. \$4,800. (415) 724-4204.

MacGREGOR 26X, 2002. Very loaded, very little use. Trailer, bottom paint, roller furling, jiffy reefing, halyards to cockpit, stove, GPS/depth, sunshade, cockpit windows, cockpit cushions and table, large wheel, swim ladder, VHF, shore power, dual batteries, compass, all gear, 50 hp Suzuki 4-stroke, more. \$21,900. Call for details. Dan or Jeff (415) 456-2644.



RANGER 26. Very clean. No leaks or smells. New: Traveler, battery, much new running rigging. New deck layout and more. 3 headsails, main, spinnaker. Reliable 8 hp outboard. Solid, safe SF Bay racer/cruiser. \$3,500. (408) 386-3355.

O'DAY 25, 1979. Shoal draft, swing keel. Roller furling jib and standing rig 2002. Honda 9.9 4-stroke 2003. Stereo, depth, wheel steering, two anchors, enclosed head, battery charger, trailer. Good condition. \$4,500/obo. (530) 265-4313 or richacamp@aol.com.



ISLANDER 28, 1977. \$16,000/OBO. Great shape, spinnaker, two jibs, two mains, other sails available. Great shape. Currently at Treasure Island. For more information, call Allen (925) 368-5542, or visit: <http://www.sztukowski.com/pages/5/index.htm>

CAL 25 POP-TOP, 1967. In very good condition. Many upgrades this year. Spinnaker like new. 2003 Honda 9.9 4-stroke with only 20 hours, just serviced. Transferable slip, Berkeley Marina, G-300. \$3,000/firm. Call Bill (510) 653-3457.

H-28 KETCH, 1965. Good condition, new 25 hp Universal diesel, recent rigging, new bottom paint, depth, VHF. Needs galley work. Easy to sail, Bay and ocean. Motivated seller. \$15,000. Call (415) 452-9619 or chalang1@comcast.net.



CATALINA 27, 1975. Great condition, easy sailing with all new: Bottom, standing rigging, keel nuts, traveller. Rigged singlehanding, lines aft, self-tending jib, autotiller, lazyjacks, depth. Nice interior, stereo. Strong Atomic 4. Richmond. \$8,700/obo. (415) 260-4222.

CAL 25. Good main, jib, genoa. Excellent Honda. New paint topside, interior, mast and boom. Bottom 2003. Sound hull, no blisters. 12v and 110. Good battery. Enclosed head, icebox, sink, anchor and rode. New VHF. Sleeps 4. Delta. \$6,400. (530) 230-8800.

US YACHT 25, 1981 by Bayliner. Honda 7.5 ob, propane stove, enclosed head Porta-Potti. Main, 2 jibs. Overall good condition. Lines to cockpit, easy to single-hand, all safety gear, trailerable. Berthed Vallejo. \$2,600. (707) 252-3006.

PEARSON COMMANDER 26. Full keel, large cockpit, sleeps 4. 8 hp Johnson outboard, sails very good. New paint: deck and interior. New bunk cushions, many extras. \$6,000/obo. Paul (925) 784-1009 or John (925) 945-7669.

CATALINA 27, 1981. Traditional layout, standard rig, very good condition, newer sails, roller furling jib, tiller, depthmeter, good condition Atomic 4, electric head, 2 anchors, VHF, Origo stove. New: Gauges, carpet, wiring. Lots of extras. \$10,000. Vallejo. RussR2005@yahoo.com or (925) 457-9538.

26-FT MARIEHOLM FOLKBOAT, 1975. Good condition. New standing rigging, 2 sets good sails, 5 hp Honda ob. Clean boat. See photos: <www.sailsea.org> \$7,000/obo. Call Jay (209) 617-1384.

CAL 2-25, 1979. 2004 9.9 Honda extra-long shaft, electric start. Adjustable backstay, roller furling, newer interior, two anchors, VHF, depthfinder, 9+ sails, tiller, windex. Two-axle trailer. Lake Tahoe boat. \$13,500. Call Duke (775) 544-1476 or (775) 786-3452.

26-FT INTERNATIONAL FOLKBOAT. Built 1971 Marieholms, Sweden. VHF radio, head with holding tank, spinnaker and gear. 5 hp longshaft ob engine. Great Berkeley berth. Last haulout 2004. \$6,000/obo. Call (510) 653-4216 or email: if644@comcast.net.

ERICSON 27, 1972. Two boat owner needs to sell to finance world cruise. Great day/coastal cruiser. Too much new equipment to list. New running and standing rigging, gas tank, shaft, spreader brackets, boom, all lines led aft. \$10,500. (415) 259-8626.

MacGREGOR 26X, 2000. One of the nicest on the Bay. Includes many options such as a quick on-and-off dodger, cockpit sunshade, or make it a complete cockpit enclosure for bad weather use. Cabin has teak accents and enclosed head. Sleeps 6. Galley includes refrigerator, stove, microwave. Other options include roller furling jib, easy-lift for mast, shorepower, bottom paint, 50 hp motor, trailer, VHF radio, etc. Reduced for quick sale. \$18,895. Call (415) 456-2644 or (707) 227-9262.

HAWKFARM 28, 1978. Great condition. 10 sails, new rigging, autopilot, VHF, nice interior, diesel. I moved to Hawaii, the boat's in Eureka CA. Must sell. \$6,000/obo. Really need money for school. (208) 630-4883 or pelicanwad@hotmail.com.



SC-27. Looks new with new epoxy bottom, hull and deck LP, upholstery, VHF, foredeck hatch and halyards. Sprit, GPS Map, ob, symmetric and asymmetric spinnakers. 9 sails. \$12,950. Trailer available. (702) 656-1850 or Capteos@cox.net for more pics.

CAL 2-27, 1976. Atomic 4 doesn't run. Needs bottom paint, very good condition otherwise. Nearly new: Quantum main and #4, Nexus depth/speed/wind, battery boxes/charger/wiring, jib sheets and Garhauer vang/blocks, lifelines, spreaders. 110v fridge. \$3,500. Doug (925) 454-1849 or email dnpoland@stanfordalumni.org.

EXPRESS 27, 1982. Hurricane. Hull #20. Dry sailed. Two sets of sails, 2 hp Honda, trailer with new brakes, bearings, and tires. Located in Stockton. Asking \$14,750. Call Russ (209) 478-5411 (hm) or (916) 612-8151 (cell).



RANGER 26, 1974, NEREUS, \$9,000. Pristinely restored from keel to masthead. Meticulously organized for singlehanded racing. Autohelm, racing sails, main, 4 jibs, all new spinnaker gear. Resprayed at Svendsen's Boat Yard. Recognized in *Latitude 38*, May 2004, and in *Sail Magazine* October 2004. Featured in *Boat Works* winter issue as a success story. Call Nicholas (510) 654-2541 or (415) 810-6474.

CATALINA 250 SLOOP, 1995. Lake Tahoe boat, excellent condition. Freshwater only. LOA 25', beam 8'6". 2002 Mercury outboard 9.9 hp, like new, only 10 hours. Retractable keel, easy launching. Dual-axle galvanized trailer. Rigs in less than an hour. Special mast-stepping gear for easy rigging. 100% working jib, full batten main. Galley, Porta-Potti, sleeps 4 comfortably. Solar panel battery charging system. Great boat for cruising/exploring any body of water. Asking \$16,950. Call Greg (530) 308-0113 or (530) 546-5116.

LANCER 28 with new Yamaha 9.9 electric start outboard. Stored near Lake Isabella and can be shipped on my trailer; trailer doesn't come with boat. Good condition and dry. Normal gear, sails, etc. \$6,500/obo. Scott (760) 223-0628.

CATALINA 25, 1987. Wing keel, trailer. Stored inside, not in water for 8 years. Fully loaded, excellent condition. Full instrumentation, extra sails, extra rigging. 10 hp 4-stroke ob. Too much to list, call for specs. Stored Reno. \$18,000. Tim (775) 747-1111 (wk) or (775) 225-5083 (cell) or tim@sierratelephonesystems.com.

29 TO 31 FEET

CAL 2-29, 1975. Wheel steering, dodger, full sail inventory, fore and aft anchors, inflatable runabout with Honda outboard. Fully equipped, good condition. Ready to sail away. Freshwater berthed in Stockton. This is my eighth sailboat. I bought her because she's a good boat, I'm selling because I'm moving. \$15,000. Call (209) 915-7057 or nmrvdgg@netzero.net.

HUNTER 29.5, 1997. In excellent condition. Fully equipped. Lazyjacks, roller furling, Yanmar diesel, Autohelm, AM/FM stereo, etc. \$41,000/obo. Please call (510) 632-2370 or (510) 614-9817 (eves).

CATALINA 30, 1982. New sails, tilt-away mast and winch, wheel steering, Atomic 4 but 2 cyl 18 hp Yanmar diesel ready. Excellent condition but diesel not yet installed. Epoxy bottom job completed 8/04. As is \$13,500. Call (510) 830-7982.

BUCANEER 29.5 (BAYLINER), 1979. Sleek, fast, clean, solid sailing vessel. Sleeps 7. Volvo MD7A diesel, full complement of sails, auto-PFDs, GPS, nav station, head, plus many extras. Alameda. Priced to sell fast at \$9,800. Call (559) 565-3115 or eric_inman@excite.com.

CATALINA 30, 1985. Water-cooled diesel with 650 hours. Dinette table mounts to bulkhead. Harken furler, dodger, new standing rigging. Built-in refrigerator, CNG stove and oven, lazyjacks, AH4000, knot/depth meter, VHS radio, battery charger, cockpit cushions, dripless shaft and shower sump pump to keep bilge clean. Engine just serviced by professional mechanic with new hoses, belt, coolant, alt bracket, fuel filters and valves adjusted. Boat in excellent condition. Comes with transferable Moss Landing slip. \$29,500. (831) 753-2001 or Skipper030@aol.com.

YANKEE 30, 1974. Comes with full complement of sails, Autohelm, new gas tank, new batteries. Engine in good shape. Needs cosmetic TLC. Berthed in Benicia. \$5,000. Call (707) 246-9969 or email: piratebryan@msn.com.



HENDERSON 30 SPORTBOAT. *Fast Twitch.* Custom kelp cutter and many extras for inshore and offshore racing. Coastal Cup, Trans Tahoe, Ensenada, San Clemente Island, etc. race veteran. On trailer in San Diego. \$55,000. Call (858) 755-6265 for full details.

ISLANDER 30 Mk II, 1972. New Volvo Penta MD2030 diesel engine, 30 hp, only 57 hours. New deluxe instrument panel. New LectraSan waste water treatment system. New dripless packing system. New Simrad autopilot. GPS, VHF. Pedestal steering. Stove, oven. Hauled for bottom paint, barrier coat Aug 2004, no blisters. Thru hull fittings and valves replaced. Love this boat, bought a larger boat. First \$25,000 offer gets great sailboat, great deal. (916) 870-4435 or (916) 427-1899 or jpecorel@earthlink.net.

HUNTER 31, 1985. Professionally serviced. New battery charger, bilge pump, safety lines all around. Two jibs, nice roomy interior for overnights. Yanmar, wheel. Has been a great Bay boat with long list of details. Located Alameda. \$22,500. (510) 337-0818.

RAWSON 30. Located Crescent City, CA. Documented. Volvo diesel, cruise equipped. \$9,000/firm. Call for details. (530) 224-1760 or haleykay@sbcglobal.net.

ISLANDER 30, 1968. Atomic 4, extra sails. Must sell. \$5,000/obo. Call (707) 449-4634.

NEWPORT 30 Mk II, 1972. Fully battened double reef main, very good condition, roller furling jib, new depthsounder and prop shaft, VHF, compass, anchor and rode, sleeps 7. Very spacious. \$8,900. Richmond Bay Marina. (530) 241-5622, ask for Jack.

OLSON 30, WARPETH. Very nice boat, ready to race or daysail, double-axle trailer, 3.5 hp Nissan outboard motor. Dry sailed. Good sail inventory. Lying Santa Cruz. Asking \$15,500. Call Ryan (831) 234-3229 or Geoff (831) 595-4180.

HUNTER 29.5, 1996. Excellent condition. Roller furling, Yanmar diesel, Autohelm, AM/FM stereo, dodger, refrigerator, H/C pressure water, charger. Berthed in Alameda. Must sell. Will take best offer. Please leave voicemail (510) 870-8654 or email: wkcho@ix.netcom.com.

CATALINA 30, 1989 in great condition. Roller furling, autopilot, wheel steering, new standing rigging, radar, GPS, dodger, 120 Vac inverter, 3 batteries and quick charge system, 25 hp diesel engine, VHF, stereo, 5 gal propane, cabin heater, refrigeration, new wind, depth, and speed instruments, 4 sails including asymmetrical spinnaker. \$35,000. Call Denny (707) 486-0412.

NEWPORT 30, 1978. In good condition. Located in Stockton. 2 mainsails, 3 jibs, dodger, good running Atomic 4. Very comfortable boat. She needs a good home. \$8,647/obo. Call (209) 479-1769 or jrjong@mail.com.



ISLANDER BAHAMA 30. Wheel steering. Recent diesel engine overhaul. Teak and holly below, beautiful, sleeps 6, alcohol stove, toilet. Excellent cushions. Owner anxious. \$14,000. Monterey mooring. (831) 297-2059.

FOR A SONG: CASCADE 29, 1962. Hull #8. Classic plastic. Rebuilt Palmer P-60 original gas. Needs all sails, cosmetic work. Very sound. Must sell. No reasonable offer refused. Boat in Bodega Bay. (707) 823-1298.

ISLANDER 30 Mk II, 1976. Wheel steering. Volvo diesel, low hours. 5 sails, VHF, CD, depth, knot, etc. Richmond Harbor. Great, solid boat. \$15,000. (916) 419-9711 or leosail@sbcglobal.net.

SANTANA 30/30, \$19,500. All the gear and sails you need, including used-twice AirX spinnaker, new deck hardware, Pentax performance headsails, Autohelm 1000 and other basic electronics. The S3030 is the ideal racer/cruiser in 30 feet. Website: <http://www.california.com/~ahebert/gabrieli/wisdom/wisdom.html> Email: alanhsails@yahoo.com or (650) 299-1850.

PEARSON 31, 1978. Hull #6. Great boat. Very good condition. 24 hp Volvo diesel VHF, GPS. Head, navigation station, galley, dinette, 2 anchors, lazyjacks, stereo and more. \$11,500. (510) 527-2312.

CATALINA 30, 1980. Excellent condition with wheel. New GPS/depth/knot, standing rigging, roller furling, 130 RF jib, Garhauer traveler, battery charger, interior cushions and upholstery, microwave, refrigerator, hinged teak hatch doors, C-Cushions, and swim ladder. \$15,995. (530) 470-0511.

CLIPPER MARINE 30 SLOOP, 1975. Brisbane Marina. Well maintained, clean, 6' headroom, fixed keel, lead shoes. Fiberglass hull, 1 tiller, transom-hung rudder. New standing and running rigging. New Harken roller furler. Yanmar 2GM20FV diesel, less than 200 hours. Shore power, 2-burner stove, ice box, self-contained portable toilet. See: <http://lolltech.com/Clipper> (case sensitive). \$11,500/obo. Bob (650) 355-5166 (lv msg) or (650) 996-4631 (cell).

30-FT CENTER COCKPIT S2-9.2C, 1978. Diesel, wheel steering, North mainsail, lazyjacks, gennaker, furler, dodger, BBQ, Autohelm. Excellent liveaboard, 6' interior headroom, sleeps 6, teak interior, holding tank, alcohol stove. \$26,000. David (415) 572-6506 or buckaroo500@yahoo.com.

ERICSON 30+, 1984. Immaculate. Completely refit and well-maintained, with many extras. Perfect for daysailing, coastal cruising, or club racing. See website for details and pics: <http://www.jamesw.com/arae> \$32,000. Call (510) 748-9712 or email: jlw_@yahoo.com.

PEARSON 30 SLOOP, 1977. Fast and safe sailboat. Pocket cruiser, weekender or daysailer. Strong construction. Classic lines. Sleeps comfortably six adults. Large dining area, immaculate interior. Wheel steering and engine controls at steering pedestal. Top-of-the-line new dodger with built-in handrails and new cockpit weather canvas. New mainsail and roller furling jib. Atomic 4 inboard and backup auxiliary outboard bracket on transom. VHF, depthometer and knotmeter. New survey. Beautiful yacht. \$13,000/obo. Call (650) 380-5535.

CATALINA 30, 1982. Excellent condition. Loaded. Too much information to list, call for full details. \$25,000/obo. Charles (415) 420-3957.

ERICSON 30+, 1982. Original owner. Inboard Universal diesel, wheel steering, head with holding tank, alcohol stove with oven. Berthed at Port of Redwood City. Must sell, as is, \$15,000/obo. Please call (650) 367-8184 (eves).

ISLANDER 29. 5 sails, led aft, 2 anchors, radio, fridge, micro, dinette, nice wood interior, legal head. New: Prop shaft, thruhulls, head, bottom 2 years. Honda 10, low hours, new battery, wood work, and recent painting, includes inflatable kayak. \$4,950. (510) 689-3432 or you1234@yahoo.com.



CATALINA 30, 1976. Tiller steering, great Atomic 4. New folding prop, refrigerator, hot/cold water, new upholstery, new standing and running rigging, several sails. Constantly maintained and upgraded. <www.Eurydicercing.com/forsale> \$12,499/obo. Gmbieri@pacbell.net or (916) 455-7665.

RAWSON 30. All new GPS, chartplotter, radar. Just hauled, new paint inside and out. Dodger. \$7,500/firm. (707) 745-6138 or sailor_boy_94510@yahoo.com.

CATALINA 30, 1984. Tabernacle mast, custom traveler, Data Marine wind instruments, AP, DS, wheel, diesel with low hours, small Achilles dinghy, propane stove/oven. Lifelines and rigging replaced 2002. Very clean boat. \$26,500/obo. (831) 462-9786.

SANTANA 30/30 PC, 1985. \$26,000/obo. This is the best-maintained 30 footer on the Bay and is in immaculate condition inside and out. Excellent performance boat with large accommodations below for cruising. Racing fleet (SF 30s) in the Bay that is competitive and fun. Bottom painted June 2004. Simrad Instruments 2003. Cruising sails and racing sails in excellent condition. 2002 Elliott Pattison #1, 2002 EP #3, 2002 EP main, 2002 EP .75 spinnaker. Please call Jon (415) 314-8821 or fsailor67-latitude@yahoo.com.

32 TO 35 FEET

32-FT ERICSON 32-200, 1989. 23 hp Universal diesel. 6.5' draft. Dodger 5 years old. 10'10" beam. Sleeps 6 with master aft cabin. Beautiful teak interior, 12v refrigeration, Harken roller furling. Well maintained. \$53,000. Located Benicia with liveaboard slip available. Call Mike (504) 296-3330.

MARINE ENGINE CO.

Complete Engine Services • Gas & Diesel
30 Years Experience • Reasonable Rates
Tune-Ups • Oil Changes • Engine Rebuilding, etc.
(415) 332-0455



MARINE SURVEYS • SAMS / ABYC / NFPA
Captain Alan Hugenot, AMS® • 30 years experience
Power & Sail • Hull • Rigging • Engine • Electric
••• All major credit cards accepted •••
www.captainhugenot.com • (415) 531-6172

Boat Smith

Custom Marine Woodwork
#1 Hunter's Point Shipyard, SF
(415) 822-2554



Customizing • Restoration • Repair
Fine Woodwork for both Power & Sail
Free Consultation
Competitive Rates
Online portfolio: www.theboatsmith.com



NOR-CAL COMPASS ADJUSTING

Magneuto™ System Exclusively
Boat Remains in Berth • Eliminates Deviation
Authorized Compass Repair • All Major Brands
Hal McCormack • Phone/Fax: (415) 892-7177

MELGES 32 PROTOTYPE. Exceptional opportunity to own a very high performance keelboat with first-to-finish potential. Fantastic race record. PHRF 27. Very good condition, trailer, 4 hp outboard, complete inventory. Race ready. Located Lake Tahoe. (530) 583-8700.

CATALINA 34, 1987. Well equipped, maintained, three headsails, furling self-tacking jib, newer dodger, full sunshade, weather cloths, refrigeration, propane stove, heater, wind and depth instruments, reliable diesel, CD, upgraded 12v, beautiful teak interior, many extras, recent excellent survey. \$49,500. (650) 969-9327.

1D-35, RACER'S EDGE. This boat is ultra clean with an excellent North/UK self inventory. Professionally maintained and ready to race. New bottom, full cover, 2 mains, 8 jibs, 6 spinnakers. Price reduced to \$78,000. Call (310) 822-5205 or (310) 213-5205.

1977 O'DAY WITH CENTER COCKPIT / aft cabin configuration. Aft cabin has double berth and navigation station. Forward is main salon with galley to starboard and head to port, settees with drop leaf table and V-berth forward. Vetus (Mitsubishi) engine, 30 hp, 1980s, in great condition, no trouble in five years, regularly serviced. New battery charger and 3 new batteries. Hauled for bottom paint in November 2004. 50-gallon fuel tank, alcohol-fueled stove/oven, s/s with hot and cold water pressure, ice box, radar, VHF radio, depth-sounder, autopilot. Mainsail, working jib and genoa, roller furling for headsail. Was great liveaboard for five years. *La Ballenita - The Little Whale.* \$20,000/negotiable. Holly (510) 543-8160.



ERICSON 32. Good sailing vessel, easy to singlehand. Self-tending jib, new upholstery entire boat, refinished interior. Professionally maintained. Volvo MD2B diesel engine, recently rebuilt. 3-burner stove with oven, lots of wood below. Asking \$18,500/obo. Call (209) 462-6271.

CATALINA 320, 1994, #143. Great shape and loaded. 27 hp Perkins, 100% and 135% jibs, cruising spinnaker, whisker pole, windspeed/point, depthsounder, Autohelm 4000, battery charger, GPS, stereo, 100 amp alternator and smart regulator, microwave, propane stove, macerator pump, pressure hot water. VHF, adjustable backstay, roller furling, Flexo-fold prop, self-tailing winches, dodger, cockpit table and cockpit cushions, electric windlass and Fortress anchor. Pt. Richmond. \$59,000. Call (415) 310-4173 or the Taproom@prodigy.net.

ALDEN 34 SLOOP. Perkins diesel engine, runs but needs work. Good sails, sleeps 4, private head, shower, galley. Could be a nice liveaboard. Berthed in San Leandro. \$7,500. Jim (209) 786-6003.

ARIES 32, 1980. Double-ended sloop, full keel, Westerbeke 25 hp diesel, ss stove with oven. One owner. Needs standing rig and TLC. \$9,500. (650) 867-9700.

CAPE DORY 33, 1980. \$59,500. Last 4 years all new: Sails, canvas covers, dodger, refrigeration, electrical panel/wiring, standing rigging, lifelines, stereo, VHF, ultraleather interior cushions etc. Photos: <http://mace.photosite.com/CapeDory33/> Call (530) 559-5100 or email: Larry.Mace@gt.com.

CAL 34, POPULAR 1979 SLOOP. Roller jib, tabernacle mast, low hours Yanmar diesel. New Hogan mainsail. Basically sound. Needs some TLC. I can't sail, yet I'm willing to remain minority partner or sell for fair offer. Call Randy (925) 708-6868.

COLUMBIA 34, 1971. New Yanmar 3GM30FV, 20 hours. New mechanicals, exhaust, heater. Hauled 2/03, bottom job, thru hulls, hoses, updated electrical panel, upholstery. Main, spinnaker, 2 jibs. Bill Tripp bubble-top. Spacious, wheel steering, radar, extras. Plastic classic. \$22,000. Gail (510) 526-8758.

J/105, 1992. Pre-scrimp model. Fresh-water use only, Lake Tahoe. Shoal draft, tiller. Proline epoxy bottom paint, Autohelm tiller/pilot, GPS chartplotter. Mast-mounted Sailcomp. Quantum Kevlar main and jib, North 89%, 110% spinnakers. \$79,000. Call (530) 318-0522 or email: tahoesail@hotmail.com.

ISLANDER 34, 1978. Motivated seller. Sausalito liveaboard slip. New 30 hp Volvo, new mainsail. Beautiful, custom teak interior with hot/cold pressurized water. New 30 gal water, new diesel tank. Edson wheel, bronze ports, windlass. See website: <http://www.geocities.com/specializedwood/photopagespiral.html> \$17,000/obo. (415) 454-0412.

IRWIN CITATION 34, 1986. Great sailing performance cruiser. New: Canvas, inverter, Vacuflush, mainsail, electrical, upholstery, Yanmar 3GMF, Force 10 oven, Garhauer-rigged. 2nd owner. Queen of Long Beach Show 1987. Alameda. First \$50,000 takes her. (925) 518-6482. Seeing is believing.

CATALINA 34, 1987. Very popular coastal cruiser that has been very well maintained. Autopilot, GPS, extensive canvas, rewired electrical, 8-ft dinghy with 8 hp outboard, and much much more. \$48,500. Call (714) 595-3646 or Pudauida1@aol.com.

COLUMBIA 34. Great liveaboard, beautiful below. Short on gear, room for new. Sails great. Must sell now. \$20,000/obo. (831) 869-6443.

ERICSON 35+, 1983. 35.5-ft LOA performance cruiser for SF Bay, Hawaii capable. In excellent shape, many recent upgrades. All new: Jib and mainsails, LP stove, GPS, traveler, lifelines and cockpit cushions. Has blue dodger, spinnaker, extra sail set, furler, DS, KM, wind, Autohelm 6000, 12v fridge, Universal diesel with hi-amp alternator, hydraulic backstay, etc. Documented. Emeryville. \$59,900. Email for photos: pmchin47@hotmail.com or (925) 642-7600.

BEAUTIFUL 34-FT COLUMBIA Mk II sloop. Baja veteran. 300 hours on Yanmar 3GM30V. PUR40E and PUR06 water-makers, 2 autopilots, Furuno radar, GPS, Loran, fridge/freezer. Profurl, shower, hot/cold water, sails. Dickinson diesel heater, fresh topside, etc. New bottom job and survey. Roomy, fast, strong. \$28,000/obo. Duncan (415) 902-0771.

APHRODITE 101, 1985. 33-ft narrow beam racer/cruiser. Fractional rig, well maintained. Yanmar, low hours. See boat pics, specs, history and references: <www.van-zuiden.com/101> Call Jerry (650) 941-6387.

PEARSON ALBERG 35. Excellent condition and great brightwork. Boat has been well maintained and has many upgrades. She needs a new engine and bottom paint. Owner is retiring. Great price at \$14,700. (510) 528-0562.

36 TO 39 FEET

TAYANA 37, 1987. Moving to mountains. Boat in Florida, ready to sail back to Caribbean. Original owner, continuously maintained. New Awlgrip. No teak decks, no cast iron tanks. \$115,000. Photos/info: <www.tayanalaes.com> or call (904) 891-6744.



BLACK & McANDREWS 38, 1976. Converted to cruising 1984. Two singlehanded circumnavigations by all five southern capes. Set up for singlehanded. Extensively proven in harsh conditions to be strong and fast. See <www.rockisland.com/~fliit/> Lying Orcas Island, WA. \$47,800. (360) 376-7661.

MORGAN, 382, 1980. Well equipped, good electronics, GPS, hard dodger, Perkins 4-108, Autohelm, Monitor windvane, electric windlass, Adler-Barbour. Asking \$62,500. For specs please call (213) 500-0009 or (213) 999-1450 or email: oukiva80@hotmail.com.



NEW YORK 36 SLOOP, 1983. Draft: 6'4", 10,000 lbs, HD polyester fiberglass construction, fin keel spade rudder, Volvo Penta 15 hp diesel. Good condition. Richmond Marina. \$32,000. Call for survey report. (925) 683-4539 or rodney.franks@usa.net.

CATALINA 380, 2000. Loaded, full electronics. Leisure furl boom, Vectran mainsail, electric winch and windlass, inverter/charger, ultra leather interior. Yanmar engine, 130 hours. Glass Mat batteries, full cockpit canvas, electric head, much more. Alameda. Asking \$155,000. (916) 632-9317.

ISLANDER 36, 1974. In very nice condition with beautiful interior. New 35 hp diesel engine, newer standing rigging, etc. Overall well kept. She has never been raced, does not blister. 2nd owner. \$45,000. (408) 591-8796 (days/eves). No brokers please.

HUGHES 38 SLOOP, 1970 with Monterey slip. S&S design, built in Eastern Canada. New Universal diesel engine, 60 hours. Pictures available. \$38,000. Call (831) 915-4984 or (831) 775-2475 (wk).



CATALINA 36 Mk II. Built in 2000, well maintained sailboat with a rare slip in Santa Cruz Harbor and added tax benefits, if desired, through the Pacific Yachting and Sailing Charter fleet, Santa Cruz, CA. \$116,000. (831) 461-1270. No brokers.

REPO: 1969 CHEOY LEE CLIPPER 36 ketch, located Mazatlan, a great live-aboard area. Boat needs TLC, but is priced right. Owner financing available if needed. Why suffer in California? Email: panamajackmzt@yahoo.com or call 011-52 (669) 988-0509.

UNION 36, 1983. Beautiful teak interior and recent electronics, refrigeration, rigging upgrades. Everything in excellent condition except she needs new bottom paint. Do-it-yourself and save \$\$ \$79,900/obo. (510) 551-4852.

IRWIN 37 Mk IV, 1980. Center cockpit cutter. 2 heads with showers, 2 cabins, hot pressure water, galley with propane stove/oven and small refrigerator. Rigging and boat in good condition, but not cruise ready. \$40,000. (415) 305-4256.

CATALINA 36, 1987. Universal diesel, new sails and standing rigging, self-tending roller furling headsail. Dodger and full cockpit bimini and enclosure. Loaded with every option including air conditioning. No blisters, like new, beautiful condition. \$69,500. (925) 228-2852.

PACIFIC SEACRAFT CREALOCK 37, 1997 cutter. Excellent condition and well equipped. See: <www.coug.net/boat> \$188,500. Call (206) 250-2527 (eves).



ISLANDER 36, 1980. \$45,000. Brand new mast, rigging, Harken furler. New epoxy bottom. Raymarine ST60 instrument package. Autohelm, Heart inverter, VHF radio. Pathfinder diesel, runs well. Hood Vectran main and 110% jib. Custom covers. Well-maintained interior. Call Sean (510) 864-8403 or email: sean@svendsens.com.

DOWNEAST 38, 1976. Epoxy bottom, Farymann diesel, full keel, needs TLC. Located Ventura, CA. \$29,500. (805) 676-1092 or (661) 245-2814.

ISLANDER 36, 1985. Very clean, well maintained. Great boat that sails well. \$63,500. <http://www.parkwebdesign.com/islander.htm> (619) 977-9584.

CATALINA 36, 1989. Very well maintained, new standing rigging, lifelines, Foss rudder, oversized wheel, all Harken gear. Quick vang, new bottom, fridge, head system, North sails, DVD, hot water, and much more. \$69,000. (415) 460-1365 or (415) 272-1228.

ISLANDER 36, 1980. Never raced, set up for cruising including 6-man Givens liferaft, hard bottom Zodiac and 10 hp 4-cycle Honda engine. Many extras. Excellent condition. Must see. \$55,000. (510) 881-7743.



BRISTOL 38.8, 1983. Aft cockpit. Modified fin keel with centerboard. Original owner. Professionally maintained. Clint Pearson builder. Ted Hood designer. Berthed Blaine, WA. Fully cruise equipped. \$129,000. For information and pictures call Dick Grier (707) 586-2994 or email: grierholm@att.net.

38-FT STEEL CUTTER. Vanderstadt design. Oco Steel, yard built, steel/alum topside, center cockpit. 85 hp Lehman diesel, low hours. Full keel, bluewater cruiser, all the gear. Cruise ready. San Diego slip. Must sell, please, serious inquires only. \$55,000/obo. Call (619) 994-0763 (lv msg).



CARRERA 38 SLOOP. Graceful and fast. 38 x 8 x 6.5 x 9,000-lbs. New Quantum sails, new Harken winches, new yellow Awlgrip topsides. \$42,000. Call (510) 524-9166 (eves).

C&C 37R, 1989. Fast cruiser/racer. Too many upgrades to list. Opportunity to own a great, fast boat at a great price. Has full survey with haulout. Asking \$46,500. Kevin (415) 305-9029 for pictures/info.

CAL 39 II, 1978. Well maintained classic performance cruiser. Perkins 4-108 diesel. Roller furling with 5 jib selections, plus drifter and spinnaker. New main 2002. Hydraulic backstay adjustment. Quickvang. Radar, depth, speed, EPIRB, windlass, dodger, holding tank, much, much more. \$72,000. Call (209) 465-9761 or email: marjfrries@sbcglobal.net for full information.

HUNTER LEGEND 35.5, 1989. \$46,500/obo. Excellent condition. New paint in April. Two-boat owner needs to part with one. Located Marina Bay Yacht Harbor, D-169. For pictures and equipment list email: dougot@aol.com or call Doug (707) 765-9248.

39-FT STEEL CUTTER, 1986. Serious cruiser, Folkes 39, factory built. Total refit in 2004/05, sandblasted, paint 2004. Yanmar 30GM 110amp Balmar alt. with smart Max-charger. New self-sufficient electrical system. Solar, Raytheon radar and tridata, SSB, fridge, watermaker, VHF. New plumbing and holding tank. Interior very clean and spacious, new varnish on all interior and exterior teak. Lots of storage, dry bilge. Ready to go. \$65,000. Pics and specs: <www.geocities.com/stal_delfin> or call Robert (619) 886-3940.

ESPRIT 37, 1978. Perry designed, Nordic built. Seaworthy cruiser and Bay sailer. Beautiful teak interior, rebuilt BMC 37 hp diesel, separate shower, hot water, refrigerator, windvane, windlass, rod rigging, electronics and more. Must see: <www.flyingcloud9.com> \$87,000. Call (415) 250-3592.



2002 C&C 110. 36 feet, navy topsides, full electronics package, many options, aluminum mast, saildrive, 2 headsails, jib furler, new mattress, fridge, CD, fans, immaculate. \$159,999. Call (650) 592-3742.

APACHE 37 SLOOP. Fast sailing, furling jib, gas engine, private head, galley, sleeps 6. Berthed at Pier 39, slip lease also available. \$17,500. Call Jim (209) 786-6003.



CATALINA 36, 1987. Excellent condition. Brand new standing and running rigging. Bow roller / lifelines new 2003. New bottom Nov. 2004. Professionally maintained. Just completed total engine service. 3 batteries, 2 new. Radar, GPS, wind, speed, depth, VHF, Autohelm ST4000. Self-tacking jib, Harken roller furling. New main, rigid vang. \$64,500/obo. Call (925) 408-6927 or email: pettyd@bsci.com.

40 TO 50 FEET

TASWELL 43, 1992. Center cockpit cutter. Excellent condition. New dodger, Autohelm 7000, Furuno 24-mile radar. ICOM SSB, GPS, chartplotter. Balmar smart charger, inverter. Glacier Bay refrigeration, watermaker, davits, dual racors, liferaft, oversized electric windlass, cruising spinnaker. Sausalito. \$299,000. (650) 804-6218.



THE ELEGANT LORD NELSON. LOA 41 feet. Final hull #27, 1988. Original owner. Continuous refinements and upgrades. Perfect balance of immense strength, spacious accommodations and storage. The ultimate traditional world cruiser offering style, comfort and safety. A truly beautiful thoroughbred. Documented. Incorporated, offering tax advantages and liability protection. Located in San Diego. See: <http://www.turtleheadmarina.com/LordNelson.htm> \$137,500. Jack Crockett (619) 865-0831.



COLUMBIA 45 SHOAL KEEL KETCH, 1972. Hull #3. Solid and clean motorsailer. Perkins 4-107 with 425 hours. 200 gal fuel, 200 gal water. Independent hydraulic inside steering station. Paneled wood interior throughout. Tiled shower, galley and heads. Great liveaboard or go anywhere. Additional photos and info at: <http://www.msnusers.com/Columbia45Hull3> \$65,000. Call (415) 420-4299 or email: eprincipe01@hotmail.com.

SPENCER 42, 1966. Fully equipped ocean cruiser, just returned from Mexico. Fiberglass hull, Yanmar 44 hp, 210 gal diesel, 110 gal water. ICOM SSB and VHF, Pactor III, Furuno radar and GPS, Spectra watermaker, CPT autopilot, Aries windvane, EPIRB. Force 10 stove and BBQ, fridge. Ideal windlass, 5 anchors, 3/8" chain, 3 solar panels, inverter, 7 sails, dodger, full awnings, 2 dinghies, 25 hp ob. Located San Rafael. \$75,000. Call (530) 470-0450 or elkebrown@sbcglobal.net.



HALLBERG-RASSY 42 KETCH, 1982. Lying in Florida. 53 hp Volvo, very well equipped for bluewater sailing with updated electronics, autopilot, GPS. Rebuilt motor and transmission, 7' draft, new sails. \$130,000. Call (401) 261-3714.



CHEOY LEE 40 MIDSHIPMAN. New Yanmar engine, new canvas in enclosed center cockpit, ketch rigged, fiberglass, new systems. New Force 10, aft stateroom with head/shower, forward stateroom with head/shower. \$79,900. Call Bob (510) 719-7153.



KETTENBURG K-40, 1959. Classic in excellent condition. Galley, head, V-berth, sleeps 6. Nav station with electronics. Westerbeke 30 diesel. Self-steering Hydrovane, Autohelm, new transmission and prop shaft. Engine gone through. \$28,900. San Diego. (760) 344-6480.

GARDEN MARINER 40, 1965. Mahogany planked, roomy, comfortable, standing headroom throughout, ss propane galley, wood stove, rowing dinghy, davits, anchors, chain rode, sails, hard dodger, many extras. Fixer-upper, needs a new life. First \$20,000 takes it all. Mark (650) 952-2269.



HUDSON SEAWOLF 44, 1979. Cutter rig, full keel, center cockpit ketch. Fiberglass deck, recent new aluminum masts, standing and running rigging, hydraulic windlass, bow pulpit, roller furling. Dodger, windvane, refrigerator, freezer, TV, stereo, DVD, instant hot water, inverter, radar, SSB, aft stateroom, solar powered and more. Bluewater cruiser/veteran. Elegant and solid, classic Garden design. \$85,000/obo. Scott (760) 504-5781 or Colette (760) 504-5782.



EAST BAY SAIL & COVER CLEANING
mildew, rust, grunge
(510) 523-9011

OFFSHORE PASSAGEMAKING INSTRUCTION IN THE SOUTH PACIFIC
John & Amanda Neal are dedicated to providing you with hands-on, documented instruction aboard their Hallberg-Rassy 46 *Mahina Tiare III*, drawing on their combined 368,000 miles and 55 years of experience.
www.mahina.com • (360) 378-6131

CAPTAIN JERRY • SAIL SAN FRANCISCO

Specializing in anxious learners ~ Bay deliveries
USCG Skipper • 42-ft sloop • pleasure or instruction • up to six people
2-hour instruction \$99 • Half-day cruise \$190 • Full-day cruise \$300
(707) 645-7110 or jahlering@sbcglobal.net



YACHT DELIVERY

Ex-Navy Captain/yachting journalist • Delivering yachts worldwide since 1972 • Sail / Power • Detailed knowledge of harbors and bar crossings from Alaska to Panama • Experienced from Florida to 60°N to the Black Sea
Resumé: www.master350.com • (250) 954-0427 • Cell: (250) 951-5201

AT OUR DOCKS



BENETEAU OCEANIS 40 CC, 2001
An opportunity of a lifetime. Nearly new one owner boat. Teak decks & rub strake, many upgrades. Ready to do Mexico now. Seller financing available. Only \$175,000.



FARR 44, 1989 Finest custom Bruce Farr performance cruiser. Built by world renowned builders/sailors. Meticulously maintained for the discerning sailor, she stands out in a crowd. Special opportunity to own at \$190,000.

Call Tartan C&C Yachts (510) 769-9400



QUALITY SAILS FOR LESS!

**SPECIALIZING IN
HIGH QUALITY
CUSTOM FIT
AFFORDABLE
CRUISING SAILS**

Peter Nevada
Northern California (510) 523-3337
Representative bluepelicanmarine@sbcglobal.net

**10% BAJA HA-HA DISCOUNT THRU SEPT!
SAILMAKERS TO THE WORLD**

RODGERS & ASSOCIATES



established
1978

Certified
Marine Surveyors

As appointed by Boat US Insurance Services
and Institute of London Underwriters
ASA - NAMS - LLOYDS

Tel: 831-475-4468
jrogers@rogersandassociates.com

www.rogersandassociates.com

**MARINE
ENGINE CO.**

PERKINS • YANMAR • ATOMIC 4 • VOLVO
WESTERBEKE • UNIVERSAL • BETA MARINE

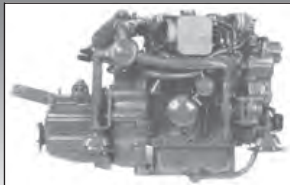

CALL NOW FOR LOW ENGINE QUOTES

- Engine Repowering and Rebuilding
- Engine Sales, Service and Parts
- Complete Marine Engine Service

(415) 332-0455

CAL 43, 1970. Proven cruiser with great gear. <<http://users.adelphia.net/~anchrvtch/SummerWind/SummerWind.html>> Price now \$65,000/obo. (360) 636-9262.



RHODES 41 BOUNTY II. The ultimate plastic classic, keeps her great looks and legendary strength without the headaches. Very clean and uncluttered with underdeck Aries vane and huge tankage. She's ready to go anywhere, rigged to sail famously without drama. Just hauled, fresh survey, insured and on her mooring in the Virgin Islands. One owner loved last 32 years. \$65,000. Email: Warren@StrykerRealEstate.com for additional photos and equipment list or call (340) 776-2697.



CATALINA 42, 1989. 3 cabin, 2 head, fin keel and upgraded Mark II rudder. Less than 510 hours on a 44 hp Yanmar. Lifelines and standing rigging replaced 2004. Details at: <<http://smitten4sale.com>>

1982 HARDIN KETCH. Hull #120. A real bluewater cruiser. No teak deck, but lots below, aluminium spars, recently and fully equipped for extensive liveaboard cruising, and really ready to go. Extensive inventory. Will deliver/help. \$129,000. Email: shellback8067@yahoo.com.



1981 HUNTER SAILING YACHT in a berth at the Ala Wai Small Boat Harbor in Honolulu. She is set up with 2 cabins each with in-suite head and shower, new 76 hp Yanmar engine, 670 hours, and her standing rig was replaced this April. Please call Chris (661) 304-3779 or look up this fine vessel on yachtworld. I am not a broker, I am an owner in this boat.

WAUQUIEZ CENTURION 40, 1986. Upgraded. Excellent condition. Cruise ready. Located Ionian Islands and Croatia's Dalmation Coast. Engine rebuilt 2005. AC, watermaker, MaxProp, Heart 1000 inverter/charger, separate shower, Raymarine 6000 autopilot. Shoal draft/Scheel keel allows transit European canal systems. \$135,000. Email: mahalo1dg@yahoo.com for pictures and complete inventory.



CUSTOM STEEL CUTTER. 50'6" x 11'6" x 6'4". 64 hp Ford diesel, propane stove, diesel heat, hot and cold pressure water. Separate head, shower. Insulated hull, new construction, needs ceiling and rig. Documented. \$60,000. Coos Bay, OR. (541) 888-0930.

CUSTOM BREWER 46 KETCH, 1972. Teak hull, center cockpit. Major upgrades in last five years including new 76 hp diesel. Large equipment inventory. \$125,000. Located in San Diego. See details at: <www.custombrewerketch.us>



SUPERB 45-FT OFFSHORE KETCH. Designed by Huntingford and custom built for us with 1" solid fiberglass hull below waterline, insulated non-skid deck, U-shaped galley, large aft cabin, vast storage lockers, all built to highest standards for safety and comfort as proven and maintained by us over the last 14 years. 80 hp Cummins, solar, wind, Kubota diesel power, all electronics and multi-anchor systems. \$176,000 US, a real value. Email: djbyrne@shaw.ca or call for full details, inspection and familiarization. (604) 898-4432.



STEEL ADAMS 40, 1985. Cruise ready. Located San Diego. \$89,500/obo. (619) 297-3209.



BLUEWATER DELIVERY & SURVEY

100+ Trips • Mexico • Canada
Captain Terry

Cell (415) 722-7695 • bluwater@juno.com

SMALL AD, SMALL PRICES • RIGGING ONLY

Standing and running rigging, life lines, furling gear, winches, line, windlasses, travelers, wire and terminals, blocks, vang, etc. Problem solving is our specialty. We are a rigging shop specializing in discount mail order. Free catalog.

www.riggingonly.com • (508) 992-0434 • email: riggingonly@comcast.net

FORMOSA 50, 1977. Recent disability forces sale. Rock bottom price \$89,900. Needs some TLC. Located in San Diego, CA. Email: LAZURIN21@aol.com.



BALTIC 42 DP, 1981. Racing/cruising sloop. Equipment inventory and sailing gear were upgraded for the 2002 Pacific Cup, including new standing and running rigging, major engine overhaul, new sails. This pedigree Baltic is perfect for the serious racer or family cruiser. Spacious teak interior throughout with teak and holly sole. Recently surveyed. Foreclosure sale. Price has been reduced to \$114,000. (831) 684-0802 or (831) 234-6788.



SLOCUM 43, 1984. Bluewater cruiser. \$145,000. Perkins 4-108 diesel, radar, GPS, VHF, ICOM 710, autopilot, solar panels, inverter, windvane, Windbugger, diesel heater, watermaker. Berthed at Brick Yard Cove, Pt. Richmond. (708) 343-6641 or email: clark@ensolv.com for photos and equipment list.



GREAT OPPORTUNITY. Lots of boat for the money. 46-ft ferro-cement ketch. Hawaii and Mexico veteran. Setup for singlehanded sailing. Center cockpit, diesel, radar, GPS, autopilot, electric windlass. Beautiful wood interior. Located Vallejo, CA. \$47,500. rbybarra@aol.com or (510) 928-9100.

41-FT RHODES BOUNTY II, 1959. Fiberglass sloop, classic beauty, excellent condition. Solid fiberglass construction. Universal diesel, radar, hydraulic wheel steering, propane stove/oven, VHF, EPIRB406, SSB with tuner, windlass. 9 sails, new upholstery, inflatable. Much more. \$45,000. San Diego. richardshp@hotmail.com or (858) 483-8697.

NORSEMAN 447, 1985. Center cockpit. Truly Bristol. Cruise ready. Includes huge inventory of cruising gear and spare parts. See: <www.norseman447.com> for photos and details. \$260,000. (714) 305-8936.

JADE 48, 1978. Aluminum offshore cruising boat. Built by Metalu in France. Center cockpit, ketch rig. Chose this boat after our first circumnavigation for a Pacific loop with our family. \$169,000. Call (503) 723-4401.



HUNTER PASSAGE 450, 2001. *Catalyst* is an extraordinary 45' center cockpit for family cruising. Main and jib furling. 76 hp Yanmar and 8kw Kohler gen, less than 200 hours on each. Two-zone AC and heat. 2 FPD TVs, DVD player in stateroom and PlayStation2 and VCR in salon, Sony stereo system. Raymarine (ST60) electronics, RL70CRC+ color radar/GPS, 2kw Radome, Autohelm 7000+. Fully integrated and slaved computer built into chart station running Raytech Navigator 4.1 software. DSL hardware, wireless network and printer making a perfect remote office. Avon tender and 5 hp Merc and much more. Pristine condition. \$239,000. Call for pictures and full details: (925) 447-6442.

MORGAN OUT ISLANDER 416, 1982. 2nd owner, tall ketch rig, walk-through to rear cabin. Center cockpit, Perkins diesel, Westerbeke genset. Two jibs, freezer. Clean survey in 2003. Excellent condition. All records. San Leandro Marina. \$85,000/firm. Dale (510) 517-9572.



41-FT YAWL, 1960. Sparkman and Stephens. Double planked mahogany on oak. Teak decks, cabin, interior. Spruce spars. Full sail inventory, ground tackle. Recent paint and bottom paint. 6'3" headroom. \$29,500. Call for more information. (503) 708-0817.

FARR 40 ONE TON. Ocean race modifications. All gear required for Pacific Cup and OYRA offshore racing. Berthed in SF. \$75,000. Call Mike (916) 769-0299 or email: mcaplan@golyon.com.

J/40, 1986. New Yanmar 3JH4E 2004, 3-blade Maxprop, autopilot, radar, inverter, battery package, solar panels, Muir windlass, extra ground tackle, MOB gear, liferaft, Profurl, Navtec hydraulics, dodger, bimini, lots of cruising gear. New bottom August 2005. \$146,000. (510) 339-1445.

ACAPULCO 40 under advanced construction by Al Fuller, yacht builder/master craftsman. Deck plus forward cabin teak work installed. Main cabin framed and insulated. Extensive inventoried equipment, Volvo Penta engine and fittings included. \$42,500/offers. (209) 966-5338 or (619) 296-1180 or mas@yosemite.net.

VALIANT 40, 1983. HULL #245. Mexico vet. New engine and main, Trimble GPS, W-H autopilot, solar, ProFurl, inverter, micro, electric windlass. All lines led to cockpit for singlehanding. Monitor, ICON SSB, watermaker, 24-mi radar. \$155,000. (530) 308-8000.

51 FEET & OVER

60-FT PILOTHOUSE KETCH. Perkins diesel engine, runs great. Very roomy. Full kitchen, head, shower, bedroom with double bed, 900 gal fuel, 250 gal water. GPS, radar, depthfinder. Great for travel, liveaboard. \$49,000. Jim (209) 786-6003.



60-FT STEEL KETCH. Aluminum house, 6 cyl Perkins diesel engine. Great cruising vessel. 1.5 gph at 8.5 knots, 400 gal fuel. Custom-built 12 cu. ft. freezer/fridge. Black walnut and cedar finish. 2 heads, 1 shower/tub, 2 staterooms. Must sacrifice for \$225,000. For more info and history: <www.geocities.com/que_sera_salvaged/index.html> or call Ken (503) 709-5552 or (503) 543-3337.



SAMSON 55 FERRO CEMENT SLOOP. Project boat. New, never been on water. Built new in Half Moon Bay. On gigantic trailer. New 85 hp diesel engine, 200 gals fuel, 150 gals water. Hydraulic steering, windlass. Dry storage available. \$20,000/firm. Call (650) 224-1462.

BUEHLER 64, 2002. Steel double-ended staysail schooner. 64' x 17' x 6'6". Wonderful cruiser/liveaboard. Flush deck, 135 hp Perkins, 13-ft inflatable, spacious interior with queen stateroom. Must sell. See: <http://photos.yahoo.com/orlovicr> Make me an offer. Asking \$115,000. (650) 773-6327.



66' LOD, 80' LOA, 1923. English wooden ketch. Teak decks, mahogany hull, English oak frames. Beautiful mahogany interior. Perkins 6 cyl engine, Onan genset, radar. Most beautiful, stout vessel built by Thornycroft. Very seaworthy. Very good condition. Asking \$299,000. Michael (415) 479-7128.

98-FT MOTORSAILER. Great condition, many extras, great liveaboard, great world class cruiser. Low time machinery, 4 heads, 6 staterooms plus masters quarters and crew quarters. Machine shop and diving compressor. Trade for real estate or small business. (925) 783-0605.

CLASSICS



FELLOWS & STEWART ISLAND CLIPPER. *Nirvana*. 44'3" auxiliary sloop. 1946 classic, beautiful lines, solidly built, carefully restored. Fast, full keeled, fir on oak/bronze/African mahogany, coach roof. Full cover. 6' headroom, 8'7" draft, 9'10" beam. Recent survey rates her in 'above BUC condition'. Located Alameda. Price reduced: \$45,000/obo. Call Rob (510) 461-2175 or (510) 886-2115 or robmickele@msn.com.

KANWARA IS ON THE MARKET. 42' on deck, classic designed Maurice Griffith ketch, launched in 1946, built at Johnson and Jago, Leigh on Sea. Solid mahogany on oak, built for the ocean sailing, a great liveaboard. Top-of-the-line autopilot, 2 steering stations, great diesel engine, diesel heater, lots of tankage, refastened, very well kept, needs varnish. A great sailing vessel and easy singlehander. Must part ways. \$28,000. Call (650) 794-9519.

WOODRUM MARINE

Specializing in custom interior cabinetry, tables, cabinets, countertops, cabinsoles. For power or sail.

CARPENTRY
Mobile cabinet shop
Call Lon Woodrum at:
415-332-5970



Private Sailing Instruction

- Individual instruction on your boat to meet your needs and goals
- Certified instructor • 25 yrs experience • USCG 100 ton Master
- Available for skippered charters and West Coast deliveries
- Dan at (650) 325-1147 or elizabethdan@earthlink.net



ALPHABOAT graphics

Creative and durable vinyl lettering, artwork and logos for your boat.
alphaboatgraphics@comcast.net • (510) 599-1197

VOLPAR, Inc.

(408) 986-0848 • (800) 258-4545
Parts / Service • Penta Only
M-F 10am-8pm • Sa-Su 10am-7pm (pst)
email: Volpar@Volpar.com

VOLVO PENTA



McGinnis Insurance

Yacht & Boat Insurance Only
Pleasure Craft Specialists since 1972

Call us at: **800-486-4008**

mcginnsins@aol.com

License #0570469

Ryan's Marine

Cruisers' Electricity
SALE

Specializing in
Marine Electrical Services
for Your Boat

Balmar product specials for August and September only.
Call now for pricing and special rates on installations

- Charging systems for you boat from simple systems to complex alternator and inverter/charger systems.
- Installing Guest Galvanic Isolators that meet new ABYC standards and bonding system repairs or upgrades.

Ryan Schofield
Owner since 1997



(510) 385-3842
rssailor@yahoo.com

VOLVO PENTA

ENGINES • PARTS • SERVICE

We Ship Anywhere

1-800-326-5135

Call us for your nearest Volvo Penta dealer
1-800-326-5135



MARINE SERVICE INC

AUTHORIZED POWER CENTER

(415) 453-1001
FAX: (415) 453-8460
www.helmutsmarine.com
619 Canal Street
San Rafael, CA 94901

Margaret W Fago

Watercolor
510 522-1309

Boat Portraits
mwfago@earthlink.net
www.mesart.com/mwfago



50-FT YACHT, 1946, 1-1/4" cedar planking on oak, brass fastened, running 671, Allison 2:1, galley, head, flybridge, partial restoration. \$25,000 invested. Project boat. As is, \$10,000/obo. Call Mike (925) 325-6301.



CLASSIC HAVEN 12.5. Joel White's centerboard version of Herreshoff's 16-ft daysailer. Yellow cedar on oak, bronze fastened, Marconi rig. Full cockpit cover. Launched 1995. In water, Newport Beach, CA. \$16,500. Bob (949) 400-9856.



1980 MURRAY PETERSON COASTER III schooner. 42 feet, cedar over oak, teak and holly interior, 100 hp Detroit diesel, 12 sail inventory. A traditional beauty. \$145,000. Call (208) 315-1050 or email: lifeepbaker@hotmail.com.



1937 CLASSIC IOD RACING SLOOP. Built by John Bjarne Aas in Norway. Designed for roughwater competition. Completely restored and ready to sail. LOA 33'5", beam 6'9", draft 5'4". Located at SDYC. \$23,000. Kay (619) 224-1411 or email: sangelz@msn.com.



1937 PILOTHOUSE LAUNCH. The Yacht *Tyee* is a one-of-a-kind Price design, built at the W.F. Dunn shipyard in Norfolk, Virginia as a private liveaboard vessel for a Navy surgeon. Needs haulout. \$7,500/obo. Email: maxferry@pacbell.net.

MULTIHULLS

CORSAIR MARINE F-27, 1990. Beautifully maintained. New main, Pineapple spinnaker, Pineapple genoas, Raytheon electronics, new nets. Sausalito slip available. See details at: www.corsairf-27forsale.com \$44,000. Email: Chuck@sanfranciscosailing.com.



FOUNTAIN-PAJOT LUXURY CATAMARAN. 53-ft. Fully customized 1991 world cruiser with all the extras. Spacious, light, with panoramic views. 4 double cabins plus crew quarters. Just back from 5-year world cruise, see Edwards Family Interviews, July, August *Latitude 38*. Completing \$150,000 upgrade including: New mast, sails, rigging, lines and much more. \$649,000. See: www.Rhapsodie.us Call Caren (650) 529-1985 or email: caren_edwards@earthlink.net.



CORSAIR MARINE C31R 2002. Immaculate condition, drysailed from hydrohoist, no paint. UK tapedrive main, jib, screacher, UK spinnaker, rotating carbon fiber wing mast, carbon fiber bowsprit, full electronics, ground tackle, autopilot and more. San Diego, CA. Further reduced: \$105,000. Call (619) 571-5446.



SEARUNNER 34 TRIMARAN. Pro built, foam core, cutter rigged. Seven sails, new Yanmar 2GM diesel, less than 26 hours. Radar, 2 GPSs, inflatable dinghy and 5 hp Nissan outboard. VHF receiver, The Captain nav program, many spares. Nicest 34 around, strongly built, very well maintained, ready to go now. Located Pensacola. \$43,000. Email: chuckphelan@cox.net.



MAX PROP OWNERS!

Expert in-water installation, removal & repitching service.
We are PYI-recommended. All models serviced.

(925) 671-2826 • www.fastbottoms.com

ALTERNATORS • 105 AMP • 1/2 OFF LIST

DUAL FAN INT/EX REGULATOR FITS YANMAR & 2-IN MOUNT
ALTRA CRUISING 3-STAGE ALTERNATOR REGULATOR

XANTREX SERVICE • INFO@EPOWERNOW.COM • (619) 770-8093

CROWTHER SPINDRIFT 39 CATAMARAN, 1980. Glass/Airex. Perkins 4-108, hydraulic drive, twin screw. 2 heads/holding tanks. VHF, Ham, speed/depth, radar, GPS chartplotter. Cutter rig, 9 winches, many sails, spacious galley. 2 dinghies, mast steps. Richmond. \$69,500/offer. (775) 790-0264 (cell) or (775) 588-1931 (hm) or tahoeddy@hotmail.com.

CAPRICORN CAT IS FOR SALE. 45 feet, Duracore/glass sandwich construction. One of the best performing cruising catamarans on the West Coast. Six-time class winner of the Banderas Bay Regatta. Has cruised much of the South Pacific. \$349,000. Joanandblair@aol.com for details or (707) 815-3205 (cell).



CUSTOM 60' PERFORMANCE TERM charter cat 1999. 4 guest cabins with heads/showers, 2 crew quarters, epoxy honeycomb vacuum bag, USA built. Harken, hardtop daggerboard, Calvert Vectran main, jib and screacher. Dyform, Yanmars, autoprops, Balmar, Glacier Bay freezer and 2 refers. Gel cell batteries (10), flatscreen TV, DVD, VCR, CD. Spectra watermaker. One of the fastest charter cats in the Caribbean. Open, light and airy. Worldwide delivery available. \$950,000. (340) 998-1976.

42-FT GLASS CATAMARAN. Project boat in sailing condition. 20 hp Mercury motor. In Delta. \$7,900 or trade. (209) 931-4030.



SACRIFICE 35' PIVER LODESTAR cruising trimaran, yard built (Taiwan). Solid, sleek, heavy-duty aluminum/stainless rig, beachable keel, wheelhouse, Yanmar diesel (saildrive), loaded, gear, sails. Needs haulout: Paints, tools, supplies included. Mexico ready (hours). *INSANEDIAEGO*. Sail your dream. \$9,999/trades? (415) 497-3731 or brad-low@sbcglobal.net.

CONDOR 40 TRIMARAN, 1988. Designed and built as a rugged offshore racer and high performance cruiser. A great boat with much new equipment. The only Condor on the West Coast and includes a transferable end-tie in Southern California. \$55,000. (714) 544-2543.

EBM 36 RACING CAT. New in 2005. Comes with slip in Channel Islands Harbor and trailer. So Cal ORCA overnight legal. Want to go fast, very fast. <www.2-of-10.com> \$150,000. Ed (805) 653-0902 or Bob (805) 320-6325.

BROWN 31. Solid wing, no A-frame. Completely restored, no cruising gear. New main, 2 good jibs, new Honda 9.9. Light, fast and fun. Jeff (707) 974-6069 or jefalder@yahoo.com.

DRAGONFLY 800SW, 1992. \$45,000. \$17000+ in recent upgrades: New traveler beam, new water stays, new high-torque propeller, new standing and running rigging, new teak cockpit seats, new electrical panel, battery, new roller furler and headstay, 2 new carbon jibs: 80%, 110%. Includes: Kevlar main, 2 carbon jibs, asymmetric spinnaker, symmetric spinnaker, boatspeed, electronic compass, 6 hp 2-stroke outboard, and the hatch and deck windows don't leak. Excellent condition, and very fast. San Francisco. Call (415) 789-5241 or email: aaron.cooperband@comcast.net.

POWER & HOUSEBOATS

ALBIN 25, 1971. 21D Albin engine. No trailer. Needs TLC, all original. V-berth, stern cabin, head, galley. Runs good. Seaworthy. A very cool boat. \$6,500. (707) 374-3201 or ontheslew@aol.com.



65-FT WOOD CLASSIC, 1939. Heavy built ex-trawler. GMC 12V-71, 21 kw generator. Full electronics. Lots of equipment. Ready to go. Would make great conversion. More pics/details: ancona@mcn.org. Asking \$112,000 or any reasonable offer. Call (707) 964-5423.



NAUTICA 41 MOTOR YACHT, 1987. Twin 225 hp fuel-efficient Lehman diesels, low hours. 8k Onan genset. Turnkey fiberglass outside, hand-carved teak inside. 14' beam, 6'5" draft, 20 tons. 2 staterooms, 2 heads. Too many extras to list. \$210,000. (805) 654-8708.

44-FT LEISURE CRAFT HOUSEBOAT, 1974. All amenities for living aboard or vacation get-away. Refrigerator, 4-burner propane stove with oven, shower, loft with queen bed, spiral staircase to upper deck. No engine. Delta location. \$17,900. (916) 777-4394.



BEAUTIFUL SUNDOWNER 36 TUG. Free West Coast shipping. Cozy tri-cabin arrangement, lovely teak. Crusair heat/AC. Photos and specs at: <www.thishouseforyou.com/boats.htm> or email: clickjohn@msn.com. \$117,000, broker inquiries ok.

WELLCRAFT 31 SUNCRUISER, 1980. Great Bay and Delta boat. Dual 350s. Good electronics. Full galley/head/dinette. Sleeps 5. Excellent maintenance record. Hull paint 2004. Stored on hard in Napa. Asking \$19,000, will look at all offers. Barbara (707) 321-3559.

1983/2004 CHRIS CRAFT 410. 41-ft fiberglass classic, rebuilt/refurbished in 2004. Twin Volvo TAMD70D diesels with engine synch and automatic hydraulic roll stabilizer. Brand new 8kw genset, two heater-A/C units, electric/electronic systems, consoles, control and instrumentation. New teak and upholstered interior, carpet and teak sole, full-sized Island queen bed in master. Two heads with showers, new fridge, stove, convection and micro oven. A fast cruiser or apartment at the marina. Just too big for me alone. A steal at \$85,000. Will consider smaller cruiser as part trade. Joseph (707) 942-4310 (eves).



40-FT TA CHIAO PILOTHOUSE trawler, 1979. Flybridge, Portuguese walk, twin 120 Lehman's, genset, radar, autopilot, queen master, pilothouse berth and dinette, spiral staircase to forward berthing. Bright, beautiful teak interior. Great live-aboard or cruiser. SF Bay. \$89,000. (406) 931-0008 or hanging3@hotmail.com.

1944 MILITARY TUG LIGHT. Runs and looks great. Never commissioned, she's been roaming these waters her whole life. \$3,750. Burt (209) 609-3123.

OWN AN HISTORICAL BOAT. 1922 Monterey built by Bacci Bros in San Francisco. New deck beams, deck, splash rail. Professionally wired, new instruments, 4 cylinder diesel engine (1945) runs great. \$12,500/obo. Also, 1965 William Garden 44' trawler built by Albert Jensen and Sons. Great liveboard. Needs some work. Interior great, new Graco toilet and LectraSan installed. Cummins diesel with 2,500 hours. Espar diesel heater. \$14,500/obo. Call (530) 795-0495.



47-FT STEPHENS 1948. Twin 671 Detroit diesels, excellent condition, cruises at 15. Aft cabin, flybridge. Mahogany interior, galley, 2 heads, spiral stairs, wood hull, deck, heads need work. Emeryville. \$19,000. Email: huk66@sbcglobal.net for pics or call (510) 428-0562.

36-FT STEPHENS SEDAN CRUISER, 1958. Beautiful boat. New wood 1988. New port topside and deck 1991. Hull and decks good. Dry. New paint and varnish, needs engine work. Great liveboard. Sausalito. \$17,000. (415) 331-5191.

85-FT WWII AIR/SEA RESCUE BOAT, 1944. Double-planked mahogany/Alaskan pine hull. Detroit diesel 671s. See: <www.ourvista.com> for pics. Great as liveboard. Asking \$49,500/obo. (650) 799-3299.



43.5-FT LaBELLE TRAWLER. Sausalito berth. Volvo 165 hp diesels, 500 hours. 7.5 Onan. Large safety glass enclosure, panoramic vista. Full canvas. Large custom galley. Walkaround queen, tub, large guest stateroom with head. Excellent workmanship. Ask \$169,000/obo. May finance. (415) 331-5251.

1978 SEA RAY EXPRESS 30 with live-aboard slip. Twin engines run great. Good condition, recent Coast Guard Auxiliary vessel exam certification. \$28,500. Call Mimi (650) 544-6160.



GOLDEN STATE DIVERS

Hull Cleaning & Zinc Replacement
Reliable, professional divers are ready to clean your boat anywhere in the Bay Area and Delta • Racers call for pre-race cleaning that morning
(707) 849-9025 • www.goldenstatedivers.com

MARINE & ENGINE SURVEYORS

Prompt • Competitive • SAMS Accredited
SF Bay Area • Most Surveys at \$12 per Foot
Purchasing • Insurance Renewals • Accidents
Sheldon R. Caughey, AMS • (415) 332-2550 or 990-9707



Let us post a for-sale flyer on the Web for you! See examples at
www.YachtFlyers.com
or call toll-free (888) 862-8501

COMPLETE MARINE WOODWORK

Design / Restoration • Expert European Craftsmanship • Interior / Exterior
Repairs / Maintenance • Marine Windows & Frame Replacement
Wood & Dry Rot Repairs • Varnish Work • Marine Painting
References Available • Reasonable Rates • Call (415) 331-6718

OUR MISSION:
THE BEST POSSIBLE COVERAGE
AT THE BEST POSSIBLE PRICE

Complete offshore, coastal and Bay cruising packages from experienced insurance professionals.
 Liveaboard insurance

FOWLER INSURANCE AGENCY
 4460 Black Avenue, Suite K
 Pleasanton, CA 94566
(888) 408-8108
 Fax (925) 485-4869
www.fowler-insurance.com



JIFFY JAX

The *fast, secure* sail-flaking system with 4, 6 or 8 belay lines

- Custom made for your boat
- No modifications to your sail or sail cover
- Fast deploy with one hook per side
- Easy installation
- 5-year warranty

www.jiffyjax.com
 Email: service@jiffyjax.com
(480) 993-5280 *Patent Pending*



VOYAGER 48 CATAMARAN™ ...\$489,000
ATLANTIC 42 CATAMARAN™ ...\$389,000



- Brokerage boats, lightly used, ready to cruise
- Proven offshore designs – Fast, safe, comfortable
- Cored epoxy/glass/carbon construction

CHRIS WHITE DESIGNS
(508) 636-6111
www.chriswhitedesigns.com

BOTTOM LINER
 Marina Approved Custom Nylon Liners

- *Easily Secures to Your Boat Slip*
- *Protects Boat Bottom from Growth & Electrolysis*
- *Keeps Boat Bottom Clean and Smooth*
- *Never Clean or Paint Your Bottom Again!*

(925) 642-9438
www.bottomliner.com



PARTNERSHIPS

RANGER 33, 1978. 1/2 interest for sale. \$12,000/obo. Berkeley berth. Please contact DJ for details: (415) 515-1353.

RENTING IS EASIER AND LESS \$\$. Islander 33. \$175/month. Fully equipped, Loran, 2 GPSs, dinghy and outboard, propane stove and BBQ. Spinnaker, etc. Rebuilt engine. Only 2 renters, owner does maintenance. San Rafael slip. (415) 883-6564.

1/2 SHARE IN J/33. GREAT TIBURON berth (Corinthian), great partner, great deal. Selling 1/2 equity share. Outstanding condition except sails. Great racer/cruiser. You won't find better partnership deal. \$17,000 or make offer. Serious buyers email: daniel.shefter@gs.com or call (415) 425-1927.

2006 PACIFIC CUP SYNDICATION: Farr 40 One Ton. Boat berthed in SF. Ocean race equipped for Pacific Cup and OYRA series. Need partners. Boat came in 2nd in class in 2004 PacCup. Email: mcaplan@golyon.com or call Mike (916) 769-0299.

SOUTH OF THE BORDER

AHOY, BAJA HA-HA & SOUTHBOUND cruisers. Think *MexiColder*. Custom, low-amp, affordable refrigeration. Designed and built in the tropics for the tropics. 10% discount off unit for first 5 fall reservations. Call on VHF Channel 72 in Mazatlán. <www.mexicolder.com> Email: sales@mexicolder.com. Surveys too: <www.marinesurveysmexico.com>



VICTORY/TRINTELLA 40. Located in La Paz. Van de Stadt design, fiberglass ketch, teak interior. US documented. Center cockpit, rebuilt Perkins 4-236, roller furling, propane stove/oven, fridge/freezer, autopilot, GPS, radar. Cruise ready. Hull and bottom just repainted. \$72,500. Email: patatsea42@aol.com.

PARADISE VILLAGE CONDO RENTAL. Located Banderas Bay, 5-star resort Nuevo Vallarta. 2 bedroom, 2 bath, overlooking pool and marina. Many amenities. See <www.paradisevillage.com> A relaxing tropical getaway in Mexico. Something for everyone. (510) 865-7580 or email: jnmoores@aol.com for details.

LEARN TO SAIL IN THE SEA OF CORTEZ. San Carlos Sailing School, an ASA school based in San Carlos, Sonora. Specializing in learn-to-sail cruises, vacations. Also offer boat rentals, day trips. See: <<http://mexicosailing.com>> or call (800) 874-4830.

COLUMBIA 24, 1963. Full keel, 5'9" headroom. New Honda 4-stroke, dodger, bimini, bottom and topsides paint. Good sails, Navic vane, Bruce and Danforth anchors. Water tank, propane stove. Strong boat. Marina Chahué, Huatulco, Oaxaca. \$5,500. Robert: r_croz@hotmail.com.

TRADE

HAVE '55 PORSCHE SPEEDSTER replica in pieces. Want cabin cruiser large enough to weekend on, preferably running, or something else interesting. Value \$12,000. Will deliver. Call Stephen (707) 695-4346 or slyingst@comcast.net.

WANTED

SEEKING \$1 BOAT. You love your 40 to 50 foot sloop and don't want to send it to the wrecker. We'll restore it and keep sailing it on the Bay. Photographer and artist couple wants your great boat. Erik (510) 633-2526.

USED GEAR

MARINE GARAGE SALE. Starting Saturday, Sept 17 at 8 am. 60 Libertyship Way, Sausalito. For info call (415) 332-2500.

15-FT PARA-TECH PARACHUTE SEA anchor, (WM \$900), \$450. 48" Para-Tech Delta drogue, (WM \$215), \$110. Both in original package, never opened. Located Ventura, CA. Call (303) 619-3011 or email: richard.pearson@att.net.

NEW SPECTRA WATERMAKER. Ventura 150 with MPC Controller and Z-Brane cleaning unit. Completely automatic and chemical free system. New in box, never installed. \$4,900. (408) 234-4402 or email: john@castlerock.com.

BARIENT 25s. Single speed. Not STL. Working great, look great. Got a pair. Asking \$250/ea/obo. George (510) 849-9137 (after 6 pm).

BOMAR PORTS AND HATCH. Brand new, complete, beautiful, stored 10 years, never used. Two 17", four 12". Forward hatch 19" x 19". Hatch mounted/removed, never sailed. All cast alum/mag. Over \$5,000 spent, asking \$2,500/obo for all. Call for specifics. George (510) 849-9137.

How do you know if your boat has a lien on it?

MARINELIENS.COM
 MarineLiens Ltd. is an independently owned and operated Web-based information clearinghouse.

SEA SENSE
The Women's Sailing & Powerboating School
 San Francisco, Florida, Italy & many other locations
1 (800) 332-1404 or (727) 865-1404
www.seasenseboating.com

ARIES WINDVANE, \$500. 100 amp Balmar alternator, never used, \$300. Avon 310 inflatable and 5 hp Mariner outboard, \$750. RAM for Autohelm 3000, \$50. Uniden MC1010 VHF, \$60. Seafit fan, \$20. Furuno GP30 GPS display, only \$50. (707) 584-0311 or haringtn@sbcglobal.net.

MONITOR WINDVANE in good condition. Call or leave message for John (925) 831-8229.

30 HP VOLVO DIESEL with transmission, \$1,600. 50 hp Isuzu Starret with transmission rebuilt, \$1,800. Volvo, Atomic 4, Isuzu parts, cheap. Borg-Warner transmission, \$600. Cheap installation by trained cockroaches, if needed. (415) 272-5776.



KEEP YOUR BOAT DRY & CLEAN. Sunbrella full boat cover with sand bag slots to hold down skirt. Very good condition, \$1,600. Also, like new rainbow jib for 26 footer, \$350. (530) 230-8800.

MONITOR WINDVANE, SSB/HAM (ICOM, SGC, Furuno), autotuners, Avon RU-285, outboards (2-8hp), Volvo saildrive, Survivor-35, paranchor, Yanmar spares, Martec folding props, headsails, charts/guides (Mex, Pacific, NW, Carib). Blipper, lifeseling, windlasses (S/L555, Plath), heaters (cabin, water), anchors, chain, hookah, bilge pumps. (415) 497-3731 or email: brad-low@sbcglobal.net.

2 NEW SAILRITE SEWING MACHINES below dealer cost. One straight stitch only, \$250. One straight stitch and zig-zag, \$400. Both brand new in the box. Also, Sunbrella in some colors, \$9/yard. Other canvas supplies available. (707) 486-1087.

3-KW FARYMANN DIESEL GENERATOR. 350 hours on the engine, salt-water cooled, single cylinder, small, \$950. Ericson 30+ North mainsail, decent condition, \$400. Newport 30 110 and 150, (I think), good shape, \$600/both. (707) 486-1087.

NEW BOTTOM PAINT AND USED SAILS. Save hundreds of dollars. New anti-fouling bottom paint in various colors. Mains and jibs for sailboats 8 to 30 feet. Call or email for list of sail sizes, bottom paint quantities and prices. (650) 380-5535 or ship65seaeagle@yahoo.com.

HPA310 WEST MARINE BY AVON dinghy, pelican wheels, new 2002, excellent condition, \$1,899. Four Solara 56w solar panels, regulator, new, \$499/each. Xantrex Prosigne 1,000w inverter with transfer switch, remote on/off, like new, \$499. A lot of other gear. (619) 840-1011.

RIX SWEET AIR COMPRESSOR. Gas model SA-3G. A totally oil-free breathing-air compressor. Fill tanks directly without dryers, purification or filters. Unused since factory serviced. More information <www.rixindustries.com> New \$5,000. Sell \$3,000. Also, Pfaff 130 portable sewing machine, \$150. (775) 882-6028.

USED SAILS. Merit 25: 100%, 150% genoas, many to choose from, \$200 to \$300/ea. Good to excellent condition. J/24 mains and jibs, \$100 to \$200/ea. Santana 22 sails, \$50/ea. Misc. others. Call Rich (650) 363-1390.

TWO YANMAR 52 DIESEL ENGINES each with 3,000 hours, Model #4JH2E, with or without saildrives, Model #SD31. 74-ft mast designed for catamaran. Two 32" destroyer wheels. Misc. parts, membrane and high pressure pump for high output watermaker, never used. Teleflex Capilano hydraulic steering parts. Call (415) 269-5165.

COMMERCIAL SEWING MACHINE. Pfaff 138. Straight and zig-zag with full sized table, excellent condition, \$525. Also, Avon 9' inflatable, wood floor/paddles, \$350. (925) 371-8086.

MISCELLANEOUS

GOING TO MEXICO THIS FALL? Selling brand-new, still in the box Kenwood Marine SSB TKM707; new in box MarineAIR CMP-16k 16000BThU air conditioner; used 10' Avon. In San Diego. Email: bongolo@pol.net for details, pictures.

OUTBOARDS. 2 hp Honda, 4-stroke, longshaft, \$700. 4 hp Tohatsu, 4-stroke, \$850. Both like new with less than 10 hours use. 8 hp Evinrude Yachtwin, longshaft, alternator, \$300. Automatic anchor light, \$50. Carson Valley. (775) 267-0344.

CAPTAIN'S LICENSE CLASSES. OUPV (6-pack)/100 ton masters, plus towing and sailing endorsements. Week-night classes. US Coast Guard approved courses. Successful completion of course satisfies USCG exam requirements. Offered by US Maritime Academy of California. Classes start September 26 in San Mateo. Other locations are Ventura, Newport Beach, San Leandro. See: <www.usmaritime.us> Mike (650) 298-9489.

EAST COAST CHARTS, 2005. Maptch Chart Kits: Florida East Coast, Norfolk-Florida, Chesapeake and Delaware Bays. Navionic Gold Cartridges East Coast, Gentlemen's Guide Passages South, Georgia Coast Waterways, St. John's River Guide. Alpha 3000 autopilot, spear gun. Email: sonrisa249@aol.com.

CLUBS & MEMBERSHIPS

SINGLE SAILORS ASSOCIATION welcomes all experience levels. Our members enjoy cruising, group sails, daysailing, socials and other activities. Meetings at Ballena Bay Yacht Club, Alameda, second Thursday of each month, drop-ins OK. Member PICYA. Visit our website at <www.sail-ssa.org> (510) 273-9763.

SF BAY OCEANIC CREW GROUP supports the marine environment through education and sailing experiences in the Bay and coastal waters. We welcome dedicated skippers and crew who enjoy sharing and learning. Please see our website: <www.crewgroup.org> or call (650) 588-4263.

CLUB NAUTIQUE PASSAGE MAKER Membership. Includes all US Sailing courses, charter discounts, and club events. This is a great way to learn to sail and get out on the Bay. Check out: <http://www.clubnautique.net/> Asking \$2,600, regularly \$3450. (831) 419-7286.

NON-PROFIT

CG AUXILIARY FLOTILLA 17 CLASSES. Yerba Buena Island. Pre-registration required. Call (415) 399-3411 or email: uwphoto@mac.com. Boating Skills and Seamanship, Sept. 13-Oct. 27, 2005, Tues. & Thurs., 7:30-9:30 pm. Basic Coastal Navigation, Oct. 31-Nov. 21, 2005, Mon. & Thurs., 7:15-9:45pm. Advanced Coastal Navigation, Nov. 28-Dec.15, 2005, Mon. & Thurs., 7:15-9:45pm. GPS for Mariners available if interest merits.

BOATING SKILLS AND SEAMANSHIP class, offered by US Coast Guard Auxiliary, Flotilla 12. Covers the basics of boating. Class meets on Tuesdays 7:30 - 9:30 pm for ten weeks, beginning October 4. Classes will be held at the Sausalito Cruising Club. Enrollment limited to 20 students. Course fee of \$75 includes textbook. Pre-registration encouraged. To register call John Sullivan (415) 924-1842 (10am - 9pm).

MARIN POWER & SAIL SQUADRON promotes high standards of navigation and seamanship, offers members free classes ranging from Seamanship to Celestial Navigation plus cruises and social events. Come join us. Call (415) 883-6777 for details.



PROPERTY SALE/RENT



COLUMBIA RIVERFRONT LOT, Cathlamet, WA. 13,960 sq. ft. Level, buildable, utilities included. Watch the ships go by. Possible private dock. 1.5 hours to Portland. 45 min to Astoria. \$160,000. See: <www.geocities.com/riverfrontwa> (360) 849-4020.

ELEGANT 3/3 HOME IN PUERTA SALINA Marina, BC. Located between Rosarito Beach and Ensenada, this graceful 3,000-sq. ft. home within walking distance of the marina has numerous amenities. See at: <www.bajacaliforniaarealty.net> \$399,000. Call (510) 444-2028.



BEAUTIFUL BEACH HOUSE. Semi-furnished. Halfway between Napa and SF. 3 bedrooms, 2.5 baths, over the water on the Carquinez Straights. \$2,500/monthly, first, last, deposit. (707) 255-0124.

BERTHS & SLIPS

SOLAR PLANET IS STILL IN MEXICO. Boy it is nice down there. Want to rent a very nice, 50', 18' wide upwind slip in Emery Cove Marina on San Francisco Bay, from now until December 2005, maybe longer? Call Leif (415) 725-6666.

50-FT SLIP AT PIER 39. Heart of San Francisco Bay. Short distance from many attractions in the City. Call now to reserve your space in San Francisco's most exclusive marina. Call Sean (318) 388-4303.

PIER 39 40-FOOT SLIP lease for sale. E-44. \$19,000. Call (209) 586-7593 or (831) 588-3182.

GREAT LOCATION, 36-FT, B SLIP at Pier 39 in San Francisco. On the widest row near the Embarcadero. Easy access. Parking, marina facilities and more. \$9,500/obo. John (415) 819-0489.



Splash around with mermaids!
www.morethanmermaids.com
cards • prints • tiles
bookmarks • magnets



Visit our Website

www.latitude38.com

Electronic Latitude, updated daily, in glorious color! Place a Classified Ad with your credit card on our secure server. Buy a LogoWear hat or t-shirt. Subscribe! Peruse some of our Archives as well as dozens of interesting links. *Try it, you'll Love it!!*

BALLENA ISLE MARINA • OFFICE SPACE FOR RENT
Views of SF skyline and Bay Bridge • 500 to 6,000 feet available
First and second floors • Plenty of parking • Shade trees • Ocean breezes
Restaurant • Deli • Yacht Club on site • (510) 523-5528
1150 Ballena Blvd., #111, Alameda • bchase@ballenaisle.com

Sailing to distant shores, leaving SF behind?

Work with a realtor who sails and sells in SF.
1% of profits go to Save the Bay foundations.

John McCory • (415) 999-7207
www.johnatzephyr.com



SSB RADIO E-MAIL



SeaTECH SYSTEMS™

Computerized Navigation & Communication

800.444.2581 • 281.334.1174

navcom@sea-tech.com • www.sea-tech.com

Call for FREE Info on SeaTech Packages and CAPN Demo Disk



HEAVY DUTY DEEP CYCLE MARINE BATTERIES

Available at the following local marine chandleries and service distributors:



ALAMEDA

- Alameda Prop & Machine
- Fortman Marina Store
- Mariner Boat Works
- Star Marine
- Svendsen's Chandlery
- BENICIA**
- Cruising Seas Services

MARTINEZ

- Diablo Marine
- OAKLAND**
- Golden State Diesel
- Sea-Power
- OAKLEY**
- Big Break Marina
- RICHMOND**
- Bay Marine

AMERICAN BATTERY • Hayward, CA • (510) 259-1150

MEXICO IN COLOR

from  GERRY

COMPLETE GUIDE to the SEA OF CORTEZ on CD-ROM
365 Color Photos, Cabo San Lucas to San Carlos \$95 pp
CRUISING GUIDE to the MIDDLE GULF, 200 Color Photos
Puerto Escondido to the Islas Encantadas \$37 pp
CRUISING GUIDE to SAN CARLOS, 74 Color Photos
Guaymas Harbor to Bahia Kino \$25 pp

 Gerry Sea of Cortez Charts

Box 976, Patagonia, AZ 85624 www.gerrycruise.com



The Wincher

The wincher changes your regular winch into a self-tailing one. Four sizes are available. It is a product that, by means of one, singlehand movement, renders your conventional winch self-sheeting and self-locking. The Wincher is made of a specially designed rubber body that fits down on top of the winch. As the sheet is being winched home and is put under increasing load, the coils 'climb' up the winch drum and fasten against the ribs in the underside of the rubber body.

Watski USA

P.O. Box 878, Walpole, NH 03608
(603) 756-3330 • Fax (603) 756-3336

BERTHS & SLIPS, CONT.

TWO 36-FT SLIPS, PIER 39. \$11,000/each/obo, discount for both. Great mid-dock, shoreside location. Excellent marina facilities. Terrific sailing. Beautiful views. Walk Fisherman's Wharf, North Beach restaurants, Downtown SF, Pacific Bell Park nearby. \$3/12 hour garage parking, F-line stop adjacent. Best spot for Fleet Week/New Year's/July 4th. Call Luciana (213) 312-8329 or email: lakanamu@nossaman.com.

40+ FOOT SLIP AT PIER 39. I-8. Big boat, side furthest from the seals. Easy access for big yachts. 30 years remaining. Parking, marina facilities, and much more. Make reasonable offer I can't refuse. (209) 293-3111.

SAUSALITO SIDE-TIE TO 30-FT. Excellent facilities. Reasonable rent. Special deal for boat being sold. (415) 331-5251.

40-FT SLIP FOR RENT. Emery Cove Marina, F13. Close to parking and amenities. \$300/month. Call (530) 268-2043.

CREW

CAPTAIN/SWEETHEART NEEDED. Join this mermaid on her super luxury catamaran. Cruise the Caribbean for an endless vacation full of fun, laughter, love and adventure. Email for photos and more info and tell me about yourself. Smilingmermaid@hotmail.com.



SEEKING CRUISING LADY. Duration of voyage: as long as it's fun. Requirements: she loves life and the sea, appreciates high quality food and music, she's open to the possibilities. Life is short. Start with a simple phone call. Joe (310) 823-6609.

CAPT. ERIK SOLD BOAT, seeks boat owner who needs help to sail on Bay. 15 years experience, lots on Bay. Good at repairs, 50s, blond and blue, Cal grad, maybe help recent widow to sail? Boats 30 to 50 feet. (510) 633-2526.

RETIRED SAILOR, 55, LOOKING FOR female sailor who also loves gardening. Retired to a lakefront house on Clearlake with boats on dock, gardens around house. Active lifestyle and ability to travel. Part-time kids and animals. Email: pshrive@yahoo.com.



JOB OPPORTUNITIES

SALES POSITION. Tremendous opportunity for energetic, ethical and proven salesperson to sell brokerage and high-end dealership yachts. Visionary owners looking to take company to a new level. Be part of a rewarding and lucrative organization. <www.DreamCatcherYachts.com> Call Zak (949) 633-1822.

YACHT MAINTENANCE PEOPLE NEEDED. Rapidly growing, full-service yacht maintenance company has 2 openings primarily in Peninsula Area. Boat Washer, willing to work hard, may also need to polish and wax, experience in painting/varnishing would be a plus. Boat Mechanic, this individual will need good problem assessment abilities to diagnose engine problems. Both positions require own transportation as travel between marinas required. Fax resumé to (510) 521-0968 or call office (510) 521-0967 for application.

MADDEN MAST AND RIGGING has an opening for an experienced sailboat rigger. This is a full-time position and includes full benefits and top wages. Call Steve (410) 280-2752 or fax (410) 280-2751 or email: stevemadden@mindspring.com. EOE.

SPINNAKER SAILING IN REDWOOD City is looking for a part-time boat maintenance person. Must have experience with rigging, painting, varnishing, light electrical and plumbing. Outboard motors and diesels a plus. Call Rich (650) 363-1390.

INSTRUCTORS, 6-PAK CAPTAINS AND crew. Spinnaker Sailing of SF is hiring. P/T or F/T, midweek and weekend shifts available. Flexible schedule. This company is growing fast for one reason, its people. Fax resumé to (415) 543-7405 or email: rendezvous@earthlink.net. Questions? (415) 543-7333.

CUSTOM MARINE AND UPHOLSTERY shop seeks experienced industrial seamstress. Must be familiar with walking-foot sewing machine. Experience with cushions, draperies and canvas products preferred. Email: wwdesignz@hotmail.com or call (510) 908-3939.

CLUB NAUTIQUE, SAN FRANCISCO Bay's premier sailing school, has an immediate opening for a School Director working out of our Alameda base. We teach sailing from Basic Keelboat to Offshore Passage Making and also teach trawler classes. School Director responsible to General Manager for all operations of school. Benefits commensurate with experience. Please email resumé to David Forbes: dforbes@clubnautique.net.

YACHT SALES, BUSINESS ASSISTANCE, boat workers, organizational help. Unique opportunity in Sausalito. (415) 331-5251.



Dixieland Jazz Band for your Club or Private Party

THE SPIRIT OF '29

We'll play on your boat, in your club, or on our Model A Ford flatbed truck • SF Bay Area
Call Eliot Kenin • (800) 886-8749

NORTH TO CALIFORNIA:

THE SPANISH VOYAGES OF DISCOVERY 1533-1603

History book by Paul A. Myers. Cortes and Ulloa explore Baja.

Exciting new info on Cabrillo, Alarcon, Vizcaino, Manila galleons.

\$22.95 from Internet booksellers or Llumina Press: (866) 229-9244

PART-TIME CAPTAIN WANTED. 18-passenger tour launch at Pier 39. USCG license, 50+ tons. Weekends required. Call (415) 781-3950 or email: steamboat42@earthlink.net.

BUSINESS OPPORTUNITIES



CUSTOM YACHT CHARTER BUSINESS for sale. 12-year-old California corporation. Includes 1988 53-ft bluewater coastal cruiser presently berthed in South San Francisco. Cremation scatterings, film shoots, overnights, special events. Great income for liveaboard skipper. Visit: <http://vycyachtcharters.com> \$250,000 karel@pacbell.net or (650) 222-9475.

BOAT RENTAL & CHARTER BUSINESS. Located at Deer Harbor Marina in the heart of San Juan Islands. Positive growth since 1998. Great opportunity for future growth. Lease in effect thru Nov. 2008 with extension of three more years possible. Business performs boat rentals, ASA certification school, skippered charter operations. Great fleet of 8 boats including J24s, Boston Whaler, Armstrong runabouts. Great location, fun, profitable business to run. Listed in top 10 of google's search for 'boat rentals'. See: <www.orcasboats.com>

NEED HELP TO COMPLETE 70-FT sailboat in exchange for: Complete set of frames, plans and most materials to complete your own 60-foot hull. Or maybe a long Caribbean cruise. Boat location Richmond, CA. Don (510) 526-2128.

MARINE CANVAS & UPHOLSTERY shop for sale. 15 years in same Sausalito waterfront location. Great repeat clientele. Will train. \$60,000/obo. (415) 331-6527.

TOO LATE TO CLASSIFY

C&C 26, 1977. One owner, berthed in Delta since new. Sleeps 4-5, full cover, 10' beam, 8 hp Yanmar diesel, 3 Pineapple headsails, 2 new batteries, VHF and anemometer, includes 8' Montgomery sailing dinghy. \$8,000/obo. (916) 383-6527 or mrab1@juno.com.



FREE BOAT STOVE. Three-burner, gimballed Hillerange alcohol stove. Good condition. Includes pressure tank. Call (650) 743-4417.



BENETAU FIRST 42, 1984. One of the nicest racer/cruisers on the Bay. Radar, Adler-Barbour cold plate, Volvo diesel heater, TV/VCR, 2 cabins, 2 heads, mahogany interior. Sails like a dream. \$99,000. (415) 246-2801.



24-FT WAVELENGTH by W.D. Shock, 1985. PHRF *Rocket Ship*. Turnkey operation. Bottom faired to perfection. New sails, rod rigging, new sheets, new Tuff Luff headfoil. 4-stroke 2 hp longshaft engine. Wireless Tactick compass. Trail-Right trailer. Only dry-sailed. \$10,000. Jon (818) 400-3303 or (818) 206-8261.



MARINER/MAYFLOWER 48 KETCH, 1979. Center cockpit bluewater sailer. George Stadell design with spacious traditional teak interior, dual heads, 2 large staterooms. In good repair with new fuel tanks, many extras and ready for ocean passage. Located in Alameda, CA. \$129,000. (925) 787-2497.

Classy Idea!

www.latitude38.com

Place your *Classified Ad* on our *Website* with your credit card. Fast, easy, convenient and secure. Deadline is *always* the 18th at 5pm. Your ad will run in the magazine, then be posted on the *Website*. **Try It!**

Marine Engine Service AT YOUR SLIP!



30 years experience • Universal/Westerbeke dealers
Repairs/Tune-ups all models • Engine Surveys, Instruction

BAY MARINE DIESEL 510-435-8870

baymarinediesel@sbcglobal.net

Donate your Boat

Cars, Trucks, RVs, & Real Estate
We handle all DMV & Smog 2005 Tax Deduction
Running or Not (restrictions apply)

BLUEWATER NETWORK 800-324-7432

"Proceeds help **Bluewater Network** reduce greenhouse gases, clean up our air and water, and protect marine mammals and wildlife."

Wm. E. Vaughan

Maritime Attorney & Consultants

17 Embarcadero Cove, Oakland, CA 94606

(510) 532-1786

Fax (510) 532-3461

evstarmr@ix.netcom.com

Avoid Rocks, Shoals, Excessive Costs and Taxes!

We can help you plan any Maritime Transaction. Resolving Marine Insurance Coverage, Warranty and Purchase/Sale/Construction/Repair/Charter Disputes since 1960. Lifelong SF Bay/Delta/Coastal Racer/Cruiser & Sailor. Affiliate Member, Society of Accredited Marine Surveyors.

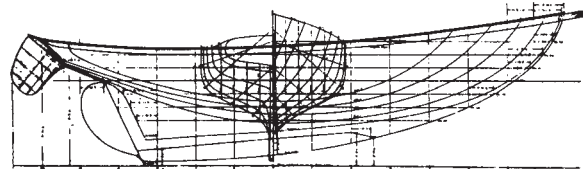

MAKELA BOATWORKS

Family owned since 1948

Wooden Boat Building • Repair and Restoration

19280 South Harbor Drive • Fort Bragg, CA 95437

(707) 964-3963

email: howard@makelaboatworks.com • www.Makelaboatworks.com

SEGWAY OF OAKLAND

212 International Blvd., Oakland • Rent, buy, or lease
All models in stock • New & Used • Only \$35 for a lesson

(510) 832-2429



Beware of Scams!

www.latitude38.com

If you use your email address in your ad, please be WARY of Internet scams. Especially, if they want to pay you MORE than you're asking. It's too good to be true! For more info on these cons, see: <www.craigslist.com/about/scams.html> Brave New World!

weatherguy.com
 Defense Applications and Marine Forecast Service
Rick Shema

970 N. Kalaheo Ave • Suite C-104 • Kailua, Hawaii 96734

Toll Free: (866) 882-WXGY (9949)
 Mobile: (808) 291-WXGY
 Office: (808) 254-2525
 Fax: (808) 254-1525

email: rick@weatherguy.com
 website: www.weatherguy.com

BAYSIDE BOATWORKS INC.
 WORK GUARANTEED

Featuring **AULGRIP** Paints



New Rail • 200,000# Capacity • To 130'

We Specialize in 'Classic' Refinishing

(415) 332-5744
 2360 Marinship Way
 Sausalito, CA 94965

Monterey Bay Marine

Cabo Yachts • Scout Boats • Zodiac
 EZ Loader
 Yamaha • Honda • Suzuki

www.montereybaymarine.com 831.479.4595

WEDLOCK, STONE & RAMSAY
 Marine Surveyors



50 years combined experience in the marine field

NAMS Associate ABYC Certified SAMS Associate
 www.wedlockandstone.com
 (415) 505-3494

USED SAILS



SAIL EXCHANGE

- Largest inventory
- Pay cash for surplus
- Over 20 years in business
- Inspected, rated and offered with no risk, money-back guarantee

www.sailexchange.com
 (800) 628-8152

Use the Autopilot Favored by Singlehanded Racers

Celebrating Our 30th Anniversary!

Because for More than 30 Years ALPHA PILOTS Have Delivered the Highest Performance, Reliability and Low Power Consumption These Competitors Demand!



A World Class Product Built in the USA

Alpha Systems, Inc.
 6809 96th Avenue SE, Mercer Island, WA 98040
 (800) 257-4225 (206) 275-1200
 sales@alphamarinesystems.com www.alphamarinesystems.com

CHRIS CATTERTON
C.C. RIGGING
 510.710.1360

- RIGGING & RIG SURVEYS
- SPAR REFURBISHING
- MAIN & JIB FURLING
- BAY AREA SERVICE



Call for a QUOTE!
 Low prices, high standards.

HAWAII

LONG TERM DRY STORAGE
 Clear Customs at our dock

GENTRY'S KONA MARINA
 HONOKOHAU HARBOR

156°1'30" W
 19°40'20" N

888-458-7896
 TOLL FREE

The friendliest boatyard in Hawaii

GOLDEN STATE DIESEL MARINE

PARTS
YANMAR • UNIVERSAL • WESTERBEKE
PERKINS • ISUZU • PATHFINDER • ATOMIC 4

SERVICE
DIESEL ENGINES



351 EMBARCADERO
OAKLAND, CA 94606

(510) 465-1093

PRODUCT DESIGN
FOR THE MARINE AND
WATER SPORTS INDUSTRIES
**MECHANICAL & ELECTRICAL
ENGINEERING**



E-M DESIGNS
171 Ocean Blvd.
Box 97
Half Moon Bay
CA 94019-0097
650-728-3406
www.emdesigns.com

QUICK ATTACH® SWAGELESS FITTINGS

Three easy steps...

1. Cut wire straight.
2. Insert Wire.
3. Tighten Fitting. Done!

The best on the market!



Available in Eyes, Studs, Jaws, & Turnbuckles
Wire sizes from 5/32" to 1/2"

**Strength, Quality
and Dependability...
plus a Lifetime Warranty!**

**Stainless Steel Marine Hardware,
Rigging & Fittings at Reasonable Prices.**

www.BOSUNSUPPLIES.COM

Or call toll-free for catalog and to order

(888) 433-3484

RPARTS

REFRIGERATION PARTS SOLUTION

100% INTERNET BASED We carry a complete line of refrigeration parts for maintenance, repair, and upgrades for all brands including Grunert, Glacier Bay,

Marine Air, Sea Frost, Adler/Barbour and more. We are also

pleased to offer R28+ vacuum insulation panels (independent lab tests) all at Rprices: guaranteed lowest!



www.rparts.com



ADVERTISERS' INDEX

A to Z Marine Services..... 101	Bo'sun Supplies..... 241	Diesel Fuel Filtering 38	Golden State Dsl Marine... 241	Landfall Navigation..... 93
AB Marine 107	Boat US 153	Dimen Marine Financing..... 6	Grand Marina 2	Landing School, The 242
ABC Yachts 250	Boat US Insurance..... 167	Discovery Yachts 244	H.F. Radio 173	Larry R. Mayne Yacht &
Agape Villages..... 195	Bottom Liner 236	Downwind Marine 112	H&S Yacht Sales 26,27	Ship Broker..... 243
Alameda Prop & Machine. 107	Bottom Sidlers 216	Doyle Sails 75	Hanse North America..... 15	Larsen/Neil Pryde Sails 114
Almar Marinas 163	Boy Scouts Pacific Harbors. 246	Easom Rigging 137	Hansen Rigging 193	Lee Sails 232
Alpha Marine Systems..... 240	Boy Scouts San Francisco... 248	Edensaw Woods..... 90	Harken 58,70	Lemest Yacht Sales 244
American Battery 238	Brisbane Marina 23	EM Design 241	Hayn Marine..... 111	Lewmar Marine..... 79
Aqua Marine..... 146	British Marine 28	Emery Cove Yacht Harbor.. 101	Haynes Sails 242	List Marine Enterprises 222
Aquatic Protection Agency. 245	Brookes & Gatehouse..... 111	Emeryville Marina..... 113	Heineken Regatta..... 34	Loch Lomond Marina 175
Bair Island Marina 78	Cabrillo Yacht Sales 248	Encinal Yacht Club 146	Helms Yacht & Ship Brks .. 245	Lowrie Yacht Harbor..... 220
Baja Ha-Ha Sponsors 48,49	Cal Maritime Academy..... 106	Ensenada Cruiseport Vlg ... 168	Helmut's Marine Service ... 234	Maine Cats 205
Baja Naval 216	CC Rigging 240	Essex Credit Corp. 85	Hogin Sails 52	Makela Boatworks 239
Baja Schooner Cruises..... 205	City Yachts 17	Fago, Margaret - Artist 234	Holmes Marine	Marina Bay Yacht Harbor ... 30
Ballena Bay Yacht Brokers... 16	Clipper Yacht Harbor 194	Farallone Yacht Sales 12	Specialties..... 169	Marina de la Paz..... 166
Ballena Isle Marina Coop ... 24	Club Nautique..... 42	Flying Cloud Yachts..... 25	Hood Sails 67	Marina El Cid..... 218
Bay Island Yachts 11	Coast Marine 195	Foam Creations 162	Hydrovane 170	Marina Las Hadas..... 172
Bay Marine Boatworks..... 83	Conch Charters 204	Footloose Yacht Charters... 200	Hylas Yachts..... 8,9	Marina Mazatlan..... 225
Bay Marine Diesel..... 239	Corinthian Yacht Club..... 30	Forespar 92	Island Yacht Club 36	Marina Palmira..... 174
Bay Propeller 113	Costa Cardonal 242	Fortman Marina..... 56	J/World 77	Marina Puesta del Sol..... 221
Bay Risk Insurance 55	Cover Craft 162	Fowler Insurance Agency .. 236	Jack Rabbit Marine 111	Marina Real 224
Bayside Boatworks 240	Coyote Point Marina 196	Fridge Freeze 143	Jiffy Jax..... 236	Marina San Carlos..... 143
Beneteau..... 7	Cruising Charts..... 238	Garhauer Marine..... 97	Katadyn..... 171	Marina Village 147
Berkeley Boat Sales 243	Cruising Direct Sails 142	Gentry's Kona Marina 240	Kissinger Canvas 32	Marine Engine Co..... 232
Berkeley Marina 38	Cruising Specialists 82	Gianola & Sons 44	KKMI Boat Yard 20,21	Marine Lube..... 136
Berkeley Marine Center 73	CYOA Yacht Charters..... 203	Glacier Bay..... 115	KKMI Engines 225	Mariner Boat Yard..... 220
Beta Marine Engines 108	Danard Marine Products... 219	Glen Cove Marina 219	KKMI/Nautor's Swan 53	Mariner's General Ins. 40
Bluewater Insurance 109	Desolation Sound Charters. 205	Go Cats/Tahiti Yacht Charters .	KKMI Yacht Sales.....	Mariners Choice..... 44
Bluewater Network..... 239	DeWitt Studio 152 202 22,30,32,34,74	Maritime Institute..... 217



Norman Diego's
THE MEXICAN INN
 CABO SAN LUCAS
Next to the Port Captain's Office
 Abasolo y 16th Septiembre
 \$55 + tax – includes breakfast

**SPECIAL RATES FOR
 BAJA HA-HA CRUISERS & FAMILY**

www.themexicaninn.com
 US: (866) 434-3467 • Cabo (624) 143-4987

THE CURE FOR THE COMMON CAREER

The Landing School
 of Boatbuilding & Design
 www.thelandingschool.edu

REPAIRS REPAIRS REPAIRS



HAYNES SAILS
A full service sail loft

Call
(415) 459-2666
 for appointment

Sail from your own front door! Beachfront & Oceanview
Home Site Lots on the Sea of Cortez

Costa Cardonal
an ecology-sensitive, sailing-friendly community near Mulege
All lots over 18,000 sq. ft.
 Roads, water, open space, boat storage, caretaker, many amenities.
Starting at \$60,000
 Secure ownership through Mexican Bank Trust & US Title Insurance
www.CostaCardonal.com 1(866) OUR-BAJA

ADVERTISERS' INDEX

Marotta Yachts..... 249	Orange Coast College 91	Roanston Marine, Inc. 84	Society of Accredited Marine	Ventura Harbor Boatyard.. 222
Mazatlan Marine Center/ PV Yachts 28	Owl Harbor 44	Rooster Sails..... 192	Surveyors/SAMS 196	Voyager Marine..... 54
McGinnis Insurance..... 234	Outboard Motor Shop..... 105	Ryan's Marine 234	South Beach Harbor 37	Watermaker Store, The 225
McGrath Pacific..... 64,65	Oyster Cove Marina..... 143	Sail California 60,61,62	South Beach Riggers..... 39	Watski 238
Minney's Yacht Surplus 247	Oyster Point Marina 96	Sail Exchange 240	South Beach Sailing Center 39	Waypoint..... 173
Modern Sailing Academy ... 94	Pacific Coast Canvas..... 109	Sail Warehouse, The 243	Southern California	weatherguy.com 240
Monterey Bay Canvas 22	Pacific Marine Foundation. 197	Sailing Pro Shop 33	Yacht Sales..... 34	Wedlock, Stone & Ramsay
Monterey Bay Marine..... 240	Pacific Yacht Imports..... 13	Sailrite Kits 68	Spectra Watermakers 112	Marine Surveyors 240
Mortgage West..... 157	Paradise Village..... 89	Sailtime 47	Spinlock..... 194	West Marine 19
Musto and Dubarry 72	Passage Yachts 4,5	Sal's Inflatable Services ... 153	Spinnaker Sailing of	West Marine Bargain Ctr.. 107
Mystic Stainless & Aluminum, LLC 109	Passage Yachts	San Diego Yacht Club..... 179	Redwood City..... 98	West Marine Boat Svc 31
Napa Valley Marina 76	Brokerage 245	San Francisco Boat Works.. 197	Spinnaker Shop, The 179	West Marine Books/Charts 104
Nelson Yachts/Sydney	Pearson Yachts West..... 87	San Francisco Estuary	Starbuck Canvas..... 100	West Marine Rigging..... 45
Yachts 18	Peter Crane Yacht Sales 246	Project 29	Sunsail Charters..... 201	Westwind Precision Details.. 39
Nelson's Marine 252	Pineapple Sails 3,72	San Leandro Marina..... 35	Svendsen's Boat Works..... 41	Whale Point Marine Supply 50
New Era Yachts 247	Playitas Club del Mar 175	Sausalito Yacht & Ship..... 243	Svendsen's Metal Works 88	White, Chris Designs..... 236
Norpac Yachts 251	Point Loma Publishing 175	Scanmar International..... 101	Swedish Marine..... 10	Wichard, Inc. 115
North Beach Canvas 39	Port Townsend Shipwrights . 95	Schaefer Marine 153	Swiftsure Yachts 103	Windtoys 224
North Sails - San Francisco . 57	Pusser's Rum 99	Schmidt, Charlotte Yachts.. 244	Tartan/C&C Yachts 14,232	Wizard Yachts, Ltd. 248
NCMA, Northern California	Quantum Pacific 43	Schoonmaker Point Marina .. 80	The Mexican Inn 242	Wooden Boat 28
Fall Boat Show 59	R-Parts 241	Scullion, Jack D.	Tim's Zodiac Marine..... 179	Wooden Boat Foundation ... 38
Northwest Yacht Brokers	Raiatea Carenage Services	Yacht Services..... 115	TMM/Tortola Marine	Wright Way Designs 218
Assn./Sailfest Northwest.. 51 156	Sea Frost..... 113	Management 204	Yachtfinders/Windseekers .. 22
Ocean Marine 246	Randall Burg Yacht & Ship 244	Sea Scouts of Marin 243	Tradewinds Sailing 63	Yachtright..... 243
Oceanus Marine, LLC 100	Reliable Marine	Sea-Power Marine..... 105	Trident Funding..... 69	Yale Cordage..... 192
OCENS Weather 170	Electronics 102	Seacoast Marine Finance.. 110	UK Sails..... 81	
OCSC Sailing..... 71	Richardson Bay Marina 223	Seashine 46	Vallejo Marina..... 32	
	Rigworks..... 66	Seatech 238	Van Isle Marina 247	
	Rodgers & Assoc..... 232	Selden Mast, Inc. USA..... 86	Vaughan, William E. 239	

Don't forget to tell 'em that
Latitude sent you!

PASSPORT 40

B&G instruments, Furuno radar, Tumble, Magellan GPS, ICOM radio, Maxwell windlass, 3-blade Max prop, Switlik liferaft, Harken traveler, 3-speed (BIG) winches, Natec backstay adj., watermaker, weatherfax, hard-top dodger, 150 amp alternator, lots of sails, stores and scores of spare everything. Ready for oceans now. Just fill the tanks and fridge and do the haw haw. See at: www.trialrun.org.

\$179,950

Yachtright

510-523-8300 fax 510-523-8302
2021 Alaska Packer Place,
Alameda, CA 94501



**Top Quality, One Owner
CATAMARANS
Available Now**

Gemini 105\$154,900
Lagoon 380.....\$269,500
Lagoon 410.....**SOLD**
Belize 43\$425,000

SAUSALITO YACHT AND SHIP

**NEW
DOWNTOWN
OFFICES
& SALES
DOCKS**

**New location!!! Parking – YES!!!
Sell your boat from our downtown docks.
For our listings, the rate is \$8/ft.
Licensed Yacht Brokers since 1981
Accredited Marine Surveys normally \$12/ft
www.yachtworld.com/sausalitoyacht
(415) 332-2550 or (415) 990-9707
1306 Bridgeway at Turney**

SAUSALITO CALIFORNIA

Brisbane Boat Sales +



35' WELLCRAFT, '85
Performance cruiser. \$28,900



25' ALBIN DELUXE TRAWLER, '76
Two cabins in 25 feet! Only \$12,900



28' UNIFLITE SALTY DOG, '76
Complete overhaul. Only \$24,900

53' PARTY FISHING BOAT, '63, F/G\$119,000
46' CHRIS CRAFT CORSAIR, '56\$99,000
46' x 22' FLOATING HOME, '02\$225,000
26' SEAFARER, '74\$4,900
26' MacGREGOR, '97, trailer\$12,900

**Now Brisbane and
Berkeley Boat Sales**

(510) 548-1202
cell (415) 515-9215

www.berkeleyboatsales.com

LRM

www.yachtworld.com/larrymayne



**WYLIECAT 30, '06
OUTBOARD
\$132,500**



**GRAND BANKS 32, '67
DIESEL, WOODIE.
\$42,500**

Wyliecat 30, '97, Bristol, inboard & fast \$120,000
Ensign 22, '72 \$1,000
West Wight Potter 19, '01, dodger, O/B \$11,000

Larry R. Mayne (650) 888-2324
maynesails@aol.com lic. calif. yacht broker

See the
NEW WYLIECAT 44
at the
Annapolis Boat Show
in October!



**Sea Scouts of Marin and
San Francisco Sailing Whaleboats**

(415) 956-5700 x121

or email: ntarl@dictyon.com

No reasonable offers refused • We accept boat donations, too!

See our latest boats at: www.dictyon.com/boats.html

BOAT CLEARANCE SALE

All prices slashed 75%+

Make us an offer – All boats must be sold!



**PLEASURE CRUISER
23' SLOOP**

Extra sails, life jackets,
kitchenette with pump sink.

\$500

RHODES 19, '62, with trailer \$500	COLUMBIA 22, two to choose from \$500
CAL 24, '69, VHF radio, sails \$500	COLUMBIA CHALLENGER 24, '63 \$500
ISLANDER BAHAMA 24 \$500	ISLANDER 21, 2 headsails, Standard Horizon fathos \$500
CAL 25, '68 \$500	PEARSON ELECTRA 22 \$500
SEA RAY 21, '79, with excellent 2-axle trailer, boat and engine need work \$500	CHRYSLER 22, '76, VHF, fathos \$500

Small boats and Zodiacs \$100 to \$500

FAST SHIPPING!

NEW AND USED SAILS!

Specializing in production boats and featuring the largest selection of stock sails available anywhere! Save with warehouse volume discounts on Stock Sails, Custom Sails, Sail Covers, Furlers and Accessories. All top Quality.

**All Fully
Guaranteed!**

- Full Batten Mains
- Furling Genoa's
- Storm Jibs
- Trysails
- Furling Units
- Custom Canvas
- Used Sails



FREE CATALOG!!



THE SAIL WAREHOUSE



Ph. (831) 646-5346

www.thesailwarehouse.com

Randall Burg

YACHT AND SHIP, Inc.

www.rbyachts.com
info@rbyachts.com
Cell: (310) 493-3366

Marina del Rey Office (310) 574-9449
Newport Beach Office (949) 675-5940

More than 100 pre-owned yachts on our Web site!



50' MASON, 1958
Full restoration.
\$110,000



46' HUNTER, 2000
\$217,500



41' HUNTER SLOOP, 2000
Loaded.
\$169,000



38' HUNTER SLOOP, 2001
Loaded.
\$138,000



46' HUNTER 466 SLOOP, 2004
Loaded.
\$255,000



42' HUNTER SLOOP, 2003
Loaded.
\$241,000



38' BENETEAU OCEANIS 381, 1998
\$135,000



35' YORKTOWN OLYMPIAN, 1975
\$65,000

NEW HUNTER LISTINGS!

NEWLAND 368

Francis Who II Sistership to 1992 Singlehanded TransPac Winner Pegasus XIV

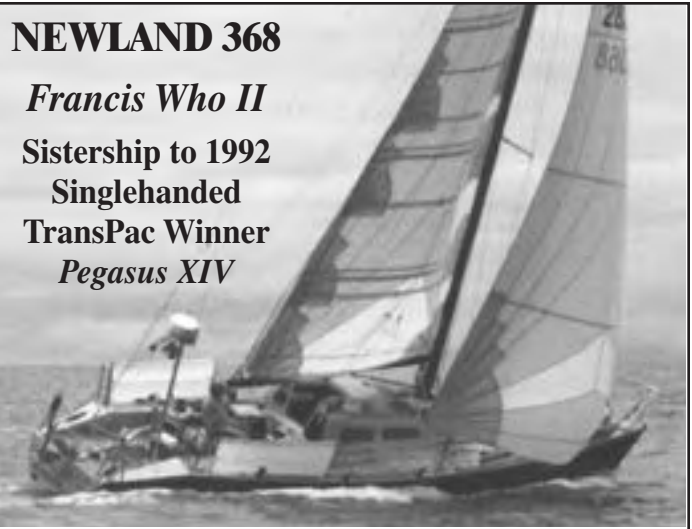

Downwind surf boat. Built for the Singlehanded TransPac, she is a 20+ knot boat. She has accommodations for a small crew and will sleep four adults. There is a galley and a head onboard so she is capable of getting you around the course or cruising to the islands. Recently reduced to \$49,950 by a motivated owner – we will consider all offers.

LEMEST

yacht sales, inc.

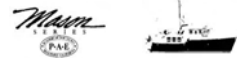

Dealer for: MASON 4, MASON 44, MASON 63, MASON 64, NORDHAVN Series Long Range Trawler

24703 Dana Drive, Dana Point Marina, Island Side
Dana Point, CA 92629

949.496.4933 • Fax 949.496.1905



1985 BABA/PANDA 40
Lovely, fresh example of this classic Perry/Ta Shing cruiser. Low hours, extensive recent upgrades. **\$189,900.**



1999 AMEL SUPER MARAMU 53
Our docks, ready to cruise. Very extensive standard Amel equipment plus many owner upgrades. **\$459,900.**



2001 SIMONIS 53 This 3 cabin, 2 head yacht was custom built for bluewater cruising, and is priced well below replacement at **\$899,500.**



2001 TARTAN 3700
Better than new, beautiful yacht. Many custom features, including carbon tape-drive sails. **\$249,500.**

44' LaFitte 44, '84	\$164,500	40' Passport, '87	\$187,500
44' Amazon PH, '86	\$249,500	40' Valiant PH, '83	\$119,500
42' Passport, '86	\$225,000	35' Wauquiez, '82	\$69,900
41' Malò, '01	\$465,000	33' Wauquiez, '81	\$62,500
42' Westsail CC, '75	\$139,000	33' Wauquiez, '82	\$64,500
40' Malò, New Demo	CALL	32' Valiant, '78	\$54,900
40' Valiant, '78	\$135,000	29' Trintella, '68	\$26,500



DISCOVERY YACHTS

Seattle, WA 98109 • 800.682.9260

www.discoveryyachts.net

Dealers for: MALÒ, REGINA of VINDÒ, FARR PILOTHOUSE YACHTS
VALIANT, FINNGULF, LATITUDE 46 & PASSPORT YACHTS

CHARLOTTE SCHMIDT

YACHT SALES

4100A Harbor Blvd.
Oxnard, CA 93035
Fax (805) 382-2374

When Experience Counts

(805) 382-2375

Csyachtsales@cs.com

www.yachtworld.com/charlotteschmidt



48' MASON STEEL CUST. CTR Al Mason designed, built by Thackwray Yachts in N.Z. 85 hp dsl, Autohelm AP 7000, Furuno 24-mi radar, SSB radio, watermaker, liferaft, Avon dinghy. Stunning inter. Contact Capt. John Barr for appt.



49' HALLBERG-RASSY, 1985
Volvo diesel, new generator, hydraulic furling main and jib, three staterooms, hard dodger, quality craftsmanship, original owner. **Asking \$339,000**



44' ISLANDER
Lapworth design, Perkins diesel, hard dodger, furling jib, dinghy with outboard. Possible slip. **\$49,900**



43' SPINDRIFT PILOTHOUSE, 1983
Ford Lehman, 80 hp diesel, radar, solar panels, dual steering, equipped for family cruising. Owner moved out of state. All offers encouraged.



31' MARINER KETCH, 1971
Perkins 50 hp diesel, aluminum spars, refrigeration, dodger, dinghy with outboard. Full canvas. **Asking \$39,000**



40' ENDEAVOUR, 1982
CC, radar, inverter, dodger, autopilot, new upholstery, excellent condition. **\$106,000**



46' CROSS 46R High performance trimaran. Very fast, lots of fun, and room to cruise. Call now – just \$149,000.

NEW
Introducing
the Corsair Sprint!

**A Rocket Ship
Under \$50k!!**



CORSAIR'S NEW 28 Center Cockpit
Promotional special
\$89,000 sailaway with trailer.



CORSAIR 36
New cruising rocketship. Lightly used.
Only \$229,000. Call for a demo sail.

BROKERAGE

- PRO SPORT 20 powercat ...demo \$29,000
- PRO SPORT 22 powercat ... demo 59,000
- CORSAIR 24 MKII42,000
- SEA SPORT NAVIGATOR75,000
- CORSAIR F-2746,000
- CORSAIR F-2749,900
- CORSAIR F-2755,000
- PASSPORT 2869,000
- PRO SPORT 2860 WA89,900
- CONTOUR 3045,000
- GEMINI 105115,000
- WILDCAT 35 catamaran.....179,500
- CROWTHER 39 catamaran79,500



YACHT SALES INC.

314 Tideway Drive, Alameda, CA 94501

For details on these and other yachts, visit us at

www.helmsyacht.com

(510) 865-2511

**Donate your boat or volunteer
your time to save our oceans!**

Rules have changed January 1, so call us first because we will still get you top dollar value for your vessel donation. Our program uses your equipment, so the selling value is not critical to your donation value.

Our programs include:

Cruise Ship Monitoring • California Coastline Survey
Point Source Investigations • BlueBoater Education

Donate your boat: call Kurt at **(415) 235-0756**
or email kurtw@aquaticprotection.org
Website www.aquaticprotection.org

Volunteer opportunities listed on our Web site.

We rely on volunteers to help our small non-profit maximize our effectiveness. From working on boats, taking water samples or coordinating programs, there are lots of opportunities to help.

CRAB FEED/SILENT AUCTION • December 9

OUR EXISTING INVENTORY FOR SALE:

- 38' Tollycraft – good shape, twin V8s, Berkeley \$5,500
- Coronado 25 fixed keel sailboat – nice shape..... \$1,800
- 32' Fairliner Sedan with twin 318s, radar, loaded..... \$8,900
- Apollo 22, 1977, powerboat. Deep V \$2,900
- Columbia 24 fixed keel sailboat – decent shape \$1,650

LIST WITH US FOR RESULTS!

Featured Boat of the Month



\$287,000

X-412, 2001



\$127,000

BENETEAU 361, 2001



\$109,000

BENETEAU 352, 1999



\$107,000

HUNTER 376 ~ 1998



\$138,500

BENETEAU 381, 1999



\$149,000

PASSPORT 40, 1985



\$27,000

ERICSON 35, 1976



\$42,000

MENGER CAT 19, 2003



\$295,000

BENETEAU 473, 2002

**WE SEE MOST OF
THE BAY AREA'S
BUYERS**

**LIST WITH US
FOR RESULTS!**

www.passageyachts.com



1220 BRICKYARD COVE RD.
PT. RICHMOND, CA 94801

(510) 236-2633



NORDIC 44

When it comes to yacht interiors, it isn't the space that makes the interior, it's what you do with the space. This 1980 Nordic 44 has the space you'd expect of a large 44. It's what has been done with the space that sets her apart from ordinary yachts. She has two private staterooms, each with its own head and one with a separate stall shower, a two-settee saloon and a well thought out galley. She is powered with a new Isuzu 70 hp diesel. She's luxurious in the best sense, the luxury of quality that gives meaning and satisfaction. When you experience the Nordic 44, you'll know the best that yachting has to offer. *Sarah* is offered at \$175,000.



NORSEMAN 535

Ocean Marine is pleased to offer *Loki*, a 1989 Norseman 535, hull number 5 of five built. The 53 Norseman was built on a strictly custom basis. This beautiful yacht has undergone a complete refit from her systems to her exceptional new custom interior. She carries a hydraulic roller furling and hydraulic winches, a genset, bow thruster, and new state-of-the-art electronics. *Loki's* layout features three staterooms, two heads and a galley fit for gourmet dining. If you are looking for something that far surpasses any expectations, she is a truly elegant, custom yacht that will amaze even the most discerning buyer. *Loki* is offered at \$595,000.

OCEAN MARINE

LAKE UNION

YACHT SALES

Contact Ken

(206) 931-7998

www.oceanmarine.biz

2046 Westlake Ave. N., Seattle, WA 98109

oceanmarine@earthlink.net • Fax (206) 285-2981

Peter Crane Yacht Sales and Charters

In Santa Barbara – experienced, interested, friendly, low pressure

Brokerage without Walls

Peter Crane (805) 963-8000 • Mark Scott-Paine (805) 455-7086



1984 Fully Custom Islander 40
Singlehanded TransPac vet.
\$95,000



1968 Morgan 54
A very cool looking boat.
Nice equipment. **\$99,000**



1967 Trintella 29 fiberglass sloop
Beautiful jewel-like
Dutch pocket cruiser. **\$28,000**



1957 Alden 40 sloop
Stunningly beautiful. Won last
year's McNish Classic. **\$99,000**



Tartan 38 Tall Rig
Fully cruise ready.
\$99,900



1999 Azimut 58
The Ferrari of yachts.
\$799,000

Info & photos: www.petercraneyachts.com pc@petercraneyachts.com

**How to find a good home for your boat,
get a generous tax deduction,
and feel great about it at the same time...**

DONATE YOUR BOAT TO SEA SCOUTS

**You can help us fill the needs of our
expanding Scout programs:**

- The Sea Scouts can use any serviceable vessels, either sail or power, modern or classic.
- Donors can eliminate berthing fees, insurance costs, commissions, and the hassle of selling a used boat while receiving the most generous values allowed by law.
- Vessel transfers are speedy and efficient. We arrange all the necessary documents with DMV or Coast Guard.

The training vessel *Odyssey*, a 1938 Sparkman-Stephens yawl and the flagship of our Sea Scout program (see *Sightings*, Sept. '99 issue).

**For a no obligation information package,
please contact us at**



**PACIFIC HARBORS COUNCIL
BOY SCOUTS OF AMERICA**

877-409-0032 • BSBoats@aol.com

NEW ERA *yachts*

2099 Grand St. #9B-03, Alameda, CA 94501
(510) 523-5988 • sales@newerayachts.com



51' JEANNEAU
 Bruce Farr design, four cabin layout, diesel, furling main & jib. **\$190,000.**



47' BRISTOL, 1992
 Ted Hood design, solid craftsmanship, furling main & jib. Extensively equipped. **\$439,000.**



47' VAGABOND KETCH, 1981
 This is a cruiser's cruiser. Stylish, roomy, functional and manageable, and most of all, affordable. Offered at **\$199,999.**



46' WILLIE EVANS CUSTOM
 Completed 1990. This sturdy, spacious cruiser is well travelled, well equipped, lots of bang for the buck. **\$57,500.**



44' FREEDOM KETCH, 1981
 New sails, booms, rigging. Cruise equipped. Radar, GPS, etc. **\$129,500**



39' YORKTOWN, 1980
 Cruise ready entry level cruiser, well equipped, canvas, roller furling, electronics. **\$69,500.**



37' PEARSON 365, 1976
 Customized, oversized self-tailing winches, MaxProp radar, inverter. **\$47,000.**



TAYANA 37 There's no better maintained or documented Tayana 37 in the world! Upgraded with extensive equipment, she's first class. **\$124,900.**



36' COLUMBIA, 1973
 Great plastic classic. Family ready Bay cruiser. **\$29,500.**



36' SCHOCK, 1983
 Excellent sailing characteristics, well equipped, diesel, 3 spinnakers. **\$32,000.**



45' CHRIS CRAFT, 1967
 Classic woodie. Completely refurbished engines 1987. Completely refurbished 1995. Great opportunity at **\$49,950.** Have a look!



37' CHRIS CRAFT, 1963
 A sweet Constellation tri-cabin with recent haul-out and bottom job plus refastened teak and upgrades. **\$69,000.**

Call us about our ALOHA 32, CATALINA 30, NORSEA 27

CHRIS CRAFT CORNER

1982 ALDEN MARK I TALL RIG



- One owner
- Decks 18 months old
- Fresh Perkins engine
- Fresh standing & running rig
- Extraordinary below decks
- 6 pages of additions and improvements

\$224,000

Van Isle Marina
 2320 Harbour Rd., Sidney, BC V8L 2P6
 Ph (250) 213-8547 Fax (250) 888-7696
Allan MacTier and Ron Drane, Yacht Brokers
www.vanislemarina.com



Samarang

55' Schooner (69' LOA) built in 1934
 at the South Coast Shipyard in Newport Beach. A rugged little ship easily handled by two. 4-53 Detroit-New Northern Lights 5kw diesel gen. Large cockpit, uncluttered teak decks (new 1" teak overlay in '95), cedar planking on double sawn oak frames. 17 SS Barientts, 16 sails.

Best PHRF time in history of Ensenada Race!

\$250,000

Ernie Minney (949) 645-1790
 (Courtesy to Brokers)

CABRILLO YACHT SALES

"Discover The Difference"
Two Locations to Serve You!

(619) 523-1745

www.cabrilloyachts.com

Sun Harbor Marina (next to Fisherman's Landing)
5060 N. Harbor Drive • San Diego • CA 92106 • Fax (619) 523-1746

tayana yachts sales/service

www.cabrilloyachts.com



64' TAYANA, 2005

- In Stock
- 200 hp diesel
- 650 fuel
- Roller main/boom
- Electric windlass
- Bow thruster
- Four cabins
- Air/Heat



46' TAYANA PILOTHOUSE
325 gal. fuel, dual stations – could be yours for the new year!



52' TAYANA AFT COCKPIT
Only 5 years old with outstanding equipment.



48' TAYANA DECK SALON
Stock shipping in September – could be yours for the new year.



80' MOTORSAILER, 1987
Twin diesels, 1,000 gals of fuel, twin generators, air/heat, auto furling sails.



37' YAMAHA, 1983
Center cockpit, big interior, good quality.



50' KETTENBURG As original cond.! Beautifully maintained. Must see! \$99,000. Also a 50' Caulkins sloop.



45' & 41' MORGANS
Both are well equipped with good cruising gear.



36' UNION POLARIS



39' CAL CORINTHIAN
Cruise equipped, ready for fun. Plus 37' Yamaha



31' PACIFIC SEACRAFT
Mariah model, finely built and priced to sell.



54' CT KETCH
Awesome space. Grand salon area, huge master.



41' BIANCA 414
Swedish-built sloop built to very high standards. \$85,000.

Your Mexico / Pacific Coast Connection

For Tayana Yachts and 75 Used Yachts

www.cabrilloyachts.com

Mexico Connection Keith Demott (520) 743-7833

GO FASTER Wizard YACHTS LTD.

Bill Lee
Dan O'Brien
Tom Carter



345 Lake Ave., Suite G
Santa Cruz, CA 95062
(831) 476-9639 fax (831) 476-0141
www.fastisfun.com



SANTA CRUZ 52 Excellent racer/cruiser. Vic-Maui race winner. Two head, two stateroom layout. **\$445,000**



SANTA CRUZ 50 Water ballast, deep cockpit, low hard dodger, recent mast, great sails and equipment. **\$165,000**



CATALINA 36, 1983 Extensive equipment, many upgrades, wind vane, windlass, solar panel, Alaska vet. 1 year SC slip avail. **\$44,500**



CATALINA 320 Extremely clean and unused interior. Very little use. 1 year Santa Cruz slip available. **\$79,900**



WESTSAIL 32 Sturdy double ender with nice factory interior. Full keel. 1 year Santa Cruz slip available. **\$51,000**



50' CHANCE DESIGN Ex-racer, now fast cruiser. Round-the-world vet and ready to go again. **\$59,900**

Give A Little...

Now Accepting
Automobiles!



Give A Yacht...

Your generosity will give your boat a new home and give you a nice tax break and great satisfaction...

Our growing Scout program needs your support:

- Any serviceable vessel can be used.
- We'll make the transfer quick and easy.
- Tax benefits from donating can meet and sometimes even exceed the amount realized from selling your vessel.
- You can eliminate the bills associated with the cost of owning your boat.

Donations
Are Tax
Deductible



Donate Your Boat to the Sea Scouts

San Francisco Bay Area Council,
Boy Scouts of America

For more information contact: Aaron Bedell
1-800-231-7963 x145 • aaronb@sfbac.org



Marotta Yachts of Sausalito

Brokers of Fine Sail and Motor Yachts

415-331-6200 • info@marottayachts.com



See at:
www.marottayachts.com

J/42, 2000 Shows practically new inside & out. Deep draft version preferred on Bay. Well equipped w/ carbon fiber mast & Quantum Spectra sails, nice elect., Espar dsl heating. Bright, airy inter. w/ varnished cherry complimented by teal green Ultrasuede leather, more. Lying in great Sausalito YH slip! **\$289,000**



See at:
www.marottayachts.com

43' HANS CHRISTIAN, 1987
Rare Hans Christian 43 Traditional cutter with a custom Mark II interior with the Pullman berth and two heads. In very nice shape, she underwent a \$60,000 refit in 1998 for an extended cruise that was never taken. **\$219,000**



42' BENEATU FIRST 42s7, 1999 The last 42s7 launched, she embodies all the improvements Beneteau made in building her 150+ sisterships! Two cabin owner's version. An unusual combination of short rig and deep keel makes her perfect for conditions here. **\$195,000**



See at:
www.marottayachts.com

41' SCEPTRE raised cabintop performance cruiser, 1989. Deep, comfortable cockpit, step-thru transom, keel stepped mast, skeg hung rudder, wide decks with deep anchor well. Beautifully constructed in Vancouver, BC, powerful sailor, in very nice shape, lying in transferable Sausalito slip. **\$169,900**



See at:
www.marottayachts.com

38' SABRE MkII, 1990
This East Coast gem is nice both above and below, is well equipped and the only Sabre 38 available on West Coast at present, very competitively priced and lying in a transferable Sausalito Yacht Harbor slip. **\$144,000**



See at:
www.marottayachts.com

33' HANS CHRISTIAN HANSA CUTTER, 1983 Very capable offshore boat w/ full keel, high ballast-to-weight ratio, deep cockpit & oversized rudder placed far aft; safe/sea kindly under power/sail. Lovely solid teak inter. built to H.C.'s exacting standards. More than \$50k spent on her past several years. **\$124,000**



See at:
www.marottayachts.com

40' VALIANT CUTTER, 1975
Equipped for cruising and in nice shape overall. Recent Quantum genoa ('04) on ProFurl roller furler ('94), substantial dodger ('03), engine and transmission rebuilt ('96), etc. Most importantly: NO BLISTERS! **\$119,000**



NEW LISTING

See at:
www.marottayachts.com

38' WAUQUIEZ HOOD, 1982 Exceptional performance cruiser, the French equivalent of a Swan. This one is bristol—the interior shows as new. Beautiful teak decks in fine shape. The retractable centerboard allows access to areas inaccessible to most sailboats this size. Transferable Sausalito YH slip. **\$95,000**



NEW LISTING

See at:
www.marottayachts.com

42' CHRIS CRAFT COMANCHE, 1969 This lovely fiberglass classic, designed by Sparkman & Stephens and built in the U.S. during Chris Craft's heyday, is in outstanding shape and, with almost \$45,000 in improvements over the last 3 years, shows much newer than her age. Transferable SausYH slip. **\$68,000**



See at:
www.marottayachts.com

sistership
33' WAUQUIEZ GLADIATEUR, 1984 Classic European sloop in fantastic condition above and below, shows much newer than actual. Major refit '97 including repower, electronics, windvane, sails, dodger, etc. Interior shows as new, no teak decks but teak in cockpit looks new. Transferable Sausalito YH slip. **\$64,900**



See at:
www.marottayachts.com

TWO HUNTER 310s, both 1999. The 310 is a member of Hunter's newest generation: cockpit arches are standard, the cockpit well is virtually circular, the rig is fractional, the hull is rounded with lots of freeboard and beam, and windows proliferate in astounding profusion. **\$57,500 & \$54,500**



See at:
www.marottayachts.com

34' CATALINA, 1987 The Catalina 34, launched in 1986 and still being built, is one of Catalina's most popular boats. She offers the space of a typical 36 footer at a very affordable price. This particular example is very clean and sports the deep keel as well as a keel-stepped mast, RF and dodger, more. **\$54,500**



REDUCED

See at:
www.marottayachts.com

31' HUNTER, 310, 2000 Versatile All around Bay racer/cruiser with large comfortable cockpit and light airy interior with 6'4" headroom. These are great first boats or for experienced sailors looking to downsize into something low maintenance and easy to sail single or short handed. **\$49,000**



See at:
www.marottayachts.com

FLICKA 24, 1976 Never cruised, this Bruce Bingham-designed classic shows bristol. Finished to Pacific Seacraft's high standards, one of the nicest late model Flickas on the market today. Rebuilt 9hp Yanmar dsl, new fuel tank, new interior, refinished brightwork, rewired, new dodger/canvass, new roller furler. **\$43,500**



See at:
www.marottayachts.com

25' PACIFIC SEACRAFT, 1976 Don't be deceived by her size—like the Flicka, these boats have crossed oceans. With her full keel, she's right at home in typical Bay conditions, and with lines led aft she's easy to singlehand. She's in fine shape in and out, shows much newer than her actual age. **\$21,500**

100 BAY STREET • SAUSALITO • CALIFORNIA 94965



43' SWAN TOURING MODEL, 1986
Perfect for two couples. Two cabins, two heads,
great galley. \$235,000

Anchorage Brokers & Consultants YACHTS

www.yachtworld.com/anchoragebrokers



#1 Gate 5 Road

Sausalito, CA 94965

(415) 33-2SAIL

(415) 332-7245

abcyacht@ix.netcom.com

CLAY & TERESA PRESCOTT • DARROW BISHOP • PHIL HOWE • JAMES BUSKIRK • MARLAINE PIPAL



WANTS OFFERS

38' CABO RICO, '78
New main and headsail roller furling. *New* leather interior, new teak and holly cabin sole. \$75,000



41' NEWPORT, 1979, a strong, beautifully designed performance cruiser designed by C&C, \$51,500. Also: 33' NEWPORT, '84, \$36,500



30' NONSUCH, 1982
Wishbone rig, Hinterhoeller design. \$57,500



CT 54 P.H., 1980
4 strm, watermaker, bow thruster, inside helm, blue-water cruiser, liveboard slip S.F. Bay. \$241,000



37' IRWIN (2), 1973
Real clean, new sails—and a 1979 (pictured). Slip in Sausalito. Both \$40,000

SAIL		POWER	
55' Marco Polo '83	40,000	34' Hunter '85	41,000
53' Amel ketch '98	440,000	33' Newport '84	36,500
52' Hartog schooner... '99	195,000	32' Nantucket yawl '71	16,500
51' Jeanneau '94	169,000	32' Pearson Vanguard '63	24,000
50' Gulfstar, Mex. '77	89,000	31' Hunter '98	53,900
49' Gus March Cust. '91	195,000	30' Catalina 2 from	29,900
48' C&C '73	199,000	30' Isl. Bahama 4 from	20,000
47' Vagabond '80	150,000	30' S-2 CC '78	26,000
44' Hylas '86	185,000	30' Pacific '71	15,000
43' Swan '86	235,000	30' Catalina '83	29,900
43' Slocum '84	149,500	30' Pearson 303 '85	30,500
43' Hans Christian '88	219,000	30' Nonsuch '82	57,500
42' Bavaria '05	235,000	30' Baba '79	60,000
41' Newport '79	51,500	29' Gulf Pilothouse '84	23,000
40' Brewer PH '88	129,000	29' Van der Stadt '69	16,000
40' Cheoy Lee MS '75	79,000	28' Isl. Bahama '82	19,000
40' Newporter '62	25,000	25' Pacific Seacraft '78	18,000
38' Ericson '81	45,000	28' Fiberform '76	10,000
38' Ingrid '74/'84	95,000	27' Sea Ray '83	14,000
38' Colin Archer '51	58,000	27' Sea Ray 270 '88	28,900
37' Irwin CC (2) '73/'80	40,000	26' Calkins '63	15,900
36' Hartog '92	24,500	26' Star Fire '86	25,000
36' Islander (3) '76/'78	49,500	26' Lobster Boat '86	35,000
36' Steadfast '49,500	49,500	24' Olympic '97	Call
34' Islander '75/'85	31,500	24' Bayliner '98	25,500
		24' Regal 242, trailer... '98	37,000
		24' Slipjack '76	14,000



JEANNEAU 51, 1994
Fast, safe, dependable cruiser. \$169,500



35' & 30'
BABA's - 35', 1979, \$77,500
30', 1979, \$60,000 (pictured) new sails & motor. Both in Sausalito.



40' MARINER KETCH, 1974
Garden design, Perkins, Roberts AP, Furuno GPS. \$49,400



40' BREWER PILOTHOUSE CUTTER, 1988
Ted Brewer design, large open salon area with galley. Cruise equipped pullman berth plus V-berth. \$129,500



SLOCUM 43, 1984
Turnkey cruiser. Best priced one on the market. \$149,500



BAJA HA-HA IDEAS
37' VAGABOND...\$150,000 (pictured)
32' RHODES TRAVLER. Well equipped...\$42,500
30' CATALINA. SSB, Monitor...\$26,900
29' GULF PH, 1984...\$23,000

TWO LOCATIONS
SAN RAFAEL & SAUSALITO
(415) 457-9772 (415) 332-7245
Slips Available at the
San Rafael Sales Dock -
\$6 per foot



WOODIES: Three 57' CHRIS CRAFT
Two 50' STEPHENS
53' GRAND BANKS (pictured)



HATTERAS 58 (pictured) and HATTERAS 38
Two 34' TOLLYCRAFTS
34' CHB



WELL EQUIPPED
HYLAS 47, 1986 ~ \$215,000
Ultimate bluewater performance cruiser. Hard to find.
3 staterooms. Newer Perkins 85 hp and dodger.
HYLAS 44, 1986 ~ \$185,000

NORPAC YACHTS

On
Hwy 101

SAN RAFAEL YACHT HARBOR
557 Francisco Blvd., San Rafael, CA 94901

(415) 485-6044 • FAX (415) 485-0335

email: info@norpacyachts.com

FOR MORE
SEE OUR
norpacyachts.com
WEBSITE

**THEY'RE SELLING!
LIST YOUR BOAT NOW!**

LONG RANGE STEEL



50' DEFEVER STEEL TRAWLER YACHT. New dsl main, genset, dbl aft cabin, bow thruster, 3 S/Rs, 2 heads w/showers, dsl heat, flybridge & P/H helms, radar, etc! Heavy duty, serious long-range cruiser. **\$169,000 Ask**



35' MARINER KETCH by Wm. Garden. '66 Far East Yachts launch. Major refit near done. Copper-riveted, dsl, wheel, new sails. Well-built traditional bluewater cruiser. **Try \$17,200**



41' ISLANDER FREEPORT. Ctr cockpit ketch. Aft stateroom. Less than 100 hrs on new 100 hp Yanmar dsl. Radar, GPS-chart & more! Big & comfy & looks great! **\$74,950 Ask**



33' RANGER SLOOP. A great Gary Mull, NA design. All glass, diesel, enclosed marine head, full lifelines/pulpits, 4 bags sails incl. 2 genoas & more. These are WONDERFUL boats. **\$28,500 Ask**

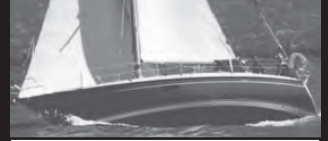

34' DUFOUR SLOOP. Dsl, spinnaker, full lifelines & pulpits, wheel steering, teak & holly interior, sleeps 6, enclosed head, galley, dinghy, stereo/TV/VCR, more. Great sailer, nice shape. **\$34,000**



ISLANDER 36 BLUEWATER CRUISER. Dsl, furling, 2 spinn, dodger & full covers, vane, vang, self-tailers, inverter, solar, radar, ham, 2 VHF's, AP, color/map GPS, EPIRB, more! **\$34,000**



42' ED MONK CLASSIC CRUISER. Launched by Washington's famed Tacoma Shipyard in 1942. Low hours diesel. Full boat cover. Just cruised Alaska to S.F. Oil heat, radar, etc. Great condition & charm. **\$59,900**



52' HACKER CLASSIC COMMUTER, 1931. Beautiful art deco interior, 2 great staterooms, big salon, twin 700 ci Scripps mains & much more. **Try \$65,000/offer**



50' GULFSTAR KETCH. Center cockpit. Loaded w/cruising gear, much new—too much to list. Dsl, dodger, genset, radar & much more! A big, comfortable bluewater cruiser in great shape w/all the amenities! **Ask \$124,500**



35' CONTESSA Sloop by Doug Peterson. Famous for great sailing & high quality. English-built performance cruiser w/dsl, furling, 2 spinn, good inventory, dsl heat, radar, etc. Computer w/nav. programs, more. **\$39,000**

SAIL

56' HERRESHOFF MARCO POLO Schooner by Legendary Yachts. Shows as Perfect. Absolutely breathtaking... Ask 600,000

50' ALDEN MALABAR IV Schooner. Needs restoration. Dsl. She'll be a beauty when done. Illness forces sale. Asking 5,950/offers

48' CAMPER NICHOLSON PILOT CUTTER by Laurent Giles, diesel, fascinating history. Real estate acreage trades OK... 47,000

48' STEEL PILOTHOUSE SCHOONER, '85, Dsl., 14' beam, 32 tons... 135,000 obo

47' VAGABOND ketch. Project... 86,000 obo

41' BLOCK ISLAND CTR. Proj... 24,950 obo

40' NEWPORTER ketch. Perkins 4-108 diesel. Big, lots of potential! Ask 27,500

37' SEARUNNER TRIMARAN. Dsl/elect drive. Nice, clean & fast... Asking 38,000

32' ENGLISH-BUILT NANTUCKET yawl by Offshore Yachts, Ltd. Diesel, wheel and more! Saily cruiser... Asking 18,950

32' COLUMBIA SABRE. Race/cruise, 5 bags including spinnaker, Honda 4 stroke, good condition... Asking 5,000

32' CLIPPER Slp. F/G, O/B... Ask 4,600

29' ERICSON 1/B, lots new... 12,500

28.5' PEARSON TRITON. F/G, dsl. Near total refit of Alberg's legendary Pocket World Beater. If you can find a better small cruiser anywhere near this price... BUY HER!... Ask 16,000

28' SAMURAI Sloop. Just refitted & overhauled. Diesel, mahog/oak/bronze, full cover & more... Asking 9,999

28' ERICSON Sloop. Dsl, whl, inflatable & O/B, self-tailers, more!... Ask 18,000

28' H-28 HERRESHOFF ketch. Classic beauty, 1/B, very nice!... Ask 18,000

27' EXCALABAR Slp, O/B, clean... 3,700

25' 1" FOLKBOAT classic wood beauty at Lake Tahoe... Ask 10,000

25' YAMAHA Sloop. Dsl, skeg rudder, spin & good inventory, full lifelines/pulpits & more!... REDUCED! Asking 7,900

24' RHODES/MacCarty by Seafarer. O/B, main, jib, genoa, all glass... Ask 3,500

24' O'DAY Slp. Honda 8 hp, solar charge, great shape!... Ask 7,500

22' CATALINA 22 Sloop, O/B... Ask 2,200

43' STEPHENS 1955 classic sedan. Absolutely Bristol. \$40,000 worth of new Volvo V8s just installed. Must be seen... 175,000

43' GRAN MARINER Cruising Houseboat, twin V-8s, full upper deck enclosure. Marin LIVEBOARD BERTH possible. Roomy... Asking 46,950

36' CHRIS CRAFT EXPRESS. Twin V-8s. Full canvas... REDUCED—Try 6,500

36' UNIFLUTE. F/B, aft cabin, twins, radar, GPS & more!... Asking 59,950

35' BERTRAM F/B, S/F. Twin dsl. Outstanding condition. All glass... Ask 99,500

34' CHB TRAWLER. Fiberglass, big flybridge, 2 private staterooms w/heads, shower, full galley, big salon, diesel, genset, radar, dink & more... Ask \$59,850

33' CHRIS CRAFT SPORT FISHER, fiberglass, flybridge, twin V8s, radar, VHF, dual helms, aft enclosure, shower, galley, autopilot, more!... REDUCED: Ask 29,500

32' CRUISERS INC. F/G, full canvas, fully equipped and ready for fun 29,950

31' TOLLYCRAFT EXPRESS. twin V8s, shower & much recent upgrading. Ask 21,000

29' TOLLYCRAFT EXPRESS cruiser. Twins, good boat, runs well, great potential... 3,250

28' MAXUM 2700 SCR EXPRESS CRUISER. Under 100 hrs, 350 V8, full canvas, shower, fast & super clean Ask 37,500

28' SEA RAY Sundancer w/new twins, 3 axle tit, shower, full cover & more!... 35,000

28' CARVER 2827 Voyager. F/B, twin 220 Crusaders, glass & more... Inquire

28' OWENS FLAGSHIP. Twins. EXCELLENT 1959 GEM!... Ask 25,000

26' CAULKINS BARTENDER, new heads & manifolds... Try 7,500

25' BAYLINER CIERRA, '88, very nice. Full Delta canvas... Asking 39,500

25' APOLLO cruiser. Dbl. axle tit, V8, refit, very nice!... 9,950

22' CHRIS CRAFT CAVALIER cuddy, inboard, beautifully restored... 12,500

OTHER

60' STEEL BARGE, 20-ton A frame, spuds, deck house, more... Offers/55,000

56' LCM-6 w/dive support, steel, W/H, twin 671s, full elect... 49,500

ALDEN MALABAR



32' loa, ALDEN MALABAR JR. Lovely classic auxiliary sloop by John G. Alden. 1/B, mahogany, bronze & oak. Cut away forefoot, full keel, full lifelines. Rare offering of a famous design by a master. **Asking \$17,000**

IDEAL CLASSIC LIVEBOARD/CRUISER



65' CLASSIC, '31 WHEELER M.Y. 16' beam. Over S40K hull refurbishment in October '04, and she is ready for you to finish restoration. Wheel House, diesels, three heads, huge salon, crew's quarters, more. **Asking \$64,500**



34' ANGELMAN SEA SPIRIT KETCH. Copper riveted, mahogany, diesel, shower, full galley including fridge, cabin heat, inflatable and more. A BEAUTIFUL BOAT. **Asking \$30,000**



30' ERICSON SLOOP
Inboard, dodger, roller furling, new sails in 2003. New canvas. Nice boat. **\$15,500/offer**

The OLD KERMIT PARKER BROKERAGE
Serving the Boating Community at this Location since 1956.

20th Anniversary!
 Celebrate With Us With Half Off Haulouts!*



NELSON *Yachts*

Grand Soleil • Sydney
 Hunter Trailerables
 (510) 337-2870

FEATURED BROKERAGE



Located
 in Our Dry
 Storage
 Yard

J/105, 1998. Well cared for and ready to
 join the hot J/105 one design fleet. **\$99,000**
See ad page 18!

SPECIALIZING IN



LINEAR POLYURETHANE COATINGS



***HALF-PRICE HAULOUTS
 ON ALL FULL SERVICE
 BOTTOM/REPAIR JOBS**

Either Way You Look at It...



Nelson's Marine offers the most colorful palette
 of marine services available in the Bay Area.

- Full Service Boat Yard
- Dry Storage
- Yacht Sales
- Chandlery
- Associated Marine Tenants

If your boat needs it – we can do it!

Nelson's Marine Seminar Series

Diesel Engines & Propulsion Sept. 17 \$249

A day-long, in-depth, hands-on seminar covering:
 Diesel Engines • Transmissions • Shafts • Propellers
 Stuffing Boxes • Cutlass Bearings

Know Your Boat Sept. 24 \$89

A day-long, introductory seminar covering your boat's major systems:
 AC/DC Electric Basics • Corrosion • Pumps & Plumbing
 Diesel Engines • Props & Shafts • Rig & Deck

Nelson's Marine

(510) 814-1858 FAX (510) 769-0815
 1500 FERRY POINT, ALAMEDA, CA 94501

LOCATED IN THE NELSON'S MARINE COMPLEX:

Fred Andersen Woodworking	(510) 522-2705
Drake Marine Services	(510) 521-0967
Hansen Rigging	(510) 521-7027
Metropolis Metal Works	(510) 523-0600
Rooster Sails	(510) 523-1977
Jack D. Scullion Yacht Services	(510) 919-0001
UK/Halsey Sailmakers	(510) 523-3966