



Catalogue

2018/2019

Vision • Inspection • Power



Contents

4 INTRODUCTION



A LIGHTING Vehicle Lighting



D LIGHTING Accessory Lighting



E
**IN-VEHICLE
 POWER**
 Inverters
 & Multisockets



F
BATTERY CARE
 Chargers
 & Analysers



G
**WORKSHOP
 EQUIPMENT**
 LED Inspection
 Lamps & Tools

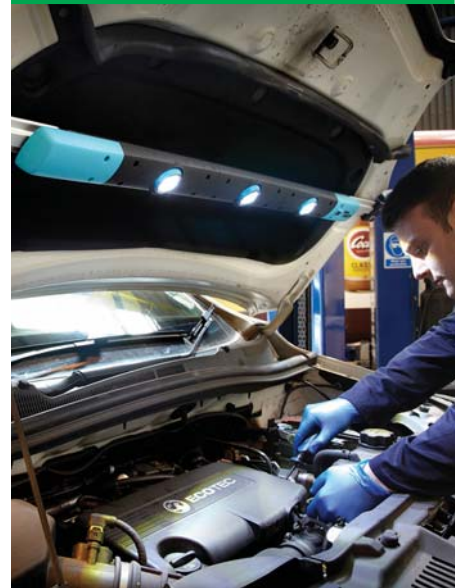

H
**PORTABLE
 LIGHTING**
 Torches
 & LED lamps



J
TYRE CARE
 Air Compressors
 & Tyre Repair



K
**RETAIL
 ACCESSORIES**
 Emergency Kits,
 Travel Essentials



Welcome to Ring



Welcome to Ring

Ring is a leading European supplier to the automotive aftermarket, providing exceptional quality bulbs, tyre care products, battery care products, dash cameras, garage and workshop equipment and vehicle conversion components. Ring has over 40 years' experience in the automotive sector, pushing the boundaries in automotive lighting, auto electrics and professional equipment.

Quality and service are at the centre of everything Ring does. We work with businesses to help them reach their goals, and ensure that our products perform exceptionally for the motorists, technicians, fleet managers and professionals using them on a daily basis. Our success has been shown in the 170 product awards we've won throughout Europe, for products including our high performance halogen bulbs, tyre care, professional battery analysis tools and inspection lighting.

Headquartered in Leeds, UK and with our European office in Paris, we are ideally placed to help meet the needs of our customers. Ring's specialist team of over 165 people, across Europe, ensures we are at the forefront of product development, quality assurance and customer support services. From our purpose-built 6000m² distribution facility, Ring fulfils 64,000 orders to over 60 countries annually. UK customers benefit from a next day delivery service and with 6500 pallet locations in the warehouse holding 6000 different product lines, Ring is proud of its 97% availability rate, meaning customers get the products they need in a timescale that works for their business.

www.ringautomotive.com





Ring's range of products are all developed to meet the exacting standards of our customers. Our ranges include:

- **High performance automotive lighting.** Ring has over 40 years' experience in automotive bulb development, and is a recognised leader in the field of lighting. We were the first to market with a +100% brighter performance halogen headlight, and the Ring Xenon150 bulb is the longest lasting +150% brighter bulb on the market. Our innovations in LED and HID bulbs have helped us provide a comprehensive, forward-looking bulb range.
- **Car maintenance motorists can trust.** Ring's award-winning tyre care and battery care products helps motorists to stay on the road and gives them the confidence to enjoy driving. Our car accessory products include in-car charging, travel kits and dash cameras to help drivers make the most of their cars.
- **Garage and workshop equipment, made for professionals.** Technicians need equipment they can rely on. Ring's range of garage lighting and professional battery care is designed with the professional workshop in mind.
- **Complete commercial vehicle offering.** Ring offers a wide range of commercial vehicle components, all produced to meet industry regulations and – with its sister company, Ring Carnation – vehicle conversion for remote working.
- **Ring has won over 170 product awards.** These have come from throughout Europe, for products across our range. This includes accolades for professional battery care products, vehicle lighting, workshop inspection lighting, tyre care products and dash cameras.



Introduction



Quality Assurance



Ring's Quality Assurance (QA) laboratories contain some of the most advanced testing equipment in Europe. We have achieved the highest standards in Quality Assurance and been independently assessed by BSI, achieving ISO:9001 for the manufacture and assembly of automotive lighting.

The facilities

Our lighting testing facilities are an important part of our QA labs. This is where we ensure our vehicle bulbs comply with vehicle lighting regulations, including ECE Reg 37. The CCD ProMetric Light Imaging Photometer in our light tunnel measures light at over 1.5 million points; this accuracy allows us to be confident that all Ring bulbs meet the high standards necessary. The lab tests whether our bulbs have the correct beam pattern and perform consistently across different headlamp standards.

Having the photometer in-house means we can continuously test bulbs against industry standards and verify the performance of our lighting products. We also have a vehicle vibration simulator, which replicates real-world driving conditions and assesses the endurance of our products. Using these tests, we can make sure that our bulbs meet legal and practical requirements for our customers.

It's not just bulbs that are put through their paces – each product has tests designed specifically for it. We simulate real-world conditions for our inverters, to ensure that they can withstand work site conditions. We test the max load and power for extended periods of time to ensure they perform reliably.

Our award-winning tyre inflator range is tested using a calibrated tank, which measures inflation speed and tests the accuracy of the gauges. Smart chargers have revolutionised battery care. This technology can charge, protect, repair and analyse batteries to help them last longer and detect faults. Our digital oscilloscope measures voltage and current, to ensure the chargers are completing all the stages in the charge cycle.

We test our products in extreme conditions – heating them and freezing them – to make sure that wherever they are used in the world, they can withstand operating conditions. This includes testing packaging, to make sure every aspect of the product will perform in all environments.



VIP: Delivering More for our Customers

Ring develops state-of-the-art solutions for automotive aftermarkets, transforming vehicles and workshops through innovation in our three product areas: *vision*, *inspection* and *power*. Because we bring these products together, we have a unique offering that makes us highly competitive and ensures a strong business proposition.

Vision	Inspection	Power
<ul style="list-style-type: none"> • Vehicle Lighting • Wiper Blades • Dash Cameras 	<ul style="list-style-type: none"> • Workshop Equipment • Inspection Lighting • Diagnostic Tools 	<ul style="list-style-type: none"> • Battery Care • Tyre Care • In Vehicle Power 

VIP: Our Core Values

VIP goes beyond our product portfolio: it is at the heart of everything we do. It helps us deliver exceptional quality, value and service to our customers – and in turn unleash demand from their target markets.

Value-added service and customised programmes develop unique solutions.

Innovation in product and range differentiation creates opportunities to grow both market share and profitability.

Performance in developing product ranges, fit for market with our own in-house Research and Product Development Teams.

Introduction



Delivering More for our Customers

Ring has developed support services to help our customers profit. We work collaboratively with our customers to help meet challenges and make the most of opportunities.

Our marketing support provides the collateral that customers need – whether that's in-store point of sale, digital content or literature.

All of this is supported by our customer service team of dedicated account co-ordinators, who work alongside the Ring sales managers to make sure the needs and expectations of each individual customer are met. With headquarters in both Leeds and Paris, we are ideally placed to give our customers the support they need.



VEHICLE LIGHTING

Vehicle Lighting Guide	A2
Performance Halogens	A6
LED Bulbs	A16
Filament Style LED Bulbs	A17
Premium LED Bulbs	A18
Performance LED Bulbs	A19
Silver Enigma	A20
Premium Headlamp Bulbs	A21
HID Bulbs	A22
Long Life Bulbs	A24
Rapid Response Bulbs	A25
Blister Bulbs	A26
Essentials Range	A30
Bulb Kits	A32
Value Packs	A34
Biker Bulbs	A35
12V and 24V Bulbs	A37
24V Truckmaster Bulbs	A38
Panel Bulb Kits	A40
Bulb Connectors	A41
Bulb Stands	A42
Marketing Support	A43

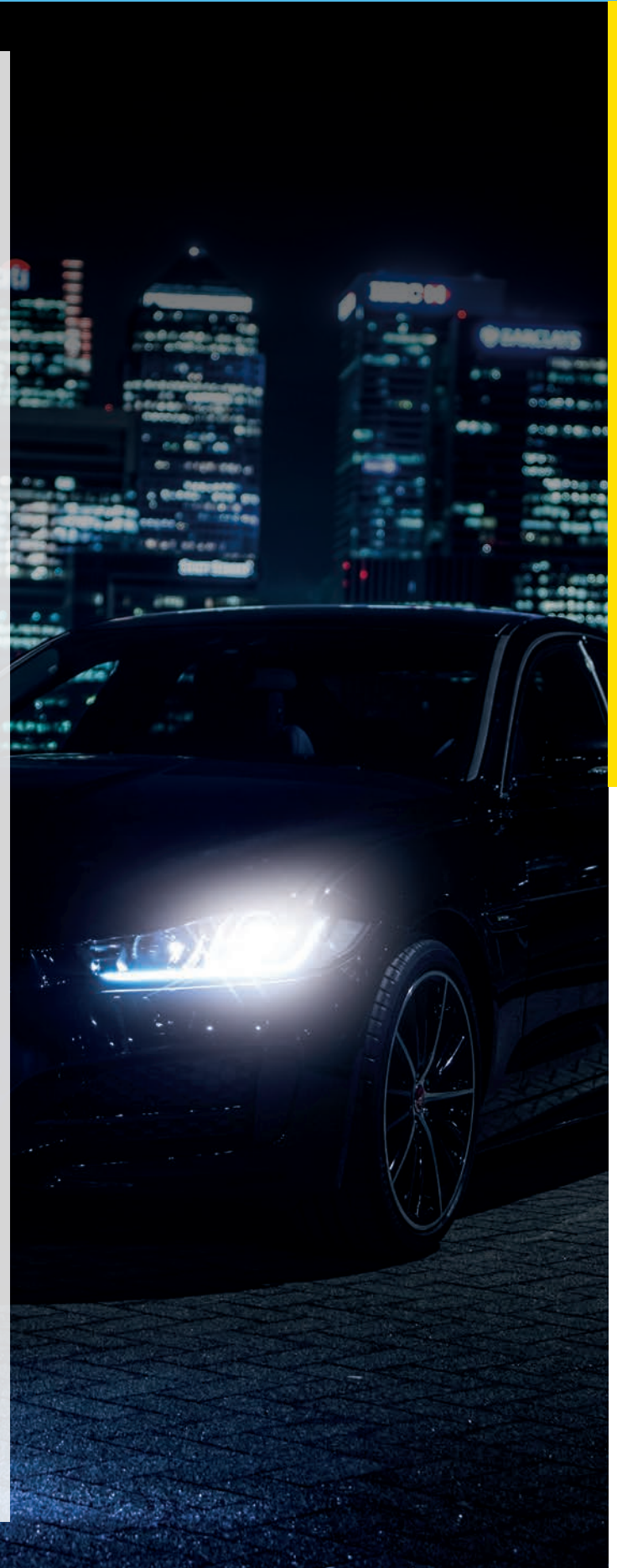

Vehicle Lighting

12V Passenger Vehicles

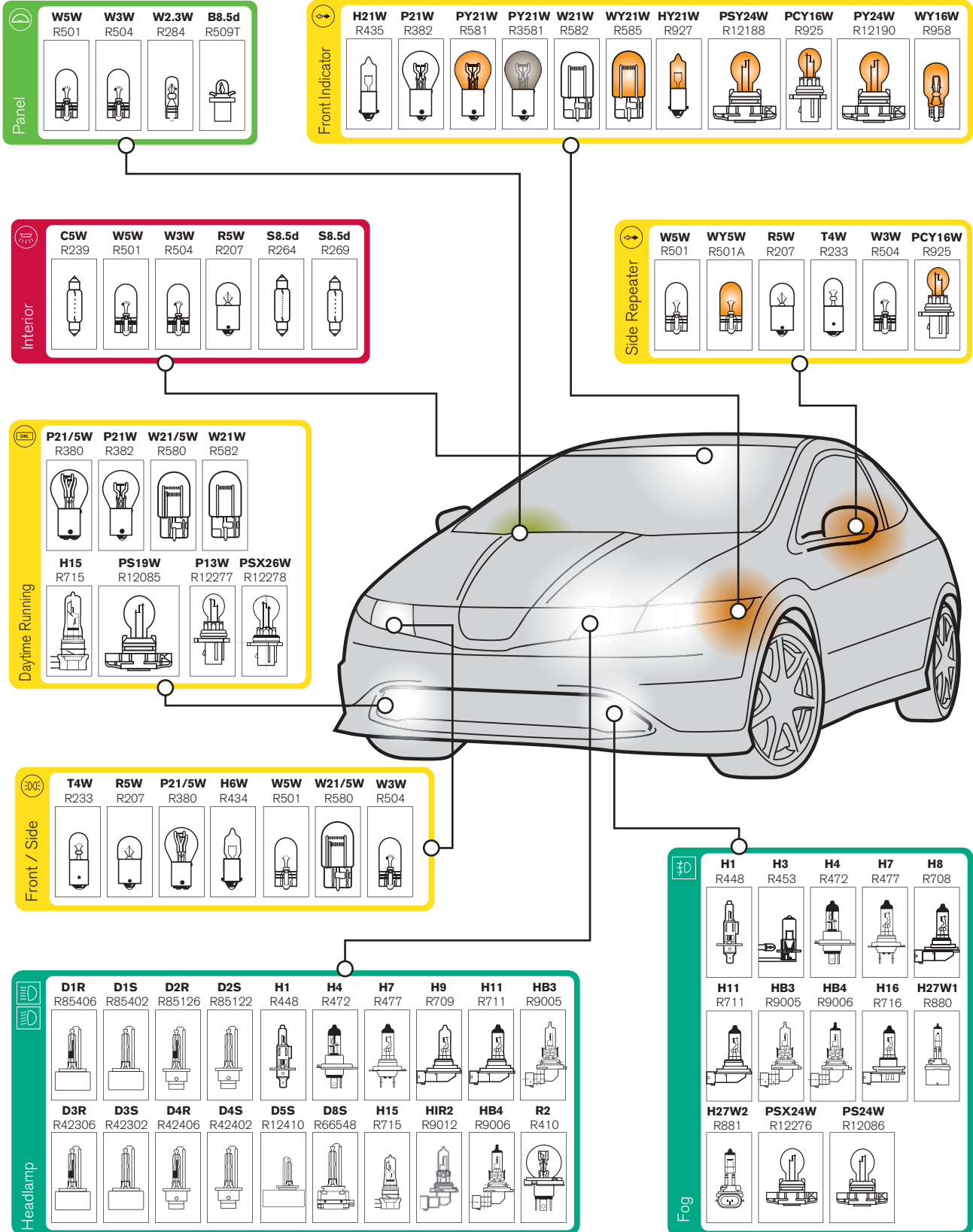

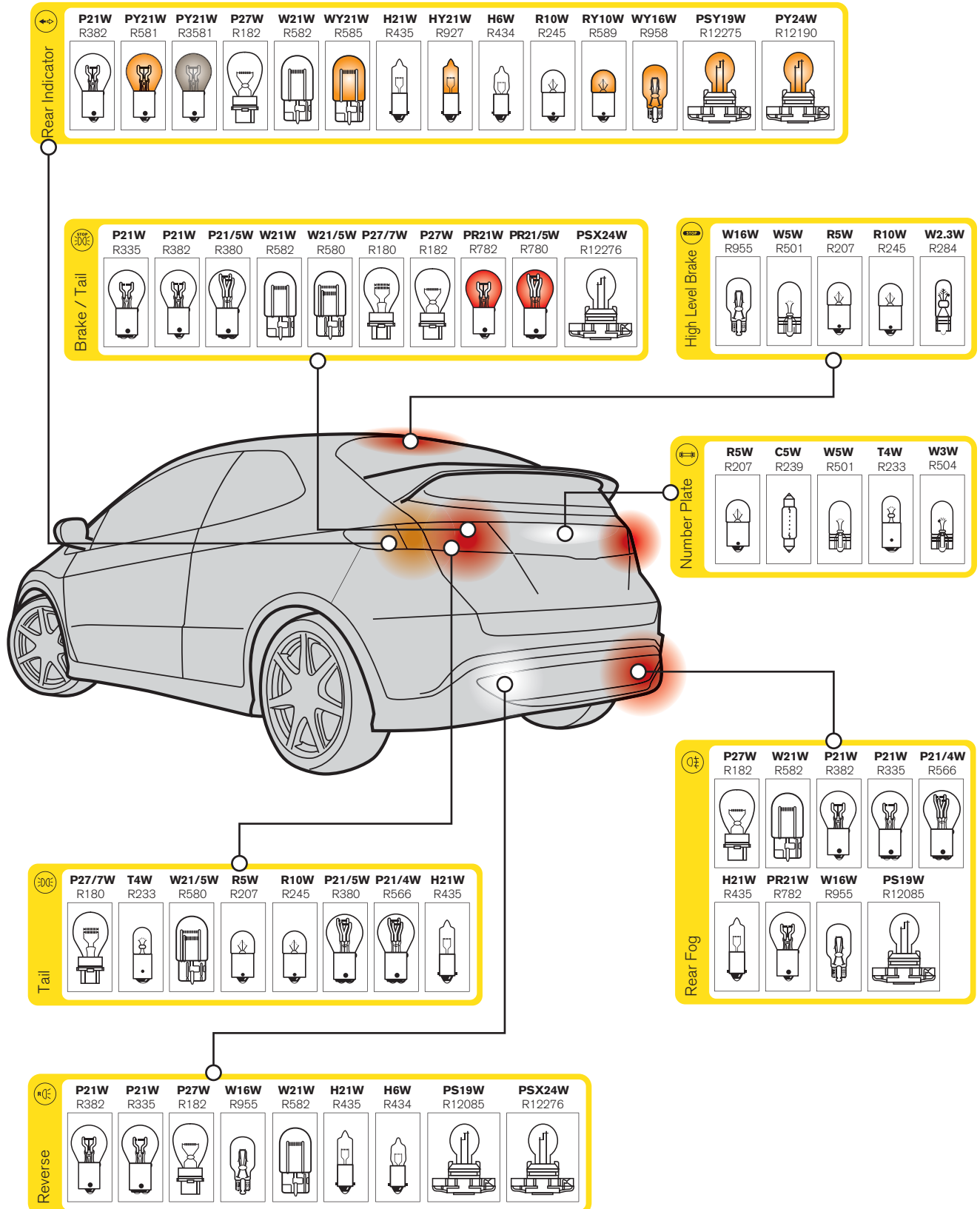

Vehicle Lighting

24V Commercial Vehicles

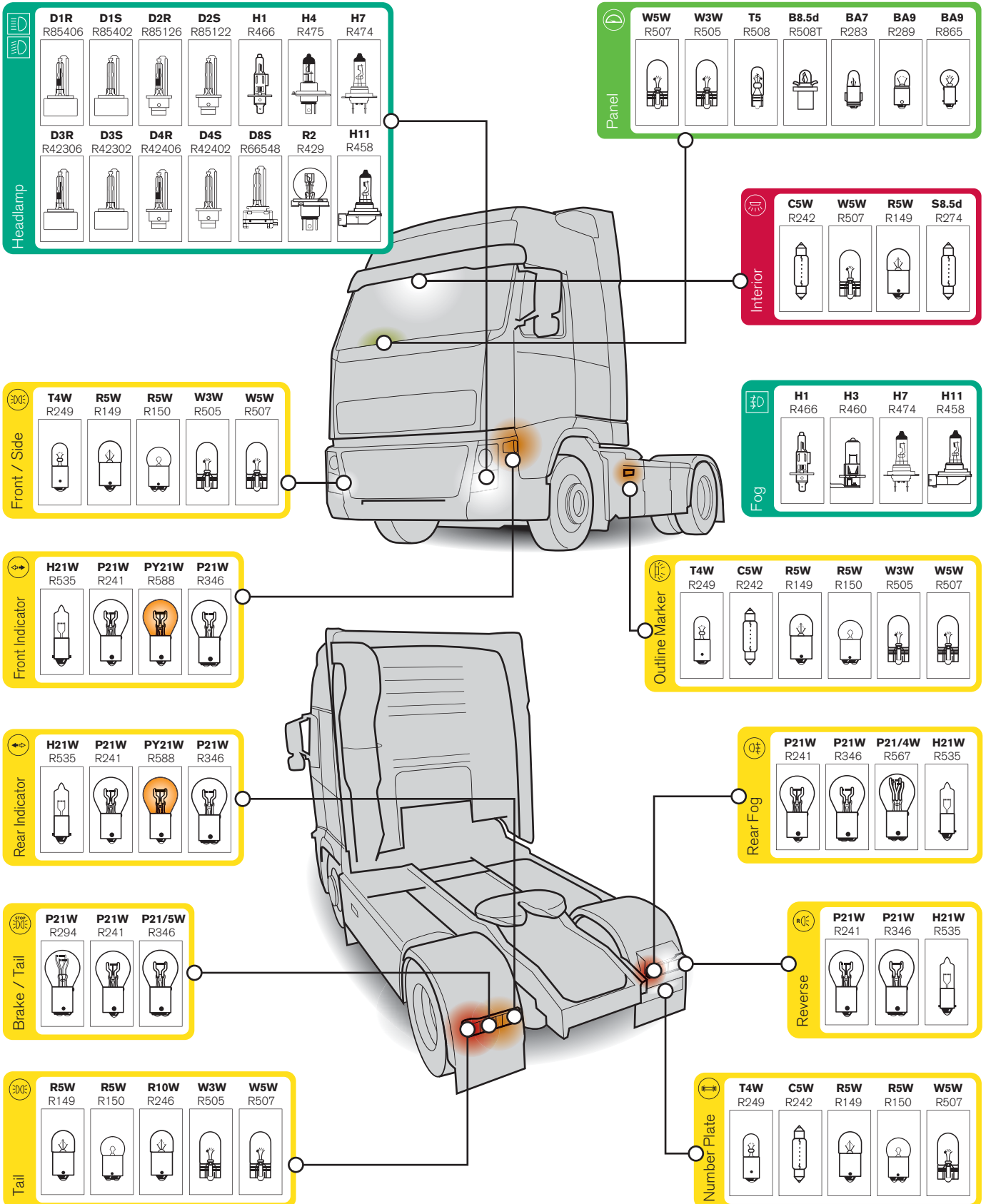

6V & 12V Motorcycles

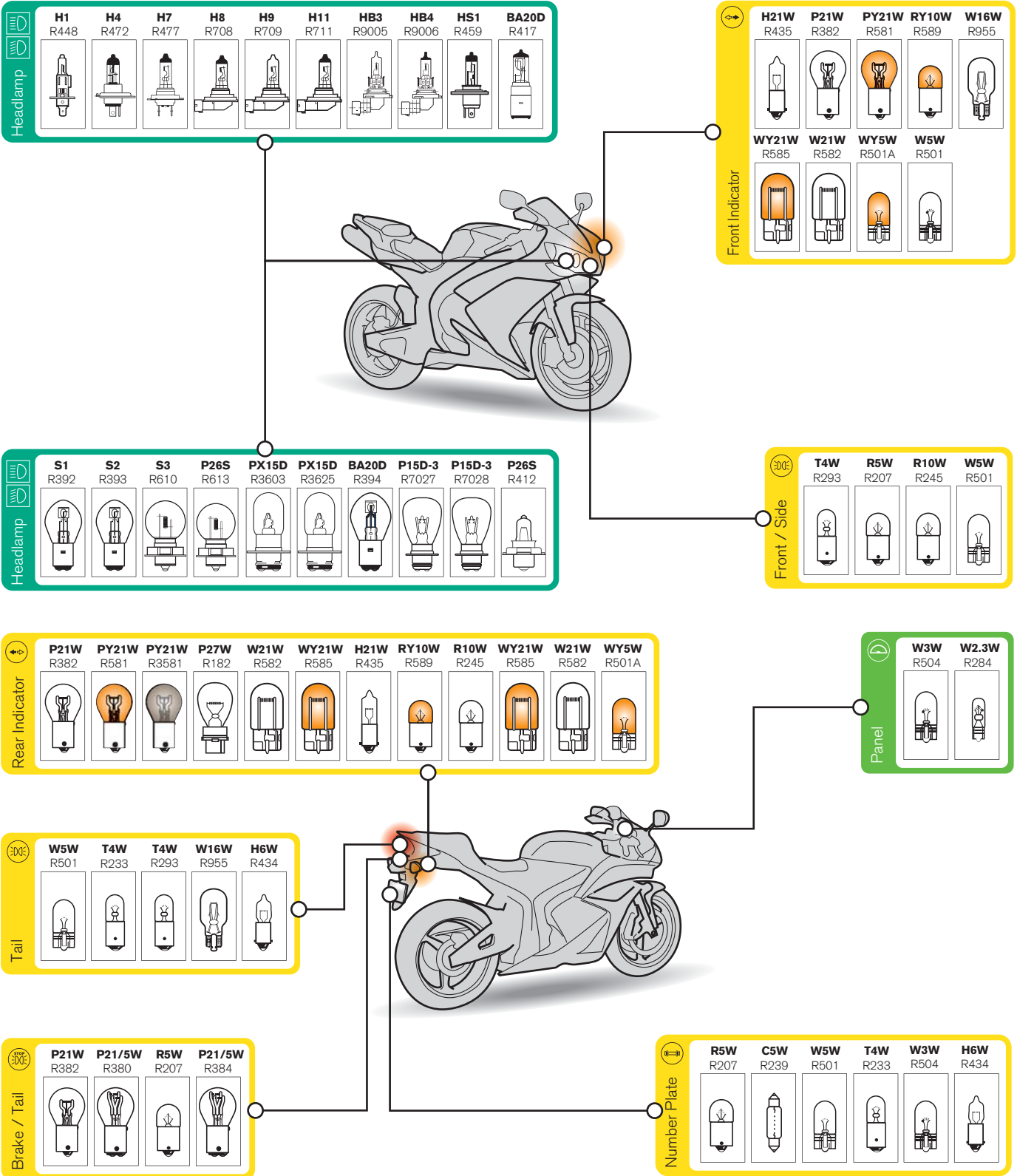

Vehicle Lighting

Which bulb should I choose?

BRIGHTER

I want more light on the road ahead

WHITER

I want a whiter looking headlamp

LONGER LIFE

I want a longer lasting headlamp



Xenon150 Brighter Headlamp

Up to 150% more light on the road for a safer and more comfortable journey.

+150% more light

150% more light on the road



Xenon5000 Whiter Headlamp

Up to 5000K Xenon cool white light.

+50% more light

Up to 5000K White light



Long Life Headlamp

Lasts up to 3x longer than a standard equivalent bulb. Ideal for high mileage drivers.



Xenon130 Brighter Headlamp

Up to 130% more light on the road for a safer and more comfortable journey.

+130% more light

130% more light on the road



Xenon4400 Whiter Headlamp

Up to 4400K Xenon cool white light.

+30% more light

Up to 4400K White light



XenonMax Brighter Headlamp

Up to 100% more light on the road. Enhanced performance for greater light output.

+100% more light

100% more light on the road



Xenon4000 Whiter Headlamp

Up to 4000K Xenon cool white light.

+100% more light

Up to 4000K White light



UltraXenon Brighter Headlamp

Up to 60%* more light on the road. Enhanced performance for greater light output.

+60% more light

60% more light on the road



RallySport Brighter Headlamp

Off-road – intense white light and high power beam (80 – 160W).

OFF ROAD

White High power beam



SportzBlue Whiter Headlamp

Intense blue-white light and high power beam (80 – 100W).

OFF ROAD

Up to 3900K Intense blue-white light

Off road only

*compared to standard halogen bulb



Xenon150 Brighter Headlamp

Puts up to 150%* more light on the road

- Up to 150% more light on the road ahead allows the driver to see more at a distance of 75m
- See and be seen with a beam pattern up to 80m longer than a standard bulb
- Better visibility of road markings and signs
- A whiter look in the headlamp compared to a standard bulb
- No changes to vehicle wiring required

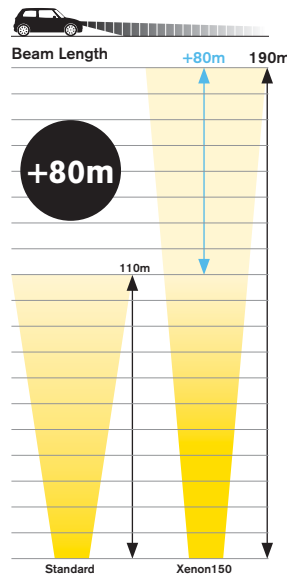

+150%

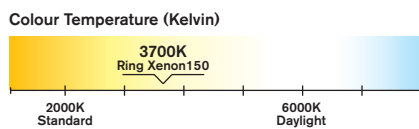
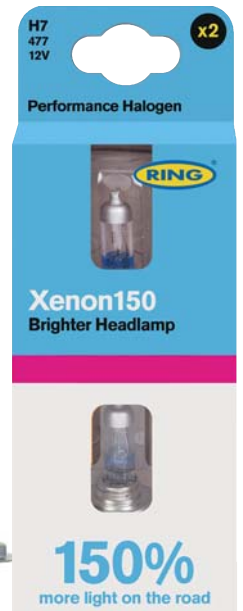

Twin

Ref	Voltage	Wattage	ECE	Cap	Kelvin	Upgrades	Barcode
RW1572	12V	60/55W	H4	P43t	3700K	R472	5055175240800
RW1577	12V	55W	H7	PX26d	3700K	R477	5055175240479

Retail Solutions

Ref	Description	Barcode
BU150	Ring Xenon150 counter top display unit c/w 8 x H7, 4 x H4	5055175241326



BU150

Scan to watch the video



*compared to standard halogen bulb

Vehicle Lighting

Performance Halogens A8



Xenon130

Brighter Headlamp

Puts up to 130%* more light on the road

- Improve night vision with up to 130% more light on the road for a safer and more comfortable journey
- Maximum performance is achieved through micro filament technology and 100% Xenon gas.
- See and be seen more clearly with up to a 60m longer beam than a standard bulb
- Better visibility of road markings and signs is produced through a whiter light that is closer to daylight
- A stylish finish is achieved through the silver tip
- No changes to vehicle wiring required

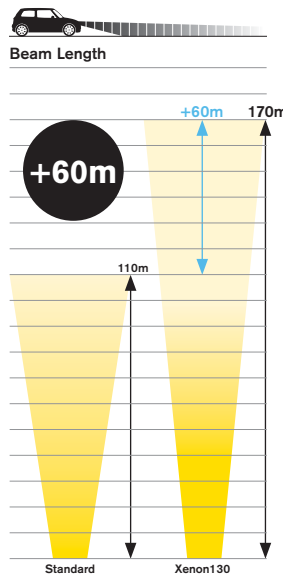

+130%

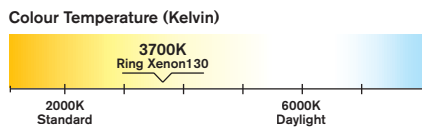

E Road Legal



Twin

Ref	Voltage	Wattage	ECE	Cap	Kelvin	Upgrades	Barcode
RW3348	12V	55W	H1	P14.5s	3700K	R448	5055175239491
RW3372	12V	60/55W	H4	P43t	3700K	R472	5055175236957
RW3377	12V	55W	H7	PX26d	3700K	R477	5055175236964
RW3306	12V	51W	HB4	P22d	3700K	R9006	5055175239507
RW3311	12V	55W	H11	PGJ19-2	3700K	R711	5055175239514

Retail Solutions

Ref	Description	Barcode
BU5900	Ring Xenon130 counter top display unit c/w 8 x H7, 4 x H4	5055175237312



BU5900



Scan to watch the video



*compared to standard halogen bulb



XenonMax Brighter Headlamp

Puts up to 100%* more light on the road

- Xenon gas technology and precise filament for improved performance
- Increased light output allows other road users to be seen more clearly at a distance of 75m on dipped beam
- Provides better reflections from road markings and signs
- H4, H7, H11 and HB4 have silver caps to blend in with reflector when unlit
- No changes to wiring required

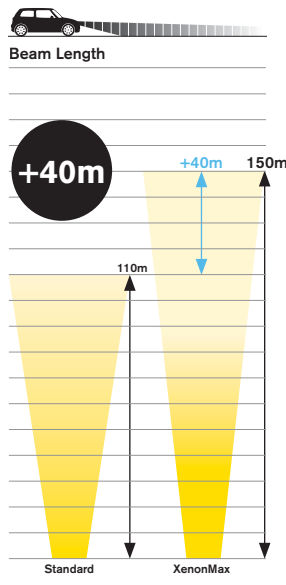

+100%

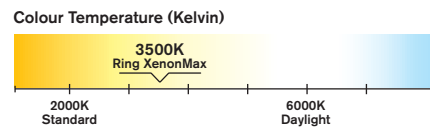
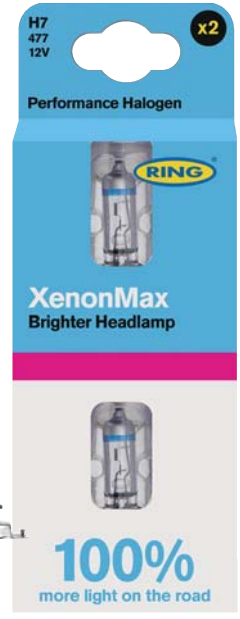

Twin

Ref	Voltage	Wattage	ECE	Cap	Kelvin	Upgrades	Barcode
RW1048	12V	55W	H1	P14.5s	3500K	R448	5055175214917
RW1053	12V	55W	H3	PK22s	3500K	R453	5055175221946
RW1072	12V	60/55W	H4	P43t	3500K	R472	5055175214344
RW1077	12V	55W	H7	PX26d	3500K	R477	5055175214351
RW1005	12V	60W	HB3	P20d	3500K	R9005	5055175217154
RW1006	12V	51W	HB4	P22d	3500K	R9006	5055175217161
RW1011	12V	55W	H11	PGJ19-2	3500K	R711	5055175217178

*compared to standard halogen bulb

Vehicle Lighting

Performance Halogens A10



UltraXenon Brighter Headlamp

Puts up to 60%* more light on the road

- Improved light output provides better reflections from road markings and signs
- Other road users can be seen more clearly at a distance of 75m on dipped beam
- No changes to wiring required

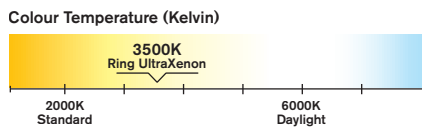
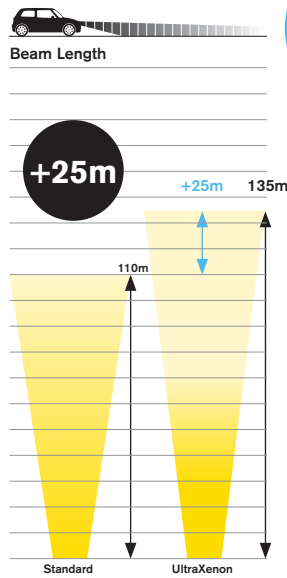

Twin

Ref	Voltage	Wattage	ECE	Cap	Kelvin	Upgrades	Barcode
RW948	12V	55W	H1	P14.5s	3500K	R448	5011274194826
RW972	12V	60/55W	H4	P43t	3500K	R472	5011274197223
RW977	12V	55W	H7	PX26d	3500K	R477	5011274197728
RW9905	12V	60W	HB3	P20d	3500K	R9005	5055175200583
RW9906	12V	51W	HB4	P22d	3500K	R9006	5055175200590

*H4 up to 60% brighter, H1 and H7 up to 50% brighter than a conventional headlamp bulb.



Xenon5000 Whiter Headlamp

The whitest road legal bulb

- Enhance the look of your vehicle
- Creates an LED headlamp look
- White light blends with LED DRL lamps
- Closer to daylight for a more comfortable night time drive
- See road signs and markings earlier with reflective white light
- Crisp white light and high power beam
- H4 and H7 references have stylish silver tip to blend into headlamp when unlit
- Puts up to 50%* more light on the road for safer and more comfortable night driving

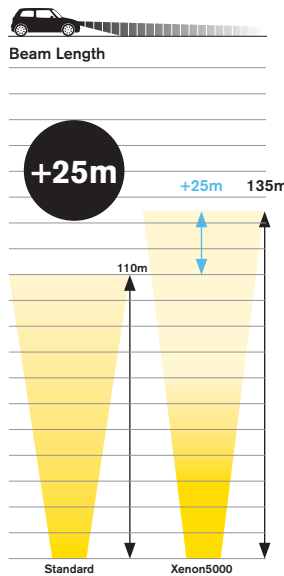

5000K

+50%

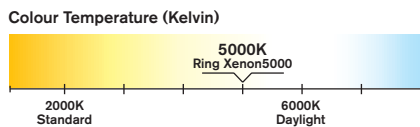
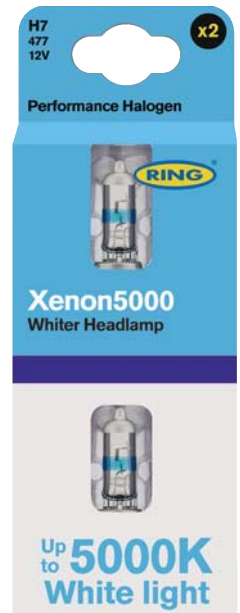

(E) Road Legal



Twin

Ref	Voltage	Wattage	ECE	Cap	Kelvin	Upgrades	Barcode
RW5048	12V	55W	H1	P14.5s	5000K	R448	5055175243597
RW5072	12V	60/55W	H4	P43t	5000K	R472	5055175243573
RW5077	12V	55W	H7	PX26d	5000K	R477	5055175243580
RW5011	12V	55W	H11	PGJ19-2	5000K	R711	5055175243603

Scan to watch the video



*compared to standard halogen bulb

Vehicle Lighting

Performance Halogens A12



Xenon4400 Whiter Headlamp

Enhance the look of your vehicle

- Creates Xenon HID headlamp look
- Closer to daylight colour blends with DRL bulbs
- Puts up to 30%* more light on the road for safer night driving
- Crisp white light and power beam
- H4 and H7 references have stylish silver tip to blend into headlamp when unlit

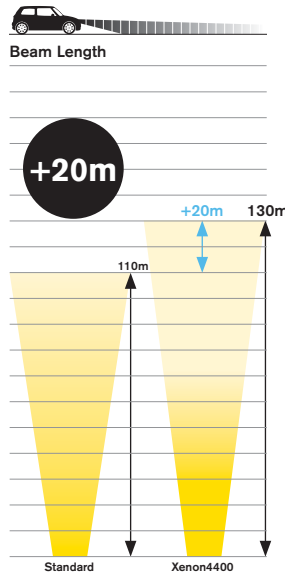

4400K

+30%

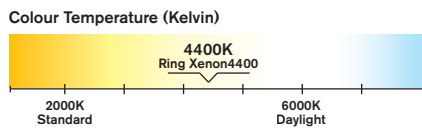

Twin

Ref	Voltage	Wattage	ECE	Cap	Kelvin	Upgrades	Barcode
RW4448	12V	55W	H1	P14.5s	4400K	R448	5055175235011
RW4472	12V	60/55W	H4	P43t	4400K	R472	5055175235028
RW4477	12V	55W	H7	PX26d	4400K	R477	5055175235035

Scan to watch the video



*compared to standard halogen bulb



Xenon4000 Whiter Headlamp

Enhance the look of your vehicle

- Crisp white light
- H4 and H7 references have stylish silver tip to blend into headlamp when unlit

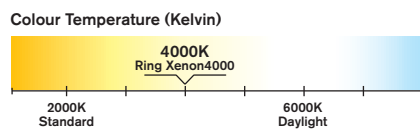
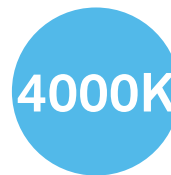
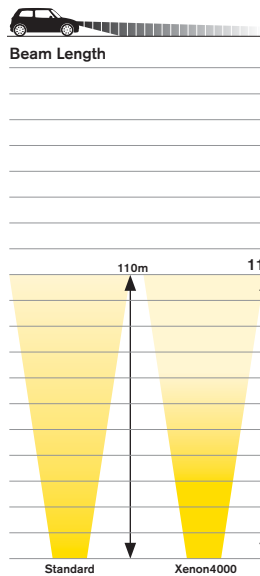

Twin

Ref	Voltage	Wattage	ECE	Cap	Kelvin	Upgrades	Barcode
RW1348	12V	55W	H1	P14.5s	4000K	R448	5055175229492
RW1372	12V	60/55W	H4	P43t	4000K	R472	5055175229508
RW1377	12V	55W	H7	PX26d	4000K	R477	5055175229515

Vehicle Lighting

Performance Halogens A14



SportzBlue

3900K



Off-road intense white light with blue reflector hue

- Up to 3900K white light with a darker blue hint
- 80-100W produces a high power beam pattern
- H4 and H7 have a silver cap to blend in with reflector when unlit
- Ideal for off-roaders, sports and rally drivers
- Changes to wiring or fuses may be required
- Off road use only

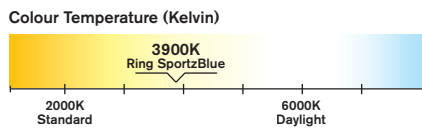

Twin

Ref	Voltage	Wattage	ECE	Cap	Kelvin	Upgrades	Barcode
RW668	12V	80W	H1	P14.5s	3900K	R448	5011274166823
RW684	12V	100/80W	H4	P43t	390K	R472	5011274168421
RW664	12V	80W	H7	PX26d	3900K	R477	5011274166427

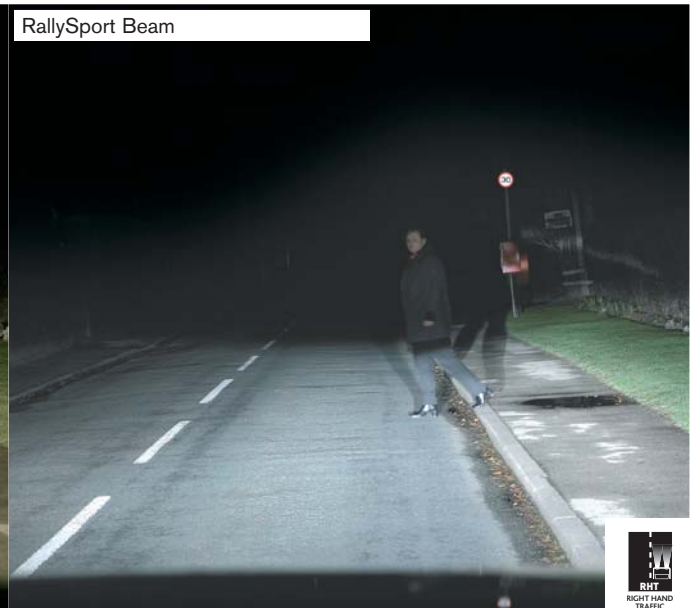

Performance Halogens A15



RallySport Brighter Headlamp

Off-road intense white light and high power beam

- 80-160W produces a high power beam pattern
- Off road use only
- Ideal for sport or rally drivers
- Changes to wiring or fuses may be required

3500K

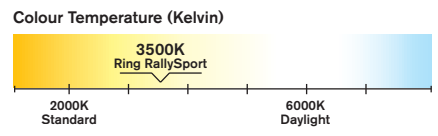

Twin

Ref	Voltage	Wattage	ECE	Cap	Kelvin	Upgrades	Barcode
RW481	12V	100W	H1	P14.5s	3500K	R448	5011274094973
RW499	12V	130W	H1	P14.5s	3500K	R448	5011274095000
RW483	12V	100W	H3	PK22s	3500K	R453	5011274094980
RW492	12V	130W	H3	PK22s	3500K	R453	5011274095017
RW473	12V	100/55W	H4	P43t	3500K	R472	5011274094966
RW484	12V	100/80W	H4	P43t	3500K	R472	5011274148423
RW490	12V	130/90W	H4	P43t	3500K	R472	5011274095000
RW590	12V	160/90W	H4	P43t	3500K	R472	5011274159030
RW464	12V	100W	H7	PX26d	3500K	R477	5055175201306

Vehicle Lighting

Whiter Sidelights A16



Whiter Sidelights

- Designed to 'colour match' headlamp upgrade bulbs
- Create a whiter look by upgrading your sidelight bulbs to match the latest performance halogen upgrade bulbs
- Whiter bulbs will enhance the look of your vehicle particularly those with Daytime Running Lights

Upgrade to a stylish look

- Direct replacement for existing bulbs
- Optional plug and play resistor kit for vehicles with bulb failure warning system (LED501RES / LED382RES)
- Off road or internal use only

Colour Temperature (Kelvin)

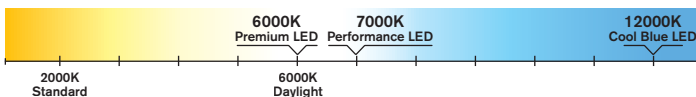

12V Bulbs

Product Code	Bulb Ref	Bulb Type	Application	Colour Temp	Lumens	More Info
R801	501	W5W	Sidelight	4000K		
R833	233	T4W	Sidelight	4000K		
R1401	501	W5W	Sidelight	4400K		

12V Blister Bulbs

Product Code	Bulb Ref	Bulb Type	Application	Colour Temp	Lumens	More Info
RW801	501	W5W	Sidelight	4000K		
RW833	233	T4W	Sidelight	4000K		
RW1401	501	W5W	Sidelight	4400K		
RW882	582	W21W	Sidelight	4000K		
RW888	580	W21/5W	Sidelight	4000K		

12V Blister LEDs

Product Code	Bulb Ref	Bulb Type	Application	Colour Temp	Lumens	More Info
RW2396LED	239	C5W	Number Plate & Interior	6000K	35	39mm White
RW23912LED	239	C5W	Number Plate & Interior	12000K	35	39mm Blue
RW5016LED	501	W5W	Sidelight & Interior	6000K	40	White
RW50112LED	501	W5W	Sidelight & Interior	12000K	35	Blue
LED501RES	-	W5W/W3W	-	-	-	LED Resistor kit for W5W
LED382RES	-	P21W/PY21W	-	-	-	LED Resistor kit for P21W/PY21W



Optimised light output

- Filament technology gives a uniform light output, just like a standard bulb
- Up to 6000K bulbs
- Longer life
- Vibration resistant
- Designed to replace a standard bulb
- Off road or internal use only

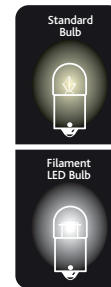

12V Filament Style LEDs

Product Code	Bulb Ref	Bulb Type	Application	Colour Temp	Lumens	More info
RW2336FSLED	233	T4W	Side & Tail	6000K	40	
RW2396FSLED	239	C5W	Number Plate & Interior	6000K	45	CANbus Technology
RW5016FSLED	501	W5W	Side & Interior	6000K	60	CANbus Technology
RW2073FSLED	207	R5W	Side & Tail	3000K	60	
RW2453FSLED	245	R10W	Side & Tail	3000K	125	
RW3803FSLED	380	P21/5W	Brake/Tail	3000K	380/40	Nichia LED
RW3823FSLED	382	P21W	Brake & Indicator	3000K	390	Nichia LED
RW581AFSLED	581	PY21W	Indicator	2000K	280	Nichia LED & Amber
RW501AFSLED	501A	WY5W	Side Repeater	2000K	40	Amber
RW589AFSLED	589	RY10W	Indicator	2000K	75	Amber

24V Filament Style LEDs

Product Code	Bulb Ref	Bulb Type	Application	Colour Temp	Lumens	More Info
RB1493FSLED	149	R5W	Side & Tail	3000K	55	
RB2463FSLED	246	R10W	Side & Tail	3000K	110	
RB5076FSLED	507	W5W	Side, Tail & Interior	6000K	65	
RB2496FSLED	249	T4W	Side & Tail	6000K	45	
RB2413FSLED	241	P21W	Brake & Indicator	3000K	395	Nichia LED
RB2943FSLED	294	P21/5W	Brake/Tail	3000K	410/55	Nichia LED
RB2426FSLED	242	C5W	Number Plate & Interior	6000K	50	
RB1506FSLED	150	R5W	Side & Tail	6000K	55	
RB3463FSLED	346	P21W	Brake & Indicator	3000K	395	Nichia LED

Vehicle Lighting

Premium LED Bulbs A18



LED bulbs for a whiter look

- Latest CANbus technology
- Up to 6000K bulbs
- Longer life
- Vibration resistant
- Extra bright
- Off road or internal use only



Colour Temperature (Kelvin)

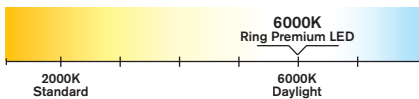

12V Premium LEDs

Product Code	Bulb Ref	Bulb Type	Application	Colour Temp	Lumens	More Info
RW207LED	207/245	R5W/R10W	Signalling	6000K	400	
RW239CBLED	239	C5W	Number Plate & Interior	6000K	200	CANbus Technology
RW380LED	380	P21/5W	Signalling	6000K	510/150	
RW382LED	382	P21W	Signalling	6000K	530	
RW501CBLED	501	W5W	Side & Interior	6000K	220	CANbus Technology
RW477FLED	477	H7	Fog Lamp only	6000K	600	
RW711FLED	711	H11	Fog Lamp only	6000K	600	

24V Premium LEDs

Product Code	Bulb Ref	Bulb Type	Application	Colour Temp	Lumens	More Info
RB1496LED	149	R5W	Signalling	6000K	400	
RB1506LED	150	R5W	Signalling	6000K	400	
RB2416LED	241	P21W	Signalling	6000K	530	
RB2426LED	242	C5W	Number Plate & Interior	6000K	200	CANbus Technology
RB2496LED	249	T4W	Signalling	6000K	200	
RB5076LED	507	W5W	Side & Interior	6000K	220	CANbus Technology



LED bulbs for a whiter look

- 3D technology
- Up to 7000K bulbs
- Longer life
- Vibration resistant
- Extra bright
- Off road or internal use only

Colour Temperature (Kelvin)

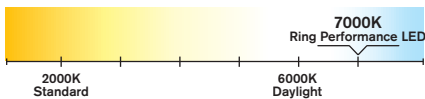

270° Light distribution

3D Technology

Many LED designs are '2D': 2D LEDs have a flat surface forcing the light to be emitted in one direction only. This can be a problem with LEDs, as no matter how many other LEDs are added to the lamp in any position, the light distribution may be uneven. Our 3D LEDs are made with a flexible LED beading which can be used to simulate the shape of a standard bulb thus giving an even light distribution.

12V Performance LEDs

Product Code	Bulb Ref	Bulb Type	Application	Colour Temp	Lumens	More Info
RW380DLED	380	P21/5W	Signalling	7000K	300/100	3D Technology
RW382DLED	382	P21W	Signalling	7000K	560	3D Technology
RW501DLED	501	W5W	Side & Interior	7000K	200	3D Technology

Vehicle Lighting

Silver Enigma A20

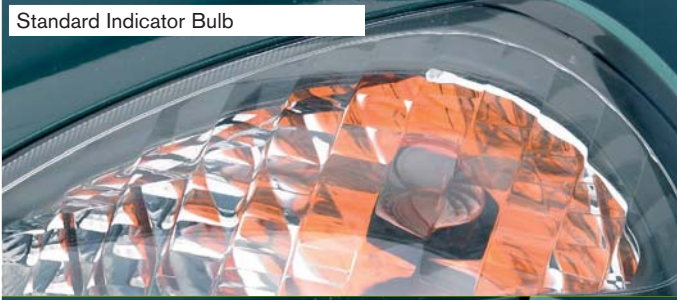

Standard Indicator Bulb

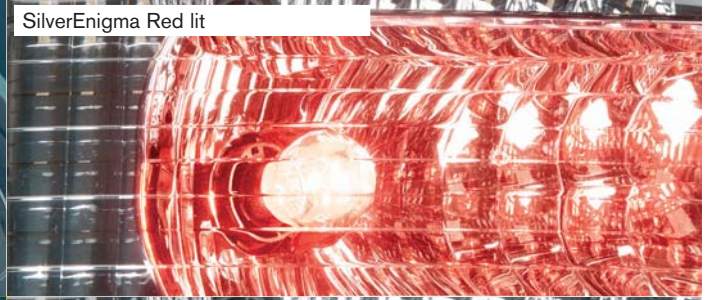

SilverEnigma Red lit



SilverEnigma Indicator Bulb

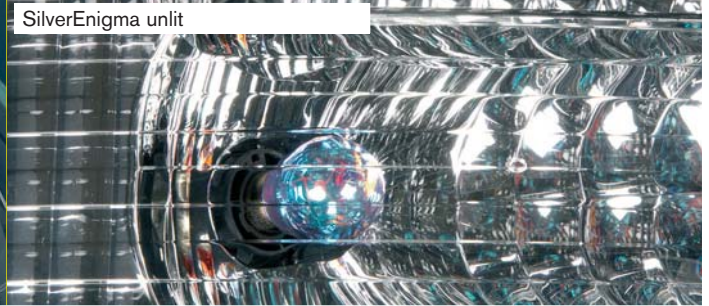

SilverEnigma unlit



SilverEnigma Styling Bulb

Flashes amber, looks clear when unlit

- Flashes amber and provides a clear integrated look when unlit
- Ring SilverEnigma is interchangeable with conventional bulbs
- Upgrades R581 amber indicator bulb



Illuminates red, looks clear when unlit

- Illuminates red and provides a clear integrated look when unlit
- Vehicle Specific OE replacement bulb
- Upgrades R782 stop light bulb
- Upgrades R780 stop and tail bulb

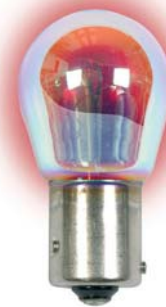

Single

Ref	Voltage	Wattage	ECE	Cap	Upgrades	Barcode
R3782	12V	21W	PR21W	BAW15s	R782	5055175215013
R3780	12V	21/5W	PR21/5W	BAW15d	R780	5055175215020

Twin

Ref	Voltage	Wattage	ECE	Cap	Upgrades	Barcode
RW3581	12V	21W	PY21W	BAU15s	R581	5011274168414
RW3782	12V	21W	PR21W	BAW15s	R782	5055175243689
RW3780	12V	21/5W	PR21/5W	BAW15d	R780	5055175243696



Designed for today's modern headlamp units

- Optimise the efficiency of lighting equipment with Ring Premium headlamp bulbs
- The output and efficiency of vehicle headlamps is not only determined by the shape, size and manufacturing quality of the reflector but also the quality of the bulb
- Smaller headlamp designs require a bulb with a more precise filament position



Ring Premium Headlamp Bulb Range – Single Blister

Ref	Voltage	Wattage	ECE	Cap	Barcode
RU448EQ	12V	55W	H1	P14.5s	5011274184414
RU472EQ	12V	60/55	H4	P43t	5055175201016
RU477EQ	12V	55	H7	PX26d	5055175201030

Ring Premium Headlamp Bulb Range – Twin Blister

Ref	Voltage	Wattage	ECE	Cap	Barcode
RW448EQ	12V	55W	H1	P14.5s	5011274144845
RW472EQ	12V	60/55W	H4	P43t	5055175201030
RW477EQ	12V	55W	H7	PX26d	5055175201047

Vehicle Lighting

OE Xenon HID A22



- Ring Xenon HID bulbs are OE manufactured
- Direct OE replacement for existing discharge bulb
- Long life - 3000 hours
- E Approved / Road legal

Colour Temperature (Kelvin)

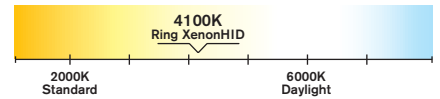

4100K
Standard colour temperature

Ring Xenon HID - Boxed

Part No.	Type	Voltage	Wattage	Base	Barcode
R85406	D1R*	85V	35W	PK32d-3	5055175215129
R85402	D1S*	85V	35W	PK32d-2	5055175215112
R85126	D2R*	85V	35W	P32d-3	5055175211480
R85122	D2S*	85V	35W	P32d-2	5055175211473
R42306	D3R	42V	35W	PK32d-6	5055175235882
R42302	D3S*	42V	35W	PK32d-5	5055175230610
R42406	D4R	42V	35W	P32d-6	5055175235899
R42402	D4S*	42V	35W	P32d-5	5055175230627
R12410	D5S	12V	25W	PK32d-7	5055175239903
R66548	D8S	12V	25W	PK32d-1	5055175243719

Ring Xenon HID - Blister

Part No.	Type	Voltage	Wattage	Base	Barcode
RU85406	D1R*	85V	35W	PK32d-3	5055175220239
RU85402	D1S*	85V	35W	PK32d-2	5055175220222
RU85126	D2R*	85V	35W	P32d-3	5055175220215
RU85122	D2S*	85V	35W	P32d-2	5055175220208
RU42302	D3S*	42V	35W	PK32d-5	5055175242903
RU42402	D4S*	42V	35W	P32d-5	5055175242910

Fitting Video



Scan to watch the video

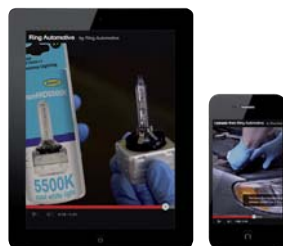



- Ring Xenon HID bulbs are OE manufactured
- 20% more light than a standard HID bulb
- 5500K colour temperature for a whiter light
- Long life - 3000 hours
- E Approved / Road legal

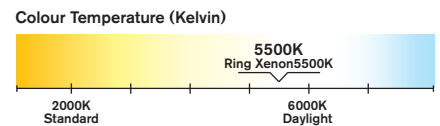

5500K
 High colour temperature

Ring Xenon HID 5500K

Part No.	Type	Voltage	Wattage	Base	Barcode
R854025K	D1S*	85V	35W	PK32d-2	5055175237619
R851265K	D2R*	85V	35W	P32d-3	5055175237589
R851225K	D2S*	85V	35W	P32d-2	5055175237572
R423025K	D3S*	42V	35W	PK32d-5	5055175243535
R424025K	D4S*	42V	35W	P32d-5	5055175243542



- Ring Xenon HID bulbs are OE manufactured
- 100% more light on the road ahead
- 4100K colour temperature
- Long life - 3000 hours
- E Approved / Road legal

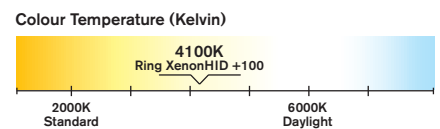

+100%
 More light on the road

Ring Xenon HID +100%

Part No.	Type	Voltage	Wattage	Base	Barcode
R85402100	D1S*	85V	35W	PK32d-2	5055175243559
R85122100	D2S*	85V	35W	P32d-3	5055175243566



*Now available in welded blister single pack.
 All Ring HID bulbs are Lead free.
 All Ring D3 and D4 bulbs are Mercury free.

Vehicle Lighting

Long Life Bulbs A24



Lasts up to 3x longer than the standard equivalent bulb

- Ideal for day and night use and high mileage drivers
- Improved resistance to vehicle overvoltage
- Suitable for vehicles with optional 'lights on' function or daytime running systems

Coping with Overvoltage

On many of today's modern vehicles the measured voltage can be higher than 12V in order to cope with the additional electronic devices and electric motors.

Bulbs for cars are currently manufactured to operate at 12V and tested at 13.2V however, if the constant running voltage is higher than this it can result in a rapid decrease in the life expectancy of the bulb. Ring Automotive's Long Life bulbs provide a better resistance to vehicle overvoltage.



Reference	Voltage	Wattage	ECE	Cap	Barcode
RU477LL	12V	55W	H7	PX26d	5011274147747
RU472LL	12V	60/55W	H4	P43t	5011274147242
RU448LL	12V	55W	H1	P14.5s	5011274144852
RU453LL	12V	55W	H3	PK22s	5011274045333
RU711LL	12V	55W	H11	PGJ19-2	5055175243610
RW380LL	12V	21/5W	P21/5W	BAY15d OSP	5011274138042
RW382LL	12V	21W	P21W	BA15s SCC	5011274138240
RW207LL	12V	5W	R5W	BA15s SBC	5011274120740
RW245LL	12V	10W	R10W	BA15s SCC	5011274124540
RW501LL	12V	5W	W5W	W2.1x9.5d	5011274250195
RW239LL	12V	5W	C5W	S8.5d 11x38mm	5011274123949
RW581LL	12V	21W	PY21W	BAU15s OSP	5011274158149
RW233LL	12V	4W	T4W	BA9s MCC	5011274123345



Gain time, gain distance, avoid rear end collisions

- Faster light-up* and greater light intensity provides earlier warning to following vehicles
- A shorter, more precise filament produces up to **20% more luminance** than a standard bulb
- Up to 3 metres** extra stopping distance



Twin blister

Ref	Voltage	Wattage	ECE	Cap	Upgrades	Barcode
RW380RR	12V	21/5W	P21/5W	BAY15d	R380	5055175215303
RW382RR	12V	21W	P21W	BA15s	R382	5055175215310
RW207RR	12V	5W	R5W	BA15s	R207	5055175215327
RW245RR	12V	10W	R10W	BA15s	R245	5055175215334

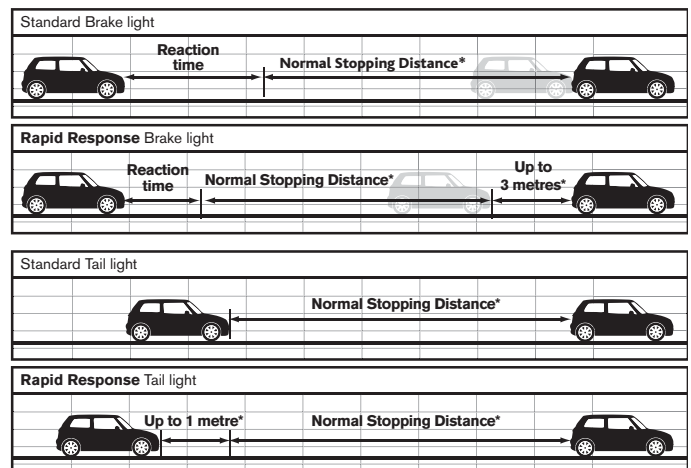

*Based on travelling speeds of 62mph

*Faster light applies to brake and tail, and brake, tail and indicator bulbs only.
 **Up to 3 metres applies to brake and tail and brake bulbs only.

Vehicle Lighting

Blister Bulbs A26



Profit makers

Twin packed blister bulbs offer a greater profit making opportunity than single blister, especially as a consumer is less likely to shop around when selecting a replacement bulb which is normally an emergency purchase.

In addition as the footprint of the card is the same it will yield more profit per linear foot than a single alternative.

Dimensions:

Small blister: 87 x 116mm

Twin headlamp blister: 87 x 235mm

RW=  Twin Blister Pack

RU=  Single Blister Pack

Single Blister Pack

Twin Blister Pack

ECE Ref →
Part No →
Voltage →
Bulb type →

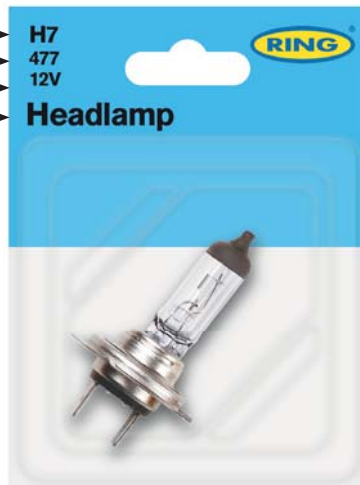

Hints and tips on changing the bulb

ECE Ref →
Part No →
Voltage →
Bulb type →



Additional information to aid decision making

Colour coded to highlight range →

Provides early warning

Product Code: RU477



Barcode

12V Single Bulb Blister Pack Headlamps
12V Twin Packs

Ref	Volts	Watts	ECE	Cap	E approved	Application Colour	Pack Qty	Barcode	Ref	Pack Qty Barcode
RU12	12V	60/55W	H4	P45t			10 x 1	5011274101213		
RU410	12V	45/40W	R2 ASY	P45t	(E)		10 x 1	5011274141011		
RU448	12V	55W	H1	P14.5s	(E)		10 x 1	5011274144814		
RU453	12V	55W	H3	PK22s	(E)		10 x 1	5011274145316	RW453	10 x 1 5055175209739
RU472	12V	60/55W	H4	P43t	(E)		10 x 1	5011274147211	RW472	10 x 1 5011274147273
RU477	12V	55W	H7	PX26d	(E)		10 x 1	5011274147716	RW477	10 x 1 5011274147723
RU479	12V	55W	H2	PK22s	(E)		10 x 1	5011274147969		
RU480	12V	100W	H2	X511			10 x 1	5011274148010		
RU491	12V	130W	H2	X511			10 x 1	5011274149161		
RU708	12V	35W	H8	PGJ19-1	(E)		10 x 1	5011274170813		
RU709	12V	65W	H9	PGJ19-5	(E)		5 x 1	5011274057091		
RU711	12V	55W	H11	PGJ19-2	(E)		5 x 1	5011274057114		
RU715	12V	55/15W	H15	PGJ23t-1	(E)		5 x 1	5055175217536		
RU716	12V	19W	H16	PGJ19-3	(E)		5 x 1	5055175243740		
RU880	12V	27W	H27W/1	PG13	(E)		5 x 1	5011274188016		
RU881	12V	27W	H27W/2	PGJ13	(E)		5 x 1	5011274188115		
RU9005	12V	60W	HB3	P20d	(E)		10 x 1	5011274190538		
RU9006	12V	51W	HB4	P22d	(E)		5 x 1	5011274090067		
RU9012	12V	55W	HIR2	PX22d	(E)		5 x 1	5055175243627		

12V Single Bulb Blister Pack Exterior/Interior
12V Twin Packs

Ref	Volts	Watts	ECE	Cap	E approved	Application Colour	Pack Qty	Barcode	Ref	Pack Qty Barcode
RU180	12V	27/7W	P27/7W	W2.5x16q	(E)		5 x 1	5011274118013		
RU182	12V	27W	P27W	W2.5x16d	(E)		5 x 1	5011274118211		
RU183	12V	27/7W	PY27/7W	WX2.5x16q			5 x 1	5011274018368		
RU207	12V	5W	R5W	BA15s SCC	(E)		10 x 1	5011274120719	RW207	10 x 1 5011274120726
RU209	12V	5W	R5W	BA15d SBC	(E)		10 x 1	5011274120917	RW209	10 x 1 5011274120924
RU233	12V	4W	T4W	BA9s MCC	(E)		10 x 1	5011274123314	RW233	10 x 1 5011274123321
RU237	12V	7W		S8.5d 10x40mm		Frosted	10 x 1	5011274123710	RW237	10 x 1 5011274123727
RU239	12V	5W	C5W	S8.5d 11x38mm	(E)		10 x 1	5011274123918	RW239	10 x 1 5011274123925
RU245	12V	10W	R10W	BA15s SCC	(E)		10 x 1	5011274124519	RW245	10 x 1 5011274124526
RU256	12V	3W		S7d 8x38mm			10 x 1	5011274125615	RW256	10 x 1 5011274125622
RU264	12V	10W		S8.5d 11x44mm			10 x 1	5011274126414	RW264	10 x 1 5055175202518
RU265	12V	10W		S8.5d 15x44mm			10 x 1	5011274126513		
RU269	12V	10W		S8.5d 11x30mm			10 x 1	5011274126919	RW269	10 x 1 5011274126933
RU958	12V	16W	WY16W	W2.1x9.5d	(E)	Amber	10 x 1	5055175243634		

Vehicle Lighting









12V Single Bulb Blister Pack Exterior/Interior (continued)

12V Twin Packs





















Ref	Volts	Watts	ECE	Cap	E approved	Application	Colour	Pack Qty	Barcode	Ref	Pack Qty	Barcode
RU270	12V	18W		S8.5d 15x44mm				10 x 1	5011274127015			
RU272	12V	10W		S8.5d 11x38mm				10 x 1	5011274127213	RW272	10 x 1	5011274127206
RU273	12V	21W		S8.5d 15x44mm				10 x 1	5011274127312	RW273	10 x 1	5011274127329
RU280	12V	1.5W		LES E5/8				10 x 1	5011274128012			
RU281	12V	2W		BA7s				10 x 1	5011274128111	RW281	10 x 1	5011274128128
RU284	12V	2.3W	W2.3W	W2x4.6d	E			10 x 1	5011274128425	RW284	10 x 1	5011274128432
RU286	12V	1.2W		W2x4.6d				10 x 1	5011274128616	RW286	10 x 1	5011274128623
RU286A	12V	1.2W		W2x4.6d			Amber	10 x 1	5011274128517			
RU286G	12V	1.2W		W2x4.6d			Green	10 x 1	5011274128654	RW286G	10 x 1	5055175203201
RU286R	12V	1.2W		W2x4.6d			Red	10 x 1	5011274128531			
RU297	12V	2.2W		W2.1x9.5d				10 x 1	5011274129712	RW297	10 x 1	5055175203188
RU32/3	12V	32/4W		BAY15d OSP				10 x 1	5011274132316			
RU335	12V	21W	P21W	BA15d SBC	E			10 x 1	5011274133511	RW335	10 x 1	5011274133528
RU343	12V	21W		BA15s SCC			Amber	5 x 1	5011274134365			
RU380	12V	21/5W	P21/5W	BAY15d OSP	E			10 x 1	5011274138011	RW380	10 x 1	5011274138028
RU382	12V	21W	P21W	BA15s SCC	E			10 x 1	5011274138219	RW382	10 x 1	5011274138226
RU433	12V	20W		BA9s MCC				5 x 1	5011274143312			
RU434	12V	6W	H6W	BAX9s	E			10 x 1	5011274143411	RW434	10 x 1	5055175202532
RU435	12V	21W	H21W	BAY9s	E			5 x 1	5011274143510			
RU501	12V	5W	W5W	W2.1x9.5d	E			10 x 1	5011274150112	RW501	10 x 1	5011274150129
RU501A	12V	5W	WY5W	W2.1x9.5d	E		Amber	10 x 1	5011274150181	RW501A	10 x 1	5011274151195
RU504	12V	3W	W3W	W2.1x9.5d	E			10 x 1	5011274150419	RW504	10 x 1	5011274150426
RU509T	12V	1.2W		B8.5D			Black base	10 x 1	5011274150914	RW509T	10 x 1	5055175202549
RU509TBBK	12V	1.2W	B8.3D				Black base	5 x 1	5011274150990			
RU509TGR	12V	2W	BX8.5D				Green base	5 x 1	5011274150945			
RU509TMBE	12V	1.5W	BX8.4D				Beige Base	5 x 1	5011274150938			
RU509TMBK	12V	1.2W	BX8.4D				Black base	5 x 1	5011274150921			
RU509TML	12V	1.2W	B8.4D				Blue Base	5 x 1	5011274290528			
RU509TMGR	12V	2W	BX8.4D				Green base	5 x 1	5011274290542			
RU509TMOR	12V	1.12W	BX8.4D				Orange base	5 x 1	5011274150983			
RU509TOR	12V	1W	BX8.5D				Orange base	5 x 1	5011274290535			
RU509TWGY	12V	1.2W	BX8.4D				Grey base	5 x 1	5011274290559			
RU512PCB	12V	2CP	P.C.B 10mm Tall Twistlock					5 x 1	5011274151218			
RU512TR	12V	2CP	B12.3d 10mm Twistlock					5 x 1	5011274151225			
RU512WB	12V	2W	Kw2.1x9.5D				White base	5 x 1	5011274151232			
RU566	12V	21/4W	P21/4W	BAZ15d OSP	E			10 x 1	5011274156619	RW566	10 x 1	5011274156626
RU580	12V	21/5W	W21/5W	W3x16q	E			10 x 1	5011274158064	RW580	10 x 1	5055175202525
RU581	12V	21W	PY21W	BAU15s OSP	E		Amber	10 x 1	5011274158118	RW581	10 x 1	5011274158132
RU582	12V	21W	W21W	W3.16d	E			10 x 1	5011274158262			
RU585	12V	21W	WY21W	W3.16d	E		Amber	10 x 1	5011274158514	RW585	10 x 1	5011274158521
RU64122	12V	3W		B10D			Brown base	5 x 1	5011274164126			
RU64124	12V	5W		B10D			Black base	5 x 1	5011274164133			
RU643	12V	2.2W		BA9s MCC				10 x 1	5011274164317			
RU780	12V	21/5W	PR21/5W	BAW15d	E		Red	5 x 1	5055175220581			
RU782	12V	21W	PR21W	BAW15s	E		Red	5 x 1	5055175220598			
RU955	12V	16W	W16W	W2.1x9.5d T15	E			10 x 1	5011274195526			
RU987	12V	2.2W		E10/13 MES				10 x 1	5011274198718	RW987	10 x 1	5011274198725
RU989	12V	5W		BA9s MCC				10 x 1	5011274198916	RW989	10 x 1	5011274198923

12V International Single Clamshell Pack Headlamps













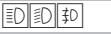

12V Twin Packs

Ref	Volts	Watts	ECE	Cap	E approved	Application	Colour/Type	Pack Qty	Barcode	Ref	Pack Qty	Barcode
REU448	12V	55W	H1	P14.5s	Ⓔ			1 x 10	5055175200699			
REU448LL	12V	55W	H1	P14.5s	Ⓔ		Long Life	1 x 10	5055175227023			
REU453	12V	55W	H3	PK22s	Ⓔ			1 x 10	5055175200804			
REU472	12V	60/55WH4		P43t	Ⓔ			1 x 10	5055175200668	REW4721 x 10	5055175227764	
REU472LL	12V	60/55WH4		P43t	Ⓔ		Long Life	1 x 10	5055175226552			
REU477	12V	55W	H7	PX26d	Ⓔ			1 x 10	5055175200675	REW4771 x 10	5055175227771	
REU477LL	12V	55W	H7	PX26d	Ⓔ		Long Life	1 x 10	5055175226569			
REU9005	12V	60W	HB3	P20d	Ⓔ			1 x 10	5055175226538			
REU9006	12V	51W	HB4	P22d	Ⓔ			1 x 10	5055175226545			

12V International Double Clamshell Pack Exterior/Interior

Ref	Volts	Watts	ECE	Cap	E approved	Application	Colour	Pack Qty	Barcode
REW207S	12V	5W	R5W	BA15s SCC	Ⓔ			1 x 10	5055175200682
REW209	12V	5W	R5W	BA15d SBC	Ⓔ			1 x 10	5055175200866
REW233	12V	4W	T4W	BA9s MCC	Ⓔ			1 x 10	5055175200743
REW239	12V	5W	C5W	S8.5d 11x38mm	Ⓔ			1 x 10	5055175200729
REW245S	12V	10W	R10W	BA15s SCC	Ⓔ			1 x 10	5055175200712
REW264	12V	10W		S8.5d 11x44mm				1 x 10	5055175200781
REW269	12V	10W		S8.5d 11x30mm				1 x 10	5055175200774
REW272	12V	10W		S8.5d 11x38mm				1 x 10	5055175200811
REW286	12V	1.2W		W2x4.6d				1 x 10	5055175200736
REW297	12V	2.2W		W2.1x9.5d				1 x 10	5055175200798
REW335	12V	21W	P21W	BA15d SBC	Ⓔ			1 x 10	5055175200828
REW343	12V	21W		BA15s SCC			Amber	1 x 10	5055175200873
REW380	12V	21/5W	P21/5W	BAY15d OSP	Ⓔ			1 x 10	5055175200644
REW382	12V	21W	P21W	BA15s SCC	Ⓔ			1 x 10	5055175200637
REW501	12V	5W	W5W	W2.1x9.5d	Ⓔ			1 x 10	5055175200651
REW501A	12V	5W	W5W	W2.1x9.5d	Ⓔ		Amber	1 x 10	5055175200859
REW504	12V	3W	W3W	W2.1x9.5d	Ⓔ			1 x 10	5055175200842
REW509T	12V	1.2W		B8.5D			Black base	1 x 10	5055175200767
REW566	12V	21/4W	P21/4W	BAZ15d OSP	Ⓔ			1 x 10	5055175200750
REW580	12V	21/5W	W21/5W	W3x16q	Ⓔ			1 x 10	5055175200835
REW581	12V	21W	PY21W	BAU15s OSP	Ⓔ		Amber	1 x 10	5055175200705

24V Blister Packs

Reference	Volts	Watts	ECE	Cap	E Approved	Application	Barcode
RW149	24V	5W	R5W	BA15s SCC	Ⓔ		5011274114946
RW150	24V	5W	R5W	BA15d SBC	Ⓔ		5011274115012
RW241	24V	21W	P21W	BA15s SCC	Ⓔ		5011274124113
RW242	24V	5W	C5W	S8.5d 11 X 38	Ⓔ		5011274124212
RW246	24V	10W	R10W	BA15s SCC	Ⓔ		5055175230078
RW249	24V	4W	T4W	BA9s MCC	Ⓔ		5011274124915
RW346	24V	21W	P21W	BA15d SBC	Ⓔ		5011274134617
RU466	24V	70W	H1	P14.5s	Ⓔ		5055175230108
RU474	24V	70W	H7	PX26d	Ⓔ		5055175230061
RU475	24V	75/70W	H4	P43t	Ⓔ		5011274323073
RW505	24V	3W	W3W	W2.1x9.5d Capless	Ⓔ		5055175230085
RW507	24V	5W	W5W	W2.1x9.5d Capless	Ⓔ		5055175230092
RW508	24V	1.2W		W2x4.6d			5011274150815
RW508T	24V	1.2W		B8.5d (Black base)			5011274150822
RW588	24V	21W	PY21W	BAU15s (Amber)	Ⓔ		5055175230115

Vehicle Lighting

Essentials Range A30



Essentials Range

A range of fast moving bulbs and consumables for forecourts

- Bulbs are one of the highest profit makers in the auto aftermarket
- Essential distress purchase and expected to be stocked in a forecourt
- Bulbs in a tamper proof packaging to prevent pilfering
- Planogram service available



50 cm wide x 56cm high

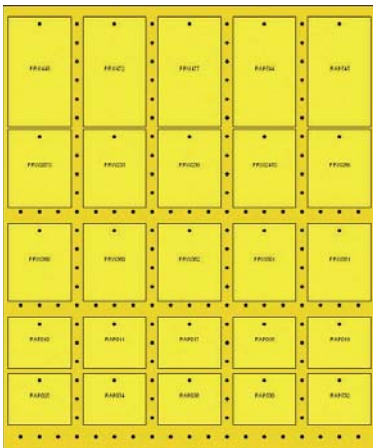

A = 8.5cm x 7cm



B = 8.5cm x 10.5cm



C = 8.5cm x 14.7cm

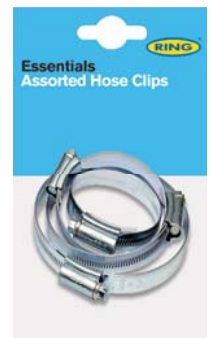

D = 8.5cm x 14.7cm

Essentials Bulbs

Reference	Volts	Watts	ECE	Cap	E Approved	Applications	Pack size	Pack Qty	Barcode
FRU448	12V	55W	H1	P14.5s	ⓔ		C	10	5055175210438
FRU472	12V	60/55W	H4	P43t	ⓔ		C	10	5055175210414
FRU477	12V	55W	H7	PX26d	ⓔ		C	10	5055175210421
FRW207	12V	5W	R5W	BA15s SCC	ⓔ		B	10	5055175210476
FRW233	12V	4W	T4W	BA9s MCC	ⓔ		B	10	5055175210520
FRW239	12V	5W	C5W	S8.5d 11x38mm	ⓔ		B	10	5055175210506
FRW245	12V	10W	R10W	BA15s SCC	ⓔ		B	10	5055175210490
FRW286	12V	1.2W		W2x4.6d			B	10	5055175210513
FRW380	12V	21/5W	P21/5W	BAY15d OSP	ⓔ		B	10	5055175210452
FRW382	12V	21W	P21W	BA15s SCC	ⓔ		B	10	5055175210445
FRW501	12V	5W	W5W	W2.1x9.5d	ⓔ		B	10	5055175210469
FRW581	12V	21W	PY21W	BAU15s OSP	ⓔ		B	10	5055175210483

FRW= Twin Blister Pack

FRU= Single Blister Pack

Essentials Consumables

A range of fast moving automotive consumables including fuses, tape and connectors

Reference	Description	Pack size	Pack Qty	Barcode
RAP010	Assorted Blade Fuses 15, 20, 25, 30 Amp	A	10	5011274901011
RAP011	Assorted Blade Fuses 3, 5, 7.5, 10 Amp	A	10	5011274901110
RAP017	Assorted Mini Blade Fuses 2, 4, 5, 7.5 Amp	A	10	5011274901714
RAP018	Assorted Mini Blade Fuses 10, 15, 20, 25 Amp	A	10	5055175210537
RAP019	Cable Connectors	A	10	5055175210544
RAP025	Assorted Ceramic Fuses, 5, 8, 16, 25 Amp	A	10	5011274902513
RAP034	Assorted Glass Fuses 10, 15, 25, 35 Amp	A	10	5011274903411
RAP038	Assorted Mains 240V Fuses, 3, 5, 13 Amp	A	10	5011274903817
RAP530	Mirror Fixing Pads	A	10	5011274953010
RAP532	Plastic Valve Caps	A	10	5011274953218
RAP544	Assorted Hose Clips	D	10	5011274954413
RAP545	PVC Insulation Tape	D	10	5011274954512

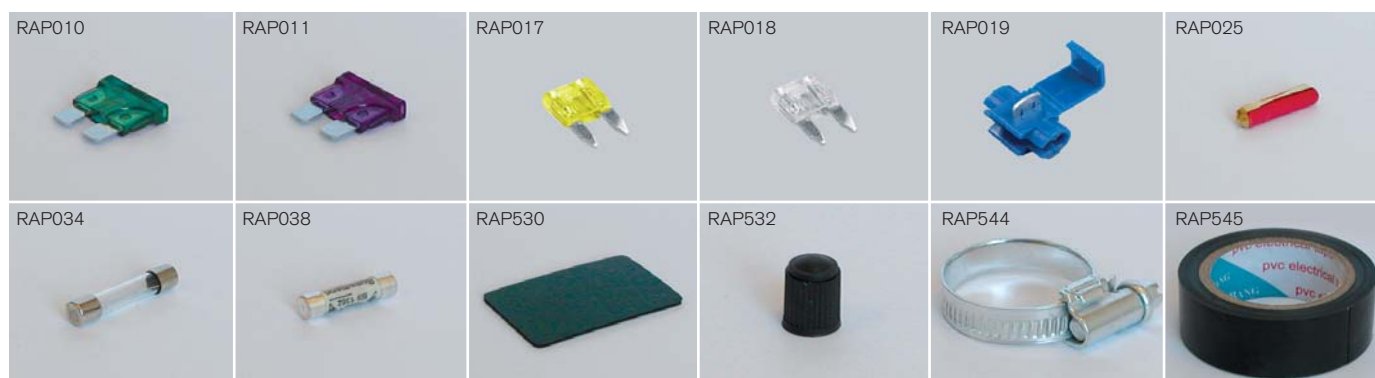

Vehicle Lighting

Bulb Kits A32



12V Auto Bulb Kits

- A compact stylish kit that fits into the glove compartment
 - All bulbs are E approved as required
 - Mandatory in many European countries
 - Range covers all popular vehicle types
 - All bulbs can be replaced
 - Contains bulbs for headlamps and exterior lighting
 - UV cut headlamp bulbs suitable for plastic headlamps
- Don't leave home without one!



Universal Multi Headlamp 12V Auto Bulb Kit

- Suitable for vehicles fitted with H4, H1 or H7 headlamp bulbs
- 3 headlamp bulbs
- 12 additional bulbs
- 4 blade fuses
- Transferable from vehicle to vehicle



BU027

Mini 12V Auto Bulb Kit

- Compact kit for easy storage
- Contains major bulbs for exterior lighting plus fuses
- Universal kit contains 3 headlamps



Universal Standard 12V Auto Bulb Kits

Ref	Suitable For Vehicles Fitted With:	Headlamp Bulbs	Additional Bulbs	Fuses	Barcode
BU007	H4 (R472) Headlamp Bulbs	1	9	3	5011274000745
BU008	H1 (R448) Headlamp Bulbs	1	9	3	5011274000806
BU077	H7 (R477) Headlamp Bulbs	1	9	3	5011274007706
BU031	HB3 (R9005) Headlamp Bulbs	1	10	3	5011274031114
BU041	HB4 (R9006) Headlamp Bulbs	1	10	3	5011274041113
BU042	HB3 (R9005) & HB4 (R9006) Headlamp Bulbs	2	10	3	5011274042226
BU072	H4 (R472) Headlamp Bulbs plus wedge base bulbs for Japanese vehicles	1	10	3	5011274072223
BU073	H7 (R477) Headlamp Bulbs plus wedge base bulbs for Japanese vehicles	1	10	3	5011274073336
BU078	H7 (R477) & H1 (R448) Headlamp Bulbs	2	10	3	5011274078881
BU079	H7 (R477) & HB3 (R9005) Headlamp Bulbs	2	10	3	5011274079994
BU080	H7 (R477) & H11 (R711) Headlamp Bulbs	2	6	2	5055175234861
BU087	H4 (R472) & H1 (R448) Headlamp Bulbs	2	10	3	5011274087777

Mini 12V Auto Bulb Kit

BU050	H4 (472) Headlamp Bulb	1	5	2	5055175219042
BU051	H1 (448) Headlamp Bulb	1	5	2	5055175219059
BU052	H7 (477) Headlamp Bulb	1	5	2	5055175219066
BU053	H7/H1 (477/448)	2	5	2	5055175219073
BU054	H7, H4, H1 (477/472/448) Headlamp Bulb		3	5	3 5055175219080

Universal Multi Headlamp 12V Auto Bulb Kit

BU027	H4 (R472) & H1 (R448) & H7 (R477) Headlamp Bulbs	3	12	4	5055175215631
-------	--	---	----	---	---------------

Vehicle Lighting

Value Packs A34



Value Packs

Great Value Promotional Line

- Includes free headlamp
- Ideal promotional tool to trade up
- Increases profitability



Reference	Description	Case Qty	Barcode
RVP477	H7 Value Pack	10x1	5055175226637

Contents

Reference	Volts	Watts	ECE	Cap	E Approved	Application	Qty
R477	12	55	H7	PX26d	ⓔ	ⓔ ⓔ ⓔ ⓔ	2
R380	12	21/5	P21/5W	BAY15d OSP	ⓔ	ⓔ ⓔ	1
R382	12	21	P21W	BA15s SCC	ⓔ	ⓔ ⓔ ⓔ ⓔ	1
R245	12	10	R10W	BA15s SCC	ⓔ	ⓔ ⓔ ⓔ ⓔ	1
R501	12	5	W5W	W2.1x9.5d	ⓔ	ⓔ ⓔ ⓔ ⓔ	1
10 amp blade fuse							1

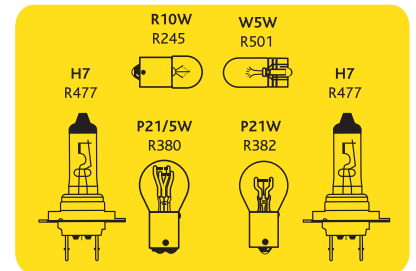

Reference	Description	Case Qty	Barcode
RVP472	H4 Value Pack	10x1	5055175226644

Contents

Reference	Volts	Watts	ECE	Cap	E Approved	Application	Qty
R472	12	60/55	H4	P43t	ⓔ	ⓔ ⓔ ⓔ ⓔ	2
R380	12	21/5	P21/5W	BAY15d OSP	ⓔ	ⓔ ⓔ	1
R382	12	21	P21W	BA15s SCC	ⓔ	ⓔ ⓔ ⓔ ⓔ	1
R245	12	10	R10W	BA15s SCC	ⓔ	ⓔ ⓔ ⓔ ⓔ	1
R501	12	5	W5W	W2.1x9.5d	ⓔ	ⓔ ⓔ ⓔ ⓔ	1
10 amp blade fuse							1

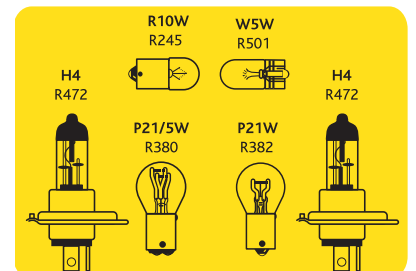

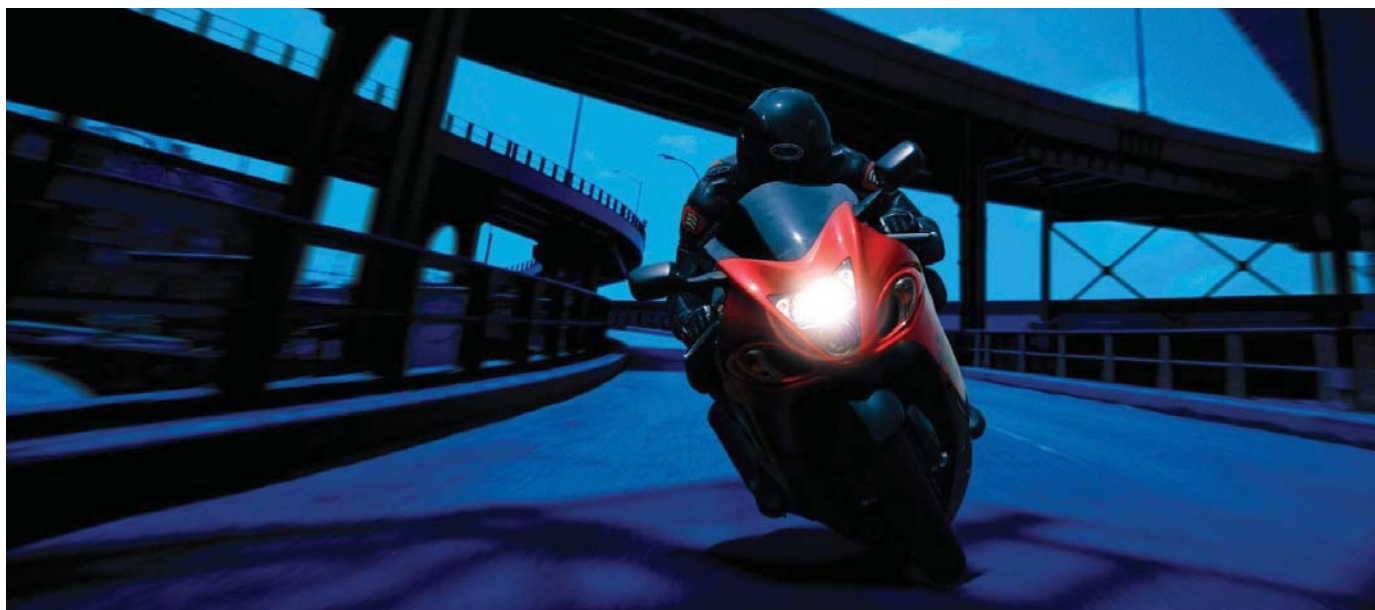

Biker Bulbs

For over 40 years Ring has been pushing the boundaries of motorcycle lighting. We were the first company to produce a halogen bulb that put up to 100% more light on the road XenonMax. Today it is Xenon150 that sets the standard. For a motorcyclist, being seen is equally important as seeing. We have designed a full range of lighting solutions to provide the safety your customer needs as well as the styling they are looking for.



Performance Halogens

Ref	Volts	Watts	ECE	Cap	E approved	Application	Kelvin	Upgrades	Barcode
RMU412	12V	20W	-	P26S	-		-	R412	5055175213132
RMU417	12V	35/35W	-	BA20D	-		-	R417	5055175213149

Xenon150

Ref	Volts	Watts	ECE	Cap	E approved	Application	Kelvin	Upgrades	Barcode
RMU1572	12V	60/55W	H4	P43t	ⓔ		3700K	R472	5055175243641
RMU1577	12V	55W	H7	PX26d	ⓔ		3700K	R477	5055175243658

XenonMax

Ref	Volts	Watts	ECE	Cap	E approved	Application	Kelvin	Upgrades	Barcode
RU1048	12V	55W	H1	P14.5s	ⓔ		-	R448	5055175214924
RU1072	12V	60/55W	H4	P43t	ⓔ		-	R472	5055175214368
RU1077	12V	55W	H7	PX26d	ⓔ		-	R610	5055175214375

UltraXenon

Ref	Volts	Watts	ECE	Cap	E approved	Application	Kelvin	Upgrades	Barcode
RU948	12V	55W	H1	P14.5s	ⓔ		-	R448	5011274194819
RU972	12V	60/55W	H4	P43t	ⓔ		-	R472	5011274197216
RU977	12V	55W	H7	PX26d	ⓔ		-	R477	5011274197711
RU9905	12V	60W	HB3	P20d	ⓔ		-	R9005	5055175200606
RU9906	12V	51W	HB4	P22d	ⓔ		-	R9006	5055175200613

Vehicle Lighting

Boxed

Ref	Volts	Watts	ECE	Cap	E approved	Application	Barcode	Ref	Barcode
RMU3625	6V	25/25W	-	Px15D	-		5055175211572	R3625	5055175213118
RMU392	6V	25/25W	S1	BA20D	E		5055175211596	R392	5011274053925
RMU393	6V	35/35W	S2	BA20D	E		5055175211602	R393	5011274039332
RMU3603	12V	25/25W	-	Px15D	-		5055175211565	R3603	5055175213101
RMU394	12V	25/25W	S1	BA20D	E		5055175211619	R394	5055175213125
RMU395	12V	35/35W	S2	BA20D	E		5055175211626	R395	5011274039592
RMU418	12V	23W	-	BA9s Amber	-		5055175213583	R418	5055175212555
RMU448	12V	55W	H1	P14.5s	E		5055175211725	R448EQ	5011274041824
RMU459	12V	35/35W	HS1	PX43t	E		5055175211657	R459	5055175210902
RMU472	12V	60/55W	H4	P43t	E		5055175211732	R472	5011274047207
RMU477	12V	55W	H7	PX26d	E		5055175211671	R610	5055175213217
RMU610	12V	15W	S3	P26S	E		5055175211671	R610	5055175213217
RMU613	12V	20W	-	P26S	-		5055175211688	R613	5055175213156
RMU711	12V	55W	H11	PGJ19-2	E		5055175213590	R711	5011274071165
RMU7027	12V	35/35W	-	P15D-3	-		5055175211695	R7027	5055175213163
RMU7028	12V	45/40W	-	P15D-3	-		5055175211701	R7028	5055175213170
RMW207S	12V	5W	R5W	BA15s	E		5055175211794	207S	5011274021764
RMW233	12V	4W	T4W	BA9s	E		5055175211800	R233	5011274023362
RMW239	12V	5W	C5W	S8.5d	E		5055175211817	R239	5011274023966
RMW245S	12V	10W	R10W	BA15s	E		5055175211824	R245S	5011274024574
RMW380	12V	21/5W	P21/5W	BAY15d	E		5055175211831	R380	5011274038007
RMW382	12V	21W	P21W	BA15s	E		5055175211848	R382	5011274038205
RMW501	12V	5W	W5W	W2.1x9.5d	E		5055175211855	R501	5011274405160
RMW581	12V	21W	PY21W	BAU15s	E		5055175211862	R581	5011274058166
RMU293	6V	4W	T4W	BA9s	E		5055175211558	R293	5011274029363
RMU384	6V	21/5W	P21/5W	BAY15d	E		5055175211589	R384	5011274038465
RMU286	12V	1.2W	-	Capless W2x4.6d	-		5055175211718	R286	5011274028671
RMU504	12V	3W	W3W	Capless W2.1x9.5d	E		5055175211756	R504	5011274050467
RMU589	12V	10W	RY10W	BA15s	E		5055175211664	R589	5055175213200



12V and 24V Bulbs

With a range of over 650 references, Ring offers a one stop shop for autobulbs, from the fastest selling retail headlamp bulbs to specialist bulbs for the Engineering specifier in the commercial vehicle and construction equipment markets

Designed and manufactured to OE standards and E approved, where required, to ECE regulation 37 or 99, every bulb in the range is quality assured through our Quality Assurance department. You can rest assured that all the bulbs have been developed, tested and approved by our engineers.

Innovation is key to our bulb range, developing the latest technology performance bulbs for our customers. Ring are at the forefront of developing OE bulbs and making them available to the aftermarket as soon as a new vehicle application enters the market, ensuring that our customers can offer the same bulbs as the vehicle manufacturers.

Available in boxed packs for trade or in blister packs for self selection retail sale.

Full details can be found in the Ring Technical bulb guide.



Vehicle Lighting

24V TruckMaster Bulbs A38



24V TruckMaster Bulbs

Fleet managers and drivers require a source of lighting they can depend on to deliver long life and durability.

Ring's OEM TruckMaster Heavy Duty Long Life (HDLL) 24v bulbs have been specifically designed to withstand excessive vibrations which vehicles are subjected to. Long life is achieved through a combination of filament technology and the gas mixture inserted within the glass envelope to a high pressure.

This improved performance provides substantial cost savings against vehicle downtime and maintenance costs. Overall running costs are improved by simply fitting Ring Automotive TruckMaster HDLL bulbs.

LIFE VS. COST

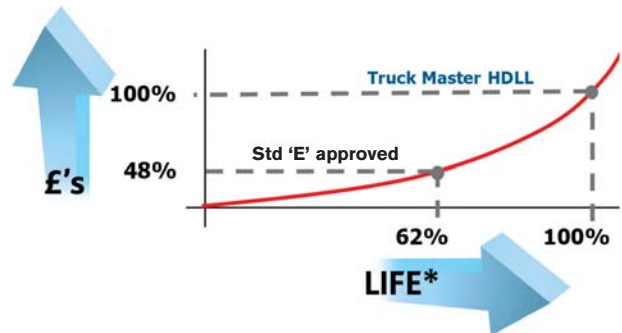

- Analysing the performance using life v's cost highlights the importance of specifying the correct bulb
- The correct bulb can save a vehicle downtime & costly servicing

* Based on static life test results
Graph to be used as a guide only
Bulb life may vary dependent on environmental factors

MAIN BENEFITS:

- Heavy Duty – Increased resistance to excessive vibration reducing maintenance downtime
- Long Life – Allows for higher mileage before regular replacement is required.
- Compliance with legal requirements – Reduced rates of bulb failure, improves driver's Operator Compliance Risk Score.

TECHNOLOGY:

- Reinforced filament providing extra strength and robustness against vibrations.
- Manufactured in Europe to OE (Original Equipment) specification and subjected to further vibration testing and conforms to IEC60810 European Vibration Standard.

OE Bulbs – Heavy Duty Long Life

The fleets choice where enduring performance is required for high mileage vehicles. Manufactured to OEM standards and E approved.

Suitable for commercial vehicles and construction equipment.

Available in heavy duty long life where extended life and vibration resistance is required to keep a vehicle on the road for even longer.



Part Number	Description	Watts
RTM149HDLL	24V 5W SCC BA15s Side & Tail	5W
RTM150HDLL	24V 5W SBC BA15d Side & Tail	5W
RTM241HDLL	24V 21W SCC BA15s Brake/Indicator/Reverse/Rear Fog	21W
RTM246HDLL	24V 10W SCC BA15s Side & Tail	10W
RTM249HDLL	24V 4W MCC BA9s Side & Tail	4W
RTM346HDLL	24V 21W SBC BA15d Brake/Indicator/Reverse/Rear Fog	21W

Part Number	Description	Watts
RTM588HDLL	24V 21W P21W BAU15s Indicator (Amber)	21W
RTM460HDLL	24V 70W H3 PK22s Halogen Headlamp	70W
RTM466HDLL	24V 70W H1 P14.5s Halogen Headlamp	70W
RTM474HDLL	24V 70W H7 PX26d Halogen Headlamp	70W
RTM475HDLL	24V 75/70W H4 P43t Halogen Headlamp	75/70W
RTM711HDLL	24V 70W H11 PGJ19-2 Halogen Headlamp	70W

OE Bulbs - Standard

Part Number	Description	Watts
RTM149	24V 5W SCC BA15s Side & Tail	5W
RTM150	24V 5W SBC BA15d Side & Tail	5W
RTM241	24V 21W SCC BA15s Brake/Indicator/Reverse/Rear Fog	21W
RTM242	24V 5W S8.5d 11 X 38 Festoon	5W
RTM246	24V 10W SCC BA15s Side & Tail	10W
RTM249	24V 4W MCC BA9s Side & Tail	4W
RTM274	24V 10W Festoon S8. 5d 11 X 41	10W
RTM283	24V 3W Peanut BA7s Indicator & Panel	3W
RTM289	24V 2W MCC BA9s Indicator & Panel	2W
RTM294	24V 21/5W OSP BAY15d Brake & Tail	21/5W
RTM346	24V 21W SBC BA15d Brake/Indicator/Reverse/Rear Fog	21W
RTM505	24V 3W Capless W2.1X9.5d Indicator & Panel	3W

Part Number	Description	Watts
RTM507	24V 5W Capless W2.1X9.5d Indicator & Panel	5W
RTM508	24V 5W Capless W2.1X9.5d Indicator & Panel	5W
RTM508T	24V 1.2W B8.5D (Black Base) Tachograph Panel Bulb	1.2W
RTM588	24V 21W P21W Bau15s Indicator Bulb (Amber)	21W
RTM865	24V 2.8W MCC BA9s Indicator & Panel	2.8W
RTM460	24V 70W H3 PK22s Halogen Headlamp	70W
RTM466	24V 70W H1 P14.5s Halogen Headlamp	70W
RTM474	24V 70W H7 PX26d Halogen Headlamp	70W
RTM475	24V 75/70W H4 P43t Halogen Headlamp	75/70W
RTM711	24V 70W H11 PGJ19-2 Halogen Headlamp	70W

Vehicle Lighting



Panel Bulb Kits

- Full colour selector guide
- All popular references
- Durable, resealable compartment box
- Product locator for easy and accurate replenishment
- Available in:
 - RPB121 12V Standard
 - RPB122 12V Special
 - RPB243 24V Standard



Contents

RPB121		12V Standard Panel Bulb Kit		RPB122		12V Special Panel Bulb Kit		RPB243		24V Standard Panel Bulb Kit	
Ref	Qty	Ref	Qty	Ref	Qty	Ref	Qty	Ref	Qty	Ref	Qty
R509TMOR	2	R509TMBK	3	R509TMGY	3	R509TVI	3	R508TMRE	2	R508TMGR	2
R509TMBE	2	R509TMGR	2	R509TBL	3	R509TBE	3	R508TBR	4	R508T	10
R509TML	3	R509TOR	2	R86021001	3	R86021002	3	R508TBGY	4	R1471	10
R509T	10	R509TGR	3	R509TLBK	2	R509TKBK	2	R1791	10	R6929	2
R509TBBK	2	R509TBWH	2	R509TPBK	3	R509TWBR	3	R508TWBR	2	R508TCWH	2
R509TWGR	2	R509TWGY	2	R64124	2	R64122	2	R508CTCR	2	R508A	2
R509TDBK	2	R509TEBK	2	R509TCTR	3	R509TCGY	3	R508B	2	R508G	2
R509THGY	3	R286	10	R509TCGY/1.8	2	R509TCGYFR	2	R508R	2	R508TUWH	2
R286A	3	R286B	3	R509TCWH	3	R509TFBK/12	3	R508TVWH	2	R86021003	2
R286G	5	R286R	3	R509TFBK/14	2	R509TFGY	3	R86028166	2	R8328	2
R501A	5			R512TR	2	R512PC	1	R86024918	2		
				R509TQWH	2	R509TYBK	3				
				R512WB	2	R509TSBK	2				
				R88005996	2	R509TJBR	2				

Bulb Connectors

- Direct replacement
- Suitable for bulb upgrade higher wattage bulbs

Ceramic Bulb Holders



Part No RBH001
Bulb Fitment H1/H3
 P14.5s/PK22s
Cable Rating 8.2A
Cable Length 130mm
 Straight cable exit



Part No RBH002
Bulb Fitment H1/H3
 P14.5s/PK22s
Cable Rating 8.2A
Cable Length 130mm
 Angled cable exit

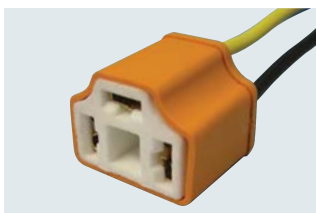

Part No RBH003
Bulb Fitment H4
 P43t/P45t
Cable Rating 8.2A
Cable Length 130mm
 Straight cable exit



Part No RBH004
Bulb Fitment H4
 P43t/P45t
Cable Rating 8.2A
Cable Length 130mm
 Angled cable exit

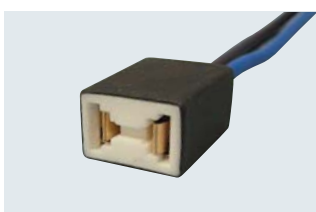

Part No RBH005
Bulb Fitment H7
 PX26d
Cable Rating 8.2A
Cable Length 130mm
 Straight cable exit

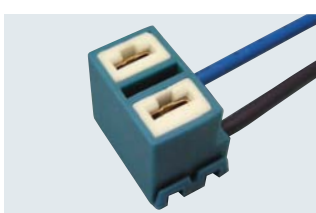

Part No RBH006
Bulb Fitment H7
 PX26d
Cable Rating 8.2A
Cable Length 130mm
 Angled cable exit



Part No RBH007
Bulb Fitment H11
 PGJ19-2
Cable Rating 8.2A
Cable Length 130mm
 Straight cable exit



Part No RBH008
Bulb Fitment 9004 /9007
 P29t/Px29t
Cable Rating 8.2A
Cable Length 130mm
 Straight cable exit



Part No RBH009
Bulb Fitment 9005
 P20d
Cable Rating 8.2A
Cable Length 130mm
 Straight cable exit



Part No RBH010
Bulb Fitment 9006
 P22d
Cable Rating 8.2A
Cable Length 130mm
 Straight cable exit

Standard Bulb Holders



Part No RBH011
Bulb Fitment BA15D
Cable Rating 8.2A
Cable Length 130mm
 Straight cable exit



Part No RBH012
Bulb Fitment BA15S
Cable Rating 8.2A
Cable Length 130mm
 Straight cable exit



Part No RBH013
Bulb Fitment BA9S
Cable Rating 8.2A
Cable Length 130mm
 Straight cable exit



Part No RBH014
Bulb Fitment BAY15D
Cable Rating 8.2A
Cable Length 130mm
 Straight cable exit

Vehicle Lighting

Single Boxed Stands

Ring provides your customers with a range of solutions to having Autobulbs at the point of installation. Carrying the fast moving references in a choice of either single or 10 way boxes, these wall mounted stands safely contain the stock in the workshop right next to the job in hand.



BU180

Stand Complete with Stock

Ref	Qty	Ref	Qty	Ref	Qty
RB380	10	RB239	13	RB207S	13
RB269	13	RB382	10	RB233	13
RB209	13	RB286	13	RB581	10
RB501	13	RB245S	13	RB501A	13
R472	6	R453	10	R477	7
R448EQ	10				
Total:	180				

BU280

Stand Complete with Stock

Ref	Qty	Ref	Qty	Ref	Qty
RB149	13	RB505	13	RB150	13
RB507	13	RB241	10	RB508	13
RB242	13	RB508T	13	RB246	13
R460	10	RB249	13	R466	10
RB294	10	R474	7	RB346	10
R475	6				
Total:	180				

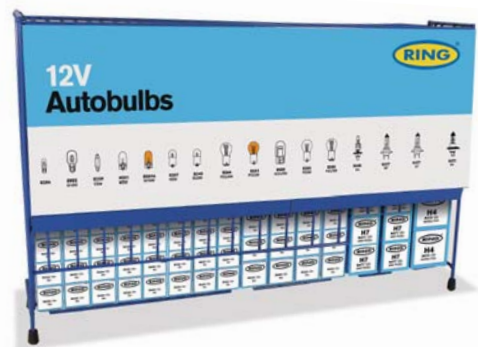

BU194

Stand Complete with Stock

Ref	Qty	Ref	Qty	Ref	Qty
R472	6	RB585	4	RB233	5
R477	16	R434	4	RB245S	5
R448	11	RB335	4	RB504	5
RB380	11	RB343	4	RB501A	5
RB382	11	R435	4	RB501	14
RB581	11	RB272	5	RB239	14
RB566	4	RB955	5	RB207S	14
RB580	4	RB269	5	RB286	14
RB582	4	RB264	5	Total:	194

BU126

Stand Complete with Stock

Ref	Qty	Ref	Qty	Ref	Qty
R448	5	R472	5	R477	6
RB380	10	RB382	10	RB581	10
RB245S	10	RB207S	10	RB209	10
RB501	10	RB501A	10	RB233	10
RB239	10	RB286	10		
Total:	126				

Marketing Support

For mechanics, knowledge equals confidence.

Therefore we set out to provide as much technical support as a mechanic will require. Our comprehensive bulb literature is constantly updated to ensure mechanics have access to the latest information. We provide work outs and training events to ensure mechanics maximise their sales of bulbs.



Marketing Support A43

Vehicle Lighting

Vehicle Lighting A44



ACCESSORY LIGHTING

Daytime Running Lamps	D2
Daytime Styling Lamps	D3
Styling Lamps	D5
Classic Lighting	D6
4x4 & Off-road Lamps	D8
Brake & Number Plate Lights	D9
Rear Fog & Reversing Lamps	D10

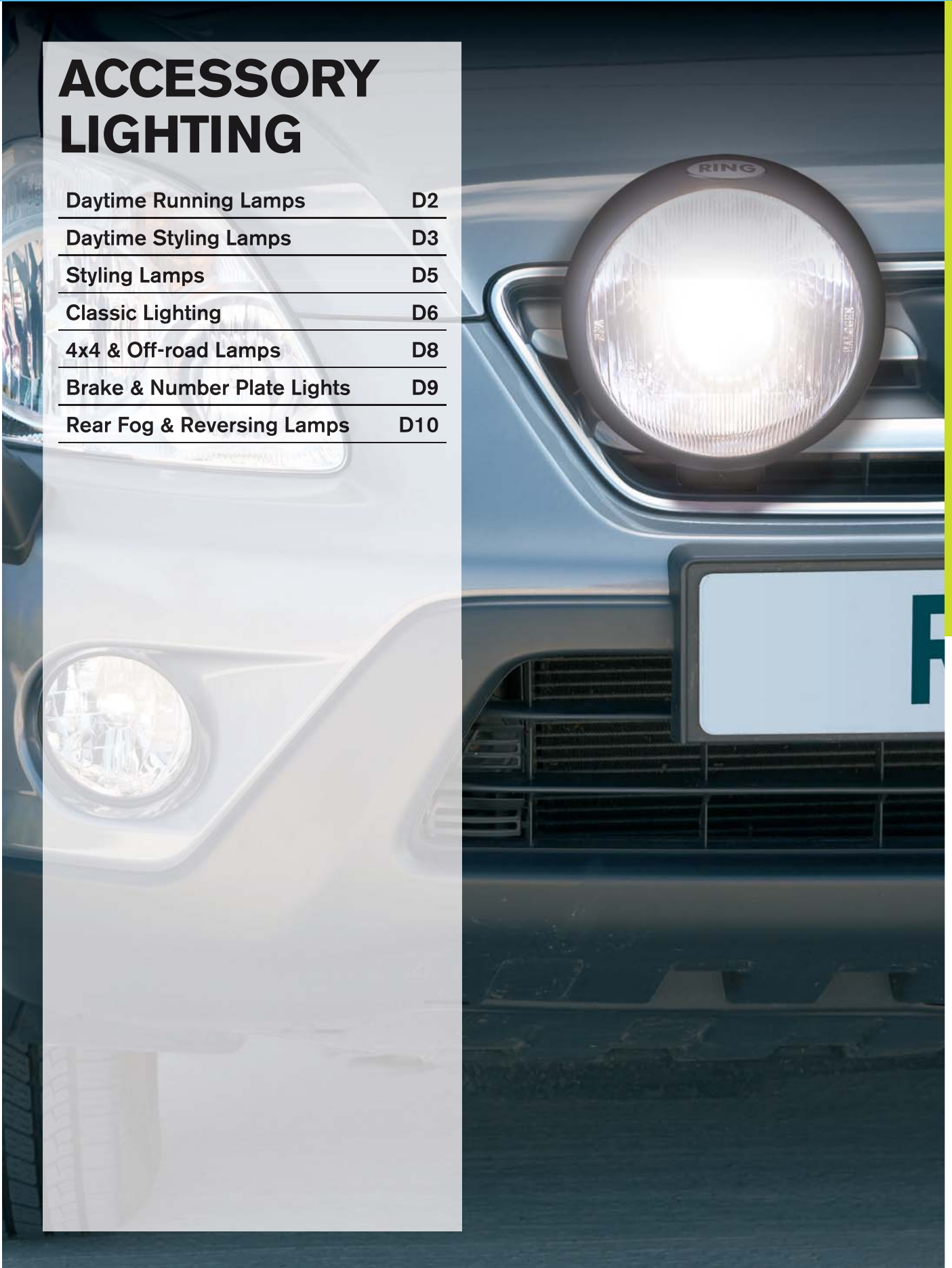

Lighting

Aurora 150mm LED Daytime Running Lamps

12/24V
Voltage

- Fitted with 5 x 1.5w ultra bright LEDs
- Provides a narrow, intense beam of light
- Complete with automatic switching unit so lights illuminate when the engine is switched on but will extinguish when the vehicle sidelights are turned on
- Includes fixing brackets
- Fitting instructions included
- Lamps are E marked to ECE R87



Product Code	Description	Case Quantity	Fitting Kit	Housing/ Body	Reflector	Lens	Replacement Bulb	Pack Dimensions	Barcode
BRL0397	Aurora LED DRL	5	✓	Aluminium	ABS	Acrylic	5 x non-replaceable LED	W168 x H205 x D94mm	5055175214962

Lyra Dual Function LED Day/Night Lamps

12/24V
Voltage

- Dual function includes daytime running and night-time styling function providing 24 hour operation
- Lights will illuminate when engine is started to comply with legislation via a built in automatic lights-on kit
- 18 Ice white LEDs in each unit for maximum light output
- E marked to ECE Reg 87 and ECE Reg 7 complies with DRL & DSL legislation – road legal
- Fitting instructions included

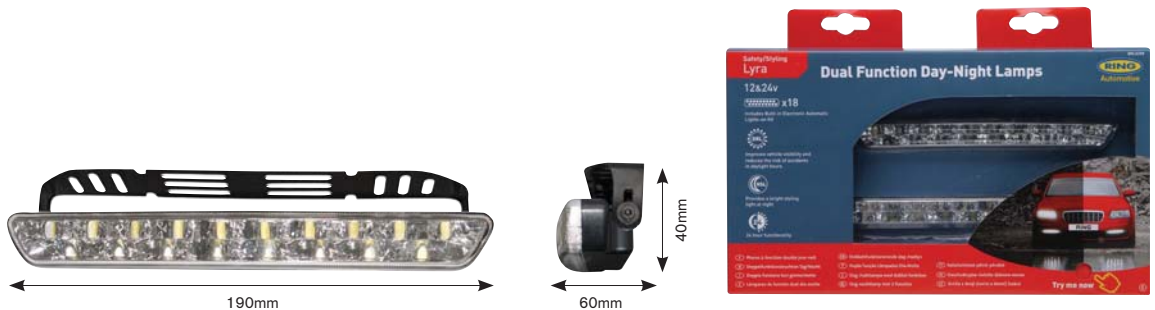

Product Code	Description	Case Quantity	Fitting Kit	Housing/ Body	Reflector	Lens	Replacement Bulb	Pack Dimensions	Barcode
BRL0398	Lyra Dual Function LED Day/Night Lamp	10	✓	ABS	ABS	PMMA	18 x non-replaceable LED	W307 x H215 x D67mm	5055175216546 (UK) 5055175217598 (Euro)

Cruise-lite Diamond Ice LED Daytime Styling Lamps

- Improves vehicle visibility and reduces the risk of accidents in daylight hours
- Fitted with 11 x ice white LEDs
- Provides a bright, narrow beam of light
- Includes fixing brackets
- Fitting instructions included
- Lamps are E marked to ECE R7
- 12V only
- Includes self-adhesive strip for fast fixing

12V

Voltage

Daytime Styling Lamps D3



Product Code	Description	Case Quantity	Fitting Kit	Housing/ Body	Reflector	Lens	Replacement Bulb	Pack Dimensions	Barcode
BRL0395	Cruise-lite Diamond Ice LED Daytime Styling Lamps	10	x	ABS	ABS	Acrylic	11 x non-replaceable LED	W140 x H170 x D60mm	5055175214955

Cruise-lite Ice LED Daytime Styling Lamps

- Improves vehicle visibility and reduces the risk of accidents in daylight hours
- Fitted with 8 x ice white LEDs
- Provides a bright, narrow beam of light
- Includes fixing brackets and self-adhesive strip
- Fitting instructions included
- E marked to ECE R7
- 12V only

12V

Voltage



Product Code	Description	Case Quantity	Fitting Kit	Housing/ Body	Reflector	Lens	Replacement Bulb	Pack Dimensions	Barcode
BRL0379	Cruise-lite Ice LED Daytime Styling Lamps	10	x	ABS	ABS	Acrylic	8 x non-replaceable LED	W140 x H170 x D60mm	5011274037918

Lighting

Ultra Slim Cruise-lite Ice LED Daytime Styling Lamps

12V
Voltage

- Daytime styling lamp
- Fitted with 6 x ice white LEDs per lamp
- Slimline – will fit in most locations
- Self adhesive mounting reduces fitting time
- E marked to ECE Reg 7
- 12V only

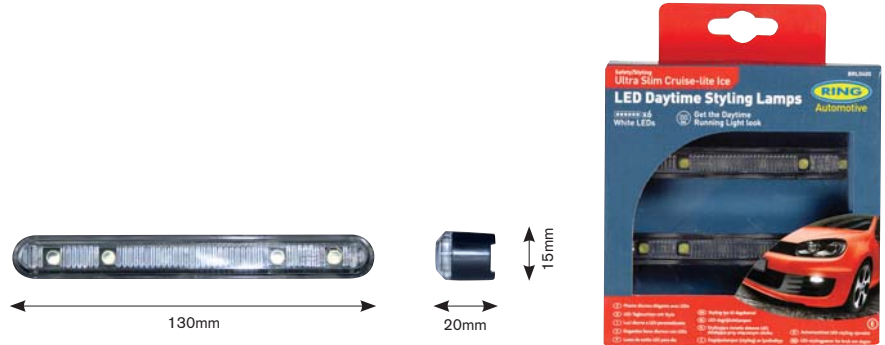

Product Code	Description	Case Quantity	Self adhesive mount	Housing/ Body	Reflector	Lens	Replacement Bulb	Pack Dimensions	Barcode
BRL0400	Slimline Cruise-lite LED Daytime Styling Lights	20	✓	ABS	ABS	PMMA	6 x non-replaceable LED	W140 x H170 x D60mm	5055175220246

Micro Cruise-lite Rectangular Fog Lamps

12V
Voltage

- Small, power packed Halogen sub-bumper lamp
- Reinforced metal housing
- Advanced multi-surface reflector for improved light output
- Complete with 2 x 12V 55W halogen bulbs (fitted)
- Includes fitting brackets
- Fitting instructions
- Lamps and bulbs are 'E' approved

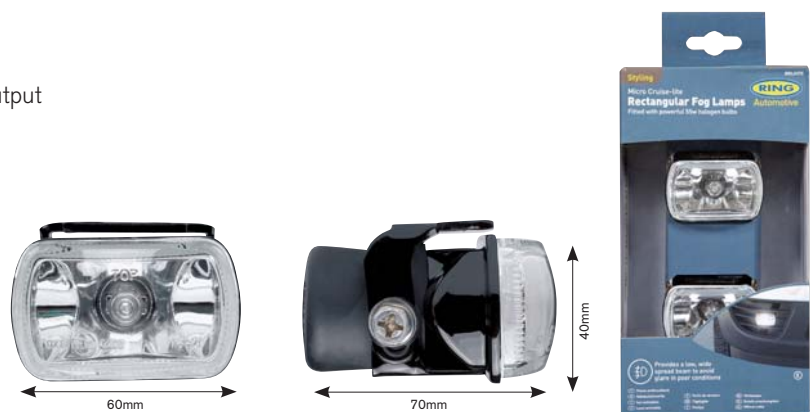

Product Code	Description	Case Quantity	Fitting Kit	Housing/ Body	Reflector	Lens	Replacement Bulb	Pack Dimensions	Barcode
BRL0370	Micro Cruise-lite	12	✓	Black Steel	Vacuum Metalised Multi-surface	Thermal Shock Resistant Glass	R453 H3 (12V 55W)	W149 x H212 x D70mm	5011274037017

Compact Cruise-lite Round Driving Lamps

12V

Voltage

- Power packed Halogen driving lamp
- Reinforced metal housing
- Advanced multi-surface reflector for improved light output
- Complete with 2 x 12V 55W halogen bulbs (fitted)
- Includes fitting brackets
- Fitting instructions
- Lamps and bulbs are 'E' approved



Product Code	Description	Case Quantity	Fitting Kit	Housing/ Body	Reflector	Lens	Replacement Bulb	Pack Dimensions	Barcode
BRL0382	Compact Cruise-lite	12	✓	Reinforced Metal	Vacuum Metalised Multi-surface	Thermal Shock Resistant Glass	R453 H3 (12V 55W)	W150 x H190 x D100mm	5011274038212

Chrome-lite Chrome Finish Driving Lamps

12V

Voltage

- Power packed Halogen driving lamp
- Metal housing with polished chrome finish
- Advanced multi-surface reflector
- Complete with 2 x 12V 55W halogen bulbs (fitted)
- Includes fitting brackets
- Fitting instructions
- Lamps and bulbs are 'E' approved



Product Code	Description	Case Quantity	Fitting Kit	Housing/ Body	Reflector	Lens	Replacement Bulb	Pack Dimensions	Barcode
BRL0384	Chrome-lite	5	✓	Chrome Plated Steel	Chrome Plated Steel	Glass	R453 H3 (12V 55W)	W325 x H195 x D100mm	5055175201726

Lighting

Roadrunner Fog & Driving Lamps

- Designed and manufactured in the U.K.
- All lamps and bulbs are E approved
- For mounting above or below the bumper
- Complete with 2 x 12V 55W H3 'E' approved Halogen bulbs
- Comprehensive, easy to follow fitting instructions included

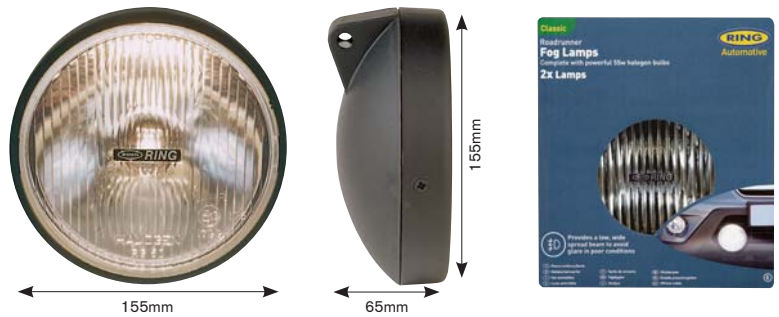

Product Code	Description	Case Quantity	Grilles	Fitting Kit	Housing/ Body	Reflector	Lens	Mounting bolt/bracket	Pack Dimensions	Barcode
RL020	Roadrunner Round Driving Lamps	5			Co-polymer Plastic	Vacuum Metalised Multi-surface	Thermal Shock Resistant Glass	Zinc-plated Steel	W400 x H220 x D100mm	5011274320508
RL021	Roadrunner Round Fog Lamps	5								5011274321505
RL020G	Roadrunner Round Driving Lamps	5	✓							5011274320515

Replacement Bulb: R453 H3 (12V 55W)
Fitting Kit: RLFK200

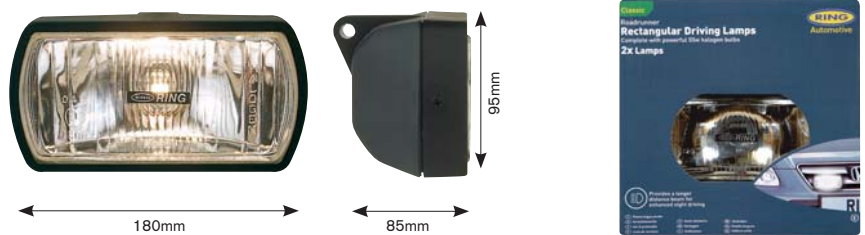

Product Code	Description	Case Quantity	Grilles	Fitting Kit	Housing/ Body	Reflector	Lens	Mounting bolt/bracket	Pack Dimensions	Barcode
RL022	Roadrunner Rectangular Driving Lamps	5			Co-polymer Plastic	Vacuum Metalised Multi-surface	Thermal Shock Resistant Glass	Zinc-plated Steel	W400 x H220 x D100mm	5011274322502
RL023	Roadrunner Rectangular Fog Lamps	5								5011274323509
RL022G	Roadrunner Rectangular Driving Lamps	5	✓							5011274322519
RL023G	Roadrunner Rectangular Fog Lamps	5	✓							5011274323516

Replacement Bulb: R453 H3 (12V 55W)
Fitting Kit: RLFK200

Microline Fog & Driving Lamps

- Compact slimline design
- Exclusively designed and manufactured in the UK
- All lamps and bulbs are E approved
- Designed to be mounted above or below the bumper, flush or spoiler fit
- Complete with tilt washer which provides full adjustment when mounting lamps flush or spoiler fit
- Complete with 2 x 12V 55W H3 'E' approved Halogen bulbs
- Comprehensive, easy to follow fitting instructions included

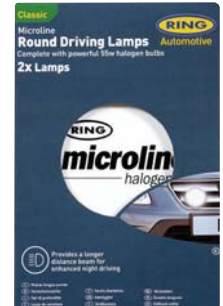

Product Code	Description	Case Quantity	Covers	Fitting Kit	Housing/ Body	Reflector	Lens	Mounting bolt/bracket	Pack Dimensions	Barcode
BRL056 (Export Only)	Microline Round Driving Lamps	6			Co-polymer Plastic	Vacuum Metalised Multi-surface	Thermal Shock Resistant Glass	Zinc-plated Steel	W150 x H220 x D180mm	5011274356002
BRL056C	Microline Round Driving Lamps	6	✓							5011274355609
BRL0562C	Microline Round Driving Lamps	6	✓	✓						5011274356200

Replacement Bulb: R453 H3 (12V 55W)



Product Code	Description	Case Quantity	Covers	Fitting Kit	Housing/ Body	Reflector	Lens	Mounting bolt/bracket	Pack Dimensions	Barcode
BRL054 (Export Only)	Microline Rectangular Driving Lamps	6			Co-polymer Plastic	Vacuum Metalised Multi-surface	Thermal Shock Resistant Glass	Zinc-plated Steel	W150 x H220 x D180mm	5011274354503
BRL055 (Export Only)	Microline Rectangular Fog Lamps	6								5011274355500
BRL055C	Microline Rectangular Fog Lamps	6	✓							5011274355548
BRL0552C	Microline Rectangular Fog Lamps	6	✓	✓						5011274355555

Replacement Bulb: R453 H3 (12V 55W)

Lighting

Sportsline Driving Lamps

- Effective reflector and lens for maximum light output
- Multi-position bracket for maximum flexibility
- For above bumper mounting
- Complete with 2 x 12V 55W halogen bulbs (fitted)
- Includes two fitting brackets and comprehensive instructions
- Lamps and bulbs are 'E' approved

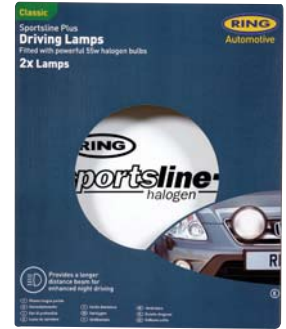

Product Code	Description	Case Quantity	Covers	Fitting Kit	Housing/ Body	Reflector	Lens	Mounting bolt/bracket	Pack Dimensions	Barcode
RL180C (Export Only)	Sportsline Round Driving Lamps	1	✓		Black Co-polymer Plastic	Vacuum Metalised Steel Plate	Thermal Shock Resistant Glass	Integral Toothed Bracket and Zinc Plated Bolt	W200 x H200 x D200mm	5011274001803
RL1802	Sportsline Round Driving Lamps	1	✓	✓						5011274018023

Replacement Bulb: R453 H3 (12V 55W)

Rally Giant Driving Lamps

- Twin metal backed Rally lamps
- Lamps and bulbs are E approved
- Can be fitted to any car
- Universal mounting bracket
- Complete with 2 x 12V H3 'E' approved powerful Halogen bulbs
- Easy to follow fitting instructions

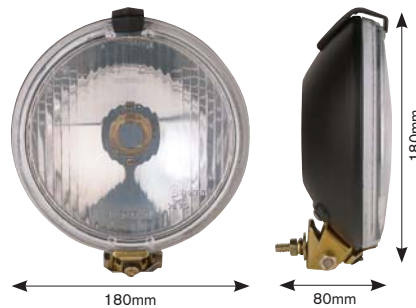

Product Code	Description	Case Quantity	Covers	Fitting Kit	Housing/ Body	Reflector	Lens	Mounting bolt/bracket	Pack Dimensions	Barcode
RL030C	Rally Giant Round Driving Lamps	5	✓		Coated Steel	Vacuum Metalised Steel Plate	Thermal Shock Resistant Glass	Zinc-plated Steel	W405 x H235 x D100mm	5011274331504

Replacement Bulb: R453 H3 (12V 55W)

Universal 12V LED Number Plate Lights



Standard



LED

- Produces a bright white light to illuminate number plate
- 6000K 2 x 0.5W LEDs in each lamp
- Up to 10 x life of a standard bulb
- Self adhesive fixing
- Complete with 2 x W5W (501) and 2 x C5W (239) bulb holders plus 4 splice connectors to suit most vehicles
- Estimated fitting time approx. 30 mins
- E marked

Component Parts

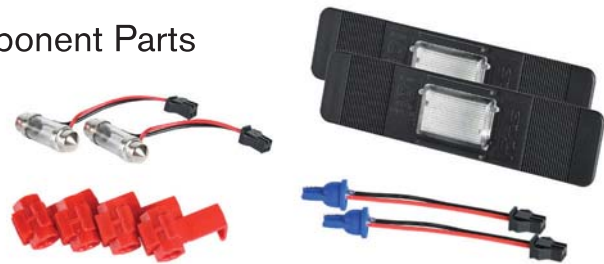

Product Code	Light Source	Case Quantity	Pack Dimensions	Barcode
BRL0403	2 x 0.5W LED	10 x 1	W101 x H181 x D36mm	5055175228020

Lighting

Reversing Lamp



Product code	RL013
Light Source	Single Bulb R382 (included)
Pack Dimensions	W145 x H105 x D75mm
Product Dimensions	W140 x H75 x D70 mm
Case Quantity	68
Barcode	5011274301378

Rear Fog and Reversing Lamp



Includes bracket & bulb

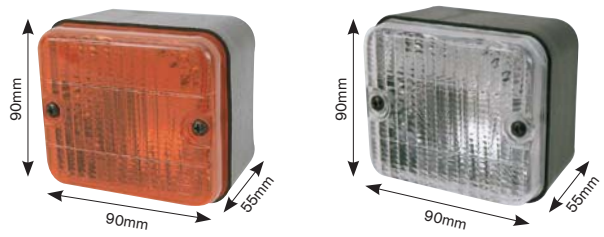

Product code	RL014/15
Light Source	Single Bulb R382 (included)
Pack Dimensions	W95 x H140 x D58mm
Case Quantity	68
Barcode RL014 Rear Fog	5011274301477
Barcode RL015 Reversing	5011274301576

Fast Fit Kit

- Provides all the necessary wiring and comprehensive fitting instructions to fit a pair of lamps quickly and effectively
- Includes 30A relay, in-line fuse, all necessary wiring pre-wired to relay, illuminated rocker switch and bracket
- Pack dimensions: W116mm x H173mm x D66mm



Product Code	RLFK200
Case Qty	6
Barcode	5011274320003

Also available

RELAYS

- RLFK20 12V 20A Relay
- RLFK30 12V 30A Relay
- RLFK1230F 12V 30A Fused Relay

IN-VEHICLE POWER

Micro USB Multisockets	E2
USB Multisockets	E3
Multisockets	E4
USB Charging	E6
Connectivity	E8
DC Power Connectors	E10
Power Inverters	E11
Inverters	E18

In-Vehicle Power



MULTISOCKETS

Features



Battery analyser displays available vehicle battery power and early warning for alternator not charging the vehicle battery.



Glowing socket – for quick night time location.

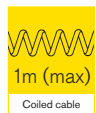

1m Coiled cable – no loose trailing wires across the car.



Fitment collar – to suit most DC power sockets and prevents the plug becoming accidentally dislodged.

Manufactured from scratch resistant ABS to compliment quality car interiors.

- Micro USB retractable tip to charge phones, smart phones and most sat navs
- Fast charge 2A USB charging socket suitable for charging smart phones, mp3 players and tablet devices, including iPhone, iPod and iPad
- 2 x 12V DC sockets suitable for powering products up to 10A

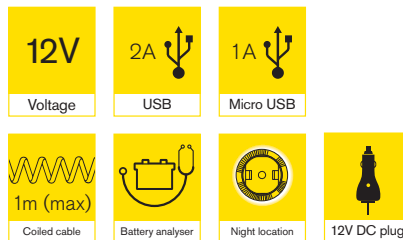

Specifications

Product Code	RMS15
Input Voltage	12V
Total Output (max)	10A
12V Socket Output (max)	10A
Micro USB Output (max)	1A
USB Output	2A
Fuse	10A glass fuse
Cable	1m (extended)
Pack Dimensions	H202 x W172 x D90
Case Quantity	8 x 1
Barcode	5055175226620

CE Approved

All Ring multisockets are tested and certified to the relevant EMC Directives



- 1A USB charging socket suitable for charging smart phones and mp3 players, including iPhone & iPod
- 2 x 12V DC sockets suitable for powering products up to 8A

- 1A USB charging socket suitable for charging smart phones and mp3 players, including iPhone & iPod
- 2 x 12V DC sockets suitable for powering products up to 8A

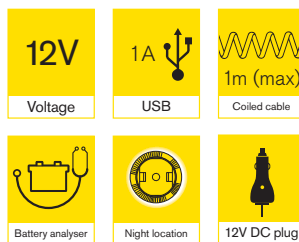
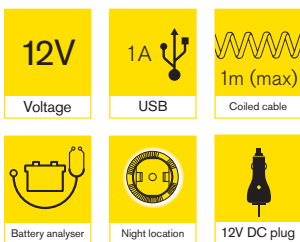

Specifications	UK/Euro
Product Code	RMS10
Input Voltage	12V
Total Output (max)	8A
12V Socket Output (max)	8A
Micro USB Output (max)	-
USB Output	1A
Fuse	8A glass fuse
Cable	1m (extended)
Pack Dimensions	H202 x W172 x D105
Case Quantity	10 x 1
Barcode	5055175212289

Specifications	
Product Code	RMS7
Input Voltage	12V
Total Output (max)	8A
12V Socket Output (max)	8A
Micro USB Output (max)	-
USB Output	1A
Fuse	8A glass fuse
Cable	1m (extended)
Pack Dimensions	H202 x W172 x D67
Case Quantity	10 x 1
Barcode	5055175212258

In-Vehicle Power



- 4 x 12V DC sockets suitable for powering products up to 8A

- 3 x 12V DC sockets suitable for powering products up to 8A

12V Voltage	Battery analyser
Night location	12V DC plug

12V Voltage	Battery analyser
Night location	12V DC plug

Specifications	
Product Code	RMS4
Input Voltage	12V
Total Output (max)	8A
12V Socket Output (max)	8A
Micro USB Output (max)	-
USB Output	-
Fuse	8A glass fuse
Cable	1m (extended)
Pack Dimensions	H202 x W172 x D67
Case Quantity	10 x 1
Barcode	5055175200507

Specifications	
Product Code	RMS3
Input Voltage	12V
Total Output (max)	8A
12V Socket Output (max)	8A
Micro USB Output (max)	-
USB Output	-
Fuse	8A glass fuse
Cable	1m (extended)
Pack Dimensions	H202 x W172 x D67
Case Quantity	10 x 1
Barcode	5055175200491



- 2 x 12V DC sockets suitable for powering products up to 8A

- 2 x 12V Sockets suitable for powering products up to 10A
- Compact design

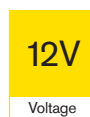
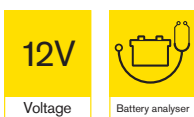

Specifications

Product Code	RMS2
Input Voltage	12V
Total Output (max)	8A
12V Socket Output (max)	8A
Micro USB Output (max)	-
USB Output	-
Fuse	8A glass fuse
Cable	1m (extended)
Pack Dimensions	H202 x W172 x D69
Case Quantity	10 x 1
Barcode	5055175200484

Specifications

Product Code	RMS1
Input Voltage	12V
Total Output (max)	10A
12V Socket Output (max)	10A
Micro USB Output (max)	-
USB Output	-
Fuse	10A glass fuse
Cable	-
Pack Dimensions	H202 x W115 x D82
Case Quantity	10 x 1
Barcode	5055175200477

In-Vehicle Power



Ring USB Charging Socket provides a “plug and go” solution to convert your cigarette lighter socket into a USB power Output. The Ring USB Charging Socket provides up to 1 A of power from your vehicle’s 12V or 24V cigarette lighter socket. It is compatible with smart phones and mp3 players, including iPhone and iPod

- 1A USB port
- Super compact design
- Compatible with 12V & 24V



Allows charging of two devices simultaneously such as smart phones, tablets, mp3 players, cameras and sat nav. Smart Universal Fast Charging Technology enables the USB Charger to detect the mobile device and charge it at an optimal rate.

Integrated Smart-Fuse protects your vehicle and device against:

- Short Circuit
- Over temperature
- Over load
- Over current
- Over input Voltage
- Reverse polarity

12/24V	1A
Voltage	USB

12/24V	2x	12.5W	5V 2.5A
Voltage	USB Sockets	High speed	High power

Specifications	
Product Code	RMS19
Input Voltage	12V/24V
Total Output (max)	1A
USB Output	1A
Fuse	Auto Switch Fuse
Pack Dimensions	H202 x W115 x D33mm
Case Quantity	10 x 1
Barcode	5055175221229

Specifications	
Product Code	RMS22
Input Voltage	12/24V
Total Output (max)	2.5A
Fuse	Smart
Pack Dimensions	H185 x W75 x D40
Case Quantity	10 x 1
Barcode	5055175242569



Allows charging of up to three devices simultaneously such as smart phones, tablets, mp3 players, cameras and sat nav.

Smart Universal Fast Charging Technology enables the USB Charger to detect the mobile device and charge it at an optimal rate.

Integrated Smart-Fuse protects your vehicle and device against:

- Short Circuit
- Over temperature
- Over load
- Over current
- Over input Voltage
- Reverse polarity

Allows charging of up to four devices simultaneously such as smart phones, tablets, mp3 players, cameras and sat nav.

Smart Universal Fast Charging Technology enables the USB Charger to detect the mobile device and charge it at an optimal rate.

Integrated Smart-Fuse protects your vehicle and device against:

- Short Circuit
- Over temperature
- Over load
- Over current
- Over input Voltage
- Reverse polarity

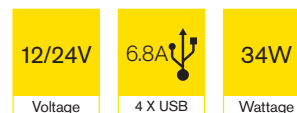

Specifications	
Product Code	RMS20
Input Voltage	12V/24V
Total Output (max)	6.8A
Fuse	Smart
Pack Dimensions	H184 x W105 x D30mm
Case Quantity	20 x 1
Barcode	5055175239040

Specifications	
Product Code	RMS21
Input Voltage	12V/24V
Total Output (max)	6.8A
Fuse	Smart
Pack Dimensions	H184 x W105 x D30mm
Case Quantity	20 x 1
Barcode	5055175239057

In-Vehicle Power

Lightning & Micro USB Cable

This 2-in-1 cable with reversible connector allows connection of mobile devices compatible with both Lightning and Micro USB making it ideal for users with multiple platform devices.



1m	Charge & sync	Anti-tangle
Cable length		

- **Reversible lightning and micro USB connector**
- **Supporting both charge & sync**
- **One metre length braided cable**
With metal housing designed for extra strength and durability

Specifications	
Product Code	R2IN1C
Charging cable	✓
Data Sync	✓
Cable Length	1m
Pack Dimensions	H185 x W75 x D20
Weight	14g
Case Quantity	10 x 1
Barcode	5055175242590

Lightning & Micro USB Keyring

Keep connected at all times with the 2-in-1 Lightning and Micro cable keyring. The reversible connector allows connection of mobile devices compatible with both Lightning and Micro USB making it ideal for users with multiple platform devices.



12cm	Charge & sync
Cable length	

- **Reversible lightning and micro USB connector**
- **12cm in length**
This lightweight and portable cable connects easily to your keys
- **Hard wearing rubber finish**
Helps protect the connectors from dust and dirt

Specifications	
Product Code	R2IN1K
Charging cable	✓
Data Sync	✓
Cable Length	12cm
Pack Dimensions	H185 x W75 x D20
Weight	12g
Case Quantity	10 x 1
Barcode	5055175242606

Hands-free Aux Cable

Under UK law, it is illegal to hold a phone or sat nav while driving. Keep safe and legal with the Ring hands free Aux cable.

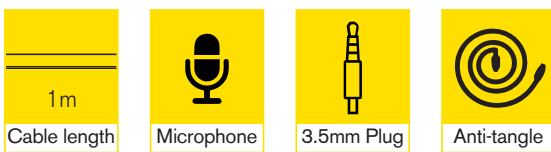

- Hands free calling**
 On any vehicle with a 3.5mm AUX jack socket
- Inline button**
 For call answering as well as music track control
- Built in microphone**
 Works in conjunction with your phone mic for improved sound quality, allowing sound from music as well as GPS to come direct from your phone to your stereo

Specifications

Product Code	RHFAUX
Connector	3.5mm audio jack
Cable Length	1m
Pack Dimensions	H185 x W75 x D20
Weight	4g
Case Quantity	10 x 1
Barcode	5055175242583

Magnetic Phone Mount

The RMAVM's strong magnetic attachment makes it suitable for mounting even the largest of mobile phones in your vehicle.



- Adjustable clamp**
 Ensures it fits easily and securely into most car air vents
- 360 degree adjustability**
 Allows for optimum viewing angles to be achieved
- Two magnetic phone discs and built in cable management clip**
 Ensure cables are neatly positioned when in use

Specifications

Product Code	RMAVM
Accessories	2 x Magnetic phone discs
Pack Dimensions	H185 x W75 x D40
Weight	58g
Case Quantity	10 x 1
Barcode	5055175242576

DC POWER CONNECTORS



RLPA001

Accessory Din Plug

- Part Number: RLPA001
- 16A max load
- Compatible with RLPA002
- Can be used with either 12V or 24V vehicles to power accessory products in the cab



RLPA002

Accessory Din Socket

- Part Number: RLPA002
- 16A max load
- Compatible with RLPA001
- Can be used with either 12V or 24V vehicles to power accessory products in the cab



RLPA003

Cigar Lighter Plug

- Part Number: RLPA003
- Replacement heater plug for cigar lighter sockets

POWER INVERTERS

Mains power from your vehicle

An inverter can provide a 230V AC mains power source from your vehicle battery. The PowerSource range of inverters offers models suitable for powering equipment from small in-vehicle chargers up to large power tools used in more demanding field service applications.



PowerSource

From 60W to 500W the PowerSource inverters are suited to leisure and occasional use applications such as charging mobile phones, laptops etc. for periods up to 4 hours continuously. They connect either by attaching directly to your vehicles battery or by plugging into the vehicles 12V DC power socket.



PowerSourcePro

Providing power from 1000W to 4000watts, the PowerSourcePro range of modified sine wave inverters is suitable for powering the majority of equipment such as mains power tools, microwaves, fridges and compressors.

They are well suited to more demanding applications and can provide power for up to 12 hours continuously. They are provided with heavy duty input cables and cIAs for direct connection to batteries and feature rugged extruded casings.



PowerSourcePure

The PowerSourcePure inverters provide an extremely pure sine wave output which replicates the normal domestic mains supply, as such they are ideal for powering more sensitive electronic equipment.

They are particularly suitable for powering products not compatible with modified sine wave inverters, such as certain power tool re-chargers, coffee machines, laser printers and sensitive audio/video equipment. Some models offer integral earth leakage protection to simplify installations and provide additional safety.

The hard wired outputs on these models also allow a more integrated solution for service vehicle and similar installations. If you need to power a wide variety of mains appliances in remote locations then a pure sine wave inverter is the most suitable choice.

CE Approved All Ring Professional Inverters are tested and certified to the relevant EMC & LVD Directives

E Approved All Ring Pure Sine Wave inverters are certified to the relevant E-Mark Directives

In-Vehicle Power

Selecting the right inverter

Selecting Inverter Type

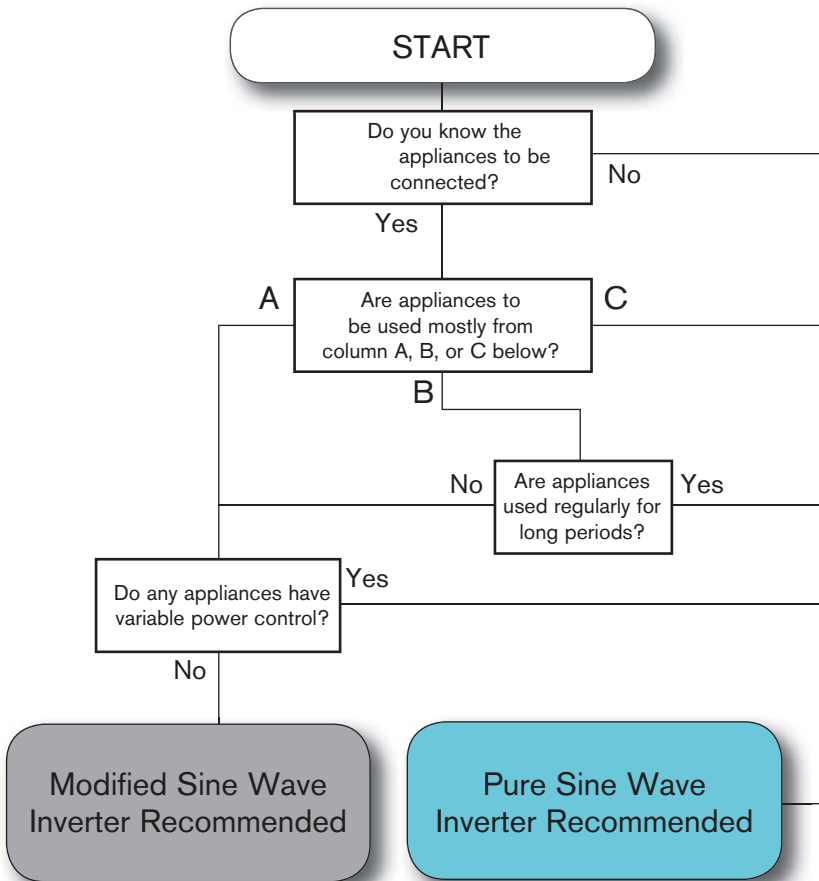

Selecting Inverter Size

Rated Power

Find the power rating for all appliances that could be used at the same time. If only the operating current is shown then use the following formula to calculate the power:

$$\text{Power (Watts)} = \text{Current} \times 240$$

Examples

Laptop	150W
Angle grinder	500W
Work light	300W
TOTAL	950W

In this instance a Ring inverter with at least 1000W Output would be recommended.

Surge Power

Check the inverter can handle the startup or surge power required by the equipment. For example a microwave with a cooking power of 800W can require up to 2400W surge power during startup, therefore an inverter with this surge capability will be needed.



Compatibility Chart

The following chart shows which appliances are recommended for each type of inverter, including those which are only suitable for pure sine wave inverters.

Continuous Rating	A Products which are generally compatible with all inverter types	B Products which may be incompatible or not run effectively with modified sine (MSW) inverters	C Products which may cause damage to modified sine (MSW) inverters
10W - 50W	Phone charger / Desk fan	Digital clock / Rechargeable shaver(C)	HID worklights(C) / Night lights(C)
50W - 100W	Portable stereo / DVD player	Fluorescent IAs(C)	Transformerless power tool chargers (C)
100W - 150W	Small LCD TV	Laptop computer	Instant start fluorescent lights
150W - 200W	Inkjet printer		
200W - 300W	Desktop PC	Large Stereo	
300W - 500W	Small electric drill(I) / Small fridge	Variable speed drill(I) / Oxygen concentrator	Laser printers
500W - 750W	Small angle grinder(I)	Microwave oven(I) / Bread maker	
750W - 1000W	Industrial water pump(I)	Coffee machine	
1000W - 1500W	Large angle grinder(I)		
1500W - 2000W	Circular saw(I) / Hot air gun / Vacuum cleaner(I)		
2000W +	Electric chainsaw(I) / Fan heater		

(I) - Inductive loads which may require startup power 2-5 times the continuous power (C) - Capacitive loads which may create high current spikes on MSW inverters

Pure Sine Wave Inverters

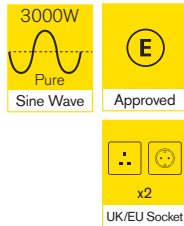

RINVP3000/REINVP3000

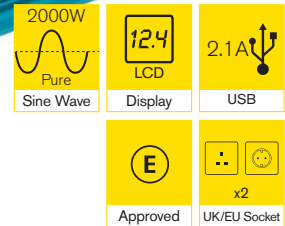

RINVP20/REINVP20
24V: RINVPB20/REINVPB20

- 3000 watt pure sine wave output
- Operating mode & fault indicators
- Up to 12 hours continuous use
- Compact heavy duty extruded casing
- Optional wired remote contrl (RINVWRC)

- 2000 watt pure sine wave output
- Integrated multi-function LCD display
- Operating mode & fault indicators
- Power saving mode
- Up to 12 hours continuous use
- Compact heavy duty extruded casing
- Optional current sensor module (RINVCM)
- Optional bluetooth module (RINVBM)
- Optional display mounting kit (RINVFRM)

Specifications	UK/Euro	UK/Euro	UK/Euro
Product Code	RINVP3000 (UK), REINVP3000 (EU)	RINVP20 (UK), REINVP20 (EU)	RINVPB20 (UK), REINVPB20 (EU)
Cont Power Rating (up to 12 hrs)	3000 watts	2000 watts	2000 watts
Peak Power Rating (up to 200ms)	6000 watts	4000 watts	4000 watts
Output Voltage	230V AC±10%	200/220/230/240V AC ±10%	200/220/230/240V AC ±10%
Output Frequency	50Hz	50/60Hz	50/60Hz
Output Waveform	Pure Sine Wave	Pure Sine Wave	Pure Sine Wave
Input Voltage Range	10V - 16V (12V nom)	9.5V-16.5V (12V nom)	19V-33V (24V nom)
Input Current	294 amps (max)	196amps (max)	98amps (max)
Efficiency @ 75% load	> 85%	90%	90%
No Load Current	< 1.5amp	< 2.0amp	<1.5amp
Power Saving Mode	No	Yes	Yes
Power Saving Mode Current	-	<0.2amp	< 0.2amp
Low Battery Alarm	10.5 ± 1 volt	10.0V-11.5V ±0.5 volt	20.0V-23.0V ±0.5 volt
Low Battery Shutdown	10.0 ± 1 volt	9.5V-11.0V ±0.5 volt	19.0V-22.0V ±0.5 volt
Thermal Protection	60± 10°C	60 ± 10°C	60 ± 10°C
USB Port	No	2.1amp	2.1amp
Display Panel Port	Yes	Yes	Yes
Current Sensor Port	No	Yes	Yes
Comms Port	No	Yes	Yes
Input Cable Gauge / Length	60mm ² / 95cm	38mm ² / 95cm	22mm ² / 95cm
Dimensions (LxWxH)	520 x 286 x 96	420 x 247 x 118.5	420 x 247 x 118.5
Weight	10.8kg	5.9kg	5.9kg
Case Quantity	2 x 1	2 x 1	2 x 1
Barcode	5055175234120 (UK) 5055175234182 (Euro)	5055175242729 (UK) 5055175242798 (Euro)	5055175243467 (UK) 5055175243481 (Euro)

In-Vehicle Power

Pure Sine Wave Inverters

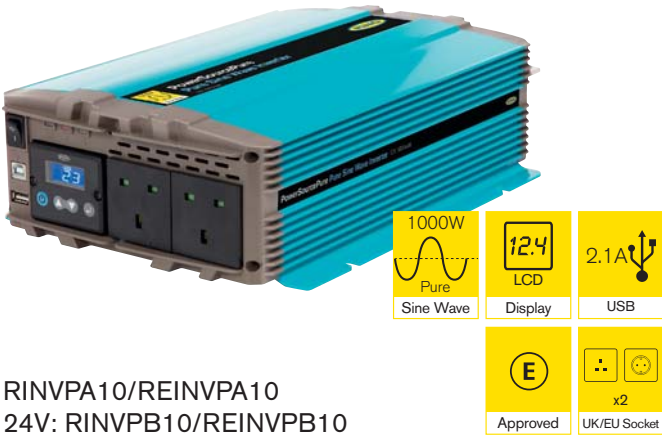

RINVPA10/REINVPA10
24V: RINVPB10/REINVPB10

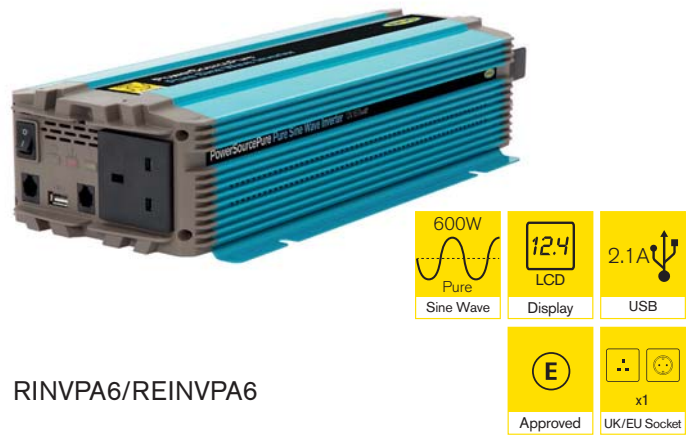

RINVPA6/REINVPA6

- 1000 watt pure sine wave output
- Integrated multi-function LCD display
- Operating mode & fault indicators
- Power saving mode
- Up to 12 hours continuous use
- Compact heavy duty extruded casing
- Optional current sensor module (RINVCM)
- Optional bluetooth module (RINVBM)
- Optional display mounting kit (RINVFRM)

- 600 watt pure sine wave output
- Operating mode & fault indicators
- Power saving mode
- Up to 12 hours continuous use
- Compact heavy duty extruded casing
- Optional multi-function LCD display (RINVLCD)
- Optional battery sensor module (RINVCM)
- Optional bluetooth module (RINVBM)

Specifications	UK/Euro	UK/Euro	UK/Euro
Product Code	RINVPA10 (UK), REINVPA10 (Euro)	RINVPB10 (UK), REINVPB10 (Euro)	RINVPA6 (UK), REINVPA6 (Euro)
Cont Power Rating (up to 12 hrs)	1000 watts	1000 watts	600 watts
Peak Power Rating (up to 200ms)	2000 watts	2000 watts	1200 watts
Output Voltage	200/220/230/240V AC ±10%	200/220/230/240V AC ±10%	200/220/230/240V AC ±10%
Output Frequency	50/60Hz	50/60Hz	50/60Hz
Output Waveform	Pure Sine Wave	Pure Sine Wave	Pure Sine Wave
Input Voltage Range	9.5V-16.5V (12V nom)	19V-33V (24V nom)	9.5V-16.5V (12V nom)
Input Current	98amps (max)	49amps (max)	59amps (max)
Efficiency @ 75% load	90%	90%	90%
No Load Current	< 1.6amp	<1.1amp	< 1.50amp
Power Saving Mode	Yes	Yes	Yes
Power Saving Mode Current	< 0.2amp	<0.2amp	< 0.2amp
Low Battery Alarm	10.0V-11.5V ±0.5 volt	20.0V-23.0V ±0.5 volt	10.0V-11.5V ±0.5 volt
Low Battery Shutdown	9.5V-11.0V ±0.5 volt	19.0V-22.0V ±0.5 volt	9.5V-11.0V ±0.5 volt
Thermal Protection	60 ± 10°C	60 ± 10°C	60 ± 10°C
USB Port	2.1amp	2.1amp	2.1amp
Display Panel Port	Yes	Yes	Yes
Current Sensor Port	Yes	Yes	Yes
Comms Port	Yes	Yes	Yes
Input Cable Gauge / Length	22mm ² / 95cm	22mm ² / 95cm	14mm ² / 95cm
Dimensions (LxWxH)	320 x 247 x 118.5	320 x 247 x 118.5	340 x 170 x 81.5
Weight	4.3kg	4.3kg	2.8kg
Case Quantity	2 x 1	2 x 1	4 x 1
Barcode	5055175242712 (UK), 5055175242781 (Euro)	5055175243450 (UK) 5055175243474 (Euro)	5055175242705 (UK) 5055175242774 (Euro)

Pure Sine Wave Inverters with RCD

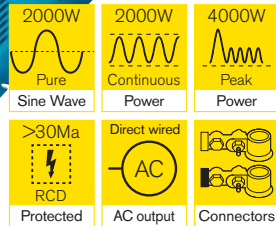

RINVPR2000/
24V: RINVPR2024

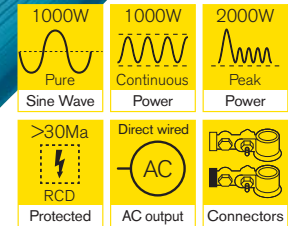

RINVPR1000/
24V: RINVPR1024

- Integrated Earth leakage protection (RCD)
- Direct wired ac Outputs provides a more integrated solution
- Pure sine wave Output ensures best possible appliance compatibility
- Provides power for up to 12 hours of continuous use
- LED display showing operating mode & fault conditions

- Fully protected against overload, over temperature & low/high Voltages
- Heavy duty extruded casing suitable for professional use
- Optional wired remote control (RINWVRC)

Specifications

Product Code	RINVPR2000	RINVPR2024	RINVPR1000	RINVPR1024
Continuous Power Rating (up to 12hrs)	2000W	2000W	1000 watts	1000 watts
Surge Power Rating (up to 1sec)	4000W	4000W	2000 watts	2000 watts
Output Voltage	230V AC±10%	230V AC±10%	230V AC±10%	230V AC±10%
Output Frequency	50Hz	50Hz	50Hz	50Hz
Output Waveform	Pure Sine Wave	Pure Sine Wave	Pure Sine Wave	Pure Sine Wave
Input Voltage Range	10V - 16V	20V - 30V	10V - 16V	20V - 30V
Efficiency	> 85%	> 85%	> 85%	> 85%
No Load Current Draw	<1.5A	<1.0A	<1.3A	<1.0A
RCD Trip Current	30mA	30mA	30mA	30mA
Low Battery Alarm	10.5 ± 1 volt	21 ± 1 volt	10.5 ± 1 volt	21 ± 1 volt
Low Battery Shutdown	10.0 ± 1 volt	20 ± 1 volt	10.0 ± 1 volt	20 ± 1 volt
Thermal Protection	60± 10°C	60± 10°C	60± 10°C	60± 10°C
USB Port	No	No	2A (max)	2A (max)
Remote Control Port	Yes	Yes	Yes	Yes
Dimension (L x W x H)	385 x 290 x 96	385 x 290 x 96	394 x 224 x 96	394 x 224 x 96
Weight	7.7kg	7.7kg	6.3kg	6.3kg
Case Quantity	2 x 1	2 x 1	2 x 1	2 x 1
Barcode	5055175234106	5055175234113	5055175234069	5055175234076

Accessories

RINWVRC Remote Control Panel

In-Vehicle Power

Modified Sine Wave Inverters



RINVM40

RINVMA30/ REINVMA30

- 4000 watt modified sine wave output
- Integrated multi-function LCD display
- Operating mode & fault indicators
- Up to 12 hours continuous use
- Compact heavy duty extruded casing
- Optional current sensor module (RINVCM)
- Optional display mounting kit (RINVFRM)

- 3000 watt modified sine wave output
- Integrated multi-function LCD display
- Operating mode & fault indicators
- Up to 12 hours continuous use
- Compact heavy duty extruded casing
- Optional current sensor module (RINVCM)
- Optional display mounting kit (RINVFRM)

Specifications	UK	UK/Euro
	RINVMA40	RINVMA30 (UK), REINVMA30 (Euro)
Product Code	RINVMA40	RINVMA30 (UK), REINVMA30 (Euro)
Cont Power Rating (up to 12 hrs)	4000 watts	3000 watts
Peak Power Rating (up to 200ms)	8000 watts	6000 watts
Output Voltage	230 AC $\pm 10\%$	230 AC $\pm 10\%$
Output Frequency	50Hz	50Hz
Output Waveform	Modified Sine Wave	Modified Sine Wave
Input Voltage Range	10.0V-16V (12V nom)	10.0V-16V (12V nom)
Input Current	392amps (max)	294amps (max)
Efficiency @ 75% load	89%	89%
No Load Current	<1.0amp	<0.90amp
Power Saving Mode	No	No
Power Saving Mode Current	-	-
Low Battery Alarm	10.5V ± 0.5 volt	10.5V ± 0.5 volt
Low Battery Shutdown	10.0V ± 0.5 volt	10.0V ± 0.5 volt
Thermal Protection	60 $\pm 10^\circ\text{C}$	60 $\pm 10^\circ\text{C}$
USB Port	No	No
Display Panel Port	Yes	Yes
Current Sensor Port	Yes	Yes
Comms Port	No	No
Input Cable Gauge / Length	38mm ² x 2 / 95cm	60mm ² / 95cm
Dimensions (LxWxH)	460 x 170 x 162	400 x 170 x 162
Weight	7.0kg	5.7kg
Case Quantity	2 x 1	2 x 1
Barcode	5055175242767	5055175242750 (UK), 5055175242828 (Euro)

Modified Sine Wave Inverters

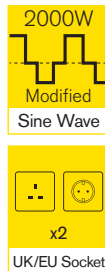

RINVMA20/REINVMA20
24V: RINVB20/REINVB20

- 2000 watt modified sine wave output
- Operating mode & fault indicators
- Up to 12 hours continuous use
- Compact heavy duty extruded casing
- Optional multi-function LCD display (RINVLCD)
- Optional current sensor module (RINVCM)

RINVMA10/REINVMA10
24V: RINVB10/REINVB10

- 1000 watt modified sine wave output
- Operating mode & fault indicators
- Up to 12 hours continuous use
- Compact heavy duty extruded casing
- Optional multi-function LCD display (RINVLCD)
- Optional current sensor module (RINVCM)

Specifications	UK/Euro	UK/Euro	UK/Euro	UK/Euro
Product Code	RINVMA20 (UK), REINVMA20 (Euro)	RINVB20 (UK), REINVB20 (Euro)	RINVMA10 (UK), REINVMA10 (Euro)	RINVB10 (UK), REINVB10 (Euro)
Cont Power Rating (up to 12 hrs)	2000 watts	2000 watts	1000 watts	1000 watts
Peak Power Rating (up to 200ms)	4000 watts	4000 watts	2000 watts	2000 watts
Output Voltage	230 AC \pm 10%	230 AC \pm 10%	230 AC \pm 10%	230 AC \pm 10%
Output Frequency	50Hz	50Hz	50Hz	50Hz
Output Waveform	Modified Sine Wave	Modified Sine Wave	Modified Sine Wave	Modified Sine Wave
Input Voltage Range	10.0V-16V (12V nom)	20V-32V (24V nom)	10.0V-16V (12V nom)	20V-32V (24V nom)
Input Current	196amps (max)	98amps (max)	98amps (max)	49amps (max)
Efficiency @ 75% load	89%	89%	89%	89%
No Load Current	<0.80amp	<0.55amp	<0.70amp	<0.45amp
Power Saving Mode	No	No	No	No
Power Saving Mode Current	-	-	-	-
Low Battery Alarm	10.5V \pm 0.5 volt	21.0V \pm 0.5 volt	10.5V \pm 0.5 volt	21.0V \pm 0.5 volt
Low Battery Shutdown	10.0V \pm 0.5 volt	20.0V \pm 0.5 volt	10.0V \pm 0.5 volt	20.0V \pm 0.5 volt
Thermal Protection	60 \pm 10°C	60 \pm 10°C	60 \pm 10°C	60 \pm 10°C
USB Port	No	No	2.1amp	2.1amp
Display Panel Port	Yes	Yes	Yes	Yes
Current Sensor Port	Yes	Yes	Yes	Yes
Comms Port	No	No	No	No
Input Cable Gauge / Length	38mm ² / 95cm	22mm ² / 95cm	14mm ² / 95cm	14mm ² / 95cm
Dimensions (LxWxH)	340 x 170 x 162	340 x 170 x 162	340 x 170 x 81.5	340 x 170 x 81.5
Weight	4.6kg	4.6kg	2.7kg	2.7kg
Case Quantity	2 x 1	2 x 1	4 x 1	4 x 1
Barcode	5055175242743 (UK) 5055175242811 (Euro)	5055175243504 (UK) 5055175243528 (Euro)	5055175242736 (UK) 5055175242804 (Euro)	5055175243498 (UK) 5055175243511 (Euro)

In-Vehicle Power

PowerSource Inverters



- A range of three inverters – 150W, 300W and 500W.
- Includes a high power 2A USB socket suitable for recharging smart phones, MP3 players and tablets.
- Manufactured from lightweight durable ABS.
- Supplied with either DC plug to connect directly to the vehicle's DC power socket or battery clips for connection directly to the vehicle battery.



12V Voltage	 Crocodile clamps	 12V DC plug	 USB	 150W Inverter	 300W Inverter	 500W Inverter
-----------------------	---	--	--	---	---	--

Specifications	UK/Euro	UK/Euro	UK/Euro
Product Code	RINVU500 (UK), REINVU500 (Euro)	RINVU300 (UK), REINVU300 (Euro)	RINVU150 (UK), REINVU150 (Euro)
Max Power Rating (5 mins)	500W	300W	150W
Continuous Power Rating (4h)	400W	240W	120W
Peak Power Rating	1000W	600W	300W
No Load Current Draw	0.3A	0.25A	0.15A
Waveform	MSW	MSW	MSW
USB Output	5V/2.1A	5V/2.1A	5V/2.1A
Power Connection	Battery Clips	Battery Clips	DC Plug
Weight	1.28 kg	0.8 kg	0.58 kg
Pack Dimensions	H196 x W225 x D75	H234 x W234 x D85	H234 x W234 x D85
Case Quantity	5 x 1	5 x 1	5 x 1
Barcode	5055175229003 (UK), 5055175229034 (Euro)	5055175228990 (UK) 5055175229027 (Euro)	5055175228983 (UK) 5055175229010 (Euro)

Direct Plug-in Inverter



- 75W of power for recharging small electronic appliances
- Flexible design to suit different vehicles
- Compact & lightweight allows it to be easily stored
- LED indicator displays connection status

12V		
Voltage	12V DC plug	75W Inverter

Specifications	UK	Euro
Product Code	RINV75	REINV75 / RSINV75
Max Power Rating (5 mins)	75W	75W
Continuous Power Rating (4 hrs)	56W	56W
Peak Power Rating	150W	150W
No Load Current Draw	0.1A	0.1A
Waveform	MSW	MSW
USB Output	-	-
Power Connection	DC Plug	DC Plug
Weight	0.25 kg	0.25 kg
Pack Dimensions	H183 x W183 x D58	H183 x W183 x D58
Case Quantity	20 x 1	20 x 1
Barcode	5011274007508	5055175201399 / 5055175201399

In-Vehicle Power

In-Vehicle Power E20



BATTERY CARE

Professional Battery Chargers	F4
Professional SmartChargers	F5
Trolley Charger/Starters	F6
Bench Charger/Starters	F7
Battery Chargers	F8
Battery Analysers	F17
Battery Load Testers	F19
Professional PowerPacks	F21
Jump Starters	F26
PowerPacks	F28
Solar Maintainers	F32
Solar Power Charger	F34
Booster Cables	F35
Battery Terminals	F38

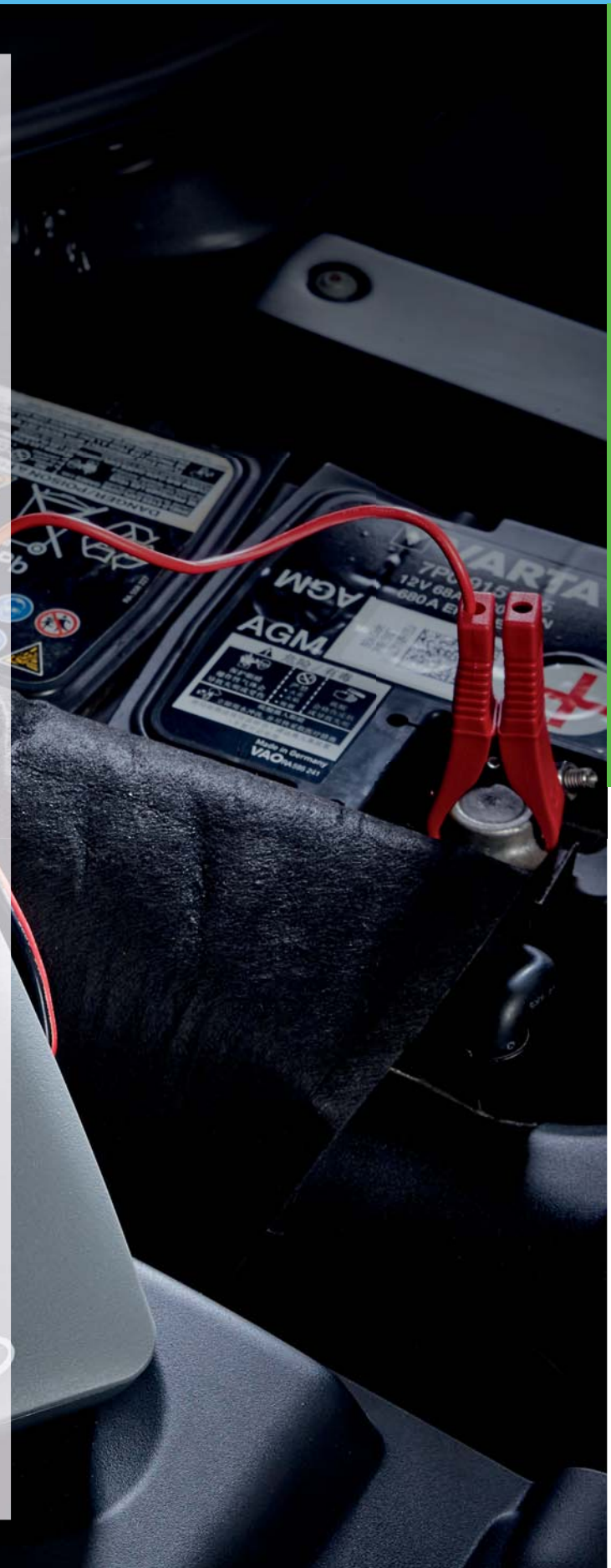

Battery Care

Battery Chargers and Smart Battery Chargers

Vehicle power requirements are on the increase and have been for many years. With the inclusion of more advanced engine management systems, in-car multimedia and other electronic features designed to improve the driving experience, the vehicles power and battery requirements have also had to be updated to cope with this.

Gone are the days when the traditional lead acid battery was the only battery type available. Today because of a vehicle's much higher power requirements many new types are available.

It is expected that by 2020 80% of all vehicles manufactured in Europe will include START/STOP technology. START/STOP vehicles include special AGM (Advanced Glass Matt) or EFB (Enhanced Flooded Battery) batteries to deliver the high power performance these vehicles need.

The RSC706 is a charging solution for modern electric or hybrid vehicles.

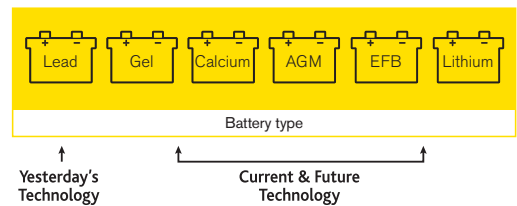

Battery Chargers

- Ideally suited for traditional lead acid (wet) and Gel batteries
- Products available in both plastic cases and metal cases for tougher environments
- Automatic chargers provide 2x charge settings (fast/slow)

Smart Battery Chargers

- Suitable for most vehicle battery types, including start/stop vehicles
- Charges twice as fast as a standard battery charger
- Can be left safely connected to a battery for an indefinite period
- Include battery maintenance features to increase battery performance and prolong battery life

6/12/24V	Lead Gel
Voltage	Battery type

6/12/24V	Lead Gel Calcium AGM EFB	START STOP
Voltage	Battery type	Start/stop

CE Approved

All Ring Chargers and Smart Chargers are tested and certified to the relevant EMC & LVD Directives

Selecting the right charger

A battery represents an expensive investment. A large percentage of these batteries will not last up to their designed life, typically five years. Poor battery maintenance, including over charging and undercharging are significant reasons why batteries fail. Therefore, selecting the right battery charger is an important choice.

Stage 1 Identify the vehicle type

Select your vehicle type, each Ring charger or SmartCharger includes the type of vehicles it can charge

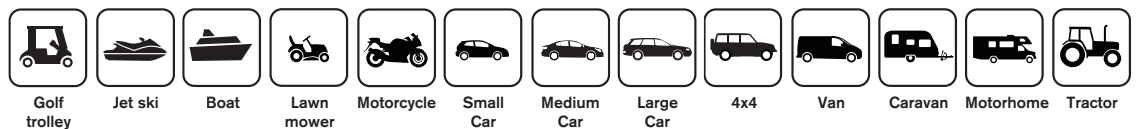

Stage 2 Identify the battery size and battery charging rate

Most vehicle batteries are rated in Ah (amp hours). As a guide use the following to calculate recharge time: 6 hours minimum, 24hrs maximum, typical 10hrs.

E.G. 120Ah battery – average optimal charging rate for that battery is 12A.

Ave: 120Ah / 10Hrs = 12A, Min: 120Ah / 24hrs = 5A, Max: 120Ah / 6Hrs = 20A

Chargers with multiple charging rates do provide fast charging and maintenance charging options



Stage 3 Identify the battery type

Lead acid or wet batteries are the traditional automotive battery type and can be charged by both standard chargers and smart chargers.

Gel batteries often used as a deep cycle, leisure or a marine battery solution. Due to their sensitivity to overcharging smart chargers are the best charging solution

Calcium batteries require a higher charging voltage and therefore require a smart charge solution

AGM batteries used in a large number of **START/STOP** vehicles allow for a higher charging current to fast charge and also need a regulated charging voltage meaning that smart is the best charging solution.

Stage 4 Identify other features required

Other features to consider when selecting your battery charger include:

Weatherproof SmartChargers up to 4A are IP65 weatherproof, safely allowing outdoor charging of a battery

Battery maintenance functions – 7 stage SmartChargers include features to recover a deeply discharged battery prolonging battery life and improving performance

High power standard chargers include an **engine start function** for an immediate jump starting

For **long term connection** and batteries/vehicles used only seasonally SmartChargers are the best solution as when the battery is fully charged additional charge is only applied when required.

Choose your battery charger

Battery Care

Professional Battery Chargers

Battery Charging for Professionals

SmartChargePro

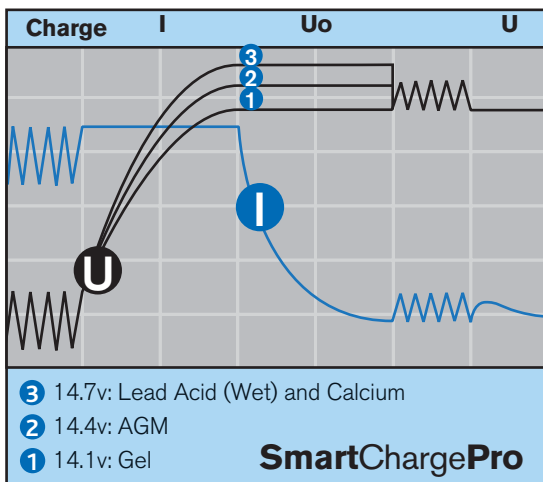

Battery type



Battery type



Battery type



Battery type



Battery type

TradeCharge

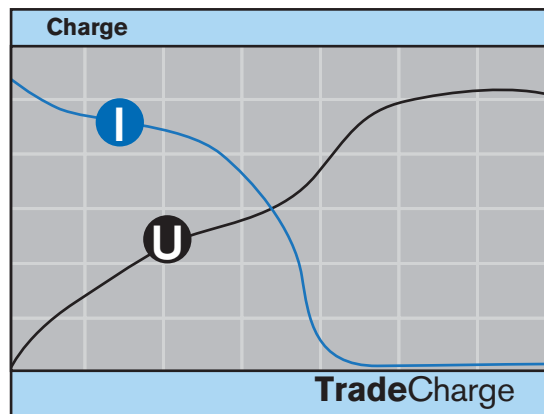

Battery type

SmartChargePro features:

Programmable Multi Chemistry

Designed to suit all vehicle battery types: Lead acid (wet), Gel, Calcium and AGM. Adjusts the charge to match precisely the specific battery type – extending battery life and improving battery performance.

12V	
Voltage	Battery type

Battery Type	Voltage
Lead Acid (wet)	14.7v
Gel	14.1v
AGM	14.4v
Calcium	14.7v

Battery Support Unit (Power Supply)

Ideal for maintaining a constant battery voltage level when appliances or vehicle diagnostic equipment are connected and require power. Ideal if diagnostic equipment is used.

Manual Reconditioning

Restores a battery from a deeply discharged state allowing the battery to operate at full performance and increases battery life.

Fast Charging

With up to 50A charging capacity available, a battery can be quickly recharged and functional.

Temperature Compensation

Adjusts the charge rate to compensate for any increase in the battery temperature.

LCD Display

Multi functioning LCD display provides all the required information to identify exactly the state of the battery and where you are in the charging process.

CE Approved All Ring Battery Chargers are tested and certified to the relevant EMC & LVD Directives.

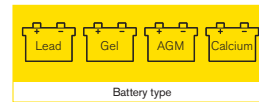
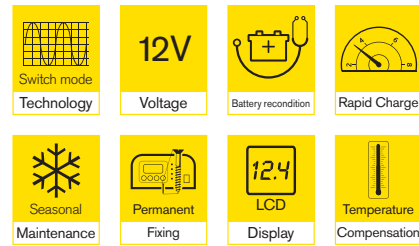
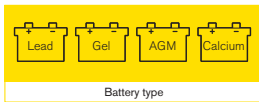
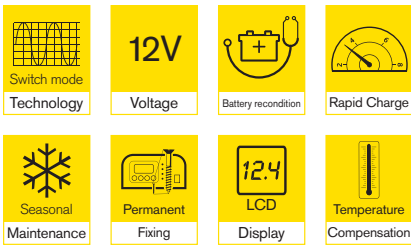

50A, 12V Professional SmartCharger

- 8 stage intelligent battery smart charger
- Up to 50 amp charging current
- Battery support unit maintains the battery voltage when diagnostics are connected drawing power
- Programmable multi-chemistry specific charging profile for different battery types
- Multifunction LED
- Manual battery reconditioning
- Temperature compensation

25A, 12V Professional SmartCharger

- 8 stage intelligent battery smart charger
- Up to 25 amp charging current
- Battery support unit maintains the battery voltage when diagnostics are connected drawing power
- Programmable multi-chemistry specific charging profile for different battery types
- Multifunction LED
- Manual battery reconditioning
- Temperature compensation

Specifications

Product Code	RSCPR50
AC Input Voltage	230V
DC Output Voltage	12V
Charge Rates	2/6/12/25/50A
LCD Display	✓
Battery Capacity	14-1000Ah
Battery Compatibility	Flooded/Calcium/Gel/AGM
Temp Compensation	✓
Weight	4.1kg
Pack Dimensions	H97 x W304 x D425mm
Case Quantity	4 x 1
Barcode	5055175221298
Accessories	RSCPRC Remote control panel

Product Code	RSCPR25
AC Input Voltage	230V
DC Output Voltage	12V
Charge Rates	2/6/12/25A
LCD Display	✓
Battery Capacity	14-500Ah
Battery Compatibility	Flooded/Calcium/Gel/AGM
Temp Compensation	✓
Weight	3.2kg
Pack Dimensions	H97 x W304 x D425mm
Case Quantity	4 x 1
Barcode	5055175221274
Accessories	RSCPRC Remote control panel

Battery Care

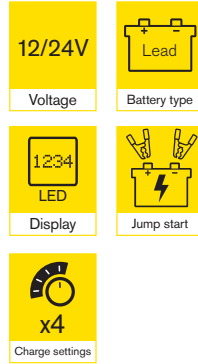
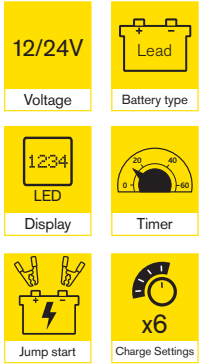

55A, 12V/24V Trolley Charger/Starter

- Up to 55 amp charging current
- Outputs for 12V and 24V batteries
- Selectable charging and jump start functions
- 6 x charge rate settings
- 60 minute timer
- Fully insulated high capacity battery clamps
- Rugged metal casings and transport handles
- Easy to read digital charge status
- Thermal and overload protection
- High impact wheels with metal bearings

40A, 12V/24V Trolley Charger/Starter

- Up to 40 amp charging current
- Outputs for 12V and 24V batteries
- Selectable charging and jump start functions
- 4 x charge rate settings
- Fully insulated high capacity battery clamps
- Rugged metal casings and transport handles
- Easy to read digital charge status
- Thermal and overload protection
- High impact wheels with metal bearings

Specifications

Product Code	RCBT55T
AC Input Voltage	230 Volts
AC Input Power (12/24V)	1400 / 2600 Watts
Charge Current (effective RMS)	55 Amps
Start Current (effective RMS)	420 Amps
Battery Capacity	60 - 600Ah
Output Fuse	2 x 50 Amps
Weight	28kg
Pack Dimensions	H818 x W513 x D433mm
Case Quantity	1 x 1
Barcode	5055175223551

Product Code	RCBT40T
AC Input Voltage	230 Volts
AC Input Power (12/24V)	1200 / 2000 Watts
Charge Current (effective RMS)	40 Amps
Start Current (effective RMS)	280 Amps
Battery Capacity	50 - 400Ah
Output Fuse	1 x 50 Amp
Weight	21kg
Pack Dimensions	H750 x W453 x D407mm
Case Quantity	1 x 1
Barcode	5055175223544



30A/35A, 12V/24V Bench Charger/Starter

- Outputs for 12V and 24V batteries
- Selectable charging and jump start functions
- Dual charge rate settings
- Fully insulated high capacity battery clamps
- Rugged metal casing
- Easy to read analogue charge status
- Thermal and overload protection



27A, 12V/24V Bench Charger/Starter

- 27A high capacity battery charger
- Charges both 12V and 24V batteries
- Includes 150A engine start
- Includes both slow and fast charging options
- Extra long 1.5m cables
- Heavy duty fully insulated battery clamps
- Ammeter to display charging status
- Rugged metal casing
- Thermal and overload protection

Specifications		
Product Code	RCBT35	RCBT30
AC Input Voltage	230 Volts	230 Volts
AC Input Power (12/24V)	800 / 1400 Watts	650 / 1200 Watts
Charge Current (effective RMS)	35 Amps	30 Amps
Start Current (effective RMS)	180 Amps	150 Amps
Battery Capacity	40 - 350Ah	30 - 300Ah
Output Fuse	1 x 50 Amp	Thermal
Weight	14kg	11kg
Pack Dimensions	H373 x W486 x D426mm	H354 x W403 x D338mm
Case Quantity	1 x 1	1 x 1
Barcode	5055175223537	5055175223520

Specifications	
Product Code	RCBT27
Charger Type	Automatic
Battery Capacity	30-300Ah
Charging Current	27A
Charging Voltage	14.4V
Nominal Voltage	12V
Battery Clamps Cable Length	1.5m
Weight	11.5Kg
Pack Dimensions	H260 x W320 x D320
Case Quantity	1 x 1
Barcode	5055175235134

Battery Care

Vehicle electronics have become more sophisticated. The number of battery types have increased, but motorists knowledge has not. Ring's 700 series of Smart Battery Chargers handles this complex technology through a design that is easy to use. The ultra compact range includes models with multi-stage charging and units with dedicated charging profiles for modern START/STOP vehicles.



Clear indication



Green Flashing LED – Charging mode
Green Solid LED – Fully charged
Red Solid LED – Battery Fault

- **Compact design**
For a more desirable looking product

- **User friendly operation**
Intuitive design that's simple to operate

- **Connect and forget**
Automatically stops charging when battery is full

- **Maintenance charging**
Ideal for long term battery connection

New brand packaging



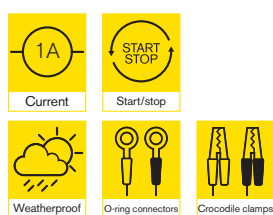

**RSC701
Smart Maintenance**

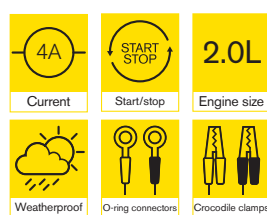
- 3 stage charge cycle for keeping batteries in good condition
- Easy to operate – no buttons to press
- Auto selects 6V or 12V
- Ideal for long term connection
- Includes both battery clamps and connectors
- Weatherproof

**RSC704
Smart Battery Charger**

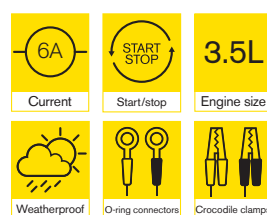
- 3 stage charge cycle for keeping batteries in good condition
- Protects against over charging
- Fast & slow charge rate settings
- One button operation
- Ideal for long term connection
- Includes both battery clamps and connectors
- Weatherproof

**RSC706
Advance Smart Charger**

- 8 stage charge cycle to optimise battery health
- Protects against over charging
- Battery repair to increase performance and life
- Fast & slow charge rate settings
- Std battery & START/STOP settings
- Lithium mode for electric vehicles
- Protects battery in cold temperatures
- Weatherproof

**RSCBM
Start/Stop technology
Battery Monitor**

- Compatible with all Ring 700 series Smart Chargers
- Traffic lights indicate the state of charge
- Ideal for long term battery connection

Specifications

Product Code	RSC701 (UK), RESC701 (Euro)	RSC704 (UK), RESC704 (Euro)	RSC706 (UK), RESC706 (Euro)	RSCBM
Battery Capacity (Charging)	20Ah	90Ah	110Ah	–
Battery Capacity (Maintenance)	60Ah	140Ah	160Ah	–
Charging Current	1A	4A	–	–
Nominal Voltage	6V / 12V	12V	12V	12V
Lithium Charging mode	–	–	–	–
Battery Clamps	1.8M	1.8M	1.8M	–
Cable Length	1.8M	1.8M	1.8M	0.38M
Charge Rate Indicator	–	–	–	✓
Winter Charging Mode	–	–	✓	–
Battery Repair Function	–	–	✓	–
Maintenance Mode Setting	–	✓	✓	–
Battery Clamps and Terminal Connectors	✓	✓	✓	–
Weight	0.57g	0.63g	0.96g	0.08g
Pack Dimensions	H274 x W177 x D60mm	H274 x W177 x D60mm	H287 x W241 x D60mm	H125 x W52 x D41mm
Case Quantity	10	10	10	100
Barcode	5055175241463 (UK) 5055175241500 (Euro)	5055175241470 (UK) 5055175241517 (Euro)	5055175241487 (UK) 5055175241524 (Euro)	5055175241494

Battery Care

Battery Chargers F10

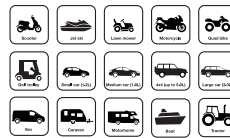

12 amp
For vehicles up to 5.0L

12V

Voltage

Lead

Gel

Calcium

AGM

EFB

START/STOP

Start/stop

RSC612 12A SmartCharger

- Multi stage fully automatic SmartChargers
- Auto Charge applies the fastest charge, based on battery size
- Includes settings for both standard vehicles and START/STOP
- Includes battery repair tools to increase performance and battery life
- Includes the following battery and alternator analysis tools:
 - Battery voltage – displays as a % the voltage status of a battery
 - Start power test – measures voltage drop during engine start to identify potential battery issues

Alternator check – tests the recharging performance of the vehicles alternator

Battery cranking performance (RSC612/RESC612) – measures the battery's cold cranking performance to determine engine starting ability

- Interactive LCD display
- Memory saver function allows vehicle and audio settings to be retained if the battery is removed

Patent pending

Specifications

Product Code	RSC612
Battery Capacity	25-300Ah
Charging Current	Variable up to 12A
Nominal Voltage	12V
Battery Clamps Cable Length	1.8m
Winter Charging Mode	✓
Battery Voltage Test	✓
Alternator Test	✓
Start Power Test	✓
Battery Performance (CCA/EN) Test	✓
Weight	1.77kg
Pack Dimensions	H280 x W270 x D88
Case Quantity	3 x 1
Barcode	5055175235301



2.0L	6/12V		
Engine size	Voltage	Battery type	Start/stop

RSC404 Smart Battery Charger

- Help improve your vehicle battery's performance and increase its life
- Multi-stage smart charge cycle repairs and protects vehicle battery
- Charges twice as fast as a standard charger, and applies multi-stage charging cycle to repair damage and protect against overcharging. Includes winter charge mode, for effective charging in cold weather
- Ideal for START/STOP vehicles
- Suitable for lead acid, gel, calcium, EFB and AGM batteries
- Rated IP65 making it weatherproof
- Interactive LCD display
- Digital screen making selecting the right mode easy

Specifications

Product Code	RSC404 (UK), RESC404 (Euro)
Battery Capacity (Charging)	90Ah
Battery Capacity (Maintenance)	140Ah
Nominal Voltage	6V/12V
Battery Clamps Cable Length	1.5m
Winter Charging Mode	✓
Battery Repair Function	✓
Maintenance Mode Setting	✓
Battery Clamps Only	✓
Weight	0.65g
Pack Dimensions	H136 x W255 x D58mm
Case Quantity	4
Barcode	5055175241739 (UK) 5055175243405 (Euro)

Battery Care

RCBT60T

12/24V Fully Automatic 60A Battery Charger with SmartCharger Technology



3 Stage SmartCharge technology

Optimises battery performance and improve a batteries ability to hold charge

Includes jump starting function

540A starting current for when a flat battery needs to be revived quickly

Suitable for 12V, 24V and Stop/Start batteries

Will work across mixed battery types in cars to commercial vehicles



LED display shows voltage, current and charge mode selected

Making it easy to select the required charging mode and review charging performance



Specifications

Product Code	RCBT60T
Input Voltage AC	230V
AC Input Power	900W
Charge Current	60A (RMS) / 40A (EN)
Start Current	540A (RMS)
Cranking Cut-off	30 seconds
Charging Voltage (12V/24V)	Lead acid 14.5V / 29.0V AGM 14.8V / 29.6V Gel 13.8V / 27.6V
Battery Capacity (12V)	20-700Ah
Battery Capacity (24V)	20-350Ah
Dimension (LxWxH)	360 x 375 x 875mm
Weight	18.5Kg
Barcode	5055175236803

12.0L

Engine size

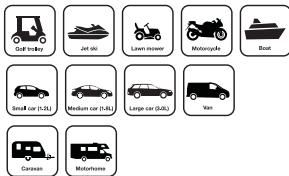

20 amp
Suitable for 12V vehicles
up to 12,000cc

5.0L

Engine size

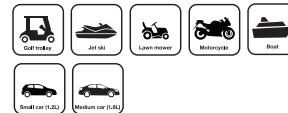

12 amp
Suitable for 6V/12V vehicles
up to 5,000cc

- Fully automatic battery chargers with fast/slow charge settings
- Tough metal and rubberised construction
- Includes both LED indicators and ammeter to display charge status
- 6V and 12V charging solutions available
- Engine start option available

6/12V

Voltage



Battery type



Ammeter



Jump start



Fully automatic



LED indicator

Specifications

Product Code	RCB320 (UK), RECB320 (Euro)	Product Code	RCB312 (UK), RECB312 (Euro)
Charger Type	Automatic	Charger Type	Automatic
Battery Capacity	20-225Ah	Battery Capacity	20-180Ah
Charging Current	20A (fast)/3A (slow)	Charging Current	12A (fast)/3A (slow)
Nominal Voltage	12V	Nominal Voltage	6V/12V
Battery Clamps Cable Length	1.8m	Battery Clamps Cable Length	1.8m
Engine Start	150A	Engine Start	-
Weight	7.2Kg	Weight	4.17Kg
Pack Dimensions	H230 x W470 x D280	Pack Dimensions	H205 x W410 x D220
Case Quantity	2 x 1	Case Quantity	2 x 1
Barcode	5055175212142 (UK), 5055175212227 (Euro)	Barcode	5055175212135 (UK), 5055175212210 (Euro)

Not suitable for use on START/STOP batteries

Battery Care

3.0L

Engine size

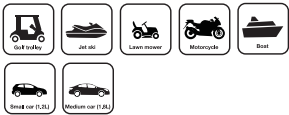

12 amp
Suitable for 12V vehicles
up to 3,000cc

2.5L

Engine size

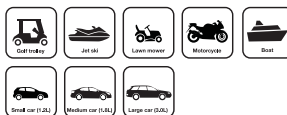

8 amp
Suitable for 12V vehicles
up to 2,500cc

1.6L

Engine size

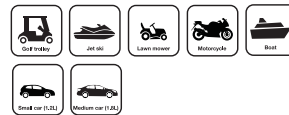

6 amp
Suitable for 6v / 12V vehicles
up to 1,600cc

- A range of automatic and manual battery chargers
- LED indicators display 'Charging' and 'Charged' status
- Models available for both 6v and 12V charging
- Convenient storage location for the battery clips and AC mains plug

12V Voltage

Lead, Gel Battery type

1234 LED Display

Fully automatic

LED indicator

6/12V Voltage

Lead Battery type

LED indicator

Specifications

Product Code	RCB212 (UK), RECB212 (Euro)	RCB208 (UK), RECB208 (Euro)	RCB206 (UK), RECB206 (Euro)
Charger Type	Automatic	Automatic	Manual
Battery Capacity	20-180Ah	20-120Ah	20-70Ah
Charging Current	12A (fast)/3A (Slow)	8A (fast)/3A (Slow)	6A
Nominal Voltage	12V	12V	6V/12V
Battery Clamps Cable Length	1.3m	1.3m	1.3m
Weight	3.8Kg	2.61Kg	2.53Kg
Pack Dimensions	H250 x W275 x D125	H250 x W275 x D125	H250 x W275 x D125
Case Quantity	3 x 1	3 x 1	3 x 1
Barcode	5055175212128 (UK), 5055175212203 (Euro)	5055175212111 (UK), 505517521297 (Euro)	5055175212104 (UK), 5055175212180 (Euro)

Not suitable for use on START/STOP batteries

1.6L

Engine size

1.2L

Engine size



RCB106/RECB106

RCB104/RECB104



RECB75

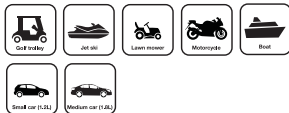

6 amp
Suitable for 12V vehicles
up to 1,600cc

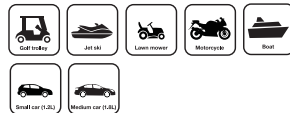

4 amp
Suitable for 12V vehicles
up to 1,200cc



0.75 amp
Suitable for 6V/12V
Maintenance charging

- A range of 4A and 6A manual battery chargers and 0.75A maintenance charger
- LED indicators display 'Charging' and 'Charged' status
- 4A / 6A suitable for charging 12V lead acid batteries
- Maintenance chargers suitable for 6V/12V lead acid and Gel batteries
- 4A / 6A include convenient storage location for the battery clips and AC mains plug

12V

Voltage



Battery type



LED indicator

6/12V

Voltage

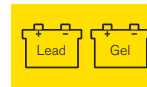

Battery type



LED indicator



Maintenance

Specifications

Product Code	RCB106 (UK), RECB106 (Euro)	RCB104 (UK), RECB104 (Euro)	RECB75 (Euro)
Charger Type	Manual	Manual	Automatic
Battery Capacity	20-70Ah	20-50Ah	1-35Ah Charging 1-100Ah Maintain
Charging Current	6A	4A	0.75A (fast) 0.15A (Slow)
Nominal Voltage	12V	12V	6v/12V
Battery Clamps Cable Length	1.2m	1.2m	1.8m
Battery Connection Provided	Clamps	Clamps	Clamps/Connectors
Weight	2.17Kg	1.18Kg	1.18Kg
Pack Dimensions	H220 x W220 x D240	H220 x W220 x D240	H240 x W160 x D88
Case Quantity	3 x 1	3 x 1	6 x 1
Barcode	5055175212098 (UK), 5055175212173 (Euro)	50551875212081 (UK), 5055175212166 (Euro)	5055175230511 (Euro)

Battery Care

1.6L

Engine size



6 amp
Suitable for 12V vehicles
up to 1,600cc

1.2L

Engine size



4 amp
Suitable for 12V vehicles
up to 1,200cc

- A range of 4A and 6A manual battery chargers
- LED indicators display 'Charging' and 'Charged' status
- Suitable for charging 12V lead acid batteries

12V

Voltage



Battery type



LED indicator

Specifications

Product Code	RCB6 (UK)
Charger Type	Manual
Battery Capacity	20-50Ah
Charging Current	6A
Nominal Voltage	12V
Battery Clamps Cable Length	1.2m
Weight	2.2Kg
Pack Dimensions	H202 x W160 x D240
Case Quantity	3 x 1
Barcode	5055175230580

Product Code	RCB4 (UK)
Charger Type	Manual
Battery Capacity	20-70Ah
Charging Current	4A
Nominal Voltage	12V
Battery Clamps Cable Length	1.2m
Weight	1.58Kg
Pack Dimensions	H202 x W160 x D240
Case Quantity	3 x 1
Barcode	5055175230573

12V Voltage	SLI AGM EFB Battery type
Multi-function	x80 Data storage Graphical Display
Battery ranges CCA 40-600 100-2000	Diode ripple test USB compatible
Integral printer	PC report



12V Graphical Battery Analyser with Printer

- Multi-function testing of battery, alternator, starter and vehicle earth
- Intuitive Graphical User Interface
- Integrated thermal printer for instant recording of results
- Memory storage up to 80 results allows multi-vehicle testing
- Battery range setting for smaller motorcycle batteries
- Selectable battery types for Wet, AGM & EFB
- Temperature compensation for more accurate results

- Alternator diode ripple test function
- Date and time stamp on print out
- Includes icon driven software to allow report printing via PC
- Robust storage case

Suitable for EFB & AGM 'Stop/Start' Batteries

Specifications	
Product Code	RBAG700
Test Method	Microprocessor controlled
Voltage	12V
Battery Types	Wet, AGM & EFB
Display Type	Graphic LCD with backlight
Battery CCA Ranges	40-600 (low range), 100-2000 (high range)
Battery Standards	CCA/SAE, DIN, EN1, EN2, IEC, JIS, CA/MCA
Battery Test	✓
Alternator Test	✓
Diode Ripple Test	✓
Starter Test	✓
Earth Test	✓
Data Download & Printing	✓
Integral Printer	✓
Pack Dimensions	260(H) x 360(W) x 98(D)
Case Quantity	8 x 1
Barcode	5055175235004

Software Included



Battery Care

12V Voltage	SLI AGM EFB Battery type	
Multi-function	Graphical Display	PC report
Battery ranges CCA 40-600 100-2000	Diode ripple test	USB compatible



12V Graphical Battery Analyser

- Multi-function testing of battery, alternator and starter
- Intuitive Graphical User Interface
- Battery range setting for smaller motorcycle batteries
- Selectable battery types for Wet, AGM & EFB
- Temperature compensation for more accurate results
- Alternator diode ripple test function
- Includes icon driven software to allow report printing via PC
- Robust storage case

Specifications

Product Code	RBAG500
Test Method	Microprocessor controlled
Voltage	12V
Battery Types	Wet, AGM & EFB
Display Type	Graphic LCD with backlight
Battery CCA Ranges	40-600 (low range), 100-2000 (high range)
Battery Standards	CCA/SAE, DIN, EN1, EN2, IEC, JIS, CA/MCA
Battery Test	✓
Alternator Test	✓
Diode Ripple Test	✓
Starter Test	✓
Data Download & Printing	✓
Pack Dimensions	220(H) x 260(W) x 70(D)
Case Quantity	20 x 1
Barcode	5055175238036

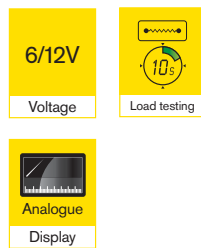
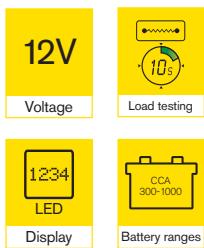

12V Digital Battery Load Tester

- Testing for battery, alternator and starter motor
- Fully automatic testing
- 125amp load test current
- Digital LED display
- Selectable battery capacity
- Rugged metal casing
- High capacity battery clamps
- Reverse polarity protection

6/12V Analogue Battery Load Tester

- Testing for battery, alternator and starter motor
- Compatible with 6V and 12V batteries
- 50amp load test current
- Easy to read analogue display
- Rugged metal casing
- High capacity battery clamps
- Reverse polarity protection

Specifications

Product Code	RBA15
Test Method	125A Load
Battery Types	12V
Display Type	LED (7-segment)
Battery CCA Ranges	300 - 1000
Battery Standards	CCA
Battery Test	✓
Alternator Test	✓
Starter Test	✓
Earth Test	-
Data Download & Printing	-
Pack Dimensions	H325 x W165 x D85mm
Case Quantity	10 x 1
Barcode	5055175229232

Product Code	RBA10
Test Method	50A Load
Battery Types	6V/12V
Display Type	Analogue
Battery CCA Ranges	300 - 500
Battery Standards	-
Battery Test	✓
Alternator Test	✓
Starter Test	✓
Earth Test	-
Data download & Printing	-
Pack Dimensions	H325 x W165 x D85mm
Case Quantity	10 x 1
Barcode	5055175229225

Battery Care



- 12V**
Voltage
- CCA 100-1700**
Battery ranges
- 1234**
LED
Display

Battery Analyser 12V Digital

- Microprocessor controlled battery testing
- Scrolling alpha-numeric LED display
- Programmable battery capacity and battery standards
- Test batteries in and out of vehicle
- Reverse polarity protection



- 12/24V**
Voltage
- 1234**
LED
Display
- 12V DC plug**

Battery Tester DC Plug

- Voltmeter with fused DC plug
- LED display shows battery voltage
- LED indicators show voltage as high, medium or low
- Connects to the vehicle's DC power socket



- 12/24V**
Voltage
- 1234**
LED
Display
- Crocodile clamps**

Battery Tester Battery Clips

- Voltmeter with insulated crocodile clips
- LED display shows battery voltage
- LED indicators show voltage as high, medium or low
- Connects directly to the battery terminals
- Polarity safe

Specifications

Product Code	RBA50	RBA3	RBA4
Battery Type	12V	12/24V	12/24V
Cable Length	70cm	30cm	90cm
Battery CCA Range	100 - 1700	-	-
Weight	0.28Kg	0.135Kg	0.135Kg
Pack Dimensions	H220 x W260 x D70mm	H175 x W75 x D60mm	H175 x W75 x D60mm
Case Quantity	20 x 1	10 x 1	10 x 1
Barcode	5055175229249	5055175215990	5055175216003

Power Packs

Multi-vehicle jump starting when you need it most

TradeStart professional power packs are able to provide multiple, high capacity jump starts in the most demanding of environments. The packs feature high capacity AGM batteries, some of which use 'pure lead' technology, widely used in aviation and military applications for their proven reliability and long service life. Ideal for car and commercial retailers, fleet operators, service engineers and agricultural outlets.



Ring power packs offer a choice of battery types from occasional light commercial use up to repeated starting on heavy goods vehicles.



BATTERY TYPES

Standard Sealed lead acid battery providing cost effective jump starting for light commercial vehicles



Heavy duty version of a sealed lead acid battery which offers improved starting performance compared to the standard SLA Battery.



Spiral wound AGM technology battery providing a more powerful starting performance than SLA batteries along with a lower self discharge

CE Approved All Ring Power Packs are tested and certified to the relevant EMC & LVD Directives.

Battery Care

Professional PowerPacks F22



TradeStart S4000

- Safeguard protection for safer operation
- High capacity spiral wound AGM batteries
- 1000 amp capacity clamps
- Start up to 7 litre truck engines
- 2 x 12V DC sockets
- Multi-function LED display
- Fault warning indicator and buzzer
- Rugged metal casing & transport handle
- High impact wheels with metal bearings
- Integrated cable storage

TradeStart S3000

- Safeguard protection for safer operation
- Heavy duty sealed lead acid batteries
- 1000 amp capacity clamps
- Start up to 5.5 litre truck engines
- 2 x 12V DC sockets
- Battery status indicators
- Reverse polarity warning buzzer and indicator
- Rugged metal casing
- Integrated cable storage

Specifications

Product Code		RPPS4000
Voltage		12V 24V
Peak Amps		4000A 2000A
Cranking Amps		1500A 800A
Cold Cranking Amps		620A 310A
Battery Size		2 x 26Ah
Battery Type		Spiral AGM
Battery Shelf Life		18 months
Battery Service Life		up to 8 years
Starting Ability	12V Petrol engines 12V Diesel engines 24V Diesel engines	up to 12 litres up to 9 litres up to 7 litres
Charge Time From Flat		11.5hrs to 95%
Charger Specification		4 Amp, 12V
Cable Length/Gauge		1.5 Metre, 35mm ²
Weight		33kg
Pack Dimensions		H580 x W355 x D335mm
Case Quantity		1 x 1
Barcode		5055175236049

Product Code		RPPS3000
Voltage		12V 24V
Peak Amps		3000A 1500A
Cranking Amps		1200A 600A
Cold Cranking Amps		550A 225A
Battery Size		2 x 22Ah
Battery Type		HD SLA
Battery Shelf Life		9 months
Battery Service Life		up to 4 years
Starting Ability	12V Petrol engines 12V Diesel engines 24V Diesel engines	up to 10 litres up to 7.5 litres up to 5.5 litres
Charge Time From Flat		10.5hrs to 95%
Charger Specification		4 Amp, 12V
Cable Length/Gauge		1.5 Metre, 35mm ²
Weight		19kg
Pack Dimensions		H390 x W340 x D290mm
Case Quantity		1 x 1
Barcode		5055175236056

12/24V Voltage	All sizes Petrol Engine size	14.0L Diesel Engine size
35mm ² Copper cables	CCA 1400/700 Cranking amps	3720/1860A Peak amps

Up to
10x starts
per charge
(24V 7 Litre)



Professional PowerPacks **F23**

ProStart ULTRA

A dual voltage 12 and 24V powerpack for high capacity jump starts in demanding environments such as truck and bus depots

- Pure lead AGM batteries for high amperage starting
- Cast bronze jaws with bridging strap
- Double insulated pure copper starting cables
- Reverse polarity warning buzzer
- External replaceable fuse
- Shatterproof polymer casing
- Starts 24V diesel engines up to 500HP
- Optional trolley (Part: RPPTR)

Specifications		
Product Code	RPP1400	
Voltage	12V/24V	
Peak Amps	3720A / 1860A	
Cranking Amps	1400A / 700A	
Cold Cranking Amps	720A / 360A	
Battery Size	2 x 22Ah	
Battery Type	Pure Lead AGM	
Starting Ability	Petrol Engines Diesel (with battery) Diesel (no battery)	Most Car, 4x4, LCV & Agricultural Engines 24V Engines up to 500HP / 14 Litres 24V Engines up to 250HP / 7 Litres
Charger Specification	4 Amp, 12V	
Cable Length/Gauge	1.8 Metre, 35mm ²	
Weight (net)	20.5kg	
Pack Dimensions	H600 x W550 x D190mm	
Case Quantity	1 x 1	
Barcode	5055175237893	



Optional trolley
Part number: RPPTR

Battery Care

12V Voltage	5.5L Petrol Engine size	4.0L Diesel Engine size
25mm² Copper cables	CCA 700 Cranking amps	1860A Peak amps

Up to
20x starts
per charge
(12V 2 Litre)



ProStart COMPACT

A powerful but portable 12V powerpack suitable for light commercial, agriculture and breakdown services

- Pure lead AGM batteries for high amperage starting
- Cast bronze jaws with bridging strap
- Double insulated pure copper starting cables
- Internal replaceable fuse
- Illuminated battery / charge meter
- Shatterproof polymer casing
- Starts 12V diesel engines up to 250HP

Specifications

Product Code	RPP700	
Voltage	12V	
Peak Amps	1860A	
Cranking Amps	700A	
Cold Cranking Amps	360A	
Battery Size	1 x 20Ah	
Battery Type	Pure Lead AGM	
Starting Ability	Petrol Engines	12V Engines up to 350HP / 5.5 Litres
	Diesel (with battery)	12V Engines up to 250HP / 4.0 Litres
	Diesel (no battery)	12V Engines up to 150HP / 2.5 Litres
Charger Specification	1.3 Amp, 12V	
Cable Length/Gauge	1.3 Metre, 25mm ²	
Weight (net)	9.3kg	
Pack Dimensions	H440 x W400 x D190mm	
Case Quantity	1 x 1	
Barcode	5055175237886	

12V Voltage	3.5L Petrol Engine size	2.0L Diesel Engine size
25mm² Copper cables	CCA 440 Cranking amps	1600A Peak amps

Up to
10x starts
per charge
(12V 1.6 Litre)



ProStart MINI

An extremely compact 12V powerpack ideal for multiple jump starts in car workshops and dealerships

- Pure lead AGM batteries for high amperage starting
- Cast bronze jaws with bridging strap
- Double insulated pure copper starting cables

- Illuminated battery / charge meter
- Shatterproof polymer casing
- Starts 12V diesel engines up to 150HP

Specifications

Product Code	RPP440	
Voltage	12V	
Peak Amps	1600A	
Cranking Amps	440A	
Cold Cranking Amps	220A	
Battery Size	1 x 12Ah	
Battery Type	Pure Lead AGM	
Starting Ability	Petrol Engines Diesel (with battery) Diesel (no battery)	12V Engines up to 250HP / 3.5 Litres 12V Engines up to 150HP / 2.0 Litres -
Charger specification	1.3 Amp, 12V	
Cable length/gauge	0.6 Metre, 25mm ²	
Weight (net)	6.5kg	
Pack dimensions	H600 x W550 x D190mm	
Case Quantity	1 x 1	
Barcode	5055175237879	

Battery Care

Jump Starters F26

2.0L Engine size	⚡ 2h Charging time
12V DC socket	LED light
2.1A USB	Jump start



Compact Lithium Jump Starter 12V, 6000mAh

- Lithium Cobalt LiCoO2 jump starter
- A safe, high powered compact jump starter that also provides power to recharge electronic gadgets
- Provides an emergency power solution that fits easily into your glove box
- 3-in-1 jump starter for vehicles up to 2.0L
- Powerbank function – Has 1 x high powered USB socket for charging electronic appliances including smart phones and tablets
- Fast 2hr recharge time
- Suitable for small to medium cars & vans
- Intelligent clamp for safe battery jump starting
- Appeals to both the D.I.Y./Light Use & enthusiast
- 'Safe Connect' system makes jump starting quick and safe
- LED torch
- Supplied with Micro USB charging cable
- Reverse polarity, short circuit and anti-spike protection

Specifications

Product Code	RPPL200
Internal Battery Voltage (nominal)	11.1V
USB Output	5V 2.4A or 9V 2.0A
Starting Current	150A
Peak Current	300A
Max Cranking Time	3 secs
Battery Type	Lithium Cobalt LiCoO2
Battery Capacity	6000mAh
Operating Temperature	-20c to 40c
Cable Clamp Opening	30mm
Weight	300g
Product Dimensions	H170 x W85 x D19mm
Pack Dimensions	H120 x W118.5 x D85mm
Case Quantity	10
Barcode	5055175243382

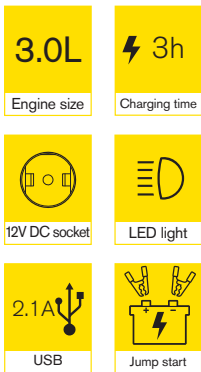

High Powered Compact Lithium Jump Starter 12V, 13,000mAh

- Lithium Cobalt LiCoO2 jump starter
- A safe, high powered compact jump starter that also provides power to recharge electronic gadgets
- Provides an emergency power solution that fits easily into your glove box
- 3-in-1 jump starter for vehicles up to 3.0L
- Powerbank function – 2 x high powered USB socket for charging electronic appliances including smart phones and tablets
- Recharges in only 3hrs time
- Suitable for small to medium cars & vans
- Intelligent clamp for safe battery jump starting
- Appeals to both the D.I.Y./Light Use & enthusiast
- 'Safe Connect' system makes jump starting quick and safe
- LED torch
- Supplied with Micro USB charging cable
- Reverse polarity, short circuit and anti-spike protection

Specifications

Product Code	RPPL300
Internal Battery Voltage (nominal)	14.8V
USB Output	5V 2.4A or 9V 2.0A or 12V 1.5A
Starting Current	300A (5 seconds)
Peak Current	600A
Max Cranking Time	3 secs
Battery Type	Lithium Cobalt LiCoO2
Battery Capacity	13,000mAh
Operating Temperature	-20c to 40c
Cable Clamp Opening	30mm
Weight	490g
Product Dimensions	H164 x W86 x D30mm
Pack Dimensions	H120 x W118.5 x D85mm
Case Quantity	10
Barcode	50551 75243399

CE Approved

Battery Care

PowerPacks F28



The ultimate jumpstart and leisure accessory

High Capacity PowerPacks

12V, 33Ah PowerPacks, designed to jump-start vehicles up to 3.5L, including 4x4s, vans and small 12V commercial vehicles.

PowerPacks

12V, 17Ah PowerPacks which are ideal for jump-starting vehicles up to 2.0L.

Features

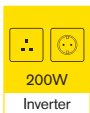

PowerSource Inverter

Provides 230V AC mains power to run the following typical applications.

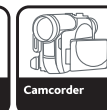
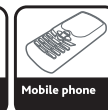
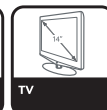

Charging Station

The charging station provides a convenient and easy to use charging solution for your PowerPack.

Also available separately
– Part No. RPPDC



Inverter Power Test

Pressing the Inverter Power Test button will display the available battery time using the inverter.



Battery Power Alarm

When the battery voltage reduces to between 11.2V and 10.5V an alarm sounds to remind the end user to recharge the PowerPack. Press any button to disable this alarm for 8 hours.



Battery Power Test

The Battery Power Test displays the available battery power and provides a visual aid to remind the end user to recharge the PowerPack.



Compressor

RPP165/ REPP165/RPP170/REPP170 include a 150PSI compressor and adaptors which is suitable for inflating vehicle tyres and leisure inflatables.

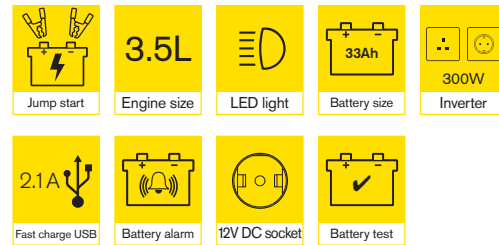
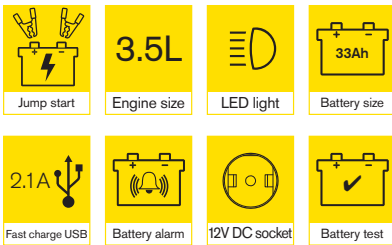

PowerPack with Charging Station

- Suitable for jump starting 12V vehicles
- 2.1A high power USB charging socket
- LED work light
- 12V DC power socket
- Includes charging station

PowerPack with 300W Inverter and Charging Station

- Suitable for jump starting 12V vehicles
- 230V mains, 300W inverter
- 2.1A high power USB charging socket
- LED work light
- 12V DC power socket
- Includes charging station

Specifications

Product Code	RPP260 (UK), REPP260 (Euro)
Voltage	12V
Peak Amps	800A
Battery Size	33Ah
300w Inverter	-
Charging Station	✓
Weight	14.55Kg
Pack Dimensions	325(H) x 360(W) x 355(D)
Case Quantity	1 x 1
Barcode	5055175232317 (UK), 5055175232331 (Euro)

Product Code	RPP265 (UK), REPP265 (Euro)
Voltage	12V
Peak Amps	800A
Battery Size	33Ah
300w Inverter	✓
Charging Station	✓
Weight	14.92Kg
Pack Dimensions	325(H)x360(W)x355(D)
Case Quantity	1 x 1
Barcode	5055175232324 (UK), 5055175232348 (Euro)

Battery Care

PowerPacks F30

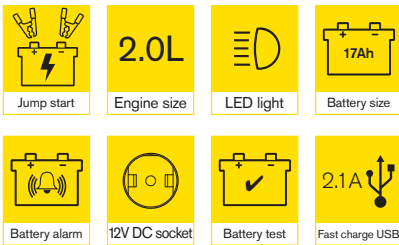

PowerPack

- Suitable for jump starting 12V vehicles
- 2.1A high power USB charging socket
- LED work light
- 12V DC power socket

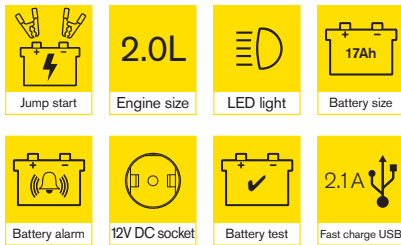

PowerPack with Compressor and Charging Station

- Suitable for jump starting 12V vehicles
- 2.1A high power USB charging socket
- 150PSI compressor
- LED work light
- 12V DC power socket
- Includes charging station

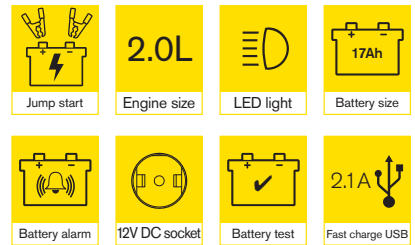

PowerPack with Compressor, 200W Inverter and Charging Station

- Suitable for jump starting 12V vehicles
- 230V mains, 200W inverter
- 2.1A high power USB charging socket
- 150PSI compressor
- LED work light
- 12V DC power socket
- Includes charging station

Specifications

Product Code	RPP160 (UK), REPP160 (Euro)	RPP165 (UK), REPP165 (Euro)	RPP170 (UK), REPP170 (Euro)
Voltage	12V	12V	12V
Peak Amps	650A	650A	650A
Battery Size	17Ah	17Ah	17Ah
150PSI Compressor	-	✓	✓
200W Inverter	-	-	✓
Charging Station	-	✓	✓
Weight	8.50Kg	9.42Kg	9.93Kg
Pack Dimensions	325(H)x360(W)x270(D)	325(H)x360(W)x305(D)	325(H)x360(W)x305(D)
Case Quantity	2 x 1	2 x 1	2 x 1
Barcode	5055175232256 (UK), 5055175232287 (Euro)	5055175232263 (UK), 5055175232294 (Euro)	5055175232270 (UK), 5055175232300 (Euro)

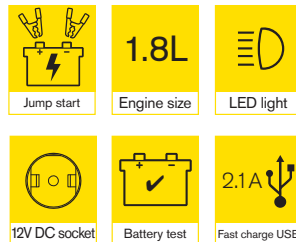
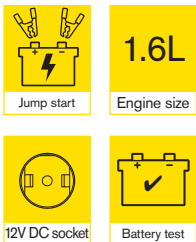

Compact PowerPack

- Suitable for jump starting 12V vehicles
- Ideal for vehicles up to 1.6L
- 12V DC power socket

Compact PowerPack with LED Light and USB Charging Sockets

- Suitable for jump starting 12V vehicles
- Ideal for vehicles up to 1.8L
- LED work light
- 2x high power USB charging sockets
- 12V DC power socket

Available as a pre-merchandised display pack

Order RPP145MB X 12 to receive the stand pre-packed with 12 units of RPP145

Order RPP148MB X 12 to receive the stand pre-packed with 12 units of RPP148

Order REPP145MB X 12 to receive the stand pre-packed with 12 units of REPP145

Order REPP145MB X 12 to receive the stand pre-packed with 12 units of REPP148

Specifications

Product Code	RPP145 (UK), REPP145 (Euro)	RPP148 (UK), REPP148(Euro)
Voltage	12V	12V
Peak Amps	450A	500A
Battery Size	7Ah	9Ah
LED Light	-	✓
USB	-	✓ x2
Weight	4Kg	4.50Kg
Pack Dimensions	268(H) x 236(W) x 155(D)	268(H) x 236(W) x 155(D)
Case Quantity	4 x 1	4 x 1
Barcode	5055175233512 (UK), 5055175233536 (Euro)	5055175233529 (UK), 5055175233543 (Euro)

Battery Care

Solar

Keep your battery levels topped up

Clean, green and free energy wherever you are



Works in overcast conditions



Durable water resistant casing



Reverse polarity protected



	Leisure Vehicles			Car		Van	Motorcycle	Golf Trolley	Jet Ski	Boat	Shed/Garage
	up to 50Ah	up to 100Ah	up to 200Ah	Small cars	Large cars						
RSP150	✓			✓			✓	✓	✓		
RSP240	✓	✓		✓	✓		✓	✓	✓		
RSP600	✓	✓	✓	✓	✓	✓	✓	✓	✓	✓	✓



RSP150



up to 50Ah



RSP240



up to 100Ah

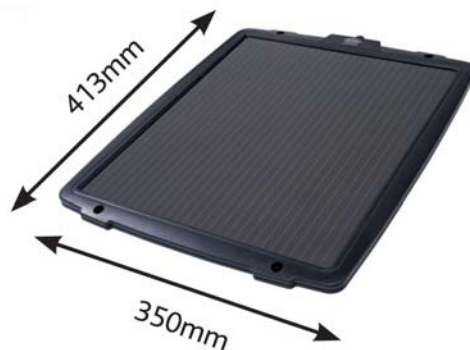

RSP600



up to 200Ah

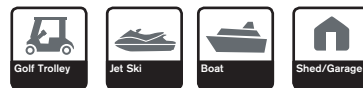

- Supplied with 12V DC power plug and battery clips
- Maintains most 12V battery types
- Flashing LED charge indicator - RSP150
- Suction cups for easy mounting - RSP150/240

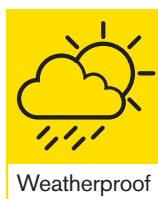

Solar Panel Power Cable

Connects your solar panel to your battery via your vehicles OBDII port



Provides a permanently 'ON' link between a solar panel and your battery for long term battery maintenance.

Part N°: RSPOBD

Specifications

Product Code	RSP150	RSP240	RSP600
Power rating (Pmax)	1.5watts (1000W/m ² , 25°C)	2.4watts (1000W/m ² , 25°C)	6.0watts (1000W/m ² , 25°C)
Voltage (at Pmax)	17.5v	17.5v	17.5v
Current (at Pmax)	86mA	138mA	343mA
Battery Voltage (nominal)	12V	12V	12V
Weight	670g	1150g	2800g
Dimensions	352x125x14mm	350x214x14mm	498x345x15mm
Barcode	5055175216515	5055175219219	5055175230733

Battery Care

Solar Power Charger F34

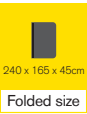

Solar Power Charger - 5V, 14W

Foldable solar panel for charging smartphones and tablets

- 5V, 14W solar panel
- Suitable for recharging smartphones, tablets and other 5V electronic gadgets
- Folds up to a convenient size for easy storage
- The solar panel is splash proof (USB socket must remain dry)

Specifications

Product Code	RSP1400
Power Rating (max) (5 cells x 2.8w)	14.0W
Output Voltage	5.0V
Output Current	USB1: 1A USB2: 2.1A
Dimensions	240 x 165 x 45mm (folded) 240 x 750 x 25mm (open)
Pack Dimensions	H202 x W250 x D50mm
Case Quantity	8 x 1
Barcode	5055175236926

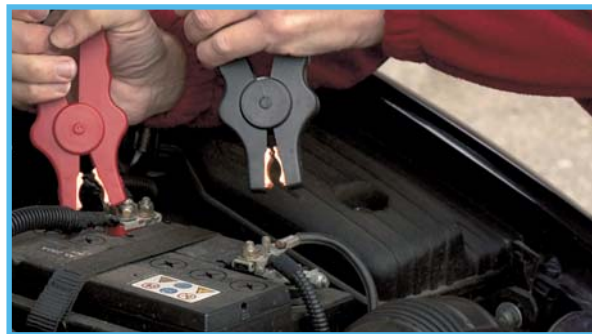
Quality:

Each set of cables are manufactured using multi-strand conductors and coated in flexible PVC. All cables are colour coded red and black in order to identify correct polarity.

Safety:

A full set of instructions are printed on the packaging of all products. Additionally, instructions are printed on a durable tag attached to the cables.

RBC500
Commercial Copper Booster Cables

- Fully insulated heavy duty clamps additional safety
- Suitable for agricultural and commercial use
- Supplied in protective nylon bag

RBC350
Commercial Copper Booster Cables

- Fully insulated heavy duty clamps additional safety
- Suitable for LGV and commercial use
- Supplied in protective nylon bag

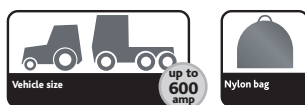
RBC250
Professional Copper Booster Cables

- Fully insulated heavy duty clamps for extra safety
- Suitable for professional use
- Supplied in a protective plastic carry case



Suitable for vehicles up to 5.5L

Specifications

Product Code	RBC500	RBC350	RBC250
Cross Section Area	50mm ²	35mm ²	25mm ²
Cable Length	5.0 Metres	4.5 Metres	3.5m
Continuous Rating	600 Amps	450 Amps	350A
Weight	6.4kg	4.4kg	3.1Kg
Pack Dimensions	H350 x W350 x D125mm	H320 x W320 x D80mm	H238 x W267 x D75
Case Quantity	2 x 1	4 x 1	4x1
Barcode	5011274051082	5011274035082	5011274025083

CE Approved All Ring Booster Cables are tested and certified to the relevant EMC & LVD Directives.

Battery Care

5.5L

Engine size



RBC250A Professional Booster Cables

- Fully insulated heavy duty clamps for extra safety
- Suitable for professional use
- Supplied in a protective nylon bag



Suitable for vehicles up to 5.5L

3.5L

Engine size



RBC160 Professional Booster Cables

- Fully insulated heavy duty clamps for extra safety
- Suitable for professional use
- Supplied in a protective nylon bag



Suitable for vehicles up to 3.5L

Specifications

Product Code	RBC250A
Cross Sectional Area	25mm ²
Cable Length	3.5m
Continuous Rating	350A
Weight	3.1Kg
Pack Dimensions	H238 x W267 x D75
Case Quantity	4x1
Barcode	5055175234960

Product Code	RBC160
Cross Sectional Area	16mm ²
Cable Length	3.0m
Continuous Rating	300A
Weight	2.5Kg
Pack Dimensions	H285 x W285 x D75
Case Quantity	4x1
Barcode	5011274016081

2.0L

Engine size



**RBC101
Booster Cables**

- Fully insulated clamps for extra safety
- Supplied in a durable polybag with handle

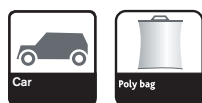

Suitable for vehicles up to 2.0L

1.6L

Engine size



**RBC060
Booster Cables**

- Plated steel clamps with insulated handles
- Supplied in a durable polybag with handle

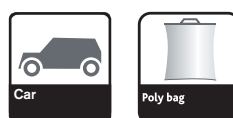

Suitable for vehicles up to 1.6L

Specifications

Product Code	RBC101
Cross Sectional Area	8.5mm ²
Cable Length	3.0m
Continuous Rating	200A
Weight	1.9Kg
Pack Dimensions	H400xW305xD75
Case Quantity	8x1
Barcode	5011274010182

Product Code	RBC060
Cross Sectional Area	6mm ²
Cable Length	2.5m
Continuous Rating	150A
Weight	1.4Kg
Pack Dimensions	H340xW265xD75
Case Quantity	10x1
Barcode	5011274006082

Battery Terminals



Twin Screw Clamping Type

- Die cast zinc alloy (RBT1 - RBT4)
- Die cast brass (RBT5 - RBT8)
- RoHS compliant
- Blister packed in singles - 115mm (H) x 86mm (W)

Specifications

Product Code	RBT1	RBT2	RBT3	RBT4	RBT5	RBT6	RBT7	RBT8
Polarity Type	Positive	Negative	Positive	Negative	Positive	Negative	Positive	Negative
Cable size (mm ²)	25 - 40	25 - 40	40 - 60	40 - 60	25 - 40	25 - 40	40 - 60	40 - 60
Amps	400	400	630	630	400	400	630	630
Cable Entry Hole (mm)	9	9	11	11	9	9	11	11
Clamp Bolt (mm)	8	8	8	8	8	8	8	8
Post Entry Hole (mm)	18.4	16.7	18.3	15.7	18.4	16.7	18.3	15.7

Crimp/Ring Band Type

- Manufactured from die cast bronze
- RoHS compliant
- Blister packed in singles - 115mm (H) x 86mm (W)

Specifications

Product Code	RBT20	RBT21	RBT25	RBT26	RBT27	RBT28
Polarity Type	Positive	Negative	Positive	Negative	Positive	Negative
Cable size (mm ²)	25 - 40	25 - 40	25 - 40	25 - 40	25 - 40	25 - 40
Amps	400	400	420	420	420	420
Stud Type			M10	M10		
Clamp Bolt (mm)	6	6	6	6	6	6
Post Entry Hole (mm)	18.3mm	16.7mm	18.3mm	16.7mm	17.8mm	16.7mm

WORKSHOP EQUIPMENT

Introduction to Inspection Lamps	G2
Inspection Lamps	G4
Inspection Torches	G18
Head Torch	G22
Worklights	G23
Leak Detection Dyes	G25

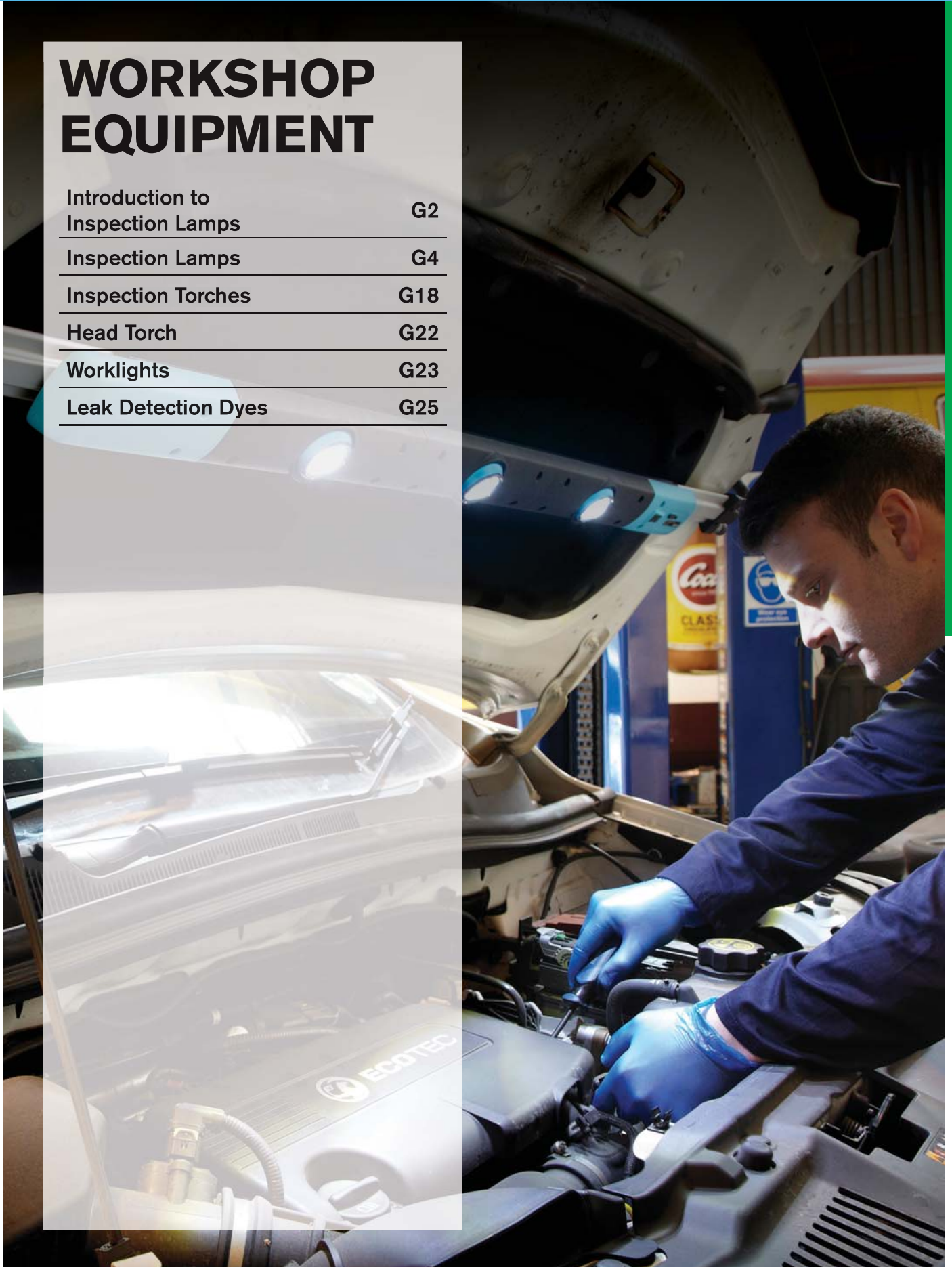



Inspection lamps

The right tool for every job...

Whatever the job, Ring Automotive has the right inspection lamp for you.

Bright, portable, rechargeable, resistant to oil and dirt and tough enough to withstand knocks in a workshop.

Features Explained

High Power

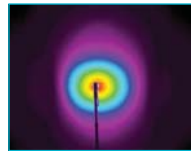
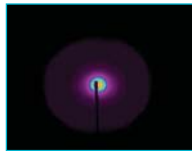
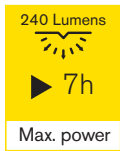

High power lamps utilise the latest technology to provide a brighter, uniform wide angle light output compared with conventional LEDs. This allows a larger area of the engine bay to be illuminated.

Virtually Unbreakable

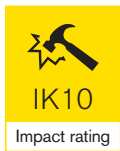

This is an international numeric classification for protection provided by enclosures for electrical equipment against external mechanical impacts created by various types of hammer. Up to a maximum of IK10 the larger the number the tougher the product.



Scan the QR code to see how tough this product is. <https://tinyurl.com/ybop948z>

Multi-Positioning



Multi-positioning is an essential feature for directional lighting allowing "hands free" operation. The magnets, ratcheting mechanisms and hooks allow you to position the light output exactly where you need it.

Light Output



Lumens are measurements of total light output. Making this measurement applicable for torches.

CE Approved



All Ring inspection lamps are tested and certified to the relevant EMC & LVD Directives.

RURL1000 REURL1000	RUBL1000 REUBL1000	RIL5500HP REIL5500HP	RIL5300HP REIL5300HP	RIL3800HP REIL3800HP	RIL3900HP REIL3900HP	RIL3600HP REIL3600HP	RIL4000 REIL4000	RIL2900HP REIL2900HP	RIL2500HP REIL2500HP
1000 Lumens	1000 Lumens	430 Lumens	240 Lumens	250 Lumens	UP TO 400 Lumens	250 Lumens	350 Lumens	250 Lumens	250 Lumens
				Torch function	Torch function	Torch function	Torch function		
▶16h Operating time	▶15h Operating time	▶6h Operating time	▶6h Operating time	▶5h Operating time	▶3h Operating time	▶3h Operating time	▶3h Operating time	▶3h Operating time	▶3h Operating time
⚡6.5h Charging time	⚡6.5h Charging time	⚡4h Charging time	⚡3h Charging time	⚡3h Charging time	⚡4h Charging time	⚡4.5h Charging time	⚡5h Charging time	⚡2.5h Charging time	⚡3h Charging time
6000K Colour temp	6000K Colour temp	6000K Colour temp	6000K Colour temp	6000K Colour temp	6000K Colour temp	6000K Colour temp	6000K Colour temp	6000K Colour temp	6000K Colour temp
Multi-angle	Multi-angle	Multi-angle	Multi-angle	Multi-angle	Multi-angle	Multi-angle	Multi-angle		
Rechargeable	Rechargeable	Rechargeable	Rechargeable	Rechargeable	Rechargeable	Rechargeable	Rechargeable	Rechargeable	Rechargeable
Magnet		Magnet	Magnet	Magnet	Magnet	Magnet	Magnet	Magnet	Magnet
60° Beam angle	60° Beam angle	Al ¹³ Aluminium	Al ¹³ Aluminium					IK07 Impact rating	IK07 Impact rating

Ramp Light LED Inspection Lamp



1000 Lumens	6000K Colour temp	1000 Lumens ▶ 6h Max. power	350 Lumens ▶ 15h Max. life	6.5h Charging time	Multi-angle	Rechargeable	60° Beam angle	Magnet
-----------------------	-----------------------------	--	---	------------------------------	--------------------	---------------------	--------------------------	---------------

- 3 x 5W LEDs provide 1000 lumens light output
- 3 levels of light output:
High (3 lamps) - 1000 Lumens
Med (2 lamps) - 675 Lumens
Low (1 lamp) - 350 Lumens
- 6000K colour temperature for bright white light
- 90° adjustable magnetic plate allow you to angle the lamp perfectly to the working area
- 40° adjustable head to shine exactly where it is required
- 60° wide angle illumination
- Sturdy polycarbonate, ABS and Aluminium construction
- 6.5hr recharge time
- Rechargeable 3.7V 10400mAh Li-ion battery
- Illuminated battery status indicator
- Includes AC mains adapter

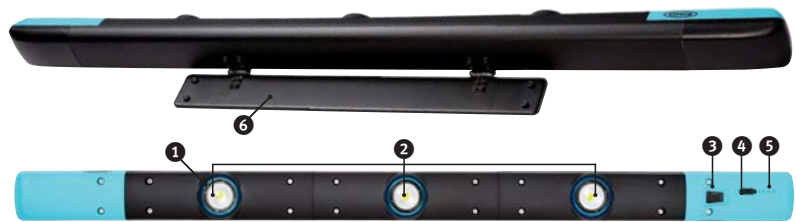

Specifications

Product Code	RURL1000 (UK), REURL1000 (Euro)
Light Output	1000 Lumens (3 lamps) 675 Lumens (2 lamps) 350 Lumens (1 lamp)
Battery	3.7V Li-ion, 10400mAh, 38.48Wh
Mains Adaptor	Input: 230V AC 50/60Hz Output: 5V DC 2000mA
Operating Time	5h (3 lamps) 10h (2 lamps) 16h (1 lamp)
Product Dimensions	H65 x W1000 x D65mm
Weight	1.8kg
Case Quantity	4 x 1
Barcode	5055175240251 (UK), 5055175240268 (Euro)

Key

- ❶ Polycarbonate Lens
- ❷ 3x 5W LED COB
- ❸ Power Button
- ❹ Charging Socket
- ❺ Battery Indicator
- ❻ 90° Adjustable mounting bracket

Under Bonnet LED Inspection Lamp



1000 Lumens	6000K Colour temp	1000 Lumens ▶ 6h Max. power	350 Lumens ▶ 15h Max. life	6.5h Charging time	Multi-angle	Rechargeable	60° Beam angle	1.75m 1.2m Extendable arms
----------------	----------------------	-----------------------------------	----------------------------------	-----------------------	-------------	--------------	-------------------	----------------------------------

- 3 x 5W LEDs provide 1000 lumens light output
- Long operating time allows full working day usage
- 3 levels of light output:
High (3 lamps) - 1000 Lumens
Med (2 lamps) - 675 Lumens
Low (1 lamp) - 350 Lumens
- 6000K colour temperature for bright white light
- 40° adjustable head to shine light on the engine bay exactly where it is required
- 60° wide angle illumination
- Sturdy polycarbonate, ABS and Aluminium construction
- Rechargeable 3.7V 10400mAh Li-ion battery
- Hook design allows usage with different vehicle types including, cars, vans and 4x4s
- Illuminated battery status indicator
- Includes AC mains adaptor

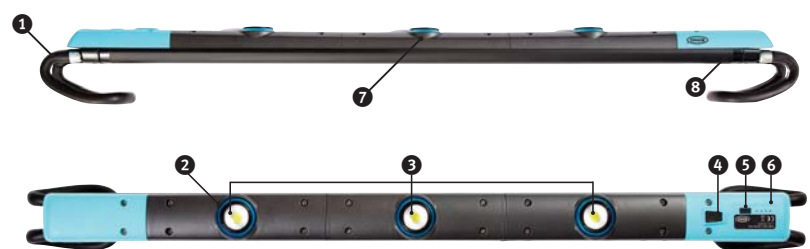
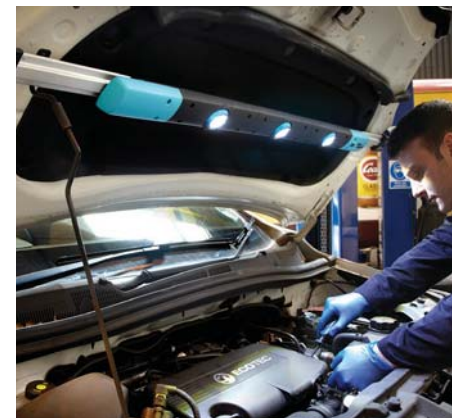
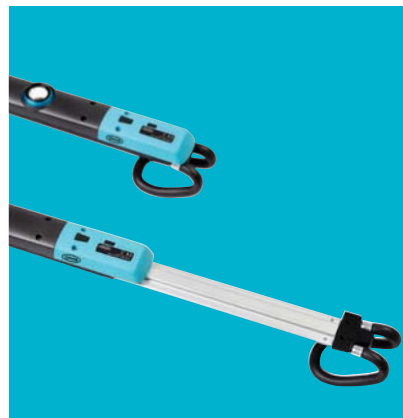

Specifications

Product Code	RUBL1000 (UK), REUBL1000 (Euro)
Light Output	1000 Lumens (3 lamps) 675 Lumens (2 lamps) 350 Lumens (1 lamp)
Battery	3.7V Li-ion, 10400mAh, 38.48Wh
Mains Adaptor	Input: 230V AC 50/60Hz Output: 5V DC 2000mA
Operating Time	6h (3 lamps) 10h (2 lamps) 15h (1 lamp)
Product Dimensions	H110 x W1195 x D120mm
Weight	2.196kg
Case Quantity	4 x 1
Barcode	5055175238715 (UK), 5055175239224 (Euro)

Key

- 1 Padded Hooks
- 2 Polycarbonate Lens
- 3 3x 5W COB LED
- 4 Power Button
- 5 Charging Socket
- 6 Battery Indicator
- 7 40° Adjustable Lamps
- 8 Extends to 1.75m

AI5 LED Inspection Lamp

430 Lumens	6000K Colour temp	430 Lumens ▶ 3h Max. power	230 Lumens ▶ 6h Max. life	4h Charging time
Al Aluminium	Multi-angle	Li-ion Rechargeable	Magnet	

- Rechargeable and cordless
- New technology COB LED provides 430 lumens light output
- Tough robust aluminium and rubber construction designed for every day use
- Includes AC mains charging adaptor



AI5 Colour Match LED Inspection Lamp

400 Lumens	4500K Colour temp	400 Lumens ▶ 2.5h Max. power	200 Lumens ▶ 4.5h Max. life	4h Charging time
Al Aluminium	Multi-angle	Li-ion Rechargeable	Magnet	CRI LED

- Rechargeable and cordless
- CRI95 (Colour Rendering Index) LED provides 4500K light. Ideal for use in bodyshops for colour matching and identifying body imperfections
- Tough robust aluminium and rubber construction designed for every day use
- Includes AC mains charging adaptor



Specifications

Product Code	RIL5500HP (UK), REIL5500HP (Euro)	RIL5500CRI (UK), REIL5500CRI (Euro)
Light Output	430 Lumens (high) 230 Lumens (low)	400 Lumens (high) 200 Lumens (low)
Battery	7.4V Li-ion 1300mAh, 9.62Wh	7.4V Li-ion 1300mAh, 9.62Wh
Mains Adaptor	230V AC 50/60Hz 8.4V 500mA	230V AC 50/60Hz 8.4V 500mA
Operating Time	Up to 3h (high) 6h (low)	Up to 2.5h (high) 4.5h (low)
Product Dimensions	H207 x W67 x D30mm	H207 x W67 x D30mm
Weight	0.438kg	0.438kg
Case Quantity	6 x 1	6 x 1
Barcode	5055175238883 (UK) 5055175239545 (Euro)	5055175238890 (UK) 5055175239552 (Euro)



Key

- | | |
|--|----------------------------------|
| 1 Rubber protection | 8 Power button |
| 2 Integral hanging hook | 9 Aluminium construction |
| 3 Concave construction to protect lens | 10 5W COB LED (RIL5500HP) |
| 4 Multi-angle mechanism | 10 5W CRI95 COB LED (RIL5500CRI) |
| 5 Anti-slip comfortable grip | 11 Toughened glass optical lens |
| 6 Magnetic base | |
| 7 Charging socket | |

AI3 LED Inspection Lamp

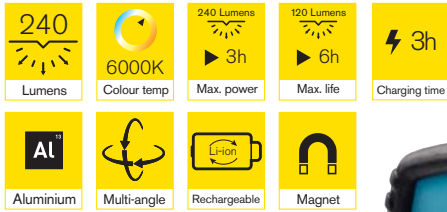

- Rechargeable and cordless
- New technology COB LED provides 240 lumens light output
- Tough robust aluminium and rubber construction designed for every day use
- Multi-positioning for directional lighting

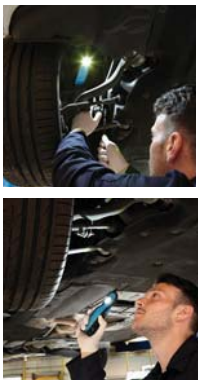

AI3 Colour Match LED Inspection Lamp

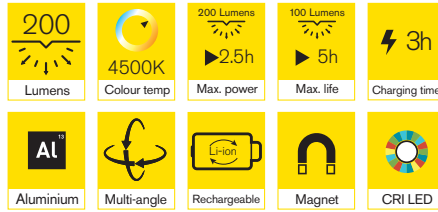

- Rechargeable and cordless
- CRI95 (Colour Rendering Index) LED provides 4500K light. Ideal for use in bodyshops for colour matching and identifying body imperfections
- Powerful 200 lumen light output
- Tough robust aluminium and rubber construction designed for every day use

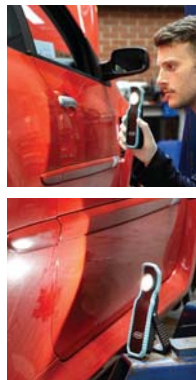

Specifications

Product Code	RIL5300HP (UK), REIL5300HP (Euro)	RIL5300CRI (UK), REIL5300CRI (Euro)
Light Output	240 Lumens (high) 120 Lumens (low)	200 Lumens (high) 100 Lumens (low)
Battery	3.7V Li-ion 2600mAh, 9.62Wh	3.7V Li-ion 2600mAh, 9.62Wh
Mains Adaptor	230V AC 50/60Hz 5V 750mA	230V AC 50/60Hz 5V 750mA
Operating Time	Up to 3h (high) 6h (low)	Up to 2.5h (high) 5h (low)
Product Dimensions	H190 x W61 x D30mm	H190 x W61 x D30mm
Weight	0.398kg	0.398kg
Case Quantity	20 x 1	20 x 1
Barcode	5055175240190 (UK) 5055175240220 (Euro)	5055175240206 (UK) 5055175240237 (Euro)



Key

- ① Rubber protection
- ② Concave construction to protect lens
- ③ Multi-angle mechanism
- ④ Anti-slip comfortable grip
- ⑤ Magnetic base
- ⑥ Charging socket
- ⑦ Power button
- ⑧ Aluminium construction
- ⑨ 3W COB LED
- ⑩ 3W CRI95 COB LED (RIL5300CRI)
- ⑩ Optical lens

MAGflex Slim LED Inspection Lamp

Designed to illuminate the narrowest of spaces. The Magflex slim is a professional, rechargeable inspection lamp, with a bright light output and versatile mounting options.

250 Lumens	6000K Colour temp	250 Lumens Max. power	125 Lumens Max. life	3h Charging time
Torch function	5V Micro USB	Multi-angle	Rechargeable	Magnet

- Slim design allows the lamp to fit in the narrowest of spaces
- Up to 250 lumens output provides bright white light to illuminate work area
- Torch function for a concentrated beam
- 180° ratcheting design and integral hanging hook to position light exactly where it is required



Specifications

Product Code	RIL3800HP (UK), REIL3800HP (Euro)
Light Output	250 Lumens (high) 125 Lumens (Low)
Battery	3.7V Li-ion, 1800mA, 6.66Wh
Operating Time	3h (High) 5h (Low)
Charging Time	3h
Product Dimensions	H455 x W88 x D48mm
Weight	0.15kg
Case Quantity	20 x 1
Barcode	5055175242538 (UK), 5055175242309 (Euro)



Key

- 1 Power button
- 2 Charging socket
- 3 Hanger
- 4 Magnetic base
- 5 Torch function
- 6 3W COB LED
- 7 Comfortable hand grip
- 8 Multi-angle mechanism

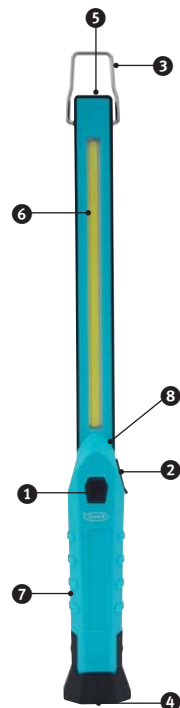

MAGflex Pivot Slim Inspection Lamp

Created to illuminate the most inaccessible of spaces. The MAGflex Pivot combines a slim design with multi axis rotation and tilt, meaning light can be directed exactly where required and the flexible mounting options allow hands free working.

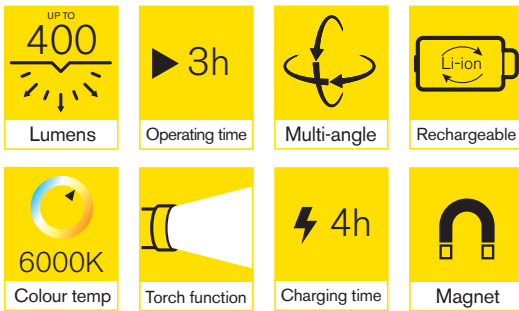

- Multi axis rotation and tilt for full angle illumination
- Slim design to illuminate the smallest of spaces
- Fully foldable and pocket sized
- Multiple magnets and hanging hook for hands free working
- High power LED torch function for a focused light



Specifications

Product Code	RIL3900HP (UK), REIL3900HP (EU)
Light Output	Up to 400 Lumens
Battery	3.7V Li-ion, 2600mAh
Mains Adaptor	Input: 230V AC 50/60Hz Output: 5V DC 1000mA
Operating Time	3h
Charging Time	4h
Product Dimensions	H230 x W30 x D42mm
Weight	0.134kg
Case Quantity	12 x 1
Barcode	5055175242934 (UK), 5055175242941 (EU)

Key

- 1 LED Torch
- 2 5W COB LED
- 3 ON/OFF Dimmer Switch
- 4 Torch ON/OFF
- 5 Magnet
- 6 Charging Indicator
- 7 Charging Socket
- 8 Integral Hanging Hook

MAGflex Twist LED Inspection Lamp

Twist the light where you need it and reach even the darkest corners of the engine bay.

250 Lumens	Rechargeable	3h Operating time	4.5h Charging time
Torch function	6000K Colour temp	Multi-angle	Magnet



- Rechargeable and cordless
- New technology COB LED provides 250 lumens light output
- Lamp can rotate 360° with a 180° ratcheting design to allow ultimate directional lighting
- White light output simulates daylight
- Wide angle of light output that has uniform intensity
- Magnet for hands free use
- Integral hanging hook
- High power LED torch function
- Anti slip comfortable grip
- Li-ion battery for faster consistent recharging
- Includes AC mains charger and 12V DC charging lead



Specifications

Product Code	RIL3600HP (UK), REIL3600HP (Euro)
Light Output	250 Lumens
Battery	3.7V Li-ion, 2200mA, 8.14Wh
Mains Adaptor	Input: 230V AC 50/60Hz Output: 5V DC 500mA
Operating Time	3h
Charging Time	4.5h
Product Dimensions	H242 x W51 x D42mm
Weight	0.488g
Case Quantity	10 x 1
Barcode	5055175236995 (UK), 5055175237213 (Euro)



Key

- 1 High power 1W torch
- 2 Robust polycarbonate lens
- 3 Integral hanging hook
- 4 3W COB LED
- 5 Magnet
- 6 Charging indicator
- 7 Charging socket
- 8 Power button
- 9 360° Rotating mechanism
- 10 Anti-slip comfortable grip
- 11 Ratchet mechanism
- 12 Magnetic base

MAGflex LED Inspection Lamp

This award winning lamp combines 180° ratcheting function with wide angle illumination.

350 Lumens	Torch function
3h Operating time	5h Charging time
Rechargeable	Multi-angle
6000K Colour temp	Magnet



- Rechargeable and cordless
- New technology strip LED provides 350 lumens light output
- Multi-positioning for directional lighting
- White light output simulates daylight
- Optical lens provides wide angle uniform illumination
- Magnet for hands free use
- 2 x Integral hanging hooks
- High power LED torch function
- Anti slip comfortable grip
- Li-ion battery for faster consistent recharging
- Includes AC mains charger and 12V DC charging lead

Specifications

Product Code	RIL4000 (UK), REIL4000 (Euro)
Light Output	350 Lumens (lamp) 85 Lumens (torch)
Battery	3.7V Li-ion, 2000mAh, 7.4Wh
Mains Adaptor	230V AC 50/60Hz 5V 1000mA
Operating Time	Up to 3h
Pack Dimensions	H337 x W140 x D61mm
Weight	0.396kg
Case Quantity	10 x 1
Barcode	5055175229393 (UK) 5055175229409 (Euro)









Key

- 1 High power 1W torch
- 2 Robust polycarbonate optical lens
- 3 Integral hanging hooks
- 4 3W SMD Strip LEDs
- 5 Power button
- 6 Charging socket
- 7 Magnets
- 8 Anti-slip comfortable grip
- 9 Ratchet mechanism
- 10 Magnetic base

ERGO Robust LED Inspection Lamp

Engineered to survive, this lamp is more than equipped to withstand the wear and tear of a workshop environment.

 250 Lumens	 IK07 Impact rating
 3h Operating time	 2.5h Charging time
 Rechargeable	 6000K Colour temp
 Magnet	



- Rechargeable and cordless
- New technology COB LED provides 250 lumens of light output
- Virtually indestructible construction
- Charging station for easy recharge
- Integral belt clip
- Magnet for hands free use
- NiMH battery for consistent recharging
- Includes AC mains charging adaptor



Key

- 1 3W COB LED
- 2 Precision reflector provides wide angle light output
- 3 Virtually unbreakable polycarbonate lens
- 4 Charging indicator
- 5 ON/OFF switch
- 6 Soft comfortable grip
- 7 Battery
- 8 Charging station
- 9 Magnetic belt clip

Specifications

Product Code	RIL2900HP (UK), REIL2900HP (Euro)
Light Output	250 Lumens
Battery	3.6V NiMH, 1800mAh
Mains Adaptor	230V AC 50Hz 6V 500mA
Operating Time	Up to 3h
Pack Dimensions	H380 x W113 x D85mm
Weight	0.452kg
Case Quantity	10 x 1
Barcode	5055175235165 (UK) 5055175235172 (Euro)

ERGO LED Inspection Lamp

Pocket-sized rechargeable torch - ideal for quick inspections.

Lumens	Impact rating
Operating time	Charging time
Rechargeable	Colour temp
Magnet	



- Rechargeable and cordless
- New technology COB LED provides 250 lumens of light output
- Compact design allows easy storage
- Precision reflector provides wide angle light output
- Integral belt clip
- Magnet for hands free use
- Tough and robust polycarbonate lens
- Lithium ion battery for faster consistent recharging
- Includes AC mains charging adaptor and 12V DC charging lead

Specifications

Product Code	RIL2500HP (UK), REIL2500HP (Euro)
Light Output	250 Lumens
Battery	3.7V Li-ion, 1800mAh
Mains Adaptor	230V AC 50Hz 5V 1000mA
Operating Time	Up to 3h
Pack Dimensions	H380 x W80 x D65mm
Weight	0.308kg
Case Quantity	10 x 1
Barcode	5055175232195 (UK) 5055175232201 (Euro)



Key

- 1 3W COB LED
- 2 Precision reflector
- 3 Magnet
- 4 Belt clip
- 5 Polycarbonate lens
- 6 Mains adaptor indicator
- 7 ON/OFF switch
- 8 Ergonomic handle
- 9 Charging point

Magnetic Flexi

-  70
Lumens
-  Magnet
-  Rechargeable
-  Multi-angle
-  4h
Operating time
-  IK07
Impact rating
-  5h
Charging time

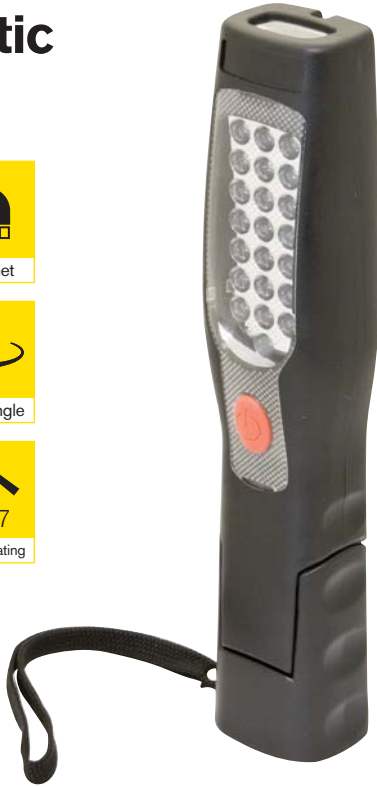





- Rechargeable and cordless
- LED torch function
- Magnet for hands free use
- Multi-positioning for directional lighting
- 2 x integral hanging hooks
- Anti slip comfortable grip
- Lithium ion battery for faster consistent recharging
- Includes AC mains charging adaptor and 12V DC charging lead

Specifications

Product Code	REIL2250 (Euro)
Light Output	70 Lumens
Battery	3.7V Li-ion, 1200mAh
Mains Adaptor	230V AC 50/60Hz 5V 300mA
Operating Time	Up to 4h
Pack Dimensions	H298 x W98 x D82mm
Weight	0.366kg
Case Quantity	10 x 1
Barcode	5055175217116 (Euro)

Compact

-  105
Lumens
-  IK07
Impact rating
-  Rechargeable
-  5h
Operating time
-  4h
Charging time



- Rechargeable and cordless
- Compact design allows easy storage
- Precision reflector provides wide angle light output
- Integral belt clip
- NiMH battery for consistent recharging
- Includes AC mains charging adaptor

Specifications

Product Code	RIL2500 (UK), REIL2500 (Euro)
Light Output	105 Lumens
Battery	3.6V NiMH, 1800mAh
Mains Adaptor	230V AC 50Hz 6V 500mA
Operating Time	Up to 5h
Pack Dimensions	H380 x W65 x D86mm
Weight	0.274kg
Case Quantity	10 x 1
Barcode	5055175203089 (UK), 5055175203164 (Euro)

Hi-Vis Compact Multi-Positional

The fluorescent colour of this lamp helps prevent accidentally leaving it in engine bays, which reduces time wasted searching for them and saves cost.

105 Lumens	IK07 Impact rating
Rechargeable	Multi-angle
5h Operating time	High visibility
4h Charging time	







- Rechargeable and cordless
- Hook/stand feature for multi-positional use
- Compact design allows easy storage
- Tough robust design for demanding conditions
- Precision reflector provides wide angle light output
- Integral belt clip
- NiMH battery for consistent recharging
- Includes AC mains charger

Specifications

Product Code	RIL2550HV (UK)
Light Output	105 Lumens
Battery	3.6V NiMH, 1800mAh
Mains Adaptor	230V AC 50Hz 6V 500mA
Operating Time	Up to 5h
Pack Dimensions	H380 x W65 x D86mm
Weight	0.366kg
Case Quantity	10 x 1
Barcode	50551 75229430 (UK)



LED Inspection Lamp and Torch

-  60 Lumens
-  Magnet
-  Rechargeable
-  4h Operating time
-  Multi-angle







- Rechargeable and cordless
- Magnetic and folding design
- Polycarbonate lens
- Torch function
- Includes 230v charging adaptor
- Integral hook and belt clip

Specifications

Product Code	RIL40
Light Output	60 Lumens
Battery	3.7V Li-ion, 1200mAh
Mains Adaptor	230V AC 50/60Hz 5V 300mA
Operating Time	Up to 4h
Pack Dimensions	H241 x W53 x D124mm
Weight	0.308kg
Case Quantity	10 x 1
Barcode	5055175227481

Professional Pocket Lamp

-  120 Lumens
-  Magnet
-  Rechargeable
-  5h Operating time
-  4h Charging time



- Rechargeable and cordless
- High powered LEDs provides a bright light output
- Anti-slip comfortable grip
- Magnet for hands free use
- LED torch function for focussed light output
- Precision reflector provides wide angle light output
- Tough and robust polycarbonate lens for demanding conditions
- Lithium ion battery for faster consistent recharging
- Includes AC mains charging adaptor

Specifications

Product Code	RIL2300 (UK), REIL2300 (Euro)
Light Output	120 Lumens
Battery	3.7V Li-ion, 1200mAh
Mains Adaptor	230V AC 50/60Hz 5V 300mA
Operating Time	Up to 5h
Pack Dimensions	H231 x W55 x D95mm
Weight	0.13kg
Case Quantity	10 x 1
Barcode	5055175232157 (UK), 5055175232164 (Euro)

Hazard Safe ATEX Torch

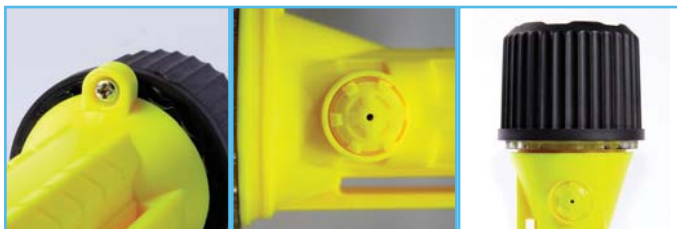

- Intrinsically safe for use in hazardous locations
- Waterproof construction
- Virtually unbreakable polycarbonate lens
- Optional high and low levels of light output
- Ex ia IIC T4 Ga

Specifications

Product Code	RT5185
Light Output	200 Lumens
Battery	4 x AA (Included)
Operating Time	Up to 50h
Pack Dimensions	H220 x W55 x D57mm
Weight	0.214kg
Case Quantity	10 x 1
Barcode	5055175234625

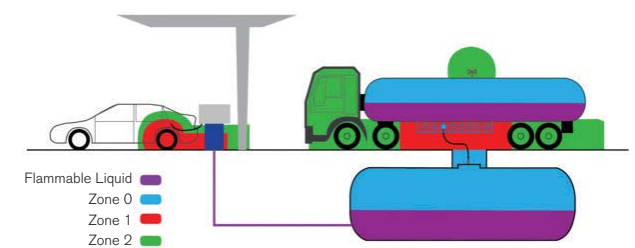

- Ex Explosion protection
- i Intrinsically safe (Limits the energy of sparks on surface temperatures)
 - a Suitable for zones 0, 1, 2
 - II Suitable for environments containing gases and vapour*
 - C *such as Acetylene, Hydrogen
 - T4 Temperature class up to 135°C
 - G Electrical equipment for gases, vapours and mists
 - a Very high protection level (2 faults)

Zoom110 Micro LED Inspection Torch



- Up to 110 lumen torch provides bright white light
- Standard setting has a wide-angle light output for total illumination of the work area
- Optical 6x zoom for a focused beam of light to see into the distance
- Built in IC protection to protect battery from over charge or discharge
- Complete with USB to Micro USB cable for convenient 2.5hr charge time
- Magnetic base for hands free usage



Specifications

Product Code	RIT1010
Light Output	110 Lumens (high) 60 Lumens (low)
Battery	3.7V Li-ion, 600mAh, 2.22Wh
Functions	High, low
Operating Time	Up to 2h (high) 2.5h (low)
Product Dimensions	H89 x W28 x D28mm
Weight	0.07kg
Case Quantity	50 x 1
Barcode	5055175240329

Key

- 1 Optical lens
- 2 Focus control
- 3 Anti-slip comfortable grip
- 4 Belt clip
- 5 Protective socket cover
- 6 Charging indicator
- 7 Power button
- 8 Micro USB socket
- 9 Magnet
- 10 USB to micro USB charging cable

Zoom150 Duo LED Inspection Torch

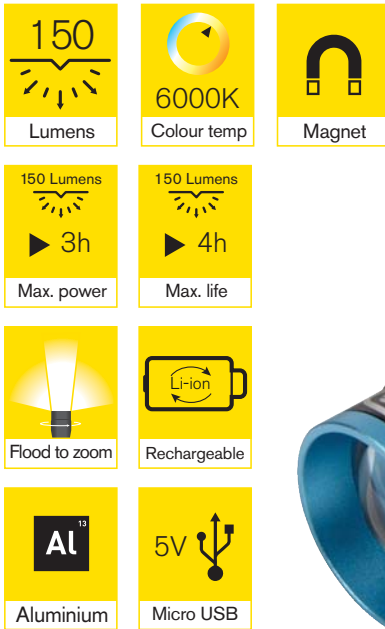

- Up to 150 lumen torch provides bright white light
- Standard setting has a wide-angle light output for total illumination of the work area
- Optical 6x zoom for a focused beam of light to see into the distance
- Torch mode up to 150 lumens – 3 h illumination time
- Lamp mode up to 150 lumens – 4 h illumination time
- Magnetic base for hands free usage
- Li-ion rechargeable battery, 2.96Wh
- Built in IC protection to protect battery from over charge or discharge
- Complete with USB to Micro USB cable for convenient recharging
- 6hr recharge time



Specifications

Product Code	RIT1040
Light Output	150 Lumens (high) 150 Lumens (low)
Battery	3.7V Li-ion, 800mAh, 2.96Wh
Functions	Torch, lamp
Operating Time	Up to 3h (torch) 4h (lamp)
Product Dimensions	H159 x W27 x D27mm
Weight	0.112kg
Case Quantity	50 x 1
Barcode	5055175240299

Key

- Optical lens
- Focus control
- Anti-slip comfortable grip
- LED lamp strip
- Protective socket cover
- Charging indicator
- Power button
- Micro USB socket
- Magnet
- USB to micro USB charging cable

Zoom300 LED Inspection Torch

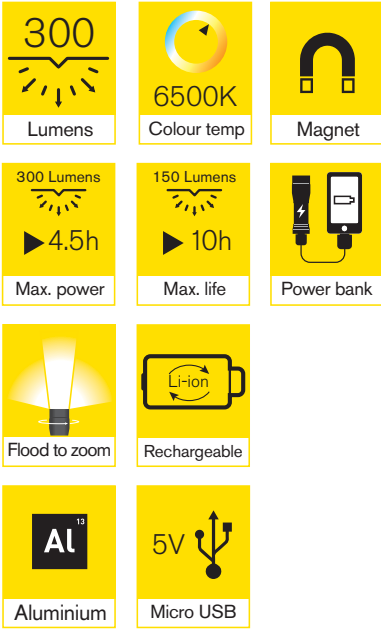

- Up to 300 lumen torch provides bright white light
- Standard setting has a wide-angle light output for total illumination of the work area
- Optical 6x zoom for a focused beam of light to see into the distance
- Max power mode up to 300 lumens – 4.5 h illumination time
- Max life mode up to 150 lumens – 10 h illumination time
- Magnetic base for hands free usage
- Li-ion rechargeable battery, 8.14Wh
- Built in IC protection to protect battery from over charge or discharge
- Complete with USB to Micro USB cable for convenient recharging
- Power bank functionality, ideal for an emergency charge of a mobile phone
- 6hr recharge time

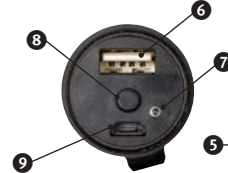

Specifications

Product Code	RIT1050
Light Output	300 Lumens (high) 150 Lumens (low)
Battery	3.7V Li-ion, 2200mAh, 8.14Wh
Functions	High, low
Operating Time	Up to 4.5h (high) 10h (low)
Product Dimensions	H145 x W38 x D38mm
Weight	0.23kg
Case Quantity	25 x 1
Barcode	5055175240282

Key

- 1 Optical lens
- 2 Focus control
- 3 Anti-slip comfortable grip
- 4 Belt clip
- 5 Protective socket cover
- 6 USB socket
- 7 Charging indicator
- 8 Power button
- 9 Micro USB socket
- 10 Magnet
- 11 USB to micro USB charging cable

Zoom750 LED Inspection Torch

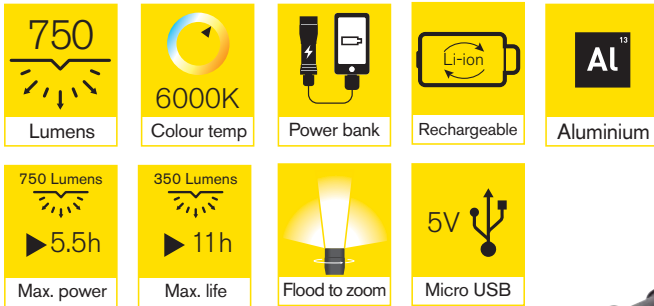

- Up to 750 lumen torch provides bright white light
- Standard setting has a wide-angle light output for total illumination of the work area
- Optical 6x zoom for a focused beam of light to see into the distance
- Max power mode up to 750 lumens – 5.5 h illumination time
- Max life mode up to 350 lumens – 11 h illumination time
- Li-ion rechargeable battery, 16.28Wh
- Built in IC protection to protect battery from over charge or discharge
- Complete with USB to Micro USB cable for convenient recharging
- Power bank functionality, ideal for an emergency charge of a mobile phone
- 12hr recharge time

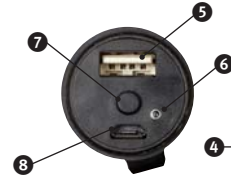

Specifications







Product Code	RIT1060
Light Output	750 Lumens (high) 350 Lumens (low)
Battery	3.7V Li-ion, 4400mAh, 16.28Wh
Functions	High, low
Operating Time	Up to 5.5h (high) 11h (low)
Product Dimensions	H210 x W44 x D44mm
Weight	0.372kg
Case Quantity	10 x 1
Barcode	5055175240275

Key

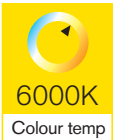
- 1 Optical lens
- 2 Focus control
- 3 Anti-slip comfortable grip
- 4 Protective socket cover
- 5 USB socket
- 6 Charging indicator
- 7 Power button
- 8 Micro USB socket
- 10 USB to micro USB charging cable

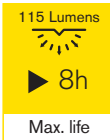
Zoom240 LED Head Torch

Rechargeable head torch with optical zoom to provide a wide angle light or focused beam. Designed with the professional in mind.

 240 Lumens	 6000K Colour temp	 240 Lumens ▶ 7h Max. power	 115 Lumens ▶ 8h Max. life
 Flood to zoom	 Rechargeable	 5V Micro USB	 Al ¹³ Aluminium

- Up to 240 lumen torch provides a bright white light to illuminate the work area
- Optical 4 x zoom for a focused beam of light to see into the distance
- Max power mode up to 240 lumens, 7h operating time
- Max life mode up to 8h operating time, 115 lumens output
- Lightweight aluminium construction and comfortable strap, can withstand knocks and be comfortably worn all day
- Built in IC protection to protect battery from over charge and maintain a consistent battery output



Specifications

Product Code	RIT1070
Light Output	240 Lumens (high) 115 Lumens (low)
Battery	3.7V Li-poly, 2800mAh, 10.36Wh
Functions	High, low, zoom
Operating Time	Up to 7h (high) 8h (low)
Product Dimensions	H46 x W74 x D48mm
Weight	0.192kg
Case Quantity	25 x 1
Barcode	5055175240336

20W Cordless LED Worklight

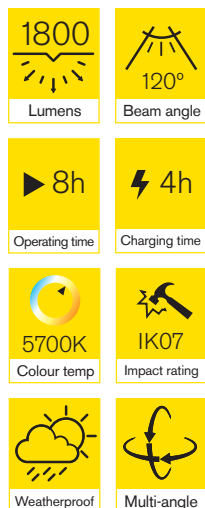

- 20W COB LED provides 1800 lumens of light output
- Rechargeable and cordless
- Provides a pure white light that replicates natural daylight
- Wide angle of light output that has uniform intensity
- Complete with adjustable floor stand and carry handle
- Tough robust die cast aluminium and tempered glass construction
- Rubber coated edge and carry handle to prevent scratches
- Cool operating temperature for comfort and safety
- Lithium ion battery for faster consistent recharging
- Includes AC mains charger

Specifications

Product Code	RWL20(UK), REWL20 (Euro)
Light Output	1800 Lumens (high) 400 Lumens (low)
Battery	11.1V Li-poly, 4400mAh, 48.84Wh
Functions	High, low
Operating Time	Up to 2h (high) 8h (low)
Product Dimensions	H220 x W225 x D70mm
Weight	1.8kg
Case Quantity	6 x 1
Barcode	5055175237428 (UK), 5055175237435 (Euro)

50W COB LED Worklight

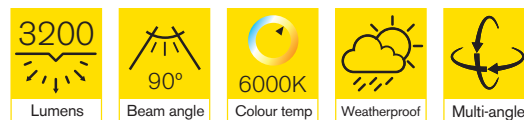









- 50W COB+ LED provides 3200 lumens of light output
- Provides a pure white light that replicates natural daylight
- Wide angle of light output that has uniform intensity
- Complete with adjustable floor stand and carry handle
- Tough robust die cast aluminium and tempered glass construction
- IP65 construction for indoor and outdoor use
- Cool operating temperature for comfort and safety
- Includes 3m (approximately) of cable

Specifications

Product Code	RWL50
Voltage	100-240v
Battery	N/A
Mains Adaptor	N/A
Cable Length	3m (approx)
Cable Rating	HO5RN3G
Power Consumption	50W
Pack Dimensions	L365 x H315 x D375mm
Case Quantity	2 x 1
Barcode	5055175234670

†Chip on board

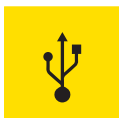
8W LED Rechargeable Work Light

 Lumens	 Weatherproof
 Colour temp	 Rechargeable
 Operating time	 Charging time
 USB compatible	 Multi-angle



- 8W COB LED provides 730 lumens of light output
- Rechargeable and cordless
- Provides a whiter light
- Wide angle of light output that has uniform intensity ideal for illuminating workshops, garages and outdoor areas
- Complete with adjustable floor stand and carry handle
- Cool operating temperature for comfort and safety
- Lithium ion battery for faster consistent recharging
- Includes USB charging lead
- LED battery power indicator

Specifications	UK/Euro
Product Code	RWL8
Light Output	730 Lumens (high) 430 Lumens (low)
Operating Time	1.5 hours (high) 2.5 hours (low)
Battery	7.4v Li-ion 1800mAh 13.32Wh
USB Cable	5v, 1000mA
Barcode	5055175237442

RLD1 Air Conditioning



Without UV

With UV

- Using RLD5 inject into A/C system and detect any refrigerant leaks from the system
- 5ml per 250ml of refrigerant

Specifications

Product Code	RLD1
Dose Qty/Volume	5ml
Pack Dimensions	H60 x W100 x D70mm
Case Quantity	1 x 12
Barcode	5055175226101

RLD2 Coolant System

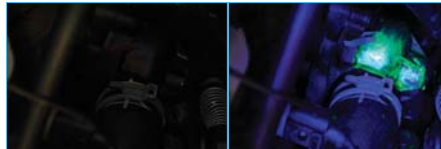

Without UV

With UV

- Add to coolant system to detect leaks in water pipes and radiators
- 25ml per 10 litres of either OAT(pink)/IAT(yellow) automotive coolants

Specifications

Product Code	RLD2
Dose Qty/Volume	25ml
Pack Dimensions	H60 x W100 x D70mm
Case Quantity	1 x 6
Barcode	5055175226118

RLD3 Surface Water Leaks



Without UV

With UV

- Spray directly onto bodywork and window seals using a spray bottle (not included) to detect any surface leaks
- 25ml per 10 litres of water

Specifications

Product Code	RLD3
Dose Qty/Volume	25ml
Pack Dimensions	H60 x W100 x D70mm
Case Quantity	1 x 6
Barcode	5055175226125

RLD4 Automotive Oils & Fuels



Without UV

With UV

- Detect Hydraulic, Engine Oil and Petrol/Diesel fluid leaks
- Suitable for all oil types (mineral, semi synthetic and synthetic)
- 25ml per 8-10 litres of petrol engine oil, 3-5 litres of diesel engine oil, 10 litres of hydraulic fluid and 15 litres of petrol/diesel fuel

Specifications

Product Code	RLD4
Dose Qty/Volume	25ml
Pack Dimensions	H60 x W100 x D70mm
Case Quantity	1 x 6
Barcode	5055175226132

RLD6 Cleaner/Degreaser



- Cleaner/degreaser to clean up excess dye

Specifications

Product Code	RLD6
Dose Qty/Volume	500ml
Pack Dimensions	H335 x W160 x D55mm
Case Quantity	1 x 1
Barcode	5055175226248

Workshop

Workshop Equipment G26

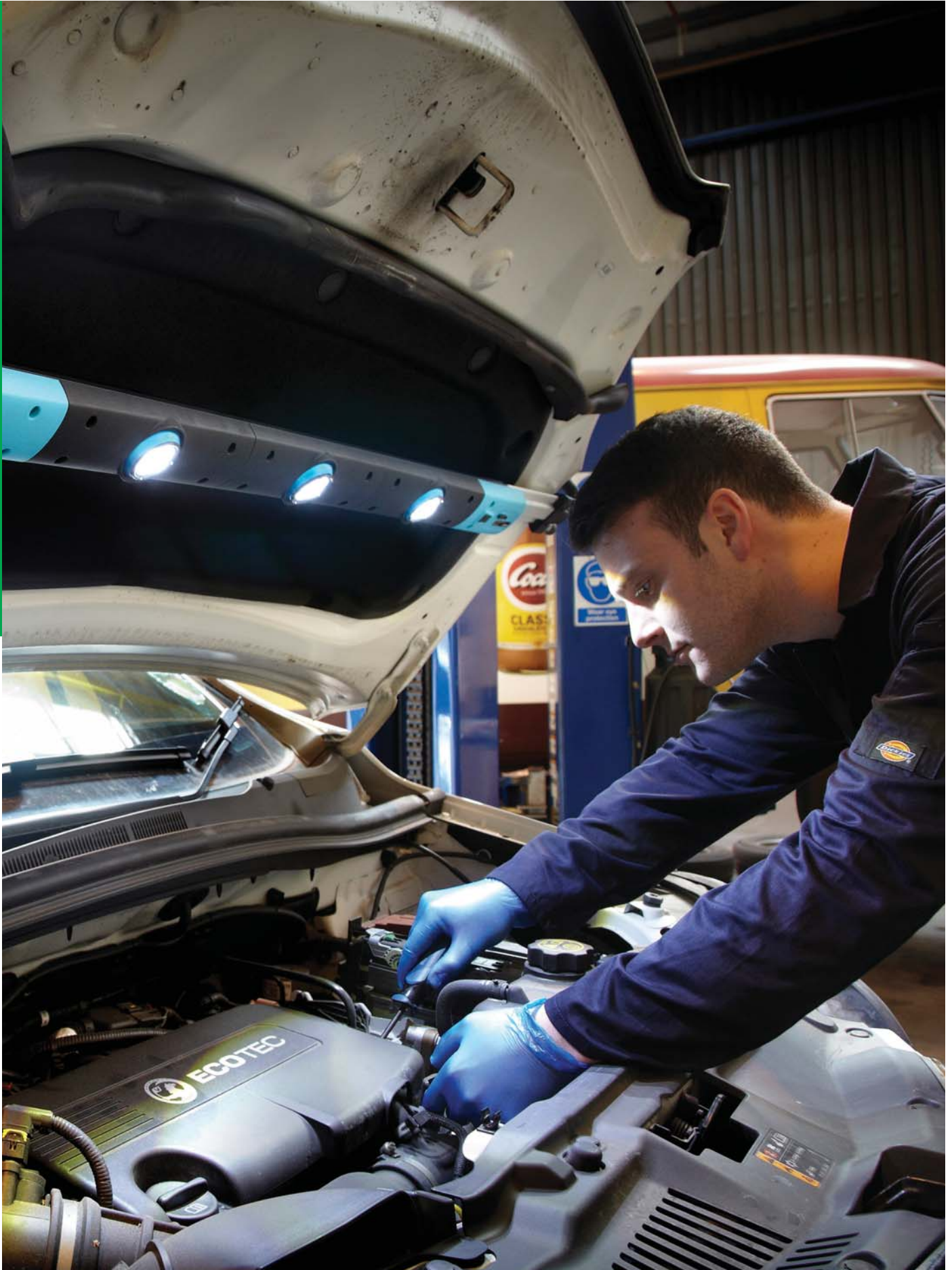

PORTABLE LIGHTING

Heavy Duty Torches	H2
Inspection Work Lights	H8
LED Lamps	H10
LED Task Lighting	H15
LED Headlamps	H16
LED Torches	H17
Batteries	H18



Portable Lighting

Compact CREE LED torch



- Aluminium construction
- Belt clip
- Flood to zoom
- High low and flash function
- Supplied in blister pack

Specifications	UK/Euro
Product Code	RT5193
Light Output	Up to 65 lumens (high) Up to 35 lumens (low)
Battery	1 x AA
Functions	on (high), on (low), on (flashing)
Operating Time	Up to 3h (high), Up to 4h (low)
Product Dimensions	D28 x W28 x L100mm
Case Quantity	1 x 1
Pack Dimensions	D28 x W100 x H220mm
Barcode	5055175241111



 Max. power	 Max. life	 Beam distance
 Batteries	 Aluminium	 Flashing



Heavy Duty CREE LED torch



- Aluminium construction
- Flood to zoom
- High low and flash function
- Supplied in blister pack

Specifications	UK/Euro
Product Code	RT5194
Light Output	Up to 200 lumens (high) Up to 100 lumens (low)
Battery	3 x AAA
Functions	on (high), on (low), on (flashing)
Operating Time	Up to 2h (high), Up to 20h (low)
Product Dimensions	D34 x W34 x L120mm
Case Quantity	1 x 1
Pack Dimensions	D34 x W100 x H220mm
Barcode	5055175241104



 200 Lumens ▶ 2h Max. power	 100 Lumens ▶ 20h Max. life	 60m Beam distance
 3 x AAA Batteries	 Al Aluminium	 Flashing



Portable Lighting

Heavy Duty Torches H4

Telescopic LED torch with lamp



- Aluminium construction
- Magnetic base
- Flood to zoom
- Supplied in blister pack



Specifications	UK/Euro
Product Code	RT5195
Light Output	Up to 220 lumens (torch) Up to 250 lumens (lamp high) Up to 110 lumens (lamp low)
Battery	4 x AAA
Functions	Torch on (high), lamp on (high), lamp on (low),
Operating Time	Up to 5.5h (torch high), Up to 17h (lamp low)
Product Dimensions	D42 x W42 x L170mm
Case Quantity	1 x 1
Pack Dimensions	D42 x W140 x H310mm
Barcode	5055175241098

<p>Torch</p> <p>220 Lumens</p> <p>▶ 5.5h</p> <p>Max. power</p>	<p>Lamp</p> <p>250 Lumens</p> <p>▶ 13.5h</p> <p>Max. power</p>	<p>Lamp</p> <p>110 Lumens</p> <p>▶ 17h</p> <p>Max. life</p>	<p>▶ 80m</p> <p>Beam distance</p>
--	--	---	-----------------------------------

<p>4 x AAA</p> <p>Batteries</p>	<p>Al¹³</p> <p>Aluminium</p>	<p>Magnet</p>
---------------------------------	---	---------------



Heavy Duty Rubber Torch



- Tough shockproof rubber torch
- Wrist strap
- Non slip grip
- 3 x D cell batteries included
- Supplied in blister pack

Specifications	UK/Euro
Product Code	RT5196
Light Output	Up to 50 lumens
Battery	3 x D
Operating Time	Up to 25h
Product Dimensions	D70 x W70 x L250mm
Case Quantity	1 x 1
Pack Dimensions	D70 x W195 x H320mm
Barcode	5055175241081

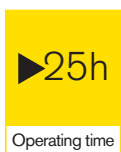

Portable Lighting

Heavy Duty Torches H6

LED Rubber torch



- Tough, shockproof rubber torch
- Up to 100,000 hours burn time
- Non slip grip
- 2 x AA batteries included
- Supplied only as a merchandising unit of 8

Specifications	UK/Euro
Product Code	RT5148
Case Quantity	8 x 1
Pack Dimensions	W277 x H188 x D215mm
Product Dimensions	W37 x H148 x D37mm
Barcode	5055175216836

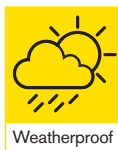
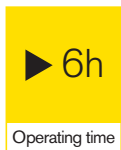

LED Rubber torch





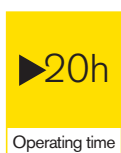

- Tough, shockproof rubber torch
- Up to 100,000 hours burn time
- Non slip grip
- 2 x D cell batteries included
- Supplied only as a merchandising unit of 8

Specifications	UK/Euro
Product Code	RT5149
Case Quantity	8 x 1
Pack Dimensions	W290 x H265 x D280mm
Product Dimensions	W68 x H198 x D68mm
Barcode	5055175216843



Portable Lighting

3W Utility Inspection Light

 180 Lumens	 Hook
 3 x AA Batteries	 Magnet

- 3W COB Flat Inspection Light
- 180 lumens
- Anti slip grip
- ABS material with rubber paint finish
- Magnet
- 360° rotating hook
- 3 x AA batteries included



Specifications	UK/Euro
Product Code	RRL660
Light Output	180 lumens
Battery	3 x AA
Functions	On, Off
Operating time	Up to 2h* on high mode
Product Dimensions	D35 x W62 x H198mm
Barcode	05055175319896
Case Quantity	CDU of 12 x 1
CDU Dimensions	D202 x W210 x H227mm



* Battery life is approximate

3W COB Mini Work Light

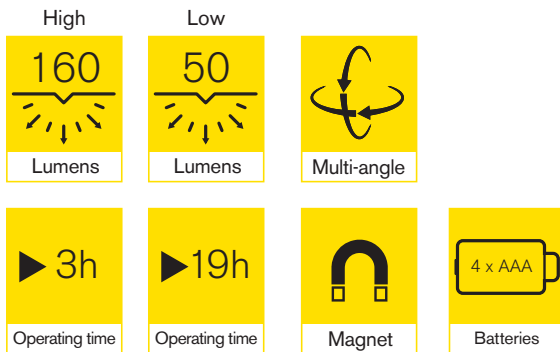

- 3W COB LED technology
- 160 lumens on high power, 50 lumens on low power
- SOS function
- ABS material with rubber paint finish
- 360° rotation
- Magnetic base made of aluminium
- 4 x AAA batteries included

Specifications	UK/Euro
Product Code	RRL570
Light Output	160 lumens (high), 50 lumens (low), 160 lumens (SOS)
Battery	4 x AAA
Functions	On (high), On (low), On (SOS)
Operating time	Up to 3.3h ¹ (high), 19.5h (low), 21h (SOS function)
Product Dimensions	D20 x W80 x H75mm
Barcode	05055175319872
Case Quantity	CDU of 12 x 1
CDU Dimensions	D180 x W180 x H80mm



¹ Battery life is approximate

Portable Lighting

LED Lamps H10

LED Extendable Lamp



Lamp	Torch
220 Lumens	60 Lumens
▶ 8h Operating time	90° Beam angle
Magnet	3 x AAA Batteries

- Perfect for DIY, around the home or car
- Dual function
- Bright white LED lamp
- Auto switch on when the lamp is extended
- High power LED torch
- Torch can be angled from 0-90°
- Magnetic base for hands free use
- 3 x AAA batteries included

Specifications	UK/Euro
Product Code	RIL80
Battery	3 x AAA
Product Dimensions	W33 x H195 x D27mm
CDU Quantity	1 x 12
CDU Dimensions	L165 x H200 x D152mm
Barcode	5055175236131



Mini LED Lamp



Lamp 100 Lumens	Torch 16 Lumens	 7.5h Operating time
 3 x AAA Batteries	 Torch function	 Multi-angle
 Magnet	 Hook	

- Perfect for DIY, around the home or car
- 100 Lumen lamp with 16 Lumen torch
- Stand allows for 270 degree light
- Magnetic base and hanging hook for hands free working
- Includes batteries
- Supplied only as a merchandised unit of 12

Specifications	UK/Euro
Product Code	RIL82
Battery	3 x AAA
Product Dimensions	W43 x H163 x D35mm
CDU Quantity	1 x 12
CDU Dimensions	L200 x H225 x D170mm
Barcode	5055175236766



• Battery life is approximate

Portable Lighting

LED Lamps H12

Rechargeable LED Lamp



200 Lumens	2h Operating time	2.5h Charging time
Rechargeable	Torch function	Multi-angle
Magnet	USB compatible	Hook

- Perfect for DIY, around the home or in the car
- 200 Lumen lamp with torch
- Stand rotates 270° for directional light
- Magnetic base and hanging hook for hands free working
- Rechargeable via micro USB socket
- Supplied only as a merchandised unit of 12

Specifications	UK/Euro
Product Code	RIL83
Battery	3.7V Li-ion, 800mAh, 2.96Wh
Product Dimensions	W43 x H163 x D35mm
CDU Quantity	1 x 12
CDU Dimensions	L198 x H281 x D221mm
Barcode	5055175240183



• Battery life is approximate

LED Pocket Lamp

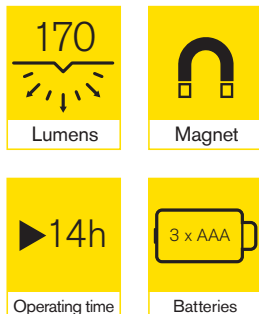

- Stylish and compact pocket lamp. Soft touch finish for comfort and durability. Complete with a strong magnetic base and swivel pocket clip for hands free use
- 170 lumen output makes it ideal for use in the car, at home, leisure activities and DIY
- 3 x AAA batteries included
- Supplied as a merchandising unit of 12

Specifications	UK/Euro
Product Code	RIL56
Battery	3 x AAA
Product Dimensions	H165 x W27 x D27mm
CDU Quantity	1 x 12
CDU Dimensions	H180 x W140 x D177mm
Barcode	5055175242545



• Battery life is approximate

Portable Lighting

LED Lamps H14

Ultra Bright COB LED Pocket Lamp

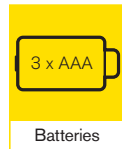
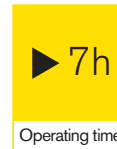

- Perfect for DIY, leisure, around the home or car
- 110 lumen lamp
- COB LED provides a wide angle of light that has a uniform intensity
- Small ergonomic grip
- Magnetic clip for hands free use
- Integral swivel pocket clip
- 3 x AAA batteries included
- Supplied only as a merchandising unit of 12



Specifications	UK/Euro
Product Code	RIL54
Battery	3 x AAA
Product Dimensions	W21 x H164 x D28mm
CDU Quantity	12 x 1
CDU Dimensions	L155 x H177 x D136mm
Barcode	5055175237480

• Battery life is approximate

110
Lumens

▶ 7h
Operating time

Magnet

3 x AAA
Batteries



Pocket Lamp

- Magnetic
- Integral swivel pocket clip
- Includes batteries



RIL51



RIL50

Specifications	Blister UK/Euro	CDU UK/Euro
Product Code	RIL51	RIL50
Battery	3 x AAA	3 x AAA
Case Quantity	12 x 1	12 x 1
Pack Dimensions	L65 x H179 x D18mm	L65 x H179 x D18mm
Pack Quantity	8 x 12	8 x 12
Barcode	5055175228501	5055175227832

70
Lumens

▶ 9h
Operating time

Torch function

4 x AAA
Batteries



Hand Light

- Lamp and torch functionality
- Wrist strap
- Includes batteries



RIL60

Specifications	UK/Euro
Product Code	RIL60
Battery	4 x AAA
Case Quantity	16 x 1
Pack dimensions	L180 x H180 x D180mm
Pack Quantity	4 x 16
Barcode	5055175229317

Portable Lighting

High Performance Headlamp



Multi-angle



Lumens



Flashing



Red LED



Weatherproof



Batteries



Operating time

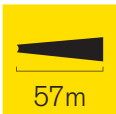

Beam distance

- Bright white LED
- High – Low – Red LED – Flashing function
- Red LED with flashing mode
- Adjusts through 45° to focus on area
- 3 x AAA batteries included
- Battery life*: 8 hours

Specifications

Product Code	RT5191
Case Quantity	6 x 1
Pack Dimensions	W155 x H165 x D55mm
Product Dimensions	W60 x H40 x D35mm
Barcode	5055175235318

LED Headlamp



Lumens

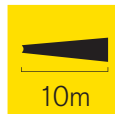

Beam distance



Batteries

- Bright white LED
- Up to 100,000 hours burn time
- Adjusts through 90° to focus on work area
- 3 x AAA batteries included
- Battery life*: 8 hours

Specifications

Product Code	RT5174
Case Quantity	6 x 1
Pack Dimensions	W180 x H127 x D82mm
Product Dimensions	W70 x H60 x D56mm
Barcode	5055175225982

* Battery life is approximate

9 LED Aluminium Torch



- 9x Super bright LEDs
- Tactical On/Off switch
- Up to 100,000 hours burn time
- Handy carry strap
- 3 x AAA battery included
- Supplied only as a merchandising unit of 12
- Battery life*: 8.5 hours



30
Lumens

25m
Beam distance

3 x AAA
Batteries

Specifications

Product Code	RT5158
Case Quantity	12 x 1
Pack Dimensions	W66 x H150 x D53mm
Product Dimensions	Ø30 x L90mm
Barcode	5055175229799

LED Keyring Torch



- 1x Bright white LED
- Low power consumption
- Up to 100,000 hours burn time
- 2 x button cell batteries included
- Battery life*: 3 hours

4
Lumens

5m
Beam distance

2 x CR2019
Batteries

Specifications

Product Code	RT5157
Case Quantity	12 x 1
Pack Dimensions	W105 x H170 x D20mm
Product Dimensions	W26 x H60 x D8mm
Barcode	5055175217307

LED Rechargeable Car Torch



- Rechargeable via 12V socket
- Red LED light charging indicator
- Adjustable fitment clips for a secure fit
- Twist top cap to switch on
- Suitable for most vehicles

15
Lumens

8m
Beam distance

Specifications

Product Code	RRCT01
Case Quantity	12 x 1
Pack Dimensions	H125 x W95 x D5mm
Product Dimensions	H20 x W60 x D20mm
Barcode	5055175229164

* Battery life is approximate

Portable Lighting

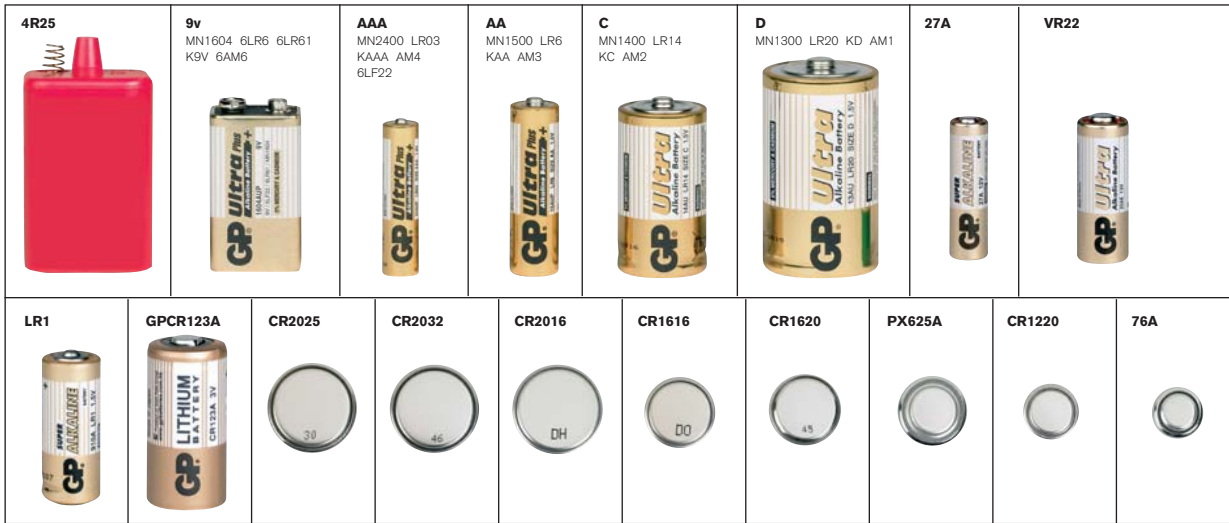

- Alkaline batteries lasting up to six times longer than zinc chloride for high drain equipment
- Dry cell batteries manufactured to BS397 Part 1 & 2 and to ISO9000 and ISO9001
- All batteries are guaranteed against leakage
- Fitting instructions and general guidance information on each pack
- Date coded
- Dry cell 9V is 100% mercury free, rest are 100% free of both mercury and cadmium

KEY FOB BATTERIES

REFERENCE	CELL TYPE	BATTERIES PER BLISTER	CARDS PER BOX	VOLTS	BARCODE
VR22 (23A)	Alkaline	1	10	12	4891199004193
27A	Alkaline	1	10	12	4891199003783
76A (LR44/A76A)	Alkaline	1	10	1.5	4891199003967
PX625A	Alkaline	1	10	1.5	5011716300068
LR1 (910A)	Alkaline	2	10	1.5	4891199000065
CR1220	Lithium	1	10	3	4891199004346
CR2016	Lithium	1	10	3	4891199021381
CR2025	Lithium	1	10	3	4891199021404
CR2032	Lithium	1	10	3	4891199003721
CR1616	Lithium	1	10	3	4891199003691
CR1620	Lithium	1	10	3	4891199003691
CR2450	Lithium	1	10	3	4891199063916
GPCR123A	Lithium	1	10	3	4891199001086

BLISTER PACK - HI POWER - ZINC CHLORIDE

REFERENCE	CELL TYPE	BATTERIES PER BLISTER	CARDS PER BOX	VOLTS	BARCODE
23105G	4R25	Not Blister	6	6	5338061001488

BLISTER PACK - LONG LIFE - ALKALINE

REFERENCE	CELL TYPE	BATTERIES PER BLISTER	CARDS PER BOX	VOLTS	BARCODE
GP13AU	D	2	10	1.5	4891199034442
GP14AU	C	2	10	1.5	4891199034473
GP15AU	AA	4	10	1.5	4891199027598
GP24AU	AAA	4	10	1.5	4891199027659
GP25	AAAA	2	10	1.5	4891199058615
GP1524AU	AA	24	8	1.5	4891199082979
GP2424AU	AAA	24	8	1.5	4891199083082
GP1604AU	9v	1	10	9.0	4891199034688

RECHARGEABLE BATTERIES

REFERENCE	CELL TYPE	BATTERIES PER BLISTER	CARDS PER BOX	VOLTS	BARCODE
GPR132	AA	4	10	1.2	891199119576
GPR63	AAA	4	10	1.2	891199119637

TYRE CARE

Air Compressors	J2
Tyre Gauges	J19
Foot Pumps	J20
Emergency Tyre Kits	J21
Tyre Repair	J22



Tyre Care

Air Compressors

Building on Ring's award winning and market leading air compressor range, Ring is delighted to launch its next generation of air compressors. Specifically designed to meet the requirements of leisure and travel within or around vehicles, the elegant styling of Ring's custom-designed air compressors captures the latest technology and design, whilst providing a functional product. Running your tyres at the correct pressure is essential to your road safety, saves money, fuel and can reduce your CO₂ emissions.



	Cordless 4 in 1	3 in 1	Premium	Time saver	Time saver	Easy Use	Easy Use	Great Value	Great Value	Professional	Heavy Duty Caravan and Motorhome	Heavy Duty 4x4	Analogique	Van	Motorcycle and Car
Part number	RTC6000 RET6000	RTCS000	RTC1000	RTC600	RTC500	RTC400	RTC300	RTC200	RTC100	RAC900	RAC830	RAC820	RAC710	RAC700	RAC605
Air compressor	2 mins*	3 mins*	2 mins*	3 mins*	3 mins*	3.5 mins*	3.5 mins*	4.5 mins*	4.5 mins*	1.5 mins*	2 mins*	2.5 mins*	2 mins*	3.5 mins*	3 mins*
Air pump (for inflation and deflation of airbeds and other large items)	2 mins**	2 mins**													
12V fused power	12V DC plug	12V DC plug	12V DC plug	12V DC plug	12V DC plug	12V DC plug	12V DC plug	12V DC plug	12V DC plug		12V DC plug	12V DC plug	12V DC plug	12V DC plug	12V DC plug
Direct to battery clips										Crocodile clamp					Crocodile clamp
Cordless / Rechargeable	Cordless														
USB output	USB port														
Digital gauge	30.0" Digital gauge 76 x 48mm	30.0" Digital gauge 76 x 48mm	30.0" Digital gauge 76 x 48mm	30.0" Digital gauge 40 x 25mm	30.0" Digital gauge 40 x 25mm	30.0" Digital gauge 32 x 16mm	30.0" Digital gauge 23 x 12mm				30.0" Digital gauge 40mm dia.	30.0" Digital gauge 40 x 20mm			30.0" Digital gauge
Analogue gauge								Analogue gauge 50mm dia.	Analogue gauge 40mm dia.	Analogue gauge 45mm dia.			Analogue gauge 55mm dia.	Analogue gauge 50mm dia.	
Quick set	30.0" Quick set	30.0" Quick set	30.0" Quick set								30.0" Quick set	30.0" Quick set			
Auto stop	STOP Auto stop	STOP Auto stop	STOP Auto stop	STOP Auto stop	STOP Auto stop						STOP Auto stop	STOP Auto stop			STOP Auto stop
Deflation valve	Deflator valve	Deflator valve	Deflator valve	Deflator valve	Deflator valve					Deflator valve	Deflator valve	Deflator valve			
Wind up cord		Wind up cord	Wind up cord	Wind up cord		Wind up cord		Wind up cord							
Worklight	Light	Light	Light	Light	Light	Light					Light	Light	Light		Light
Storage case	Storage case	Storage case	Storage case	Storage case	Storage case					Storage case	Storage case	Storage case	Storage case	Storage case	Storage case
Inflation time	2 mins*	3 mins*	2mins*	3 mins*	3 mins*	3.5 mins*	3.5 mins*	4.5 mins*	4.5 mins*	1.5 mins*	2 mins*	2.5 mins*	2 mins*	3.5 mins*	3 mins*

* Approx based on inflating a 13" tyre to 35psi ** Approx based on inflating a single air bed

Design Features

Ring has created a unique and evolutionary design for its new range of air compressors. During the design process, product functionality was paramount, resulting in the enhanced product features below.

Cable storage

Neat and tidy storage for fused 12V power plug.



Wind up power cable gets you back on the road faster.



Air hose storage

Kink-eliminating, easy access, air-hose storage. Screw stem valve connector and flexible air line helps to reach awkward valve positions.



Gauges/Buttons

Large On/Off push switch for easy use with dirty or greasy hands.



Analogue gauge measuring pressure as PSI, BAR and kPA.



Increased screen size with status bar for improved visibility in all light conditions. Larger setting dial for easier use.



Quick set digital gauge: stops automatically and remembers pressure until next time. Measures in PSI, BAR and kPA.

Light

Flat design and directional LED light gives you maximum stability and illumination where you need it.



Tyre deflation valve

Quickly reduces unwanted pressure.



Adaptor kit & air pump

Adaptor kit for bikes, air beds and other leisure accessories. Air pump allows for rapid inflation and deflation of much larger items.



Storage case

Handy durable storage case.



USB output and cordless operation

Rechargeable model includes a power bank which allows you to have power anywhere and at anytime.



Valve cap storage

Handy storage compartment to help prevent loss of valve caps.



Tyre Care

RTC6000/RETC6000 Cordless 4 in 1 Digital Tyre Inflator with Air Pump



Features

- Inflates a tyre in 2 minutes*
- Inflates a single air bed in 2 minutes
- Quick setting digital gauge that automatically stops at the set pressure and remembers pressure until next time. Measures in PSI, BAR and kPA. Switch to air pump mode to rapidly inflate and deflate air beds and other large inflatables
- Easy to read W76 x H48mm digital screen with status bar helping you to keep track in any condition
- Extra-long 70cm flexible air hose with easy access storage compartment specifically designed to reduce kinks. Premium brass screw stem connector helps reach awkwardly placed tyre valves
- Tyre deflation valve quickly releases unwanted pressure
- Fitted with extra-long 3.5m power cable and fused 12V DC power plug so you can still inflate even after the on board rechargeable battery is fully discharged. Additional 230V AC power cable included for recharging
- Cordless. On board rechargeable lithium-ion battery 2200mAh
- Handy on board power bank. USB output 2.4A. Never be without power again, perfect for emergency use
- Valve cap storage compartment for safe keeping when inflating
- Flat design and directional white LED light gives you maximum stability and illumination where you need it
- Large On/Off button for easy use with dirty/greasy hands or in poor lighting conditions
- Complete with 10 piece adaptor kit for bikes, air beds and other inflatables, 4 x spare valve caps, 1 x spare fuse and 1 x pair gloves
- Complete with handy storage case

Accessories



Specifications

Product Code	RTC6000 (UK), RETC6000 (EU)
Voltage	12V DC / 230V AC
Max Amperage	15A
Wattage	180W
Max Pressure Reading	100PSI
Air Line Length	70cm
Product Size	L298 x W250 x H80mm
Pack Size	L90 x W318 x H290mm
Power Cable	3.5m
Pack Weight	2.02kg
Case Quantity	4 x 1
Barcode	5055175242422 (UK), 5055175242439 (EU)

*Approx based on inflating a 13" tyre to 35PSI

RTC5000 3 in 1 Digital Tyre Inflator with Air Pump



Features

- Inflates a tyre in 3 minutes*
- Inflates a single air bed in 2 minutes
- Quick setting digital gauge that automatically stops at the set pressure and remembers pressure until next time. Measures in PSI, BAR and kPA. Switch to air pump mode to rapidly inflate and deflate air beds and other large inflatables
- Easy to read W76 x H48mm digital screen with status bar helping you to keep track in any condition
- Flexible air hose with easy access storage compartment specifically designed to reduce kinks. Screw stem valve connector helps reach awkwardly placed tyre valves
- Tyre deflation valve quickly releases unwanted pressure
- Fitted with 3.3m power cable and fused 12V DC power plug to help you reach all around the vehicle
- Wind up power cable gets you back on the road faster
- Valve cap storage compartment for safe keeping when inflating
- Flat design and directional white LED light gives you maximum stability and illumination where you need it
- Large On/Off button for easy use with dirty/greasy hands or in poor lighting conditions
- Complete with 10 piece adaptor kit for bikes, air beds and other inflatables, 4 x spare valve caps, 1 x spare fuse and 1 x pair gloves
- Complete with handy storage case

Specifications

Product Code	RTC5000
Voltage	12V
Max Amperage	10A
Wattage	120W
Max Pressure Reading	100PSI
Air Line Length	65cm
Product Size	L298 x W250 x H80mm
Pack Size	L90 x W318 x H290mm
Power Cable	3.3m
Pack Weight	1.53kg
Case Quantity	4 x 1
Barcode	5055175242415

Accessories



Image for illustrative purposes only

*Approx based on inflating a 13" tyre to 35PSI

Tyre Care

RTC1000 Premium Rapid Digital Tyre Inflator



Features

- Inflates a tyre in 2 minutes*
- Quick setting digital gauge that automatically stops at the set pressure and remembers pressure until next time. Measures in PSI, BAR and kPA
- Easy to read W76 x H48mm digital screen with status bar helping you to keep track in any condition
- Extra-long 70cm flexible air hose with easy access storage compartment specifically designed to reduce kinks. Premium brass screw stem connector helps reach awkwardly placed tyre valves
- Tyre deflation valve quickly releases unwanted pressure
- Fitted with extra-long 3.5m power cable and fused 12V DC power plug to help you reach all around the vehicle
- Wind up power cable gets you back on the road faster
- Valve cap storage compartment for safe keeping when inflating
- Flat design and directional white LED light gives you maximum stability and illumination where you need it
- Large On/Off button for easy use with dirty/greasy hands or in poor lighting conditions
- Complete with 3 piece adaptor kit for bikes, air beds and other inflatables, 1 x spare fuse, 4 x spare valve caps and 1 x pair gloves
- Complete with handy storage case

Specifications

Product Code	RTC1000
Voltage	12V
Max Amperage	15A
Wattage	180W
Max Pressure Reading	100PSI
Air Line Length	70cm
Product Size	L219 x W200 x H88mm
Pack Size	L95 x W230 x H245mm
Power Cable	3.5m
Pack Weight	1.07kg
Case Quantity	6 x 1
Barcode	5055175242408

Accessories



*Approx based on inflating a 13" tyre to 35PSI

RTC600 Time Saver Digital Tyre Inflator



Features

- Inflates a tyre in 3 minutes*
- Programmable digital gauge that automatically stops at the set pressure and remembers pressure until next time. Measures in PSI, BAR and kPA
- Large W40 x H25mm digital screen
- Flexible air hose with easy access storage compartment specifically designed to reduce kinks. Screw stem valve connector helps reach awkwardly placed tyre valves
- Tyre deflation valve quickly releases unwanted pressure
- Fitted with 3.3m power cable and fused 12V DC power plug to help you reach all around the vehicle
- Wind up power cable gets you back on the road faster
- Valve cap storage compartment for safe keeping when inflating
- Flat design and directional white LED light gives you maximum stability and illumination where you need it
- Large On/Off button for easy use with dirty/greasy hands or in poor lighting conditions
- Complete with 3 piece adaptor kit for bikes, air beds and other inflatables
- Complete with handy storage case

Specifications

Product Code	RTC600
Voltage	12V
Max Amperage	10A
Wattage	120W
Max Pressure Reading	100PSI
Air Line Length	65cm
Product Size	L219 x W200 x H88mm
Pack Size	L95 x W230 x H245mm
Power Cable	3.3m
Pack Weight	0.91kg
Case Quantity	6 x 1
Barcode	5055175242392

Accessories



*Approx based on inflating a 13" tyre to 35PSI

Tyre Care

RTC500 Time Saver Digital Tyre Inflator



Features

- Inflates a tyre in 3 minutes*
- Programmable digital gauge that automatically stops at the set pressure and remembers pressure until next time. Measures in PSI, BAR and kPA
- Large W40 x H25mm digital screen measures in PSI, BAR, kPA
- Flexible air hose with easy access storage compartment specifically designed to reduce kinks. Screw stem valve connector helps reach awkwardly placed tyre valves
- Tyre deflation valve quickly releases unwanted pressure
- Fitted with 3.3m power cable and fused 12V DC power plug to help you reach all around the vehicle
- Valve cap storage compartment for safe keeping when inflating
- Flat design and directional white LED light gives you maximum stability and illumination where you need it
- Large On/Off button for easy use with dirty/greasy hands or in poor lighting conditions
- Complete with 3 piece adaptor kit for bikes, air beds and other inflatables
- Complete with handy storage case

Specifications

Product Code	RTC500
Voltage	12V
Max Amperage	10A
Wattage	120W
Max Pressure Reading	100PSI
Air Line Length	65cm
Product Size	L219 x W200 x H88mm
Pack Size	L95 x W230 x H245mm
Power Cable	3.3m
Pack Weight	0.89kg
Case Quantity	6 x 1
Barcode	5055175242385

Accessories



*Approx based on inflating a 13" tyre to 35PSI

RTC400 Easy Use Digital Tyre Inflator



Features

- Inflates a tyre in 3.5 minutes*
- Simply select pressure measurement and press On/Off
- W32 x H16mm digital screen measures in PSI, BAR, kPA for improved reading of pressures
- Flexible air hose with easy access storage compartment specifically designed to reduce kinks. Screw stem valve connector helps reach awkwardly placed tyre valves
- Fitted with 3m power cable and fused 12V DC power plug to help you reach all around the vehicle
- Wind up power cable gets you back on the road faster
- Valve cap storage compartment for safe keeping when inflating
- Flat design and directional white LED light gives you maximum stability and illumination where you need it
- Large On/Off button for easy use with dirty/greasy hands or in poor lighting conditions
- Complete with 3 piece adaptor kit for bikes, air beds and other inflatables

Specifications

Product Code	RTC400
Voltage	12V
Max Amperage	10A
Wattage	120W
Max Pressure Reading	100PSI
Air Line Length	50cm
Product Size	L197 x W180 x H80mm
Pack Size	L82 x W185 x H234mm
Power Cable	3m
Pack Weight	0.67kg
Case Quantity	10 x 1
Barcode	5055175242378

Accessories



*Approx based on inflating a 13" tyre to 35PSI

Tyre Care

RTC300 Easy Use Digital Tyre Inflator



Features

- Inflates a tyre in 3.5 minutes*
- Simply select pressure measurement and press On/Off
- W23 x H12mm digital screen measures in PSI, BAR, kPA
- Flexible air hose with easy access storage compartment specifically designed to reduce kinks. Screw stem valve connector helps reach awkwardly placed tyre valves
- Fitted with 3m power cable and fused 12V DC power plug to help you reach all around the vehicle
- Valve cap storage compartment for safe keeping when inflating
- Flat design gives you maximum stability during use
- Large On/Off button for easy use with dirty/greasy hands or in poor lighting conditions
- Complete with 3 piece adaptor kit for bikes, air beds and other inflatables

Specifications

Specifications	RTC300
Product Code	RTC300
Voltage	12V
Max Amperage	10A
Wattage	120W
Max Pressure Reading	100PSI
Air Line Length	50cm
Product Size	L197 x W180 x H80mm
Pack Size	L82 x W185 x H234mm
Power Cable	3m
Pack Weight	0.65kg
Case Quantity	10 x 1
Barcode	5055175242361

Accessories



*Approx based on inflating a 13" tyre to 35PSI

RTC200 Great Value Analogue Tyre Inflator



Features

- Inflates a tyre in 4.5 minutes*
- 50mm diameter analogue pressure gauge in PSI, BAR, kPA for easy reading of pressures
- Flexible air hose with easy access storage compartment specifically designed to reduce kinks. Screw stem valve connector helps reach awkwardly placed tyre valves
- Fitted with 3m power cable and fused 12V DC power plug to help you reach all around the vehicle
- Wind up power cable gets you back on the road faster
- Valve cap storage compartment for safe keeping when inflating
- Flat design gives you maximum stability during use
- Large On/Off button for easy use with dirty/greasy hands or in poor lighting conditions
- Complete with 3 piece adaptor kit for bikes, air beds and other inflatables

Specifications

Product Code	RTC200
Voltage	12V
Max Amperage	10A
Wattage	120W
Max Pressure Reading	100PSI
Air Line Length	50cm
Product Size	L197 x W180 x H80mm
Pack Size	L82 x W185 x H234mm
Power Cable	3m
Pack Weight	0.67kg
Case Quantity	10 x 1
Barcode	5055175242354

Accessories



*Approx based on inflating a 13" tyre to 35PSI

Tyre Care

RTC100 Great Value Analogue Tyre Inflator



Features

- Inflates a tyre in 4.5 minutes*
- 40mm diameter analogue pressure gauge in PSI, BAR, kPA
- Flexible air hose with easy access storage compartment specifically designed to reduce kinks. Screw stem valve connector helps reach awkwardly placed tyre valves
- Fitted with 3m power cable and fused 12V DC power plug to help you reach all around the vehicle
- Valve cap storage compartment for safe keeping when inflating
- Flat design gives you maximum stability during use
- Large On/Off button for easy use with dirty/greasy hands or in poor lighting conditions
- Complete with 3 piece adaptor kit for bikes, air beds and other inflatables

Specifications

Product Code	RTC100
Voltage	12V
Max Amperage	10A
Wattage	120W
Max Pressure Reading	100PSI
Air Line Length	50cm
Product Size	L197 x W180 x H80mm
Pack Size	L82 x W185 x H234mm
Power Cable	3m
Pack Weight	0.65kg
Case Quantity	10 x 1
Barcode	5055175242347

Accessories



*Approx based on inflating a 13" tyre to 35PSI

RAC900 Professional High Power Air Compressor



Features

- Inflates a car tyre in 90 seconds*
- Inflates a 4x4 tyre in 4 mins**
- Free 2 year guarantee
- Up to 3 times faster than a standard compressor
- Flexible hose with quick release inflator/deflator and large gradient pressure gauge
- Pressure gauge in lb/in², PSI, kg/cm², BAR
- Complete with industrial style brass nozzle
- 7m coiled air line hose
- Fitted with quick release 12V battery clips
- Thermal overload protection
- Waterproof On/Off switch
- Inline fuse
- Carry handle
- Anti-vibration rubber mounted feet
- Durable storage case with carry handle
- Proven performance as used by breakdown professionals

Specifications

Product Code	RAC900
Voltage	12V DC
Max Amperage	23A
Wattage	280W
Max Pressure Reading	100PSI
Air Line Length	7m extended
Product Size	L175 x W84 x H155mm
Pack Size	L335 x W225 x H200mm
Power Cable	2.4m
Pack Weight	2.94kg
Case Quantity	3 x 1
Barcode	5055175210735

Accessories



*Approx based on inflating a 13" tyre to 35PSI

**Approx based on inflating a 22" to 40PSI

Tyre Care

RAC830 Heavy Duty Caravan and Motorhome Rapid Digital Tyre Inflator



Features

- Twin piston allows high pressure rapid inflation. Perfect for caravan, motorhome, SUV, 4x4, van and standard car tyres
- Time saving: 2 minute inflation for car tyres*
4.5 minute inflation for 4x4 tyres**
- Quick setting digital gauge that automatically stops at the set pressure and remembers pressure until next time. Measures in PSI, BAR and kPA
- Large display: Makes it easier to read the blue backlit gauge day or night
- Night time illumination: The white light helps you to inflate your tyre on the roadside
- Accidental over inflation: Use the deflation valve to release extra pressure
- Inflate: Sports balls and small inflatables can be inflated with the 3 adaptors supplied
- Simple connection: Flexible air hose and durable brass screw valve connector
- Fits in boot: Handy storage case

Specifications

Product Code	RAC830
Voltage	12V
Max Amperage	15A
Wattage	180W
Max Pressure Reading	100PSI
Air Line Length	85cm
Product Size	L120 x W258 x H170mm
Pack Size	L127 x W303 x H190mm
Power Cable	3.5m
Pack Weight	2.88kg
Case Quantity	3 x 1
Barcode	5055175236629

Accessories



*Approx based on inflating a 13" tyre to 35PSI

**Approx based on inflating a 22" to 40PSI

RAC820 Heavy Duty 4x4 Digital Tyre Inflator



Features

- Heavy duty model is perfect for 4x4, SUV, caravan, van and standard car tyres
- Time saving: 2.5 minute inflation for car tyres*
5 minute inflation for 4x4 tyres**
- Quick setting digital gauge that automatically stops at the set pressure and remembers pressure until next time. Measures in PSI, BAR and kPA
- Night time illumination: The white light helps you to inflate your tyre on the roadside
- Accidental over inflation: Use the deflation valve to release extra pressure
- Inflate: Sports balls and small inflatables can be inflated with the 3 adaptors supplied
- Simple connection: Flexible air hose and durable brass screw valve connector
- Fits in boot: Handy storage case

Specifications

Specifications	RAC820
Product Code	RAC820
Voltage	12V
Max Amperage	15A
Wattage	180W
Max Pressure Reading	75PSI
Air Line Length	83cm
Product Size	L118 x W240 x H162mm
Pack Size	L120 x W280 x H180mm
Power Cable	3.5m
Pack Weight	2.22kg
Case Quantity	3 x 1
Barcode	5055175236612

Accessories



*Approx based on inflating a 13" tyre to 35PSI

**Approx based on inflating a 22" to 40PSI

Tyre Care

RAC710 Analogique Compresseur d'air



Features

- Inflates a tyre in under 2 minutes*
- Homologated analogue pressure gauge
- Built in white light for night time illumination
- Pressure gauge in BAR
- Complete with a 3 piece adapter kit for bikes, air beds and other inflatables
- Flexible air hose with screw stem connector
- Separate On/Off power and light switches
- Fitted with a fused 12V power plug
- Complete with handy storage case
- Only available in France

Specifications

Product Code	RAC710
Voltage	12V
Max Amperage	15A
Wattage	180W
Max Pressure Reading	10 BAR
Air Line Length	100cm
Product Size	L100 x W200 x H160mm
Pack Size	L122 x W270 x H186mm
Power Cable	3m
Pack Weight	3kg
Case Quantity	3 x 1
Barcode	5055175235967

Accessories



*Approx based on inflating a 13" tyre to 2.41 BAR

RAC700 Van Analogue Tyre Inflator



Features

- Inflates a car tyre in 3.5 minutes*
- Inflates a 4x4 tyre in 9 mins**
- 12V air compressor suitable for LCV, 4x4 and standard car tyres
- Pressure gauge in PSI, kg/cm², BAR
- Complete with 3 piece adaptor kit
- Fitted with fused 12V power plug
- Flexible air hose with tyre valve thumb lock system
- Carry handle
- Anti-vibration rubber mounted feet
- On/Off switch
- Complete with handy storage case

Specifications

Product Code	RAC700
Voltage	12V DC
Max Amperage	12A
Wattage	144W
Max Pressure Reading	140PSI
Air Line Length	60cm
Product Size	L185 x W84 x H160mm
Pack Size	L141 x W242 x H192mm
Power Cable	3m
Pack Weight	2.6kg
Case Quantity	6 x 1
Barcode	505517520971

Accessories



*Approx based on inflating a 13" tyre to 35PSI

**Approx based on inflating a 22" to 40PSI

Tyre Care

RAC605 Motorcycle & Car Digital Tyre Inflator



Features

- Inflates a motorcycle tyre in 3 minutes**
- Inflates a car tyre in 3 minutes*
- Includes motorcycle specific adaptors
- Preset pressure mode with automatic switch off
- Pressure gauge in PSI, BAR, kPA
- Built in white light for direction and red light for alert/SOS
- Complete with handy storage case

Specifications

Product Code	RAC605
Voltage	12V
Max Amperage	12A
Wattage	120W
Max Pressure Reading	999PSI
Air Line Length	60cm
Product Size	L180 x W72 x H180mm
Pack Size	L200 x W95 x H201mm
Power Cable	3.3m
Pack Weight	1.35kg
Case Quantity	10 x 1
Barcode	5055175219240

Accessories



*Approx based on inflating a 13" tyre to 35PSI

** Approx based on inflating a 17" motorcycle tyre to 40PSI

Tyre Gauges

Analogue tyre gauge

- Tyre pressure measurement PSI/BAR
- Gauge range 0-120PSI/0-8 BAR



Product Code: RTG1
Barcode: 5055175220123

Analogue tyre & depth gauge

- Tyre pressure measurement PSI/BAR
- Gauge range 0-120PSI/0-8 BAR
- Tread depth range 0-25mm



Product Code: RTG2
Barcode: 5055175220130

Analogue dial tyre gauge

- Tyre pressure measurement PSI/BAR
- Gauge range 0-100PSI/0-7.5 BAR



Product Code: RTG3
Barcode: 5055175220147

Digital tyre keyring gauge

- LED
- PSI, BAR, kPA, kg/cm²



Product Code: RTG4
Barcode: 5055175220154

Digital tyre gauge



Product Code: RTG5
Barcode: 5055175220161

Digital tyre & tread depth gauge



Product Code: RTG6
Barcode: 5055175220178

Programmable digital tyre & tread depth gauge



Product Code: RTG7
Barcode: 5055175220185

Disclaimer. Contents artwork may vary.

Tyre Care

Foot Pumps J20

Foot Pumps

RFP1



RFP2



- Durable anti slip rubber tread plate
- Graduated PSI & BAR gauge
- Flexible air hose with tyre valve thumb lock system
- Adaptors for bikes and inflatables with handy storage case
- Rubber feet for added stability
- Footplate retaining clip for easy storage

Product Code	Description	Pack Quantity	Barcode
RFP1	Single Barrel Foot Pump	10 x 1	5055175220086
RFP2	Double Barrel Foot Pump	6 x 1	5055175220093

Emergency Tyre Kits

Don't be stranded: be prepared for a puncture or tyre deflation by carrying an emergency tyre repair kit



Contents

12V Analogue Air Compressor

- Pressure gauge in PSI, kg/cm², BAR
- Complete with 3 piece adaptor kit for bikes, air beds and other inflatables
- Flexible air hose with screw valve connector
- Separate On/Off power switch
- Fitted with fused 12V power plug

Analogue Tyre Pressure & Depth Gauge

- Tyre pressure measurement in PSI/BAR
- Gauge range 0-120 PSI/0-8BAR
- Tread depth range 0-25mm

Accessories

- 1 x pair of protective gloves
- 1 x pair of cleaning wipes

Tyre Repair Sealant

- 400ml tyre sealant
- 1 aerosol for one tyre, a single use product for tyres up to and including 16"
- A temporary repair designed to get you home: with no need for any tools or wheel changes
- Will not repair tyres that have come off the rim, are ripped, have punctures larger than 5mm or have damaged walls

Product Code	Language	Barcode
RTK1	English	5055175228198
RTK1FR	French	5055175230139
RTK1ES	Spanish	5055175233178
RTK1NL	Dutch	5055175230047
RTK1P	Portuguese	5055175234762

Tyre Repair

Emergency puncture repair sealant

Tyre Repair Sealant

- 400ml tyre sealant
- The sealant is an equal mix of a hydrocarbon propellant and water based liquid latex
- 1 aerosol for one tyre, a single use product for tyres up to and including 16"
- A temporary repair designed to get you home no need for any tools or wheel changes
- For use on tubeless tyres only
- The tyre needs to be repaired or replaced as soon as possible
- Will not repair tyres that have come off the rim, are ripped, have punctures larger than 5mm or have damaged walls
- Once the aerosol is completely empty and the tyre is re-inflated, immediately drive for 6-12 miles (10-20km) at a reduced speed do not exceed 30mph/45kph so the product can be distributed uniformly in the tyre
- Simple to use instructions printed on the can
- M.S.D.S. sheet available on request
- Supplied only as a merchandising unit of 6



Product Code	Language	Barcode
RTS1	English	5055175228181
RTS1FR	French	5055175230122
RTS1ES	Spanish	5055175233161
RTS1NL	Dutch	5055175230054
RTS1P	Portuguese	5055175234731

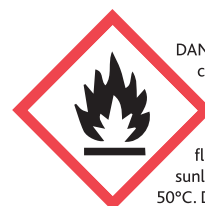

DANGER: Extremely flammable aerosol. Pressurised container: May burst if heated. Do not pierce or burn, even after use. Keep away from heat, hot surfaces, sparks, open flames and other ignition sources. - No smoking. Do not spray on an open flame or other ignition sources. Protect from sunlight. Do not expose to temperatures exceeding 50°C. Dispose of contents/container in accordance with local regulations. Keep out of reach of children.

RETAIL ACCESSORIES

First Aid Kits	K2
Travel Kits	K4
Travel Essentials	K5
Breathalysers	K6
Towing	K7
Fire Extinguishers	K8
Bungeeclic System	K9
Ratchet Tie Downs	K13
Twist Ties	K14
12V Vacuum Cleaners	K15
Rechargeable Vacuum Cleaner	K17
Car Mats	K18
Wheel Trims	K24
Dash Cameras	K26



Mini First Aid Kit

Be prepared for emergencies by carrying a first aid kit.

Mini first aid kit stored in a lightweight, compact carry case. Great for people on the move and ideal for treating minor injuries.



Kit Contents

- 4 x Disposable gloves
- 1 x Triangular bandage
- 2 x Sterile wound compress
- 12 x Safety pins
- 6 x Wet wipes
- 1 x Adhesive tape
- 1 x First aid blanket
- 1 x Pair of scissors
- 1 x Elastic bandages
- 1 x Sterile first aid dressing
- 22 x Plasters
- 1 x First aid kit manual
- 1 x Carry case



Product Code	RCT12
Case Quantity	24 x 1
Pack Dimensions	H140 x W155 x D70mm
Packaging	Backing card
Barcode	5055175242446

DIN13164-2014 First Aid Kit

Be prepared for emergencies by carrying a first aid kit.

First aid kit that includes a comprehensive range of essential items. Ideal for the car, camping and the home; this item is also certified for travelling within the EU.



Kit Contents

- 1 x Adhesive tape
- 14 x Plasters
- 4 x Sterile first aid dressings
- 2 x Sterile compress (burn dressings)
- 5 x Elastic bandages
- 6 x Sterile wound compress
- 1 x First aid blanket
- 2 x Wet wipes
- 2 x Triangular bandages
- 1 x Pair of scissors
- 4 x Disposable gloves
- 1 x First aid kit manual
- 1 x Carry case



Product Code	RCT11
Case Quantity	4 x 1
Pack Dimensions	H190 x W220 x D80mm
Packaging	Backing card
Barcode	5055175241760

Travel Kits

Be prepared for all types of journeys by carrying a travel kit in your vehicle. Ensure that you are geared up for the journey ahead and make travelling as stress free as possible.

European Travel Kit

Kit contains essential items for travel in Europe



Kit Contents

- 1 x Warning Triangle (ECE R27)
- 2 x High Visibility Jackets (EN471, CE)
- 1 x Universal Bulb Kit (E marked)
- 1 x Set of Beam Converters
- 1 x GB Sticker
- 1 x First Aid Kit (CE)
- 1 x Foil Blanket
- 1 x Twin Pack of Breathalyser Tests (NF approved)
- 1 x Compact Carry Bag

Product Code	RCT1
Case Quantity	4 x 1
Pack Dimensions	215 x 450 x 100mm
Packaging	Colour Printed Box
Barcode	5055175229812

Emergency Travel Kit

Be prepared for emergencies on the roadside



Kit Contents

- 1 x Warning Triangle (ECE R27)
- 1 x High Visibility Jacket (EN471, CE)
- 1 x Universal Bulb Kit (E marked)
- 1 x Rubber Torch (CE)
- 1 x Pair of Cotton Gloves
- 1 x Set of Jump Leads (CE)
- 1 x First Aid Kit (CE)
- 1 x Foil Blanket
- 1 x Compact Carry Bag

Product Code	RCT2
Case Quantity	4 x 1
Pack Dimensions	215 x 450 x 100mm
Packaging	Colour Printed Box
Barcode	5055175230764

Emergency Warning Triangle

Warning triangles are essential for roadside emergencies and breakdowns. This E approved compact warning triangle has a strong sturdy stand and stores away into a compact carry case.



Product Code	RCT1360
Case Quantity	20 x 1
Pack Dimensions	440 x 60 x 30mm
Packaging	Plastic case
Barcode	5055175232430

High Visibility Jacket

EN471 and CE approved. Be seen on the roadside with this high visibility jacket.



Product Code	RCTHV2
Case Quantity	100 x 1
Pack Dimensions	370 x 130 x 432mm
Packaging	Polythene Bag
Barcode	5055175237794

Magnetic GB Plate

Legally required in most EU countries. Easy to fit, re-usable and no adhesive required.



Product Code	RCT1260
Case Quantity	10 x 1
Pack Dimensions	169 x 151 x 2mm
Packaging	Blister Pack
Barcode	5055175211350

GB Sticker

Legally required in most EU countries.



Product Code	RCT1100
Case Quantity	10 x 1
Pack Dimensions	243 x 124 x 1mm
Packaging	Polythene Bag
Barcode	5011274910129

Beam Converters

Legally required in most EU countries, fits most headlamps. Pack includes fitting instructions and application guide.



Product Code	RCT1250
Case Quantity	10 x 1
Pack Dimensions	244 x 128 x 2mm
Packaging	Blister Pack
Barcode	5055175211343

Poncho

Universal transparent poncho, keeps you dry in an emergency. Lightweight and compact in size.



Product Code	RP1
Case Quantity	300 x 1
Pack Dimensions	169 x 95mm
Barcode	5055175211343

Retail Accessories

Breathalysers K6

Twin Pack of Disposable Breathalysers

Complies with the French legislation. All vehicles travelling to France must by law carry two NF approved breathalysers.



Product Code	RCTBR3
CDU Quantity	12 x 1
Pack Dimensions	128 x 176 x 152mm
Packaging	CDU
Barcode	5055175236315



Towing

A tow rope is a handy item to carry in your vehicle should your car break down and need to be towed out of the road away from danger, to your home or a repairer.

Elasticated Tow Rope

(4 Metres extended)



- Suitable for towed vehicles up to 2,000kg (2 tonnes)
- Suitable for small to medium cars
- Complete with 2x snap hook fixings
- Includes towing flag and warning sign
- Extended tow rope length approx. 4.0 metres
- Elasticated for safer towing

Product Code	RCT1560
Case Quantity	10 x 1
Pack Dimensions	175 x 280 x 54mm
Packaging	Nylon Zip Bag
Barcode	5055175222196



Towing Pole

(1.8 Metre)



Product Code	RCT1500
Case Quantity	10 x 1
Pack Dimensions	1800mm Length
Packaging	Colour Printed Box
Barcode	5055175211022

3,500kg Heavy Duty Tow Rope

(4 Metres)



- Suitable for towed vehicles up to 3,500kg (3.5 tonnes)
- Suitable for small, medium and large cars
- Complete with 2x snap hook fixings
- Includes towing flag and warning sign
- Tow rope length approx. 4.0 metres
- Approved to BSAU 187:2000

Product Code	RCT1540
Case Quantity	10 x 1
Pack Dimensions	160 x 290 x 54mm
Packaging	Nylon Zip Bag
Barcode	5055175211268

2,000kg Tow Rope

(4 Metres)



- Suitable for towed vehicles up to 2,000kg (2 tonnes)
- Suitable for small to medium cars
- Complete with 2x snap hook fixings
- Includes towing flag and warning sign
- Tow rope length approx. 4.0 metres
- Approved to BSAU 187:2000

Product Code	RCT1520
Case Quantity	10 x 1
Pack Dimensions	250 x 285 x 75mm
Packaging	Clam Blister Pack
Barcode	5055175211251

Retail Accessories

Fire Extinguishers

A safety essential every vehicle should have.

- Ideal for automotive, domestic and leisure use
- CE marked, meets current European legislation
- ABC rating for solid, liquid, gas, and electrical fires
- Light weight aluminium cylinders
- Comes complete with strong, secure, mounting bracket
- 2 year warranty

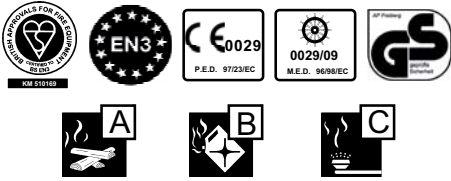

1kg Dry Powder ABC Fire Extinguisher



Product Code	RCT1740
Case Quantity	6 x 1
Product Dimensions	300 x 85 x 85mm
Packaging	Shrink Wrap
Barcode	5055175223452

1kg Dry Powder ABC Fire Extinguisher

(with pressure gauge)



Product Code	RCT1750
Case Quantity	6 x 1
Product Dimensions	300 x 85 x 85mm
Packaging	Shrink Wrap
Barcode	5055175223469

2kg Dry Powder ABC Fire Extinguisher

(with pressure gauge)



Product Code	RCT1760
Case Quantity	6 x 1
Product Dimensions	380 x 120 x 120mm
Packaging	Shrink Wrap
Barcode	5055175229348

bungeecllic Load Securing System

Load Securing Kit

bungeecllic is a unique load securing system, which allows you to customise the bungee to suit your needs. It can be used to secure loads at work, at home, or leisure.

Kit contents

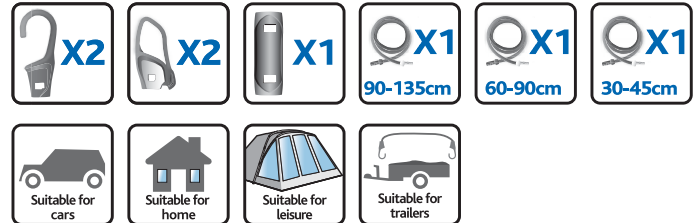

View this video to see the bungeecllic in action

Product Code	RLS1
Case Quantity	6 x 1
Pack Dimensions (CDU)	286mm x 287mm x 205mm
Packaging	Sleeve/Counter Top Display Unit
Barcode	5055175232409

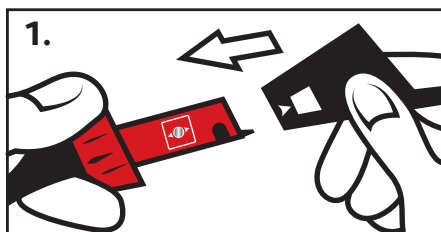

1. Choose your bungee cord length

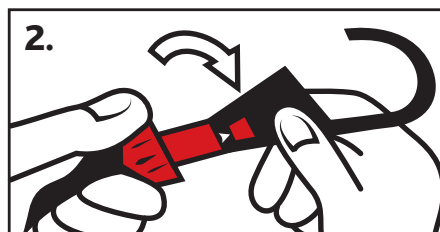

2. Choose your connection

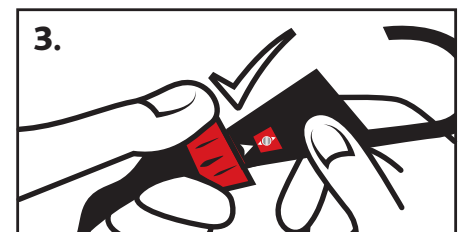

3. Twist and lock

It's as easy as clic & connect

Retail Accessories

Bungee System K10

bungeeclíc Load Securing System

bungeeclíc is a unique load securing system, which allows you to customise the bungee to suit your needs.



10 Piece Bungee Clic Kit

Kit contents



22 Piece Bungee Clic Kit

Kit contents

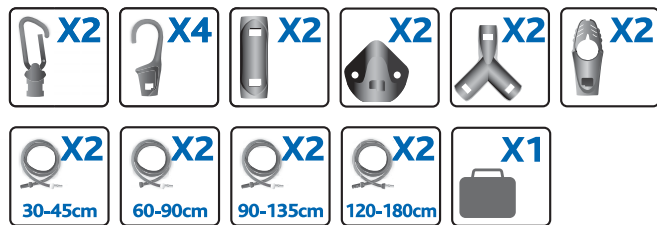

Product Code	RLS10
Case Quantity	6 x 1
Pack Dimensions	280 x 350 x 45mm
Packaging	Blister
Barcode	5055175236322

Product Code	RLS9
Case Quantity	6 x 1
Pack Dimensions	410 x 350 x 50 mm
Packaging	Blister
Barcode	5055175236179

It's as easy as clic & connect



View this video to see the bungeeclíc in action



bungeecllic Load securing system

It's as easy as clic & connect

Bungee Cords – (Twin Pack)

bungeecllic is a complete system for securing loads and objects. It can be customised in a variety of ways to build the correct length ties needed for securing objects.

No more unsafe coupling or wrong lengths. The range of accessories and connections allow you to custom build and adapt to suit whatever loads you need to fix or secure into place.

bungeecllic 30cm
Bungee cords



30cm extends to 45cm

bungeecllic 60cm
Bungee cords



60cm extends to 90cm

Product Code	RLS30	RLS60
Case Quantity	6 x 1	6 x 1
Pack Dimensions	116 x 386 x 220mm	116 x 386 x 220mm
Barcode	5055175234250	5055175234267

bungeecllic 90cm
Bungee cords



90cm extends to 135cm

bungeecllic 120cm
Bungee cords



120cm extends to 160cm

Product Code	RLS90	RLS120
Case Quantity	6 x 1	6 x 1
Pack Dimensions	116 x 386 x 220mm	116 x 386 x 220mm
Barcode	5055175234274	5055175234281

Min/Max working load for all items: 0-80kg

Retail Accessories

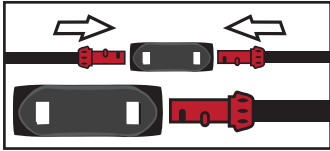
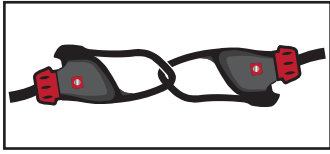

1. bungeelic Locking Hooks



2. bungeelic Straight Connector



Product Code	RLS3	RLS4
Case Quantity	6 x 1	6 x 1
Pack Dimensions	116 x 386 x 220mm	116 x 386 x 220mm
Barcode	5055175234212	5055175234229

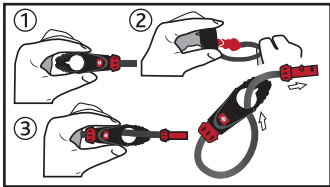
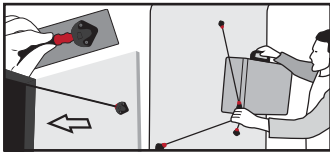
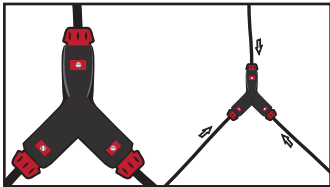

3. bungeelic Y Connector



4. bungeelic Wall Mount



5. bungeelic Adjustable Hook



Product Code	RLS5	RLS6	RLS7
Case Quantity	6 x 1	6 x 1	6 x 1
Pack Dimensions	116 x 386 x 220mm	116 x 386 x 220mm	116 x 386 x 220mm
Barcode	5055175234236	5055175234243	5055175234618

Ratchet Tie Downs

Tie down your loads with ease; the Ring Ratchet Systems are easy to fit in just four movements, quick to release by pulling the red button to remove your strap. Both models come with a handy practical storage feature so the ratchet and strap can be kept neatly together when not in use.

Suitable for:

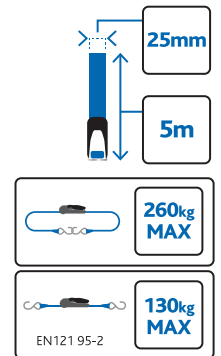
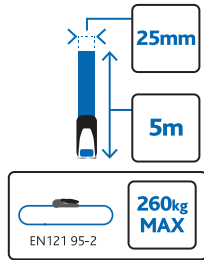

Ratchet Tie Down

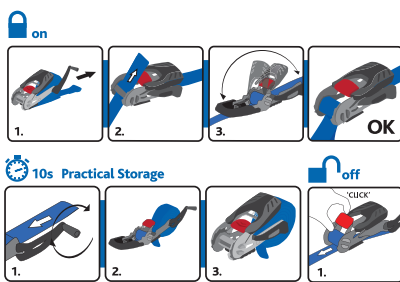

Product Code	RLS11
Case Quantity	6 x 1
Pack Dimensions	150mm x 45mm x 190mm
Packaging	Colour Printed Box with Euroslot
Barcode	5055175236742

Ratchet Tie Down with S Hooks

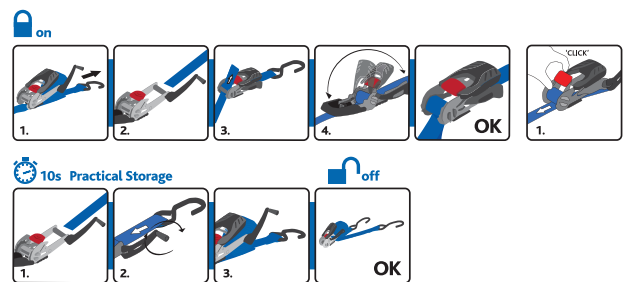

Product Code	RLS12
Case Quantity	6 x 1
Pack Dimensions	150mm x 45mm x 190mm
Packaging	Colour Printed Box with Euroslot
Barcode	5055175236759



Scan here to see the Ratchet Tie Downs in action



Retail Accessories

Twist Ties K14

Twist Ties

Twist Ties can be used to secure loads at work, at home, or leisure. The range of different lengths allows you to use the ties to fix or secure different items into place.

- Secure your home and work loads with these tough, reusable ties
- Extremely easy to use – Just bend and twist to secure
- Perfect for DIY, around the home or car
- Strong core made of flexible steel – they can be pulled, twisted and tied time and time again
- Different lengths available – whatever you need, there's a Twist tie to suit
- A tough rubber coating that provides excellent grip
- Many ways to carry, hang, store or tie things of all different shapes and sizes

Wrap, twist, bend or bind

Product Code	RTT80 (80cm)	RTTK6 (Multi cm)
Case Quantity	12 x 1	12 x 1
Pack Dimensions	520 x 130 x 10mm	520 x 130 x 10mm
Barcode	5055175238449	5055175238456



Twist Ties
80cm cords / 4pcs



Twist Ties
Multi cords / 6pcs

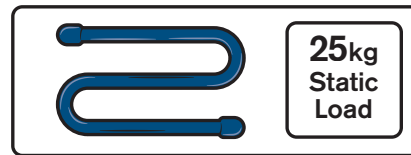

Wind it

Knot it

Re-use it



12V Vacuum Cleaner

- 12V powered vacuum cleaner, ideal for cleaning vehicles
- Good suction power for effective cleaning
- Comes with a hose and crevice tool

12V	85W
Voltage	Wattage



12V Vacuum Cleaner K15

Specifications





Product Code	RVAC0
Input Power	12V
Dust Capacity	470ml
Air Flow	40cfm
Suction Power	>30mbar
Cable Length	4M Max
Case Quantity	3x1
Pack Dimensions	H168xW402xD120mm
Packaging	Colour Printed Box
Barcode	5055175237725

Contents



Retail Accessories

12V Vacuum Cleaner K16

12V Voltage	85W Wattage
 12V DC plug	 LED light
 Dual speed	 Twin motor drive
 Motorised brush	



12V Vacuum Cleaner





- 12V powered vacuum cleaner, ideal for cleaning vehicles
- High suction power for effective cleaning
- Dual speed power button
- Incorporated LED light to light up your cleaning area
- Comes with a unique motorised brush ideal for picking up dirt deep within fibres



Specifications

Product Code	RVAC1
Input Power	12V
Dust Capacity	470ml
Air Flow	40cfm
Suction Power	>30mbar
Cable Length	4M Max
Motor Power	85W
Case Quantity	3x1
Pack Dimensions	H168 x W402 x D120mm
Packaging	Colour Printed Box
Barcode	5055175235486

Contents

 INSTRUCTIONS	 4 MTRS	 MOTORISED BRUSH
 TOOLS	 SET OF REMOVABLE FILTERS	



11.1V Voltage	90W Wattage
▶16m Operating time	Li-ion Rechargeable
LED light	Dual speed
Twin motor drive	Motorised brush



Rechargeable Vacuum Cleaner

- Cordless vacuum cleaner, ideal for use in and around the home
- Powered by a li-ion battery
- High suction power for effective cleaning
- Dual speed power button
- Incorporated LED light to light up your cleaning area
- Comes with a unique motorised brush ideal for picking up dirt deep within fibres



Specifications

Product Code	RVAC2 (UK), REVAC2 (Euro)
Input Power	Li-ion Rechargeable
Dust Capacity	470ml
Air Flow	39cfm
Suction Power	>30mbar
Operating Time	16m*
Charging Time	6h
Motor Power	90W
Case Quantity	3x1
Pack Dimensions	H168 x W412 x D160mm
Packaging	Colour Printed Box
Barcode	5055175235493 (UK) 5055175235509 (Euro)

Contents



Retail Accessories

Introduction

Ring offer a range of car mats. The range offers a number of unique, innovative designs that are exclusive to Ring.

Following extensive primary research, the mats have been designed to reflect the demands of consumers. The new range of mats are of the highest quality and standards. The range consists of high quality PVC mats, carpet mats and combined PVC and carpet mats, all of which are universal and are available in black and grey.



Ultra Shield 6000



- Universal mat, with trimmable features.
- Set of 4 mats (2 front, 2 rear).
- Protects your interior from dirt, water and stains.
- Hard wearing.
- Durable.
- Non-slip backing.
- Luxury thick carpet.

Specifications

Product Code	RMAT26
Colour	Black
Material	Synthetic rubber and 600gsm polyethylene terephthalate carpet
Front mat dimensions	755 x 470mm
Rear mat dimensions	755 x 450mm
Mat weight (set of 4)	4.4kg
Case Quantity	4 x 1
Barcode	5055175229768

Ultra Shield 5000

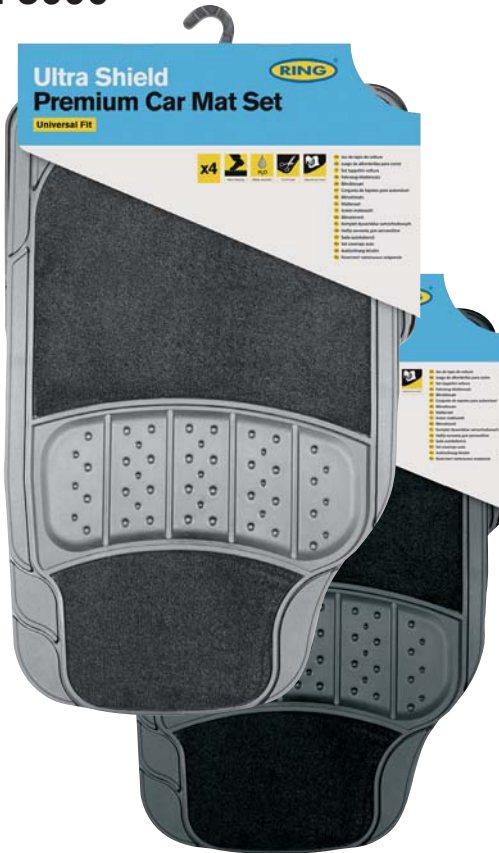

- Universal mat, with trimmable features.
- Set of 4 mats (2 front, 2 rear).
- Protects your interior from dirt, water and stains.
- Hard wearing.
- Durable.
- Non-slip backing.

Specifications

Material	Synthetic rubber and polyethylene terephthalate carpet
Front mat dimensions	760 x 465mm
Rear mat dimensions	470 x 475mm
Mat weight (set of 4)	4.15kg
Case Quantity	4 x 1

Product Code	RMAT1	RMAT2
Colour	Black	Grey
Barcode	5055175215921	5055175215938

Ultra Shield 4000



- Universal mat, with trimmable features.
- Set of 4 mats (2 front, 2 rear).
- Protects your interior from dirt, water and stains.
- Hard wearing.
- Durable.
- Non-slip backing.
- Patented interlocking grips on the underside of the mat for non-slip grip when driving.
- Easy to clean.
- Odourless.
- Eco-friendly 100% recyclable.





Specifications

Product Code	RMAT17
Colour	Black
Material	100% recyclable PVC and 100% polypropylene carpet
Front mat dimensions	700 x 500mm
Rear mat dimensions	400 x 460mm
Mat weight (set of 4)	4.8kg
Case Quantity	4 x 1
Barcode	5055175228273

Retail Accessories

Car Mats K20

Dura Shield 3000

-  Universal fit
-  Non-slip backing
-  Cut to size
-  H₂O
Water resistant
-  x4
-  Hard wearing







- Universal mat, with trimmable features.
- Set of 4 mats (2 front, 2 rear).
- Protects your interior from dirt, water and stains.
- Extra deep surface grooves to trap debris.
- Hard wearing.
- Heavy duty.
- Durable.
- Non-slip backing.
- Patented interlocking grips on the underside of the mat for non-slip grip when driving.
- Easy to clean.
- Odourless.
- Eco-friendly 100% recyclable.

Specifications

Product Code	RMAT15
Colour	Black
Material	100% recyclable PVC
Front mat dimensions	710 x 550mm
Rear mat dimensions	465 x 390mm
Mat weight (set of 4)	5kg
Case Quantity	4 x 1
Barcode	5055175228242

Dura Shield 2000

-  Universal fit
-  Non-slip backing
-  Cut to size
-  H₂O
Water resistant
-  x4
-  Hard wearing



- Universal mat, with trimmable features.
- Set of 4 mats (2 front, 2 rear).
- Protects your interior from dirt, water and stains.
- Hard wearing.
- Durable.
- Non-slip backing.
- Patented interlocking grips on the underside of the mat for non-slip grip when driving.
- Easy to clean.
- Odourless.
- Eco-friendly 100% recyclable.

Specifications

Product Code	RMAT13
Colour	Black
Material	100% recyclable PVC
Front mat dimensions	700 x 500mm
Rear mat dimensions	400 x 470mm
Mat weight (set of 4)	4.8kg
Case Quantity	4 x 1
Barcode	5055175228228

Dura Shield 1000



- Universal mat, with trimmable features.
- Set of 4 mats (2 front, 2 rear).
- Protects your interior from dirt, water and stains.
- Hard wearing.
- Durable.
- Non-slip backing.
- Patented interlocking grips on the underside of the mat for non-slip grip when driving.
- Easy to clean.
- Odourless.
- Eco-friendly 100% recyclable.

Specifications

Product Code	RMAT11
Colour	Black
Material	100% recyclable PVC
Front mat dimensions	670 x 470mm
Rear mat dimensions	465 x 360mm
Mat weight (set of 4)	3.6kg
Case Quantity	6 x 1
Barcode	5055175228204

Carpet Shield 7000



- Universal mat
- Set of 4 mats (2 front, 2 rear)
- Non slip backing
- Protects your interior from dirt and stains
- Tough woven binding
- Pile weight of 550g/m², extra thick quality carpet.
- PVC drivers heel pad for extra durability.

Specifications

Product Code	RMAT33
Colour	Black
Material	550g/m ² polyethylene terephthalate carpet mat and PVC heel pad with black trim
Front mat dimensions	660 x 440mm
Rear mat dimensions	285 x 395mm
Mat weight (set of 4)	1.95kg
Case Quantity	4 x 1
Barcode	5055175240022

Retail Accessories

Car Mats K22

Carpet Shield 6000



Universal fit



Non-slip backing



400gm carpet



x4



Wipe/brush clean



- Universal mat
- Set of 4 mats (2 front, 2 rear)
- Non slip backing
- Protects your interior from dirt and stains
- Tough woven binding
- Pile weight of 350gm.
- PVC drivers heel pad for extra durability.

Specifications

Product Code	RMAT31
Colour	Black
Material	100% recyclable PVC and 100% polypropylene carpet
Front mat dimensions	570 x 430mm
Rear mat dimensions	250 x 360mm
Mat weight (set of 4)	1.25kg
Case Quantity	4 x 1
Barcode	5055175240015

Carpet Shield 5000



Universal fit



Non-slip backing



500gm carpet



x4



Wipe/brush clean



- Universal mat
- Set of 4 mats (2 front, 2 rear)
- Non slip backing
- Protects your interior from dirt and stains
- Tough woven binding
- Pile weight of 500gm, extra thick quality carpet.
- Available in black and grey

Specifications

Material	500gm m ² polyethylene terephthalate carpet mat with matching trim binding
Front mat dimensions	650 x 445mm
Rear mat dimensions	285 x 395mm
Mat weight (set of 4)	1.6kg
Case Quantity	4 x 1

Product Code	RMAT28	RMAT29
Colour	Grey	Black
Barcode	5055175239989	5055175239996

Carpet Shield 4000

(Sold in a pack of 5 sets. 2 black, 2 blue, 1 red)

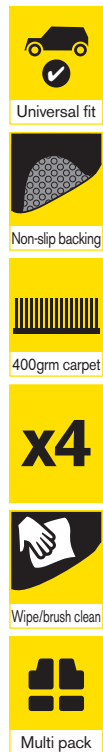

- Universal mat
- 1 Pack contains 5 x sets of 4 mats (2 front, 2 rear)
- Non slip backing
- Protects your interior from dirt and stains
- Tough woven binding
- Pile weight of 350gsm.
- Multi pack of black carpet car mats with colour trim
- 1 pack contains 2 x Black, 2 x Blue, 1 x Red

Specifications

Product Code	RMAT27
Colour	Black with coloured trim
Material	350gsm m ² polyethalene terephthalate carpet mat with black, red or blue trim
Front mat dimensions	290 x 415mm
Rear mat dimensions	250 x 360mm
Mat weight (set of 4)	0.95kg
Case Quantity	5 x 1
Barcode	5055175239972

Merchandising

Ring universal floor mats have been exclusively designed to protect your car interior from dirt, water and stains, whilst complimenting any vehicle interior. Our product range offers a wide range of designs, materials and styles to suit all needs.

Our triangular merchandising display can hold up to 18 mats. (Base width: diagonal 760x760mm) Part number: BU779.



Available on free loan with the following stock package:

Part Number	Quantity
RMAT2	3
RMAT11	6
RMAT15	4
RMAT17	4
RMAT28	8
RMAT29	4
RMAT31	4
Total	33 Mats

For more information on our range of car mats visit our website:



<http://tinyurl.com/bqryqgz>

Retail Accessories

Wheel Trims K24



- High gloss finish
- Will not rust
- Stylish designs
- Available in 13"-17" sizes



Patented fitting ring for maximum security



Set of 4 trims



Cable ties not required



Impact resistant for longer life

Polus 13"

Chrome finish nuts



Part No	Size	Barcode	Outer Qty
RWT1349	13"	5055175210254	4 x 1 Set

Vegas 13"-16"

Chrome finish nuts



Part No	Size	Barcode	Outer Qty
RWT1333	13"	5055175210230	4 x 1 Set
RWT1433	14"	5055175210247	4 x 1 Set
RWT1533	15"	5055175226897	4 x 1 Set
RWT1633	16"	5055175226903	4 x 1 Set

Gyro 13"-17"

Chrome finish nuts



Part No	Size	Barcode	Outer Qty
RWT1379	13"	5055175226859	4 x 1 Set
RWT1479	14"	5055175226866	4 x 1 Set
RWT1579	15"	5055175226873	4 x 1 Set
RWT1679	16"	5055175226880	4 x 1 Set
RWT1779	17"	5055175233833	4 x 1 Set

Flare 14"-16"

Chrome finish nuts



Part No	Size	Barcode	Outer Qty
RWT1477	14"	5055175226774	4 x 1 Set
RWT1577	15"	5055175226781	4 x 1 Set
RWT1677	16"	5055175226798	4 x 1 Set

Nelux 14"-15"

Chrome finish ring



Part No	Size	Barcode	Outer Qty
RWT1432	14"	5055175241999	4 x 1 Set
RWT1532	15"	5055175242002	4 x 1 Set

Enbossa 14"-15"

Two tone
Chrome finish nuts



Part No	Size	Barcode	Outer Qty
RWT1442	14"	5055175241968	4 x 1 Set
RWT1542	15"	5055175241975	4 x 1 Set

Chase 13"-15"

Chrome finish nuts



Part No	Size	Barcode	Outer Qty
RWT1330	13"	5055175241920	4 x 1 Set
RWT1430	14"	5055175241937	4 x 1 Set
RWT1530	15"	5055175241944	4 x 1 Set

Polar 14"

White coloured to the core
Chrome finish nuts



Part No	Size	Barcode	Outer Qty
RWT1431	14"	5055175241951	4 x 1 Set

Commercial 16"

Deep dish suitable for:
Citroen Relay, Fiat Ducato,
Ford Transit, Mercedes
Sprinter, Mercedes Vito,
Peugeot Boxer,
Renault Master,
Renault Trafic,
Vauxhall Vivaro,
Volkswagen LT,
Volkswagen T4



Part No	Size	Barcode	Outer Qty
RWT1628	16"	5055175241982	4 x 1 Set

Velis 13"-15"



Part No	Size	Barcode	Outer Qty
RWT1329	13"	5055175241890	4 x 1 Set (Bagged)
RWT1429	14"	5055175241906	4 x 1 Set (Bagged)
RWT1529	15"	5055175241913	4 x 1 Set (Bagged)

Ikon 13"-14"

Chrome finish nuts



Part No	Size	Barcode	Outer Qty
RWT1391	13"	5055175226910	4 x 1 Set (Bagged)
RWT1491	14"	5055175226927	4 x 1 Set

Retail Accessories



RBGDC200 FULL HD GPS 2.0" Display Dash Camera









This GPS model adds global position recording, which allows playback on Google® Maps using the software provided. It also features a wider angle display, smoother Full HD video and superior low light performance.

Software Included



Specifications

Product Code	RBGDC200
Video Resolution (max)	1920x1080 @ 30fps
Camera Resolution (max)	14 Mega Pixels
Display Size	2.0"
Lens Type	6 Element glass
Viewing angle	140°
Aperture	F/2.0
Battery	110mA Li-Po
Storage Card (not included)	Up to 32GB
Audio Recording	✓
Shock Sensor	✓
Loop Recording	✓
Auto Start/Stop	✓
Night Vision LEDs	-
Number Plate Stamp	-
GPS Tracking	✓
Playback Software	✓
USB Port	✓
HDMI port	✓
Weight	95.9g
Dimensions (mm) (L x W x H)	99x40x23

 Image quality	 GPS	 Camera	 Loop recording
 Display size	 Shock sensor	 Auto start/stop	 Rechargeable





RBGDC50 HD 2.7" Display Dash Camera

This compact model has all the features of the RBGDC10 but adds a larger wide screen display for easy setup and playback. Also included is number plate entry for recording vehicle details into each video.

Specifications

Product Code	RBGDC50
Video Resolution (max)	1920x1080 @ 25fps
Camera Resolution (max)	12 Mega Pixels
Display Size	2.7"
Lens Type	4 Element glass
Viewing Angle	120°
Aperture	F/2.4
Battery	200mA Li-Po
Storage Card (not included)	Up to 32GB
Audio Recording	✓
Shock Sensor	✓
Loop Recording	✓
Auto Start/Stop	✓
Night Vision LEDs	✓
Number Plate Stamp	✓
GPS Tracking	-
Playback Software	-
USB Port	✓
HDMI Port	✓
Weight	56g
Dimensions (mm) (L x W x H)	87x54x44

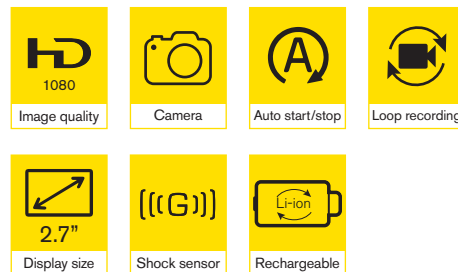

Retail Accessories



RBGDC15 HD 1.5" Display Dash Camera

With recording resolutions up to 1080 pixels and a 120° four element glass lens, fine details are recorded. The loop recording and auto start/stop features ensure video is never missed. A built-in shock sensor and file locking helps protect vital video evidence.

Specifications

Product Code	RBGDC15
Video Resolution (max)	1920x1080 @ 25fps
Camera Resolution (max)	12 Mega Pixels
Display Size	1.5"
Lens Type	4 Element glass
Viewing Angle	120°
Aperture	F/2.5
Battery	200mA Li-Po
Storage Card (not included)	Up to 32GB
Audio Recording	✓
Shock Sensor	✓
Loop Recording	✓
Auto Start/Stop	✓
Night Vision LEDs	✓
Number Plate Stamp	-
GPS Tracking	-
Playback Software	-
USB Port	✓
HDMI Port	-
Weight	42g
Dimensions (mm) (L x W x H)	65x42x39

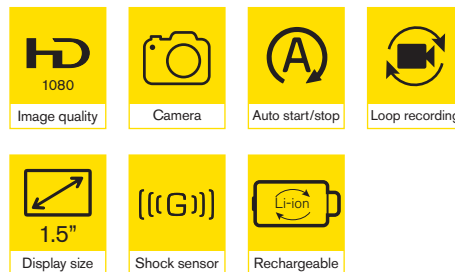





Ring Automotive Limited . Gelderd Road, Leeds, LS12 6NA United Kingdom
Telephone +44 (0)113 213 2000 Fax +44 (0)113 231 0266

European Headquarters . 5, Rue de la Haye, Bât. Le Dôme, 5ème étage
93 290 Tremblay-en-France
Tél +33 (0)1 48 16 09 23 . Fax +33 (0)1 48 16 09 24

Email autosales@ringautomotive.com . www.ringautomotive.com

    /ringautomotive

In line with our policy of continuous product development, Ring Automotive Limited reserve the right to alter specification without notice. Whilst every care has been taken in compiling the information in this catalogue, Ring Automotive Limited cannot accept legal liability for any errors or omissions. Manufacturers' names and part numbers are for reference only. Illustrations are intended only to be representative of the parts offered, sizes quoted are nominal. © Copyright 2018 Ring Automotive Limited.

CAT930



BS EN ISO 9001:2008
FM 504682

