



---

# Minimum Landscape Design & Construction Standards

2020 Update



## TABLE OF CONTENTS

<b>1.0</b>	<b>OBJECTIVES &amp; DESIGN PRINCIPLES</b> .....	<b>1</b>
1.1	Introduction .....	1
1.2	Objectives .....	1
1.3	Design Principles .....	1
<b>2.0</b>	<b>PUBLIC LANDS TO WHICH THE MINIMUM LANDSCAPE DESIGN STANDARDS APPLY</b> .....	<b>3</b>
2.1	Public Land Categories .....	3
2.2	Summary of Developer Responsibility .....	3
<b>3.0</b>	<b>DESIGN STANDARDS</b> .....	<b>5</b>
3.1	General Requirements .....	5
3.2	Requirements for Municipal Reserves (MR) .....	13
3.3	Requirements for Municipal Open Space .....	17
3.4	Requirements for Roadways .....	21
<b>4.0</b>	<b>SUBMISSION REQUIREMENTS, DESIGN APPROVAL PROCESS &amp; CONSTRUCTION INSPECTION</b> .....	<b>24</b>
4.1	Drawing Submission Requirements .....	24
4.2	Construction Procedures .....	27
4.3	Landscape Construction Approval Processes .....	27
<b>5.0</b>	<b>SPECIFICATIONS</b> .....	<b>30</b>
<b>6.0</b>	<b>DESIGN DETAIL DRAWINGS</b> .....	<b>64</b>
<b>7.0</b>	<b>DEFINITIONS</b> .....	<b>75</b>

### List of Tables

**Table 1** - Developer Responsibility & Associated Guidelines for Development

**Table 2** - Minimum Landscape Requirements Summary

**Table 3** - Required Setbacks from Utilities & Infrastructure

**Table 4** - Acceptable Boulevard Tree Species

**Table 5** - Required and Recommended Recreation Facilities for Neighborhood & Community Parks

**Table 6** - Required Setbacks from Roads, Sidewalks & Multiways

## 1.0 OBJECTIVES & DESIGN PRINCIPLES

### 1.1 Introduction

The purpose of the Minimum Landscape Design and Construction Standards is to provide Developers and Landscape Architectural Consultants with an outline for:

- the minimum requirements for the design of public landscapes and recreational infrastructure/ amenities;
- the preparation of submissions to the City of Leduc;
- the implementation of landscape construction; and
- the processes and procedures to obtain approvals from the City of Leduc.

### 1.2 Objectives

The City of Leduc's objectives for its public landscapes are:

- to strive to create innovative and functional park spaces which facilitate a wide range of recreation activities;
- to provide outdoor spaces that contribute to the reduction of environmental stress, maintenance requirements and increase green infrastructure;
- to create attractive streetscapes using street trees that will enhance the urban forest while increasing shade cover over paved areas and pedestrians' sidewalks, reducing the urban heat island effect, etc.
- to ensure the City's park spaces are accessible to all residents of the City of Leduc; and
- to recognize and preserve heritage and significant cultural landscapes that are valuable to the history and character of the community.

### 1.3 Design Principles

The following design principles shall be considered by Landscape Architectural Consultants when designing landscape, open space and recreation infrastructure in the City of Leduc. Designs shall:

- aim to ensure the security, safety, and accessibility of the public;
- consider the protection of valuable cultural features;
- ensure the preservation of significant natural landscapes;
- aim to introduce unique and decorative design features within the landscape; and
- employ sustainable design practices in all aspects of the project.



The following are important topics and guidelines which shall be considered in the design process:

### 1.3.1 LEADERSHIP IN ENERGY AND ENVIRONMENTAL DESIGN (LEED) –LEED FOR NEIGHBORHOOD DEVELOPMENT

Sustainable landscape and urban design practices are outlined in the LEED design assessment criteria. Specific landscape related LEED topics include:

#### **Heat Island Reduction**

The urban heat island effect can be reduced with increased tree planting and solid surfacing with a high reflectivity or open grid pavement.

#### **Water Efficiency**

The collection and reuse of rainwater onsite to water plants and turf is a sustainable practice that is covered under the LEED criteria.

The LEED rating system is a valuable guide for the design of sustainable development.

### 1.3.2 UNIVERSALLY ACCESSIBLE DESIGN

The mobility needs of all individuals in any public space shall be considered. The Americans with Disabilities Act Standards for Accessible Design “sets guidelines for accessibility to places of public accommodation (and open space) by individuals with disabilities. These guidelines are to be applied during the design, construction, and alteration of such...facilities to the extent required by regulations issued by Federal agencies, including the Department of Justice, under the Americans with Disabilities Act in its latest edition.

### 1.3.3 CPTED (CRIME PREVENTION THROUGH ENVIRONMENTAL DESIGN)

Safety and security must be a high priority for any public space. CPTED guidelines have gained wide international acceptance as design criteria for the built environment with a goal of reducing the potential for crime.

### 1.3.4 ALBERTA BUILDING CODE FOR STRUCTURES

This building code is relevant for buildings and structures such as recreational facilities and public washrooms. The 2019 Alberta Building Code (ABC) “sets out technical provisions for the design and construction of new buildings. It also applies to the alteration, change of use and demolition of existing buildings. The ABC complements the 2019 Alberta Fire Code in its latest edition, and both are indispensable for building officials, educators and professionals in the construction industry.”

### 1.3.5 DESIGN FOR WINTER CITIES

**Wind:** Incorporate landscape design strategies to block wind, particularly prevailing winds and downdrafts.

**Sunshine:** For gathering or seating areas maximize exposure to sunshine through orientation and design.

**Colour:** Use colour on site features and amenities to enliven the winterscape.

**Lighting:** Create visual interest with lighting, while being mindful of obtrusive or unsafe intensity, spread, contrast and colours.

**Winter Infrastructure:** Design and incorporate infrastructure and amenities that supports desirable outdoor winter activities and improves comfort and access in cold weather.





## 2.0 PUBLIC LANDS TO WHICH THE MINIMUM LANDSCAPE DESIGN STANDARDS APPLY

### 2.1 Public Land Categories

The City of Leduc categorized public lands and open space in its Park, Open Space and Trails Master Plan in its latest edition. These categories include:

#### 2.1.1 MUNICIPAL RESERVE

This category includes public land that is classified as Neighborhood Park, Community Park, Regional Park, and Linear Parks/Greenway. These various types of parks are further defined in the City of Leduc Parks, Open Space and Trails Master Plan in its latest edition.

#### 2.1.2 ENVIRONMENTAL RESERVE

Environmental reserves should be conserved in its natural state and protected from disturbance.

#### 2.1.3 MUNICIPAL OPEN SPACE

This category includes public land that is classified as Public Utility Lots, Stormwater Management Facilities and Major Utility Corridors.

#### 2.1.4 ROADWAYS

These are classified as arterial, collector and local road Rights-of-Way (ROW). The landscape of these ROWs may include the boulevard between private property and the curb, medians, cul-de-sac islands, and entry feature areas.

### 2.2 Summary of Developer Responsibility

The table below outlines responsibilities and partnership opportunities for Developers of public open space. The table also describes the standards or guidelines that apply to each land category and classification. Where developer responsibility is indicated, the developer must meet the minimum landscape requirements.



**Table 1 – Developer Responsibility & Associated Guidelines for Development**

Land Category	Park and Open Space Classification	Developer Responsibility	* Partnership Opportunities	Applicable City of Leduc Guidelines & Standards
<b>Municipal Reserve</b>	Regional Park		✓	Park, Open Space & Trails Master Plan & Minimum Landscape Design Standards
	Community Park	✓	✓	Minimum Landscape Design Standards
	Neighborhood Park	✓	✓	Minimum Landscape Design Standards
	Linear Parks/ Greenways	✓	✓	Minimum Landscape Design Standards & Minimum Landscape Design Standards
<b>Environmental Reserve</b>	Natural Areas/Environmental Reserves/Conservation Reserves		✓	Park, Open Space & Trails Master Plan
<b>Municipal Open Space</b>	Stormwater Management Facilities (SWMFs)	✓		Minimum Landscape Design Standards
	Public Utility Lot (PUL)/ Walkways	✓		Minimum Landscape Design Standards
<b>Multiway**</b>		✓		City of Leduc Eng. Standards and Multiway Trail Detail
<b>Roadways</b>	Arterial, Collector, Local Roads – Medians & Boulevards	✓		Minimum Landscape Design Standards

\* Where partnership opportunities are indicated, developers to collaborate with the City of Leduc to provide amenities and enhancements beyond the standards specified in this document.

\*\* The Developer is responsible for the construction of the multiways.



### 3.0 DESIGN STANDARDS

#### 3.1 General Requirements

The following general landscape requirements apply to all public open space noted in Section 2.0. These standards establish the minimum requirements for landscape development. Please refer to the following sections for detailed standards.

**Table 2 - Minimum Landscape Requirements Summary**

		Landscape Requirement				
		Planting ***	Topsoil & Sod	Fencing	Park Facilities	Trails & Multiway Linkages
Municipal Reserve **	Regional Park			Minimum 1.2m Height Uniform Fence at all boundaries between public and private property	Facilities will be required at the discretion of the City of Leduc - See Table 5 for requirements	Trail linkages to be developed to Multiway standards
	Community Park	75 Trees per hectare excluding areas do	✓∩			
	Neighbourhood Park	sportfields, courts, sledding hill, recreation building etc.	✓∩			
	Linear Parks/ Greenways		✓∩			
Municipal Open Space	PUL/Walkway	No trees permitted	✓∩	Minimum 1.2m Height Uniform Fence at all boundaries between public and private property	Bollards	Trail linkages to be developed to Multiway standards
	Stormwater Management Facility	75 Trees per hectare above N.W.L.	topsoil & seed		Trash Receptacles, Bench	
	Major Utility Corridor	Within limitations of utility company	✓∩		n/a	
Environmental Reserve	Natural Areas/ Environmental Reserves/ Conservation Reserves	Shall be conserved in its natural state & protected from disturbance	n/a	n/a	n/a	n/a
Roadways *	Arterial	See Table 6 Tree Spacing on Boulevards/ Medians	✓	1.8m Height Uniform Fence for Flankages and Backs of Lots (at the discretion of the City of Leduc)****	n/a	n/a
	Collector	See Table 6 Tree Spacing on Boulevards/ Medians	✓		n/a	n/a
	Local Roads (with separate walk)	See Table 6 Tree Spacing on Boulevards/ Medians	✓		n/a	n/a

\* Tree planting requirements to be evaluated for rural and industrial cross-sections.

\*\* See **Table 5** for recommended facilities for Neighborhood and Community Parks

\*\*\* Substitution rate: 1 tree = 5 shrubs

\*\*\*\* Noise attenuation fencing as required in the Development Agreement.

∩ Seed at the discretion of the City of Leduc see section 3.1.2.



### 3.1.1 LANDSCAPING – GENERAL

These general minimum landscape design standards apply to all public lands and open space as outlined in this document. Please refer to specific land category sections for more detailed requirements.

- .1 All trees and shrubs shall be planted as per the Tree Planting Detail and Shrub Planting Detail included in Section 6.0 and be sourced from a Clean Plants Certified Nursery certified by the Canadian Nursery Certification Institute (CNCI). Some exemptions may apply at the City's discretion.
- .2 The existing landscape must be considered in the design of any project. Existing healthy native tree stands, wetlands, and other natural features shall be considered in the planning and design of the project and preserved where possible to reduce the impact on the local environment and habitats. An undisturbed offset buffer of a minimum of 5m from private property to existing tree stands are to be provided. Retained landscapes must be protected during construction.
- .3 Naturalized landscape plans can be submitted and shall be approved by the City of Leduc. The plans must include native plant species that are hardy to the existing soil conditions and climate will reduce the long-term maintenance requirements and resources.
- .4 All sites shall be finished with topsoil and sod. At the discretion of the City of Leduc, seed may be approved with suitable access controls (fencing) to ensure establishment. Sod is still required in areas of intensive recreation use or for erosion control.
- .5 All tree planting shall be a minimum 50 mm caliper for deciduous and 2.0 m height for coniferous unless approved by the City of Leduc. There is no maximum size limit for trees but may be subject to a long maintenance/ establishment period. A tree mix of deciduous and coniferous is generally desired.
- .6 Minimum shrub spacing shall be based on spread at maturity as recommended in the Alberta Yards & Gardens Manual. Minimum shrub size at planting, with the exception of naturalization areas, shall be 300 mm height for deciduous shrubs and 450 mm spread for coniferous shrubs. See specifications for Trees, Shrubs and Groundcover for more detailed requirements.
- .7 Plant materials and their arrangement shall be selected to suit soil characteristics, drainage, micro-climate, aspect and the site's intended use.
- .8 Shrubs shall be massed within planting beds and planted at minimum spacing of 80% maturity size. The intent is to achieve a balance between shrub health and maintenance concerns with close planting, and the desire to achieve a visually full coverage that reduces weed growth. Plant symbols on all drawings shall be drawn at mature size. Ornamental shrub beds to have aluminum edger, at the discretion of the City of Leduc.
- .9 Shrubs at mature size shall be completely contained within the planting bed.
- .10 Tree planting shall be in groupings or mulched beds to encourage improved growth and survivability.
- .11 Planting bed layouts shall be designed to facilitate the maneuverability of large turf maintenance and cutting equipment. A minimum of 2.2 m is required between the edge of a bed and all other vertical elements such as fencing, furniture and buildings.
- .12 A minimum distance of 2.2 m shall be provided between free-standing vertical decorative features such as signs and sculptures.
- .13 No other groundcovers or shrubs shall be planted in the same planting bed as aggressive groundcovers, (i.e., gout weed) and the requirement for mulch shall be deleted.





- .14 Annual plantings shall be approved and planted as temporary landscaping, however, all annuals must be maintained until the end of the maintenance period, and must be removed prior to FAC approval. The annual bed must be rehabilitated to match the surrounding landscaping, as per approved drawings.
- .15 Low maintenance, hardy perennials are acceptable in planting beds. Species selection is subject to review by the City of Leduc.
- .16 Design shall exhibit diversity of tree species hardy to the Leduc area in order to reduce the spread of disease and to mitigate the potential visual impact of losing one particular species in an area.
- .17 Noxious weeds shall be controlled according to the Provincial Weed Control Act in its latest edition.
- .18 All areas shall be kept free from weeds from construction commencement until issuance of Final Acceptance Certificate (FAC). Failure to do so will result in weed removal by the City, and all costs shall be borne by the Developer/Contractor.
- .19 The site shall be designed to permit access of maintenance vehicles including water and pruning lift trucks.
- .20 Fire Smart: All existing vegetation to remain inside or within 100m of the development shall receive treatment and consideration in accordance with the Wildfire Risk Assessment prepared for the development and/or the Fire Smart – Protecting Your Community Form Wildfire (Fire Smart Canada).
  - Priority Zone 1 (Fuel Removal) – Remove all highly flammable vegetation as outlined by Fire Smart Canada’s “Fire Smart Guide to Landscaping”, within 10m of any permanent structure. This defensible zone is to help prevent a fire from being carried towards or away from the building.
    - This area is to be graded, top-soiled and seeded or sodded at the discretion of the City of Leduc. Seed mix will depend on the application.
    - Additional tree clearing may be required, as directed by the Municipality, to accommodate drainage.
  - Priority Zone 2 (Fuel Reduction) – This area between the property line up to a minimum of 30m is to be developed to reduce the wildfire threat. Topographical considerations can be made upon approval of Parks representative.
    - Thin coniferous trees to a minimum of 3.0 m crown spacing.
    - Remove all dead standing and fallen trees.
    - Prune all ladder fuels (low branches up to a minimum of 2.0m above ground level at the lowest point.
  - Priority Zone 3 (Fuel Management) – This area extends beyond 30m to 100m from a structure. Vegetation management in this area may only be necessary where interface hazard is extreme due to fuel type and/or slope. In those instances, apply fuel reduction as outlined for Zone 2.

Clean-up: Chip the material to be removed back onto the forest floor, no greater than 50 mm thickness.

All Fire Smart protection clearing is to be approved by Parks prior to commencement.

- .21 When existing boulevard trees are within or adjoining new construction tree protection is required. Reference detail 1.4.



- .22 Only low maintenance, non-invasive and hardy perennials will be accepted.
- .23 The use of artificial turf in public landscapes is prohibited unless specifically approved for special locations where it would improve accessibility or have other proven benefits.

**3.1.1.1 Tree Planting Setbacks for Utilities & Infrastructure**

- 1. Trees shall be set back a minimum distance, as measured from the center of the tree trunk, from utilities and infrastructure as per **Table 3**.

**Table 3 - Required Setbacks from Utilities & Infrastructure**

Type of Utility or Utility Structure	Minimum Setback Distance in Metres
Light Poles	3.5 m
Fire Hydrants	3.5 m
Stop & Yield Signs	2.0 m
Other Signs	2.0 m
Underground Power lines	1.0 m
Power Hardware (Pedestals, transformers, etc.)	3.5 m
Gas & All other Services	1.5 m
Shallow Underground Utilities (Cables, Telephone)	1.0 m
Sanitary & Storm Sewer Mains, Manholes & Services	1.8 m
Watermains, Water Services & Water Valves	1.8 m

- 2. If a minimum utility clearance of 1.0 m may not be maintained from the edge of the tree spade excavation, the involved utility company must be contacted for approval and/or safe planting procedures, (i.e. by hand digging), at the expense of the contractor. Drawings are to indicate that approval for such plantings has been received from the utility company and are to identify the plantings affected.
- 3. Planting distances from intermediate and high-pressure gas pipelines shall be adhered to as required by pipeline authority crossing or ground disturbance agreements.
- 4. Setback distances apply to all tree and tree form shrub species (such as Amur Maple). In certain instances, species with suckering type root systems or large hanging canopies shall require increased setbacks, (i.e. poplars and willows).
- 5. The minimum setback for *Populus spp.* from private property lines and paved areas shall be 10 m due to their invasive and shallow root structure. Planting locations for columnar varieties are acceptable along arterial and other road ROW fence lines as there are few species suitable for narrow spaces.



**3.1.1.2 Acceptable Tree Species**

1. Species of trees and shrubs shall be selected to suit the site's planting conditions and microclimate. Please refer to *Alberta Yards and Gardens* (Government of Alberta) in its current edition for appropriate species.
2. Special consideration shall be given to the suitability of a species (including size, growth habit, hardiness, and maintenance requirements) for boulevard and median plantings.
3. For Municipal Reserve and Municipal Open Space, diversity of species, aesthetics, hardiness, disease resistance, natural occurrence, rate of growth and growth habit shall be considered when selecting varieties.
4. Municipal Reserve and Municipal Open Space planting may allow for tree spacing at 75% of mature tree size to increase landscape density.

**Table 4 - Acceptable Boulevard and Park Tree Species**

**S = Street:** This species has been determined to perform well in roadway planting situations.

**P = Park:** This species has been determined to perform well in a variety of open space situations.

Deciduous Trees			Code	
Botanical Name	Common Name	Recommended Spacing	S	P
<i>Acer ginnala</i>	Amur Maple	8 m	S	P
<i>Acer negundo</i>	Manitoba Maple	4 m	S	P
<i>Acer saccharinum</i>	Silver Maple	10 m		P
<i>Aesculus glabra</i>	Ohio Buckeye	5 m	S	P
<i>Amelanchier alnifolia</i>	Saskatoon	3 m		P
<i>Crataegus x mordenensis</i> 'Toba'	Toba Hawthorn	5 m	S	P
<i>Crataegus x mordenensis</i> 'Snowbird'	Snowbird Hawthorn	5 m	S	P
<i>Crataegus succulenta</i>	Fleshy Hawthorn	5 m		P
<i>Crataegus cerronis</i>	Chocolate Hawthorn	5 m	S	P
<i>Eleagnus angustifolia</i>	Russian Olive	8 m	S	P
<i>Fraxinus pennsylvanica</i> 'Patmore'	Patmore Ash	8 m	S	P
<i>Fraxinus pennsylvanica</i> 'Prairie Spire'	Prairie Spire Green Ash	8 m	S	P
<i>Fraxinus pennsylvanica</i> (seedless variety)	Green Ash	8 m	S	P
<i>Hippophae rhamnoides</i>	Sea Buckthorn	1 m		P
<i>Malus x 'Spring Snow'</i>	Spring Snow Flowering Crab	5 m	S	P
<i>Populus balsamifera</i>	Balsam Poplar	10 m		P
<i>Populus tremula Erecta</i>	Swedish Columnar Aspen	2 m	S	P
<i>Populus tremuloides</i>	Trembling Aspen	5 m	S	P
<i>Populus x canadensis</i> 'Tower'	Tower Poplar	2 m		P



<i>Populus x Jackii</i>	Northwest Poplar	10 m	<b>S</b>	<b>P</b>
<i>Prunus cerasus</i>	Sour Cherry	8 m		<b>P</b>
<i>Prunus maackii</i>	Amur Cherry	6 m	<b>S</b>	<b>P</b>
<i>Pyrus ussuriensis</i>	Ussurian Pear	3 m		<b>P</b>
<i>Quercus macrocarpa</i>	Bur Oak	8 m	<b>S</b>	<b>P</b>
<i>Salix alba</i>	White Willow	3 m		<b>P</b>
<i>Salix alba var. vitellina</i>	Golden Willow	10 m		<b>P</b>
<i>Salix discolor</i>	Pussy Willow	2.5 m		<b>P</b>
<i>Salix pentandra</i>	Laurel Leaf Willow	10 m		<b>P</b>
<i>Shepherdia argentea</i>	Buffaloberry	2 m		<b>P</b>
<i>Sorbus americana</i>	American Mountain Ash	6 m	<b>S</b>	<b>P</b>
<i>Sorbus aucuparia</i>	European Mountain Ash	4 m	<b>S</b>	<b>P</b>
<i>Sorbus decora</i>	Showy Mountain Ash	5 m	<b>S</b>	<b>P</b>
<i>Syringa prestoniae</i>	Preston Lilac	3 m		<b>P</b>
<i>Syringa reticulata 'Ivory Silk'</i>	Japanese Tree Lilac	6 m		<b>P</b>
<i>Tilia americana</i>	American Linden	8 m	<b>S</b>	<b>P</b>
<i>Tilia cordata</i>	Little Leaf Linden	8 m	<b>S</b>	<b>P</b>
<i>Tilia x flavescens 'Dropmore'</i>	Dropmore Linden	8 m	<b>S</b>	<b>P</b>
<i>Tilia cordata 'Ronald'</i>	Norlin Linden	8 m	<b>S</b>	<b>P</b>
<i>Ulmus americana</i>	American Elm	10 m	<b>S</b>	<b>P</b>
<i>Ulmus americana 'Brandon'</i>	Brandon Elm	8 m	<b>S</b>	<b>P</b>
<i>Ulmus davidiana var. japonica 'Discovery'</i>	Discovery Elm	8 m	<b>S</b>	<b>P</b>
<i>Ulmus pumila</i>	Siberian/Manchurian Elm	8 m	<b>S</b>	<b>P</b>
<b>Coniferous Trees</b>			<b>Code</b>	
<b>Botanical Name</b>	<b>Common Name</b>	<b>Recommended Spacing</b>	<b>S</b>	<b>P</b>
<i>Abies balsamea</i>	Balsam Fir	4 m		<b>P</b>
<i>Juniperus scopulorum</i>	Rocky Mountain Juniper	4 m		<b>P</b>
<i>Larix sibirica</i>	Siberian Larch	8 m		<b>P</b>
<i>Picea abies</i>	Norway Spruce	8 m		<b>P</b>
<i>Picea glauca</i>	White Spruce	8 m		<b>P</b>
<i>Picea pungens</i>	Colorado Blue Spruce	8 m		<b>P</b>
<i>Pinus aristata</i>	Bristlecone Pine	4 m		<b>P</b>
<i>Pinus banksiana</i>	Jack Pine	4 m		<b>P</b>
<i>Pinus cembra</i>	Swiss Stone Pine	4 m		<b>P</b>
<i>Pinus contorta var. latifolia</i>	Lodgepole Pine	4 m		<b>P</b>
<i>Pinus flexilis</i>	Limber Pine	4 m		<b>P</b>





<i>Pinus mugo</i>	Mugo Pine	4 m		P
<i>Pinus ponderosa</i>	Ponderosa Pine	10 m		P
<i>Pinus sylvestris</i>	Scots Pine	8 m		P
<i>Pinus uncinata</i>	Mountain Pine	4 m		P
<i>Pseudotsuga menziesii</i>	Douglas Fir	8 m		P

Note: other tree species may be considered.

### 3.1.1.3 Tree & Shrub Equivalency

Shrubs can be substituted for trees in Municipal Reserve and Municipal Open Space areas at a rate of 5 shrubs being equal to 1 tree up to 1/3 of the required tree quantity. This substitution rate is not applicable to Roadway landscaping.

### 3.1.1.4 Soil Volume

Enhanced soil volumes are required to increase critical rooting space. Soil volumes should be designed not deeper than 1m with increased area to achieve the minimum soil volume requirement. Based on tree size to soil volume relationships the list below is recommended:

- Large Canopy trees are defined as trees that under normal conditions can support canopies of 74m<sup>2</sup> or spread over 5 m and require a minimum soil volume of 17m<sup>3</sup>.
- Small canopy trees are defined as trees that are under normal conditions have a spread of 5m and require a minimum soil volume of 11m<sup>3</sup> and under ideal conditions require 17m<sup>3</sup> to reach its full potential.
- Should the design of the area not allow for the minimum required soil volume, please contact Parks for recommendations.
- Minimum topsoil depth for all tree planting shall be 500mm.

### 3.1.2 TOPSOIL & TURF

- .1 Topsoil shall be graded and levelled as required for all sites and then sodded (or seeded at the discretion of the City of Leduc, with a grass seed appropriate for the landscape type).
- .2 All disturbed areas (other than planting beds, infrastructure, etc.) shall be stabilized with turf.
- .3 Sodding shall be required instead of seed in all areas of intensive use, grass swales, and for repair of existing turf as follows:
  - extend sod 4.5 m beyond intensive use areas (playground, tot lots);
  - extend sod 1.5 m beyond edge of all multiways;
  - extend sod 2.0 m from each side of center line of grass swales.
- .4 Seeding may be acceptable beyond areas outlined above at the discretion of the City of Leduc at drawing review.
- .5 For areas such as creeks, ponds, riparian zones, a suitable seed mix shall be approved by the City of Leduc prior to installation.



### 3.1.3 FENCING

- .1 All fences shall be designed and constructed according to the minimum standard depicted in the fence details included in Section 6.0. Alternative fence designs may be acceptable upon review by the City of Leduc.
- .2 All fencing shall meet the requirements set out in the Development Agreement for the subdivision.
- .3 All fence styles shall be designed to complement other proposed architectural and urban amenities and match existing fence where adjacent.
- .4 All fences shall be built a minimum of 150 mm within private property.
- .5 Uniform fencing shall be provided between all private property and public property. Uniform fencing shall be constructed adjacent to Municipal Reserve, Municipal Open Space and Collector and Arterial Roadways. Fencing along private properties fronting onto local roads is not required.
- .6 All noise attenuation fencing required as stated in the Development Agreement will be reviewed and inspected by the City of Leduc Engineering Department. See the Minimum Engineering Design Standards for construction requirements and details of noise attenuation fencing. The inclusion of gates between private and public property shall be at the discretion of the City of Leduc.

### 3.1.4 SITE FURNITURE

- .1 Provision of site furniture shall be required to enhance public open space in all seasons (i.e. be comfortable, durable and attractive). Proposed site furniture shall be arranged in accordance with CEPTD (Crime Prevention Through Environmental Design).
- .2 Proposed site furniture shall be submitted to the City of Leduc for review.
- .3 The following setbacks shall be required:
  - Benches - 2.0 m minimum from edge of walkway or multiway;
  - Waste Receptacles - 2.0 m min. from walkway or multiway, and minimum 2.0 m from benches or picnic tables (due to odors, wasps, etc.);
  - Picnic Tables - 1.0 m minimum from edge of walkway or multiway;
  - Ensure a minimum 300 mm hard surface mowing strip from furniture to mown grass areas.
- .4 Refer to Section 6.0 for detailed construction drawings of site furniture and technical requirements.
- .5 All trash receptacles to be Haul-All Hide-A Bag and to be the garbage and recycling duplex units. Colour may vary for trash receptacles.
- .6 T-bollards to be installed at walkway or multiway connection to road right of ways.
- .7 Bench spacing along multiways and trails at the discretion of the City. Environmentally sensitive areas should be assessed on an individual basis.

### 3.1.5 MULTIWAYS & LINKAGES TO MULTIWAYS

- .1 Multiways are required to be built by developers in areas designated as Municipal Reserve and Municipal Open Space to provide linkages to and between primary multiways routes and tertiary multiways (sidewalks) routes.
- .2 Refer to City of Leduc Minimum Engineering Standards for detailed design requirements and specifications for multiways.



3.1.6 NATURALIZATION

- .1 Grass slopes 3:1 or greater to be naturalized and not mown regularly. Newly constructed slopes should be seeded with a naturalized or native seed mix.
- .2 Bioswales are encouraged and when implemented should include grasses and/or other vegetation, enhanced topsoil at least 450mm depth, and an underlying infiltration layer.
- .3 Where naturalization planting is used, plant material may be substituted as per the following:

Full Size Tree	Potted Tree	Potted Tree	Shrubs	Trees or Shrubs – Whips & Plugs
(1) 60mm Cal.	(2) 40mm Cal.	(5) 20mm Cal.	(5) 5 Gallon Pot	(25) minimum 100mm Pot

- A maximum of 10% of the required 60mm caliper trees on a site may be substituted for smaller material.
  - Shrub size requirement can be substituted at a rate of 5 shrub plugs for 1 full size shrub.
- .4 Naturalized areas must be set back 30m from playgrounds.

3.1.7 LOW IMPACT DEVELOPMENT (LID)

- .1 Bioswales and bioretention gardens are encouraged and when implemented should include grasses and/or other vegetation, enhanced topsoil at least 450mm depth, and may include an underlying infiltration layer.
- .2 Vegetation selections for LID facilities should consider the following soil conditions: a well-drained soil that receives periodic inundation, and a slowly drained soil that is moist to wet for most of the growing seasons.
- .3 Select plant varieties that will thrive on the site conditions and that grow well together. Species selection should consider:
  - Tolerance of seasonal salt loadings depending on facility location;
  - Pollutant uptake capacity;
  - Maintenance needs, including mowing and pruning;
  - Reduction of water and fertilizer needs after establishment; and,
  - Resistance to pests.

## 3.2 Requirements for Municipal Reserves (MR)

The following requirements apply to Neighborhood Parks and Community Parks:

3.2.1 PLANTING

- .1 All municipal reserves must be planted at the rate of 75 trees per one hectare of land. Five (5) shrubs shall be substituted for one tree, up to 1/3 of the total required tree quantity. Sports fields, courts, sledding hills, buildings, infrastructure, and other recreation facilities such as playgrounds are not included in the area of required planting.
- .2 All landscaping shall conform to required setbacks as described in **Tables 3 and 6**.



- .3 All trees and shrubs shall be planted as per the Tree Planting Detail and Shrub Planting Detail included in Section 6.0.
- .4 Acceptable tree species and recommended spacing is outlined in **Table 4**, however tighter tree spacing at 75% of mature tree size shall be approved by the City of Leduc.
- .5 Alternative tree and shrub species for MR planting shall be considered and are subject to approval by the City of Leduc or designate.
- .6 Municipal Reserves shall be graded, leveled, or contoured to drain freely.
- .7 Topsoil and sod (or seed at the discretion of the City of Leduc) shall be installed and established as specified in Section 5.0.

### 3.2.2 FENCING

- .1 All fencing shall meet the requirements set out in the Development Agreement for the subdivision.
- .2 Lands designated as Municipal Reserve shall be separated from private property by permanent fencing. Fence must be built a minimum of 150 mm within private property.
- .3 Fencing shall be a minimum 1.2 metres in height.
- .4 Fencing adjacent to parkland that contains, or will contain, sports fields shall be a minimum 1.5 m height and prevent penetration of sports balls such as those used for soccer or baseball.
- .5 Gates are required where private property backs onto open spaces and Municipal Reserve lands. Gates are to be a maximum of 1.0 metres in width and must swing open to private property. Gate design and location on lot to be reviewed by the City of Leduc.

### 3.2.3 TRAIL LINKAGES

Multiways are to connect various open spaces. These multiways shall be constructed by the Developer and included through Municipal Reserve and Municipal Open Space as per the provisions of the City of Leduc's Parks, Open Space and Trails Master Plan in its latest edition.

### 3.2.4 FACILITIES

The following facilities shall be required in neighborhood parks with the location being approved by the City of Leduc:

- Playground equipment for 18 month to 5-year olds;
- Sledding Hill;
- Park Amenities; and
- Furniture.





**Table 5 – Required and Recommended Recreation Facilities for Neighborhood & Community Parks**

	Park Classification	
	Neighborhood Park	Community Park
Park Size	Greater than 0.5 ha	Facility Dependent
Minimum Landscape Design Standards	✓	✓
<b>Facilities</b>		
Multi-use Ball Diamond	◇	◇
Senior Baseball		◇
Junior Soccer Field	◇	
Senior Soccer/Football		◇
Rugby Field		◇
400m Track & Field		◇
Multi-use Field	◇	◇
Tennis Courts		◇
Outdoor Rink	◇	◇
Pre-school Age Playground	✓	
School Age Playground	◇	◇
Sledding Hill	✓ (one per neighborhood)	
Park Amenities & Furniture	✓	✓
Washrooms or Porta Potty's		◇
Passive Area	◇	◇

◇Recommended Facilities ✓Required Facilities

### 3.2.4.1 Playgrounds

- .1 A playground for children age 18 month to 5 years is required. Natural playgrounds are acceptable, and all playground designs will be reviewed by the City of Leduc. Seating area shall be provided and arranged accordingly for parental viewing.
- .2 Playground design should consider year-round use and be durable, safe, comfortable and attractive in all seasons. All equipment shall comply with relevant CSA standards and supported by a letter of compliance (CSA Z614-07 including Annex H recommendations).
- .3 Equipment shall be of excellent quality and be free of structural faults and defects.
- .4 Installation shall be done by an approved Canadian Playground Safety Institute (CPSI) installer.
- .5 Playground components shall include, as a minimum, a composite play structure and a two (2) bay swing set with two (2) belt seats and two (2) bucket seats. All swings shall be anti-wrap swings.
- .6 Playground surfacing shall be CSA approved and only engineered wood fiber or poured-in-place rubber are acceptable. Engineered wood fiber surfacing permits universal access. Rubberized pellets and playground sand are not permitted.



- .7 Playground edging may be concrete curbing with rounded edges, flat topped boulders or CCA treated wood. See the City of Leduc Minimum Engineering Design Standards for concrete mix specifications.
- .8 A bench shall be provided for parental viewing.
- .9 Playgrounds and seating areas shall be placed in locations to maximize sunlight and avoid shadows from nearby buildings and schools.

### 3.2.4.2 Sledding Hill

- .1 A natural or manmade hill for sledding shall be provided. The hill shall be sodded on sledding side of hill and may be seeded with grass seed ( to the discretion of the City of Leduc) on other sides of hill. A sledding hill must be safe for use by all ages.
- .2 A level staging area shall be established at the top of the hill for participants to prepare for their ride.
- .3 The average slope of the hill shall be no more than 1:3 slope for the length of the run.
- .4 The orientation of the hill shall direct sledders away from any obstacles and roadways.
- .5 A run-out area at the bottom of the hill shall be long enough to allow sledders to slow down to a safe and obstructed stop. The run-out area may be inclined to bring sledders to a stop.
- .6 A walkway area off to the side of the sledding area shall be provided to allow participants to return to the top of the hill safely.
- .7 A sign shall be placed near the staging area at the top of the hill with the following information (see standard detail provided):
  - Danger – use hill at your own risk;
  - Users assume full responsibility for determining if conditions are safe for sledding;
  - No supervision is provided by the City;
  - Use caution when sledding and be considerate to others;
  - Sledding can be a hazardous activity and presents substantial risk; and
  - Makeshift ramps and jumps are prohibited.

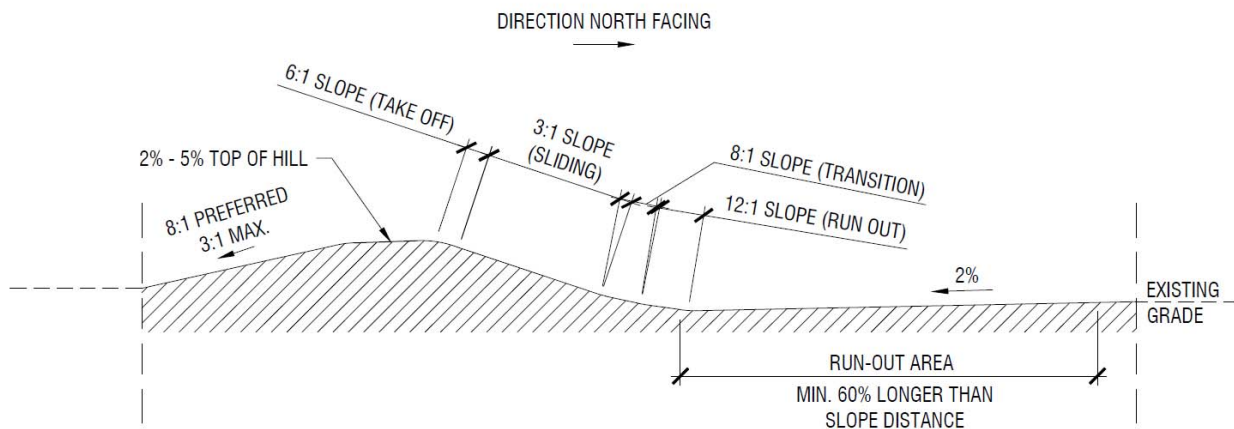

SLEDDING HILL CROSS SECTION



#### 3.2.4.4 Sports Fields

- .1 All sports fields shall have a minimum 10m buffer from edge of sports fields and between sports fields.
- .2 Drainage swales or any other obstruction are not to be within sports field buffers or between sports fields.

#### 3.2.4.5 School Park Development

School Park sites are to be at a minimum topsoiled and sodded [or seeded at the discretion of the City of Leduc with suitable access controls (fencing) to ensure establishment] and the minimum required trees provided depending on the timing of the school site development in relation to the subdivision development timing.

#### 3.2.5 PARK AMENITIES & FURNITURE

Furniture such as benches, picnic tables and waste receptacles shall be provided in all Municipal Reserve land as per Table 5.

#### 3.2.6 TOPSOIL & TURF

- .1 Area designated as Municipal Reserve must be graded, leveled, or contoured to drain freely, topsoiled and sodded (or seeded at the discretion of the City of Leduc see section 3.1.2).
- .2 Sod used on sport fields shall have all netting removed prior to installing sod.

### 3.3 Requirements for Municipal Open Space

This section includes the requirements for all municipal open space including public utility lots (PUL), stormwater management facilities, and major utility corridors.

#### 3.3.1 PUBLIC UTILITY LOTS (PUL's) & WALKWAYS

- .1 PUL's or walkways shall not include trees. Shrubs may be approved if a minimum of 2m offset from edge of walk to the mature spread of the specified shrubs.
- .2 PUL and walkway areas shall be graded, topsoiled and sodded at the discretion of the City of Leduc at drawing review.
- .3 Furniture shall be provided by the Developer and placed at strategic locations within a walkway.
- .4 Bollards shall be the T- or L- swing type as per standard detail included.
- .5 Where a walkway is designated as an emergency access route, adequate clearance shall be provided for vehicular access.

#### 3.3.2 STORMWATER MANAGEMENT FACILITIES (SWMF)

- .1 Constructed wetlands, dry ponds, wet ponds and areas surrounding new stormwater management facilities must be graded, topsoiled, and seeded and trees installed at a rate of 75 trees per hectare by the Developer to the satisfaction of the City of Leduc. The area below the Normal Water Line (NWL) shall not be included in the hectare measurement.
- .2 The minimum setbacks for tree planting shall be as outlined in **Tables 3** and **6**.



- .3 In dry ponds, the area for the tree planting requirement shall be calculated above the 1 in 5 year water level.
- .4 Plant material appropriate to withstand flooding conditions, shall be located below the 1 in 5 flood line. Species planted below the 1 in 5 year flood level shall be approved by the City of Leduc.
- .5 Shrubs shall be massed within large mulched planting beds above the 1 in 5 year flood level to create major focal areas on the slopes of the pond. It is suggested that trees be positioned within mulched planting beds. When used boulders shall be located within mulched areas.
- .6 Wood chip mulch shall not be used in planting beds below the 1 in 25 flood line. Biodegradable erosion blankets or rock mulch are permitted.
- .7 Above the 1 in 25 year flood level, all planting beds are to have a minimum depth of 100 mm deciduous wood chip mulch or approved alternate.
- .8 All planting below the 1 in 25 year water line shall be naturalized.
- .9 These areas shall be weed and erosion free at CCC and FAC inspections and for the duration of the maintenance period;
- .10 A siltation barrier shall be installed around the periphery of the water area and any eroded material is to be removed and/or relocated to its original position on a monthly basis between CCC and FAC;
- .11 Fast growing shrubs and trees shall be planted to aid in erosion control.
- .12 Major storm sewer outlets and inlets should be landscaped with plants and large rocks to provide visual screening.
- .13 All naturalized shrub beds shall include appropriate mulch or groundcover as approved by the City of Leduc.
- .14 Live soils sourced from local source to be installed 1m above and 1m below normal water level.
- .15 It should be noted that the City of Leduc is located in close proximity to the Edmonton International Airport, and as such, is subject to restrictions on stormwater pond design as outlined in the Edmonton International Airport Vicinity Protection Area Regulation, and other Transport Canada and NAV CANADA policies and regulations. Many of these policies and regulations are intended to reduce bird attractants near airports. To follow these policies and regulations reducing vegetation habitat complexity and diversity within and near the pond is required.

In areas of the City where aviation restrictions related to the airport do not apply (for example, the far western and south western portion of the City), consideration should be given to replacing traditional retention ponds with a naturalized or constructed wetland. General considerations for design standards include (but are not limited to the following):

- The shoreline and slopes of naturalized stormwater facilities should vary in consistency, size, and configuration to create distinct habitat zones that reflect the potential frequency of flooding.
- Habitat zones within the facility should include the following:
  - a. Deep marsh: these areas should have standing water depths that range between 15 and 90 cm (Shaw and Fredine 1971). Common vegetation in this zone includes herbaceous emergent, floating, floating-leaved, and submergent vegetation, with the major dominance by cattails and bulrushes.
  - b. Shallow marsh: this habitat zone should have soils that are saturated or inundated by standing water, with water depths ranging between 5 and 15 cm (Shaw and Fredine





1971). Herbaceous emergent vegetation, such as bulrushes and sedges, and floating vegetation are common in this vegetation zone.

- c. Wet meadow: this zone is permanently saturated and seasonally flooded, with water depths ranging between 0 and 5 cm. Common vegetation in this zone includes sedges and water-loving grasses and forbs.
  - d. Riparian zone: the shores adjacent to the naturalised facility should include vegetation such as shrubs (e.g. willows), that can function to filter nutrients and sediments from surface water runoff.
- Vegetation should be interspersed throughout the facility to improve water quality, create habitat for insects and amphibians, and discourage use by species such as Canada goose. This can be achieved through placement of floating islands, or through the creation of vegetation benches that are placed at the appropriate height to encourage establishment of deep marsh emergent vegetation.
- .16 Vegetated floating islands may be incorporated in storm water management facilities. Floating islands are to be anchored in place in a location that is approved by the City of Leduc. Special formulated planting mixes designed specifically to floating islands are to be used. The size and quantity of floating islands are subject to the discretion of the City. Floating islands must be vegetated and only low maintenance, non-invasive and hardy vegetation will be accepted for floating islands.
- .17 One aerator/fountain shall be installed at each residential neighbourhood storm water management facility (SWMF). The aerator/fountain is to be installed and functional for CCC approval. After CCC the City will take over maintenance and operation of the aerator/fountain and FAC will not be required. All aerator/fountains are to be as follows (or approved equal):

Supplier: Otterbine Barebo, Inc.	Model #: Tri-Star
Horsepower: 3	Voltage: 208-230
Phase: Single	Hertz: 60
Cord Gauge & Length: 10/3 300'	Unit Serial #: D3-0714-10498
PCC Serial #: PSW3-0714-10443	

### 3.3.3 MAJOR UTILITY CORRIDORS

- .1 These guidelines shall provide for some limited development without compromising the safety and/or integrity of high-pressure natural gas facilities or power utilities.
- .2 The Landscape Architect shall contact the appropriate utility authority regarding acceptable tree species, sizes and locations on utility ROWs.
- .3 The Landscape Architect shall submit landscape drawings to the utility companies for approval for all development on ROWs.
- .4 In the event that the Utility Authority will not allow landscaping in the ROW, the requirement for all or a portion of the landscaping will be waived.
- .5 The Landscape Architect shall provide to the City of Leduc written confirmation from the Utility Authority when landscaping in utility corridors is not approved.
- .6 The Landscape Architect shall contact the Utility Authority to review designs and achieve permission in the form of a Crossing Agreement. The Crossing Agreement is to be submitted with any landscape plans submitted to the City for review.



- .7 Utility corridors where landscaping is permitted shall be planted with a minimum of 75 trees per hectare designed and massed into major groupings in mulched tree beds. Minimum deciduous tree caliper shall be 60 mm. Minimum coniferous tree height shall be 2.5 m.
- .8 All tree planting shall adhere to the required setbacks outlined in **Tables 3** and **6** and those that are required by the utility companies.
- .9 Shrubs shall be massed within planting beds.
- .10 Naturalized planting shall be approved by the City of Leduc as an alternative to manicured landscapes in utility corridors.
- .11 Developments within high pressure natural gas ROWs shall be approved by the appropriate utility authority. Issues affecting the scope of landscape areas in these locations include:
  - Restricted grade modifications over the pipeline;
  - Walkway alignment along the ROW may not be located over the pipeline;
  - Planting may be permitted in the ROW; however, location and species may be restricted.
- .12 Existing developments along utility ROWs that do not comply with these standards shall remain until redevelopment occurs.

#### 3.3.4 TOPSOIL & TURF

Topsoil shall be graded and levelled as required for all open space sites and then sodded (or seeded at the discretion of the City of Leduc with a grass seed appropriate for the landscape type see section 3.1.2).

#### 3.3.5 FENCING

- .1 Uniform fencing shall be provided adjacent to a PUL, Walkway, or Major Utility Corridor and must be a minimum of 1.5 metres in height.
- .2 1.2 metres high uniform fence shall be provided between a SWMF and private residential property.
- .3 All noise attenuation fencing required as stated in the Development Agreement shall be reviewed and inspected by the City of Leduc Engineering Department. See City of Leduc Minimum Engineering Standards for construction requirements and details of noise attenuation fencing.
- .4 Gates are required where private property backs onto Municipal Open Space lands. Gates are to be a maximum of 1.0 metres in width and must swing open to private property. Gate design and location on lot to be reviewed by the City of Leduc.
- .5 Fence shall be built a minimum of 150 mm within private property.

#### 3.3.6 TRAIL LINKAGES

Municipal Open Space provides corridors for multiways. Linkages to these multiways are the responsibility of the Developer and shall be developed to the multiway standards and as per the provisions of the City of Leduc's Parks, Open Space and Trails Master Plan in its latest edition.



### 3.4 Requirements for Roadways

This section includes the requirements for landscape and fencing of boulevards, medians, and road islands for Arterial, Collector, and Local Roadways.

#### 3.4.1 PLANTING - GENERAL

- .1 Trees shall be provided to enhance the urban forest environment. Trees are to be located as per recommended spacing and required setbacks (measured from centre of the tree trunk) along all road ROW boulevards as described in **Tables 3 and 6**.

**Table 6 - Required Setbacks from Roads, Sidewalks & Multiways**

Type of Roadway or Walkway	Minimum Setback Distance in Metres*
Arterial Roadways	
Median Curb face	2.0 m
with 1.5m sidewalk	2.5 m
with multiway	2.0 m
Collector Roadways	
Median Curb face	2.0 m
Boulevard curb face with Multiway	1.7 m
Boulevard Curb face	1.9 m
Local Roadways	
Median Curb face	2.0 m
Boulevard Curb face	1.2 m
Driveways	1.5 m
Multiways	2.0 m
Sidewalks	1.0 m

\*Any proposed distances less than this are at the discretion of the City of Leduc.

- .2 Acceptable tree species and recommended spacing is outlined in **Table 4**. These trees have been selected for their high canopy and low maintenance qualities.
- .3 Special consideration shall be given to the suitability of a species (including size, growth habit, hardiness, and maintenance requirements) for boulevard and median plantings.
- .4 Alternative tree and shrub species for roadway planting shall be considered and are subject to approval by the City of Leduc.
- .5 When lots back onto an existing roadway the area between the back of walk and the back of lot fence shall be graded, topsoiled and sodded.
- .6 Traffic and pedestrian site lines in road ROW's must be respected as per the guidelines set out in the Transportation Association of Canada Manual.
- .7 Tree trenching is encouraged in boulevards and medians. Continuous trenching is to follow Detail 1.4 Typical Tree Root Trench to encourage improved growth and survivability.



- .8 All tree planting shall be a minimum 60 mm caliper for deciduous and 2.5 m height for coniferous unless approved by the City of Leduc. A tree mix of deciduous and coniferous is generally desired.
- .9 All boulevards, road islands, medians and entry feature designs must be low maintenance. Designs shall include, where appropriate, trees, shrubs, groundcovers, mulch and/or sod to the satisfaction of the City of Leduc.
- .10 The required cross slope shall not be less than 2% from center of island to curb.
- .11 A minimum depth of 200 mm topsoil and sod is required for all boulevard landscaping between uniform fence along a flankage lot and the sidewalk, and between curb and sidewalk.

#### 3.4.2 FENCING (ADJACENT TO ROADWAYS)

- .1 All fencing shall meet the requirements set out in the Development Agreement for the subdivision.
- .2 Noise attenuation fencing shall be included as required by Development Agreement for the subdivision along arterial or other major roads. All noise attenuation fencing will be reviewed and inspected by the City of Leduc Engineering Department. See Engineering Design Standards for construction requirements and details of noise attenuation fencing.
- .3 Uniform fencing shall be constructed between private and public property along back of lots and flankages of residential lots when adjacent to collector roads.
- .4 Step-down uniform fence, or approved alternative, shall be provided for all residential side yards, abutting collector and arterial roads.
- .5 Fencing is not required between private property and local roads.

#### 3.4.3 ARTERIAL ROADS

- .1 The design intention of this standard is to provide shading and low sun blocking for roadways and sidewalks for the purpose of screening between the arterial roadway and adjacent properties. The standard does not dictate that there must be rows of trees or shrubs, only an equivalent amount of plant material. Designs unique to each roadway are encouraged.
- .2 Arterial rights-of-way shall be graded, topsoiled and sodded and landscaped to the satisfaction of the City of Leduc. Seed may be acceptable at the discretion of the City of Leduc at drawing review.
- .3 There shall be the equivalent of a row of trees in the boulevards and medians at the recommended spacing noted in **Table 4**. Where appropriate, boulevards and medians shall be designed to include continuous large planting beds with trees, shrubs and groundcovers.
- .4 Planting requirements on arterial roadways adjoining natural areas shall be reviewed on an individual basis and a relaxing of the planting standard for areas behind sidewalks would be considered.
- .5 Naturalization design of arterial boulevards shall be considered in appropriate locations.

#### 3.4.4 COLLECTOR ROADS

- .1 Planting beds are encouraged along collector boulevards and medians, however, shrubs must be low growing, with a maximum 500 mm mature height.



- .2 Boulevards shall be graded, topsoiled and sodded between the back of curb and the sidewalk or fence by the Developer to the satisfaction of the City of Leduc. The minimum cross-fall for boulevards is 2%.
- .3 Shrubs and trees may be planted between back of lot or flankage fencing and the sidewalk if approved by the City of Leduc.
- .4 Trees shall be planted on collector roads at a spacing recommended in **Table 4**.

#### 3.4.5 LOCAL ROADS

- .1 The City requires the equivalent of 1 street tree per lot for local roads. If the tree cannot be accommodated within the area between the front property line and the curb, the developer must commit to an equivalent tree being planted in the front 5m of the lot. Any landscaping included on local roads shall be reviewed by the City of Leduc.
- .2 Boulevards shall be graded, topsoiled and sodded where separate sidewalk is provided by the Developer, to the satisfaction of the City of Leduc. The minimum cross-fall for boulevards is 2%.
- .3 Flankage boulevards shall be graded, topsoiled and sodded between the property line and the back of curb.
- .4 Where local roads can accommodate at least two or more trees in a row, trees shall be planted at a spacing recommended in **Table 4**.

#### 3.4.6 ROAD ISLAND, MEDIAN & ENTRY FEATURES

- .1 Medians shall be 4.0 m or wider for tree planting. Shrub planting is not acceptable in narrow medians.
- .2 Turf areas within road islands and medians shall be allowed only at the discretion of the City of Leduc.
- .3 All paving stone and paving stone headers, concrete or other special hard surfaces shall be to the satisfaction of the City of Leduc.
- .4 Cross-section details of road islands and medians are to be drawn at an appropriate scale showing all underground utilities within 3.0 m of planting root zones. Cross-sections shall illustrate a suitable rooting zone for proposed planting, indicating the width, soil depth, mulch and plant form (tree or shrub).
- .5 Planting cross-sections and planting plan details shall be cross-referenced to engineering and landscape plans.
- .6 The required cross slope shall not be less than 2% from centre of island/median to curb.
- .7 On existing arterial roadways this planting standard shall be applied when the arterial is substantially upgraded. Allowance shall be made to avoid conflicts with existing utilities.
- .8 When roadway construction is staged, trees and shrubs are required only on the portion being developed.



## 4.0 SUBMISSION REQUIREMENTS, DESIGN APPROVAL PROCESS & CONSTRUCTION INSPECTION

### 4.1 Drawing Submission Requirements

Plans for the landscaping of all public lands as outlined in Section 2.0 must be submitted to the City of Leduc for review. All landscape plans shall comply with this and all relevant City of Leduc planning and policy documents.

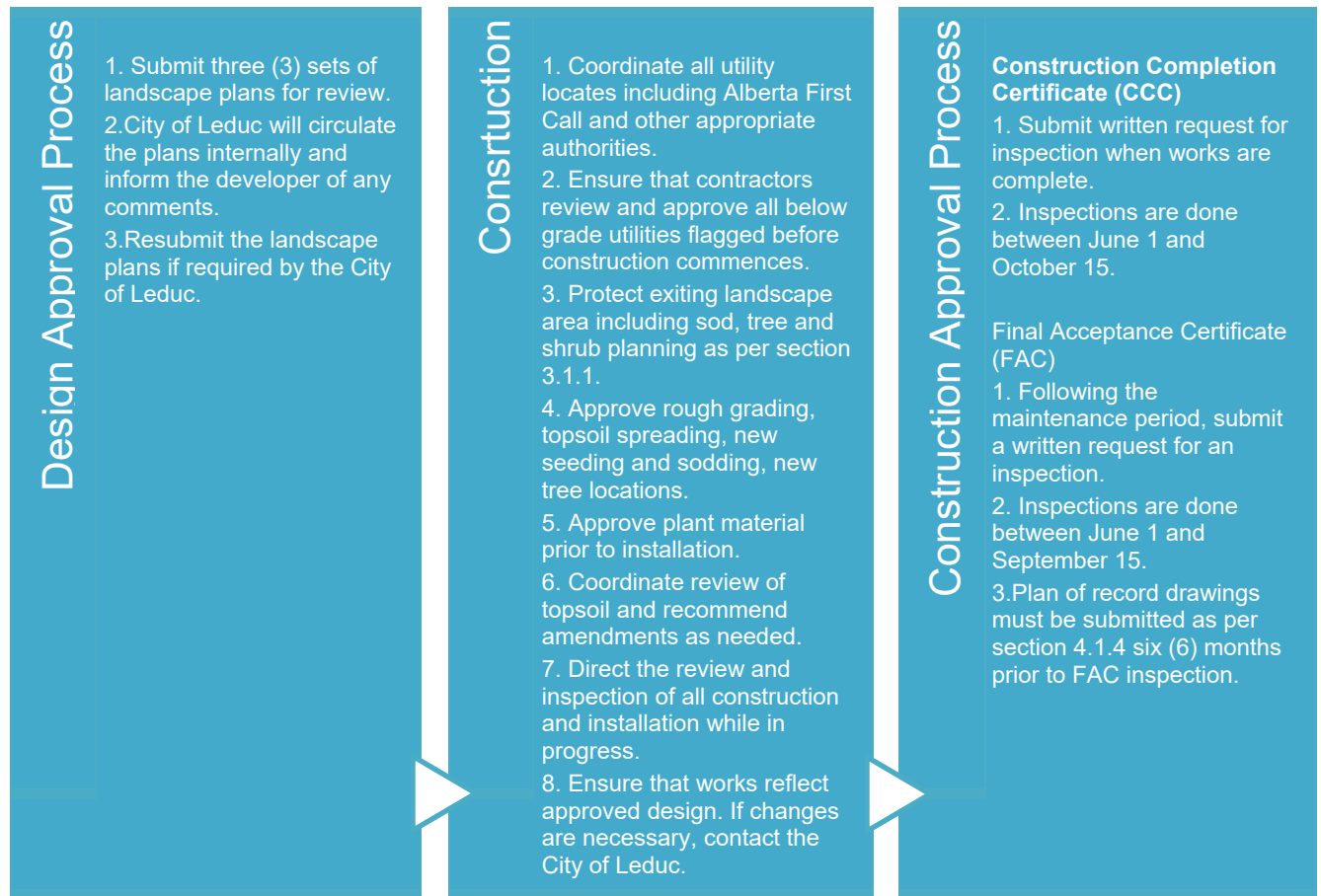

#### 4.1.1 DESIGN APPROVAL PROCESS

- .1 The design approval process includes the following procedures:
  - The Landscape Architect must stamp and submit three (3) sets of landscape plans for review by the City of Leduc;
  - The City of Leduc will circulate the plans internally and inform the Landscape Architect of any required drawing revisions, comments, or clarification;
  - The Landscape Architect shall resubmit the landscape plans, if required, to the City of Leduc for approval.



- .2 The City shall endeavor to review the plans and specifications promptly. However, the Developer shall schedule their submission of plans and specifications such as to allow the City not less than three (3) weeks for review of the documents.

#### 4.1.2 LANDSCAPE DRAWING REQUIREMENTS

- .1 Planting plans shall be drawn to a scale of 1:500, or larger if necessary. Location and fencing plans may be drawn at a smaller scale. Detail drawings should be drawn at an adequate scale to clearly explain design intent.
- .2 The landscape drawing set shall include key/context plans, grading plans, demolition plans, existing conditions, planting plans and construction detail drawings.
- .3 The landscape plans shall include the following information:
  - Developer's Name;
  - Subdivision/neighborhood name;
  - Project name;
  - Project stage or phase;
  - North arrow, drawing scale, date of drawing submission;
  - Lot, block and plan numbers;
  - All applicable property lines;
  - Adjoining street names;
  - Limit of construction;
  - Legend;
  - Existing vegetation, fencing, structures, and features; all to be labelled and shown to represent approximate extent or canopy size;
  - Proposed landscape planting, fencing, furniture, pathways, structures, and features;
  - all to be labelled and shown at mature size;
  - All Environmental Reserves, Municipal Reserves, Conservation Easements, existing vegetation and other natural features to remain and/or be removed, as applicable;
  - Areas of Municipal Reserves and SWMF in table format;
  - Alignments and locations of all utilities and associated furniture including, but not limited to, power, storm, sanitary, water, gas and telecommunications;
  - Rights-of-ways, pipeline crossing agreement numbers and easements;
  - Location of all street lighting and fire hydrants;
  - Location of all proposed driveways;
  - Alignments of immediately adjacent existing and proposed streets, walks, roads and ditches;
  - The Landscape Architect's stamp, signed and dated. The Landscape Architect must be registered in the Province of Alberta;





- Other professional stamps as required, and signed, sealed and dated (i.e. architectural, electrical, mechanical, structural).
- .4 Planting plans shall include:
    - Botanical and common name of all proposed plants;
    - Total quantity of each plant;
    - Notes including root ball size and type (e.g. b & b, bare root, potted), tree branching heights for boulevard trees, special conditions, or unique installation criteria;
    - Height and/or spread of each plant at time of installation;
    - Minimum caliper size of each plant at time of installation;
    - Minimum plant spacing for each plant;
    - Proposed seed mix and sod specifications.
  - .5 Grading Plans shall show proposed finished contours or spot elevations, top and toe of berm elevations, swales, corners and center of sports fields, corners of retained play areas and ditches as required.
  - .6 Key or context plans shall outline the phasing or staging and all street names in the immediate context.
  - .7 Construction details of all proposed planting, hard surfaces, fencing, structures, furniture and other features shall be included where necessary. Architectural, structural, mechanical and/or electrical plans must be included as required. Testing of asphalt and concrete will be required. Consult the City of Leduc Engineering Standards for guidelines and requirements.
  - .8 All relevant plans are to be submitted to all utility companies, and high- and intermediate-pressure gas line providers for their review. The City of Leduc requires one copy of any relevant utility crossing/ground disturbance agreements or other legal instrument as may be deemed appropriate. Where the Consultant's work includes landscape construction within railway, pipeline crossing or other major utility corridors, the landscape plans shall be submitted in accordance with these standards with final approval being subject to the approval of the utility or authority as evidenced by signed approved drawings. One copy of the Crossing Agreement must be submitted to the City prior to commencement of construction of the landscape improvements.

#### **4.1.3 REDLINE DRAWINGS**

1. Where a modification to the information on the landscape drawings is required, redline drawings must be submitted to the City of Leduc for review. Redline drawings shall be completed by the Developer's Landscape Architect showing any and all changes made to the approved design drawings before construction begins. Once the redline drawings are approved, they become the drawing set used for the landscape construction and construction inspection approvals at CCC and FAC.

#### **4.1.4 PLAN OF RECORD DRAWINGS**

1. Plan of record drawings are those that record all built conditions of the site once construction has been completed. Included shall be the actual location, length, size, capacity, materials, gradient and year of construction of the municipal improvement constructed within the subdivision area.
2. Plan of record drawing submissions shall be in digital format and include an unlocked AutoCAD file and a PDF drawing at full drawing size. These files shall be submitted on a compact disc to the City of Leduc approximately 6 months prior to FAC inspection.



## 4.2 Construction Procedures

- .1 The Developer's Landscape Architect shall ensure that the contractor(s) shall adhere to the following procedures through the construction process:
  - Ensure that utility locates are performed prior to any construction, including Alberta First Call and other appropriate authorities;
  - Review and approve all below grade utilities flagged before construction commences;
  - Protect existing landscaped areas including natural areas, sod, tree and shrub planting;
  - Approve rough grading, topsoil spreading, new seeding and sodding, new tree locations;
  - Approve plant material prior to installation;
  - Coordinate review of topsoil and recommend amendments as needed;
  - Direct the review and inspection of all construction and installation while in progress.
- .2 The failure of construction to comply with approved plans and specifications will be considered sufficient cause to stop work or invoke the security clauses of the Development Agreement. Construction deficiencies shall be rectified to meet the approved plans and specifications, at the Developer's expense.
- .3 The Developer's Landscape Architect shall submit a request to the City in writing for plant material substitutions. If approved, the Developer's Landscape Architect shall identify the approved changes on the Redline or Plan of Record drawing, as appropriate.
- .4 The Developer's Landscape Architect shall submit to the City a request in writing for permission to use collected plant material.
- .5 Every precaution shall be taken to not damage, injure or mark existing structures or landscaping on city owned property. Should the Developer, his consultants, employees or equipment incur any damage, it shall be restored at the developer's expense and to the satisfaction of the City of Leduc. If remediation work is not done by the developer, the work will be completed by the appropriate city department or delegate at the Developer's expense.
- .6 The Developer shall ensure that adjacent property is protected from dust, sand, and wet soil during construction. It is the Developer's responsibility to ensure all debris is removed from adjacent lands, and construction damage is repaired to its original condition.
- .7 Landscaped areas must be kept free from weeds between construction commencement and issuance of FAC. Failure to do so will result in control action by the City, and all costs shall be borne by the Developer/Contractor.

## 4.3 Landscape Construction Approval Processes

### 4.3.1 CONSTRUCTION COMPLETION CERTIFICATE (CCC)

- .1 When landscape construction work is satisfactorily complete, the Developer's Landscape Architect shall submit a written request for a CCC inspection of the works. The request shall include three (3) copies of the City of Leduc CCC form completed with the required project information, and two (2) copies of the approved or redline drawing at an 11" x 17" size.



- .2 CCCs are to be attained for the following improvements (and any others listed in the subdivision conditions):
  - CCC Turf and Planting for Boulevards;
  - CCC Turf and Planting for MR, ER, SWMF, Arterial Road;
  - CCC Park Amenities and Playground Equipment;
  - CCC Fence.
- .3 In preparation for acceptance of the development by the City, a Construction Completion Certificate (CCC) shall be issued subject to the following conditions and procedures:
  - a. The Developer's Landscape Architect, Contractor(s), and City Representatives shall attend the CCC inspections. Attendees shall be requested to sign the CCC form to show agreement with any noted deficiencies.
  - b. Following the CCC inspection, the City will forward a copy of the inspection report listing all deficiencies to the Landscape Architect or delegate, and the Contractor.
  - c. All deficiencies identified during the CCC inspection shall be repaired or corrected within 15 business days of the inspection. Upon the correction of all listed deficiencies, the Landscape Architect or delegate will request a re-inspection. If all deficiencies are corrected, the City of Leduc will approve the CCC. If deficiencies are not corrected by the agreed date, the Developer's Landscape Architect must request a new CCC inspection. The maintenance period will commence from the CCC approval date.
  - d. The Developer shall maintain all work before the CCC and during the maintenance period after the CCC approval date.
- .4 CCC inspections may be requested between June 1st and October 15th, weather permitting, at the discretion of the City of Leduc.
- .5 The Developer will maintain residential boulevards for which a CCC is required until FAC is obtained, unless stated otherwise in the Development Agreement.
- .6 80% germination is required at the time of CCC inspection for seeded areas that will be mown.

#### **4.3.2 FINAL ACCEPTANCE CERTIFICATE (FAC)**

- .1 After the required maintenance period has come to an end, the Developer's Landscape Architect shall submit a written request for a FAC inspection. The request shall include three (3) copies of the City of Leduc FAC form completed with the required project information, 1 copy of the approved CCC, and two (2) copies of the approved or plan of record landscape drawings at an 11" x 17" size.
- .2 FACs are to be attained for the following improvements (and any others listed in the subdivision conditions):
  - FAC Turf and Planting for Boulevards;
  - FAC Turf and Planting for MR, ER, SWMF Arterial Road;
  - FAC Park Amenities and Playground Equipment.
- .3 Plan of record drawings shall be submitted on a compact disc to the City of Leduc approximately 6 months prior to FAC inspection, and shall include an unlocked AutoCAD file and a PDF drawing at full drawing size.



- .4 In preparation for acceptance of the development by the City, an FAC shall be issued subject to the following conditions and procedures:
  - a. The Developer's Landscape Architect, Contractor(s), and City Representatives shall attend the FAC inspection. Attendees shall be requested to sign the FAC form to show agreement with any written deficiencies.
  - b. Following the FAC inspection, the City will forward a copy of the inspection report listing all deficiencies to the Landscape Architect or delegate.
  - c. All deficiencies identified during the FAC inspection shall be repaired or corrected within 15 business days of the inspection. Upon correction of all listed deficiencies the Landscape Architect or delegate will request a re-inspection. If all deficiencies are corrected, the City of Leduc will approve the FAC. If deficiencies are not corrected by agreed date, the Developer's Landscape Architect's must request a new FAC inspection. The maintenance period expires upon FAC approval.
- .5 FAC inspections may be requested between June 1st and September 15th, weather permitting, at the discretion of the City of Leduc. The exceptions are fencing (excluding noise attenuation fence) and site amenities which can be inspected year round, provided snow cover, temperature, etc. does not prevent the ability to perform a thorough inspection.
- .6 If tree and shrub replacement are required at FAC, a maximum of 25% of the plant material can be replaced during the deficiency correction period. Quantities exceeding 25% of replaced plant material will result in an FAC rejection. The application can be submitted for inspection the following growing season. This ensures the plant material has grown over a winter season.

#### **4.3.3 MAINTENANCE PERIOD**

The maintenance period on all landscape works is two years from the date of CCC approval until FAC approval. During this maintenance period, the Developer is responsible for maintaining all plant material, turf, site amenities, and repairing any damage to these items.



## 5.0 SPECIFICATIONS

<b>Specification No.</b>	<b>Specification Title</b>
32 31 00	Fences
32 92 00	Turf and Grasses
32 93 00	Trees, Shrubs and Groundcovers
32 91 00	Topsoil and Subgrade Preparation
32 91 13	Mulches



## 1. GENERAL

### 1.1 SCOPE

Supply and installation of chain link and wood screen fencing.

### 1.2 RELATED SECTIONS

City of Leduc Schedule 'E1' – Part 1: Minimum Engineering Design Standards, 4.0 Concrete Work.

### 1.3 EXAMINATION

**1.3.1** Report to the City of Leduc, in writing, any conditions or defects encountered on the site before or during any construction upon which the work of this section depends and which may adversely affect its performance.

**1.3.2** Do not commence work until those conditions or defects have been investigated and corrected.

**1.3.3** Commencement of work shall imply acceptance of existing surfaces and conditions and no claims for damages or extras resulting from such conditions or defects will be accepted later, except in cases where such conditions could not have been known prior to commencing work.

### 1.4 QUALIFICATIONS

**1.4.1** All work shall be done by experienced, qualified personnel, under the direction and supervision of a foreman with at least 5 years of experience.

### 1.5 PRODUCT DELIVERY, HANDLING AND STORAGE

**1.5.1** Prior to the commencement of installation all materials may be inspected and approved on site at the discretion of the City of Leduc. Any rejected fence components will be noted on a site instruction form and presented to the contractor for follow-up.

**1.5.2** Give timely notice, in writing, to the Developer's Landscape Architect when materials are available for inspection.

**1.5.3** Remove all rejected materials from site immediately.

## 2. PRODUCTS

### 2.1 CHAIN LINK

**2.1.1** Pipe material shall be hot-dipped, zinc-coated, butt-welded, Schedule 40 seamless steel pipe fabricated in conformance with ASTM A120, and zinc coating shall be not less than 0.61 kg per square metre of total surface area.



**2.1.2** Line posts shall support fencing in wet areas and shall be a minimum of 3600 mm in length and capped with galvanized steel or aluminum caps.

**2.1.3** Posts and rails: hot-dip galvanized welded steel pipe, standard weight (schedule 40, ASTM A120), zinc-coated at minimum 550 g/m<sup>2</sup> and with the following minimum dimensions:

<b>Fabric Height (Metres)</b>	<b>1.2</b>	<b>1.5</b>	<b>1.8</b>	<b>2.1</b>	<b>2.4</b>
Line post outside diameter (mm)	48.3	48.3	60.3	60.3	60.3
Length (metres)	2.0	2.3	2.6	2.9	3.2
Terminal post (end, gate, corner, straining) (mm)	73.0	73.0	88.9	88.9	88.9
Length (metres)	2.3	2.6	2.9	3.2	3.5
Rail and brace outside diameter (mm)	-	-	42.2	42.2	42.2

**2.1.4** Fittings shall conform to the ASTM F626 as follows:

	<b>Minimum Dimension (mm)</b>	<b>Min Zinc Coating g/m<sup>2</sup></b>	<b>Fabricated from:</b>
<b>Post cap and rail end</b>	varies	366	Pressed steel or cast iron
<b>Top rail sleeve</b>	2.0 thick x 175 long	366	Round steel tubing
<b>Tie wire and clip</b>	3.5 diameter (9 gauge aluminum)	122	Round steel tubing
<b>Tension and brace bands</b>	2.0 thick x 19.0 wide	366	Pressed steel
<b>Tension bar</b>	2.0 thick x 16.0 wide	366	Steel strip
<b>Turnbuckle</b>	varies	366	Steel
<b>Barb arm</b>	2.0 tick (14 – gauge)	366	Pressed steel

**2.1.5** Wire shall be not less than 4.8 mm diameter, single strand, electro-galvanized wire that will withstand at least 6 dips in conformance with ASTM A239. Wire shall have an ultimate tensile strength at least equal to that specified for wire for chain link fabric, and shall have a corrosion protection system equal to that specified for fabric.

**2.1.6** Fabric shall be Type I steel fabric, mesh size 50mm, medium style; class A zinc-coated, grade 1 at minimum 490 g/m<sup>2</sup>.

**2.1.7** Nominal wire diameter of fabric shall be 3.5mm (9-gauge).

**2.1.8** Fabric selvage shall have twisted top and knuckled bottom.

**2.1.9** Fabric height: 1.2, 1.5, 1.8, 2.1 or 2.4 m as specified.

## **2.2 WOOD SCREEN FENCE**

**2.2.1** Pressure treated timber and lumber shall be #1 construction grade.

**2.2.2** Spruce, Western Pine, Cedar, or Douglas Fir, dressed and conforming to C.S.A. standards.



**2.2.3** Posts shall be:

- Graded by an agency certified by the Canadian Lumber Standards Administration Board and marked with a recognized and visible grade stamp;
- Graded in accordance with National Lumber Grades Authority for Canadian Lumber and CSA 0141-1970;
- Minimum cross-sectional dimension to be 150 mm x 100 mm;
- Pressure treated and stained, prior to installation of stringers or fence boards, and may be touched up after construction where stain has been removed;
- Free of knots, bark and contain no cracks more than 50% of the depth or exceed 25% of width of posts.

**2.2.4** Stringers, fascia and boards shall be:

- Graded by an agency certified by the Canadian Lumber Standards Administration Board and marked with a recognized and visible grade stamp;
- Graded in accordance with National Lumber Grades Authority for Canadian Lumber and CSA 0141-1970;
- Free of loose knots, bark and have straight edges. Re-sawn lumber will not be accepted;
- Pre-stained with two coats of stain and maybe touched up after construction where stain has been removed.

**2.3 CONCRETE****2.3.1** Concrete for piles to conform to City of Leduc Schedule 'E1' – Part 1: Minimum Engineering Design Standards, 4.0 Concrete Work with the following modified criteria:

- Minimum compressive strength: 20.0 MPa at 28 days;
- Maximum aggregate size: 25mm.

**2.3.2** As a minimum, footing and post depth shall be sufficient to reach undisturbed material.**2.4 FASTENERS****2.4.1** Nails, spikes, bolts and lag screws to be hot dipped galvanized in accordance with C.S.A.**3. EXECUTION****3.1 GRADING****3.1.1** The fence contractor shall do minor levelling of the ground where necessary.**3.1.2** Remove debris and correct ground undulations along fence line to obtain smooth uniform gradient between posts. Provide clearance between bottom of fence and ground surface as per relevant detail.



**3.2 ERECTION OF FENCE**

- 3.2.1** Stake out fence lines and locations of end and corner posts. Pay attention to grades as marked on site.
- 3.2.2** All fencing shall be parallel with the property line and located inside private property where the outermost portion of the fence post is 150 mm from property line.
- 3.2.3** All fences shall be a minimum of 1.2 m high with posts set into concrete. The exception is stepdown fencing with a minimum height of 1.0 metres.

**3.3 CHAIN LINK FENCE CONSTRUCTION**

- 3.3.1** Chain link fence construction shall be executed as per Detail 2.3.
- 3.3.2** Place concrete in post hole and embed post to a minimum depth below ground of 900 mm. Extend concrete 50 mm above ground level and crown to drain away from post. Brace post in plumb position and true to alignment and elevation until the concrete has set. Let concrete footing cure for a minimum 5 days before proceeding with further work.
- 3.3.3** Spaces between line posts shall be uniform and shall not exceed 3.0 metres measured parallel to ground surface.
- 3.3.4** Set corner post where change in alignment exceeds 20°.
- 3.3.5** Dig or drill post holes to the following minimum diameters and depths that will allow at least 150 mm of footing below bottom of post:

<b>Fabric height (metres)</b>	<b>1.2</b>	<b>1.5</b>	<b>1.8</b>	<b>2.1</b>	<b>2.4</b>
<b>Line post hole diameter (mm)</b>	200	200	250	250	250
<b>Depth (mm)</b>	900	900	900	900	900
<b>Terminal post hole diameter (mm)</b>	300	300	360	360	360
<b>Depth (mm)</b>	1200	1200	1200	1200	1200

- 3.3.6** Set end post at termination of fence.
- 3.3.7** Where end or corner posts are more than 150 m apart over reasonably smooth grade, set straining posts at equal intervals not exceeding 150 m on a straight continuous stretch of fence. Set additional straining posts at sharp changes in grade.
- 3.3.8** In poor soil conditions, set post into concrete footing of such diameter and depth as will provide adequate stability to the fence, subject to acceptance by the City of Leduc.
- 3.3.9** Support top rail at each line post with a line post cap so that a continuous brace is formed between terminal posts. Join rails with sleeves to allow for expansion and contraction.
- 3.3.10** Securely fasten top rail to terminal posts using rail ends and brace bands.
- 3.3.11** Fabric shall be suitably tensioned and attached to terminal posts using tension bars and bands.
- 3.3.12** Tension bars shall be threaded through fabric mesh and shall be connected to terminal posts by means of tension bands spaced not more than 375 mm apart.



- 3.3.13** Fabric shall be placed facing public property.
- 3.3.14** Fabric shall be fastened with tie wire to line posts at approximately 300 mm o/c, and to top rails, braces, and tension wire at approximately 450 mm o/c. Give tie wires a minimum of 2 twists. Tie wires are to be folded inwards to prevent injury.
- 3.3.15** Installed fabric shall have a smooth uniform appearance free of sag, dent and bulge.
- 3.3.16** Bottom of fabric and bottom tension wire shall be 50 mm above finished grade.
- 3.3.17** Bottom tension wire shall be strung along the bottom selvage of the fabric, pulled taut, and firmly attached to end, corner, and straining posts with tension bands and turnbuckles.
- 3.3.18** Clean damaged surfaces with wire brush to remove loose and cracked spelter coatings. Then apply 2 coats of approved zinc pigmented paint.

### **3.4 WOOD SCREEN FENCE CONSTRUCTION**

- 3.4.1** Post installation shall be set in concrete as per Detail 2.1.
- 3.4.2** Spaces between line posts shall be uniform and shall not exceed 3.0 metres measured parallel to ground surface.
- 3.4.3** Cracks in posts or boards 6 - 12mm in width are to be re-stained with fence stain ensuring stain penetrates core wood.
- 3.4.4** Board spacing shall be tight ensuring spacing between boards does not exceed 10 mm when boards are dry.
- 3.4.5** Posts and any wood in contact with the ground to be pressure treated as per 2.3.1.
- 3.4.6** Fence posts to be stained prior to installation of stringers and fence boards.
- 3.4.7** Touch up stain to be applied after construction to any boards where stain as been removed, i.e. nail holes, faded, see through, etc.
- 3.4.8** Nailer strips to be fastened to post.
- 3.4.9** Bottom stringer shall be 50-100mm above finished grade and no turf may contact the stringer.

### **3.5 CLEAN-UP**

- 3.5.1** Remove all excess materials and debris from the site and repair any damage to surroundings.

### **3.6 CONSTRUCTION COMPLETION INSPECTION (CCC)**

- 3.6.1** Fencing shall be constructed as per detail and as outlined on the landscape plan. All wood components must be stained and no bare wood shall be showing on either posts or boards.

### **END OF SECTION**



## 1. GENERAL

### 1.1 SCOPE

The supply and installation of materials for seeding, sodding, fertilizing, watering, maintenance and inspection of turf grasses. The creation of naturalized grass areas is included.

### 1.2 RELATED SECTIONS

Topsoil, Subgrade Preparation; Section 32 91 00;  
Trees, Shrubs, and Groundcovers; Section 32 93 00;  
Mulches; Section 32 91 13.

### 1.3 EXAMINATION

- 1.3.1 Report to the City of Leduc, in writing, any conditions or defects encountered on the site before or during any construction upon which the work of this section depends and which may adversely affect its performance.
- 1.3.2 Do not commence work until those conditions or defects have been investigated and corrected.
- 1.3.3 Commencement of work shall imply acceptance of existing surfaces and conditions and no claims for damages or extras resulting from such conditions or defects will be accepted later, except in cases where such conditions could not have been known prior to commencing work.

### 1.4 QUALIFICATIONS

- 1.4.1 All work shall be done by experienced, qualified personnel, under the direction and supervision of a foreman with at least 5 years of horticultural experience.
- 1.4.2 The work shall be done to conform to best horticultural practice and the specifications, in accordance with the Canadian Nursery Landscape Association (C.N.L.A) standards.

### 1.5 PRODUCT DELIVERY, HANDLING AND STORAGE

- 1.5.1 Supply grass seed in standard containers, tagged with identification as to the analysis of seed species mixture, percentages of seed, year of seed production, net weight and date.
- 1.5.2 Deliver seed to site only when required or in a weatherproof place on site and in such a manner that its effectiveness is not impaired.
- 1.5.3 Protect sod during transportation with tarpaulin to prevent sun scalding and drying out and to ensure its healthy condition upon arrival at the site.
- 1.5.4 Sod must be installed on the day of arrival at site. If delays in installation occur due to weather, protect sod on site from sun, keep sod moist and store in a cool place until installation. Sod that is dried out and not in a healthy growing condition will be rejected.





**1.6 SAMPLES**

- 1.6.1 Samples of grass seed may be requested for approval by the City of Leduc.
- 1.6.2 Retain approved samples on site until work has been inspected.
- 1.6.3 All work shall conform to approved samples.

**1.7 SUBSTITUTION**

- 1.7.1 All requests for substitutions of seed mixes shall be vetted through the Consultant responsible for preparing the contract drawings. Such requests shall be forwarded to the City of Leduc for approval prior to installation.

**1.8 INSPECTION**

- 1.8.1 The City of Leduc will inspect all seed and sod installations.
- 1.8.2 Prior to the commencement of installation, all materials may be inspected and approved either at the source of local supply or on site at the discretion of the City of Leduc. Previous approval will not impair the right of the City of Leduc during the course of construction to reject sod which has been damaged or which, in any way, does not conform to the specifications. Any rejected seeding or sodding will be noted on a site instruction form and presented to the contractor for follow-up.
- 1.8.3 Give timely notice, in writing, to the Consultant when materials are available for inspection.
- 1.8.4 At the time of inspection, all turf shall be alive and in a healthy, satisfactory growing condition.
- 1.8.5 Remove all rejected materials from site immediately.

**2. PRODUCTS**

**2.1 SEED MIXTURE**

- 2.1.1 Grass seed shall be Canada #1 certified seed meeting the most current requirements of the “Canadian Seeds Act.”
- 2.1.2 The mixture shall comply with Federal and Provincial seed laws, be free of disease, weed seeds, and foreign matter, and have a minimum germination of 75% and a minimum purity of 97%. Bags containing the seed mixture shall be clearly tagged, showing the name of the supplier, the contents, the date and location of bagging, and the year of seed production.
- 2.1.3 Seed varieties shall be mixed, and application rate set to suit the conditions and location. Acceptable seed mixes and application rates for dry seeding are:

Seed mix name / locations for use	Application Rate	Species / Variety Mix
General Parks Mix – for parks, SWMFs (mown areas), (Substitutions may be acceptable).	125kg per hectare	30% Bedazzled Kentucky Bluegrass 20% Midnight Kentucky Bluegrass 20% Bonaire Kentucky Bluegrass 20% Aberdeen Creeping Red Fescue 10% Dominator Perennial Ryegrass



Seed mix name / locations for use	Application Rate	Species / Variety Mix
Sports Turf – for sports fields. (Irrigated & non-irrigated substitutions may be acceptable).	125kg per hectare	25% Jump Start – Kentucky Bluegrass 25% Bedazzled – Kentucky Bluegrass 25% Bewitched - Kentucky Bluegrass 25% Water Works – Kentucky Bluegrass
Boulevard Mix – for roadways, PULs, medians, and walkways	125kg per hectare	30% Turf-type Tall Fescue – single variety 20% Hard Fescue – single variety 20% Domestic Wheatgrass – single variety 20% Creeping Red Fescue – minimum 2 varieties 10% Perennial Ryegrass – single
Naturalization Mix – for non-mown naturalized areas	150kg per hectare	30% Slender / Awned / Bearded Wheatgrass 25% Mountain Brome 25% Sheep Fescue 5% Green Needle Grass 5% Western Wheatgrass 5% Northern/Stream bank Wheatgrass 5% Fringed/Nodding Brome

**2.1.4** See section 3.4 for application rates for hydroseeding.

**2.1.5** The Landscape Architect may recommend alternatives to the above seed mixes. These shall be identified on the landscape plans prior to review and approval of drawings by the City of Leduc.

**2.1.6** All seed and sod shall conform to horticultural standards of, and comply with, all sections of the latest edition of C.N.L.A. standards for the Leduc area.

**2.2 SOD**

**2.2.1** Sod shall be certified No. 1 cultivated turf grass sod of the type as specified on the approved landscape plans, grown and sold in accordance with the classification of the Nursery Sod Growers Association of Alberta and Western Turfgrass Association Standards.

**2.2.2** At time of delivery to site, it shall have a strong, fibrous root system with thick and healthy growth and delivered within 24 hours of the time of cutting. Sod showing signs of deterioration due to age or lack of moisture will be rejected.

**2.2.3** Sod shall be free from stones, tears, and burned or bare spots and delivered moist, cut in strips of uniform width and thickness.

**2.3 BINDER FOR HYDROSEEDING**

- 2.3.1** Use Turfmaster Hydro Seal or equivalent compatible binder additive at the manufacturer's recommended rate, sufficient to mix a consistent slurry.
- 2.3.2** Binder shall be mixed and supplied by a recognized supplier and shall have tested rates of purity.

**2.4 HYDROSEED MULCH**

- 2.4.1** Material shall be wood cellulose fibre containing no contaminants.
- 2.4.2** Fibre shall be supplied by a recognized supplier and shall have a certified weight and composition.
- 2.4.3** Minimum application rate is 16.0 kg of air dry fibre per 100m<sup>2</sup>.
- 2.4.4** Fibre shall be measured as it is fed into the seeder.

**2.5 FERTILIZER**

- 2.5.1** Fertilizers shall be clearly labelled and supplied in unopened moisture-proof containers.
- 2.5.2** Use standard commercial fertilizers, with guaranteed chemical analysis.
- 2.5.3** All inorganic fertilizers shall be complete, commercial fertilizers of an approved manufacturer. They shall contain not less than 60% urea-formaldehyde and contain the specified percentages of weight.
- 2.5.4** Supply and deliver fertilizers in bags, clearly marked with the name of the manufacturer, contents, weight and analysis.
- 2.5.5** At time of turf installation, fertilizer shall be slow release formulated 16-32-0 or 11-54-0 or approved equivalent by the City of Leduc.
- 2.5.6** Fertilize three times per growing season:
- Spring – Apply 12-51-0 fertilizer (or approved equal) before May 31st,
  - Summer- Apply 27-14-0 fertilizer (or approved equal) during the first two weeks of July,
  - Fall – Apply 16-20-0 fertilizer (or approved equal) during the last two weeks of August.
- 2.5.7** Fertilizer shall be granular water-soluble type.

**2.6 EQUIPMENT**

- 2.6.1** Cultivators capable of scarifying, discing or harrowing.
- 2.6.2** Dry seeders of the "Brillion" type or approved equal, capable of rolling and covering the seed with 3 mm to 6 mm of soil; or of the cyclone type, with flexible wire mat drag, and rolled with a light turf roller weighing between 90 and 114 kg into the prepared seedbed in two directions in equal amounts. Equipment must roll and cover the seed with 3 mm to 6 mm of soil.
- 2.6.3** Hydro seeders that are capable of thoroughly mixing water, seed, fertilizer and pulverized wood fibre and of uniformly spraying the mix at designated rate.
- 2.6.4** Rollers must be of suitable size and mass.
- 2.6.5** Wooden pegs, to be used for pegging sod on slopes steeper than 1:3, shall be approved hardwood pegs, 230 mm long minimum and approximately 25 mm x 25 mm square, or approved equal. Pegs shall be of sufficient length to ensure satisfactory anchorage of sod.





### 3. EXECUTION

#### 3.1 PLANTING SEASON

- 3.1.1 Installation of grass seed is recommended between May 1 to September 15.
- 3.1.2 Installation of sod is recommended between May 1 and September 30.

#### 3.2 SITE PREPARATION

- 3.2.1 Existing subgrade shall be 250 mm below finished grades shown on drawings for all seeded areas and 200mm depth for sod.
- 3.2.2 Verify existing subgrade on site and report discrepancies immediately to the Consultant.
- 3.2.3 Remove all fill, which has been temporarily placed against the back face of curbs and structures and adjacent to walks and pavements. Excavate such fill to 250 mm below finished grade.
- 3.2.4 Remove excavated material, stones, roots, and debris, lumps and sod pieces from site and dispose of, unless directed otherwise.
- 3.2.5 Where necessary, regrade subgrade, until it conforms to the drawings and Consultant's approval.
- 3.2.6 Scarify existing subgrade to a minimum depth of 75 mm and remove all stones 50 mm in diameter and larger and all live weeds from the surface.
- 3.2.7 Obtain approval of finished subgrade from Consultant before proceeding with the work.
- 3.2.8 Spread topsoil over area and grade evenly. Float the surface until smooth and fine grade to eliminate rough or low areas. The minimum depth of topsoil under all sodded areas is 200mm and seeded areas shall be 250 mm.
- 3.2.9 Apply fertilizers within 48 hours before laying sod, and work well into the topsoil by disking, raking or harrowing.
- 3.2.10 Firm sod-bed by rolling before application.
- 3.2.11 Apply fertilizer according to manufacturer's instructions or as directed by the City of Leduc.
- 3.2.12 Apply fertilizer with spreader at designated rate and mix thoroughly into the upper portions of topsoil.
- 3.2.13 Final grade shall be flush with adjacent surfaces for seeded areas and shall be 25 mm below finished grade of adjacent work for sodded areas.
- 3.2.14 Fine-grade area and roll with a 68 kg to 90 kg roller to make finished surface smooth and firm against footprints, and apply roller in two directions perpendicular to each other
- 3.2.15 After rolling, check finished surface for depressions, lumps and other irregularities and correct same by re-rolling where necessary.

#### 3.3 SEEDING

- 3.3.1 Do not seed when prepared topsoil is covered with frost, snow or standing water. Proceed with seeding operations only during favorable weather conditions in accordance with sound horticultural practices. Seeding shall not occur if the soil temperature is below 13 °C.
- 3.3.2 Seeding shall not be carried out when wind velocities are above 8 km/h.



- 3.3.3** For slopes 3 horizontal to 1 vertical or less, grass seed shall be sown at a rate (kg / 100 m<sup>2</sup>) as per product recommendation in two passes of a mechanical spreader at 90° to each other.
- 3.3.4** For slopes greater than 3 horizontal to 1 vertical, a hydro-seeder of approved design capable of thoroughly mixing water, grass seed, fertilizer and pulverized wood fibre shall be used.
- 3.3.5** Hand broadcast seeding is unacceptable under any conditions except for site specific repair work and pre-approved work in naturalization areas.

### **3.4 HYDROSEEDING**

- 3.4.1** Use a hydro seeder to seed slopes 3 horizontal to 1 vertical or steeper with Naturalization Mix as noted in 2.1.3. In other flatter areas, use General Park Mix as in 2.1.3.
- 3.4.2** Mix seed with water, mulch and fertilizer in the following suggested quantities:
- Grass Seed 24 kg/1000 m<sup>2</sup>
  - Water 468 L/1000 m<sup>2</sup>
  - Mulch 170 kg/1000 m<sup>2</sup>
  - Fertilizer 50 kg/1000 m<sup>2</sup>
- 3.4.3** Hydroseeding should not be carried out in wind velocities which cause seed mix to be blown and shall not be carried out when wind velocities are above 8 km/h.
- 3.4.4** Measure quantities of materials to be fed into the seeder, either by weight or by using another approved system.
- 3.4.5** Application rates:
- Grass seed at 2.0 kg per 100 m<sup>2</sup> or as specified for the seed type;
  - Water 106 L / 100 m<sup>2</sup>;
  - Mulch 16 kg / 100 m<sup>2</sup> or sufficient to apply the specified amount of seed and fertilizer per 100m<sup>2</sup>.
- 3.4.6** Thoroughly mix seed, fertilizer, mulch, binder (if specified) and water in a slurry and uniformly apply in one operation of apply seed and fertilizer mixture then cover with an approved mulch.

### **3.5 SEED GERMINATION USING DRY SEED, AND HYDROSEED APPLICATIONS**

- 3.5.1** If seed fails to germinate within four growing months, re-cultivate and re-seed until germination takes place.
- 3.5.2** Approximately six weeks after germination, there should be a supplementary fertilizer treatment 27-14-0, at a rate determined by topsoil analysis or such other fertilizer as may be deemed appropriate by the City of Leduc.

### **3.6 SOD HARVESTING REQUIREMENTS**

- 3.6.1** Sod shall be cut by approved methods in accordance with the recommendations of the Landscape Alberta Nursery Trades Association (LANTA) and shall be:
- a minimum of eighteen months old;
  - of a quality that satisfies weed tolerance rates as outlined by the LANTA;
  - 20 - 25 mm in uniform thickness;
  - cut in strips of uniform width;
  - sufficiently moist so that no burning of the edges has occurred;
  - harvested at 12 mm soil depth, cut uniform free of any holes and tears.
- 3.6.2** Handle sod carefully when loading and installing to prevent tearing or breaking.

**3.7 SODDING**

- 3.7.1** Sodding is required where specified by the City of Leduc.
- 3.7.2** Sod shall be laid evenly with staggered joints closely butted together and matched to the existing grades or surrounding areas.
- 3.7.3** Lay sod as soon as possible upon arrival on the site but within 48 hours.
- 3.7.4** Blend sod smoothly and uniformly and flush to adjoining grass areas and/or paving and top surface of curbs, unless shown otherwise on drawings.
- 3.7.5** Sod shall be laid at right angles to the slope along the contours of the slope. If sodding occurs on any slope steeper than 3 Horizontal to 1 Vertical, sod may be pegged, 25 per 10m<sup>2</sup>, with short wooden pegs to prevent sod from slipping. Pegs to be pounded flush with ground.
- 3.7.6** Top dress seams as required with Class 'B' topsoil.
- 3.7.7** All areas shall be rolled with a medium roller (90 to 114 kg) to provide close contact between sod and topsoil and to produce a smooth and even surface.
- 3.7.8** Let sod and soil dry out sufficiently to prevent damage, then roll sod with a roller to ensure good bond between sod and soil and to smooth out humps and depressions.
- 3.7.9** Immediately after rolling, saturate sod and upper 100 mm of soil with fine spray. Do not cause erosion. To prevent grass and soil from drying out, continue adequate watering for 21 days after laying or until roots are well established.
- 3.7.10** Four weeks after laying and following initial cutting apply organic supplementary fertilizer 27-14-0, at a rate determined by topsoil analysis or such other fertilizer as may be determined by the City of Leduc.
- 3.7.11** On slopes steeper than 2:1, lay sod perpendicular to slope and peg every row with wooden pegs at intervals not exceeding .6 m.
- 3.7.12** Drive pegs flush with sod, so as not to interfere with moving operations.
- 3.7.13** Upon completion of all sodding work, arrange for inspection by the Consultant. Give timely notice for such inspection.
- 3.7.14** Approval of work at such inspection will establish completion of work. Partial completion does not relinquish maintenance responsibilities by the Contractor.

**3.8 CLEAN-UP**

- 3.8.1** Immediately after installation, remove all debris and excess material from the roadways, walkways and surrounding areas, leaving the area neat and tidy. Clean all areas, which are contaminated as a result of landscape construction operations.
- 3.8.2** Maintain all areas neat and tidy at all times until acceptance.

**3.9 CONSTRUCTION COMPLETION INSPECTION (CCC)**

- 3.9.1** At time of the construction completion inspection, all sodded areas shall have a healthy, even stand of grass, free of diseases, weeds, thin, burned-out patches or non-flush joints and shall be not more than 65 mm in height.
- 3.9.2** At time of the construction completion inspection, all areas to have been seeded must have evenly spread topsoil, and seed evenly spread as per 2.1.3.



**3.10 WARRANTY**

- 3.10.1** The Contractor is fully responsible for the general health and quality of all sodded and seeded areas from CCC approval until FAC approval.
- 3.10.2** Areas showing deterioration, bare spots or thin areas shall be re-seeded or re-sodded at the Contractor's expense.

**3.11 MAINTENANCE**

- 3.11.1** Maintenance shall include all measures necessary to establish and maintain seeded and sodded areas in an acceptable, vigorous and healthy growing condition for a period of at least two years from the issuance of a Construction Completion Certificate and until the issuance of the Final Acceptance Certificate. Maintenance shall include:
- Mowing at regular intervals to maintain a minimum height of 60mm and a maximum height of 75mm. Mowing is required for establishment of naturalized seed areas. Do not cut more than 1/3 of blade height at any one mowing. Remove heavy clippings immediately;
  - Replacing areas that show root growth failure, deterioration, bare or thin spots or which have been damaged by any means;
  - Removing and replacing dead sod;
  - Top dressing and rolling to repair ruts or erosion.
- 3.11.2** The City of Leduc may direct the use of herbicides for weed control and chemicals and pesticides as control measures for disease and insects. They shall be applied in accordance with manufacturer's recommendations by a licensed applicator. Damage resulting from the Contractor's improper use of herbicides shall be remedied at the Contractor's own expense.
- 3.11.3** The City of Leduc must be advised 48 hours prior to the spraying of any chemicals, herbicides or pesticides.
- 3.11.4** The Contractor is responsible for supplying, loading, hauling and distributing water and fertilizer for maintenance purposes.

**3.12 PROTECTION AFTER COMPLETION**

- 3.12.1** Assume full responsibility for protection of all seeded and sodded areas until all project work has been completed, approved and accepted.
- 3.12.2** Erect protective fencing and post signs where necessary and maintain such works until acceptance and remove same after acceptance of work, unless directed otherwise.

**3.13 FINAL INSPECTION & ACCEPTANCE (FAC)**

- 3.13.1** At time of the final inspection, all grassed areas shall have a healthy, even stand of grass, free of diseases, weeds, thin, burned-out patches or non-flush joints and shall be not more than 65 mm in height.
- 3.13.2** At time of final inspection all turf shall be alive and in a healthy satisfactory growing condition, free from weeds.
- 3.13.3** Final inspection of seeded or sodded areas will be made prior to the end of the warranty period.

**END OF SECTION**



## 1. GENERAL

### 1.1 SCOPE

Supplying trees, shrubs, groundcovers and other associated materials; planting, transplanting, plant maintenance and inspections.

### 1.2 RELATED SECTIONS

Topsoil, Subgrade Preparation; Section 32 91 00;

Lawn & Grasses; Section 32 92 00;

Mulches; Section 32 91 13.

### 1.3 EXAMINATION

**1.3.1** Report to the City of Leduc, in writing, any conditions or defects encountered on the site before or during any construction upon which the work of this section depends and which may adversely affect its performance.

**1.3.2** Do not commence work until those conditions or defects have been investigated and corrected.

**1.3.3** Commencement of work shall imply acceptance of existing surfaces and conditions and no claims for damages or extras resulting from such conditions or defects will be accepted later, except in cases where such conditions could not have been known prior to commencing work.

### 1.4 QUALIFICATIONS

**1.4.1** All planting and related work shall be done by experienced, qualified personnel, under the direction and supervision of a foreman with at least 5 years of horticultural and planting experience.

**1.4.2** The work shall be done to conform with best horticultural practice and the specifications, in accordance with the Canadian Nursery Landscape Association (C.N.L.A) standards.

### 1.5 PRODUCT DELIVERY, HANDLING AND STORAGE

**1.5.1** Supply manufactured items such as fertilizer, in standard containers, clearly indicating contents, weight, component analysis and the name of the manufacturer.

**1.5.2** Store manufactured materials susceptible to deterioration, in a weatherproof place on site and in such a manner that their effectiveness is not impaired.

**1.5.3** Supply plant material as specified on the plant list on the approved landscape drawings.

**1.5.4** Handle plant material with reasonable care and skill to prevent injuries to trunk, branches, roots, root balls and containers.

**1.5.5** Protect plants during shipment with tarpaulin or other suitable covering and carefully tie in all branches before transporting to prevent excessive drying from sun and wind or breakage from wind and equipment. Pad all points of contact between plant material and equipment.

- 1.5.6** For trees dug by tree spade, the root ball shall be placed in burlap and a wire basket. Wire baskets shall be laced at the top and of sufficient strength to withstand lifting the tree by the top loops of the basket at a minimum of two points.
- 1.5.7** Trees in foliage are moved by the basket method or “balled and bur lapped” method, the foliage and root ball must be covered by a tarp.
- 1.5.8** Container stock should be handled as much as possible by the pot only, in order to reduce breakage.
- 1.5.9** All plants should be unloaded and checked immediately upon arrival and watered as required. Trees with cracked or broken root balls will not be accepted.
- 1.5.10** Trees with broken, deformed, dead, co-dominant or missing leaders will not be accepted.
- 1.5.11** All plant material that cannot be planted during the current day’s operations shall be heeled in with topsoil or mulch and watered. All plant material should be planted within 24 hours of delivery to site.
- 1.5.12** Root balls, roots, trunks, branches and leaves shall be protected on site from drying, frost, construction equipment, or other damage and be kept moist until planted.
- 1.5.13** Replacement of all damaged stock is at the Contractor’s expense.
- 1.5.14** Subgrade material from the digging of tree pits by a tree spade is to be removed from the site at the Contractor’s expense if it cannot be utilized on site.

## **1.6 SAMPLES**

- 1.6.1** Samples of mulch and accessories for tree guying and staking may be requested for approval by the City of Leduc.
- 1.6.2** Retain approved samples on site until work has been inspected.
- 1.6.3** All work shall conform to approved samples.

## **1.7 SUBSTITUTION**

- 1.7.1** All substitutions shall be made through a change order to the contract.
- 1.7.2** All requests for substitutions shall be vetted through the Landscape Architect responsible for preparing the contract drawings. Such requests shall be forwarded to the City of Leduc for approval.

## **1.8 INSPECTION**

- 1.8.1** Prior to the commencement of installation all materials may be inspected and approved either at the source of local supply or on site at the discretion of the City of Leduc. Previous approval will not impair the right of the City of Leduc during the course of construction to reject plants which have been damaged or which, in any way, do not conform to the specifications. Any rejected plant materials will be noted on a site instruction form and presented to the contractor for follow-up.
- 1.8.2** Give timely notice, in writing, to the Consultant when materials are available for inspection.
- 1.8.3** Planting of plant materials, prior to inspection by the Consultant, will be Contractor's responsibility. The Consultant reserves the right to reject any plants, whether planted or not, which do not conform to the specifications and/or drawings. Remove all rejected materials from the site immediately.





- 1.8.4 Do not remove any labels from plants until CCC has been approved by the City of Leduc.
- 1.8.5 Partial acceptance will be given when planting work has been delayed due to circumstances beyond the control of the Contractor or where planting would be in discordance with good horticultural practices and would jeopardize the performance of the work and plants.
- 1.8.6 Final Inspection of all planting will be made at the end of the specified warranty period.
- 1.8.7 At the time of inspection, all plants shall be alive and in a healthy, satisfactory growing condition.

## 2. PRODUCTS

### 2.1 PLANT MATERIAL

- 2.1.1 All plant materials shall conform to horticultural standards of, and comply with, all sections of the latest edition of C.N.L.A. standards for the Leduc area.
- 2.1.2 They shall be nursery grown in Alberta, under proper cultural practices as recommended by the C.N.L.A, unless approved otherwise of sound stock, typical of species or variety.
- 2.1.3 All plant materials shall be clearly labelled as to variety, size and source of supply. Do not remove labels until after final inspection.
- 2.1.4 Any plants dug from native stands, wood lots, orchards, or neglected nurseries and have not received proper cultural maintenance as advocated by the C.N.L.A, shall be designated as “collected” plants. The City will not permit the use of “collected” plants unless previously inspected and approved in writing.
- 2.1.5 Plants shall be true to type and structurally sound, well branched, healthy and vigorous and free of disease, insect infestations, insect eggs, rodent damage, sunscald and frost cracks. They shall be densely foliated when in leaf and have a healthy, well-developed fibrous root system. Pruning wounds shall show vigorous bark on all edges and all parts shall be moist and show live, green cambium tissue when cut.
- 2.1.6 Container-grown material is acceptable providing plants have been grown in the container for at least one growing season, but not longer than two. Containers must be large enough to permit proper root development.
- 2.1.7 Trees shall have a straight well developed single leader unless that would be uncharacteristic to the tree species. Clump or multi-stem trees shall have three or more stems originating from a common base.
- 2.1.8 Shrubs shall have natural form typical of the species with a minimum of four canes.
- 2.1.9 Vines shall have at least four runners, each of a minimum length of 300mm.
- 2.1.10 Groundcovers shall have well-developed tops, size proportionate to the developed roots typical of the species.
- 2.1.11 Annual plants to be of vigorous growth with healthy leaf and stem tissue and without sign of wilting. All plants to be full-form without missing or broken branches and of a shape typical of the particular species.
- 2.1.12 Plants that have been top-worked, sheared, or colour treated are not acceptable.





- 2.1.13** All plant materials shall conform to the measurements specified on the plant list on the approved landscape drawings except that plants larger than specified may be used if approved by the City of Leduc. If larger plants are used, the root ball shall be increased in proportion to the size of the plant as per Clause 2.1.17. Groundcover plants shall have healthy tops to a size proportionate to the above root requirements typical of the species.
- 2.1.14** Plants shall be freshly dug and shall be in a healthy, vigorous condition at arrival on the site. Heeled-in plants or plants from cold storage will not be accepted. Whenever practical trees shall be supplied from nurseries located within the same plant hardiness zone and having the same conditions and types of soils as the area of the project site. Plants specified as “B.R.”, shall be moved with bare roots, while in a dormant condition. Plants, specified “B&B”, shall be moved with solid balls, wrapped in burlap, or approved equal. Root balls shall not be cracked or broken at time of planting.
- 2.1.15** All plants shall be measured when the branches are in their normal position. Height and spread dimensions specified refer to the main body of the plant and not from branch tip to root base or from branch tip to branch tip. Where trees are measured by caliper (cal) reference is made to the diameter of the trunk measured 150 mm above ground for trees up to 100 mm cal.; for trees larger than 100 mm, caliper to be measured 300 mm above ground.
- 2.1.16** The size of root balls for trees shall be as specified below. Ball sizes are minimums and shall be adjusted according to growth habits of plants. Ball sizes shall be sufficiently large to contain a least 75% of the fibrous root system.

<b>Caliper</b>	<b>Root Ball Diameter</b>
----------------	---------------------------

*Deciduous Trees*

25 – 50 mm (1-2")	0.6 m (2'-0")
50 mm (2")	0.8 m (2'-6")
76 mm (3")	0.9 m (3'-0")
101 mm (4")	1.1 m (3'-6")
125 mm (5")	1.37 m (4'-6")
150 mm (6")	1.5 m (5'-0")

*Coniferous Trees*

1.8 m – 2.4 m (6'-8")	0.8 m (2'-6")
2.4 m - 3.0 m (8'-10')	0.9 m (3'-0")
3.0 m - 3.6 m (10'-12')	1.0 m (3'-6")
3.6 m - 4.2 m (12'-14')	1.2 m (4'-0")
4.2 m - 4.8 m (14'-16')	1.3 m (4'-6")



**2.1.17** The ball depth-ratio for “B&B” deciduous and coniferous trees shall be not less than as follows:

<b>Root Ball Diameter</b>	<b>Depth</b>
up to 0.6 m (2'-0")	not less than 0.45 m (1'-6")
0.6 m to 1.4 m (2'-0" to 4'-6")	not less than 0.45 m (1'-6") to .76 m respectively (2'-6")
1.4 m and over (4'-6")	not less than 50% of ball diameter

**2.1.18** All root balls less than 460 mm in diameter shall be wrapped with 5 oz. hessian burlap or approved equal. Balls from 460 mm to 760 mm in diameter shall be double burlapped. Balls of 1 m and larger in diameter shall be double burlapped and drum laced with 6 mm rope at 200 mm spacing.

**2.2 CONIFEROUS**

**2.2.1** All trees shall be suitable for immediate planting and be of normal shape and quality for the species.

**2.2.2** Spruce varieties shall have uniform branching which starts no higher than 300mm from the root collar. On Pine varieties, branching shall be no higher than 600mm from the root collar.

**2.2.3** The root balls shall contain all the original soil in which the tree has grown and shall be free of all weeds. It shall be firmly wrapped in burlap and secured to prevent any soil from spilling or drying out. Any increase or decrease in tree size shall require a corresponding adjustment to the root ball size to conform to C.N.L.A. standards.

**2.3 DECIDUOUS TREES**

**2.3.1** All trees are to be suitable for planting as street trees and are to be free of branches to a point not below sixty percent of their height.

**2.3.2** All bare root trees shall have a heavy fibrous root system that has been developed by proper cultural treatment, such as transplanting or root pruning and shall have a spread not less than specified.

**2.3.3** The root ball shall contain all the original soil in which the tree has grown and shall be free of all weeds. It shall be firmly wrapped in burlap and secured to prevent any soil from spilling or drying out. Any increase or decrease in tree size shall require a corresponding adjustment to the root ball size to conform to C.N.L.A. standards.

**2.3.4** Trees collected from native stands or established plantings must be so designated. Root balls shall be at least ten percent larger in diameter than nursery grown stock.

**2.3.5** All trunks shall be straight, clean and free from stubs and portions of decay, splits, or other damage.



### 3. EXECUTION

#### 3.1 PLANTING SEASON

- 3.1.1** Plant trees, shrubs and groundcovers only during periods that are normal for such work (i.e. spring planting, April 15 - June 15, fall planting August 15 – October 15). It is recommended that coniferous material should be planted in the spring season only.

#### 3.2 SITE PREPARATION

- 3.2.1** All rough grading, excavating work for planting beds and the preparation of subgrades, which are to receive planting soil mixture shall be as described below.
- 3.2.2** Dig out the tree holes or pits, planting beds and shrub holes to required depth and remove excess soil off site or as directed by the City of Leduc.

#### 3.3 PLANTING SOILS

- 3.3.1** Soil mixes shall be as shown on standard details and as specified by Section 32 91 00 – Topsoil, Subgrade Preparation.

#### 3.4 HYDROSEEDING

- 3.4.1** Immediately after digging all plants, the root system shall be kept moist to prevent drying out until planted.
- 3.4.2** Plants specified “bare root” shall be dug and moved while dormant, with the major portion of the fibrous root system provided.
- 3.4.3** All plants specified as “balled and burlapped” shall be dug and moved while dormant unless directed otherwise by the City of Leduc, with the major portion of the fibrous root system provided.
- 3.4.4** Wrap root balls as per C.N.L.A. standards.
- 3.4.5** All plants specified may be moved with a mechanical tree spade providing adequate roots are kept as specified and provided that no excavation shall occur within 1m, or as otherwise specified, of utility trench alignments.
- 3.4.6** Minimum utility clearances must be maintained from the edge of the excavation by the tree spade of the Contractor’s equipment. The involved utility must be contacted for approval and for any required safety procedures, for example, hand digging.
- 3.4.7** Before removing plants from containers for planting, the plants shall be well watered to reduce injury.
- 3.4.8** In many plants, roots have a tendency to circle the container. When this is apparent, outside roots should be gently loosened.



**3.5 PLANTING BED PREPARATION**

- 3.5.1** Stake out all tree locations and planting beds and obtain approval from the City of Leduc or designated representative before excavating. The location of trees and planting areas, where shown on drawings, is approximate only and may require adjustment due to site conditions.
- 3.5.2** The outline of all planting beds shall be staked out on site and finalized to the approval of the City of Leduc or designated representative.
- 3.5.3** Planting beds shall be prepared to a minimum excavation depth of 650 mm below finished grade, filling with minimum 500mm depth topsoil.
- 3.5.4** Construct watering swales using topsoil from around the base of the plant. The use of watering swales may be required by the City of Leduc and shall be at the Contractor's expense.
- 3.5.5** Install aluminum landscape edger's, around perimeter of planting shrub beds. Landscape edging to be a maximum 12mm higher than existing surrounding grades.
- 3.5.6** Install 100mm depth of shredded deciduous or cedar coniferous woodchip mulch or other approved mulch as specified on the landscape drawings. Finished grade of mulch to match adjacent turf grades or top of landscaping edging upon final settlement.
- 3.5.7** Mulch shall be a clean, deciduous woodchip mulch, free of materials listed in section 2.1., and ranging between 50mm to 100mm in diameter. Contractor to provide sample for approval.

**3.6 TREE AND SHRUB PLANTING OUTSIDE PREPARED PLANTING BEDS**

- 3.6.1** Locations of all trees and shrubs to be marked and approved by the Landscape Architect or designated representative prior to installation.
- 3.6.2** All trees shall have topsoil surrounding the sides of the root ball as per Section 32 91 00 – Topsoil, Subgrade Preparation.
- 3.6.3** All shrubs shall have topsoil surrounding the sides of the containerized roots or exposed bare roots as detailed.
- 3.6.4** If soil conditions warrant (e.g. clay soils) and as directed by the City of Leduc, root holes dug by mechanical equipment shall be scarified to ensure that are no glazed walls.
- 3.6.5** For tree root holes dug by a tree spade, provide root ball support of compacted native soil in the base of the root hole as detailed.
- 3.6.6** Tree root holes shall be excavated 400mm (16 inches) greater in diameter than the root ball or spread of roots and deep enough to allow for a 150mm layer of topsoil mixture beneath the ball or roots.
- 3.6.7** Trees and shrubs shall be set in the centre of the root holes and positioned such that, following settlement, the crown of the plant should be level with the surrounding finished grade. For trees, the trunk flare of the plant shall be higher than the surrounding finished grade.
- 3.6.8** Trees and shrubs shall be faced to give the best appearance or relationship to adjacent structures, walkways or park features. When planting continuous rows of trees (i.e. boulevard planting), all stems must be aligned in a straight line.
- 3.6.9** Planting topsoil shall be firmly tamped in place in such a manner that the plant retains its vertical position. Particular care shall be taken to ensure that no air pockets remain under or around the roots. The planting topsoil shall be thoroughly watered immediately after tamping. All non-porous or non-biodegradable containers shall be completely removed. Any settling of planting topsoil shall be brought up to the intended grade after settlement and prior to issuance of the Final Acceptance Certificate (FAC).



- 3.6.10** When planting topsoil is installed up to about one half of the root ball height, ties shall be cut and the top portion of the burlap on balled and burlapped plants shall be cut back carefully so as not to disturb the root ball.
- 3.6.11** Top 1/3 of wire baskets to be folded back or removed and the top 1/3 of the burlap to be cut back and removed from root ball hole.
- 3.6.12** Damaged or broken roots of bare root stock should be cut back with a sharp knife to living parts remaining. Spread roots out gently and evenly in the root hole and complete installation of topsoil.
- 3.6.13** The planting topsoil shall not be placed while frozen or muddy.
- 3.6.14** Add 100mm of shredded wood chip mulch over exposed portion of tree root ball and extend mulch 100mm beyond edge of root hole.
- 3.6.15** Watering in of tree and shrub root holes: all planting beds shall be filled to grade with planting topsoil and watered in immediately after planting. The use of a water probe to ensure the removal of all air spaces in the topsoil surrounding the plant's root ball is an acceptable method of watering in. The use of a water probe will be used to water in all tree spade transplanted trees.

**3.7 STAKING AND GUYING**

- 3.7.1** Install staking as detailed or specified immediately after installation.
- 3.7.2** Trees shall be braced upright in position by guy wire or stakes in accordance with the following:

<b>Coniferous:</b>	<u>Tree Height</u>	<u>Tree Support Method</u>
	Up to 1.5m	1 stake with 1 tie (optional)
	1.5m - 3.0m	2 stakes with 2 ties (optional)
	3.0m - 3.5m	3 guy wires with 3 anchors
	3.5m and over	4 guy wires with 4 anchors
<b>Deciduous:</b>	<u>Tree Caliper</u>	<u>Tree Support Method</u>
	Up to 30mm	1 stake with 1 tie
	30mm - 100mm	2 stakes with 2 ties
	100mm - 150mm	3 guy wires with 3 anchors
	150mm and over	4 guy wires with 4 anchors

- 3.7.3** Wire for trees requiring guys shall be looped around the tree and anchored in such a manner that looped wire will not interfere with normal growth. Guys shall be placed around the trunk at a point to ensure adequate support of the tree and in such a manner that the tree stem or branches will not be subjected to undue strain or injury. Anchors shall be equally spaced around the tree pit.
- 3.7.4** Anchors required for the support of guyed trees shall be painted metal "T" bars 40mm x 40mm x 5mm thick and 700mm to 750mm long. Wires for fastening to anchors shall be pliable #12, factory galvanized and of sufficient strength to withstand any wind pressure.
- 3.7.5** Anchors shall be left 150mm above grade unless otherwise directed by the City of Leduc and colour coded according to 3.7.9.
- 3.7.6** Stakes: - "T" bar steel stakes 40mm x 40mm x 5mm thick x 2.0-2.5m length, U-bar stakes will be approved as a substitute, primed with one coat of zinc-rich paint to CGSB 1-GP-1816. Colour to be approved by the City of Leduc. The top 300mm of the tree stake to be colour coded as per Clause 3.7.9. Ties shall be placed around the trunk to provide adequate support and to prevent damage.



- 3.7.7** Guys shall be taped with fluorescent orange coloured tape in intensively trafficked areas. All guy wires to be folded or bent in such a fashion so as not to be exposed outwardly. New black rubber hose, two-ply, reinforced and 12mm diameter, or approved equal, shall be used to encase wires where they circle the trunk or branch.
- 3.7.8** The Contractor shall be responsible for keeping guys taut at all times and replacing broken guys in accordance with the specified maintenance period and to ensure that the guys do not damage the tree trunk during growth.
- 3.7.9** Staking colours:
- 2020- Blue;
  - 2021- White;
  - 2022- Yellow;
  - 2023- Green;
  - 2024- Blue;
  - 2025- White.

### **3.8 TRANSPLANTING EXISTING TREES**

- 3.8.1** Size of root ball: 12 times the tree caliper measured at 300mm above grade and deep enough to enclose 75% of the existing root depth. All stock greater than 100mm will be measured 1500mm above ground level.
- 3.8.2** Basket, double burlap and drum lace, or wire basket root ball before moving, or dig and transport by tree spade.
- 3.8.3** Place excavated tree spade root plugs in former tree locations where possible.
- 3.8.4** Size of new tree root hole is to be in accordance with standard details.
- 3.8.5** Plant, guy or stake, and maintain as outlined herein.
- 3.8.6** Maintenance and warranty period for transplanted plants as follows:
- a) All stock 0 -100mm cal. shall be 2 year;
  - b) All stock 100 - 150mm cal. shall be 3 years;
  - c) All stock 150 - 200mm cal. shall be 5 years;
  - d) No materials above 200mm cal. will be accepted.

### **3.9 TREE WRAPPING**

- 3.9.1** Promptly after planting, wrap all deciduous tree trunks with ½" x ½" sq. galvanized page wire attaching wire to itself with a min. of four 12" zip ties, or white plastic expandable tubing, with overlap and extending from ground level to just below branches. This wrapping prevents rodent damage to the trunk and bark of the tree.

### **3.10 CLEAN-UP**

- 3.10.1** Immediately after planting, remove all debris and excess material from the site, leaving the area neat and tidy. Clean all areas, which are contaminated as a result of planting operations.
- 3.10.2** Do not burn debris and rubbish unless approved by the City of Leduc.
- 3.10.3** Maintain all areas neat and tidy at all times until acceptance.



**3.11 CONSTRUCTION COMPLETION INSPECTION (CCC)**

- 3.11.1** Plant pits and tree and shrub beds shall be freshly cultivated, free of weeds, building materials, clay clumps, broken branches and rubbish and left in a neat and tidy condition.
- 3.11.2** All plant material and trees shall be alive and in a healthy, satisfactory growing condition, and pruned as required to remove deadwood and promote healthy form.

**3.12 WARRANTY**

- 3.12.1** The Contractor is fully responsible for the general health and quality of all plant material delivered and installed.
- 3.12.2** All plant material shall be maintained and warranted for a period of two years, unless otherwise stated within the project scope of work/specifications, from the date of issuance of the Construction Completion Certificate. There is no warranty requirement on annuals, unless further noted.
- 3.12.3** During the warranty period, make periodic inspections and all plant materials found dead or not in a healthy, satisfactory growing condition or which, in any other way, does not meet the requirements of the specifications, shall be replaced immediately by the Contractor at the Contractor's own expense and do all maintenance.
- 3.12.4** Tag or mark, in a permanently visible manner, all replacement trees and notify the City of Leduc, in writing, of the date on which replacements were planted. Include a sketch showing location of replaced plants. Plant replacements at a time which is in accordance with practices recommended by the C.N.L.A.
- 3.12.5** Notify the City of Leduc, in writing, of any corrective or preventative measures necessary to safeguard plants.

**3.13 MAINTENANCE**

- 3.13.1** Maintenance shall include all measures necessary to establish and maintain all plants in an acceptable, vigorous and healthy growing condition for a period of at least two years from the issuance of a Construction Completion Certificate and until the issuance of the FAC.
- 3.13.2** Cultivation and weeding of planting beds and tree pits is the responsibility of the Contractor. The City of Leduc may direct the use of herbicides for weed control; they shall be applied in accordance with manufacturer's recommendations by a licensed applicator. Damage resulting from the Contractor's use of herbicides shall be remedied at the Contractor's own expense.
- 3.13.3** The City of Leduc may direct the use of chemicals and pesticides as control measures for disease and insects. If used, they shall be applied in accordance with the manufacturer's recommendations by a licensed applicator. Damage resulting from the Contractor's use of chemicals and pesticides shall be remedied at the Contractor's own expense.
- 3.13.4** The City of Leduc must be advised 48 hours prior to the spraying of any chemicals, herbicides or pesticides.
- 3.13.5** Pruning, including the removal of dead, broken and diseased branches, shall be undertaken immediately upon installation and in accordance with approved International Society of Arboriculture pruning methods.
- 3.13.6** Maintain all accessories in good conditions such as tree guys and tree stakes. The City of Leduc will direct the repair or replacement of all such accessories when required.
- 3.13.7** Water trees and shrubs in sufficient quantities to meet the plants' requirements.





- 3.13.8** The Contractor is responsible for supplying, loading, hauling and distributing water and fertilizer for maintenance purposes.
- 3.13.9** Newly planted trees may require the application of a completely water-soluble high phosphorous fertilizer (i.e. 10-52-10). No fertilizer should be applied during July and August. The Landscape Architect may recommend other fertilizers for trees, shrubs and groundcovers as required. The Contractor will provide written confirmation of the dates for water and fertilizer applications prior to the issuance of the FAC.
- 3.13.10** Straighten all plants, which lean or sag during the maintenance period.
- 3.13.11** At the time of inspection for FAC and at the conclusion of the maintenance period, all non-mulched planting beds and tree pits shall be freshly cultivated. All planting beds shall be free of weeds, leaves and debris and shall be in a tidy condition.
- 3.13.12** All tree stakes are required to be removed after issuance of the FAC by the City of Leduc.

### **3.14 PRUNING**

- 3.14.1** All deciduous plants shall be pruned immediately after planting and as required during the maintenance period according to International Society of Arboriculture standards. The amount of pruning shall be limited to the minimum necessary to remove dead or injured branches. Pruning shall be done in such a manner as to preserve the natural character and shape of the plants. Only clean, sharp tools shall be used. All cuts shall be clean and cut to the branch collar, leaving no stubs. Cuts, bruises, or scars on the bark shall be tracked back to living tissue and removed. The affected areas shall be shaped so as not to retain water.
- 3.14.2** Pruning for selected species as follows:
- Elm October 1 to March 31;  
or as approved by the Project Manager.

### **3.15 REPLACEMENTS**

- 3.15.1** The cost of replacements resulting from carelessness or neglect on the part of the Contractor shall be borne by the Contractor before the issuance of the FAC.
- 3.15.2** The cost of replacements resulting from theft, vandalism, carelessness or neglect on the part of others, or any causes due to circumstances beyond the control of the Contractor, shall be borne by the City of Leduc.
- 3.15.3** All required replacements shall be by plants of the same size and species as specified on the plant list and shall be supplied and planted in accordance with the landscape drawings and specifications.
- 3.15.4** Dead plant material, or missing plant material due to the Contractor's negligence, shall be replaced as soon as conditions permit, but during the normal planting season as outlined in 3.1.1.

### **3.16 PROTECTION AFTER COMPLETION**

- 3.16.1** Assume full responsibility for protection of all planted areas until all project work has been completed, approved and accepted.
- 3.16.2** Erect protective fencing and post signs where necessary and maintain such works until acceptance and remove same after acceptance of work, unless directed otherwise.

**3.17 PROTECTION OF EXISTING TREES**

- 3.17.1** Establish suitable barriers around existing trees and shrubs to be saved to minimize damage during construction.
- 3.17.2** For minimum distance from existing trees to excavate, see Tree Protection Zone Calculation Table on detail 1.3 Tree Protection Zone.
- 3.17.3** Prune any broken branches.
- 3.17.4** If soil disturbance affects stability, install stakes as per 32 95 00.

**3.18 RESTORATION**

- 3.18.1** Restore pavement, grassed areas, planted areas, and structures damaged or disturbed during execution of work, to City of Leduc standards.

**3.19 FINAL INSPECTION & ACCEPTANCE (FAC)**

- 3.19.1** At time of final inspection all plants shall be in a healthy, vigorous growing condition, planted in full accordance with drawings, specifications, and conditions. Trees and shrubs shall be pruned as required to remove deadwood and promote healthy form.
- 3.19.2** Planting beds and tree saucers shall be freshly cultivated and free of all weeds and debris.

**END OF SECTION**



## 1. GENERAL

### 1.1 SCOPE

The work shall include the fine grading and subgrade preparation, as well as the supply and installation of topsoil for grassed areas and tree and shrub planting.

### 1.2 RELATED SECTIONS

Trees, Shrubs, and Groundcovers; Section 32 93 00;

Turf and Grasses; Section 32 92 00;

Mulches; Section 32 91 50.

### 1.3 EXAMINATION

**1.3.1** Report to the City of Leduc, in writing, any conditions or defects encountered on the site before or during any construction upon which the work of this section depends and which may adversely affect its performance.

**1.3.2** Do not commence work until those conditions or defects have been investigated and corrected.

**1.3.3** Commencement of work shall imply acceptance of existing surfaces and conditions and no claims for damages or extras resulting from such conditions or defects will be accepted later, except in cases where such conditions could not have been known prior to commencing work.

### 1.4 QUALIFICATIONS

**1.4.1** All installation of topsoil shall be done by experienced, qualified personnel of the trade under the direction and supervision of a qualified foreman/ supervisor with at least 5 years of horticultural experience.

**1.4.2** The work shall be done to conform with best horticultural practice and the specifications, in accordance with the Canadian Nursery Landscape Association (C.N.L.A) standards.

### 1.5 PRODUCT DELIVERY, HANDLING AND STORAGE

**1.5.1** Supply manufactured items such as fertilizer, in standard containers, clearly indicating contents, weight, component analysis and the name of the manufacturer.

**1.5.2** Store manufactured materials susceptible to deterioration, in a weatherproof place on site and in such a manner that their effectiveness is not impaired.

### 1.6 SAMPLES

**1.6.1** The contractor shall submit to the City of Leduc a sample and an independent laboratory analysis of topsoil from each source to be used in the performance of this work seven calendar days in advance of delivery to the site. The laboratory analysis shall include tests for N, P, K, minor element values, soluble salt content, electrical conductivity, pH and physical values (sand, clay and organic material). If necessary, correct additions, e.g. bonemeal, limestone, pesticides, phosphates, sulfates shall be added as approved by the City.



- 1.6.2 Retain approved samples on site until work has been inspected.
- 1.6.3 Additional samples and testing may be required by the City of Leduc during the construction period.
- 1.6.4 All topsoil used on site shall conform to approved samples.

**1.7 INSPECTION**

- 1.7.1 Prior to the commencement of installation all materials may be inspected and approved either at the source of local supply or on site at the discretion of the City of Leduc.
- 1.7.2 Give timely notice, in writing, to the Consultant when materials are available for inspection.
- 1.7.3 Remove all rejected materials immediately from the site.

**2. PRODUCTS**

**2.1 TOPSOIL COMPOSITION**

- 2.1.1 Topsoil may be sourced from a local site within the City of Leduc as long as soil is suitable for plant growth.
- 2.1.2 Topsoil to be used to specified depths for all grassed areas, tree planting, shrub beds, perennial and annual planting, unless otherwise noted.
- 2.1.3 Topsoil shall be of a natural, fertile agricultural soil of the "A" horizon layer capable of sustaining vigorous plant growth. It shall be the best of quality and screened.
- 2.1.4 Topsoil shall be free of subsoil, clay lumps, stones, live plants and other roots, sticks or other extraneous matter over 50 mm in diameter.
- 2.1.5 Topsoil shall be a Class B type - 35% Sand; 30% Clay; 35% Silt. These values are approximate, and a 5% variation from these values for each component is permissible.
- 2.1.6 An increase in the percentage content of sand may be considered to improve drainage and shall require review and approval by the City of Leduc.

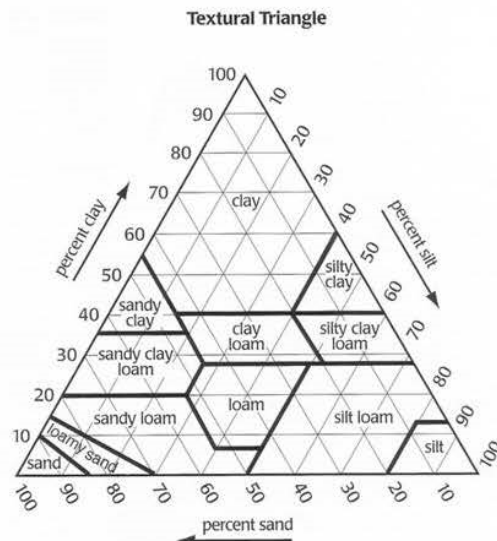





**2.1.7** Topsoil values are to conform to the following:

- Organic matter - 5 – 10% by dry mass
- Toxic chemicals - None
- Electrical conductivity - Max. 1.5 ohms per cm2
- pH value - 6.0 – 7.5
- Sodium absorption - 6

**2.2 TOPSOIL ADDITIVES**

**2.2.1** Compost may be used to amend the topsoil to meet minimum requirements as noted in Section 2.1.6. The compost must be well decomposed, stable, weed-free and containing no substances noxious to plants. It may be derived from biosolids or municipal solid waste. It is to be screened and pass through a specified screen as approved by the City of Leduc and will meet the foreign matter requirements of the Canadian Council of Ministers of the Environment (CCME). When tested by an accredited testing laboratory, it shall meet the following criteria:

- Biosolids Compost: CCME – category A or B, pH 6.0-8.0 (TMECC 1.5 dilution), conductivity maximum 15 dS/m (TMECC 1.5 dilution), organic matter – minimum 30% dry weight, screen size 1/4, 3/8 or 1/2".
- MSW Compost: CCME – category A or B, pH 5.0-7.5 (TMECC 1.5 dilution), conductivity maximum 8 dS/m (TMECC 1.5 dilution), organic matter – minimum 30% dry weight, screen size 3/8" min.

**2.2.2** All compost shall be analyzed for total nitrogen, P2O5, and K2O expressed on a dead weight basis however no minimum nutrient content is required.

**2.2.3** Sand: When tested by means of laboratory sieves, the sand shall meet the following grading requirements and be uniformly graded between the limits given:

<b>Passing</b>	<b>Cumulative % by Weight</b>
2.5mm (No. 8)	100
1.25mm (No. 16)	90 – 100
0.8mm (No. 20)	80 – 90
1.315mm (No. 50)	30 – 60
10.16mm (No. 100)	2 – 10
0.063mm (No. 200)	1% maximum

**2.2.4** Sand shall be natural and coarse, except for the removal of very fine particles and gravel, and conform to the above specifications. Sand shall be free from vegetation, clay balls, or other extraneous material. Reasonable care in the selection of material in a pit shall be used to produce a uniform product.

### 3. EXECUTION

#### 3.1 PRODUCT DELIVERY, HANDLING AND STORAGE

- 3.1.1 If topsoil is to be stockpiled on public lands, locations must be designated by the City of Leduc.
- 3.1.2 No soil stockpiling by the Contractor on future Municipal Reserve lands is allowed unless written permission is granted by the City of Leduc. Such permission will not be unreasonably withheld for short term temporary stockpiling on the understanding that the contractor is responsible for subsequent removal of all materials not desired by the City of Leduc, and the required rehabilitation of the site.

#### 3.2 SUBGRADE

- 3.2.1 Preferred subgrade material is clean clay. Marginal clay fills containing a small percentage of topsoil are acceptable under certain conditions as outlined below. More porous subgrades may be considered for locations where infiltration is suitable.
- 3.2.2 Subgrade materials are to provide sufficient bearing strength for the intended surfacing whether hard surface or grass. Grass areas must be of sufficient strength to support vehicles such as tree movers and mowing machinery without rutting during dry periods.
- 3.2.3 A clean clay subgrade is required for future hard surface areas. Clay must be compacted to the required S.P.D. as per relevant paving detail and approved by a geotechnical engineer.
- 3.2.4 All subgrade material is to be free of weeds, rock, wood, debris and areas of soft soils.
- 3.2.5 Berms and toboggan hills may be constructed with topsoil. The topsoil is to be placed in maximum 150mm depth lifts and machine compacted to the satisfaction of the City of Leduc. Larger lifts may be allowed at the discretion of the City of Leduc.
- 3.2.6 Subgrade material is to be placed in maximum 150mm depth lifts and machine compacted to the satisfaction of the City of Leduc or as directed by the geotechnical engineering report.
- 3.2.7 Adjustments to design grades must be submitted by the Landscape Architect in writing and must be agreed to by the City of Leduc.
- 3.2.8 Subgrade surface shall be approximately 250mm below finished grade to accommodate topsoil and turf or mulch. A tolerance of 50 mm is permitted. It is to be free of noticeable dips and bumps and must have positive drainage. Ponding is not permitted.
- 3.2.9 Subgrade material from the digging of tree pits by a tree spade is to be removed from the site at the Contractor's expense if it cannot be utilized on site.

#### 3.3 SITE PREPARATION

- 3.3.1 All rough grading, excavating work for planting beds and the preparation of subgrades, which are to receive planting soil mixture shall be as described below.

#### 3.4 PLACING TOPSOIL

- 3.4.1 The City of Leduc shall approve the subgrade prior to placing topsoil and approve finished grade before the Contractor proceeds with the next phase of work. This approval procedure is mandatory.

- 3.4.2** Do not place topsoil when either the topsoil or subgrade is frozen, excessively wet, extremely dry or otherwise in a condition detrimental to proper grading, compaction or cultivation.
- 3.4.3** Topsoil is to be spread uniformly on prepared subsoil to achieve a minimum compacted or settled depth of 200mm for sodded areas and 250mm for seeded areas unless otherwise stated. Topsoil may be placed up to 250mm depth under seeded and sodded areas. Deeper profiles of topsoil are to be approved by the City of Leduc prior to installation.
- 3.4.4** Compost or other amendments are to be spread evenly and worked into the topsoil.
- 3.4.5** Topsoil shall be thoroughly disced, harrowed and floated to a minimum depth of 75 mm.
- 3.4.6** Cultivate topsoil to a depth of 50mm, breaking down lumps. Remove stones larger than 50mm, weeds, roots and other foreign matter.
- 3.4.7** Manually spread topsoil around trees and plants to prevent damage by grading and levelling equipment.
- 3.4.8** Float the area until surface is smooth. Cut smooth and flush areas adjacent to pavement and catch basin rims. Remove all lumps, rocks, roots and other debris from the finished material and from the site.
- 3.4.9** Place erosion control devices around all catch basins and manholes.
- 3.4.10** Final topsoil grade is to be within 25mm of design grade and must be free of dips and bumps and exhibit positive drainage. Ponding is not permitted unless it is a component of the approved design. The minimum required depth of topsoil must be maintained.
- 3.4.11** Compact topsoil to the satisfaction of the City of Leduc.
- 3.4.12** Final topsoil grades for seeded areas shall be level with finished grade at surface structures (i.e. manholes, sidewalks and curbs).
- 3.4.13** For sodding, the final grade of topsoil shall be 25mm below finished grade at surface structures (i.e. manholes, sidewalks and curbs).
- 3.4.14** When abutting an existing turfed area, the existing turf shall be cut so as to form a straight joint with the new seeded or sodded area.

### **3.5 CLEAN-UP**

- 3.5.1** Immediately after construction, remove all soil, debris and excess material from the site, leaving the area neat and tidy. Clean all areas, which are contaminated as a result of planting operations.
- 3.5.2** Do not burn debris and rubbish unless approved by the City of Leduc.
- 3.5.3** Maintain all areas neat and tidy at all times until acceptance.

### **END OF SECTION**





## 1. GENERAL

### 1.1 SCOPE

The supply and installation of organic mulches for planting beds and tree wells.

### 1.2 RELATED SECTIONS

Topsoil, Subgrade Preparation; Section 32 91 00;  
Trees, Shrubs, and Groundcovers; Section 32 93 00.

### 1.3 EXAMINATION

- 1.3.1 Report to the City of Leduc, in writing, any conditions or defects encountered on the site before or during any construction upon which the work of this section depends and which may adversely affect its performance.
- 1.3.2 Do not commence work until those conditions or defects have been investigated and corrected.
- 1.3.3 Commencement of work shall imply acceptance of existing surfaces and conditions and no claims for damages or extras resulting from such conditions or defects will be accepted later, except in cases where such conditions could not have been known prior to commencing work.

### 1.4 QUALIFICATIONS

- 1.4.1 All planting and related work shall be done by experienced, qualified personnel, under the direction and supervision of a foreman with at least 5 years of horticultural and planting experience.
- 1.4.2 The work shall be done to conform to best horticultural practice and the specifications, in accordance with the Canadian Nursery Landscape Association (C.N.L.A) standards.

### 1.5 PRODUCT DELIVERY, HANDLING AND STORAGE

- 1.5.1 Supply mulch as specified on approved landscape drawings and specifications.
- 1.5.2 Protect mulch stockpile on site from contamination of airborne herbicides, pesticides, fertilizers and other hazardous chemicals.
- 1.5.3 Avoid the placement of mulches in excessively wet conditions or when frozen.
- 1.5.4 All organic mulches shall be generally free of diseases, molds, fungi and insect infestations.
- 1.5.5 All organic mulches shall be free of inorganic materials such as metal, glass, rock and other foreign materials.

### 1.6 SUBSTITUTION

- 1.6.1 All mulches shall be supplied and installed as specified. Substitutions will not be allowed unless approved by the City of Leduc.

**1.7 INSPECTION**

- 1.7.1 Samples of mulch shall be approved by the City of Leduc prior to installation.
- 1.7.2 Retain approved samples on site until work has been inspected.
- 1.7.3 All work shall conform to approved samples.
- 1.7.4 Give timely notice, in writing, to the Consultant when materials are available for inspection.
- 1.7.5 Remove all rejected materials from site immediately.

**2. PRODUCTS****2.1 DECIDUOUS WOOD CHIP MULCH**

- 2.1.1 Mulch shall be approved shredded deciduous or coniferous wood mulch.
- 2.1.2 Material shall be from chipped ash, elm, maple, poplar, birch, cedar and other approved trees. Mulch may contain bark and wood chipped to sizes ranging from 50 mm to 100 mm. Mulch shall be free of bark, stringy twigs, seed, non-organic material, wood preservatives or diseased wood. There shall be no more than 5% of the following materials in total: soil, sawdust, peat moss, coniferous wood and needles.

**2.2 PROHIBITED MULCHES**

- 2.2.1 The following mulches are prohibited: inorganic, sawdust and shavings, peat moss, manures or raw composts, paper products, plastics, rubbers, aluminum foils, gelatinous sprays, plywood and other lumbers containing chemical adhesives or wood preservatives.

**3. EXECUTION****3.1 INSTALLATION**

- 3.1.1 Plants must be watered before mulch is installed.
- 3.1.2 During application all mulches shall be kept at least 50 mm away from tree trunks and bases of shrubs.
- 3.1.3 Apply mulches in areas as per drawings and spread by hand rake to a settled depth of 100 mm.

**3.2 PREPARATION**

- 3.2.1 Tree wells and planting beds shall be free of weeds prior to mulch installation.

**3.3 CLEAN-UP**

- 3.3.1 Immediately after installation, remove all mulches and other debris from the roadways, walkways and surrounding areas, leaving the area neat and tidy. Clean all areas, which are contaminated as a result of landscape construction operations.
- 3.3.2 Maintain all areas neat and tidy at all times until acceptance.

**3.4 MAINTENANCE**

- 3.4.1** All mulched areas shall be weed free during Construction Completion Certificate and Final Acceptance Certificate inspections. Spot control of weed growth shall be carried out as necessary.
- 3.4.2** During the period between CCC and FAC inspections, the landscape contractor is to top up mulch applications to retain minimum required depth of 100 mm.
- 3.4.3** Following FAC approval, the City of Leduc will be responsible for maintaining mulch applications to the specified depth and quality.

**END OF SECTION**



## 6.0 DESIGN DETAIL DRAWINGS

<b>Detail No.</b>	<b>Detail Title</b>
1.1	Typical Tree Installation
1.2	Typical Shrub Planting Detail
1.3	Tree Protection Zone Detail
1.4	Typical Tree Root Trench Detail
2.1	Wood Screen Fence Detail
2.2	Wood Screen Fence Step Down Detail
2.3	Chain Link Fence Details
3.1	Gravel Pathway Detail
4.1	T-Bollard Layout
4.2	HID-A-BAG II Combo Waste & Recycle Container

\* Noise attenuation fence: See City of Leduc Minimum Engineering Standards for construction requirements and details.

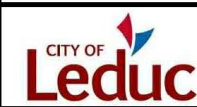
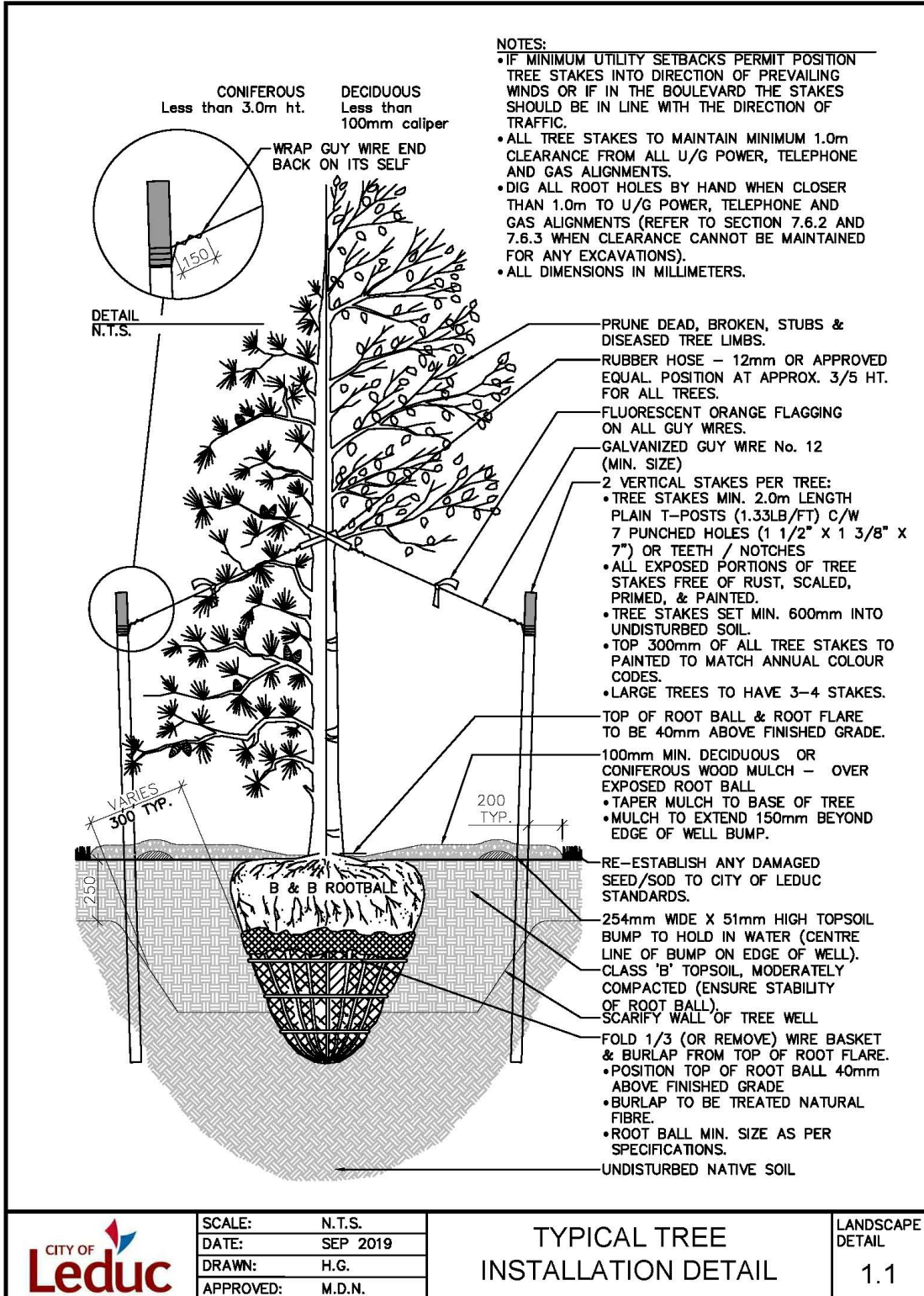

SCALE:	N.T.S.
DATE:	SEP 2019
DRAWN:	H.G.
APPROVED:	M.D.N.

TYPICAL TREE  
INSTALLATION DETAIL

LANDSCAPE DETAIL
1.1



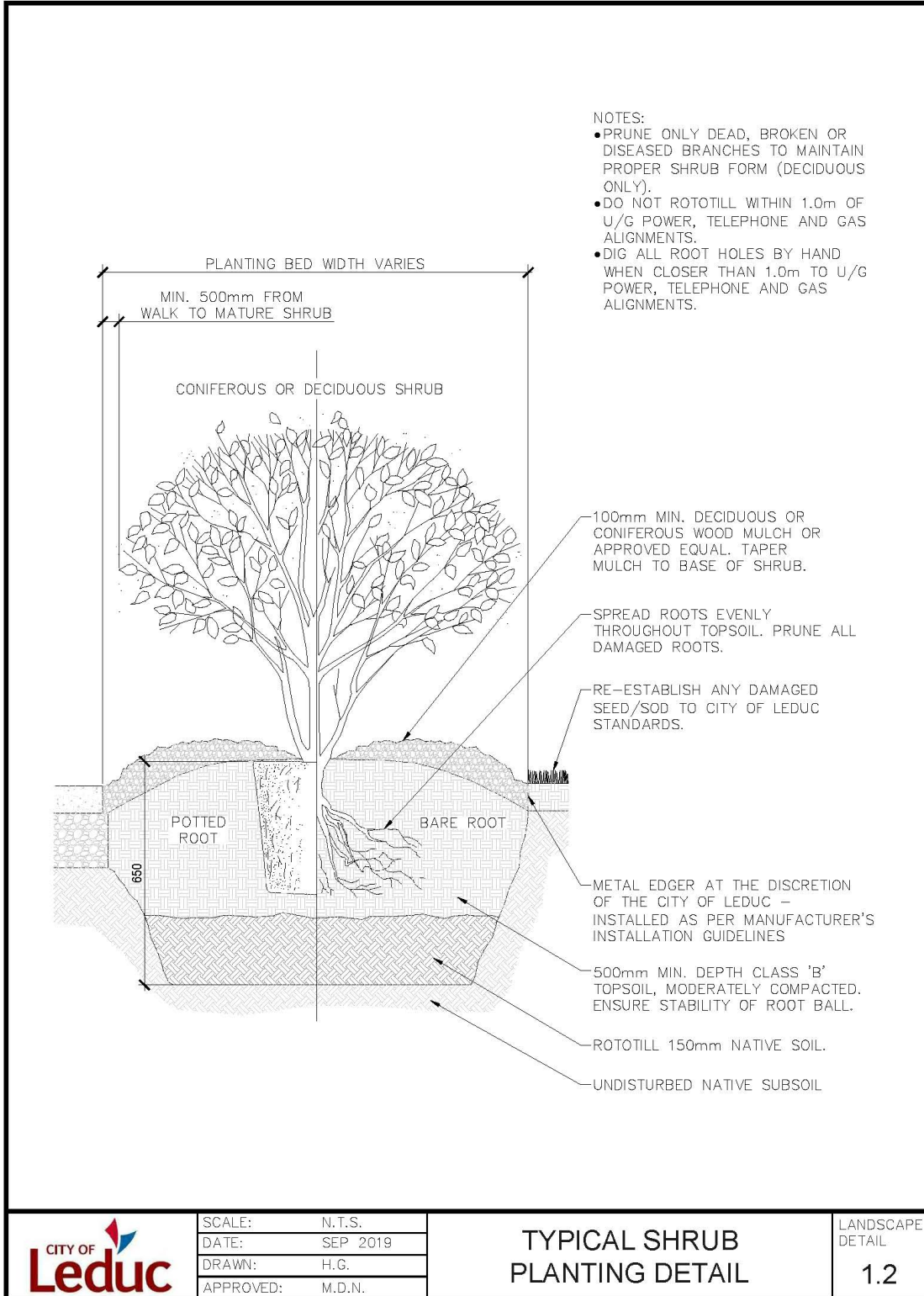



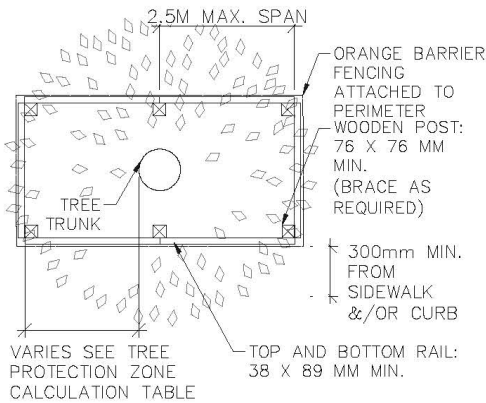

PLAN

TREE PROTECTION ZONE CALCULATION TABLE	
TRUNK DIAMETER (DBH)	MINIMUM PROTECTION DISTANCE REQUIRED (MEASURE FROM THE OUTSIDE EDGE OF TREE TRUNK)
10 CM & UNDER	1.2 METERS
11 – 30 CM	1.8 METERS
31 – 40 CM	2.4 METERS
41 – 50 CM	3.0 METERS
51 – 60 CM	3.6 METERS
61 – 70 CM	4.2 METERS
71 – 80 CM	4.8 METERS
>80 CM	5.0 METERS

NOTES:

- WOOD POST: (MIN. 76MM WIDTH) INSTALLED TO A DEPTH OF 500MM (ALBERTA FIRST CALL REQUIRED)
- TOP AND BOTTOM RAIL: (MIN. 38 X 89MM CONSTRUCTION, MAX. SPAN 2.5M), CROSS BRACING AS REQUIRED.
- HEIGHT OF THE FENCE: MIN.1.2 METERS
- NO GROUND DISTURBANCE WITHIN 1.2 METER OF THE TREE TRUNK (I.E. POST INSTALLATION)
- POSTS SET BACK FROM SIDEWALK AND CURB: MIN 300MM
- FENCE MATERIAL: MINIMUM ORANGE BARRIER FENCE OR METAL CHAIN LINK FENCE
- ATTACH A SIGN ON TWO SIDES OF THE TREE PROTECTION BARRIER. SIGNAGE TO READ TREE PROTECTION ZONE DO NOT REMOVE FENCE DURING CONSTRUCTION

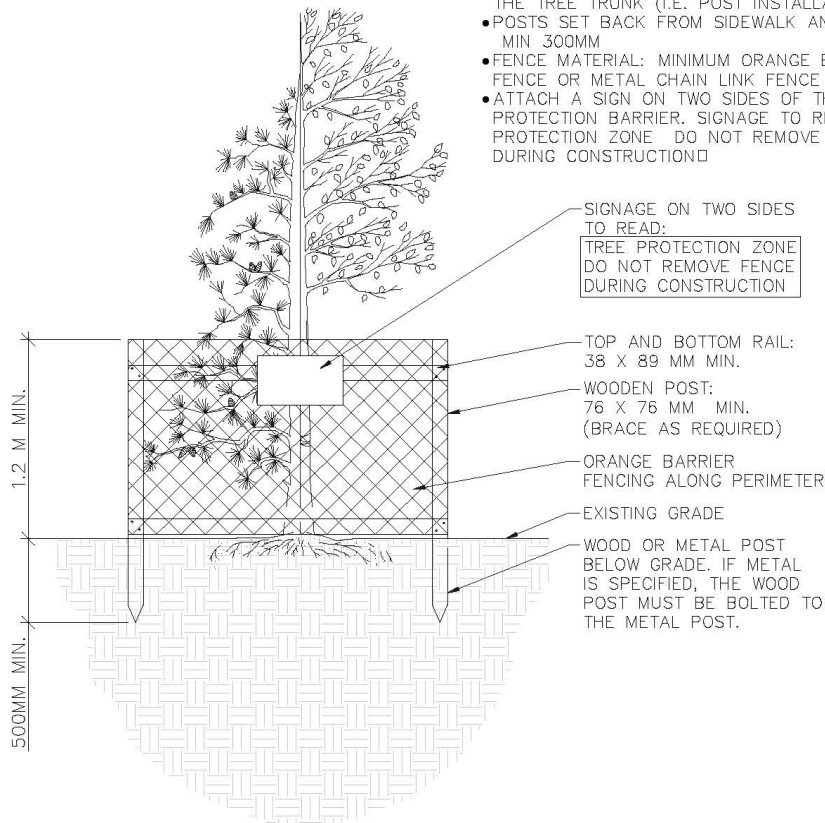

	SCALE: N.T.S.	<h2>TREE PROTECTION ZONE DETAIL</h2>	LANDSCAPE DETAIL <b>1.3</b>
	DATE: SEP 2019		
	DRAWN: H.G.		
	APPROVED: M.D.N.		

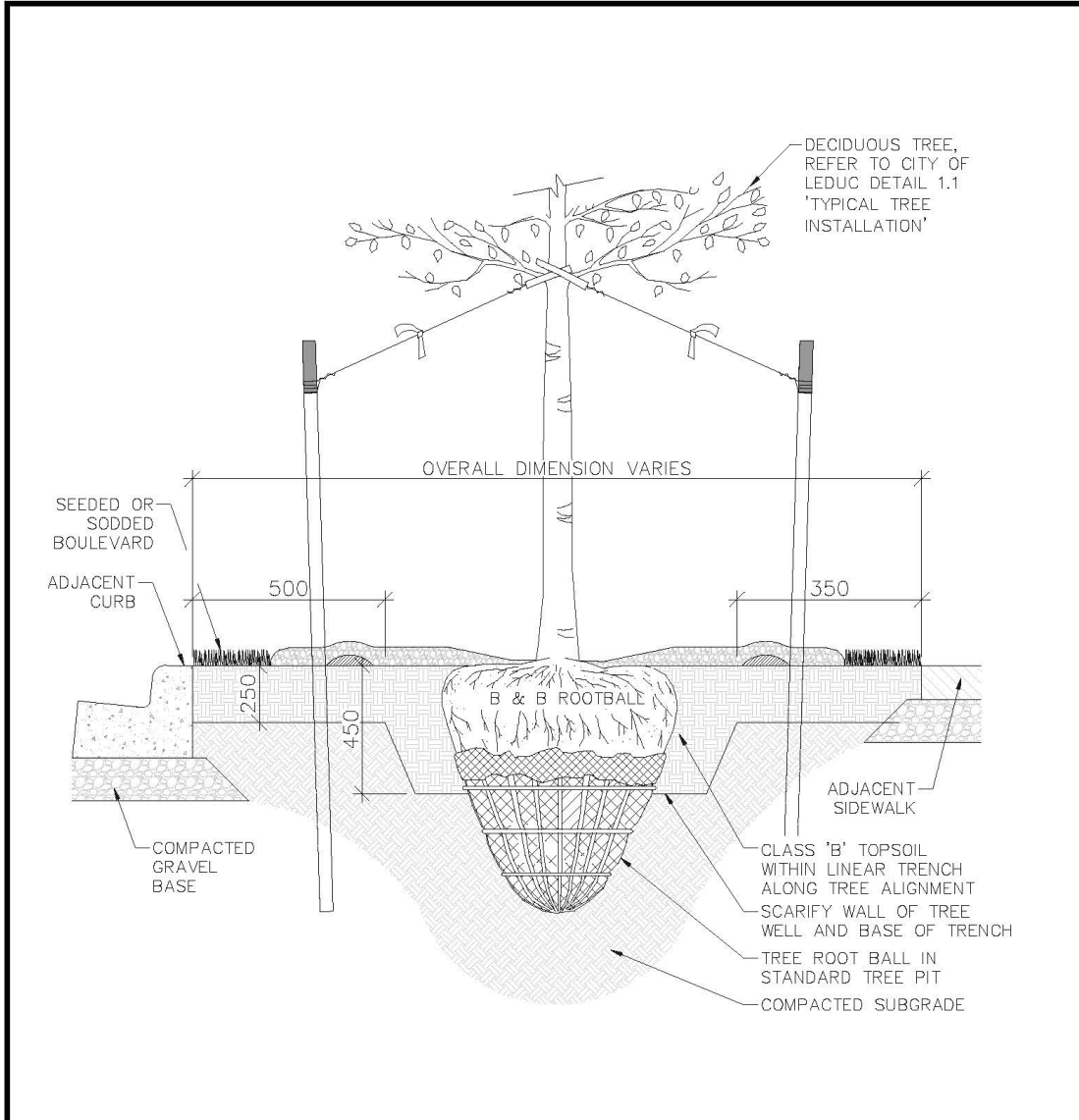

NOTES:

- ALL COMPONENTS AND WORKMANSHIP TO CONFORM TO SPECIFICATION SECTION 02931 NATURALIZATION AS WELL AS THE RELATED SECTIONS.
- ALL TREE STAKES TO MAINTAIN MINIMUM 1.0m CLEARANCE FROM ALL U/G POWER, TELEPHONE AND GAS ALIGNMENTS.
- IF MINIMUM UTILITY SETBACKS PERMIT POSITION TREE STAKES INTO DIRECTION OF PREVAILING WINDS OR IF IN THE BOULEVARD THE STAKES SHOULD BE IN LINE WITH THE DIRECTION OF TRAFFIC.
- DIG ALL ROOT HOLES BY HAND WHEN CLOSER THAN 1.0m TO U/G POWER, TELEPHONE AND GAS ALIGNMENTS
- ALL DIMENSIONS IN MILLIMETERS.

	SCALE:	N.T.S.	<b>TYPICAL TREE ROOT TRENCH DETAIL</b>	LANDSCAPE DETAIL <b>1.4</b>
	DATE:	SEP 2019		
	DRAWN:	H.G.		
	APPROVED:	M.D.N.		

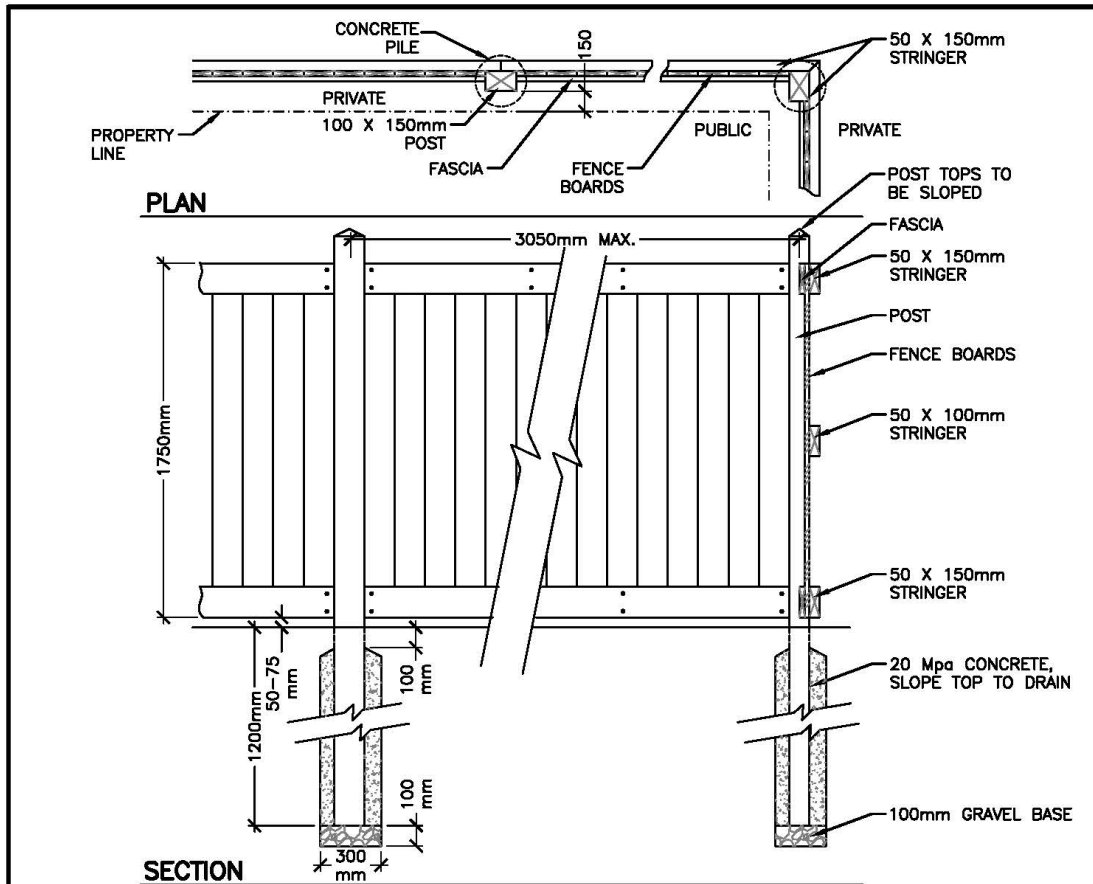

**NOTES:**

1. **POSTS:**  
100mm X 150mm X 3000mm LONG, ROUGH CUT SPF PRESSURE TREATED TIMBER.
2. **STRINGERS:**  
2 - 50mm X 150mm S4S SPF PRESSURE TREATED STRINGERS, FASTENED WITH 2 - 75mm #10 ZINC SCREWS PER CONNECTION. MOUNT STRINGERS FACING PRIVATE PROPERTY. WHERE FENCE TERMINATES, ANGLE CUT STRINGER END AT 45 DEGREES.  
1 - 50mm X 100mm S4S SPF PRESSURE TREATED STRINGERS, FASTENED WITH 2 - 75mm #10 ZINC SCREWS PER CONNECTION. MOUNT STRINGERS FACING PRIVATE PROPERTY. WHERE FENCE TERMINATES, ANGLE CUT STRINGER END AT 45 DEGREES.
3. **FASCIA:**  
2 - 25mm X 150mm S4S SPF FASCIA FASTENED WITH 2 - 63mm #8 ZINC SCREWS PER CONNECTION SPACED AT 600mm.
4. **FENCE BOARDS:**  
25mm X 150mm X 1750mm LONG S4S SPF FENCE BOARDS FASTENED WITH 2 - 50mm LONG GALVANIZED STAPLES PER CONNECTION.
5. **FINISH:**  
PAINT OR STAIN TO BE APPROVED BY THE CITY OF LEDUC PRIOR TO CONSTRUCTION.
6. **HARDWARE:**  
ALL HARDWARE TO BE GALVANIZED, UNLESS OTHERWISE NOTED.
7. ALL COMMON FENCING TO BE INSTALLED 150mm INSIDE PRIVATE PROPERTY.
8. FENCING SHALL NOT ENCROACH ON GAS EASEMENTS.

	SCALE: N.T.S.	<b>WOOD SCREEN FENCE DETAILS</b>	LANDSCAPE DETAIL <b>2.1</b>
	DATE: DEC 2009		
	DRAWN: O.P.		
	APPROVED: M.D.N.		

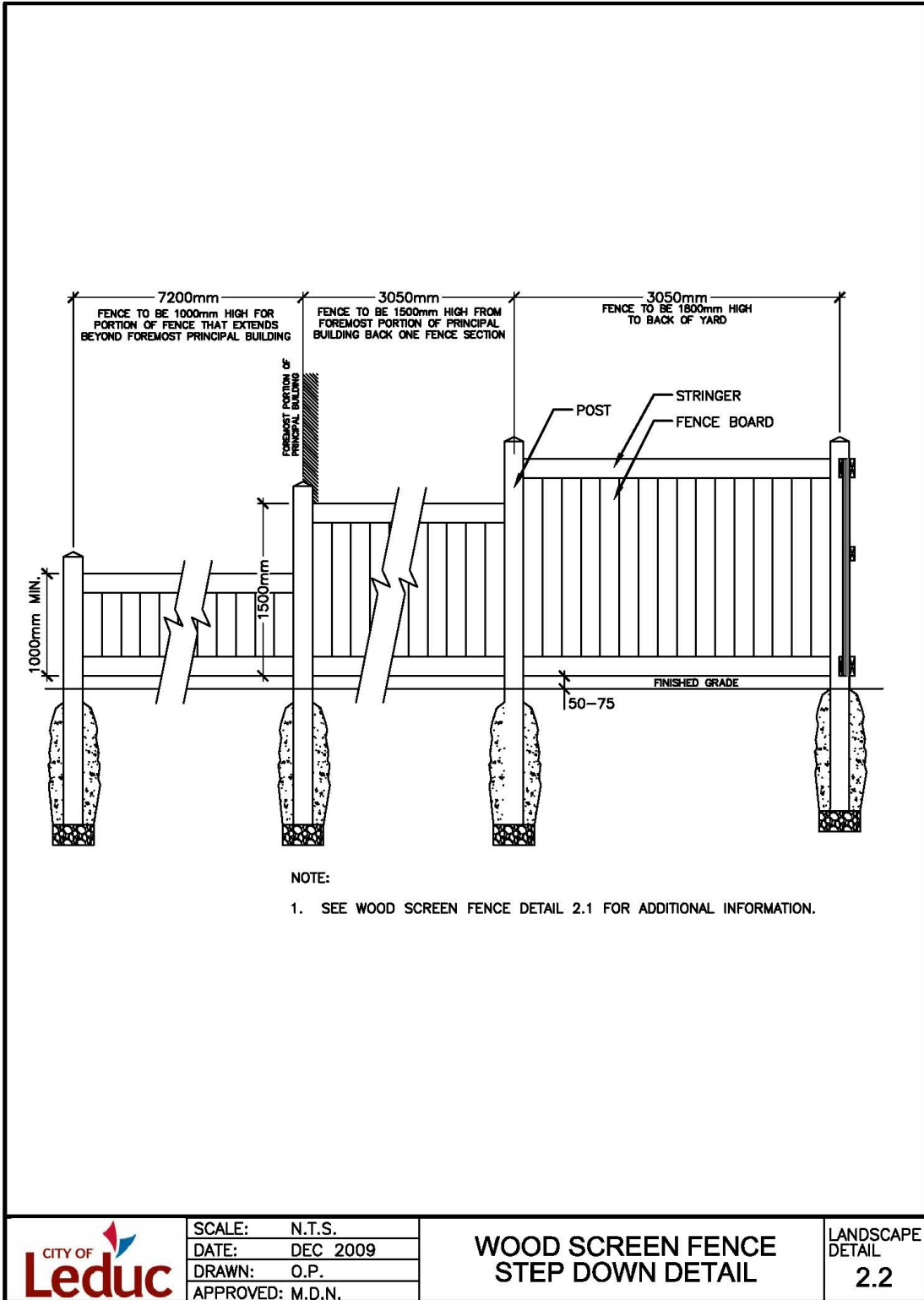

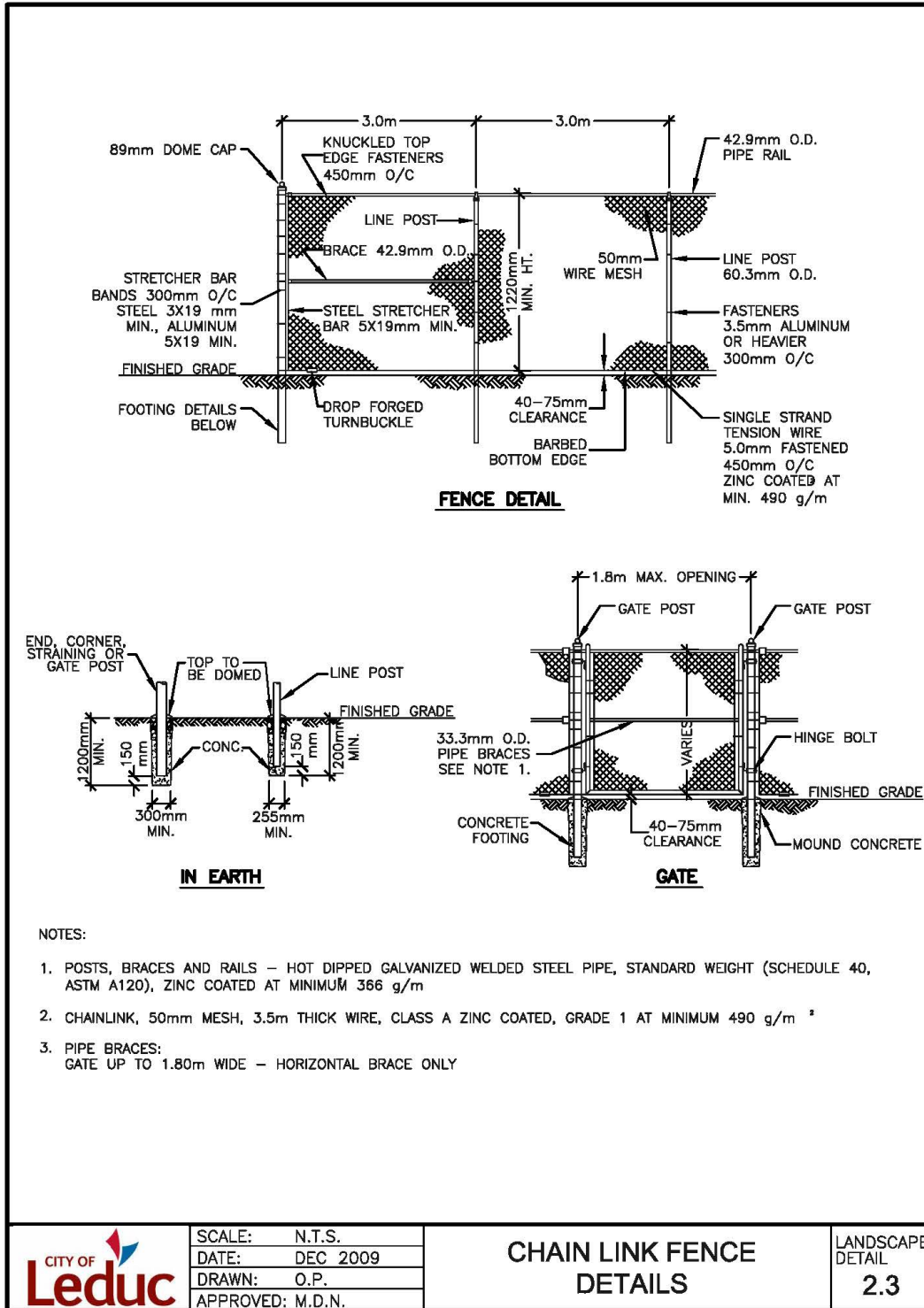



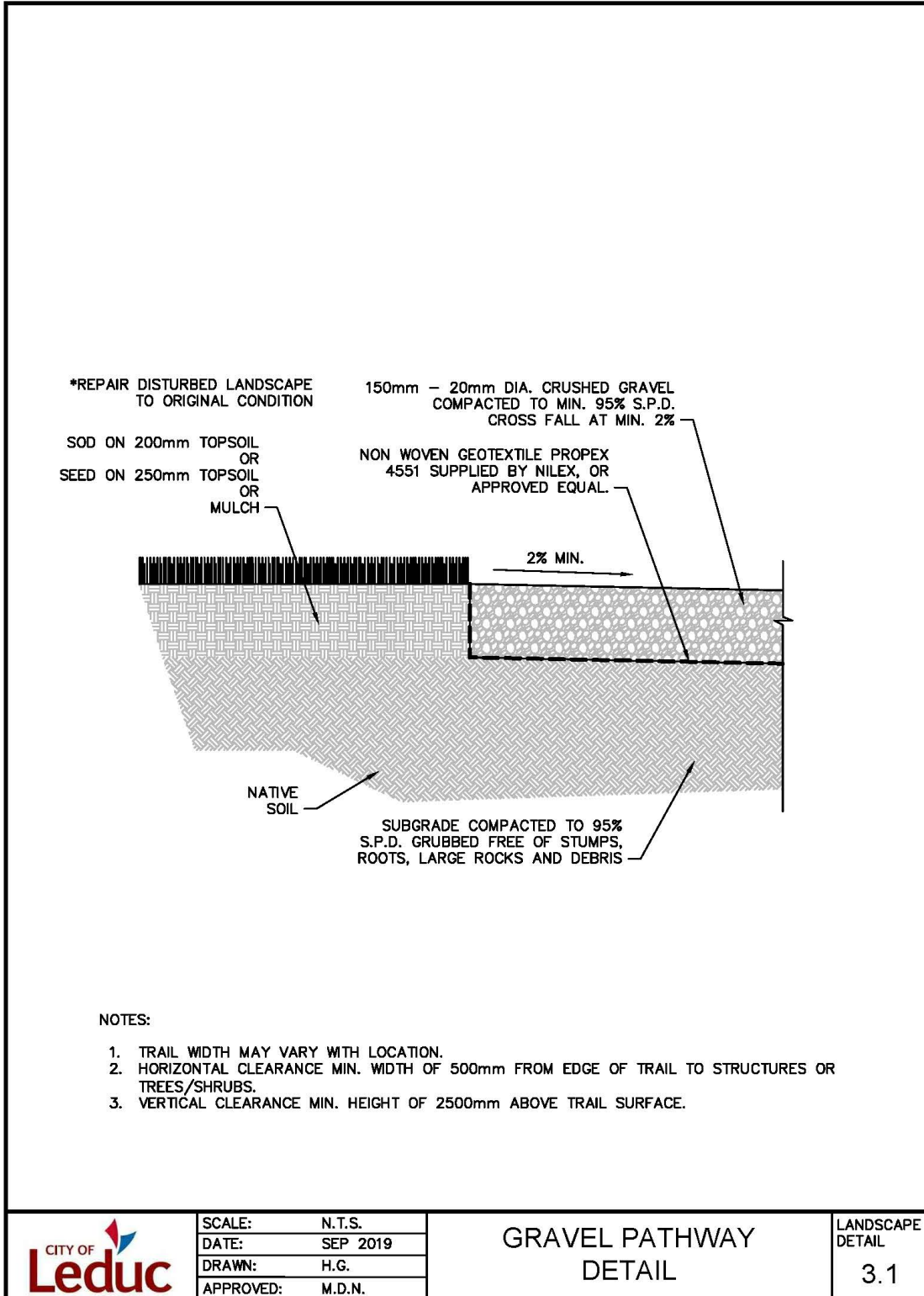

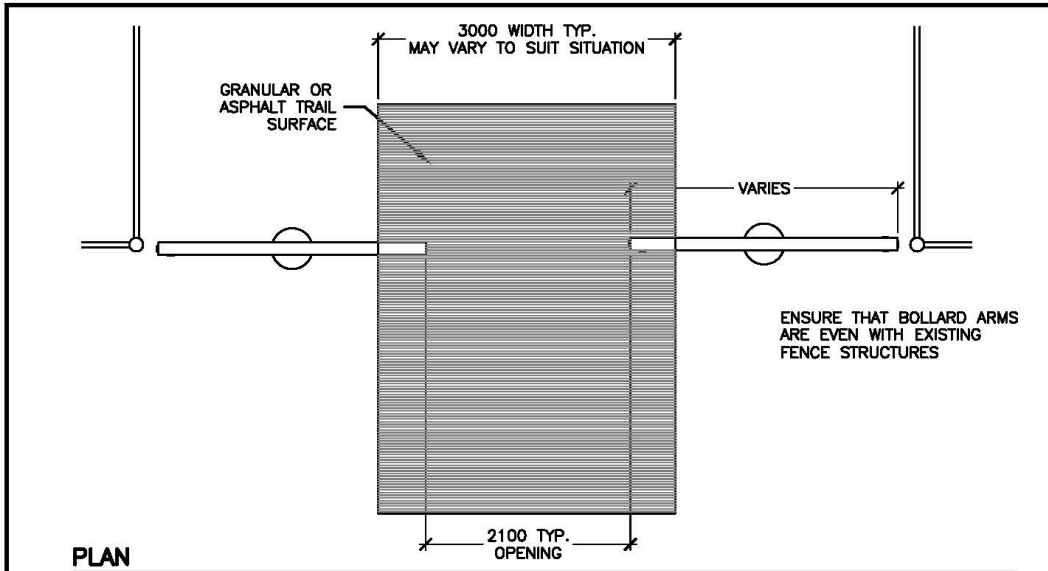

**PLAN**

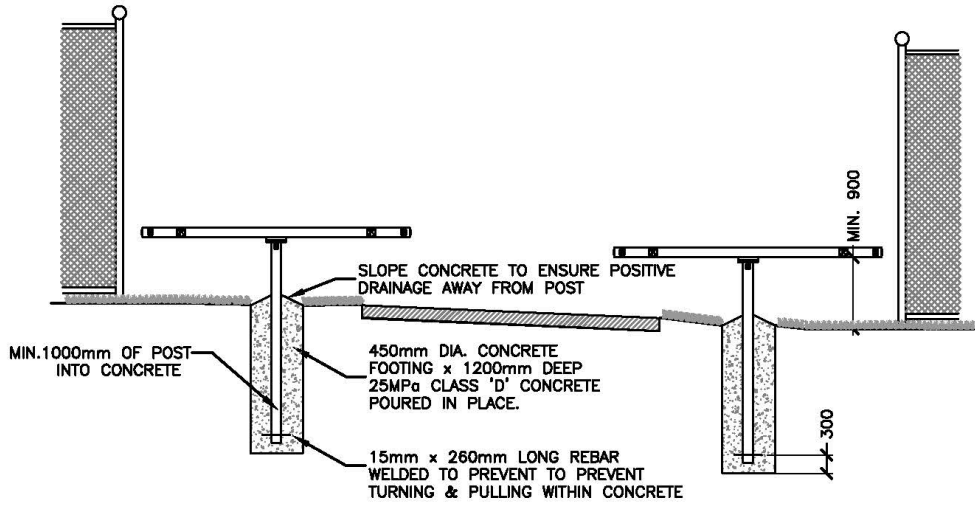

**ELEVATION**

- NOTES:
1. ENSURE THAT BOLLARD ARMS ARE EVEN WITH EXISTING STRUCTURES.
  2. FOOTING LOCATIONS MAY VARY BASED ON TRAIL WIDTH.
  3. T-BOLLARDS SUPPLIED BY CHILDSPACE OR APPROVED EQUAL.
  4. INSTALL AS PER MANUFACTURERS SPECS.
  5. ALL METAL TO BE GALVANIZED. POWDER COATING OPTIONAL.

	SCALE: N.T.S.	<h3>T-BOLLARD LAYOUT</h3>	LANDSCAPE DETAIL <b>4.1</b>
	DATE: DEC 2009		
	DRAWN: O.P.		
	APPROVED: M.D.N.		



- NOTE:
- SUPPLIED BY HAUL-ALL.
  - INSTALL AS PER MANUFACTURERS INSTALLATION INSTRUCTIONS.
  - ALL DIMENSIONS IN MILLIMETERS

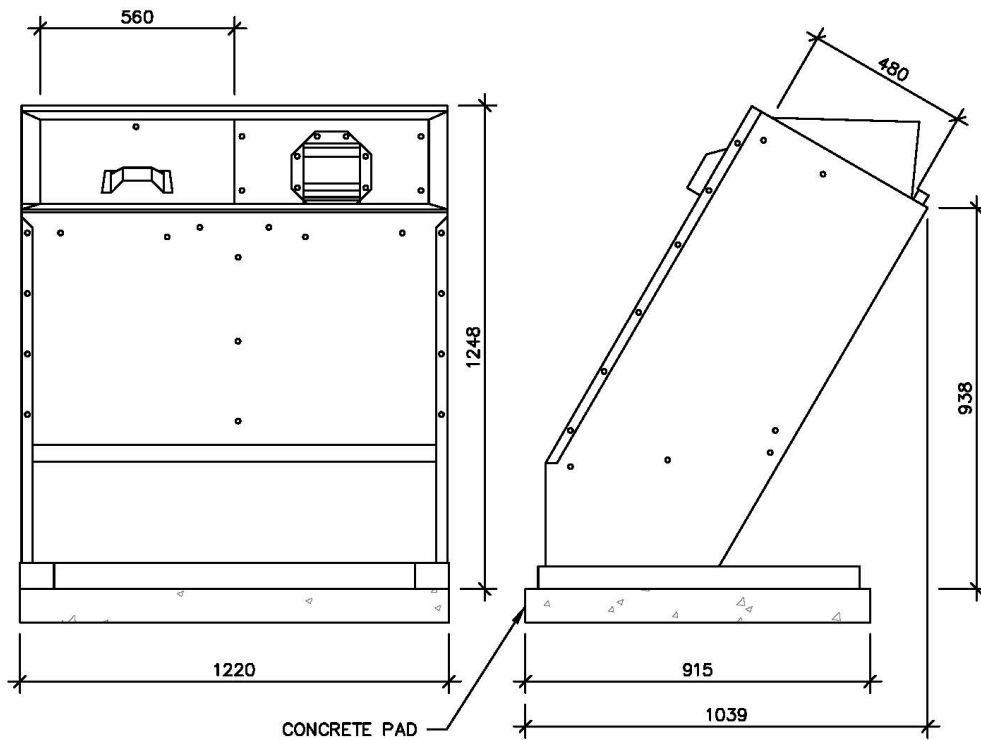

	SCALE:	N.T.S.	<b>HID-A-BAG II COMBO WASTE &amp; RECYCLE CONATINER</b>	LANDSCAPE DETAIL <b>4.2</b>
	DATE:	SEP 2019		
	DRAWN:	H.G.		
	APPROVED:	M.D.N.		



## 7.0 DEFINITIONS

The following definitions are used throughout the text of this document.

<b>Authority</b>	is any outside agency with jurisdiction over development approval on lands not controlled by the City of Leduc. (i.e. gas or electrical companies)
<b>Boulevard Planting</b>	refers to all trees, shrub beds, groundcover, and turf planted within the road right-of-way within the City of Leduc. This includes planting adjacent to sidewalks and in medians.
<b>Community Park</b>	provides opportunities for active and passive recreation at the community level. These parks provide recreational facilities for community sports, tournaments, special events and passive activities. Provisions of recreation facilities in these parks should be based on an evaluation of the projected needs of the overall City at the time of development. The size of the park is dependent upon the recreational facility needs of the City.
<b>Construction Completion Certificate (CCC)</b>	is the written acceptance certificate issued by the City of Leduc acknowledging the completion of construction of a municipal improvement. Once the CCC is issued, the maintenance period commences.
<b>Developer's Contractor</b>	are the accredited professionals retained by the Developer including, but not be limited to, landscaping, fencing, and masonry contractors, and any other trade required to complete landscape development.
<b>Developer's Consultant</b>	are the accredited consulting professionals retained by the Developer including but not be limited to Landscape Architects, Land Use Planners, Architects, Engineers, and Land Surveyors.
<b>Director, Community, Development and Service Planning</b>	is the management position within the City of Leduc responsible for the development, implementation and enforcement of the Landscape Design and Construction Standards, 2010. The Director, Community Development and Service Planning may designate a representative to approve any and all improvements proposed by the Developer including reviewing drawings and carry out inspections.
<b>Environmental Reserve (ER)</b>	Subject to 664(1) section 663 of the Municipal Government Act, a subdivision authority may require the owner of a parcel of land that is the subject of a proposed subdivision to provide part of that parcel of land as environmental reserve if it consists of <ul style="list-style-type: none"> <li>(a) a swamp, gully, ravine, coulee or natural drainage course;</li> <li>(b) land that is subject to flooding or is, in the opinion of the subdivision authority, unstable, or</li> <li>(c) a strip of land, not less than 6 metres in width, abutting the bed and shore of any lake, river, stream or other body of water for the</li> </ul>



	purpose of preventing pollution, or providing public access to and beside the bed and shore.
<b>Final Acceptance Certificate (FAC)</b>	is the written acceptance certificate issued by the City of Leduc for the municipal improvements, once any and all repairs, defects, and deficiencies have been completed and the Maintenance Period has expired This certificate releases any further guarantee or maintenance responsibilities by the Developer for the local improvements specified in the certificate.
<b>Landscaping</b>	is the preservation of natural features and the enhancement of public property within subdivision areas including but not limited to: grading, the planting of any plant material, the construction of fencing, walkways, multiways, storm water management facilities, driveways and other site features as designed by a registered Landscape Architect, and approved by the City of Leduc.
<b>Landscape Architect</b>	a professional who is a registered member in good standing with the Alberta Association of Landscape Architects, and is currently licensed to practice in Alberta.
<b>Landscape Plans</b>	are the drawings and specifications prepared by the Landscape Architect on behalf of the Developer which include the design, installation and construction methods of all municipal landscape improvements.
<b>Letter In Lieu</b>	a letter provided by the Landscape Architect to the City of Leduc in lieu of Plan of record Drawings. This letter states that no substantial changes to the landscaping have occurred on site and thus, is an acceptable substitute to the set of Plan of record drawings.
<b>Maintenance Period</b>	is the minimum two (2) year period which is required, after a CCC, during which the Developer and their contractor are responsible for maintaining all municipal improvements, and repairing any and all damage that occurs. The maintenance period is considered complete with the issuance of the Final Acceptance Certificate signed by the City of Leduc.
<b>Municipal Reserve (MR)</b>	<p>According to the Municipal Government Act, Section 666(1) subject to section 663, a subdivision authority may require the owner of a parcel of land that is the subject of a proposed subdivision:</p> <p>(a) to provide part of that parcel of land as municipal reserve, school reserve, or municipal and school reserve,</p> <p>(b) to provide money in place of municipal reserve, school reserve, or municipal and school reserve, or</p> <p>to provide any combination of land or money referred to in clauses (a) and (b).</p>
<b>Multiway Trail System</b>	is a system of multiways through the City of Leduc. The multiways are intended to be used for cycling, walking, running and inline skating. The intent is to link parks, recreation facilities, shopping areas, and city





	neighborhoods. Multiways are to be 3.0m width asphalt trails. Nature trails are to be 1.5 – 2.5 m width granular or mulch material.
<b>Neighborhood Park</b>	is a parcel of Municipal Reserve that may contain various recreational facilities to accommodate the activity requirements of various user groups including elementary school children. This park type is usually surrounded by residential lots with public access from a road frontage and may include access through utility lots.
<b>Plan Approval</b>	approval of plans shall be in principle only and if unforeseen conditions arise which may adversely affect the development, the design may be subject to review by the City of Leduc and revision by the Consultant in accordance with generally accepted engineering and Landscape Architecture construction practices.
<b>Plan of Record Drawings</b>	are the drawings that records all built conditions of the site once construction has been completed. Included shall be the actual location, length, size, capacity, materials, gradient and year of construction of the municipal improvements constructed within the subdivision area. These must be submitted to the City of Leduc 6 months prior to the anticipated FAC inspection date. The submission shall be in the form of a compact disc with an unlocked AutoCAD file and a full-size PDF file of the drawings.
<b>Public Property</b>	refers to all properties, easements and rights-of-way within and adjacent to the subdivision area which are to be owned or administered by the City of Leduc following the registration of a plan of subdivision for the subdivision area.
<b>Public Utility Lot</b>	according to the Municipal Government Act, Public Utility Lot or PUL refers to a parcel of land required to be given to the City under part 17 Division 8 for public utilities. Public utilities are defined as a system or works used to provide one or more of the following for public consumption, benefit, convenience or use and include water or stream, sewage disposal, public transportation operated by or on behalf of the municipality, irrigation, drainage, fuel, electric power, heat, waste management, telecommunications, and those things provided for public consumption, benefit, convenience or use.
<b>Red Line Drawings</b>	a set of drawings completed by the Landscape Architect showing any and all changes made to the approved design drawings before construction begins. Redline drawings are to be submitted to the City of Leduc for approval, and once approved, become the drawing set used for construction of improvements and approvals.
<b>Shall</b>	the word 'shall' denote a mandatory requirement.
<b>Should</b>	the word 'should' or 'may' denotes an optional or suggested recommendation.