

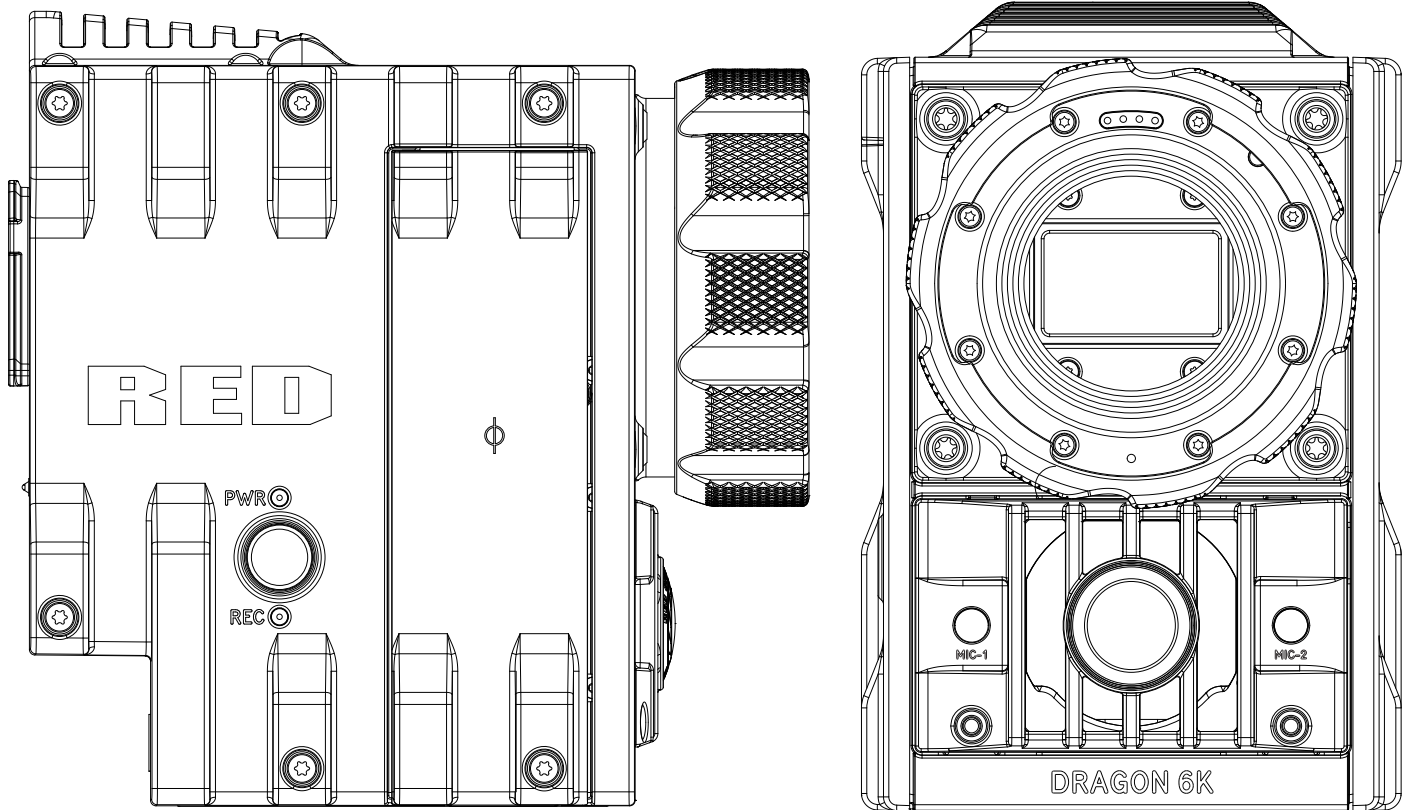

RED DSMC OPERATION GUIDE: EPIC/SCARLET



EPIC | SCARLET | V6.0
RED DRAGON | MYSTERIUM-X | MONOCHROME

RED.COM

TABLE OF CONTENTS

Disclaimer	3	Chapter 6: Record and Monitor Audio	139
Copyright Notice	3	Overview	139
Trademark Disclaimer	3	Audio Data Path	139
Compliance Statements	4	Set Up Audio	140
Safety Instructions	6	Audio Input (Source) Options	140
Battery Storage and Handling	7	Audio Output Options	143
Shipping Disclaimer	7	Control Headphone Volume (BRAIN)	143
Chapter 1: Camera Introduction	8	Audio Meter (VU Meter)	144
Read Before You Shoot	8	Audio During Playback	145
DSMC BRAIN	9	Chapter 7: REDMOTE Operation	146
RED Digital Sensors	10	Overview	146
R3D File Format and REDCODE	11	Controls, Connectors, and LEDs	147
Shoot For Video and Stills	12	REDMOTE Basics	149
Post Production with REDCINE-X PRO	12	REDMOTE LCD Display Menu	152
HDRx and MAGIC MOTION	13	Upgrade REDMOTE Firmware	153
Additional Resources	13	Chapter 8: Timecode, Genlock, Multi-Camera Setup	156
Chapter 2: Camera System Components	14	Timecode	156
Additional Resources	14	Genlock	159
BRAIN	15	Master/Slave Operation	161
Media Modules	16	Set Up Stereo/3D Configuration	164
REDMAG and RED MINI-MAG Systems	18	Set Up a Camera Array	165
Adaptor Modules	19	Set Up Motion Control (MoCo)	167
Power Modules	21	Compatible Devices	169
RED Batteries and Chargers	22	Chapter 9: Upgrade Camera Firmware	170
Other Modules	22	Verify Current Camera Firmware	170
Displays and Electronic Viewfinders	25	Upgrade Camera Firmware	170
LEMO Adaptors	28	Chapter 10: Camera System Maintenance	172
Camera Control Modules	29	BRAIN and Accessory Exterior Surfaces	172
Lens Mounts	32	Clean the Camera Sensor or OLPF	173
DSMC Interchangeable OLPFs	33	Clean EVF Screen	173
Rails, Mounts, Tactical Gear, and Cables	33	Clean LCD Screens	173
Chapter 3: Basic Operations	34	Water Damage	174
Power Operations	34	Adjust Back Focus	174
Configure Your Camera	35	Chapter 11: Troubleshoot Your Camera	175
DSMC Interchangeable OLPF System	43	Perform a Stress Test	175
Use a Tripod or Monopod	47	General Troubleshooting	175
Video Monitor Outputs	48	Appendix A: Technical Specifications	183
Record	48	EPIC DRAGON	183
Chapter 4: Basic Menus and Controls	50	SCARLET DRAGON	185
GUI Menu Introduction	50	EPIC MYSTERIUM-X	186
Upper Status Row (Basic Menu)	51	SCARLET MYSTERIUM-X	187
Live Action Area	55	BRAIN Dimensions	189
Lower Status Row	56	Appendix B: Input/Output Connectors	199
Navigation Controls	61	Record/Monitor Out Ports	200
Chapter 5: Advanced Menus	68	Communication Ports	201
Advanced Menus	68	Audio Ports	205
Settings Menu	69	Power Ports	206
Media Menu	123	SSD Module Connectors	206
Playback Menu	124	Appendix C: Lens Mounts and Lenses	207
Power Menu	127	Lens Mounts	207
HDRX Menu	128	Lenses	210
Focus Menu	128	Appendix D: Default Key Functions	217
Exposure Assist	134	Preset Default Key Functions	220
Presets Menu	136	Appendix E: Menu Map	221

RED DSMC OPERATION GUIDE: EPIC/SCARLET

DISCLAIMER

RED® has made every effort to provide clear and accurate information in these installation instructions, which are provided solely for the user's information. While thought to be accurate, the information in this document is provided strictly "as is" and RED will not be held responsible for issues arising from typographical errors or user's interpretation of the language used herein that is different from that intended by RED. All safety and general information is subject to change as a result of changes in local, federal or other applicable laws.

RED reserves the right to revise this document and make changes from time to time in the content hereof without obligation to notify any person of such revisions or changes. In no event shall RED, its employees or authorized agents be liable to you for any damages or losses, direct or indirect, arising from the use of any technical or operational information contained in this document.

For comments or questions about content in this Operation Guide, please send a detailed email to OpsGuides@red.com.

COPYRIGHT NOTICE

COPYRIGHT © 2015 RED.COM, INC.

All trademarks, trade names, logos, icons, images, written material, code, and product names used in association with the accompanying product are the copyrights, trademarks, or other intellectual property owned and controlled exclusively by RED.COM, INC.

TRADEMARK DISCLAIMER

All other company, brand, and product names are trademarks or registered trademarks of their respective holders. RED has no affiliation to, is not associated with or sponsored by, and has no express rights in third-party trademarks. Adobe is a registered trademark of Adobe Systems Incorporated. AJA is a registered trademark of AJA Video Systems, Inc. Cooke and S4/i are registered trademarks of Cooke Optics Limited. DaVinci is a registered trademark of Blackmagic Design in the U.S. and other countries. Distagon, Makro-Planar, and Otus are registered trademarks of Carl Zeiss AG. Fujinon is a registered trademark of FUJIFILM CORPORATION. HDMI is a registered trademark of HDMI Licensing LLC in the United States and other countries. Leica is a registered trademark of Leica Microsystems. Loctite is a registered trademark of Henkel AG & Company KGaA. Nikkor and Nikon are registered trademarks of Nikon Corporation. Canon is a registered trademark of Canon, U.S.A. Apple, Macintosh, and QuickTime are registered trademarks of Apple Inc. in the U.S. and other countries. Windex is a registered trademark of S. C. Johnson & Son, Inc. Windows is a registered trademark of Microsoft Corporation. LEMO is a registered trademark of LEMO USA. Sony is a registered trademark of Sony Corporation. TORX is a registered trademark of Acument Intellectual Properties, LLC in the United States or other countries. IOS is a registered trademark of Cisco in the U.S. and other countries.

RED DSMC OPERATION GUIDE: EPIC/SCARLET

COMPLIANCE STATEMENTS

INDUSTRIAL CANADA EMISSION COMPLIANCE STATEMENTS

This device complies with Industry Canada license-exempt RSS standards RSS 139 and RSS 210. Operation is subject to the following two conditions: (1) this device may not cause interference, and (2) this device must accept any interference, including interference that may cause undesired operation of the device.

This Class B digital apparatus complies with Canadian ICES-003.

Le présent appareil est conforme aux CNR d'Industrie Canada applicables aux appareils radio exempts de licence. L'exploitation est autorisée aux deux conditions suivantes : (1) l'appareil ne doit pas produire de brouillage, et (2) l'utilisateur de l'appareil doit accepter tout brouillage radioélectrique subi, même si le brouillage est susceptible d'en compromettre le fonctionnement. Cet appareil numérique de la classe B est conforme à la norme NMB-003 du Canada.

FEDERAL COMMUNICATIONS COMMISSION (FCC) STATEMENTS



This equipment has been tested and found to comply with the limits for a Class B digital device, pursuant to part 15 of the FCC Rules. These limits are designed to provide reasonable protection against harmful interference in a residential installation. This equipment generates, uses and can radiate radio frequency energy and, if not installed and used

in accordance with the instructions, may cause harmful interference to radio communications. However, there is no guarantee that interference will not occur in a particular installation. If this equipment does cause harmful interference to radio or television reception, which can be determined by turning the equipment off and on, the user is encouraged to try to correct the interference by one or more of the following measures:

- ▶ Reorient or relocate the receiving antenna.
- ▶ Increase the separation between the equipment and receiver.
- ▶ Connect the equipment into an outlet on a circuit different from that to which the receiver is connected.
- ▶ Consult the dealer or an experienced radio/TV technician for help.

In order to maintain compliance with FCC regulations, shielded cables must be used with this equipment. Operation with non-approved equipment or unshielded cables is likely to result in interference to radio and TV reception. The user is cautioned that changes and modifications made to the equipment without the approval of manufacturer could void the users authority to operate this equipment.

NOTE: This device complies with Part 15 of the FCC Rules.

Operations subjected to the following two conditions (1) this device may not cause harmful interference, and (2) this device must accept any interference received, including that may cause undesirable interference.



CAUTION: Exposure to Radio Frequency Radiation.

The device shall be used in such a manner that the potential for human contact is minimized

This equipment complies with FCC radiation exposure limits set forth for an uncontrolled environment. This equipment should be installed and operated with a minimum distance of 20 cm between the radiator and your body.



CAUTION: Regulations of the FCC and FAA prohibit airborne operation of radio-frequency wireless devices because their signals could interfere with critical aircraft instruments.



CAUTION: If the device is changed or modified without permission from RED, the user may void his or her authority to operate the equipment.

AUSTRALIA AND NEW ZEALAND STATEMENTS

RED declares that the radio equipment described in this document comply with the following international standards.

- ▶ IEC 60065 - Product Safety
- ▶ ETSI EN 300 328 - Technical requirement for radio equipment

RED declares digital devices described in this document comply with the following Australian and New Zealand standards.

- ▶ AS/NZS CISPR 22 – Electromagnetic Interference
- ▶ AS/NZS 61000.3.2 – Power Line Harmonics
- ▶ AS/NZS 61000.3.3 – Power Line Flicker

JAPAN STATEMENTS



This is a Class B product based on the standard of the Voluntary Control Council for Interference (VCCI) for information technology equipment. If this equipment is used near a radio or television receiver in a domestic environment, it may cause radio interference. Install and use the equipment according to the instruction manual.

この装置は、情報処理装置等電波障害自主規制協議会(VCCI)の基準に基づくクラス B 情報技術装置です。この装置は家庭環境で使用することを目的としていますが、ラジオやテレビジョン受信に近接して使用されると、受信障害を引き起こすことがあります。取扱説明書に従って正しい取り扱いをしてください。

EUROPEAN UNION COMPLIANCE STATEMENTS



RED declares that the radio equipment described in this document comply with the R&TTE Directive (1999/5/EC) issued by the Commission of the European Community.

Compliance with this directive implies conformity to the following European Norms (in brackets are the equivalent international standards).

- ▶ EN 60065 (IEC 60065) – Product Safety
- ▶ ETSI EN 300 328 Technical requirement for radio equipment
- ▶ ETSI EN 301 489 General EMC requirements for radio equipment.

RED DSMC OPERATION GUIDE: EPIC/SCARLET

INFORMATION

Products with the CE marking comply with the EMC Directive (2004/108/EC) and the Low Voltage Directive (2006/95/EC) issued by the Commission of the European Community. Compliance with these directives implies conformity to the following European Product Family Standards.

- ▶ EN 55022 (CISPR 22) – Electromagnetic Interference
- ▶ EN 55024-1 (CISPR 24) – Electromagnetic Immunity
- ▶ EN 61000-3-2 (IEC610000-3-2) – Power Line Harmonics
- ▶ EN 61000-3-3 (IEC610000) – Power Line Flicker
- ▶ EN 60065 (IEC60065) – Product Safety

WASTE ELECTRICAL AND ELECTRONIC EQUIPMENT (WEEE)

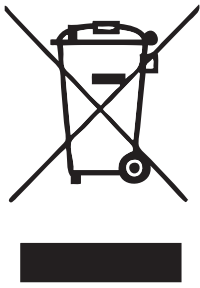

The Waste Electrical and Electronic Equipment (WEEE) mark applies only to countries within the European Union (EU) and Norway. This symbol on the product and accompanying documents means that used electrical and electronic products should not be mixed with general household waste. For proper treatment, recovery and recycling, please take this product to designated collection points where it will be accepted free of charge. Alternatively, in some countries you may be able to return your products to your local retailer upon purchase of an equivalent

new product.

Disposing of this product correctly will help save valuable resources and prevent any potential negative effects on human health and the environment, which could otherwise arise from inappropriate waste handling. Please contact your local authority for further details of your nearest designated collection point. Penalties may be applicable for incorrect disposal of this waste, in accordance with your national legislation.

For business users in the European Union, if you wish to discard electrical and electronic equipment, please contact your dealer or supplier for further information.

USAGE RESTRICTIONS FOR PRODUCTS THAT INCORPORATE REDLINK



Products that fall into this category are denoted by inclusion of the Class 2 identifier symbol (exclamation mark in a circle) accompanying the CE Mark on the products regulatory label, example to the left.

FRANCE

Usage Restrictions - Geographic Area Where Restriction Applies : France

For mainland France

- ▶ 2.400 - 2.4835 GHz (Channels 1-16) authorized for indoor use
- ▶ 2.400 - 2.454 GHz (Channels 1-10) authorized for outdoor use

Restrictions d'utilisation - Zone géographique où les restrictions s'appliquent : France

Pour la France métropolitaine

- ▶ 2.400 - 2.4835 GHz (Canaux 1 à 16) autorisé en usage intérieur
- ▶ 2.400 - 2.454 GHz (canaux 1 à 10) autorisé en usage extérieur

NORWAY

This subsection does not apply for the geographical area within a radius of 20 km from the centre of Ny-Ålesund

Dette gjelder ikke for det geografiske området innenfor en radius av 20 km fra sentrum av Ny-Ålesund

RESPONSIBLE PARTY

RED Digital Cinema
34 Parker
Irvine, CA 92618
USA

RED DSMC OPERATION GUIDE: EPIC/SCARLET

SAFETY INSTRUCTIONS

- ▶ DO NOT use the camera or accessories near water. Avoid exposing your camera to moisture. The unit is not waterproof, so contact with water could cause permanent damage to the unit as well as electric shock and serious injury to the user. DO NOT use the camera in the rain or under other conditions with high moisture without appropriate protection, and immediately remove power source if camera or accessories are exposed to moisture.



WARNING: To reduce the risk of fire or electric shock, do not expose the camera to rain or moisture.

- ▶ DO NOT expose the camera to laser beams, as laser beams may damage the sensor.
- ▶ DO NOT expose your camera to excessive vibration or impact (shock). Be careful not to drop your camera. Internal mechanisms may be damaged by severe shock. Mechanical alignment of optical elements may be affected by excessive vibration.
- ▶ ELECTROMAGNETIC INTERFERENCE: The use of devices using radio or other communication waves may result in the malfunction or interference with the unit and/or with audio and video signals.
- ▶ Clean only using a dry cloth. When cleaning your camera, remember that it is not waterproof and moisture can damage electronic circuitry. DO NOT rinse or immerse any element of the camera, lens or other accessory, keep them dry at all times. DO NOT use soaps, detergents, ammonia, alkaline cleaners, and abrasive cleaning compounds or solvents. These substances may damage lens coatings and electronic circuitry.
- ▶ Maintain sufficient ventilation—DO NOT block any ventilation openings or obstruct cooling fan airflow.

CAUTION: Proper camera ventilation requires a minimum 0.5" (1.25 cm) clearance between the camera ventilation openings and external surfaces. Verify that objects that can block the fan intake and exhaust ports do not impede airflow. Failure to permit adequate airflow may result in overheating of the camera, degraded operation and in extreme situations, damage to the camera.



- ▶ DO NOT operate or store near any heat sources such as radiators, heat registers, stoves, or any other apparatus that produce heat. Store in a protected, level and ventilated place. Avoid exposure to temperature extremes, damp, severe vibration, strong magnetic fields, direct sunlight or local heat sources during storage. Remove any batteries from the camera before storage. Recommended storage and usage temperatures for your camera, lenses and other accessories are:
 - Operating range: 0°C to 40°C (32°F to 104°F)
 - Storage range: -20°C to 50°C (-4°F to 122°F)

If there are any performance issues with your camera or accessories when operating within this temperature range, please file a support ticket on <https://support.red.com>.

- ▶ The DSMC Side Handle, side SSD modules, rear modules, and lens mounts are NOT HOT SWAPPABLE, meaning you cannot remove or install them while the camera is turned on. Before installing or removing any of these accessories, you MUST turn off the camera. Failure to do so may result in damage to the accessory and/or camera BRAIN that will not be covered under warranty.

- ▶ DO NOT bypass the third prong of the grounding-type plug on the power cord of the DSMC AC Power Adaptor. A grounding-type plug has two blades and a third “grounding” prong. The third prong is provided for your safety. A grounding-type plug shall be connected to an outlet with a protective earthen connection. If the grounding-type plug does not fit into your outlet, do not attempt to modify the plug or outlet, consult a qualified electrician.
- ▶ Protect all power cords from being pinched, walked on or driven over by a vehicle. Replace any power cords suspected of sustaining damage due to crushing or other forms physical damage.

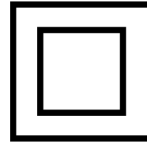

Products marked with this symbol are class 2 devices. These devices are not provided with a grounding type plug.



CAUTION: The power cord plug for the DSMC AC Power Adaptor is used as the power disconnect. To disconnect all power from the DSMC AC Power Adaptor, unplug the power cord plug from the wall outlet. During use, the power cord plug should remain easily accessible at all times.

- ▶ Lithium-ion batteries may be subject to special handling requirements pursuant to federal and local laws. Please refer to specific shipping instructions included with your battery regarding proper transport of your battery. Do not handle your battery if it is damaged or leaking. Disposal of batteries must be in accordance with local environmental regulations. For example, California law requires that all rechargeable batteries must be recycled by an authorized recycle center. Storing batteries fully charged or in high temperature conditions may permanently reduce the life of the battery. Available battery capacity may also be temporarily lessened after storage in low temperature conditions.



WARNING: DO NOT expose the battery to excessive heat.



WARNING: Danger of explosion if an incorrect battery is charged with the RED Charger or is used to power the camera and accessories. Replace only with the same or equivalent type battery.



CAUTION: Refer all service and repair to qualified RED service personnel. To reduce the risk of electric shock, and damage to the camera or accessories, DO NOT attempt to perform any servicing other than any procedures that are recommended in the operating instructions.



INDOOR USE ONLY: Products marked with this symbol are designed for use indoors only.

RED DSMC OPERATION GUIDE: EPIC/SCARLET

BATTERY STORAGE AND HANDLING



WARNING: Failure to read, understand, and follow these instructions may result in overheating, chemical leakage, smoke emission, fire, or other potentially harmful results.

Always follow proper battery handling and storage practices. Improper handling and/or failure to abide by proper storage instructions may cause permanent damage to batteries, or degrade battery charge holding capacity. Improper handling practices or failure to comply with instructions may also put you at risk.

Lithium-Ion batteries, like the REDVOLT®, REDVOLT XL, and RED BRICK®, self-discharge over time. When storing for long periods of time, store batteries separately from the camera or charger and remember to charge batteries to a capacity level of 40% to 60%. If batteries will be stored for long periods of time, RED recommends that you check the charge level at least once every six (6) months, and recharge batteries to a capacity level of 40% to 60%.

When not in use, remove the battery from the camera or charger and store the battery in a cool, dry place. Avoid extreme hot temperatures (such as inside a hot car), corrosive gas, and direct sunlight. The optimal storage temperature for batteries is between -20°C to 20°C (-4°F to 68°F).



WARNING: Batteries stored in a discharged state for long periods of time may self-discharge and lose the ability to hold a charge.



WARNING: If recharging operation fails to complete even when a specified recharging time has elapsed, immediately stop further recharging.

- ▶ DO NOT store batteries in a fully charged state for extended periods of time.
- ▶ DO NOT store batteries in a fully discharged state for extended periods of time.
- ▶ DO NOT store batteries in the camera, in a camera module, or in a charger for extended periods of time.
- ▶ DO NOT use batteries for purposes other than their intended use.
- ▶ DO NOT store batteries in extreme hot or cold temperatures.
- ▶ DO NOT store batteries in direct sunlight.
- ▶ DO NOT use third-party chargers with your RED batteries.
- ▶ DO NOT disassemble or modify the battery.
- ▶ DO NOT overcharge batteries. Overcharging may increase internal temperature beyond the recommended limits and cause permanent damage to the battery.
- ▶ DO NOT connect the positive (+) and negative (-) terminals to a metal object such as a wire.
- ▶ DO NOT transport or store the battery together with metal objects such as jewelry, hairpins, etc. as they may generate heat if they come into contact with the battery.
- ▶ DO NOT discard the battery into fire or heat.
- ▶ DO NOT store, use, or recharge the battery near a heat source such as a fire or a heater.
- ▶ DO NOT allow the battery to get wet.

- ▶ DO NOT pierce the battery with pointed or other sharp objects.
- ▶ DO NOT step on, throw, or strike the battery with a hammer.
- ▶ DO NOT use a battery that appears to be deformed or damaged.
- ▶ DO NOT directly solder the battery.
- ▶ DO NOT put the battery into a microwave oven or a pressurized container.
- ▶ DO NOT use or subject the battery to intense sunlight or hot temperatures such as in a car in hot weather.
- ▶ DO NOT use it in a location where static electricity may be present.
- ▶ DO NOT exceed the recharging temperature range of 0°C to 40°C (32°F to 104°F).
- ▶ RED recommends that you only use RED chargers to recharge RED batteries.
- ▶ Store the battery in a location where children cannot reach it.
- ▶ If the battery leaks or gives off a bad odor, discontinue use immediately.
- ▶ If the battery gives off an odor, generates heat, becomes discolored or deformed, or in any way appears abnormal during use, recharging or storage, immediately remove it from the equipment or battery charger and discontinue use.
- ▶ If electrolyte begins leaking from the battery and comes into contact with your skin or clothing, immediately wash it away with running water. Failure to do this may result in skin inflammation.
- ▶ If the battery leaks and the electrolyte reaches the eyes, do not rub them. Instead, rinse the eyes with clean running water and immediately seek medical attention. Failure to do this may result in eye injury.
- ▶ If you find discoloration, a bad odor due to leakage, overheating and/or other irregularities when using the battery for the first time, contact your Bomb Squad representative immediately.



NOTE: For more information regarding RED battery charging and instructions for care, please refer to our [Terms and Conditions](#).

SHIPPING DISCLAIMER

Shipment of Lithium Ion cells and batteries is subject to national and international shipping requirements. A Class 9 Certified shipper is required to transport these products within the United States. REDVOLT, REDVOLT XL, and RED BRICK batteries are considered Dangerous Goods. Other products such as REDVOLT AA and RED Li 7.2V batteries may also be classified as Dangerous Goods when purchased in bulk. Applicable laws prohibit the shipping of batteries that are physically damaged. We urge you to look into the formal rules and regulations of shipping Class 9 Dangerous Goods prior to preparing your shipment. For more information on these regulations, please visit www.iata.org and www.dot.gov.

For more information, see our FAQs for [Regulated Items \(Dangerous Goods\)](#).

01

CAMERA INTRODUCTION



EPIC Digital Still and Motion Cameras (DSMC)

The EPIC and SCARLET cameras are part of the RED® Digital Still and Motion Camera (DSMC®) system. The DSMC family includes WEAPON, EPIC, and SCARLET® cameras. With an ultra-high megapixel count, high frame rate, significant processing power, high dynamic range, and the advantages of a raw file format, each camera offers the ability to simultaneously capture video and stills.

This guide is for EPIC and SCARLET only. This section introduces the imaging capabilities and advanced features of the EPIC and SCARLET system. For information about WEAPON cameras, see the [DSMC Operation Guide: WEAPON](#), available at www.red.com/downloads.

The EPIC and SCARLET system includes the following cameras (organized by sensor type):

SENSOR TYPE	CAMERA
RED DRAGON®	EPIC-M RED DRAGON (CARBON FIBER) EPIC-M RED DRAGON EPIC-X RED DRAGON SCARLET DRAGON®
MYSTERIUM-X®	EPIC-M MYSTERIUM-X EPIC-X MYSTERIUM-X SCARLET-X® MYSTERIUM-X
MONOCHROME	EPIC-M MONOCHROME EPIC-X MONOCHROME
RED DRAGON MONOCHROME	EPIC-M RED DRAGON MONOCHROME

READ BEFORE YOU SHOOT

Read this operation guide carefully and in its entirety before assembling or operating your camera or other RED accessories. In addition to this document, RED offers the following operation guides for the camera system:

- ▶ [DSMC Power Operation Guide](#)
- ▶ [DSMC Media Operation Guide](#)

To download RED operation guides, visit the [RED downloads page](#) at www.red.com/downloads.

DSMC BRAIN



*EPIC-M BRAIN
(Left) and
SCARLET-X BRAIN
(Right)*

At the center of the RED modular system is the DSMC BRAIN®, housing the critical image capture electronics and digital image sensor.

The expansive RED arsenal of modules, monitors, lens mounts, controllers, power, media, and other accessories supports both the EPIC and SCARLET BRAINS. Modular lens mounts enable you to use your existing Canon®, Nikon®, Leica-M®, and PL lenses to capture the perfect shot.

EPIC-M AND EPIC-X

EPIC-M and EPIC-X BRAINS are the pinnacle of professional cinema-grade cameras, capable of capturing video and stills at up to 6K resolution at 100 frames per second (FPS). Designed with an entirely modular architecture, advanced image processing capabilities, and integrated audio system, the EPIC delivers a remarkable amount of technology—packed into a five (5) lb body.

EPIC-M RED DRAGON (CARBON FIBER)

The EPIC-M RED DRAGON (CARBON FIBER) is engineered with carbon fiber and magnesium parts to significantly reduce weight. Due to the material characteristics of carbon fiber and magnesium, hardware and mounting points differ from the standard aluminum BRAIN and weight restrictions may apply. Some components are not compatible with the EPIC-M RED DRAGON (CARBON FIBER).

NOTE: Use ONLY designated side SSD modules, magnesium lens mounts, and hardware with the EPIC-M RED DRAGON (CARBON FIBER).

SCARLET-X

The SCARLET-X BRAIN leaves one-dimensional DSLRs in its wake, letting you capture up to 6K video and stills with the RED DRAGON sensor, or 5K video and stills with the MYSTERIUM-X sensor. The SCARLET-X offers the same raw potential as the EPIC with the .R3D® file format that offers unmatched dynamic range, image latitude, and evolving color science.

RED DIGITAL SENSORS

Each EPIC or SCARLET BRAIN is equipped with one of the following sensors:

- ▶ RED DRAGON (6K)
- ▶ MYSTERIUM-X (5K)
- ▶ MONOCHROME (5K)
- ▶ RED DRAGON MONOCHROME (6K)

RED DRAGON SENSOR (6K)

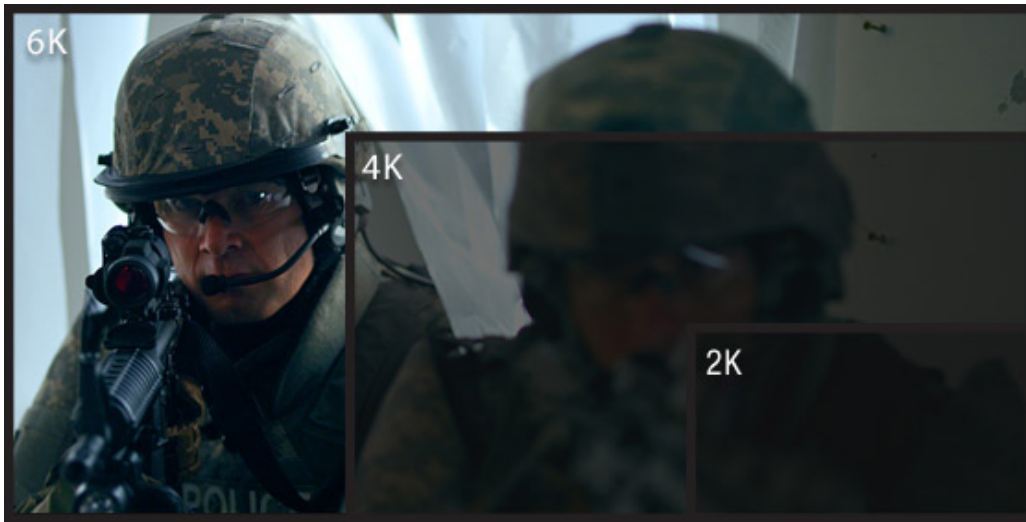

*RED DRAGON
6K Resolution*

The RED DRAGON (6K) sensor captures over nine (9) times more resolution than standard HD. The result is unrivaled detail and impressive native exposure that exceeds 35mm film in both latitude and image density.

The RED DRAGON (6K) sensor is a model for image innovation, leading the way in the evolution of digital cinema technology. Boasting an industry-leading 19 megapixels at 6K resolution, the RED DRAGON (6K) supports 100+ frames per second (FPS), 16.5+ stops of dynamic range, and advanced color science.

MYSTERIUM-X SENSOR



*MYSTERIUM-X
5K Resolution*

The MYSTERIUM-X sensor was designed specifically to capture an industry-leading 5K resolution digital image. The EPIC MYSTERIUM-X provides variable frame rate imaging at up to 95 FPS at 5K FF resolution, and up to 400 FPS at 1K WS resolution.

RED DSMC OPERATION GUIDE: EPIC/SCARLET

The MYSTERIUM-X sensor includes high-precision analog to digital conversion, capable of delivering up to 13.5 stops of dynamic range with daytime light sources 800 ISO. With HDRx®, dynamic range can be extended up to approximately 18 stops.

MONOCHROME AND RED DRAGON MONOCHROME SENSORS



*MONOCHROME
Sensor Still*

The MONOCHROME (5K) and RED DRAGON MONOCHROME (6K) are the black and white (B&W) equivalent of the MYSTERIUM-X and RED DRAGON sensors, respectively. Both MONOCHROME sensors use their unique sensor pattern to achieve optimum resolution and extended dynamic range. The MONOCHROME sensors also take advantage of greater light sensitivity and tonal transfer in gradients, far exceeding the monochrome quality of a color image converted to black and white.

NOTE: The MONOCHROME and RED DRAGON MONOCHROME sensors are only available with EPIC BRAINS.

R3D FILE FORMAT AND REDCODE

The R3D file format was developed by RED to provide an efficient and manageable RAW video data format that promotes advanced post-production editing capabilities. In the R3D file format, the digital image received from the sensor is formatted as a pixel-defect corrected (but in all other aspects unprocessed) 16-bit per pixel RAW data frame. Each RAW frame, or sequence of RAW frames in a clip, is compressed using a proprietary wavelet based REDCODE® RAW compression, then stored to a RED MINI-MAG® or REDMAG™ 1.8" SSD.

RAW data is recorded independently of any RGB domain color processing such as ISO, White Balance, or other RGB color space settings. Instead, color parameters are saved as reference metadata; that is, color is not burned into the recorded RAW data. This recording technique promotes flexibility in RGB color processing, which can be deferred to post-production or adjusted in the field, without affecting the recorded RAW data image quality or dynamic range.

REDCODE is a visually lossless, wavelet-based compression codec that reduces R3D RAW files into a manageable size, allowing longer recording times on media. The ability to compress RAW data is one of the significant technologies that RED has brought to the industry.

For more information, see the [DSMC Media Operation Guide](http://www.red.com/downloads), available at www.red.com/downloads.

NOTE: REDCINE-X PRO® can create and export .RMD “Look” files which may then be imported as camera monitor path color processing presets. This information is stored as reference metadata, so that these color processing choices can be the default values used in post-production. For more information, go to [“Looks” on page 137](#).

SHOOT FOR VIDEO AND STILLS

High resolution video, such as the digital footage captured by the camera, has surpassed the detail necessary to produce professional full-sized prints. Because of the ability to record at high frame rates and resolution, the camera is ideally suited to capture video and still images, simultaneously.

The camera is equipped with a Stills mode that makes it easier to capture stunning images. With presets optimized for stills and Swipe-Up Shortcuts for the RED Touch display, switching from Motion mode to Stills mode is seamless. Using REDCINE-X PRO, or other editing applications supporting the RED SDK, you can pull full resolution still images from R3D files.

NOTE: Stills mode is compatible with v6.0 firmware or later.

POST PRODUCTION WITH REDCINE-X PRO



REDCINE-X PRO

REDCINE-X PRO is a professional coloring toolset, equipped with an integrated timeline and a post effects software collection that provides the ideal environment to edit, organize, and prepare your R3D files.

RED TETHER, included in REDCINE-X PRO, allows you to record footage from your camera directly to a computer or an external drive. Using tethering bypasses the need to record to an SSD and offload to a computer later, saving you time.

NOTE: RED TETHER is included in REDCINE-X PRO build 35 or later.

Download the latest version of REDCINE-X PRO on the [RED Downloads page](http://www.red.com/downloads) at www.red.com/downloads.

HDRX AND MAGIC MOTION



HDRx

HDRx

HDRx extends dynamic range up to six (6) stops by simultaneously capturing two (2) images of identical resolution and frame rate. The first image is a normally exposed track (A-track), while the second is an underexposed track (X-track) with an exposure value that reflects the additional stops of highlight protection. These tracks are “motion-conjoined” during recording, leaving no time gap between the two (2) exposures. This is different from traditional alternating exposures, which have small gaps between tracks, producing unwanted motion tracks.

MAGIC MOTION

MAGIC MOTION is a post production method that combines two (2) HDRx tracks to create an image with both natural motion blur (from the A-track) and sharper reference (the X-track). MAGIC MOTION produces an image with an extraordinary dynamic range that is not available with any other motion capture camera.

Shooting at 24 FPS with a 180° (1/48 sec) shutter on traditional film or digital cameras produces motion blur throughout, which is not the way the human eye observes motion. For example, ask someone to swing their arm. What you would observe in a traditional recording of this action is constant motion blur until the arm stops. However, what your eye sees is both motion blur and a sharper reference of the arm throughout the motion path. MAGIC MOTION creates an image that matches the natural motion observed by the human eye.

ADDITIONAL RESOURCES

The following resources offer additional information about RED, the camera system, and the RED community:

- ▶ **RED.com:** Check the [official RED website](#) for the latest information about RED products.
- ▶ **RED Learn Articles:** RED offers [in-depth technical articles](#) about RED cameras, post-production, and digital cinematography.
- ▶ **RED.com/downloads:** Go to the [RED Downloads page](#) to download the latest firmware, operation guides, and post-production software.
- ▶ **DSMC Toolkit:** Go to the [RED Downloads page](#) to find the DSMC Toolkit, which offers many helpful tools and resources to customize and improve your camera workflow.
- ▶ **Support.red.com:** Check the [RED SUPPORT site](#) for FAQs, or to file a support ticket.
- ▶ **Bomb Squad Support:** For more information, contact your Bomb Squad representative.
- ▶ **In-Camera Help:** Select the **Help** button on an in-camera screen to open up the help for that screen.
- ▶ **Reduser.net:** Discuss all things RED on the [REDUSER](#) third-party forum.

02

CAMERA SYSTEM COMPONENTS



*EPIC-M RED
DRAGON Kit*

This section provides an overview of the camera system components, including:

- ▶ “BRAIN” on page 15
- ▶ “Media Modules” on page 16
- ▶ “REDMAG and RED MINI-MAG Systems” on page 18
- ▶ “Adaptor Modules” on page 19
- ▶ “RED Batteries and Chargers” on page 22
- ▶ “Other Modules” on page 22
- ▶ “Displays and Electronic Viewfinders” on page 25
- ▶ “LEMO Adaptors” on page 28
- ▶ “Camera Control Modules” on page 29
- ▶ “Lens Mounts” on page 32
- ▶ “DSMC Interchangeable OLPFs” on page 33
- ▶ “Rails, Mounts, Tactical Gear, and Cables” on page 33

WARNING: Modules, displays, and accessories are NOT HOT SWAPPABLE, meaning that you cannot remove or install the item while the camera is turned on. Before installing or removing a module, display, or accessory, you MUST turn off the camera. Failure to do so may result in damage to the item or camera that is not covered under warranty.

NOTE: Availability of components listed in this chapter is subject to change at any time.

ADDITIONAL RESOURCES

For more information on power and media, see the following guides, available at www.red.com/downloads:

- ▶ [DSMC Power Operation Guide](#)
- ▶ [DSMC Media Operation Guide](#)

BRAIN

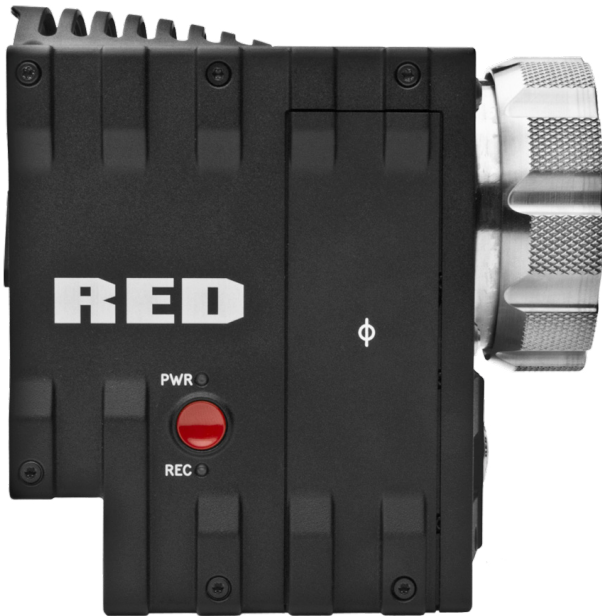

EPIC BRAIN (Side)

The DSMC BRAIN® is the image processing center of the camera system and supports power, media, and other modules.

BRAIN CONTROL: PWR/REC KEY

- ▶ Fully press and hold the **PWR/REC** key for two (2) seconds to turn on/off.
- ▶ When the camera is on, fully press and then release the **PWR/REC** key to toggle record start/stop.

BRAIN LEDS

This section describes the LED functions for the camera.

LED	COLOR/FLASHING	DESCRIPTION
Power Status LED (PWR)	Off	No power present
	Green	Power present; camera on
	Amber flashing	Power present; 5–10 min of battery time left
	Amber	Power present; camera booting
	Red flashing	Power present; < 5 min of battery time left
	Red	Power present; camera off
Record Status LED (REC)	Off	No media present
	Green	Ready to record
	Amber	Finalizing
	Red flashing (slow)	Recording; 25% media left
	Red flashing (fast)	Recording; 5% media left
Power Status LED (PWR) and Record Status LED (REC)	Both green flashing	Firmware update in progress
	Both red flashing	Firmware update error

MEDIA MODULES

This section describes the media modules. RED offers the following media modules:

ITEM	PART NUMBER
DSMC 1.8" SSD Side Module	720-0013
DSMC 1.8" SSD Side Module (DRAGON) ¹	N/A
Carbon Fiber DSMC 1.8" SSD Side Module (DRAGON) ²	N/A
RED MINI-MAG® Side SSD Module	720-0021
Carbon Fiber RED MINI-MAG Side SSD Module ²	N/A
Rear SSD Module	720-0009

1. The DSMC 1.8" SSD Side Module (DRAGON) is only available with the purchase of a RED DRAGON sensor-based BRAIN.

2. Carbon fiber side SSD modules are only available with the purchase of a carbon fiber BRAIN.

SIDE SSD MODULES



RED MINI-MAG Side SSD Module

Media modules attach to the camera to enable the use of RED MINI-MAG or REDMAG™ 1.8" SSD media. Both side SSD module systems have the same EVF/LCD LEMO® connector, user keys, and REC button.

SIDE SSD MODULE CONNECTOR

CONNECTOR	CONNECTOR TYPE	CONNECTOR FUNCTION
EVF/LCD	N/A	Power and external monitoring support for an electronic viewfinder or display

WARNING: The side SSD modules are NOT HOT SWAPPABLE, meaning you cannot remove or install modules while the camera is turned on. Before installing or removing modules you MUST turn off the camera. Failure to do so may result in damage to the module or camera that will not be covered under warranty.

For more information, see the [DSMC Media Operation Guide](http://www.red.com/downloads), available at www.red.com/downloads.

RED DSMC OPERATION GUIDE: EPIC/SCARLET

SIDE SSD MODULE CONTROLS

#	CONTROL	DESCRIPTION
1	User Key 1	Programmable key User Key 1 + 2 Press: Eject Media
2	REC button	Programmable key Full Press: Record Toggle Half Press: AF Start
3	User Key 2	Programmable key User Key 1 + 2 Press: Eject Media

REAR SSD MODULE



Rear SSD Module

The Rear SSD Module secures to the back of a Module Adaptor or a +1 Adaptor Module to serve as a rear location for recording to a REDMAG 1.8" SSD.

For more information, see the [DSMC Media Operation Guide](http://www.red.com/downloads), available at www.red.com/downloads.

REDMAG AND RED MINI-MAG SYSTEMS



RED MINI-MAG (120GB)

REDMAG 1.8" SSDs and RED MINI-MAG® SSDs deliver fast and reliable recording options for your camera. A RED STATION® enables you to connect media to your computer for offloading and editing.

RED offers the following RED MINI-MAG SSDs and compatible RED STATIONS:

ITEM	PART NUMBER	REQUIRED FIRMWARE
RED MINI-MAG (120GB)	750-0075	v5.3.47 or later; or v6.0.40 or later
RED MINI-MAG (240GB)	725-0082	v5.1.47 or later
RED MINI-MAG (512GB)	725-0078	v5.1.34 or later
RED MINI-MAG (1TB) ¹	725-0081	v5.3.34 or later

1. The RED MINI-MAG 1TB can take up to 20 seconds to mount to a computer or a camera.

RED offers the following REDMAG 1.8" SSDs and compatible RED STATIONS:

ITEM	PART NUMBER
REDMAG 1.8" SSD (48GB)	750-0044
REDMAG 1.8" SSD (64GB)	750-0025
REDMAG 1.8" SSD (128GB) ¹	750-0021
REDMAG 1.8" SSD (240GB) ²	750-0061
REDMAG 1.8" SSD (256GB) ¹	750-0026
REDMAG 1.8" SSD (512GB) ¹	750-0037
RED STATION REDMAG 1.8"	750-0006
RED STATION REDMAG 1.8" (MINI)-ESATA	750-0035
RED STATION REDMAG 1.8" (MINI)-USB 3.0	750-0036
RED STATION REDMAG 2.5"	750-0007

1. These REDMAG 1.8" SSDs are no longer available for purchase at red.com, but are still supported by RED.

2. The REDMAG 1.8" SSD (240GB) requires that your camera is on firmware v5.1.44 or later.

For more information, see the [DSMC Media Operation Guide](http://www.red.com/downloads), available at www.red.com/downloads.

ADAPTOR MODULES

This section describes the adaptor modules.



Module Adaptor (left) and +1 Adaptor Module (right)

Adaptor modules enable you to connect other modules to the camera for expandable functionality. The +1 Adaptor Module provides an auxiliary power port for accessories and an additional EVF/LCD port for additional monitor viewing and output.

Both adaptor modules also offer additional 1/4-20 mounting points on top for configuration support. Most modules require a Module Adaptor or +1 Adaptor Module to attach to your camera.

For more information, go to [“Configure Your Camera” on page 35](#).

WARNING: The Module Adaptor is NOT compatible with the +1 Adaptor Module.

WARNING: The +1 Adaptor Module IS NOT compatible with the Module Adaptor.

WARNING: DO NOT use the EVF/LCD port if a Pro I/O Module is connected to the camera.

RED offers the following adaptor modules:

ITEM	PART NUMBER
Module Adaptor	720-0008
+1 Adaptor Module ¹	720-0018

1. The +1 Adaptor Module requires that your camera is on firmware v4.08 or later.

+1 ADAPTOR MODULE CONNECTIONS



+1 Adaptor Module

#	CONNECTOR	CONNECTOR TYPE	CONNECTOR FUNCTION
1	Mounting	1/4-20 mounting	Supports bolt-on auxiliary equipment
2	EVF/LCD ¹	N/A	Custom digital video and power interconnection between the camera and RED EVF or RED LCD; Pinout not published
3	Auxiliary power out (PWR)	4-pin 0B LEMO	Supplies unregulated (+) 11.5 to 17 V battery pass-through; Connect to 2-pin LEMO accessories with the RED 4-Pin to 2-Pin Adaptor Cable; Max sustained current is 2 A
4	REDMOTE [®] dock connector	8-point POGO connector	Power and support for the REDMOTE
5	Dock connector	SEARAY connector	Supports power and communication with modules

1. **WARNING:** DO NOT use the EVF/LCD connector if a Pro I/O Module is connected to the camera.

NOTE: The default auxiliary power output setting is on. To toggle the power setting on/off, go to **Menu > Power > Power Out > +1 PWR**. The last power output setting is saved until a firmware upgrade or a factory reset.

+1 ADAPTOR MODULE ACCESSORIES

For more information, as well as a full list of EVF/LCD cables and other accessory cables, visit www.red.com.

ACCESSORY	CONNECTOR TYPE	CONNECTOR FUNCTION	PART NUMBER
4-Pin To 2-Pin Adaptor Cable ¹	4-pin 0B to 2-pin 0B LEMO	Power support for 2-pin based accessories	790-0334
Micro HDMI-to-HDMI Adaptor ²	Micro HDMI to Standard HDMI	HDMI video connection from the camera to support auxiliary EVF/LCD attachment	N/A

1. The 4-Pin to 2-Pin Adaptor Cable converts 4-pin power into a 2-pin female LEMO connection, enabling support for 2-pin based accessories from the +1 Adaptor Module or Pro I/O Module.

2. The Micro HDMI-to-HDMI Adaptor is field-replaceable.

POWER MODULES

This section describes the power modules for the camera.



Pro Battery Module (Quad)

Power modules attach to a Module Adaptor or +1 Adaptor Module to provide the camera with flexible power options for REDVOLT®, REDVOLT XL, and RED BRICK® batteries. When used in combination with a DSMC AC Power Adaptor or DSMC Side Handle, you can hot-swap batteries without interrupting recording.

RED offers the following power modules:

ITEM	PART NUMBER
Pro Battery Module (Dual)	720-0005
Pro Battery Module (Quad)	720-0006
REDVOLT XL Module ¹	740-0031
Quickplate Module	790-0343
Backpack Quickplate (Short)	790-0342
RED Quickplate	790-0008

1. The REDVOLT XL Module requires that your camera is on firmware v5.1.29 or later.

For more information, see the [DSMC Power Operation Guide](http://www.red.com/downloads), available at www.red.com/downloads.

RED BATTERIES AND CHARGERS

This section describes the RED lithium-ion batteries and charger solutions.



REDVOLT XL (left) and REDVOLT (right)

The REDVOLT, REDVOLT XL, and RED BRICK are lightweight, rechargeable lithium-ion battery cells that provide sustained power to the camera. These batteries provide long-term mobile power and attach to the camera via a power module or other RED accessory, such as the DSMC Side Handle. RED chargers replenish lost capacity for REDVOLT, REDVOLT XL, and RED BRICK batteries.

RED offers the following batteries and chargers:

ITEM	PART NUMBER
REDVOLT	740-0020
REDVOLT XL	740-0021
RED BRICK	740-0002
REDVOLT Travel Charger	790-0134
REDVOLT Charger (Quad)	740-0015
RED CHARGER	740-0006

For more information, see the [DSMC Power Operation Guide](http://www.red.com/downloads), available at www.red.com/downloads.

OTHER MODULES

This section describes other modules. RED offers the following miscellaneous modules:

ITEM	PART NUMBER
Pro I/O Module	720-0004
REDCAST Module ¹	720-0025

1. The REDCAST Module requires that your camera is on firmware v5.2.28 or later.

PRO I/O MODULE



Pro I/O Module

The Pro I/O Module brings together the essential input and output (I/O) connections in one (1) module, providing a central hub for professional audio and video components. The Pro I/O Module offers the following features:

- ▶ Centralized ports that make it easy to manage connections and cables.
- ▶ LCD/EVF port that allows you to connect an additional RED LCD or EVF.
- ▶ Customizable triggers that interface with third-party GPIO and RS232 control devices using Pro I/O cables.
- ▶ Mounting points for an additional module or a REDMOTE.
- ▶ Internal cooling system that maintains an appropriate operating temperature.

For more information, see the [Pro I/O Module Operation Guide](http://www.red.com/downloads), available at www.red.com/downloads.

REDCAST MODULE



REDCAST Module

The REDCAST™ Module allows for live 4K streaming, enabling you to capture and view action in real-time. Compatible with both EPIC DRAGON and SCARLET DRAGON cameras, the REDCAST Module uses four (4) 3G-SDI output connections to broadcast 4K video at up to 60 frames per second. Five (5) 1/4-20 mounting holes are built into the top of the module, allowing for various mechanical peripherals to be attached.

For more information, see the [REDCAST Module Operation Guide](http://www.red.com/downloads), available at www.red.com/downloads.

DISPLAYS AND ELECTRONIC VIEWFINDERS

RED offers the following displays and electronic viewfinders (EVFs):

ITEM	RESOLUTION	PART NUMBER
DSMC ² RED Touch 7.0" LCD ¹	1920 x 1136	730-0018
DSMC ² RED Touch 4.7" LCD ¹	1280 x 720	730-0019
RED Touch 5.0" LCD ²	800 x 400	730-0008
RED Touch 7.0" LCD ^{2, 3}	1920 x 1136	730-0007
RED Touch 9.0" LCD ²	1280 x 768	730-0011
RED PRO LCD 7" ²	1024 x 600	730-0009
DSMC ² RED EVF (OLED) ³	1920 x 1080	730-0021
BOMB EVF® (LCOS) ²	1280 x 784	730-0004
BOMB EVF (OLED) ²	1280 x 1024	730-0010

1. Using this display with an EPIC or SCARLET camera requires a DSMC² LEMO Adaptor B.

2. Using this display with a WEAPON camera requires a DSMC² LEMO Adaptor A.

3. RED offers multiple mounting solutions for each camera type.

3. The RED Touch 7.0" LCD requires that your camera is on firmware v5.2.38 or later.

For a full list of LCD and EVF user keys and default actions, go to [“Default Key Functions”](#) on page 217.

RED LCDS



RED Touch 7.0" LCD

RED displays provide important camera parameters on the graphical user interface (GUI) and offer a variety of monitor viewing options. RED touchscreen displays enable you to use gestures to navigate menus and adjust camera parameters. RED displays feature 8-bit RGB, 4:4:4 progressive scan, providing up to 16.7 million colors and up to 70% NTSC color gamut.

LCD PRECAUTIONS

WARNING: DO NOT use a RED display as a handle to lift or carry the camera. Damage to a RED display or other components of the camera system caused by using the display as a handle are not covered under warranty.

WARNING: DO NOT use the threaded holes in the RED Touch LCD base to mount the display to the camera.

RED DSMC OPERATION GUIDE: EPIC/SCARLET

Damage to a RED display or other components of the camera system caused by using these threaded holes is not covered under warranty.

IMPORTANT: The RED Touch LCD swivel axis has a total adjustment range of approximately 360° (180° clockwise or counterclockwise from the nominal “rear-facing” orientation). The tilt axis range of adjustment is approximately 180°. Damage to a RED display or other camera components caused by excessive force is not covered under warranty.

IMPORTANT: The DSMC² RED Touch 4.7" LCD has a tilt axis range of approximately 240° (90° forward and 150° backward). Damage to a RED display or other camera components caused by excessive force is not covered under warranty.

BOMB EVFS

The BOMB EVF (LCOS) and BOMB EVF (OLED) deliver specialized viewing solutions for the camera. The BOMB EVF (LCOS) is a high-definition, lightweight, and low-profile viewfinder. The BOMB EVF (OLED) uses OLED technology, providing deeper blacks and more color accurate images.

ITEM	CONTRAST RATIO	DIOPTER RANGE
BOMB EVF (LCOS) ¹	1000:1 typical	2.0 to -5.0.1
BOMB EVF (OLED) ¹	>10,000:1 typical	2.0 to -5.0.1

1. Using these displays with a WEAPON camera requires a DSMC² LEMO Adaptor A.

WARNING: DO NOT point the BOMB EVF (OLED) eyepiece at direct sunlight. Continued exposure to direct sunlight may damage the EVF. Point the eyepiece away from sunlight when not in use. Damage to the BOMB EVF (OLED) caused by continued exposure to direct sunlight is not covered under warranty.

BOMB EVF FEATURES



BOMB EVF (OLED)

#	FEATURE	DESCRIPTION
1	EVF connector	Custom digital video and power interconnection between the camera and RED EVF; Pinout not published
2	EVF Tally LED	When enabled, the LED illuminates red when recording; For more information, go to “Indicator” on page 103
3	Key 1	Programmable key Magnify: Toggle
4	Key 2	Programmable key Exposure Check: Toggle
5	Eyepiece heater	The integrated eyepiece heater automatically heats the eyepiece when the EVF detects a low ambient temperature

RED DSMC² OPERATION GUIDE: EPIC/SCARLET

DSMC² RED EVF

The DSMC² RED EVF (OLED) is a high definition electronic viewfinder designed as the ideal single-viewer monitoring solution. Featuring the latest OLED technology, this EVF provides an unmatched personal viewing experience with a 1080p OLED micro-display, and improved color accuracy with 30-bit RGB color representation. View and monitor your RED footage as it is intended with truer colors and deeper blacks in a larger field of view.

Engineered with OBSOLESCENCE OBSOLETE[®] in mind, the DSMC² RED EVF (OLED) is perfect for use with WEAPON, EPIC, or SCARLET cameras. RED offers multiple mounting solutions for each camera type.

WARNING: DO NOT point the DSMC² RED EVF (OLED) eyepiece at direct sunlight. Continued exposure to direct sunlight may damage the EVF. Point the eyepiece away from sunlight when not in use. Damage to the DSMC² RED EVF (OLED) caused by continued exposure to direct sunlight is not covered under warranty.

DSMC² RED EVF FEATURES



DSMC² RED EVF

#	FEATURE	DESCRIPTION
1	DSMC ² RED EVF Mount	The DSMC ² RED EVF Mount
2	EVF connector ¹	Custom digital video and power interconnection between the EVF and other RED devices; Pinout not published
3	Key 1	Programmable key Magnify: Toggle
4	Key 2	Programmable key Exposure Check: Toggle
5	Mounting point	Mounting point for the DSMC ² RED EVF Mounting Plate (Top)
6	DSMC ² RED EVF Modular Optical Block	Fully coated with a > 32° field of view

1. Not visible. Shown with the DSMC² RED EVF Mount attached.

LEMO ADAPTORS

This section describes the DSMC² LEMO Adaptor A and the DSMC² LEMO Adaptor B. These adaptors enable you to use EPIC/SCARLET displays with your WEAPON camera and use WEAPON displays with your EPIC/SCARLET camera. For more information on available displays, go to “[Displays and Electronic Viewfinders](#)” on [page 25](#).

ITEM	PART NUMBER
DSMC ² LEMO Adaptor A	720-0037
DSMC ² LEMO Adaptor B	720-0038

LEMO ADAPTOR A



DSMC² LEMO Adaptor A

The DSMC² LEMO Adaptor A makes your existing RED Touch and RED PRO displays, as well as RED EVFs, fully compatible with the WEAPON camera system. The DSMC² LEMO Adaptor A converts the pogo connection on the WEAPON camera to a legacy EVF/LCD LEMO port. The DSMC² LEMO Adaptor A is designed to attach to the primary (top), or the secondary (side) EVF/LCD port on the WEAPON camera.

When used along with the DSMC² LEMO Adaptor B, this adaptor enables you to mount a DSMC² RED Touch LCD away from the camera—to a NOGA arm or other stable mounting point.

The DSMC² LEMO Adaptor A is compatible with the BOMB EVF, (LCOS) and (OLED) models, or later.

LEMO ADAPTOR B



DSMC² LEMO Adaptor B

The DSMC² LEMO Adaptor B enables you to use a DSMC² RED Touch LCD with your existing EPIC or SCARLET camera. The DSMC² LEMO Adaptor B converts the display signal from a pogo connection to a legacy EVF/LCD LEMO port. The DSMC² LEMO Adaptor B is designed to mount to your EPIC or SCARLET camera using standard 1/4-20 mounting holes.

When used along with the DSMC² LEMO Adaptor A, this adaptor enables you to mount a DSMC² RED Touch LCD away from the camera—to a NOGA arm or other stable mounting point.

CAMERA CONTROL MODULES

This section describes the camera control modules. These devices provide a wide array of programmable buttons, controls, and other features to interact with the camera.

RED offers the following remotes and controls:

ITEM	PART NUMBER
DSMC Side Handle	720-0012
RED Switchblade-M ¹	720-0026
REDMOTE	770-0006
REDLINK® Bridge (REDLINK Development Kit)	720-0028

1. The RED Switchblade-M requires that your camera is on firmware v5.2.28 or later. Full functionality requires firmware v5.3 or later.
2. The REDLINK Bridge requires that your camera is on firmware v5.2.28 or later.

DSMC SIDE HANDLE



DSMC Side Handle

The DSMC Side Handle provides programmable menu controls and a battery compartment that holds one (1) REDVOLT battery. The DSMC Side Handle LCD display shows camera parameter values and illuminates for operation in dark environments. When a REDVOLT is installed in the DSMC Side Handle, batteries connected to other power modules may be hot-swapped, providing uninterrupted operation.

For a full list of DSMC Side Handle user keys and default actions, go to [“Default Key Functions” on page 217](#).

NOTE: Upgrading your camera to v5.3 also upgrades the DSMC Side Handle. During the upgrade, you will be instructed to shut down the camera twice so that the firmware upgrades successfully. Any DSMC Side Handle that is upgraded to v5.3 can only be used with cameras running v5.2 or later. To use a DSMC Side Handle with v5.1 after you have upgraded it to v5.3, first downgrade to v5.2, and then downgrade to v5.1.

RED SWITCHBLADE-M



RED Switchblade-M

The RED Switchblade-M is a low-profile and lightweight interface solution that mounts to the side of the camera. With a 1.7" OLED display and full navigation controls, the RED Switchblade-M grants full access to menus while optimizing the size and weight of your camera configuration.

For a full list of RED Switchblade-M user keys and default actions, go to [“Default Key Functions” on page 217](#).

NOTE: The RED Switchblade-M requires camera firmware v5.2.28 or later. Full functionality requires camera firmware v5.3 or later.

REDMOTE



REDMOTE

The REDMOTE is a remote camera control unit that attaches to the rear of the camera or rearmost expansion module. The REDMOTE may be detached from the camera or rearmost module and provide wireless remote control of the camera over the proprietary REDLINK protocol.

For a full list of REDMOTE user keys and default actions, go to [“Default Key Functions” on page 217](#).

For more information, go to [“REDMOTE Operation” on page 146](#).

IMPORTANT: To operate properly, upgrade both REDMOTE and camera firmware to the most recent version.

REDLINK BRIDGE

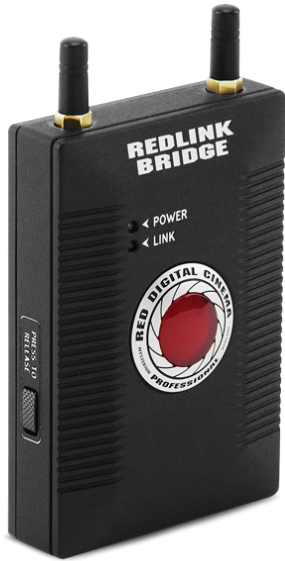

REDLINK Bridge

The REDLINK Bridge is a wireless module that provides communication support for third-party app development. The REDLINK Bridge attaches to the rear of the camera or other compatible rear module. The REDLINK Bridge is part of the REDLINK Development Kit and uses the REDLINK Command Protocol (RCP) to communicate information between the camera and your application.

For more information, see the [REDLINK Bridge Operation Guide](http://www.red.com/downloads), available at www.red.com/downloads.

NOTE: The REDLINK Bridge requires camera firmware v5.2.8 or later.

LENS MOUNTS



DSMC Mg PL Mount 2.0

RED offers the following lens mounts:

ITEM	PART NUMBER
DSMC Mg PL Mount 2.0	725-0024
DSMC Ti PL Mount	725-0022
DSMC AI Canon Mount	725-0026
DSMC Ti Canon Mount	725-0005
DSMC AI Nikon Mount	725-0006
DSMC Ti Nikon Mount	725-0007
DSMC AI Leica-M Mount	725-0008
DSMC MOTION MOUNT Ti PL ¹	725-0012
DSMC MOTION MOUNT Ti Canon ¹	725-0014

1. The DSMC RED MOTION MOUNT requires that your camera is on firmware v5.1.14 or later.

DSMC INTERCHANGEABLE OLPFs

This section describes the DSMC interchangeable optical low pass filter (OLPF) system and modular OLPFs.



DSMC Interchangeable OLPF System

NOTE: The DSMC interchangeable OLPF system is only compatible with the DRAGON sensor.

The DSMC interchangeable OLPF system is an upgrade to the optical low-pass filter (OLPF) in your EPIC DRAGON or SCARLET DRAGON. The modular mounting system enables you to remove and replace OLPFs to achieve optimal color reproduction in any lighting and environment.

For more information, go to “[DSMC Interchangeable OLPF System](#)” on page 43.

RED offers the following modular DSMC interchangeable OLPFs for EPIC DRAGON and SCARLET DRAGON:

ITEM	LABEL ¹	PART NUMBER	REQUIRED FIRMWARE
DSMC Skin Tone-Highlight OLPF	S	790-0461	v5.2.28 or later
DSMC Low Light Optimized OLPF	L	790-0462	v5.2.28 or later
DSMC H ₂ O OLPF	H	790-0472	v5.3.29 or later
DSMC Standard OLPF	D	790-0517	v6.0.37 or later
DSMC IR Pass OLPF (Color)	I	790-0473	v5.3.33 or later
DSMC Monochrome OLPF ²	M	790-0481	v5.2.9 or later
DSMC IR Pass OLPF (Monochrome) ²	I	790-0474	v5.3.33 or later

1. Visible on the top inside part of the OLPF assembly.

2. Monochrome OLPFs are for use with the DRAGON MONOCHROME sensor ONLY.

RAILS, MOUNTS, TACTICAL GEAR, AND CABLES

RED offers a wide variety of support gear, mounting platforms, cables, accessories, and other equipment. For more information, visit the [RED Store](#) at www.red.com/store.

03 | BASIC OPERATIONS

POWER OPERATIONS

This section describes the basic power operations of the camera system.

For more information, see the [DSMC Power Operation Guide](http://www.red.com/downloads), available at www.red.com/downloads.

WARNING: Modules, displays, and accessories are NOT HOT SWAPPABLE, meaning that you cannot remove or install the item while the camera is turned on. Before installing or removing a module, display, or accessory, you MUST turn off the camera. Failure to do so may result in damage to the item or camera that is not covered under warranty.

POWER INPUTS



SEARAY Connector (top) and DC IN Connector (bottom)

There are two (2) primary power inputs that provide power to the camera:

#	POWER INPUT	DESCRIPTION
1	SEARAY power connector	Provides power to the camera from attached modules
2	DC IN connector	Provides power to the camera using a DSMC Power Adaptor or certain battery modules, such as the Backpack Quickplate

NOTE: Additionally, one (1) REDVOLT® battery may be used in conjunction with the DSMC Side Handle to provide short term power and support hot-swapping of other power sources.

POWER PRIORITY

When multiple power sources are connected to the camera, power consumption is prioritized in this sequence:

1. DC power supply (DC IN connector)
2. Attached RED BRICK® (Lowest state of charge first)
3. Battery module batteries (SEARAY connector; lowest state of charge first)
4. REDVOLT battery in an attached DSMC Side Handle

POWER CONSUMPTION

The camera draws approximately 60 W when recording in 5K resolution, at 24 FPS.

Under typical conditions batteries provide the following operating time:

- ▶ **REDVOLT:** Powers the camera and accessories for approximately 30 minutes.
- ▶ **REDVOLT XL:** Powers the camera and accessories for approximately 90 minutes.
- ▶ **RED BRICK:** Powers the camera and accessories for approximately 120 minutes.

POWER STATUS

The power status of the current primary power source displays in the Lower Status Row of the graphical user interface (GUI). Navigate to the Power In menu at **Menu > Power > Power In** for the status of all connected power sources. For more information, go to “[Power Menu](#)” on page 127.

APPROVED EXTERNAL DC POWER

The camera accepts input voltages of 11.5 V to 17 V DC, and can draw a maximum current of 12 A. The camera can be powered continuously by connecting one (1) of the following to the DC IN port on the camera:

- ▶ **DSMC AC Power Adaptor**
- ▶ **RED BRICK Charger:** Requires a 2B-to-1B Power Adaptor Cable.
- ▶ **RED BRICK:** Requires a Backpack Quickplate or Battery Belt Clip (DSMC). Also supported by a RED Quickplate or RED Cradle using a 2B-to-1B Power Adaptor Cable.
- ▶ **XLR DC power source:** Requires an XLR Power Cable.

TURN ON THE CAMERA

1. Attach a power source to the camera.
The Power Status LED illuminates red, indicating that an appropriate power source is connected.
2. Press and release the **PWR/REC** key on the right side of the camera.
The Power Status LED turns off, and within five (5) seconds illuminates yellow as the camera turns on.
The Power Status LED then illuminates green to confirm that the camera is turned on and ready to use.

NOTE: The Power Status LED flashes red when there is less than five (5) minutes of operating time remaining.

TURN OFF THE CAMERA

Use one of the following methods to turn off the camera:

- ▶ Go to **Menu > Power** and select **Shutdown**.
- ▶ Press and hold **PWR/REC** until the **Shutting Down...** notification shows on the display.

NOTE: The camera turns off automatically if the supply voltage drops to 11.5 V.

CONFIGURE YOUR CAMERA

This section describes common options for configuring your camera system.

INSTALL THE DSMC SIDE HANDLE

WARNING: Before installing or removing the DSMC Side Handle, you MUST turn off the camera.

REQUIRED TOOL: T10 TORX® driver

1. Turn off the camera.
2. Use a T10 TORX driver to remove the single screw located at the bottom of the BRAIN side plate (if the side plate is installed).

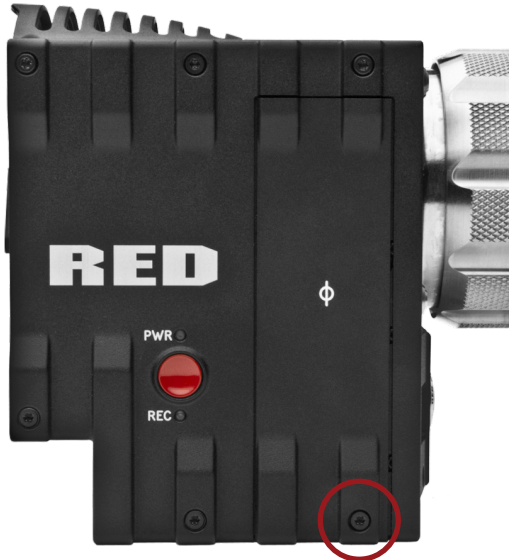

Remove the BRAIN Side Plate

3. Rotate the BRAIN side plate upwards to disengage the lip at the top of the side plate from the camera, and remove the BRAIN side plate.
4. Insert the lip on the DSMC Side Handle into the slot where the lip of the BRAIN side plate was installed.
5. Press the DSMC Side Handle down flush along the side of the camera.
6. Rotate the thumbscrew upward while applying steady pressure until tight.

REMOVE THE DSMC SIDE HANDLE

WARNING: Before installing or removing the DSMC Side Handle, you MUST turn off the camera.

REQUIRED TOOL: T10 TORX driver

1. Turn off the camera.
2. Rotate the thumbscrew downward until the DSMC Side Handle detaches from the camera body.
3. Disengage the tension lip on the DSMC Side Handle by pulling the bottom away from the camera.
4. Insert the tension lip on the BRAIN side plate into the recess on the side of the camera.
5. Install the appropriate screw at the bottom of the BRAIN side plate using a T10 TORX driver. DO NOT exceed 70 in-oz, or damage may occur.
 - **EPIC side plate screw:** M3x0.5 x 8 mm
 - **SCARLET side plate screw:** M3x0.5 x 5.5 mm

WARNING: DO NOT OVERTIGHTEN.

INSTALL THE RED SWITCHBLADE-M

WARNING: Before installing or removing the RED Switchblade-M, you MUST turn off the camera.

REQUIRED TOOL: T10 TORX driver

1. Turn off the camera.
2. Use a T10 TORX driver to remove the single screw located at the bottom of the BRAIN side plate (if the side plate is installed).
3. Rotate the BRAIN side plate upwards to disengage the lip at the top of the side plate from the camera, and remove the BRAIN side plate.
4. Insert the lip on the RED Switchblade-M into the slot where the lip of the BRAIN side plate was installed.
5. Press the Switchblade-M down flush along the side of the camera.
6. Tighten the thumbscrew until finger-tight, then engage the thumbscrew mechanism.

REMOVE THE RED SWITCHBLADE-M

WARNING: Before installing or removing the RED Switchblade-M, you MUST turn off the camera.

REQUIRED TOOL: T10 TORX driver

1. Turn off the camera.
2. Disengage the thumbscrew mechanism.
3. Loosen the thumbscrew until the Switchblade-M detaches from the camera.
4. Pull the bottom of the RED Switchblade-M away from the camera to disengage the tension lip.
5. Remove the RED Switchblade-M from the camera.
6. Insert the tension lip on the BRAIN side plate into the recess on the side of the camera.
7. Install the appropriate screw at the bottom of the BRAIN side plate using a T10 TORX driver. DO NOT exceed 70 in-oz, or damage may occur.
 - **EPIC side plate screw:** M3x0.5 x 8 mm
 - **SCARLET side plate screw:** M3x0.5 x 5.5 mm

WARNING: DO NOT OVERTIGHTEN.

INSTALL THE MODULE ADAPTOR

You must install an adaptor module on the back of the camera before you install a module.

REQUIRED TOOL: T20 TORX driver

1. Turn off the camera.
2. Remove the REDMOTE, if attached.
3. Position the Module Adaptor over the V-mount on the rear of the camera.



Install Module Adaptor

4. Apply pressure and tighten the four (4) captive screws in a cross pattern ("X" pattern) approximately two (2) turns each using a T20 TORX driver. **DO NOT FULLY TIGHTEN.**
5. Fully tighten the four (4) screws in a cross pattern ("X" pattern) using a T20 TORX driver.

WARNING: DO NOT OVERTIGHTEN.



Tighten screws

REMOVE THE MODULE ADAPTOR

REQUIRED TOOL: T20 TORX driver

1. Turn off the camera.
2. Use a T20 TORX driver to loosen the screws attaching the Module Adaptor to the camera.



3. Remove the Module Adaptor from the camera.

INSTALL THE +1 ADAPTOR MODULE

REQUIRED TOOL: T20 TORX driver

1. Turn off the camera.
2. Remove the REDMOTE, if attached.
3. Position the +1 Adaptor Module over the V-mount on the rear of the camera.



Install the +1 Module Adaptor

RED DSMC OPERATION GUIDE: EPIC/SCARLET

4. Insert the HDMI connector into the **HDMI** port on the camera.



Insert the HDMI connector to the BRAIN

5. Apply pressure and tighten the four (4) captive screws in a cross pattern ("X" pattern) approximately two (2) turns each using a T20 TORX driver. **DO NOT FULLY TIGHTEN.**

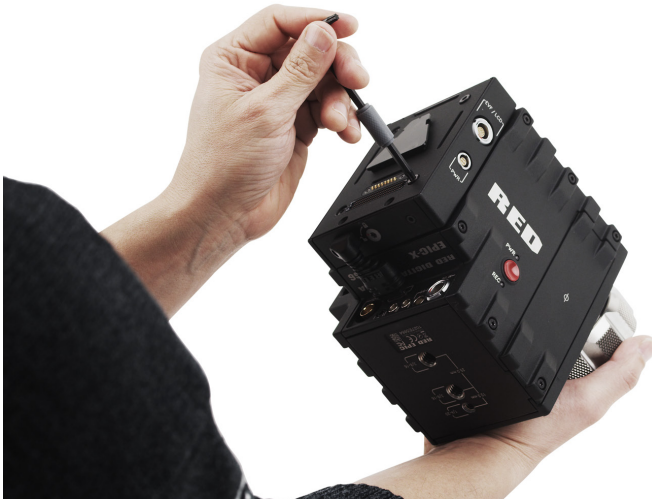

Tighten screws

6. Fully tighten the four (4) screws in a cross pattern ("X" pattern) using a T20 TORX driver.
WARNING: DO NOT OVERTIGHTEN.

REMOVE THE +1 ADAPTOR MODULE

REQUIRED TOOL: T20 TORX driver

1. Turn off the camera.
2. Loosen the four (4) captive mounting screws in a cross pattern ("X" pattern) using a T20 TORX driver.
3. Disconnect the HDMI connector from the camera.
4. Remove the +1 Adaptor Module from the camera.

ATTACH A MODULE

REQUIRED TOOL: T20 TORX driver

1. Turn off the camera.
2. Insert the lip at the top of the module into the recess at the top of the adaptor module.



Insert module lip

3. Rotate the module down flush with the rear of the adaptor module.



Press module flush

4. Apply pressure and use a T20 TORX driver to turn the lock on the bottom of the adaptor module clockwise into the **Lock** position.

REMOVE A MODULE

REQUIRED TOOL: T20 TORX driver

1. Turn off the camera.
2. Use a T20 TORX driver to turn the lock on the adaptor module counter-clockwise to the **Unlock** position.
3. Rotate the module upwards and away from the adaptor module to disengage.
4. Remove the module.

REPLACE THE HOOD SCOOP

REQUIRED TOOL: T8 TORX driver

The hood scoop on some EPIC-X and EPIC-M models extends beyond the rear plane of the camera. RED offers shorter hood scoops so that you can attach an LCD or other accessory to the mounting locations on the top of the +1 Adaptor Module.



Replace the hood scoop

To replace fan hood scoop, follow the instructions below:

1. Turn off the camera.
2. Remove the four (4) M3x0.5 x 6 mm screws holding the hood scoop using a T8 TORX driver.
3. Remove the hood scoop.
4. Position the replacement hood scoop on the camera.
5. Align the hood scoop screw holes with the threaded holes.
6. Insert and tighten the four (4) M3x0.5 x 6 mm screws in a cross pattern ("X" pattern) using a T8 TORX driver. **DO NOT FULLY TIGHTEN.**
7. Fully tighten the four (4) M3x0.5 x 6 mm cap screws evenly in a cross pattern ("X" pattern). **DO NOT** exceed 30 in-oz, or damage may occur.

WARNING: DO NOT OVERTIGHTEN.

DSMC INTERCHANGEABLE OLPF SYSTEM

This section describes the process for swapping an DSMC interchangeable OLPF.

WARNING: Read these instructions carefully and in their entirety before removing or installing a DSMC interchangeable OLPF. Damage caused to the OLPF module, camera, or sensor due to improper handling or use is not covered under warranty.

WARNING: Once a DSMC interchangeable OLPF is removed from the camera, the sensor is exposed. Improper handling of the OLPF modules or camera during this procedure may compromise the installation or cause irreparable damage to your camera or sensor.

WARNING: DO NOT allow any dirt or debris to enter the optical cavity.

WARNING: This procedure is ONLY applicable to DRAGON sensor cameras that are compatible with the DSMC Interchangeable OLPF system.

WARNING: Use only DSMC OLPFs. DO NOT use WEAPON RED DRAGON OLPFs. For any questions about OLPF compatibility, please contact your Bomb Squad representative.

SWAP A DSMC INTERCHANGEABLE OLPF

REQUIRED TOOLS: T20 TORX driver, T6 TORX driver

1. Turn off the camera.
2. Remove any modules, cables, or other accessories that may interfere with operations.
3. Loosen and remove the four (4) M4x0.7 x 8 mm lens mount screws in a cross pattern ("X" pattern) using a T20 TORX driver.

NOTE: The DSMC Mg PL Mount 2.0 has captive screws that are not removable from the mount.

NOTE: Screw removal may require a large handle T20 TORX driver and additional leverage.

4. Remove the lens mount.



Remove Lens Mount

5. Use a damp, lint-free cloth to gently wipe down the area around the lens mount and OLPF module. Remove as much dust and debris as possible.

RED DSMC OPERATION GUIDE: EPIC/SCARLET

6. Remove the four (4) M2x0.4 x 4 mm OLPF module screws (P/N 600-0224) in a cross pattern ("X" pattern) using a T6 TORX driver.



*Remove OLPF
module screws*

7. Remove the OLPF module and place it in its protective case.



*Remove the OLPF
module*

RED DSMC OPERATION GUIDE: EPIC/SCARLET

8. Use an LED light to ensure that the optical cavity is clean and free from dust or debris.



Ensure optical cavity is clean and free of debris

9. Ensure the desired OLPF module is clean and free of debris.
10. Insert the OLPF module.
11. Replace and loosely tighten the four (4) M2x0.4 x 4 mm OLPF module screws (P/N 600-0224) in a cross pattern ("X" pattern) using a T6 TORX driver. DO NOT FULLY TIGHTEN.



Replace the OLPF module and screws

12. Fully tighten the four (4) OLPF module screws in a cross pattern ("X" pattern) using a T6 TORX driver. DO NOT exceed 30 in-oz, or damage may occur.
WARNING: DO NOT OVERTIGHTEN.
13. Replace the lens mount.

RED DSMC OPERATION GUIDE: EPIC/SCARLET

14. Replace and loosely tighten the four (4) M4x0.7 x 8 mm lens mount screws in a cross pattern ("X" pattern) using a T20 TORX driver. DO NOT FULLY TIGHTEN.

NOTE: The DSMC Mg PL Mount 2.0 has captive screws that are not removable from the mount.

15. Fully tighten the four (4) lens mount screws in a cross pattern ("X" pattern) using a T20 TORX driver. DO NOT exceed 350 in-oz, or damage may occur.

NOTE: DO NOT OVERTIGHTEN.

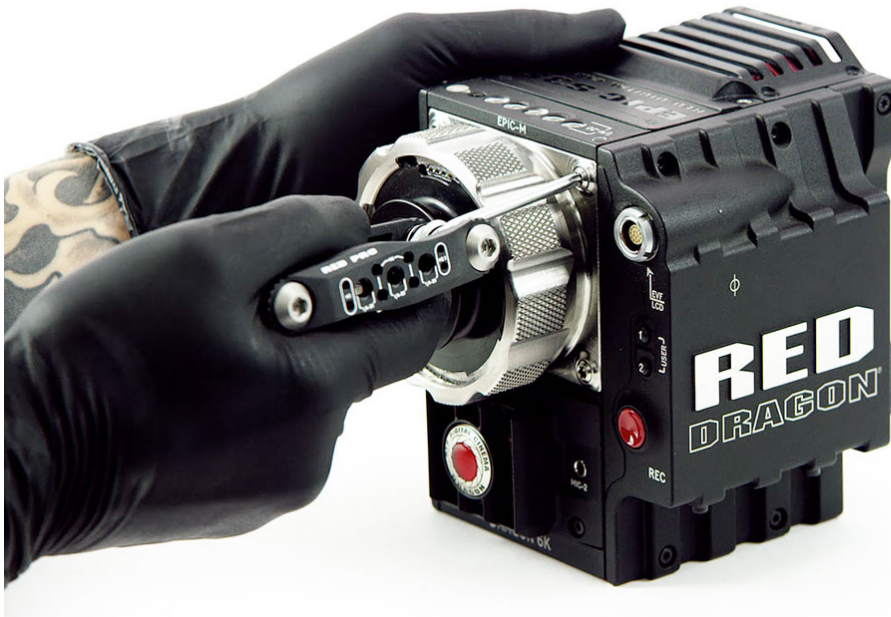

Replace Lens Mount

16. Turn on the camera.
17. Go to **Menu > Settings > Maintenance > OLPF**.
18. Select the installed OLPF from the **Type** drop-down menu.

IMPORTANT: Ensure the correct OLPF type is selected from the drop-down menu. Failure to select the correct OLPF type will affect color accuracy. For more information, go to "OLPF" on page 121.



OLPF Type menu selection

VERIFY INSTALLED OLPF

You can see which DSMC interchangeable OLPF is installed even when a lens mount is attached. The OLPF type is labeled in two (2) locations on each DSMC interchangeable OLPF.



OLPF Type Labels

#	LOCATION ON ASSEMBLY	LABEL	VISIBLE WITH
1	Top inside	Identifier symbol, such as (S)	PL mounts
2	Front bottom	OLPF type	All mounts

USE A TRIPOD OR MONOPOD

This section describes the camera mounting points and mounting equipment for use with a tripod or monopod. The camera is equipped with two (2) 3/8-16 mounting holes and one (1) 1/4-20 mounting hole on the bottom of the camera. These mounting points are designed for use with a variety of mounting plates and hardware, to support tripods and other support systems.

WARNING: Ensure that the tripod, monopod, or support system is designed and rated to handle the weight of your camera configuration. RED is not responsible for any damage caused by using a tripod, monopod, mount, or support system that does not provide sufficient support.

WARNING: DO NOT use excessive force to mount a support accessory, as this may damage the screw threading. RED offers the following products for use with tripods and other support systems:

ITEM	PART NUMBER
Mounting Plate (DSMC)	790-0094
DSMC Modular Assault Plate Pack	790-0224
DSMC Quick Release Platform Pack	790-0183
Quick Release Platform Pack (Bolt-On)	790-0078
Quick Release Platform (Dovetail)	790-0079
Quick Release Platform (Mini)	790-0390
Dovetail Mounting Plate (Long)	790-0083
Dovetail Mounting Plate (Short)	790-0084

For more information, visit the [RED store](http://www.red.com/store) at www.red.com/store.

VIDEO MONITOR OUTPUTS

The monitoring path converts RAW sensor data to a white balanced 12-bit depth 1920 x 1080 pixel RGB 4:4:4 video signal. The signal may be modified using ISO, White Balance, or other RGB color space adjustments. The signal is then scaled and gamma-corrected to provide monitor outputs at 10-bit depth in 4:2:2 YCC or 8-bit depth in 4:4:4 RGB.

The camera offers the following monitor outputs:

- ▶ **EVF/LCD:** Supports a RED EVF or LCD display.
- ▶ **HD-SDI:** Provides a 720p or 1080p output suitable for monitoring or recording to an external VTR or DDR device. It may be configured for 10-bit LIN (VIDEO) or 10-bit LOG (FILM) encoded data.
- ▶ **HDMI:** Provides a 480p, 720p, or 1080p output suitable for monitoring via a Windows® monitor or most HDTVs.

VIDEO MONITOR CATEGORIES

Video monitor outputs are separated into three (3) categories:

- ▶ **VIEWFINDER:** The Upper Status Row, Live Action Area, and Lower Status Row display. Default output is the EVF/LCD connector located on the front face of the side SSD module. If an EVF or LCD is not connected, you can transfer the VIEWFINDER output to either the HDMI or 3G-SDI (HD-SDI) output from the camera.
- ▶ **PROGRAM/Clean:** None of the graphic overlays display.
- ▶ **PREVIEW:** The Live Action Area and associated graphic overlays display.

For more information about changing the video monitor category of your monitor, go to [“Monitor Control” on page 72](#).

RECORD

Perform one of the following actions to begin recording:

- ▶ Press **PWR/REC** on the camera.
- ▶ Press **REC** on an attached side SSD module.
- ▶ Press **REC** on an attached DSMC Side Handle.
- ▶ **Double-Tap Right 25% to Record** on an attached touchscreen display (when enabled).

NOTE: To enable Double-Tap Right 25% to Record, go to **Menu > Settings > Display > Monitor Control > Advanced > Gestures**.

RECORD VIA HD-SDI OR HDMI

This section describes how to record via HD-SDI or HDMI through simultaneous record (recording to an SSD and an external recorder at the same time) or external record only. For more information on how to enable default menus for a external recorder, go to [“Cannot Use Touchscreen or DSMC Side Handle” on page 178](#).

SIMULTANEOUS RECORD

You can record simultaneously to an external recorder and a RED SSD. To record simultaneously, follow the instructions below:

1. Connect the camera to an external recorder with an HD-SDI or HDMI cable.
2. Ensure an SSD is inserted in the camera and formatted.
3. Begin recording.

EXTERNAL RECORD

You can record to an external recorder without recording to an SSD. To record to an external device only, follow the instructions below:

1. Connect the camera to an external recorder with an HD-SDI or HDMI cable.
2. Ensure the SSD is ejected.
3. Go to **Menu > Settings > Recording > Mode**.
4. Select **External** from the **Storage** drop-down menu.
5. Begin recording.

04 | BASIC MENUS AND CONTROLS

This chapter describes the Basic Menus and controls, including:

- ▶ “Upper Status Row (Basic Menu)” on page 51
- ▶ “Live Action Area” on page 55
- ▶ “Lower Status Row” on page 56
- ▶ “Navigation Controls” on page 61

GUI MENU INTRODUCTION

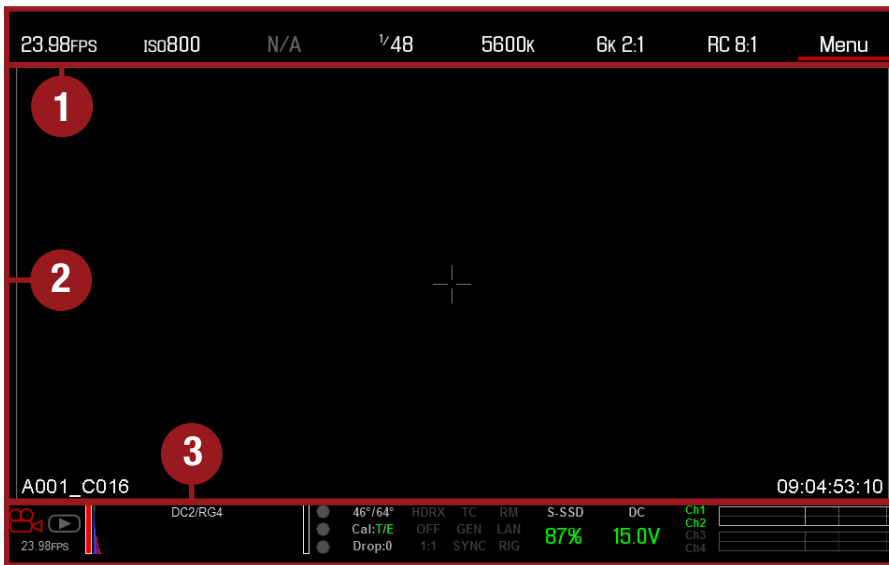

GUI Control Menu

This section describes the structure and layout of the graphical user interface (GUI) that overlays the video monitor signal. Advanced GUI menu controls enable convenient access to menus, overlays, and other critical camera information. Functionality varies based on monitor output type and firmware version.

The GUI menu is separated into three (3) main sections:

#	ITEM	DESCRIPTION
1	Upper Status Row (Basic Menu)	Easy access to primary camera capture parameters. Go to “Upper Status Row (Basic Menu)” on page 51.
2	Live Action Area	Live camera recording view, overlays, guides, and more. Go to “Live Action Area” on page 55.
3	Lower Status Row	Critical camera parameters, record/playback modes, media and power status, and audio meter. Go to “Lower Status Row” on page 56.

UPPER STATUS ROW (BASIC MENU)

The Upper Status Row displays basic project parameters. The currently selected parameter in the Upper Status Row is underlined with a red bar. The Upper Status Row is also known as the Basic Menu.

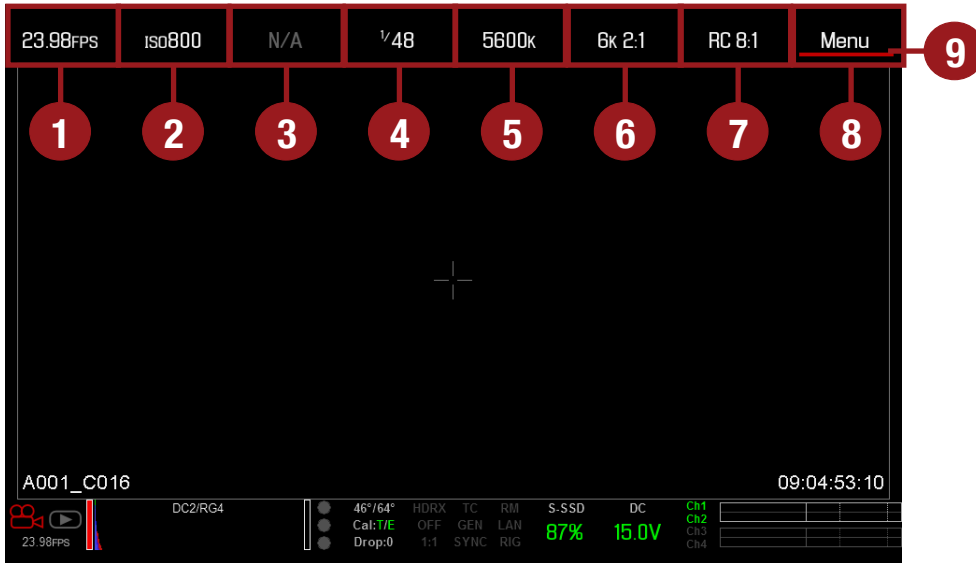

Upper Status Row

The Upper Status Row includes the following GUI elements:

#	ITEM	DESCRIPTION	FOR MORE INFORMATION, GO TO...
1	Frame Rate (FPS)	Recording frame rate	“Frame Rate” on page 84
2	ISO	Camera sensitivity	“ISO” on page 80
3	Aperture	Lens aperture (F stop) information	“Aperture” on page 54
4	Exposure (Shutter)	Integration time or shutter angle	“Exposure” on page 89
5	Color Temperature	White balance	“Color Temperature” on page 83
6	Resolution	Record resolution	“Format” on page 90
7	REDCODE®	REDCODE compression setting	“REDCODE” on page 54
8	Menu	Access advanced settings	“Advanced Menus” on page 68
9	Cursor	Indicates currently selected Upper Status Row element	N/A

ACCESS ADVANCED MENUS

For every Upper Status Row item, (except for REDCODE) you can select the **Advanced...** button to access the related menu in the Advanced Menus.

For example, select **Advanced...** in the Frame Rate menu to open **Menu > Settings > Project > Frame Rate**.

For more information about Advanced Menus, go to [“Advanced Menus” on page 68](#).

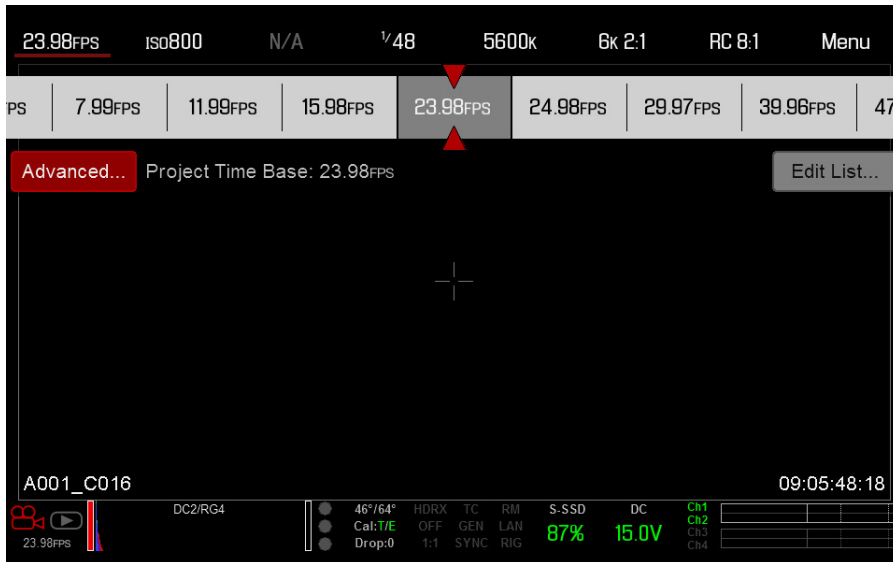

Select “Advanced...”
Button



“Advanced...” Menu

FEATURE: EDIT LIST

Select the **Edit List...** button in the Upper Status Row menus to change the values that display for each setting. For example, if you open the Frame Rate menu and select **Edit List...**, the camera lets you add or remove values to available frame rates.

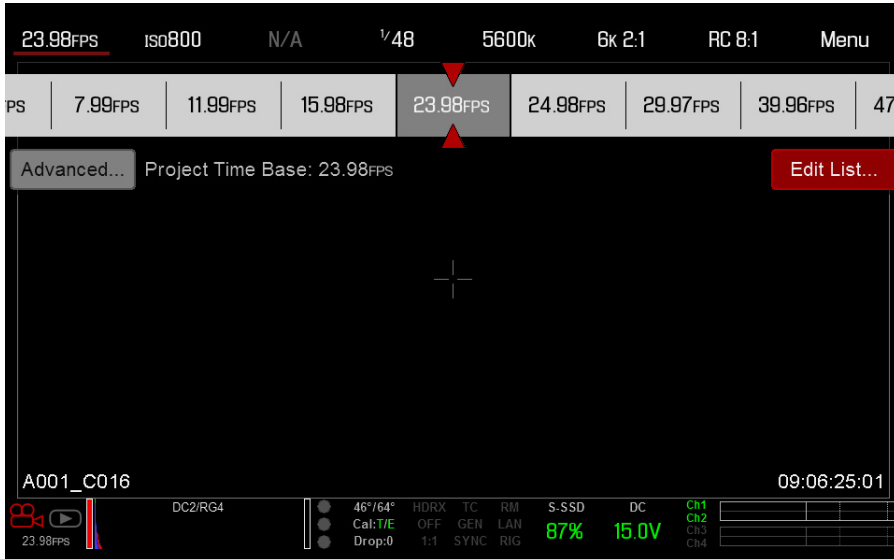

Select "Edit List..." Button

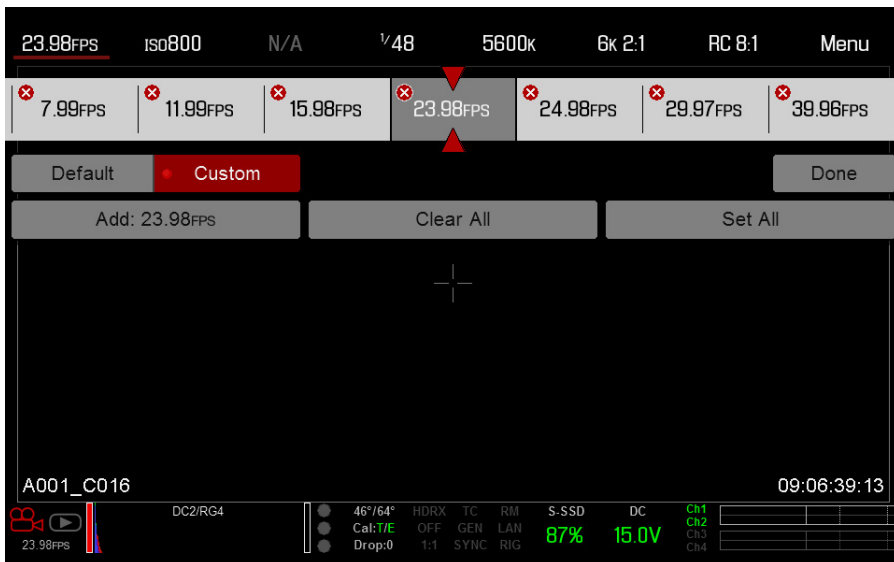

"Edit List..." Menu

APERTURE

The aperture (also known as the T stop or F stop) parameter displays when a compatible mount and lens are installed. The aperture controls the depth of field of the image and, in combination with the shutter speed/angle setting, controls the amount of light that reaches the sensor (exposure).

- ▶ Increasing the aperture to a higher number increases the depth of field, but reduces the exposure (brightness).
- ▶ Decreasing the aperture to a lower number decreases the depth of field, but increases the exposure (brightness).

RED DSMC PL MOUNT INSTALLED

The current aperture of the attached lens displays when a DSMC® PL mount is installed and a supported lens equipped with Cooke® S4/i® system is attached.

DSMC NIKON MOUNT AND CANON MOUNT INSTALLED

The Aperture menu is visible when a DSMC Nikon® Mount, DSMC Canon® Mount, or DSMC RED® MOTION MOUNT Ti Canon is installed and a supported lens is attached. This enables you to adjust the aperture of the attached lens.

Select the **Advanced...** button to access the **Menu > Settings > Setup > Lens** screen. For more information, go to “Autofocus Modes (DSMC, Nikon, and Canon Mounts)” on page 130.

REDCODE

Select the target REDCODE compression ratio for your project.

If the camera is able to achieve the target compression ratio, the compression ratio displays in white. If the camera is unable to achieve the target compression ratio, the compression ratio displays in yellow.

The current compression ratio is automatically recalculated when changes are made to the project resolution, aspect ratio, anamorphic setting, frame rate, HDRx mode, media, or the target REDCODE compression ratio.

- ▶ **MYSTERIUM-X**: Range is 3:1 to 18:1. Default is 8:1.
- ▶ **RED DRAGON**: Range is 2:1 to 22:1. Default is 8:1.

For maximum available REDCODE values, see the [DSMC Media Operation Guide](http://www.red.com/downloads) at www.red.com/downloads.

LIVE ACTION AREA

The Live Action Area contains the recorded image area plus Surround View look around area, plus overlays for Frame Guides, Safe Action/Safe Title, Clip Name, and Timecode values. The color of each overlay can be customized to maximize the contrast between the guide(s) and scene being captured.

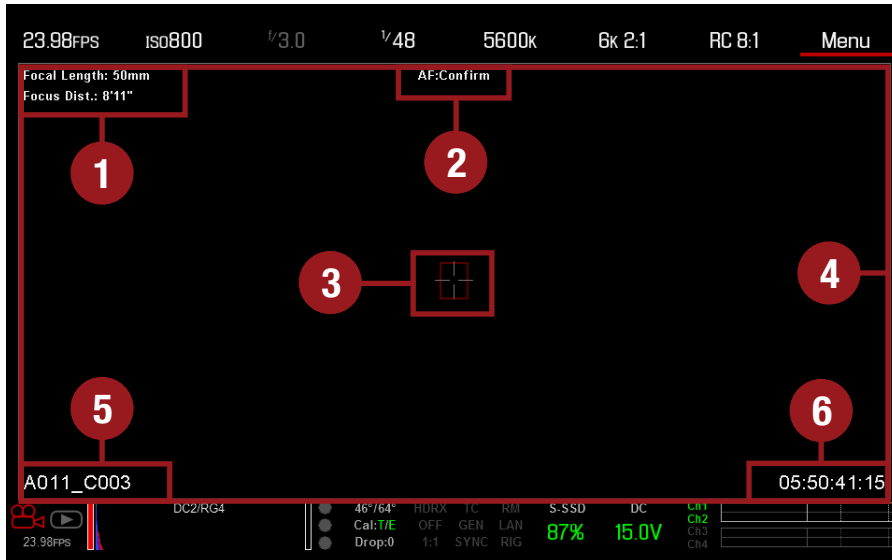

Live Action Area

The Live Action Area includes the following GUI elements:

#	ITEM	DESCRIPTION	FOR MORE INFORMATION, GO TO...
1	Lens Information	Lens information when using supported Canon, Nikon, or Cooke lenses	“Lens Information” on page 55
2	AF Status	Currently selected auto focus mode	“Focus Menu” on page 128
3	Center Crosshair and Spot Focus Guide	Crosshair: Center of selected guide Reference guides: Safe Action/Safe Title, Picture Center, Grid Overlay	“General Tab” on page 79
4	Frame Guides	Record or sensor projection area	“Guides” on page 78
5	Clip Filename	Filename of the clip being recorded, or filename of the next clip to be recorded	DSMC Media Operation Guide
6	Timecode Value	Current timecode value	“Timecode” on page 90

LENS INFORMATION

This section describes the lens information displays when a supported lens is attached.

PL LENSES

Displays the focal length and focal distance when a DSMC PL mount is installed and a lens with the Cooke S4/i system (or equivalent) is attached. For more information, go to [“Lens Tab” on page 78](#).

CANON AND NIKON LENSES

Displays the focal length and focal distance when a DSMC Canon Mount or a DSMC Nikon Mount is installed and an electronically supported lens is attached. When AF is set to Manual or Confirm mode, the focus distance displays as a pair of Near–Far distances. When in AF mode, a single estimated focus distance displays.

The focal length and focal distance values and range vary depending on the attached lens. When the focal length of the lens changes, the current values displays. For more information, go to [“Lens Tab” on page 78](#).

LOWER STATUS ROW

The Lower Status Row provides access to key system information and camera values.

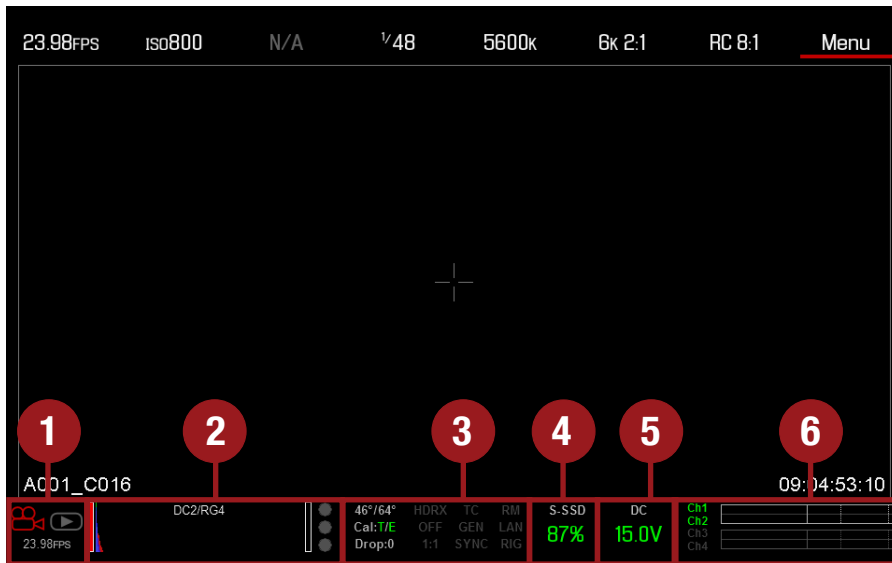

Lower Status Row: Motion

The Lower Status Row in Motion mode provides key system information and camera values, including:

#	LOWER STATUS ROW ITEM	SUB-ITEM/DESCRIPTION	FOR MORE INFORMATION, GO TO...
1	Camera Mode	Swipe up to toggle Motion/Stills/Playback modes	“Camera Mode” on page 57
2	Histogram	Histogram; tap to access the Tools menu	“Histogram” on page 58
3	System Status Indicators	Tap to access the System Status menu	“System Status” on page 120
		Temperature: Camera sensor and core temperature, respectively	“Sensor Calibration” on page 110
		Cal: T/E	“CAL: T/E Indicator” on page 58
		HDR: Displays when HDRx mode is on	“HDRX Menu” on page 128
		False Color Mode: Displays modes	“False Color Modes” on page 69
		Magnify: Tallies 1:1 if magnify is selected	“Magnify” on page 71
		Timecode	“Timecode” on page 156
		Genlock	“GEN Indicator” on page 59
		Sync	“SYNC Indicator” on page 59
		RM: Indicates link to REDMOTE	“REDMOTE Operation” on page 146
		LAN	“LAN Indicator” on page 59
		RIG: Indicates 3D rig metadata is present	N/A
4	Media Status	Media location and remaining media capacity; tap to access the Media Menu	“Media Menu” on page 123
5	Power Status	DC voltage in or % of remaining battery capacity; tap to access the Power menu	“Power Status” on page 59
6	Audio Meter	Audio input selection and levels; tap to access the Audio menu	“Audio Meter Levels” on page 145

CAMERA MODE

The Camera Mode allows you to seamlessly toggle between Motion mode, Stills mode, and Playback. To select a camera mode, select the **Camera Mode** icon in the Lower Status Bar, swipe up, and select a camera mode.

NOTE: Setting adjustments made in Stills mode do not affect the settings in Motion mode, and vice versa.

NOTE: You can also switch between Stills and Motion mode by using the Motion/Stills switch on the DSMC Side Handle and REDMOTE.

You can select the following camera modes:

- ▶ “Motion Mode” on page 57
- ▶ “Stills Mode” on page 57
- ▶ “Playback Menu” on page 124

MOTION MODE

Motion mode optimizes your camera settings for capturing motion. This mode defaults the camera to Continuous Record. Motion mode includes the following features:

- ▶ Motion recording modes:
 - “Continuous Record” on page 98
 - “Internal Timelapse Timer” on page 98
 - “Frame Trigger” on page 98
 - “Speed Ramp Mode” on page 99
 - “REDCODE Burst” on page 99
- ▶ Swipe-Up Shortcuts
 - Camera Mode
 - Tools
 - Media
 - Power

NOTE: For more information, go to “Swipe-Up Menu” on page 62.

- ▶ Default Motion Preset (RED)

NOTE: For more information, go to “Default Key Functions” on page 217.

STILLS MODE

Stills mode optimizes your camera settings for capturing stills. In Stills mode, the camera defaults to 6K 3:2, REDCODE 3:1, Auto Exposure Single Shot, and Multi-Shot mode. Stills mode includes the following features:

- ▶ Stills recording modes:
 - “Multi-Shot” on page 100
 - “Motion + Stills” on page 101
- ▶ Swipe-Up Shortcuts:
 - Auto Exposure
 - Auto Focus
 - Record Mode

NOTE: For more information, go to “Swipe-Up Menu” on page 62.

- ▶ Default Stills Preset (RED)

NOTE: For more information, go to “Preset Default Key Functions” on page 220.

HISTOGRAM

This section describes the elements that comprise the Histogram section in the Lower Status Row. This section of the GUI helps ensure that recorded footage is properly exposed.

Tap the Histogram in the Lower Status Row to access the Tools menu. For more information, go to [“Tools” on page 69](#).

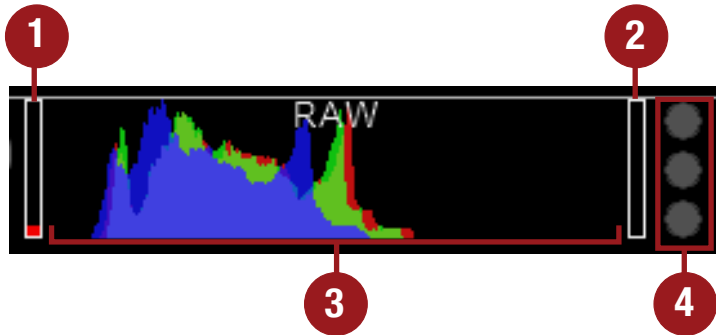

Histogram (Exposure)

#	ITEM	DESCRIPTION
1	RAW Level Bar (left) ¹	Also known as a “goal post”. Displays the amount of pixels in the image that are underexposed (noise)
2	RAW Level Bar (right) ¹	Also known as a “goal post”. Displays the amount of pixels in the image that are overexposed (clipping)
3	RGB Histogram	Provides a visual representation of exposure and sensor data levels for Red, Green, and Blue channels; meter is affected by White Balance, ISO, and VIEW/LOOK settings
4	RAW Clip Meter	Also known as “traffic lights”. Provides a visual representation of exposure and sensor data levels for Red, Green, and Blue channels; Circles (traffic lights) will light up when clipping occurs

1. The RAW Level Bars display the amount of pixels in the image that are noisy or clipped in relation to the total number of pixels in the image. For example, if the left RAW Level Bar is 1/8 of the total height, that means that approximately 1/8 of the total pixels in the total image are at an exposure level that is at risk of displaying noise when pushed to higher ISO or FLUT® values in post production.

SYSTEM STATUS INDICATORS

This section describes the colors and behavior of the System Status indicators in the Lower Status Row. Tap the System Status indicators in the Lower Status Row to access the System Status menu. For more information, go to [“System Status” on page 120](#).

CAL: T/E INDICATOR

The CAL: T/E indicator shows changes to temperature (T) or exposure (E) in relation to the active calibration map. If the temperature or exposure change significantly, black shade the camera at the desired temperature and exposure. Failure to properly calibrate the sensor may reduce image quality.

- ▶ **Green:** Sensor temperature or exposure are properly calibrated for current settings.
- ▶ **Yellow:** Slight change in sensor temperature or exposure.
- ▶ **Red:** Significant change in sensor temperature or exposure.
- ▶ The – and + indicate whether the sensor temperature or exposure has decreased or increased, respectively.

NOTE: T and E indicators change colors independently of each other.

TC INDICATOR

The TC indicator shows the current timecode status.

- ▶ **Grey:** No analog timecode is detected.
- ▶ **Red:** Analog timecode is detected but not enabled.
- ▶ **Green:** Analog timecode is used to jam the time of day timecode.

For more information, go to [“Timecode, Genlock, Multi-Camera Setup” on page 156](#).

GEN INDICATOR

The GEN indicator shows the current genlock status.

- ▶ **Grey:** No genlock signal is detected, or the signal cannot cross-lock to project (24.00 FPS vs. 23.98 FPS).
- ▶ **Red:** During process of sync, or genlock is lost while recording.
- ▶ **Green:** A genlock signal matching the current HD-SDI monitor rate is locked.
- ▶ **Yellow:** Timing is cross-locked to compatible but not matching monitor rate. For example, genlock is 24.00 FPS, and HD-SDI monitor rate is 25.00 FPS.

NOTE: When the GEN indicator is yellow, DO NOT perform 3D operation. This warns that genlock source settings and camera settings are not aligned, so phasing of the sync between cameras is not guaranteed.

For more information, go to [“Timecode, Genlock, Multi-Camera Setup” on page 156](#).

SYNC INDICATOR

The SYNC indicator shows the current sensor sync status, based on genlock.

- ▶ **Grey:** The sensor sync mode is not set to genlock.
- ▶ **Red:** The sensor sync mode is set to genlock, but is not locked to a genlock signal. This may occur if genlock or sensor sync is lost while recording.
- ▶ **Green:** The sensor sync mode and HD-SDI monitor rate are locked to a compatible genlock signal.

For more information, go to [“Timecode, Genlock, Multi-Camera Setup” on page 156](#).

LAN INDICATOR

The LAN indicator shows the current status of an external LAN connection through the Gig-E port.

- ▶ **Grey:** External control of the camera is not enabled.
- ▶ **Yellow:** If the LAN indicator is yellow, external camera control is not possible. For more information, go to [“Cannot Control Camera Externally” on page 176](#).

POWER STATUS

The Power Status element displays the current supply voltage or remaining battery capacity. Tap the Power Status element to access the Power menu. For more information, go to [“Power Menu” on page 127](#).

DC IN SUPPLY VOLTAGE

When powering the camera via DC power, the current voltage displays. When powering the camera using batteries, the remaining battery capacity displays. The remaining capacity is indicated by the following colors:

- ▶ **Green:** 12.0 V and up
- ▶ **Yellow:** 11.8 V to 11.9 V
- ▶ **Red:** 11.6 V to 11.7 V

NOTE: The camera turns off automatically if the supply voltage drops to 11.5 V.

BATTERY TIME REMAINING

When using a REDVOLT or REDVOLT XL battery, the power status displays the location of the power source (example: SH: DSMC Side Handle; RM: Rear Module) and the remaining battery capacity. When using a RED BRICK battery connected to DC IN, the power status displays BRICK and the remaining battery capacity.

The color of the displayed battery capacity represents the amount of time remaining:

- ▶ **Green:** >10 minutes
- ▶ **Yellow:** 5 to 10 minutes
- ▶ **Red:** <5 minutes

NAVIGATION CONTROLS

This section describes basic controls for navigating the camera menus.

TOUCHSCREEN NAVIGATION

RED Touch displays offer intuitive menu control and four (4) programmable buttons.



RED Touch 7.0" LCD

#	RED TOUCH BUTTON	DESCRIPTION
1	User Key 1	Toggle 1:1 Magnify on/off
2	Up Button	Increase display brightness
3	Down Button	Decrease display brightness
4	User Key 2	Toggle Exposure Mode on/off

NOTE: RED Touch display keys are programmable. For more information, go to [“Key Mapping” on page 103](#).

Navigate the menus using a touchscreen by using the following gestures:

- ▶ **Tap:** Tap has many functions:
 - Tap to select a Basic Menu, submenu, or button.
 - If a menu is open, tap anywhere outside the menu to save any changes and close the menu.
 - Tap the right or left regions of the touchscreen to access the programmable soft keys.
- ▶ **Swipe:** Swipe to select different values in spinners or drop-down menus. For more information, go to [“Swipe-Up Menu” on page 62](#).
- ▶ **Double-Tap:** If the monitor is in Clean mode, changes to Overlay mode.
- ▶ **Hold:** Tap and hold an icon to bring up an advanced interface display.
- ▶ **Pinch:** Move two (2) fingers apart/together to increase/decrease the size of the image. By default, this gesture is disabled.

For more information, go to [“Gestures” on page 76](#).

RED DSMC OPERATION GUIDE: EPIC/SCARLET

SWIPE-UP MENU

The Swipe-Up Menu is available in the Lower Status Row on RED Touch displays and provides Swipe-Up Shortcuts for Motion mode, Stills mode, and Playback.

NOTE: Swipe-Up shortcuts are available on v6.0 firmware or later.

For example, select the **Camera Mode** icon in the Lower Status Bar, swipe up, and select a **Camera Mode**.



Swipe Up to Select a Camera Mode

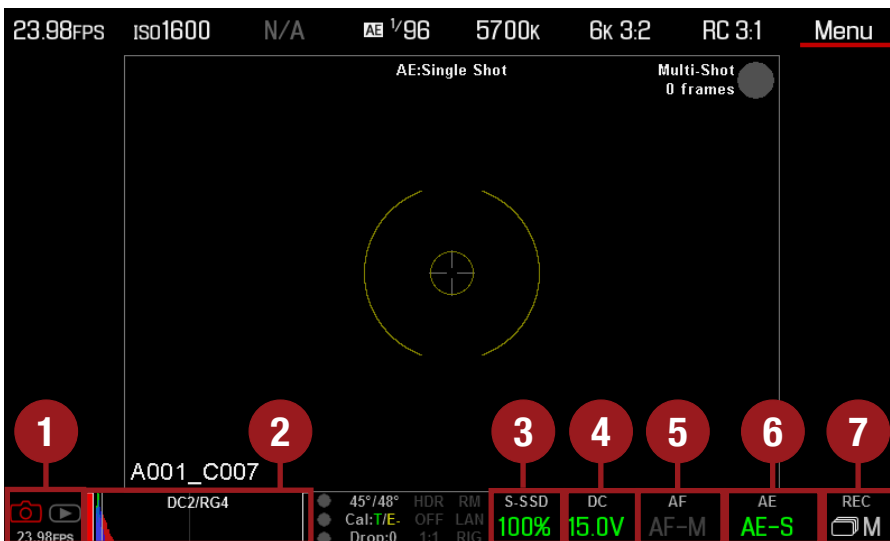

Stills Mode

#	SWIPE-UP SHORTCUT	DESCRIPTION
1	Camera Mode ¹	Select Playback, Motion, or Stills
2	Tools	Set Horizon, RAW, Magnify, Zebras, and False Color
3	Media	View as Percentage or Time Remaining, eject media, view clip thumbnails
4	Power	View as Percentage or Time Remaining
5	Auto Focus ²	Set Zone, Size, and Mode
6	Auto Exposure ²	Set Exp Comp, Speed, Metering, Priority, and Mode
7	Record Mode ²	Select Multi-Shot or Motion + Stills

1. For more information about Stills mode and Motion mode, go to “Camera Mode” on page 57.

2. Shortcuts only available in Stills Mode.

NAVIGATION GROUP

The Navigation Group is the primary control interface on the DSMC Side Handle, RED Switchblade-M, and REDMOTE.

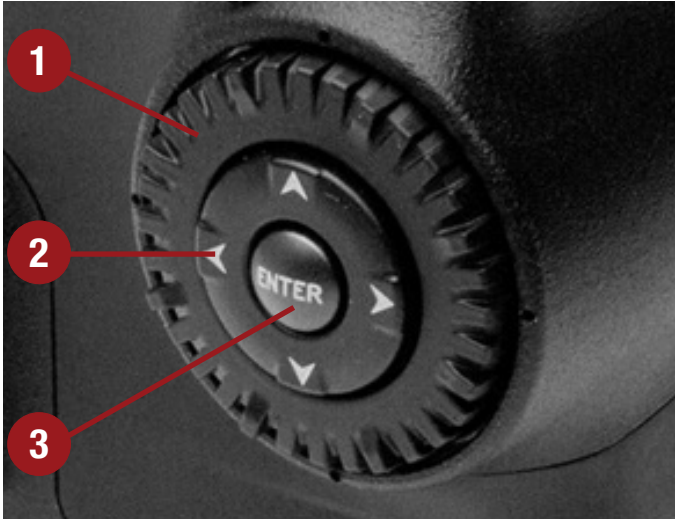

Navigation Group

#	NAVIGATION GROUP ELEMENT	DESCRIPTION
1	Scroll Wheel	Select and adjust the value of a selected setting
2	Directional Keys (D-Pad)	Navigate menus and menu items
3	ENTER key	Press ENTER to confirm a setting or access the selected menu

Navigate the menus using a DSMC Side Handle, RED Switchblade-M, or REDMOTE using the following controls:

- ▶ Press **ENTER** to open the menu, then rotate the **Scroll Wheel** clockwise to move right, counterclockwise to move left to highlight the desired menu or parameter. Press **ENTER** to select.
- ▶ Press the **Up Navigation Key** to open the related Advanced Settings menu, if one (1) is available.

For more information, go to [“Default Key Functions” on page 217.](#)

For more information on the REDMOTE, go to [“REDMOTE Operation” on page 146.](#)

RED DSMC OPERATION GUIDE: EPIC/SCARLET

DSMC SIDE HANDLE

This section describes the controls and display of the DSMC Side Handle.



DSMC Side Handle Controls

#	CONTROL/ITEM	DESCRIPTION
1	LCD Display	Go to “DSMC Side Handle Display” on page 65
2	User Keys (1–4) ¹	User 1-4 keys are used to select a slot on the DSMC Side Handle Display. The front rotary then adjusts the value of the selected slot.
3	Menu Button	Access menus or exit currently selected menu
4	Rocker Switch	Open (Up)/Close (Down) Iris
5	User Keys (5–7)	5: Toggle Exposure Mode on/off 6: Key Disabled 7: Eject Media
6	Thumbwheel Lock	Install and remove the DSMC Side Handle
7	LCD Backlight Button	Toggles LCD backlight illumination
8	Navigation Group	Navigate menus and menu items; go to “Navigation Group” on page 63
9	User Keys (A–D)	A: Cycle Auto-Focus Mode B: Auto White Balance C: Toggle 1:1 Magnify on/off D: Toggle Exposure Mode on/off
10	Rotary Dial	Adjust camera parameter values based on the underlined value on the DSMC Side Handle LCD Display
11	Focus/Record Button	Half-press for auto-focus; full press to Start/Stop Record
12	Stills/Motion Mode Switch	Toggles between Stills/Motion Mode, enabled in v6.0 firmware or later
13	Battery Door Release	Press to open the battery door
14	PC Sync Port	Triggers external flashes or strobes

1. Press User Keys **1** + **4** simultaneously to lock/unlock DSMC Side Handle buttons to prevent inadvertent menu changes.

NOTE: DSMC Side Handle keys are programmable. For more information, go to [“Key Mapping”](#) on page 103.

RED DSMC OPERATION GUIDE: EPIC/SCARLET

DSMC SIDE HANDLE DISPLAY

The DSMC Side Handle displays Basic Menu parameters and other system status information.

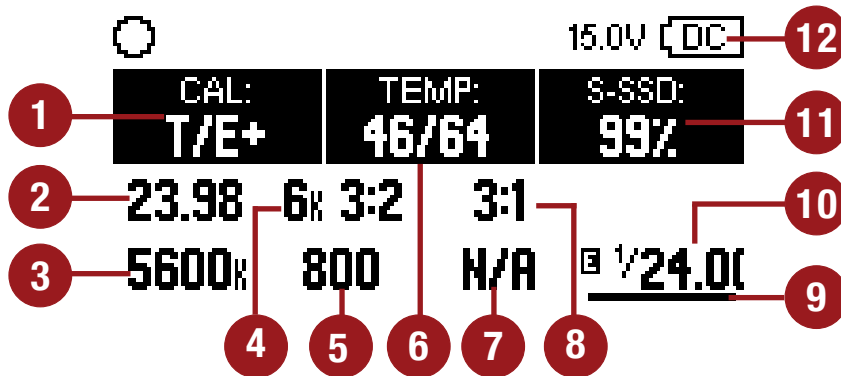

DSMC Side Handle Display

The DSMC Side Handle displays the following camera parameters:

#	DISPLAY ITEM	DESCRIPTION
1	Calibration	Indicator of relative change in sensor temperature and exposure since last calibration
2	Recording Frame Rate	Current recording frame rate
3	White Balance	Color temperature
4	Resolution	Recording resolution
5	ISO	Camera sensor sensitivity
6	Temperature	Displays camera sensor and core temperature, respectively
7	Lens Information	Displays aperture when a supported Canon, Nikon, or Cooke lens is attached
8	REDCODE	REDCODE compression setting
9	Cursor	User 1-4 keys are used to move the cursor to select a slot. The front rotary then adjusts the value of the selected slot.
10	Shutter Speed	Integration time or shutter angle
11	Media Status	Displays media location and remaining media capacity
12	Power Status	Indicates DC supply voltage or % of remaining battery capacity including current supply voltage

RED SWITCHBLADE-M

This section describes the controls and display of the RED Switchblade-M.

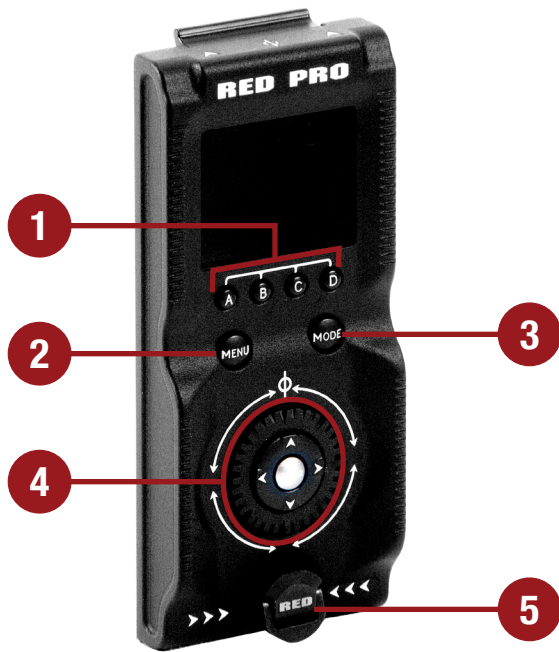

RED Switchblade-M Controls

#	CONTROL/ITEM	DESCRIPTION
1	User Keys (A–D) ¹	A: Cycle Auto-Focus Mode B: Auto White Balance C: Toggle 1:1 Magnify D: Toggle Exposure Mode
2	MENU Button ²	Access menus or exit currently selected menu
3	MODE Button	Toggle RED Switchblade-M between Remote and Local Modes
4	Navigation Group	Navigate menus and menu items; Go to “Navigation Group” on page 63
5	Mounting Thumbscrew	Install and remove the RED Switchblade-M

1. Press User Keys **A** + **D** simultaneously to lock/unlock RED Switchblade-M buttons to prevent inadvertent menu changes.
2. MODE Button functionality requires camera firmware v5.3 or later.

NOTE: RED Switchblade-M keys are programmable. For more information, go to [“Key Mapping” on page 103](#).

OPERATION MODES

The RED Switchblade-M OLED display reflects the currently selected mode. Use the **Scroll Wheel** and **Directional Keys** to navigate menus. Press **MENU** to access the Advanced Menu.

Press **MODE** to toggle between the following modes:

- ▶ **Remote Mode:** Navigate with RED Switchblade-M controls, using an attached LCD, EVF, or other monitor as a reference. The RED Switchblade-M displays the primary control screen.
- ▶ **Local Mode:** Navigate using the RED Switchblade-M controls and display. User Keys A-D are inactive.

KEY LOCK/UNLOCK

Lock the keys on the RED Switchblade-M to prevent inadvertent button presses and menu changes.

- ▶ **Lock:** Press **A** + **D** simultaneously.
- ▶ **Unlock:** Press **A** + **D** simultaneously. Alternatively, press and hold **ENTER** while keys are locked.

RED DSMC OPERATION GUIDE: EPIC/SCARLET

RED SWITCHBLADE-M DISPLAY

The RED Switchblade-M OLED display provides basic camera parameters during operation.

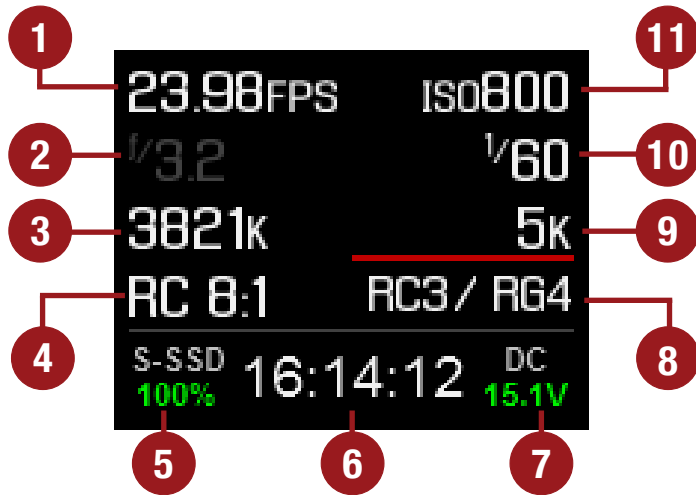

*RED Switchblade-M OLED
(Local Mode)*

The RED Switchblade-M displays the following camera parameters:

#	DISPLAY ITEM	DESCRIPTION
1	Frame Rate	Current Recording Frame Rate
2	Lens Information	Displays aperture when a supported Canon, Nikon, or Cooke lens is attached
3	White Balance	Color temperature
4	REDCODE	REDCODE compression setting
5	Media Status	Displays media location and remaining media capacity
6	Timecode	Current timecode value
7	Power Status	Indicates DC supply voltage or % of remaining battery capacity including current supply voltage
8	Color and Gamma Space	Currently selected RED color and gamma space settings
9	Resolution	Recording resolution
10	Shutter Speed	Integration time or shutter angle
11	ISO	Camera sensor sensitivity

05

ADVANCED MENUS

ADVANCED MENUS



Advanced Menu

The Advanced Menus include:

ADVANCED MENU	DESCRIPTION	FOR MORE INFORMATION, GO TO...
Settings	Camera settings including: Display, Look, Project, Audio, Recording, Setup, and Maintenance	“Settings Menu” on page 69
Media	SSD operations including: format, eject, and more	“Media Menu” on page 123
Playback	View clips recorded to the attached SSD	“Playback Menu” on page 124
Power	Power sources, settings, status, and shutdown	“Power Menu” on page 127
HDRX	HDRx mode and settings	“HDRX Menu” on page 128
Focus	Focus modes, features, settings, and rack focus	“Focus Menu” on page 128
Exposure Assist	Automatic exposure settings and controls	“Exposure Assist” on page 134
Presets	Adjust Looks, key mappings, I/O, and more	“Presets Menu” on page 136

ACCESS THE ADVANCED MENUS

- ▶ Tap the **Menu** button on the DSMC® Side Handle or REDMOTE®.
- ▶ Tap the **Menu** icon on the touchscreen.
- ▶ Select the **Advanced...** button in any menu from the Upper Status Row (except the REDCODE menu).

SETTINGS MENU



Settings Menu

The Settings menu includes: Display, Look, Project, Audio, Recording, Setup, and Maintenance.

DISPLAY

The Display menu includes: Tools, Zebra, Monitor Control, Modes, Guides, Test Signals, and REDCAST™ (the REDCAST menu is only accessible when a REDCAST Module is installed).

TOOLS

The Tools menu provides access to false color and display modes.

For more information, see the [Exposure with RED Cameras: False Color & Zebra Tools](http://www.red.com/learn/red-101/exposure-false-color-zebra-tools) article, available at www.red.com/learn/red-101/exposure-false-color-zebra-tools.

FALSE COLOR MODES

False color modes include: Off, Exposure, Video, Focus, Edge, and Gio Scope.

NOTE: Only monitors with the Tools check box selected in the Monitor Control menu show the false colors. For more information, go to [“Motor Control” on page 109](#).

NOTE: False color modes affect video recorded through HDMI® or HD-SDI to an external recorder if the Tools check box is selected in the Monitor Control menu. When recording through HDMI or HD-SDI, use false color modes only to help configure project settings, and then disable the mode before recording.

OFF

Disables all false color modes.

EXPOSURE

Displays color overlay on top of a desaturated image that allows you to check for proper exposure. When enabled, the “E√” indicator displays in the Lower Status Row.

The Exposure meter colors indicate the following information:

- ▶ **Purple:** Underexposed; indicates sensor exposure levels that may be noisy if gained up in post-production.
- ▶ **Green:** IRE 41–48; based on the RGB levels of the video out signal and not the RAW data.
- ▶ **Red:** Overexposed; indicates sensor exposure levels that are clipping.

Purple (underexposure) and red (overexposure) are based on RAW data and show areas that are clipping or close to clipping. The RGB settings (settings in the Look menu) DO NOT affect the Exposure indicators.

RED DSMC OPERATION GUIDE: EPIC/SCARLET

VIDEO

Displays a color overlay that indicates the video level of the RGB monitor path (calibrated to the SMPTE test signal). When enabled, the “V√” indicator displays in the Lower Status Row.

Colors are based on the RGB levels of the video out signal (that is, the “cooked” look, and not RAW data). The RGB settings (settings in the Look menu) affect the Video indicators.

The Video indicators represent the following IRE values (at all other values, the desaturated image represents the luminance value of the ISO adjusted image):

- ▶ **Purple:** IRE 0–4
- ▶ **Blue:** IRE 5
- ▶ **Teal:** IRE 10–12
- ▶ **Green:** IRE 41–48
- ▶ **Pink:** IRE 61–70
- ▶ **Straw:** IRE 92–93
- ▶ **Yellow:** IRE 94–95
- ▶ **Orange:** IRE 96–98
- ▶ **Red:** IRE 99–100

FOCUS

Emphasizes contrast and edges in the image without changing brightness or image content making it easier to judge focus. Adjust zoom and focus to easily see which objects are coming into focus. When enabled, the “F√” indicator displays in the Lower Status Row.

EDGE

Shows the edges/outlines of objects that are in focus. When enabled, the “F√” indicator displays in the Lower Status Row.

NOTE: The Edge setting may interfere with recordings done via HDMI or HD-SDI in Clean mode.

GIO SCOPE

Displays a color overlay on top of a desaturated image, identifying the 16 stops of light within the full dynamic range of the RED DRAGON® sensor. On cameras with the MYSTERIUM-X® sensor, you can still select up to 16 stops. However, the camera will not detect the top and bottom stops.

When enabled, the “G√” indicator displays in the Lower Status Row. The Gio Scope indicators are based on RAW data. The RGB settings (settings in the Look menu) DO NOT affect the indicators.

Each number indicates a different stop of light.

- ▶ **11:** Represents mid-grey.
- ▶ **16:** Represents the top stop, and is broken up into 1/8th increments to show highlight roll-off. Each 1/8th stop is represented by a different shade of red, ranging from light red (less light) to dark red (most light).

RED DSMC OPERATION GUIDE: EPIC/SCARLET

DISPLAY MODES

Display mode options include: Magnify, RAW, and Horizon.

MAGNIFY

Displays the central region of the sensor in 1:1 pixel resolution. When enabled, the 1:1 text in the Lower Status Row turns green, and the AF Window and the magnified region display. The AF Window determines the center point of the magnified region. If the lens or lens mount is not capable of autofocus with the camera, use Confirm mode to turn on the AF Window. The camera automatically exits magnify mode when recording begins.

The Magnify tool magnifies a 1920 x 1020 region, centered on a 1920 x 1080 display. If the resolution is lower than 1920 x 1020, the image border cannot be magnified. Use the following equations to determine the area of the image border that will not be magnified:

- ▶ **Border width:** $(1920 - W) / 2$
- ▶ **Border height:** $(1020 - H) / 2$

NOTE: Frame rate and resolution cannot be modified in Magnify mode.

RAW

Displays images unaffected by the RGB settings (settings in the Look menu). When enabled, the word RAW displays in the Histogram in the Lower Status Row.

The RAW image parameters are:

- ▶ **Color Space:** REDcolor2
- ▶ **Gamma Space:** REDlogFilm
- ▶ **White Balance:** 5600K
- ▶ **ISO:** 800 ISO
- ▶ **Tint:** 0 Tint

NOTE: When enabled, RAW affects video recorded via HDMI or HD-SDI to an external recorder. Otherwise, RAW image parameters DO NOT affect image metadata; the parameters only affect the monitor output.

HORIZON

Displays an overlay that provides a reference to the position of the horizon. The Horizon overlay consists of two (2) short side-bars that are always horizontally centered on the monitor, and a single longer horizon-line that adjusts to the horizon based on the orientation of the camera.

The side-bars are green if the pitch is within +/- 1° of the calibrated zero position, otherwise they are red. The horizon-line is green if the roll is within +/- 1° of the calibrated zero position, otherwise it is red.

To add numerical values for the pitch and roll to the Horizon overlay, follow the instructions below:

1. Go to **Menu > Settings > Display > Monitor Control > Overlay**.
2. Select **Create...**, **Clone...**, or **Edit...**, respectively, for the desired overlay action.
3. Select a location on the interface to add the numerical data for the Horizon overlay.
4. Select **Motion: Gyro Data (GYRO)** from the **Item** drop-down menu.
5. Select the desired text size.
6. Select **Add**.
7. Select **Save**.
8. Go to **Menu > Settings > Display > Monitor Control > Monitor**, and select the overlay from the **Overlay** drop-down menu.

NOTE: The internal gyroscope and accelerometer must be calibrated for the Horizon overlay to function properly. For more information, go to [“Gyroscope and Accelerometer Calibration” on page 112](#).

ZEBRA

Use Zebra mode to enable and adjust the upper and lower values for two (2) independent zebra indicators. Use Zebra 1 for highlight exposure, and use Zebra 2 for mid-tones or shadows. Zebras are visible in Magnify mode and are disabled by default. As with other IRE-based modes, zebra mode is applicable to the current ISO and Look settings, and not the RAW image.

For more information, see the [Exposure with RED Cameras: False Color & Zebra Tools](http://www.red.com/learn/red-101/exposure-false-color-zebra-tools) article, available at www.red.com/learn/red-101/exposure-false-color-zebra-tools.

ENABLE ZEBRA INDICATORS

1. Go to **Menu > Settings > Display > Zebra**.
2. Select a **Zebra** check box.
3. Select the low and high IRE values. Each value range is 1–100.
 - **Zebra 1:** Areas of the image exposed within the IRE range are indicated by diagonal lines at -45° . Default is IRE 98–100.
 - **Zebra 2:** Areas of the image exposed within the IRE range are indicated by diagonal lines at 45° . Default range is IRE 41–48.

MONITOR CONTROL

Use the Monitor Control menu to configure monitor and overlay settings, control surface priorities, brightness, and gestures.

MONITOR

Select the monitor to configure from the drop-down menu at the top of the menu. The other settings on the menu are applicable to the selected monitor.

NOTE: Changes to Monitor Control settings take effect when you close the menu.

MODE

Determines the elements displayed on the monitor:

- ▶ **Clean:** Only the video displays. The Upper Status Row, Lower Status Row, and overlays do not display.
- ▶ **Overlay:** The overlay displays. Overlays include the Upper Status Row and the Lower Status Row.
- ▶ **Mirror:** The monitor mirrors another screen at the same resolution. You cannot mirror a screen that is set to Clean. The Mirror option is available based on the settings of the other attached monitors, and includes the name of the monitor that can be mirrored.

NOTE: You can set a maximum of four (4) monitors to Overlay at a time. To assign additional monitors to Overlay, mirror a monitor with the same resolution that is set to Overlay.

NOTE: When two (2) touchscreens are attached to the camera with the same resolution and one (1) is currently the control surface, set the other to mirror it and give the effect of having two (2) control surfaces.

OVERLAY

Select which overlay shows on top of the video. RED® provides preset overlays, which have “(RED)” in the overlay name. Create custom overlays in the Overlay tab. For more information, go to [“Overlays” on page 74](#).

RESOLUTION

Select the output resolution for monitors (you cannot select a resolution for LCDs and EVFs, since the resolution is determined automatically). For more information about available HD-SDI and HDMI resolutions, go to [“3G-SDI \(HD-SDI\) Out” on page 200](#) and [“HDMI Out” on page 201](#).

RED DSMC OPERATION GUIDE: EPIC/SCARLET

FREQUENCY

Determines the monitor frequency. Available frequencies depend on the selected monitor. The LCD resolution defaults to 60.00 Hz, which is the optimal refresh rate for the RED LCDs.

For HD-SDI monitors, the frequency depends on the project time base. For more information, go to [“3G-SDI \(HD-SDI\) Out” on page 200](#) and [“HDMI Out” on page 201](#).

HD-SDI Auto: Sets the frequency equal to the Project Time Base, except when the Project Time Base is 47.95/48 FPS. When the Project Time Base is 47.95/48 FPS, the frequency is half that rate (23.98/24 Hz).

CURVE

Determines which curve the camera applies to the monitor when using the Independent Display LUT feature. For more information, go to [“Independent Display LUT” on page 81](#).

TOOLS

Enables the false color modes on the monitor. For more information, go to [“Tools” on page 69](#).

FLIP/MIRROR UI

NOTE: This setting is NOT available on the RED Touch 7.0" LCD. For more information, go to [“Flip/Mirror” on page 73](#).

Flip the graphical user interface (GUI) vertically and mirror horizontally (not rotated). Use this setting when mounting a monitor upside down. This setting only affects the monitor, and does not affect captured footage.

FLIP VIDEO

NOTE: This setting is NOT available on the RED Touch 7.0" LCD. For more information, go to [“Flip/Mirror” on page 73](#).

Flip footage horizontally, so that it is upside down. This setting only affects the monitor, and does not affect captured footage.

FLIP/MIRROR

NOTE: This setting is ONLY available on the RED Touch 7.0" LCD.

Mirror and flip (invert) the graphical user interface (GUI) and footage, effectively rotating the entire displayed image 180°. Use this setting when mounting a monitor or the entire camera rig upside down. This setting only affects the monitor, and does not affect captured footage.

FRAMED OVERLAY

The video display is scaled down on the monitor so that the overlay items fit outside of the video area rather than over it. This setting only affects the monitor, and does not affect captured footage.

AUTO HIDE MENUS

Hides the Upper Status Row and Lower Status Row. When this option is disabled, the video is scaled so that the menus are not overlaid on the video. When this option is enabled, the video is not scaled. This option creates a control surface on a monitor without scaling the video. This setting only affects the monitor, and does not affect captured footage.

To toggle display/hide the menus when Auto Hide Menus is enabled, perform either of the following actions:

- ▶ Press the **Menu** button on the DSMC Side Handle or RED Switchblade-M.
- ▶ Tap the touchscreen.

NOTE: Enabling this option on a non-control surface results in the menus never displaying on that monitor.

OVERLAYS

Create custom overlays that include specific items. Overlays can be stored on the camera or transferred to SSD to be shared with other cameras.

- ▶ **Camera:** Overlays saved internally on the camera display in the Overlay drop-down menu on the Monitor Control > Monitor tab.
- ▶ **Media:** Overlays saved to an SSD can be found at On Media: \overlays:.

NOTE: Overlays that end with (RED) are provided by default and cannot be edited, deleted, or exported.

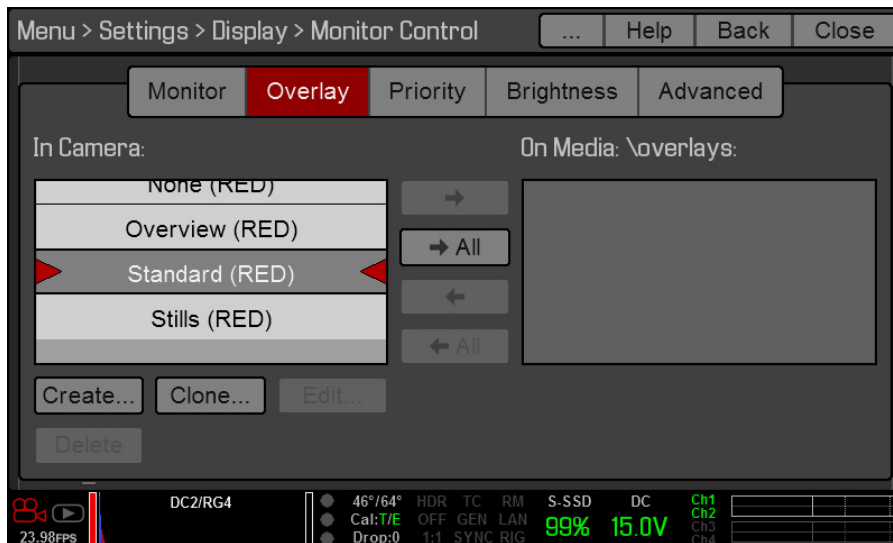

OVERLAY ACTIONS

- ▶ **Create...:** Create a new custom overlay using a blank overlay template in the Overlay Editor.
- ▶ **Clone...:** Create a new custom overlay using the selected camera overlay as a template in the Overlay Editor.
- ▶ **Edit...:** Edit the selected camera overlay in the Overlay Editor.
- ▶ **Delete:** Delete the selected camera overlay.

EXPORT AND IMPORT OVERLAYS

- ▶ **→**: Export selected overlay from camera to SSD.
- ▶ **All →**: Export all overlays from camera to SSD.
- ▶ **←**: Import selected overlay from SSD to camera.
- ▶ **All ←**: Import all overlays from SSD to camera.

CREATE AND EDIT OVERLAYS

1. Go to **Menu > Settings > Display > Monitor Control > Overlay.**
2. Select **Create**, or select an existing overlay and select **Clone** or **Edit**.
3. If creating a new overlay, enter a name for the overlay and select **OK**.
4. Select any of the following check boxes to add the corresponding guides to the overlay:
 - Frame Guide
 - Action Guide
 - Title Guide

RED DSMC OPERATION GUIDE: EPIC/SCARLET

5. Select a button on the matrix to add a user interface element to that position on the matrix.
By default, the Magnify indicator (MI) is on the top left, the Record indicator (REC) is on the top right, the Clip Name (CLIP) is on the bottom left, and the Timecode (TC) is on the bottom right.
Selecting one (1) of the buttons opens a new dialog that lets you choose a user interface element.
6. Select the **Item** that you want to add.
7. Select the **Size** of the item.
8. If adding a Custom Label (LBL), enter the **Custom Text** for that item.
9. Select **Add** to return to the previous screen.
10. Add all of the items to the overlay.
11. Select **Create** or **Save**.

The new overlay displays in the Camera list.

NOTE: Except for the Custom Label (LBL), you can only add each element once. If you add an element you have already added to the overlay, the element moves to the new position.

LUTS

The LUTs menu is only accessible when a REDCAST Module is installed. For more information, see the [REDCAST Module Operation Guide](#), available at www.red.com/downloads.

PRIORITY



The camera can only have one (1) control monitor for interacting with camera settings. The Priority tab determines the order in which a monitor becomes the control monitor. If you plan on removing or adding monitors during a shoot, set up the priority list ahead of time.

For a monitor to become the control monitor, the following must occur:

- ▶ The monitor must be set to Overlay mode in the Monitor Control menu.
- ▶ Each monitor that has higher priority on the list must be either detached or not set to Overlay mode.

EXAMPLE

By default, the monitor priority is:

1. BRAIN LCD
2. BRAIN EVF
3. BRAIN HDMI

RED DSMC OPERATION GUIDE: EPIC/SCARLET

If you remove an LCD when an EVF is attached, then the EVF becomes the control monitor. If you then remove the EVF when an HDMI monitor is attached, the HDMI monitor becomes the control monitor. If you then re-attach the LCD, then the LCD is the control monitor again.

BRIGHTNESS

Control the brightness of each LCD and EVF. Move to the right for a brighter display; move to the left for a dimmer display. Side UI LCD controls the brightness of the Switchblade-M LCD.

NOTE: A rear LCD/EVF is an LCD/EVF that is plugged into any rear RED module, such as the +1 Adaptor Module or the Pro I/O Module.

ADVANCED

Provides access to additional monitor settings.

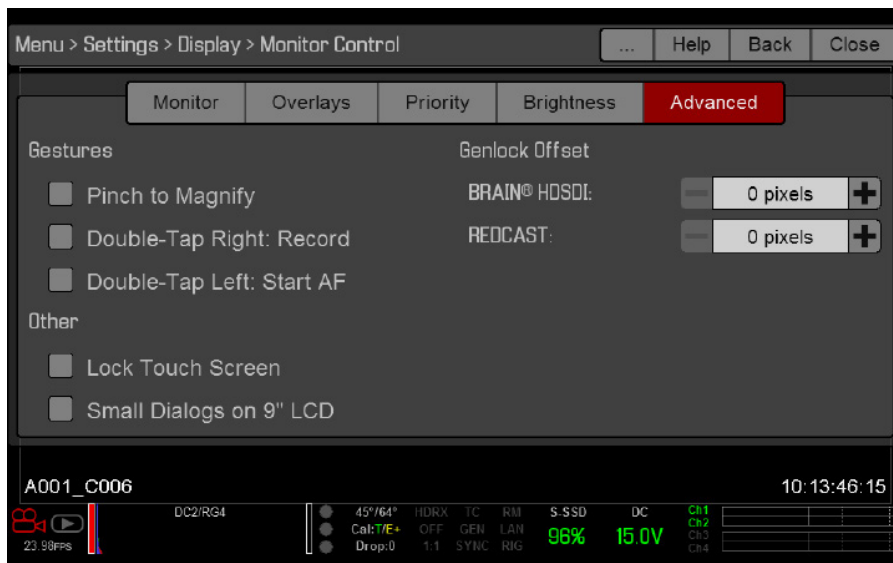

GESTURES

- ▶ **Pinch to Magnify:** Move two (2) fingers apart or together to toggle 1:1 Magnify. For more information, go to [“Magnify” on page 71](#).
- ▶ **Double-Tap Right 25% to Record:** Double-tap the right 25% of the video area on the LCD to toggle record.
- ▶ **Double-Tap Left 25% to Start AF:** Double-tap the left 25% of the video area on the LCD to start autofocus when compatible lenses are used.

For a list of compatible lenses, go to [“Lens Mounts and Lenses” on page 207](#).

OTHER

- ▶ **Lock Touch Screen:** Touchscreen control is locked. To unlock, tap the screen and follow the on-screen instructions.
- ▶ **Use Small Dialogs on 9" LCD:** The dialogs on the RED Touch 9.0" LCD are smaller than the default dialogs.

GENLOCK OFFSET

Offset the video of the HDSOI out or REDCAST Module to align it with the genlock signal:

- ▶ **Negative offset:** Advances the video, so the video reaches the switcher earlier than it would otherwise.
- ▶ **Positive offset:** Advances the video, so the video reaches the switcher later than it would otherwise.

MODES

Use the Modes menu to determine how the following settings display:

- ▶ Camera
- ▶ Lens

CAMERA TAB

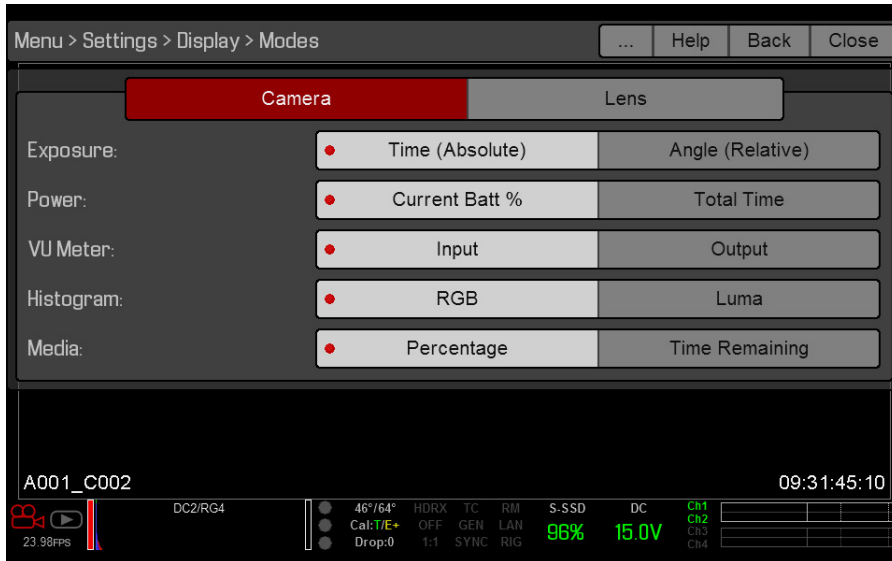

Display Mode: Camera

EXPOSURE

- ▶ **Time (Absolute):** Displays the exposure time in seconds (1/xx sec). When you change the frame rate in this mode, the shutter time stays the same, but the shutter angle changes. Time (Absolute) is the default.
- ▶ **Angle (Relative):** Displays the exposure as an angle (1–360°). When you change the frame rate in this mode, the shutter angle stays the same, but the exposure time changes.

POWER

- ▶ **Current Batt %:** Displays the remaining percentage of active battery. (Default)
- ▶ **Total Time:** Displays the total run-time left of battery power, taking into account all available batteries.

VU METER

- ▶ **Input:** Displays levels of audio inputs (pre-mixer). (Default)
- ▶ **Output:** Displays levels of audio outputs (post-mixer).

HISTOGRAM

NOTE: The Histogram setting is not accessible on cameras with MONOCHROME or RED DRAGON MONOCHROME sensors.

- ▶ **RGB:** Displays red, green, and blue channels on histogram. (Default)
- ▶ **Luma:** Displays luma channel on histogram.

MEDIA

- ▶ **Percentage:** Displays media space remaining as a percentage. (Default)
- ▶ **Time Remaining:** Displays media space remaining as time in hours and minutes (HHH:MM).

LENS TAB

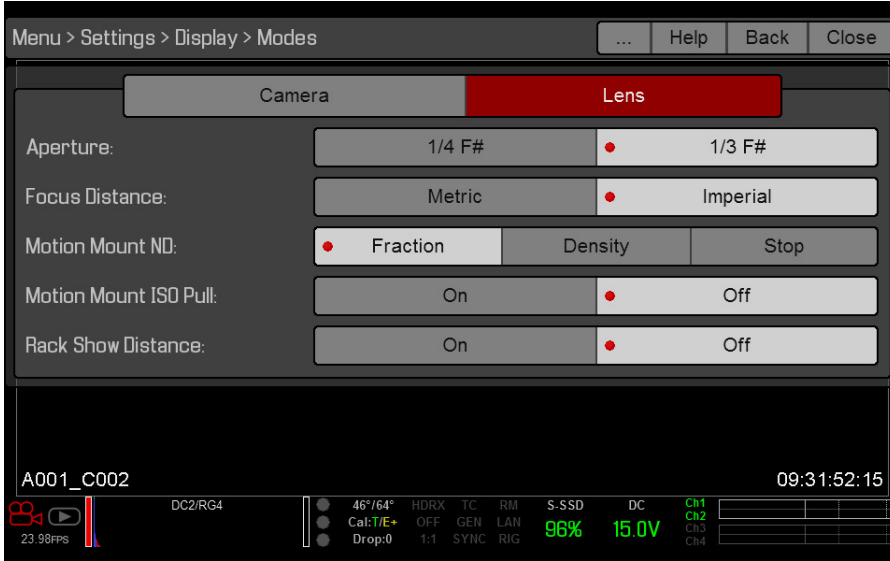

Display Mode: Lens

APERTURE

- ▶ **1/4 F#:** Aperture increments in 1/4 stops.
- ▶ **1/3 F#:** Aperture increments in 1/3 stops. (Default)

FOCUS DISTANCE

- ▶ **Metric:** Displays lens focus distances in meters.
- ▶ **Imperial:** Displays lens focus distances in feet and inches. (Default)

MOTION MOUNT ND AND MOTION MOUNT ISO PULL

Only applicable when using a DSMC RED MOTION MOUNT®. For more information, see the [RED MOTION MOUNT Operation Guide](http://www.red.com/downloads), available at www.red.com/downloads.

RACK SHOW DISTANCE

- ▶ **On:** Displays the focus distance of each rack point on the Live Action Area when rack focus is enabled. For more information, go to “[Set Up Rack Focus](#)” on page 132.
- ▶ **Off:** Does not display the focus distance of rack points when rack focus is enabled. (Default)

GUIDES

Use the Guides menu to configure the Frame Guide, Action Guide, and Title Guide.

MODE

- ▶ **Off:** Disable all guides.
- ▶ **Full:** Guide has the same aspect ratio as the record format.
- ▶ **4:3, 16:9, 1.85:1, 1.9:1, 2.4:1:** Guide has the selected aspect ratio.
- ▶ **User:** Select an aspect ratio from the drop-down menu that displays when you select this option.
- ▶ **Absolute:** Guide is defined by absolute pixel dimensions rather than aspect ratio and scale. When you select Absolute, the Width/Height fields replace the Scale field.

SCALE

Percentage to scale guide from its maximum possible size. Available range is 0–100%.

RED DSMC OPERATION GUIDE: EPIC/SCARLET

WIDTH/HEIGHT

The Width/Height fields replace the Scale field when you select Absolute from the Mode drop-down menu. Select the values for the width and height of the guide in pixels.

OFFSET X/Y

Percentage to offset guide from its default centered position. Available range is 0–100%.

- ▶ **100%:** Right-aligned (for X offset) and bottom-aligned (for Y offset).
- ▶ **-100%:** Left-aligned (for X offset) and top-aligned (for Y offset).

APPEARANCE

- ▶ **Line Style:** Select one of the following line styles: Solid, Dashed, or Bracket.
- ▶ **Color:** Select the color that has the highest contrast to the scene. The default is White.
- ▶ **Opacity:** Set the guide opacity. Available options are 0%, 25%, 50%, 75% and 100%.

RELATIVE TO FRAME GUIDE

Select the **Relative to Frame Guide** check box to size and position the guide relative to (and have it bounded by) the Frame Guide instead of the record format.

NOTE: The Relative to Frame Guide check box is available on the Action Guide and Title Guide tabs.

GENERAL TAB

Enable/Disable and select the location (Relative To), color, and opacity of the following elements:

- ▶ **Center:** The center crosshair.
- ▶ **Grid:** Rule-of-thirds grid.
- ▶ **Shading:** The shaded region outside of the area of interest.

TEST SIGNAL

Use the Test Signal menu to replace the video monitor outputs with one of the following video test patterns:

- ▶ Chip Chart
- ▶ SMPTE Bars
- ▶ Luma

To enable a test signal, select the test signal box. To exit, tap the touchscreen or press the **Enter** or **Menu** button on the DSMC Side Handle or REDMOTE. If needed, enable an **Audio Tone**.

NOTE: Test signals are not recordable; they are provided to help align external HD-SDI and HDMI monitors.

REDCAST

The REDCAST menu is only accessible when a REDCAST Module is installed. For more information, see the [REDCAST Module Operation Guide](http://www.red.com/downloads), available at www.red.com/downloads.

LOOK

The Look menu includes: Color, Gain, ISO/FLUT, Sharpness, Curves, Color/Gamma, Color Temperature, and LGG (Lift, Gamma, Gain).

The Look settings affect the look of the monitor path, but do not affect the recorded RAW data.

RED DSMC OPERATION GUIDE: EPIC/SCARLET

COLOR

- ▶ **Saturation:** Adjusts color saturation. Range is 0.0 (monochrome) to 4.0 (super color). Default is 1.0.
- ▶ **Contrast:** Adjusts the overall contrast of the image. Range is -1.0 (flat) to 1.0 (max contrast). Default is 0.0.
- ▶ **Brightness:** Adjusts brightness without crushing highlights. Available range is -10.0 to 10.0. Default is 0.0.
- ▶ **Exp Comp:** Adjusts exposure compensation. Available range is -7.0 to 7.0. Default is 0.0.

GAIN

Adjust the Red channel, Blue channel, and Green channel individually. The range for each is 0.0 (none of the color) to 10.0, and the default for each is 1.0.

ISO/FLUT

Use the ISO/FLUT menu to adjust ISO, FLUT, and Shadow. For more information, see the following articles:

- ▶ [Exposure with RED Cameras: Strategy](http://www.red.com/learn/red-101/exposure-with-red-cameras), available at www.red.com/learn/red-101/exposure-with-red-cameras
- ▶ [ISO Speed Revisited](http://www.red.com/learn/red-101/iso-speed-revisited), available at www.red.com/learn/red-101/iso-speed-revisited

ISO

Select the camera ISO rating. The sensitivity value increments in 1/3 stops. When the ISO rating is adjusted, the camera logs the change as metadata and the monitor path reacts accordingly. Higher ISO values lead to brighter images in the monitor path, and vice versa.

RED recommends setting the ISO to the default, then adjust the aperture, lighting, and ND filters to match. The ISO can later be adjusted around one (1) stop for fine-tuning.

Range is ISO 250 to 12,800. Default is ISO 800.

NOTE: For MONOCHROME and RED DRAGON MONOCHROME, the default is ISO 2000.

FLUT

Floating Point Lookup Table (FLUT) is an exposure control exclusive to RED. FLUT works like a traditional ISO setting, but can be fine-tuned in post-production to any level of exposure precision. FLUT automatically protects highlights and shadows, even when changed substantially.

The FLUT setting is expressed in terms of relative exposure value (EV), where each unit represents a 1-stop change in midtone exposure level. Range is -8.0 to 8.0. Default is 0.0.

SHADOW

Shadow adjusts the toe value of the FLUT (the tone near black). Increasing the Shadow value raises the video level of near blacks. Lowering the Shadow value crushes the video level of near blacks. Range is -2.0 to 2.0. Default is 0.0.

SHARPNESS

Control the sharpness of each monitor output. Move to the left for a sharper image; move to the right for a less sharp image.

CURVES

Define the individual curves for the Luma, Red, Green, and Blue channels. You can only adjust one (1) curve at a time. Select **Reset Curve** to reset a curve.

NOTE: Luma is the only channel on cameras with MONOCHROME or RED DRAGON MONOCHROME sensors.

COLOR/GAMMA

Adjust the monitor output Color Space and Graded Gamma curves. These settings affect metadata only, and can be changed in REDCINE-X PRO.

COLOR SPACE AND GRADED GAMMA SPACE

RED recommends using the most recently released Color Space and Graded Gamma settings. Use legacy settings (such as REDcolor2) only if you need to record footage to match footage that you recorded with that legacy setting.

For more information, see the [Understanding REDlogFilm and REDgamma](http://www.red.com/learn/red-101/redlogfilm-redgamma) article, available at www.red.com/learn/red-101/redlogfilm-redgamma.

INDEPENDENT DISPLAY LUT

NOTE: Independent Display LUT is disabled when a REDCAST Module is attached.

NOTE: When Independent Display LUT is enabled, the menu may change from light gray to dark gray. The camera applies the color and gamma spaces after rendering the user interface, so changing these settings affects the user interface.

Independent Display LUT allows you to apply a different gamma space to each monitor (this feature does not apply a LUT). You can record via HD-SDI or HDMI, apply a LUT through a LUT box, and then view a different look on each monitor.

USE THE INDEPENDENT DISPLAY LUT FEATURE

To set up the Independent Display LUT feature, follow the instructions below:

1. Go to **Menu > Settings > Look > Color/Gamma**.
2. Select the **Independent Display LUT** check box.

RED DSMC OPERATION GUIDE: EPIC/SCARLET

3. If you plan on outputting ACES, select the **ACES Proxy** check box.

The camera calculates the neutral gamma space based on if the ACES Proxy check box is selected.

- **ACES Proxy deselected:** Neutral Gamma Space is REDLogFilm.
- **ACES Proxy selected:** Neutral Gamma Space is ACES (ACES Proxy). For more information, go to “ACES Proxy” on page 83.

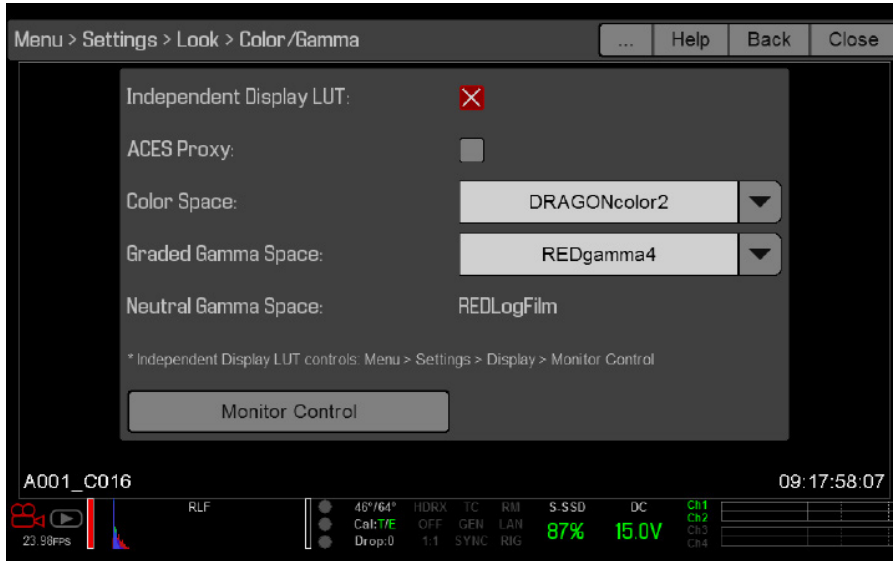

4. Select the **Monitor Control** button at the bottom of the menu.

The Monitor Control menu opens.

5. Select the monitor to configure from the drop-down menu at the top of the menu.
6. Select the curve that you want to apply to the output for the selected monitor from the **Curve** drop-down menu:
 - **Neutral:** The Neutral Gamma Space displayed on the Color/Gamma menu is applied to the output.
 - **Graded:** The Graded Gamma Space selected on the Color/Gamma menu is applied to the output.

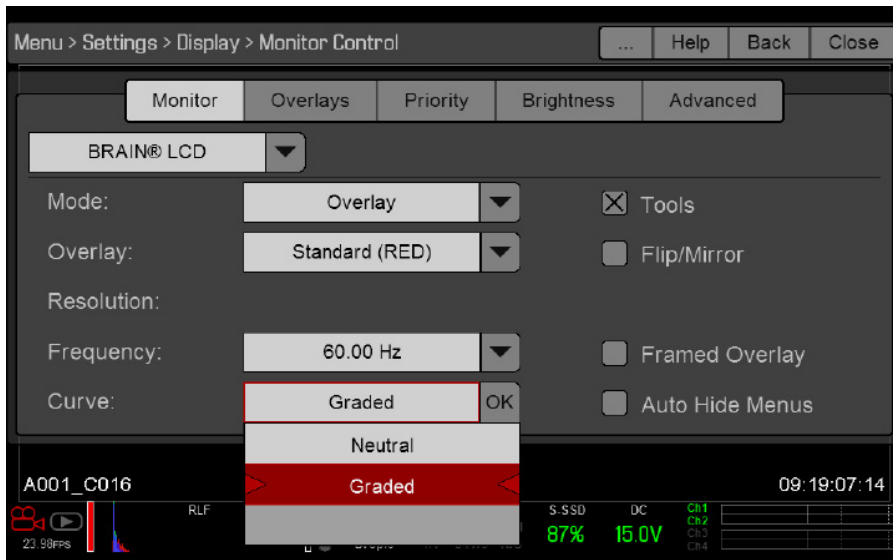

7. Repeat **Step 5** and **Step 6** for each monitor you are using.
8. To return to the Color/Gamma menu, select **Close**. To close all menus, tap any area outside of the menu.

RED DSMC OPERATION GUIDE: EPIC/SCARLET

ACES PROXY

Select the **ACES Proxy** check box to generate an ACES-compliant solution. When this option is enabled, all monitors output an ACES proxy that corresponds to ACESproxy10 (10-bit encoding). The firmware adjusts the proxy output for each camera and sensor type to ensure that the raw image data is properly transformed into the ACES color space.

You can record via HD-SDI or HDMI, apply a LUT through a LUT box, and then view the footage in real-time on an external third-party monitor. Use a LUT that incorporates the Reference Rendering Transform (RRT) and Output Device Transform (ODT) to create the look you want to achieve for your display.

Enabling the ACES Proxy option does not change the footage recorded to the SSD, but does add an ACES metadata tag to the R3D file. The R3D has the most recently-selected color space and graded gamma space (you cannot select color space and graded gamma space when ACES Proxy is enabled).



COLOR TEMPERATURE

Select a color temperature. The range is 1700 to 10,000 KELVIN, and the default is 5600 KELVIN.

NOTE: The Color Temperature settings are not accessible on cameras with MONOCHROME or RED DRAGON MONOCHROME sensors.

TINT

Color temperature calculations assume a pure light source that may not be true in the specific scene the camera is imaging. To compensate for any residual colorcast, the Tint parameter adjusts the RGB color balance with a compensating magenta-green color component. Tint range is -100 to 100, with a default of 0.000.

NOTE: Selecting Auto White Balance calculates a new Tint value. The value does not change if you adjust the color temperature manually. Selecting a preset resets Tint to 0.000.

RED DSMC OPERATION GUIDE: EPIC/SCARLET

PRESETS

Each preset has 0.000 Tint. Available preset options are:

- ▶ **Incandescent:** 2800 K
- ▶ **Tungsten:** 3200 K
- ▶ **Fluorescent:** 4500 K
- ▶ **Flash:** 5500 K
- ▶ **Daylight:** 5600 K
- ▶ **Cloudy:** 7500 K
- ▶ **Shade:** 9000 K

AUTO WHITE BALANCE

Auto white balance analyzes the central 25% of the image visible in the monitor to calculate a color temperature that will render a white object as white.

To use auto white balance, follow the instructions below:

1. Place a white or grey object under the ambient light.
2. Go to **Menu > Settings > Look > Color Temp.**
Alternatively, select **Color Temperature > Advanced...** from the Upper Status Row.
3. Select **Auto White Balance.**

LGG (LIFT, GAMMA, GAIN)

Adjust the lift, gamma, and gain for the Red channel, Blue channel, and Green channel individually.

PROJECT

The Project menu includes: Frame Rate, Exposure, Timecode, Slate, and Format.

FRAME RATE

RECORDING FRAME RATE

Select the recording frame rate (also referred to as the capture frame rate). The recording frame rate is the number of frames per second (FPS) that are recorded. The recording frame rate is different from the project time base, which is the rate at which the footage will be played back.

The default recording frame rate is 23.98 FPS. If you change the project time base, the recording frame rate automatically changes its value to match the project time base.

PROJECT TIME BASE

Select the project time base, which is the rate at which the footage will be played back. The project time base displays in the lower left corner of the display.

The following project time bases are available:

- ▶ 23.98 FPS (Default)
- ▶ 24.00 FPS
- ▶ 25.00 FPS
- ▶ 29.97 FPS
- ▶ 47.95 FPS
- ▶ 48.00 FPS
- ▶ 50.00 FPS
- ▶ 59.94 FPS

RED DSMC OPERATION GUIDE: EPIC/SCARLET

VARISPEED

When a recording frame rate other than the current project time base is selected, the FPS text turns yellow and the word Varispeed replaces the Audio Meter in the lower right corner of the display.

Audio is not recorded in Varispeed mode.

EPIC DRAGON FRAME RATES

The table below describes the maximum frame rate for each resolution of the EPIC DRAGON.

The minimum frame rate is always 1 FPS.

The table below omits rows for the anamorphic formats, since the maximum frame rate for each anamorphic format and the corresponding non-anamorphic format is the same.

NOTE: Frame rates below are based on a 23.98 time base, 8:1 compression, and Lookaround disabled.

FORMAT	MAX FRAME RATE (FPS)	FORMAT	MAX FRAME RATE (FPS)
6K FF	82.81	3.5K FF	138.94
6K 2:1	85.05	3.5K 2:1	145.39
6K WS	100.67	3.5K WS	172.00
6K HD	83.33	3.5K HD	134.13
6K 6:5	82.81	3.5K 3:2	116.54
6K 3:2	82.81	3.5K 4:3	103.69
6K 4:1	168.91	3.5K 5:4	97.25
6K 8:1	333.11	3.5K 4:1	287.92
5.5K FF	88.49	3.5K 8:1	400.00
5.5K 2:1	92.60	3K FF	160.27
5.5K WS	109.56	3K 2:1	168.91
5.5K HD	86.28	3K WS	200.27
5.5K 4:1	183.51	3K HD	160.27
5.5K 8:1	360.49	3K 6:5	160.27
5K FF	96.39	3K 3:2	135.51
5K 2:1	101.45	3K 4:3	120.60
5K WS	120.38	3K 5:4	113.14
5K HD	96.39	3K 4:1	333.11
5K 6:5	96.39	3K 8:1	400.00
5K 4:1	200.27	2.5K FF	192.09
5K 8:1	390.44	2.5K 2:1	200.88
4.5K FF	113.33	2.5K WS	237.08
4.5K 2:1	113.33	2.5K HD	194.36
4.5K WS	134.13	2.5K 3:2	161.45
4.5K HD	109.92	2.5K 4:3	143.80
4.5K 3:2	90.81	2.5K 5:4	134.95
4.5K 4:1	224.92	2.5K 4:1	392.77

RED DSMC OPERATION GUIDE: EPIC/SCARLET

FORMAT	MAX FRAME RATE (FPS)	FORMAT	MAX FRAME RATE (FPS)
4.5K 8:1	400.00	2.5K 8:1	400.00
4K FF	120.83	2K FF	240.55
4K 2:1	127.38	2K 2:1	252.55
4K WS	150.72	2K WS	301.10
4K HD	120.83	2K HD	240.55
4K 6:5	120.83	2K 6:5	240.55
4K 3:2	102.08	2K 3:2	202.74
4K 4:3	90.81	2K 4:3	180.49
4K 5:4	85.16	2K 5:4	169.34
4K 4:1	252.55	2K 4:1	400.00
4K 8:1	400.00	2K 8:1	400.00

RED DSMC OPERATION GUIDE: EPIC/SCARLET

SCARLET DRAGON FRAME RATES

The table below describes the maximum frame rate for each resolution of the SCARLET DRAGON.

The minimum frame rate is always 1 FPS.

NOTE: Frame rates below are based on a 23.98 time base, 8:1 compression, with Lookaround disabled.

FORMAT	MAX FRAME RATE (FPS)
6K FF	12.08 (in Burst mode)
5K FF	24.62
5K 2:1	25.95
5K WS	30.71
5K HD	26.24
5K 6:5	38.63
4K FF	38.61
4K 2:1	40.87
4K WS	48.22
4K HD	41.16
4K 6:5	60.74
3K FF	67.86
3K 2:1	71.54
3K WS	84.67
3K HD	72.31
3K 6:5	81.22
2K FF	121.83
2K 2:1	128.49
2K WS	150
2K HD	121.83
2K 6:5	121.83

RED DSMC OPERATION GUIDE: EPIC/SCARLET

EPIC MYSTERIUM-X AND SCARLET MYSTERIUM-X FRAME RATES

The table below describes the maximum frame rate for each resolution of the EPIC MYSTERIUM-X and SCARLET MYSTERIUM-X.

The minimum frame rate is always 1 FPS.

The table below omits rows for the anamorphic formats, since the maximum frame rate for each anamorphic format and the corresponding non-anamorphic format is the same.

NOTE: Frame rates below are based on a 23.98 time base, 8:1 compression, with Lookaround disabled.

FORMAT	MAX FRAME RATE (FPS) EPIC MYSTERIUM-X	MAX FRAME RATE (FPS) SCARLET MYSTERIUM-X
5K FF	95.83	12
5K 2:1	100.83	12
5K WS	120.83	12
5K HD	95.83	12
5K 1.22:1	95.83	12
4K FF	120.83	30
4K WS	152.47	36
4K HD	120.83	30
3K FF	159.88	48
3K WS	200.88	60
3K HD	159.88	48
2K FF	239.67	60
2K WS	301.79	75
2K HD	239.67	60
1K HD	356.58	90
1K WS	400	120

RED DSMC OPERATION GUIDE: EPIC/SCARLET

EXPOSURE

Select the exposure (shutter speed) of each frame. You can change exposure while recording.

Decreasing shutter speed increases the amount of time that light hits the sensor, which increases exposure and motion blur of moving objects. Increasing shutter speed decreases the amount of time that light hits the sensor, which decreases exposure and motion blur of moving objects.

The Upper Status Row displays the exposure as either shutter speed or shutter angle. For more information, go to [“Exposure” on page 69](#).

If the camera is able to achieve the target exposure, the exposure value displays in white. If the camera is unable to achieve the target exposure, the exposure value displays in yellow, and the camera uses the closest available exposure.

NOTE: If using speed ramp mode, select an exposure that is valid for each ramp target frame rate. If the camera ramps to a frame rate that is incompatible with the current exposure, the exposure changes to the longest exposure possible for the frame rate. For more information, go to [“Speed Ramp Mode” on page 99](#).

NOTE: You cannot change the exposure when HDR is enabled.

INTEGRATION TIME

Enter the exposure value as a shutter speed (1/xx sec).

- ▶ **MYSTERIUM-X:** Slowest speed is 1/recording frame rate. For 24 FPS, the slowest speed is 1/24 sec.
- ▶ **RED DRAGON:** Slowest speed is 1/8 sec, regardless of the recording frame rate.

The fastest speed is 1/131,579 sec. Default is 1/48 sec.

SHUTTER ANGLE

Enter the exposure value as a shutter angle (xx°). Range is 1.000–360.000°. Default is 180.000°.

EXPOSURE CONVERSIONS

The table below lists common shutter speed and shutter angle equivalents.

SHUTTER SPEED (1/XX SEC)	SHUTTER ANGLE (°)	SHUTTER SPEED (1/XX SEC)	SHUTTER ANGLE (°)
1/32	270	1/120	72
1/48	180	1/192	45
1/50	172.8	1/348	22.5
1/60	144	1/696	11
1/96	90	1/1000	8.6

CONVERT SHUTTER SPEED TO SHUTTER ANGLE

Shutter Angle = (Shutter Speed x Frame Rate x 360)

Example: (1/48 x 24 x 360) = 180

CONVERT SHUTTER ANGLE TO SHUTTER SPEED

Shutter Speed = 1/(Frame Rate x 360/Angle)

Example: 1/(24 x 360/180) = 1/48

RED DSMC OPERATION GUIDE: EPIC/SCARLET

TIMECODE

For more information about timecode, go to [“Timecode, Genlock, Multi-Camera Setup”](#) on page 156.

TIMECODE SOURCE	MODE	DESCRIPTION
User Provided (Internal)	Use Real Time Clock (RTC)	Uses the internal Real Time Clock as the timecode counter source. You can set the hours, minutes, and seconds in the numerical boxes on the screen.
	Set Manually	Define a custom value as the timecode counter seed. Set the hours, minutes, and seconds in the numerical boxes on the screen.
External: BRAIN	Varies by device	Uses the timecode from an external device connected to the timecode connector on the camera.
External: Rear Module	Varies by device	Uses the timecode from an external device connected to a Pro I/O Module or a REDCAST Module.

LTC OUT

Select the **LTC Out** check box to output the linear timecode signal generated by the camera through the timecode (TCODE) port on the Pro I/O Module.

NOTE: If jamming camera timecode to a timecode device, ensure that LTC Out is disabled.

SLATE

Use the Slate menu to add metadata to clips. After configuring the following fields, the information populates in the Media menu when formatting media:

- ▶ Cam ID
- ▶ Cam Pos

NOTE: The scene name is limited to eight (8) characters.

AUTO-INCREMENT TAKE

To automatically increment the take number when the camera stops recording, follow the instructions below:

1. Go to **Menu > Settings > Project > Slate > Scene**.
2. Enter a value in the **Take** box.

AUTO SLATE

Frame values for **Auto Head Frames** and **Auto Tail Frames** on the **Auto Slate** tab, these values only show in-camera. The Auto Head Frames and Auto Tail Frames metadata values are currently disabled in REDCINE-X PRO.

FORMAT

Use the Format menu to select the resolution, aspect ratio, anamorphic setting, and lookaround setting. After selecting format settings, select **Set Format**.

RED DSMC OPERATION GUIDE: EPIC/SCARLET

EPIC DRAGON FORMATS

The table below describes the formats that are available for EPIC DRAGON.

Default for EPIC DRAGON is 6K 2:1.

The table below omits rows for the anamorphic formats, since the pixel dimensions for each anamorphic format and the corresponding non-anamorphic format are the same. For more information, go to [“Anamorphic” on page 96](#).

EPIC DRAGON offers a 6:5 aspect ratio for each resolution. Using a 6:5 aspect ratio at 2x anamorphic gives you a 2:40:1 aspect ratio.

RESOLUTION	DESCRIPTION	DIMENSIONS (PIXELS)	
		WIDTH	HEIGHT
6K FF	6K RAW Full Frame	6144	3160
6K 2:1	6K RAW 2:1	6144	3072
6K WS	6K RAW Wide Screen—2.4:1	6144	2592
6K HD	6K RAW HD—16:9	5568	3132
6K 3:2	6K RAW 3:2	4752	3160
6K 6:5	6K RAW 6:5	3792	3160
6K 4:1	6K RAW 4:1	6144	1536
6K 8:1	6K RAW 8:1	6144	768
5.5K FF	5.5K RAW	5632	2948
5.5K 2:1	5.5K RAW 2:1	5632	2816
5.5K WS	5.5K RAW Wide Screen—2.4:1	5632	2376
5.5K HD	5.5K RAW HD—16:9	5376	3024
5.5K 4:1	5.5K RAW 4:1	5632	1408
5.5K 8:1	5.5K RAW 8:1	5632	704
5K FF	5K RAW Full Frame	5120	2700
5K 2:1	5K RAW 2:1	5120	2560
5K WS	5K RAW Wide Screen—2.4:1	5120	2160
5K HD	5K RAW HD—16:9	4800	2700
5K 6:5	5K RAW 6:5	3240	2700
5K 4:1	5K RAW 4:1	5120	1280
5K 8:1	5K RAW 8:1	5120	640
4.5K FF	4.5K RAW	4608	2412
4.5K 2:1	4.5K RAW 2:1	4608	2304
4.5K WS	4.5K RAW Wide Screen—2.4:1	4608	1944
4.5K HD	4.5K RAW HD—16:9	4224	2376
4.5K 3:2	4.5K RAW 3:2	4320	2880
4.5K 4:1	4.5K RAW 4:1	4608	1152
4.5K 8:1	4.5K RAW 8:1	4608	576
4K FF	4K RAW Full Frame	4096	2160

RED DSMC OPERATION GUIDE: EPIC/SCARLET

RESOLUTION	DESCRIPTION	DIMENSIONS (PIXELS)	
		WIDTH	HEIGHT
4K 2:1	4K RAW 2:1	4096	2048
4K WS	4K RAW Wide Screen—2.4:1	4096	1728
4K HD	4K RAW HD—16:9	3840	2160
4K 6:5	4K RAW 6:5	2592	2160
4K 3:2	4K RAW 3:2	3840	2560
4K 4:3	4K RAW 4:3	3840	2880
4K 5:4	4K RAW 5:4	3840	3072
4K 4:1	4K RAW 4:1	4096	1024
4K 8:1	4K RAW 8:1	4096	512
3.5K FF	3.5K RAW Full Frame	3584	1876
3.5K 2:1	3.5K RAW 2:1	3584	1792
3.5K WS	3.5K RAW Wide Screen—2.4:1	3584	1512
3.5K HD	3.5K RAW HD—16:9	3456	1944
3.5K 3:2	3.5K RAW 3:2	3360	2240
3.5K 4:3	3.5K RAW 4:3	3360	2520
3.5K 5:4	3.5K RAW 5:4	3360	2688
3.5K 4:1	3.5K RAW 4:1	3584	896
3.5K 8:1	3.5K RAW 8:1	3584	448
3K FF	3K RAW Full Frame	3072	1620
3K 2:1	3K RAW 2:1	3072	1536
3K WS	3K Wide Screen—2.4:1	3072	1296
3K HD	3K RAW HD—16:9	2880	1620
3K 6:5	3K RAW 6:5	1944	1620
3K 3:2	3K RAW 3:2	2880	1920
3K 4:3	3K RAW 4:3	2880	2160
3K 5:4	3K RAW 5:4	2880	2304
3K 4:1	3K RAW 4:1	3072	768
3K 8:1	3K RAW 8:1	3072	384
2.5K FF	2.5K RAW Full Frame	2560	1340
2.5K 2:1	2.5K RAW 2:1	2560	1280
2.5K WS	2.5K Wide Screen—2.4:1	2560	1080
2.5K HD	2.5K RAW HD—16:9	2304	1296
2.5K 3:2	2.5K RAW 3:2	2400	1600
2.5K 4:3	2.5K RAW 4:3	2400	1800
2.5K 5:4	2.5K RAW 5:4	2400	1920
2.5K 4:1	2.5K RAW 4:1	2560	640

RED DSMC OPERATION GUIDE: EPIC/SCARLET

RESOLUTION	DESCRIPTION	DIMENSIONS (PIXELS)	
		WIDTH	HEIGHT
2.5K 8:1	2.5K RAW 8:1	2560	320
2K FF	2K RAW Full Frame	2048	1080
2K 2:1	2K RAW 2:1	2048	1024
2K WS	2K RAW Wide Screen—2.4:1	2048	864
2K HD	2K RAW HD—16:9	1920	1080
2K 3:2	2K RAW 3:2	1920	1280
2K 4:3	2K RAW 4:3	1920	1440
2K 5:4	2K RAW 5:4	1920	1536
2K 6:5	2K RAW 6:5	1296	1080
2K 4:1	2K RAW 4:1	2048	512
2K 8:1	2K RAW 8:1	2048	256

RED DSMC OPERATION GUIDE: EPIC/SCARLET

SCARLET DRAGON FORMATS

The table below describes the formats that are available for SCARLET DRAGON.

SCARLET DRAGON offers a 6:5 aspect ratio for each resolution. Using a 6:5 aspect ratio at 2x anamorphic gives you a 2:40:1 aspect ratio.

RESOLUTION	DESCRIPTION	DIMENSIONS (PIXELS)	
		WIDTH	HEIGHT
6K	6K RAW Full Frame	6144	3160
6K 3:2	6K RAW 3:2	4752	3160
6K 6:5	6K RAW 6:5	3792	3160
5K	5K RAW Full Frame	5120	2700
5K 2:1	5K RAW 2:1	5120	2560
5K WS	5K RAW Wide Screen—2.4:1	5120	2160
5K HD	5K RAW HD—16:9	4800	2700
5K 6:5	5K RAW 6:5	3240	2700
4K	4K RAW Full Frame	4096	2160
4K 2:1	4K RAW 2:1	4096	2048
4K WS	4K RAW Wide Screen—2.4:1	4096	1728
4K HD	4K RAW HD—16:9	3840	2160
4K 6:5	4K RAW 6:5	2592	2160
3K	3K RAW Full Frame	3072	1620
3K 2:1	3K RAW 2:1	3072	1536
3K WS	3K RAW Wide Screen—2.4:1	3072	1296
3K HD	3K RAW HD—16:9	2880	1620
3K 6:5	3K RAW 6:5	1944	1620
2K	2K RAW Full Frame	2048	1080
2K 2:1	2K RAW 2:1	2048	1024
2K WS	2K RAW Wide Screen—2.4:1	2048	864
2K HD	2K RAW HD—16:9	1920	1080
2K 6:5	2K RAW 6:5	1296	1080

RED DSMC OPERATION GUIDE: EPIC/SCARLET

EPIC MYSTERIUM-X AND SCARLET MYSTERIUM-X FORMATS

The table below describes the formats that are available for EPIC MYSTERIUM-X and SCARLET MYSTERIUM-X.

- ▶ **EPIC MYSTERIUM-X:** Default is 5K 2:1.
- ▶ **SCARLET MYSTERIUM-X:** Default is 4K.

The table below omits rows for the anamorphic formats, since the pixel dimensions for each anamorphic format and the corresponding non-anamorphic format are the same. For more information, go to [“Anamorphic” on page 96](#).

RESOLUTION	DESCRIPTION	DIMENSIONS (PIXELS)		DIMENSIONS (MM)		
		WIDTH	HEIGHT	WIDTH	HEIGHT	DIAGONAL
5K FF	5K RAW Full Frame	5120	2700	27.65	14.58	31.26
5K 2:1	5K RAW 2:1	5120	2560	27.65	13.82	30.91
5K WS	5K RAW Wide Screen—2.4:1	5120	2160	27.65	11.66	30.01
5K HD	5K RAW HD—16:9	4800	2700	25.92	14.58	29.74
5K 1.22:1	5K RAW 1.22:1	3300	2700	17.80	14.58	23.01
4K FF	4K RAW Full Frame	4096	2160	22.12	11.66	25.01
4K WS	4K RAW Wide Screen—2.4:1	4096	1708	22.12	9.22	23.96
4K HD	4K RAW HD—16:9	3840	2160	20.74	11.66	23.79
3K FF	3K RAW Full Frame	3072	1620	16.59	8.75	18.75
3K WS	3K Wide Screen—2.4:1	3072	1284	16.59	6.93	17.98
3K HD	3K RAW HD—16:9	2880	1620	15.55	8.75	17.84
2K FF	2K RAW Full Frame	2048	1080	11.06	5.83	12.50
2K WS	2K RAW Wide Screen—2.4:1	2048	854	11.06	4.61	11.98
2K HD	2K RAW HD—16:9	1920	1080	10.37	5.83	11.90
1K HD	1K RAW HD—16:9	1280	720	6.91	3.89	7.93
1K WS	1K Wide Screen—2.4:1	1280	480	6.91	2.59	7.38

RESOLUTION

Select the **Resolution**.

- ▶ For a list of EPIC DRAGON resolutions, go to [“EPIC DRAGON Formats” on page 91](#).
- ▶ For a list of SCARLET DRAGON resolutions, go to [“SCARLET DRAGON Formats” on page 94](#).
- ▶ For a list of EPIC MYSTERIUM-X and SCARLET MYSTERIUM-X resolutions, go to [“EPIC MYSTERIUM-X and SCARLET MYSTERIUM-X Formats” on page 95](#).

ASPECT RATIO

Select the **Aspect Ratio**. The available aspect ratios are determined by the selected resolution.

- ▶ For a list of aspect ratios for EPIC DRAGON, go to [“EPIC DRAGON Formats” on page 91](#).
- ▶ For a list of aspect ratios for SCARLET DRAGON, go to [“SCARLET DRAGON Formats” on page 94](#).
- ▶ For a list of aspect ratios for EPIC MYSTERIUM-X and SCARLET MYSTERIUM-X, go to [“EPIC MYSTERIUM-X and SCARLET MYSTERIUM-X Formats” on page 95](#).

RED DSMC OPERATION GUIDE: EPIC/SCARLET

ANAMORPHIC

Select an **Anamorphic** setting, if applicable. The anamorphic setting de-squeezes the image on the monitor and marks the footage as anamorphic in the clip metadata. When you open the clip in REDCINE-X PRO, the program automatically de-squeezes the image. The available anamorphic settings depend on your camera type.

- ▶ **EPIC DRAGON:** Supports anamorphic 1.3x and 2x with each format.
- ▶ **SCARLET DRAGON:** Supports anamorphic 2x for 5K 6:5.
- ▶ **EPIC MYSTERIUM-X and SCARLET MYSTERIUM-X:** Supports the following:
 - **5K FF:** Anamorphic 1.3x and 2x
 - **5K 1.22:1:** Anamorphic 2x

NOTE: Anamorphic de-squeeze on the RED PRO LCD 7.0" requires that your camera is on firmware v5.3 or later.

DE-SQUEEZED RESOLUTION AND DE-SQUEEZED ASPECT RATIO

When you enable anamorphic, both the actual format and the de-squeezed format display at the bottom of the Format menu.

When anamorphic is enabled, the camera does not crop the sensor image, so the recorded image has the same resolution and dimensions as the corresponding non-anamorphic format.

After de-squeezing the footage in post production, the resulting footage has a different format than the original recorded image. The format of the de-squeezed footage is the second format (resolution and aspect ratio) that displays on the Format menu.

Since the camera does not crop the image, you will have additional horizontal area to frame the image. Then, crop or scale the footage to the intended aspect ratio.

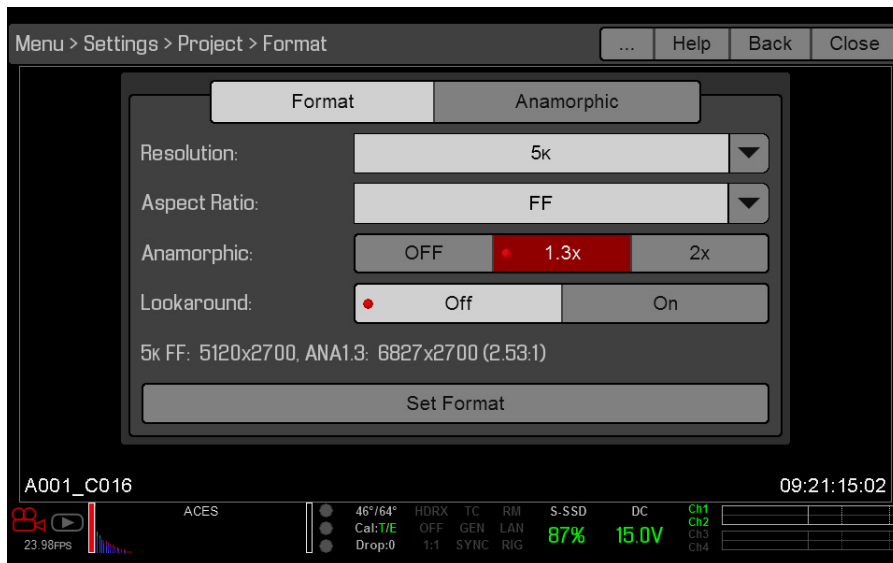

RED DSMC OPERATION GUIDE: EPIC/SCARLET

SHORT-CUT TO INDUSTRY-STANDARD ANAMORPHIC FORMATS

To quickly access industry-standard anamorphic formats, go to **Menu > Settings > Project > Format > Anamorphic**. The Anamorphic tab is a short-cut to all of the industry-standard anamorphic formats, so that you can easily select the most common anamorphic formats.

The Anamorphic tab lists the following anamorphic formats:

- ▶ **EPIC DRAGON:** Every format with a 6:5, 5:4, or 4:3 aspect ratio and a 1.3x or 2x anamorphic setting
- ▶ **SCARLET DRAGON:** 5K 6:5 2x
- ▶ **EPIC MYSTERIUM-X and SCARLET MYSTERIUM-X:** 5K 1.22:1 2x

NOTE: The Anamorphic tab only lists industry-standard anamorphic formats. To access all of the anamorphic and non-anamorphic formats, go to **Menu > Settings > Project > Format > Format**.

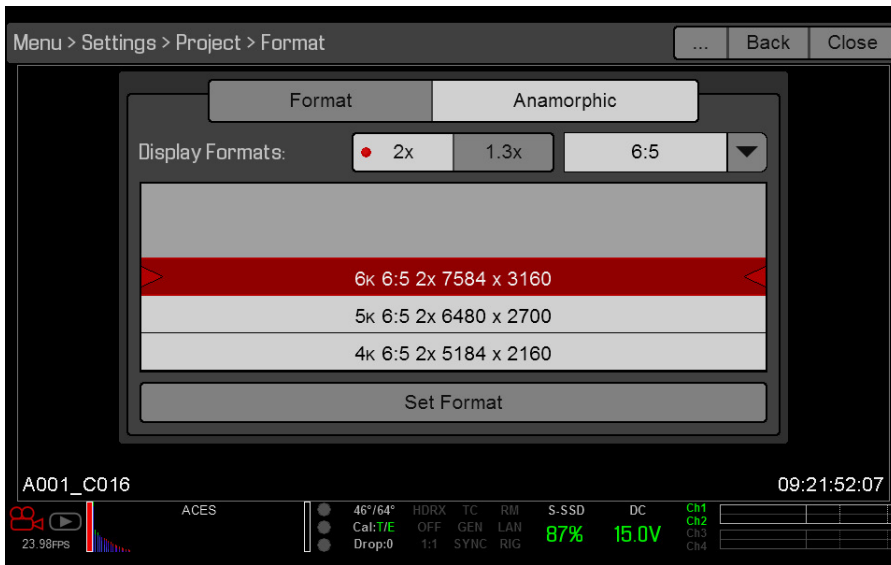

LOOKAROUND

When Lookaround is enabled, the Frame Guide and recording area are scaled down on the display so that you can see what images will enter the recording area.

To assign a Shading overlay to the Lookaround area (the area outside of the recording area), go to **“General Tab” on page 79**.

Lookaround limits the available frame rates. Also, Lookaround is either very limited or not possible for high resolutions (such as 5K Full Frame in EPIC MYSTERIUM-X and 6K Full Frame in EPIC DRAGON). At high resolutions, the recording area on the display shows the full sensor area or full sensor height, so there is no extra room for Lookaround.

UHD

The UHD menu is only accessible when a REDCAST Module is installed. For more information, see the **REDCAST MODULE Operation Guide**, available at www.red.com/downloads.

AUDIO

The Audio menu lets you configure the audio subsystem. For more information, go to **“Record and Monitor Audio” on page 139**.

RECORDING

The Recording menu includes: Mode, Frame Processing, Pre-Record, and Indicator.

RED DSMC OPERATION GUIDE: EPIC/SCARLET

MODE

You can select the following recording modes: Continuous Record, Internal Timelapse Timer, Frame Trigger, REDCODE Burst, Speed Ramp Mode, Multi-Shot, and Motion + Stills.

STORAGE

You can select the following storage locations:

- ▶ **Local:** Stores footage directly to an SSD
- ▶ **Network:** Stores footage to a network
NOTE: The Network option is only available on an EPIC DRAGON or SCARLET DRAGON.
- ▶ **External:** Stores footage to an external device
NOTE: In External storage, you can only select Continuous Record and Motion + Stills recording modes.

CONTINUOUS RECORD

NOTE: This mode is not available in Stills mode.

Continuous Record is the “normal” recording mode. The camera continuously records frames at the current recording frame rate. You can limit each recording to a specific amount of frames using the Limit Recording to setting.

INTERNAL TIMELAPSE TIMER

NOTE: This mode is not available in Stills mode.

In Internal Timelapse Timer mode, the camera records a specified number of frames at a specified interval. The current recording frame rate determines the timing of the frames per pulse.

For example, in Internal Timelapse Timer mode, you can choose to record a total amount of 1000 frames, and take 1 frame every 4.67 seconds. After recording 1000 frames (which takes 4,670.00 seconds), the recording process stops.

To use Internal Timelapse Timer mode, follow the instructions below:

1. Go to **Menu > Settings > Recording > Mode**.
2. Select **Internal Timelapse Timer** from the **Mode** drop-down menu.
3. Use the **Limit Recording to** fields to set the recording to end at a predefined frame limit (optional).
4. Select the number of frames to be captured in the **Record** field.
5. Select the time interval from the **Interval** field (range is 1–3,599 sec). The Interval setting specifies the frequency at which the frame or group of frames is captured.
6. Close the menu.
7. Start recording to start the interval.

The overlay displays the number of frames recorded out of the total amount of frames.

FRAME TRIGGER

NOTE: This mode is not available in Stills mode.

In Frame Trigger mode, the camera records the specified number of frames for each external trigger. This mode limits the REDCODE based on sustainable record rates.

To use Frame Trigger mode, follow the instructions below:

1. Go to **Menu > Settings > Recording > Mode**.
2. Select **Frame Trigger** from the **Mode** drop-down menu.
3. Use the **Limit Recording to** fields to set the recording to end at a predefined frame limit (optional).
4. Select a **Pre Count** and **Post Count**. For more information, go to [“Pre Count and Post Count” on page 100](#).
5. Close the menu.

6. Start recording.

The overlay displays the number of frames recorded out of the total amount of frames.

NOTE: There may be a delay between receiving the external trigger and capturing the next frame(s). The delay may be as long one (1) frame period at the current recording frame rate. To completely synchronize frames to an external trigger, set **Sensor Sync Mode** to **MoCo**. For more information, go to [“Sync” on page 106](#).

SPEED RAMP MODE

NOTE: This mode is not available in Stills mode.

Speed Ramp mode lets you program the current recording frame rate to transition to different recording frame rates during recording.

1. Go to **Menu > Settings > Recording > Mode**.
2. Select **Speed Ramp Mode** from the **Mode** drop-down menu.
3. Use the **Limit Recording to** fields to set the recording to end at a predefined frame limit (optional).
4. Select a ramp target:
 - **Ramp A/B/C/D:** Each ramp target is tied to a specific Target/Duration combination.
 - **Ramp Reset:** Ramp to the starting frame rate with the specified Duration.
5. Set the **Target** frame rate.
6. Set the **Duration**, which is how long it takes to transition from the current frame rate to the target frame rate.
7. Go to **Menu > Settings > Setup > Keys** and program a key to start the speed ramp:
 - Record: Start Speed Ramp A/B/C/D
 - Record: Start Speed Ramp Reset
8. Start recording.
9. To start speed ramp, press the key that you have mapped to start the speed ramp.

The frame rate transitions to the target frame rate during the duration you set up.

NOTE: If using speed ramp mode, select an exposure that is valid for each ramp target frame rate. If the camera ramps to a frame rate that is incompatible with the current exposure, the exposure changes to the longest exposure possible for the frame rate.

REDCODE BURST

NOTE: This mode is not available in Stills mode.

In REDCODE Burst mode, the camera can record at a lower compression (REDCODE) for the specified amount of frames.

When REDCODE Burst mode is enabled and recording starts, the camera captures a “burst” of frames at the lower REDCODE, and then continues to record at the next available REDCODE. To add more bursts to clips during recording, press any key mapped to “Record: Mark Frame”.

To use REDCODE Burst mode, follow the instructions below:

1. Go to **Menu > Settings > Recording > Mode**.
2. Select **REDCODE Burst** from the **Mode** drop-down menu.
3. Use the **Limit Recording to** fields to set the recording to end at a predefined frame limit (optional).
4. Select a **Pre Count** and **Post Count**. For more information, go to [“Pre Count and Post Count” on page 100](#)
5. Close the menu.
6. Start recording.

RED DSMC OPERATION GUIDE: EPIC/SCARLET

PRE COUNT AND POST COUNT

When Frame Trigger or Burst mode is enabled, select the number of frames for the Pre Count and Post Count:

- ▶ **Pre Count:** The camera captures the frame cache from the time preceding the marker.
- ▶ **Post Count:** The camera captures the remaining frame cache after the marker.

The maximum frame counts are listed in the Available column, and are based on format and REDCODE.

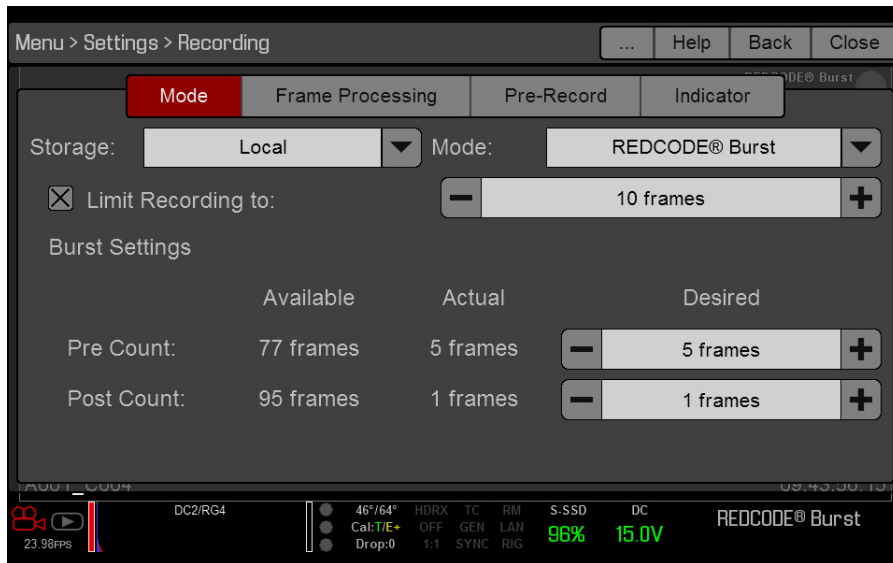

MULTI-SHOT

NOTE: Multi-Shot mode is only available on an EPIC DRAGON or SCARLET DRAGON.

NOTE: The camera does not sync timecode in Multi-Shot mode.

NOTE: This mode is available in Motion mode, but is only recommended in Stills mode.

Multi-Shot mode removes restrictions on Recording Frame Rate and REDCODE, allowing you to shoot at a high resolution, high frame rate, and low compression. These restrictions are removed because the camera records first to the camera's memory, and then offloads (while recording) to SSD after the camera's buffer fills up. Since the camera records only as fast as the buffer can transfer data, frames are dropped from the clip.

Multi-Shot mode has two sub-modes:

- ▶ Basic Multi-Shot mode
- ▶ Advanced Multi-Shot mode

BASIC MULTI-SHOT MODE

In Basic Multi-Shot mode, you can record a one-frame clip by pressing a Record key, or you can continuously record frames by holding a Record key. This mode is the easiest way to shoot stills, but there is some latency (about 700 milliseconds) when you press Record.

This mode only involves Record keys on the side SSD modules, REDMOTE, and DSMC Side Handle. Pressing the PWR/REC key on the camera initiates Advanced Multi-Shot mode.

To use Basic Multi-Shot mode, perform one of the following:

- ▶ Press a **Record** key to record a one-frame clip.
- ▶ Press and hold a **Record** key to start a new clip and continuously add frames to that clip. Release the **Record** key to stop adding frames and end the clip.

ADVANCED MULTI-SHOT MODE

In this mode, the camera is continuously recording, but is not saving frames. This eliminates the delay you get in Basic Multi-Shot mode. Since the camera is continuously recording, the camera requires the same amount of power it does during Continuous Record (as opposed to Preview mode). Unlike Basic mode, all frames are added to one (1) clip, instead of to separate clips.

To use Advanced Multi-Shot mode, follow the instructions below:

1. Press the **PWR/REC** key on the camera to start a new clip. This initial press adds one (1) frame to the clip.
2. Press a **Record** key on the side SSD module, REDMOTE, or DSMC Side Handle to add frames to the clip:
 - Press a **Record** key once to add a few frames to the clip. (The number of frames varies, and depends on the buffer.)
 - Press and hold a **Record** key to continuously add frames; release the **Record** key to stop adding frames.
3. Press the **PWR/REC** key on the camera to end the clip.

NOTE: You cannot shut down the camera until you end the clip.

ENABLE MULTI-SHOT MODE

To enable Multi-Shot mode, follow the instructions below:

1. Set the camera to Stills mode.
2. Go to **Menu > Settings > Recording > Mode**.
3. Select **Multi-Shot** from the **Mode** drop-down menu.
4. Use the **Limit Recording to** fields to set the recording to end at a predefined frame limit (optional).
5. Close the menu.
6. For more information on using the different sub-modes, go to:
 - [“Basic Multi-Shot Mode” on page 100](#)
 - [“Advanced Multi-Shot Mode” on page 101](#)

MOTION + STILLS

NOTE: This mode is available in Motion mode, but is only recommended in Stills mode.

Motion + Stills mode is identical to Continuous Record, except that when you initiate recording by pressing the PWR/REC key on the camera, all other Record keys mark frames for the duration of the clip. (If you initiate recording by pressing any other Record key, you can press any key mapped to “Record: Mark Frame” to mark stills.)

To use Motion + Stills mode, follow the instructions below:

1. Set the camera to Stills mode.
2. Go to **Menu > Settings > Recording > Mode**.
3. Select **Motion + Stills** from the **Mode** drop-down menu.
4. Use the **Limit Recording to** fields to set the recording to end at a predefined frame limit (optional).
5. Close the menu.
6. Press the **PWR/REC** key on the camera to start recording.
7. Press a **Record** key on the side SSD module, REDMOTE, or DSMC Side Handle to mark a frame.
8. Press the **PWR/REC** key on the camera to stop recording.

FRAME PROCESSING

NOTE: Frame processing is not supported in Speed Ramp Mode. For more information, go to “[Speed Ramp Mode](#)” on page 99.

Frame processing allows for the combination of multiple captured frames into one recorded frame. The combination occurs before the resulting frame is encoded. You can select the following frame processing settings: No Frame Processing, Frame Summing, Frame Averaging.

When in Frame Summing mode or Frame Averaging mode, the current integration time is applied to each frame. This means if the integration time is not the entire frame time (or 360°) there are gaps between the images used to create the combined frame. This may lead to unexpected motion artifacts.

The effect of frame processing is only visible during record. In Frame Summing mode, this means the exposure changes between preview and record. Experiment with the exposure and frame processing settings to achieve the effect you want.

NO FRAME PROCESSING

Normal frame processing mode. The Frames to Process selection does not affect recording.

FRAME SUMMING

Frame Summing combines the specified number of frames into one frame, and adds together the exposure time for each of the original frames. The resulting frame has an effective integration time that is equal to the current integration time multiplied by the number of frames.

For example, if you select 16 as the Frames to Process value, and set exposure to 1/48 sec, the resulting image has an effective integration time of 1/3 sec (16 x 1/48).

Frame summing results in a final image that is brighter and possibly blurrier than any of the original frames, so you can use frame summing to achieve the effect of long-exposure.

FRAME AVERAGING

Frame Averaging combines the specified number of frames into one frame, and averages the exposure time for each of the original frames. The resulting frame has an effective integration time that is equal to the current integration time.

For example, if you select 16 as the Frames to Process value, and set exposure to 1/48 sec, the resulting image still has the exposure value of 1/48 sec, along with the effect of long-exposure.

You can use frame averaging to achieve the effect of long-exposure along with the benefits of reduced noise. However, frame averaging does affect motion blur characteristics.

PRE-RECORD

When enabled, the Pre-Record setting continuously captures a cache of footage before recording starts. Select to have 4–30 seconds (incremented at two second intervals) of pre-record time added to the actual footage. When Pre-Record is enabled, you will not miss the start of a shot by being a little slow on the trigger.

- ▶ **Pre-Record Duration:** Select the pre-record time.
- ▶ **Always trigger Pre-Record before recording:** When selected, Pre-Record always starts when recording starts:
 - A. Press **PWR/REC** to activate Pre-Record.
 - B. Press **PWR/REC** a second time to start recording.
 - C. Press **PWR/REC** a third time to stop recording.
- ▶ **Trigger Pre-Record Now:** When selected, the Pre-Record menu closes and Pre-Record mode starts.

NOTE: Always perform a Secure Format before using Pre-Record. A Secure Format restores the SSD back to factory out-of-box settings, and optimizes the SSD for Pre-Record.

NOTE: To use Pre-Record only for specific situations, map Pre-Record to a key (**Menu > Settings > Setup > Keys > Record: Start Pre-Record**). For more information, go to “[Keys](#)” on page 103.

INDICATOR

- ▶ **Enable Sounds:** Select this check box to enable sounds. Then select sounds for the following actions:
 - Record Start
 - Record Stop
 - Mark Still Frame
- ▶ **EVF Tally Light:** Select this check box to enable the EVF Record Tally LED on the EVF to illuminate red when recording.

SETUP

The Setup menu includes: Keys, Date/Time, Communication, REDMOTE, GPIO/Sync, Fan Control, Lens, and Motor Control.

KEYS

Map keys to often-used actions to easily control the camera. For a full list of the default key mappings, go to [“Default Key Functions” on page 217](#).

KEY MAPPING

To map or remap a user key:

1. Press the user key that you want to map.
2. Select an action from the **Press** (or **CCW**) drop-down menu that you want to map to the user key.
3. To un-map a key, select **-Key Disabled-** from the drop-down menu.
4. If you want, map a **Release** or **(CW)** action to the key.
A Release action occurs when a pressed key is released.

OPTIONS

- ▶ **MENU key returns to settings menu:** Pressing the Menu key on a side module or REDMOTE moves you up one level in the menu tree.
- ▶ **Lock Side Module keys:** None of the module keys perform any actions when pressed, unless you set up the exceptions below:
 - Record key remains active when locked
 - Navigation keys remain active when locked
- ▶ **Show key action notifications:** A notification displays on the bottom of the display when you perform an action mapped to a key.

SOFT KEYS

The following sets of soft keys are available on the touchscreen:

- ▶ **A, B, C, D:** Left side of the touchscreen
- ▶ **1, 2, 3, 4:** Right side of the touchscreen

To map or remap a soft key, select an action from the drop-down menu next to the key you want to map.

- ▶ **Enable Soft Keys on touchscreen:** Tap the left or right side of the touchscreen to show the soft keys.
- ▶ **Show key actions as labels:** When the soft keys display, the number/letter of the key and the key action display.

RED DSMC OPERATION GUIDE: EPIC/SCARLET

ADVANCED

Use the Advanced tab to map any key, even if the key is not currently accessible. For example, you can map the REDMOTE keys even if a REDMOTE is not present.

WARNING: It is possible to remap the navigation keys using this tab. However, if you do not have a touchscreen attached, it is possible to lock out control. Be careful when remapping navigation keys.

DATE/TIME

Use the Date/Time menu to reset the internal clock of the camera. The time and date are timestamps on R3D files when recording to an SSD. The camera uses the 24-hour clock convention (military time). For example, enter 2:35 p.m. as 14:35:00.

The date and time are saved when you close the Date/Time menu.

COMMUNICATION

Use the Communication menu to allow one (1) or more cameras to communicate with each other or external devices.

You can use the serial port or a direct Ethernet cable to connect two (2) cameras, or one (1) camera and one (1) external device. If the camera is connected via Ethernet to a hub or router, multiple cameras and devices can communicate with each other.

For example, on a multi-rig 3D shoot, you can send commands to an individual camera (Example: Set CAM_A_L to 1/48 exposure), to a group of cameras (Example: Set 3DRIG_A to 48 FPS), or to all cameras (Example: Start Recording on all cameras).

RED DSMC OPERATION GUIDE: EPIC/SCARLET

CAMERA NAME

Use the Camera menu to set up a unique identifier for your camera (or a group of cameras). All command filtering happens on the receiver side of the communication link. Use camera names and group names to address commands to a specific camera or group of networked cameras.

- ▶ **Camera ID:** Enter a unique camera name to use in network communications. The field is limited to eight (8) characters.
- ▶ **Group ID:** Enter a group name to identify the camera as a member of a group of devices. The field is limited to eight (8) characters, and the default name is DEFAULT.
- ▶ **Target:** Specify which devices the camera can send commands to:
 - **All:** The camera can send commands to all devices on the network.
 - **None:** The camera can only receive commands. The camera cannot send commands.
 - **Custom:** The camera can send commands to a specific camera/device (enter the name of the camera/device in the Target ID text box) or a specific group (enter the name of the group in the Target ID text box). The camera/group name must match the name entered in the Name/Group field of the target device(s).

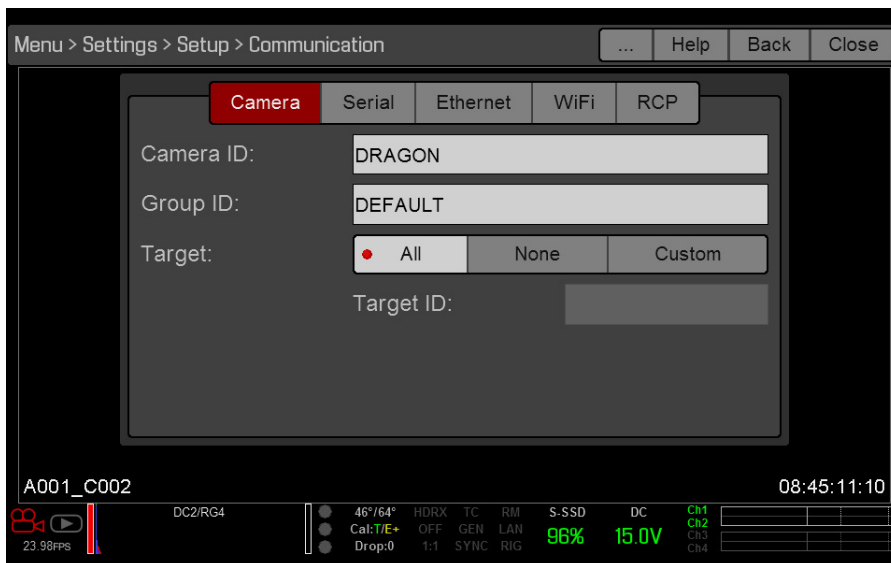

SERIAL PROTOCOL

The camera can communicate to external devices via the CTRL and the GIG-E connectors (camera-to-camera communication is possible only via GIG-E or the REDLINK® Bridge).

Select one of the following protocols from the **Serial Protocol** drop-down menu:

- ▶ None (Default)
- ▶ Element Technica
- ▶ 3ality SPC 7XXX
- ▶ REDLINK Command Protocol

RED DSMC OPERATION GUIDE: EPIC/SCARLET

ETHERNET

Use the settings on the Ethernet tab to configure the GIG-E port. Each camera or device requires a unique IP address. For camera-to-camera communication via Ethernet, both cameras need to be in the same sub-net (have the same netmask address) and have the same gateway address.

- ▶ **Enable DHCP:** Enables DHCP. If a DHCP-server is available in the communications network, the camera obtains an IP address, netmask address, and gateway address automatically from the DHCP server. You cannot manually enter anything in the IP Address, Netmask, and Gateway fields when this check box is selected.
- ▶ **Enable Camera to Camera:** A change to settings on this camera is sent to other cameras via the network as a SET command (as UDP packets). The SET command then sets the property on other cameras. If this camera receives a SET command, the camera does not send the command to other cameras/devices.
- ▶ **Enable External Control:** This camera can be controlled via TCP/IP from an external device.

WIFI

The settings on the WiFi menu are only used when a REDLINK Bridge is attached to the camera. For more information, see the [REDLINK Bridge Operation Guide](http://www.red.com/downloads), available at www.red.com/downloads.

RCP

Select the **Enable Remote Control Panel (RCP)** check box to enable a remote control panel (RCP).

COMPATIBLE REMOTE CONTROL PANELS (RCP)

The following remote control panels have been confirmed for compatibility with the camera:

- ▶ Sony® RCP-1500
- ▶ Sony RCP-1501
- ▶ Sony RCP-1530
- ▶ Sony MSU-1500

REDMOTE

Use the REDMOTE menu to pair a REDMOTE to the camera. For more information, go to “[REDMOTE Operation](#)” on page 146.

- ▶ **Wireless Enable:** When selected, the camera produces a wireless signal. Disable wireless in any setting in which the wireless signal could interfere with other devices, such as in a helicopter.
- ▶ **Wireless Channel:** Select the communication channel for the wireless connection in the event of interference from other wireless devices.
- ▶ **Camera MAC:** View the camera MAC address.

GPIO/SYNC

SYNC

Use the Sync menu to set up genlock and Motion Control (MoCo). For more information, go to “[Timecode, Genlock, Multi-Camera Setup](#)” on page 156.

SENSOR SYNC MODE

Sensor Sync Mode allows the shutter timing (scan start) to sync to an external signal.

- ▶ **Off:** Sensor runs at the current recording frame rate. This is the default option.
- ▶ **Genlock:** Sensor synchronizes with the incoming compatible genlock signal.
- ▶ **MoCo:** Each rising edge on the sync input triggers a frame to be captured.

RED DSMC OPERATION GUIDE: EPIC/SCARLET

GENLOCK SOURCE

Select a genlock input:

- ▶ BRAIN (Default)
- ▶ Rear Module (Pro I/O Module or REDCAST Module)

BRAIN GPIO

- ▶ **GPI Function (Camera Input):** Select one (1) of the following options to configure the input for devices connected to the SYNC connector on the camera:
 - **Sync In:** The camera input is used as a sync-in signal for MoCo.
 - **General Purpose In:** Use the **BRAIN GPI In High/Low** drop-down menus to map inputs to actions.
- ▶ **GPO Function (Camera Output):** Select an options to configure the output for devices connected to the CTRL connector on the camera:
 - **Sync Out:** Provides an output sync signal to act as a shutter start tally.
 - **Recording Indicator Out:** Provides a signal when recording is in process.

For more information, go to [“Input/Output Connectors”](#) on page 199.

GEN AND SYNC STATUS INDICATORS

The Lower Status Row of the camera display has GEN and SYNC indicators, which change color based on the current genlock and sync statuses. For more information, go to [“System Status Indicators”](#) on page 58.

FAN AND TEMPERATURE MANAGEMENT

The camera is controlled by complex thermal algorithms to ensure that the sensor and camera operate at safe temperatures. Each fan control mode affects the sensor temperature, sensor warm-up time, fan speed, and resulting fan noise.

When selecting a fan mode, first take into consideration how each fan mode behaves, and then select a fan mode that fits the needs of your project.

Regardless of sensor type and fan mode, you will get the best image quality by performing a black shading calibration at the temperature you want to use for your shoot.

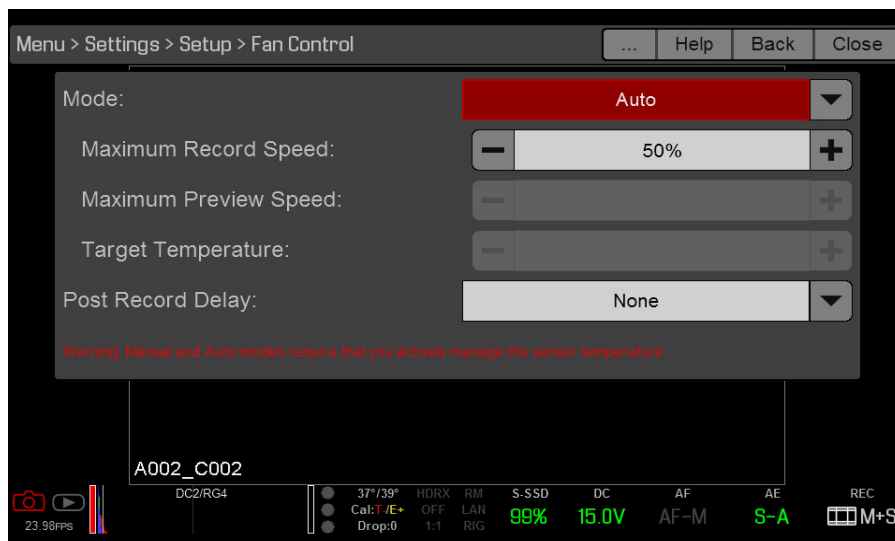

RED DSMC OPERATION GUIDE: EPIC/SCARLET

FAN CONTROL MODES

Select a fan control mode for the bottom fan. If a top fan is installed, it runs at a constant speed when necessary.

NOTE: After selecting a new fan setting, run the camera until the core temperature stabilizes, and then perform a black shading calibration.

NOTE: If using a top fan, the top fan may not run immediately after turning on the camera, as the top fan runs when the camera requires additional cooling power.

NOTE: Manual and Auto modes require that you actively manage the sensor temperature, because these modes focus on controlling fan speed and do not target a narrow sensor temperature range. Use the T/E status indicators as guides for proper temperature calibration.

NOTE: Maximum speeds are intended as target speeds only; actual fan speeds may be higher at times due to long recording times or high ambient temperatures.

ADAPTIVE (TARGET TEMPERATURE)

Adaptive is the default mode for EPIC DRAGON and SCARLET DRAGON.

Select a Target Temperature and the bottom fan self-adjusts to maintain the selected temperature. The default Target Temperature is 65°C. After the camera reaches the Target Temperature, and if the ambient temperature remains constant, Adaptive mode results in a consistent fan speed and fan noise over time.

Targeting a higher temperature raises the sensor temperature, lengthens the sensor warm-up time, and lowers the fan speed. Targeting a lower temperature lowers the sensor temperature, shortens the sensor warm-up time, and increases the fan speed.

NOTE: The intent of Target Temperature is to set the sensor temperature so that you can then create a calibration map for that temperature.

NOTE: When the camera turns on, the Target Temperature is the temperature of the current calibration map, regardless of what the Target Temperature was before you turned off the camera. Setting a calibration map also overrides the Target Temperature. For more information, go to [“Sensor Calibration” on page 110](#).

- ▶ **EPIC DRAGON and SCARLET DRAGON:** Target temperature range is 55°C to 70°C. A target temperature of 65°C works best across most environmental conditions.
- ▶ **EPIC MYSTERIUM-X and SCARLET MYSTERIUM-X:** Target temperature range is 45°C to 70°C. Target temperatures above 50°C give noticeable fan noise improvements when compared to Auto mode.

ADAPTIVE PREVIEW QUIET RECORD

NOTE: Target Temperature only affects standby mode.

- ▶ **Record mode:** The camera uses Quiet fan mode. For more information, go to [“Quiet” on page 108](#).
- ▶ **Standby mode:** The camera uses Adaptive fan mode. For more information, go to [“Adaptive \(Target Temperature\)” on page 108](#).

AUTO

Auto is the default mode for EPIC MYSTERIUM-X and SCARLET MYSTERIUM-X.

Select a maximum bottom fan record speed, and the standby mode fan speed self-adjusts accordingly so that enough cooling is provided overall.

The default Maximum Record Speed is 50%. The Maximum Record Speed range is 25–100%. A slower speed setting results in a faster standby mode fan speed, and vice versa.

QUIET

The bottom fan self-adjusts to maintain the lowest possible noise level in record and standby mode while still cooling the camera. Using Quiet results in a higher sensor temperature when compared to Auto mode.

RED DSMC OPERATION GUIDE: EPIC/SCARLET

MANUAL

Select a speed for the bottom fan in both record and standby modes. The bottom fan self-adjusts to maintain the selected speeds. The default Maximum Record Speed is 50% and the default Maximum Preview Speed is 75%. The range for both Maximum Record Speed and Maximum Preview Speed is 25–100%.

POST RECORD DELAY

Select the amount of time that it takes for the bottom fan to switch from record to preview mode.

LENS

LENS TAB

The options displayed on the Lens tab change based on the attached lens mount.

PL MOUNT

- ▶ **Enable Power to Lens:** Ensures that the camera powers the lens via the lens mount. This feature is enabled by default, but the camera saves the last selected setting. Deselect when using a Fujinon® T2.9 Cabrio Premier PL lens. If you disable this feature for the Fujinon Cabrio, re-enable it when using other lenses. For more information, go to “[Fujinon T2.9 Cabrio Premier PL Lenses](#)” on page 211.
- ▶ **Auto-Detect PL Lenses:** By default, this feature is enabled.
- ▶ **Detect Lens:** Detects a lens, if one is attached.

CANON AND NIKON LENS SETTINGS

The options below display when a DSMC Nikon Mount or DSMC Canon Mount is installed with a supported lens.

- ▶ **Aperture:** Enter the aperture value. The range and default depend on the lens.
- ▶ **Focus:** Enter the focal distance. The default value is the value from the lens. The range depends on the lens.

MOTION MOUNT TAB

The Motion Mount menu is only accessible when a DSMC RED MOTION MOUNT is installed. For more information, see the [RED MOTION MOUNT Operation Guide](#), available at www.red.com/downloads.

MOTOR CONTROL

Use the Motor Control menu to set up the RED 3-Axis Lens Control System. For more information, see the [RED 3-Axis Lens Control System Operation Guide](#), available at www.red.com/downloads.

MAINTENANCE

The Maintenance menu includes: Save Log, Upgrade, Calibrate, Self Test, Restore System, Rediscover, System Status, and OLPF.

SAVE A LOG FILE

A LOG file is a detailed text file of the processes and operations performed by the camera. If you contact RED for support, you may be asked to send a LOG file.

To save a LOG file, follow the instructions below:

1. Ensure that a REDMAG 1.8" SSD or RED MINI-MAG SSD is properly mounted to the camera.
2. Go to **Menu > Settings > Maintenance**.
3. Select **Save Log**.

The LOG file is saved as a *.txt file in the SSD root directory.

For more information about RED support or to create a support ticket, go to <https://support.red.com>.

NOTE: The camera automatically saves a LOG file when it is turned off properly and an SSD is mounted.

UPGRADE

You can check for upgrades for the following items:

- ▶ **Camera:** Go to “[Upgrade Camera Firmware](#)” on page 170.
- ▶ **REDMOTE:** Go to “[Upgrade REDMOTE Firmware](#)” on page 153.
- ▶ **Media:** For more information on the media upgrade procedure, see the [DSMC Media Operation Guide](#), available at www.red.com/downloads.

CALIBRATE

The Calibrate menu includes: Sensor, Gyro/Acc, and Lens.

SENSOR CALIBRATION

Sensor calibration, also known as black shading, is a process during which the camera optimizes image quality by ensuring that pixel sensitivity remains consistent throughout the sensor. Black shading generates a calibration map based on system and environment settings. After calibration, the sensor shows a uniform noise profile over the whole area without any falloffs on any side.

For more information on sensor calibration, see the [Black Shading Calibration](#) article, available at www.red.com/learn/red-101/black-shading-calibration.

NOTE: Calibration maps will still be available after performing a system restore.

CHECK NOISE PROFILE

To check the current noise profile, follow the instructions below:

1. Ensure that the camera reaches the temperature you want to use for your shoot.
2. Set the exposure to the exposure you want to use for your shoot.
3. Put a lens cap on the lens (if a lens is attached) or a front body cap on the camera (if a lens is not attached).
4. Go to **Menu > Settings > Look > FLUT**.
5. Set **FLUT** to **8.000**.
6. Check the noise that displays on the monitor:
 - The noise is random, with no fixed patterns or lines. The sensor is calibrated.
 - The noise has patterns or lines. Calibrate the sensor. For more information, go to “[Calibration Capture \(Black Shading\)](#)” on page 111.

WHEN TO CALIBRATE SENSOR

Calibration is required:

- ▶ After an extreme change in temperature (+/- 30°F or +/-15°C) from the current calibration map.
- ▶ After an extreme change in exposure time (+/- 1/2 sec) from the current calibration map.
- ▶ If either the T or E in the CAL: T/E indicator is not green.
- ▶ If the noise profile shows patterns or lines. For more information, go to “[Check Noise Profile](#)” on page 110.
- ▶ For EPIC DRAGON or SCARLET DRAGON: After each firmware upgrade.
- ▶ For EPIC MYSTERIUM-X or SCARLET MYSTERIUM-X: After a firmware upgrade if instructed to do so in the firmware release notes.

To check the temperature/exposure of the current calibration file, go to **Menu > Settings > Maintenance > System Status > Calibration**.

RED DSMC OPERATION GUIDE: EPIC/SCARLET

CALIBRATION CAPTURE (BLACK SHADING)

Not including preparation time, the calibration procedure takes several minutes. To perform black shading, follow the instructions below:

1. Ensure that the camera reaches the temperature you want to use for your shoot.
2. Set the exposure to the exposure you want to use for your shoot.
3. Ensure that the sensor is as dark as possible.
 - Preferably, take off the lens, and install the front body cap.
 - If you cannot take off the lens, put a lens cap on the lens. (Not all lens caps completely block IR. Lens caps are made to protect the lens, not necessarily to block light.)
 - If possible, use a dark room.
 - Just closing the aperture is NOT sufficient.
4. Ensure a properly formatted SSD is attached to the camera. Even if you are not saving the calibration map to the camera, an SSD is required to store RAW images during calibration.
5. Go to **Menu > Settings > Maintenance > Calibrate > Sensor**.
NOTE: If the calibration map name is “empty”, that means that the only calibration map on your camera is the factory calibration.
6. For EPIC DRAGON or SCARLET DRAGON, you can create up to four (4) calibration maps at a time. Select a check box for each calibration map you want, select the exposure you want for each from the drop-down menus, and go to [Step 10](#).
7. For EPIC MYSTERIUM-X or SCARLET MYSTERIUM-X, select one (1) of the following:
 - **Save As user HS:** The calibration map created by black shading will overwrite the user HS calibration map. User HS is the name for the current in-camera user-created calibration map.
 - **Save To Media:** The calibration map created by black shading will be saved to an SSD.
 - Leave both **Save** check boxes deselected: The calibration will only be applied until the camera turns off, and will not be saved.
8. For EPIC MYSTERIUM-X or SCARLET MYSTERIUM-X, select the last check box. The label for the check box is the name of the user-created calibration map you will be overwriting.
NOTE: If the calibration map name is “empty”, that means that the only calibration map on your camera is the factory calibration.
NOTE: The Start Capture button is disabled until you select this check box.
9. For EPIC MYSTERIUM-X or SCARLET MYSTERIUM-X, select the exposure you want to use for the calibration from the drop-down menu.
10. Select **Start Capture**.
A dialog box displays, reminding you to cover the sensor and insert an SSD.
11. Select **OK** to continue.
The system initializes and then makes multiple passes through the following phases of the calibration:
 - Capturing
 - Analyzing
 - Erasing
 - Programming
12. When the Calibration Successful dialog displays, select **OK** to complete black shading.
The new calibration map is automatically selected.

RED DSMC OPERATION GUIDE: EPIC/SCARLET

CALIBRATION MAP NAMING CONVENTIONS

Each calibration map has a unique name that uses the format described in the table below:

NAME	DESCRIPTION	EXAMPLE
Exposure	Current exposure; to set exposure, go to Menu > Setting > Projects > Exposure	48
Sensor Temperature	Sensor temperature (Celsius); in the Lower Status Row, this is the number to the left of the forward slash (Temp: 34/35)	32C
Year	Year that the calibration map is created (yyyy)	2014
Month	Month that the calibration map is created (mm)	01
Day	Day that the calibration map is created (dd)	28
Time	Time according to the 24-hour clock in the camera (hhmmss)	122150

For example, a sequence of calibration maps may look like this:

1. 48_32C_20140128122150
2. 72_34C_20140128122858
3. 120_41C_20140128124306

NOTE: If you mount an SSD with calibration files to your computer, each calibration map displays as a sub-folder in a folder called Calibration. To save a calibration map to your hard drive, copy the entire sub-folder (for example, 48_32C_20140128122150) to your drive.

CALIBRATION MANAGEMENT

Use the Calibration Management menu to apply, import, and export calibration maps.



- ▶ **Calibration:** The calibration maps that are saved internally on the camera:
 - **Factory:** This is the calibration map generated during the manufacturing process, and is the default map.
 - **User HS:** The user-created calibration maps.
- ▶ **Media:** The calibration maps that are on the SSD in the path shown (for example, S-SSD\calibration).

CALIBRATION MAP ACTIONS

- ▶ **Set:** Apply the selected camera calibration map.
- ▶ **Delete:** Delete the selected camera calibration map. You cannot delete the factory map.
- ▶ **Apply:** Apply the selected calibration map temporarily (without importing to the camera)

EXPORT AND IMPORT CALIBRATION MAPS

Calibration maps can be stored on the camera or transferred to SSD to be shared with other cameras. You can also build a library of calibration maps to use in different settings.

- ▶ : Export selected calibration map from camera to SSD.
- ▶ : Import selected calibration map from SSD to camera. This overwrites the user HS calibration map.

GYROSCOPE AND ACCELEROMETER CALIBRATION

The internal three-axis gyroscope and three-axis accelerometer need to be calibrated for the Horizon overlay to function properly. The Gyro/Acc calibration file is stored in the flash memory of the camera, so you DO NOT need to recalibrate after restoring the camera or upgrading firmware. For more information, go to [“Horizon” on page 71](#).

To calibrate the Horizon overlay, follow the instructions below:

1. Turn on the camera and place it on a level surface.
2. Wait for the camera core temperature to reach room temperature.

RED DSMC OPERATION GUIDE: EPIC/SCARLET

3. Go to **Menu > Settings > Maintenance > Calibration > Gyro/Acc** and select **Low Temperature Calibration**.
4. After the calibration finishes, wait for the camera core temperature to reach maximum operating temperature.
5. When the camera reaches maximum operating temperature, select **High Temperature Calibration**.

LENS CALIBRATION

There are many electronic lenses that are compatible with the DSMC Canon Mount or DSMC Nikon Mount, but are not electronically supported by the camera. The Lens Calibration feature allows you to create custom lens configuration files for these electronic lenses so that you can use rack focus and autofocus.

A custom configuration file might not make an unsupported lens as precise as a fully supported lens. However, a custom configuration file provides the aperture range and focal lengths so that you can electronically control the lens with the camera.

NOTE: The camera may not be able to calibrate some electronic lenses.

NOTE: The camera does not create calibration files for lenses that are already electronically supported. For a full list of supported lenses, go to [“Lens Mounts and Lenses” on page 207](#).

CREATE LENS CALIBRATION FILES

The calibration process creates a calibration file for the current focal length of the electronic lens. Calibrate the lens at each available focal length to create a full lens calibration file.

1. Attach a DSMC Canon Mount or DSMC Nikon Mount to the camera.
2. Attach an electronic lens.
3. Manually set the first focal length you want to calibrate.

RED DSMC OPERATION GUIDE: EPIC/SCARLET

4. There are two (2) ways to start the lens calibration process:
- When you attach a lens that the camera does not recognize, the “Unsupported Lens Found” dialog box displays and asks if you want to calibrate the lens. Select **Create Custom Lens Config**.

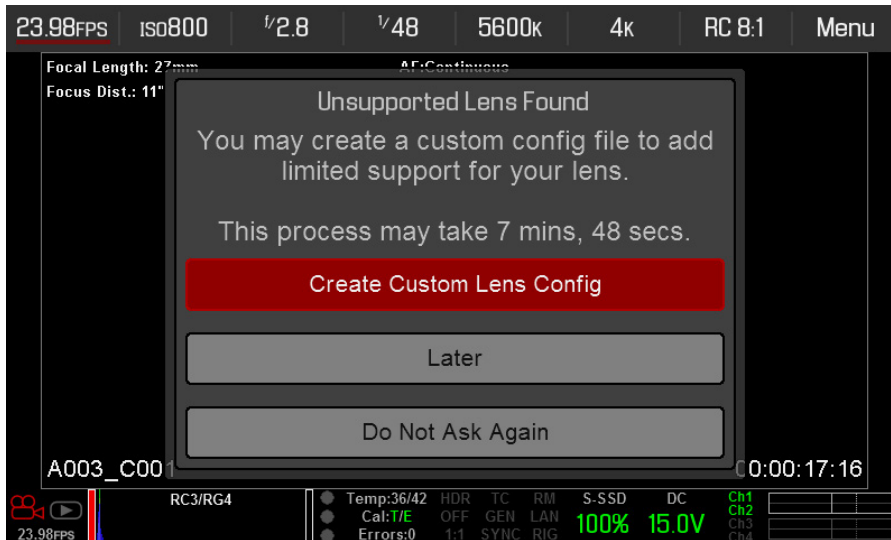

- Go to **Menu > Settings > Maintenance > Calibrate > Lens** and select **Create...**

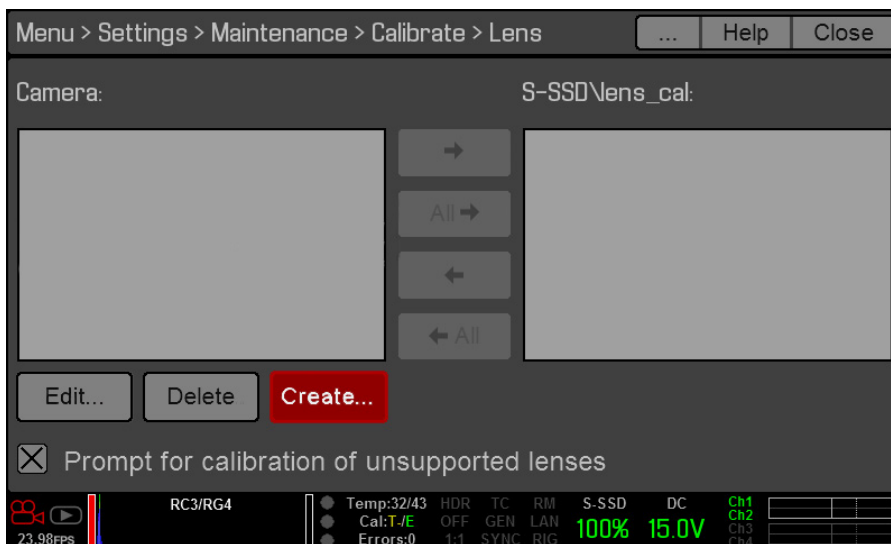

RED DSMC OPERATION GUIDE: EPIC/SCARLET

The lens calibration process for the current focal length starts and a progress bar displays. Once the calibration process starts, DO NOT touch the lens, as doing so may cause the lens to calibrate incorrectly.

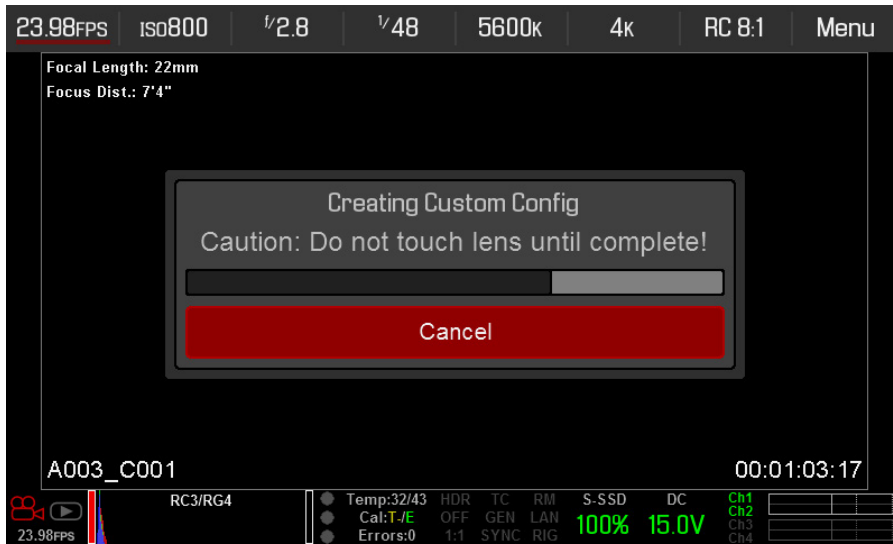

5. Select **OK** after the calibration file is created.
6. To calibrate the next focal length, follow the instructions below:
 - A. Go to **Menu > Settings > Maintenance > Calibrate > Lens**.
 - B. Select the calibration file name in the **Camera** list and select **Edit...**

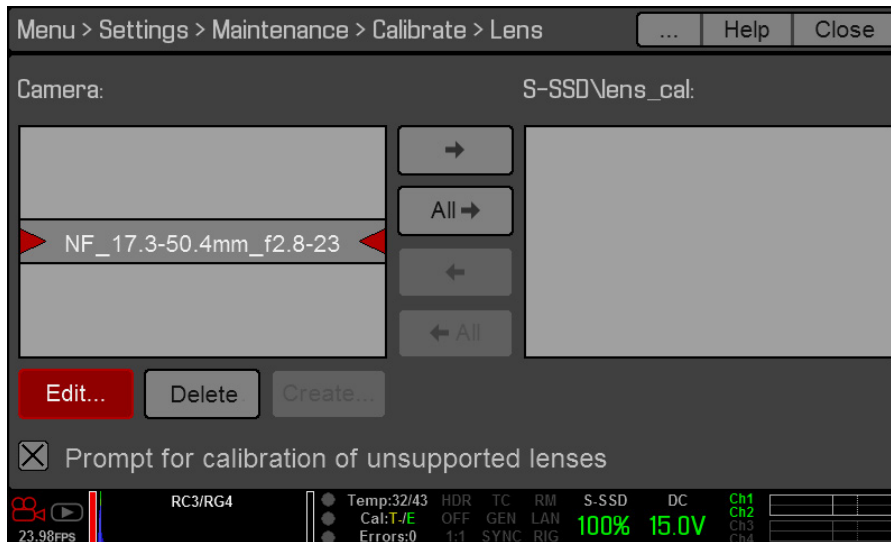

RED DSMC OPERATION GUIDE: EPIC/SCARLET

- C. Manually set the next focal length.
- D. Select **Add Cal @ xx...**, where “xx” is the current focal length.

NOTE: If you calibrate a focal length that has already been calibrated, the new files overrides the previous file.

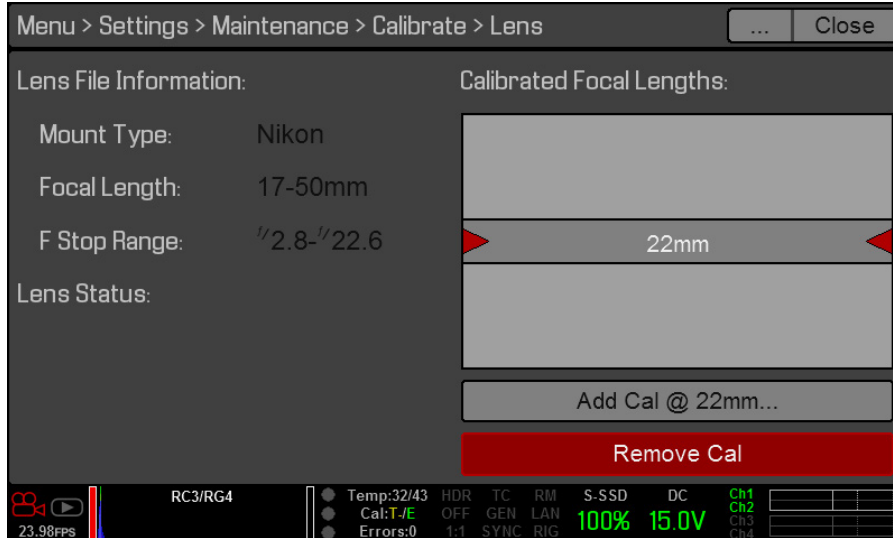

The lens calibration process for the current focal length starts and a progress bar displays. Once the calibration process starts, DO NOT touch the lens, since that may cause incorrect calibration.

- 7. Repeat **Step 6** for each focal length of the lens.

The lens calibration file remains on the camera after system restores and firmware upgrades.

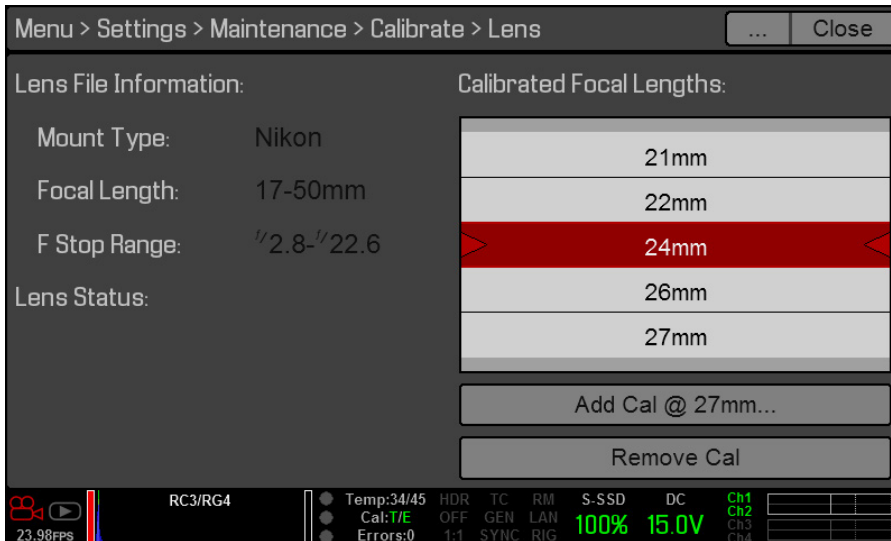

VIEW AND MODIFY LENS CALIBRATION INFORMATION

1. Go to **Menu > Settings > Maintenance > Calibrate > Lens**.
2. Select the calibration file name in the **Camera** list and select **Edit....**

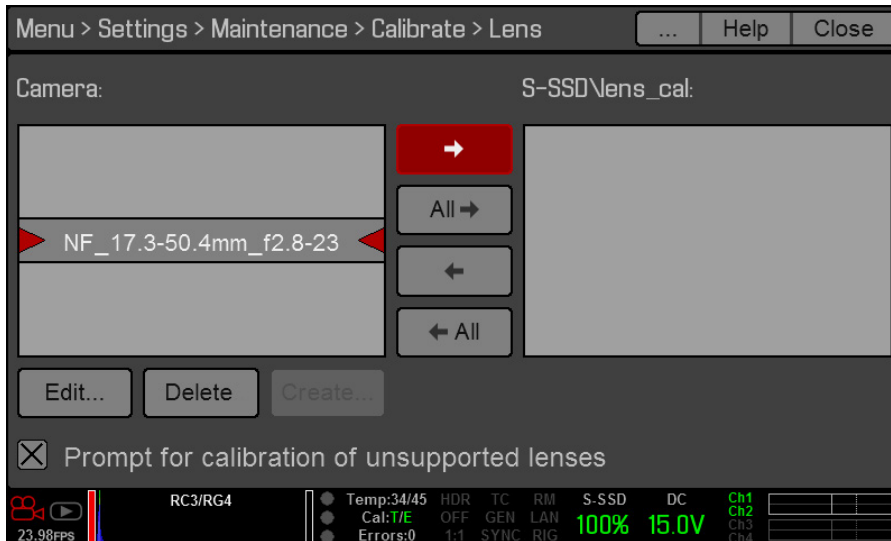

The following information displays:

- Mount Type
 - Focal Length
 - F Stop Range: Overall aperture range of lens.
 - Lens Status
 - Calibrated Focal Lengths
3. You can perform any of the following actions:
 - **Add Cal @ xx...:** Calibrate the current focal length; “xx” is the current focal length.
 - **Remove Cal:** Remove the calibration for the selected focal length.

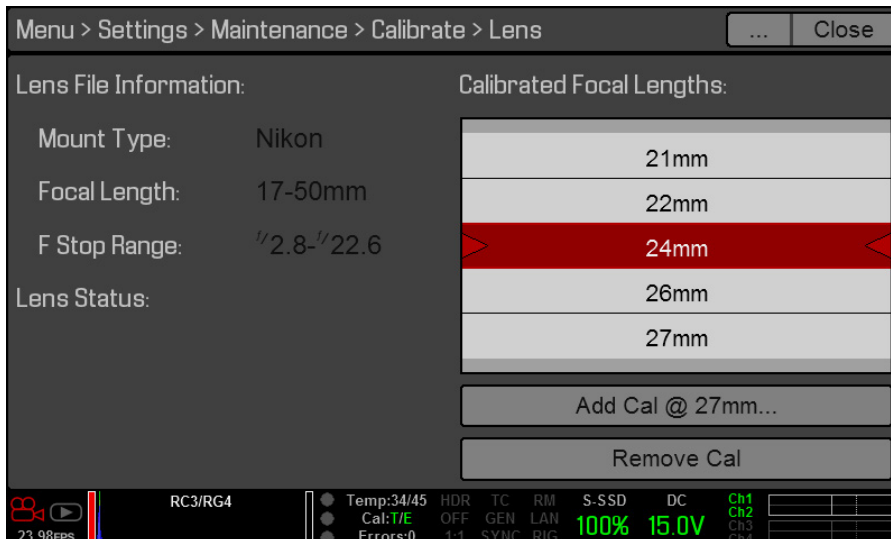





RED DSMC OPERATION GUIDE: EPIC/SCARLET

EXPORT AND IMPORT LENS CALIBRATION FILES

Lens calibration files can be stored on the camera or transferred to SSD to be shared with other cameras. When exporting lens calibration files from camera to SSD, the files are saved to a folder on the SSD called “lens_cal”.

DO NOT change the file name of the calibration file after you save it to an SSD.

- ▶  : Export selected file from camera to SSD.
- ▶ **All**  : Export all files from camera to SSD.
- ▶  : Import selected file from SSD to camera.
- ▶ **All**  : Import all files from SSD to camera.

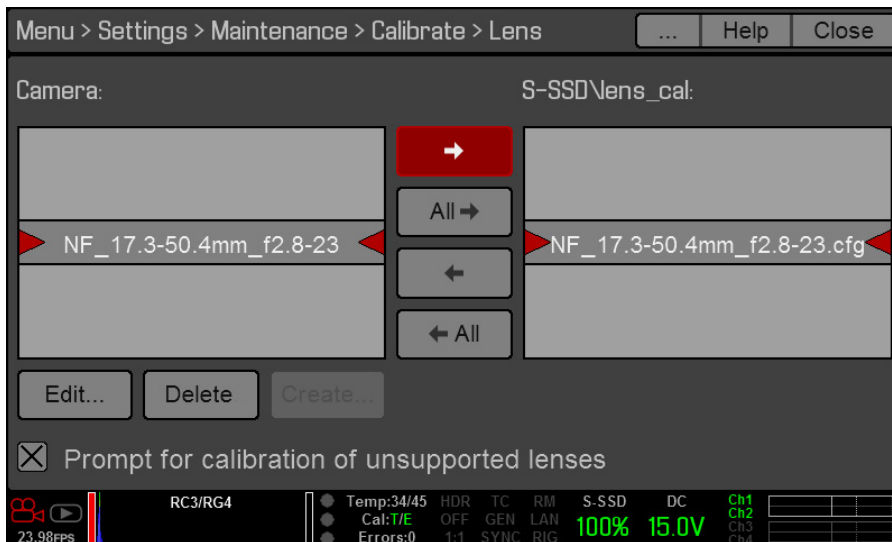

LENS CALIBRATION ACTIONS

- ▶ **Edit...:** View and edit the selected file.
- ▶ **Delete:** Delete the selected file.
- ▶ **Create...:** Create a new file. This option is disabled if you already have a calibration file for the attached lens.
- ▶ **Prompt for calibration of unsupported lenses:** Select this check box to ensure that the “Unsupported Lens Found” dialog box displays every time the camera detects an unsupported electronic lens at boot-up. Deselect this check box to disable the “Unsupported Lens Found” dialog box.

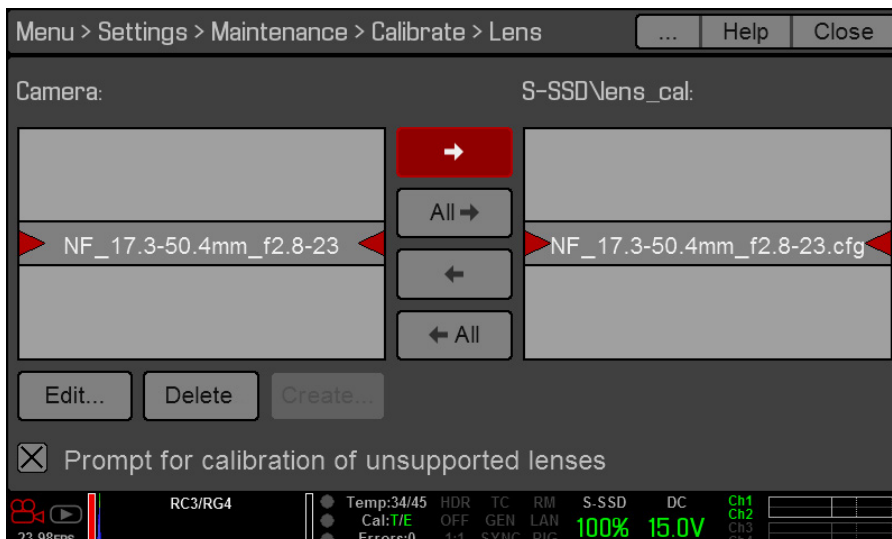

SELF-TEST

The Self-Test menu includes: Enable Sensor Test Pattern and Touchscreen.

ENABLE/DISABLE SENSOR TEST PATTERN

The Sensor Test Pattern feature is only used during manufacturing. The sensor test pattern is a white screen.

TOUCHSCREEN

To perform a touchscreen self-test, follow the instructions below:

1. Go to **Menu > Settings > Maintenance > Self Test**.
2. Select **Touchscreen**.
A grid of green squares displays on the touchscreen.
3. Touch each box with your finger.
Each green box turns blue.
4. To exit the self-test, perform one (1) of the following actions:
 - Touch all of the boxes, so that they are all blue.
 - Press and hold the touchscreen.
 - Press the **Enter** or **Menu** button on the DSMC Side Handle or REDMOTE.

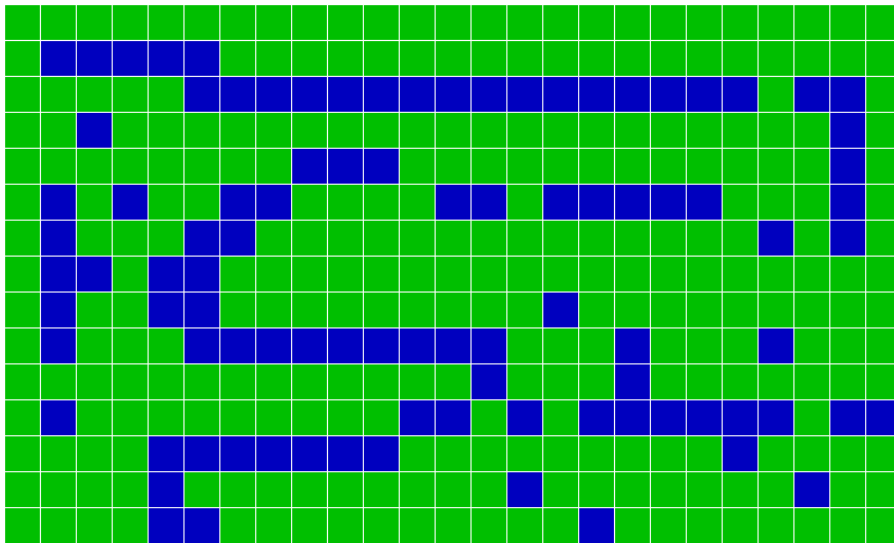

RESTORE SYSTEM

Restore System changes all settings to the factory default values. To perform a Restore System, follow the instructions below:

1. Go to **Menu > Settings > Maintenance**.
2. Select **Restore System**.
3. Select **YES** on the screen that asks you to confirm the action.
The camera turns off.
4. Turn on the camera.

NOTE: After performing a system restore, pair the REDMOTE to the camera again.

REDISCOVER (HARDWARE REDISCOVER)

Rediscover all hardware and caches the data for future boot cycles. Perform a Hardware Rediscover if a module or lens mount is not functioning correctly.

To perform a Hardware Rediscover, follow the instructions below:

1. Go to **Menu > Settings > Maintenance**.
2. Select **Rediscover**.
3. Select **Yes** on the screen that asks you to confirm the Hardware Rediscover.
The camera turns off.
4. Turn on the camera.

SYSTEM STATUS

The System Status menu displays key project and system information on the following tabs: Project Status, Module Status, Camera Info, and Media Info.

PROJECT STATUS

Displays the current camera and project settings.

MODULE STATUS

Displays which modules are attached to the camera.

- ▶ **Not Detected:** The module is either not attached, or is not detected by the camera.
- ▶ **Attached:** The module is attached and detected.

CAMERA INFO

Displays the following camera information:

- ▶ **Type:** Camera type and sensor type.
- ▶ **Firmware Version:** Current firmware version.
- ▶ **PIN:** The personal identification number that is specific to your camera.
- ▶ **SVN Revision:** The current firmware number.
- ▶ **Runtime:** The number of hours that the camera has been turned on.

MEDIA INFO

Displays the following media information:

- ▶ **Active Media:** Active media, module type.
- ▶ **Model Number:** Storage capacity, SSD type, and version/revision of the SSD.
- ▶ **Serial Number:** Serial number of the SSD.
- ▶ **Firmware Version:** Firmware version of the SSD.
- ▶ **Size:** Total capacity on the SSD.
- ▶ **Size Available:** Total capacity left on the SSD that can be recorded to.

NOTE: When an SSD is not attached, the Media Info tab displays “No Active Media is Present”.

OLPF

NOTE: The OLPF menu is only available on an EPIC DRAGON or SCARLET DRAGON.

RED offers multiple optical low-pass filters (OLPFs) for EPIC DRAGON and SCARLET DRAGON. Each OLPF optimizes certain characteristics to take full advantage and control of each shooting environment. The camera checks the OLPF type, and adjusts the color science based on the selected OLPF.

CHECK INSTALLED OLPF (IF YOU HAVE A FIXED OLPF)

If your camera has a fixed OLPF (if you do not have the DSMC interchangeable OLPF system), then your camera automatically detects which OLPF is installed.

To see which OLPF is installed when you have a fixed OLPF, follow the instructions below:

1. Go to **Menu > Settings > Maintenance > OLPF**.

The OLPF type displays:

- **SKIN TONE-HIGHLIGHT:** Also known as “OLPF, Version 2”. Currently shipping in new cameras unless otherwise requested.
- **LOW LIGHT OPTIMIZED:** Also known as “OLPF, Version 1”.

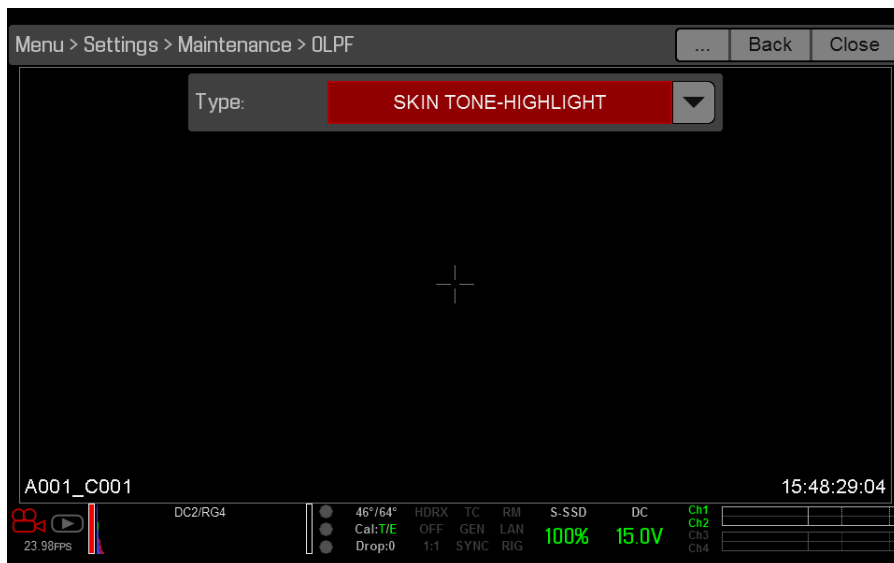

RED DSMC OPERATION GUIDE: EPIC/SCARLET

SELECT OLPF TYPE (IF YOU HAVE THE DSMC INTERCHANGEABLE OLPF SYSTEM)

If your camera has the DSMC interchangeable OLPF system, then you must select the correct OLPF type that is installed.

Select your OLPF type by following the instructions below:

1. Go to **Menu > Settings > Maintenance > OLPF**.
2. Select your OLPF type from the **Type** drop-down menu:

IMPORTANT: Ensure the correct OLPF type is selected from the drop-down menu. Failure to select the correct OLPF type will affect color accuracy.

NOTE: If you are unsure which OLPF is installed, go to [“Verify Installed OLPF”](#) on page 47.

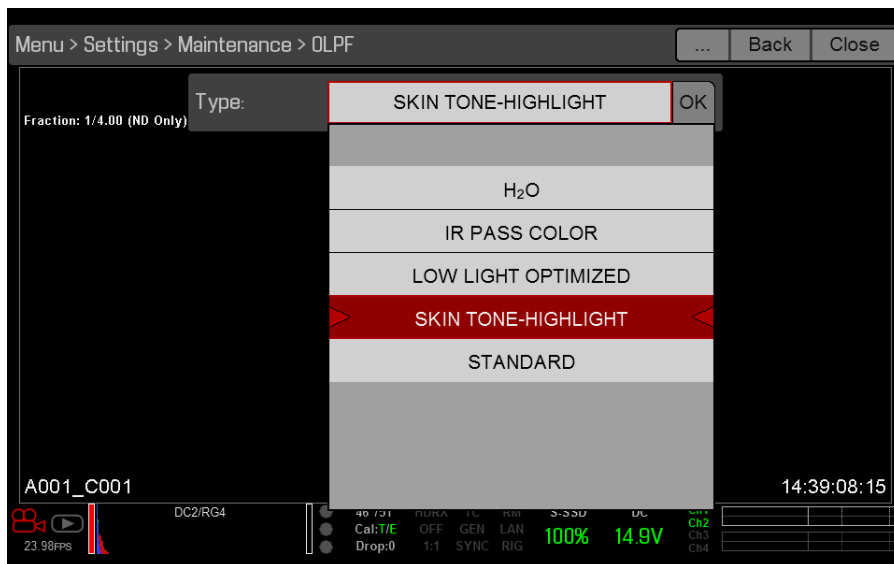

MEDIA MENU

The Media Menu allows you to format and eject an SSD and to view and load clips on the SSD.

For more information about using media, see the [DSMC Media Operation Guide](http://www.red.com/downloads), available at www.red.com/downloads.

DEVICE

Format and eject (unmount) the SSD.

To see information about the SSD in the camera, select **More Info....**

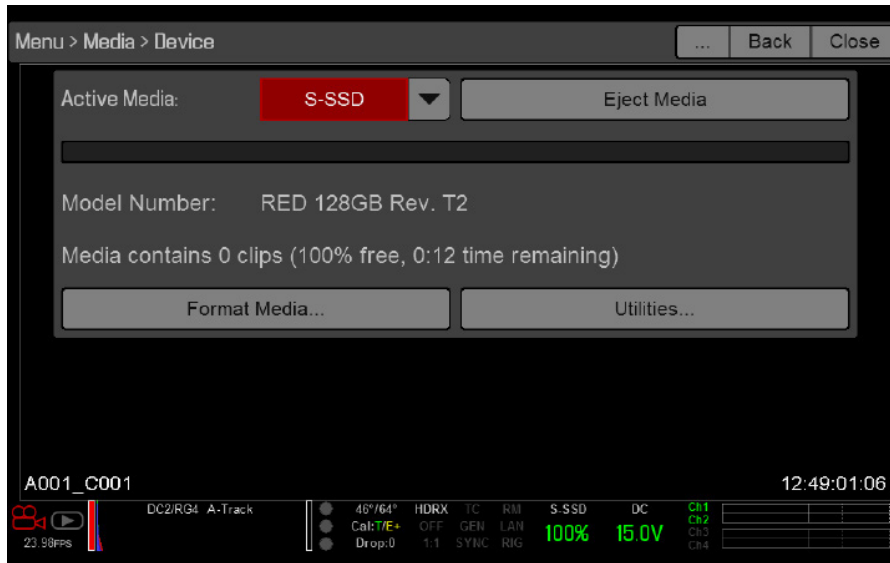

CLIPS

View and load clips on the SSD in thumbnail view.



PLAYBACK MENU

To view clips from the SSD:

- ▶ Go to **Menu > Playback**.
- ▶ Press the **Record/Playback** toggle in the lower left corner of the touchscreen.



NOTE: The camera uses RGB color space in Playback mode by default, regardless of settings in Record mode. To playback clips in RAW mode, go to **Menu > Settings > Display > Tools** and select **RAW**.

PLAYBACK MENUS

In Playback mode, the menu is pared-down, so you cannot access all menus. Some menus offer different options.

MEDIA

Lists all available clips on the attached SSD. You can perform the following actions:

- ▶ : Move selected clip to the Play List.
- ▶ **All** : Move all clips to the Play List.
- ▶ **Apply Image Metadata:** Image data (such as color, gain, and curves) recorded with the image displays with the playback image. When deselected, the current playback Look settings are used.
- ▶ **Load:** Closes the menu and brings up the selected clip in Playback mode.

RECORD (EXIT)

Select **Record** to exit Playback mode. You can also press any button mapped to Record to exit Playback mode.

META

Displays the metadata for the selected clip.

PLAYBACK STATUS BAR

Displays the progress of the clip during playback. When using the touchscreen, swipe your finger right and left to fast-forward and rewind the clip, respectively.

PLAYBACK CONTROLS

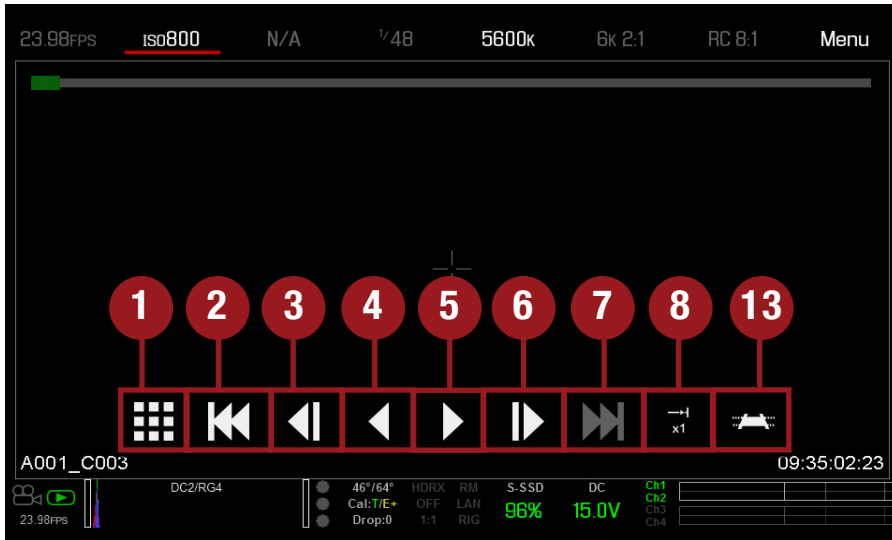

Playback Controls

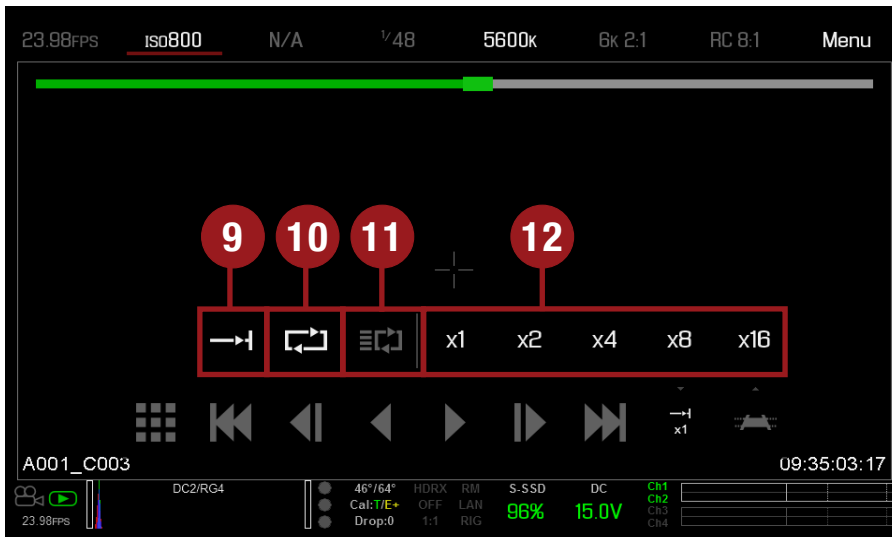

Play Options



Marker Options

RED DSMC OPERATION GUIDE: EPIC/SCARLET

The table below describes the Playback controls.

#	CONTROL	DESCRIPTION
1	Clips	View clips as thumbnails ¹
2	Load Previous Clip	Loads the previous clip in the playlist.
3	Frame-by-Frame Reverse	Moves through the clip frame-by-frame in reverse.
4	Reverse Play/Pause toggle	Plays clip in reverse, and toggles between play and pause.
5	Play/Pause toggle	Toggles between play and pause.
6	Frame-by-Frame Forward	Moves through the clip frame-by-frame.
7	Load Next Clip	Loads the next clip in the playlist.
8	Play Options	Displays the following subset of options: Play Once, Loop, Loop Playlist, and Playback Speed.
9	Play Once	Plays clip to the end, and does not repeat the clip.
10	Loop	Plays the clip on a loop.
11	Loop Playlist	Loops all clips in the playlist. To create a playlist, go to Menu > Playback > Menu > Media > Playlist , and move clips to the Play List field.
12	Playback Speed	Option to select x1, x2, x4, x8, or x16 playback speed.
13	Marker Options	Displays the following subset of options: In Point, Remove In/Out Point, Out Point, Previous Marker, and Next Marker.
14	In Point	Sets a red In Point marker in the Playback Status Bar. Use an In Point marker in conjunction with an Out Point marker to play only a certain portion of a clip. The In/Out Point markers help when the clip is long and you want to focus on a particular segment.
15	Remove In/Out Point	Removes the In/Out Point markers and skips to the end of the clip.
16	Out Point	Sets a red Out Point marker in the Playback Status Bar. Use an Out Point marker in conjunction with an In Point marker to play only a certain portion of a clip. The In/Out Point markers help when the clip is long and you want to focus on a particular segment.
17	Previous Marker	Goes to the previous marked frame, which displays as a red line in the Playback Status Bar. Disabled when there are no marked frames.
18	Next Marker	Goes to the next marked frame, which displays as a red line in the Playback Status Bar. Disabled when there are no marked frames.

1. Thumbnail view is only available on an EPIC DRAGON or SCARLET DRAGON. On MYSTERIUM-X cameras, a logo appears instead of a thumbnail.

POWER MENU

The Power menu displays the power status of all attached power sources and allows you to turn off the camera.



NOTE: For more information about powering the camera, see the [DSMC Power Operation Guide](http://www.red.com/downloads), available at www.red.com/downloads.

POWER IN

The power status displays for the BRAIN DC, DSMC Side Handle, Rear 1, Rear 2, Rear 3, and Rear 4. The menu displays the voltage of the source or the percentage of the power left, as well as the time left, if applicable.

POWER OUT

The Power Out menu shows the status of the power out ports on the Pro I/O Module and the +1 Adaptor Module. The statuses are:

- ▶ **N/A:** The device is not present.
- ▶ **OK:** The power out port is functional.
- ▶ **FAULT:** A short or overcurrent tripped the electronic fuse. Remove the device that is connected to the module, as it may be drawing too much power. Select **RESET** to clear the fault.

POWER SAVE

You can select the following power saving options (the default for each is Never):

- ▶ **Low Power Preview:** The camera uses a lower amount of power after the specified period of inactivity.
- ▶ **Sleep:** All monitors turn off and keys do not perform mapped actions after the specified period of inactivity. Tap the touchscreen or press a key to exit Sleep mode.
- ▶ **Auto Shutdown:** The camera turns off after the specified period of activity.

SHUTDOWN

Shutdown controls are interlocked to prevent the camera from being accidentally turned off. For more information about different ways to turn off your camera, go to [“Turn Off the camera” on page 35](#).

1. Go to **Menu > Power**.
2. Select **Shutdown**.

The Shutting Down... message displays and the camera turns off.

HDRX MENU

NOTE: HDRX mode cannot be modified when test signals are enabled.

NOTE: You cannot change the exposure when HDRX is enabled.

NOTE: You cannot use HDRX mode when:

- A MOTION MOUNT is installed.
- A Sensor Sync Mode (Genlock or MoCo) is enabled.
- Speed Ramp mode is enabled.
- A Frame Processing mode (Frame Summing or Frame Averaging) is enabled.

By default HDRX is disabled, and the HDRX indicator in the Lower Status Row is grey.

To enable HDRX, follow the instructions below:

1. Go to **Menu > HDRX**.

2. Select **HDRX**.

The HDRX text in the Lower Status Row turns white.

3. Select the number of **Factors**. The range is 1–6, and the default is 2.

4. Select which track you want the display to show:

- **A Track:** This track shows the video with the selected aperture and exposure settings applied.
- **X Track:** This track shows the video with the additional stops applied.



NOTE: For more information, see the [High Dynamic Range Video with HDRx](http://www.red.com/learn/red-101/hdrx-high-dynamic-range-video) article, available at www.red.com/learn/red-101/hdrx-high-dynamic-range-video.

FOCUS MENU

The Focus menu includes: Mode and Rack.

MODE TAB

The Mode Tab is used to enable and select Focus parameters, including Mode, Zone, Size, and Enhanced A/F.

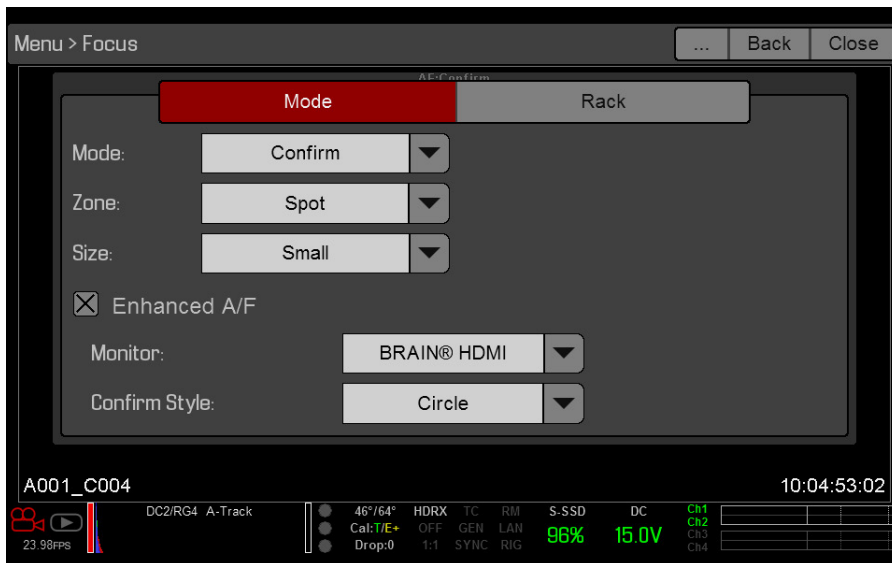

Focus Menu: Mode

MODE

Select one (1) of the following from the **Mode** drop-down menu:

- ▶ **Manual:** When selected, all focus operations are manual.
- ▶ **Confirm:** Enables the Center or Spot focus target. This mode provides additional focus assistance by using red, yellow, and green color changes to the focus spot window. Inadequate subject illumination and/or contrast may interfere using Confirm mode.

For best results with Confirm mode, “rock” the focus ring: Focus through the point of optimal focusing and back again in decreasing amplitude, as when “zeroing-in” for precision manual focus.

AUTOFOCUS MODES (DSMC, NIKON, AND CANON MOUNTS)

When any of the following conditions are met, the Modes drop-down menu has additional options:

- ▶ DSMC Nikon Mount and a supported lens is attached. The lens focus switch is set to “A” or “M/A”.
- ▶ DSMC Canon Mount and a supported lens is attached. The lens focus switch is set to “AF”.
- ▶ DSMC Canon MOTION MOUNT and a supported lens is attached. The lens focus switch is set to “AF”.

When any of the above conditions are met, the following options display in the Modes drop-down menu:

- ▶ **Single:** When you press the key mapped to AF: Start, the camera performs single-shot AF. Optimized for rapid focus even under low-contrast conditions. Works with both Center and Spot zones.
- ▶ **Continuous:** When you press the key mapped to AF: Start, the camera attempts to keep objects in the target in focus. Works best with good lighting and contrast. Works with both Center and Spot zones.
- ▶ **Touch Track:** Dynamically updates a positionable AF point using the touchscreen. Only works with Spot zone. Keep target on subject while moving across frame, as the lens continuously focuses on that target.
- ▶ **Rack:** Enables rack focus. Only works with Spot zone. For more information, go to [“Rack Focus” on page 132](#).

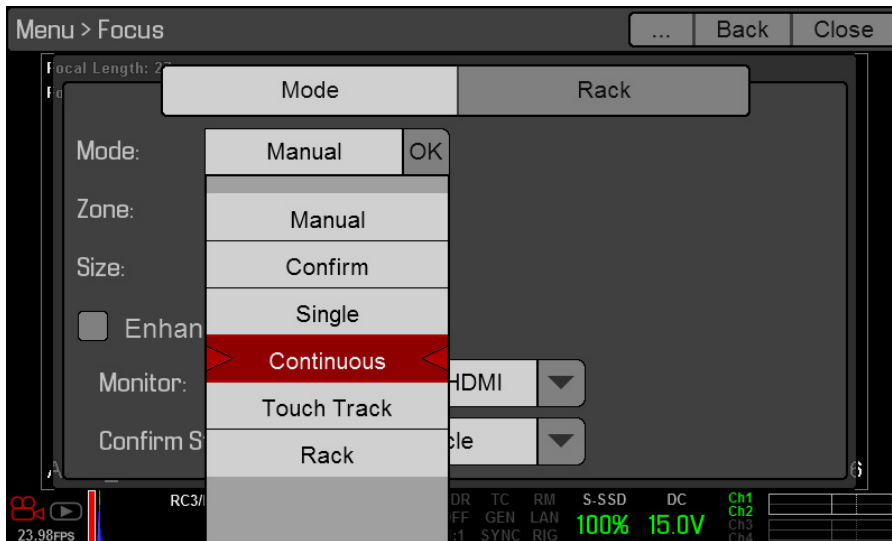

In Single, Continuous, and Touch Track modes, a single target displays on the screen that indicates where the image will be in focus. In Rack mode, multiple targets display on the screen to indicate the different areas between which the camera will rack focus.

Press the key mapped to AF Mode: Cycle (REDMOTE/DSMC Side Handle button A default) to cycle through the Focus Mode options in order.

Autofocus performance may be reduced under the following conditions:

- ▶ Subject is dark or distant.
- ▶ Inadequate contrast between the subject and background.
- ▶ Scene has reflective highlights.
- ▶ Subject is backlit.
- ▶ Inadequate surface contrast/detail inside the window.

NOTE: Use Edge mode for assistance in these conditions. For more information, go to [“Edge” on page 70](#).

RED DSMC OPERATION GUIDE: EPIC/SCARLET

ZONE

Available zones are Center and Spot (default). Both the Center and Spot targets change color to indicate the focus state of the objects in the targets.

TARGET COLOR	DESCRIPTION
Blue	Camera is focusing
Red	Objects are out of focus
Yellow	Objects are almost in focus
Green	Objects are in focus

CENTER

Provides a large target square for focus that is centered in the recording area.

SPOT

Provides a small target for precise focus that you can move around the recording area.

MOVE THE SPOT FOCUS TARGET

Move Spot target with touchscreen:

- ▶ Tap and hold the touchscreen on the location you want to relocate the Spot target.
- ▶ Tap and hold the touchscreen where the Spot target currently is, and drag the Spot target.

Move Spot target with DSMC Side Handle or REDMOTE:

1. Go to the main screen.
2. Press the **Down Arrow** in the Navigation Group.
The Spot target line weight increases and the red cursor under Menu dims slightly.
3. Use the directional arrows to move the Spot target to the desired location.
4. Press **ENTER**.
5. To exit, press the **Menu** button.

SIZE

Choose a sizes for the Spot target.

ENHANCED A/F

Enhanced A/F is an autofocus algorithm that offers better performance and improved visual indicators in Confirm mode.

ENABLE ENHANCED A/F

1. Go to **Menu > Focus > Mode**.
2. Select **Confirm** from the **Mode** drop-down menu.
3. Select an option from the **Zone** drop-down menu.
4. If you selected Spot from the Zone drop-down menu, select a size from the **Size** drop-down menu.
5. Select the **Enhanced A/F** check box.
6. Select the monitor dedicated to using the Enhanced A/F feature from the **Monitor** drop-down menu:
 - BRAIN HDMI
 - BRAIN HD-SDI

The selected monitor is in Clean mode (no overlay) with a set resolution of 720p and update frequency of 60

RED DSMC OPERATION GUIDE: EPIC/SCARLET

Hz. The target does not display on the selected monitor. You cannot control the monitor until you disable the Enhanced A/F feature.

7. Select the Confirm target style from the **Confirm Style** drop-down menu:

CONFIRM STYLE	DESCRIPTION	OBJECTS IN TARGET ARE IN FOCUS...	OBJECTS IN TARGET ARE OUT OF FOCUS
None	Square target; operates like the target square in Confirm mode	Target is yellow or green	Target is red
Circle	Yellow circle around a square target	Target is yellow or green; circle is almost the same size as the square	Target is red; circle gets bigger
Bar	Bar target	Target is yellow or green; vertical bar on the right side is filled up	Target is red; vertical bar on the left side is almost empty
Pie	Pie target	Target is yellow or green; line around the curve is filled up	Target is red; line around the curve is almost empty

8. Close the **Focus** menu.

The target displays on the touchscreen, and the monitor that you selected for the Enhanced A/F feature is in Clean mode.

RACK FOCUS

Use the Rack tab to configure up to four (4) focus points and execute rack focus between them.

SET UP RACK FOCUS

1. Ensure that a DSMC Nikon Mount, DSMC Canon Mount, or DSMC Canon MOTION MOUNT is installed and that a supported lens is attached to the camera.
2. Go to **Menu > Focus > Mode**.
3. Select **Rack** from the **Mode** drop-down menu.
Spot is automatically selected from the Zone drop-down menu, since rack focus only works with Spot zone.
4. Select a size from the **Size** drop-down menu.
5. Go to the **Rack** tab.
6. Use the **Rack Speed** slider to change the speed at which the lens moves. Move the slider to the left for a slower speed, and to the right for a faster speed.
7. Select the number of rack points (1–4) from the **Rack Points** drop-down menu.

RED DSMC OPERATION GUIDE: EPIC/SCARLET

8. To reset the focus distance to the value calculated by the autofocus algorithm, select **Re-Autofocus**.

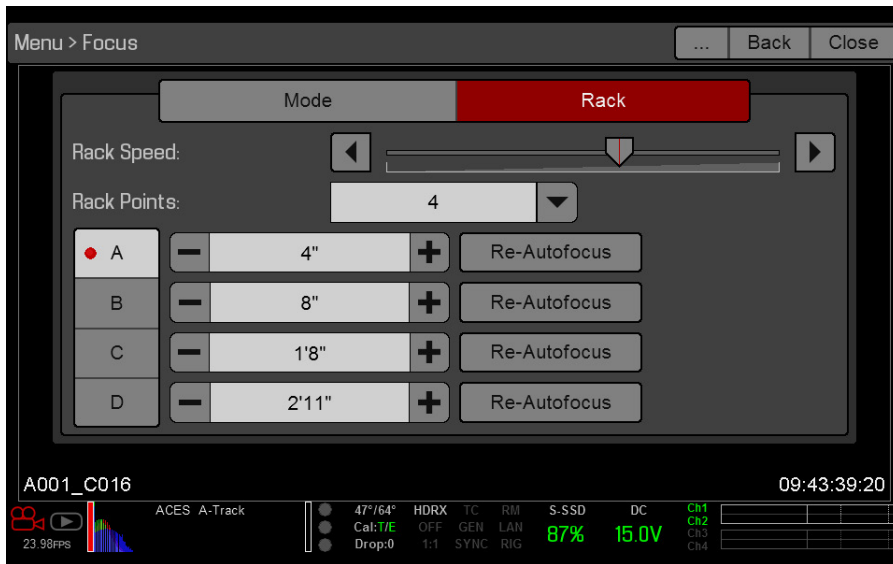

9. To set a rack point location, follow the instructions below:

- Select the rack point: **A**, **B**, **C**, or **D**.
- Select **Close** to return to the main screen.
- Tap and hold the touchscreen where you want the rack point to be, or press and drag the rack point. When you move a rack point, the camera autofocuses.

NOTE: To prevent a rack point from being accidentally moved, the rack point is less sensitive to touch than the other focus targets. To fine-tune the rack point location, first drag the rack point farther than it needs to be, and then drag it to where you want it to be.

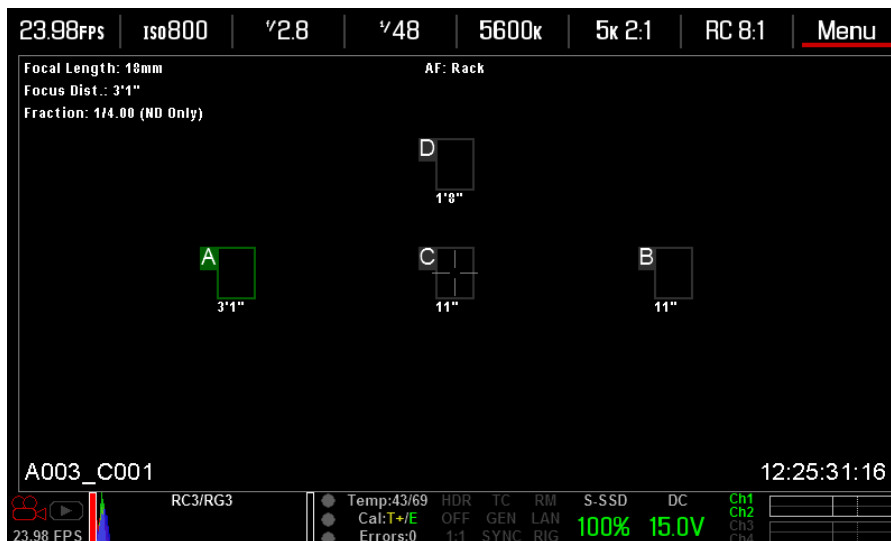

NOTE: To view the focus distance for each rack point on the main screen, go to **Menu > Settings > Display > Modes** and enable **Rack Show Distance** mode. For more information, go to [“Lens Tab” on page 78](#).

10. Select another rack point by performing any of the following actions:

- Select another rack point on the touchscreen.
- Press the key mapped to **AF: Start** (default is SH Record Half Press) to cycle to the next rack point in order (A, B, C, and D). For example, if rack point A is selected when you trigger the AF: Start action, the focus racks from point A to point B.
- Press a key that is mapped to racking to a specific rack point.

MAP KEYS TO CYCLE RACK FOCUS

You can map user keys to rack focus to different rack points. For more information, go to [“Keys” on page 103](#). You can map the following actions:

- ▶ AF: Start
- ▶ AF: Rack to A
- ▶ AF: Rack to B
- ▶ AF: Rack to C
- ▶ AF: Rack to D

EXPOSURE ASSIST

The Exposure Assist menu provides access to settings for the Auto Exposure (AE) feature. The AE feature maintains a constant image brightness, even if the actual scene brightness changes.

The AE feature is different than traditional AE, in that RED AE only controls the amount of light that hits the sensor, either by adjusting aperture or exposure. RED AE analyzes RAW data before the ISO curve, and ensures that the sensor matches the user-selected brightness.

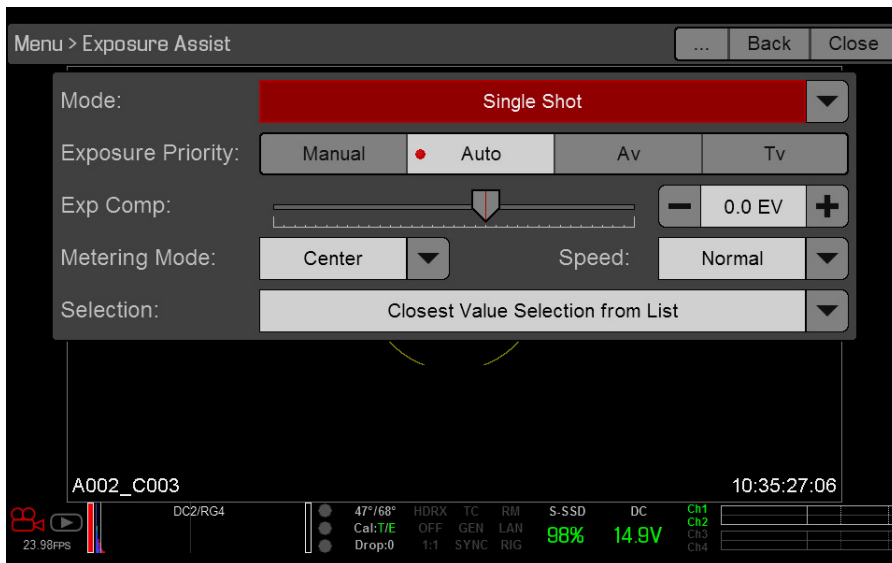

AUTO EXPOSURE MODES

The Exposure Assist modes determine when the AE tools go into effect:

- ▶ **Off:** The AE tools are not enabled.
- ▶ **Single Shot:** Map one of the following actions to trigger the AE tools:
 - AE: Start
 - AE/AF: Start
- ▶ **Continuous in Preview:** The AE tools are enabled in preview only.
- ▶ **Continuous in Preview/Record:** The AE tools are enabled in both preview and record.

NOTE: In Stills mode, AE/AF: Start is mapped to Record Half Press by default. For more information, go to [“Default Key Functions” on page 217](#).

EXPOSURE PRIORITY

- ▶ **Manual:** You have full control of aperture and shutter. (Default)
- ▶ **Auto:** The camera sets the aperture and shutter to meet the selected exposure.
- ▶ **Av (Aperture Value):** You set the aperture, and then the camera sets the shutter to meet the selected exposure.
- ▶ **Tv (Time Value):** You set the shutter, and then the camera sets the aperture to meet the selected exposure.

EXP COMP AND EV SHIFT

Use the **Exp Comp** (Exposure Compensation) slider and the **EV Shift** setting to adjust the brightness of the image. The default setting of zero (0) attempts to match the average brightness on an 18% grey-target. When AE is enabled, the target and current measured brightness for the selected metering area display in the histogram as a grey and white line, respectively.

You can also map these actions to user keys:

- ▶ **AE: Decrease EV Offset:** Reduces the EV Offset in increments of 0.2.
- ▶ **AE: Increase EV Offset:** Increases the EV Offset in increments of 0.2.

METERING MODE

Metering determines the area of the sensor that is used for brightness evaluation:

- ▶ **Spot:** Weights the measurement to the center 5% of the sensor, approximately.
- ▶ **Center:** Weights the measurement to the center 25% of the sensor, approximately.
- ▶ **Average:** Averages the entire image area of the sensor.

SPEED

The Speed setting determines how quickly the algorithm adapts to changing light.

- ▶ **Slow:** Settings adapt in small steps. Use this setting for fewer and gradual adjustments.
- ▶ **Normal:** Settings adapt in medium steps.
- ▶ **Fast:** Settings adapt in large steps.

SELECTION

The Selection setting determines which values the algorithm uses. This enables you to modify the list of values so that the algorithm selects only specific parameters. Use **Free Value Selection** to improve accuracy.

For example, you can modify the aperture list to include f/2.8 and f/5.6. If Free Value Selection is enabled, the algorithm only selects aperture parameters between f/2.8 and f/5.6. This setting limits the range of focal depth.

AE INDICATORS

When the AE feature is able to match the sensor brightness, the overlay turns yellow. If the brightness fluctuates more than half of a stop, the overlay turns red.

When AE is enabled, the “AE” indicator displays before the aperture and exposure parameters in the Upper Status Row. The user-selected brightness and current measured brightness display in the histogram as grey and white lines, respectively.

AE LIMITS

All limits, includes custom modifications made to available menu items, are taken into account when AE is active. For example, if you modify the available list of exposure values, only those values are considered.

PRESETS MENU

The camera has three (3) types of presets:

- ▶ **Camera Presets:** These store and recall camera setup information, such as in-camera Looks, key mappings, I/O configurations, and more. The camera has a number of factory-installed presets.
- ▶ **Looks:** These allow you to save the specific color, image, white balance, and detail settings to be used for other projects. Looks that are generated in-camera display on the Camera Presets tab. Looks that are generated in REDCINE-X PRO and are imported to the camera display on the Looks tab.
- ▶ **Auto Presets:** These allow you to specify pre-selected presets for Startup, Preview, Motion, Stills, and Playback.

You can create custom presets and Looks. Presets and Looks can be stored on the camera or transferred to SSD, so that you can build a library of presets and Looks, or quickly copy presets and Looks from one camera to another via SSD.

- ▶ **Camera:** Presets or Looks that are saved internally on the camera.
- ▶ **Media:** Presets or Looks that are on the SSD in the path shown (for example, On Media: \presets:).

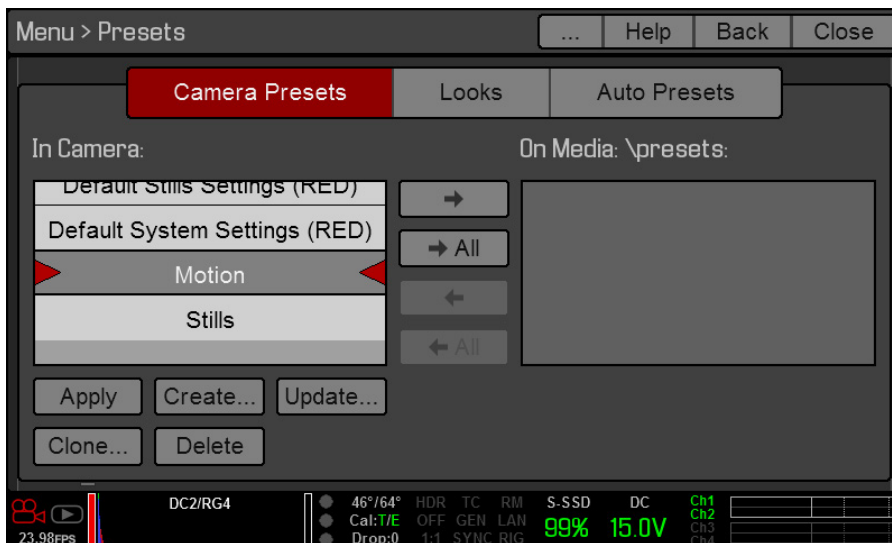

Presets Menu





CAMERA PRESETS

PRESETS ACTIONS



- ▶ **Apply:** Apply the selected preset.
- ▶ **Create...:** Create a new preset using the current settings.
- ▶ **Update...:** Update the selected preset by allowing the parameter set to be modified and all the values to be updated to their current in-camera values. You cannot update factory-installed presets, which end with "(RED)".
- ▶ **Clone...:** Create a new preset using the selected preset as a template.
- ▶ **Delete:** Delete the selected preset.

EXPORT AND IMPORT PRESETS

Presets can be stored on the camera or transferred to SSD to be shared with other cameras. When exporting presets from camera to an SSD, the presets are saved to a folder on the SSD called “Presets”. When importing presets from an SSD to camera, the presets must be stored on the SSD in a folder called “Presets”.

- ▶  : Export selected preset from camera to SSD.
- ▶ **All**  : Export all presets from camera to SSD.
- ▶  : Import selected preset from SSD to camera.
- ▶  **All**: Import all presets from SSD to camera.

CREATE PRESETS

1. Set up the camera how you want the preset to be configured.
For example, if you want to create a preset specifically for your zebra indicators, first go to **Menu > Settings > Display > Zebra** and configure the zebras the exact way that you want them to be in the preset.
2. Go to **Presets > Camera Presets**.
3. Select **Create**, or select an existing preset and select **Clone** or **Update**.
4. If creating a new preset, enter a name for the preset and select **OK**.
5. Select the following tabs to display different sets of preset options: **Display, Key, Look, Project,** and **System**.
6. Select the following:
 -  : Add selected setting to the preset.
 - **All**  : Add all settings to the preset.
 -  **X**: Remove selected setting from the preset.
7. Select **Create**.
The preset is saved and stored in the camera.



LOOKS

A Look is made up of the following settings: Color, Gain, FLUT, Sharpness, Curves, Color/Gamma, Color Temperature, and LGG (Lift, Gamma, Gain). These settings are configured either in-camera (in **Menu > Settings > Look**) or in REDCINE-X PRO (in the Looks panel).

CREATE AND MANAGE IN-CAMERA LOOKS

Create in-camera looks in the **Menu > Presets > Camera Presets** tab. Modify and manage the in-camera Looks the same way as any other presets created in the Camera Presets tab. For more information, go to “[Camera Presets](#)” on page 136.

IMPORT LOOKS FROM REDCINE-X PRO



1. While your SSD is mounted to your computer, create a folder on the SSD called **Looks**.
2. Save your RMD files (that have been exported from REDCINE-X PRO) to the **Looks** folder on the SSD.
3. Eject the SSD from your computer.
4. Mount the SSD to your camera.
5. Go to **Presets > Looks**.
6. Select one (1) of the following:
 -  : Import selected Look from SSD to camera.
 -  **All**: Import all Looks from SSD to camera.

For more information, see the “[REDCINE-X PRO: Saving Looks to Camera](#)” video tutorial, available at www.red.com/learn/workflow/redcine-x-saving-looks-camera.

MANAGE IMPORTED LOOKS

Manage Looks imported from REDCINE-X PRO in the **Presets > Looks** tab. When exporting Looks from camera to SSD, the Looks are saved to a folder on the SSD called “Looks”.

You can perform the following actions with imported Looks:

- ▶  : Export selected Looks from camera to SSD.
- ▶ **All**  : Export all Looks from camera to SSD.
- ▶ **Apply**: Apply the selected Look.
- ▶ **Delete**: Delete the selected Look.

AUTO PRESETS

- ▶ **On Startup**: The selected preset is applied every time the camera is turned on.
- ▶ **On Enter Preview**: The selected preset is applied every time the camera enters Preview mode, including at startup and when exiting Playback mode.
- ▶ **On Enter Playback**: The selected preset is applied every time the camera enters Playback mode.

06 | RECORD AND MONITOR AUDIO

OVERVIEW

The camera can record up to two (2) discrete stereo channels of uncompressed 24-bit, 48 KHz audio. A Pro I/O Module provides two (2) channels of microphone level or line level audio inputs, and up to four (4) digital AES audio inputs. In total, the camera supports eight (8) incoming audio channels, and can record up to four (4) audio channels.

Input signals are routed via a high-quality pre-amplifier and soft clip analog limiter (the limiter is optional) to achieve the desired recording levels and maximize dynamic range.

Audio data is synchronized with video and timecode and embedded in the R3D® file. You can export audio data from REDCINE-X PRO® as separate audio files.

Audio is also embedded in any HD-SDI and HDMI® output connected to the camera.

For more information about using the Pro I/O Module, see the [Pro I/O Operation Guide](http://www.red.com/downloads), available at www.red.com/downloads.

AUDIO DATA PATH

The diagram below shows how the camera records and outputs audio.

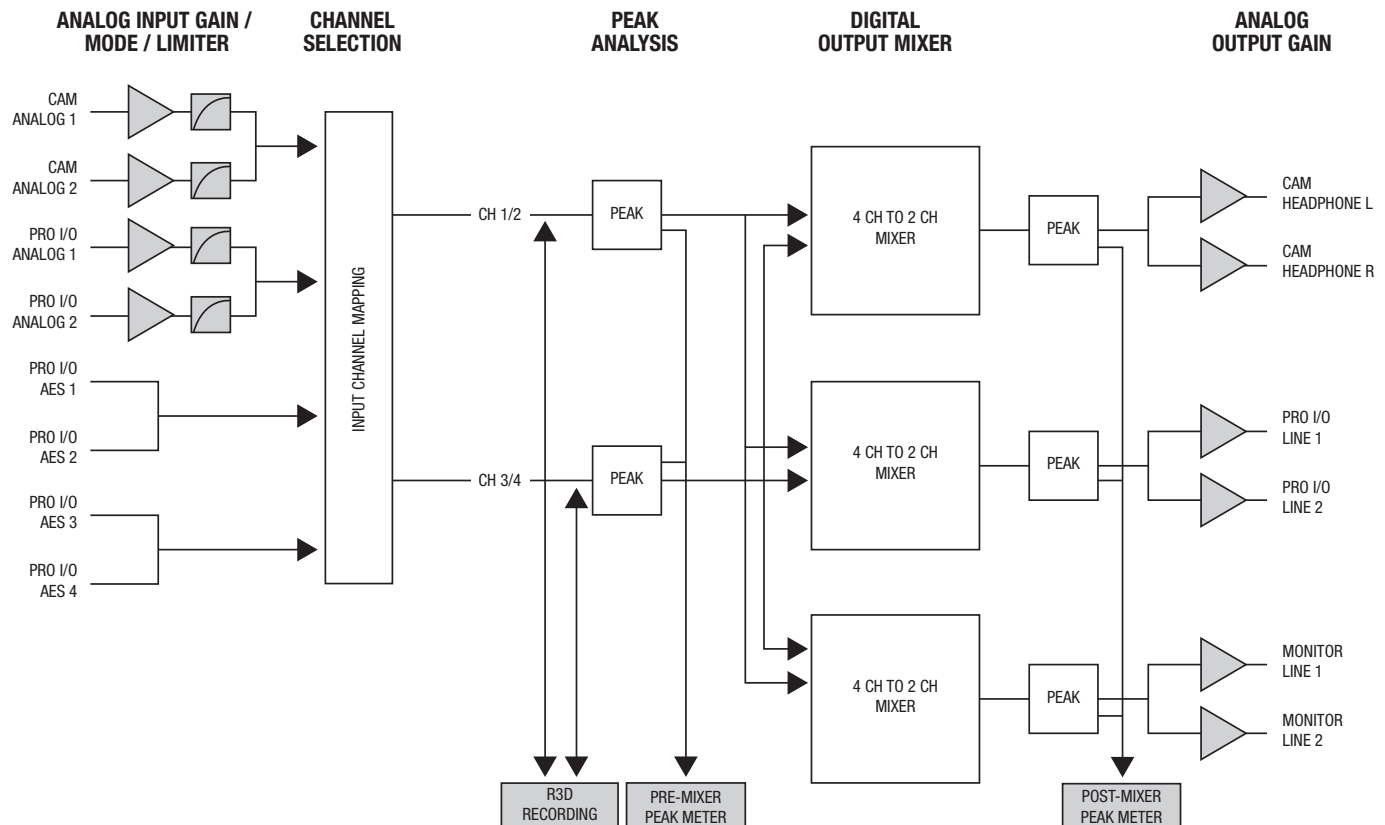

SET UP AUDIO

To set up audio, go to **Menu > Settings > Audio**, and adjust the input, pre-amplifier, headphone, and mix settings.

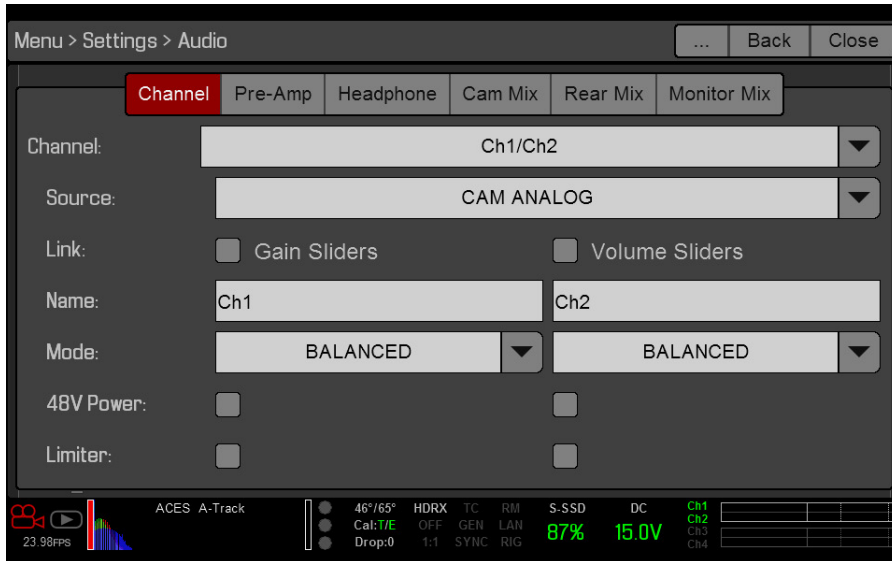

AUDIO INPUT (SOURCE) OPTIONS

SOURCE NAME	CHANNEL PAIRS	MODULE	CONNECTORS
NONE	N/A	N/A	N/A
CAM ANALOG	Ch1/Ch2, Ch3/Ch4	BRAIN	MIC-1, MIC-2
PRO I/O ANALOG	Ch1/Ch2, Ch3/Ch4	Pro I/O Module	AUDIO 3, AUDIO 4
PRO I/O AES A	Ch1/Ch2, Ch3/Ch4	Pro I/O Module	AES
PRO I/O AES B	Ch3/Ch4	Pro I/O Module	AES

NONE

Select **NONE** to disable recording audio.

CAM ANALOG AND PRO I/O ANALOG (MICROPHONE)

The camera provides two (2) microphone jacks for recording two (2) channels of microphone level analog audio. The Pro I/O Module provides two (2) XLR connectors for recording two (2) additional channels of microphone level audio. The sensitivity of the microphone and the pre-amp gain determine the recording level of the microphone input.

PRO I/O ANALOG (LINE IN)

The Pro I/O Module provides two (2) XLR connectors for recording two (2) channels of line level analog audio. Line input passes without gain through the system. The signal provided by the field production mixer or other external line level source determines the recording level of the line input.

NOTE: Line level audio is only available via the Pro I/O Module.

PRO I/O AES A/B (DIGITAL INPUT)

The AES connector on the Pro I/O Module allows an input of 24-bit, 48 KHz AES digital audio.

NOTE: Digital input audio is only available via the Pro I/O Module.

LINK

- ▶ **Gain Sliders:** Ensures that each pre-amplifier (Pre-Amp) slider has the same value. If you select the check box while the sliders have different values, you must change one (1) slider for all sliders to sync up.
- ▶ **Volume Sliders:** Ensures that each headphone (Headphone) slider has the same value, so that you can control the master volume for headphones. If you select the check box while the sliders have different values, you must change one (1) slider for all sliders to sync up.

CHANNEL NAME

You can rename each audio channel. The default names are Ch1, Ch2, Ch3, and Ch4. The channel names display in the Audio Meter, but are not included in the clip metadata. For more information, go to [“Audio Meter \(VU Meter\)” on page 144](#).

CHANNEL MODES

Match the channel mode to the incoming audio signal.

MODE	SOURCE	DESCRIPTION
NONE	NONE	Audio recording disabled.
BALANCED	CAM ANALOG, PRO I/O ANALOG	Balanced microphone input. Enables the 48V phantom power option. Typically used with microphones that have XLR connectors and internal batteries.
UNBALANCED	CAM ANALOG, PRO I/O ANALOG	Unbalanced microphone input with 3.3V bias. Disables the 48V phantom power option. Typically used with unpowered microphones that have 3.5 mm TRS plugs.
LINE	PRO I/O ANALOG	Fixed input gain with limiter settings if limiter is enabled. Disables the 48V phantom power option.
AES	PRO I/O AES A, PRO I/O AES B	Only mode available for AES input. Disables the limiter and 48V phantom power options.

PHANTOM POWER (48V POWER)

Select the **48V Power** check box to enable 48V phantom power for an audio channel. The 48V phantom power option is only available when the channel mode is set to BALANCED.

LIMITER

Select the **Limiter** check box to add a limiter to the analog input signal chain. Use the limiter in dynamic environments where external mixers are not practical for controlling signal strength. The limiter is only available with analog audio input.

PRE-AMP

The pre-amplifier range is 30 dB to 60 dB. The default is 32 dB. To adjust amplification levels, follow the instructions below:

1. Go to **Menu > Settings > Audio > Pre-Amp**.
2. Move the **Pre-Amp** (pre-amplifier) sliders up and down to adjust the amplification levels.

NOTE: To link the amplification for each channel, go to **Menu > Settings > Audio > Channel** and select the **Gain Sliders** check box. For more information, go to [“Link” on page 141](#).

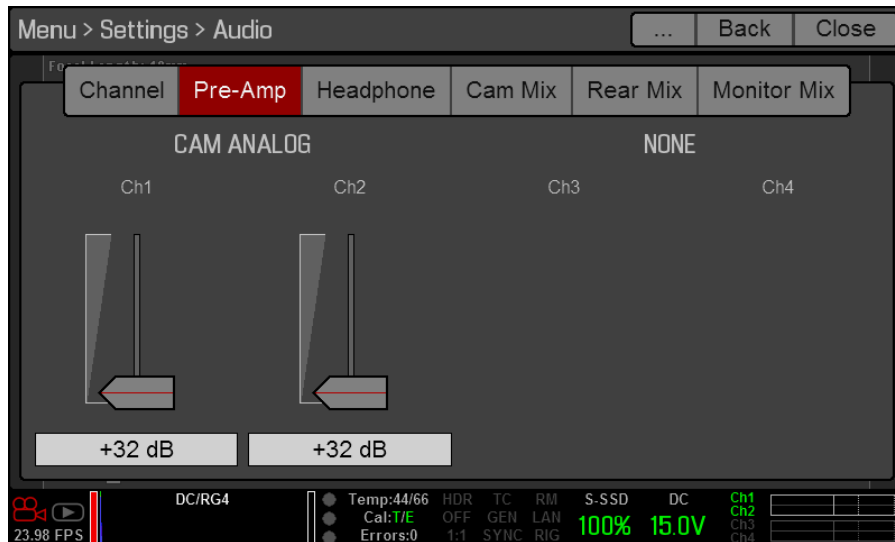

AUDIO OUTPUT OPTIONS

- ▶ **DSMC BRAIN:** One (1) 2-channel headphone output. For maximum quality, use high impedance headphones.
- ▶ **Pro I/O Module:** One (1) XLR connector that supports 2-channel line level analog output. The signal strength of the line out cannot be controlled, and is fixed at -15 dB gain.
- ▶ **HDMI and HD-SDI monitor:** Both output two (2) channels of 24-bit 48 KHz uncompressed, embedded digital audio. Select and mix the stereo channels in the Monitor Mix menu at **Menu > Settings > Audio > Monitor Mix**. To monitor audio via HDMI or HD-SDI, the third-party monitor must support audio.

CONTROL HEADPHONE VOLUME (BRAIN)

The volume range for Left and Right is -28 dB to -0 dB. The default is -9 dB. To adjust headphone volume, use the following instructions:

1. Go to **Menu > Settings > Audio > Headphone**.
2. Move the **Headphone** sliders up and down to adjust the volume.
3. To toggle mute/unmute, select **ACTIVE** and **MUTE**, respectively.

NOTE: To link the volume for Left and Right, go to **Menu > Settings > Audio > Channel** and select the **Volume Sliders** check box. For more information, go to [“Link” on page 141](#).

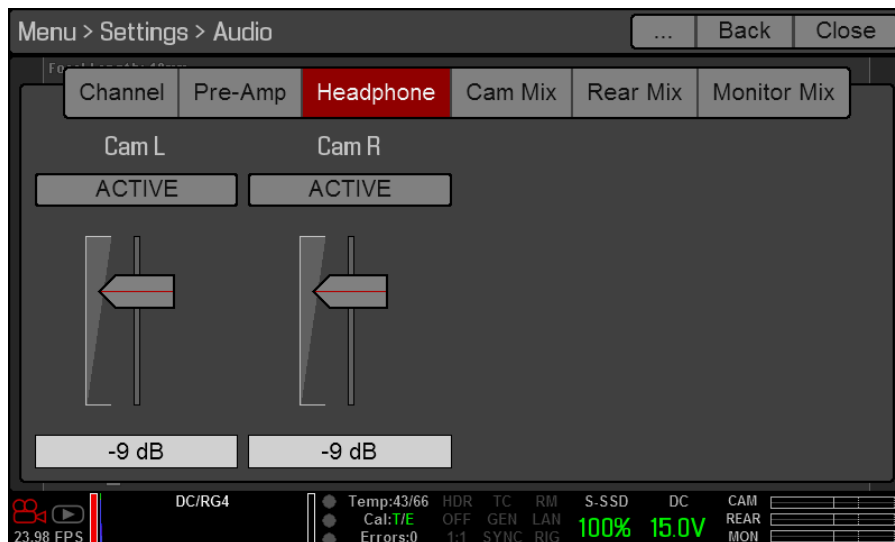

CONTROL AUDIO MIX (CAM MIX, REAR MIX, AND MONITOR MIX)

The camera features a digital audio mixer that controls the volume and stereo settings for each input channel. The mixer affects audio monitoring (such as headphones) and audio recorded to external devices. The mixer DOES NOT affect audio embedded in the R3D file.

The range for each channel is 0% to 100%. The default for each active channel is 100%. Channel 3 and Channel 4 are active only when there is audio input via the Pro I/O Module.

The digital mixer normalizes each output to prevent the output from exceeding the signal range. For example, if you pass Channel 1 to an output at 100%, and then mix Channel 2 into the same output, the level of Channel 1 decreases to 50%.

Assign each audio channel to the Left, Middle, or Right side of the stereo mix. Move the sliders up and down to adjust the volume.

You can control the volume and stereo for each audio monitoring option:

- ▶ **Cam Mix (Camera Mix):** Headphones plugged into the camera.
- ▶ **Rear Mix:** Line out plugged into the Pro I/O Module. The input gain is fixed.
- ▶ **Monitor Mix:** External HDMI and HD-SDI monitors that support audio.

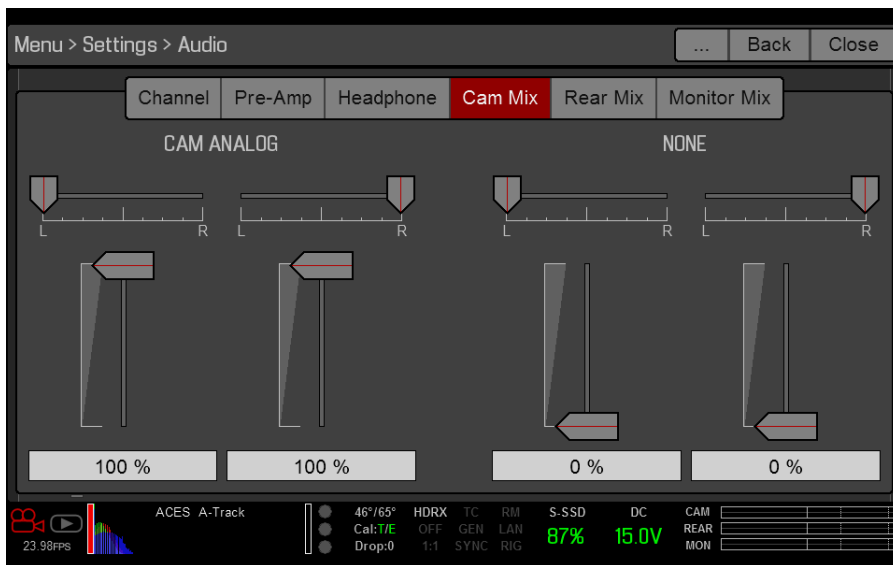

AUDIO METER (VU METER)

The Audio Meter displays at the bottom-right corner of the viewfinder, and displays either the incoming audio channels (default), or the outgoing audio (Cam Mix, Rear Mix, and Monitor Mix). For more information, go to [“VU Meter” on page 77](#).

INCOMING AUDIO CHANNELS

When you select Input as the VU Meter Source, the Audio Meter displays the incoming audio channels (default). For more information, go to [“VU Meter” on page 77](#). Channel 1 and Channel 2 are the default channels, correlating with the MIC-1 and MIC-2 inputs on the camera. Channel 3 and Channel 4 are greyed out unless the camera detects audio input via the Pro I/O Module.

The channel names selected in the Audio menu determine the channel names displayed in the Audio Meter. For more information, go to [“Channel Name” on page 141](#).

The Audio Meter shows the incoming audio signal when a source is selected, even if the channel is not recorded. When a channel is recorded, the channel indicator left of the Audio Meter is green.

OUTGOING AUDIO

When you select Output as the VU Meter Source, the Audio Meter displays the Cam Mix, Rear Mix, and Monitor Mix levels. For more information, go to “VU Meter” on page 77.

When recording to an external device, use the Output levels to help accurately monitor recorded audio.

AUDIO METER LEVELS

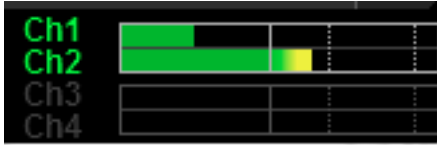

The camera updates the Audio Meter 12 times per second with the maximum signal from the last 1/12 of a second period. The range of the Audio Meter is -52 dBFS to 0 dBFS.

The lines and colors indicate danger of clipping, as described in the table below:

LINE	DBFS	BAR COLOR	DESCRIPTION
First line (far left border; solid)	-52 dBFS	Green	Audio is not clipping
Second line (solid)	-20 dBFS	Green	Audio is not clipping
Third line (dashed)	-12 dBFS	Yellow	Audio close to clipping
Fourth line (dashed)	-2 dBFS	Red	Audio is clipping
Fifth line (far right border; solid)	0 dBFS	Red	Audio is clipping (if signal exceeds -1 dBFS, the whole bar is red)

NOTE: In the American broadcast and post production systems, -20 dBFS roughly corresponds to 0 VU and 4 dBu. In a digital system, dBu is an approximation; the correct unit for digital audio levels is dBFS.

AUDIO DURING PLAYBACK

The camera plays all recorded channels during playback, and automatically unmutes any muted audio outputs.

To access audio settings during playback, go to **Menu > Settings > Audio** and select the following tabs:

- ▶ Control
- ▶ Mix

07

REDMOTE OPERATION

OVERVIEW



REDMOTE

The REDMOTE® is a remote camera control unit that attaches to the rear of the camera or other expansion module. When detached from the camera, the REDMOTE provides wireless camera control using the proprietary REDLINK™ protocol. Whether attached or operating wirelessly, the REDMOTE provides access to all necessary controls, including record start/stop, Shutter Speed, White Balance, ISO, and programmable User Keys. The color LCD displays critical camera settings, including media and battery capacity, timecode and clip name, lens data and exposure information.

The REDMOTE has a rechargeable Lithium Ion battery that automatically recharges when docked to the camera or other module. It can also be recharged using the built-in USB 2.0 connector. Under typical operating conditions, the REDMOTE provides up to eight (8) hours of battery life and supports wireless communication at a range of approximately 50 ft. The REDMOTE supports 16 (0-15) wireless channels ranging from 2.4 GHz to 2.4835 GHz. The default channel is 0.

IMPORTANT: To operate properly, upgrade both REDMOTE and camera firmware to the most recent version.

CONTROLS, CONNECTORS, AND LEDS

This section describes the REDMOTE controls, connectors, and color LCD display.

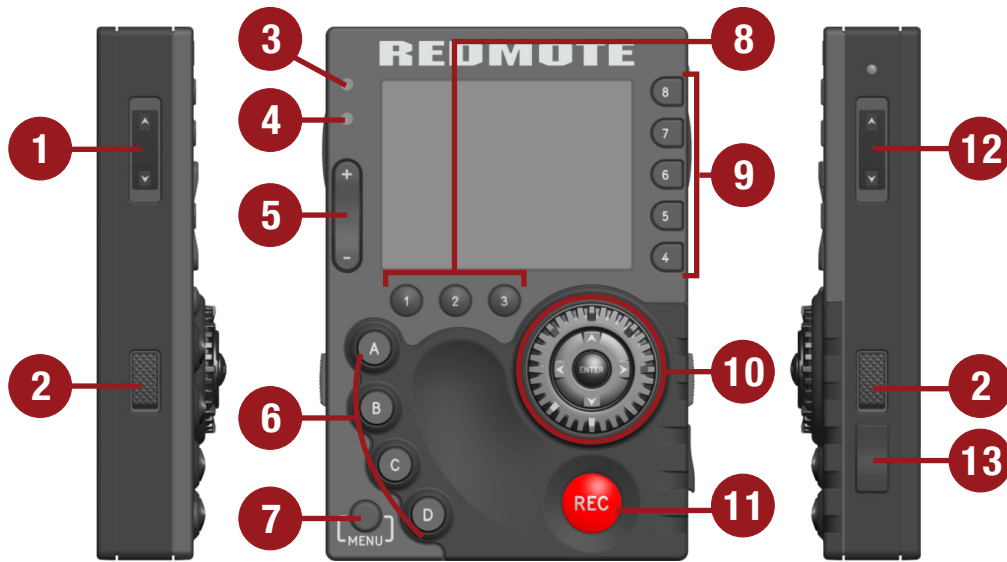

REDMOTE

The following table describes default REDMOTE control actions. Each control is also programmable.

#	REDMOTE CONTROL	DESCRIPTION
1	Stills/Motion Switch	Toggles between Stills/Motion Mode, enabled in v6.0 firmware or later
2	Release Buttons	Press and hold to undock the REDMOTE
5	Rocker Switch	Up: Iris open; Down: Iris close
6	User Function Keys	Go to “Default Key Functions” on page 217
7	Menu Button	Toggle between basic and advanced menus
8	Soft Menu Buttons (1-3)	Go to “Soft Menu Buttons (1-3)” on page 148
9	Soft Menu Buttons (4-8)	Go to “Customize REDMOTE Setting Menus” on page 151
10	Navigation Group	Go to “Navigation Group” on page 148
11	Focus/Record Button	Half press initiates auto focus; full press toggles record start/stop
12	Power/Lock Switch	Go to “Power/Key Lock Switch” on page 149
13	Mini-USB Power Port	Charges the internal battery; upgrade firmware

For a full list of default user key actions for the REDMOTE, go to [“Default Key Functions”](#) on page 217.

COMPATIBLE CABLE

- ▶ **790-0230:** RED® Mini-USB-to-USB cable

RED DSMC OPERATION GUIDE: EPIC/SCARLET

REDMOTE LEDS

There are two (2) status LED indicators located above the rocker switch on the left side of the LCD display.

#	REDMOTE LED	COLOR/FLASHING	DESCRIPTION
3	Power/Recording LED	Red	Camera startup; camera recording
4	Status/Connectivity LED	Green	Camera ready; REDMOTE connected
		Green flashing	Searching/Establishing communication

SOFT MENU BUTTONS (1-3)

There are three (3) Primary Soft Menu Buttons located below the left side of the REDMOTE LCD. These buttons provide quick access to REDMOTE advanced operations.

- ▶ **Button 1:** Access Connect Menu.
- ▶ **Button 2:** Toggle between Local and Remote Modes.
- ▶ **Button 3:** Access Setup Menu.

REDMOTE CONTROL MODES

Press **Button 2** to toggle between Remote Mode and Local Mode. The current mode displays on the REDMOTE LCD, directly above the Primary Soft Menu Buttons. Use the **Scroll Wheel** and **Directional Keys** to navigate with the cursor. For more information, go to [“Navigation Group” on page 148](#).

- ▶ **Local Mode:** Navigate menus using the REDMOTE controls and display.
- ▶ **Remote Mode:** Navigate menus with REDMOTE controls, using an attached LCD, EVF, or other monitor as a reference.

NOTE: When in Remote Mode, the current menu item does not display on the REDMOTE.

REDMOTE SETUP

The Setup Menu includes:

- ▶ **Turn Wireless On/Off:** Toggles the REDLINK wireless link on/off.
- ▶ **Setup System:** Provides access to REDMOTE settings.
- ▶ **Setup Slot:** Program the menu slots on the REDMOTE LCD.

SETUP SYSTEM

The Setup System Menu allows you to change REDMOTE settings and shows the MAC address and REDMOTE firmware version.

The following adjustable settings are available:

- ▶ **Brightness:** LCD backlight intensity. Set the value to maximum for daylight visibility, or reduce it for standard operation and prolonged battery life. Default is Maximum.
- ▶ **Volume:** Volume of the REDMOTE speaker. Default is Minimum.
- ▶ **Auto Shutdown:** Amount of inactivity time before the REDMOTE turns off automatically. Default is off.

NAVIGATION GROUP

Use the Navigation Group to navigate the camera menus and change settings.

- ▶ **Scroll Wheel:** Select and adjust the value of a selected setting.
- ▶ **Directional Keys (D-Pad):** Navigate menus.
- ▶ **ENTER:** Press **ENTER** to confirm a setting or access the selected menu.

POWER/KEY LOCK SWITCH

- ▶ **Turn on:** Press and hold the switch in the down position for two (2) seconds.
- ▶ **Turn off:** Press and hold the switch in the down position for five (5) seconds. Or, press the switch down into the down position and release to access the Shutdown menu.
- ▶ **Lock keys:** Move the switch to the up position to prevent unintentional operation. “KEYS LOCKED” display above the Primary Soft Menu Buttons when lock is enabled.

REDMOTE BASICS

This section describes the common REDMOTE operations.

DOCK THE REDMOTE

1. Position the REDMOTE V-Mount dock over the V-Mount on the BRAIN or rear module.
2. Slide the REDMOTE down until you hear a click, which indicates the REDMOTE is securely attached.

NOTE: Docking the REDMOTE automatically pairs the REDMOTE with the camera when the camera is turned on and wireless settings are enabled.

UNDOCK THE REDMOTE

1. Press both **Release** buttons, located on the sides of the REDMOTE.
2. Slide the REDMOTE up to release from the V-Mount on the BRAIN or rear module.
3. Remove the REDMOTE.

TURN ON THE REDMOTE

- ▶ When docked, the REDMOTE automatically turns on when the camera is turned on.
- ▶ Slide and hold the **Power/Key Lock** switch in the down position for two (2) seconds, then release.

TURN OFF THE REDMOTE

- ▶ When docked, the REDMOTE automatically turns off when the camera is turned off.
- ▶ Slide and hold the **Power/Key Lock** switch in the down position for five (5) seconds, then release.
- ▶ Slide and hold the **Power/Key Lock** switch in the down position momentarily, then release. Select the desired option from the Shutdown menu and press **Enter**:
 - **Shutdown Cam + REDMOTE:** Turn off both camera and the REDMOTE
 - **Shutdown REDMOTE:** Turn off the REDMOTE only.
 - **Shutdown Camera:** Turn off the camera only. Option not available when the REDMOTE is docked.

NOTE: For maximum battery life, remove power from the REDMOTE by pressing the Power/Lock Switch down into the off position and release. Then use the menu to turn off the device. When turning off the REDMOTE using the Power/Lock Switch, a slight power draw remains and continues to drain the battery.

RECORD START/STOP

- ▶ **Start Record:** Press and release the **REC** button. The Power/Recording LED illuminates red and the Timecode value on the LCD display changes to red text.
- ▶ **Stop Record:** Press and release the **REC** button. When media recording processes are complete, the Power/Recording LED turns off and the Timecode value on the LCD display changes back to white text.

PAIR THE REDMOTE

There are two (2) ways to pair the REDMOTE to a camera:

- ▶ Dock to pair
- ▶ Pair wirelessly

When a REDMOTE and camera are paired:

- ▶ The REDMOTE displays the camera settings.
- ▶ VIEWFINDER outputs display green RM status and signal strength indicators in the Lower Status Row.

NOTE: You can pair the REDMOTE to multiple BRAINS. However, you can only control one BRAIN at a time.

DOCK TO PAIR

1. Turn on the BRAIN.
2. Dock the REDMOTE to the back of the BRAIN or rear module.

NOTE: When the REDMOTE is removed from the camera, it automatically scans for the wireless signal and connects to that camera.

PAIR WIRELESSLY

1. Turn on the camera.
2. Go to **Menu > Settings > Setup > REDMOTE**.
3. Select **Scan for REDMOTES**.
4. When the scan is complete, select the REDMOTE from the scan list.
5. Select **Pair ->**.
6. Select **Close** to exit the menu.

NOTE: To see the REDMOTE MAC address, go to **Setup > Setup System**. The MAC address displays at the bottom of the LCD.

7. On the REDMOTE, press **Button 2**.
The Connect Menu opens.
8. On the REDMOTE, use the **Scroll Wheel** or **Directional Keys** to select the camera from the list and press **ENTER**.

If the camera does not display, select **RESCAN...** and press **ENTER**. If the camera is still missing from the list, ensure that camera settings are properly configured in the Communication and REDMOTE menus.

RECONNECT REDMOTE TO A PAIRED CAMERA

Follow the instructions below to reconnect the REDMOTE to a camera that is has been to paired to before.

1. Press **Button 1** to scan for paired cameras within wireless range. A scan takes about 20–30 seconds.
NOTE: The Connect Menu is hidden on the LCD when the REDMOTE is attached to a camera or rear module.
2. Select the camera and press **Enter**.

The REDMOTE connects to the selected camera.

NOTE: If the REDMOTE fails to find a camera within range, select **Rescan** and press **ENTER** in the Navigation Group to force a second scan.

RECONNECT THE REDMOTE AFTER SIGNAL LOSS

On loss of wireless communication, the REDMOTE scans for the camera it was last paired with. If the REDMOTE is unable to reconnect after 30 seconds, the manual Scan menu opens.

DISCONNECT THE REDMOTE FROM A PAIRED CAMERA

1. Press **Button 1**.
2. Select **DISCONNECT**.
3. Press **ENTER**.

CHARGE THE REDMOTE

A fully discharged REDMOTE battery requires approximately six (6) hours to fully charge. You can use the REDMOTE while it charges.

Charge the REDMOTE using either of the following methods:

- ▶ Dock the REDMOTE to a camera or rear module.
- ▶ Connect the REDMOTE to a computer, cell phone charger, or other sufficient power source using the RED Mini-USB-to-USB cable. If the power supply does not provide enough voltage, an “Error Charging” message displays.

CHARGE INDICATORS

The battery indicator in the lower right of the REDMOTE LCD indicates remaining battery life and charge status.

- ▶ **Green:** The battery has a sufficient charge, or is fully charged.
- ▶ **Yellow:** The battery is somewhat depleted and should be recharged soon.
- ▶ **Red:** The battery is nearly discharged and should be recharged immediately. Wireless communication is at risk of being lost when the battery indicator is red.

CUSTOMIZE REDMOTE SETTING MENUS

When operating the REDMOTE in Local mode, you can configure the settings displayed in each status window. Settings can be assigned to one (1) of the five (5) pages available under Soft Menu Buttons (4-8).

To customize settings, follow the instructions below:

1. Ensure the camera is on and wirelessly connected to the REDMOTE.
2. If the REDMOTE is in Remote Mode, press **Button 2** to toggle to Local Mode.
3. Select the Soft Menu Button (4-8) page you would like to set the desired setting on.
4. Use the **Directional Keys** to move the red cursor to the desired setting location.
5. Press **Button 3**.
6. Select **Setup Slot** and press **ENTER**.
7. Select the desired setting from the available list.
8. Press **Enter**.

REDMOTE LCD DISPLAY MENU

The REDMOTE LCD displays key camera settings of a paired and connected camera. There are five (5) available REDMOTE Setting menus, accessible with the Soft Menu Buttons (4-8).

NOTE: Soft Menu Buttons 7 and 8 are not defined.

The primary REDMOTE Setting Menu (Button 4) displays the following menu elements:

REDMOTE ITEM	DESCRIPTION
HDR	Displays HDRx mode status
1:1	Tallies when magnify is selected
False Color	Displays false color overlay mode
LAN	Indicates communication via Ethernet connection
RIG	Indicates 3D rig metadata is present
SYNC	Indicates sensor shutter sync status
GEN	Indicates presence of valid Genlock signal/HD-SDI sync to genlock
TC	Indicates presence of valid SMPTE timecode signal
Aperture	Displays aperture when using supported Canon, Nikon, or Cooke lenses
Focus Dist.	Displays optimum focus distance when using supported Canon, Nikon, or Cooke lenses
Sensitivity	Camera sensor sensitivity
Exposure	Integration time or shutter angle
Color Temp	White balance
Format	Recording resolution
REDCODE	REDCODE compression setting
Recording Frame Rate	Current frame capture rate
Project Time Base	Current project time base
Clip Filename	Filename of the current clip or next clip to be shot
Histogram	RGB Histogram
Model	EPIC or SCARLET
Media Status	Media location and remaining media capacity %
RAW Clip Meter	RGB sensor RAW clipping status
Timecode	Current timecode value
Battery Indicator	Displays battery life or charge status of REDMOTE
Audio Meter	Audio input selection and levels
Power Status	Indicates DC supply voltage or % of remaining battery capacity including current supply voltage
Camera ID	Displays camera ID
Wireless Status	Displays signal strength when connected wirelessly

UPGRADE REDMOTE FIRMWARE

This section describes the REDMOTE firmware upgrade process using Mac®, Windows®, and the camera.

UPGRADE REDMOTE WITH CAMERA

When you dock a REDMOTE, the camera checks to see if the REDMOTE is running the latest firmware. If the REDMOTE firmware is slightly outdated, you have the option to update the REDMOTE firmware through the camera. If REDMOTE firmware is severely outdated, you will be instructed to install updates via USB.

NOTE: The REDMOTE and camera must be re-paired after upgrading camera firmware.

UPGRADE REDMOTE (MAC)

This section describes the REDMOTE firmware upgrade process using a Mac.

INSTALL REDMOTE UPGRADE UTILITY (MAC)

The REDMOTE Upgrade Utility enables you to upgrade REDMOTE firmware from your computer.

1. Download the **REDMOTE Upgrade Utility**, available at www.red.com/downloads.
2. Uncompress and open the zip file.
3. Open the **REDMOTE_Upgrade_Utility** folder.
4. Open the **Mac** folder.
5. Open **REDMOTE.dmg**.
6. Open **REDMOTE Upgrade Utility**.
7. Continue to [“Configure REDMOTE Connection with Computer \(Mac\)” on page 153](#).

CONFIGURE REDMOTE CONNECTION WITH COMPUTER (MAC)

Next, establish a connection between the Mac and the REDMOTE.

1. Disable WiFi and disconnect the Ethernet cable connected to your computer.
NOTE: An internet connection interferes with the computer’s attempt to recognize the REDMOTE.
2. Connect a USB to mini-USB cable between the Mac and the USB connector on the REDMOTE.
NOTE: When properly connected to the computer, the battery charge indicator flashes.
3. Open **System Preferences** and select **Network**.

NOTE: This screen may open automatically when the REDMOTE is connected.

4. Look for a device called **RNDIS/...Gadget**.
5. Change **Configure IPv4** setting to **Manually**.
6. In the **IP Address** field, enter **192.168.0.1**.
7. In the **Subnet Mask** field, enter **255.255.255.0**.
8. Click **Apply**.

The Status changes to Connected.

NOTE: After entering the IP address, you may not connect during the upgrade procedure. If you check the IP address you see that it is 0.0.0.0 and the status of the device is Connected, you may need to re-enter the IP address.

9. Go back to **REDMOTE Upgrade Utility** and click **Connect** to establish a connection with the REDMOTE.
“Connection is Established With REDMOTE” displays when connected. If the connection is not established, then disable all internet connections and try again.
10. Go to [“Upgrade REDMOTE Firmware \(Mac\)” on page 154](#).

UPGRADE REDMOTE FIRMWARE (MAC)

1. Download the **REDMOTE Firmware**, available at www.red.com/downloads.
NOTE: Review the **read_me_redmote_vX.X.XX** instructions contained in the **REDMOTE_vX.X.XX.zip** file.
2. Uncompress the zip file.
3. Open the **REDMOTE_vX.X.XX** folder.
4. Click **Select File** in **REDMOTE Upgrade Utility**.
5. Open the **redmote.1.bin** file in the **REDMOTE_Firmware_vX.X.XX** folder.
"Selected File: redmote.1.bin" displays.
6. Click **Start Upgrade**.
When the file transfer is complete, the REDMOTE displays "Firmware Upgrade Successfully Done".
7. Click **OK**.
8. Click **Disconnect** to close the REDMOTE Upgrade Utility.
The REDMOTE automatically reboots.
After the upgrade is complete, the REDMOTE displays "POWER UP" and then "SEARCHING".
9. Select **Cancel**.
10. On the REDMOTE, go to **Setup > Setup System** and verify the current REDMOTE firmware version.
The REDMOTE upgrade is complete.
11. You may need to re-pair the REDMOTE with the camera after upgrading firmware. For more information, go to "[Pair the REDMOTE](#)" on page 150.

UPGRADE REDMOTE (WINDOWS)

This section describes the REDMOTE firmware upgrade process using Windows.

INSTALL REDMOTE UPGRADE UTILITY (WINDOWS)

1. Download the **REDMOTE Upgrade Utility**, available at www.red.com/downloads.
2. Uncompress and open the zip file.
3. Open the **REDMOTE_Upgrade_Utility** folder.
4. Open the **Win** folder.
5. Open **REDMOTE_upgrade_setup.exe**.
6. Click **Extract All**.
7. Select a destination and click **Extract**.
NOTE: If an error occurs during the installation of the REDMOTE Upgrade Utility, right-click the setup file and select **Run as Administrator** to proceed.
8. Go to the location where you extracted the **DSMC_Toolkit_vX.X** file.
9. Open the **REDMOTE_Upgrade_Utility** folder.
10. Open the **Win** folder.
11. Open **REDMOTE_upgrade_setup.exe**. The License Agreement opens.
12. Click **I Agree**.
13. Ensure that the **Install REDMOTE Firmware update** check box is selected and click **Next**.
14. Select a destination and click **Next**.
15. Select a **Start Menu** folder where program shortcuts will be created. Default is REDMOTE Update.
16. Click **Install**.
17. Click **Close** after setup completes successfully.
18. Go to "[Configure REDMOTE Connection with Computer \(Windows\)](#)" on page 155.

CONFIGURE REDMOTE CONNECTION WITH COMPUTER (WINDOWS)

Next, you must establish a connection between the Windows and the REDMOTE.

1. Disable WiFi and disconnect the Ethernet cable connected to your computer.
NOTE: An internet connection interferes with the computer's attempt to recognize the REDMOTE.
2. Connect a USB to mini-USB cable between the computer and the USB connector on the REDMOTE.
If connecting for the first time, a RNDIS/Gadget driver is installed on the system.
When the driver is installed, the battery charge indicator flashes on the REDMOTE.
NOTE: If the REDMOTE does not connect to the Windows computer, download the **REDMOTE Firmware** file from www.red.com/downloads, open the **read_me_redmote_vX.X.XX** file, and follow the instructions to manually set up the network connection. For additional assistance, contact RED SUPPORT at <https://support.red.com>.
3. Open the **REDMOTE_update** program from the **Start Menu** folder you created the shortcut for.
4. Click **Connect** to establish a connection between the REDMOTE and REDMOTE_update.
When the REDMOTE is connected, "Connection is Established With REDMOTE" displays. If the connection is not established, disable all internet connections and try again.
5. Go to "[Upgrade REDMOTE Firmware \(Windows\)](#)" on page 155.

UPGRADE REDMOTE FIRMWARE (WINDOWS)

1. Download the **REDMOTE Firmware**, available at www.red.com/downloads.
NOTE: Review the **read_me_redmote_vX.X.XX** instructions contained in the **REDMOTE_vX.X.XX.zip** file.
2. Uncompress the zip file.
3. Open the **REDMOTE_Firmware_vX.X.XX** folder.
4. Click **Select File** in **REDMOTE Upgrade Utility**.
5. Go to the **redmote.1.bin** file located in the **REDMOTE_Firmware_vX.X.XX** folder and click **Open**.
"Selected File: redmote.1.bin" displays.
6. Click **Start Upgrade**.
When the file transfer is complete, the REDMOTE displays "Firmware Upgrade Successfully Done".
7. Click **OK**.
8. Click **Disconnect** to close the REDMOTE Upgrade Utility.
The REDMOTE reboots.
After the upgrade is complete, the REDMOTE displays "POWER UP" and then "SEARCHING".
9. Select **Cancel**.
10. On the REDMOTE, go to **Setup > Setup System** and verify the current REDMOTE firmware version.
REDMOTE upgrade is complete.
11. You may need to re-pair the REDMOTE with the camera after upgrading firmware. For more information, go to "[Pair the REDMOTE](#)" on page 150.

08

TIMECODE, GENLOCK, MULTI-CAMERA SETUP

This chapter describes timecode, genlock, and multi-camera operations such as 3D and array setup.

TIMECODE

Timecode is a numeric sequence based on SMPTE 12M that aids in the management and synchronization of footage and audio. Timecode is embedded in recorded RAW files as metadata and in HANC metadata provided by the HD-SDI monitor output. The camera can generate timecode on its own or can receive and sync to timecode generated by an external source.

Timecode displays in the lower right corner of the Live Action Area on the graphical user interface (GUI) and is embedded as metadata. Timecode is represented as an eight (8) digit sequence (HH:MM:SS:FF), where:

- ▶ **HH:** Hours
- ▶ **MM:** Minutes
- ▶ **SS:** Seconds
- ▶ **FF:** Frames

NOTE: Timecode is most accurate and effective when coupled with genlock. For more information, go to “Genlock” on page 159.

NOTE: The camera cannot output internally generated timecode on its own. A Pro I/O Module or REDCAST™ Module is required to output timecode generated by the camera.

NOTE: For more information on HANC metadata, see [HD-SDI HANC Metadata Information](http://www.red.com/developers), available at www.red.com/developers.

TIMECODE DISPLAY MODES

- ▶ **Time of Day (TOD):** Displays the time of day (HH:MM:SS:FF). TOD timecode runs continuously and is not affected by recording. TOD timecode can be synchronized with the Real-Time Clock (RTC) in the camera.
- ▶ **Edge:** Edge timecode is continuous between clips, meaning that when recording starts, timecode begins. and when recording stops, timecode stops. By default, Edge timecode default begins at 01:00:00:00, but can be configured in the Media menu (**Menu > Media > Device > Format**).

SET UP INTERNAL TIMECODE

To set up and adjust timecode generated by the camera, follow the instructions below:

1. Go to **Menu > Settings > Project > Timecode**.
2. Select the desired **Timecode Display** mode.
3. Set **Source** to **User Provided**.
4. Select the **LTC Out** check box to perform Linear Timecode Out, if applicable.

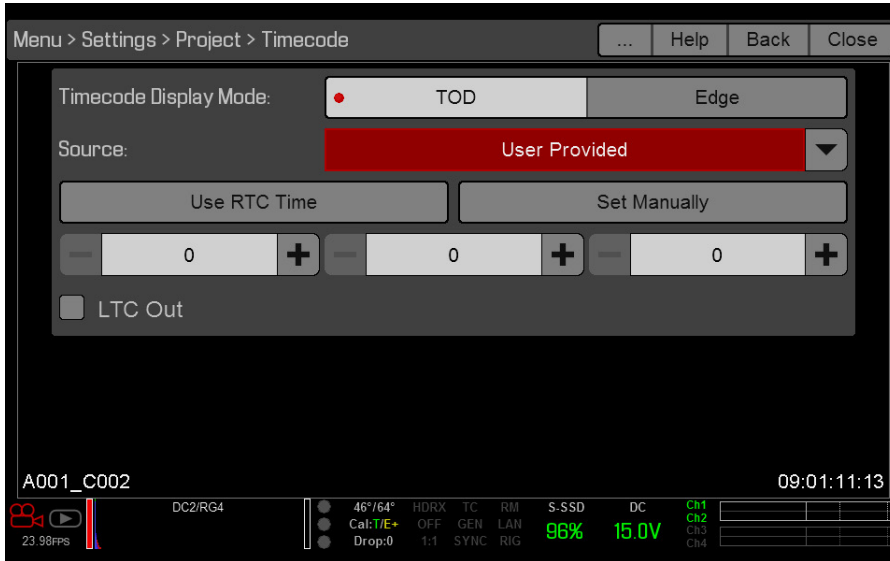

Source: User Provided

5. Use the additional controls to sync TOD timecode with the RTC or set manually. Alternatively, go to **Menu > Media > Device > Format Media...** to set Edge timecode manually. The **TC** indicator in the Lower Status Row remains grey when internal timecode is enabled.

INPUT EXTERNAL TIMECODE

To set up and adjust timecode generated by an external device, follow the instructions below.

1. Connect the external timecode generator to the camera using a 3BNC-to-00 LEMO® Sync Cable.
 - A. Connect the yellow BNC connector to the output on the timecode generator.
 - B. Connect the 00B LEMO connector to the **SYNC** port on the camera.
 - C. Go to **Menu > Settings > Project > Timecode**.
2. Select the desired **Timecode Display Mode**.

RED DSMC OPERATION GUIDE: EPIC/SCARLET

3. Set **Source** to **External: BRAIN**.

The **TC** indicator in the Lower Status Row turns green when an external timecode source is locked.

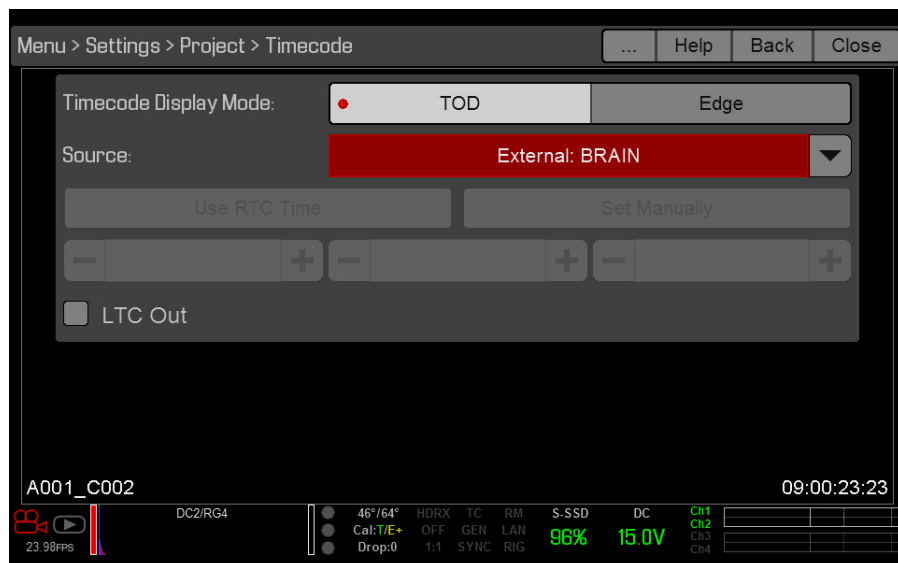

Source: External: BRAIN

NOTE: When an external source is selected but not present, timecode displays **User Provided** settings.

REQUIRED CABLE

- ▶ **790-0154:** 3BNC-to-00 LEMO Sync Cable

GENLOCK

Generator locking (genlock) is a tri-level signal used to synchronize video and audio systems. Genlock is based on SMPTE 296M and 274M.

There are two (2) important genlock sync modes:

- ▶ Monitor Sync
- ▶ Sensor Sync

NOTE: For genlock to function correctly, the cameras must be on the same firmware version, and must be using the same project time base and recording frame rate.

MONITOR SYNC

Monitor Sync occurs when a genlock signal is provided that is compatible with the current monitor output frequency. Monitor Sync is achievable even if the camera is using another form of synchronization to sync the camera sensor.

1. Connect the desired genlock device to the camera using a 3BNC-to-00 LEMO Sync Cable.
 - A. Connect the green BNC connector to the genlock device.
 - B. Connect the 00B LEMO connector to the **SYNC** port on the camera.
2. Go to **Menu > Settings > Display > Monitor Control > Monitor**.
3. Select **BRAIN HDSDI** from the drop-down menu.
4. Select the desired monitor output frequency from the **Frequency** drop-down menu.

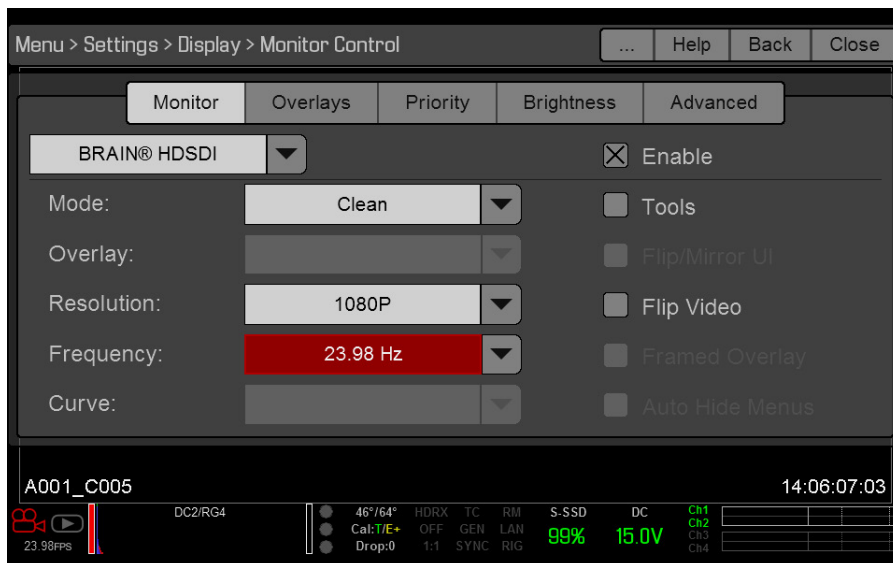

HD-SDI Output Frequency

NOTE: Select **Auto** to automatically match the HD-SDI output to the current Project Time Base.

Monitor Sync is achieved automatically when a genlock signal is provided that is compatible with the current monitor output frequency. When Monitor Sync is achieved, the **GEN** indicator in the Lower Status Row illuminates green.

SENSOR SYNC

Sensor Sync is achieved when a genlock signal is provided that is compatible with the current monitor output frequency, project time base, and recording frame rate. While operating in Sensor Sync, sensor timing is locked to the genlock signal.

Sensor Sync requires the following synchronized settings:

SETTING	MENU LOCATION PATH
Genlock signal frequency	N/A; external genlock device
HD-SDI monitor output frequency	Menu > Settings > Display > Monitor Control
Project Time Base	Menu > Settings > Project > Frame Rate
Recording Frame Rate	Menu > Settings > Project > Frame Rate

NOTE: HDRx is not available when Genlock Sensor Sync is enabled.

To set up and enable Sensor Sync Mode, follow the instructions below:

1. Connect the desired genlock device to the camera using a 3BNC-to-00 LEMO Sync Cable.
 - A. Connect the green BNC connector to the genlock device.
 - B. Connect the 00B LEMO connector to the **SYNC** port on the camera.
2. Go to **Menu > Settings > Setup > GPIO/Sync > Sync**.
3. Select **Genlock** from the **Sensor Sync Mode** drop-down menu.
4. Select **BRAIN** from the **Genlock Source** drop-down menu.

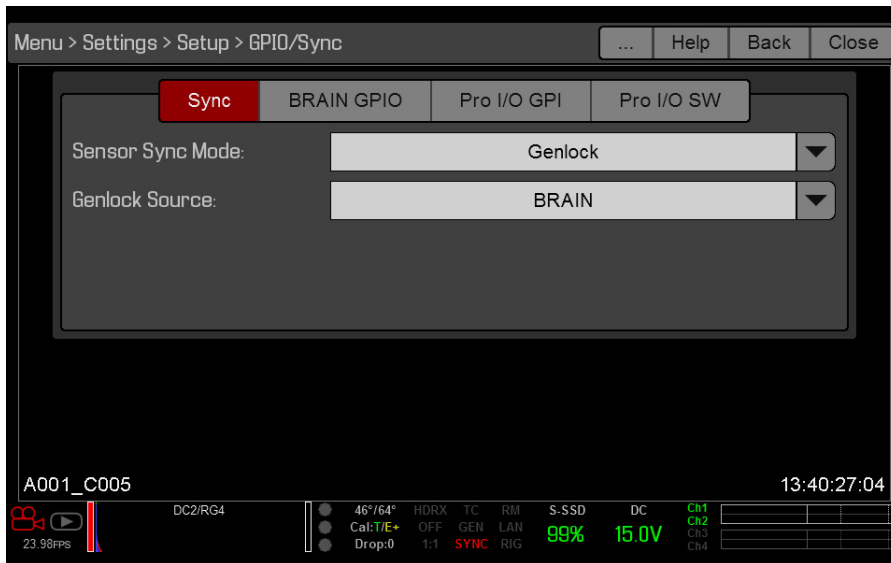

Sync Settings

5. Go to **Menu > Settings > Display > Monitor Control**.
6. Select **BRAIN HDSDI** from the drop-down menu.
7. Select the desired monitor output frequency from the **Frequency** drop-down menu.

NOTE: Select **Auto** to automatically match the HD-SDI output to the current project time base.

The **GEN** indicator in the Lower Status Row turns green when a compatible genlock signal is present and genlock is enabled. The **SYNC** indicator in the Lower Status Row turns green when Sensor Sync is achieved.

MASTER/SLAVE OPERATION

This section describes operation in Master/Slave configuration and clip naming conventions for clips recorded on those cameras. Master/Slave is the most common configuration for Stereo/3D productions.

When cameras are operated in Master/Slave configuration, you can perform the following operations:

- ▶ **Power:** Turn off the Master camera to turn off both cameras.
- ▶ **Record:** Press the **PWR/REC** key on the Master camera to start/stop recording on both cameras.
- ▶ **Change settings:** Change settings on the Master camera, to change settings on the Slave camera.

NOTE: The Master camera controls metadata and basic camera parameters of the Slave cameras. Any other setting changes required by the Slave cameras must be made before recording.

For a Master/Slave configuration to function, the cameras must have the same:

- ▶ Firmware version
- ▶ Project time base
- ▶ Recording frame rate
- ▶ BRAIN
- ▶ Sensor

SET UP MASTER/SLAVE OPERATION

1. Connect cameras using a Master/Slave Gig-E Cable.
2. On the Master camera, follow the instructions below:
 - A. Go to **Menu > Settings > Setup > Communication**.
 - B. Type a name for the camera (Example: CAM A, LEFT, MASTER, etc) in the **Name** field.
 - C. Set **Target** to **All**.

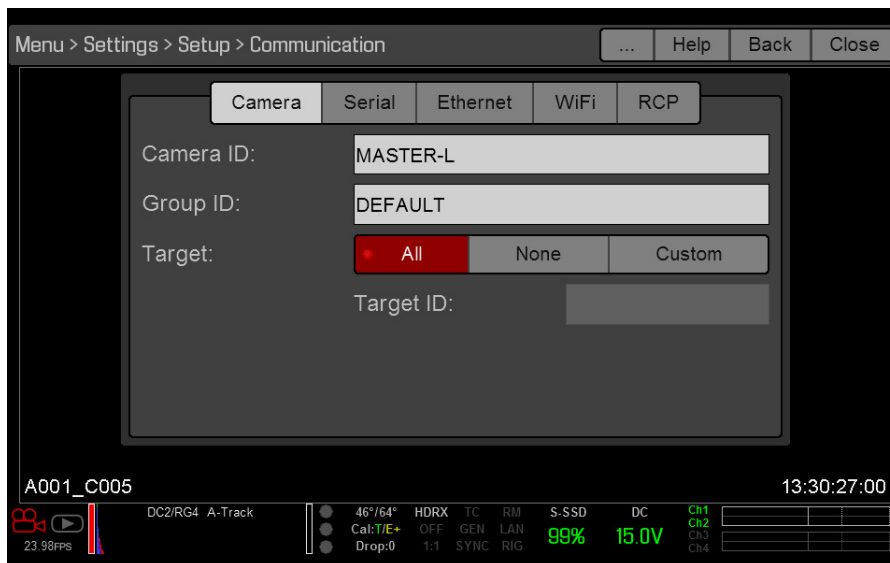

Master Settings

- D. Go to **Menu > Settings > Setup > Communication** and select the **Ethernet** tab.
 - E. Verify the **Enable Camera to Camera** check box is selected.
3. On the Slave camera(s), follow the instructions below:
 - A. Go to **Menu > Settings > Setup > Communication**.
 - B. Type a name for the camera (Example: CAM B, RIGHT, SLAVE, etc) in the **Name** field.

RED DSMC OPERATION GUIDE: EPIC/SCARLET

C. For **Target**, select **None**.

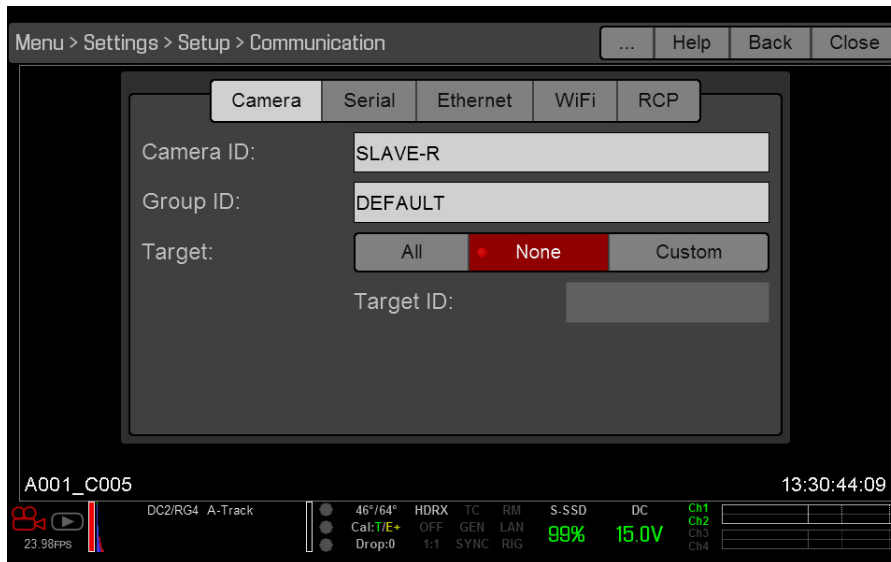

Slave Settings

D. Go to **Menu > Settings > Setup > Communication** and select the **Ethernet** tab.

E. Verify the **Enable Camera to Camera** check box is selected.

The **LAN** indicator in the Lower Status Row illuminates green.

NOTE: Cameras can also be set up in Master/Master configuration. To set as Master/Master, set **Target** to **All** on both cameras, allowing either camera to make changes and control record start/stop.

SET REEL NUMBER, CAMERA ID, AND CAMERA POSITION

To prepare media and slate settings for a Master/Slave or Stereo/3D production, follow the instructions below:

1. On both Master and Slave cameras, go to **Menu > Media > Device** and select **Format Media....**
2. On both Master and Slave cameras, select the desired **Reel No** and **Cam ID** settings.

NOTE: The Reel No and Cam ID settings on both cameras should match.

3. On the Master camera, change the **Cam Pos** value to **Left**, representing “left eye”.

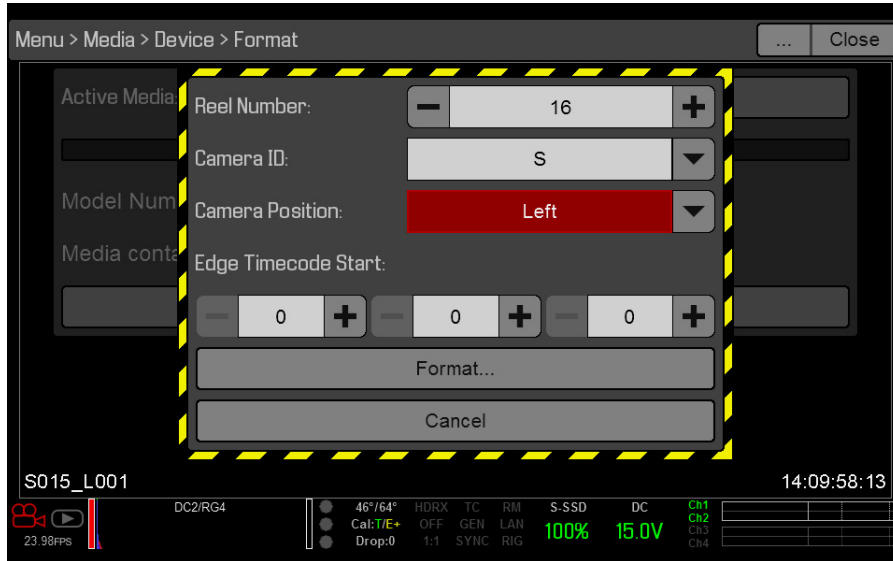

Master Camera Settings

4. On the Slave camera, change the **Cam Pos** value to **Right**, representing “right eye”.
5. On both cameras, select **Format...** to format media and set Reel No, Cam ID, and Cam Pos settings.

NOTE: Cam ID and Cam Pos settings can also be found at **Menu > Settings > Project > Slate > Camera**.

MULTI-CAMERA CLIP NAMING CONVENTIONS

This section describes automatic camera-generated clip naming conventions based on slate settings. Cameras use the Reel No, Cam ID, and Cam Pos settings to generate a custom clip name.

For example, if you have two (2) cameras in Master/Slave configuration and format media on both cameras with the following settings:

CAMERA	REEL NO	CAM ID	CAM POS
Master	1	S	Left
Slave	1	S	Right

The first clip recorded by this Master/Slave camera configuration is:

- ▶ **Master:** S001_L001_0503B6.R3D
- ▶ **Slave:** S001_R001_0503R7.R3D

NOTE: B6 and R7 are examples of camera-generated wildcard characters.

NOTE: If both camera settings are on left on the default, recorded clips will have the same filename structure. The only exception is the camera-generated wildcard characters. For example:

- ▶ **Master:** A001_C001_0503B6.R3D
- ▶ **Slave:** A001_C001_0503R7.R3D

NOTE: Reel No, Cam ID, and Cam Pos can be set when formatting media at **Menu > Media > Device**.

SET UP STEREO/3D CONFIGURATION

This section describes basic procedures for connecting two (2) cameras in a Master/Slave configuration for 3D operation.

NOTE: When providing the signals to a Stereo Image Processor (SiP) for verifying 3D alignment, set the HD-SDI monitor output on both cameras to have the same overlay configuration.

NOTE: For genlock to function correctly, the cameras must be on the same firmware version, and must be using the same project time base and recording frame rate.

To set up a Stereo/3D setup, follow the instructions below.

1. On both cameras, set the desired project time base and recording frame rate.
2. On both cameras, follow the instructions in [“Sensor Sync” on page 160](#) to achieve Sensor Sync genlock status.

The **GEN** and **SYNC** indicators in the Lower Status Row illuminate green.

3. Follow the instructions in [“Set Up Master/Slave Operation” on page 161](#) to set Master and Slave camera settings.
4. On both cameras, follow the instructions in [“Set Reel Number, Camera ID, and Camera Position” on page 163](#) to prepare media and camera settings.

3D CONFIGURATION EXAMPLE

The diagram below is an example of how to set up a 3D configuration.

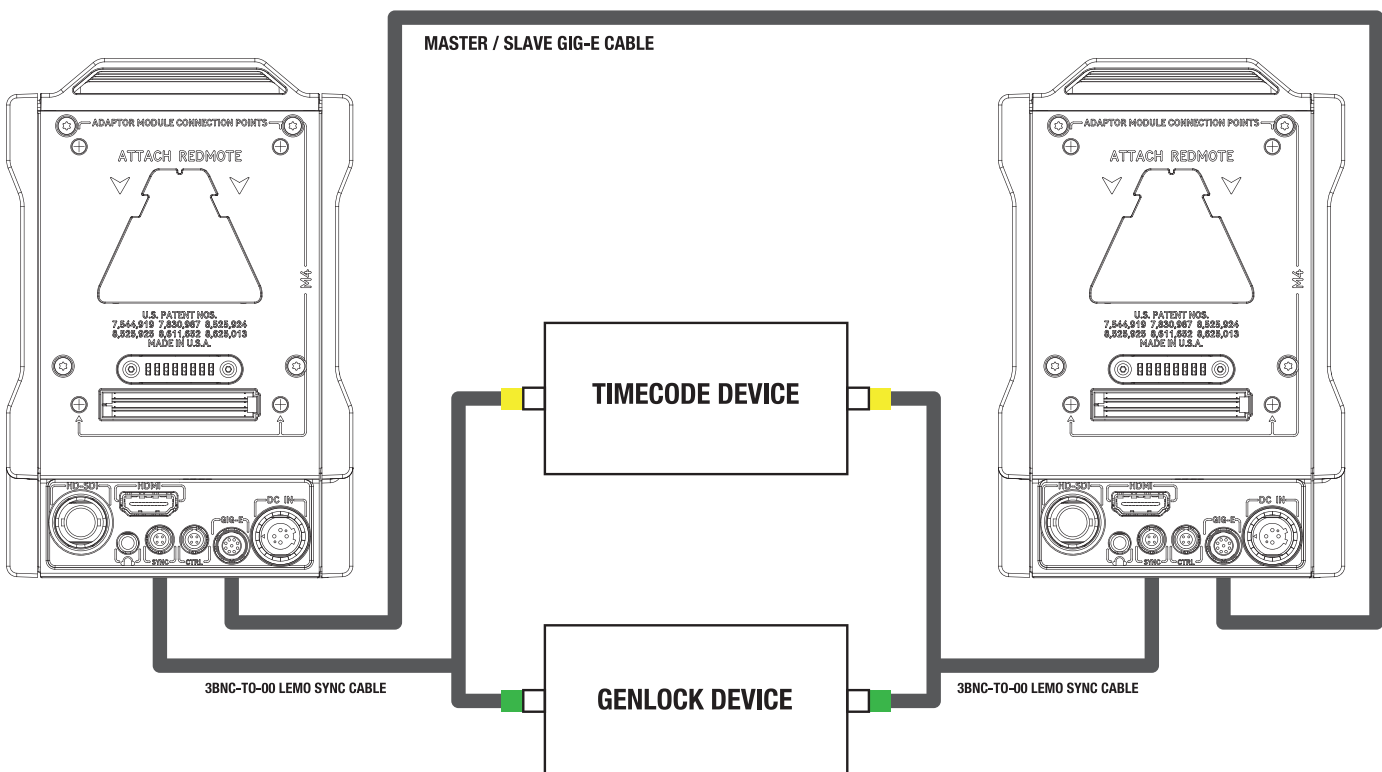

REQUIRED CABLES

- ▶ **790-0163:** Master/Slave Gig-E Cable
- ▶ **790-0154:** 3BNC-to-00 LEMO Sync Cable (required per camera)

SET UP A CAMERA ARRAY

You can sync more than two (2) cameras for applications and productions that require a camera array. To set up a camera array, you need a 1000Base-T gigabit Ethernet router.

NOTE: For genlock to function correctly, the cameras must be on the same firmware version, and must be using the same project time base and recording frame rate.

NOTE: To operate a camera array setup from a Windows computer or workstation, you need one of several applications provided by RED® or third-party developers.

For more information on camera control, see the REDLINK® SDK, available at www.red.com/developers.

To set up a camera array, follow the instructions below:

1. On each camera, go to **Menu > Settings > Setup > Communication** and set the following:
 - On the **Camera** tab, set **Target** to **All**.
 - On the **Camera** tab, enter a matching name in the **Group** field.
 - On the **Ethernet** tab, ensure that **Enable DHCP**, **Enable Camera to Camera**, and **Enable External Control** are all selected.

NOTE: All cameras must have the same **Group** name.

2. Follow the instructions in “[Sensor Sync](#)” on [page 160](#) to connect each camera to the genlock device. The **GEN** and **SYNC** indicators in the Lower Status Row illuminate green.
3. Follow the instructions in “[Set Up Master/Slave Operation](#)” on [page 161](#) to set Master and Slave camera settings.

NOTE: Instead of using the Master/Slave Gig-E Cable, connect each camera to the router using a LEMO-To-CAT5E Ethernet Cable.

 - A. Connect the LEMO connector to the **GIG-E** port on the camera.
 - B. Connect the Ethernet connector to the router.
4. On all cameras, follow the instructions in “[Set Reel Number, Camera ID, and Camera Position](#)” on [page 163](#) to prepare media and camera settings.

CAMERA ARRAY EXAMPLE

The diagram below is an example of how to set up a camera array.

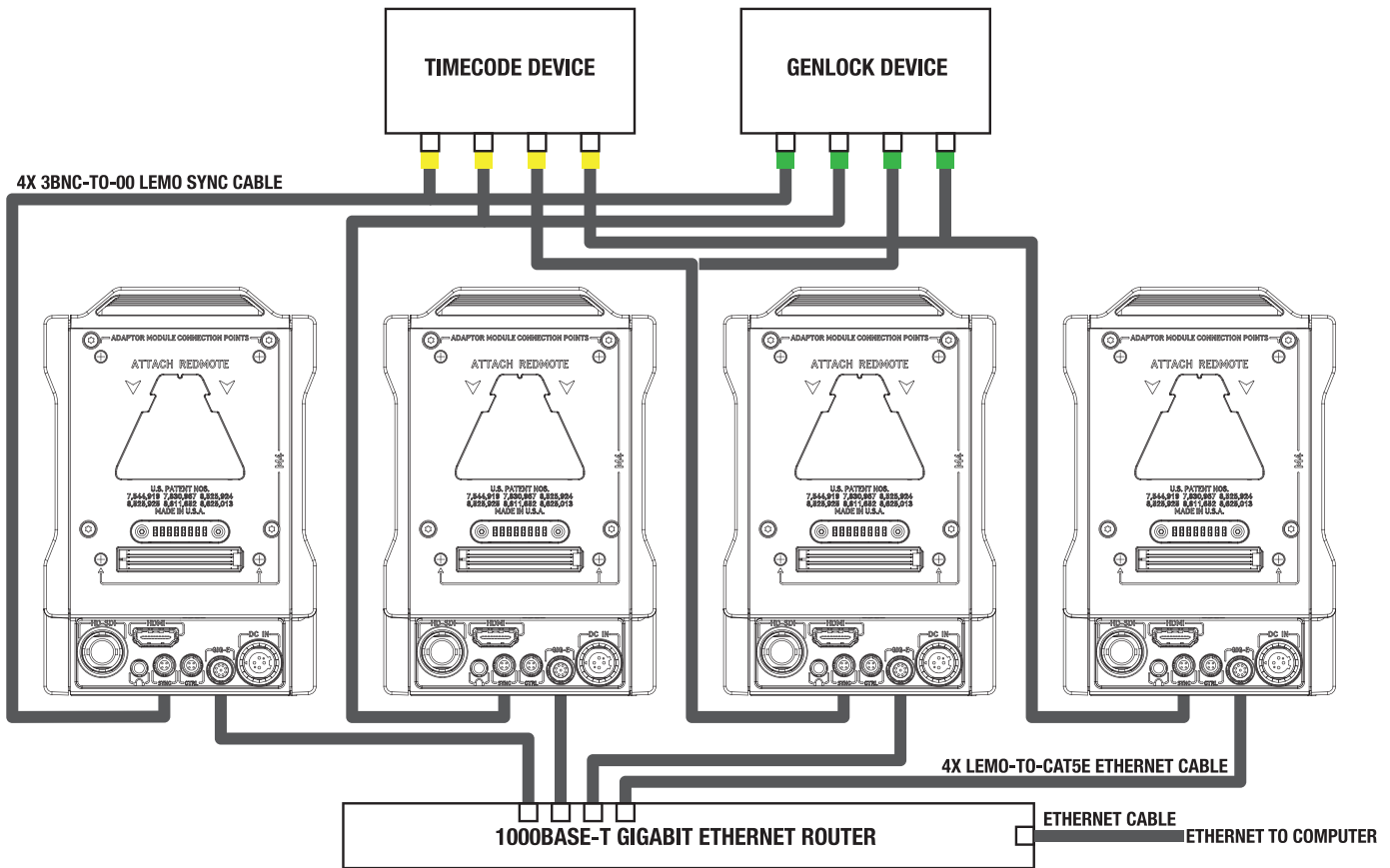

REQUIRED CABLES

- ▶ **790-0154:** 3BNC-to-00 LEMO Sync Cable (required per camera)
- ▶ **790-0159:** LEMO-To-CAT5E Ethernet Cable (9') (required per camera)

SET UP MOTION CONTROL (MOCO)

Motion Control, or “MoCo” for short, is a form of sensor synchronization used to automate precision camera movements required for special effects and difficult shots. Motion Control uses GPIO signals transmitted using the SYNC (GPI) and CTRL (GPO) ports on the camera or a connected Pro I/O Module or REDCAST Module.

For more information on GPIO connections, go to [“Input/Output Connectors” on page 199](#).

NOTE: When using MoCo, set the frame rate to be at least two times (2x) the fastest trigger rate used. When using MoCo, REDCODE is calculated based on FPS/2. Therefore, if you are in MoCo mode, and the frame rate is 100.83 FPS, the maximum REDCODE is calculated based on a frame rate of 50.415 FPS.

NOTE: HDRx is not available when MoCo is enabled.

NOTE: Genlock and timecode can also be used with MoCo.

To set up MoCo, follow the instructions below:

1. Connect the Motion Control device to the camera using a 3BNC-to-00 LEMO Sync Cable.
 - **Sync In:** Connect the white BNC connector to the Motion Control device and the 00B LEMO connector to the **SYNC** port on the camera.
 - **Sync Out:** Connect the yellow BNC connector to the Motion Control device and the 00B LEMO connector to the **CTRL** port on the camera.
2. Go to **Menu > Settings > Setup > GPIO/Sync > Sync**.
3. Select **MoCo** from the **Sensor Sync Mode** drop-down menu.

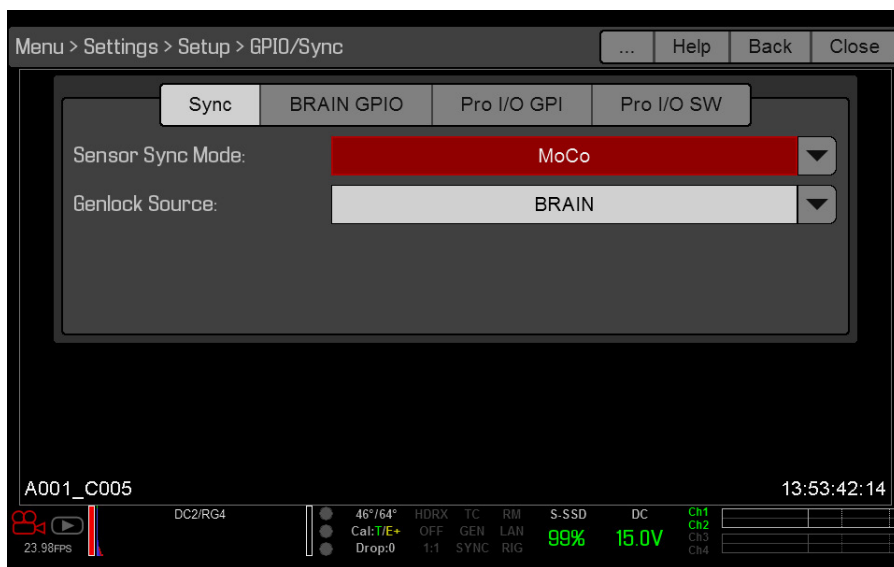

MoCo GPIO/Sync Settings

4. Select the **BRAIN GPIO** tab.

5. Select **Sync In** from the **GPI Function** drop-down menu.

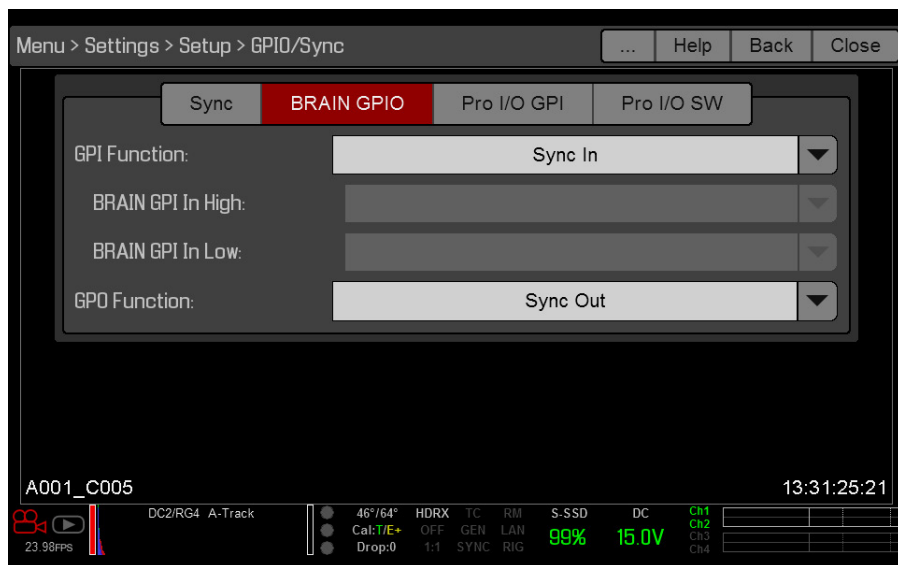

MoCo BRAIN/GPIO Settings

6. Select **Sync Out** from the **GPO Function** drop-down menu. (Optional)
Supply a pulse from the Motion Control device to sync the shutter to the rising edge of the sync input. For more information, refer to the manufacturer's instructions for the Motion Control device.

REQUIRED CABLE

- ▶ **790-0154:** 3BNC-to-00 LEMO Sync Cable (required per SYNC and CTRL port used)

COMPATIBLE DEVICES

The following timecode and genlock devices are compatible with the camera. Additional timecode devices may be compatible, but have not yet been tested by RED®.

COMPATIBLE TIMECODE DEVICES

The following timecode devices have been confirmed for compatibility with the camera:

- ▶ Ambient ACL 202CT
- ▶ Ambient LOCKIT ACL 203
- ▶ Ambient ACL 204
- ▶ Ambient ACC 501 Clockit Controller
- ▶ Ambient ACD-301 Lockit Slate
- ▶ Denecke SB-3 Syncbox Time-Code Generator
- ▶ Sound Devices 788T
- ▶ Sound Devices 744
- ▶ Sound Devices PIX-240
- ▶ Zaxcom Nomad 12
- ▶ Zaxcom ZFR100
- ▶ Zaxcom ZFR200

COMPATIBLE GENLOCK DEVICES

The following genlock devices have been confirmed for compatibility with the camera:

- ▶ AJA® GEN10 HD/SD/AES Sync Generator with Universal Power Supply
- ▶ Ambient ACL 202CT
- ▶ Ambient ACL 203
- ▶ Ambient ACL 204
- ▶ Denecke SB-T
- ▶ Evertz Master Clock 5600MSC

NOTE: Ensure that your genlock device provides a full-strength genlock signal to each camera. Splitting a genlock signal weakens it, which may compromise the sync between cameras.

09

UPGRADE CAMERA FIRMWARE

Your camera functionality may be upgraded by installing the latest firmware. Make a habit of frequently visiting www.red.com/downloads to check for new versions of camera firmware, updated operation guides, and post production software.

Your REDMOTE® also requires a firmware upgrade. For more information on upgrading your REDMOTE, go to “Upgrade REDMOTE Firmware” on page 153.

VERIFY CURRENT CAMERA FIRMWARE

To see the firmware version that is currently installed on your camera, go to **Menu > Settings > Maintenance > System Status > Camera Info**. A higher number reflects a later release.

UPGRADE CAMERA FIRMWARE

Install the most recent firmware. Unless otherwise specified in the online release notes, you do not need to upgrade to any firmware in between your current version and the most recent version available online.

NOTE: You must black shade an EPIC DRAGON or SCARLET DRAGON® after upgrading it.

NOTE: Upgrading your camera deletes all in-camera user-generated Preset, Look, and Custom Overlay files.

1. If you have user-generated preset files on your camera, follow the instructions below to save the files to an SSD:
 - A. Turn on the camera, insert an SSD (RED MINI-MAG® or RED STATION® REDMAG™ 1.8") into the camera, and format the SSD.
 - B. Go to **Menu > Presets** and copy user-generated Camera Preset and Look files to the SSD.
 - C. Go to **Menu > Settings > Display > Monitor Control** and copy user-generated Overlay files to the SSD.
 - D. Turn off the camera, and remove the SSD. You will copy the files back to your camera after the upgrade procedure, as described in [Step 14](#).
2. Connect an SSD (RED MINI-MAG or RED STATION REDMAG 1.8") to your computer.

NOTE: On Mac® computers with REDCINE-X PRO® installed, RED Watchdog mounts the SSD as Read-Only by default, which means that you are unable to write files (including firmware upgrade files) to the SSD. Change the **Mount** preference to **Read-Write** before attempting to copy firmware to the SSD.
3. Download the most recent firmware for your camera from www.red.com/downloads:
 - **EPIC DRAGON Firmware:** Use for any EPIC BRAIN with a RED DRAGON® or RED DRAGON MONO-CHROME sensor.
 - **SCARLET DRAGON Firmware:** Use for any SCARLET BRAIN with a RED DRAGON sensor.
 - **SCARLET Firmware:** Use for any SCARLET® BRAIN with a MYSTERIUM-X® sensor.
 - **EPIC Firmware:** Use for any EPIC BRAIN with a MYSTERIUM-X or MONOCHROME sensor.
4. Unzip the firmware zip file.
5. Copy the **force_upgrade** folder and its contents to the top level of the SSD directory.
6. Eject or unmount the SSD, and then remove the SSD.
7. Ensure the camera is turned off and the REDMOTE is undocked.

RED DSMC OPERATION GUIDE: EPIC/SCARLET

8. Insert the SSD with the force_upgrade folder into your camera.

9. Turn on the camera.

The upgrade runs automatically.

During upgrade, the fans run at high speed and the PWR and REC LEDs flash green. After approximately 15 seconds, the LEDs stop flashing and the camera turns off. Nothing displays on the external monitors during the upgrade.

10. After the camera turns off, remove the SSD and wait 10 seconds.

11. Turn on the camera.

The camera may take 30 seconds or longer to upgrade all the attached modules. During this time the PWR and REC LEDs flash green and nothing displays on the external monitors.

12. If this is your first time upgrading firmware, a pop-up menu opens with the Software License Agreement (SLA). Select **Agree**.

NOTE: If you do not agree to the SLA, the camera cannot be used. The SLA continues to display until it is accepted.

13. Go to **Menu > Settings > Maintenance > System Status > Camera Info** and verify that the firmware version listed matches the firmware version that you downloaded.

14. To restore user-generated preset files to your camera, follow the instructions below:

A. Turn on the camera and insert the SSD with the saved preset files into the camera.

B. Go to **Menu > Presets** and copy user-generated Camera Preset and Look files from the SSD to the camera.

C. Go to **Menu > Settings > Display > Monitor Control > Overlays** and copy user-generated Overlay files from the SSD to the camera.

15. After upgrading an EPIC DRAGON or SCARLET DRAGON, go to **Menu > Settings > Maintenance > Calibrate > Sensor** and black shade your camera using the **Black Shading (default)** option. For more information, go to [“” on page 110](#)

NOTE: You must black shade an EPIC DRAGON or SCARLET DRAGON after upgrading it.

16. After offloading firmware upgrade files and preset files from an SSD, reformat the SSD before recording.

10

CAMERA SYSTEM MAINTENANCE

All RED® products are designed for rugged durability, but precision instruments demand proper care. Follow the instructions in this chapter to clean, maintain, and store RED devices.

WARNING: DO NOT rinse or immerse the camera or other accessories in water. Keep dry at all times.

WARNING: DO NOT use soaps, detergents, ammonia, acetone, alkaline cleaners, abrasive cleaning compounds, or solvents. These substances may damage lens coatings and electronic circuitry.

WARNING: DO NOT use an excess of cleaning solution.

WARNING: DO NOT reuse swabs or wipes.

WARNING: DO NOT attempt to clean the sensor or optical cavity for any reason. If the sensor becomes dirty, contact your Bomb Squad representative.

WARNING: DO NOT attempt to modify, dismantle, or open the camera, lens, or other accessory as doing so may expose you to electric shock and serious injury. There are no user-serviceable parts inside. Alteration or repairs made to the camera, lens, or other accessory, except by a RED authorized service facility, voids the all warranties.

WARNING: Use caution with compressed air and gas dusters, since the high pressure, oily residue, cold air, particulates, and moisture may cause damage. You may use a filtered, non-residue gas duster to clean non-critical areas, such as around the fans and other recesses on the exterior of the camera. Damage to the camera or other components of the camera system caused by using compressed air or gas dusters is not covered under warranty.

WARNING: DO NOT use compressed air and gas dusters on the sensor or on any optics.

BRAIN AND ACCESSORY EXTERIOR SURFACES

- ▶ Use a filtered, non-residue gas duster to clean non-critical areas, such as around the fans and other recesses on the exterior of the camera.
- ▶ Clean with a dry lint-free cloth. When cleaning your camera and accessories, remember that the devices are not waterproof and moisture can damage electronic circuitry.

BRAIN AND ACCESSORY STORAGE

RED recommends that you store the camera and accessories in the water-resistant cases available in the [RED Store](http://www.red.com/store) at www.red.com/store. These cases feature laser-cut foam to keep the camera and accessories secure.

WARNING: DO NOT store the camera or accessories in any place with extreme temperatures, direct sunlight, high humidity, severe vibration, or strong magnetic fields.

CLEAN THE CAMERA SENSOR OR OLPF

The camera sensor and optical low-pass filter (OLPF) are EXTREMELY sensitive to dust, debris, and contamination. As with all optical glass, any type of physical contact with the OLPF may scratch or damage the surface. RED recommends that you clean the camera sensor or OLPF using physical contact ONLY if absolutely necessary.

ALWAYS use an air bulb to remove any particles or contaminants—such as dust—before cleaning the sensor or OLPF with electronics swabs or wipes and cleaning solution. Cleaning the sensor or OLPF without removing solid particles and contaminants greatly increases the risk of scratching the optical surface.

RED recommends using a Delkin Devices Digital Duster Kit (or equivalent) to clean the sensor or OLPF.

WARNING: Clean the camera sensor AT YOUR OWN RISK. The camera sensor is covered by a layer of protective glass, but will not protect the sensor from improper care. Damage to the sensor caused by improper handling is NOT covered under warranty. If the sensor becomes dirty, contact your Bomb Squad representative.

WARNING: Handle the DSMC interchangeable OLPFs carefully. DO NOT touch the OLPF glass. Failure to follow proper instructions may scratch or damage the OLPF.

CLEAN EVF SCREEN

NOTE: This section describes only how to clean the screen on the DSMC²™ RED EVF, and not how to clean the entire device.

This section explains how to clean the screen on the DSMC² RED EVF. The screen is accessed by removing the DSMC² RED EVF Modular Optical Block.

Use an ionized rubber air bulb to clean the screen on the DSMC² RED EVF. If there are still particles on the screen after using an air bulb, gently wipe the screen with a rolled-up, particulate-free, non-abrasive optical-grade wipe.

NOTE: Cleaning the screen without first removing solid particles increases the risk of scratching the screen. As with many screens, any type of physical contact with the screen may scratch the surface.

PROHIBITED EVF SCREEN CLEANERS

DO NOT use any of the items listed below to clean the screen on the DSMC² RED EVF. These products have not been tested on RED products and may cause damage or streaking.

- ▶ Compressed air
- ▶ Gas dusters
- ▶ Solvents
- ▶ Rubbing alcohol
- ▶ Isopropyl alcohol
- ▶ Windex®
- ▶ Third-party cleaning kits
- ▶ Pre-packaged lens cleaner containing any additives, such as detergent, anti-static compounds, or fragrance
- ▶ RED Microfiber Bag

WARNING: Damage to any screens or other components of the camera system caused by using prohibited cleaners is not covered under warranty.

CLEAN LCD SCREENS

NOTE: This section describes only how to clean the screen on each specified device, and not how to clean the entire device.

This section explains how to clean the screens on the following devices:

- ▶ RED PRO LCD
- ▶ RED Touch LCD

RED DSMC OPERATION GUIDE: EPIC/SCARLET

- ▶ DSMC Side Handle
- ▶ REDMOTE®

APPROVED LCD SCREEN CLEANERS

Use only the following products to clean LCD screens:

- ▶ Ionized rubber air bulb
- ▶ Pancro Professional Lens Cleaner (or equivalent)
- ▶ Photographic Solutions PEC*PADs (or equivalent)
- ▶ RED Microfiber Bag

NOTE: Before cleaning the screen with swabs or wipes and a cleaning solution, ALWAYS use an ionized rubber air bulb to remove any solid particles. Cleaning the screen without removing solid particles increases the risk of scratching the screen.

PROHIBITED LCD SCREEN CLEANERS

DO NOT use any of the items listed below to clean LCD screens. These products have not been tested on RED products and may cause damage or streaking.

- ▶ Compressed air
- ▶ Gas dusters
- ▶ Solvents
- ▶ Rubbing alcohol
- ▶ Isopropyl alcohol
- ▶ Windex
- ▶ Third-party cleaning kits
- ▶ Pre-packaged lens cleaner containing any additives, such as detergent, anti-static compounds, or fragrance

WARNING: Damage to any screens or other components of the camera system caused by using prohibited cleaners is not covered under warranty.

SCREEN STORAGE

Store any RED device with a screen in a RED Microfiber bag. Storing devices in a RED Microfiber bag preserves the superior quality of the specialized AR and AS coatings on the LCDs.

Hand wash and air-dry the RED Microfiber bag regularly.

WATER DAMAGE

If your device has come in contact with water or you suspect water damage, contact your Bomb Squad representative immediately.

WARNING: DO NOT attempt to power any device that may have water damage.

WARNING: DO NOT place the device in a container of rice, silica gel, or desiccant packets in an attempt to dry the device.

ADJUST BACK FOCUS

Adjust back focus by using the RED Focus or a focus chart. For more information about using the RED Focus, see the [RED Focus Operation Guide](http://www.red.com/downloads), available at www.red.com/downloads.

11

TROUBLESHOOT YOUR CAMERA

PERFORM A STRESS TEST

Perform a stress test before important projects to ensure the reliability and stability of your gear. A stress test subjects your camera system and equipment to the increased stress of prolonged operation. If any components are developing issues, this test will help identify those problems before you have an equipment failure during a major shoot.

1. Configure your camera.
2. Perform a black shade calibration (sensor calibration).
3. Enable the Sensor Test Pattern in the Maintenance menu.
4. Select the desired resolution.
5. Select the highest available frame rate.
6. Perform a secure format of the SSD.
7. Record a full SSD of footage.
8. Perform a secure format of the SSD.
9. Repeat **step 6** to **step 8** to test multiple SSDs.
10. If any errors occur, save a log file and submit a Technical Support request at <https://support.red.com>.

NOTE: Problems or dropped frames found during the stress test display as “Errors” in the bottom of the user interface.

GENERAL TROUBLESHOOTING

FIRMWARE DOES NOT UPGRADE

SYMPTOM

- ▶ During an attempt to upgrade firmware, the PWR and REC LEDs flash red.
- ▶ After an attempt to upgrade firmware, the firmware version does not change.

POTENTIAL RESOLUTIONS

- ▶ After downloading the firmware upgrade file, ensure that you unzip the file before saving it to the SSD.
- ▶ Ensure that the “force_upgrade” folder is saved to the top level of the SSD, and not to a subfolder.

“UPGRADING ATTACHED PERIPHERALS” MESSAGE

SYMPTOM

During an attempt to upgrade firmware, the display shows the message “Upgrade Attached Peripherals”. After turning the camera off and then on, the same message displays, and then prompts you to turn off the camera.

POTENTIAL RESOLUTION

- ▶ Ensure that you are upgrading your camera to the newest firmware version.
- ▶ One (1) of your modules or lens mounts (collectively known as “peripherals”) may be experiencing issues. Remove all peripherals (except for the SSD module), and upgrade firmware. Then attach another peripheral, and upgrade firmware again. Repeat this process, upgrading one (1) peripheral at a time. This will identify which peripheral is experiencing issues. If there is a peripheral that will not upgrade, submit a Technical Support request at <https://support.red.com>.

PRESET COULD NOT BE APPLIED

SYMPTOM

The display shows the following message: “Preset Could Not Be Applied”.

POTENTIAL RESOLUTION

Turn off the camera, power it back up, and attempt to apply the preset that failed.

CANNOT CONTROL CAMERA EXTERNALLY

SYMPTOM

The camera displays the message “For reliable external control over Ethernet your camera’s hardware may need to be upgraded. Please contact your Bomb Squad representative”.

POTENTIAL RESOLUTIONS

If you see this message, contact your Bomb Squad representative to have your hardware upgraded. You will not be able to control the camera externally until the hardware is upgraded.

GENERAL: MODULE OR LENS MOUNT NOT FUNCTIONING

SYMPTOM

Module or lens mount is not functioning correctly, or is not communicating with the camera.

POTENTIAL RESOLUTIONS

- ▶ Perform a Hardware Rediscover. For more information, go to “[Rediscover \(Hardware Rediscover\)](#)” on page 120.
- ▶ Upgrade your camera firmware. For more information, go to “[Upgrade Camera Firmware](#)” on page 170.
- ▶ Perform a System Restore. For more information, go to “[Restore System](#)” on page 119.

CAMERA DOES NOT RECOGNIZE LENS

SYMPTOM

The camera does not recognize the attached lens.

POTENTIAL RESOLUTIONS

- ▶ Ensure that the lens is compatible. For more information, go to [“Lens Mounts and Lenses” on page 207](#).
- ▶ If using a PL lens, ensure that the camera is providing power to the lens: go to **Menu > Settings > Setup > Lens** and select the **Enable Power to Lens** check box.
- ▶ Detect the lens: go to **Menu > Settings > Setup > Lens** and select **Detect Lens**.
- ▶ Perform a Hardware Rediscover. For more information, go to [“Rediscover \(Hardware Rediscover\)” on page 120](#).

CAMERA DISPLAYS N/A FOR APERTURE

SYMPTOM

The camera displays N/A for aperture when a lens is attached.

POTENTIAL RESOLUTIONS

- ▶ Ensure that your lens is completely locked in place.
- ▶ Remove your lens mount. Check the connection points for damage or debris. Install your lens mount.
- ▶ Perform a Hardware Rediscover. For more information, go to [“Rediscover \(Hardware Rediscover\)” on page 120](#).
- ▶ Re-install your camera firmware.
- ▶ If your camera is on beta firmware, downgrade to the release build.
- ▶ If you are using a DSMC PL mount, go to **Settings > Setup > Lens** and ensure that power is enabled.

NOTE: Some lenses do not display the aperture information because they are incompatible. Some PL lenses do not have i-technology data.

CAMERA CANNOT PAIR TO REDMOTE

SYMPTOM

The camera cannot pair to the REDMOTE®.

POTENTIAL RESOLUTIONS

- ▶ Ensure REDMOTE display indicates IDLE before attempting to pair the camera to the REDMOTE.
- ▶ Ensure the REDMOTE is detached from the rear of the camera and turned on.
- ▶ Ensure the REDMOTE wireless is turned on.
- ▶ Ensure display does not show the message “REDLINK Upgrade Required”.

CANNOT SEE MENUS ON LCD TOUCHSCREEN

SYMPTOM

The LCD touchscreen does not display menus.

POTENTIAL RESOLUTION

Double-tap the LCD touchscreen to exit Clean mode.

SCREEN FREEZES OR DOES NOT DISPLAY

SYMPTOM

The screen freezes or does not display.

POTENTIAL RESOLUTION

Perform a Hard Restore. For more information, go to [“Perform a Hard Restore” on page 180](#).

LCD FLICKER

SYMPTOM

The LCD or monitor is flickering.

POTENTIAL RESOLUTIONS

- ▶ Go to **Menu > Settings > Display > Monitor Control** and adjust the **Frequency** to **60 Hz**.
- ▶ Use a different cable.
- ▶ Ensure cables are properly attached.

CANNOT USE TOUCHSCREEN OR DSMC SIDE HANDLE

SYMPTOM

Cannot control the camera via the touchscreen or the DSMC Side Handle.

POTENTIAL RESOLUTIONS

- ▶ Perform a Hard Restore. For more information, go to [“Perform a Hard Restore” on page 180](#).
- ▶ If you are using an HD-SDI or HDMI® monitor, enable menus on the monitors and control the camera via the DSMC Side Handle:
 - A. Connect an SSD (RED MINI-MAG® or RED STATION REDMAG 1.8") to your computer.

NOTE: On Mac® computers with REDCINE-X PRO® installed, RED® Watchdog mounts the SSD as Read-Only by default, which means that you are unable to write files (including firmware upgrade files) to the SSD. Change the **Mount** preference to **Read-Write** before attempting to copy firmware to the SSD.
 - B. On the SSD, create a new folder, and name it **force_preset**.
 - C. Download the [DSMC Toolkit](http://www.red.com/downloads) from www.red.com/downloads.
 - D. Open the **Preset_Files** folder.
 - E. Open the folder that corresponds to the firmware version you are using.
 - F. Save the appropriate **enable_menus** file to the **force_preset** folder on your SSD.
 - G. Eject or unmount the SSD, and then remove the SSD.
 - H. Ensure the camera is turned off and the REDMOTE is undocked.
 - I. Insert the SSD into your camera.
 - J. Turn on the camera.

The camera automatically applies the preset.

“CRITICAL FAILURE” OR “SERIOUS ERROR” MESSAGES

SYMPTOM

When you upgrade or turn on the camera, the display shows a message with the phrase “Critical Failure” or “Serious Error”.

POTENTIAL RESOLUTIONS

- ▶ Update the camera firmware to the latest release build available for download at www.red.com/downloads.
- ▶ Submit a Technical Support request at <https://support.red.com>. Include the following with the request:
 - Log file. For more information, go to “[Save a LOG File](#)” on page 109.
 - List of modules, lens, and third-party accessories that were attached when the error occurred.
 - Method for powering the camera when the error occurred (include battery types, power modules, and power cables).

ERROR 0X00000020

SYMPTOM

The display shows a message with the phrase “Error 0x00000020. Please save log and send to RED support.”

POTENTIAL RESOLUTIONS

- ▶ Perform a secure format of the SSD. For more information, see the [DSMC Media Operation Guide](#), available at www.red.com/downloads.
- ▶ Update the camera firmware to the latest release build available for download at www.red.com/downloads.
- ▶ Submit a Technical Support request at <https://support.red.com>. Include the following with the request:
 - Log file. For more information, go to “[Save a LOG File](#)” on page 109.
 - List of modules, lens, and third-party accessories that were attached when the error occurred.
 - Method for powering the camera when the error occurred (include battery types, power modules, and power cables).

TIGHTEN DC IN CONNECTOR

SYMPTOM

The DC IN connector nut is loose.

POTENTIAL RESOLUTIONS

Tighten the loose DC IN connector nut using a pair of heavy duty strong point tweezers.

WARNING: DO NOT OVERTIGHTEN.

OPTIONAL: Add a small amount of Loctite® 222 (low strength thread locker) to the threads of the DC IN connector nut to prevent the connector from becoming loose again.

CAMERA DOES NOT TURN ON

SYMPTOM

The camera does not turn on (does not boot up), even when powered.

POTENTIAL RESOLUTIONS

- ▶ Remove all accessories and power the camera using the DSMC AC Power Adaptor.
- ▶ Perform a Hard Restore. For more information, go to [“Perform a Hard Restore” on page 180](#).
- ▶ Update the camera firmware to the latest release build available for download at www.red.com/downloads.

PERFORM A HARD RESTORE

A common way to resolve camera firmware issues is to perform a Hard Restore. A Hard Restore functions like a System Restore in that it changes all settings to the factory default values.

To perform a Hard Restore, follow the instructions below:

1. With the camera turned off, hold the **PWR/REC** key on the camera for 20 seconds or until the fans turn at a high speed.
2. Release the **PWR/REC** key.

The screen displays correctly.

NOTE: User key settings will be reset as well as any other changes from the default settings. The REDMOTE will also require pairing to communicate wirelessly with the camera.

IMAGE APPEARS GRAINY

SYMPTOM

Image or footage appears grainy.

POTENTIAL RESOLUTIONS

- ▶ Perform a black shading calibration before recording additional clips. For more information, go to [“Sensor Calibration” on page 110](#).
- ▶ Check the histogram to ensure proper exposure. Noise occurs if an image is overexposed or underexposed. For more information, go to [“Stills Mode” on page 57](#).
- ▶ Use the lowest REDCODE® compression possible for the settings you have selected. For more information, go to [“REDCODE” on page 54](#).
- ▶ Use a higher resolution.
- ▶ If you have the DSMC interchangeable OLPF system installed, verify that you have the correct OLPF selected in the OLPF menu. For more information, go to [“Verify Installed OLPF” on page 47](#).
- ▶ Use Adaptive fan mode to regulate the camera temperature. Noise occurs when the temperature from the applied calibration map is not in sync.

POLARIZER AFFECTS IMAGE

SYMPTOM

The image has a faint vertical rainbow artifact.

EXPLANATION

When using a polarizer with an EPIC DRAGON or SCARLET DRAGON (with either a Skin Tone-Highlight or a Low Light Optimized OLPF), a faint vertical rainbow artifact might appear on the image. This artifact is not exclusive to EPIC DRAGON or SCARLET DRAGON cameras, and can occur on other cameras depending upon camera orientation and direction of the polarized light. The rainbow artifact is caused by a complex interaction between the scene lighting, lens, polarizer, OLPF, and the camera.

POTENTIAL RESOLUTIONS

- ▶ Reorient the polarizer or the camera.
- ▶ Avoid using a polarizer.

BLACK AND WHITE IMAGE

SYMPTOM

The display shows that an image is in black and white, and the menus are still in color.

POTENTIAL RESOLUTIONS

- ▶ Go to **Menu > Settings > Look > Color**, and check the **Saturation** setting. If the Saturation setting is set to a low value, change the Saturation to a higher value.
- ▶ Perform a System Restore. For more information, go to [“Restore System” on page 119](#).

INCORRECT COLOR TEMPERATURE

SYMPTOM

The camera color temperature is off and the image looks warmer or cooler than normal.

POTENTIAL RESOLUTIONS

- ▶ Perform an auto white-balance. For more information, go to [“Color Temperature” on page 83](#).
- ▶ Perform a black shade calibration. For more information, go to [“Calibrate” on page 110](#).
- ▶ If you have the DSMC interchangeable OLPF system installed, verify that you have the correct OLPF selected in the OLPF menu. For more information, go to [“Verify Installed OLPF” on page 47](#).

TIMECODE OR GENLOCK DOES NOT FUNCTION

SYMPTOM

The SYNC, GEN, and/or TC light is red, yellow, or greyed out.

POTENTIAL RESOLUTIONS

- ▶ Ensure your timecode or genlock device is compatible. For more information, go to [“Compatible Devices” on page 169](#).
- ▶ Use a different cable.
- ▶ Ensure your timecode or genlock device settings match your project settings.
- ▶ Ensure your timecode or genlock device is set to the correct source. For more information, go to [“Timecode” on page 156](#) or [“Genlock” on page 159](#).
- ▶ Ensure that your Sensor Sync Mode is set to **Genlock**. For more information, go to [“Sensor Sync” on page 160](#).
- ▶ Set the ACN (Ambient Clockit Network) to **Off**.

CAMERA KEEPS PROMPTING BLACK SHADE MESSAGE

SYMPTOM

Your camera keeps prompting you to black shade the camera.

POTENTIAL RESOLUTIONS

- ▶ Ensure that you complete the sensor calibration process. For more information, go to [“Sensor Calibration” on page 110](#).
- ▶ Go to **Menu > Settings > Maintenance > Calibrate** and select **user1 Calibration Map**. Click **Set**.
- ▶ Go to **Menu > Settings > Maintenance > Calibrate** and delete all user-created calibration maps. Then perform a Reset Defaults. For more information, go to [“Restore System” on page 119](#).

MOUNT TYPE: UNKNOWN

SYMPTOM

The error message “Mount type: Unknown” displays in **Menu > Settings > Setup > Lens**.

POTENTIAL RESOLUTIONS

- ▶ Ensure that a lens mount is installed.
- ▶ Ensure that a compatible lens mount is installed.
NOTE: Third-party lens mounts are not compatible with the camera.

AUDIO BUFFER OVERFLOW WARNING

SYMPTOM

When you press the Record key, the error message “Audio Buffer Overflow Warning” displays.

POTENTIAL RESOLUTIONS

Perform a Secure Format of the SSD. For more information, see the [DSMC Media Operation Guide](#), available at www.red.com/downloads.

A

TECHNICAL SPECIFICATIONS

EPIC DRAGON

EPIC DRAGON TECHNICAL SPECIFICATIONS

SPECIFICATION	DESCRIPTION
Sensor	19 megapixel RED DRAGON® sensor
Pixel Array	6144 (h) x 3160 (v)
S/N Ratio	80 dB
Dynamic Range	16.5+ stops
Max Image Area	6144 (h) x 3160 (v)
Lens Coverage	30.7mm (h) x 15.8mm (v) x 34.5 mm (d)
Max Depth of Field	Equivalent to S35mm (Motion)/APS-H (Still) lenses
Acquisition Formats	Go to “EPIC DRAGON Formats” on page 91 for a full list
Project Frame Rates	23.98, 24, 25, 29.97, 47.96, 48, 50, 59.94 FPS, all resolutions
Delivery Formats	4K : DPX, TIFF, OpenEXR (.RED via REncode Plugin) 2K : DPX, TIFF, OpenEXR (.RED via REncode Plugin) 1080p RGB or 4:2:2, 720p 4:2:2 : Quicktime®, JPEG Avid AAF, MXF. 1080p 4.2.0, 720p 4:2:0 : H.264,.MP4
Program Output	3G-SDI (HD-SDI) Clean Feed 1080p RGB or 4:2:2, 720p 4:2:2 SMPTE Timecode, HANC Metadata, 24-bit 48Khz Audio
Monitor Output ¹	3G-SDI (HD-SDI) and HDMI with Frame Guides and Lookaround 1080p, 720p, 480p ¹ : RGB or 4:2:2 SMPTE Timecode, HANC Metadata, 24-bit 48Khz Audio
Digital Media	REDMAG™ 1.8" SSD: 48GB, 64GB, 128GB, 256GB, 512GB RED MINI-MAG®: 120GB, 240GB, 512GB, 1TB
REDCODE	To see all of the maximum available REDCODE® values, see the DSMC Media Operation Guide at www.red.com/downloads
Audio	2 channel, uncompressed, 24 bit, 48KHz Optional 4 channel, and AES/EBU digital audio
Remote Control	REDLINK® Wireless, Ethernet, RS232, GPI Trigger
Weight	5 lbs (body only)

RED DSMC OPERATION GUIDE: EPIC/SCARLET

EPIC DRAGON TECHNICAL SPECIFICATIONS

SPECIFICATION	DESCRIPTION
Construction	Aluminum Alloy
Operating Temperature Range	0°C to 40°C (32°F to 104°F)
Storage Temperature Range	-20°C to 50°C (-4°F to 122°F)

1. 480p is available for HDMI only.

SCARLET DRAGON

SCARLET DRAGON TECHNICAL SPECIFICATIONS

SPECIFICATION	DESCRIPTION
Sensor	19 megapixel RED DRAGON sensor
Pixel Array	6144 (h) x 3160 (v)
S/N Ratio	80 dB
Dynamic Range	16.5+ stops
Max Image Area	6144 (h) x 3160 (v)
Lens Coverage	30.7mm (h) x 15.8mm (v) x 34.5 mm (d)
Max Depth of Field	Equivalent to S35mm (Motion)/APS-H (Still) lenses
Acquisition Formats	Go to "SCARLET DRAGON Formats" on page 94 for a full list
Project Frame Rates	23.98, 24, 25, 29.97, 47.96, 48, 50, 59.94 FPS, all resolutions
Delivery Formats	4K: DPX, TIFF, OpenEXR (.RED via REncode Plugin) 2K: DPX, TIFF, OpenEXR (.RED via REncode Plugin) 1080p RGB or 4:2:2, 720p 4:2:2 : Quicktime, JPEG Avid AAF, MXF. 1080p 4.2.0, 720p 4:2:0 : H.264,.MP4
Program Output	3G-SDI (HD-SDI) Clean Feed 1080p RGB or 4:2:2, 720p 4:2:2 SMPTE Timecode, HANC Metadata, 24-bit 48Khz Audio
Monitor Output ¹	3G-SDI (HD-SDI) and HDMI with Frame Guides and Lookaround 1080p, 720p, 480p ² : RGB or 4:2:2 SMPTE Timecode, HANC Metadata, 24-bit 48Khz Audio
Digital Media	REDMAG 1.8" SSD: 48GB, 64GB, 128GB, 240GB, 256GB, 512GB RED MINI-MAG: 120GB, 240GB, 512GB, 1TB
REDCODE	To see all of the maximum available REDCODE® values, see the DSMC Media Operation Guide at www.red.com/downloads
Audio	2 channel, uncompressed, 24 bit, 48KHz Optional 4 channel, and AES/EBU digital audio
Remote Control	REDLINK Wireless, Ethernet, RS232, GPI Trigger
Weight	5 lbs (body only)
Construction	Aluminum Alloy
Operating Temperature Range	0°C to 40°C (32°F to 104°F)
Storage Temperature Range	-20°C to 50°C (-4°F to 122°F)

1. 480p is available for HDMI only.

EPIC MYSTERIUM-X

EPIC MYSTERIUM-X TECHNICAL SPECIFICATIONS

SPECIFICATION	DESCRIPTION
Sensor	14 megapixel MYSTERIUM-X® sensor
Pixel Array	5120 (h) x 2700 (v)
S/N Ratio	66 dB
Dynamic Range	13.5 stops, up to 18 stops with HDRx
Max Image Area	5120 (h) x 2700 (v)
Lens Coverage	27.7mm (h) x 14.6mm (v) x 31.4 mm (d)
Max Depth of Field	Equivalent to S35mm (Motion)/APS-H (Still) lenses Equivalent to 16mm (Motion) lens in 2K RAW
Acquisition Formats	Go to “ EPIC MYSTERIUM-X and SCARLET MYSTERIUM-X Formats ” on page 95 for a full list
Project Frame Rates	23.98, 24, 25, 29.97, 47.96, 48, 50, 59.94 FPS, all resolutions
Delivery Formats	4K: DPX, TIFF, OpenEXR (.RED via REncode Plugin) 2K: DPX, TIFF, OpenEXR (.RED via REncode Plugin) 1080p RGB or 4:2:2, 720p 4:2:2 : Quicktime, JPEG Avid AAF, MXF. 1080p 4.2.0, 720p 4:2:0 : H.264,.MP4
Program Output	3G-SDI (HD-SDI) Clean Feed 1080p RGB or 4:2:2, 720p 4:2:2 SMPTE Timecode, HANC Metadata, 24-bit 48Khz Audio
Monitor Output ¹	3G-SDI (HD-SDI) and HDMI with Frame Guides and Lookaround 1080p, 720p, 480p ¹ : RGB or 4:2:2 SMPTE Timecode, HANC Metadata, 24-bit 48Khz Audio
Digital Media	REDMAG 1.8" SSD: 48GB, 64GB, 128GB, 256GB, 512GB RED MINI-MAG: 120GB, 240GB, 512GB, 1TB
REDCODE	To see all of the maximum available REDCODE values, see the DSMC Media Operation Guide at www.red.com/downloads
Audio	2 channel, uncompressed, 24 bit, 48KHz Optional 4 channel, and AES/EBU digital audio
Remote Control	REDLINK Wireless, Ethernet, RS232, GPI Trigger
Weight	5 lbs (body only)
Construction	Aluminum Alloy
Operating Temperature Range	0°C to 40°C (32°F to 104°F)
Storage Temperature Range	-20°C to 50°C (-4°F to 122°F)

1. 480p is available for HDMI only.

SCARLET MYSTERIUM-X

SCARLET MYSTERIUM-X TECHNICAL SPECIFICATIONS

SPECIFICATION	DESCRIPTION
Sensor	14 megapixels MYSTERIUM-X sensor
Pixel Array	5120 (h) x 2700 (v)
S/N Ratio	66 dB
Dynamic Range	13.5 stops, up to 18 stops with HDRx 6 FPS with 5K Full Frame and HDRx 15 FPS with 4K HD and HDRx
Max Image Area	5120 (h) x 2700 (v)
Lens Coverage	27.7mm (h) x 14.6mm (v) = 31.4 mm (d)
Max Depth of Field	Equivalent to S35mm (Motion)/APS-H (Still) lenses Equivalent to 16mm (Motion) lens in 2K RAW
Acquisition Formats	Go to “EPIC MYSTERIUM-X and SCARLET MYSTERIUM-X Formats” on page 95 for a full list
Project Frame Rates	23.98, 24, 25, 29.97, 47.96, 48, 50, 59.94 FPS, all resolutions
Delivery Formats	4K : DPX, TIFF, OpenEXR (.RED via REncode Plugin) 2K : DPX, TIFF, OpenEXR (.RED via REncode Plugin) 1080p RGB or 4:2:2, 720p 4:2:2 : Quicktime, JPEG Avid AAF, MXF. 1080p 4.2.0, 720p 4:2:0 : H.264,.MP4
Program Output	3G-SDI (HD-SDI) Clean Feed 1080p RGB or 4:2:2, 720p 4:2:2 SMPTE Timecode, HANC Metadata, 24-bit 48Khz Audio
Monitor Output ¹	3G-SDI (HD-SDI) and HDMI with Frame Guides and Lookaround 1080p, 720p, 480p ¹ : RGB or 4:2:2 SMPTE Timecode, HANC Metadata, 24-bit 48Khz Audio
Digital Media	REDMAG 1.8" SSD: 48GB, 64GB, 128GB, 256GB, 512GB RED MINI-MAG: 120GB, 240GB, 512GB, 1TB
REDCODE	To see all of the maximum available REDCODE values, see the DSMC Media Operation Guide at www.red.com/downloads
Audio	2 channel, uncompressed, 24 bit, 48KHz Optional 4 channel, and AES/EBU digital audio
Remote Control	REDLINK Wireless, Ethernet, RS232, GPI Trigger
Weight	5 lbs (body only)
Construction	Aluminum Alloy
Color	Battleship Gray BRAIN® Body Black Canon® Mount and SIDE SSD All DSMC® Modules Black
Operating Temperature Range	0°C to 40°C (32°F to 104°F)

RED DSMC OPERATION GUIDE: EPIC/SCARLET

SCARLET MYSTERIUM-X TECHNICAL SPECIFICATIONS

SPECIFICATION	DESCRIPTION
Storage Temperature Range	-20°C to 50°C (-4°F to 122°F)

1. 480p is available for HDMI only.

BRAIN DIMENSIONS

NOTE: Dimensions are shown in mm.

The optical axis height of all EPIC/SCARLET cameras is 95.90 mm.

EPIC BRAIN DIMENSIONS

FRONT VIEW

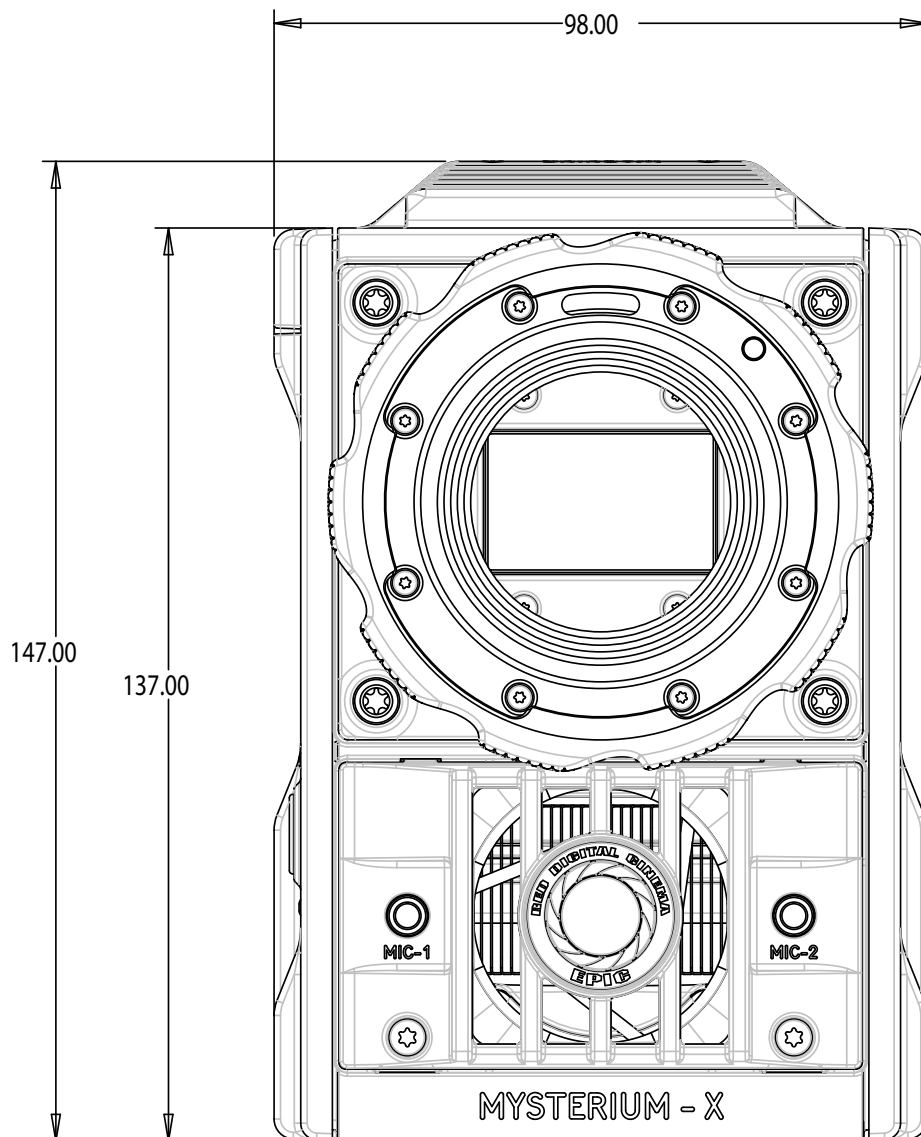

RED DSMC OPERATION GUIDE: EPIC/SCARLET

SIDE VIEW

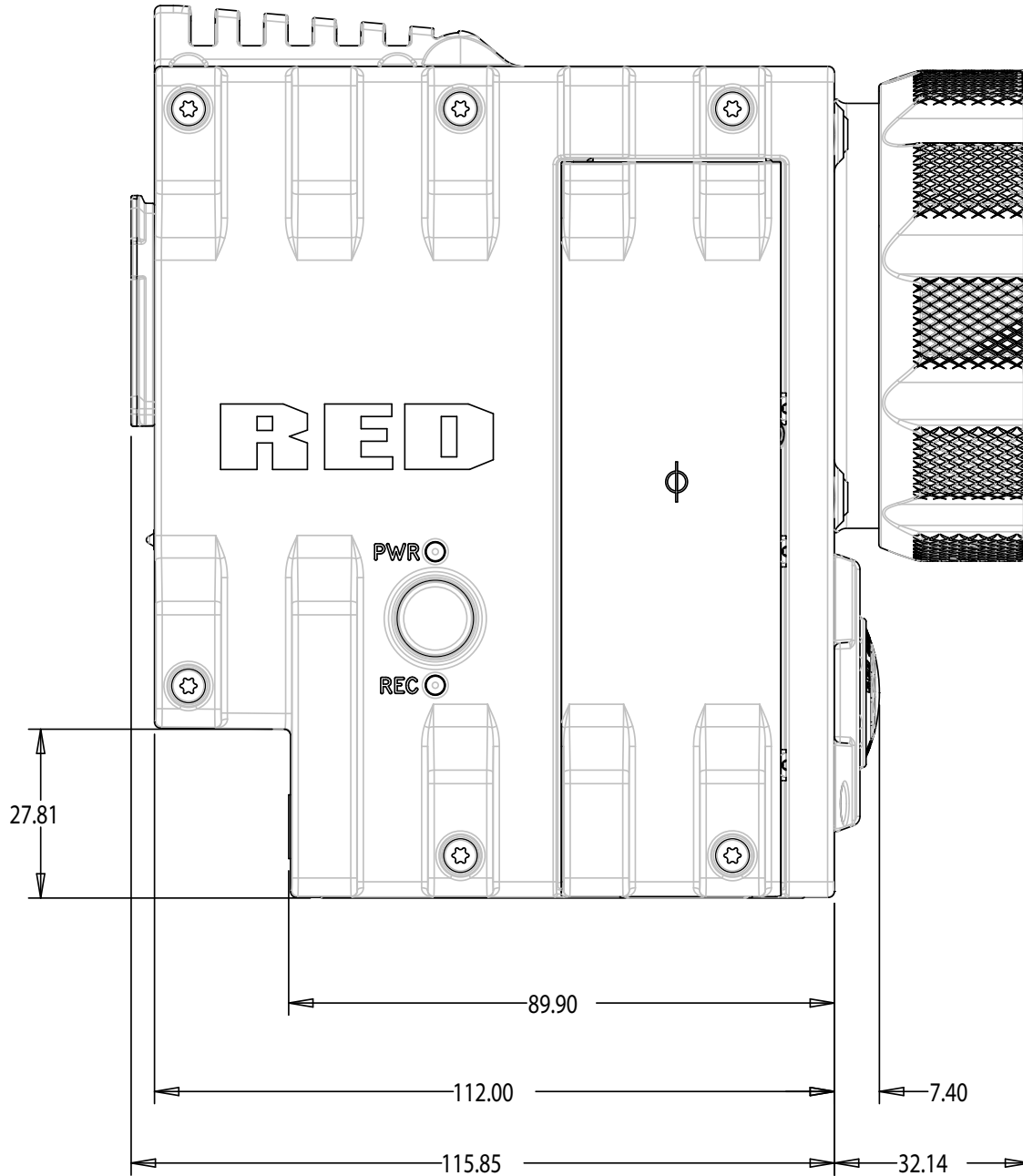

RED DSMC OPERATION GUIDE: EPIC/SCARLET

TOP VIEW

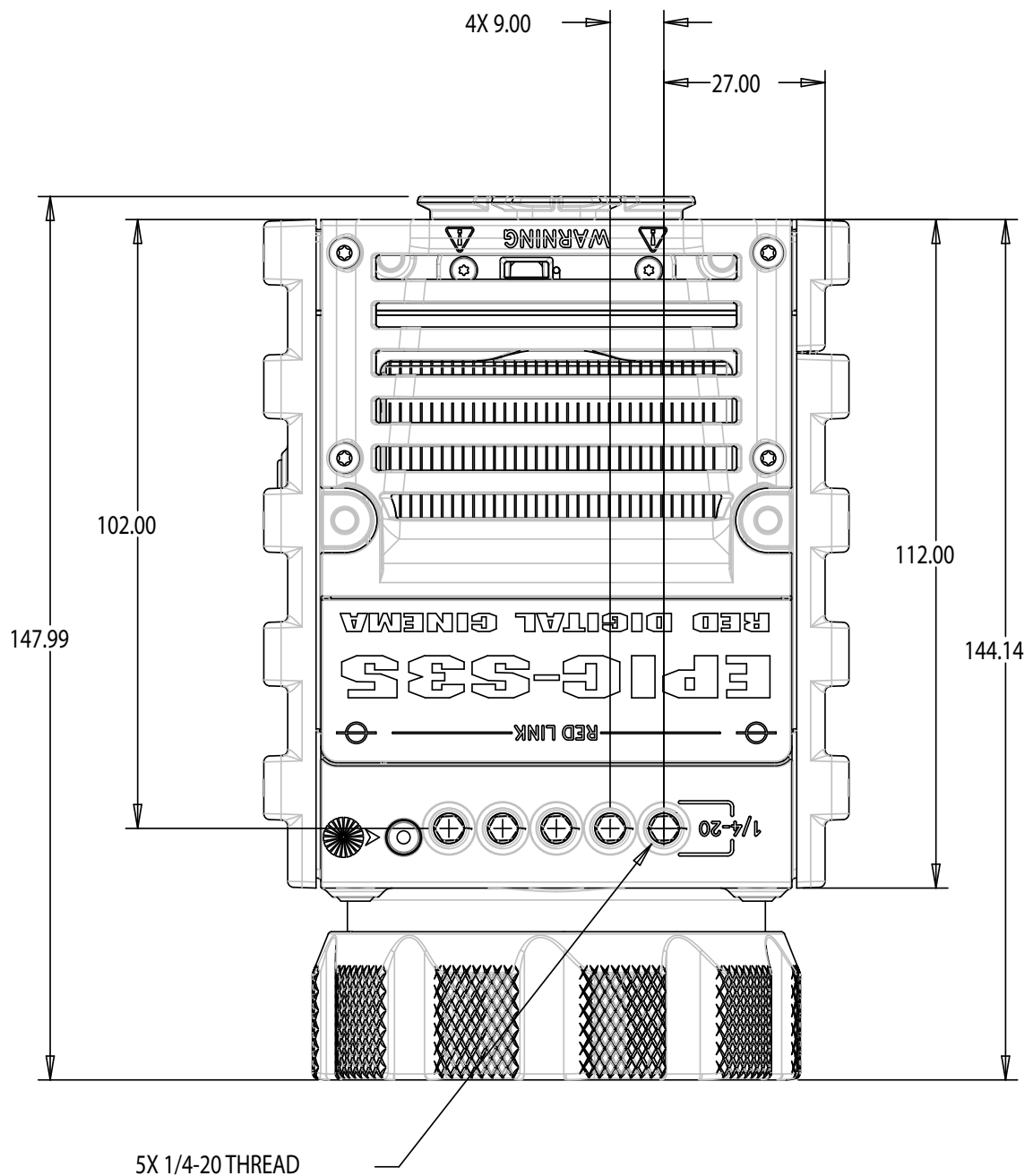

BOTTOM VIEW

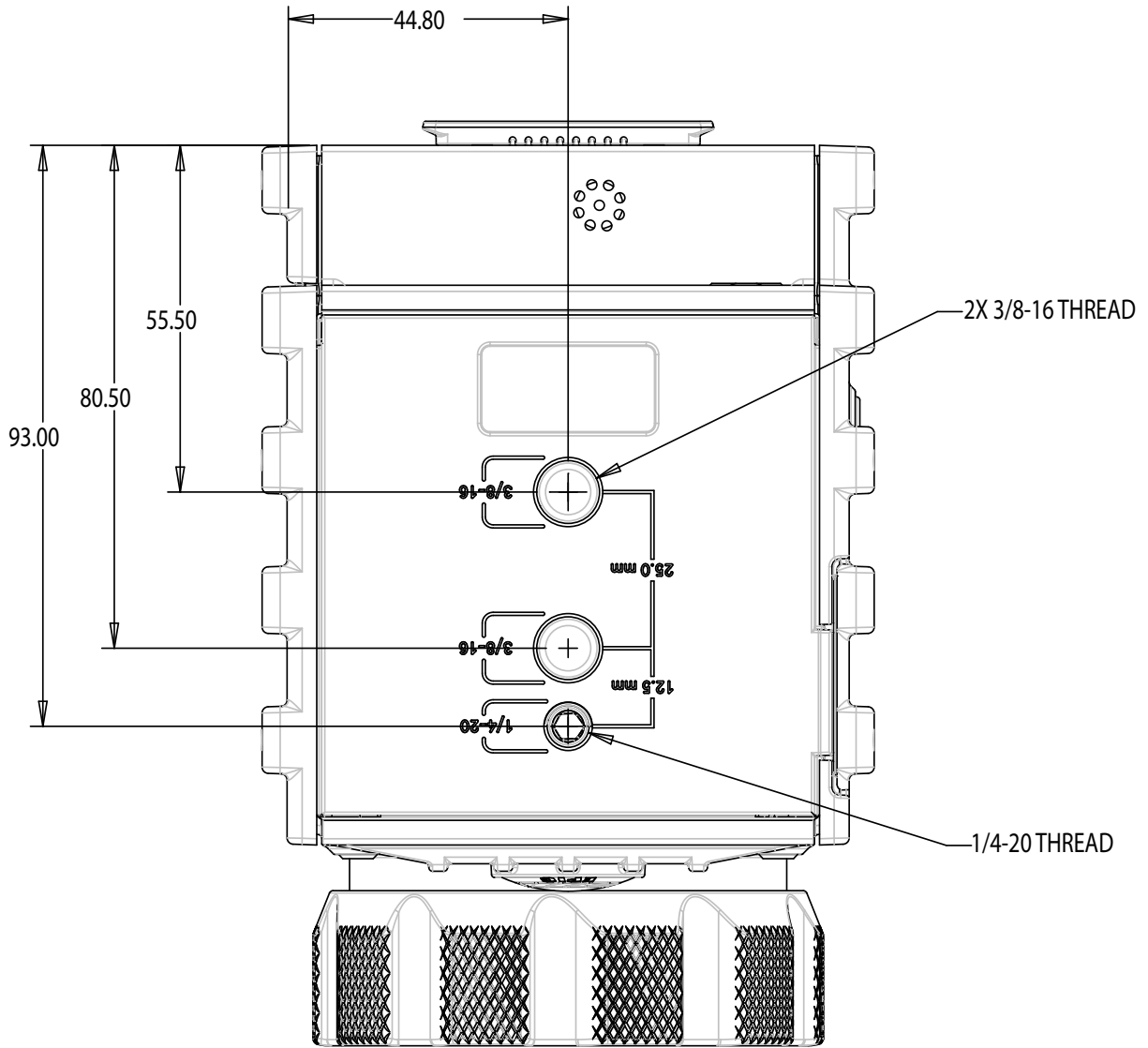

BACK VIEW

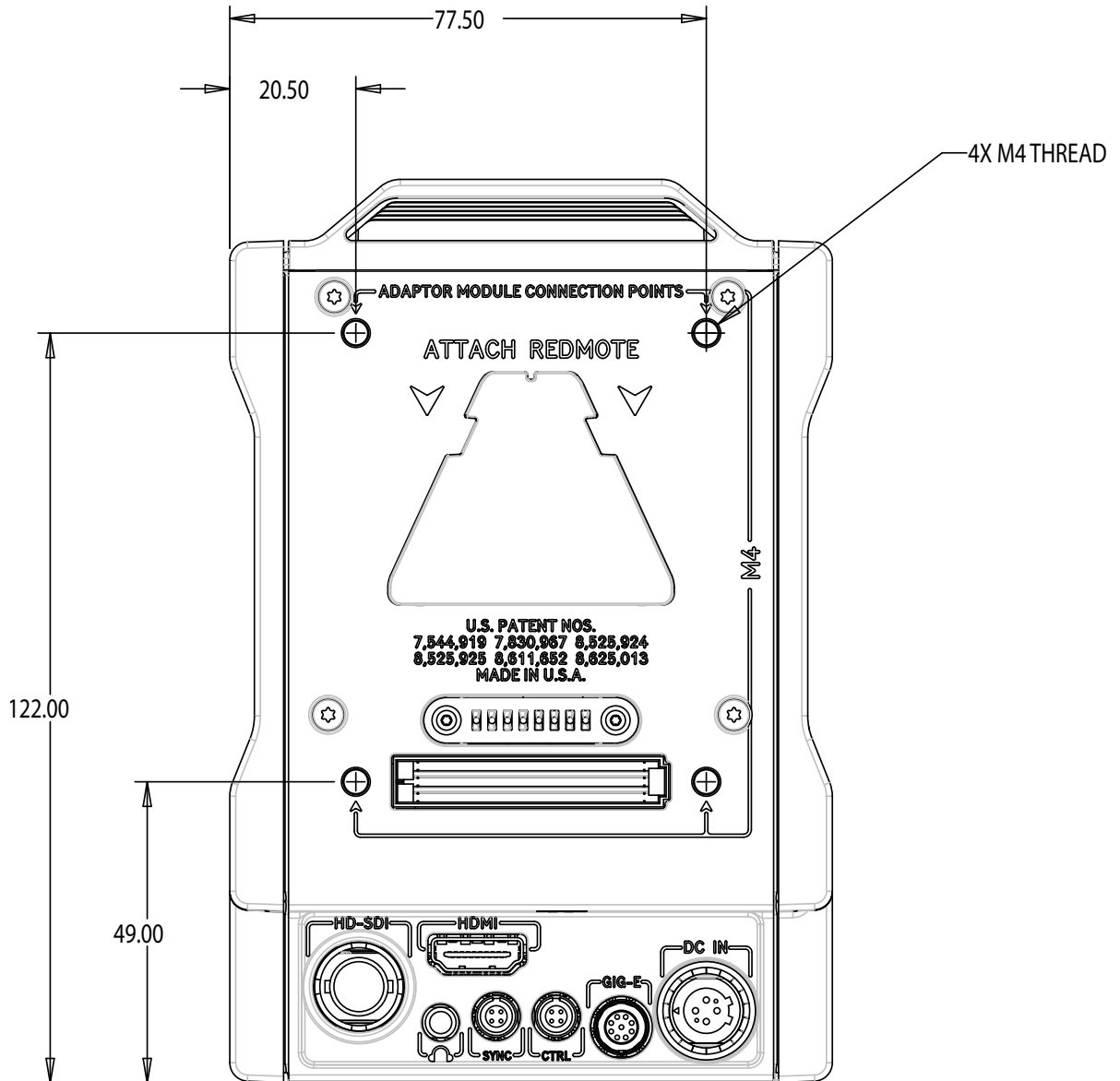

SCARLET BRAIN DIMENSIONS

FRONT VIEW

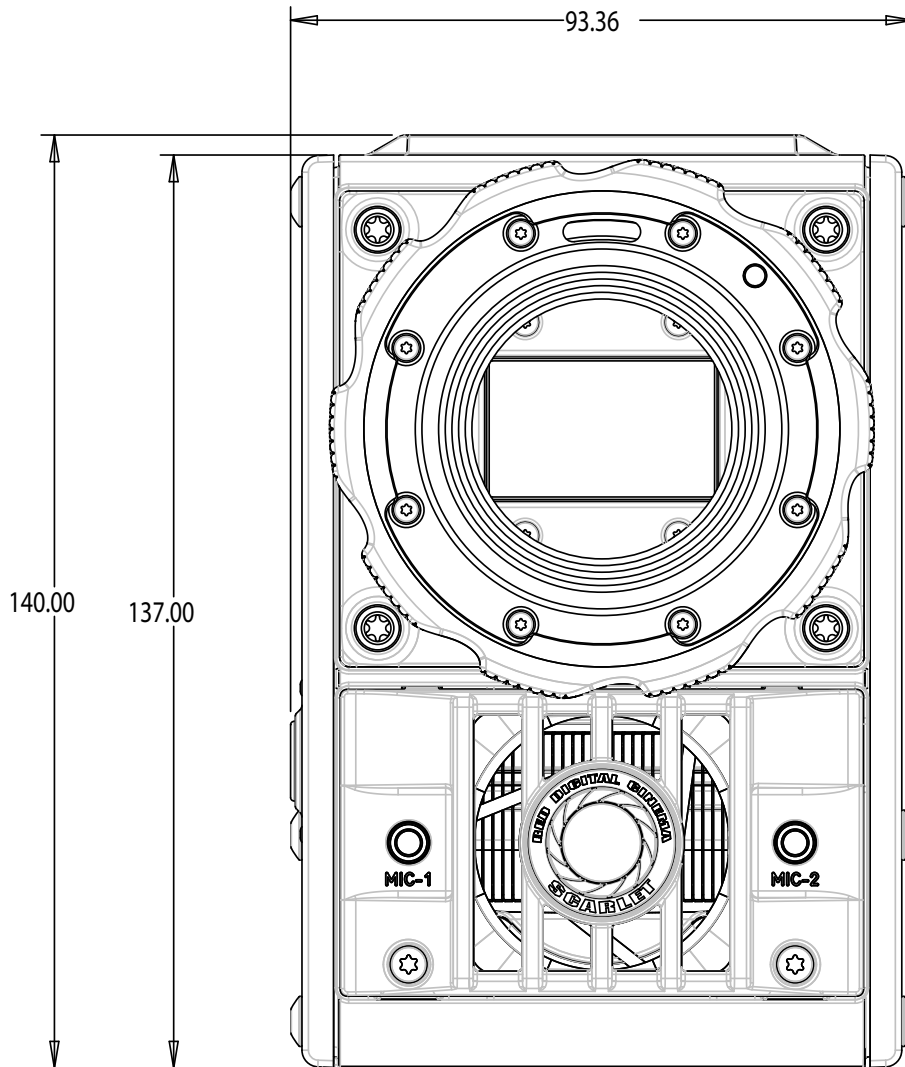

SIDE VIEW

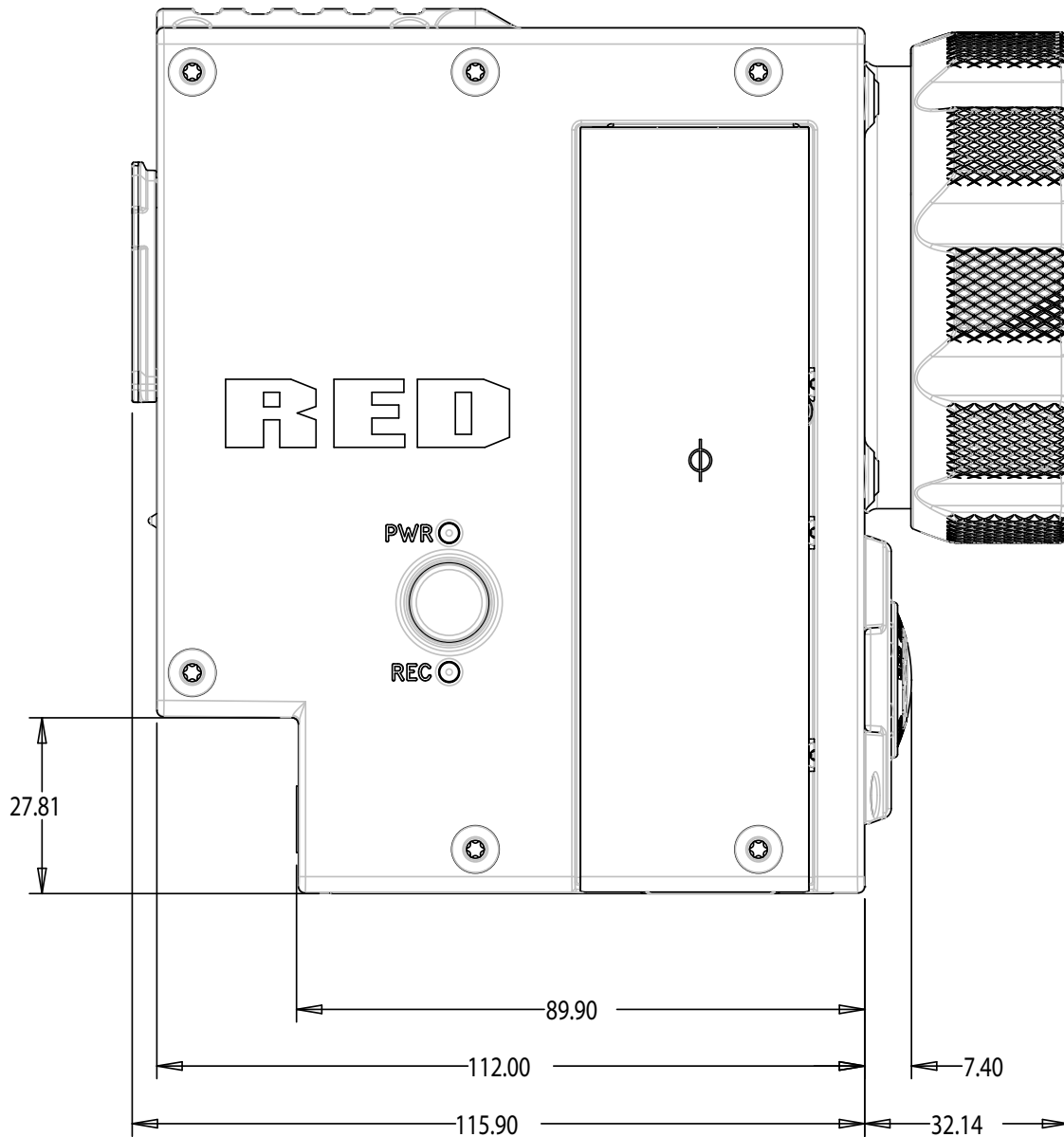

RED DSMC OPERATION GUIDE: EPIC/SCARLET

TOP VIEW

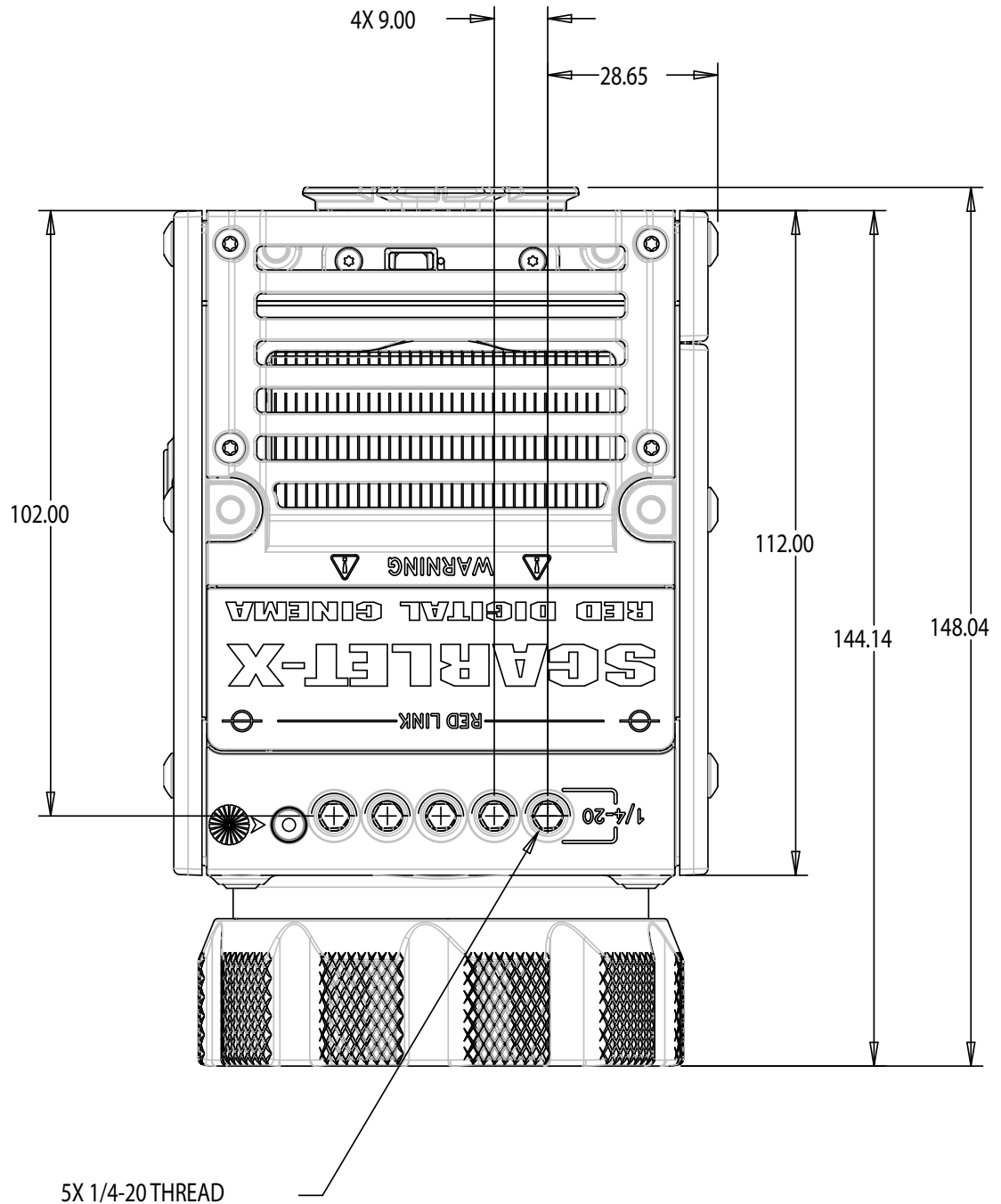

RED DSMC OPERATION GUIDE: EPIC/SCARLET

BOTTOM VIEW

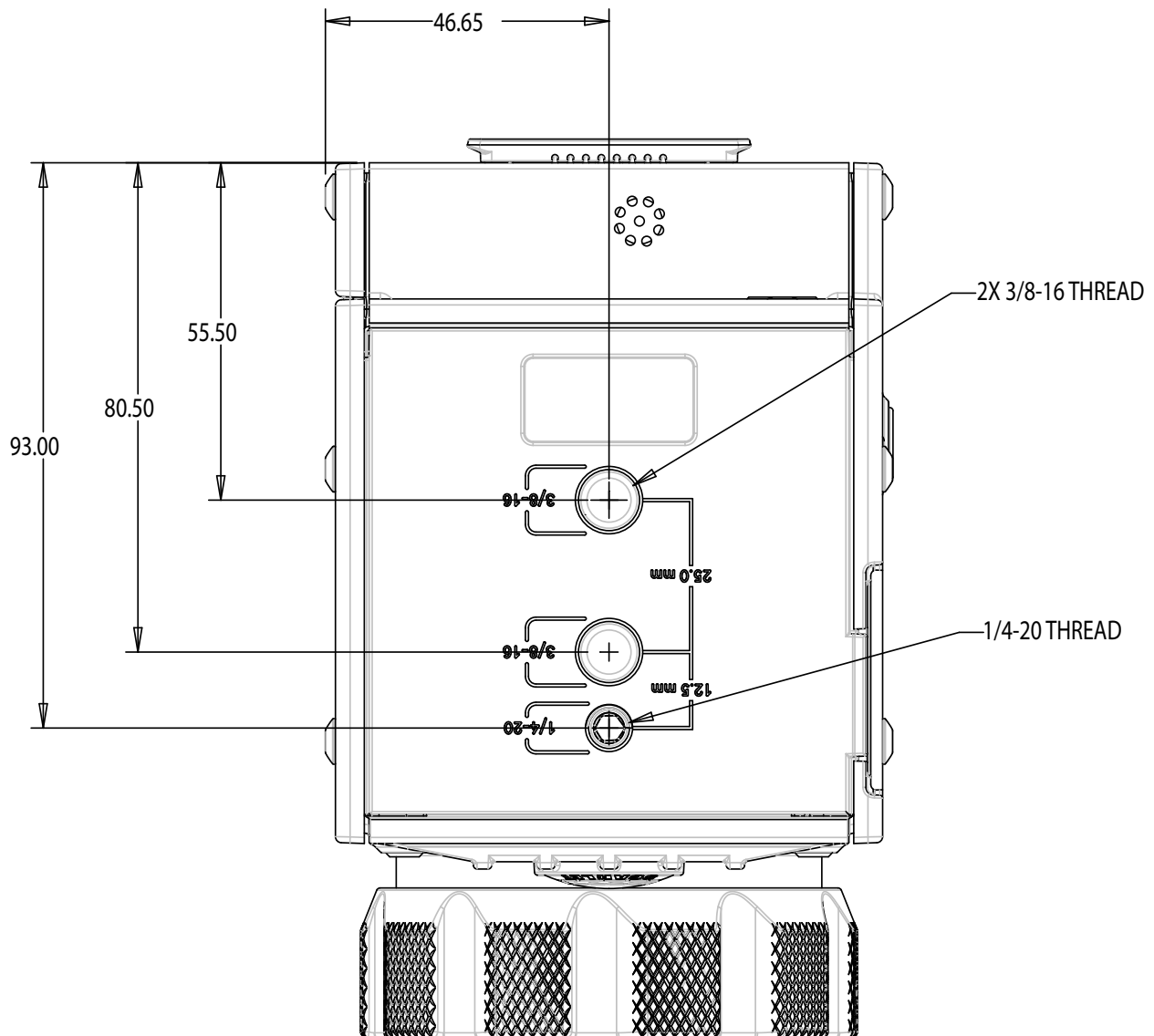

RED DSMC OPERATION GUIDE: EPIC/SCARLET

BACK VIEW

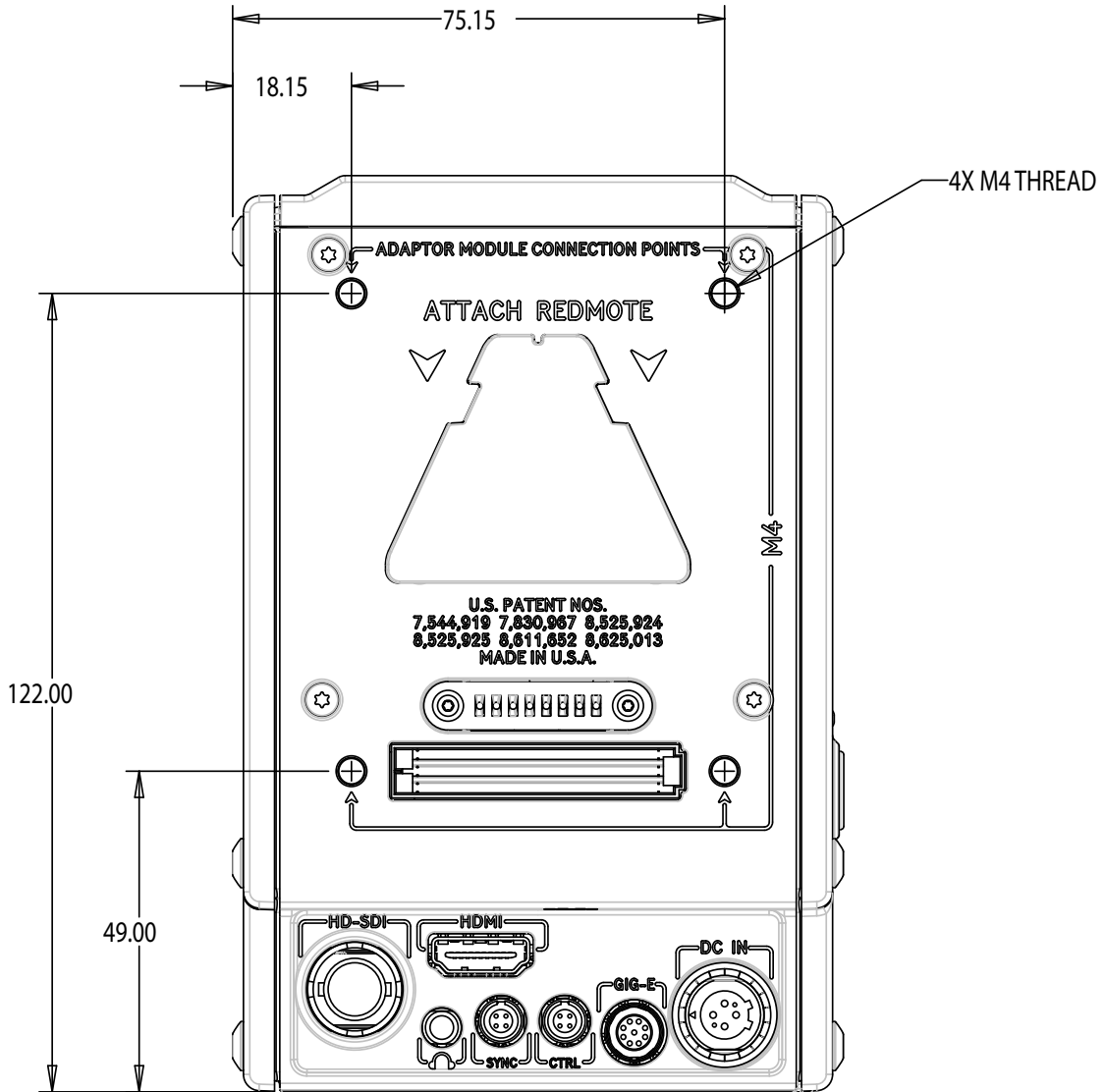

B

INPUT/OUTPUT CONNECTORS

This appendix provides pinout information for the input/output connectors on the camera.

NOTE: When connecting a cable to a connector, align the key and red marker on the cable connector with the corresponding key and marker on the device connection.

NOTE: Connector diagram images are for reference only. Diagrams are not to scale.

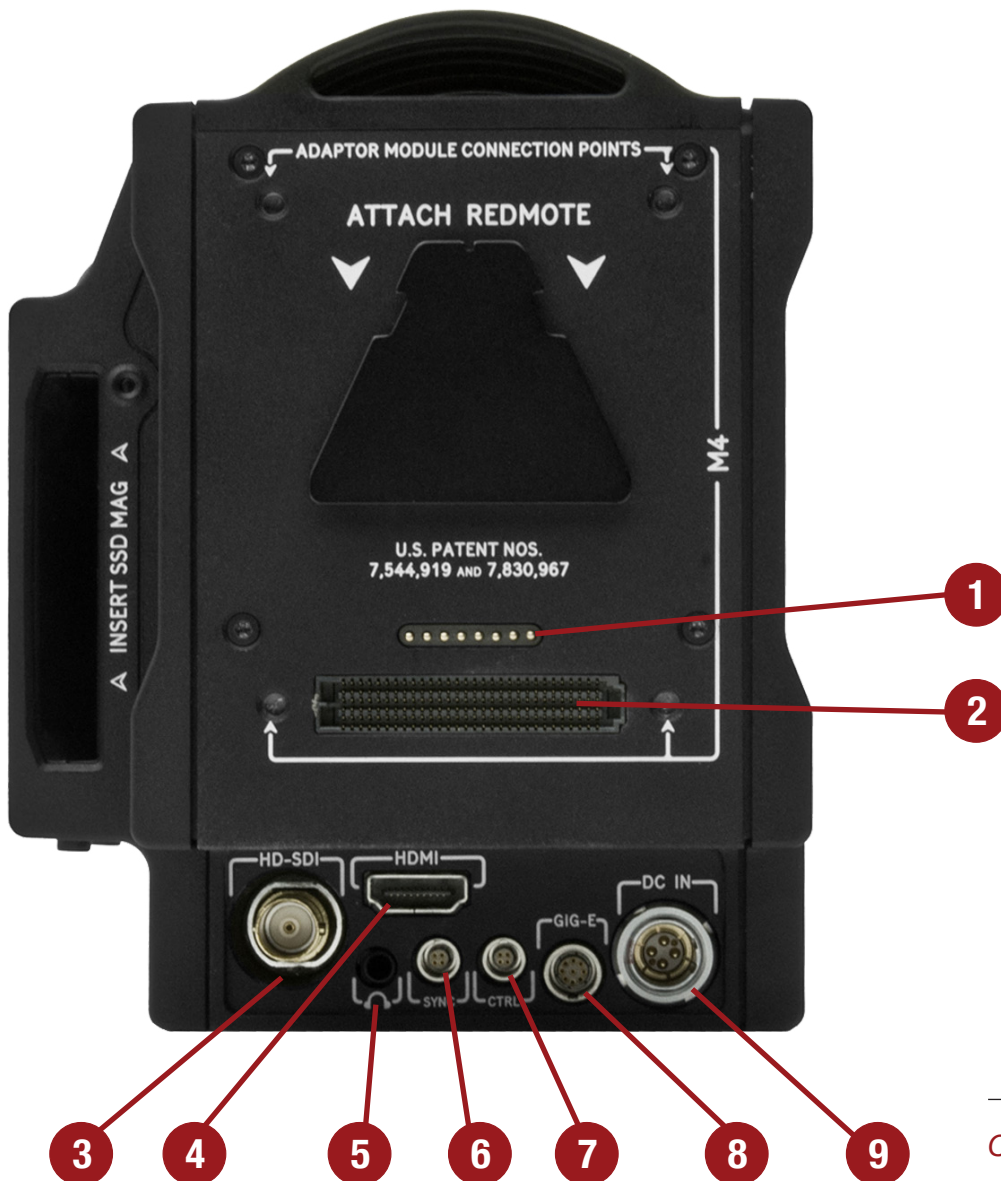

Connectors

RED DSMC OPERATION GUIDE: EPIC/SCARLET

#	CONNECTOR	CONNECTOR TYPE	FOR MORE INFORMATION, GO TO...
1	REDMOTE Dock	8-point POGO	“REDMOTE Operation” on page 146
2	Module Power	SEARAY	“Power Inputs” on page 34
3	HD-SDI	BNC	“3G-SDI (HD-SDI) Out” on page 200
4	HDMI	HDMI	“HDMI Out” on page 201
5	Headphone Jack	3.5mm stereo	“Headphone” on page 205
6	SYNC	4-pin 00B LEMO®	“SYNC (Video Sync In)” on page 201
7	CTRL	4-pin 00B LEMO	“CTRL (RS232 Control)” on page 203
8	GIG-E	9-pin 0B LEMO	“DC IN (Power Input)” on page 206
9	DC IN	6-pin 1B LEMO	“DC IN (Power Input)” on page 206
N/A	MIC-1, MIC-2 (Front)	3.5 mm stereo	“SSD Module Connectors” on page 206

RECORD/MONITOR OUT PORTS

3G-SDI (HD-SDI) OUT

A standard 75 ohm BNC connector provides the following output:

- ▶ Broadcast specification 3G-SDI (HD-SDI) video output (default mode is Clean)
- ▶ Two (2) channels of embedded audio
- ▶ Time of Day and Edge timecode
- ▶ Record Tally flag
- ▶ Clip name information (as SMPTE RP-188 VITC2 HANC metadata)

For more information, go to “[Monitor](#)” on page 72.

The 3G-SDI (HD-SDI) output provides the formats described in the table below:

3G-SDI (HD-SDI) OUTPUT FORMATS ¹		
VIDEO FEED ²	FREQUENCY (HZ) ³	SMPTE STANDARD
720p	23.98, 24.00, 25.00, 29.97, 30.00, 50.00, 59.94	SMPTE ST 292-1 (1.485 Gbps)
1080p 10-bit 4:2:2	23.98, 24.00, 25.00, 29.97, 30.00	SMPTE ST 292 (1.485 Gbps)
1080p 10-bit 4:2:2	50.00, 59.94, 60.00	3G-SDI SMPTE ST 424 (2.970 Gbps) SMPTE ST 425 (2.970 Gbps)

1. Ensure you select a frequency supported by your monitor.

2. The output is progressive scan (p); it does not support progressive segmented frame (PsF) or interlaced (i) scan formats.

3. The frequency options depend on project time base. If you have a non-drop frame project time base (such as 24.00), you can select only non-drop frame frequencies. If you have a drop frame project time base (such as 23.98), you can select only drop frame frequencies.

75 OHM BNC CONNECTOR

PIN	SIGNAL	DESCRIPTION	DIRECTION
Center	3G-SDI	SMPTE ST 424	Out
Shield/Screen	GROUND	Camera ground	N/A

RED DSMC OPERATION GUIDE: EPIC/SCARLET

COMPATIBLE CABLE

- ▶ **790-0341**: RED® HD-SDI Cable (6')

HDMI OUT

A standard HDMI connector provides the following output:

- ▶ High-definition video output (default mode is Overlay)
- ▶ Two (2) channels of embedded audio

The HDMI output provides the formats described in the table below:

HDMI OUTPUT FORMATS ¹	
VIDEO FEED ²	FREQUENCY (HZ)
480p	50.00, 60.00
720p	24.00, 25.00, 30.00, 50.00, 60.00
1080p	24.00, 25.00, 30.00, 50.00, 60.00

1. Ensure you select a frequency supported by your monitor.

2. The HDMI output is progressive scan (p); it does not support progressive segmented frame (PsF) or interlaced (i) scan formats.

COMPATIBLE CABLE

- ▶ **790-0331**: RED HDMI Cable (5')

COMMUNICATION PORTS

SYNC (VIDEO SYNC IN)

The 4-pin 00B LEMO SYNC connector accepts timecode, genlock, and General Purpose Input (GPI) signals.

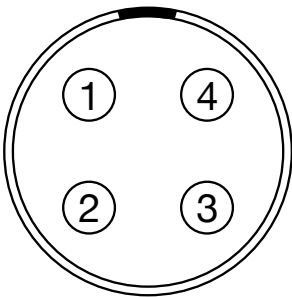

Front Face of the SYNC (Video Sync) Connector (Looking at the Camera)

4-PIN 00B LEMO SYNC CONNECTOR			
PIN	SIGNAL	DESCRIPTION	DIRECTION
1	GROUND	Common ground	N/A
2	SS/GPI	Shutter sync/general purpose input trigger	In
3	TIMECODE	SMPTE unbalanced timecode input	In
4	GENLOCK	Tri-level sync input	In

NOTE: Mating connector is FGG.00.304.CLAD.

RED DSMC OPERATION GUIDE: EPIC/SCARLET

SYNC TRIGGER BUTTON CIRCUIT

The SYNC connector has a 3.3 V Schmitt trigger (5 V tolerant). The trigger is not a switch closure circuit, so it requires that the trigger source supplies current. Both edges of the input signal may be used as a trigger.

For example, this is the behavior of the circuit when the GPI trigger is used for record start/stop:

- ▶ **Start Record:** On ground to 3.3 V transition
- ▶ **During Record:** Hold at 3.3 V
- ▶ **Stop Record:** On 3.3 V to ground transition
- ▶ **During Stop:** Hold at ground

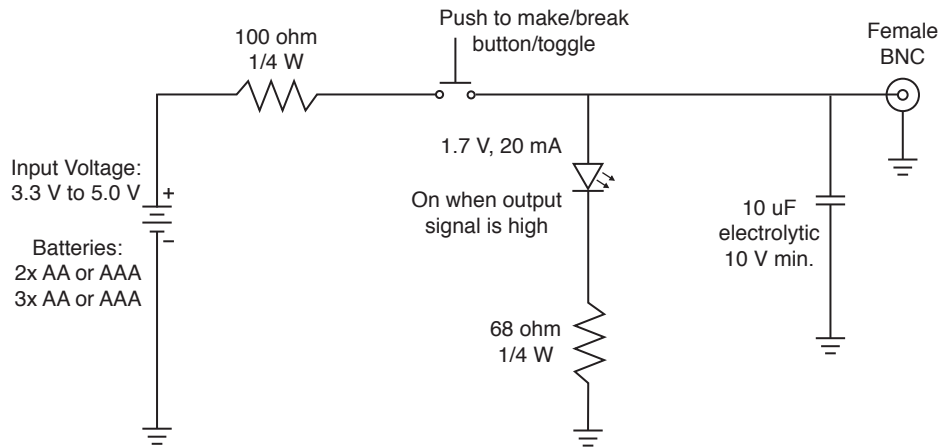

*Trigger Button
Circuit Diagram*

NOTE: In the diagram above, values are approximate. Use standard values.

COMPATIBLE CABLES

- ▶ **790-0154:** 3BNC-to-00 LEMO Sync Cable
- ▶ **790-0187:** 4-Pin 00 LEMO-to-Flying Lead
- ▶ **790-0415:** RED Start/Stop Cable (14-Pin LEMO to SYNC, CTRL, BNC)
- ▶ **790-0428:** RED Start/Stop Cable (14-Pin to 00B SYNC)

CTRL (RS232 CONTROL)

The 4-pin 00B LEMO CTRL connector supports RS232 remote control for 3D camera communication and third-party metadata ingest applications. For more information, go to “[BRAIN GPIO](#)” on page 107.

The General Purpose Out (GPO) tally presents 3.3 V at a maximum of 0.04 A between pins 1 and 3. When used as a record tally, the rising edge of the pulse indicates start of record, falling edge represents end of record.

For more information about controlling the camera via RS232, download the REDLINK® SDK, available at www.red.com/developers.

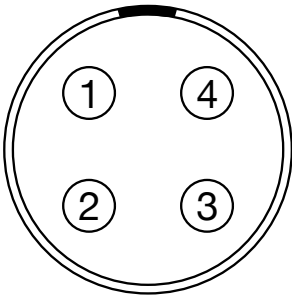

*Front Face of the CTRL (RS232)
Connector (Looking at the Camera)*

4-PIN 00B LEMO CTRL CONNECTOR

PIN	SIGNAL	DESCRIPTION	DIRECTION
1	GROUND	Common ground	N/A
2	232 RX	RS232 RX	In
3	SS/GPO	Shutter sync/general purpose output	Out
4	232 TX	RS232 TX	Out

NOTE: Mating connector is FGG.00.304.CLAD.

COMPATIBLE CABLES

- ▶ **790-0154:** 3BNC-to-00 LEMO Sync Cable
- ▶ **790-0187:** 4-Pin 00 LEMO-to-Flying Lead
- ▶ **790-0415:** RED Start/Stop Cable (14-Pin LEMO to SYNC, CTRL, BNC)

GIG-E (ETHERNET)

The GIG-E 9-pin 0B LEMO connector provides a 1000BASE-T (IEEE 802.3ab) gigabit Ethernet connection for remote camera setup, master/slave camera communication, and external metadata ingest. Since the GIG-E connector does not support slower speeds (10BASE-T and 100BASE-T), ensure that any device you connect to supports 1000BASE-T.

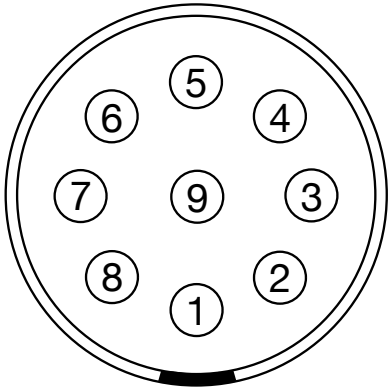

*Front Face of the GIG-E Connector
(Looking at the Camera)*

9-PIN 0B LEMO GIG-E CONNECTOR

PIN	SIGNAL	DESCRIPTION	DIRECTION
1	BI_DC +	Data pair C+	N/A
2	BI_DC -	Data pair C-	N/A
3	BI_DD+	Data pair D+	N/A
4	BI_DD -	Data pair D-	N/A
5	BI_DA-	Data pair A-	N/A
6	BI_DA+	Data pair A+	N/A
7	BI_DB+	Data pair B+	N/A
8	BI_DB-	Data pair B-	N/A
9	N/A	Do not connect	N/A

NOTE: Mating connector is FGG.0B.309.CLAD.

COMPATIBLE CABLES

- ▶ **790-0159:** LEMO-to-CAT5E Ethernet Cable (9')
- ▶ **790-0163:** Master/Slave Gig-E Cable (4')

AUDIO PORTS

MIC-1, MIC-2 (MICROPHONE AUDIO)

The two (2) 3.5mm microphone jacks are microphone level analog audio inputs. Each jack has 2.4K ohm of nominal impedance. For more information, go to [“Record and Monitor Audio” on page 139](#).

- ▶ **MIC-1:** Ch1
- ▶ **MIC-2:** Ch2

MICROPHONE JACK

PIN	SIGNAL	DESCRIPTION	DIRECTION
TIP	IN +	Mic input (+48V phantom power, optional)	In
RING	IN -	Mic Input (+48V phantom power, optional)	In
SLEEVE	GND	Camera ground	N/A

COMPATIBLE CABLE

- ▶ **790-0229:** XLR Microphone Cable (20”)

HEADPHONE

The 3.5mm stereo jack provides two (2) channels of audio for monitoring. For maximum quality, use high impedance headphones.

HEADPHONE JACK

PIN	SIGNAL	DESCRIPTION	DIRECTION
TIP	LEFT	Left channel audio	Out
RING	RIGHT	Right channel audio	Out
SLEEVE	GND	Camera ground	N/A

POWER PORTS

DC IN (POWER INPUT)

The 6-pin 1B LEMO connector accepts DC input power from 11.5 V DC to 17 V DC. A built-in power conditioner protects against reverse-polarity connections, electrostatic discharge (ESD), undervoltage, overvoltage, and overcurrent.

WARNING: Both pairs of +VBATT and GROUND pins must be wired. Using a third-party power cable that wires only one (1) pair of +VBATT and GROUND pins may damage the power supply or the camera. Damage to the power supply or other components of the camera system caused by using an inappropriate power cable is not covered under warranty.

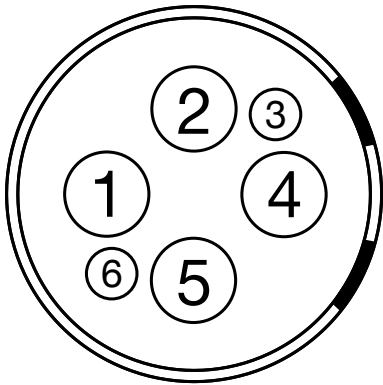

Front Face of the DC In Power Input Connector (Looking at the Camera)

6-PIN 1B DC INPUT CONNECTOR

PIN	SIGNAL	DESCRIPTION
1	+VBATT	Power input, +11.5 to +17 V DC
2	+VBATT	Power input, +11.5 to +17 V DC
3	SCL-BATT	Serial battery bus clock
4	GROUND	Power return (camera ground)
5	GROUND	Power return (camera ground)
6	SDA-BATT	Serial battery bus data

NOTE: Mating connector is FGJ.1B.306.CWLD72Z.

COMPATIBLE CABLES

- ▶ **790-0138:** 2B-to-1B LEMO Power Adaptor Cable
- ▶ **790-0164:** XLR Power Cable (10')
- ▶ **790-0165:** XLR Power Cable (30")

SSD MODULE CONNECTORS

The connectors for the side SSD modules and the REAR SSD MODULE are described in the [DSMC Media Operation Guide](#), available at www.red.com/downloads.

C

LENS MOUNTS AND LENSES

LENS MOUNTS

This section describes camera lens mounts. Camera mounts may be configured with 19mm rods to accommodate most cinematography lenses, matte boxes, and follow focus systems.

CAMERA MOTION MOUNTS

The RED® MOTION MOUNT® is a revolutionary and adjustable lens mount system for your camera. By integrating a global shutter, temporal anti-aliasing soft shutter, and variable neutral density (ND) system into a single lens mount, the MOTION MOUNT delivers on-the-fly shutter adjustments to reduce motion blur and temporal aliasing. The ND filter also includes a linear polarizer and IR filter for improved image color and contrast.

For more information, see the [MOTION MOUNT Operation Guide](http://www.red.com/downloads), available at www.red.com/downloads.

NOTE: HDRx is not available while the MOTION MOUNT is installed.

REMOVE A LENS MOUNT

NOTE: You can change lens mounts in the field. However, RED® recommends that you change lens mounts only in a dust-free environment.

REQUIRED TOOL: T20 TORX® driver

1. Turn off the camera.
2. Attach the camera to a stable platform or position the camera on a clean and level work surface so that the lens mount screws are accessible.
3. Remove the lens and any camera modules, cables, or other accessories that might interfere with removing the lens mount.
4. If removing the DSMC Mg PL Mount 2.0, turn the locking ring slightly counter-clockwise so that you can access the lens mount screws.
5. Loosen and remove the four (4) M4x0.7 x 8 mm lens mount screws in a cross pattern (“X” pattern) using a T20 TORX driver.

NOTE: The DSMC Mg PL Mount 2.0 has captive screws that are not removable from the mount.

NOTE: Screw removal may require a large handle T20 TORX driver and additional leverage.



*Remove the Lens
Mount Screws*

6. Remove the lens mount from the camera.



Remove the Lens Mount

INSTALL A LENS MOUNT

NOTE: You can change lens mounts in the field. However, RED recommends that you change lens mounts only in a dust-free environment.

REQUIRED TOOL: T20 TORX driver

1. Ensure that the camera is turned off and remove any accessories or cables that may interfere with installation.
2. Inspect the gold electrical contact pins on the front of the camera and the gold contact pads on the rear of the lens mount to ensure that they are free of any contamination.
3. Align the lens mount on the front of the camera. The camera connection pins must align with the lens mount pins.



Align Lens Mount Pins

4. If installing the DSMC Mg PL Mount 2.0, turn the locking ring slightly counter-clockwise so that you can access the lens mount screws.
5. Replace and loosely tighten the four (4) M4x0.7 x 8 mm lens mount screws in a cross pattern ("X" pattern) using a T20 TORX driver.

WARNING: DO NOT FULLY TIGHTEN.

NOTE: The DSMC Mg PL Mount 2.0 has captive screws that are not removable from the mount.



Tighten Screws

6. Tighten the four (4) lens mount screws evenly in a cross pattern ("X" pattern) using a T20 TORX driver. DO NOT exceed 350 in-oz, or damage may occur.

WARNING: DO NOT OVERTIGHTEN.

7. After installation, a hardware rediscover or firmware upgrade may be required, particularly if you are installing a MOTION MOUNT. If a MOTION MOUNT is not recognized, you will be unable to access the Motion Mount menu at **Menu > Settings > Setup > Lens**.

To perform a hardware rediscover, go to **Menu > Settings > Maintenance > Rediscover**. A system reboot is required after a hardware rediscover.

NOTE: If you need to replace any screws, please contact your Bomb Squad representative.

LENSES

This section describes lenses and lens operations for the camera system.

WARNING: All lenses are hot swappable. However, lens mounts are NOT HOT SWAPPABLE, meaning you cannot remove or install lens mounts while the camera is turned on. Before installing or removing lens mounts, you MUST turn off the camera. Failure to do so may result in damage to the lens mounts or camera that will not be covered under warranty.

LENS WEIGHT AND LENS SUPPORT

Use a lens support system when mounting heavy or long lenses to your camera.

When mounting a heavy or long lens, ensure that the full weight of the lens is never directly on the camera or lens mount. Mount the lens to the support system first, and then carefully mount the lens to the camera.

Due to the lightweight construction of the carbon fiber BRAIN and magnesium mounts, most setups with the carbon fiber BRAIN require a lens support system for all but the lightest lenses.

WARNING: Failure to use lens supports appropriate for the lens and camera setup may lead to damage of the camera and lens mount. Any damage caused by not using a lens support system will not be covered under warranty.

POSITIVE LOCK (PL) LENSES

This section describes the appropriate method for attaching and detaching PL lenses. For more information, refer to the original manufacturer's instructions. This section also lists lenses supported by the camera PL mounts.

WARNING: ALWAYS protect your equipment, when it is not in use, by replacing lens caps and mount caps.

ATTACH PL LENSES

1. Rotate the locking ring counter-clockwise to release the camera mount cap.
2. Remove the rear lens cap and the camera mount cap.
3. Align the key and contact pads (if present) on the PL lens with the key and connector pins on the camera PL mount.
4. Insert the lens into the camera PL mount.
5. Rotate the locking ring clockwise to secure the lens in place.

DETACH PL LENSES

1. Rotate the locking ring counter-clockwise to release the PL lens.
2. Remove the PL lens from the camera PL mount.
3. Replace the rear lens cap and camera mount cap when the lens is not in use.

CAMERA PL MOUNT SUPPORTED LENSES

The DSMC Mg PL Mount 2.0, DSMC TI PL Mount, and the RED MOTION MOUNT Ti PL are compatible with most standard PL mount cinema lenses and devices. For information about the compatibility of the RED MOTION MOUNT Ti PL, see the [MOTION MOUNT Operation Guide](http://www.red.com/downloads) at www.red.com/downloads.

WARNING: Using a non-standard PL mount lens or device with a camera PL mount may damage the camera and lens mount. Any damage caused by not using a standard PL mount lens or device will not be covered under warranty.

RED DSMC OPERATION GUIDE: EPIC/SCARLET

FUJINON T2.9 CABRIO PREMIER PL LENSES

NOTE: The VTR switch on the lens is mapped to Record: Toggle by default. The VTR switch can be mapped to another key.

The following Fujinon® T2.9 Cabrio Premier PL lenses are compatible with all camera PL mounts, but must be powered externally and configured a specific way:

- ▶ Fujinon 14-35mm T2.9 Cabrio Premier PL
- ▶ Fujinon 19-90mm T2.9 Cabrio Premier PL

To set up the Fujinon T2.9 Cabrio Premier PL lenses, follow the instructions below. Refer to the manufacturer's operation manual for detailed information about setting up and using the lens.

1. Attach the lens to the camera PL mount.
2. On the lens, set the **Camera Communication** switch to **On**.
3. On the lens, set the **LDS, /i Select** switch to **Off**.
4. Connect an external power source to the lens.
5. Go to **Menu > Settings > Setup > Lens**.
6. Deselect the **Enable Power to Lens** check box.

NOTE: This option is only available when a camera PL mount is attached to the camera.

7. The lens should be successfully connected. However, if lens data does not display within 10 seconds, go to **Menu > Settings > Setup > Lens** and select **Detect Lens**.

CANON EF LENSES

This section describes the appropriate method for attaching and detaching Canon® EF lenses. For more information, refer to the original manufacturer's instructions. This section also lists lenses supported by the DSMC Canon EF Mount.

WARNING: ALWAYS protect your equipment, when it is not in use, by replacing lens caps and mount caps.

ATTACH CANON EF LENSES

1. Rotate the secondary locking ring counter-clockwise to disengage.
2. Press the lens release button and rotate the lens cap counter-clockwise to remove the camera mount cap.
3. Remove the rear lens cap.
4. Align the red dot on the lens with the red dot on the DSMC Canon Mount and position the lens in the mount.
5. Turn the lens clockwise until it clicks into place.
6. Rotate the secondary locking ring clockwise to engage.

DETACH CANON EF LENSES

1. Rotate the secondary locking ring counter-clockwise to disengage.
2. Press and hold the lens release button. While holding the lens release button, turn the lens counterclockwise until it stops and remove it from the camera mount.
3. Replace the rear lens cap and camera mount cap when the lens is not in use.

RED DSMC OPERATION GUIDE: EPIC/SCARLET

DSMC CANON MOUNT SUPPORTED LENSES

The DSMC Canon Mount and DSMC Canon MOTION MOUNT electronically support the following lenses:

COMPATIBLE LENS TYPE	FOCAL LENGTH
Canon EF	Canon EF 11-24mm f/4L USM
	Canon EF 14mm f/2.8L II USM
	Canon EF 15mm f/2.8 Fisheye
	Canon EF 16-35mm f/2.8L II
	Canon EF 17-40mm f/4L
	Canon EF 20mm f/2.8 USM
	Canon EF 24mm f/1.4L II
	Canon EF 24mm f/2.8
	Canon EF 24mm f/2.8 IS USM
	Canon EF 24-70mm f/2.8L
	Canon EF 24-70mm f/2.8L II USM
	Canon EF 24-70mm f/4L IS USM
	Canon EF 24-105mm f/4L IS
	Canon EF 28mm f/1.8 USM
	Canon EF 28mm f/2.8
	Canon EF 28mm f/2.8 IS USM
	Canon EF 28-105mm f3.5 II USM
	Canon EF 28-300mm f/3.5-5.6L IS
	Canon EF 35mm f/1.4L
	Canon EF 35mm f/2
	Canon EF 35mm f/2.0 IS USM
	Canon EF 50mm f/1.2L
	Canon EF 50mm f/1.4 USM
	Canon EF 50mm f/1.8 II
	Canon EF 50mm f/1.8 STM
	Canon EF 50mm f/2.5 Compact Macro
	Canon EF 70-200mm f/2.8L IS
	Canon EF 70-200mm f/2.8L IS II USM
	Canon EF 70-200mm f/2.8L USM
	Canon EF 70-200mm f/4L
	Canon EF 70-300mm f/4.5-5.6 DO IS USM
	Canon EF 70-300mm f/4-5.6L IS
	Canon EF 70-300mm f/4-5.6L IS USM
	Canon EF 85mm f/1.2L II
	Canon EF 85mm f/1.8 USM
	Canon EF 100mm f/2.0 USM
	Canon EF 100mm f/2.8L Macro IS USM
	Canon EF 100-400mm f/4.5-5.6L IS

RED DSMC OPERATION GUIDE: EPIC/SCARLET

COMPATIBLE LENS TYPE	FOCAL LENGTH
Canon EF	Canon EF 100-400mm f/4.5-5.6L IS II USM ¹
	Canon EF 135mm f/2.0L
	Canon EF 135mm f/2.8 Soft Focus
	Canon EF 180mm f/3.5L Macro
	Canon EF 200mm f/2.0L IS
	Canon EF 200mm f/2.8L II
	Canon EF 200-400mm f/4L IS USM Extender 1.4x
	Canon EF 300mm f/2.8L IS
	Canon EF 300mm f/2.8L IS II USM
	Canon EF 300mm f/2.8L IS II USM with 1.4x III Extender
	Canon EF 300mm f/2.8L IS II USM with 2x III Extender
	Canon EF 300mm f/4L IS
	Canon EF 400mm f/2.8 IS II USM
	Canon EF 400mm f/2.8L IS
	Canon EF 400mm f/2.8L IS with 1.4x Extender
	Canon EF 400mm f/2.8L IS with 2x Extender
	Canon EF 400mm f/4.0 DO IS
	Canon EF 400mm f/5.6L
	Canon EF 500mm f/4L IS
	Canon EF 500mm f/4L IS USM
	Canon EF 500mm f/4L IS with 1.4x Extender
	Canon EF 500mm f/4L IS with 2x Extender
	Canon EF 500 f/4L IS II USM
	Canon EF 600mm f/4L IS
	Canon EF 600mm f/4L IS II USM
	Canon EF 800mm f/5.6L IS
	Canon EF-S
Canon EF-S 15-85mm f/3.5-5.6 IS USM	
Canon EF-S 17-55mm f/2.8 IS USM	
Canon EF-S 18-200mm f/3.5-5.6 IS	
Canon EF-S 60mm f/2.8 Macro USM	
Sigma	Sigma 10-20mm f/3.5 EX DC HSM
	Sigma 15mm f/2.8 EX DG Diagonal Fisheye
	Sigma 17-70mm f/2.8-4 DC Macro OS HSM
	Sigma 18-35mm DC HSM
	Sigma 20mm f/1.8 EX DG ASP RF
	Sigma 24mm f/1.8 EX DG ASP Macro AF
	Sigma 24-70mm f/2.8 IF EX DG HSM
	Sigma 28mm f/1.8 EX DG ASP Macro AF
	Sigma 50mm f/1.4 EX DG HSM
	Sigma 85mm f/1.4 EX DG HSM

RED DSMC OPERATION GUIDE: EPIC/SCARLET

COMPATIBLE LENS TYPE	FOCAL LENGTH
Sigma APO	Sigma APO 120-300mm f/2.8 EX DG OS HSM Sigma APO 180mm f/2.8 Macro EX DG OS HSM
Tamron	Tamron SP 10-24mm f/3.5-4.5 Di II Tamron SP 15-30mm f/2.8 Di VC USD ¹ Tamron SP 24-70mm f/2.8 Di VC USD
Tokina	Tokina AT-X 116 Pro DX, 11-16mm f/2.8 SD IF DX Tokina AT-X 116 Pro DX-II, 11-16mm f/2.8 SD IF DX
Zeiss Distagon®	Zeiss Distagon T* 15mm f/2.8 ZE Zeiss Distagon T* 18mm f/3.5 ZE Zeiss Distagon T* 21mm f2.8 ZE Zeiss Distagon T* 25mm f/2 ZE Zeiss Distagon T* 28mm f/2 ZE Zeiss Distagon T* 35mm f2 ZE
Zeiss Makro-Planar®	Zeiss Makro-Planar T* 100mm f/2 Z
Zeiss Planar	Zeiss Planar T* 50mm f1.4 ZE Zeiss Planar T* 85mm f1.4 ZE
Zeiss Otus®	Zeiss Otus 55mm f/1.4

1. Image stabilization (IS) requires that your camera is on firmware v6.2 or later.

NIKON F-MOUNT LENSES

This section describes the appropriate method for attaching and detaching Nikon® F-Mount lenses. For more information, refer to the original manufacturer's instructions. This section also lists lenses supported by the DSMC Nikon F-Mount.

WARNING: ALWAYS protect your equipment, when it is not in use, by replacing lens caps and mount caps.

ATTACH NIKON F-MOUNT LENSES

1. Rotate the secondary locking ring counter-clockwise to disengage.
2. Press the lens release button and rotate the lens cap clockwise to remove the camera mount cap.
3. Remove the rear lens cap.
4. Align the mounting index (white dot) on the lens with the mounting index on the DSMC Nikon mount and position the lens in the bayonet mount.
5. Rotate the lens counter-clockwise until it clicks into place, being careful to NOT press the lens release button.
6. Rotate the secondary locking ring clockwise to engage.

DETACH NIKON F-MOUNT LENSES

1. Rotate the secondary locking ring counter-clockwise to disengage.
2. Press and hold the lens release button. While holding the lens release button, turn the lens clockwise until it stops and remove it from the camera mount.
3. Replace the rear lens cap and camera mount cap when items are not in use.

RED DSMC OPERATION GUIDE: EPIC/SCARLET

DSMC NIKON MOUNT SUPPORTED LENSES

The DSMC Nikon Mount electronically supports the following lenses:

COMPATIBLE LENS TYPE	FOCAL LENGTH
Nikkor AF	AF Nikkor 28mm f/2.8D
	AF Nikkor 50mm f/1.8D
	AF DX Fisheye-Nikkor 10.5mm f/2.8G ED
	AF Fisheye-Nikkor 16mm f/2.8D ¹
Nikkor AF-S	AF-S Nikkor 10-24mm f/3.5-4.5G ED IF DX
	AF-S Nikkor 14-24mm f/2.8 G ED
	AF-S Nikkor 17-35mm f/2.8D ED IF
	AF-S Nikkor 17-55mm f/2.8G ED DX
	AF-S Nikkor 24mm f/1.4 G ED
	AF-S Nikkor 24-70mm f/2.8 G ED
	AF-S Nikkor 35mm f/1.4 G
	AF-S Nikkor 40mm f/2.8G DX
	AF-S Nikkor 50mm f/1.4 G
	AF-S Nikkor 70-200mm f/2.8G ED VR II
	AF-S Nikkor 85mm f/1.4 G
	AF-S Nikkor 200-400mm f/4G VR II
	AF-S Nikkor 600mm f/4G ED VR N
	AF-S Micro-Nikkor 60mm f/2.8 G ED
AF-S Micro-Nikkor 105mm f/2.8G VR IF-ED	
Sigma	Sigma 17-70mm f/2.8-4 DC Macro OS HSM C
	Sigma 18-35mm f/1.8 DC HSM
	Sigma 24-105mm f/4 DG OS HSM
	Sigma 120-300mm f/2.8 DG OS HSM
Sigma APO	Sigma APO 120-300mm f/2.8 EX DG OS HSM
Tamron	Tamron SP 24-70mm f2.8 Di VC USD ¹
Tokina	Tokina AT-X 107 DX, 10-17mm f/3.5-4.5 Fisheye DX ¹
	Tokina AT-X 116 Pro DX, 11-16mm f/2.8 SD IF DX ¹
	Tokina AT-X 116 Pro DX-II, 11-16mm f/2.8 SD IF DX ¹
Zeiss Distagon	Zeiss Distagon T* 21mm f/2.8 ZF.2 ¹
	Zeiss Distagon T* 35mm f/1.4 ZF.2 ¹
Zeiss Planar	Zeiss Planar T* 50mm f/1.4 ZF.2 ¹
	Zeiss Planar T* 85mm f/1.4 ZF.2 ¹

1. Iris control only, no AF.

RED DSMC OPERATION GUIDE: EPIC/SCARLET

AL LEICA-M MOUNT LENSES

This section describes the appropriate method for attaching and detaching Leica-M® lenses. For more information, refer to the original manufacturer's instructions. This section also lists lenses supported by the DSMC AL Leica-M Mount.

WARNING: ALWAYS protect your equipment, when it is not in use, by replacing lens caps and mount caps.

ATTACH LEICA-M LENSES

1. Rotate the locking ring counter-clockwise to release the camera mount cap.
2. Remove the rear lens cap and the camera mount cap.
3. Align the mounting index (white dot) on the lens with the mounting index on the DSMC AL Leica-M mount.
4. Insert the lens into the DSMC AL Leica-M mount.
5. Rotate the locking ring clockwise to secure the lens in place.

DETACH LEICA-M LENSES

1. Rotate the locking ring counter-clockwise to release the Leica-M lens.
2. Remove the Leica-M lens from the DSMC AL Leica-M mount.
3. Replace the rear lens cap and camera mount cap when the lens is not in use.

DSMC AL LEICA-M MOUNT SUPPORTED LENSES

The DSMC AL Leica-M Mount is compatible with most Leica M-series lenses with focal lengths of 50mm and greater, EXCEPT for the 50mm f2.0 Dual-Range Summicron. The 50mm f2.0 Dual-Range Summicron has a protruding lug on the exterior of the lens body for mounting a supplementary finder. This lug interferes with the locking ring on the DSMC AL Leica-M Mount. Most Leica lenses with focal lengths of less than 50mm will encounter mechanical interference between the rear lens cell and the camera's front panel.

EPIC DRAGON AND SCARLET DRAGON

If you are using an EPIC DRAGON or SCARLET DRAGON® camera, you do not need to install a new OLPF frame. You can attach most Leica-M lenses without causing any interference with camera.

EPIC MYSTERIUM-X AND SCARLET MYSTERIUM-X

If you are using an EPIC MYSTERIUM-X® or SCARLET MYSTERIUM-X camera, you need to install a new OLPF frame (included with the DSMC AL Leica-M Mount). Leica-M lenses are incompatible with older models of the OLPF frame originally installed in the EPIC MYSTERIUM-X and SCARLET MYSTERIUM-X.

For more information, go to [OLPF Frame Installation Instructions](http://www.red.com/downloads) available at www.red.com/downloads.

WARNING: Attempting to mount Leica lenses of focal lengths of less than 50mm could result in damage to the lens and/or the camera.

D

DEFAULT KEY FUNCTIONS

DEFAULT KEY FUNCTIONS

ITEM	KEY	FUNCTION
Camera BRAIN®	Record Full Press	Record: Toggle
	GPI In High	Record: Start
	GPI In Low	Record: Stop
Side SSD Module	Record Full Press	Record: Toggle/Multi-Shot Start
	Record Full Release	Record: Multi-Shot Stop
	Record Half Press	AF: Start
	User 1+2 Press	Eject Media
LCD (Primary and Secondary)	Up Press	Br. Up (Increase Brightness)
	Down Press	Br. Down (Decrease Brightness)
	User 1 Press	Magnify: Toggle
	User 2 Press	Exposure Check: Toggle
	User 1+2 Press	LCD: Toggle Lock
EVF (Primary and Secondary)	User 1 Press	Magnify: Toggle
	User 2 Press	Exposure Check: Toggle

RED DSMC OPERATION GUIDE: EPIC/SCARLET

DEFAULT KEY FUNCTIONS

ITEM	KEY	FUNCTION
DSMC® Side Handle	User A Press	AF Mode: Cycle
	User B Press	WB: Auto Calc
	User C Press	Magnify: Toggle
	User D Press	Exposure Check: Toggle
	User 1 Press	SH: Key 1
	User 2 Press	SH: Key 2
	User 3 Press	SH: Key 3
	User 4 Press	SH: Key 4
	User 5 Press	Exposure Check: Toggle
	User 6 Press	Key Disabled
	User 7 Press	Eject Media
	User 1+4 Press	SM: Toggle Key Lock
	Nav Menu Press	Navigation: Menu
	Nav North Press	Navigation: Up
	Nav South Press	Navigation: Down
	Nav East Press	Navigation: Right
	Nav West Press	Navigation: Left
	Nav Enter Press	Navigation: Select
	Backlight Press	SH: Toggle Backlight
	Movie Select	Focus Mode: Motion
	Still Select	Focus Mode: Still
	Record Full Press	Record: Toggle/Multi-Shot Start
	Record Full Release	Record: Multi-Shot Stop
	Record Half Press	AF: Start
	Rocker + Press	Iris: Open
	Rocker - Press	Iris: Close
	Rotary Front CW	Navigation: CW
	Rotary Front CCW	Navigation: CCW
	Rotary Jog CW	Navigation: CW
	Rotary Jog CCW	Navigation: CCW

RED DSMC OPERATION GUIDE: EPIC/SCARLET

DEFAULT KEY FUNCTIONS

ITEM	KEY	FUNCTION
RED Switchblade-M	User A Press	AF Mode: Cycle
	User B Press	WB: Auto Calc
	User C Press	Magnify: Toggle
	User D Press	Exposure Check: Toggle
	User A+D Press	SM: Toggle Key Lock
	Nav Menu Press	Navigation: Menu
	Nav North Press	Navigation: Up
	Nav South Press	Navigation: Down
	Nav East Press	Navigation: Right
	Nav West Press	Navigation: Left
	Nav Enter Press	Navigation: Select
	Rotary Front CW	Navigation: CW
	Rotary Front CCW	Navigation: CCW
REDMOTE®	User A Press	AF Mode: Cycle
	User B Press	WB: Auto Calc
	User C Press	Magnify: Toggle
	User D Press	Exposure Check: Toggle
	Still Select	Focus Mode: Still
	Movie Select	Focus Mode: Motion
	Nav Menu Press	Navigation: Menu
	Nav North Press	Navigation: Up
	Nav South Press	Navigation: Down
	Nav East Press	Navigation: Right
	Nav West Press	Navigation: Left
	Nav Enter Press	Navigation: Select
	Rotary Front CW	Navigation: CW
	Rotary Front CCW	Navigation: CCW
	Record Full Press	Record: Toggle/Multi-Shot Start
	Record Full Release	Record: Multi-Shot Stop
	Record Half Press	AF: Start
	Rocker + Press	Iris: Open
	Rocker - Press	Iris: Closed
	PRO I/O GPIO	GPI A LOW
GPI B Low		Record: Toggle
SW 1 Low		Go to: Playback
SW 2 Low		Record: Toggle

PRESET DEFAULT KEY FUNCTIONS

The following table describes default key functions for the Default Stills and Motion presets.

NOTE: You cannot update factory-installed presets, which end with "(RED)".

PRESET DEFAULT KEY FUNCTIONS		
ITEM	KEY	FUNCTION
Default Stills Preset (RED)	User A Press	Record: Mark Frame
	User B Press	Playback/Preview: Toggle
	User C Press	Magnify: Toggle
	Record Half Press	AE/AF: Start
	Rocker + Press	Iris Open
	Rocker - Press	Iris Close
	Rotary Front	Increment/Decrement Value
	User 1 Press ¹	SH: Key 1
	User 2 Press ¹	SH: Key 2
	User 3 Press ¹	SH: Key 3
	User 4 Press ¹	SH: Key 4
	User 1+4 Press	Toggle Key Lock
Default Motion Preset (RED)	User A Press	AF Mode: Cycle
	User B Press	WB: Auto Calc
	User C Press	Magnify Toggle
	User D Press	Exposure Check: Toggle
	Rocker + Press	Iris Open
	Rocker - Press	Iris Close
	Rotary Front	Increment/Decrement Value
	User 1 Press ¹	SH: Key 1
	User 2 Press ¹	SH: Key 2
	User 3 Press ¹	SH: Key 3
	User 4 Press ¹	SH: Key 4
	User 1+4 Press	Toggle Key Lock

1. User 1-4 keys are soft keys used to select a slot. The front rotary then adjusts the value of the selected slot.

E

MENU MAP

See the menu map on the following page.

The menu map is applicable to the following cameras, except as noted throughout this guide:

- ▶ EPIC-M RED DRAGON™ (CARBON FIBER)
- ▶ EPIC-M RED DRAGON
- ▶ EPIC-X RED DRAGON
- ▶ SCARLET DRAGON
- ▶ EPIC-M MYSTERIUM-X
- ▶ EPIC-X MYSTERIUM-X
- ▶ SCARLET-X MYSTERIUM-X
- ▶ EPIC-M MONOCHROME
- ▶ EPIC-X MONOCHROME
- ▶ EPIC-M RED DRAGON MONOCHROME

RED DSMC OPERATION GUIDE: EPIC/SCARLET

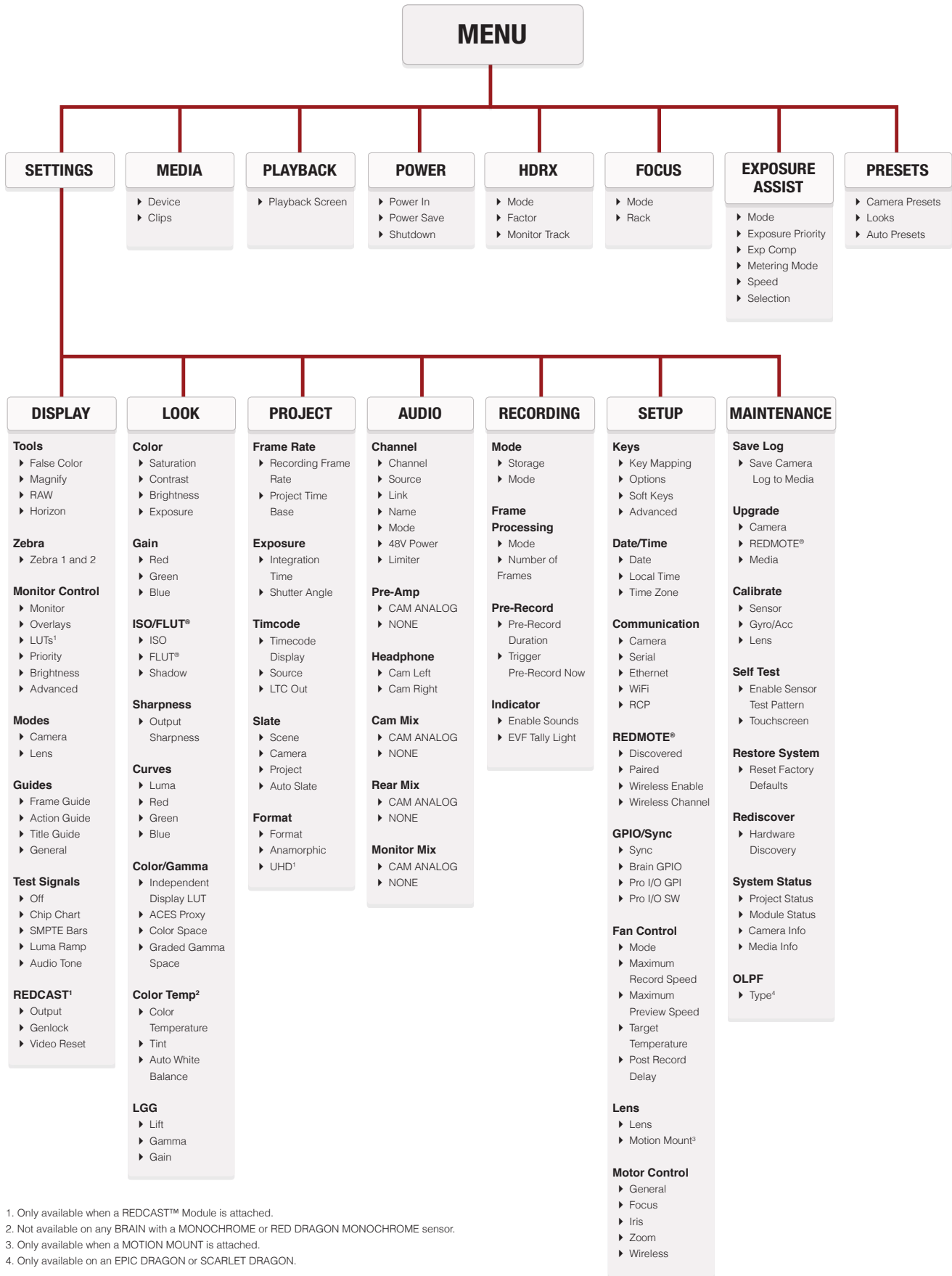

1. Only available when a REDCAST™ Module is attached.
 2. Not available on any BRAIN with a MONOCHROME or RED DRAGON MONOCHROME sensor.
 3. Only available when a MOTION MOUNT is attached.
 4. Only available on an EPIC DRAGON or SCARLET DRAGON.



RED DIGITAL CINEMA

COPYRIGHT© 2015 RED.COM, INC.

All trademarks, trade names, logos, icons, images, written material, code and product names used in association with the accompanying product are the copyrights, trademarks or other intellectual property owned and controlled exclusively by RED.COM, INC.