

**For the best selection of refrigeration products visit
your local Liebherr authorised dealer**



Your local Liebherr authorised dealer will help you make the right choice of refrigeration for your lifestyle. Liebherr dealers are refrigeration experts and can give you all the detailed information on designs, technology, storage capacity and energy savings to ensure you have the refrigeration product to meet your family's requirements.

Ask your Liebherr authorised dealer for more detailed information about the other Liebherr refrigeration products in the brochures shown on this page; Freestanding Refrigeration, Project Planning, Wine Storage, BioFresh Appliances and Side-By-Side Fridge Freezers, or visit our website!



Subject to modification. Printed in Germany by Stark, 0047/3.5/01.10

Built-in
Refrigeration &
Freezing
2010/2011



LIEBHERR
Design, Quality and Innovation

**Kitchen Appliance Distributors LTD, Unit 13, Cherry Orchard Industrial Estate, Dublin 10,
Ireland, Tel: (00 353) 1 6266798, Fax: (00 353) 1 6266634, E-mail: sales@kad.ie
www.kad.ie**

For the best selection of refrigeration products visit your local Liebherr authorised dealer



Your local Liebherr authorised dealer will help you make the right choice of refrigeration for your lifestyle. Liebherr dealers are refrigeration experts and can give you all the detailed information on designs, technology, storage capacity and energy savings to ensure you have the refrigeration product to meet your family's requirements.

Ask your Liebherr authorised dealer for more detailed information about the other Liebherr refrigeration products in the brochures shown on this page; Freestanding Refrigeration, Project Planning, Wine Storage, BioFresh Appliances and Side-By-Side Fridge Freezers, or visit our website!



Subject to modification. Printed in Germany by Stark, 0048/0,5/01,10

Built-in
Refrigeration &
Freezing
2010/2011

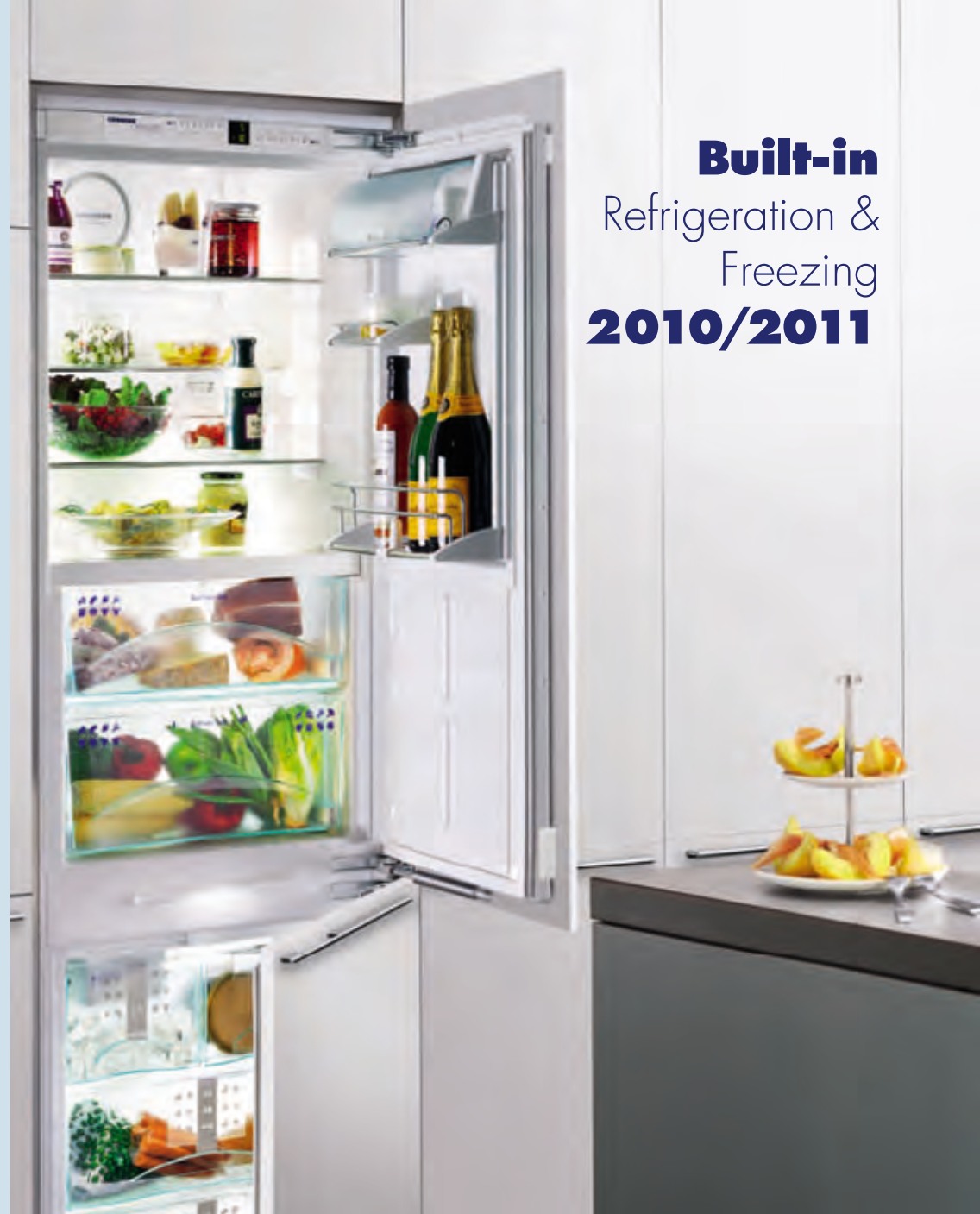

www.liebherr.com

LIEBHERR
Design, Quality and Innovation

For the best selection of refrigeration products visit your local Liebherr authorised dealer



Freestanding
Refrigeration
& Freezing



Project Planning

Your local Liebherr authorised dealer will help you make the right choice of refrigeration for your lifestyle. Liebherr dealers are refrigeration experts and can give you all the detailed information on designs, technology, storage capacity and energy savings to ensure you have the refrigeration product to meet your family's requirements.

Ask your Liebherr authorised dealer for more detailed information about the other Liebherr refrigeration products in the brochures shown on this page; Freestanding Refrigeration, Project Planning, Wine Storage, BioFresh Appliances and Side-By-Side Fridge Freezers, or visit our website!



Wine Special



BioFresh Special



Side-by-Side Special



Subject to modification. Printed in Germany by Stark, 0046/25/01-10

Built-in
Refrigeration &
Freezing
2010/2011

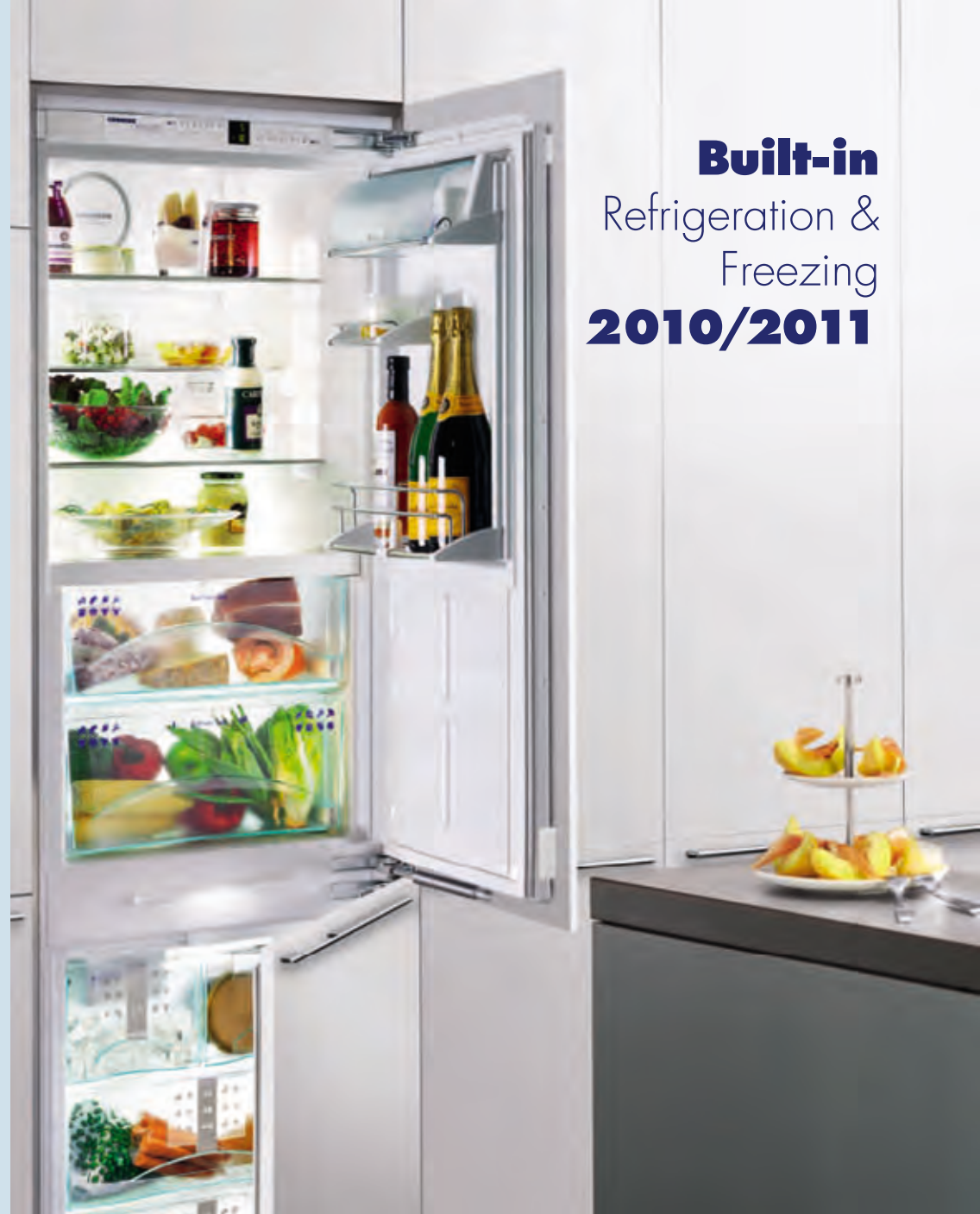

LIEBHERR

Design, Quality and Innovation

Coolectric LTD, Interchange Point, Renny Park Road, Newport Pagnell, Bucks, MK16 0HA
National Salesline 08444 122 655 • National Free Fax 0800 197 6591
Email sales@coolectric.co.uk • Website: www.myliebherr.co.uk



1 Know-how that matters!

Liebherr-Hausgeräte has specialised in developing and manufacturing first class refrigerators and freezers of premium quality and cutting edge design for over 50 years. Innovative ideas are constantly added to the products for enhancing freshness, improving ease-of-use and saving even more energy to raise customer product value.

2 Premium product quality

To ensure the renowned Liebherr quality, only first class components are used. For example, accurate electronic control systems are used in conjunction with optimised refrigeration components. During the manufacturing process the appliances undergo comprehensive testing and inspection to ensure perfect workmanship and flawless functionality. This means Liebherr appliances have a long service life.

3 Innovative ideas

Liebherr appliances boast a compelling array of innovative ideas. Take, for example, the freestanding Premium appliances with the new electronic control system and user-friendly Touch feature, or the PremiumPlus models with the innovative LED lighting, convenient IceMaker with twist tray, or GlassLine shelves for versatile use.

4 Classical design

The combination of classical, timeless design with high quality materials like glass and stainless steel makes Liebherr appliances the focus point in any kitchen.

5 Environmentally friendly

For Liebherr, being actively green starts at the very beginning of the design process. In keeping with this ethos, Liebherr uses high quality components for its appliances to provide long and safe operation and top energy efficiency. All plastics are marked for recycling. The manufacturing processes are also geared to efficient use of resources. To give one example: the heat naturally generated during manufacture of the appliances is recycled as heating energy.

6 Super energy efficiency



By deploying state-of-the-art, precision electronics combined with finely tuned, highly efficient refrigeration systems, Liebherr offers a wide range of energy saving appliances. All the product groups feature models securing great savings in the A+ and A++ top energy efficiency classes.

7 BioFresh feature



In the BioFresh compartments many types of food stay fresher for longer. Food retains its healthy vitamins, aroma and appetising appearance up to three times longer than in conventional fridges. To accomplish this, the temperature is accurately kept at just above 0 °C, together with ideal humidity in each of the BioFresh drawers. These drawers can be used individually, as HydroSafes with high humidity or as DrySafes with low humidity to enable versatile storage.

8 NoFrost - professional quality freezing performance



The NoFrost system from Liebherr provides fast, fan-assisted freezing performance for the safe storage of food with lasting freshness. The NoFrost system dispenses with fixed shelving, allows more flexible capacity storage and keeps the freezer constantly frost-free making defrosting a thing of the past.

9 Perfect climate for fine wines



Liebherr's wine storage cabinets and multi-temperature wine cabinets are designed specifically to keep wine in its optimum environment. These appliances feature state-of-the-art electronic control systems, special vibration free compressors and a host of features such as tinted glazed doors, activated charcoal filters or stable, hand crafted wooden shelves on telescopic rails.

10 Awards given to the range



The design quality of Liebherr appliances is confirmed by independent institutions. The built-in IKB 3454 model with BioFresh technology in energy efficiency class A+ was awarded the PlusX award for user convenience and environmental friendliness. Liebherr also won the PlusX 2007 title as the Most Innovative Brand of large appliances.

How to find the right built-in appliance

Liebherr offers built-in appliances for integrated use or with décor panel. To find the appliance for you, simply choose the method of integration, the aperture and the features of the model that best suits your needs.

Aperture Sizes *

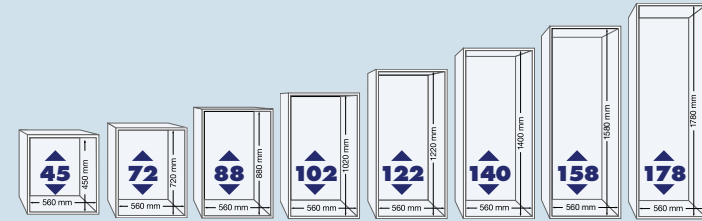

Built-in appliances for integrated use



The appliances will fit easily behind your unit door, so are ideal for integration into a fitted kitchen, creating a uniform look. Note the method by which the door is fitted:

Sliding system

The unit door is hinged on the cabinet and connected to the appliance door with sliding rails. When the door is opened and closed, the unit door slides along the rails.



The door-on-door system

The unit door is fixed directly onto the appliance door.



Built-in appliances for integrated use

								Page	
BioFresh-appliances							IKB 2410 IKB 2810	ICBN 3066 ICBN 3056 IKB 3660 IKB 3454	15
Combined fridge-freezers								ICUS 2913 ICN 3066 ICN 3056 ICS 3113 IC 3013 ICUNS 3013 ICUS 3013	22
Fridges			IK 1710 IK 1504 IKS 1720	IKP 2050	IKP 2450 IKS 2420 IK 2410 IK 2214	IKP 2850 IKP 2654		IK 3620 IK 3414	30
Freezers		IG 956	IG 1156 IGS 1113				IG 1956	IGN 2566	48

Built-in appliances with décor panel



Built in appliances for use with décor panels can be fitted with a panel finished to match the other kitchen units. Décor panels are available from specialist suppliers. Panels can be fitted with a thickness of up to 4 mm. Built-in appliances are supplied with aluminium coloured décor frame as standard, brown or white frames are also available as accessories. If the height of an existing décor panel is too small for a replacement appliance, it can be made to fit with equaliser trims of various heights in the same colour as the décor frame. One or two equaliser trims (top and/or bottom) may be used depending on how much has to be equalised and taking visual aspects into account. The trims are available in three heights (16, 41, 60 mm) and colours (brown, white, aluminium): part no. 9733.

For more information to décor panels and reference numbers please see installation diagrams in the middle of the catalogue.

Built-in appliances with décor panel

								Page	
Fridges			EK 1750		EK 2450				37
Freezers			EG 1113						49
Multi-temperature wine cabinet with glass door					WTEes 2053				56
Wine storage cabinets with glass door	WKEes 553								57

*see installation drawings for binding dimensions

How to find the right under worktop appliance

Liebherr offers under-worktop appliances for integrated use or with décor panels. To find the right appliance for you, simply choose the method of integration, the aperture and the model features that best suits your needs.

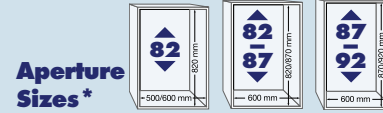

Top quality for your kitchen

The models:

Comfort

Liebherr's superior quality means well thoughtout features and a comprehensive range of equipment. The renowned Liebherr quality means that you get many benefits from the product features and innovative ideas.

Premium

Liebherr fridges and freezers incorporate cutting edge technology that only high quality appliances demand, right down to the finest detail. A characteristic feature of Premium models is the high standard of design in conjunction with a host of innovative ideas and a comprehensive array of equipment.

PremiumPlus

Top of the range Liebherr fridges and freezers with the exclusive extra bonus of additional equipment. Here, the individuality, needs and requirements of the customer take centre stage. Highlights of PremiumPlus models are the Premium features, complemented by the outstanding and unique product benefits of PremiumPlus. These product features are geared to give maximum convenience and the latest product design trends. The two top features of the PremiumPlus are the unique light column for the fridge compartment and the innovative BioFresh lighting.

Built under integrated refrigeration



By fitting the fridge and freezer under an existing worktop and behind the unit door, you can create a uniform look in your kitchen. The unit door is attached permanently to the appliance with the door-on-door method. Ventilation and air extraction are provided through the plinth and no ventilation grill is required in the work surface.

The door-on-door system

The unit door is fixed directly onto the appliance door.



				Page
Fridges		UIK 1610 UIK 1414	KIUe 1350	42
	Freezers	UIG 1313		52

Built under décor panel refrigeration



A décor panel (thickness up to 4 mm) matching the kitchen units is attached to the appliance door. Décor panels are available from specialist suppliers. These appliances are available with white décor trims (ventilation grill, décor frames, plinth). Ventilation and air extraction are provided at the front of the appliance therefore no ventilation grill is required in the work surface.

				Page
Fridges	UK 1720			43
Wine multi-temperature wine cabinet with glass door		WTUes 1653		56
Wine storage cabinet with glass door		WKUes 1753		57

Energy
Manufacturer: **LIEBHERR**
Model: **IKP 2654**

More efficient

A
B
C
D
E
F
G

Less efficient

Energy consumption kWh/year (based on standard test results for 24 h)
Actual consumption will depend on how the appliance is used and where it is located.

172

Fresh food volume l: 222
Frozen food volume l: 20

Noise
dB(A) re 1pW
Further information is contained in the product brochures.

Norm EN 153, May 1990
Nomenclature Label Directive 84/203/EEC



Super savings in energy consumption

Many Liebherr fridges and freezers come in the best energy efficiency classes A++ and A+++ and are therefore the top energy savers in any home.

Using state-of-the-art electronic control units in conjunction with optimised refrigerating systems has achieved a further significant reduction in energy consumption in comparison with previous economical models.

*see installation drawings for binding dimensions



A unique feature is the lighting in the PremiumPlus range

Hallmarks of the PremiumPlus range are two light columns integrated into the liner on either side. Inside there are numerous LEDs ensuring a uniform illumination of the interior. The special satin finish of the light cover creates a pleasant lighting atmosphere.



BioFresh lighting

In the PremiumPlus appliances the BioFresh compartments have LED lighting, ensuring a clear view of the food stored inside. The LED lighting is elegantly integrated into the side wall for a flush finish.



Freezer compartment lighting

This innovation provides a perfect view inside the freezer compartment. In the combined BioFresh fridge-freezers of the PremiumPlus range, the freezer compartment now features interior lighting. Integrated above the freezer drawers is a LED light strip ensuring ideal illumination of the opened, transparent drawers to give you an even better view of the stored food.



The **BioFresh drawers** are mounted on telescopic rails which means they are flush with the inner compartment. Even at an opening angle of 90°, they can be pulled-out and are removable.



In the PremiumPlus appliances the **BioFresh compartments** have LED lighting, ensuring a clear view of all the food stored inside. The LED lighting is elegantly integrated into the side wall for a flush finish.



The humidity can be set in the HydroSafe - for best storage conditions for fruits and vegetables.



BioFresh – Maximising the life of fresh produce

The BioFresh safes guarantee the perfect climate for long-term freshness. With the temperature maintained just above 0°C and with an ideal humidity level, fruit, vegetables, meat and fish retain their healthy vitamins, delicate aroma and appetising appearance up to three times longer than in a traditional refrigerator compartment.



The state-of-the-art BioFresh technology offers the perfect storage solution: the BioFresh drawers can be individually controlled as either HydroSafes, with high humidity, or as DrySafes, with low humidity to give a versatile storage solution. This means the ideal climate can be provided for all types of produce.

BioFresh – Take a fresh look at healthy eating

The information below relates to the storage of produce in a BioFresh compartment compared with a traditional refrigerator compartment.



Broccoli + 8 days



Prawns + 1 day



Raspberries + 2 days



Artichokes + 7 days



Grapes + 17 days



Carrots + 30 days



Asparagus + 8 days



Apples + 30 days

An highlight in any kitchen



Illustration: ICBN 3066



In the **BioFresh** compartments food retains its healthy vitamins, aroma and appetising appearance up to three times longer than in a conventional fridge. Through its advanced technology the temperature is accurately kept at just above 0°C. Each drawer can be used individually and provides ideal humidity - HydroSafes with high humidity or DrySafes with low humidity - for a versatile storage solution.

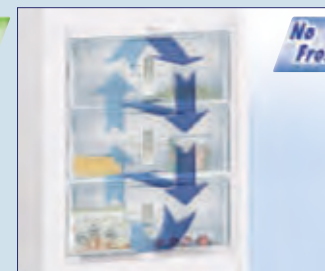

The **NoFrost** system from Liebherr provides rapid, fan-assisted, frost-free freezing for the safe, long-term storage of food. The NoFrost technology creates a much larger storage capacity and keeps the freezer constantly frost-free to make defrosting a thing of the past.



The clearly laid out, precision **control system with MagicEye** ensures that the digitally displayed temperature you select is kept exactly to the degree chosen. The clear arrangement of the function buttons makes for easy and convenient use.

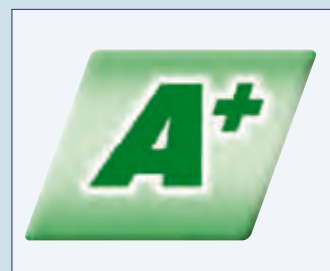

Super savings in energy consumption.

Many Liebherr fridge-freezers come in the energy efficiency class A+ and are therefore the top energy savers in any home - day in, day out. Deploying state-of-the-art electronic control units in conjunction with optimised refrigerating systems has achieved a further significant reduction in energy consumption in comparison with previous economical models.



The **SoftSystem** ensures that the door closes gently even when fully loaded. The door closes automatically from an opening angle of approximately 30°.



An innovative and unique detail is the **integrated bottle shelf**. When you need to store very tall bottles, the bottle rack in the door can be moved upwards allowing the entire depth of the appliance to be used. Alternatively, the glass shelf under the bottle shelf can be utilised.

Electronic control system

- MagicEye with digital temperature display for refrigerator compartment and NoFrost freezer compartment
- Separate temperature regulation for refrigerator and freezer compartment using buttons
- Automatic SuperCool function
- Automatic SuperFrost function, quantity-controlled
- Visual and audible warning signal in case of malfunction
- Audible door alarm
- Control lamp for mains, alarm, SuperCool, SuperFrost, FrostControl and child lock

Fridge compartment

- Automatic defrosting
- Forced air cooling with fan
- GlassLine storage shelves - 1 sectioned, with slide under half shelf option
- GlassLine storage racks with bottle and can holders
- Smooth, easy-to-clean compartment liner with elegant holding columns for rearrangement of the glass shelves
- LED interior light with ICBN 3056
- LED light column on either side for even, high-class illumination of the interior with ICBN 3066
- Integrated bottle shelf for versatile use
- Swivel lid for butter and cheese compartment with egg tray

BioFresh compartment

- Automatic defrosting, forced air cooling
- Pull-out BioFresh safes mounted on telescopic rails
- DrySafe with low humidity - for fish, meat and dairy products
- HydroSafe with adjustable humidity for fruit and vegetables
- LED lighting with ICBN 3066

Freezer compartment

- NoFrost. Automatic defrosting
- Forced air cooling
- FrostSafe system with completely enclosed, transparent drawers
- LED lighting for ideal illumination of the extended drawers with ICBN 3066
- VarioSpace due to removable drawers and intervening glass shelves
- IceMaker with fixed water connection with ICBN 3066
- Ice cube tray with ICBN 3056

Features

- SoftSystem to cushion door closure
- Door opening angle of 115°
- Height-adjustable feet at the front
- Reversible door



Illustration: ICBN 3066



DuoCooling uses two separate cooling circuits to independently control fridge and freezer compartment temperatures.

With DuoCooling there is no air exchange between fridge and freezer compartments so odour transfer is prevented and food is stored in optimum conditions.



The **IceMaker** provides you with a constant supply of ice cubes for every occasion. Whether you fancy a cold drink or you're having a big party, the IceMaker automatically keeps your supplies topped up.



The distinctive **GlassLine equipment** puts the finishing touches to the overall impression of high quality conveyed by the interior. The shelves are made of safety glass, as are the racks with stainless steel trims in the door interior. The sectioned, slide-under glass shelf lends itself to versatile use as it can be inserted at different heights, just as the user pleases.



BioFresh fridge-freezers

ICBN 3066 PremiumPlus



ICBN 3056 Premium



Door assembly	Door on door
Net capacity	178 litre
	including BioFresh compartment
	67 litre
	Freezer compartment
	60 litre
Energy efficiency class (kWh in 365 days)	$\leq A$ (298 kWh)
Climate rating	SN-ST
Aperture dimensions in cm (h/w/d)	177.2-178.8 / 56-57 / at least 55
Separately adjustable cooling circuits	2 - DuoCooling

Door assembly	Door on door
Net capacity	178 litre
	178 litre
	67 litre
	62 litre
Energy efficiency class (kWh in 365 days)	$\leq A$ (298 kWh)
Climate rating	SN-ST
Aperture dimensions in cm (h/w/d)	177.2-178.8 / 56-57 / at least 55
Separately adjustable cooling circuits	2 - DuoCooling

Door assembly	Door on door
Net capacity	178 litre
	178 litre
	67 litre
	62 litre
Energy efficiency class (kWh in 365 days)	$\leq A$ (298 kWh)
Climate rating	SN-ST
Aperture dimensions in cm (h/w/d)	177.2-178.8 / 56-57 / at least 55
Separately adjustable cooling circuits	2 - DuoCooling

Electronic control system

- MagicEye with digital temperature display
- Automatic SuperCool function
- Audible door alarm
- Control lamp for mains, alarm and SuperCool

Fridge compartment

- Automatic defrosting
- Forced air cooling with fan
- GlassLine storage shelves - 1 sectioned, with slide under half shelf option
- GlassLine storage racks with bottle and can holders
- Smooth, easy-to-clean compartment liner with elegant holding columns for rearrangement of the glass shelves
- LED interior light with Premium models
- LED light column on either side for even, high-class illumination of the interior with PremiumPlus models
- Integrated bottle shelf for versatile use
- Swivel lid for butter and cheese compartment with egg tray

BioFresh compartment

- LED lighting with PremiumPlus models
- Automatic defrosting, forced air cooling
- Pull-out BioFresh safes mounted on telescopic rails
- DrySafe with low humidity - for fish, meat and dairy products
- HydroSafe with adjustable humidity for fruit and vegetables

Features

- SoftSystem to cushion door closure
- Door opening angle 115°
- Height-adjustable feet at the front
- Reversible door



An innovative and unique detail is the **integrated bottle shelf**. When you need to store very tall bottles, the bottle rack in the door can be moved upwards allowing the entire depth of the appliance to be used. Alternatively, the glass shelf under the bottle shelf can be utilised.



In the PremiumPlus appliances the BioFresh compartments have **LED lighting**, ensuring an ideal, clear view of the food stored inside. The LED lighting is elegantly integrated into the side wall for a flush finish.



Hallmarks of the PremiumPlus range are two **light columns** integrated into the liner on either side, inside which there are numerous LEDs ensuring uniform illumination of the interior. The special satin finish of the light cover creates a pleasant lighting atmosphere.

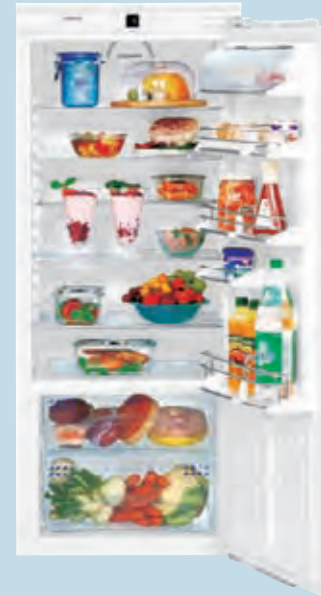

BioFresh fridges	IKB 3660 PremiumPlus 178	IKB 3454 PremiumPlus 178	IKB 2810 Premium 140	IKB 2410 Premium 122
Door assembly	Door on door	Door on door	Door on door	Door on door
Net capacity	Fridge compartment 307 litre including BioFresh compartment 91 litre Freezer compartment	Fridge compartment 261 litre 91 litre 27 litre	Fridge compartment 236 litre 60 litre	Fridge compartment 201 litre 60 litre
Energy efficiency class (kWh in 365 days)	<A> (166 kWh)	<A> (295 kWh)	<A> (156 kWh)	<A> (151 kWh)
Climate rating	SN-ST	SN-ST	SN-ST	SN-ST
Aperture dimensions in cm (h/w/d)	177.2-178.8 / 56-57 / at least 55	177.2-178.8 / 56-57 / at least 55	139.7-141.3 / 56-57 / at least 55	122-123.6 / 56-57 / at least 55



Type/model numbers	ICBN 3066 PremiumPlus	ICBN 3056 Premium	IKB 3660 PremiumPlus	IKB 3454 PremiumPlus	IKB 2810 Premium	IKB 2410 Premium
Model classification ¹	10	10	10	10	10	10
Energy efficiency class	<A+	<A+	<A+	<A+	<A+	<A+
Energy consumption in 365 days	298 kWh	298 kWh	166 kWh	295 kWh	156 kWh	151 kWh
Net capacity total	238 litre	240 litre	307 litre	288 litre	236 litre	201 litre
Fridge compartment	178 litre	178 litre	307 litre	261 litre	236 litre	201 litre
including BioFresh compartment	67 litre	67 litre	91 litre	91 litre	60 litre	60 litre
Freezer compartment	60 litre	62 litre		27 litre		
Star coding ²	★★★★	★★★★		★★★★		
Storage time during malfunctions	20 h	24 h		19 h		
Freezing capacity in 24h	10 kg	10 kg		2 kg		
Climate rating ³	SN-ST	SN-ST	SN-ST	SN-ST	SN-ST	SN-ST
Voltage/Connection rating	220-240 V / 1.0 A	220-240 V / 1.0 A	220-240 V / 0.8 A	220-240 V / 0.8 A	220-240 V / 0.8 A	220-240 V / 0.8 A
Fridge compartment						
Defrosting	Automatic	Automatic	Automatic	Automatic	Automatic	Automatic
Interior light	LED light column	LED	LED light column	LED light column	LED	LED
SuperCool	•	•	•	•	•	•
BioFresh-Safes	2	2	3	3	2	2
BioFresh lighting	LED		LED	LED		
Bottle shelf	integrated, for variable use	integrated, for variable use	integrated, for variable use	integrated, for variable use	integrated, for variable use	integrated, for variable use
Door interior	GlassLine	GlassLine	GlassLine	GlassLine	GlassLine	GlassLine
Freezer compartment						
NoFrost/SmartFrost	NoFrost	NoFrost				
Defrosting	Automatic	Automatic		Manual		
SuperFrost	Quantity controlled	Quantity controlled				
Cold storage accumulators	2	2				
Ice cube tray		•		•		
IceMaker ⁴	fixed water connection					
Ice cube capacity in 24 h	0.8 kg					
Ice cube stock	1 kg					
Type of appliance						
Door assembly	Door on door	Door on door	Door on door	Door on door	Door on door	Door on door
Dimensions						
Height	177.2 - 178.8 cm	177.2 - 178.8 cm	177.2 - 178.8 cm	177.2 - 178.8 cm	139.7 - 141.3 cm	122 - 123.6 cm
Width/Depth incl. distance from wall	56-57 / at least 55	56-57 / at least 55	56-57 / at least 55	56-57 / at least 55	56-57 / at least 55	56-57 / at least 55
Features						
Door alarm	audible	audible	audible	audible	audible	audible
Temperature alarm	visual and audible	visual and audible				
SoftSystem	•	•	•	•	•	•

1) Model classification 10: BioFresh appliances

2) ★★★★★ = freezer compartment with -18 °C or colder

3) Climate Ratings: SN +10 °C to +32 °C, N +16 °C to +32 °C, ST +16 °C to +38 °C, T +16 °C to +43 °C

4) IceMaker – automatic ice-cube maker (can be switched off) with fixed water connection and solenoid valve (needs to be plumbed in)

Fridge-freezers



The **NoFrost system** from Liebherr provides rapid, fan-assisted, frost-free freezing for the safe, long-term storage of food. The NoFrost technology creates a much larger storage capacity and keeps the freezer constantly frost-free to make defrosting a thing of the past.



SmartFrost system
Compared to other static freezers, Liebherr's SmartFrost technology freezes food faster, and reduces ice build-up by 50%, making defrosting simpler and quicker. It also provides a more flexible storage area with greater capacity and improved energy consumption for lower running costs.



All **transparent drawers** are extra deep. They are designed so that all frozen foods, from a duck to a boxed pizza, will fit conveniently and neatly, and are easy to remove. Every drawer can be used for both freezing and storage, so there's no need to repack the food once it has been frozen.



The **SoftSystem** ensures that the door closes gently even when fully loaded. The door closes automatically from an opening angle of approximately 30°.



The **IceMaker** provides you with a constant supply of ice cubes for every occasion. Whether you fancy a cold drink or you're having a big party, the IceMaker automatically keeps your supplies topped up.



A special quality of light
A special quality of interior illumination is created with the innovative LED light housing in all the single door-on-door fridges of the Premium range. What's more, the LED technology means that the light housing is compactly incorporated into the compartment liner.

Electronic control system

- MagicEye with digital temperature display for refrigerator and freezer compartment (with ICN models)
- MagicEye with LED temperature display (with IC 3013 and ICS 3113)
- Separate temperature regulation for refrigerator and freezer compartment using buttons (with ICN models)
- Separate temperature regulation for refrigerator compartment and freezer compartment (with IC 3013 and ICS 3113)
- Automatic SuperCool function (with ICN models)
- Automatic SuperFrost function, quantity-controlled (with ICN models)
- Automatic SuperFrost function, time-controlled (with IC 3013 and ICS 3113)
- Visual and audible warning signal in case of malfunction
- Audible door alarm (with ICN models)
- Control lamp for mains, alarm, SuperCool, SuperFrost, FrostControl and child lock (with ICN models)
- Control lamp for mains, alarm, SuperFrost (with IC 3013 and ICS 3113)

Fridge compartment

- Automatic defrosting
- Forced air cooling with fan
- GlassLine storage shelves - 1 sectioned, with slide under half shelf option
- GlassLine storage racks with bottle and can holders (with ICN models)
- Comfort GlassLine door rack with glass shelf and plastic frame (with IC 3013 and ICS 3113)
- Smooth, easy-to-clean compartment liner with elegant holding columns for rearrangement of the glass shelves
- LED interior light (with ICN models)
- Interior light (with IC 3013 and ICS 3113)
- Fruit and vegetables drawers with pull-out roller system (with ICN models)
- Fruit and vegetable drawers (with IC 3013 and ICS 3113)
- Swivel lid for butter and cheese compartment with egg tray (with ICN models)

Freezer compartment

- NoFrost: Automatic defrosting (with ICN models)
- Forced air cooling (with ICN models)
- SmartFrost: Easy defrosting with smooth and easy-to-clean interior (with IC 3013 and ICS 3113)
- FrostSafe system with completely enclosed, transparent drawers
- VarioSpace due to removable drawers and intervening glass shelves
- IceMaker with fixed water connection (with ICN 3066)
- Ice cube tray (except ICN 3066)

Features

- SoftSystem to cushion door closure (with ICN models)
- Height-adjustable feet at the front
- Reversible door



The transparent vegetable bins provide a clear view of the stored food and slide out effortlessly on the **roller system**. The roller plates integrated in the floor of the liner are easy to remove for cleaning.



DuoCooling uses two separate cooling circuits to independently control fridge and freezer compartment temperatures.

With DuoCooling there is no air exchange between fridge and freezer compartments so odour transfer is prevented and food is stored in optimum conditions.



The highly efficient forced **air system** ensures that freshly stored food is rapidly cooled down and that the cooling temperature is uniform throughout the interior. The fan is switched off by a door contact when the door is opened, saving valuable energy.



Fridge-freezers	ICN 3066 Premium 178	ICN 3056 Premium 178	IC 3013 Comfort 178	ICS 3113 Comfort 178
Door assembly	Door on door	Door on door	Door on door	Door slider
Net capacity	Fridge compartment 200 litre Freezer compartment 60 litre	Fridge compartment 200 litre Freezer compartment 62 litre	Fridge compartment 200 litre Freezer compartment 81 litre	Fridge compartment 231 litre Freezer compartment 57 litre
Energy efficiency class (kWh in 365 days)	<A> (292 kWh)	<A> (292 kWh)	<A> (303 kWh)	<A> (292 kWh)
Climate rating	SN-T	SN-T	SN-T	SN-T
Aperture dimensions in cm (h/w/d)	177.2-178.8 / 56-57 / at least 55	177.2-178.8 / 56-57 / at least 55	177.2-178.8 / 56-57 / at least 55	177.2-178.8 / 56-57 / at least 55
Separately adjustable cooling circuits	2 - DuoCooling	2 - DuoCooling	2 - DuoCooling	2 - DuoCooling

Electronic control system

- MagicEye with LED temperature display
- Temperature regulation for the refrigerator compartment
- Automatic SuperFrost function, time-controlled
- Control lamp for mains and SuperFrost
- Visual and audible warning signal in case of malfunction (ICUNS 3013)

Fridge compartment

- Automatic defrosting
- Forced air cooling with ICUNS models
- GlassLine storage shelves - 1 sectioned, with slide under half shelf option
- Comfort GlassLine door rack with dividers
- Smooth, easy-to-clean compartment liner with elegant holding columns for rearrangement of the glass shelves
- Interior light
- Fruit and vegetable drawers
- Egg tray

Freezer compartment

- NoFrost: Automatic defrosting (with ICUNS)
- Forced air cooling (with ICUNS)
- SmartFrost: Easy defrosting with smooth and easy-to-clean interior (with ICUS models)
- FrostSafe system with completely enclosed, transparent drawers
- VarioSpace due to removable drawers and intervening glass shelves
- Ice cube tray

Features

- Height-adjustable feet at the front
- Reversible door

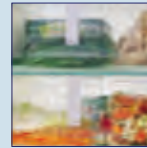

All transparent drawers are extra deep. They are designed so that all frozen foods, from a duck to a boxed pizza, will fit conveniently and neatly, and are easy to remove. Every drawer can be used for both freezing and storage, so there's no need to repack the food once it has been frozen.



SmartFrost system
Compared to other static freezers, Liebherr's SmartFrost technology freezes food faster, and reduces ice build-up by 50%, making defrosting simpler and quicker. It also provides a more flexible storage area with greater capacity and improved energy consumption for lower running costs.



VarioSpace
Freezer drawers and glass shelves can be removed. VarioSpace allows for practical storage solutions for all types of larger produce.



Fridge-freezers	ICUNS 3013 Comfort 178	ICUS 3013 Comfort 178	ICUS 2913 Comfort 158
Door assembly	Door slider	Door slider	Door slider
Net capacity Fridge compartment	200 litre	201 litre	190 litre
Freezer compartment	62 litre	81 litre	57 litre
Energy efficiency class (kWh in 365 days)	$\triangleleft A_1 >$ (335.8 kWh)	$\triangleleft A_1 >$ (288.4 kWh)	$\triangleleft A_1 >$ (259.2 kWh)
Climate rating	SN-T	SN-ST	SN-ST
Aperture dimensions in cm (h/w/d)	177.2-178.8 / 56-57 / at least 55	177.2-178.8 / 56-57 / at least 55	157.4-159 / 56-57 / at least 55

Fridge-freezers for integrated use



Type/model numbers	ICN 3066 Premium	ICN 3056 Premium	IC 3013 Comfort	ICS 3113 Comfort	ICUNS 3013 Comfort	ICUS 3013 Comfort	ICUS 2913 Comfort
Model classification ¹	07	07	07	07	07	07	07
Energy efficiency class	<A>	<A>	<A>	<A>	<A>	<A>	<A>
Energy consumption in 365 days	292 kWh	292 kWh	303 kWh	292 kWh	335.8 kWh	288.4 kWh	259.2 kWh
Net capacity total	260 litre	262 litre	281 litre	288 litre	262 litre	282 litre	247 litre
Fridge compartment	200 litre	200 litre	200 litre	231 litre	200 litre	201 litre	190 litre
Freezer compartment	60 litre	62 litre	81 litre	57 litre	62 litre	81 litre	57 litre
Star coding ²	★★★★	★★★★	★★★★	★★★★	★★★★	★★★★	★★★★
Storage time during malfunctions	20 h	24 h	30 h	30 h	30 h	30 h	30 h
Freezing capacity in 24h	10 kg	10 kg	14 kg	10 kg	4 kg	6 kg	6 kg
Climate rating ³	SN-T	SN-T	SN-T	SN-T	SN-T	SN-ST	SN-ST
Voltage/Connection rating	220-240 V / 1.0 A	220-240 V / 1.0 A	220-240 V / 1.0 A	220-240 V / 1.0 A	220-240 V / 1.0 A	220-240 V / 1.0 A	220-240 V / 1.0 A
Fridge compartment							
Defrosting	Automatic	Automatic	Automatic	Automatic	Automatic	Automatic	Automatic
Interior light	LED	LED	light bulb	light bulb	light bulb	light bulb	light bulb
PowerCooling	•	•	•	•	•		
SuperCool	•	•					
Fruit and vegetable drawers	2	2	2	2	2	2	2
Door interior	GlassLine	GlassLine	Comfort GlassLine	Comfort GlassLine	Comfort GlassLine	Comfort GlassLine	Comfort GlassLine
Freezer compartment							
NoFrost/SmartFrost	NoFrost	NoFrost	SmartFrost	SmartFrost	NoFrost	SmartFrost	SmartFrost
Defrosting	Automatic	Automatic	Manual	Manual	Automatic	Manual	Manual
SuperFrost	Quantity controlled	Quantity controlled	Time controlled	Time controlled	Time controlled	Time controlled	Time controlled
Cold storage accumulators	2	2	2	2	2	2	2
IceMaker ⁴	fixed water connection						
Ice cube capacity in 24 h	0.8 kg						
Ice cube stock	1 kg						
Type of appliance							
Door assembly	Door on door	Door on door	Door on door	Door slider	Door slider	Door slider	Door slider
Dimensions							
Height	177.2 - 178.8 cm	177.2 - 178.8 cm	177.2 - 178.8 cm	177.2 - 178.8 cm	177.2 - 178.8 cm	177.2 - 178.8 cm	157.4 - 159 cm
Width/Depth incl. distance from wall	56-57 / at least 55	56-57 / at least 55	56-57 / at least 55	56-57 / at least 55	56-57 / at least 55	56-57 / at least 55	56-57 / at least 55
Features							
SoftSystem	•	•					

1) Model classification 7: Fridge-freezers (4-star freezer compartment)

2) ★★★★★ = freezer compartment with -18 °C or colder

3) Climate Ratings: SN +10 °C to +32 °C
N +16 °C to +32 °C
ST +16 °C to +38 °C
T +16 °C to +43 °C

4) IceMaker – automatic ice-cube maker (can be switched off) with fixed water connection and solenoid valve (needs to be plumbed in)

Attractive, practical, energy-saving: the single door Premium fridges



Super savings in energy consumption.

Many Liebherr fridges come in the best energy efficiency classes A+ and A++ and are therefore the top energy savers in any home - day in, day out. Deploying state-of-the-art electronic control units in conjunction with optimised refrigerating systems has achieved a further significant reduction in energy consumption in comparison with previous economical models.



Vegetable drawers on removable rollers

The transparent vegetable drawers running on rollers are designed to form a harmonious synthesis with the interior and provide a clear view of the stored food. They slide out effortlessly on the roller system. The roller plates, integrated in the floor of the liner come as standard in all the single door-on-door fridges in the Premium range, without BioFresh, from the 122 cm aperture size upwards.



A special quality of light

A special quality of interior illumination is created with the innovative LED light housing in all the single door-on-door fridges of the Premium range. What's more, the LED technology means that the light housing is compactly incorporated into the compartment liner.

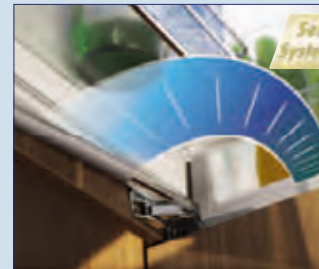

The **SoftSystem** ensures that the door closes gently even when fully loaded. The door closes automatically from an opening angle of approximately 30°.



The clearly laid out, precision **control system with MagicEye** ensures that the digitally displayed temperature you select is kept exactly to the degree chosen. The clear arrangement of the function buttons makes for easy and convenient use in IKP models.



Important features of the **compartment liner** in the single-door fridges are two elegant vertical support columns on either side at the front and rear, lit by numerous LEDs. The inner liner is designed to make shelf adjustment easy. This concept ensures greater flexibility when rearranging the glass shelves. A further advantage is the smooth compartment liner, making it easy-to-clean.

Electronic control system

- MagicEye with digital temperature display
- Temperature regulation for refrigerator compartment
- Automatic SuperCool function
- Control lamp for mains and SuperCool

Fridge compartment

- Automatic defrosting
- GlassLine storage shelves - 1 sectioned, with slide under half shelf option
- GlassLine storage racks with bottle and can holders
- Smooth, easy-to-clean compartment liner with elegant holding columns for rearrangement of the glass shelves
- LED interior light
- Fruit and vegetables drawers with pull-out roller system (except IKP 2050)
- Bottle shelf (with IKP 2850 and IKP 2450)
- Swivel lid for butter and cheese compartment with egg tray

Features

- SoftSystem to cushion door closure
- Door opening angle 115°
- Height-adjustable feet at the front
- Reversible door

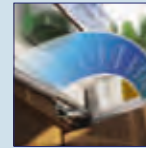

The **SoftSystem** feature provides added safety and convenience. Integrated on the door, the SoftSystem cushions movement when the door is closed. This SoftSystem ensures that the door closes gently even when fully loaded. The door closes automatically from an opening angle of approximately 30 °.



The transparent **vegetable drawers running on rollers** are designed to form a harmonious synthesis with the interior and provide a clear view of the stored food. They slide out effortlessly on the roller system. The roller plates, integrated in the floor of the liner, come as standard in all the single door-on-door fridges of the Premium range without BioFresh from an aperture size of 122 cm upwards.



The innovative **LED light housing** creates first class interior illumination. What's more, the LED technology means that the light housing compactly incorporates into the compartment liner.



Fridges	IKP 2850 Premium 140	IKP 2654 Premium 140	IKP 2450 Premium 122	IKP 2050 Premium 102
Door assembly	Door on door	Door on door	Door on door	Door on door
Net capacity	Fridge compartment 259 litre Freezer compartment	222 litre 20 litre	224 litre	184 litre
Energy efficiency class (kWh in 365 days)	<A> (139 kWh)	<A++> (172 kWh)	<A> (134 kWh)	<A> (128 kWh)
Climate rating	SN-T	N-ST	SN-T	SN-T
Aperture dimensions in cm (h/w/d)	139.7-141.3 / 56-57 / at least 55	139.7-141.3 / 56-57 / at least 55	122-123.6 / 56-57 / at least 55	102.4-104 / 56-57 / at least 55

Electronic control system

- MagicEye with LED temperature display
- Automatic SuperCool function
- Control lamp for mains and SuperCool

Fridge compartment

- Automatic defrosting
- Forced air cooling with fan (with IK 3620 and IK 3414)
- GlassLine storage shelves - 1 sectioned, with slide under half shelf option
- Comfort GlassLine door rack with glass shelf and plastic frame
- Smooth, easy-to-clean compartment liner with elegant holding columns for rearrangement of the glass shelves
- Interior light
- Fruit and vegetable drawers mounted on telescopic rails (with IK 3620 and IK 3414)
- Fruit and vegetable drawers (with IK 2214 and IK 2410)
- Egg tray

Freezer compartment

- Ice cube tray (with IK 2214 and IK 3414)

Features

- Door opening angle 115°
- Height-adjustable feet at the front
- Reversible door



The highly efficient forced air system ensures that freshly stored food is rapidly cooled down and that the cooling temperature is uniform throughout the interior. The fan is switched off by a door contact when the door is opened, saving valuable energy.



The elegant **GlassLine shelves** made of safety glass are shatter-proof, scratch-resistant and easy-to-clean. The high-quality stainless steel trims are the perfect complement. The height-adjustable shelves can be relocated to suit personal requirements at any time.



The automatic **SuperCool** function lowers the refrigerator temperature down to as far as +2°C - ideal for rapidly cooling freshly stored food.



Fridges	IK 3620 Comfort 178	IK 3414 Comfort 178	IK 2410 Comfort 122	IK 2214 Comfort 122
Door assembly	Door on door	Door on door	Door on door	Door on door
Net capacity	Fridge compartment 330 litre	282 litre	224 litre	190 litre
	Freezer compartment	27 litre		16 litre
Energy efficiency class (kWh in 365 days)	<A> (149 kWh)	<A> (273 kWh)	<A> (134 kWh)	<A> (223 kWh)
Climate rating	SN-T	N-ST	SN-T	N-ST
Aperture dimensions in cm (h/w/d)	177.2-178.8 / 56-57 / at least 55	177.2-178.8 / 56-57 / at least 55	122-123.6 / 56-57 / at least 55	122-123.6 / 56-57 / at least 55

- **Electronic control system**
- MagicEye with LED temperature display (IK 1710)
- Automatic SuperCool function
- Control lamp for mains and SuperCool

Fridge compartment

- Automatic defrosting
- GlassLine storage shelves - 1 sectioned, with slide under half shelf option
- Comfort GlassLine door rack with glass shelf and plastic frame
- Smooth, easy-to-clean compartment liner with elegant holding columns for rearrangement of the glass shelves
- Interior light
- Fruit and vegetable drawers
- Egg tray

Features

- Door opening angle 115° (with IK 1504 and IK 1710)
- Height-adjustable feet at the front
- Reversible door



The clearly laid out, precision control system with **MagicEye** keeps the temperature at exactly the level you select. It is simple and convenient to use. The SuperCool function is ideal if you want to chill fresh food quickly.



The elegant **GlassLine shelves** made of safety glass are shatter-proof, scratch-resistant and easy-to-clean. The high-quality stainless steel trims are the perfect complement. The height-adjustable shelves can be relocated to suit personal requirements at any time.



Models in the Comfort range come with **Comfort GlassLine**: high quality glass equipment for the door interior. Comfort GlassLine shelves made of satin finished safety glass with steel railings and plastic surround. The can and bottle racks have an adjustable holder for secure storage of the food in the door interior.



Fridges	IK 1710 Comfort 88	IK 1504 Comfort 88	IKS 2420 Comfort 122	IKS 1720 Comfort 88
Door assembly	Door on door	Door on door	Door slider	Door slider
Net capacity	Fridge compartment 152 litre	Fridge compartment 118 litre	Fridge compartment 227 litre	Fridge compartment 155 litre
	Freezer compartment 16 litre	Freezer compartment 16 litre	Freezer compartment 16 litre	Freezer compartment 16 litre
Energy efficiency class (kWh in 365 days)	<A> (124 kWh)	<A> (192 kWh)	<A> (132 kWh)	<A> (122 kWh)
Climate rating	SN-T	N-ST	SN-ST	SN-ST
Aperture dimensions in cm (h/w/d)	87.4-89 / 56-57 / at least 55	87.4-89 / 56-57 / at least 55	122-123.6 / 56-57 / at least 55	87.4-89 / 56-57 / at least 55



A special feature in the fridges with décor panel is the **MagicEye with LED temperature display**. It is easy and convenient to use.



The exquisite **GlassLine equipment** puts the finishing touches to the high quality and overall impression of the stylish interior. The shelves and the storage racks in the inner door are made of glass with stainless steel trims. Two easily attachable plastic components mean it can now be inserted at different heights, as required.



The automatic **SuperCool** function lowers the refrigerator temperature down as low as +2°C - ideal for rapidly cooling freshly stored food.



Electronic control system

- MagicEye with LED Temperature display
- Automatic SuperCool function
- Control lamp for mains and SuperCool

Fridge compartment

- Automatic defrosting
- GlassLine storage shelves - 1 sectioned, with slide under half shelf option
- GlassLine storage racks with bottle and can holders
- Smooth, easy-to-clean compartment liner with elegant holding columns for rearrangement of the glass shelves
- Interior light
- Fruit and vegetable drawers
- Swivel lid for butter and cheese compartment with egg tray

Features

- Height-adjustable feet at the front
- Reversible door



Fridges	EK 2450 Comfort ¹²²	EK 1750 Comfort ⁸⁸
	with décor panel	with décor panel
Door assembly	flush	flush
Net capacity Fridge compartment	227 litre	155 litre
Energy efficiency class (kWh in 365 days)	<A> (132 kWh)	<A> (122 kWh)
Climate rating	SN-ST	SN-ST
Aperture dimensions in cm (h/w/d)	122-122.6 / 56-57 / at least 55	87.4-88 / 56-57 / at least 55



Type/model numbers	IKP 2850 Premium	IKP 2654 Premium	IKP 2450 Premium	IKP 2050 Premium	IK 3620 Comfort	IK 3414 Comfort	IK 2410 Comfort	IK 2214 Comfort	IK 1710 Comfort	IK 1504 Comfort	IKS 2420 Comfort	IKS 1720 Comfort	EK 2450 Comfort	EK 1750 Comfort
Model classification ¹	01	07	01	01	01	07	01	07	01	07	01	01	01	01
Energy efficiency class	<A>	<A>+	<A>	<A>	<A>+	<A>+	<A>	<A>	<A>	<A>	<A>	<A>	<A>	<A>
Energy consumption in 365 days	139 kWh	172 kWh	134 kWh	128 kWh	149 kWh	273 kWh	134 kWh	223 kWh	124 kWh	192 kWh	132 kWh	122 kWh	132 kWh	122 kWh
Net capacity total	259 litre	242 litre	224 litre	184 litre	330 litre	309 litre	224 litre	206 litre	152 litre	134 litre	227 litre	155 litre	227 litre	155 litre
Fridge compartment	259 litre	222 litre	224 litre	184 litre	330 litre	282 litre	224 litre	190 litre	152 litre	118 litre	227 litre	155 litre	227 litre	155 litre
Freezer compartment		20 litre				27 litre		16 litre		16 litre				
Star coding ²		★★★★				★★★★		★★★★		★★★★				
Storage time during malfunctions	15 h	15 h				15 h		15 h		15 h				
Freezing capacity in 24h		2 kg				2 kg		2 kg		2 kg				
Climate rating ³	SN-T	N-ST	SN-T	SN-T	SN-T	N-ST	SN-T	N-ST	SN-T	N-ST	SN-ST	SN-ST	SN-ST	SN-ST
Voltage/Connection rating	220-240 V / 0.8 A	220-240 V / 1.2 A	220-240 V / 0.8 A	220-240 V / 0.8 A	220-240 V / 0.8 A	220-240 V / 0.8 A	220-240 V / 0.8 A	220-240 V / 1.2 A	220-240 V / 0.8 A	220-240 V / 1.2 A	220-240 V / 0.8 A	220-240 V / 0.8 A	220-240 V / 0.8 A	220-240 V / 0.8 A
Fridge compartment														
Defrosting	Automatic	Automatic	Automatic	Automatic	Automatic	Automatic	Automatic	Automatic	Automatic	Automatic	Automatic	Automatic	Automatic	Automatic
Interior light	LED	LED	LED	LED	light bulb	light bulb	light bulb	light bulb	light bulb	light bulb	light bulb	light bulb	light bulb	light bulb
PowerCooling	•				•	•								
SuperCool	•	•	•	•	•	•	•	•	•	•	•	•	•	•
Fruit and vegetable drawers	2	2	2	2	2	2	2	2	2	2	2	2	2	2
Bottle shelf	bottle rack		bottle rack											
Door interior	GlassLine	GlassLine	GlassLine	GlassLine	Comfort GlassLine	Comfort GlassLine	Comfort GlassLine	Comfort GlassLine	Comfort GlassLine	Comfort GlassLine	Comfort GlassLine	Comfort GlassLine	GlassLine	GlassLine
Freezer compartment														
Defrosting		Manual				Manual		Manual		Manual				
Ice cube tray		•				•		•		•				
Type of appliance														
Built-in-/under-worktop appliance	integrated / -	integrated / -	integrated / -	integrated / -	integrated / -	integrated / -	integrated / -	integrated / -	integrated / -	integrated / -	integrated / -	integrated / -	décor panel / -	décor panel / -
Door assembly	Door on door	Door on door	Door on door	Door on door	Door on door	Door on door	Door on door	Door on door	Door on door	Door on door	Door slider	Door slider	flush	flush
Dimensions														
Height	139.7 - 141.3 cm	139.7 - 141.3 cm	122 - 123.6 cm	102.4 - 104 cm	177.2 - 178.8 cm	177.2 - 178.8 cm	122 - 123.6 cm	122 - 123.6 cm	87.4 - 89 cm	87.4 - 89 cm	122 - 123.6 cm	87.4 - 89 cm	122 - 122.6 cm	87.4 - 88 cm
Width/Depth incl. distance from wall	56-57 / at least 55	56-57 / at least 55	56-57 / at least 55	56-57 / at least 55	56-57 / at least 55	56-57 / at least 55	56-57 / at least 55	56-57 / at least 55	56-57 / at least 55	56-57 / at least 55	56-57 / at least 55	56-57 / at least 55	56-57 / at least 55	56-57 / at least 55
Features														
SoftSystem	•	•	•	•										

1) Model classification
Model classification

7: Fridge-freezers (4-star freezer compartment)
1: Fridges

2) ★★★★★ = freezer compartment with -18 °C or colder

3) Climate Ratings:
SN +10 °C to +32 °C
N +16 °C to +32 °C
ST +16 °C to +38 °C
T +16 °C to +43 °C



Illustration: UK 1720

Build under fridges



Front ventilation

Air flow on Liebherr undercounter appliances enters and exits at the front of the appliance. This happens at plinth level or at the top edge of the appliance depending on the model type. The advantage is no ventilation grill is required in the worktop.



UK 1610 is suitable for Side-by-Side installation in conjunction with the UIG 1313 under-worktop freezer for integrated use (fridge must be on the left).



The elegant **GlassLine shelves** made of safety glass are shatter-proof, scratch-resistant and easy-to-clean. The high-quality stainless steel trims are the perfect complement. The height-adjustable shelves can be relocated to suit personal requirements at any time.



The precision control system of the UK models creates a stunning visual impact. This precision electronic control system enhances the ease and convenience of use. The **SuperCool function** quickly reduces the temperature of the fridge compartment; ideal for rapidly cooling down freshly stored food.



Attractive and practical. The food inside your KIUe 1350 fridge is easy-to-see and access with the practical pullout shelves and drawer.



Models in the Comfort range come with **Comfort GlassLine**: high quality glass equipment for the door interior. Comfort GlassLine features are shelves made of satin finished safety glass with steel railings and plastic surround. The can and bottle racks have an adjustable holder for secure storage of the food in the door interior.

Electronic control system

- MagicEye with LED refrigerator temperature display (with UIK 1414 and UIK 1610)
- Automatic SuperCool function (with UIK 1414 and UIK 1610)
- Control lamp for mains and SuperCool (with UIK models)

Fridge compartment

- Automatic defrosting
- GlassLine storage shelves - 1 sectioned, with slide under half shelf option (except KIUe 1350)
- Interior light
- Fruit and vegetable drawers
- Egg tray

Features

- Door opening angle 115° (with UIK models)
- Front ventilation and air extraction therefore no ventilation grill in the worktop necessary
- Variable plinth: height and depth can be adjusted in line with other kitchen units (except UK 1720)
- Feet at the back can be adjusted from the front with UIK models
- Reversible door (except KIUe 1350)



Attractive and practical. The food inside your fridge is easy-to-see and access with the practical pullout shelves and drawer.



Front ventilation
Air flow on Liebherr undercounter appliances enters and exits at the front of the appliance.

This happens at plinth level or at the top edge of the appliance depending on the model type. The advantage is no ventilation grill is required in the worktop.



The precision control system of the UIK models creates a stunning visual impact. This precision electronic control system enhances the ease and convenience of use. The **SuperCool function** quickly reduces the temperature of the fridge compartment; ideal for rapidly cooling down freshly stored food.







Build under fridges	KIUe 1350 Premium 	UIK 1610 Comfort 	UIK 1414 Comfort 	UK 1720 Comfort 
Door assembly	pull-out drawer	Door on door	Door on door	flush
Net capacity	Fridge compartment 112 litre Freezer compartment	137 litre	98 litre 16 litre	152 litre
Energy efficiency class (kWh in 365 days)	<A> (146 kWh)	<A> (118.6 kWh)	<A> (223 kWh)	<A> (117.5 kWh)
Climate rating	SN-T	SN-T	N-ST	SN
Aperture dimensions in cm (h/w/d)	87-92 / 60 / at least 55.3	82-87 / 60 / at least 55	82-87 / 60 / at least 55	82 / 60 / at least 57
				with décor panel



Illustration: UIK 1414



Type/model numbers	KIUe 1350 Premium	UIK 1610 Comfort	UIK 1414 Comfort	UK 1720 Comfort
Model classification ¹	01	07	07	07
Energy efficiency class	<A>	<A>	<A>	<A>
Energy consumption in 365 days	146 kWh	118.6 kWh	223 kWh	117.5 kWh
Net capacity total	112 litre	137 litre	114 litre	152 litre
Fridge compartment	112 litre	137 litre	98 litre	152 litre
Freezer compartment			16 litre	
Star coding ²			★★★★	
Storage time during malfunctions			12 h	
Freezing capacity in 24h			2 kg	
Climate rating ³	SN-T	SN-T	N-ST	SN
Voltage/Connection rating	220-240 V / 0.8 A	220-240 V / 1.2 A	220-240 V / 1.2 A	220-240 V / 1.2 A
Fridge compartment				
Defrosting	Automatic	Automatic	Automatic	Automatic
Interior light	light bulb	light bulb	light bulb	light bulb
Fruit and vegetable drawers	1	1	1	2
Door interior		plastic	plastic	Comfort GlassLine
Freezer compartment				
Defrosting			Manual	
Type of appliance				
Built-in-/Under-worktop appliance	- / integrated	- / integrated	- / integrated	- / décor panel
Door assembly	Door on door	Door on door	Door on door	flush
Dimensions				
Height	87 - 92 cm	82 - 87 cm	82 - 87 cm	82 cm
Width/Depth incl. distance from wall	60 / at least 55.3	60 / at least 55	60 / at least 55	60 / at least 57

1) Model classification 1: Fridges 2) ★★★★★ = freezer compartment with -18 °C or colder 3) Climate Ratings: SN +10 °C to +32 °C
 N +16 °C to +32 °C
 ST +16 °C to +38 °C
 T +16 °C to +43 °C

Low energy Built-in freezers

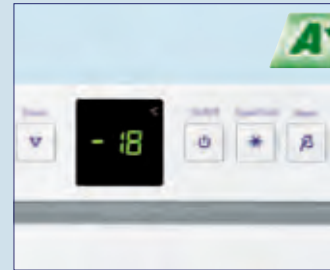

A special feature in the freezers of the Premium range is the clearly laid out, precision control system with **MagicEye**. This ensures accurate temperature control. Clearly arranged function buttons make the appliance simple and convenient to operate. The automatic SuperFrost function freezes food rapidly while preserving the vitamins.



The **NoFrost system** from Liebherr provides rapid, fan-assisted, frost-free freezing for the safe, long-term storage of food. The NoFrost technology creates a much larger storage capacity and keeps the freezer constantly frost-free to make defrosting a thing of the past.



SmartFrost system
Compared to other static freezers, Liebherr's SmartFrost technology freezes food faster, and reduces ice build-up by 50%, making defrosting simpler and quicker. It also provides a more flexible storage area with greater capacity and improved energy consumption for lower running costs.



The **SoftSystem** ensures that the door closes gently even when fully loaded. The door closes automatically from an opening angle of approximately 30°.



VarioSpace
Freezer drawers and glass shelves can be removed. VarioSpace - the practical storage solutions for larger produce.



All **transparent drawers** are extra deep. They are designed so that all frozen foods, from a duck to a boxed pizza, will fit conveniently and neatly, and are easy to remove. Every drawer can be used for both freezing and storage, so there's no need to repack the food once it has been frozen.

Electronic control system

- MagicEye with digital temperature display with Premium models
- MagicEye with LED temperature display with Comfort models
- SuperFrost function, quantity-controlled with Premium models
- SuperFrost function, time-controlled with Comfort models
- Visual and audible warning signal in case of malfunction
- Control lamp for mains, alarm and SuperFrost

Freezer compartment with IGN 2566

- NoFrost: Automatic defrosting
- Forced air cooling
- IceMaker with fixed water connection
- FrostSafe system with completely enclosed, transparent drawers
- Five drawers mounted on telescopic rails
- VarioSpace due to removable drawers and intervening glass shelves

Freezer compartment with SmartFrost models

- SmartFrost: Easy defrosting with smooth and easy-to-clean interior
- FrostSafe system with completely enclosed, transparent drawers
- VarioSpace due to removable drawers and intervening glass shelves

Features

- Door opening angle 115° (except IGS 1113)
- Height-adjustable feet
- Reversible door



The **IceMaker** provides you with a constant supply of ice cubes for every occasion. Whether you fancy a cold drink or you're having a big party, the IceMaker automatically keeps your supplies topped up.



VarioSpace Freezer drawers and glass shelves can be removed. VarioSpace allows for practical storage solutions for all types of larger produce.

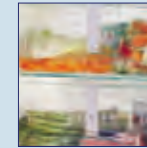

All **transparent drawers** are extra deep. They are designed so that all frozen foods, from a duck to a boxed pizza, will fit conveniently and neatly, and are easy to remove. Every drawer can be used for both freezing and storage, so there's no need to repack the food once it has been frozen.



Freezers	IGN 2566 Premium ↑ 178	IG 1956 Premium ↑ 140	IG 1156 Premium ↑ 88	IGS 1113 Comfort ↑ 88	EG 1113 Comfort ↑ 88
					with décor panel
Door assembly	Door on door	Door on door	Door on door	Door slider	flush
Net capacity	206 litre	186 litre	104 litre	104 litre	104 litre
Energy efficiency class (kWh in 365 days)	<A> (302.9 kWh)	<A> (259.2 kWh)	<A> (204.4 kWh)	<A> (204.4 kWh)	<A> (204.4 kWh)
Climate rating	SN-T	SN-T	SN-T	SN-T	SN-T
Aperture dimensions in cm (h/w/d)	177.2-178.8 / 56-57 / at least 55	139.7-141.3 / 56-57 / at least 55	87.4-89 / 56-57 / at least 55	87.4-89 / 56-57 / at least 55	87.4-88 / 56-57 / at least 55



Compared to other static freezers, Liebherr's **SmartFrost** technology freezes food faster, and reduces ice build-up by 50%, making defrosting simpler and quicker. It also provides a more flexible storage area with greater capacity and improved energy consumption for lower running costs.



VarioSpace
Freezer drawers and glass shelves can be removed. VarioSpace allows for practical storage solutions for all types of larger produce.

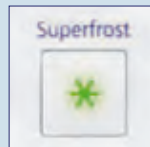

With the **automatic SuperFrost function**, temperatures down to as low as -32 °C are reached in no time. This means food can be frozen in an especially advantageous manner to preserve the vitamins, taste and appearance. After the freezing operation is over, the appliance switches back automatically to the normal mode.

Electronic control system

- MagicEye with LED temperature display
- Automatic SuperFrost function, time-controlled
- Visual and audible warning signal in case of malfunction
- Control lamp for mains, alarm and SuperFrost

Freezer compartment

- SmartFrost: Easy defrosting with smooth and easy-to-clean interior
- FrostSafe system with completely enclosed, transparent drawers
- VarioSpace due to removable drawers and intervening glass shelves

Features

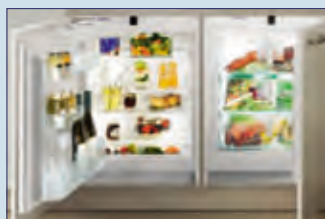

- Door opening angle 115°
- Front ventilation and air extraction therefore no ventilation grill in the worktop necessary
- Variable plinth: height and depth can be adjusted in line with other kitchen units
- 4 high adjustable feet at the front
- Reversible door



UIK 1610 is suitable for Side-by-Side installation in conjunction with the UIG 1313 under-worktop freezer for integrated use (fridge must be on the left).



Built under freezer
Door assembly
Net capacity
Energy efficiency class (kWh in 365 days)
Climate rating
Aperture dimensions in cm (h/w/d)

UIG 1313 Comfort	 	
Door on door	97 litre	<A+> (188 kWh)
Climate rating	SN-T	82-87 / 60 / at least 55



Type/model numbers	IGN 2566 Premium	IG 1956 Premium	IG 1156 Premium	IG 956 Premium	IGS 1113 Comfort	EG 1113 Comfort	UIG 1313 Comfort
Model classification ¹	08	08	08	08	08	08	08
Energy efficiency class	<A+>	<A+>	<A+>	<A+>	<A+>	<A+>	<A+>
Energy consumption in 365 days	302.9 kWh	259.2 kWh	204.4 kWh	186.2 kWh	204.4 kWh	204.4 kWh	188 kWh
Net capacity total	206 litre	186 litre	104 litre	77 litre	104 litre	104 litre	97 litre
Star coding ²	★★★★	★★★★	★★★★	★★★★	★★★★	★★★★	★★★★
Storage time during malfunctions	34 h	32 h	32 h	32 h	32 h	32 h	32 h
Freezing capacity in 24h	18 kg	16 kg	12 kg	11 kg	12 kg	12 kg	12 kg
Climate rating ³	SN-T	SN-T	SN-T	SN-T	SN-T	SN-T	SN-T
Voltage/Connection rating	220-240 V / 1.3 A	220-240 V / 0.9 A	220-240 V / 0.9 A	220-240 V / 0.9 A	220-240 V / 1.3 A	220-240 V / 1.3 A	220-240 V / 1.3 A
Freezer compartment							
NoFrost/SmartFrost	• / -	- / •	- / •	- / •	- / •	- / •	- / •
Defrosting	Automatic	Manual	Manual	Manual	Manual	Manual	Manual
VarioSpace	•	•	•	•	•	•	•
Cold storage accumulators	2	2	2	2	2	2	2
IceMaker ⁴	fixed water connection						
Ice cube capacity in 24 h	0.8 kg						
Ice cube stock	1.5 kg						
Type of appliance							
Built-in-/under-worktop appliance	integrated / -	integrated / -	integrated / -	integrated / -	integrated / -	décor panel / -	- / integrated
Door assembly	Door on door	Door on door	Door on door	Door on door	Door slider	flush	Door on door
Dimensions							
Height	177.2 - 178.8 cm	139.7 - 141.3 cm	87.4 - 89 cm	71.4 - 73 cm	87.4 - 89 cm	87.4 - 88 cm	82 - 87 cm
Width/Depth incl. distance from wall	56-57 / at least 55	56-57 / at least 55	56-57 / at least 55	56-57 / at least 55	56-57 / at least 55	56-57 / at least 55	60 / at least 55
Features							
Temperature alarm	visual and audible	visual and audible	visual and audible	visual and audible	visual and audible	visual and audible	visual and audible
SoftSystem	•	•	•	•	•	•	•
FrostSafe	•	•	•	•	•	•	•
FrostControl	•	•	•	•	•	•	•

1) Model classification 8: Freezers 2) ★★★★★ = freezer compartment with -18 °C or colder 3) Climate Ratings: SN +10 °C to +32 °C ST +16 °C to +38 °C N +16 °C to +32 °C T +16 °C to +43 °C 4) IceMaker – automatic ice-cube maker (can be switched off) with fixed water connection and solenoid valve (needs to be plumbed in)

Built-in wine cabinets

It is only under perfect conditions that a good wine can develop into a really excellent vintage and maintain its long-term value. Wine storage and multi-temperature wine cabinets from Liebherr are the ideal answer. Incorporating the latest climate technology, they provide the ideal conditions for wines to mature in peace and reach their peak of flavour. Featuring a state-of-the-art electronic control system, special compressors and a host of helpful features, such as the activated carbon filter and the specially designed doors with UV protection, these appliances are tailored for storing wine perfectly.



The Vinidor range

The Vinidor range combines the advantages of wine storage cabinets and multi-temperature wine cabinets in one appliance. This range offers two wine zones in which the temperature can be individually set to the exact degree required. This means that, for instance, red and white wine can be kept at their ideal serving temperatures in the same appliance. These cabinets also provide the ideal conditions for long-term storage of large quantities.

5 to 20 °C

5 to 20 °C



Wine storage cabinets

Wine storage cabinets are the ideal choice for storing larger wine collections over the long-term. However, these appliances are also ideally suited for keeping larger quantities at drinking temperature. The selected temperature is maintained at a uniform, constant level throughout the interior of wine storage cabinets.

5 to 20 °C



Perfect conditions for fine wines

No matter whether we're talking about wine production, storage or tasting, the right temperature is crucial. It's a vital factor in creating a perfect vintage. Not only for growing the grapes, for producing, maturing and storing the wine but, first and foremost, for the flavour. The temperature at which a wine is served is essential for savouring the flavour at its very best.



All the Vinidor appliances feature an innovative **LED lighting concept**. There is LED lighting in each temperature zone, integrated in the ceiling and in the insulation plates. This advanced technology ensures uniform illumination throughout the interior. Since any heat generated by the LEDs is minimal, wines can be presented, bathed in light, for a longer time period.



The wine storage cabinets from Liebherr have an **activated charcoal filter**, which can be easily changed, that purifies the incoming fresh air to obtain the optimum odour-free quality. Each wine compartment in the Vinidor appliances range has an activated charcoal filter of its own.



The Vinidor range features secure **wooden pull-out shelves** providing a good overview and convenient access to the bottles. The handmade shelves crafted from untreated wood are ideal for storing bottles of Bordeaux safely. Storing the bottles in opposite directions on the pull-out shelves permits full use of the capacity.

The built-in appliance WTEes 2053 comes with half-folding wooden shelves for presenting wines or storing open bottles.

Electronic control system

- Electronic control system in insulation panel
- Electronic temperature control, separately adjustable ranges, each between +5°C and +20°C
- Digital temperature display for upper and lower temperature range
- Visual and audible warning signal in case of malfunction
- Audible door alarm



Interior

- 2 separately adjustable temperature ranges
- Perfect climate conditions through forced air cooling and activated charcoal filter
- Control of humidity by shiftable ventilation
- WTEEs: 6 storage shelves, 4 of which are wooden pull-out shelves, of which 2 are foldable
- WTUes: 5 storage shelves, 3 of which are wooden pull-out shelves
- LED interior light can be dimmed or permanently switched on or off

The Vinidor appliances feature an innovative LED lighting concept. There is LED lighting in each temperature zone, integrated in the ceiling and in the insulation plates. This advanced technology ensures uniform illumination throughout the interior. Since any heat generated by the LEDs is minimal, wines can be presented, bathed in light, for a longer time period.

Features

- Reversible doors
- Elegant stainless steel handle
- Isolation tinted glazed door with stainless steel frame
- WTUes can be fitted under worktop; height of plinth can be adjusted by 50 mm with adjustable feet; ventilation and air extraction through the plinth, so no ventilation grill necessary in the work surface
- SoftSystem to cushion door closure (WTEes 2053)
- Lockable door



Electronic control system

- Electronic temperature control, one temperature range adjustable between +5°C and +20°C
- Touch electronic with WKEes 553
- Digital temperature display
- Visual and audible warning signal in case of malfunction
- Audible door alarm



Interior

- Perfect climate conditions through forced air cooling and activated charcoal filter
- WKUes: 4 storage shelves, 3 of which are pull-out grid shelves with front
- WKEes: 3 storage shelves, whereof 2 are wooden pull-out shelves
- LED interior light can be dimmed or permanently switched on or off
- WKUes: Interior light permanently shiftable

Accurately maintaining the right temperature is vital for wine to reach optimum maturity. The precision electronic Touch control system allows the temperature to be regulated to exactly the degree wanted ranging between 5°C and 20°C. All the functions can be simply and conveniently operated at the touch of a finger on the **electronic touch panel**. The temperature is indicated in the control display.

Features

- Reversible doors
- Elegant stainless steel handle with WKUes 1753
- Elegant recessed grip with WTEes 553
- Tinted isolation glazed door with stainless steel frame
- WKUes 1753 can be fitted under worktop; height of plinth can be adjusted by 50 mm with adjustable feet; ventilation and air extraction through the plinth, so no ventilation grill necessary in the work surface
- Lockable door with WKUes 1753



The wooden pull-out shelves provide an overview and convenient access to the bottles. The handmade shelves crafted from untreated wood are ideal for storing bottles of Bordeaux safely.



Built-in wine cabinets

WTEes 2053 Vinidor

122

WTUes 1653 Vinidor

82-87



Door assembly	flush
Net capacity	187 litre
Energy consumption (in 365 days)	207 kWh
Temperature zones	2
Temperature range	+5°C to +20°C
Max. No. of DIN norm bordeaux bottles 0.75 Ltr	64
Climate rating	SN-ST
Aperture dimensions in cm (h/w/d)	122.1-122.5 / 56-57 / at least 55

Door assembly	flush
Net capacity	126 litre
Energy consumption (in 365 days)	251 kWh
Temperature zones	2
Temperature range	+5°C to +20°C
Max. No. of DIN norm bordeaux bottles 0.75 Ltr	38
Climate rating	SN-ST
Aperture dimensions in cm (h/w/d)	82-87 / 60 / at least 58

Built-in wine cabinets

WKUes 1753 GrandCru

82-87

WKEes 553 GrandCru

45



Door assembly / material	flush
Net capacity	133 litre
Energy consumption (in 365 days)	179 kWh
Temperature zones	1
Temperature range	+5°C to +20°C
Max. No. of DIN norm bordeaux bottles 0.75 Ltr	59
Climate rating	SN-ST
Aperture dimensions in cm (h/w/d)	82-87 / 60 / at least 58

Door assembly / material	flush
Net capacity	47 litre
Energy consumption (in 365 days)	130 kWh
Temperature zones	1
Temperature range	+5°C to +20°C
Max. No. of DIN norm bordeaux bottles 0.75 Ltr	18
Climate rating	SN
Aperture dimensions in cm (h/w/d)	45 / 56 / at least 55



Type/model numbers	WTEs 2053 Vinidor	WTUs 1653 Vinidor	WKUs 1753 GrandCru	WKEs 553 GrandCru
Energy consumption in 365 days	207 kWh	251 kWh	179 kWh	130 kWh
Net capacity	187 litre	126 litre	133 litre	47 litre
Max. No. of DIN norm bordeaux bottles 0.75 Ltr	64	38	59	18
Climate rating ¹	SN-ST	SN-ST	SN-ST	SN
Voltage	220-240	220-240	220-240	220-240
Connection rating	1.2	1.0	1.0	0.5
wine storage compartment				
Temperature zones	2	2	1	1
Temperature range	+5°C to +20°C	+5°C to +20°C	+5°C to +20°C	+5°C to +20°C
Separately adjustable cooling circuits	2	2	1	1
Door	tinted glazed door	tinted glazed door	tinted glazed door	tinted glazed door
Type of control	MagicEye with digital temperature display internal digital	MagicEye with digital temperature display internal digital	MagicEye with digital temperature display internal digital	MagicEye with digital temperature display internal digital
Temperature display	internal digital	internal digital	internal digital	internal digital
Child proof function	•	•	•	•
Malfunction: Warning signal	visual and audible	visual and audible	visual and audible	visual and audible
Door open: warning signal	audible	audible	audible	audible
Type of appliance				
Built-in-/under-worktop appliance	Built-in appliance	Under-worktop appliance	Under-worktop appliance	Built-in appliance
Door assembly	flush	flush	flush	flush
Dimensions				
Height	122.1 - 122.5 cm	82 - 87 cm	82 - 87 cm	45 cm
Width/Depth incl. distance from wall	56-57 / at least 55	60 / at least 58	60 / at least 58	56 / at least 55
Features				
Shelf material	wooden shelf	wooden shelf	grid shelves with front wooden panel	wooden shelf
Storage shelves	6	5	4	3
Wooden pull-out shelves on telescopic rails	4	3	3	2
Activated charcoal filter	•	•	•	•
Lock	•	•	•	
SoftSystem	•			

1) Climate Ratings: **SN** +10 °C to +32 °C
N +16 °C to +32 °C
ST +16 °C to +38 °C
T +16 °C to +43 °C

Installation diagrams.

Whether you are redesigning your kitchen, installing a new appliance or replacing your existing one, you'll find exactly the right appliance for your needs from the comprehensive range of built-in fridges and freezers from Liebherr. Liebherr specialises in the manufacture of freezers and fridges of the highest quality and with all the benefits of state-of-the-art refrigeration technology.

IK 3414 ****

IK 3620

IKB 3454 ****

IKB 3660

Maximum weight of furniture door:
19.5 kg

NB:

The cupboard door is attached to the appliance door. No cupboard hinges needed.

Height/width/depth of installation space in mm:
1772-1788/560-570/min. 550.
Air vent min. 38 mm

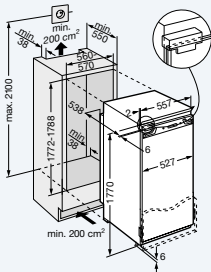

IGN 2566 ****

Maximum weight of furniture door:
20 kg

NB:

The cupboard door is attached to the appliance door. No cupboard hinges needed.

Height/width/depth of installation space in mm:
1772-1788/560-570/min. 550.
Air vent min. 38 mm

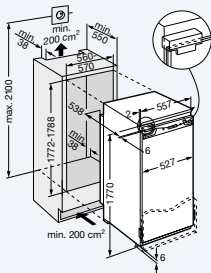

ICN 3056 ****

ICN 3066 ****

ICBN 3056 ****

ICBN 3066 ****

IC 3013 ****

NB:

The cupboard door is attached to the appliance door. No cupboard hinges needed.

Height/width/depth of installation space in mm:
1772-1788/560-570/min. 550.
Air vent min. 38 mm.

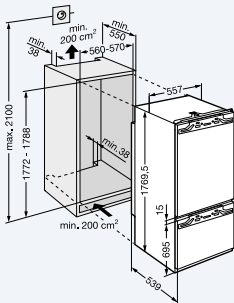

LIEBHERR

Design, Quality and Innovation

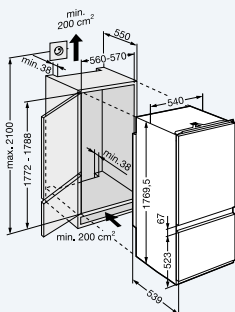
ICS 3113 ★★★★★

Height/width/depth
of installation space in mm:
1772-1788/560-570/min. 550.
Air vent min. 38 mm.

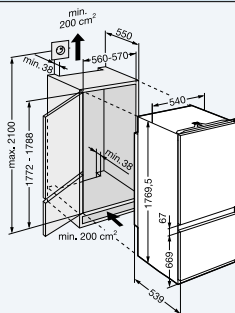
ICUS 3013 ★★★★★
ICUNS 3013 ★★★★★

Height/width/depth
of installation space in mm:
1772-1788/560-570/min. 550.
Air vent min. 38 mm.

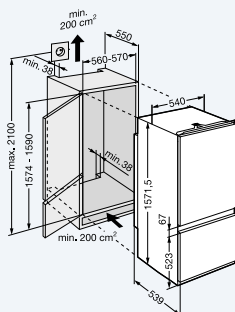
ICUS 2913 ★★★★★

Height/width/depth
of installation space in mm:
1574-1590/560-570/min. 550.
Air vent min. 38 mm.

IKP 2654 ****
IKP 2850
IKB 2810
IG 1956 ****

NB:
 The cupboard door
 is attached to
 the appliance door.
 No cupboard hinges needed.
 Height/width/depth
 of installation space in mm:
 1397-1413/560-570/min. 550.
 Air vent min. 38 mm.

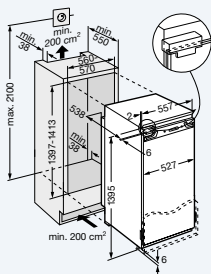

IK 2214 ****
IK 2410
IKP 2450
IKB 2410

NB:
 The cupboard door
 is attached to
 the appliance door.
 No cupboard hinges needed.
 Height/width/depth
 of installation space in mm:
 1220-1236/560-570/min. 550.
 Air vent min. 38 mm.

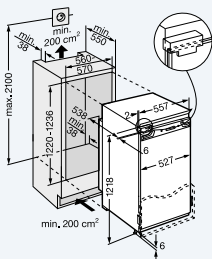

IKS 2420

Height/width/depth
 of installation space in mm:
 1220-1236/560-570/min. 550.
 Air vent min. 38 mm.

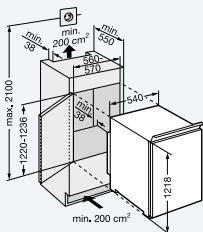

EK 2450

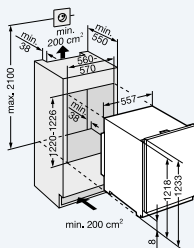

Height/width/depth
of installation space in mm:
1220-1226/560-570/min. 550.
Air vent min. 38 mm.
Decor panel height/width in mm:
1206/585, max. thickness 4 mm.

WTEs 2053

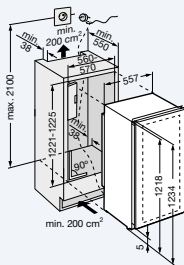

NB:
No cupboard door needed.
Height/width/depth
of installation space in mm:
1221-1225/560-570/min. 550.
Air vent min. 38 mm.
Glass door with stainless steel
frame.

IKP 2050

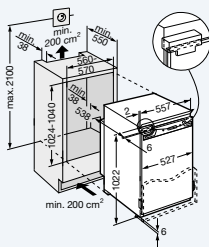

NB:
**The cupboard door
is attached to
the appliance door.
No cupboard hinges needed.**
Height/width/depth
of installation space in mm:
1024-1040/560-570/min. 550.
Air vent min. 38 mm.

IK 1504 ****

IK 1710

IG 1156 ****

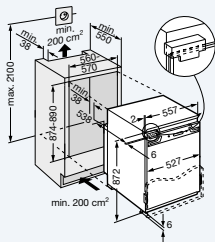

NB:
The cupboard door
is attached to
the appliance door.
No cupboard hinges needed.
Height/width/depth
of installation space in mm:
874-890/560-570/min. 550.
Air vent min. 38 mm.

IKS 1720

IGS 1113 ****

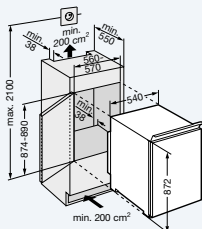

Height/width/depth
of installation space in mm:
874-890/560-570/min. 550.
Air vent min. 38 mm.

EK 1750

EG 1113 ****

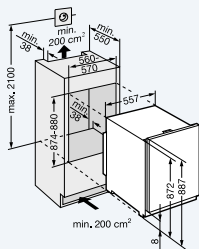

Height/width/depth
of installation space in mm:
874-880/560-570/min. 550.
Air vent min. 38 mm.
Decor panel height/width in mm:
860/585 max. thickness 4 mm.

KIUe 1350

NB:

The cupboard door is attached to the appliance door.

No cupboard hinges needed.

Height/width/depth of installation space in mm: 870-920/600/553.

Plinth height at appliance height of 868 mm (height of worktop 900 mm) adjustable between 100 and 170 mm, or between 150 and 220 mm at appliance height of 918 mm (height of worktop 950 mm).
Depth of plinth 22-77 mm.

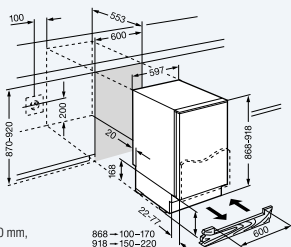

UIK 1610

UIK 1414 ****

UIG 1313 ****

NB:

The cupboard door is attached to the appliance door.

No cupboard hinges needed.

Height/width/depth of installation space in mm: 820-870/600/550.

Plinth height at appliance height of 818 mm (height of worktop 850 mm) adjustable between 100 and 170 mm, or between 150 and 220 mm at appliance height of 868 mm (height of worktop 900 mm).
Depth of plinth 22-77 mm.

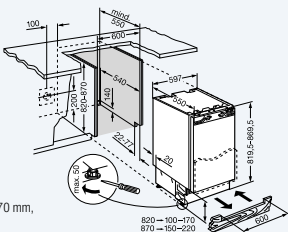

WKUes 1753

WTUes 1653

NB:

No cupboard door needed.

Height/width/depth of installation space in mm: 820-870/600/min. 580.

Height of plinth can be adjusted by 50 mm with adjustable feet
Glass door with stainless steel frame.

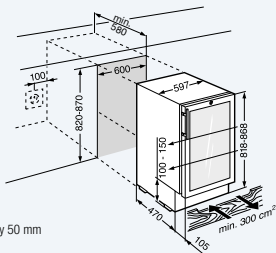

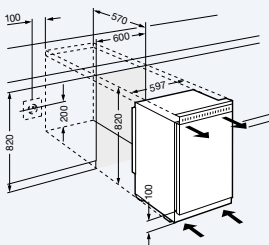
UK 1720 * * * * *

Height/width/depth
of installation space in mm:
820/600/570.
Decor panel height/width
in mm: 678/585,
max. thickness 4 mm.

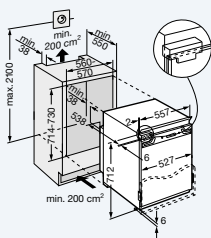
IG 956 * * * * *

NB:
The cupboard door
is attached to
the appliance door.
No cupboard hinges needed.
Height/width/depth
of installation space in mm:
714-730/560-570/min. 550.
Air vent min. 38 mm.

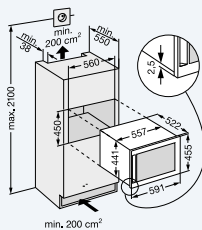
WKEs 553

NB:
No cupboard door needed.
Height/width/depth
of installation space in mm:
450/560/min. 550. Air vent min. 38 mm.
Glass door with stainless steel frame.

Equaliser trims

for built-in appliances with décor panel

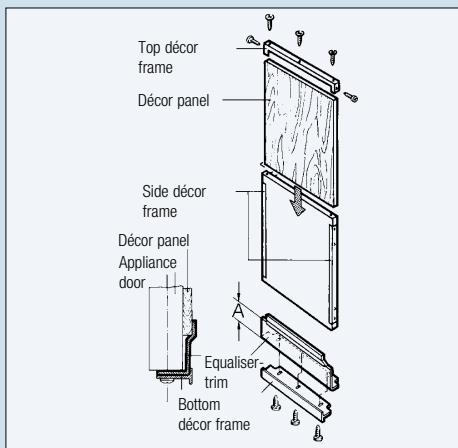

Equaliser trims part no. 9733...

Hight A in mm	Color		
	brown	white	aluminum
16	...032	...035	...050
41	...033	...036	...051
60	...034	...037	...052

Fixed water connection

for ICN 3066 / ICBN 3066 / IGN 2566

Fixed water connection for IceMaker is necessary (3/4 BSP Connection)!

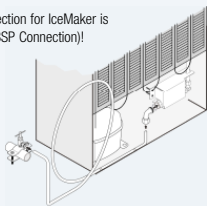

Supplied with 1.5 mtr hose for IceMaker connection.
3 mtr hose available as an accessory (Part No. 6030 785)