

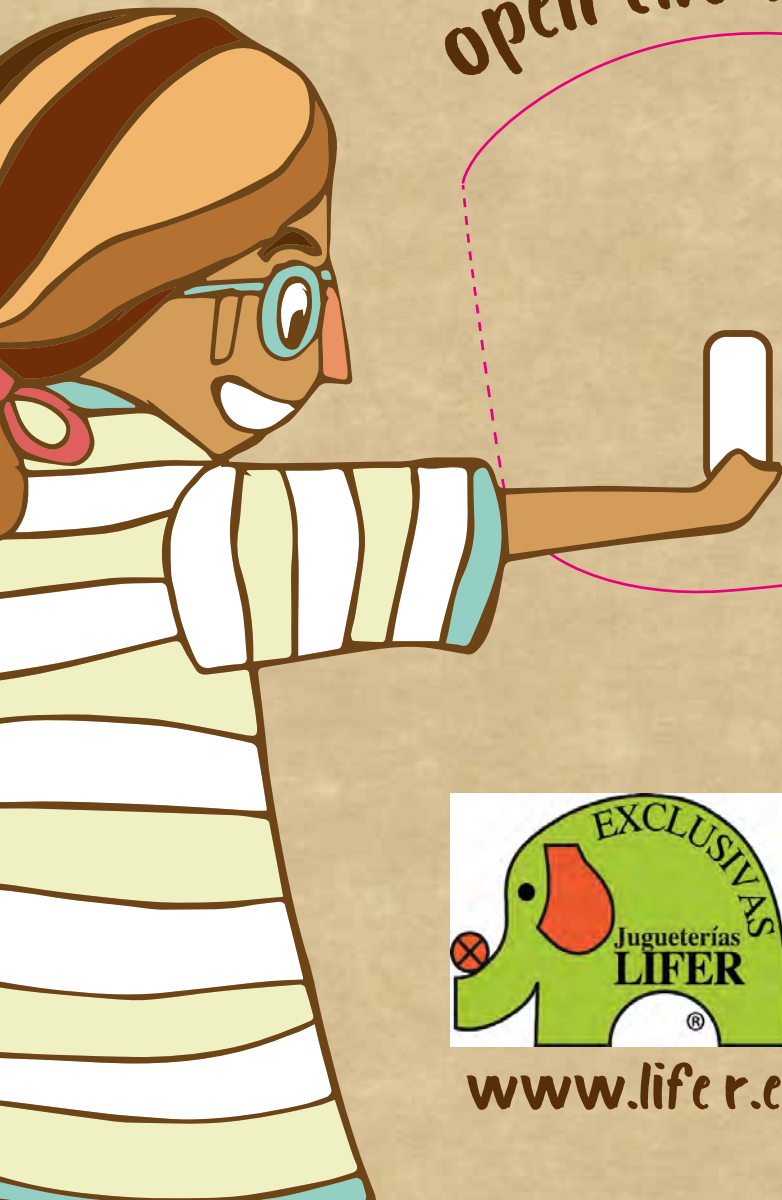

2023

Recursos didáticos
Didactic resources

Abri r la ventana
open the window!



www.lifer.es





www.lifer.es

Jugueterías LIFER, somos una empresa familiar nacida en Canarias, con vocación de servicio a las familias. Nuestro trabajo lo hacemos a través de una red de tiendas especializadas y nuestra tienda ONLINE www.lifer.es, de venta de juguetes material didáctico, libros infantiles +y juveniles, juegos de mesa, manualidades etc.

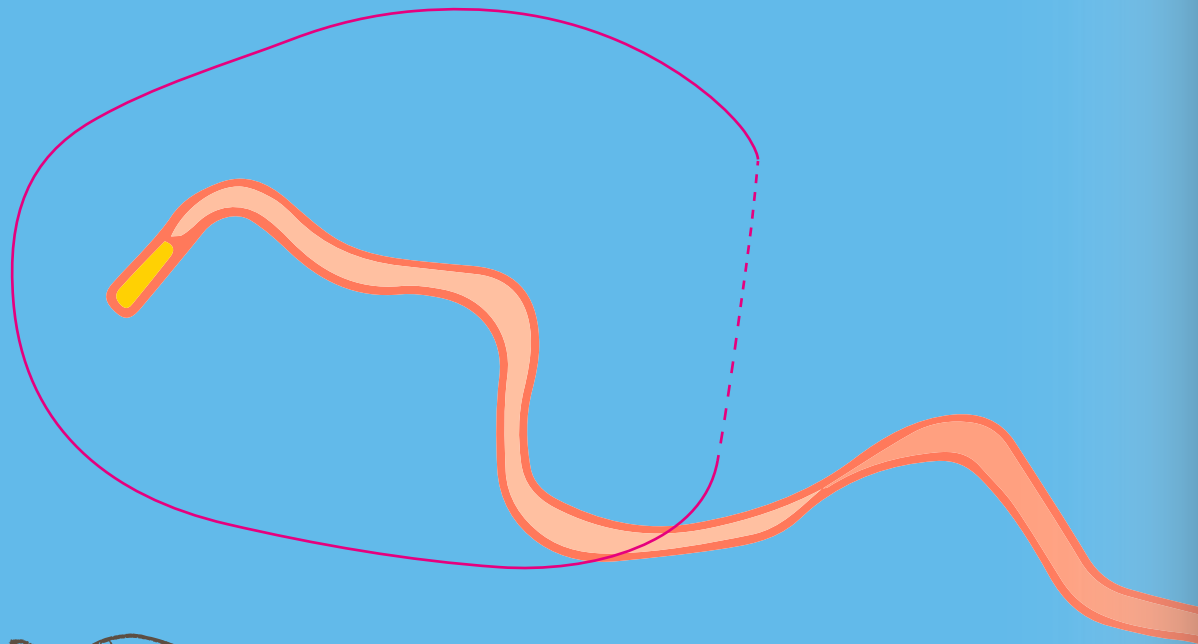

Calle de Nava y Grimón, 46
38201 San Cristóbal de la Laguna
922 25 23 43
www.lifer.es info@lifer.es

by **akros**



☆ we love playing together! ☆

2023
Recursos didácticos
Didactic resources





Comprometidos con el planeta
Committed to the planet

- pg. 22 **Emociones** / Emotions
- pg. 46 **Creatividad** / Creativity
- pg. 58 **Medioambiente** / The environment
- pg. 88 **Asociación** / Association
- pg. 126 **Razonamiento y matemáticas** / Reasoning and mathematics
 - Lógica y cálculo / Logic and calculation
 - Maxi memory / Maxi memory
 - Inteligencias múltiples / Multiple intelligences
 - Orientación espacial / Spatial orientation
 - Secuencias temporales / Time sequences
 - Autonomía y gestión del tiempo / Autonomy and time management
- pg. 180 **Destreza manual** / Manual dexterity
- pg. 190 **Camita** / Cot
- pg. 8 **Educación en valores** / Values education
- pg. 30 **Los sentidos** / The senses
- pg. 50 **Alimentación saludable** / Healthy eating
- pg. 74 **Diversidad y cultura** / Diversity & culture
- pg. 96 **Lenguaje** / Language
- pg. 168 **Puzles** / Puzzles
- pg. 184 **Recursos aula** / Schoolroom resources

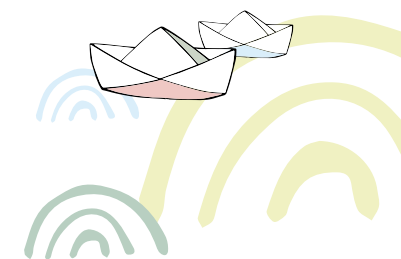
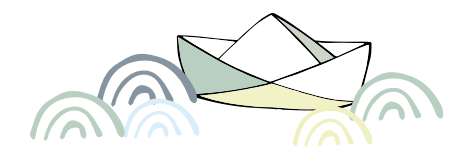



Comprometidos con el medioambiente Committed to the environment

Nuestro compromiso para promover acciones responsables con los bosques y el medioambiente, nos ha llevado a lograr la certificación FSC® (Forest Stewardship Council®).

¿Quién se beneficia?

Our commitment to promote responsible actions with the forests and the environment has led us to achieve FSC® certification (Forest Stewardship Council®).

Who benefits?



Certificate Code
SGSCH-COC-060436

License Code
FSC-C153015

Pregúntanos por nuestro listado de productos FSC® (Forest Stewardship Council®).

Ask us about our list of products FSC® (Forest Stewardship Council®).



. at school .



. at home .



. special needs .



. for seniors .



ECO-SIZE packaging ✓

FSC® certification ✓

plastic wrap reduction ✓

cardboard handle ✓

paper reduction (non-printed guides) ✓

OEKO-TEX® Standard 100 ✓

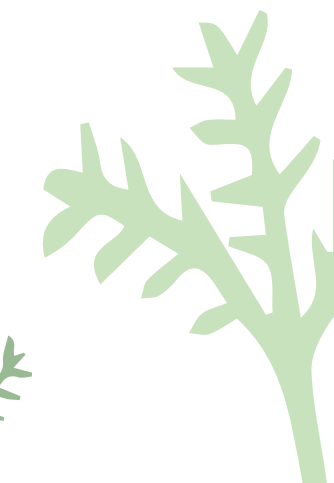

NEW PRODUCTS



SCHOOL, FAMILY & PEACE
INCLUSIÓN SOCIAL
 SOCIAL INCLUSION
 Ref. 20844

page 9



LAS 3 R: REDUCE, REUTILIZA Y RECICLA
 THE 3 RS: REDUCE, REUSE AND RECYCLE
 Ref. 20819

page 60



¡DESCUBRE LAS EXPRESIONES DEL ARTE!
 DISCOVER THE DIFFERENT FORMS OF ART!
 Ref. 30768

page 75



RELIGIONES DEL MUNDO: RESPETO Y CONVIVENCIA
 WORLD RELIGIONS: RESPECT AND COEXISTENCE
 Ref. 30767

page 76



TOPOLOGY-BIRDS. ORIENTACIÓN ESPACIAL
 SPATIAL ORIENTATION
 Ref. 20520

page 149



EL RETO DE LAS VOCALES
 THE VOWEL CHALLENGE
 Ref. 30672

page 98

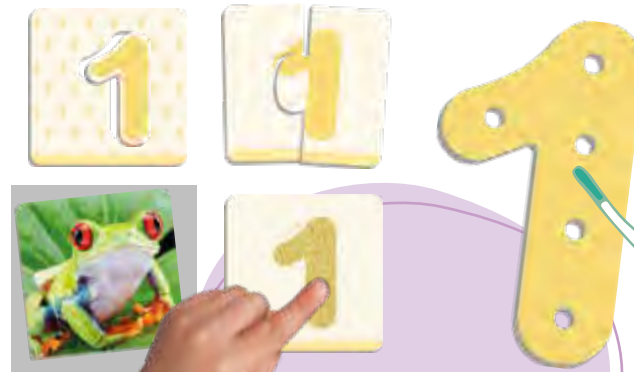

EL RETO DE LOS NÚMEROS DEL 1 AL 10
 THE NUMBER CHALLENGE FROM 1 TO 10
 Ref. 30673

page 128



PHOTO-HISTORY. ¡JUEGA Y DESCUBRE CARACTERÍSTICAS DE LAS ETAPAS DE LA HISTORIA!
 PHOTO-HISTORY. PLAY AND LEARN ABOUT PERIODS IN HISTORY!
 Ref. 30766

page 78



APRENDE A SUMAR Y RESTAR CON LLEVADAS
 LEARN TO ADD AND SUBTRACT AND CARRY OVER
 Ref. 30677

page 130

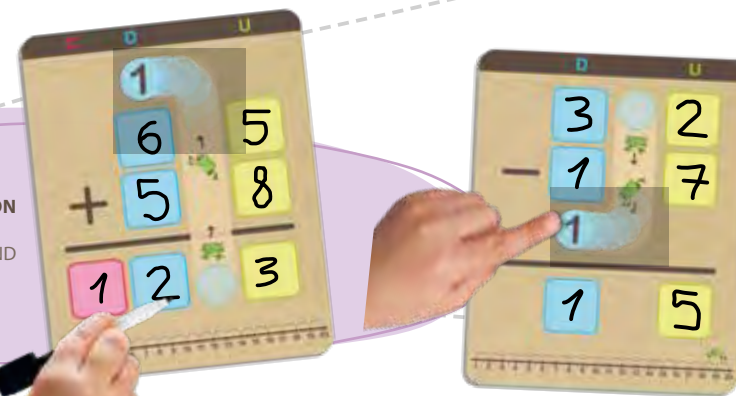

NEW

NOVEDADES / NEW PRODUCTS

NEW

NOVEDADES / NEW PRODUCTS



Educación en valores Values education



INCLUSION MEMORY

NEW

SCHOOL, FAMILY & PEACE INCLUSIÓN SOCIAL SOCIAL INCLUSION

Ref. 20844



Descubre la diversidad que existe en el cole, en casa y en la vida para reflexionar acerca de valores de respeto, tolerancia, cooperación, integración, colaboración y solidaridad. Este memory de inclusión social con imágenes reales nos muestra un mundo más inclusivo y promueve valores que fomentan la paz.

Memory de inclusión social.

Discover the diversity there is at school, at home and in life to reflect on the values of respect, tolerance, cooperation, integration, collaboration and solidarity. This social inclusion memory game uses real pictures to show a more inclusive world and promote values that encourage peace.

Social inclusion memory game.

GRAN TAMAÑO
BIG SIZE
10,1 x 7,3 CM

36 FICHAS
CARDS

3-8
years

SPECIAL
NEEDS



MUY RESISTENTE
HIGH QUALITY

36 + 20,2 x 13 x 6 cm

NEW

MAXI-MEMORY IGUALDAD MAXI-MEMORY EQUALITY

3-8 years SPECIAL NEEDS SENIORS Ref. 20407

Memory actual para trabajar valores de igualdad, asociando parejas de profesiones que desempeñan mujeres y hombres por igual. Una forma divertida de ejercitar la memoria y desarrollar la atención transmitiendo valores.

A modern memory game for working on equality values, by matching pairs of professions that are done by both men and women equally. A fun way of exercising memory skills and developing attention while instilling values.



← 9 cm →

¿Qué quieres ser de mayor?
What do you want to be when you grow up?



Encuentra más maxi-memories
Find more maxi-memories
page 144

MUY RESISTENTE
HIGH QUALITY

34 + 20,2 x 13 x 6 cm

LA RULETA DE LA AUTOESTIMA SELF-ESTEEM ROULETTE

Ref. 20846

¡Descubre jugando en grupo tus aptitudes y fortalezas! La ruleta de la autoestima permite aumentar el autoconcepto de niñas y niños de forma dinámica, divertida, positiva y enriquecedora.

Discover your skills and strengths by playing in group! The self-esteem roulette increases the self-concept of both girls and boys in a dynamic, fun, positive and enriching way.

3-8 years SPECIAL NEEDS



3 RULETAS SPINNING WHEELS

Me encanta la forma en que...
I love the way you...
x24 REESCRIBIBLES REWRITABLE

smile

dance

love

MUY RESISTENTE
HIGH QUALITY



3 + 24 + 24 + 12 + 23,6 x 18,7 x 7,2 cm



LÁMINAS ANTI-BULLYING ANTI-BULLYING POSTERS

Ref. 20841

Láminas anti-bullying para manifestar en los centros una actitud de tolerancia cero contra el acoso escolar y ayudar a prevenirlo. Muestran situaciones de acoso escolar: físico, psicológico, de exclusión social y ciberacoso. Diseñado para colgar en la pared.

Anti-bullying posters for underlining a zero-tolerance attitude against bullying in schools and helping to prevent it. They show different situations of school bullying: physical, mental or psychological, social exclusion, trolling or cyber bullying. Designed to be hung on the wall.

3+ years

SPECIAL NEEDS

LAVABLE Y RESISTENTE
WASHABLE AND HIGH QUALITY

6 LÁMINAS
POSTERS



← ø 30 cm →



VIDEO



STOP
BULLYING



EDUCAR CONTRA EL ACOSO ESCOLAR LEARNING TO PREVENT BULLYING

Ref. 20840

Set de 5 secuencias que permiten educar y concienciar a los más pequeños para prevenir situaciones de acoso escolar antes de que existan, así como dotarles de estrategias para afrontarlas.

Set of five sequences for teaching children how to prevent situations of bullying before they even happen and equipping them with the strategies to tackle it.

4-8 years



STOP
BULLYING



MUY RESISTENTE
HIGH QUALITY

5 SECUENCIAS
SEQUENCES

TAMAÑO REAL/ REAL SIZE (11,5 x 11,5 cm)



VIDEO



20

11,5 x 11,5 cm

20,2 x 13 x 6 cm



JUGAMOS EN IGUALDAD LET'S PLAY ON EQUAL TERMS!

Ref. 20839

Puzles de dos piezas para fomentar en los más pequeños una educación inclusiva y no sexista, con niñas y niños que realizan diferentes actividades por igual. Partiendo del principio de igualdad, estos puzles contribuyen a transmitir valores de respeto y tolerancia, fomentando la coeducación desde edades muy tempranas.

Two-piece puzzles to promote inclusive and non-sexist development in young children, with girls and boys doing different activities equally. Starting out from the principle of equality, these puzzles contribute to transmitting values of respect and tolerance, promoting co-education from a very early age.

2-5 years

2+

SPECIAL NEEDS

18 PUZLES
PUZZLES



GRAN TAMAÑO
BIG SIZE
17 x 8,5 cm



MUY RESISTENTE
HIGH QUALITY



36
8,5 x 8,5 cm
+

20,2 x 13 x 6 cm



PONTE EN MI LUGAR PUT YOURSELF IN MY SHOES

Ref. 20845

Mejora las habilidades
sociales y la empatía
Improves social skills
and empathy



Observa las diferentes situaciones, ponte en el lugar de los personajes y describe cómo se sienten. Favorece el desarrollo de habilidades sociales como la empatía, la identificación de las emociones, y ayuda a desarrollar la conciencia emocional.

Observe the different situations, put yourself in the shoes of the characters, and describe how they feel. This encourages the development of social skills such as empathy, the identification of emotions, and helps to develop an emotional conscience.

3-8 years

SPECIAL NEEDS

10 ESCENAS + 15 PERSONAJES + 10 EMOCIONES
SCENES CHARACTERS EMOTIONS



31 cm



VIDEO

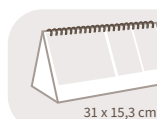

31 x 15,3 cm



33,3 x 23,5 x 2 cm



SOLUCIÓN DE CONFLICTOS / RESOLVING CONFLICTS

Cada juego consta de 7 sencillas historias que narran dos formas diferentes de resolver conflictos, mostrando las consecuencias de tomar una buena o una mala decisión.

Each game consists of seven short stories which relate two different ways of resolving conflicts, showing the consequences of making a good or a bad decision.



¡Aprende idiomas!
Learn languages!

DOWNLOAD ONLINE
AUDIO MP3

- 7 Cuentos / 7 Stories
- Guía pedagógica / Educational guide
- Textos de los cuentos / Texts of the stories
- Láminas para colorear / Pictures for colouring in

SOLUCIÓN DE CONFLICTOS: EN CASA RESOLVING CONFLICTS: AT HOME

Ref. 20830

3-8 years

SPECIAL NEEDS

UPDATED
PRODUCT!

7 SECUENCIAS
SEQUENCES



2 SOLUCIONES
SOLUTIONS



30

+



+



13,5 x 16,5 cm

23,6 x 18,7 x 7,2 cm

SOLUCIÓN DE CONFLICTOS: LAS MENTIRAS RESOLVING CONFLICTS: LIES

Ref. 20832

3-8 years

SPECIAL NEEDS

UPDATED
PRODUCT!

¡Aprende idiomas!
Learn languages!



7 SECUENCIAS
SEQUENCES



2 SOLUCIONES
SOLUTIONS



30

+



+



13,5 x 16,5 cm

23,6 x 18,7 x 7,2 cm



SOLUCIÓN DE CONFLICTOS: EN EL COLEGIO RESOLVING CONFLICTS: AT SCHOOL

Ref. 20831

3-8 years SPECIAL NEEDS

7 SECUENCIAS SEQUENCES



¡Aprende idiomas!
Learn languages!

2 SOLUCIONES SOLUTIONS



UPDATED PRODUCT!



¡Aprende idiomas!
Learn languages!



DOWNLOAD ONLINE AUDIO MP3

30 + 4 + 23,6 x 18,7 x 7,2 cm

ACTITUDES POSITIVAS: TOLERANCIA Y COOPERACIÓN A POSITIVE ATTITUDE: TOLERANCE AND COOPERATION

3-6 years SPECIAL NEEDS Ref. 20810

Observa las 4 imágenes de cada tablero y descarta con la cruz la actitud incorrecta. Para trabajar valores de tolerancia y cooperación.

Look at the 4 images on each board and cross out the wrong type of behaviour. For exploring the values of tolerance and cooperation.



MUY RESISTENTE
HIGH QUALITY

12 + + 23,6 x 18,7 x 7,2 cm



ACTITUDES POSITIVAS: AFECTO, SALUD Y SEGURIDAD A POSITIVE ATTITUDE: AFFECTION, HEALTH AND SAFETY

3-6 years SPECIAL NEEDS Ref. 20811

Observa las 4 imágenes de cada tablero y descarta con la cruz la actitud incorrecta. Para trabajar valores de afecto, salud y seguridad.

Look at the 4 images on each board and cross out the wrong type of behaviour. For exploring the values of affection, health and safety.



MUY RESISTENTE
HIGH QUALITY



LOS BUENOS MODALES / GOOD BEHAVIOUR

Juegos de asociación de parejas, que muestran un buen y un mal comportamiento, en diferentes situaciones del entorno cotidiano del niño.

A series of games of association for matching cards that show examples of good and bad behaviour in different everyday situations.

3-8 years

SPECIAL NEEDS



TAMAÑO REAL / REAL SIZE



LOS BUENOS MODALES: EL COLEGIO GOOD BEHAVIOUR: THE SCHOOL

Ref. 20801

34
9 x 9 cm
+
20,2 x 13 x 6 cm



MUY RESISTENTE
HIGH QUALITY

LOS BUENOS MODALES: EN CASA GOOD BEHAVIOUR: AT HOME

Ref. 20802



MUY RESISTENTE
HIGH QUALITY

34
9 x 9 cm
+
20,2 x 13 x 6 cm



LOS BUENOS MODALES: PRECAUCIÓN Y SEGURIDAD GOOD BEHAVIOUR: PREVENTION AND SAFETY

Ref. 20803



MUY RESISTENTE
HIGH QUALITY

34
9 x 9 cm
+
20,2 x 13 x 6 cm





Emociones
Emotions

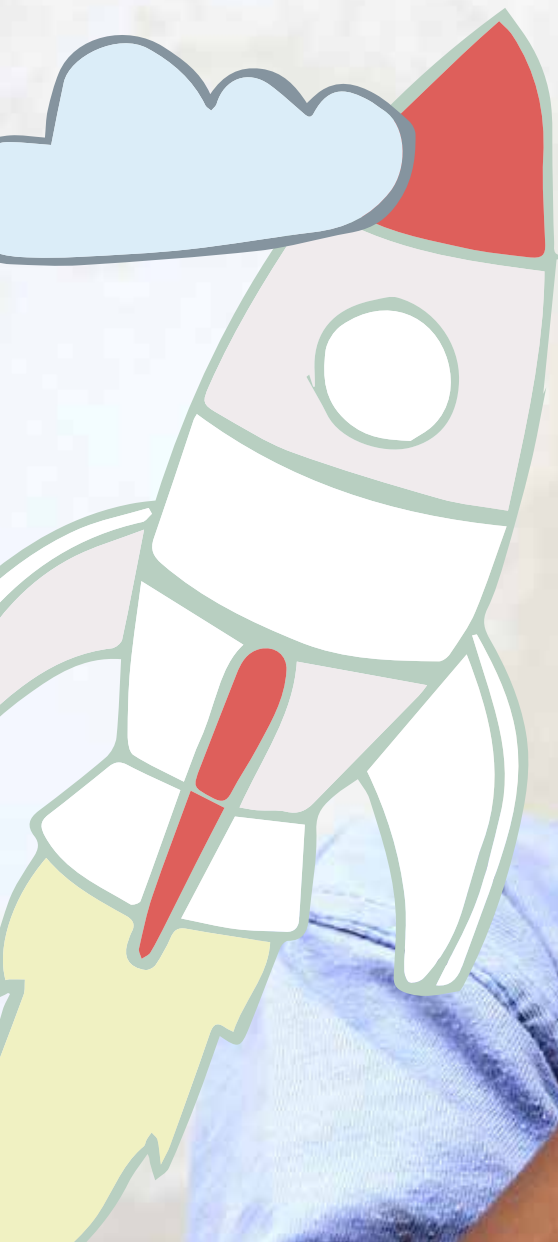

¡DA VIDA A TUS EMOCIONES!
GIVE LIFE TO YOUR EMOTIONS!

3-8 years SPECIAL NEEDS Ref. 20547

¡Los robots quieren sentir las emociones y vamos a ayudarles! Expresa las emociones básicas representándolas de diferente forma a través de los sentidos. Una manera diferente de conocer las emociones, que permite adquirir una visión más completa de cada una de ellas.

The robots want to learn emotions and we are going to help them! Express basic emotions by representing them in different ways through the senses. A different way of finding out about emotions, providing a more complete view of each of them.

10 EMOCIONES
EMOTIONS



¡Expresa las emociones a través de los sentidos!
Express the emotions through the senses!

Mímica
Mime

Sonido
Sound

Historia
Story

Dibujo
Drawing

4 ROBOTS



GRAN TAMAÑO
BIG SIZE
28 x 20 cm

40 + 2 + 23,6 x 18,7 x 7,2 cm
10 x 5,6 cm ø 18 cm



LAS EXPRESIONES EXPRESSIONS

Ref. 20542

Juego para aprender a identificar expresiones faciales. Permite asociar diferentes iconos de expresiones con imágenes de expresiones reales.

A game for learning to identify facial expressions from icons and associating them with photos of real expressions.

3-6 years SPECIAL NEEDS SENIORS

10 EXPRESIONES
EXPRESSIONS

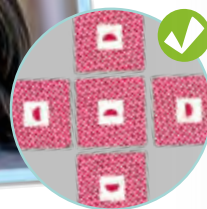
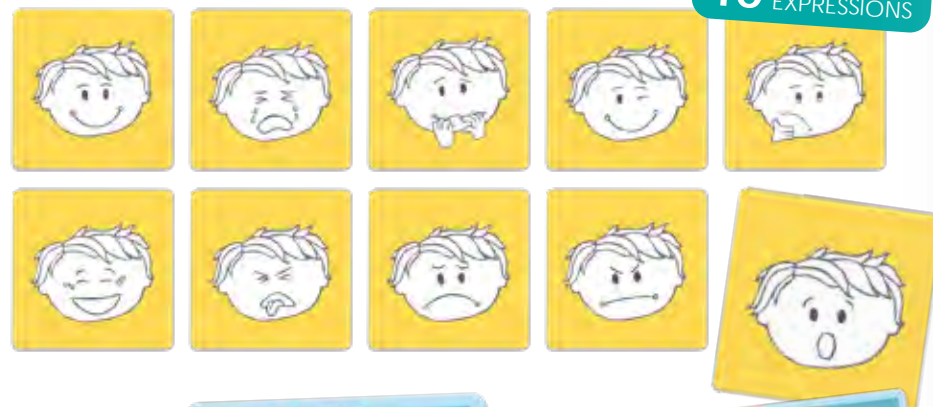

MUY RESISTENTE
HIGH QUALITY

50

9 x 9 cm

+



20,2 x 13 x 6 cm

BINGO: SONIDOS DE LAS EMOCIONES BINGO: THE SOUNDS OF EMOTIONS

3-8 years SPECIAL NEEDS 1-12 players Ref. 20630



Juego de asociación con sistema de bingo para aprender a diferenciar y reconocer las emociones básicas, asociando la imagen de cada emoción con su sonido correspondiente.

A game of association which uses the bingo system to learn how to differentiate and recognise the basic emotions, associating the image of each emotion with its corresponding sound.



16 cm



DOWNLOAD ONLINE
AUDIO MP3

- Sonidos Bingo / Bingo sounds
- Guía pedagógica / Educational guide
- Actividades para trabajar las emociones / Activities for working on emotions

12

16 x 16 cm

+

12

16 x 16 cm

+

60

16 x 16 cm

+



23,6 x 18,7 x 7,2 cm

RECONOCER Y GUIAR LAS EMOCIONES RECOGNIZE AND GUIDE THE EMOTIONS

Ref. 20545

Juego para aprender a reconocer, a partir de expresiones y gestos, las 10 emociones básicas que guían nuestro comportamiento. Permite nombrarlas, clasificarlas en agradables y desagradables, y ordenarlas según su intensidad.

A game for learning to recognize the 10 basic emotions that guide our behaviour by means of expressions and gestures. It helps the children to name these emotions, classify them as pleasant or unpleasant, and put them in order according to their level of intensity.



10 EMOCIONES
EMOTIONS



MUY RESISTENTE
HIGH QUALITY

Mar Romera

Desarrollado en colaboración con Mar Romera.
Especialista en Inteligencia Emocional.
Presidenta de la Asociación Pedagógica Francesco Tonucci.
Developed in collaboration with Mar Romera.
Specialist in Emotional Intelligence.
President of the Francesco Tonucci Pedagogical Association.



VIDEO

MAXI-SELLOS DE LAS 10 EMOCIONES MAXI-STAMPS OF THE 10 EMOTIONS

Ref. 20546

Set con 10 maxi-sellos para jugar y representar las 10 emociones básicas que guían nuestro comportamiento: alegría, seguridad, admiración, curiosidad, sorpresa, ira, asco, tristeza, miedo y culpa. Permite identificar y expresar nuestras emociones. Ayuda a desarrollar habilidades sociales y emocionales. Aptos para cualquier tinta.

Set of 10 large stamps for representing and playing with the 10 basic emotions that guide our behaviour: happiness, self-confidence, admiration, curiosity, surprise, anger, disgust, sadness, fear and guilty. Helps children to identify and express their emotions and to develop their social and emotional skills. Can be used with any ink.



10 MAXI SELLOS
MAXI STAMPS



MADERA
WOOD

10 EMOCIONES
EMOTIONS

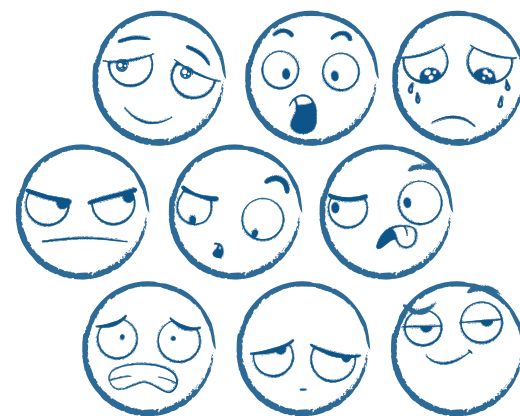

TAMAÑO REAL
REAL SIZE



VIDEO

In collaboration with
Mar Romera

SET PUZZLES: LAS 10 EMOCIONES SET OF PUZZLES: THE 10 EMOTIONS

Ref. 20544

2-6 years

2+

SPECIAL NEEDS



Set de 10 puzzles de las emociones básicas que guían nuestro comportamiento, y 10 iconos que ayudan a identificarlas. Puzzles progresivos de 3, 4 y 6 piezas. Realizados con piezas grandes en cartón grueso de máxima calidad y resistencia. Apropiado para niños a partir de 2 años.

Set of 10 puzzles featuring the basic emotions that guide our behaviour, plus 10 matching icons to help identify them. Progressive puzzles of 3, 4 and 6 pieces. Made from large pieces of thick, strong, top quality cardboard. Suitable for children aged two and upwards.



+10 FICHAS MODELO
GUIDE CARDS



10 PUZZLES
PUZZLES



GRAN TAMAÑO
BIG SIZE



MUY RESISTENTE
HIGH QUALITY



VIDEO

MARIONETAS DE EMOCIONES EMOTIONS PUPPETS

Ref. 64001

Set de 6 marionetas para descubrir las emociones con la representación de 2 cuentos. Cuatro marionetas son reversibles. El contenido audio MP3 incluye la grabación completa de 2 cuentos con música y diálogos.

Set of 6 hand puppets to learn and discover about emotions by representing 2 stories. Four hand puppets are reversible. The MP3 content includes the full recording of 2 stories with music and dialogues.

3-8 years
SPECIAL NEEDS

2 AUDIO-CUENTOS
AUDIO-STORIES



Alegría
Happiness



Tristeza
Sadness



Alegría
Happiness



Enfado
Anger



Vergüenza
Embarrassment



Miedo
Fear



Alegría
Happiness



Sorpresa
Surprise

¡Aprende idiomas!
Learn languages!



DOWNLOAD ONLINE
AUDIO MP3

- 2 Cuentos / 2 Stories
- Guía pedagógica / Educational guide
- Actividades para trabajar las emociones / Activities for working on emotions
- Guión de los cuentos / Script of the stories
- Láminas para colorear / Pictures for colouring in



VIDEO





Los sentidos The senses



TACTO-MEMORY DISCRIMINACIÓN VISUAL TOUCH-MEMORY VISUAL DISCRIMINATION

Ref. 20412

¡Original memory táctil con ilustraciones especialmente creadas con mucho contraste y textura rugosa! Desarrolla la discriminación visual y táctil, la atención y la memoria espacial. También adecuado para personas con discapacidad visual.

Original touch-memory game using illustrations specially created with a great deal of contrast and a rough texture! Develop visual and touch discrimination, attention and spatial memory. Also suitable for people with visual impairment.



TAMAÑO REAL
REAL SIZE
Ø 9 cm

34 FICHAS
CARDS

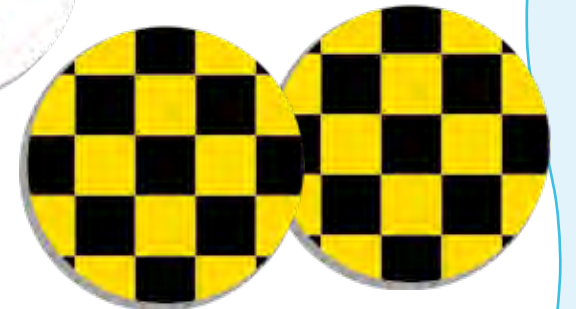

MUY RESISTENTE
HIGH QUALITY



34 + 20,2 x 13 x 6 cm



LOS 5 SENTIDOS / THE 5 SENSES

Ref. 20610

Lanza el dado e identifica distintas situaciones de la vida real, en las que percibimos con el órgano sensorial que aparece en el dado.

Throw the dice and match the different real-life situations with the relevant sense organ that appears on the dice.



UPDATED PRODUCT!



5 SENTIDOS SENSES

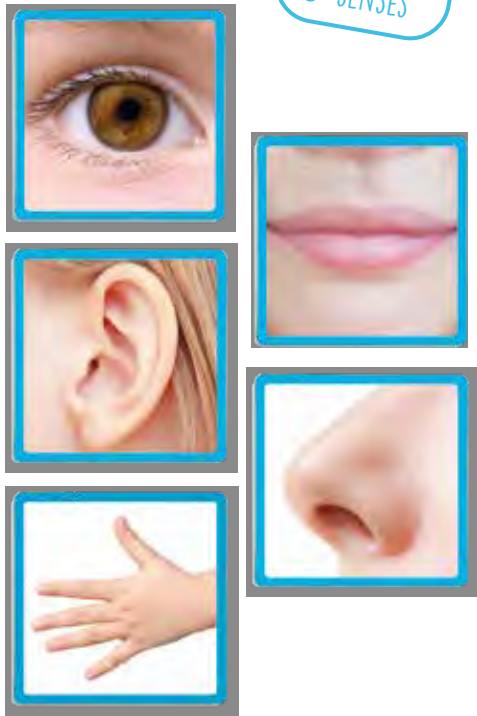

50 FICHAS CARDS

MUY RESISTENTE HIGH QUALITY



TACTO-FOTO / TOUCH-PHOTO

Ref. 20611

Juego sensorial para desarrollar el sentido del tacto, a partir de la diferenciación de 8 texturas diferentes, y su asociación a diversas fotografías, estableciendo una relación visual-táctil.

A sensorial game for developing the sense of touch, based on distinguishing eight different textures and matching them to different photos, establishing a visual-tactile association.



Desarrolla el sentido del tacto
Develops the sense of touch



32 FICHAS CARDS

8 TEXTURAS TEXTURES x2

MUY RESISTENTE HIGH QUALITY



TAMAÑO REAL / REAL SIZE

EL OLFATO: LAS FRUTAS Y SUS AROMAS THE SENSE OF SMELL: FRUITS AND THEIR AROMAS

Ref. 20600

Juego sensorial para desarrollar el sentido del olfato, a partir de la diferenciación de los aromas de distintas frutas.

Sensorial game for developing the sense of smell by distinguishing the aroma of different fruits.



12 Aromas

24 FICHAS
CARDS



MUY RESISTENTE
HIGH QUALITY

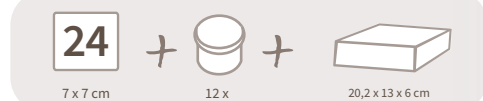

BINGO CON 25 SONIDOS Y SUS NOMBRES BINGO WITH 25 SOUNDS AND THEIR NAMES



Serie de 3 juegos para aprender a diferenciar, en cada uno, 25 sonidos y conocer sus nombres.

A series of three games for learning to differentiate, in each one, 25 sounds and discovering their names.



- Bingo sonidos / Bingo sounds
- Guía pedagógica / Educational guide

BINGO: LOS ANIMALES Y LA NATURALEZA / BINGO: ANIMALS AND NATURE

Ref. 20620



BINGO: LA CASA Y LA CIUDAD BINGO: THE HOUSE AND THE CITY

Ref. 20621

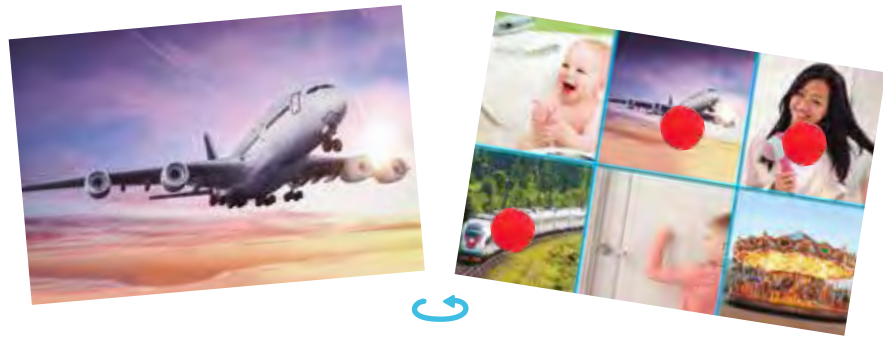

UPDATED PRODUCT!



¡Aprende idiomas!
Learn languages!



25 + 150 + 19,5 x 13,5 cm 23,6 x 18,7 x 7,2 cm

BINGO: ACCIONES E INSTRUMENTOS MUSICALES BINGO: ACTIONS AND MUSICAL INSTRUMENTS

Ref. 20622



UPDATED PRODUCT!

¡Aprende idiomas!
Learn languages!

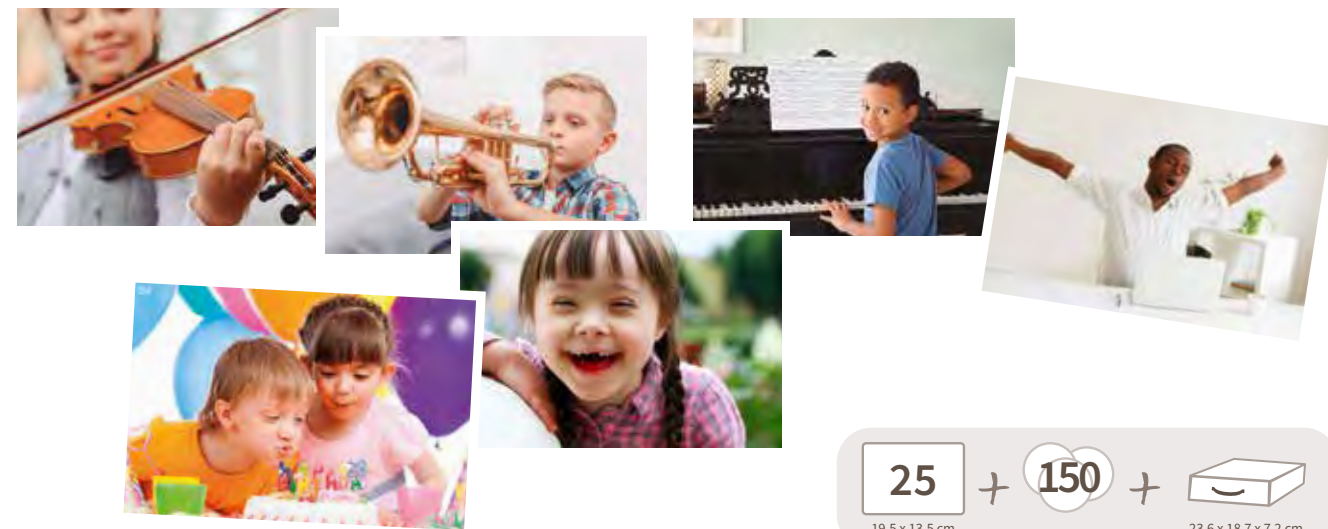

25 + 150 + 19,5 x 13,5 cm 23,6 x 18,7 x 7,2 cm

SET BANDEJA Y PIZARRA MULTISENSORIAL DE PRESCRITURA XL SET OF MULTI-SENSORY PRE-WRITING TRAY AND BOARD XL

Ref. 20617

3-6 years

SPECIAL NEEDS



Bandeja multisensorial de gran tamaño para desarrollar la preescritura y la coordinación ojo-mano, mediante la representación creativa de figuras a través del tacto. Permite crear y experimentar en grupo. Inspirado en la metodología Montessori.

Large multisensory tray for developing pre-writing skills and hand-eye coordination by creating figures through touch. Allows children to create and experiment as a group. Inspired by the Montessori methodology.



Experimenta en grupo
For group play

eco wood

GRAN TAMAÑO
BIG SIZE

100% CREATIVE



2 PIZARRAS
BOARDS

MAGNÉTICO
MAGNETIC

BORRA
ERASE

BORRA
ERASE

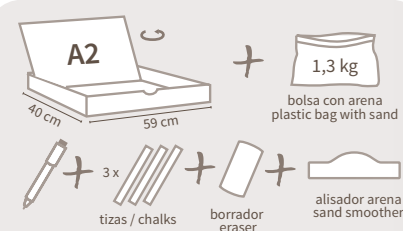

SET BANDEJA Y PIZARRA MULTISENSORIAL DE PRESCRITURA SET OF MULTI-SENSORY PRE-WRITING TRAY AND BOARD

3-6 years

SPECIAL NEEDS



Ref. 20616

Bandeja multisensorial para desarrollar la preescritura y la coordinación ojo-mano, mediante la representación creativa de figuras a través del tacto. Inspirado en la metodología Montessori.

Multi-sensory tablet for developing pre-writing skills and eye-to-hand coordination through the creative representation of figures using touch. Inspired by the Montessori methodology.



MAGNÉTICO
MAGNETIC

eco wood

100% CREATIVE



2 PIZARRAS
BOARDS

BORRA
ERASE

BORRA
ERASE

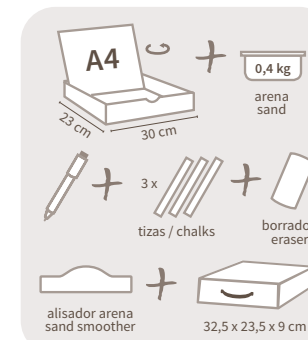

VIDEO

DOMINÓ TACTO-VISUAL TACTILE-VISUAL DOMINOES

Ref. 20615

Dominó táctil de gran tamaño con textura rugosa por ambos lados. Con ilustraciones de mucho contraste para desarrollar la discriminación visual y táctil mediante el juego del dominó. Adecuado para personas con discapacidad visual.

Large-format tactile domino game with a rough texture on both sides. Illustrated with a lot of contrast to develop visual and tactile discrimination while playing dominoes. Suitable for use by people with visual impairment.

3-8 years
SPECIAL NEEDS
SENIORS



Textura rugosa ambos lados
Tactile surface both sides

28 FICHAS
CARDS

MUY RESISTENTE
HIGH QUALITY



13 cm



VIDEO

TACTO-FICHAS PARA ENLAZAR RECORRIDOS TACTILE CARDS FOR LACING PATHS

3-6 years
SPECIAL NEEDS
SENIORS
Ref. 20614

Crea divertidos recorridos enlazando las fichas según colores y texturas. Mejora la discriminación visual, la discriminación táctil y la psicomotricidad fina. Set de 36 fichas con textura rugosa y 10 cordones ergonómicos para enlazar.

Create fun routes by lacing the cards according to colour and texture. Helps to improve visual and tactile discrimination, and fine psychomotor skills. Set of 36 tactile cards and 10 ergonomic laces for linking them.

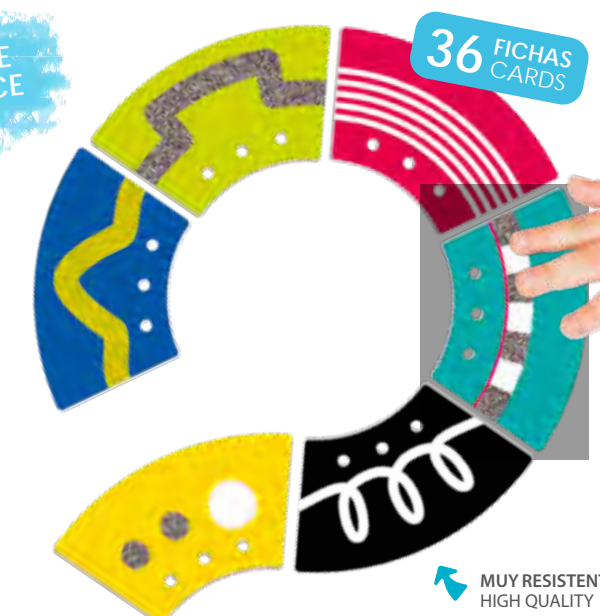

MUY RESISTENTE
HIGH QUALITY

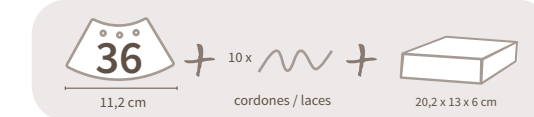

MAXI-MEMORY TÁCTIL "NUESTRO ENTORNO" TACTILE MAXI-MEMORY "EVERYDAY LIFE"

Ref. 20410

Memory táctil de gran tamaño con diferentes texturas sobre imágenes reales de nuestro entorno para trabajar la discriminación táctil, la memoria visual y la atención a través del sentido del tacto. Permite jugar al memory clásico y al memory táctil. Inspirado en la metodología Montessori.

A large-format tactile memory game with different textures featuring real images of everyday life for working on tactile discrimination, visual memory and attention through the sense of touch. You can play both the classic and tactile memory games. Inspired by the Montessori methodology.



TACTILE SURFACE



TAMAÑO REAL/ REAL SIZE (9 x 9 cm)



Diferentes texturas
Different textures

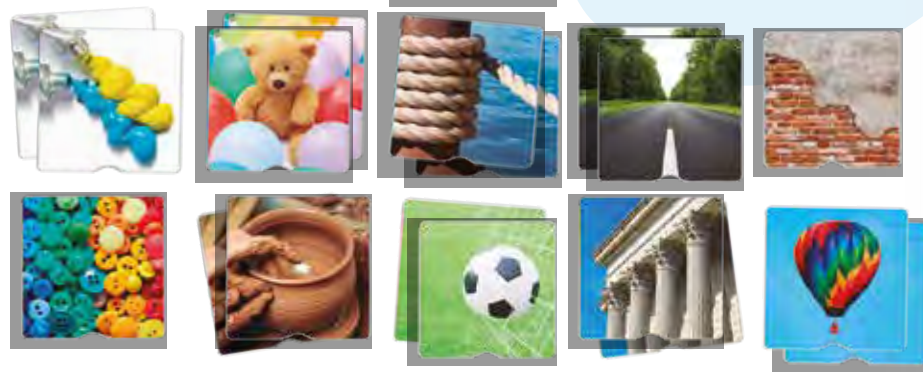

MUY RESISTENTE
HIGH QUALITY



VIDEO

34

9 x 9 cm



20,2 x 13 x 6 cm

MAXI-MEMORY TÁCTIL "NATURALEZA" TACTILE MAXI-MEMORY "NATURE"

Ref. 20411

Memory táctil de gran tamaño con diferentes texturas sobre imágenes reales de la naturaleza para trabajar la discriminación táctil, la memoria visual y la atención a través del sentido del tacto. Permite jugar al memory clásico y al memory táctil. Inspirado en la metodología Montessori.

A large-format tactile memory game with different textures featuring real images of our environment for working on tactile discrimination, visual memory and attention through the sense of touch. You can play both the classic and tactile memory games. Inspired by the Montessori methodology.



TACTILE SURFACE



Diferentes texturas
Different textures



MUY RESISTENTE
HIGH QUALITY



VIDEO

34

9 x 9 cm



20,2 x 13 x 6 cm

TACTO-FICHAS DE NÚMEROS Y PREESCRITURA TACTILE NUMBER CARDS FOR PRE-WRITING

Ref. 20612

Tacto-fichas de preescritura que trabajan números y diferentes recorridos para la preescritura, mediante fichas rugosas a través del tacto. Inspirado en la metodología Montessori.

Tactile pre-writing cards for working with numbers and different routes to pre-writing using touch to identify tactile surfaces. Inspired by the Montessori methodology.

3-6 years SPECIAL NEEDS Montessori methodology

TACTILE SURFACE

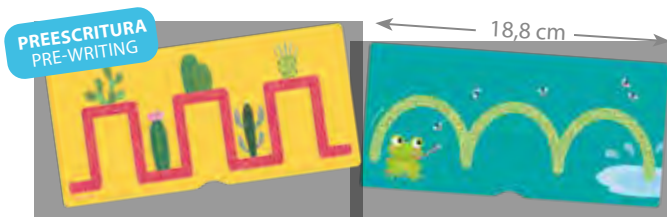

18,8 cm



23 FICHAS CARDS x2



NÚMEROS NUMBERS

MUY RESISTENTE HIGH QUALITY



SIGNOS MATEMÁTICOS MATHS SYMBOLS



VIDEO



TACTO-FICHAS DE LETRAS Y SIGNOS DE PUNTUACIÓN TACTILE LETTER CARDS WITH PUNCTUATION SIGNS

3-6 years SPECIAL NEEDS Montessori methodology Ref. 20613

Tacto-fichas de preescritura que trabajan las letras y los signos de puntuación, mediante fichas rugosas a través del tacto. Incluye mayúsculas y minúsculas, diferenciando en ambos casos, las vocales de las consonantes (incluye las letras: œ - ç - ll - ñ). Inspirado en la metodología Montessori.

Tactile pre-writing cards for working with letters and punctuation signs using touch to identify tactile surfaces. Includes capital and lower-case letters, differentiating in each case the vowels from the consonants (includes letters: œ - ç - ll - ñ). Inspired by the Montessori methodology.

mayúsculas capitals + minúsculas lower case



TAMAÑO REAL / REAL SIZE (9 x 9 cm)

TACTILE SURFACE

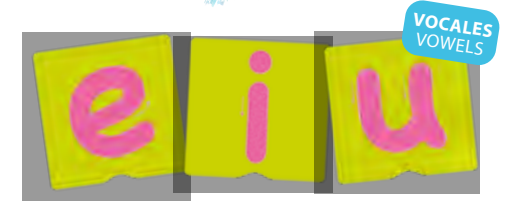

VOCALES VOWELS



CONSONANTES CONSONANTS

MUY RESISTENTE HIGH QUALITY

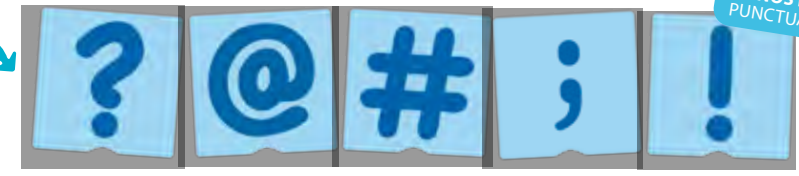

SIGNOS PUNTUACIÓN PUNCTUATION MARKS

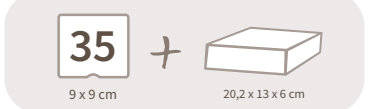

VIDEO



Creatividad
Creativity



6 COLORES
COLORS



LA VENTANA MÁGICA
THE MAGIC WINDOW

Ref. 33105

¡Una ventana creativa para dibujar y recrear el mundo! Incluye 6 rotuladores borrables de colores para dejar volar tu imaginación. Permite también trabajar la preescritura y completar fichas de conceptos básicos (fichas no incluidas). Puedes utilizarla tanto en vertical, como plana sobre la mesa. Inspirada en la metodología Montessori.

A creative window to draw and recreate the world! Includes 6 erasable coloured felt pens to let your imagination fly. It also facilitates working on pre-writing with the completion of basic concepts sheets (sheets not included). You can use it both vertically and flat on the table. Inspired by Montessori methodology.

3-8 years

SPECIAL NEEDS

Montessori methodology

100% CREATIVE

eco wood



Compatible with



MULTI-SENSORY PRE-WRITING TRAY AND BOARD page 39

To practice any concept!



Pre-writing

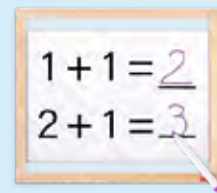

Maths

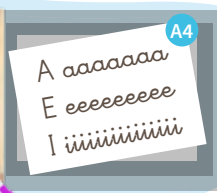

Language

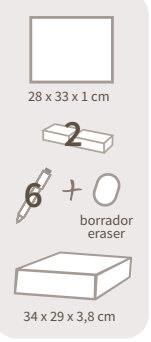

DADOS REESCRIBIBLES REWRITABLE DICE

Ref. 33103

3-8 years

SPECIAL NEEDS

Set de 3 dados reescribibles con 1 rotulador borrable para trabajar múltiples conceptos.

Set of three rewritable dice with an erasable felt-tip pen for working on all kinds of concepts.

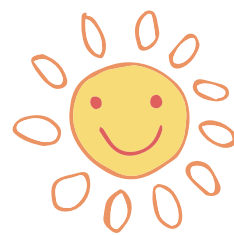

100% CREATIVE



DOMINÓ CREATIVO CREATIVE DOMINOES

Ref. 20529

Un original dominó para asociar colores de una forma diferente y crear figuras sorprendentes. Desarrolla la creatividad y la inteligencia visual-espacial. Inspirado en la metodología Waldorf.

An original domino game for associating colours in a different way and creating amazing figures. Develops creativity and visual-spatial intelligence. Inspired by the Waldorf Method.

3-8 years

SPECIAL NEEDS

SENIORS

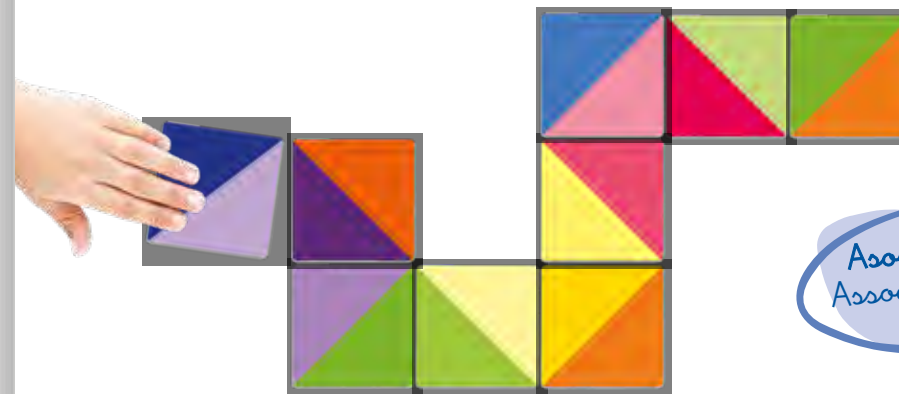

100% CREATIVE



MUY RESISTENTE
HIGH QUALITY





Alimentación saludable
Healthy eating



LA BALANZA ENERGÉTICA: ACTIVIDAD FÍSICA Y ALIMENTACIÓN
THE ENERGY BALANCE: PHYSICAL ACTIVITY AND FOOD

4-10 years Ref. 20556

Conoce de una forma divertida cuánta energía nos proporcionan los alimentos y cuánta gastamos realizando diferentes actividades. Descubre con la balanza si la energía de los alimentos que comes y la que gastas durante el ejercicio están equilibradas. Aprende además, que no toda la energía que nos aportan los alimentos es de la misma calidad. Set compuesto por una balanza, 36 tarjetas de alimentos, 12 tarjetas de actividades, y 40 fichas de madera.

A fun way of learning how much energy is provided by food, and how much energy you expend doing different activities. Use the scales to discover whether there is a balance between the energy of the food you eat and the energy you expend during exercise. Also learn that not all the energy provided by foods is of the same quality. The set comprises scales, 36 food cards, 12 activity cards, and 40 wooden counters.

● = ● = 25 kcal



¡Descubre cuánta energía necesitas!
Find out how much energy you need!

In collaboration with
CGCODN
General Council
Dietitians-Nutritionists

TAMAÑO REAL / REAL SIZE



MUY RESISTENTE
HIGH QUALITY



eco wood



balanza scale + ? + 40 + 48 + 23,6 x 18,7 x 7,2 cm



LOS SUPERPODERES DE LOS ALIMENTOS SALUDABLES

THE SUPERPOWERS OF HEALTHY FOOD

Ref. 20557

3-8 years

SPECIAL NEEDS

¡Descubre el “superpoder” que esconden los alimentos y conviértete en un “superhéroe” de la alimentación saludable! Este juego ayuda a fomentar hábitos de alimentación saludables y enseña la importancia de consumir una amplia variedad de alimentos nutritivos. Además, permite clasificarlos según sus nutrientes principales y el grupo de alimentos al que pertenecen.

Discover the “superpowers” hidden in foods and become a “superhero” of healthy eating! This game helps to promote healthy eating habits and teaches the importance of consuming a wide variety of nutritious foods. In addition, it promotes their classification according to the main nutrients they contain and the food group to which they belong.

GRUPOS ALIMENTARIOS/ FOOD GROUPS

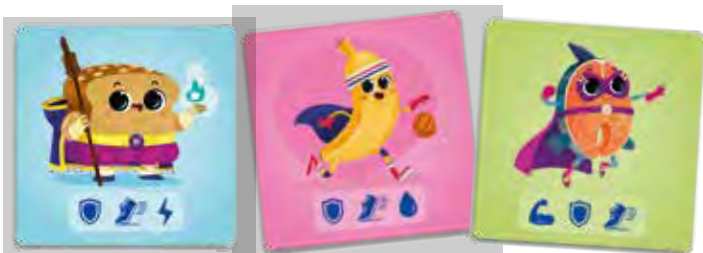

5

7 cm

+

45

7 x 7 cm

+



23,6 x 18,7 x 7,2 cm



SUPERPODERES/ SUPERPOWERS



Hidratación
Hydration



Protección
Protection



Fuerza
Strenght



Agilidad
Agility



Energía
Energy

x45



TAMAÑO REAL/ REAL SIZE



MUY RESISTENTE
HIGH QUALITY

¡Aprende a comer variado!
Let's eat from all food groups!



5 PERSONAJES
CHARACTERS
SUPERHEROES



DESCUBRIR LAS ALERGIAS E INTOLERANCIAS ALIMENTARIAS

LEARNING ABOUT FOOD ALLERGIES AND INTOLERANCES

Ref. 20555

¿Sabemos lo que comemos?
Este juego nos permite descubrir las alergias e intolerancias alimentarias más comunes, conocer qué alimentos pueden provocarlas, y qué síntomas causan. Ayuda a generar empatía hacia los compañeros con intolerancias alimentarias y favorece la aceptación e integración de los mismos en el aula.

Do we know what we're eating?
This game lets you discover the most common food allergies and intolerances, which foods cause them, and what symptoms they can cause. It helps to generate empathy towards fellow students with food intolerances and encourages their acceptance and integration in the classroom.



3-8 years

SPECIAL NEEDS

45 ALIMENTOS FOOD

In collaboration with CGCODN General Council Dietitians-Nutritionists



VIDEO

MUY RESISTENTE HIGH QUALITY

8 + 57 + 23,6 x 18,7 x 7,2 cm

8 ALÉRGENOS ALLERGENS

PESCADO FISH	HUEVO EGGS
GLUTEN GLUTEN	LECHE MILK
FRUTOS DE CÁSCARA NUTS	CACAHUETE PEANUTS
FRUTA FRUIT	MARISCO SHELLFISH

EL SEMÁFORO DE LA ALIMENTACIÓN SALUDABLE

THE TRAFFIC LIGHT OF HEALTHY EATING

4-8 years Ref. 20553

Juego de asociación para aprender a relacionar alimentos básicos con los colores del semáforo, en base a la frecuencia con que se deben tomar dichos alimentos, siendo el verde "a diario", el amarillo "semanal" y el rojo "cuanto menos, mejor".

A game of association to relate basic foodstuffs with the colours of a traffic light, based on how frequently they should be eaten, where green means "daily", yellow means "weekly" and red means "the less the better".

54 ALIMENTOS FOOD



In collaboration with CGCODN General Council Dietitians-Nutritionists



18 cm

MUY RESISTENTE HIGH QUALITY

7 cm

6 + 54 + 30 + 23,6 x 18,7 x 7,2 cm

¿DE DÓNDE VIENEN LOS ALIMENTOS? WHERE DOES FOOD COME FROM?

Ref. 20551

Juego de asociación para aprender a clasificar los alimentos según su procedencia.

A game of association for learning to classify foodstuffs depending on their origin.

3-6 years SPECIAL NEEDS SENIORS

MUY RESISTENTE
HIGH QUALITY



5 + 30 + 23,6 x 18,7 x 7,2 cm



5 ESCENARIOS
SCENES

LA PIRÁMIDE DE LA ALIMENTACIÓN SALUDABLE THE HEALTHY EATING PYRAMID

Ref. 20554

Lanza el dado y completa la pirámide con los alimentos correspondientes al color del dado. Aprende a relacionar alimentos básicos con los colores según la frecuencia con que se deben tomar dichos alimentos, siendo el verde "a diario", el amarillo "semanal" y el rojo "cuanto menos, mejor".

Throw the dice and complete the pyramid with the corresponding food items, taking into account that green is for food that should be eaten "daily", yellow the ones which should be eaten "weekly" and red is for food that should be eaten "the less the better".

3-8 years SPECIAL NEEDS

MUY RESISTENTE
HIGH QUALITY



66 x 45 cm + 3,5 cm + 54 + poster + 32,5 x 23,5 x 9 cm



In collaboration with
CGCODN
General Council
Dietitians-Nutritionists



Medioambiente
The environment



MI PLANETA Y SU ENERGÍA MY PLANET AND ITS ENERGY

Ref. 20822

Descubre el origen de la energía y cómo se transforma para llegar hasta nuestras casas y ciudades. Conoce las diferentes fuentes de energía, renovables y no renovables, de nuestro planeta.

Discover the origin of energy and how it is transformed to reach our houses and cities. Learn about the different sources of energy, both renewable and non-renewable, on our planet.

4-8
years



Energía no renovable
Non-renewable energy

Ø 36,5 cm

GRAN TAMAÑO
BIG SIZE
Ø 36,5 cm



MUY RESISTENTE
HIGH QUALITY

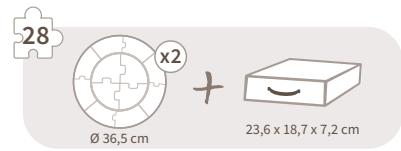

Energía renovable
Renewable energy



LAS 3 R: REDUCE, REUTILIZA Y RECICLA THE 3 Rs: REDUCE, REUSE AND RECYCLE

Ref. 20819

NEW

Aprende hábitos sostenibles para disminuir el consumo de recursos que utilizamos, como el agua o la energía, reducir los residuos que generamos, reutilizar envases, prendas y objetos que tenemos en nuestro entorno, y reciclar adecuadamente. Juego de observación y clasificación con imágenes reales de gran tamaño.

¡Gira la ruleta y aprende a ser un consumidor responsable con el medioambiente!

Learn sustainable habits to reduce the consumption of the resources we use, such as water or energy, reduce the waste we generate, reuse packaging, clothing and objects that we have in our surroundings and recycle properly. Observation and classification game with real, large-size pictures.

Spin the wheel and learn to be an environmentally-friendly consumer!

44 FICHAS
CARDS



TAMAÑO REAL
REAL SIZE
Ø 7,4 cm

3-8 years
SPECIAL NEEDS
SENIORS

Ø 15 cm

¡Lanza la ruleta!
¡Ser sostenible urge!
Spin the wheel!
Being sustainable is an urgent matter!

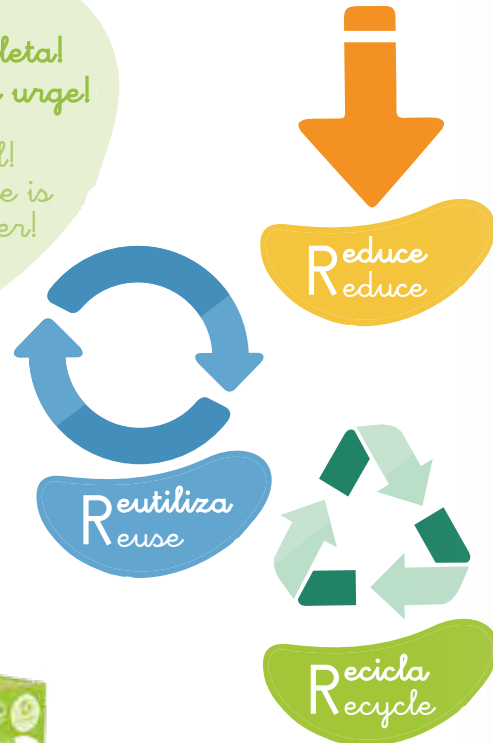

44 + 1 + 20,2 x 13 x 6 cm

¡Ayudamos a alargar la vida del planeta!
Help us to help the planet live longer!



REDUCE EL CONSUMO DE AGUA Y DE ENERGÍA
REDUCE WATER AND ENERGY WASTE



MUY RESISTENTE
HIGH QUALITY

REUTILIZA
REUSE



RECICLA
RECYCLE



NUESTRO MUNDO SOSTENIBLE OUR SUSTAINABLE WORLD

Ref. 20823

Juego de asociación que invita a realizar pequeños cambios en nuestro día a día, y ayuda a concienciar sobre la necesidad de contribuir con nuestras acciones a crear un mundo más sostenible. Con imágenes reales de gran tamaño y sistema autocorrector en el reverso.

¡Educar es contribuir a mejorar las personas, y con ellas el mundo!

Association game which invites us to make small changes in our everyday lives to raise awareness of the need to create a more sustainable world with our actions. With large real images and a self-marking system on the back.

Educating is helping people to improve the world!



34 FICHAS
CARDS

GRAN TAMAÑO
BIG SIZE
9x9 cm



MUY RESISTENTE
HIGH QUALITY



34 + 20,2 x 13 x 6 cm

¡DISFRUTA LAS ESTACIONES DEL AÑO! ENJOY THE SEASONS OF THE YEAR!

Ref. 38900

Un original juego de asociación para descubrir actividades que se realizan en primavera, verano, otoño e invierno. Sus imágenes reales invitan a recorrer las estaciones del año una y otra vez. Cada estación lleva un marco de diferente color que permite asociarla fácilmente con sus fichas. ¡Lanza el dado y empieza a jugar!

¡Disfruta de tu estación del año favorita!

An original association game to discover activities that are carried out in spring, summer, autumn and winter. The real images invite you to explore the seasons of the year again and again. Each season has a different coloured frame which enables you to associate it with its cards easily. Throw the dice and start playing!

Enjoy your favourite season!

GRAN TAMAÑO
BIG SIZE
Ø 26,3 cm



Ø 26,3 cm

4 ESTACIONES
SEASONS

x24



¡Disfruta de tu estación favorita!
Enjoy your favourite season!



MUY RESISTENTE
HIGH QUALITY



28 + x4 + + 20,2 x 13 x 6 cm

NATUDOMINO INSECTOS NATUDOMINO INSECTS

Ref. 20825

¡Un espectacular dominó de fichas grandes para descubrir pequeños insectos con imágenes reales! Desarrolla la atención mientras exploras de cerca el mundo de los insectos. Fichas reversibles que también permiten jugar con el sistema de dominó clásico.

An amazing dominoes game with large cards for discovering small insects using real images! Develop your attention while exploring the world of insects in close-up. Reversible cards that also enable you to play classic dominoes.



28 FICHAS
CARDS



MUY RESISTENTE
HIGH QUALITY

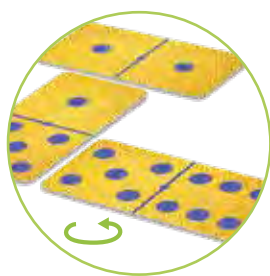

GRAN TAMAÑO
BIG SIZE
13 cm



NATUDOMINO ANIMALES EN EXTINCIÓN NATUDOMINO ANIMALS IN EXTINCTION

Ref. 20824

¡Un espectacular dominó de fichas grandes, con imágenes reales, para conocer algunos animales que se encuentran en peligro de extinción! Desarrolla la atención mientras descubres animales que están en riesgo de desaparecer. Fichas reversibles que también permiten jugar con el sistema de dominó clásico.

An amazing dominoes game with large cards using real images to discover some animals in danger of extinction! Develop your attention while discovering animals that are in danger of disappearing forever. Reversible cards that also enable you to play classic dominoes.



28 FICHAS
CARDS



GRAN TAMAÑO
BIG SIZE
13 cm



MUY RESISTENTE
HIGH QUALITY

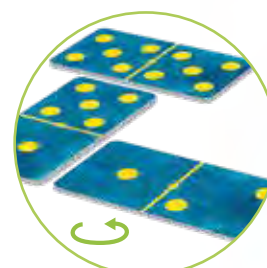

NATUDOMINO MARAVILLAS DE LA NATURALEZA

NATUDOMINO WONDERS OF NATURE

Ref. 20826

¡Un espectacular dominó de fichas grandes para descubrir maravillas de la naturaleza con imágenes reales! Desarrolla la atención mientras exploras curiosidades del mundo natural. Fichas reversibles que también permiten jugar con el sistema de dominó clásico.

An amazing dominoes game with large cards for discovering the wonders of nature using real images! Develop your attention while exploring interesting details about the natural world. Reversible cards that also enable you to play classic dominoes.



MUY RESISTENTE
HIGH QUALITY



GRAN TAMAÑO
BIG SIZE
13 cm

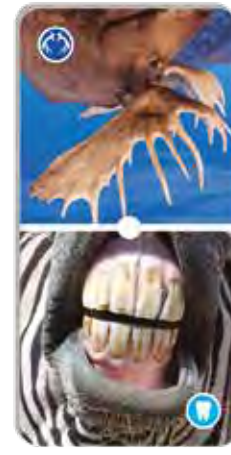
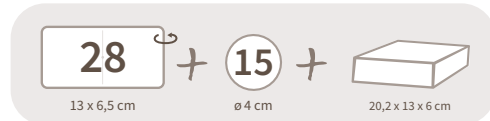

GRAN TAMAÑO
BIG SIZE
13 cm

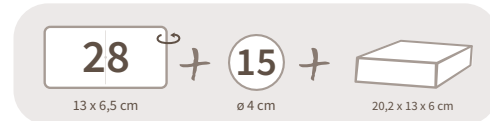
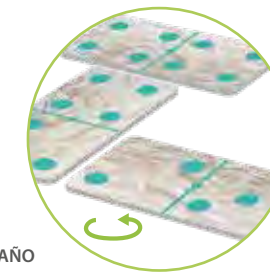

NATUDOMINO EL ZOOM DE LOS ANIMALES

NATUDOMINO THE ZOOM OF ANIMALS

Ref. 20827

¡Un espectacular dominó de fichas grandes, con imágenes reales, para descubrir de forma ampliada detalles curiosos de los animales! Desarrolla la atención mientras observas animales de cerca. Fichas reversibles que también permiten jugar con el sistema de dominó clásico.

An amazing dominoes game with large cards, using real images to discover interesting details about animals! Develop your attention while looking at animals in close-up. Reversible cards that also enable you to play classic dominoes.



MUY RESISTENTE
HIGH QUALITY



MAXI SECUENCIAS: ¿POR QUÉ RECICLAMOS? MAXI-SEQUENCES: WHY DO WE RECYCLE?

Ref. 30643

3-8 years

SPECIAL NEEDS

Secuencias para ayudar a los más pequeños a entender la importancia de reciclar. Descubre en qué se transforman los materiales que reciclamos y comprende en pocos pasos el proceso del reciclado. Fichas de gran tamaño.

Sequences to help children to appreciate the importance of recycling. Find out what the materials we recycle are turned into and understand the recycling process in a few steps. Large format cards.



GRAN TAMAÑO
BIG SIZE
11,5 cm



MUY RESISTENTE
HIGH QUALITY

11,5 cm

20

11,5 x 11,5 cm



20,2 x 13 x 6 cm

SEPARAR Y RECICLAR SEPARATING AND RECYCLING

Ref. 20552

Juego de asociación para aprender a separar y clasificar los distintos tipos de residuos: orgánicos, plásticos, envases, latas, papel, cartón, vidrio, pilas, baterías, etc.

A game of association for learning to separate and classify different kinds of rubbish: organic, plastic, bottles, cans, paper, cardboard, glass, batteries, etc.

3-8 years



MUY RESISTENTE
HIGH QUALITY

5 CONTENEDORES
CONTAINERS



35 FICHAS
CARDS



3,5 cm

+

35

6,1 x 6,1 cm

+

5

+

32,5 x 23,5 x 9 cm

+

32,5 x 23,5 x 9 cm



LOS BUENOS MODALES: EL MEDIOAMBIENTE GOOD BEHAVIOUR: THE ENVIRONMENT

Ref. 20800

Juego de asociación de parejas, que muestra un buen y un mal comportamiento, para la adecuada conservación del medioambiente.

Association game for matching cards that show examples of good and bad behaviour in different natural situations, with the aim of promoting environmental care.

3-8 years SPECIAL NEEDS



VIDEO



TAMAÑO REAL/ REAL SIZE



34 + 9 x 9 cm 20,2 x 13 x 6 cm

MUY RESISTENTE
HIGH QUALITY

CUIDAR EL PLANETA TAKING CARE OF THE EARTH

Seis divertidas historias que narran las aventuras de dos hermanos que aprenden sencillos métodos para ahorrar agua y energía.

Six entertaining stories that relate the adventures of a brother and sister who learn some simple methods to save water and energy.

30

13,5 x 16,5 cm



23,6 x 18,7 x 7,2 cm



¡Aprende idiomas!
Learn languages!



DOWNLOAD ONLINE
AUDIO MP3

- 6 Cuentos / 6 Stories
- Guía pedagógica / Educational guide
- Textos de los cuentos / Texts of the stories
- Láminas para colorear / Pictures for colouring in



CUIDAR EL PLANETA: AHORRAR AGUA TAKING CARE OF THE EARTH: SAVING WATER

Ref. 20820

4-7 years



6 CUENTOS
STORIES

UPDATED
PRODUCT!

CUIDAR EL PLANETA: RECICLAR Y AHORRAR ENERGÍA TAKING CARE OF THE EARTH: RECYCLING AND SAVING ENERGY

Ref. 20821

4-7 years



6 CUENTOS
STORIES

UPDATED
PRODUCT!

RELIGIONES DEL MUNDO: RESPETO Y CONVIVENCIA WORLD RELIGIONS: RESPECT AND COEXISTENCE

Ref. 30767

NEW

Juego de asociación con fotografías para descubrir y conocer diferentes religiones. Ofrece la oportunidad de desarrollar una educación en valores, como base para la resolución de conflictos. Permite promover una cultura de paz y respeto desde edades muy tempranas. En el juego se muestran las siguientes religiones: budismo, cristianismo, hinduismo, islam y judaísmo. ¡Lanza el dado y descúbrelas!

Association game with photographs to discover and learn about different religions. It offers the chance to develop an education based on values as a basis for resolving conflicts. It helps you promote a culture of peace and respect from a very early age. The game features the following religions: Buddhism, Christianity, Hinduism, Islam and Judaism. Throw the dice and learn all about them!

3-8 years
SPECIAL NEEDS

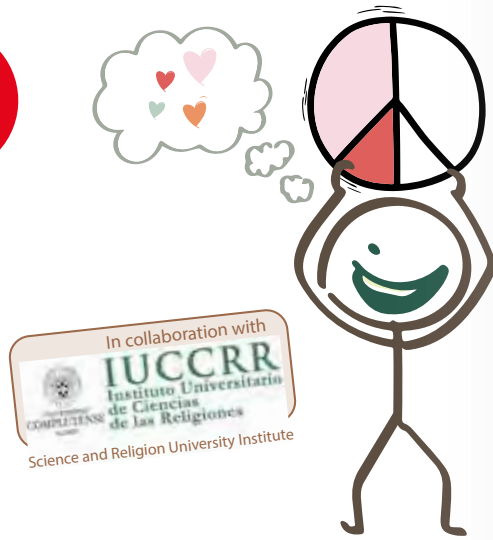

5 RELIGIONES
RELIGIONS

CRISTIANISMO
CHRISTIANITY



DADO RELIGIONES
RELIGION DICE

ISLAM
ISLAM



x30

10 x 7 cm

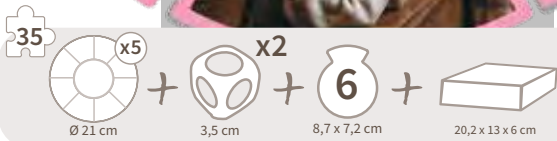

HINDUISMO
HINDUISM

JUDAÍSMO
JUDAISM

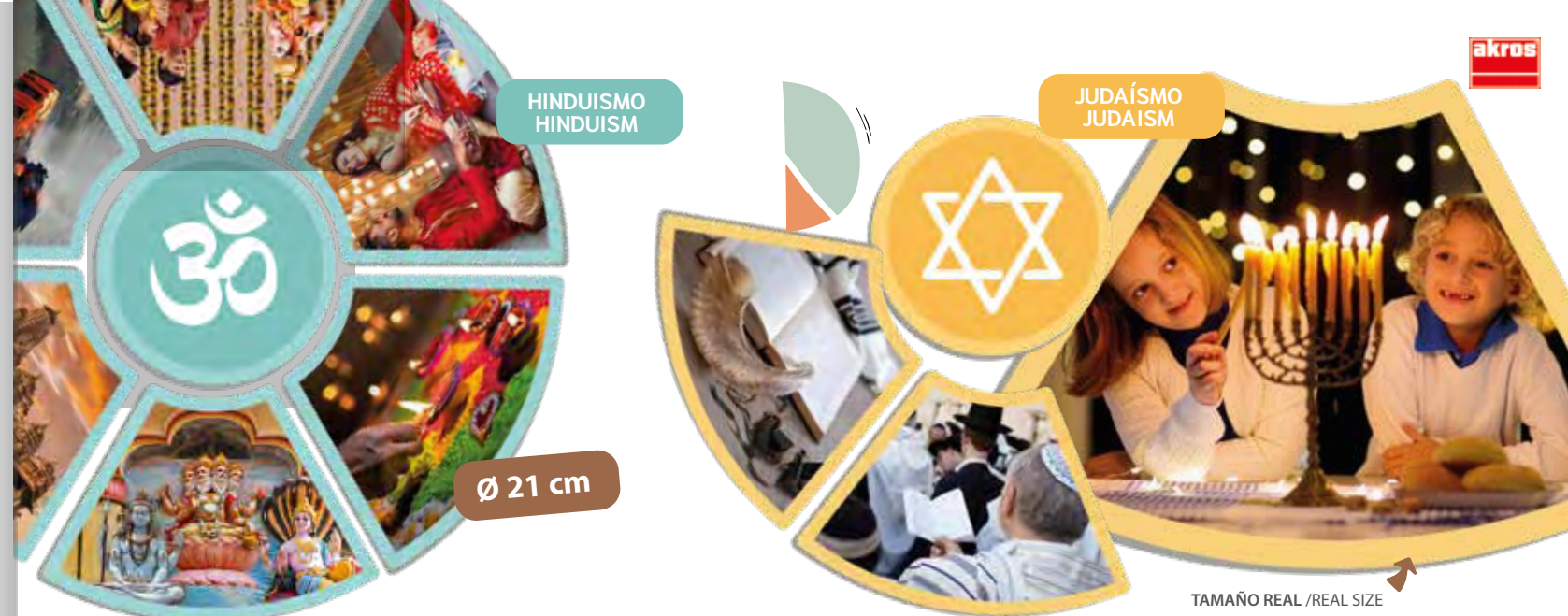

Ø 21 cm

TAMAÑO REAL / REAL SIZE

BUDISMO
BUDDHISM



6 CATEGORÍAS
CATEGORIES

¡Asocia también por categorías!
Association also by categories!



DADO CATEGORÍAS
CATEGORY DICE

- Acto del rezo
The act of prayer
- Símbolos religioso
Religious symbol
- Espacio de culto
Place of worship
- Celebración
Celebration
- Unión matrimonial
Marriage
- Más allá de la vida
The after-life

PHOTO-HISTORY. ¡JUEGA Y DESCUBRE CARACTERÍSTICAS DE LAS ETAPAS DE LA HISTORIA!
 PHOTO-HISTORY. PLAY AND LEARN ABOUT PERIODS IN HISTORY!

Ref. 30766

3-8 years

SPECIAL NEEDS

SENIORS

Juego de asociación con fotografías para conocer y clasificar las características sociales, económicas y culturales de cada una de las etapas de la historia. Descubre cómo han evolucionado la economía, los medios de transporte, la arquitectura, la pintura, los oficios, las viviendas, la indumentaria, y algunos de los inventos más representativos a través de las etapas de la historia. Incluye un gran puzle con la línea cronológica del tiempo.

Association game with photographs to discover and classify the social, economic and cultural characteristics of each period in history. Discover how the economy, transport, architecture, paintings, occupations, housing and clothing have evolved, and learn about some of the most representative inventions from different periods in history. It includes a large puzzle with a chronological timeline.

NEW

RULETA ETAPAS
STAGE WHEEL



RULETA ÁREAS
AREA WHEEL

Ø 14 cm

¡Viaja por la historia con imágenes reales!
 Travel through history with real pictures!

Ø 21 cm

EDAD ANTIGUA
ANCIENT TIMES



PREHISTORIA
PREHISTORY

5 ETAPAS
STAGES



TAMAÑO REAL
REAL SIZE
8,5 x 7,2 cm

x40

EDAD MEDIA
THE MIDDLE AGES

EDAD MODERNA
THE MODERN AGE

EDAD CONTEMPORANEA
THE CONTEMPORARY AGE

TAMAÑO REAL
REAL SIZE

8 ÁREAS
AREAS

¡Descubre cómo hemos evolucionado en diferentes áreas!
 Discover how we've evolved in different areas!

- | | | | |
|--|---|--|-------------------------|
| | Economía y necesidades primarias
Economy and basic needs | | Vestimenta
Clothing |
| | Pintura
Painting | | Transporte
Transport |
| | Arquitectura
Architecture | | Oficios
Occupations |
| | Inventos
Invention | | Vivienda
Home |

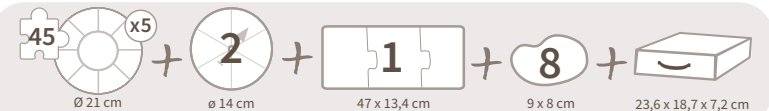

¡DESCUBRE LA HISTORIA DE LA HUMANIDAD!
DISCOVER THE HISTORY OF HUMANITY!

Ref. 30765

Juego de asociación para descubrir las diferentes etapas de la historia y ordenar cronológicamente muchos de sus principales acontecimientos, desde la prehistoria hasta la actualidad: Prehistoria, Edad Antigua, Edad Media, Edad Moderna y Edad Contemporánea. Puedes unir todas las etapas seguidas y formar ¡hasta 2,70 metros de historia! También incluye un gran puzzle con la línea cronológica del tiempo.

A game of association to learn about different historical periods and put some of their key events into chronological order, from prehistory through to the present day: Prehistory, the Ancient Age, the Middle Ages, the Modern Age, and the Contemporary Age. By linking all the ages in order you can form up to 2.70 metres of history! Includes a large jigsaw puzzle showing the chronological timeline.

3-8 years

SPECIAL NEEDS

SENIORS

5 ETAPAS STAGES



PREHISTORIA
PREHISTORY

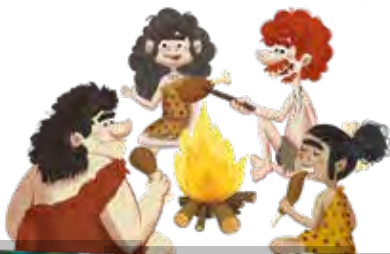

EDAD ANTIGUA
ANCIENT AGE

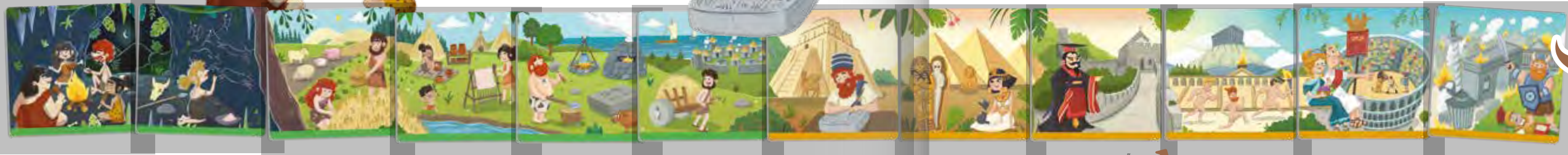

GRAN TAMAÑO
BIG SIZE
9x9 cm

MUY RESISTENTE
HIGH QUALITY

¡Hasta 2,70 metros de HISTORIA!
Up to 2.70 metres of HISTORY!

EDAD MEDIA
MIDDLE AGES



30

9 x 9 cm

+

1

9 x 45 cm

+

5

18 x 15,5 cm

+



23,6 x 18,7 x 7,2 cm



+ LÍNEA CRONOLÓGICA DEL TIEMPO
CHRONOLOGICAL TIMELINE

45 cm



2.500.000 B.C.

3.500 B.C.

476

1492

1789

MAXI-MEMORY DIVERSIDAD Y FORMAS DE VIVIR
MAXI-MEMORY DIVERSITY AND WAYS OF LIVING

Ref. 20409

Descubre diferentes formas de vivir y realizar actividades cotidianas en el mundo, como ir al cole, obtener agua, jugar, viajar y muchas más. Con este memory de imágenes reales en fichas de gran tamaño conocerás cómo viven en otros lugares y aprenderás la gran diversidad que existe en el mundo actual, al mismo tiempo que desarrollas la atención y ejercitas la memoria.

¡Conocer las diferencias es el primer paso para aprender a respetar la diversidad!

Discover different ways of living and carrying out daily activities in the world, including going to school, getting water, playing, travelling and much more. With this memory game using real images on large cards, you will find out about how people live in other places and learn about the great diversity of today's world. You will also develop your attention and exercise your memory.

Understanding differences is the first step in learning to respect diversity!

3-8 years SPECIAL NEEDS SENIORS



GRAN TAMAÑO
BIG SIZE
9 x 9 cm



34 FICHAS
CARDS

MUY RESISTENTE
HIGH QUALITY



34 + 20,2 x 13 x 6 cm



¡DESCUBRE LOS CONTINENTES DEL MUNDO!
DISCOVER THE CONTINENTS OF THE WORLD!

Ref. 38995

Sencillo juego de asociación para viajar por los continentes, familiarizarnos con su ubicación geográfica y descubrir con imágenes reales la gran diversidad de paisajes, tradiciones y culturas que existe en el mundo actual. Cada continente lleva un marco de diferente color que permite asociarlo fácilmente con sus fichas. ¡lanza el dado y empieza a jugar!

¡Conocer el mundo es el primer paso para aprender a respetarlo!

Simple association game to travel through the continents and get familiar with their geographical location and discover the great diversity of landscapes, traditions and cultures that exist in today's world using real images. Each continent has a different colored frame which easily enables you to associate it with its cards. Throw the dice and start playing!

Understanding the world is the first step in learning to respect it.

3-8 years SPECIAL NEEDS SENIORS

MUY RESISTENTE
HIGH QUALITY

Ø 20,8 cm

GRAN TAMAÑO
BIG SIZE

6 CONTINENTES
CONTINENTS

¡Viaja por todos los continentes!
Travel all over the continents!



x36

42

Ø 20,8 cm x6 + 3,5 cm + 20,2 x 13 x 6 cm



SET PUZLES FAMILIAS DEL MUNDO ACTUAL (4 uds.)

SET FAMILIES OF TODAY'S WORLD PUZZLES (4 units)

Ref. 50201

Puzles para conocer la diversidad de las familias actuales. Pack de 4 grandes puzles con diferentes familias del mundo actual, para niños a partir de 2 años. Cada puzle está compuesto por 6 piezas de gran tamaño. Realizados en cartón grueso de máxima resistencia.

Puzzles for learning about the diversity of present-day families. A pack of four large puzzles featuring different families from the modern world, aimed at children aged two and over. Each puzzle comprises six large pieces made from thick, sturdy cardboard.

2-5 years 2+ SPECIAL NEEDS



4 MAXI PUZLES
MAXI PUZZLES



GRAN TAMAÑO
BIG SIZE



48 x 16 cm



MUY RESISTENTE
HIGH QUALITY



SET 12 PUZLES - NIÑOS FELICES DEL MUNDO

SET OF 12 PUZZLES – HAPPY CHILDREN OF THE WORLD

Ref. 50223

Set de 12 puzles progresivos de 3, 4 y 6 piezas, con imágenes de niños felices de todo el mundo. Realizados con piezas grandes en cartón grueso de máxima calidad y resistencia, para niños a partir de 2 años.

Set of 12 progressive puzzles of 3, 4 and 6 pieces featuring images of happy children from all over the world. Made from large pieces of thick, strong, top quality cardboard, for children aged two and upwards.

2-6 years 2+ SPECIAL NEEDS

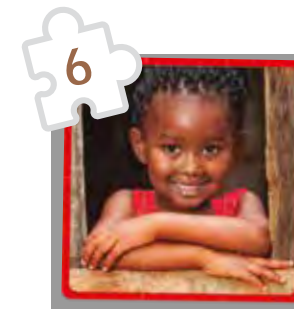
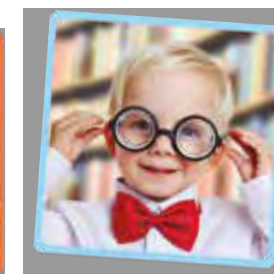
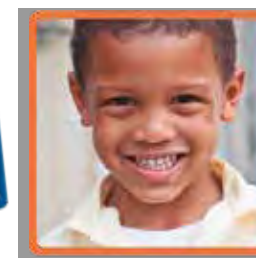

MUY RESISTENTE
HIGH QUALITY



ENLAZAR FAMILIAS DEL MUNDO LACING FAMILIES OF THE WORLD

Ref. 52311

3-6 years

SPECIAL NEEDS

Montessori

Set de 24 figuras de madera que permite al niño enlazarlas representando su propia familia y jugar con las figuras que se mantienen de pie. Incluye 6 cordones de colores. Desarrolla la psicomotricidad fina en niños a partir de 3 años. Inspirado en la metodología Montessori.

Set of 24 wooden figures for linking up. Children can link up their own family and play with the characters, which are also free-standing. Includes six coloured laces. Develops fine motor skills in children over three years old. Inspired by the Montessori methodology.

eco wood

REVERSIBLE



Fácil de ensartar
Easy to handle



24 FIGURAS
FIGURES



VIDEO

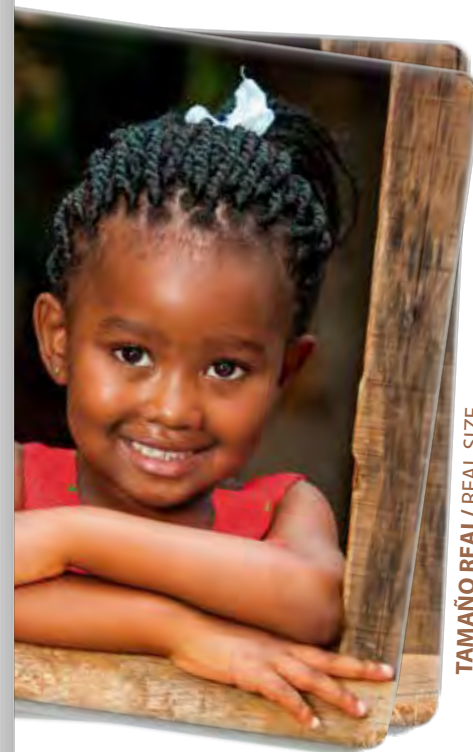
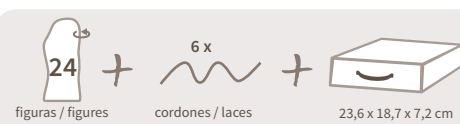

TAMAÑO REAL/ REAL SIZE

MAXI-MEMORY CULTURAS / MAXI-MEMORY CULTURES

Ref. 20403

3-8 years

SPECIAL NEEDS

Montessori



MUY RESISTENTE
HIGH QUALITY

34

9 x 9 cm

+



20,2 x 13 x 6 cm



VIDEO

MAXI-MEMORY LUGARES DEL MUNDO / MAXI-MEMORY PLACES OF THE WORLD

Ref. 20404

3-8 years

SPECIAL NEEDS

Montessori



MUY RESISTENTE
HIGH QUALITY

34

9 x 9 cm

+



20,2 x 13 x 6 cm



VIDEO



TAMAÑO REAL/ REAL SIZE



Asociación
Association

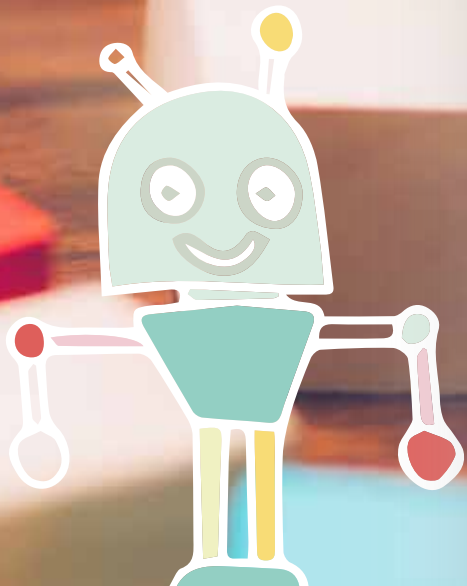

DOMINÓ ATENCIÓN SELECTIVA SELECTIVE ATTENTION DOMINOES

Ref. 33050

Un divertido dominó especialmente indicado para trabajar la atención selectiva, a través de la asociación de diferentes formas y colores. Dirige la atención a un atributo de las figuras, la forma o el color, para realizar la asociación. Fichas reversibles que permiten múltiples formas de juego.

A fun dominoes game, especially suited to work on selective attention through the association of different shapes and colours. Direct your attention to one attribute of the figures, the shape or colour, to make the association. Reversible cards that enable multiple ways to play.



GRAN TAMAÑO
BIG SIZE
13,4 cm

28 FICHAS
CARDS

MUY RESISTENTE
HIGH QUALITY

3-8 years
SPECIAL NEEDS

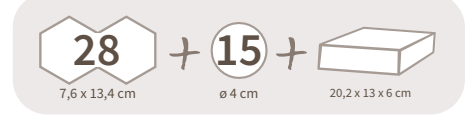

ASOCIACIONES ASSOCIATIONS

Ref. 20530

Juego de asociación compuesto por 34 parejas de fichas que muestran una relación funcional entre los objetos.

A game of association for creating 34 pairs of cards which show a functional relationship between the objects.



68 fichas
cards

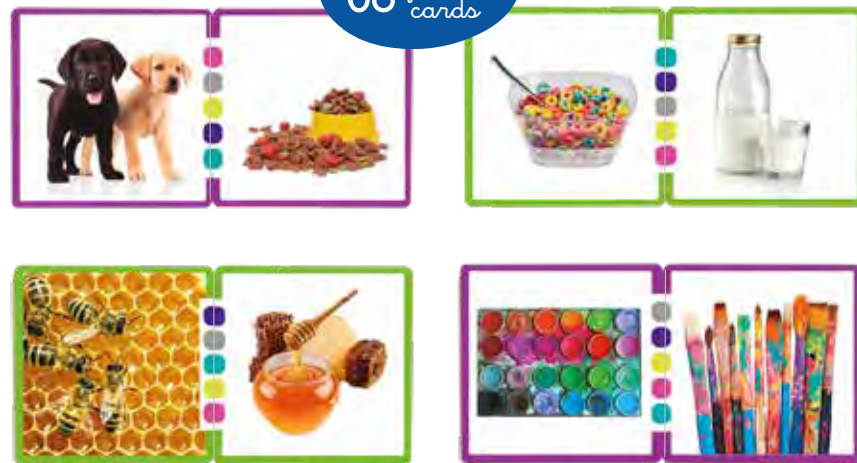

MUY RESISTENTE
HIGH QUALITY



CONTRASTES CONTRASTS

Ref. 20531

Juego de asociación compuesto por 34 parejas de fichas que representan conceptos opuestos o contrarios.

A game of logical association for creating 34 pairs of cards which represent opposite concepts.



68 fichas
cards



MUY RESISTENTE
HIGH QUALITY

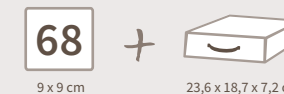

MUY RESISTENTE
HIGH QUALITY

¿QUÉ TIENEN EN COMÚN? WHAT DO THEY HAVE IN COMMON?

Ref. 20532

Observa, asocia y descubre la relación que existe entre las imágenes.

Observe, associate and realize the relationship between the pictures.



¿DÓNDE VIVEN LOS ANIMALES? WHERE DO ANIMALS LIVE?

Ref. 20562

Juego de asociación para descubrir dónde viven los animales:
en la granja, en la selva, en el desierto, en los polos o bajo el agua.

A game of association for learning about where do animals live:
on the farm, in the jungle, in the desert, at the Poles or in the sea.

3-6
years

SPECIAL
NEEDS

SENIORS



La granja
The farm

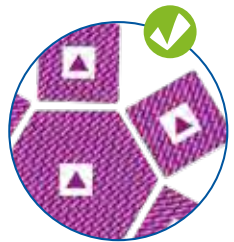

MUY RESISTENTE
HIGH QUALITY

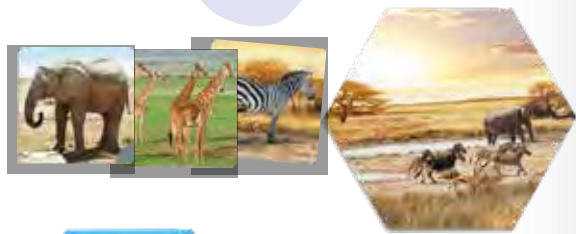

La selva
The jungle



El mar
The sea



El desierto
The desert



Los polos
The Poles



VIDEO

5 + 30 + 23,6 x 18,7 x 7,2 cm



VIDEO

5 ESCENARIOS
SCENES



Cocina
Kitchen



MUY RESISTENTE
HIGH QUALITY



Comedor-salón
Dining-room



Baño
Bathroom



Jardín
Garden



Habitación
Bedroom

¿DÓNDE ESTAMOS EN LA CASA? WHERE ARE WE IN THE HOUSE?

Ref. 20564

Juego de asociación para aprender a clasificar las acciones que se realizan en las distintas estancias de una casa.

A game of association for learning how to classify the actions associated with the different rooms in the house.

3-6
years

SPECIAL
NEEDS

SENIORS

5 ESCENARIOS
SCENES

5 + 30 + 23,6 x 18,7 x 7,2 cm



VIDEO



LOS OFICIOS / TRADES

Ref. 20560

Juego de asociación para aprender a relacionar los elementos y útiles de trabajo característicos de cada oficio. ¡Descubre hasta 12 profesiones diferentes!

Match the objects to their corresponding trade or profession. Discover up to 12 different jobs!

3-6 years

SPECIAL NEEDS

SENIORS

4 colours easy to play



VIDEO

48

7,5 x 7,5 cm

+

12

8 x 15 cm

+



23,6 x 18,7 x 7,2 cm



MI PRIMERA EDUCACIÓN VIAL MY FIRST ROAD SAFETY LESSON

Ref. 20575

Lanza el dado y completa las señales de tráfico con situaciones del entorno vial que se corresponden con dicha señal.

Throw the dice and match the traffic signs to the situations that correspond to each sign.

3-8 years

SPECIAL NEEDS

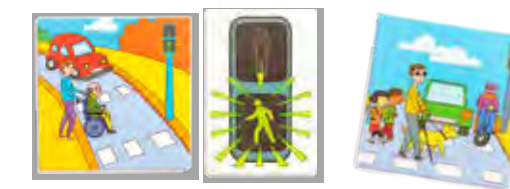
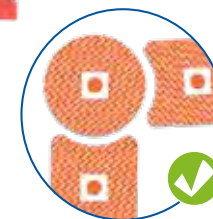

MUY RESISTENTE
HIGH QUALITY

DOWNLOAD ONLINE
MULTIMEDIA GAME

- Juego interactivo multimedia / Interactive multimedia game
- Guía pedagógica / Educational guide
- Láminas para colorear / Pictures for colouring in



6

+

21

+



3,5 cm

+



23,6 x 18,7 x 7,2 cm

ABC

Lengua je
Language



A
a
C



4 RULETAS
SPINNING WHEELS

LETRAS Y FONEMAS
LETTERS & PHONEMES

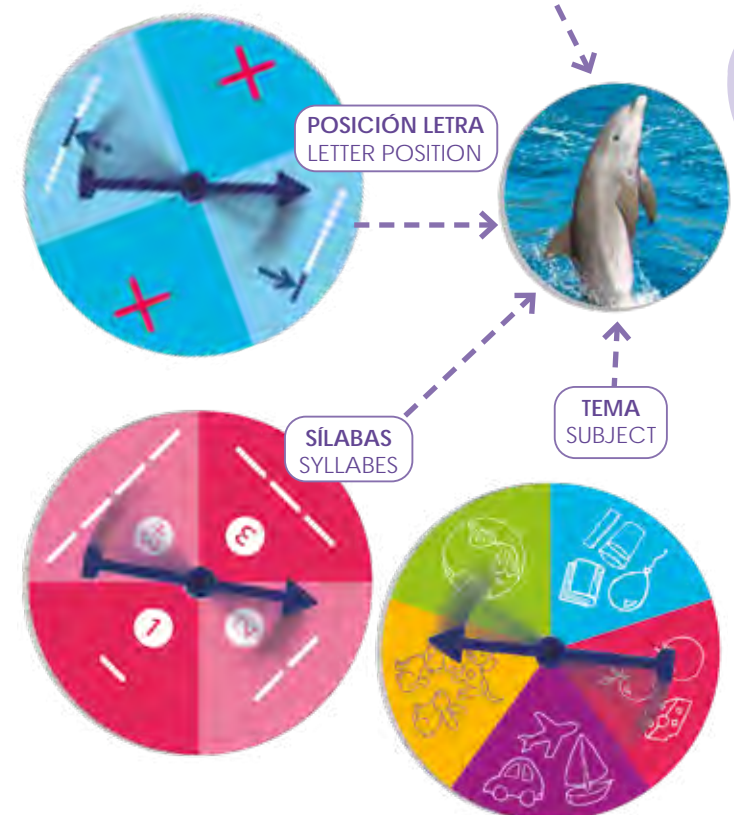

LA RULETA DE LA PRELECTURA
THE PRE-READING ROULETTE

Ref. 20039

¡Gira la ruleta y busca imágenes que comiencen por una letra o fonema, contengan esa letra o fonema, o bien tengan un número determinado de sílabas! Juego con fotografías para segmentar las palabras en sílabas mentalmente e identificar fonemas y letras de manera progresiva. La conciencia fonológica es fundamental para generar una buena base de prelectura. Segmentar en fonemas, deletrear y silabear a partir de imágenes está especialmente indicado cuando existen dificultades específicas de aprendizaje como la dislexia.

Spin the roulette and search for images that start with a specific letter or phoneme, that contain that letter or phoneme, or that have a specific number of syllables! A game containing photographs to help you to mentally segment words into syllables and identify phonemes and letters in a progressive way. Phonological awareness is essential for creating a good foundation before reading. Segmenting phonemes, spelling and dividing words into syllables using images is particularly indicated when there are specific learning difficulties such as dyslexia.

Conciencia fonológica
y dislexia
Phonological awareness
and dyslexia

4-8 years
SPECIAL NEEDS
SENIORS



80 FICHAS
CARDS



LOS 4 JUEGOS DEL SOPLO THE 4 BLOWING GAMES

Ref. 20030

Cuatro divertidos juegos que permiten entrenar la intensidad, potencia y direccionalidad del soplo para conseguir desarrollar un esquema respiratorio correcto.

Four fun games which help to exercise blowing intensity, strength and directional skills to develop optimum breathing patterns.

3-8 years

SPECIAL NEEDS



100% RECYCLED RECYCLABLE



VIDEO



31 x 22 x 5,5 cm

Ø 3 cm

32,5 x 23,5 x 9 cm

LAS AVENTURAS DEL SOPLO BLOWING ADVENTURES

Ref. 20031

¡Supera los obstáculos, dirige la pelota y alcanza tu objetivo! Dos divertidos escenarios que permiten entrenar la intensidad, potencia y direccionalidad del soplo para conseguir desarrollar un esquema respiratorio correcto. Se puede jugar solo o por parejas.

Go through obstacles, direct the ball and reach your goal! Two fun scenes that help to exercise intensity, strength and directional blowing skills to develop optimum breathing patterns. You can play alone or in pairs.

3-8 years

SPECIAL NEEDS



- Direccionalidad del soplo
• Directional blowing
- Intensidad / Strength
- Control



2 ESCENARIOS
SCENES

+ OBSTÁCULOS
OBSTACLES



MUY RESISTENTE
HIGH QUALITY

GRAN TAMAÑO
BIG SIZE

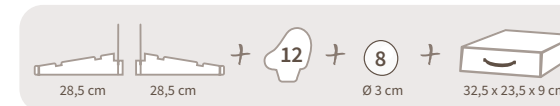

28,5 cm

28,5 cm

12

Ø 3 cm

32,5 x 23,5 x 9 cm

¡ADIVINA QUÉ REPRESENTO! GUESS WHAT I AM!

Ref. 20543

Lanza el dado y coge una ficha según el color que te haya salido. Sin enseñarla a nadie, dale la vuelta al reloj de arena y comienza la representación. Quien adivine lo que representas antes de acabar el tiempo, se queda la ficha. ¡Gana quien consiga más!

Throw the dice and pick up the corresponding colour card. Don't show it to anyone, turn over the hourglass and start acting. Whoever manages to guess what you're representing before the time runs out gets to keep the card. The winner is the person with the most cards!

3-8 years SPECIAL NEEDS



40 FICHAS
CARDS



PERSONAJES
CHARACTERS



ACCIONES
ACTIONS



ANIMALES
ANIMALS



OBJETOS
OBJECTS



EL CUERPO HUMANO: ¿CÓMO SOY? HUMAN BODY: WHAT AM I LIKE?

Ref. 30245

Una forma divertida de aprender las partes del cuerpo y descubrir cómo somos por fuera y por dentro. Juega a construir los puzzles del cuerpo humano y conoce nuestra estructura ósea y nuestros principales órganos. Contiene 3 puzzles reversibles de gran tamaño.

A fun way of learning about the different parts of the human body and discovering what we're like inside and outside. While playing with puzzles of the human body, children learn about our bone structure and most important organs. Contains three large reversible puzzles.

3-6 years SPECIAL NEEDS



3 MAXI PUZZLES
MAXI PUZZLES

6 CUERPOS
BODIES

FLEXIBLE



LAVABLE Y RESISTENTE
WASHABLE
AND HARD-WEARING

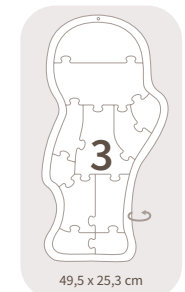

¡ PARA COLGAR EN LA PARED!
FOR HANGING ON THE WALL!



FOTOGRAFÍAS / PHOTOGRAPHS

ADIVINA QUÉ ESTÁN PENSANDO GUESS WHAT THEY'RE THINKING

Ref. 20514

Observa las diferentes imágenes, ponte en el lugar de los personajes, y adivina qué están pensando. Mejora las habilidades sociales, la comunicación y la empatía. Incluye 54 fotografías y 22 globos de diálogo para expresar lo que piensan los personajes.

Observe the different pictures, put yourself in the character's shoes, and try to guess what they're thinking. Helps to improve social skills, communication and empathy. Includes 54 photographs and 22 dialogue balloons to express what the characters are thinking.

3-8 years SPECIAL NEEDS SENIORS



Mejora las habilidades sociales y la empatía
Improves social skills and empathy

54 FOTOGRAFÍAS
PHOTOGRAPHS

22 GLOBOS DE DIÁLOGO
DIALOGUE BALLOONS



22

+

54

+



16,6 x 11,6 cm

20,2 x 13 x 6 cm

FOTOGRAFÍAS DE ANIMALES / ANIMAL PHOTOGRAPHS

Ref. 20505

54 fotografías de animales domésticos, de granja, salvajes y acuáticos en su hábitat.
54 photos of pets, farm animals and wild animals in their habitats.

3-8 years SPECIAL NEEDS SENIORS



FOTOGRAFÍAS DE ACCIONES (VERBOS) / ACTION PHOTOGRAPHS (VERBS)

Ref. 20506

54 fotografías de diferentes acciones cotidianas.
54 photos of different everyday actions.

3-8 years SPECIAL NEEDS SENIORS

54

16,6 x 11,6 cm

+



+



20,2 x 13 x 6 cm



FOTOGRAFÍAS DE ALIMENTOS / FOOD PHOTOGRAPHS

Ref. 20507

54 fotografías de diferentes alimentos.
54 photos of different food items.

3-8 years SPECIAL NEEDS SENIORS



FOTOGRAFÍAS DE OBJETOS DE LA CASA / HOUSEHOLD OBJECTS PHOTOGRAPHS

Ref. 20508

54 fotografías de distintos objetos de la casa.
54 photographs of different household objects.



FOTOGRAFÍAS DEL CUERPO Y PRENDAS DE VESTIR / BODY PARTS AND CLOTHES PHOTOGRAPHS

Ref. 20509

54 fotografías con imágenes del cuerpo y prendas de vestir.
54 photographs showing body parts and clothes.



UPDATED PRODUCT!



54
16,6 x 11,6 cm
+
+
+
20,2 x 13 x 6 cm

FOTOGRAFÍAS DE SECUENCIAS / SEQUENCE PHOTOGRAPHS

Ref. 20510

54 fotografías que representan 14 actividades secuenciadas (de 3, 4 o 5 escenas).
54 photographs which represent short sequential stories (of 3, 4 or 5 scenes).



2 + 54 +
16,6 x 11,6 cm 20,2 x 13 x 6 cm

FOTOGRAFÍAS DE ADJETIVOS / PHOTOGRAPHS OF ADJECTIVES

Ref. 20511

54 fotografías que representan adjetivos básicos.
54 photographs which represent basic adjectives.



¿DÓNDE ESTÁ EL ERROR? / WHERE IS THE MISTAKE?

Ref. 20513

54 fotografías para identificar dónde está el error de cada imagen.
54 photographs for identifying the deliberate mistake in each photo.



BUSCA LAS DIFERENCIAS / FIND THE DIFFERENCES

Ref. 20512

54 fotografías para buscar las diferencias en 27 parejas.
54 photographs for identifying the differences between 27 pairs.



LOTO: 72 ALIMENTOS

LOTTO: 72 FOOD ITEMS

Ref. 20525

3-8 years

SPECIAL NEEDS

SENIORS

1-12 players

Loto de 72 alimentos para trabajar la asociación de dos formas: imagen con imagen, e imagen con palabra correspondiente.

A lotto game of 72 food items to practice association in two different ways: picture plus picture, and picture plus word.



MUY RESISTENTE
HIGH QUALITY

melon

banana

DOWNLOAD ONLINE
FOR PRINTING



¡Aprende idiomas!
Learn languages!



2 COLOURS
EASY TO PLAY

72 + 12 + +
5,5 x 5,5 cm 12 x 18 cm hojas adhesivas adhesive pages 23,6 x 18,7 x 7,2 cm

LOTO: 72 ANIMALES

LOTTO: 72 ANIMALS

Ref. 20526

Loto de 72 animales para trabajar la asociación de dos formas: imagen con imagen, e imagen con palabra correspondiente.

A lotto game of 72 animals to practice association in two different ways: picture plus picture, and picture plus word.

3-8 years

SPECIAL NEEDS

SENIORS

1-12 players



MUY RESISTENTE
HIGH QUALITY



penguin

dromedary

DOWNLOAD ONLINE
FOR PRINTING



¡Aprende idiomas!
Learn languages!



2 COLOURS
EASY TO PLAY

72 + 12 + +
5,5 x 5,5 cm 12 x 18 cm hojas adhesivas adhesive pages 23,6 x 18,7 x 7,2 cm

AUTODICTADO VERBOS SELF-LEARNING: VERBS

Juego de asociación para unir 108 verbos con su imagen correspondiente. Disponible en varios idiomas.

A game of association for matching 108 verbs with their corresponding images. Available in a wide variety of languages.



¡Aprende idiomas!
Learn languages!



Ref. 20090 FR



Ref. 20090 DE



Ref. 20090 ES



Ref. 20090 EN

MUY RESISTENTE
HIGH QUALITY



Idiomas sujetos a disponibilidad / Languages according to availability

AUTODICTADO SUSTANTIVOS SELF-LEARNING: NOUNS

Juego de asociación para unir 108 sustantivos con su imagen correspondiente. Disponible en varios idiomas.

A game of association for matching 108 nouns with their corresponding images. Available in a wide variety of languages.



UPDATED
PRODUCT!

¡Aprende idiomas!
Learn languages!



Ref. 20050 EN



Ref. 20050 FR



Ref. 20050 DE



Ref. 20050 ES

MUY RESISTENTE
HIGH QUALITY



Idiomas sujetos a disponibilidad / Languages according to availability

MACRO PUZLE ABECEDARIO MACRO ALPHABET PUZZLE

Ref. 30601

3-6 years

SPECIAL NEEDS

Forma y completa el abecedario con este macro puzzle. Relaciona los objetos con su inicial correspondiente. Incluye póster del tamaño del puzzle.

Make and complete the alphabet with this macro puzzle. Match the objects with their corresponding initial. A puzzle size poster is included.

MUY RESISTENTE
HIGH QUALITY

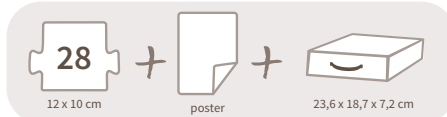

BUSCA LAS LETRAS/ FIND THE LETTERS

4-8 years

SPECIAL NEEDS

32 imágenes y 88 letras para formar las palabras representadas en cada imagen. Además permite formar muchas otras palabras.

32 pictures and 88 letters to form the word represented by each picture. It also lets you create lots of other words.

Ref. 30670 ES

Ref. 30670 FR

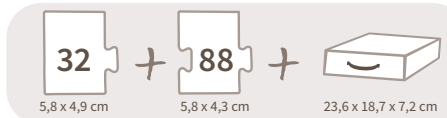
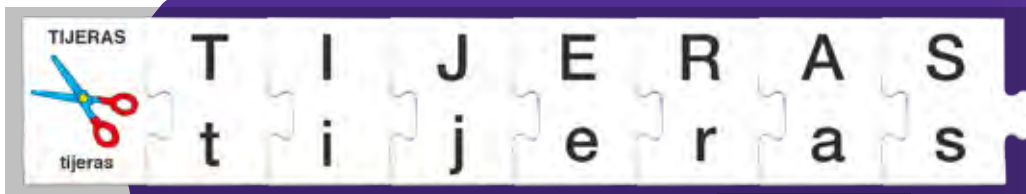

MUY RESISTENTE
HIGH QUALITY

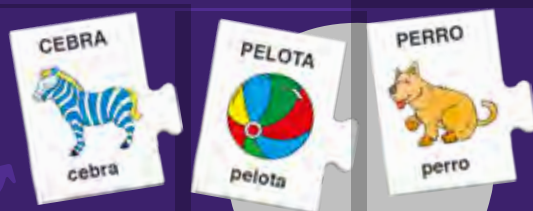

ALFABETO - SET DE 216 LETRAS ALPHABET - SET OF 216 LETTERS

Ref. 32010

Maletín con 216 letras, por un lado en mayúsculas y por el otro en minúsculas. Es válido para varios idiomas. Incluye las letras de los alfabetos de diferentes idiomas.

A briefcase containing 216 letter cards with capitals on one side and lower case on the other. It also includes letters from the alphabets of other languages.

4-8 years

SPECIAL NEEDS

SENIORS

TAMAÑO REAL/ REAL SIZE



mayúsculas capitals + minúsculas lower case



¡Aprende idiomas!
Learn languages!

MUY RESISTENTE
HIGH QUALITY

216 LETRAS
LETTER CARDS



VIDEO

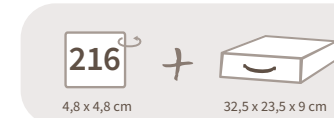

PICTO-DADOS DE CUENTOS CLÁSICOS

PICTO-DICE OF CLASSIC STORIES

Ref. 20048

Juego para aprender a formar frases con hasta 90 pictogramas de personajes de cuentos clásicos. Construye multitud de frases con 15 dados que, según su color, representan distintos elementos de la oración.

A game for learning to construct sentences with up to 90 pictograms of characters from classic children's stories. Build lots of sentences with 15 dice which, depending on their colour, represent the different elements of a sentence.

4-8 years SPECIAL NEEDS

TAMAÑO REAL / REAL SIZE

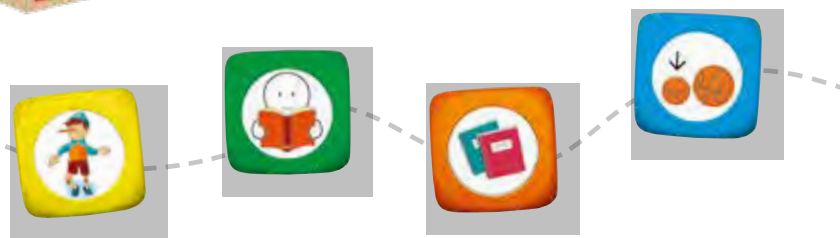

15 MAXI DADOS
MAXI DICE



¡Aprende idiomas!
Learn languages!



DOWNLOAD ONLINE
AUDIO MP3

- 6 Cuentos clásicos / 6 Classic stories
- Los Tres Cerditos / The Three Little Pigs
 - Pulgarcito / Tom Thumb
 - La Tortuga y La Liebre / The Tortoise & The Hare
 - El Gato con Botas / Puss in Boots
 - La Cenicienta / Cinderella
 - Pinocho / Pinocchio



DADOS PARA CREAR HISTORIAS

DICE FOR MAKING UP STORIES

Ref. 30770

Lanza los dados y deja volar tu imaginación. Crea diferentes historias con los personajes, animales, objetos y acciones que aparecen en los dados.

Throw the dice and let your imagination run wild. Make up stories with the characters, animals, objects and actions that appear on the dice.

3-8 years SPECIAL NEEDS



TAMAÑO REAL / REAL SIZE



MARIONETAS / PUPPETS

Elige tu set de marionetas y representa tu propio cuento. Cada set incluye la grabación y el guion de los cuentos.

Choose your puppet set and perform your own story. Each set includes the recording and the script of the stories.

3-8 years

SPECIAL NEEDS



¡Aprende idiomas!
Learn languages!



DOWNLOAD ONLINE
AUDIO MP3

- 2 Cuentos clásicos / 2 Classic stories
- Guía pedagógica / Educational guide
- Guion de los cuentos / Script of the stories
- Paisajes de fondo para colorear / Background scenery for colouring in



MARIONETAS: CAPERUCITA ROJA Y LOS TRES CERDITOS PUPPETS: LITTLE RED RIDING HOOD AND THE THREE LITTLE PIGS

Ref. 65001



VIDEO

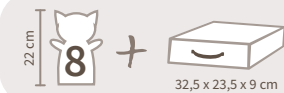

MARIONETAS: EL MAGO MICO Y EL CANTO DEL GALLO PUPPETS: MICO THE MAGICIAN AND THE CROW OF THE ROOSTER

Ref. 65002



VIDEO



120 FICHAS
CARDS



DOWNLOAD ONLINE
MULTIMEDIA GAME

- Juego interactivo multimedia / Interactive multimedia game
- Guía pedagógica / Educational guide
- Palabras de las imágenes / Words relating to the images
- Fichas para colorear y trabajar el trazo de las letras / Pictures for colouring in and working on the correct writing of the letters

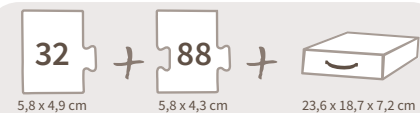

VIDEO

FOTO- FORMAR PALABRAS PHOTO-MAKING WORDS

Ref. 20045

32 imágenes y 88 letras para formar las palabras representadas en cada imagen. Además permite formar muchas otras palabras. Adaptado para poder formar palabras en 11 idiomas diferentes.

32 photos and 88 letters to form the word represented by each photo. It also lets you create lots of other words. It can be used to form words in 11 different languages.

4-8 years

SPECIAL NEEDS



MUY RESISTENTE
HIGH QUALITY



¡Aprende idiomas!
Learn languages!



MÉTODO LOGO-BITS

"LOGO-BITS" SPEECH CARDS METHOD



Paloma Gutiérrez

Método completo de trabajo con el que Paloma Gutiérrez, logopeda experta en trastornos del lenguaje y de la comunicación, autora del Método Logo-Bits, ha logrado enseñar a hablar a niños y adultos afectados por algún trastorno, síndrome, traumatismo o enfermedad.

Los ejercicios básicos que propone el Método Logo-Bits ayudan a trabajar la funcionalidad de las estructuras implicadas en el habla, la deglución, la respiración y la masticación.

The complete working method with which Paloma Gutiérrez, an expert speech therapist specializing in language and communication disorders and author of the Logo-Bits Method, has managed to teach children and adults affected by any disorder, syndrome, trauma or disease how to talk.

The basic exercises in the Logo-Bits Method help to work the functional elements of the structures involved in speaking, swallowing, breathing and chewing.



Logopeda especialista en trastornos del lenguaje y la comunicación. Especializada en enseñar a hablar a niños y adultos afectados por algún trastorno, síndrome, traumatismo o enfermedad. Investigadora activa y autora del Método Logo-Bits. Este programa completo de trabajo, experimentalmente contrastado durante más de 15 años, está destinado para el tratamiento de cualquier dificultad o patología relacionadas con el habla y la comunicación.

Speech therapist specialist in language and communication disorders. Specialized in teaching to talk to children and adults affected by some disorder, syndrome, trauma or disease. Active researcher and author of the Logo-Bit Method. This comprehensive program of work, experimentally proven for more than 15 years, is suitable for the treatment of any difficulty or pathology related to speech and communication.



LOGO-BITS DE PRAXIAS OROFACIALES

LOGO-BITS CARDS FOR ORAL MOTOR SPEECH THERAPY

Ref. 20020



* COMPRUEBA TU IDIOMA CON NOSOTROS
CHECK YOUR LANGUAGE WITH US



Tarjetas de praxias orofaciales que trabajan el correcto posicionamiento de labios, lengua, mandíbula y paladar, logrando una adecuada coordinación y fuerza de la musculatura orofacial. Los bits de praxias orofaciales forman parte de la Terapia Miofuncional (TMF), especialmente indicada para reeducar los hábitos de succión, respiración, masticación, deglución, articulación y fonación.

These orofacial practice cards help people to adopt the correct positioning of the lips, tongue, jaw and palate, maximizing the coordination and strength of the orofacial muscles. Orofacial praxis cards are part of Myofunctional Therapy (TMF) which is especially recommended for re-educating the habits of sucking, breathing, chewing, swallowing, articulation and phonation.



LOGO-BITS DE ROTACISMO PARA PRONUNCIAR BIEN LA /R/ Y /RR/
 LOGO-BITS CARDS FOR PRONOUNCING R AND RR PROPERLY RHOTACISM

Ref. 20025 **5+** years **SPECIAL NEEDS** **SENIORS**

Tarjetas de entrenamiento articulatorio para reeducar la correcta pronunciación de los fonemas /R/ y /RR/, y corregir el rotacismo. Las tarjetas contienen fonemas de repetición de lectura silábica. También incluye tarjetas con imágenes y palabras que contienen los fonemas /R/ y /RR/ para realizar más ejercicios fonéticos.

Pronunciation training cards for re-educating students in the correct pronunciation of the phonemes /R/ and /RR/ by correcting rhotacism. The cards contain repetition phonemes for syllable reading. It also contains cards with pictures and words that contain the phonemes /R/ and /RR/ for additional phonetic exercises.

NARÁ

nará



R

RR

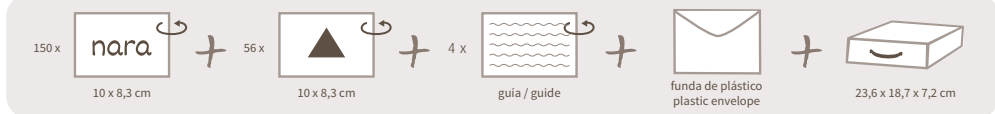

LOGO-BITS PARA DISCRIMINACIÓN DE LA S/Z
 LOGO-BITS CARDS FOR DIFFERENTIATING S / Z

Ref. 20026 **5+** years **SPECIAL NEEDS** **SENIORS**

Tarjetas de entrenamiento articulatorio para reeducar la correcta pronunciación y discriminación de los fonemas /S/ y /Z/, y corregir su defecto de articulación. Las tarjetas contienen fonemas de repetición de lectura silábica. También incluye tarjetas con imágenes y palabras que contienen los fonemas /S/ y /Z/ para realizar más ejercicios fonéticos.

Articulation training cards to re-educate students in how to differentiate between and properly pronounce the phonemes /S/ and /Z/, correcting any pronunciation errors. The cards contain repetition phonemes for syllable reading. It also contains cards with pictures and words that contain the phonemes /S/ and /Z/ for additional phonetic exercises.



zozú ZOZÚ



Z

S

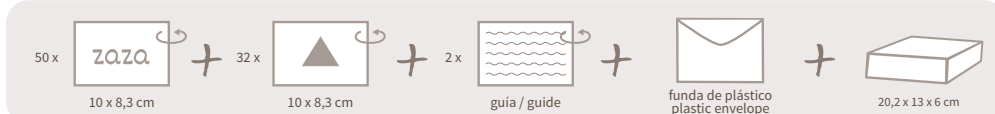

LA MÉTHODE LOGO-BITS



Claire-Lise Goasguen



Spécialiste ayant adapté la méthode LOGO-BITS de Paloma Gutiérrez. Orthophoniste spécialisée dans les troubles de la communication, du langage oral et écrit et de la mémoire, exerçant auprès de patients multilingues.

LECTO-BITS D'INITIATION À LA LECTURE PAR LES VOYELLES

Ref. 20021 FR **3+** years **SPECIAL NEEDS** **SENIORS**

Cartes d'initiation à une lecture facile par les voyelles grâce à un système d'entraînement ludique : les « Lecto-bits ». Permet de développer l'habileté de la lecture sans la nécessité de connaître toutes les lettres de l'alphabet (seulement les voyelles). Contient six niveaux de difficultés. Les fiches permettent d'accélérer le processus d'apprentissage normal de la lecture chez n'importe quel enfant, tout comme d'améliorer les performances de ceux présentant des difficultés d'apprentissage de la lecture.

LECTO-BITS DE SYLLABES SIMPLES POUR SOUTENIR LA PAROLE ET AMÉLIORER LA LECTURE

Ref. 20022 FR **5+** years **SPECIAL NEEDS** **SENIORS**

Cartes contenant toutes les syllabes combinées du système phonétique français pour améliorer la reconnaissance des lettres et des sons, et pour fluidifier la tâche de lecture. Ce matériel peut aussi servir à détecter des difficultés sur un phonème concret, de façon à pouvoir le travailler par la suite avec les cartes de la Méthode LOGO-Bit correspondantes. Ces cartes permettent d'accélérer l'apprentissage normal de la lecture chez n'importe quel enfant tout comme d'améliorer les performances de ceux présentant des difficultés d'apprentissage de la lecture.

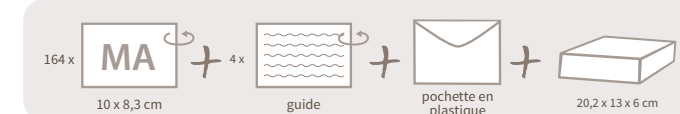
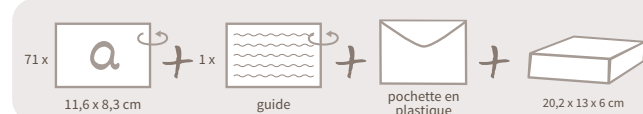

LOGO-BITS DE DISCRIMINATION AUDITIVE (CH/S) ET (J/Z)

Ref. 20026 FR

Cartes d'entraînement articulaire pour réduire la prononciation correcte des phonèmes Ch, S, J, Z, et améliorer la discrimination auditive entre eux (CH/S) (J/Z). Elles sont utiles pour corriger les troubles d'articulation comme le retard de parole. Ce matériel est composé de fiches de bisyllabes utilisables en procédures de répétition et de lecture. Inclues également des fiches-mots et des fiches-images afin de compléter le travail rééducatif.

5+ years SPECIAL NEEDS SENIORS



LOGO-BITS POUR BIEN PRONONCER LES GROUPES CONSONANTIQUES

Ref. 20024 FR

Cartes d'entraînement articulaire pour réduire la prononciation correcte des groupes consonantiques (BL CL FL GL PL- BR CR DR FR GR PR TR). Inclues également des fiches-mots et des fiches-images contenant les groupes consonantiques travaillés afin de compléter le travail rééducatif.

5+ years SPECIAL NEEDS SENIORS

L Plume

R Brouette

PULU PULU PULU PULU **PLU**

PULU → **PLU**

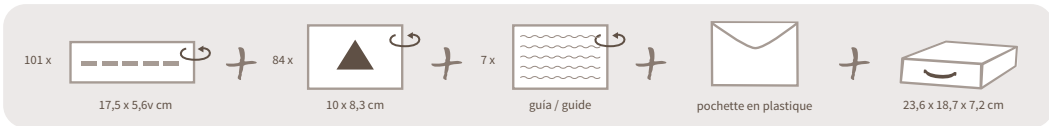

LOGO-BITS DES DIFFÉRENTES ASSOCIATIONS DE CONSONNES AU SEIN DE GROUPES BISYLLABIQUES POUR AMÉLIORER LE CONTRÔLE PHONOLOGIQUE ET LA PRONONCIATION

Ref. 20023 FR

Cartes d'entraînement phonologique et articulaire pour pratiquer grâce à la répétition de toutes les différentes associations de consonnes au sein de groupes bisyllabiques, et ainsi faciliter l'obtention des points d'articulation corrects et le contrôle phonologique. Ces cartes permettent la détection de défauts de prononciation sur un phonème précis ainsi que leur correction en fonction du point d'articulation. Améliore la discrimination auditive entre les différents phonèmes.

5+ years SPECIAL NEEDS SENIORS

F

Trouble : sigmatisme par omission ou substitution
Phonème labio-dental - Fricative - Sourde
Commandé de réaliser les exercices de Logo-Bits de Praxies Bucco-faciales et de souffle.

Production
prolongé pendant que le thérapeute réalise un appui digital
re afin que s'y appuient les incisives supérieures du patient.
Thérapeute produit le modèle à répéter.)

Thérapeute
avec donner un soutien verbal : " exemple des èvres pour
lu baiser légèrement séparées. Onomatopées " bruit du
ligué Fffuu. Il est possible d'utiliser une bougie pour
mouvement correct lors de l'émission de l'air."

FAFA	FAFE	FAFI	FAFO	FAFU
FEFA	FEFE	FEFI	FEFO	FEFU
FIFA	FIFE	FIFI	FIFO	FIFU
FOFA	FOFE	FOFI	FOFO	FOFU
FUFA	FUFE	FUFI	FUFO	FUFU

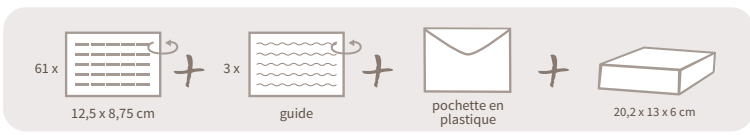

CH/S

J/Z

SESSÉ **sessé**

ZAZI **zazi**

CH Chat

S Sapin

J Orange

Z Zèbre

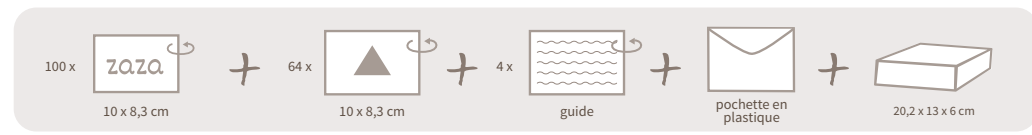



Razonamiento y matemáticas

Reasoning and mathematics

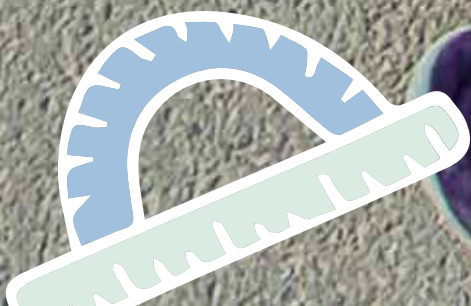

MUY RESISTENTE
HIGH QUALITY

AMIGOS DEL 10

FRIENDS OF 10

Ref. 30676

¡Busca las parejas de monstruos que suman 10!
Una forma divertida de aprender a componer
y descomponer el número 10, base para
desarrollar el cálculo mental con el método
ABN. Juego dinámico para facilitar el cálculo
rápido de operaciones elementales.

Find the monster pairs that add up to 10! A
fun way to learn number bonds to 10, the
basis for developing mental arithmetic with
the number-based algorithm (ABN) method.
A dynamic game to facilitate the rapid
calculation of elementary operations.

4-8
years

SPECIAL
NEEDS



- Cálculo matemático
Numbers bonds to 10
- Rapidez mental
Mental agility
- Razonamiento lógico
Logical reasoning



EL RETO DE LOS NÚMEROS DEL 1 AL 10
THE NUMBER CHALLENGE FROM 1 TO 10

Ref. 30673

Descubre los números del 1 al 10 a través de los sentidos, de forma manipulativa y creativa. Encontrarás recorridos táctiles, encajables, puzzles y piezas silueteadas para enlazar con los cordones. Además, aprenderás a contar del 1 al 10 con divertidas fotos reales ¡Gira las ruletas, aprende y diviértete!

Discover the numbers from 1 to 10 using the senses in a hands-on, creative way. You will find tactile paths, pieces that fit together, puzzles and outline pieces to tie together with ergonomic laces. You will also learn to count from 1 to 10 with fun real photos. Spin the wheels, learn and have fun!

3-6 years
 SPECIAL NEEDS
 Montessori inspired

GRAN TAMAÑO
 BIG SIZE
 8 cm

NEW

10 NÚMEROS
NUMBERS



5 RETOS
CHALLENGES

enlazable
 tie together

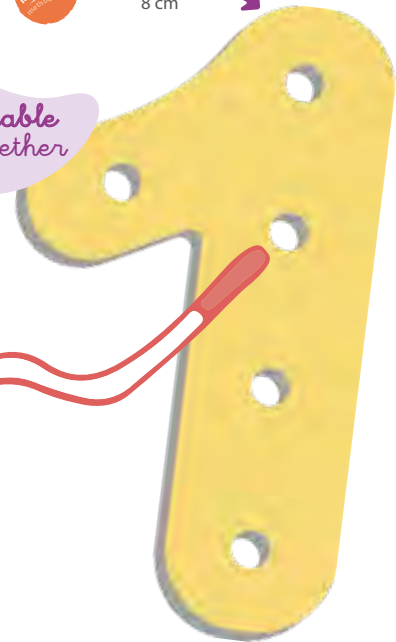

encajable
 fit together



puzzle
 puzzle



contar
 counting



recorrido táctil
 tactile

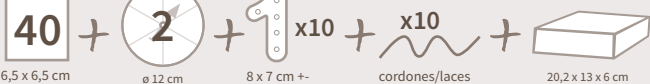

TACTILE SURFACE

Fácil de ensartar
 Easy to handle



INCLUYE 10 CORDONES
 10 LACES INCLUDED



MUY RESISTENTE
 HIGH QUALITY



x10

Fotos reales para aprender a contar
 Real pictures to learn how to count



NEW

LÓGICA Y CÁLCULO / LOGIC AND CALCULATION

NEW

LÓGICA Y CÁLCULO / LOGIC AND CALCULATION

APRENDE A SUMAR Y RESTAR CON LLEVADAS
LEARN TO ADD AND SUBTRACT AND CARRY OVER

NEW

Ref. 30677

Aprende a sumar y restar con llevadas mediante un sencillo método para entender el paso entre las unidades y las decenas. Los 8 tableros son reescribibles para practicar tantas veces como quieras, y en la base incluyen una recta numérica para facilitar el cálculo. Contiene dos sistemas para realizar la resta con llevadas por compensación y por agrupamiento. Incluye una tabla para trabajar los dobles del 1 al 10 y la descomposición del número 10. ¡Ahora sumar y restar es fácil y divertido!

Learn to add and subtract and carry over using a simple method to understand the step between tens and units. The 8 boards are rewritable so you can practise as many times as you like, and the base includes a number line to make the calculations easier. It contains two systems to subtract and carry over by exchanging and equal addition. It includes a table to work on doubling numbers from 1 to 10 and decomposing the number 10. Now, adding and subtracting is easy and fun!

6-10 years

SPECIAL NEEDS

Tablero suma x4
Adding board

GRAN TAMAÑO
BIG SIZE
20,5 cm

¡Fácil y divertido!
Easy and fun!



Rewritable
Reescribible

Tablero resta x4
Subtracting board

Dos métodos para aprender a restar: / Two methods for learning subtraction:

1 **Resta por compensación**
Subtraction by equal addition

2 **Resta por agrupamiento**
Subtraction by exchanging



MUY RESISTENTE
HIGH QUALITY



Recta numérica para facilitar el cálculo.
Number line for easy calculation.

APRENDE Y COMPRENDE LAS TABLAS DE MULTIPLICAR

LEARN AND UNDERSTAND MULTIPLICATION TABLES

Ref. 30698

Juega, comprende y memoriza las TABLAS DE MULTIPLICAR a tu ritmo y partiendo de lo que sabes. Un procedimiento único, creativo, divertido y contrastado, para lograr un aprendizaje comprensivo. Con este juego podrás aprender y memorizar las tablas de multiplicar, comprobarlas y repasarlas, poner a prueba tu dominio, interpretar y resolver problemas. ¡Se aprende jugando!

Play, understand and memorise MULTIPLICATION TABLES at your own pace, and starting from what you already know. A unique, creative, fun and proven process to gain a comprehensive understanding. With this game, you will be able to learn and memorise the multiplication tables, check them and revise them, test your knowledge, interpret and solve problems. Learn through play!

6-12 years

SPECIAL NEEDS

1-10 players

Cartas juego x30
Playing cards



Cartas comprobación
Verification cards



José Antonio Fernández Bravo

Desarrollado por José Antonio Fernández Bravo. Doctor en Ciencias de la Educación y experto en neurodidáctica para el desarrollo del pensamiento matemático. Escritor, investigador, maestro, formador, profesor universitario y colaborador de la UNESCO.
Developed by José Antonio Fernández Bravo. Doctor in Education Sciences and expert in neurodidactics for the development of mathematical thinking. Writer, researcher, teacher, trainer, university professor and UNESCO collaborator.

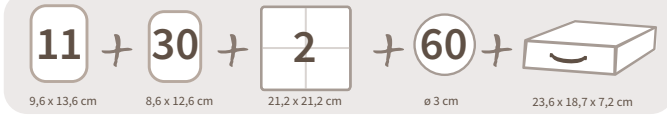

¡Aprendizaje intuitivo y progresivo!
Intuitive and progressive learning!

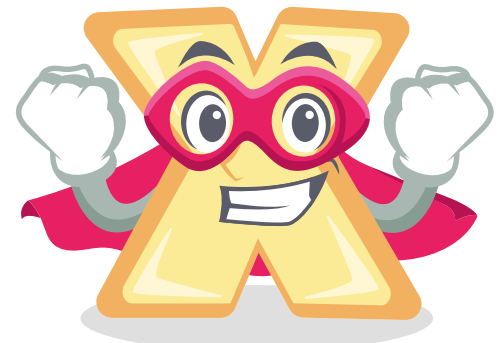

¡Aprende jugando y comprende haciendo!
Learn by playing and understand by doing!



Tablero productos
Products board

Tablero factores
Factors board

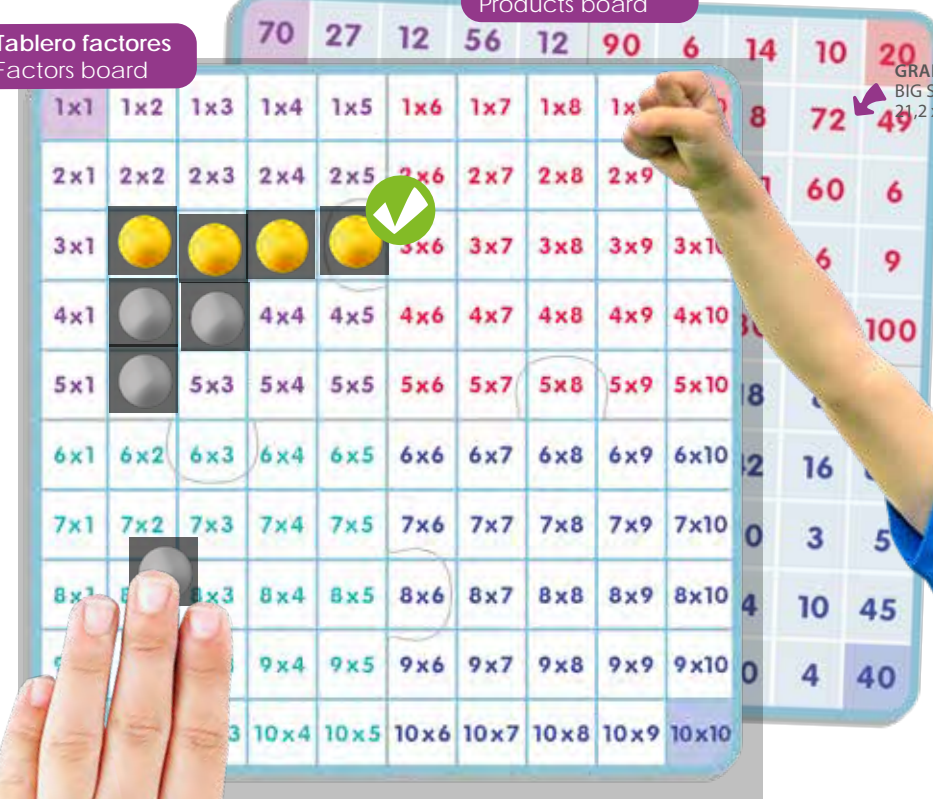

GRAN TAMAÑO
BIG SIZE
21,2 x 21,2 cm

MUY RESISTENTE
HIGH QUALITY



DESCUBRE LOS NÚMEROS Y SU DESCOMPOSICIÓN

LEARNING ABOUT NUMBERS AND THEIR DECOMPOSITION

Ref. 30696

4+ years

Cartas para desarrollar el sentido matemático y comprender los números hasta el 10. Para trabajar de forma intuitiva: composición, descomposición, igualdad, equivalencia, adición y sustracción. Estimulan la emoción, la creatividad, el razonamiento y el cálculo, bases para el desarrollo del pensamiento numérico y matemático.

De forma intuitiva
Intuitively

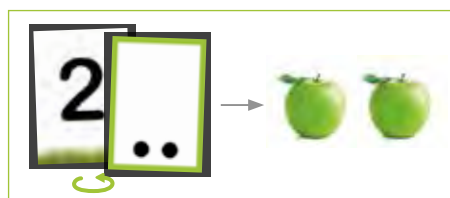

Juega a componer y descomponer los números
Play to compose and decompose numbers

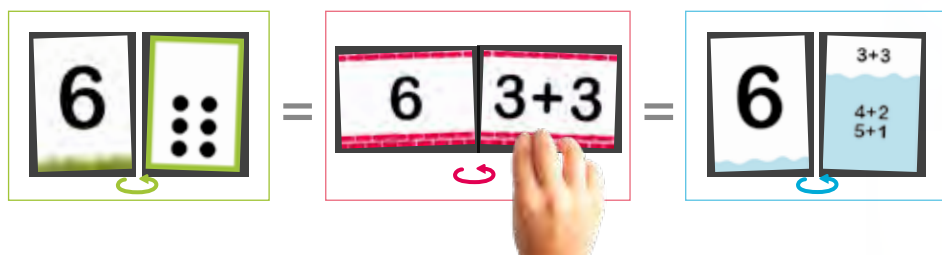

Juega con lo que ves, pon a prueba lo que sabes
Play with what you see, test what you know

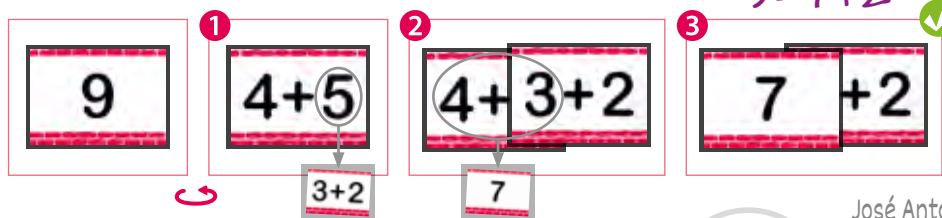

José Antonio Fernández Bravo

Desarrollado por José Antonio Fernández Bravo.
Experto en neurodidáctica para la educación matemática.
Escritor, maestro, formador, investigador y profesor universitario.
Developed by José Antonio Fernández Bravo.
Expert in neurodidactics for mathematics education.
Writer, teacher, trainer, researcher and university professor.



INVENTAR Y RESOLVER PROBLEMAS MATEMÁTICOS

INVENTING AND SOLVING MATHEMATICAL PROBLEMS

6-14 years

Ref. 30697

¡Gira las ruletas y juega a inventar problemas matemáticos! Ayuda a entender cómo se estructuran los problemas y a descubrir cómo se resuelven, según el nivel de conocimiento de cada niño. Estimula la emoción, la creatividad, el razonamiento y el cálculo, bases para el desarrollo del pensamiento lógico y matemático.

Spin the roulette wheel and play at inventing mathematical problems! Helps children to understand how problems are structured and to learn how to solve them, according to each child's level of knowledge. Stimulates emotions, creativity, reasoning and calculation skills, the foundations for developing logical and mathematical thinking.

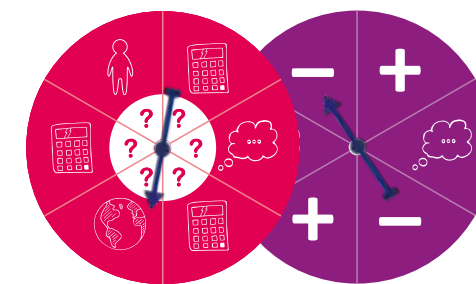

- Tema enunciado
Subject statement
- Pregunta
Question
- Operación
Operation
- Datos
Data
- Resultado
Result

MUY RESISTENTE
HIGH QUALITY

42 FICHAS
CARDS



José Antonio Fernández Bravo

Desarrollado por José Antonio Fernández Bravo.
Experto en neurodidáctica para la educación matemática.
Escritor, maestro, formador, investigador y profesor universitario.
Developed by José Antonio Fernández Bravo.
Expert in neurodidactics for mathematics education.
Writer, teacher, trainer, researcher and university professor.



MIS PRIMEROS NÚMEROS LARGOS CON BLOQUES BASE 10

MY FIRST LONG NUMBERS IN BASE 10 BLOCKS

Ref. 30691

Set que permite representar los números largos del 1 al 999 con material manipulativo base 10. Las fichas de números son reversibles: en el reverso muestran la misma cantidad del anverso representada con los bloques de base 10. Inspirado en la metodología Montessori y realizado con los colores de la metodología Montessori.

A set representing long numbers from 1 to 999 with base 10 manipulative material. The number cards are reversible: the back shows the same amount as the front but in the form of base 10 blocks. Inspired by the Montessori methodology, and using the colours of the Montessori methodology.



MUY RESISTENTE
HIGH QUALITY



APILABLES / STACKABLE

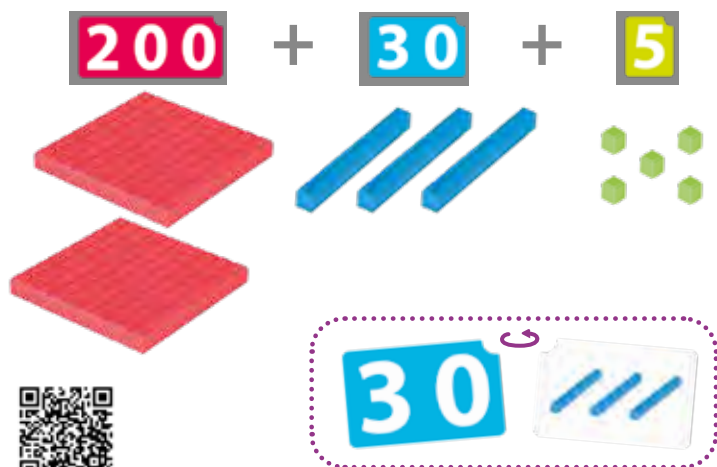

VIDEO

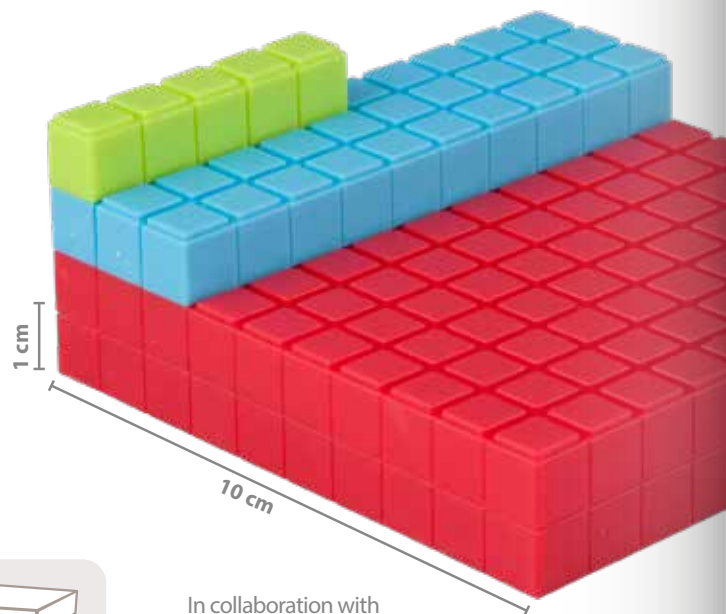

In collaboration with
José Ángel Murcia

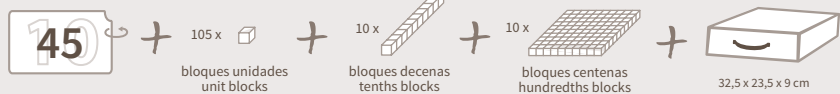

SELLOS DE DESCOMPOSICIÓN NUMÉRICA BASE 10

BASE 10 NUMERICAL BREAKDOWN STAMPS

Ref. 30692

Sellos de descomposición numérica base 10 para representar cantidades. Incluye 4 sellos que representan la unidad, la decena, la centena y el millar. Aptos para cualquier tinta.

Stamps featuring numbers based on the decimal system for representing amounts and quantities. Includes four stamps representing ones, tens, hundreds and thousands. Can be used with any ink.



MADERA
WOOD

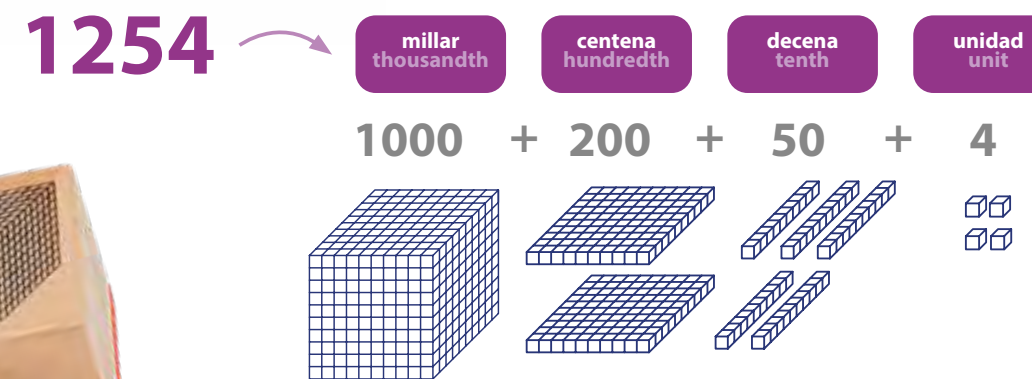

José Ángel Murcia

Desarrollado en colaboración con José Ángel Murcia. Matemático. Premio Bitácoras al Mejor Blog de Educación.

Developed in collaboration with José Ángel Murcia. Mathematician Bitácoras Award for the Best Education Blog.



VIDEO



eco wood



SET LÓGICA PLAY SET LOGIC GAME

Set de lógica para aprender a reconocer y diferenciar colores, formas, tamaños y cantidades. Desarrolla la observación y la atención.

A logic game for learning to recognise and differentiate colours, shapes, sizes and quantities. It helps to develop observation and attention skills.

4-7 years SPECIAL NEEDS SENIORS Montessori

UPDATED PRODUCT!

SET LÓGICA PLAY 1 (4 uds.) SET LOGIC GAME 1 (4 units)

Ref. 52510

30 cm

+ 4 POSTERS

Formas geométricas 1
Geometrics shapes 1

Objetos
Objects

Tamaños
Sizes

Frutas
Fruits

UPDATED PRODUCT!

SET LÓGICA PLAY 2 (4 uds.) SET LOGIC GAME 2 (4 units)

Ref. 52520

+ 4 POSTERS

Juguetes
Toys

Transportes
Transports

Formas geométricas 2
Geometrics shapes 2

Utensilios
Utensils

x4

25 + [] + []

30 x 22,5 cm poster



EURODOMINÓ EURODOMINOES

Ref. 30675



28 FICHAS
CARDS

REVERSIBLE

Una forma divertida de conocer las monedas y los billetes de Euro mediante una sencilla asociación. Además, este dominó de gran tamaño ayuda a familiarizarnos con el cambio del dinero.

A fun way of learning about Euro banknotes and coins with a simple association. In addition, this big size dominoes helps children to familiarise themselves with currency exchange.

4-8 years SPECIAL NEEDS SENIORS

NIVEL 1
LEVEL 1

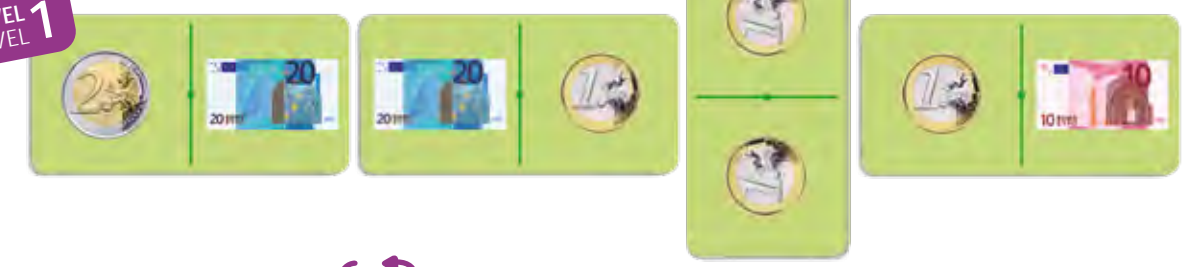

NIVEL 2
LEVEL 2



MUY RESISTENTE
HIGH QUALITY



28 + 15 + []

13 x 6,5 cm ø 4 cm 20,2 x 13 x 6 cm



LÓGICA Y CÁLCULO / LOGIC AND CALCULATION



LÓGICA Y CÁLCULO / LOGIC AND CALCULATION

BINGO: DESCUBRIR DEL 1 AL 10
BINGO: LEARNING TO COUNT FROM 1 TO 10

Ref. 20524

3-6 years

SPECIAL NEEDS

1-25 players

Juego para aprender a contar del 1 al 10, y asociar la grafía de los números con sus respectivas cantidades. El profesor enseña dos tarjetas: un número o cantidad y un objeto. Los niños tienen que completar sus tarjetas a modo de bingo, cuando alguna de sus imágenes se corresponda con lo que el profesor muestra.

A game for learning to count from 1 to 10, and associate the writing of the numbers with their respective amounts. The teacher shows two cards: a number or a quantity and an object. Children must complete their cards like a bingo game when it coincides with what the teacher shows.

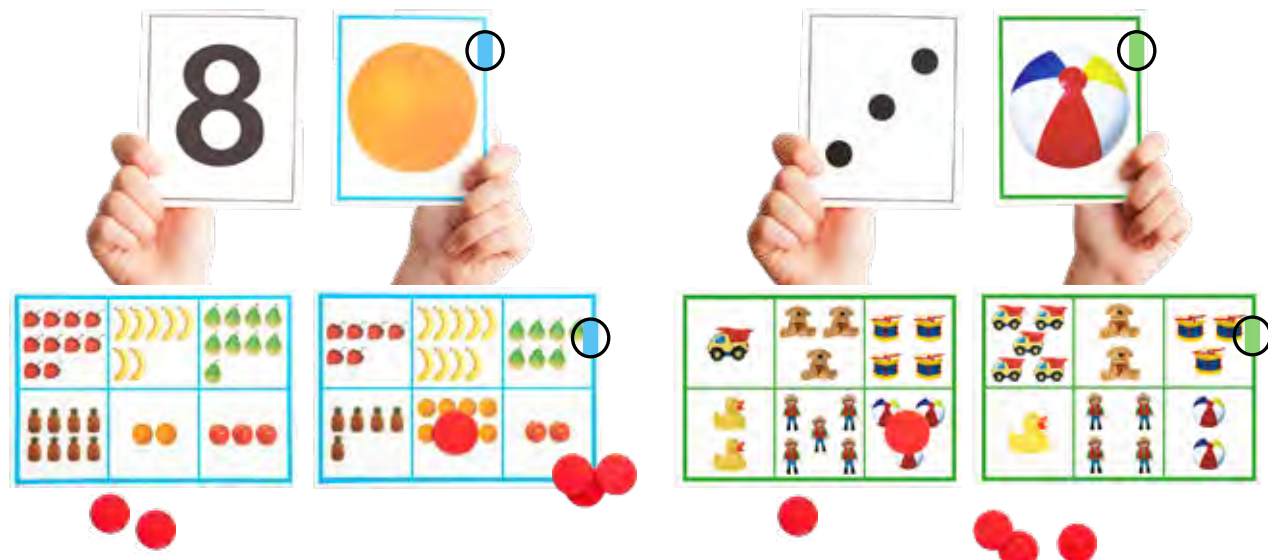

CLASIFICAR COLORES Y APRENDER A CONTAR
CLASSIFY COLOURS AND LEARN TO COUNT

Ref. 33110

300 fichas de 6 colores diferentes para trabajar la clasificación, con la ayuda de 4 maxidados que incluyen colores, puntos y números para aprender a contar, y los signos de sumar y restar para realizar operaciones básicas con las fichas.

300 counters in 6 different colours for practising colour classification using the 4 large dice which have colours, dots and numbers for learning to count as well as plus and minus signs for doing basic sums with the counters.

3-7 years

SPECIAL NEEDS



1 *Clasificar colores*
Classify colours

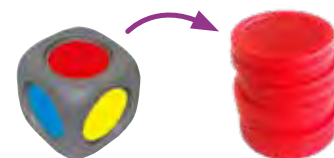

2 *Aprender a contar*
Learn to count



3 *Sumar y restar / Add and subtract*

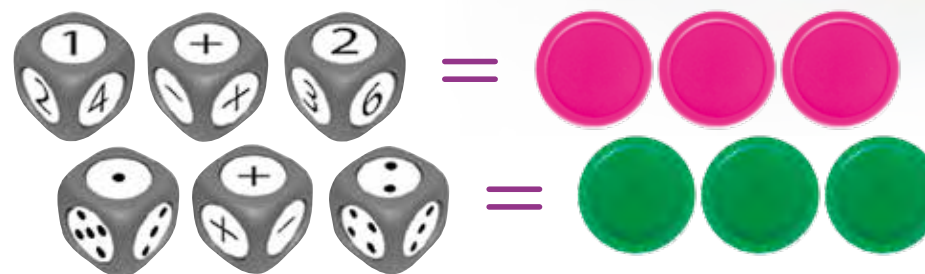

APRENDER A SUMAR / LEARN TO ADD UP

Ref. 30690

100 fichas a dos caras, con operaciones de sumas elementales, de dos sumandos de distinto color por el anverso y los resultados en rojo por el reverso. Recomendado para el desarrollo inicial de las capacidades y habilidades de las matemáticas básicas.

100 cards printed on both sides, with operations of elemental sums, of two addends of different colours on the obverse and the results in red on the reverse side. It is recommended for the initial development of capabilities and abilities of basic mathematical material.



VIDEO

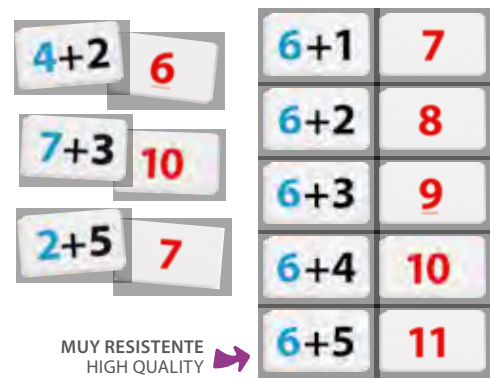
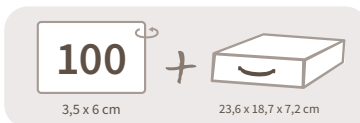

MUY RESISTENTE
HIGH QUALITY



6 cm

APRENDER A MULTIPLICAR / LEARN TO MULTIPLY

Ref. 30680

100 fichas a dos caras, por un lado con el multiplicando en azul y el multiplicador en negro, y por el otro lado el resultado en rojo. La diferenciación de colores en el multiplicando permite la agrupación de fichas para trabajar las tablas de multiplicar.

100 cards printed on both sides, one with the multiplicand in blue and the multiplier in black, and on the other the result in red. The different colours allow the cards to be grouped together to work with multiplication tables.



VIDEO

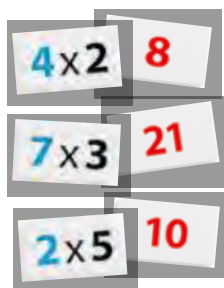

MUY RESISTENTE
HIGH QUALITY



KIT DE CÁLCULO / CALCULATION KIT

Ref. 32020

Conjunto de 216 fichas para trabajar los números y realizar operaciones matemáticas. Todas las fichas están en negro por el anverso y en rojo por el reverso.

A set of 216 cards for working with numbers and doing calculations. All the cards are in black on the front and red on the back.



216 FICHAS
CARDS

MUY RESISTENTE
HIGH QUALITY

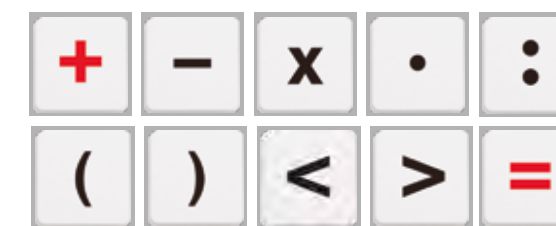
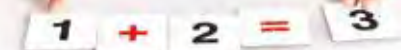

VIDEO

MAXI-MEMORY

Memory con imágenes reales en fichas de gran tamaño para ejercitar la memoria y trabajar la atención.

Memory game featuring true-life images on large format cards for exercising the memory and working on attention skills.

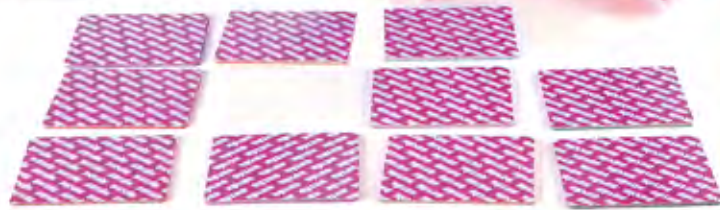
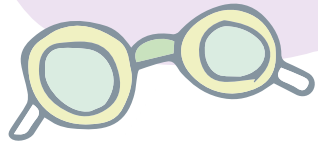

TAMAÑO REAL/ REAL SIZE

MAXI-MEMORY UNIVERSO / MAXI-MEMORY UNIVERSE

Ref. 20405

3-8 years SPECIAL NEEDS SENIORS



MUY RESISTENTE HIGH QUALITY



VIDEO

MAXI-MEMORY MASCOTAS / MAXI-MEMORY PETS

Ref. 20401

2-8 years 2+ SPECIAL NEEDS SENIORS

MUY RESISTENTE HIGH QUALITY

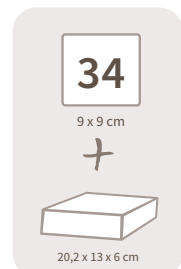

VIDEO



TAMAÑO REAL/ REAL SIZE

TAMAÑO REAL/ REAL SIZE

MAXI-MEMORY ALIMENTOS SANOS / MAXI-MEMORY HEALTHY FOOD

Ref. 20402

2-8 years 2+ SPECIAL NEEDS SENIORS

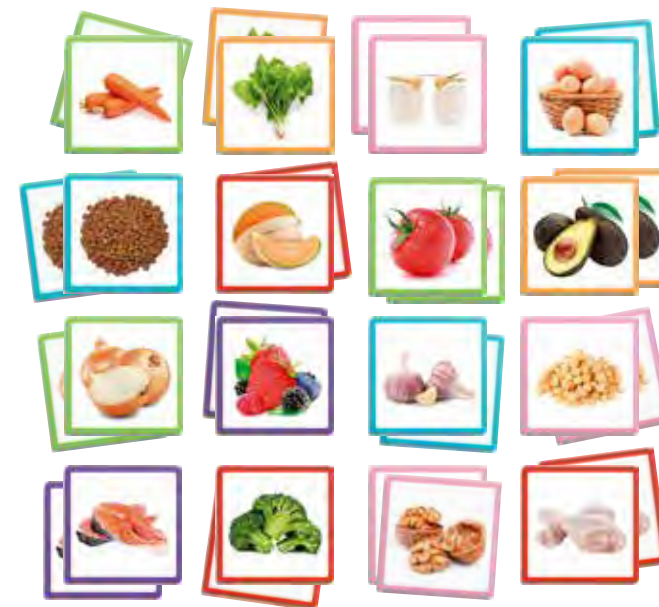

MUY RESISTENTE HIGH QUALITY

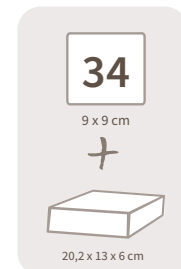

VIDEO



MAXI-MEMORY INVENTOS
MAXI-MEMORY INVENTIONS

3-8 years  Ref. 20406

Viaja en el tiempo y descubre en cada pareja de imágenes la evolución de inventos que han cambiado la historia. Un sorprendente memory con imágenes reales en fichas de gran tamaño para ejercitar la memoria y trabajar la atención.

Travel back in time, and in each pair of pictures discover the progress of the inventions that have changed history. An amazing memory game with large, real-life images for exercising memory skills and working on attention issues.

¡Viaja en el tiempo a través de los inventos!
Travel back in time through inventions!



17 INVENTOS
INVENTIONS



MUY RESISTENTE
HIGH QUALITY

34 + 
9 x 9 cm 20,2 x 13 x 6 cm

MAXI-MEMORY HIGIENE Y SALUD
MAXI-MEMORY HYGIENE AND HEALTH

3-8 years  **SPECIAL NEEDS**  Ref. 20408

¿Cuántos hábitos de higiene y salud conoces? Con este memory de imágenes reales en fichas de gran tamaño descubrirás y fomentarás hábitos saludables de higiene, al mismo tiempo que desarrollas la atención y ejercitas la memoria.

How many hygiene and health habits do you know? With this memory game involving real images on large cards, you will learn about and encourage healthy hygiene habits, while exercising the memory and working on attention skills.



MUY RESISTENTE
HIGH QUALITY

34 + 
9 x 9 cm 20,2 x 13 x 6 cm

EL RETO DE LAS INTELIGENCIAS MÚLTIPLES
THE CHALLENGE OF MULTIPLE INTELLIGENCES

Ref. 20005

5-10 years

Divertidos retos para desarrollar diferentes tipos de inteligencia y conocer los puntos fuertes de cada persona. El juego está inspirado en la Teoría de las Inteligencias Múltiples de Howard Gardner y permite trabajar las ocho inteligencias que se proponen en su modelo, así como conocer las que predominan en cada persona.



VIDEO

MULTIPLE INTELLIGENCES

Some fun challenges to develop different kinds of intelligences and understand the strengths of each individual. The game is inspired by Howard Gardner's Theory of Multiple Intelligences and allows the eight intelligences proposed by his model to be exercised, as well as identifying which intelligence predominates in each person.

64 RETOS CHALLENGES

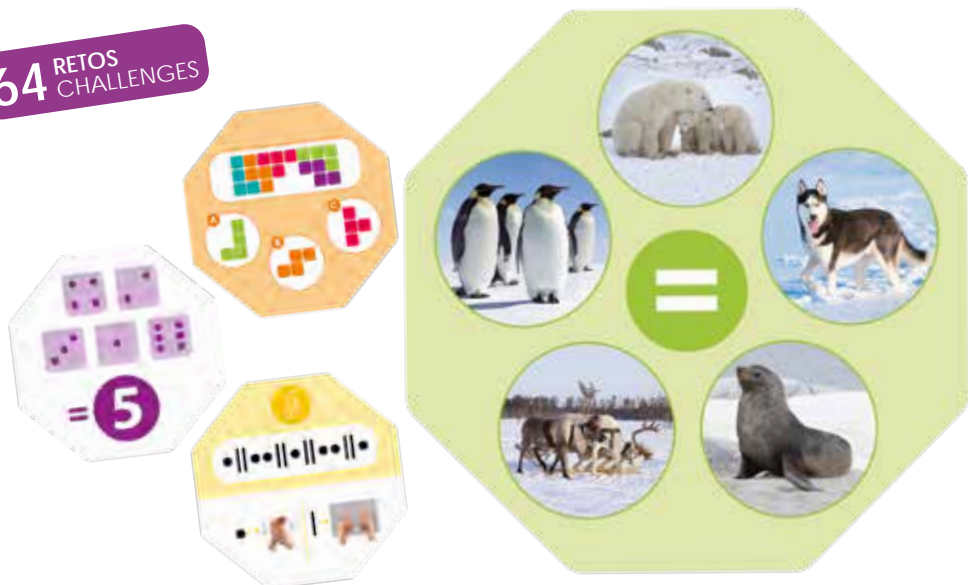

MUY RESISTENTE
HIGH QUALITY

8 INTELIGENCIAS INTELLIGENCES

- Lógico-matemática
Logical-mathematical
- Musical
- Verbal-lingüística
Verbal-linguistic
- Naturalista
Naturalistic
- Intrapersonal
- Corporal-cinestésica
Bodily-kinesthetic
- Visual-espacial
Visual-spatial
- Interpersonal



NEW

TOPOLOGY-BIRDS. ORIENTACIÓN ESPACIAL.
TOPOLOGY-BIRDS. SPATIAL ORIENTATION.

Ref. 20520

Original memory para desarrollar la orientación espacial y aprender posiciones espaciales opuestas: delante-detrás, dentro-fuera, encima-debajo, a la derecha-a la izquierda, cerca-lejos, y juntos-separados. ¡Forma parejas de divertidos pájaros en posiciones espaciales opuestas, y pon a prueba tu observación y memoria! Fichas de gran tamaño con escenarios reales.

Original memory game to develop spatial orientation and learn opposing spatial positions: in front-behind, inside-outside, on-under, to the right-to the left, near-far and together-apart. Form pairs of birds in opposite spatial positions and test your observation skills and your memory! Large cards with real scenarios.

¿Dónde estoy?
Where am I?

delante-detrás
in front-behind

GRAN TAMAÑO
BIG SIZE
10,8 x 6,8 CM

36 FICHAS
CARDS

3-8 years SPECIAL NEEDS



izquierda-derecha
to the left-to the right



cerca-lejos
near-far



dentro-fuera
inside-outside



juntos-separados
together-apart



encima-debajo
on-under

MUY RESISTENTE
HIGH QUALITY



ROBOCODING: COORDENADAS Y CODIFICACIÓN BÁSICA

ROBOCODING: COORDINATES AND EARLY CODING

Ref. 20521 4-8 years

¿Codificar sin ordenador? ¡Es la mejor forma de empezar! Gira las ruletas y sitúa a los robots en el tablero. Aprende las coordenadas y tus primeros conceptos de codificación. Descubre que cualquier reto puede dividirse en una secuencia de pequeños pasos. Crea esas secuencias de movimientos con tus compañeros de forma cooperativa, y te darás cuenta de que hay diferentes formas de alcanzar un mismo objetivo.

Coding without a computer? It's the best way to start! Spin the roulette wheels and put the robots on the board. Learn about coordinates and first concepts of early coding. Discover how any challenge can be divided into a sequence of smaller steps. Create these sequences of movements with your friends in a cooperative way, and you will find out that there are different ways to achieve the same goal.



JUEGO COOPERATIVO
COOPERATIVE

- COORDENADAS
COORDINATES
- SECUENCIACIÓN
SEQUENCING
- PENSAMIENTO LÓGICO
LOGICAL THINKING
- RESOLUCIÓN DE PROBLEMAS
PROBLEM SOLVING
- APRENDIZAJE COOPERATIVO
COOPERATIVE LEARNING

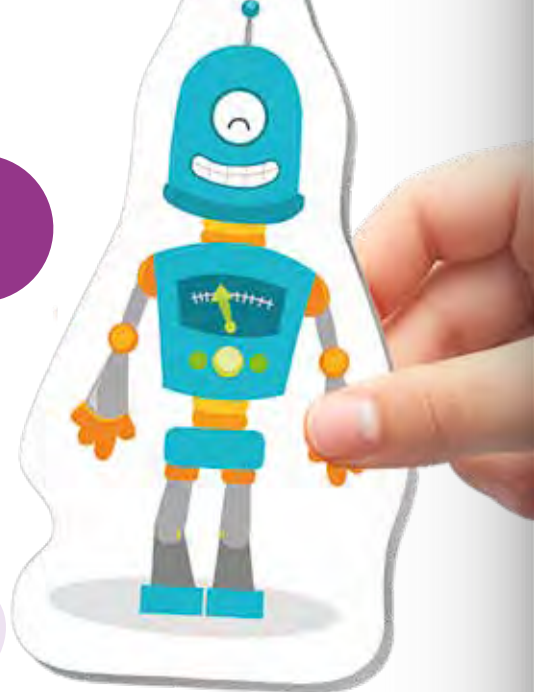

TAMAÑO REAL / REAL SIZE

100%
SCREEN
FREE



MUY RESISTENTE
HIGH QUALITY



¡Guía a los robots y
codifica sin ordenador!
Let's help the robots and
codify without a computer!



BIG SIZE
GRAN TAMAÑO
31,5 cm

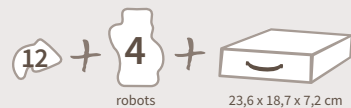

DESCUBRIR FIGURAS GEOMÉTRICAS EN EL ENTORNO

DISCOVER GEOMETRIC SHAPES IN EVERYDAY LIFE

Ref. 20535

Juego de asociación compuesto por 7 cuerpos geométricos y 35 imágenes de objetos del entorno, que representan las figuras geométricas en la vida real.

A game comprising 7 geometric shapes and 35 photos of everyday objects which represent geometric figures in real life.

3-8 years SPECIAL NEEDS



MUY RESISTENTE
HIGH QUALITY



MI DERECHA Y MI IZQUIERDA MY LEFT AND MY RIGHT

Ref. 20538

4-8 years

SPECIAL NEEDS

Este juego ayuda a desarrollar el conocimiento de la derecha y la izquierda, mediante la representación de las fichas con el personaje de frente y de espaldas, y los objetos que se colocan a uno y otro lado del personaje.

This game introduces children to the notion of left and right by means of cards showing a person seen from the front and from behind. The cards show different objects, which can be located on both sides of the character.

7 FICHAS SILUETeadAS
SILHOUETTED CARDS

REVERSIBLE



24 FICHAS MODELO
PATTERN CARDS

Incluye indicador mano derecha
Includes bracelet right hand



MUY RESISTENTE
HIGH QUALITY

GRAN TAMAÑO
BIG SIZE



22,5 cm

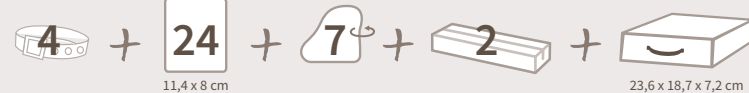

¿DÓNDE ESTÁ? / WHERE IS IT?

Ref. 20522

UPDATED PRODUCT!

Bingo de posiciones para el desarrollo de la orientación espacial, con dos modalidades de juego: el bingo de las posiciones opuestas (tarjetas con marco azul) y el bingo de la orientación espacial (tarjetas con marco rojo).

A bingo for developing spatial orientation featuring two games: a bingo of opposites (blue frame bingo cards) and a bingo of spatial orientation (red frame bingo cards).

1-25 players

4-7 years

GRAN TAMAÑO
BIG SIZE
22 cm

eco wood



GRAN TAMAÑO
BIG SIZE
7,5 cm



Orientación espacial
Spatial orientation

Posiciones opuestas
Opposite positions



¿Dónde está tu animal favorito?
Where is your favourite animal?



APILABLE MAGNÉTICO MAGNETIC STACKING GAME

Ref. 20590

Juego de observación y manipulación que permite descubrir las propiedades del magnetismo, al representar las fichas con los anillos magnéticos.

A game of observation and handling which allows children to discover the properties of magnetism by replicating the cards with the magnetic rings.



VIDEO



TOPOLOGÍA / TOPOLOGY

Ref. 20523

Playset para desarrollar la percepción espacial y el conocimiento de los distintos cuerpos geométricos a través de la observación y la manipulación. Incluye 14 cuerpos geométricos y 15 regletas para representar hasta 50 imágenes diferentes.

This playset develops spatial perception and helps children learn about different geometric shapes through observation and handling. A briefcase containing 14 geometric shapes and 15 rods to form up to 50 different geometrical patterns.



VIDEO



ESCUCHAR Y ORDENAR CUENTOS LISTEN AND PUT THE STORIES IN ORDER

Ref. 30760

Escucha los 6 cuentos clásicos y ordena las viñetas. Cada cuento lleva un marco de diferente color. Desarrolla la percepción cronológica y la secuenciación temporal.

Listen to the 6 classic stories and put the cartoons in order. Each story has a different coloured frame, which helps to develop a sense of time and chronological perception.

3-6 years

SPECIAL NEEDS

6 CUENTOS CLÁSICOS
CLASSIC STORIES



MUY RESISTENTE
HIGH QUALITY



32

7,8 x 11,2 cm

+



20,2 x 13 x 6 cm



¡Aprende idiomas!
Learn languages!



¡Aprende idiomas!
Learn languages!



DOWNLOAD ONLINE
AUDIO MP3

- 6 Cuentos clásicos / 6 Classic stories
- Los Tres Cerditos / The Three Little Pigs
 - Pulgarcito / Tom Thumb
 - La Tortuga y La Liebre / The Tortoise & The Hare
 - El Gato con Botas / Puss in Boots
 - La Cenicienta / Cinderella
 - Pinocho / Pinocchio

HISTORIAS DIVERTIDAS EN LA CASA FUNNY STORIES FROM HOME

Ref. 30750

Contiene 12 divertidas historias que transcurren en el hogar. Incluye fichas interrogante para dejar volar la imaginación e inventar finales diferentes.

Game comprising 12 amusing stories which occur at home. It includes question-cards to let your imagination run wild and imagine different endings.

3-8 years

SPECIAL NEEDS

12 HISTORIAS
STORIES



MUY RESISTENTE
HIGH QUALITY



VIDEO

70

9 x 9 cm

+



23,6 x 18,7 x 7,2 cm



SECUENCIAS BÁSICAS / BASIC SEQUENCES

SECUENCIAS BÁSICAS: NITA Y ZARO-1
BASIC SEQUENCES: NITA AND ZARO-1

Ref. 30651

2-6 years

2+

SPECIAL NEEDS



VIDEO



SECUENCIAS BÁSICAS: NITA Y ZARO-2
BASIC SEQUENCES: NITA AND ZARO-2

Ref. 30652



VIDEO



34

9 x 9 cm

+



20,2 x 13 x 6 cm

SECUENCIAS PRODUCCIÓN / FOOD PRODUCTION SEQUENCES

SECUENCIAS PRODUCCIÓN: NITA Y ZARO-1
FOOD PRODUCTION SEQUENCES: NITA AND ZARO-1

Ref. 30660

3-8 years



VIDEO



34

9 x 9 cm

+



20,2 x 13 x 6 cm



ANTES Y DESPUÉS BEFORE AND AFTER

Ref. 20540

Juego de asociación, con fotografías distribuidas en series temporales de tres imágenes, que representan el antes-mediante-después.

A game of association comprising sets of three time-sequenced photos representing before, during and after.

3-8 years

SPECIAL NEEDS



MUY RESISTENTE
HIGH QUALITY



5 COLOURS
EASY TO PLAY



10

7,5 x 22,5 cm

+

60

7,5 x 7,5 cm

+



23,6 x 18,7 x 7,2 cm



VIDEO



MAXI-SECUENCIAS NATURALES NATURE MAXI-SEQUENCES

Ref. 30641 2-6 years 2+ SPECIAL NEEDS SENIORS



6 SECUENCIAS SEQUENCES



20 11,5 x 11,5 cm + 20,2 x 13 x 6 cm

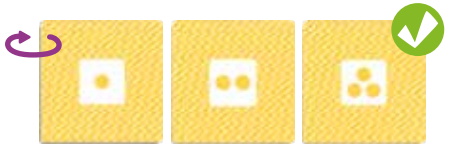

MAXI-SECUENCIAS DE PRODUCCIÓN PRODUCTION MAXI-SEQUENCES

Ref. 30642 3-8 years SPECIAL NEEDS SENIORS



5 SECUENCIAS SEQUENCES



MUY RESISTENTE HIGH QUALITY

20 11,5 x 11,5 cm + 20,2 x 13 x 6 cm



6 SECUENCIAS SEQUENCES



MUY RESISTENTE HIGH QUALITY

20 11,5 x 11,5 cm + 20,2 x 13 x 6 cm



AUTONOMÍA Y GESTIÓN DEL TIEMPO
AUTONOMY AND TIME MANAGEMENT



SECUENCIAS TEMPORALES / TIME SEQUENCES

MAXI-SECUENCIAS DE HÁBITOS DIARIOS MAXI-SEQUENCES DAILY HABITS

Ref. 30639 3-8 years SPECIAL NEEDS



5 SECUENCIAS SEQUENCES



MUY RESISTENTE HIGH QUALITY

20 11,5 x 11,5 cm + 20,2 x 13 x 6 cm



MAXI-SECUENCIAS HÁBITOS DE AUTONOMÍA MAXI-SEQUENCES AUTONOMY HABITS

Ref. 30640 2-6 years 2+ SPECIAL NEEDS



11,5 cm



SECUENCIAS TEMPORALES / TIME SEQUENCES

CALENDARIO SEMANAL WEEKLY CALENDAR

Calendario semanal para iniciar a los más pequeños en el concepto temporal a través de diferenciar entre ayer, hoy y mañana. Permite situar los días de la semana y el mes. Incluye sencillas secuencias temporales de 3 pasos e imágenes para trabajar el clima.

A weekly calendar to introduce very young children to the concept of time, distinguishing between yesterday, today and tomorrow. You can position the days of the week and the month. It includes simple three-step time sequences and pictures of the weather.

3-6 years

SPECIAL NEEDS



¡Aprende idiomas!
Learn languages!

Ref. 39000 A



Ref. 39000 B



Ref. 39000 C



Ref. 39000 D



Idiomas sujetos a disponibilidad / Languages according to availability



78 x 43 cm

+

61

9 x 9 cm

+

22

9 x 4,5 cm

+



32,5 x 23,5 x 9 cm

CALENDARIO UNIVERSAL UNIVERSAL CALENDAR

3-8 years

SPECIAL NEEDS

Ref. 30120

Calendario con una estructura muy intuitiva que facilita a los más pequeños entender la organización del tiempo. Su estructura deductiva vertical permite ir de lo global a lo particular, y ayuda a los niños a generar una imagen clara y esquemática de la composición del tiempo en un año. Partiendo del año y las estaciones, a través de los meses y las semanas, hasta llegar a la fecha exacta del día en que se encuentran.

A calendar with a very intuitive structure that helps young children to understand how time is organized. Its vertical deductive structure allows children to move from global to individual concepts and helps them to form a clear and schematic image of the composition of time over a year. It is based on the year and its seasons, travelling through months and weeks and finally coming to the exact day of the week on which the game takes place.

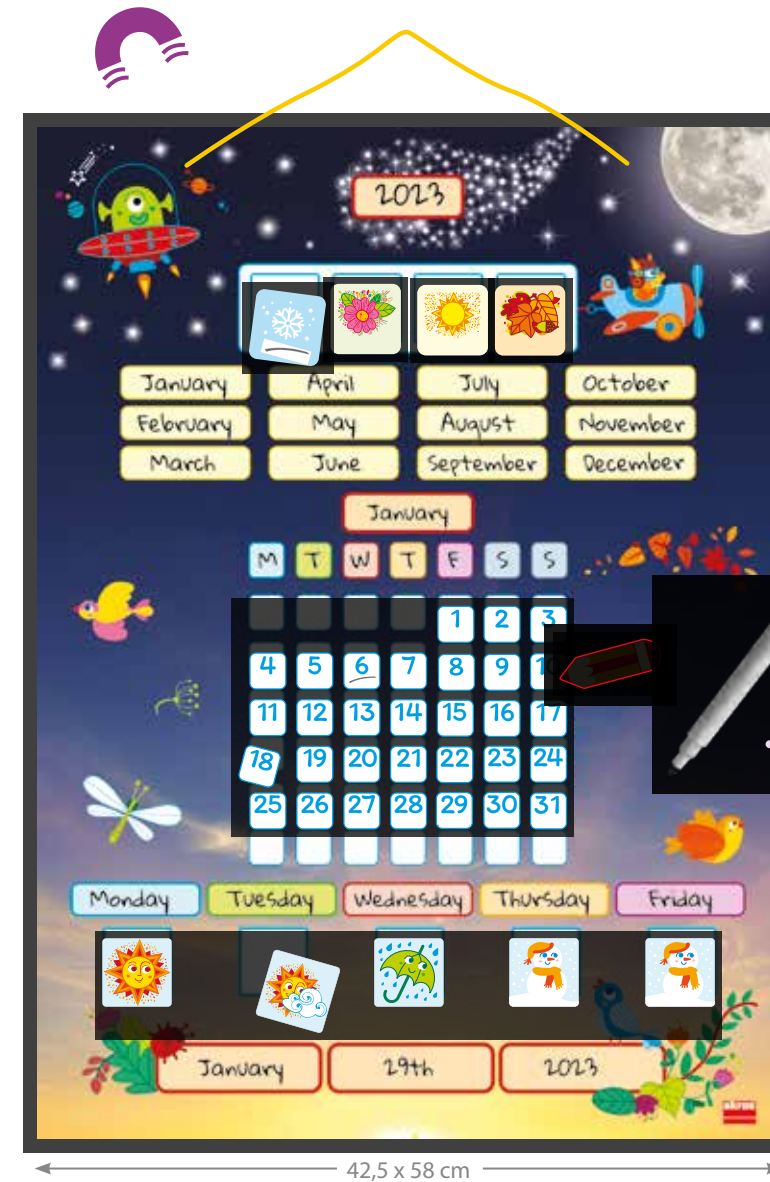

42,5 x 58 cm

4

estaciones / seasons

+

31

números / numbers

+

20

clima / weather

+



+

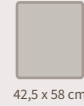

42,5 x 58 cm

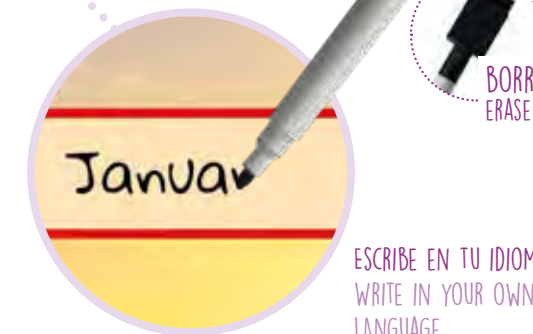

BORRA
ERASE

ESCRIBE EN TU IDIOMA
WRITE IN YOUR OWN
LANGUAGE

PLANNING DE ACTIVIDADES DIARIAS
PLANNING DAILY ACTIVITIES

Ref. 39010

3-8 years

SPECIAL NEEDS

UPDATED PRODUCT!

Panel para planificar las actividades que se hacen a lo largo del día, tanto en casa como en el colegio, y asociarlas con las horas del día, en formato analógico y digital (12 h / 24 h).

A board for planning everyday activities at both home and school, associating them with the hours of the day in both the AM/PM and 24-hour-clock versions.



12h (am/pm)



24h



¡Planifica tus actividades!
 Plan your activities!



GRAN TAMAÑO
 BIG SIZE
 105 x 35 cm



LAS NUEVAS TECNOLOGÍAS: EQUILIBRA TUS ACTIVIDADES
NEW TECHNOLOGIES: BALANCE YOUR ACTIVITIES

Ref. 38990

8 CATEGORÍAS
 CATEGORIES



Identifica qué actividades sueles hacer, reflexiona y equilíbralas. El objetivo del juego es hacer consciente al niño de los riesgos del uso excesivo de un tipo de actividad, para que sea capaz de equilibrar su tiempo libre con diferentes actividades. Ayuda a educar para el ocio, previniendo el sedentarismo, el abuso de las nuevas tecnologías y el aislamiento social.

Helps children to identify which activities they usually do and to think about how they can balance them. The aim of the game is to make children aware of the risks of doing too much of one activity so they can learn how to balance their free time with different activities. Helps children to learn about leisure time and how to prevent a sedentary lifestyle, excessive use of new technologies and social isolation.

5-10 years

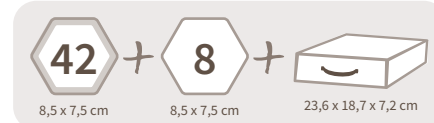

CONSTRUIMOS LA HORA LET'S BUILD THE TIME

Ref. 30694

3-6 years

SPECIAL NEEDS



eco wood



Maxi-set de madera para trabajar el tiempo y aprender a descomponer la hora en piezas de 5, 15 y 30 minutos. Ayuda a comprender la estructura del reloj de forma manipulativa. Permite descubrir las nociones básicas para aprender a decir la hora. Inspirado en la metodología Montessori.

Big size wooden time-set for learning how to break down an hour into pieces of 5, 15 and 30 minutes. Provides a hands-on understanding of the structure of a clock, helping children to familiarise themselves with the basic notions of learning how to tell the time. Inspired by the Montessori Methodology.

INSPIRED BY
MONTESSORI
METHODOLOGY



¡Comprende la hora!
Understand the hour!

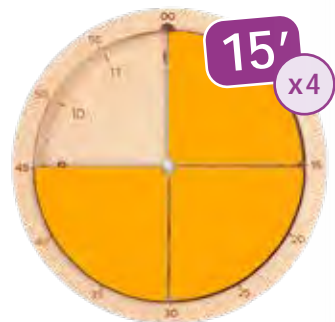
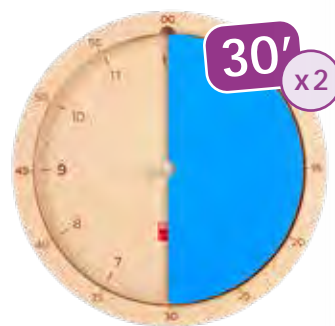

Ø 22,4 cm

+



pieza 30'
piece of 30'

+



pieza 15'
piece 15'

+

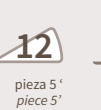

pieza 5'
piece 5'

+



+



23,5 x 23,5 x 3 cm

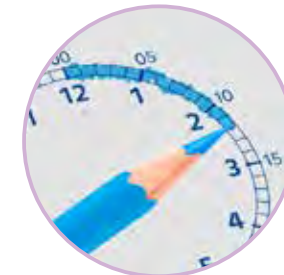

MADERA
WOOD



MUY RESISTENTE
HIGH QUALITY



MAXI SELLO: ¿QUÉ HORA ES? MAXI-STAMP: WHAT TIME IS IT?

4-8 years

SPECIAL NEEDS

Ref. 30693

Pon el sello, lanza los dados y ¿qué hora es? Permite practicar la hora en formato analógico y digital de una forma divertida. Incluye un maxi-sello de madera y dos dados de 12 caras. Apto para cualquier tinta.

Stamp, throw the dice, and what time is it? It allows children to practice telling the time in analogue and digital format in a fun way. Includes a big size stamp and two dice (12-sided dice). Can be used with any ink.

analógico y digital
analog and digital



Puzles
Puzzles



SET PUZLES ANIMALES (9 uds.)
SET ANIMAL PUZZLES (9 units)

Ref. 50200

Set de 9 puzles progresivos (de 3, 4 y 6 piezas) con diferentes temáticas del mundo animal, para niños a partir de 2 años. Realizados con cartón grueso de gran calidad.

A pack of 9 progressive jigsaw puzzles (with 3, 4 and 6 pieces) on different themes from the animal world, for children aged 2 and over. Made from thick, high quality cardboard.

2-5 years 2+ SPECIAL NEEDS



MUY RESISTENTE
HIGH QUALITY

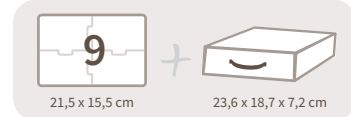

MAXI PUZLES ANIMALES MAXI PUZZLES ANIMALS

Ref. 50221

Set de 9 puzles silueteados con animales de gran tamaño, de 3 y 4 piezas, para niños a partir de 2 años. Realizados con piezas grandes en cartón grueso de máxima calidad y resistencia.

Set of nine large format 3-4 piece puzzles of animal silhouettes for children aged two and upwards. Made from large pieces of thick, strong, top quality cardboard.



9 MAXI PUZLES
MAXI PUZZLES



18,5 cm

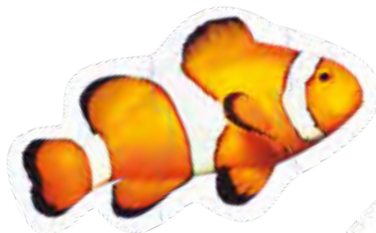

MUY RESISTENTE
HIGH QUALITY



VIDEO



MAXI PUZLES ALIMENTOS SANOS MAXI PUZZLES HEALTHY FOOD

Ref. 50222

Set de 9 puzles silueteados con alimentos de gran tamaño, de 3 y 4 piezas, para niños a partir de 2 años. Realizados con piezas grandes en cartón grueso de máxima calidad y resistencia.

Set of nine large format 3-4 piece puzzles of food silhouettes for children aged two and upwards. Made from large pieces of thick, strong, top quality cardboard.



9 MAXI PUZLES
MAXI PUZZLES

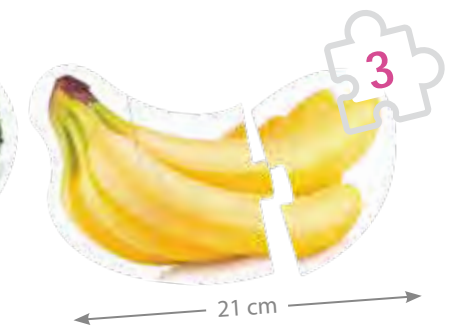

21 cm



MUY RESISTENTE
HIGH QUALITY



VIDEO

PUZZLES DE OBSERVACIÓN OBSERVATION PUZZLES

Packs de 4 puzzles para trabajar la observación. El objetivo es encontrar en los puzzles, los elementos que aparecen en el marco. Realizados en un material flexible, lavable y muy resistente.

A pack of 4 jigsaw puzzles for practising observation skills. The aim is to find the different elements on the cover picture in the jigsaw. Made from flexible, washable, hard-wearing material.

SET PUZZLES OBSERVACIÓN: CUENTOS CLÁSICOS (4 uds.) SET OBSERVATION PUZZLES: FAIRYTALES (4 units)

Ref. 50515

3-7 years SPECIAL NEEDS

¡Busca y encuentra!
Search and find it!

4 PUZZLES
PUZZLES



33 x 24 cm

15



Pinocho / Pinocchio
El Gato con Botas / Puss in Boots
Los Tres Cerditos / The Three Little Pigs
Caperucita Roja / Little Red Riding Hood

4
33 x 24 cm

FLEXIBLE

Lavable, resistente
y con cantos redondeados
Washable, hard-wearing
and with rounded corners



TAMAÑO REAL / REAL SIZE



24



SET PUZZLES OBSERVACIÓN: LAS 4 ESTACIONES (4 uds.) SET OBSERVATION PUZZLES: THE FOUR SEASONS (4 units)

Ref. 50524

3-7 years SPECIAL NEEDS

¡Busca y encuentra!
Search and find it!

4 PUZZLES
PUZZLES



33 x 24 cm

Primavera / Spring
Verano / Summer
Otoño / Autumn
Invierno / Winter

4
33 x 24 cm

PUZZLES COOPERATIVOS COOPERATIVE PUZZLES



Realiza los 4 puzzles por separado y forma un puzzle gigante al unirlos todos. Realizados en un material flexible, lavable y muy resistente.

Make the 4 puzzles individually and then form a big one by putting them all together. Made from flexible, washable, hard-wearing material.

FLEXIBLE

Lavable, resistente y con cantos redondeados
Washable, hard-wearing and with rounded corners



SET PUZZLES COOPERATIVOS: LA GRANJA (4 uds.) SET COOPERATIVE PUZZLES: THE FARM (4 units)

Ref. 50615

3-6 years

SPECIAL NEEDS



GRAN TAMAÑO
BIG SIZE
66 x 48 cm

15 x4



33 x 24 cm

SET PUZZLES COOPERATIVOS: LA CIUDAD (4 uds.) SET COOPERATIVE PUZZLES: THE CITY (4 units)

Ref. 50624

3-6 years

SPECIAL NEEDS



GRAN TAMAÑO
BIG SIZE
66 x 48 cm

TAMAÑO REAL/ REAL SIZE



33 x 24 cm

24 x4

SET PUZZLES ZARO Y NITA 4 PIEZAS (4 uds.) SET 4-PIECE ZARO AND NITA PUZZLES (4 units)

Ref. 55044

2-4 years

2+

eco wood



+4 POSTERS

4 PUZZLES
PUZZLES

Nita jugando
Nita playing

4

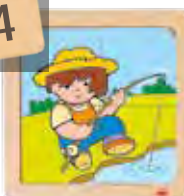

Zaro pescando
Zaro fishing



Nita y la lluvia
Nita and the rain



Zaro en la mesa
Zaro at the table

SET PUZZLES ZARO Y NITA 6 PIEZAS (4 uds.) SET 6-PIECE ZARO AND NITA PUZZLES (4 units)

2-5 years

2+

Ref. 55066

+4 POSTERS

4 PUZZLES
PUZZLES



Nita durmiendo
Nita sleeping

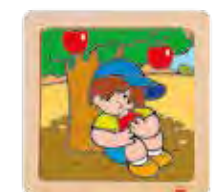

Zaro y el manzano
Zaro and the apple tree

4
14,7 x 14,7 cm

+

4
posters



Nita en el parque
Nita in the park



Zaro se despierta
Zaro wakes up

6

SET PUZZLES ZARO Y NITA 9 PIEZAS (4 uds.) SET 9-PIECE ZARO AND NITA PUZZLES (4 units)

2-5 years

2+

Ref. 55099

+4 POSTERS

4 PUZZLES
PUZZLES



Nita en la nieve
Nita in the snow

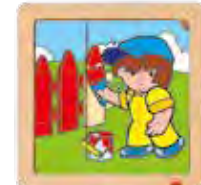

Zaro pintor
Zaro the painter

4
14,7 x 14,7 cm

+

4
posters



Nita en la granja
Nita on the farm



Zaro en clase
Zaro in the class

9

4 PUZLES
PUZZLES



Primavera / Spring



Verano / Summer

+ 4 POSTERS



SET PUZLES LAS 4 ESTACIONES (4 uds.)
SET THE 4 SEASONS PUZZLES (4 units)

Ref. 52215

3-5 years

SPECIAL NEEDS



Otoño / Autumn

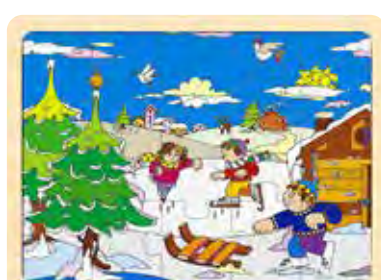

Invierno / Winter



VIDEO



29,5 x 22 cm

+

4

posters

4 PUZLES
PUZZLES



Feria / Fair



Circo / Circus

+ 4 POSTERS



SET PUZLES TIEMPO LIBRE (4 uds.)
SET FREE TIME PUZZLES (4 units)

Ref. 52224

4-6 years

SPECIAL NEEDS



Camping / Camping

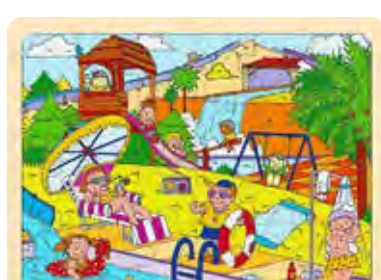

Parque Acuático / Waterpark

eco wood



SET PUZLES TRANSPORTES (4 uds.)
SET TRANSPORT PUZZLES (4 units)

Ref. 52235

5-7 years

SPECIAL NEEDS



29,5 x 22 cm

+

4

posters



VIDEO



SET PUZLES LUGARES (4 uds.)
SET PLACES PUZZLES (4 units)

Ref. 52248

5-7 years

SPECIAL NEEDS

4 PUZLES
PUZZLES



Estación de tren / Train station



Estación de autobús / Bus station

+ 4 POSTERS



Aeropuerto / Airport



Puerto / Port

4 PUZLES
PUZZLES



Sala de juegos / Play room



En la ciudad / In the city

+ 4 POSTERS



Granja / Farm



Selva / Jungle

SET PUZLE-SECUENCIAS: LOS 3 CERDITOS Y CENICIENTA (2 uds.)
SET OF PUZZLE-SEQUENCES: THE THREE LITTLE PIGS AND CINDERELLA (2 units)

Ref. 52302

Set de 8 puzles de madera, distribuidos en 2 cuentos clásicos. Cada cuento se sitúa sobre un soporte de madera que incluye 4 puzles con divertidas ilustraciones que narran el cuento a modo de secuencias temporales. Cada uno de los 8 puzles de madera está formado por 4 piezas. Dirigido a niños a partir de 2 años.

A set of eight wooden puzzles divided into two classic fairy tales. Each tale is based on a wooden support which includes four puzzles with attractive illustrations that narrate the story in time sequences. Each of the eight wooden puzzles comprises four pieces. Aimed at children aged two and over.

2-5 years 2+ SPECIAL NEEDS Montessori compatible

+ 2 POSTERS



8 MINI-PUZLES
MINI-PUZZLES



Los tres cerditos
The three little pigs
-
Cenicienta
Cinderella

2 + 2
30 x 30 cm posters

GRAN TAMAÑO
BIG SIZE



Más puzles... / More puzzles...

JUGAMOS EN IGUALDAD
LET'S PLAY ON EQUAL TERMS!

Ref. 20839 page 14



MI PLANETA Y SU ENERGÍA
MY PLANET AND ITS ENERGY

Ref. 20822 page 59



SET PUZLES FAMILIAS DEL MUNDO ACTUAL
SET FAMILIES OF TODAY'S WORLD PUZZLES

Ref. 50201 page 84



SET 12 PUZLES - NIÑOS FELICES DEL MUNDO
SET OF 12 PUZZLES - HAPPY CHILDREN OF THE WORLD

Ref. 50223 page 85

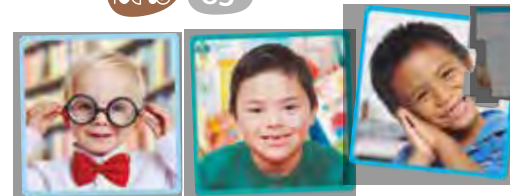

SET PUZLES: LAS 10 EMOCIONES
SET OF PUZZLES: THE 10 EMOTIONS

page 28 Ref. 20544



ECO-PUZLES: ¡SALVEMOS EL PLANETA!
ECO-PUZZLES: LET'S SAVE THE PLANET!

page 72 Ref. 52270



EL CUERPO HUMANO: ¿CÓMO SOY?
HUMAN BODY: WHAT AM I LIKE?

ABC page 103 Ref. 30245



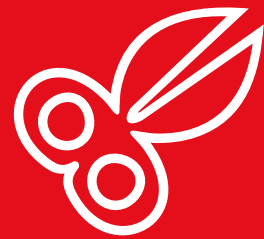

Destreza manual Manual dexterity



BOTE 20 PUNZONES PREESCRITURA 20 PRE-WRITING AWLS CONTAINER

Ref. 20010

3-6 years SPECIAL NEEDS

Punta de latón inoxidable
Sharp rustproof brass point

Evita que los dedos se deslicen
Stops fingers from slipping

Facilita la posición de los dedos
Makes it easy to position the fingers

Evita que ruede
Stops it from turning



VIDEO



PATENTED

✓
Para trabajar la psicomotricidad fina
For practising psychomotor skills
Ayuda en la preescritura
Promotes early writing skills
Para zurdos y diestros
Suitable for left- and right-handed children

20 UNIDADES
UNITS



12 x 7 cm

SET BANDEJA Y PUNZÓN PREESCRITURA (4 SETS) SET OF PRE-WRITING TRAY AND AWL (4 SETS)

Ref. 20015

3-6 years SPECIAL NEEDS

Fácil extracción
Easy to remove

Protección punta
Protects the stylus tip



x4

Marco con velcro para sujetar el papel
Velcro frame for securing paper

Fieltro: no se desgasta
Felt: resists wear and tear



x4



ENLAZAR FAMILIAS DEL MUNDO LACING FAMILIES OF THE WORLD

Ref. 52311

3-6 years

SPECIAL NEEDS

Montessori

Set de 24 figuras de madera que permite al niño enlazarlas representando su propia familia y jugar con las figuras que se mantienen de pie. Incluye 6 cordones de colores. Desarrolla la psicomotricidad fina en niños a partir de 3 años. Inspirado en la metodología Montessori.

Set of 24 wooden figures for linking up. Children can link up their own family and play with the characters, which are also free-standing. Includes six coloured laces. Develops fine motor skills in children over three years old. Inspired by the Montessori methodology.

eco wood

REVERSIBLE



Fácil de ensartar
Easy to handle



24 FIGURAS
24 FIGURES



VIDEO

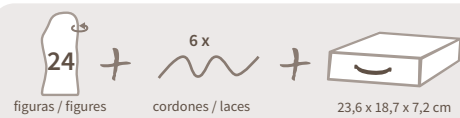

24 figuras / figures 6 x cordones / laces 23,6 x 18,7 x 7,2 cm

ENLAZAR PROFESIONES LACING PROFESSIONS

3-6 years

SPECIAL NEEDS

Montessori

Ref. 52312

Set de 24 figuras de madera que permite al niño enlazar cada oficio con sus elementos y jugar con las figuras que se mantienen de pie. Incluye 8 cordones de colores. Desarrolla la psicomotricidad fina en niños a partir de 3 años. Inspirado en la metodología Montessori.

Set of 24 wooden figures for linking up each profession with its respective elements and play with the characters, which are also free-standing. Includes eight coloured laces. Develops fine motor skills in children over three years old. Inspired by the Montessori methodology.

eco wood

24 FIGURAS
24 FIGURES



REVERSIBLE



Fácil de ensartar
Easy to handle

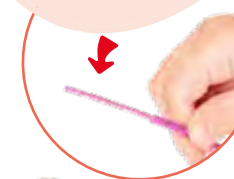

VIDEO



24 figuras / figures 8 x cordones / laces 23,6 x 18,7 x 7,2 cm





Recursos aula
Schoolroom resources



SET DADOS DE LA HORA (30 uds.)
TIME DICE SET (30 units)

Ref. 70050

4-8
years

SPECIAL
NEEDS

Lanza los dados y ¿qué hora es? Incluye 30 dados de 12 caras para practicar la hora: 15 dados con las horas y 15 dados con los minutos, en incrementos de cinco minutos. Para jugar toda la clase.

Throw the dice, and what time is it? Includes 30 dice (12-sided dice) for learning how to tell the time: 15 dice showing hours and 15 showing minutes, in increments of five minutes. For the whole class to play.

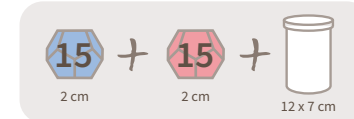

Dados de 12 caras
12-sided dice

SOPORTES DE MADERA PARA FICHAS (2 uds.)
WOODEN CARD HOLDERS (2 units)

Ref. 40115

2+

SPECIAL
NEEDS

SENIORS

Soportes de madera de gran calidad, para colocar fichas de hasta 3 mm de grosor. Incluye 2 soportes de 22,5 cm.

High quality wooden supports to hold cards (up to 3 mm thick). Includes two supports of 22,5 cm.

MADERA
WOOD

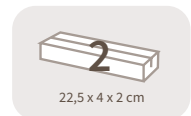
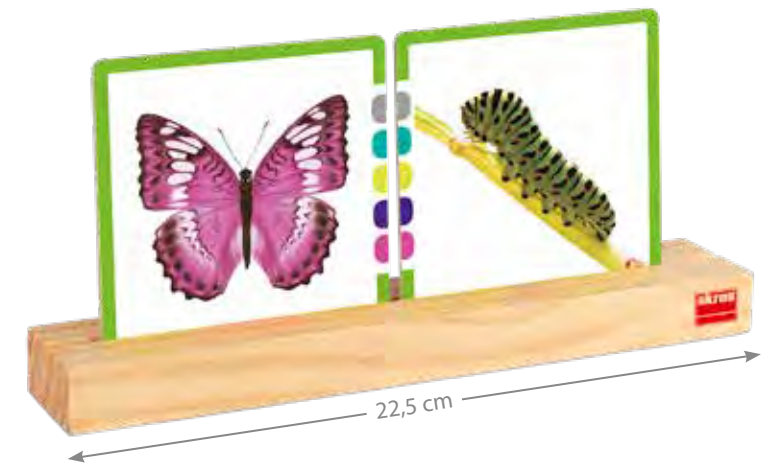

CORDONES ERGONÓMICOS PARA COSER Y ENLAZAR ERGONOMIC LACES FOR LACING AND LINKING

Ref. 70110 **SET DE 10 CORDONES / SET OF 10 LACES**

Ref. 70130 **SET DE 30 CORDONES / SET OF 30 LACES**

Set de cordones ergonómicos para coser y enlazar con manos pequeñas. La terminación de 2,5 cm de los cordones facilita su sujeción. Cordones de 100 cm de 10 colores diferentes.

Set of ergonomic laces for little hands to practice lacing and linking objects. The 2,5 cm tips of the laces make them easy to handle. 100 cm laces in 10 different colours.

3-6 years

SPECIAL NEEDS

Approved by Montessori methodology



CORDONES ERGONÓMICOS
ERGONOMIC LACES

10 COLORES
COLOURS

Fácil de ensartar
Easy to handle



IDENTIFICADOR ADHESIVO IDENTIFYING STICKER

Ref. 40150

SPECIAL NEEDS

SENIORS



28

5,5 x 3,7 cm

ARENA PARA METODOLOGÍA MONTESSORI SAND FOR MONTESSORI METHODOLOGY

0+ years

SPECIAL NEEDS

Approved by Montessori methodology

Arena natural de sílice, lavada y secada, para desarrollar la creatividad de los más pequeños. Apta para todas las edades. Saco ideal para rellenar espacios, bandejas, areneros y áreas de juego.

Natural silica sand, washed and dried, to develop the creativity of the little ones. Suitable for all ages. Bag to fill spaces, trays, sand pits and playing areas.

1 kg

Ref. 70021

5 kg

Ref. 70020



PIZARRA METÁLICA ENROLLABLE Y BORRABLE / ROLL-UP ERASABLE METALLIC BOARD

Ref. 30959

Pizarra metálica enrollable y borrrable. Es práctica y ligera. Permite escribir y/o jugar con fichas magnéticas. Incluye imanes para fijar la pizarra a la pared.

Roll-up erasable metallic board. Practical and light. It allows writing and/or playing with magnetic cards. It includes magnets in order to fix the board on the wall.



70 x 50 cm



Borrable
Erasable



Transportable
Easy to carry



Imanes para su fijación
Affixed by magnets

BANDAS MAGNÉTICAS ADHESIVAS / ADHESIVE MAGNETIC BANDS

Ref. 30957

9 bandas magnéticas adhesivas a una cara, que permiten convertir cualquier ficha de mesa en una ficha magnética.

9 magnetic bands with one adhesive side for turning any counter into a magnet.

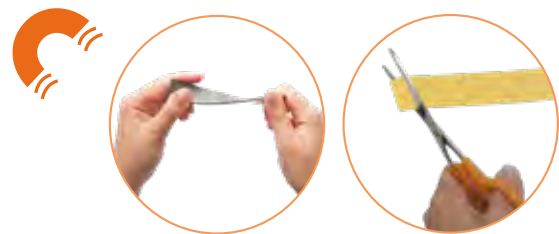

11,5 x 2 x 0,15 cm

**PANEL MULTIUSOS
MULTI-USE BOARD**

Ref. 40105



Panel expositor, fabricado con lona plastificada de especial resistencia, con bandas transparentes. Material muy útil para facilitar tareas en la enseñanza. Fichas no incluidas.

A display panel made from very hard-wearing plasticized canvas with transparent bands. A very useful piece of equipment for daily teaching tasks. Cards not included.

Lavable
Washable

Ignífugo M2
M2 Fireproof

20 BOLSILLOS
POCKETS



80 cm

104 cm

**TABLEROS MANUALIDADES
HANDICRAFT BOARDS**

Ref. 50906

3-8
years

Tableros de madera de chopo contrachapados para la realización de manualidades. Disponible en paquetes de 10 unidades y en cajas de 300 unidades (30 paquetes de 10 unidades).

Boards made from laminated poplar, suitable for all kinds of handicrafts. Available in packets of 10 units and in boxes of 300 units (30 packets of 10 units).



330 x 240 x 3 mm

Camita / Cot

Zzz



¡Ahora más ECO!
Now more ECO!

100% recicladas/reciclables
100% recycled / recyclable

Made in SPAIN
CAMA EVOLUTION
EVOLUTION COT

PATENTED

10 años de garantía
years guarantee



VIDEO

131 x 55 x 11 cm

tela termosoldada
thermoformed fabric
Sin Velcro®
With no Velcro®

- más segura / safer
Sin hueco entre tejido y patas
No gap between the fabric and legs
- fácil acceso para la limpieza
easily accessible for cleaning
- más transpirable
more breathable
- ignífuga M2
M2 fireproof



Estatura máxima 118 cm / Up to 118 cm tall
Peso máximo 50 kg / Maximum weight 50 kg

Súper ligera (3,65 kg)
Super light (3,65 kg)



Apilable
Stackable



Máxima estabilidad
Exceptionally stable



Máximo de camas
apilables recomendado (10uds.)
Maximum stackable cots
recommended (10 units)



* También apilable con el modelo anterior
Also stackable with the previous cot

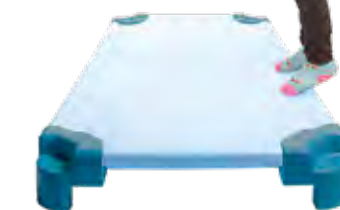

Fabricada conforme a las
Normas Europeas de Seguridad
Manufactured in accordance with
European Safety Standards

Zzz

Fácil de montar / Easy to assemble
sin herramientas / no tools needed
ni tornillos / no screws



CAMA AUTOMONTABLE / SELF-ASSEMBLY COT

Fácil de transportar
Easy to transport



Fácil de almacenar
Easy to store

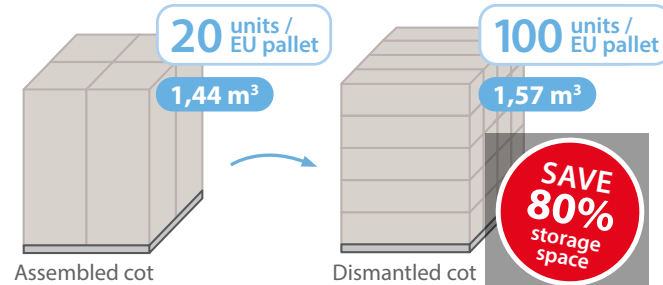

- ⊕ Ecológica / Ecofriendly
- ⊖ Combustible y embalaje / Fuel and less packaging



Opciones de compra
Purchase options

CAMA DESMONTADA / DISMANTLED COT

INCLUYE / INCLUDES:

• Cama / Cot



• Identificador adhesivo
Identifying sticker



Ref. 40501 D

1 unidad / caja
unit / box

Ref. 40501 DS

INCLUYE / INCLUDES:

• Cama / Cot



• Identificador adhesivo
Identifying sticker



Ref. 40505 DS

5 unidades / caja
units / box

CAMA MONTADA / ASSEMBLED COT

Ref. 40501 M

1 unidad / caja
unit / box

Ref. 40501 MS

• Sábana / Sheet

Ref. 40505 M

5 unidades / caja
units / box

Ref. 40505 MS



Ventajas distribuidor

- Ahorro de espacio en el transporte
- Ahorro de espacio de almacenamiento
- Diferentes opciones de compra
- Diferentes opciones de precios
- Servicio posventa: recambios disponibles

Advantages for you

- Saves transport space
- Saves storage space
- Different purchase options
- Different price options
- After-sales service: parts available

Ventajas usuario

- Más segura
- Más transpirable
- Ignífuga M2
- Apilable con la cama anterior
- Servicio posventa: recambios disponibles

Advantages for users

- Safer
- More breathable
- M2 fireproof
- Can be stacked on previous cot
- After-sales service: parts available

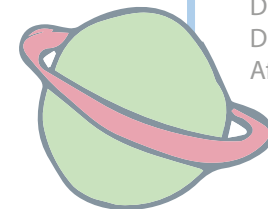

Accesorios
Accessories

SÁBANA / SHEET

Ref. 40210

131 x 58 cm



50 % Cotton
50 % Polyester



SÁBANA-SACO
SLEEPING BAG

Ref. 40220

131 x 58 cm



50 % Cotton
50 % Polyester



SÁBANA IMPERMEABLE
Y TRANSPIRABLE
BREATHABLE
WATERPROOF SHEET

Ref. 40215

131 x 58 cm

100 % Cotton

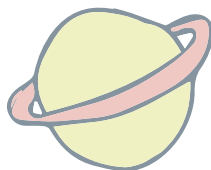

IDENTIFICADOR ADHESIVO
IDENTIFYING STICKER



Ref. 40150

Incluye 28 unidades
28 units included

4 x



SET RUEDAS CON FRENO (4 uds.)
SET OF WHEELS WITH BRAKE (4 pcs)

Ref. 40514

ALMOHADA IGNÍFUGA / FIREPROOF PILLOW

Ref. 40221

+ GRATIS - Incluye funda 100 % algodón
FREE - Includes 100 % cotton pillowcase



MANTA-SACO IGNÍFUGA CON GOMAS
FIREPROOF BLANKET-BAG WITH ELASTIC CORNERS

Ref. 40232

130 x 60 cm



100 % Polyester



100 % Polyester



MANTA IGNÍFUGA CON GOMAS
FIREPROOF BLANKET WITH ELASTIC CORNERS

Ref. 40231

100 x 75 cm

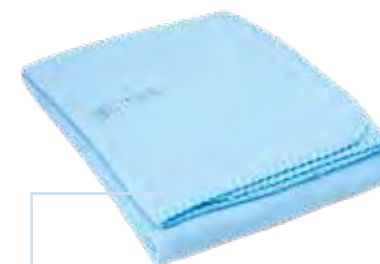

MANTA IGNÍFUGA (100 x 75 cm)
FIREPROOF BLANKET (100 x 75 cm)

Ref. 40233

100 % Polyester



MANTA IGNÍFUGA (150 x 100 cm)
FIREPROOF BLANKET (150 x 100 cm)

Ref. 40234

100 % Polyester



Ref.	Product	Page	TDHD	DYSLEXIA	DYSPHASIA	DYSCALCULIA	DYSGRAPHIA	DYSPRAXIA	ASD/TEA	Special Needs	Alzheimer
20005	The challenge of multiple intelligences	148	●								
20010	20 pre-writing awls container	181									
20015	Set of pre-writing tray and awl (4 sets)	181	●								
20020	Logo-bits cards for oral motor speech therapy	119		●	●						
20021	Lecto-bits cards for starting to read with vowels	120		●	●						
20022	Lecto-bits cards with phonetic syllables	120		●	●						
20023	Logo-bits cards with all consonant clusters	121		●	●						
20024	Logo-bits cards with consonant clusters	121			●						
20025	Logo-bits cards Rhotacism	122			●						
20026	Logo-bits cards for differentiating S / Z	122			●						
20021FR	Lecto-bits d'initiation à la lecture (voyelles)	123		●	●						
20022FR	Lecto-bits de syllabes simples	123		●	●						
20023FR	Logo-bits de groupes bisyllabiques	124		●	●						
20024FR	Logo-bits groupes consonantiques	124			●						
20026FR	Logo-bits de discrimination (CH / S) (J / Z)	125			●						
20030	The 4 blowing games	100			●						
20031	Blowing adventures	101			●						
20039	The pre-reading roulette	97	●	●							
20045	Photo - making words	117		●	●						
20048	Picto-dice of classic stories	114			●						
20050	Self-learning nouns	111		●	●						
20090	Self-learning verbs	110		●	●						
20401	Maxi-memory pets	144									
20402	Maxi-memory healthy food	145									
20403	Maxi-memory cultures	87									
20404	Maxi-memory places of the world	87									
20405	Maxi-memory universe	145	●								
20406	Maxi-memory inventions	146	●								
20407	Maxi-memory Equality	10	●								
20408	Maxi-memory hygiene and health	147	●								
20409	Maxi-memory diversity and ways of living	82	●								
20410	Tactile maxi-memory "everyday life"	42	●	●							
20411	Tactile maxi-memory "nature"	43	●	●							
20412	Touch-memory visual discrimination	31	●								
20505	Animal photographs	105			●						
20506	Action photographs (verbs)	105			●						
20507	Food photographs	105			●						
20508	Household objects photographs	106			●						
20509	Body parts and clothes photographs	106			●						
20510	Sequence photographs	106			●						
20511	Photographs of adjectives	107			●						
20512	Find the differences	107	●								
20513	Where is the mistake?	107	●								
20514	Guess what they're thinking	104			●						
20520	NEW Topology-Birds. Spatial orientation.	149	●								
20521	RoboCoding: Coordinates and early coding	150									
20522	Where is it?	153	●								
20523	Topology	155									
20524	Bingo: Learning to count from 1 to 10	140				●					
20525	Lotto: 72 food items	108		●	●						
20526	Lotto: 72 animals	109		●	●						
20529	Creative dominoes	49									
20530	Associations	90									
20531	Contrasts	91									

Ref.	Product	Page	TDHD	DYSLEXIA	DYSPHASIA	DYSCALCULIA	DYSGRAPHIA	DYSPRAXIA	ASD/TEA	Special Needs	Alzheimer
20532	What do they have in common?	91									
20535	Discover geometric shapes in everyday life	151		●		●					
20538	My left and my right	152		●							
20540	Before and after	159									
20542	Expressions	24	●								
20543	Guess what I am!	102			●						
20544	Set of puzzles - the 10 emotions	28	●								
20545	Recognize and guide the emotions	26	●								
20546	Maxi-stamps of the 10 emotions	27	●								
20547	Give life to your emotions!	23	●								
20551	Where does food come from?	56									
20552	Separating and recycling	69	●								
20553	The traffic light of healthy eating	55									
20554	The healthy eating pyramid	57									
20555	Learning about food allergies and intolerances	54	●								
20556	The energy balance: physical activity and food	51									
20557	The superpowers of healthy food	52									
20560	Trades	94									
20562	Where do animals live?	92									
20564	Where are we in the house?	93									
20575	My first road safety lesson	95									
20590	Magnetic stacking game	154									
20600	The sense of smell: the fruits and their aromas	34	●								
20610	The 5 senses	32									
20611	Touch-photo	33	●								
20612	Tactile number cards for pre-writing	44	●	●							
20613	Tactile letter cards with punctuation signs	45	●	●							
20614	Tactile cards for lacing paths	41									
20615	Tactile-visual dominoes	40	●								
20616	Set multi-sensory pre-writing tray and board	39	●	●							
20617	Set multi-sensory pre-writing tray and board XL	38	●	●							
20620	Bingo: animals and nature	35									
20621	Bingo: the house and the city	36									
20622	Bingo: actions and musical instruments	37									
20630	Bingo: the sounds of emotions	25									
20800	Good behaviour: the environment	70	●								
20801	Good behaviour: the school	20	●								
20802	Good behaviour: at home	21	●								
20803	Good behaviour: prevention and safety	21	●								
20810	A positive attitude: tolerance and cooperation	19	●								
20811	A positive attitude: affection, health and safety	19	●								
20819	NEW The 3 Rs: Reduce, Reuse and Recycle	60	●								
20820	Taking care of the earth: saving water	71									
20821	Taking care of the earth: recycling and saving energy	71									
20822	My planet and its energy	59	●								
20823	Our sustainable world	62	●								
20824	Natudomino animals in extinction	65	●								
20825	Natudomino insects	64	●								
20826	Natudomino wonders of nature	66	●								
20827	Natudomino the zoom of animals	67	●								
20830	Resolving conflicts: at home	16									
20831	Resolving conflicts: at school	18									
20832	Resolving conflicts: lies	17									
20839	Let's play on equal terms!	14									

New products **NEW**
Updated products ●

Ref.	Product	Page	SPECIAL NEEDS													
			TDHD	DYSLEXIA	DYSPHASIA	DYSCALCULIA	DYSGRAPHIA	DYSPRAXIA	ASD/TEA	Intellectual disability	Visual disability	Auditory disability	Motor disability	ALZHEIMER		
20840	Learning to prevent bullying	13	●													
20841	Anti-bullying posters	12														
NEW 20844	School, family & peace. Social inclusion.	9	●												●	●
20845	Put yourself in my shoes	15	●													
20846	Self-esteem roulette	11	●													
30120	Universal calendar	163														
30245	Human body: What am I like?	103														
30601	Macro alphabet puzzle	112		●	●											
30639	Maxi-sequences of daily habits	161	●													
30640	Maxi-sequences autonomy habits	161	●													
30641	Nature maxi-sequences	160													●	●
30642	Production maxi-sequences	160													●	●
30643	Maxi-sequences: Why do we recycle?	68													●	●
30651	Basic sequences: Nita and Zaro 1	158														
30652	Basic sequences: Nita and Zaro 2	158														
30660	Food production sequences: Nita and Zaro 1	158														
30670	Find the letters	112		●												
NEW 30672	The vowel challenge	98		●												
NEW 30673	The number challenge from 1 to 10	128		●												
30675	Eurodominoes	139	●												●	●
30676	Friends of 10	127	●													
NEW 30677	Learn to add and subtract and carry over	130														
30680	Learn to multiply	142														●
30690	Learn to add up	142														●
30691	My first long numbers in base 10 blocks	136	●													
30692	Base 10 numerical breakdown stamps	137	●													
30693	Maxi-stamp: What time is it?	167	●	●												
30694	Let's build the time	166	●	●												
30696	Learning about numbers and decomposition	134	●													
30697	Inventing and solving mathematical problems	135	●	●												
30698	Learn and understand multiplication tables	132	●	●												
30750	Fun stories from home	157			●											
30760	Listen and put the stories in order	156			●											
30765	Discover the history of humanity!	80	●												●	●
NEW 30766	Photo-history. Play and learn about...	78	●												●	●
NEW 30767	World religions: respect and coexistence	76	●												●	●
NEW 30768	Discover the different forms of art!	75	●												●	●
30770	Dice for making up stories	115			●											
30957	Adhesive magnetic bands	188	●	●	●	●	●									●
30959	Roll-up erasable metallic board	188	●	●	●	●	●									●
32010	Alphabet - Set of 216 letters	113		●	●											●
32020	Calculation kit	143				●										●
33050	Selective attention dominoes	89	●													
33103	Rewritable dice	48		●	●	●										
33105	The magic window	47	●													
33110	Classify colours and learn to count	141				●										
38900	Enjoy the seasons of the year!	63	●													
38990	New technologies: Balance your activities	165	●													
38995	Discover the continents of the world!	83														●
39000	Weekly calendar	162														
● 39010	Planning daily activities	164	●													
40105	Multi-use board	189	●													●
40115	Wooden card holders (2 units)	185														●
40150	Identifying sticker	186	●													●

Ref.	Product	Page	SPECIAL NEEDS													
			TDHD	DYSLEXIA	DYSPHASIA	DYSCALCULIA	DYSGRAPHIA	DYSPRAXIA	ASD/TEA	Intellectual disability	Visual disability	Auditory disability	Motor disability	ALZHEIMER		
40210	Sheet	194														
40215	Breathable waterproof sheet	194														
40220	Sleeping bag	194														
40221	Fireproof pillow	195														
40231	Fireproof blanket with elastics	195														
40232	Fireproof blanket-bag with elastics	195														
40233	Fireproof blanket (100 x 75 cm)	195														
40234	Fireproof blanket (150 x 100 cm)	195														
40501D	Evolution cot dismantled (1 unit)	193														
40501DS	Evolution cot dismantled + sheet (1 unit)	193														
40505D	Evolution cot dismantled (5 units)	193														
40505DS	Evolution cot dismantled + sheet (5 units)	193														
40501M	Evolution cot assembled (1 unit)	193														
40501MS	Evolution cot assembled + sheet (1 unit)	193														
40505M	Evolution cot assembled (5 units)	193														
40505MS	Evolution cot assembled + sheet (5 units)	193														
40514	Set of wheels with brake (4 pcs)	194														
50200	Set animal puzzles (9 units)	169														
50201	Families of today's world (4 units)	84														
50221	Maxi puzzles - animals	170														
50222	Maxi puzzles - healthy food	171														
50223	Set of 12 puzzles - happy children	85	●													●
50515	Set observation puzzles fairytales (4 units)	172	●													
50524	Set observation pzz the four seasons (4 units)	173	●													
50615	Set cooperative puzzles the farm (4 units)	174														
50624	Set cooperative puzzles the city (4 units)	174														
50906	Handicraft boards	189														
52215	Set the 4 seasons puzzles (4 units)	176														
52224	Set free time puzzles (4 units)	176														
52235	Set transport puzzles (4 units)	177														
52248	Set places puzzles (4 units)	177														
52270	Eco-puzzles: Let's save the Planet!	72														
52302	Set puzzle-seq. The 3 Little Pigs & Cinderella	178	●	●												
52311	Lacing families of the world	86	●	●												
52312	Lacing professions	183	●	●												
● 52510	Set logic game 1 (4 units)	138	●	●												●
● 52520	Set logic game 2 (4 units)	138	●	●												●
55044	Set 4-piece Zaro and Nita puzzles (4 units)	175														
55066	Set 6-piece Zaro and Nita puzzles (4 units)	175														
55099	Set 9-piece Zaro and Nita puzzles (4 units)	175														
64001	Emotions puppets	29														
65001	Puppets: Little red riding hood & The 3 little pigs	116														
65002	Puppets: Mico magician & The crow of rooster	116														
70020	Sand for Montessori Methodology (5 kg)	187	●	●												
70021	Sand for Montessori Methodology (1 kg)	187	●	●												
70050	Time dice set (30 units)	185		●		●										
70110	Set ergonomic laces (10 units)	186	●	●												
70130	Set ergonomic laces (30 units)	186	●	●												

Montessori methodology
 Seniors
 Special needs
 Intellectual disability
 Visual disability
 Auditory disability
 Motor disability

New products
Updated products

We love playing with you!



¡Encuentra otras categorías según tus necesidades!
Find other categories to suit your needs!

**SPECIAL
NEEDS**

Juegos para necesidades especiales
Products for children with special needs

2+

Juegos para niños de 2 años
Products for children aged 2+

**metodología
Montessori**

Juegos inspirados en la Metodología Montessori
Products inspired by the Montessori Methodology



Juegos para la tercera edad
Products suitable for seniors

akroseducational.com

AKROS INTERDIDAK, S.L. y AKROS son marcas registradas.

CE Todos los productos Akros están fabricados con materiales homologados que cumplen las normativas europeas sobre seguridad.
AKROS INTERDIDAK, S.L., se reserva, por razones técnicas o de otra índole, el derecho a modificar o anular cualquier producto o medida de este catálogo, incluidos los envases. Prohibida la reproducción total o parcial por cualquier procedimiento del contenido de este catálogo sin el permiso expreso de AKROS INTERDIDAK, S.L.

AKROS INTERDIDAK, S.L. and AKROS are registered trademarks.

CE All Akros products are manufactured with officially approved materials that meet European safety standards.
AKROS INTERDIDAK, S.L. reserves the right to modify or withdraw any product, measurement or container from this catalogue for technical and other reasons. The entire or partial reproduction by any procedure of the contents of this catalogue is strictly prohibited except by express permission from AKROS INTERDIDAK, S.L.



www.lifer.es



Jugueterías LIFER

Venta "on line"
www.lifer.es

Visite Jugueterías LIFER en:

TENERIFE:



LA LAGUNA

Calle de Nava y Grimón, 46
San Cristóbal de la Laguna Tel. :
922 25 23 43 E-mail: info@lifer.es

LA OROTAVA

Avenida Obispo Benítez De Lugo, 10
LA OROTAVA (Tenerife)
Tel. :922 337 929 E-mail: laorotava@lifer.es

SANTA CRUZ DE TENERIFE

Calle Juan Pablo II, 24
Santa Cruz de Tenerife España
Tel.: 922 276802 E-mail: santacruz@lifer.es

LAS CHAFIRAS

Calle Uruguay 4, Polígono Las Chafiras.
San Miguel de Abona (Tenerife)
Tel.: 922109981 E-mail: chafiras@lifer.es

GRAN CANARIA:



LAS PALMAS DE G.C,

C/ León y Castillo, 399,
35007 LAS PALMAS DE GRAN CANARIA
Tel. :928 227 967 E-mail: laspalmas@lifer.es



akros educational 
sales@akroseducational.com 
+34 96 274 34 63 
C/ Viena, 17 - P.I. Mas de Tous 
46185 La Pobla de Vallbona, Valencia, ESPAÑA



www.lifer.es



Calle de Nava y Grimón, 46
38201 San Cristóbal de la Laguna
922 25 23 43
www.lifer.es info@lifer.es

always learning

together



akros educational

sales@akroseducational.com

+34 96 274 34 63

C/ Viena, 17 - P.I. Mas de Tous
46185 La Pobla de Vallbona, Valencia, ESPAÑA

