



Exceptional LED alternatives for unique applications

LED Specialty Lamps

Philips speciality LED lamps are the smart alternative to standard incandescent. Their unique lamp design provides form factors to fit in standard applications with incredible energy savings.

Benefits

- Long life -- lowers maintenance costs by reducing re-lamp frequency
- Excellent color consistency with high 80+ color rendering (CRI)

Features

- 15,000-hour rated average life
- Instant on
- Emits virtually no UV/IR light
- No mercury for a safe environment
- Some lamps over 90% energy saving when compared to halogen

Application

- Landscape Lighting
- Hospitality
- Residential

LED Specialty Lamps

Versions



LEDcapsule Wedgebase 1,2W



SPPR_LEDCLL_0005-Product photo



LEDcapsule Wedgebase 2W



LED G4 12V 2 POS2



LEDlinear 7,5W R7S



LEDcapsule 3,6W G9



LEDcapsule CorePro 20W G4 capsule 830 ND



LEDbulb Specialty NAM Others E12 FR

LED Specialty Lamps

Versions



LED G4 12V 1 POS2

Dimensional drawing

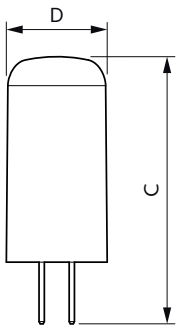
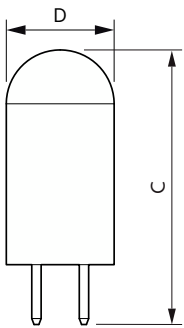
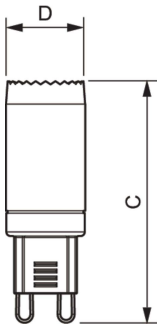

Product	D	C
3T3/PER/830/ND/G9/120V 6/1PF	17.7 mm	53 mm

Product	D	C
1T3/G4/830/ND/12V 6/1PF	14.5 mm	38 mm
1T3/LED/830/G4/ND/12V 6/1BC	14.5 mm	38 mm
2T3/G4/830/ND 12V 6/1PF	14.5 mm	38 mm

Product	D	C
LED 10W G4 WH 12V ND SRT6	13 mm	35 mm
LED 20W G4 WH 12V RF ND SRT6	13 mm	35 mm

LED Specialty Lamps

Dimensional drawing

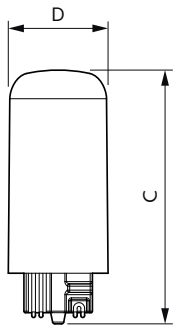
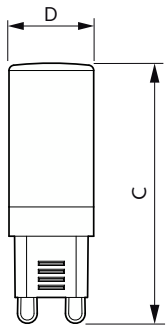
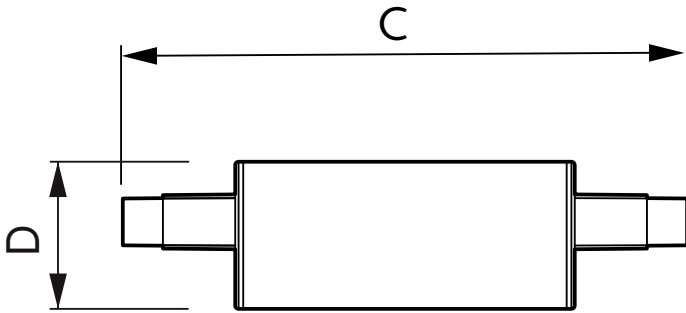

Product	D	C
7.5R7S/PER/830/ND/120V 4/1BC	29 mm	79 mm

Product	D	C
3.6T3/PER/830/ND/G9/120V 6/1BC	17 mm	51.5 mm
3.6T3/PER/830/ND/G9/120V 6/3PF	17 mm	51.5 mm

Product	D	C
1.2T5/SPC/830/ND/12V/BC/2PK 6/2	13 mm	34 mm
2T5/LED/830/ND/12V/BC/2PK 6/2	13 mm	34 mm

Product	D	C
14R7S/PER/830/ND/120V 4/1BC	29 mm	119 mm
14R7S/PER/830/ND/120V 4/1PF	29 mm	119 mm

LED Specialty Lamps

Dimensional drawing

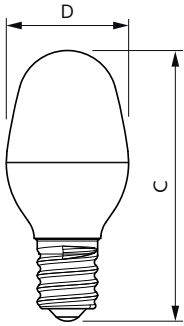

Product	D	C
0.5C7/LEDnight light/E12/MilkyND120V 2PF	23 mm	52 mm

General Information	
Nominal lifetime	15,000 hour(s)
Light Technical	
Color rendering index (CRI)	80
LLMF At End Of Nominal Lifetime (Nom)	70 %
Operating and Electrical	
Starting Time (Nom)	0.5 s
Controls and Dimming	
Dimmable	No

General Information

Order Code	Full Product Name	Cap-Base	Rated Lifetime (Hours)	Switching Cycle
929002389596	1.2T5/SPC/830/ND/12V/BC/2 PK 6/2	Wedgebase	15,000 hour(s)	50,000
929001266835	3T3/PER/830/ND/G9/120V 6/1PF	G9	15,000 hour(s)	50,000
929002389636	2T5/LED/830/ND/12V/BC/2P K 6/2	Wedgebase	15,000 hour(s)	50,000
929002389117	LED 20W G4 WH 12V RF ND SRT6	G4	15,000 hour(s)	50,000
929001357525	7.5R7S/PER/830/ND/120V 4/1BC	R7s	-	50,000
929001373325	14R7S/PER/830/ND/120V 4/1BC	R7s	-	50,000
929001373335	14R7S/PER/830/ND/120V 4/1PF	R7s	-	50,000

Order Code	Full Product Name	Cap-Base	Rated Lifetime (Hours)	Switching Cycle
929001840825	3.6T3/PER/830/ND/G9/120V 6/1BC	G9	-	50,000
929001840855	3.6T3/PER/830/ND/G9/120V 6/3PF	G9	15,000 hour(s)	50,000
929001844223	2T3/G4/830/ND 12V 6/1PF	G4	-	50,000
929001224613	0.5C7/LEDnight light/E12/ MilkyND120V 2PF	E12	-	20,000
929002388917	LED 10W G4 WH 12V ND SRT6	G4	15,000 hour(s)	50,000
929001844003	1T3/LED/830/G4/ND/12V 6/1BC	G4	-	50,000
929001844023	1T3/G4/830/ND/12V 6/1PF	G4	-	50,000

Light Technical

LED Specialty Lamps

Order Code	Full Product Name	Beam Angle (Nom)	Correlated Color		
			Temperature (Nom)	Color Code	Luminous Flux
929002389596	1.2T5/SPC/830/ND/12V/BC/2PK 6/2	-	3000 K	830	120 lm
929001266835	3T3/PER/830/ND/G9/120V 6/1PF	-	3000 K	830	250 lm
929002389636	2T5/LED/830/ND/12V/BC/2PK 6/2	-	3000 K	830	200 lm
929002389117	LED 20W G4 WH 12V RF ND SRT6	300 degree(s)	3000 K	830	215 lm
929001357525	7.5R7S/PER/830/ND/120V 4/1BC	-	3000 K	830	800 lm
929001373325	14R7S/PER/830/ND/120V 4/1BC	-	3000 K	830	1,500 lm
929001373335	14R7S/PER/830/ND/120V 4/1PF	-	3000 K	830	1,500 lm
929001840825	3.6T3/PER/830/ND/G9/120V 6/1BC	-	3000 K	830	370 lm

Order Code	Full Product Name	Beam Angle (Nom)	Correlated Color		
			Temperature (Nom)	Color Code	Luminous Flux
929001840855	3.6T3/PER/830/ND/G9/120V 6/3PF	-	3000 K	830	370 lm
929001844223	2T3/G4/830/ND 12V 6/1PF	-	3000 K	830	200 lm
929001224613	0.5C7/LEDnight light/E12/MilkyND120V 2PF	-	2700 K	827	30 lm
929002388917	LED 10W G4 WH 12V ND SRT6	300 degree(s)	3000 K	830	120 lm
929001844003	1T3/LED/830/G4/ND/12V 6/1BC	-	3000 K	830	100 lm
929001844023	1T3/G4/830/ND/12V 6/1PF	-	3000 K	830	100 lm

Operating and Electrical

Order Code	Full Product Name	Input Frequency	Line Frequency	Power Consumption	Wattage Equivalent
929002389596	1.2T5/SPC/830/ND/12V/BC/2PK 6/2	- Hz	- Hz	1.2 W	7 W
929001266835	3T3/PER/830/ND/G9/120V 6/1PF	50 to 60 Hz	50 to 60 Hz	3 W	25 W
929002389636	2T5/LED/830/ND/12V/BC/2PK 6/2	- Hz	- Hz	2 W	18 W
929002389117	LED 20W G4 WH 12V RF ND SRT6	- Hz	-	1.8 W	20 W
929001357525	7.5R7S/PER/830/ND/120V 4/1BC	60 Hz	60 Hz	7.5 W	100 W
929001373325	14R7S/PER/830/ND/120V 4/1BC	60 Hz	60 Hz	14 W	200 W
929001373335	14R7S/PER/830/ND/120V 4/1PF	60 Hz	60 Hz	14 W	200 W
929001840825	3.6T3/PER/830/ND/G9/120V 6/1BC	60 Hz	60 Hz	3.6 W	40 W

Order Code	Full Product Name	Input Frequency	Line Frequency	Power Consumption	Wattage Equivalent
929001840855	3.6T3/PER/830/ND/G9/120V 6/3PF	60 Hz	60 Hz	3.6 W	40 W
929001844223	2T3/G4/830/ND 12V 6/1PF	- Hz	- Hz	2 W	20 W
929001224613	0.5C7/LEDnight light/E12/MilkyND120V 2PF	60 Hz	60 Hz	0.5 W	-
929002388917	LED 10W G4 WH 12V ND SRT6	- Hz	-	1 W	10 W
929001844003	1T3/LED/830/G4/ND/12V 6/1BC	- Hz	- Hz	1 W	0 W
929001844023	1T3/G4/830/ND/12V 6/1PF	- Hz	- Hz	1 W	10 W

Temperature

LED Specialty Lamps

Order Code	Full Product Name	Ambient temperature range	T-Case Maximum (Nom)
929002389596	1.2T5/SPC/830/ND/12V/BC/2PK 6/2	-	80 °C
929001266835	3T3/PER/830/ND/G9/120V 6/1PF	-	65 °C
929002389636	2T5/LED/830/ND/12V/BC/2PK 6/2	-	80 °C
929002389117	LED 20W G4 WH 12V RF ND SRT6	-20 to +35 °C	71 °C
929001357525	7.5R7S/PER/830/ND/120V 4/1BC	-	100 °C
929001373325	14R7S/PER/830/ND/120V 4/1BC	-	100 °C

Order Code	Full Product Name	Ambient temperature range	T-Case Maximum (Nom)
929001373335	14R7S/PER/830/ND/120V 4/1PF	-	100 °C
929001840825	3.6T3/PER/830/ND/G9/120V 6/1BC	-	78 °C
929001840855	3.6T3/PER/830/ND/G9/120V 6/3PF	-	78 °C
929001844223	2T3/G4/830/ND 12V 6/1PF	-	56 °C
929001224613	0.5C7/LEDnight light/E12/MilkyND120V 2PF	-20 °C to 45 °C	90 °C
929002388917	LED 10W G4 WH 12V ND SRT6	-20 to +35 °C	52 °C
929001844003	1T3/LED/830/G4/ND/12V 6/1BC	-	51 °C
929001844023	1T3/G4/830/ND/12V 6/1PF	-	51 °C

Mechanical and Housing

Order Code	Full Product Name	Bulb Finish	Bulb Shape
929002389596	1.2T5/SPC/830/ND/12V/BC/2PK 6/2	-	Capsule
929001266835	3T3/PER/830/ND/G9/120V 6/1PF	-	Capsule
929002389636	2T5/LED/830/ND/12V/BC/2PK 6/2	Clear	Capsule
929002389117	LED 20W G4 WH 12V RF ND SRT6	Clear	Capsule
929001357525	7.5R7S/PER/830/ND/120V 4/1BC	Clear	Others
929001373325	14R7S/PER/830/ND/120V 4/1BC	Clear	Others
929001373335	14R7S/PER/830/ND/120V 4/1PF	-	Others

Order Code	Full Product Name	Bulb Finish	Bulb Shape
929001840825	3.6T3/PER/830/ND/G9/120V 6/1BC	-	Capsule
929001840855	3.6T3/PER/830/ND/G9/120V 6/3PF	-	Capsule
929001844223	2T3/G4/830/ND 12V 6/1PF	-	Capsule
929001224613	0.5C7/LEDnight light/E12/MilkyND120V 2PF	Frosted	Others
929002388917	LED 10W G4 WH 12V ND SRT6	Clear	Capsule
929001844003	1T3/LED/830/G4/ND/12V 6/1BC	Frosted	Capsule
929001844023	1T3/G4/830/ND/12V 6/1PF	-	Capsule

Approval and Application

Order Code	Full Product Name	Energy Consumption kWh/1000 h
929002389596	1.2T5/SPC/830/ND/12V/BC/2PK 6/2	2 kWh
929001266835	3T3/PER/830/ND/G9/120V 6/1PF	-
929002389636	2T5/LED/830/ND/12V/BC/2PK 6/2	3 kWh
929002389117	LED 20W G4 WH 12V RF ND SRT6	2 kWh
929001357525	7.5R7S/PER/830/ND/120V 4/1BC	-
929001373325	14R7S/PER/830/ND/120V 4/1BC	-
929001373335	14R7S/PER/830/ND/120V 4/1PF	-
929001840825	3.6T3/PER/830/ND/G9/120V 6/1BC	-
929001840855	3.6T3/PER/830/ND/G9/120V 6/3PF	-
929001844223	2T3/G4/830/ND 12V 6/1PF	-
929001224613	0.5C7/LEDnight light/E12/MilkyND120V 2PF	-
929002388917	LED 10W G4 WH 12V ND SRT6	1 kWh
929001844003	1T3/LED/830/G4/ND/12V 6/1BC	- kWh
929001844023	1T3/G4/830/ND/12V 6/1PF	-

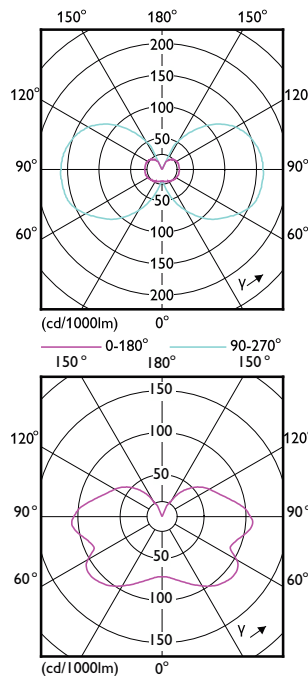

LED Specialty Lamps

