

Link

*People
and Products
Connecting the World
of Entertainment*





- 6 PDlink
- 8 EMEA Rack Distro
- 9 EMEA Rubber Box Distro
- 10 EMEA Box Rack
- 11 EMEA Company Switch
- 12 Facility Panels and Backboxes
- 14 Main Panels
- 16 Portable Power Boxes
- 17 Power Cord Splitters
- 18 North America Power Distribution
- 22 PDlink Fixed Speed Chain Motor Control
- 24 GOLD & Custom Stage Boxes
- 26 AD System
- 28 Compact & Modular Stage Box
- 30 Stage Boxes
- 31 Drive AMP I/O Systems
- 32 Snake SNK-FNT-FNN
- 34 Widget
- 36 Boxes and Panels



- 40 Introduction
- 42 Redundant Rugged Switches
- 44 Multinetwork Optical Backbone
- 45 Networking Diagram
- 46 Digital Stage Box

eurocable

- 86 Wiring Cables
- 87 Microphone Cables/Starquad Cable
- 88 AES/DMX Cables
- 89 DMX Cables
- 90 DMX PUR Jacket
- 91 DMX Cables for Special Applications
- 92 Musical Instrument Cable
- 93 SS Spiral Copper Shield Multipair
- 94 SSAD AES/EBU Aluminium Foil Shield Multipair
- 95 SSAD AES/EBU 24 AWG Aluminium Foil Shield Multipair
- 96 SSA Aluminium Foil Shield Multipair
- 97 SSAS Overall Shield Multipair
- 98 Speaker Cables
- 99 Multicore Speaker Cables (4 to 8 Conductors)
- 100 Multicore Speaker Cables (18 to 24 Conductors)
- 101 Multicore Speaker Cables (36 to 48 Conductors)
- 102 Powered Audio/DMX Cables
- 103 Powered Audio/DMX Cables
- 104 CAT PUR Jacket
- 105 CAT6 LAN Cable
- 106 CAT Solid Bare
- 107 CAT Stranded
- 108 Hybrid Cable for Data and Power
- 109 Hybrid Cables for Data and Power
- 110 Hybrid Cables for Data, Audio and Power
- 111 Multidata CAT6 Cables
- 112 Multisignal CAT6 with Audio
- 113 Hybrid Digital Data and Coaxial Cable
- 114 Unbreakable Optical Cables
- 116 Hybrid Optical Cables
- 117 Optical Camera Cable
- 118 Analog Video Cables
- 119 RF Coaxial Cables
- 120 Digital Video Cables (HDTV)
- 121 Miniature HDTV Video Cables
- 122 Triax Camera Cables
- 123 Power Cables
- 124 Power Multilines & Data
- 125 LKS Data Flat Cable
- 126 ULP
- 127 Chain Hoist and Control Cables
- 128 Assembled Cables
- 132 Cable Reels
- 133 Reference Table



- 50 LK Audio Multipin
- 52 Speaker Connectors
- 54 Multisignal Speaker
- 56 LKO Optical System
- 58 LKG Gigabit System
- 60 LKG Video & Data Connector
- 62 LKS Data Systems
- 64 LKS 19 Pin
- 66 Multi-Coax Connectors
- 68 Hermaphrodite Connectors / W Style Connectors
- 70 LKH Head to Ballast Connectors
- 72 LKR Chain Motor Connectors
- 74 Power Link
- 76 LK Tools
- 78 Cable Relief
- 79 Dimensional Data
- 80 Standard Wiring
- 83 Reference Table

Terms of Sale

PRICES

All prices are expressed in Euro (€), excluding V.A.T. and may be subject to change without any notice.

PAYMENT

All goods must be paid in advance by wire transfer. Any other payment terms must be previously agreed and allowed by LINK Srl.

ORDERS

Minimum order value is € 1.000. A written order must always be sent, either by email or by fax, as confirmation of telephone instructions. The contractual tie raised from the accomplishment of each single order is governed by the regulations of these conditions of sale.

The buyer renounces to its own possible conditions of purchase, unless differently agreed upon and specifically accepted in writing by LINK Srl.

DELIVERY

Goods are normally dispatched within one week from confirmation of order. Nevertheless this delivery term is purely arbitrary as it may depend on both production times and circumstances beyond our control such as strikes, customs clearance and carriers.

LINK Srl cannot therefore be responsible in any case and for any reason for any damage caused by delayed deliveries. The buyer is not authorized in any case to cancel the order, without prior written authorization, or to claim for any reimbursement of damages to any order or shipment whatsoever.

SHIPMENTS

All goods are shipped Ex-Works and travel at the buyer's risk. For this purpose, the buyer must indicate the means of transport chosen when placing the order. LINK Srl will not be responsible for any theft, loss or damage with regard to the carriage of goods.

The buyer undertakes to verify the number of items and their integrity in debate with either its carrier or its forwarding agent. Any theft, loss or damage to the goods in transit must be notified and claimed to them upon receipt of goods.

LINK Srl may offer transportation on the buyer's behalf at rates to be agreed upon prior to shipment. In the event of any theft, loss or damage in such cases, a note must be made in writing on the transport document upon delivery and to LINK Srl immediately, otherwise no reimbursement can be claimed by the buyer.

RETURN OF GOODS

No returned goods can be accepted without prior authorization by LINK Srl. Once authorized, as defective goods or not in conformity with the order, they will be returned to LINK Srl carriage free, accompanied by a regular Return Bill detailing invoice numbers for each item returned, the products will be credited at the price applied at the time of purchase, less 10%.

Goods accepted back as defective that should show marks of poor packing or improper use, will not be replaced but immediately returned to the buyer freight collect.

WARRANTY

The warranty is limited to the replacement of the products which are recognized as defective, except when directly or indirectly damaged, as per art. 1490 and subsequent amendments of the Italian Civil Code.

The warranty does not include the normal perishability of goods nor the consequences of incorrect installation or breakage caused by improper use or lack of care.

The products have to be perfectly installed attentively following the instructions of mounting/use. With this aim, the buyer exempts LINK Srl from any responsibility regarding improper use, non-observance of the safety regulations, technical specification or instructions of use.

TECHNICAL SPECIFICATIONS

All products are liable to change without prior notice, in view of the manufacturing policy based on "continuous improvement" of the product quality.

OWNERSHIP

In case of total or partial invoice payment failure over the due term, the relative interests will be immediately charged to the buyer at the current rate as well as the additional bank commissions and fees. LINK Srl will be authorized to hold any further supply of goods in case of failure of payment due to any reason.

The property of goods supplied by LINK Srl shall not pass to the buyer until the agreed price, including possible freight charges and taxes, are completely paid.

In case of both total or partial payment failure, LINK Srl will immediately resume the ownership of the goods, leaving unprejudiced all other legal and contractual consequences of arrearage.

GENERAL CONDITIONS

The placing of orders to LINK Srl imply the knowledge and full acceptance of the above mentioned conditions of sale by the buyer.

Any issue which is not mentioned in these Terms of Sale will be ruled by the current Italian law.

LEGAL CONSTRUCTION

All contracts concluded with LINK Srl shall be governed by the Italian law. LINK Srl elects the Court of Rome as governing Forum in case of controversies.



- 6 PDlink
- 8 EMEA Rack Distro
- 9 EMEA Rubber Box Distro
- 10 EMEA Box Rack
- 11 EMEA Company Switch
- 12 Facility Panels and Backboxes
- 14 Main Panels
- 16 Portable Power Boxes
- 17 Power Cord Splitters
- 18 North America Power Distribution
- 22 PDlink Fixed Speed Chain Motor Control
- 24 GOLD & Custom Stage Boxes
- 26 AD System
- 28 Compact & Modular Stage Box
- 30 Stage Boxes
- 31 Drive AMP I/O Systems
- 32 Snake SNK-FNT-FNN
- 34 Widget
- 36 Boxes and Panels

*People and Products
Connecting the World
of Entertainment*

PDlink

PDlink is the next generation of power and signal distribution designed to deliver a truly unified and modular interconnect system. Leveraging decades of experience and innovation, Link combines LK connectors, eurocable hybrid signal and power cables for power, data, audio, speaker, and video distribution.

Constructed with heavy duty aluminium or extremely robust rubber (polyethylene), both versions are lightweight and easy to handle. The main and branch units support a number of standard configurations suited for amplifier, FOH, and video racks. The Socapex compatible 6 circuit units integrate seamlessly with your existing lighting distribution to easily extend power for peripheral equipment racks.

PDlink breakers can be just “magneto thermal” (MCB) or with residual current (RCB) too. Panels are laser labelled and can be custom labelled at a minimal additional cost.

Standard **PDlink** units are designed to seamlessly integrate with the **DGlink** Ethernet and signal distribution systems and can also be custom designed on request. Contact us to learn about PDlink. It can be offered as an OEM solution, or designed for your specific touring needs.



An Injector box integrates either a DMX splitter or network switch to distribute network and control on all the LKS Data breakouts. It is available for surface or rack mount, and both can be equipped with 2 or 4 smart connectors.

- Free standing robust portable enclosure to fit most 19" rack configurations
- 100% Magnetic / Hydraulic Breakers, unaffected by heat
- Web based monitoring and remote control options
- Modular flexible design
- Integrating power with audio, DMX, Ethernet, and video signals
- Durable, smear resistant power coat finish with high-contrast labeling
- Custom configurations available
- Advanced, and road proven mechanical and electrical design
- USA, European, MEA Configurations with Listings



PDlink

Hybrid Stage Diagram

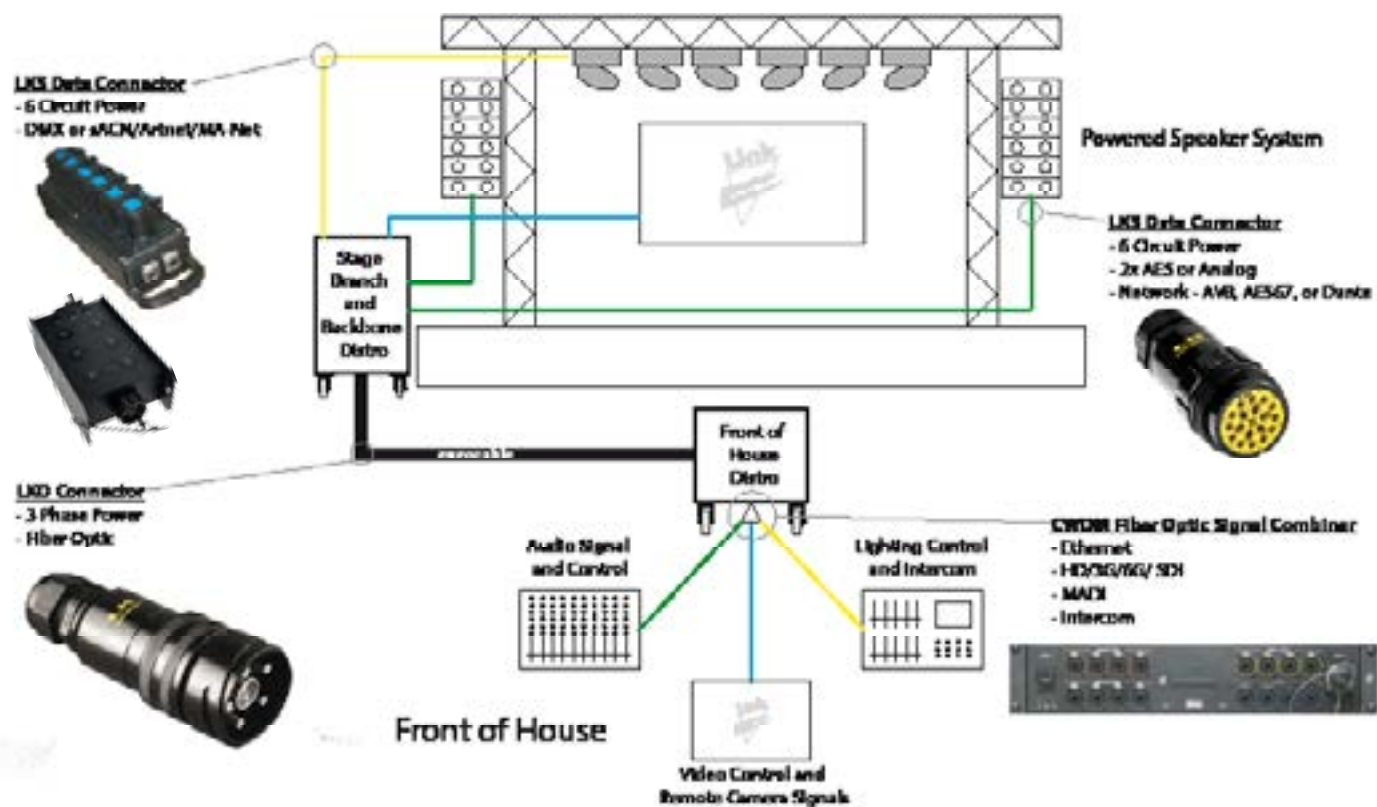

EMEA Rack Distro

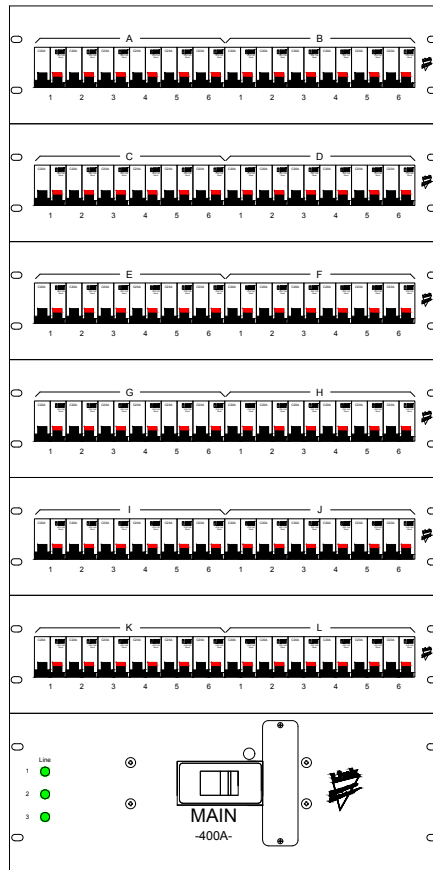
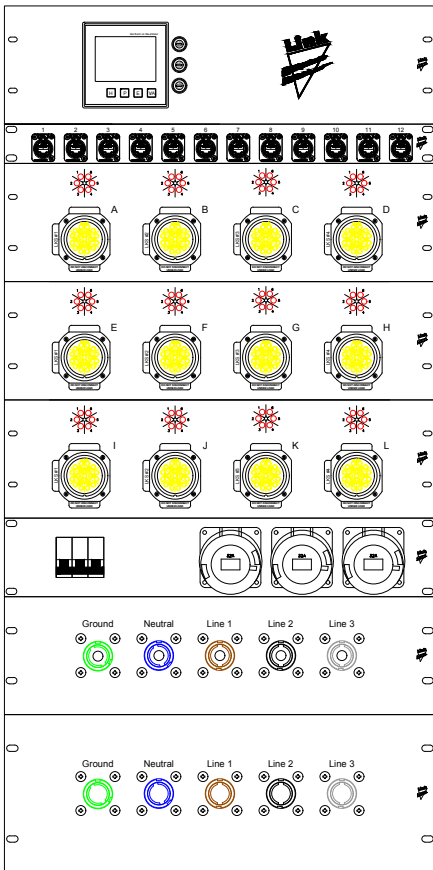

- 400A - 400Vac (4p) RCB Input breaker
- 5 x single pole (Power Link) In and Through connectors
- Digital Multimeter
- 12x LKS Data Outputs
- 72x RCCB 20A/30mA (1p+N) - 240Vac
- 3x CEE 32A - 240Vac sockets
- 3x MCB 32A (1p+N) - 240Vac
- 12x EtherCON Input

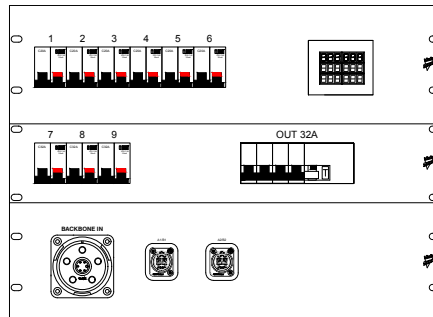
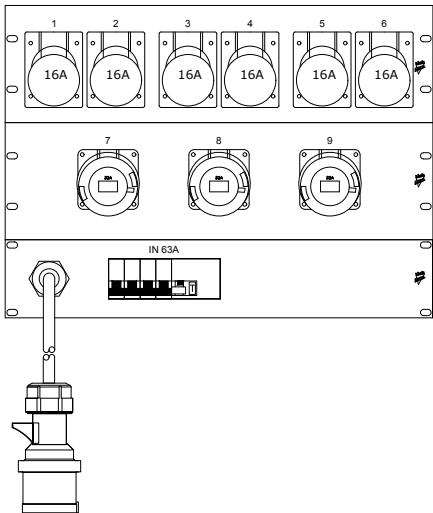

- CEE 63A - 400Vac (5p) Power cord plug
- RCCB 63A/300mA (4p+N) - 400Vac
- 4x optical fibers and 32 Amp 400Vac (5p) Out Through LKO connector
- 2x OpticalCON DUO
- 6x CEE 16A - 240Vac sockets
- 6x RCCB 16A/30mA (1p+N) - 240Vac
- 3x CEE 32A - 240Vac sockets
- 3x RCCB 32A/30mA (1p+N) - 240Vac
- RCCB 32A/30mA (4p+N) - 400Vac
- Digital Multimeter

Injector Boxes



EMEA Rubber Box Distro

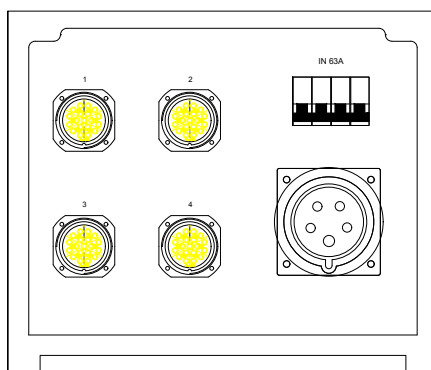
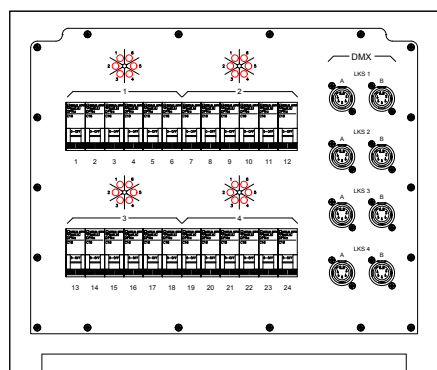

- CEE 63A - 400Vac (5p) plug
- 63A - 400Vac (4p) RCB Input breaker
- 4x LKS Data Gigabit (6x 20A power lines + 2x DMX Output)
- 8x XLR5 poles Male (DMX to LKS Data injectors)
- 24x RCCB 20A/30mA (1p+N)- 240Vac

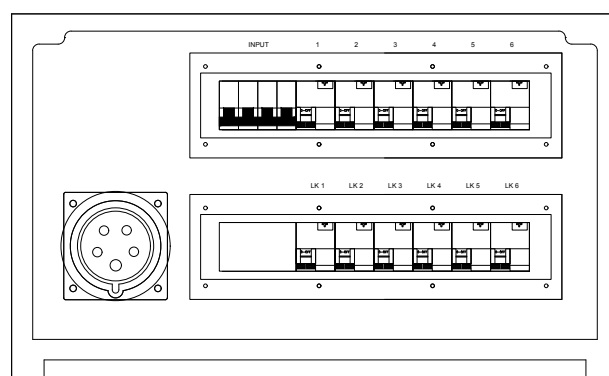
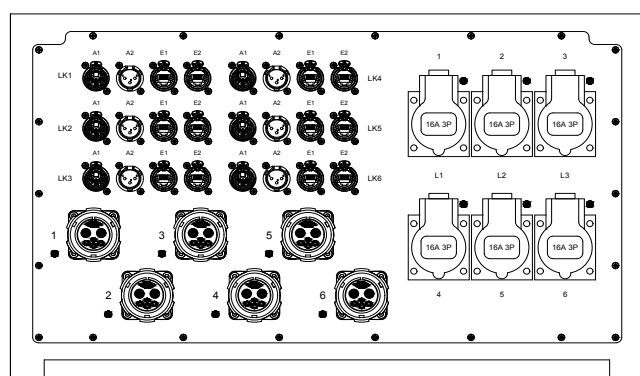

- CEE 63A - 400Vac (5p) plug
- 63A - 400Vac (4p) RCB Input breaker
- 6x CEE 16A - 240Vac socket
- CEE 63A - 400Vac (5p) plug
- 63A - 400Vac (4p) RCB Input breaker
- 6x CEE 16A - 240Vac socket

PDlink Portable Power Distro

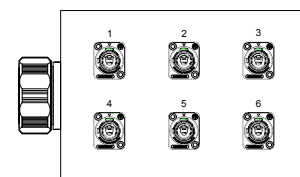
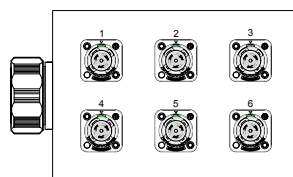
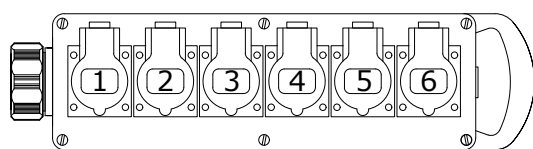

- LKS Data Giga Input
- 6x CEE 16 Amp
- 1x EtherCON

- LKS Data Giga Input
- 6x powerCON True 1
- 1x EtherCON

- LKS Data Giga Input
- 6x powerCON
- 1x EtherCON

*Aliscat available for these boxes on request



EMEA Box Rack

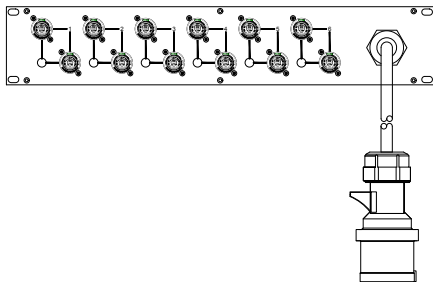

- Digital Multimeter
- CEE 32A - 400Vac (5p) Power cord plug
- RCCB 32A/30mA (4p+N) - 400Vac
- 6x MCB 16A (1p+N) - 240Vac
- 12x PowerCON Out

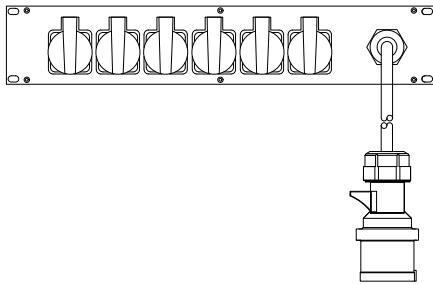

- Digital Multimeter
- CEE 32A - 400Vac (5p) Power cord plug
- RCCB 32A/30mA (4p+N) - 400Vac
- 6x MCB 16A (1p+N) - 240Vac
- 6x CEE 16A - 240Vac socket

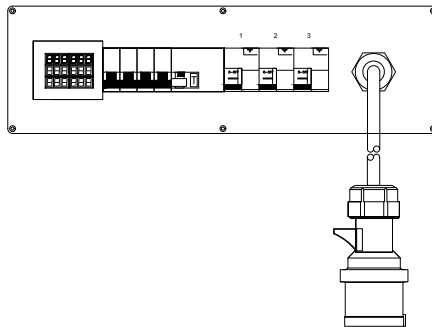
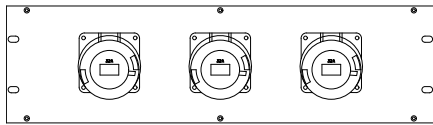

- Digital Multimeter
- CEE 32A - 400Vac (5p) Power cord plug
- RCCB 32A/30mA (4p+N) - 400Vac
- 3x RCCB 32A/30mA (1p+N) - 240Vac
- 3x CEE 32A - 240Vac socket

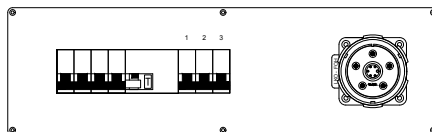
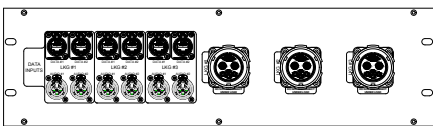

- 4x optical fibers and 32 Amp 400Vac (5p) Out Through LKO connector
- 3x LKG 24/2E10 FP (2x Ethernet Gigabit + 2x DMX/AES/Analog lines + 1x 16A - 240Vac Power line)
- 6x EtherCON (Ethernet, Ethernet, DMX, AES,... patch/injectors to LKG)
- 6x XLR M (Ethernet, DMX, AES ... patch/injectors to LKG)
- 6x XLR F (Ethernet, DMX, AES ... patch/injectors to LKG)

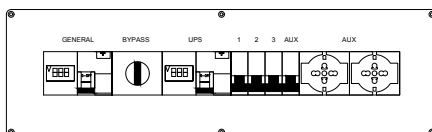
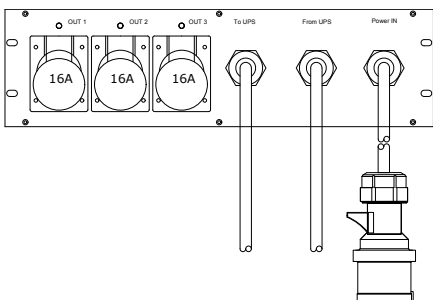

- 2x Digital Power Meter
- RCCB 16A/30mA (1p+N) - 240Vac
- CEE 16A - 240Vac (3p) Power cord plug
- 16 Amp Power cord In from UPS
- 3x CEE 16A - 240Vac socket
- 2x Shucko/universal 16A - 240Vac socket
- 4x MCB 32A (1p+N) - 240Vac
- 1 bypass switcher

EMEA Company switch

Link manufactures tailor made Company Switches up to 1000A in compliance with IEC/EN standards, for EMEA countries (IEC 61439-1-2). Link' Company Switches meet the specifications of the major "Design Companies" specialized in:

- Theatre
- Opera House
- Convention Center
- University
- Studios
- Theme Park
- Stadium
- Concert Hall
- Conference Center
- Multimedia Center

400A

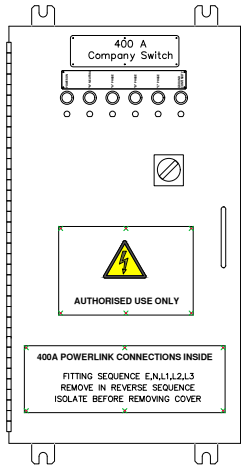

Single pole receptacle:

- Powder coat finish
- Welded mounting tabs
- Steel 15/10 sheet
- Single pole (PowerLink) connection chamber
- Shunt trip segregation by connection chamber
- Indicator lights
- Laser labeling
- Colored and insertion guided single pole receptacle (Power Link)

Circuit Breaker:

- Rated current: 400A
- Rated operational voltage: 690Vac
- 3 poles
- Overload protection (Thermal)
- Short circuit protection (Magnetic)
- Short circuit protection (Magnetic)
- Compliance with international standards: IEC/EN 60947-2, UL489

250A

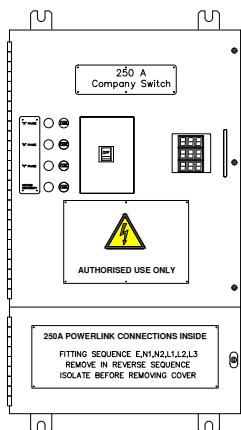

Single pole receptacle:

- 250A
- 600 VAC
- Powder coat finish
- Welded mounting tabs
- Steel 15/10 sheet
- Shunt trip segregation by connection chamber
- Indicator lights
- Laser labeling

Circuit Breaker:

- Rated current: 250A
- Rated operational voltage: 690Vac
- 3/4 pole version
- Overload protection (Thermal)
- Short circuit protection (Magnetic)
- Compliance with international standards: IEC 60947-2, UL489

Stainless Steel Outlet Box

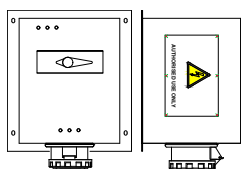

Receptacle (CEE- PCE 345-6):

- 125A
- 380-480 Vac
- 4/5 pole version
- IP67 (available on request)

Circuit Breaker:

- Nominal current: 125A
- 4 Poles
- Compliance with international standards: IEC 60947-2, UL489



Facility Panels and Backboxes



Link's comprehensive range of Facility Panels and boxes allows you to configure complete connectivity and control solutions for any size venue. Whether your project requires simple single and double gang faceplates, or a more extensive stage manager station or control panel, our team of application engineers collaborates with your team to provide the optimal design for your venue. Multiple connectors, switch, and PCB components are available to ensure reliability and expedite installation.

We offer a wide range of box types, sizes, finishes, colors and labeling options, laser custom engraving, and silkscreening.

Link's facility panels have been deployed globally in:

- Auditoriums & Lecture Halls
- Theaters
- Broadcast Facilities
- Computer Classrooms
- Corporate Board Rooms
- Distance Learning Classrooms
- Network & Data Control Centers
- Presentation Rooms
- Residential Home Theaters
- Sound Masking Systems
- Stadiums & Arenas
- Video Conferencing Rooms

Specifiers and Integrators are invited to contact Link to receive standard templates, specifications, and .dwg libraries to accelerate your design process.

Facility Panels and Backboxes



TYPICAL SCB-PLB CONSTRUCTION

FLUSH MOUNT

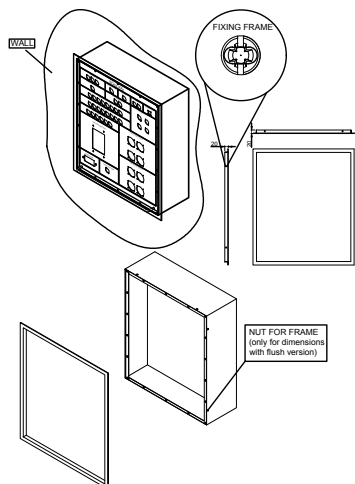

SURFACE MOUNT SAME AS RECESSED

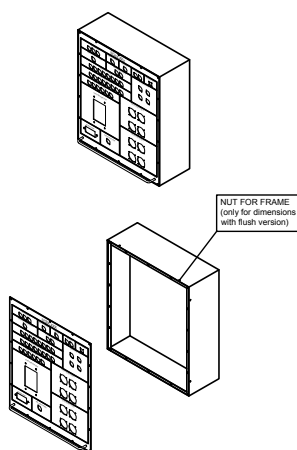

RECESSED MOUNT WITH PANEL

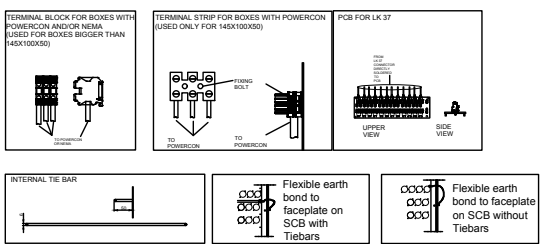
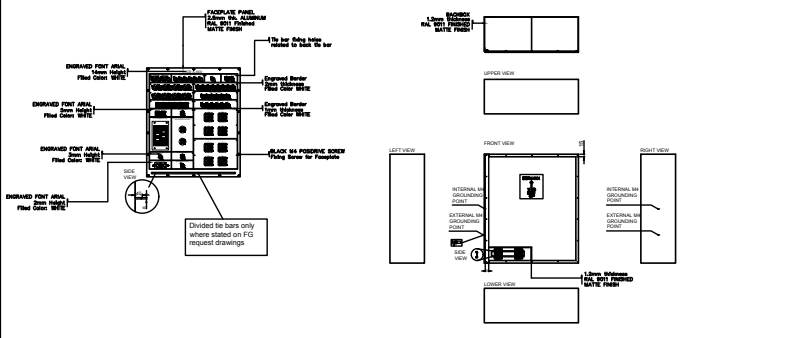
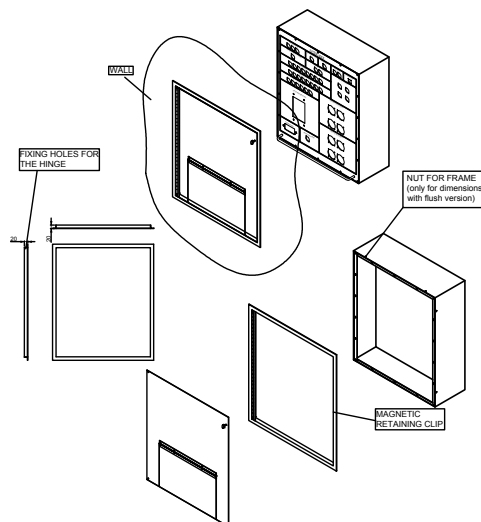

Main Panels

PD P1RU ETH.004



PD P1RU ETH.008



PD P1RU ETH.012

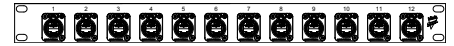

PD P2RU LKS DATA.001

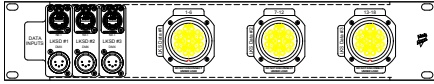

PD P2RU LKS DATA.004

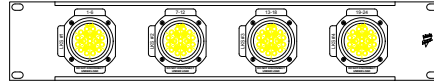

PD P2RU LKS.004

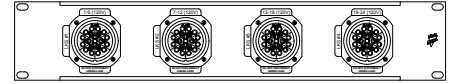

PD P3RU LKS DATA.001

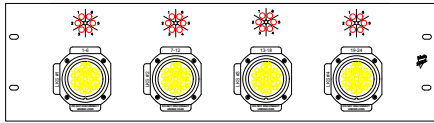

PD P3RU AUXD.001

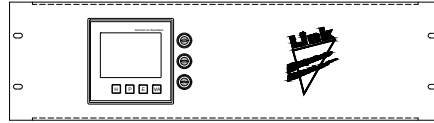

PD P3RU SCH.006

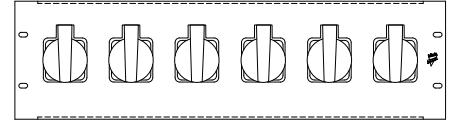

PD P3RU PATCH.001

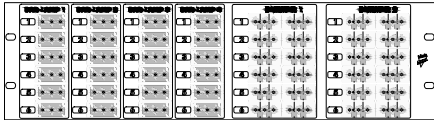

PD P3RU AUXA.001

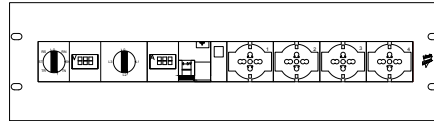

PD P3RU C16-32A.001

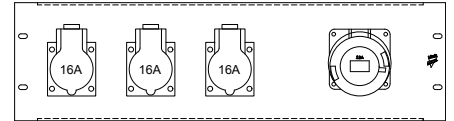

PD P2RU PATCH.001

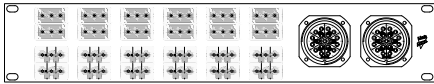

PD P2RU PCON.001

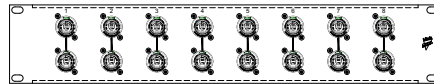

PD P2RU C16A.006

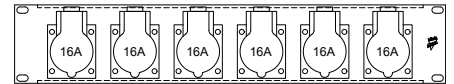

PD P4RU PLINK.001

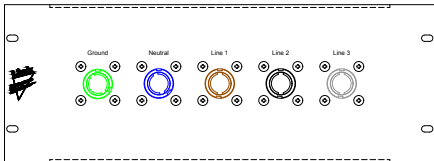

PD P4RU PLINK.002

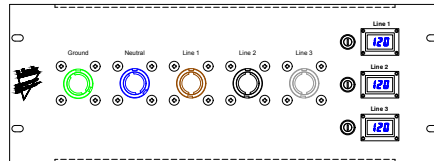

PD P4RU MAIN.001

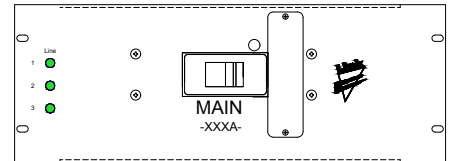

PD P2RU LKG.001



PD P2RU LKO.001

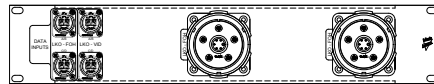

PD P1RU PCON.008



PD P1RU PCON-T.008



Main Panels

PD P3RU C32AIN-OUT.001

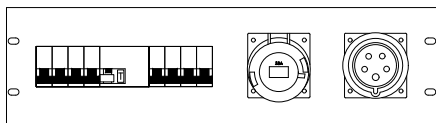

PD P3RU C63A.001

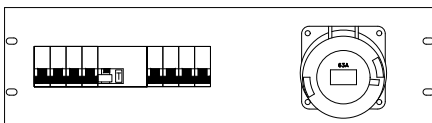

PD P3RU LKSIN-OUT.001

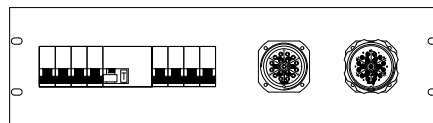

PD P3RU LKG.001

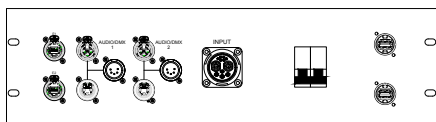

PD P3RU LKO.001

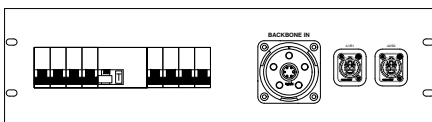

PD P3RU LKSIN-OUT.002

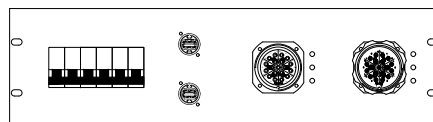

PD P3RU C63A.002

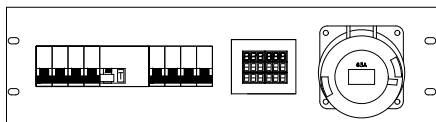

PD P3RU C16A.001

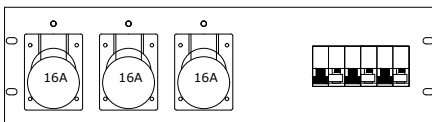

PD P3RU C32A.003

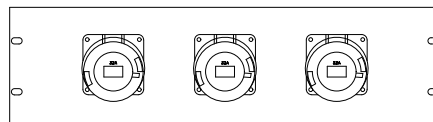

PD P3RU C16A.006

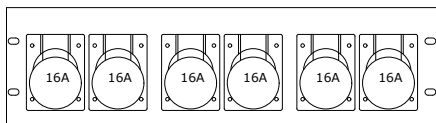

PD P3RU DPNVG.001

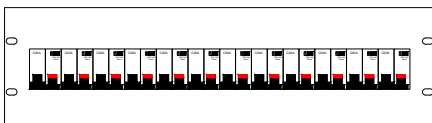

PD P3RU DPNVG.002



PD P2RU PCON.012

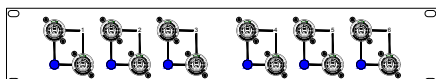

PD P2RU PCON-T.012

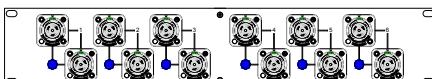

PD P2RU C32A.002

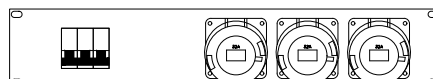

PD P2RU C32A.001

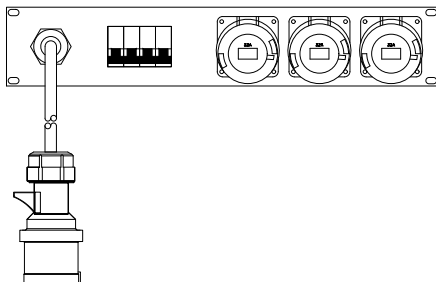

PD P2RU C63A.003

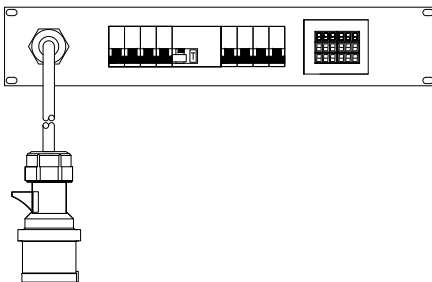

PD P2RU LKS-LED.001

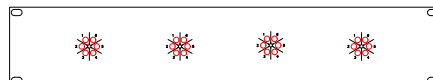

Portable Power Boxes

Purposely designed for mobile electrical distributions, these portable Power Boxes meet the majority of all electrical needs in an easy-to-carry Flight case. This equipment is manufactured using only high quality components and is available in 32A and 63A versions. They comply with IEC/EN regulations related to Power Boxes and are provided with IEC/EN declaration of conformity, test reports and instructions.

Code

PBO32 TDV	32A 3-phases Power Box, 9x16A m-phase sockets
PBO63 TDV	63A 3-phases Power Box, 12x16A m-phase sockets



PBO63 TDV

Technical Characteristics:	PBO63 TDV	PBO32 TDV
- Input by CEE plug - 380V:	63A	32A
- Magneto-thermal/differ. main switch	63A	32A
- Digital voltmeter with commuter	✓	✓
- CEE 16A mono-phase sockets	12	9
- 15A Universal sockets	4	2
- Magneto-thermal with red light for each sockets	✓	✓
- Black finished metal chassis	✓	✓
- Flight case with built-in handle and top cover	✓	✓
- Weight	21Kg	16Kg
- Dimensions (cm)	56x53x21	52x38x21



The digital voltmeter is available with phase/phase and phase/neutral commuter.



PBO32 TDV

Power Cord Splitter

The LKS "spiders" are break in/out connectors and can be supplied wired with 6x2.5 mm² cables in lengths of 1.5 or 2 m each. The 6 power cables can be terminated with any 16-20A / 100-240Vac sockets or plugs.

Code

BRIDP000302H1CL	LKS19 female Break in 1.5m wired w/ 6x2.5mm ²
BRIDP000302H2CL	LKS19 female Break in 2m wired w/ 6x2.5mm ²
BRODR000302H1CL	LKS19 male Break out 1.5m wired w/ 6x2.5mm ²
BRODR000302H2CL	LKS19 male Break out 2m wired w/ 6x2.5mm ²
BRIDPC1B00302H1CL	LKS19 female Break in 1.5m wired w/ 6x2.5mm ² with 6 PCE 16A black
BRIDPC1B00302H2CL	LKS19 female Break in 2m wired w/ 6x2.5mm ² with 6 PCE 16A black
BRODR1B00302H1CL	LKS19 male Break out 1.5m wired w/ 6x2.5mm ² with 6 PCE 16A black
BRODR1B00302H2CL	LKS19 male Break out 2m wired w/ 6x2.5mm ² with 6 PCE 16A black



Cord splitter manufactured with 2.5 mm² H07 RN-F rubber cable overall length 1 meter, (any length can be supplied too), featuring bare ends or wired with any 16-32A / 100-240Vac sockets or plugs.

Code

SPY2 15 055/055	Y-Cord 16A splitter 1.5mm ² H07RNF (1x55+2x55)
SPY2 15 100/150	Y-Cord 16A splitter 1.5mm ² H07RNF (1x100+2x150)
SPY2 25 055/055	Y-Cord 32A splitter 2.5mm ² H07RNF (1x55+2x55)
SPY2 25 100/150	Y-Cord 32A splitter 2.5mm ² H07RNF (1x100+2x150)
SPY3 25 055/055	3-Cord 32A splitter 2.5mm ² H07RNF (1x55+3x55)
SPY2 15 16 055/055	Y-Cord 16A splitter wired H07RNF (1x55+2x55)
SPY2 25 16 055/055	Y-Cord 32A splitter wired H07RNF (1x55+2x55)



A robust thermolene case supplied in two versions: complete with an incoming LKS male connector 19 pin plug and 2 LKS female connectors 19 pin sockets or with an incoming LKS female connector and one male plus one female outgoing connectors.

Code

LKS SPY 19M	Splitter moulding male/2 female LKS connectors
LKS SPY 19F	Splitter moulding female/female-male LKS connectors



North America Power Distribution

PDlink is the next generation of power and signal distribution designed to deliver a truly unified and modular interconnection system. Leveraging decades of experience and innovation, Link combines LK connectors, **eurocable** hybrid signal and power cables to offer a unified line of 19" high density rack mounted units for power, data, audio, speaker, and video distribution.

Constructed with heavy duty, yet lightweight aluminium, the main and branch units support a number of standard configurations suited for amplifier, FOH, and video racks. The Socapex compatible 6 circuit units integrate seamlessly with your existing lighting distribution to easily extend power for peripheral equipment racks.

All PDlink breakers are magnetic/hydraulic rated for full load in the harshest of conditions. Panels are clearly labelled and can be custom labelled at a minimal additional cost.

Standard PDlink units are designed to perfectly integrate with the DGLink Ethernet and signal distribution systems and can also be custom designed on request. Contact us to learn about PDlink. It can be offered as an OEM solution, or designed for your specific touring needs.



- Free standing robust portable enclosure to fit most 19" rack configurations

- 100% Magnetic / Hydraulic Breakers, unaffected by heat

- Web based monitoring and remote control options

- Modular flexible design

- Integrating power with audio, DMX, Ethernet, and video signals

- Durable, smear resistant power coat finish with high-contrast labeling

- Custom configurations available

- Advanced, and road proven mechanical and electrical design

- USA, European, MEA Configurations with Listings



PDlink Standard Lighting Power Distribution

Lighting - Small

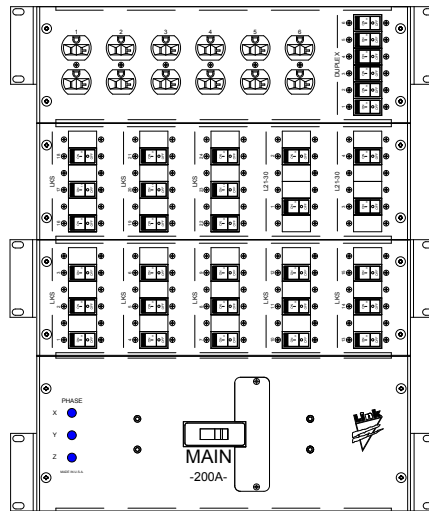
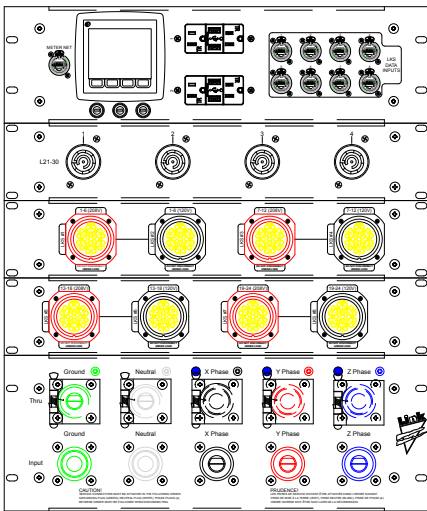

Small Lighting Distro

- 200 Amp Main Input
- Cam-lock In and Through
- Digital Multi-Function Power Meter- Network Output
- 4x Sets of LKS Data 120/208V Outputs - Shared 2 Pole Breakers
- 4x L21-30 Outputs
- 8x Edison Duplex Outputs

Lighting - Large

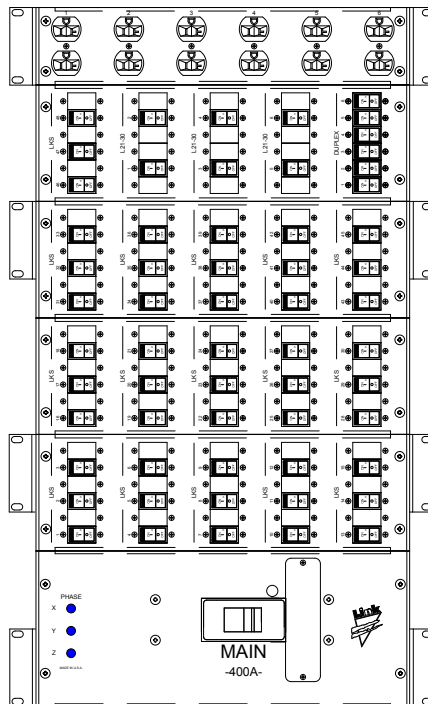
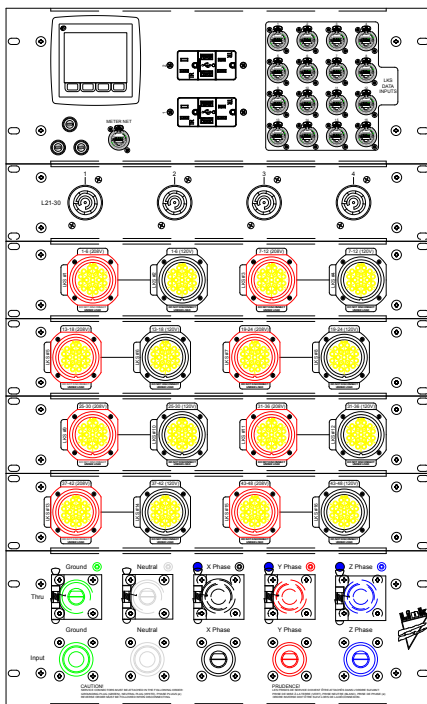

Large Lighting Distro

- 400 Amp Main Input
- Cam-lock In and Through
- Digital Multi-Function Power Meter- Network Output
- 8x Sets of LKS Data 120/208V Outputs - Shared 2 Pole Breakers
- 4x L21-30 Outputs
- 8x Edison Duplex Outputs

PDlink LKS Data Portable Breakout Distribution

Full range of options available with different connectors and configurations. Standard and stocked shown.

Edison

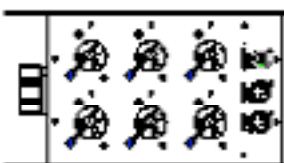

L6-20



PowerCON



PowerCON True1

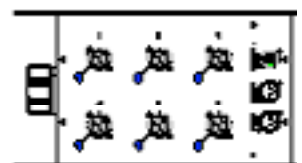

PDlink Standard A/V Power Distro

A/V Distro - Small

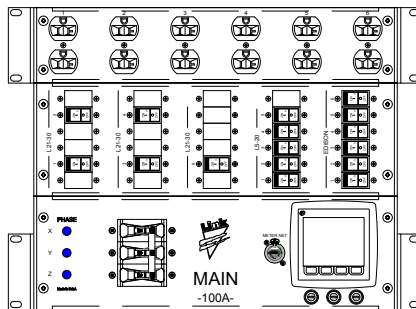
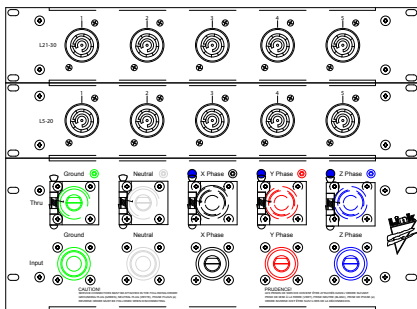

Small A/V Distro

- 100 Amp Main Input
- Cam-lock In and Through
- Digital Multi-Function Power Meter - Network Output
- 5x L21-30 Outputs
- 5x L5-20 Outputs
- 6x Edison Duplex Outputs

A/V Distro - Large

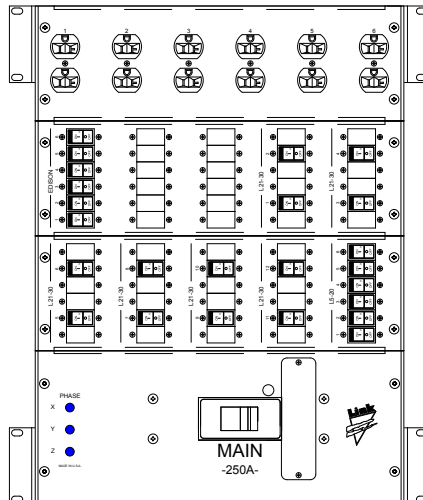
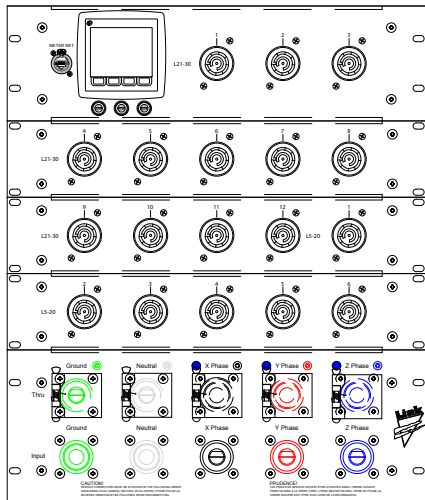

Large A/V Distro

- 250 Amp Main Input
- Cam-lock In and Through
- Digital Multi-Function Power Meter - Network Output
- 12x L21-30 Outputs
- 6x L5-20 Outputs
- 6x Edison Duplex Outputs



PDlink Rack Distro

Full range of options available with different connectors and configurations. Standard and stocked shown.

RL 2U6D 8EE

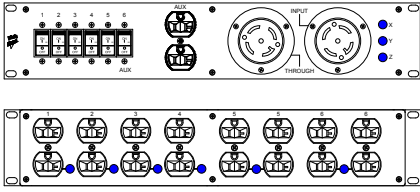

- L21-30 Input and Through
- 8x Edison Outputs on 6 Circuits

RL 2U6D 4BB2EE

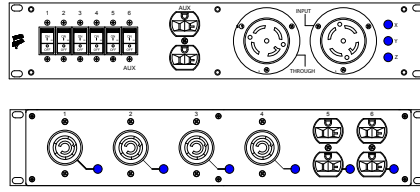

- L21-30 Input and Through
- 4x L5-30 Outputs on 4 Circuits
- 2x Edison Outputs on 2 Circuits

RL 2U6D 12GG

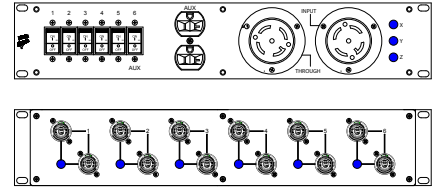

- L21-30 Input and Through
- 12x PowerCON Outputs on 6 Circuits

RL 2U6C 8EE

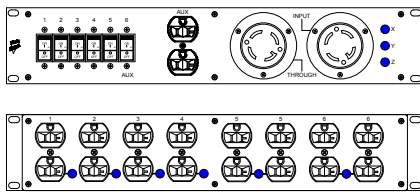

- L14-30 Input and Through
- 8x Edison on 6 Circuits

RL 2U6E 8EE

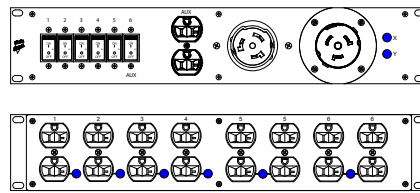

- 50A 125/250V Input and Through
- 8x Edison on 6 Circuits

RL 1U1G 5EE

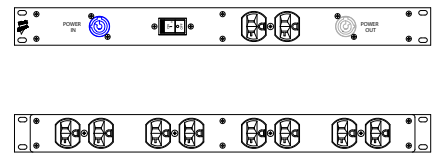

- PowerCON Input and Through
- 5x Edison on 1 Circuit

PDlink Portable Power Distro

RL P 3D 6EE

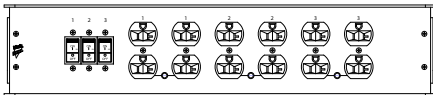

- L21-30 Input and Through
- 6x Edison on 3x20A Circuits

RL P 3D 12GG

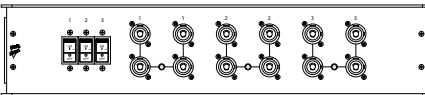

- L21-30 Input and Through
- 12x PowerCON on 3x20A Circuits

RL P 3D 12HH

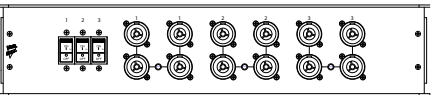

- L21-30 Input and Through
- 12x True 1 on 3x20A Circuits



PDlink Fixed Speed Chain Motor Control

PDlink Chain Motor Control is the culmination of years of real world development leveraging decades of experience and innovation. Working with our OEM partners Link combines LK Connectors, **eurocable** hybrid signal and power cables to offer a unified line of controllers whether you need 2 or 128 motors!

These units include advanced features such as the ability to sense and change the phase order remotely from the pendant by a certified operator with a key-switch. Additionally the control pendant features large, brightly lit up/down toggles, a highly flexible and durable **eurocable** control extension, and reliable analog controls that can be used up to 1500 feet.

Working closely with our OEM partner in addition to standard offerings we've also developed a specialty unit intended for large-scale rigging situations that is truss mountable into any size truss 12x12" and up, and features an LK Connectors LKH 28A-9 multipin allowing for 60 amps of total power; more than enough power to run 8x 2-ton motors simultaneously.

Standard PDlink Chain Motor Controllers units are available in a wide range of physical formats using a variety of power input options such as L21-30, "California Twist" 50 amp, the LKH 28A-9, connector and Cam-Locks. Output options include "dual twist" NEMA connectors, dual pin and sleeve connectors, and the industry standard P7, P14, and C7 multipins as part of our LKR series of connectors.



- Developed with leading entertainment rigging company

- Physical Formats Include Flight Cases, Truss Mountable, and "Suite Case"

- Multi-pin Power Inputs up to 80A allowing 8x 2-Ton Motors

- Use of Industry Standard LK Connectors for remotes and hoists

- Reliable Analog Remote Control with max distance over 1500 feet

- Large, bright up/down switches easily operated even with gloves on!

- Remote Phase Sense and Switch from pendant controller

- Easily Replaceable Mechanical Control Relays

- Installation Versions Available

- ETL Listed



PDlink Fixed Speed Chain Motor Control

ML F4D 8AA1U

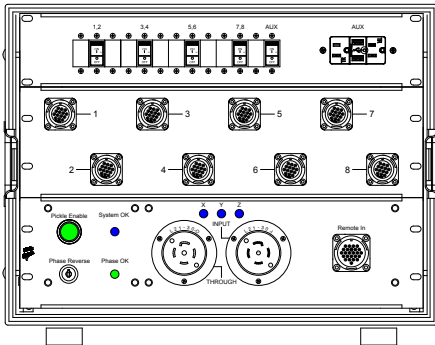

ML F4D 8CC1U

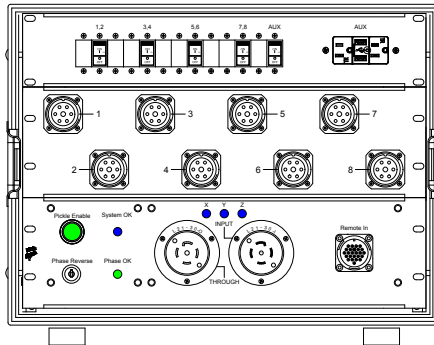

ML S4D 8CC1U

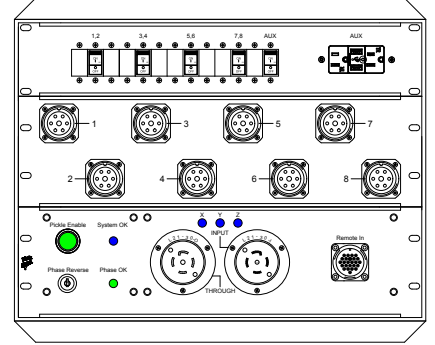

ML F4F 8AA

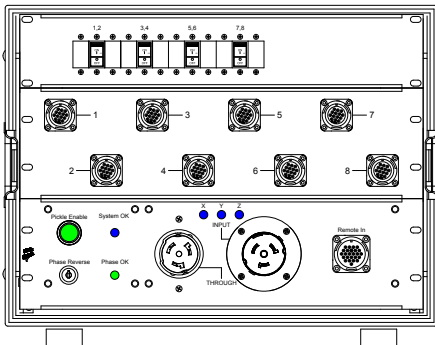

ML F6F 8AA

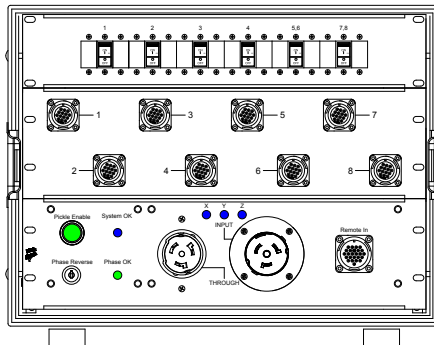

ML F2D 4EUU

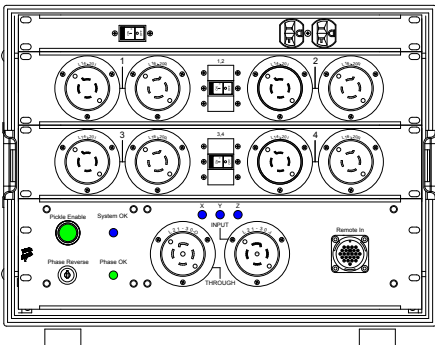

ML F8V 8AA1U

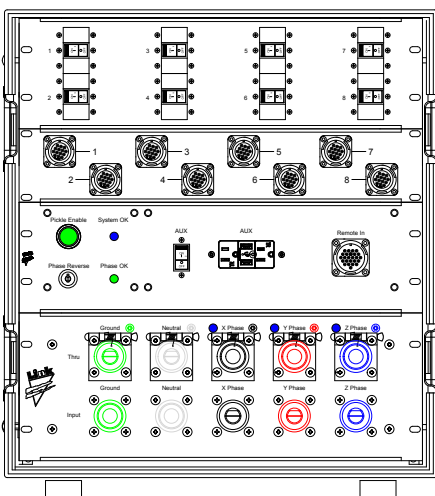

ML T8T 8AA

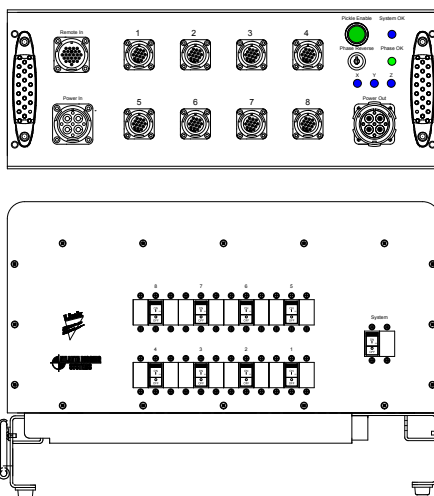

ML R4D 8AA1D

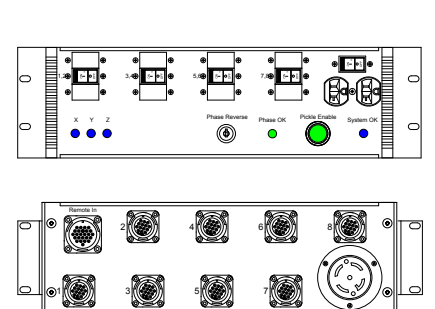

ML R1D 2CC

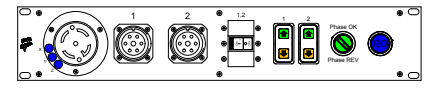

GOLD & Custom Stage Boxes

SB Gold

SB Gold48, 56 and 64 channel Stage Boxes, have been purposely designed to satisfy the need of distributing signals in large venues.

Ideal when used with individually shielded multi-pair **eurocable** (e.g. 48, 56 and 64 pairs) on cable reels and with LK audio multi-pin connectors (e.g. 150 and 200 pins). These Stage Boxes, manufactured in 19" rack boxes, feature individual Ground Lift switches and are also available with passive splitters.

All the connector contacts used in the SB Gold Stage Box (XLR and LK multipin) are gold plated, to guarantee the maximum contact reliability. The HD 600 cable reel can store up to 100 meters of 48, 56 or 64 individually shielded **eurocable** pairs (the use of a Flight Case is strongly recommended).



Code

SB 48	Stage box 48 IN with GND lift (2 LK150)
SB 48/8	Stage box 48 IN; last 8 ch. in parallel with 8 male XLR; GND lift (2 LK150)
SB 48x8	Stage box 48 IN with GND lift + 8 OUT (2 LK200)
SB 56	Stage box 56 IN with GND lift (2 LK200)
SB 56/8	Stage box 56 IN; last 8 ch. in parallel with 8 male XLR; GND lift (2 LK200)
SB 56X8	Stage box 56 IN with GND lift + 8 OUT (2 LK200)
SB 64	Stage box 64 IN with GND lift (2 LK200)
SB 48X8 3	Stage box 48 IN with GND lift + 8 OUT (3 LK200)
SB 56X8 3	Stage box 56 IN with GND lift + 8 OUT (3 LK200)

Splitted version

SB 48 SPL	Stage box 48 IN with GND lift (2 LK150)
SB 48/8 SPL	Stage box 48 IN; last 8 ch. in parallel with 8 male XLR; GND lift (2 LK150)
SB 48X8 SPL	Stage box 48 IN with GND lift + 8 OUT (2 LK200)
SB 56 SPL	Stage box 56 IN with GND lift (2 LK200)
SB 56/8 SPL	Stage box 56 IN; last 8 ch. in parallel with 8 male XLR; GND lift (2 LK200)
SB 56X8 SPL	Stage box 56 IN GND lift + 8 OUT (2 LK200)
SB 64 SPL	Stage box 64 IN with GND lift (2 LK200)
SB 48X8 SPL 3	Stage box 48 IN with GND lift + 8 OUT (3 LK200)
SB 56X8 SPL 3	Stage boxes 56 IN with GND lift + 8 OUT (3 LK200)

SB Gold accessories

AV HD600	Steel cable reel, OD 600 mm, width 600
AV FS600	Cable restraining straps for HD600
FLY HD600	Fly case for HD600
FLY SB	Flight case for stage box

GOLD & Custom Stage Boxes



Custom Solutions

Link offers customized engraving on standard panels as well as fully customized panel construction and engraving services. Our application engineers directly work with our customers to design products directly from specifier or end user provided documentation. Submittal drawings will be provided for final approval prior to manufacturing. Our precision CNC machines, laser engraving and paint lines are capable of producing a single product or large quantities suited for your specific requirements.

High precision engraving and fine painting



From scratch...

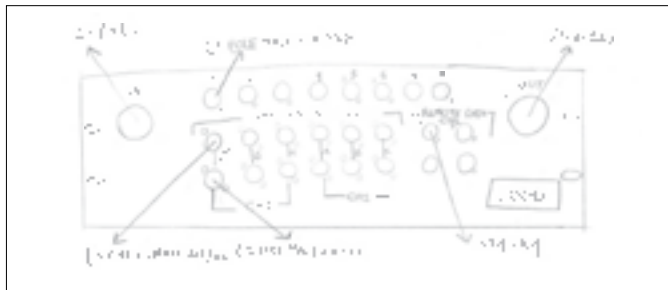

Step 1

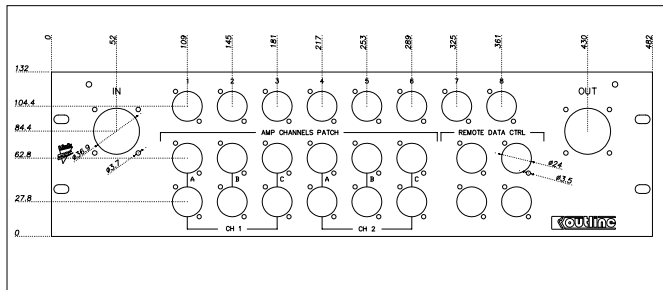

Step 2



Step 3

When forwarding your drawings please remember:

- Panel dimensions.
- Height and cut out of the connectors.
- Writing and markings.

AD System

The modular concept of the AD Distribution System allows the assembly of Stage Boxes tailored to the customers' exact requirement providing an open system which is adaptable to future possible needs. With the basic elements such as the 8 channels INPUT and OUTPUT modules, AD Split and ADF modules a wide range of configurations are obtainable. The internal connections with ribbon connectors and cables ensure maximum flexibility to the system, while the multipin LK connectors offer a perfect connection stability for decades.



AD OUTPUT Modules



The output module has eight male XLRs on the front panel and one 26 pin ribbon cable connector mounted on a PCB.

ADF Modules



ADF 2RU panels use the capability of the multi-pin LK range to connect from 8 up to 64 audio lines using only one cable. The 26 pin ribbon cable connectors allow XLR connections. They can be used for FOH, Monitor, REC, AUX or other connections, as well as Sub-snake boxes.

AD SPLIT

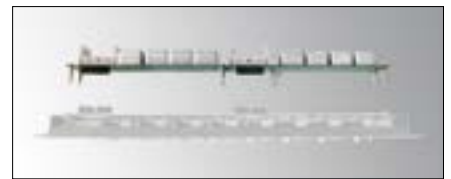

The AD SPLIT modules have been purposely engineered for highly professional applications. They provide a clean split signal thus maintaining the same quality in multiple outputs over long distances. Each Input channel is divided by the AD SPLIT module into 4 outputs, two are in physical parallel, with and without Ground disconnection (Ground Lift). The other two are individually split by high quality triple-shielded transformers. The Ground Lift switch on the AD 8 IN acts as "Switch out", providing Ground separation to the second parallel output (Direct Out) which can be used to assign the 48 Vdc Phantom power on each channel.

AD INPUT Modules



The standard input panels feature a Ground Lift switch for each channel and a further PCB (AD Link) connected on "Switch out" to set each channel in parallel to three ribbon cable connectors. The unit features a second ribbon exit called "Direct Out" dedicated to the mixer to assign the Phantom Power. The Ground Lift switch on the AD 8 IN acts only on "Switch out", providing Ground separation to the second output (Direct Out) which can be used to assign the 48 Vdc Phantom power on each channel. The input modules are available in two versions: the AD 8 IN and the AD 8 IN 8 J, with eight Combo connectors allowing XLR input (balanced signals) or a jack plug (unbalanced signals). The unbalanced signals are balanced by transformers.

AD Flat



The connection between the AD and ADF modules is made with ribbon extension cables. They are also available in different lengths on request.

AUDIO "SPLITTER" TRANSFORMER (TRIPLE FARADAY SHIELDS)		
Transformer characteristics	Transformer ratio	01:01:01
	Induttance primary circuit at 100 Hz, 1V	> 12 Hz
	Resistance primary circuit	56 ohm
	Resistance primary circuit 1	140 ohm
	Resistance primary circuit 2	135 ohm
	Distortion (THD) at 50 Hz	< 0.05% (+30 dbU)
		< 1% (+13 dbU)
	Commod-made rejection ratio (CMRR) 150 ohm balanced source	≥ 70 db (1 KHz)
		≥ 50 db (20 KHz)

AD System

AD 8 ch System Audio Distribution

AD 8 IN	AD 8 ch. Input module	AD 8 OUT	AD 8 ch. output module
AD 8 IN GL	AD 8 ch. Input module with Ground Lift	AD 8 OUT GL	AD 8 ch. module with Ground Lift
AD 8 IN 8 J GL	AD 8 ch. Input module with transformer and Ground Lift	AD D-SUB A	AD 8 ch. SUB-D 25 Interface module for Analogue Exits
AD 8 IN-F GL	AD 8 ch. Input module with Ground Lift and European-style terminal block	AD D-SUB D	AD 8 ch. interface module for Digital Exits
AD LINK	AD 8 ch. link module 1-IN 3-OUT (spare part)	AD FL 26 30	AD flat cable extension 30 cm
		AD FL 26 40	AD flat cable extension 40 cm
		AD SPLIT II	AD splitter 8 IN 16+16 OUT Ground Lift with triple shield transf.

AD 8 IN GL

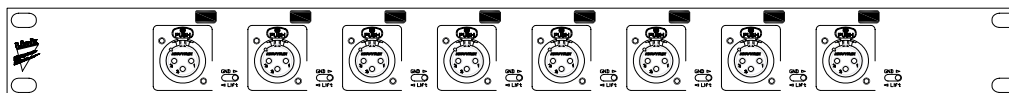

ADF DF 25 1	ADF 2U panel + 1 LK 25 panel female with 60 cm ribbon cable	ADF DM 85 1	ADF 2U panel + 1 LK 85 panel male 24 ch. with 70 cm ribbon cable
ADF DF 25 2	ADF 2U panel + 2 LK 25 panel female with 60 cm ribbon cable	ADF DM 85 2	ADF 2U panel + 2 LK 85 panel male 24 ch. with 70 cm ribbon cable
ADF DF 25 3	ADF 2U panel + 3 LK 25 panel female with 60 cm ribbon cable	ADF DM150 148	ADF 2U panel + 1 LK 150 panel male 48 ch. with 70 cm ribbon cable
ADF DF 25 4	ADF 2U panel + 4 LK 25 panel female with 60 cm ribbon cable	ADF DM150 248	ADF 2U panel + 2 LK 150 panel male 48 ch. with 70 cm ribbon cable
ADF DF 25 5	ADF 2U panel + 5 LK 25 panel female with 60 cm ribbon cable	ADF DM200 164	ADF 2U panel + 1 LK 200 panel male 64 ch. with 70 cm ribbon cable
		ADF DM200 264	ADF 2U panel + 2 LK 200 panel male 64 ch. with 70 cm ribbon cable

ADF DF 25 5

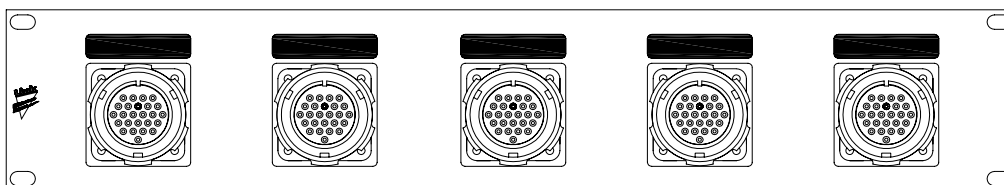

AD 12 ch System Audio Distribution

AD 12 IN	AD 12 ch. Input module	AD 12 IN/SPL-F GL	AD 12 ch. Input with transf., G-Lift and European-style terminal block
AD 12 IN GL	AD 12 ch. Input module with Ground Lift	AD LINK 3PT40	AD 12 ch. link module 1-IN-3-OUT (spare part)
AD 12 IN/SPL GL	AD 12 ch. input module with transformer and Ground Lift	AD 12 OUT	AD 12 ch. output module

AD 12 IN GL

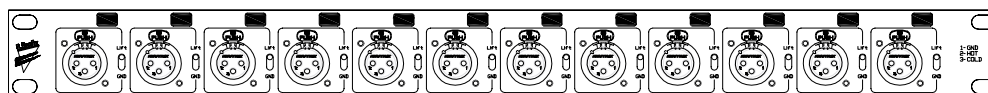

AD FL 40 30	AD flat cable extension 30 cm	ADF DM150 148-12	ADF 2U panel + 1 LK 150 panel male 48 ch. with 70 cm ribbon cable
AD FL 40 40	AD flat cable extension 40 cm	ADF DM150 248-12	ADF 2U panel + 2 LK 150 panel male 48 ch. with 70 cm ribbon cable
ADF DF 37 1	ADF 2U panel + 1 LK 37 panel female with 60 cm ribbon cable	ADF DM200 164-12	ADF 2U panel + 1 LK 200 panel male 64 ch. with 70 cm ribbon cable
ADF DF 37 2	ADF 2U panel + 2 LK 37 panel female with 60 cm ribbon cable	ADF DM200 264-12	ADF 2U panel + 2 LK 200 panel male 64 ch. with 70 cm flat cable/70 cm ribbon cable
ADF DF 37 3	ADF 2U panel + 3 LK 37 panel female with 60 cm ribbon cable		
ADF DF 37 4	ADF 2U panel + 4 LK 37 panel female with 60 cm ribbon cable		
ADF DM 85 1-12	ADF 2U panel + 1 LK 85 panel male with 60 cm ribbon cable		
ADF DM 85 2-12	ADF 2U panel + 2 LK 85 panel male with 60 cm ribbon cable		

ADF DM 85 2-12

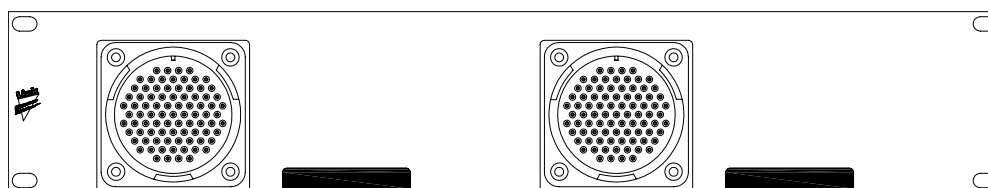

Compact & Modular Stage Boxes

Stage Box with LK panel male



The compact design and its raised bottom, simplify the use in narrow space allowing the cables to be gathered beneath it. The SB box mounts a LK multipin panel connector for an easy cable disconnection.

Stage box with fan out



The SBF range features SSA cable (individually shielded multi-pair **eurocable**) hard wired to the XLRs into the box and a XLRs fan out on the other end. The individual pairs are protected by Techflex to maintain ultimate flexibility. Use of coloured Techflex allows the easy identification of fan channels.

Stage Box with multipair extension



The SBS range features SSA cable (individually shielded multi-pair **eurocable**), permanently connected to the box with an LK multi-pin connector on the other end.

19" Box with LK panel male



The SP System permits separate IN & OUT channels (by 8 to 64) on Stage by running only one multi-pair cable on the long distance (Stage to Mix). The box is manufactured in 15/10 mild steel.

19" Box with fan out



The SBF range features SSA cable (individually shielded multi-pair **eurocable**) hard wired to the XLRs in the box and an XLRs fan on the other end (available in various input and output combinations). The individual pairs are protected by Techflex to maintain ultimate flexibility. Use of coloured Techflex allows the easy identification of fan channels.

19" Box with 2 LK panel male



The SP2 System is ideal for applications where two devices, generally, mixers are used. It features a second LK multipin chassis connector in parallel, to split and carry the audio lines to the Monitor Mixer (FOH, MON, REC, ...), like in the SP System.



Compact & Modular Stage Boxes

SB Boxes with LK chassis male connector

SB08AN	SB box 8 ch with LK25 chassis male connector
SB08X4AN	SB box 8x4 ch with LK37 chassis male connector
SB12AN	SB box 12 ch with LK37 chassis male connector
SB12X4AN	SB box 12x4 ch with LK54 chassis male connector
SB16X4AN	SB box 16x4 ch with LK85 chassis male connector
SB16X8AN	SB box 16x8 ch with LK85 chassis male connector
SB20X4AN	SB box 20x4 ch with LK85 chassis male connector
SBF08AN*MF3	SB box 8 ch in, with *m SSA eurocable and 8XLR M fan out
SBF08X4AN*MF3	SB box 08x4 ch with *m SSA eurocable and 8XLR M+4XLR F fan out

SB Boxes with LK chassis male connector and cable

SBS08AN*M	SB box 8 ch in, with 5m SSA eurocable and LK 25 inline male connector
SBS12AN*M	SB box 12 ch in, with 5m SSA eurocable and LK37 inline male connector

* Insert the length required to complete the code.

Box 19'' with LK chassis male connectors

SP12X4AN	Box 19'' - 12x4 ch with LK54 chassis male connector
SP16X4AN	Box 19'' - 16x4 ch with LK85 chassis male connector
SP16X8AN	Box 19'' - 16x8 ch with LK85 chassis male connector
SP20X4AN	Box 19'' - 20x4 ch with LK85 chassis male connector
SP24X4AN	Box 19'' - 24x4 ch with LK85 chassis male connector
SP24X8AN	Box 19'' - 24x8 ch with LK150 chassis male connector
SP28X4AN	Box 19'' - 28x4 ch with LK150 chassis male connector
SP32X8AN	Box 19'' - 32x8 ch with LK150 chassis male connector

Box 19'' with 2xLK chassis male connectors

SP220X4AN	Box 19'' 20X4 ch with 2 LK85 chassis male connectors
SP224X4AN	Box 19'' 24X4 ch with 2 LK85 chassis male connectors
SP228X4AN	Box 19'' 28X4 ch with 2 LK150 chassis male connectors
SP232X8AN	Box 19'' 32X8 ch with 2 LK150 chassis male connectors

SP232X8AN

SB Boxes with XLR fan out and cable

SBF12AN5*F3	SB box 12 ch in, with *m SSA eurocable and 12XLR M fan out
SBF16X4AN*MF3	SB box 16x4 ch with *m SSA eurocable and 16XLR M+4XLR F fan out
SBF16X8AN*MF3	SB box 16x8 ch with *m SSA eurocable and 16XLR M+8XLR F fan out
SBF20X4AN*MF3	SB box 20x4 ch with *m SSA eurocable and 20XLR M+4XLR F fan out

* Insert the length required to complete the code.

19'' Boxes with XLR fan out and cable

SPF12X4AN*MF3	Box 19'' - 12x4 ch with *m SSA eurocable and 12XLR M+4XLR F fan out
SPF16X4AN*MF3	Box 19'' - 16x4 ch with *m SSA eurocable and 16XLR M+4XLR F fan out
SPF20X4AN*MF3	Box 19'' - 20x4 ch with *m SSA eurocable and 20XLR M+4XLR F fan out
SPF24AN*MF3	Box 19'' - 24 ch with *m SSA eurocable and 24XLR M fan out
SPF24X4AN*MF3	Box 19'' - 24x4 ch with *m SSA eurocable and 24XLR M+4XLR F fan out
SPF28X4AN*MF4	Box 19'' - 28x4 ch with *m SSA eurocable and 28XLR M+4 XLR F fan out

* Insert the length required to complete the code.



Stage Boxes

Stage Box
SB ADS BOX with LK Chassis Male Connector
SB2 ADS BOX with 2xLK Chassis Male Connectors
SBS ADS BOX with LK Line Connector and cable
SBF ADS BOX with XLR Fan Out and cable
SP Box 19" with LK Chassis Male Connector
SP2 Box 19" with 2xLK Chassis Male Connectors
SPS Box 19" with LK Line Connector and cable
SPF Box 19" with XLR Fan Out and cable
SBR ADS BOX with LK Chassis Female Connector
SBSR ADS BOX with LK Line Female Connector and cable
SBFR ADS BOX with XLR Fan In and cable
SPR Box 19" with LK Chassis Female Connector
SPSR Box 19" with LK Line Female Connector and cable
SPFR Box 19" with XLR Fan In and cable

Rubberized locking ring
R Black B Blue E Red Y Yellow G Green S Grey O Orange
D Dust Cap
H Mesh eye cable grip
K Mesh cable gland
DK Dust cap + Mesh cable gland
DH Dust cap + Mesh eye cable grip
Rubberized Locking Ring + Dust Cap + Mesh Cable Gland (Gold Pack)
G Black GB Blue GE Red GY Yellow GG Green GS Grey GO Orange
Rubberized Locking Ring + Dust Cap (Regular Pack)
RD Black RB Blue RE Red RY Yellow RG Green RS Grey RO Orange
Rubberized Locking Ring + Mesh Cable Gland (Hard Pack)
HR Black HB Blue HE Red HY Yellow HG Green HS Grey HO Orange
Rubberized Locking Ring + Mesh Cable Gland Grip (Light Pack)
LR Black LB Blue LE Red LY Yellow LG Green LS Grey LO Orange
Rubberized Locking Ring + Mesh Cable Gland + Mesh Cable Gland Grip (Silver Pack)
SR Black SB Blue SE Red SY Yellow SG Green SS Grey SO Orange
Rubberized Locking Ring + Dust Cap + Mesh Cable Gland + Mesh Cable Gland Grip (Platinum Pack)
PR Black PB Blue PE Red PY Yellow PG Green PS Grey

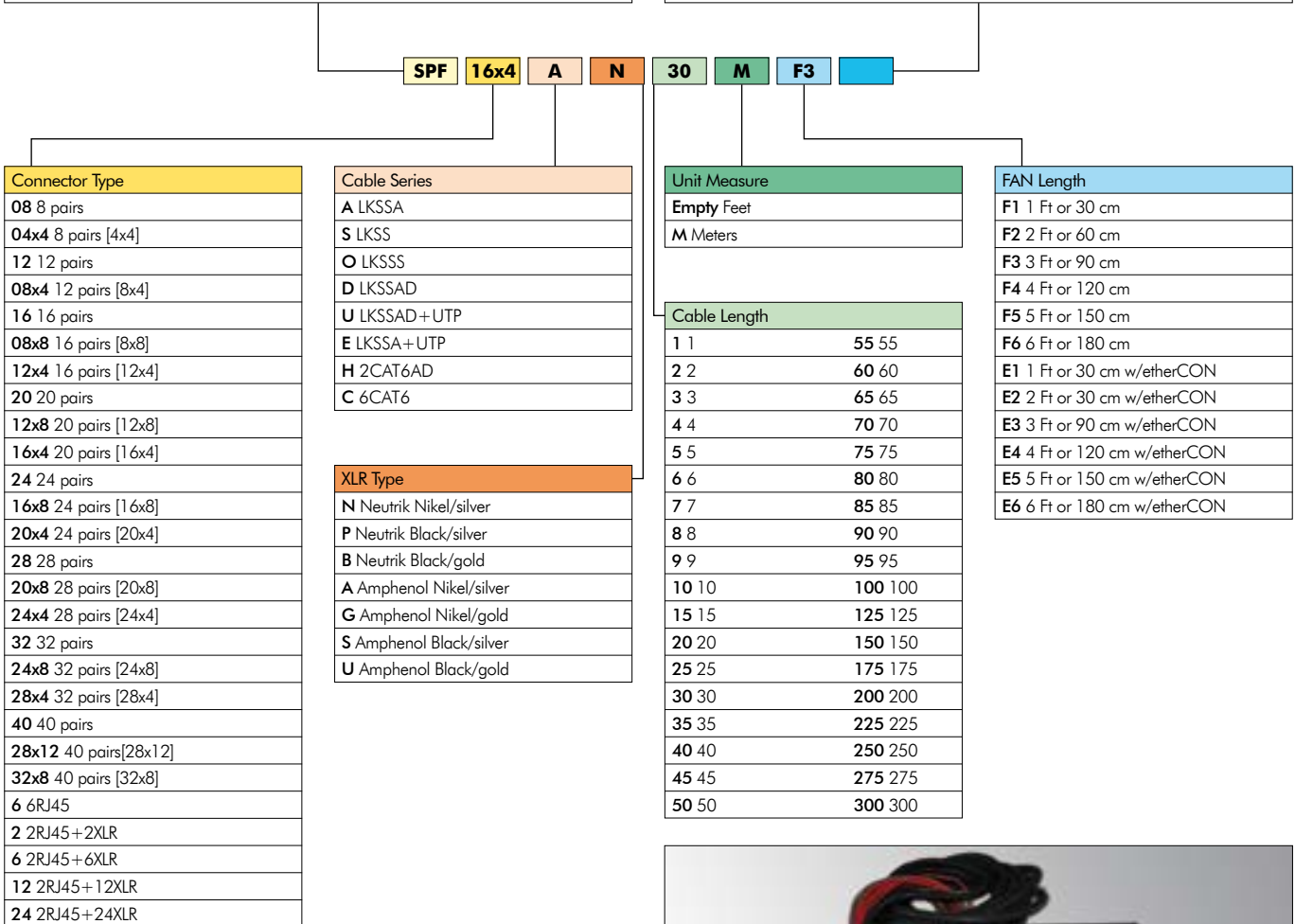

This expanded version of the stage box has a permanently connected multi-pair **eurocable** and is available in various input and output combinations.

Drive AMP I/O Systems

The Link Drive and Speaker Cable Distribution System combines several of our cutting edge products in a practical and easy to use system reflecting the company's philosophy to provide innovative and reliable wiring solutions. Manufactured with robust rack mounted interface boxes and specifically designed to terminate all audio drive lines, Ethernet and speaker outputs. Available also in active versions with AES/EBU splitters and/or Ethernet switches, the active Drive boxes can be designed to meet customer needs.

Decades of cooperation and partnership with the biggest speaker manufacturers, enables Link to be the worldwide reference point for wiring speaker systems, either active or passive, offering to the market the largest range of speaker cable and connectors (up to 24 pairs) designed also for Speaker Cable Distribution Systems.

Example featuring:

- LK 54 pin Input and Through connectors terminate to 8 audio pairs on the rear panel for amplifiers and 2 EtherCON connectors for data.
- 4 audio pairs terminate to the front panel for auxiliary connections.
- Speakon NL4 connectors on the rear panel terminate to one LKA 16 Pin Speaker Connector and two NL8 connectors to feed up to 8 independent loudspeaker channels.



eurocable 16N40 - Ultra Flexible 16 conductor Speaker Multi-Core

Specifically designed for the touring systems which use "Socapex" type connectors, the new LK16N40 16x4 mm2 (+/- 11 AWG) multi-core respects the **eurocable** tradition of providing robustness and flexibility for portable applications while maintaining exceptional audio performances. Combined with the LKS 16 speaker connector, LK16N40 speaker cable offers stunning reliability and easy use.



eurocable SSAD12C2F Audio Multi-Core

Designed to transport audio and data signals featuring 12 individually jacketed shielded audio pairs with two integrated CAT6 UTP Ethernet cables for data and/or digital audio transmission.

The LK 54 multi-pin connectors ease connection between DRIVE I/O and AMP I/O easy.



Snake SNK-FNT-FNN

Snake SNK

All the extensions, Fan in (FNN) and Fan out (FNT) described here below can be used with AD Distribution systems and are assembled using individually shielded multipair **eurocable** and the multipin LK connectors range. The SNK extension range is terminated with LK multi-pin cable connectors on both ends, to enable the connection between the XLRs Fan out and the stage box.



Number of channels	
02 2 pairs	40 40 pairs
04 4 pairs	48 48 pairs
08 8 pairs	56 56 pairs
12 12 pair	64 64 pairs
16 16 pairs	6 6RJ45
20 20 pairs	2 2RJ45+2XLR
24 24 pairs	6 2RJ45+6XLR
28 28 pairs	12 2RJ45+12XLR
32 32 pairs	24 2RJ45+24XLR

Cable Length	
1	55
2	60
3	65
4	70
5	75
6	80
7	85
8	90
9	95
10	100
15	125
20	150
25	175
30	200
35	225
40	250
45	275
50	300

Unit Measure
Empty Feet
M Meters

Snake-extension
SNK all LKA series
SNKW for LKW series and LKI 176

SNK 20 C 150 M R

Cable Series
A LKSSA
S LKSS
O LKSSS
D LKSSAD
U LKSSAD+UTP
E LKSSA+UTP
H 2CAT6AD
C 6CAT6

Rubberized locking ring
R Black B Blue E Red Y Yellow G Green S Grey O Orange
D Dust Cap
H Mesh eye cable grip
K Mesh cable gland
KB Black mesh cable gland
DK Dust cap + Mesh cable gland
DH Dust cap + Mesh eye cable grip
Rubberized Locking Ring + Dust Cap + Mesh Cable Gland (Gold Pack)*
G Black GB Blue GE Red GY Yellow GG Green GS Grey GO Orange
Rubberized Locking Ring + Dust Cap (Regular Pack)
RD Black RB Blue RE Red RY Yellow RG Green RS Grey RO Orange
Rubberized Locking Ring + Mesh Cable Gland (Hard Pack)*
HR Black HB Blue HE Red HY Yellow HG Green HS Grey HO Orange
Rubberized Locking Ring + Mesh Cable Gland Grip (Light Pack)
LR Black LB Blue LE Red LY Yellow LG Green LS Grey LO Orange
Rubberized Locking Ring + Mesh Cable Gland + Mesh Cable Gland Grip (Silver Pack)
SR Black SB Blue SE Red SY Yellow SG Green SS Grey SO Orange
Rubberized Locking Ring + Dust Cap + Mesh Cable Gland + Mesh Cable Gland Grip (Platinum Pack)
PR Black PB Blue PE Red PY Yellow PG Green PS Grey

*Add B for black mesh cable gland

Snake SNK-FNT-FNN

FAN
FNT fan-out for all LKA series
FNN fan-in for all LKA series
FNTW fan-in for W1, 2 & 4 style
FNNW fan-out for W1, 2 & 4 style
FXF LK female to XLRs female
FXM LK male to XLRs male
FXFW W1, W2 or W4 style to XLRs female
FXMW W1, W2 or W4 style to XLRs male
XMF XLRs male to XLRs female
XFF XLRs female to XLRs female
XMM XLRs male to XLRs male

Inputs & Outputs
02 2 pairs
04 4 pairs
02X2 4 pairs [2x2]
08 8 pairs
04x4 8 pairs [4x4]
12 12 pairs
08x4 12 pairs [8x4]
16 16 pairs
08x8 16 pairs [8x8]
12x4 16 pairs [12x4]
20 20 pairs
12x8 20 pairs [12x8]
16x4 20 pairs [16x4]
24 24 pairs
16x8 24 pairs [16x8]
20x4 24 pairs [20x4]
28 28 pairs
20x8 28 pairs [20x8]
24x4 28 pairs [24x4]
32 32 pairs
24x8 32 pairs [24x8]
28x4 32 pairs [28x4]
40 40 pairs
28x12 40 pairs [28x12]
32x8 40 pairs [32x8]
48 48 pairs
32x16 48 pairs [32x16]
40x8 48 pairs [40x8]
56 56 pairs
32x24 56 pairs [32x24]
40x16 56 pairs [40x16]
48x8 56 pairs [48x8]
64 64 pairs
40x24 64 pairs [40x24]
48x16 64 pairs [48x16]
56x8 64 pairs [56x8]
6 6RJ45
2 2RJ45+2XLR
6 2RJ45+6XLR
12 2RJ45+12XLR
24 2RJ45+24XLR

Cable Length	
1	55
2	60
3	65
4	70
5	75
6	80
7	85
8	90
9	95
10	100
15	125
20	150
25	175
30	200
35	225
40	250
45	275
50	300

Unit Measure
Empty Feet
M Meters

FAN Length
F1 1 Ft or 30 cm
F2 2 Ft or 60 cm
F3 3 Ft or 90 cm
F4 4 Ft or 120 cm
F5 5 Ft or 150 cm
F6 6 Ft or 180 cm
E1 1 Ft or 30 cm w/etherCON
E2 2 Ft or 30 cm w/etherCON
E3 3 Ft or 90 cm w/etherCON
E4 4 Ft or 120 cm w/etherCON
E5 5 Ft or 150 cm w/etherCON
E6 6 Ft or 180 cm w/etherCON

FNT 20X4 C B 150 M F3 R

Cable Series
A LKSSA
S LKSS
O LKSSS
D LKSSAD
U LKSSAD+UTP
E LKSSA+UTP
H 2CAT6AD
C 6CAT6

XLR Type
N Neutrik Nickel/silver
P Neutrik Black/silver
B Neutrik Black/gold
A Amphenol Nickel/silver
G Amphenol Nickel/gold
S Amphenol Black/silver
U Amphenol Black/gold

Rubberized locking ring
R Black B Blue E Red Y Yellow G Green S Grey O Orange
D Dust Cap
H Mesh eye cable grip
K Mesh cable gland
KB Black mesh cable gland
DK Dust cap + Mesh cable gland
DH Dust cap + Mesh eye cable grip
Rubberized Locking Ring + Dust Cap + Mesh Cable Gland (Gold Pack)*
G Black GB Blue GE Red GY Yellow GG Green GS Grey GO Orange
Rubberized Locking Ring + Dust Cap (Regular Pack)
RD Black RB Blue RE Red RY Yellow RG Green RS Grey RO Orange
Rubberized Locking Ring + Mesh Cable Gland (Hard Pack)*
HR Black HB Blue HE Red HY Yellow HG Green HS Grey HO Orange
Rubberized Locking Ring + Mesh Cable Gland Grip (Light Pack)
LR Black LB Blue LE Red LY Yellow LG Green LS Grey LO Orange
Rubberized Locking Ring + Mesh Cable Gland + Mesh Cable Gland Grip (Silver Pack)
SR Black SB Blue SE Red SY Yellow SG Green SS Grey SO Orange
Rubberized Locking Ring + Dust Cap + Mesh Cable Gland + Mesh Cable Gland Grip (Platinum Pack)
PR Black PB Blue PE Red PY Yellow PG Green PS Grey

*Add B for black mesh cable gland

Techflex

The use of the coloured Techflex allows the easy identification of the channels in the "Fan", easily extricates the XLRs Fan and improves its protection and flexibility. The unique braided construction and wide expandability allows quick and easy "Fan" sheathing. The range of colors allows easy and systematic color channel identification even in complex and crowded wiring. Techflex is braided from 10 mil polyethylene terephthalate monofilament yarns. The material has a wide operating temperature range, is resistant to chemical degradation, UV radiation, and abrasion. The sleeving cuts easily and cleanly with an hot knife and once installed, will beautify and protect any wire, hose or cable application.

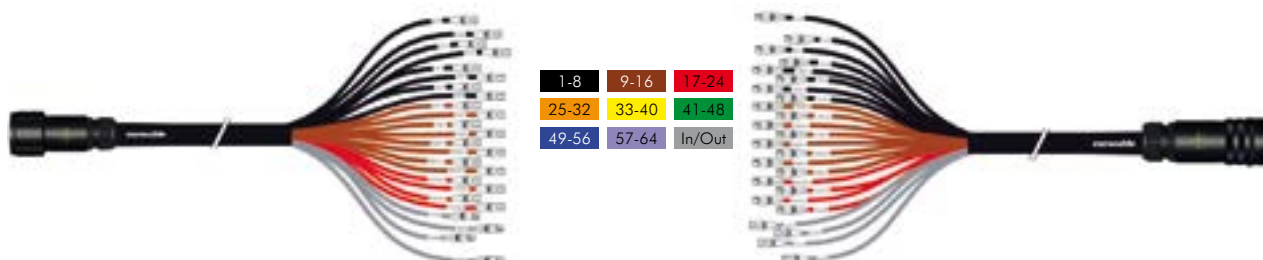

Snake FNT-FNN

The FNT-FNN range has an LK multi-pin cable connector on one end and an XLRs Fan-Out (customizable) on the other end. This is made up of singularly shielded and jacketed pairs, which are protected by a special colored Techflex increasing robustness and flexibility. The extensions may be rolled up on cable reels for easy handling.

Widget

Introducing Link's latest distribution solution, WidgetLink. Acting as "Swiss knives" for CAT5/6 cables, allows the standard Cat 5 and Cat 6 cabling to send multiple signals down a single cable thanks to a small range of Break-In, Break-out and adapters. The use of Cat 5/6 cable can be applied to DMX, Analog Audio, Balanced AES3 Digital Audio, and even hybrid combinations including 10/100 Ethernet.

1, 2, 3, or even 4 discrete signals can be sent down each individual Cat 5/6 cable. Shielded cable is required for applications using phantom power, 4 discrete signals, and/or hybrid combinations.

Thanks to its low loss characteristics, Cat 5/6 can increase the maximum length in many applications. For example, balanced AES3 signals have a typical distance limit of 100 meters on standard 110 ohm twisted-pair type cable, but can travel up to 300 meters on Cat5/6 cable, depending on the equipment being used. In a hybrid configuration, the maximum distance is dictated by the IEEE 802.3u Fast Ethernet standard. For DMX over Cat5/6 cable, distances of over 500 meters are possible, depending on equipment.

Link's **eurocable** brand is guaranteed to provide dependable signal integrity using our WidgetLink products, particularly when paired with our CVS LK CAT6 STP cable. Other hybrid solutions are also offered with various cable configurations. For example, our CVS LK 1CAT6SF 12/3 cable, which features a 12 AWG / 3 conductor power line with a shielded Cat 6 cable for "driveline" type applications.

- Multiple signals down a single Cat5/6 Cable
- Supports DMX, Analog Audio, and AES Digital Audio
- Hybrid solutions available including 10/100 Ethernet
- 4 total channels if using shielded cable
- "Fan," "barrel," and stage box type configurations
- Custom configurations available



Widget PCBs

The DB25 widget is an extremely cost-effective solution for break-ins and break-outs to XLR and even extensions using standard shielded Cat cables.



DB25 PCB front



DB25 PCB rear

Widget

Barrel to Male

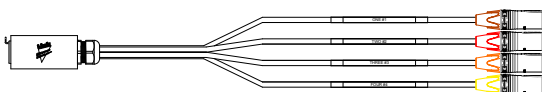

- WDO CAT4XLR3B6
- 3 Pin - Audio
- WDI CAT4DMX5B6
- 5 Pin - DMX

Barrel to Female

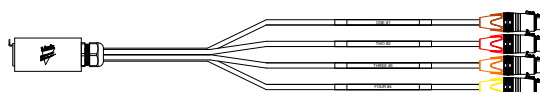

- WDI CAT4XLR3B6
- 3 Pin - Audio
- WDO CAT4DMX5B6
- 5 Pin - DMX

etherCON to Male

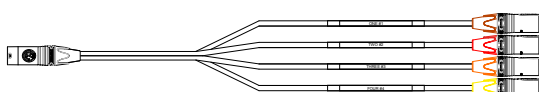

- WEO CAT4XLR3B6
- 3 Pin - Audio
- WEI CAT4DMX5B6
- 5 Pin - DMX

etherCON to Female

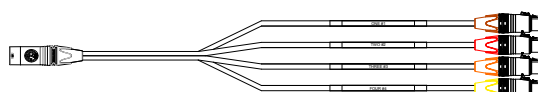

- WEI CAT4XLR3B6
- 3 Pin - Audio
- WEO CAT4DMX5B6
- 5 Pin - DMX

RJ45 to Male

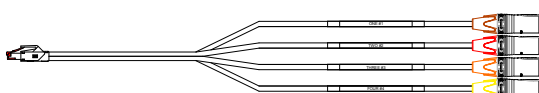

- WRO CAT4XLR3B6
- 3 Pin - Audio
- WRI CAT4DMX5B6
- 5 Pin - DMX

RJ45 to Female

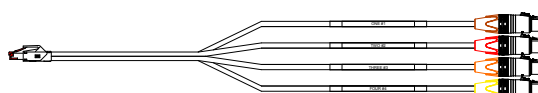

- WRI CAT4XLR3B6
- 3 Pin - Audio
- WRO CAT4DMX5B6
- 5 Pin - DMX

Barrel to Male with Mega

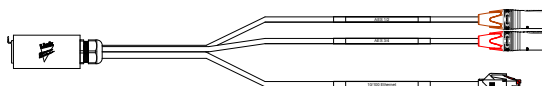

- WDO VDRIVE R6
- Allows for two audio or DMX signals with 100BASE-TX Megabit ethernet

Barrel to Female with Mega

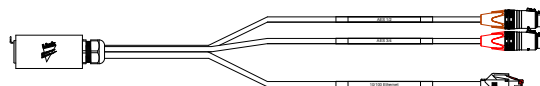

- WDI VDRIVE R6
- Allows for two audio or DMX signals with 100BASE-TX Megabit ethernet

Barrel to Male with Control

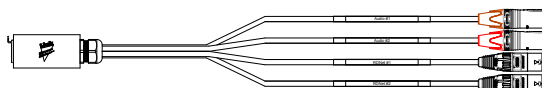

- WDO RDNET E6
- Allows for two audio signals and two serial control signals for powered speaker systems

Barrel to Female with Control

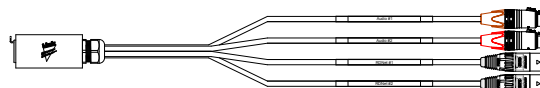

- WDI RDNET E6
- Allows for two audio signals and two serial control signals for powered speaker systems

Stage Box

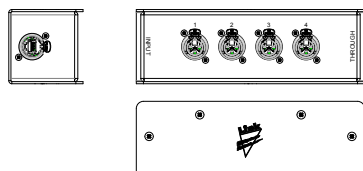

Hybrid Stage Box

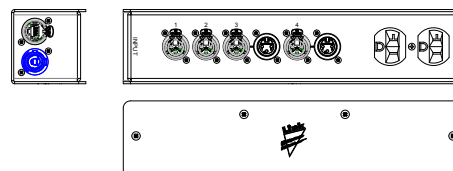

Boxes and Panels

19" Boxes

19" boxes are the ideal base to build up your own easy-to-set audio or video power derivations. They are manufactured in 12/10 steel plate and finished in orange peel black dust epoxy. They are suitable for housing all kinds of 19" rack panels. All boxes are pre-punched for LK connectors. Punching is made on the connector size depending on the number of channels suitable for the specific box. This may be covered by an appropriate plate if not required.



19" Rack Boxes



The front and the rear panel are manufactured in 30/10 black finished aluminium plate; they are available in 1, 2 and 3 rack units consisting of a "U" shaped base and top lid. They can be supplied customized with pre-punched and laser labelled holes on the front and rear upon request.

Prepunched panels



Pre-punched panels are available in a wide range of size configurations for easy and time-saving assembly of various types of connectors (XLRs, CEE form sockets, LK connectors). They are manufactured in 15/10 steel plate and finished in smooth black dust epoxy with silkscreen identification.

Blank panels



Standard

These panels, featuring 19" standard rack size, are mostly used to cover empty units on the racks. Manufactured in 30/10 aluminium plate, they are finished in smooth, black dust, epoxy and can also be supplied customized with pre-punched and laser labeled holes upon request.

Reinforced

Similar characteristics of the standard panels but manufactured in 20/10 aluminium plate with a 90° fold, top and bottom, to give better rigidity. They are finished in smooth, black dust, epoxy can be also supplied customized with pre-punched and laser labeled holes upon request.

Ventilation panels



Specifically designed to give extra ventilation in the racks. They are manufactured in 20/10 aluminium plate finished in smooth, black dust, epoxy and have a 90° fold, top and bottom, to give better rigidity.

Blank and punched lids

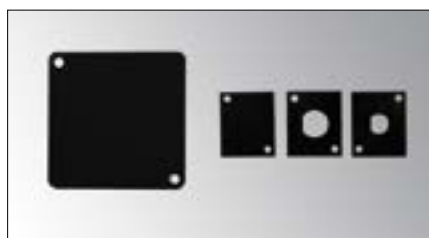

Blank lids - finished in smooth, black dust, epoxy - are available for the entire range of LK connectors (PF2 L***) as well as blank lids and for BNC "D" series XLR adaptors (PF D, PF BNC, ...).

Boxes and Panels

19" Boxes

BOX P1 25	1U Stage box, punched for LK25
BOX P2 35 54	2U Stage box, punched for LK 37 and LK 54
BOX P3 85/150	3U Stage box, punched for LK 85 and LK 150
BOX P4 85/150	4U Stage box, punched for LK 85 and LK 150

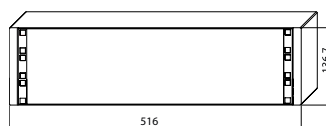

19" Rack Boxes

BOX R1D	1U Rack box, depth 170mm (BR 1BOXD+PB1A+PB1R)
BOX R2D	2U Rack box, depth 170mm (BR 2BOXD+PB2A+PB2R)
BOX R3D	3U Rack box, depth 170mm (BR 3BOXD+PB3A+PB3R)

19" Rack boxes can be supplied on request in different depth

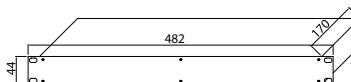

Blank Panels

PN1 A	1U blank rack panel
PN2 A	2U blank rack panel
PN3 A	3U blank rack panel
PN4 A	4U blank rack panel
PN5 A	5U blank rack panel
PN6 A	6U blank rack panel
PN1 AR	1U reinforced blank rack panel
PN2 AR	2U reinforced blank rack panel
PN3 AR	3U reinforced blank rack panel
PN4 AR	4U reinforced blank rack panel
PN5 AR	5U reinforced blank rack panel
PN6 AR	6U reinforced blank rack panel

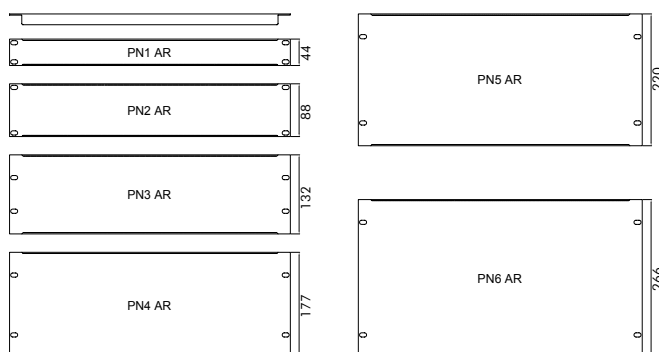

Ventilation panels

PN1 ARV	1U reinforced ventilation rack panel
PN2 ARV	2U reinforced ventilation rack panel
PN3 ARV	3U reinforced ventilation rack panel
PN3 AR3V	3U reinforced ventilation rack panel 3 slots

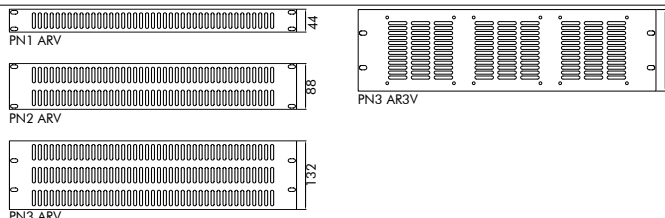

Prepunched panels

PF1 08T	1U prepunched panel for 8 XLR with T-bar
PF1 J08T	1U prepunched panel for 8 XLR + 8 Jacks with T-bar
PF1 12T	1U prepunched panel for 12 XLR with T-bar
PF1 16T	1U prepunched panel for 16 XLR with T-bar
PF2 L51925	2U prepunched panel for 5 LK 25
PF2 L43554	2U prepunched panel for 4 LK 37/54 and LKS 19 pins
PF2 L285	2U prepunched panel for 2 LK 85/150/200
PF2 GW	2U prepunched panel for 6 Gewiss 16A sockets
PF2 VI	2U prepunched panel for 24 Din module
PF3 VI	3U prepunched panel for 24 Din module
PFAV1X04	Prepunched AX 100 cable reel side panel for 4 XLR
PFAV2X12	Prepunched SP 380 cable reel side panel for 12 XLR
PFAV3X24	Prepunched SP 450 cable reel side panel for 24 XLR

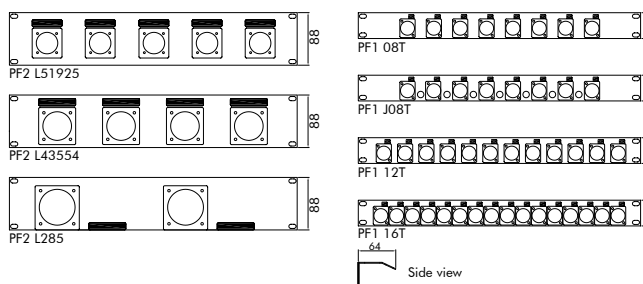

Blank and punched lids

PF D	Blanking plate for D series punching
PF BNC	Adapter plate BNC - D series
PF BNC FP	Adapter plate BNC - solder
PF TP 19/25	Lid for LK 25 punching
PF TP 35/54	Lid for LK 37/54 punching
PF TP 85/150	Lid for LK 85/150/200 punching

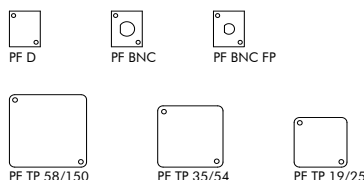





40	Introduction
42	Redundant Rugged Switches
44	Multinetwork Optical Backbone
45	Networking Diagram
46	Digital Stage Box

*People and Products
Connecting the World
of Entertainment*



DGlink media switches and stage boxes were designed to meet the dynamic digital audio, lighting, and video transport requirements for live events and on site broadcast applications.



Redundant Rugged Switches



MultiNetwork Optical Backbone



Digital Stage Box

Designed for the live event professional in mind, DGlink products are configurable, ruggedized, and redundant, leveraging the latest electronics to support most contemporary audio, video and lighting protocols.

DGlink 19" rack mountable switches leverage the latest electronics from Cisco™, Extreme Networks™, and Luminex packaged in a robust enclosure with touring grade connectors. Redundant power supply and PCB configurations are available to ensure 100% uptime for your critical applications.

The DGlink MOB incorporates WDM and MTP/MPO technologies to deliver a framework that transports up to 24 discrete networks over a hybrid power+data backbone. Leveraging hybrid LK Connectors and **eurocables**, DGlink MOB is designed for large broadcast and entertainment applications that require power and signals to be transported over extended distances.

Modular and fully configurable, DGlink stage boxes allow for selection of audio protocols, number of inputs and outputs, connectors, and layouts. Introduced in 2010, DGlink was the first digital stage box to support Dante. Designed to be compatible with existing analog cabling and subsnake systems, the digital electronics can be coupled with analog components such as transformer splits and LK multipin connectors to easily integrate with your existing infrastructure.

Redundant Rugged Switches

HW Series

The DGLink multimedia switches were designed to address the specific needs presented in live event production. Today's Audio, Video, and Lighting over Ethernet protocols require low latency transport, specific quality of service (QoS) control, and precision clocking to ensure that all multimedia transport and control signals arrive error free and synchronized. Whether you are designing for a fixed theatrical installation or a concert tour, DGLink switches are available in configurations to support your specific application.

DGLink 19" rack mountable switches leverage the latest electronics from Cisco™, Extreme Networks™, and Luminex™, packaged in a robust enclosure, with touring grade connectors. Redundant power supply and PCB configurations are available to ensure 100% uptime for your critical applications. Our team of experienced engineers helps you select the best internal hardware based on specific show requirements.



DGLink switches are available in multiple I/O configurations supporting various optical and copper port and connector configurations.

DGLink electronics can also be fitted into other enclosures with supporting electronics and customized to address special packaging requirements.

DGLink supports common entertainment layer 2 and layer 3 protocols such as sACN, Art-Net AVB, Dante, and AES67. Options are also available for Precision Time Protocol (PTP) IEEE 1588v2. DGLink switches support specific VLAN configurations and Multi-Select configurations for easy reprogramming in the field.

Optical:

- Single-mode and Multi-mode
- Link LKG/LKO
- Expanded Beam/HMA
- Neutrik OpticalCON QUAD
- Neutrik OpticalCON DUO
- SC
- LC

Copper:

- Neutrik EtherCON
- 100 Mbps
- 1000 Mbps
- 10 Gbps

Redundant Rugged Switches

Models

HW C1 8-0/0-0 O2S2 DIEEU	Rugged Gigabit switch with 8 copper [etherCON] plus 2 fiber [OpticalCon] ports
HW C1 4-4/0-0 O2S2 V2 DIEEU	Rugged Gigabit switch with 2 V-Lan / 4 copper [etherCON] plus 1 fiber [opticalCON] ports each V-Lan
HW C1 10-0/0-0 DIEEU	Rugged Gigabit switch with 10 copper [etherCON] ports
HW C1 5-5/0-0 V2 DIEEU	Rugged Gigabit switch with 10 copper [etherCON] ports / 2 V-Lan
HW C2 9-9/0-0 O2S2 DIEEU	Rugged dual Gigabit switch with 9 copper [etherCON] + 1 fiber [OpticalCon] ports on both primary and secondary
HW C2 9-9/0-0 O2S2 DIEEU	Rugged dual Gigabit switch with 10 copper [etherCON] ports on both primary and secondary
HW N2 5-5/0-0 DIEEU	Rugged dual Gigabit switch with 5 copper [etherCON] ports on both primary and secondary
HW BP12A2	12Vdc Battery Pack (2Ah)



Features	HW C1 8-0/0-0 HW C1 4-4/0-0	HW C1 10-0/0-0 HW C1 5-5/0-0	HW C2 9-9/0-0	HW C2 10-10/0-0
RJ45 ports (10/100/1000 Mbps)	8	10	9+9	10+10
SFP ports	2	-	1+1	-
Connectors	etherCON, opticalCON	etherCON	etherCON, opticalCON	etherCON
Power supply	Dual 110 -240 Vdc	Dual 110 -240 Vdc	Dual 110 -240 Vdc	Dual 110 -240 Vdc
Switch redundancy	Virtual	Virtual	Full	Full
Spanning Tree	Yes	Yes	Yes	Yes
IGMP	1, 2, and 3 snooping	1, 2, and 3 snooping	1, 2, and 3 snooping	1, 2, and 3 snooping
QoS	4 Hardware queues	4 Hardware queues	4 Hardware queues	4 Hardware queues
Vlan	Yes	Yes	Yes	Yes
Layer 3	Yes	Yes	Yes	Yes
ACL Filter	Yes	Yes	Yes	Yes
Ipv6	Yes	Yes	Yes	Yes
Port mirroring	Yes	Yes	Yes	Yes
Bandwidth management	Yes	Yes	Yes	Yes
Storm control	Yes	Yes	Yes	Yes
SNMP	Yes	Yes	Yes	Yes
Jumbo frames	10 KB	10 KB	10 KB	10 KB
MAC table	up to 8000	up to 8000	up to 8000	up to 8000
Bonjour protocol	Yes	Yes	Yes	Yes
LEDs	Activity / Speed (1Gpbs)	Activity / Speed (1Gpbs)	Activity / Speed (1Gpbs)	Activity / Speed (1Gpbs)
Flash memory	16MB	16MB	2x 16MB	2x 16MB
CPU memory	128MB	128MB	2x 128MB	2x 128MB

Multinetwork Optical Backbone

ONE FIBER OPTIC CABLE CARRYING MANY SIGNALS AUDIO, VIDEO, CONTROL, ETHERNET...
 DELIVERED KILOMETERS FAR AWAY MAINTAINING THE ORIGINAL SIGNAL INTEGRITY

The DGlink MOB incorporates WDM and MTP/MPO technologies to deliver a framework that transports up to 24 discrete networks over a hybrid power+data backbone. Leveraging hybrid LK Connectors and **eurocable**, DGlink MOB is designed for large broadcast and entertainment applications that require power and multiple transport and control protocols to be transported over extended distances.



The DGlink MOB can be configured to support multiple signals: 3G HD-SDI, MADI, Dante, AES67, sACN, and Art-Net. (Dark Fiber ports are also available on request)
 Single Mode and Multi-Mode configurations are available and can support distances up to 120 km. DGlink MOB WDM modules comply with ITU G.695 and G.696 ITU o T G.652 (11/2009) standards and can provide up to 18 discrete channels in a single enclosure.

All DGlink Ruggedized Redundant Switch I/O port options are also available in the DGlink MOB.

Optical:

- Single-mode and Multi-mode
- Link LKG/LKO
- Expanded Beam/HMA
- Neutrik OpticalCON QUAD
- Neutrik OpticalCON DUO
- SC
- LC

Copper:

- Neutrik etherCON
- 100 Mbps
- 1000 Mbps
- 10 Gbps

Networking Diagram

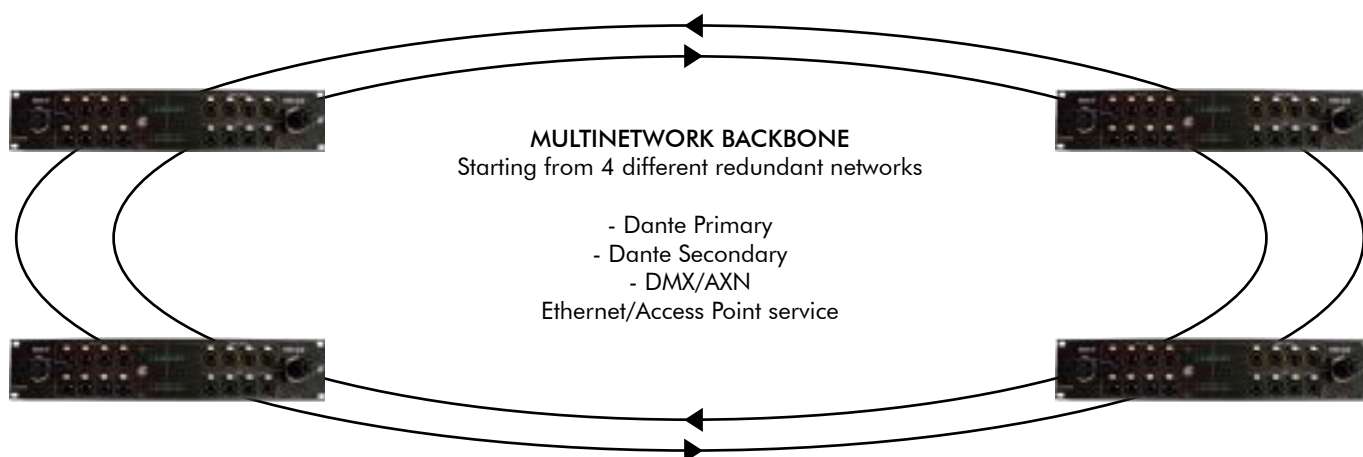
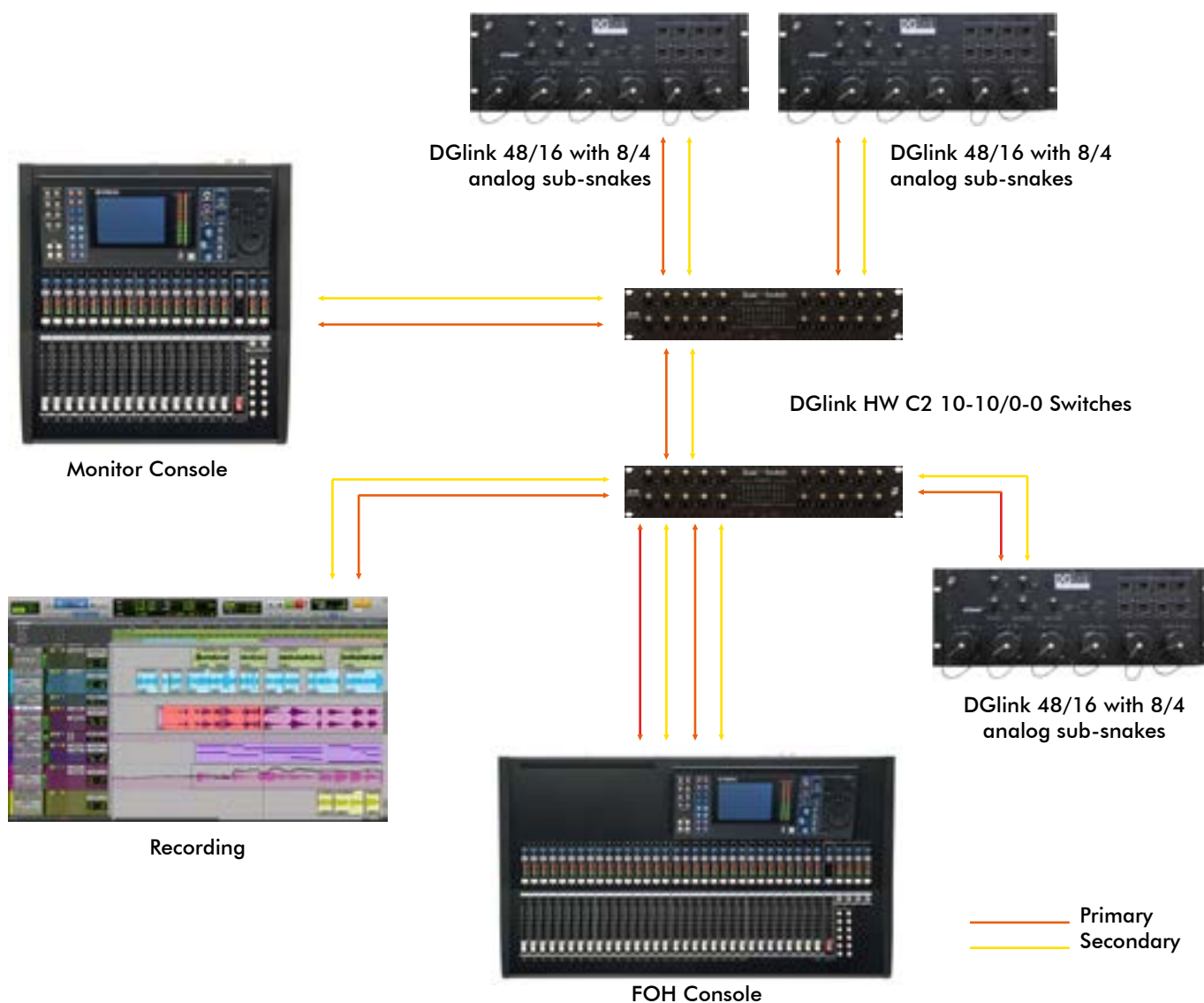

Digital Stage Box

Due to the high grade of customization for all DGLink products, we highlight some standard basic solutions which can be configured and expanded to provide the right answer for your needs.

MDP System (Multi Digital Protocol)

DGLink MDP supports the transport and distribution of analog and digital audio while facilitating additional communication, control, and monitoring signals. The DGLink architecture is modular and can be configured to suit existing needs and be extensible for the future at the same time. DGLink can be combined with **eurocable** hybrid cables and LK Connectors to provide a single touring grade cable and connection point between the front of house and the stage. Built on a robust processing engine, DGLink supports 24-bit resolution and sampling frequencies up to 48KHz.

DGLink MDP also has options for redundant power supplies and external battery back-up. The optional AES-EBU drive module reclocks, rebuffers, splits, and distributes 12 channels of AES-E-BU digital audio throughout multiple amplifier racks.



Features

Multiple protocols: DGLink MDP has the option to transport and convert 2 simultaneous protocols (Dante, MADI, Ether-sound)

Customization: DGLink can be easily configured to integrate with pre-existing conventional stage boxes, sub snakes and splitters. DGLink can also provide direct or transformer isolated analog inputs for conventional monitor and broadcast consoles.

Modular Channel Counts: The 8 channel DGLink digital converter modules support up to 64 bidirectional channels of Analog to Digital (ADC) and Digital to Analog (DAC).

Control & Settings: The 8 channel DGLink digital converter modules support up to 64 bidirectional channels of Analog to Digital (ADC) and Digital to Analog (DAC).



Models

DGL D32/16E	DGLink "Dante Brooklyn II" 32 inputs / 16 outputs
DGL M32/16E	DGLink "MADI" 32 inputs / 16 outputs
DGL D48/08E	DGLink "Dante Brooklyn II" 48 inputs / 8 outputs
DGL M48/08E	DGLink "MADI" 48 inputs / 8 outputs
DGL D48/16E	DGLink "Dante Brooklyn II" 48 inputs / 16 outputs
DGL M48/16E	DGLink "MADI" 48 inputs / 16 outputs
DGL D48/24E	DGLink "Dante Brooklyn II" 48 inputs / 24 outputs
DGL M48/24E	DGLink "MADI" 48 inputs / 24 outputs
DGL D64/24E	DGLink "Dante Brooklyn II" 64 inputs / 24 outputs
DGL M64/24E	DGLink "MADI" 64 inputs / 24 outputs
DGL DAMAC64	DGLink "Dante Brooklyn II-MADI" converter 64/64 ch



Mini DGLink

Mini DGLink is the little brother of MDP housed in 1U and 2U 19" rack modules. The Mini supports up to 16 channels of input and 8 channels of output in a compact 1U configuration. I/O configurations available for XLR, sub-D 25 pin or LK input and output connectors. Dual HA (Head Amps) output options are also available supporting different gain settings for the same analog input at two different destinations (e. g. FoH, Monitor, Broadcast). MINI supports 24-bit resolution and sampling frequencies up to 96kHz using a Dante Brooklyn II digital audio board.



Features

Configuration: Mini DGLink comes in 1U/2U configurations up to 16 inputs and 8 outputs. Options for Dual Head Amp and Redundant Power Supply are available on request. Different I/O configurations are available. All configurations are available with Dante protocol.

Control & Settings: DGLink comes with free Windows & IPAD software to remotely control all parameters on up to 8 units simultaneously (gain, +48V Phantom Power, Pad).

Models

DGM D08/0E F8XI	1U DGLink Mini "Dante Brooklyn II" 8 inputs
DGM D0/08E F8XO	1U DGLink Mini "Dante Brooklyn II" 8 outputs
DGM D08/08E F8XI8XO	2U DGLink Mini "Dante Brooklyn II" 8 inputs / 8 outputs
DGM D16/0E F16XI	2U DGLink Mini "Dante Brooklyn II" 16 inputs
DGM D16/08E F8XI8XOR8XI	2U DGLink Mini "Dante Brooklyn II" 16 inputs / 8 outputs

- Fiber
- Primary
- Secondary

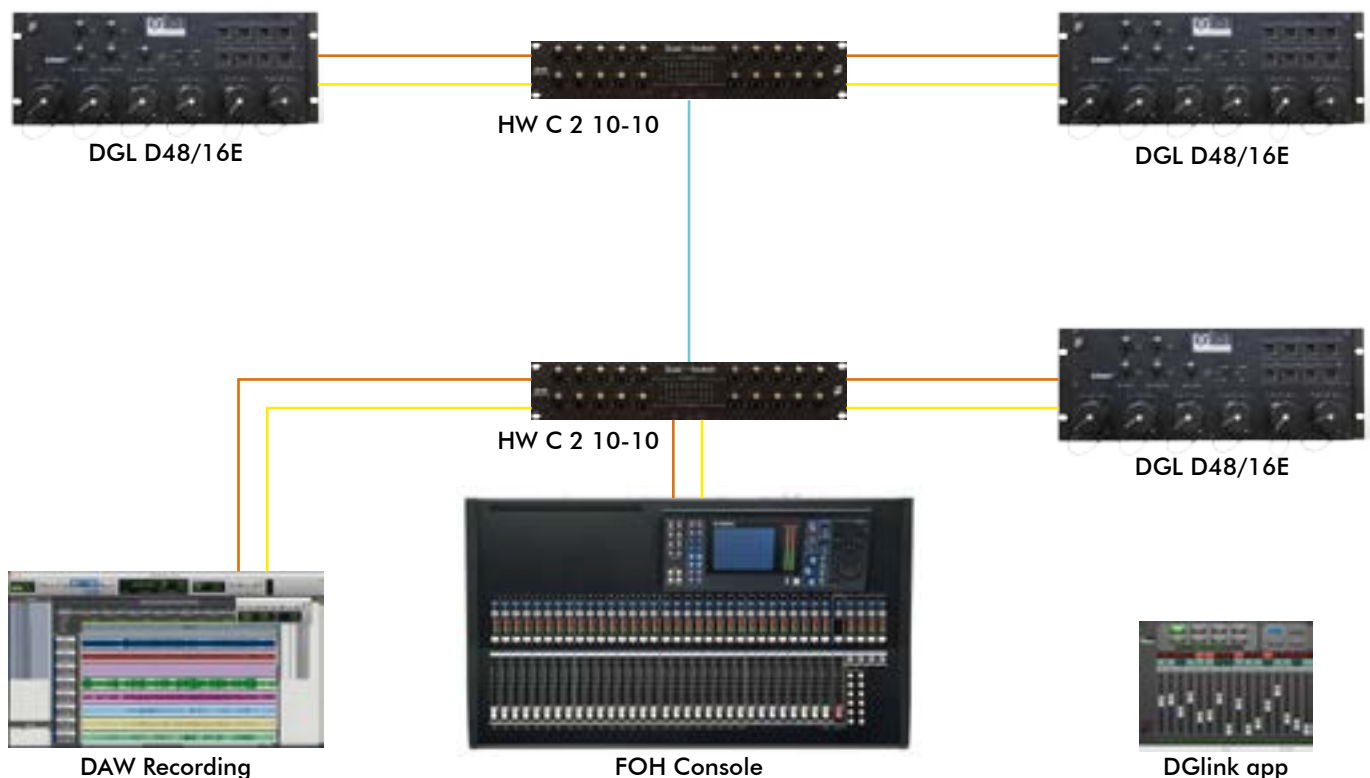





50	LK Audio Multipin
52	Speaker Connectors
54	Multisignal Speaker
56	LKO Optical System
58	LKG Gigabit System
60	LKG Video & Data Connector
62	LKS Data Systems
64	LKS 19 Pin
66	Multi-Coax Connectors
68	Hermaphrodite Connectors / W Style Connectors
70	LKH Head to Ballast Connectors
72	LKR Chain Motor Connectors
74	Power Link
76	LK Tools
78	Cable Relief
79	Dimensional Data
80	Standard Wiring
83	Reference Table

*People and Products
Connecting the World
of Entertainment*

LK Audio Multipin

Based on the MIL-DTL-5015 and VG 95234 standards, LK Audio connectors adhere to the basic principles of strength and reliability of specified military components. The restyling and construction of the LK Audio range has been specifically designed to meet the needs of the entertainment industry. LK Audio configurations and their wiring standards, support secure connection for all Live and PA Rental business applications.

- 13 to 200 crimp gold pins (4 to 66 channels) in male/female panel and cable versions
- Based on military standard MIL-C-5015 and VG 95234 for superior strength and reliability
- Easy and error-free mating for fast connections
- Excellent resistance against accidental unlocking caused by shocks and vibrations
- Audible snap in quick bayonet lock
- Cable version with easy-grip long metal locking ring
- Roller studs for easier coupling
- Body made of high quality aluminium with resistant black finishing
- Guaranteed for over 2000 coupling operations
- IP68 rated when mated
- Cable strain relief with locknut (or with anti-bending spring from 13 to 54 pins version)

Options

- Black and colored (blue, red, green, yellow) rubber locking rings
- Silver pins (for 13 to 85 pin versions)
- Solder pins for the entire range available
- Male and female connector dust caps
- Reverse configurations available on request



The **LK Audio Multipin** range features from 13 to 200 pins (4 to 66 channels) **Studs** are rollover version ensuring easier coupling and a longer number of operations due to a lower wear and tear of coupling ramps.



Rubber locking rings are available for cable connectors in all configurations.

Reverse Series Locking ring on male connectors available on request in all configurations.

STANDARD WIRING



LK Audio Series Connector (from 13 to 150 poles, pins are to be ordered separately. 200 poles pins included)

Cable mounting

Male



Code	Cable relief
LK 13 MV	PG11
LK 19 MV	PG16
LK 25 MV	PG16
LK 37 MV	PG21
LK 54 MV	PG21
LK 85 MV	PG29
LK 150 MV	PG36
LKI 200 MV (solder pins)	PG36
LKA 200 MV (crimp pins)	PG36

Female



Code	Cable relief
LK 13 FV	PG11
LK 19 FV	PG16
LK 25 FV	PG16
LK 37 FV	PG21
LK 54 FV	PG21
LK 85 FV	PG29
LK 150 FV	PG36
LKI 200 FV (solder pins)	PG36
LKA 200 FV (crimp pins)	PG36

Panel mounting

Male



Code	
LK 13 MP	13 poles
LK 19 MP	19 poles
LK 25 MP	25 poles
LK 37 MP	37 poles
LK 54 MP	54 poles
LK 85 MP	85 poles
LK 150 MP	150 poles
LKI 200 MP (solder pins)	200 poles
LKA 200 MP (crimp pins)	200 poles

Female



Code	
LK 13 FP	13 poles
LK 19 FP	19 poles
LK 25 FP	25 poles
LK 37 FP	37 poles
LK 54 FP	54 poles
LK 85 FP	85 poles
LK 150 FP	150 poles
LKI 200 FP (solder pins)	200 poles
LKA 200 FP (crimp pins)	200 poles

Cable mounting with rubber locking ring

Female



Code	
LKP * FV	* poles
LKP * FV **	* poles, ** color

LKA Connectors for PCB



Code	
LKI 13 MP PCB	13 poles
LKI 25 MP PCB	25 poles
LKI 37 MP PCB	37 poles
LKI 54 MP PCB	54 poles
LKI 85 MP PCB	85 poles
LKI 150 MP PCB	150 poles

Pins

Male



Code	
LK PMD	Gold for LK 13-19-25-37-54-85
LK PMA	Silver for LK 13-19-25-37-54-85
LK PMD R	Gold for LK 150
LK PMD RR C	Gold for LK 200

Solder version available

Female



Code	
LK PFD T	Gold for LK 13-19-25-37-54-85
LK PFA T	Silver for LK 13-19-25-37-54-85
LK PFD R T	Gold for LK 150
LK PFD RR C	Gold for LK 200

Solder version available

Accessories

Dust cap



LK 20 TPMN	For LK 13-19
LK 24 TMPN	For LK 25
LK 28 TPMN	For LK 37
LK 32 TPMN	For LK 54
LK 40 TPMN	For LK 85-150-200

For connectors without locking ring

Dust cap



LK 20 TPFN	For LK 13-19
LK 24 TPFN	For LK 25
LK 28 TPFN	For LK 37
LK 32 TPFN	For LK 54
LK 40 TPFN	For LK 85-150-200

For connectors with locking ring

Rubber locking ring



LK 20 RL**	For LK 13-19
LK 24 RL**	For LK 25
LK 28 RL**	For LK 37
LK 32 RL**	For LK 54
LK 40 RL**	For LK 85-150-200

Items subject to Minimum Order Qty

**	Bl	R	G	Y
	Blue	Red	Green	Yellow

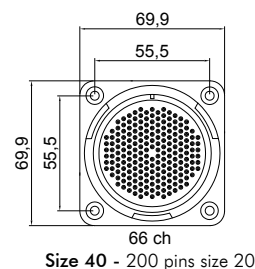
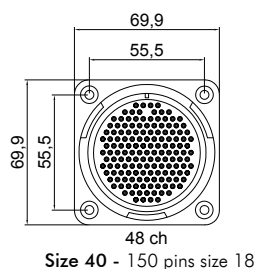
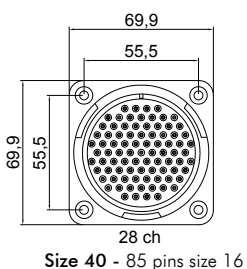
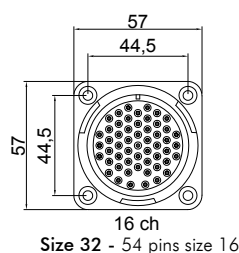
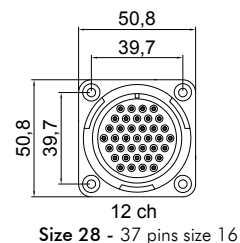
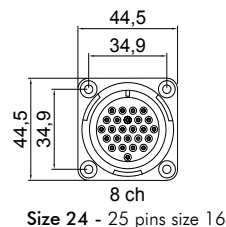
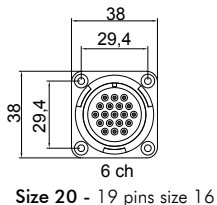
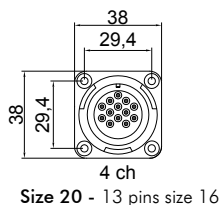

Speaker Connectors

The LK 08, LK 09, and LKA 16 series of connectors are ideal for portable speaker applications. Based on the LK Series MIL-SPEC designs, these connectors are extremely robust, IP rated, and available with impact resistant rubber locking rings. The LK 08 series is fully compatible with popular CA-COM configurations.

LK 08 and LK 09 Features

- 8 or 9 (4 on request) crimp or solder gold pins in male/female panel and cable versions
- Intermatable with CA-COM style connectors
- Audible snap in quick bayonet lock
- Cable version with easy-grip long metal locking ring
- Roller studs for easier coupling
- M32x1.5 cable strain relief with locknut as standard

LK 16 Features

- Also available in a 19 pins version as utilized by D&B
- 16 crimp or solder gold pins in male/female panel and cable versions
- Intermatable with Socapex style connectors
- Silk screen identification
- PG29 cable strain relief as standard

Common Features

- Easy and error-free mating for fast connections
- Excellent resistance against accidental unlocking caused by shocks and vibrations
- Body made of high quality aluminium with resistant black finishing
- Guaranteed for over 2000 coupling operations
- IP68 rated when mated

Options

- Black and colored (blue, red, green, yellow) rubber locking rings
- Male and female connector dust caps



LKI Speaker connectors are fully intermateable with CA-COM style connectors and are becoming increasingly popular with leading loudspeaker manufacturers due to their robust construction ideal for touring applications.



LKA 16 (crimp pins) and **LKI 16** (solder pins) connectors are based on standard LKS Socapex style connectors but have been adapted to use only 16 pins, following indications from the largest rental companies. The standard Socapex style LKS 19 pin connector is also available, as utilized by D&B. Rubber locking ring available on both bayonet style and screw coupling connectors.

The **LKI 08 adapter** features a male and female LKI 08 connector mounted back to back without locking rings. It enables the connection of two 8 pin extension cables, thus obtaining the desired length needed.



LK 08 Connectors

Cable mounting with rubber locking ring



Male reverse

LK* 08R MV P 8 poles gold pins

LK* 08R MV P ** 8 poles gold pins

Items subject to Minimum Order Qty

Female

LK* 08 FV P 8 poles gold pins

LK* 08 FV P ** 8 poles gold pins

Items subject to Minimum Order Qty

Panel mounting

Female reverse



LK* 08R FP 8 poles gold pins

Cable mounting with locking ring



Male reverse

LK* 08R MV 8 poles gold pins

Female

LK* 08 FV 8 poles gold pins

Adapter



LKA 08 EXT 08 Adapter

Configurations on request only:



Cable mounting male

Cable mounting female reverse



Panel mounting male

LK 09 Connectors

Cable mounting

Male



LK* 09 MV 9 poles gold pins

Female



LK* 09 FV 9 poles gold pins

Panel mounting

Male



LK* 09 MP 9 poles gold pins

Female



LK* 09 FP 9 poles gold pins

Cable mounting with rubber locking ring

Female



LK* 09 FV P 9 poles gold pins

* Use letter "A" to order crimp version or "I" for solder version connectors

** Rubber locking ring color

Accessories

Dust cap



LK 22 TPMN LK 08 without locking ring

LK 22 TPFN LK 08 with locking ring



LK 20 TPMN LK 09 without locking ring

LK 20 TPFN LK 09 with locking ring

Rubber locking ring



LK 20 RL ** For LK 09

LK 22 RL ** For LK 08

Items subject to Minimum Order Qty

** **B** Blue **R** Red **G** Green **Y** Yellow

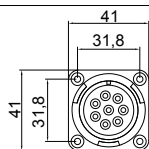

LK 08
Size 22 - 8 pins size 12

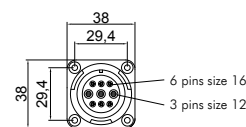

LK 09
Size 20

Multisignal Speaker

The LKA 32/25 and LKA 48/6 connectors are designed specifically to support high-density line array configurations where multiple speaker channels are required. Based on the LK Series MIL-SPEC designs, these connectors are extremely robust, IP rated, and available with impact resistant rubber locking rings. The integral digital pairs in the LKA 48/6 transport common laser & inclinometer signals.

LK 48/6 Features

- 48 pins size 12 plus 6 pins size 18 in male/female panel and cable versions
- Up to 24 speaker channels plus two AES/EBU channels for laser pointing and inclinometer control
- PG36 cable strain relief as standard (use of mesh cable relief suggested)

LK 32/25 Features

- 25 pins (12 independent speaker channels)
- Wide range of snake and break-in/out cables
- PG36 cable strain relief as standard

Common Features

- Based on military specifications MIL-C-5015 and VG 95234 for high strength and reliability
- Easy and error-free mating for fast connections
- Excellent resistance against accidental unlocking caused by shocks and vibrations
- Guaranteed for over 2000 coupling operations
- Audible snap in quick bayonet lock
- IP68 rated when mated
- Body made of high quality aluminium with resistant black finishing
- Cable version with easy-grip long metal locking ring
- Roller studs for easier coupling

Options

- Black and colored (blue, red, green, yellow) rubber locking rings
- Male and female connector dust caps



The **LKA 48/6** connector was designed to connect speaker clusters using as few cables as possible. It can carry up to 18 speaker and 2 AES/EBU channels with the **eurocable** 36N40AD2 cable or up to 48 speaker and 2 AES/EBU channels with the **eurocable** 48N40AD2 cable.



The **LKA 32/25** can transport 12 independent speaker channels and together with the **eurocable** 24N40 cable it expands Link's ability to provide customized AMP boxes, snakes, and break-in/out solutions to fulfill the increasing demands of its customers. A wide range of snake and break-in/out cables are available with connector options used by leading speaker manufacturers: Neutrik-NL, Amphenol Eps, or circular CA-COM compatible connectors.

STANDARD WIRING

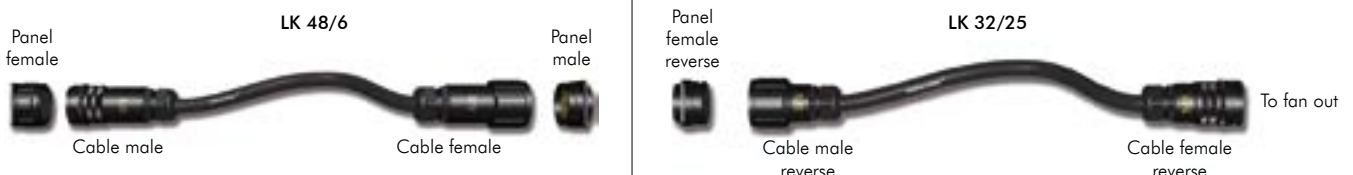

LK 48/6 Connectors

Cable mounting

Male



LK* 48/6 MV 54 poles
LK* 48/6 MVK plus kellems
LK* 48/6 MVK M63 (on request)

Panel mounting

Male



LK* 48/6 MP 54 poles

Female



LK* 48/6 FV 54 poles
LK* 48/6 FVK plus kellems
LK* 48/6 FV M63 (on request)

Female



LK* 48/6 FP 54 poles

Cable mounting with rubber locking ring

Female



LK* 48/6 FV P 54 poles
LK* 48/6 FVK P plus kellems
LK* 48/6 FVK M63 P (on request)

LK 32/25 Connectors

Cable mounting



Female reverse
LK* 32/25R FV 25 poles

Panel mounting

Female reverse



LK* 32/25R FP 25 poles

Cable mounting with locking ring



Male reverse
LK* 32/25R MV 25 poles

Male reverse



LK* 32/25R MP 25 poles

Cable mounting with rubber locking ring



Male reverse
LK* 32/25R MV P 25 poles

Other configurations available on request

* Use letter "A" to order crimp version or "I" for solder version connectors

Accessories

Dust cap



LK 32 TPMN For LK 32/25 without locking ring
LK 32 TPFN For LK 32/25 with locking ring
LK 40 TPMN For LK 48/6 without locking ring
LK 40 TPFN For LK 48/6 with locking ring

Rubber locking ring



LK 32 RL ** For LK 32/25
LK 40 RL ** For LK 48/6
 Items subject to Minimum Order Qty

** **B** Blue **R** Red **G** Green **Y** Yellow

Robust strain relief



PG36 standard configuration.
 M63 for LK 48/6 and LK 32/25, PG42 for LK 32/25 on request and subject to Minimum Order Quantity. Mesh cable gland available.

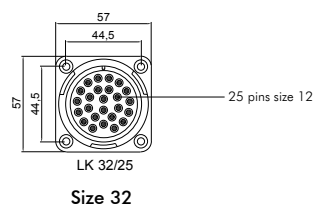
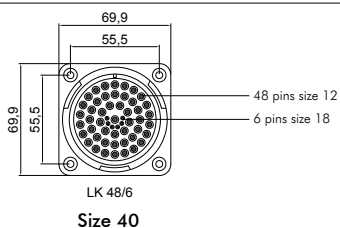

LKO Optical System

The LKO hybrid optical/power connector features a 4 channel expanded beam optical connection and 5 x 8 AWG electrical contacts.

The power contacts are ideal for transporting a three phase 32A power source in addition to the tactical optical cable (4 Single mode 90/125 wires, ref. **eurocable** CVS LK FO4SM 8/5).

When coupled with the PDlink smart distribution system and our new FO4SM 8/5 hybrid **eurocable** (featuring 4 strands of single mode optical fibre 9/125 and 5 x 10 mm² 8 AWG conductors), Link provides a complete solution for transporting power and data to lighting and powered speaker systems.

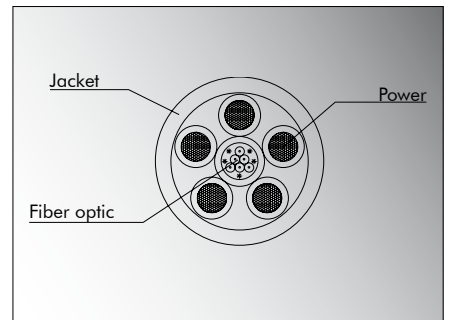

- 2 or 4 channels expanded beam optical connection plus 5 x 10 mm² (8 AWG)
- Easy and error-free mating for fast connections
- Fast LinkLock backshell
- Excellent resistance against accidental unlocking caused by shocks and vibrations
- Audible snap in quick bayonet lock
- Cable version with easy-grip long metal locking ring
- Roller studs for easier coupling
- Body made of high quality aluminium with resistant black finishing
- Guaranteed for over 2000 coupling operations
- IP68 rated when mated
- PG29 cable strain relief as standard

Options

- Black and colored (blue, red, green, yellow) rubber locking rings
- Male and female connector dust caps

PDlink Distribution System

PDlink is the next generation of power and signal distribution designed to deliver a truly unified and modular interconnect system.

Leveraging decades of experience and innovation, Link combines LK connectors, **eurocable** hybrid signal and power cables to offer a unified line of 19" high density rack mounted units for power, data, audio, speaker, and video distribution.



STANDARD WIRING



LKO Extensions

LKO Extensions Ordering Code



SNKO 32T4 S 150 M B

Number of fiber channels	
2 channels	32T2
4 channels	32T4

Cable Length	
1	55
2	60
3	65
4	70
5	75
6	80
7	85
8	90
9	95
10	100
15	125
20	150
25	175
30	200
35	225
40	250
45	275
50	300

Unit Measure	
Feet	
Meters	M

Accessories
R Black B Blue E Red Y Yellow G Green S Grey O Orange
D Dust Cap
H Mesh eye cable grip
K Mesh cable gland
DK Dust cap + Mesh cable gland
DH Dust cap + Mesh eye cable grip
Rubberized Locking Ring + Dust Cap + Mesh Cable Gland (Gold Pack)
G Black GB Blue GE Red GY Yellow GG Green GS Grey GO Orange
Rubberized Locking Ring + Dust Cap (Regular Pack)
RD Black RB Blue RE Red RY Yellow RG Green RS Grey RO Orange
Rubberized Locking Ring + Mesh Cable Gland (Hard Pack)
HR Black HB Blue HE Red HY Yellow HG Green HS Grey HO Orange
Rubberized Locking Ring + Mesh Cable Gland Grip (Light Pack)
LR Black LB Blue LE Red LY Yellow LG Green LS Grey LO Orange
Rubberized Locking Ring + Mesh Cable Gland + Mesh Cable Gland Grip (Silver Pack)
SR Black SB Blue SE Red SY Yellow SG Green SS Grey SO Orange
Rubberized Locking Ring + Dust Cap + Mesh Cable Gland + Mesh Cable Gland Grip (Platinum Pack)
PR Black PB Blue PE Red PY Yellow PG Green PS Grey

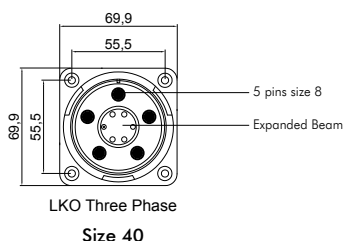
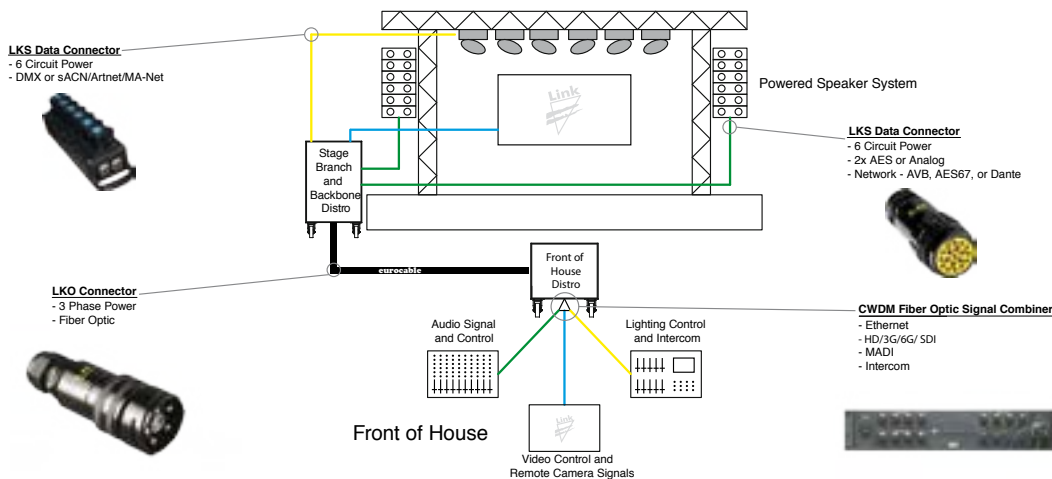

LKG Gigabit System

The LKG Gigabit series of connectors is ideal for applications that require multiple CAT6A connections + Power. Available with configurations of 1, 2, 4, and 6 CAT6A connections and power from single phase 20A to three phase 30A, LKG is ideal for Front Of House and cross stage connections that require hybrid power + data.



LKG 24/2E6: 2 Gigabit contacts, 6 pins size 16.



LKG 24/2E10: 2 Gigabit contacts, 3 pins size 12, 1 pin size 16, 6 pins size 18.



LKG T 32 4E: 4 Gigabit contacts, 5 pins size 8, with fast LinkLock backshell



LKG 28/2E36: 2 Gigabit contacts, 36 pins size 18.



LKG 24/2E20: 2 Gigabit contacts, 20 pins size 18.

- Available in 8 different configurations in male/female panel and cable versions
- 8 kinds of hybrid cables specifically designed for each LKG connector type
- High quality CAT6 Gigabit circular contacts
- Easy and error-free mating for fast connections
- Audible snap in quick bayonet lock
- Excellent resistance against accidental unlocking caused by shocks and vibrations
- Guaranteed for over 2000 coupling operations
- IP68 rated when mated
- Body made of high quality aluminium with resistant black finishing
- Cable version with easy-grip long metal locking ring
- Roller studs for easier coupling



LKG 32/6E, LKG 32/4E: 6 or 4 Gigabit contacts.



LKG 20/1E3: 1 Gigabit contact, 3 pins size 12.

eurocable



LKG Gigabit Extensions

LKG Extensions Ordering Code



SNKG 2 S 150 M B

Number of Channels	
2 CAT + 2 Audio	2
2 CAT + 6 Audio	6
2 CAT + 12 Audio	12
2 CAT + 2 Audio + 1 Power	2P
4 CAT	4
6 CAT	6
1 CAT + 1 Power	1
4 CAT + 1 Power	4P

Cable Length	
1	35
2	40
3	45
4	50
5	55
10	60
15	65
20	70
25	75
30	100

Unit Measure	
Feet	
Meters	M

Cable serie	
2CAT6F AD2 (2CAT + 2 Audio)	2H
2CAT6F AD6 (2CAT + 6 Audio)	6H
SSAD12C2F (2CAT + 12 Audio)	P
2CAT6SF 12/3 AD2 (2CAT + 2 Audio + 1 Power)	X
4CAT6F (4CAT)	N
6CAT6F (6CAT)	F
1CAT6S 16/3 (1CAT + 1 Power)	R
1CAT6S 12/3 (1CAT + 1 Power)	Y
4CAT6SF 10/5 (4CAT + 1 Power)	Q

Accessories	
R Black B Blue E Red Y Yellow G Green S Grey O Orange (Rubber locking ring)	
D Dust Cap	
H Mesh eye cable grip	
K Mesh cable gland	
DK Dust cap + Mesh cable gland	
DH Dust cap + Mesh eye cable grip	
Rubberized Locking Ring + Dust Cap + Mesh Cable Gland (Gold Pack)	
G Black GB Blue GE Red GY Yellow GG Green GS Grey GO Orange	
Rubberized Locking Ring + Dust Cap (Regular Pack)	
RD Black RB Blue RE Red RY Yellow RG Green RS Grey RO Orange	
Rubberized Locking Ring + Mesh Cable Gland (Hard Pack)	
HR Black HB Blue HE Red HY Yellow HG Green HS Grey HO Orange	
Rubberized Locking Ring + Mesh Cable Gland Grip (Light Pack)	
LR Black LB Blue LE Red LY Yellow LG Green LS Grey LO Orange	
Rubberized Locking Ring + Mesh Cable Gland + Mesh Cable Gland Grip (Silver Pack)	
SR Black SB Blue SE Red SY Yellow SG Green SS Grey SO Orange	
Rubberized Locking Ring + Dust Cap + Mesh Cable Gland + Mesh Cable Gland Grip (Platinum Pack)	
PR Black PB Blue PE Red PY Yellow PG Green PS Grey	



PDlink is the next generation of power and signal distribution designed to deliver a truly unified and modular interconnect system. Leveraging decades of experience and innovation, Link combines LK connectors, **eurocable** hybrid signal and power cables to offer a unified line of 19" (or rubber customized box as in picture) high density rack mounted units for power, data, audio, speaker, and video distribution.



LKG 20/1E3
Size 20



LKG 24/2E6
Size 24



LKG 24/2E10
Size 24



LKG 24/2E20
Size 24



LKG 28/2E36
Size 28

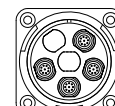

LKG 32/4E
Size 32

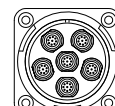

LKG 32/6E
Size 32

LKG Video & Data Gigabit Connector

The LKG 32/3ERG6 connector is specifically designed for live entertainment and Broadcast-TV applications with MADI digital audio and HD-SDI connections. The combination of CAT6A and RG6 in one trunk cable allows you to send a wide variety of signals over extended distances.

- Available in male/female panel and cable versions
- 3 high quality CAT6A Gigabit circular contacts plus 4 RG6 coaxial contacts
- Easy and error-free mating for fast connections
- Audible snap in quick bayonet lock
- Excellent resistance against accidental unlocking caused by shocks and vibrations
- Guaranteed for over 2000 coupling operations
- IP68 rated when mated
- Body made of high quality aluminium with resistant black finishing
- Cable version with easy-grip long metal locking ring
- Roller studs for easier coupling



The **LKG 32/3E4RG6** connector features 3 CAT6A Gigabit and 4 RG6 coaxial contacts.



CVS LK3CAT6SF 4RG6 Cable

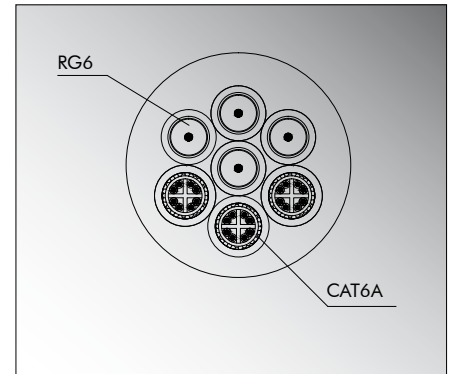

CVS LK3CAT6SF 4RG6 Section

Application examples

Stage Audio Application

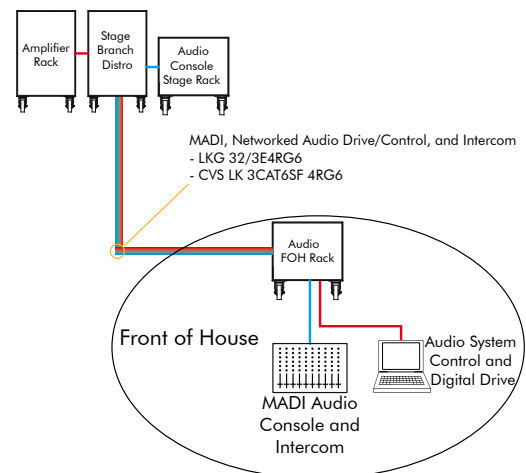
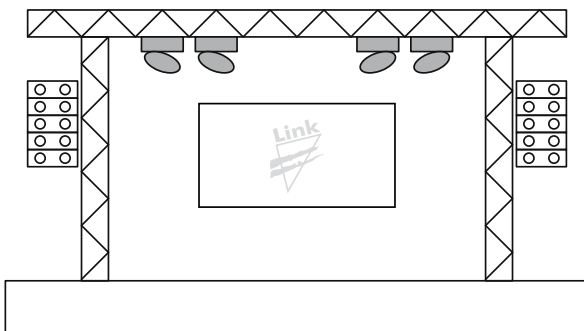

LKG Video & Data Gigabit Extensions



SNKG 3 G 150 M B

Cable Length	
1	35
2	40
3	45
4	50
5	55
10	60
15	65
20	70
25	75
30	100

Unit Measure	
Feet	
Meters	M

Accessories
R Black B Blue E Red Y Yellow G Green S Grey O Orange
D Dust Cap
H Mesh eye cable grip
K Mesh cable gland
DK Dust cap + Mesh cable gland
DH Dust cap + Mesh eye cable grip
<i>Rubberized Locking Ring + Dust Cap + Mesh Cable Gland (Gold Pack)</i>
G Black GB Blue GE Red GY Yellow GG Green GS Grey GO Orange
<i>Rubberized Locking Ring + Dust Cap (Regular Pack)</i>
RD Black RB Blue RE Red RY Yellow RG Green RS Grey RO Orange
<i>Rubberized Locking Ring + Mesh Cable Gland (Hard Pack)</i>
HR Black HB Blue HE Red HY Yellow HG Green HS Grey HO Orange
<i>Rubberized Locking Ring + Mesh Cable Gland Grip (Light Pack)</i>
LR Black LB Blue LE Red LY Yellow LG Green LS Grey LO Orange
<i>Rubberized Locking Ring + Mesh Cable Gland + Mesh Cable Gland Grip (Silver Pack)</i>
SR Black SB Blue SE Red SY Yellow SG Green SS Grey SO Orange
<i>Rubberized Locking Ring + Dust Cap + Mesh Cable Gland + Mesh Cable Gland Grip (Platinum Pack)</i>
PR Black PB Blue PE Red PY Yellow PG Green PS Grey

Stage Video Application

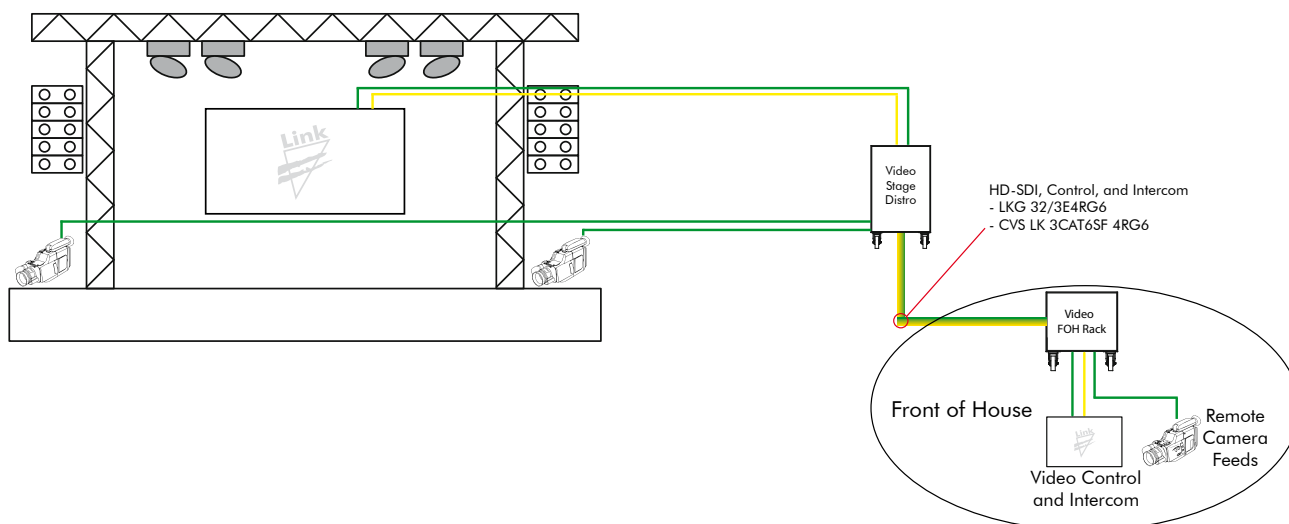

LKS Data Systems

The LKS Data connector introduces the next evolution of LK connectors incorporating integral data transport while maintaining compatibility with all conventional "Socapex" style 19 pin power connectors. Link's innovative coaxial pin design, coupled with our proprietary mounting method, permits the connection of conventional 19 pin 6 circuit power cables into the female panel mount and inline versions of the LKS Data connector. When mated the matching LKS Data male connector, the connector pair not only transports 6 circuits of power but also carries DMX, Gigabit Ethernet, or digital audio. The LKS Data connector also leverages a printed circuit board to provide easy termination of both ground and data contacts.



When coupled with the PDlink smart distribution system and our new CAT5SF 12/14 hybrid **eurocable**, Link provides a complete solution for transporting power and data to lighting and powered speaker systems.

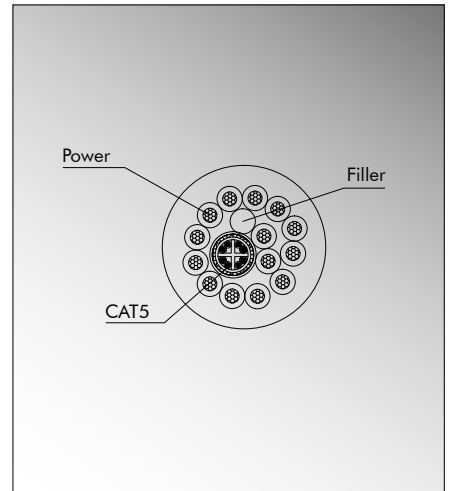

- Screw coupling connector
- Fully compatible with Socapex SL 419 series
- Integrated data transport
- Fast LinkLock backshell
- Easy "blind mating" alignment
- Proprietary pin block and mounting configuration supports 6 circuits of L/N/G contacts plus up to 4 data contacts retaining compatibility with conventional Soca cables
- Gold plated machined pins
- Integrated locking ring set screw
- Plastic insulating sleeve
- Body ground fulfilling UL & NEC requirements
- IP67 rated when mated
- Interchangeable locking rings
- Wide range of cable strain reliefs
- Anti spinning system

Options

- Tulip/retention spring pins
- Long backshell
- Black and colored (blue, red, green, yellow) rubber locking rings
- Male and female connector dust caps

Extensions

When coupled with the PDlink smart distribution system and our new CAT5SF 12/14 hybrid **eurocable**, Link provides a complete solution for transporting power and data to lighting and powered speaker systems.



LKS Data Systems

PDlink Power Distribution

Due to the high grade of customization for all PDlink products, we highlight some standard basic solutions which can be configured and expanded to provide the right answer for your needs.

LKS Data Extensions Ordering Code

Typology	
Power Data Mega	M
Power Data Giga	G

Cable Type	
Hybrid power/data	E
Hybrid power/data flat	F

Accessories	
No accessories	
Dust cap	D

Test	
No test	
PAT test	P

Connector Type (12 pins)	
LKS Data die cast	LKSDD
LKS Data machined	LKSDM

Locking Ring Type	
Black with black rubber locking ring	BB
Black with black metal locking ring	B0

Cable Length	
5	35
10	40
15	45
20	50
25	55
30	60

Packaging	
Velcro strap and cable label	V2
Coil&Carry with handle	VA
Cable label with clear heatshrink	CL

Contact Type	
Retention tulip for female	0
Tulip for female	1

LKS Data Break In/Out Ordering Code

Typology	
Break In Data Giga	BRDGI
Break In Data Mega	BRDMI
Break Out Data Giga	BRDGO
Break Out Data Mega	BRDMO

LKS Data Color	
Black	B
Silver	S
Red	R
Blue	BL
Yellow	Y

Data Type	
Hirose CAT5 with booth	H
EtherCON	E
XLR 3P MV	3M
XLR 3P FV	3F
XLR 5P MV	5M
XLR 5P FV	5F

Length	
6 x 1m	0
6 x 1.5m	1
6 x 2m	2

Power Connectors Type	
PCE CEE 16A IP44	C1
PCE CEE 16A IP67	C2
PowerCON 20A	P2
PowerCON 32A	P3
No connectors	0

Color	
Black	B
Silver	S

Cable Type	
H07RNF 3G2.5 + CAT5	H
Titanex 3G2.5 + CAT5	T

Dust cap	
No	
Yes	D

Packaging	
Velcro strap and cable label	V2
Coil&Carry with handle	VA
Cable label with clear heatshrink	CL

LKS Data Type	
Male die cast with rubber locking ring	DDR
Male die cast with metal locking ring	DDP
Male machined with rubber locking ring	DMR
Male machined with metal locking ring	DMP
Female die cast	DDF
Female machined	DMF

LKS 19 Pin

The LKS range has been designed for professional lighting and power distribution applications. While maintaining full compatibility with Socapex SL 419 series, LKS connectors represent a significant breakthrough in reliability and safety. Based on the LK Series MIL-SPEC designs, these connectors are extremely robust, IP rated and available with impact resistant rubber locking rings.



The **LKS** connectors range represents a real breakthrough in terms of reliability and safety.



UL-CSA

The highest UL-CSA Rating obtained with a rubber insert: UL Recognized for 25A of continuous current (20A CNR). The exclusive rubber silk-screened insert provides for easy and secure pin insertion while maintaining the highest continuous current ratings.

The gold plated contacts with retaining spring pins ensure reliable mating every time.

- Screw coupling connector
- Fully compatible with Socapex SL 419 series
- Ground first contact
- Gold plated machined pins accepting conductors from 1.5 to 4 mm²
- Dual ground rings
- Plastic insulating sleeve
- Body ground fulfilling UL & NEC requirements
- IP67 rated when mated
- Interchangeable locking rings
- Wide range of cable strain reliefs
- Anti spinning system

Options

- Tulip/retention spring pins
- Long backshell (standard in Spider version)
- Integrated locking ring set screw (standard in Spider version)
- Black and colored (blue, red, green, yellow) rubber locking rings
- Male and female connector dust caps
- Fast LinkLock backshell



FAST LINKLOCK BACKSHELL

Secure locks and quickly unlocks with a 1/4 turn every time, time after time. Only available in machined version.



LOCKING SET SCREW

With a captive Helicoil retention system guarantees connector integrity in the harshest touring applications.



LKS 19 PIN SPIDER

The LKS 19 pin spider connector maintains the width of the PG29 and guarantees secure fan out terminations with a highly resistant strain relief.



ANTI-SPINNING SYSTEM

A new internal head design incorporating an innovative keying solution ensures that rubber inserts are secured and will not spin.

LKS 19 Pin

LKS Ordering Code

Version	
Die cast aluminium	D
Machined aluminium	M

Connector Type	
Cable male solder	LMS
Cable male crimp	LMC
Cable female solder retention tulip	LFSR
Cable female solder tulip	LFST
Cable female crimp retention tulip	LFCSR
Cable female crimp tulip	LFCT
Panel male solder	PMS
Panel male crimp	PMC
Panel female solder retention tulip	PFSR
Panel female solder tulip	PFST
Panel female crimp retention tulip	PFCSR
Panel female crimp tulip	PFCT

LKS **D** **LMS** **PA** **M29** **B** **1**

Locking ring	
Without ring	
Aluminium black painted	PA
Aluminium black rubberized	RA
Aluminium colored rubberized	R*
Aluminium black anodized	A
Aluminium colored anodized	**
Long aluminium black painted	LPA
Long aluminium black rubberized	LRA
Long alum. colored rubberized	LR*
Long alum. black anodized	LA
Long alum. colored anodized	L**

Backshell version	
Aluminium PG29	M29
Aluminium PG36	M36
Aluminium PG42	M42
Aluminium long version PG29	L29
Aluminium long version PG36	L36
Aluminium for six way cable relief	MS
Aluminium metric thread M40	M40
Set screw version: add	X

Shell & Backshell version	
Black painted	B
Black anodized	A
Colored anodized	A**

Items subject to Minimum Order Qty

* **B** Blue **R** Red **G** Green **Y** Yellow **GR** Grey

** **B** Blue **R** Red **G** Green **Y** Yellow **S** Silver

Special Version	
No special version	
PCB common ground	CG

Cable relief	
Plastic PG29	1
Plastic PG36	2
Plastic PG42	3
Aluminium (silver) w/ stainless mesh PG29	4S
Aluminium (silver) w/ stainless mesh PG36	5S
Rubber six way x 1,5 mm cable	S1
Rubber six way x 2,5 mm cable	S2
Plastic M40 x 1,5	6
Plastic M40 x 1,5 R	6R

New 1/4 turn lock shell/backshell available on request



Tulip Pins

The conventional 4 blade tulip style provides ample contact surface area for maximum conduction.



Retention Spring Pins

The enhanced spring pin provides the maximum surface area of a conventional tulip pin with the added benefit of a stainless steel spring clip.

Grounding PCB

Grounding PCB ensures a safe and reliable connection to all pins.



Serviceable Plastic Insulating Sleeve

Easily installed or removed once terminations are completed. They provide a reliable insulation between the connector housing and internal conductors.



Durable Backshell

Available in two lengths for ultimate serviceability.



The anodized aluminium version is available in multiple colors (see color table above).

Accessories

Dust cap



For connectors:

LKS 19 TPM with locking ring
LKS 19 TPF without locking ring

Ground ring



LKS GD A

Enables the equipotential connection of the 7 ground contacts.

Rubber locking ring



LKS 32 RA*

For LKS

Items subject to Minimum Order Qty

* **B** Blue **R** Red **G** Green **Y** Yellow **GR** Grey

Robust strain relief



PG29 and PG36 configurations, with two size spider grips for fan in/out. Optional PG42, M40 or mesh cable gland are also available.

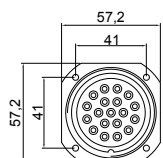

LKS 19
19 pins size 12

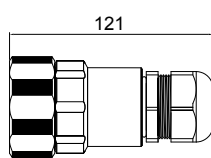

LKS with PG29 backshell

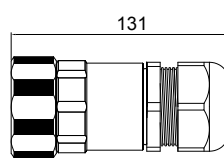

LKS with PG36 backshell

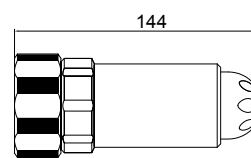

LKS 19 Spider

Multi-Coax Connectors

The LK Multi-Coax connectors are ideal for Broadcast-TV and OB Van applications that require multiple video and signal connections in harsh environments. Based on the LK Series MIL-SPEC designs, these connectors are extremely robust, IP rated, and available with impact resistant rubber locking rings.



The **LKA 40/89** connector is the largest in the coax series and it features 80 pins size 18 for signal transmission, 6 coaxial pins and 3 pins size 12 for power.

- Available in male/female panel and cable versions
- High quality coax contacts (HDTV grade)
- Easy and error-free mating for fast connections
- Audible snap in quick bayonet lock
- Excellent resistance against accidental unlocking caused by shocks and vibrations
- Guaranteed for over 2000 coupling operations
- IP68 rated when mated
- Body made of high quality aluminium with resistant black finishing
- Cable version with easy-grip long metal locking ring
- Roller studs for easier coupling
- PG36 cable strain relief as standard

Options

- Black and colored (blue, red, green, yellow) rubber locking rings
- Male and female connector dust caps



The **LKA 40/58** connector features 46 pins size 18 for signal transmission and 12 coaxial pins.



The **LKA 40/18** connector features 18 coaxial pins.

STANDARD WIRING



LKA 40/18

Cable mounting

Male



LKA 40/18 MV 18 poles
LKA 40/18 MVK plus kellems

Female



LKA 40/18 FV 18 poles
LKA 40/18 FVK plus kellems

Panel mounting

Male



LKA 40/18 MP 18 poles

Female



LKA 40/18 FP 18 poles

Cable mounting with rubber locking ring

Female



LKA 40/18 FV P 18 poles
LKA 40/18 FVK P plus kellems

Accessories

Dust cap



LK 40 TPMN For connectors without locking ring

LKA 40/58

Cable mounting

Male



LKA 40/58 MV 58 poles
LKA 40/58 MVK plus kellems

Female



LKA 40/58 FV 58 poles
LKA 40/58 FVK plus kellems

Panel mounting

Male



LKA 40/58 MP 58 poles

Female



LKA 40/58 FP 58 poles

Cable mounting with rubber locking ring

Female



LKA 40/58 FV P 58 poles
LKA 40/58 FVK P plus kellems

Dust cap



LK 40 TPFN For connectors with locking ring

LKA 40/89

Cable mounting

Male



LKA 40/89 MV 89 poles
LKA 40/89 MVK plus kellems

Female



LKA 40/89 FV 89 poles
LKA 40/89 FVK plus kellems

Panel mounting

Male



LKA 40/89 MP 89 poles

Female



LKA 40/89 FP 89 poles

Cable mounting with rubber locking ring

Female



LKA 40/89 FV P 89 poles
LKA 40/89 FVK P plus kellems

Rubber locking ring



LK 40 RL** For Coax connectors
Items subject to Minimum Order Qty

** **B** Blue **R** Red **G** Green **Y** Yellow

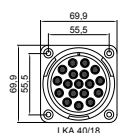

Size 40

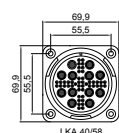

Size 40

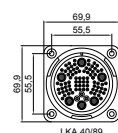

Size 40

Hermaphrodite Connectors

The LK 176 series of connectors is directly compatible with the Whirlwind W4 series. Based on the LK range high quality manufacturing, these connectors are extremely robust, IP rated.

- 176 pins hermaphrodite insert in panel and cable versions
- Intermatable with MASS series connectors
- Screw coupling connector
- IP68 rated when mated
- PG36 cable strain relief as standard
- Heavy duty machined metal shell made of high quality aluminium with highly resistant black finishing

Options

- Male and female connector dust caps
- Mesh cable relief



W Style Connectors

The LK 39 and LK 61 are directly compatible with the Whirlwind W1 and W2 connectors respectively. Based on the LK range high quality manufacturing, these connectors are extremely robust, IP rated.

- 39 or 61 gold plated solder pins
- Based on military specifications MIL-26482
- Easy and error-free mating for fast connections
- Audible snap in quick bayonet lock
- Excellent resistance against accidental unlocking caused by shocks and vibrations
- Guaranteed for over 2000 coupling operations
- IP68 rated when mated
- Body made of high quality aluminium with resistant black finishing
- Cable version with easy-grip long metal locking ring
- Cable strain relief as standard

Options

- Male and female connector dust caps
- Mesh cable relief



STANDARD WIRING

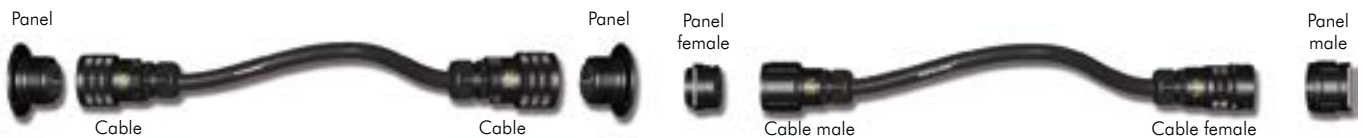

Hermaphrodite Connector

Panel mounting



LKI M176 PS

with pins

Cable mounting



LKI M176 VS

with pins

W Style Connectors

39 pins

Cable mounting

Male



LKW 39LM 39P with pins and skin top
LKW 39LM D plus dust cap
LKW 39LM DK plus kellems

Panel mounting

Male



LKW 39PM 39P with pins
LKW 39PM D plus dust cap

Female



LKW 39LF 39P with pins and skin top
LKW 39LF D plus dust cap
LKW 39LF DK plus kellems

Female



LKW 39PF 39P with pins
LKW 39PF D plus dust cap

Accessories

Dust cap



For connectors with locking ring
LKW MDC39 For LKW 39
LKW MDC61 For LKW 61
LKI M176 TPV For cable connector

Dust cap



For connectors without locking ring
LKW FDC39 For LKW 39
LKW FDC61 For LKW 61
LKI M176 TPP For panel connector

61 pins

Cable mounting

Male



LKW 61LM 61P with pins and skin top
LKW 61LM D plus dust cap
LKW 61LM DK plus kellems

Panel mounting

Male



LKW 61PM 61P with pins
LKW 61PM D plus dust cap

Female



LKW 61LF 61P with pins and skin top
LKW 61LF D plus dust cap
LKW 61LF DK plus kellems

Female



LKW 61PF 61P with pins
LKW 61PF D plus dust cap

Mesh cable gland

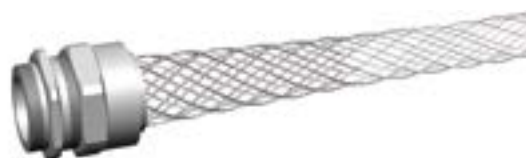

MCG PG2111 For LKW 39-61 (cable O.D. from 14.30 mm to 17.40 mm)
MCG PG2114 For LKW 39-61 (cable O.D. from 19.10 mm to 22.20 mm)
MCG PG3618 For LKI M176 (cable O.D. from 25.40 mm to 28.60 mm)
MCG PG3620 For LKI M176 (cable O.D. from 28.60 mm to 31.80 mm)

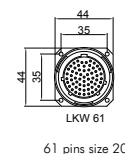
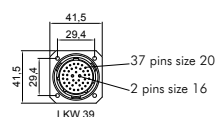
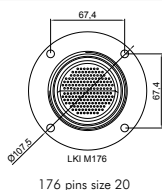





LKH Head to Ballast Connectors

The LKH series of connectors was originally designed to support head to ballast connections for most manufacturers of film and broadcast luminaires (Arri, Desisti, LTM, Mole-Richardson). LKH configurations are ideal for compact power + control connections up to 80A.



- Cable version with easy-grip long metal locking ring
- Roller studs for easier coupling
- Body made of high quality aluminium with resistant black finishing
- Front and rear panel mounting available
- IP68 rated when mated
- First in/last out ground contacts
- Shell grounding
- Silver plated solder or crimp contacts
- Machined backshells
- Suitable to fit various cable overall diameters
- Color code identification
- 400 W to 20kW range
- Cable strain relief as standard

UL listed insert			
Item			
LKH 24-2			
LKH 28-22			
LKH 28A-9			



Options

- Black and colored (blue, red, green, yellow) rubber locking rings
- Male and female connector dust caps

EXAMPLE	
Photo	Item
	LKH 26-24-2-PSSW-00PG
	LKH 01-24-2-SSSO-P21PG
	LKH 06-24-11-PSSO-P21BG
	LKH 02-24-11-SSSO-00PG

Accessories

Dust cap



For male and female connectors

Rubber locking ring



Items subject to Minimum Order Qty

- ** B R G Y
Blue Red Green Yellow

Ground pin



See connectors ordering code table

Special Version

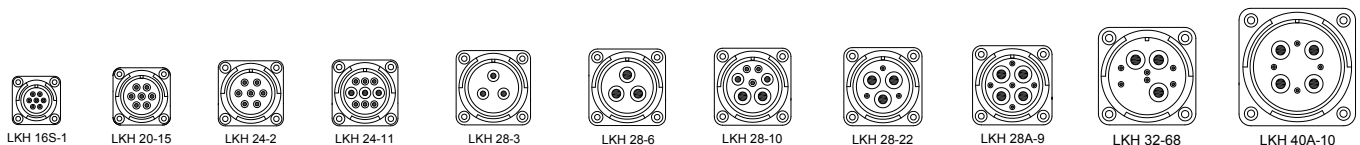

LKH Head to Ballast Connectors

LKH Connectors ordering code

Connector Type		LKH <input type="text"/> - <input type="text"/> - <input type="text"/> <input type="text"/> <input type="text"/> - <input type="text"/> <input type="text"/> <input type="text"/> <input type="text"/> <input type="text"/>									
Cable mount without locking ring	01										
Panel without locking ring	02										
Cable mount with locking ring	06										
Panel with locking ring	26										
Arrangement		Shell/contact version		Backshell		Cable relief		Special version		Body ground	
16S-1		Female/Female	S	No	0	No	0	Assigned by Link		No	0
20-15		Male/Male	P	Black aluminium	P	PG11	11			Yes	G
24-2		Female/Male	SP			PG13.5	13	Shell*/locking ring			
24-11		Male/Female	PS			PG16	16	Hard black locking ring		H	
28A-9						PG21	21	Black aluminium shell for 01 and 02 connector type		P	
28-10						PG29	29	Black aluminium shell for 06 and 26 connector type		P	
28-22						PG36	36	Black aluminium shell with black rubber locking ring		B	
28-3						PG11 with spring	11S	Black aluminium shell with blue rubber locking ring		Bl	
28-6						PG13.5 with spring	13S	Black aluminium shell with green rubber locking ring		G	
32-68						PG16 with spring	16S	Black aluminium shell with red rubber locking ring		R	
40A-10						PG21 with spring	21S	Black aluminium shell with yellow rubber locking ring		Y	
		Pins version									
		No	0								
		Gold	G								
		Silver	S								
		Pins Type									
		No	0								
		Crimp	C								
		Solder	S								
		PCB	P								
		Screw	V								

Insert rotation	Arrangement										
	16S-1	20-15	24-2	24-11	28-3	28-6	28A-9	28-10	28-22	32-68	40A-10
W	80	80	80	35	70	70	110	80	70	65	65
X	-	-	-	110	145	145	250	110	145	135	125
Y	-	-	-	250	215	215	260	250	215	225	225
Z	280	280	280	325	290	290	280	280	290	275	310

LKH Contacts ordering code

Size		LK P <input type="text"/> <input type="text"/> <input type="text"/> <input type="text"/> <input type="text"/>									
00											
04											
08											
12											
16											
18											
20											
		Version		Type		Special version		Max wire size for crimp			
		Female	S	Crimp	C	Extended (ground)		mm ² ...		E	
		Male	P	Solder	S	Protected				P	
				PCB	P						
				Screw	V						
		Treatment									
		Gold	G								
		Silver	S								

Pins size	Type and quantity of contacts by connector										
	16S-1	20-15	24-2	24-11	28-3	28-6	28A-9	28-10	28-22	32-68	40A-10
4						3	4	2	3	3	4
8				3	3			2			
12		7	7	6				3			
16	7						5		3	6	4
Total	7	7	7	9	3	3	9	7	6	9	8

P (Watt)	Arrangement by manufacturer								
	Arri	De Sisti	Strand	CMC	Mole	Lee	LTM	Sunray	
575	24-2W	24-2Z	24-2Z	24-2Z	24-2Z	16S-1	20-15	24-2Z	
1.200	24-2W	24-2W	24-2W	24-2W	24-2W	20-15	20-15	24-2W	
2.500	24-2	24-2	24-2	24-2	24-2	20-15	24-2	24-2	
4.000	24-2	24-11	24-11	24-11	24-2	24-11X	24-11	24-11	
6.000	28-22 (2)	32-68	32-68	32-68	28A-9 (1)	24-11	28A-9 (1)	28A-9 (1)	
12.000	28A-9 (2)	32-68	40A-10	28-10	40A-10	24-11	28A-9 (2)	28-10	
18.000	28A-9 (2)	32-68	40A-10	28-10	40A-10		28A-9 (2)	28-10	

(1) Male pins on connector with locking ring - (2) Female pins on connector with locking ring

LKR Chain Motor Connectors

With the addition of the standard P7 and P14 chain motor fly cable connectors, Link is maintaining the basic principle of strength and reliability of the military connectors. The restyling and construction of this range have been specifically studied to meet the needs of the entertainment industry. LKR configurations and their wiring standards, well established in the market, allow easy connection with all existing cable assemblies, chain motors, and controllers.



LKR P7: M32 plastic spring skin top as standard for cable connectors.



LKR P14: M32 plastic spring skin top as standard for cable connectors.

- 7 or 14 pins in male/female panel and cable versions
- Excellent resistance against accidental unlocking caused by shocks and vibrations
- Audible snap in quick bayonet lock
- Guaranteed for over 2000 coupling operations
- IP68 rated when mated
- Body made of high quality aluminium with resistant black finishing
- Cable version with easy-grip long metal locking ring
- Roller studs for easier coupling
- M32 cable strain relief as standard

Options

- Black and colored (blue, red, green, yellow) rubber locking rings
- Male and female connector dust caps
- Size 16 silver pins
- Solder or crimp pins
- PG16 and PG21 cable relief with locknut or anti-bending spring



Rubber locking ring available

STANDARD WIRING



LKR P7 Connectors

LKR P14 Connectors

(pins are to be ordered separately)

Cable mounting

Male



LKR P7 MV 7 poles

Panel mounting

Male



LKR P7 MP 7 poles

Female



LKR P7 FV 7 poles

Female



LKR P7 FP 7 poles

Cable mounting with rubber locking ring

Male



LKR P7 MV P 7 poles

Cable mounting

Male



LKR P14 MV 14 poles

Panel mounting

Male



LKR P14 MP 14 poles

Female



LKR P14 FV 14 poles

Female



LKR P14 FP 14 poles

Cable mounting with rubber locking ring

Male



LKR P14 MV P 14 poles

Pins

Male



Crimp version

LK P12 PGC1,5 1.5 mm² LKR P7
LK P12 PGC03A 4 mm² LKR P7
LK PMD LKR P14

Solder version

LK P12 PGS LKR P7
LK PMD S LKR P14

Gold for:

Female



Crimp version

LK P12 SGC1,5T 1.5 mm² LKR P7
LK P12 SGC03AT 4 mm² LKR P7
LK PFD T LKR P14

Solder version

LK P12 SGST LKR P7
LK PFD T S LKR P14

Gold for:

Accessories

Dust cap



LK 20 TPMN For connectors without locking ring
LK 20 TPFN For connectors with locking ring

Rubber locking ring



LK 20 RL ** For LK P7/P14
Items subject to Minimum Order Qty
** **B** Blue **R** Red **G** Green **Y** Yellow

Robust strain relief



M32 plastic spring standard configuration. PG16 and PG21 are available on request and subject to minimum order quantity. Mesh cable gland available.

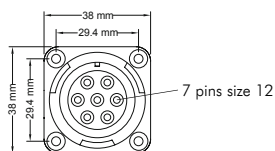

LKR P7
Size 20

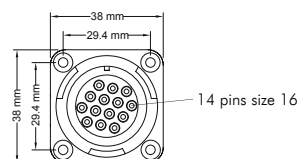

LKR P14
Size 20

Power Link

The Power Link single pole connector series is designed for power distribution systems, offering the ultimate features in safety and reliability under the most severe operating conditions.

Typical applications for Power Link include three/phase motors, generators, load banks and lighting distributions panels. Power Link connectors are also suitable for utility companies and heavy industry environments. Power Link connectors are designed and tested to comply with European and US electrical safety standards and specifications. They are available in 400A and 660A versions.



CE



The Power Link connector series has permanent integral keys which prevent the accidental connection of dissimilar types (e.g. Earth and line 1).

Each connector type has a unique keyed position. Visual identifications are easily made by means of the color insulator.



LARGER O.D. CABLE

Originally designed for PG29 cable relief, now enhanced to use M40 version to expand the range of cables accepted.



The drain protected connector features a patented double protection to prevent accidental touch of the drain contact under load. The drain contact must be unlocked supplying uniform pressure on the entire Teon part (by means of the female connector).

- Secondary locking pin to prevent accidental disconnection
- Glass filled nylon insulators and insulated nylon tip on live contact to prevent injuries to operator
- High degree of insulation with maximum resistance to oil, fuel acids and water
- 23 springs contact element granting minimum insertion force and guarantees multiple points of contact, ensuring minimal power loss.
- IP67 rated when mated
- 400A or 660A drain/source panel and line versions
- M40 or PG29 cable strain relief
- Screw or crimp contacts

Options

- Crimp contacts
- Protected male version
- Without secondary locking pin



METRIC VERSION

Backshell with integral handgrip, enabling comfortable grip.



Exclusive locking system, featuring the connection of the protected contact purely on metal parts.

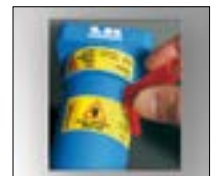

The secondary locking pin can be unlocked through the Pin Key using only one hand.

Power Link



POWER Link

How to order Connectors

Max Current Rating	
400A	
660A	6

Type	
Line Drain	LD
Line Source	LS
Panel Drain	PD
Panel Source	PS



Male Protected Version	
Standard Version	
Male Protected Version	P

Key	
Phase 1	1
Phase 2	2
Phase 3	3
Ground	E
Neutral	N



Colors	
Brown	BN
Black	BK
Grey	GR
Green	GN
Blue	BL
Red	R
White	W

Locking Pin (only for Drain type)	
Without secondary locking pin	
With secondary locking pin	L

Cable Grip		
PG29		
M40x1.5 19-28mm		RMN
M40x1.5 10-23mm		RMR
M40x1.5 22-32mm		RML

Contact Type	
Screw Type	1
Crimp contact 35-50mm ²	2
Crimp contact 70-95mm ²	3
Crimp contact 120-150mm ²	E
Crimp contact up to 300mm ²	N

Technical data		
Max current Rating	400A	660A
Minimum Flashover	9.5 kV dc or ac	9.5 kV dc or ac
Maximum Rated Voltage to Earth	2 kV ac/3 kV dc	2 kV ac/3 kV dc
Operating Voltage	600 Vac	600 Vac
Operating Temperature	-30 to 125 C°	-30 to 125 C°
Insulation Resistance	>5 M Ω/500 Vdc	>5 M Ω/500 Vdc
AWG/mm ²	2-4/0 33.6-107.2	6/0 170.3
Threaded M12 Torque Maximum	12.0 Nm	12.0 Nm
IP Rating (mated condition)	IP 67	IP 67
Operating Cycles	500 minimum	500 minimum

	GROUND	NEUTRAL	LINE 1	LINE 2	LINE 3
	KEY 1	KEY 2	KEY 3	KEY 4	KEY 5
EUROPE HD 308 S2	GN	BL	BN	BK	GR
U.S.A.	GN	W	BK	R	BL

Accessories

Pin key



LK PL KEY Pin Key

Dust cap



LK PL TPD** Drain
LK PL TPS** Source

Only available for EU HD 308 S2 version
** **1BN** **2BK** **3GR** **EGN** **NBL**
Brown Black Grey Green Blue

Spare parts



LK PL LOCK Drive pin **LK PL R*** Compression sleeve

*35	(35mm ²)
*50	(50mm ²)
*70	(70mm ²)
*95	(95mm ²)
*120	(120mm ²)

LK Tools

LK CRIMP

The crimp contact option for the LKA, LKS and LKH range of connectors, allows large assembly time savings, and gives a perfect, reliable and durable connection with the use of LK CRIMP or LK CRIMP PN with Turret tools (LK TR).

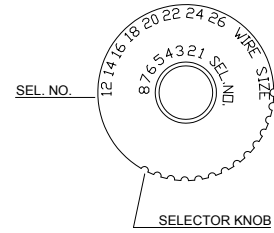

LK CRIMP

Crimping tool for LKA-LKS-LKH

LK CRIMP PN

Pneumatic crimping tool for LKA-LKS-LKH

Contact Size	AWG 26	AWG 24	AWG 16	AWG 14	AWG 12	Wire Size
20	1	2				Sel. No.
18	1	2				
16	1	2				
12			6	7	8	

POSITIONER

Every pin size has its own positioner (LK PS.), to be mounted on the universal turret LK TR. The mounting position is selected following the female or male contact type.



LK PS LKS

Positioner for LKS pins

LK PS 12

Positioner for pins size 12 LKH

LK PS 16

Positioner for pins size 16 LKA 13-85

LK PS 18

Positioner for pins size 18 LK 150

LK PS 20

Positioner for pins size 20 LK 200

TURRET

The turret, fitted on the LK CRIMP, allows the positioner's assembly.



LK TR

Turret

DRIVE PIN

Female contacts may be inserted with the aid of the plug LK SP (12, 12 LKS, 16, 18 or 20) as shown in the drawing.



LK SP LKS

Drive pin for LKS

LK SP 12

Drive pin size 12 for LKH

LK SP 16

Drive pin size 16 for LKA 13-85

LK SP 18

Drive pin size 18 for LK 150

LK SP 20

Drive pin size 20 for LK 200

LK SPCATM

Male drive pin for Gigabit contacts

LK SPCATF

Female drive pin for Gigabit contacts

INSERTER

The insertion of contacts is made by the inserter LK INS (12, 16, 18 or 20 following the contact size). For easier contact insertion use an alcohol lubricant.



LK INS12

Inserter for pin size 12 (LKS-LKH)

LK INS16

Inserter for pin size 16 (LK 13-85 poles)

LK INS18

Inserter for pin size 18-20 (LK 150-200 poles)

LK INS/CAT

Inserter for Gigabit contacts



LK Tools

DUMMY

Dummy range is available for the assembly of the LK connector back shells. Dummy tools can be fixed to a panel or gripped in a vice: lock the back shell in place by means of the LK K BK key. Once the LK K has been fixed to the panel or to the vice, place the connector for assembly in the mating position. Next, screw the back shell firmly into place with the LK K BK key. This allows to screw the backshell at best, avoiding unscrewing during operations.



LK K 20	Dummy for size 20 (13 poles)
LK K 20LR	Dummy for size 20 (13 poles with locking ring)
LK K 24	Dummy for size 24 (25 poles)
LK K 24LR	Dummy for size 24 (25 poles with locking ring)
LK K 28	Dummy for size 28 (37 poles)
LK K 28LR	Dummy for size 28 (37 poles with locking ring)
LK K 32	Dummy for size 32 (54 poles)
LK K 32LR	Dummy for size 32 (54 poles with locking ring)
LK K 40	Dummy for size 40 (85/150/200 poles)
LK K 40LR	Dummy for size 40 (85/150/200 poles with locking ring)

EJECTOR HANDLE

To extract the contacts the use of LK EX MNUNIV ejector is required; it contains the metal points suitable for the different sizes (LK EX..), both for female and male contacts.



LK EX MNUNIV Handle

The handle on which the ejector points are screwed on. This unit also contains them internally by opening the rear lid.

EJECTOR

The main contacts used in the LK range can be contained inside the LK EX MNUNIV and must be screwed into the front part of the Handle.



LK EX12F	Female size 12 LKS
LK EX12F R	Female size 12 LKH and Speaker Connectors
LK EX12M	Male size 12 LKS
LK EX12M R	Male size 12 LKH and Speaker Connectors
LK EX16F	Female size 16 for connector LK
LK EX16M	Male size 16 for connector LK
LK EX18F	Female size 18 for connector LK
LK EX18M	Male size 18 for connector LK
LK EX20F	Female size 20 for connector LK
LK EX20M	Male size 20 for connector LK
LK EX/CAT M	Male for Gigabit contacts
LK EX/CAT F	Female for Gigabit contacts

LK K BK KEY



LK K BK/KIT LK tighten tool-strap wrench-set of two

Recommended Tightening Torque

Shell/Backshell		
Shell Size	Coupling Torque Maximum (Nm)	Uncoupling Torque Minimum (Nm)
16S	2.71	0.45
18	3.16	0.56
20	3.61	0.68
22	4.06	0.78
24	4.96	0.78
28	5.88	0.90
32	7.35	1.01
40	8.34	1.47

PG & METRIC THREAD	Torque Backshell/Clamp (Nm)	Torque for cap nut (Nm)
PG11	3.75	2.50
PG13.5	3.75	2.50
PG16	5.00	3.30
PG21	7.50	5.00
PG29	7.50	5.00
PG36	7.50	5.00
PG42	7.50	5.00
M40 x 1.5	13.00	13.00



Cable Relief

SKIN TOP • Cable Clamp

The use of SKIN TOP cable clamps, which are important accessories in the industrial field, allows perfect connection of any cable to all types of equipment, ensuring perfect functioning. They are mostly used in the audio-lighting environment, as cable clamps for multipin connectors and cable entries in various types of boxes, e.g. stageboxes. SKIN TOP cable clamps allow easy and quick installation. The new trapezoid shaped multiple thread allows rapid tightening. The IP 68 watertight cable clamp is mounted on the tightening nut, ensuring a firm grip with no traction and no loosening risk.



SKIN TOP WITH SPRING

Cable clamp with anti-bend spiral, range from PG 11 to PG 21. It provides additional safety to the cable preventing it to be curved over its bend radius. Black (RAL 9005). Water-tightness degree IP 68.

METAL SKIN TOP

Available on request, nickel-plated brass cable clamp for heavy-duty applications. With all the advantages of the Skin Top range. Water-tightness degree IP 68. Range from PG 11 to PG 36.



Cable O.D.	
From 5 to 10 mm	PG11
From 6 to 12 mm	PG13,5
From 10 to 14 mm	PG16
From 13 to 18 mm	PG21
From 14 to 25 mm	PG29

SK TOP PM13	PG11 for cables 5-10 mm
SK TOP PM19	PG13,5 for cables 6-12 mm
SK TOP PM35	PG16 for cables 10-14 mm
SK TOP PM54	PG21 for cables 13-18 mm

SK TOP MN13	PG11 for cables 5-10 mm
SK TOP MN19	PG13,5 for cables 6-12 mm
SK TOP MN35	PG16 for cables 10-14 mm
SK TOP MN54	PG21 for cables 13-18 mm
SK TOP MN85	PG29 for cables 14-25 mm
SK TOP MN150	PG36 for cables 22-32 mm

SKIN TOP

SK TOP PN13	PG11 for cables 5-10 mm
SK TOP PN19	PG13,5 for cables 6-12 mm
SK TOP PN35	PG16 for cables 10-14 mm
SK TOP PN54	PG21 for cables 13-18 mm
SK TOP PN85	PG29 for cables 14-25 mm
SK TOP PN150	PG36 for cables 22-32 mm

METAL NUT

SK TOP MD13	For SK TOP MN 13
SK TOP MD19	For SK TOP MN 19
SK TOP MD35	For SK TOP MN 35
SK TOP MD54	For SK TOP MN 54
SK TOP MD85	For SK TOP MN 85
SK TOP MD150	For SK TOP MN 150

PLASTIC NUT

SK TOP PD13	For SKINTOP PG11
SK TOP PD19	For SKINTOP PG13.5
SK TOP PD35	For SKINTOP PG16
SK TOP PD54	For SKINTOP PG21
SK TOP PD85	For SKINTOP PG29
SK TOP PD150	For SKINTOP PG36

When Skin tops are used for panel mount, a nut (plastic or metal) will be required

Mesh cable gland & grip

The MCG grips series features a patented swivel design that provides superior cable pull-out protection. This unique design virtually eliminates premature mesh fatigue thereby maximizing both cable and connection life so that downtime and costs are greatly reduced. This is the only swivel grip for extreme flexing applications that is specified by industry experts to meet their flexing requirements.

MESH CABLE GLAND

MCG PG1108	Mesh cable gland PG11 - Cable OD from 11.10 mm to 12.70 mm
MCG PG1609	Mesh cable gland PG16 - Cable OD from 11.10 mm to 14.30 mm
MCG PG1611	Mesh cable gland PG16 - Cable OD from 14.30 mm to 17.40 mm
MCG PG2111	Mesh cable gland PG21 - Cable OD from 14.30 mm to 17.40 mm
MCG PG2114	Mesh cable gland PG21 - Cable OD from 19.10 mm to 22.20 mm
MCG PG2914	Mesh cable gland PG29 - Cable OD from 19.10 mm to 22.20 mm
MCG PG2916	Mesh cable gland PG29 - Cable OD from 22.20 mm to 25.40 mm
MCG PG2918	Mesh cable gland PG29 - Cable OD from 25.40 mm to 28.60 mm
MCG PG2920	Mesh cable gland PG29 - Cable OD from 28.60 mm to 31.80 mm
MCG PG3618	Mesh cable gland PG36 - Cable OD from 25.40 mm to 28.60 mm
MCG PG3620	Mesh cable gland PG36 - Cable OD from 28.60 mm to 31.80 mm



MESH CABLE GRIP

MCG SE013	Mesh cable grip - Cable OD from 12.70 mm to 13.20 mm
MCG SE014	Mesh cable grip - Cable OD from 16.00 mm to 18.80 mm
MCG SE015	Mesh cable grip - Cable OD from 19.10 mm to 22.90 mm
MCG SE016	Mesh cable grip - Cable OD from 25.40 mm to 31.50 mm
MCG SE017	Mesh cable grip - Cable OD from 31.80 mm to 37.80 mm

Dimensional Data

Cable Dimension to be used with PG or Metric Glands

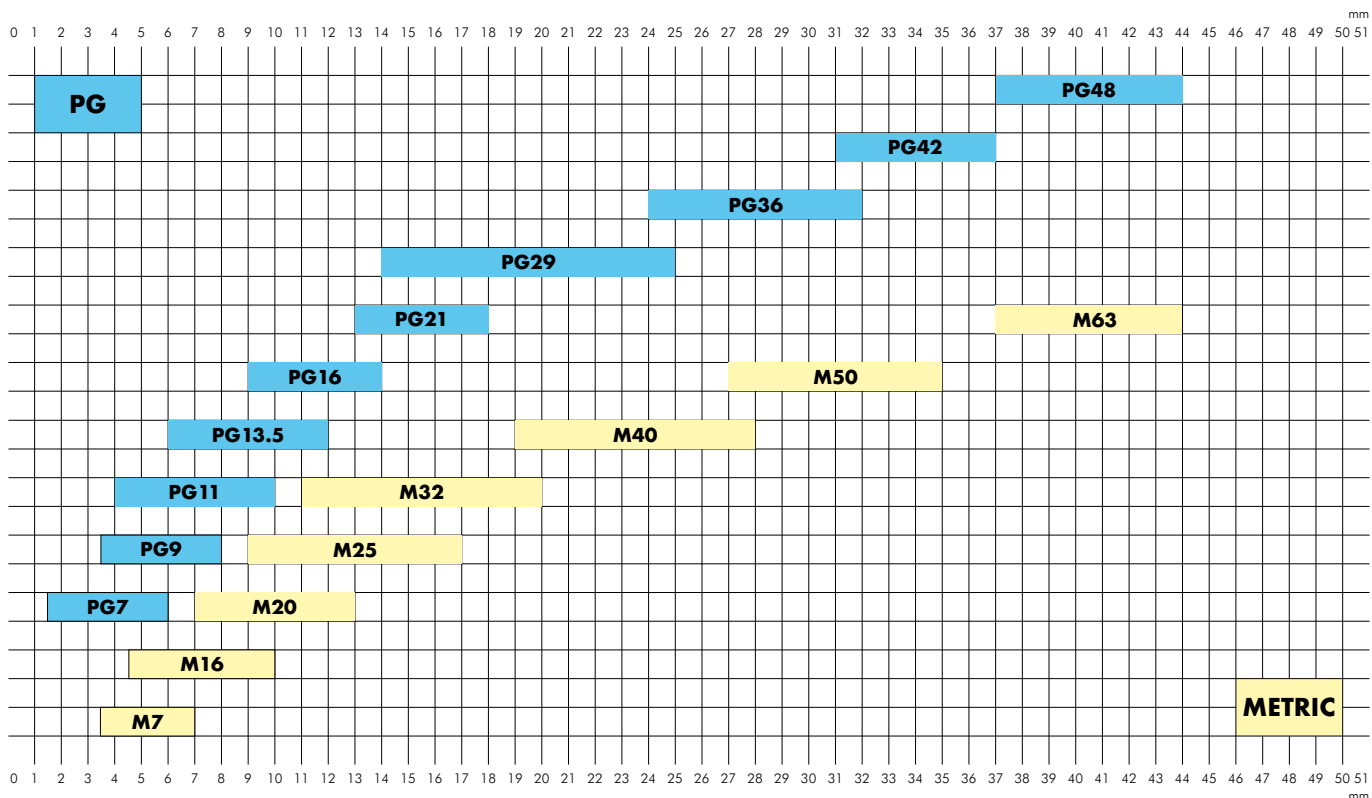

Dimensional Data

Size	No. Pins	L1 mm	L2 mm 03 rear mount.	L3 mm	L4 mm	L5 mm	D1 mm	D2 mm	D3 mm
20	13	33.8	23	4	38	29.4	34.2	28.5	3.2
24	25	33.8	23	4	44.5	34.9	40.9	35.3	3.7
28	37	35.7	24	4	50.8	39.7	46.7	41.4	3.7
32	54	37.3	24	4	57	44.5	53.4	47.8	4.3
40	85/150/200	37.2	24	4	69.9	55.5	65.2	59	4.3

Size	No. Poles LKA	L1 mm	L3 mm	L4 mm	L5 mm	D1 mm	D3 mm
20	13	38.6	4	38	29.4	42.5	3.2
24	25	41	4	44.5	34.9	50	3.7
28	37	41.8	4	50.8	39.7	57	3.7
32	54	44	4	57	44.5	64	4.3
40	85/150/200	45	4	69.9	55.5	75.5	4.3

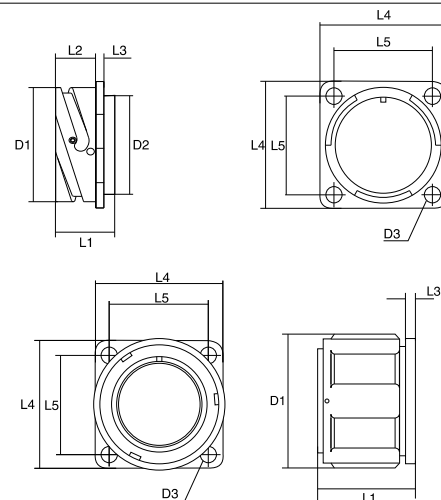

Pins

Contact Size	Max Current (Short time)	Rated and Test Current	Potential Drop Maximum	Used on Connectors:
20	7.5A	7.5A	83mV	LK 200; LKW M176, 39, 61
18	10A	7.5A	83mV	LK 150, 40/89
16	22A	13A	74mV	LK 09, 13, 19, 25, 37, 54, 85; LKW 39; LKH 165-1, 28A-9, 28-22, 32-68, 40A-10
12	41A	23A	63mV	LK 08, 09, 48/6, 32/25, 40/58, 40/89; LKH 20-15, 24-2, 24-11, 28-10
8	73A	46A	65mV	LKH 24-11, 28-3, 28-10
4	135A	80A	58mV	LKH 28-6, 28A-9, 28-10, 28-22, 32-68, 40A10
0	245A	150A	53mV	

Standard Wiring

4 ch - LK 13			
Ch	+	-	G
1	B	C	E
2	F	K	H
3	J	D	A
4	N	M	G
General ground			L

6 ch - LK 19			
Ch	+	-	G
1	B	C	A
2	E	F	D
3	H	J	G
4	L	M	K
5	P	R	N
6	T	U	S
General ground			V

8 ch - LK 25			
Ch	+	-	G
1	A	E	F
2	G	C	B
3	D	H	J
4	M	L	K
5	Q	P	N
6	W	S	R
7	T	X	Y
8	Z	V	U
General ground			a

12 ch - LK 37			
Ch	+	-	G
1	E	F	A
2	B	C	G
3	H	J	D
4	S	T	K
5	L	M	U
6	V	W	N
7	P	R	X
8	a	b	g
9	c	d	i
10	e	f	m
11	n	p	h
12	r	s	k
General ground			Z

16 ch - LK 54			
Ch	+	-	G
1	W	f	r
2	J	R	a
3	k	v	AC
4	E	M	V
5	e	q	y
6	B	H	P
7	Z	j	u
8	D	L	U
9	d	p	x
10	A	G	O
11	Y	h	t
12	C	K	T
13	c	n	w
14	F	N	X
15	g	s	AB
16	S	b	m
General ground			AG

28 ch - LK 85			
Ch	+	-	G
1	A	B	C
2	E	F	H
3	J	K	L
4	N	P	R
5	S	T	U
6	X	Y	Z
7	a	b	c
8	d	f	g
9	h	i	j
10	k	m	n
11	p	q	r
12	t	u	v
13	w	x	y
14	z	AA	AB
15	AC	AD	AE
16	AF	AH	AJ
17	AK	AL	AM
18	AP	AR	AS
19	AT	AU	AV
20	AW	AX	AY
21	AZ	BA	BB
22	BC	BD	BE
23	BJ	BK	BL
24	BM	BN	BP
25	BS	BT	BU
26	BV	BR	BF
27	BH	AN	s
28	W	M	D
General ground			V

48 ch - LK 150			
Ch	+	-	G
1	1	2	3
2	5	6	7
3	8	9	10
4	11	12	13
5	14	15	16
6	17	18	19
7	21	22	23
8	24	25	26
9	27	28	29
10	20	30	31
11	32	33	34
12	35	36	37
13	38	39	40
14	41	42	43
15	44	45	46
16	47	48	49
17	50	51	52
18	53	54	55
19	57	58	59
20	60	61	62
21	63	64	65
22	66	67	68
23	69	70	71
24	72	73	74
25	75	76	77
26	78	79	80
27	82	83	84
28	85	86	87
29	88	89	90
30	91	92	93
31	94	95	96
32	97	98	99
33	100	101	102
34	103	104	105
35	56	81	106
36	107	108	109
37	110	111	112
38	113	114	115
39	116	117	118
40	119	120	121
41	122	123	124
42	125	126	127
43	139	128	129
44	130	131	132
45	133	134	135
46	136	137	138
47	140	141	142
48	143	144	145
General ground			150

66 ch - LK 200			
Ch	+	-	G
1	A1	A2	A3
2	A4	A5	A6
3	B8	C10	C11
4	B7	B6	B5
5	B4	B3	B2
6	B1	C2	C1
7	C3	C4	C5
8	C7	C8	C9
9	D12	D11	D10
10	D9	D8	D7
11	D6	D5	D4
12	D3	D2	D1
13	F1	E1	E2
14	E3	E4	E5
15	E6	E7	E8
16	E9	E10	E11
17	E12	E13	F14
18	F13	F12	F11
19	F10	F9	F8
20	F7	F6	F5
21	F4	F3	F2
22	G1	G2	G3
23	G4	G5	G6
24	G7	G8	G9
25	G10	G11	G12
26	G13	G14	G15
27	H14	H13	H12
28	H11	H10	H9
29	H6	H5	H4
30	H3	H2	H1
31	L1	L2	L3
32	L4	L5	L6
33	H7	L7	M7
34	H8	L8	M8
35	L9	L10	L11
36	L12	L13	L14
37	M14	M13	M12
38	M11	M10	M9
39	M6	M5	M4
40	M3	M2	M1
41	N1	N2	N3
42	N4	N5	N6
43	N7	N8	N9
44	N10	N11	N12
45	N13	N14	N15
46	P13	P12	P11
47	P10	P9	P8
48	P7	P6	P5
49	P4	P3	P2
50	P1	R1	R2
51	R3	R4	R5
52	R6	R7	R8
53	R9	R10	R11
54	R12	R13	P14
55	S12	S11	S10
56	S9	S8	S7
57	S6	S5	S4
58	S3	S2	S1
59	T1	T2	U1
60	T3	T4	T5
61	T7	T8	T9
62	T11	T10	U8
63	U7	U6	U5
64	U4	U3	U2
65	V1	V2	V3
66	V4	V5	V6
General ground			T6

Standard Wiring

Speaker - LK 08		
Ch	Red (+)	Black (-)
1	E	F
2	G	H
3	C	D
4	A	B

Speaker - LK 32/25		
Ch	Red (+)	Black (-)
1	A	B
2	C	D
3	E	F
4	G	H
5	I	J
6	K	L
7	M	N
8	O	P
9	Q	R
10	T	U
11	V	W
12	X	Y

Speaker - LK 48/6			
Ch	Red (+)	Black(-)	Ground
1	1	2	
2	3	4	
3	5	6	
4	7	8	
5	9	10	
6	11	12	
7	13	14	
8	15	16	
9	17	18	
10	19	20	
11	21	22	
12	23	24	
13	25	26	
14	27	28	
15	29	30	
16	31	32	
17	33	34	
18	35	36	
19	37	38	
20	39	40	
21	41	42	
22	43	44	
23	45	46	
24	47	48	
Audio1	A	B	C
Audio2	D	E	F

LKG 20/1E3								
Power	Brown	Yellow Green	Blue					
	L	G	N					
CAT6	White Orange	Orange	White Green	Blue	White Blue	Green	White Brown	Brown
E1	1	2	3	4	5	6	7	8

LKG 24/2E6								
Audio ch	+	-	G					
1	1	2	3					
2	4	5	6					
CAT6	White Orange	Orange	White Green	Blue	White Blue	Green	White Brown	Brown
E1	1	2	3	4	5	6	7	8
E2	1	2	3	4	5	6	7	8

LKG 24/2E10								
Audio ch	+	-	G					
1	1	2	5					
2	3	4	6					
Power	Brown	Yellow Green	Blue	Shield				
	L	G	N	7				
CAT6	White Orange	Orange	White Green	Blue	White Blue	Green	White Brown	Brown
E1	1	2	3	4	5	6	7	8
E2	1	2	3	4	5	6	7	8

LKG 24/2E20								
Audio ch	+	-	G					
1	1	2	3					
2	4	5	6					
3	13	14	15					
4	7	8	9					
5	10	11	12					
6	16	17	18					
CAT6	White Orange	Orange	White Green	Blue	White Blue	Green	White Brown	Brown
E1	1	2	3	4	5	6	7	8
E2	1	2	3	4	5	6	7	8

LKG 28/2E36								
Audio ch	+	-	G					
1	1	2	3					
2	4	5	6					
3	7	8	9					
4	19	20	21					
5	22	23	31					
6	29	30	32					
7	10	11	12					
8	13	14	15					
9	16	17	18					
10	24	25	26					
11	27	28	36					
12	33	34	35					
CAT6	White Orange	Orange	White Green	Blue	White Blue	Green	White Brown	Brown
E1	1	2	3	4	5	6	7	8
E2	1	2	3	4	5	6	7	8

LKG 32/6E								
CAT6	White Orange	Orange	White Green	Blue	White Blue	Green	White Brown	Brown
E1	1	2	3	4	5	6	7	8
E2	1	2	3	4	5	6	7	8
E3	1	2	3	4	5	6	7	8
E4	1	2	3	4	5	6	7	8
E5	1	2	3	4	5	6	7	8
E6	1	2	3	4	5	6	7	8

LKS - 6 Lamps			
Ch	Fase	Neutral	Ground
1	1	2	13
2	3	4	14
3	5	6	15
4	7	8	16
5	9	10	17
6	11	12	18
General ground			19



Standard Wiring

12 ch - LKW39			
Ch	+	-	G
1	p	n	q
2	W	A	X
3	N	f	P
4	L	e	M
5	J	d	K
6	G	c	H
7	E	b	F
8	D	a	Z
9	C	B	Y
10	U	i	V
11	i	h	T
12	R	g	S

20 ch - LKW61			
Ch	+	-	G
1	JJ	HH	NN
2	MM	KK	PP
3	BB	AA	CC
4	s	FF	W
5	r	EE	V
6	e	D	x
7	f	E	y
8	q	DD	U
9	S	p	T
10	P	N	R
11	m	k	n
12	L	K	M
13	J	i	j
14	H	G	h
15	g	F	z
16	d	C	W
17	B	A	c
18	b	a	Z
19	v	u	Y
20	t	GG	X

58 ch - LKI M176 (input)				
Ch		+	-	G
1	S	87	88	86
2	P	87	88	86
3	S	84	85	83
4	P	84	85	83
5	S	81	82	80
6	P	81	82	80
7	S	78	79	77
8	P	78	79	77
9	S	75	76	74
10	P	75	76	74
11	S	72	73	71
12	P	72	73	71
13	S	69	70	68
14	P	69	70	68
15	S	66	67	65
16	P	66	67	65
17	S	62	63	61
18	P	62	63	61
19	S	59	60	58
20	P	59	60	58
21	S	56	57	55
22	P	56	57	55
23	S	53	54	52
24	P	53	54	52
25	S	50	51	49
26	P	50	51	49
27	S	47	48	46
28	P	47	48	46
29	S	44	45	43
30	P	44	45	43
31	S	41	42	40
32	P	41	42	40
33	S	38	39	37
34	P	38	39	37
35	S	33	34	32
36	P	33	34	32
37	S	30	31	29
38	P	30	31	29
39	S	27	28	26
40	P	27	28	26
41	S	24	25	23
42	P	24	25	23
43	S	19	20	18
44	P	19	20	18
45	S	16	17	15
46	P	16	17	15
47	S	13	14	12
48	P	13	14	12
49	S	9	10	8
50	P	9	10	8
51	S	6	7	5
52	P	6	7	5
53	S	21	22	11
54	P	21	22	11
55	S	2	3	1
56	P	2	3	1
57	S	35	36	64
58	P	35	36	64
General ground		4		

58 ch - LKI M176 (output)				
Ch		+	-	G
1	P	87	88	86
2	S	87	88	86
3	P	84	85	83
4	S	84	85	83
5	P	81	82	80
6	S	81	82	80
7	P	78	79	77
8	S	78	79	77
9	P	75	76	74
10	S	75	76	74
11	P	72	73	71
12	S	72	73	71
13	P	69	70	68
14	S	69	70	68
15	P	66	67	65
16	S	66	67	65
17	P	62	63	61
18	S	62	63	61
19	P	59	60	58
20	S	59	60	58
21	P	56	57	55
22	S	56	57	55
23	P	53	54	52
24	S	53	54	52
25	P	50	51	49
26	S	50	51	49
27	P	47	48	46
28	S	47	48	46
29	P	44	45	43
30	S	44	45	43
31	P	41	42	40
32	S	41	42	40
33	P	38	39	37
34	S	38	39	37
35	P	33	34	32
36	S	33	34	32
37	P	30	31	29
38	S	30	31	29
39	P	27	28	26
40	S	27	28	26
41	P	24	25	23
42	S	24	25	23
43	P	19	20	18
44	S	19	20	18
45	P	16	17	15
46	S	16	17	15
47	P	13	14	12
48	S	13	14	12
49	P	9	10	8
50	S	9	10	8
51	P	6	7	5
52	S	6	7	5
53	P	21	22	11
54	S	21	22	11
55	P	2	3	1
56	S	2	3	1
57	P	35	36	64
58	S	35	36	64
General ground		4		

Metric²/AWG Wire Size Equivalents

In Europe, wire and cables are expressed in mm² (cross sectional area), while in USA the AWG (American Wire Gauge) is the standard system used for both solid and strand conductors. See the cross reference scheme below.

AWG	32	30	28	26	24	22	21	20	18	17	16	14	13	12	11	10	8	6	4	2	1	2/0	3/0	4/0
mm ²	0.032	0.051	0.081	0.13	0.20	0.33	0.41	0.52	0.82	1.04	1.31	2.08	2.62	3.31	4.17	5.26	8.37	13.3	21.2	33.6	42.4	67.4	85	107

Cross references refer to solid copper wire. For stranded conductors a range of values must be considered i.e. AWG 24 stranded conductors are comprised between a range of 0.20 mm² and 0.24 mm².

Conductor Resistance

mm ²	0.03	0.05	0.08	0.14	0.22	0.34	0.38	0.50	0.75	1.50	2.50	4.00
Ohm/km	578	350	232	146	76.40	55	44	34.50	23	14.70	8.80	4.50

Capacity Reference Table for **eurocable** Reels

Cable O.D.(mm)	4	6	8	10	12	15	18	20	22	24	26	28	30	32
AV AX100	250	111	63	40	28									
AV SP380	731	325	183	117	81	52	36	29						
AV SP450			227	145	101	64	45	36	30	25				
AV SK460				180	125	80	56	45	37	31	27			
AV GT310RM	398	166	84	64	39	22								
AV GT380RM	740	319	170	114	82	43	29	24						
AV HD260				246	171	109	76	62	51	43	36	31	27	24
AV HD350					231	148	102	83	69	58	49	42	37	32
AV HD500						211	146	119	98	82	70	60	53	46
AV HD600											140	120	105	92
AV HD600 R											100	90	75	65

Capacity table for cable reels, based on O.D. of the cable used. Measure the O.D. (mm) of your cable to choose the appropriate cable reel. The above values are expressed in meters.

LK
connectors

eurocable







*People and Products
Connecting the World
of Entertainment*

- 86 Wiring Cables
- 87 Microphone Cables/Starquad Cable
- 88 AES/DMX Cables
- 89 DMX Cables
- 90 DMX PUR Jacket
- 91 DMX Cables for Special Applications
- 92 Musical Instrument Cable
- 93 SS Spiral Copper Shield Multipair
- 94 SSAD AES/EBU Aluminium Foil Shield Multipair
- 95 SSAD AES/EBU 24 AWG Aluminium Foil Shield Multipair
- 96 SSA Aluminium Foil Shield Multipair
- 97 SSAS Overall Shield Multipair
- 98 Speaker Cables
- 99 Multicore Speaker Cables (4 to 8 Cond)
- 100 Multicore Speaker Cables (18 to 24 Cond)
- 101 Multicore Speaker Cables (36 to 48 Cond)
- 102 Powered Audio/DMX Cables
- 103 Powered Audio/DMX Cables
- 104 CAT PUR Jacket
- 105 CAT6 LAN Cable
- 106 CAT Solid Bare
- 107 CAT Stranded
- 108 Hybrid Cable for Data and Power
- 109 Hybrid Cables for Data and Power
- 110 Hybrid Cables for Data, Audio and Power
- 111 Multidata CAT6 Cables
- 112 Multisignal CAT6 with Audio
- 113 Hybrid Digital Data and Coaxial Cable
- 114 Unbreakable Optical Cables
- 116 Hybrid Optical Cables
- 117 Optical Camera Cable
- 118 Analog Video Cables
- 119 RF Coaxial Cables
- 120 Digital Video Cables (HDTV)
- 121 Miniature HDTV Video Cables
- 122 Triax Camera Cables
- 123 Power Cables
- 124 Power Multilines & Data
- 125 LKS Data Flat Cable
- 126 ULP
- 127 Chain Hoist and Control Cables
- 128 Assembled Cables
- 132 Cable Reels
- 133 Reference Table

Wiring Cables

All **eurocable** wiring cables have been specifically designed for fixed installations and to wire up devices within a rack, where signal integrity over long runs and small gauge sizes are particularly important. All the wiring cable range guarantees clean and constant audio signal transmission to ensure natural and realistic sound. Highly efficient shielding from hum, noise and radio interference is guaranteed. They consist of two insulated twisted conductors and drain wire. The new AES/EBU cable has been designed to wire up digital audio devices.

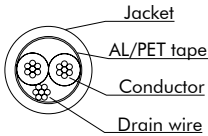
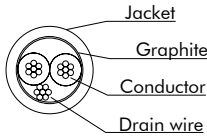
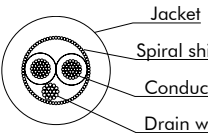
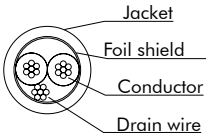
INSTALLATION	INSTALLATION	INSTALLATION	INSTALLATION
JACKET COLOR ■	JACKET COLOR ■	JACKET COLOR ■	JACKET COLOR ■
500 m/1640 feet	200 m/656 feet	200 m/656 feet	200 m/656 feet
ON CARDBOARD REELS	ON CARDBOARD REELS	ON CARDBOARD REELS	ON CARDBOARD REELS
			
CVS LKDD02A	CVS LK02N3	CVS LK02N3R	CVS LK02N2A
			
		CPR Eca: EN 60332	CPR Eca: EN 60332
FLAME RETARDANT: IEC 60332-3 CAT. "C", EN 50363-4	FLAME RETARDANT: EN 50363-4	FLAME RESISTANT: IEC 60332-3 CAT. "C", EN 50266-2	FLAME RESISTANT: IEC 60332-3 CAT. "C", EN 50266-2

ELECTRICAL DATA				
D.C.R. at 20°C	Conductor	94 ohm/km		75 ohm/km
	Shield			25 ohm/km
Capacitance at 1KHz	Cond/Cond	70 pF/m	85 pF/m	
	Cond/Sh		170 pF/m	160 pF/m
Nominal Impedance	1 KHz	600 ohm/100m		
Attenuation	1 KHz	0.50 db/100m		
Inductance		<58 μH/100m		
GENERAL DATA				
Cable	O.D.	4.30 mm (± 0.2 mm)	3.70 mm	3.10 mm
	Standard reels			200 m
	Weight Kg/100m		2.20	1.40
	Op. temp.	-20°C/+70°C		-35°C/+65°C
Jacket	Material	PVC TM2		PVC
	Nom. Thick.	0.50 mm	0.65 mm	0.30 mm
Shield	Material	Aluminium/PET tape + drain wire	Conductive graphite + drain wire	Bare copper spiral shield
	Coverage	100%	95%	100%
Conductor	Qty	2		
	Strand	7 x 0.20 mm		30 x 0.10 mm
	Area/AWG	0.22 mm ² /24		
	Insul. O.D.	1.60 mm	1.00 mm	1.10 mm
	Material	Electrolytic tinned copper		Bare copper polyethylene insulated

Not suitable for applications above 50 volt ac; 75 volt dc.

Microphone Cables/Starquad Cable

eurocable CVS LK02N6E microphone cable consists of two insulated twisted conductors and drain wire, all shielded with a high-density spiral copper. The insulation is made of high-quality polyethylene which does not shrink, nor misshape at high temperatures when soldering.

eurocable CVS LK04N7 starquad features balanced quad structure specifically designed to minimize hum and noise, obtaining the best RF-rejection performances. Suitable for long run applications and where the maximum definition of recorded sound is of critical importance.

MOBILE	INSTALLATION/MOBILE							
JACKET COLOR	JACKET COLOR							
100 m/328 feet ON CARDBOARD REELS	100 m/328 feet ON CARDBOARD REELS							
CVS LK02N6E	CVS LK04N7							
CVS LKCode	02N6E	02B6E	02G6E	02R6E	02V6E	02Y6E	CVS LK04N7	
ELECTRICAL DATA								
D.C.R. at 20°C	Conductor	≤ 78 ohm/km						
	Shield	≤ 39 ohm/km						
Capacitance	Conductor/Conductor 1 KHz	160 pF/m						
	Conductor/Shield 1 KHz	80 pF/m						
Nominal Impedance 1 KHz	600 ohm/100m						110 ohm/100 m (55 Quad. com.)	
Attenuation 1 KHz	0.50 db/100m						3.80 - 6.70 db/100 m	
Inductance	< 58 μH/100 m						-	
Vel. of Prop.	-						66%	
GENERAL DATA								
Cable	O.D.	6.00 mm						7.00 mm
	Standard reels	100 m						
	Weight Kg/100m	4.60						6.00
	Operating temperature	-5°C/+70°C						Installation -20°C/+70°C - Mobile 5°C/+70°C
Jacket	Material	PVC						
	Color	Black	Blue	Grey	Red	Green	Yellow	Black
	Nominal Thickness	1.80 mm						1.40 mm
Shield	Material	Bare copper, Spiral shield plus 20 AWG tinned copper drain wire						Tinned copper braid shield plus 24 AWG tinned copper drain wire
	Coverage	100%						> 90%
Conductor	Qty	2						4
	Strand	30 x 0.10 mm						
	Area/AWG	0.22 mm ² /24						
	Insul. O.D.	1.10 mm						1.40 mm
	Material	Bare copper polyethylene insulated						Bare copper foamed polyethylene insulated

Microphone and Mic Starquad cables with Jacks or 3 pin XLR Neutrik connectors

SIGNAL INTEGRITY

MNJMSSEN

Microphone cable wired with Neutrik silver Jack
Also available with black connectors



MNXESSEN

Microphone cable wired with Neutrik XLR 3 silver/silver
Also available with black connectors



MNXEBGEN

Microphone cable wired with Neutrik XLR 3 black/gold



MNXESSQN

Starquad cable wired with Neutrik XLR 3 silver/silver
Also available with black connectors



MNXEBGQN

Starquad cable wired with Neutrik XLR 3 black/gold



Length (meters): **3 5 10 15**
 Feet Meters

With packaging, no heat shrink
 No packaging, no heat shrink

No packaging, with heat shrink
 With packaging and heat shrink

All products are also available with Amphenol connectors

Not suitable for applications above 50 volt ac; 75 volt dc.

AES/DMX Cables

The **eurocable** digital cables are engineered for connecting digital audio equipment compliant to the standards set by AES/EBU (for audio amplifier) as well as for DMX data transmission in lighting control applications. Featuring 110 ohm nominal impedance and extremely low capacitance.

CVS LKD2P6DS

Stock in USA, on request in EMEA countries.

MOBILE	MOBILE	MOBILE	INSTALLATION
DIGITAL	DIGITAL	DIGITAL	DIGITAL
JACKET COLOR	JACKET COLOR	JACKET COLOR	JACKET COLOR
100 m/328 feet ON CARDBOARD REELS	100 m/328 feet ON CARDBOARD REELS	305 m/1000 feet ON WOODEN REELS	100 m/328 feet ON CARDBOARD REELS
CVS LKDD02S2	CVS LKDD02S2BL	CVS LKD2P6DS	CVS LKD2N4.5

ELECTRICAL DATA			
D.C.R. at 20°C	Conductor	≤ 94.2 ohm/km	
	Shield	20 ohm/km	
Capacitance 1 KHz	Cond/Cond	70 pF/m	
	Cond/Sh	85 pF/m	
Nominal Imp.	110 ohm/100m		
Attenuation 3-8 MHz	3.70 - 5.90 db/100 m		5.90 - 8.80 db/100 m
Vel. of Prop.	80%		
GENERAL DATA			
Cable	O.D.	6.00 mm	
	Standard reels	100 m	305 m
	Weight Kg/100m	5.00	
	Op. temp.	-20°C/+70°C	
Jacket	Material	PVC	
	Nom. Thick.	1.00 mm	
Shield	Material	Braided electrolytic bare copper shield plus drain wire	
	Coverage	80%	
Conductor	Qty	2	
	Strand	7 x 0.203 mm	
	Area/AWG	0.20 mm ² /24	
	Insul. O.D.	1.6 mm	
	Material	Electrolytic tinned copper flexible conductor	
		Bare copper foamed polyethylene insulated	

Digital cable (O.D. 6mm) with 3 pin XLR Neutrik connectors SIGNAL INTEGRITY

<p>MNXESSDN Black</p> <p>MNXESSDB Blue</p> <p>MNXESSDP Purple</p> <p>Digital double-shield cable wired with Neutrik XLR 3 silver/silver</p> <p>Also available with XLRs 5 poles</p>	<p>MNXEBSDN Black</p> <p>MNXEBSDB Blue</p> <p>MNXEBSDP Purple</p> <p>Digital double-shield cable wired with Neutrik XLR 3 black/silver</p> <p>Also available with XLRs 5 poles</p>	<p>MNXEBGDN Black</p> <p>MNXEBGDB Blue</p> <p>MNXEBGDP Purple</p> <p>Digital double-shield cable wired with Neutrik XLR 3 black/gold</p> <p>Also available with XLRs 5 poles</p>
<p><input type="checkbox"/> Length: 3 5 10 15</p> <p><input type="checkbox"/> Feet <input type="checkbox"/> Meters</p> <p><input type="checkbox"/> With packaging, no heat shrink</p> <p><input type="checkbox"/> No packaging, no heat shrink</p> <p><input type="checkbox"/> No packaging, with heat shrink</p> <p><input type="checkbox"/> With packaging and heat shrink</p> <p style="text-align: right;">All products are also available with Amphenol connectors</p>		

Not suitable for applications above 50 volt ac; 75 volt dc.

Not suitable for applications above 50 volt ac; 75 volt dc.







DMX Cables

eurocable DMX cable range meets the DMX 512-A standard for data transmission in digital mixing control applications, networking of scanners and lighting systems.

All cables have high flexibility and small gauge which is suitable for easy XLR connection.

Available in three different versions and with different colored jackets on request.

The DMX CC cable consists of one Data pair and two voltage supply pairs for transmission of voltage up to 50 V.

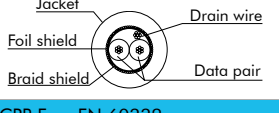
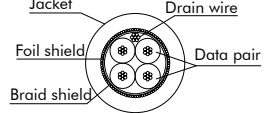
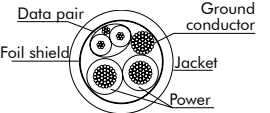
INSTALLATION/MOBILE	INSTALLATION/MOBILE	INSTALLATION/MOBILE
JACKET COLOR 	JACKET COLOR 	JACKET COLOR 
200 m/656 feet	200 m/656 feet	200 m/656 feet
ON WOODEN REELS	ON WOODEN REELS	ON WOODEN REELS
		
CVS LKDMX S	CVS LKDMX D	CVS LKDMXCC
		
CPR Eca: EN 60332	FLAME RESISTANT: IEC 60332-3, EN 60332-1	FLAME RESISTANT: IEC 60332-3, EN 60332-1

ELECTRICAL DATA				
Description		Single pair for DMX 512	Double pair for DMX 512	DMX 512 w/color change power supply
D.C.R.	Conductor	65 ohm/km		
	Shield	19 ohm/km	14 ohm/km	150 ohm/km
Capacitance 1 KHz	Conductor/Conductor	40 pF/m	45 pF/m	33 pF/m
	Conductor/Shield	90 pF/m	75 pF/m	82 pF/m
Nominal Impedance		110 ohm		
Attenuation	256 KHz	2 db/100 m		
Vel. of Prop.		78%		
Inductance		55 µH/100 m		
GENERAL DATA				
Cable	O.D.	5.50 mm	7.80 mm	
	Standard reels	200 m		
	Weight Kg/100m	4.20	7.50	11.50
	Operation temperature	-20° C/+70° C		
Jacket	Material	PVC flame resistant		
	Nominal Thickness	0.85 mm	1.75 mm	0.70 mm
Shield	Material	First: Aluminium - Mylar foil Second: Tinned copper braid		First: Aluminium - Mylar foil
	Coverage	First: 100% - Second: 75%		100%
Conductor	Quantity	2	2 + 2	Data: 1 - Power: 2
	Strand	7 x 0.20 mm		
	Area/AWG	0.22 mm ² /24		
	Insulation O.D.	1.60 mm		
	Material	Annealed tinned copper foamed polyethylene insulated		
		Data: 7 x 0.20 - Power: 43 x 0.25 mm		
		Data: 0.22 mm ² /24 Power: 2 mm ² /14		
		Data: 1.60 mm - Power: 2.70 mm		
		Data: Tinned copper PE. insulated Power: Tinned copper PVC insulated		

DMX cables with 3, 4 and 5 pin XLR connectors

SIGNAL INTEGRITY

DNX3ESSS

DMX single pair cable wired with Neutrik XLR 3p silver/silver



DNX3EBSS

DMX single pair cable wired with Neutrik 3p black/silver



DNX5ESSS

DMX double pair wired with Neutrik XLR 5p silver/silver



DNX5ESSD

DMX double pair cable wired with Neutrik 5p silver/silver







DNX4ESSC

DMX single pair with 2x2mm² power wired with Neutrik 4p silver/silver



* Length (meters): **3 5 10 15**
 Feet  Meters

 With packaging, no heat shrink
 No packaging, no heat shrink



 No packaging, with heat shrink
 With packaging and heat shrink

All products are also available with Amphenol connectors

Not suitable for applications above 50 volt ac; 75 volt dc.

DMX PUR Jacket

A new polyurethane sheath protects our DMX S Single pair and DMX D Double pair cables from critical conditions. Flexible & extra strong it has been built to be the most durable jacketed cable. **eurocable** DMX cable range meets the DMX 512-A standard for data transmission in lighting control applications. All cables have high flexibility and small gauge which is suitable for easy XLR connection.

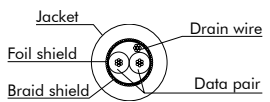
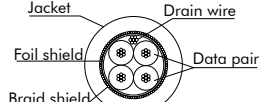
MOBILE	MOBILE
JACKET COLOR 	JACKET COLOR
200 m/656 ft ON CARDBOARD REELS	200 m/656 ft ON CARDBOARD REELS
	
CVS LKDMX S PUR	CVS LKDMX D PUR
	
HALOGEN FREE	HALOGEN FREE
FLAME RETARDANT: IEC 60754-1, IEC 61034-1, IEC 60332-1, EN 50267-2-1, EN 50268-2-1, EN 50265-2-1	FLAME RETARDANT: IEC 60754-1, IEC 61034-1, IEC 60332-1, EN 50267-2-1, EN 50268-2-1, EN 50265-2-1

ELECTRICAL DATA			
Description		Single pair for DMX 512	Double pair for DMX 512
D.C.R.	Conductor	65 ohm/km	65 ohm/km
	Shield	19 ohm/km	14 ohm/km
Capacitance 1 KHz	Conductor/Conductor	40 pF/m	45 pF/m
	Conductor/Shield	90 pF/m	75 pF/m
Nominal Impedance		110 ohm	110 ohm
Attenuation	256 KHz	2 db/100 m	2 db/100 m
Vel. of Prop.		78%	80%
Inductance		55 μH/100 m	55 μH/100 m
GENERAL DATA			
Cable	O.D.	5.50 mm	7.90 mm
	Weight Kg/100m	3.20	6.80
	Operating temperature	-20°C/+70°C	
Jacket	Material	LSZH PUR	
	Nominal Thickness	0.85 mm	1.75 mm
Shield	Material	First: Aluminium - Mylar foil / Second: Tinned copper braid	
	Coverage	First: 100% - Second: 75%	
Conductor	Quantity	2	2+2
	Strand	7 x 0.20 mm	7 x 0.20 mm
	Area/AWG	0.22 mm ² /24	0.22 mm ² /24
	Insulation O.D.	1.60 mm	1.60 mm
	Material	Annealed tinned copper foamed polyethylene insulated	

DMX PUR cables with 3 and 5 pin XLR connectors

SIGNAL INTEGRITY

DNX3ESSP * * *

DMX single pair cable wired with Neutrik XLR 3p silver/silver



DNX3EBSP * * *

DMX single pair cable wired with Neutrik 3p black/silver



DNX5ESSP * * *

DMX double pair wired with Neutrik XLR 5p silver/silver



DNX5ESDP * * *

DMX double pair cable wired with Neutrik 5p silver/silver



* Length (meters): **3 5 10 15**
■ Feet M Meters

□ With packaging, no heat shrink
Y No packaging, no heat shrink

U No packaging, with heat shrink
W With packaging and heat shrink



All products are also available with Amphenol connectors

Not suitable for applications above 50 volt ac; 75 volt dc.

DMX Cables for Special Applications

eurocable CVS LKDMX D L cable meets the DMX 512-A standard for data transmission in lighting control applications. The 20 AWG conductors guarantee no signal degradation for long-distance applications required for fixed installations.

eurocable CVS LKDMX CC UV PROOF cable consists of one Data pair and two voltage supply pairs for transmission of voltage up to 50 V. The special tough jacket in PUR UV Proof up has been specifically designed for outdoor use in extreme weather condition.

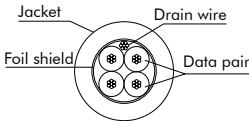
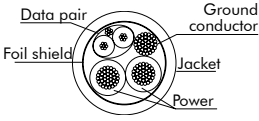
MOBILE	
JACKET COLOR ■	
	
CVS LKDMX D L *	CVS LKDMXCC PUR-UV ML43
	
FLAME RETARDANT: IEC 60754-1, IEC 61034-1, IEC 60332-1, EN 50267-2-1, EN 50268-2-1, EN 50265-2-1	FLAME RETARDANT: IEC 60332-1, EN 60332-1

ELECTRICAL DATA			
Description		Double pair for DMX 512	DMX 512 w/color change power supply
D.C.R.	Conductor	32.5 ohm/km	Data: 150 ohm/km - Power: 8.96 ohm/Km
Capacitance 1 KHz	Conductor/Conductor	45 pF/m	30 pF/m
	Conductor/Shield	80 pF/m	70 pF/m
Nominal Impedance		110 ohm	
Attenuation	1 KHz	2 db/100 m	
Vel. of Prop.		80%	
Inductance		60 μH/100 m	
GENERAL DATA			
Cable	O.D.	8.30 mm	7.50 mm
	Standard reels	500 m	
	Operating temperature	-20°C/+70°C	-40°C/+80°C
Jacket	Material	PVC Flame Retardant	TPU UV Proof
	Nominal Thickness	1.75 mm	0.70 mm
Shield	Material	Aluminium - Mylar foil	
	Coverage	100%	
Conductor	Quantity	2+2	2 Data conductors + 2 Power conductors
	Strand	19 x 0.20 mm	Data: 19 x 0.10 mm - Power: 43 x 0.254 mm
	Area/AWG	0.5 mm ² /20	Data: 0.15 mm ² /26 - Power: 2 mm ² /14
	Insulation O.D.	2.00 mm	Data: 1.6 mm - Power: 2.7 mm
	Material	Annealed tinned copper foamed polyethylene insulated	Tinned copper

Not suitable for applications above 50 volt ac; 75 volt dc.

* on request

Musical Instrument Cable

eurocable single conductor cable mainly used for the connection of guitars and musical instruments pickups.

This cable gives superior performance with its special double shield (thermoplastic and spiral copper shield) that provides excellent insulation even from noise caused by the shield rubbing against the dielectric (microphone effect), at the same time preserving flexibility and high-temperature resistance. The robust cable design ensures optimal performances on live stage applications.

MOBILE
 JACKET COLOR ■
 100 m/328 feet ON CARDBOARD REELS



CVS LK01N6S2

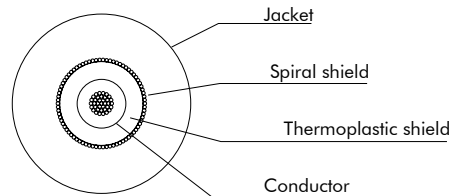

ELECTRICAL DATA		
D.C.R. at 20°C	Conductor	≤ 78 ohm/km
	Shield	≤ 50 ohm/km
Capacitance	Conductor/Conductor 1 KHz	-
	Conductor/Shield 1 KHz	130 pF/m
Nominal Impedance 1 KHz		360 ohm/100m
Attenuation 1 KHz		0.25 db/100m
Inductance		< 16 μH/100m
GENERAL DATA		
Cable	O.D.	6.00 mm
	Standard reels	100 m
	Weight Kg/100m	3.50
	Operating temperature	-5°C/+70°C
Jacket	Material	PVC
	Nominal Thickness	1.70 mm
Shield (double)	Material	First: Conductive graphite - Second: Spiral bare copper shield
	Coverage	First: 100% - Second: 95%
Conductor	Qty	1
	Strand	30 x 0.10 mm
	Area/AWG	0.22 mm ² /24
	Insul. O.D.	1.70 mm
	Material	Bare copper polyethylene insulated

Instrumental double shielded cable with Neutrik Jacks

INJMSSN ****

Instrumental cable wired with Neutrik silver Jack



INJMBSSN ****

Instrumental cable wired with Neutrik black Jack



* Length (meters): **3 5 10 15**
F Feet M Meters

 With packaging, no heat shrink
Y No packaging, no heat shrink

U No packaging, with heat shrink
W With packaging and heat shrink

All products are also available with Amphenol connectors

Not suitable for applications above 50 volt ac; 75 volt dc.

SS Spiral Copper Shield Multipair

eurocable SS series key features are high flexibility and long flex life. Thanks to these properties SS is one of the most popular cables for critical outdoor use applications. The external jacket is extra flexible PVC ensures anti-treading and anti-abrasion features. The XLPE conductor insulation, featuring a low dielectric-constant for low capacitance, is particularly resistant to high temperatures thus avoiding jacket shrinkage when soldering the conductor. This particular construction is ideal for continuous winding and unwinding, its use with HD series cable reels is although recommended. All pairs are individually shielded, twisted and identified by numbers and letters printed on the internal yellow jackets. Available on request from 20 to 48 pairs.

MOBILE

JACKET COLOR ■

200-500 m/656-1640 feet ON WOODEN REELS

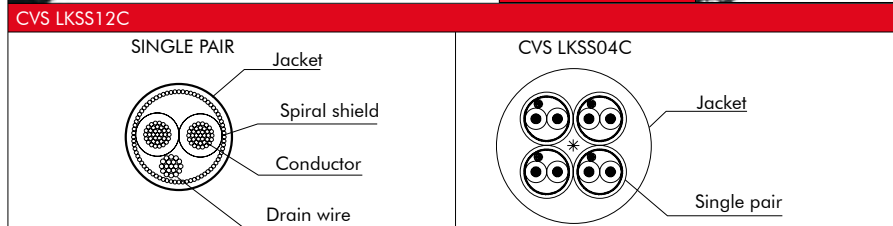

eurocable
SSS range:
great reliability
thanks to a
braided tinned
copper shield
plus a overall
cotton braid.

CVS LKSSCode	02C	04C	08C	12C	16C	20C*	24C*	28C*	32C*	40C*	48C*	
ELECTRICAL DATA												
D.C.R. at 20°C	Conductor					85 ohm/km						
	Shield					40 ohm/km						
Capacitance	Conductor/Conductor 1 KHz					100 pF/m						
	Conductor/Shield 1 KHz					180 pF/m						
Nominal Impedance 1 KHz					530 ohm/100 m							
Attenuation 1 KHz					0.20 db/100 m							
Induttance					70 µH/100 m							
GENERAL DATA												
Pairs cable		2	4	8	12	16	20	24	28	32	40	48
Cable	O.D.	8.0 mm	9.6 mm	12.8 mm	14.9 mm	16.9 mm	18.9 mm	20.3 mm	21.6 mm	23.2 mm	25.4 mm	27.8 mm
	Standard reels	500 m					200 m					
	Weight Kg/100m	10.30	15.40	27.00	36.80	46.30	60.50	67.90	73.60	86.80	106.70	123.20
	Operating temperature	-20° C/+70° C										
Jacket	Material	PVC										
	Nominal Thickness	1.25 mm	1.50 mm	1.75 mm	1.85 mm	2.05 mm			2.25 mm	2.45 mm		
Shield	Material	Bare copper, Spiral shield plus 24 AWG tinned copper drain wire										
	Coverage	> 95%										
Conductor	Qty	2 x 2	4 x 2	8 x 2	12 x 2	16 x 2	20 x 2	24 x 2	28 x 2	32 x 2	40 x 2	48 x 2
	Strand	28 x 0.10 mm										
	Area/AWG	0.22 mm ² /24										
	Insul. O.D.	1.00 mm										
	Material	Annealed bare copper. XLPE insulated										

*on request

Snakes, Fan-in and Fan-out

For further information and configurations, see pages 32-33



SNK **16** **S** ***** **M** **R**



Fan out **FNT** **20X4** **S** **P** ***** **M** **F3** **R**



Fan in **FNN** **20X4** **S** **P** ***** **M** **F3** **R**

* Length Feet M Meters

Not suitable for applications above 50 volt ac; 75 volt dc.

SSAD AES/EBU Aluminium Foil Shield Multipair

The **eurocable** SSAD multipair digital cables are designed for digital audio equipment and compliant to the standards set by AES/EBU. Featuring 110 ohm nominal impedance, extremely low capacitance, these cables are suitable for carrying multiple high quality digital audio signals in both fixed and outdoor applications. All pairs are individually shielded, twisted, and held together by a holding tape and identified by numbers and letters. SSAD multipair is available from 2 to 16 pairs, and from 24 to 48 pairs on request.

INSTALLATION/MOBILE	
DIGITAL	
JACKET COLOR ■	
200-500 m/656-1640 feet ON WOODEN REELS	
  <div style="background-color: red; color: white; padding: 5px; display: inline-block;">The digital multipair range is also available on request with LSZH jacket (HFSSAD).</div> 	
CVS LKSSAD12C	
SINGLE PAIR	CVS LKSSAD04C
CPR Eca: EN 60332	

CVS LKSSAD Code	02C	04C	08C	12C	16C	24C*	32C*	48C*		
ELECTRICAL DATA										
D.C.R. at 20°C	Conductor	< 143 ohm/km								
	Shield	< 40 ohm/km								
Capacitance	Conductor/Conductor 1 KHz	50 pF/m								
	Conductor/Shield 1 KHz	100 pF/m								
Nominal Impedance	3 - 8 MHz		110 ohm/100 m							
Attenuation	3 - 8 MHz		7 - 10 db/100 m							
Vel. of Prop.	80%									
GENERAL DATA										
Pairs cable	2	4	8	12	16	24	32	48		
Cable	O.D.	8.80 mm	10.30 mm	12.90 mm	15.40 mm	17.40 mm	22.20 mm	25.50 mm	30.80 mm	
	Standard reels	500 m					200 m			
	Weight Kg/100m	8.50	12.00	18.00	25.00	32.50	48.20	61.70	88.30	
	Operating temperature	-20°C/+70°C								
Jacket	Material	PVC								
	Nominal Thickness	1.20 mm	1.30 mm		1.45 mm	1.65 mm	1.75 mm	1.90 mm		
Shield	Material	Aluminium - Mylar foil, Shield plus tinned copper drain wire								
	Coverage	100%								
Conductor	Qty	2 x 2	4 x 2	8 x 2	12 x 2	16 x 2	24 x 2	32 x 2	48 x 2	
	Strand	7 x 0.16 mm								
	Area/AWG	0.14 mm ² /26								
	Insul. O.D.	1.20 mm								
	Material	Annealed tinned copper cellular polyolefine insulated								

* on request

Snakes, Fan-in and Fan-out

For further information and configurations, see pages 32-33

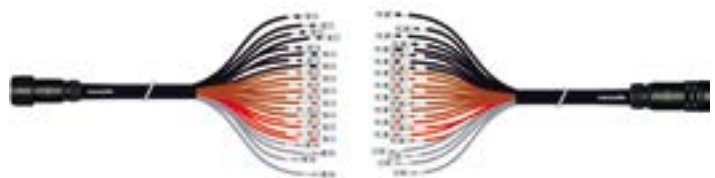

SNK 16 D * M R

Fan out FNT 20X4 D B * M F3 R

* Length Feet M Meters

Fan in FNN 20X4 D B * M F3

Not suitable for applications above 50 volt ac; 75 volt dc.

SSAD AES/EBU 24 AWG Aluminium Foil Shield Multipair

The **eurocable** SSAD 24AWG multipair digital cables have a PURPLE outer jacket. Designed for digital audio equipment and compliant to the standards set by AES/EBU, this cable features 110 ohm nominal impedance and extremely low capacitance. These cables are suitable for carrying multiple high quality digital audio signals in both fixed and outdoor applications. All pairs are individually shielded, twisted, and held together by a holding tape and identified by numbers and letters. SSAD AES/EBU 24 AWG multipair is available in 4, 8 and 12 pairs.

Stock in USA, on request in EMEA countries.

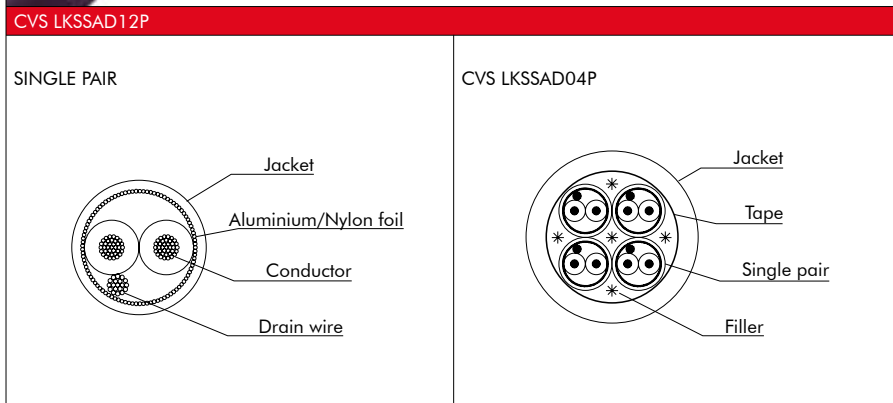
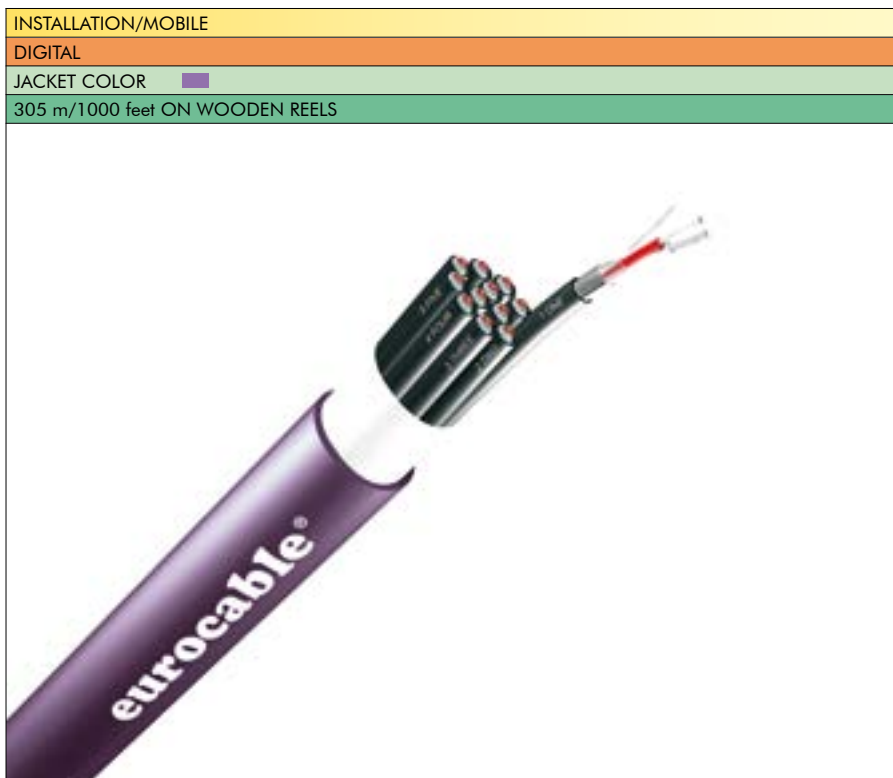

CVS LKSSADCode	04P		08P		12P	
ELECTRICAL DATA						
D.C.R. at 20°C	Conductor	< 95 ohm/km				
	Shield	< 40 ohm/km				
Capacitance	Conductor/Conductor 1 KHz	50 pF/m				
	Conductor/Shield 1 KHz	100 pF/m				
Nominal Impedance	3 - 8 MHz	110 ohm/100 m				
Attenuation	3 - 8 MHz	7 - 10 db/100 m				
Vel. of Prop.		80%				
GENERAL DATA						
Pairs cable		4	8	12		
Cable	O.D.	11.50 mm	14.60 mm	17.60 mm		
	Standard reels	305 m/1000 ft				
	Weight Kg/100m	12.00	18.00	25.00		
	Operating temperature	-20°C/+70°C				
Jacket	Material	PVC				
	Nominal Thickness	1.30 mm				
Shield	Material	Aluminium - polyester tape plus tinned copper drain wire (7 x 0.20 mm)				
	Coverage	100%				
Conductor	Qty	4 x 2	8 x 2	12 x 2		
	Strand	7 x 0.20 mm				
	Area/AWG	0.20 mm ² /24				
	Insul. O.D.	1.45 mm				
	Material	Annealed tinned copper cellular polyolefine insulated				

Not suitable for applications above 50 volt ac; 75 volt dc.

SSA Aluminium Foil Shield Multipair

eurocable SSA construction consists of individual pairs enclosed in an aluminum/mylar foil shield with drain wire inside the foil for easier installation. All pairs are individually shielded, twisted and identified by numbers and letters. The external jacket in extra flexible PVC ensures anti-treading and anti-abrasion features. The use with HD series cable reels is recommended. Available on request from 2 to 16 pairs, and from 20 to 64 pairs on request.

INSTALLATION/MOBILE

JACKET COLOR ■

200-500 m/656-1640 feet ON WOODEN REELS

CVS LKSSA12C

SINGLE PAIR

Jacket
Foil shield
Conductor
Drain wire

CVS LKSSA04C

Jacket
Single pair

CPR Eca: EN 60332

FLAME RESISTANT: IEC 60332-3 CAT. "C", EN 50266-2

CVS LKSSACode	02C	04C	08C	12C	16C	20C*	24C	28C	32C*	40C	48C*	56C*	64C*	
ELECTRICAL DATA														
D.C.R. at 20°C	Conductor	< 90 ohm/km												
	Shield	< 40 ohm/km												
Capacitance	Conductor/Conductor 1 KHz	140 pF/m												
	Conductor/Shield 1 KHz	250 pF/m												
Nominal Impedance 1 KHz	440 ohm/100 m													
Attenuation 1 KHz	0.24 db/100 m													
Inductance	80 µH/100 m													
GENERAL DATA														
Pairs cable	2	4	8	12	16	20	24	28	32	40	48	56	64	
Cable	O.D. mm	7.20	9.50	11.60	14.40	16.60	17.80	19.00	21.50	22.70	24.50	27.30	27.70	29.90
	Standard reels	500 m						200 m						
	Weight Kg/100m	9.00	12.50	21.00	27.70	38.50	46.60	53.60	64.80	71.80	86.00	97.50	111.72	128.04
	Operating temperature	-20°C/+70°C												
Jacket	Material	PVC flame resistant												
	Nominal Thickness	1.20	1.40	1.50	1.70	2.00	1.50	2.00	2.10	2.20	2.30	2.50		
Shield	Material	Aluminium / Mylar foil, Shield plus 24 AWG drain wire												
	Coverage	100%												
Conductor	Qty	2 x 2	4 x 2	8 x 2	12 x 2	16 x 2	20 x 2	24 x 2	28 x 2	32 x 2	40 x 2	48 x 2	56 x 2	64 x 2
	Strand	7 x 0.20 mm												
	Area/AWG	0.22 mm ² /24												
	Insul. O.D.	1.05 mm												
	Material	Annealed bare copper. XLPE insulated.												

* on request

Snakes, Fan-in and Fan-out

For further information and configurations, see pages 32-33



SNK **16** **A** ***** **M** **R**

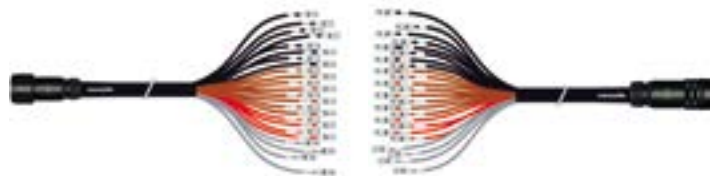

Fan out **FNT** **20X4** **A** **B** ***** **M** **F3** **R**

Fan in **FNN** **20X4** **A** **B** ***** **M** **F3** **R**

* Length Feet **M** Meters

Not suitable for applications above 50 volt ac; 75 volt dc.

SSAS Overall Shield Multipair

eurocable SSAS construction consists of individual pairs enclosed in an aluminum/mylar foil shield with drain wire inside the foil for easier installation.

All pairs are individually shielded, twisted and identified by numbers and letters and then are enclosed in an overall braid tinned copper shield. This particular construction is ideal for continuous winding and unwinding, its use with HD series cable reels is although recommended.

Available on request from 2 to 48 pairs.

INSTALLATION/MOBILE
DIGITAL
JACKET COLOR ■
200-500 m/656-1640 feet ON WOODEN REELS



CVS LKSSAS32C

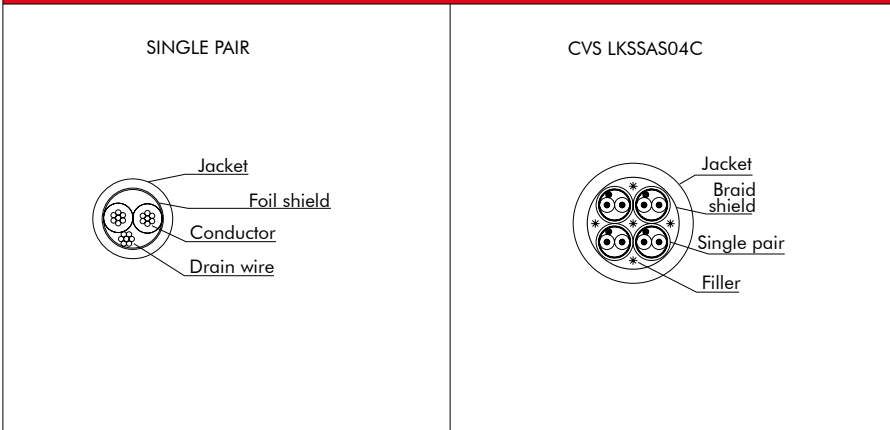

CVS LKSSASCode	02C*	04C*	08C*	12C*	16C*	24C*	28C*	32C*	36C*	48C*	
ELECTRICAL DATA											
D.C.R. at 20°C	Conductor	< 90 ohm/km									
	Shield	< 40 ohm/km									
Capacitance	Conductor/Conductor 1 KHz	140 pF/m									
	Conductor/Shield 1 KHz	250 pF/m									
Nominal Impedance 1 KHz	440 ohm/100 m										
Attenuation 1 KHz	0.24 db/100 m										
Inductance	80 μH/100 m										
GENERAL DATA											
Pairs cable	2	4	8	12	16	24	28	32	36	48	
Cable	O.D.	8.30 mm	10.10 mm	13.00 mm	15.50 mm	18.10 mm	21.10 mm	22.40 mm	22.60 mm	23.90 mm	28.20 mm
	Standard reels	500 m					200 m				
	Weight Kg/100m	9.30	13.40	22.60	30.40	43.20	58.10	67.50	72.20	84.50	100.60
	Operating temperature	-20°C/+70°C									
Jacket	Material	PVC									
	Nominal Thickness	1.20 mm	1.40 mm	1.55 mm	1.60 mm	2.00 mm			2.20 mm		
Shield	Material	Annealed tinned copper braid									
	Coverage	80%									
Conductor	Qty	2 x 2	4 x 2	8 x 2	12 x 2	16 x 2	24 x 2	28 x 2	32 x 2	36 x 2	48 x 2
	Strand	7 x 0.20 mm									
	Area/AWG	0.22 mm ² /24									
	O.D.	2.80 mm									
	Material	Annealed tinned copper braid PVC insulated									

Not suitable for applications above 50 volt ac; 75 volt dc.











*on request

Speaker Cables

Choosing high-quality speaker cable is very important. It ensures that all the information transmitted by the source is accurately and completely transmitted to the loudspeakers.

All **eurocable** speaker cables have been specifically designed for that. They are well-known for their extreme flexibility due to the very high strand count of individual conductors.

The jacket is resistant PVC ensures optimal performance in critical outdoor applications

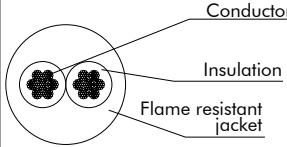
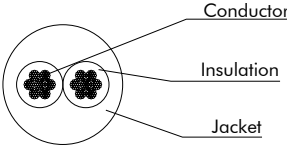
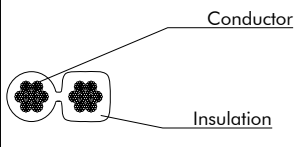
MOBILE	MOBILE	INSTALLATION
JACKET COLOR 	JACKET COLOR 	JACKET COLOR 
100 m/328 feet	100 m/328 feet	100 m/328 feet
ON CARDBOARD REELS	ON CARDBOARD REELS	ON CARDBOARD REELS
 		
		
TWINAXIAL	TWINAXIAL	PARALLEL
		
CPR Eca: EN 60332		
FLAME RESISTANT: IEC 60332-3 CAT. "C", EN 50266-2		FLAME RESISTANT: IEC 60332-3 CAT. "C", EN 50266-2

CVS LKCode	02N15	02N25	02N40	02N15E	02N25E	02N15P	02N25P	
GENERAL DATA								
Cable	O.D.	8.00 mm	9.20 mm	11.50 mm	7.40 mm(± 0.2 mm)	8.60 mm(± 0.2 mm)	3.50 x 7.40 mm	4.00 x 8.40 mm
	Standard reels	100 m						
	Weight Kg/100m	9.60	14.30	20.50	9.60	14.30	5.50	7.90
Jacket	Operating temperature	+5°C/+70°C			-20°C/+70°C			
	Material	PVC flame resistant			PVC TM2		PVC flame resistant	
	Nominal Thickness	1.20 mm	1.00 mm	1.50 mm	1.20 mm	1.00 mm	≥ 1.00 mm	0.70 mm
Conductor	D.C.R. [ohm/km] at 20° C	13	8	5	13	8	13	8
	Quantity	2						
	Strand	48 x 0.2 mm	80 x 0.2 mm	128 x 0.2 mm	48 x 0.2 mm	80 x 0.2 mm	48 x 0.2 mm	80 x 0.2 mm
	Area/AWG	1.5 mm²/16	2.5 mm²/13	4.0 mm²/11	1.5 mm²/16	2.5 mm²/13	1.5 mm²/16	2.5 mm²/13
	Insul. O.D.	2.80 mm	3.40 mm	4.00 mm	2.80 mm	3.40 mm	-	
Material	Bare copper fire resistant PVC insulated			Electrolytic bare copper		Bare copper PVC insulated		

Speaker cable with Neutrik speakON connectors

SIGNAL INTEGRITY

S21FX215

Speaker cable 2x1.5 mm² (02N15) wired with Neutrik speakON 50A connectors



S21FX225

Speaker cable 2x2.5 mm² (02N25) wired with Neutrik speakON 50A connectors



S21FX215E

Speaker cable 2x1.5 mm² (02N15E) wired with Neutrik speakON 50A connectors







S21FX225E

Speaker cable 2x2.5 mm² (02N25E) wired with Neutrik speakON 50A connectors



* Length (meters): **3** **5** **10** **15**
 Feet  Meters

 With packaging, no heat shrink
 No packaging, no heat shrink

 No packaging, with heat shrink
 With packaging and heat shrink

Multicore Speaker Cables (4 to 8 Conductors)

All **eurocable** multicore speaker cables were specifically designed for touring applications. They are flame resistant and known for their extreme flexibility due to the very high strand count of individual conductors. Speaker cables are designed with no center conductor attributing to their superior strength in field applications where long hanging lengths are required. All channel pairs are clearly labeled and arranged using our unique production process to ensure identical distance to the red (+) and black (-) conductors. The eurocable series of multicore speaker cables and LK multi-conductor speaker connectors are available in 4, 6, 8, 16, 24, 36 and 48 conductor configurations. The CVS LK06N25 cable version is available on request.

MOBILE

JACKET COLOR ■

200 m/656 feet ON WOODEN REELS

CE

CVS LK04N40

04N25-04N40

06N25-06N40

08N25-08N40

FLAME RESISTANT: IEC 60332-3 CAT. "C", EN 50266-2

CVS LKCode	04N25	04N40	06N25*	06N40	08N25	08N40	
GENERAL DATA							
Cable	O.D.	11.10 mm	13.20 mm	14.20 mm	15.50 mm	16.00 mm	19.50 mm
	Standard reels	200 m					
	Weight Kg/100m	21.50	34.50	35.00	47.60	47	65.50
Operating temperature 5°C/+70°C							
Jacket	Material PVC fire resistant						
	Nominal Thickness	≥ 1.20 mm	≥ 1.80 mm	≥ 1.60 mm	≥ 1.50 mm	≥ 1.60 mm	≥ 1.80 mm
Conductor	D.C.R. [ohm/km] at 20° C	8	5	8	5	8	5
	Quantity	4		6		8	
	Strand	80 x 0.2 mm	128 x 0.2 mm	80 x 0.2 mm	128 x 0.2 mm	80 x 0.2 mm	128 x 0.2 mm
	Area/AWG	2.50 mm ² /13	4.00 mm ² /11	2.50 mm ² /13	4.00 mm ² /11	2.50 mm ² /13	4.00 mm ² /11
	Insul. O.D.	3.4	4.0	3.4	4.0	3.4	4.0
Material PVC fire resistant							

*on request

Speaker cable with Neutrik speakONconnectors SIGNAL INTEGRITY

S41FX425 **

Speaker cable 4x2.5 mm² wired with Neutrik speakON 50A connectors

S41FT425 **

Speaker cable 4x2.5 mm² wired with Neutrik speakON 50A connectors Metal

S81FC840 **

Speaker cable 8x4 mm² wired with Neutrik speakON connectors

S41FX440 **

Speaker cable 4x4 mm² wired with Neutrik speakON 50A connectors

S41FT440 **

Speaker cable 4x4 mm² wired with Neutrik speakON 50A connectors Metal

S81FT840 **

Speaker cable 8x4 mm² wired with Neutrik speakON connectors Metal

* Length (meters): **3 5 10 15**
 ■ With packaging, no heat shrink
 □ No packaging, with heat shrink
■ Feet
 ■ Meters
 ■ No packaging, no heat shrink
 ■ With packaging and heat shrink

Multicore Speaker Cables (18 and 24 Conductors)

The CVS LK18N40 and CVS LK24N40 multicore speaker cables were specially designed to meet the needs of new audio systems in the touring applications. All eurocable speaker cables are flame resistant and are designed with a no-center conductor, attributing to their superior strength in field applications where long hanging lengths are required. Channel pairs are clearly labeled and arranged using our unique production process to ensure identical distance for the red (+) and black (-) conductors. When used with LKA 32/25 connectors, they guarantee to support high-density line array configurations where multiple speaker channels are required. Based on the LK Series MIL-SPEC designs, these connectors are extremely robust, IP rated, and available with impact-resistant rubber locking rings.



MOBILE

JACKET COLOR ■

200 m/656 feet ON WOODEN REELS

CE

CVS LK24N40

Jacket

Conductor

Filler

Jacket

Conductor

Filler

FLAME RESISTANT: IEC 60332-3 CAT. "C", EN 50266-2

	CVS LK18N40	CVS LK24N40
GENERAL DATA		
Cable	D.C.R. [ohm/km] at 20° C	5
	O.D.	22.80 mm
	Standard reels	200 m
	Weight Kg/100m	106
	Operating temperature	-15° C/+80° C
Jacket	Material	PVC fire resistant
	Nominal Thickness	2.00 mm
Conductor	Qty	18
	Strand	128 x 0.20 mm
	Area/AWG	4.00 mm ² /11
	Insul. O.D.	3.8 mm
	Material	Annealed bare copper PVC flame resistant insulated

Snakes, Fan-in and Fan-out

SPK 24N40 LK MFR * M H

* Length Feet M Meters

FNTS F 24 BRNM * M F3

FNTS B 24 ERNM * M

Multicore Speaker Cables (36 and 48 Conductors)

Today's professional line arrays require more granular control in order to effectively leverage high-density power amplifiers and DSP control.

The **eurocable** series of multicore speaker cables, and LK multi-conductor speaker connectors, were specifically designed for touring applications.

All eurocable speaker cables are flame resistant and are designed with a no-center conductor, attributing to their superior strength in field applications where long hanging lengths are required. Channel pairs are clearly labeled and arranged using our unique production process to ensure identical distance for the red (+) and black (-) conductors.

The CVS LK36N40AD2 and LK48N40AD2 also contain digital pairs to transport common laser and inclinometer signals.



MOBILE
JACKET COLOR ■
92 m/300 feet ON WOODEN REELS

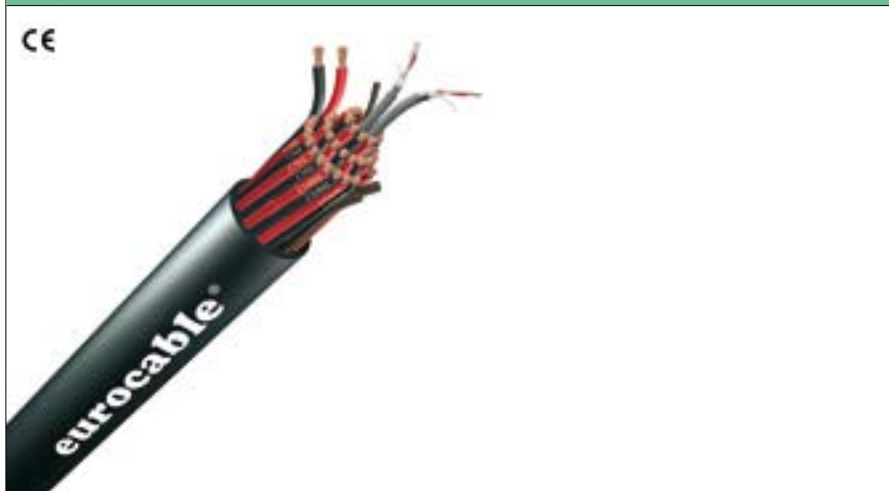

CVS LK48N40AD2

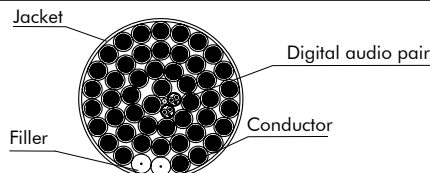

FLAME RESISTANT: IEC 60332-3 CAT. "C", EN 50266-2

GENERAL DATA		CVS LK36N40AD2*	CVS LK48N40AD2*	Speaker	Audio
Cable	O.D.	≤ 31.10 mm	≤ 35.00 mm	3.60 mm	1.20 mm
	Standard reels	92 m			
	Weight Kg/100m	197	257	-	-
	Operating temperature	-20° C/+70° C			
Jacket	Material	PVC			
	Nominal Thickness	2.10 mm		1.00 mm	0.60 mm
Shield	Material	-			Aluminium - Polyester foil + tinned copper drain wire 7 x 0.16 mm
	Coverage	-			-
Conductor	Qty	-	-	36 (36N40AD2) 48 (48N40AD2)	2
	Strand	-	-	128 x 0.20 mm	7 x 0.16 mm
	Area/AWG	-	-	4.00 mm ² /11	0.14 mm ² /26
	Insul. O.D.	-	-	3.60 mm	1.20 mm
	Material	-	-	Annealed bare copper PVC insulated	Annealed tinned copper polyolefine insulated

*on request

Snakes



SPK 48N40AD2 LK1 MR * M H

* Length Feet M Meters

Custom fan-in&out on request



Powered Audio/DMX Cables

SPKAL range

The **eurocable** SPKAL series of self-powered cables are ideal for use on stage, delay and main speaker systems or wherever self-powered are employed. The tried and tested **eurocable** design for this type of cable ensures interference-free operation with the benefit of running only one cable for power and audio. LK Connectors multipin solutions are also available for the SPKAL range.

DMX CC

The DMX CC cable meets the DMX 512-A standard for data transmission in digital mixing-control applications, networking of scanners and lighting systems. It consists in one Data pair and two voltage supply pairs for transmission of voltage up to 50 V.

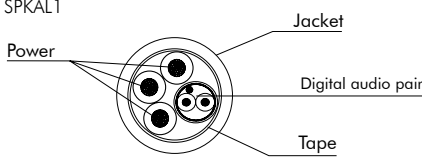
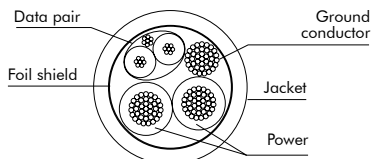
MOBILE	INSTALLATION/MOBILE
DIGITAL	DIGITAL
JACKET COLOR ■■■	JACKET COLOR ■■■
200-305 m/656-1000 feet ON WOODEN REELS	200 m/656 feet ON WOODEN REELS
	
SPKAL1	DMXCC
 <p>Labels: Jacket, Digital audio pair, Tape, Power</p>	 <p>Labels: Ground conductor, Jacket, Power, Foil shield, Data pair</p>
FLAME RESISTANT: IEC 60332-3 CAT. "C", EN 50266-2	FLAME RESISTANT: IEC 60332-3, EN 60332-1

CVS LKCode	SPKAL1	SPKAL2	SPKAL4	DMXCC	
ELECTRICAL DATA					
D.C.R. at 20°C	Conductor	Audio: 160 ohm/km			Data: 80 ohm/km - Power: 10 ohm/km
	Shield	< 15 ohm/km			150 ohm/km
Capacitance	Conductor/Conductor 1 KHz	30 pF/m			33 pF/m
	Conductor/Shield 1 KHz	70 pF/m			82 pF/m
Nominal Impedance	110 ohm				
Attenuation [db/100m]	7 at 3 MHz/10 at 6 MHz			at 256 KHz	
Vel. of Prop.	80%			78%	
GENERAL DATA					
Cable	O.D.	10.50 mm	11.60 mm	12.40 mm	7.80 mm
	Standard reels	200 m	305 m		200 m
	Weight Kg/100m	17	20.50	24	11.50
	Operating temperature	-20°C/+70°C			
Jacket	Material	PVC flame resistant			
	Nominal Thickness	1.30 mm	1.50 mm		0.70 mm
Shield	Material	Tinned copper braid + PET/ALL. tape			Aluminium - Mylar foil
	Coverage	First: 86% - Second: 100%			100%
Conductor	Quantity	Audio: 1	Audio: 1	Audio: 2	Data: 1
		Power: 3	Power: 3	Power: 3	Power: 2
	Strand	Audio: 7 x 0.15 mm			Data: 7 x 0.20mm
		Power: 48 x 0.19 mm	Power: 80 x 0.19 mm		Power: 43 x 0.25 mm
	Area/AWG	Audio: 0.13/26			Data: 0.22 mm ² /24
	Insulation O.D.	Power: 1.5/16 (L1) 2.08/14 (L2/L4)			Power: 2 mm ² /14
Audio: 1.50 mm			Data: 1.60 mm		
Material	Power: 2.8 mm	Power: 3.4 mm		Power: 2.70 mm	
	Audio: Tinned copper polyethylene insulated			Data: Tinned copper P.E. insulated	
Power: Bare copper fire resistant PVC insulated					Power: Tinned copper PVC insulated

SPKAL Speaker with power (3x1.5 or 3x2.5 mm²) cable with Neutrik powerCON and XLR connectors SIGNAL INTEGRITY

SPPX1STK1

SPKAL1-one digital audio pair and 3x1.5 mm² power cable Neutrik powerCON and XLR black/gold



SPPX2STK2

SPKAL2-one digital audio pair and 3x2.5 mm² power cable Neutrik powerCON and XLR black/gold









SPPX2STK4

SPKAL4-two digital audio pairs and 3x2.5 mm² power cable Neutrik powerCON and 2 XLR black/gold





For DMXCC cables see page 89

-  Length (meters): **3 5 10 15**
-  Feet
-  With packaging, no heat shrink
-  No packaging, no heat shrink
-  No packaging, with heat shrink
-  With packaging and heat shrink

Powered Audio/DMX Cables

The **eurocable** AD1P1 and AD1P2 are built with one main power line (3x1.5 mm²) with an individual external jacket and one or two 110 ohm balanced digital cables. They were specifically designed to meet the most demanding request in different audio, video and lighting applications such as colour change control, follow spots with intercom, powered loudspeaker and monitor control.

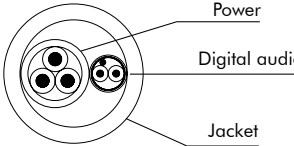
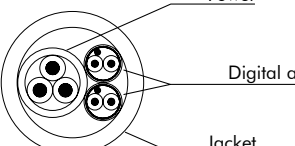
INSTALLATION/MOBILE	INSTALLATION/MOBILE
DIGITAL	DIGITAL
JACKET COLOR ■	JACKET COLOR ■
200 m/656 feet ON WOODEN REELS	200 m/656 feet ON WOODEN REELS
	
CVS LKAD1P1	CVS LKAD2P1
	

ELECTRICAL DATA		
D.C.R. at 20°C	Conductor	75 ohm/km
	Shield	25 ohm/km
Capacitance	Conductor/Conductor 1 KHz	80 pF/m
	Conductor/Shield 1 KHz	160 pF/m
Nominal Impedance		110 ohm
Attenuation [db/100m]		5 at 3 MHz/8.5 at 6 MHz/11.5 at 8 MHz
Vel. of Prop.		80%
GENERAL DATA		
Cable	O.D.	14.90 mm
	Standard reels	200 m
	Weight Kg/100m	20.70
	Operating temperature	-20°C/+70°C
Jacket	Material	PVC TM2
	Nominal Thickness	1.50 mm
Shield	Material	Audio: Tinned copper spiral shield
	Coverage	100%
Conductor	Quantity	Audio: 1 - Power: 1
	Strand	Audio: 28 x 0.10 mm - Power: 48 x 0.20 mm
	Area/AWG	Audio: 0.22mm ² /24 - Power: 3 x 1.5mm ² /3 x 15
	Insulation O.D.	Audio: 3.75mm - Power: 7.70mm
	Material	Audio: Annealed bare copper, polyolefine insulated, external jacket: PVC Power: Annealed tinned bare copper, PVC insulated, external jacket: PVC

Audio with power (3x1.5 mm²) cable with Neutrik powerCON and XLR connectors

SPPX1STD1

AD1P1-one digital audio pair and 3x1.5 mm² power cable Neutrik powerCON and XLR black/gold



SPPX2STD2

AD2P1-two digital audio pairs and 3x1.5 mm² power cable Neutrik powerCON and 2 XLR black/gold



SIGNAL INTEGRITY



* Length (meters): **3** **5** **10** **15**
 Feet Meters

With packaging, no heat shrink
 No packaging, no heat shrink

No packaging, with heat shrink
 With packaging and heat shrink

CAT PUR Jacket

A polyurethane sheath protects the **eurocable** CAT6 and CAT7 PUR range. Specifically created for mobile outdoor transmission, these cables are flexible, strong, and were designed to be the most durable jacketed cables available today. Link's testing criteria exceed all established nominal standards.

eurocable CAT7 cables undergo ISO/IEC 11801 certification tests Class F in which the complete range of relevant frequencies is analyzed. The test ensures that each value, at every frequency up to 1500 MHz, is compliant with the standard at the specified length. **eurocable** CAT7 is the first cable for Dante that was tested successfully to 150m and is guaranteed to 120m for mobile applications.

eurocable CAT6 cables undergo EIA/TIA 568B.2 and ISO/IEC 11801 certification tests in which the complete range of relevant frequencies are analyzed. The test ensures that each value, at every frequency up to 500 MHz, is compliant with the standard at the specified length. The eurocable CAT6 is designed for transmitting high bandwidth signals over long distances (typically 300 ft or 90m as per the published standard).

MOBILE	MOBILE
JACKET COLOR ■	JACKET COLOR ■
500 m/1640 ft ON WOODEN REELS	300 m/1000 ft ON WOODEN REELS
CVS LKCAT7 SFTP PUR	CVS LKCAT6A STP PUR
HALOGEN FREE	HALOGEN FREE
FLAME RETARDANT: IEC 60332-1, IEC 60332-3-24, IEC 60754-1, IEC 61034-, EN 50265-2-1, EN 50305, EN 50268-2-1	FLAME RETARDANT: IEC 60754-1, IEC 61034-1, IEC 60332-1, EN 50267-2-1, EN 50268-2-1, EN 50265-2-1

TRANSMISSION SPECIFICATIONS for CAT7																					
Frequency [MHz]	1	4	10	16	20	31.25	62.5	100	125	155.5	175	200	250	300	450	600	750	900	1000	1200	1500
Attenuation (max)	2.00	3.50	5.30	6.60	7.50	9.50	13.50	16.50	18.80	21.00	21.20	23.20	25.40	28.40	36.00	41.00	47.80	52.00	55.30	59.00	70.00
NEXT (min)	90.00	90.00	90.00	90.00	85.00	85.00	80.00	80.00	80.00	80.00	75.00	75.00	75.00	70.00	70.00	65.00	65.00	65.00	65.00	55.00	50.00
ACR (min)	88.00	86.50	84.70	83.40	77.50	75.50	66.50	63.50	61.20	59.00	53.80	51.80	49.60	41.60	34.00	24.00	17.20	13.00	9.70	-4.00	-20.00
Return Loss (min)	25.00	25.00	25.00	25.00	25.00	25.00	25.00	25.00	25.00	25.00	25.00	25.00	25.00	25.00	25.00	20.00	20.00	20.00	20.00	20.00	15.00

TRANSMISSION SPECIFICATIONS (for CAT6)										
Frequency [MHz]	1	10	20	31.2	62.5	100	155.5	200	250	300
Attenuation (max)	1.8	5.4	7.7	9.6	13.7	17.4	21.9	25	28.1	30.8
NEXT (min)	100	80	70	65	60	60	55	55	50	45
ACR (min)	98.2	74.6	62.3	55.4	46.3	42.6	33.1	30	21.9	14.2
Return Loss (min)	25	25	25	25	25	25	25	20	20	20

ELECTRICAL DATA		
D.C.R. at 20°C	≤ 57.50 ohm/Km	80 ohm/Km
Insulation resistance	> 5000 mOhm/Km	-
Insulation voltage	1 Kv	-
Mutual capacitance	43 pF/m at 800Hz	56 pF/m at 800Hz
Nominal Impedance 1 KHz	100 ohm (nom)	
Propagation velocity	77%	67%

GENERAL DATA		
Cable	O.D.	10 mm
	Weight Kg/100m	11.35
Jacket	Material	Flame Retardant LSZH PUR
	Color	Black
Overall shield	Material	Tinned copper braid
	Coverage	40% / 80%
Single pair shield	Material	Aluminium/Polyester tape
	Coverage	100%
Conductor	Quantity	4 x 2
	Strand	1 x 0.64 mm / 1 x 0.57 mm
	Area/AWG	0.32 mm²/22 / 0.26 mm²/23
	Material	Solid Bare - Red copper

Not suitable for applications above 50 volt ac; 75 volt dc.

CAT6 LAN Cable

The **eurocable** CAT6 LAN is designed for fixed installation in Local Area Networks, such as campus or riser, due to its high electrical and flammability performance. **eurocable** CAT6 LAN supports gigabit signals over extended distances (typically 300ft or 90m as per the published standard) and guarantees the highest possible performance for the cost.

Link's testing criteria exceeds all established nominal standards as identified below.

CAT6 cables undergo EIA/TIA 568B.2 and ISO/IEC 11801 certification tests in which the complete range of relevant frequencies are analyzed. The test ensures that each value, at every frequency up to 500 MHz, is compliant with the standard at the specified length.

INSTALLATION	
JACKET COLOR	■
500 m/1640 ft ON WOODEN REELS	



CVS LKLANCAT6A U/UTP

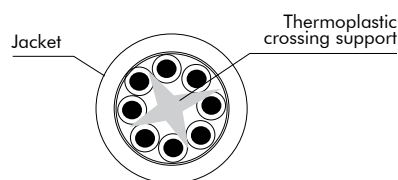







HALOGEN FREE
FLAME RETARDANT: ISO/IEC 11801, IEC 61156-5, EN 50173, EN 50288-11-1, EIA-TIA 568C.22

TRANSMISSION SPECIFICATIONS										
Frequency [MHz]	1	10	20	31.2	62.5	100	155.5	200	250	300
Attenuation (max)	1.8	5.4	7.7	9.6	13.7	17.4	21.9	25	28.1	30.8
NEXT (min)	100	80	70	65	60	60	55	55	50	45
ACR (min)	98.2	74.6	62.3	55.4	46.3	42.6	33.1	30	21.9	14.2
Return Loss (min)	25	25	25	25	25	25	25	20	20	20
GENERAL DATA										
Cable	O.D.	6.6 mm								
	Standard reels	500 m								
	Operating temperature	-20° C/+60° C								
	Weight Kg/100m	4.64								
Jacket	Material	LSZH engineering resin + PVC								
	Nominal Thickness	1 mm								
Conductor	Quantity	4 x 2								
	Strand	1 x 0.57								
	Area/AWG	0.26 mm² /23								
	Material	Solid Bare - Red copper								

Not suitable for applications above 50 volt ac; 75 volt dc.

CAT Solid Bare

eurocable CAT cables are very flexible and resistant to damage and they are ideal for distributed backbone between equipment rooms, remote workstations and telecommunications closets. They were specifically designed for long distance cabling runs. Link's testing criteria exceeds all established nominal standards as identified below. CAT6 cables undergo EIA/TIA 568B.2 and ISO/IEC 11801 certification tests in which the complete range of relevant frequencies are analyzed. The test ensures that each value, at every frequency up to 500 MHz, is compliant with the standard at the specified length.

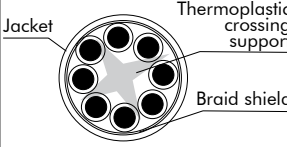
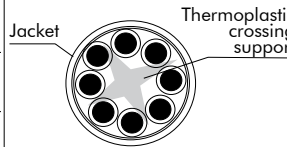
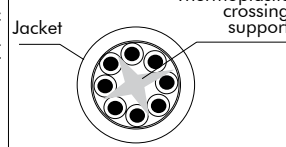
MOBILE	MOBILE	MOBILE
JACKET COLOR 	JACKET COLOR 	JACKET COLOR 
305 m/1000 ft	305 m/1000 ft	305 m/1000 ft
ON WOODEN REELS	ON WOODEN REELS	ON WOODEN REELS
		
CVS LKCAT6A STP	CVS LKCAT6A UTP	CVS LKCAT5E
 <p>Jacket, Thermoplastic crossing support, Braid shield</p>	 <p>Jacket, Thermoplastic crossing support</p>	 <p>Jacket, Thermoplastic crossing support</p>

TRANSMISSION SPECIFICATIONS (for CAT6)

Frequency [MHz]	1	10	20	31.2	62.5	100	155.5	200	250	300
Attenuation (max)	1.8	5.4	7.7	9.6	13.7	17.4	21.9	25	28.1	30.8
NEXT (min)	100	80	70	65	60	60	55	55	50	45
ACR (min)	98.2	74.6	62.3	55.4	46.3	42.6	33.1	30	21.9	14.2
Return Loss (min)	25	25	25	25	25	25	25	20	20	20

TRANSMISSION SPECIFICATIONS (for CAT5)

Frequency [MHz]	1	4	8	10	16	20	25	31.25	62.50	100	155	200	250
Attenuation (max)	2	3.7	5.3	5.9	7.5	8.4	9.5	10.6	15.3	19.8	25.1	29.8	32.8
NEXT (min)	74.3	65.2	60.7	59.3	56.2	54.7	53.3	51.8	47.3	44.3	41.4	39.7	38.3
ACR (min)	72.2	61.4	55.4	53.3	48.6	46.3	43.8	41.2	31.9	24.5	16.2	10.8	5.4
PS-NEXT (min)	72.3	63.2	58.7	57.3	54.2	52.7	51.3	49.8	45.3	42.3	39.4	37.7	36.3
Return Loss (min)	20	23	24.5	25	25	25	24.3	23.6	21.5	20.1	19	18	17.3

GENERAL DATA

Cable	O.D.	8.50 mm (± 0.2 mm)		6.80 mm
	Weight Kg/100m	10.40		4.29
	Operating temperature	-20°C/+70°C		
Jacket	Material	External: PVC, Internal: LSZH polymer		Reticulated Elastomeric Mixture
Overall shield	Material	Annealed tinned copper braid shield	-	-
	Coverage	80%	-	-
Conductor	Quantity	4 x 2		
	Strand	1 x 0.555 mm		7 x 0.145 mm
	Area/AWG	0.26 mm ² /23		0.12 mm ² /26
	Material	Solid Bare - Red copper		Stranded- Red copper

CAT6 STP cable with etherCON and RJ45 connectors (also available with patch cable)

SIGNAL INTEGRITY

ER6N5S6S 

CAT6 STP cable wired with Neutrik etherCON silver



ER6N5B6S 

CAT6 STP cable wired with Neutrik etherCON black



ER6H5S6S 

CAT6 STP cable wired with Neutrik etherCON silver/RJ45



ER6H5B6S 

CAT6 STP cable wired with Neutrik etherCON black/RJ45



ER6R5P6S 

CAT6 STP cable wired with RJ45







* Length (meters): **3 5 10 15**
 Feet Meters

With packaging, no heat shrink
 No packaging, no heat shrink

No packaging, with heat shrink
 With packaging and heat shrink





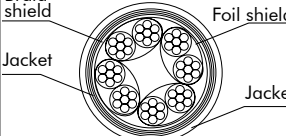
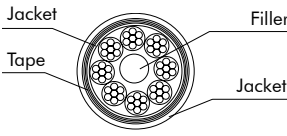
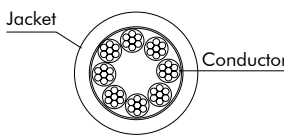





CAT Stranded



eurocable CAT stranded cables are specifically created for mobile applications. Their extremely flexible and robust jacket guarantees reliable performance in critical conditions. Link's testing criteria exceeds all established nominal standards as identified below. CAT patch cables undergo EIA/TIA 568B.2 and ISO/IEC 11801 certification tests in which the complete range of relevant frequencies are analyzed. The test ensures that each value, at every frequency up to 500 MHz, is compliant with the standard at the specified length.





MOBILE	MOBILE	
JACKET COLOR 	JACKET COLOR 	
305 m/1000 ft ON WOODEN REELS	305 m/1000 ft ON WOODEN REELS	
		
CVS LKCAT6A SFTP P	CVS LKCAT6 UTP P	CVS LKCAT5E SF P
		

TRANSMISSION SPECIFICATIONS (for stranded conductors)														
Frequency [MHz]	1	4	8	10	16	20	25	31.25	62.50	100	155	200	250	
Attenuation (max)	2	3.7	5.3	5.9	7.5	8.4	9.5	10.6	15.3	19.8	25.1	29.8	32.8	
NEXT (min)	74.3	65.2	60.7	59.3	56.2	54.7	53.3	51.8	47.3	44.3	41.4	39.7	38.3	
ACR (min)	72.2	61.4	55.4	53.3	48.6	46.3	43.8	41.2	31.9	24.5	16.2	10.8	5.4	
PS-NEXT (min)	72.3	63.2	58.7	57.3	54.2	52.7	51.3	49.8	45.3	42.3	39.4	37.7	36.3	
Return Loss (min)	20	23	24.5	25	25	25	24.3	23.6	21.5	20.1	19	18	17.3	
TRANSMISSION SPECIFICATIONS (for CAT5)														
Frequency [MHz]	1	4	8	10	16	20	25	31.25	62.50	100	155	200	250	
Attenuation (max)	2	3.7	5.3	5.9	7.5	8.4	9.5	10.6	15.3	19.8	25.1	29.8	32.8	
NEXT (min)	74.3	65.2	60.7	59.3	56.2	54.7	53.3	51.8	47.3	44.3	41.4	39.7	38.3	
ACR (min)	72.2	61.4	55.4	53.3	48.6	46.3	43.8	41.2	31.9	24.5	16.2	10.8	5.4	
PS-NEXT (min)	72.3	63.2	58.7	57.3	54.2	52.7	51.3	49.8	45.3	42.3	39.4	37.7	36.3	
Return Loss (min)	20	23	24.5	25	25	25	24.3	23.6	21.5	20.1	19	18	17.3	
GENERAL DATA														
Cable	O.D.	7.70 mm					7.50 mm					6.50 mm		
	Weight Kg/100m	5.95					6.16					5.80 mm		
	Operating temperature	-20°C/+70°C												
Jacket	Material	External: PVC, Internal: LSZH polymer									PVC			
Overall shield	Material	Tinned copper braid					-					-		
	Coverage	40%					-					-		
Shield on single pair	Material	Aluminium/Polyester tape									-			
	Coverage	100%					-					-		
Conductor	Quantity	4 x 2												
	Strand	7 x 0.145 mm					7 x 0.20 mm							
	Area/AWG	0.12 mm ² /26					0.22 mm ² /24							
	Material	Stranded - Red copper									Annealed bare red copper			

CAT6A UTP cable with EtherCON and RJ45 connectors (also available with patch cable) SIGNAL INTEGRITY

<p>ER6N5S6U </p> <p>CAT6 UTP cable wired with Neutrik EtherCON silver</p> 	<p>ER6N5B6U </p> <p>CAT6 UTP cable wired with Neutrik EtherCON black</p> 	
<p>ER6H5S6U </p> <p>CAT6 UTP cable wired with Neutrik EtherCON silver/RJ45</p> 	<p>ER6H5B6U </p> <p>CAT6 UTP cable wired with Neutrik EtherCON black/RJ45</p> 	<p>ER6R5P6U </p> <p>CAT6 UTP cable wired with RJ45</p> 

 Length (meters): **3 5 10 15**
  With packaging, no heat shrink
  No packaging, with heat shrink
 All products are also available with Amphenol connectors

 Feet
  Meters
  No packaging, no heat shrink
  With packaging and heat shrink

Not suitable for applications above 50 volt ac; 75 volt dc.

Hybrid cable for Data and Power

The **eurocable** 4CAT6SF 10/5 cable contains 4 CAT6 and 5 wire 32A three-phase power conductors designed to address the growing demand for multiple Ethernet lines and power in one cable. When coupled with new LKG 40/4E5 connector, setup time for power and data runs is greatly reduced and reliability is greatly improved. With a single Stage/Front of House "safe connection", you may run MADI Tx/Rx and a Primary/Secondary Dante Network. Any combination of audio protocols, Streaming ACN, and Video are possible while proving 32A 3-phase power to FOH. The 4 integral **eurocable** CAT6 cables support gigabit signals over extended distances (typically 300ft or 90m as per the published standard)

***Please note that some digital audio protocols may permit longer distances than the ethernet standard allows and can be tested for specific manufacturer applications.*

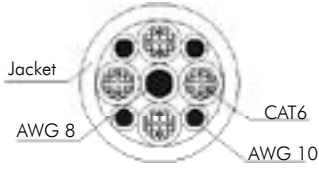
MOBILE		
JACKET COLOR ■		
200 m/656 ft ON WOODEN REELS		
		
		
IEC 60228, CEI EN 50363 (as far as applicable), UL 1581, UL 758, reference styles AWM 2464, ISO/IEC 11801, IEC 61156-5, EN 50173, EN 50288-11-1, EIA-TIA 568C.22		
AWG 10	AWG 8	CAT6 SF UTP

ELECTRICAL DATA			
D.C.R. at 20°C	<5.27 Ohm/km	<2.14 ohm/km	-
Rated Voltage	300 V		
Test Voltage	1500 Vacx1"		
Nominal Impedance	-	-	100 Ohm
Velocity of Propagation	-	-	67%
GENERAL DATA			
Cable	O.D.	28.80 mm	
	Color	Black RAL 9005	
	Bending Radius	10 x O.D.	
	Operating temperature	-20°C/+80°C	
Overall Jacket	Material	PVC	
	Jacket single type	Material	LSZH Thermoplastic Material
Shield	Material	-	Aluminium/polyester tape tinned copper braid
	Coverage	-	54%
		-	78%
Conductor	Qty	4	4 (4x2)
	Area/AWG	6 mm²/10	0.25 mm²/23
	Strand	168x0.20 mm cl.6	1x0.57 mm
	Insul. O.D.	5 mm (nom)	8 mm (nom.)
	Material	Bare copper	Bare copper polyethylene insulated

Snakes

For further information and configurations, see pages 58-59



SNKG **4P** **Q** ***** **M** **R**



***** Length **■** Feet **M** Meters

Hybrid Cables for Data and Power

eurocable hybrid cable range 1 CAT6 cable + 1 Power line are designed to address the growing need to transmit Ethernet and power over one cable.

These cable include 3x12 AWG (3,3 mm²) or 3x16 AWG (1,5 mm²) power wires plus one SF/UTP CAT6A signal over extended distances. (typically 300 ft. or 90 m as per the published standard)

Note: The maximum length stated references the furthest distance allowed while maintaining EIA/TIA 568.B.2 certification. Actual performance may be greater depending on the protocol.

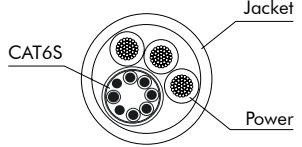
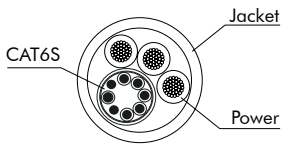
MOBILE		MOBILE	
JACKET COLOR ■		JACKET COLOR ■	
200 m/656 ft ON WOODEN REELS		200 m/656 ft ON WOODEN REELS	
			
CVS LK1CAT6SF 12/3		CVS LK1CAT6SF 16/3	
			
CEI EN 60228, CEI EN 50363		CEI EN 60228, CEI EN 50363	
3 x 3.30 mm ²	CAT6	3 x 1.50 mm ²	CAT6v hghh

ELECTRICAL DATA					
D.C.R. at 20° C		< 5.2 ohm/Km	-	< 13.3 ohm/Km	-
Test voltage		2000 Vca x 1' cond/cond	-	2000 Vca x 1' cond/cond	-
		2000 Vca x 1' cond/shield	-	2000 Vca x 1' cond/shield	-
GENERAL DATA					
Cable	O.D.	15.30 mm		13.40 mm	
	Material	PVC (TM2)			
	Weight Kg/100m	33.70		23.80	
Shield	Material	-	I Aluminium polyester tape	-	I Aluminium polyester tape
		-	II Annealed tinned copper braid	-	II Annealed tinned copper braid
	O.D. wire	-	0.10 mm	-	0.10 mm
	Coverage	-	100%	-	100%
	Wrapping	-	> 80%	-	> 80%
Conductor	Single conductor O.D.	68 x 0.25 mm/12 AWG	4 x 2 x 23 AWG	46 x 0.20 mm/16 AWG	4 x 2 x 23 AWG
		2.37 mm	0.57 mm	1.60 mm	0.57 mm
	Material	Annealed red copper	Bare copper wire	Annealed red copper	Bare copper wire
		PVC insulated	Polyethylene insulated	PVC insulated	Polyethylene insulated

Snakes

For further information and configurations, see pages 58-59



SNKG 1 Y * M R

SNKG 1 R * M R

* Length Feet M Meters

Hybrid Cables for Data, Audio and Power

eurocable 2CAT6SF 12/3 AD2 is designed to address the growing need to transmit power + data signals over one cable. This cable includes 3x12 AWG (3,5 mm²) double shielded power cable, two AES individually jacketed and shielded audio pairs, plus two SF/UTP CAT6 signals over extended distances. (typically 300 ft. or 90 m as per the published standard)

Note: The maximum length stated references the furthest distance allowed while maintaining EIA/TIA 568.B.2 certification. Actual performance may be greater depending on the protocol.

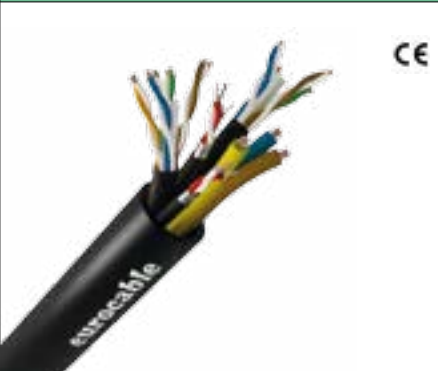
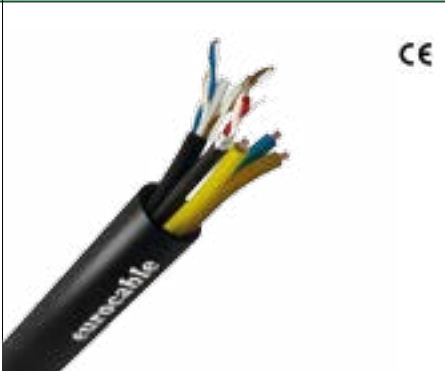
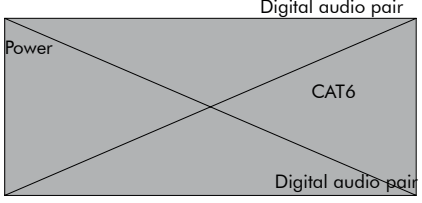
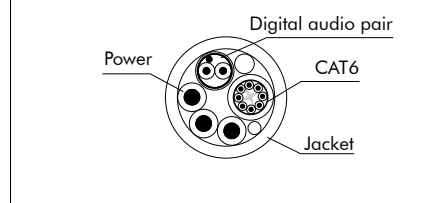
MOBILE			
DIGITAL			
JACKET COLOR ■			
152 m/500 ft ON WOODEN REELS			
			
CVL LK2CAT6SF 12/3 AD2		CVL LK1CAT6SF 12/3 AD1	
			

GENERAL DATA				
Cable	O.D.	21.30 mm		16.20 mm
	Weight Kg/100m	46.90		36.70 mm
	Operating temperature	-20°C/+70°C		-20°C/+80°C
	Volt. Rate (Power)	600 V		300 V
Jacket	Nominal Thickness	1.70 mm		1.60 mm
	Color	Black		
	Material	PVC		
		Audio	CAT6	Power
Cable	O.D.	4.00 mm	8.00 mm	10.60 mm
Jacket	Material	PVC		
	Nominal Thickness	0.65 mm	0.53 mm	
Shield	Material	Aluminium - Polyester tape plus 18 x 0.10 mm drain wire	Aluminium - Polyester tape plus drain wire	-
	Coverage	100%	100%	-
Conductor	Qty	2 (CVL LK2CAT6SF 12/3 AD2) 1 (CVL LK1CAT6SF 12/3 AD1)	2 (CVL LK2CAT6SF 12/3 AD2) 1 (CVL LK1CAT6SF 12/3 AD1)	3
	Strand	18 x 0.10 mm	1 x 0.58 mm	70 x 0.25 mm
	Area/AWG	0.14 mm ² /26	0.22 mm ² /24	3.44 mm ² /12
	Insulation O.D.	1.20 mm	1.00 mm	1.00 mm
	Material	Annealed tinner copper polyolefine insulated	Solid bare copper polyolefine insulated	Annealed bare copper PVC insulated

Snakes

For further information and configurations, see pages 58-59



SNKG 2P X * M R

SNKG 2P L * M R

* Length Feet M Meters

Multidata CAT6A Cables

The **eurocable** multiCAT6 flexible cables are designed to answer the growing needs of running more data signals in mobile applications.

Designed for transmitting high bandwidth signals over long distances (typically 300 ft or 90 m as per the published standard). Please note that some digital audio protocols may permit longer distances than the Ethernet standard allows and can be tested for specific manufacturer applications(*).

Multidata CAT6 is available in two versions:

4CAT6F

Four **eurocable** F/UTP cables in an extra flexible and robust PVC jacket with overall braid shield

6CAT6F

Six eurocable F/UTP cables in an extra flexible and robust PVC jacket with an overall braided shield.

**Please consider that extended stress, or poor termination practices, can alter the primary electrical values of this type of cable. Using a cable reel is highly recommended.*

MOBILE
JACKET COLOR
200 m/656 ft ON WOODEN REELS



CVS LK6CAT6F

Single CAT6A

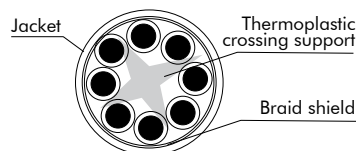

CVS LK4CAT6F	CVS LK6CAT6F
--------------	--------------

TRANSMISSION SPECIFICATIONS											
Frequency [MHz]	1	10	20	31.2	62.5	100	155.5	200	250	300	500
Attenuation (max)	1.8	5.4	7.7	9.6	13.7	17.4	21.9	25	28.1	30.8	40
NEXT (min)	100	80	70	65	60	60	55	55	50	45	42
ACR (min)	98.2	74.6	62.3	55.4	46.3	42.6	33.1	30	21.9	14.2	2
Return Loss (min)	25	25	25	25	25	25	25	20	20	20	15

GENERAL DATA		
Cable	O.D.	22.10 mm / 27.50 mm
	Standard reels	200 m
	Weight Kg/100m	49.40 / 73.30
	Operating temperature	-20°C/+70°C
Jacket	Material	PVC
	Shield	Tinned copper braid
Shield	Material	Tinned copper braid
	Coverage	80%
Conductor	Quantity	4 x 4 x 2 / 6 x 4 x 2
	Strand	1 x 0.57 mm
	Area/AWG	0.26 mm²/23
	Material	Solid bare red copper polyethylene insulated

Snakes

For further information and configurations, see pages 58-59



SNKG 4 N * M R

SNKG 6 C * M R

* Length Feet M Meters

Not suitable for applications above 50 volt ac; 75 volt dc.

Multisignal CAT6 with Audio

The **eurocable** 2CAT6F AD2 and 2CAT6F AD6 cables perfectly respond to the need of CAT6A drive snake connectivity and other applications where both CAT6 and balanced lines are required in one cable.

CVS LK2CAT6AF AD2



Featuring two CAT6 lines (maximum length 90 m) and two balanced AES audio lines in one jacket, the 2CAT6F AD2 is ideal for connecting the ever-increasing number of FOH digital systems and stage components. The two balanced pairs can be used for intercom, tie lines or any other audio applications. Built following **eurocable's** perfect balance between flexibility and durability renowned worldwide.

CVS LK2CAT6AF AD6

The 2CAT6F AD6 cable offers the same characteristics as before, featuring six balanced AES audio lines

CVS LK2CAT6AF AD12

The 2CAT6F AD12 cable offers the same characteristics as before, featuring twelve balanced AES audio lines

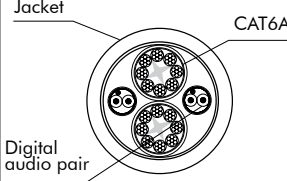
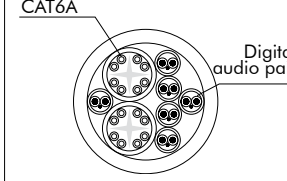
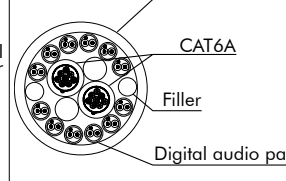
MOBILE	MOBILE	MOBILE
JACKET COLOR 	JACKET COLOR 	JACKET COLOR
305 m/1000 ft	305 m/1000 ft	305 m/1000 ft
ON WOODEN REELS	ON WOODEN REELS	ON WOODEN REELS
		
CVS LK2CAT6AF AD2	CVS LK2CAT6AF AD6	CVS LK2CAT6AF AD12
		

TRANSMISSION SPECIFICATIONS													
Frequency [MHz]	1	10	20	31	63	100	125	155	175	200	250	300	500
Attenuation (max)	2,1	5,9	8,4	10,5	15	19,1	21,5	24,1	25,7	27,6	31,1	34,3	45,3
NEXT (min)	75,3	60,3	55,8	52,9	48,4	45,3	43,8	42,4	41,7	40,8	39,3	38,1	34,8
ACR (min)	68	48	42	38,1	32,1	28	26,1	24,2	23,1	22	20	18,5	14
PS-NEXT (min)	72	57	53	50	45	42	40,8	39,4	38,7	37,8	36,3	35,1	31,8
Return Loss (min)	20	25	25	23,6	21,5	20,1	19,4	18,8	18,4	18	17,3	17,3	17,3
GENERAL DATA													
Cable	O.D.	18.70 mm			20.40 mm			23.50 mm					
	Standard reels				305 m								
Jacket	Material	PVC											
	Nominal Thickness	2.46 mm			2.00 mm			2.50 mm					
Conductor	Quantity	Audio: 2 - CAT6A: 2			Audio: 6 - CAT6A: 2								
	Strand	Audio: 18 x 0.10 mm - CAT6: 1 x 0.555 mm											
	Area/AWG	Audio: 0.14 mm ² /26 - CAT6A: 0.24 mm ² /23											
	Insulation O.D.	Audio: 1.25 mm											
	Material	Audio: Tinned copper polyolefin insulated - CAT6A: Solid bare copper polyethylene insulated											

Snakes

For further information and configurations, see pages 58-59



- SNKG** 2 H * M R
- SNKG** 6 H * M R
- SNKG** 12 H * M R

* Length Feet M Meters

Not suitable for applications above 50 volt ac; 75 volt dc.

Hybrid Digital Data and Coaxial Cable

CVS LK3CAT6SF 4RG6 is an exciting addition to Link's **eurocable** lineup of hybrid cables. It contains 3 CAT6 F/UTP cables and 4 RG6 coaxial cables.

It is designed especially for live entertainment and Broadcast-TV applications, with MAD1 digital audio and HD-SDI video signals. The combination of CAT6 and RG6 in one trunk cable wired with LKG 32/3E4RG6, allows the user to send a wide variety of signals between locations by means of a single connection. This cable is also compatible with Link's complete line of Widget series digital or analog break-in and break-out adapters. With the ability to run distances of over 100 meters, this cable is an ideal fit for the stage to FOH or remote to OB applications



MOBILE
DIGITAL
JACKET COLOR ■
152 m/500 ft ON WOODEN REELS



CVS LK3CAT6SF 4RG6

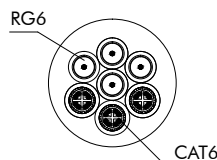

		Coax	CAT6
ELECTRICAL DATA			
D.C.R. at 20°C	Inner conductor	22.5 Ohm/Km	-
	Outer conductor	8.3 Ohm/Km	-
Nominal impedance		75 Ohm	100 Ohm
Vel. of Prop.		84%	67%
GENERAL DATA			
Cable	O.D.	28.6 mm	
	Weight Kg/100m	88.10	
Jacket	Material	Flame retardant PVC	
	Nominal Thickness	2.6 mm	
Shield	Material	I aluminium/polyester/aluminium foil	I aluminium polyester tape
		II tinned copper braid	II annealed tinned copper braid
	Coverage	I 100% - II 96%	I 100% - II 80%
Conductor	Quantity	4	3 x 4 x 2
	Strand	1 mm	1 x 0.57 mm
	Area/AWG	0.785 mm ² /18	0.25 mm ² /23
	Insulation O.D.	4.60 mm	1.10 mm
	Jacket O.D.	6.95 mm	8 mm
	Material	Red copper polyethylene insulated PVC jacket	Bare copper wire polyethylene insulated, external jacket flame retardant LSZH thermoplastic material

Snakes

For further information and configurations, see pages 60-61



SNKG 3 G * M R

* Length Feet **M** Meters

Not suitable for applications above 50 volt ac; 75 volt dc.

Unbreakable Optical Cables

The **eurocable** FOHD unbreakable fiber optic cables from Link have been created to satisfy the demanding elements of the entertainment market when using new signal distribution systems with connections for optical signals, where cables that can withstand the day to day use for live events is crucial.

Available in 6, 12 and 24 ch single-mode and multi-mode versions and 5,10 mm and 7,10 mm overall diameters, are designed to tolerate extreme bend radiuses with low attenuation, the triple jacketed cable is reinforced with aramid fibers to ensure maximum tensile strength.

Available with multiple termination methods, FOHD is a next-generation cable specifically designed for live entertainment and broadcast applications.

FLAME RESISTANT: IEC 60332-1-2
HALOGEN FREE
MOBILE
JACKET COLOR
1000 m/3280 feet ON WOODEN REELS

Single-Mode Unbreakable Optical Cables

TECHNICAL DATA			
Attenuation		≤ 0,4 dB/Km at 1310 nm	
		≤ 0,3 dB/Km at 1550 nm	
Operating temperature	Installation	-5° C +50° C	
	Operation	-40° C +80° C	
Minimum bending radius		2.5 cm	
Breaking load		2000 N	3000 N
GENERAL DATA			
Cable	Fiber O.D.	0.255 mm	
	Cable O.D.	5.10 mm	7.10 mm
Jacket	Inner jacket	Material	LSZH compound
		Color	Yellow
	Second jacket	Material	PVC
		Color	Black
	Outer jacket	Material	PUR
		Color	Black
Under jacket strength element		Aramid fiber braid	

Multi-Mode Unbreakable Optical Cables

TECHNICAL DATA			
Attenuation		≤ 3 dB/Km at 850 nm	
		≤ 1.5 dB/Km at 1310 nm	
Operating temperature	Installation	-10° C +60° C	
	Operation	-10° C +60° C	
Minimum bending radius		2.5 cm	
Breaking load		2000 N	3000 N
GENERAL DATA			
Cable	Fiber O.D.	0.255 mm	
	Cable O.D.	5.10 mm	7.10 mm
Jacket	Inner jacket	Material	LSZH compound
		Color	Blue
	Second jacket	Material	PVC
		Color	Black
	Outer jacket	Material	PUR
		Color	Black
Under jacket strength element		Aramid fiber braid	

Unbreakable Optical Cables

6 Fibers

12 Fibers

24 Fibers



6 Fibers Single-Mode - Ø 5.10 mm

CVS LKFOHD6SM09-5



12 Fibers Single-Mode - Ø 5.10 mm

CVS LKFOHD12SM09-5



24 Fibers Single-Mode - Ø 5.10 mm

CVS LKFOHD24SM09-5



6 Fibers Single-Mode - Ø 7.10 mm

CVS LKFOHD6SM09-7



12 Fibers Single-Mode - Ø 7.10 mm

CVS LKFOHD12SM09-7

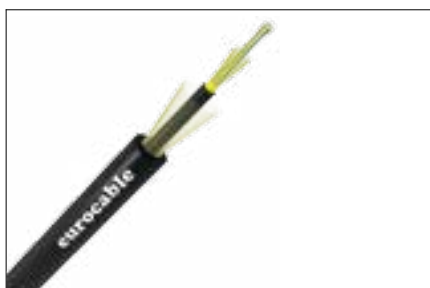

24 Fibers Single-Mode - Ø 7.10 mm

CVS LKFOHD24SM09-7



6 Fibers Multi-Mode - Ø 5.10 mm

CVS LKFOHD6MM50-5



12 Fibers Multi-Mode - Ø 5.10 mm

CVS LKFOHD12MM50-5



24 Fibers Multi-Mode - Ø 5.10 mm

CVS LKFOHD24MM50-5



6 Fibers Multi-Mode - Ø 7.10 mm

CVS LKFOHD6MM50-7



12 Fibers Multi-Mode - Ø 7.10 mm

CVS LKFOHD12MM50-7



24 Fibers Multi-Mode - Ø 7.10 mm

CVS LKFOHD24MM50-7

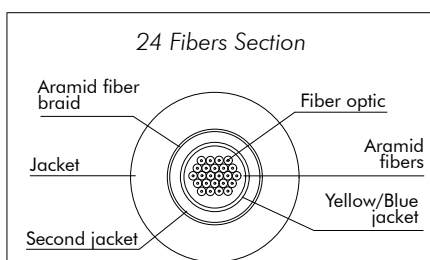
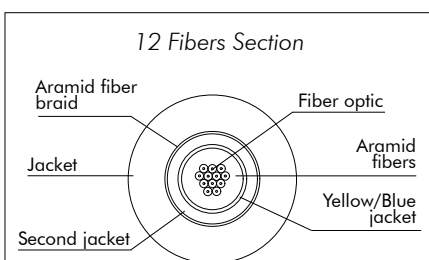
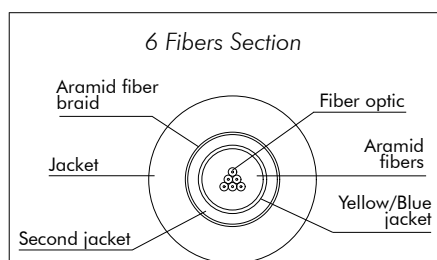

Hybrid Optical Cables

The new CVS LKFO4SM 8/5 hybrid cable features 4 strands of Single-mode Optical Fibre (SMF) (9/125) and 5 conductors of 10mm². Specifically designed for live entertainment and broadcast events, this addition to the **eurocable** line by Link offers users the unique ability to deliver power and any kind of signal for extended distances in harsh environments.

When coupled with Link's new LKO hybrid expanded beam style connector, setup time is reduced and reliability in the field is greatly improved. Designed with tactical characteristics, the LKFO4SM 8/5 cable is cut/abrasion resistant and can also be terminated to conventional fan-in/out on request.

By leveraging the optical, mechanical, and electrical expertise of our team, Link provides our clients with configurable solutions for the transport of power, Ethernet, audio, video, DMX, and GPI/O. With the addition of the DGLink mux/demux modules, we can provide up to 72 optical channels at 10Gps each.

Best Product at LDI Las Vegas



MOBILE	
JACKET COLOR	■
FLAME RESISTANT: IEC 60332-3 CAT. "C", EN 50226-2	



MAX CURRENT CAPACITY PER CABLE LENGTH				
Ampacity (each phase)	32A	25A	16A	10A
Max lenght (m) Δu=4%	140m	180m	280m	450m

CVS LKFO4SM 8/5

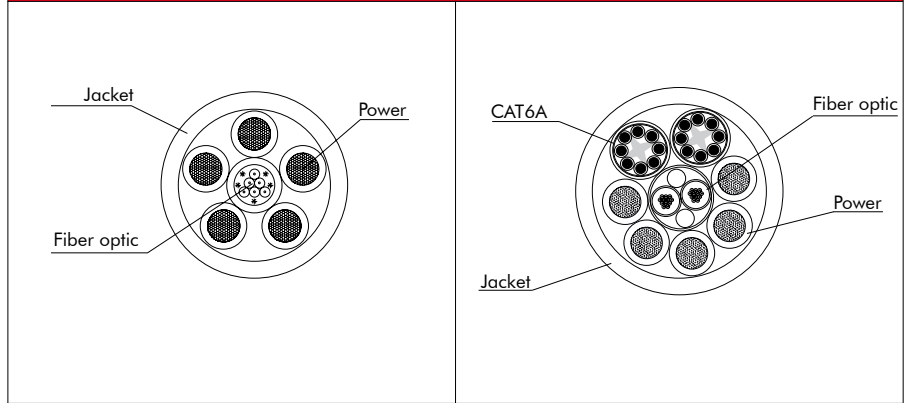

CVS LKFO4SM 8/5 **CVS LKF012S12M 2C6 8/5**

ELECTRICAL DATA			Power	SM fiber	Power	12SM+12MM fiber	CAT6A
D.C.R. at 20°C			< 2.14 ohm/Km	-	< 2.14 ohm/Km	-	80 ohm/Km
Operating Voltage			0.6/1KV	-	0.6/1KV	-	-
Test Voltage Cond/Cond			2000 Vca x 1'	-	2000 Vca x 1'	-	-
Attenuation			-	< 0.4 dB/Km at 1300 nm	-	SM: <0.4dB/Km at 1300nm MM: ±3dB/Km at 850nm	-
			-	< 0.25 dB/Km at 1550 nm	-	SM: <0.25dB/Km at 1500nm MM: ±1.5dB/Km at 1310nm	-
GENERAL DATA							
Cable	O.D.		21.00 mm			28.00 mm	
	Minimum Bending Radius		11 x O.D.			15 x O.D.	
Overall Jacket	Material			PVC			
	Color			Black			
Internal Jacket	Material			PVC			
	Conductor	Quantity		5	4 (+2)	5	12 + 12
Area/AWG		10 mm ² /8	-	10 mm ² /8	-	0.26 mm ² /23	
Fillers		-	Aramid fibers	-	Aramid fibers	-	
Strand/Structure		Fiber type	119 x 0.30 mm	OS2 9/125 μM	119 x 0.30 mm	SM: OS2 9/125 μM MM: OM3 50/125 μM	1 x 0.57 mm
Material		Annealed red copper	Tight Nylon 250 μM	Annealed red copper	Tight Nylon 250 μM	Red copper	

Snakes

SNKO 32T4 S * M B

* Length Feet M Meters

Optical Camera Cable

This Hybrid HD Camera Cable with 2 x SM 9/125 + 4 x AWG20 + 2 x AWG24, compliant with the SMPTE 311M-Standard, contains Single-Mode Optical Fibers, Auxiliary, and Signal Conductors. This robust cable allows the interconnection of cameras and base station for the simultaneous transmission of power, video, audio, and control. It is suitable for all new digital camera systems of well-known manufacturers.

MOBILE	
JACKET COLOR	■
1000 m/3280 feet ON WOODEN REELS	
CVS LKFOHCC	
FLAME RETARDANT: IEC 60754-1, IEC 61034-1, IEC 60332-1, EN 50267-2-1, EN 50268-2-1, EN 50265-2-1 HALOGEN FREE	

TECHNICAL DATA				
Optical data	Attenuation		< 0.40 dB/Km at 1310 nm	
			< 0.25 dB/Km at 1550 nm	
Electrical data at 20° C	Conductor resistance		≤ 33.0 ohm/Km (20 AWG)	
	Insulation resistance		≤ 91.0 ohm/Km (24 AWG)	
	Test voltage		≥ 500 Mohm x Km	
			1000 Vdc per 1 min	
GENERAL DATA				
Cable	O.D.		9.00 +/- 0.30 mm	
	Operating temperature		[-20°C +80°C]	
	Storage temperature		[-30°C +80°C]	
	Min. static bending radius		7.50 x O.D.	
	Min. dynamic bending radius		10 x O.D.	
	Weight Kg/100m		10.70	
	Max pulling force		20 N/ mm ²	
	Tensile strength		> 700 N	
Jacket	Material		Flame Retardant LSZH PUR	
	Color		Black	
	Separator		Fleece tape	
	Shield		Tinned copper braid	
	Coverage		≥ 80%	
	Bundle tape		Fleece tape	
		2 x FIBER OPTIC	4 x 0.60 mm²	2 x 0.22 mm²
Core/Conductor		FO single-mode (9/125)	Tinned copper	Tinned copper
		According to ITU-T G652	AWG 20	AWG 24
	Tight coating/Insulation	Polyamide	Polyolefin	Polyolefin
	Color	Blue, yellow	2 black, 2 white	Red, grey
	Diameter	0.90 mm	1.50 mm	1.10 mm

Analog Video Cables



eurocable offers a wide range of video coaxial cables, suitable for all analog video transmissions.

CVS LKRG58C17

Shielded with copper braid and PVC jacketed to guarantee long life and high flexibility.

CVS LKRG59S2A

Double shielded with aluminum and red copper braids and PVC jacketed, has been developed for analog and digital video devices up to 800 MHz. Complying to BBC PSF 1/3M standard.

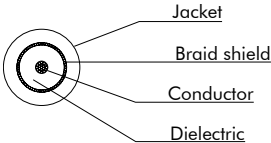
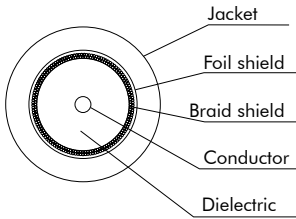
MOBILE	INSTALLATION/MOBILE
ANALOG	ANALOG/DIGITAL
JACKET COLOR ■	JACKET COLOR ■
1000 m/3280 feet ON WOODEN REELS	1000 m/3280 feet ON WOODEN REELS
	
CVS LKRG58C17	CVS LKRG59S2A
	

ELECTRICAL DATA			
D.C.R. at 20°C	Conductor	36.50 ohm/km	62 ohm/km
	Shield	14 ohm/km	13 ohm/km
Capacitance at 20°C		100 pF/m	67 pF/m
Nominal Impedance		50 ohm	75 ohm
Attenuation	10 MHz	4.10 db/100 m	-
	50 MHz	9.70 db/100 m	6.80 db/100 m
	100 MHz	13.90 db/100 m	-
	200 MHz	20.40 db/100 m	14.20 db/100 m
Vel. of Prop.		66%	
GENERAL DATA			
Cable	O.D.	5.00 mm	6.10 mm
	Standard reels	1000 m	
	Weight Kg/100m	4.00	4.98
	Operating temperature	-20°C/+70°C	-25°C/+80°C
Jacket	Material	PVC	Low smoke emission PVC
	Nominal Thickness	0.75 mm	0.80 mm
Shield	Material	Tinned copper	First: Aluminium-polyester-aluminium foil
		Braid shield	Second: Red copper braid
	Coverage	95%	First: 100% - Second: 83%
Conductor	Quantity	1	
	Strand	19 x 0.18 mm	1 x 0.60 mm
	Area/AWG	0.48 mm ² /25	0.28 mm ² /23
	Dielectric O.D.	2.95 mm	3.70 mm
	Material	Annealed tinned copper, polyethylene insulated	Bare copper, polyethylene insulated

Not suitable for applications above 50 volt ac; 75 volt dc.

RF Coaxial Cables



The new RG-8 type **eurocable** coaxial cables are designed for 50 Ohm radiofrequency transmission over long distances.

CVS LKRG8-7

eurocable CVS LKRG8-7 is made with a stranded copper conductor, gas-injected foam HDPE insulation, copper and polyester foil, red copper braid shield and a tough Flame Retardant Non-Corrosive PVC jacket of 7,3 mm Overall Diameter.

CVS LKRG8-10

eurocable CVS LKRG8-10 is made with a stranded copper conductor, gas-injected foam HDPE insulation, copper and polyester foil, red copper braid shield and a tough Flame Retardant Non-Corrosive PVC jacket of 10,3 mm Overall Diameter.

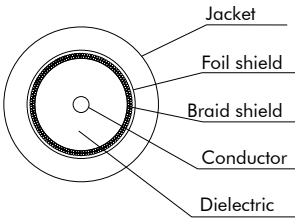
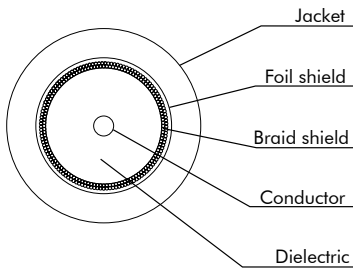
INSTALLATION/MOBILE	INSTALLATION/MOBILE
JACKET COLOR ■	JACKET COLOR ■
1000 m/3280 feet	1000 m/3280 feet
ON WOODEN REELS	ON WOODEN REELS
	
CVS LKRG8-7	CVS LKRG8-10
	
FLAME RETARDANT: IEC 60332-1, EN 60332-1	FLAME RETARDANT: IEC 60332-1, EN 60332-1

ELECTRICAL DATA			
D.C.R. at 20°C	Conductor	7.80 ohm/km	4 ohm/km
	Shield	11 ohm/km	7.40 ohm/km
Capacitance at 20°C		80 pF/m	
Nominal Impedance		50 ohm	
Attenuation	10 MHz	1.80 db/100 m	1.40 db/100 m
	50 MHz	4.30 db/100 m	3 db/100 m
	100 MHz	6.30 db/100 m	4 db/100 m
	200 MHz	9.20 db/100 m	5.70 db/100 m
Vel. of Prop.		80%	84%
GENERAL DATA			
Cable	O.D.	7.30 mm	10.30 mm
	Standard reel	500 m	
	Weight Kg/100m	7.30	14
	Operating temperature	-30°C/ +70°C	
Jacket	Material	FRNC PVC	
	Nominal Thickness	0.80 mm	1.10 mm
Shield	Material	First: Copper-polyester foil Second: Red copper braid	
	Coverage	First: 100% - Second: 72%	First: 100% - Second: 73%
	Quantity	1	
Conductor	Strand	7 x 0.65 mm	7 x 0.95 mm
	Area/AWG	2.30 mm ² /14	5 mm ² /10
	Dielectric O.D.	5 mm	7.25 mm
	Material	Red copper, polyethylene insulated	

Not suitable for applications above 50 volt ac; 75 volt dc.

Digital Video Cables (HDTV)

eurocable HDTV cables designed following the SMPTE specs for the SDI and HDTV video distribution.

CVS LKRG59DS

Coaxial SDI-HDTV RG59 cable, maintains an exceptional Return Loss value better than the minimum SMPTE recommended level.

Also available in 4K version.









CVS LKRG6DS

Coaxial cable RG6 features a "gas injected" technology. This cable has a very low attenuation even at the highest frequencies and it is primarily indicated when the signal transmission distance to cover is considerable.

Also available the 4K version.

CVS LKRG11DSHF

Ideal for long-distance, backbone applications, with high video and audio performances for television and internet transmission. RG11 cable offers improved performances and low signal loss over a long length.

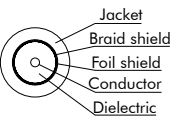
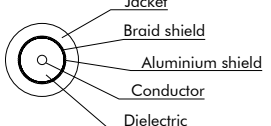
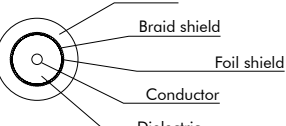
INSTALLATION	INSTALLATION	INSTALLATION
DIGITAL/HDTV	DIGITAL/HDTV	DIGITAL/HDTV
JACKET COLOR 	JACKET COLOR 	JACKET COLOR 
1000 m/3280 feet ON WOODEN REELS	1000 m/3280 feet ON WOODEN REELS	500 m/1640 feet ON WOODEN REELS
		
		
CVS LKRG59DS	CVS LKRG6DS	CVS LKRG11DSHF
		
		HALOGEN FREE

ELECTRICAL DATA			
D.C.R. at 20°C	Conductor	35 ohm/km	22.5 ohm/km
	Shield	9 ohm/km	8.3 ohm/km
Capacitance	-	53 pF/m	
Nominal Impedance	75 ohm		
Attenuation db/100 m - MHz	5.4 at 50 / 10.6 at 200 / 16.4 at 470 / 22.7 at 860 / 25 at 1000 / 29.4 at 1350 / 33.9 at 1750 / 38.1 at 2250 / 46 at 3000	8.7 at 200 / 13.2 at 470 / 18.5 at 862 / 20.2 at 1000 / 23.8 at 1350 / 25.6 at 1500 / 27.6 at 1750 / 31 at 2150 / 33.1 at 2400 / 35.9 at 2750 / 38 at 3000	0.8 at 5 / 2.8 at 50 / 5.9 at 200 / 8.9 at 470 / 12.1 at 800 / 13.5 at 1000 / 17.4 at 1500 / 21.1 at 2150 / 24.0 at 2750 / 25.4 at 3000
Vel. of Prop.	84%	84%	
GENERAL DATA			
Cable	O.D.	6.00 mm	7.00 mm
	Standard reels	1000 m	
	Weight Kg/100m	5.40	6.58
	Operating temperature	-30°C/+70°C	
Jacket	Material	Low smoke emission PVC	PVC
	Nominal Thickness	0.80 mm	0.90 mm
Shield	Material	First: Aluminium foil Second: Tinned copper braid	First: Aluminium - Polyester - Aluminium Material foil - Second: Tinned copper braid
	Coverage	First: 100% - Second: 96%	First: 100% - Second: 96%
Conductor	Quantity	1	
	Strand	1 x 0.80 mm	1 x 1.00 mm
	Area/AWG	0.50 mm ² /20	0.79 mm ² /18
	Dielectric O.D.	3.65 mm	4.60 mm
	Material	Solid bare copper, foamed polyethylene insulated	
			Red copper, foamed polyethylene insulated

Not suitable for applications above 50 volt ac; 75 volt dc.

Miniature HDTV Video Cables





eurocable miniaturized HDTV cables are designed for video applications where the space is a critical issue.

CVS LKRG179DS

Mini coaxial cable for HDTV connections, CATV applications, computer connections, cable modems. High-frequency signal transmissions for any video applications.

CVS LKRX75S2

Low loss (0.6/2.8) digital video cable for use in HDTV distributions, offers similar characteristics of RG59DS in a smaller diameter. It's ideal for medium distance range connection. Also available the 4K version.

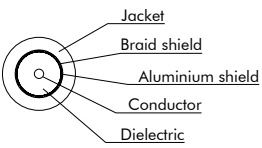
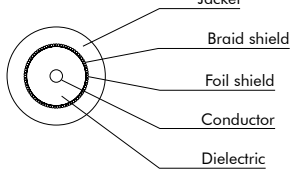
INSTALLATION	INSTALLATION
DIGITAL/HDTV	DIGITAL/HDTV
JACKET COLOR 	JACKET COLOR 
1000 m/3280 feet	500 m/1640 feet
ON WOODEN REELS	ON WOODEN REELS
	
CVS LKRG179DS	CVS LKRX75S2
	

ELECTRICAL DATA			
D.C.R. at 20°C	Conductor	244 ohm/km	62 ohm/km
	Shield	32.4 ohm/km	12.8 ohm/km
Capacitance at 20°C		54 pF/m	56 pF/m
Nominal Impedance			75 ohm
Attenuation db/100 m - MHz		1.9 at 1 / 4.3 at 5 / 4.7 at 6 / 5.1 at 7 / 6.1 at 10 / 6.7 at 12 / 16.1 at 67.5 / 16.6 at 71.5 / 18.4 at 88.5 / 19.6 at 100	7.3 at 50 / 16.9 at 230 / 21.4 at 470 / 32.9 at 1000 / 38.2 at 1350 / 41.1 at 1500 / 44.1 at 1750 / 49.7 at 2150 / 53.6 at 2400 / 61 at 3000
Vel. of Prop.		81%	78%

GENERAL DATA			
Cable	O.D.	2.54 mm	4.50 mm
	Standard reels	1000 m	500 m
	Weight Kg/100m	11.30	3.00
	Operating temperature	-30°C/+70°C	
Jacket	Material	PVC	Low smoke emission PVC
	Nominal Thickness	0.15 mm	0.60 mm
Shield	Material	First: Aluminium - Polyester tape Second: Tinned copper braid	First: Aluminium - Mylar foil Second: Tinned copper braid
	Coverage	First: 100% - Second: 95%	First: 100% - Second: 93%
Conductor	Quantity	1	
	Strand	1 x 0.30 mm	1 x 0.60 mm
	Area/AWG	0.07 mm ² /29	0.28 mm ² /23
	Dielectric O.D.	1.42 mm	2.80 mm
	Material	Annealed copper polyolefine insulated	Annealed solid bare copper, foamed polyolefine insulated

Not suitable for applications above 50 volt ac; 75 volt dc.

Triax Camera Cables

eurocable triax cables are used to connect Video Broadcast cameras. They feature 75 ohm nominal impedance, low attenuation values at long run, long flex life jacket. This cable is available in 8 and 11 mm overall diameter versions, to be chosen depending on the distances to cover. Available in 14 mm overall diameter on request.

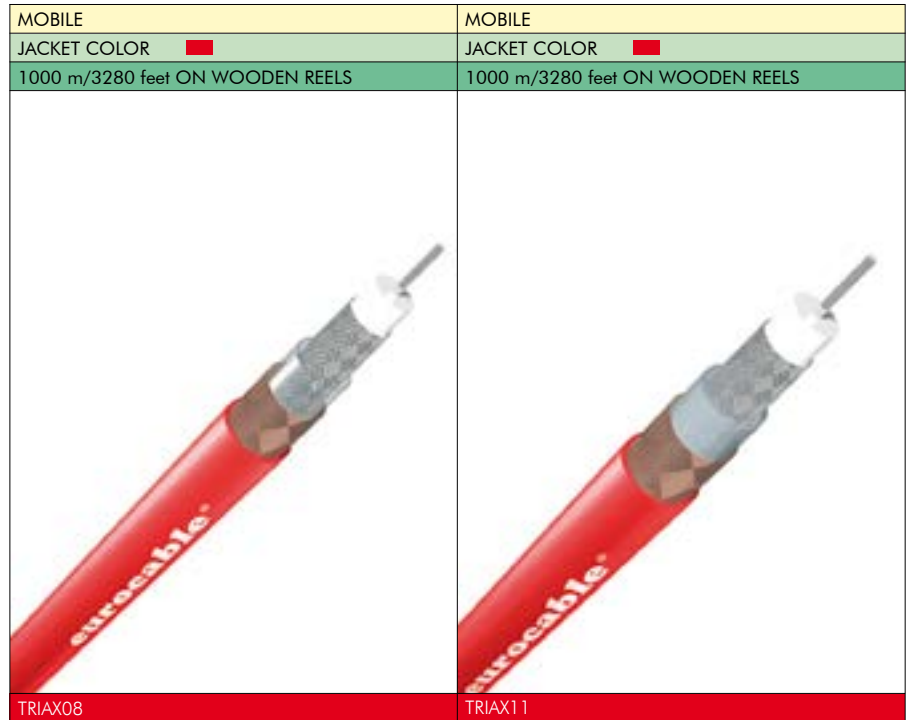

TRIAX08

TRIAX11

CVS LKTRIAX08

CVS LKTRIAX11

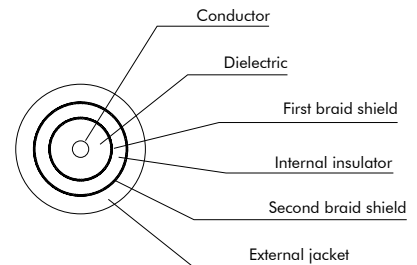
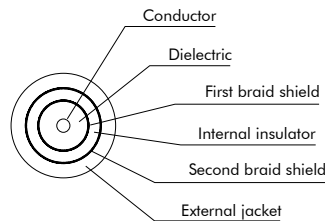

CVS LKCode		TRIAX08	TRIAX11
ELECTRICAL DATA			
D.C.R. at 20°C	Conductor	< 22.40 ohm/km	< 11.50 ohm/km
	Shield	First	< 8.50 ohm/km
		Second	< 7.80 ohm/km
Capacitance		55 pF/m	
Nominal Impedance		75 ohm	
Attenuation db/100 m - MHz		1.0 at 1 / 2.0 at 5 / 2.8 at 10 / 4.0 at 20 / 5.8 at 40 / 6.4 at 50 / 7.1 at 60 / 9.1 at 100	0.6 at 1 / 1.4 at 5 / 2.0 at 10 / 2.8 at 20 / 4.0 at 40 / 4.6 at 50 / 5.0 at 60 / 6.5 at 100
Vel. of Prop.		80%	
Inductance		30 μH/100 m	
GENERAL DATA			
Cable	O.D.	8.30 mm	10.90 mm
	Standard reels	1000 m	
	Weight Kg/100m	10.50	17.80
	Operating temperature	-20°C/+70°C	
Jacket	Material	PVC TM2	
	Nominal Thickness	0.55 mm	1.00 mm
Shield	Material	First: Silver plated braid shield Second: Bare copper braid shield	
	Coverage	First: 90% - Second: 90%	
Conductor	Quantity	1	
	Strand	1 x 1.00 mm	1 x 1.40 mm
	Area/AWG	0.78 mm ² /18	1.50 mm ² /16
	Dielectric O.D.	4.50 mm	6.30 mm
	Material	Silvered solid copper foamed, polyolefine insulated	

Not suitable for applications above 50 volt ac; 75 volt dc.

Power Cables

All the **eurocable** lighting power cables have been designed to maintain their integrity in the harshest of touring conditions. Their flexibility, robustness and high flame resistant rate allow ideal performances in fixed and outdoor applications.

CVS LK6/3G2.5

eurocable lighting power CVS LK6/3G2.5 (19x2.5mm²) consists of six circuits individually numbered and colored following the HD 308/2001 European standard. A unique cable specifically designed and produced for LKS and/or 19 pins lighting connectors (SOCA compatible).



The pairs arrangement follows the standard SOCA pin assignment, making assembly operations easier and faster.

CVS LK6/3G4

Same construction as before with an enlarged section of 4 mm².

CVS LK19G1.5

eurocable CVS LK19G1.5 is realized in the lighting power cables standard configuration to offer good performances at an excellent price.

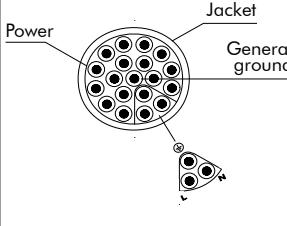
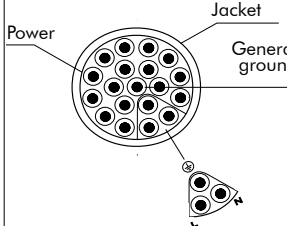
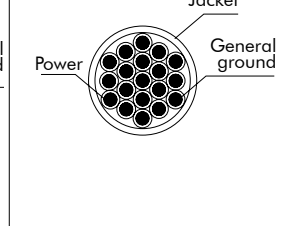
JACKET COLOR ■	JACKET COLOR ■	JACKET COLOR ■
200 m/565 feet ON WOODEN REELS	200 m/565 feet ON WOODEN REELS	200 m/656 feet ON WOODEN REELS
CE	CE	CE
		
CVS LK6/3G2.5	CVS LK6/3G4*	CVS LK19G1.5
		
FLAME RESISTANT: IEC 60332-3 CAT. "C", EN 50266-2	FLAME RESISTANT: IEC 60228, EN 50363	FLAME RESISTANT: IEC 60332-3 CAT. "C", EN 50266-2

GENERAL DATA			
Cable	O.D.	18.60 mm	22.40 mm
	Standard reels	200 m	
	Weight Kg/100m	67.90	100.50
	Operating temperature	-20°C/+70°C	
Jacket	Material	PVC TM2	
	Nominal Thickness	3.00 mm	3.70 mm
Conductor	D.C.R. at 20° C	≤ 8.31 ohm/km	≤ 5.43 ohm/km
	Insulation Resistance	> 128 Mohm/km	-
	Voltage test	2500 Vc.ax5' cond/cond	3000 Vc.ax5' cond/cond
	Quantity	19	
	Strand	48 x 0.25 mm	65 x 0.25 mm
	Area/AWG	2.31 mm ² /13	3.34 mm ² /12
	Insulation O.D.	3.00 mm	3.70 mm
Material	Annealed copper TM2 PVC flame retardant insulated		

* on request

Snakes



PD	LKD	E	B	G	19	02	E	*	DR
PD	LKD	E	B	G	19	04	E	*	DR
PD	LKD	E	B	G	19	01	E	*	DR

* Length

Power Multilines & Data

New **eurocable** hybrid smart lighting cables from Link is designed for transporting 6 circuits of 20A power and multiple data types. Intended to be used in conjunction with the new LKS DATA Connector, these new cables offer a single solution for transporting data and power to remote locations or up to the truss. Available with a number of break-in and break-out methods, as well as a complete line electronics and smart power distribution solution to provide a unified power and data backbone for your next production.





CVS LK1CAT5SF 12/14

eurocable powered hybrid 14x12AWG plus one Cat5e SFTP patch cable. Compliant to UL 2464 can be used up to 300V at up to 80° C.

CVS LK1CAT6SF 12/14

eurocable powered hybrid 14x12AWG plus one Cat6 SFTP patch cable. Compliant to UL 1581 (VW-1, FT1, FT2) can be used up to 600V at up to 90° C.

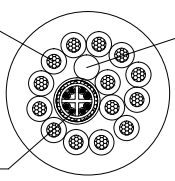
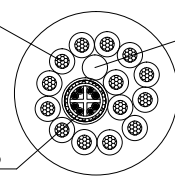

MOBILE		MOBILE	
DIGITAL		DIGITAL	
JACKET COLOR ■		JACKET COLOR ■	
152 m/500 feet ON WOODEN REELS		152 m/500 feet ON WOODEN REELS	
 			
			
UL 2464 80°C, 300V		UL 1581 90°C (VW-1, FT1, FT2), 600V	
CVS LK1CAT5SF 12/14		CVS LK1CAT6SF 12/14	
Power	Filler	Power	Filler
			
FLAME RESISTANT: IEC 60332-3 CAT. "C", EN 50266-2			
Power	CAT5 SFTP	Power	CAT6 SF/UTP

ELECTRICAL DATA					
D.C.R. at 20°C		< 5.43 ohm/Km	< 91 ohm/Km	< 5.43 ohm/Km	< 87.6 ohm/Km
Operating voltage		0.6/1 KV	-	0.6/1 KV	-
Test voltage	Conductor/Conductor	2000 Vca x 1'	1000 Vca x 1'	2000 Vca x 1'	1000 Vca x 1'
	Conductor/Shield	2000 Vca x 1'	1000 Vca x 1'	2000 Vca x 1'	1000 Vca x 1'
Nominal Impedance		110 ohm	100 ohm	110 ohm	100 ohm
Velocity of propagation Cable		-	80%	-	80%
GENERAL DATA					
Cable	O.D.	23.3 mm		24.3 mm	
	Standard reels	152 m			
	Weight Kg/100m	91.80		95	
	Operating temperature	-20°C/+80°C		-15°C/+90°C	
Overall jacket	Material	PVC compliant with UL-2464		PVC compliant with UL-1581	
	Thickness	2.3 mm		2 mm	
Jacket on single type	Material	-	PVC compliant with UL-2464	-	PVC compliant with UL-1581
	O.D.	-	6.50 mm	-	7.90 mm
Shield	Material	-	I Aluminium / polyester tape II Tinned copper braid	-	I Aluminium / polyester tape II Tinned copper braid
	Coverage	-	100% ≥ 65%	-	100% ≥ 65%
Conductor	Quantity	14	4 x 2		
	Area/AWG	3.5 mm²/12	0.22 mm²/24	3.5 mm²/12	0.22 mm²/24
	Strand	70 x 0.25 mm	70 x 0.20 mm	70 x 0.25 mm	1 x 0.53 mm
	Material	Annealed copper PVC insulated	Annealed copper foamed polyolefin insulated	Annealed copper PVC insulated	Bare copper foamed polyolefin insulated

Snakes



PD **G** **LKSDD** **BB** E **1** **E** * **04** **D** **CL** **P**

* Length

LKS Data Flat Cable

The new flat cable CVSLK1CAT5SF 14/14 has been designed for use with the LKS DATA connector equipped with backshell and cable clamp for flat cables. It allows the transport of 6 single-phase 16A power circuits and a CAT5E SFTP data cable.

The Flat cable is particularly suitable for correct collection in contexts where motorized trusses are used, or automatic or manual handling systems that require particular cable management methods and minimum bending radius. The possibility of using a single cable to carry power and data in these contexts makes it unnecessary to pass on additional types of cables to control the devices to be reached (such as lighting fixtures, motors, etc ...), preventing cables from becoming entangled during handling.

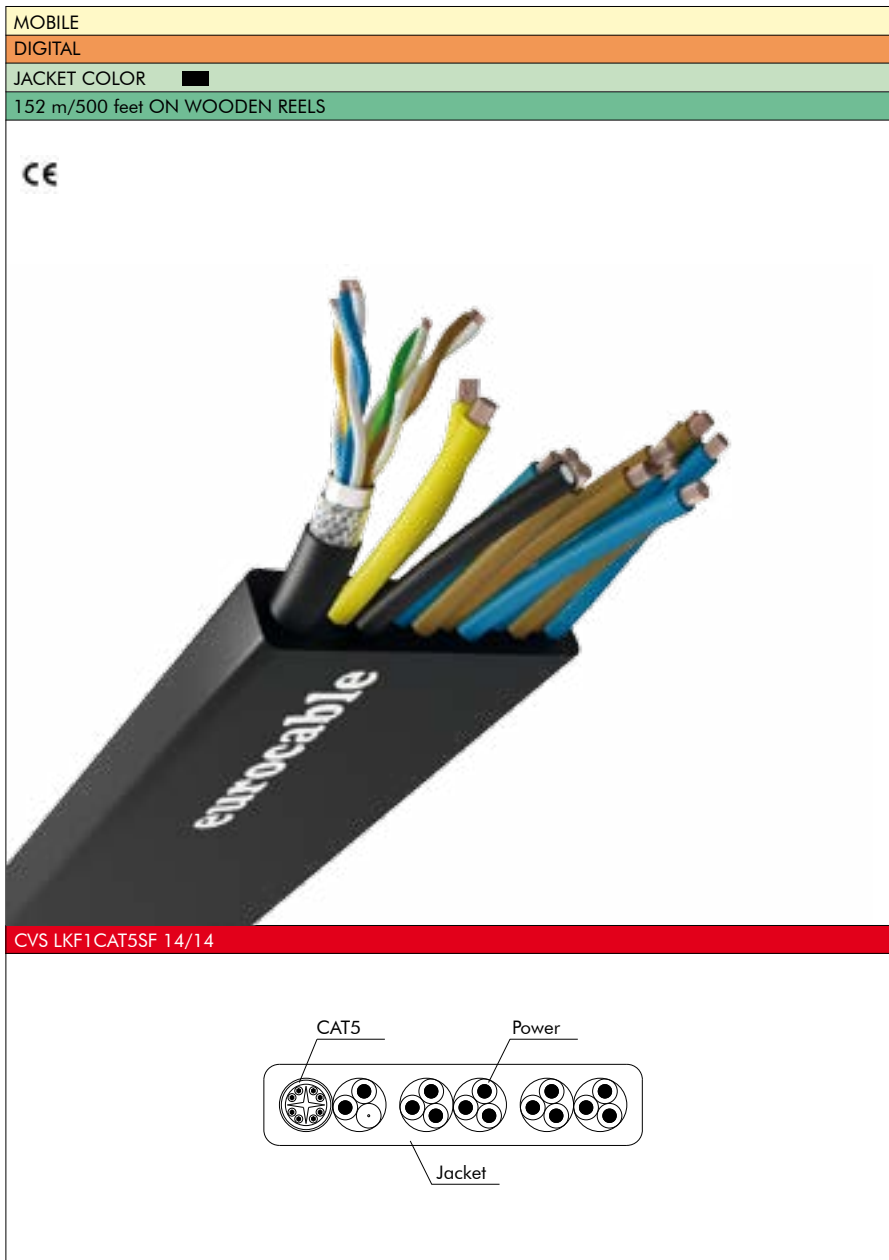

CVS LKF1 CAT5SF 14/14

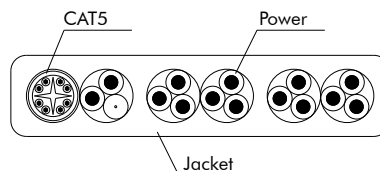

FLAME RESISTANT: IEC 60332-1-2, IEC 60228

ELECTRICAL DATA		Power	CAT5 SFTP
Rated voltage		300 V	30 V
Test voltage		1500 Vca x 1'	500 Vca x 1'
Conductor DC resistance		8.62 ohm/Km (at 20°C)	87.6 ohm/Km (at 20°C)
Characteristic impedance		-	100 ohm (nom.)
GENERAL DATA			
Cable	Dimensions	49x10.5 mm	
	Minimum bending radius	100 mm	
	Operating temperature	-20°C/+60°C	
Jacket	Material	PVC	
	Color	Black	
Shield	Material	-	I Aluminium / polyester tape II Tinned copper braid
	Coverage	-	I 100% II 65%
Conductor	Quantity	14	4 x 2
	Strand	140 x 0.15 mm	70 x 0.20 mm
	Area/AWG	2.5 mm ² /14	0.22 mm ² / 24 AWG
	Insulation O.D.	3.2 mm	1 mm
	Material	Bare copper PVC insulated	Bare copper foamed polyolefin insulated

ULP

The **eurocable** ULP carries Link Power which is an Eschelon Communications, the protocol used in ETC's Unison Control Stations.

Link Power allows topology free and polarity independent wiring. This allows the installer to wire control stations in any configuration: star, bus, loop or any combination. The Link ULP cable was specifically designed to provide all conductors necessary to support Link Power.

INSTALLATION

JACKET COLOR



CVS LKULP

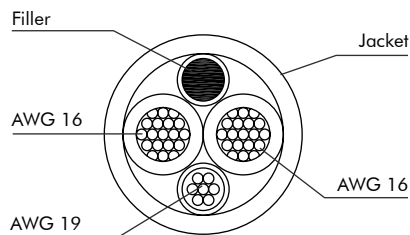

FLAME RESISTANT: IEC 60332-3-24 CAT. "C", IEC 60332-1-2

GENERAL DATA		
Cable	O.D.	7.1 mm
	Bending Radius	8 x O.D.
	Operating temperature	-20°C / +70°C
Jacket	Material	PVC
	Nominal Thickness	0.60 mm
Conductor	Quantity	2 x AWG16 - AWG19
	Strand	AWG16: 19 x 0.30 mm - AWG19: 24 x 0.20 mm
	Area/AWG	1.5 mm ² /16 - 0.9 mm ² /19
	Insulation O.D.	2.7 mm (AWG16) - 1.8 mm (AWG19)
	Material	PVC

Chain Hoist Power and Control Cables

The **eurocable** CTL series of cables have been specially designed for the special applications of control and power "Fly" cables for chain hoists used in rigging for the entertainment industry. In accordance with ANSI E1.6-4 - 2013 / Rig/2010-2008r2, this cable has been designed without a center conductor as specified in section 8.2.4. "Due to the nature of flex and movement of the hoist power/control cable, a center conductor is subject to extreme tension and pulling forces that can lead to the failure of the hoist to operate or ungrounded conditions, depending on the pinout of the control system".



The LK Connectors LKR series of connectors are compatible with the industry standard P7 and P14 multipin connectors, and are a perfect match for this cable.

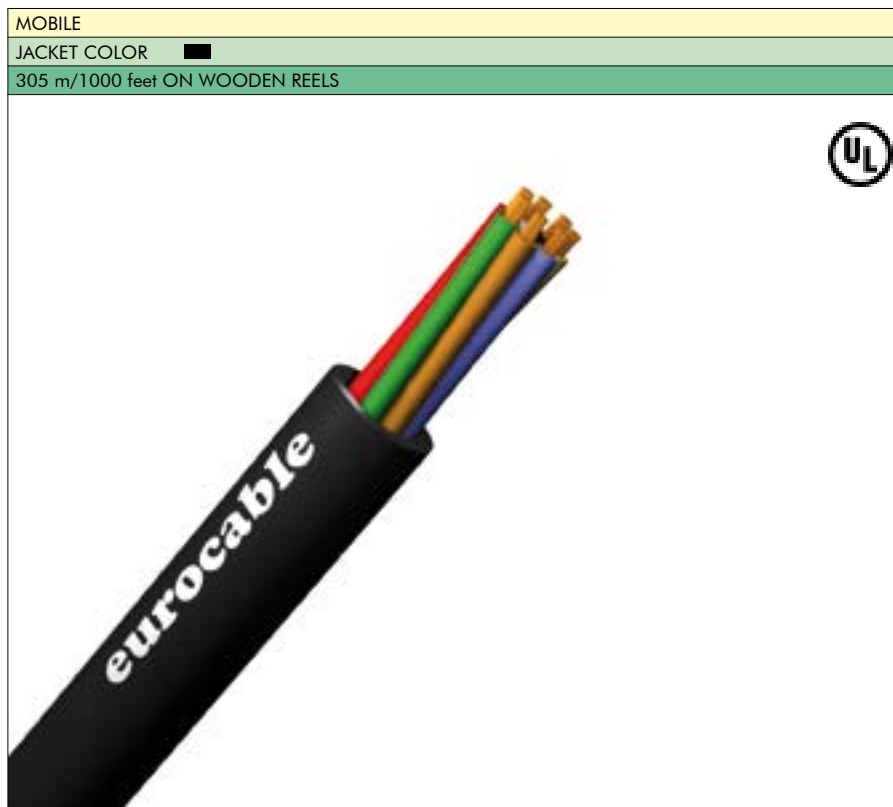

CVS LKCTL 16/7

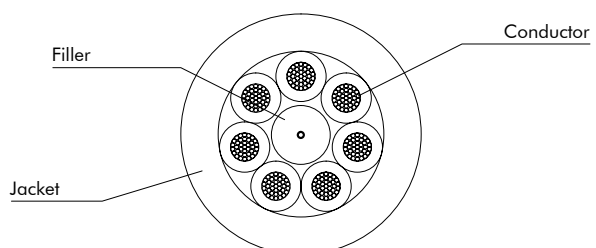

CVS LKCode	CTL 16/7	CTL 14/7	
GENERAL DATA			
Cable	O.D.	14.85 mm	18.65 mm
	Standard reels	305 m	
	Weight Kg/100m	27.50	46.50
	Standard	UL SEOOW 600V 105°C / CSA STOOW 600V 105°C	
Jacket	Material	TPE	
	Nominal Thickness	2 mm	
Conductor	Quantity	7	7
	Strand	26 x 0.25 mm	41 x 0.25 mm
	Area/AWG	1.31 mm ² /16	2.08 mm ² /14
	Insulation O.D.	3.10 mm	4.35 mm
	Material	PVC (Green/Brown/Lt Blue/Yellow/Black/White-Purple/Red)	

Snakes



- ME **16/7** **P7** *
- ME **16/7** **P14** *

* Length

eurocable Assembled Cables



Introducing the **eurocable** range of assembled cables. Manufactured in Italy, leveraging over 3 decades of "real world" experience in live entertainment and broadcast, **eurocable** caters to the demands of the touring professional. Assembled with Neutrik connectors by our team of experts using the most advanced technologies, the **eurocable** range offers a large selection of hybrid and conventional options engineered for flexibility and durability.

Instrumental double shielded cable with Neutrik Jacks

INJMSSSN

Instrumental cable
Neutrik silver Jack



INJMBSN

Instrumental cable
Neutrik black Jack

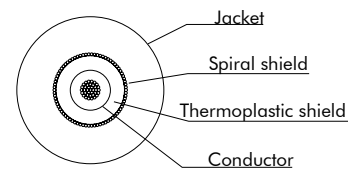

Microphone cable with Neutrik Jacks or 3 pin XLR connectors

MNXESSEN

Microphone cable
Neutrik XLR 3
silver/silver



MNXEBSN

Microphone cable
Neutrik XLR 3
black/silver



MNXEBGEN

Microphone cable
Neutrik XLR 3
black/gold

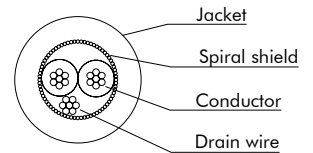

MNJMSSEN

Microphone cable
Neutrik silver Jack



MNJMBSN

Microphone cable
Neutrik black Jack



Mic double shielded cable with Neutrik 3 pin XLR connectors

MNXESSN

Mic Double-shield cable
Neutrik XLR 3
silver/silver



MNXEBSN

Mic Double-shield cable
Neutrik XLR 3
black/silver



MNXEBGSN

Mic Double-shield cable
Neutrik XLR 3
black/gold

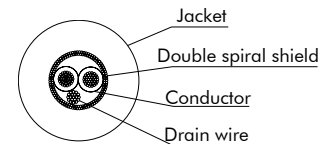

Mic Starquad cable with Neutrik 3 pin XLR connectors

MNXESSQN

Starquad cable
Neutrik XLR 3
silver/silver



MNXEBSQN

Starquad cable
Neutrik XLR 3
black/silver



MNXEBGSQN

Starquad cable
Neutrik XLR 3
black/gold

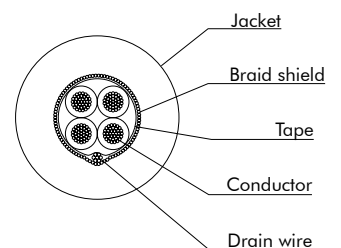

Length: 3 5 10 15

Feet

Meters

With packaging, no heat shrink

No packaging, no heat shrink

No packaging, with heat shrink

With packaging and heat shrink

Also available with
Amphenol connectors

Assembled cables

Digital double shielded cable with Neutrik 3 pin XLR connectors

MNXESSDN * * □

Digital Double-shield cable
Neutrik XLR 3
silver/silver



MNXEBSDN * * □

Digital Double-shield cable
Neutrik XLR 3
black/silver



MNXEBGDN * * □

Digital Double-shield cable
Neutrik XLR 3
black/gold

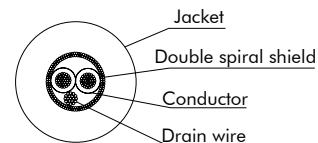

Speaker cable with Neutrik speakON connectors

S21FX215 * * □

Speaker cable 2x1.5 mm²
speakON 50A connectors



S21FX225 * * □

Speaker cable 2x2.5 mm²
speakON 50A connectors

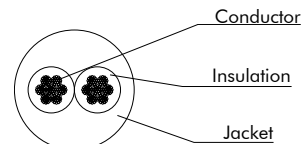

S41FX425 * * □

Speaker cable 4x2.5 mm²
speakON 50A connectors



S41FT425 * * □

Speaker cable 4x2.5 mm²
speakON 50A connectors

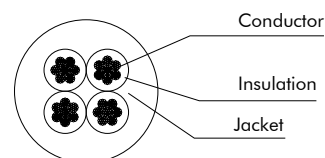

S41FX440 * * □

Speaker cable 4x4 mm²
speakON 50A connectors



S41FT440 * * □

Speaker cable 4x4 mm²
speakON 50A connectors



S81FC840 * * □

Speaker cable 8x4 mm²
speakON connectors



S81FT840 * * □

Speaker cable 8x4 mm²
speakON 50A connectors

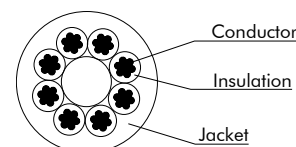

DMX cable with 3, 4 and 5 pin XLR connectors

DNX3ESSS * * □

DMX single pair
Neutrik XLR 3p
silver/silver



DNX3EBSS * * □

DMX single pair
Neutrik XLR 3p
black/silver



DNX5ESSS * * □

DMX single pair
Neutrik XLR 5p
silver/silver

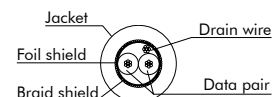

DNX5ESSD * * □

DMX double pair Neutrik XLR 5p
silver/silver

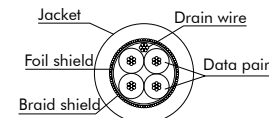

DNX4ESSC * * □

DMX single pair with 2x2 mm² power
Neutrik XLR 4p silver/silver

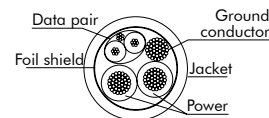

* Length: **3 5 10 15**

□ Feet

□ Meters

□ With packaging, no heat shrink

□ No packaging, no heat shrink

□ No packaging, with heat shrink

□ With packaging and heat shrink

Also available with
Amphenol connectors

Assembled cables

SPKAL Speaker with power (3x1.5 or 3x2.5 mm²) cable with Neutrik powerCON and XLR connectors

SPPX1STK1

SPKAL1-one digital audio pair and 3x1.5 mm² power cable
Neutrik powerCON and XLR black/gold

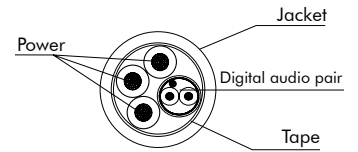

SPPX1STK2

SPKAL2-one digital audio pair and 3x2.5 mm² power cable
Neutrik powerCON and XLR black/gold

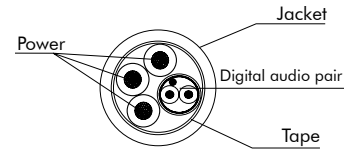

SPPX2STK4

SPKAL4-two digital audio pairs and 3x2.5 mm² power cable
Neutrik powerCON and 2 XLR black/gold

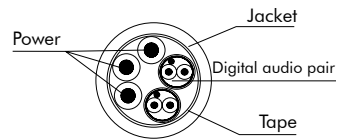

Audio with power (3x1.5 mm²) cable with Neutrik powerCON and XLR connectors

SPPX1STD1

A D1P1-one digital audio pair and 3x1.5 mm² power cable
Neutrik powerCON and XLR black/gold

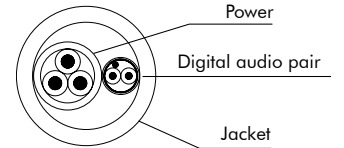

SPPX2STD2

AD2P1-two digital audio pairs and 3x1.5 mm² power cable
Neutrik powerCON and 2 XLR black/gold

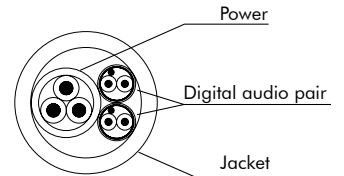

CAT 5 and 6 Ethernet cables

ER5N5S5E

CAT5E
etherCON NE8MC-1



ER5N5B5E

CAT5E
etherCON NE8MC-B-1



ER5R5P5E

CAT5E
RJ45/RJ45



ER5H5S5E

CAT5E
etherCON
NE8MC-1/RJ45



ER5H5B5E

CAT5E
etherCON
NE8MC-B-1/RJ45

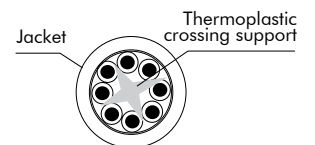



 Length: **3 5 10 15**

 Feet

 Meters

 With packaging, no heat shrink

 No packaging, no heat shrink

 No packaging, with heat shrink

 With packaging and heat shrink

Assembled cables

ER5N5S5P   

CAT5E SF P
etherCON NE8MC-1



ER5N5B5P   



CAT5E SF P
etherCON NE8MC-B-1



ER5R5P5P   

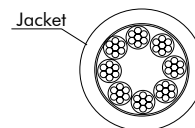

CAT5E SF P
RJ45/RJ45



ER5H5S5P   

CAT5E SF P
etherCON
NE8MC-1/RJ45



ER5N5B5P   

CAT5E SF P
etherCON
NE8MC-B-1/RJ45



ER6N5S6U   

CAT6 UTP
etherCON NE8MC-1



ER6N5B6U   



CAT6 UTP
etherCON NE8MC-B-1

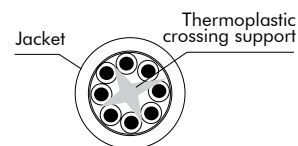

ER6R5P6U   

CAT6 UTP
RJ45/RJ45



ER6H5S6U   



CAT6 UTP
etherCON
NE8MC-1/RJ45



ER6H5B6U   



CAT6 UTP
etherCON
NE8MC-B-1/RJ45



ER6N5S6S   

CAT6 STP
etherCON NE8MC-1



ER6N5B6S   



CAT6 STP
etherCON NE8MC-B-1



ER6R5P6S   



CAT6 STP
RJ45/RJ45



ER6H5S6S   



CAT6 STP
etherCON
NE8MC-1/RJ45



ER6H5B6S   

CAT6 STP
etherCON
NE8MC-B-1/RJ45



ER6N5S6X   

CAT6 UTP P
etherCON NE8MC-1



ER6N5B6X   



CAT6 UTP P
etherCON NE8MC-B-1

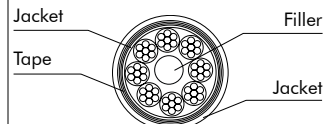

ER6R5P6X   

CAT6 UTP P
RJ45/RJ45



ER6H5S6X   

CAT6 UTP P
etherCON
NE8MC-1/RJ45



ER6H5B6X   

CAT6 UTP P
etherCON
NE8MC-B-1/RJ45





 Length: **3 5 10 15**

 Feet

 Meters

 With packaging, no heat shrink

 No packaging, no heat shrink

 No packaging, with heat shrink

 With packaging and heat shrink

Cable reels HD Series

Especially designed to minimize cable stress, the HD cable reels are particularly useful in live applications where quick and easy winding and unwinding are required. Sturdily constructed, they enable cables to be neatly and safely stored away. Ideal for OB Van applications, available on wheels or in flight-cases.



HD Series

This range of cable reels features rubber supports making them stockable to save space both when in use and during storage.



AV HD 600 with FLY HD600

From the HD cable reels range, the new HD 600 can carry up to 100 meters of 48, 56 or 64 pairs cables.

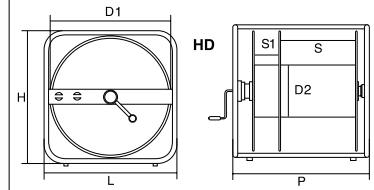

How choose your cable reel holder according to cable size:

$$L = \frac{K}{D^2} \times 1.000$$

L = Cable length (m)

D = Overall diameter (mm)

K = see table

AV Code	HD 260	HD 350	HD 500	HD 600 R	HD 600	FS 350	FS 500	FS 600 R	FS 600
DIMENSIONAL DATA									
Length mm	-					800	900	1100	1500
K mm ³	24.6	33.3	47.5	71.1	94.77	-	-	-	-
D1 mm	400			600		-	-	-	-
D2 mm	160			250		-	-	-	-
S/S1	260/90	350/90	500/90	400/95	600/100	-	-	-	-
H mm	450			640	650	-	-	-	-
P mm	440	530	680	600	800	-	-	-	-
L mm	450			650		-	-	-	-
Weight Kg	14	15	16	28	32	-	-	-	-
Packaging dimensions cm	46.5x50x46.5	53.5x49x46.5	68x49x46	70x69x70	81x69x68	-	-	-	-

Cable reels SP Series

Manufactured in plastic and special rubber, they meet all safety and quality requirements. All cable reels are equipped with brake.

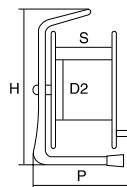
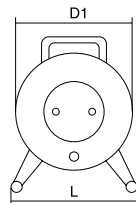

AV GT Series



AV Code	AX100	SP380	GT310RM	GT380RM	GT450	GT450.OFFEN
GENERAL DATA						
Material	Thermoplastic					
DIMENSIONAL DATA						
K mm ³	4.00	11.70	-	-	17.50	17.50
D1 mm	264	385	310	380	445	445
D2 mm	135	178	170	236	296	296
S mm	110	142	132	182	187	187
H mm	365	450	367	491	555	555
P mm	200	200	229	291	312	310
L mm	280	325	263	310	345	345
Weight Kg	1.30	3.50	1.60	3.90	5.60	5.10
Packaging dimensions cm	38 x 21.5 x 29	45 x 24.5 x 39	45 x 33 x 32	61 x 43.5 x 40	56 x 34 x 46	56 x 34 x 46

AV Code	FS 350	FS 500	SC 170	KOMB 450	Komb SO
Description	Cable restraining strap. Velcro stop length 80 cm	Cable restraining strap. Velcro stop length 90 cm	Cable support flange for AV SP380	Side lid for AV GT450	Cable support flange for items AV SP380 and AV SK460

Code	PFAV1X04	PFAV2X12	PFAV3X24
Description	Side panel for AV AX100 for 4 XLRs	Side panel for AV SP380 for 12 XLRs	Side panel for AV GT450 for 24 XLRs

Metric²/AWG Wire Size Equivalents

In Europe, wire and cables are expressed in mm² (cross sectional area), while in USA the AWG (American Wire Gauge) is the standard system used for both solid and strand conductors. See the cross reference scheme below.

AWG	32	30	28	26	24	22	21	20	18	17	16	14	13	12	11	10	8	6	4	2	1	2/0	3/0	4/0
mm ²	0.032	0.051	0.081	0.13	0.20	0.33	0.41	0.52	0.82	1.04	1.31	2.08	2.62	3.31	4.17	5.26	8.37	13.3	21.2	33.6	42.4	67.4	85	107

Cross references refer to solid copper wire. For stranded conductors a range of values must be considered i.e. AWG 24 stranded conductors are comprised between a range of 0.20 mm² and 0.24 mm².

Conductor Resistance

mm ²	0.03	0.05	0.08	0.14	0.22	0.34	0.38	0.50	0.75	1.50	2.50	4.00
Ohm/km	578	350	232	146	76.40	55	44	34.50	23	14.70	8.80	4.50

Capacity Reference Table for **eurocable** Reels

Cable O.D.(mm)	4	6	8	10	12	15	18	20	22	24	26	28	30	32
AV AX100	250	111	63	40	28									
AV SP380	731	325	183	117	81	52	36	29						
AV SP450			227	145	101	64	45	36	30	25				
AV SK460				180	125	80	56	45	37	31	27			
AV GT310RM	398	166	84	64	39	22								
AV GT380RM	740	319	170	114	82	43	29	24						
AV HD260				246	171	109	76	62	51	43	36	31	27	24
AV HD350					231	148	102	83	69	58	49	42	37	32
AV HD500						211	146	119	98	82	70	60	53	46
AV HD600											140	120	105	92
AV HD600 R											100	90	75	65

Capacity table for cable reels, based on O.D. of the cable used. Measure the O.D. (mm) of your cable to choose the appropriate cable reel. The above values are expressed in meters.

eurocable

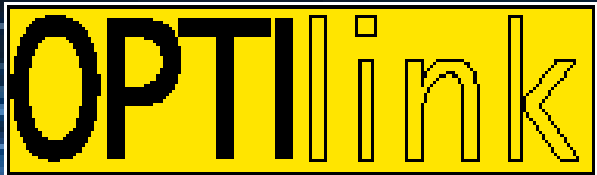
The logo for OPTILink, featuring the word "OPTILink" in a bold, sans-serif font. The letters "OPTI" are in a solid yellow color, while "link" is in a white, outlined font. The entire logo is contained within a yellow rectangular box with a thin white border.

OPTILink

The background of the slide is a dark blue gradient with numerous bright blue, glowing lines that radiate from the right side towards the left, creating a sense of depth and movement, reminiscent of fiber optic cables or data transmission paths. Small white and blue dots are scattered throughout the scene, adding to the digital aesthetic.

**Providing innovative
fiber cabling solutions**

Fast Termination Connectors

Features and benefits:

- Termination in one minute
- Compatible with 250µm, 900µm, 2.0mm, and 3.0mm jacket
- No crimping or proprietary tooling required
- Confirmation window for easy verification
- Easy fiber insertion
- Industry leading hinge clamp strain relief
- Up to 4 wiring operations



SC connector

Specifications		
Insertion loss	Multimode	Typical ≤ 0.3 / MAX 0.5
	Singlemode	Typical ≤ 0.3 / MAX 0.5
	Singlemode APC	Typical ≤ 0.3 / MAX 0.6
Return loss	≥ 26dB (FPC)	≥ 45dB (UPC) ≥ 55dB (APC)

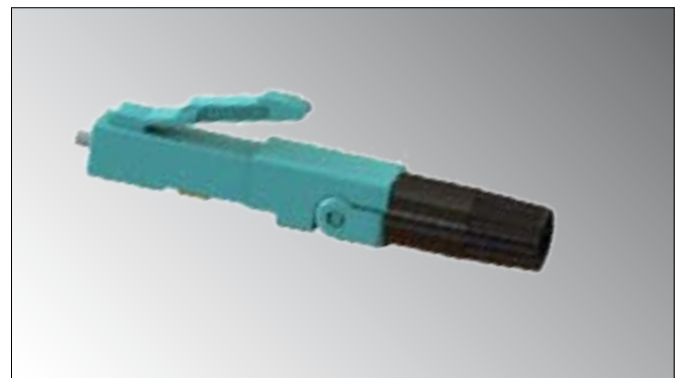

LC connector

Splice-On Connectors

Features and benefits:

- Field-installable
- Low insertion/High return loss
- No heating process required
- Wing-adhesive quick protection
- Fast work time
- Termination time: 12 seconds

Item	Description
Connector type	SC/LC
Jacket type	900µm, 2mm, 3mm, 3mm Drop round, 2x3 Drop rectangular
Polish	APC or UPC
Insertion loss	SM < 0.1dB / MM < 0.1dB
Return loss	SM > 60dB (APC), > 55dB (UPC) / MM > 30dB (UPC)
Operating temp.	-40°C to 75°C

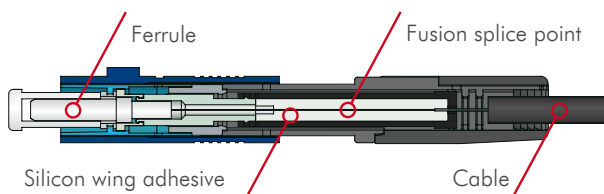

Booth type



SC connector



Hard boot

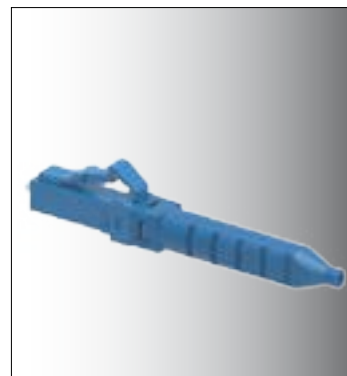

LC connector



Screw boot



Soft boot

Ask for **eurocable** unbreakable Optical cables CVS LKFOHD range

Splicer

Features and benefits:

- Optimized for: Single core, less than 0.1 dB loss; Dual core, less than 0.2 dB loss.
- No heating-process required
- Wing-adhesive protection
- Micro 5pin port charging, chargeable with power bank or phone charger
- Minimized size

Item	Description	
Connector type	Single core	Dual core
Jacket type	Single-mode (G.652&G.657), Multi-mode (G.651), DSF (G.653), NZDS (G.655)	
Fiber cleave length	9 ~10mm	10mm
Typical average splice loss	0.1 dB or less	0.2 dB or less
Splicing time	10 sec	12 sec
Viewing method	1 axis CMOS camera	
Operating condition	Altitude: 0 to 3660m, -10°C to 50°C / Humidity: 0 to 95% RH, non-dew	
Protection method of fusion-spliced point	Wing-adhesive protection	Wing-adhesive protection, heating sleeve (optional)
Splicing cycle of battery	100 cycles with internal battery, chargeable by portable power bank	
	Installed battery by Micro 5 pin USB port (phone charger)	
	2000 splices	
	110(W)x115(L)x60(H) mm / 0.65kg	



Splicer single core



Splicer dual core

Tools



High Precision Fiber Optic **Cleaver**

Designed for excellent portability, the Fiber Optic Cleaver is well-shaped and high-performing.

This high precision fiber optic cleaver is pro designed in structure, its blade provides approximately 40,000 cleaves.

High precision fiber optic cleaver is ideal for fusion splicing standard 125/250 μ m & 125/900 μ m fibers and preparing fiber for various pre-polished field-installation connectors.



Pen Shape **Visual Fault Locator** is a compact but powerful fiber optical cable test tool, with an output power up to 10mW, which can be used to locate sharp bends & breaks in jacketed or bare fiber at more than 10km. It can also be applied to identify the connectors in patch panels and identify the fibers during splicing operation. The choice of a continuous wave output mode for steady fault illumination or a flashing output mode makes easier fault location possible.



Microscope display



Display with data save function (SD card)



Microscope Probe



Inspection Wi-Fi converter
(for iOS & Android)



Microscope display with power meter

Portable, video microscope used to inspect all kinds of fiber optic terminations, allows the inspection without removing the connector from the female adapter. Fast and easy to use, particularly useful working "on field".
Build your own tool set combining the Microscope Probe with the various accessories available!



Fiber Optic **Cleaner Pen** for LC, SC, MPO/MPT and LEMO connectors.



Cassette cleaner for LC, SC, FC and ST connectors and replacement tape.



Cassette cleaner for LC, SC, FC and ST connectors and replacement tape.



Fiber Optic **Swabs**, for cleaning contaminations from all 1.25/2.5mm adapters and connectors leaving no area unattended.

Handy one-at-a-time dispensing **wipes** packs with special plastic guard to reduce airborne lint, keep contaminants out of box and reduce electrostatic discharge.



Fiber Optic **Kevlar Cutter**, made of high quality carbon steel to cut the kevlar fibers.



Fiber Optic **Stripper**, to provide a quick, easy, and reliable way to remove the fiber jackets from an optical fiber.