

LONGFORD County Development Plan



Volume III ANNEX

Table of Contents

Annex 1: Section 28 Ministerial Guidelines

Annex 2: Strategies and Plans affecting the Development Plan

Annex 3: Socio Economic Profile of Municipal Districts in County Longford

Annex 4: Housing Strategy

Annex 5: Infrastructure Assessment Report

Annex 6: Settlement Asset Based Criteria Table

Annex 7: Rural Design Guidelines

Annex 8: Shopfront Design Guidelines

Annex 9: County Longford Retail Strategy

Annex 10: Mid Shannon Wilderness Park

Annex 11: Landscape Character Assessment

Annex 1:

Section 28 Ministerial Guidelines

Section 28 Ministerial Guidelines

Architectural Heritage Protection – Guidelines for Planning Authorities (2004)
Architectural Heritage Protection for Places of Worship - Guidelines for Planning Authorities (2003)
Architecture Policy Guidelines 2009-2015
Best Practice Urban Design Manual - Part 1 & 2 (2009)
Childcare Facilities Guidelines for Planning Authorities (2001)
Development Contribution Scheme for Planning Authorities – (Circular PD 5/2007)
Development Contribution Scheme for Planning Authorities - Circular PD4/2003
Development Management Guidelines- Guidelines for Planning Authorities (2007)
Development Plans Guidelines - Guidelines for Planning Authorities (2007)
Spatial Planning and National Roads Guidelines (2012) — Funfair Guidance
Draft Revised Wind Energy Development Guidelines (DHPLG, 2019)
Implementation of new EPA Code of Practice on Waste Water Treatment and Disposal Systems Serving Single Houses - Circular PSSP1/10
Implementing Regional Planning Guidelines- Best Practice Guidance (2010)
Implementation Roadmap for the National Planning Framework (Gol, 2018)
Landscape and Landscape Assessment
Provision of Schools and the Planning System – Code of Practice for Planning Authorities, The Department of Education and Science and the Department of the Environment, Heritage and Local Government (2008)
Quarries and Ancillary Activities- Guidelines for Planning Authorities (2004)
Retail Planning Guidelines
Section 261A of the Planning and Development Act, 2000 and related provisions, Guidelines for Planning Authorities (2012)
Smarter Travel, A Sustainable Transport Future, A New Transport Policy for Ireland 2009 - 2020
Strategic Environmental Assessment (SEA)
Sustainable Rural Housing Development Guidelines (2005)
Sustainable Residential Development in Urban Areas (2009)
Sustainable Urban Housing: Design Standards for New Apartments - Guidelines for Planning Authorities (2007)
Taking in Charge of Housing Estates / Management Companies
Taking in Charge of Residential Developments Circular Letter PD 1/08
Telecommunications Antennae and Support Structures- Guidelines for Planning Authorities (1996)
The Planning System and Flood Risk Management - Guidelines for Local Authorities (2009)
The Planning System and Flood Risk Management – Technical Appendices (2009)
Tree Preservation Guidelines
Waste Water Discharge (Authorisation) Regulations - Circular PD 7/09
Wind Energy Development Guidelines (2006)

Annex 2:

**Strategies and Plans affecting the
Development Plan**

Strategies and Plans affecting the Development Plan

EU and National

Action Plan for Jobs 2018
Action Programme for Effective Local Government, Putting People First
National Strategy on Children and Young People's Participation in Decision-Making 2015-2020
Better Outcomes Brighter Futures: The National Policy Framework for Children and Young People 2014-2020
Children First – National Guidance for Protection and Welfare of Children
Creative Ireland Programme
eGovernment Strategy 2017-2020
Enterprise 2025 Renewed
Food Wise 2025
Future Jobs Ireland – Current Strategy 2017-2020
Healthy Ireland – A framework for Improved Health & Wellbeing 2013-2025
Innovation 2020
Keeping Communities Safe – Fire Services Framework
Local Authority People Strategy
National Broadband Plan
National Climate Change Adaptation Framework
National Cyber Security Strategy
National Development Plan 2018-2027
National Digital Strategy
National Disability Inclusion Strategy 2017-2021
National Heritage Plan – Heritage Ireland 2030
National Homeless Strategy
National Housing Strategy for People with a Disability
National Implementation Plan 2018 – 2020
National Positive Ageing Strategy
National Social Policy for Ireland 2019-2022
National Traveller and Roma Inclusion Strategy 2017-2021
Our Public Libraries 2022: Inspiring, Connecting and Empowering Communities
Project 2040 - National Planning Framework Project 2040
Public Service 2020
Public Sector Energy Efficiency Strategy
Rebuilding Ireland – Action Plan for Housing and Homelessness
Realising Our Rural Potential – Action Plan for Rural Development
Renewable Electricity Policy & Development Framework
River Basin Management Plan for Ireland
Social Housing Strategy
Strategy to Support the Community & Voluntary Sector in Ireland
Sustainable, Inclusive and Empowered Communities 2019-2024
The Migrant Integration Strategy
The Shannon Mighty River of Ireland: A Tourism Masterplan (2020-2030)
Traveller Accommodation Programme
UN Goals 2030
Waterways Ireland Heritage Plan 2016-2020
Water Services Policy Statement 2018-2025

Regional

Border Midland West Regional Operational Programme 2014 -2020
Eastern and Midland Regional Spatial and Economic Strategy 2019-2031
Just Transition Report (May 2020)
Midlands Regional Enterprise plan to 2020
Midlands Regional Homeless Strategy
Midlands Region Waste Management Plan Regional Enterprise Strategy 2018-2020
Midland Western Regional Assembly Operational Programmes

Local

County Longford Age Friendly Strategy 2015-2020
County Longford Arts Development Strategy 2014-2020
County Longford Culture and Creativity Plan 2018-2022
County Longford Childcare Strategic Plan
County Longford Diaspora Strategy 2019-2023
County Longford Heritage Plan, 2015-2020
County Longford Local Economic & Community Plan 2016-2022
County Longford Tourism Strategy
Longford County Council Climate Change Adaptation Strategy 2019
Longford County Council Corporate Plan 2019-2024
Longford County Council Fire Service Operations Plan 2011-2015
Longford County Council Irish Language Scheme
Longford County Council Litter Management Plan
Longford County Council Occupational Health & Safety Management System
Longford County Council Procurement Plan
Local Enterprise Development Plan
Longford Healthy County Plan 2018-2022
Longford Libraries and Archives Plan
Longford Sports Partnership Strategy 2018-2022
Longford Social Inclusion & Community Activation Programme Annual Plan Longford
Inter-Cultural Strategic Plan – Longford County Council 2018-2022
Rural Development Project 2014-2020

Annex 3:

**Socio Economic Profile of Municipal
Districts**

Socio-economic profile of the Municipal Districts in County Longford

Introduction

This annex provides an understanding of the socio-economic and demographic datasets, assessment and commentary (including trends and spatial analysis), mapping and data visualisation (tables, charts, graphs and figures) for each Municipal District within County Longford to further assist with the review of the Longford County Development Plan. As previously noted, the Municipal Districts were revised in 2018 and the Electoral Districts of Breanrisk, Cloonee and Corboy transferred from the Granard Municipal District into the Longford Municipal District. The information herein reflects the data from the 2016 Census based on those revised boundaries.

Demographic Profile

Population Distribution

Longford MD was the smallest (by area) and most populous MD with a population of 16,046. Higher concentrations of population density were evident on the outskirts of Longford town as illustrated in Table 1 and Figure 1.

Table 1: Population distribution within Longford MD (Source: CSO)

Electoral District	Total Population in 2016
Longford No. 1 Urban	3592
Longford No. 2 Urban	1029
Breanrisk	839
Caldragh	2172
Cloondara	687
Cloonee	738
Corboy	388
Longford Rural	5704
Newtown Forbes	897

Ballymahon MD was the largest (by area) and second most populous MD with a population of 14,153. Higher concentrations of people were evident in and around the towns of Ballymahon, Keenagh, Edgeworthstown and Lanesborough as illustrated in Table 2 and Figure 2.

Table 2: Population distribution within Ballymahon MD (Source: CSO)

Electoral District	2016 Population
Agharra	444
Ballymahon	2674
Cashel East	302
Cashel West	589
Doory	424
Forgney	491
Foxhall	528
Kilcommock	1062
Kilglass	709
Ledwithstown	363
Ballymuigh	250
Meathas Truim	2335
Ardagh East	670
Ardagh West	450
Killashee	437
Mountdavis	252
Moydow	730
Rathcline	1443

Granard MD was the second largest (by area) and least populous MD with a population of 10,674. Higher concentrations of people were evident in and around the towns of Drumlish and Granard as illustrated in Table 3 and Figure 3.

Table 3: Population distribution within Granard MD (Source: CSO)

Electoral District	2016 Population
Abbeylara	298
Ballinalee	625
Bunlahy	195
Columbkille	592
Coolamber	382
Creevy	308
Crosagstown	247
Currygrane	139
Dalystown	196
Drummeel	116
Firry/Newgrove	196
Gelshagh	351
Granard Rural	301
Granard Urban	1096
Knockanbaun	169
Lislea	145
Milltown	344
Moatfarrell	217
Moyne	326
Mullanalaghta	298
Sonnagh	245
Aghaboy	681
Ballinamuck East	599
Ballinamuck West	437
Drumgort	422
Drumlish	1475
Killoe	274

Population Growth and Change

Historic Change

The population has changed over time as noted in Table 4 and illustrated in Figure 3. Particularly high growth was evident in and around Longford town and Cloondara whilst Newtownforbes declined during that time. As set out in Table 14, historically Caldragh has grown extensively whilst Longford town and Newtownforbes have been more variable since 1981.

Table 4: Population Growth in Longford MD per ED during 1981 – 2016 (Source: CSO)

Electoral District	% Change 1981 - 1986	% Change 1986 - 1991	% Change 1991 - 1996	% Change 1996 - 2002	% Change 2002 - 2006	% Change 2006 - 2011	% Change 2011 - 2016
Longford No. 1 Urban	-9.50%	-3.19%	3.53%	-4.95%	10.28%	0.96%	13.56%
Longford No. 2 Urban	-5.26%	-2.55%	9.24%	0.28%	12.52%	17.88%	9.12%
Breanrisk	2.02%	-8.38%	0.50%	6.29%	10.75%	14.77%	2.82%
Caldragh	18.86%	7.00%	22.90%	12.60%	25.93%	28.97%	5.39%
Cloondara	-1.21%	-1.93%	-1.43%	-0.54%	4.74%	7.13%	11.53%
Longford Rural	12.07%	0.24%	-2.96%	20.72%	16.89%	8.84%	3.86%
Cloonee	0.71%	-0.18%	6.02%	3.17%	9.87%	7.07%	1.51%
Corboy	2.31%	-1.41%	3.14%	9.42%	-3.54%	4.72%	-2.76%
Newtown Forbes	12.87%	-0.69%	6.22%	10.29%	5.31%	1.12%	-0.55%

The population in Ballymahon MD increased during 2011 – 2016 from 13,284 to 14,153 (i.e. by 6.5%). As noted in Table 5 and illustrated in Figure 3, particularly high growth was evident in and around Ballymahon, Edgeworthstown and Keenagh (Kilcommock ED) during that time whilst in contrast Doory and Cashel East declined during that time. As set out in Table 15, historically most areas have experienced spurts of growth and decline. However Kilcommick, Ledwithstown, Kilashee and Ardagh east have significantly grown in the most recent Censuses.

Table 5: Population Growth in Ballymahon MD per ED during 1981 – 2016 (Source: CSO)

Electoral District	% Change 1981 - 1986	% Change 1986 - 1991	% Change 1991 - 1996	% Change 1996 - 2002	% Change 2002 - 2006	% Change 2006 - 2011	% Change 2011 - 2016
Agharra	-5.76%	-10.56%	11.18%	-7.54%	7.85%	27.73%	-2.63%
Ballymahon	3.18%	-4.26%	-3.59%	-0.71%	16.41%	29.13%	14.91%
Cashel East	2.39%	3.63%	-7.00%	-12.90%	-3.70%	3.53%	-6.50%
Cashel West	-0.47%	-9.21%	-1.22%	-4.78%	1.67%	4.57%	2.97%
Doory	6.46%	-4.34%	4.23%	3.77%	16.20%	9.86%	-7.22%
Forgney	0.72%	-9.03%	-0.78%	3.42%	13.49%	11.43%	-1.21%
Foxhall	-3.67%	-10.66%	5.97%	15.55%	18.33%	2.94%	0.57%
Kilcommock	3.82%	-5.44%	1.18%	-2.84%	2.41%	60.17%	11.44%
Kilglass	-11.59%	-5.34%	1.09%	5.95%	4.93%	14.59%	0.28%
Ledwithstown	5.86%	-9.23%	-8.81%	-4.09%	10.47%	24.91%	1.97%
Ballymuigh	4.62%	-5.51%	-0.39%	-0.39%	-3.53%	2.44%	-0.79%
Meathas Truim	12.80%	-1.40%	-7.43%	4.97%	40.62%	30.05%	16.28%
Ardagh East	4.78%	-6.35%	-8.00%	0.00%	7.37%	7.92%	9.30%

Socio-economic Profile for County Longford							June 2020
Ardagh West	-8.60%	-2.06%	3.00%	15.74%	10.58%	4.78%	-2.17%
Killashee	-1.97%	-4.02%	-1.67%	-0.43%	21.37%	52.11%	1.16%
Mountdavis	7.22%	-6.25%	-5.13%	6.49%	3.55%	22.55%	0.80%
Moydow	5.49%	2.04%	3.10%	-1.59%	5.75%	13.41%	9.28%
Rathcline	4.73%	-4.81%	-4.44%	1.60%	1.66%	10.78%	1.05%

The population in Granard MD has changed over time as noted in Table 6 and illustrated in Figure 3. Particularly high growth was evident in and around Granard, Ballinalee and the north and west Aughnaccliffe whilst Abbeylara, Killoe and a number of other areas declined during that time. As set out in Table 6, individual areas have been subject to contrasting periods of population growth and decline since 1981 with significant growth evident in Ballinalee, Coolamber, and Ballinamuck East in recent Censuses.

Table 6: Population Growth in Granard MD per ED during 1981 – 2016 (Source: CSO)

Electoral District	% Change 1981 - 1986	% Change 1986 - 1991	% Change 1991 - 1996	% Change 1996 - 2002	% Change 2002 - 2006	% Change 2006 - 2011	% Change 2011 - 2016
Abbeylara	-1.79%	4.01%	-1.75%	-12.50%	28.16%	8.28%	-12.35%
Ballinalee	3.32%	-10.89%	-0.83%	5.32%	20.48%	32.01%	4.52%
Bunlahy	-2.82%	-13.95%	12.16%	0.60%	0.00%	12.57%	3.72%
Columbkille	1.34%	-5.43%	-7.60%	0.00%	1.51%	-1.32%	-0.84%
Coolamber	-6.76%	-5.43%	0.00%	0.77%	22.05%	15.58%	2.96%
Creevy	-9.16%	0.58%	-10.32%	-7.67%	19.03%	-9.01%	-1.60%
Crosagstown	0.00%	6.83%	-5.02%	8.65%	-3.98%	11.06%	2.49%
Currygrane	-20.47%	14.85%	-6.03%	15.60%	-0.79%	2.40%	8.59%
Dalystown	-6.45%	6.32%	-5.41%	-2.86%	2.94%	7.43%	4.26%
Drummeel	-2.17%	-20.00%	2.78%	14.41%	0.00%	8.66%	-15.94%
Firry/Newgrove	-13.07%	8.67%	5.85%	5.03%	5.74%	-1.81%	-9.68%
Gelshagh	-7.08%	-12.61%	-4.70%	13.38%	-0.93%	5.96%	3.85%
Granard Rural	2.04%	-12.00%	-1.14%	-1.92%	17.19%	-1.33%	1.69%
Granard Urban	4.12%	-8.74%	-3.93%	-13.64%	-7.90%	9.43%	7.35%
Knockanbaun	0.66%	-11.11%	-8.82%	6.45%	10.61%	3.42%	11.92%
Lislea	-2.92%	-4.82%	3.16%	-12.88%	7.04%	-8.55%	4.32%
Milltown	2.39%	-4.08%	0.00%	-1.82%	8.67%	7.41%	-8.75%
Moatfarrell	9.87%	-21.56%	-5.34%	27.42%	18.35%	16.58%	-0.46%
Moyne	-2.05%	-10.73%	-6.45%	0.63%	-4.98%	3.28%	3.49%
Mullanalaghta	-1.62%	-5.59%	4.88%	-2.99%	1.03%	1.36%	-0.33%
Sonnagh	-4.99%	-5.56%	-8.17%	0.00%	1.78%	-0.35%	-14.04%
Aghaboy	-4.86%	-4.13%	0.82%	3.46%	17.09%	14.77%	-0.44%
Ballinamuck East	5.10%	-6.59%	-10.02%	-4.33%	2.16%	15.19%	9.71%
Ballinamuck West	-4.77%	-3.97%	-1.52%	1.32%	-3.92%	13.61%	-12.77%
Drumgort	-5.19%	-12.52%	-3.80%	-3.26%	4.57%	-1.61%	-1.40%
Drumliah	1.05%	-0.26%	3.63%	3.63%	12.92%	48.34%	6.34%
Killoe	-11.64%	-3.29%	-5.26%	-7.19%	6.34%	-2.98%	-6.48%

Future Change

The Longford MD is expected to grow by 2,156 people or 13.4% with the most significant growth evident in and around Longford town as demonstrated in Table 7.

Table 7: Projected Population Growth in Longford MD during 2016 – 2027

Electoral District	Population change 2016-2027	Population change 2016-2027 (%)
Longford No. 1 Urban	563	16%
Longford No. 2 Urban	168	16%
Breanrisk	101	12%
Caldragh	290	13%
Cloondara	48	7%
Longford Rural	762	13%
Cloonee	94	13%
Corboy	25	6%
Newtown Forbes	105	12%

The Ballymahon MD is expected to grow by 1,663 people or 12% with the most significant growth evident in and around Ballymahon, Keenagh, Edgeworthstown and Killashee as demonstrated in Table 8.

Table 8: Projected Population Growth in Ballymahon MD during 2016 – 2027

Electoral District	Population change 2016-2027	Population change 2016-2027 (%)
Agharra	40	9%
Ballymahon	358	13%
Cashel East	15	5%
Cashel West	27	5%
Doory	44	10%
Forgney	51	10%
Foxhall	59	11%
Kilcommock	146	14%
Kilglass	73	10%
Ledwithstown	25	7%
Ballymuigh	21	8%
Meathas Truim	381	16%
Ardagh East	60	9%
Ardagh West	50	11%
Killashee	67	15%
Mountdavis	27	11%
Moydow	83	11%
Rathcline	136	9%

The Granard MD is expected to grow by 1,111 people or 10.4% with the most significant growth evident in and around Drumlish, Ballinalee and Coolamber as demonstrated in Table 9.

Table 9: Projected Population Growth in Granard MD during 2016 – 2027

Electoral District	Population change 2016-2027	Population change 2016-2027 (%)
Abbeylara	25	8%
Ballinalee	88	14%
Bunlahy	17	9%
Columbkille	37	6%
Coolamber	51	13%
Creevy	28	9%
Crosagstown	22	9%
Currygrane	15	11%
Dalystown	18	9%
Drummeel	5	4%
Firry	12	6%
Gelshagh	36	10%
Granard Rural	34	11%
Granard Urban	141	13%
Knockanbaun	18	10%
Lislea	4	3%
Milltown	43	12%
Moatfarrell	25	11%
Moyne	17	5%
Mullanalaghta	28	10%
Sonnagh	15	6%
Aghaboy	70	10%
Ballinamuck East	75	13%
Ballinamuck West	40	9%
Drumgort	26	6%
Drumlish	215	15%
Killoe	6	2%

Structure and Age Profile

Within Longford MD, the average age is 35.9 years which is the youngest of all MDs in the county, which can be associated with the relatively high proportion under 14 years (23.9% of the population) and relatively low proportion over 65 years (13.4%). An age profile pyramid for Longford MD is provided in Figure 4.

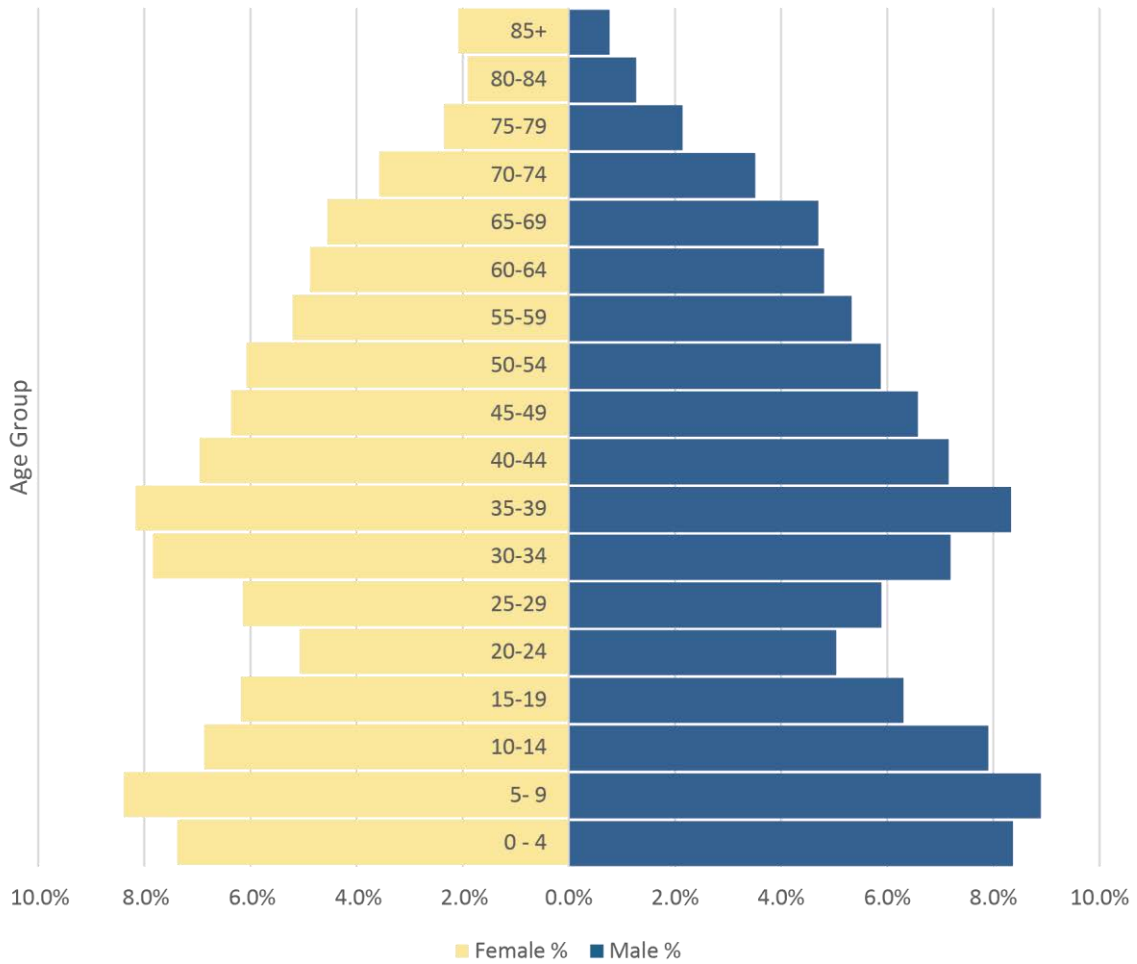

Figure 4: Population Age Pyramid for Longford MD (Source: CSO)

Within Ballymahon MD, the average age is 37.1 years with 22.8% of the population under 14 years, 61.7% of the population between 15 – 64 years and 15.5% above 65 years. An age profile pyramid for Ballymahon MD is provided in Figure 5.

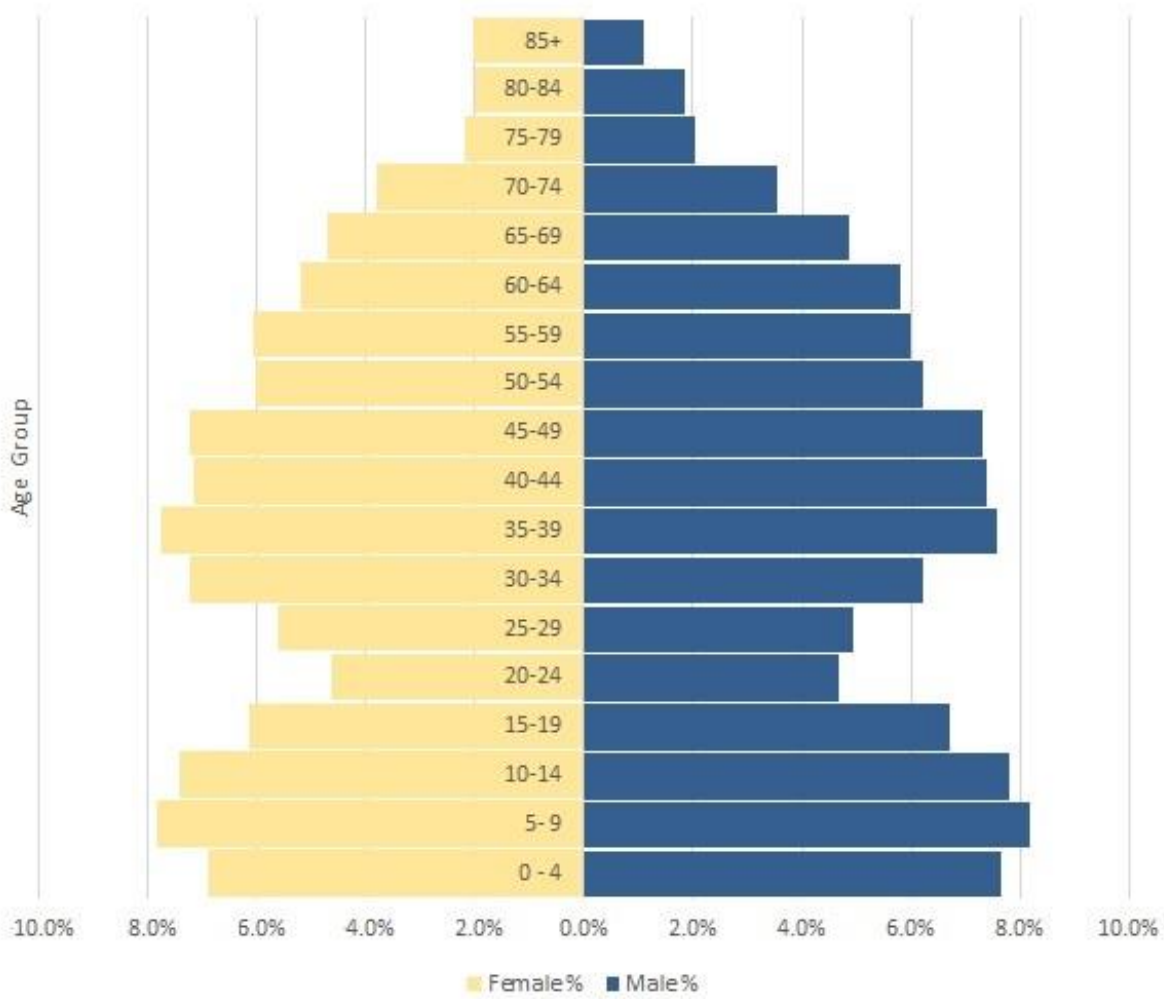

Figure 5: Population Age Pyramid for Ballymahon MD (Source: CSO)

Within Granard MD, the average age is 37.9 years which is the highest of all MDs in the county, which can be associated with the relatively high proportion over 65 years (15.7% of the population) and relatively low proportion under 14 years (22.8%). An age profile pyramid for Granard MD is provided in Figure 6.

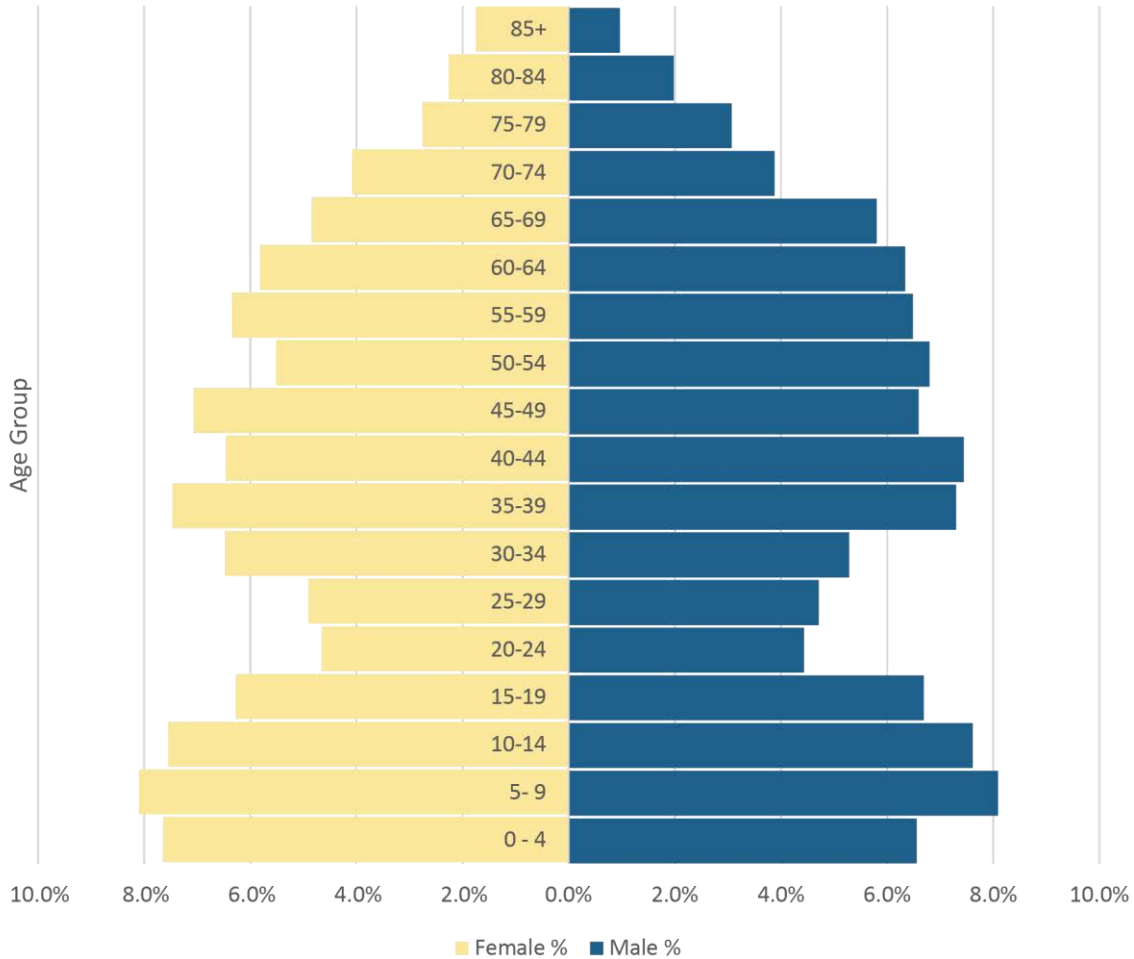

Figure 6: Population Age Pyramid for Granard MD (Source: CSO)

Ethnicity

Longford MD has the most diverse population with 79% of the population identifying as being of Irish nationality as illustrated in Figure 7.. Relatively high proportions of Polish and other Europeans are present, particularly in and around Longford town as demonstrated in Table 10 and Figure 7.

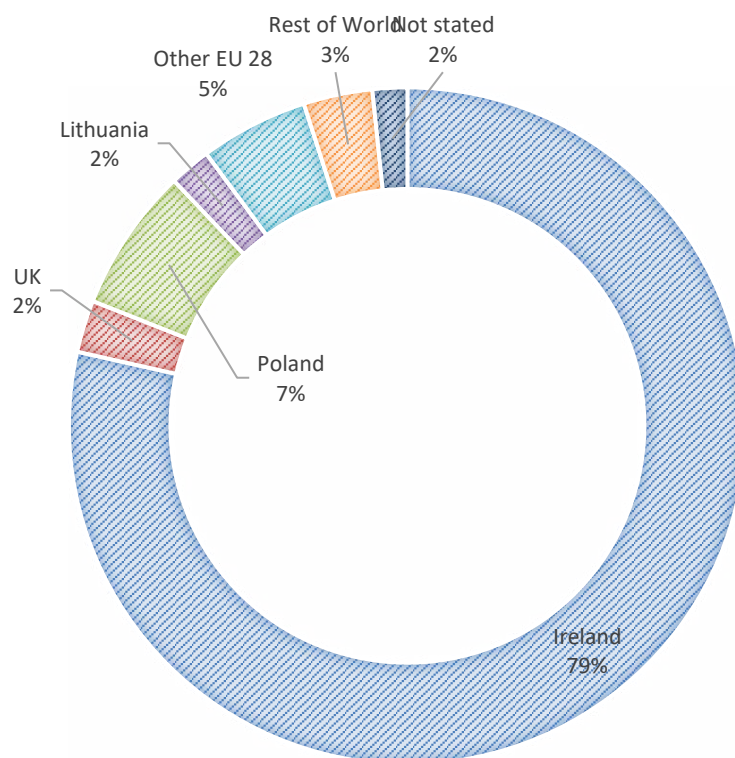

Figure 7: Nationalities within Longford MD (Source: CSO)

Table 10: Usually resident population in Longford MD by place of birth and nationality (Source: CSO)

Location	Birthplace	Nationality	Birthplace %	Nationality %
Ireland	11,940	12,525	74.8%	78.5%
UK	916	398	5.7%	2.5%
Poland	1,023	1,097	6.4%	6.9%
Lithuania	283	317	1.8%	2.0%
Other EU 28	770	825	4.8%	5.2%
Rest of World	1,020	526	6.4%	3.3%
Not stated	-	264	0.0%	1.7%
Total	11,940	15,952	100.0%	100.0%

84.3% of the population within Ballymahon MD identifying as being of Irish nationality as illustrated in Figure 8. Relatively high proportions of Polish and British are present when compared to other nationalities and non-nationals are generally concentrated in Ballymahon and Edgeworthstown as demonstrated in Table 11 and Figure 8.

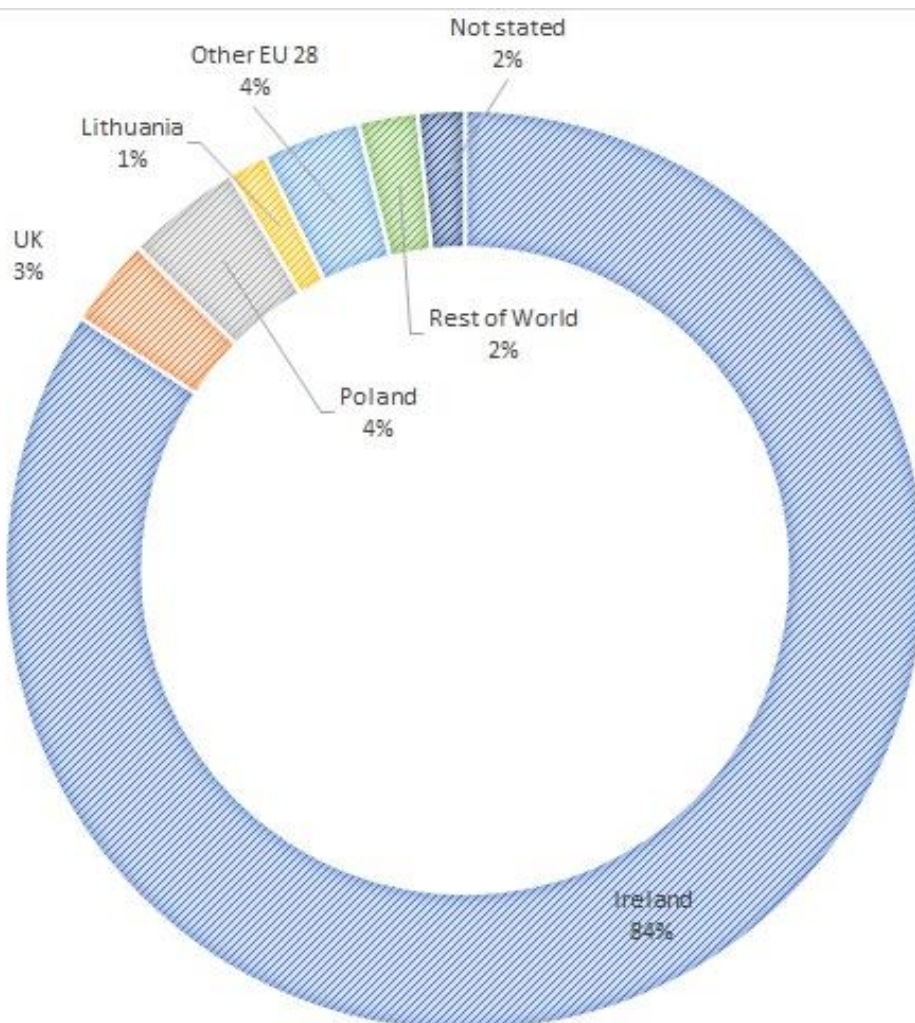

Figure 8: Nationalities within Ballymahon MD (Source: CSO)

Table 11: Usually resident population in Ballymahon MD by place of birth and nationality (Source: CSO)

Location	Birthplace	Nationality	Birthplace %	Nationality %
Ireland	11,493	11,869	82%	84%
UK	900	443	6%	3%
Poland	527	573	4%	4%
Lithuania	179	190	1%	1%
Other EU 28	464	487	3%	3%
Rest of World	524	292	4%	2%
Not stated	0	233	0%	2%
Total	14,087	14,087	100%	100%

Granard MD has the least diverse population with 90% of the population identifying as being of Irish nationality as illustrated in Figure 9. British and Polish are the largest non-national communities with pockets evident around Granard as demonstrated in Table 12 and Figure 9.

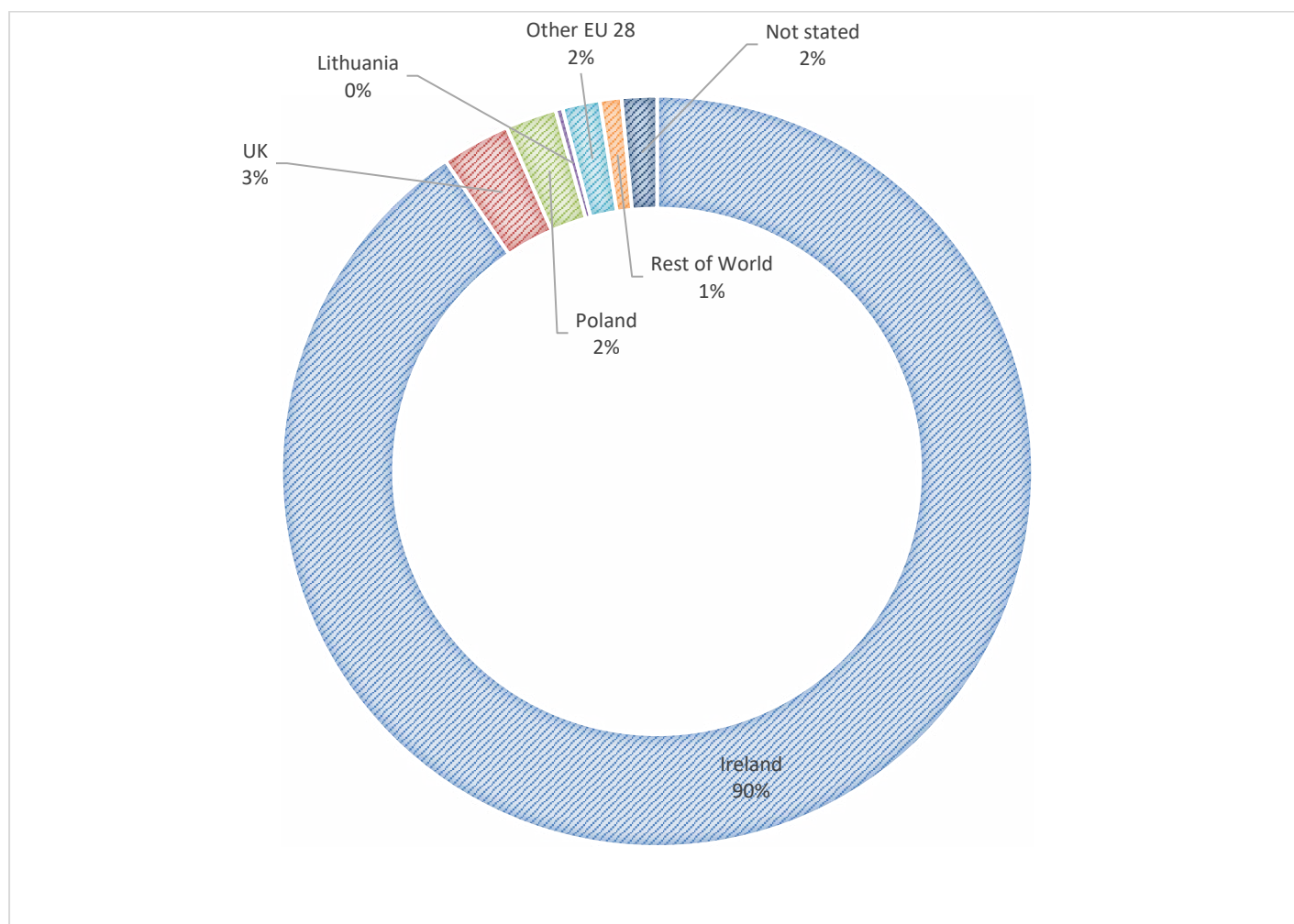

Figure 9: Nationalities within Granard MD (Source: CSO)

Table 12: Usually resident population in Granard MD by place of birth and nationality (Source: CSO)

Location	Birthplace	Nationality	Birthplace %	Nationality %
Ireland	9,299	9,606	87.6%	90.5%
UK	691	314	6.5%	3.0%
Poland	224	233	2.1%	2.2%
Lithuania	31	33	0.3%	0.3%
Other EU 28	173	171	1.6%	1.6%
Rest of World	198	99	1.9%	0.9%
Not stated	-	160	0.0%	1.5%
Total	10,616	10,616	100.0%	100.0%

Households

Longford MD has the smallest average household size of all MDs in 2016 (2.67 persons per household). Further, there was a relatively low proportion of households with five or more persons as illustrated in Figure 10.

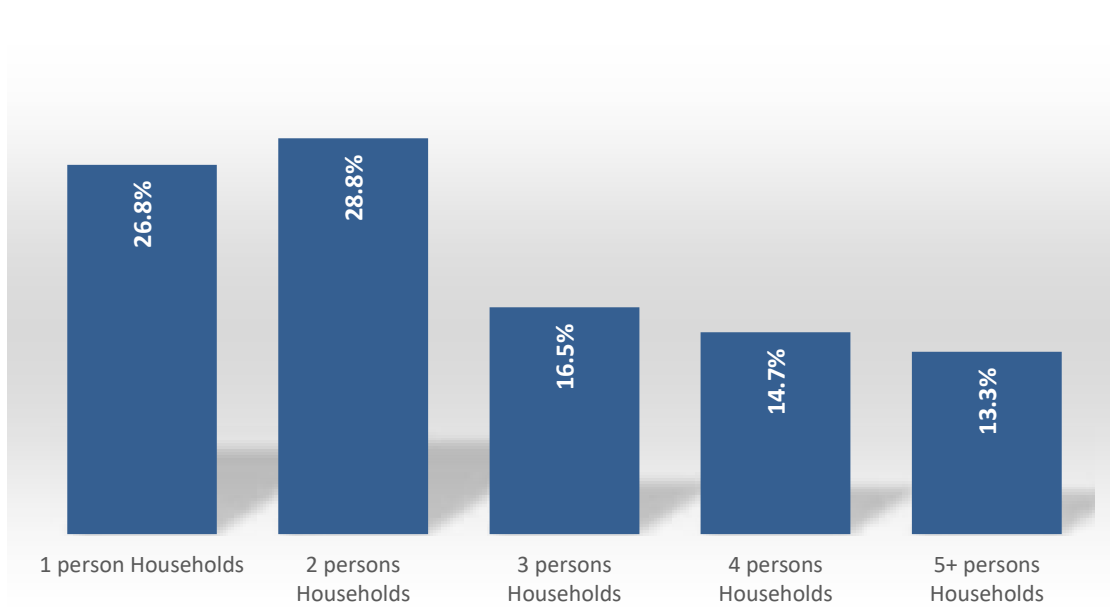

Figure 10: Private households by size in Longford MD (Source: CSO)

Ballymahon MD has an average household size of 2.70 persons per household in 2016 which was equivalent to the county comparison. As illustrated in Figure 11, there was a relatively high proportion of one and two person households.

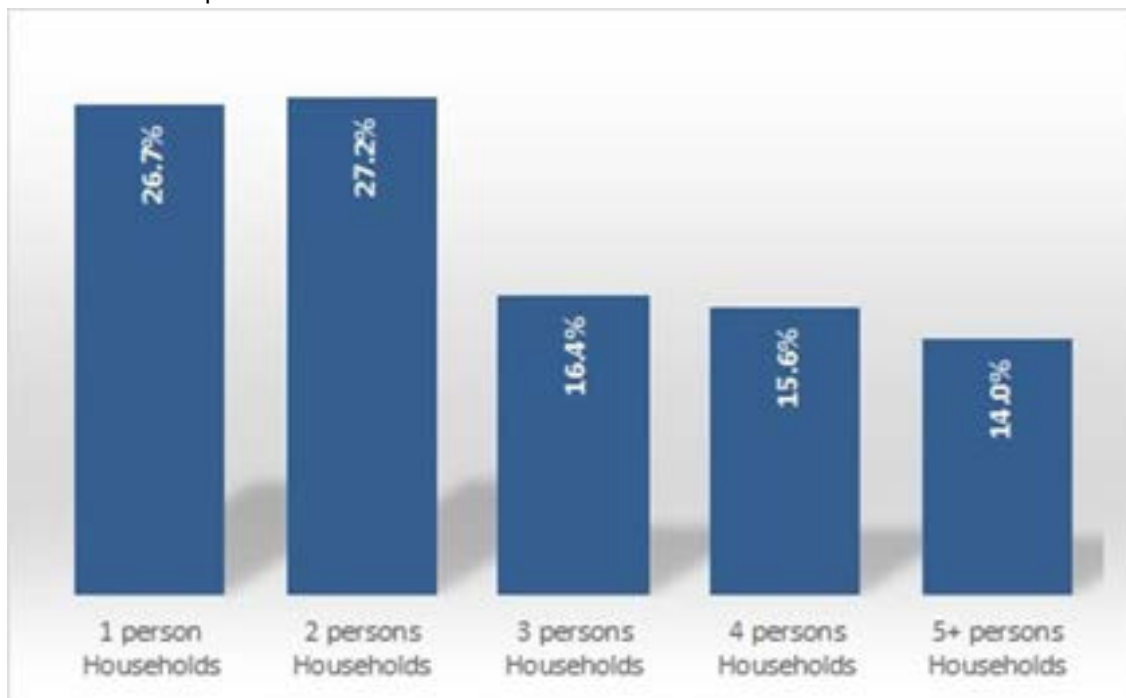

Figure 11: Private households by size in Ballymahon MD (Source: CSO)

Granard MD has the largest average household size of all MDs in 2016 (2.73 persons per household). Further, there was a relatively high proportion of households with four and five or more persons as illustrated in Figure 12.

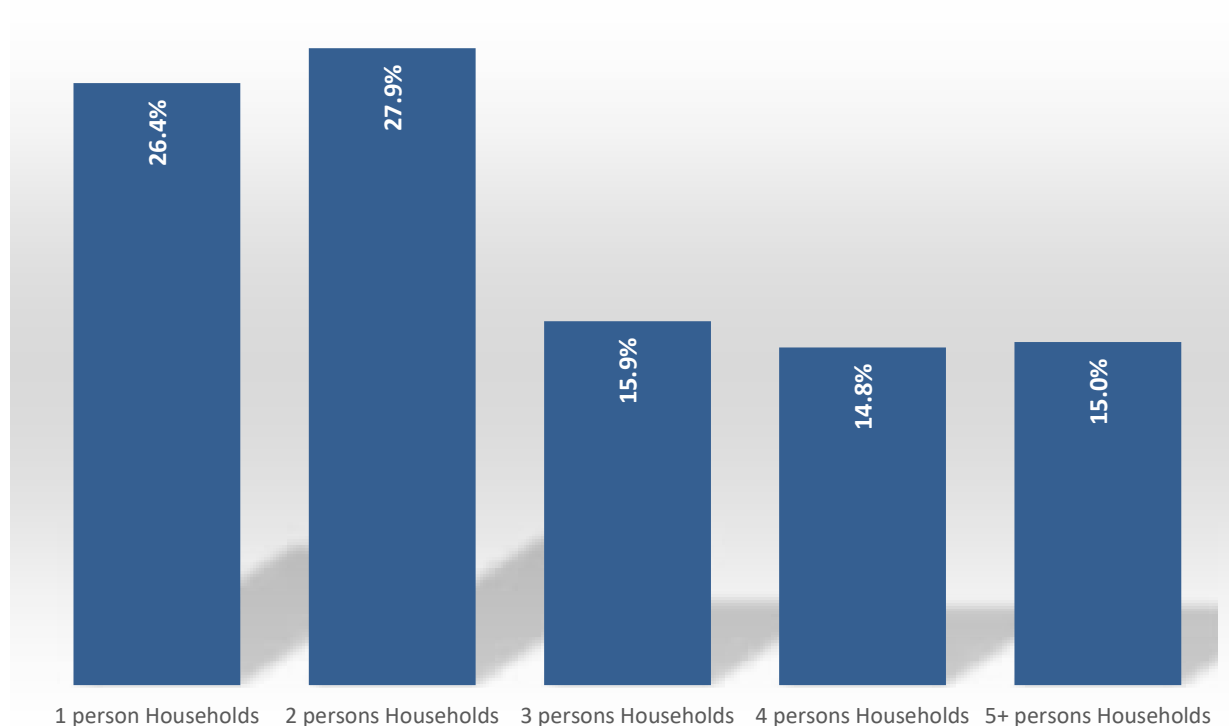

Figure 12: Private households by size in Granard MD (Source: CSO)

Socio-economic Profile

Education

As illustrated in Table 13 and Figure 13, the educational attainment in Longford MD is relatively good with a relatively high proportion of the population having been educated to Master level or higher when compared to other MDs.

Table 13: Educational attainment in the population over 15 years in Longford MD (Source: CSO)

Proportion	Number of persons	% of persons
Third Level (Level 7+)	1,996	19.8%
Third Level (Level 6+)	3,033	30.1%
Up to Leaving Cert	5,247	52.1%
Primary or Less	1,566	15.5%
Masters of Higher	552	5.5%

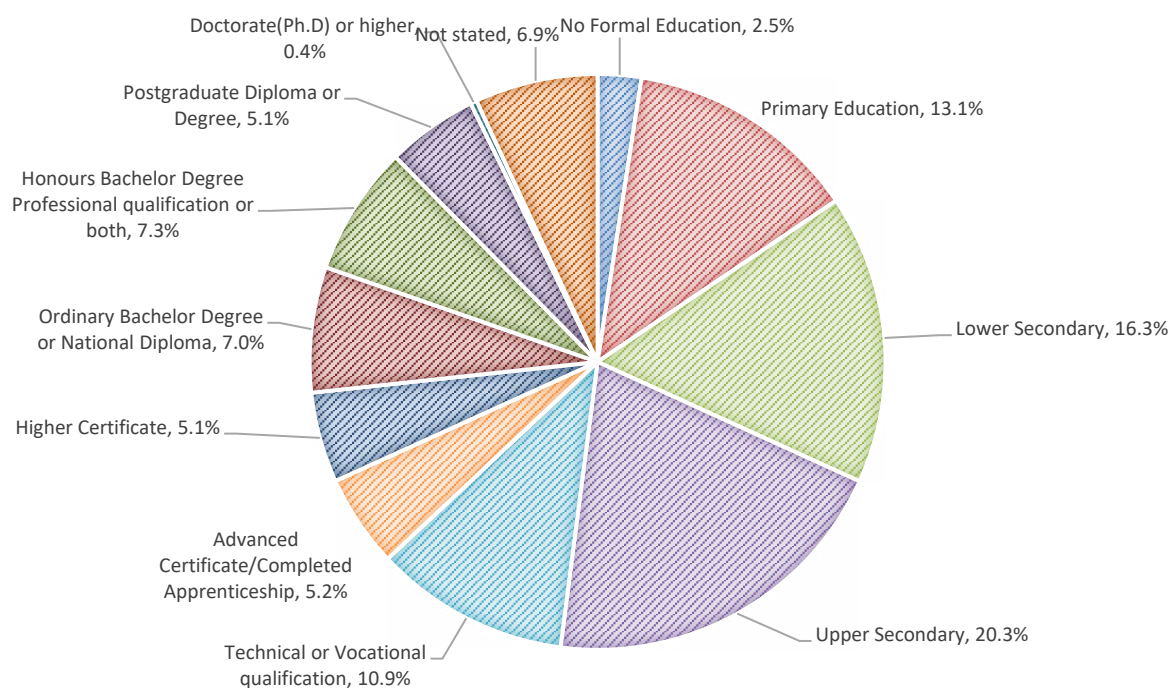

Figure 13: Education by highest level achieved within Longford MD (Source: CSO)

As illustrated in Table 14 and Figure 14, the educational attainment in Ballymahon MD is relatively good with a relatively high proportion of the population having been educated to Third Level (i.e. at least Level 6 on the NFQ) when compared to other MDs.

Table 14: Educational attainment in the population over 15 years in Ballymahon MD (Source: CSO)

Proportion	Number of persons	% of persons
Third Level (Level 7+)	1,835	20.10%
Third Level (Level 6+)	2,885	31.70%
Up to Leaving Cert	4,568	50.10%
Primary or Less	1,441	15.80%
Masters of Higher	485	5.30%

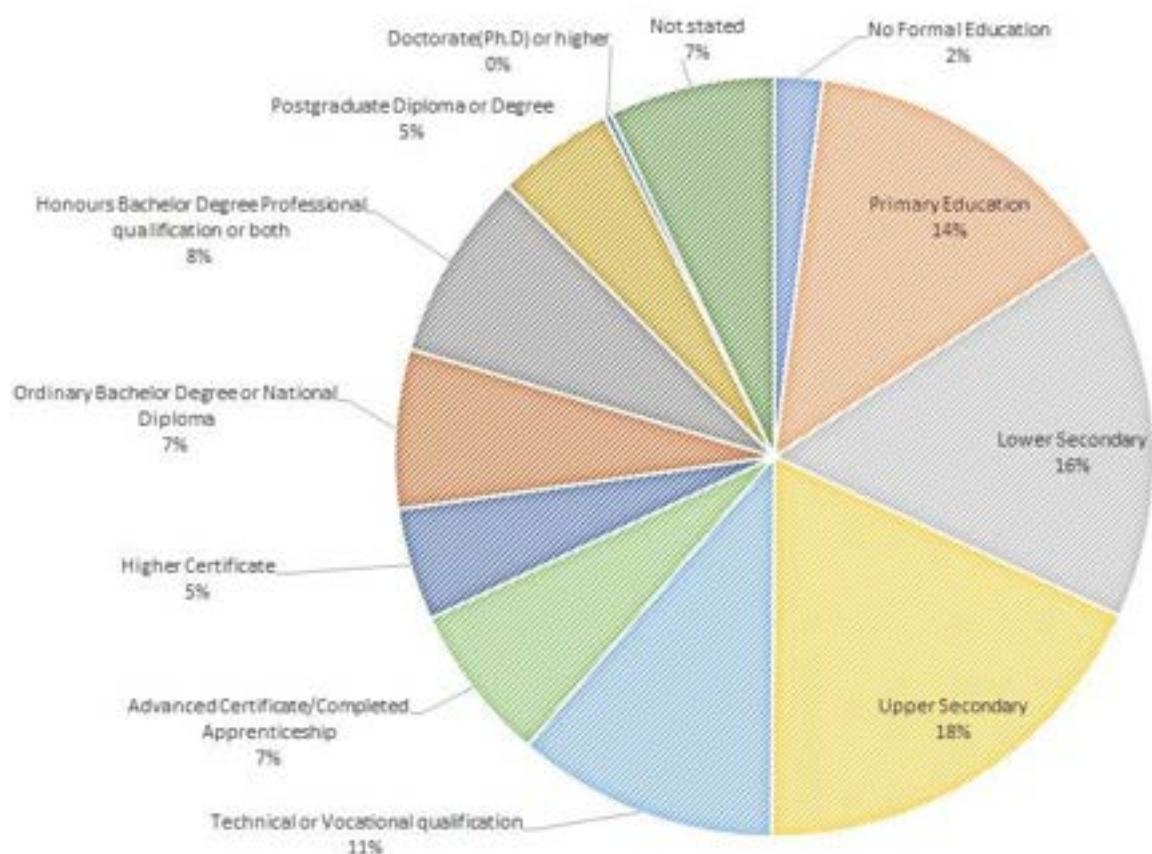

Figure 14: Education by highest level achieved within Ballymahon MD (Source: CSO)

As illustrated in Table 15 and Figure 15, the educational attainment in Granard MD is good and generally comparable to the county average in terms of educational attainment.

Table 15: Educational attainment in the population over 15 years in Granard MD (Source: CSO)

Proportion	Number of persons	% of persons
Third Level (Level 7+)	1,232	17.7%
Third Level (Level 6+)	1,985	28.5%
Up to Leaving Cert	3,812	54.7%
Primary or Less	1,297	18.6%
Masters of Higher	295	4.2%

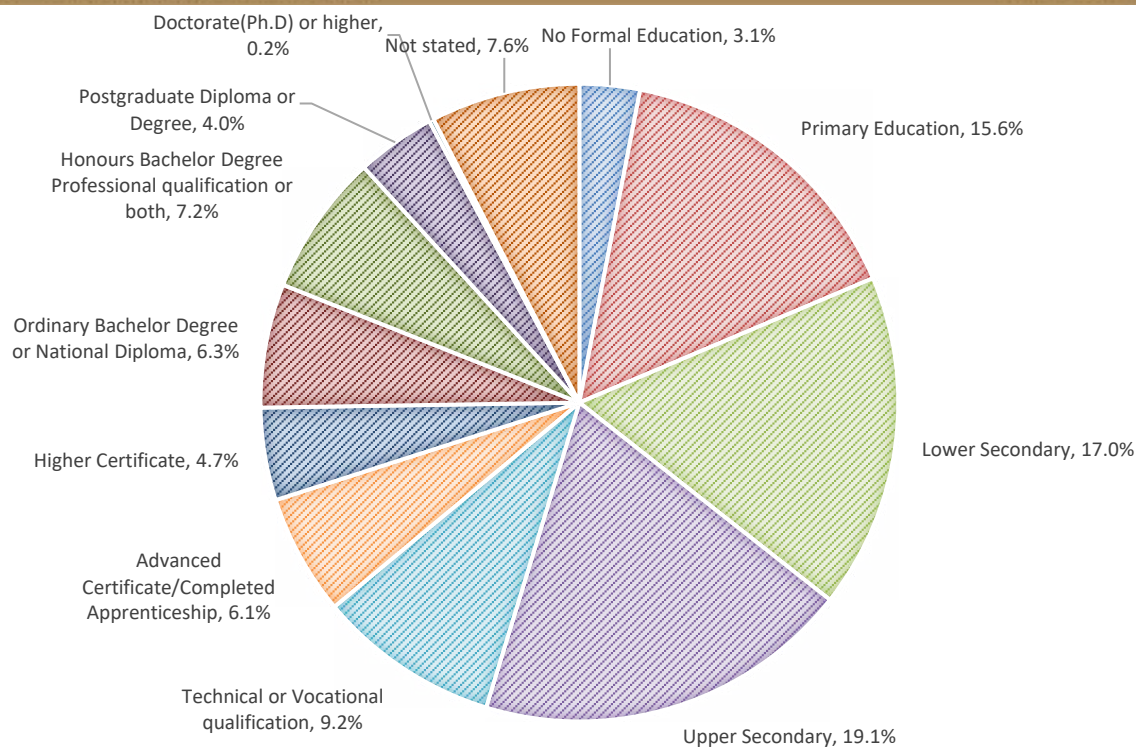

Figure 15: Education by highest level achieved within Granard MD (Source: CSO)

Deprivation

In order to further explore deprivation and affluence, Figure 16, Figure 17 and Figure 18 illustrate the Pobal Index Score based on Small Areas within the MDs of Longford, Ballymahon and Granard respectively. The following can be drawn from this analysis:

- Inequalities and pockets of affluence and disadvantage are evident across County Longford and within each of the individual MDs.
- Inequalities are evident within Longford MD – The northern part of Longford town is marginally above average whilst some areas to the south are very and extremely disadvantaged.
- The majority of the rest of the Longford MD is generally marginally above or below the average score.
- The western section of Ballymahon MD is marginally above average whilst the centre and eastern part being marginally below average (particularly around Legan and Edgeworthstown).
- The majority of Granard MD is marginally below average with some parts in the west part disadvantaged and some sections of Granard town being very disadvantaged.
- When comparing the north and south of Edgeworthstown (i.e. those portions in Ballymahon MD against those in the Granard MD), inequalities were evident albeit they are relatively small (i.e. areas to the north in the Granard MD are marginally above average whilst those in the Ballymahon MD are marginally below average).

Annex 4:

Housing Strategy

Longford Housing Strategy 2021 - 2027

Submission by:



Future Analytics

On behalf of:



March 2021

Fourth Draft



Contents

1	Introduction	3
1.1	Overview	3
1.2	Housing Strategy / HNDA – Guiding Principles	3
1.3	Housing Need Demand Assessment (HNDA).....	4
1.4	Methodology	6
2	Strategic, Legislative and Policy Landscape	11
2.1	National Legislation and Policy	11
2.1.1	Planning and Development Act 2000	11
2.1.2	Planning and Development (Amendment) (No. 3) Regulations 2018.....	11
2.1.3	The Planning and Development (Housing) and Residential Tenancies Act 2016.....	12
2.1.4	Urban Regeneration and Housing Act 2015	12
2.1.5	The Housing (Miscellaneous Provisions) Act 2009	13
2.1.6	Project Ireland 2040 – National Planning Framework.....	13
2.1.7	Implementation Roadmap for the National Planning Framework	15
2.1.8	Project Ireland 2040 – National Development Plan 2018-2027	16
2.1.9	Housing Supply Target Methodology for Development Planning (December 2020)	16
2.1.10	Sustainable Urban Housing: Design Standards for New Apartments Guidelines for Planning Authorities	17
2.1.11	Rebuilding Ireland – Action Plan for Housing and Homelessness, 2016	17
2.1.12	National Vacant Housing Reuse Strategy 2018-2021.....	19
2.1.13	Social Housing Strategy 2020: Support, Supply and Reform.....	20
2.1.14	Construction 2020: A Strategy for a Renewed Construction Sector	20
2.1.15	The National Housing Strategy for People with a Disability 2011-2016.....	21
2.2	Regional Policy	21
2.2.1	The Regional Spatial and Economic Strategy (RSES) 2019-2031.....	21
2.3	Local Policy.....	22
2.3.1	Longford County Development Plan 2021 – 2027	22
2.3.2	Longford County Housing Strategy 2015-2021.....	22
2.3.3	County Longford Local Economic and Community Plan 2016-2022	23
2.3.4	County Longford Age Friendly Strategy 2015-2020	23
2.3.5	Longford County Council Traveller Accommodation Programme 2019-2024	23
3	Current Context: Review and Analysis of Existing Supply and Needs.....	24
3.1	Population.....	24
3.2	Existing Housing Stock and Supply	26
3.2.1	Stock and Composition	26
3.2.2	Housing Tenure	28

3.2.3 Unfinished Housing Development	30
3.2.4 Housing Permissions	31
3.3.5 Social Housing Stock	32
4 Housing Needs in Longford	34
4.1 Overview	34
4.2 Inputs.....	35
4.2.1 Population Projections.....	35
4.2.2 Estimated Households	35
4.2.3 Income Analysis	38
4.2.5 Central Bank Rules and Mortgage Capacity.....	42
4.2.6 Analysis of Historic Ownership Market.....	43
4.2.7 Analysis of Historic Private Rental Market.....	47
4.3 Assessment of Needs	48
4.3.1 Ownership.....	48
4.3.2 Private Rental.....	53
4.4 HNDA Components	55
4.4.1 Household Composition.....	55
4.4.2 Household Tenure.....	56
4.4.3 Single Rural Dwellings	57
4.5 Conclusion	61
5 Meeting Housing Requirements in Longford	62
5.1 Overview	62
5.2 Social Housing Supply and Demand	62
5.2.1 Existing Social Housing Needs.....	62
5.2.2 Meeting Social Housing Demand	63
5.5.3 Delivery Methods and Targets.....	66

1 Introduction

1.1 Overview

This Housing Strategy has been prepared by KPMG Future Analytics on the behalf of Longford County Council to meet the statutory requirements set out under Section 94 of Planning and Development Act, 2000 (as amended). Under Part V of the Act, each planning authority must prepare a Housing Strategy which will cover the period of its development plan.¹ Each strategy must have regard to the proper planning and sustainable development of the area and must address the overall supply of housing within the administrative boundary of the Local Authority. The Housing Strategy also addresses relevant provisions contained within the Housing (Miscellaneous Provision) Act, 2009 and the Urban Regeneration and Housing Act 2015.

The purpose of the Housing Strategy is to ensure that the proper planning and sustainable development of County Longford provides for the housing of the existing and future population of the area in the manner set out in this Strategy. The County Development Plan and the Housing Strategy will embrace the Vision set out in the Social Housing Strategy 2020 which states that *“every household in Ireland will have access to secure, good quality housing suited to their needs at an affordable price in a sustainable community”*.

The Housing Strategy is a critical component which informs the policies and objectives of the County Development Plan, playing a key role in translating national housing policies and housing supply responses to the local level. Since the previous Housing Strategy was prepared there have been significant changes in planning legislation and policy. In particular, this Housing Strategy must be consistent with the National Planning Framework (NPF) and the Eastern and Midland Regional Spatial and Economic Strategy (RSES).

In line with this, the NPF requires each Local Authority to undertake a Housing Need Demand Assessment (HNDA) which must underpin and support the preparation of housing strategies and all related housing policy outputs. The HNDA for County Longford, as elaborated in Section 1.2 – 1.4. and Section 4, provides a robust evidence base to inform decision-making around current and future housing supply in accordance with the HNDA requirements as set out in the NPF and all other relevant statutory requirements, including the DHLGH’s *“Housing Supply Target Methodology for Development Planning: Guidelines for Planning Authorities”*.

1.2 Housing Strategy / HNDA – Guiding Principles

An evidence-based and future-proofed methodological approach has been adopted to ensure that the Housing Strategy for County Longford meets the housing needs of the county and its residents while remaining in keeping with local, regional and national guidelines. The Strategy is underpinned by a HNDA which provides a robust baseline to inform and guide policies and objectives under the Longford County Development Plan 2021-2027.

Declines in the construction sector and wider economic activity during the previous decade, coupled with Ireland’s economic recovery have led to ongoing challenges around fluctuations in the supply, demand and price of housing. It has also led to opportunities, with a greater mix of house types and tenures diversifying Ireland’s housing market. Increased levels of activity in the construction sector will provide new homes to meet current and projected demand and contribute to County Longford’s social housing stock by way of Part V obligations. The HNDA incorporates a range of socio-economic and demographic data to analyse current levels of demand and supply within Longford and project for future need over the lifetime of the Development Plan (i.e. to 2027) and beyond to 2031. It incorporates demand across different tenures, including owner-occupied, the rental

¹ The Longford County Development Plan 2021-2027 is expected to come into force in Winter 2027 for a duration of six years. For modelling purposes, the HNDA has rounded this period to the nearest whole quarters, covering Q1 2022 – Q4 2027 inclusive.

sector and social housing and provides estimates of future housing needs based on employment growth, income levels and affordability in the housing market as described in detail in Section 1.4.

1.3 Housing Need Demand Assessment (HNDA)

Under Section 94 (1) (a) of the Planning and Development Act 2000 (as amended), each planning authority:

“shall include in any development plan a strategy for the purpose of ensuring that proper planning and sustainable development of the area of the development plan provides for the housing of the existing and future population of the area in the manner set out in the strategy”.

In order to ensure that the plan-making system is supported by a robust methodology to inform policies and funding initiatives around housing and associated land requirements, the NPF has introduced a new requirement for each Local Authority to develop a Housing Need Demand Assessment (HNDA). The HNDA will support the preparation of housing strategies and all related housing policy outputs, e.g. city and county development plans, local area plans, traveller accommodation plans etc.

The NPF indicates that the purpose of the HNDA tool is to:

- Assist local authorities to develop long-term strategic views of housing need across all tenures.
- Provide a robust evidence base to support decisions about new housing supply, wider investment and housing related services that inform an overall national housing profile.
- Inform policies about the proportion of social and affordable housing required, including the need for different types and sizes of provision.
- Provide evidence to inform policies related to the provision of specialist housing and housing related services.

The NPF notes that HNDAs are designed to give broad, long run estimates of what future housing need might be, rather than precision estimates and this is described in further detail in Section 2.1.9. The approach must be logical, sequential and allow for updating, monitoring and evaluation, therefore the HNDA undertaken as part of this Development Plan spans two key stages – current and future outlook; and assesses three core areas: Population, Housing and Economy. These are set out in Figure 1.1 with the sequential steps involved in the development and application of this HNDA model presented in Section 1.4

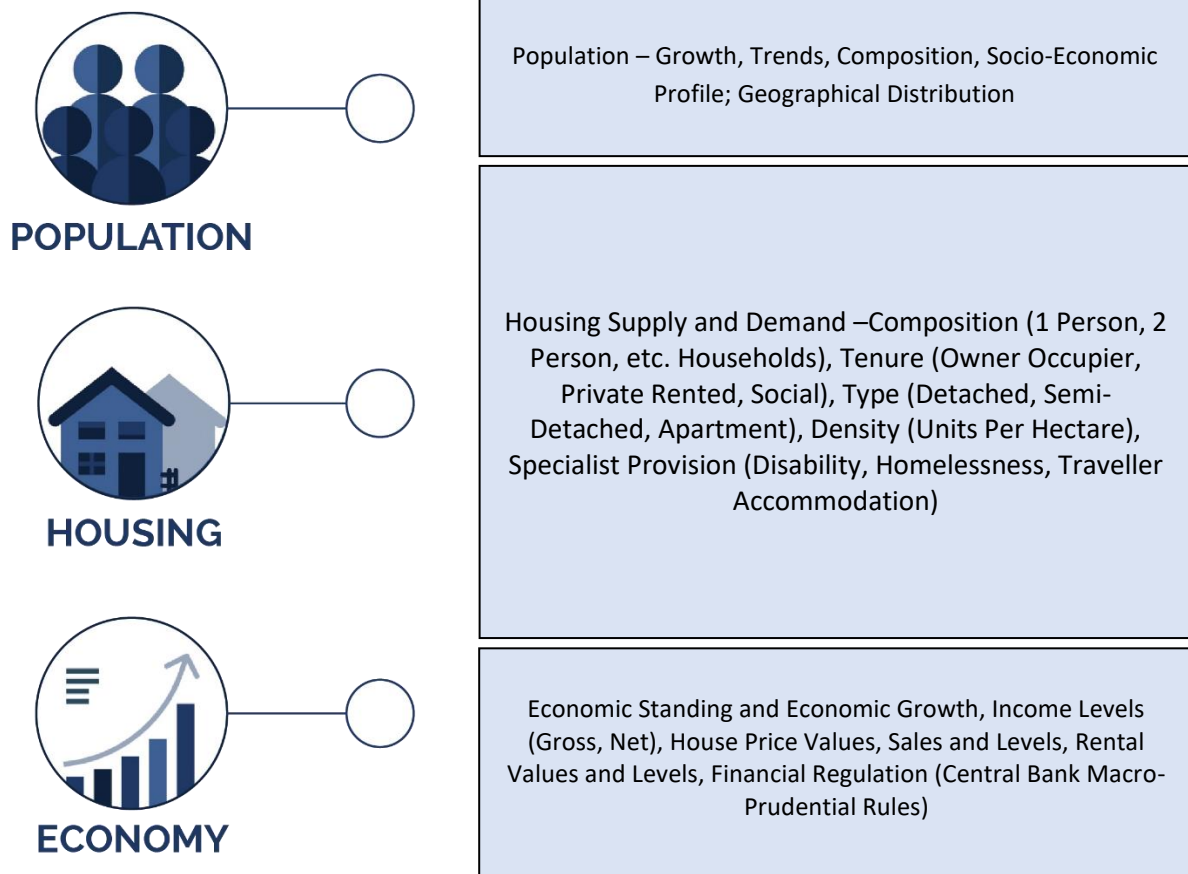

Figure 1.1: HNDA Assessment Areas. Source: KPMG Future Analytics

The methodological approach along with key inputs and outputs to the HNDA is summarised in Figure 1.2. This process seeks to enhance how acute and unmet demand for housing is identified before it arises by providing a robust assessment of regional and localised influences, such as population and migration, in quantifying needs and demands. The key evidence inputs which drive the model are:

1. **Demographic trends, affordability trends and wider economic trends.** The use of **economic forecasting or econometric** work underpins this section. Data requirements include **household composition/projections, house prices, rents, and loan to value (LTV) mortgage rates, economic activity and employment rates, etc.**
2. **Housing Stock Profile Pressures (and existing need) and management issues.** This involves undertaking a detailed profile of local **housing stock**, including **local authority housing**, to identify the main issues relating to supply and demand, ineffective stock and overall condition as well as priorities for future stock management. Information is required on **dwelling size, dwelling type, dwelling condition and stock pressures (occupancy/under occupancy stock turnover, etc.).**
3. **Estimating Future Housing Need and Demand.** This is broken down into: **owner occupation, private sector, below market rent and social rent.**

1.4 Methodology

This Section provides an overview of the components involved in the development and application of this HNDA model. There are four components of the model, as shown in Figure 1.2.



Figure 1.2: Overview of the HNDA Model

The first component of the model explores population and household scenarios for the county over the plan period. A number of population scenarios for County Longford have been investigated to 2031 and a ‘Policy-Intervention Scenario’ has been applied for the purpose of this analysis into the housing needs of the county as described in detail in Section 4.2.1.

The second component alongside population projections is the determination of future households. This is established through the calculation of the Housing Supply Target for the plan period for County Longford in accordance with the ‘Housing Supply Target Methodology for Development Planning’ DHLGH guidelines (December 2020), as described in Section 4.2.2. This provides plan period targets and annualised household figures for analysis in the HNDA.

The third component relates to an assessment of housing and rental affordability. This assessment supports the identification of social (and affordable) housing needs for County Longford during the plan period. There are 15 steps as part of this, as illustrated in Table 1.2

Finally, Section 5 brings together the HNDA outputs and analyses how current and future housing need can be met while Section 6 sets out policy objectives for the delivery of this Housing Strategy for County Longford.

The overall structure of this Housing Strategy is summarised in Table 1.1.

Table 1.1: Structure of the Longford Housing Strategy 2021-2027

Section 2	Strategic, Legislative and Policy Landscape
Section 3	Current Housing Context: Review and Analysis of Existing Supply and Needs
Section 4	Future Housing: Projected Housing Need and Supply
Section 5	Analysis of Housing Requirements in Longford
Section 6	Policy Objectives to Deliver Housing Strategy
Section 7	Conclusion

Table 1.2: Approach to the HNDA for the Longford Housing Strategy 2021-2027

Step	Method
<p>Step 1 Determination of Annual Population Projections</p>	<p>Determination of annual population over the County Development Plan period. The agreed population projection scenario / target can reflect a “low”, “medium” or “high” growth projection-based upon county, regional, national and global specific factors. Longford County Council have applied a high growth scenario that aligns with the NPF.</p>
<p>Step 2 Determination of Pre-Plan Total Households</p>	<p>Determination of pre-plan total households based on latest CSO data and estimation of pre-plan housing completions</p>
<p>Step 3 Determination of Additional Households</p>	<p>Determination of additional households over the plan period based on agreed Housing Supply Targets.</p>
<p>Step 4 Calculation of Estimated Distribution of Household Disposable Incomes</p>	<p>Calculation of estimated distribution of annual and weekly household disposable income per decile of the established (by the CSO) of the 10 deciles in the baseline year.</p> <p>The national annual disposable incomes per decile are adjusted to city/county level based on application of an “inflater” or “deflator” rate.</p>
<p>Step 5 Calculation of Average Annual Household Disposable Income Distribution</p>	<p>Calculation of estimated distribution of annual household disposable income per household decile throughout the Development Plan period.</p> <p>This calculation considers a forecast GDP growth rate to reflect anticipated change incomes over the Development Plan period. It should be noted, that this approach is also taken in relation to average annual gross income for the purpose of understanding mortgage capacity and qualification.</p>
<p>Step 6 Calculation of Average Monthly Household Disposable Income Distribution</p>	<p>Calculation of estimated distribution of monthly household disposable incomes for each of the 10 household deciles throughout the Development Plan period.</p> <p>This is an exercise to ensure that incomes are scaled to provide the monthly (rather than annual) estimates of disposable income per household in each decile.</p>
<p>Step 7 Determination of Distribution of Total Anticipated Households</p>	<p>This is the calculation of estimated distribution of household units for each of the 10 household deciles throughout the Development Plan period.</p> <p>The number and distribution of total households per decile throughout the Development Plan period reflects projected number of private households per year during the Development Plan period as well as the distribution of housing units in the State from the Household Budget Survey.</p>

<p>Step 8 Determination of Distribution of Additional Anticipated Households</p>	<p>Calculation of estimated distribution of additional anticipated household units for each of the 10 household deciles throughout the Development Plan period.</p> <p>Similarly to the step above, this specifically reflects the number of additional anticipated households per decile per year throughout the Development Plan period.</p>
<p>Step 9 Calculation of Projected House Price Bands</p>	<p>Calculation of projected house price bands based on the percentage split of the established (by the DHPLG) 8 price bands.</p> <p>Historic transactional housing market data is considered to understand changes in average house price and future adjustments. This facilitates an estimation of each of the projected house price bands and proportional market split based on the split of the 8 price bands and a projected annual price increase or decrease.</p>
<p>Step 10 Calculation of Mortgage Capacity of Households</p>	<p>Determination as to whether households in each decile can qualify for a mortgage that enables them to purchase a house in the lowest price band under the current macro-prudential rules, as set out by the Central Bank of Ireland.</p> <p>This is based on understanding the threshold in the lowest price band per year during the Development Plan period and application of the “<i>Annuity Formula</i>”. The “<i>Annuity Formula</i>” is based on the determination of an “<i>Affordability Threshold</i>”, a “<i>Loan to Value Ratio</i>”, an “<i>Annual Percentage Rate (APR) - Interest Rate</i>”, the determination of a “<i>Monthly Percentage Rate (MPR) - Interest Rate</i>”, and the determination of a “<i>Loan Term (Years/Months)</i>”.</p> <p>If a household in any decile does not have sufficient income to meet the macro-prudential rules (i.e. 3.5 times their gross income is less than 90% of the value of purchase a house in the lowest projected price band), they do not qualify for a mortgage and progress to private rental (See Step 11). Those households that can qualify for a mortgage progress to the needs assessment for ownership (See Step 10).</p>
<p>Step 11 Calculation of Projected Needs for Ownership</p>	<p>Calculation of the approximate affordable house price for each of the ten deciles per year during the Development Plan period based on the application of the ‘<i>annuity formula</i>’. Once established, a calculation of the households surplus and/or deficit per price band is undertaken with respect to the number of households that can qualify for a mortgage:</p> <ul style="list-style-type: none"> a) Based on the application of the “<i>Annuity Formula</i>” calculate the housing affordability (i.e. Approximate Affordable House Price) for each of the 10 household deciles. b) Based on the determination of additional households required, the projected house price bands and the housing affordability, calculate the number of households not meeting the “<i>Affordability Criteria</i>”. This facilitates a calculation of the surplus/deficit of household at the lowest price band with respect to the number of households that can qualify for a mortgage.

<p>Step 12 Calculation of Projected Needs for Private Rental</p>	<p>Calculation of the households that will not meet the affordability criteria to privately rent a home during the Development Plan period with respect to the number of households that cannot qualify for a mortgage.</p> <p>Historic rental market data is analysed to enable an estimate of projected rental price by unit type during the plan period. Based on this and the household income, a calculation of the households not meeting the affordability criteria to privately rent a home has been undertaken with respect to the number of households that cannot qualify for a mortgage and those households that cannot afford to purchase a home.</p>
<p>Step 13 Summary of Projected Social Housing Need</p>	<p>Calculation of the households who can be classified as having an affordability problem during the Development Plan period so as to adequately inform the necessary provision units within the City/County.</p> <p>This is a summary of the anticipated housing need for the City/County Council as set out in the preceding steps and reflects assessments for both mortgage qualification and private rental affordability. Specifically, the number of additional households anticipated over the Development Plan period, the number of those households that do not qualify for a mortgage and number of those households that do not qualify for a mortgage and cannot afford private rental is provided based on the outcomes of the preceding steps.</p>
<p>Step 14 Historic Data Analysis and Approximate Projection of Tenure, Size Cohort, and Dwelling Type.</p>	<p>Calculation of historic intercensal change for private household tenure, cohort sizes and dwelling type to determine annualised change. This informs the basis of an annual rate of change for which additional anticipated households can be roughly forecasted for household tenure, cohort sizes and dwelling type.</p>
<p>Step 15 Analysis of Single Rural Dwellings</p>	<p>Analysis of CSO Granted Permissions data to determine distribution of rural one-off dwellings.</p>

2 Strategic, Legislative and Policy Landscape

2.1 National Legislation and Policy

2.1.1 *Planning and Development Act 2000*

Under Part V of the Planning and Development Act 2000 (as amended) Local Authorities are required to ensure that their Development Plans are consistent with high-level strategic policies and national population projections. As such Development Plans are to incorporate a Core Strategy that demonstrates consistency with relevant national and regional objectives as set out in the NPF and RSES as well as the strategic policy as described herein such as Rebuilding Ireland.

Local Authorities are also required to prepare and incorporate a Housing Strategy into their Development Plan, the purpose of which is to ensure that the housing needs of the existing and future population of the development plan area are met. Section 94 of the Act states that:

“...each housing strategy should have regard to the proper planning and sustainable development of an area and should be concerned with the overall supply of housing within the planning authority.”

The Act further specifies that Housing Strategy’s must consider:

- The existing and likely future need for social housing
- The need to ensure that housing is available for people of different incomes.
- The need to ensure the availability of a mixture of house types and sizes to cater for the requirements of different categories of households, including the special requirements of elderly persons and persons with disabilities
- the need to counteract segregation in housing between persons of different social backgrounds.

2.1.2 *Planning and Development (Amendment) (No. 3) Regulations 2018*

The Planning and Development (Amendment) (No. 3) Regulations 2018 is a recent, relevant legislative update. This amendment exempts the temporary change of use of certain vacant commercial premises to residential use, i.e. this can occur without the need to obtain planning permission. However, this change of use, and any related works, must occur by 31 December 2021. In addition, the existing structure or part of the structure, which is the subject of the change of use, is required to be vacant for a period of two years immediately prior to when the development takes place. A number of other conditions and limitations apply, notably including:

- There shall be no more than 9 individual residential units within a building (i.e. staying below the Part V social housing threshold).
- No works permitted to protected structures unless a s.57 declaration has issued to indicate the works will not affect the character or elements of the structure which has been identified for protection.
- Works to the ground floor of any structure shall not conflict with an objective in a development plan for the structure to remain in retail use, with the exception of works solely for the provision of on-street access to upper floors.
- The exemption applies to existing buildings that have a current commercial use (with reference to Class 1, 2, 3, and 6 of Part 4 to Schedule 2 of the Principal Regulations).

2.1.3 The Planning and Development (Housing) and Residential Tenancies Act 2016

The Planning and Development (Housing) and Residential Tenancies Act 2016 provides a legislative basis for measures introduced under the Rebuilding Ireland: Action Plan for Housing and Homelessness to expedite the construction of large-scale residential developments. These “strategic housing developments” avail of a fast-track application process, whereby applications for planning permission are submitted apply directly to An Bord Pleanála. This measure was introduced under the Rebuilding Ireland Action Plan for Housing and Homelessness in order to streamline the planning process and accelerate the delivery of new housing and student accommodation units.

Part 2(3) of the Act defines the following types of developments as qualifying as Strategic Housing Developments:

- a) the development of 100 or more houses on land zoned for residential use or for a mixture of residential and other uses,
- b) the development of student accommodation units which, when combined, contain 200 or more bed spaces, on land the zoning of which facilitates the provision of student accommodation or a mixture of student accommodation and other uses thereon,
- c) development consisting of shared accommodation units that when combined contain 200 or more bed spaces on land the zoning of which facilitates the provision of shared accommodation or a mixture of shared accommodation and other uses,
- d) development that contain a mixture of houses, student accommodation or shared living units,
- e) the alteration of an existing planning permission granted under section 34 (other than under subsection (3A) where the proposed alteration relates to development specified in paragraph (a), (b), or (c).

Under this streamlined application process applicants engage with the relevant Local Authority and An Bord Pleanála in a Pre-Application Consultation to discuss a proposed development, determine its legitimacy and highlight any potential issues that may arise. Then upon submission of an application for planning permission, An Bord Pleanála are to provide a decision within sixteen weeks of application. To maintain this deadline there is no provision for the applicant to provide further information in support of their application once submitted, and no provision for an appeals process by which the applicant or any third party can dispute An Bord Pleanála’s decision. As such decisions to grant or refuse permission for strategic housing developments can only be disputed by way of a Judiciary Review.

2.1.4 Urban Regeneration and Housing Act 2015

Under Part V Section 91(4)(c) of the Planning and Development Act 2000 there is a social housing requirement of 10% which planning authorities must apply to planning permission for housing on all lands zoned for residential use, or for a mixture of residential and other uses. The Urban Regeneration and Housing Act was introduced in 2015 and it includes amendments to the Planning and Development Act 2000, as amended. Specifically, these amendments determine thresholds for this social housing requirement and specify how private developers can meet their obligations to contribute to the provision of social housing.

The previous social housing obligations were not applicable in the case of developments including four or fewer residential units, however the new obligations are not applicable in respect of developments that include nine or fewer units. The use of cash payments as an alternative to social housing units is no longer permitted, and provision has been made for the transfer of residential units outside the lands which are subject to planning permission, but within the relevant Development Plan area. The full list of social housing delivery options now permitted are outlined below.

Part V delivery options (Post Act 2015)

- The transfer of ownership of lands, subject to the planning permission application to a local authority for the provision of social housing remains the default option. The land option must be acceptable to the local authority
- The transfer of ownership to the local authority, or persons nominated, of completed social housing units on the land, subject to planning permission
- The transfer of ownership to the local authority, or person nominated, of completed social housing units on other land, not subject to the planning permission. There is no longer a requirement for the developer to build housing units on other land to fulfil his/her Part V obligations. The developer might have a stock of suitable houses or he/she can simply acquire housing units for such purposes. This allows social housing units to be delivered in a more timely fashion in another location, in the event that the development that is the subject of the planning permission does not meet the social housing or mixed tenure needs of the local authority:
- The Part V obligation can now be fulfilled by developers through long term leasing of properties: and
- A combination of the Part V options above is also allowed.

The Urban Regeneration and Housing Act 2015 also introduced wider changes aimed to encourage activity in the construction sector. A vacant site levy was introduced, which provides Local Authorities with the power to apply levies to property owners who do not take steps to develop vacant and under-utilised in areas identified for priority development under the local Development Plan. Developers were also permitted to avail of reduced development contributions for developments that had previously been granted permission but were yet to commence.

2.1.5 The Housing (Miscellaneous Provisions) Act 2009

The Housing (Miscellaneous Provisions) Act 2009 makes amendments and extensions to provisions under the Housing Acts 1966 to 2004 to provide Local Authorities with a strategic framework for the delivery and management of housing services. This requires Local Authorities to adopt housing services plans to cover the delivery and management of housing services within the Local Authorities' areas, as well as homelessness action plans and anti-social behaviour strategies. It provides a legislative basis for objective methods to assess need and allocating social housing support which incorporate household size, household income and house and rental prices within a Local Authority's administrative area. The Act also extends the legislative basis for the provision of rented social housing by means of leasing or contract arrangements with private landlords.

2.1.6 Project Ireland 2040 – National Planning Framework

The National Planning Framework (NPF) is a high-level strategy that will shape Ireland's growth and development up to the year 2040. Drawing upon lessons learned from the implementation of the National Spatial Strategy 2002-2022, the NPF calls for a shift from an uncoordinated "business as usual" approach to planning, and provides a framework for the sustainable development of Ireland's existing settlements.

The NPF sets an overall national target to deliver 550,000 additional households by 2040. This is supported by a number of National Policy Objectives that seek to deliver residential development at a suitable density and scale:

- **National Policy Objective 32:** To target the delivery of 550,000 additional households to 2040.
- **National Policy Objective 33:** Prioritise the provision of new homes at locations that can support sustainable development and at an appropriate scale of provision relative to location
- **National Policy Objective 35:** Increase residential density in settlements, through a range of measures including reductions in vacancy, re-use of existing buildings, infill development schemes, area or site-based regeneration and increased building heights.

To underpin the delivery of these targets the NPF requires Local Authorities to develop a Housing Need Demand Assessment (HNDA) as noted in Section 1 and set out in National Policy Objective 37 as follows:

“A ‘Housing Need Demand Assessment’ (HNDA) is to be undertaken for each Local Authority Area in order to correlate and accurately align future housing requirements. The HNDA is:

- to be undertaken by Local Authorities with coordination assistance to be provided by the Regional Assemblies, and also at a Metropolitan scale, particularly where inter-county and inter-regional settlement interactions are to be planned for and managed;*
- to primarily inform housing policies, housing strategies and associated land use zoning policies as well as assisting in determining where new policy areas or investment programmes are to be developed;*
- and to be supported, through the establishment of a coordination and monitoring unit to assist Local Authorities and Regional Assemblies in the development of the HNDA (DHPLG, Regional Assemblies and the Local Authorities). This will involve developing and coordinating a centralised spatial database for Local Authority Housing data that supports the HNDA being undertaken by Local Authorities.”*

The NPF also emphasises the need for more affordable homes for sale or rent. More proactive land management and coordinated and efficient provision of enabling infrastructure, particularly on Local Authority and State-owned lands, are set out as central measures to delivering affordability in the housing sector.

Housing will need to be well-located, affordable and diverse in order to cater for the increased demand particularly for smaller homes suitable for one and person households. Housing should be re-usable, adaptable and accessible to ensure that homes can meet the changing needs of households over time (Objective 34). New housing provision should be met within existing settlements and should be tailored to meet the future housing needs of the settlement in which it is located.

Building resilience and being able to adequately respond to future demand will also involve the re-use of existing housing stock. Higher residential densities are to be pursued in urban areas with a greater emphasis on infill/brownfield, reduction in vacancies, area or site based regeneration and increased building heights (Objective 35).

Objective 36 of the NPF provides a commitment to introduce new statutory guidelines that will ensure consistency of approach, implementation and monitoring of housing requirements at a regional (Regional Spatial and Economic Strategies), metropolitan and local authority levels (Core Strategies).

The NPF also sets out measures and objectives to reconcile future housing requirements effectively. For this, key evidence inputs to inform and drive robust, evidence based Housing Need Demand Assessment (HNDA) Models that underpin local authority Housing Strategies are set out as follows:

- Demographic trends, affordability trends and wider economic trends.
- Housing Stock Profile Pressures (and existing need) and management issues.
- Estimating Future Housing Need and Demand.

Objective 37 sets out a requirement for Local Authorities to undertake HNDAs to form housing policies, strategies and land use zoning policies and to facilitate more informed decision making on investment programmes for housing. Furthermore, coordination and monitoring units are to be established to assist Local Authorities and Regional

Assemblies in the development of the HDNA. This unit will also be responsible for a new centralised spatial database for Local Authority housing data that informs the development of the HNDAs.

2.1.7 Implementation Roadmap for the National Planning Framework

The Implementation Roadmap for the NPF supports the alignment of national, regional and local planning policy and objectives. It provides transitional population projections for the period up to 2031 and sets out mechanisms to ensure that Development Plans align with the NPF and RSES in addressing the six-year period up to 2026/2027. They allow for the Development Plan Review Process to be deferred on a once-off basis up to three months after the relevant RSES has been finalised, and for Review Processes underway to be suspended until the relevant RSES has been finalised. This aims to ensure that Development Plans can benefit from latest available data and policy contexts. Recently adopted plans that were completed before the relevant RSES can also be brought forward for early review or variation to render them consistent with relevant regional policies and objectives.

As such, most City and County Development Plans will undergo a process of review by 2020/2021 and will cover the six-year period up to 2026/2027. 2027 will provide an assessment of the first full round of Development Plans that have been prepared in accordance with the NPF and RSES for Ireland's three regions. This assessment will coincide with several other key deadlines; 2026 is also a Census Year (i.e. updated demographic and socio-economic data is likely to be available) and 2027 will see a review of the ten-year National Development Plan. Further, Development Plans prepared in 2020/2021 will commence review in 2025/2026 and will require demographic data for the six-year period beyond to 2031. Therefore, the Roadmap provides transitional population projections in line with these deadlines, noting that:

“The critical population projection periods are to 2026 and 2031, with a particular emphasis on the initial six-year period to 2026, for city and county development plans that are to be formulated during the 2019-20/21 period.”

Table 2.1 Transitional Regional and County Population Projections to 2031 for the Eastern and Midland Regional Assembly

Regions and Counties	2016	2026	2031
Mid-East			
Kildare	222,500	249,000-254,000	259,000-266,500
Meath	195,000	216,000-221,000	225,500-231,500
Wicklow	142,500	155,000-157,500	160,500-164,000
Louth	129,000	139,000-144,500	144,000-151,500
Subtotal	689,000	759,000-777,000	789,000-813,500
Midlands			
Westmeath	89,000	96,500-98,500	100,000-102,500
Laois	84,500	92,500-94,000	95,500-97,500
Offaly	78,000	85,000-86,500	88,000-90,000
Longford	41,000	44,500-45,500	46,000-47,000
Subtotal	292,500	318,500-324,500	329,500-337,000
Dublin			
Dublin	1,347,500	1,489,000-1,517,500	1,549,500-1,590,000
Total	2,329,000	2,566,500-2,619,000	2,668,000-2,740,500

2.1.8 Project Ireland 2040 – National Development Plan 2018-2027

Building resilience in housing is a key element of Project Ireland 2040 with wide ranging measures set out in the NPF and the associated National Development Plan 2018-2027. With regards to housing, this includes measures to reduce vacancy rates and to bring habitable properties back into use particularly in cities and large towns where demand is highest. The NPF provided for the establishment of a land-management to be known the National Regeneration and Development Agency, to release strategically located land banks for redevelopment. This objective has been effected through the establishment of the Land Development Agency (LDA), which has now commenced operation.

In terms of social housing, the National Development Plan will, through a planned capital investment of over €4.2 billion, seek the delivery of some 40,000 new social housing homes by 2021. Direct Local Authority build, acquisitions, refurbishment of formerly empty homes and provision by housing bodies were identified as the chief delivery mechanisms. By 2021, it was aimed to have 12,000 social housing homes made available annually by Local Authorities and approved housing bodies for social housing. This level of provision was to be maintained over the remainder of the period of the National Development Plan, resulting in 112,000 households having their housing needs met through social housing by 2027. The NPF advocated the development of diverse neighbourhoods with a healthy balance of public and private housing.

2.1.9 Housing Supply Target Methodology for Development Planning (December 2020)

The NPF is based on demographic and econometric projections undertaken by the Economic and Social Research Institute (ESRI) in 2017. Following publication of the NPF in 2018, the NPF 'Roadmap' circular was issued to all planning authorities, setting out projected county population ranges for 2026 and 2031. As part of the development plan process, planning authorities must demonstrate the manner in which their core strategy and other elements of the plan are consistent with the established NPF Roadmap population projections for their local authority area.

In order to strengthen the relationship between national and regional population projections and their integration into the development planning process at local authority level, the Department commissioned the ESRI to further develop work previously undertaken for the NPF. The findings of the ESRI work were published as a research paper on Structural Housing Demand at County Level in December 2020. Following publication of this, the 'Housing Supply Target Methodology for Development Planning: Guidelines for Planning Authorities issued under Section 28 of the Planning and Development Act, 2000 (as amended)' was published.

This ESRI research applies the projection model to four different development scenarios:

- Baseline – projecting a 'business as usual' scenario which is based on current trends and medium-term projections for the Irish economy;
- NPF 50:50 City – consistent with the NPF strategy;
- High Migration – incorporating assumptions around high international migration flows into Ireland based on higher economic growth than the baseline; and
- Low Migration – incorporating assumptions around lower international migration flows into Ireland based on lower economic growth than the baseline.

The ESRI research model is intended to enable structural household demand levels for each local authority area to be set out under the four different scenarios for each year to 2040. The Section 28 Guidelines state that "The NPF 50:50 City scenario is broadly consistent with the National Planning Framework strategy and consequently, the 2018 NPF 'Roadmap' document". As such, the Section 28 Guidelines further indicate that this is the recommended housing

demand scenario to be used by planning authorities in their planning functions in order to plan for the provision of housing to meet projected levels of demand in their administrative area, in accordance with the NPF strategy.

Thus, planning authorities must now demonstrate the manner in which their core strategy and other elements of the plan are consistent with the NPF 50:50 City housing demand projection scenario identified by the ESRI. Deviation from this scenario, the Guidelines state, must be evidence-based and consistent with these guidelines.

The Guidelines set a methodology for the application of population and housing projections into Local Authority plan processes. The calculation of the housing supply target for County Longford is detailed in Section 4.2.2.

2.1.10 Sustainable Urban Housing: Design Standards for New Apartments Guidelines for Planning Authorities

In March 2018 the Department of Housing, Planning and Local Government updated the guidelines relating to the Design Standards for New Apartments. These guidelines have been adopted in appreciation of the need to move towards higher density and more sustainable forms of living within Ireland's urban areas, to which apartment living is deemed essential. They also recognise the importance of the challenge in meeting the housing needs of a growing population in Ireland's key cities, thus following the direction of travel outlined in the NPF.

The guidelines state that County Development Plans must appropriately consider the need to both sustainably increase housing supply and to ensure that a greater proportion of housing development takes place within its existing built-up areas. However, they warn that while it has become practice for some statutory development plans to specify an across-the-board mix (types/sizes) in relation to the composition of individual apartment schemes, there is a need for greater flexibility with regard to approaches to apartment mix more generally. This is particularly relevant where a comprehensive HNDA has not been undertaken. To this effect the following Specific Planning Policy forms part of the guidelines:

*“Apartment developments may include up to 50% one-bedroom or studio type units (with no more than 20-25% of the total proposed development as studios) and there shall be no minimum requirement for apartments with three or more bedrooms. Statutory development plans may specify a mix for apartment and other housing developments, **but only further to an evidence based Housing Need and Demand Assessment (HNDA)**, that has been agreed on an area, county, city or metropolitan area basis and incorporated into the relevant development plan(s).” (emphasis added)*

As such, the production of a Housing Needs Demand Assessment (HNDA) provides local authorities with an up to date and robust evidence base thus allowing them to appropriately determine and plan for the specific housing/apartment needs (including household compositions) within their administrative area covering the period of their statutory development plan.

2.1.11 Rebuilding Ireland – Action Plan for Housing and Homelessness, 2016

Rebuilding Ireland: Action Plan for Housing and Homelessness was published in July 2016. This Action Plan recognises issues around supply and affordability in Ireland's housing sector and provides a multi-stranded approach to achieve key housing objectives up to 2021. These include an increase in the supply of social housing, increasing housing build numbers to services different tenures, and tackling homelessness. Actions to meet these objectives are organised under five pillars:

- Pillar 1: Address Homelessness
- Pillar 2: Accelerate Social Housing

- Pillar 3: Build More Homes
- Pillar 4: Improve the Rental Sector
- Pillar 5: Utilise Existing Housing.

Actions under Pillar 1 of the Action Plan were aimed at enhancing supports for homeless people and families and alleviating the unacceptable level of families in emergency accommodation. Key actions included a Rapid-Build Housing Programme to expediate social housing supply, with a target of 1,500 rapid-delivery units by 2018, and enhanced Housing Assistance Payment (HAP) supports. In January 2016 rent limits were increased under the national Rent Supplement and HAP schemes, to provide greater security for tenants and families that are at risk of becoming homeless if their rent increases.

Pillar 2 built upon actions delivered under the Social Housing Strategy 2020. That Social Housing Strategy was published in 2014 and it set a commitment to deliver 35,000 new social housing units by 2020. The Action Plan further increased this target to the delivery of 47,000 new social housing units over the period 2016-2021 and pledged enhanced support for existing initiatives for the delivery of social housing through the following:

- **Local Authority Construction & Acquisition (also known as the Social Housing Investment Programme (SHIP))** - To provide funding to local authorities for the provision of social housing by means of construction and acquisition. It also covers expenditure under the Rapid Build Housing Programme, Part V acquisitions, Land Aggregation Scheme and the Special Resolution Fund for unfinished housing developments.
- **Capital Assistance Scheme (CAS)** - To provide essential funding to AHBs for the provision of accommodation for persons with specific categories of housing need such as Homeless and Older Persons, People with Disabilities, Returning Emigrants and Victims of Domestic Violence.
- **Vacant Housing Repair and Leasing Initiative** - This scheme enables local authorities, having identified appropriate vacant privately-owned properties in their functional areas, to provide upfront financial assistance to meet reasonable renovation works and to enter into long term lease arrangements with property owners. Renovation costs will be recouped from rent over an agreed period.
- **Part V Delivery** - The Action Plan sets out a commitment to ensure adequate resources are made available to both local authorities and Approved Housing Bodies, to allow them to purchase or lease newly built private dwellings to the fullest extent envisaged by Part V of the Planning and Development Act 2000. In addition, where appropriate, the leasing of additional privately developed dwellings beyond the extent envisaged by Part V is supported. Furthermore, the up-front purchase of the Part V social housing requirement will be facilitated, subject to the introduction of strict controls.

Significantly Pillar 3 of the Action Plan introduced measures for a stream-lined planning application process to allow applications for larger housing development schemes (comprising 100 units or more) to be made directly to An Bord Pleanála. These measures were given a legislative basis in the Planning and Development (Housing) and Residential Tenancies Act 2016 as set out in Section 2.1.3.

Pillar 4 of the Action Plan focuses on the rental sector and its growth in the overall tenure mix for Ireland's housing sector. A declining rate of home ownership, decreasing household size, a growing population influenced by high inward migration rates, and increasing rates of new household formation were identified as factors pointing to the growth of the rental sector and the increased role it is likely to play into the future. The Action Plan notes that a strong rental sector supports a mobile labour market "*better able to adapt to new job opportunities and changing household circumstances*" and is suited to accommodating a range of households - including mobile professionals, students and indeed lower-income households.

Pillar 5 recognises that achieving optimum occupancy of both social and private housing stock is an effective way of meeting housing needs. It commits to the development of an overall national vacant housing re-use strategy, as well as introducing the following actions to ensure that our existing housing stock is utilised in an efficient manner to meet housing demand:

- **Better management of social housing stock** -A vacated social house should not remain vacant for an extended period. The refurbishment and re-letting of units between tenancies with minimal delay will be achieved through the adoption of a national re-letting performance standard across all local authorities, a preventative maintenance approach to housing stock management and funding mechanisms to incentivise the swift turnaround of units.
- **Choice-based letting** -Choice-based letting is a method used to allocate social housing in a manner that offers more choice and involvement for applicant households in selecting a new home. Local Authorities that have implemented such an approach have seen refusal rates drop, and so a choice-based allocation system will be introduced and implemented across all Local Authorities in a manner tailored to their specific circumstances.
- **Review of Tenant (Incremental) purchase** - The ongoing review of the Tenant (Incremental) Purchase Scheme in consultation with Local Authorities, to make the scheme more attractive for social housing tenants and help people who would otherwise struggle to buy a home to meet their home ownership ambitions.
- **Housing Agency Vacant Housing Purchase Initiative** - The Housing Agency will receive up to 70 million in capital funding to support the acquisition of suitable portfolios of vacant properties for social housing directly from financial institutions and investors.

2.1.12 National Vacant Housing Reuse Strategy 2018-2021

The National Vacant Housing Reuse Strategy was published in 2018 to support Pillar 5 of the Rebuilding Ireland: Action Plan for Housing and Homelessness. Drawing together policies and actions aimed at reducing vacancy in Ireland's housing stock it sets out the Strategic Objective of:

“ensuring that existing housing stock is used to the maximum degree possible – focusing on measures to use vacant stock to renew urban and rural areas.”

To accomplish this overall Strategic Objective the Strategy sets out a range of actions that will be implemented at a national and local level, grouped under five key objectives.

- **Objective 1 Establish robust, accurate, consistent and up-to-date data sets on vacancy.** - This includes actions aimed at securing an accurate picture of vacancy rates across different Local Authorities and identifying recoverable dwellings that can be re-introduced into the housing stock.
- **Objective 2 Bring forward measures to ensure, to the greatest degree possible, that vacant and underused privately owned properties are brought back to use** - This includes actions aimed at identifying and addressing barriers to bring private properties that are subject to long-term vacancies back into the housing stock.
- **Objective 3 Bring forward measures to minimise vacancy arising in Social Housing Stock** - This includes actions for the effective management of our national social housing stock to ensure that vacant social houses do not remain vacant for extended periods of time.
- **Objective 4 Continued engagement with and provision of support to key stakeholders to ensure suitable vacant properties held by banks, financial institutions and investors are acquired for social housing use** -This includes actions to ensure that the Housing Agency has adequate capital funding to acquire vacant properties from NAMA and other stakeholders for use as social housing.
- **Objective 5 Foster and develop cross-sector relationships, collaborating in partnership to tackle vacant housing matters** - This includes actions to tackle vacancy in urban and rural areas such as the utilisation of the

Urban Regeneration and Rural Regeneration Development Fund's and the rollout of a dedicated Urban Regeneration Scheme, as well as support partnerships between Government Departments and Local Authorities.

2.1.13 Social Housing Strategy 2020: Support, Supply and Reform

The Social Housing Strategy 2020: Support, Supply and Reform was adopted in November 2014 and sets out the framework for the delivery of new social housing and for social housing assessment, delivery and financing. The vision set out Strategy that:

“every household in Ireland will have access to secure, good quality housing suited to their needs at affordable prices in a sustainable community”.

The national Social Housing Strategy is based on three pillars:

- **Pillar 1:** Provide for 35,000 new social housing units, over a six-year period, to meet the additional social housing supply requirements as determined by the Housing Agency²;
- **Pillar 2:** Support up to 75,000 households through an enhanced private rental sector; and
- **Pillar 3:** Reform social housing supports to create a more flexible and responsive system.

Phase 1 sets a target of 18,000 additional housing units and 32,000 HAP/RAS units by the end of 2017. Phase 2 sets a target of 17,000 additional housing units and 43,000 HAP/RAS units by end 2020. The Strategy states that significant exchequer funding will be allocated to ensure that the early phases of the Strategy will deliver on the targets. An enhanced role for the Approved Housing Bodies (AHBs) is also a key component to deliver the vision.

The Strategy also states that a new tenant purchase scheme for existing local authority houses will be put in place. The development of an individual housing 'passport' that would facilitate tenant mobility between local authorities will be examined.

Exchequer funding of €5.7bn has been committed to by the Government over the lifetime of the Strategy, and Longford County Council expects to spend in excess of €200 million from this fund in the delivery of its Social Housing Programme 2017 to 2019.

2.1.14 Construction 2020: A Strategy for a Renewed Construction Sector

Construction 2020 was published by the Government in 2014 and sets out a detailed, time-bound set of actions to support the return of Ireland's construction sector to sustainable levels. The vision is that Ireland will have a competitive, innovative, dynamic, safe and sustainable construction sector; one that makes its full and proper contribution to the economy and to job creation, and one that is based on best practice and capable of delivering the economic and social infrastructure we need to build to sustain a prosperous future.

Some of the key commitments include:

- Putting in a place a National Framework for Housing Supply and an Annual Statement of Projected Housing Supply and Demand;

² Increased to 47,000 units in *Rebuilding Ireland – Action Plan for Housing and Homelessness, 2016*

- Establishing a Housing Supply Coordination Task Force for Dublin;
- Assessing existing construction and property data sources for appropriateness including identifying any gaps and quality shortcomings;
- Examining the key barriers to housing mobility and make recommendations to Government;
- Developing a national policy towards professionalising the private rental sector;
- Establishing a working group and invite public comment on the feasibility and impact of setting minimum thermal efficiency performance standards in rental properties;
- Publishing a Social Housing Strategy and introducing legislation to regulate the Approved Housing Body sector;
- Review of Part V requirements;
- Publishing of the Homelessness Implementation Plan and implementation of the key recommendations of the Homelessness Oversight Group's First Report in Q2 2016;
- Continuing to implement the Government Action Programme on Unfinished Housing Developments and the Budget 2014 Special Resolution Fund.

2.1.15 The National Housing Strategy for People with a Disability 2011-2016

The National Housing Strategy for People with a Disability 2011-2016 sets out a framework of initiatives to provide for the housing needs of vulnerable and disadvantaged households. The Strategy was affirmed in the Action Plan for Housing and extended to 2020 to deliver on its aims and continue to guide and progress policy. The strategy has nine strategic aims:

- To promote and mainstream equality of access for people with a disability to the full range of housing options available suited to individual and household need.
- To develop national protocols and frameworks for effective interagency cooperation which will facilitate person-centred delivery of housing and relevant support services.
- To support people with a disability to live independently in their own homes and communities, where appropriate.
- To address the specific housing needs of people with an intellectual and/or physical disability, moving from congregated settings in line with good practice, including through the development of frameworks to facilitate housing in the community.
- To address the specific housing needs of people with a mental health disability, including through the development of frameworks to facilitate housing in the community, for people with low and medium support needs moving from mental health facilities, in line with good practice.
- To consider good practice in the design, coordination and delivery of housing and related supports.
- To facilitate people with a disability to access appropriate advice and information in respect of their housing needs.
- To improve the collection and use of data/information regarding the nature and extent of the housing needs of people with a disability.
- To provide a framework to support the delivery, monitoring and review of agreed actions.

2.2 Regional Policy

2.2.1 The Regional Spatial and Economic Strategy (RSES) 2019-2031

The RSES for the Eastern and Midland region came into force in June 2019, superseding the Regional Planning Guidelines for the Midland Region. The RSES is a high-level plan that seeks to support the implementation of the NPF by providing a strategic planning and economic framework for the region's sustainable growth and development. It

echoes the NPF in emphasising sustainable development patterns and seeks to focus growth within the footprint of existing urban areas and in key regional growth settlements. The RSES seeks to determine at a regional scale how best to achieve the shared goals set out in the National Strategic Outcomes (NSOs) of the NPF. To this end, the RSES sets out 16 Regional Strategic Outcomes (RSOs), which are aligned with international, EU and national policy and which in turn set the framework for city and county development plans.

Specifically, the RSES sets out Regional Policy Objectives to support Local Authorities in completing Housing Need Demand Assessments as required under the NPF and to provide for a diverse range of housing types and tenures. The strategy seeks to:

“Support local authorities, approved housing bodies and other sectoral agencies in the provision of a greater diversity of housing type and tenure, including social and affordable housing and exploring new models of low-cost rental and affordable homeownership”.

In relation to Longford, the Settlement Strategy for the region designates Longford town as a ‘Key Town’. The designation of these settlements under the Settlement Hierarchy for the region has informed the settlement hierarchy as described in detail in Core strategy whilst the relevant Regional Policy Objectives has informed the development of this Housing Strategy for Longford.

2.3 Local Policy

2.3.1 Longford County Development Plan 2021 – 2027

The Longford County Development Plan 2021 – 2027 sets out the planning framework during the plan period demonstrates consistency with national and regional policy hierarchy. It provides a clear evidence-base for the reservation of land to meet housing and population targets whilst setting a vision for County Longford that are underpinned by strategic aims to ensure delivery against objectives.

The County Development Plan aims to build on the strategies, policies and objectives of the previous County Development Plan (2015 – 2021) which was prepared during a time of economic uncertainty stemming from a global and national crisis. The review process and preparation of the Plan has had regard to key recent development trends and national, regional and local policy developments, with a particular regard being placed on the need to deliver social housing within County Longford as described herein.

2.3.2 Longford County Housing Strategy 2015-2021

The Longford County Housing Strategy 2015-2021 provided a comprehensive review of demographics and housing demand within County Longford to inform the Longford County Development Plan 2015-2021. It projected need for the planning provision of housing, as well as the demand for social and affordable housing within the County based on data from the 2011 census and regional population targets. This analysis identified a requirement for 2,120 households during the lifetime of the County Development Plan.

Given the difficult economic situation at the time the Housing Strategy did not envision Longford County Council building a substantial number of social or affordable housing units during the Plan’s lifetime. However, it was acknowledged that there would be a need for social housing irrespective of overall social housing output. In order to meet this, need the Housing Strategy advocated for the implementation of Part V requirements of 14% in all new housing schemes subject to the type and location of the housing units required by the planning authority at a given

time. This Strategy will be superseded by this Housing Strategy and the County Development Plan as described in Section 2.3.1.

2.3.3 County Longford Local Economic and Community Plan 2016-2022

The Longford Local Economic and Community Plan (LECP) 2016-2021 was completed to meet provisions under the Local Government Reform Act 2014. The LECP is an action-focused plan whose purpose is to identify and implement actions to achieve sustainable economic growth and improved social outcomes within County Longford. A series of LECP objectives and actions to achieve these ambitions are set out throughout the plan.

2.3.4 County Longford Age Friendly Strategy 2015-2020

The Longford Age Friendly Strategy 2015 -2020 was developed by the Age Friendly Alliance following an extensive consultation with older people throughout the county. In achieving the overall vision of the Strategy which is *'to make Longford a better place to grow old in'*, 42 actions have been developed based on and in alignment with the Age Friendly Ireland (AFI) Programme. Longford's ambition to become age friendly includes to:

- Become one of the greatest places to grow old in;
- Have easily accessible public buildings, shops and services;
- Incorporate older people's views into significant decisions being made about the County;
- Promote a positive attitude to ageing and address stereotypes about older people; and
- Create opportunities for older people to be engaged with their County socially, as employees and as volunteers.

Within the strategy, the following information in relation to housing has been raised by older people as an issue in relation to their accommodation needs:

- Older people feel that they need more support to continue to live independently.
- Policing of privately rented dwellings, particularly with regard to anti-social behaviour is an area of concern for older people.
- Older people would like more information about, and access to grants to improve security, e.g. locks and alarms.
- Improved street lighting is needed in existing housing developments and new builds, to make older people feel safer.

2.3.5 Longford County Council Traveller Accommodation Programme 2019-2024

The Longford County Council Traveller Accommodation Programme (TAP) 2019-2024 fulfils requirements under the Housing (Traveller Accommodation) Act 1998. The TAP aims to meet the accommodation needs of travellers in Longford within a five-year period up to 2024 whilst recognising the ethnic identity of the Traveller community and aiming to provide accommodation that is suitable to their specific needs. As such, the TAP provides for standard housing options, as well as traveller-specific accommodation such as halting sites, temporary/emergency sites and one-off rural houses within County Longford. It is Council policy that different housing options will be provided in accordance with an assessment of need and are subject to feasibility.

3 Current Context: Review and Analysis of Existing Supply and Needs

3.1 Population

Census 2016 results show that Ireland's population stood at 4,761,865 in April 2016, an increase of 173,613 (3.8%) since April 2011. There were 200 urban settlements across the country, which together accommodated 63% of Ireland's population. County Longford is located within the Eastern and Midland Regional Assembly area, the most populous region in the state with over 2.3 million people. Recent trends show that population growth is set to continue having regard to the Region's young demographic profile and a return to net inward migration as the Country returns to economic growth after a severe economic crash in 2008.

A brief overview of the population in County Longford shows that the county saw a population increase of 4.8% (1,873 additional persons) between 2011 and 2016, as the population increased to 40,873 from 39,000 people. As the Key Town within the County Longford settlement hierarchy, Longford Town experienced a rate of growth broadly consistent with the county average between 2011 and 2016, with the population increasing by 4.24%. The population change across the various settlements identified in the settlement hierarchy is set out in Table 3.1.

Table 3.1: Population Growth in Longford 2011-2016

County	Population 2011	Population 2016	Growth Rate (2011-2016)	Growth Rate % (2011-2016)
Longford County	39,000	40,873	1,873	4.80%
Settlements				
Longford Town	9,601	10,008	407	4.24%
Granard ³	1,021	1,096	75	6.8%
Edgeworthstown	1,744	2,072	328	18.81%
Ballymahon	1,563	1,877	314	20.09%
Lanesborough (County Longford) ⁴	727	757	30	4.0%
Abbeyshrule ⁵	-	224	-	-
Ardagh ⁵	-	210	-	-
Aughnaccliffe	148	177	29	19.59%
Ballinamuck ⁵	-	232	-	-
Ballinalee	308	347	39	12.66%
Cloondara ⁵	-	449	-	-
Carriglass ⁵	-	161	-	-
Drumlish	835	931	96	11.5%
Keenagh	498	581	83	16.67%
Legan	199	215	16	8.04%
Newtownforbes	759	778	19	2.50%

³ CSO Settlement boundary change between 2011-2016; 2011 boundaries used here. 2016 boundaries give a population of 816.

⁴ County Longford population for Lanesborough derived through analysis of CSO Census 'Small Area' data

⁵ CSO data unavailable for 2011. 2016 figures are based on analysis of CSO Census Small Areas and include some rural hinterlands.

The population distribution across urban and rural areas in County Longford remained consistent between 2011 and 2016. According to the CSO, 13,957 people (34.2%) were living in urban settlements⁶ in Longford in 2016 whilst 26,916 (65.85%) were living in smaller towns and villages, as well as in the rural remainder of the county. In 2011, census results showed a distribution between the urban and rural population as 33.1% and 66.9% respectively. Thus, the marginal increase (+ 1%) in urban living in County Longford was broadly aligned with the prevailing state-wide direction of travel of urbanisation.

The age profile of the EMRA region in 2016 was relatively young with nearly half a million children or approximately 1 in 5 people (22%) in the Region aged under 14 years of age. In County Longford this figure is broadly similar, standing at 23.3% as set out in Table 3.2. In total, the number of children of pre-school age (0-4 years) in Longford is 3,051 (7.5%). 5,205 (12.7%) are of primary school going age (5-12 years) and a further 3,432 (8.4%) are of secondary school going age (13-18 years). An extended age profile of the county is presented in Figure 3.1.

Census 2016 results show that Ireland’s population has been getting steadily older since the 1980s. In 2016, 37.2% of the Irish population were aged 45 and over, compared with 34.4% in 2011 and 27.6% in 1986. 13.4% of the national population were over 65 years in 2016. As with the state, both the EMRA region and County Longford are ageing. As the RSES notes, by 2031 there will be a significant increase in the regional population aged over 65 and as such, there is a need to plan for adequate healthcare, accommodation and services to enable independent living for as long as possible, encourage active lifestyles and address isolation for older residents.

Table 3.2: Age Dependency Ratios (2016)

	0-14 years	15-64 years	Over 65 years	Young Age Ratio (%)	Old Age Ratio (%)	Total Dependency Ratio (%)
County Longford	9,508	25,541	5,824	23.3%	14%	37.5%
MD						
MD Ballymahon	3,244	8,915	1,994	22.9%	14.1%	37.0%
MD Granard	2,430	6,569	1,675	22.8%	15.7%	38.5%
MD Longford	3,834	10,057	2,155	23.9%	13.4%	37.3%

⁶ The CSO defines a settlement of more than 1,500 people as ‘urban’.

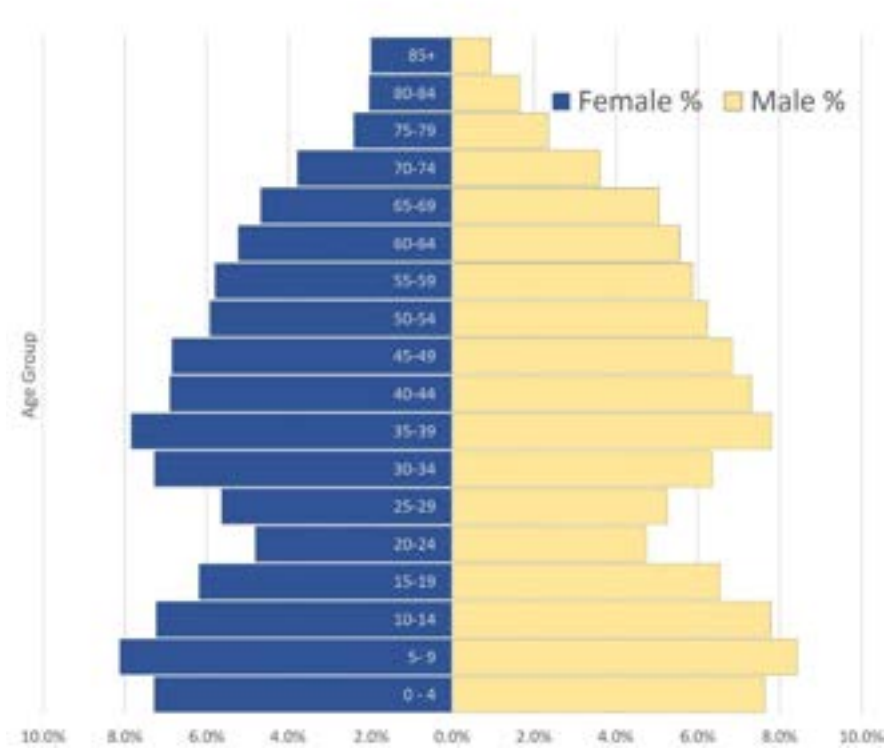

Figure 3.1: Age Profile for County Longford

3.2 Existing Housing Stock and Supply

3.2.1 Stock and Composition

Census 2016 results record a total housing stock of 18,591 units in County Longford, which represents a marginal decrease of 232 units since 2011. The number of vacant units in 2016 stood at 2,824 (excluding holiday homes and those dwellings deemed to be temporarily absent).

The 2011 Census data does not distinguish between categories of vacancy and indicates that there were 4,363 unoccupied dwellings in 2011. In contrast, the 2016 data illustrates the number of temporarily absent dwellings, unoccupied holiday homes and other vacant dwellings. For comparison purposes, the total number of vacant dwellings across these three categories in 2016 is 3,445. As such, there is an overall decline of 918 in the number of vacant dwellings between 2011-2016. This indicates the existing vacant stock absorbing much of the growing need for housing in the county. A summary of the information on the existing housing stock is provided in Table 3.3.

The proportional breakdown of housing tenures, privately owned, privately rented and publicly rented accommodation in the three Municipal Districts of Ballymahon, Granard and Longford is set out in Table 3.6. As can be seen home ownership in Longford MD (at 50%) is below the county average while privately rented (24%) and social housing i.e. rented from the Local Authority and rented from voluntary bodies (22%) are well above the county average. Home ownership (77%) is highest and well in excess of the county average (63.7%) in Granard MD where social housing provision is also at its lowest (8%).

Table 3.6: Household Tenure – Occupancy Type County Longford and Municipal Districts 2016

County Longford	Owner occupied with mortgage	Owner occupied no mortgage	Rented from private landlord	Rented from Local Authority	Rented from voluntary body	Occupied free of rent	Not stated	Total
No. households	3,864	5,753	2,621	2,031	167	257	399	15,092
% Households	26%	38%	17%	13%	1%	2%	3%	100%
MD Ballymahon								
No. households	1,443	1,984	872	657	21	93	139	5,209
% Households	28%	38%	17%	13%	< 1%	2%	3%	100%
MD Granard								
No. households	1,146	1,880	398	319	6	83	106	3,938
% Households	29%	48%	10%	8%	< 1%	2%	3%	100%
MD Longford								
No. households	1,275	1,889	1,351	1,055	140	81	154	5,945
% Households	21%	32%	23%	18%	2%	1%	3%	100%

Table 3.3: Existing Housing Stock (2016)

County	Housing stock	Holiday homes	Other vacant	Temporarily Absent	Total vacancy	% Vacancy ⁷
Longford	18,591	278	2,824	343	2,824	15.19%
MD						
MD Granard	5,027	128	870	75	870	17.31%
MD Ballymahon	6,343	102	911	104	911	14.36%
MD Longford	7,221	48	1,043	164	1,043	14.44%

Household size cohort represents the number of people per households. Over half (54.7%) of households in Longford in 2016 had just one or two persons living in that household as illustrated Table 3.4; however this generally compares to the national figures on household size cohorts.

Table 3.4: Existing Household Size Cohorts (2016)

County Longford	Households	Persons	Households %	Persons %
1 person	4,035	4,035	26.7%	9.9%
2 persons	4,233	8,466	28.0%	20.8%
3 persons	2,466	7,398	16.3%	18.1%
4 persons	2,274	9,096	15.0%	22.3%

⁷ The percentage vacancy rate provided is based on 'Other Vacancy' category as a percentage of total housing stock and excludes vacant holiday homes and those temporarily absent.

5+ persons	2,114	11,780	14.0%	28.9%
Total	15,122	40,775	100.0%	100.0%

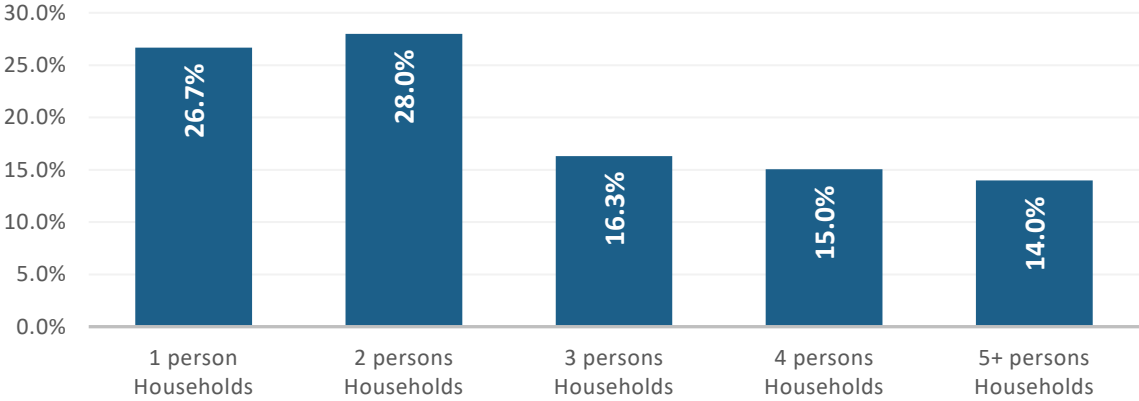

Figure 3.2: Household Composition in County Longford

There were 15,122⁸ private households and an average household size of 2.70, which is marginally lower than the national rate of 2.75. 93.9% of households comprised of a house or bungalow while 4.2% were apartments in 2016. At a national level, 12% of all occupied households in Ireland were apartments. The NPF notes that while the overall proportion of households living in apartments is growing, we remain considerably behind European averages in terms of the numbers and proportion of households living in apartments, especially in our cities and larger towns and this is particularly evident within County Longford. Further, the NPF states that apartments will need to become a more prevalent form of housing, particularly in Ireland’s cities in order to more effectively address the challenge of meeting the housing needs of a growing population in our key urban areas.

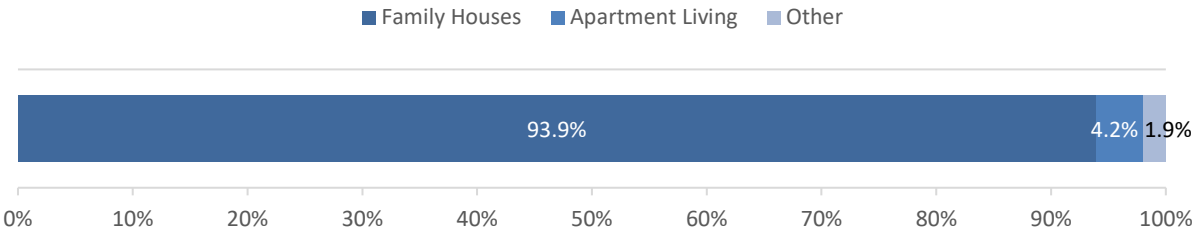

Figure 3.3: Existing Household Typology % (2016)

3.2.2 Housing Tenure

Home ownership remains the dominant tenure in Longford with 63.7% of households within this category in 2016. 40% of these households pay a mortgage. 17.4% of households were in the private rental market, while 14.6% (2,198) of rented properties comprise social housing, an increase of almost 3% since 2011. Table 3.5 provides a concise illustration of housing tenures across Longford County.

⁸ CSO 2016 – Including Caravan/Mobile Home as a household

Table 3.5: Housing Tenure County Longford (2016)

County Longford	Households	Persons	Households %	Persons %
Social Housing ⁹	2,198	5,758	14.6%	14.1%
Rented (Privately)	2,621	7,259	17.4%	17.8%
Owner Occupied (All)	9,617	26,155	63.7%	64.2%

The proportional breakdown of housing tenures, privately owned, privately rented and publicly rented accommodation in the three Municipal Districts of Ballymahon, Granard and Longford is set out in Table 3.6. As can be seen home ownership in Longford MD (at 50%) is below the county average while privately rented (24%) and social housing i.e. rented from the Local Authority and rented from voluntary bodies (22%) are well above the county average. Home ownership (77%) is highest and well in excess of the county average (63.7%) in Granard MD where social housing provision is also at its lowest (8%).

⁹ The specifically relates to all households that rent from the local authority or voluntary body

Table 3.6: Household Tenure – Occupancy Type County Longford and Municipal Districts 2016

County Longford	Owner occupied with mortgage	Owner occupied no mortgage	Rented from private landlord	Rented from Local Authority	Rented from voluntary body	Occupied free of rent	Not stated	Total
No. households	3,864	5,753	2,621	2,031	167	257	399	15,092
% Households	26%	38%	17%	13%	1%	2%	3%	100%
MD Ballymahon								
No. households	1,443	1,984	872	657	21	93	139	5,209
% Households	28%	38%	17%	13%	< 1%	2%	3%	100%
MD Granard								
No. households	1,146	1,880	398	319	6	83	106	3,938
% Households	29%	48%	10%	8%	< 1%	2%	3%	100%
MD Longford								
No. households	1,275	1,889	1,351	1,055	140	81	154	5,945
% Households	21%	32%	23%	18%	2%	1%	3%	100%

3.2.3 Unfinished Housing Development

The 2017 National Housing Development Survey which tracks progress on unfinished housing developments since 2010 indicates that there were 11 unfinished housing developments in County Longford at the time of the 2017 survey. However, following the inspection of these 11 unfinished housing development sites in 2017, a further reduction in unfinished housing developments (36.4%) was achieved, leaving a remaining 7 sites to be brought forward to 2018. A total of 548 units are spread across these 7 sites. Of the 548 units, 23.9% are occupied and 9.1% are nearing completion as set out in Table 3.7.

Table 3.7: Unfinished Housing Developments (Source: DHPLG 2017)

Status	Number of Units
Occupied	131
Vacant	76
Near Complete	50
Partially constructed (to wall plate, DPC or foundations)	31
Not started	0
Planning Expired	260
All units	548

3.2.4 Housing Permissions

Table 3.8 illustrates the number of granted planning applications (by unit) in County Longford between 2006 and 2019. As discussed in further detail in Section 4.4.3, it should be noted that the quantum of applications and thus indirectly, the number of granted units during specific years in that period (i.e. the overall market dynamics) has varied greatly and likely been influenced by the macroeconomic trends (including the recession and rising costs to build a home). Longford County Council confirm that this was notable in relation to the overall number applications submitted for houses and apartments in settlements during and following the recession in the mid-late 2000s.

59.2% of these relate to permissions granted for houses and apartments via development scheme applications, while 40.8% relate to one-off houses. The yearly average of one-off houses granted planning permission over the 2006-2020 period is 63%. A more a specific analysis focusing on the last three years (2018-2020) indicates that 41% of the total number of residential units granted have been for one-off houses.

Table 3.8: Granted Planning Applications for Residential Units in County Longford between 2006 and 2019

Granted Planning Applications	2006	2007	2008	2009	2010	2011	2012	2013	2014	2015	2016	2017	2018	2019	2020	Grand Total
No. Houses and Apartments	515	658	245	309	1	2	2	17	2	6	13	20	44	110	144	2,088
No. One-Off Houses	263	309	207	86	57	35	41	24	19	35	54	76	53	80	74	1,413
Houses and Apartments % of Total	66.2%	68.0%	54.2%	78.2%	1.7%	5.4%	4.7%	41.5%	9.5%	14.6%	19.4%	20.8%	45.4%	57.9%	66.1%	59.6%
One-Off House % of Total	33.8%	32.0%	45.8%	21.8%	98.3%	94.6%	95.3%	58.5%	90.5%	85.4%	80.6%	79.2%	54.6%	42.1%	33.9%	40.4%
Total	778	967	452	395	58	37	43	41	21	41	67	96	97	190	218	3,501

3.3.5 Social Housing Stock

In accordance with Section 9 of the Housing Act 1988, housing authorities are required to undertake an assessment of housing need in their administrative area. The social housing stock in County Longford as of March 2020 is as set out in Table 3.9.

Table 3.9: Current Social Housing Stock (March 2020)

	County Longford
Housing Stock (directly owned by Longford CC)	2,121
Social Leasing	124
Rental Accommodation Scheme (RAS) or other Leasing Programme	210
Housing Assistance Payment (HAP) Units	334
Approved Housing Body (AHB) Units	514
Total	2,789

3.3.5.1 Approved Housing Bodies – AHBs

AHBs also provide social housing and are formed for the purpose of relieving housing need and the provision and management of housing. They are established by a voluntary management board to benefit the community in which they are based, and are approved and funded by the Department of Housing, Planning and Local Government.

Housing cooperatives such as these AHBs can provide both social rented housing and housing to purchase. AHBs are self-help and jointly owned member/user housing associations or societies. Projects undertaken may be in response to the needs of the elderly, people with disabilities, homeless persons or families and single people on low incomes. Some AHBs may be formed to specialise in meeting a particular housing need, others develop with broader aims. The specific housing services offered will depend on the aims or concerns of the members, the needs of tenants as well as the financial and other resources available for both capital costs and ongoing management running costs.

A list of AHBs that are active in County Longford is set out below:

Table 3.10: Operational Approved Housing Bodies in County Longford

List of Operational Approved Housing Bodies in the County
Cluid
Respond
Tuath
iCare Housing CLG
St. Christopher's Housing Association
Disabled Persons of Longford
County Longford Association for Mentally Handicapped
Newgrove Housing Association
Society of Saint Vincent de Paul

3.3.4.2 Social Housing Vacancy

Table 3.11 sets out the current social housing stock by unit type across county Longford and within each MD. This demonstrates that the proportion of the stock owned

Table 3.11: Current Social Housing Stock owned by Longford County Council by Unit Type (March 2020)

	1-bedroom	2-bedroom	3-bedroom	4-bedroom	5-bedroom	Total
County Longford	34	556	1,378	142	9	2,119
MD Ballymahon	3	160	423	34	3	623
MD Granard	14	122	284	22	3	445
MD Longford	17	263	642	84	3	1,009
MD not classified		11	29	2		42

Table 3.12 sets out the current status of that social housing stock and as of March 2020, there were 84 vacant social housing units in Longford. The majority of those vacant units are in varying stages of being re-let, under maintenance, under offer and/or accepted for tenants.

Table 3.12: Current Status of Social Housing Stock owned by Longford County Council (March 2020)

	Allocated	Occupied	Redundant	Vacant	Total
County Longford	60	1,960	15	84	2,119
MD Ballymahon	8	608		12	628
MD Granard	28	411	6	31	476
MD Longford	24	941	9	41	1015

4 Housing Needs in Longford

4.1 Overview

This chapter sets out the demographic, economic and social inputs of relevance and estimates the projected population, households and associated housing needs in County Longford during the plan period. Specifically, this chapter demonstrates how the various demographic and market factors interact with the assessment of future housing needs and demands within County Longford. This aligns with the methodology that has been described in Section 1.4 and the chapter has therefore been structured in the following way with further details also available in the relevant appendices:

- Section 4.2 (Inputs) – Describes the relevant information that has supported the analysis that has been undertaken herein.
- Section 4.3 (Assessment of Needs) – Describes the assessment of projected needs for ownership and private rental (in Section 4.3.2 and 4.3.3 respectively). A summary of the calculation of the households who can be classified as having an affordability problem during the plan period so as to adequately inform the necessary provision units within County Longford has been set out in Section 4.3.3.
- Section 4.4 (HNDA Components) - Describes the specific analysis that has been undertaken in relation to the dynamic components of the housing market in County Longford as set out under National Policy Objective 37 of the NPF.

The majority of the information presented herein relates to the plan period. The Longford County Development Plan 2021-2027 is expected to come into force in late November 2021 for a plan period of six years; for modelling purposes and to calculate the Housing Supply Target following departmental guidance, this has been rounded to the nearest whole quarters, covering Q1 2022 – Q4 2027 inclusive. Where appropriate the information for additional years has been identified and have been presented to understand progression from the baseline (i.e. 2016). Further details on the analysis undertaken is presented in Appendices 1 - 4.

4.2 Inputs

4.2.1 Population Projections

The future population of County Longford has been set out for target years 2026 and 2031 in the National Planning Framework Implementation Roadmap (July 2018). An interpolation of the required level of change per annum was developed to produce annualised figures between the Q1 2022 and Q4 2027 lifetime of the plan. This was first done for the period 2016 to 2026, and then for the period 2027 to 2031 (as there are different growth rates per period).

The projected population over the plan period in County Longford is outlined in Table 4.1 with further detail provided in Appendix 1. The population of County Longford will increase by 2,614 people during the plan period to a total of 45,800 in 2027.

Table 4.1: Overview of Projected Population throughout the plan period (as per 'High NPF' aligned scenario)

Projection Scenario	2021	2022	2023	2024	2025	2026	2027	2028
NPF High Aligned	43,187	43,649	44,112	44,575	45,037	45,500	45,800	46,100
Growth (absolute)	463	463	463	463	463	463	300	300
Growth (relative)	1.1%	1.1%	1.1%	1.0%	1.0%	1.0%	0.7%	0.7%

4.2.2 Estimated Households

As part of the development plan process, planning authorities must demonstrate the manner in which their plan is consistent with the NPF and established NPF Implementation Roadmap population projections for their local authority area. In December 2020, the DHLGH issued guidelines to assist planning authorities to incorporate these projections into the preparation of development plans and housing strategies in a consistent and coherent approach.

These Guidelines build on research undertaken by the Economic and Social Research Institute (ESRI) into regional demographics and structural housing demand at county level. The ESRI's research applies a projection model to four different development scenarios, including a Baseline ('business as usual') scenario and the 'NPF 50:50 City Scenario.' The Section 28 Guidelines state that "the NPF 50:50 City scenario is broadly consistent with the National Planning Framework strategy and consequently, the 2018 NPF 'Roadmap' document". As such, the Section 28 Guidelines indicate that this is the recommended housing demand scenario to be used by local authorities to plan for the provision of housing to meet projected levels of demand.

Thus, planning authorities must now demonstrate the manner in which their core strategy and other elements of the plan are consistent with the established NPF Roadmap population projections for their local authority area and accordingly, with the related NPF 50:50 City housing demand projection scenario identified by the ESRI.

The Guidelines set a methodology for the application of population and housing projections into Local Authority plan processes and the setting of Housing Supply Targets for the relevant plan period.

As set out below, Longford County Council have finalised the following calculation of housing demand for the plan period. Longford County Council will not pursue optional adjustments ('E' or 'F'), and therefore will pursue a **total housing supply target of 2,568** for the Longford County Development Plan over a plan period¹⁰ anticipated to cover approximately Q1 2022 – Q4 2027 inclusive.

¹⁰ For calculation purposes, the plan period has been rounded to whole quarters.

Table 4.2: Calculation of Housing Supply Targets for County Longford over the plan period¹¹

Longford County Council		Annual Average Households	Total Households
A	ESRI NPF scenario projected new household demand 2017 to end Q4 2027	277	3,042
B	Actual new housing supply 2017 to end Q3 2021 (Source: CSO to Q4 2020, pro-rata of 2020 data for remainder)	103	517
C	Homeless households and unmet need ¹²	-	43
D	Plan Housing Demand = Total (A-B+C) For plan period Q1 2022 – Q4 2027 (6 years)	428	2,568
E	<i>Potential Adjustment 1 to end 2026 portion of plan period – not pursued</i>		
F	<i>Potential adjustment 2 to end 2026 portion of plan period to facilitate convergence to NPF strategy, applicable where B exceeds or is close to D (where justified) – not pursued</i>		

Table 4.3 identifies the additional households that are anticipated during the plan period. The Core Strategy includes all population and household figures between 2016 and the end of the plan period. The additional years and units built will be adjusted when local area plans are being prepared.

Table 4.3: Overview of Projected Households in County Longford throughout the Plan Period¹³

County Longford	2022	2023	2024	2025	2026	2027	Total
Total households over the Plan period	16,067 ¹⁴	16,495	16,923	17,351	17,779	18,207	-
Total additional households over the Plan period	428	428	428	428	428	428	2,568

¹¹ Following 'Housing Supply Target Methodology for Development Planning' (DHLGH, December 2020)

¹² Homeless households as of January 2021, plus unmet need as of Census 2016; source: DHLGH, February 2021.

¹³ Average Household Size is not being applied to determine anticipated households from future population growth. Instead the additional households over the period are informed directly by the HST calculations, see Table 4.2.

¹⁴ Informed by the addition of recorded housing completion between 2017-Q4 2020, including an assumed continuation of 2020's rate of completion through full year 2021 (122 dwellings).

The number and distribution of total households per decile throughout the plan period has been estimated from the distribution of housing units in the State from the Household Budget Survey¹⁵. Table 4.4 identifies the distribution of total households across each of the ten deciles during the plan period.

Table 4.4 Distribution of total households per decile (No. Households) in County Longford

Year	2022	2023	2024	2025	2026	2027
1st Decile	1,579	1,621	1,663	1,705	1,747	1,789
2nd Decile	1,699	1,744	1,789	1,834	1,880	1,925
3rd Decile	1,682	1,727	1,772	1,817	1,861	1,906
4th Decile	1,677	1,722	1,767	1,811	1,856	1,901
5th Decile	1,647	1,691	1,735	1,778	1,822	1,866
6th Decile	1,598	1,640	1,683	1,725	1,768	1,810
7th Decile	1,546	1,587	1,628	1,669	1,711	1,752
8th Decile	1,551	1,592	1,633	1,674	1,716	1,757
9th Decile	1,544	1,585	1,626	1,667	1,708	1,749
10th Decile	1,546	1,587	1,628	1,669	1,711	1,752
Total	16,067	16,495	16,923	17,351	17,779	18,207

Similar to the preceding step, the number of additional anticipated households per decile has been estimated throughout the plan period. Table 4.5 identifies the distribution of additional anticipated households across each of the ten deciles during the plan period.

Table 4.5 Distribution of additional households per decile (No. Households) in County Longford

Year	2022	2023	2024	2025	2026	2027
1st Decile	42	42	42	42	42	42
2nd Decile	45	45	45	45	45	45
3rd Decile	45	45	45	45	45	45
4th Decile	45	45	45	45	45	45
5th Decile	44	44	44	44	44	44
6th Decile	43	43	43	43	43	43
7th Decile	41	41	41	41	41	41
8th Decile	41	41	41	41	41	41
9th Decile	41	41	41	41	41	41
10th Decile	41	41	41	41	41	41
Total	428	428	428	428	428	428

¹⁵ CSO (2017) Household Budget Survey 2015-2016 - Table HS029: Households in sample by deciles and year.

4.2.3 Income Analysis

Disposable income is the amount of income, after tax is deducted, that is available for spending and saving. It functions as an important measure of housing affordability¹⁶ in an area i.e. the ability of a household to purchase their own home. The weekly and annual disposable incomes at national level from the CSO's Household Budget Survey (from 2015-2016) have been adjusted to county level based on application of "inflater/deflator" rate (by comparing the relative differences between the State and County Longford in terms of non-decile split household disposable income).

Information at sub-county level is not available and the county information has been considered accurate for the purpose of this analysis. The Average Annual Disposable Income for County Longford from the CSO's Household Budget Survey was €17,542 (less than 1% below the Midlands Region average), therefore a county deflator of 0.850 has been applied (on the basis of a national average annual disposable income of €20,638)¹⁷.

As noted above, disaggregation into ten income segments or 'deciles' has been undertaken to represent the proportion of households in Longford within each decile during the survey. Table 4-6 indicates that in 2017 after taxes, about one third of the households in County Longford (i.e. the first three deciles) have an average annual disposable income of up to €20,921, or the equivalent of €402 per week.

¹⁶ Section 93 of the Planning and Development Act 2000, defines 'affordability' as "a person who is in need of accommodation and whose income would not be adequate to meet the payments of a mortgage for the purchase of a house to meet his or her accommodation needs because the payments calculated over the course of a year would exceed 35% of that person's annual income net of income tax and pay related social insurance..."

¹⁷ The measure of price inflation/deflation in an area, relative to the national measure at that time.

Table 4.6: Calculation of Distribution of Weekly and Annual Household Disposable Incomes in County Longford

Income Range	Average Weekly Disposable Income (State) (€) (2009-2010)	Average Weekly Disposable Income (State) (€) (2015-2016)	Percentage Change from 2009-2010 to 2015-2016	Assumed Annual Percentage Income Increase from 2010 to 2016	Adjusted Average Weekly Disposable Income (State) (€) (2017)	Percentage of Households in Each Category (State)	Average Annual Disposable Income (State) (€) (2017)	Longford County Deflator	Longford Average Annual Disposable Income (€) (2017)
1st Decile	189	197	4.5%	0.9%	199	9.83%	10,357	0.850	8,803
2nd Decile	301	324	7.8%	1.6%	329	10.57%	17,131	0.850	14,561
3rd Decile	431	466	8.0%	1.6%	473	10.47%	24,613	0.850	20,921
4th Decile	549	594	8.1%	1.6%	603	10.44%	31,364	0.850	26,659
5th Decile	669	726	8.4%	1.7%	738	10.25%	38,380	0.850	32,622
6th Decile	803	866	7.9%	1.6%	880	9.94%	45,736	0.850	38,875
7th Decile	972	1,026	5.6%	1.1%	1,038	9.62%	53,974	0.850	45,877
8th Decile	1,184	1,216	2.7%	0.5%	1,222	9.65%	63,547	0.850	54,014
9th Decile	1,473	1,473	0.0%	0.0%	1,473	9.61%	76,615	0.850	65,122
10th Decile	2,289	2,229	-2.6%	-0.5%	2,217	9.62%	115,300	0.850	98,003

It should be noted that the COVID-19 pandemic is also likely to impact on the housing market in terms of house prices and market rental rates. Analysis of the historic information from the Property Price Register and the Rental Tenancies Board has been undertaken to better reflect local circumstances. This has been described in Section 4.2.5 and Section 4.2.6 respectively, however the macroeconomic impact of the COVID-19 pandemic has not yet materialised in the local housing market.

To inform the forward projection of affordability in County Longford during the plan period, the baseline figures have been inflated annually using forecasted growth rates in relation to Gross Domestic Product (GDP). The forecasted GDP rates have considered the estimated distribution of household disposable incomes for 2016 from the CSO’s Household Budget Survey and been determined based on historic and the latest forecasted GDP growth rates during the plan period (from the Department of Finance, Central Bank, ESRI and European Union – refer to Section 4.2.4).

Based on the available consensus in economic outlook at the time of production of this study and as described in detail in Appendix 4, GDP growth of 8.2% and 5.5% was considered during 2018 and 2019 respectively, whilst a -9.4% decline is anticipated expected for 2020. A 6.4% recovery in 2021 and a 2.8% GDP growth has been conservatively applied thereafter. The key outputs of this are shown in Table 4.7 which highlights a notable difference in average annual disposable incomes across each of the 10 deciles for each year during the plan period.

Table 4.7: Average Annual Household Disposable Incomes per decile in County Longford

Year	2022	2023	2024	2025	2026	2027
% Growth	2.8%	2.7%	2.7%	2.5%	2.5%	2.5%
1st Decile	9,956	10,225	10,501	10,764	11,033	11,309
2nd Decile	16,468	16,913	17,370	17,804	18,249	18,705
3rd Decile	23,661	24,299	24,956	25,579	26,219	26,874
4th Decile	30,150	30,964	31,800	32,595	33,410	34,245
5th Decile	36,895	37,891	38,914	39,887	40,884	41,906
6th Decile	43,966	45,153	46,372	47,532	48,720	49,938
7th Decile	51,885	53,286	54,724	56,093	57,495	58,932
8th Decile	61,088	62,737	64,431	66,042	67,693	69,386
9th Decile	73,650	75,639	77,681	79,623	81,613	83,654
10th Decile	94,358	96,905	99,522	102,010	104,560	107,174

Given the context provided and information as outlined above (i.e. Calculation of Average Annual Household Disposable Income Distribution), the incomes have been scaled to provide the monthly (rather than annual) estimates of disposable income per household in each decile as described in Table 4.8.

Table 4.8: Average Monthly Household Disposable Incomes per decile in County Longford

Year	2022	2023	2024	2025	2026	2027
% Growth	2.8%	2.7%	2.7%	2.5%	2.5%	2.5%
1st Decile	830	852	875	897	919	942
2nd Decile	1,372	1,409	1,447	1,484	1,521	1,559
3rd Decile	1,972	2,025	2,080	2,132	2,185	2,240
4th Decile	2,512	2,580	2,650	2,716	2,784	2,854
5th Decile	3,075	3,158	3,243	3,324	3,407	3,492
6th Decile	3,664	3,763	3,864	3,961	4,060	4,162
7th Decile	4,324	4,440	4,560	4,674	4,791	4,911
8th Decile	5,091	5,228	5,369	5,504	5,641	5,782
9th Decile	6,138	6,303	6,473	6,635	6,801	6,971
10th Decile	7,863	8,075	8,293	8,501	8,713	8,931

4.2.4 Economic Outlook

The local and regional economy is a critical part of the housing market needs and incomes which can impact on demand and supply. In order to understand the longer-term economic outlook for County Longford, particularly in relation to how household incomes may change over time forecasted growth rates in relation to Gross Domestic Product (GDP) have been considered as described in detail in Appendix 4.

Further, it should be noted that this Strategy has been prepared during the COVID-19 pandemic which is ongoing at the time of writing and publication. As such, prioritisation in relation to future forecasted GDP growth has been given to those data sources that are reflective of emerging consensus on economic outlook. The following GDP growth rates have therefore been applied herein for those reasons as set out in Appendix 4:

- **2020:** -9.4% GDP growth (i.e. contraction of the economy) which is the average of the economic forecasts that have been determined from the average of those forecasts from Davys, the ESRI, Central Bank, Department of Finance and European Union that reflect the ongoing COVID-19 pandemic.
- **2021:** 6.4% GDP growth which aligns with the latest Davys, Department of Finance and European Union forecasts (i.e. the only datasets for next year that reflects the ongoing COVID-19 pandemic).
- **2022:** 2.8% GDP growth which aligns with the Department of Finance forecast¹⁸
- **2023 - 2024:** 2.7% GDP growth which aligns with the Department of Finance forecast¹⁸
- **2025 onwards:** 2.5% GDP growth which aligns with the Department of Finance forecast¹⁸.

¹⁸ This forecast was issued by the Department of Finance in advance of the COVID-19 pandemic, however it is considered reflective of their anticipated return to pre-pandemic levels of output as set out in the April 2020 document from the Department of Finance.

4.2.5 Central Bank Rules and Mortgage Capacity

The Central Bank have put measures in place that set limits on size of mortgages that consumers can borrow to purchase a home. These measures have been set through the use of loan-to-value (LTV)¹⁹ and loan-to-income (LTI)²⁰ limits. An assumed preference for home ownership over rental has been applied as part of this model. It has therefore been analysed whether households could qualify for a mortgage that would enable them to purchase a house in the lowest price band under these rules. The key variables used to determine whether households in a decile can qualify for a mortgage are therefore:

- LTV ratio of 0.90
- a maximum LTI ratio of 3.5; and
- the upper value of the first house price band for that year (as set out in Section 4.2.5).

As such if a household does not have sufficient income to meet the Central Bank rules (i.e. 3.5 times their gross income is less than 90% of the value of purchase a house in the lowest projected price band for that year), they do not qualify for a mortgage that would enable them to purchase a home. Table 4-9 describes the mortgage capacity of households on that basis and further detail is provided in Appendix 2.

Table 4.9: Mortgage Capacity of Households per decile (euro) in County Longford based on Central Bank Rules

Year	2022	2023	2024	2025	2026	2027
1st Decile	32,797	33,682	34,591	35,456	36,343	37,251
2nd Decile	54,866	56,347	57,869	59,315	60,798	62,318
3rd Decile	79,591	81,740	83,946	86,045	88,196	90,401
4th Decile	104,151	106,963	109,851	112,597	115,412	118,297
5th Decile	132,383	135,957	139,628	143,118	146,696	150,364
6th Decile	163,673	168,092	172,631	176,946	181,370	185,904
7th Decile	199,945	205,344	210,888	216,160	221,564	227,103
8th Decile	243,819	250,403	257,163	263,593	270,182	276,937
9th Decile	310,973	319,370	327,993	336,192	344,597	353,212
10th Decile	509,561	523,319	537,449	550,885	564,657	578,774

Table 4.9 outlines that during the plan period, the first decile (throughout the entire plan period) does not have sufficient gross household income to meet the requirements of the Central Bank rules. Specifically, 3.5 times their gross income is less than 90% of the value of purchase a house in the lowest projected price band and hence they do not qualify for a mortgage and progress to private rental. Those households that can qualify for a mortgage progress to the need's assessment for ownership.

¹⁹ The LTV limit requires one to have a minimum deposit before you can get a mortgage. First-time buyers are allowed up to 90% LTV, meaning they're required to provide a minimum deposit of 10% upfront for any property.

²⁰ The LTI limit restricts the amount of money one can borrow to a maximum of 3.5 times your gross income.

4.2.6 Analysis of Historic Ownership Market

This section sets out background information on house price trends in the current market within County Longford. To ensure the most up to date market context, 2019 has been selected as the baseline year and property transactions as recorded on the Residential Property Price Register during that year have been considered representative to understand house prices and the distribution of housing units per price band. Table 4.10 sets out the 385 transactions that occurred in County Longford across the eight price bands during 2019.

Table 4.10: House Sales²¹ in County Longford in 2019

Price Band	Number of Transaction	Percent of Transactions
0-50,000	40	10.4%
50,000-75,000	53	13.8%
75,000-100,000	81	21.0%
100,000-150,000	105	27.3%
150,000-200,000	52	13.5%
200,000-250,000	32	8.3%
250,000-300,000	12	3.1%
300,000+	10	2.6%
Total	385	100.0%

It is important to consider how house prices may change over time, particularly fluctuations during the plan period. Specifically, the distribution of the price of units in the housing market during 2010 – 2019 have been reviewed for County Longford. The distribution of price bands in 2019 has been held fixed during the plan period because the selection of the nominated price bands and associated distribution of houses within those price bands in 2019 was considered reflective of a functioning, typical housing market for the area following review of information from Daft²² and the CSO²³ which further contextualised the historic market in County Longford. Table 4.11 sets out the historic information on the housing market in County Longford for context.

²¹ It should be noted that this relates to House Sales that are inclusive of VAT

²² <https://www.daft.ie/report/ronan-lyons-2019q4-dafthouseprice>

²³ <https://www.cso.ie/en/statistics/prices/residentialpropertypriceindex/>

Table 4.11 Historic House Price Metrics in County Longford

Year	RPPR	CSO HPA02	CSO HPM02	CSO HPA06	Daft
2011	-26.0%	-33.0%	-32.62%	-24.90%	-57.4%
2012	-17.6%	-14.1%	-16.11%	-16.50%	9.9%
2013	-19.6%	-12.4%	-10.37%	-10.50%	-4.1%
2014	2.9%	16.5%	15.88%	5.80%	12.2%
2015	5.0%	2.3%	4.37%	14.00%	-20.7%
2016	15.5%	17.5%	15.96%	15.30%	9.8%
2017	15.2%	6.1%	5.48%	12.10%	19.5%
2018	9.3%	8.2%	7.25%	12.60%	6.5%
2019	17.3%	21.8%	21.68%	6.30%	-3.1%

Given the context of the recent recession and subsequent periods of growth, the average house price change over the past five years has been used as a basis for future changes in average house price from 2021 onwards (i.e. future baseline). Given the volatile nature of County Longford’s property sales as illustrated in Table 4.11, an average of the five-year historic data recorded by the PPR, CSO (HPA02, HPM02 and HPA06) and Daft.ie reported statistics was applied. Overall, these future estimations for the housing market in County Longford are considered reflective of economic conditions and housing supply generally improving and its associated positive influence on the housing market.

It should be noted that the COVID-19 pandemic is also likely to impact on the housing market in terms of house prices and market rental rates as identified in Section 4.2.4. This macroeconomic outlook has therefore been considered in addition to the historic information that has been set out above. As such, an adjusted rate of reduction has been applied in addition to relevant data in relation to the impacts of the COVID-19 pandemic on the housing market.

Recent research²⁴ estimates how the COVID-19 pandemic may impact on the housing market from 2020 and 2022. For the purpose of this analysis, the ‘sluggish’ recovery scenario set out by ESRI has been adopted and this indicates a -7%, -17%, -12% dip below the baseline in 2020, 2021 and 2022. These impacts have been factored into the estimated change in average house price growth during those years and it is anticipated therefore that the average house prices within County Longford may change over time as described in Table 4-12. Further information in relation to the projected house price bands per year is provided in Appendix 3.

Table 4.12: Actual and Anticipated Change in Average Prices in the Housing Market

2015 (Actual)	2016 (Actual)	2017 (Actual)	2018 (Actual)	2019 (Actual)	2020	2021	2022	2023	2024	2025	2026	2027
1.0%	14.8%	11.7%	8.8%	12.8%	2.8%	-7.2%	-2.2%	9.8%	8.0%	6.0%	6.0%	4.0%

²⁴<https://www.esri.ie/publications/property-prices-and-covid-19-related-administrative-closures-what-are-the-implications>

This information has supported the estimation of projected house price bands based on the percentage split of the 8 price bands as outlined in Table 4.11. The following is therefore considered to reflect market changes to the end of the plan period including:

- Annual short-term decline in growth from 2020 at 2.8%, down 10% from 2019.
- Decline in projected band prices in 2021 with -7.2% change with a rebound to -2.2% by 2022
- Return to growth somewhat in line with historic growth at 9.8% with gradual conservative reduction applied thereafter.

Based on the above, the projected house prices during the plan period have been determined as set out in Table 4.14.

Table 4.14: Calculation of projected house price bands during the plan period

Year	Average Price Change	1st Band	2nd Band		3rd Band		4th Band		5th Band		6th Band		7th Band		8th Band
2019	12.8%	50,000	50,001	75,000	75,001	100,000	100,001	150,000	150,001	200,000	200,001	250,000	250,001	300,000	300,001
2020	2.8%	51,403	51,404	77,105	77,106	102,807	102,808	154,210	154,211	205,613	205,614	257,017	257,018	308,420	308,421
2021	-7.2%	47,706	47,707	71,559	71,560	95,411	95,412	143,117	143,118	190,823	190,824	238,529	238,530	286,234	286,235
2022	-2.2%	46,659	46,660	69,989	69,990	93,319	93,320	139,978	139,979	186,638	186,639	233,297	233,298	279,957	279,957
2023	9.8%	51,235	51,236	76,853	76,854	102,470	102,471	153,705	153,707	204,941	204,942	256,176	256,177	307,411	307,412
2024	8.0%	55,334	55,335	83,001	83,002	110,668	110,669	166,002	166,003	221,336	221,337	276,670	276,671	332,004	332,005
2025	6.0%	58,654	58,655	87,981	87,982	117,308	117,309	175,962	175,963	234,616	234,617	293,270	293,271	351,924	351,925
2026	6.0%	62,173	62,175	93,260	93,261	124,347	124,348	186,520	186,521	248,693	248,694	310,866	310,868	373,040	373,041
2027	4.0%	64,660	64,661	96,990	96,992	129,320	129,322	193,981	193,982	258,641	258,642	323,301	323,302	387,961	387,962

4.2.7 Analysis of Historic Private Rental Market

This section sets out background information on rental price and demand by unit type within the current rental market in County Longford. To ensure the most up to date market context, 2019 has been selected as the baseline year and rental information as recorded by the Residential Tenancies Board during that year have been considered representative.

An overview of the market rents for County Longford during 2019 is provided in Table 4-15 with further historic information in relation to the rental prices by unit type provided in Appendix 3.

Table 4.15: Private Rental Market Price in 2019

RTB Data for Longford County 2019					
One bed	Two bed	Three bed	Four plus bed	All bedrooms	YOY change (All)
461	559	599	683	587	7.7%

It should be noted that historic demand by unit type was extracted and analysed to understand specific demand in the private rental market over time. Table 4.16 sets out the varying demand for individual unit types during 2011 – 2019 which is considered reflective of the typical demand for an individual unit type within County Longford. As such, this demand by unit type has been held fixed to understand future demand per unit type throughout the plan period.

Table 4.16: Projected Demand by Unit Type in the Private Rental Market

RTB Demand %	
1 Bed	10.8%
2 Bed	30.6%
3 Bed	44.0%
4+ Bed	14.6%
Total	100.0%

Similar to the house prices, historic information has been considered to forecast future changes in market rents by unit type going forward. Specifically, analysis of the change in average rental price for all bedroom units over the past four years (i.e. 2016 – 2019) has been used as a baseline. Additionally as set out in Section 4.2.4 and 4.2.5 and in the absence of any rental market specific analysis, the impact and recovery from the COVID pandemic under the ‘sluggish scenario’ as outlined by ESRI²⁵ has also been factored into the analysis of future market rental prices (i.e. in the same manner as the house prices as described in Section 4.2.5).

The changes in rental prices are therefore anticipated to be 1.5% growth in 2020, 8.5% decline in 2021 and 3.5% decline in 2022 with growth of 8.5% onwards with a conservative tapering over the plan period. Table 4.17 sets out the projected rental prices by unit type on this basis.

²⁵ Under the assumption that the nature of COVID-19s impact on the housing market effects the rental market alike

Table 4.17: Projected Rental Prices by Unit Type in County Longford

Year	Annual Change	One bed	Two bed	Three bed	Four plus bed
2021	1.5%	428	519	556	634
2022	-8.5%	413	501	537	612
2023	-3.5%	448	544	582	664
2024	8.5%	484	587	629	717
2025	8.0%	523	634	679	775
2026	8.0%	565	685	734	837
2027	5.0%	593	719	770	878

4.3 Assessment of Needs

4.3.1 Ownership

Housing Affordability is associated with disposable income available to a household which has been determined as described in detail in Section 4.2.3.

Section 93 of the Planning and Development Act 2000, defines affordability by setting the parameters for an ‘eligible person’ as "a person who is in need of accommodation and whose income would not be adequate to meet the payments of a mortgage for the purchase of a house to meet his or her accommodation needs because the payments calculated over the course of a year would exceed 35% of that person's annual income net of income tax and pay related social insurance...". It therefore is generally accepted that if housing costs exceed 35 per cent of a household’s disposable income, the housing is unaffordable and housing costs consume a disproportionately high amount of household income. Based on this information, we have calculated the number of households not meeting the “Affordability Criteria”.

The projections for household income during the plan period are applied to the DoECLG Model Housing Strategy annuity formula as set out in Table 4.18. This formula determines the maximum affordable house price for each of the ten income deciles based on a number of evidence-based variables that have been established through analysis of historic mortgage data from the Central Bank of Ireland. The key variables used in the annuity formula include an affordability threshold of a maximum of 35% expenditure of household income on mortgage costs, a loan to value ratio of 0.90, an annual interest rate (APR) of 3%, and a loan term of 29 years.

Table 4.18: Approximate Affordable House Price per decile in Longford County

Year	2022	2023	2024	2025	2026	2027
1st Decile	74,933	76,956	79,034	81,010	83,035	85,111
2nd Decile	123,944	127,290	130,727	133,995	137,345	140,779
3rd Decile	178,075	182,883	187,821	192,516	197,329	202,262
4th Decile	226,915	233,041	239,333	245,317	251,450	257,736
5th Decile	277,677	285,174	292,874	300,196	307,701	315,393
6th Decile	330,899	339,833	349,008	357,734	366,677	375,844
7th Decile	390,496	401,040	411,868	422,164	432,718	443,536
8th Decile	459,762	472,175	484,924	497,047	509,473	522,210
9th Decile	554,306	569,272	584,642	599,258	614,240	629,596
10th Decile	710,156	729,330	749,022	767,747	786,941	806,614

Based on the determination of additional households required (Refer to Section 4.2.2), the projected house price bands (i.e. Table 4.14), the determination of households that can qualify for a mortgage (Refer to Section 4.2.5) and the calculation of housing affordability (Refer to Table 4.18), the housing surplus/deficit per price band has been determined as set out in Table 4.19.

A surplus within a price band has been identified where the number of housing units anticipated is greater than the number of households that qualify for a mortgage and have the ability to purchase a home at the upper value of that house price band. A deficit has been identified within a price band where there is a fewer households anticipated compared to the number of households that qualify for a mortgage and have the ability to purchase a home at the upper value of that house price band.

Throughout the plan period, there is generally a housing surplus in the lower price bands and housing deficit in the higher price bands as identified in Table 4.19. A sufficient number of houses are anticipated overall as households in the upper price bands can purchase a house in a lower price band.

Additionally, the first decile (throughout the plan period) will not qualify for a mortgage (due to the current Central Bank rules), therefore there will be sufficient number of houses within County Longford to those households that qualify for a mortgage and have the ability to purchase a home at the upper value of the lowest house price band.

Table 4.19: Determination of Purchase Affordability for Households Qualifying for Mortgage in County Longford for the plan period

Year	Range	No. of Additional Anticipated Households That Qualify for a Mortgage	Running Total	Affordability Threshold	Household Price Band(s)	Upper Value of Price Band	No. of Households That Qualify for a Mortgage Able to Purchase at Upper Value	% of Housing Units Anticipated per Price Band	No. Housing Units Anticipated per Price Band	Housing Surplus (+) or Deficit (-) per Price Band
2022	1st Decile	0	0	74,933	1 st , 2 nd and 3 rd Bands	93,319	34	45.2%	174	140
	2nd Decile	45	45	123,944	4th Band	139,978	37	27.3%	105	69
	3rd Decile	45	90	178,075	5th Band	186,638	40	13.5%	52	12
	4th Decile	45	135	226,915	6th Band	233,297	39	8.3%	32	-7
	5th Decile	44	179	277,677	7th Band	279,957	37	3.1%	12	-25
	6th Decile	43	221	330,899	8th Band	None	None	2.6%	10	-
	7th Decile	41	262	390,496						
	8th Decile	41	304	459,762						
	9th Decile	41	345	554,306						
	10th Decile	41	386	710,156						
		386 (of 428)						100.00%	386	
2023	1st Decile	0	0	76,956	1 st , 2 nd and 3 rd Bands	102,470	36	45.2%	174	138
	2nd Decile	45	45	127,290	4th Band	153,705	39	27.3%	105	66
	3rd Decile	45	90	182,883	5th Band	204,941	43	13.5%	52	9
	4th Decile	45	135	233,041	6th Band	256,176	42	8.3%	32	-10
	5th Decile	44	179	285,174	7th Band	307,411	41	3.1%	12	-29
	6th Decile	43	221	339,833	8th Band	None	None	2.6%	10	-
	7th Decile	41	262	401,040						
	8th Decile	41	304	472,175						
	9th Decile	41	345	569,272						
	10th Decile	41	386	729,330						
		386 (of 428)						100.00%	386 (of 428)	

Year	Range	No. of Additional Anticipated Households That Qualify for a Mortgage	Running Total	Affordability Threshold	Household Price Band(s)	Upper Value of Price Band	No. of Households That Qualify for a Mortgage Able to Purchase at Upper Value	% of Housing Units Anticipated per Price Band	No. Housing Units Anticipated per Price Band	Housing Surplus (+) or Deficit (-) per Price Band
2024	1st Decile	0	0	79,034	1 st and 2 nd Bands	83,001	29	24.2%	93	65
	2nd Decile	45	45	130,727	3 rd and 4 th Bands	166,002	51	48.3%	186	136
	3rd Decile	45	90	187,821	5th Band	221,336	45	13.5%	52	7
	4th Decile	45	135	239,333	6th Band	276,670	44	8.3%	32	-12
	5th Decile	44	179	292,874	7th Band	332,004	42	3.1%	12	-30
	6th Decile	43	221	349,008	8th Band	None	None	2.6%	10	-
	7th Decile	41	262	411,868						
	8th Decile	41	304	484,924						
	9th Decile	41	345	584,642						
	10th Decile	41	386	749,022						
		386 (of 428)						100.00%	386 (of 428)	
2025	1st Decile	0	0	81,010	1 st and 2 nd Bands	87,981	30	24.2%	93	64
	2nd Decile	45	45	133,995	3 rd and 4 th Bands	175,962	53	48.3%	186	134
	3rd Decile	45	90	192,516	5th Band	234,616	47	13.5%	52	6
	4th Decile	45	135	245,317	6th Band	293,270	46	8.3%	32	-14
	5th Decile	44	179	300,196	7th Band	351,924	43	3.1%	12	-31
	6th Decile	43	221	357,734	8th Band	None	None	2.6%	10	-
	7th Decile	41	262	422,164						
	8th Decile	41	304	497,047						
	9th Decile	41	345	599,258						
	10th Decile	41	386	767,747						
		386 (of 428)						100.00%	386 (of 428)	

Year	Range	No. of Additional Anticipated Households That Qualify for a Mortgage	Running Total	Affordability Threshold	Household Price Band(s)	Upper Value of Price Band	No. of Households That Qualify for a Mortgage Able to Purchase at Upper Value	% of Housing Units Anticipated per Price Band	No. Housing Units Anticipated per Price Band	Housing Surplus (+) or Deficit (-) per Price Band
2026	1st Decile	0	0	83,035	1 st and 2 nd Bands	93,260	31	24.2%	93	63
	2nd Decile	45	45	137,345	3 rd and 4 th Bands	186,520	54	48.3%	186	132
	3rd Decile	45	90	197,329	5th Band	248,693	48	13.5%	52	4
	4th Decile	45	135	251,450	6th Band	310,866	54	8.3%	32	-22
	5th Decile	44	179	307,701						
	6th Decile	43	221	366,677	7th Band	373,040	39	3.1%	12	-27
	7th Decile	41	262	432,718	8th Band	None	None	2.6%	10	-
	8th Decile	41	304	509,473						
	9th Decile	41	345	614,240						
	10th Decile	41	386	786,941						
			386 (of 428)						100.00%	386 (of 428)
2027	1st Decile	0	0	85,111	1 st and 2 nd Bands	96,990	31	24.2%	93	62
	2nd Decile	45	45	140,779	3 rd and 4 th Bands	193,981	55	48.3%	186	131
	3rd Decile	45	90	202,262	5th Band	258,641	60	13.5%	52	-8
	4th Decile	45	135	257,736						
	5th Decile	44	179	315,393	6th Band	323,301	44	8.3%	32	12
	6th Decile	43	221	375,844	7th Band	387,961	39	3.1%	12	27
	7th Decile	41	262	443,536	8th Band	None	None	2.6%	10	-
	8th Decile	41	304	522,210						
	9th Decile	41	345	629,596						
	10th Decile	41	386	806,614						
			386 (of 428)						100.00%	386 (of 428)

4.3.2 Private Rental

Analysis of affordability in relation to private rental has been undertaken in order to ensure a comprehensive understanding of the housing market. The key variables used to determine whether households in a decile can qualify for a private rental for a specific unit are:

- Disposable income per decile throughout the plan period as described in Section 4.2.3;
- Projected market rents per unit type as set out in Section 4.2.6;
- Additionally, the demand for a particular unit type (as set out in Section 4.2.6) has been factored to estimate what type of unit the additional anticipated households are more likely to prefer to rent.

As such if a household does not have sufficient income to meet the private rental rates for a unit in a given year (i.e. 35% of their disposable income is less than average market rent), they cannot afford the rent by themselves. An overview of those that cannot afford private rental is provided in Table 4.20, with further information per decile per unit provided in Appendix 3.

Table 4.20: Number of additional anticipated households that do not qualify for a mortgage and cannot afford private rental (based on RTB Demand allocation by Unit Type)

Year	2022	2023	2024	2025	2026	2027
1 Bed	5	5	5	5	5	5
2 Bed	13	13	13	13	13	13
3 Bed	18	18	18	18	18	18
4+ Bed	6	6	6	6	6	6
Total	42	42	42	42	42	42

4.3.3 Summary of Projected Needs during the Plan Period

This section summarises the overall housing requirements for County Longford having regard to the analysis that has been undertaken as described in detail in Section 4.2 and 4.3.

Between Q1 2022 and Q4 2027, a population increase of 2,614 people is projected for County Longford. This indicates that the total population in County Longford will be 45,800 people by the end of 2027 as set out in Section 4.2.1 and described in detail in the Core Strategy.

The population targets for this plan period establish a total housing target of 2,568 additional anticipated households. This is the equivalent of an average of 428 units per annum across County Longford during the plan period. This will result in a total of 18,207 households in County Longford by Q4 2027 as set out in Section 4.2.2 and described in detail in the Core Strategy.

The anticipated social housing need for Longford County Council as set out in the preceding steps, reflects the assessments for mortgage qualification and the affordability for ownership and private rental. The social (and affordable) housing requirement within County Longford throughout the plan period is equivalent to those that do not qualify for a mortgage and those that cannot afford private rental, which is equivalent to 9.8% of the total of additional households in County Longford during Q1 2022 – Q4 2027. This is the **identified social (and affordable) housing requirement of 252 households** for the plan period which has been summarised in Table 4.21 and Figure 4.1.

Table 4.21: Summary of Anticipated Additional Households and Requirements for the Plan Period

		2022	2023	2024	2025	2026	2027	2021-2027
Additional Anticipated Households	Total	428	428	428	428	428	428	2,568
No. of Additional Households That Do Not Qualify for a Mortgage	Subset of Above	42	42	42	42	42	42	252
No. of Additional Anticipated Households That Do Not Qualify for a Mortgage AND Cannot Afford Private Rental	Subset of Above	42	42	42	42	42	42	252
Housing Shortfall (%)	Of Total	9.8%	9.8%	9.8%	9.8%	9.8%	9.8%	9.8%

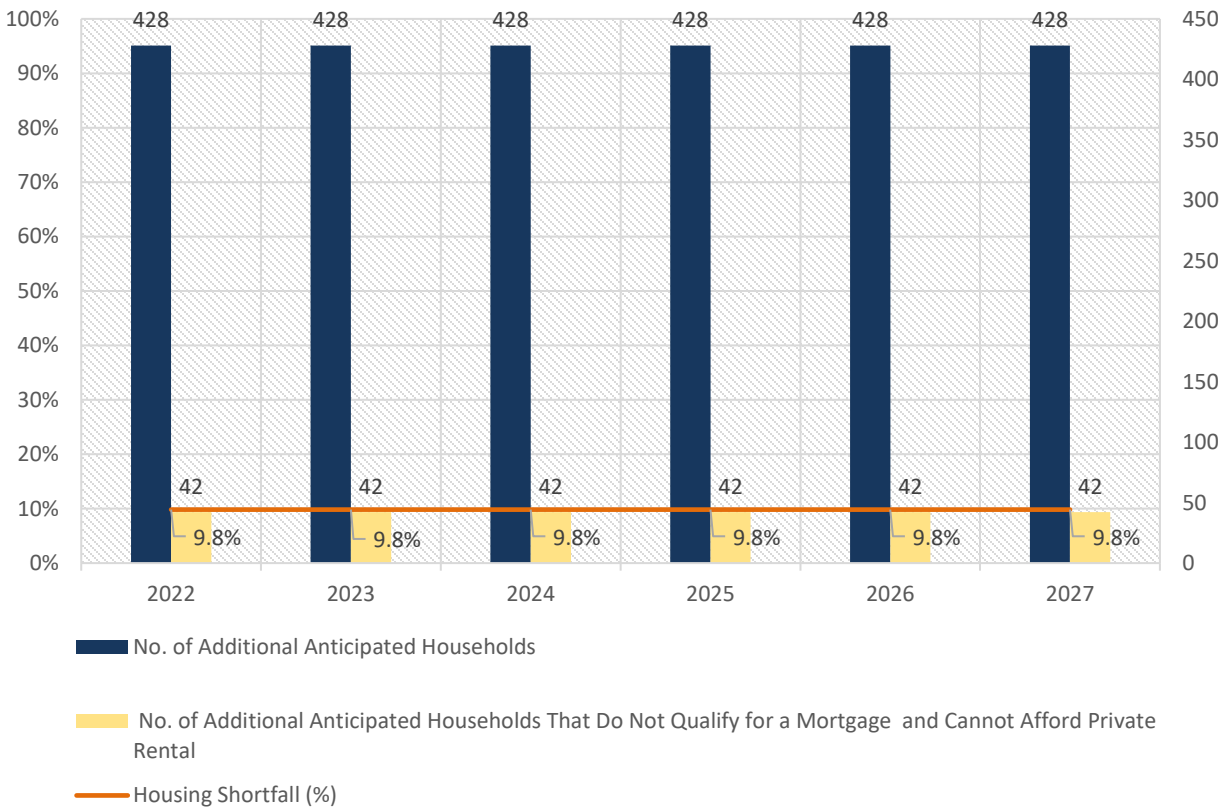

Figure 4.1: Summary of Longford County Social (and Affordable) Housing Needs throughout the plan period

4.4 HNDA Components

4.4.1 Household Composition

As set out in Section 6.6 of the NPF, information on household composition and projections in relation to household size are informative evidence inputs that can assist with understanding stock profile pressures. Analysis of the historic household sizes (specifically the household size cohort per household) has therefore been undertaken to help discern and forecast how the composition of households may change during the plan period.

Analysis of historic information (i.e. during the 2002, 2006, 2011 and 2016 Census) in relation to the composition of households has been undertaken at the County level to understand these dynamics and estimate how they may change over time. Specifically, the intercensal average has been used to determine a trended annual average change in household composition and this indicates the following changes can be anticipated during the plan period:

- 1 person households will increase by an average of 0.19% annually
- 2 person households will increase by an average of 0.18% annually
- 3 person households will increase by an average of -0.03% annually
- 4 person households will increase by an average of -0.05% annually
- 5+ person households will increase by an average of -0.28% annually

Figure 4.2 and Table 4.22 indicates the estimated proportion and number of households by size during the plan period.

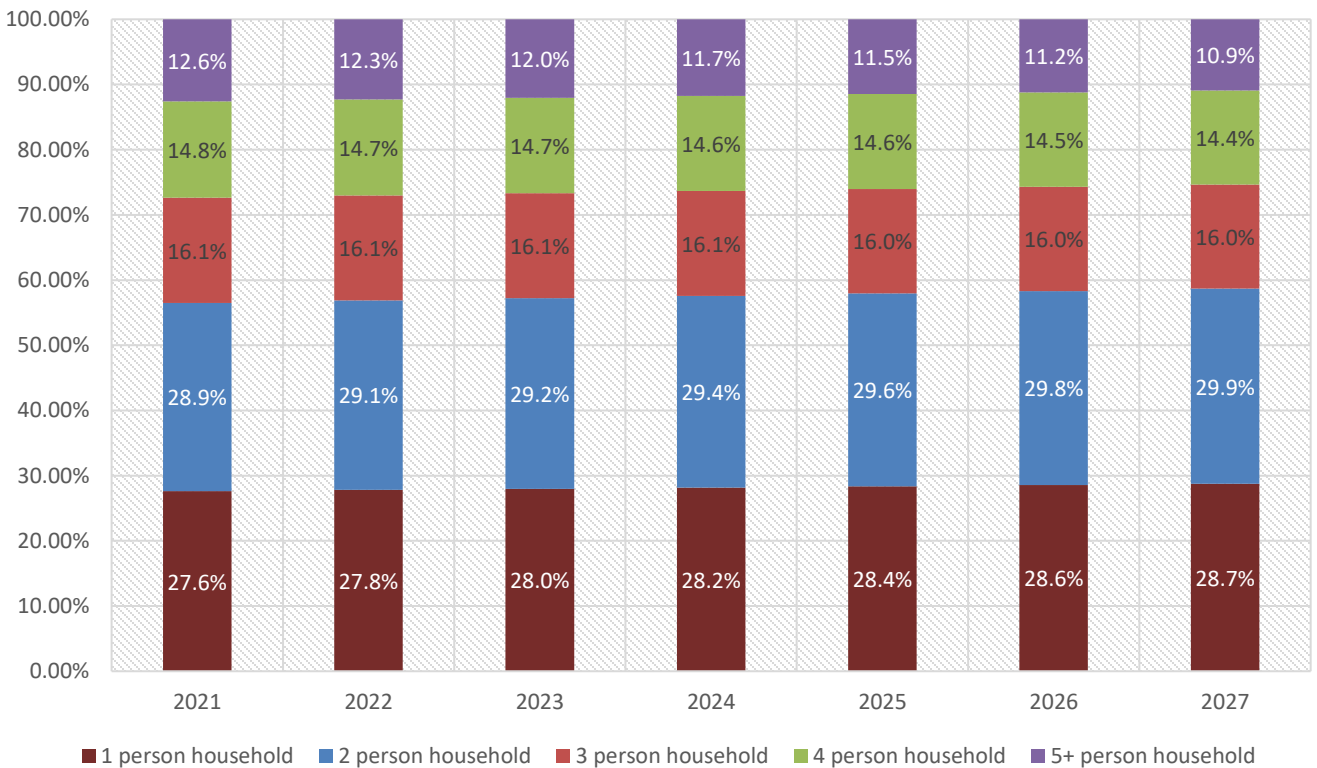

Figure 4.2: Forecasted Household Size Cohort in County Longford during the plan period

Table 4.22: Household Size Cohort Forecasts for Additional Anticipated Households in County Longford during the plan period

Additional Anticipated Households	2022	2023	2024	2025	2026	2027	2028
1 Person Household	119	120	121	121	122	123	726
2 Person Household	124	125	126	127	127	128	758
3 Person Household	69	69	69	69	68	68	412
4 Person Household	63	63	63	62	62	62	374
5 + Person Household	53	51	50	49	48	47	298
Total Additional Anticipated Households	428	428	428	428	428	428	2,568

4.4.2 Household Tenure

Tenure is another important consideration for the delivery of housing and Section 6.6 of the NPF identifies the need to estimate the demand for different tenure types. Analysis of the historic tenure split has therefore been undertaken to help discern and forecast how the household tenure may change during the plan period.

Analysis of historic information for County Longford (i.e. during the 2002, 2006, 2011 and 2016 Census) in relation to the household tenure has been to understand these dynamics and estimate how they may change over time. Specifically, the intercensal average has been used to determine a trended annual average change in household tenure.

Historic data indicates the intercensal observed change between 2002-2016 and an annual average change applied forward for the plan period as a continuation of trends was applied. The following changes can be anticipated during the plan period:

- Annual average change of -1.02% observed in owner occupied households (average intercensal change of -5.1%)
- Annual average change of 0.7% observed in privately rented households (average intercensal change of -3.5%)
- Annual average change of 0.33% observed in other rented households (average intercensal change of -1.6%)

The applied changes for the additional anticipated households are indicated in Table 4.23 and Figure 4.3.

Table 4.23: Household Tenure Forecasts for Additional Anticipated Households in County Longford during plan period

Additional Anticipated Households	2022	2023	2024	2025	2026	2027	Total
Owner occupied	254	250	245	241	236	232	1,458
Private Rental	94	97	100	103	106	109	610
Other Rental	80	81	83	84	85	87	500
No. of Additional Anticipated Households	428	428	428	428	428	428	2,568

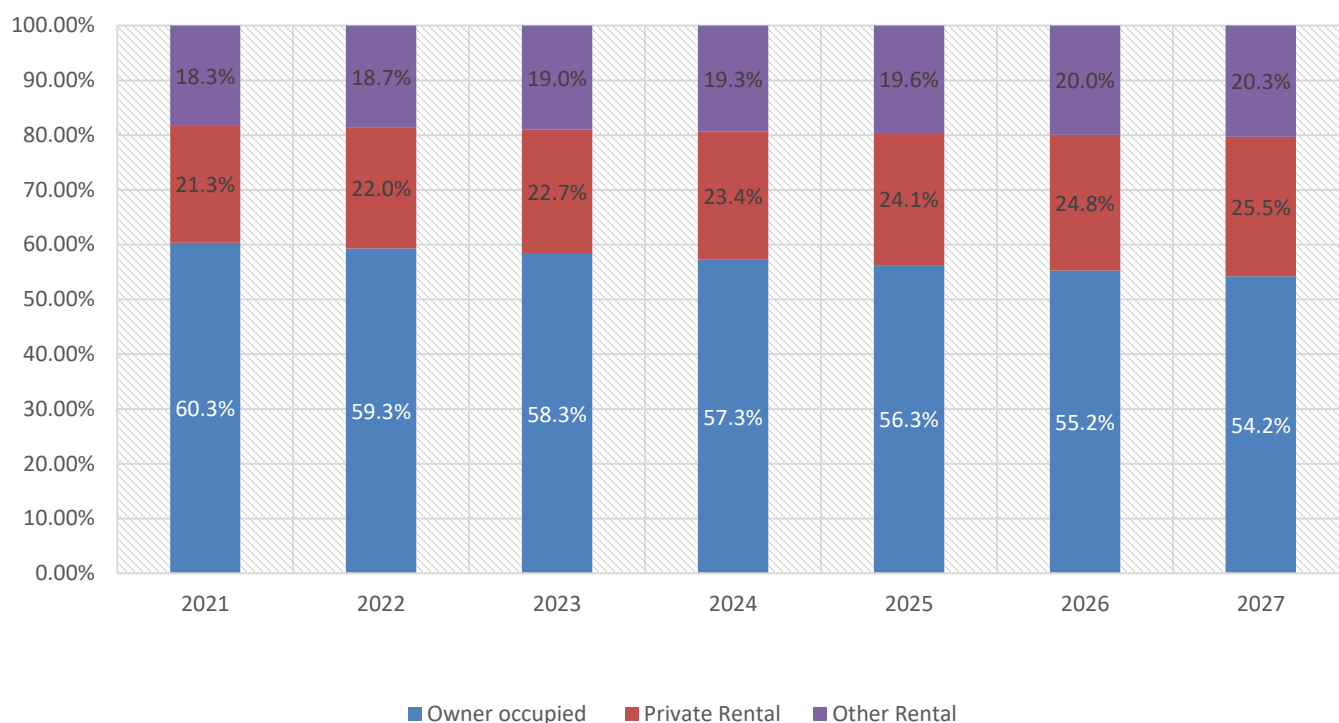

Figure 4.3: Household Tenure Forecasts for Households in County Longford during plan period

4.4.3 Single Rural Dwellings

Analysis of historic information (i.e. during 2006 – 2020) on granted planning applications (by number of units) in County Longford has been undertaken. This helps understand the proportion of housing units that are single rural dwellings that have been approved during that period and provides an indication of the dynamics between the urban and rural housing market within the county. This data classifies new housing units as either apartments/flats, houses built as part of a scheme, and single or one-off houses (which are predominately rural, although inclusive of some homes built within settlements).

As outlined in Table 4.24, approximately 40.4% of granted units during that period were for one-off houses. This equates to an average 63% per year, however large fluctuations were evident throughout the years as illustrated in Figure 4.4. Therefore, the trajectory for future applications should be moderated with this in mind. It should be noted that whilst these are granted planning applications (by unit), **this does not equate to a housing unit which has been built.**

These fluctuations may be associated with the wider economic context, associated demands for particular dwelling type or locational preferences within the housing market as well as variables such as land availability, resource availability and/or demands in any given year. Generally, it is recognised that a single rural dwelling is sized according to what the applicants can afford to build along with their actual requirements. Analysis has determined that the average floor size for one-off houses has also been analysed for context as set out in Table 4.25 and determined to be 267.16 m² during that period.

Data on new homes completed between 2011 and 2020 is also available from the CSO.²⁶ This shows that the number of one-off homes completed in County Longford has also fluctuated greatly over the past decade but has also seen a notable decline, from a high of 89% in 2013 to a low of 35% in 2019. Overall, 58% of homes completed over the period were classed as one-off houses. The proportion of one-off houses built increased to 58% in 2020. However, this may reflect the impact of the COVID-19 pandemic, with multi-unit developments potentially more subject to disruption than one-off homes. Completions also represent a lag compared to planning permissions, due to the time taken to construct new homes and scheme homes in particular. As such, recent data on permissions can indicate potential delivery in the medium term as permissions move to completions. It therefore can represent a more robust basis for considering potential future trajectory.

As detailed previously, Longford County has a total housing target of 2,568 units over the plan period. If the total proportion of historic one-off granted planning permissions (40.4% of all granted units between 2006 and 2020) were applied to this target, this **would equate to 1,036 units delivered as one-off houses**.

However, it must be noted that this is a projection based on historic trends and the baseline conditions and factors that have enabled recent single rural dwelling delivery. It is a 'policy-off' forecast that may not reflect future policy decisions at national and local level or future market conditions. It is also based on data from some years when the housing market was frequently operating abnormally and following unsustainable cycles of boom and bust. Absolute numbers of one-off homes delivered since 2011 have remained relatively stable, while proportions have tended to decline as overall housing delivery increases. This may be the case over the plan period 2021-2027 if overall housing delivery meets targets and delivers greater housing affordability and housing options for rural communities within towns and villages.

Furthermore, there is now a clear impetus in planning policy through the NPF to direct more housing delivery towards existing settlements with a target of delivering at least 30% of all new homes in County Longford delivered within the built-up footprint of existing settlements. It therefore will be appropriate for the Longford County Development Plan 2021-2027 to balance potential demand for single rural dwellings (as informed by historic trends) against broader planning goals in allocating new housing for rural areas through the Core Strategy.

²⁶ This data is based on ESB electricity connections. It is also classified in terms of single houses, scheme houses, and apartments/flats. At local authority level, data on single houses completed also includes houses built within settlements. However, the [CSO has indicated](#) that at national level over 80% of these single houses are rural, and the proportion is likely to be higher in a rural county such as Longford.

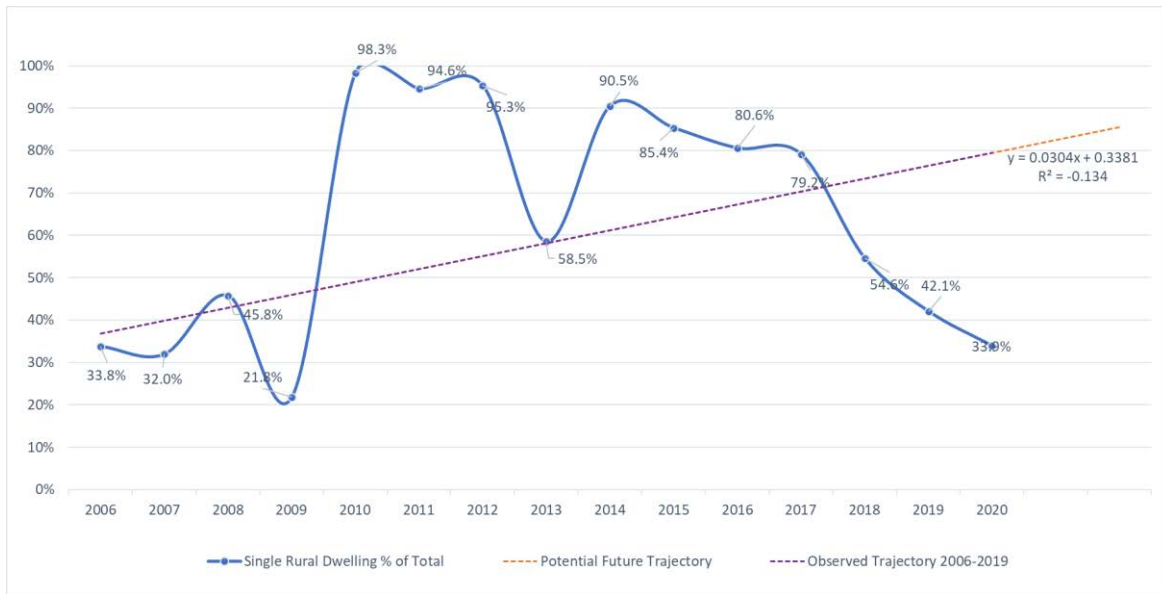

Figure 4.4 Analysis of Historic Granted Planning Applications (in Units) for One-Off Houses in County Longford

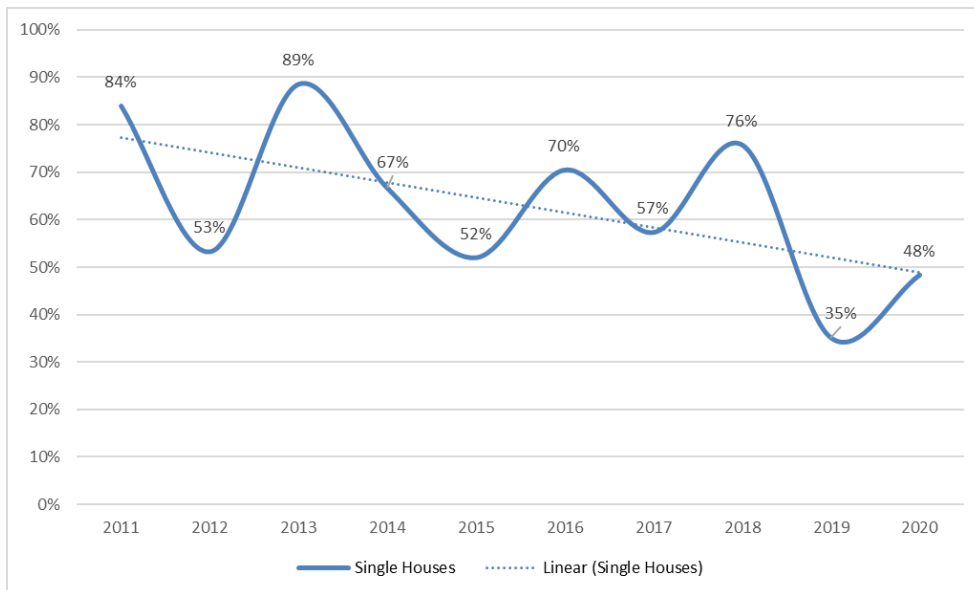

Figure 4.5 Analysis of Historic Completions (in Units) for One-Off Houses in County Longford

Table 4.24: Analysis of Historic Granted Planning Applications (in Units) for One-Off Houses in County Longford

Granted Planning Applications	2006	2007	2008	2009	2010	2011	2012	2013	2014	2015	2016	2017	2018	2019	2020	Total
Houses and Apartments #	515	658	245	309	1	2	2	17	2	6	13	20	44	110	144	2,088
One-Off House #	263	309	207	86	57	35	41	24	19	35	54	76	53	80	74	1,413
Houses and Apartments %	66.2%	68.0%	54.2%	78.2%	1.7%	5.4%	4.7%	41.5%	9.5%	14.6%	19.4%	20.8%	45.4%	57.9%	66.1%	59.6%
One-Off House %	33.8%	32.0%	45.8%	21.8%	98.3%	94.6%	95.3%	58.5%	90.5%	85.4%	80.6%	79.2%	54.6%	42.1%	33.9%	40.4%
Total	778	967	452	395	58	37	43	41	21	41	67	96	97	190	218	3,501

Table 4.25: Analysis of Floor Size of Granted Planning Applications for One-Off Houses in County Longford

Granted Planning Applications	2006	2007	2008	2009	2010	2011	2012	2013	2014	2015	2016	2017	2018	2019	2020	Average
Average floor size of SRD (m ²)	235.73	245.70	268.68	301.50	312.23	281.03	278.80	288.28	252.95	275.03	243.25	255.73	253.80	247.60	269	267.29

Table 4.26: Analysis of Historic Housing Completions (in Units) for One-Off Houses in County Longford

Housing Completions	2011	2012	2013	2014	2015	2016	2017	2018	2019	2020	Total
Houses and Apartments #	8	36	4	18	24	18	32	16	85	63	304
One-Off House #	42	41	31	36	26	43	43	50	46	59	417
Houses and Apartments %	16%	47%	11%	33%	48%	30%	43%	24%	65%	52%	42%
One-Off House %	84%	53%	89%	67%	52%	70%	57%	76%	35%	48%	58%
Total	50	77	35	54	50	61	75	66	131	122	721

4.5 Conclusion

Between 2021 and 2027, this Strategy forecasts a population increase of 3,076 in County Longford. This in turn indicates a total population of 45,800 in 2027 and a total housing target for Longford of 2,568 units over the plan period 2021-2027, the equivalent of 167 units per annum.

It has been determined that 252 of the 2,568 additional anticipated households will not qualify for a mortgage during the plan period. Additionally, these 252 households will not meet the affordability criteria for private rental. Households which are identified as not qualifying for a mortgage and not being able to meet the 'Affordability Criteria' over the plan period are therefore considered to require social (and affordable) housing. This equates to an average of 9.8% of the additional anticipated households or the identified social requirement throughout the plan period is **252 units**.

5 Meeting Housing Requirements in Longford

5.1 Overview

This chapter set out specific information summarising the existing situation about how social housing support is administered by Longford County Council, with the latest existing data, delivery methods and targets set out herein. There are several means available to Longford County Council to meet need for social housing. An overview of how social housing support is currently administered by Longford County Council, including the existing delivery methods and progress against targets is set out in Section 5.5.3.

These mechanisms to deliver social housing will help form the basis of meeting identified social housing need over the plan period. This information therefore informs the development of policy objectives for this Housing Strategy that have been presented in Section 6 as it sets out the existing situation in advance of the implementation of the policy objectives as well the overview of the projected future requirements in relation to housing in County Longford (which have been set out in Section 4.5).

5.2 Social Housing Supply and Demand

5.2.1 Existing Social Housing Needs

The Social Housing Support Need Analysis identifies the latest situation (as of March 2020) in relation to the existing social housing need of County Longford. In March 2020, 933 households were on the social housing waiting list in County Longford as set out in Table 5.1.

With respect to unit type requirements, the greatest demand is for three-bedroom properties which account for 56.5% of the need. This is followed by two-bedroom units (37.2%). The overall requirements and current demand by unit type as well as the specified location within County Longford are detailed in Table 5.1.

It should be noted that the assessed future housing need over the plan period of 252 units is in addition to the existing requirement for 933 households as recorded on the social housing waiting list in March 2020. It should also be noted that whilst 933 households are currently on the social housing waiting list, between 2018 and 2019, the social housing waiting list in County Longford reduced by 8.5%.

Table 5.1: Social Housing Need by Unit Type and Area (March 2020)

Area of Choice	1 Bed	2 Bed	3 Bed	4 Bed	Total Applicants
Ardagh	0	0	0	1	1
Aughnaccliffe	0	9	9	0	18
Ballinalee	0	17	16	0	33
Ballinamuck	0	3	5	1	9
Ballymahon	2	43	63	2	110
Clondra	0	1	1	0	2
Colehill	0	5	4	1	10
Drumlish	0	12	34	6	52
Edgeworthstown	0	35	46	2	83
Granard	0	9	17	2	28
Kenagh	0	14	14	0	28
Killashee	1	3	12	1	17
Killoe	0	1	0	0	1
Lanesboro	2	16	20	1	39
Legan	0	7	6	1	14
Longford	14	165	267	21	467
Newtowncashel	0	0	1	0	1
Newtownforbes	0	7	12	1	20
Longford County Total Number	19	347	527	40	933
Longford County Total %	2%	37.2%	56.5%	4.3%	100%

5.2.2 Meeting Social Housing Demand

5.2.2.1 Overview

Longford County Council will continue to meet their identified social housing provision requirements via a combination of the existing delivery schemes that are in place. Currently, social housing support is administered by the Housing Department within Longford County Council through those mechanisms summarised below and described in further detail thereafter:

- A social rented tenancy in a property owned and managed by the local authority and a tenancy in a property the local authority is managing or has leased from a private owner.
- A social rented tenancy in property owned and managed by an approved housing body (AHB).

- Longford County Council provides accommodation specifically for Travellers and for people with specific housing needs such as older persons, people with disabilities and the homeless etc.
- A tenancy where the local authority arranges short or long-term leases with private landlords for particular properties (i.e. people that are in receipt of rent supplement for 18 months or longer are eligible to apply for this type of accommodation).

5.2.2.2 Social Rental Tenancy from and/or via the Local Authority

This relates to a social rented tenancy in any property that owned and managed by Longford County Council or alternatively, this may relate to any tenancy in a property that Longford County Council is managing or has leased from a private property owner. These can include:

- Construction Projects – This is the construction of properties specifically by Longford County Council.
- Acquisitions - This is the purchase by Longford County Council of a second-hand house on the open market.
- Portfolio Acquisitions – This related to suitable portfolios of vacant properties which can be secured by Longford County Council from financial institutions and investors.
- Turnkeys - Longford County Council buy a new house(s) from a developer, that are ready for a tenant to move into.
- Provision of Social Housing under Part V of the Planning and Development Acts 2000 - While the provision of social housing via traditional Part V mechanism will continue to play a role in the delivery of social housing in County Longford, other delivery channels for social housing are likely to be more significant in terms of their potential to contribute to the social housing targets set out. The statutory context for the provision of social and affordable housing has changed under the Urban Regeneration and Housing Act 2015. The amendments include that there will be a requirement for up to 10% social housing in developments in excess of nine units. The use of cash payments in lieu of social housing provision is no longer allowed. Provision is made for the transfer of completed units on other land not subject to the planning permission to be provided. Provision is also made for the Part V obligation to be fulfilled by developers through long term leasing of properties and rental accommodation availability agreements.
- Buy and Renew - Under this scheme Longford County Council can buy sub-standard properties, which have been vacant for over a year, refurbish them and bring them back into use through the Council's housing stock. The purchase cost plus the cost of refurbishment can't exceed what a comparable property would attain on the private market. This initiative, which complements the Repair & Leasing Scheme, is designed to assist local authorities and AHBs (Approved Housing Bodies) to harness the accommodation potential that exists in certain vacant properties for social housing use.
- Tenant Purchase Scheme: In January 2016, a new scheme for the purchase of existing local authority houses came into effect – The Tenant (Incremental) Purchase Scheme 2016.

5.2.2.3 Social Rental Tenancy from an AHB

This relates to a social rented tenancy in any property that is owned and managed by an AHB. As set out in Section 3.3.5.1, AHBs provide social housing and are formed for the purpose of relieving housing need and the provision and management of housing. They are established by a voluntary management board to benefit the community in which they are based and are approved and funded by the Department of Housing, Planning and Local Government.

Such housing cooperatives (i.e. the AHBs) can provide both social rented housing and/or housing to purchase. AHBs are self-help and jointly owned member/user housing associations or societies. Projects undertaken by an AHB may be in response to the needs of specific communities such as the elderly, people with disabilities, homeless persons or families and single people on low incomes. Some AHBs have also been formed to specialise in meeting a particular housing need whilst others have been developed with broader aims. The specific housing services offered will depend on the aims or concerns of the members, the needs of tenants as well as the financial and other resources available for both capital costs and ongoing management running costs. As set out in Section 3.3.5.1, there are nine AHBs operating in County Longford.

5.2.2.4 Specialist Support Provided by Longford County Council

Longford County Council provides accommodation specifically for individual groups such as travellers and for people with specific housing needs such as people with disabilities and the homeless. The current delivery programmes responding to specific needs include the Refugee Resettlement Programme and the Traveller Accommodation Plan. Under the Refugee Resettlement refugees are being allocated social housing in Longford. The families are part of approximately 4,000 people which the government has committed to receiving through the Irish Refugee Protection Programme. County Councils will continue to work with Central Government and relevant State Agencies Office in responding to its requirements to support refugees as they undergo their resettlement process in Co. Longford.

Under the provisions of the Housing Traveller Accommodation Act 1998, all Local Authorities are required to prepare, adopt and implement a Traveller Accommodation Programme (TAP) to meet the accommodation needs of the county's indigenous Traveller community. The current TAP for Longford County Council sets out the strategy for the provision of Traveller accommodation and support services during 2019-2024. An assessment of the accommodation need was carried out to inform the TAP. This statutory assessment of need assessed all applicants seeking assistance with accommodation. The number of approved Traveller families seeking accommodation is 23. Having regard to this it is considered that a total of 108 units of accommodation should be provided over the five-year programme to cater for the existing demand and projected demand as set out in Table 5.2. The following housing options will be utilised to accommodate this need throughout the plan period for the TAP (i.e. 2019 – 2024):

- Standard Local Authority Housing
- Traveller Voluntary Housing Bodies
- Group Housing
- Long Term Leasing
- Rental Accommodation Scheme
- Housing Assistance Payment Scheme
- Rebuilding Ireland Home Loan.

Table 5.2: Breakdown of Traveller Accommodation Targets in Longford 2019-2024 in Longford

Type	2019/20	2020/21	2021/22	2022/23	2023/24	Total
Transient	0	0	0	0	0	0
Permanent Halting Site	0	0	0	0	0	0
Standard L.A Housing	12	12	12	12	12	60
HAP	6	5	5	4	4	24
RAS/Lease	2	2	2	2	2	10
Voluntary Housing Body	2	2	2	2	2	10
Group Housing	0	0	0	4	0	4
Total	22	21	21	24	20	108

5.2.2.5 Local Authority Support for Leases with Private Landlords

This relates to a tenancy where the local authority arranges short or long-term leases with private landlords for particular properties. Specifically, this applies to people that have been in receipt of rent supplement for 18 months or longer who are deemed eligible to apply for this type of accommodation from Longford County Council. They can receive this support by way of either the Housing Assistance Payment (HAP), the Rental Accommodation Scheme (RAS) or Repair and Lease.

HAP is a scheme under the Housing Miscellaneous Provisions Act 2014 for people who have a long-term housing need and who qualify for social housing support. It is administered by housing authorities and will eventually replace long-term rent supplement (i.e. RAS). The HAP scheme aims to allow all social housing supports to be accessed through the local authorities (i.e. Longford County Council in this instance) in order to enable people to take up full-time employment whilst maintaining their housing support. Under the HAP scheme, the applicant finds appropriate private rented accommodation (within specific caps) and the Local Authority then pays the landlord directly and the tenant pays a rent to the local authority based on the differential rent scheme.

The RAS is an initiative to cater for the accommodation needs of certain persons in receipt of rent supplement, (i.e. who are assessed as having a long-term housing need, normally for more than 18 months). Longford County Council pays rent directly to the accommodation providers on behalf of the tenant (which is a maximum of 92% of the market rent). Longford County Council makes use of the private and voluntary sector to engage in a contractual arrangement that secures medium-long term rented accommodation on behalf of the applicant/tenant.

The Rebuilding Ireland Action Plan for Housing and Homelessness introduced a new scheme, the Vacant Housing Repair and Leasing Initiative (i.e. Repair and Lease). This scheme specifically targets the delivery of social housing and seeks to ensure that existing housing stock is used to the maximum degree possible. The basis of the scheme is that repair and improvement works to suitable vacant properties are funded to bring them up to the standard for rented accommodation and the cost of the works is then deducted from lease payments over an agreed lease term.

5.5.3 Delivery Methods and Targets

It is anticipated that Longford County Council will continue to meet their social housing needs via a combination of these existing delivery schemes (as set out in Section 5.5.2) and through the introduction or greater emphasis of other either existing or recently established schemes and mechanisms. This section assesses different delivery channels available to County Longford and their progress to date in achieving the recent targets in relation to social housing (i.e. as set out in the Rebuilding Ireland: Action Plan for Housing and Homelessness) has been examined.

As set out in Section 2.1.11, Rebuilding Ireland recognises issues around supply and affordability in Ireland’s housing sector and provides a multi-stranded approach to achieve key housing objectives up to 2021. A national commitment to deliver 138,000 additional social housing units during 2016-2021 which equates to 83,760 HAP homes, 3,800 RAS homes and over 50,000 new homes (broken down into 33,617 builds, 6,830 acquisitions and 10,036 leases).

Within County Longford, a target of delivering 309 properties during 2018 – 2021 was set out by Rebuilding Ireland. Additionally, a target of delivering 257 units across all social housing delivery streams was set for 2019 as illustrated in Table 5.3.

Table 5.3: Social Housing Targets for County Longford that have been set out under Rebuilding Ireland

Targets 2018-2021	Targets 2019
-------------------	--------------

Build, Acquisition and Leasing	Build	Acquisition	Leasing	HAP and RAS	All social housing streams
309	76	7	15	159	257

Progress on the delivery of social housing units is documented as part of quarterly updates by the Department of Housing, Planning and Local Government. The most recently available progress update is the annual summary data to the end of 2019 and is documented in Table 5.4. This demonstrates that the total output in County Longford in 2019 was 308 units, which indicates that Longford County Council achieved 120% of its Rebuilding Ireland Target to 2019. This follows 2018 when Longford County Council also exceeded the target by delivering 326 units or 148% of its requirements ²⁷. In total between 2018-2021, 309 units were targeted to be delivered by way of ‘building, acquisition and leasing’. Through 2018-2019, Longford County Council have already delivered 261 units through these mechanisms. Thus, over the course of 2020-2021 only 48 additional units are required to be delivered through ‘building, acquisition and leasing’ mechanisms in order to meet the Rebuilding Ireland targets. This is an encouraging indicator as to Longford County Council’s ability to provide its social housing requirements in line with the aspirations of Rebuilding Ireland.

Table 5.4: Progress on Rebuilding Ireland Social Housing Targets 2019

County Longford to the end of 2019	Total #
All Build Total	87
Acquisition Total	49
Leasing	8
RAS ^[2] & HAP ^[3]	164
Total Output 2019 under Rebuilding Ireland	308 Units Delivered (120% of target)

- 1. New leasing units operational are defined as the number of new leasing units delivered under this scheme in the given period. This program was previously known as long term leasing until 2014.*
- 2. RAS - New transfers is defined as the number of households which have moved from Rent Supplement to RAS in that specific year. It includes households who remained in their existing accommodation and those for whom the LA had to source new properties.*
- 3. HAP - New Households Supported refers to the number of qualified households with an established housing need who are being accommodated under the HAP scheme for that year.*

²⁷ Department of Housing, Planning and Local Government, ‘Details of social housing delivery on a local authority basis for 2019’. Online: <https://rebuildingireland.ie/news/details-of-social-housing-delivery-on-a-local-authority-basis-for-2019/>

6 Policy Objectives to Deliver the Housing Strategy

This section builds on the analysis of housing requirements presented in the HNDA and Housing Strategy. It sets out policy objectives below to guide and deliver new homes of appropriate type and tenure to meet Longford’s housing requirements over the plan period.

Table 6.1: Policy objectives for the Longford Housing Strategy 2021-2027

It is a policy of Longford County Council:	
HO1	To provide new homes to meet expected future housing requirements in the County as identified by the Housing Supply Target. A total of 2,568 new homes shall be provided over the plan period to meet requirements a result of forecast population growth. New homes shall be provided in a planned and coordinated manner in accordance with the aims and policies of the Core Strategy, the RSES, and the National Planning Framework.
HO2	To seek the provision of an appropriate mix of housing types and tenures to ensure homes for communities in towns, villages and rural areas and to meet the needs of people of all incomes and needs.
HO3	To provide for new housing in existing settlements to ensure that settlements grow in a manner that is sustainable, includes provision of sufficient social and economic infrastructure, and to a scale which aligns with the Settlement Hierarchy set out in the Core Strategy.
HO4	To provide new housing in rural areas including one-off homes in accordance with the Development Plan where it meets the social and economic needs of these areas, tackles isolation, and promotes social inclusion.
HO5	To provide housing appropriate to the needs of the elderly (in accordance with the Longford Age Friendly Strategy 2015-2020 and any subsequent strategies), persons with disabilities, lone parents, Travellers, and the homeless. The Council shall support and promote the use of Universal Design principles and life-long adaptability in new housing developments to meet the needs of diverse groups and an aging population.
HO6	To seek high quality of design in all housing development having due regard to Government policy relating to sustainable development, which aims to reduce the demand for travel within existing settlements, and the need to respect and reflect the established character of rural areas.
HO7	To provide social and affordable housing to meet forecast future housing need over the plan period as identified in the HNDA. The Council will endeavour to deliver a further 252 social and affordable housing units over the plan period to meet this forecasted need as resources allow. New units shall be delivered having regard to the aims and policies of the Core Strategy and the needs of

It is a policy of Longford County Council:	
	local communities, including the need to deliver sustainable development, social integration and an appropriate mix of housing types and tenures.
HO8	To make use of a range of delivery mechanisms to provide new social and affordable homes including new builds, acquisitions, renovations and acquisitions of vacant homes, leasing, and housing supports including RAS and HAP.
HO9	To require that 10% of lands zoned for residential use, or for a mixture of residential and other uses, be reserved for social and affordable housing in accordance with the Urban Regeneration and Housing Act 2015, the Planning and Development Act 2000 (as amended) and any future revised Guidance.
HO10	To tackle vacancy and to secure new homes, tackle dereliction and deliver regeneration by bringing vacant sites back into use. This shall be pursued through the application of the vacant site levy in accordance with the Urban Regeneration and Housing Act 2015. The Council shall also endeavour to bring about the timely re-use of vacant Council-owned housing stock.
HO11	To promote the regeneration of town centres through the retention of town centre residential units and through encouraging the reuse of upper floors above commercial premises for residential accommodation.
HO12	To provide appropriate accommodation to meet the needs of the Travelling Community and to secure the implementation of the Longford County Council Traveller Accommodation Programme 2019-2024.
HO13	To support the on-going monitoring and review of the HNDA in accordance with the forthcoming guidance on HNDA methodology to be issued by the Department of Housing, Local Government and Heritage.

Annex 5:

Infrastructure Assessment Report

INFRASTRUCTURE ASSESSMENT REPORT

This copy of the IAR includes the adopted changes and amendments agreed in the Chief Executive's Report on the Proposed Material Amendments to the Longford County Development Plan (adopted 19th October 2021).

Contents Page:

Table of Contents

1. INTRODUCTION.....	3
2. PLANNING POLICY CONTEXT.....	5
3. SETTLEMENT HIERARCHY – ASSET-BASED CRITERIA.....	7
4. METHODOLOGY OF CRITERIA AND ASSESSMENT.....	9
APPENDIX A - INITIAL SIEVE MAPPING EXERCISE.....	13
APPENDIX B – FURTHER ITERATIVE MAPPING.....	23
APPENDIX C: ROADS DEPARTMENT INFRASTRUCTURAL EVALUATION.....	39
APPENDIX D: WATER SERVICES INFRASTRUCTURAL SETTLEMENT ASSESSMENT.....	43
APPENDIX E – SETTLEMENT ASSESSMENTS & MAPPING.....	72
APPENDIX F – SETTLEMENT ZONINGS (RESIDENTIAL & EMPLOYMENT LANDS).....	88
Appendix – F1 Key Town Longford Town:.....	89
Appendix – F2 Self-Sustaining Growth Towns Granard:.....	93
Appendix – F3 Self-Sustaining Towns Ballymahon.....	97
Appendix – F4 Self-Sustaining Towns Edgeworthstown.....	99
Appendix – F5 Self-Sustaining Towns Lanesborough.....	103
Appendix – F6 Towns & Villages Aughnaccliffe.....	105
Appendix – F7 Towns & Villages Ballinalee.....	107
Appendix – F8 Towns & Villages Drumlish.....	109
Appendix – F9 Towns & Villages Keenagh.....	113
Appendix – F10 Towns & Villages Legan.....	115
Appendix – F11 Towns & Villages Newtownforbes.....	117
Appendix – F12 Smaller Villages & Settlements : Abbeyshrule, Ardagh, Ballinamuck & Clondra.....	119
APPENDIX G – REVISIONS TO THE ZONED SITES FOLLOWING THE ADOPTION OF THE CHIEF EXECUTIVE’S REPORT ON THE PROPOSED MATERIAL ALTERATIONS (RESIDENTIAL & EMPLOYMENT LANDS).....	126
Appendix G1 – Revised Further Iteration Plan showing the New Residential & Employment sites (Drumlish).....	132
Appendix G2 – Revised Roads Section Infrastructure Assessment for Drumlish.....	133
Appendix G3 – Revised Water Services Infrastructure Assessment of the sites in Drumlish.....	134
Appendix G4 - Revised Settlement Assessment and Mapping of the zoned lands in Drumlish.....	137

1. INTRODUCTION

This report has been developed in order to provide an assessment of available infrastructure to service the Settlements of County Longford and inform the County Development Plan and the land zoning assessment of the hierarchy of settlements in the Plan

The National Planning Framework (NPF) emphasises the requirement for better linkage between the zoning of land for development and the availability of or investment in infrastructure that is required to facilitate development. The following three National Policy Objectives (NPOs) are relevant:

NPO 72a: Planning authorities will be required to apply a standardised, tiered approach to differentiate between (i) zoned land that is serviced and (ii) zoned land that is serviceable within the life of the plan.

NPO 72b: When considering zoning land for development purposes that require investment in service infrastructure, planning authorities will make a reasonable estimate of the full cost of delivery of the specified services and prepare a report, detailing the estimated cost at draft and final plan stages.

NPO 72c: When considering zoning land for development purposes that cannot be serviced within the life of the relevant plan, such lands should not be zoned for development.

The NPF further states that an Infrastructural Assessment must be aligned with the approved infrastructural investment programme(s) of the relevant delivery agency(ies), or be based on a written commitment by the relevant delivery agency to provide the identified infrastructure within a specified timescale (i.e. within the lifetime of the plan). The Planning Authority may also commit to the delivery of the required and identified infrastructure in its own infrastructural investment programme (i.e. Budgeted Capital Programme) in order to support certain lands for zoning. The Infrastructural Assessment must include a reasonable estimate of the full cost of delivery of the required infrastructure to the identified zoned lands.

Further guidance will be provided by the Department Housing, Planning and Local Government in respect of Infrastructural Assessments in updated Statutory Guidelines that will be issued under Section 28 of the Planning & Development Act 2000 (as amended).

The purpose of this report is therefore to:

- Identify potential sites for residential and employment zoning within the main settlement hierarchy of County Longford.
- Examine the suitability of a site for future development based on NPF objectives, the RSES and the Draft Longford County Development Plan 2021-2027 etc.
- Assess the infrastructure requirements to service each site.

- Assess and weight the planning and serviceability/infrastructural provision for each site to enable a Tier to be assigned, as may be applicable.
- Where sites are identified as Tier 1 or Tier 2 lands, the assessment should clearly identify the likely development services required to support new development and where possible provide an indicative timeframe for delivery i.e. short to medium term or longer term.

It noted from the outset, in terms of reasonable estimate of costs, that Irish Water, has indicated that it does not have resources or capacity to carry out such an exercise and therefore no costings have been provided in terms of water services.

It should be noted that this report forms a working draft of the overall Infrastructure Assessment Report and forms a 'live' document during the development plan process, owing to recommended amendments to land use zonings arising from the public consultation process of the plan, as well as recommendations from prescribed bodies such as the office of the Planning Regulator (OPR), the Eastern and Midland Regional Assembly (EMRA) and the Office of Public Works, among others. Moreover, the Water Services Section and Environment Section of Longford County Council are currently undertaking an assessment of estimated costs for future infrastructure provisions with the aim of providing this estimated costing with the finalised Infrastructure Assessment Report to be inserted into the amended Draft Plan.

The report has been updated and revised following a submission on the Draft Plan by the Office of the Planning Regulator (OPR). The format and structure of the report has changed with the report including mapping showing the combined assessment of the residential and employment lands and presented as T1, T2 and un-serviced lands.

2. PLANNING POLICY CONTEXT

There have been a number of significant developments which will influence future land use zoning in County Development Plans and Local Area Plans. In particular, the National Planning Framework (NPF) sets out a tiered approach for zoning lands as discussed in Section 1 of this report. The following National Policy Objectives are relevant:

- National Policy Objective 72a: *‘Planning authorities will be required to apply a standardised, tiered approach to differentiate between i) zoned land that is serviced and ii) zoned land that is serviceable within the life of the plan’.*
- National Policy Objective 72b: *‘When considering zoning lands for development purposes that require investment in service infrastructure, planning authorities will make a reasonable estimate of the full cost of delivery of the specified services and prepare a report, detailing the estimated cost at draft and final plan stages’.*
- National Policy Objective 72c: *‘When considering zoning land for development purposes that cannot be serviced within the life of the relevant plan, such lands should not be zoned for development’.*

The NPF places an emphasis on the need for compact, smart and sustainable growth and requires 30% of all new housing to be within existing urban footprints (outside of the five cities), thus reducing the amount of greenfield land required to meet future housing requirements.

Moreover, the NPF specifically discusses the prioritising of development lands and states that there are *“many other planning considerations relevant to land zoning beyond the provision of basic enabling infrastructure including overall planned levels of growth, location, suitability for the type of development envisaged, availability of and proximity to amenities, schools, shops or employment, accessibility to transport services etc. Weighing up all of these factors, together with the availability of infrastructure, will assist planning authorities in determining an order of priority to deliver planned growth and development”* (emphasis added).

The NPF further notes that Guidance will be issued under Section 28 of the Planning and Development Act 2000 (as amended) in relation to infrastructural assessments.

Appendix 3 of the NPF provides a methodology for a tiered approach to land zoning as referred to in NPO 72a. The implementation of this tiered approach allows for greater co-ordination between land use zoning and infrastructure availability. Appendix 3 of the NPF provides a description of Tier 1 (Serviced Zoned Land) and Tier 2 (Serviceable Zoned Land) as follows:

Tier 1: Serviced Zoned Land

Land that is able to connect to existing development services i.e. road and footpath access, public lighting, foul sewer drainage, surface water drainage and water supply, for which there is service capacity available.

Tier 2: Serviceable Zoned Land

Land that is not currently sufficiently serviced to support new development but has the potential to become fully serviced within the life of the Plan. The potential for the delivery of the required services and / or capacity to support new development must be identified.

It is therefore appropriate that sustainable planning criteria are used to inform the assessment of each site, in addition to infrastructural criteria, in line with the NPF's requirement of the prioritisation of development land.

In this regard, lands have only been identified for development where they are able to connect to existing development services for which there is service capacity available or has the potential to become fully serviced within the life of the Plan.

3. SETTLEMENT HIERARCHY – ASSET-BASED CRITERIA

Settlement		Population 2016	NEW growth allocation 2016-27	NEW Population Growth to 2027	Remaining Wastewater Capacity (P.E.)	Water capacity (IW submission)	WWTP Future Investment	Connectivity – Transport Infrastructure
Key Town (Density 35-40 units/ha)	Longford Town	10,008	25%	2502	2392	Some headroom available		Very good – Train station, bus services, national road network with good inter-regional links
Self-Sustaining Growth Town (25 units/ha)	Granard	1,096	25%	274	208	Some headroom available		Local bus services, Bus stops x2 with national road network links
Self-Sustaining Towns (25 units/ha)	Ballymahon	1,877	15%	282	-316	-	IW indicate WWTP upgrade planned post-2024	Local bus services, national road network and good regional links to Athlone and Mullingar
	Edgeworthstown	2,072	15%	311	-447	Some headroom available	IW indicate WWTP upgrade planned post-2024	Very good- train station, bus services, national road network, good inter-regional links
	Lanesborough	757	20%	151	-94	Some headroom available		Local bus services, national road network with good links to Longford, Ballymahon and Roscommon
Towns and Villages (20 units/ha)	Aughnaccliffe	177	18%	32	62	Some headroom available		Bus stop x1
	Ballinalee	347	18%	62	350	Some headroom available		Limited – no public transport provision
	Drumlish	931	15%	140	-2	Some headroom available	IW indicate capacity of 150	Bus stop x1
	Keenagh	581	18%	105	436	Some headroom available		Bus stop x1
	Legan	215	16%	34	758	Some headroom available		Limited – no public transport provision
	Newtownforbes	778	18%	140	690	Some headroom available		Bus stop x1
Serviced Rural Villages (15 units/ha)	Abbeysrhole	224	15%	34	183	Some headroom available		Limited – no public transport provision
	Ardagh	210	15%	32	254	Some headroom available		Limited – no public transport provision
	Ballinamuck	232	15%	35	337	Some headroom available		Bus stop x1
	Clondra	449	15%	67	335	Some headroom available		Limited – no public transport provision
Rural Settlement Clusters								
Open Countryside		20,919	3.5%	727				
Total		40,873		4,927				

The table above distils the proposed growth strategy for the county in terms of settlement hierarchy, projected population and housing growth and allocation per settlements and settlement tier, as well identifying some of the critical infrastructural features pertaining to these settlements. Further details on specific infrastructural deficits and requirements for relevant settlements over the plan period will be furnished in the finalised draft Infrastructural Assessment Report, pending final agreement with internal departments and costing/budget requirements.

4. METHODOLOGY OF CRITERIA AND ASSESSMENT

In the absence of Departmental guidance, which is expected to issue under Section 28 of the Planning and Development Act 2000 (as amended) as referred to in the NPF, this Infrastructural Assessment has been developed in accordance with Appendix 3 of the NPF.

The Planning Department undertook a review of the available land supply within the defined study areas of the main settlements of Longford as defined in the Core Strategy. This included the following settlements as defined in the Settlement Hierarchy:

Key Town	Longford Town	
Self-Sustaining Growth Towns	Granard	
Self-Sustaining Towns	Ballymahon Edgeworthstown Lanesborough	
Towns & Villages	Aughnacliffe Ballinalee Drumlish	Keenagh Legan Newtownforbes
Villages & Smaller settlements	Abbeysrule Ardagh	Ballinamuck Clondra

To inform the appropriate zoning of land, the Infrastructure Assessment comprises of quantitative and qualitative research analysis.

The qualitative analysis consists of a template of criteria to gather pertinent information from the relevant departments within Longford County Council. This method is to be used to gain an understanding of underlying conditions and provide insights into infrastructural issues.

The quantitative assessment comprises of an interactive assessment of the subject lands (residential – employment), combining existing and proposed zoning, overlaid with infrastructural mapping depicting key infrastructure elements such as foul sewer, water main, pumping station, roadway, pathway etc. in order to appropriately determine and allocate lands as Tier 1 ('Connected'), or Tier 2 ('Potential Development') and areas of 'No Development'.

This Infrastructural Assessment was conducted on an iterative basis, liaising with the Water Services and Roads Departments of the Council, with additional input from Irish Water in identifying potential shortfall in water supply and wastewater treatment capacities and where targeted investment in upgrading of such infrastructure may likely take place over the plan period, notwithstanding Irish Water's own Strategic Funding Plan.

A critical feature of this process was the overarching requirement to provide for more 'compact growth' forms of future development within our settlements, regardless of scale, whereby a town centre first approach in terms of sequential development was advocated in identifying primary land for development.

The following documents have been included in the IAR which includes the following:

Appendix A: Shows the mapping work undertaken at the pre-draft stage of the Development Plan Review and indicates the assessments undertaken of each settlement and included a review of the indicative amount of serviced lands available. The maps for each settlement indicate the potential development capacities based on the following criteria using advice from Water Services and Irish Water:

- Opportunities for potential development
- Sites where no development is possible
- Connected sites

Appendix B: Shows the mapping work and the identification of potential sites following the initial work undertaken and presented in Appendix A. The maps show the identified potential Residential and Employment lands and includes the overlay of the constrained use layer (potential flooding). These maps were used to inform zoning selections and were then further used in the assessments by Water Services and Roads Section to score each site.

Appendix C: Shows the infrastructure assessment completed by the Roads Section and the scoring applied to each of the sites - New Residential and Employment Sites. The assessments include scores for roads as well as drainage.

Appendix D: Includes the Infrastructure Assessment scoring for the main settlements provided by the Water Services Department and includes water supply and wastewater treatment capacity. This section of the assessment has gone into further detail and assesses the costs of providing the required and identified infrastructure.

Appendix E: Brings the infrastructure assessment reports together and shows the combined scores for the assessments from Roads and Water Services for each settlement. Each settlement is mapped and the zoned lands categorised Tier 1 Serviced, Tier 2 Serviceable and Un-serviced.

Appendix F: Shows the land zonings for each of the settlements.

Appendix G: Shows the revisions to the zoned sites following the adoption of the Chief Executive's Report on the proposed material alterations (Residential and Employment Lands).

Whilst this approach is considered to be in accordance with the overarching principles espoused in the NPF, and particularly in accordance with NPO 3c, there are scenarios in some settlements where more peripheral lands are serviced and more centralised lands are not. Whilst these incidences are infrequent, it remains prudent to develop out these serviced lands irrespective of their location given the levels of investment that have taken place in servicing such lands to begin with.

All selected sites within the settlements were identified and analysed against Infrastructure capacity in terms of:

- Water supply
- Wastewater capacity
- Drainage, extent of SuDS requirements and flood risk
- Roads and transportation
- Level of conformance to and ability to contribute to the achievement of Strategic Outcomes of the NPF (principally fulfilling compact growth); and
- Compliance with emerging/Draft Core Strategy with respect to settlement hierarchy and interrelated quantum of population and housing growth and resultant land requirements to accommodate projected growth.

The identified sites were afforded a planning and serviceability weighting (Score of 100 to 0) to assess the overall suitability for zoning within the Draft Longford County Development Plan 2021-2027. The weighting applied to the sites is represented by a traffic light system and ranges from:

Tier Determination Range			
High	Tier 1	100-67	Serviced
Medium	Tier 2	66-33	Serviceable
Low		32-0	No Development/Un-serviced and Unserviceable within Plan lifetime

In the case of lands identified as falling within the ‘high’ level of serviceability rating a green colour was applied which equates to Tier 1 lands in accordance with the NPF tiered approach to zoning. Such lands are serviced land, comprising of lands that are able to connect to existing development services for which there is service capacity available and therefore be able to accommodate new development. In such instances the site achieves sustainable planning criteria also.

Where lands were deemed to have a ‘medium’ level of serviceability rating an orange/light red colour was applied. These lands can be described as serviceable land, comprising lands that are not currently sufficiently serviced to support new development but have the potential to become fully serviced within the life of the Plan

or where there are planned infrastructure upgrades. In such instances the sites were considered to achieve a moderate status on sustainable planning criteria also.

In the event that lands demonstrated a 'low' level of serviceability they were excluded from consideration in forming the designation of zonings for the plan area. There are major infrastructural deficiencies and/or these sites achieved a poor status on sustainable planning criteria. These lands would be classed as 'No Development' and excluded from further assessment.

The findings of both the qualitative and quantitative assessments have informed an evidence-based assessment of each site. As a result of this assessment it is clear that, for a range of infrastructural reasons, some sites are better placed to deliver employment and residential use in the short to medium term (Tier 1 lands).

APPENDIX A - INITIAL SIEVE MAPPING EXERCISE

The maps presented in this section of the report are based on the previous County Development Plan 2015-2021 and show the land-use zonings and the areas identified for potential development.

These assessments of settlements in the County were undertaken with colleagues from Water Services and Irish Water and was undertaken in March 2020 and informed the drafting and development of the Draft County Development Plan 2021-2027 and the accompanying land-use zonings.

For each settlement the maps identify those areas:

- Potential development
- No development
- Sites that are connected

The mapping exercise was used to inform the identification of potential development sites for Residential and Employment uses within the settlements of the County.

Longford Town Initial Infrastructure Assessment

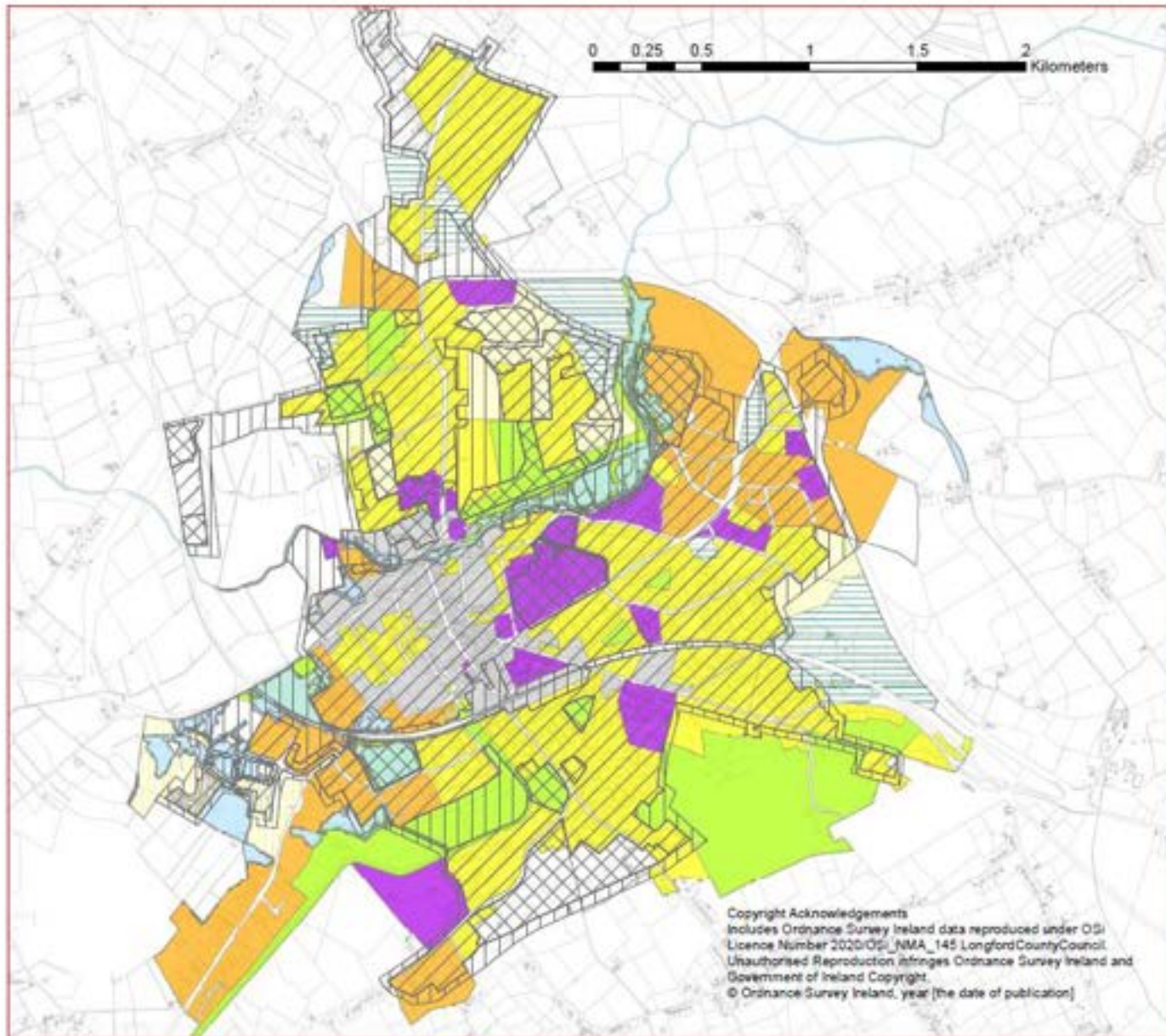

Granard
Initial Infrastructure Assessment

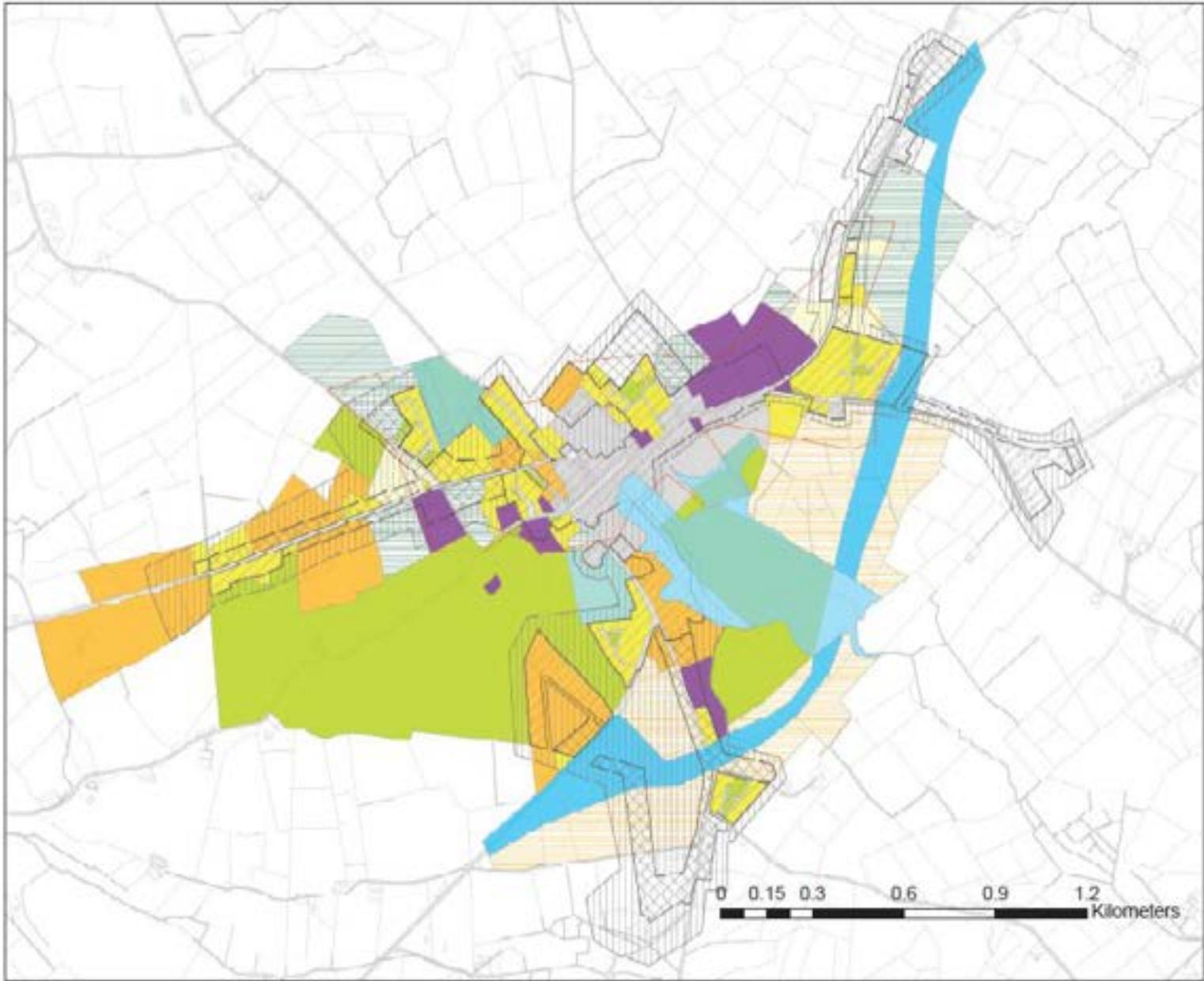

Legend

- Longford Settlement Flood Zone (2010)
- Conveyed
- Potential Development
- No Development
- County Longford (2010) Settlements

Granard

- All other values

Appendix B

- Industrial/Commercial/Warehousing
- New Residential
- Recreation/Amenity & Green Space
- Residential
- Social/Community/Education
- Strategic Industrial Reserve
- Strategic Residential Reserve
- Tourism
- Town Core
- Transport & Utility Objective



Ballymahon Initial Infrastructure Assessment

Legend

-  Potential Development
-  No Development
-  Connected
-  Longford Settlement Flood Zones 2004/10
-  County Longford CSO Settlements
- Ballymahon_polygon**
-  -all other values-
- Appendix B**
-  Industrial/Commercial/Warehousing
-  New Residential
-  Recreation/Amenity & Green Space
-  Residential
-  Residential/Community Services/Care
-  Site Remediation Objective
-  Social/Community/Public Utility
-  Strategic Residential Reserve
-  Train Corridor



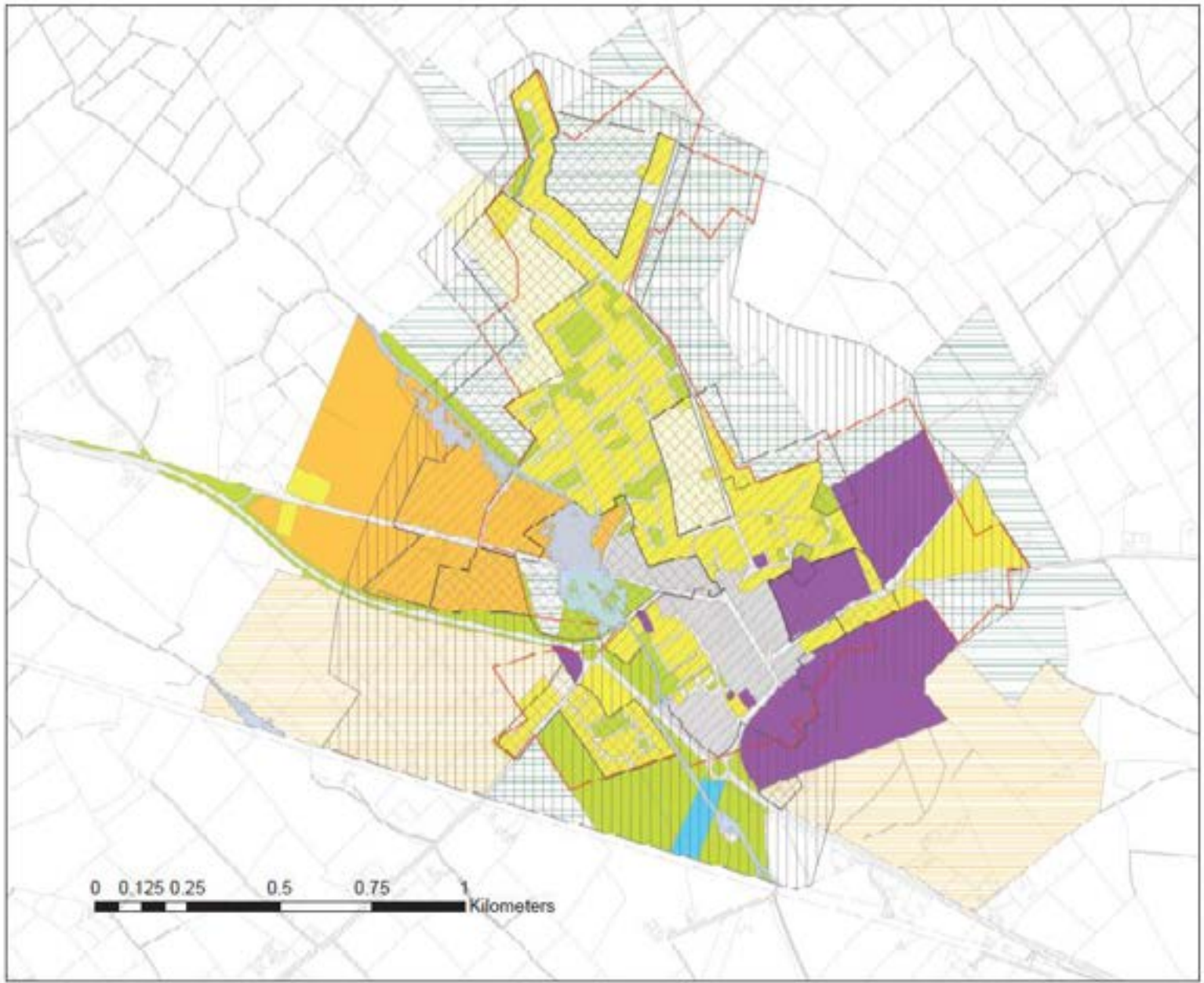

Edgeworthstown
Initial Infrastructure

Legend

- Longport Settlement (Post 2006, 2010)
- Potential Development
- No Development
- Conserved
- County Longport CDO Settlements
- Edgeworthstown polygon
- not other values

Appendix B

- Industrial/Commercial/Warehousing
- New Residential
- Recreation/Open Space & Green Space
- Residential
- Social/Community/Education
- Strategic Industrial Reserve
- Strategic Residential Reserve
- Town Core
- Transport & Utilities Infrastructure



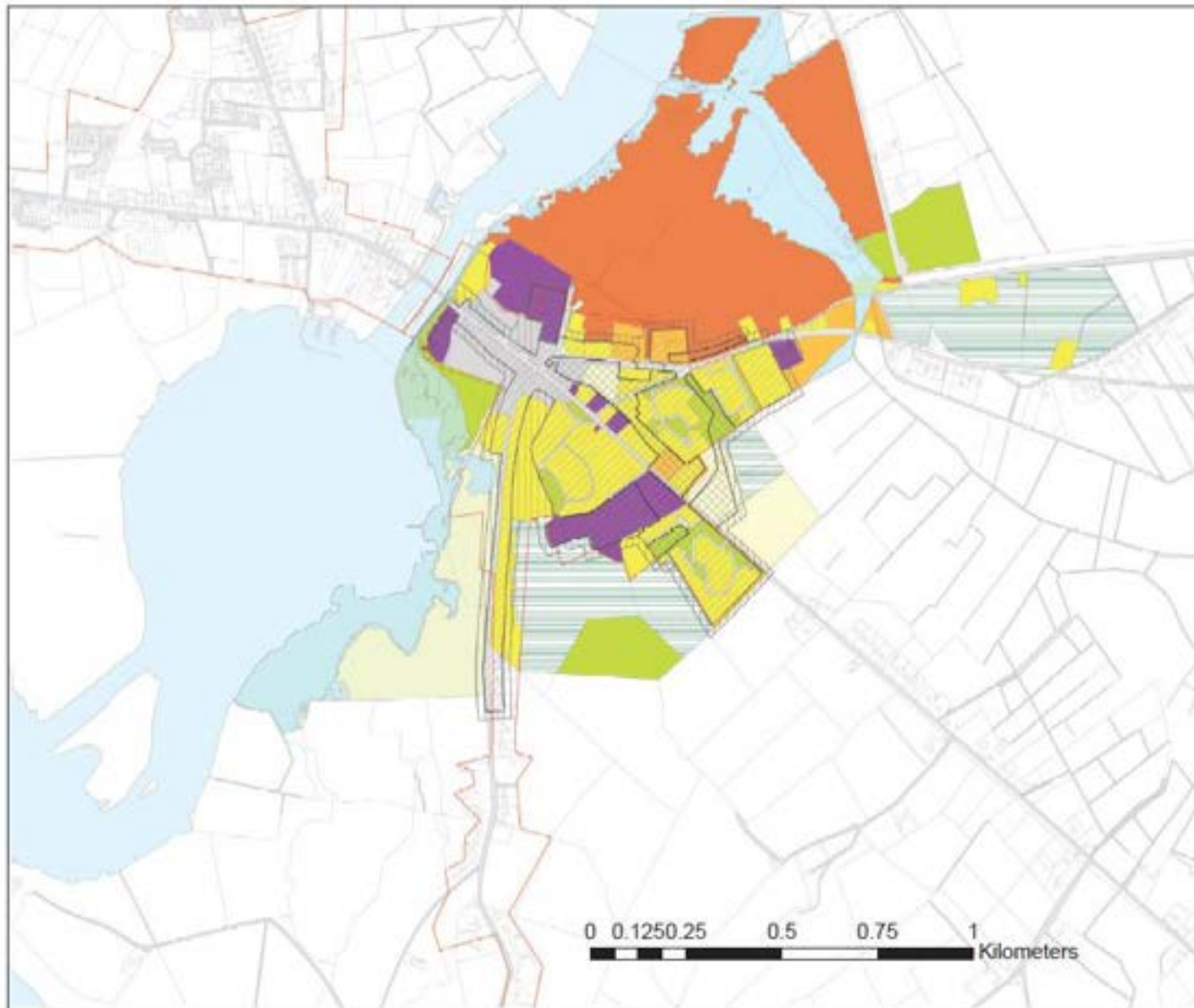

Lanesborough Initial Infrastructure



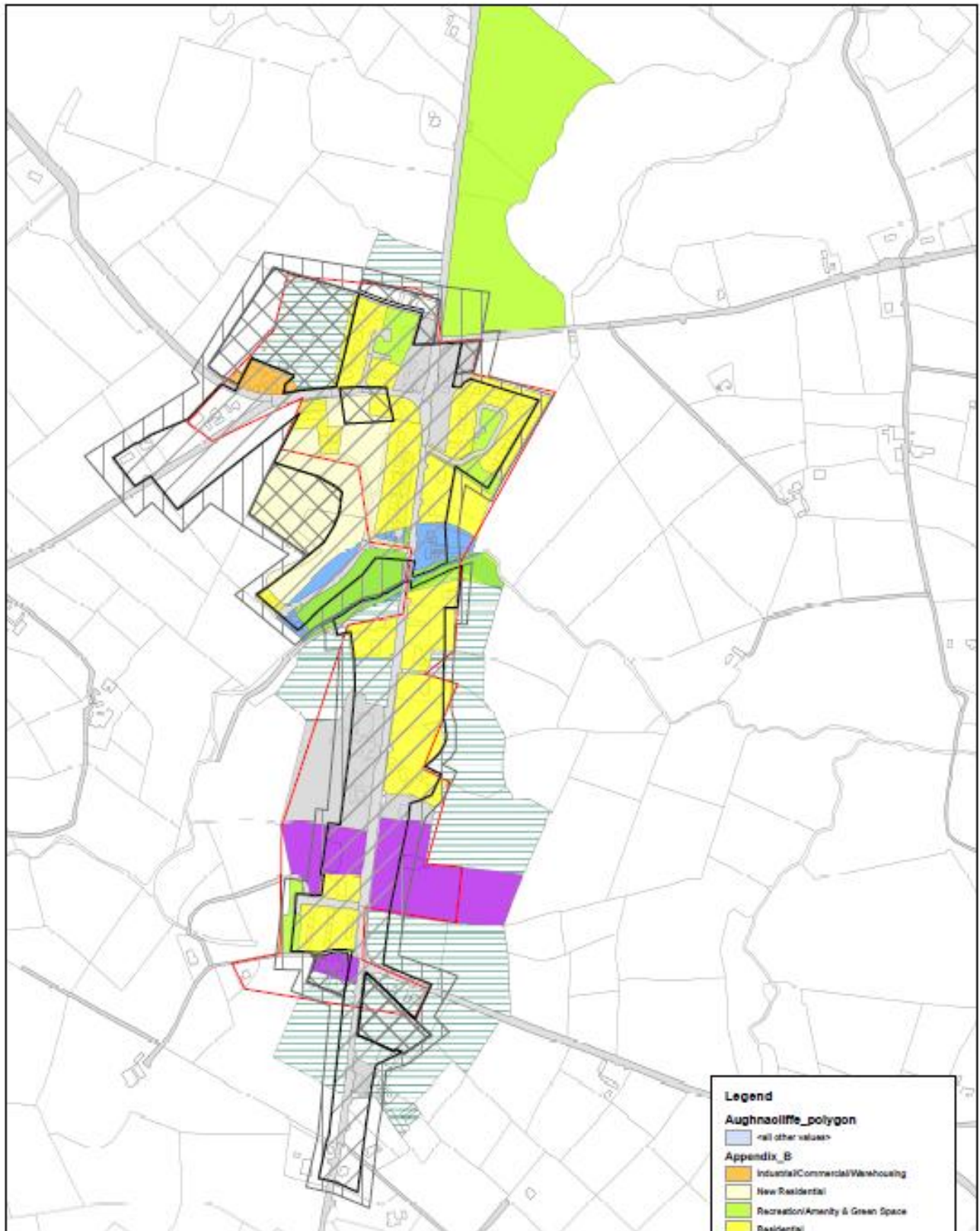

Aughnaclyffe
Initial Infrastructure Assessment



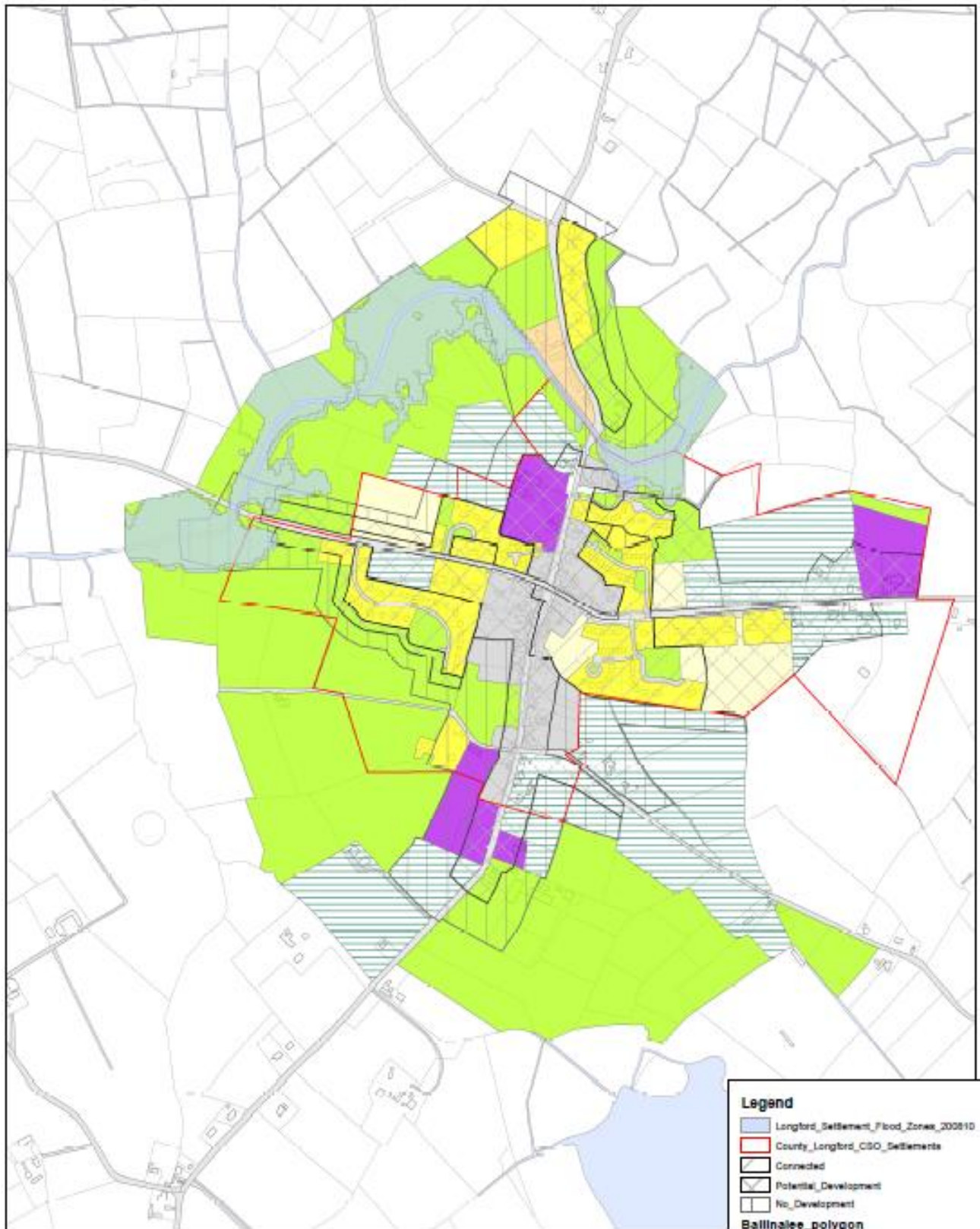

Ballinalee
Initial Infrastructure Assessment



Legend

- Longford Settlement Flood Zones_200810
- County Longford CSO Settlements
- Connected
- Potential Development
- No Development
- Ballinalee_polygon**
- all other urban
- Appendix_B**
- Light Industrial/Commercial/Service
- New Residential
- Recreation/Amenity & Green Space
- Residential
- Social/Community/Education
- Strategic Residential Reserve
- Town Core

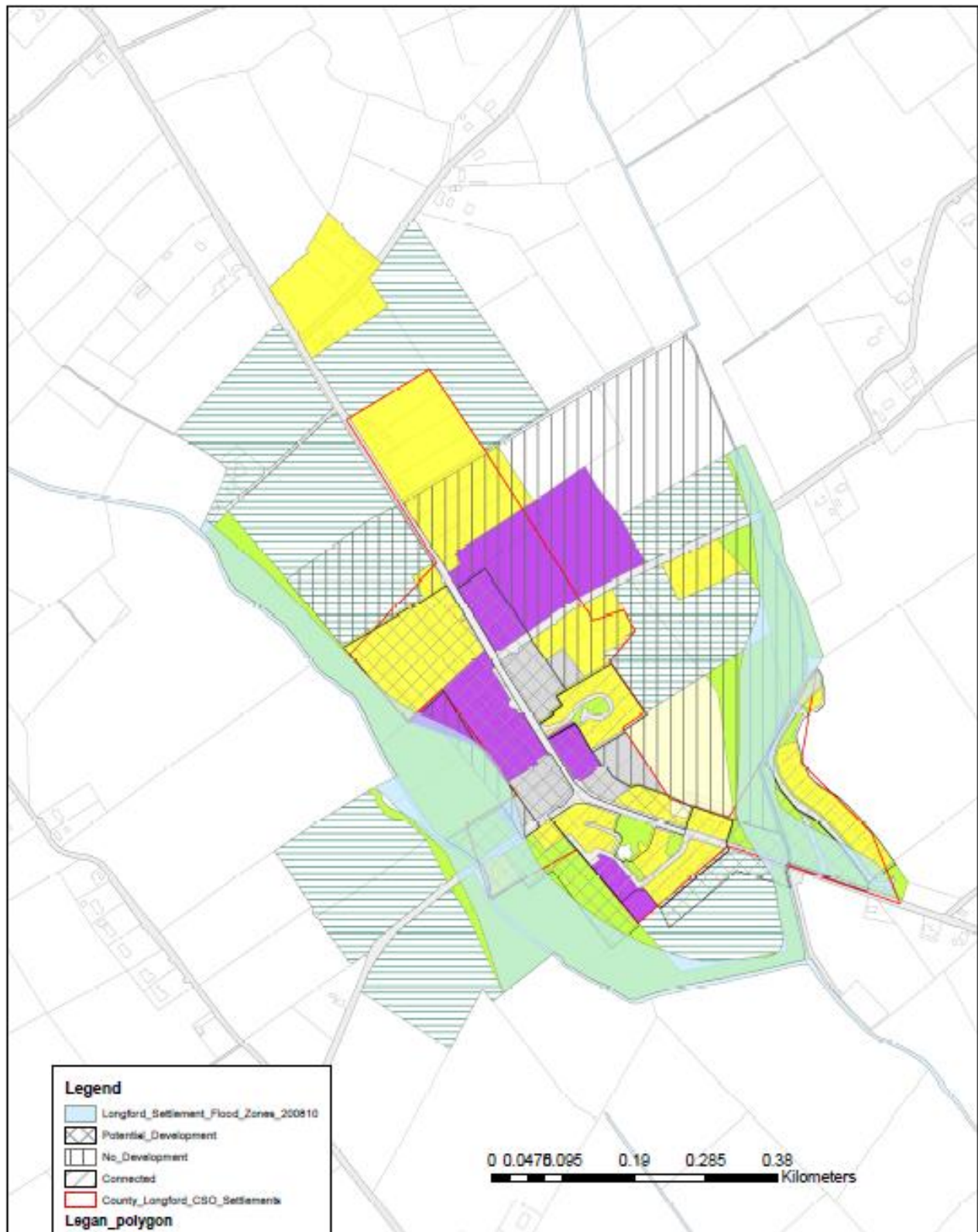

Legan
Initial Infrastructure Assessment



Newtownforbes Initial Infrastructure Assessment

Legend

-  Potential_Development
-  No_Development
-  Connected
-  <all other values>

Appendix_B

-  New Residential
-  Recreation/Amenity & Green Space
-  Residential
-  Social/Community
-  Social/Community/Education
-  Strategic Residential Reserve
-  Town Core
-  Tourism & Events

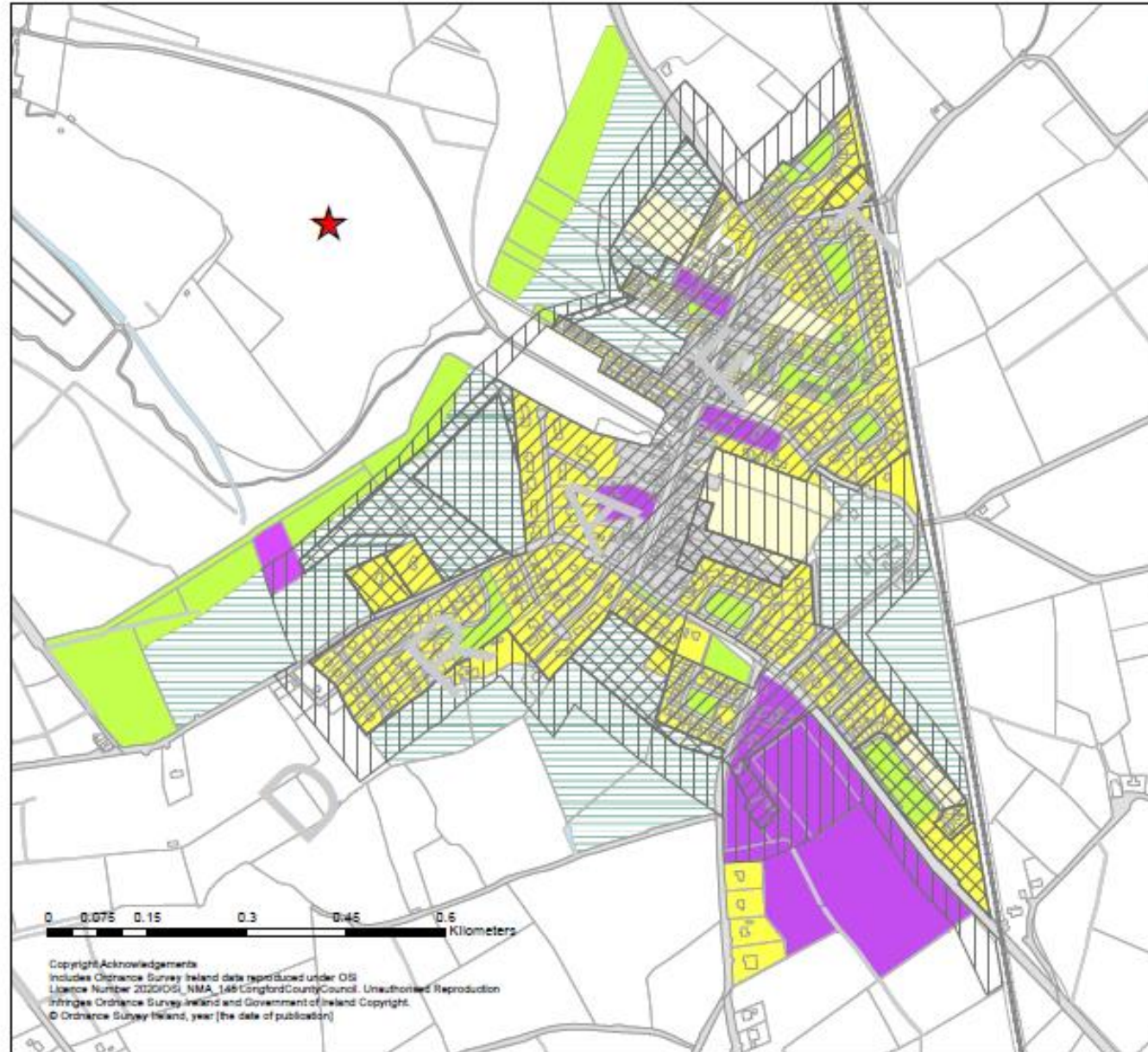

APPENDIX B – FURTHER ITERATIVE MAPPING

The following settlement maps show the proposed residential and employment lands proposed for inclusion in the Draft Plan and represent the zoned lands on which the Infrastructure Assessment is based.

The settlement plans show the residential and employment lands and are coded with a reference number – R1, R2 etc for residential sites; E1, E2 etc for employment sites.

The number and coding of the settlement areas is used in the infrastructure assessments provided by the Roads Section (refer to Appendix C) and Water Services (refer to Appendix D).

The maps in addition also have constrained use mapped which highlights the areas of the settlements at risk of flooding.

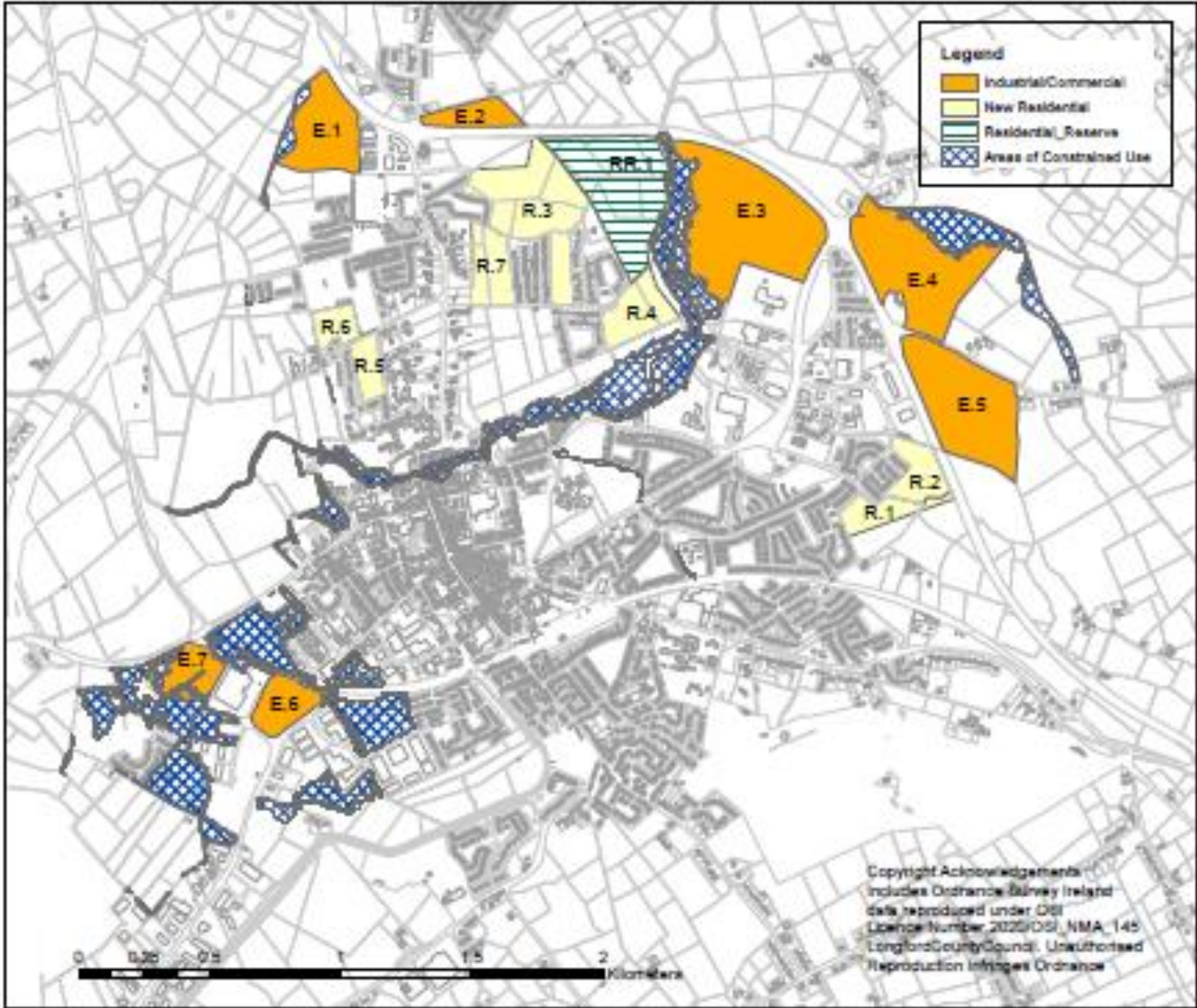

Longford Town
 Infrastructural Assessment-
 Further Iteration



Copyright Acknowledgements
 Includes Ordnance Survey Ireland data reproduced under OSI
 Licence Number 2020/OSI_NMA_145 Longford County Council. Unauthorised Reproduction
 infringes Ordnance Survey Ireland and Government of Ireland Copyright
 © Ordnance Survey Ireland, year 2021

Granard Infrastructural Assessment- Further Iteration

Legend

- Industrial/Commercial/Warehousing
- New Residential
- Strategic Industrial Reserve
- Areas of Constrained Use

Notes:

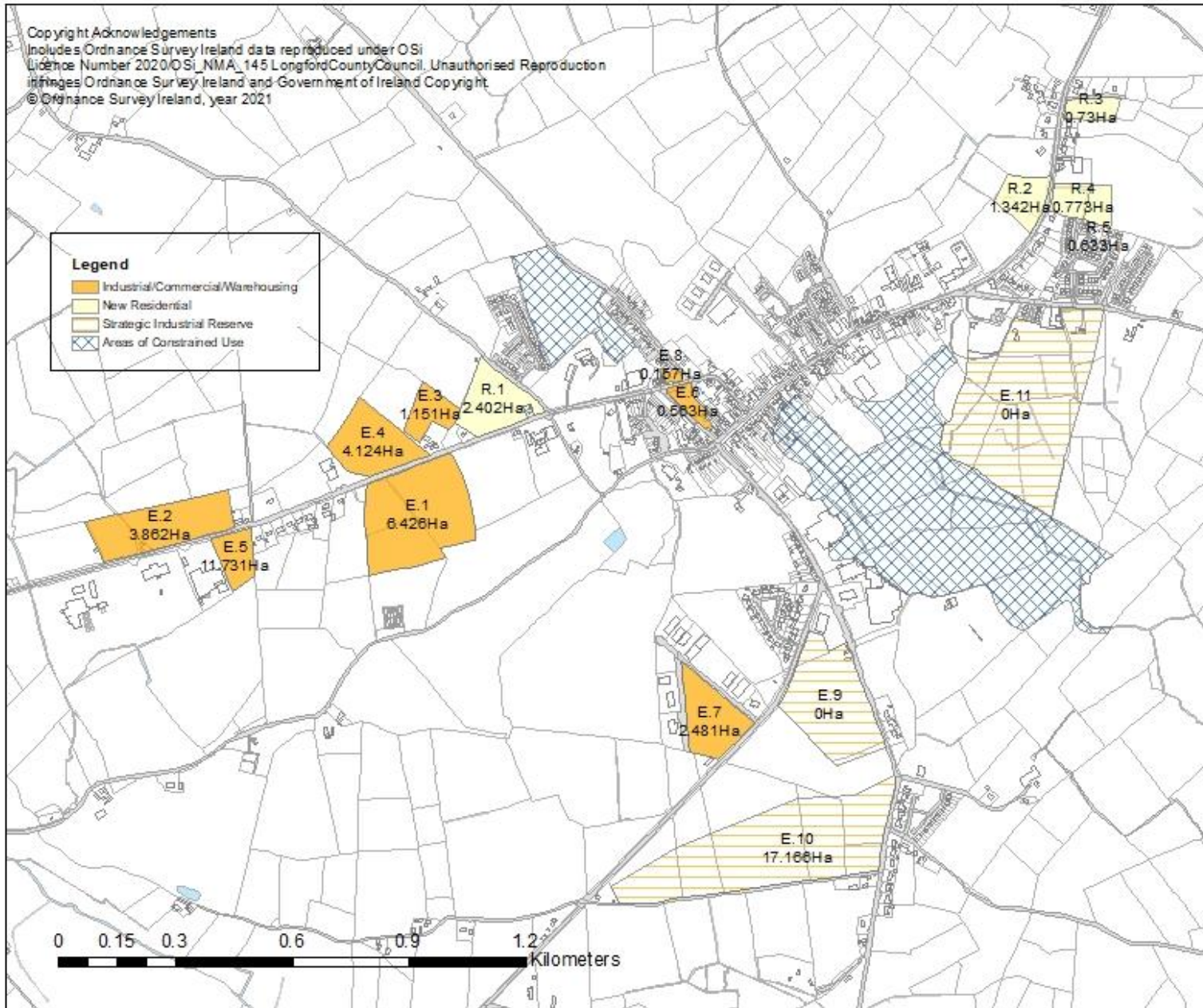

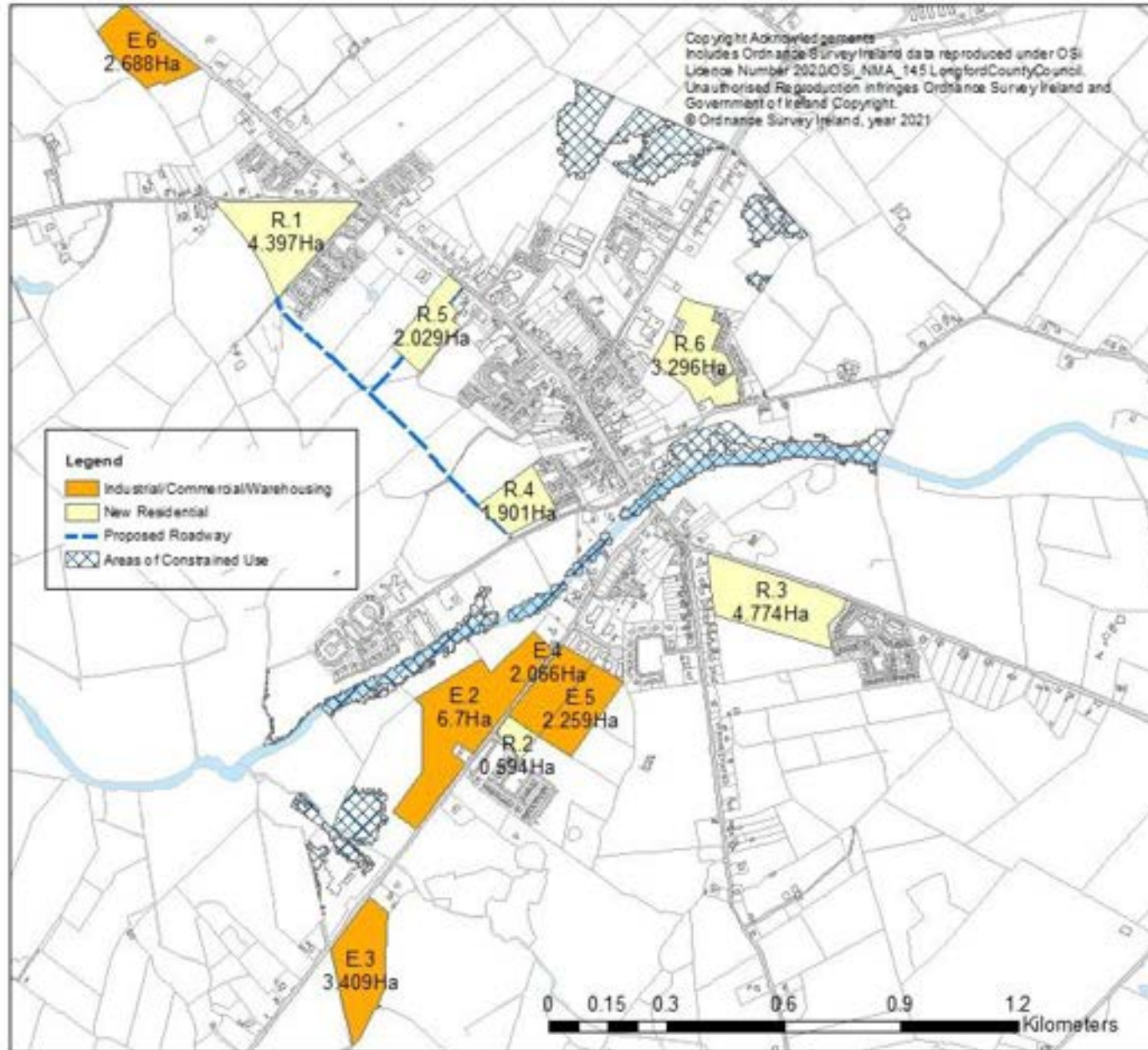

Ballymahon Infrastructural Assessment- Further Iteration

Notes:



Copyright Acknowledgements
 Includes Ordnance Survey Ireland data reproduced under
 OSI
 Licence Number 2020/OSI_NMA_145
 Longford County Council. Unauthorised Reproduction
 infringes Ordnance Survey Ireland and Government of
 Ireland Copyright.
 © Ordnance Survey Ireland, year 2021

Edgeworthstown Infrastructural Assessment- Further Iteration

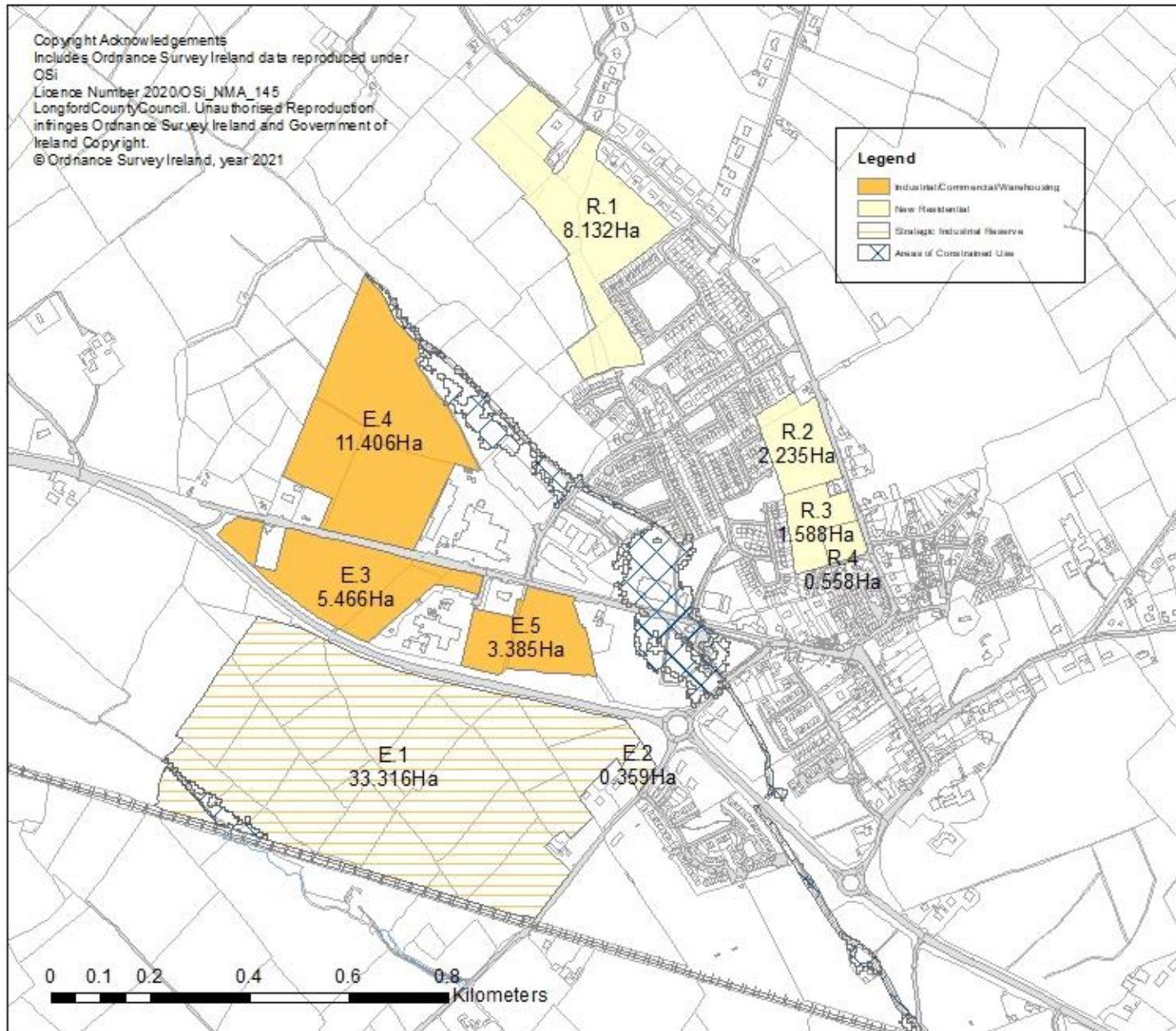

Legend

- Industrial/Commercial/Warehouse
- New Residential
- Strategic Industrial Reserve
- Areas of Constrained Use

Notes:



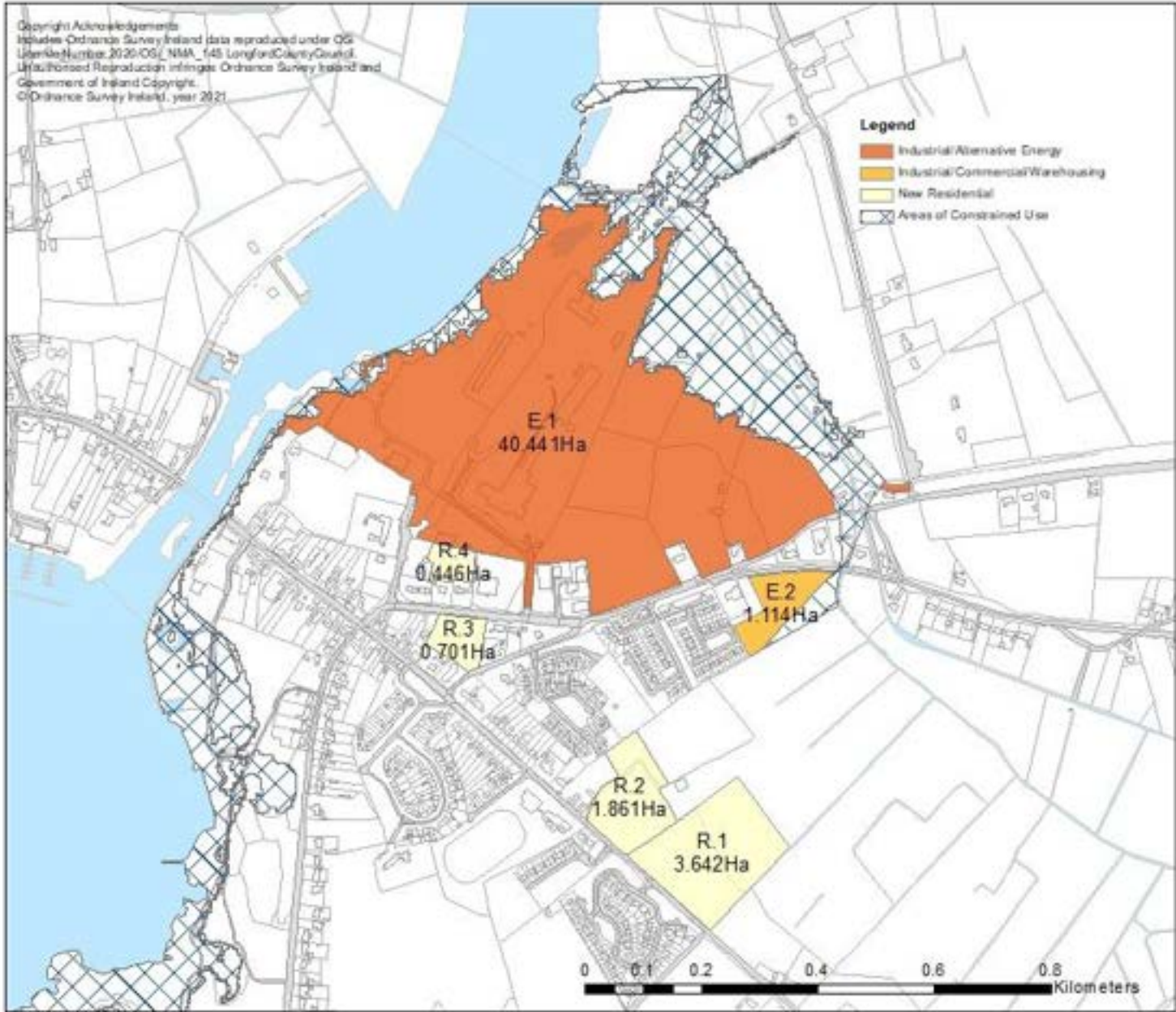

Lanesborough Infrastructural assessment- further iteration

Notes:



Copyright Acknowledgements
Includes Ordnance Survey Ireland data reproduced under OSI
Licence Number 2020/OSI_NMA_145 LongfordCountyCouncil
Unauthorized reproduction infringes Ordnance Survey Ireland and
Government of Ireland Copyright.
© Ordnance Survey Ireland, year 2021

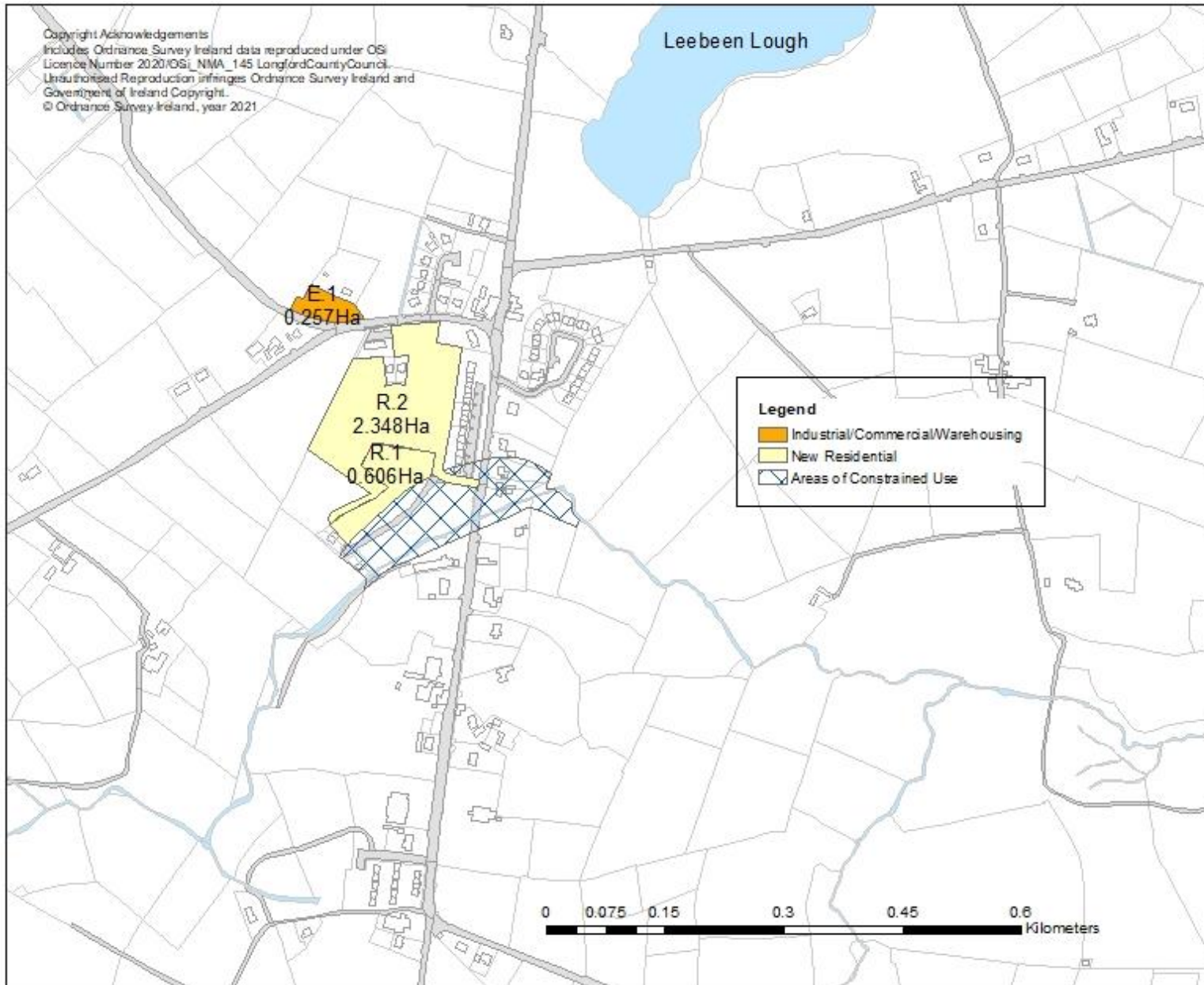

Aghnacliffe Infrastructural Assessment- Further Iteration

Notes:



Ballinalee
 Infrastructural assessment-
 Further Iteration

Copyright Acknowledgements:
 Includes Ordnance Survey Ireland data reproduced under OS
 Licence Number 2020-OS/NMA_145 LongfordCountyCouncil.
 Unauthorized reproduction infringes Ordnance Survey Ireland and
 Government of Ireland Copyright.
 © Ordnance Survey Ireland, year 2021

Notes:

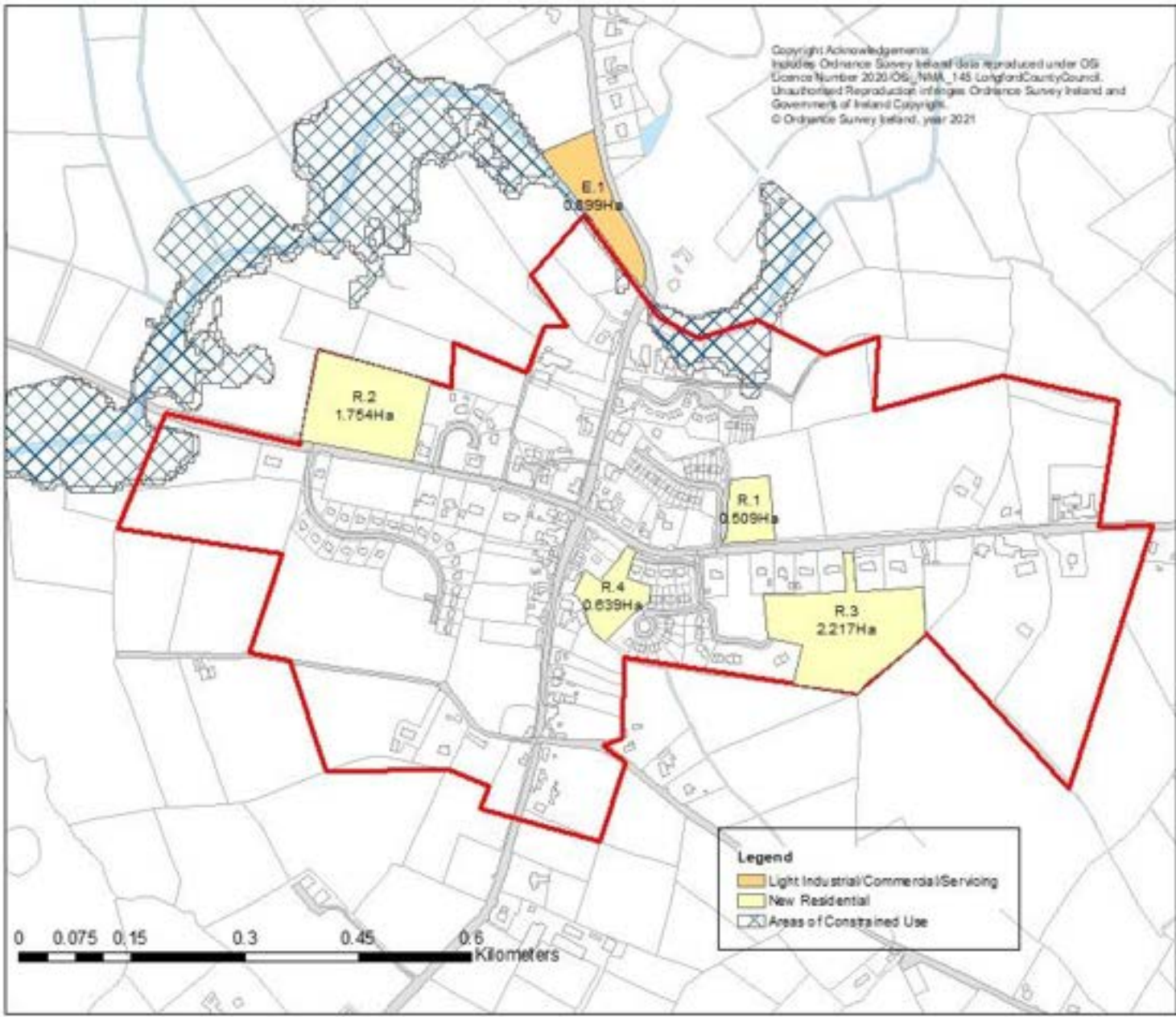

Copyright Acknowledgements
 Includes Ordnance Survey Ireland data reproduced under
 OSI
 Licence Number 2020/OSI_NMA_145
 Longford County Council. Unauthorised Reproduction
 infringes Ordnance Survey Ireland and Government of
 Ireland Copyright.
 © Ordnance Survey Ireland, year 2021

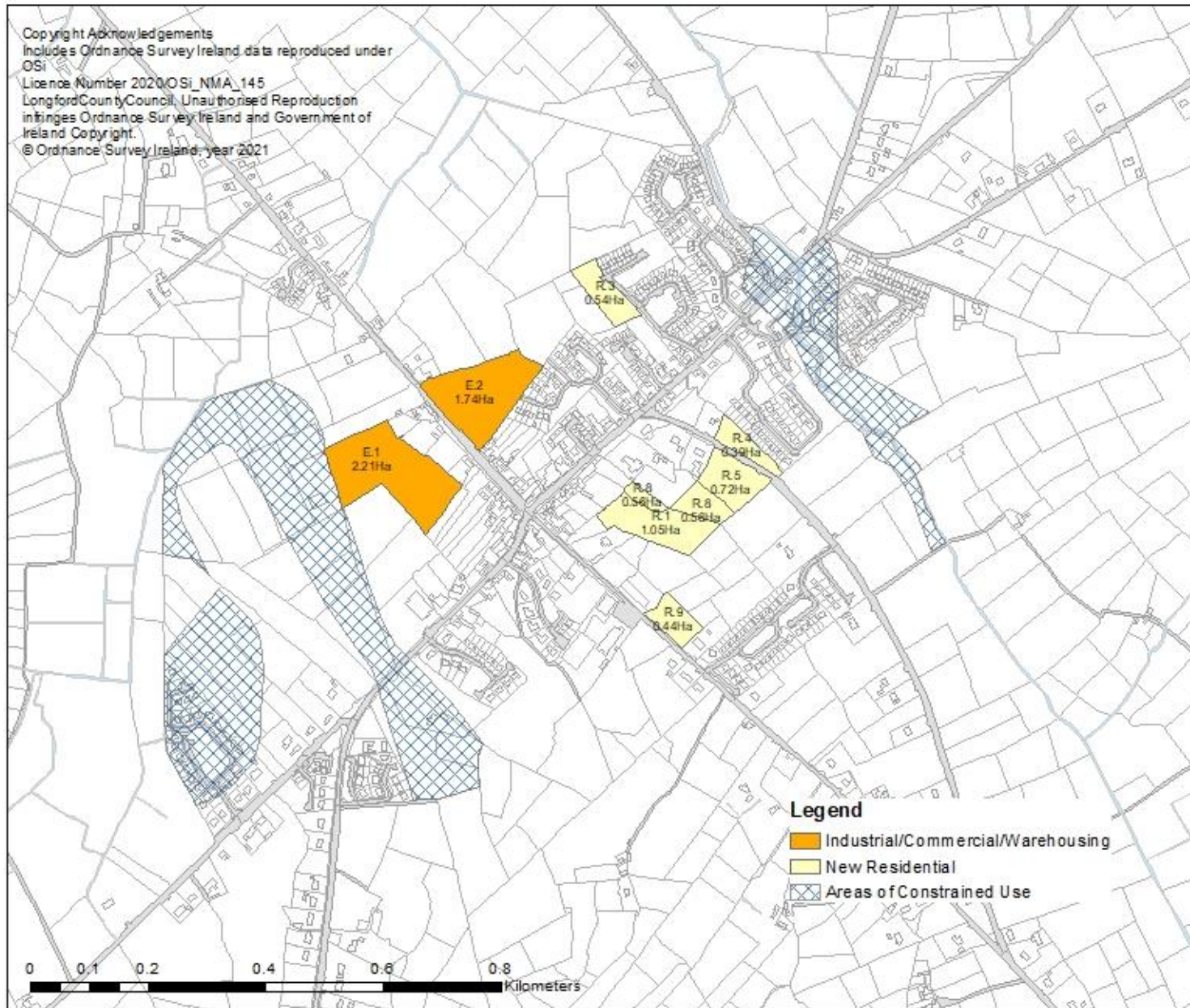

Drumlish Infrastructural assessment- Further Iteration

Notes:



Copyright Acknowledgements
Includes Ordnance Survey Ireland data reproduced under OSI
Licence Number 2020/05/NMA, 145 Longford County Council. Unauthorised reproduction
infringes Ordnance Survey Ireland and Government of Ireland Copyright.
© Ordnance Survey Ireland, year 2021

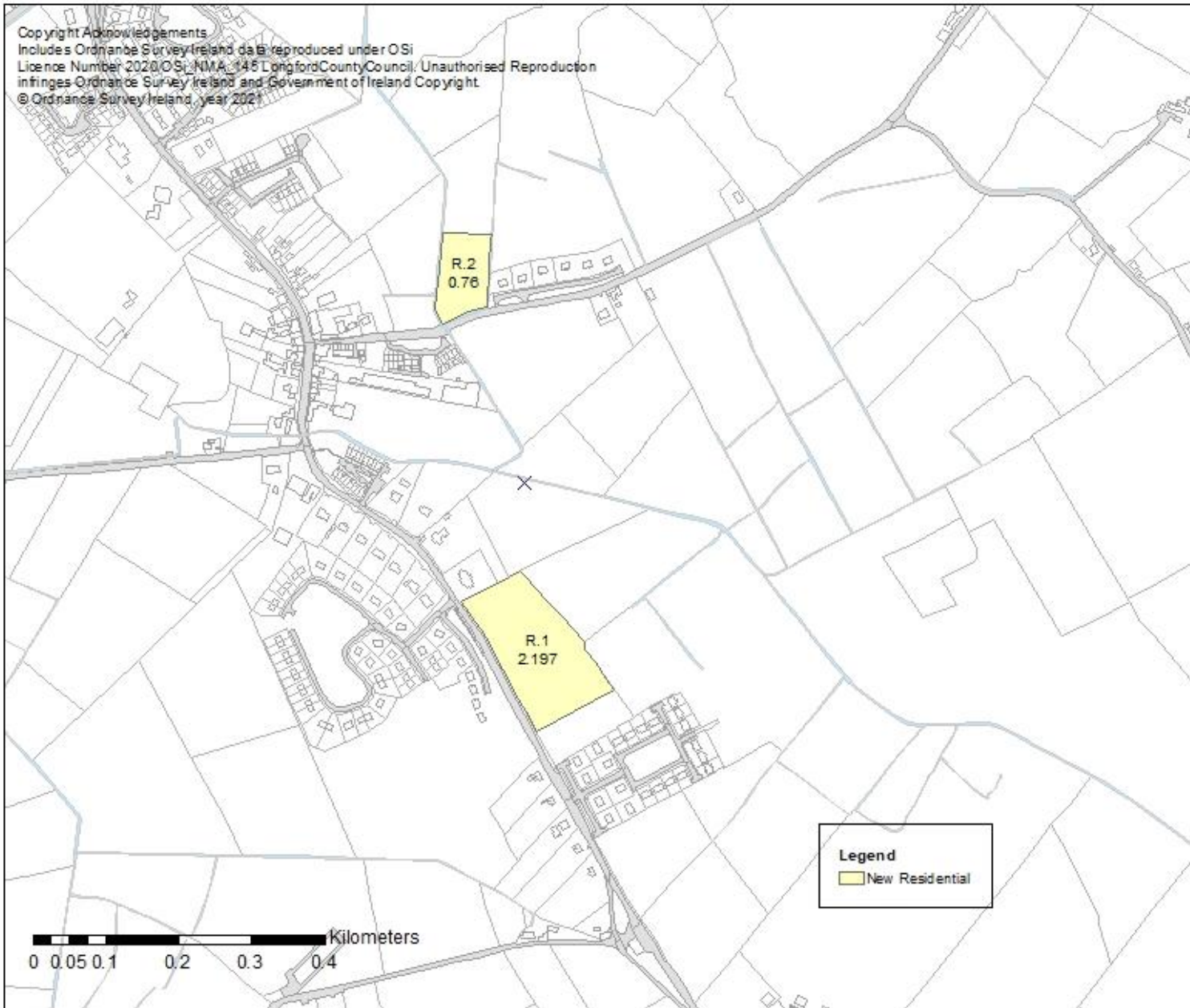

Keenagh Infrastructural Assessment- Further Iteration

Notes:



Copyright Acknowledgements
Includes Ordnance Survey Ireland data reproduced under OSI
Licence Number 2020/O SI_NMA_145 Longford County Council.
Unauthorised reproduction infringes Ordnance Survey Ireland and
Government of Ireland Copyright.
© Ordnance Survey Ireland, year 2021

Legan Infrastructural assessment- Further Iteration

Notes:

Legend

- New Residential
- Areas of Constrained Use

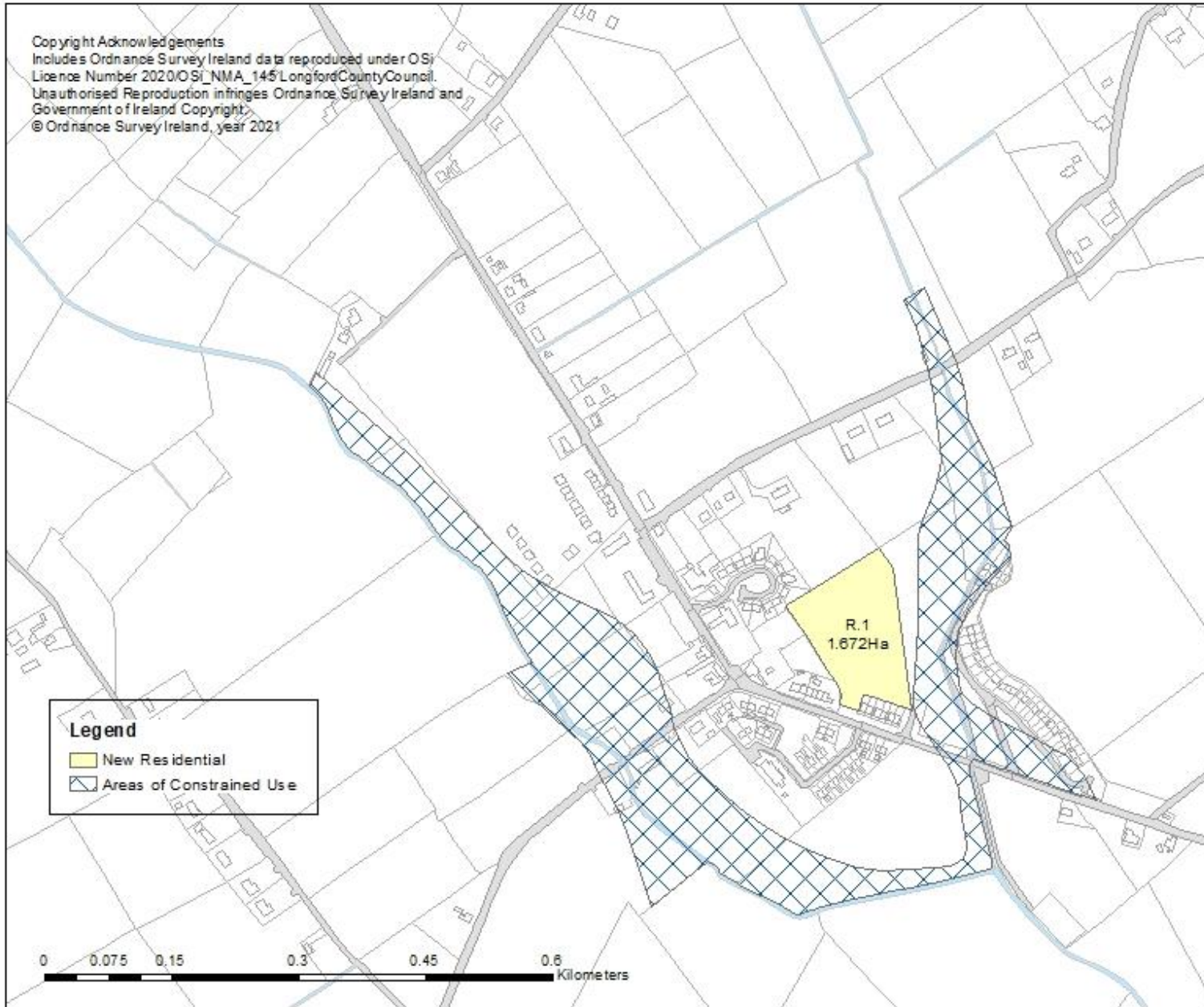

Newtownforbes
 Infrastructural Assessment-
 Further Iteration

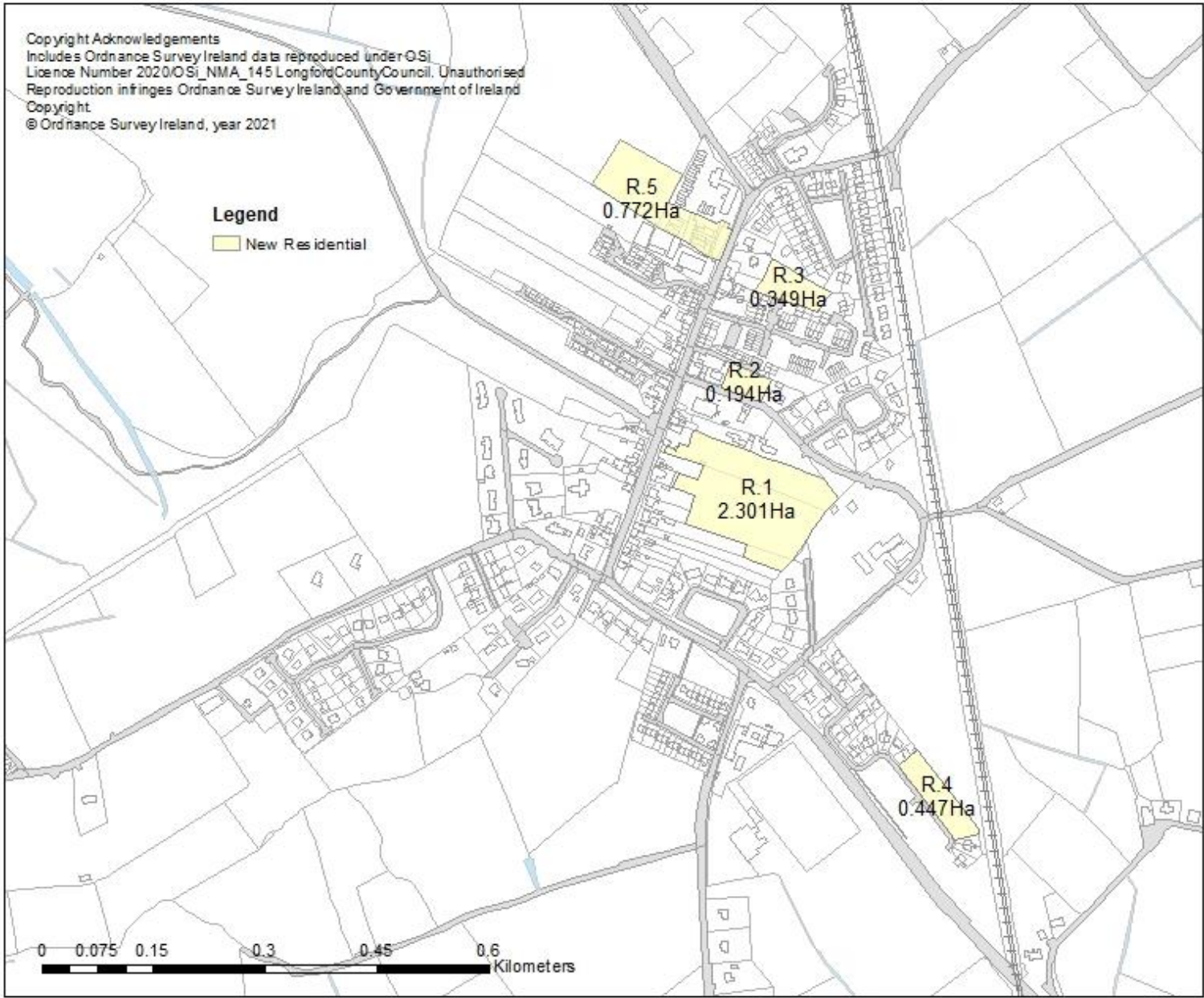

Notes:



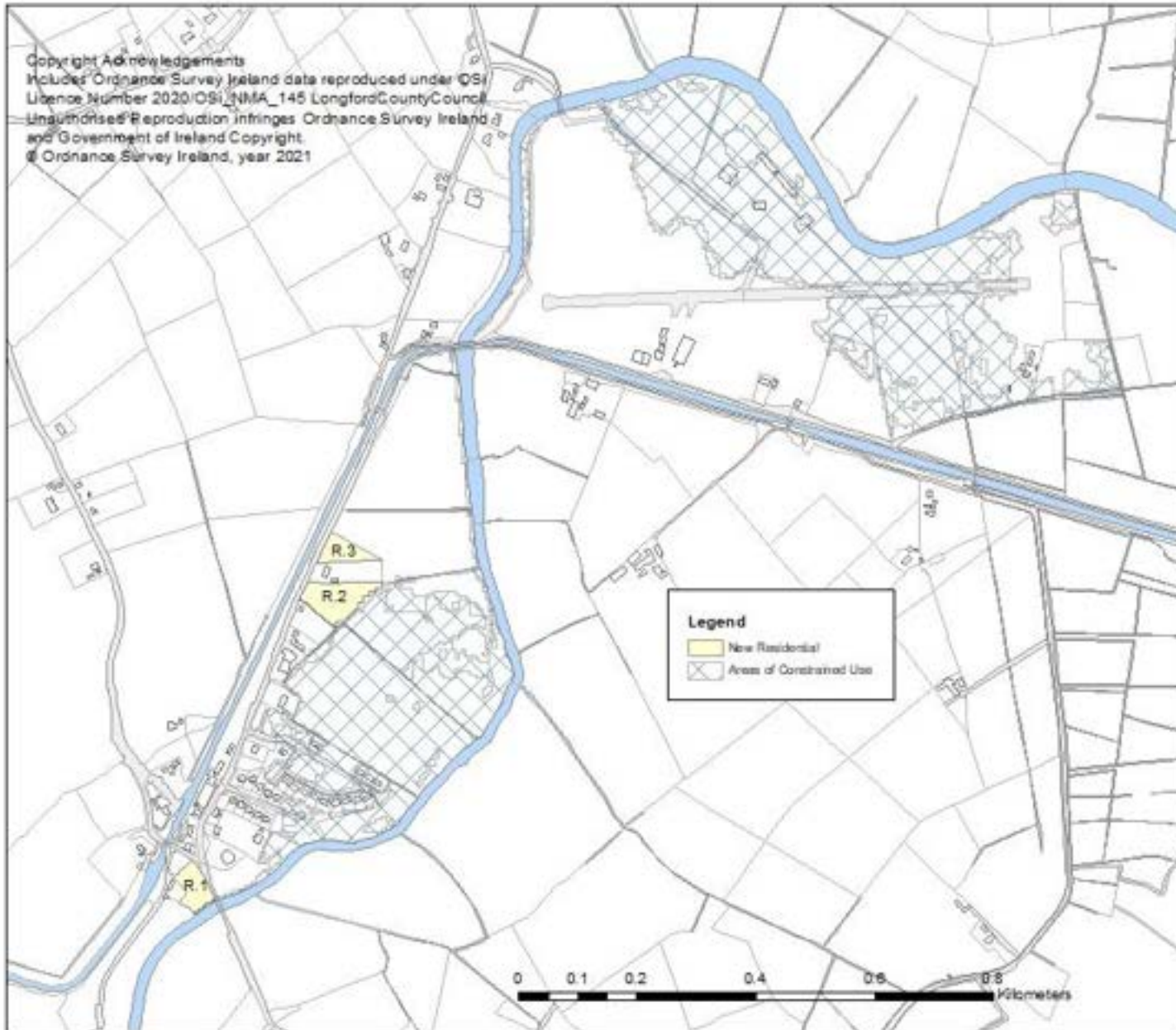

Abbeyshrule Infrastructural assessment- Further Iteration

Notes



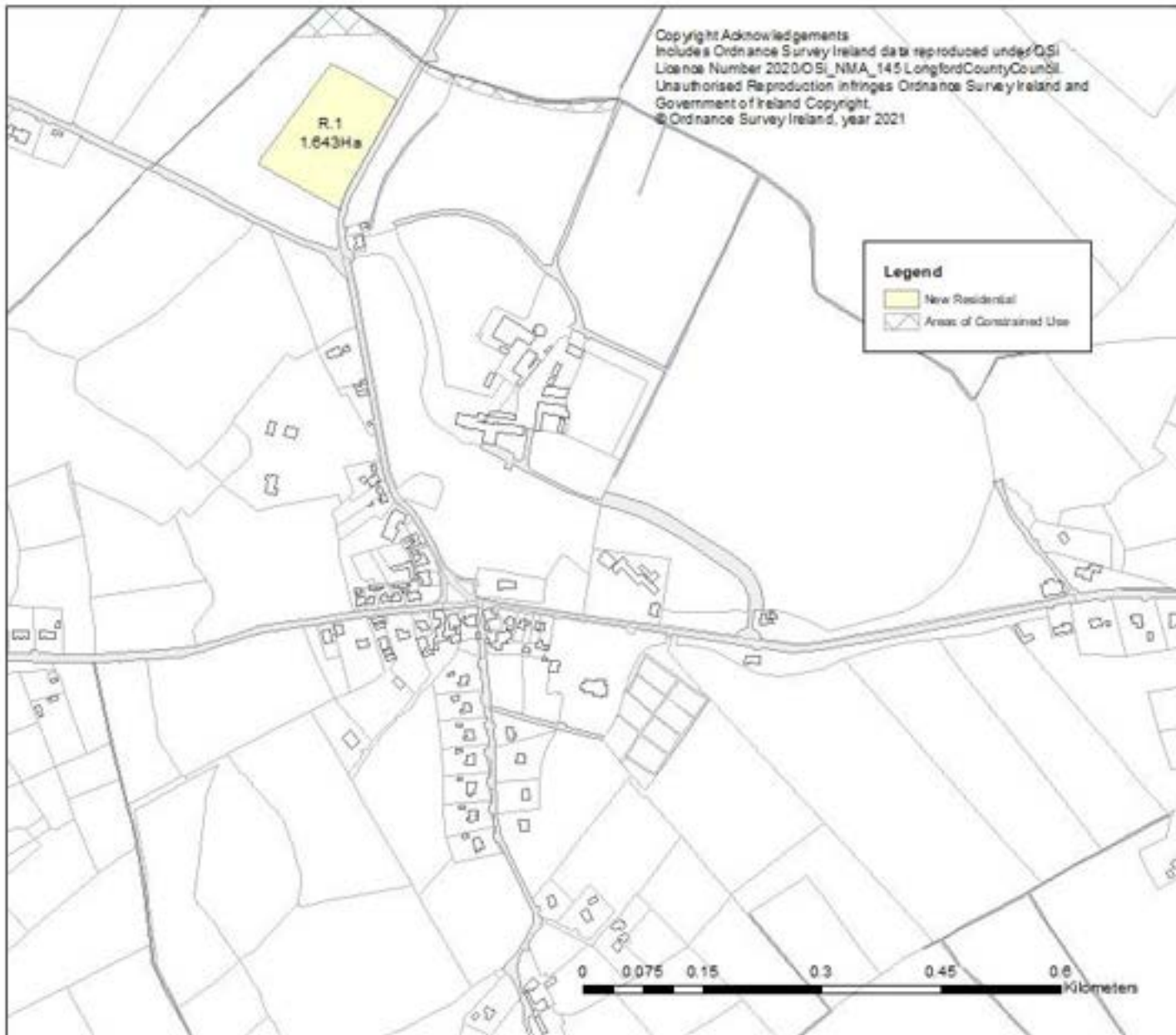

Ardagh Infrastructural assessment- Further Iteration

Notes



Ballinamuck Infrastructural assessment- Further Iteration

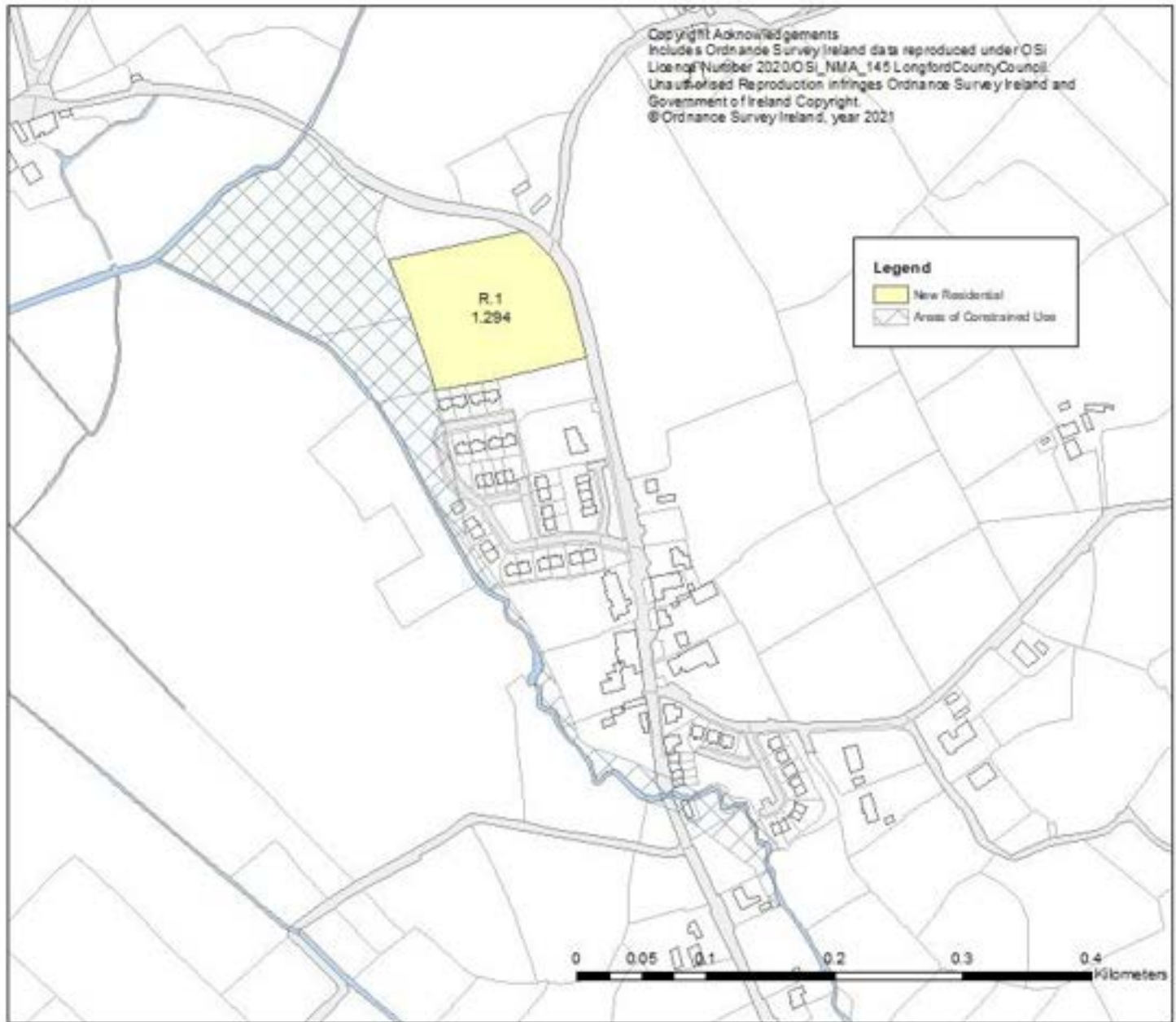

Notes



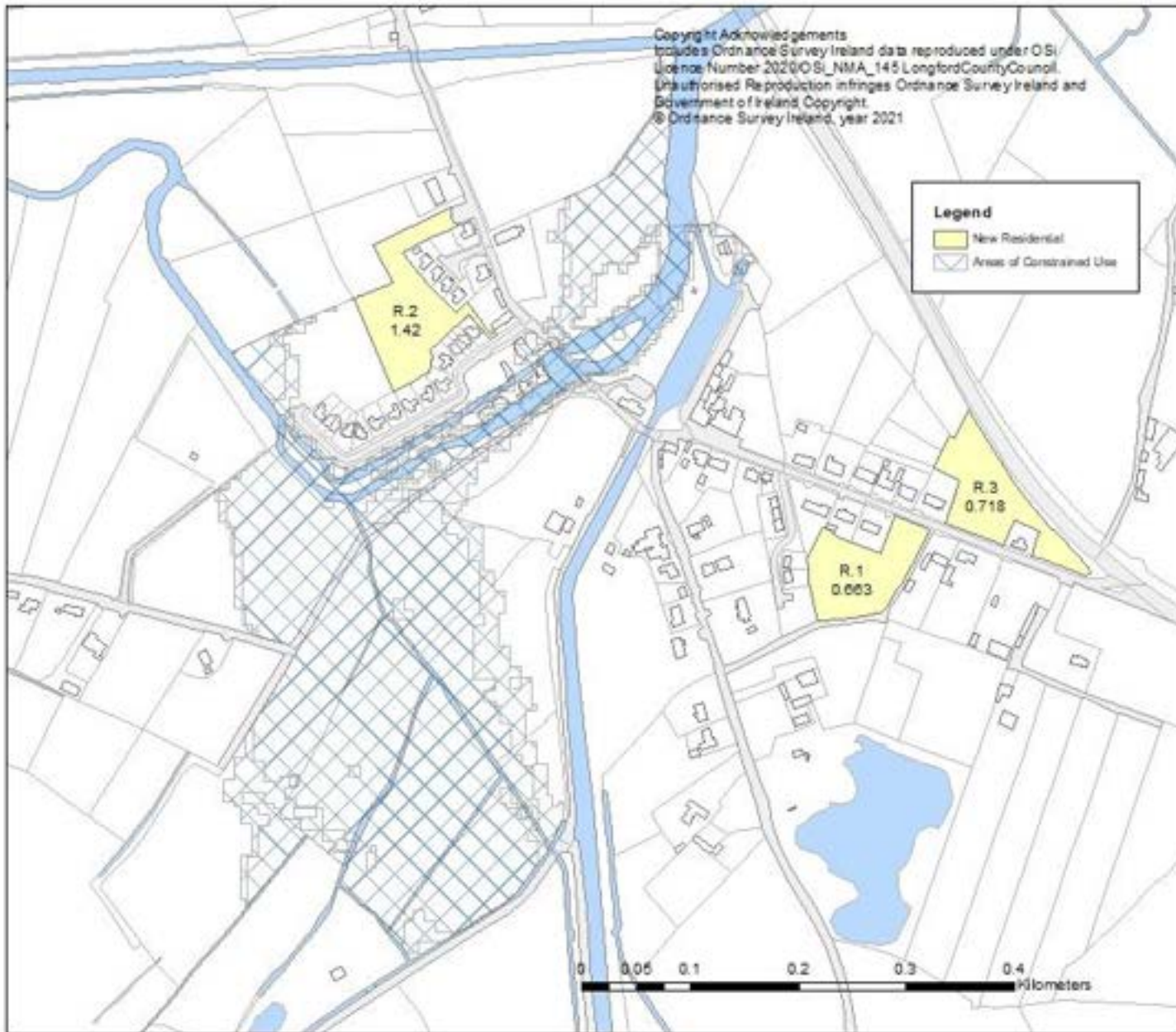

Clonra Infrastructural assessment- Further Iteration

Notes



APPENDIX C: ROADS DEPARTMENT INFRASTRUCTURAL EVALUATION

The following tables show the Roads infrastructure assessment results for each of the main settlements including Longford Town, Granard, Ballymahon, Edgeworthstown, Lanesborough and Drumlish and the associated zoned lands.

The assessment is presented as a number indexed out of 100 and has been evaluated on the available road network, pavements, lighting and other infrastructure in the locality, along with the required works to create a safe access to the site. The assessment also includes an assessment of the zoned lands based on the drainage and flooding of the area.

The assessment has not included details about proposed road improvements, junction realignments and information concerning local road accidents and other matters

The review also does not include an assessment of the costs involved in servicing the zoned lands in respect of roads and drainage, rather it provides an indication of the serviceability of the lands as of January to March 2021.

LONGFORD TOWN

HOUSING LANDS		R1	R2	R3	R4	R5	R6	R7	RR1
CRITERIA	WEIGHTING								
ROADS	100	100	90	50	100	90	80	80	50
DRAINAGE	100	80	80	90	90	90	80	90	60

EMPLOYMENT LANDS		E1	E2	E3	E4	E5	E6	E7
CRITERIA	WEIGHTING							
ROADS	100	50	50	50	50	50	100	100
DRAINAGE	100	50	50	80	80	50	70	70

GRANARD TOWN

HOUSING LANDS		R1	R2	R3	R4	R5
CRITERIA	WEIGHTING					
ROADS	100	100	100	100	100	70
DRAINAGE	100	50	50	50	50	50

EMPLOYMENT LANDS		E1	E2	E3	E4	E5	E6	E7	E8	SIR - E9	SIR - E10	SIR - E11
CRITERIA	WEIGHTING											
ROADS	100	100	100	100	100	100	100	100	100	100	100	100
DRAINAGE	100	50	50	50	50	50	30	100	30	50	50	80

BALLYMAHON

HOUSING LANDS		R1	R2	R3	R4	R5	R6
CRITERIA	WEIGHTING						
ROADS	100	100	100	100	100	100	60
DRAINAGE	100	80	50	10	50	50	80

EMPLOYMENT LANDS		E1	E2	E3	E4	E5	E6
CRITERIA	WEIGHTING						
ROADS	100	100	100	100	100	100	100
DRAINAGE	100	50	50	50	50	50	50

EDGEWORTHSTOWN

HOUSING LANDS		R1	R2	R3	R4
CRITERIA	WEIGHTING				
ROADS	100	100	100	100	100
DRAINAGE	100	50	50	50	50

EMPLOYMENT LANDS		SIR - E1	SIR - E2	E3	E4	E5
CRITERIA	WEIGHTING					
ROADS	100	0	50	100	100	100
DRAINAGE	100	50	50	50	50	50

LANESBOROUGH

HOUSING LANDS		R1	R2	R3	R4
CRITERIA	WEIGHTING				
ROADS	100	100	100	65	65
DRAINAGE	100	50	50	30	40

EMPLOYMENT LANDS		E1	E2
CRITERIA	WEIGHTING		
ROADS	100	100	70
DRAINAGE	100	50	50

DRUMLISH

HOUSING LANDS		R1	R2	R3	R4	R5	R6	R7
CRITERIA	WEIGHTING							
ROADS	100	100	100	100	100	100	80	100
DRAINAGE	100	50	50	50	50	50	80	75

EMPLOYMENT LANDS		E1
CRITERIA	WEIGHTING	
ROADS	100	100
DRAINAGE	100	80

APPENDIX D: WATER SERVICES INFRASTRUCTURAL SETTLEMENT ASSESSMENT

The following tables show the infrastructure assessment results produced by the Water Services Section of the Council, for each of the settlements and the associated zoned lands.

The assessment is presented as a number indexed out of 100 and has been based on the available capacity within the wastewater treatment network of each settlement. The assessment provides an indicative assessment given the available information as of January to March 2021.

The assessment has sought to identify the estimates of costs for servicing sites within the settlements, these costs are rough estimates and indicative only given available information at the time of the assessment and should not be used for any other purposes except for as to give an estimate of costs for servicing the sites only.

The assessment identifies specific settlements with known capacity constraints which includes the settlements of Ballymahon, Edgeworthstown, Lanesborough and Drumlish.

WASTEWATER INFRASTRUCTURE

Wastewater treatment infrastructure headroom assessment.

The following overview details the designed treatment plants in the key settlements with the PE (person equivalent) Design, the actual PE currently using the facility and the calculated PE available capacity and headroom allowing for a 10% variation. The identified headroom is therefore presented with figures highlighted in green showing available headroom, or – no capacity and constraints highlighted in red.

Infrastructure assessment

Wastewater infrastructure

		PE design	source	PE actual		PE available	% range	Headroom
							10	
1	Longford Town	20000	EPA license	15,608	PE 2020 AER	4392	2,000	2392
2	Granard	3200	EPA license	2,672	PE 2020 AER	528	320	208
3	Ballymahon	2125	EPA license	2,359	PE 2020 AER	-234	213	-447
4	Edgeworthstown	2700	EPA license	2,746	PE 2020 AER	-46	270	-316
5	Lanesborough	1600	EPA license	1,534	DBO Dec2020 report	66	160	-94
6	Aughnaccliffe	400	EPA COA	298	DBO Dec2020 report	102	40	62
7	Ballinalee	600	EPA COA	190	DBO Dec2020 report	410	60	350
8	Drumlisk	1200	EPA COA	1,082	PE 2020 AER	118	120	-2
9	Keenagh	1000	EPA COA	464	LD 2020 records	536	100	436
10	Legan	1000	EPA COA	142	LD 2020 records	858	100	758
11	Newtownforbes	1800	EPA license	930	PE 2020 AER	870	180	690
12	Abbeyshrule	300	EPA COA	87	DBO Dec2020 report	213	30	183
13	Ardagh	300	EPA COA to be applied for	17	DBO Dec2020 report	284	30	254
14	Ballinamuck	500	EPA COA	113	LD 2020 records	387	50	337
15	Clondra	600	EPA COA	206	DBO Dec2020 report	395	60	335

WASTEWATER INFRASTRUCTURE SUMMARY BY SETTLEMENT AND LANDS ZONED

The following table provides a summary of the scores for each of the settlements and the identified residential/housing lands and the employment/industrial lands.

WASTEWATER INFRASTRUCTURE REFER TO SETTLEMENT MAPS FOR ZONING LOCATION											
DOMESTIC	R1	R2	R3	R4	R5	R6	R7	R8			
LONGFORD TOWN	89	89	88	86	69	29	48	32			
GRANARD	72	72	72	68	58						
BALLYMAHON	13	48	25	38	41	40					
EDGEWORTHSTOWN	40	38	38	35							
LANESBOROUGH	46	50	38								
AUGHNACLIFFE	80	79									
BALLINALEE	82	84	76	66							
DRUMLISH	61	29	59	66	87	16	61				
KEENAGH	91	86									
LEGAN	94										
NEWTOWNFORBES	86	70	70	73	83						
ABBEYSHRULE	68	33	4								
ARDAGH	98										
BALLINAMUCK	76										
CLONDRA	20	69									
NON-DOMESTIC	E1	E2	E3	E4	E5	E6	E7	E8	E9	E10	E11
LONGFORD TOWN	31	44	54	43	39	47	45				
GRANARD	39	24	39	43	18	18	43	18		43	
BALLYMAHON		24	9	34	34	13					
EDGEWORTHSTOWN	21	29	28	28	28						
LANESBOROUGH	3	19									
AUGHNACLIFFE	97										
BALLINALEE	96										
DRUMLISH	24										
KEENAGH											
LEGAN											
NEWTOWNFORBES											
ABBEYSHRULE											
ARDAGH											
BALLINAMUCK											
CLONDRA											

Wastewater Cost Assessments for each settlement:

The following table(s) presented are considered (calculated) and provide a reasonable estimate for the full cost of delivery of the wastewater services and the amount is provided as a per unit cost with reference to:

- The headroom capacity in the existing network, pump stations and the wastewater treatment plant (from data currently available as of March 2021).
- Distance to the connection point on the existing service network.
- Potential number of units (housing or commercial (wet or dry)).

For each of the main settlement areas, including Longford Town, Granard, Ballymahon, Edgeworthstown and Lanesborough a detailed cost assessment has been undertaken for the zoned lands (residential or employment); for each zoning a percentage score has been assigned. The percentage score is used to identify the approximate cost for the required wastewater infrastructure upgrade for each area.

- Residential lands sites at 100% = low cost estimated at €4,000 per unit, which ranges to 0% = a high cost at €16,000. Certain zoned lands may be assigned an expensive cost, where the amount is determined to be far greater than €16,000.
- Employment lands sites scored at 100% are considered low cost estimated at €4,000, which ranges to 0% and considered a high cost at €100,000. Certain zoned lands may be assigned an expensive cost, where the amount is determined to be far greater than €100,000.

In all circumstances the figures are identified as broad estimates of potential costs. For any potential development a detailed assessment of available services and estimated costs should be undertaken by the Developer and in consultation with Irish Water in respect of wastewater and water supply, prior to any potential development and at pre-application.

LONGFORD TOWN:

		LONGFORD TOWN									
		Longford D0060									
Residential lands	R1	R2	R3	R4	R5			Residential lands			
good %		96	96	93	93	63			100%	4,000	
network	30m road new 100m upgrade	50m road new 100 upgrade	380 green 380 upgrade	200 green 200 upgrade	580 green 580 upgrade	PS possible			0%	16,000	
SPS		0	0	0	0	300			expensive	>16,000	
WWTP		0	0	0	0	0					
Employment lands	E1	E2	E3	E4	E5	E6			Employment lands		
ready %		30	51	50	31	34	41			100%	4,000
network	400 m green	no public road connect	200m road upgrade	connect 1/2 only	200m upgrade road PS 500 rising	280m road			0%	100,000	
SPS	PS 400rising WWTP UPGRADE 300m		0	0	PS 300 rising N4		0			expensive	>100,000
WWTP	main upgrade		0	0	0	0	0				

GRANARD

		Granard D0187												
Residential lands		R1	R2	R3	R4	R5								
good %			50	51	52	48	45							
network	50m upgrade road		30m road new	10m road new	60m road new	80m road new								
SPS			0	0	0	0	0							
WWTP	wwtp upgrade 200m upgrade green			0	0	0	0							
Employment lands		E1	E2	E3	E4	E5	E6	E7	E8	E9	E10	E11		
ready %			30	18	29	30	20	6	30	expensive	27	31	26	
network	connect 1/2		300m new road	60m road new	road crossing	connect 1/2 only	300 upgrade network	connect	300 upgrade network	400 upgrade network	connect	400 upgrade network		
SPS			0 SPS 300 rising										0 PS 800 rising	
WWTP	wwtp upgrade 200m upgrade green			0									0	0



BALLYMAHON

	Ballymahon D0096								
Residential lands	R1	R2	R3	R4	R5	R6	R7	R8	
good %	expensive		15 expensive		7	8	13	12	10
network	75m network upgrade 75m new road		200m net upgrade, 350 new road athlone PS		180m new road		60m new road	next to R6	
SPS	new pump station /900 gravity wwtg upgrade 150m network upgrade		250m new road athlone rd	auburn upgrade		ballymulvey upgrade		ballymulvey upgrade 30m green	
WWTP			0	0	0	0	0	0	0
Employment lands	E1	E2	E3	E4	E5	E6			
ready %		1	2 expensive		8	8	7		
network	350m new road	200m new road new +upgrade athlone rd	new 750 +upgrade athlone rd	0 road crossing athlone rd	no public access 100 m new green	connect			
SPS	new +upgrade athlone rd sps 300 wwtg upgrade 150m network upgrade	athlone rd sps 300	athlone rd sps	athlone rd sps	athlone rd sps		0		
WWTP			0	0	0	0	0	0	

EDGEWORTHSTOWN

		EDGEWORTHSTOWN Edgeworthstown D0098						
Residential lands		R1	R2	R3	R4			
good %		19	17	10	expensive			
network	45m new green		2*20m road upgrade	120m upgrade	150m upgrade			
SPS		0	0	0	0			
WWTP	wwtp upgrade 600m green upgrade network 100m road crossing			0	0	0		
Employment lands		E1	E2	E3	E4	E5		
ready %		11	20	21	21	21		
network		0	0	0	0	0		
SPS		0	0	0	0	0		
WWTP	wwtp upgrade 600m green upgrade network 750 road crossing			0	0	0	0	

Residential lands	
100%	4,000
0%	16,000
expensive	>16,000

Employment lands	
100%	4,000
0%	100,000
expensive	>100,000

LANESBOROUGH

	LANESBORO		Ballyleague D0220	
Residential lands	R1	R2	R3	
good %		20	20	14
network	250m network upgrade	70m reroute upgrade	120m upgrade	
SPS		0	0	0
WWTP	wwtp upgrade 750m network upgrade		0	0
Employment lands	E1	E2		
ready %		3	27	
network	new ps required stream	100 new road		
SPS	new ps required ESB		0	
WWTP	wwtp upgrade 750m network upgrade		0	

Residential lands	
100%	4,000
0%	16,000
expensive	>16,000

Employment lands	
100%	4,000
0%	100,000
expensive	>100,000

LONGFORD TOWN – DETAILED ASSESSMENT RESIDENTIAL LANDS:

INFRASTRUCTURE ASSESSMENT										
Settlement	LONGFORD TOWN									
Water supply zone	Lough Forbes 7 MI/day									31,111
Agglomeration	Longford D0060									
Residential lands			R1	R2	R3	R4	R5	R6	R7	RR1
Wastewater	headroom	2,392	89	89	88	86	69	29	48	32
Employment lands			E1	E2	E3	E4	E5	E6	E7	
Wastewater			31	44	54	43	39	47	45	
See Zoning Maps for reference number										
Report, detailing the estimated cost at draft plan stage										

RESIDENTIAL LANDS			R1	R2	R3	R4	R5	R6	R7	RR1	
Required services		network	30m road new 100m upgrade	50m road new 100 upgrade	380 green 380 upgrade	200 green 200 upgrade	200m road upgrade				
		SPS						PS possible 300			
		WWTP									
CONNECTION	3929		392900	392900	1178700	392900	275030	314320	432190	1178700	
extra on connection	442	IW	0	0	0	0	0	0	0	0	
NETWORK			31000	35000	133000	70000	50000	0	75000	1490000	
Network upgrade	250	roads section	100	100	380	200	200		300	600	
Network new road	200		30	50						6400	
Network upgrade green	150										
Network new green	100				380	200				600	
PUMP			0	0	0	0	143000	428000	260000	654500	
SCADA	14000	jobs Tobin reports						1	1	1	
valve chamber	4000							2	2	1	
variable speed	12500							2	2	2	
benching	2500							1	1	1	
Atex pump replace	13000							2	2	2	
discharge +vent	3500									1	
recertification electric	2500							2	2	1	
rising main	250							250	390	730	
Pump Station new	250000	burn quotes 2019							1	1	
WWTP upgrade per 1000	0.8		1619.048	103448	103448	310345	103448	72414	259200	356400	
	2.7		1200000	3132	270	270	810	270	189	216	
NETWORK+SPS+WWTP sum total			9546188	527348	531348	1622045	566348	540444	1001520	1123590	
size land parcel estimating water DMA	m2		459*184/2271*149+1277*308+25272*199							294*485/2	
housing density estimating Dammit report number	dwelling/ha		75							85	
	25 dwellings/ha		33000							38000	
=(13+10+6+6)*8*(1+15green+5scho if pump			33000							38000	
	406 m2/ dwelling		95							109	
	1095.12 m2/ dwelling		45							52	
=(11+8+11+6)*(6+14+6)*(1+(15 road 2/3 1/3 split			78							90	
	9 dwellings/ha		70							80	
1160 added dwelling PE	1593	chosen num	100	100	300	100	70	80	110	300	
	cost % figure in table										
	4000	100									
	8000	67	-121								
	12000	33	-118								
	16000	0	-121								
Costs per unit			5,273	5,313	5,407	5,663	7,721	12,519	10,214	12,112	
	Score to table		89	89	88	86	69	29	48	32	
	=Deficit/+headroom		- 740		Plant needs upgrade						

LONGFORD TOWN – DETAILED ASSESSMENT EMPLOYMENT LANDS:

EMPLOYMENT LANDS			E1	E2	E3	E4	E5	E6	E7
Required services	300	network	400 m green	no public road cc	200m road upgrade	connect 1/2 only	200m upgrade roac	280m road	280m road
		SPS	PS 400 rising			PS 300 rising	PS 500 rising N4		
		WWTP							
CONNECTION	3929		90367	31432	235740	157160	157160	47148	39290
extra on connection	442		0	0	0	0	0	0	0
NETWORK			0	60000	50000	0	50000	70000	70000
Network upgrade	350				200		200	280	280
Network new road	200			300					
Network upgrade green	150								
Network new green	100								
PUMP			432000	0	0	325000	375000	0	0
SCADA	14000		1						
valve chamber	4000		1						
variable speed	12500		1						
benching	2500		1						
Atex pump replace	13000		1						
discharge +vent	3500		1						
recertification electric	2500		1						
rising main	250		520			300	500		
Pump Station new	250000		1			1	1		
WWTP upgrade per 100	2	692736641	263359	91603	687023	458015	458015	137405	114504
	10	3000000	2620	230	80	600	400	400	120
NETWORK+SPS+WWTP sum total		696942039	785726	183,035	972,763	940,175	1,040,175	254,553	223,794
size land parcel estimated		m2	205*280	78*335	481*362	147*374	320*380	240*150	160*270
trade density estimated	Number	number	15	4	15	8	20	6	5
5 trades/ha		m2	77010	28710	206700	146870	141790	39410	33220
=+(45)*30*(1+(15green	trades/ha	if pump	75410	28710	206700	145270	141790	39410	33220
2025			38	14	102	73	70	19	16
10385	m2/ trade		7	3	20	14	14	4	3
=+(100)*67*(1+(15 green	m2/ trade	2/3 1/3 split	28	10	75	53	51	14	12
1	trades/ha	50:50 split	23	8	61	43	42	12	10
193 added PE trade	1800	chosen num	23	8	60	40	40	12	10
cost % figure in table									
3900	100								
8000	67	-124							
30000	33	-647							
100000	0	-2121							
Costs per unit			34,162	22,879	16,213	23,504	26,004	21,213	22,379
Score to table			31	44	54	43	39	47	45
added PE total	5062								
=-Deficit/+headroom	-	2,670			Plant needs upgrade				

BALLYMAHON – DETAILED ASSESSMENT RESIDENTIAL LANDS:

INFRASTRUCTURE ASSESSMENT		25/ha	67000	34090	20660	22590	26880		
Settlement	BALLYMAHON	43970	5940	47740	19010	20290	32960		
Water supply zone	Abbeyshrule 3 MI/day	13,333							
Agglomeration	Ballymahon D0096	4.397	0.594	4.774	1.901	2.029	3.296		
Residential lands		R1	R2	R3	R4	R5	R6	R7	R8
Wastewater	headroom	- 447	13	48	25	38	41	40	
Employment lands		E1	E2	E3	E4	E5	E6	E7	E8
Wastewater		#DIV/0!	24	9	34	34	13		
See Zoning Maps for reference number			6.7	3.409	2.066	2.259	2.688		
Report, detailing the estimated cost at draft plan stage									

RESIDENTIAL LANDS				R1	R2	R3	R4	R5	R6	R7	R8
Required services	150	network	150m network upgrade			200m net upgrade, 350 new road		180m new road		60m new road	next to R6
		SPS	new pump station /900 gravity			athlone PS upgrade, 250m new road	auburn upgrade		ballymulvey upgrade		ballymulvey upgrade 30m green
		WWTP		wwtp upgrade 150m network upgrade 1/2 road							
CONNECTION	3929			353610	58935	392900	157160	157160	216095	0	0
extra on connection	442	IW		0	0	0	0	0	0	0	0
NETWORK				49191.176	1323.5294	238823.53	39529.412	39529.412	4852.9412	12000	3000
Network upgrade	350	roads section		75		200					
Network new road	200			75		350		180		60	
150 Network upgrade green	200			39.705882	6.6176471	44.117647	17.647059	17.647059	24.264706	0	0
Network new green	100										30
PUMP				337500	0	52000	49500	0	52000	0	0
SCADA	14000	bs Tobin reports				1	1		1		1
valve chamber	4000					1	1		1		
variable speed	12500					1	1		1		
benching	2500					1	1		1		1
Atex pump replace	13000					1	1		1		
discharge +vent	3500					1	1		1		
recertification electric	2500					1			1		1
rising main	250		350								
Pump Station new	250000	urn quotes 2	1								
WWTP upgrade per 100	1.4	2100000		555882	92647	617647	247059	247059	339706	0	0
	2.7	2100000	918	243	40.5	270	108	108	148.5	0	0
NETWORK+SPS+WWTP	sum total	4279110		1,296,184	152,906	1,301,371	457,248	443,748	612,654	12,000	3,000
size land parcel estimate	g water DMA m2			310*270/2	71*56	357*110	154*133	189*104	206*136	242*102/2	170*94
housing density estimate	Dammit repo number			102	8	72	70	32	70	30	30
	25 dwellings/ha m2			43970	5940	47740	19010	20290	32960	12342	15980
	=(13+10+6+6)*8*(1+(15green+5schif pump			42370	5940	46140	17410	20290	31360	12342	15980
	406 m2/ dwelling			108	15	118	47	50	81	30	39
	1095.12 m2/ dwelling			40	5	44	17	19	30	11	15
	=(11+8+11+6)*(6+14+6)*(1+(15 road 2/3 1/3 spl			66	12	93	37	39	64	24	31
	9 dwellings/ha 50:50 split			74	10	81	32	34	56	21	27
340	added dwelling PE	918	chosen nu	90	15	100	40	40	55	0	0
	cost % figure in table										
	4000 100										
	8000 67		-121								
	12000 33		-118								
	16000 0		-121								
	Costs per unit			14,402	10,194	13,014	11,431	11,094	11,139		
	Score to table			13	48	25	38	41	40		
	=-Deficit/+headroom	- 1,365		Plant needs upgrade							

BALLYMAHON – DETAILED ASSESSMENT EMPLOYMENT LANDS:

EMPLOYMENT LANDS			E1	E2	E3	E4	E5	E6
Required services	150	network	350m new road	200m new road		road crossing	no public access	connect
		SPS	new +upgrade athlone rd sps 300	new +upgrade athlone rd sps 300	new 750 +upgrade athlone rd sps	upgrade athlone rd sps	upgrade athlone rd sps	upgrade moygh rd sps
		WWTP	wwtp upgrade 150m network upgrade 1/2 road					
CONNECTION	3929		0	78580	39290	23574	27503	31432
extra on connection	442		0	0	0	0	0	0
NETWORK			7000	51764.706	5882.3529	3529.4118	14117.647	4705.8824
Network upgrade	350							
Network new road	200		350	200				
150 Network upgrade green	200		0	58.823529	29.411765	17.647059	20.588235	23.529412
Network new green	100						100	
PUMP			494500	507000	582000	42000	42000	402000
SCADA	14000		1	1	1	1	1	1
valve chamber	4000		1	1	1			1
variable speed	12500		1	1	1	1	1	1
benching	2500		1	1	1			1
Atex pump replace	13000		1	1	1	1	1	1
discharge +vent	3500		1	1	1			1
recertification electric	2500		1	1	1	1	1	1
rising main	250		770	820	1120			400
Pump Station new	250000		1	1	1			1
WWTP upgrade per 100	0.6	9000000	0	352941	176471	105882	123529	141176
10	9000000	510	0	200	100	60	70	80
NETWORK+SPS+WWTP	sum total	3319879	564500	990,286	803,643	174,986	207,150	579,314
size land parcel estimated		m2	224*300	103*330+15	166*240/2	230*80	230*90	90*250
trade density estimated	Number	number	15	4	50	8	20	6
5	trades/ha	m2	67200	67000	34090	20660	22590	26880
=(45)*30*(1+(15green	trades/ha	if pump	65600	65400	32490	19060	20990	25280
2025			33	33	17	10	11	13
10385	m2/ trade		6	6	3	2	2	3
=(100)*67*(1+(15 green	m2/ trade	2/3 1/3 spl	24	24	12	7	8	10
1	trades/ha	50:50 split	20	20	10	6	7	8
51 added PE trade	510	chosen nu	0	20	10	6	7	8
cost % figure in table								
4000	100							
8000	67	-121						
30000	33	-647						
100000	0	-2121						
Costs per unit			#DIV/0!	49,514	80,364	29,164	29,593	72,414
Score to table			#DIV/0!	24	9	34	34	13
added PE total	1428							
=-Deficit/+headroom	- 1,875							
								Plant needs upgrade

EDGEWORTHSTOWN – DETAILED ASSESSMENT RESIDENTIAL LANDS:

INFRASTRUCTURE ASSESSMENT		333160	3690	54660	114060	33850
Settlement	EDGEWORTHSTOWN	81320	22350	15880	5680	
Water supply zone	Lough Forbes / Abbeyshrule	13,333				
Agglomeration	Edgeworthstown D0098	8.132	2.235	1.588	0.568	
Residential lands		R1	R2	R3	R4	
Wastewater	headroom - 316	40	38	38	35	
Employment lands		E1	E2	E3	E4	E5
Wastewater		21	29	28	28	28
See Zoning Maps for reference number						
Report, detailing the estimated cost at draft plan stage						

RESIDENTIAL LANDS			R1	R2	R3	R4	
Required services	775	network	45m new green	2*20m road upgrade	120m upgrade	120m upgrade	reroute upgrade
		SPS					
		WWTP	wwtp upgrade 600m green upgrade network 20m road crossing				
CONNECTION	3929		550060	157160	117870	39290	0
extra on connection	442	IW	0	0	0	0	0
NETWORK			67204.545	27272.727	18954.545	10318.182	0
Network upgrade	250	roads section	12.727273	3.6363636	2.7272727	0.9090909	
Network new road	200			50			
600 Network upgrade green	150		381.81818	109.09091	81.818182	27.272727	
Network new green	100		67.5		60	60	
PUMP			0	0	0	0	0
		Jacobs Tobin reports					
SCADA	14000						
valve chamber	4000						
variable speed	12500						
benching	2500						
Atex pump replace	13000						
discharge +vent	3500						
recertification electric	2500						
rising main	250						
Pump Station new	250000	iburn quotes 2019					
WWTP upgrade per 100	1	1500000	954545	272727	204545	68182	0
	2.7	1500000	594	378	108	81	27
NETWORK+SPS+WWTP		sum total	2488130	1,571,810	457,160	341,370	117,790
size land parcel estimating water DMA fit	m2		512*175+280*	192*134	139*134	71*62	
housing density estimate Dammit report	number		160	45	30	10	
23 dwellings/ha	m2		81320	22350	15880	5680	
=(11+10+11+6)*8*(1+(15green+5school if pump			81320	22350	15880	5680	0
440.8 m2/ dwelling			184	51	36	13	0
2046.33 m2/ dwelling			40	11	8	3	0
=(23+9+15+6)*(9+19+5)*(1+(15 road+1 2/3 1/3 split			136	37	27	10	0
5 dwellings/ha		50:50 split	112	31	22	8	0
220 added dwelling PE	594	chosen numk	140	40	30	10	0
cost % figure in table							
4000 100							
8000 67		-121					
12000 33		-118					
16000 0		-121					
Costs per unit			11,227	11,429	11,379	11,779	#DIV/0!
Score to table			40	38	38	35	#DIV/0!
=-Deficit/+headroom	- 910						Plant needs upgrade

EDGEWORTHSTOWN – DETAILED ASSESSMENT EMPLOYMENT LANDS:

EMPLOYMENT LANDS			E1	E2	E3	E4	E5
Required services	600	network					
	750	SPS	newPS				
		WWTP	wwtp upgrade 600m green upgrade network 750 road crossing				
CONNECTION	3929		196450	3929	39290	78580	19645
extra on connection	442		0	0	0	0	0
NETWORK			375000	7500	96802.326	193604.65	48401.16
750 Network upgrade	750		436.04651	8.7209302	87.209302	174.4186	43.60465
Network new road	200		-545.058	-10.9012			
600 Network upgrade green	450		348.83721	6.9767442	69.767442	139.53488	34.88372
Network new green	100						
PUMP			875000	0	0	0	0
SCADA	14000						
valve chamber	4000						
variable speed	12500						
benching	2500						
Atex pump replace	13000						
discharge +vent	3500						
recertification electric	2500						
rising main	250		2500				
Pump Station new	250000		1				
WWTP upgrade per 100	1.5	2500000	1308140	26163	261628	523256	130814
10	2250000	860	500	10	100	200	50
NETWORK+SPS+WWTP sum total		4184202.1	2754589.5	37,592	397,720	795,440	198,860
size land parcel estimating water DMA fit		m2	657*400	52*62	344*162	277*377	111*83+148*171
trade density estimated Dammit report		number	42	1	10	20	2
2 trades/ha		m2	333160	3690	54660	114060	33850
=(45)*65*(1+(15green+20 parking+15rc if pump			331560	3690	54660	114060	33850
4387.5 m2/ trade			76	1	12	26	8
51770 m2/ trade			6	0	1	2	1
=(200)*167*(1+(15 green+25 parking+12/3 1/3 split			53	1	9	18	5
0 trades/ha		50:50 split	41	0	7	14	4
86 added PE trade	860	chosen numk	50	1	10	20	5
cost % figure in table							
4000	100						
8000	67	-121					
30000	33	-647					
100000	0	-2121					
Costs per unit			55,092	37,592	39,772	39,772	39,772
Score to table			21	29	28	28	28
added PE total	1454						
=-Deficit/+headroom	- 1,770						
							Plant needs upgrade

GRANARD – DETAILED ASSESSMENT RESIDENTIAL LANDS

INFRASTRUCTURE ASSESSMENT			64260	38620	11510	41240	17300							
Settlement	GRANARD		24020	13420	7300	7730	6330							
Water supply zone	Lough Kinale	1 Ml/day	31,111											
Agglomeration	Granard D0187		2.402	1.342	0.73	773	0.633							
Residential lands			R1	R2	R3	R4	R5							
Wastewater	headroom	208	72	72	72	68	58							
Employment lands			E1	E2	E3	E4	E5	E6	E7	E8	E9	E10	E11	
Wastewater			39	24	39	43	18	18	43	18	#DIV/0!	43	#DIV/0!	
See Zoning Maps for reference number report, detailing the estimated cost at draft plan stage														

RESIDENTIAL LANDS			R1	R2	R3	R4	R5
description required serv	200	network	140 up	190 up	50 up	190 up	
		SPS					abbeylara rd up
		WWTP					
CONNECTION	3929		314320	196450	98225	98225	78580
extra on connection	442	IW	0	0	0	0	0
NETWORK			35000	23750	12500	23750	0
Network upgrade	250	roads section	140	95	50	95	
Network new road	200						
Network upgrade green	150						
Network new green	100						
PUMP			0	0	0	0	42000
		Jacobs Tobin reports					
SCADA	14000						1
valve chamber	4000						
variable speed	12500						1
benching	2500						
Atex pump replace	13000						1
discharge +vent	3500						
recertification electric	2500						1
rising main	250						
Pump Station new	250000	burn quotes 2019					
WWTP upgrade per 100	0.4	600000	240000	150000	75000	75000	60000
	2.7	600000	540	216	135	67.5	67.5
NETWORK+SPS+WWTP sum total		1522800	589,320	370,200	185,725	196,975	180,580
size land parcel estimating water DMA 1m2			266*191/2	113*113	53*155	85*78	61*93
housing density estimation Dammit report number			75	40	3	20	20
46 dwellings/ha m2			24020	13420	7300	7730	6330
=(11+8+6)*(7.5)*(1+(15 road+1 school) if pump			24020	13420	7300	7730	4730
219.375 m2/ dwelling			109	61	33	35	29
371.2 m2/ dwelling			65	36	20	21	17
=(12+11+9)*8*(1+(15green+5school+2/3 1/3 split			95	53	29	30	25
27 dwellings/ha 50:50 split			87	49	20	28	23
200 added dwelling PE	540	chosen num	80	50	25	25	20
cost % figure in table							
4000	100						
8000	67	-121					
12000	33	-118					
16000	0	-121					
Costs per unit			7,367	7,404	7,429	7,879	9,029
Score to table			72	72	72	68	58
=-Deficit/+headroom	-	332					
							Plant needs upgrade

GRANARD – DETAILED ASSESSMENT EMPLOYMENT LANDS:

EMPLOYMENT LANDS			E1	E2	E3	E4	E5	E6	E7	E8	E9	E10	E11	
Required services		200	network connect 1/2	300m new road	60m road new	road crossing	connect 1/2 only	300 upgrade net	connect	300 upgrade net	400 upgrade net	connect	400 upgrade network	
			SPS	SPS 300 rising									PS 800 rising	
			WWTP											
CONNECTION			3929	98225	58935	19645	58935	7858	10068	19645	10068	0	196450	0
extra on connection		442		0	0	0	0	0	5	0	5	0	0	0
NETWORK				56000	60000	12000	0	75000	75000	0	75000	100000	0	100000
Network upgrade		250						300	300	0	300	400	10	400
Network new road		200		280	300	60								
0 Network upgrade green			150											
Network new green		100						100						
PUMP				0	325000	0	0	0	0	0	0	0	0	500000
SCADA		14000												
valve chamber		4000												
variable speed		12500												
benching		2500												
Atex pump replace		13000												
discharge +vent		3500												
recertification electric		2500												
rising main		250			300									1000
Pump Station new		250000			1									1
WWTP upgrade per 100		1.6	2400000	495868	297521	99174	297521	39669	39669	99174	39669	0	991736	0
10		2400000	1210	250	150	50	150	20	20	50	20	0	500	0
NETWORK+SPS+WWTP sum total			4257829	650,093	741,456	130,819	356,456	122,527	124,737	118,819	124,737	100,000	1,188,186	600,000
size land parcel estimated		m2	234*260	360*110	71*116+5	165*163	87*136	44*95+21	210*239	233*36	260*172	544*197	470*240	
trade density estimated		Number	4	15	4	10	5	3	8	1	20	40	45	
5 trades/ha		m2	64260	38620	11510	41240	17300	5630	24810	1570	0	171660	0	
=+(45)*30*(1+(15green		trades/ha	if pump	64260	37020	11510	41240	17300	5630	24810	1570	0	171660	-1600
2025				32	19	6	20	9	3	12	1	0	85	0
10385		m2/ trade		6	4	1	4	2	1	2	0	0	17	0
=+(100)*67*(1+(15 green		m2/ trade	2/3 1/3 split	23	14	4	15	6	2	9	1	0	62	0
1 trades/ha			50:50 split	19	11	3	12	5	2	7	0	0	51	0
121 added PE trade		2010	chosen num	25	15	5	15	2	2	5	2	0	50	0
cost % figure in table														
4000		100												
8000		67	-121											
30000		33	-647											
100000		0	-2121											
Costs per unit			26,004	49,340	26,164	23,764	61,264	62,369	23,764	62,369	#DIV/0!	23,764	#DIV/0!	
Score to table			39	24	39	43	18	18	43	18	#DIV/0!	43	#DIV/0!	
added PE total		1750	E1	E2	E3	E4	E5	E6	E7	E8	E9	E10	E11	
=Deficit/+headroom		- 1,542	Plant needs upgrade											

LANESBOROUGH – DETAILED ASSESSMENT RESIDENTIAL LANDS:

INFRASTRUCTURE ASSESSMENT			404000	11140		
Settlement	LANESBOROUGH		36420	18610	7010	4460
Water supply zone	Lanesboro 2 2 MI/day		4444			
Agglomeration	Ballyleague D0220		3642	1861	0.701	0.446
Residential lands			R1	R2	R3	R4
Wastewater	headroom	- 94	46	50	38	16
Employment lands			E1	E2	E3	E4
Wastewater			3	19		
See Zoning Maps for reference number report, detailing the estimated cost at draft plan stage						

RESIDENTIAL LANDS			R1	R2	R3	R4
description required serv	750	network	250m network upgrade	70m reroute upgrade	120m upgrade	110+60m upgrade
		SPS				new PS
		WWTP	wwtp upgrade 750m network upgrade			
CONNECTION	3929		235,740	117,870	58,935	19645
extra on connection	442	IW	0	0	0	0
NETWORK			62,500	17,500	30,000	42500
Network upgrade	250	roads section	250	70	120	170
Network new road	200					
Network upgrade green	150					
Network new green	100					
PUMP			0	0	0	0
SCADA	14000	bs Tobin reports				
valve chamber	4000					
variable speed	12500					
benching	2500					
Atex pump replace	13000					
discharge +vent	3500					
recertification electric	2500					
rising main	250					
Pump Station new	250000	urn quotes 2019				
WWTP upgrade per 100	0.4	580827	327,273	163,636	81,818	8100
water DI	2.7	600000	297	162	81	40.5
limit re		NETWORK+SPS+WWTP sum total	1165517	625,513	299,006	170,753
size land parcel estimated		m2	512*175+281	192*134	139*134	
housing density estimated		number	160	45	30	
	25	dwellings/ha	36420	18610	7010	4460
	=+(13+10+6+6)*8*(1+(15green+5sch if pump		36420	18610	7010	4460
	406	m2/ dwelling	83	42	16	10
	1095.12	m2/ dwelling	18	9	3	2
	=+(11+8+11+6)*(6+14+6)*(1+(15 roa 2/3 - 1/3 spl		61	31	12	7
	5	dwellings/ha	50	26	10	6
110	added dwelling PE	297	chosen nu	60	30	15
	cost % figure in table					
	4000	100				
	8000	67	-121			
	12000	33	-118			
	16000	0	-121			
	Costs per unit		10,425	9,967	11,384	14,049
	Score to table		46	50	38	16
	=-Deficit/+headroom	- 391				
				Plant needs upgrade		

LANESBOROUGH – DETAILED ASSESSMENT EMPLOYMENT LANDS:

EMPLOYMENT LANDS			E1	E2	
Required services	750	network	new ps required street	100 new road	
		SPS	new ps required ESB		
		WWTP	wwtp upgrade 750m network upgrade		
CONNECTION	3929		58,935	3,929	
extra on connection	442		0	0	
NETWORK			-	-	
Network upgrade	250				
Network new road	200				
0 Network upgrade green	150				
Network new green	100				
PUMP			500,000	0	
SCADA	14000				
valve chamber	4000				
variable speed	12500				
benching	2500				
Atex pump replace	13000				
discharge +vent	3500				
recertification electric	2500				
rising main	250		1000		
Pump Station new	250000		1		
WWTP upgrade per 1000	0.6	900000	843750	56250	
10	900000	160	150	10	
NETWORK+SPS+WWTP sum total	1462864	1,402,685	60,179		
size land parcel estimated	m2		580*180+43(209*77/2		
trade density estimated	Number	number	42	1	
6 trades/ha	m2		404400	11140	
=(35)*30*(1+(15green	trades/ha	if pump	402800	11140	
1575			257	7	
57427.5	m2/ trade		7	0	
=(90)*95*(1+(15 green	m2/ trade	2/3 1/3 spl	174	5	
0 trades/ha		50:50 split	132	4	
16 added PE trade	160	chosen nu	15	1	
cost % figure in table					
4000	100				
8000	67	-121			
30000	33	-647			
100000	0	-2121			
Costs per unit			93,512	60,179	
Score to table			3	19	
added PE total	457				
=-Deficit/+headroom	- 551			Plant needs upgrade	

AUGHNACLIFFE – DETAILED ASSESSMENT RESIDENTIAL LANDS:

INFRASTRUCTURE ASSESSMENT			2570			
Settlement	AUGHNACLIFFE		6060	23480		
Water supply zone	Smear	1 MI/day	4444			
Agglomeration	Aughnaclyffe A0535		0.606	2.348		
Residential lands			R1	R2	R3	R4
Wastewater	headroom	62	80	79	#DIV/0!	#DIV/0!
Employment lands			E1	E2	E3	E4
Wastewater			97	#DIV/0!		
See Zoning Maps for reference number report, detailing the estimated cost at draft plan stage						

RESIDENTIAL LANDS			R1	R2		
description required services	network	40m up	160m upgrade			
	SPS					
	WWTP					
CONNECTION	3929		15,716	58,935		
extra on connection	442	IW	0	0	0	
NETWORK			10,000	40,000		
Network upgrade	250	roads section	40	160		
Network new road	200					
Network upgrade green	150					
Network new green	100					
PUMP			0	0	0	
SCADA	14000	bs Tobin reports				
valve chamber	4000					
variable speed	12500					
benching	2500					
Atex pump replace	13000					
discharge +vent	3500					
recertification electric	2500					
rising main	250					
Pump Station new	250000	urn quotes 2019				
WWTP upgrade per 100	0	0	-	-		
Water D	2.7	0	51	10.8	40.5	
mit re	NETWORK+SPS+WWTP	sum total	124651	25,716	98,935	
size land parcel estimated	m2		107*43	128*100		
housing density estimated	number		10	28		
	23 dwellings/ha	m2	6060	23480		
=(11+10+11+6)*8*(1+(15green+5scif pump			6060	23480		
440.8	m2/ dwelling		14	53		
2046.33	m2/ dwelling		3	11		
=(23+9+15+6)*(9+19+5)*(1+(15 roa2/3 1/3 spl			10	39		
5 dwellings/ha	50:50 split		8	32		
19	added dwelling PE	51	chosen nl	4	15	
	cost % figure in table		half	half		
	4000	100				
	8000	67	-121			
	12000	33	-118			
	16000	0	-121			
	Costs per unit		6,429	6,596	#DIV/0!	#DIV/0!
	Score to table		80	79	#DIV/0!	#DIV/0!
	=-Deficit/+headroom	11				Plant needs upgrade

AUGHNACLIFFE – DETAILED ASSESSMENT EMPLOYMENT LANDS:

EMPLOYMENT LANDS			E1			
Required services		network	road crossing	100 new road		
		SPS				
		WWTP				
CONNECTION	3929			4,371		
extra on connection	442			1		
NETWORK				0		
Network upgrade	250					
Network new road	200					
0 Network upgrade green	150					
Network new green	100					
PUMP				0		
SCADA	14000					
valve chamber	4000					
variable speed	12500					
benching	2500					
Atex pump replace	13000					
discharge +vent	3500					
recertification electric	2500					
rising main	250					
Pump Station new	250000					
WWTP upgrade per 100	0	0		0		
	10	0	10	10		
NETWORK+SPS+WWTP sum total		4371		4,371		-
size land parcel estimated		m2		36*62		
trade density estimated	Number	number		1		
	6 trades/ha	m2		2570		
=(35)*30*(1+(15green	trades/ha	if pump		2570		
1575				2		
57427.5	m2/ trade			0		
=(90)*95*(1+(15 green	m2/ trade	2/3 1/3 spl		1		
0	trades/ha	50:50 split		1		
1 added PE trade	10	chosen nu		1		
cost % figure in table						
	4000	100				
	8000	67	-121			
	30000	33	-647			
	100000	0	-2121			
Costs per unit				4,371	#DIV/0!	#DIV/0!
Score to table				97	#DIV/0!	#DIV/0!
added PE total	61					
=-Deficit/+headroom	1					Plant needs upgrade

BALLINALEE – DETAILED ASSESSMENT EMPLOYMENT LANDS:

EMPLOYMENT LANDS			E1			
Required services	750	network	new ps required street	100	new road	
		SPS	new ps required ESB			
		WWTP	wwtp upgrade 750m network upgrade			
CONNECTION	3929			8,742		
extra on connection	442			2		
NETWORK				0		
Network upgrade	250					
Network new road	200					
0 Network upgrade green	150					
Network new green	100					
PUMP				0		
SCADA	14000					
valve chamber	4000					
variable speed	12500					
benching	2500					
Atex pump replace	13000					
discharge +vent	3500					
recertification electric	2500					
rising main	250					
Pump Station new	250000					
WWTP upgrade per 100	0	0		843750		
	10	0	20	150		
NETWORK+SPS+WWTP sum total		8742		1,402,685		
size land parcel estimated		m2		190*45		
trade density estimated	Number	number		15		
	2 trades/ha	m2		8990		
=+(35)*30*(1+(15green	trades/ha	if pump		8990		
1575				2		
57427.5	m2/ trade			0		
=+(90)*95*(1+(15 green	m2/ trade	2/3 1/3 spl		1		
0	trades/ha	50:50 split		1		
2 added PE trade	20	chosen nu		2		
cost % figure in table						
3900	100					
8000	67	-124				
30000	33	-647				
100000	0	-2121				
Costs per unit				4,371	#DIV/0!	#DIV/0!
Score to table				96	#DIV/0!	#DIV/0!
added PE total	250					
=-Deficit/+headroom	100					Plant needs upgrade

DRUMLISH – DETAILED ASSESSMENT RESIDENTIAL LANDS:

INFRASTRUCTURE ASSESSMENT			58840	11140					
Settlement	DRUMLISH		15490	3130	10300	3890	7140	19600	2750
Water supply zone	Lough Forbes	7 MI/day	31111						
Agglomeration	Drumlish D0489		1.549	0.313	1.03	0.389	0.714	1.96	0.275
Residential lands			R1	R2	R3	R4	R5	R6	R7
Wastewater	headroom	- 2	61	29	59	66	87	16	61
Employment lands			E1	E2	E3	E4	E5	E6	E7
Wastewater			24	#DIV/0!					
See Zoning Maps for reference number			5.884						
report, detailing the estimated cost at draft plan stage									

RESIDENTIAL LANDS			R1	R2	R3	R4	R5	R6	R7	
Required services	network		90road upgrade	140m road upgrade	90m road upgrade	110+60m upgrade			40m road upgrade	
Residential lands	SPS					new PS		Barrow upgrade /350m		
	WWTP		Capacity Upgrade wwtp							
CONNECTION		3929	137,515	31,432	98,225	39290	58935	176805	27503	
extra on connection	IV	442	0	0	0	0	0	0	0	
NETWORK			22,500	35,000	22,500	0	0	35000	22500	
Network upgrade	roads section	250	90	140	90	170			90	
Network new road		200								
Network upgrade green		150								
Network new green		100						350		
PUMP			0	0	0	0	0	350000	0	
SCADA	bs Tobin reports	14000								
valve chamber		4000								
variable speed		12500								
benching		2500								
Atex pump replace		13000								
discharge +vent		3500								
recertification electric		2500								
rising main		250								
Pump Station new	urn quotes 2019	250000	1							
WWTP upgrade per 10€		0.4 431298.6	144,828	33,103	103,448	41379	24300	72900	11340	
Water D	2.7	600000	391.5	94.5	21.6	67.5	27	40.5	121.5	18.9
limit r	NETWORK+SPS+WWTP	sum total	1488504	304,843	99,535	224,173	80669.31	83235	634705	61343
size land parcel estimated	m2		206*53	48*43	119*86	129*36	94*75	125*120	59*47	
housing density estimated	number		35	4	28	16	15	36	6	
	29 dwellings/ha	m2	15490	3130	10300	3890	7140	19600	2750	
+=(12+8+4)*10*(1+(15green+5school+10lif pump			15490	3130	10300	3890	7140	18000	2750	
348 m2/ dwelling			45	9	30	11	21	56	8	
737.1 m2/ dwelling			21	4	14	5	10	27	4	
+=(12+8+9+6)*(3+12+3)*(1+(15 road+1 school+10lif pump	2/3- 1/3 spl		37	7	24	9	17	46	7	
14 dwellings/ha	50:50 split		33	7	22	8	15	41	6	
145 added dwelling PE	297	chosen nt	35	8	25	10	15	45	7	
cost % figure in table										
3900	100									
8000	67	-124								
12000	33	-118								
16000	0	-121								
Costs per unit			8,710	12,442	8,967	8,067	5,549	14,105	8,763	
Score to table			61	29	59	66	87	16	61	
=-Deficit/+headroom	- 394		Plant needs upgrade							

DRUMLISH – DETAILED ASSESSMENT EMPLOYMENT LANDS:

EMPLOYMENT LANDS			E1							
Required services		network								
Employment Lands		SPS								
		WWTP								
CONNECTION	3929			78,580						
extra on connection	442			0						
NETWORK				0						
Network upgrade	250									
Network new road	200									
0 Network upgrade green	150									
Network new green	100									
PUMP				0						
SCADA	14000									
valve chamber	4000									
variable speed	12500									
benching	2500									
Atex pump replace	13000									
discharge +vent	3500									
recertification electric	2500									
rising main	250									
Pump Station new	250000									
WWTP upgrade per 100	0.6	900000		900000						
10	900000	200		200						
NETWORK+SPS+WWTP sum total		978580		978,580						
size land parcel estimated		m2		300*200						
trade density estimated	Number	number		15						
5 trades/ha		m2		58840						
+=(45)*30*(1+(15green		trades/ha		if pump						
2025				29						
10385	m2/ trade			6						
+=(100)*67*(1+(15 gree	m2/ trade			21						
1	trades/ha			17						
20 added PE trade	200	chosen nu		20						
	cost % figure in table									
	3900	100								
	8000	67		-124						
	30000	33		-647						
	100000	0		-2121						
	Costs per unit			48,929	#DIV/0!	#DIV/0!	#DIV/0!	#DIV/0!	#DIV/0!	#DIV/0!
	Score to table			24	#DIV/0!	#DIV/0!	#DIV/0!	#DIV/0!	#DIV/0!	#DIV/0!
added PE total	592									
=-Deficit/+headroom	-	594								
					Plant needs upgrade					

KEENAGH – DETAILED ASSESSMENT RESIDENTIAL LANDS:

INFRASTRUCTURE ASSESSMENT					
Settlement	KEENAGH		27990	17570	
Water supply zone	Lough Forbes	7 MI/day	31111		
Agglomeration	Ballyleague D0220		2799	1757	
Residential lands			R1	R2	R3
Wastewater	headroom	- 94	91	86	#DIV/0!
Employment lands			E1	E2	E3
Wastewater			#DIV/0!	#DIV/0!	
See Zoning Maps for reference number					
report, detailing the estimated cost at draft plan stage					

RESIDENTIAL LANDS			R1	R2	
Required services		network	Clough Dillon Upgrade	Clough Ree well upgrade	
		SPS			
		WWTP			
CONNECTION	3929		196,450	117,870	
extra on connection	442	IW	0	0	
NETWORK			0	0	
Network upgrade	250	roads section			
Network new road	200				
Network upgrade green	150				
Network new green	100				
PUMP			52000	52000	
SCADA	14000	bs Tobin rep	1	1	
valve chamber	4000		1	1	
variable speed	12500		1	1	
benching	2500		1	1	
Atex pump replace	13000		1	1	
discharge +vent	3500		1	1	
recertification electric	2500		1	1	
rising main	250				
Pump Station new	250000	urn quotes 2019			
WWTP upgrade per 100	0	0	0	0	
Water Demand	2.7	600000	216	135	81
Permit re	NETWORK+SPS+WWTP sum total		418320	248,450	169,870
size land parcel estimated		m2	130*120	250*105	
housing density estimated		number	30	25	
	29	dwellings/ha	27990	17570	
=(12+8+4)*10*(1+(15green+5school+10		if pump	26390	15970	
348		m2/ dwelling	80	50	
737.1		m2/ dwelling	38	24	
=(12+8+9+6)*(3+12+3)*(1+(15 road+1 sc		2/3 1/3 spl	66	42	
		50:50 split	59	37	
14		dwellings/ha			
80	added dwelling PE	216	chosen nu	50	30
	cost % figure in table				
	3900	100			
	8000	67	-124		
	12000	33	-118		
	16000	0	-121		
	Costs per unit		4,969	5,662	
	Score to table		91	86	#DIV/0!
	=-Deficit/+headroom	220			Plant needs upgrade

LEGAN – DETAILED ASSESSMENT RESIDENTIAL LANDS:

INFRASTRUCTURE ASSESSMENT				
Settlement	LEGAN		16720	
Water supply zone	Abbeyshrule	3 MI/day	13333	
Agglomeration	Ballyleague D0220		1672	
Residential lands			R1	R2
Wastewater	headroom	758	94	#DIV/0!
Employment lands			E1	E2
Wastewater			#REF!	#REF!
See Zoning Maps for reference number				
Report, detailing the estimated cost at draft plan stage				

RESIDENTIAL LANDS			R1		
Required services		network	85 along 15 cross upgrade		
		SPS			
		WWTP			
CONNECTION	3929			137,515	
extra on connection	442	IW		0	
NETWORK				25,000	
Network upgrade	250	roads section		100	
Network new road	200				
Network upgrade green	150				
Network new green	100				
PUMP				0	
SCADA	14000	bs Tobin reports			
valve chamber	4000				
variable speed	12500				
benching	2500				
Atex pump replace	13000				
discharge +vent	3500				
recertification electric	2500				
rising main	250				
Pump Station new	250000	turn quotes 2019			
WWTP upgrade per 1000 PE	0	0		-	
Water DI	2.7	0	94.5	94.5	
Commit re	NETWORK+SPS+WWTP	162515	162515	162,515	
size land parcel estimated		m2		130*120	
housing density estimated		number		30	
	29 dwellings/ha	m2		16720	
=(12+8+4)*10*(1+(15green+5school+10business		if pump		16720	
	348 m2/ dwelling			48	
	737.1 m2/ dwelling			23	
=(12+8+9+6)*(3+12+3)*(1+(15 road+1 school+1		2/3 1/3 spl		40	
	14 dwellings/ha	50:50 split		35	
35	added dwelling PE	95	chosen nu	35	
	cost % figure in table				
	3900	100			
	8000	67	-124		
	12000	33	-118		
	16000	0	-121		
	Costs per unit			4,643	#DIV/0!
	Score to table			94	#DIV/0!
	=-Deficit/+headroom	664			Plant needs upgrade

NEWTOWNFORBES – DETAILED ASSESSMENT RESIDENTIAL LANDS:

INFRASTRUCTURE ASSESSMENT							
Settlement	NEWTOWNFORBES		23010	1940	3490	4470	7720
Water supply zone	Lough Forbes	7 MI/day	31111				
Agglomeration	Newtownforbes		2.301	0.194	0.349	0.447	0.772
Residential lands			R1	R2	R3	R4	R5
Wastewater	headroom	690	86	70	70	73	83
Employment lands			E1	E2	E3	E4	E5
Wastewater			#REF!	#REF!			
See Zoning Maps for reference number							
Report, detailing the estimated cost at draft plan stage							

RESIDENTIAL LANDS			R1	R2	R3	R4	R5	
Required services		network	180m new road	60m road	50 new	50 upgrade	80m reroute	
		SPS				Cluain doire	upgrade	
		WWTP						
CONNECTION	3929		157,160	117,870	58,935	19645	0	
extra on connection	442	IW	0	0	0	0	0	
NETWORK			66,000	17,500	30,000	42500	0	
Network upgrade	250	roads section	120	60	50		80	
Network new road	200		180		50			
80 Network upgrade green	150						80	
Network new green	100							
PUMP			0	0	0	26500	0	
SCADA	14000	bs Tobin reports					1	
valve chamber	4000						1	
variable speed	12500							
benching	2500						1	
Atex pump replace	13000							
discharge +vent	3500						1	
recertification electric	2500						1	
rising main	250							
Pump Station new	250000	urn quotes 2019						
WWTP upgrade per 100	0	0	0	0	0	0	0	
Water D	2.7	0	197.1	108	10.8	16.2	21.6	40.5
limit re	NETWORK+SPS+WWTP sum total		448817	223,160	30,716	46,071	57932	90935
size land parcel estimated	m2		193*120	58*33	80*39	135*32	200*46+93*33	
housing density estimated	number		60	45	30			
32 dwellings/ha	m2		23010	1940	3490	4470	7720	
=(11+10+4+6)*7*(1+(15green+5school+1	if pump		23010	1940	3490	2870	7720	
315 m2/ dwelling			73	6	11	14	25	
1832 m2/ dwelling			13	1	2	2	4	
=(15+4+8+6+15+6)*(4+13+6+8)*(1+(15rc	2/3 1/3 spl		53	4	8	10	18	
5 dwellings/ha	50:50 split		43	4	6	8	4	
73 added dwelling PE	197	chosen nu	40	4	6	8	15	
cost % figure in table								
3900 100								
8000 67		-124						
12000 33		-118						
16000 0		-121						
Costs per unit			5,579	7,679	7,679	7,242	6,062	
Score to table			86	70	70	73	83	
=-Deficit/+headroom	493						Plant needs upgrade	

ABBEYSHRULE – DETAILED ASSESSMENT RESIDENTIAL LANDS:

INFRASTRUCTURE ASSESSMENT					
Settlement	ABBEYSHRULE		3230	5910	2910
Water supply zone	Ballymahon	3 MI/day	31111		
Agglomeration	Abbeysrule		2.301	0.194	0.349
Residential lands			R1	R2	R3
Wastewater	headroom	183	68	33	4
Employment lands			E1	E2	E3
Wastewater			#REF!	#REF!	
See Zoning Maps for reference number					
Report, detailing the estimated cost at draft plan stage					
RESIDENTIAL LANDS			R1	R2	R3
Required services		network	75m new	260m new	140m new
		SPS		PS Upgrade	PS Upgrade
		WWTP			
CONNECTION	3929		19,645	39,290	19,645
extra on connection	442	IW	0	0	0
NETWORK			20,000	65,000	50,000
Network upgrade	250	oads section	80	260	200
Network new road	200				
Network upgrade green	150				
Network new green	100				
PUMP			0	16000	8000
SCADA	14000	bs Tobin reports		0.667	0.333
valve chamber	4000			0.667	0.333
variable speed	12500				
benching	2500				
Atex pump replace	13000				
discharge +vent	3500			0.667	0.333
recertification electric	2500			0.667	0.333
rising main	250				
Pump Station new	250000	urn quotes 2019			
WWTP upgrade per 100	0	0	0	0	0
Water D	2.7	0	54	13.5	27
mit re					
NETWORK+SPS+WWTP sum total		237580	39,645	120,290	77,645
size land parcel estimated		m2	86*76	152*108	215*91
housing density estimated		number	20	15	25
23 dwellings/ha		m2	3230	5910	2910
=(11+10+11+6)*8*(1+15green+5school+if pump			3230	4310	1310
440.8 m2/ dwelling			7	13	7
2046.33 m2/ dwelling			2	3	1
=(23+9+15+6)*(9+19+5)*(1+(15 road+1 s 2/3 1/3 spl			5	10	5
5 dwellings/ha		50:50 split	4	8	4
20 added dwelling PE	54	chosen nu	5	10	5
cost % figure in table					
3900 100					
8000 67		-124			
12000 33		-118			
16000 0		-121			
Costs per unit			7,929	12,029	15,529
Score to table			68	33	4
=-Deficit/+headroom	129				Plant needs upgrade

APPENDIX E – SETTLEMENT ASSESSMENTS & MAPPING

The following maps show the lands zoned and include a table providing the combined assessment and appropriate tiering and colour coding of the zoned sites in each of the settlements.

The assessment has sought to combine the assessments that have been undertaken from Water Services in respect of wastewater treatment and Roads Section in respect of the roading infrastructure and identified areas of drainage and flooding.

The assessment identifies the lands according to a colour coding using a simplified traffic light system. The assessments have combined the previous into a combined overview for the settlement. The sites are coded as follows:

LAND ZONING CODING		
Score	Tier	Colour
100-67	1	Green
66-34	2	Yellow
33-0	No Development	Red

Longford Town Infrastructural Assessment- Further Iteration

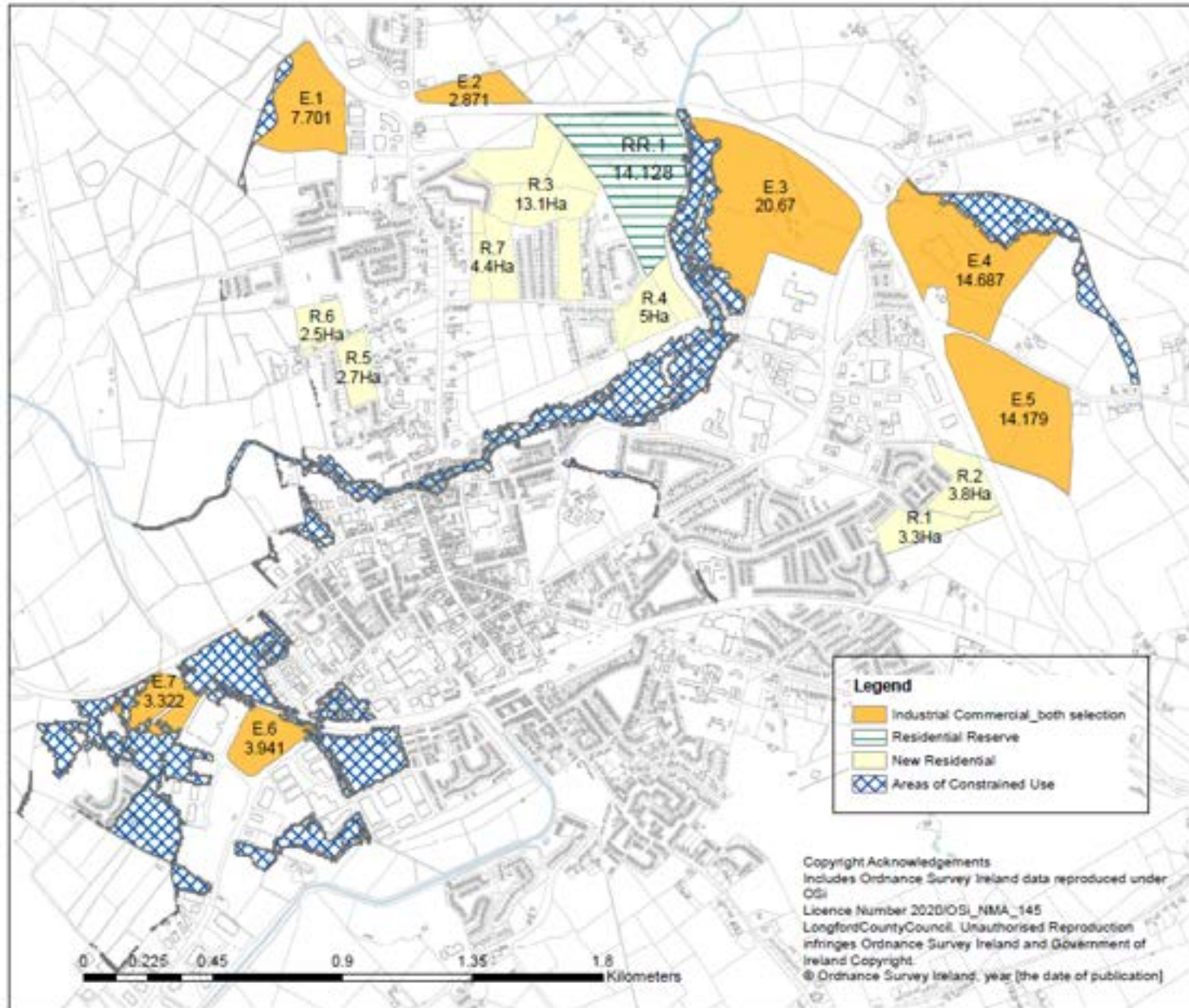

Residential Zonings	Tier-1—Green	Tier-2—Amber	No-Development—Red
R1	■	■	■
R2	■	■	■
R3	■	■	■
R4	■	■	■
R5	■	■	■
R6	■	■	■
R7	■	■	■
RR1	■	■	■

Employment Zonings	Tier-1—Green	Tier-2—Amber	No-Development—Red
E1	■	■	■
E2	■	■	■
E3	■	■	■
E4	■	■	■
E5	■	■	■
E6	■	■	■
E7	■	■	■



Copyright Acknowledgements
 Includes Ordnance Survey Ireland data reproduced under OSI
 Licence Number 2020/OSI_NMA_145 LongfordCountyCouncil. Unauthorised Reproduction
 infringes Ordnance Survey Ireland and Government of Ireland Copyright.
 © Ordnance Survey Ireland, year 2021

Legend

- Industrial/Commercial/Warehousing
- New Residential
- Strategic Industrial Reserve
- Areas of Constrained Use

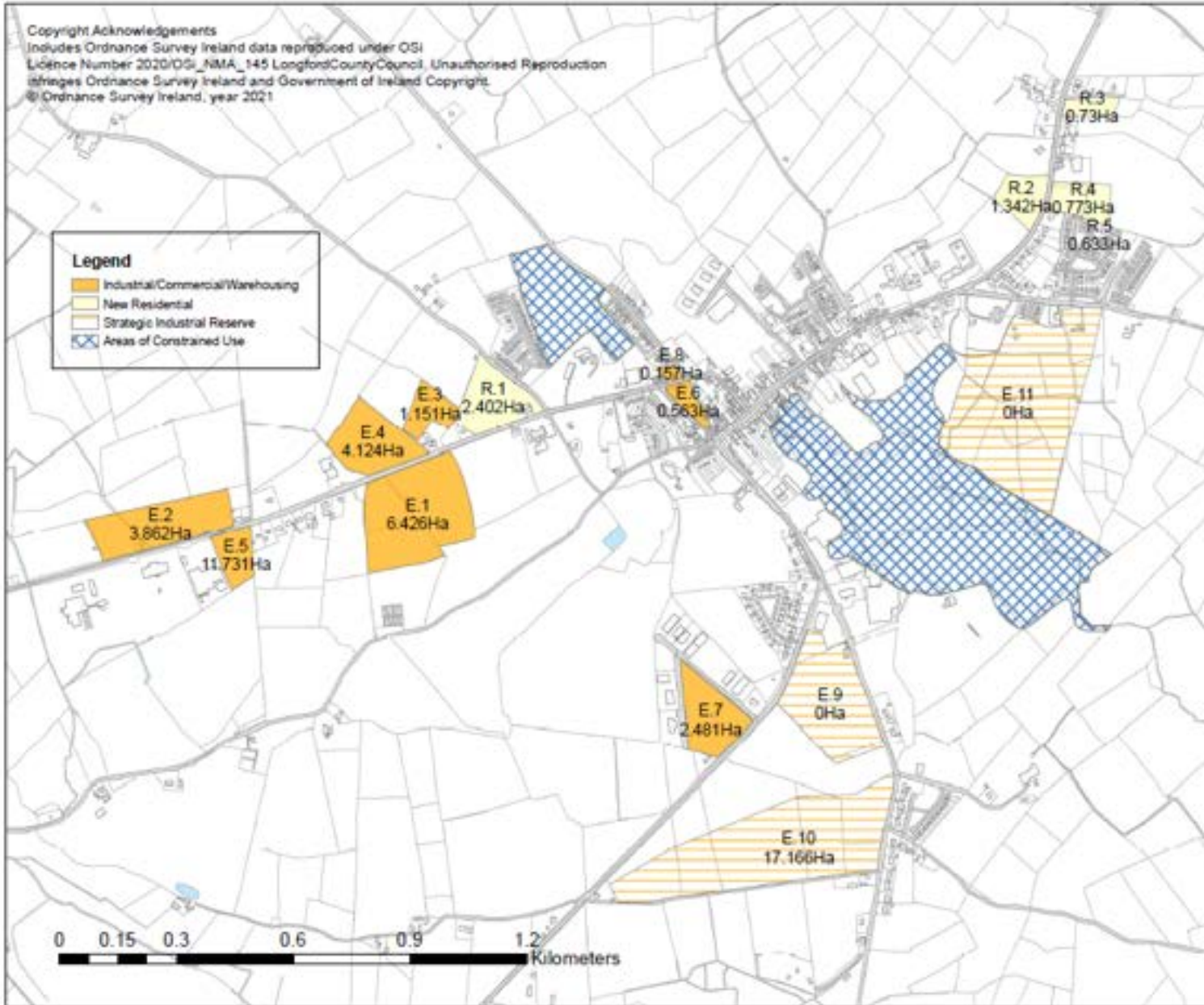

Granard Infrastructural Assessment- Further Iteration

Residential Zonings	Tier 1 – Green Tier 2 – Amber No Development - Red
R1	
R2	
R3	
R4	
R5	

Employment Zonings	Tier 1 – Green Tier 2 – Amber No Development - Red
E1	
E2	
E3	
E4	
E5	
E6	
E7	
E8	
E9	
E10	
E11	



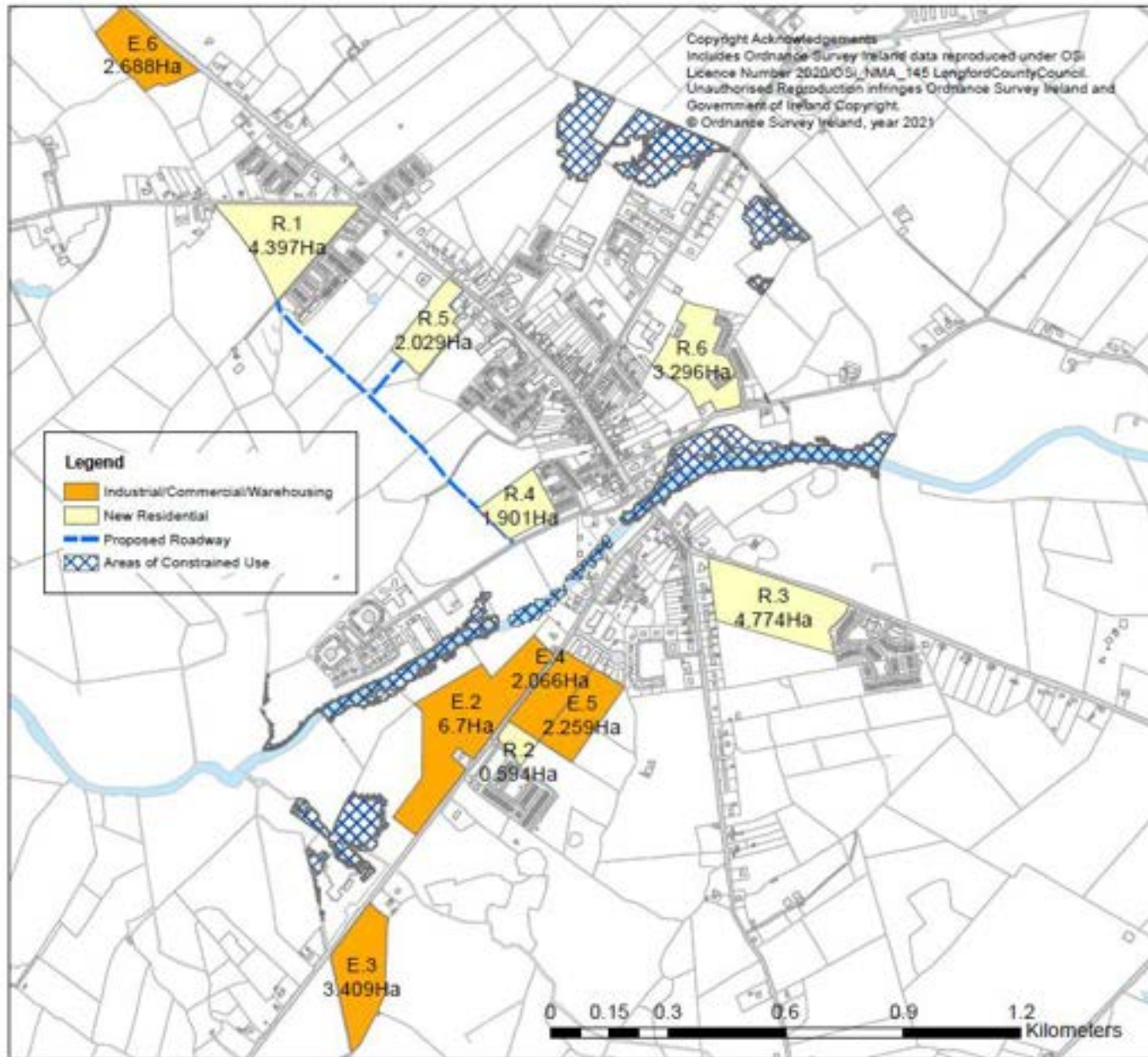

Ballymahon Infrastructural Assessment- Further Iteration

Residential Zonings	Tier 1 – Green Tier 2 – Amber No Development - Red
R1	Red
R2	Amber
R3	Red
R4	Amber
R5	Amber
R6	Amber

Employment Zonings	Tier 1 – Green Tier 2 – Amber No Development - Red
E1	Green
E2	Red
E3	Red
E4	Amber
E5	Amber
E6	Red



Copyright Acknowledgements
 Includes Ordnance Survey Ireland data reproduced under
 OSI
 Licence Number 2020/OSI_NMA_145
 LongfordCountyCouncil. Unauthorised Reproduction
 infringes Ordnance Survey Ireland and Government of
 Ireland Copyright.
 © Ordnance Survey Ireland, year 2021

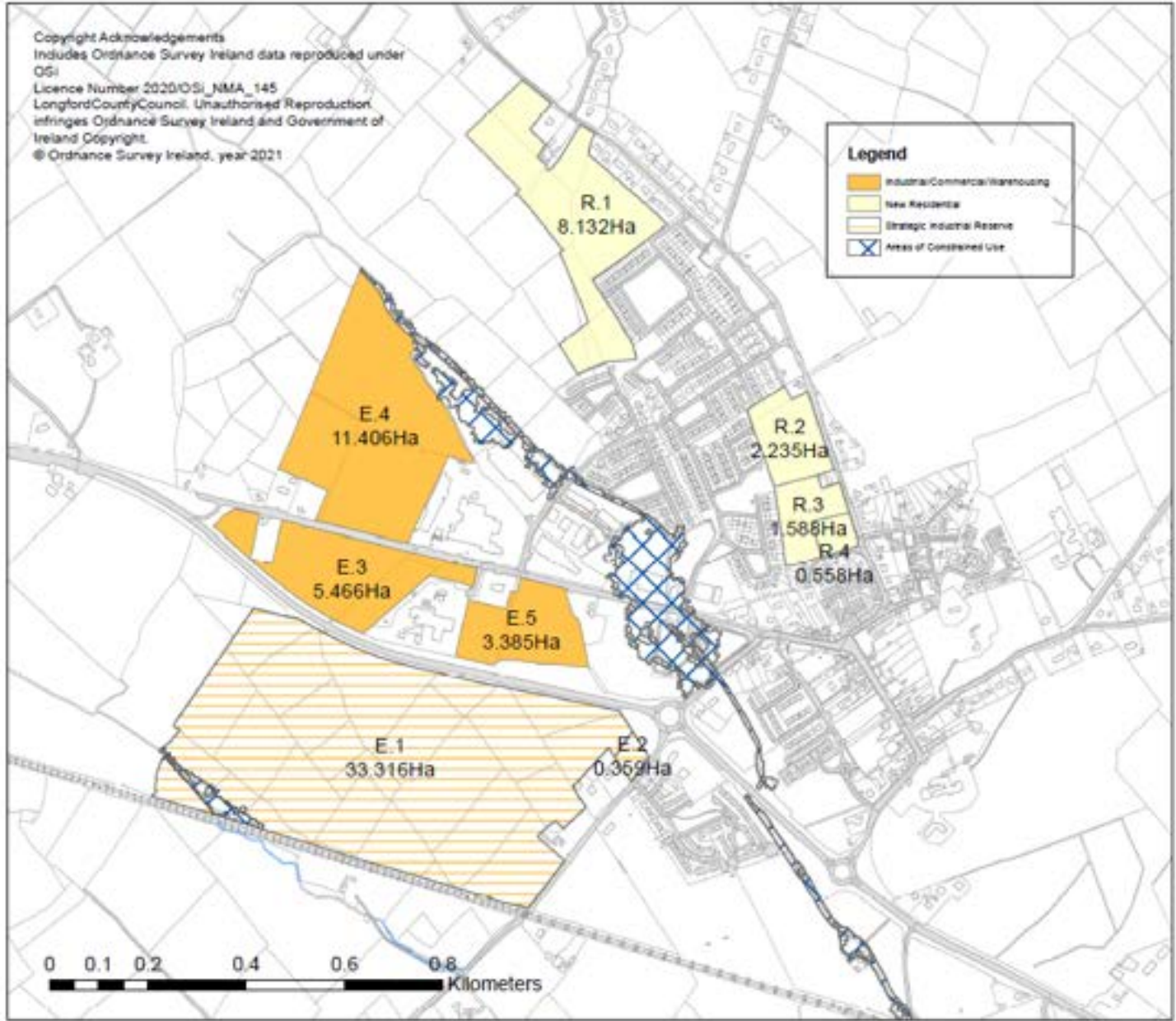

Edgeworthstown Infrastructural Assessment- Further Iteration

Residential Zonings	Tier 1 – Green Tier 2 – Amber No Development - Red
R1	Amber
R2	Amber
R3	Amber
R4	Amber

Employment Zonings	Tier 1 – Green Tier 2 – Amber No Development - Red
E1	Red
E2	Red
E3	Red
E4	Red
E5	Red



Copyright Acknowledgements
 Includes Ordnance Survey Ireland data reproduced under OS
 Licence Number 2020/03_NMA_145 LongfordCountyCouncil
 Unauthorised Reproduction infringes Ordnance Survey Ireland and
 Government of Ireland Copyright
 © Ordnance Survey Ireland, year 2021

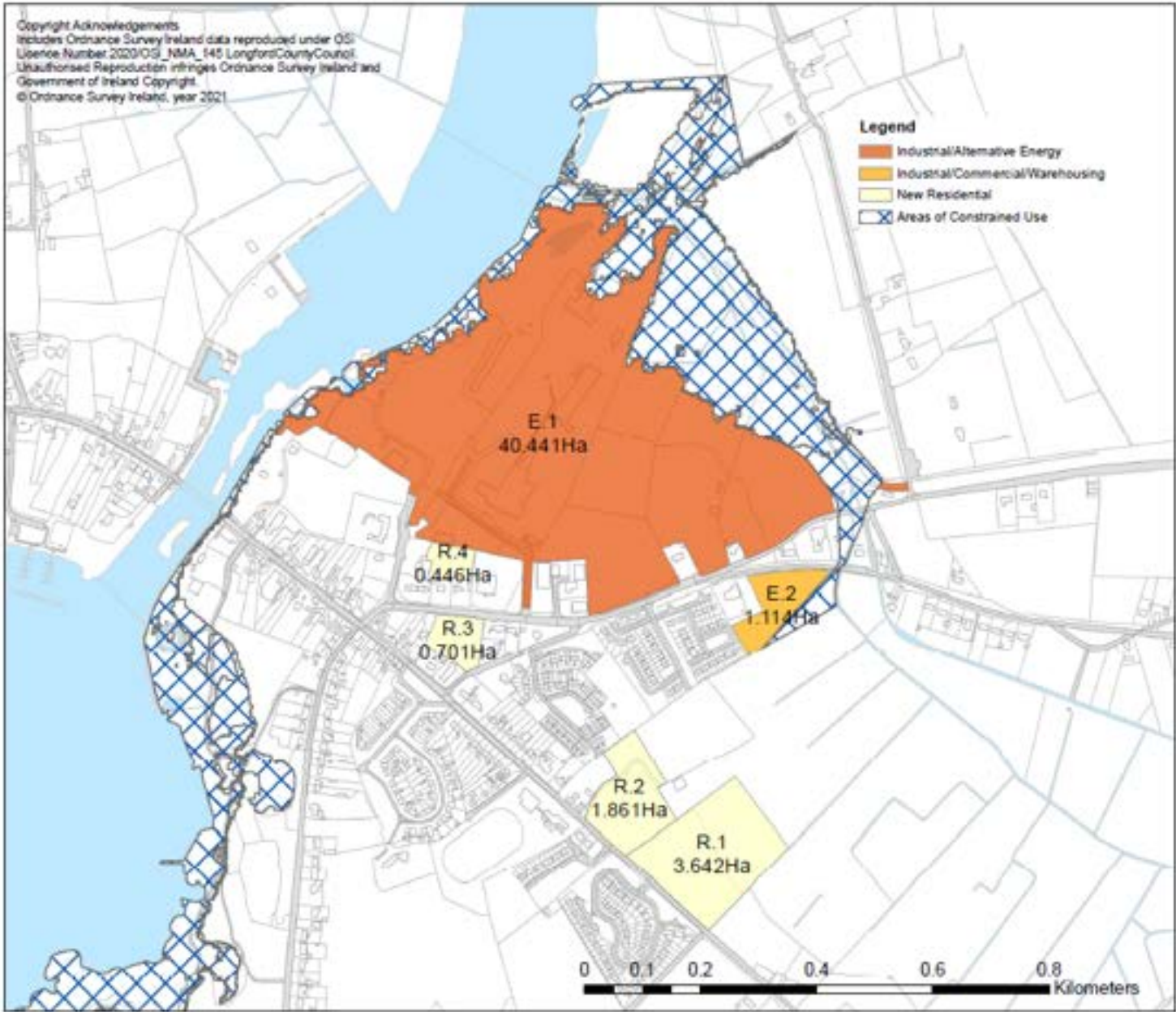

Lanesborough Infrastructural assessment- further iteration

Residential Zonings	Tier 1 – Green Tier 2 – Amber No Development - Red
R1	Amber
R2	Amber
R3	Amber
R4	Amber

Employment Zonings	Tier 1 – Green Tier 2 – Amber No Development - Red
E1	Red
E2	Red



Copyright Acknowledgements
 Includes Ordnance Survey Ireland data reproduced under OS
 License Number 2020/OS_NMA_145 Longford County Council.
 Unauthorised Reproduction Infringes Ordnance Survey Ireland and
 Government of Ireland Copyright.
 © Ordnance Survey Ireland, year 2021

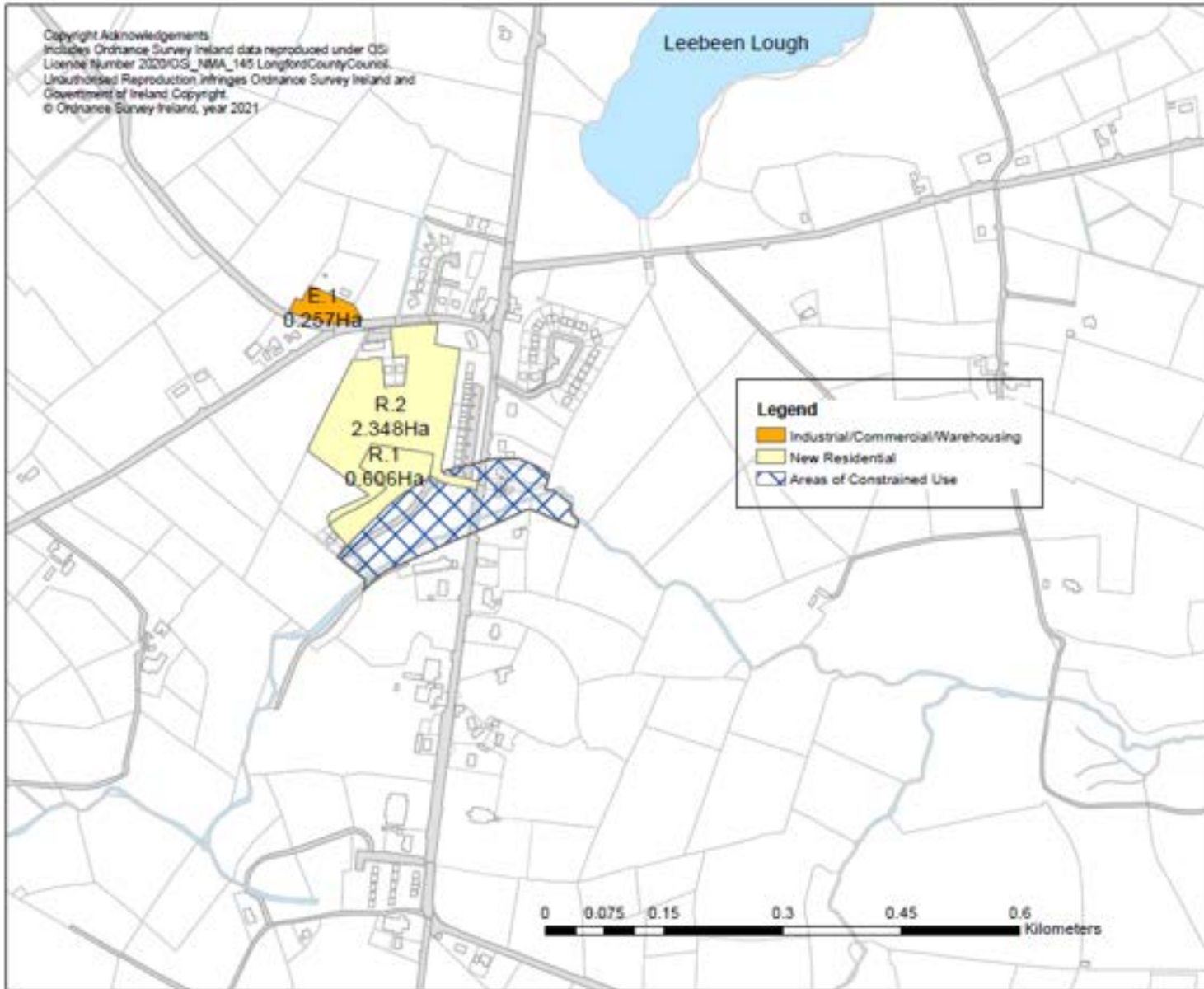

Aghnaccliffe Infrastructural Assessment- Further Iteration

Residential Zonings	Tier 1 – Green Tier 2 – Amber No Development - Red
R1	
R2	

Employment Zonings	Tier 1 – Green Tier 2 – Amber No Development - Red
E1	



Ballinalee Infrastructural assessment- Further Iteration

Copyright Acknowledgements
 Includes Ordnance Survey Ireland data reproduced under OS
 Licence Number 2020/001_NWA_145 Longford County Council
 Unauthorised reproduction infringes Ordnance Survey Ireland and
 Government of Ireland Copyright.
 © Ordnance Survey Ireland, year 2021

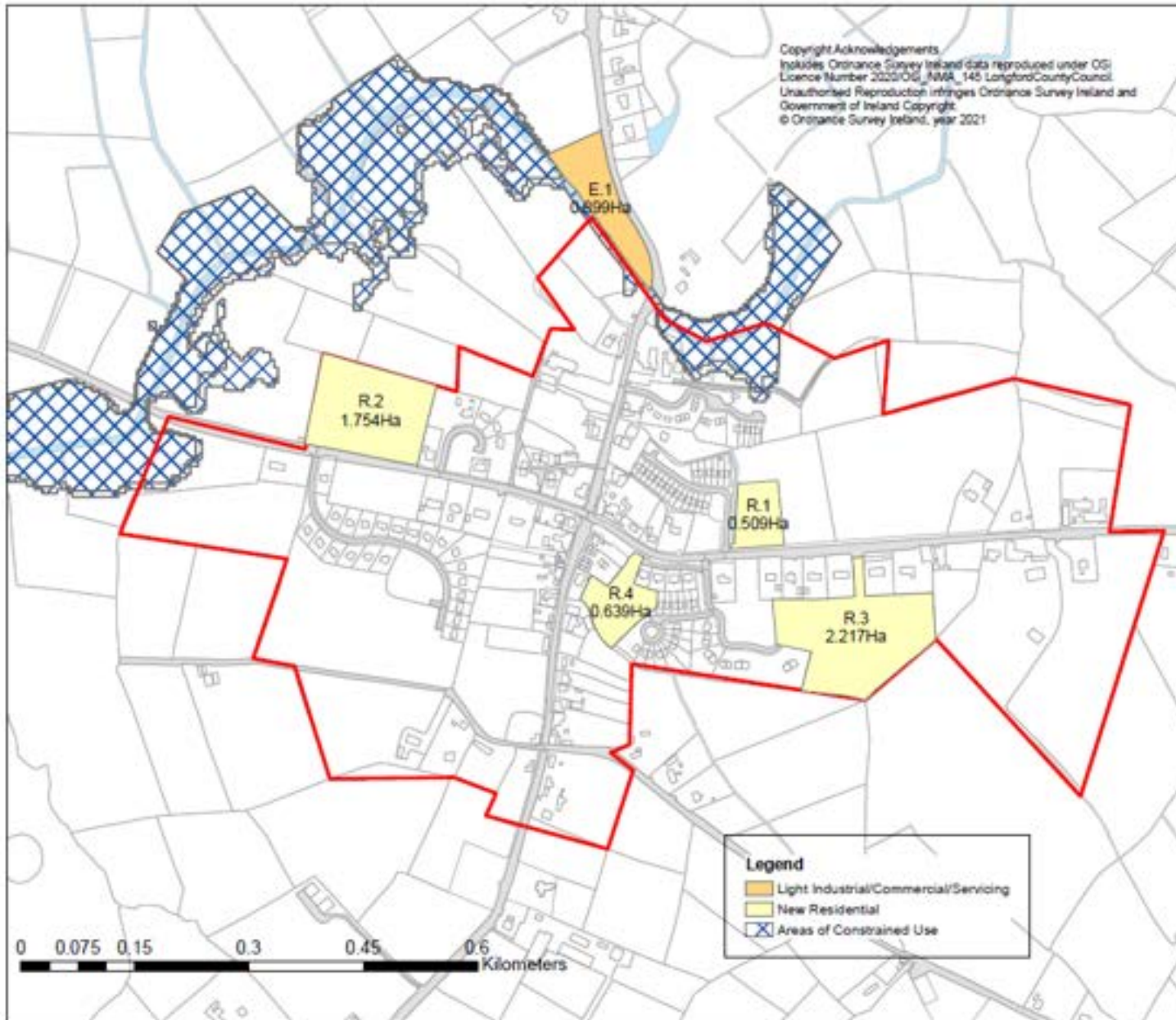

Residential Zonings	Tier 1 – Green Tier 2 – Amber No Development - Red
R1	
R2	
R3	
R4	

Employment Zonings	Tier 1 – Green Tier 2 – Amber No Development - Red
E1	

Copyright Acknowledgements
 Includes Ordnance Survey Ireland data reproduced under
 ODI
 Licence Number 2020/OSI_NMA_145
 LongfordCountyCouncil. Unauthorised Reproduction
 infringes Ordnance Survey Ireland and Government of
 Ireland Copyright.
 © Ordnance Survey Ireland, year 2021

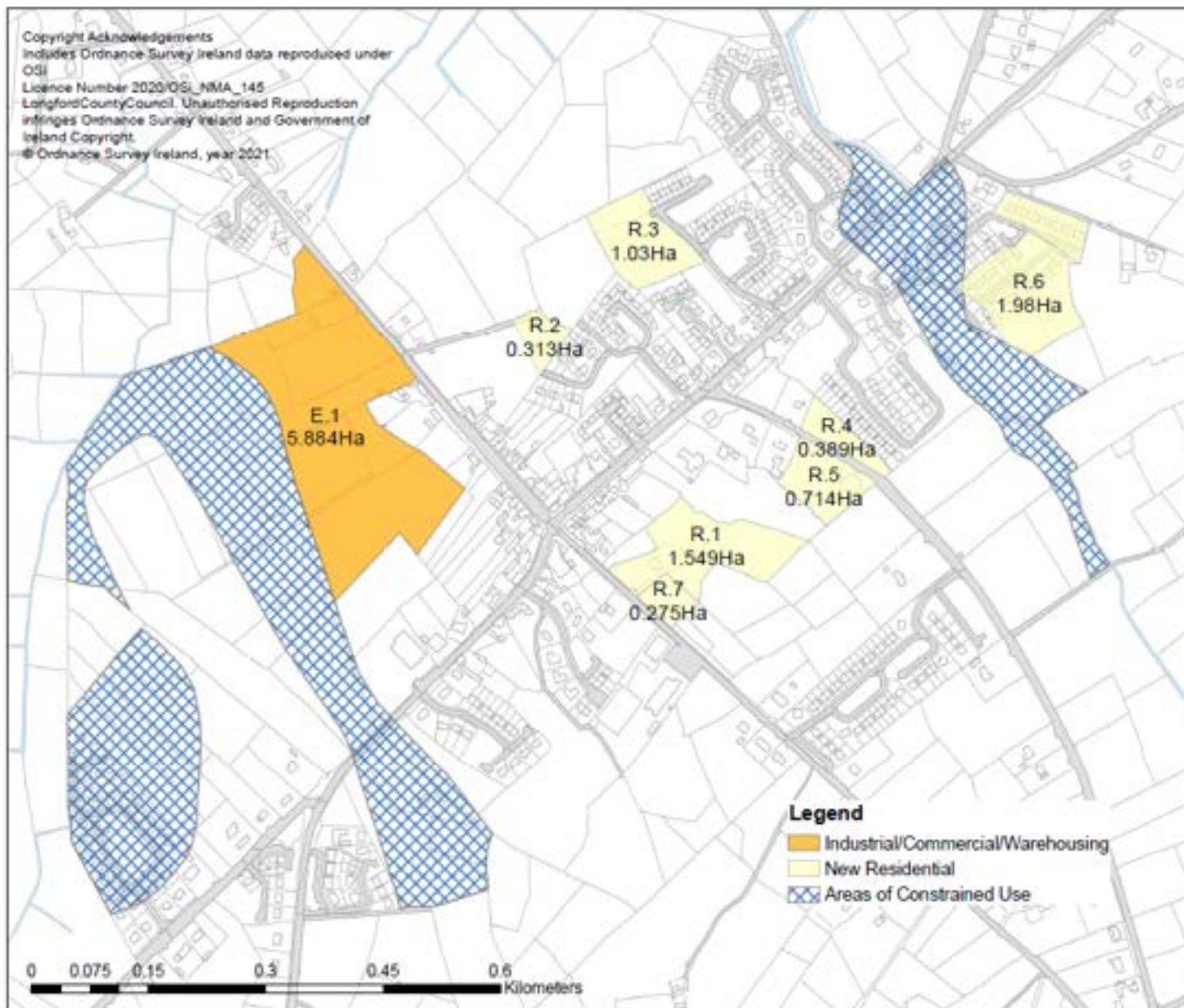

Drumlish Infrastructural assessment- Further Iteration

Residential Zonings	Tier 1 – Green Tier 2 – Amber No Development - Red
R1	Red
R2	Red
R3	Amber
R4	Green
R5	Green
R6	Red
R7	Amber

Employment Zonings	Tier 1 – Green Tier 2 – Amber No Development - Red
E1	Red

Legend

- Industrial/Commercial/Warehousing
- New Residential
- Areas of Constrained Use



Copyright Acknowledgements
 Includes Ordnance Survey Ireland data reproduced under OSI
 Licence Number 2020/OSI/NMA/145 Longford County Council. Unauthorised reproduction
 infringes Ordnance Survey Ireland and Government of Ireland Copyright.
 © Ordnance Survey Ireland, year 2021

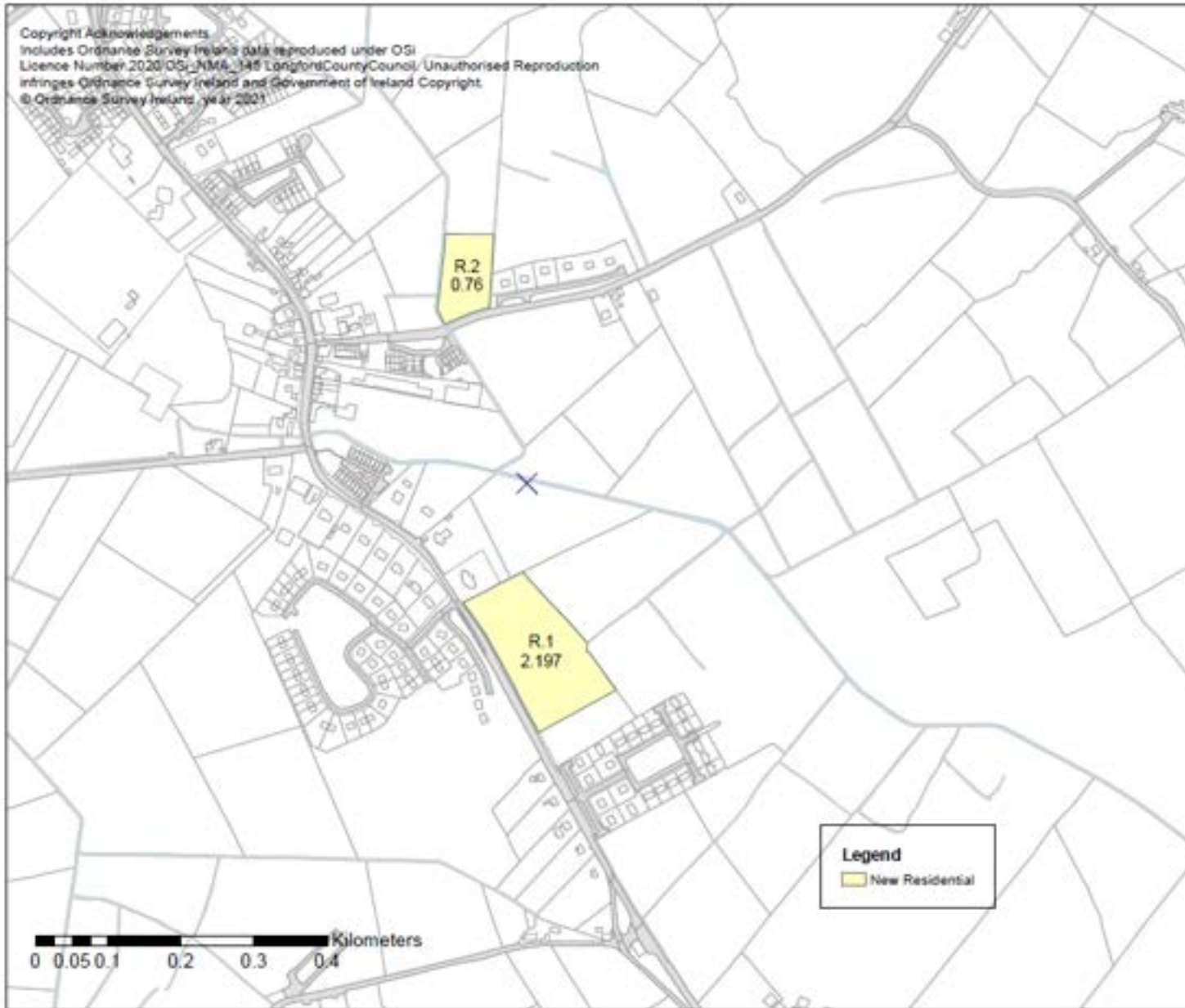

Keenagh Infrastructural Assessment- Further Iteration

Residential Zonings	Tier 1 – Green Tier 2 – Amber No Development - Red
R1	
R2	



Copyright Acknowledgements
 Includes Ordnance Survey Ireland data reproduced under OSI
 Licence Number 2020/OSI_NMA_148 Longford County Council
 Unauthorised reproduction infringes Ordnance Survey Ireland and
 Government of Ireland Copyrights
 © Ordnance Survey Ireland, year 2021

Legan Infrastructural assessment- Further Iteration

Residential Zonings	Tier 1 – Green Tier 2 – Amber No Development - Red
R1	

Legend

- New Residential
- Areas of Constrained Use





Copyright Acknowledgements
 Includes Ordnance Survey Ireland data reproduced under OSI
 Licence Number 2020/OSI_NMA_145 LongfordCountyCouncil. Unauthorised
 Reproduction infringes Ordnance Survey Ireland and Government of Ireland
 Copyright.
 © Ordnance Survey Ireland, year 2021

Legend

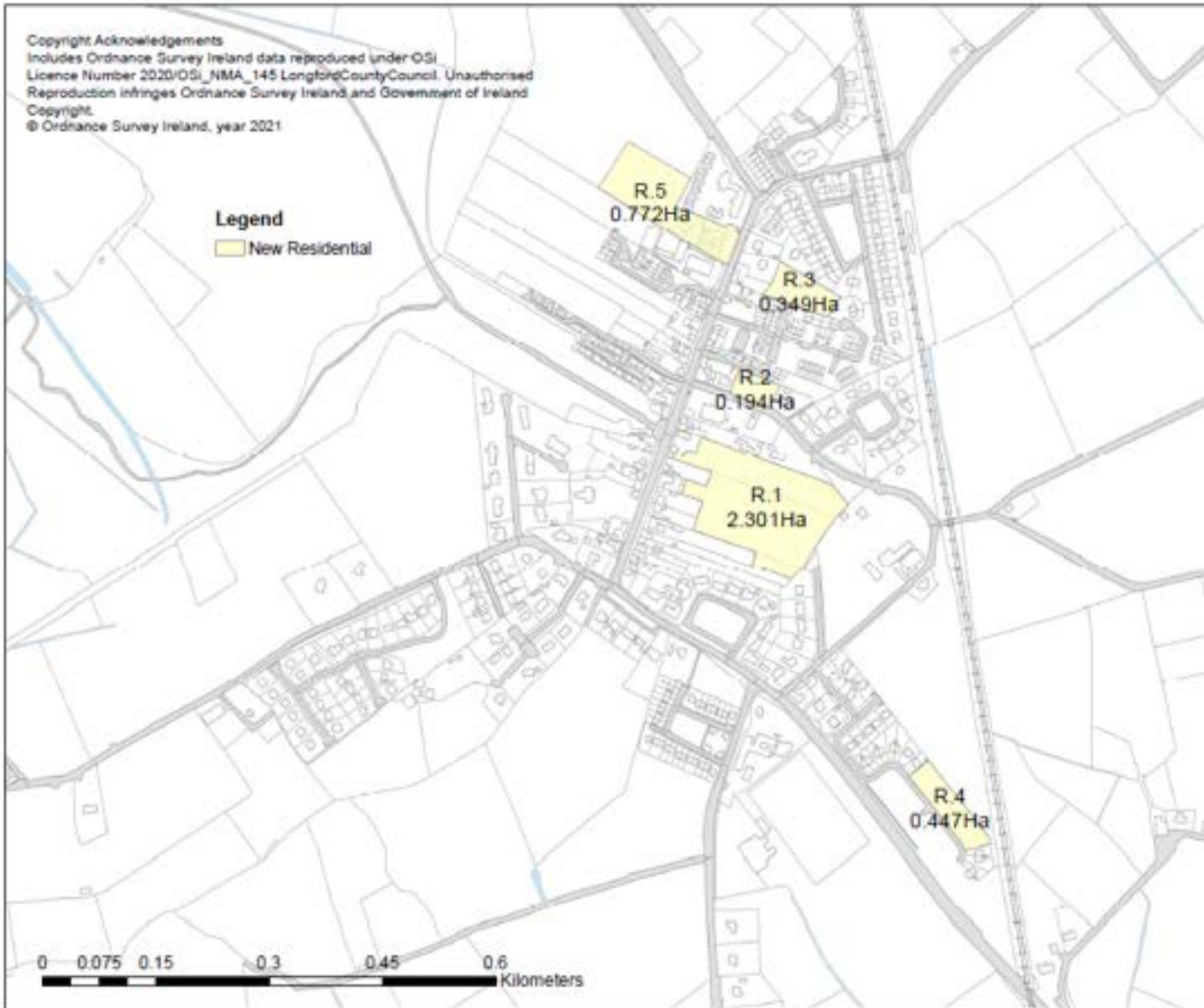
 New Residential

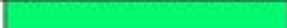

**Newtownforbes
 Infrastructural Assessment-
 Further Iteration**

Residential Zonings	Tier 1 – Green Tier 2 – Amber No Development - Red
R1	
R2	
R3	
R4	
R5	



Copyright Acknowledgements
 Includes Ordnance Survey Ireland data reproduced under OSI
 Licence Number 2020/OSI_NMA_145 LongfordCountyCouncil.
 Unauthorised reproduction infringes Ordnance Survey Ireland
 and Government of Ireland Copyright.
 © Ordnance Survey Ireland, year 2021

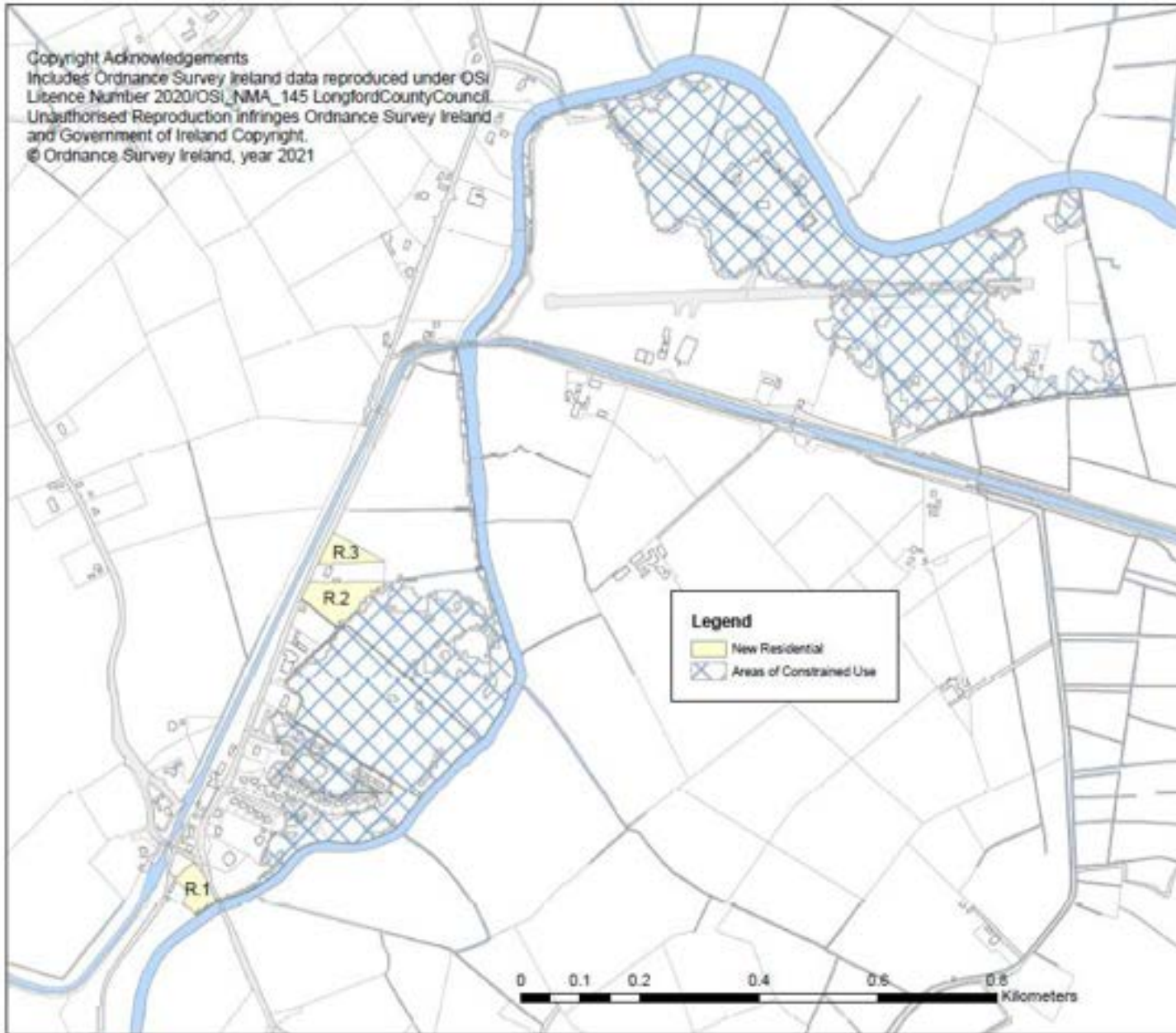

Abbeyshrule Infrastructural assessment- Further Iteration

Residential Zonings	Tier 1 – Green Tier 2 – Amber No Development - Red
R1	
R2	
R3	



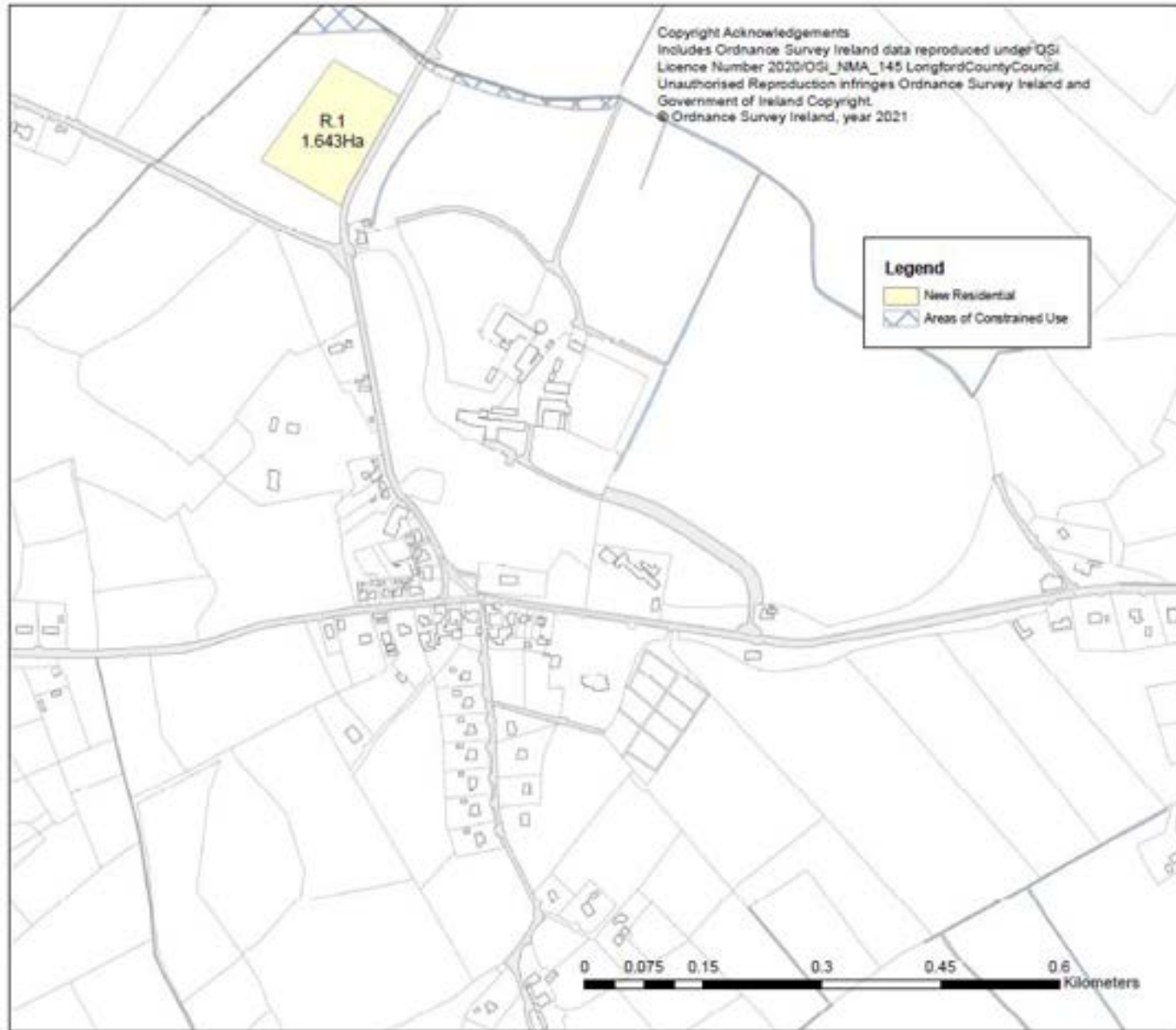

Ardagh Infrastructural assessment- Further Iteration

Residential Zonings	Tier 1 – Green Tier 2 – Amber No Development - Red
R1	

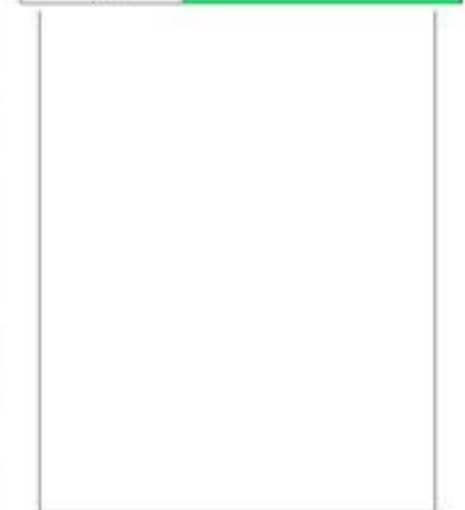

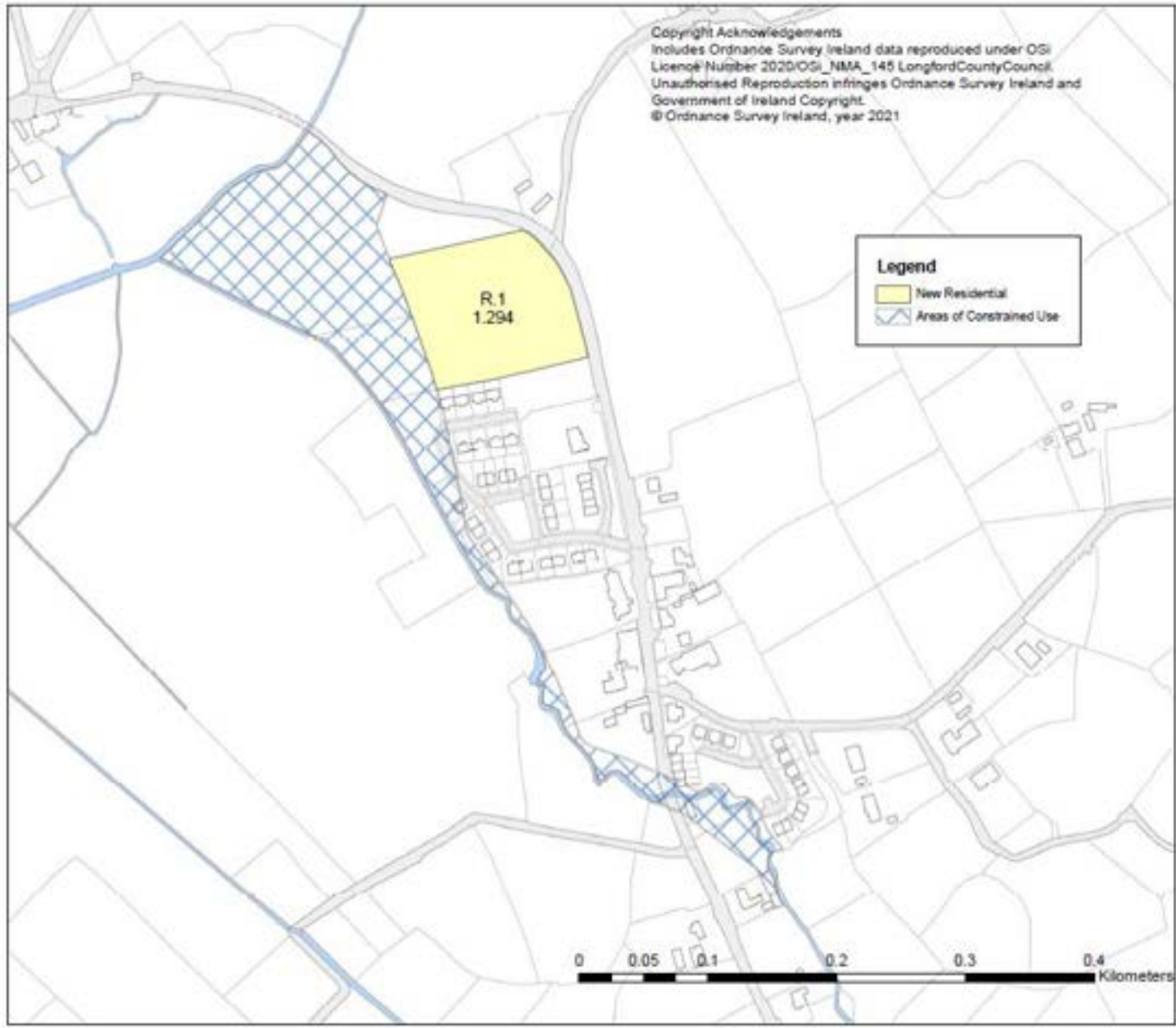

Ballinamuck Infrastructural assessment- Further Iteration

Residential Zonings	Tier 1 – Green Tier 2 – Amber No Development - Red
R1	



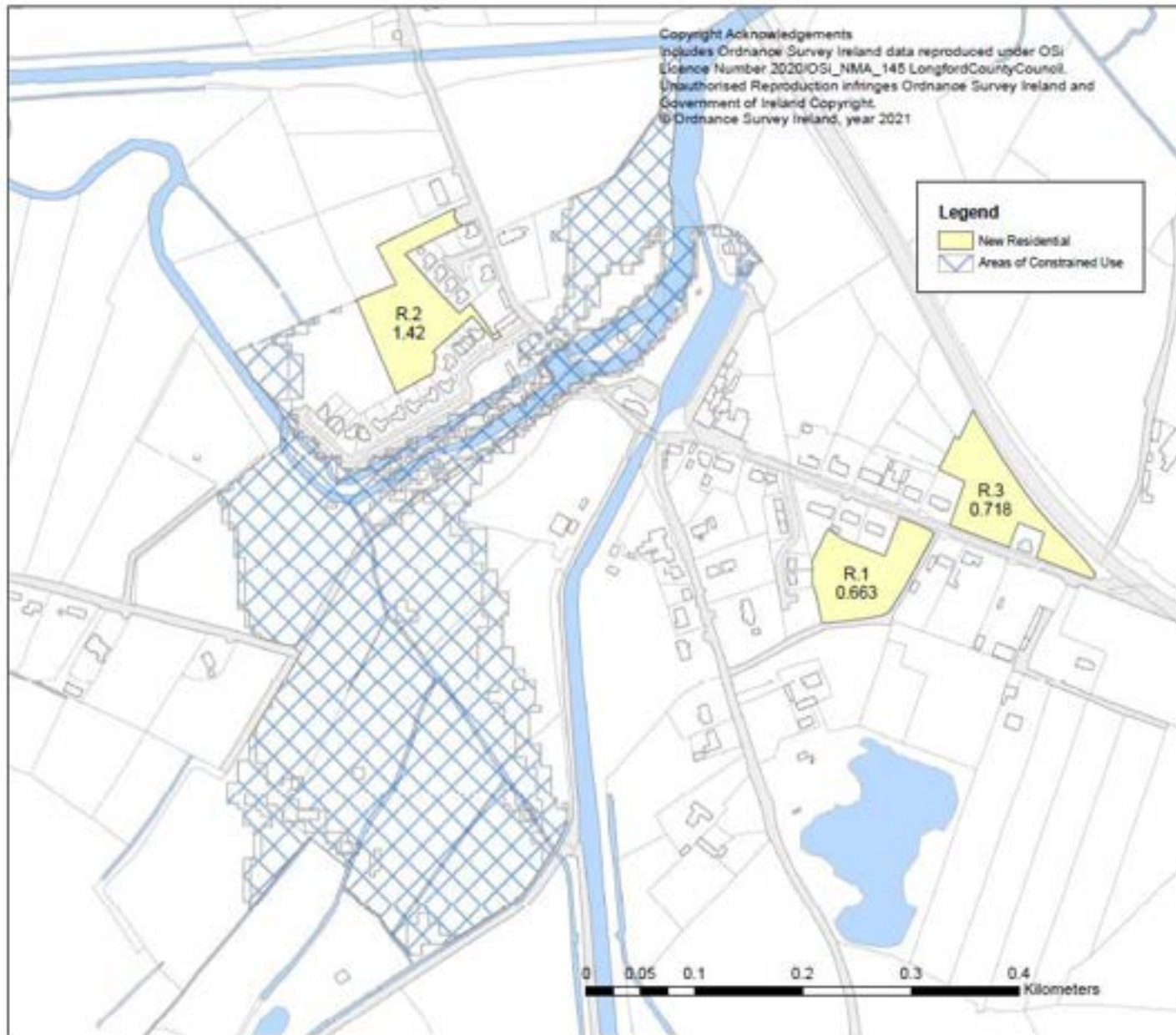

Clonra Infrastructural assessment- Further Iteration

Residential Zonings	Tier 1 – Green Tier 2 – Amber No Development - Red
R1	
R2	
R3	



APPENDIX F – SETTLEMENT ZONINGS (RESIDENTIAL & EMPLOYMENT LANDS)

The lands zoned for residential and employment lands have been assessed according to the infrastructure available to service the sites. The lands identified as being serviced are identified in the following settlement plans.

The background and preliminary background information used in the iterative process of assessing the settlements and the identified sites are included in the preceding appendices.

The revised settlement land-use zonings have been informed by the Submission from the OPR and EMRA which requested that the zoning of lands be informed by an Infrastructure Assessment, flood zonings, and alignment with and consideration of National Planning Policy especially in respect of compact growth and the aim of delivering growth within establishment settlements and within their defined CSO settlement boundaries. The settlements are presented according to the settlement hierarchy.

Key Town	Longford Town	
Self-Sustaining Growth Towns	Granard	
Self-Sustaining Towns	Ballymahon Edgeworthstown Lanesborough	
Towns & Villages	Aughnaccliffe Ballinalee Drumlish	Keenagh Legan Newtownforbes
Villages & Smaller settlements	Abbeyshrule Ardagh	Ballinamuck Clondra

The following maps and plans show the proposed land-use zoning changes for the main settlements and these should be read in conjunction with the previous appendices and assessments:

Appendix – F1 Key Town Longford Town:

The land-use zonings for Longford Town have been revised in accordance with this Infrastructure Assessment framework and the resulting land-use zoning plan for Longford is presented below.

The settlement maps presented in the initial Draft County Development Plan 2021-2027 were based on the current County Development Plan 2015-2021 and the initial infrastructure assessment undertaken in early 2020 (January to April) and informed the review of the land-use zonings for the key settlements and the drafting of the County Development Plan 2021-2027.

Following the Public Consultation on the Draft Longford County Development Plan 2021-2027 and the review of Submissions and Observations received during the consultation period (27th October 2020 until 18th January 2021) the land use zoning plans for the settlements were revised and the Further Iteration Plans are included in this report under Appendix C (produced during the period December 2020 to March 2021).

An additional review of the Infrastructure Assessment Report was undertaken following the development of the Chief Executive's Report on the Submissions received, specifically the submissions from the OPR and EMRA as well as other thematic and area specific submissions. Therefore, the quantum of lands zoned new residential and industrial / commercial / warehousing have been reduced. The revised zoning map identifies and presents a more sustainable and compact form of development reflecting the CSO boundary of the town and core principle of the NPF.

The Further Iteration of the Infrastructure Assessment, the inclusion of the flood risk zonings and the CSO settlement boundary has highlighted specific areas that are subsequently identified as undevelopable and or constrained, lacking the infrastructure required to service the lands, or lands at high risk of flooding. The subsequent settlement plan Longford Proposed Material Amendments (June 2021) identifies those sites where land-use zonings have been amended/revised and the changes identified.

Of specific note are the amendments to the zonings to the north and east of the Longford town and the N4 national road. Additional changes are located along the river Camlin in the centre of Longford, as well as lands to the south-west and south of the town. Part of these lands are identified to be constrained uses and impacted by flood issues.

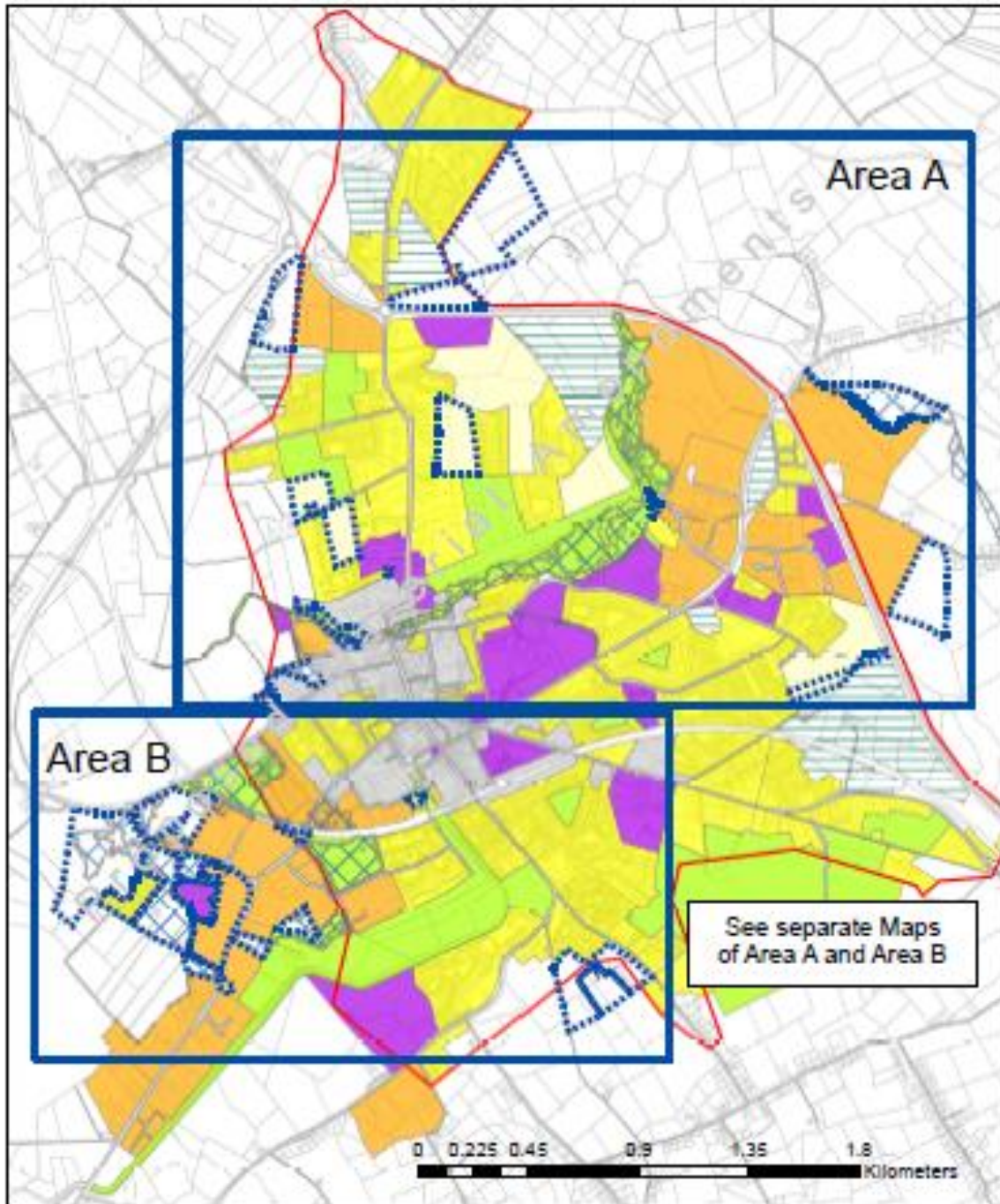

Longford Town
 Proposed Material Amendments
 Outline of Area A & Area B
 County Development Plan 2021-2027



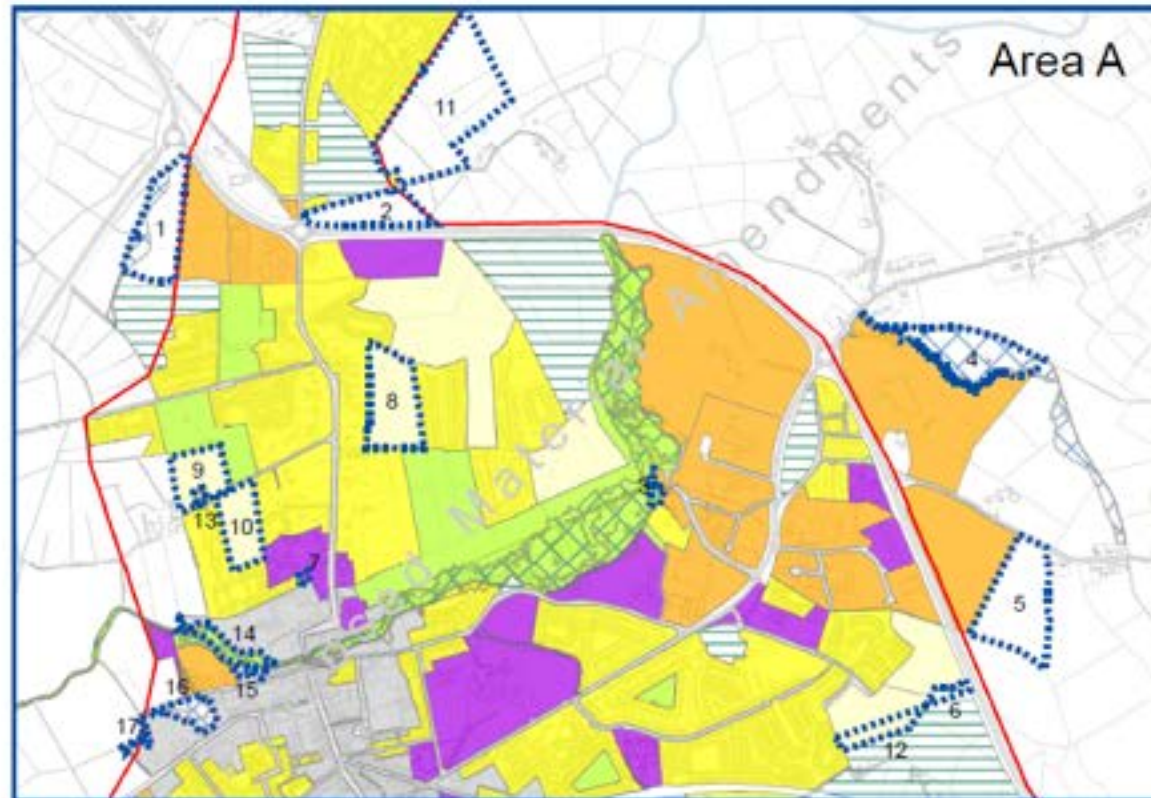

Copyright Acknowledgements
 Includes Ordnance Survey Ireland data reproduced under OLI Licence Number 2020-011_1204_141 Longford County Council. Unauthorised Reproduction infringes Ordnance Survey Ireland and Government of Ireland Copyright.
 © Ordnance Survey Ireland, year the date of publication



Longford Town Proposed Material Amendments



Zoning Changes - Area A

Draft Plan Zoning in Draft Plan	Alteration Amended Zoning	Parcel No. Area on Map
Industrial/Commercial/Warehousing		
	No Zoning	1
	No Zoning	2
	Recreational/Amenity/Green Space	8
	No Zoning	4
	No Zoning	5
New Residential		
	Residential Reserve	6
Residential		
	Social/Community/Education/Public Utility	7
Residential Reserve		
	New Residential	9
	New Residential	10
	No Zoning	11
	New Residential	12
	Residential	13
Town Core		
	No Zoning	14
	No Zoning	15
	No Zoning	16
	No Zoning	17

Longford Town
Proposed Material Amendments
County Development Plan 2021-2027

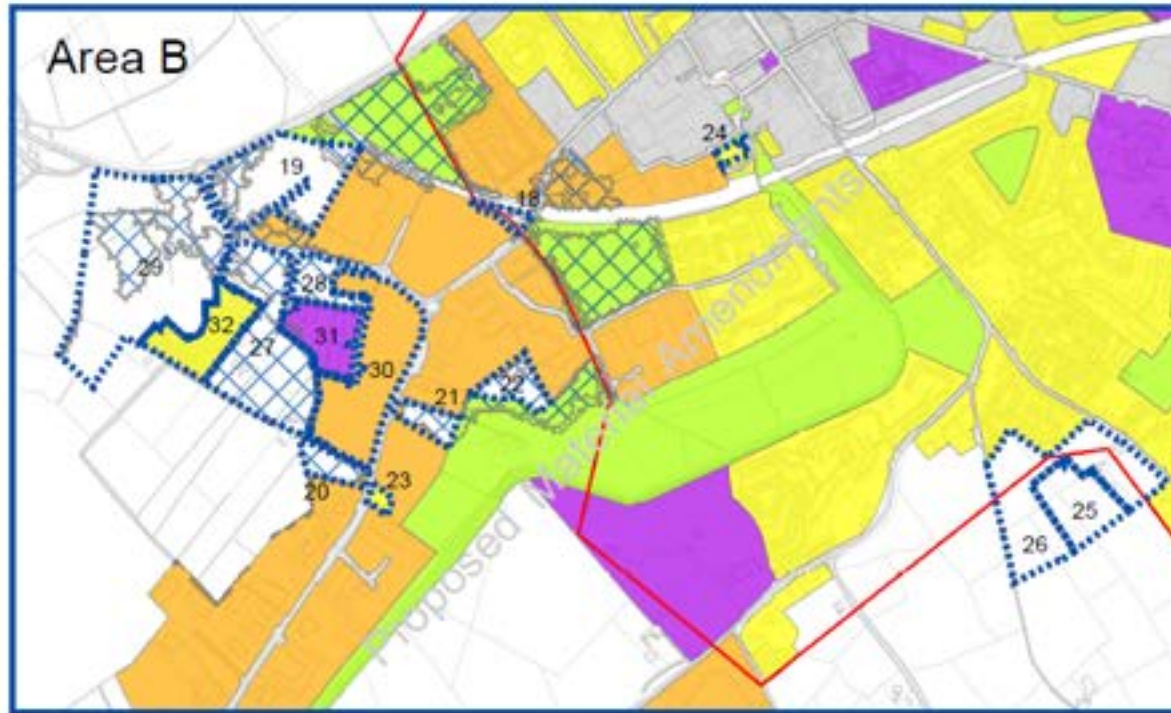

Legend

- Changed Zoning
- Areas of Constrained Land Use
- CSO Settement Boundary
- Town Core
- Industrial/Commercial/Warehousing
- Recreational/Amenity/Green Space
- New Residential
- Residential
- Social/Community/Education/Public Utility
- Strategic Residential Reserve



Copyright Acknowledgements
Includes Ordnance Survey Ireland data reproduced under
OS
Licence Number 2020/OSI_NMA_145
Longford County Council. Unauthorised Reproduction
infringes Ordnance Survey Ireland and Government of



Zoning Changes - Area B

Draft Plan Zoning in Draft Plan	Alteration Amended Zoning	Parcel/No Area on Map
Industrial/Commercial/Warehousing		
No Zoning	No Zoning	18
No Zoning	No Zoning	19
No Zoning	No Zoning	20
No Zoning	No Zoning	21
No Zoning	No Zoning	22
Residential	Residential	23
Residential	Residential	24
Recreation/Amenity/Green Space		
No Zoning	No Zoning	25
Residential Reserve		
No Zoning	No Zoning	26
Site Resolution Objective		
No Zoning	No Zoning	27
No Zoning	No Zoning	28
No Zoning	No Zoning	29
Industrial/Commercial/Warehousing	Industrial/Commercial/Warehousing	30
Social/Community/Education/Public Utility	Social/Community/Education/Public Utility	31
Residential	Residential	32

Appendix – F2 Self-Sustaining Growth Towns Granard:

The land-use zonings for Granard Town have been revised in accordance with the Infrastructure Assessment framework and the resulting land-use plan for the settlement is presented below.

The settlement maps presented in the initial Draft County Development Plan 2021-2027 were based on the current County Development Plan 2015-2021 and the initial infrastructure assessment undertaken in early 2020 and informed the review of the land-use zonings for the key settlements and the drafting of the County Development Plan 2021-2027.

Following the Public Consultation on the Draft Longford County Development Plan 2021-2027 and the review of Submissions and Observations received during the consultation period (27th October 2020 until 18th January 2021) the land use zoning plans for the settlements were revised and the Further Iteration Plans are included in this report under Appendix C (produced during the period December 2020 to March 2021). An additional review of the Infrastructure Assessment Report was undertaken following the development of the Chief Executive's Report on the Submissions received, specifically the submissions from the OPR and EMRA as well as other thematic and area specific submissions.

The Infrastructure Assessment, the inclusion of the flood risk zonings and the CSO settlement boundary has highlighted specific areas that are subsequently identified as undevelopable and or constrained, lacking the infrastructure required to the service the lands, or lands at high risk of flooding. The subsequent settlement plan identifies those sites where land-use zonings have been amended/revised and the changes identified. The revised zoning map for Granard identifies a more sustainable and compact form of development reflecting the CSO boundary of the town and core principle of the NPF, the EMRA RSES and Submission of the OPR on the Draft Plan.

The quantum of lands zoned new residential and industrial/commercial/warehousing have been reduced within Granard. Within Granard significant areas of land have been revised and the land-use maps showing zone 'A' west of the town and zone 'B' east present the proposed amendments.

In the Granard area 'A' large areas of land have been de-zoned from industrial/commercial/warehousing, in particular those areas outside of the CSO settlement boundary and along the regional and national roads. The revised zoning plan presents a more compact form of development. Granard Area 'B' to the east of the town a significant number of amendments are indicated reflecting the constrained land-use (flooding) issues and the identified CSO boundary. Lands beyond this boundary have been de-zoned accordingly.

Copyright Acknowledgements
 Includes Ordnance Survey Ireland data reproduced under OSI
 Licence Number 2020/OS_NMA_145 Longford County Council.
 Unauthorised reproduction infringes Ordnance Survey Ireland and
 Government of Ireland Copyright.
 © Ordnance Survey Ireland, year [the date of publication]

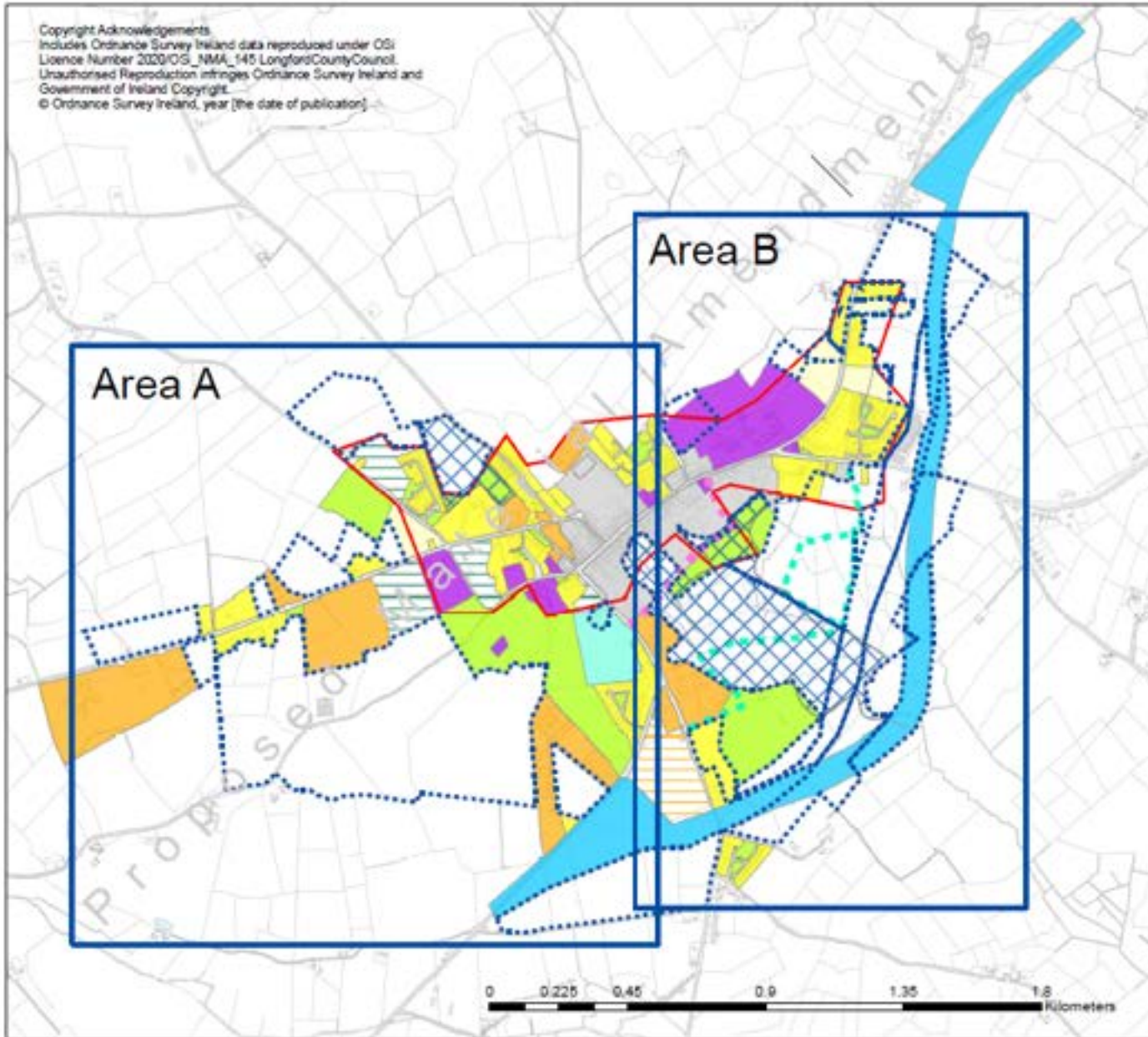

Granard Proposed Material Amendments Area A & Area B

County Development Plan 2021-2027

Legend

- Changed Zoning
- Areas of Constrained Land Use
- CSO Settlement Boundary
- Industrial/Commercial/Warehousing
- New Residential
- Recreation/Amenity/Green Space
- Reservation Objective
- Residential
- Social/Community/Education/Public Utility
- Strategic Industrial Reserve
- Strategic Residential Reserve
- Tourism
- Town Core
- Amenity Walkway
- Proposed Service Road Granard

See separate Maps
 of Area A and Area B



Granard
Proposed Material Amendments
County Development Plan 2021-2027

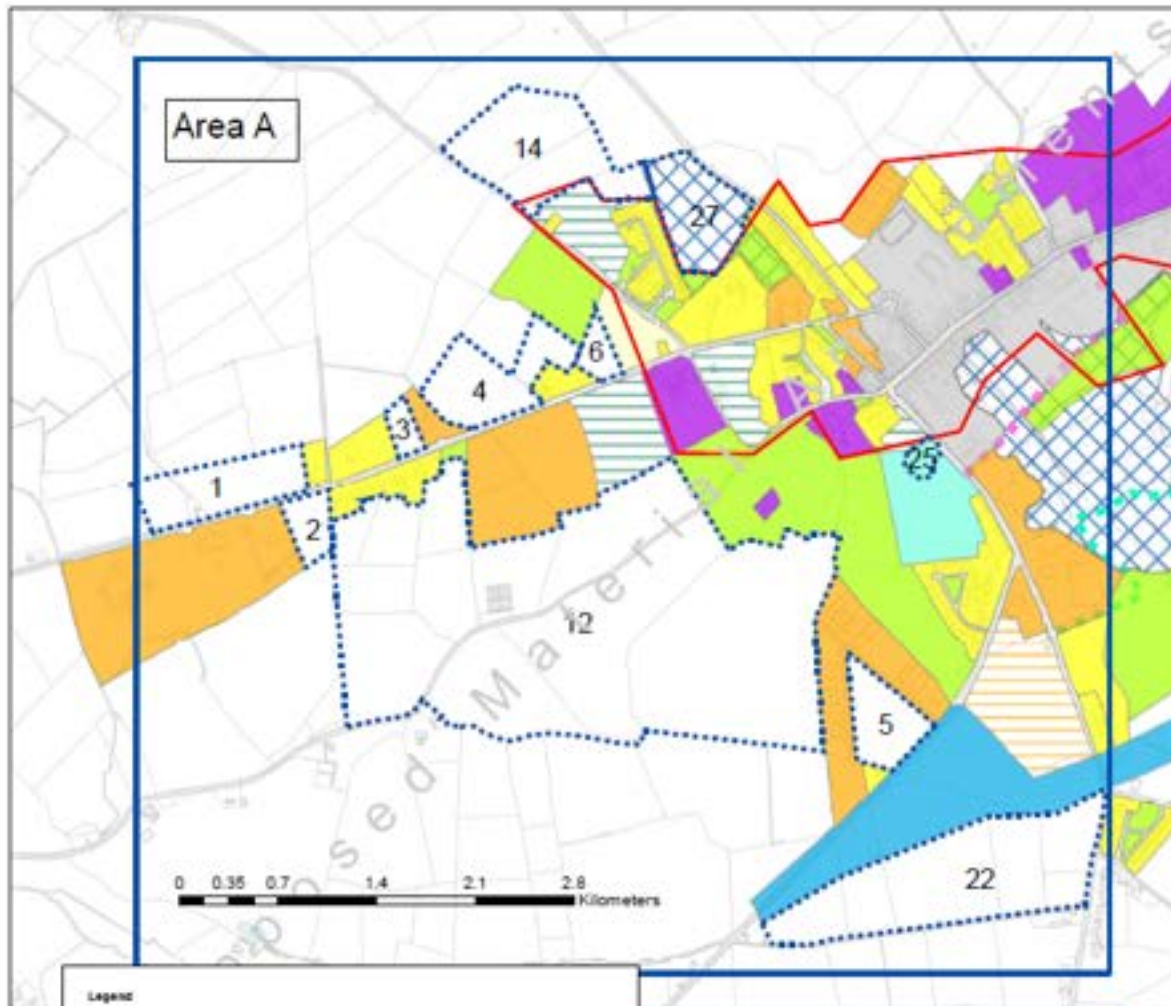
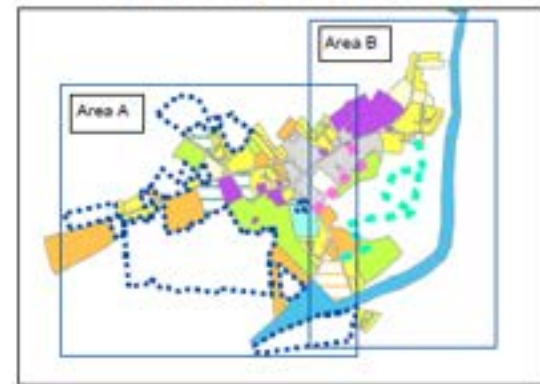

Legend

- Changed Zoning
- CDO Settlement Boundary
- Areas of Constrained Land Use
- Industrial/Commercial/Warehousing
- New Residential
- Recreation/Amenity/Green Space
- Reservation Objective
- Residential
- Social/Community/Education/Public Utility
- Strategic Industrial Reserve
- Strategic Residential Reserve
- Tourism
- Town Core
- Amenity Walkway
- Proposed Service Road Grant

Copyright Acknowledgements
Includes Ordnance Survey Ireland data reproduced under OS Licence Number 2020/001_A184_188 Longford County Council. Unauthorised reproduction infringes Ordnance Survey Ireland and Government of Ireland Copyright. © Ordnance Survey Ireland, year (the date of publication)



Zoning Changes

Draft Plan: Zoning in Draft Plan	Alteration: Amended Zoning	Parcel No: Area on Map
Industrial/Commercial/Warehousing		
No Zoning	No Zoning	1
No Zoning	No Zoning	2
No Zoning	No Zoning	3
No Zoning	No Zoning	4
No Zoning	No Zoning	5
New Residential		
No Zoning	No Zoning	6
Recreation/Amenity/Green Space		
No Zoning	No Zoning	27
Recreational/Amenity/Green Space		
No Zoning	No Zoning	12
Residential Reserve		
No Zoning	No Zoning	14
Strategic Industrial Reserve		
No Zoning	No Zoning	22
Town Core		
Tourism	Tourism	25

Granard Proposed Material Amendments - Area B County Development Plan 2021-2027

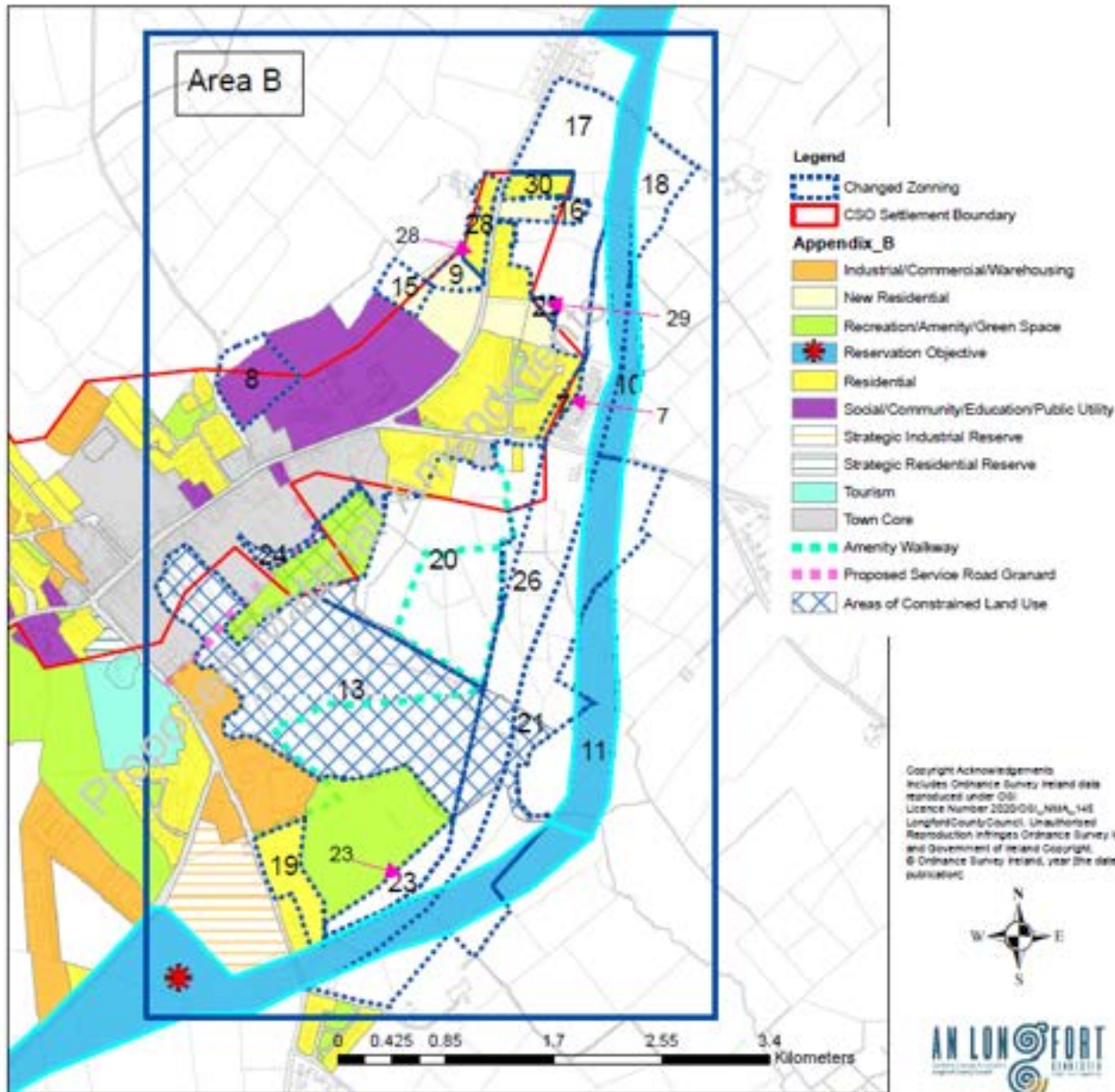

Zoning Changes - Area B

Draft Plan: Zoning in Draft Plan	Alteration Amended Zoning	Parcel No. Area on Map
New Residential		
Residential		7
No Zoning		29
No Zoning		
New Residential		9
Reserved Objective		10
Reserved Objective		11
Residential		28
Recreational/Town Core/Industrial		
No Zoning		13
Social/Community/Education/Public Utility		
Residential		19
Strategic Industrial Reserve		
Social/Community/Education/Public Utility - No Zoning		8
No Zoning & Residential		20
No Zoning & Transport & Utility Objective		21
No Zoning		23
Strategic Residential Reserve		
New Residential & No Zoning		15
New Residential		16
No Zoning		17
No Zoning		18
Residential		30
Town Core		
No Zoning		24
Transport & Utility Objective		
No Zoning		26
- - - Amenity Walkway - New ★ Transport & Utility Objectives - New position for proposed road		

Copyright Acknowledgements
Includes Ordnance Survey Ireland data
reproduced under OSL
Licence Number 2020/00_NIMA_145
Longford County Council. Unauthorised
Reproduction infringes Ordnance Survey Ireland
and Government of Ireland Copyright.
© Ordnance Survey Ireland, year the date of
publication.



Appendix – F3 Self-Sustaining Towns Ballymahon

The land-use zonings for Ballymahon has been revised in accordance with the Infrastructure Assessment framework and the resulting land-use plan for the settlement is presented below.

The settlement maps presented in the initial Draft County Development Plan 2021-2027 were based on the current County Development Plan 2015-2021 and the preliminary infrastructure assessment undertaken in early 2020 which informed the review of the land-use zonings for the key settlements and the drafting of the County Development Plan 2021-2027.

Following the Public Consultation on the Draft Longford County Development Plan 2021-2027 and the review of Submissions and Observations received during the consultation period (27th October 2020 until 18th January 2021) the land use zoning plans for the settlements were revised and the Further Iteration Plans are included in this report under Appendix C (produced during the period December 2020 to March 2021). An additional review of the Infrastructure Assessment Report was undertaken following the development of the Chief Executive's Report on the Submissions received, specifically the submissions from the OPR and EMRA as well as other thematic and area specific submissions.

The Infrastructure Assessment, the inclusion of the flood risk zonings and the CSO settlement boundary has highlighted specific areas that are subsequently identified as undevelopable and or constrained, lacking the infrastructure required to the service the lands, or lands at high risk of flooding. The revised settlement plan identifies those sites where land-use zonings have been amended/revised and the changes identified. The subsequent zoning map for Ballymahon identifies a more sustainable and compact form of development reflecting the CSO boundary of the town and core principle of the NPF, the EMRA RSES and Submission of the OPR on the Draft Plan.

The quantum of lands zoned new residential and industrial/commercial/warehousing have been reduced within Ballymahon significant areas of land have been revised and lands re-zoned. The settlement has significant infrastructure capacity issues which have been identified and as a consequence the quantum of residential and industrial/commercial/warehousing lands zoned within the town settlement have been significantly reduced. The revised zoning plan presents a more compact form of development, with proposed new residential development located within the defined CSO settlement boundary following the principle of compact growth and sustainable urban development. Significant areas to the south of the town, the north and east of the town have been de-zoned.

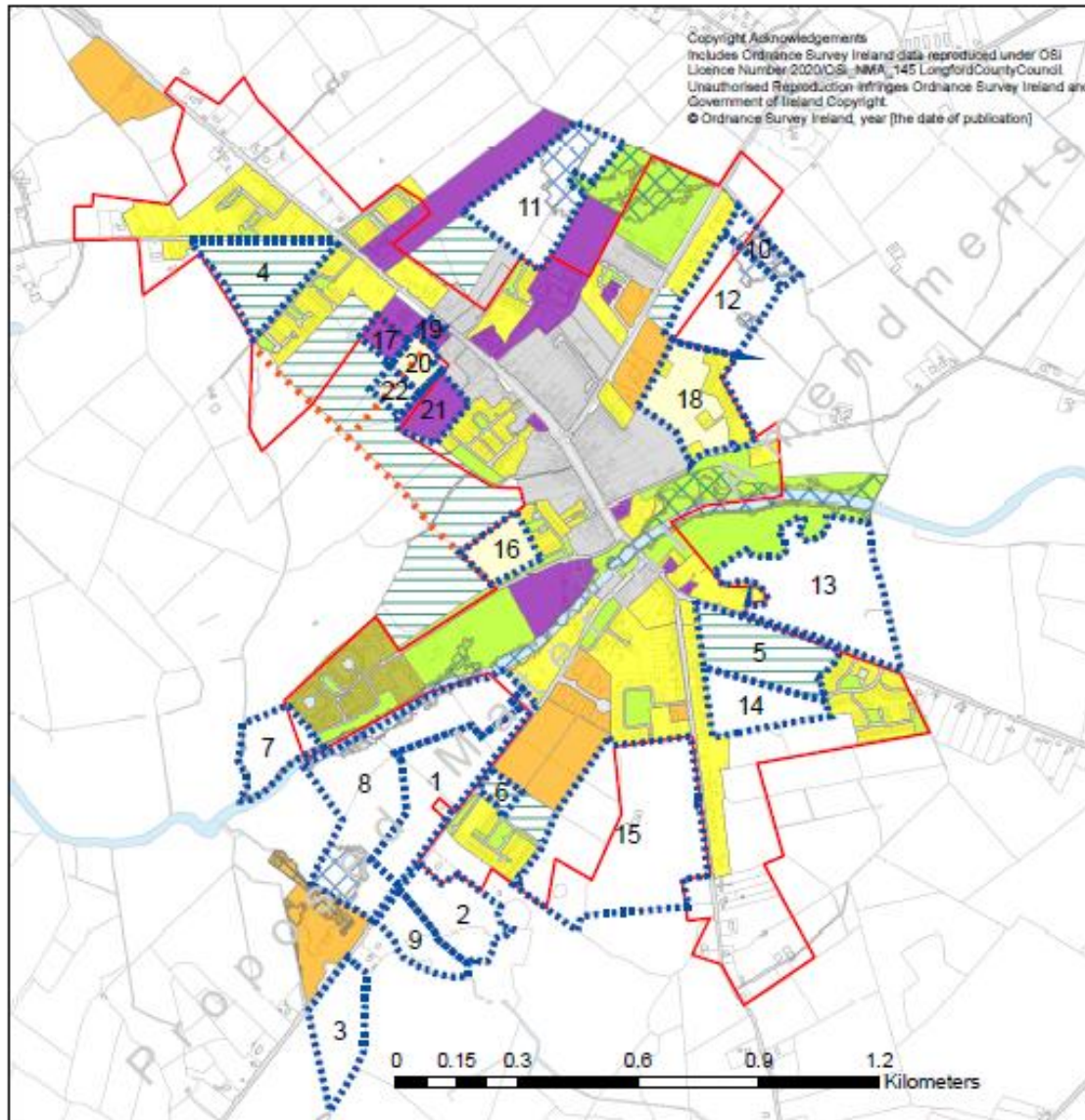

Ballymahon Proposed Material Amendments County Development Plan 2021-2027

- Legend
- Changed Zoning
 - Industrial/Commercial/Warehousing
 - New Residential
 - Recreation/Amenity & Green Space
 - Residential
 - Residential/Community Services/Med Centre
 - Social/Community/Education/Public Utility
 - Strategic Residential Reserve
 - Town Core
 - CSO Settlement Boundary
 - Areas of Constrained Land Use
 - Proposed Roadway

Zoning Changes		
Draft Plan: Zoning in Draft Plan	Alteration: Amended Zoning	Parcel No: Area on Map
Industrial/Commercial/Warehousing	No Zoning	1 - 3
New Residential	Strategic Residential Reserve	4 - 6
Recreation/Amenity/Green Space	No Zoning	7 - 10
Residential Reserve	No Zoning	11 - 15
	New Residential	16
	Social/Community/Education/Public Utility	17
Site Resolution Objective	Residential & New Residential	18
Town Core	Social/Community/Education/Public Utility	19, 21
	New Residential	20
	Strategic Residential Reserve	22
	Proposed Roadway	



Appendix – F4 Self-Sustaining Towns Edgeworthstown

The land-use zonings for Edgeworthstown has been revised in accordance with the Infrastructure Assessment framework and the resulting land-use plan for the settlement is presented below.

The settlement maps presented in the initial Draft County Development Plan 2021-2027 were based on the current County Development Plan 2015-2021 and the preliminary infrastructure assessment undertaken in early 2020 which informed the review of the land-use zonings for the key settlements and the drafting of the County Development Plan 2021-2027.

Following the Public Consultation on the Draft Longford County Development Plan 2021-2027 and the review of Submissions and Observations received during the consultation period (27th October 2020 until 18th January 2021) the land use zoning plans for the settlements were revised and the Further Iteration Plans are included in this report under Appendix C (produced during the period December 2020 to March 2021). An additional review of the Infrastructure Assessment Report was undertaken following the development of the Chief Executive's Report on the Submissions received, specifically the submissions from the OPR and EMRA as well as other thematic and area specific submissions.

The Infrastructure Assessment, the inclusion of the flood risk zonings and the CSO settlement boundary have identified areas that are constrained and lacking the infrastructure required to the service the lands, or lands at high risk of flooding. The subsequent settlement plans (Area A west and Area B east) identifies those sites where land-use zonings have been amended/revised and the changes identified.

The quantum of lands zoned new residential and industrial/commercial/warehousing have been reduced. The revised zoning map identifies a more sustainable and compact form of development reflecting the CSO boundary of the town and core principle of the NPF, the EMRA RSES and Submission of the OPR on the Draft Plan.

Within Edgeworthstown significant areas of land have been revised and lands re-zoned. The settlement has significant infrastructure capacity issues, especially in relation to wastewater which have been identified and as a consequence the quantum of residential, residential reserve and industrial/commercial/warehousing and reserve lands zoned within the town settlement have been significantly reduced. Significant areas within Area A to the north, west and south of the town have been de-zoned. Significant lands within the Area B (east) have also been re-zoned including lands to the north, east and south of the town.

Edgeworthstown
 Proposed Material Amendments
 County Development Plan 2021-2027

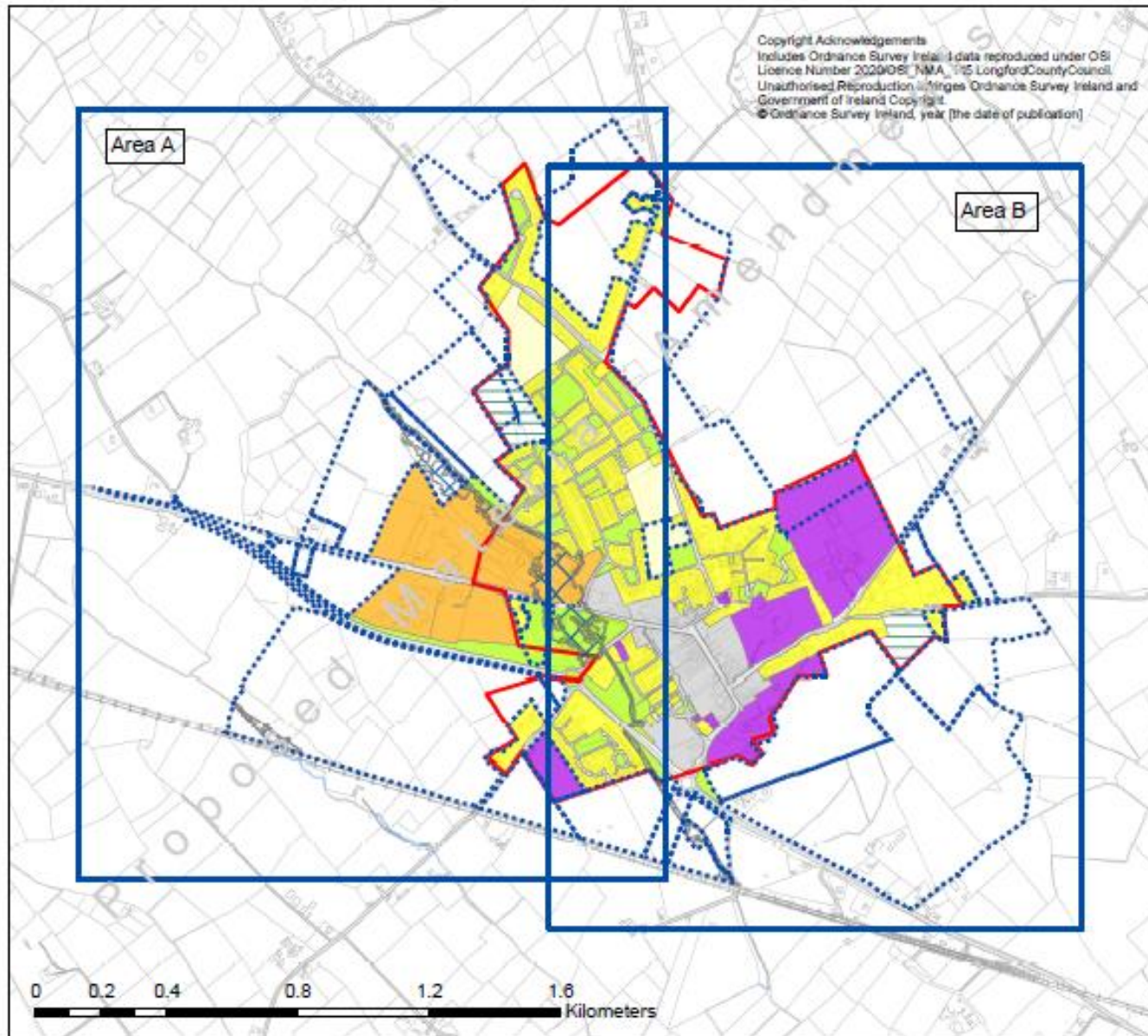

See separate Maps
 of Area A and Area B



Edgeworthstown Proposed Material Amendments County Development Plan 2021-2027

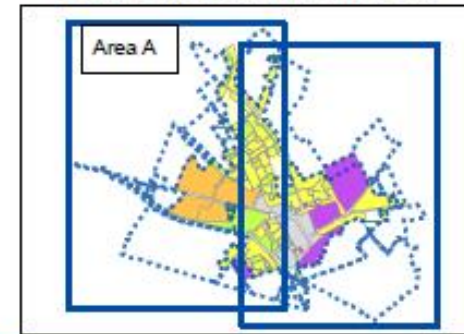
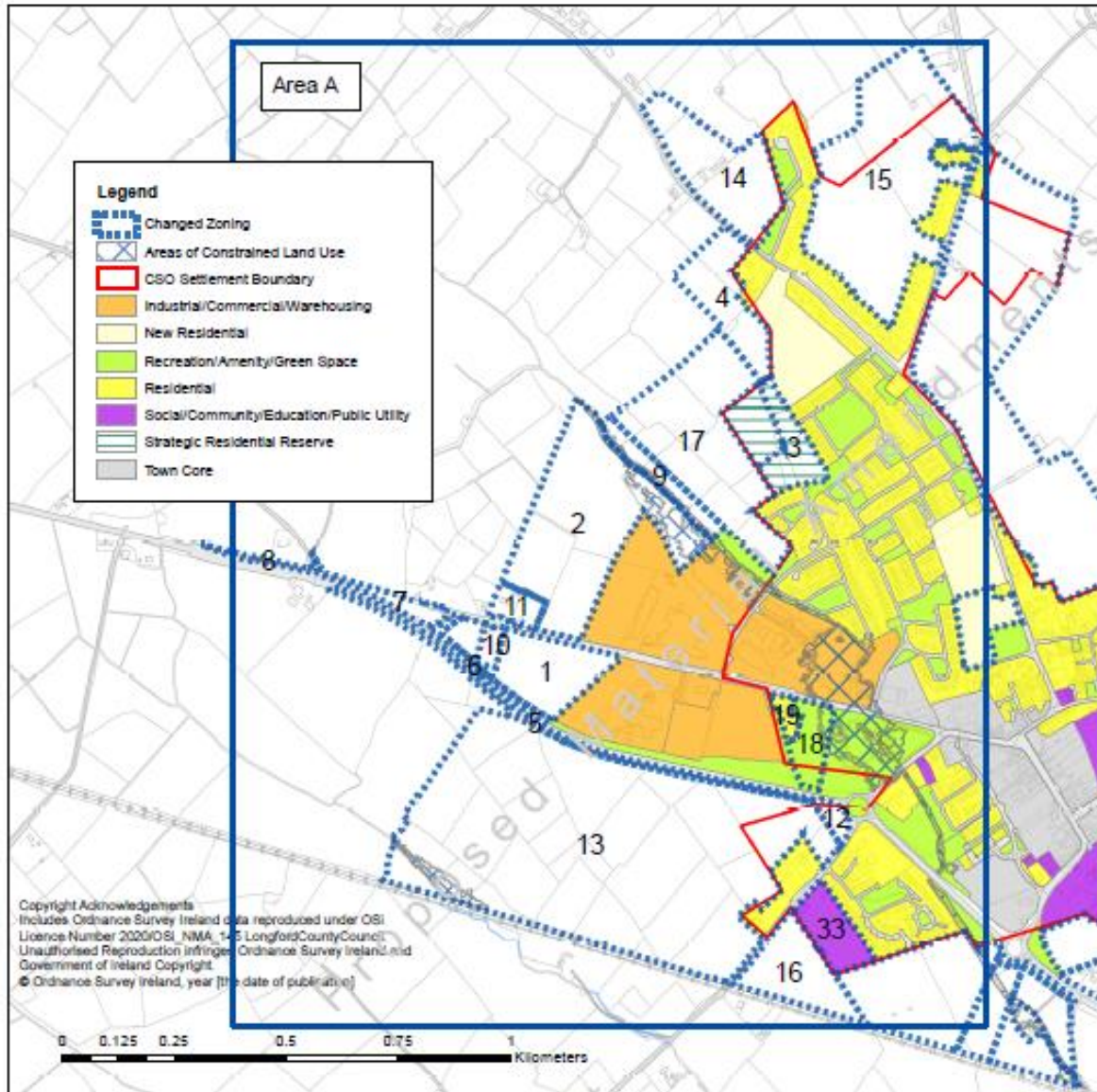

Changed Zoning		
Draft Plan: Zoning in Draft Plan	Alteration: Amended Zoning	Parcel No. Area on Map
Industrial/Commercial/Warehousing	No Zoning	1, 2
New Residential	Strategic Residential Reserve	3
	No Zoning	4
Recreational/Amenity/Green Space	No Zoning	5 - 9
	Social/Community/Education/Public Utility	33
Residential	No Zoning	10, 11
Social/Community/Education/Public Utility	No Zoning	12
Strategic Industrial Reserve	No Zoning	13
Strategic Residential Reserve	No Zoning	14 - 17
	Recreational/Amenity/Green Space	18
	Residential	19



Edgeworthstown Proposed Material Amendments County Development Plan 2021-2027

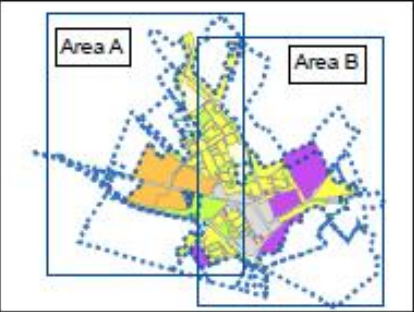
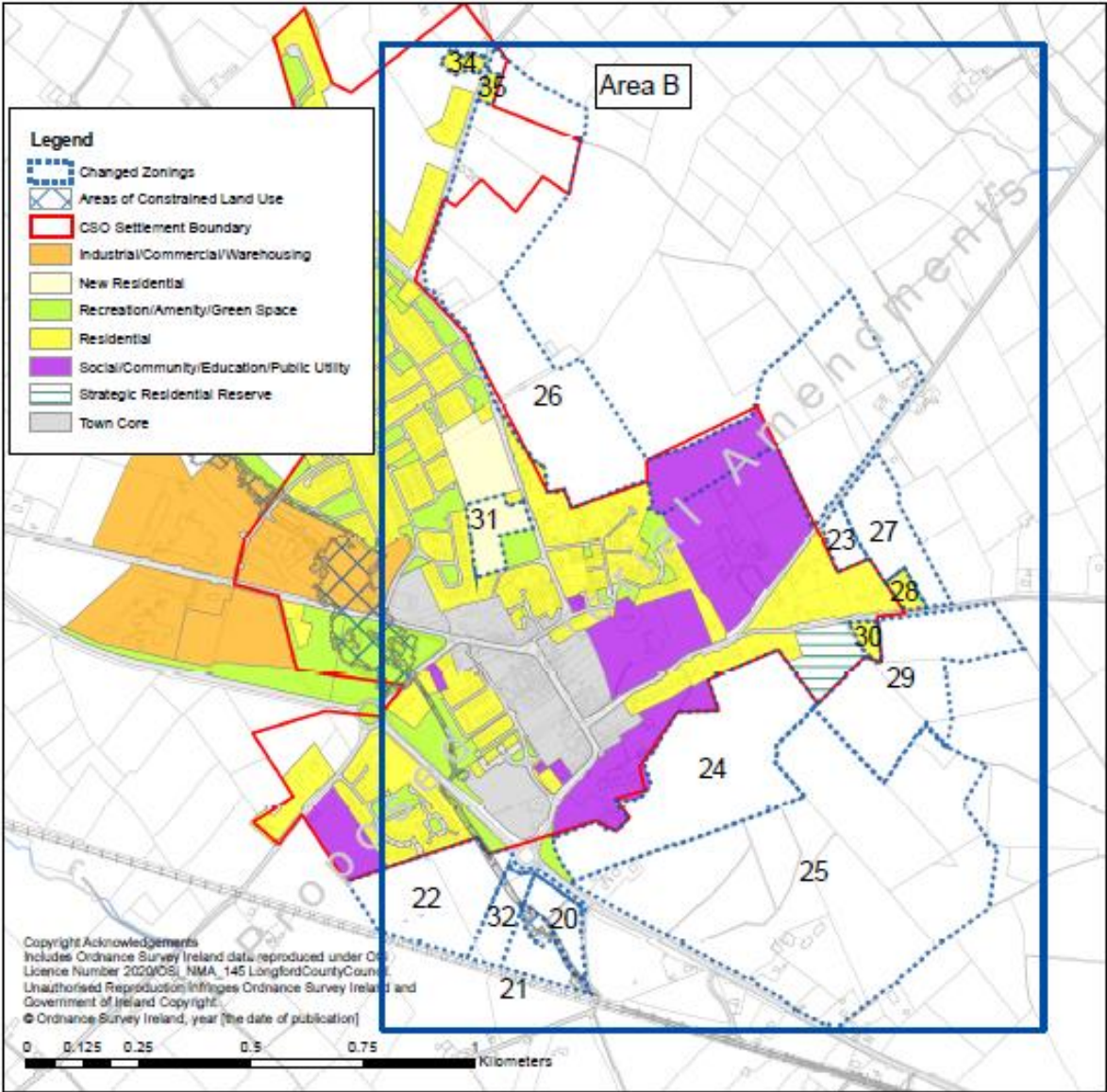

Changed Zoning		
Draft Plan: Zoning in Draft Plan	Alteration: Amended Zoning	Parcel No.: Area on Map
Recreational/Amenity/Green Space	No Zoning	20 - 22
Residential	No Zoning	23
Social/Community/Education	No Zoning	24
Strategic Industrial Reserve	No Zoning	25
Strategic Residential Reserve	Residential	24, 26, 30, 35
	Social/Community/Education/Public Use+No Zoning	26
	No Zoning	27, 29
	New Residential	31
Transport and Utilities Infrastructure	No Zoning	32



Appendix – F5 Self-Sustaining Towns Lanesborough

The land-use zonings for Lanesborough has been revised in accordance with the Infrastructure Assessment framework and the resulting land-use plan for the settlement is presented below.

The settlement maps presented in the initial Draft County Development Plan 2021-2027 were based on the current County Development Plan 2015-2021 and the preliminary infrastructure assessment undertaken in early 2020 which informed the review of the land-use zonings for the key settlements and the drafting of the County Development Plan 2021-2027.

Following the Public Consultation on the Draft Longford County Development Plan 2021-2027 and the review of Submissions and Observations received during the consultation period (27th October 2020 until 18th January 2021) the land use zoning plans for the settlements were revised and the Further Iteration Plans are included in this report under Appendix C (produced during the period December 2020 to March 2021). An additional review of the Infrastructure Assessment Report was undertaken following the development of the Chief Executive's Report on the Submissions received, specifically the submissions from the OPR and EMRA as well as other thematic and area specific submissions.

The Infrastructure Assessment, the inclusion of the flood risk zonings and the CSO settlement boundary have identified areas that are constrained and lacking the infrastructure required to the service the lands, or lands at high risk of flooding. The subsequent settlement plan identifies those sites where land-use zonings have been amended/revised and the changes identified.

The quantum of lands zoned new residential and industrial/commercial/warehousing have been reduced. The revised zoning map identifies a more sustainable and compact form of development reflecting the CSO boundary of the town and core principle of the NPF, the EMRA RSES and Submission of the OPR on the Draft Plan.

Within Lanesborough significant areas of land have been revised and lands re-zoned and or de-zoned. Significant areas to the north, east and south of the town have been de-zoned in particular lands which were zoned Strategic Residential Reserve. Proposed new residential lands are now located within the existing CSO boundary.

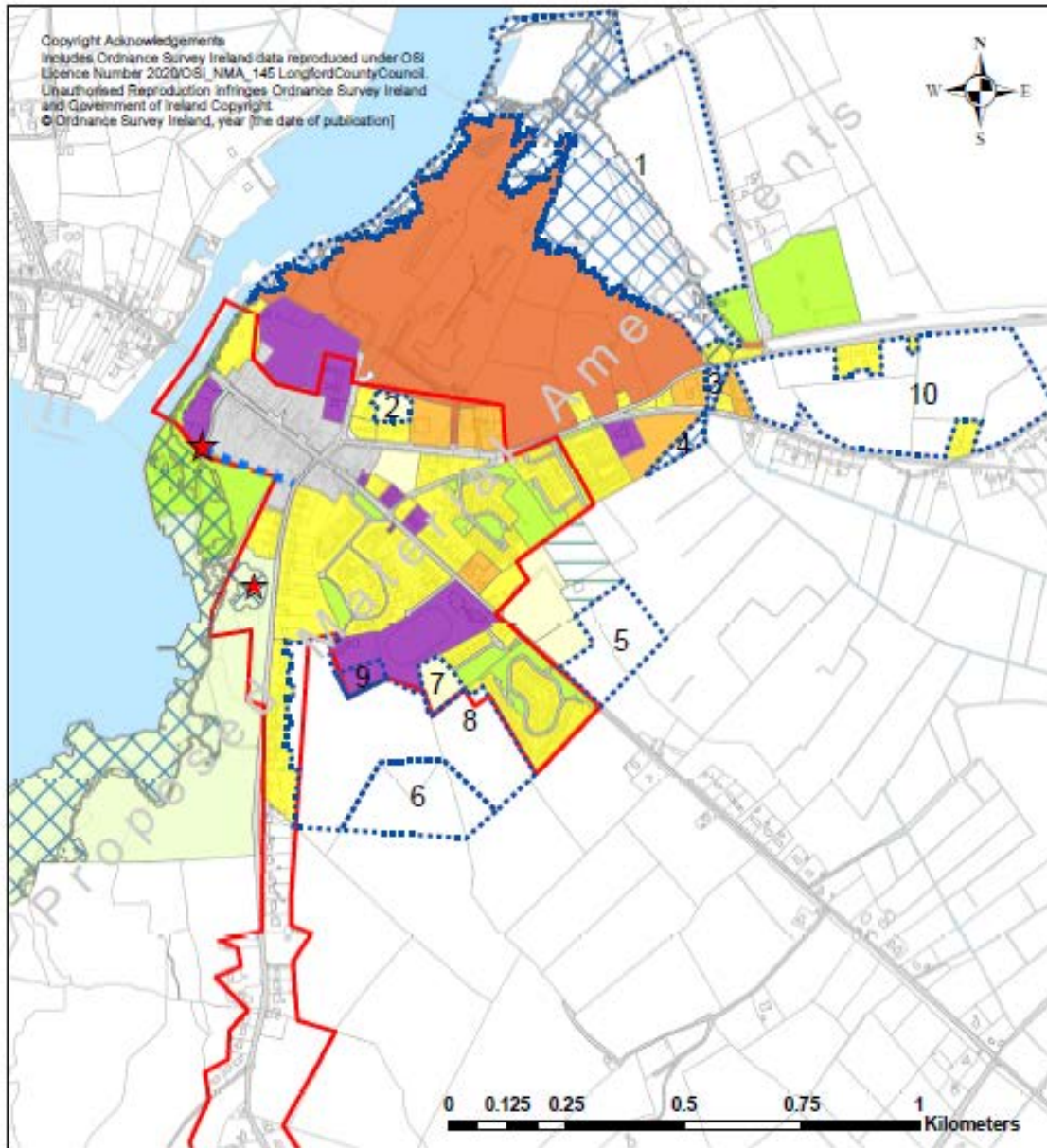

Lanesborough Proposed Material Amendments County Development Plan 2021-2027

Legend

- Changed Zoning
- Areas of Constrained Land Use
- Proposed Road - New
- CDO Settlement Boundary
- Industrial/Alternative Energy
- Industrial/Commercial/Warehousing
- New Residential
- Protected Area/Passive Amenity
- Recreation/Amenity/Green Space
- Residential
- Social/Community/Education/Public Utility
- Strategic Residential Reserve
- Town Core
- Tourism Objective/URDF Funded Projects - New

Zoning Changes		
Draft Plan: Zoning in Draft Plan	Alteration: Amended Zoning	Parcel No: Area on Map
Industrial/Alternative Energy		
	No Zoning	1
	New Residential	2
Industrial/Commercial/Warehousing		
	No Zoning	3
	No Zoning	4
New Residential		
	No Zoning	5
Recreational/Amenity/Green Space		
	No Zoning	6
Residential		
	New Residential	7
Strategic Residential Reserve		
	No Zoning	8
	Social/Community/Education/Public Utility	9
	No Zoning	10

Tourism Objective/URDF Funded Projects - New

Proposed Road - New

Appendix – F6 Towns & Villages Aughnaclyffe

The land-use zonings for Aughnaclyffe has been revised in accordance with the Infrastructure Assessment framework and the resulting land-use plan for the settlement is presented below.

The settlement maps presented in the initial Draft County Development Plan 2021-2027 were based on the current County Development Plan 2015-2021 and the preliminary infrastructure assessment undertaken in early 2020 which informed the review of the land-use zonings for the key settlements and the drafting of the County Development Plan 2021-2027.

Following the Public Consultation on the Draft Longford County Development Plan 2021-2027 and the review of Submissions and Observations received during the consultation period (27th October 2020 until 18th January 2021) the land use zoning plans for the settlements were revised and the Further Iteration Plans are included in this report under Appendix C (produced during the period December 2020 to March 2021). An additional review of the Infrastructure Assessment Report was undertaken following the development of the Chief Executive's Report on the Submissions received, specifically the submissions from the OPR and EMRA as well as other thematic and area specific submissions.

The Infrastructure Assessment, the inclusion of the flood risk zonings and the CSO settlement boundary have identified areas that are constrained and lacking the infrastructure required to service the lands, or lands at high risk of flooding. The subsequent settlement plan identifies those sites where land-use zonings have been amended/revised and the changes identified

The quantum of lands zoned new residential and industrial/commercial/warehousing have been reduced. The revised zoning map identifies a more sustainable and compact form of development reflecting the CSO boundary of the town and core principle of the NPF, the EMRA RSES and Submission of the OPR on the Draft Plan.

Within Aughnaclyffe large areas of land have been revised and lands re-zoned and or de-zoned. The revised zoning plans presents a more compact form of development, with proposed new residential development located within the defined CSO settlement boundary following the principle of compact growth and sustainable urban development.

Significant areas to the north, lands to the west, the east and the south of the town have been revised. The amount of lands zoned Strategic Residential Reserve have been reduced.

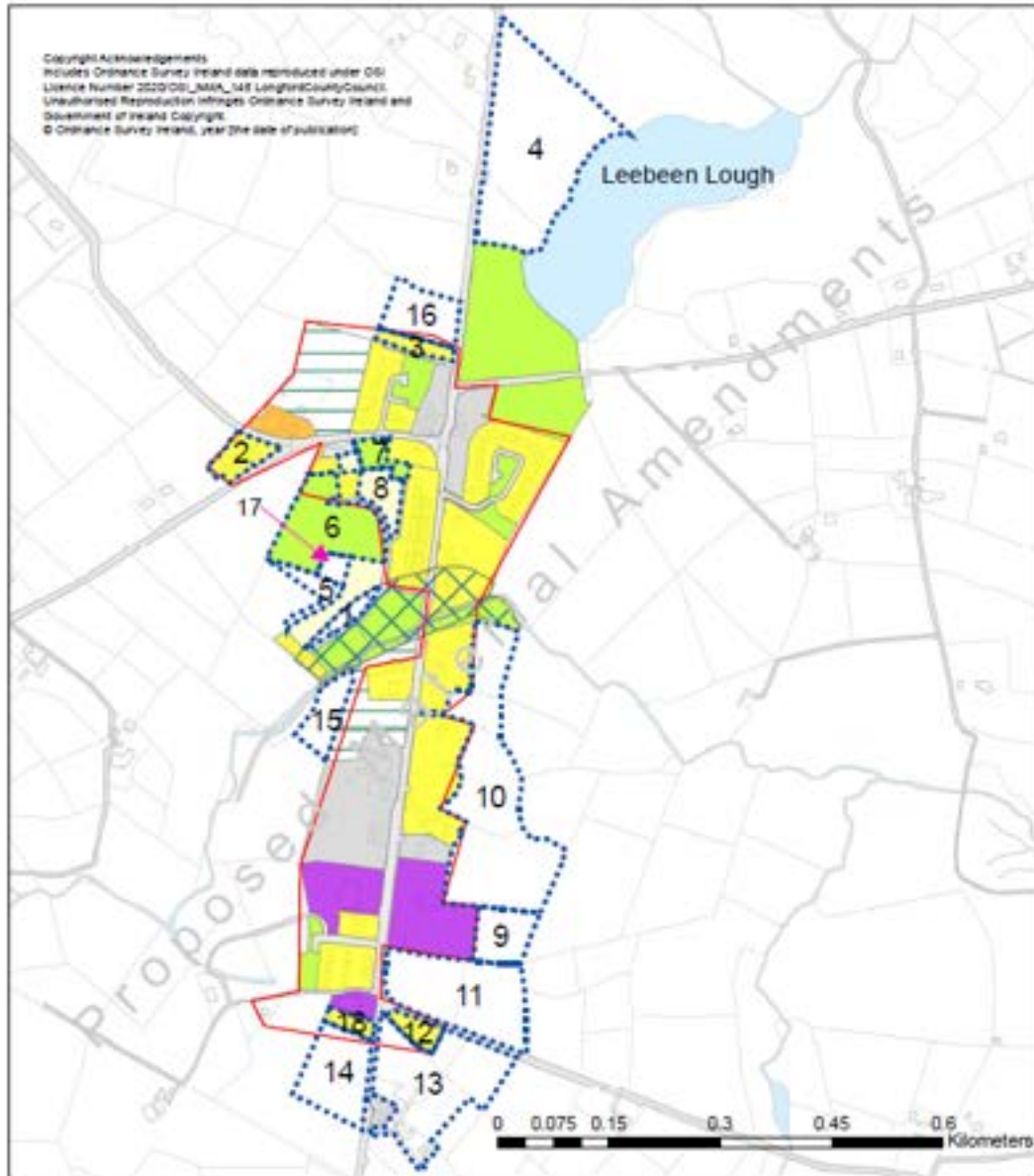

Aghnaclyffe Proposed Material Amendments County Development Plan 2021-2027

Legend

Changed Zoning	Recreation/Amenity/Green Space
CDO Settlement Boundary	Residential
Areas of Constrained Land Use	Social/Community/Education/Public Utility
Industrial/Commercial/Warehousing	Strategic Residential Reserve
New Residential	Town Core

Changed Zoning

Draft Plan: Zoning in Draft Plan	Alteration: Amended Zoning	Parcel No.: Area on Map
New Residential		
	No Zoning	1, 17
No Zoning		
	Residential	2, 3
Recreational/Amenity/Green Space		
	No Zoning	4
Site Resolution Objective		
	No Zoning	5
	Recreational/Amenity/Green Space	6, 7
	New Residential	8
Social/Community/Education/Public Utility		
	No Zoning	9
Strategic Residential Reserve		
	No Zoning	10, 11, 13, 14, 15, 16
	Residential	12
	Residential	18



Appendix – F7 Towns & Villages Ballinalee

The land-use zonings for Ballinalee has been revised in accordance with the Infrastructure Assessment framework and the resulting land-use plan for the settlement is presented below.

The settlement maps presented in the initial Draft County Development Plan 2021-2027 were based on the current County Development Plan 2015-2021 and the preliminary infrastructure assessment undertaken in early 2020 which informed the review of the land-use zonings for the key settlements and the drafting of the County Development Plan 2021-2027.

Following the Public Consultation on the Draft Longford County Development Plan 2021-2027 and the review of Submissions and Observations received during the consultation period (27th October 2020 until 18th January 2021) the land use zoning plans for the settlements were revised and the Further Iteration Plans are included in this report under Appendix C (produced during the period December 2020 to March 2021). An additional review of the Infrastructure Assessment Report was undertaken following the development of the Chief Executive's Report on the Submissions received, specifically the submissions from the OPR and EMRA as well as other thematic and area specific submissions.

The Infrastructure Assessment, the inclusion of the flood risk zonings and the CSO settlement boundary have identified areas that are constrained and lacking the infrastructure required to the service the lands, or lands at high risk of flooding. The subsequent settlement plan identifies those sites where land-use zonings have been amended/revised and the changes identified.

The quantum of lands zoned new residential and industrial/commercial/warehousing have been reduced. The revised zoning map identifies a more sustainable and compact form of development reflecting the CSO boundary of the town and core principle of the NPF, the EMRA RSES and Submission of the OPR on the Draft Plan.

Within Ballinalee significant areas of land have been revised and lands re-zoned and or de-zoned. The revised zoning plan presents a more compact form of development, with proposed new residential development located within the defined CSO settlement boundary following the principle of compact growth and sustainable urban development.

Significant areas to the north identified as constrained use have been de-zoned, further lands to the west and east and to the south have also been revised. The quantum of lands zoned as Strategic Residential Reserve and Recreation/Amenity/Green Space lands have been de-zoned.

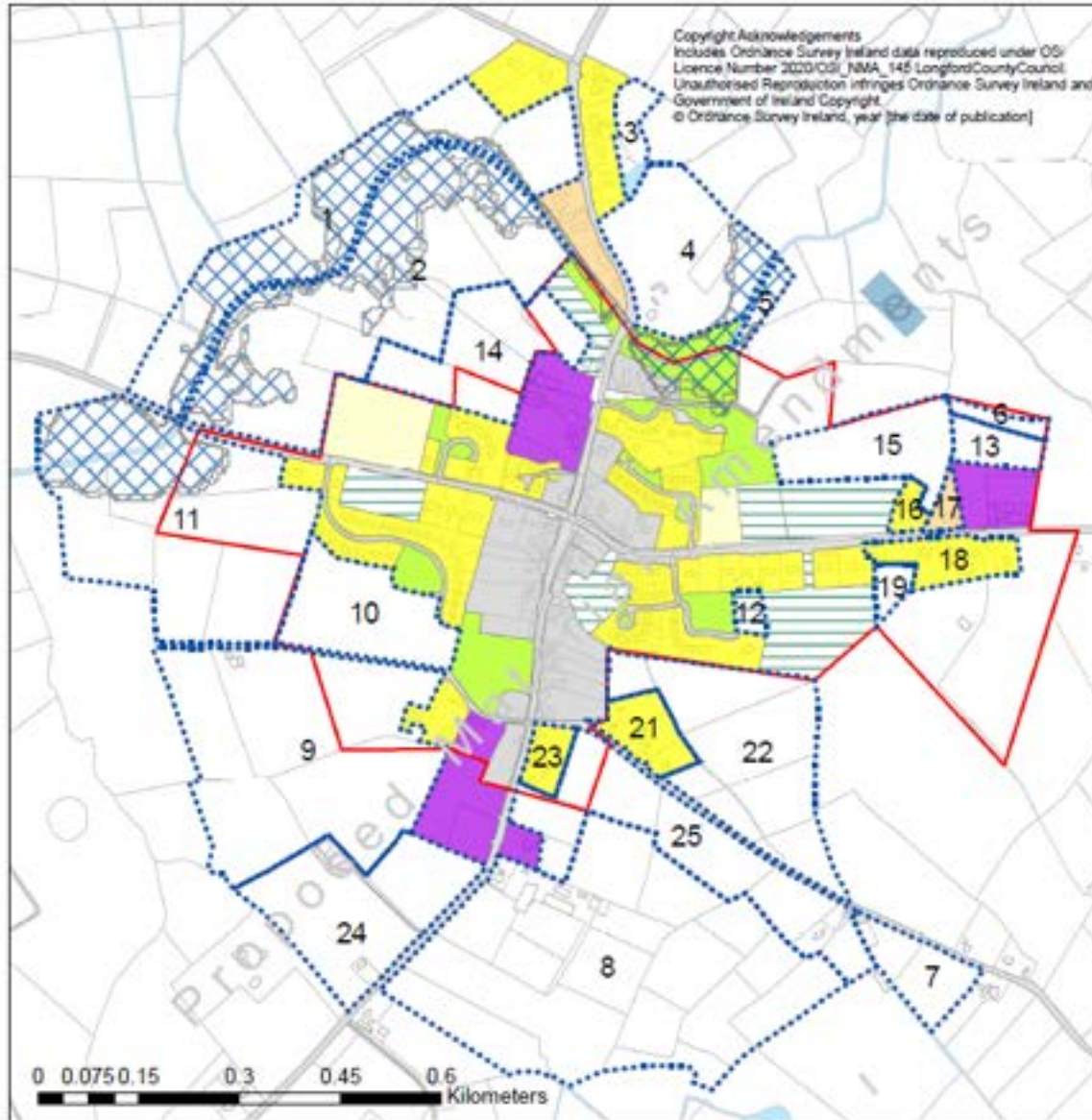

Ballinalee Proposed Material Amendments County Development Plan 2021-2027

- Legend**
- Changed Zoning
 - Areas of Constrained Land Use
 - COO Settlement Boundary
 - Light Industrial/Commercial/Service
 - New Residential
 - Recreation/Amenity/Green Space
 - Residential
 - Social/Community/Education/Public Utility
 - Strategic Residential Reserve
 - Town Core

Changed Zoning		
Draft Plan: Zoning in Draft Plan	Alteration: Amended Zoning	Parcel No.: Area on Map
Recreational/Amenity/Green Space		
	No Zoning	1 - 11
Residential		
	Strategic Residential Reserve	12
Social/Community/Education/Public Utility		
	No Zoning	13
Strategic Residential Reserve		
	No Zoning	14, 15, 19, 22, 24, 25
	Residential	16, 18, 21, 23
	Light Industrial/Commercial/Service	17



Appendix – F8 Towns & Villages Drumlish

The land-use zonings for Drumlish has been revised in accordance with the Infrastructure Assessment framework and the resulting land-use plan for the settlement is presented below.

The settlement maps presented in the initial Draft County Development Plan 2021-2027 were based on the current County Development Plan 2015-2021 and the preliminary infrastructure assessment undertaken in early 2020 which informed the review of the land-use zonings for the key settlements and the drafting of the County Development Plan 2021-2027.

Following the Public Consultation on the Draft Longford County Development Plan 2021-2027 and the review of Submissions and Observations received during the consultation period (27th October 2020 until 18th January 2021) the land use zoning plans for the settlements were revised and the Further Iteration Plans are included in this report under Appendix C (produced during the period December 2020 to March 2021). An additional review of the Infrastructure Assessment Report was undertaken following the development of the Chief Executive's Report on the Submissions received, specifically the submissions from the OPR and EMRA as well as other thematic and area specific submissions.

The Infrastructure Assessment, the inclusion of the flood risk zonings and the CSO settlement boundary have identified areas that are constrained and lacking the infrastructure required to the service the lands, or lands at high risk of flooding. The subsequent settlement plan identifies those sites where land-use zonings have been amended/revised and the changes identified.

The quantum of lands zoned new residential and industrial/commercial/warehousing have been reduced. The revised zoning maps identifies a more sustainable and compact form of development reflecting the CSO boundary of the town and core principle of the NPF, the EMRA RSES and Submission of the OPR on the Draft Plan.

Within Drumlish significant areas of land have been revised and lands re-zoned and or de-zoned. The revised zoning plans (Area A – west) (Area B- east) presents a more compact form of development, with proposed new residential development located within the defined CSO settlement boundary following the principle of compact growth and sustainable urban development.

Map zoned Area A (west) identifies significant areas to the north identified as constrained use have been de-zoned, further lands to the west and east and to the south have also been revised. Additional existing residential lands have been included. **Map zoned Area B (east)** identifies large areas as constrained use, and significant lands have been de-zoned which had been previously zoned as Strategic Residential Reserve; in particular those located around the periphery of the settlement and outside of the CSO boundary.

Drumlish
Proposed Material Amendments
County Development Plan 2021-2027

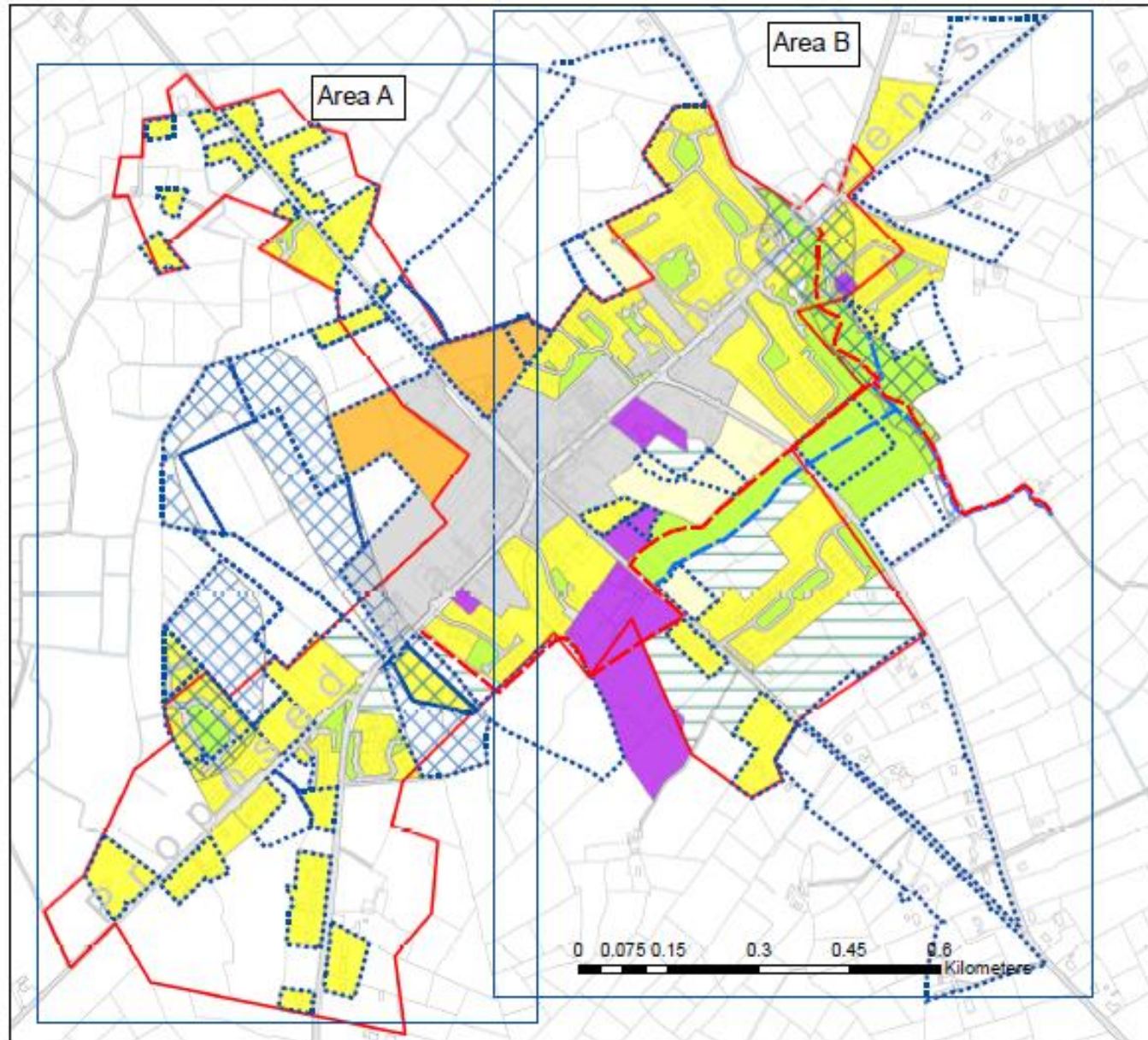

Legend

- Changed Zoning
- Industrial/Commercial/Warehousing
- New Residential
- Recreation/Amenity/Green Space
- Residential
- Social/Community/Education/Public Utility
- Strategic Residential Reserve
- Town Core
- Walkway
- Bridle Path
- CSO Settlement Boundary
- Areas of Constrained Land Use

See separate Maps
of Area A and Area B

Copyright Acknowledgements
Includes Ordnance Survey Ireland data reproduced under OSI
License Number 2020/OSI_NMA_145 Longford County Council.
Unauthorized reproduction infringes Ordnance Survey Ireland and
Government of Ireland Copyright.
© Ordnance Survey Ireland, year [the date of publication]



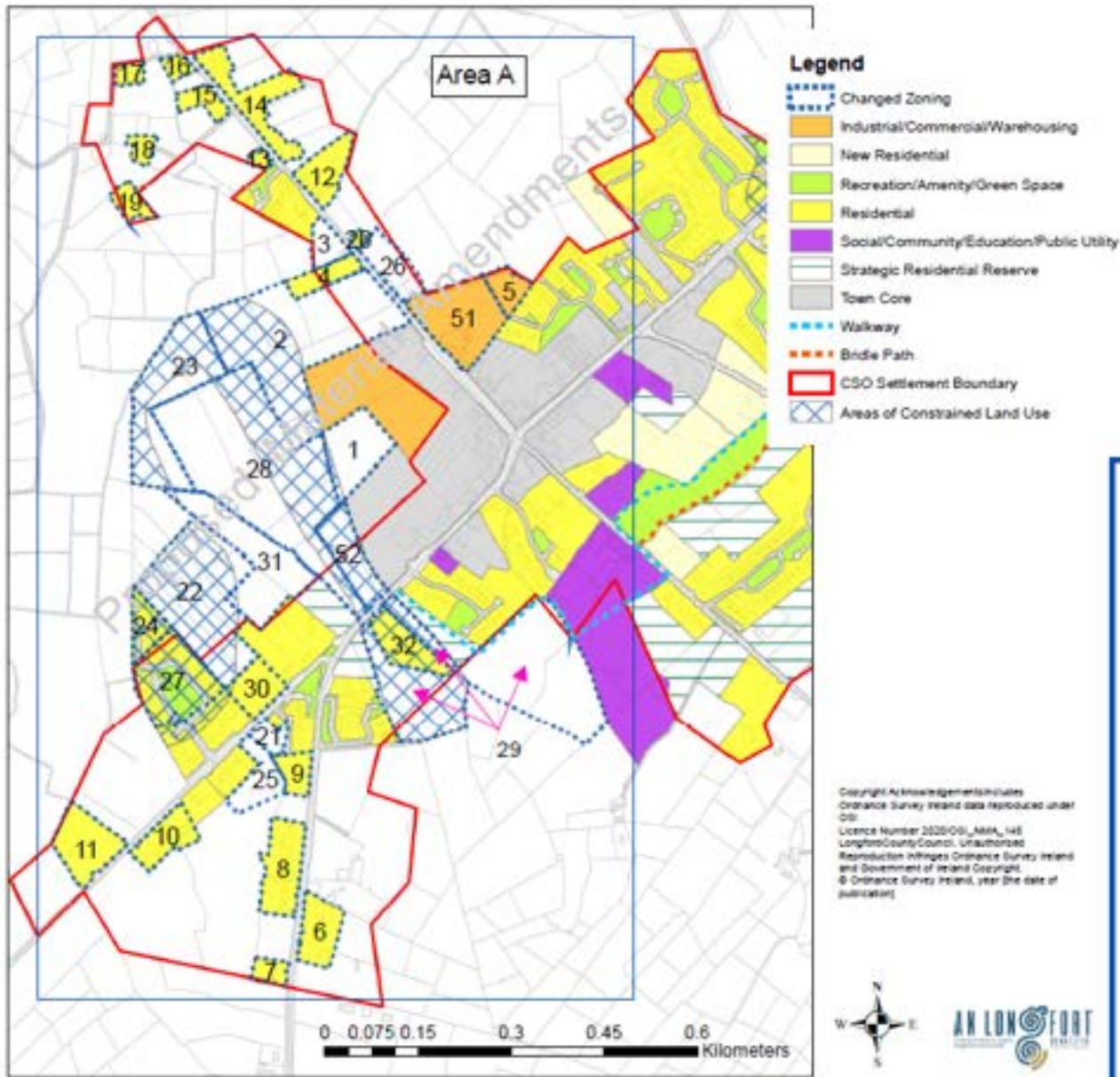

Drumlish Proposed Material Amendments County Development Plan 2021-2027



Zoning Changes		
Draft Plan Zoning in Draft Plan	Attention Amended Zoning	Parcel No: Area on Map
Industrial/Commercial/Warehousing		
No Zoning		1 - 3
Residential		4
New Residential		
	Industrial/Commercial/Warehousing	5
No Zoning		
	Residential	6 - 20
Recreational/Amenity/Green Space		
	No Zoning	21
	No Zoning	22 - 25
	Residential	24
Residential		
	No Zoning	25 - 26
Site Resolution Objective		
	Residential	27
Strategic Industrial Reserve		
	No Zoning	28
Strategic Residential Reserve		
	No Zoning	29, 31
	Residential	30, 32
Town Core		
	Industrial/Commercial/Warehousing	31
	No Zoning	32

Walkway (Amended) Bridle Path (New)

Drumlish
Proposed Material Amendments
County Development Plan 2021-2027

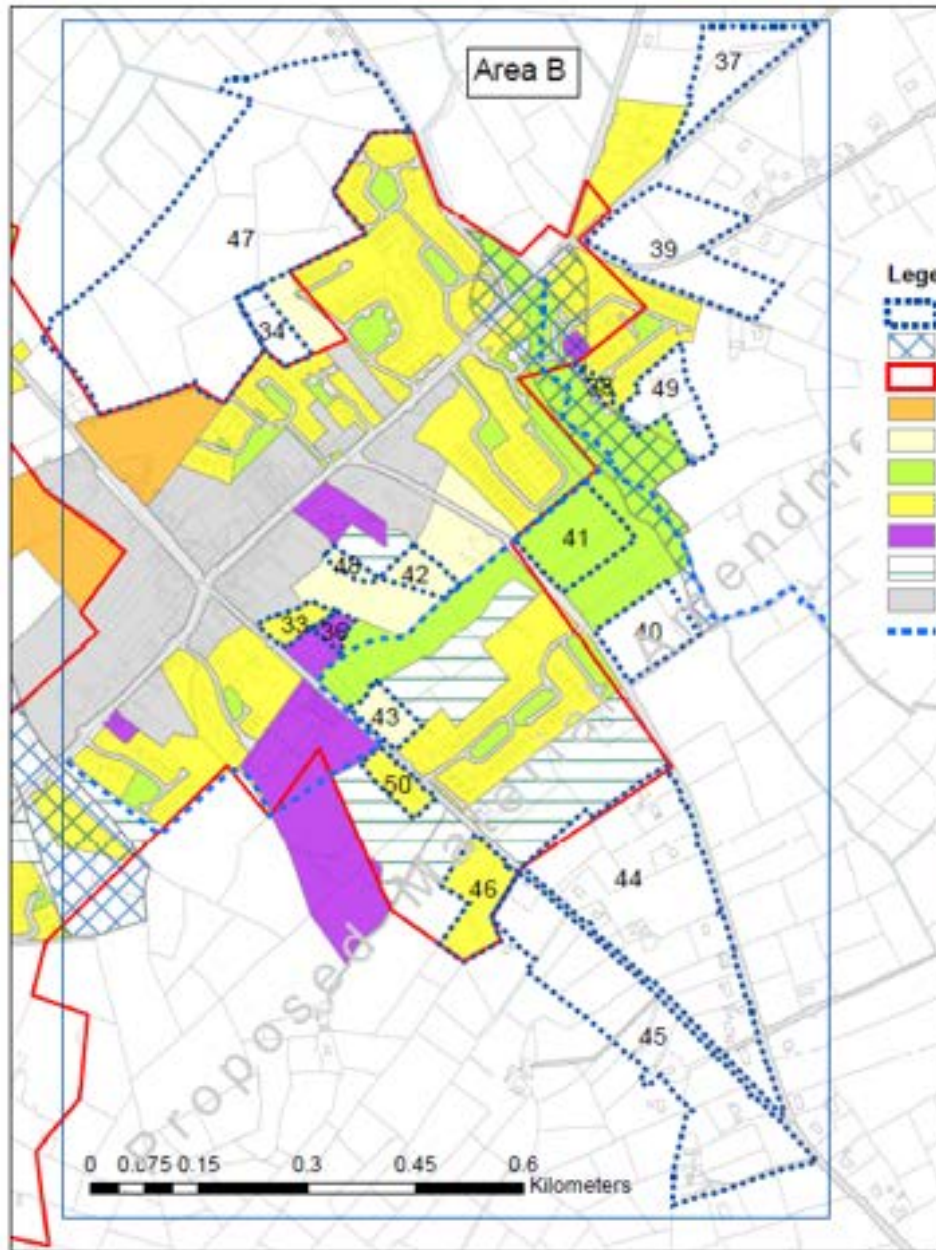

- Legend**
- Changed Zoning
 - Areas of Constrained Land Use
 - CSO Settlement Boundary
 - Industrial/Commercial/Warehousing
 - New Residential
 - Recreation/Amenity/Green Space
 - Residential
 - Social/Community/Education/Public Utility
 - Strategic Residential Reserve
 - Town Core
 - Walkway

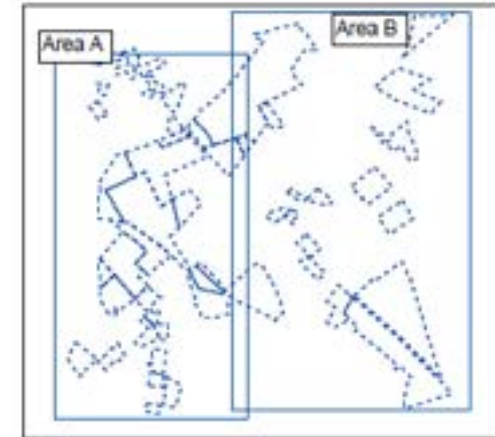

Copyright Acknowledgements includes
Ordnance Survey Ireland data reproduced under OSL
Licence Number 2020-001, JMM, 145
Longford County Council. Unauthorised reproduction
infringes Ordnance Survey Ireland
and Government of Ireland Copyright.
© Ordnance Survey Ireland, year 2021



Zoning Changes - Area B		
Draft Plan Zoning in Draft Plan	Alteration Amended Zoning	Parcel No. Area on Map
New Residential		
Residential		33
No Zoning		34
Social/Community/Education/Public Utility		36
Recreational/Amenity/Green Space		
No Zoning		37
Residential		38
Strategic Residential Reserve		
No Zoning		39, 40, 44, 45, 47, 49
Recreational/Amenity/Green Space		41
New Residential		42, 43, 48
Residential		46, 50

- Walkway
- Bridle Path

Appendix – F9 Towns & Villages Keenagh

The land-use zonings for Keenagh has been revised in accordance with the Infrastructure Assessment framework and the resulting land-use plan for the settlement is presented below.

The settlement maps presented in the initial Draft County Development Plan 2021-2027 were based on the current County Development Plan 2015-2021 and the preliminary infrastructure assessment undertaken in early 2020 which informed the review of the land-use zonings for the key settlements and the drafting of the County Development Plan 2021-2027.

Following the Public Consultation on the Draft Longford County Development Plan 2021-2027 and the review of Submissions and Observations received during the consultation period (27th October 2020 until 18th January 2021) the land use zoning plans for the settlements were revised and the Further Iteration Plans are included in this report under Appendix C (produced during the period December 2020 to March 2021). An additional review of the Infrastructure Assessment Report was undertaken following the development of the Chief Executive's Report on the Submissions received, specifically the submissions from the OPR and EMRA as well as other thematic and area specific submissions.

The Infrastructure Assessment, the inclusion of the flood risk zonings and the CSO settlement boundary have identified areas that are constrained and lacking the infrastructure required to the service the lands, or lands at high risk of flooding. The subsequent settlement plan identifies those sites where land-use zonings have been amended/revised and the changes identified.

Within Keenagh the quantum of lands zoned new residential and industrial/commercial/warehousing have been reduced, large areas of land have been revised and lands re-zoned and or de-zoned. The revised zoning plan presents a more compact form of development, with proposed new residential development located within the defined CSO settlement boundary following the principle of compact growth and sustainable urban development.

Significant areas to the north, to the south west and east have been revised and lands de-zoned identified as constrained use have been de-zoned, further lands to the west and east and to the south have also been revised. The quantum of lands zoned for Strategic Residential Reserve zoned lands have been de-zoned and New Residential lands zoned within the CSO boundary.

Keenagh Proposed Material Amendments County Development Plan 2021-2027

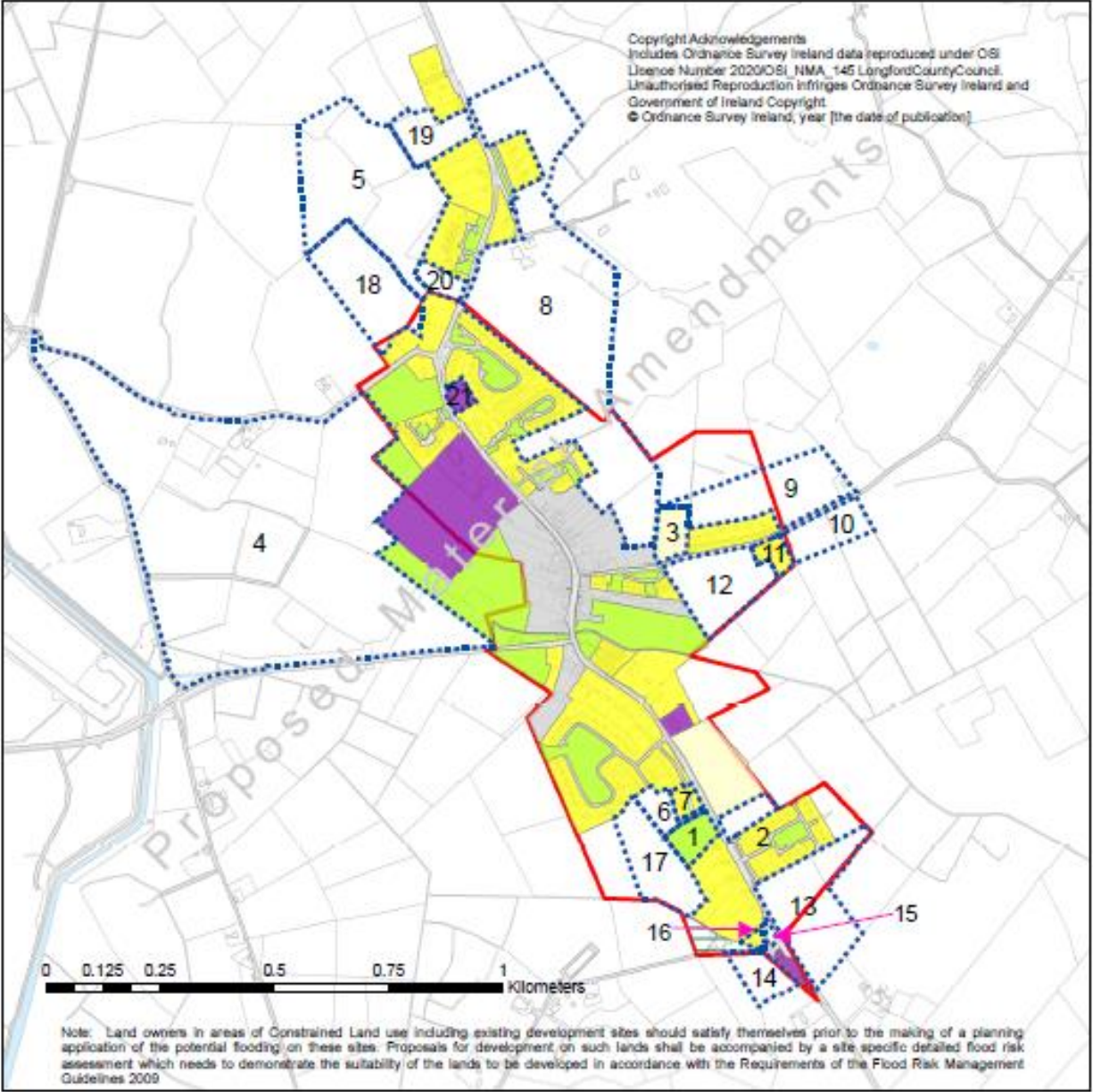

Copyright Acknowledgements
Includes Ordnance Survey Ireland data (reproduced under OSI
Licence Number 2020/OSI, NMA, 145 Longford County Council.
Unauthorised reproduction infringes Ordnance Survey Ireland and
Government of Ireland Copyright.
© Ordnance Survey Ireland, year [the date of publication]

- Legend**
- Changed Zoning
 - Areas of Constrained Land Use
 - CSO Settlement Boundary
 - New Residential
 - Recreation/Amenity & Green Space
 - Residential
 - Social/Community/Education/Public Utility
 - Strategic Residential Reserve
 - Town Core

Zoning Changes		
Draft Plan: Zoning in Draft Plan	Alteration: Amended Zoning	Parcel No: Area on Map
New Residential		
	No Zoning	2
Recreational/Amenity/Green Space		
	No Zoning	4
	No Zoning	5
Residential		
	Social/Community/Education/Public Utility	21
Site Resolution Objective		
	Recreation/Amenity/Green Space	1
	No Zoning	6
	Residential	7
Strategic Residential Reserve		
	New Residential	3
	No Zoning	8 - 10, 12 - 19
	Residential	11, 16
Town Core		
	No Zoning	20



Appendix – F10 Towns & Villages Legan

The land-use zonings for Legan has been revised in accordance with the Infrastructure Assessment framework and the resulting land-use plan for the settlement is presented below.

The settlement maps presented in the initial Draft County Development Plan 2021-2027 were based on the current County Development Plan 2015-2021 and the preliminary infrastructure assessment undertaken in early 2020 which informed the review of the land-use zonings for the key settlements and the drafting of the County Development Plan 2021-2027.

Following the Public Consultation on the Draft Longford County Development Plan 2021-2027 and the review of Submissions and Observations received during the consultation period (27th October 2020 until 18th January 2021) the land use zoning plans for the settlements were revised and the Further Iteration Plans are included in this report under Appendix C (produced during the period December 2020 to March 2021). An additional review of the Infrastructure Assessment Report was undertaken following the development of the Chief Executive's Report on the Submissions received, specifically the submissions from the OPR and EMRA as well as other thematic and area specific submissions.

The Infrastructure Assessment, the inclusion of the flood risk zonings and the CSO settlement boundary have identified areas that are constrained and lacking the infrastructure required to the service the lands, or lands at high risk of flooding. The subsequent settlement plan identifies those sites where land-use zonings have been amended/revised and the changes identified.

The quantum of lands zoned new residential and industrial/commercial/warehousing have been reduced. The revised zoning maps identifies a more sustainable and compact form of development reflecting the CSO boundary of the town and core principle of the NPF, the EMRA RSES and Submission of the OPR on the Draft Plan.

Within Legan significant areas of land have been revised and lands re-zoned and or de-zoned. The revised zoning plan presents a more compact form of development, with proposed new residential development located within the defined CSO settlement boundary following the principle of compact growth and sustainable urban development.

Significant areas to the north, to the south west and east have been revised and lands de-zoned identified as constrained use have been de-zoned, further lands to the west and east and to the south have also been revised. The quantum of the lands zoned Strategic Residential Reserve have been de-zoned.

Legan
Proposed Material Amendments
 County Development Plan 2021-2027

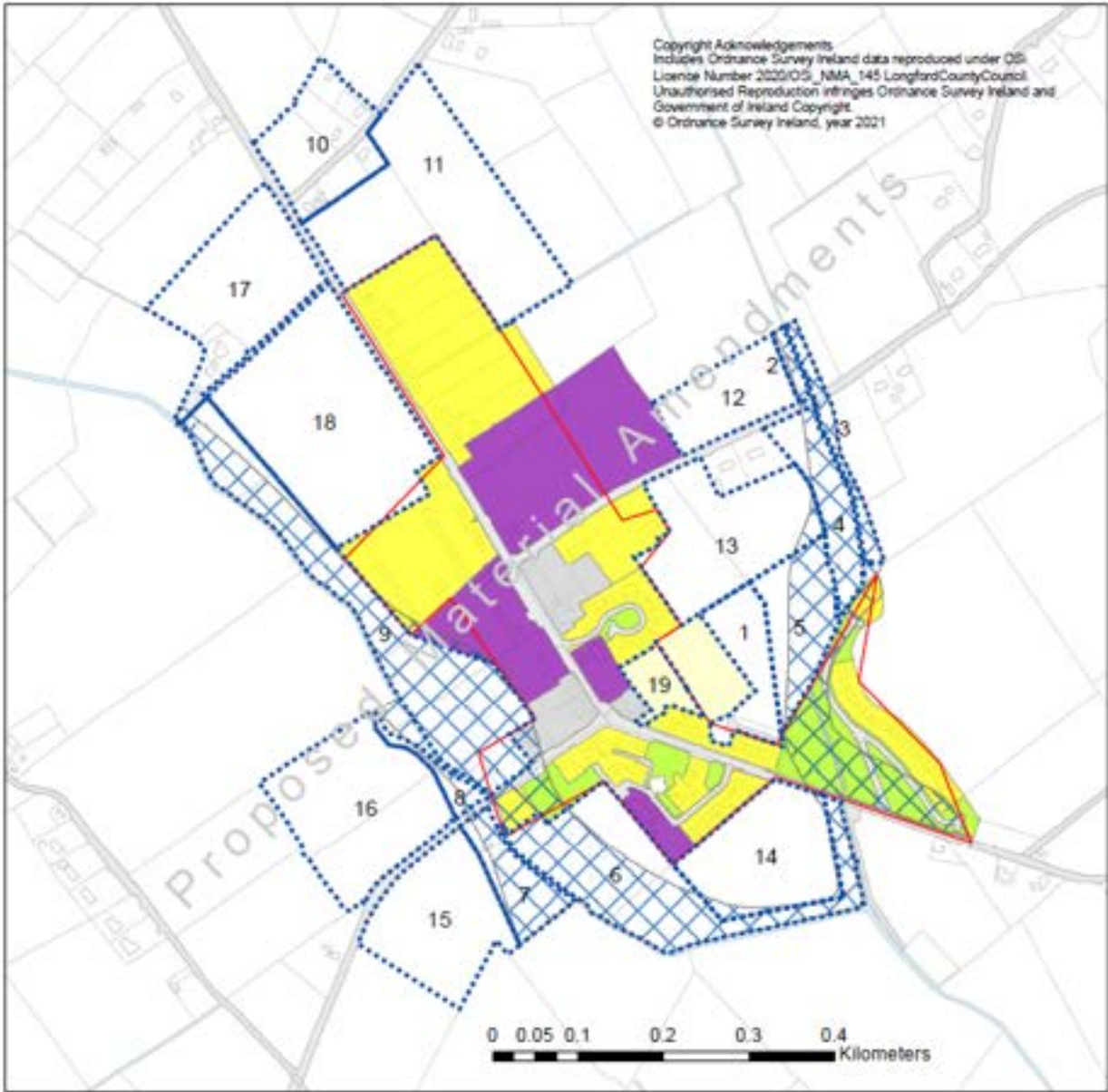

Legend

- Changed Zoning
- CSO Settlement Boundary
- Areas of Constrained Land Use
- New Residential
- Recreation/Amenity/Green Space
- Residential
- Social/Community/Education/Public Utility
- Town Core

Zoning Changes		
Draft Plan: Zoning in Draft Plan	Alteration: Amended Zoning	Parcel No: Area on Map
New Residential	No Zoning	1
Recreation/Amenity/Green Space	No Zoning	2 - 9
Strategic Residential Reserve	No Zoning	11 - 18
Town Core	New Residential	19



Appendix – F11 Towns & Villages Newtownforbes

The land-use zonings for Newtownforbes has been revised in accordance with the Infrastructure Assessment framework and the resulting land-use plan for the settlement is presented below.

The settlement maps presented in the initial Draft County Development Plan 2021-2027 were based on the current County Development Plan 2015-2021 and the preliminary infrastructure assessment undertaken in early 2020 which informed the review of the land-use zonings for the key settlements and the drafting of the County Development Plan 2021-2027.

Following the Public Consultation on the Draft Longford County Development Plan 2021-2027 and the review of Submissions and Observations received during the consultation period (27th October 2020 until 18th January 2021) the land use zoning plans for the settlements were revised and the Further Iteration Plans are included in this report under Appendix C (produced during the period December 2020 to March 2021). An additional review of the Infrastructure Assessment Report was undertaken following the development of the Chief Executive's Report on the Submissions received, specifically the submissions from the OPR and EMRA as well as other thematic and area specific submissions.

The Infrastructure Assessment, the inclusion of the flood risk zonings and the CSO settlement boundary have identified areas that are constrained and lacking the infrastructure required to the service the lands, or lands at high risk of flooding. The subsequent settlement plan identifies those sites where land-use zonings have been amended/revised and the changes identified.

The quantum of lands zoned new residential and industrial/commercial/warehousing have been reduced. The revised zoning maps identifies a more sustainable and compact form of development reflecting the CSO boundary of the town and core principle of the NPF, the EMRA RSES and Submission of the OPR on the Draft Plan.

Within Newtownforbes significant areas of land have been revised and lands re-zoned and or de-zoned. The revised zoning plan presents a more compact form of development, with proposed new residential development located within the defined CSO settlement boundary following the principle of compact growth and sustainable urban development.

Significant areas to the north, to the west and east have been revised and lands de-zoned identified as constrained use have been de-zoned, further lands to the west and east and to the south have also been revised. The quantum of lands zoned Strategic Residential Reserve have been de-zoned. New residential development sites have been reduced and located within the defined CSO boundary.

Copyright Acknowledgements
 Includes Ordnance Survey Ireland data reproduced under OSI
 Licence Number 2006/OSI_NMA_145 LongfordCountyCouncil.
 Unauthorised Reproduction infringes Ordnance Survey Ireland and
 Government of Ireland Copyright.
 © Ordnance Survey Ireland, year [the date of publication]

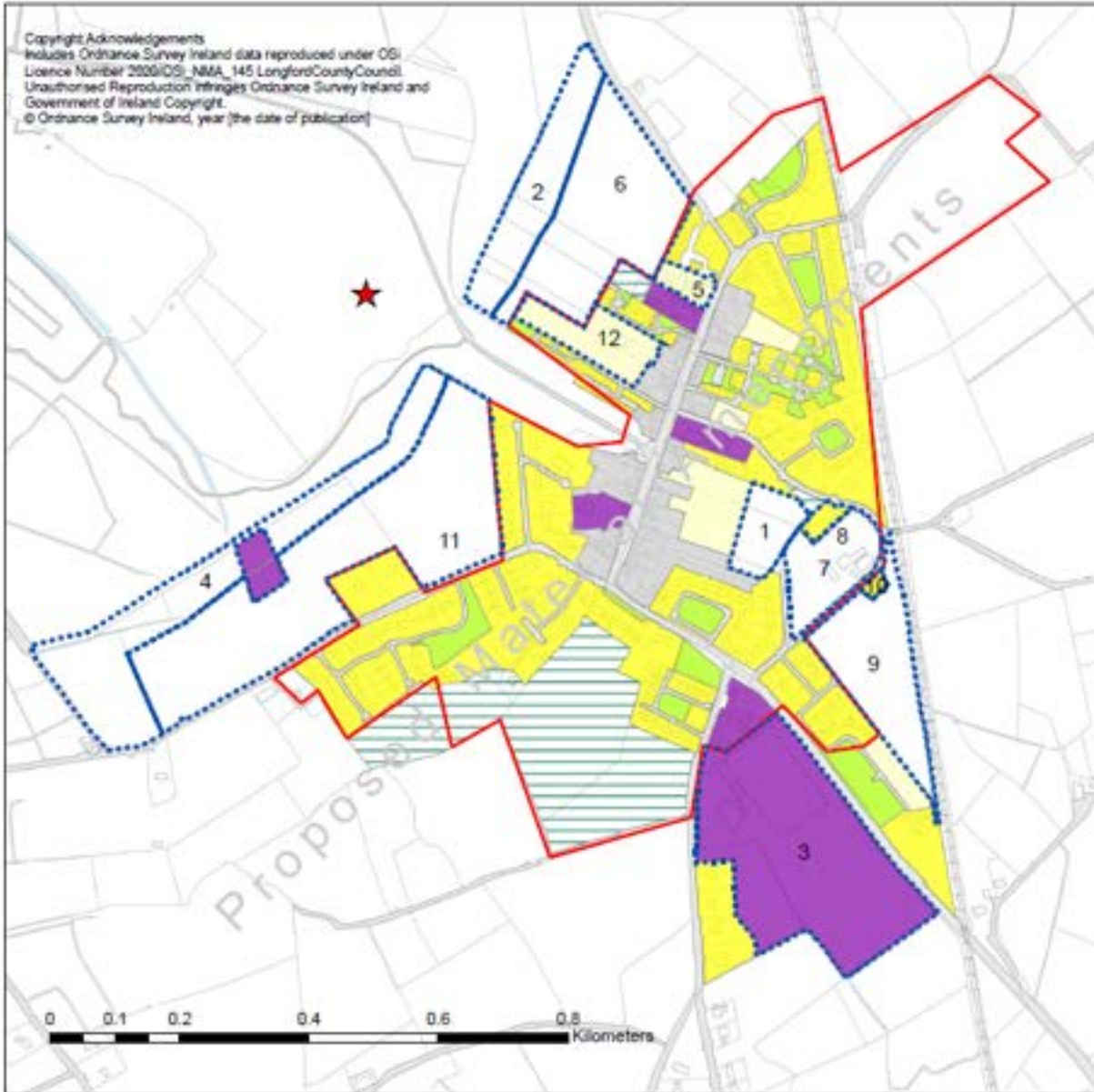

Newtownforbes Proposed Material Amendments County Development Plan 2021-2027

Legend

- Changed Zoning
- Areas of Constrained Land Use
- CSO Settlement Boundary
- New Residential
- Recreation/Amenity/Green Space
- Residential
- Social/Community/Education/Public Utility
- Strategic Residential Reserve
- Town Core
- Tourism & Events

Zoning Changes		
Draft Plan: Zoning in Draft Plan	Alteration: Amended Zoning	Parcel No: Area on Map
New Residential	No Zoning	1
	Residential	12
Recreation/Amenity/Green Space	No Zoning	2, 4
	Social/Community/Education/Public Utility	3
	Residential	11
Social/Community/Education/Public Utility	No Zoning	5
	New Residential	5
Strategic Residential Reserve	No Zoning	6, 7, 8, 11
	Residential	8
	Residential	10
	New Residential	12



Appendix – F12 Smaller Villages & Settlements : Abbeyshrule, Ardagh, Ballinamuck & Clondra

The following settlements and their land-use zonings have been reviewed and revised according to the CSO boundary, constrained land use and the submissions from the OPR and EMRA requesting more compact growth.

- Abbeyshrule
- Ardagh
- Ballinamuck
- Clondra

Copyright Acknowledgements
 Include Ordnance Survey Ireland data reproduced under OSI
 Licence Number 2020/OSI_NMA_145 Longford County Council
 Unauthorised Reproduction infringes Ordnance Survey Ireland and
 Government of Ireland Copyright.
 © Ordnance Survey Ireland, year (the date of publication)

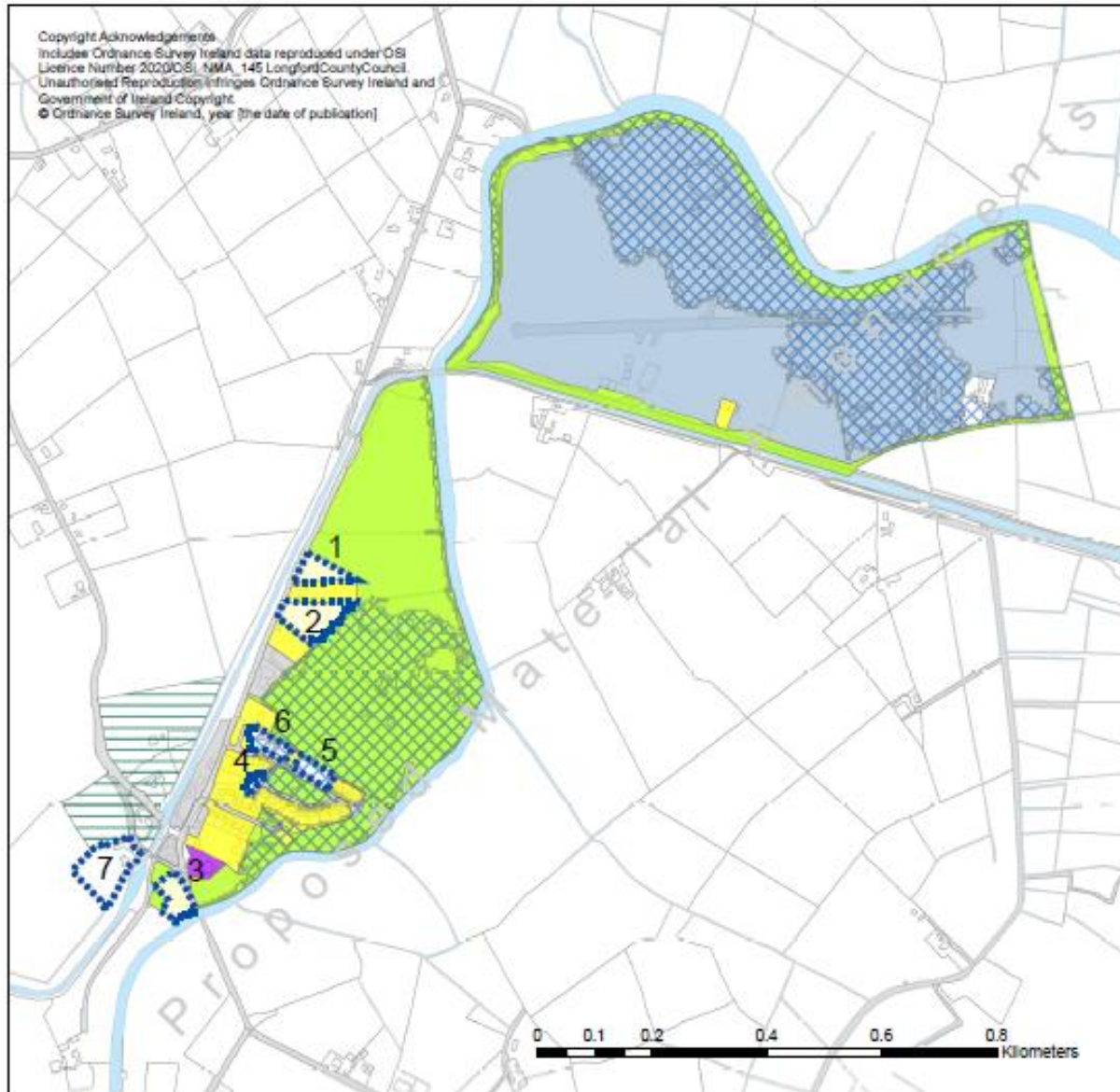

Abbeyshrule Proposed Material Amendments County Development Plan 2021-2027

Legend

- Zone Changes selection
- Areas of Constrained Land Use
- CSO Settlement Boundary
- Airport Development Objective
- New Residential
- Recreation/Amenity/Green Space
- Residential
- Social/Community/Education/Public Utility
- Strategic Residential Reserve
- Town Core

Zoning Changes		
Draft Plan: Zoning in Draft Plan	Alteration: Amended Zoning	Parcel No: Area on Map
Recreation/Amenity/Green Space		
	New Residential	1
	New Residential	2
	New Residential	3
Residential		
	No Zoning	4
	No Zoning	5
	No Zoning	6
Strategic Residential Reserve		
	No Zoning	7



Ardagh
Proposed Material Amendments
County Development Plan 2021-2027

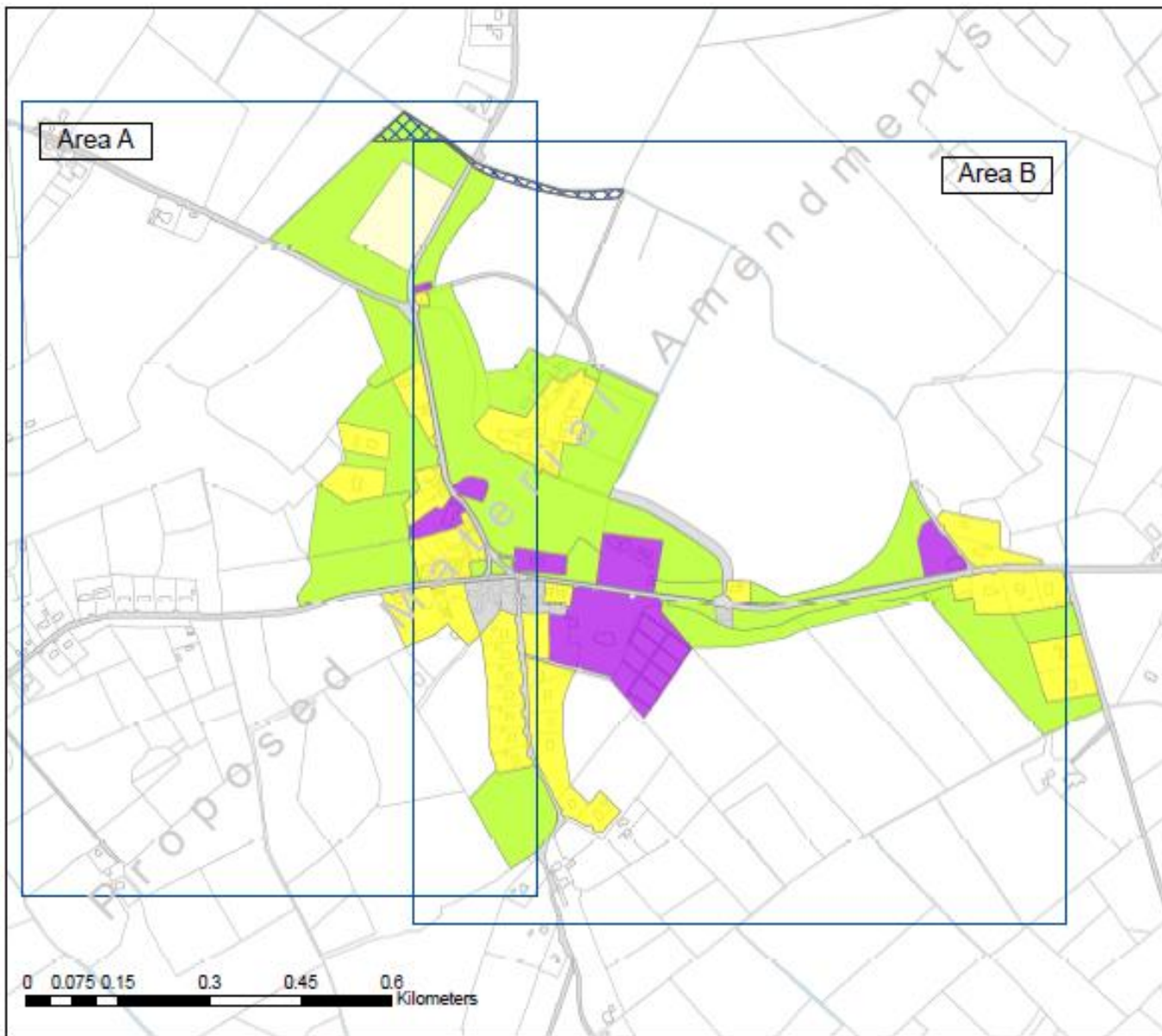

Legend

- Changed Zoning
- New Residential
- Recreation/Amenity/Green Space
- Residential
- Social/Community/Education/Public Utility
- Strategic Residential Reserve
- Tourism
- Town Core
- CSO Settlement Boundary
- Areas of Constrained Land Use

See separate Maps
of Area A and Area B

Copyright Acknowledgements
Includes Ordnance Survey Ireland data reproduced under OSI
Licence Number 2020/OSI_NMA_145 LongfordCountyCouncil.
Unauthorised Reproduction infringes Ordnance Survey Ireland and
Government of Ireland Copyright.
© Ordnance Survey Ireland, year [the date of publication]



Ardagh
Proposed Material Amendments
County Development Plan 2021-2027

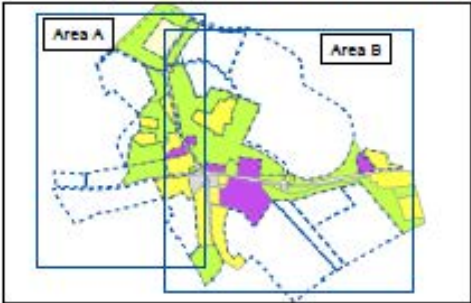
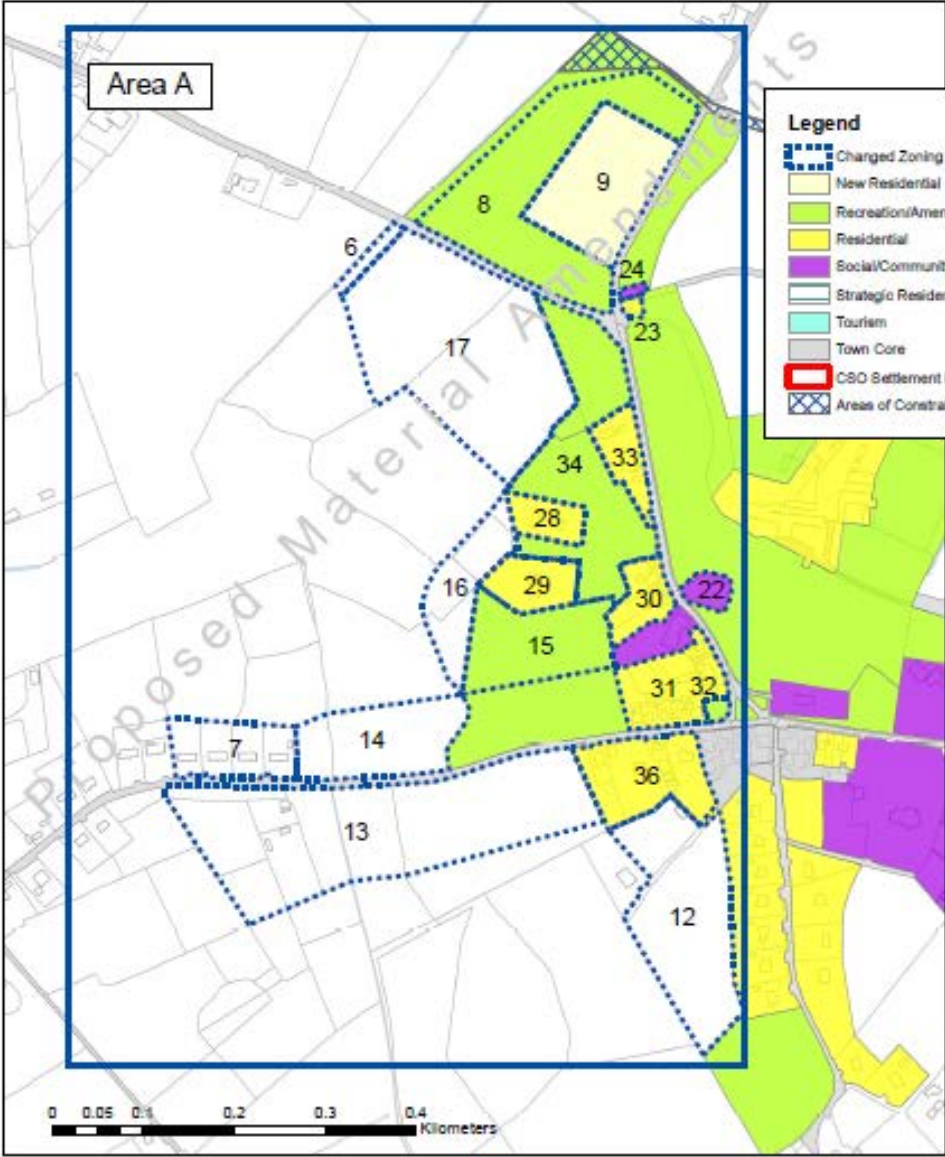

Changed Zoning		
Draft Plan: Zoning in Draft Plan	Alteration: Amended Zoning	Parcel No.: Area on Map
Recreational/Amenity/Green Space		
	No Zoning	6
Residential		
	No Zoning	7
Strategic Residential Reserve		
	Recreational/Amenity/Green Space	8, 15
	New Residential	9
	No Zoning	12, 13, 14, 16, 17
Tourism		
	Social/Community/Education/Public Utility	22, 24
	Residential	23
Town Core		
	Residential	28 - 31, 33, 36
	Recreational/Amenity/Green Space	32, 34

Copyright Acknowledgements
Includes Ordnance Survey Ireland data reproduced under
ODL
Licence Number 2020/ODI_NMA_145
Longford County Council. Unauthorised Reproduction
Infringes Ordnance Survey Ireland and Government of
Ireland Copyright
© Ordnance Survey Ireland, year [the date of publication]



Ardagh
Proposed Material Amendments
County Development Plan 2021-2027

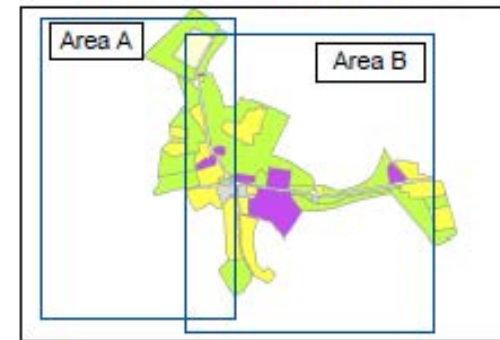
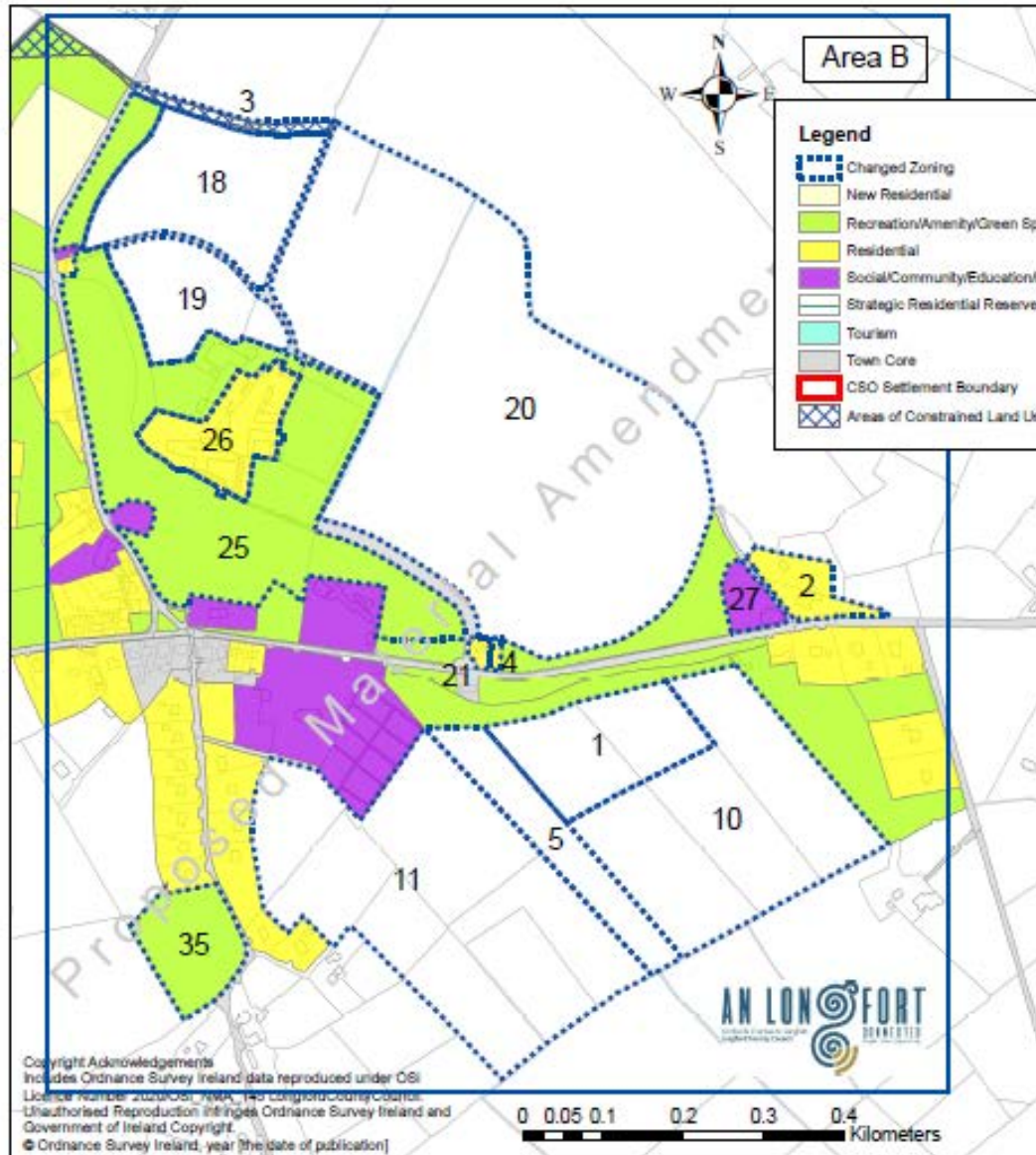

Changed Zoning

Draft Plan: Zoning in Draft	Alteration: Amended Zoning	Parcel No: Area on Map
New Residential		
	No Zoning	1
No Zoning		
	Residential	2
Recreational/Amenity/Green Space		
	No Zoning	3
	Residential	4
	No Zoning	5
Strategic Residential Reserve		
	No Zoning	10
	No Zoning	11
	Recreational/Amenity/Green Space	35
Tourism		
	No Zoning	18
	No Zoning	19
	No Zoning	20
	Residential	21
	Recreational/Amenity/Green Space	25
	Residential	26
Town Core		
	Social/Community/Education	27

Ballinamuck Proposed Material Amendments County Development Plan 2021-2027

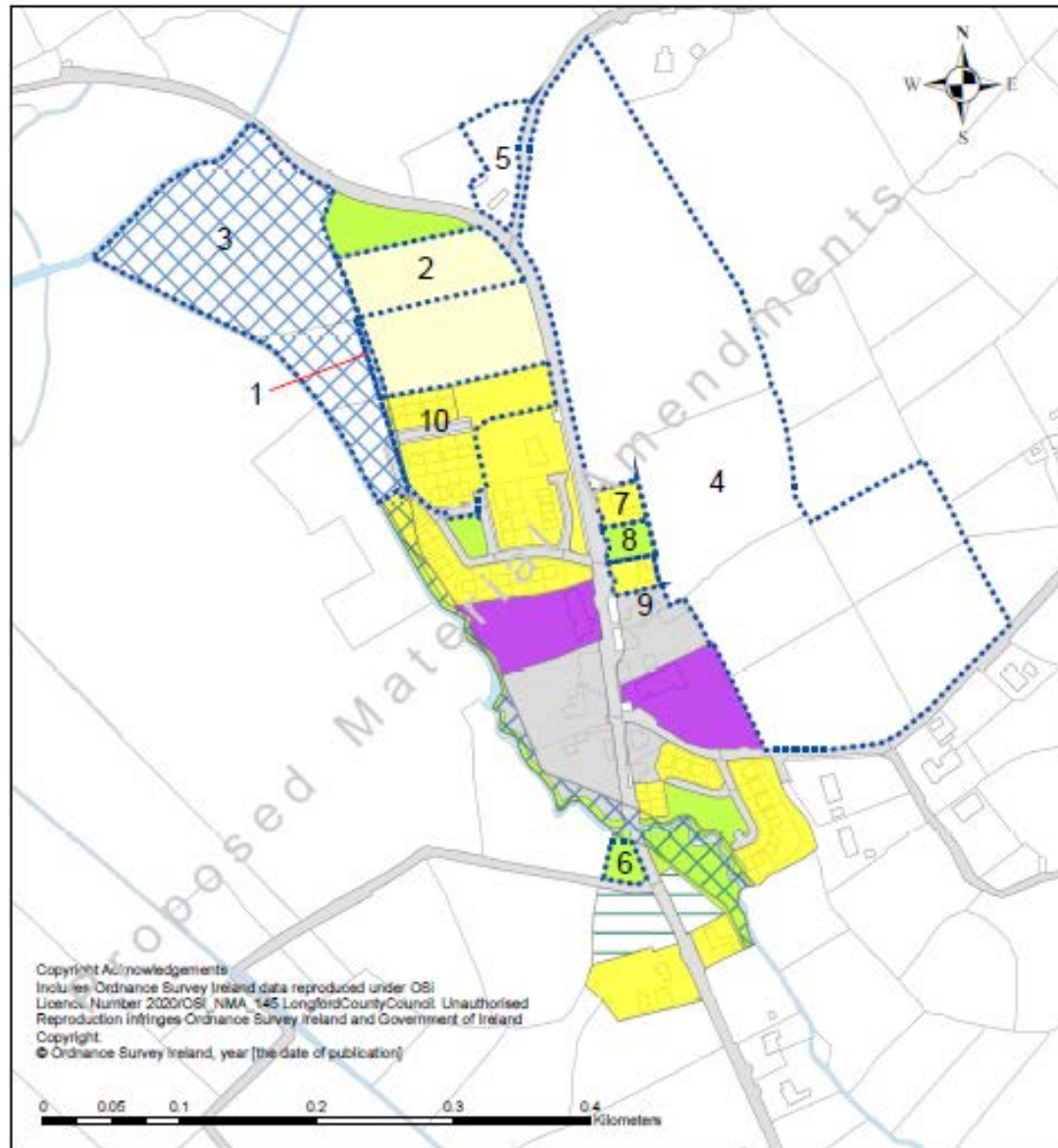

Legend

- Changed Zoning
- New Residential
- Recreation/Amenity/Green Space
- Residential
- Social/Community/Education/Public Utility
- Strategic Residential Reserve
- Town Core
- CGO Settlement Boundary
- Areas of Constrained Land Use

Zoning Changes

Draft Plan: Zoning in Draft	Alteration: Amended Zoning	Parcel No: Area on Map
New Residential		
No Zoning		1
Residential		10
Recreational/Amenity/Green Space		
New Residential		2
No Zoning		3
Strategic Residential Reserve		
No Zoning		4
No Zoning		5
Recreational/Amenity/Green Space		6
Town Core		
Residential		7
Recreational/Amenity/Green Space		8
Residential		9



Clondra Proposed Material Amendments County Development Plan 2021-2027

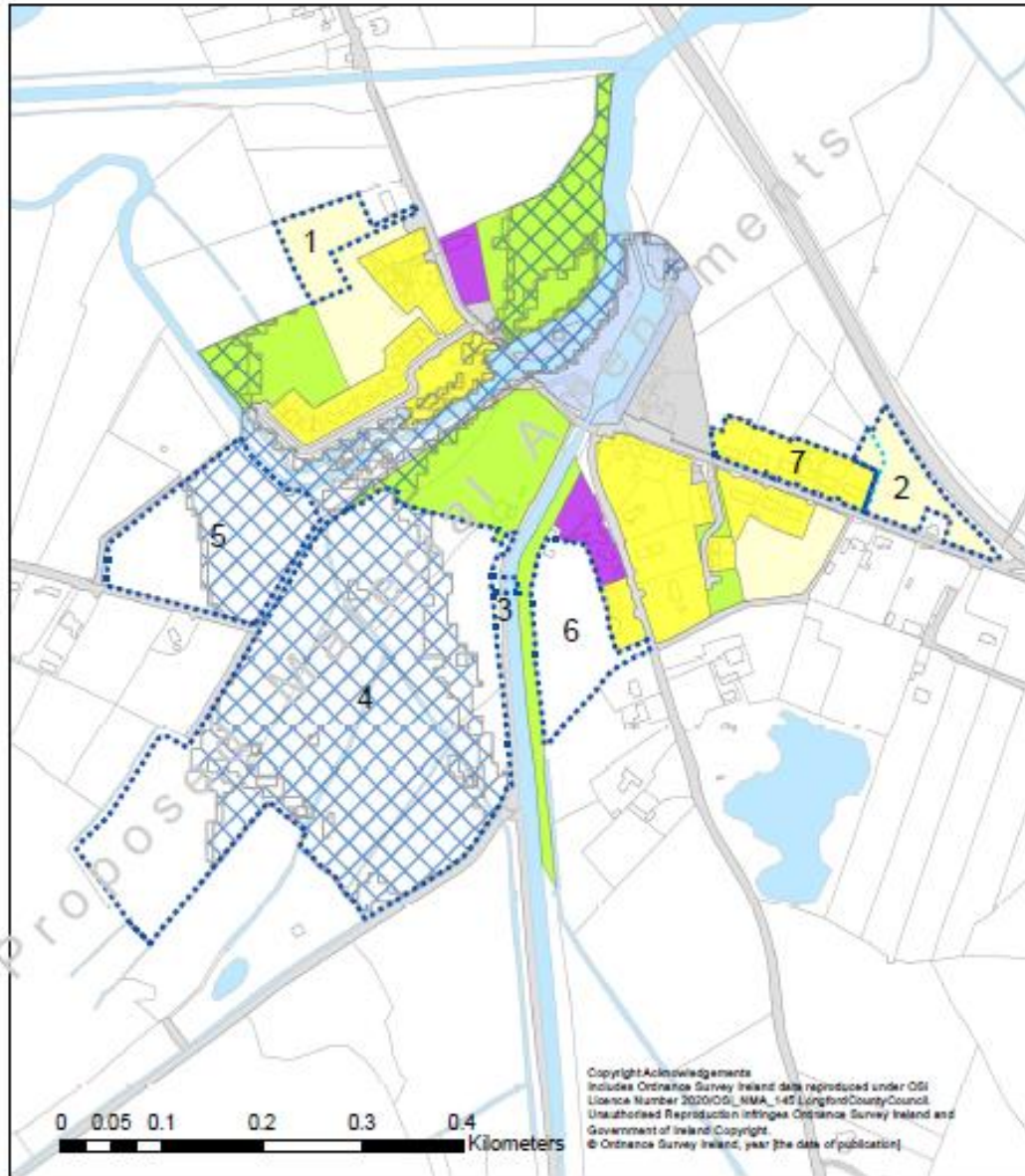

Legend

- Changed Zoning
- Canal Redevelopment Area
- New Residential
- Recreation/Amenity/Green Space
- Residential
- Social/Community/Education/Public Utility
- Town Core
- Proposed Road
- OSO Settlement Boundary
- Areas of Constrained Land Use

Zoning Changes

Draft Plan: Zoning in Draft Plan	Alteration: Amended Zoning	Parcel No: Area on Map
No Zoning		
	New Residential	1
	New Residential	2
	Residential	7
Pedestrian Bridge		
	No Zoning	3
Tourism		
	No Zoning	4
	No Zoning	5
	No Zoning	6



APPENDIX G – REVISIONS TO THE ZONED SITES FOLLOWING THE ADOPTION OF THE CHIEF EXECUTIVE’S REPORT ON THE PROPOSED MATERIAL ALTERATIONS (RESIDENTIAL & EMPLOYMENT LANDS)

The following information identifies the revisions made to the land zonings following the adoption of the Chief Executive Report produced for the Material Amendments of the County Development Plan 2021-2027.

Ballymahon

The Chief Executives Report on the proposed Material Alterations referenced the de-zoning of lands zoned Strategic Residential Reserve R1 and R3. Both sites were scored Red No Development in the IAR and have been de-zoned in the final version of the Longford County Development Plan 2021-2027.

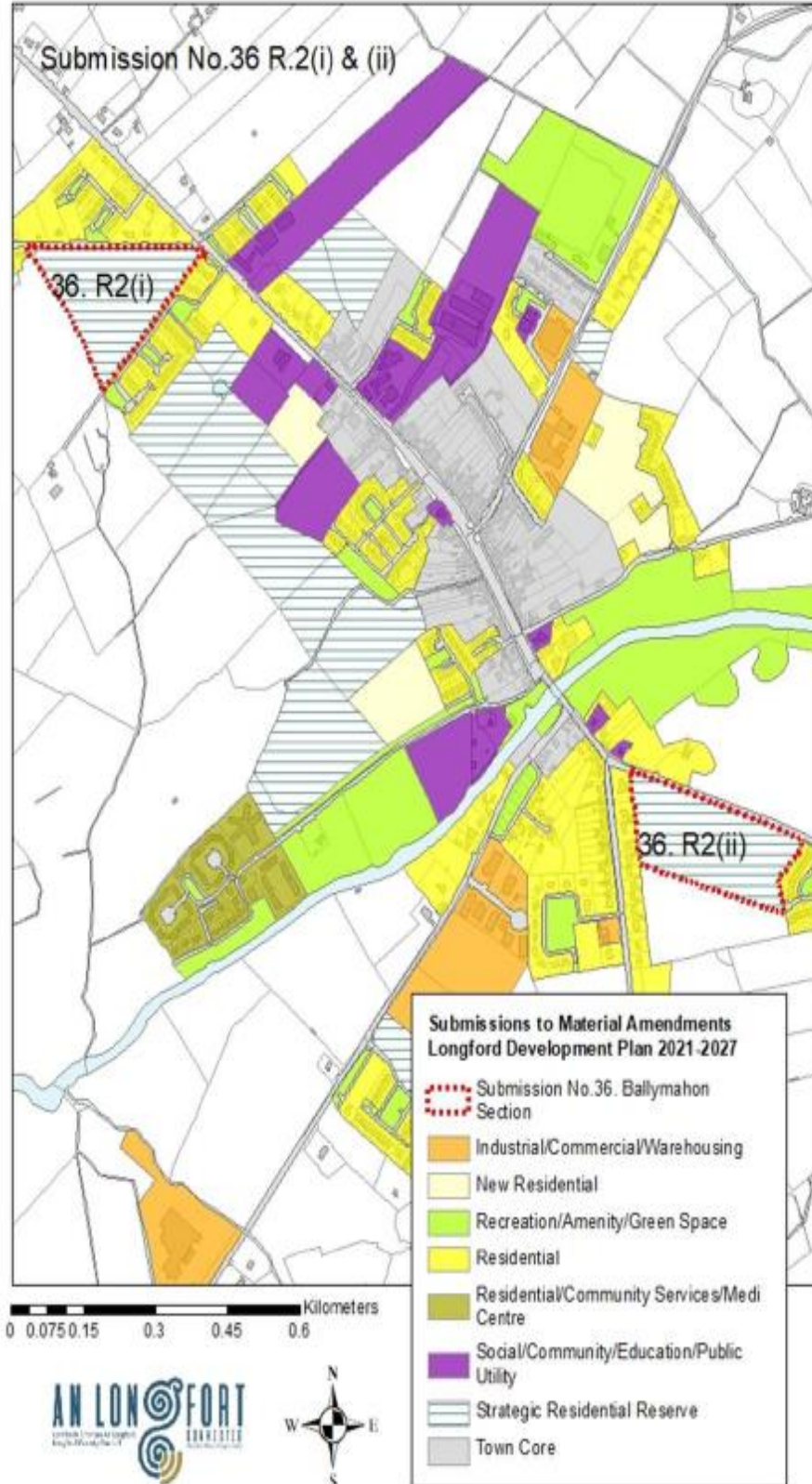

Abbeyshrule

The Chief Executives Report on the proposed Material Alterations referenced the de-zoning of lands in areas of constrained use (lands affected by flooding). The lands zoned R1 (land pocket 19 on the attached plan) are reduced in size as reflected in the attached map along the south-east edge of the site.

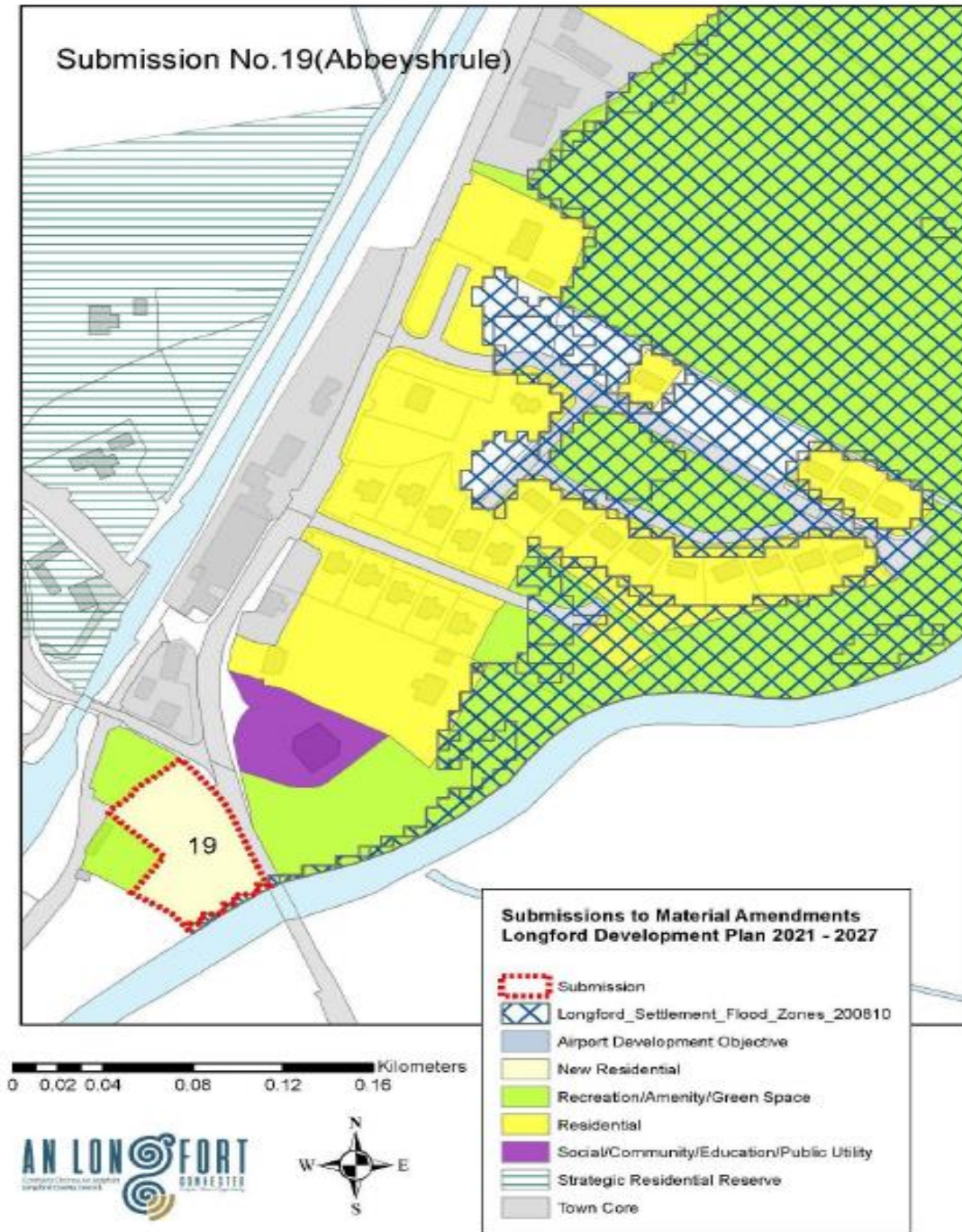

Ballinamuck

The Chief Executives Report on the proposed Material Alterations referenced the de-zoning of lands in areas of constrained use (lands affected by flooding). The lands zoned Town Centre have been revised – the revisions do not impact the findings of the infrastructure assessment report for the settlement as these lands are already developed. However, the settlement maps used in the report have been revised to take account of the areas of constrained use.

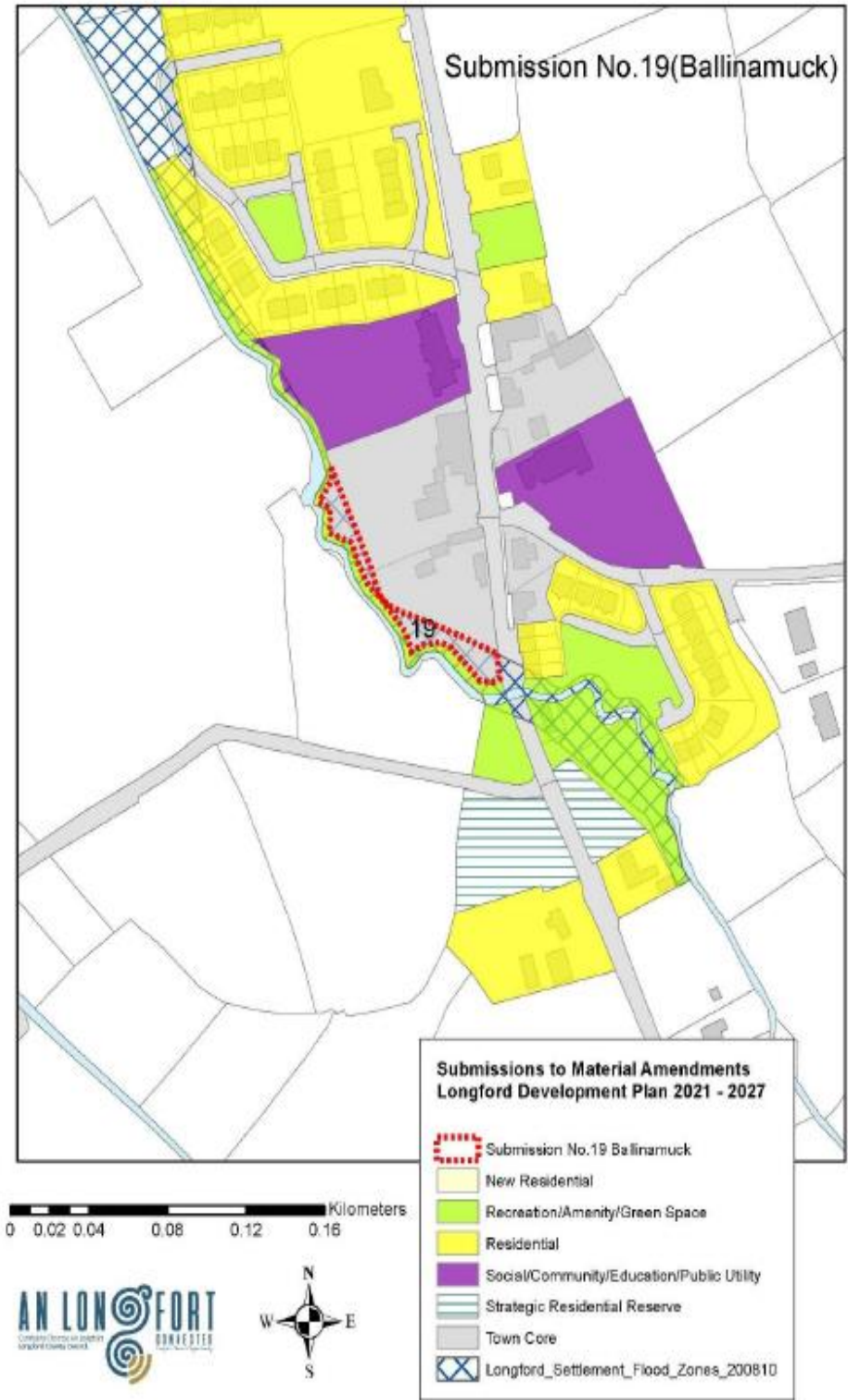

Clondra

The Chief Executives Report on the proposed Material Alterations referenced the de-zoning of new residential lands in areas of constrained use (lands affected by flooding). This amendment was included in the original report and the lands were removed from the infrastructure assessment of the site and the settlement. The lands impacted are shown on the attached map and are to the west of the site no.1.

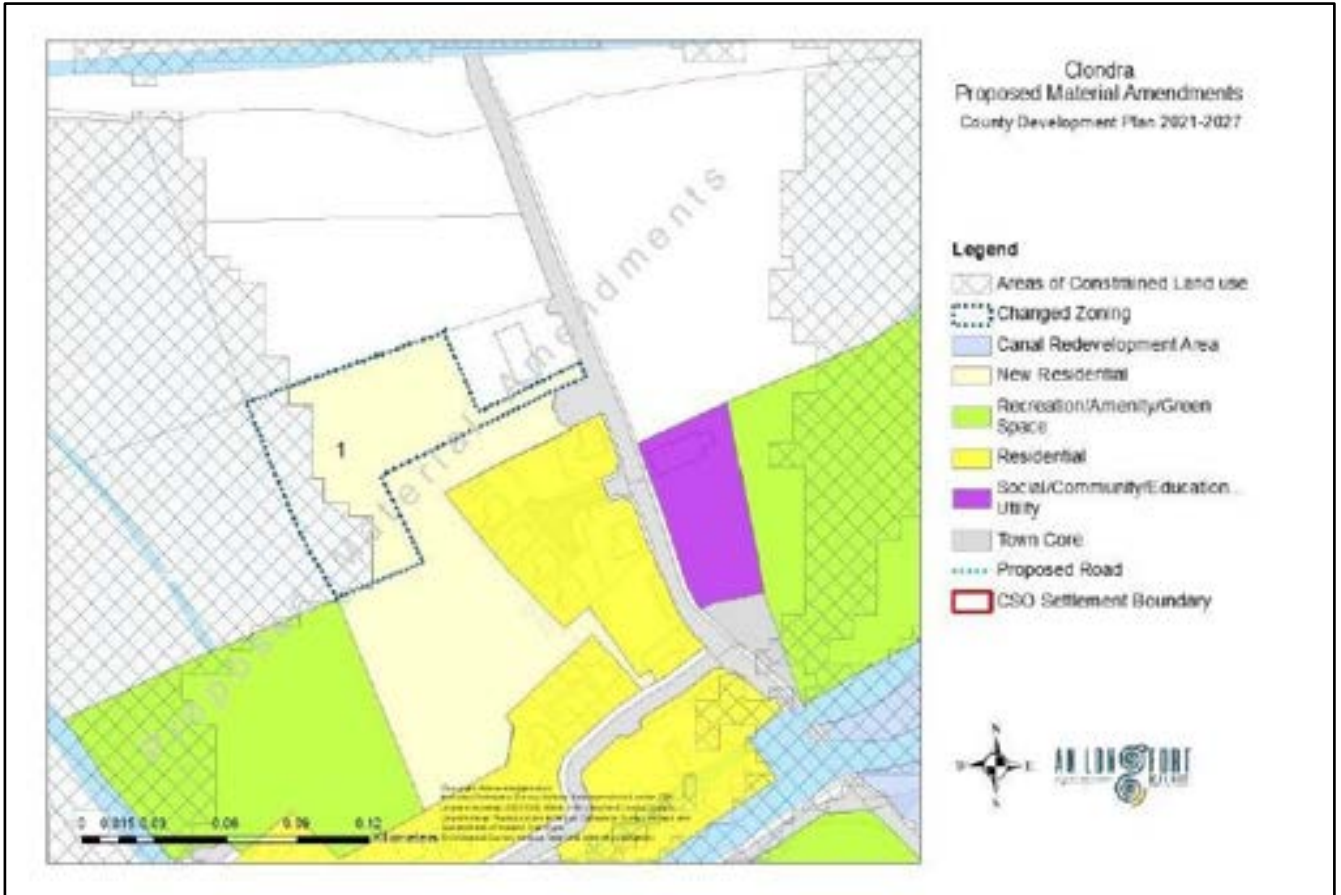

Drumlish

The Chief Executive Report on the proposed Material Alterations included a revised land zoning plan for the Drumlish Settlement. This plan included a revised zoning of new residential sites and an amendment to the employment lands zoned in Drumlish.

Following the adoption of the Chief Executives Report an infrastructure assessment of the revised lands has been included into the report. This includes the following:

- **Appendix G1** – Revised further iteration plan showing the lands zoned new residential and employment.
- **Appendix G2** – Revised Roads Section assessment of the lands zoned new residential and employment.
- **Appendix G3** – Revised Water Services assessment of the lands zoned new residential and employment.
- **Appendix G4** – Revised settlement assessment and mapping of the zoned lands.

Appendix G1 – Revised Further Iteration Plan showing the New Residential & Employment sites (Drumlish)

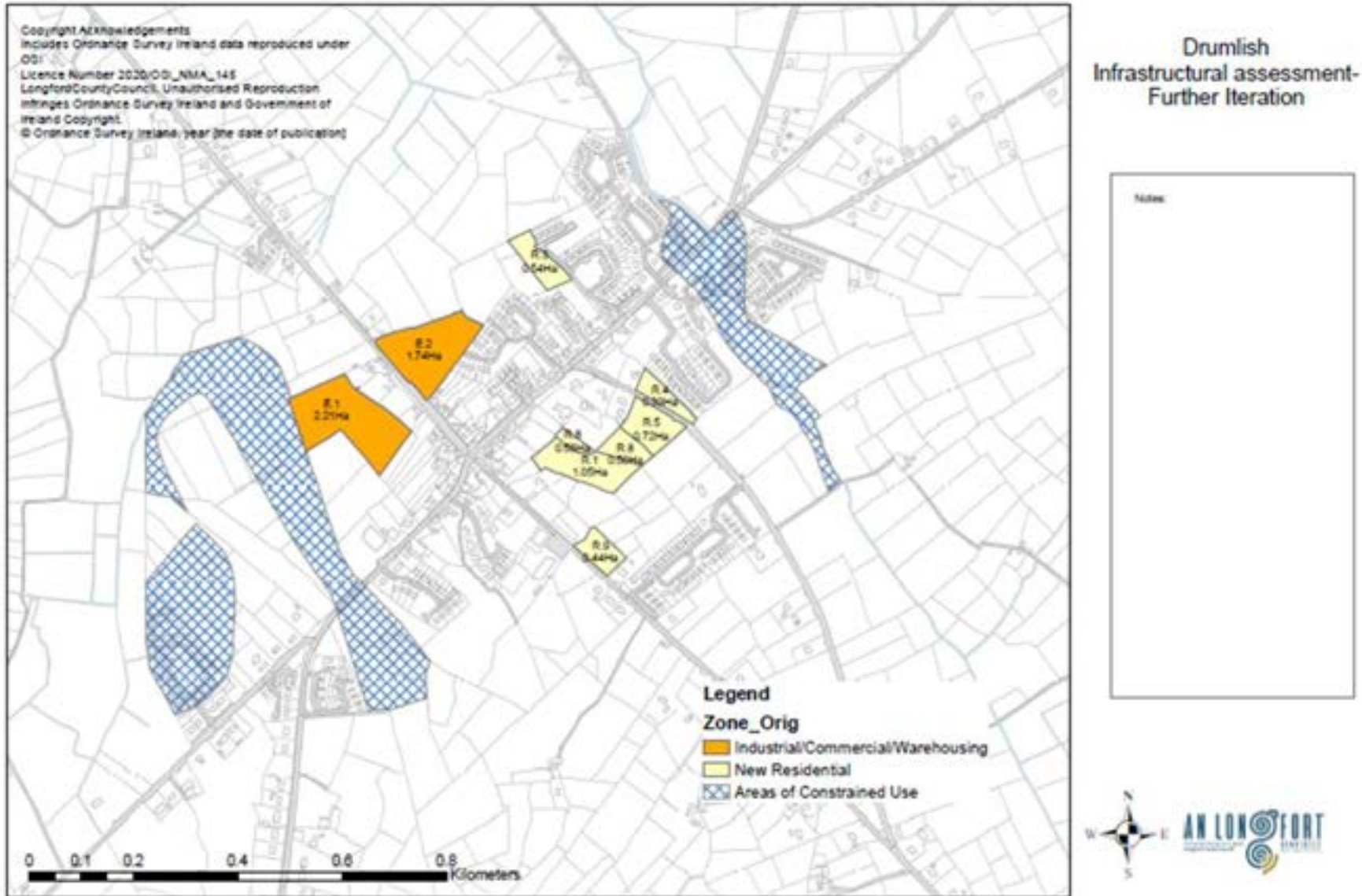

Appendix G2 – Revised Roads Section Infrastructure Assessment for Drumlish

The tables below indicate the zoned lands updated to reflect the revised zoned map as adopted in Oct 2021.

HOUSING LANDS		R1	R2	R3	R4	R5	R6	R7	R8	R9
CRITERIA	WEIGHTING									
ROADS	100	100		100	100	100			50	100
DRAINAGE	100	50		50	50	50			50	50

EMPLOYMENT LANDS		E1	E2
CRITERIA	WEIGHTING		
ROADS	100	100	100
DRAINAGE	100	80	80

Appendix G3 – Revised Water Services Infrastructure Assessment of the sites in Drumlish

The following table provides a summary of the scores for Drumlish and the identified residential/housing lands and employment/industrial lands.

DRUMLISH – DETAILED WATER / WASTEWATER ASSESSMENT

INFRASTRUCTURE ASSESSMENT			58840	11140								
Settlement	DRUMLISH		15490		10300	3890	7140	19600	2750			
Water supply zone	Lough Forbes	7 MI/day	31111									
Agglomeration	Drumlish D0489		1,549		1.03	0.389	0.714	1.96	0.275			
Residential lands			R1	R2	R3	R4	R5	R6	R7	R8	R9	
Wastewater	headroom	- 2	61		35	66	87			11	68	
Employment lands			E1	E2	E3	E4	E5	E6	E7	E8	E9	
Wastewater			24	24								
See Zoning Maps for reference number report, detailing the estimated cost at draft plan stage			5,884									
RESIDENTIAL LANDS			R1	R2	R3	R4	R5	R6	R7	R8	R9	
Required services		network	90road upgrade	40um road upgrade	90um road upgrade	110+60um upgrade				40um road upgrade		
Residential lands		SPS				new PS		Barrow upgrade /350m				
		WWTP	Capacity Upgrade wwtp									
CONNECTION	3929		137,515	31,432	98,225	39,290	58,935					
extra on connection	442	IW	0	0	0	0	0	0				
NETWORK			22,500	35,000	22,500	0	0					
Network upgrade	250	roads section	90	140	90	170						
Network new road	200											
Network upgrade green	150											
Network new green	100											
PUMP			0	0	0	0	0					
SCADA	14000	jobs Tobin reports										
valve chamber	4000											
variable speed	12500											
benching	2500											
Atex pump replace	13000											
discharge +vent	3500											
recertification electric	2500											
rising main	250											
Pump Station new	250000	turn quotes 2019										
WWTP upgrade per 1000 PE	0.4	431298.621	144,828	33,103	103,448	41,379	24,300					
drinking water DMA figures 2.7	600000	391.5	94.5	21.6	67.5	27	40.5					
NETWORK+SPS+WWTP	sum total	1488503.62	304,843	99,535	224,173	80,669.31	83,235					
size land parcel estimated		m2	206*53	48*43	119*86	129*36	94*75					
housing density estimated		number	35	4	28	16	15					
	29 dwellings/ha	m2	15490	3130	10300	3890	7140					
=+(12+8+4)*10*(1+(15green+5school+10business+15road)/100)												
	348 m2/ dwelling	if pump	15490	3130	10300	3890	7140					
	737.1 m2/ dwelling		45	9	30	11	21					
=+(12+8+9+6)*(3+12+3)*(1+(15road+1 school+1 business)/100)												
	14 dwellings/ha	2/3 1/3 split	17	7	24	5	17					
	93 added dwelling PE	50:50 split	33	7	22	8	15					
	297 chosen numl		35	8	25	10	15			0	0	
	cost % figure in table											
	3900 100											
	8000 67	-124										
	12000 33	-118										
	16000 0	-121										
	Costs per unit		8,710		8,967	8,067	5,549			5,549	8,067	
	Score to table		61		58	66	87			11	68	
	-Deficit/+headroom	- 394	Plant needs upgrade									

EMPLOYMENT LANDS			E1	E2	
Required services		network			
Employment Lands		SPS			
		WWTP			
CONNECTION					
	3929				
extra on connection	442		0	0	
NETWORK					
			0	0	
Network upgrade	250				
Network new road	200				
0 Network upgrade green	150				
Network new green	100				
PUMP					
			0	0	
SCADA	14000				
valve chamber	4000				
variable speed	12500				
benching	2500				
Atex pump replace	13000				
discharge +vent	3500				
recertification electric	2500				
rising main	250				
Pump Station new	250000				
WWTP upgrade per 1000 PE		0.6 900000	900000	900000	
	10	900000	200	200	200
NETWORK+SPS+WWTP			sum total	978580	978,580 978,580
size land parcel estimated		m2	300*200	300*200	
trade density estimated Number		number	15	15	
	5 trades/ha	m2	58840	58840	
+=(45)*30*(1+(15green+20 parking+15road)/100)		trades/ha	if pump	58840	58840
	2025			29	29
	10385	m2/ trade		6	6
+=(100)*67*(1+(15 green+25 parking+15 road)/100)		m2/ trade	2/3 1/3 split	21	21
	1 trades/ha		50:50 split	17	17
40 added PE trade		200		20	20
cost % figure in table					
	3900	100			
	8000	67	-124		
	30000	33	-647		
	100000	0	-2121		
Costs per unit				48,929	48,929
Score to table				24	24
added PE total		592			
=-Deficit/+headroom		- 594			Plant needs upgrade

Appendix G4 - Revised Settlement Assessment and Mapping of the zoned lands in Drumlish

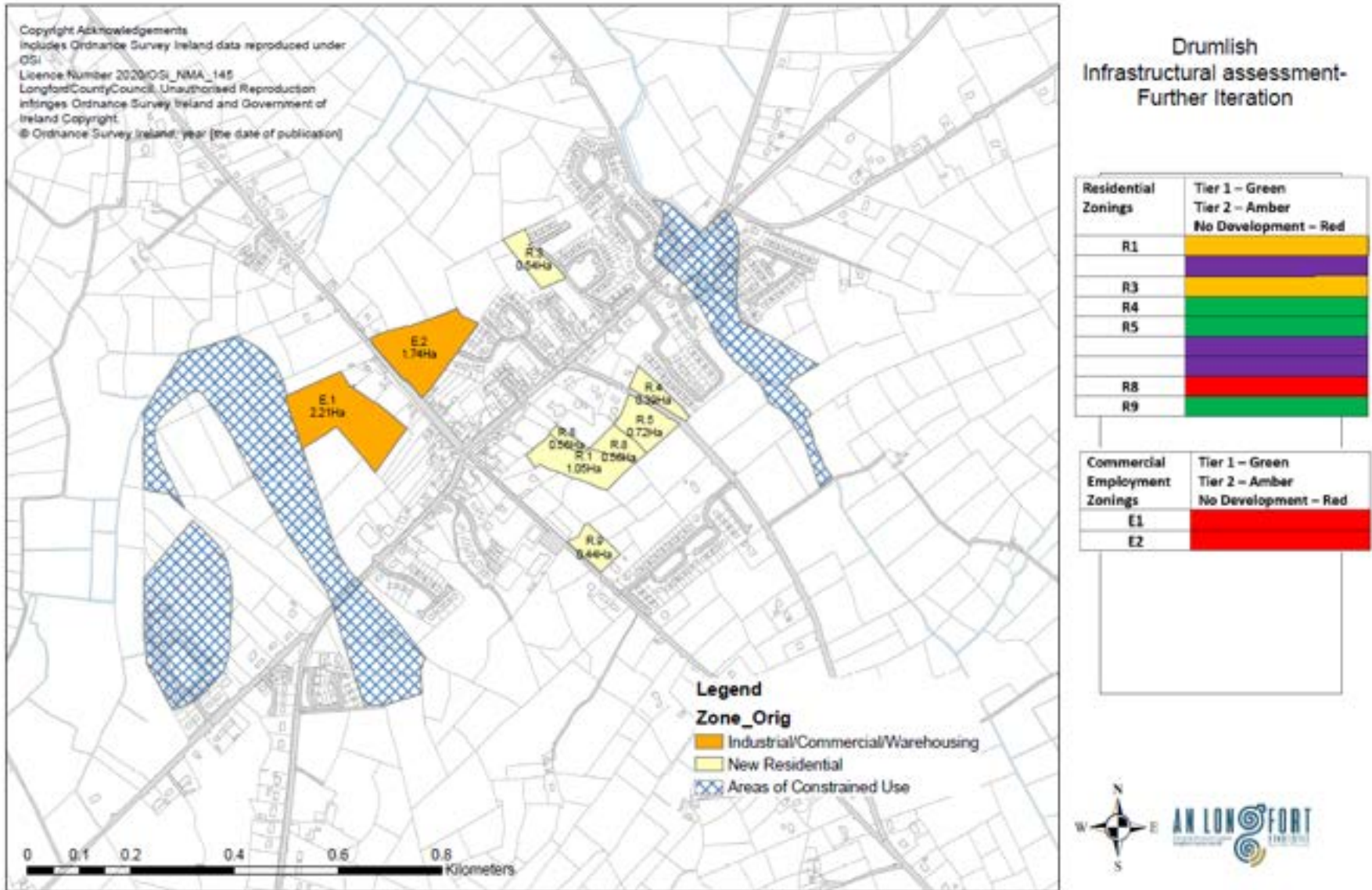

Annex 6:

**Settlement Asset Based Criteria
Table**

Settlement	Scale (Population size and rate of increase/decrease between 1996-2016) where data provides for comparison. Longford County – (30,166 - 40,873) = +35.5%	FAC Medium Population Projection Year 2027 (and rate of change from 2016)	Function	Infrastructure: (Wastewater, water supply, broadband connectivity)	Human Capital (Level of education, skillset of labour force)	Placemaking (Public realm spaces, connectivity of spaces, residential and employment densities)	Enterprise Ecosystem (Formation rates for new businesses, growth of existing businesses – scale-ups, numbers of employment in types of sector)	Connectivity (Transport infrastructure, urban and rural transport options)	Natural Capital (Open space and green infrastructure provisions, environmental and ecologically sensitive sites, flood extents)
Longford Town	6,984 - 10,008 (43% increase)	12,389 (+23.8%)	Jobs to Resident Workforce Ratio = 1.596. Note: The average ratio of jobs to resident workers in the Eastern and Midland Regional Assembly area is 0.86. Main employment, administrative and retail	<u>Wastewater</u> 20,000 PE (Collected PE = 17,623 – 2,377 PE Remaining Capacity). <u>Broadband</u> Settlement serviced by 100% High-Speed Fibre Broadband Coverage	<u>5 Primary Schools</u> 1,208 places enrolled 2019/2020 <u>1 Special School</u> 29 places enrolled 2019/2020 <u>3 Post-Primary School</u> 1,401 places enrolled 2019/2020	A number of formal and informal public and communal spaces and public realm features associated with the settlement, notably the Albert Reynolds Peace Park and the Royal Canal amenity features. Good pedestrian connectivity. Vehicular connectivity	Labour Force participation rate = 60.2%. Unemployment rate = 19.6% based on 2016 Census. Jobs to Resident Workforce Ratio = 1.596. Note: The average ratio of jobs to resident workers in the Eastern and Midland Regional Assembly area is 0.86.	Good public transport links available, including Irish Rail services, Bus Éireann local and national services. Good walking connectivity throughout and around the settlement. Recognised deficiency in dedicated cycle lanes.	A number of formal and informal green spaces and key amenity features present, most notably, the Albert Reynolds Peace Park and the Royal Canal, with ecological corridor linkages throughout. Nearest Natura 2000 site is approx. 3km west of town centre (Brown

			centre in County Longford with a high level of public transport services and connectivity within local, regional and national settings.				Key employment industries within the settlement include manufacturing, commerce and trade and professional services which together, make up of the 15,172 total number of persons at work in Longford Town based on the 2016 Census.		Bog SAC – Site Code: 002346).
Edgeworths town	737 - 2,072 (181% increase)	2,606 (+25.8%)	Second largest settlement in population terms. Good level of social and community infrastructure such as schools, library, sports grounds. High-level of public transport connectivity owing to Irish Rail station	<u>Wastewater</u> 2,700 PE (Collected PE = 2,656 – 44 PE remaining capacity) <u>Broadband</u> Settlement serviced by 99% High-Speed Fibre Broadband Coverage	<u>2 Primary Schools</u> 404 places enrolled 2019/2020		Jobs to Resident Workforce Ratio = 0.735.		

			and proximity to N4 route. <u>Commuter Trips</u> <u>Ratio between jobs and resident workers</u> <u>Retail Hierarchy</u>						
Ballymahon	790 - 1,877 (138% increase)	2,341 (+24.7%)	<u>Commuter Trips</u> <u>Ratio between jobs and resident workers</u> <u>Retail Hierarchy</u>	<u>Wastewater</u> 2,125 PE (Collected PE = 2,622) <u>Broadband Settlement</u> serviced by 93%-96% High-Speed Fibre Broadband Coverage	<u>1 Primary School</u> 355 places enrolled 2019/2020 <u>2 Post-Primary Schools</u> 1,079 places enrolled 2019/2020		Jobs to Resident Workforce Ratio = 0.817.		
Lanesborough - Ballyleague	984 - 1,454* (48% increase)	N/A	<u>Commuter Trips</u> <u>Ratio between jobs and resident workers</u>	<u>Wastewater</u> 3,200 PE (Collected PE = 2,191 – 1,009 PE Remaining Capacity)	<u>2 Primary Schools</u> 165 places enrolled 2019/2020		Jobs to Resident Workforce Ratio = 0.646.		

			<u>Retail Hierarchy</u>		<u>1 Post-Primary School</u> 193 places enrolled 2019/2020 **				
Granard	1,173 – 1,096*** (-0.06% decrease) CSO Settlement defined population (2016) = 816	1,003 (+22.9% in CSO defined Settlement population)	<u>Commuter Trips</u> <u>Ratio between jobs and resident workers</u> <u>Retail Hierarchy</u> Strong rural-urban interdependencies are a feature of the Region, with positive correlations between rural economic performance and regional accessibility.	<u>Wastewater</u> 3,200 PE (Collected PE = 1,775 – 1,425 PE Remaining Capacity). <u>Broadband Settlement</u> serviced by 100% High-Speed Fibre Broadband Coverage	<u>1 Primary School</u> 190 places enrolled 2019/2020 <u>2 Post-Primary School</u> 731 places enrolled 2019/2020		Jobs to Resident Workforce Ratio = 2.353.		
Abbeyshrule	224 (Small Area - 2016 Census)	N/A	<u>Commuter Trips</u>	<u>Wastewater</u> 300 PE (Collected PE = 85 – 215 PE	-				

			<u>Ratio between jobs and resident workers</u> <u>Retail Hierarchy</u>	Remaining Capacity). <u>Broadband Settlement</u> identified for planned fibre broadband deployment					
Ardagh	471 (2 no. Small Areas – 2016 Census)	N/A	<u>Commuter Trips</u> <u>Ratio between jobs and resident workers</u> <u>Retail Hierarchy</u>	<u>Wastewater</u> 450 PE (Collected PE = 58 – 392 PE Remaining Capacity).	<u>1 Primary School</u> 221 places enrolled 2019/2020				
Aughnaccliffe	177 (2016)	223 (+25.98%)	<u>Commuter Trips</u> <u>Ratio between jobs and resident workers</u> <u>Retail Hierarchy</u>	<u>Wastewater</u> 300 PE – unknown collection and headroom PE	<u>1 Primary School</u> 113 places enrolled 2019/2020				
Ballinamuck	232 (Small Area - 2016 Census)	N/A	<u>Commuter Trips</u> <u>Ratio between jobs and resident workers</u>	<u>Wastewater</u> 500 PE (Collected PE = 64 – 436 PE Remaining Capacity).	<u>1 Primary School</u> 87 places enrolled 2019/2020				

			<u>Retail Hierarchy</u>						
Ballinalee	347 (2016 Census)	441 (+27%)	<u>Commuter Trips</u> <u>Ratio between jobs and resident workers</u> <u>Retail Hierarchy</u>	<u>Wastewater</u> 600 PE (Agglomeration = 194 PE 2018)	<u>1 Primary School</u> 149 places enrolled 2019/2020				
Clondra	202 (Small Area - 2016 Census)	N/A	<u>Commuter Trips</u> <u>Ratio between jobs and resident workers</u> <u>Retail Hierarchy</u>	<u>Wastewater</u> 600 PE (Collected PE = 158 – 442 PE Remaining Capacity).	<u>1 Primary School</u> 97 places enrolled 2019/2020				
Drumlish	274 – 931 (240% increase)	1,173 (+26%)	<u>Commuter Trips</u> <u>Ratio between jobs and resident workers</u> <u>Retail Hierarchy</u>	<u>Wastewater</u> 1,200 PE (Collected PE = 1,005 – 195 PE Remaining Capacity)	<u>1 Primary School</u> 230 places enrolled 2019/2020				
Keenagh	223 – 581 (161% increase)	732 (+26%)	<u>Commuter Trips</u>	<u>Wastewater</u> 1,000 PE (Collected PE =	<u>1 Primary School</u>				

			<u>Ratio between jobs and resident workers</u> <u>Retail Hierarchy</u>	692 – 308 PE Remaining Capacity)	167 places enrolled 2019/2020				
Legan	215	260 (+20.9%)	<u>Commuter Trips</u> <u>Ratio between jobs and resident workers</u> <u>Retail Hierarchy</u>	<u>Wastewater</u> 1,000 PE (Collected PE = 192 – 808 PE Remaining Capacity)	<u>1 Primary School</u> 45 places enrolled 2019/2020				
Newtownforbes	470 – 778 (66% increase)	965 (+19.3%)	<u>Commuter Trips</u> <u>Ratio between jobs and resident workers</u> <u>Retail Hierarchy</u>	<u>Wastewater</u> 1,800 PE (Collected PE = 976 – 824 PE Remaining Capacity)	<u>1 Primary School</u> 363 places enrolled 2019/2020				

Annex 7:

Rural Design Guidelines

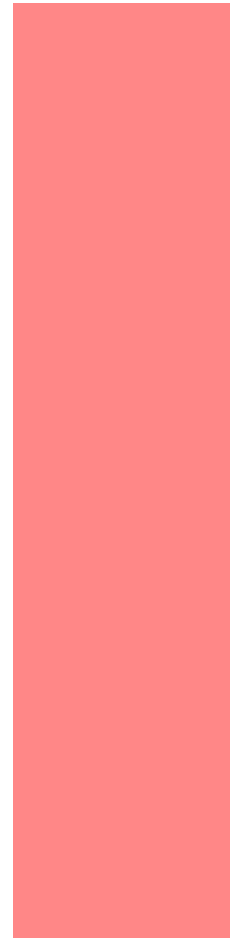

**Rural Design Guidance
For Residential
Developments in Rural
County Longford**

<u>INTRODUCTION.....</u>	<u>IV</u>
<u>STAGE 1 - BASIC CONCEPTS.....</u>	<u>V</u>
NEED TYPE	IV
LONGEVITY AND ADAPTABILITY	IV
SUSTAINABILITY.....	IV
BUDGET	V
<u>STAGE 2 - SITE SELECTION.....</u>	<u>VI</u>
<u>STAGE 3 – SITE LAYOUT</u>	<u>VIII</u>
ACCESS AND ROADSIDE FRONTAGE.....	IX
LANDSCAPING	XIV
<u>STAGE 4 – DETAILED HOUSE DESIGN.....</u>	<u>XV</u>
SHAPE AND FORM	XV
ANNEXES AND GARAGES.....	XVI
MATERIALS AND FINISHES.....	XVI
WINDOWS	XVIII
DOORS AND PORCHES.....	XIX
EXTERNAL FINISHES	XXI
ROOFS	XXI

INTRODUCTION

This guidance document is not intended as a set of rigid, prescriptive rules to which all new development must adhere, but a guiding set of principles that will act as an aid to potential developers, particularly in the early stages of the planning process.

Longford County has a unique and strong identity and character. One of the principal aims of this guide is to retain and strengthen this character for the benefit of its population and future generations. This does not mean that the countryside should be static or decline, it simply means that care should be exercised in the location and siting of developments in the Countryside.

This document has been compiled in the form of sections that follow a logical sequence in the establishment of a dwelling, from concept phase onto location and through to layout and detailed house design.

Photographs are provided throughout to illustrate points made in the text. These photos are from the National Inventory of Architectural Heritage for County Longford and as such, have a particular significance for the County.

It should be noted that pre-planning meetings are always advised in the case of applications for the development of houses in rural County Longford to discuss potential issues and prevent delays in the planning process once initiated.

STAGE 1 - BASIC CONCEPTS

The basic requirements of the end user should be considered prior to the drawing up of detailed plans for the development of a dwelling in rural County Longford. It is recommended that the potential applicant engage the services of a suitably qualified professional at this stage.

These requirements will have significant implications for the location, design, layout and appearance of the finished dwelling and should be carefully considered. They will include, but are not limited to, the following issues:

Need Type

There are many categories of home owner and the house location, siting and design should be chosen to reflect this need. These include owners with young families, empty-nesters, holiday homeowners, home-office users and those with sheltered housing requirements. The category of user should be reflected in the design process.

Longevity and Adaptability

Consideration should be given to the ability of the dwelling to accommodate the changing needs of a household, thereby allowing a family to reside in it over a lifetime, changing and adapting as needs be.

Sustainability

This incorporates the concepts outlined above, combined with location, siting, choice of building materials and finishes and the use of design initiatives and technology to reduce dependence on fossil fuels.

The location of the dwelling in relation to places of work, education, recreation and other activities is a consideration, as is the siting of the dwelling to achieve maximum shelter from prevailing winds and rain while benefiting from solar energy.

Choice of materials is important in terms of the sustainability of their production methods, how they are delivered from their place of manufacture and their inherent sustainability, i.e. how well do they wear and can they be repaired/maintained.

The use of alternative energy sources such as solar cells, geothermal solutions and wind energy should be considered at this point as it is much more efficient for these elements to be integrated into the overall house design rather than attempt to retrofit at a later date.

Budget

Transport, fuel requirements, decoration and furnishing, boundary and surface treatments are some of the many details that contribute to the ongoing development costs that may be hidden at the preliminary stages.

STAGE 2 - SITE SELECTION

Careful site selection can address many issues that could otherwise prove costly and time consuming to resolve at a later time in the design process. Developments should be integrated into and work with the landscape as opposed to dominating it, for example, sites with natural screening and shelter provided by hedgerows, trees and topography should be utilised to reduce the impact of the proposal in the wider landscape and preserve privacy.

Site selection with a view towards the utilisation of natural features will also reduce the need for costly earthworks and landscaping and increase the sustainability of the project (see *Site Layout* and *Landscaping* Sections in *Stage 3*).

The potential for the development to benefit from passive heat and solar energy through appropriate orientation should also be maximised, an important consideration at site selection stage.

Road safety is an important concern. Sites with poor access/sightlines or those that require the removal of significant amounts of roadside hedgerow should be avoided. New accesses onto National roads are generally not permitted.



Site selection that maximises the use of existing features will help to create an appropriate backdrop for a development, providing visual integration with its setting, privacy and shelter.



Hedgerows, ditches and other established roadside boundaries are important landscape elements that significantly contribute to the visual amenity and biodiversity of an area.

The availability of services for the site should be considered as part of the site selection process and included in the budgeting phase. The visual impact of service/access provision can sometimes be greater than that of the development itself, i.e. overhead wiring, access roads cutting through contours, masts and aerials for T.V./broadband connection.

At this stage, potential applicants should consult the Longford County Development Plan for potential locational issues in terms of landscape

vulnerability, which can include areas of archaeological, ecological and visual sensitivity. Other areas such as infrastructural study corridors and areas of known aquifer vulnerability may be best avoided.

STAGE 3 – SITE LAYOUT

A well considered site layout will maximise the benefits of choosing the appropriate site as outlined above. The layout will need to accommodate all aspects of the development, including domestic effluent disposal, site services and access.

Existing site features such as topography and landcover, farm buildings, walls etc. should be used to maximise privacy, screening and shelter. Avoid breaking the skyline in elevated areas as this adds significantly to visual impact.

The proposed dwelling should be located away from areas prone to flooding, where the water table is close to the surface or where drainage appears sluggish, as indicated by ground conditions such as seasonal ponding, poaching by livestock and a visual inspection of dominant vegetation types.

Developments should be carefully located on sloping sites to minimise cut and fill requirements.

Care should be taken to avoid vulnerable features such as wells and watercourses and potentially sensitive archaeological areas.

Maximising passive solar gain is an important element of the site layout process. Generally, glazing should be minimised on northern elevations to conserve heat and maximised on southern facades to capture solar gain (this issue will be addressed further in *Stage 4 – House Design*).

Access and Roadside Frontage

The majority of dwellings in rural County Longford are located along public roadsides. Traditionally, these dwellings were located on the roadside edge, many at a 90 angle, sometimes with outbuildings opposite, creating a street-like relationship with the carriageway.

The advent of high speed vehicles and the necessary accompanying road safety standards has abolished this practice in the development of new dwellings.



Dwellings now tend to be set-back, with a large front lawn, running parallel to the road frontage with the original boundary treatment removed and a straight tarmacadam driveway cutting across contours from the entrance back to the dwelling.

Driveways and entrances create a significant visual impact, particularly in upland areas and roadsides with well established hedgerows and a high level of visual enclosure.

Access roads should be inobtrusively located and designed to follow, as opposed to cut across, land contours. Driveway design should incorporate surface water drainage provisions to prevent run-off on to adjacent roadways and subsequent surface damage.



A combination of sympathetic boundary treatment, good site selection and appropriate driveway design enhances an attractive rural setting.

Hard surfaces and parking areas should be screened from view where possible, preferably to the rear of the building(s).

Accesses and front boundary treatments should aim to minimise removal of existing hedgerows, ditches and stone walls, which are often significant contributors to the character and biodiversity of a rural area. The maintenance of the hedgerow at a suitable height or the

relocation of the proposed entrance to a more appropriate position should be considered above removal.



Whitewashed, barrel-style piers with stone wall splays on each side form an attractive entranceway commonly seen in rural areas.

Where removal is unavoidable, sensitive set-back replacement should be carried out to reflect the original treatment and retain the boundary as a functioning wildlife corridor where possible.

Proposed new boundary treatments and accesses should take cognisance of traditional practice in the area and aim to enhance, rather than detract from the existing roadside

character.

Care should be taken at design stage to ensure adequate sightlines are achieved by maintaining wall and vegetation below 1.2m for required distances



There are a broad range of traditional entrance treatments in County Longford, some of which are pictured here.



Stone walls are commonly used, into which features and detailing have often been inserted to add interest and break monotony. Backplanting with vegetation and/or the use of native climbing species can be used to soften the effect of a development from the roadside.



Pedestrian gates were once a common and attractive feature of front boundary walls that have waned in popularity as vehicles have become more prolific.





Painted wrought iron gates and associated steps, piers and stiles are recognisable features throughout the rural area that create interest and variety in frontage treatments. Front boundary walls, where blockwork is used, should always be plastered/rendered and/or painted and capped.

Landscaping

The primary purpose of landscaping in these guidelines is to link the proposed dwelling with its surrounding countryside. As discussed in previous sections, mature trees and hedgerows on or adjacent to the site should be retained where possible.



Additional planting should utilise native species indigenous to the area in order to help the proposal blend effectively. Large expanses of “pool table” lawns, edged with exotic species and highly visible against surrounding agricultural landscapes, should be avoided. Plant groupings should form organic shapes and soften building lines from external view points.

Planting of shelter belts using species indigenous to the local area can be useful in buffering high winds, creating shelter from driving rain and shade from strong sunshine, as well as increasing the privacy of dwelling and its attendant spaces.



The promotion of biodiversity and retention of wildlife corridors is an important consideration, particularly in or adjacent to protected habitats or other ecologically sensitive areas. Block planting of suitable native woodland species can address these issues.



1.

Earthworks such as cut and fill should aim for gentle, natural looking slopes (Diagram 1.) rather than truncated shelf-like projections with an artificial appearance (Diagram 2.).

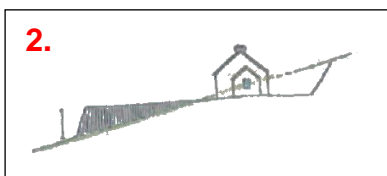

2.

Excavated material should be spread to mould with and softly curve around the original contours. Additional planting should be utilised to further soften the outline of the dwelling against face of the cut, thereby blending the development into the hillside.

Excavated material should be spread to mould with and softly curve around the original contours. Additional planting should be utilised to further soften the outline of the dwelling against face of the cut, thereby blending the development into the hillside.

STAGE 4 – DETAILED HOUSE DESIGN

House design should be a detailed response to the specific conditions of the site, combined with the basic concepts identified at *Stage 1*.

Shape and form

Simple shapes work best in the Countryside. New developments should take their cues from the vernacular architecture that exists in the area. Bulky forms should be avoided or mitigated where possible by appropriate roof design and detailing (see Diagram) – long plans may prove a suitable alternative.



The roof profile, chimney positioning, porch detailing and window treatment on the house opposite emphasises horizontal bulk and is at odds with traditional proportions and appearance.

Simple amendments such as those illustrated opposite successfully address the balance and create a dwelling much more in keeping with County Longford vernacular building tradition

Simple, clean roof lines are preferable to fussy complicated shapes. Pitches should generally fall in the range of 40°-45°.

Proportions are particularly important in rural situations in terms of visual impact. Care should be taken to preserve vertical emphasis on the front or visible elevation, and maintaining a high solid to void ratio (i.e. more wall than opening).

Distinctions are generally not made between single and two-storey dwellings, except where there are potential privacy/overlooking issues, where the dwelling is proposed in an elevated area and/or where the construction of a particular type prevails.



The labourer's cottage, pictured left, is a distinctive feature of Longford's rural environment and but one example of vernacular building type. These dwellings were constructed from the 1880's on and many remain in existence today, particularly in the south and east of the County and in the vicinity of the Canal.

These dwellings consist of a simple plan with the bedroom contained in the attic space. Simple roof profiles and horizontally emphasised proportions dominate the appearance.

Annexes and Garages



Annexes such as conservatories, sun-rooms and garages should appear as forms similar but subordinate to the main form of the dwelling. Materials used should reflect those of the main dwelling.

Garages should generally be separate from the main dwelling or appear so through appropriate setback

The above picture illustrates how annexes and extensions were addressed in their traditional form. The annexes are clearly subordinate to the main body of the dwelling, which maintains a stand alone presence and a distinct vertical emphasis in its proportions.

Outbuildings were commonly grouped around the main dwelling, creating a courtyard or

street-like enclosure or grouping of buildings. This clustering effect is more desirable than the establishment of large, stand alone double garage structures that compete with the main dwelling for visual dominance.

Materials and finishes

Traditionally, natural and locally sourced materials were favoured in dwelling construction. Traditional building forms, materials and detailing were designed as a response to local climatic conditions, reducing exposure to the elements and thereby minimising heat loss and water ingress.

Natural and traditional materials such as wood and stone also facilitate repair rather than replacement, e.g. uPVC versus wooden windows and doors, an important consideration in the sustainability of a development.

Modern materials and heating methods have allowed a greater range of finishes and detailing, many of which can look incongruous and ill-suited to countryside situations.

In addition to visual considerations, the need for sustainable building solutions would point towards the use of locally sourced products that reduce dependence on fossil fuels in terms of their manufacture, transport and longevity.

Building features and finishes more suited to warmer climates, such as balconies and open arched porches, will be discouraged.

Natural, locally sourced stone will be considered as a finish material where appropriate, however, the use of reconstituted concrete cladding and other artificial cladding materials will be discouraged.

Windows

Painted hardwood finishes are favoured above uPVC and aluminium finishes, both in terms of appearance and sustainability.



Horizontally emphasised windows should be avoided, as should fussy uPVC glazing, particularly where sub-divided by internal glazing bars.



The windows pictured here illustrate traditional forms that exist in rural County Longford, many of which lend themselves to modern interpretation in terms of proportion and scale.



The use of plaster banding and reveals further defines the feature and creates interest. Note how division and sub-division are used to maintain a vertical emphasis in each case.

Doors and Porches

Doors should be simply designed and comprise a minimum of materials. Glazing should be restricted to the upper half of the door. Patio type or double doors should be avoided on the front elevation of the dwelling



Porches and recessed doors were traditionally used to combat adverse weather conditions. Porches can also be used as a design feature to turn corners and create active frontage on two sides of a dwelling.



Fanlights and slit windows are often used to allow light in to hallways and entrance areas, usually with decorative effects such as stained glass and mullions.



The use of brightly painted hardwood doors can be a useful device for adding a splash of colour in to an otherwise neutral façade, with attractive results.

External finishes

The external finishes of a dwelling are particularly important in terms of its compatibility and ability to harmonise with the surrounding landscape. Painted nap plaster or rough/wet dash finishes are appropriate in this setting, as are coloured renders.



The use of brightly painted doors and windows can be used to brighten up a render finish

Large expanses of red and/or yellow brick are not appropriate in rural County Longford as they are not locally sourced, have not been traditionally used as a finish material and are more appropriate to urban locations. In certain circumstances and locations, and depending on the design of the dwelling, the limited use of brick as a detailing material only may be considered.

Dry dash finishes are difficult to maintain and have a tendency to leach minerals, leaving permanent and unsightly vertical streaks down external walls, and, as such, are not encouraged.

Roofs

As discussed at *Stage 3*, roofs should be simply designed. This also follows for roofing materials which should be blue or blue/black slate or tile, with a matte or semi-matte finish. Ridge tiles should generally be of the same colour as the main roofing material, except in certain areas where terracotta/painted ridges are part of the vernacular.



Pitched or hipped roofs are generally acceptable. Extensions or garages/outbuildings should have a similar roofing material of a similar pitch. Half-hips, dutch gables and mansard roofs are generally not acceptable (with the exception of Ardagh village and surrounds, where half-hipped roofs are established by tradition).



The roof and roofing material is an important element in the visual impression of a dwelling, particularly in terms of how the bulk of the building is articulated. Traditional rural built forms were long in plan and appearance. Pitches are usually set between 40° - 45°.



Hipped roofs can be utilised to reduce the visual bulk of square plan houses, an effect that is negated where chimneys are placed at either gable end.



Chimneys are important visual features in a dwelling and should be located on the ridge line where possible, particularly in the case of hipped roofs, or located to the rear. The traditional style chimneys illustrated above are all substantial structures and read as strong design elements. Thin, insubstantial chimney structures should be avoided.

Care should be taken to create an overall design response at roof level. Aerials, satellite dishes and other receivers should be screened from view where possible.

CONTEMPORARY HOUSE DESIGN

Whilst it is evident from the aforementioned design guidance that consideration must be given to the existing and traditional built heritage of County Longford, there is also a growing desire to build homes that reflect advances in technology and fulfil the needs of modern lifestyles. Successful contemporary design in Longford will be measured by how well these objectives are met.

Design proposals of this nature should provide 21st century architecture that is innovative, sustainable, environmentally conscious and firmly of its time and place. Proposals should not seek to replicate, mimic or imitate, but fuse new building technologies and styles with the built character of what has gone before, interpreting traditional in the contemporary context.

Contemporary and inventive design is a welcome addition to the rural countryside. However, given that successful contemporary design is site specific, original and inventive, it is difficult to be prescriptive. In this regard proposals should be expertly and sensitively handled. Accordingly, it is strongly advised to engage the services of a skilled architect and consult with the Local Authority at pre-planning stage.



Contemporary rural house (left) granted planning permission at Mollyglass, Co. Longford. Credit; CAST Architecture. Photo sourced from

<http://castarchitecture.ie/?project=rural-house-ii-longford>

Contemporary extension (below) at Newcastle Demesne, Ballymahon, Co. Longford. Credit; ODOS Architects. Photo sourced from

http://www.e-architect.co.uk/images/jpgs/ireland/ballymahon_house_o010310_rh3.jpg



Annex 8:

Shopfront Design Guidelines

Design Guidance

SHOPFRONTS

Longford County Council - Planning Department
August 2019



1 Introduction

2 Policy Context

- 2.1. Local
- 2.2. Regional
- 3.3. National

3 Process

- 3.1. Works Requiring Planning Permission
- 3.2. Initial Design Considerations
- 3.3. Pre-Planning Design Advice
- 3.4. Making an Application

4 Shop Front Elements

5 Guidelines

G1. Proportion

- A. Doors/Access
- B. Windows
- C. Stall Riser
- D. Fascia

G2. Materials & Colour

- A. Materials
- B. Colour

G3. Outlook

- A. Active Frontage
- B. Security

G4. Signage

- A. Typology
- B. Lettering
- C. Lighting

G5. Projections

- A. Hanging & Projecting Signs
- B. Awnings

A well-designed shopfront should respect both the building itself and the character of its street. Good design is positive for the overall appearance of the streetscape, ensuring a high-quality retail environment which is more attractive to shoppers, visitors, and opportunities for inward investment. These guidelines aim to strike a balance between encouraging best practice in shopfront design, while facilitating creativity and expression, and shall apply to all retail units as defined under Use Class 1 and 2 (inclusive of restaurants, cafes, bars and takeaways), Part 4 of the Planning and Development Regulations 2001 (as amended).

All designs should adhere to Building Regulations to ensure that they are in line with space, design and accessibility standards.

This document is based on planning policies set out at local, regional and national level.

2.1. Local

Longford County Development Plan (CDP) 2015-2021

- Policy ECON 13
'Development Standards – Building Layout & Design';
- Policy ARCH 5
'Architectural Heritage';
- Appendix 13
'Shop Front Design Guidelines';
- Annex 2
'Retail Strategy'.

County Longford Local Economic & Community Plan (LECP) 2016 – 2022.

Longford Town & Environs Local Area Plan (LAP) 2016 - 2022.

2.2. Regional

Eastern and Midland Regional Assembly (EMRA) – Regional Spatial & Economic Strategy (RSES) 2019-2031

- Regional Policy Objective 6.12 & 6.13
'Town Centre Renewal'
- Regional Policy Objectives 9.11 & 9.12
'Healthy Placemaking'.

2.3. National

National Planning Framework (NPF) 2040

- National Policy Objective 4
'Making Stronger Urban Places'
- National Policy Objective 6
'Making Stronger Urban Places'
- National Policy Objective 11
'Making Stronger Urban Places'
- National Policy Objective 13
'Making Stronger Urban Places'
- National Policy Objective 17
'Planning for Diverse Rural Places'

3.1. Works Requiring Planning Permission

- New shopfront;
- Any alternation to an existing façade shopfront which materially affects the appearance of a shopfront (e.g. removing the stall riser, installing another door, installing security grills or shutters, etc.);
- 'Change of use' from shop to any other use aside from 'Residential' where the limitations apply.
- Works to a Protected Structure;
- Works which will materially affect the character of an Architectural Conservation Area (ACA).

On matters relating to advertisement signage, the applicant is advised to review 'Section 2, Part 2, Article 6, Exempt Development – Advertisements' of the current Planning and Development Regulations 2001 (as amended) for such developments considered exempt.

3.2. Design Considerations

- Is the host building a Protected Structure?
- Is the host building located in an Architectural Conservation Area (ACA)?
- What are the qualities and proportion of the rest of the building?
- Does the building have a distinctive architectural style or character (e.g. Georgian)?
- How would a shopfront fit into the host façade/ streetscape?

Longford County Council (LCC) will always encourage the retention, conservation or restoration of period shopfronts. However, where a new shopfront is deemed appropriate by the Local Authority, the new shopfront shall have regard to the design guidance as set out in this document.

3.3. Pre-Planning Design Advice

Longford County Council hold regular pre-planning information meetings with perspective applicants. Interested parties will have the opportunity to meet a planner or architect who can broadly advise them about their proposal. The dates of the meeting are agreed in advance by appointment only.

3.4. Making an Application

- Application Form;
- Fee;
- A Site location Plan to a scale of 1:1000 with site outlined in red;
- An existing elevation of the shopfront and the host building together with adjoining properties;
- Drawing of the shopfront, plans, sections and elevations at a scale of 1:50, showing relationship to host building;
- Joinery or stone detail to 1:10 or 1:5;
- Details of shutters, housing, materials and fittings;
- Specification for signs and materials;
- Shopfront finish;
- Illumination design;
- Photographs of the existing shopfront and adjoining premises;
- Aspirational photographs representation of the 'look and feel' you would like to achieve.

4 Shop Front Elements

A. Cornice

Area above the fascia, either decorative or plain;

B. Console/Corbel

A decorative or plain element at the top of the pilaster. Its height determines height of fascia;

C. Fascia

Area at the top of the shop front where the shop sign is to be positioned;

D. Fanlight

A fan-like window placed over another window or commonly a doorway;

E. Transom

A horizontal element that forms a division between units of a window or door;

F. Mullion

A vertical element that forms a division between units of a window or door;

G. Pilaster

A vertical dividing element between shops, usually sitting forward of the shop front;

H. Sill

Horizontal element at the bottom of the window frame;

J. Plinth

The base element upon which a column, pedestal or structure rest. Usually resting on the ground;

K. Stall Rises

This is the solid section beneath the window sill;

Shop Number

Street number positioned on the fascia or fanlight;

Projecting Sign

Sign that is at a right angle to the fascia and has the same name on it.

Awning

An external shade that folds or rolls out providing shelter and shade;

Traditional

Modern

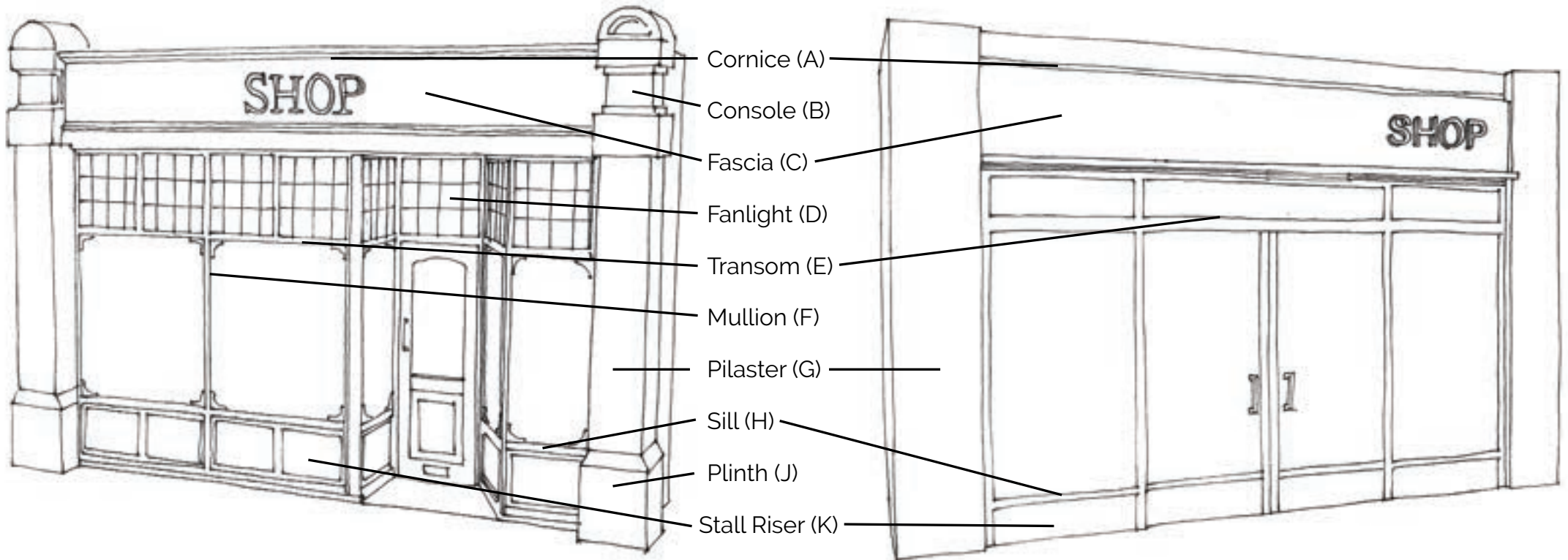

Fig. 1. Shop Front Elements Sketch.



G1. Proportion

Well-proportioned windows and doors help to achieve good shopfront design and create an important first impression. Their size and scale should be proportionate to the openings on the upper floors and it is desirable that they should align with other details of the building such as aligning the stall riser with the height of a plinth.

A. Doors/Access

Recessed doorways create additional interest and should be complimented by a quality surface finish at the threshold. A glass visibility panel is recommended in all new doors and its position and size should be such that wheelchair users and people with disabilities can be seen through it.

All new shopfronts should be designed to make access easier for people with disabilities, the elderly, the very young, people with pushchairs, and the visually impaired. Where possible, level access should be provided. Where this is not possible, raise the pavement level in the vicinity of the doorway or providing a non-slip ramp (gradient between 1:12 & 1:20). Revolving doors and folding doors will generally not be favourably considered.

All new shopfronts should be designed to make access easier for people with disabilities, the elderly, the very young, people with pushchairs, and the visually impaired.

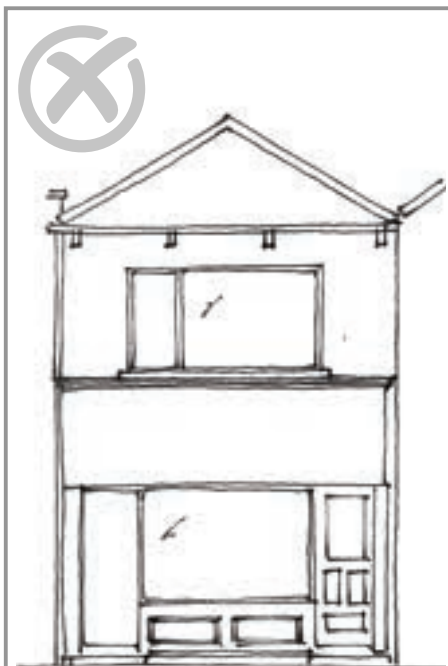

Fig. 2. Proportions.

Some shopfronts incorporate doors to upper floor accommodation. Where existing, this arrangement should be retained, but generally proposals to create such access arrangements will be discouraged. Access to the upper accommodation should preferably be from the rear of the building. Where there is no option but to make a secondary door for access to the upper floor, this door should be an integral part of the shopfront design and should be in keeping with other elements of the shopfront.

B. Windows

Large expanses of glass or completely open shops are usually out of scale with both the street scene and the upper floors of the premises and can create a featureless shopfront. Long runs of horizontal façades should be broken up by vertical divisions or features. Generally, clear glazing should be used, and frosted/tinted/opaque glass only used in circumstances where the overall design concept would warrant the use of such materials. Good examples are occasionally found on windows to public houses. The profusion of stickers/adhesives in shop windows should be avoided.

Generally, clear glazing should be used, and frosted/tinted/opaque glass only used in circumstances where the overall design concept would warrant the use of such materials.



Fig. 3. Vacant retail premises of poor shopfront design, having ground floor window style, size and position not in keeping with upper floor



Fig. 4. Quality materials and finishes, and design and proportion respectful of upper floor window locations.

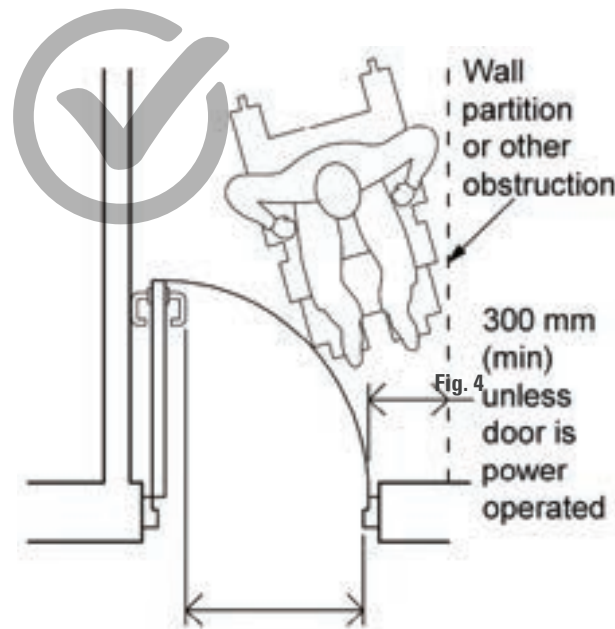

Fig. 5. Effective clear width (Section 1.2, Technical Guidance Document Building Regulations 2010.)

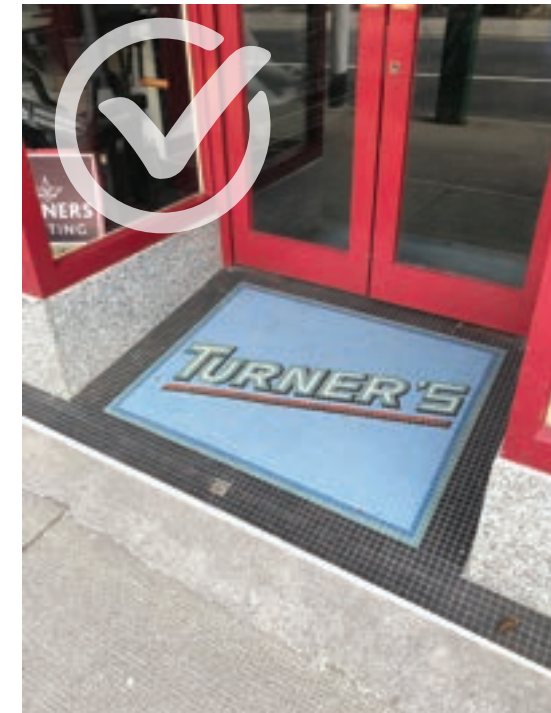

Fig. 6. Recessed doorway with quality threshold finish.



C. Stall Riser

Stall risers focus attention on the window display and raise it up to the shopper's viewpoint. They provide a strong, solid base, protecting the shopfront from damage and giving proportion and character. It is an attractive feature which is traditionally of timber panels, stone or rendered brick, and should be retained and restored. It is desirable to provide a stall riser of at least 400mm to 600mm in height. Timbers should never run directly to the ground - instead a small stone plinth should be provided between the timber and the ground.

Stall risers are often omitted from contemporary designs to maximise the display area or for simplicity of form. The visual success of this is dependent on the use of high-quality materials and detailing, and the omission of a stall riser will therefore only be acceptable where this can be achieved.

D. Fascia

The design of the fascia is a key element of shopfront design and carries the name of the business. In traditional shopfronts the depth of the fascia is quite small. Fascia panels should be proportionate to the size of the building and the length of the shopfront and should not exceed 20% of the overall height of the shopfront to prevent it dominating the façade.

An over deep or shallow fascia can spoil a shopfront. If there is an internal dropped ceiling, existing steel beam or other obstruction, reducing the height of the fascia can be problematic. However, good design by way of the insertion of a sub-fascia, or other design mechanism, can overcome this.

If a shopfront occupies more than one building, the fascia should be subdivided and relate to the individual character of each. Facias extending above the level of first-floor window sills and obscuring architectural details will not be acceptable.

On traditional shopfronts the fascia needs a strong moulding at the top. This should provide a drip detail to protect the fascia from weathering.

Fascia signs should be sensitively positioned across the shopfront and should not:

- Obscure first floor windows or window sills;
- Extend uninterrupted across a number of buildings;
- Cover or ignore any architectural details, such as corbels or pilasters;
- Protrude out from the building further than a depth of 0.25m;
- Form more than 20% of the overall height or surface area of the shopfront; or
- Contain advertisements for other shops or products.

It is desirable to provide a stall riser of at least 400mm to 600mm in height.



Fascia panels should be proportionate to the size of the building and the length of the shopfront and should not exceed 20% of the overall height of the shopfront to prevent it dominating the façade.



Fig. 10. Absence of stall riser framing the shopfront



Fig. 11. No stall riser to shop front, unsympathetic to window positions above, and failure to integrate adjacent doorway into shopfront



Fig. 12. Excessive signage with double fascia.



Fig. 13. Shallow shopfront fascia with unnecessary additional text.



Fig. 14. Original office shopfront with decorative detailing celebrated and retained.

G2. Materials & Colour

A. Materials

The type of material used in a shop front is an important element of the overall design and should take into account the character of the building. Designs should not employ a large number of different materials or use materials that could clash with adjoining premises or the general street scene.

As a general principle, the type and number of materials used should be kept to a minimum, and they should be of high quality, durable and easily maintained. Shiny reflected materials such

as acrylic or plastic, or the use of excessively bright or shocking colour should be avoided. The use of uPVC for windows and doors is to be discouraged. Traditional shopfronts are normally painted softwood, and these can readily be repaired if decayed, and with proper maintenance can last indefinitely. Other materials, such as bronze, cast iron, marble and stone have also had a long tradition in shopfront construction.

If the shop is part of a Protected Structure, then any changes to the shopfront material will require

Planning or Section 57 Declaration approval before works can be undertaken. The current list of Protected Structures in the county are available in the Appendix of the Longford County Development Plan 2015 - 2021 and the Longford Town & Environs Local Area Plan 2016-2022.

Shiny reflected materials such as acrylic or plastic, or lurid colour, in most cases, should be avoided.



Fig. 15. Disproportionate fascia signage over a rigid pattern of polished stone cladding and uPVC window and door framing.



Fig. 16. Solid colour palette, finish and backdrop.



Fig. 17. Plain clour scheme with handpainted lettering.

B. Colour

Colour schemes for historic shopfronts were kept simple, often single coloured, which put the goods of the window display at the centre of attention. Today, colour schemes are often used to make the shopfront itself a form of advertising. Corporate schemes in particular are often imposed without any regard to the design and location, which can contribute to the erosion of the character of an area. Thus, in historically sensitive areas, corporate retailers are expected to modify their standard design and colour scheme where this would be desirable. Walls and stone detailing which have traditionally not been painted should remain undecorated.

- Dark shades of green, grey, blue, red, browns, or black are traditional colours and preferred. Bright shades of yellow, orange and pink are inappropriate;
- Minimalist and monochrome paint combinations combined with the use of a stylish script can result in high-quality schemes. Garish colour combinations should be avoided;
- The change of colour of a shopfront which is part of a Protected Structure may require planning permission.

It is advisable to contact Longford County Council Planning Department to discuss the colour scheme before an application is submitted. Muted paint colours tend to be most appropriate, selected from 'heritage' colour range of paint manufacturers.

Colour schemes for historic shopfronts were kept simple, often single coloured, which put the goods of the window display at the centre of attention.



Fig. 18. Harsh, black and white ground floor public house shop front, contradictory to the softer, more preferred, colour palette of the upper floors.



Fig. 19. Loud and inconsistent colour presentation.



Fig. 20. Lurid colour timber shopfront over decorate original.



Fig. 21. Appropriate ground floor colour sensitively carried through to upper floor quoins, window frames and light fittings.

G3. Outlook

A. Active Frontage

An attractive window display can draw people into the shop from the street and enliven the street scene. Shop window displays should enhance the street scene and reflect the features and proportions of the building's exterior. A shop window display should be maintained at all times.

Where a shop might fall vacant there are opportunities to maintain an attractive window display to improve the look of the shop frontage. This can help to encourage new occupiers to rent the unit and prevent the area from looking run-down and less attractive to potential investors. Efforts should be made to maintain a clean and uncluttered shop window and any visible space behind it. For longer term vacancy it might be

appropriate for the shop front to incorporate window vinyls with artistic or photographic elements or the empty unit might be used for pop-up events (e.g. art exhibitions).

For the avoidance of clutter, externally mounted cabling, wires, trunking will not be permitted on the front façade of the building. Alarm boxes should be carefully located to avoid visual intrusion, and the colour should complement the background.

Obscured windows where a shop is in use, whether as a retail or non-retail use, can create unnecessary, 'dead' frontages to a street. Solid or partly in-filled windows, posters covering the

window or plastic window vinyl will not normally be acceptable in occupied shop units.

The shop window should be the most brightly-lit part of the shopfront. Internal lighting of window displays are helpful for after-hours window shopping and creating an atmosphere of warmth on the street.

For the avoidance of clutter, externally mounted cabling, wires, trunking will not be permitted on the front façade of the building.



Fig. 22. Bland and uninteresting bookmaker shopfront with unsuitable, externally mounted security shutter and shutter box.



Fig. 23. Lively shop front using soft planting to improve the aesthetic.



Fig. 24. Collection of quality materials, finishes and colours combined to convey interest and activity.



Fig. 25. Projecting roller shutter boxes will not be permitted.



Fig. 26. Externally installed, solid roller shutters will not be permitted.



Fig. 27. Roller shutter guides should be integrated into the shop front in rare cases where externally installed roller shutters are permitted.

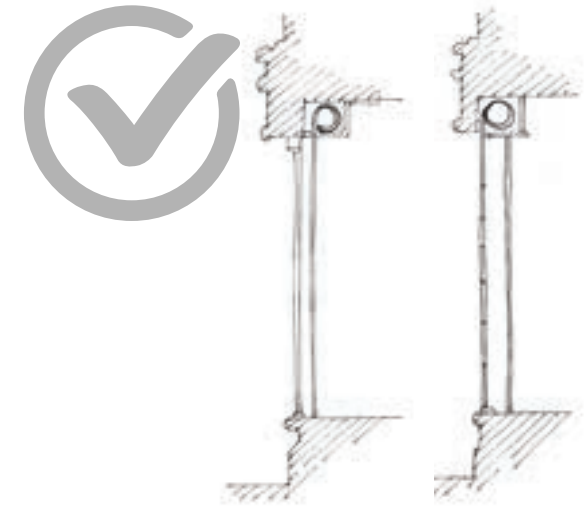

Fig. 27. Where necessary, roller shutters should be located behind external glazing. Open shutters externally are only permitted in exceptional circumstances and when integrated into the shopfront design.

B. Security

It is recognised that shop front security is an important consideration, however if not well designed and integrated it can create a hostile street scene. This can also be the case where shop fronts include blocked out windows and large alarm systems.

Laminated, security glazing should be the first-choice security solution. Sensors on the windows can be linked to an alarm or CCTV for a more comprehensive security system. Internally fitted grilles or mesh shutters are more suitable where toughened security glass is not appropriate.

The installation of externally mounted security shutters requires planning permission.

Detachable, externally-fitted iron grilles, and internal open mesh grilles, which can be fitted behind the glass, are the preferred security shutter options. Open mesh shutters cause less intrusion on the appearance of the building or shopfront, allowing views into the shops after working hours. These have the further advantage of letting light shine onto the street at night, making it more attractive to passers-by. Where security shutters are considered necessary, in cases where the premises in a high-risk area, or is a high-risk business, and if there is evidence from insurers that no other type of shutter would be acceptable for insurance purposes, shutters may be permitted provided they meet the following criteria:

- Incorporated into the shopfront design with guide channels concealed or removable;
- Open grill type, not solid, or perforated;
- Painted or coloured to match the shopfront scheme;
- Housed behind the window display.

Solid, external shutters deaden the street scene and can provide less protection for the shop than toughened security glass.

Laminated, security glazing should be the first-choice solution.

G4. Signage

A. Typology

Signage shall form an integral part of the overall design of the shopfront. Well-designed fascia signage can provide decorative interest and project an image of quality. The signage relating to any commercial ground-floor use shall be contained within the fascia board of the shopfront. Good signage is discreet,

complements the architecture of its background and can enhance the appearance of the shop and streetscape. The common theme in successful contemporary detailing is a restraint in signage size and type. Certain types of business place excessive reliance on the use of signage and advertising to promote their goods and services e.g. fast food outlets and bookmakers.

The common theme in successful contemporary detailing is a restraint in signage size and type.



Fig. 29. Excessive number of stickers on shopfront and façade windows.



Fig. 30. Disproportionate signage scale and with stunted window and door proportions.



Fig. 31. Simple and consistent shop front colour and signage on a quality timber arrangement.



Fig. 32. Overtly large lettering relative to fascia.



Fig. 33. Flat, two-dimensional print lettering on undefined box fascia.



Fig. 34. Simple, clear lettering, complemented with simple, graphic motif.



Fig. 35. Individual and pronounced lettering.



Fig. 36. Etched window lettering for window glazing only.

B. Lettering

Lettering on a fascia sign should be proportionate to the fascia dimensions. The fascia sign should state only the shop name and street number. In some cases, a simple graphic motif may also be appropriate. The choice of lettering can evoke an image and provide decorative interest. The lettering employed shall either be painted on the fascia or consist of individually mounted solid letters on the fascia board. The size of the lettering used should be in proportion to the depth of the fascia board and should not normally exceed 300mm in height. In no case should lettering exceed 400mm. Lettering designs should be kept simple and legible. Lettering or logos shall not be affixed directly to the glazing of any shop

or business windows, other than etched lettering. All sign displays inside the shop should be kept back a minimum distance of 500mm from the glazing. Lettering or logos shall not obstruct the window display and shall not exceed one quarter of the area of the window through which the advertisements are exhibited.

Notwithstanding Schedule 2, Part 2, Article 6, of the Planning and Development Regulations, 2001 (as amended) or any regulations revoking or re-enacting these regulations, all signage and advertisements on a Protected Structure or within an ACA, require planning permission.

The lettering employed shall either be painted on the fascia or consist of individually mounted solid letters on the fascia board. The size of the lettering used should be in proportion to the depth of the fascia board and should not normally exceed 300mm in height.



Fig. 37. Internal flashing signs shall be discouraged and the proliferation of adhesive use.



Fig. 38. Neat strip lighting over individual lettering.

C. Lighting

The brightness and style of illuminated signs should be in keeping with the area in which they are located, thereby minimising light pollution for residents and safety implications for drivers. External lighting of the shopfront will only be considered where it is modest and subtle, and preferably can be concealed

by the fascia or other details of the building. Spotlights supported on projecting brackets will be discouraged. The colouring and intensity of illumination should be complementary to the overall shopfront design and architectural context. Illuminated projecting signs flashing signs in the shop window, and near are illumination around windows unacceptable.

Hand-painted signs or illumination by bracket or wash lighting are preferred to internally illuminated signage.

G5. PROJECTIONS

A. Hanging & Projecting Signs

Projecting signs tend to be bulky, constructed of inappropriate materials, and are frequently internally lit. Too many hanging or projecting signs, installed at varying heights, can erode the appearance and continuity of a street scene. By establishing a standard approach, all shop signage will be visible to potential customers and at an appropriate height and size to be legible. Hanging signs are a traditional feature of shops and can add interest if well designed. Positive consideration may be given to the use of a hanging sign if a building is in multiple occupancy, and the proposed sign would lead to a significant overall reduction in the number

and scale of advertisement structures on or projecting from the face of the building. In this circumstance the following guidelines must be observed:

- Not more than one hanging / projecting sign should be displayed on a building;
- Signs should not be fixed directly to the face of a building but should be fixed by a bracket;
- Projecting signs should be fixed at fascia height adjacent to the access to the upper floors;
- Signs should depict a pictorial feature or symbol illustrating the trade or business

being undertaken and should be as transparent as possible;

- Signs should be individually designed to complement the scale, materials and design of the building;
- Signs should not obscure important features of a building or adjacent building.

Banners and flags are considered to be unsuitable forms of identification and are to be discouraged.

Murals require planning permission, except in circumstances when undertaken in partnership with the local authority

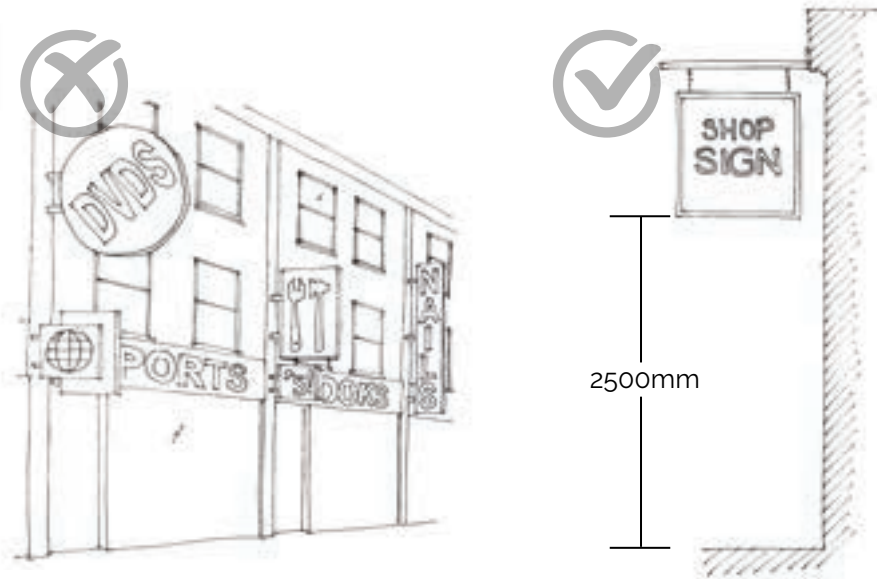

Fig. 39. Poorly placed hanging and projecting signs can create a cluttered and unattractive street scene.

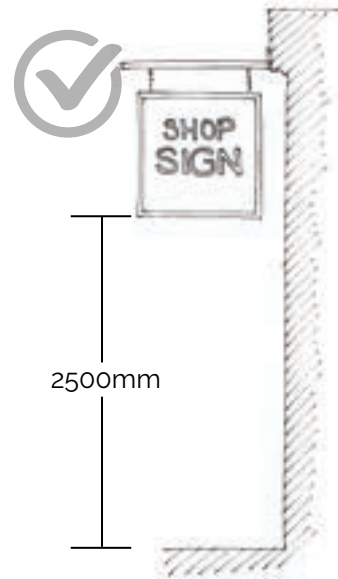

Fig. 40. 2500mm distance of projecting sign from street level.



Fig. 41. Simple, neat and solid contemporary sign projection.



Fig. 42. Mural signage of high artistic quality as a minimum requirement.

B. Awnings

Planning permission is necessary for fixed awnings. Awnings and blinds can be a lively addition to the street scene, provided they are designed as an integral part of the shopfront. Great care is needed in the selection of the style, colour, location and number of canopies and awnings, as they can affect the look of the street and obscure the view of shop fronts. Retractable, open-ended roller awnings are traditional and unobtrusive. If installing a new awning or blind, you should not obscure architectural detail. Continental 'Dutch' canopies and/or those made from shiny materials will not be permitted. Straight canvas canopies with well detailed retractable rollers incorporated into the shopfront will be preferred in most situations. Blind boxes should be integrated into the overall shopfront and preferably flush with the fascia and installed without damaging the detail of the shopfront. Shop names or advertising on the blind may be permitted if appropriate to the overall design of the building and its surroundings.

Each location must be checked to ensure the installation of same does not compromise public safety. All canopies or awnings should be at least 2500mm above the footpath once fully extended; but should not be fixed to the building any higher than ground floor level. A width of at least 0.5m from the outer edge of the canopy or awning to the kerb line should be maintained at all times.

Straight canvas canopies with well detailed retractable rollers incorporated into the shopfront will be preferred in most situations.

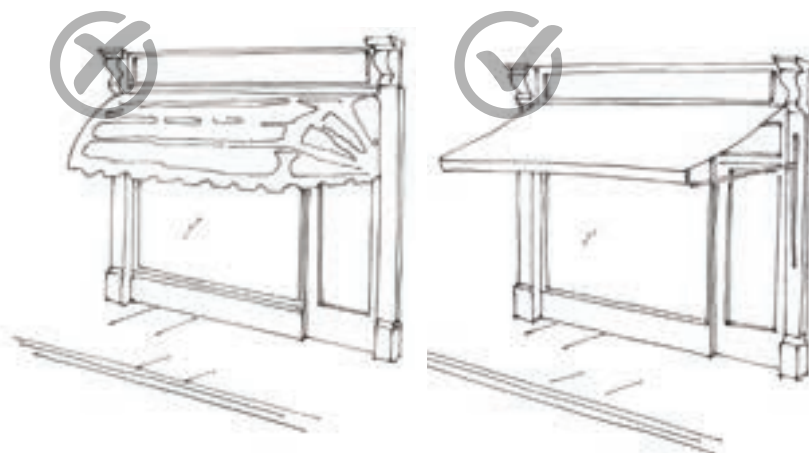

Fig. 43. Preferred awning typologies



Fig. 44. PVC or Dutch type awnings will not be permitted.



Fig. 45. Solid coloured canvas awning with limited text.



Fig. 46. Complementary colourer awning casing to shopfront colour palette.

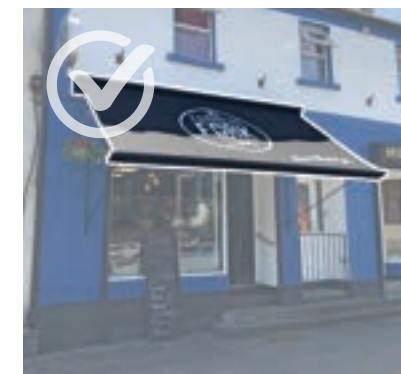

Fig. 47. Open sided awning projection.

References:

Cardiff City Strategic Planning (2011), Shop Fronts and Signage, Supplementary Planning Guidance, Cardiff, UK.

Hackney Environmental Services, Undated, London, UK. 'Shopfront Design Guide', Supplementary Planning Guidance,

London Borough of Hounslow (2013), 'Shop Front Design Guidelines', Supplementary Planning Document, London, UK.

Meath County Council Planning Department (2017), 'Shopfront and Signage Guidelines', Meath County Council, Navan, Meath.

Planning and Economic Development (2013), 'County Kildare Shopfront Guidelines, Section 4 – How to Approach Shopfront Design', Kildare County Council, Kildare.

South Dublin County Council (2014), 'Shopfront Design Guide – 2014', Dublin.

Planning Section
Longford County Council
Great Water Street
Longford Town
Longford
N39 NH56

Email: planning@longfordcoco.ie
Telephone: 043 33 43300
Website: www.longfordcoco.ie

Annex 9:

Retail Strategy

Longford County Retail Strategy 2021-2027



**Planning Department
Aras an Chontae,
Great Water Street,
Longford,
N39 T9K5**

TABLE OF CONTENTS

Executive Summary	i
1 Introduction	1
1.1 Function of the Updated Longford Retail Strategy	1
1.2 Methodology.....	1
1.3 Consideration of Vacancy	2
1.4 Definition of the Retail Typologies	3
1.5 Retail Planning Policy Context	3
1.5.1 National Policy Context	4
1.5.2 Regional Policy Context	6
1.5.3 Local Policy Context	8
1.6 Core Retail Areas	11
2 Retail Trend Analysis and Assessment of Competing Centres.....	13
2.1 Retail Trend Analysis.....	13
2.2 The Changing Nature of Retail Services in Ireland.....	14
2.3 Retail Experience Economy.....	16
2.4 Assessment of Competing Retail Centres.....	17
2.4.1 Introduction.....	17
2.4.2 Competing Centres	18
3 Health Check Analysis	22
3.1 Retail Health Check Analysis of Co. Longford.....	22
3.2 Longford Town.....	22
3.3 Granard.....	26
3.4 Edgeworthstown	28
3.5 Ballymahon.....	30
3.6 Lanesborough	32
3.7 Other Settlements	33
3.8 Summary of Commercial Floorspace Activity Since 2013.....	34
3.9 Healthcheck Conclusions.....	36
4 Projected Floorspace Requirements	38

4.1	Introduction.....	38
4.2	Population of County Longford.....	38
4.3	Expenditure Estimates.....	39
4.4	Turnover and Floorspace Capacity	43
4.5	Additional Retail Floorspace Requirements.....	44
4.6	Additional Retail Floorspace Requirement.....	45
5.	Retail Strategy and Policy Guidance.....	47
5.1	Retail Objectives and Policy Recommendations.....	47
5.2	Retail Strategy Overview.....	47
5.3	Key Retail Principles	48
5.4	Recommended Retail Policy Objectives.....	49
5.5	Criteria for the Assessment of Future Retail Development	53
5.6	Criteria for the Assessment of Different Development Types	54
5.7	Monitoring and Review	55
6.	Conclusion.....	56

EXECUTIVE SUMMARY

The Longford County Retail Strategy 2021-2027 has been compiled as part of the County Development Plan 2021-2027. It represents a re-assessment of the County's previous Retail Strategy 2015-2021 which has been prepared in a period of economic transition marked by moderate growth following the economic recession that characterised the years from 2007-2014.

Whilst this strategy has been prepared in a more positive national economic environment than the previous strategy, it clearly illustrates the on-going impacts which the recession has had on the retail market in the County, as characterised by long-term vacancy levels in many of the County's main retail centres. Moreover, the impact of the Covid-19 pandemic will have a significant bearing on overall economic growth, particularly between 2020 and 2021, which in turn will have implications for future retail expenditure and projected retail floorspace development.

The Covid-19 pandemic and the resultant public health measures introduced over this period, predominantly the three lengthy periods national lockdown restricting multiple retail operations, have also undermined the quantitative and qualitative aspects of the strategy by suspending a substantive element of overall retail activity during the period 2020-2021. At the time of writing, (June 2021) the majority of this substantive sector was beginning to open up again. However, with further emergency public health measures, such as an additional lockdown thereby restricting retail activity once again, cannot be ruled out.

Furthermore, it is anticipated that traditional retail patterns will change significantly post-Covid-19, with an increased demand on online shopping, with more competing land uses, aside from retail, arising in town centres. Consequently, this Retail Strategy should be viewed as an interim strategy in advance of a comprehensive review, post-Covid-19, of the qualitative and quantitative aspects of retail centres within the County.

Notwithstanding this, the Strategy provides notable evidence of the economic resilience of Longford's retailers and its economy, as well as providing the quantitative basis for future retail development in the County over the Plan period.

The purpose of the Longford County Retail Strategy is to ensure that the development of retail floorspace within the County is grounded in an evidence-based framework during its 6-year lifecycle. In this way, the development of additional retail floorspace can be assessed against a set of clearly defined and evidence-based criteria. This will allow for the development of a healthy retailing environment within County Longford addressing high levels of vacancy and economic decline/stagnation in urban centres and reinforcing the vitality of its urban centres facilitating competitiveness in the County and the wider midlands region.

The main findings and recommendations of this retail strategy include:

- Longford Town retains the majority of retail floorspace within the county and remains at the top of the Longford County Retail Hierarchy.
- The findings of healthcheck analysis on each of the main settlements within County Longford indicates that the settlements continue to provide vital services and functions to their residents and their surrounding hinterlands.
- A number of urban streetscape improvement schemes have been proposed for these settlements, as well as funding being secured for their development, which will make a significant contribution to the overall amenity values of the main settlements in the County.
- Despite the resurgence of the national economy in recent years, there remains high levels of vacancy within peripheral areas of the four main settlements of the County.
- The overall vacancy rate within County Longford is currently 9.34%, which is substantively less than the vacancy rate of 17.7% for the County recorded in the previous Retail Strategy 2015-2021, owing to the subsequent occupation of a number of vacant units of large floorplates as well as other premises being the subject of change of use planning permissions from retail to commercial or industrial land uses.
- Of the three retail categories, the proportion of vacancy is highest in the comparison retail floorspace category, with 21.1% of all such floorspace within the County currently vacant.
- Since 2013, only 246.5 square metres of additional retail floorspace has been built.
- Planning permission for a further 2,481 square metres of retail floorspace is due to expire before the 1st of January 2022; if not renewed or implemented prior to expiration.
- 2,036 square metres of floorspace (convenience) is due to expire before the 1st of January 2022, if not renewed or implemented prior to expiration.
- The impact of the Covid-19 pandemic is anticipated to result in a severe drop in economic growth between 2019 and 2020, before recovering rapidly in 2021 with modest growth anticipated in the years thereafter for the duration of the strategy.
- There is a requirement for at least an additional 2,100m² – 3,200m² of convenience, 2,000m² – 2,650m² comparison and 2,200m² – 4,850m² of bulky goods retail floorspace between 2021 and 2027.

1 INTRODUCTION

1.1 Function of the Updated Longford Retail Strategy

The overriding aim of the Retail Strategy is to create the appropriate conditions necessary to foster a healthy and vibrant retail environment in County Longford over the Development Plan period of 2021-2027, in the context of national, regional, and local plans, strategy, policy and guidance. To this end, the Strategy acts as an essential tool in assessing the quantum, scale and type of retail development required over the Longford County Development Plan 2021-2027 period as well as providing the vital evidence base for the relevant policies and objectives contained within Chapter 8: *Economic Development* and Chapter 16: *Development Management Standards* of the Longford County Development Plan 2021-2027 to guide future retail development over the plan period.

1.2 Methodology

This Retail Strategy has been prepared in accordance with the provisions set out in the '*Retail Planning Guidelines for Planning Authorities*', (Department of Environment, Community and Local Government, 2012). The preparation of this strategy has coincided with a period of national economic growth following the sustained economic decline that characterised between the years of 2007-2014. Notwithstanding this, the rate of recovery from this economic crash has not been equitable across the country and has largely been confined to the largest conurbations of the state, most notably within the Greater Dublin Area. However, there is increasing evidence and sentiment that more pronounced growth is now being experienced in areas outside of these locations, including County Longford.

Despite experiencing a period of resurgent growth in recent years, a number of settlements within County Longford still retain long-term vacancy levels of properties within their respective town centres. This level of long-term vacancy coincides with a more general discussion at a national-level regarding the changing nature of town centres in Ireland, where the traditional role of retail is being challenged to offer a greater range of retail choice in terms of functions and accessibility for shoppers. In this regard, there is recognition that the evening and night-time economy has a significant part to play in revitalising town centres and traditional retail cores not just in providing increased accessibility for consumers through later opening hours, but also in providing a more immersive and vibrant experience for consumers and users of town centres throughout the day and evening.

In the backdrop of the preparation of this Retail Strategy, the uncertainty of the exit of the United Kingdom from the European Union remains. Moreover, the impact of the Covid-19 pandemic will have a significant bearing on overall economic growth, particularly between 2020 and 2021, which in turn will have implications for future retail expenditure and projected retail floorspace development.

The Covid-19 pandemic and the resultant public health measures introduced over this period, predominantly the three lengthy periods national lockdown restricting multiple retail operations,

have also undermined the quantitative and qualitative aspects of the strategy by suspending a substantive element of overall retail activity during the period 2020-2021. At the time of writing, (June 2021) the majority of this substantive sector was beginning to open up again. However, with further emergency public health measures, such as an additional lockdown thereby restricting retail activity once again, cannot be ruled out.

Furthermore, it is anticipated that traditional retail patterns will change significantly post-Covid-19, with an increased demand on online shopping, with more competing land uses, aside from retail, arising in town centres. Consequently, this Retail Strategy should be viewed as an interim strategy in advance of a comprehensive review, post-Covid-19, of the qualitative and quantitative aspects of retail centres within the County.

Despite this uncertainty, and the form of future trading arrangements with the UK, retailing remains a fundamental economic function and vital service sector within County Longford.

The applied methodology of this Retail Strategy considers these aspects in detail with the following identified as key objectives of this Retail Strategy:

- Define the retail hierarchy in the County and related retail core boundaries;
- Undertake a health check appraisal of the key retail centres in Longford to ascertain the need for interventions in these areas;
- Identify the broad requirement for additional retail floorspace development in the County over the Development Plan period to support the established settlement hierarchy; and
- Provide guidance on policy recommendations and criteria for the future assessment of retail development proposals over the Development Plan period of 2021-2027.

1.3 Consideration of Vacancy

The preparation of the Longford County Retail Strategy considered retail floorspace vacancy in detail. A survey of existing floorspace in the county was undertaken (between October 2018 and September 2019), which identified a cumulative total of 5,618square metres of vacancy across convenience, comparison and bulky retail categories. This equates to 9.34% of the total retail floorspace in the County. Based on market insights, a frictional vacancy rate of 10% was held across the respective categories to foster competition in the market and the residual total was a factor in the calculated demand model. Identified demand over the plan period was subsequently rationalised on the basis of this vacancy to determine adjusted floorspace requirements. The modelled outputs illustrate that there is an identified need for additional retail floorspace from the beginning of the Plan period in 2021, across convenience, comparison and bulky retail categories.

In undertaking the preparation of this Retail Strategy, Longford County Council has sought to take a proactive approach to addressing the issue of retail floorspace vacancy, while remaining cognisant of its responsibility to facilitate growth in retail and general economic activity within the

County. The Retail Strategy has taken a cumulative approach to depleting vacant floorspace, while accommodating additional floorspace where it is required.

1.4 Definition of the Retail Typologies

Annex 1 of the 2012 Retail Planning Guidelines provides clear guidance on the classification of the two types of retail goods categories, convenience and comparison and defines each category as follows:

Convenience:

This category includes all supermarkets, convenience stores and retail food outlets (excluding fast food takeaways, restaurants, cafes including sandwich bars) serving food, alcoholic and non-alcoholic beverages, tobacco and non-durable household goods.

Comparison:

This list of goods which fall under this category is as follows: clothing and footwear, furniture, furnishings and household equipment (excluding non-durable household goods), medical and pharmaceutical products, therapeutic appliances and equipment, educational and recreation equipment and accessories, books, newspapers and magazines, goods for personal care, goods not elsewhere classified and bulky goods.

Bulky Goods:

While bulky goods category is listed under the classification of comparison floorspace above, it is considered appropriate to make a distinction within the Retail Strategy between pure comparison floorspace and floorspace used for the sale of bulky goods.

The Annex 1 definition includes a list of goods which are considered to fall within the bulky goods category as follows: Goods generally sold from retail warehouses where DIY goods or goods such as flat pack furniture are of such size that they would normally be taken away by car and not be portable by customers travelling by foot, cycle or bus, or that large floorspace would be required to display them e.g. repair and maintenance materials; furniture and furnishings; carpets and other floor coverings; household appliances; tools and equipment for the house and garden; bulky nursery furniture and equipment including perambulators; bulky pet products such as kennels and aquariums; audio-visual, photographic and information processing equipment; catalogue shops and other bulky durables for recreation and leisure. It should be noted that the above classifications are not exhaustive. Bulky goods not mentioned in the above list should be dealt with on their own merits in the context of the definition of bulky goods.

1.5 Retail Planning Policy Context

The following provides an overview of the relevant national, regional and local policy instruments that will influence the future development of the retail sector in the County.

1.5.1 National Policy Context

Project Ireland 2040 - National Planning Framework

The National Planning Framework sets out the Government's high-level strategic plan for the future growth and development of the country out to the year 2040, by which time it is estimated that an extra 1 million people will be living in the country. The NPF sets out a long-term spatial strategy for the country and forms the pinnacle of a hierarchy of spatial plans from which corresponding Regional Spatial and Economic Strategies, County/City Developments Plans and Local Area Plans follow. The NPF sets out a series of shared development goals which are expressed in the NPF as ten National Strategic Outcomes (NSOs) which address a range of development goals.

A key principle underpinning the NPF is that of 'compact growth' which espouses the sustainable growth of compact cities, towns and villages in order to add value and create more attractive places in which people can live and work. In this regard, it is recognised that retail development will be a critical element in providing an appropriate quantum and mix of retail uses which will contribute to and enhance the viability and vitality of urban settlements and their centres.

Retail Planning Guidelines for Planning Authorities (2012)

The Retail Planning Guidelines, published by the Department of the Environment, Community and Local Government (DECLG) in 2012, aim to ensure that the planning system continues to play a key role in supporting competitiveness in the retail sector for the benefit of the consumer in accordance with proper planning and sustainable development. The Guidelines provide a comprehensive retail planning and development framework to guide regional assemblies and planning authorities in the preparation of retail policy objectives for their respective strategies and development plans, as well as guiding An Bord Pleanála and planning authorities in assessing planning applications or appeals. The Guidelines are also a key source of information to retailers and developers in formulating retail development proposals. The Guidelines and accompanying '*Retail Design Manual*' have increased standards in relation to design, access and mobility, signage, landscaping, the creation of place, and town centre integration including fostering a mix of uses.

The Guidelines contain five key policy objectives for retail development:

1. Ensuring that retail development is plan-led;
2. Promoting city/town centre vitality through a sequential approach to development;
3. Securing competitiveness in the retail sector by actively enabling good quality development proposals to come forward in suitable locations;
4. Facilitating a shift towards increased access to retailing by public transport, cycling and walking in accordance with the Smarter Travel Strategy; and
5. Delivering quality urban design outcomes.

The Guidelines emphasise that in order to ensure proper planning and sustainable development, retail development and activity must follow the settlement hierarchy of the State and retail development should be appropriate to the scale and function of the settlement or part of the settlement in which it is located as designated by the NPF, relevant Regional Spatial Economic Strategy and the Core Strategies of Development Plans.

The Guidelines also provide specific guidance for the content and role of Development Plans. The following are key messages from the Guidelines for planning authorities to have regard to in the preparation of Development Plans:

- Development Plans must set out clear evidence-based policies and objectives in relation to retailing in a discrete section of the Plan;
- Joint or multi-authority retail strategies, where required, will guide the preparation of retail policies and objectives in the relevant development plans;
- The need for any additional retail warehousing should be carefully assessed in view of the significant levels of recent provision and potential impacts on vitality and viability of city and town centres;
- At a minimum, Development Plans must:
 - State the elements of their settlement hierarchy in line with the relevant Regional Planning Guidelines (now replaced by Regional Spatial Economic Strategies (RSESs));
 - Outline the level and form of retailing activity appropriate to the various components of the settlement hierarchy in its Core Strategy;
 - Define, by way of a map, the boundaries of the core shopping areas of city and town centres and also location of any district centres;
 - Include a broad assessment (square metres) of the requirement for additional retail floorspace only for those plans in the areas covered by a joint multi-authority retail strategy;
 - Set out strategic guidance on location and scale of retail development to support the settlement hierarchy, including where appropriate identify opportunity sites which are suitable and available, and which match the future retailing needs of the area;
 - Identify sites which can accommodate the needs of modern retail formats in way that maintains the essential character of the shopping area;
 - Include objectives to support action initiatives in city and town centres, such as mobility management measures that both improve accessibility of retail areas, while aiming to develop a pedestrian and cyclist friendly urban environment and vibrant street life;
 - Include public realm interventions aimed at improving the retailing experience through high-quality civic design, provision of attractive street furnishing, lighting and effective street cleaning/business improvement district type initiatives; and

- Identify relevant development management criteria for the assessment of retail developments in accordance with these guidelines.

As referenced above, the Guidelines also advocate strict guidance in relation to the sustainable organisation of retail activity in Ireland to reflect the existing national settlement structure and hierarchy. This retail hierarchy reflects the broad tiers of urban development and recognises that such a system of classification is indicative only, with scope for overlap between the specific retail functions provided in each tier.

Retail Design Manual (2012)

Accompanying the Retail Planning Guidelines (2012) is the Retail Design Manual which outlines the contribution value of high-level design to the future health of town centres and sets out the key principles of urban design which should form the framework for policies to promote quality design in Development Plans and Local Area Plans. Key urban design principles include context and character; access and connectivity; density and mixed uses and includes case studies to demonstrate the application of these principles. Given its function as a complementary document to the Retail Planning Guidelines (2012), the Manual will be particularly relevant in any future retail development and upgrade works to town centres in Longford and most notably in Longford Town which forms the primary retail destination in the County.

1.5.2 Regional Policy Context

Eastern and Midland Regional Spatial and Economic Strategy

The Eastern and Midland Regional Spatial and Economic Strategy (RSES) is the strategic plan and investment framework which provides policy context for the Eastern and Midland Regional Assembly which comprises of the following twelve local authorities: Longford, Westmeath, Offaly, Laois, Louth, Meath, Kildare, Wicklow, Fingal, Dublin City, South Dublin and Dún Laoghaire-Rathdown. The RSES provides a regional expression of the NPF which subsequently gives direction to policy making decisions at a local level through the County Development Plan.

The Eastern and Midland RSES sets out a number of high-level Regional Strategic Outcomes (RSOs) that have been developed having regard to the National Strategic Outcomes set out in the NPF. The RSES sets out a Growth Strategy for the Region in line with the growth identified in the NPF. A key element of in the development of the Growth Strategy is an asset/potential based criteria approach which integrates an evidence-based approach to the identification of suitable settlements within the Region which have the capacity for additional growth. Related to this Growth Strategy is a Settlement Strategy set out in the RSES which identifies a Settlement Hierarchy for the Region and an identification of key growth areas that will see significant development up to 2036 and beyond. In this regard, the RSES sets out the asset-based settlement typology strategy to inform the settlement hierarchies and strategies of each local authority as presented in their respective development plans.

The RSES recognises the importance of the retail sector as a significant employer and economic contributor to the region, as well as its key role in placemaking and creating attractive liveable environments. The RSES also emphasises the significant role retail can play in acting as a significant attraction for consumers as well as providing an accessible environment for other retailers and commercial service providers through the provision of strong mixed use commercial core.

The RSES reinforces the principles for retail development as established in the Retail Planning Guidelines for Planning Authorities 2012, and places emphasis on ensuring that retail development is plan-led with the promotion of town centre vitality through the sequential approach to development and the promotion of good quality development in appropriate locations whilst also facilitating a modal shift and the delivery of quality urban design outcomes.

A key feature of the RSES's retail development policy is its Retail Hierarchy for the Eastern and Midland Regional Assembly area. In this regard, the RSES prescribes five spatial levels of retail centres or functions: Level 1 – Metropolitan Centre (Dublin City Centre); Level 2 – Major Town Centres and County (Principal) Town Centres (including Longford Town); Level 3 – Town and/or District Centres & Sub-County Town Centres (key services towns including Granard); Level 4 – Neighbourhood Centres, Local Centres, Small Towns and Villages; and Level 5 – Corner Shops/Small Villages.

The RSES include the following policy objectives with respect to the retail sector:

RPO 6.9: *EMRA will support the preparation of a Retail Strategy / Strategies for the Region in accordance with the Retail Planning Guidelines for Planning Authorities 2012 to update the retail hierarchy and apply floorspace requirements for the Region.*

RPO 6.10: *Future provisions of significant retail development within the Region shall be consistent with the Retail Planning Guidelines for Planning Authorities 2012 and the retail hierarchy for Region, expressed in the RSES, until such time as this hierarchy is updated.*

The RSES also addresses the need for town centres to maintain and enhance their vitality and vibrancy and refers to the Framework for Town Centre Renewal (Retail Consultation Forum, 2017) which sets out an action plan and a range of suggested supports for town centre renewal which has the potential to support viable and sustainable towns and villages that meet the long term needs of our society, economy and environment. In this regard, the RSES contains the following policy objectives for town centre renewal:

RPO 6.11: *Local Authorities shall include objectives in Development Plan and Local Area Plans supporting emphasis on placemaking for town centres, for example through the inclusion of a Placemaking Strategy for towns and implementation of Town Centre Renewal Plans.*

RPO 6.12: Local Authorities shall support the preparation of Design Guidelines to provide for improvements in the appearance of streetscapes and for revitalising vacant spaces for example with cost effective, temporary uses that build on the longer-term vision for space.

RPO 6.13: EMRA will support the use of targeted financial incentives to re-establish the dominant role of town centres provided for in planning policy to encourage a greater take up of town centre development opportunities for retail, residential, commercial, and leisure uses.

1.5.3 Local Policy Context

Longford County Development Plan 2021-2027

The Development Plan outlines the spatial development framework for County Longford to develop sustainably over the period 2021-2027 and provides a local expression of national and regional planning policy as reflected in the National Planning Framework and the Eastern and Midland Regional Spatial and Economic Strategy respectively. A critical element of the Development Plan is the Settlement Strategy which provides the geographic framework to guide the location and scale of future development within the County over the plan period and takes cognisance of the regional settlement and retail hierarchies presented in the RSES. An intrinsic feature of this Settlement Strategy is the Settlement Hierarchy which assigns the settlements within County Longford in accordance with the spatial structure and settlements typologies set out in the RSES and categorises areas for development within the County across five tiers as illustrated below:

Longford Town – Key Town
Granard– Self-Sustaining Growth Town
Edgeworthstown, Ballymahon & Lanesborough – Self-Sustaining Towns
Towns and Villages
Rural

Tier 1 – Longford Town – Key Town

Longford Town is identified in the RSES as being a ‘Key Town’ within the region on account of its role as an economically active service town providing employment for its surrounding area as well as being endowed with high-quality transport links and the capacity to act as a regional driver to complement the Regional Growth Centre of Athlone. Its Tier 1 placing is also reflective of the substantial retail and administrative functions on offer in Longford Town, as well as its level of physical as well as social infrastructure which serves a broad, cross-regional hinterland. Accordingly, it is considered that the majority of industrial, commercial, business and retail development will also be channelled to Longford Town.

Tier 2 – Granard - Self-Sustaining Growth Town

Granard has a robust employment base, with a particular focus on manufacturing in the food and agricultural sectors, with the Pat the Baker food manufacturing company and Kiernan Milling both significant employers. In 2016, there were a total of 269 resident workers within Granard, however 633 total jobs were recorded, giving a jobs to resident workers ratio of 2.35; the highest recorded ratio within the regional area. Granard also acts as an important retail centre to its inhabitants and wider hinterland, as reflected in its designation in the RSES as a Level 3 retail centre (Town and/or District Centres & Sub-County Town Centres (Key Service Centres)). Moreover, given its proximity to the Longford-Cavan border, Granard performs as a key service provider and retail centre for a broad hinterland which extends beyond the County boundary.

Tier 3 – Edgeworthstown, Ballymahon and Lanesborough – Self-Sustaining Towns

The settlements of Edgeworthstown, Ballymahon and Lanesborough fulfil critical roles in supporting their respective communities and wider rural areas, and as such, are designated as ‘Self-Sustaining Towns’ within this Settlement Strategy. The settlements of Edgeworthstown and Ballymahon have seen significant growth over the twenty year intercensal period between 1996 and 2016 with their populations increasing by approximately 181% and 138% respectively over this period. Edgeworthstown has a long-established manufacturing and light-industrial base, with particular focus on agri-food and the service sector and also has excellent transport links owing to its proximity to key transport corridors in the form of the N4 and the Sligo-Dublin InterCity rail line. Similarly, Ballymahon has a strong manufacturing and light-industrial base, with a key retail and service-sector standing within the county, with significant growth in tourism-orientated services such as food and drink, hostels, and tourist accommodation which has coincided with the opening of the nearby Longford Forest Center Parcs resort in 2019.

Lanesborough provides an important role in the provision of local-level retailing, social and leisure functions and local services to its wider hinterland. The Development Plan places strong emphasis on the growth of the local economies in Granard and Lanesborough and the development of its vital administrative and social functions to support and complement growth in the region.

Tier 4 – Town and Villages

Aughnaclyffe, Ballinalee, Drumlish, Keenagh, Legan and Newtownforbes

These settlements have unique attributes in terms of natural and/or built heritage and specific cultural and historic associations that require specific designation to protect and enhance their character. Each settlement also has the necessary infrastructure capacity available to accommodate additional growth and to sustain and enhance existing services for the needs of their hinterlands and acting as catalysts for the rural economy of the county.

Tier 5 – Rural

Serviced Rural Villages: Abbeyshrule, Ardagh, Ballinamuck and Clondra.

Rural Settlement Clusters: Abbeylara, Ballycloughan, Ballywillan, Barry, Bunlaghy, Carriboy, Colehill, Coolarty, Cullyfad, Derraghan, Dring, Enybegs, Forgney, Killashee,

Kilnatraun, Legga, Lisryan, Melview, Moydow, Moyne, Mullinalaghta, Newtowncashel, Ratharney, Stonepark and Taghshinny.

Open Countryside

The Settlement Hierarchy acknowledges the importance of rural areas in Longford for sustaining the vitality of rural communities. In terms of the future development of these areas, this strategy places emphasis on maintaining existing rural settlement clusters with a view to the long-term enhancement of existing services and facilities and also the retention and creation of local-level employment opportunities in such small-scale settlements. These locations provide existing social and community infrastructure and services such as schools, shops, post offices, public houses and residential housing. Residential development in these areas will only be permitted at a small-scale, commensurate with existing levels of development and reflective of the character of existing settlements. Small-scale development which will alleviate the pressures for one-off housing in the open countryside will be permitted in these areas.

Longford Retail Hierarchy

The purpose of the retail hierarchy is to indicate the level and form of retailing activity appropriate to the various urban centres in the County. Taking a criteria-based approach enables the Council to protect each centre’s overall vitality and viability, whilst allowing each centre to perform its overall function within the County’s settlement hierarchy. It is the core concept of the retail hierarchy that the principal urban areas (county towns) are supported by key service towns, local service towns and to a lesser extent, smaller villages. As such this retail strategy focuses primarily on the upper levels of the hierarchy. It is important to note that this is not to deter or discourage smaller scale retail development and investment in the smaller villages. Rather, it is important to set a clear hierarchy which identifies where the distribution of new retail floorspace should be delivered and which is appropriate in scale and character to the hierarchical role of the centre.

The Longford County Retail Strategy 2015-2021 contained five tiers of retail hierarchy and was based predominantly on the settlement hierarchy produced as part of the first Longford Core Strategy prepared in 2012, the Retail Planning Guidelines (2012) and the then latest Midland Regional Planning Guidelines, published in 2010.

The retail hierarchy proposed in this Strategy adopts a similar methodology whereby the ranking of each retail centre has taken into account their respective placing within the settlement hierarchy of the County, as outlined in the Core Strategy of the Development Plan, as well as the Retail Hierarchy for the Eastern and Midland Regional Assembly as prescribed in the RSES. In respect of the latter and as referenced previously, the RSES has assigned Longford Town and Granard as Level 2 and Level 3 retail centres respectively in its Retail Hierarchy.

Taking account of the above, the revised Longford County Retail Hierarchy consisting of five tiers has been adopted for inclusion in this Strategy and is set out below:

Hierarchy Level	Retail Hierarchy Settlement Designation	Settlements
-----------------	---	-------------

Tier I	Principal Retail Centre	Longford Town
Tier II	Key Service Centre	Granard
Tier III	Service Centres	Edgeworthstown and Ballymahon
Tier IV	Local Service Centre	Lanesborough
Tier V	Rural Centres and Local Shops	Serviced Rural Villages, Rural Settlement Clusters and the Open Countryside of County Longford

Retail Policies and Objectives Contained Within Longford County Development Plan 2021-2027

The Longford County Development Plan 2021-2027 also contains a number of policies and objectives specific to retail development which were informed by this Retail Strategy and its recommendations. These policies and objectives are outlined below:

1.6 Core Retail Areas

A key policy objective of the Retail Planning Guidelines is the promotion of greater vitality in town centres through the implementation of a sequential approach to the location of all retail development. This ‘sequential approach’ prioritises core areas within town centres over edge-of-centre or out-of-centre locations, which may in some cases, have poorer functional and spatial linkages with the core. This approach recognises the importance of core areas as the most suitable locations for higher order fashion and comparison goods, as they are easily accessible for the majority of the catchment population and also provide a compact and sustainable critical mass of commercial activity and public amenities, thereby reducing the need to travel.

Given its scale and dominance of retail development and uses relative to other settlements in the County, Longford Town is the most pertinent settlement to be subject to a defined core retail area. The assessment of the County’s retail centres carried out under the previous Longford Retail Strategy 2015-2021 recognised the curtailment of retail activity from the commercial core of Longford Town, realised in the most extreme terms by the levels of commercial vacancy experienced in the economic downturn preceding the strategy. Despite the expectation that the levels of commercial vacancy would recede over the period of the previous Retail Strategy, a considerable level of commercial vacancy remains in the town.

Given the level of commercial vacancy within the settlement, coupled with a relative underperforming commercial and retail market, the Core Retail Area of Longford Town remains that which was defined under the previous Retail Strategy, namely the dense clustering of key commercial activities and is bounded by the primary thoroughfares of Main Street to the West and Dublin Street to the South, and by the secondary thoroughfare of Ballymahon Street to the South West. In accordance with the guidance on the location of all new retail activity set out in the Retail

Planning Guidelines, Longford Town's Core Retail Area is to be the focus and preferred location for retail development during the plan period.

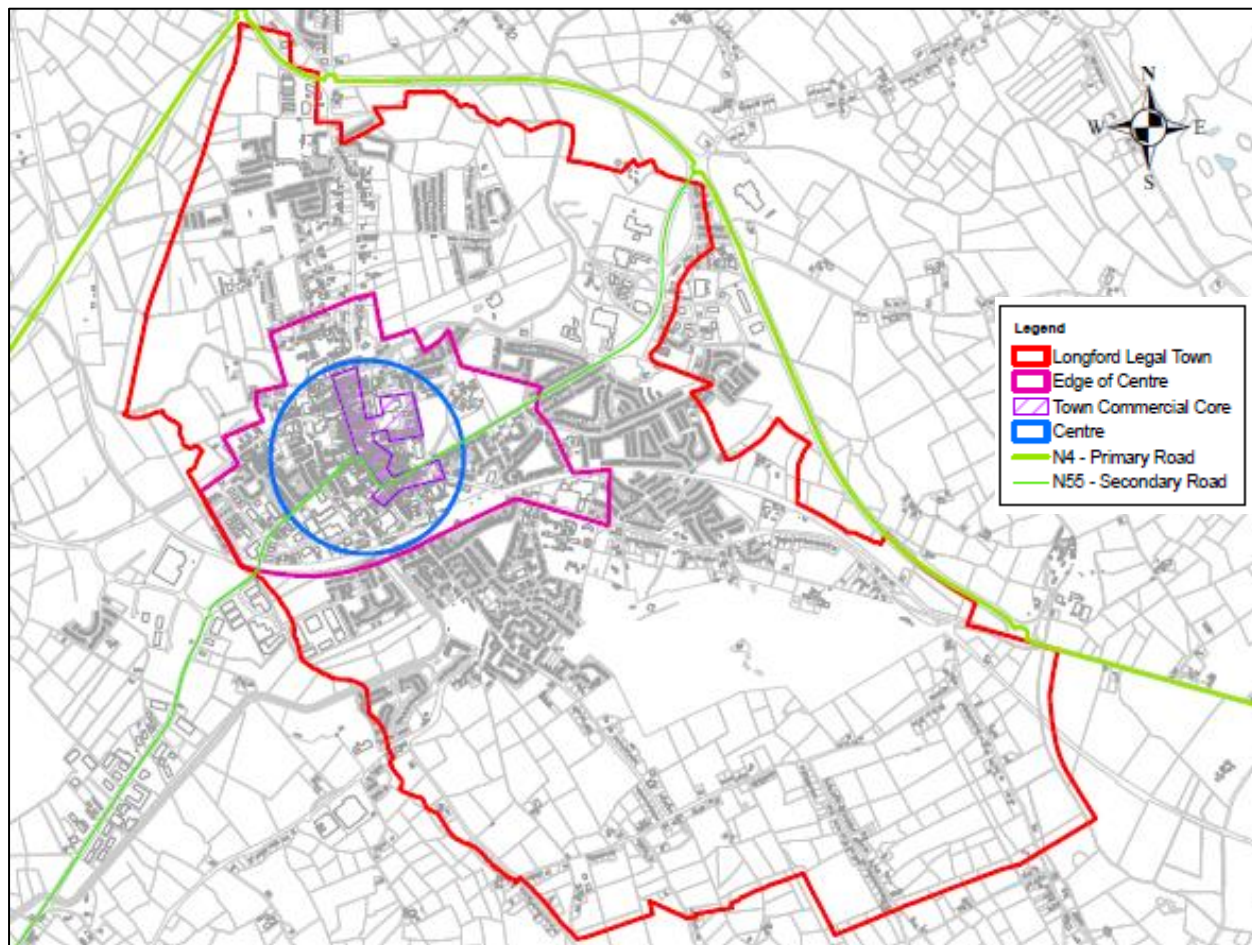

Figure 1: Defined Retail Areas of Longford Town

2 RETAIL TREND ANALYSIS AND ASSESSMENT OF COMPETING CENTRES

2.1 Retail Trend Analysis

The retail sector is a vital element of the national, regional and local economy. Nationally there are 280,000 persons employed in the provision of retail services with approximately 72% of employees based outside Dublin¹. Retail is also the biggest contributor to the Irish exchequer, generating 23% of total tax receipts in Ireland and more than twice that of the second largest sector in Ireland². Regionally, many of the largest towns exhibit the broadest retail offer, in keeping with the retail hierarchy set out in the Retail Planning Guidelines 2012. This is not to discount the role of smaller towns and settlements where the provision of retail services is often an essential feature of these communities, fulfilling the important role of providing local goods and services to the population and the surrounding rural hinterlands.

The economic downturn which preceded the previous Longford County Retail Strategy 2015-2021 severely affected the retail sector in Ireland with a 25% drop in sales and job losses in the range of 50,000. A legacy of this economic downturn has been an increase in vacancy rates within many towns and counties, as well as the replacement of higher order comparison and convenience retailing in primary frontage locations with lower order retailing or commercial premises such as bookmakers or takeaways. Furthermore, impacts of the decline in national retail sales and overall economic activity also disproportionately affected independent retailers, many of whom have had higher cost bases than the multiples with which they competed. Such trends have impacted on the attractiveness of many areas as retail destinations and urban environments in general.

Notwithstanding, from an assessment of the pre-Covid-19 pandemic Retail Sales Index, published by the Central Statistics Office (CSO) for May 2019, there has been an increase in the value of national retail sales in comparison with the corresponding months in each of the preceding four years. In May 2019 the adjusted Retail Sales Value index for all retail business excluding motor trades and bars was calculated to be 108.7 (using 2015 as the base year of the index = 100). The adjusted Retail Sales Values for the same month in the preceding years of 2018, 2017, 2016 and 2015 are published as 106.9, 104.8, 101.0 and 97.8. This trend in the retail sector is reflective of the sustained period of gradual economic recovery experienced nationally since the commencement of the economic recovery in 2014.

In terms of the future economic projections, the economic legacy of the Covid-19 pandemic will have immediate effects. It should be noted that the information provided herein is correct at the time of writing and it is recognised that the ongoing global COVID-19 pandemic is subject to change that may affect the national economy. As such, the future GDP growth estimates have been provided to reflect the published data from those sources as outlined herein to reflect the macroeconomic situation as data is limited at this time.

^{1,2} Retailireland.ie. (2018). *Retail in Depth*

The information set out in Table 2.1 collates a number of sources in relation to forecasted GDP growth (and decline) from 2020 onwards.

Table 2.1: Forecasted GDP growth (2020 – 2025)

Source	2020	2021	2022	2023	2024	2025
ESRI Economic Quarterly (March 2020) ³	-7.1%					
ESRI Economic Quarterly (May 2020) ⁴	-10.3%	7.1%				
Central Bank Q2 2020 Bulletin ⁵	-8.3%					
Department of Finance (Feb 2020) ⁶	3.9%	3.0%	2.8%	2.7%	2.7%	2.5%
Department of Finance (April 2020) ⁷	-10.5%	6.0%				
EU Spring 2020 Economic Forecast ⁸	-7.9%	6.1%				
Davys Paper (May 2020) ⁹	-10.3%	7.1%				

Whilst the precise impact of Brexit and the Covid-19 pandemic on the domestic economy remains uncertain, the economic outlook provided by the ESRI would indicate an initial contraction of GDP before a rapid return to moderate level of growth, far removed from the era of boom and bust economic trends that characterised the Celtic Tiger economic era and subsequent recession. This sustainable growth trajectory is also reflected in the retail projections contained in this strategy for County Longford.

2.2 The Changing Nature of Retail Services in Ireland

The challenges the retail sector faces also goes beyond macroeconomic considerations and the potential impacts of Brexit and the Covid-19 pandemic, due to the changing nature of shopping habits. The continued growth of online shopping is mirroring a shift in consumption patterns. Several factors driving growth in this sector include consumers’ appetite for value for money and greater variety, the increased usage of mobile devices, smart home voice assistants, improved

³ <https://www.esri.ie/publications/quarterly-economic-commentary-spring-2020>

⁴ <https://www.esri.ie/publications/quarterly-economic-commentary-summer-2020>

⁵ <https://www.centralbank.ie/publication/quarterly-bulletins/quarterly-bulletin-q2-2020>

⁶ <https://assets.gov.ie/70914/3db3ecde06404a62a369b880a3d7ea23.pdf>

⁷

https://opac.oireachtas.ie/AWData/Library3/Documents%20Laid/pdf/SPU%202020%20Final_300420_171423.pdf

⁸ https://ec.europa.eu/info/business-economy-euro/economic-performance-and-forecasts/economic-forecasts/spring-2020-economic-forecast_en

⁹ <https://static.rasset.ie/documents/news/2020/05/new-econ-forecast-may-27th.pdf>

security and convenience, as well as increased marketing and use of social media promoting online campaigns. A major challenge to the traditional retail format is that from online retailers. In 2017, online sales accounted for just over 12% (€5bn) of the overall retail sales (€40bn) of that year. Significantly for Irish retailers, however, 60% of this online retail trade went to foreign retailer¹⁰.

Global online shopping is likely to increase in market share in the coming years with companies such as Amazon continuously increasing their offering to compete on both a global, national and local level¹¹. Euromonitor International figures recently revealed that Irish shoppers are the fifth biggest internet shoppers on the planet — with €720.10 per capita and €3.3bn spent in total in 2017¹². Euromonitor International, predict that online sales in Ireland could reach just under the €5bn mark by 2022. Increasingly busy lifestyles, broadband penetration, and the rising use of technology in addition to customers' appetite for value for money and variety will continue to drive the growth of online shopping.

One significant trend which has impacted on the viability of retail services in Irish centres, and especially town centres, has been the drive by retailers to increase the size of floor plates in which they operate, precipitating the move towards out of town shopping centres and retail parks. Out of town or edge of centre retail has become a growing feature of the Irish retail offer since the 1980's but there has been a significant increase in the number of such centres, as well as their size and scale, since the early 2000's. These shopping centres and retail parks have become a feature of many urban centres throughout the country, consisting of a mixture of retailers catering to consumer demands for convenience, comparison and bulky goods. The proliferation of out of town shopping centres and retail parks has also coincided with the increasing market presence of large European and UK multinational multiples in the Irish market.

These trends, coupled with the underlying difficult economic conditions which characterised the period between 2007 and 2014, have also contributed to sizeable increases in vacancy rates within town centres, as some retailers close or move to other locations which better meet their requirements. Those that remain are forced to compete for the shrinking market share as the retail attraction of the town diminishes. The provision of parking has become another issue of note, as many towns now impose parking charges which are not applicable in out of town centres. Despite the cap on the size of retail units imposed by the Retail Planning Guidelines 2012, there remains a demand for larger multiple convenience retailers now offering a growing proportion of comparison goods within their stores.

In the case of the larger scale multiples, this move towards the provision of comparison goods reflects the policy of increasing diversification which many are pursuing to obtain a greater market

¹⁰ UCD Smurfit School, *Consumer Market Monitor – Q4 2017* (2017)

¹¹ PWC (2018). [online] Available at: <https://www.pwc.ie/publications/2018/retail-consumer-report-2018.pdf>

¹² Irish Examiner (2018). Fivefold Increase in Online Shopping Since 2007. p.11

share. These multiples are continuing to broaden the range of comparison goods which are available from their stores. This is reflected in the retail market share in Ireland which is dominated by three multiples: Dunnes Stores, SuperValu and Tesco which collectively make up approximately two thirds of the Irish convenience retail market¹³. All three retailers have become increasingly involved in the comparison market over the last decade.

Table 2.2: Multiples share of the Irish convenience market (Source: Kantar Worldpanel, September 2019)

Retailer	Market Share (%)
Dunnes Stores	22.2
Tesco	21.4
SuperValu	21.4
Aldi	12.5
Lidl	11.9
Other Outlets	10.6

The anticipated increases in online sales may have a significant impact on the future demand for retail floorspace in the medium to longer term. Some industry experts predict that the need for larger convenience/comparison stores will subside as an upward trend in home deliveries gathers pace. At present, a large proportion of the main high street convenience retailers offer online shopping with home delivery as an alternative to in-store shopping, with many multiple retail chains giving increasing priority to online aspects of their retail offer. Moreover, the UK market has seen the introduction of exclusively online convenience retailers without any physical stores of their own such as Ocado. More recently, the world’s largest e-commerce marketplace, Amazon, has launched its own online convenience retail brand, Amazon Fresh in the UK, US, Germany and Japan. Whilst none of these exclusively online convenience retail services are in operation in Ireland, it remains clear that online convenience retailing is a burgeoning service with the potential to radically change the traditional retailing landscape and provide for increased demand for storage and distribution facilities.

2.3 Retail Experience Economy

The changing nature of retail is not just confined to the physical infrastructure and the means of trade transactions. Increasingly, retail analysts and economists have referred to the increasing importance of the ‘experience economy’ for retail. In this regard, a growing trend in the retail evolutionary processes have guided economic value from commodities to goods and services to a point where consumer empowerment via technology has upset the traditional power differential between the retailer and the consumer to a stage where customers now expect more. This ‘experience economy’ goes beyond the physical aesthetics of the retail offer in terms of urban design and quality of environment and relies on the behavioural aspects of the consumer.

¹³ Kantar Worldpanel (2019), *Grocery Market Share* - September 2019

Whilst the principle of the ‘experience economy’ relies on the behavioural aspects of the customer, analysts have identified four key factors determining a customer’s shopping experience:

1. Environment – encompassing the overall atmosphere and ease of transactions.
2. Education – referring to the participation of events driven by consumers’ desire to improve knowledge/skills (e.g. demos, product advice and how-to information).
3. Escapism – encapsulates the desire to seek changes in one’s daily routine.
4. Entertainment – captures the activities designed to influence desire of products/brands (e.g. exhibitions and live events).

2.4 Assessment of Competing Retail Centres

2.4.1 Introduction

The retail industry is highly competitive and Longford’s location relative to national transport linkages is a primary consideration in this regard. Two National Primary Routes, the N4 and the N5, which connect the West and East Coasts, converge on the County, in addition to the rail line linking Sligo to Dublin. The presence of these infrastructural links, which have undergone significant upgrades in the last decade, has made the urban centres of the Greater Dublin Area much more accessible than was previously the case. It is now possible to travel between Longford Town and Dublin City Centre in 82 minutes by car and 110 minutes by train, while the travel times from Longford to retail centres such as the Liffey Valley Centre or the Blanchardstown Centre by car can be as little as 74 minutes.

A summary table of the various distances and travel times between the main urban centres of Longford and those which they compete with is presented below.

Table 2.3: Summary table of distances and travel times by road between the main urban centres of County Longford and the main urban and retail centres which they compete¹⁴.

		Longford	Granard	Edgeworthstown	Ballymahon
Athlone Town Centre	Distance	41.9km	53.1km	40.6km	21.4km
	Time	48min	54min	42min	26min
Blanchardstown Centre	Distance	117km	111km	102km	109km
	Time	1hr 18min	1hr 17min	1hr 5min	1hr 15min
Cavan Town Centre	Distance	52.1km	29km	41.3km	60.1km
	Time	52min	33min	43min	58min
Dublin City Centre	Distance	119km	118km	105km	109km
	Time	1hr 24min	1hr 22min	1hr 11min	1hr 21min
Dundrum Town Centre	Distance	129km	123km	115km	121km
	Time	1hr 43min	1hr 42min	1hr 34min	1hr 42min
Liffey Valley Retail Park	Distance	109km	109km	96km	99km
	Time	1hr 14min	1hr 12min	1hr	1hr 11min
Mullingar	Distance	43km	43km	26km	30km
	Time	37min	35min	24min	26min
Sligo Town Centre	Distance	89km	106km	100km	96.9km
	Time	1hr 10min	1hr 30min	1hr 20min	1hr 30min

¹⁴ Travel times and distances taken from Google Maps.

Table 2.4: Summary table of travel times by road between the urban centres of County Longford which feature rail links and the available competing centres served by the same rail lines¹⁵.

	Longford	Edgeworthstown
Dublin City Centre	1hr 52min	1hr 35min
Mullingar	30min	18min
Sligo	1hr 25min	1hr 35min

2.4.2 Competing Centres

In evaluating the retail alternatives which currently exist within easy access to the main settlements of County Longford, such as the Liffey Valley Shopping Centre and Retail Park, Dublin City Centre, Athlone or Mullingar, it is clear that these regional retail attractors are amongst the biggest competition to the existing retail offer in the County.

Liffey Valley Shopping Centre

Liffey Valley Shopping Centre is anchored by M&S and Dunnes Stores and offers a range of national multiples, including Carraig Donn, Easons and Lifestyle Sports, as well as large international comparison multiples such as Coast, H&M, Oasis, River Island and Topshop. The adjacent retail park includes Argos, B&Q, Carpet Right and Halfords, all of which would be classified as being within the bulky goods retail category. In addition to the retail offering, there are also other leisure amenities available, including a large multi-screen cinema as well as numerous restaurants and eateries.

Unlike many of the more recent out of town retail parks which have been developed in the last number of years, there are no large convenience multiples located within this complex, although M&S does provide a convenience offer. An extension of 10,500sqm has been completed in recent years and provides accommodation for a Penneys store as well as six restaurants over three floors and a reconfiguration of the existing VUE Cinema.

Blanchardstown Centre

The Blanchardstown Centre is recognised as one of the primary retail locations in the wider Dublin Region, and due to its location only a short distance from the M50, is easily accessible to people travelling from County Longford. As with Liffey Valley, the Blanchardstown Centre offers an abundance of free parking spaces within an extensive shopping centre and retail park complex.

The shopping centre offers several large multiples, both Irish and international, and includes some of the largest department stores within the country such as Penneys, Debenhams and Marks & Spencers. As with the Liffey Valley Shopping Centre, it also plays host to a range of both Irish (including Dunnes Stores, Easons, Lifestyle Sports and Newbridge Silverware) and internationally (French Connection, Oasis, River Island and Zara) based multiples. In addition, within the retail park there are a variety of convenience, comparison and bulky goods category retailers, including Harvey Norman, Mothercare, Next, and Mr. Price. This substantial retail offering is further

¹⁵ Timetable and rail travel information current as of 21/03/2019, as obtained from Irish Rail website.

reinforced by a wide range of other amenities including a multi-screen cinema, a theatre, a bowling alley and leisure complex, restaurants and eateries, a hotel and a library.

Dublin City Centre

The retail offering of Dublin City Centre, in keeping with its position at the top of the national retail hierarchy (as set out within the Retail Planning Guidelines 2012), is the largest within the country. As with both Liffey Valley and the Blanchardstown Centre, the improvements in infrastructural linkages have enhanced the attraction of the city as a shopping destination to wider catchments across the country. The retail offering, which is located throughout several large shopping centres (including the Ilac Centre, the Jervis Centre and the St. Stephen's Green Shopping Centre), as well as shopping districts (such as the Grafton Street and Henry Street areas) features a number of large department stores as well as flagship stores of many national and international comparison retailers.

Unlike the free parking provided in competing out-of-centre or suburban centres such as the Liffey Valley Shopping Centre and the Blanchardstown Centre, parking is not free and can be relatively expensive. However, it is notable that this element does not undermine the attraction of Dublin City Centre as a retail destination given its significant modal choice and frequency of public transport, including regular train services from Longford Town and Edgeworthstown to and from Dublin City Centre to Connolly and Pearse Street Stations, as well as direct bus links from Longford Town to Dublin by public and private operators.

Athlone

The town of Athlone is considered to be one of the primary shopping destinations within the Midland Region. Boasting a healthy and vibrant town centre, Athlone offers significant competition to retailers operating in the urban centres of County Longford. The opening of the Athlone Towncentre shopping centre in 2007 supplemented the strong retail offer already in existence at Golden Island Shopping Centre. In addition, there is a sizeable retail park located on the periphery of the town on the Old Dublin Road which serves as a location to support a number of retail warehouse type operations providing a range of goods from the convenience, comparison and bulky retail categories. The town offers a mixture of free and pay parking facilities, which offer substantial choice for those travelling by car, and there is a dedicated bus route which operates between Longford Town and the centre of Athlone on a daily basis.

The retail offer of the town itself is located within quite a compact area, with both shopping centres located within or close to the commercial core of the town. Amongst the retailers who operate from the town are comparison retailers, Barratts, Next, Zara and Oasis, with most of the convenience retailers also having a substantive presence within the town. Athlone also has a number of discount foodstores such as Mr.Price which is located in an edge-of-centre location. There are also a number of bulky goods stores including B&Q, Ganlys and Homevalue, all of which are all located in out-of-centre locations near the N6 Athlone Bypass.

Mullingar

Mullingar, like Athlone, is easily accessible from County Longford owing to the presence of the N4 road and the Irish Rail Intercity railway line between Longford Town, Edgeworthstown and Mullingar. There are a sizeable number of national and international multiples in Mullingar including Dunnes Stores and Tesco. The Harbour Place shopping centre located in the Town Centre was developed in the mid 1990's and hosts the aforementioned Dunnes Stores in addition to a number of national and international multiples, these including Carraig Donn, Boots and Holland & Barrett. Like Athlone, the retail offering in Mullingar has increased by way of the Fairgreen Shopping Centre in 2005 and mainly hosts comparison offering. Although Mullingar's convenience, comparison and bulky goods retail offering is slightly smaller than Athlone, Mullingar still represents a significant alternative to shopping in Longford.

Other Competing Centres

The **Dundrum Town Centre**, which first opened in 2005, is Ireland's largest shopping centre extending to approximately 125,000 sq.m of retail floorspace spread across over 130 stores. Unlike its competitors, the Liffey Valley or Blanchardstown Shopping Centres, Dundrum is slightly less accessible from County Longford, owing to its location approximately 1.5km from the Ballinteer exit off the M50 motorway.

Cavan Town also offers competition to retailers located in the north of County Longford, such as Granard. The Church Street and Main Street shopping area of the town includes a number of national and internal convenience and comparison retailers such as Carphone Warehouse, Dunnes Stores, Tesco, Boots, Easons and Clarks, as well as a large number of independent comparison retailers. In addition, to the substantial retail offering of the town centre itself, there are a number of retail parks which accommodate a number of large-scale comparison and bulky goods retailers, with most of the main convenience multiples having a presence in the town also.

Sligo Town's location relative to centres in Longford means that retail competition only really extends itself to those people who are travelling to Sligo for other purposes, who may subsequently conduct their retail business there. Sligo Town currently features town shopping centres, both of which are centrally located within the town. There are also several retail parks, located on the edge of the town at Carraroe and Cleveragh.

Carrick-On-Shannon also offers competition to retailers located in the north and west of County Longford, including those in Longford Town, owing to its accessibility along the N4 National Route. The town comprises of two distinct areas, physically separated by the River Shannon with the southwest bank comprising the Cortober area within the jurisdiction of Roscommon County Council and the northeast side within Leitrim County Council jurisdiction. Out of centre retail parks are in-situ on the western and eastern ends of the town, with the bulk of the town's main street shopping area comprising of several independent convenience and comparison retailers. There

is also a strong presence of tourism-related commercial uses and a good quality urban design environment with amenity spaces fronting onto the River Shannon.

3 HEALTH CHECK ANALYSIS

3.1 Retail Health Check Analysis of Co. Longford

Retailing and the provision of retail services is one of the primary functions of any urban settlement. The Retail Planning Guidelines clearly highlight how the concepts of vitality and viability are central in maintaining and enhancing town centres. As defined in Retail Planning Guidelines “*vitality is a measure of how buoyant a centre is, whilst viability refers to the commercial well-being of a town*”. The degree to which the ‘health’ of a town centre can be measured depends on a number of factors however the Retail Planning Guidelines provide general direction as to the fundamental factors which include the following:

- **Attractions** – these underpin a town and comprise the range and diversity of shopping and other activities which draw in customers and visitors.
- **Accessibility** – successful centres used to be accessible to the surrounding catchment area via a good road network and public transport facilities, and to encompass good linkages between car parks, public transport stops and the various attractions within the centre.
- **Amenity** – a healthy town centre should be a pleasant place to be in. It should be attractive in terms of environmental quality and urban design, it should be safe, and it should have a distinct identity or image.
- **Action** – to function effectively as a viable commercial centre, things need to happen. Development and improvement projects should be implemented efficiently; there should be regular and effective cleaning and maintenance and there should be co-ordinated town centre management initiatives to promote the continued improvement of the centre.

This health check analysis has been undertaken to evaluate the retail functions of the main urban settlements of Co. Longford, assessing the attraction, accessibility and amenity of each centre with the aim of making evidence-based recommendations regarding future actions for their improvement. These actions will be formulated to reinforce the existing retail offering within each of the towns, and where possible expand it, through the suggestion of issues to be addressed or measures to be continued or extended.

3.2 Longford Town

Longford Town is the primary settlement and largest population centre within County Longford. Centrally located within the County, and having the advantage of excellent quality local, regional and national linkages, the town has become a settlement of regional importance. The value of the town and the support function which it provides to its residents as well as those of its hinterland has been recognised within both a national and regional context. The Retail Planning Guidelines have defined the town as a Level 3 settlement, assigning it the role of providing a retail support at a sub-regional level¹⁶. The importance of the town within a local and regional context has also

¹⁶ Retail Planning Guidelines for Planning Authorities (2012), Section 2.2.3, page 11.

been recognised in the Eastern and Midland Regional Spatial and Economic Strategy, which has defined the town as being a ‘Key Town’ within its settlement strategy, which has subsequently been reflected in the Core Strategy of the Longford County Development Plan 2021-2027.

Attraction

In defining the attraction of Longford Town, its location is a key strength, both within the context of the County and in terms of its infrastructural linkages beyond the County. Due to its location within the national infrastructure network, there is a high volume of passing traffic, which brings with its vital retail expenditure inflow. The variety and diversity of the retail offer is much greater than that available in other settlements in the County across convenience, comparison and bulky goods retail categories.

Each of the main convenience multiples has a presence within the town. Tesco operates from a commercial core of the town, within the Longford Centre shopping centre. Planning permission was granted for a substantial redevelopment of this site in 2010, however this permission subsequently expired in 2017 without any development taking place. Other multiples such as Dunnes Stores, SuperValu, Lidl and Aldi operate stores on the periphery of the town centre, while a number of small and medium scale convenience retailers operate from stores in and around the town.

Comparison retailers within Longford Town are, for the most part, clustered into two main areas, namely the commercial core of the town and the N4 Axis Retail Park on the northern edge of the town. The commercial core of the town is dominated by a number of independent comparison retailers alongside a number of multiples including Boots, Sports Direct and Dealz. The N4 Axis Retail Park features a variety of retailers in both comparison and bulky goods categories in addition to a number of restaurants. The remaining comparison retail floorspace within the town is located within a series of small district centres within the periphery of the town.

Accessibility

Longford is strategically located within the national transportation network, with the town forming an important interchange on the East-West road network, giving excellent access to the town from the immediate hinterland and adjoining regions.

Accessibility within the town itself has been improved in recent years with the opening of the N5 Longford Bypass, which now diverts all through traffic directly onto the N4 to the north-west of the town. This has seen the removal of a substantial amount of traffic congestion and has eased both vehicular access and pedestrian permeability throughout the main commercial core of the town. This easing has been very beneficial to the town centre and the retailers who operate within it.

The provision of car parking within the town is good, with a number of both public and private car parks located at various locations in and around the town centre and periphery, all of which operate an hourly tariff system. There is also on street parking available throughout, and which is

also subject to hourly tariffs. Free car parking is available at a number of car parks located in more peripheral locations within town.

The remain some problems which can impact on the accessibility of the town and cause periodic congestion. Delivery and service vehicles accessing the various premises within the town only have access to a small number of loading bays, in particular on Main Street and Ballymahon Street, which can result in issues of double parking on occasion and can cause congestion.

Amenity

Longford is an attractive town, with a mature streetscape which features a variety of buildings of differing size, age and character. The amenity of its commercial core has benefited from the completion of the N5 Longford Bypass, which removed heavy volumes of traffic from the town centre. The streetscape of the town has retained its local character, with a range of traditional shopfronts serving to maintain the town's distinctive identity. Architecturally, the town showcases a range of vernacular style buildings reflecting the historic nature of the town such as the Courthouse, Church of Ireland, Connolly Barracks, St. Mel's Cathedral as well as distinct residential characters areas of Battery Road and St. Mel's Terrace.

Amenity and landscaping measures are ongoing throughout the town as part of an overall regeneration of the urban environment, with specific public realm redevelopments identified for the Market Square/Harbour View, Grafton Court/Longford Shopping Centre and the Royal Canal Basin. A significant element of the overall regeneration vision for the town is that of the Camlin Quarter Urban Design and Economic Framework which sets out a guide for the future economic and development potential of the Camlin Quarter which measures 22ha and encompasses Great Water Street, Little Water Street, Connolly Barracks, Richmond Street, the Camlin River and the western end of the Albert Reynolds Peace Park. Within this Quarter are a number of landmark buildings such as the Riverside Shopping Centre, buildings associated with Connolly Barracks complex and the 'Provider's' Building, all of which are currently vacant. It is envisaged that the Framework will act as a major catalyst for the regeneration of this area of Longford Town and bring enhanced amenity features for visitors and inhabitants.

Assessment

The Health Check Assessment indicates that Longford Town has a relatively good mix of comparison and convenience retailing with a number of national and international multiples well represented, along with a number of well-established independent local retailers. The town also provides for an adequate level of financial institutions and service providers throughout. Notwithstanding the above, as per retail surveys conducted, there is approximately 8,800m² of vacant retail space in Longford Town. The levels of decline in comparison retailing witnessed in the previous Retail Strategy over the period 2007-2013 remains, albeit at a significantly reduced rate for the period 2013-2019, especially in the peripheral parts of the town and on the northern end of Main Street, where longstanding vacancy is particularly problematic. In addition, many previously higher order comparison and convenience retailing in primary frontage locations has

been replaced with lower order retailing or commercial premises such as bookmakers or takeaways with a proliferation of such low order uses in some areas.

A number of areas within the town have been identified for regeneration and urban renewal. These include areas and properties within the Camlin Quarter. In this regard, the Camlin Quarter Urban Design and Economic Framework sets out the principles and envisaged scope of redevelopment for this area with the hope that this framework will act as a major catalyst for the overall regeneration of this area. In addition to the Camlin Quarter area, there is significant scope for the redevelopment of the brownfield 'Townspark' area which features a high proportion of commercial vacancy. Moreover, the site of the Longford Shopping Centre, and associated surface car park, affords a significant redevelopment opportunity. Whilst planning permission for a previous redevelopment scheme of this site has since lapsed with no development taking place, the redevelopment of this site remains a key element to the overall regeneration of Longford Town, given its central location and existing linkages with the core retail area to the west.

The general quality of the public realm and streetscape within the town centre is good, although the continuing trend of long-term vacancy rates does raise substantial concerns that dereliction is becoming a rising issue in some areas of the town. Similarly, while the overall amenity of the town remains at a good level, there is still capacity for improvement, especially in the provision of pedestrian linkages and related infrastructure as well as deficiencies in the overall connectivity of the urban street structure.

A brief assessment of rental asking prices for retail units within the town illustrates that location is a key factor with asking prices varying from €121 to €361 per m² per annum for shop units. The sale price varies from between €370 and €2,000 per m². A similar assessment of the rental asking prices for retail units show that prices can vary from €34.44 to €166.68 per m² per annum¹⁷.

Action Plan:

The health check has identified a number of key areas in Longford Town which require action. These are listed below:

- Further develop the primary and secondary shopping frontages for Longford Town, thereby better consolidating the Main Street, Dublin Street and Ballymahon Street (primary shopping frontages) in addition to better defining the role of adjoining streets (secondary shopping frontage).
- Identify and develop a sustainable use for the former Connolly Barracks site.
- Address vacancy levels to both the Longford Town Shopping Centre and the northern section of Main Street.
- Develop a coherent functionality between the Longford Town Shopping Centre, the southern part of Bridge Street, the northern section of Main Street and the remainder of

¹⁷ Information taken from analysis of published retail property prices available on Daft.ie on 16/09/2019.

the town centre including Main Street, Ballymahon Street, Dublin Street and New Street to provide an easily identifiable commercial core.

- Improve the accessibility to and attractiveness of Market Square for both pedestrians and shoppers in addition to achieving higher order retail in this area.
- Identify any vacant sites/gap sites/backlands which can be used for the provision of uses ancillary to retail, i.e. parking.
- Prepare Shopfront Design Guidelines to encourage creating attractive frontages appropriate to their setting.
- Increase the number of electric vehicle (EV) charging points in the town centre and retail centre car parks; and
- The preparation of environmental enhancement plans to allow for increased footfall throughout the town centre.

3.3 Granard

Located in the north-east of the County, Granard is the fourth largest urban settlement in County Longford, with a range of shops, public houses, community facilities and services and social infrastructure. The Longford County Development Plan 2021-2027 Core Strategy identifies Granard as a ‘Self-Sustaining Town’ within the County’s Settlement Hierarchy. Granard acts as an important driver for local economies in the area, with a number of industries located within the town which have generated significant employment opportunities. The importance of its retail function for its rural hinterland is also recognised in the RSES wherein Granard is designated as a Level 3 Retail Centre – ‘Town and/or District Centres & Sub-County Town (Key Service Centre)’. Whilst its position as a third-level settlement within the Settlement Hierarchy is reflective of a number of elements ranging from historic population trends to physical and social infrastructure, Granard is positioned as a second tier Retail Centre within this Strategy. This is reflective of the important retail function and services it provides for its broad rural hinterland and population catchment to the north-east of the County (and the neighbouring counties of Cavan and Westmeath).

Attraction

In order to establish the attraction of Granard, it is necessary to examine its key defining characteristics. Having a traditional linear townscape, Granard’s Main Street is defined by its terraces of 19th -20th century mixed commercial premises. In this context, vernacular-style shop frontages add a distinct sense of character and ambience at street level. This simple urban morphology is further complemented by a rich built and archaeological heritage. The motte to the south west of Main Street, which is classified as a National Monument in State Guardianship, is a notable historical feature which is visually prominent from the entirety of Main Street. Notwithstanding, due to its location on the N55 national secondary route and its strategic role as a local and regional connector, Granard’s attractive urban character is undermined by large volumes of heavy vehicular through traffic, which significantly impacts upon both local vehicular and pedestrian circulation, and public safety. This traffic congestion, in addition to high levels of

haphazard on-street parking, negatively impacts on the quality, capacity and character of the town's core public realm.

Granard possesses a dynamic and diverse selection of local shops, cafes, pubs and leisure facilities to attract people into the town centre. The settlement's retail offer is clustered around the commercial core of Main Street and is typically dominated by retail service provision, such as cafes and pubs, convenience retail in the form of local grocery shops and specialist retail, including florists and hardware stores. There are few instances of the comparison or bulky goods retail categories in Granard and a limited offer of convenience multiples, with only the SuperValu supermarket chain having a presence on Main Street within the town core. A cursory examination of the commercial retail unit market in Granard has revealed that there is availability in the market throughout the settlement with concentrated levels of unit availability in streets adjacent to the commercial core, such as Barrack Street.

Accessibility

Granard benefits significantly from its strategic location on national road infrastructure, with the N55 that passes through the town forming an important link in the north-south transportation network as it passes through the midlands. This has allowed the town to develop as a gateway between the north midlands and the north-west, connecting Longford to the settlements of Cavan and Dundalk as well as the wider road network of Northern Ireland. The road connections between Granard and its surrounding hinterland are also relatively good, enabling it to fulfil its role as key service town, enhancing the growth of its rural hinterland. However, it is also inadequately served by public transport, and as it is car dominated, does not cater to more vulnerable road users, including cyclists.

Amenity

While Granard possesses an attractive town centre in terms of its improved environmental quality and vernacular urban character, its amenity to potential customers and service providers is greatly undermined by its congested core, lack of permeability, pedestrian safety issues and poor provision of amenity related infrastructure such as pedestrian crossings, high quality street furniture and passive recreation space. Granard has also benefitted from funds secured under State supported streams such as the Town and Village Renewal and in particular, the Rural Regeneration and Development Fund (RRDF) where €2.87m funding was secured for the development of a heritage and amenity park located adjacent to the historic Granard motte. It is envisaged that this project, along with other urban improvement schemes initiated in recent years such as the redevelopment of the Granard Buttermarket and public realm, will act as catalysts for more longer-term improvements to the urban environment and overall amenity in the town.

Assessment

The retail offering of Granard remains in keeping with its position within the Longford County Retail Hierarchy, with a diverse mixture of retail outlets and general service provision. The accessibility and amenity of the town continues to be impacted upon by the presence of high

volumes of vehicular traffic passing through the town. There is also evidence of long-term vacancy levels in units at the north-eastern end of Main Street and leading onto Barrack Street, and from the town centre to Market Street. Such levels of longstanding vacancy inevitably impact on the overall vitality and viability of the town.

An evaluation of the retail rental market in the town indicates that the average retail asking prices for retail units equates to €91 per m² per annum for shop units¹⁸.

Action Plan

This health check has identified a number of key areas in Granard which require action. These are listed below:

- Implement measures to better manage and control traffic circulation and street parking.
- Put in place improved pedestrian crossings and infrastructure.
- Identify any vacant sites/gap sites/backlands which can be used for the provision of retail/facilities ancillary to retail, i.e. parking.
- Direct the provision of future retail development within the town into the existing commercial core of the Main Street and encouraging active frontages that adequately address and engage with this historic streetscape.
- Implement the provision of the longstanding road objective to provide a relief road to bypass the town along the N55 thereby diverting road freight volumes away from the town centre and improving its overall environment.
- Develop more coherent traffic/movement management systems within the town centre for road, pedestrian and cycle users, with a particular emphasis on the junction of Main Street and Market Street.

3.4 Edgeworthstown

The location of Edgeworthstown, on the eastern side of the County, along with the presence of two important national road linkages have long defined the town's attraction, accessibility and amenity. As a result, the town itself has developed to become a strategic interchange in the national road network and serves as a gateway to County Longford for those travelling from the east. The Longford County Development Plan 2021-2027 Core Strategy identifies Edgeworthstown as a 'Self-Sustaining Growth Town' within the County's Settlement Hierarchy.

Attraction

As with Longford Town, the location of Edgeworthstown is a key strength, with the N4 national primary and N55 national secondary routes both passing through the town. This has allowed it to take advantage of the high volume of passing trade, and to offer a mixture of services which become tailored to the needs of both local residents and those who are just passing through. The

¹⁸ Based on information gathered from local auctioneer knowledge of the retail market within the town (16/09/2019)

layout of the town is dominated by the Main Street which is orientated primarily on an East West axis and was formally part of the N4 national primary route.

There is a diverse mixture of convenience and comparison retail units located within the town in addition to a small amount of retail warehousing, located on the western periphery of the town. The retail offer of town is complimented by a range of other services including pubs, cafes, hairdressers and restaurants. There is a heavy concentration of retail activities within the core of the town, located along Dublin Street, Main Street and Pound Street, while there is a small concentration of bulky goods retail units located along the Longford Road. The majority of the retail premises within the town appear to be well kept, although vacancy does appear to be higher in more peripheral areas.

Accessibility

Edgeworthstown is very accessible, located as it is on an important interchange between the N4 national primary route, which links Dublin and the east of the country with the counties of Leitrim, Mayo, Sligo and Roscommon, and the N55, which connects the midlands to the north-west. As well as this road linkage, there is also a rail service which operates between Dublin and Sligo, and which is located just to the south of the town. Car parking within the town centre is restricted to on-street parking.

Amenity

The amenity of Edgeworthstown is dominated by its location within the national road network, with the town forming an important interchange between the N4 and the N55. The N55, which links Cavan Town to Athlone, carries a high volume of HGV traffic, all of which passes through the centre of the town, with negative impacts on amenity.

The streetscape of the town is attractive and is dominated by a largely traditional urban fabric and built form, which includes a mixture of stone front and plaster rendered buildings of various ages and functions. Many recent additions to the building stock of the town have taken place on the western periphery of the town.

Assessment

The retail offering which currently exists in Edgeworthstown is of sufficient quality and variety to continue to satisfy the role of a Strategic Town, as designated in the Settlement Hierarchy of the County Longford. There is also potential for further retail growth within the town, which reduce the vacancy rates within the more peripheral parts of the town. While the presence of the N55 does create some problems, it is also a key strength for the town. Enhancements to the pedestrian linkages and general amenity of the town could bring about substantial benefits and alleviate the negative impacts of the N55 while retaining its benefits. The retail offer is characterised by convenience food stores in the form of SuperValu and Costcutter, with a small number of specialist independent comparison retailers also, typically along Main Street of the town.

There is notable evidence of longstanding vacancy amongst some of the units within the town, particularly along the periphery of the town centre in particular the former Hotel Edgeworth and the former Ulster Bank. In respect of the latter building, there are currently plans to utilise this building as an Innovation Hub for the town with hot-desk and remote working facilities proposed to bring this substantial and architecturally significant building back in to use. Notwithstanding, there are plans in place to develop a community library within the town centre, along with further public realm improvement works along Main Street also. It is envisaged that this scheme will act as a catalyst for more longer-term improvements to the urban environment and overall amenity in the town.

Action Plan

This health check has identified a number of key areas in Edgeworthstown which require action. These are listed below:

- Environmental enhancement plans to allow for increased footfall throughout the town.
- Take measures to improve the public realm and pedestrian linkages in the town centre.
- Look to minimise the impact of the N55 on the amenity of the town.

3.5 Ballymahon

Located to the south of the County, Ballymahon is situated between the larger settlements of Athlone and Longford Town. In this context, the urban centre provides for important residential, retail, social and leisure functions. Under the Settlement Hierarchy of the previous Longford County Development Plan 2015-2021, the town was classified as a ‘Local Service Town’. However, owing to the exceptional growth, in population terms the town has experienced between the intercensal period of 2011 to 2016 where the town recorded a population increase of approximately 20% during this period. Further developments in recent years within the town and nearby, such as the Longford Wood Center Parcs site, have further enhanced the profile of the town. As a result, Ballymahon has been designated as a ‘Self-Sustaining Growth Town’ within the Settlement Hierarchy of the Longford County Development Plan 2021-2027.

Attraction

Ballymahon exhibits a traditional linear market town structure, with its commercial activity being predominantly clustered around a compact urban core centred on Main Street. The broad width of this central thoroughfare, relative to the height of the mixed commercial buildings which front onto it, combine to give Main Street a distinctive and spacious character. The quality of the streetscape and the associated public realm in Ballymahon is also good, with many traditional shopfronts still intact. There is also a generous provision of pedestrian infrastructure such as crossings and street furniture. The settlement is situated adjacent to the River Inny to the east of Lough Ree, which gives the locality its unique topographical character.

Ballymahon possess a good range of retail outlets and services relative to its size, with a variety of small cafes, pubs, grocery and specialist independent retailers. There appears to be very few incidences of national or international retail multiples within the settlement, which consists

generally of independent retailers. Moreover, there is a significant night time economy in Ballymahon with a number of restaurants, pubs and a hotel in operation.

Accessibility

Ballymahon is served by a relatively good road network which includes the N55 national secondary route from Athlone to Cavan and the R392 regional route. However, the town is relatively poorly served by public transport facilities and is heavily reliant on car-based access in comparison to some of the other settlements within the County. There is a generous amount of car parking on the Main Street, owing to its wide streetscape typically seen of a market town environment. The town experiences high volumes of traffic passing through both the N55 and R392, particularly at the north-western end of Main Street/R392 owing to associated school traffic with the Vocational School, Mercy Secondary School and St. Matthew's National School located within this vicinity. The town has been the subject of a review of infrastructural and urban design requirements which has identified improved traffic management measures at the junctions of the N55 and R392 north and south of the River Inny. Further plans for improving pedestrian and cycling permeability within the town centre are also in place, as well as measures to better utilise backland areas of Main Street to accommodate car parking thereby improving accessibility within the town.

Amenity

Overall, Ballymahon exhibits relatively high levels of public amenity and a high-quality townscape and is able to provide a good mixture of retail services to residents and passers-by alike. It also features a good quality and well-maintained public realm, in addition to high standards of vehicular management and pedestrian infrastructure. As discussed previously, there are currently plans in place to provide public realm upgrade improvement works along the Main Street/R392 road section of the town, as well as the provision of a more coordinated traffic and parking management system to serve Ballymahon. Moreover, further plans are at an advanced stage to develop cycling and pedestrian links to amenity features within the wider vicinity of the settlement. It is envisaged that these measures will further enhance the amenity value of Ballymahon and its town centre.

Assessment

The compact nature of the urban core of Ballymahon, and the presence of the N55, which passes through a substantial part of the town core, has been a key economic strength for the town, and has helped to sustain retail activity. Planned infrastructural improvements in the form of junction upgrades to the N55 and R392 routes north and south of the River Inny, together with pedestrian/cycling and public realm improvements to the Main Street/R392 town centre will also lead to significant enhancements of the urban environment of the town. In terms of the dynamism of its commercial market at present, there are a number of retail units currently available for rent particularly in the town's Main Street, with rental prices ranging between €61 and €208 per m² per annum for shop units¹⁹.

¹⁹ Information taken from analysis of published retail property prices available on Daft.ie on 16/09/2019.

Action

This health check has identified a number of key areas in Ballymahon which require action. These are listed below:

- Implement measures to improve public realm, pedestrian infrastructure and quality of streetscape.
- Manage traffic congestion and implement traffic calming.
- Continue to proactively manage car parking, circulation and public realm in the town centre.
- Improve access to the town core by non-vehicular modes of transport.

3.6 Lanesborough

Lanesborough is defined as a ‘Self-Sustaining Town’ within the settlement hierarchy of the Longford County Development Plan 2021-2027, whose functions include providing important local level retail, social, leisure and service function to its broad hinterland.

Attractiveness

Located on the eastern bank of the River Shannon at the northern perimeter of Lough Ree, the settlement of Lanesborough is characterised by a linear core urban form, known locally as ‘Main Street’, which had developed perpendicular to the adjacent river, rising gradually away from it. The townscape is defined predominantly by a non-uniform building line. The Main Street also features a high percentage of residential structures. Lanesborough offers its community a limited mix of retail services such as convenience retail, cafes, pubs and other commercial services, distributed intermittently along Main Street. A second key defining feature is its narrow and inconsistent public realm, which is dominated by car parking, heavy traffic flows and poor-quality hard landscaping, features which all conspire to make this urban centre inhospitable to pedestrians. Lanesborough offers its community a limited mix of retail services such as limited convenience retail, pubs, specialist shops and service retail, which are often not clustered together and distributed intermittently along Main Street.

Accessibility

Lanesborough, which is located adjacent to one of the main bridging points on the River Shannon, is well connected to its wider region by the N63 national secondary route which links Longford to Roscommon and also to the R392 regional road which links the town to Mullingar. As a result, the town is subject to regular traffic congestion, impacting on poor circulation within its commercial core.

Amenity

The presence of high levels of poorly managed on-street car parking, heavy vehicular congestion, poor sightlines and access/egress arrangements and the poor provision of pedestrian facilities, all conspire to significantly undermine the amenity value of this settlement for the local community. In addition, the townscape possesses a very poor relationship with the River Shannon, with the

buildings located on the lower reaches of Main Street failing to adequately utilise or respond to this important local amenity. Future plans and projects for the settlement include the provision of an interpretative centre on the eastern banks of the River Shannon to showcase the tourism offering in the region and public realm improvement works to Main Street.

Assessment

As with the example of Ballymahon, the presence of a high volume of passing traffic is an important strength for Lanesborough. The town itself has retained its functionality and continues to support a range of important support services which can be availed of by the residents of Lanesborough and its surrounding rural hinterland.

Action

This health check has identified a number of key areas in Lanesborough which require action. These are listed below:

- Implement measures to improve public realm, pedestrian infrastructure and quality of streetscape.
- Manage traffic congestion and implement traffic calming.
- Continue to proactively manage car parking, circulation and public realm in the town centre.
- Improve access to the town core by non-vehicular modes of transport.

3.7 Other Settlements

Newtownforbes

Newtownforbes is designated as a *'Town and Village'* settlement (Level 3 settlement tier) within the settlement hierarchy of the Longford County Development Plan 2021-2027. Located to the north west of Longford Town, Newtownforbes plays a critical role in sustaining the viability of local rural communities by providing essential services such as housing, lower level retail and important social facilities that allow for local growth. Located along the N4 national primary route, the settlement is well connected to the wider region and also to its immediate rural environs via the local route L1005. Newtownforbes has a distinctive rural village character with good quality public realm and limited provision of local services and convenience retail. It also possesses good provision of car parking, a general lack of vehicular congestion and safe pedestrian access. In terms of its amenity, Newtownforbes' Main Street features a number of intermittent green spaces attached to institutional and community buildings.

Action

The health check has identified a number of key areas in Newtownforbes which require action. These are listed below:

- Continue to proactively manage car parking, circulation and public realm

- Ensure a good provision of convenience and local service retail is maintained going forward.
- Identify public realm improvements such as painting schemes, window displays, planting, as well as improvements to pedestrian and cycling permeability/mobility within the town centre.

Drumlish

Drumlish is also designated as a ‘*Town and Village*’ settlement within the settlement hierarchy of the Plan and provides housing, local level retail and social facilities to its dependant rural communities, thereby acting as a local growth centre for the rural economy. The settlement of Drumlish is clustered around a central crossroads and is served by the R198 regional route which links it to Longford Town to the South. This rural village has retained much of its charm and is characterised by high-quality public realm and the limited provision of local convenience and service retail. It also possesses good provision of well managed on-street car parking, a general lack of vehicular congestion and a safe pedestrian environment.

Action

The health check has identified one key area in Drumlish which require action. These are listed below:

- Continue to proactively manage car parking, circulation and public realm in the town centre.

3.8 Summary of Commercial Floorspace Activity Since 2013

The previous Longford County Retail Strategy 2015-2021 was prepared in 2013 and 2014 and followed a period of significant economic decline which characterised local and national economies for much of the period between 2007 and 2014. Against this economic landscape, the previous Retail Strategy identified a total vacant floorspace of approximately 10,745m², which represented 17.73% of the total retail floorspace for the county, and comprised of 2,275m² convenience; 2,172m² comparison; and 6,298m² bulky goods floorspace vacancies.

In line with national trends, Longford has experienced a stagnation in retail construction activity since 2013, particularly in comparison and bulky retail floorspace provision. Evidence of this inactivity is provided in the analysis of the quantum of planning applications permitted and subsequently advanced in the intervening period, which is set out in Table 3.1 below.

It is noted that there has been a significant reduction in submitted applications for retail development since the previous Retail Strategy was prepared in 2013, with approximately 3,736m² of retail development being permitted since 2013 including permissions granted for extension of duration applications for retail development previously permitted prior to 2013. However, only a small quantum of actual additional retail development has commenced since 2013 (approximately 246.5m²). It is also worth noting that the majority of retail floorspace

commenced/deliver since 2013 has been in the convenience category (approximately 84% of total retail development since 2013). As a result, there has been little change in the baseline figure for total retail floorspace within the County over and above that which was used in the formulation of the existing retail strategy for the County.

Moreover, it is also noted that two thirds (approximately 67%) of the permitted floorspace since 2013 will have expired by 1st January 2022 if not renewed or implemented.

Table 3.1: Outline of all permitted, commenced and outstanding retail development planning permissions since 2013.

Granted and Commenced Retail Developments since 2013				
Retail Category	Permitted	Commenced	Expired or considered to be expired	Due to Expire by 01/01/2022
Total Convenience	2,446.5m ²	208m ²	-	2,036m ²
Total Comparison	1,265.3m ²	38.5m ²	-	445m ²
Total Bulky	-	-	-	-
Total	3,711.8m²	246.5m²		2,481m²

In addition to the limited growth in retail floorspace, activity since 2013 has also been characterised by a marginal decrease in total vacancy rates in the County, further emphasising the stagnation that the market within County Longford has been experiencing in the period since the preparation of the previous Retail Strategy. As illustrated in Table 3.2, a total of 5,618.94m² of retail floorspace is currently vacant across the County (16.54% of total). Table 3.3 summaries existing levels of retail floorspace in County Longford, taking account of development activity and existing levels of recorded vacancy across the County.

Table 3.2: Summary of all existing vacancy (2020) by retail category.

Total Vacancy by Retail Category	
Floorspace Category	m ²
Total Vacant Convenience Floorspace	1,087.00
Total Vacant Comparison Floorspace	1,435.62
Total Vacant Bulky Floorspace	3,096.32
Total Vacant Floorspace	5,618.94

Table 3.3: Summary of all existing retail floorspace, including 2013 and 2019 baseline figures and the vacancy rate for 2019, by retail category.

Baseline Assessment of Retail Floorspace 2019

	2013 Baseline (m ²)	Development Activity 2013-2019 (m ²)	2019 Baseline (m ²)	Total Vacancy (m ²)	Floorspace in use (m ²)	Available Floorspace in use (%)
Convenience	13,239.40	+208	13,447.40	1,087.00	12,360.40	91.92%
Comparison	11,247.46	-693.46	10,554.00	1,435.62	9,118.38	86.40%
Bulky	36,130.00	0	36,130.00	3,096.32	33,033.68	91.43%
Total	60,616.60	-485	60,131.00	5,618.94	54,512.06	90.66%

3.9 Healthcheck Conclusions

Retail provision is a key component of town centres and provides a major contribution to their vitality and viability. According, the retention of retail as a core function within a town centre remains a key element for any urban settlement. The health check analysis was carried out during a period of national economic recovery, however a quantitative assessment of retail floorspace within the County reveals a relatively stagnated retail development market when compared with similar assessments conducted for the previous Retail Strategy.

Overall, the results of the healthcheck analysis appear to indicate that, in spite of obvious and substantial difficulties in retail sector over the last 6 years relating to vacancy rates an underdeveloped market, the main settlements in County Longford continue to provide the necessary retail services required by their communities. Longford Town remains the most important retail centre within the County and is the location for the majority of the retail floorspace within both the comparison and bulky goods retail categories. It is also the chosen location for the larger convenience multiples, who, with the exception of SuperValu, have chosen the town as their sole operations within the County. All of the other settlements within the County continue to fulfil their ancillary roles to the primary centre, supporting their local communities and surrounding hinterlands, in keeping with respective positions within both the settlement and retail hierarchies.

Vacancy levels account for just over 16% of the total retail floorspace within centres across County Longford. This level of vacancy reinforces concerns expressed under health check appraisals carried out for the previous Retail Strategy. It is imperative that those retail units which are vacant at present are not allowed to become derelict. In this regard, the Council has identified a number of actions required, as well as presently undertaking a number of initiatives, aimed at addressing these issues for the identified retail centres.

In tandem with a number of policy initiatives, urban design principles and planning guidance established elsewhere within the Longford County Development Plan 2021-2027, this suite of planning policy measures will seek to arrest any further decline of town centres through targeted, site specific approaches and to improve the overall quality of environment of our urban centres as well as improving and enhancing retail provision within our identified retail centres. Underlying this approach will be cognisance of the retail hierarchy established in this Retail Strategy and ensuring that the future development of retail in these towns will not have an adverse impact on the primacy of Longford Town and in keeping with the existing scale and character of these respective settlements.

4 PROJECTED FLOORSPACE REQUIREMENTS

4.1 Introduction

This section establishes the future retail floorspace requirements for County Longford within the convenience, comparison and bulky goods retail categories, as specified within the Retail Planning Guidelines 2012. The assessment below has been produced having regard to existing floorspace capacity and projections on future demand for retail services within the County and takes account of identified levels of vacancy detailed in Section 3. This will ensure that future retail and other development in town centres will absorb existing vacancy which may otherwise hamper the vitality and viability of centres.

In brief, the following methodology has been used to define the future retail floorspace requirements for Co. Longford:

- Undertake an estimate of the population at base year and design year.
- Estimate the available expenditure per capita for each of the retail categories (convenience, comparison and bulky goods) at the base year and design year.
- Compile a projection of the total available expenditure in the base year and design year for residents of County Longford allow for assumed expenditure inflows and outflows.
- Undertake a projection of the likely increase of available expenditure which will support the provision of additional floorspace.
- Estimate the likely average turnover of new floorspace in convenience, comparison and bulky goods retail categories.
- Estimate the capacity for additional floorspace within each of the three retail categories, taking account of the existing vacancy rates and planning permissions.

4.2 Population of County Longford

The population of Longford has demonstrated substantial growth since 1996 with the most sizeable increases occurring since 2002. An analysis of census figures between 2002 and 2016 reveals that the population of the County expanded from 31,068 to 40,873, representing an increase of some 31.56% over this fourteen-year period. Whilst the inter-censal period of 2011-2016 was characterised by significant economic contraction across the country, the population of County Longford still maintained a steady increase, albeit not to the same extent as the preceding period from 2002 to 2011.

The starting point in any assessment of future floorspace requirements is projected population growth over the plan period. In this regard, future population forecasts for the County are presented in the Department of Housing, Planning and Local Government (DHPLG) publication, *'Implementation Roadmap for the National Planning Framework'*, and subsequently retained in the Eastern and Midland RSES, and provide for a population range with 20% variation for targets years of 2026 and 2031.

Taking the upper level of the population forecast range for each of the target years, the population of the County is expected to increase by 4,627 persons between 2016 and 2026 and increasing by a further 1,500 persons during the period from 2026 to 2031. Using these population forecasts, the Core Strategy of the Longford County Development Plan 2021-2027 has provided an overall population allocation for the County up to the year 2027 thereby coinciding with the plan period. This equates to a total County population growth of 4,927 to the year 2027, with the vast majority of this additional population growth to be accommodated within the settlements of Longford Town, Granard, Edgeworthstown, Ballymahon and Lanesborough. The level of envisaged population growth within Longford Town means that it should be the primary location for the majority of additional retail floorspace forecast to emerge over the plan period.

Population projections for the county for 2021 (the first year of the Longford County Development Plan 2021-2027), 2026 (population target year), 2027 (the final year of the Longford County Development Plan 2021-2027) and 2031 (population target year) are presented in Table 4.1 below and have regard to the figures contained within Longford County Council’s Core Strategy and Housing Strategy over the period of the Longford County Development Plan 2021-2027.

Table 4.1: Recorded Populations and Population Projections for County Longford

2011	2016	2021	2026	2027	2031
39,000	40,873	43,187	45,500	45,800	47,000

4.3 Expenditure Estimates

The expenditure analysis upon which the subsequent floorspace turnover calculations are formulated, have been projected using figures derived from a number of Central Statistics Office (CSO) sources including the Annual Services Inquiry, the County Incomes and Regional GDP 2015 and the Retail Sales Index.

Per capita spend on an annual basis from 2016 to 2030²⁰ has been established using the population projections outlined above in addition to the expenditure projections which will be outlined below and from the latest available historic figures for the change in the retail economy (CSO Retail Sales Index) up until the year 2018. The projection of future per capita spend for County Longford thereafter has been based upon an assumed range of per capita growth (and decline) percentages derived from a number of sources in relation to forecasted GDP growth (and decline) from 2020 onwards, as identified in Table 2.1 above which ranges between -9.4%% and 6.4% per annum for both convenience and comparison goods from 2020 onwards. This perceived volatility stems from the economic repercussions of the Covid-19 pandemic, largely over the years

²⁰ Using the latest available CSO County Incomes and Regional GDP data (23/09/2019), to include for the remaining 2 years of the existing plan, the 6-year operational period of this strategy, plus 3 additional years, as specified within the Retail Planning Guidelines 2012.

2020-2021, as discussed previously, before returning to more sustainable growth patterns for the remainder of the strategy period. The forecasted per capita spend estimates for convenience and comparison retail in County Longford over this period is set out in Table 4.2 below.

Table 4.2: Determination of Per Capita Spend on Convenience and Comparison Retail for County Longford (2016-2030)

Determination of Per Capita Spend on Convenience and Comparison Retail Expenditure					
		Annual Growth Rate (%)		Per Capita Spend (€)	
		Convenience	Comparison	Convenience	Comparison
Year					
2016	Per Capita Spend - Nationally	-	-	€3,987	€3,604
2016	Per Capita Spend - Adjusted for County Longford (National Index = 100; Longford Index = 85)	85	85	€3,389	€3,063
2017	Per Capita Spend - County Longford	3.9	3.9	€3,521	€3,182
2018	Per Capita Spend - County Longford	3.2	3.2	€3,634	€3,284
2019	Per Capita Spend - County Longford	3.2	3.2	€3,750	€3,389
2020	Per Capita Spend - County Longford	-9.4	-9.4	€3,398	€3,071
2021	Per Capita Spend - County Longford	6.4	6.4	€3,615	€3,267
2022	Per Capita Spend - County Longford	2.8	2.8	€3,716	€3,359
2023	Per Capita Spend - County Longford	2.7	2.7	€3,817	€3,449
2024	Per Capita Spend - County Longford	2.5	2.5	€3,912	€3,536
2025	Per Capita Spend - County Longford	2.5	2.5	€4,010	€3,624
2026	Per Capita Spend - County Longford	2.5	2.5	€4,110	€3,715
2027	Per Capita Spend - County Longford	2.5	2.5	€4,213	€3,808
2028	Per Capita Spend - County Longford	2.2	2.2	€4,306	€3,891
2029	Per Capita Spend - County Longford	2	2	€4,392	€3,969
2030	Per Capita Spend - County Longford	2	2	€4,479	€4,049

This table also illustrates an adjustment in the per capita spend for County Longford to account for lower average income levels when compared to the national average. The national per capita spend has been calculated based upon the total retail spend (inclusive of VAT) per capita in 2016. The Dublin Region has a higher level of disposable income (118.4 in 2016), which has an effect of inflating the national wages. The average disposable income in the majority of counties is less than 100, with CSO County incomes and Regional GDP 2016 report indicating that the disposable income in County Longford is 15 index points lower than the national average. Therefore, the available per capita retail spend in County Longford in 2016 (base year) for was €3,389 for convenience goods and €3,063 for comparison goods. Using these per capita retail spend projection figures, the total available spend for convenience, comparison and bulky goods, as calculated, is presented in Table 4.3.

Table 4.3: Recorded Populations and Population Projections for County Longford

Longford County Total Available Expenditure - Convenience / Comparison / Bulky Goods							
Year	Population	Convenience Per Capita Spend (€)	Comparison Per Capita Spend (€)	Convenience Total Available Spend (€)	Comparison Total Available Spend (€)	Comparison Total Available Spend - Excluding Bulky Goods (€)	Comparison Total Available Spend - Bulky Goods Only (€)
2016	40,873	€3,389	€3,063	€138,518,597	€125,193,999	€100,155,199	€25,038,800
2017	41,336	€3,521	€3,182	€145,551,124	€131,550,043	€105,240,034	€26,310,009
2018	41,798	€3,634	€3,284	€151,887,598	€137,276,988	€109,821,591	€27,455,398
2019	42,261	€3,750	€3,389	€158,484,313	€143,239,141	€114,591,313	€28,647,828
2020	42,724	€3,398	€3,071	€145,159,885	€131,196,438	€104,957,150	€26,239,288
2021	43,187	€3,615	€3,267	€156,123,893	€141,105,779	€112,884,623	€28,221,156
2022	43,649	€3,716	€3,359	€162,212,288	€146,608,509	€117,286,807	€29,321,702
2023	44,112	€3,817	€3,449	€168,359,119	€152,164,054	€121,731,244	€30,432,811
2024	44,575	€3,912	€3,536	€174,379,373	€157,605,199	€126,084,159	€31,521,040
2025	45,037	€4,010	€3,624	€180,591,406	€163,219,674	€130,575,740	€32,643,935
2026	45,500	€4,110	€3,715	€187,009,164	€169,020,085	€135,216,068	€33,804,017
2027	45,800	€4,213	€3,808	€192,948,246	€174,387,866	€139,510,293	€34,877,573
2028	46,100	€4,306	€3,891	€198,484,765	€179,391,807	€143,513,446	€35,878,361
2029	46,400	€4,392	€3,969	€203,771,951	€184,170,400	€147,336,320	€36,834,080
2030	46,700	€4,479	€4,049	€209,191,231	€189,068,381	€151,254,704	€37,813,676

Table 4.3 above illustrates the projected increases in population, per capita spend in both convenience and comparison goods, and total available spend in all three retail categories from 2016 to 2030. This includes the complete operational lifecycle of the Retail Strategy from 2021 to 2027.

This shows the total available spend for all retail goods growing from approximately €263m in 2016 to a projected €367m at the end of this retail strategy period in 2027 to over €398m in 2030.

Table 4.4 illustrates the adjusted retail spend for County Longford from 2016 to 2030. In adjusting the total available convenience retail spend, it has been projected that approximately 15% of the total annual available spend on convenience goods will be lost to competing centres outside the county, these including those within close proximity to certain parts of the county such as Athlone (South Longford), Mullingar (East Longford) and Cavan (North Longford), and also to the country's top shopping destinations such as Liffey Valley and Blanchardstown. In addition to the outflow referred to above, it has been projected that there will also be inflows of retail spend. This has been estimated to be equivalent to 5% of the total annual available spend on convenience goods in County Longford. This inflow is primarily accounted for by passing trade (N4, N55, N63) and the use of the county's retail offering by residents of neighbouring counties (Westmeath, Cavan, Leitrim and Roscommon).

Table 4.4: Projections of the total available convenience retail spend, as adjusted to account for inflow and outflow.

Total Available Expenditure - Convenience					Total Available Expenditure - Comparison - Non-Bulky Goods					Total Available Expenditure - Comparison - Bulky Goods				
Year	Convenience Total Available Spend (€)	Convenience Total Available Spend Outflow (%)	Convenience Total Available Spend Inflow (%)	Adjusted Convenience Total Available Spend (€)	Year	Comparison (Non-Bulky Goods) Total Available Spend (€)	Comparison (Non-Bulky Goods) Total Available Spend Outflow (%)	Comparison (Non-Bulky Goods) Total Available Spend Inflow (%)	Adjusted Comparison (Non-Bulky Goods) Total Available Spend (€)	Year	Comparison (Bulky Goods) Total Available Spend (€)	Comparison (Bulky Goods) Total Available Spend Outflow (%)	Comparison (Bulky Goods) Total Available Spend Inflow (%)	Adjusted Comparison (Bulky Goods) Total Available Spend (€)
2017	145,551,124	15%	5%	130,996,012	2017	105,240,034	10%	2%	96,820,831	2017	26,310,009	20%	1.5%	21,442,657
2018	151,887,598	15%	5%	136,698,839	2018	109,821,591	10%	2%	101,035,864	2018	27,455,398	20%	1.5%	22,376,149
2019	158,484,313	15%	5%	142,635,881	2019	114,591,313	10%	2%	105,424,008	2019	28,647,828	20%	1.5%	23,347,980
2020	145,159,885	15%	5%	130,643,896	2020	104,957,150	10%	2%	96,560,578	2020	26,239,288	20%	1.5%	21,385,019
2021	156,123,893	15%	5%	140,511,504	2021	112,884,623	10%	2%	103,853,853	2021	28,221,156	20%	1.5%	23,000,242
2022	162,212,288	15%	5%	145,991,059	2022	117,286,807	10%	2%	107,903,863	2022	29,321,702	20%	1.5%	23,897,187
2023	168,359,119	15%	5%	151,523,207	2023	121,731,244	10%	2%	111,992,744	2023	30,432,811	20%	1.5%	24,802,741
2024	174,379,373	15%	5%	156,941,436	2024	126,084,159	10%	2%	115,997,427	2024	31,521,040	20%	1.5%	25,689,647
2025	180,591,406	15%	5%	162,532,265	2025	130,575,740	10%	2%	120,129,680	2025	32,643,935	20%	1.5%	26,604,807
2026	187,009,164	15%	5%	168,308,247	2026	135,216,068	10%	2%	124,398,783	2026	33,804,017	20%	1.5%	27,550,274
2027	192,948,246	15%	5%	173,653,421	2027	139,510,293	10%	2%	128,349,469	2027	34,877,573	20%	1.5%	28,425,222
2028	198,484,765	15%	5%	178,636,289	2028	143,513,446	10%	2%	132,032,370	2028	35,878,361	20%	1.5%	29,240,865
2029	203,771,951	15%	5%	183,394,756	2029	147,336,320	10%	2%	135,549,415	2029	36,834,080	20%	1.5%	30,019,775
2030	209,191,231	15%	5%	188,272,108	2030	151,254,704	10%	2%	139,154,328	2030	37,813,676	20%	1.5%	30,818,146

As with the total available convenience retail spend, the total available comparison and bulky goods retail spend must also be adjusted. In doing so it has been projected that 10% of the total comparison retail spend will be lost to competing centres, but that the inflow of spend will also be much lower, at just 2%. In adjusting the total available bulky retail spend, the outflow lost to competing centres has been projected to be more substantial, at 20%, while the inflow of retail spend has been projected as being just 1.5%.

4.4 Turnover and Floorspace Capacity

This section identifies the turnover and floorspace capacity which will be used to calculate the subsequent minimum additional floorspace requirements over the lifetime of this retail strategy. The defined average turnover rate per square metre of floorspace in each of the three categories has been illustrated in Table 4.5. This methodology uses the total expenditure available within the County for each category and divides it by the amount of existing floorspace within that category.

The resulting figure has been used as the basis for the projection of future floorspace requirements, through a comparison exercise against the projected disposable income which is available within the specific category. The overall 2020 baseline figures indicate that 60.09% of all retail floorspace in the County is of the bulky goods retail category, while convenience and comparison retail floorspace account for 22.36% and 17.55% respectively.

Table 4.5: Current Retail Floorspace Per Retail Category and Estimated Turnover per Square Metre for County Longford

Retail Floorspace for Convenience and Comparison Goods and Turnover							
Retail Floorspace Analysis					Retail Category Turnover		
Retail Category	2020				2020		
	Gross Floor Area (sqm)	Net Floor Area (sqm)	Net Area as a % of Gross Area	Net Area as a % of Overall Total Net Area	Adjusted Total Available Spend	Net Floor Area (sqm)	Turnover Per sqm (€)
Convenience	16,809	13,447	80.00%	22.36	€130,643,896	13,447	€9,715
Comparison - Non-Bulky	13,193	10,554	80.00%	17.55	€96,560,578	10,554	€9,149
Comparison - Bulky	45,163	36,130	90.00%	60.09	€21,385,019	36,130	€592
Overall Total	75,164	60,131	-	100.00	€248,589,494	-	

4.5 Additional Retail Floorspace Requirements

Table 4.6: Outline of the cumulative projected additional retail floorspace requirements per annum, as adjusted for vacancy, from 2019-2030.

Additional Floorspace Requirements for Convenience and Comparison Goods - Adjusted for Vacancy												
Year	Convenience				Comparison - Non-Bulky				Comparison - Bulky			
	Total Annual Cumulative Floorspace Requirement (sqm)	Additional Annual Floorspace Requirement (sqm)	Vacant Floorspace (sqm)	Additional Floorspace Development Requirement (sqm)	Total Annual Cumulative Floorspace Requirement (sqm)	Additional Annual Floorspace Requirement (sqm)	Vacant Floorspace (sqm)	Additional Floorspace Development Requirement (sqm)	Total Annual Cumulative Floorspace Requirement (sqm)	Additional Annual Floorspace Requirement (sqm)	Vacant Floorspace (sqm)	Additional Floorspace Development Requirement (sqm)
2016												
2017												
2018												
2019	14,682		1,087.00		11,523		1,435.62		39,446		3,096.32	
2020	13,447	-1,234	0	-2,321	10,554	-969	2,404.39	0	36,130	-3,316	6,412.74	-9,729
2021	14,463	1,016	0	-1,306	11,351	797	1,607.24	-810	38,859	2,729	0	-7,000
2022	15,027	564	0	-742	11,794	443	0	-367	40,374	1,515	0	-5,485
2023	15,597	569	0	-172	12,241	447	0	79	41,904	1,530	0	-3,955
2024	16,154	558	0	385	12,678	438	0	517	43,403	1,498	0	-2,456
2025	16,730	575	0	961	13,130	452	0	969	44,949	1,546	0	-910
2026	17,324	595	0	1,556	13,597	467	0	1,435	46,546	1,597	0	687
2027	17,874	550	0	2,106	14,029	432	0	1,867	48,024	1,478	0	2,165
2028	18,387	513	0	2,619	14,431	403	0	2,270	49,402	1,378	0	3,543
2029	18,877	490	0	3,108	14,815	384	0	2,654	50,718	1,316	0	4,859
2030	19,379	502	0	3,610	15,209	394	0	3,048	52,067	1,349	0	6,208

The methodology used to identify the future requirements for additional retail floorspace takes account of the existing baseline floorspace figures including actual vacancy and an additional frictional vacancy, the calculated turnover per m² of retail floorspace, and the projected available retail spend. This is replicated across each of the retail categories. The key steps taken as part of the methodology include the following:

- The total cumulative floorspace requirements are calculated for each year using the turnover per sq.m and the available spend for each retail category.
- The baseline floorspace figure from the preceding year is subtracted from the total cumulative floorspace requirement to produce the additional annual floorspace requirement.
- The vacancy rate (as adjusted to allow for a 10% frictional vacancy requirement) is deducted from the additional annual floorspace requirement to define the additional floorspace development requirement, which is the final output of the exercise.

Table 4.6 also illustrates the impact of the forecasted economic decline arising from the Covid-19 pandemic and the effect of an assumed -9.4% decline in retail spend in both convenience and comparison retail spend for the year 2020. This results in a negative requirement for additional retail floorspace in this year across all three categories of retail which, along with existing vacant floorspace across convenience, comparison and bulky goods retail categories, negates the theoretical requirement for additional retail floorspace to cater for projected retail spend until the years 2024 (in the case of convenience retail floorspace development), 2023 (in the case of comparison retail floorspace development) and 2026 (in the case of bulky goods retail floorspace development). However, it should be emphasised that this does not signify that no additional retail development should take place before these respective years, but rather demonstrates the impact of economic volatility on projected retail floorspace development.

4.6 Additional Retail Floorspace Requirement

The initial baseline projections for floorspace requirements for the period to 2030 are set out in Table 4.6 above. These projections have been formulated to include adjustments for existing vacancy levels, as well as a frictional vacancy rate of 10% to ensure vital choice and competition in the market. Having regard to calculated demand, and identified vacancy, including the need to maintain a frictional vacancy rate, there is a requirement to plan for additional retail floorspace over the plan period.

The Retail Planning Guidelines advise that Retail Strategies Should “*assess the broad requirement for additional development over the plan period.... These assessments of future retail requirements are intended to provide **broad guidance** as to the additional quantum of convenience and comparison floorspace provision. They should not be treated in an **overly prescriptive** manner, nor should they serve to inhibit competition*”. For this purpose, it is not the intention of this strategy to present figures as some form of cap on retail permissions in the County, but rather to guide the general scale of overall retail provision.

Significant consideration has also been given to the quality of existing vacant retail floorspace, including the prospective suitability of available floorspace to meet the future needs of retailers in the County. A summary of additional floorspace requirements over the Longford County Development Plan period 2021-2027 for the convenience, comparison non-bulky and comparison bulky categories is set out in Table 4.7 below.

Table 4.7: Summary of additional floorspace requirements over the 2021-2027 period

Additional Floorspace Requirements 2021-2027	
Retail Category	Floorspace (sqm)
Additional Convenience	2,100-3,200
Additional Comparison	2,000-2,650
Additional Bulky	2,200-4,850

5. RETAIL STRATEGY AND POLICY GUIDANCE

5.1 Retail Objectives and Policy Recommendations

This section of the strategy contains key retail objectives to encourage and accommodate future retail development in County Longford. It also sets out criteria for the assessment of future retail proposals, in accordance with the overall aims of the Development Plan and the requirements of the Retail Planning Guidelines (DoECLG) 2012.

5.2 Retail Strategy Overview

It is considered that the majority of future floorspace requirements will be provided within the commercial core of Longford Town, taking account of its role as the Principal Retail Centre in the County, and the fact that approximately 50.7% of the envisaged population growth for the County over the plan period to 2027 is expected to take place within the town environment itself. As detailed in Section 4.2, the latter should precipitate a demand for convenience, comparison and bulky goods floorspace as the plan period progresses.

The focus of concentrating the provision of new retail floorspace within Longford Town underpins the ‘town centre first’ approach as per the Retail Planning Guidelines and will also strengthen the competitiveness of the county as a whole relative to other competing centres thereby reducing outward revenue leakage.

The spatial distribution of new floorspace in Co. Longford will be guided by the County Retail Hierarchy. Issues of location and scale are of paramount importance to the assessment of future retail proposals in the County. An overly prescriptive approach in defining the scale acceptable in different areas could inhibit potential improvements to the vitality and viability of smaller centres. Providing a broad framework for assessment purposes, the guidance in Table 5.1 provides a suitably broad framework for assessment purposes, while allowing sufficient flexibility to be applied on a case-specific basis.

Table 5.2: County Retail Hierarchy

Hierarchy	Settlement Type	County Centre	Appropriate Retail Type
Tier I	Principal Retail Centre	Longford Town	Major convenience and comparison
Tier II	Key Service Centre	Granard	Large to Medium scale convenience and medium scale comparison
Tier III	Service Centres	Edgeworthstown and Ballymahon	Medium scale convenience along with small to medium scale comparison, including tourism-related comparison
Tier IV	Local Service Centre	Lanesborough	Medium scale convenience along with small-scale comparison including tourism-related comparison
Tier V	Rural Centres and Local Shops	Serviced Rural Villages, Rural Settlement Clusters and the Open Countryside of County Longford	Predominantly lower order convenience, but not excluding tourism-related comparison

5.3 Key Retail Principles

Having regard to the information presented above in relation to the health check analysis of the main urban settlements of County Longford and the additional floorspace requirements of the County between 2021 and 2027, a series of recommended key retail principles have been devised. The primary purpose of these key retail principles will be to inform the development of policy objectives which will protect and reinforce existing retail offering and look to develop additional retail services, in keeping with the role of the settlements of County Longford, as prescribed in the Core Strategy and the Eastern and Midland RSES.

Specifically, these principles will look to inform policies that will:

- I. Ensure that the retail needs of the County's residents are provided for as much as possible within the County, whilst taking cognisance of the Regional Retail and Settlement Hierarchy as established in the Eastern and Midland RSES;
- II. Ensure that County Longford possesses a clear policy framework that will inform both the conception and assessment of retail development proposals and help to guarantee that the strategic and local convenience and comparison retailing needs of the County are met;
- III. Maintain, and where possible, enhance the existing competitiveness of the County's main centres by facilitating the development of additional retail floorspace where it can be clearly established that such development will result in tangible improvements to the retail offering of the County;
- IV. Encourage reductions in floorspace vacancy, taking account of suitability, obsolescence, and the identification of alternative uses for existing vacant floorspace within the urban centres of the County;
- V. Facilitate the regeneration of areas with scope for improvement or where there may be a high level of vacancy, obsolescence or emerging issues of dereliction, subject to the provisions of the Sequential Test;
- VI. Maintain an appropriate mix of uses and protect night-time amenities in town centre locations whilst taking cognisance of the central tenet of 'compact growth' as espoused in the National Planning Framework in targeting a greater proportion of future residential development within or close to built up areas.
- VII. Engage with the relevant stakeholders and incentivise to ensure that the environmental attractiveness of town/local centres is enhanced; and
- VIII. Address the issue of retail expenditure leakage out of the County to competing centres by looking to develop the retail offering in the County within key retail sectors where this leakage occurs.

In following these principles, the goal of the Longford County Retail Strategy 2021-2027 will be to encourage the development of a healthy, vibrant and sustainable retail environment within the urban centres of County Longford.

5.4 Recommended Retail Policy Objectives

Having regard to the objectives which have been outlined above, the following retail policy objective recommendations are provided and take cognisance of national and regional planning policy as well as the assessment presented in this Retail Strategy. These policy recommendations are intended to inform retail-specific policies presented in Chapter 8: *Economic Development* and Chapter 16: *Development Management Standards* of the Longford County Development Plan 2021-2027, thereby forming an integral component of the strategic policy framework which will ensure that all development within the County is carried out in keeping with the ideals of sustainable development.

The recommended retail policy objectives outlined below have been created with the aim of supporting the expansion of the retail offering of County Longford in a sustainable manner, whilst also seeking to develop urban environments that support an appropriate mix of uses which sustain town centres and enhance their vitality and viability and the overall quality of life of our urban places. The policy objective recommendations outlined below have been formulated with the aim of supporting the expansion of the retail offering of County Longford in a sustainable manner. Therefore, these policy objective recommendations have been designed to encourage the reuse, renewal and regeneration of vacant floorspace where possible. This approach aligns with national and regional planning policy in seeking to secure more compact and sustainable growth of our urban environments focussing on the reuse and redevelopment of previously developed 'brownfield' land and existing buildings.

Notwithstanding this key policy emphasis, where the reuse or adaptation of vacant floorspace would have a negative impact upon a retailer's ability to compete, the construction of new retail floorspace would be permissible. Any application for the development of additional retail floorspace would require a detailed assessment to ensure that it is in keeping with the proper planning and sustainable development of the area within which it is proposed and provided that it can satisfy the relevant criteria as established within this Retail Strategy, the Longford County Development Plan 2021-2027 and the Retail Planning Guidelines.

Policy Objective Recommendation 1: It is the policy of the Council to ensure that all retail development permitted accords with the relevant requirements and criteria as established within the Retail Planning Guidelines for Planning Authorities 2012 and the Longford County Retail Strategy 2021-2027.

Policy Objective Recommendation 2: It is the policy of the Council to guide retail development where practical and viable in accordance with the framework provided by the Sequential Approach to enable the vitality and viability of existing town and village centres to be sustained and strengthened.

Policy Objective Recommendation 3: It is the policy of the Council to permit retail development of a size and scale which is appropriate to the level of the town/settlement area, including its population, as defined within the County Retail Hierarchy. This policy will aim to consolidate and reinforce all existing retail enterprises within the County and permit the development of additional retail floorspace where such development is deemed to be appropriate by Longford County Council.

Policy Objective Recommendation 4: When bringing forward proposals for the creation of new retail floorspace, the Council will require applicants to undertake an assessment of the quality and suitability of existing and available floorspace in the County relative to the circumstances of their proposals.

Policy Objective Recommendation 5: It is the policy of the Council to discourage new retail development if they would either by themselves or cumulatively in conjunction with other developments seriously damage the vitality and viability of existing retail existing retail centres within the County. This policy is aimed at protecting the existing vitality and service provision of the towns, and particularly the town centres, of County Longford by preventing the development of retail enterprises in inappropriate locations or at a scale which would have a negative impact on retail competition within the County.

Policy Objective Recommendation 6: When assessing retail planning applications, it will be Council policy to have regard to the findings of the capacity assessment contained in the Longford County Retail Strategy 2021-2027, including the ability to counteract expenditure leakage. The onus will be on any applicant to demonstrate in a Retail Impact Assessment that the proposed floorspace is appropriate, having regard to the quantum of floorspace required within that specific urban centre or settlement, in addition to evidencing all other relevant variables as specified within the Retail Planning Guidelines.

Policy Objective Recommendation 7: It is the policy of the Council to encourage, in the first instance, developments which promote and protect the Longford Town Core Shopping Area as the primary location for high order comparison and large-scale convenience retail development in the County, subject to the criteria of the Retail Planning Guidelines 2012. In principle, this will not preclude the consideration of proposals in locations where mitigating and robustly justified special circumstances apply.

Policy Objective Recommendation 8: It is the policy of the Council to promote the reuse of vacant retail floorspace. Where no viable retail use can be sustained, alternative uses will be assessed on their own merits against the requirements of the proper planning and sustainable development of the areas within which they are located. This policy will be used to ensure that all proposals for the reuse of existing retail floorspace can be evaluated and the proportion of vacancy can be reduced. In addition, the identification and introduction of alternative uses for vacant retail floorspace will reduce the possibility of such floorspace falling derelict.

Policy Objective Recommendation 9: It is the policy of the Council to look to encourage the consolidation of other non-retail-based services within the town centres of the County utilising existing vacant retail floorspace where necessary. This policy will aid in enhancing the vitality of town centres, encouraging them to maintain their role as employment locations in addition to reducing the proportion of vacant retail floorspace and recognising the value which non-retail uses can contribute to the local economy through the provision of employment and general economic benefit.

Policy Objective Recommendation 10: It is the policy of the Council to continue to improve the public realm of urban centres through the encouragement of high-quality civic design, including but not limited to the provision of attractive street furniture, lighting and effective street cleaning. In addition, the introduction of business improvement district type initiatives to the principal settlements of County Longford will be evaluated to establish the contribution that such proposals could make to the viability and vitality of town centres within the County.

Policy Objective Recommendation 11: It is the policy of the Council to undertake measures to improve the accessibility of town centres by developing a pedestrian and cyclist friendly environment, which improves safety and limits traffic congestion where possible. A particular focus of this policy will be the development of additional pedestrian crossings where necessary within Longford Town centre, as well as other settlements within the County where high volumes of vehicular traffic can be seen to inhibit pedestrian movement.

Policy Objective Recommendation 12: It is the policy of the Council to encourage and facilitate retail innovation, where appropriate, to help diversify the County's retail profile and offer. Where possible, this retail innovation should be directed towards existing urban centres and settlements in the first instance but will not preclude the development of retail enterprises in other locations, where the retail innovation in question cannot be sustained within any alternative location. Such development proposals will be assessed on their own merits and must satisfy the assessment criteria of the Retail Planning Guidelines.

Policy Objective Recommendation 13: It is the policy of the Council to require a Retail Impact Assessment to be carried out for development proposals in the following general circumstances:

- a) Proposals featuring greater than 1,000m² of net floorspace for both convenience and comparison type developments in the four main towns;
- b) Proposals featuring greater than 500m² of net retail floorspace for both convenience and comparison type developments in district towns and other settlements;
- c) Or where the Planning Authority considers the development may impact on the vitality and viability of a town centre.

The Retail Impact Assessment shall include, at minimum, the criteria set out in the Retail Planning Guidelines 2012 and should demonstrate how the proposed development:

- Supports the overall strategy for town centres as set out in the development plan and not materially
- diminish the prospect of attracting private sector investment into one or more town centres;
- Does not cause an adverse impact on one or more town centres, either singly or cumulatively with recent developments or other outstanding planning permissions, sufficient to undermine the quality of the centre or its role in the economic and social life of the community;
- Does not diminish the range of activities and services that a town centre can support;
- Does not cause an increase in the number of vacant properties in the primary retail area that is likely to persist in the long term; and,
- Ensures a high standard of access both by public transport, foot and private car so that the proposal is easily accessible by all sections of society.

Policy Objective Recommendation 14: It is the policy of the Council to protect and enhance the amenities and character of town centres in accordance with the principles of proper planning and sustainable development. The Council will encourage the further improvement and development of commercial, service, social and cultural functions which its town and village centres perform while ensuring the protection of the important heritage and architectural quality of their streetscapes. This will apply to the skyline, shop fronts and advertising structures.

Policy Objective Recommendation 15: It is the policy of the Council to identify under-utilised and obsolete areas for potential renewal and to encourage and facilitate the re-use and regeneration of derelict land and buildings in the county's main towns, villages and smaller centres. The Council will use its statutory powers, where appropriate, to facilitate this and will consider such buildings and lands for inclusion in the Register of Derelict Sites or the Vacant Sites Register.

Policy Objective Recommendation 16: It is the policy of the Council to align, as far as practicable, new retail development with existing and proposed public transport infrastructure and services and encourage access by foot and cycling to reduce the dominance of private car access. Where multiple private car parking of four or more spaces is a feature of any new retail development, developers will be required to provide at least 25% of the total car parking provision for electric vehicles (EVs) including associated charging units, ducting and ancillary infrastructure. Retail development incorporating car parking under spaces will be required to provide at least one EV car parking space including associated charging units, ducting and ancillary infrastructure.

Policy Objective Recommendation 17: It is the policy of the Council to have regard to the principles provided in the Shopfront and Signage Design Guidelines 2021-2027, prepared by Longford County Council and included in Annex 6 of the Longford County Development Plan

2021-2027, and the Retail Design Manual 2012 (Department of Arts, Heritage and the Gaeltacht) in the assessment of any retail development.

5.5 Criteria for the Assessment of Future Retail Development

All applications for significant retail development should be assessed against a range of relevant criteria. The Retail Planning Guidelines for Planning Authorities (2012) provide the main principles for assessing new retail proposals. The Guidelines state that the main planning considerations for retail development include:

1. Location (site selection);
2. Suitability of use (land use zoning and specific policies/objectives);
3. Size and scale (impact, form and design); and
4. Accessibility (access and servicing arrangements).

The Sequential Test

All applications for retail developments at edge-of-centre or out-of-centre locations will be subject to the sequential test, where the following applies:

The Retail Planning Guidelines state that *“the order of priority for the sequential approach is to locate retail development in the city/town centre (and district centre if appropriate), and only to allow retail development in edge-of-centre or out-of-centre locations where all other options have been exhausted. Where retail development in an edge-of-centre site is being proposed, only where the applicant can demonstrate satisfactorily to the planning authority that there are no sites or potential sites including vacant sites/units within a town centre or within a designated district centre that are (a) suitable (b) available and (c) viable, can an edge-of-centre site be considered.*

Where retail development on an out-of-centre site is being proposed, only in exceptional circumstances where the applicant can demonstrate satisfactorily to the planning authority that there are no sites or potential sites either within the centre of a town or designated district centre or on the edge of the town centre that are (a) suitable (b) available and (c) viable, can that out-of-centre site be considered”.

Retail Impact Assessments:

Retail Impact Assessments will be required for significant retail development where due to its scale and/or location, it may impact on the vitality and viability of centres. These assessments will be prepared in accordance with the current Retail Planning Guidelines, which requires an applicant to address the following criteria and demonstrate whether or not the proposal would:

- Support the long-term strategy for city/town centres as established in the development plan, and not materially diminish the prospect of attracting private sector investment into one or more such centres;

- Have the potential to Increase employment opportunities and promote economic regeneration;
- Have the potential to increase competition within the area and thereby attract further consumers to the area;
- Respond to consumer demand for its retail offering and not diminish the range of activities and services that a centre can support;
- Cause an adverse impact on one or more centres, either singly or cumulatively with recent developments or other outstanding planning permissions (which have a realistic prospect of implementation) sufficient to undermine the quality of the centre or its wider function in the promotion and encouragement of the arts, culture, leisure, public realm function of the town centre critical to the economic and social life of the community;
- Cause an increase in the number of vacant properties in the primary retail area that is likely to persist in the long term;
- Ensure a high standard of access both by public transport, foot and private car so that the proposal is easily accessible by all sections of society; and/or
- Link effectively with an existing city/town centre so that there is likely to be commercial synergy.

Traffic and Transport Assessment

A Traffic and Transport Assessment (TTA) may be required for retail developments over a particular threshold (100m²), as set out in the Traffic Management Guidelines 2003, and the Traffic Transport Assessment Guidelines 2007.

A TTA must examine the transport impacts of a proposed development, incorporating any subsequent measures necessary to ensure roads, junctions and other transport infrastructure in the vicinity of the development are adequate to accommodate the proposed development without causing additional delays to existing and future traffic. More importantly, TTA is also important in demonstrating how a proposed retail development incorporates sustainable travel modes.

5.6 Criteria for the Assessment of Different Development Types

Large Convenience Stores

The Retail Planning Guidelines set a 3,000m² retail floorspace cap on food store development outside the four Dublin Authority areas, and the cities of Cork, Limerick/Shannon, Galway and Waterford. This strategy absorbs this requirement, which applies to new stores as well as to extensions to existing retail premises.

Retail Parks and Retail Warehouses

Retail warehouse complexes generally comprise an agglomeration of retail warehouses grouped around a common car park selling mainly bulky household goods. There is an expectation that most of the goods purchased can be transported off-site by the customer and because of this they are generally located on the edge or outside of the built-up urban area.

The key consideration in determining the distribution of floorspace is defining the appropriate and sustainable location for such retail activities. In accordance with the Retail Planning Guidelines there should be a presumption against the further development of out-of-centre retail parks and a preference for sites in or adjacent to town centres to ensure the potential for linked trips and commercial synergy. Key criteria for the assessment of retail warehouse applications include both the scale and design of the development, appropriate vehicular access and the quantitative need for such development. The Retail Planning Guidelines state that individual retail units should not be less than 700sq.m and not more than 6,000sq.m in size. These figures are gross floor area, including storage, garden centres etc. It is essential that the range of goods sold is restricted by planning conditions to bulky household items as those defined within the Retail Planning Guidelines such as household appliances, furniture and furnishings. The proportion of non-bulky goods should be limited to 20% should be clearly delineated on planning application drawings.

Local Shops

Local shops play a vital role in catering for the daily or causal needs of nearby residents or of those passing by. Primarily convenience outlets, they provide a readily accessible service for basic goods, especially for the less mobile members of communities.

Where appropriate, local shops shall be recognised in the relevant parts of the Development Plan, with ample provision for the establishment of other neighbourhood shops and services made in the zoning of additional land for residential development, where necessary.

Retailing and Motor Fuel Stations

Local shops attached to petrol filling stations are a growing sector of the retail market. However, the size of the shop associated with any petrol filling station should take account of the fact that large shops can attract additional custom, large numbers of cars can cause disruption and the preferred location for retailing is in town centres. The Retail Planning Guidelines state that when the size of such retail units is in excess of 100m² the sequential approach should apply.

5.7 Monitoring and Review

The Retail Planning Guidelines advise planning authorities to regularly monitor trends in their areas, and update retail policies and strategies as appropriate. The council acknowledges that the retail sector is one of the most dynamic sectors in the economy and that trends, influences and information can change over time. The Council is therefore committed to monitoring the contents of this strategy to ensure that:

- I. The Retail Strategy and its baseline data are kept as up to date as possible;
- II. Mechanisms that are in place to monitor the progress of the strategy are appropriate and fit for purposes over its lifetime; and
- III. The Council can intervene in a positive and timely manner through a variation to the Development Plan in order to address changing circumstances, as considered necessary.

6. CONCLUSION

The Longford County Retail Strategy 2021-2027 has been prepared for Longford County Council in accordance with the requirements of the Retail Planning Guidelines, 2012. The policy recommendations formulated as part of this Retail Strategy will form a key input into the overall planning policy framework

In compiling this Retail Strategy, due regard has been had to the most up-to-date information regarding population growth projections, the prevailing economic outlook, current retail trends and retail sales information. This has been used to provide a firm basis on which to inform future policy direction with the aim of enhancing and developing the retail offering of Co. Longford including the principal settlement Longford Town, other main settlements to smaller settlements, prioritizing the vibrancy of the town centre including its redevelopment and revitalisation where possible.

Annex 10:

Mid Shannon Wilderness Park



Mid Shannon Wilderness Park



Donall Mac An Bheatha, Senior Planner.

Sean Savage, GIS Officer,

Sylvia Smith, Technician.

Longford County Council, September 2013. (Report reviewed and updated 2020)

Contents

1.	Introduction.....	3
1.1	Mid Shannon Wilderness Park.....	3
1.2	Bord Na Móna and Cut Away Bogs.....	3
1.3	Tourism and Biodiversity	4
2.	Future of the Longford Bogs.....	4
2.1	Draft National Peatlands Strategy 2014	4
2.2	Bord Na Móna Bogs	6
	Map 1 Bord na Móna Bogs. Map 2: Longford/Roscommon Bogs and Shannon	6
2.3	Corlea Archaeological Project	7
3.	Mid Shannon Wilderness Park - Major Tourism Initiative.....	9
3.1	Amenity Potential of Mid Shannon Wilderness Park.....	10
	Map 3: Potential Mid Shannon Wilderness Park	12
	Map 4: Potential Walking Cycling Routes in Mid Shannon Wilderness Park.....	13
4.	An Ecotourism Project	14
4.1	Biodiversity.....	15
4.2	Nature conservation and biodiversity corridors	16
5.0	Timeframe for Mid Shannon Wilderness Park	17

1. Introduction

1.1 Mid Shannon Wilderness Park

The Mid Shannon area of Longford in the Republic of Ireland is a little known lake, river, forest and bog area that supports a rich and diverse range of flora and fauna, archaeological monuments and traditional cultural practices. This report sets out a proposal to develop a Mid Shannon Wilderness Park in County Longford.

The Park will be located between the Royal Canal and Lough Ree on the River Shannon. Much of the land involved is in State ownership. The development of such a large amenity park in Longford would provide the Midlands and Ireland with a major tourism attraction of international importance.

The development of a Mid Shannon Wilderness Park in Longford will combine existing natural amenity areas. These areas include Lough Ree, the Rivers Shannon, Inny and Camlin, the Royal Canal, Newcastle Wood and other forests and the future rehabilitated Bord na Móna bogs. All of these amenity areas are in very close proximity to each other and can be developed and combined to create the Wilderness Park. The Park would be developed in partnership between the various owners particularly Bord na Móna, local communities and Longford County Council.



Pic 1: Mid Shannon Wilderness Park, Lough Ree from Athlone looking North.

1.2 Bord Na Móna and Cut Away Bogs.

Bord na Móna has now completed its peat extraction work on the Longford and Roscommon bogs and has begun to plan for their future use. This will include carrying out rehabilitation work to create semi natural landscapes which will produce potentially valuable amenity lands. It is now proposed for existing local communities and Longford County Council to partner with Bord na Móna and collaborate in developing new amenity

uses for the cutaway bogs. This will not conflict with any future intention of Bord na Móna and its potential future use of the bogs. The amenity use of the rehabilitated bogs can be compatible with any future use for the bogs such as renewable energy projects.

1.3 Tourism and Biodiversity

The Mid Shannon Wilderness project aims to strengthen the integration of tourism and natural heritage, and to reconcile tourism development with conservation of biodiversity. It aims to secure environmental protection and sustainable visitor management through the creation of an innovative methodology that is of value to local communities. In European terms, the objective is to improve the environmental performance of the area and promote strategic integrated planning approaches for improving the use of land.

The aim of the project is to contribute to Ireland's and EU biodiversity objectives through the integration of tourism and biodiversity. The project will support the EU's promotion of sustainable, responsible and high-quality tourism. The project will also stimulate a heritage community within its local partnership and enrich the heritage of the area. Finally, it will support the European landscape convention through the tourism conservation actions carried out on the fragile landscape of the area.



Pic No. 2 Typical Longford Mixed Bogland.

2. Future of the Longford Bogs.

2.1 Draft National Peatlands Strategy 2014

The recently published Draft National Peatlands Strategy 2014, produced by the National Parks and Wildlife Service advocates the following partnership approach:

'NPS V 16 Responsible management of peatlands will require collaboration and partnership between land-owners, communities, public authorities, commercial organizations and non-governmental organizations. This Strategy aims to ensure that appropriate supports, structures, funding mechanisms and regulatory frameworks are in place to allow such partnership to develop.'



Pic. 3 Bord na Móna Bog

The following after use principles for cut away bogs are set down by the Draft Strategy:

NPS P 13 Bord na Móna will continue to assess and evaluate the potential of the company's land bank, using a land use review system. The assessment will help prepare a set of evidence based management plans for the various areas of peatland. These plans will also inform its cutaway bog rehabilitation programme.

NPS P 14 The policy of Bord na Móna is not to open up any undrained new bogs for peat production.

NPS P 15 Lands identified by Bord na Móna as having high biodiversity value and/or priority habitats will be reserved for these purposes as the principal future land use.

NPS P 16 Generally, Bord na Móna cutaway bogs that flood naturally will be permitted to flood unless there is a clear environmental and/or economic case to maintain pumped drainage.

NPS P 17 An examination of all publicly owned lands and privately owned cutaway will be undertaken with a view to identifying appropriate uses, which will aim to harness their potential to contribute to Ireland's environmental, ecological and economic wealth, with particular emphasis on mitigating carbon losses.

NPS P 18 In deciding on the most appropriate after use of cutaway peatlands, consideration shall be given to encouraging, where possible, the return to a natural functioning peatland ecosystem. This will require re-wetting of the cutaway peatlands which may lead in time to the restoration of the peatland ecosystem.

NPS P 19 Environmentally, socially and economically viable options should be analysed to plan the future use of industrial cutaway peatlands, in conjunction with limiting factors as outlined in Bord na Móna's Strategic Framework for the Future Use of Peatlands.

NPS P 22 The work of Bord na Móna, Coillte and the Irish Peatlands Conservation Council in developing ecologically rich futures for cutaway and formerly forested bogs will be developed. Such areas can bring new tourism and recreation attractions to the midlands and the west.

The use of the Longford Bogs for amenity purposes as part of the Mid Shannon Wilderness Park among other potential uses clearly ties in with the above principles.

2.2 Bord Na Móna Bogs

Longford contains a large portion of bogs many of which are owned by Bord Na Mona.



Map 1 Bord na Móna Bogs.



Map 2: Longford/Roscommon Bogs and Shannon

It is envisaged that overtime as the cutaway bogs are worked out one of the options under consideration by Bord na Móna is that certain bog areas would return to a natural type environment. These natural environment areas could then, in association with Lough Ree and the Shannon, the Royal Canal, and River Inny etc, form part of a proposed Mid Shannon Wilderness Park. The use of the bogs for other purposes such as renewable energy can be achieved in a compatible manner. The large national resource that the Bord na Mona Bogs are can continue to be developed to provide employment and wealth creation opportunities in the national and local interest including for tourism and amenity purposes.



Pic 4: Rehabilitated and re-colonised bog.

As well as the rehabilitated bogs, rivers and lakes, existing facilities and attractions can be utilized to enhance the attractiveness of the Mid Shannon Wilderness Park. Facilities such as the Corlea Visitors Centre, the ISPCA Animal Refuge, Commons North Park at Lanesborough, Barley Harbour, Newcastle House and wood, Clondra Harbour and Strokestown House etc. already exist and only require a minor amount of refocusing to fit into the broader picture of presenting and creating the Park.

As the Nation Peatland Strategy has recommended the future responsible management of peatlands will require collaboration and partnership between land-owners, communities, public authorities, commercial organizations and non-governmental organizations. The Mid Shannon Wilderness Park aims to ensure that the involvement and co-operation of local communities, Longford County Council and Bord na Móna are in place to allow such partnership to develop.

2.3 Corlea Archaeological Project

There is now a proposal to develop a new Corlea Archaeological and Biodiversity Project. This can be added to in time with the Royal Canal Walking/Cycling Route and the Mid Shannon Wilderness Park to provide the various communities and villages of South Longford with wonderful amenity facilities and tourism infrastructure. It will also encourage visitors to the area especially of the walking and cycling variety. This will help the area to build a more sustainable ecotourism base which will in turn provide economic benefits to the area.



Pic. 5 Corlea Visitor Centre.

Keenagh Community Group now has the agreement of Bord na Móna to develop approximately 12 acres of cutaway bog near Corlea Centre for a recreated Archaeological Iron age type settlement and to present the developing Biodiversity of a rehabilitated cutaway bog. This area has its own existing car park and shall be initially linked back to the centre and Keenagh by a dedicated walking route along the public road. This project will be developed in 2014/5. An important aspect of the proposal is that it be delivered in a very cost effective manner requiring minimal resources in input from the various bodies involved.

The above proposed walking trails and the Corlea Centre have the potential to be linked with the adjoining Royal Canal in the period 2014/15. This will facilitate boating, walking and cycling visitors coming from Dublin and the East and travelling to the West via Longford and the Shannon to visit both Longford and the Corlea Centre.



Pic. 6+ 7: Boating, Walking and Cycling on the Royal Canal.

As the portion of bog immediately adjoining the Corlea Project site is worked out and rehabilitated by Bord na Móna it is hoped to develop an additional area of bog with a direct link back to the Corlea Centre. This would provide dedicated walking trails through the bog presenting the developing biodiversity. It is expected that a portion of the low lying bog shall be re-watered and colonized with appropriate native plants, birds and fish. The timetable for this portion of the project to be achieved is expected to be between 2020-2025.



Pic. 7: Biodiversity of a Bog.

Corlea Project Update July 2020 – the project is substantially complete.

Keenagh Community Group in 2014 got the agreement of Bord na Móna to develop approximately 70 acres of cutaway bog near Corlea Trackway Centre for a restored and developing area of rich Biodiversity and rehabilitated cutaway bog.

In 2018 Corlea Archaeological and Biodiversity Project was officially opened. This now consists of 100 acres of cut away from renatured, a greenway developed connected with the Royal Canal greenway to give national access thus providing the various communities and villages of South Longford with a wonderful amenity facility and tourism infrastructure.

It has already begun to attract visitors to the area especially of the walking and cycling variety. This is helping the area to build a more sustainable ecotourism base which will in turn provide economic benefits to the area.

3. Mid Shannon Wilderness Park - Major Tourism Initiative.

The project has a wide ranging scope, benefiting visitors to the area, local communities, schools as well as improving the wider tourism attractions of Longford and the Midlands. The Corlea proposal is a stand-alone project that represents a first step in a broader development proposal for the gradual conversion of parts of the cutaway bogs in Longford to Biodiversity Parks. These emerging Biodiversity Parks could then be linked with the Shannon, Lough Ree and the Royal Canal to create a Mid Shannon Wilderness Park.



Pic. 8: Lough Ree wilderness.

When the bogs have been worked out by Bord na Móna over the next 10/20 years one of the options under consideration is that they be used as Nature and Biodiversity locations. The existing bog rail tracks could then be utilized as additional walking/cycling tracks to increase the network through the emerging Mid Shannon Wilderness Park (See below) linking with the ISPCA Animal Refuge at Derryglogher and on to Lough Ree at Lanesborough and Newtowncashel. Indeed, it may also be possible to link a walking/cycling route from Dublin through Longford and across the Shannon to Strokestown, Roosky and on to Westport and Sligo.



Pic. 9: Bord Na Móna bridge at Lanesborough.

3.1 Amenity Potential of Mid Shannon Wilderness Park

The development of the Royal Canal as a primary Walking/Cycling route from Dublin through Longford to the West can connect in with routes across the cutaway bogs and the Shannon to the Mayo and Sligo roads. The crossing of the Shannon could use the existing Bord Na Móna rail bridge at Lanesborough which would provide a traffic free crossing point. Indeed, it is possible to Link Dublin through to Roscommon via the Royal Canal in a completely vehicular traffic free environment. This would create a major piece of amenity infrastructure across the Midlands of international importance.



Pic. 10: Boating on the Royal Canal.



Pic. 11: Fishing and Horse riding.



Pic. 12: Walking on the bogs and boating on Lough Ree.

The opening up and development of the Mid Shannon area as proposed above would facilitate the promotion of Tourism and Recreation activities in the area. The usage of the beautiful natural amenities of the area such as lake, river, wood and bog would increase. The level of activity and visitors to the area would increase and this in turn would create local enterprises and additional employment in South Longford.

Mid Shannon Wilderness Park

Mid Shannon Wilderness Park including Lough Ree, the Shannon, the Bogs and the Royal Canal.



Map 3: Potential Mid Shannon Wilderness Park

Mid-Shannon Wilderness Park

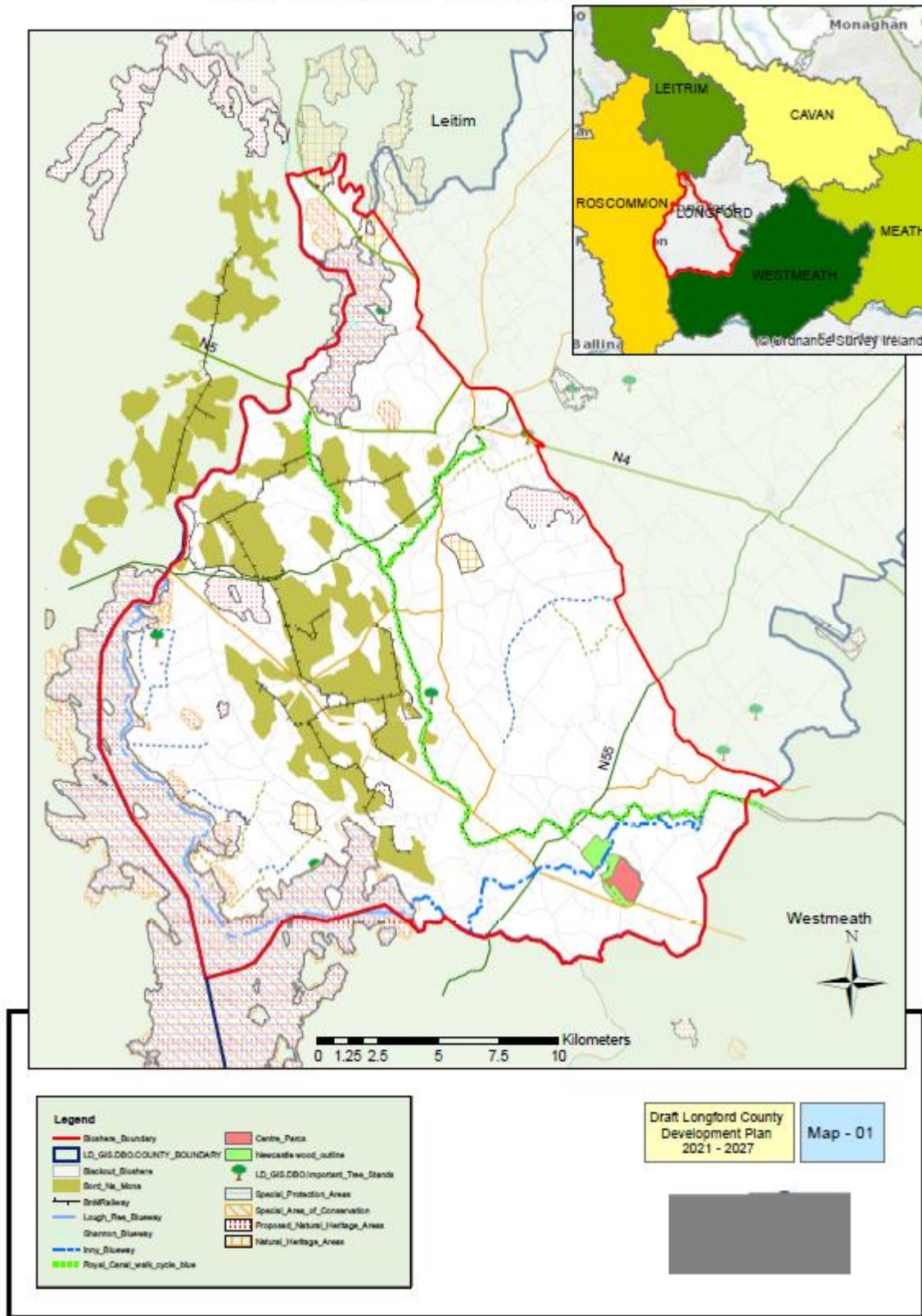

Map 4: Potential Walking Cycling Routes in Mid Shannon Wilderness Park.

The development of the Mid Shannon Wilderness Park in Longford would provide a major amenity and tourism facilities for the Midlands. The plans for the Park and the Corlea project will be sympathetic with any future uses and the conservation and biodiversity action plan of Bord na Móna. It is also intended to develop these projects in a sustainable manner bearing in mind the rich cultural and natural heritage resources of the area. The principles of Ecotourism providing for a destination with a set of standards based on sound environmental practices highlighting all that the region and its people has to offer will guide the development of the project.



Pic. 13: Forest Walks

4. An Ecotourism Project

It is intended to use the principles of Ecotourism in the development of the Mid Shannon Wilderness Park and the Corlea Project. There is an established criterion which must be met in order to qualify for the ecotourism label. These cover a wide range of practices in eight key components of ecotourism as follows:

- Environmentally sustainable practices
- Natural area focus
- Interpretation and Education
- Contributing to Conservation
- Benefiting local Communities
- Visitor Satisfaction
- Responsible Marketing and Communication
- Cultural Awareness and Respect

The Mid Shannon Wilderness Park and the Corlea Project will incorporate these principles. By meeting and possibly exceeding the above, the project will indicate its dedication to educating the visitor and tourist about the native natural world and local culture. This environmentally innovative and socially responsible project will have a very positive impact on the environment and local communities.



Pic. 14: Amenity Sign Boards for Wilderness Park

4.1 Biodiversity

Biodiversity specifically relates to the diversity of habitats, species and genetic diversity of species in the world around us from insects in the soil, to extensive woodlands, to the animals that inhabit them. Since the 1990s, Bord na Móna has adopted a programme of enhancement of biodiversity which has become closely linked to the after-use and rehabilitation of cutaway bogs.

The Corlea proposal follows the Bord na Móna programme in utilizing this proposed portion of cutaway bog to allow for the rehabilitation and re-colonisation of the bog. Re-colonisation of the bogs following peat production leads to establishment of a mosaic of habitats and species, some of which are considered rare and restricted in distribution in Ireland. The Corlea Project shall present the history of the development of the bogs, the rehabilitation programme and the developing biodiversity resource as educational tours to the visiting public.



Pic 15: Typical Bord na Móna rehabilitated and re-colonised Bogs.

The proposed biodiversity trail will tell the story of Irish peatland’s past, present and future possibilities. The cutaway bogs around Corlea which have been harvested by Bord na Móna for energy since the 1940s can be established as unique and welcoming habitats for a wide range of flora. The trail will also go through rejuvenating peat land and woodland areas of the Park and cover topics such as peat land formation, woodland ecology, native plants and animals, renewable energy and animal and plant identification.

Vital to enhancing our national biodiversity resource is the wise use and management of cutaway bogs and related lands, and creating awareness of the local, national and regional value of biodiversity of peatlands.



Pic 16: Typical rehabilitated bogs with scrub, heather and rushes.

4.2 Nature conservation and biodiversity corridors

In recent years Bord na Móna has been attempting to give due care to nature conservation and to retaining biodiversity corridors within their national bog network to sustain important refuges for peatland flora and fauna. This is a key requirement of Article 10 of the Habitats Directive. Rehabilitation of the cutaway bogs generally involves measures to accelerate re-vegetation, through activities such as drain blocking to create wetlands, and other targeted practices such as tree planting.





Pic 17: Flora and Fauna

Rehabilitation allows for the expansion of biodiversity back onto the bogs and the creation of diverse and valuable wildlife reserves. It is envisaged that, overtime, as the cutaway bogs are worked out that they will be properly managed to return to a natural type environment and may form part of a proposed Mid Shannon Wilderness Park.



Pic 18: Re-watered cut away bog by Bord na Móna

5.0 Timeframe for Mid Shannon Wilderness Park

The following time frame is proposed to deliver the various projects related to the development of the Mid Shannon Wilderness Park. Over the next ten years it is hoped to deliver various elements of the project building up to the final achievement

Table 1. Timeframe for projects.

Timetable	Project	Status
2014	Corlea Visitor Centre existing. Lough Ree and Royal Canal existing	Complete
2014/2015	Corlea Archaeological & Biodiversity Project	Complete
2015/2016	Corlea link with the Royal Canal	Complete
2015/2020	Project link across the bog top the Corlea Centre	Complete
2015/2020	Local communities to take responsibility for the local area of Bog in association with Longford County Council	Complete
2015/2018	Royal Canal walking / cycling route connecting Dublin to Clondra	Complete
2015/2030	Mid Shannon Wilderness Park	To be completed



**'I will arise and go now, for always night and day
I hear lake water lapping with low sounds by the shore;
While I stand on the roadway, or on the pavements gray,
I hear it in the deep heart's core. '**

Lake Isle of Innisfree, W. B. Yeats.

Annex 11:

Landscape Character Assessment

ANNEX 11: LANDSCAPE CHARACTER ASSESSMENT

Please note the Landscape Character Assessment was prepared as part of the Longford County Development Plan 2015-2021. Any references within the document, pertaining to the previous Development Plan, National Spatial Strategy and previous Regional Planning Guidelines are superseded by the Longford County Development Plan 2021-2027 Chapter 14 Landscape Character Assessment.

The Landscape Character Assessment remains the valid document for the assessment of landscape within the County. The County Development Plan 2021-2027 in Chapter 14 Landscape Character includes a Policy Objective reference CPO 14.2; to review and update the Landscape Character Assessment of the County during the lifetime of the Plan in the context of updated population figures and to include the latest national and regional guidance as indicated below:-

<i>CPO14.2</i>	<i>Review in the context of a regional approach to landscape assessment, the County Landscape Character Assessment following publication of statutory guidelines for Planning Authorities on local Landscape Character Assessments, as outlined in the National Landscape Strategy 2015-2025.</i>
----------------	---

Table of Contents

1.	INTRODUCTION AND CONTEXT	5
1.1	Scope	5
1.1.1	Purpose and Aims	5
1.1.2	Stakeholder Input	6
1.2	Methodology	6
1.2.1	Desk Study	6
1.2.2	Field Survey	6
1.3	Current Landscape Policies	6
1.3.1	National Spatial Strategy	6
1.3.2	Midland Regional Planning Guidelines	7
1.3.3	Longford County Development Plan 2015-2021	9
1.3.4	Conclusion	10
2.	LANDSCAPE CHARACTER	11
2.1	County Overview	11
2.1.1	Landform	11
	(a) Topography	12
	(b) Geology and Soils	12
	(c) Drainage patterns	16
2.1.2	Landcover	17
2.1.3	Human Influence	18
	(a) Settlement pattern	18
	(b) Agriculture	19
	(c) Forestry	20
	(d) Archaeology	21
	(e) Culture	21
2.2	Landscape Character Units	22
	Landscape Unit 1 – Northern Drumlin Lakeland	24
	Location and Physical Characteristics	24
	Landcover	24
	Topography	24
	Geology/Soils	25
	Drainage patterns	25
	Human Influence	25
	Settlement pattern	25
	Transport and Communications	26
	Agriculture.	26
	Industry and services	26
	History, Archaeology and Culture	27
	Recreation and Amenity	27
	Landscape Sensitivity	27
	Threats	27
	Opportunities	27
	Policy Responses	27
	Landscape Unit 2 – Northern Upland	28
	Location and Physical Characteristics	28
	Landcover	28
	Topography	29
	Geology/Soils	29
	Drainage patterns	29
	Human Influence	29

	Settlement pattern	29
	Transport and Communications	30
	Agriculture.	30
	Industry and services	31
	History, Archaeology and Culture	31
	Recreation and Amenity	32
	Landscape Sensitivity	32
	Threats	32
	Opportunities	32
	Policy Responses	32
	Landscape Unit 3 – Shannon Basin/Lough Ree	33
	Location and Physical Characteristics	33
	Landcover	33
	Topography	33
	Geology/Soils	34
	Drainage patterns	34
	Human Influence	34
	Settlement pattern	34
	Transport and Communications	35
	Agriculture.	35
	Industry and services	35
	History, Archaeology and Culture	35
	Recreation and Amenity	36
	Landscape Sensitivity	36
	Threats	36
	Opportunities	36
	Policy Responses	36
	Landscape Unit 4 – Central Corridor	37
	Location and Physical Characteristics	37
	Landcover	37
	Topography	37
	Geology/Soils	38
	Drainage patterns	38
	Human Influence	38
	Settlement pattern	38
	Transport and Communications	38
	Agriculture.	38
	Industry and services	39
	History, Archaeology and Culture	39
	Recreation and Amenity	39
	Landscape Sensitivity	39
	Threats	39
	Opportunities	39
	Policy Responses	40
	Landscape Unit 5 – Inny Basin	41
	Location and Physical Characteristics	41
	Landcover	41
	Topography	41
	Geology/Soils	41
	Drainage patterns	41
	Human Influence	42
	Settlement pattern	42
	Transport and Communications	42

	Agriculture.	42
	Industry and services	42
	History, Archaeology and Culture	42
	Recreation and Amenity	42
	Landscape Sensitivity	42
	Threats	43
	Opportunities	43
	Policy Responses	43
	Landscape Unit 6 – Peatlands	44
	Location and Physical Characteristics	44
	Landcover	44
	Topography	44
	Geology/Soils	44
	Drainage patterns	44
	Human Influence	45
	Settlement pattern	45
	Transport and Communications	45
	Agriculture.	46
	Industry and services	46
	History, Archaeology and Culture	46
	Recreation and Amenity	46
	Landscape Sensitivity	46
	Threats	47
	Opportunities	47
	Policy Responses	47
	Landscape Unit 7 – Open Agricultural	48
	Location and Physical Characteristics	48
	Landcover	48
	Topography	48
	Drainage patterns	49
	Human Influence	49
	Settlement pattern	49
	Transport and Communications	50
	Agriculture.	51
	Industry and services	51
	History, Archaeology and Culture	51
	Recreation and Amenity	51
	Landscape Sensitivity	51
	Threats	51
	Opportunities	51
	Policy Responses	52
2.3	Identification of Visual Units	53
2.4	Identification of Image Units	53
3.	LANDSCAPE VALUES	54
4.	LANDSCAPE SENSITIVITY	55
	APPENDIX 1	56

1. INTRODUCTION AND CONTEXT

This document has been prepared with reference to the Draft Landscape and Landscape Assessment Guidelines for Local Authorities as issued by the Department of the Environment in June 2000¹ (hereinafter referred to as “the guidelines”). As the guidelines are still in draft format, extensive study was carried out into the area of character assessment, and this document draws heavily on recent works throughout the country and the UK. The publication “Landscape Character Assessment – Guidance for England and Scotland”, released by the Countryside agency and Scottish Natural Heritage was used extensively due to its compatibility with the draft guidelines.

An emphasis on landscape *Character* was maintained in the formulation of this assessment. Character represents the individuality of an area based on its particular combination of features and elements. This approach contrasts with the evaluation method, which rates one particular landscape against another.

In order to formulate an effective development management and policy-making tool, the scope of the assessment must first be defined.

1.1 Scope

1.1.1 Purpose and Aims

One of the primary aims of the completed assessment is to inform the policy formulation and decision-making process in relation to the siting, design and material content of new developments.

This process is interlinked with policy documents at a national regional and local level and it is an aim of this assessment to translate the essence of these documents into a workable local context, including the following:

- National Spatial Strategy
- Government Guidelines on sustainable rural housing, location and siting of windfarms,
- mobile phone antennae and support structures, quarries etc.
- Midland Regional Planning Guidelines
- Longford County Development Plan
- Longford County Heritage Plan
- Local Area Plans and Village Policy Statements

While it is an accepted fact that the landscape is not a static entity, the level and direction of change, which is deemed acceptable over a period of time, must be

¹ It is recognised that during the statutory plan preparation period, revised guidelines were issued in June 2014 by the Department of Arts, Heritage and the Gaeltacht entitled “A Draft National Landscape Strategy for Ireland 2014 – 2024”. However, in line with the statutory requirements of the Planning and Development Act 2000 (as amended) it was not within the scope of the prescribed timeframes to facilitate the consideration of these revised guidelines at that point in the County Development Plan process.

ascertained in order to facilitate effective and efficient development control and environmental maintenance systems.

The methodology involved in this process will produce a clear, concise and transparent background for landscape preservation, conservation and enhancement policies for the county, through the use of existing material such as soil data, landcover information and hydrological sensitivity. This will be combined with information from the public, such as the areas and places within the County that form the building blocks of its unique identity and existing policy at all levels throughout the planning process.

1.1.2 Stakeholder Input

The aim of this assessment is to identify, and attempt to quantify, the landscape attributes that make Longford unique. As such, stakeholder input is a basic element of this document.

1.2 Methodology

1.2.1 Desk Study

The initial investigation involved study of available material on the natural factors that influence the landscape. This included information on geology, landform, drainage, soils, landcover and vegetation. Cultural factors such as land use, settlement patterns and the change over time of these factors were also studied and mapped. This resulted in the landscape character types and areas in the following chapters.

1.2.2 Field Survey

The landscape types and areas derived from the desk study were then analysed in the field, whereby aesthetic and perceptual aspects, perceived character and individual condition and potential sensitivity were assessed.

These components were then classified, resulting in maps defining character types and areas, which are then described, and the key characteristics of each area identified.

1.3 Current Landscape Policies

This section details the various national and local policies that relate to the landscape at present.

1.3.1 National Spatial Strategy

The NSS refers to the Midlands as a rural area that is changing and calls for policy responses that support communities where agriculture is under stress through promoting diversification in enterprise, local services and tourism. Reference is made to the protection of landscape, water resources and habitats in order to support this policy response.

Conservation of cultural identity is an important element in the development of rural areas and includes the protection of natural and other heritage resources.

Rural areas are considered in terms of a national resource, including natural environment, landscape and natural heritage, which are essential to underpin strengthened rural economies and the national economy. Resources referred to are agricultural land, water resources forestry and landscape quality.

In relation to the broad strategy for the Midlands region, the NSS identifies the rural areas to the south of Longford and north of Granard as rural areas with strong potential for diversification. The area to the north of Longford and north and east of Ballymahon is identified as having village strengthening and rural area opportunities. The central area, taking in Longford and Edgeworthstown, is defined as a broad national transport corridor.

The importance of unspoilt landscapes and inland waterway networks in the Midlands region and the accessibility of these areas to Dublin is recognised in terms of its future potential to complement the agricultural sector with additional tourism and recreational activity. The potential for the worked out bogs to be utilised in the production of wind energy with ancillary manufacturing servicing and development activities is also noted.

1.3.2 Midland Regional Planning Guidelines

The following is the vision for the Midlands region upon which the policy framework contained in the guidelines is based:

By 2022, the Midland Region will be a successful, sustainable and equitable region full of opportunities for its expanded population achieved through:

- *Enhancing the critical mass of the region by combining the strengths of the linked gateway of Athlone, Tullamore and Mullingar, as envisaged in the NSS with those of the principal towns of Longford and Portlaoise.*
- *Developing the full potential of rural areas in the region in a manner that is compatible with the strengthening of the urban structure of the region.*
- *Offering a distinctive lifestyle rooted in a high quality living environment, rich in heritage and landscape value.*
- *Harnessing the central geographical location of the region at the “heart” of Ireland with more interregional links than any other region in Ireland, to build a strategically focused network of transport and communications links.*
- *Ensuring that the natural environment of the region such as water quality, landscape, and biodiversity is protected, maintained, and enhanced, where appropriate, as a basis for future sustainable development in the region.*

The vision outlined above relates strongly to the landscape of the area as both an entity where the functions required to drive the region take place and also a strong element of the culture and identity of the region that sets it apart from other areas in the Country.

Chapter 3 deals with the development of rural areas in the region and Section 2 of the guidelines outlines the strategic goals and Planning Considerations for the Region.

Goal 11 is of particular relevance in terms of the development of rural areas and landscape implications:

To develop and market a distinctly unique image and identity for the region that will attract investment and economic activity to the region.

The development of the image of the region as the heart of Ireland, an area with a high quality of life in a relatively unspoilt environment, will rely on the continued protection and enhancement of valuable natural resources (such as agricultural land, and amenities such as the lakes, rivers, canals, bogs and uplands) and the built heritage of the region. The preservation of the environmental integrity, water and air quality and the visual environment, will play an important role in maintaining this image which is vital for the attraction of investment and population growth.

Longford County is located in the northern development area as defined by the guidelines, for which the following specific development proposal has been included

Focused promotion and marketing of the natural heritage and cultural resources of the area and its associated high quality of life, which is vital for its development and a valuable contribution towards the identity of the region as a whole.

The following common spatial issues are relevant to the development of landscape policy and are outlined in Section 7:

Environmental Issues

The midlands have specific environmental advantages that can be brought together in order to foster a unique green image for the region. The recommendations under each issue aim to promote and strengthen awareness of the high quality of life that exists in the region and how this can be maintained in tandem with enhanced economic growth.

Agriculture

The future development of agriculture in the region should take cognisance of the following issues:

- *Existing strong agricultural areas should be prioritised for development in this sector.*
- *Diversification of agriculture should be promoted to revitalise the social and economic climate in rural communities, particularly in areas of marginal land.*
- *Targeted promotion of agricultural activities should take place in areas where conditions are best suited for individual specialities, e.g. arable farming in the south, cattle fattening enterprises in central area etc. Land that is agriculturally important should be protected from inappropriate development.*
 - o *Industrial development should be promoted in appropriate rural areas.*
 - o *Environmentally sustainable agricultural practices should be promoted.*

Waterways

Policy should be formulated in relation to inland waterways, taking account of the following issues:

- *The leisure and amenity potential of the inland waterways of the region should be investigated and promoted where appropriate, particularly in line with the tourism industry.*

- *Re-opening of canals and connections between them should be prioritised as a major element in the identity and tourism potential of the region.*

Bogland

The following issues should be considered:

- *Alternative uses for cutaway and cutover boglands should be investigated, particularly in relation to the alternative and renewable energy industries.*
- *The prominence of boglands in the social, economic and cultural development of the region and as a defining element in its identity should be recognised and promoted.*

Forestry

The following issues should be considered in formulating forestry policies:

- *Deciduous forestry should be promoted as an alternative land use in suitable areas of land, particularly in areas of agricultural decline.*
- *The amenity and leisure and other spin-off industrial potential of forestry should be promoted in tandem with afforestation or re-afforestation plans.*

Natural and Built Heritage

In summary, to capitalise on the heritage assets of the region, the following issues should be considered:

- *Common heritage themes should be utilised to promote and market an identity for the region, for its internal population and in terms of the tourist industry.*
- *Heritage elements should be protected through a co-ordinated effort between all four planning authorities to ensure consistency of approach.*

Extractive Industries

Extractive industries are based on a finite resource that needs to be managed in a sustainable manner, taking account of the following aspects:

- *Extractive industry should be monitored in line with best practice Guidelines issued by the industry.*
- *The importance of the aggregates industry to ensure an adequate supply of aggregates to implement infrastructure under the NDP is acknowledged, as is the requirement to protect this non-renewable resource.*

1.3.3 Longford County Development Plan, 2015-2021

The County Development Plan outlines several landscape policies in relation to landscape, which are mainly contained in Section 6. Additional policy areas including the settlement strategy at Section 2.1.6 and rural areas at 2.1.6.5 and 3.2.2 also outline policies in relation to landscape and environmental protection.

Section 3.2.2 relates to sustainable rural policy, including the aims of minimising the negative impacts of development on agriculture and the landscape and minimising the spread of urban generated rural housing around existing pressure areas and sensitive landscapes.

Policy WS6 contains policy to restrict and curtail development in areas of known aquifer vulnerability.

Annex 3 refers to the proposed design guidelines – it is proposed that this landscape character assessment will inform the formulation of the design guidelines; therefore, the preparation of both documents should be carried out in tandem. It should be noted design guidelines have also been prepared and are in form.

Section 3.2.2.1, policy HOU RUR 1 deals with the suitability of a development in terms of the sensitivity of the rural area.

Policies HOU RUR 2, 3 and 4 deals with the sustainability of rural houses based on those who intend to reside in them.

Section 4.5 deals with tourism policy, which includes the extension of amenities, water based and walking in particular. Several areas are listed as base locations for the utilisation of specific natural resources while protecting them from unacceptable degradation as a result of their usage.

Chapter 6 states that the planning Authority will control development in protected areas – scenic views and prospects, ridge lines, broad zones of the lakes, European sites- where this has the potential for negative impacts on the scenic, heritage and cultural assets of the County.

Chapter 6 deals with environment and amenities and issues such as sustainability, prevention of pollution, litter, conservation and protection of heritage and amenities and recreational amenities. Sections 6.1 and 6.2 are possibly of most relevance to this document. The chapter covers policy on the conservation and preservation of monuments, Archaeological, architectural and heritage objects, flora, fauna and wildlife habitats, landscapes and inland waterways, geology, gardens and parks. European sites are listed in section 6.2.2. of the Plan.

1.3.4 Conclusion

The policies outlined above set a clear and positive framework for the protection and enhancement of landscapes in County Longford and the natural resources, cultural heritage and social identity that lies within and arises from them.

2. LANDSCAPE CHARACTER

Character can be defined as a distinct, recognisable and consistent pattern of elements in the landscape that makes one landscape different from another. Landscape character assessments differ from landscape evaluations in that they attempt to *classify* landscapes on their individuality rather than defining one as better as or worse than another.

Landscape can be defined as embracing all that is visible when looking across an area or areas of land. Longford County has a varied and diverse landscape for its small physical size. The upland areas of the northern county contrast sharply with the gently undulating pastoral land of the south and south east, the flat clear views over the Shannon wetlands to the river to the west, Lough Ree to the south-west, and the acres of boglands, wetlands and woodlands throughout the County.

The landscape of the County is not only important in the attraction of tourists, as has been the major emphasis on landscape preservation in the recent past. The distinctive topography, landcover and landscape elements of the County lend its population and communities a sense of identity and belonging. The aim of landscape character assessment is to identify the elements of the landscape which create this uniqueness and the extent to which it is possible to alter these landscapes before unacceptable consequences arise. The following are examples of such consequences:

- Unacceptable degradation of environmental quality, as in the case of pollution of potable water supplies/fish kills etc.
- Loss of irreplaceable archaeological artefacts.
- Loss or fragmentation of important natural habitats.
- Irreparable damage to architectural heritage.
- Privatisation of access to lakes, rivers, heritage items and scenic areas.
- Visual destruction of important areas that are recognised as fundamental elements in the identity of the county.

The guidelines propose that all Local Authorities classify the landscapes in their area according to their character, values and sensitivity. The character is defined as a product of landform and landcover, including vegetation and land-use.

Every act of development changes a landscape. This change can be positive, neutral or negative. It is government policy that in deciding for or against development that the appropriateness of that development within the given landscape context, as defined by this landscape character assessment, be considered.

2.1 County Overview

2.1.1 Landform

Landform is concerned with the spatial and formal arrangement of landscape components as a natural product of geological and geomorphological history.

(a) Topography

The topography of the County can be roughly divided into three types; flat wetlands in the basins of the Shannon and Lough Ree to the south and southwest, the Inny to the northeast and central peatland areas of the County.

The north and northwest is characterised by typical drumlin topography, with the southeast distinguished by the gently undulating limestone pastureland of the Irish Central Plain.

(b) Geology and Soils

Much of the underlying geology of the County is predominantly carboniferous limestone. Ordovician and Silurian shales intrude to the northeast. The bedrock geology of the County is illustrated in greater detail in the accompanying geology map. However, there is no absolute data on the drift/surface geology that occurs within the County. The Geological Survey Ireland (GSI) hopes to conduct a full study of the County, including details on the surface geology, which will be available in 2009-2010. This data will allow for a more detailed characterisation and description of the evolution of landscape character within the County.

A layer of glacial till overlies this geology and has been moulded in places to form Drumlins. This geology results in moderately well drained clay loam soils over much of the County, with bands of poorly drained clay loam and an associated fringe of poorly drained silting clay loams with inter drumlin peats to the north of the county.

To the west of the county lie vast expanses of basin peat with some marshland. Some of the lands adjacent to Lough Ree are comprised of shallow, well-drained loams.

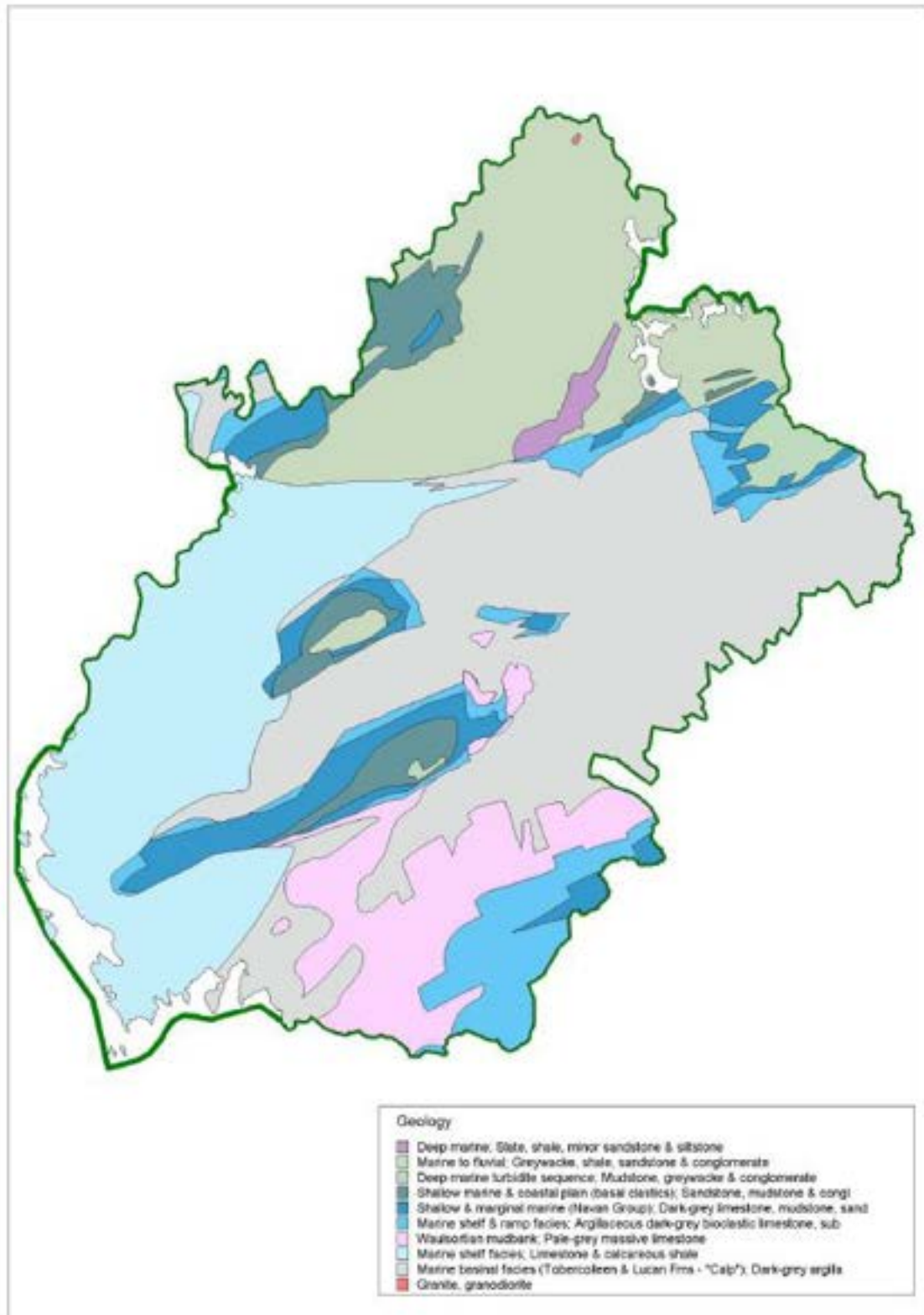

Bedrock Geology of County Longford (Source GSI)

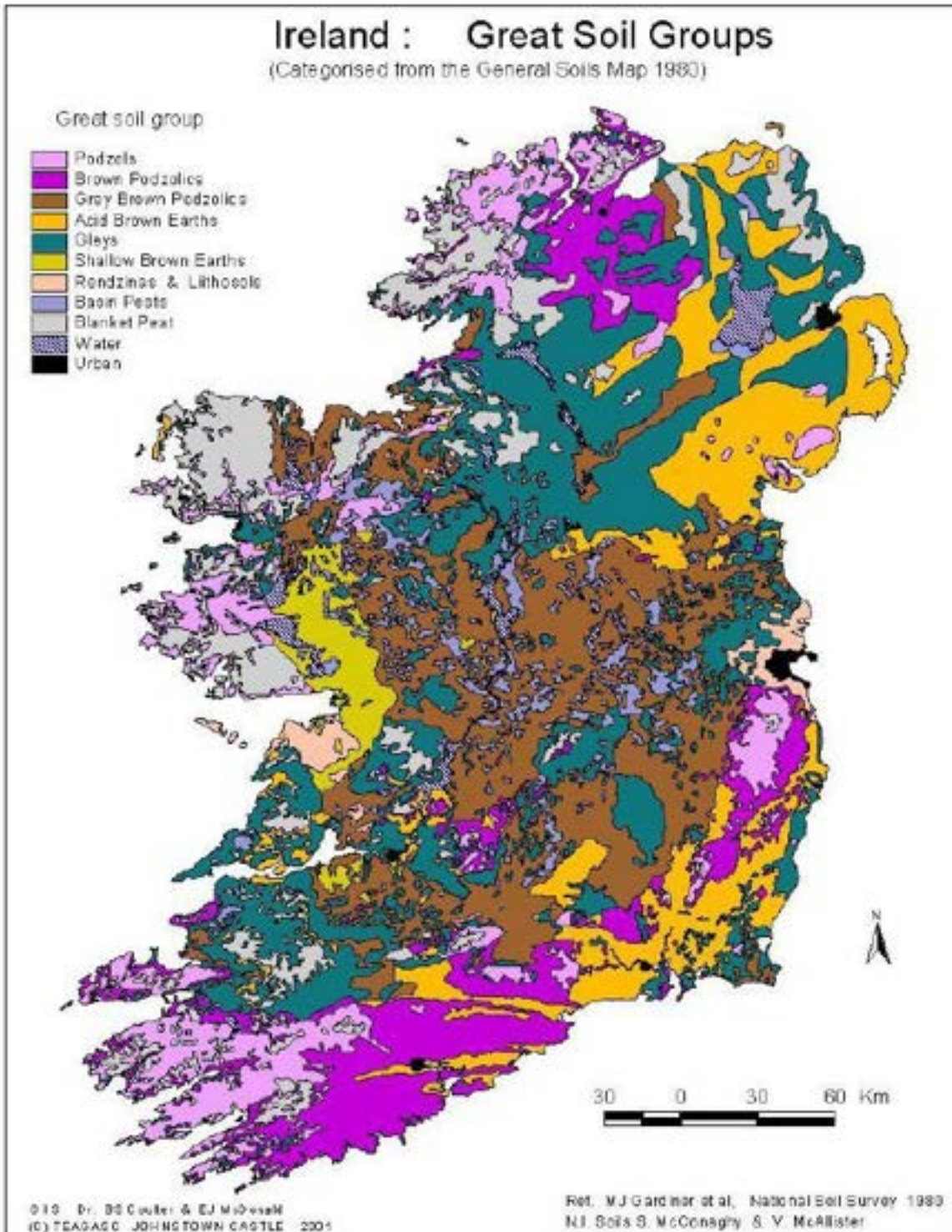

Soil types have an extensive influence on the environment of the County, dictating the landcover and land use and the extent of both. All aspects of life are influenced either directly or indirectly by soil types, including settlement patterns, transport routes, communications infrastructure, location of archaeological deposits and economic activity. Soils represent an important and non-renewable natural resource.

Longford County can broadly be categorised into three areas for classification under the great soil groups. The north of the County (the area mainly above the 100m contour) is mainly composed of gley soils, while a broad strip of basin peats runs diagonally from mid/north west to south east. Pockets of gleys and basin peats abound throughout the County. The remainder of the soils are broadly classified as grey brown podzolics. The map shown on the previous page indicates illustratively the soil groups that can be found within the County.

Gley soils are heavy, poorly drained soils not given to arable cultivation without extensive drainage and artificial enrichment. This is reflected in the pattern of agricultural activity in the northern section of the County, which tends to have smaller, more fragmented landholdings with extensive farming practices.

Landspreading of farm effluent and application of fertilisers in these areas is a delicate balance, given the poor permeability of the soil and the proliferation of waterbodies in this area, many of which are protected as European Sites and vulnerable to eutrophication through excessive nitrate run-off from land.

Threats to surface water are further increased through the poor viability of these smaller farm units as permission is sought for dwelling sites to augment farm incomes and the soil's poor percolation characteristics render them unsuitable in the most part for conventional septic tank methods of domestic effluent disposal. These problems are consistently highlighted by the Northern Regional Fisheries Board in submissions on planning applications in the area.

Due to their relatively poor agricultural characteristics, a substantial portion of these soils has been subject to afforestation, with substantial and long-term visual impacts. The forestry industry has now turned toward the use of more productive soils. The implications of this trend have yet to become apparent, but it may include the proliferation of non-managed exotic monoculture forestry tracts in previous permanent pasture regions and large areas of acidified soils.

The peat soils of the County have been harvested in antiquity, yet only on an industrial scale over the last few decades. The large scale harvesting of peat has an inordinate visual impact, given the flat nature of the landscape in which it is found and, as such, the visibility of the operation and its results over large distances.

The method of harvesting also contributes to the visual impact with large mounds of plastic covered milled peat glinting in the sunlight for kilometres and large amounts of airborne particulates being generated and dispersed during dry weather.

The biggest single environmental impact of peat harvesting is its subsequent burning to generate electricity and heat, instantaneously releasing CO₂ that has remained locked inside this carbon sink for thousands of years and contributing to the global greenhouse effect. The power station at Lanesboro in the west of the County, operated by ESB and Bord na Mona, also abstracts water from the Shannon for use as a coolant. This water is then returned to the river at a substantially higher temperature, impacting on the flora and fauna of the river system at this point.

The re-use of cut-away bog is an important issue that has yet to be addressed, that may have wide-ranging implications across a broad range of environmental sectors. This is also true of the power station itself, due for decommissioning in the next two decades.

Grey brown podzolics are more suited to agricultural practice, reflected in the number of larger landholdings and intensive farming, particularly dairying, where these soils exist. These areas exhibit a distinct landscape character, typified in the “Goldsmith Country” of the southeast County, where verdant rolling pastures predominate, with intermittent stands of mature trees and crumbling demesne walls.

Mapping of geology, in particular the drift geology, in the Longford area is poor to date.

(c) Drainage patterns

Most of County Longford is situated in the Shannon basin and lies along the north eastern shore of Lough Ree. The northern section of the County lies within the Erne catchment to the southwestern shores of Lough Gowna. The major Rivers in the County are the Camlin, which drains the midsection of the County and meets the Shannon at Clondra and the Inny, which runs along most of the southeastern county boundary to enter Lough Ree south of Ballymahon. The map overleaf shows the River Basin Districts.



Numerous lakes dot the northern section of the County, the largest of which is Lough Gowna, forming the boundary with Cavan. The north-western boundary of the County is formed by a string of lakes along the Leitrim border.

2.1.2 Landcover

Landcover in County Longford can be broadly categorised into several areas as indicated in the thematic map shown below (based on Teagasc and Corine data).

As can be seen, the dominant landcover category is dry grassland, which indicates the continued importance of agriculture in the landscape. The interspersed bog and fen, much of which is cutover and reclaimed, also represents a significant element in the landscape.

2.1.3 Human Influence

(a) Settlement pattern

The current County Development Plan, 2009-2015, identifies forty-one (41) designated settlements, which are relatively evenly dispersed throughout the County between north and south. There appears to be a current trend towards more dispersed forms of rural settlement. It is a stated aim of this character assessment to evaluate the ability of certain landscapes to absorb such settlement forms and inform policy decisions accordingly.



The population of Longford has been subject to devastating changes since famine times which had a dramatic impact on the settlement pattern of the County. Between 1841 and 1996 Longford County lost a staggering 74% of its population (from 115,491 to 30,166).²

² "North Leinster" Casey C. Rowan A., 1993 Penguin

This historical trend of depopulation would appear to be reversing, with a modest 3% population growth between 1996 and 2002 being followed by a more substantial 10% growth up to 2006. Census 2011 results show that Longford's population has continued to grow strongly since Census 2006, increasing by 4,609 persons to 39,000 persons. This represents an increase of 13.5% per cent over the 5 year intercensal period. The implications of this growth on the landscape are inevitable, not just at a County level but also on a national one, as demands for accommodation, transport and communications and other modern essentials spiral upwards.

Several major architectural phases are represented in County Longford, indicating the length and intensity of settlement within the County. The following are some examples:

- Prehistoric: Corlea Bog trackway, Flint implements at Lough Kinale
- Early Christian/Celtic Churches: St. Mels, Ardagh, St. Diarmuids, Inchcleraun Island
- Medieval: Chancel Church and Augustinian monastery, Inchcleraun, Abbeysrule,
- Abbeylara, All Saints Priory, Saints Island, Clondra Abbey, Rathcline castle, Castlerea, Elfeet, Mornin.
- 16th/18thc: Castle Forbes (built 1628, rebuilt after fire 19thc) Water garden, Rathcline Castle, Market house, Longford
- 18th/19thc: Ledwithstown house, Ardagh Glebe, Castle Cor, St. Johns Church, Longford, Kilcommock (ruin), Courthouse, Longford, Clock tower, Keenagh, Coolamber Manor, Carriglass Manor, Ballymacormack COI, Newtownforbes COI, Ballinalee COI, Killoe COI, Forgney COI, Ardagh COI, Ballymahon COI, Keenagh COI, Edgeworthstown COI, Taghshinny RCC, Newtowncashel RCC, Lanesboro RCC, Market house Ballymahon.
- Victorian: St. Mels Cathedral, Longford, St. Mel's Diocesan Seminary, Longford, St. Mary's Granard, Edgeworthstown RCC, Longford and Edgeworthstown Railway Stations, Bank of Ireland, Longford, Ulster bank, Longford, rebuilding of Castle Forbes.

It should be noted that the presence of these features might not accurately illustrate the age of a particular settlement but rather the static nature of development in a particular area.

Significant work has been carried out by the Department of the Environment, Community and Local Government in the identification of architectural structures of merit throughout the County through the preparation of the National Inventory of Architectural Heritage. This inventory is invaluable in the augmentation of the list of protected structures for the County, a process to be carried out in tandem with the preparation of the new County Development Plan.

(b) Agriculture

While the agricultural industry remains an important element in the national and local economy, it is extremely vulnerable to global changes and EU policy reform. The habitats map illustrated above indicates the dominance of agricultural land in a County context. Substantial changes in the maintenance and management of agricultural land will therefore have an inordinate visual impact at this level.

Recent changes in agricultural practices have led to trends toward enlargement in the more fertile, south eastern areas of the County, while fragmentation has occurred in the less profitable drumlin landscapes of the northern County, as farmers strive to maximise farm income from smaller, less fertile tracts of land. Farm fragmentation often occurs in the form of selling of half-acre sites for houses along road frontages. This coupled with the fact that the land in these areas is amongst the poorest in the county, the most elevated and visible, the least efficient in terms of the disposal of domestic effluent and require the removal of substantial sections of hedgerows for access purposes, the potential for landscape impact is particularly high.

Grant aid and legislation are major factors in the determination of farming practices throughout the County. Schemes such as the Rural Environmental Protection Scheme promote environmentally sensitive practices and are taken up to a greater degree throughout the County. Habitat identification and conservation, hedgerow replacement and maintenance and watercourse protection are some of the measures introduced relating to landscape.

The introduction of the nitrates regulations, in tandem with grant aided schemes for the construction of farm buildings and effluent storage, have the potential to create a significant visual impact throughout the County. The number of planning applications for slatted sheds increased significantly during this period. These regulations also place limits on livestock numbers on land which may influence vegetation growth, particularly in marginal areas where poaching is a particular problem over the winter period.

(c) Forestry

The development of forestry has a significant impact on the landscape of the County, particularly as areas chosen tend to be marginal and elevated, two factors that can equate with the most scenic areas of the County. The most familiar landscape impact of forestry is the use of non-native species planted in strong geometric patterns in elevated areas that create a stark and artificial impression when viewed from a distance. Attempts have been made to address this issue through guidelines adopted by the industry in new planting, such as careful mix of species, particularly along forest edges and maintenance of the harvest to minimise negative visual impacts.



Areas of Forestry within the County

However, there are several more subtle ways in which forestry can influence the perception of landscape. The slow and steady growth of trees can lead to the gradual and therefore imperceptible loss of views and prospects that might otherwise have been framed or enhanced by judicious and well planned planting.

(d) Archaeology

Proposals to include Archaeological landscapes have been included in submissions to the County Development Plan. As can be seen from the following map which illustrates the Record of Monuments and Places, the County is rich in archaeological heritage, particularly in the Granard area.



Record of Monuments and Places

It is proposed that the Council engage in consultation with the relevant section of the department of the Environment, Community and Local Government in order to designate, protect and promote awareness of this heritage aspect. The DoECLG have proposed the designation of archaeological landscapes, which will cover areas of intense archaeological deposits. It is suggested that any such designation, once complete, should form part of this assessment.

(e) Culture

It is envisaged that the preparation of this document will run in tandem with the preparation of the heritage plan and result in the identification of the cultural elements

that make Longford unique so that these can be protected and or promoted as part of the Council's duties and activities.

Cultural heritage includes landscapes made famous by literary figures, mythological legends and historical events. Festivals, fairs and community activities may also be included, particularly where they have a spatial dimension.

2.2 Landscape Character Units

The Clare Landscape Pilot Study differentiates between Landscape Character types and Landscape character areas. **Landscape character types** (LCT) are defined as landscapes that may occur in many areas throughout the Country and are composed of similar combinations of elements such as topography, geology, drainage and settlement patterns, landcover and use. **Landscape character areas** (LCA) are sections of the County that are treated as a unit in visual and physical terms, and that may consist of several landscape character types.

Landscape Character types in County Longford would include the peatlands/wetlands, Shannon basin and northern uplands. Landscape character areas are the individual representation of a landscape character type, e.g. Begnagh Bog.

Longford is a relatively small County with a low number of well-defined Landscape Character Types. These broadly correlate with Landscape character areas, as they tend to be geographically specific and the predominantly flat nature of the landscape facilitates topographical definition of units. For this reason, it is considered that a landscape character unit, combining both LCA and LCT as defined in the guidelines, is an appropriate method of assessment in this instance.

In broad terms, there are seven basic landscape character units in Longford which are illustrated on the map overleaf (Please also consult Appendix 1 for maps of each area.)

- **Unit 1 – Northern Drumlin Lakeland**
- **Unit 2 – Northern Upland**
- **Unit 3 – Shannon Basin/Lough Ree**
- **Unit 4 – Central Corridor**
- **Unit 5 – Inny Basin**
- **Unit 6 – Peatlands**
- **Unit 7 – Open Agricultural**

A general overview of the County is provided, following which each Character Unit is assessed in turn, providing details on the landform, characteristics, threats and degree of sensitivity of each area.

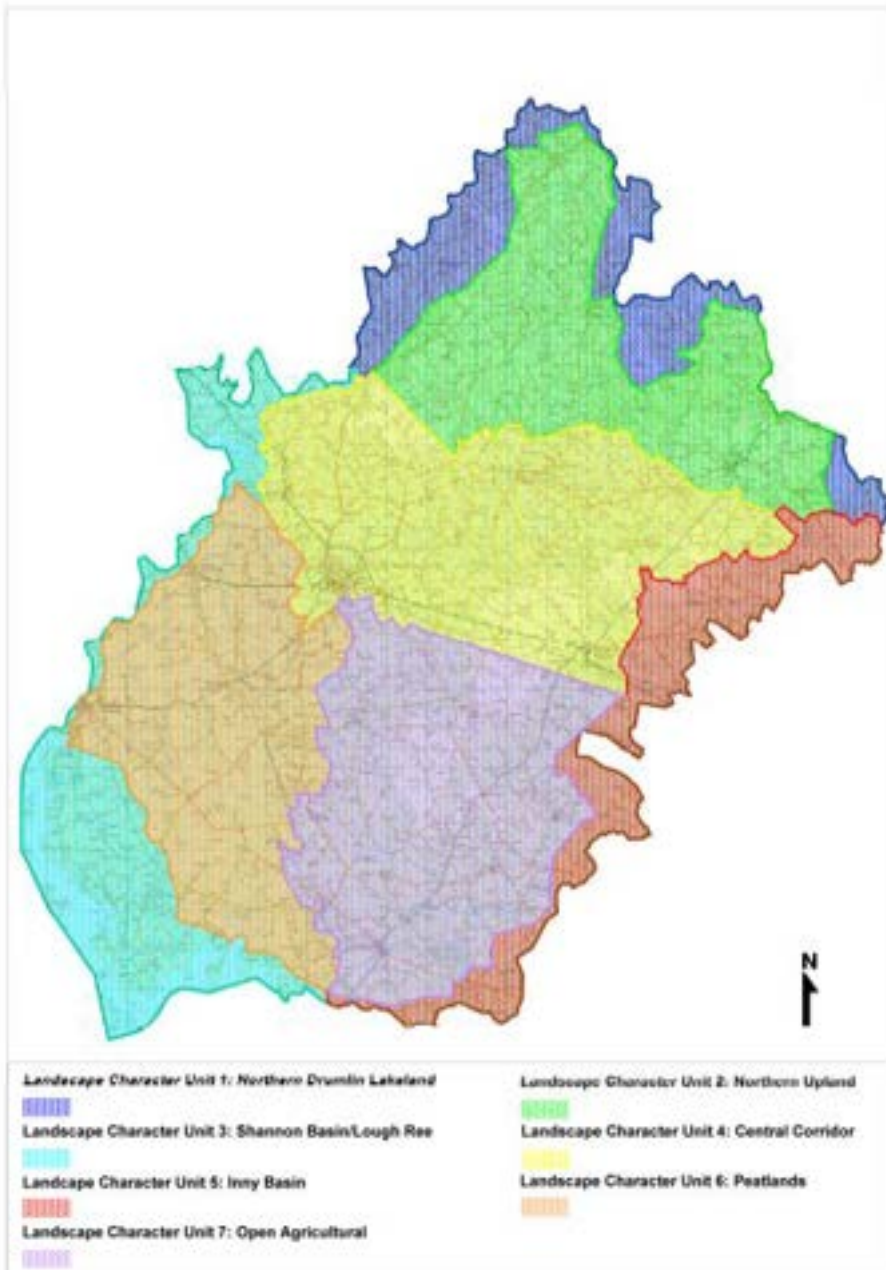

Landscape Unit 1 – Northern Drumlin Lakeland

Location and Physical Characteristics

This area consists of the North West fringe of the County and extends from Drumlish in the west to the County boundary in the north. This landscape unit also includes the areas surrounding Lough Gowna and Lough Kinale in the east of the County (also see map of the area in the context of Longford in Appendix One).

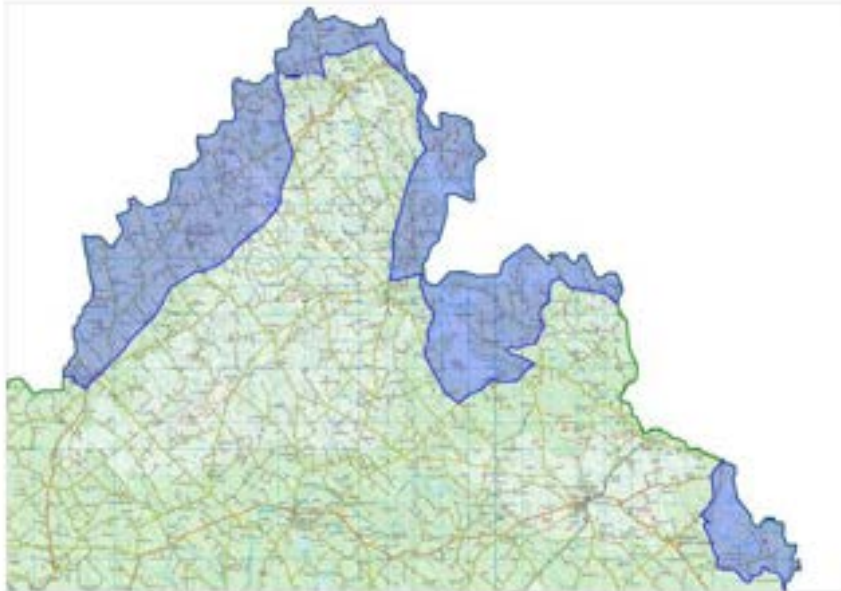

The southern boundary is mainly formed by the R198 Regional route from Longford to Arva, the Aughnacliffe to Enaghan Road and other relevant features such as the 100m contour line.



Lough Sallagh in the North-West fringe of the County

Views are available to the north into Counties Leitrim and Cavan, which more or less mirror the landscape inside the Longford Boundary.

- **Landcover**

Landcover consists of predominantly small agricultural holdings, interspersed with bogland, which becomes more dominant toward the eastern boundary of the unit and lakeland areas that dominate on the western County Boundary.

- **Topography**

The area primarily consists of rolling drumlin landscape, with agricultural land tending to be tightly enclosed and bounded by small but well established hedgerow species, at times permitting limited views of the string of lakes that border the County.



Annagh Lough

- **Geology/Soils**

The soils in this area are predominantly poorly drained gley soils with some peats.

- **Drainage patterns**

Drainage patterns are extremely complex, giving way to peatlands in the valley of the Black River and the vicinity of Annagh Lough. This area type includes the Lough Gowna Complex to the northeast of the County (included in An Foras Forbartha Inventory of Outstanding Landscapes in Ireland, 1977) and Lough Kinale and Derragh Lough in the northeast.



Lough Nabelwy

Drainage is divided between the two major River catchments of the Shannon to the southwest and the Erne to the northeast.

Human Influence

- **Settlement pattern**

The settlement pattern in the area is highly dispersed due to the nature of the topography and its influence on the agricultural practices in the area. Drumlish and Ballinamuck are the only settlements in the area, with the main concentration of development centred on these villages.



Drumlish has seen a substantial level of development over the period of the previous two Development Plan periods relative to its size with a number of recently added housing developments situated within the development boundary.

Ballinamuck has also experienced a level of housing development in recent times but at a much lesser rate to that of Drumlish.

- **Transport and Communications**

The road pattern throughout the area is relatively sparse with an emphasis on north-south communication.

The undulating drumlin nature of the topography of the area is unattractive to mobile telephony infrastructure and other masts/antennae support structures, these preferring the higher ground of the adjacent areas, while retaining strong intervisibility from this area.

- **Agriculture**

Agriculture tends to be extensive and part-time in nature, given the limited capacity of the soils in the area. Farms tend to remain fragmented, which reinforces and perpetuates the patterns of small, tightly packed fields and highly dispersed settlement.

Pylons, Farmullagh



- **Industry and services**

Industrial development in the area is limited given the lack of concentrated settlement and the poor road network.

In common with the majority of rural areas throughout the Country, utility poles and overhead wiring line the roadsides and traverse fields. Two sets of 110 kV electricity lines and their associated pylons enter the County at Farmullagh and Corglass and create a striking landscape impact.

Coarse fishing and angling on the numerous lakes is an important element of the tourist industry in the area.

- **History, Archaeology and Culture**

Known Archaeology in the area is comparatively sparse, with the exception of the islands and shores of Loughs Gowna and Kinale and in the vicinity of Cloonagh and Mullinlaghta to the east of the area. The Black Pig's Dyke, an important linear earthwork, commences at Dring on the southern shores of Lough Gowna and runs down toward Lough Kinale.

The 1798 battlefield and associated sites and monuments are significant culturally important items and are located at and in the vicinity of Ballinamuck.

- **Recreation and Amenity**

The potential for recreational and amenity development in the area is high, given the lakeshore frontage that exists for walking, angling and swimming. The local community has established a swimming pool at Annagh Lough.

Landscape Sensitivity

The sensitivity of much of this landscape can be classified as **LOW to MEDIUM** with some **HIGH** sensitivity in the vicinity of the lakes and designated scenic routes.

Threats

- Loss of inherent character due to altered landscape management practices arising as a result of EU agricultural policy reforms/further decline in agriculture.
- Removal of existing network of hedgerows and boundaries distinctive to the area through farm fragmentation/road frontage and ribbon development.
- Loss of integrity of important historical sites and cultural heritage, such as 1798 battlefield, due to insensitive or poorly located development.
- Agricultural activity and residential development in the vicinity of the lakes threatens water quality and fish stocks.
- Unsympathetic residential or amenity development at lakeshores or within their visual areas.

Opportunities

- Dense field patterns and substantial boundaries provide an enclosed landscape that can accommodate appropriately sited development without major landscape change.
- Opening up of access to lakeshores for amenity purposes.

Policy Responses

- Support appropriate development in areas of population decline.
- Encourage setting back of dwellings into fields retaining existing plot size and boundary treatment.
- Permit hedgerow removal only where necessary for road safety and, where removal is required, encourage replacement with native hedgerow species.
- Encourage access to lakes and watercourses and development of tourist accommodation within or in the vicinity of settlements, while monitoring amenity development /restricting access in environmentally sensitive locations.
- Restrict housing on lakeshores and within their visual areas.

Landscape Unit 2 – Northern Upland

Location and Physical Characteristics

This unit consists of the central northern section of the County, stretching from Drumlish in the west to Moyne in the north, Esker in the south and including the towns of Granard and Abbeylara in the east, up to and including the county boundary with Cavan.

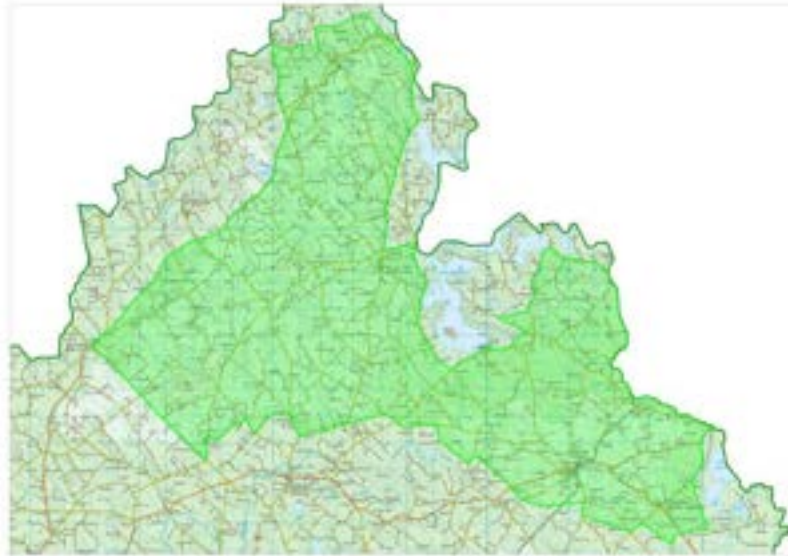

Many of the important views listed in the County Development Plan are located in this landscape unit.

- **Landcover**

Forestry is well established in the area with large coniferous and mixed forestry tracts at Corn Hill, Edenmore and Crott, with smaller pockets scattered throughout the area.



Boggy areas predominate to the western boundary in the lower reaches of the river valleys where drainage becomes sluggish and a transition zone is formed between Landscape units 1 and 2.

- **Topography**

The majority of this unit lies above the 100m contour line to the north of the County and contains Corn Hill, Edenmore and Crott.

Visible from a significant distance, given the flat nature of the surrounding Midland and Border Counties, the highest point is 278m at Corn Hill. There is high intervisibility between this area and other isolated upland areas such as Ardagh Mountain in the south of the County, the Hill of Uisneach in Westmeath and Sliabh Bán in County Roscommon.

- **Geology and Soils**

Predominantly Gley Soils, much of which is in typical drumlin formation.



- **Drainage patterns**

Drainage in the northern section of the unit is dominated by the Lough Gowna Lake complex, which falls under the catchment of the River Erne. The southern portion is drained towards the Shannon via the Camlin and Inny Rivers and their tributaries.

Human Influence

- **Settlement pattern**

The main settlements within this unit are Granard, supported by the villages of Abbeylara, Moyne, Legga, Bunlahy and Aughnacliffe.

While there has been significant activity in terms of planning applications in Granard and environs recently, few of these have been translated into actual development.

Abbeylara, a short distance to the southeast of Granard has also seen significant growth over recent times.

The village of Aughnacliffe (overleaf) and its environs enjoys views over Lough Leebeen and Lough Gowna, a possible factor in the number of development proposals in the area – over 100 dwellings have been granted in the village over the previous two Development Plan periods, a portion of which have been developed. Many of these new developments are highly visible due to the steeply undulating nature of the topography of the village, which provides enclosure to and otherwise linear and ribbon-like settlement pattern.



Moyne and Legga are located to the north of the County near the Cavan border off the R198 regional route, while Bunlahy is located to the south of the area in the vicinity of Ballinalee. These settlements were designated due to their existing level of service provision and/or facilities, such as church, school, and crèche, playing pitches etc., which provide natural congregation areas. Development has yet to become established to any significant degree in these settlements.

Rural housing in the area follows the dense pattern of extensive agriculture and the complex road network, tending to be highly dispersed with some local concentrations.

- **Transport and Communications**

The area is served by an extensive county road network, which is heavily influenced by the elevated topography and associated drainage patterns. Many of these roads are little more than laneways through the hills and valleys and are substandard in width and alignment.

The height of Corn Hill in relation to the surrounding Midland topography has made it an attractive site for the establishment of communications masts, which remain a substantial landscape feature.

A portion of the now disused Cavan railway lies to the east of Abbeylara.

- **Agriculture**

Agriculture in this area tends to be extensive, given the poor soil, drainage and access characteristics, and results in a similar but somewhat less enclosed field pattern than

Landscape Unit 1. This more open feeling in the landscape may also be attributed to the elevated nature of the topography.



- **Industry and services**

Industrial development in the area is limited, with the exception of the Granard area, where the Keirnan Feed factory dominates the landscape for a substantial distance on the approach from Ballinalee. Other industrial developments, including Pat the Baker, are predominantly located within the town where their scale is contained, and their landscape influence is minimal.

The Roadstone Quarry at Moyne (left) exerts a considerable landscape influence over Lough Naback, however, this serves to lessen the influence of the pylons and associated 110kv overhead wiring traversing the unit from east to west at this point.



- **History, Archaeology and Culture**

This landscape area has a particularly high concentration of archaeological heritage, most notably to the eastern side of the unit where the megalithic tombs at Aughnacliffe, the Black Pig's Dyke running from Dring to Lough Kinale, the Abbey at Abbeylara and

the old town at Granardkille are substantial landscape features with important national heritage and mythological associations.

Holy wells are important cultural landscape features and are scattered throughout the eastern section of the unit.

- **Recreation and Amenity**

Mainly confined to sports grounds and GAA pitches.

Landscape Sensitivity

The sensitivity of much of this landscape can be classified as **MEDIUM** to **HIGH**

Threats

- Potential future development of large-scale utility infrastructure in the upland areas.
- Encroachment of forestry onto important upland slopes and interference with designated scenic views.
- Potential loss of material and/or integrity of setting of archaeological features and artefacts.
- Potential loss of character of existing towns and villages.
- Further loss of population in Granard creating settlement pressure in surrounding rural area and historic landscape.
- Encroachment on protected views by dwelling units.

Opportunities

- Towns and villages throughout the unit are capable of accommodating substantial additional development to remove pressure from sensitive areas.
- Potential for further tourism related development, particularly in Granard.

Policy Responses

- The development of coherent countywide framework for large-scale utility infrastructure including identification and designation of permitted and restricted areas.
- The concentration of heritage artefacts and features in the eastern section of this unit may warrant the designation of a specific historic landscape to ensure heightened public awareness and their continued protection.
- Facilitate co-ordination between Coillte/Department of Agriculture Food and the Marine and natural Resources forestry strategies and development Plan Policy.
- Develop identity and character in new developments in towns and villages through the application of area specific design criteria laid out in design guide.
- Protect views and prospects.

Landscape Unit 3 – Shannon Basin/Lough Ree

Location and Physical Characteristics

This unit is located along the western boundary of the County forming the border with Counties Leitrim, Roscommon and Westmeath and taking in the Rivers Shannon, Inny and Rinn and Lough Forbes and Lough Ree.



- **Landcover**

This unit has large amounts of water cover with inland marshes, bogland and tracts of deciduous forestry in the northern section around Lough Forbes. Land cover becomes less diverse travelling south of Lanesboro on the western shores of Lough Ree, with poorly drained agricultural land forming the majority of the landcover in the area.

Relatively small and isolated pockets of bog and marshland create important habitats at Fortwilliam Turlough, Commons North and Portanure, while the Portanure Pine Woods are an important stand of trees on the shores of the lake.

- **Topography**

Lough Ree is interspersed with several small, uninhabited islands and the predominantly flat landscape provides for panoramic vistas across the lake at numerous locations.

Small hills such as those at Newtowncashel, Cullentra and Rathcline (none of which break the 90m contour line) appear much larger in this context and act as punctuation marks in otherwise homogenous topography.

The area around Lough Forbes is relatively inaccessible and visibility limited due to extensive afforestation.

- **Geology**

Much of the geology in the area to the south of Lanesboro is classified as a regionally important aquifer.

The Geological survey of Ireland has classified this area as highly to extremely vulnerable by the Geological survey of Ireland (GSI - see map).

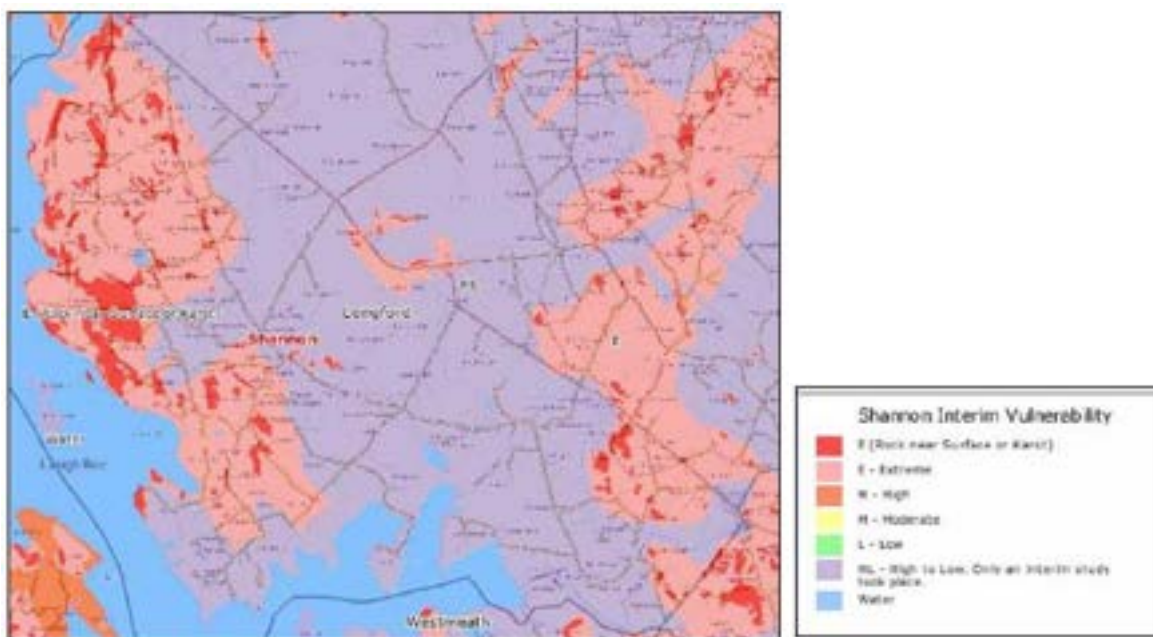

- **Drainage patterns**

The River Shannon enters the northwestern fringe of the County south of Rooskey, where it is joined by the Rinn River in Lough Forbes. Views of the watercourse are limited in this northern section due to a combination of local topographical and landcover characteristics.

The Shannon continues towards Clondra where it is joined by the Camlin River and on towards Lanesboro where it broadens out into Lough Ree. This area is particularly susceptible to flooding.

To the south of the County, the Inny enters Lough Ree via the Owenacharra River.

Human Influence

- **Settlement pattern**

The only significant settlement in the unit is Newtowncashel, a small village located in an elevated position commanding extensive views over the lake. The area has witnessed relatively low levels of development in recent times.

This lack of a defined urban or village structure means that the area is under particular pressure for once-off rural settlement, which is generally dispersed throughout the area, although to a lesser extent than the north of the County.

Some areas of concentrated ribbon development have occurred in the vicinity of adjacent settlements, such as Fisherstown at Clondra and along the Rathcline Road south of Lanesborough.

- **Transport and Communications**

The area is traversed to the north by three of the four national routes that run through the County, the N4 north of Newtownforbes, the N5 at Clondra and the N63 at Lanesborough. The remainder of the road network is relatively sparse except for the southern section and consists of third and fourth-class county roads and supporting networks of lanes and boreens.

- **Agriculture**

Agriculture in the area is, in a similar vein to the majority of the County, extensive in nature. The requirements of the nitrates regulations in terms of effluent storage and the structures required to facilitate these standards, is likely to have significant landscape impact over the coming years.

- **Industry and Services**

Industry and services are limited in the area given the highly dispersed nature of the settlement, however, those that exist have considerable visual impact. These include:

- County Council Water Treatment Plant – Lough Forbes
- Former denim factory (Burlington) at Fisherstown
- Power station at Lanesborough



The former denim factory at Fisherstown is an immense structure (in the region of 29,000m²) the impact of which is reduced given its isolated position, single storey nature and the predominantly flat landscape in which it is situated. The factory is currently occupied by a timber-frame dwelling distribution company.

- **History, Archaeology and Culture**

Castleforbes Demesne is a private estate located to the north of the unit within extensive woodlands.

Extensive early Christian remains are located in the south of the unit and on Saints Island and Inchcleraun.

Waterways corridor study has identified the potential for the discovery of underwater archaeology which is not addressed at present in the County development Plan.

- **Recreation and Amenity**

Access to and awareness of water courses and water bodies tends to be restricted in this area, given the limited road network in the vicinity and landcover barriers such as forestry and wetlands.

Parking and amenity areas have been established at Loughfarm, Bleanavoher and Barley Harbour.

An extensive amenity area has been developed south of Lanesborough, which is extensively used as a walking route by locals and has been zoned for further amenity related uses under the Lanesborough Local Area Plan.

Landscape Sensitivity

The sensitivity of the landscapes in this unit range from **MEDIUM** - along the southeastern border of the unit - to **HIGH** sensitivity - along the shores of the lake, islands, the riverbanks, and in the vicinity of the Aquifer.

Threats

- Pollution of ground and surface water sources from residential or intensive agricultural development.
- Inappropriate development and privatisation of lakeshores and riverbanks.
- Road network insufficient to cater for large numbers of visitors associated with tourism development.
- Loss of important archaeological and architectural features and/or their setting, underwater and lakeside archaeology in particular.
- Proliferation of invasive species – Japanese knotweed, rhododendron, zebra mussel – threatens biodiversity and ecosystem functioning.

Opportunities

- Development of Amenity areas along lakeshore.
- Development of accommodation base within existing village.
- Strong community involvement in village development (Tidy Towns).

Policy Responses

- Restrict development in the vicinity of the lakes and maintain aquifer protection zone for 1km around boreholes at Carrowroe.
- Effluent treatment systems in the vicinity of the lake to have nitrogen and phosphorous cleansing capabilities.
- Prepare Village policy statement for Newtowncashel to include provision for the protection of scenic route.
- Promote appropriate schemes for the control/eradication of invasive species.

Landscape Unit 4 – Central Corridor

Location and Characteristics

This area consists of the centre of the County and includes the settlements of Newtownforbes, Longford Town and Edgeworthstown extending in a northerly direction towards Drumlish in the west and Granard in the east. The southern boundary is mainly formed by the N4 National route from Longford to Mullingar.



- **Landcover**

As with the rest of the County, the main landcover constituent in this unit consists of agricultural pastures. The urban fabric of Longford Town, Edgeworthstown and Newtownforbes also cover extensive areas.

Deciduous and mixed forestry are present in pockets throughout the centre of the unit, notably at Carrickglass and Farraghroe.

- **Topography**

The land in this unit is relatively flat and low-lying, rarely breaking the 100-metre contour line, meaning that trees, field boundaries, buildings and other features generally restrict views over any significant distance.

This is contrasted with areas of distinct demesne type landscapes such as at Moatfarrell/Corbeagh.



View across agricultural landscape at Corbeagh

- **Geology**

Aquifer

- **Drainage patterns**

Drainage is toward the Shannon via a complex network of Rivers and Streams accessing the Camlin River, which is subject to seasonal flooding.

Human Influence

- **Settlement pattern**

The urban network is strongest in this area of the County, with a defined hierarchical system dominated by the settlements of Longford, Edgeworthstown and Newtownforbes, which lie along the main transport routes. Edgeworthstown and Longford exhibit a certain amount of commuter traffic to the Dublin area, but not yet to an economically significant degree.

Ballinalee is located to the northern portion of the unit and has experienced some development in recent times, consolidating the existing settlement within its defined envelope.

A Local Area Plan was prepared for Carrickglass in 2004, adding this area to the list of designated settlements in the County. There is little visibility into the remaining demesne, which is largely contained by mixed tree planting which forms a NHA due to its importance as a habitat. Permission has been granted for over 30 housing units, a retirement village, a hotel, golf course and the refurbishment of the protected manor house. The remaining elements outside of the main demesne walls, particularly the walled garden on the western side of the regional route, and the gates and lodges in the main demesne walls create notable landscape features and a particular atmosphere in the area.

Smaller designated settlements in the area include Kilnatruan on the R194, Enybegs and Coolarty.

Significant pressure exists for “one-off” housing development along the R198 regional route from Longford to Arva and there is an established ribbon development pattern in place in the Clonbalt/Cloonrollagh/Creenagh area. This pattern is repeated at Kilnashee and Cloonagh further north along this route on the approach to Drumlish.

- **Transport and Communications**

The road network is at its most dense at this point given the relatively favourable flat topography of the area. All four national routes (N4 – Dublin/Sligo N5-Longford/Castlebar, N55 Athlone/Cavan, N63-Longford/Roscommon) traverse this Landscape Unit.

The Dublin/Sligo Rail line traverses the County through the Central Corridor. Almost one-third of the planning applications for large-scale communications infrastructure in the County have been made in this area.

- **Agriculture**

Agriculture in this area is well developed in comparison to much of the County, with a wide range of agricultural activity, from large-scale dairying activity to smaller scale extensive uses, particularly to the west of the area.

- **Industry and Services**

The main industrial centre of the County is centred at Longford Town, with major installations at Lisnamuck/Templemichael, Townsparks, Ballymacormack and the Athlone Road.

Edgeworthstown has two large factories, C&D Pet foods and Paul & Vincent.

- **History, Archaeology and Culture**

A wide range of architectural and cultural heritage is present in this area, with the important occupied demesnes of Castleforbes and Carrickglass. Former settlements have left their mark on the landscape at Farraghroe, Corbeagh and Moatfarrell.

- **Recreation and Amenity**

A wide range of recreational facilities are available at Longford Town, including leisure centres and swimming pools, with planning permission granted for additional facilities in the vicinity and at Carrickglass and Edgeworthstown.

The Mall sports complex and walkway through Longford is an important and widely used amenity, augmented by Sli na Sláinte (around Longford bypass) and proposed for further links as part of the Longford Town Development Plan.

The Camlin River is a slow moving river. It holds good stocks of bream, roach and hybrids with some tench to 5lbs. Fishing is into depths of about 5ft to 10ft in normal conditions. There are some good stretches, but these can be difficult to find for first time visiting anglers. Anglers can have good sport here particularly during the early summer months. The Camlin River is part of the Midland Fisheries Group of Shannon Regional Fisheries Board managed waters and requires a fishing permit

There are also a number of GAA and soccer pitches within the Unit and a golf course in Longford Town.

Landscape Sensitivity

The sensitivity of the landscapes in this unit is generally **LOW**. Potential areas of **MEDIUM** to **HIGH** sensitivity exist in the vicinity of protected woodlands, riverbanks and in the vicinity of the Aquifer.

Threats

- Pollution of Groundwater sources in the vicinity of the aquifer to the north of Longford Town.
- Loss/fragmentation of important agricultural land/tree stands and woodlands.
- Continued ribbon development in pressure areas.

Opportunities

- High capacity for absorption of additional development.
- Existing strong urban network upon which settlement strategy can be based.

Policy Responses

- Restriction of development in pressure areas.
- Relaxed restrictions in areas of high capacity.
- Groundwater protection scheme to be installed around potential groundwater supplies.
- Important areas of agricultural land to be identified and protected from further fragmentation.
- Encourage use of existing large-scale communications infrastructure for future proposed developments.

Landscape Unit 5 – Inny Basin

Location and Characteristics

This area is located to the east of the County and forms the border with County Westmeath.

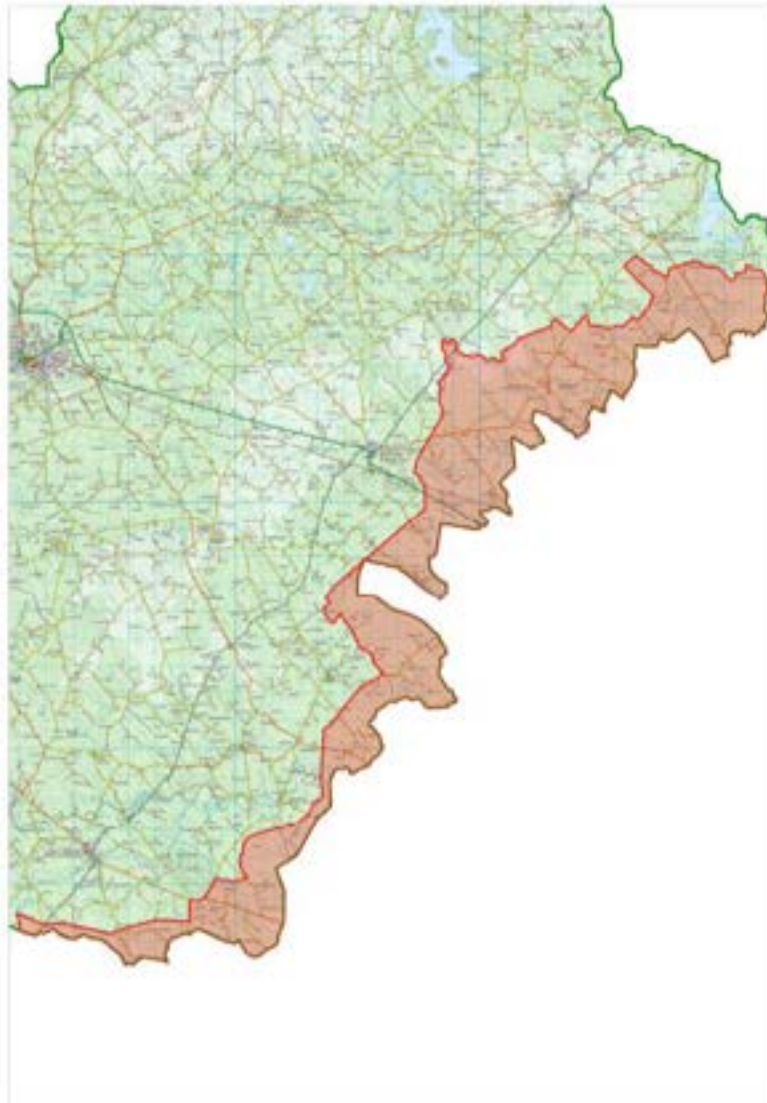

- **Landcover**

The landcover in this area is dominated by peatlands and mixed woodlands interspersed with pastures of varying quality.

- **Topography**

The area maintains a relatively flat and level topography.

- **Drainage patterns**

The Inny River makes its way from Lough Kinale in Unit 1 and follows the County Boundary for a time before veering south into County Westmeath and Lough

Derravarragh. The River re-enters County Longford east of Legan and continues west toward Ballymahon and onto Lough Ree.

The Inny dominates the drainage pattern of the area. Flows tend to be sluggish given the nature of the landcover and topography. There is one seasonal lake to the north of the region, however visibility of the lake and the River from the public road is poor and awareness of these features low, with the possible exceptions of locals and seasoned anglers.

Human Influence

The difficult nature of the terrain has meant that human influence on the landscape of the area has been limited in comparison to other units.

- **Settlement pattern**

There are two designated settlements in this unit, one in the south at Forgney and the other in the North at Lisryan. Settlement is greatest in the areas outlying Legan and Edgeworthstown, while Lisryan in particular has experienced some growth in recent times.

- **Transport and Communications**

The area is roughly bisected between north and south by the N4 and the Dublin-Sligo rail line running parallel. The remainder of the road network in the area is sparse, composed mainly of portions of County roads and small laneways.

- **Agriculture**

Agriculture in the area appears well developed in reclaimed areas.

- **Industry and Services**

There are few industries in the area given the limited road network and unstructured settlement pattern.

Services are generally confined to a local level, such as primary schools, shop, GAA pitch etc. and these facilities are generally located within the two settlements of Forgney and Lisryan.

- **History, Archaeology and Culture**

Coolamber Manor Goldsmith – Forgney Church, Hill, Pallas.

- **Recreation and Amenity**

Mainly confined to local GAA pitches.

Landscape Sensitivity

The sensitivity of the landscapes in this unit are generally **LOW**. Potential areas of **MEDIUM** to **HIGH** sensitivity exist in the vicinity of protected woodlands, riverbanks.

Threats

- Continued depopulation and associated loss of landscape management.

Opportunities

- Existing designated settlements in the area provide potential for population growth.

Policy Responses

- Target growth to existing settlements.
- Encourage provision of facilities to strengthen settlements.
- Facilitate rural housing where appropriate and in accordance with normal planning criteria.

Landscape Unit 6 – Peatlands

Location and Characteristics

This area is located in the west of the County and includes the settlements of Lanesborough and Clondra and extends towards Ballymahon in the south.



- **Landcover**

Located in the western half of the County, this area is dominated by extensive tracts of raised bog interspersed with mixed forestry and areas of scrubby vegetation.

- **Topography**

The topography is notably flat, with the majority of the land lying below the 50m contour line. This, when combined with the limited vegetation cover and extensive peat land cover mean that views are available across wide areas throughout the unit.

- **Drainage patterns**

Drainage patterns in the area are heavily influenced by artificial means employed to retain water levels and prevent inundation of commercial peatlands. The Shannon system is the main natural influence, draining the area via the Camlin, Fallan and Bilberry rivers. Seasonal flooding persists in the northern sector, particularly in the vicinity of the Camlin River.

Human Influence

- **Settlement pattern**

The settlement pattern in this unit tends to be less dispersed and more focussed into the designated towns and villages than other areas, given the difficult nature of the terrain.

The Main settlement in the area is Lanesborough, for which a Local Area Plan has been prepared. Lanesborough is located on the River Shannon at the northern end of Lough Ree and at the junction of the N63 to Roscommon and R392 to Mullingar. Historically an important fording point of the Shannon, Lanesborough declined in strategic importance with the development of Athlone to the south. The Regional Planning Guidelines for the Midlands have recognised this strategic location and role, designating Lanesboro as a local Service town in the urban hierarchy of the region, to provide local level retailing, social and leisure facilities.

Clondra is a small settlement located on the Royal Canal and at the confluence of the Camlin and Shannon Rivers, which is important in terms of its character, scenic quality and tourism potential. Local community interest in the development of the village is high.

Kilashee is a small settlement located on the N63 that has seen substantial residential planning applications under the Rural Renewal Tax Incentive Scheme.

Derraghan consists of a housing estate built by Board na Mona for its workers. Set in the centre of commercial peatlands, the area is distinctive in settlement and landscape terms, given its design, layout and density in relation to its remote location, there has been little development in the vicinity in recent years. The installation of traffic calming signage along the R392 creates an urban effect along an otherwise remote rural setting.

One off development in the area tends be confined to specific pressure areas, for example, Kilmore/Cloonmore and Tullyvrane/Lehery outside Lanesborough.

- **Transport and Communications**

The road network, particularly in the southern section, has been curtailed by the hostile landscape conditions, however communication lines become more complex in the vicinity of Longford and the Royal Canal to the north.

The road pattern around Lanesborough, particularly the R392 that travels east to Ballymahon, is notable due to its straightness and lack of consideration for the topographical features that it traverses. This is a former toll road, constructed in the

18th century and connecting Dublin to the main areas of industrial activity in the Country, at which time, Lanesborough marked the western boundary. The straight road and predominantly flat topography create a distinct and unique landscape experience while travelling across the unit.

The remains of an ancient toher road, constructed of timber, can be seen at Corlea Bog.

The Royal Canal is an important landscape feature, not only due to its heritage associations but also its wider influence on the landscape including features that were built to support it, such as the bridges, towpaths, lock-keepers' cottages and lock gates. Works are ongoing on the opening up of the canal, which will have a considerable impact on how the landscape is perceived throughout the area.

The area is well served by mobile and broadband wireless communications.

- **Agriculture**

Agricultural potential in the area is limited given the nature of the dominant landcover, however, some reclaimed sections of land support large pastoral farming enterprises, particularly in the northern sector.

- **Industry and Services**

The ESB power station at Lanesboro dominates the landscape of the area for a considerable distance, particularly at night time. Much of the industrial development in this unit is planned adjacent to the power station where it is anticipated that the landscape impact will be limited.

- **History, Archaeology and Culture**

The area has a strong industrial history in terms of the historical harvesting of peat and the transport of the finished product along the Royal Canal. The landscape impacts of this history are manifested in the industrial architecture and archaeology that abounds throughout the area.

The Corlea visitor centre interprets an iron-age bog road built across the boglands to the south of the unit. Bord na Mona preserves the boglands in the vicinity in conjunction with the Department of the Environment.

- **Recreation and Amenity**

- Canal/Clondra Harbour
- Longford Town football ground
- Future use of peatlands

Landscape Sensitivity

The visual sensitivity of the landscapes in this unit are generally **LOW**, as their flat nature allows development to be accommodated with minimum screening needed to achieve integration into its surrounds. An exception to this designation is the vicinity of the Royal Canal, where sensitivity is **HIGH**.

In environmental terms, sensitivity can be generally termed **MEDIUM** to **HIGH** due to the limited capacity of the receiving environment to cater for additional effluent loading.

Threats

- Inappropriate development in the vicinity of the Royal Canal.
- Pollution of ground and surface water due to inadequate or malfunctioning effluent treatment systems.

Opportunities

- Existing and potential recreational and amenity development.
- Ability to accommodate development in appropriate areas.

Policy Responses

- Identify appropriate areas for development.
- Develop guidelines for screening and siting measures to facilitate development.

Landscape Unit 7 – Open Agricultural

Location and Characteristics

This area is located in the east of the County and contains twelve settlements including, Ballymahon, Ardagh and Keenagh. The unit extends from below the N4 Longford to Mullingar road towards the southern edge of the County.



- **Landcover**

Located in the southeast of the County, this area contains the most versatile agricultural land in the County and is generally characterised by larger, open fields, interspersed with mature trees. Plantations of deciduous and mixed woodland punctuate the landscape.

- **Topography**

The northern section of the unit contains the most elevated area, including Farnagh Hill and Ardagh (Bawn) and Castlerea Mountain, all of which contain full and/or intermittent scenic views listed for preservation under the County Development Plan.

The southern and eastern sections of the unit consist mainly of gently undulating pastoral land.

- **Drainage patterns**

Drainage in the southern and eastern section of the unit is dominated by the River Inny, which is fed by numerous tributary streams and rivers. The northern section drains toward the Camlin River.

Human Influence

- **Settlement pattern**

This unit has the most developed urban structure of the County, being served by twelve designated settlements. Settlements tend to be established longer than in other units throughout the County and as, such, generally exhibit a strong character, identity and sense of community.

One-off and ribbon development tends to be more pronounced in the northern section of the unit, tapering off to the south where the more agriculturally productive lands are located.

Ballymahon is the largest of the settlements in this unit, having a population in the region of 830 at the last census. The town has its own unique character, with a wide street and strong horizontal and vertical building lines. Good examples of relatively intact Victorian architecture line the eastern end of the Main Street, while the centrally located Courthouse, unfortunately in a poor state of repair, occupies a plaza-like position.

Pressure for development in Ballymahon has been steady over the last number of years with over 800 housing units granted within the settlement envelope. It is therefore likely that the population figure has increased substantially since the census.

A significant number of these applications have translated into completed houses, considerably altering the appearance of the town. The most notable change has been at the Inny Bridge, where the old mill has been refurbished and an additional apartment building constructed within a linear parkland setting along the banks of the River.

A substantial townhouse and apartment development has taken place on the approach from Mullingar, which has significantly altered the appearance of the area where linear one-off development dominated.

Moydow is centrally located within the County and is a small settlement with a nucleus of a church and school. Sporadic development has taken place with permission granted for 18 houses in the vicinity.

Keenagh village, located to the western boundary of the unit, is a well-established settlement in a linear formation, located along the R397. The village has witnessed a substantial level of development over recent Development Plan periods relative to its size. Fortunately, most of these developments have managed to retain a sense of village character and identity in terms of their layout and design, relating strongly to

the street and, by utilising backland and infill sites, maintaining a pedestrian emphasis to the village. A commensurate increase in the level of social and community facilities available will help to ensure the viability and cohesion of village life in this settlement.

Ardagh is a former estate village located to the northern section of the unit. A consistently high performer in the Tidy Towns Competition, the village has a wealth of architectural heritage, which defines the settlement and creates a unique sense of place. Historically important as an Episcopal seat, the central area of the village remains relatively undeveloped and has an Architectural Conservation Area in place.

Abbeyshrule is a small village located on the Royal Canal and the River Inny. The substantial industrial architecture associated with the Canal, the Abbey, associated graveyard and the flat, pastoral environs create the distinctive ambiance of the settlement. Two housing estates are situated in the centre of the village both of which respect the scale and character of the settlement in terms of their layout, density and design.

The designated settlement of Ratharney is located nearby, at the junction of the R399 and R393. Centred on the existing shop and petrol pump (now unfortunately closed) permission has been granted for three additional houses.

Barry, Taghshinny and Colehill are small settlements clustered around a central nucleus, such as a post office in the case of Colehill, schools and pubs in Taghshinny and a “street” containing a shop in the case of Barry. Each is well established with distinctive architecture and features in each case.

Carrickboy and Ballycloughan are located to the east of the unit. Ballycloughan lies 2km south of Ardagh on the R393. The settlement consists of recent single-house development in a linear format centred on the parish church. The use of bright colours, distinctive boundary treatments and sculpture give a village feel to what would otherwise appear as standard ribbon development.

Carrickboy is located approximately 1km further south along the R393 at its junction with the N55. Consisting of a garage, former pub and a handful of houses, there is little to perceptually tie development together as a settlement. The nearby school may have a potential role in the creation of an identity for this village.

Legan is a well-established settlement on the eastern border of the County in the parish of Kilglass. Adjacent to the former Foxhall Glebe, with its important architectural and archaeological remains, the village has developed in a linear fashion with a central nucleus where the majority of recent development has taken place. Facilities in the village are well articulated.

- **Transport and Communications**

The road network in the unit is relatively dense, with the exception of the elevated areas around Ardagh and Castlereagh Mountain. The N55 traverses the unit from northeast to southwest and is served by a network of five regional routes.

The Royal Canal is important as an amenity, a landscape feature and a significant influence on the history, culture, architecture and archaeology of the area. The waterway traverses the southern portion of the unit.

The area contains almost one quarter of the mobile communications infrastructure in the County.

- **Agriculture**

Agriculture exists mainly in the northern section of this unit.

- **Industry and Services**

The majority of industry and services are provided within Ballymahon and these include Scientific Games Worldwide Services Ltd, Kepak and Readymix. It is considered that their respective locations within the town have minimal landscape impact.

- **History, Archaeology and Culture**

This area holds historical and cultural significance with the Irish writer Oliver Goldsmith as he spent time within this area of Longford.

The location of the Royal Canal within this unit also meant that a number of the settlements evolved around the Canal and indeed some of the traditional architecture within this unit is reflective of this.

- **Recreation and Amenity**

The Royal Canal and River Inny provide important amenity and recreation facilities within the unit. The Inny Kayaking Club which is based within Ballymahon has developed over the years and optimises use of this recreational resource.

Abbeyshrule Airport has developed significant aviation facility within the village of Abbeyshrule and is extremely popular with aviators from both Ireland and the UK.

Landscape Sensitivity

Visual sensitivity of the landscapes in this unit are generally **LOW**. An exception to this designation is the vicinity of the Royal Canal, the River Inny, in Upland Areas with designated scenic views, and in proximity to the heritage village of Ardagh where sensitivity is **HIGH**.

Threats

- Inappropriate development within the vicinity of the Royal Canal and River Inny.
- Encroachment of development onto the upland areas with potential interference with designated scenic views.
- Potential loss of character of existing towns and villages including unsympathetic residential developments in areas of high architectural quality, particularly within the heritage village of Ardagh.

Opportunities

- Existing and potential recreational and amenity development, particularly with relation to the River Inny and Royal Canal.
- Existing strong settlement base which has capability to absorb further development.

Policy Responses

- Fast track the formulation of Local Area Plans/ village policy statements throughout the county to create, preserve and enhance village character.
- Promote the development of adequate community and social facilities in smaller villages to maintain character, identity and pedestrian scale.

2.3 Identification of Visual Units

Visual units can be described as areas defined by spatial enclosure and pattern, which are determined, by landform and landcover.

Boundaries of visual units can usually be divided into several or a combination of the following:

- The physical limits of a view or prospect
- The physical limits of a water catchment
- The “gateway” between areas contrasting in their degree of spatial containment

Identification of visual units is a complex process, not least because the visual limits of an area can span several counties.

2.4 Identification of Image Units

Image units are generally composed of landscape areas that are dominated by a major focal point, where a visual field results from the association of this part of the landscape with this feature. Obvious examples of image units in the Longford context would include Ardagh Mountain, Corn Hill and the many lakes, rivers and other waterways throughout the county. These features exert a disproportionately large impact on their surroundings by reason of their size; shape, colour and how they interact with adjacent landscape components.

3.0 LANDSCAPE VALUES

Landscape values can be described as the environmental or cultural benefits, including services and functions that can be derived from various landscape attributes.

The following landscape elements are considered to be important within the County.

Feature	Location	Value
Boglands	Begnagh, Clonard, Kilashee, Commons North, Curry Bog	Aesthetic, ecological, historical, socio-cultural
Rivers	Shannon, Inny, Camlin and associated banks and callows	Aesthetic, ecological, historical, socio-cultural
Lakes	Lough Ree, Lough Gowna, Lough Forbes, and other lakes in the County and associated shores and islands.	Aesthetic, ecological, historical, socio-cultural, religious and mythological
Uplands	Ardagh mountain, Cairn hill	Aesthetic, ecological, historical, socio-cultural, religious and mythological
Archaeological sites, artefacts, structures and objects	Mornin and Castlereagh castles, Abbeylara, Abbeysrule, Saints Island, Inchcleraun, Granard Moat, Granardkille.	Aesthetic, ecological, historical, socio-cultural, religious and mythological
Woodlands	Newtownforbes, Newcastle, Derrycassan, Carriglass, Portanure, Legan.	Aesthetic, ecological, historical.
Architecture	Mill buildings, the Royal Canal and its associated structures, built fabric of towns and villages, churches, courthouses.	Aesthetic, ecological, historical, socio-cultural, religious.

In addition, the importance of existing artefacts etc. contained in the SMR and NHAs, SACs, SPAs and ASIs were emphasised and their continued protection underlined.

4.0 LANDSCAPE SENSITIVITY

The sensitivity of a landscape can be described as the measure of its ability to accommodate change or intervention without suffering unacceptable effects to its character and values.

In order to assess sensitivity, it is necessary to evaluate what development, if any, it is possible to locate within any given area without causing negative impact on the landscape character or values of that area.

Where it is considered that development can be located within a particular area without giving rise to negative impacts, this landscape can be deemed to be of a low sensitivity.

Conversely, an area where development would seriously damage character or damage/eliminate irreplaceable values associated with a landscape, this landscape can be termed highly sensitive.

Areas which are considered as sensitive fall into the following categories:

- Areas, structures artefacts, ruins, objects, views and routes identified as important within the County.
- Areas listed as Natural Heritage Areas and/or Special Protected areas at national level and areas included in the European Communities (Conservation of Wildbirds) (Amendment No.2) Regulations, 1996.
- Views listed for protection in the current County Development Plan, 2015-2021.
- Views/tourist designations on published maps of the County.
- Recognised areas of literary/cultural importance.

APPENDIX 1

Landscape Unit 1: Northern Drumlin Lakeland

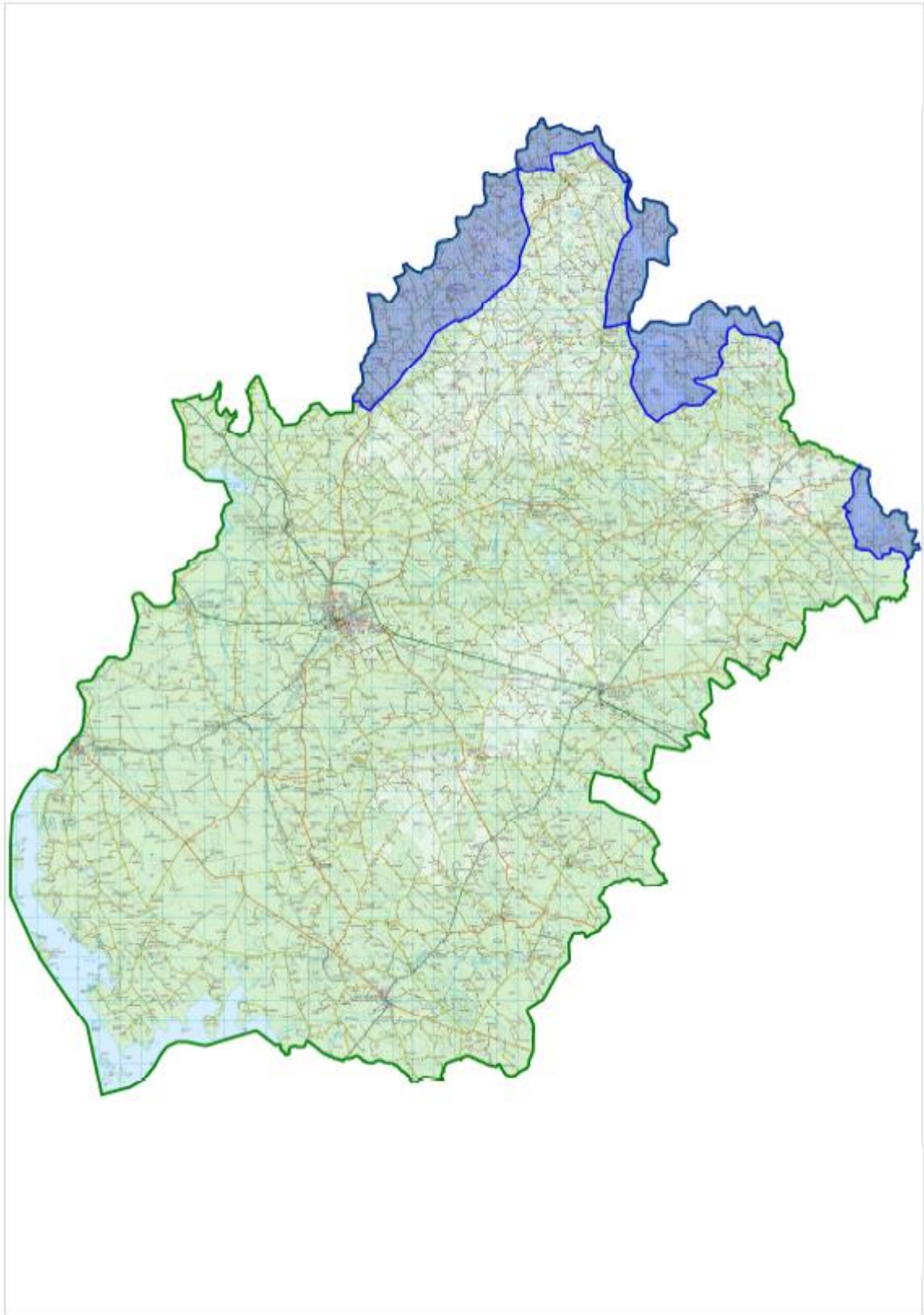

Landscape Unit 2: Northern Upland

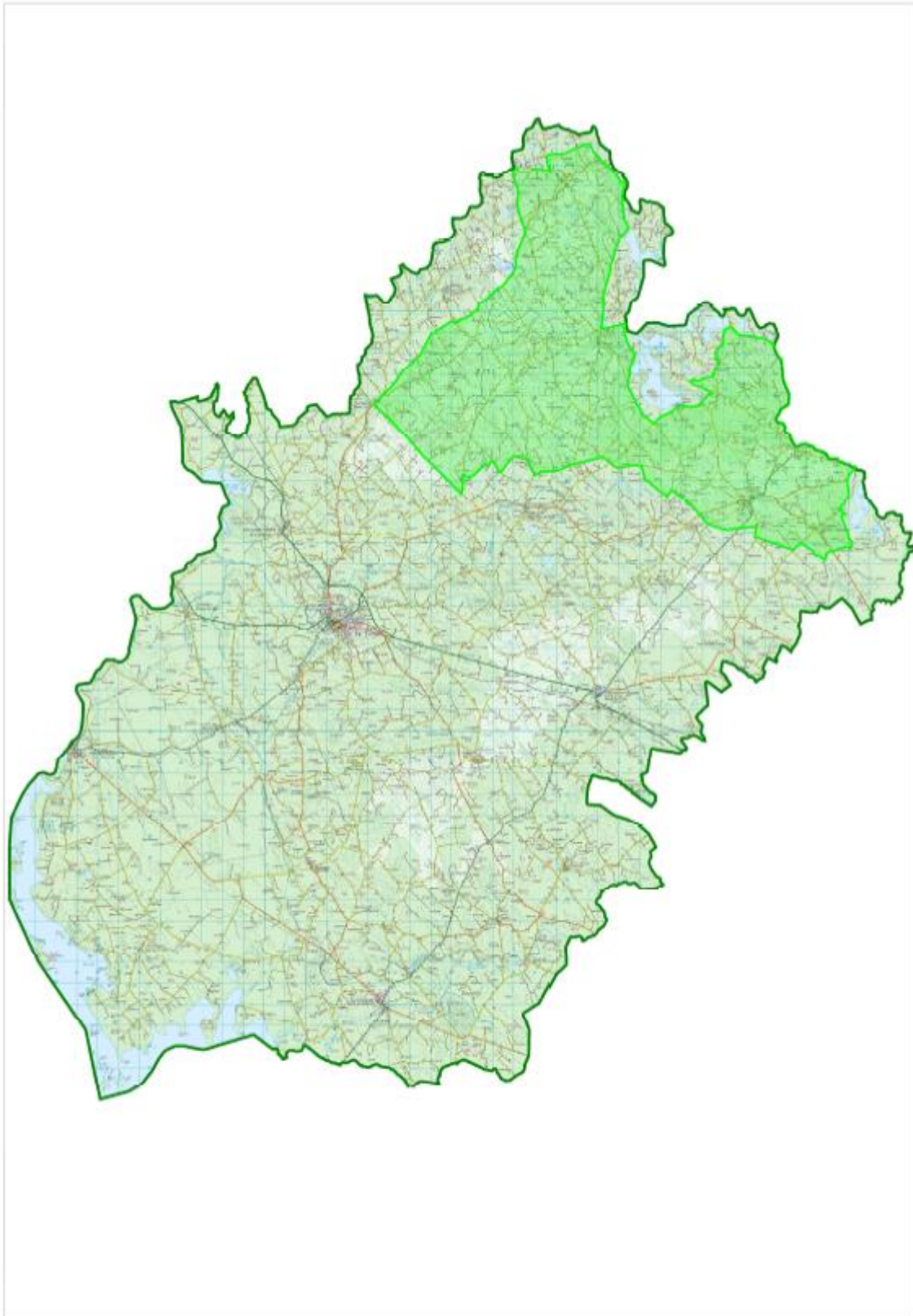

Landscape Unit 3: Shannon Basin / Lough Ree

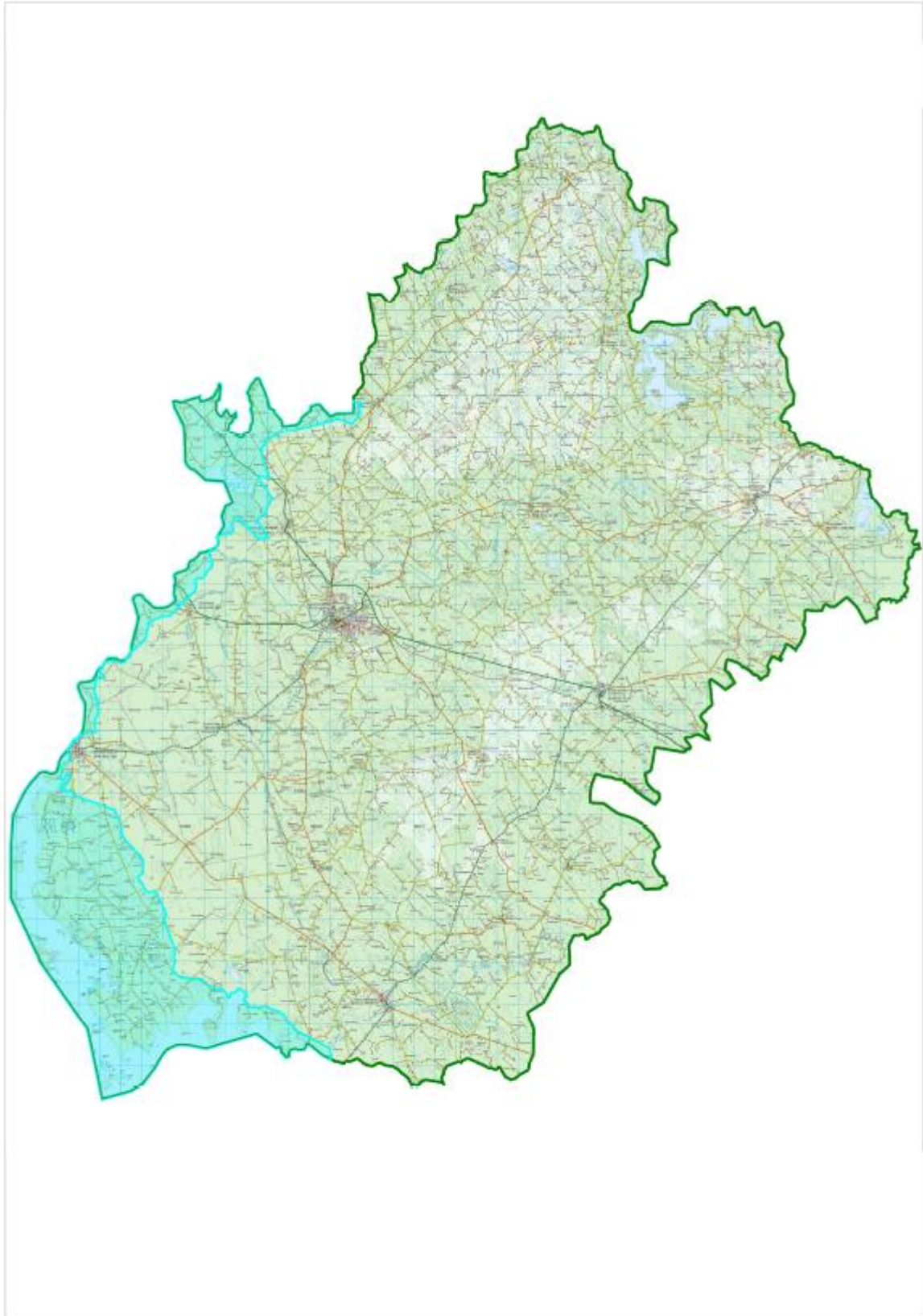

Landscape Unit 4: Central Corridor

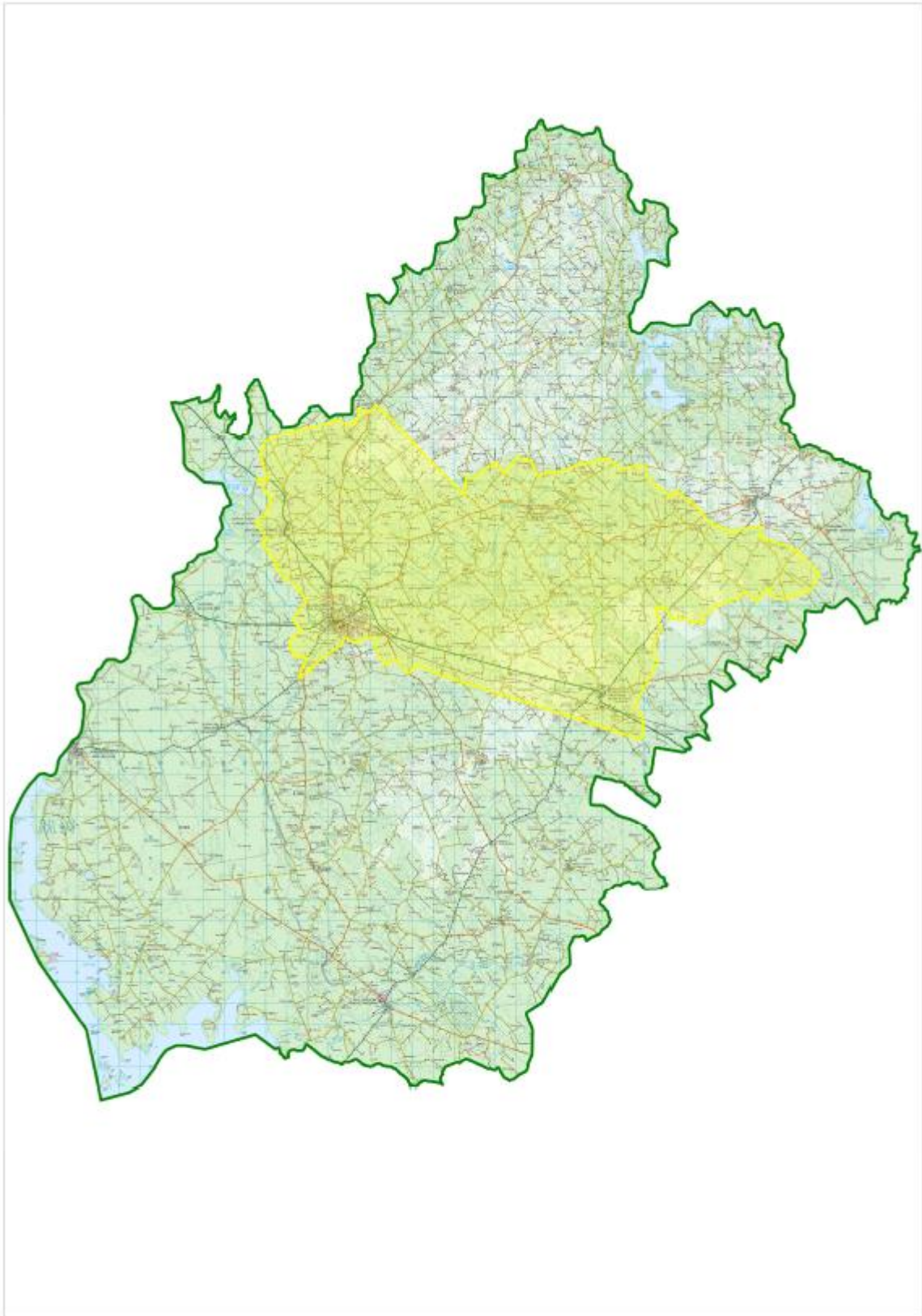

Landscape Unit 5: Inny Basin

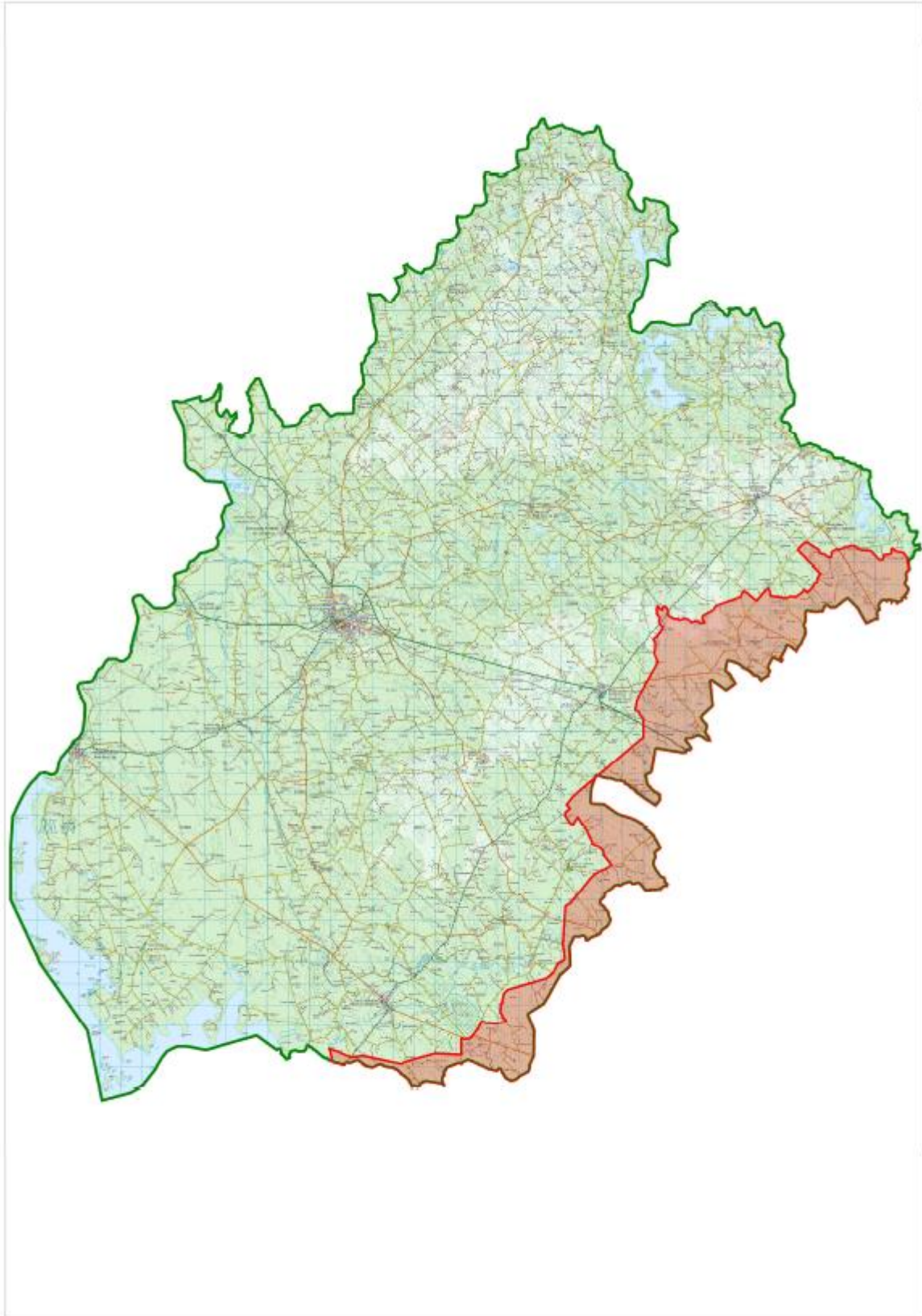

Landscape Unit 6: Peatlands

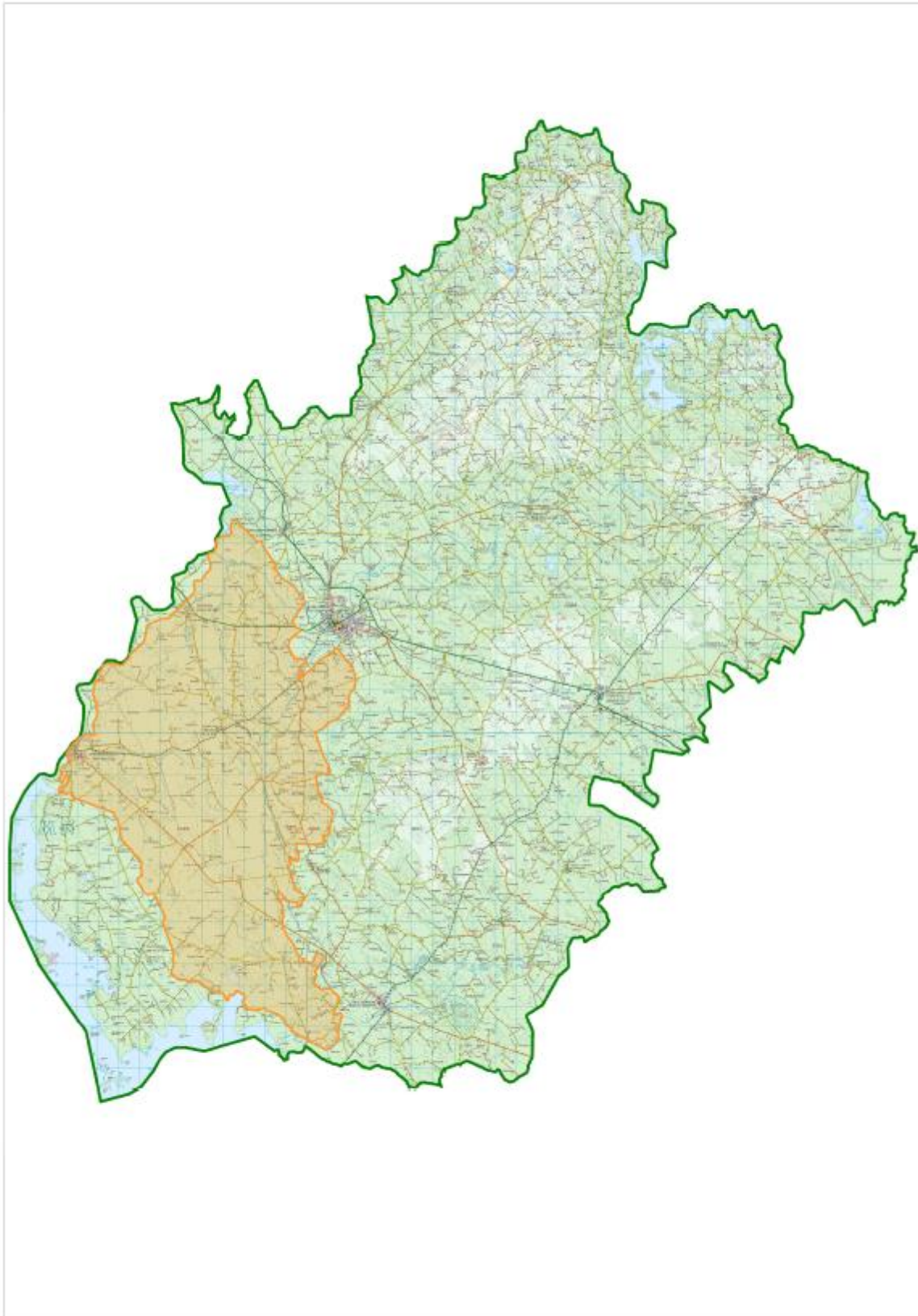

Landscape Unit 7: Open Agricultural

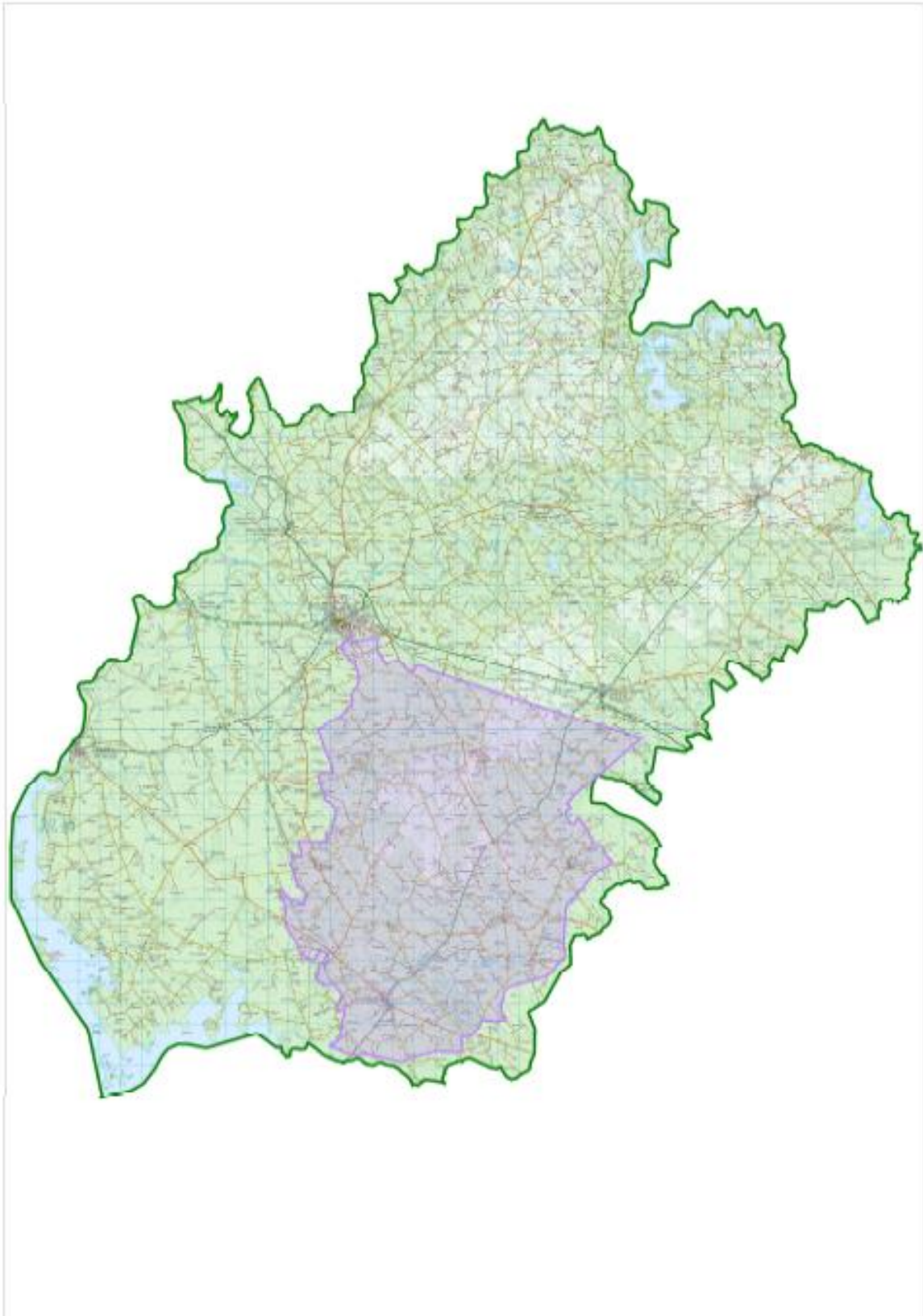

Table of Contents

Annex 1: Section 28 Ministerial Guidelines

Annex 2: Strategies and Plans affecting the Development Plan

Annex 3: Socio Economic Profile of Municipal Districts in County Longford

Annex 4: Housing Strategy

Annex 5: Infrastructure Assessment Report

Annex 6: Settlement Asset Based Criteria Table

Annex 7: Rural Design Guidelines

Annex 8: Shopfront Design Guidelines

Annex 9: County Longford Retail Strategy

Annex 10: Mid Shannon Wilderness Park

Annex 11: Landscape Character Assessment

Annex 1:

Section 28 Ministerial Guidelines

Section 28 Ministerial Guidelines

Architectural Heritage Protection – Guidelines for Planning Authorities (2004)
Architectural Heritage Protection for Places of Worship - Guidelines for Planning Authorities (2003)
Architecture Policy Guidelines 2009-2015
Best Practice Urban Design Manual - Part 1 & 2 (2009)
Childcare Facilities Guidelines for Planning Authorities (2001)
Development Contribution Scheme for Planning Authorities – (Circular PD 5/2007)
Development Contribution Scheme for Planning Authorities - Circular PD4/2003
Development Management Guidelines- Guidelines for Planning Authorities (2007)
Development Plans Guidelines - Guidelines for Planning Authorities (2007)
Spatial Planning and National Roads Guidelines (2012) — Funfair Guidance
Draft Revised Wind Energy Development Guidelines (DHPLG, 2019)
Implementation of new EPA Code of Practice on Waste Water Treatment and Disposal Systems Serving Single Houses - Circular PSSP1/10
Implementing Regional Planning Guidelines- Best Practice Guidance (2010)
Implementation Roadmap for the National Planning Framework (Gol, 2018)
Landscape and Landscape Assessment
Provision of Schools and the Planning System – Code of Practice for Planning Authorities, The Department of Education and Science and the Department of the Environment, Heritage and Local Government (2008)
Quarries and Ancillary Activities- Guidelines for Planning Authorities (2004)
Retail Planning Guidelines
Section 261A of the Planning and Development Act, 2000 and related provisions, Guidelines for Planning Authorities (2012)
Smarter Travel, A Sustainable Transport Future, A New Transport Policy for Ireland 2009 - 2020
Strategic Environmental Assessment (SEA)
Sustainable Rural Housing Development Guidelines (2005)
Sustainable Residential Development in Urban Areas (2009)
Sustainable Urban Housing: Design Standards for New Apartments - Guidelines for Planning Authorities (2007)
Taking in Charge of Housing Estates / Management Companies
Taking in Charge of Residential Developments Circular Letter PD 1/08
Telecommunications Antennae and Support Structures- Guidelines for Planning Authorities (1996)
The Planning System and Flood Risk Management - Guidelines for Local Authorities (2009)
The Planning System and Flood Risk Management – Technical Appendices (2009)
Tree Preservation Guidelines
Waste Water Discharge (Authorisation) Regulations - Circular PD 7/09
Wind Energy Development Guidelines (2006)

Annex 2:

**Strategies and Plans affecting the
Development Plan**

Strategies and Plans affecting the Development Plan

EU and National

Action Plan for Jobs 2018
Action Programme for Effective Local Government, Putting People First
National Strategy on Children and Young People's Participation in Decision-Making 2015-2020
Better Outcomes Brighter Futures: The National Policy Framework for Children and Young People 2014-2020
Children First – National Guidance for Protection and Welfare of Children
Creative Ireland Programme
eGovernment Strategy 2017-2020
Enterprise 2025 Renewed
Food Wise 2025
Future Jobs Ireland – Current Strategy 2017-2020
Healthy Ireland – A framework for Improved Health & Wellbeing 2013-2025
Innovation 2020
Keeping Communities Safe – Fire Services Framework
Local Authority People Strategy
National Broadband Plan
National Climate Change Adaptation Framework
National Cyber Security Strategy
National Development Plan 2018-2027
National Digital Strategy
National Disability Inclusion Strategy 2017-2021
National Heritage Plan – Heritage Ireland 2030
National Homeless Strategy
National Housing Strategy for People with a Disability
National Implementation Plan 2018 – 2020
National Positive Ageing Strategy
National Social Policy for Ireland 2019-2022
National Traveller and Roma Inclusion Strategy 2017-2021
Our Public Libraries 2022: Inspiring, Connecting and Empowering Communities
Project 2040 - National Planning Framework Project 2040
Public Service 2020
Public Sector Energy Efficiency Strategy
Rebuilding Ireland – Action Plan for Housing and Homelessness
Realising Our Rural Potential – Action Plan for Rural Development
Renewable Electricity Policy & Development Framework
River Basin Management Plan for Ireland
Social Housing Strategy
Strategy to Support the Community & Voluntary Sector in Ireland
Sustainable, Inclusive and Empowered Communities 2019-2024
The Migrant Integration Strategy
The Shannon Mighty River of Ireland: A Tourism Masterplan (2020-2030)
Traveller Accommodation Programme
UN Goals 2030
Waterways Ireland Heritage Plan 2016-2020
Water Services Policy Statement 2018-2025

Regional

Border Midland West Regional Operational Programme 2014 -2020
Eastern and Midland Regional Spatial and Economic Strategy 2019-2031
Just Transition Report (May 2020)
Midlands Regional Enterprise plan to 2020
Midlands Regional Homeless Strategy
Midlands Region Waste Management Plan Regional Enterprise Strategy 2018-2020
Midland Western Regional Assembly Operational Programmes

Local

County Longford Age Friendly Strategy 2015-2020
County Longford Arts Development Strategy 2014-2020
County Longford Culture and Creativity Plan 2018-2022
County Longford Childcare Strategic Plan
County Longford Diaspora Strategy 2019-2023
County Longford Heritage Plan, 2015-2020
County Longford Local Economic & Community Plan 2016-2022
County Longford Tourism Strategy
Longford County Council Climate Change Adaptation Strategy 2019
Longford County Council Corporate Plan 2019-2024
Longford County Council Fire Service Operations Plan 2011-2015
Longford County Council Irish Language Scheme
Longford County Council Litter Management Plan
Longford County Council Occupational Health & Safety Management System
Longford County Council Procurement Plan
Local Enterprise Development Plan
Longford Healthy County Plan 2018-2022
Longford Libraries and Archives Plan
Longford Sports Partnership Strategy 2018-2022
Longford Social Inclusion & Community Activation Programme Annual Plan Longford
Inter-Cultural Strategic Plan – Longford County Council 2018-2022
Rural Development Project 2014-2020

Annex 3:

**Socio Economic Profile of Municipal
Districts**

Socio-economic profile of the Municipal Districts in County Longford

Introduction

This annex provides an understanding of the socio-economic and demographic datasets, assessment and commentary (including trends and spatial analysis), mapping and data visualisation (tables, charts, graphs and figures) for each Municipal District within County Longford to further assist with the review of the Longford County Development Plan. As previously noted, the Municipal Districts were revised in 2018 and the Electoral Districts of Breanrisk, Cloonee and Corboy transferred from the Granard Municipal District into the Longford Municipal District. The information herein reflects the data from the 2016 Census based on those revised boundaries.

Demographic Profile

Population Distribution

Longford MD was the smallest (by area) and most populous MD with a population of 16,046. Higher concentrations of population density were evident on the outskirts of Longford town as illustrated in Table 1 and Figure 1.

Table 1: Population distribution within Longford MD (Source: CSO)

Electoral District	Total Population in 2016
Longford No. 1 Urban	3592
Longford No. 2 Urban	1029
Breanrisk	839
Caldragh	2172
Cloondara	687
Cloonee	738
Corboy	388
Longford Rural	5704
Newtown Forbes	897

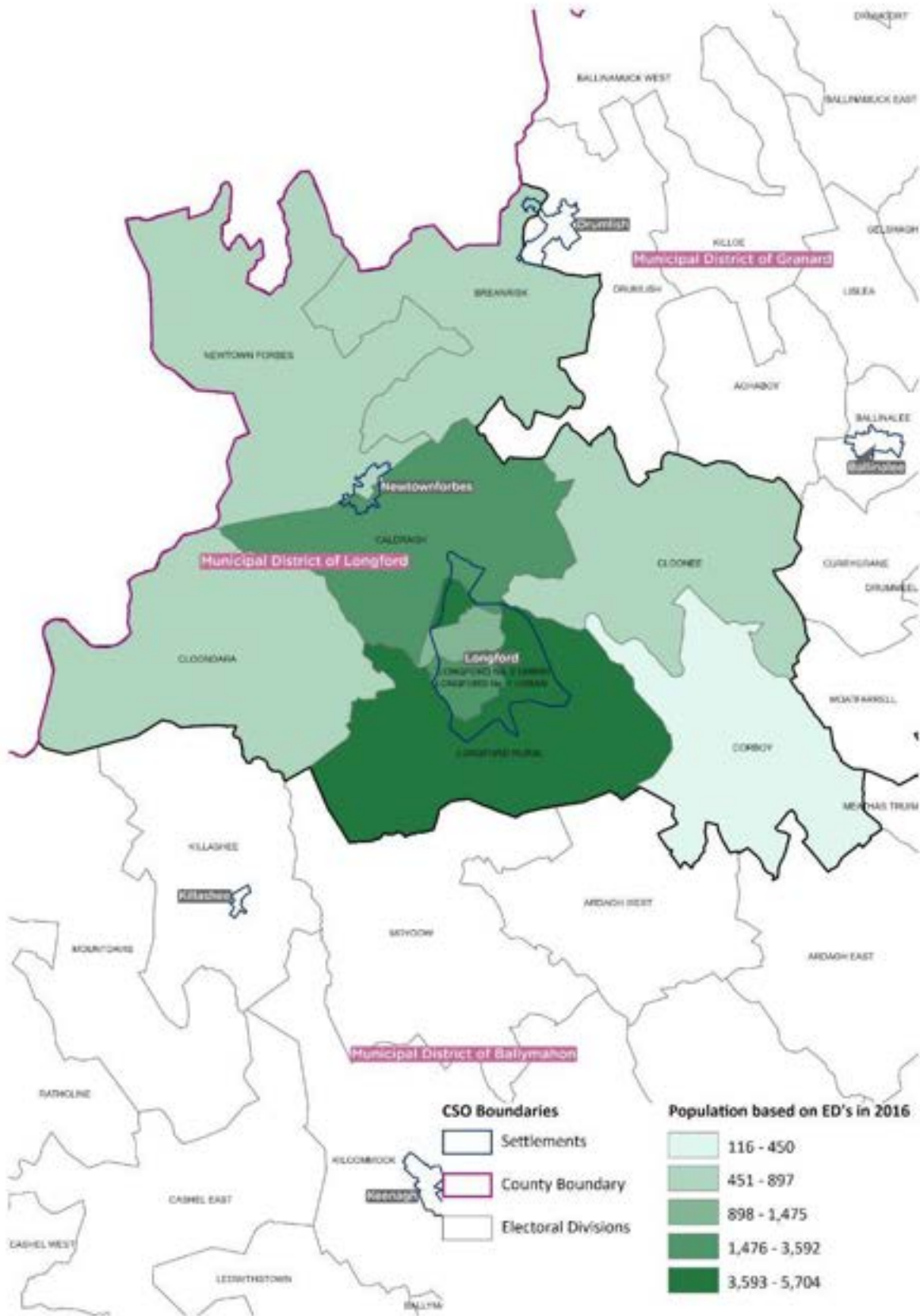

Figure 1: Population distribution and density in Longford MD based on Electoral Districts (Source: CSO)

Ballymahon MD was the largest (by area) and second most populous MD with a population of 14,153. Higher concentrations of people were evident in and around the towns of Ballymahon, Keenagh, Edgeworthstown and Lanesborough as illustrated in Table 2 and Figure 2.

Table 2: Population distribution within Ballymahon MD (Source: CSO)

Electoral District	2016 Population
Agharra	444
Ballymahon	2674
Cashel East	302
Cashel West	589
Doory	424
Forgney	491
Foxhall	528
Kilcommock	1062
Kilglass	709
Ledwithstown	363
Ballymuigh	250
Meathas Truim	2335
Ardagh East	670
Ardagh West	450
Killashee	437
Mountdavis	252
Moydow	730
Rathcline	1443

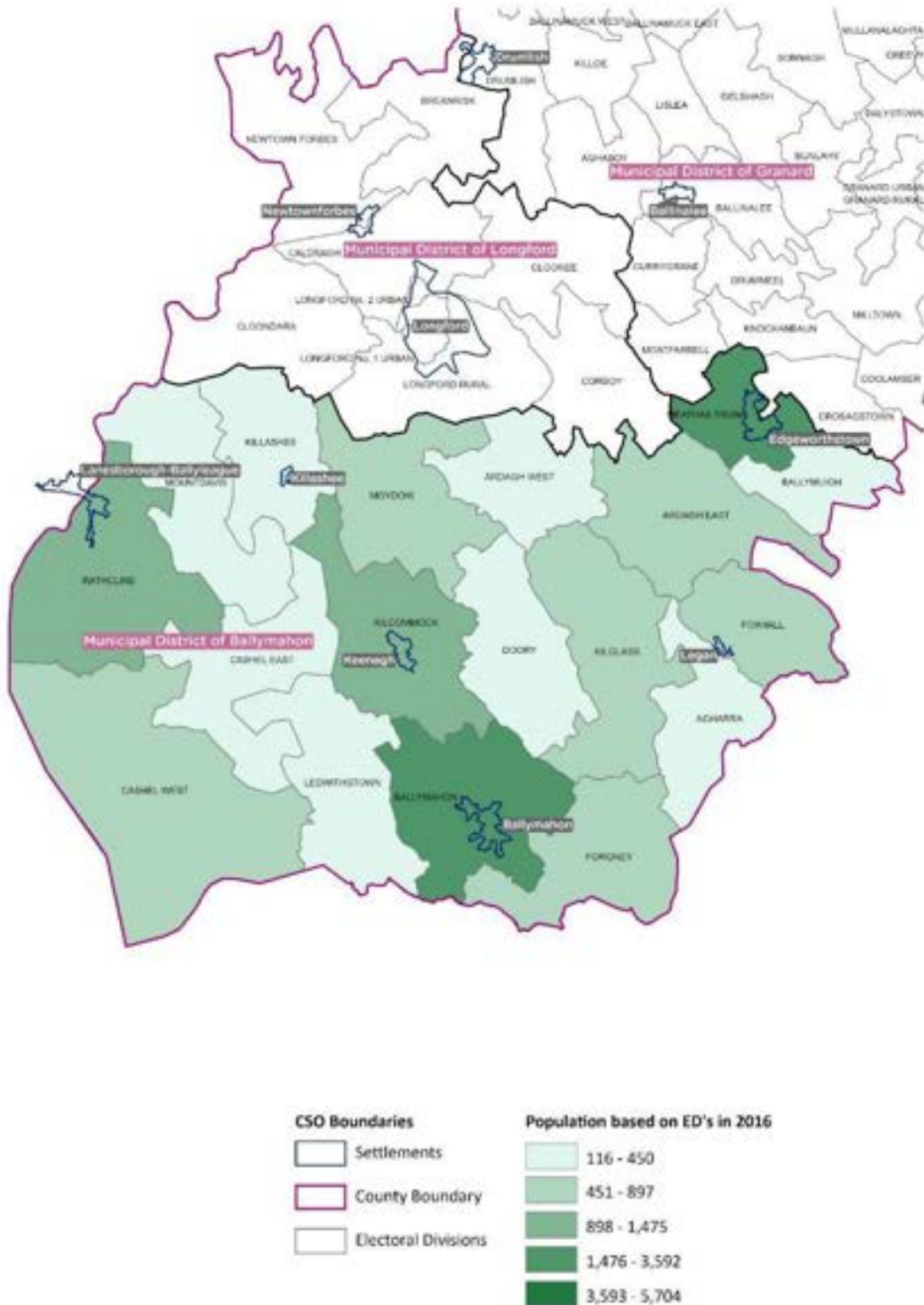

Figure 2: Population distribution and density in Ballymahon MD based on Electoral Districts (Source: CSO)

Granard MD was the second largest (by area) and least populous MD with a population of 10,674. Higher concentrations of people were evident in and around the towns of Drumlish and Granard as illustrated in Table 3 and Figure 3.

Table 3: Population distribution within Granard MD (Source: CSO)

Electoral District	2016 Population
Abbeylara	298
Ballinalee	625
Bunlahy	195
Columbkille	592
Coolamber	382
Creevy	308
Crosagstown	247
Currygrane	139
Dalystown	196
Drummeel	116
Firry/Newgrove	196
Gelshagh	351
Granard Rural	301
Granard Urban	1096
Knockanbaun	169
Lislea	145
Milltown	344
Moatfarrell	217
Moyne	326
Mullanalaghta	298
Sonnagh	245
Aghaboy	681
Ballinamuck East	599
Ballinamuck West	437
Drumgort	422
Drumlish	1475
Killoe	274

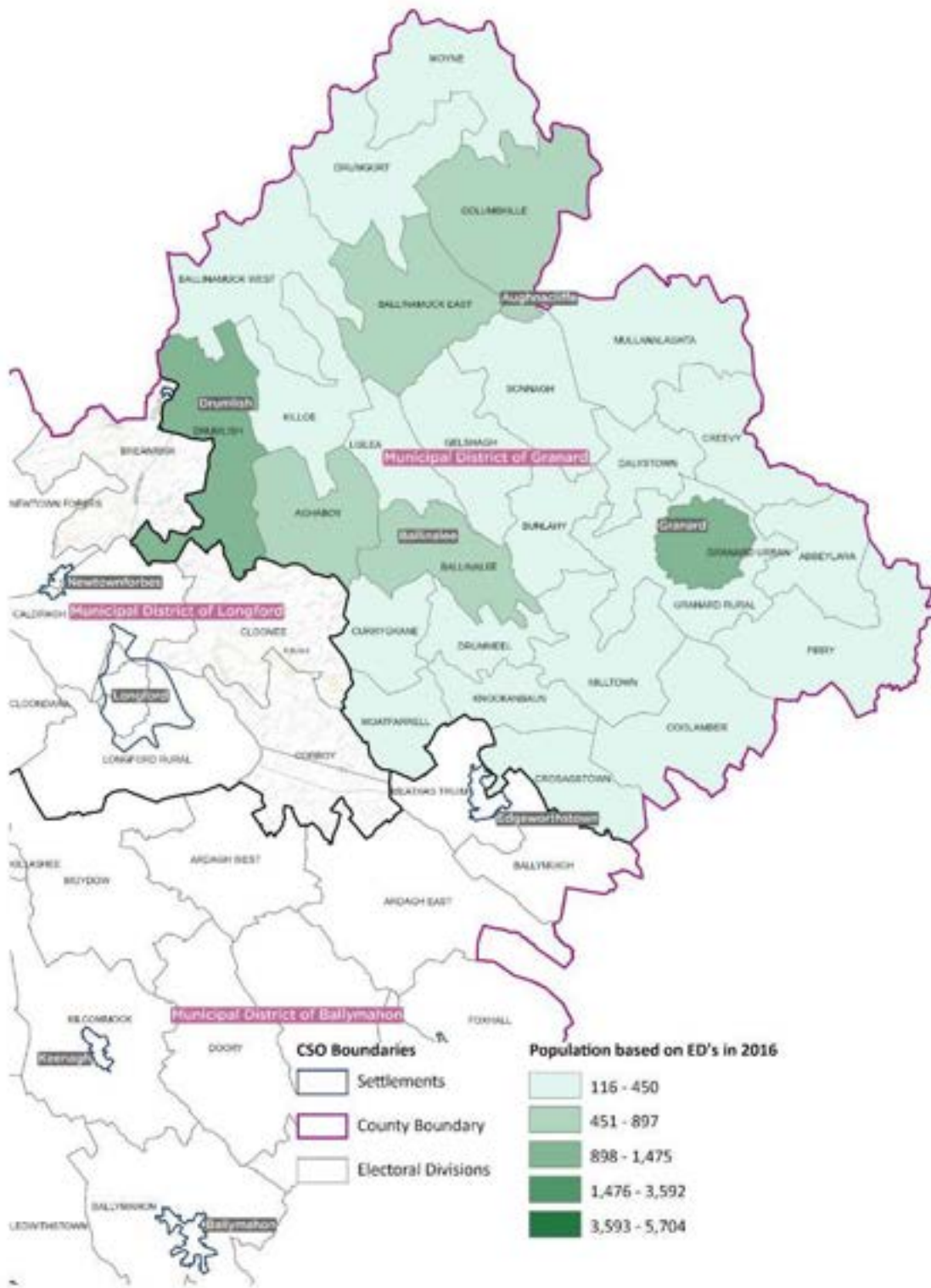

Figure 3: Population distribution and density in Granard MD based on Electoral Districts (Source: CSO)

Population Growth and Change

Historic Change

The population has changed over time as noted in Table 4 and illustrated in Figure 3. Particularly high growth was evident in and around Longford town and Cloondara whilst Newtownforbes declined during that time. As set out in Table 14, historically Caldragh has grown extensively whilst Longford town and Newtownforbes have been more variable since 1981.

Table 4: Population Growth in Longford MD per ED during 1981 – 2016 (Source: CSO)

Electoral District	% Change 1981 - 1986	% Change 1986 - 1991	% Change 1991 - 1996	% Change 1996 - 2002	% Change 2002 - 2006	% Change 2006 - 2011	% Change 2011 - 2016
Longford No. 1 Urban	-9.50%	-3.19%	3.53%	-4.95%	10.28%	0.96%	13.56%
Longford No. 2 Urban	-5.26%	-2.55%	9.24%	0.28%	12.52%	17.88%	9.12%
Breanrisk	2.02%	-8.38%	0.50%	6.29%	10.75%	14.77%	2.82%
Caldragh	18.86%	7.00%	22.90%	12.60%	25.93%	28.97%	5.39%
Cloondara	-1.21%	-1.93%	-1.43%	-0.54%	4.74%	7.13%	11.53%
Longford Rural	12.07%	0.24%	-2.96%	20.72%	16.89%	8.84%	3.86%
Cloonee	0.71%	-0.18%	6.02%	3.17%	9.87%	7.07%	1.51%
Corboy	2.31%	-1.41%	3.14%	9.42%	-3.54%	4.72%	-2.76%
Newtown Forbes	12.87%	-0.69%	6.22%	10.29%	5.31%	1.12%	-0.55%

The population in Ballymahon MD increased during 2011 – 2016 from 13,284 to 14,153 (i.e. by 6.5%). As noted in Table 5 and illustrated in Figure 3, particularly high growth was evident in and around Ballymahon, Edgeworthstown and Keenagh (Kilcommock ED) during that time whilst in contrast Doory and Cashel East declined during that time. As set out in Table 15, historically most areas have experienced spurts of growth and decline. However Kilcommick, Ledwithstown, Kilashee and Ardagh east have significantly grown in the most recent Censuses.

Table 5: Population Growth in Ballymahon MD per ED during 1981 – 2016 (Source: CSO)

Electoral District	% Change 1981 - 1986	% Change 1986 - 1991	% Change 1991 - 1996	% Change 1996 - 2002	% Change 2002 - 2006	% Change 2006 - 2011	% Change 2011 - 2016
Agharra	-5.76%	-10.56%	11.18%	-7.54%	7.85%	27.73%	-2.63%
Ballymahon	3.18%	-4.26%	-3.59%	-0.71%	16.41%	29.13%	14.91%
Cashel East	2.39%	3.63%	-7.00%	-12.90%	-3.70%	3.53%	-6.50%
Cashel West	-0.47%	-9.21%	-1.22%	-4.78%	1.67%	4.57%	2.97%
Doory	6.46%	-4.34%	4.23%	3.77%	16.20%	9.86%	-7.22%
Forgney	0.72%	-9.03%	-0.78%	3.42%	13.49%	11.43%	-1.21%
Foxhall	-3.67%	-10.66%	5.97%	15.55%	18.33%	2.94%	0.57%
Kilcommock	3.82%	-5.44%	1.18%	-2.84%	2.41%	60.17%	11.44%
Kilglass	-11.59%	-5.34%	1.09%	5.95%	4.93%	14.59%	0.28%
Ledwithstown	5.86%	-9.23%	-8.81%	-4.09%	10.47%	24.91%	1.97%
Ballymuigh	4.62%	-5.51%	-0.39%	-0.39%	-3.53%	2.44%	-0.79%
Meathas Truim	12.80%	-1.40%	-7.43%	4.97%	40.62%	30.05%	16.28%
Ardagh East	4.78%	-6.35%	-8.00%	0.00%	7.37%	7.92%	9.30%

Socio-economic Profile for County Longford							June 2020
Ardagh West	-8.60%	-2.06%	3.00%	15.74%	10.58%	4.78%	-2.17%
Killashee	-1.97%	-4.02%	-1.67%	-0.43%	21.37%	52.11%	1.16%
Mountdavis	7.22%	-6.25%	-5.13%	6.49%	3.55%	22.55%	0.80%
Moydow	5.49%	2.04%	3.10%	-1.59%	5.75%	13.41%	9.28%
Rathcline	4.73%	-4.81%	-4.44%	1.60%	1.66%	10.78%	1.05%

The population in Granard MD has changed over time as noted in Table 6 and illustrated in Figure 3. Particularly high growth was evident in and around Granard, Ballinalee and the north and west Aughnaccliffe whilst Abbeylara, Killoe and a number of other areas declined during that time. As set out in Table 6, individual areas have been subject to contrasting periods of population growth and decline since 1981 with significant growth evident in Ballinalee, Coolamber, and Ballinamuck East in recent Censuses.

Table 6: Population Growth in Granard MD per ED during 1981 – 2016 (Source: CSO)

Electoral District	% Change 1981 - 1986	% Change 1986 - 1991	% Change 1991 - 1996	% Change 1996 - 2002	% Change 2002 - 2006	% Change 2006 - 2011	% Change 2011 - 2016
Abbeylara	-1.79%	4.01%	-1.75%	-12.50%	28.16%	8.28%	-12.35%
Ballinalee	3.32%	-10.89%	-0.83%	5.32%	20.48%	32.01%	4.52%
Bunlahy	-2.82%	-13.95%	12.16%	0.60%	0.00%	12.57%	3.72%
Columbkille	1.34%	-5.43%	-7.60%	0.00%	1.51%	-1.32%	-0.84%
Coolamber	-6.76%	-5.43%	0.00%	0.77%	22.05%	15.58%	2.96%
Creevy	-9.16%	0.58%	-10.32%	-7.67%	19.03%	-9.01%	-1.60%
Crosagstown	0.00%	6.83%	-5.02%	8.65%	-3.98%	11.06%	2.49%
Currygrane	-20.47%	14.85%	-6.03%	15.60%	-0.79%	2.40%	8.59%
Dalystown	-6.45%	6.32%	-5.41%	-2.86%	2.94%	7.43%	4.26%
Drummeel	-2.17%	-20.00%	2.78%	14.41%	0.00%	8.66%	-15.94%
Firry/Newgrove	-13.07%	8.67%	5.85%	5.03%	5.74%	-1.81%	-9.68%
Gelshagh	-7.08%	-12.61%	-4.70%	13.38%	-0.93%	5.96%	3.85%
Granard Rural	2.04%	-12.00%	-1.14%	-1.92%	17.19%	-1.33%	1.69%
Granard Urban	4.12%	-8.74%	-3.93%	-13.64%	-7.90%	9.43%	7.35%
Knockanbaun	0.66%	-11.11%	-8.82%	6.45%	10.61%	3.42%	11.92%
Lislea	-2.92%	-4.82%	3.16%	-12.88%	7.04%	-8.55%	4.32%
Milltown	2.39%	-4.08%	0.00%	-1.82%	8.67%	7.41%	-8.75%
Moatfarrell	9.87%	-21.56%	-5.34%	27.42%	18.35%	16.58%	-0.46%
Moyne	-2.05%	-10.73%	-6.45%	0.63%	-4.98%	3.28%	3.49%
Mullanalaghta	-1.62%	-5.59%	4.88%	-2.99%	1.03%	1.36%	-0.33%
Sonnagh	-4.99%	-5.56%	-8.17%	0.00%	1.78%	-0.35%	-14.04%
Aghaboy	-4.86%	-4.13%	0.82%	3.46%	17.09%	14.77%	-0.44%
Ballinamuck East	5.10%	-6.59%	-10.02%	-4.33%	2.16%	15.19%	9.71%
Ballinamuck West	-4.77%	-3.97%	-1.52%	1.32%	-3.92%	13.61%	-12.77%
Drumgort	-5.19%	-12.52%	-3.80%	-3.26%	4.57%	-1.61%	-1.40%
Drumliah	1.05%	-0.26%	3.63%	3.63%	12.92%	48.34%	6.34%
Killoe	-11.64%	-3.29%	-5.26%	-7.19%	6.34%	-2.98%	-6.48%

Future Change

The Longford MD is expected to grow by 2,156 people or 13.4% with the most significant growth evident in and around Longford town as demonstrated in Table 7.

Table 7: Projected Population Growth in Longford MD during 2016 – 2027

Electoral District	Population change 2016-2027	Population change 2016-2027 (%)
Longford No. 1 Urban	563	16%
Longford No. 2 Urban	168	16%
Breanrisk	101	12%
Caldragh	290	13%
Cloondara	48	7%
Longford Rural	762	13%
Cloonee	94	13%
Corboy	25	6%
Newtown Forbes	105	12%

The Ballymahon MD is expected to grow by 1,663 people or 12% with the most significant growth evident in and around Ballymahon, Keenagh, Edgeworthstown and Killashee as demonstrated in Table 8.

Table 8: Projected Population Growth in Ballymahon MD during 2016 – 2027

Electoral District	Population change 2016-2027	Population change 2016-2027 (%)
Agharra	40	9%
Ballymahon	358	13%
Cashel East	15	5%
Cashel West	27	5%
Doory	44	10%
Forgney	51	10%
Foxhall	59	11%
Kilcommock	146	14%
Kilglass	73	10%
Ledwithstown	25	7%
Ballymuigh	21	8%
Meathas Truim	381	16%
Ardagh East	60	9%
Ardagh West	50	11%
Killashee	67	15%
Mountdavis	27	11%
Moydow	83	11%
Rathcline	136	9%

The Granard MD is expected to grow by 1,111 people or 10.4% with the most significant growth evident in and around Drumlish, Ballinalee and Coolamber as demonstrated in Table 9.

Table 9: Projected Population Growth in Granard MD during 2016 – 2027

Electoral District	Population change 2016-2027	Population change 2016-2027 (%)
Abbeylara	25	8%
Ballinalee	88	14%
Bunlahy	17	9%
Columbkille	37	6%
Coolamber	51	13%
Creevy	28	9%
Crosagstown	22	9%
Currygrane	15	11%
Dalystown	18	9%
Drummeel	5	4%
Firry	12	6%
Gelshagh	36	10%
Granard Rural	34	11%
Granard Urban	141	13%
Knockanbaun	18	10%
Lislea	4	3%
Milltown	43	12%
Moatfarrell	25	11%
Moyne	17	5%
Mullanalaghta	28	10%
Sonnagh	15	6%
Aghaboy	70	10%
Ballinamuck East	75	13%
Ballinamuck West	40	9%
Drumgort	26	6%
Drumlish	215	15%
Killoe	6	2%

Structure and Age Profile

Within Longford MD, the average age is 35.9 years which is the youngest of all MDs in the county, which can be associated with the relatively high proportion under 14 years (23.9% of the population) and relatively low proportion over 65 years (13.4%). An age profile pyramid for Longford MD is provided in Figure 4.

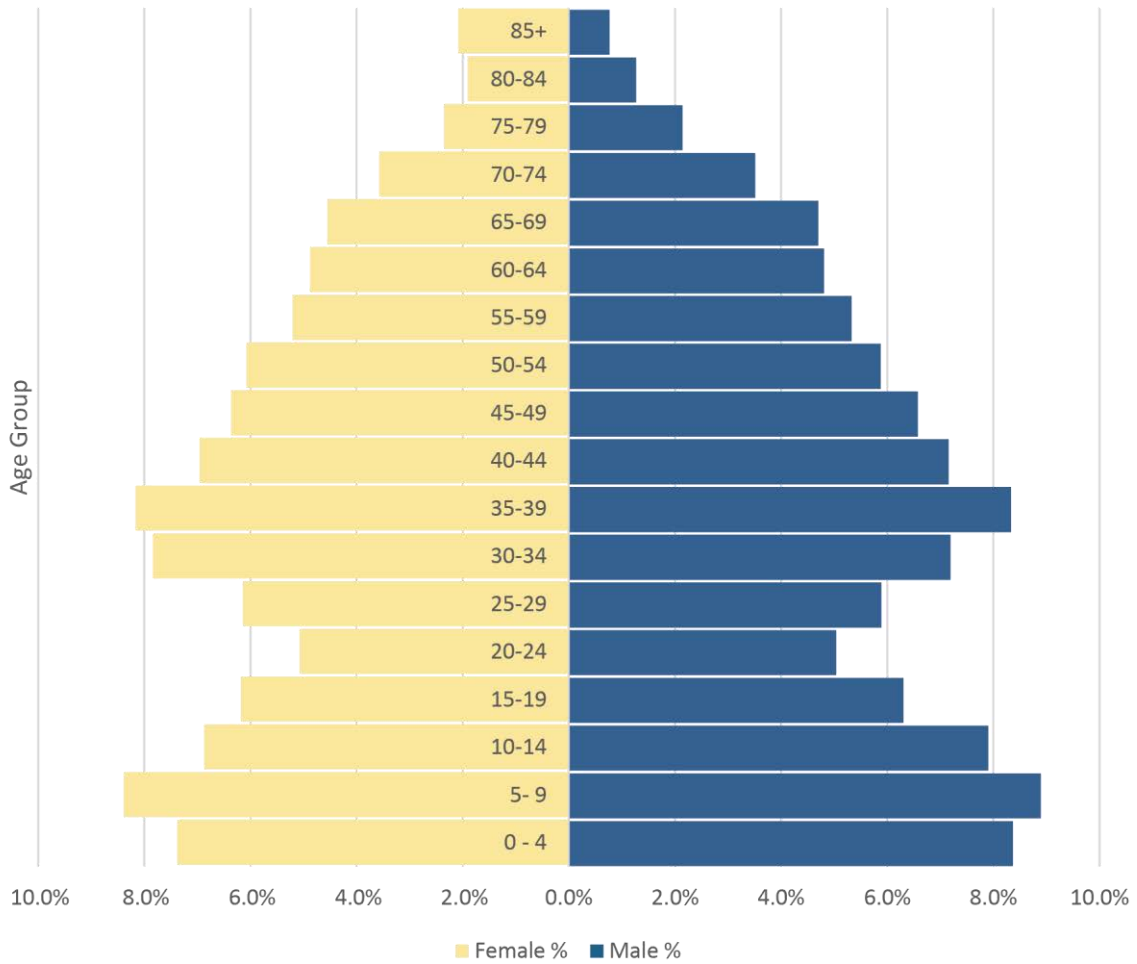

Figure 4: Population Age Pyramid for Longford MD (Source: CSO)

Within Ballymahon MD, the average age is 37.1 years with 22.8% of the population under 14 years, 61.7% of the population between 15 – 64 years and 15.5% above 65 years. An age profile pyramid for Ballymahon MD is provided in Figure 5.

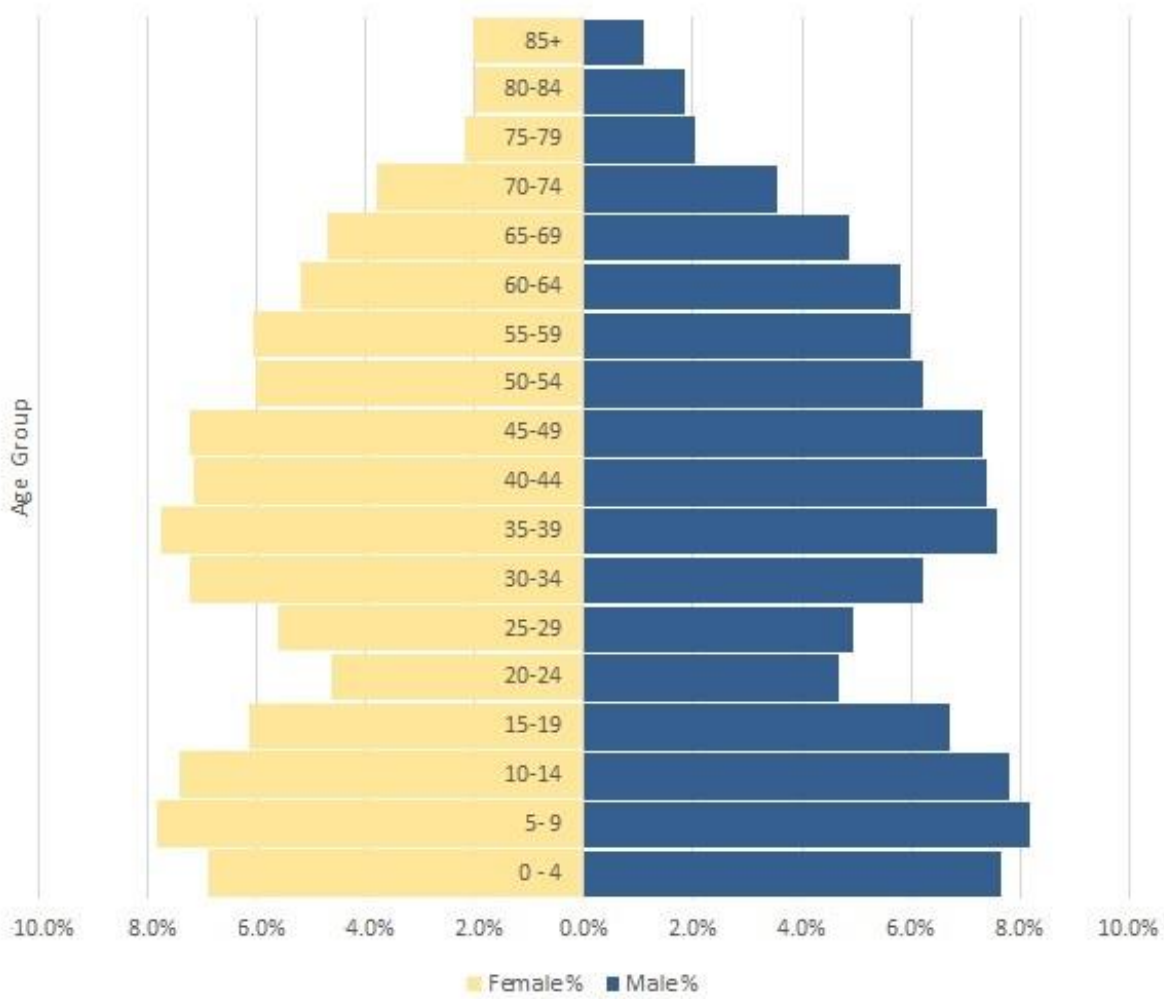

Figure 5: Population Age Pyramid for Ballymahon MD (Source: CSO)

Within Granard MD, the average age is 37.9 years which is the highest of all MDs in the county, which can be associated with the relatively high proportion over 65 years (15.7% of the population) and relatively low proportion under 14 years (22.8%). An age profile pyramid for Granard MD is provided in Figure 6.

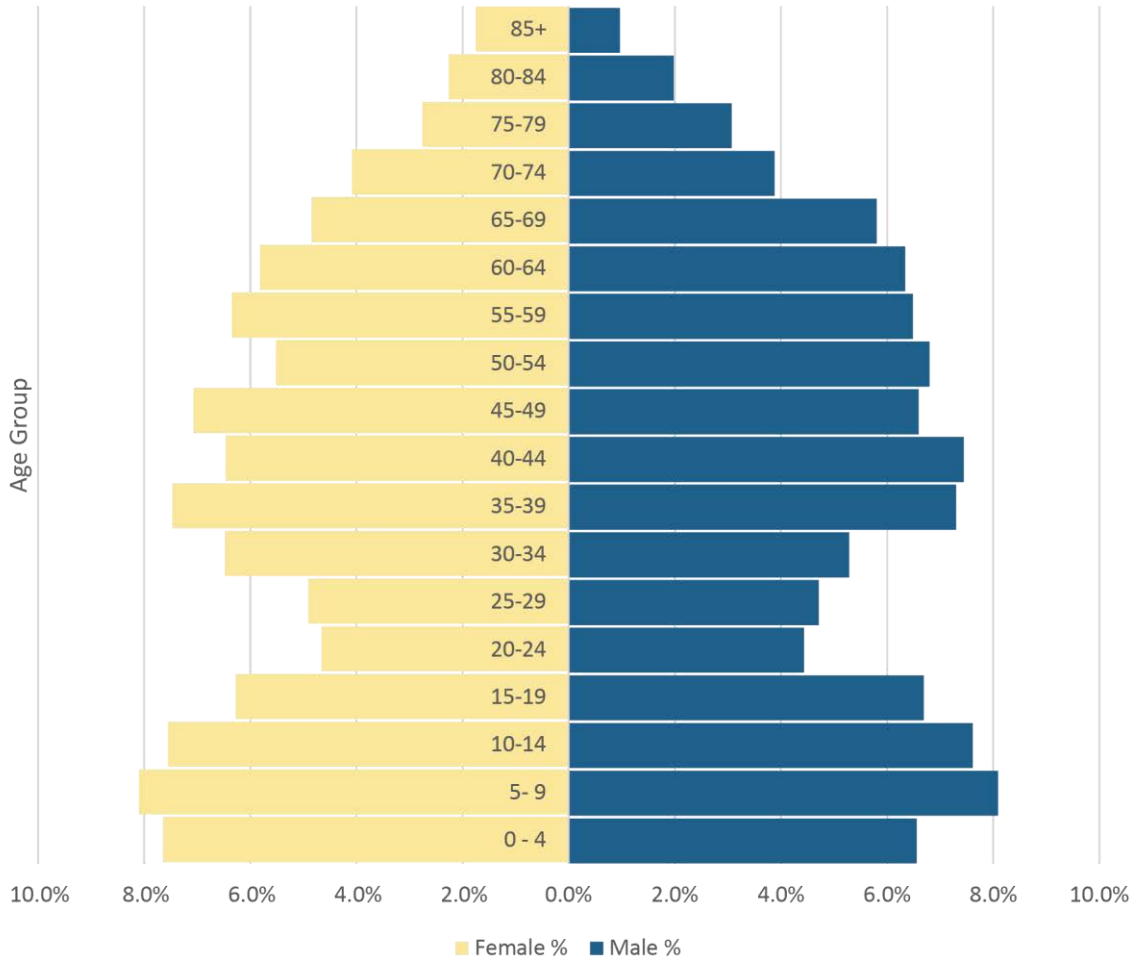

Figure 6: Population Age Pyramid for Granard MD (Source: CSO)

Ethnicity

Longford MD has the most diverse population with 79% of the population identifying as being of Irish nationality as illustrated in Figure 7.. Relatively high proportions of Polish and other Europeans are present, particularly in and around Longford town as demonstrated in Table 10 and Figure 7.

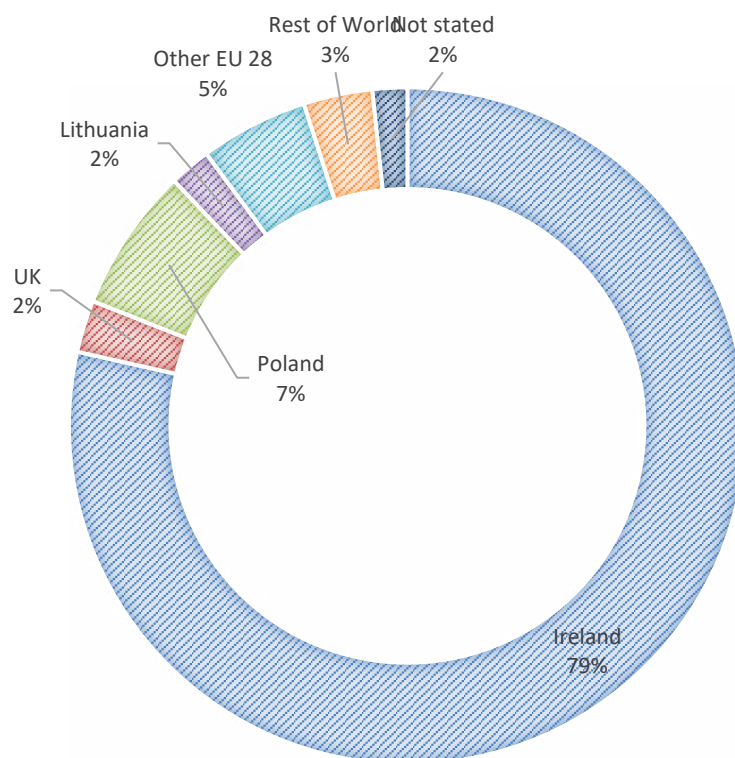

Figure 7: Nationalities within Longford MD (Source: CSO)

Table 10: Usually resident population in Longford MD by place of birth and nationality (Source: CSO)

Location	Birthplace	Nationality	Birthplace %	Nationality %
Ireland	11,940	12,525	74.8%	78.5%
UK	916	398	5.7%	2.5%
Poland	1,023	1,097	6.4%	6.9%
Lithuania	283	317	1.8%	2.0%
Other EU 28	770	825	4.8%	5.2%
Rest of World	1,020	526	6.4%	3.3%
Not stated	-	264	0.0%	1.7%
Total	11,940	15,952	100.0%	100.0%

84.3% of the population within Ballymahon MD identifying as being of Irish nationality as illustrated in Figure 8. Relatively high proportions of Polish and British are present when compared to other nationalities and non-nationals are generally concentrated in Ballymahon and Edgeworthstown as demonstrated in Table 11 and Figure 8.

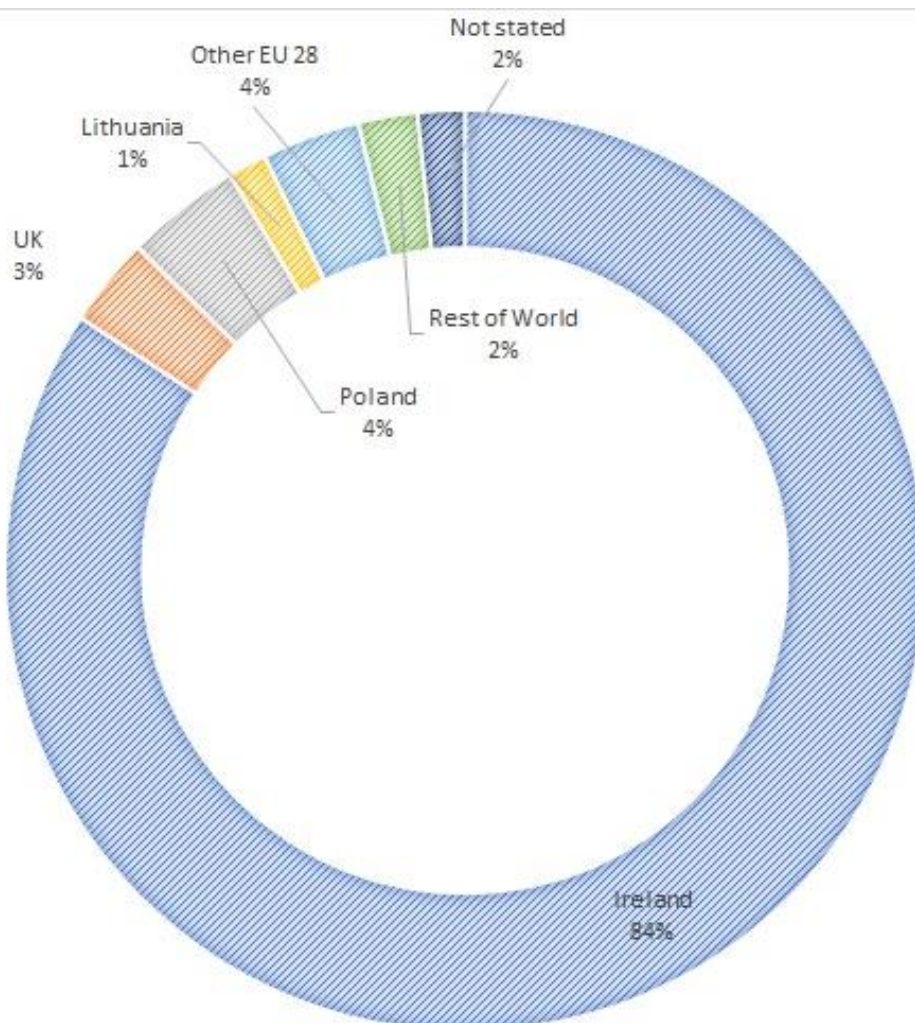

Figure 8: Nationalities within Ballymahon MD (Source: CSO)

Table 11: Usually resident population in Ballymahon MD by place of birth and nationality (Source: CSO)

Location	Birthplace	Nationality	Birthplace %	Nationality %
Ireland	11,493	11,869	82%	84%
UK	900	443	6%	3%
Poland	527	573	4%	4%
Lithuania	179	190	1%	1%
Other EU 28	464	487	3%	3%
Rest of World	524	292	4%	2%
Not stated	0	233	0%	2%
Total	14,087	14,087	100%	100%

Granard MD has the least diverse population with 90% of the population identifying as being of Irish nationality as illustrated in Figure 9. British and Polish are the largest non-national communities with pockets evident around Granard as demonstrated in Table 12 and Figure 9.

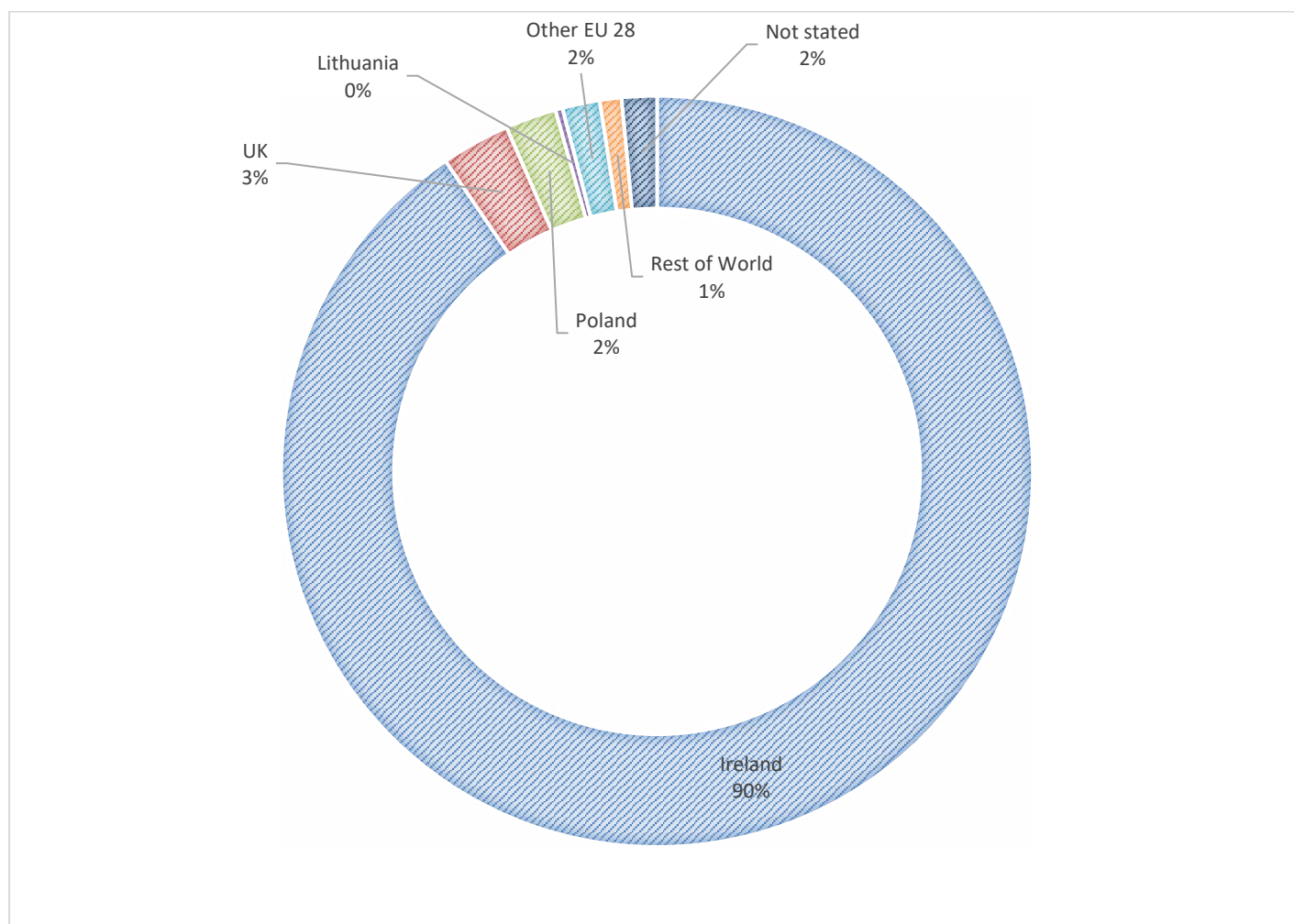

Figure 9: Nationalities within Granard MD (Source: CSO)

Table 12: Usually resident population in Granard MD by place of birth and nationality (Source: CSO)

Location	Birthplace	Nationality	Birthplace %	Nationality %
Ireland	9,299	9,606	87.6%	90.5%
UK	691	314	6.5%	3.0%
Poland	224	233	2.1%	2.2%
Lithuania	31	33	0.3%	0.3%
Other EU 28	173	171	1.6%	1.6%
Rest of World	198	99	1.9%	0.9%
Not stated	-	160	0.0%	1.5%
Total	10,616	10,616	100.0%	100.0%

Households

Longford MD has the smallest average household size of all MDs in 2016 (2.67 persons per household). Further, there was a relatively low proportion of households with five or more persons as illustrated in Figure 10.

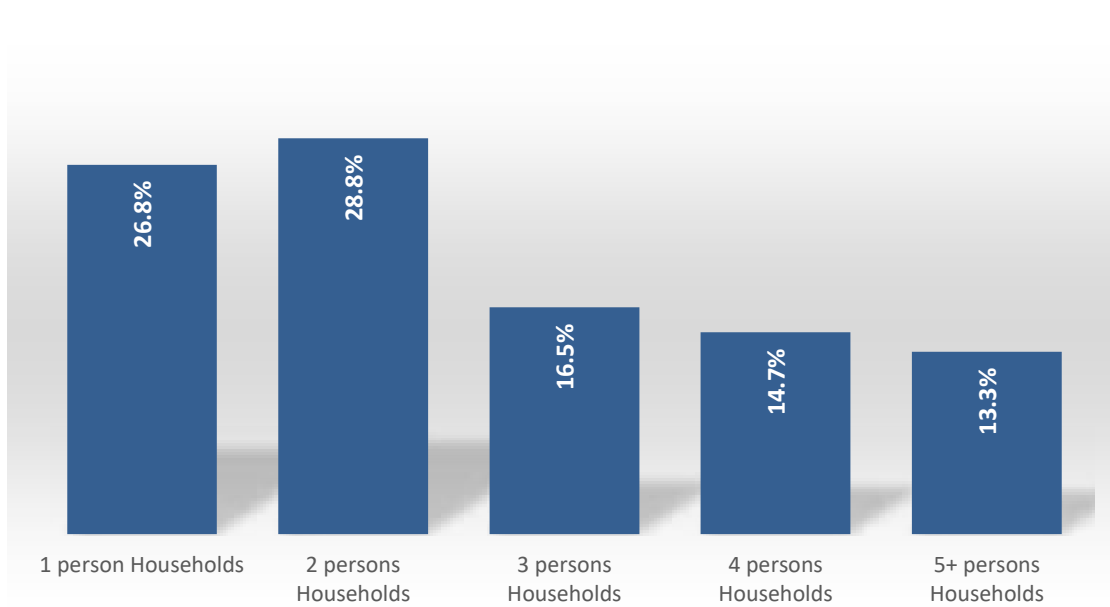

Figure 10: Private households by size in Longford MD (Source: CSO)

Ballymahon MD has an average household size of 2.70 persons per household in 2016 which was equivalent to the county comparison. As illustrated in Figure 11, there was a relatively high proportion of one and two person households.

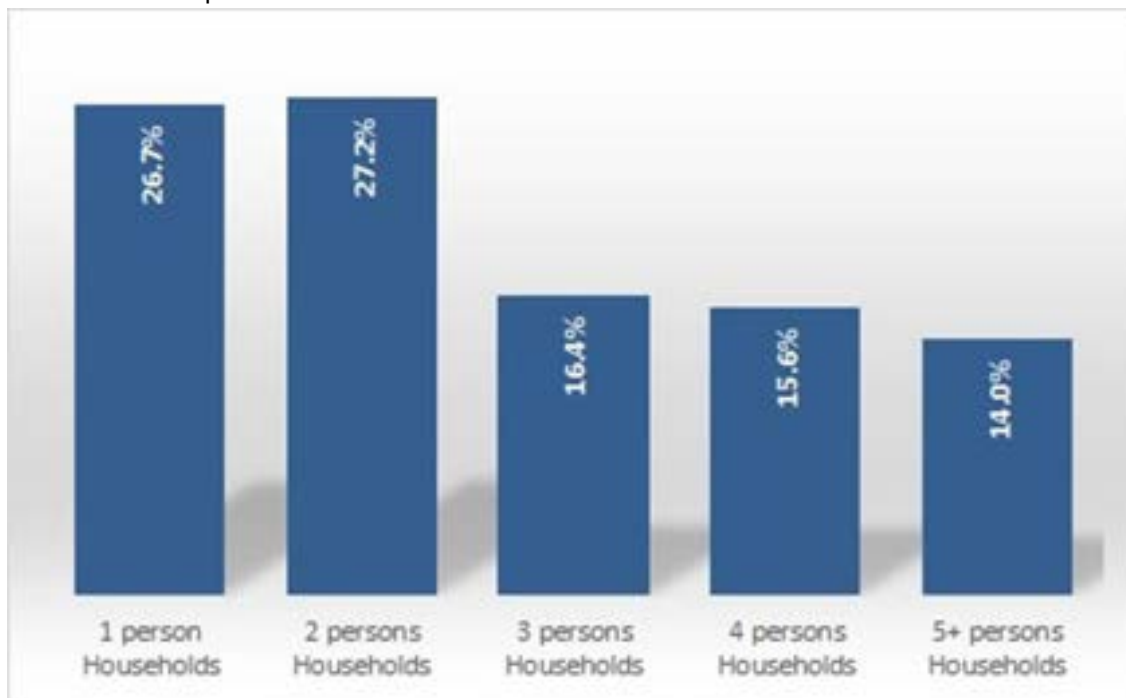

Figure 11: Private households by size in Ballymahon MD (Source: CSO)

Granard MD has the largest average household size of all MDs in 2016 (2.73 persons per household). Further, there was a relatively high proportion of households with four and five or more persons as illustrated in Figure 12.

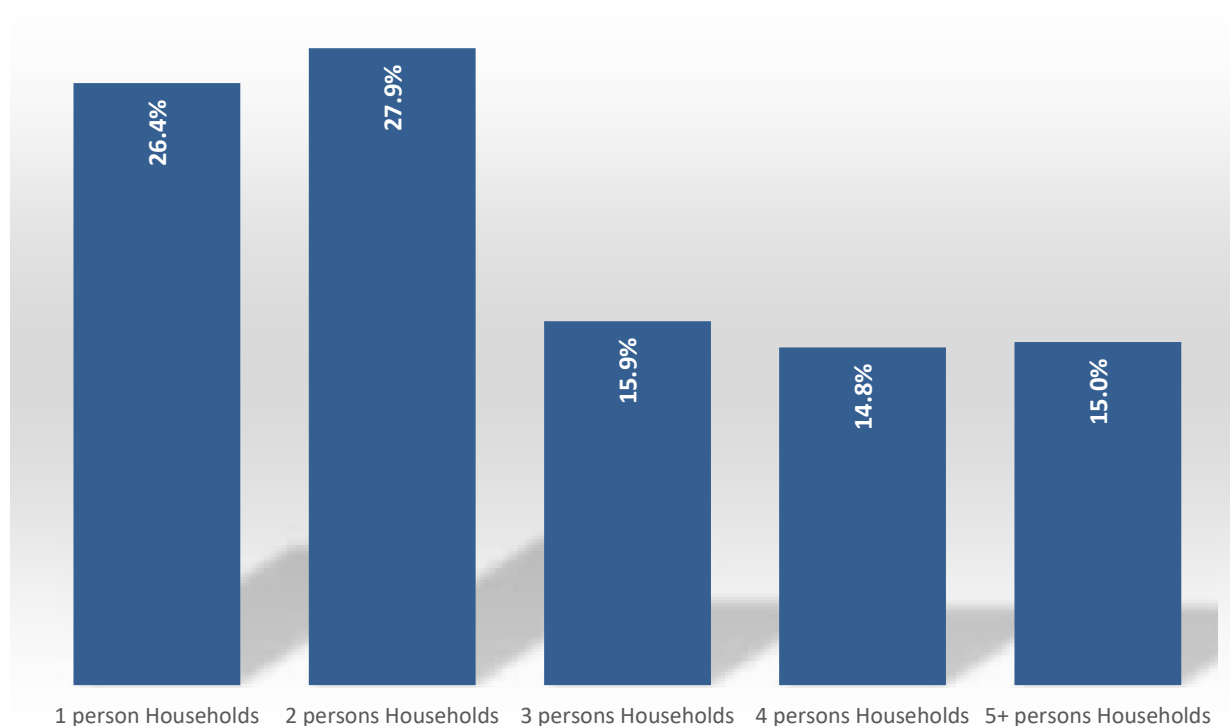

Figure 12: Private households by size in Granard MD (Source: CSO)

Socio-economic Profile

Education

As illustrated in Table 13 and Figure 13, the educational attainment in Longford MD is relatively good with a relatively high proportion of the population having been educated to Master level or higher when compared to other MDs.

Table 13: Educational attainment in the population over 15 years in Longford MD (Source: CSO)

Proportion	Number of persons	% of persons
Third Level (Level 7+)	1,996	19.8%
Third Level (Level 6+)	3,033	30.1%
Up to Leaving Cert	5,247	52.1%
Primary or Less	1,566	15.5%
Masters of Higher	552	5.5%

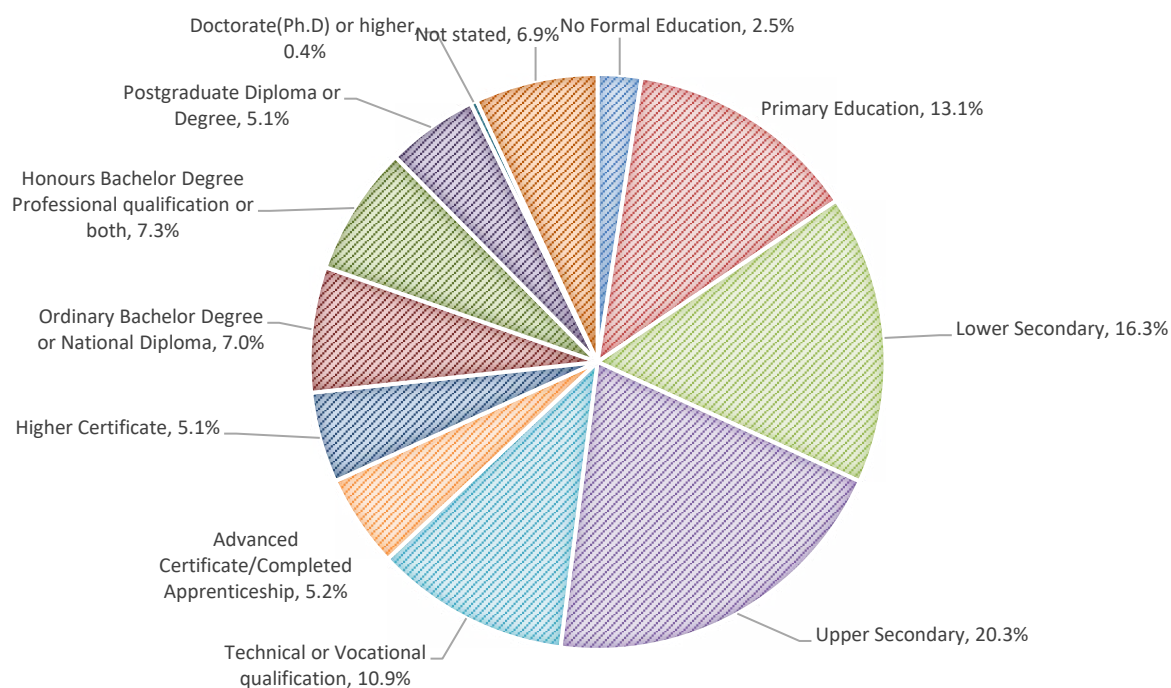

Figure 13: Education by highest level achieved within Longford MD (Source: CSO)

As illustrated in Table 14 and Figure 14, the educational attainment in Ballymahon MD is relatively good with a relatively high proportion of the population having been educated to Third Level (i.e. at least Level 6 on the NFQ) when compared to other MDs.

Table 14: Educational attainment in the population over 15 years in Ballymahon MD (Source: CSO)

Proportion	Number of persons	% of persons
Third Level (Level 7+)	1,835	20.10%
Third Level (Level 6+)	2,885	31.70%
Up to Leaving Cert	4,568	50.10%
Primary or Less	1,441	15.80%
Masters of Higher	485	5.30%

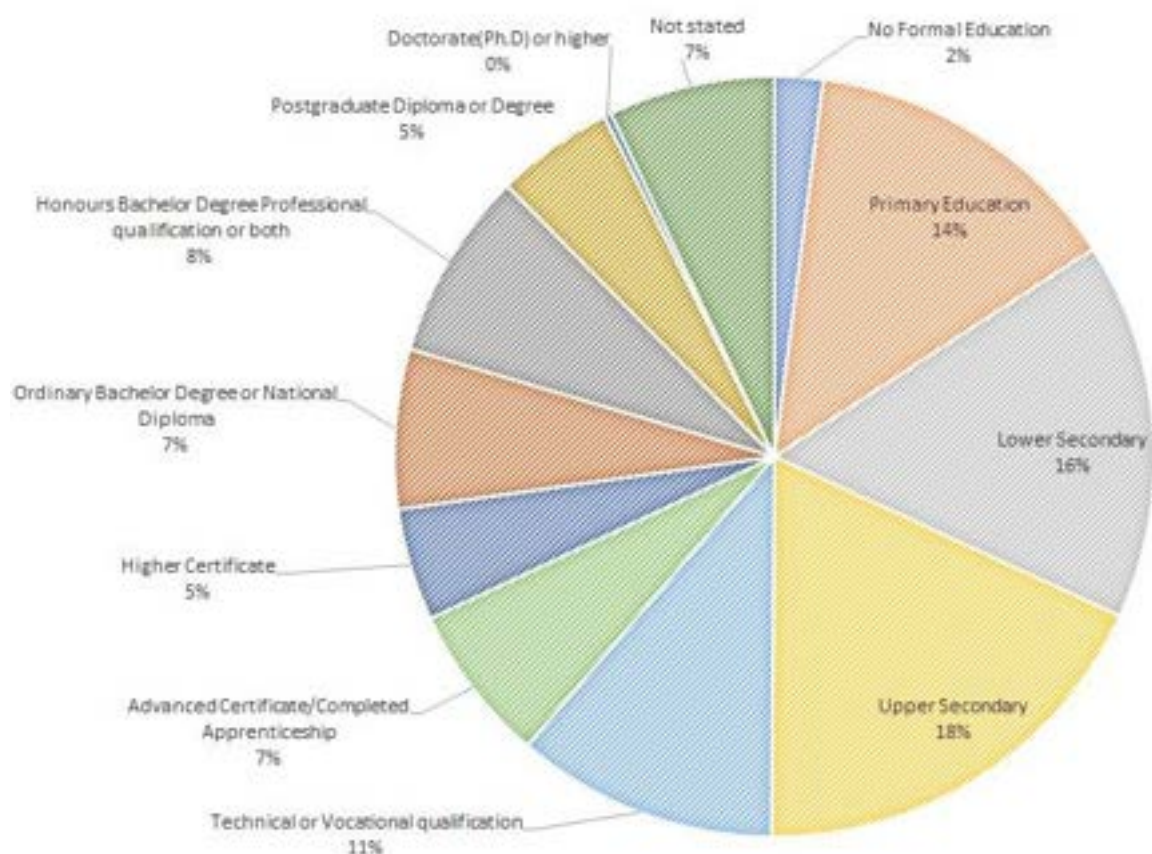

Figure 14: Education by highest level achieved within Ballymahon MD (Source: CSO)

As illustrated in Table 15 and Figure 15, the educational attainment in Granard MD is good and generally comparable to the county average in terms of educational attainment.

Table 15: Educational attainment in the population over 15 years in Granard MD (Source: CSO)

Proportion	Number of persons	% of persons
Third Level (Level 7+)	1,232	17.7%
Third Level (Level 6+)	1,985	28.5%
Up to Leaving Cert	3,812	54.7%
Primary or Less	1,297	18.6%
Masters of Higher	295	4.2%

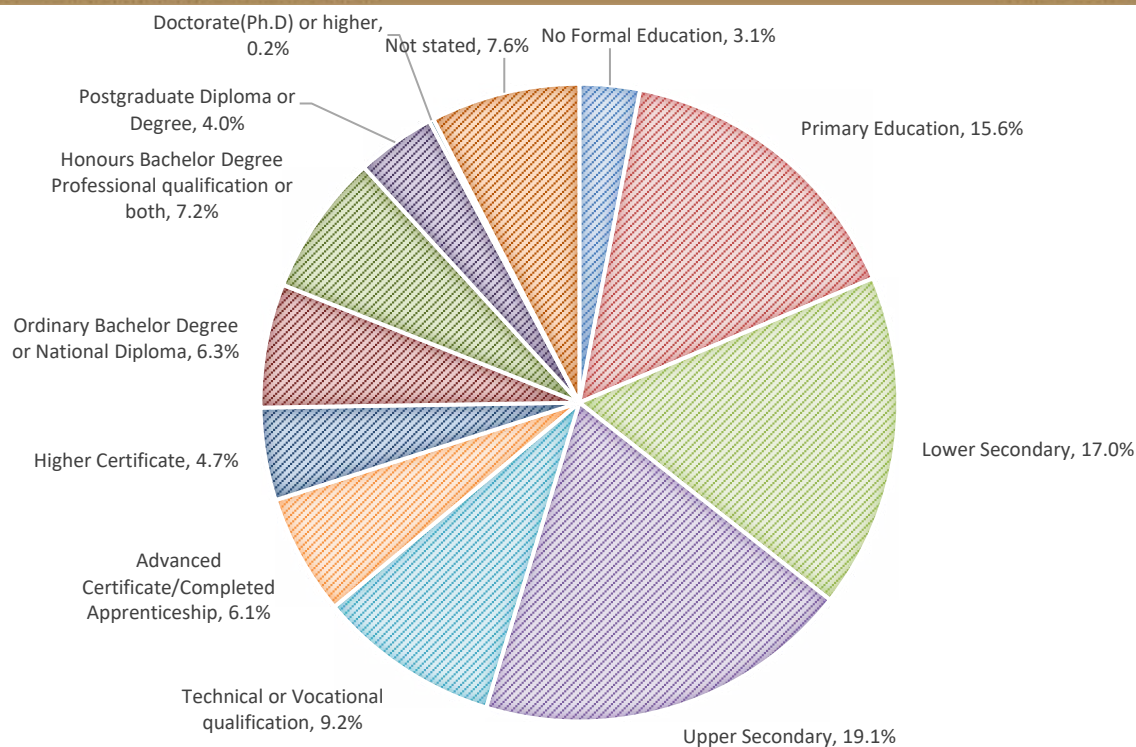

Figure 15: Education by highest level achieved within Granard MD (Source: CSO)

Deprivation

In order to further explore deprivation and affluence, Figure 16, Figure 17 and Figure 18 illustrate the Pobal Index Score based on Small Areas within the MDs of Longford, Ballymahon and Granard respectively. The following can be drawn from this analysis:

- Inequalities and pockets of affluence and disadvantage are evident across County Longford and within each of the individual MDs.
- Inequalities are evident within Longford MD – The northern part of Longford town is marginally above average whilst some areas to the south are very and extremely disadvantaged.
- The majority of the rest of the Longford MD is generally marginally above or below the average score.
- The western section of Ballymahon MD is marginally above average whilst the centre and eastern part being marginally below average (particularly around Legan and Edgeworthstown).
- The majority of Granard MD is marginally below average with some parts in the west part disadvantaged and some sections of Granard town being very disadvantaged.
- When comparing the north and south of Edgeworthstown (i.e. those portions in Ballymahon MD against those in the Granard MD), inequalities were evident albeit they are relatively small (i.e. areas to the north in the Granard MD are marginally above average whilst those in the Ballymahon MD are marginally below average).

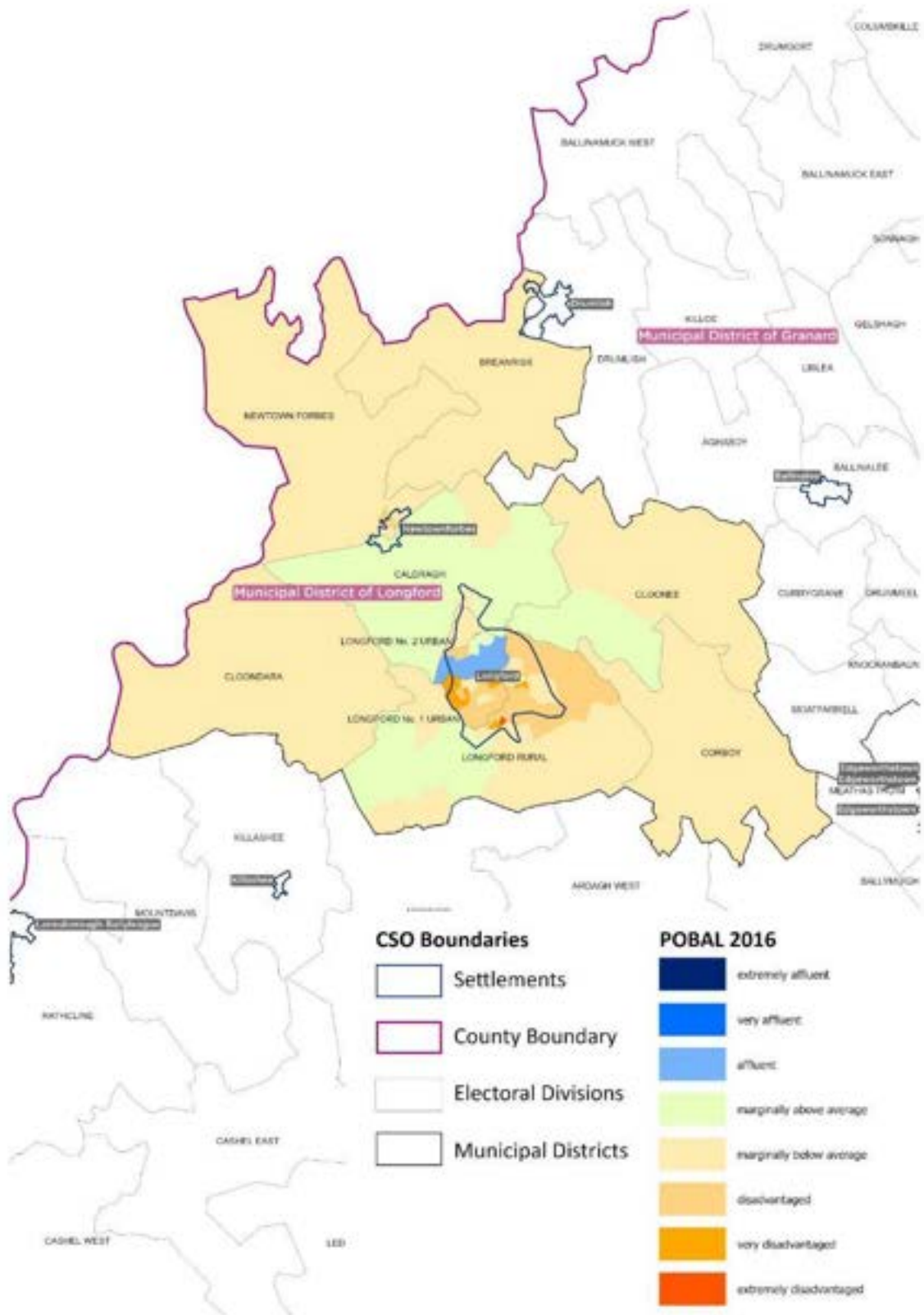

Figure 16: Pobal Index per Small Area within Longford MD (Source: Pobal)

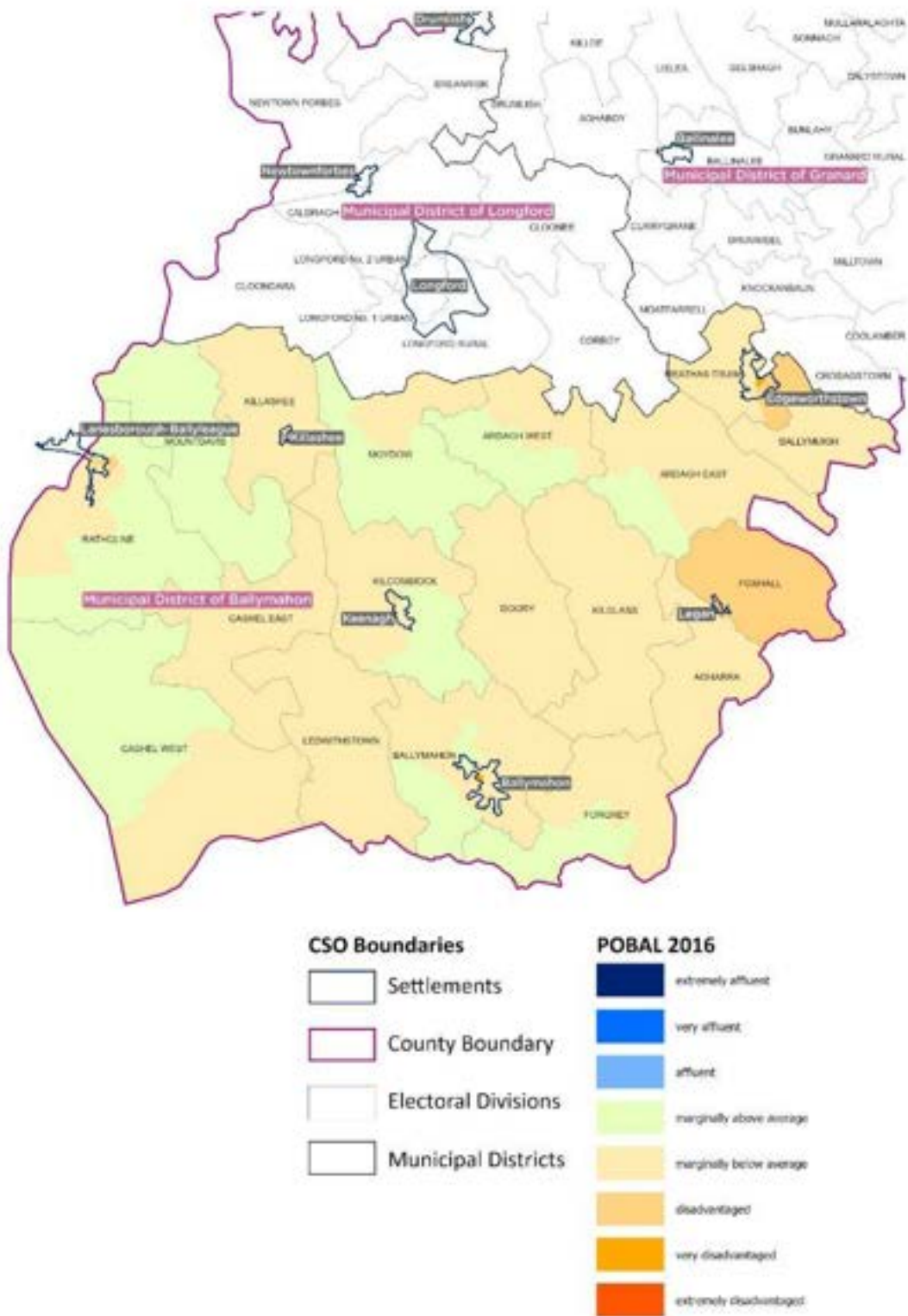

Figure 17: Pobal Index per Small Area within Ballymahon MD (Source: Pobal)

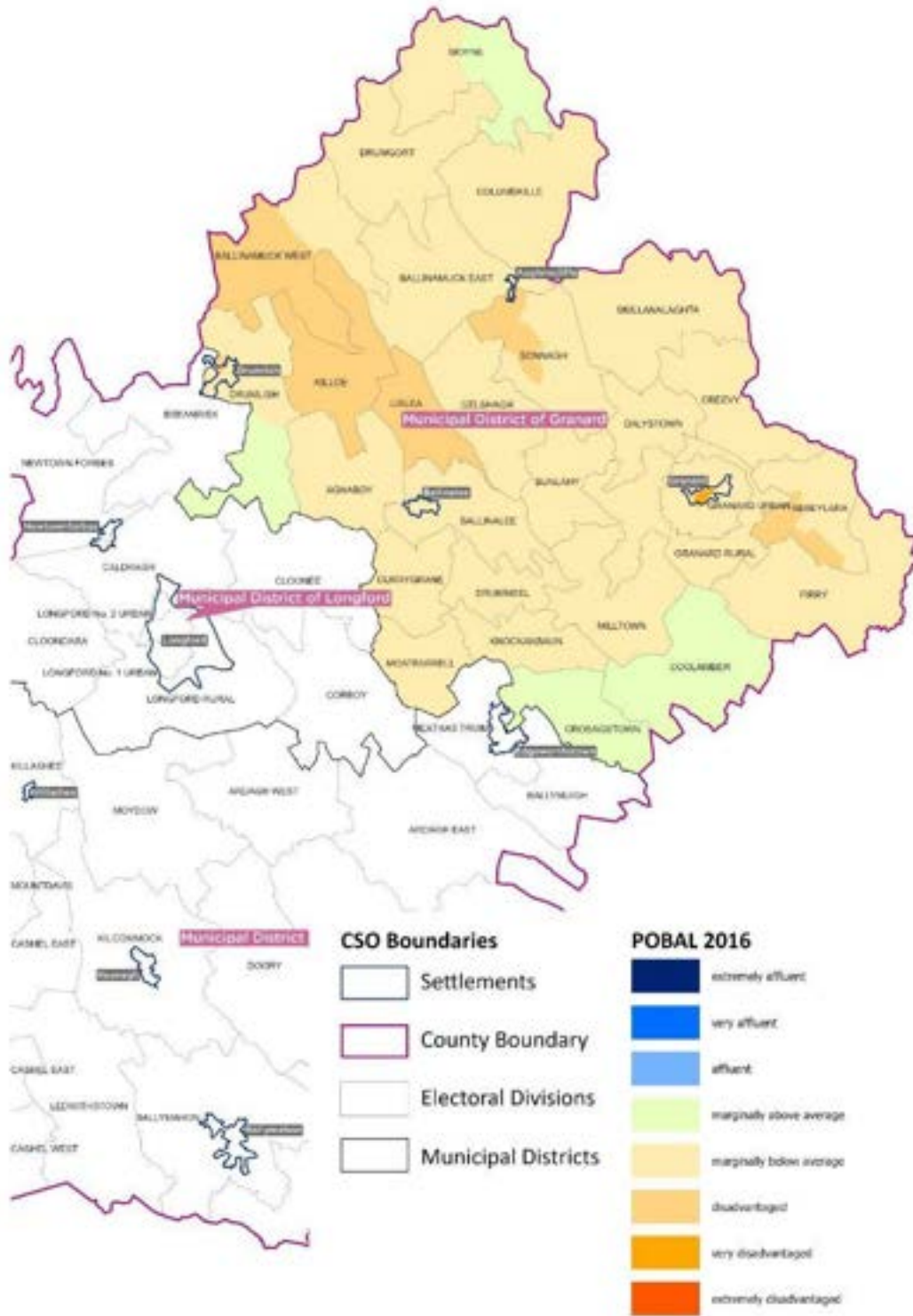

Figure 18: Pobal Index per Small Area within Granard MD (Source: Pobal)

Annex 4:
Housing Strategy

Longford Housing Strategy 2021 - 2027

Submission by:



Future Analytics

On behalf of:



March 2021

Fourth Draft



Contents

1	Introduction	3
1.1	Overview	3
1.2	Housing Strategy / HNDA – Guiding Principles	3
1.3	Housing Need Demand Assessment (HNDA).....	4
1.4	Methodology	6
2	Strategic, Legislative and Policy Landscape	11
2.1	National Legislation and Policy	11
2.1.1	Planning and Development Act 2000	11
2.1.2	Planning and Development (Amendment) (No. 3) Regulations 2018.....	11
2.1.3	The Planning and Development (Housing) and Residential Tenancies Act 2016.....	12
2.1.4	Urban Regeneration and Housing Act 2015	12
2.1.5	The Housing (Miscellaneous Provisions) Act 2009	13
2.1.6	Project Ireland 2040 – National Planning Framework.....	13
2.1.7	Implementation Roadmap for the National Planning Framework	15
2.1.8	Project Ireland 2040 – National Development Plan 2018-2027	16
2.1.9	Housing Supply Target Methodology for Development Planning (December 2020)	16
2.1.10	Sustainable Urban Housing: Design Standards for New Apartments Guidelines for Planning Authorities	17
2.1.11	Rebuilding Ireland – Action Plan for Housing and Homelessness, 2016	17
2.1.12	National Vacant Housing Reuse Strategy 2018-2021.....	19
2.1.13	Social Housing Strategy 2020: Support, Supply and Reform.....	20
2.1.14	Construction 2020: A Strategy for a Renewed Construction Sector	20
2.1.15	The National Housing Strategy for People with a Disability 2011-2016.....	21
2.2	Regional Policy	21
2.2.1	The Regional Spatial and Economic Strategy (RSES) 2019-2031.....	21
2.3	Local Policy.....	22
2.3.1	Longford County Development Plan 2021 – 2027.....	22
2.3.2	Longford County Housing Strategy 2015-2021.....	22
2.3.3	County Longford Local Economic and Community Plan 2016-2022.....	23
2.3.4	County Longford Age Friendly Strategy 2015-2020.....	23
2.3.5	Longford County Council Traveller Accommodation Programme 2019-2024.....	23
3	Current Context: Review and Analysis of Existing Supply and Needs.....	24
3.1	Population.....	24
3.2	Existing Housing Stock and Supply	26
3.2.1	Stock and Composition	26
3.2.2	Housing Tenure	28

3.2.3	Unfinished Housing Development	30
3.2.4	Housing Permissions	31
3.3.5	Social Housing Stock	32
4	Housing Needs in Longford	34
4.1	Overview	34
4.2	Inputs.....	35
4.2.1	Population Projections.....	35
4.2.2	Estimated Households	35
4.2.3	Income Analysis	38
4.2.5	Central Bank Rules and Mortgage Capacity.....	42
4.2.6	Analysis of Historic Ownership Market.....	43
4.2.7	Analysis of Historic Private Rental Market.....	47
4.3	Assessment of Needs	48
4.3.1	Ownership.....	48
4.3.2	Private Rental.....	53
4.4	HNDA Components	55
4.4.1	Household Composition.....	55
4.4.2	Household Tenure.....	56
4.4.3	Single Rural Dwellings	57
4.5	Conclusion	61
5	Meeting Housing Requirements in Longford	62
5.1	Overview	62
5.2	Social Housing Supply and Demand	62
5.2.1	Existing Social Housing Needs.....	62
5.2.2	Meeting Social Housing Demand	63
5.5.3	Delivery Methods and Targets.....	66

1 Introduction

1.1 Overview

This Housing Strategy has been prepared by KPMG Future Analytics on the behalf of Longford County Council to meet the statutory requirements set out under Section 94 of Planning and Development Act, 2000 (as amended). Under Part V of the Act, each planning authority must prepare a Housing Strategy which will cover the period of its development plan.¹ Each strategy must have regard to the proper planning and sustainable development of the area and must address the overall supply of housing within the administrative boundary of the Local Authority. The Housing Strategy also addresses relevant provisions contained within the Housing (Miscellaneous Provision) Act, 2009 and the Urban Regeneration and Housing Act 2015.

The purpose of the Housing Strategy is to ensure that the proper planning and sustainable development of County Longford provides for the housing of the existing and future population of the area in the manner set out in this Strategy. The County Development Plan and the Housing Strategy will embrace the Vision set out in the Social Housing Strategy 2020 which states that *“every household in Ireland will have access to secure, good quality housing suited to their needs at an affordable price in a sustainable community”*.

The Housing Strategy is a critical component which informs the policies and objectives of the County Development Plan, playing a key role in translating national housing policies and housing supply responses to the local level. Since the previous Housing Strategy was prepared there have been significant changes in planning legislation and policy. In particular, this Housing Strategy must be consistent with the National Planning Framework (NPF) and the Eastern and Midland Regional Spatial and Economic Strategy (RSES).

In line with this, the NPF requires each Local Authority to undertake a Housing Need Demand Assessment (HNDA) which must underpin and support the preparation of housing strategies and all related housing policy outputs. The HNDA for County Longford, as elaborated in Section 1.2 – 1.4. and Section 4, provides a robust evidence base to inform decision-making around current and future housing supply in accordance with the HNDA requirements as set out in the NPF and all other relevant statutory requirements, including the DHLGH’s *“Housing Supply Target Methodology for Development Planning: Guidelines for Planning Authorities”*.

1.2 Housing Strategy / HNDA – Guiding Principles

An evidence-based and future-proofed methodological approach has been adopted to ensure that the Housing Strategy for County Longford meets the housing needs of the county and its residents while remaining in keeping with local, regional and national guidelines. The Strategy is underpinned by a HNDA which provides a robust baseline to inform and guide policies and objectives under the Longford County Development Plan 2021-2027.

Declines in the construction sector and wider economic activity during the previous decade, coupled with Ireland’s economic recovery have led to ongoing challenges around fluctuations in the supply, demand and price of housing. It has also led to opportunities, with a greater mix of house types and tenures diversifying Ireland’s housing market. Increased levels of activity in the construction sector will provide new homes to meet current and projected demand and contribute to County Longford’s social housing stock by way of Part V obligations. The HNDA incorporates a range of socio-economic and demographic data to analyse current levels of demand and supply within Longford and project for future need over the lifetime of the Development Plan (i.e. to 2027) and beyond to 2031. It incorporates demand across different tenures, including owner-occupied, the rental

¹ The Longford County Development Plan 2021-2027 is expected to come into force in Winter 2027 for a duration of six years. For modelling purposes, the HNDA has rounded this period to the nearest whole quarters, covering Q1 2022 – Q4 2027 inclusive.

sector and social housing and provides estimates of future housing needs based on employment growth, income levels and affordability in the housing market as described in detail in Section 1.4.

1.3 Housing Need Demand Assessment (HNDA)

Under Section 94 (1) (a) of the Planning and Development Act 2000 (as amended), each planning authority:

“shall include in any development plan a strategy for the purpose of ensuring that proper planning and sustainable development of the area of the development plan provides for the housing of the existing and future population of the area in the manner set out in the strategy”.

In order to ensure that the plan-making system is supported by a robust methodology to inform policies and funding initiatives around housing and associated land requirements, the NPF has introduced a new requirement for each Local Authority to develop a Housing Need Demand Assessment (HNDA). The HNDA will support the preparation of housing strategies and all related housing policy outputs, e.g. city and county development plans, local area plans, traveller accommodation plans etc.

The NPF indicates that the purpose of the HNDA tool is to:

- Assist local authorities to develop long-term strategic views of housing need across all tenures.
- Provide a robust evidence base to support decisions about new housing supply, wider investment and housing related services that inform an overall national housing profile.
- Inform policies about the proportion of social and affordable housing required, including the need for different types and sizes of provision.
- Provide evidence to inform policies related to the provision of specialist housing and housing related services.

The NPF notes that HNDAs are designed to give broad, long run estimates of what future housing need might be, rather than precision estimates and this is described in further detail in Section 2.1.9. The approach must be logical, sequential and allow for updating, monitoring and evaluation, therefore the HNDA undertaken as part of this Development Plan spans two key stages – current and future outlook; and assesses three core areas: Population, Housing and Economy. These are set out in Figure 1.1 with the sequential steps involved in the development and application of this HNDA model presented in Section 1.4

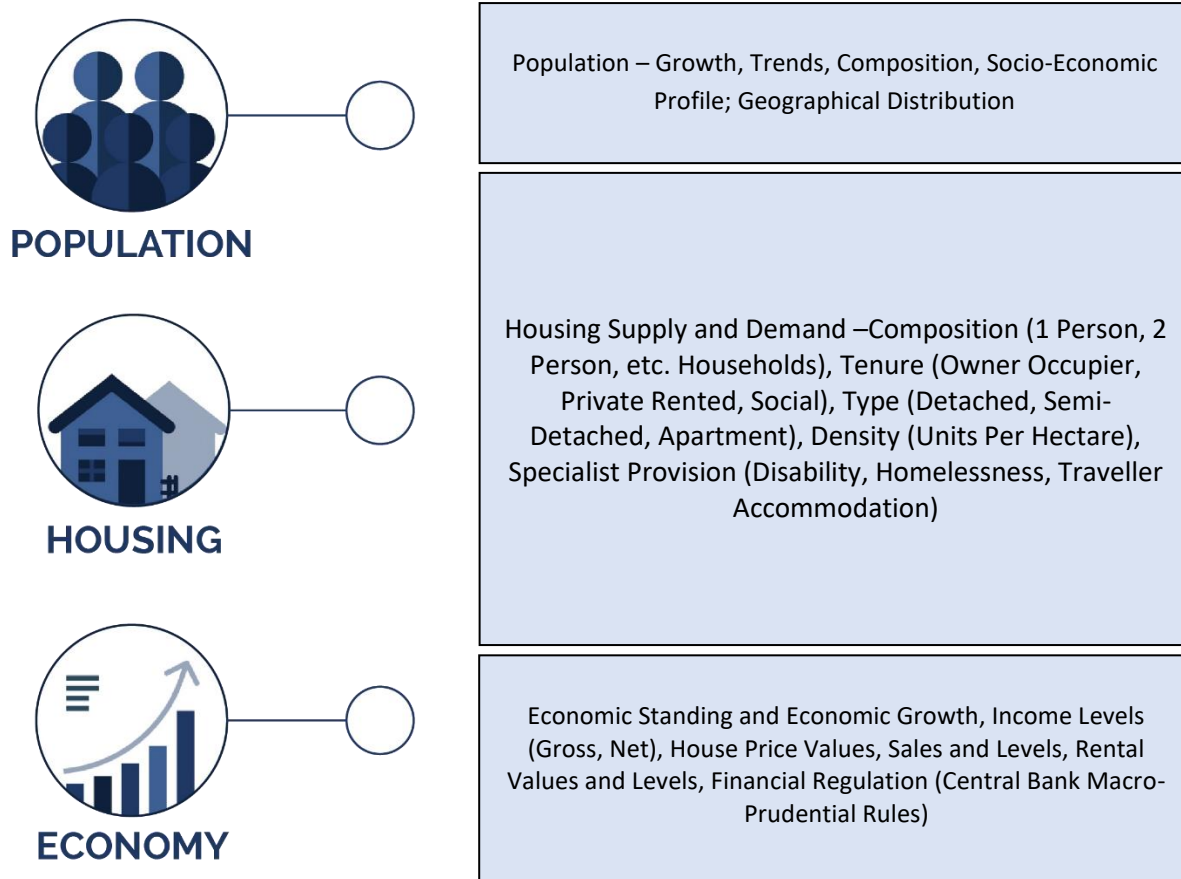

Figure 1.1: HNDA Assessment Areas. Source: KPMG Future Analytics

The methodological approach along with key inputs and outputs to the HNDA is summarised in Figure 1.2. This process seeks to enhance how acute and unmet demand for housing is identified before it arises by providing a robust assessment of regional and localised influences, such as population and migration, in quantifying needs and demands. The key evidence inputs which drive the model are:

1. **Demographic trends, affordability trends and wider economic trends.** The use of **economic forecasting or econometric** work underpins this section. Data requirements include **household composition/projections, house prices, rents, and loan to value (LTV) mortgage rates, economic activity and employment rates, etc.**
2. **Housing Stock Profile Pressures (and existing need) and management issues.** This involves undertaking a detailed profile of local **housing stock**, including **local authority housing**, to identify the main issues relating to supply and demand, ineffective stock and overall condition as well as priorities for future stock management. Information is required on **dwelling size, dwelling type, dwelling condition and stock pressures (occupancy/under occupancy stock turnover, etc.)**.
3. **Estimating Future Housing Need and Demand.** This is broken down into: **owner occupation, private sector, below market rent and social rent.**

1.4 Methodology

This Section provides an overview of the components involved in the development and application of this HNDA model. There are four components of the model, as shown in Figure 1.2.



Figure 1.2: Overview of the HNDA Model

The first component of the model explores population and household scenarios for the county over the plan period. A number of population scenarios for County Longford have been investigated to 2031 and a ‘Policy-Intervention Scenario’ has been applied for the purpose of this analysis into the housing needs of the county as described in detail in Section 4.2.1.

The second component alongside population projections is the determination of future households. This is established through the calculation of the Housing Supply Target for the plan period for County Longford in accordance with the ‘Housing Supply Target Methodology for Development Planning’ DHLGH guidelines (December 2020), as described in Section 4.2.2. This provides plan period targets and annualised household figures for analysis in the HNDA.

The third component relates to an assessment of housing and rental affordability. This assessment supports the identification of social (and affordable) housing needs for County Longford during the plan period. There are 15 steps as part of this, as illustrated in Table 1.2

Finally, Section 5 brings together the HNDA outputs and analyses how current and future housing need can be met while Section 6 sets out policy objectives for the delivery of this Housing Strategy for County Longford.

The overall structure of this Housing Strategy is summarised in Table 1.1.

Table 1.1: Structure of the Longford Housing Strategy 2021-2027

Section 2	Strategic, Legislative and Policy Landscape
Section 3	Current Housing Context: Review and Analysis of Existing Supply and Needs
Section 4	Future Housing: Projected Housing Need and Supply
Section 5	Analysis of Housing Requirements in Longford
Section 6	Policy Objectives to Deliver Housing Strategy
Section 7	Conclusion

Table 1.2: Approach to the HNDA for the Longford Housing Strategy 2021-2027

Step	Method
<p>Step 1 Determination of Annual Population Projections</p>	<p>Determination of annual population over the County Development Plan period. The agreed population projection scenario / target can reflect a “low”, “medium” or “high” growth projection-based upon county, regional, national and global specific factors. Longford County Council have applied a high growth scenario that aligns with the NPF.</p>
<p>Step 2 Determination of Pre-Plan Total Households</p>	<p>Determination of pre-plan total households based on latest CSO data and estimation of pre-plan housing completions</p>
<p>Step 3 Determination of Additional Households</p>	<p>Determination of additional households over the plan period based on agreed Housing Supply Targets.</p>
<p>Step 4 Calculation of Estimated Distribution of Household Disposable Incomes</p>	<p>Calculation of estimated distribution of annual and weekly household disposable income per decile of the established (by the CSO) of the 10 deciles in the baseline year.</p> <p>The national annual disposable incomes per decile are adjusted to city/county level based on application of an “inflator” or “deflator” rate.</p>
<p>Step 5 Calculation of Average Annual Household Disposable Income Distribution</p>	<p>Calculation of estimated distribution of annual household disposable income per household decile throughout the Development Plan period.</p> <p>This calculation considers a forecast GDP growth rate to reflect anticipated change incomes over the Development Plan period. It should be noted, that this approach is also taken in relation to average annual gross income for the purpose of understanding mortgage capacity and qualification.</p>
<p>Step 6 Calculation of Average Monthly Household Disposable Income Distribution</p>	<p>Calculation of estimated distribution of monthly household disposable incomes for each of the 10 household deciles throughout the Development Plan period.</p> <p>This is an exercise to ensure that incomes are scaled to provide the monthly (rather than annual) estimates of disposable income per household in each decile.</p>
<p>Step 7 Determination of Distribution of Total Anticipated Households</p>	<p>This is the calculation of estimated distribution of household units for each of the 10 household deciles throughout the Development Plan period.</p> <p>The number and distribution of total households per decile throughout the Development Plan period reflects projected number of private households per year during the Development Plan period as well as the distribution of housing units in the State from the Household Budget Survey.</p>

<p>Step 8 Determination of Distribution of Additional Anticipated Households</p>	<p>Calculation of estimated distribution of additional anticipated household units for each of the 10 household deciles throughout the Development Plan period.</p> <p>Similarly to the step above, this specifically reflects the number of additional anticipated households per decile per year throughout the Development Plan period.</p>
<p>Step 9 Calculation of Projected House Price Bands</p>	<p>Calculation of projected house price bands based on the percentage split of the established (by the DHPLG) 8 price bands.</p> <p>Historic transactional housing market data is considered to understand changes in average house price and future adjustments. This facilitates an estimation of each of the projected house price bands and proportional market split based on the split of the 8 price bands and a projected annual price increase or decrease.</p>
<p>Step 10 Calculation of Mortgage Capacity of Households</p>	<p>Determination as to whether households in each decile can qualify for a mortgage that enables them to purchase a house in the lowest price band under the current macro-prudential rules, as set out by the Central Bank of Ireland.</p> <p>This is based on understanding the threshold in the lowest price band per year during the Development Plan period and application of the <i>“Annuity Formula”</i>. The <i>“Annuity Formula”</i> is based on the determination of an <i>“Affordability Threshold”</i>, a <i>“Loan to Value Ratio”</i>, an <i>“Annual Percentage Rate (APR) - Interest Rate”</i>, the determination of a <i>“Monthly Percentage Rate (MPR) - Interest Rate”</i>, and the determination of a <i>“Loan Term (Years/Months)”</i>.</p> <p>If a household in any decile does not have sufficient income to meet the macro-prudential rules (i.e. 3.5 times their gross income is less than 90% of the value of purchase a house in the lowest projected price band), they do not qualify for a mortgage and progress to private rental (See Step 11). Those households that can qualify for a mortgage progress to the needs assessment for ownership (See Step 10).</p>
<p>Step 11 Calculation of Projected Needs for Ownership</p>	<p>Calculation of the approximate affordable house price for each of the ten deciles per year during the Development Plan period based on the application of the <i>‘annuity formula’</i>. Once established, a calculation of the households surplus and/or deficit per price band is undertaken with respect to the number of households that can qualify for a mortgage:</p> <ol style="list-style-type: none"> a) Based on the application of the <i>“Annuity Formula”</i> calculate the housing affordability (i.e. Approximate Affordable House Price) for each of the 10 household deciles. b) Based on the determination of additional households required, the projected house price bands and the housing affordability, calculate the number of households not meeting the <i>“Affordability Criteria”</i>. This facilitates a calculation of the surplus/deficit of household at the lowest price band with respect to the number of households that can qualify for a mortgage.

<p>Step 12 Calculation of Projected Needs for Private Rental</p>	<p>Calculation of the households that will not meet the affordability criteria to privately rent a home during the Development Plan period with respect to the number of households that cannot qualify for a mortgage.</p> <p>Historic rental market data is analysed to enable an estimate of projected rental price by unit type during the plan period. Based on this and the household income, a calculation of the households not meeting the affordability criteria to privately rent a home has been undertaken with respect to the number of households that cannot qualify for a mortgage and those households that cannot afford to purchase a home.</p>
<p>Step 13 Summary of Projected Social Housing Need</p>	<p>Calculation of the households who can be classified as having an affordability problem during the Development Plan period so as to adequately inform the necessary provision units within the City/County.</p> <p>This is a summary of the anticipated housing need for the City/County Council as set out in the preceding steps and reflects assessments for both mortgage qualification and private rental affordability. Specifically, the number of additional households anticipated over the Development Plan period, the number of those households that do not qualify for a mortgage and number of those households that do not qualify for a mortgage and cannot afford private rental is provided based on the outcomes of the preceding steps.</p>
<p>Step 14 Historic Data Analysis and Approximate Projection of Tenure, Size Cohort, and Dwelling Type.</p>	<p>Calculation of historic intercensal change for private household tenure, cohort sizes and dwelling type to determine annualised change. This informs the basis of an annual rate of change for which additional anticipated households can be roughly forecasted for household tenure, cohort sizes and dwelling type.</p>
<p>Step 15 Analysis of Single Rural Dwellings</p>	<p>Analysis of CSO Granted Permissions data to determine distribution of rural one-off dwellings.</p>

2 Strategic, Legislative and Policy Landscape

2.1 National Legislation and Policy

2.1.1 *Planning and Development Act 2000*

Under Part V of the Planning and Development Act 2000 (as amended) Local Authorities are required to ensure that their Development Plans are consistent with high-level strategic policies and national population projections. As such Development Plans are to incorporate a Core Strategy that demonstrates consistency with relevant national and regional objectives as set out in the NPF and RSES as well as the strategic policy as described herein such as Rebuilding Ireland.

Local Authorities are also required to prepare and incorporate a Housing Strategy into their Development Plan, the purpose of which is to ensure that the housing needs of the existing and future population of the development plan area are met. Section 94 of the Act states that:

“...each housing strategy should have regard to the proper planning and sustainable development of an area and should be concerned with the overall supply of housing within the planning authority.”

The Act further specifies that Housing Strategy’s must consider:

- The existing and likely future need for social housing
- The need to ensure that housing is available for people of different incomes.
- The need to ensure the availability of a mixture of house types and sizes to cater for the requirements of different categories of households, including the special requirements of elderly persons and persons with disabilities
- the need to counteract segregation in housing between persons of different social backgrounds.

2.1.2 *Planning and Development (Amendment) (No. 3) Regulations 2018*

The Planning and Development (Amendment) (No. 3) Regulations 2018 is a recent, relevant legislative update. This amendment exempts the temporary change of use of certain vacant commercial premises to residential use, i.e. this can occur without the need to obtain planning permission. However, this change of use, and any related works, must occur by 31 December 2021. In addition, the existing structure or part of the structure, which is the subject of the change of use, is required to be vacant for a period of two years immediately prior to when the development takes place. A number of other conditions and limitations apply, notably including:

- There shall be no more than 9 individual residential units within a building (i.e. staying below the Part V social housing threshold).
- No works permitted to protected structures unless a s.57 declaration has issued to indicate the works will not affect the character or elements of the structure which has been identified for protection.
- Works to the ground floor of any structure shall not conflict with an objective in a development plan for the structure to remain in retail use, with the exception of works solely for the provision of on-street access to upper floors.
- The exemption applies to existing buildings that have a current commercial use (with reference to Class 1, 2, 3, and 6 of Part 4 to Schedule 2 of the Principal Regulations).

2.1.3 The Planning and Development (Housing) and Residential Tenancies Act 2016

The Planning and Development (Housing) and Residential Tenancies Act 2016 provides a legislative basis for measures introduced under the Rebuilding Ireland: Action Plan for Housing and Homelessness to expedite the construction of large-scale residential developments. These “strategic housing developments” avail of a fast-track application process, whereby applications for planning permission are submitted apply directly to An Bord Pleanála. This measure was introduced under the Rebuilding Ireland Action Plan for Housing and Homelessness in order to streamline the planning process and accelerate the delivery of new housing and student accommodation units.

Part 2(3) of the Act defines the following types of developments as qualifying as Strategic Housing Developments:

- a) the development of 100 or more houses on land zoned for residential use or for a mixture of residential and other uses,
- b) the development of student accommodation units which, when combined, contain 200 or more bed spaces, on land the zoning of which facilitates the provision of student accommodation or a mixture of student accommodation and other uses thereon,
- c) development consisting of shared accommodation units that when combined contain 200 or more bed spaces on land the zoning of which facilitates the provision of shared accommodation or a mixture of shared accommodation and other uses,
- d) development that contain a mixture of houses, student accommodation or shared living units,
- e) the alteration of an existing planning permission granted under section 34 (other than under subsection (3A) where the proposed alteration relates to development specified in paragraph (a), (b), or (c).

Under this streamlined application process applicants engage with the relevant Local Authority and An Bord Pleanála in a Pre-Application Consultation to discuss a proposed development, determine its legitimacy and highlight any potential issues that may arise. Then upon submission of an application for planning permission, An Bord Pleanála are to provide a decision within sixteen weeks of application. To maintain this deadline there is no provision for the applicant to provide further information in support of their application once submitted, and no provision for an appeals process by which the applicant or any third party can dispute An Bord Pleanála’s decision. As such decisions to grant or refuse permission for strategic housing developments can only be disputed by way of a Judiciary Review.

2.1.4 Urban Regeneration and Housing Act 2015

Under Part V Section 91(4)(c) of the Planning and Development Act 2000 there is a social housing requirement of 10% which planning authorities must apply to planning permission for housing on all lands zoned for residential use, or for a mixture of residential and other uses. The Urban Regeneration and Housing Act was introduced in 2015 and it includes amendments to the Planning and Development Act 2000, as amended. Specifically, these amendments determine thresholds for this social housing requirement and specify how private developers can meet their obligations to contribute to the provision of social housing.

The previous social housing obligations were not applicable in the case of developments including four or fewer residential units, however the new obligations are not applicable in respect of developments that include nine or fewer units. The use of cash payments as an alternative to social housing units is no longer permitted, and provision has been made for the transfer of residential units outside the lands which are subject to planning permission, but within the relevant Development Plan area. The full list of social housing delivery options now permitted are outlined below.

Part V delivery options (Post Act 2015)

- The transfer of ownership of lands, subject to the planning permission application to a local authority for the provision of social housing remains the default option. The land option must be acceptable to the local authority
- The transfer of ownership to the local authority, or persons nominated, of completed social housing units on the land, subject to planning permission
- The transfer of ownership to the local authority, or person nominated, of completed social housing units on other land, not subject to the planning permission. There is no longer a requirement for the developer to build housing units on other land to fulfil his/her Part V obligations. The developer might have a stock of suitable houses or he/she can simply acquire housing units for such purposes. This allows social housing units to be delivered in a more timely fashion in another location, in the event that the development that is the subject of the planning permission does not meet the social housing or mixed tenure needs of the local authority:
- The Part V obligation can now be fulfilled by developers through long term leasing of properties: and
- A combination of the Part V options above is also allowed.

The Urban Regeneration and Housing Act 2015 also introduced wider changes aimed to encourage activity in the construction sector. A vacant site levy was introduced, which provides Local Authorities with the power to apply levies to property owners who do not take steps to develop vacant and under-utilised in areas identified for priority development under the local Development Plan. Developers were also permitted to avail of reduced development contributions for developments that had previously been granted permission but were yet to commence.

2.1.5 The Housing (Miscellaneous Provisions) Act 2009

The Housing (Miscellaneous Provisions) Act 2009 makes amendments and extensions to provisions under the Housing Acts 1966 to 2004 to provide Local Authorities with a strategic framework for the delivery and management of housing services. This requires Local Authorities to adopt housing services plans to cover the delivery and management of housing services within the Local Authorities' areas, as well as homelessness action plans and anti-social behaviour strategies. It provides a legislative basis for objective methods to assess need and allocating social housing support which incorporate household size, household income and house and rental prices within a Local Authority's administrative area. The Act also extends the legislative basis for the provision of rented social housing by means of leasing or contract arrangements with private landlords.

2.1.6 Project Ireland 2040 – National Planning Framework

The National Planning Framework (NPF) is a high-level strategy that will shape Ireland's growth and development up to the year 2040. Drawing upon lessons learned from the implementation of the National Spatial Strategy 2002-2022, the NPF calls for a shift from an uncoordinated "business as usual" approach to planning, and provides a framework for the sustainable development of Ireland's existing settlements.

The NPF sets an overall national target to deliver 550,000 additional households by 2040. This is supported by a number of National Policy Objectives that seek to deliver residential development at a suitable density and scale:

- **National Policy Objective 32:** To target the delivery of 550,000 additional households to 2040.
- **National Policy Objective 33:** Prioritise the provision of new homes at locations that can support sustainable development and at an appropriate scale of provision relative to location
- **National Policy Objective 35:** Increase residential density in settlements, through a range of measures including reductions in vacancy, re-use of existing buildings, infill development schemes, area or site-based regeneration and increased building heights.

To underpin the delivery of these targets the NPF requires Local Authorities to develop a Housing Need Demand Assessment (HNDA) as noted in Section 1 and set out in National Policy Objective 37 as follows:

“A ‘Housing Need Demand Assessment’ (HNDA) is to be undertaken for each Local Authority Area in order to correlate and accurately align future housing requirements. The HNDA is:

- to be undertaken by Local Authorities with coordination assistance to be provided by the Regional Assemblies, and also at a Metropolitan scale, particularly where inter-county and inter-regional settlement interactions are to be planned for and managed;*
- to primarily inform housing policies, housing strategies and associated land use zoning policies as well as assisting in determining where new policy areas or investment programmes are to be developed;*
- and to be supported, through the establishment of a coordination and monitoring unit to assist Local Authorities and Regional Assemblies in the development of the HNDA (DHPLG, Regional Assemblies and the Local Authorities). This will involve developing and coordinating a centralised spatial database for Local Authority Housing data that supports the HNDA being undertaken by Local Authorities.”*

The NPF also emphasises the need for more affordable homes for sale or rent. More proactive land management and coordinated and efficient provision of enabling infrastructure, particularly on Local Authority and State-owned lands, are set out as central measures to delivering affordability in the housing sector.

Housing will need to be well-located, affordable and diverse in order to cater for the increased demand particularly for smaller homes suitable for one and person households. Housing should be re-usable, adaptable and accessible to ensure that homes can meet the changing needs of households over time (Objective 34). New housing provision should be met within existing settlements and should be tailored to meet the future housing needs of the settlement in which it is located.

Building resilience and being able to adequately respond to future demand will also involve the re-use of existing housing stock. Higher residential densities are to be pursued in urban areas with a greater emphasis on infill/brownfield, reduction in vacancies, area or site based regeneration and increased building heights (Objective 35).

Objective 36 of the NPF provides a commitment to introduce new statutory guidelines that will ensure consistency of approach, implementation and monitoring of housing requirements at a regional (Regional Spatial and Economic Strategies), metropolitan and local authority levels (Core Strategies).

The NPF also sets out measures and objectives to reconcile future housing requirements effectively. For this, key evidence inputs to inform and drive robust, evidence based Housing Need Demand Assessment (HNDA) Models that underpin local authority Housing Strategies are set out as follows:

- Demographic trends, affordability trends and wider economic trends.
- Housing Stock Profile Pressures (and existing need) and management issues.
- Estimating Future Housing Need and Demand.

Objective 37 sets out a requirement for Local Authorities to undertake HNDAs to form housing policies, strategies and land use zoning policies and to facilitate more informed decision making on investment programmes for housing. Furthermore, coordination and monitoring units are to be established to assist Local Authorities and Regional

Assemblies in the development of the HDNA. This unit will also be responsible for a new centralised spatial database for Local Authority housing data that informs the development of the HNDAs.

2.1.7 Implementation Roadmap for the National Planning Framework

The Implementation Roadmap for the NPF supports the alignment of national, regional and local planning policy and objectives. It provides transitional population projections for the period up to 2031 and sets out mechanisms to ensure that Development Plans align with the NPF and RSES in addressing the six-year period up to 2026/2027. They allow for the Development Plan Review Process to be deferred on a once-off basis up to three months after the relevant RSES has been finalised, and for Review Processes underway to be suspended until the relevant RSES has been finalised. This aims to ensure that Development Plans can benefit from latest available data and policy contexts. Recently adopted plans that were completed before the relevant RSES can also be brought forward for early review or variation to render them consistent with relevant regional policies and objectives.

As such, most City and County Development Plans will undergo a process of review by 2020/2021 and will cover the six-year period up to 2026/2027. 2027 will provide an assessment of the first full round of Development Plans that have been prepared in accordance with the NPF and RSES for Ireland's three regions. This assessment will coincide with several other key deadlines; 2026 is also a Census Year (i.e. updated demographic and socio-economic data is likely to be available) and 2027 will see a review of the ten-year National Development Plan. Further, Development Plans prepared in 2020/2021 will commence review in 2025/2026 and will require demographic data for the six-year period beyond to 2031. Therefore, the Roadmap provides transitional population projections in line with these deadlines, noting that:

“The critical population projection periods are to 2026 and 2031, with a particular emphasis on the initial six-year period to 2026, for city and county development plans that are to be formulated during the 2019-20/21 period.”

Table 2.1 Transitional Regional and County Population Projections to 2031 for the Eastern and Midland Regional Assembly

Regions and Counties	2016	2026	2031
Mid-East			
Kildare	222,500	249,000-254,000	259,000-266,500
Meath	195,000	216,000-221,000	225,500-231,500
Wicklow	142,500	155,000-157,500	160,500-164,000
Louth	129,000	139,000-144,500	144,000-151,500
Subtotal	689,000	759,000-777,000	789,000-813,500
Midlands			
Westmeath	89,000	96,500-98,500	100,000-102,500
Laois	84,500	92,500-94,000	95,500-97,500
Offaly	78,000	85,000-86,500	88,000-90,000
Longford	41,000	44,500-45,500	46,000-47,000
Subtotal	292,500	318,500-324,500	329,500-337,000
Dublin			
Dublin	1,347,500	1,489,000-1,517,500	1,549,500-1,590,000
Total	2,329,000	2,566,500-2,619,000	2,668,000-2,740,500

2.1.8 Project Ireland 2040 – National Development Plan 2018-2027

Building resilience in housing is a key element of Project Ireland 2040 with wide ranging measures set out in the NPF and the associated National Development Plan 2018-2027. With regards to housing, this includes measures to reduce vacancy rates and to bring habitable properties back into use particularly in cities and large towns where demand is highest. The NPF provided for the establishment of a land-management to be known the National Regeneration and Development Agency, to release strategically located land banks for redevelopment. This objective has been effected through the establishment of the Land Development Agency (LDA), which has now commenced operation.

In terms of social housing, the National Development Plan will, through a planned capital investment of over €4.2 billion, seek the delivery of some 40,000 new social housing homes by 2021. Direct Local Authority build, acquisitions, refurbishment of formerly empty homes and provision by housing bodies were identified as the chief delivery mechanisms. By 2021, it was aimed to have 12,000 social housing homes made available annually by Local Authorities and approved housing bodies for social housing. This level of provision was to be maintained over the remainder of the period of the National Development Plan, resulting in 112,000 households having their housing needs met through social housing by 2027. The NPF advocated the development of diverse neighbourhoods with a healthy balance of public and private housing.

2.1.9 Housing Supply Target Methodology for Development Planning (December 2020)

The NPF is based on demographic and econometric projections undertaken by the Economic and Social Research Institute (ESRI) in 2017. Following publication of the NPF in 2018, the NPF 'Roadmap' circular was issued to all planning authorities, setting out projected county population ranges for 2026 and 2031. As part of the development plan process, planning authorities must demonstrate the manner in which their core strategy and other elements of the plan are consistent with the established NPF Roadmap population projections for their local authority area.

In order to strengthen the relationship between national and regional population projections and their integration into the development planning process at local authority level, the Department commissioned the ESRI to further develop work previously undertaken for the NPF. The findings of the ESRI work were published as a research paper on Structural Housing Demand at County Level in December 2020. Following publication of this, the 'Housing Supply Target Methodology for Development Planning: Guidelines for Planning Authorities issued under Section 28 of the Planning and Development Act, 2000 (as amended)' was published.

This ESRI research applies the projection model to four different development scenarios:

- Baseline – projecting a 'business as usual' scenario which is based on current trends and medium-term projections for the Irish economy;
- NPF 50:50 City – consistent with the NPF strategy;
- High Migration – incorporating assumptions around high international migration flows into Ireland based on higher economic growth than the baseline; and
- Low Migration – incorporating assumptions around lower international migration flows into Ireland based on lower economic growth than the baseline.

The ESRI research model is intended to enable structural household demand levels for each local authority area to be set out under the four different scenarios for each year to 2040. The Section 28 Guidelines state that "The NPF 50:50 City scenario is broadly consistent with the National Planning Framework strategy and consequently, the 2018 NPF 'Roadmap' document". As such, the Section 28 Guidelines further indicate that this is the recommended housing

demand scenario to be used by planning authorities in their planning functions in order to plan for the provision of housing to meet projected levels of demand in their administrative area, in accordance with the NPF strategy.

Thus, planning authorities must now demonstrate the manner in which their core strategy and other elements of the plan are consistent with the NPF 50:50 City housing demand projection scenario identified by the ESRI. Deviation from this scenario, the Guidelines state, must be evidence-based and consistent with these guidelines.

The Guidelines set a methodology for the application of population and housing projections into Local Authority plan processes. The calculation of the housing supply target for County Longford is detailed in Section 4.2.2.

2.1.10 Sustainable Urban Housing: Design Standards for New Apartments Guidelines for Planning Authorities

In March 2018 the Department of Housing, Planning and Local Government updated the guidelines relating to the Design Standards for New Apartments. These guidelines have been adopted in appreciation of the need to move towards higher density and more sustainable forms of living within Ireland's urban areas, to which apartment living is deemed essential. They also recognise the importance of the challenge in meeting the housing needs of a growing population in Ireland's key cities, thus following the direction of travel outlined in the NPF.

The guidelines state that County Development Plans must appropriately consider the need to both sustainably increase housing supply and to ensure that a greater proportion of housing development takes place within its existing built-up areas. However, they warn that while it has become practice for some statutory development plans to specify an across-the-board mix (types/sizes) in relation to the composition of individual apartment schemes, there is a need for greater flexibility with regard to approaches to apartment mix more generally. This is particularly relevant where a comprehensive HNDA has not been undertaken. To this effect the following Specific Planning Policy forms part of the guidelines:

*“Apartment developments may include up to 50% one-bedroom or studio type units (with no more than 20-25% of the total proposed development as studios) and there shall be no minimum requirement for apartments with three or more bedrooms. Statutory development plans may specify a mix for apartment and other housing developments, **but only further to an evidence based Housing Need and Demand Assessment (HNDA)**, that has been agreed on an area, county, city or metropolitan area basis and incorporated into the relevant development plan(s).”* (emphasis added)

As such, the production of a Housing Needs Demand Assessment (HNDA) provides local authorities with an up to date and robust evidence base thus allowing them to appropriately determine and plan for the specific housing/apartment needs (including household compositions) within their administrative area covering the period of their statutory development plan.

2.1.11 Rebuilding Ireland – Action Plan for Housing and Homelessness, 2016

Rebuilding Ireland: Action Plan for Housing and Homelessness was published in July 2016. This Action Plan recognises issues around supply and affordability in Ireland's housing sector and provides a multi-stranded approach to achieve key housing objectives up to 2021. These include an increase in the supply of social housing, increasing housing build numbers to services different tenures, and tackling homelessness. Actions to meet these objectives are organised under five pillars:

- Pillar 1: Address Homelessness
- Pillar 2: Accelerate Social Housing

- Pillar 3: Build More Homes
- Pillar 4: Improve the Rental Sector
- Pillar 5: Utilise Existing Housing.

Actions under Pillar 1 of the Action Plan were aimed at enhancing supports for homeless people and families and alleviating the unacceptable level of families in emergency accommodation. Key actions included a Rapid-Build Housing Programme to expediate social housing supply, with a target of 1,500 rapid-delivery units by 2018, and enhanced Housing Assistance Payment (HAP) supports. In January 2016 rent limits were increased under the national Rent Supplement and HAP schemes, to provide greater security for tenants and families that are at risk of becoming homeless if their rent increases.

Pillar 2 built upon actions delivered under the Social Housing Strategy 2020. That Social Housing Strategy was published in 2014 and it set a commitment to deliver 35,000 new social housing units by 2020. The Action Plan further increased this target to the delivery of 47,000 new social housing units over the period 2016-2021 and pledged enhanced support for existing initiatives for the delivery of social housing through the following:

- **Local Authority Construction & Acquisition (also known as the Social Housing Investment Programme (SHIP))** - To provide funding to local authorities for the provision of social housing by means of construction and acquisition. It also covers expenditure under the Rapid Build Housing Programme, Part V acquisitions, Land Aggregation Scheme and the Special Resolution Fund for unfinished housing developments.
- **Capital Assistance Scheme (CAS)** - To provide essential funding to AHBs for the provision of accommodation for persons with specific categories of housing need such as Homeless and Older Persons, People with Disabilities, Returning Emigrants and Victims of Domestic Violence.
- **Vacant Housing Repair and Leasing Initiative** - This scheme enables local authorities, having identified appropriate vacant privately-owned properties in their functional areas, to provide upfront financial assistance to meet reasonable renovation works and to enter into long term lease arrangements with property owners. Renovation costs will be recouped from rent over an agreed period.
- **Part V Delivery** - The Action Plan sets out a commitment to ensure adequate resources are made available to both local authorities and Approved Housing Bodies, to allow them to purchase or lease newly built private dwellings to the fullest extent envisaged by Part V of the Planning and Development Act 2000. In addition, where appropriate, the leasing of additional privately developed dwellings beyond the extent envisaged by Part V is supported. Furthermore, the up-front purchase of the Part V social housing requirement will be facilitated, subject to the introduction of strict controls.

Significantly Pillar 3 of the Action Plan introduced measures for a stream-lined planning application process to allow applications for larger housing development schemes (comprising 100 units or more) to be made directly to An Bord Pleanála. These measures were given a legislative basis in the Planning and Development (Housing) and Residential Tenancies Act 2016 as set out in Section 2.1.3.

Pillar 4 of the Action Plan focuses on the rental sector and its growth in the overall tenure mix for Ireland's housing sector. A declining rate of home ownership, decreasing household size, a growing population influenced by high inward migration rates, and increasing rates of new household formation were identified as factors pointing to the growth of the rental sector and the increased role it is likely to play into the future. The Action Plan notes that a strong rental sector supports a mobile labour market "*better able to adapt to new job opportunities and changing household circumstances*" and is suited to accommodating a range of households - including mobile professionals, students and indeed lower-income households.

Pillar 5 recognises that achieving optimum occupancy of both social and private housing stock is an effective way of meeting housing needs. It commits to the development of an overall national vacant housing re-use strategy, as well as introducing the following actions to ensure that our existing housing stock is utilised in an efficient manner to meet housing demand:

- **Better management of social housing stock** -A vacated social house should not remain vacant for an extended period. The refurbishment and re-letting of units between tenancies with minimal delay will be achieved through the adoption of a national re-letting performance standard across all local authorities, a preventative maintenance approach to housing stock management and funding mechanisms to incentivise the swift turnaround of units.
- **Choice-based letting** -Choice-based letting is a method used to allocate social housing in a manner that offers more choice and involvement for applicant households in selecting a new home. Local Authorities that have implemented such an approach have seen refusal rates drop, and so a choice-based allocation system will be introduced and implemented across all Local Authorities in a manner tailored to their specific circumstances.
- **Review of Tenant (Incremental) purchase** - The ongoing review of the Tenant (Incremental) Purchase Scheme in consultation with Local Authorities, to make the scheme more attractive for social housing tenants and help people who would otherwise struggle to buy a home to meet their home ownership ambitions.
- **Housing Agency Vacant Housing Purchase Initiative** - The Housing Agency will receive up to 70 million in capital funding to support the acquisition of suitable portfolios of vacant properties for social housing directly from financial institutions and investors.

2.1.12 National Vacant Housing Reuse Strategy 2018-2021

The National Vacant Housing Reuse Strategy was published in 2018 to support Pillar 5 of the Rebuilding Ireland: Action Plan for Housing and Homelessness. Drawing together policies and actions aimed at reducing vacancy in Ireland's housing stock it sets out the Strategic Objective of:

“ensuring that existing housing stock is used to the maximum degree possible – focusing on measures to use vacant stock to renew urban and rural areas.”

To accomplish this overall Strategic Objective the Strategy sets out a range of actions that will be implemented at a national and local level, grouped under five key objectives.

- **Objective 1 Establish robust, accurate, consistent and up-to-date data sets on vacancy.** - This includes actions aimed at securing an accurate picture of vacancy rates across different Local Authorities and identifying recoverable dwellings that can be re-introduced into the housing stock.
- **Objective 2 Bring forward measures to ensure, to the greatest degree possible, that vacant and underused privately owned properties are brought back to use** - This includes actions aimed at identifying and addressing barriers to bring private properties that are subject to long-term vacancies back into the housing stock.
- **Objective 3 Bring forward measures to minimise vacancy arising in Social Housing Stock** - This includes actions for the effective management of our national social housing stock to ensure that vacant social houses do not remain vacant for extended periods of time.
- **Objective 4 Continued engagement with and provision of support to key stakeholders to ensure suitable vacant properties held by banks, financial institutions and investors are acquired for social housing use** -This includes actions to ensure that the Housing Agency has adequate capital funding to acquire vacant properties from NAMA and other stakeholders for use as social housing.
- **Objective 5 Foster and develop cross-sector relationships, collaborating in partnership to tackle vacant housing matters** - This includes actions to tackle vacancy in urban and rural areas such as the utilisation of the

Urban Regeneration and Rural Regeneration Development Fund's and the rollout of a dedicated Urban Regeneration Scheme, as well as support partnerships between Government Departments and Local Authorities.

2.1.13 Social Housing Strategy 2020: Support, Supply and Reform

The Social Housing Strategy 2020: Support, Supply and Reform was adopted in November 2014 and sets out the framework for the delivery of new social housing and for social housing assessment, delivery and financing. The vision set out Strategy that:

“every household in Ireland will have access to secure, good quality housing suited to their needs at affordable prices in a sustainable community”.

The national Social Housing Strategy is based on three pillars:

- **Pillar 1:** Provide for 35,000 new social housing units, over a six-year period, to meet the additional social housing supply requirements as determined by the Housing Agency²;
- **Pillar 2:** Support up to 75,000 households through an enhanced private rental sector; and
- **Pillar 3:** Reform social housing supports to create a more flexible and responsive system.

Phase 1 sets a target of 18,000 additional housing units and 32,000 HAP/RAS units by the end of 2017. Phase 2 sets a target of 17,000 additional housing units and 43,000 HAP/RAS units by end 2020. The Strategy states that significant exchequer funding will be allocated to ensure that the early phases of the Strategy will deliver on the targets. An enhanced role for the Approved Housing Bodies (AHBs) is also a key component to deliver the vision.

The Strategy also states that a new tenant purchase scheme for existing local authority houses will be put in place. The development of an individual housing 'passport' that would facilitate tenant mobility between local authorities will be examined.

Exchequer funding of €5.7bn has been committed to by the Government over the lifetime of the Strategy, and Longford County Council expects to spend in excess of €200 million from this fund in the delivery of its Social Housing Programme 2017 to 2019.

2.1.14 Construction 2020: A Strategy for a Renewed Construction Sector

Construction 2020 was published by the Government in 2014 and sets out a detailed, time-bound set of actions to support the return of Ireland's construction sector to sustainable levels. The vision is that Ireland will have a competitive, innovative, dynamic, safe and sustainable construction sector; one that makes its full and proper contribution to the economy and to job creation, and one that is based on best practice and capable of delivering the economic and social infrastructure we need to build to sustain a prosperous future.

Some of the key commitments include:

- Putting in a place a National Framework for Housing Supply and an Annual Statement of Projected Housing Supply and Demand;

² Increased to 47,000 units in *Rebuilding Ireland – Action Plan for Housing and Homelessness, 2016*

- Establishing a Housing Supply Coordination Task Force for Dublin;
- Assessing existing construction and property data sources for appropriateness including identifying any gaps and quality shortcomings;
- Examining the key barriers to housing mobility and make recommendations to Government;
- Developing a national policy towards professionalising the private rental sector;
- Establishing a working group and invite public comment on the feasibility and impact of setting minimum thermal efficiency performance standards in rental properties;
- Publishing a Social Housing Strategy and introducing legislation to regulate the Approved Housing Body sector;
- Review of Part V requirements;
- Publishing of the Homelessness Implementation Plan and implementation of the key recommendations of the Homelessness Oversight Group's First Report in Q2 2016;
- Continuing to implement the Government Action Programme on Unfinished Housing Developments and the Budget 2014 Special Resolution Fund.

2.1.15 The National Housing Strategy for People with a Disability 2011-2016

The National Housing Strategy for People with a Disability 2011-2016 sets out a framework of initiatives to provide for the housing needs of vulnerable and disadvantaged households. The Strategy was affirmed in the Action Plan for Housing and extended to 2020 to deliver on its aims and continue to guide and progress policy. The strategy has nine strategic aims:

- To promote and mainstream equality of access for people with a disability to the full range of housing options available suited to individual and household need.
- To develop national protocols and frameworks for effective interagency cooperation which will facilitate person-centred delivery of housing and relevant support services.
- To support people with a disability to live independently in their own homes and communities, where appropriate.
- To address the specific housing needs of people with an intellectual and/or physical disability, moving from congregated settings in line with good practice, including through the development of frameworks to facilitate housing in the community.
- To address the specific housing needs of people with a mental health disability, including through the development of frameworks to facilitate housing in the community, for people with low and medium support needs moving from mental health facilities, in line with good practice.
- To consider good practice in the design, coordination and delivery of housing and related supports.
- To facilitate people with a disability to access appropriate advice and information in respect of their housing needs.
- To improve the collection and use of data/information regarding the nature and extent of the housing needs of people with a disability.
- To provide a framework to support the delivery, monitoring and review of agreed actions.

2.2 Regional Policy

2.2.1 The Regional Spatial and Economic Strategy (RSES) 2019-2031

The RSES for the Eastern and Midland region came into force in June 2019, superseding the Regional Planning Guidelines for the Midland Region. The RSES is a high-level plan that seeks to support the implementation of the NPF by providing a strategic planning and economic framework for the region's sustainable growth and development. It

echoes the NPF in emphasising sustainable development patterns and seeks to focus growth within the footprint of existing urban areas and in key regional growth settlements. The RSES seeks to determine at a regional scale how best to achieve the shared goals set out in the National Strategic Outcomes (NSOs) of the NPF. To this end, the RSES sets out 16 Regional Strategic Outcomes (RSOs), which are aligned with international, EU and national policy and which in turn set the framework for city and county development plans.

Specifically, the RSES sets out Regional Policy Objectives to support Local Authorities in completing Housing Need Demand Assessments as required under the NPF and to provide for a diverse range of housing types and tenures. The strategy seeks to:

“Support local authorities, approved housing bodies and other sectoral agencies in the provision of a greater diversity of housing type and tenure, including social and affordable housing and exploring new models of low-cost rental and affordable homeownership”.

In relation to Longford, the Settlement Strategy for the region designates Longford town as a ‘Key Town’. The designation of these settlements under the Settlement Hierarchy for the region has informed the settlement hierarchy as described in detail in Core strategy whilst the relevant Regional Policy Objectives has informed the development of this Housing Strategy for Longford.

2.3 Local Policy

2.3.1 Longford County Development Plan 2021 – 2027

The Longford County Development Plan 2021 – 2027 sets out the planning framework during the plan period demonstrates consistency with national and regional policy hierarchy. It provides a clear evidence-base for the reservation of land to meet housing and population targets whilst setting a vision for County Longford that are underpinned by strategic aims to ensure delivery against objectives.

The County Development Plan aims to build on the strategies, policies and objectives of the previous County Development Plan (2015 – 2021) which was prepared during a time of economic uncertainty stemming from a global and national crisis. The review process and preparation of the Plan has had regard to key recent development trends and national, regional and local policy developments, with a particular regard being placed on the need to deliver social housing within County Longford as described herein.

2.3.2 Longford County Housing Strategy 2015-2021

The Longford County Housing Strategy 2015-2021 provided a comprehensive review of demographics and housing demand within County Longford to inform the Longford County Development Plan 2015-2021. It projected need for the planning provision of housing, as well as the demand for social and affordable housing within the County based on data from the 2011 census and regional population targets. This analysis identified a requirement for 2,120 households during the lifetime of the County Development Plan.

Given the difficult economic situation at the time the Housing Strategy did not envision Longford County Council building a substantial number of social or affordable housing units during the Plan’s lifetime. However, it was acknowledged that there would be a need for social housing irrespective of overall social housing output. In order to meet this, need the Housing Strategy advocated for the implementation of Part V requirements of 14% in all new housing schemes subject to the type and location of the housing units required by the planning authority at a given

time. This Strategy will be superseded by this Housing Strategy and the County Development Plan as described in Section 2.3.1.

2.3.3 County Longford Local Economic and Community Plan 2016-2022

The Longford Local Economic and Community Plan (LECP) 2016-2021 was completed to meet provisions under the Local Government Reform Act 2014. The LECP is an action-focused plan whose purpose is to identify and implement actions to achieve sustainable economic growth and improved social outcomes within County Longford. A series of LECP objectives and actions to achieve these ambitions are set out throughout the plan.

2.3.4 County Longford Age Friendly Strategy 2015-2020

The Longford Age Friendly Strategy 2015 -2020 was developed by the Age Friendly Alliance following an extensive consultation with older people throughout the county. In achieving the overall vision of the Strategy which is *'to make Longford a better place to grow old in'*, 42 actions have been developed based on and in alignment with the Age Friendly Ireland (AFI) Programme. Longford's ambition to become age friendly includes to:

- Become one of the greatest places to grow old in;
- Have easily accessible public buildings, shops and services;
- Incorporate older people's views into significant decisions being made about the County;
- Promote a positive attitude to ageing and address stereotypes about older people; and
- Create opportunities for older people to be engaged with their County socially, as employees and as volunteers.

Within the strategy, the following information in relation to housing has been raised by older people as an issue in relation to their accommodation needs:

- Older people feel that they need more support to continue to live independently.
- Policing of privately rented dwellings, particularly with regard to anti-social behaviour is an area of concern for older people.
- Older people would like more information about, and access to grants to improve security, e.g. locks and alarms.
- Improved street lighting is needed in existing housing developments and new builds, to make older people feel safer.

2.3.5 Longford County Council Traveller Accommodation Programme 2019-2024

The Longford County Council Traveller Accommodation Programme (TAP) 2019-2024 fulfils requirements under the Housing (Traveller Accommodation) Act 1998. The TAP aims to meet the accommodation needs of travellers in Longford within a five-year period up to 2024 whilst recognising the ethnic identity of the Traveller community and aiming to provide accommodation that is suitable to their specific needs. As such, the TAP provides for standard housing options, as well as traveller-specific accommodation such as halting sites, temporary/emergency sites and one-off rural houses within County Longford. It is Council policy that different housing options will be provided in accordance with an assessment of need and are subject to feasibility.

3 Current Context: Review and Analysis of Existing Supply and Needs

3.1 Population

Census 2016 results show that Ireland's population stood at 4,761,865 in April 2016, an increase of 173,613 (3.8%) since April 2011. There were 200 urban settlements across the country, which together accommodated 63% of Ireland's population. County Longford is located within the Eastern and Midland Regional Assembly area, the most populous region in the state with over 2.3 million people. Recent trends show that population growth is set to continue having regard to the Region's young demographic profile and a return to net inward migration as the Country returns to economic growth after a severe economic crash in 2008.

A brief overview of the population in County Longford shows that the county saw a population increase of 4.8% (1,873 additional persons) between 2011 and 2016, as the population increased to 40,873 from 39,000 people. As the Key Town within the County Longford settlement hierarchy, Longford Town experienced a rate of growth broadly consistent with the county average between 2011 and 2016, with the population increasing by 4.24%. The population change across the various settlements identified in the settlement hierarchy is set out in Table 3.1.

Table 3.1: Population Growth in Longford 2011-2016

County	Population 2011	Population 2016	Growth Rate (2011-2016)	Growth Rate % (2011-2016)
Longford County	39,000	40,873	1,873	4.80%
Settlements				
Longford Town	9,601	10,008	407	4.24%
Granard ³	1,021	1,096	75	6.8%
Edgeworthstown	1,744	2,072	328	18.81%
Ballymahon	1,563	1,877	314	20.09%
Lanesborough (County Longford) ⁴	727	757	30	4.0%
Abbeyshrule ⁵	-	224	-	-
Ardagh ⁵	-	210	-	-
Aughnaccliffe	148	177	29	19.59%
Ballinamuck ⁵	-	232	-	-
Ballinalee	308	347	39	12.66%
Cloondara ⁵	-	449	-	-
Carriglass ⁵	-	161	-	-
Drumlish	835	931	96	11.5%
Keenagh	498	581	83	16.67%
Legan	199	215	16	8.04%
Newtownforbes	759	778	19	2.50%

³ CSO Settlement boundary change between 2011-2016; 2011 boundaries used here. 2016 boundaries give a population of 816.

⁴ County Longford population for Lanesborough derived through analysis of CSO Census 'Small Area' data

⁵ CSO data unavailable for 2011. 2016 figures are based on analysis of CSO Census Small Areas and include some rural hinterlands.

The population distribution across urban and rural areas in County Longford remained consistent between 2011 and 2016. According to the CSO, 13,957 people (34.2%) were living in urban settlements⁶ in Longford in 2016 whilst 26,916 (65.85%) were living in smaller towns and villages, as well as in the rural remainder of the county. In 2011, census results showed a distribution between the urban and rural population as 33.1% and 66.9% respectively. Thus, the marginal increase (+ 1%) in urban living in County Longford was broadly aligned with the prevailing state-wide direction of travel of urbanisation.

The age profile of the EMRA region in 2016 was relatively young with nearly half a million children or approximately 1 in 5 people (22%) in the Region aged under 14 years of age. In County Longford this figure is broadly similar, standing at 23.3% as set out in Table 3.2. In total, the number of children of pre-school age (0-4 years) in Longford is 3,051 (7.5%). 5,205 (12.7%) are of primary school going age (5-12 years) and a further 3,432 (8.4%) are of secondary school going age (13-18 years). An extended age profile of the county is presented in Figure 3.1.

Census 2016 results show that Ireland's population has been getting steadily older since the 1980s. In 2016, 37.2% of the Irish population were aged 45 and over, compared with 34.4% in 2011 and 27.6% in 1986. 13.4% of the national population were over 65 years in 2016. As with the state, both the EMRA region and County Longford are ageing. As the RSES notes, by 2031 there will be a significant increase in the regional population aged over 65 and as such, there is a need to plan for adequate healthcare, accommodation and services to enable independent living for as long as possible, encourage active lifestyles and address isolation for older residents.

Table 3.2: Age Dependency Ratios (2016)

	0-14 years	15-64 years	Over 65 years	Young Age Ratio (%)	Old Age Ratio (%)	Total Dependency Ratio (%)
County Longford	9,508	25,541	5,824	23.3%	14%	37.5%
MD						
MD Ballymahon	3,244	8,915	1,994	22.9%	14.1%	37.0%
MD Granard	2,430	6,569	1,675	22.8%	15.7%	38.5%
MD Longford	3,834	10,057	2,155	23.9%	13.4%	37.3%

⁶ The CSO defines a settlement of more than 1,500 people as 'urban'.

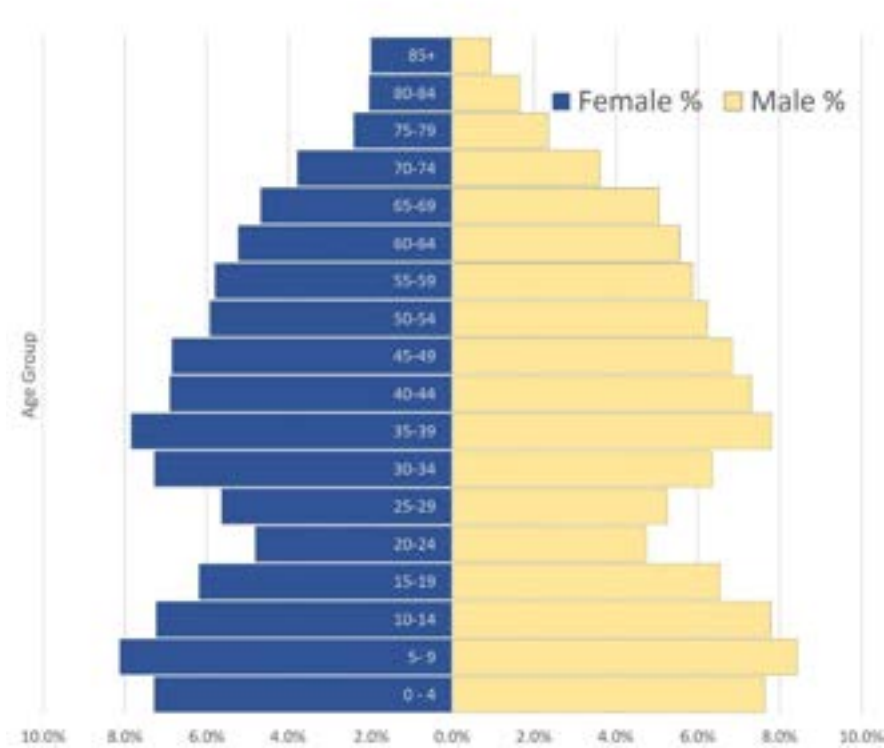

Figure 3.1: Age Profile for County Longford

3.2 Existing Housing Stock and Supply

3.2.1 Stock and Composition

Census 2016 results record a total housing stock of 18,591 units in County Longford, which represents a marginal decrease of 232 units since 2011. The number of vacant units in 2016 stood at 2,824 (excluding holiday homes and those dwellings deemed to be temporarily absent).

The 2011 Census data does not distinguish between categories of vacancy and indicates that there were 4,363 unoccupied dwellings in 2011. In contrast, the 2016 data illustrates the number of temporarily absent dwellings, unoccupied holiday homes and other vacant dwellings. For comparison purposes, the total number of vacant dwellings across these three categories in 2016 is 3,445. As such, there is an overall decline of 918 in the number of vacant dwellings between 2011-2016. This indicates the existing vacant stock absorbing much of the growing need for housing in the county. A summary of the information on the existing housing stock is provided in Table 3.3.

The proportional breakdown of housing tenures, privately owned, privately rented and publicly rented accommodation in the three Municipal Districts of Ballymahon, Granard and Longford is set out in Table 3.6. As can be seen home ownership in Longford MD (at 50%) is below the county average while privately rented (24%) and social housing i.e. rented from the Local Authority and rented from voluntary bodies (22%) are well above the county average. Home ownership (77%) is highest and well in excess of the county average (63.7%) in Granard MD where social housing provision is also at its lowest (8%).

Table 3.6: Household Tenure – Occupancy Type County Longford and Municipal Districts 2016

County Longford	Owner occupied with mortgage	Owner occupied no mortgage	Rented from private landlord	Rented from Local Authority	Rented from voluntary body	Occupied free of rent	Not stated	Total
No. households	3,864	5,753	2,621	2,031	167	257	399	15,092
% Households	26%	38%	17%	13%	1%	2%	3%	100%
MD Ballymahon								
No. households	1,443	1,984	872	657	21	93	139	5,209
% Households	28%	38%	17%	13%	< 1%	2%	3%	100%
MD Granard								
No. households	1,146	1,880	398	319	6	83	106	3,938
% Households	29%	48%	10%	8%	< 1%	2%	3%	100%
MD Longford								
No. households	1,275	1,889	1,351	1,055	140	81	154	5,945
% Households	21%	32%	23%	18%	2%	1%	3%	100%

Table 3.3: Existing Housing Stock (2016)

County	Housing stock	Holiday homes	Other vacant	Temporarily Absent	Total vacancy	% Vacancy ⁷
Longford	18,591	278	2,824	343	2,824	15.19%
MD						
MD Granard	5,027	128	870	75	870	17.31%
MD Ballymahon	6,343	102	911	104	911	14.36%
MD Longford	7,221	48	1,043	164	1,043	14.44%

Household size cohort represents the number of people per households. Over half (54.7%) of households in Longford in 2016 had just one or two persons living in that household as illustrated Table 3.4; however this generally compares to the national figures on household size cohorts.

Table 3.4: Existing Household Size Cohorts (2016)

County Longford	Households	Persons	Households %	Persons %
1 person	4,035	4,035	26.7%	9.9%
2 persons	4,233	8,466	28.0%	20.8%
3 persons	2,466	7,398	16.3%	18.1%
4 persons	2,274	9,096	15.0%	22.3%

⁷ The percentage vacancy rate provided is based on 'Other Vacancy' category as a percentage of total housing stock and excludes vacant holiday homes and those temporarily absent.

5+ persons	2,114	11,780	14.0%	28.9%
Total	15,122	40,775	100.0%	100.0%

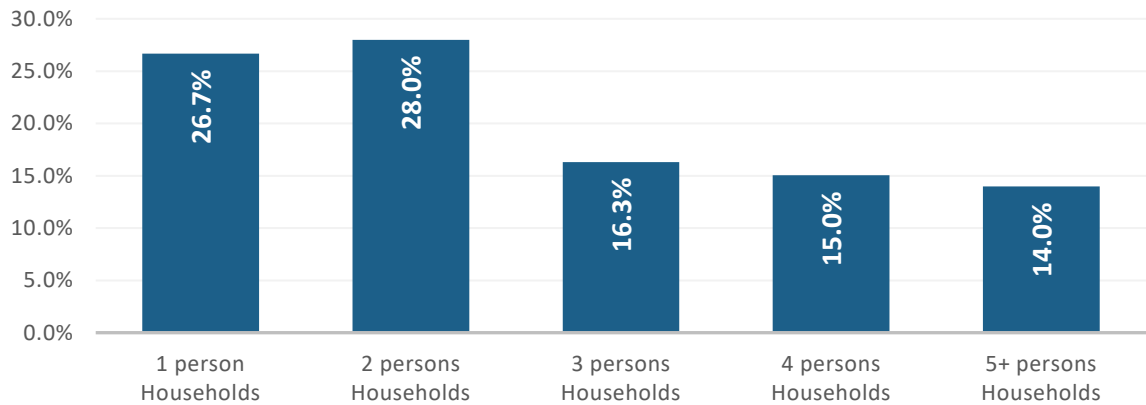

Figure 3.2: Household Composition in County Longford

There were 15,122⁸ private households and an average household size of 2.70, which is marginally lower than the national rate of 2.75. 93.9% of households comprised of a house or bungalow while 4.2% were apartments in 2016. At a national level, 12% of all occupied households in Ireland were apartments. The NPF notes that while the overall proportion of households living in apartments is growing, we remain considerably behind European averages in terms of the numbers and proportion of households living in apartments, especially in our cities and larger towns and this is particularly evident within County Longford. Further, the NPF states that apartments will need to become a more prevalent form of housing, particularly in Ireland’s cities in order to more effectively address the challenge of meeting the housing needs of a growing population in our key urban areas.

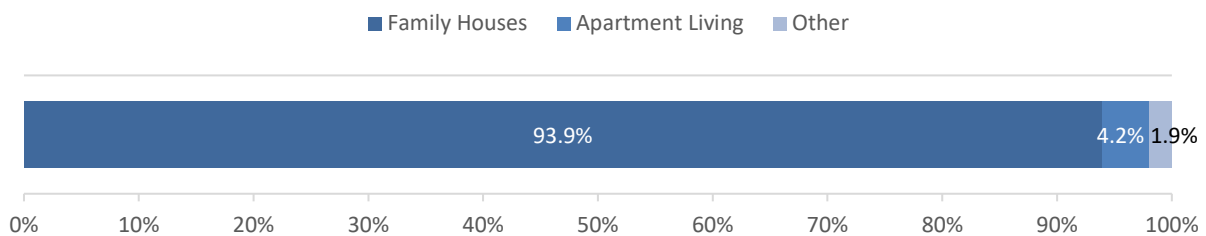

Figure 3.3: Existing Household Typology % (2016)

3.2.2 Housing Tenure

Home ownership remains the dominant tenure in Longford with 63.7% of households within this category in 2016. 40% of these households pay a mortgage. 17.4% of households were in the private rental market, while 14.6% (2,198) of rented properties comprise social housing, an increase of almost 3% since 2011. Table 3.5 provides a concise illustration of housing tenures across Longford County.

⁸ CSO 2016 – Including Caravan/Mobile Home as a household

Table 3.5: Housing Tenure County Longford (2016)

County Longford	Households	Persons	Households %	Persons %
Social Housing ⁹	2,198	5,758	14.6%	14.1%
Rented (Privately)	2,621	7,259	17.4%	17.8%
Owner Occupied (All)	9,617	26,155	63.7%	64.2%

The proportional breakdown of housing tenures, privately owned, privately rented and publicly rented accommodation in the three Municipal Districts of Ballymahon, Granard and Longford is set out in Table 3.6. As can be seen home ownership in Longford MD (at 50%) is below the county average while privately rented (24%) and social housing i.e. rented from the Local Authority and rented from voluntary bodies (22%) are well above the county average. Home ownership (77%) is highest and well in excess of the county average (63.7%) in Granard MD where social housing provision is also at its lowest (8%).

⁹ The specifically relates to all households that rent from the local authority or voluntary body

Table 3.6: Household Tenure – Occupancy Type County Longford and Municipal Districts 2016

County Longford	Owner occupied with mortgage	Owner occupied no mortgage	Rented from private landlord	Rented from Local Authority	Rented from voluntary body	Occupied free of rent	Not stated	Total
No. households	3,864	5,753	2,621	2,031	167	257	399	15,092
% Households	26%	38%	17%	13%	1%	2%	3%	100%
MD Ballymahon								
No. households	1,443	1,984	872	657	21	93	139	5,209
% Households	28%	38%	17%	13%	< 1%	2%	3%	100%
MD Granard								
No. households	1,146	1,880	398	319	6	83	106	3,938
% Households	29%	48%	10%	8%	< 1%	2%	3%	100%
MD Longford								
No. households	1,275	1,889	1,351	1,055	140	81	154	5,945
% Households	21%	32%	23%	18%	2%	1%	3%	100%

3.2.3 Unfinished Housing Development

The 2017 National Housing Development Survey which tracks progress on unfinished housing developments since 2010 indicates that there were 11 unfinished housing developments in County Longford at the time of the 2017 survey. However, following the inspection of these 11 unfinished housing development sites in 2017, a further reduction in unfinished housing developments (36.4%) was achieved, leaving a remaining 7 sites to be brought forward to 2018. A total of 548 units are spread across these 7 sites. Of the 548 units, 23.9% are occupied and 9.1% are nearing completion as set out in Table 3.7.

Table 3.7: Unfinished Housing Developments (Source: DHPLG 2017)

Status	Number of Units
Occupied	131
Vacant	76
Near Complete	50
Partially constructed (to wall plate, DPC or foundations)	31
Not started	0
Planning Expired	260
All units	548

3.2.4 Housing Permissions

Table 3.8 illustrates the number of granted planning applications (by unit) in County Longford between 2006 and 2019. As discussed in further detail in Section 4.4.3, it should be noted that the quantum of applications and thus indirectly, the number of granted units during specific years in that period (i.e. the overall market dynamics) has varied greatly and likely been influenced by the macroeconomic trends (including the recession and rising costs to build a home). Longford County Council confirm that this was notable in relation to the overall number applications submitted for houses and apartments in settlements during and following the recession in the mid-late 2000s.

59.2% of these relate to permissions granted for houses and apartments via development scheme applications, while 40.8% relate to one-off houses. The yearly average of one-off houses granted planning permission over the 2006-2020 period is 63%. A more a specific analysis focusing on the last three years (2018-2020) indicates that 41% of the total number of residential units granted have been for one-off houses.

Table 3.8: Granted Planning Applications for Residential Units in County Longford between 2006 and 2019

Granted Planning Applications	2006	2007	2008	2009	2010	2011	2012	2013	2014	2015	2016	2017	2018	2019	2020	Grand Total
No. Houses and Apartments	515	658	245	309	1	2	2	17	2	6	13	20	44	110	144	2,088
No. One-Off Houses	263	309	207	86	57	35	41	24	19	35	54	76	53	80	74	1,413
Houses and Apartments % of Total	66.2%	68.0%	54.2%	78.2%	1.7%	5.4%	4.7%	41.5%	9.5%	14.6%	19.4%	20.8%	45.4%	57.9%	66.1%	59.6%
One-Off House % of Total	33.8%	32.0%	45.8%	21.8%	98.3%	94.6%	95.3%	58.5%	90.5%	85.4%	80.6%	79.2%	54.6%	42.1%	33.9%	40.4%
Total	778	967	452	395	58	37	43	41	21	41	67	96	97	190	218	3,501

3.3.5 Social Housing Stock

In accordance with Section 9 of the Housing Act 1988, housing authorities are required to undertake an assessment of housing need in their administrative area. The social housing stock in County Longford as of March 2020 is as set out in Table 3.9.

Table 3.9: Current Social Housing Stock (March 2020)

	County Longford
Housing Stock (directly owned by Longford CC)	2,121
Social Leasing	124
Rental Accommodation Scheme (RAS) or other Leasing Programme	210
Housing Assistance Payment (HAP) Units	334
Approved Housing Body (AHB) Units	514
Total	2,789

3.3.5.1 Approved Housing Bodies – AHBs

AHBs also provide social housing and are formed for the purpose of relieving housing need and the provision and management of housing. They are established by a voluntary management board to benefit the community in which they are based, and are approved and funded by the Department of Housing, Planning and Local Government.

Housing cooperatives such as these AHBs can provide both social rented housing and housing to purchase. AHBs are self-help and jointly owned member/user housing associations or societies. Projects undertaken may be in response to the needs of the elderly, people with disabilities, homeless persons or families and single people on low incomes. Some AHBs may be formed to specialise in meeting a particular housing need, others develop with broader aims. The specific housing services offered will depend on the aims or concerns of the members, the needs of tenants as well as the financial and other resources available for both capital costs and ongoing management running costs.

A list of AHBs that are active in County Longford is set out below:

Table 3.10: Operational Approved Housing Bodies in County Longford

List of Operational Approved Housing Bodies in the County
Cluid
Respond
Tuath
iCare Housing CLG
St. Christopher's Housing Association
Disabled Persons of Longford
County Longford Association for Mentally Handicapped
Newgrove Housing Association
Society of Saint Vincent de Paul

3.3.4.2 Social Housing Vacancy

Table 3.11 sets out the current social housing stock by unit type across county Longford and within each MD. This demonstrates that the proportion of the stock owned

Table 3.11: Current Social Housing Stock owned by Longford County Council by Unit Type (March 2020)

	1-bedroom	2-bedroom	3-bedroom	4-bedroom	5-bedroom	Total
County Longford	34	556	1,378	142	9	2,119
MD Ballymahon	3	160	423	34	3	623
MD Granard	14	122	284	22	3	445
MD Longford	17	263	642	84	3	1,009
MD not classified		11	29	2		42

Table 3.12 sets out the current status of that social housing stock and as of March 2020, there were 84 vacant social housing units in Longford. The majority of those vacant units are in varying stages of being re-let, under maintenance, under offer and/or accepted for tenants.

Table 3.12: Current Status of Social Housing Stock owned by Longford County Council (March 2020)

	Allocated	Occupied	Redundant	Vacant	Total
County Longford	60	1,960	15	84	2,119
MD Ballymahon	8	608		12	628
MD Granard	28	411	6	31	476
MD Longford	24	941	9	41	1015

4 Housing Needs in Longford

4.1 Overview

This chapter sets out the demographic, economic and social inputs of relevance and estimates the projected population, households and associated housing needs in County Longford during the plan period. Specifically, this chapter demonstrates how the various demographic and market factors interact with the assessment of future housing needs and demands within County Longford. This aligns with the methodology that has been described in Section 1.4 and the chapter has therefore been structured in the following way with further details also available in the relevant appendices:

- Section 4.2 (Inputs) – Describes the relevant information that has supported the analysis that has been undertaken herein.
- Section 4.3 (Assessment of Needs) – Describes the assessment of projected needs for ownership and private rental (in Section 4.3.2 and 4.3.3 respectively). A summary of the calculation of the households who can be classified as having an affordability problem during the plan period so as to adequately inform the necessary provision units within County Longford has been set out in Section 4.3.3.
- Section 4.4 (HNDA Components) - Describes the specific analysis that has been undertaken in relation to the dynamic components of the housing market in County Longford as set out under National Policy Objective 37 of the NPF.

The majority of the information presented herein relates to the plan period. The Longford County Development Plan 2021-2027 is expected to come into force in late November 2021 for a plan period of six years; for modelling purposes and to calculate the Housing Supply Target following departmental guidance, this has been rounded to the nearest whole quarters, covering Q1 2022 – Q4 2027 inclusive. Where appropriate the information for additional years has been identified and have been presented to understand progression from the baseline (i.e. 2016). Further details on the analysis undertaken is presented in Appendices 1 - 4.

4.2 Inputs

4.2.1 Population Projections

The future population of County Longford has been set out for target years 2026 and 2031 in the National Planning Framework Implementation Roadmap (July 2018). An interpolation of the required level of change per annum was developed to produce annualised figures between the Q1 2022 and Q4 2027 lifetime of the plan. This was first done for the period 2016 to 2026, and then for the period 2027 to 2031 (as there are different growth rates per period).

The projected population over the plan period in County Longford is outlined in Table 4.1 with further detail provided in Appendix 1. The population of County Longford will increase by 2,614 people during the plan period to a total of 45,800 in 2027.

Table 4.1: Overview of Projected Population throughout the plan period (as per 'High NPF' aligned scenario)

Projection Scenario	2021	2022	2023	2024	2025	2026	2027	2028
NPF High Aligned	43,187	43,649	44,112	44,575	45,037	45,500	45,800	46,100
Growth (absolute)	463	463	463	463	463	463	300	300
Growth (relative)	1.1%	1.1%	1.1%	1.0%	1.0%	1.0%	0.7%	0.7%

4.2.2 Estimated Households

As part of the development plan process, planning authorities must demonstrate the manner in which their plan is consistent with the NPF and established NPF Implementation Roadmap population projections for their local authority area. In December 2020, the DHLGH issued guidelines to assist planning authorities to incorporate these projections into the preparation of development plans and housing strategies in a consistent and coherent approach.

These Guidelines build on research undertaken by the Economic and Social Research Institute (ESRI) into regional demographics and structural housing demand at county level. The ESRI's research applies a projection model to four different development scenarios, including a Baseline ('business as usual') scenario and the 'NPF 50:50 City Scenario.' The Section 28 Guidelines state that "the NPF 50:50 City scenario is broadly consistent with the National Planning Framework strategy and consequently, the 2018 NPF 'Roadmap' document". As such, the Section 28 Guidelines indicate that this is the recommended housing demand scenario to be used by local authorities to plan for the provision of housing to meet projected levels of demand.

Thus, planning authorities must now demonstrate the manner in which their core strategy and other elements of the plan are consistent with the established NPF Roadmap population projections for their local authority area and accordingly, with the related NPF 50:50 City housing demand projection scenario identified by the ESRI.

The Guidelines set a methodology for the application of population and housing projections into Local Authority plan processes and the setting of Housing Supply Targets for the relevant plan period.

As set out below, Longford County Council have finalised the following calculation of housing demand for the plan period. Longford County Council will not pursue optional adjustments ('E' or 'F'), and therefore will pursue a **total housing supply target of 2,568** for the Longford County Development Plan over a plan period¹⁰ anticipated to cover approximately Q1 2022 – Q4 2027 inclusive.

¹⁰ For calculation purposes, the plan period has been rounded to whole quarters.

Table 4.2: Calculation of Housing Supply Targets for County Longford over the plan period¹¹

Longford County Council		Annual Average Households	Total Households
A	ESRI NPF scenario projected new household demand 2017 to end Q4 2027	277	3,042
B	Actual new housing supply 2017 to end Q3 2021 (Source: CSO to Q4 2020, pro-rata of 2020 data for remainder)	103	517
C	Homeless households and unmet need ¹²	-	43
D	Plan Housing Demand = Total (A-B+C) For plan period Q1 2022 – Q4 2027 (6 years)	428	2,568
E	<i>Potential Adjustment 1 to end 2026 portion of plan period – not pursued</i>		
F	<i>Potential adjustment 2 to end 2026 portion of plan period to facilitate convergence to NPF strategy, applicable where B exceeds or is close to D (where justified) – not pursued</i>		

Table 4.3 identifies the additional households that are anticipated during the plan period. The Core Strategy includes all population and household figures between 2016 and the end of the plan period. The additional years and units built will be adjusted when local area plans are being prepared.

Table 4.3: Overview of Projected Households in County Longford throughout the Plan Period¹³

County Longford	2022	2023	2024	2025	2026	2027	Total
Total households over the Plan period	16,067 ¹⁴	16,495	16,923	17,351	17,779	18,207	-
Total additional households over the Plan period	428	428	428	428	428	428	2,568

¹¹ Following 'Housing Supply Target Methodology for Development Planning' (DHLGH, December 2020)

¹² Homeless households as of January 2021, plus unmet need as of Census 2016; source: DHLGH, February 2021.

¹³ Average Household Size is not being applied to determine anticipated households from future population growth. Instead the additional households over the period are informed directly by the HST calculations, see Table 4.2.

¹⁴ Informed by the addition of recorded housing completion between 2017-Q4 2020, including an assumed continuation of 2020's rate of completion through full year 2021 (122 dwellings).

The number and distribution of total households per decile throughout the plan period has been estimated from the distribution of housing units in the State from the Household Budget Survey¹⁵. Table 4.4 identifies the distribution of total households across each of the ten deciles during the plan period.

Table 4.4 Distribution of total households per decile (No. Households) in County Longford

Year	2022	2023	2024	2025	2026	2027
1st Decile	1,579	1,621	1,663	1,705	1,747	1,789
2nd Decile	1,699	1,744	1,789	1,834	1,880	1,925
3rd Decile	1,682	1,727	1,772	1,817	1,861	1,906
4th Decile	1,677	1,722	1,767	1,811	1,856	1,901
5th Decile	1,647	1,691	1,735	1,778	1,822	1,866
6th Decile	1,598	1,640	1,683	1,725	1,768	1,810
7th Decile	1,546	1,587	1,628	1,669	1,711	1,752
8th Decile	1,551	1,592	1,633	1,674	1,716	1,757
9th Decile	1,544	1,585	1,626	1,667	1,708	1,749
10th Decile	1,546	1,587	1,628	1,669	1,711	1,752
Total	16,067	16,495	16,923	17,351	17,779	18,207

Similar to the preceding step, the number of additional anticipated households per decile has been estimated throughout the plan period. Table 4.5 identifies the distribution of additional anticipated households across each of the ten deciles during the plan period.

Table 4.5 Distribution of additional households per decile (No. Households) in County Longford

Year	2022	2023	2024	2025	2026	2027
1st Decile	42	42	42	42	42	42
2nd Decile	45	45	45	45	45	45
3rd Decile	45	45	45	45	45	45
4th Decile	45	45	45	45	45	45
5th Decile	44	44	44	44	44	44
6th Decile	43	43	43	43	43	43
7th Decile	41	41	41	41	41	41
8th Decile	41	41	41	41	41	41
9th Decile	41	41	41	41	41	41
10th Decile	41	41	41	41	41	41
Total	428	428	428	428	428	428

¹⁵ CSO (2017) Household Budget Survey 2015-2016 - Table HS029: Households in sample by deciles and year.

4.2.3 Income Analysis

Disposable income is the amount of income, after tax is deducted, that is available for spending and saving. It functions as an important measure of housing affordability¹⁶ in an area i.e. the ability of a household to purchase their own home. The weekly and annual disposable incomes at national level from the CSO's Household Budget Survey (from 2015-2016) have been adjusted to county level based on application of "inflater/deflator" rate (by comparing the relative differences between the State and County Longford in terms of non-decile split household disposable income).

Information at sub-county level is not available and the county information has been considered accurate for the purpose of this analysis. The Average Annual Disposable Income for County Longford from the CSO's Household Budget Survey was €17,542 (less than 1% below the Midlands Region average), therefore a county deflator of 0.850 has been applied (on the basis of a national average annual disposable income of €20,638)¹⁷.

As noted above, disaggregation into ten income segments or 'deciles' has been undertaken to represent the proportion of households in Longford within each decile during the survey. Table 4-6 indicates that in 2017 after taxes, about one third of the households in County Longford (i.e. the first three deciles) have an average annual disposable income of up to €20,921, or the equivalent of €402 per week.

¹⁶ Section 93 of the Planning and Development Act 2000, defines 'affordability' as "a person who is in need of accommodation and whose income would not be adequate to meet the payments of a mortgage for the purchase of a house to meet his or her accommodation needs because the payments calculated over the course of a year would exceed 35% of that person's annual income net of income tax and pay related social insurance..."

¹⁷ The measure of price inflation/deflation in an area, relative to the national measure at that time.

Table 4.6: Calculation of Distribution of Weekly and Annual Household Disposable Incomes in County Longford

Income Range	Average Weekly Disposable Income (State) (€) (2009-2010)	Average Weekly Disposable Income (State) (€) (2015-2016)	Percentage Change from 2009-2010 to 2015-2016	Assumed Annual Percentage Income Increase from 2010 to 2016	Adjusted Average Weekly Disposable Income (State) (€) (2017)	Percentage of Households in Each Category (State)	Average Annual Disposable Income (State) (€) (2017)	Longford County Deflator	Longford Average Annual Disposable Income (€) (2017)
1st Decile	189	197	4.5%	0.9%	199	9.83%	10,357	0.850	8,803
2nd Decile	301	324	7.8%	1.6%	329	10.57%	17,131	0.850	14,561
3rd Decile	431	466	8.0%	1.6%	473	10.47%	24,613	0.850	20,921
4th Decile	549	594	8.1%	1.6%	603	10.44%	31,364	0.850	26,659
5th Decile	669	726	8.4%	1.7%	738	10.25%	38,380	0.850	32,622
6th Decile	803	866	7.9%	1.6%	880	9.94%	45,736	0.850	38,875
7th Decile	972	1,026	5.6%	1.1%	1,038	9.62%	53,974	0.850	45,877
8th Decile	1,184	1,216	2.7%	0.5%	1,222	9.65%	63,547	0.850	54,014
9th Decile	1,473	1,473	0.0%	0.0%	1,473	9.61%	76,615	0.850	65,122
10th Decile	2,289	2,229	-2.6%	-0.5%	2,217	9.62%	115,300	0.850	98,003

It should be noted that the COVID-19 pandemic is also likely to impact on the housing market in terms of house prices and market rental rates. Analysis of the historic information from the Property Price Register and the Rental Tenancies Board has been undertaken to better reflect local circumstances. This has been described in Section 4.2.5 and Section 4.2.6 respectively, however the macroeconomic impact of the COVID-19 pandemic has not yet materialised in the local housing market.

To inform the forward projection of affordability in County Longford during the plan period, the baseline figures have been inflated annually using forecasted growth rates in relation to Gross Domestic Product (GDP). The forecasted GDP rates have considered the estimated distribution of household disposable incomes for 2016 from the CSO’s Household Budget Survey and been determined based on historic and the latest forecasted GDP growth rates during the plan period (from the Department of Finance, Central Bank, ESRI and European Union – refer to Section 4.2.4).

Based on the available consensus in economic outlook at the time of production of this study and as described in detail in Appendix 4, GDP growth of 8.2% and 5.5% was considered during 2018 and 2019 respectively, whilst a -9.4% decline is anticipated expected for 2020. A 6.4% recovery in 2021 and a 2.8% GDP growth has been conservatively applied thereafter. The key outputs of this are shown in Table 4.7 which highlights a notable difference in average annual disposable incomes across each of the 10 deciles for each year during the plan period.

Table 4.7: Average Annual Household Disposable Incomes per decile in County Longford

Year	2022	2023	2024	2025	2026	2027
% Growth	2.8%	2.7%	2.7%	2.5%	2.5%	2.5%
1st Decile	9,956	10,225	10,501	10,764	11,033	11,309
2nd Decile	16,468	16,913	17,370	17,804	18,249	18,705
3rd Decile	23,661	24,299	24,956	25,579	26,219	26,874
4th Decile	30,150	30,964	31,800	32,595	33,410	34,245
5th Decile	36,895	37,891	38,914	39,887	40,884	41,906
6th Decile	43,966	45,153	46,372	47,532	48,720	49,938
7th Decile	51,885	53,286	54,724	56,093	57,495	58,932
8th Decile	61,088	62,737	64,431	66,042	67,693	69,386
9th Decile	73,650	75,639	77,681	79,623	81,613	83,654
10th Decile	94,358	96,905	99,522	102,010	104,560	107,174

Given the context provided and information as outlined above (i.e. Calculation of Average Annual Household Disposable Income Distribution), the incomes have been scaled to provide the monthly (rather than annual) estimates of disposable income per household in each decile as described in Table 4.8.

Table 4.8: Average Monthly Household Disposable Incomes per decile in County Longford

Year	2022	2023	2024	2025	2026	2027
% Growth	2.8%	2.7%	2.7%	2.5%	2.5%	2.5%
1st Decile	830	852	875	897	919	942
2nd Decile	1,372	1,409	1,447	1,484	1,521	1,559
3rd Decile	1,972	2,025	2,080	2,132	2,185	2,240
4th Decile	2,512	2,580	2,650	2,716	2,784	2,854
5th Decile	3,075	3,158	3,243	3,324	3,407	3,492
6th Decile	3,664	3,763	3,864	3,961	4,060	4,162
7th Decile	4,324	4,440	4,560	4,674	4,791	4,911
8th Decile	5,091	5,228	5,369	5,504	5,641	5,782
9th Decile	6,138	6,303	6,473	6,635	6,801	6,971
10th Decile	7,863	8,075	8,293	8,501	8,713	8,931

4.2.4 Economic Outlook

The local and regional economy is a critical part of the housing market needs and incomes which can impact on demand and supply. In order to understand the longer-term economic outlook for County Longford, particularly in relation to how household incomes may change over time forecasted growth rates in relation to Gross Domestic Product (GDP) have been considered as described in detail in Appendix 4.

Further, it should be noted that this Strategy has been prepared during the COVID-19 pandemic which is ongoing at the time of writing and publication. As such, prioritisation in relation to future forecasted GDP growth has been given to those data sources that are reflective of emerging consensus on economic outlook. The following GDP growth rates have therefore been applied herein for those reasons as set out in Appendix 4:

- **2020:** -9.4% GDP growth (i.e. contraction of the economy) which is the average of the economic forecasts that have been determined from the average of those forecasts from Davys, the ESRI, Central Bank, Department of Finance and European Union that reflect the ongoing COVID-19 pandemic.
- **2021:** 6.4% GDP growth which aligns with the latest Davys, Department of Finance and European Union forecasts (i.e. the only datasets for next year that reflects the ongoing COVID-19 pandemic).
- **2022:** 2.8% GDP growth which aligns with the Department of Finance forecast¹⁸
- **2023 - 2024:** 2.7% GDP growth which aligns with the Department of Finance forecast¹⁸
- **2025 onwards:** 2.5% GDP growth which aligns with the Department of Finance forecast¹⁸.

¹⁸ This forecast was issued by the Department of Finance in advance of the COVID-19 pandemic, however it is considered reflective of their anticipated return to pre-pandemic levels of output as set out in the April 2020 document from the Department of Finance.

4.2.5 Central Bank Rules and Mortgage Capacity

The Central Bank have put measures in place that set limits on size of mortgages that consumers can borrow to purchase a home. These measures have been set through the use of loan-to-value (LTV)¹⁹ and loan-to-income (LTI)²⁰ limits. An assumed preference for home ownership over rental has been applied as part of this model. It has therefore been analysed whether households could qualify for a mortgage that would enable them to purchase a house in the lowest price band under these rules. The key variables used to determine whether households in a decile can qualify for a mortgage are therefore:

- LTV ratio of 0.90
- a maximum LTI ratio of 3.5; and
- the upper value of the first house price band for that year (as set out in Section 4.2.5).

As such if a household does not have sufficient income to meet the Central Bank rules (i.e. 3.5 times their gross income is less than 90% of the value of purchase a house in the lowest projected price band for that year), they do not qualify for a mortgage that would enable them to purchase a home. Table 4-9 describes the mortgage capacity of households on that basis and further detail is provided in Appendix 2.

Table 4.9: Mortgage Capacity of Households per decile (euro) in County Longford based on Central Bank Rules

Year	2022	2023	2024	2025	2026	2027
1st Decile	32,797	33,682	34,591	35,456	36,343	37,251
2nd Decile	54,866	56,347	57,869	59,315	60,798	62,318
3rd Decile	79,591	81,740	83,946	86,045	88,196	90,401
4th Decile	104,151	106,963	109,851	112,597	115,412	118,297
5th Decile	132,383	135,957	139,628	143,118	146,696	150,364
6th Decile	163,673	168,092	172,631	176,946	181,370	185,904
7th Decile	199,945	205,344	210,888	216,160	221,564	227,103
8th Decile	243,819	250,403	257,163	263,593	270,182	276,937
9th Decile	310,973	319,370	327,993	336,192	344,597	353,212
10th Decile	509,561	523,319	537,449	550,885	564,657	578,774

Table 4.9 outlines that during the plan period, the first decile (throughout the entire plan period) does not have sufficient gross household income to meet the requirements of the Central Bank rules. Specifically, 3.5 times their gross income is less than 90% of the value of purchase a house in the lowest projected price band and hence they do not qualify for a mortgage and progress to private rental. Those households that can qualify for a mortgage progress to the need's assessment for ownership.

¹⁹ The LTV limit requires one to have a minimum deposit before you can get a mortgage. First-time buyers are allowed up to 90% LTV, meaning they're required to provide a minimum deposit of 10% upfront for any property.

²⁰ The LTI limit restricts the amount of money one can borrow to a maximum of 3.5 times your gross income.

4.2.6 Analysis of Historic Ownership Market

This section sets out background information on house price trends in the current market within County Longford. To ensure the most up to date market context, 2019 has been selected as the baseline year and property transactions as recorded on the Residential Property Price Register during that year have been considered representative to understand house prices and the distribution of housing units per price band. Table 4.10 sets out the 385 transactions that occurred in County Longford across the eight price bands during 2019.

Table 4.10: House Sales²¹ in County Longford in 2019

Price Band	Number of Transaction	Percent of Transactions
0-50,000	40	10.4%
50,000-75,000	53	13.8%
75,000-100,000	81	21.0%
100,000-150,000	105	27.3%
150,000-200,000	52	13.5%
200,000-250,000	32	8.3%
250,000-300,000	12	3.1%
300,000+	10	2.6%
Total	385	100.0%

It is important to consider how house prices may change over time, particularly fluctuations during the plan period. Specifically, the distribution of the price of units in the housing market during 2010 – 2019 have been reviewed for County Longford. The distribution of price bands in 2019 has been held fixed during the plan period because the selection of the nominated price bands and associated distribution of houses within those price bands in 2019 was considered reflective of a functioning, typical housing market for the area following review of information from Daft²² and the CSO²³ which further contextualised the historic market in County Longford. Table 4.11 sets out the historic information on the housing market in County Longford for context.

²¹ It should be noted that this relates to House Sales that are inclusive of VAT

²² <https://www.daft.ie/report/ronan-lyons-2019q4-dafthouseprice>

²³ <https://www.cso.ie/en/statistics/prices/residentialpropertypriceindex/>

Table 4.11 Historic House Price Metrics in County Longford

Year	RPPR	CSO HPA02	CSO HPM02	CSO HPA06	Daft
2011	-26.0%	-33.0%	-32.62%	-24.90%	-57.4%
2012	-17.6%	-14.1%	-16.11%	-16.50%	9.9%
2013	-19.6%	-12.4%	-10.37%	-10.50%	-4.1%
2014	2.9%	16.5%	15.88%	5.80%	12.2%
2015	5.0%	2.3%	4.37%	14.00%	-20.7%
2016	15.5%	17.5%	15.96%	15.30%	9.8%
2017	15.2%	6.1%	5.48%	12.10%	19.5%
2018	9.3%	8.2%	7.25%	12.60%	6.5%
2019	17.3%	21.8%	21.68%	6.30%	-3.1%

Given the context of the recent recession and subsequent periods of growth, the average house price change over the past five years has been used as a basis for future changes in average house price from 2021 onwards (i.e. future baseline). Given the volatile nature of County Longford’s property sales as illustrated in Table 4.11, an average of the five-year historic data recorded by the PPR, CSO (HPA02, HPM02 and HPA06) and Daft.ie reported statistics was applied. Overall, these future estimations for the housing market in County Longford are considered reflective of economic conditions and housing supply generally improving and its associated positive influence on the housing market.

It should be noted that the COVID-19 pandemic is also likely to impact on the housing market in terms of house prices and market rental rates as identified in Section 4.2.4. This macroeconomic outlook has therefore been considered in addition to the historic information that has been set out above. As such, an adjusted rate of reduction has been applied in addition to relevant data in relation to the impacts of the COVID-19 pandemic on the housing market.

Recent research²⁴ estimates how the COVID-19 pandemic may impact on the housing market from 2020 and 2022. For the purpose of this analysis, the ‘sluggish’ recovery scenario set out by ESRI has been adopted and this indicates a -7%, -17%, -12% dip below the baseline in 2020, 2021 and 2022. These impacts have been factored into the estimated change in average house price growth during those years and it is anticipated therefore that the average house prices within County Longford may change over time as described in Table 4-12. Further information in relation to the projected house price bands per year is provided in Appendix 3.

Table 4.12: Actual and Anticipated Change in Average Prices in the Housing Market

2015 (Actual)	2016 (Actual)	2017 (Actual)	2018 (Actual)	2019 (Actual)	2020	2021	2022	2023	2024	2025	2026	2027
1.0%	14.8%	11.7%	8.8%	12.8%	2.8%	-7.2%	-2.2%	9.8%	8.0%	6.0%	6.0%	4.0%

²⁴<https://www.esri.ie/publications/property-prices-and-covid-19-related-administrative-closures-what-are-the-implications>

This information has supported the estimation of projected house price bands based on the percentage split of the 8 price bands as outlined in Table 4.11. The following is therefore considered to reflect market changes to the end of the plan period including:

- Annual short-term decline in growth from 2020 at 2.8%, down 10% from 2019.
- Decline in projected band prices in 2021 with -7.2% change with a rebound to -2.2% by 2022
- Return to growth somewhat in line with historic growth at 9.8% with gradual conservative reduction applied thereafter.

Based on the above, the projected house prices during the plan period have been determined as set out in Table 4.14.

Table 4.14: Calculation of projected house price bands during the plan period

Year	Average Price Change	1st Band	2nd Band		3rd Band		4th Band		5th Band		6th Band		7th Band		8th Band
2019	12.8%	50,000	50,001	75,000	75,001	100,000	100,001	150,000	150,001	200,000	200,001	250,000	250,001	300,000	300,001
2020	2.8%	51,403	51,404	77,105	77,106	102,807	102,808	154,210	154,211	205,613	205,614	257,017	257,018	308,420	308,421
2021	-7.2%	47,706	47,707	71,559	71,560	95,411	95,412	143,117	143,118	190,823	190,824	238,529	238,530	286,234	286,235
2022	-2.2%	46,659	46,660	69,989	69,990	93,319	93,320	139,978	139,979	186,638	186,639	233,297	233,298	279,957	279,957
2023	9.8%	51,235	51,236	76,853	76,854	102,470	102,471	153,705	153,707	204,941	204,942	256,176	256,177	307,411	307,412
2024	8.0%	55,334	55,335	83,001	83,002	110,668	110,669	166,002	166,003	221,336	221,337	276,670	276,671	332,004	332,005
2025	6.0%	58,654	58,655	87,981	87,982	117,308	117,309	175,962	175,963	234,616	234,617	293,270	293,271	351,924	351,925
2026	6.0%	62,173	62,175	93,260	93,261	124,347	124,348	186,520	186,521	248,693	248,694	310,866	310,868	373,040	373,041
2027	4.0%	64,660	64,661	96,990	96,992	129,320	129,322	193,981	193,982	258,641	258,642	323,301	323,302	387,961	387,962

4.2.7 Analysis of Historic Private Rental Market

This section sets out background information on rental price and demand by unit type within the current rental market in County Longford. To ensure the most up to date market context, 2019 has been selected as the baseline year and rental information as recorded by the Residential Tenancies Board during that year have been considered representative.

An overview of the market rents for County Longford during 2019 is provided in Table 4-15 with further historic information in relation to the rental prices by unit type provided in Appendix 3.

Table 4.15: Private Rental Market Price in 2019

RTB Data for Longford County 2019					
One bed	Two bed	Three bed	Four plus bed	All bedrooms	YOY change (All)
461	559	599	683	587	7.7%

It should be noted that historic demand by unit type was extracted and analysed to understand specific demand in the private rental market over time. Table 4.16 sets out the varying demand for individual unit types during 2011 – 2019 which is considered reflective of the typical demand for an individual unit type within County Longford. As such, this demand by unit type has been held fixed to understand future demand per unit type throughout the plan period.

Table 4.16: Projected Demand by Unit Type in the Private Rental Market

RTB Demand %	
1 Bed	10.8%
2 Bed	30.6%
3 Bed	44.0%
4+ Bed	14.6%
Total	100.0%

Similar to the house prices, historic information has been considered to forecast future changes in market rents by unit type going forward. Specifically, analysis of the change in average rental price for all bedroom units over the past four years (i.e. 2016 – 2019) has been used as a baseline. Additionally as set out in Section 4.2.4 and 4.2.5 and in the absence of any rental market specific analysis, the impact and recovery from the COVID pandemic under the ‘sluggish scenario’ as outlined by ESRI²⁵ has also been factored into the analysis of future market rental prices (i.e. in the same manner as the house prices as described in Section 4.2.5).

The changes in rental prices are therefore anticipated to be 1.5% growth in 2020, 8.5% decline in 2021 and 3.5% decline in 2022 with growth of 8.5% onwards with a conservative tapering over the plan period. Table 4.17 sets out the projected rental prices by unit type on this basis.

²⁵ Under the assumption that the nature of COVID-19s impact on the housing market effects the rental market alike

Table 4.17: Projected Rental Prices by Unit Type in County Longford

Year	Annual Change	One bed	Two bed	Three bed	Four plus bed
2021	1.5%	428	519	556	634
2022	-8.5%	413	501	537	612
2023	-3.5%	448	544	582	664
2024	8.5%	484	587	629	717
2025	8.0%	523	634	679	775
2026	8.0%	565	685	734	837
2027	5.0%	593	719	770	878

4.3 Assessment of Needs

4.3.1 Ownership

Housing Affordability is associated with disposable income available to a household which has been determined as described in detail in Section 4.2.3.

Section 93 of the Planning and Development Act 2000, defines affordability by setting the parameters for an ‘eligible person’ as "a person who is in need of accommodation and whose income would not be adequate to meet the payments of a mortgage for the purchase of a house to meet his or her accommodation needs because the payments calculated over the course of a year would exceed 35% of that person's annual income net of income tax and pay related social insurance...". It therefore is generally accepted that if housing costs exceed 35 per cent of a household’s disposable income, the housing is unaffordable and housing costs consume a disproportionately high amount of household income. Based on this information, we have calculated the number of households not meeting the “Affordability Criteria”.

The projections for household income during the plan period are applied to the DoECLG Model Housing Strategy annuity formula as set out in Table 4.18. This formula determines the maximum affordable house price for each of the ten income deciles based on a number of evidence-based variables that have been established through analysis of historic mortgage data from the Central Bank of Ireland. The key variables used in the annuity formula include an affordability threshold of a maximum of 35% expenditure of household income on mortgage costs, a loan to value ratio of 0.90, an annual interest rate (APR) of 3%, and a loan term of 29 years.

Table 4.18: Approximate Affordable House Price per decile in Longford County

Year	2022	2023	2024	2025	2026	2027
1st Decile	74,933	76,956	79,034	81,010	83,035	85,111
2nd Decile	123,944	127,290	130,727	133,995	137,345	140,779
3rd Decile	178,075	182,883	187,821	192,516	197,329	202,262
4th Decile	226,915	233,041	239,333	245,317	251,450	257,736
5th Decile	277,677	285,174	292,874	300,196	307,701	315,393
6th Decile	330,899	339,833	349,008	357,734	366,677	375,844
7th Decile	390,496	401,040	411,868	422,164	432,718	443,536
8th Decile	459,762	472,175	484,924	497,047	509,473	522,210
9th Decile	554,306	569,272	584,642	599,258	614,240	629,596
10th Decile	710,156	729,330	749,022	767,747	786,941	806,614

Based on the determination of additional households required (Refer to Section 4.2.2), the projected house price bands (i.e. Table 4.14), the determination of households that can qualify for a mortgage (Refer to Section 4.2.5) and the calculation of housing affordability (Refer to Table 4.18), the housing surplus/deficit per price band has been determined as set out in Table 4.19.

A surplus within a price band has been identified where the number of housing units anticipated is greater than the number of households that qualify for a mortgage and have the ability to purchase a home at the upper value of that house price band. A deficit has been identified within a price band where there is a fewer households anticipated compared to the number of households that qualify for a mortgage and have the ability to purchase a home at the upper value of that house price band.

Throughout the plan period, there is generally a housing surplus in the lower price bands and housing deficit in the higher price bands as identified in Table 4.19. A sufficient number of houses are anticipated overall as households in the upper price bands can purchase a house in a lower price band.

Additionally, the first decile (throughout the plan period) will not qualify for a mortgage (due to the current Central Bank rules), therefore there will be sufficient number of houses within County Longford to those households that qualify for a mortgage and have the ability to purchase a home at the upper value of the lowest house price band.

Table 4.19: Determination of Purchase Affordability for Households Qualifying for Mortgage in County Longford for the plan period

Year	Range	No. of Additional Anticipated Households That Qualify for a Mortgage	Running Total	Affordability Threshold	Household Price Band(s)	Upper Value of Price Band	No. of Households That Qualify for a Mortgage Able to Purchase at Upper Value	% of Housing Units Anticipated per Price Band	No. Housing Units Anticipated per Price Band	Housing Surplus (+) or Deficit (-) per Price Band
2022	1st Decile	0	0	74,933	1 st , 2 nd and 3 rd Bands	93,319	34	45.2%	174	140
	2nd Decile	45	45	123,944	4th Band	139,978	37	27.3%	105	69
	3rd Decile	45	90	178,075	5th Band	186,638	40	13.5%	52	12
	4th Decile	45	135	226,915	6th Band	233,297	39	8.3%	32	-7
	5th Decile	44	179	277,677	7th Band	279,957	37	3.1%	12	-25
	6th Decile	43	221	330,899	8th Band	None	None	2.6%	10	-
	7th Decile	41	262	390,496						
	8th Decile	41	304	459,762						
	9th Decile	41	345	554,306						
	10th Decile	41	386	710,156						
		386 (of 428)						100.00%	386	
2023	1st Decile	0	0	76,956	1 st , 2 nd and 3 rd Bands	102,470	36	45.2%	174	138
	2nd Decile	45	45	127,290	4th Band	153,705	39	27.3%	105	66
	3rd Decile	45	90	182,883	5th Band	204,941	43	13.5%	52	9
	4th Decile	45	135	233,041	6th Band	256,176	42	8.3%	32	-10
	5th Decile	44	179	285,174	7th Band	307,411	41	3.1%	12	-29
	6th Decile	43	221	339,833	8th Band	None	None	2.6%	10	-
	7th Decile	41	262	401,040						
	8th Decile	41	304	472,175						
	9th Decile	41	345	569,272						
	10th Decile	41	386	729,330						
		386 (of 428)						100.00%	386 (of 428)	

Year	Range	No. of Additional Anticipated Households That Qualify for a Mortgage	Running Total	Affordability Threshold	Household Price Band(s)	Upper Value of Price Band	No. of Households That Qualify for a Mortgage Able to Purchase at Upper Value	% of Housing Units Anticipated per Price Band	No. Housing Units Anticipated per Price Band	Housing Surplus (+) or Deficit (-) per Price Band
2024	1st Decile	0	0	79,034	1 st and 2 nd Bands	83,001	29	24.2%	93	65
	2nd Decile	45	45	130,727	3 rd and 4 th Bands	166,002	51	48.3%	186	136
	3rd Decile	45	90	187,821	5th Band	221,336	45	13.5%	52	7
	4th Decile	45	135	239,333	6th Band	276,670	44	8.3%	32	-12
	5th Decile	44	179	292,874	7th Band	332,004	42	3.1%	12	-30
	6th Decile	43	221	349,008	8th Band	None	None	2.6%	10	-
	7th Decile	41	262	411,868						
	8th Decile	41	304	484,924						
	9th Decile	41	345	584,642						
	10th Decile	41	386	749,022						
		386 (of 428)						100.00%	386 (of 428)	
2025	1st Decile	0	0	81,010	1 st and 2 nd Bands	87,981	30	24.2%	93	64
	2nd Decile	45	45	133,995	3 rd and 4 th Bands	175,962	53	48.3%	186	134
	3rd Decile	45	90	192,516	5th Band	234,616	47	13.5%	52	6
	4th Decile	45	135	245,317	6th Band	293,270	46	8.3%	32	-14
	5th Decile	44	179	300,196	7th Band	351,924	43	3.1%	12	-31
	6th Decile	43	221	357,734	8th Band	None	None	2.6%	10	-
	7th Decile	41	262	422,164						
	8th Decile	41	304	497,047						
	9th Decile	41	345	599,258						
	10th Decile	41	386	767,747						
		386 (of 428)						100.00%	386 (of 428)	

Year	Range	No. of Additional Anticipated Households That Qualify for a Mortgage	Running Total	Affordability Threshold	Household Price Band(s)	Upper Value of Price Band	No. of Households That Qualify for a Mortgage Able to Purchase at Upper Value	% of Housing Units Anticipated per Price Band	No. Housing Units Anticipated per Price Band	Housing Surplus (+) or Deficit (-) per Price Band
2026	1st Decile	0	0	83,035	1 st and 2 nd Bands	93,260	31	24.2%	93	63
	2nd Decile	45	45	137,345	3 rd and 4 th Bands	186,520	54	48.3%	186	132
	3rd Decile	45	90	197,329	5th Band	248,693	48	13.5%	52	4
	4th Decile	45	135	251,450	6th Band	310,866	54	8.3%	32	-22
	5th Decile	44	179	307,701						
	6th Decile	43	221	366,677	7th Band	373,040	39	3.1%	12	-27
	7th Decile	41	262	432,718	8th Band	None	None	2.6%	10	-
	8th Decile	41	304	509,473						
	9th Decile	41	345	614,240						
	10th Decile	41	386	786,941						
			386 (of 428)						100.00%	386 (of 428)
2027	1st Decile	0	0	85,111	1 st and 2 nd Bands	96,990	31	24.2%	93	62
	2nd Decile	45	45	140,779	3 rd and 4 th Bands	193,981	55	48.3%	186	131
	3rd Decile	45	90	202,262	5th Band	258,641	60	13.5%	52	-8
	4th Decile	45	135	257,736						
	5th Decile	44	179	315,393	6th Band	323,301	44	8.3%	32	12
	6th Decile	43	221	375,844	7th Band	387,961	39	3.1%	12	27
	7th Decile	41	262	443,536	8th Band	None	None	2.6%	10	-
	8th Decile	41	304	522,210						
	9th Decile	41	345	629,596						
	10th Decile	41	386	806,614						
			386 (of 428)						100.00%	386 (of 428)

4.3.2 Private Rental

Analysis of affordability in relation to private rental has been undertaken in order to ensure a comprehensive understanding of the housing market. The key variables used to determine whether households in a decile can qualify for a private rental for a specific unit are:

- Disposable income per decile throughout the plan period as described in Section 4.2.3;
- Projected market rents per unit type as set out in Section 4.2.6;
- Additionally, the demand for a particular unit type (as set out in Section 4.2.6) has been factored to estimate what type of unit the additional anticipated households are more likely to prefer to rent.

As such if a household does not have sufficient income to meet the private rental rates for a unit in a given year (i.e. 35% of their disposable income is less than average market rent), they cannot afford the rent by themselves. An overview of those that cannot afford private rental is provided in Table 4.20, with further information per decile per unit provided in Appendix 3.

Table 4.20: Number of additional anticipated households that do not qualify for a mortgage and cannot afford private rental (based on RTB Demand allocation by Unit Type)

Year	2022	2023	2024	2025	2026	2027
1 Bed	5	5	5	5	5	5
2 Bed	13	13	13	13	13	13
3 Bed	18	18	18	18	18	18
4+ Bed	6	6	6	6	6	6
Total	42	42	42	42	42	42

4.3.3 Summary of Projected Needs during the Plan Period

This section summarises the overall housing requirements for County Longford having regard to the analysis that has been undertaken as described in detail in Section 4.2 and 4.3.

Between Q1 2022 and Q4 2027, a population increase of 2,614 people is projected for County Longford. This indicates that the total population in County Longford will be 45,800 people by the end of 2027 as set out in Section 4.2.1 and described in detail in the Core Strategy.

The population targets for this plan period establish a total housing target of 2,568 additional anticipated households. This is the equivalent of an average of 428 units per annum across County Longford during the plan period. This will result in a total of 18,207 households in County Longford by Q4 2027 as set out in Section 4.2.2 and described in detail in the Core Strategy.

The anticipated social housing need for Longford County Council as set out in the preceding steps, reflects the assessments for mortgage qualification and the affordability for ownership and private rental. The social (and affordable) housing requirement within County Longford throughout the plan period is equivalent to those that do not qualify for a mortgage and those that cannot afford private rental, which is equivalent to 9.8% of the total of additional households in County Longford during Q1 2022 – Q4 2027. This is the **identified social (and affordable) housing requirement of 252 households** for the plan period which has been summarised in Table 4.21 and Figure 4.1.

Table 4.21: Summary of Anticipated Additional Households and Requirements for the Plan Period

		2022	2023	2024	2025	2026	2027	2021-2027
Additional Anticipated Households	Total	428	428	428	428	428	428	2,568
No. of Additional Households That Do Not Qualify for a Mortgage	Subset of Above	42	42	42	42	42	42	252
No. of Additional Anticipated Households That Do Not Qualify for a Mortgage AND Cannot Afford Private Rental	Subset of Above	42	42	42	42	42	42	252
Housing Shortfall (%)	Of Total	9.8%	9.8%	9.8%	9.8%	9.8%	9.8%	9.8%

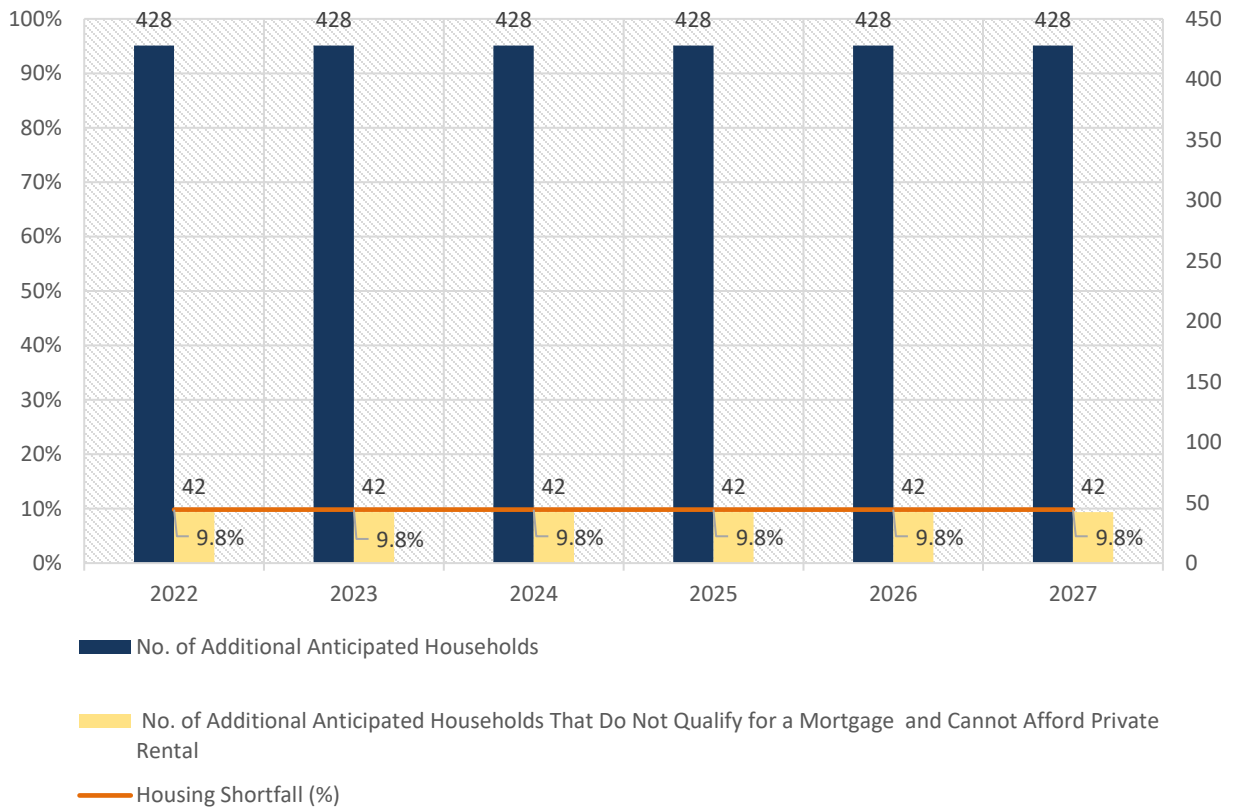

Figure 4.1: Summary of Longford County Social (and Affordable) Housing Needs throughout the plan period

4.4 HNDA Components

4.4.1 Household Composition

As set out in Section 6.6 of the NPF, information on household composition and projections in relation to household size are informative evidence inputs that can assist with understanding stock profile pressures. Analysis of the historic household sizes (specifically the household size cohort per household) has therefore been undertaken to help discern and forecast how the composition of households may change during the plan period.

Analysis of historic information (i.e. during the 2002, 2006, 2011 and 2016 Census) in relation to the composition of households has been undertaken at the County level to understand these dynamics and estimate how they may change over time. Specifically, the intercensal average has been used to determine a trended annual average change in household composition and this indicates the following changes can be anticipated during the plan period:

- 1 person households will increase by an average of 0.19% annually
- 2 person households will increase by an average of 0.18% annually
- 3 person households will increase by an average of -0.03% annually
- 4 person households will increase by an average of -0.05% annually
- 5+ person households will increase by an average of -0.28% annually

Figure 4.2 and Table 4.22 indicates the estimated proportion and number of households by size during the plan period.

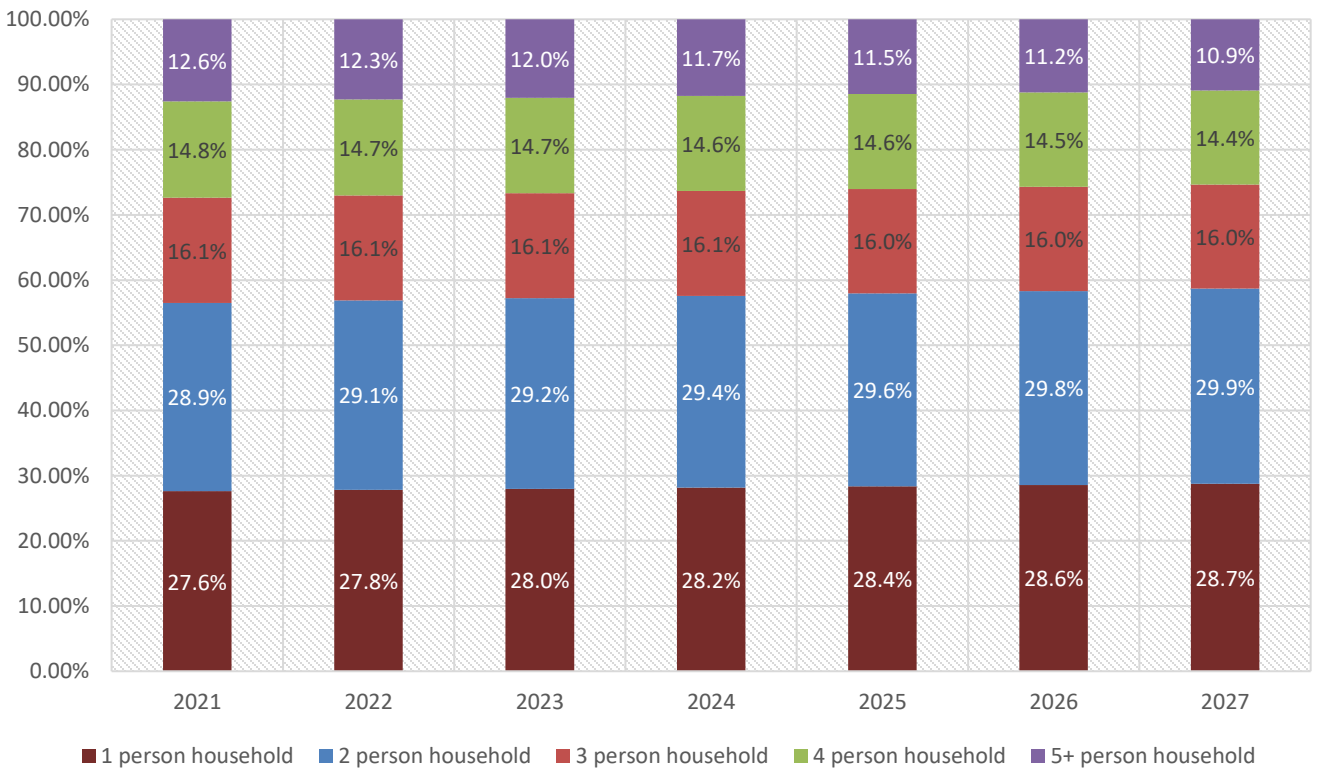

Figure 4.2: Forecasted Household Size Cohort in County Longford during the plan period

Table 4.22: Household Size Cohort Forecasts for Additional Anticipated Households in County Longford during the plan period

Additional Anticipated Households	2022	2023	2024	2025	2026	2027	2028
1 Person Household	119	120	121	121	122	123	726
2 Person Household	124	125	126	127	127	128	758
3 Person Household	69	69	69	69	68	68	412
4 Person Household	63	63	63	62	62	62	374
5 + Person Household	53	51	50	49	48	47	298
Total Additional Anticipated Households	428	428	428	428	428	428	2,568

4.4.2 Household Tenure

Tenure is another important consideration for the delivery of housing and Section 6.6 of the NPF identifies the need to estimate the demand for different tenure types. Analysis of the historic tenure split has therefore been undertaken to help discern and forecast how the household tenure may change during the plan period.

Analysis of historic information for County Longford (i.e. during the 2002, 2006, 2011 and 2016 Census) in relation to the household tenure has been to understand these dynamics and estimate how they may change over time. Specifically, the intercensal average has been used to determine a trended annual average change in household tenure.

Historic data indicates the intercensal observed change between 2002-2016 and an annual average change applied forward for the plan period as a continuation of trends was applied. The following changes can be anticipated during the plan period:

- Annual average change of -1.02% observed in owner occupied households (average intercensal change of -5.1%)
- Annual average change of 0.7% observed in privately rented households (average intercensal change of -3.5%)
- Annual average change of 0.33% observed in other rented households (average intercensal change of -1.6%)

The applied changes for the additional anticipated households are indicated in Table 4.23 and Figure 4.3.

Table 4.23: Household Tenure Forecasts for Additional Anticipated Households in County Longford during plan period

Additional Anticipated Households	2022	2023	2024	2025	2026	2027	Total
Owner occupied	254	250	245	241	236	232	1,458
Private Rental	94	97	100	103	106	109	610
Other Rental	80	81	83	84	85	87	500
No. of Additional Anticipated Households	428	428	428	428	428	428	2,568

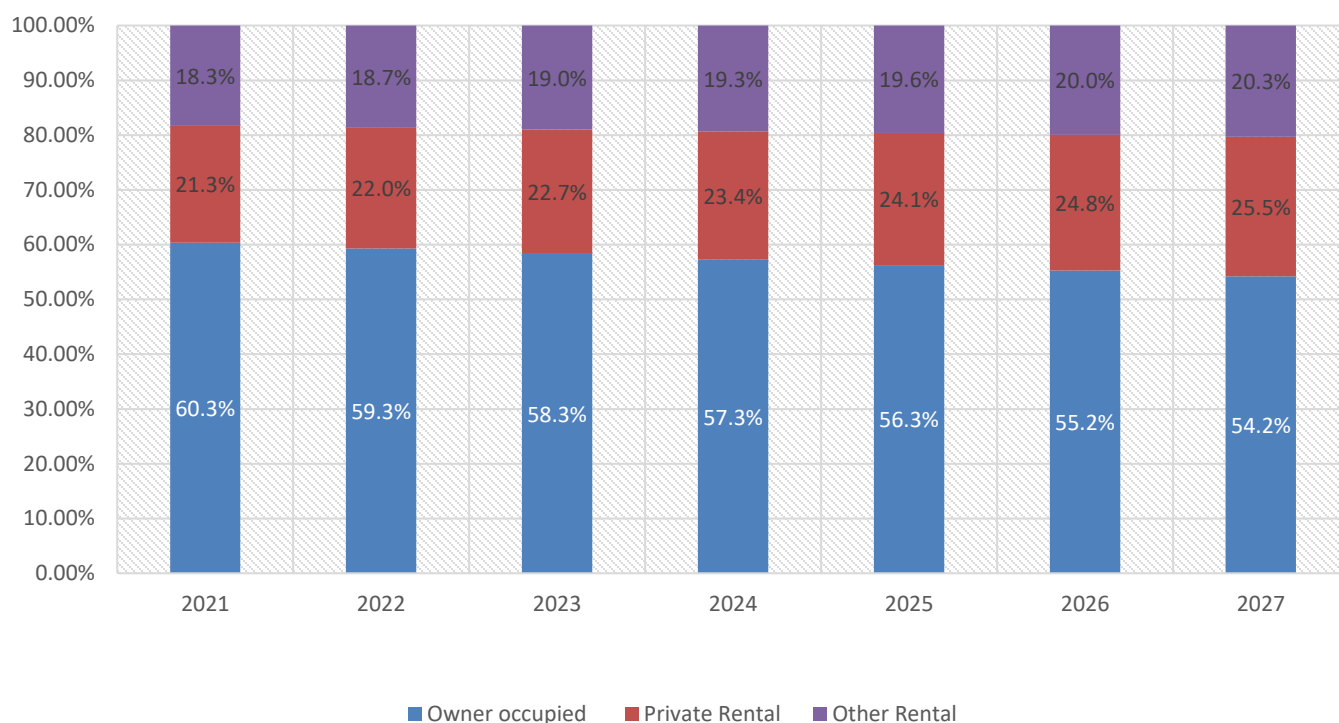

Figure 4.3: Household Tenure Forecasts for Households in County Longford during plan period

4.4.3 Single Rural Dwellings

Analysis of historic information (i.e. during 2006 – 2020) on granted planning applications (by number of units) in County Longford has been undertaken. This helps understand the proportion of housing units that are single rural dwellings that have been approved during that period and provides an indication of the dynamics between the urban and rural housing market within the county. This data classifies new housing units as either apartments/flats, houses built as part of a scheme, and single or one-off houses (which are predominately rural, although inclusive of some homes built within settlements).

As outlined in Table 4.24, approximately 40.4% of granted units during that period were for one-off houses. This equates to an average 63% per year, however large fluctuations were evident throughout the years as illustrated in Figure 4.4. Therefore, the trajectory for future applications should be moderated with this in mind. It should be noted that whilst these are granted planning applications (by unit), **this does not equate to a housing unit which has been built.**

These fluctuations may be associated with the wider economic context, associated demands for particular dwelling type or locational preferences within the housing market as well as variables such as land availability, resource availability and/or demands in any given year. Generally, it is recognised that a single rural dwelling is sized according to what the applicants can afford to build along with their actual requirements. Analysis has determined that the average floor size for one-off houses has also been analysed for context as set out in Table 4.25 and determined to be 267.16 m² during that period.

Data on new homes completed between 2011 and 2020 is also available from the CSO.²⁶ This shows that the number of one-off homes completed in County Longford has also fluctuated greatly over the past decade but has also seen a notable decline, from a high of 89% in 2013 to a low of 35% in 2019. Overall, 58% of homes completed over the period were classed as one-off houses. The proportion of one-off houses built increased to 58% in 2020. However, this may reflect the impact of the COVID-19 pandemic, with multi-unit developments potentially more subject to disruption than one-off homes. Completions also represent a lag compared to planning permissions, due to the time taken to construct new homes and scheme homes in particular. As such, recent data on permissions can indicate potential delivery in the medium term as permissions move to completions. It therefore can represent a more robust basis for considering potential future trajectory.

As detailed previously, Longford County has a total housing target of 2,568 units over the plan period. If the total proportion of historic one-off granted planning permissions (40.4% of all granted units between 2006 and 2020) were applied to this target, this **would equate to 1,036 units delivered as one-off houses**.

However, it must be noted that this is a projection based on historic trends and the baseline conditions and factors that have enabled recent single rural dwelling delivery. It is a 'policy-off' forecast that may not reflect future policy decisions at national and local level or future market conditions. It is also based on data from some years when the housing market was frequently operating abnormally and following unsustainable cycles of boom and bust. Absolute numbers of one-off homes delivered since 2011 have remained relatively stable, while proportions have tended to decline as overall housing delivery increases. This may be the case over the plan period 2021-2027 if overall housing delivery meets targets and delivers greater housing affordability and housing options for rural communities within towns and villages.

Furthermore, there is now a clear impetus in planning policy through the NPF to direct more housing delivery towards existing settlements with a target of delivering at least 30% of all new homes in County Longford delivered within the built-up footprint of existing settlements. It therefore will be appropriate for the Longford County Development Plan 2021-2027 to balance potential demand for single rural dwellings (as informed by historic trends) against broader planning goals in allocating new housing for rural areas through the Core Strategy.

²⁶ This data is based on ESB electricity connections. It is also classified in terms of single houses, scheme houses, and apartments/flats. At local authority level, data on single houses completed also includes houses built within settlements. However, the [CSO has indicated](#) that at national level over 80% of these single houses are rural, and the proportion is likely to be higher in a rural county such as Longford.

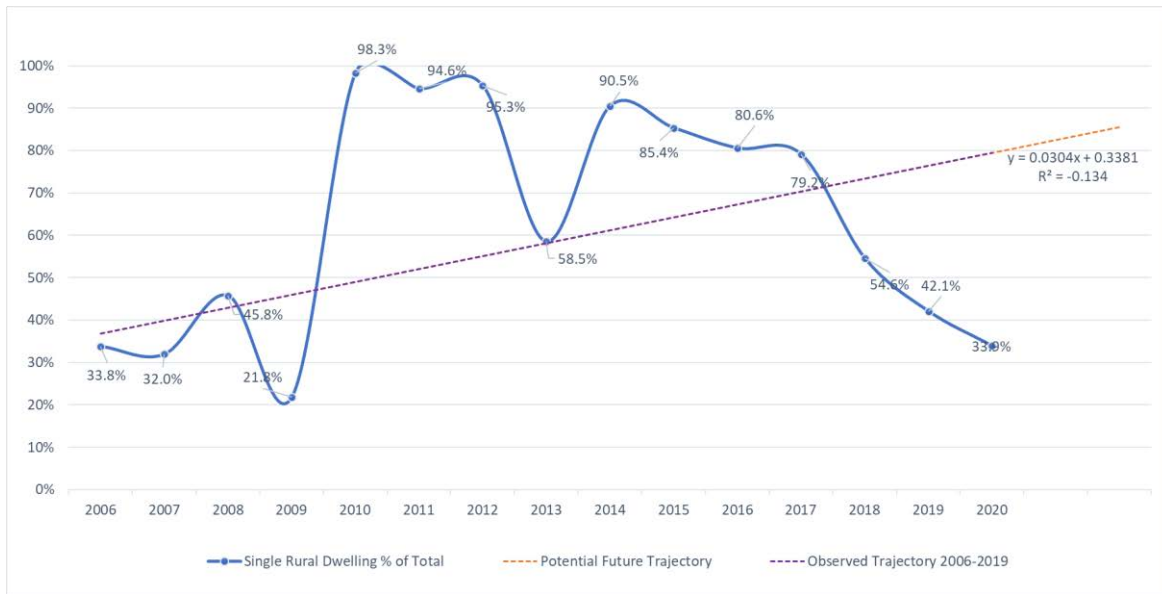

Figure 4.4 Analysis of Historic Granted Planning Applications (in Units) for One-Off Houses in County Longford

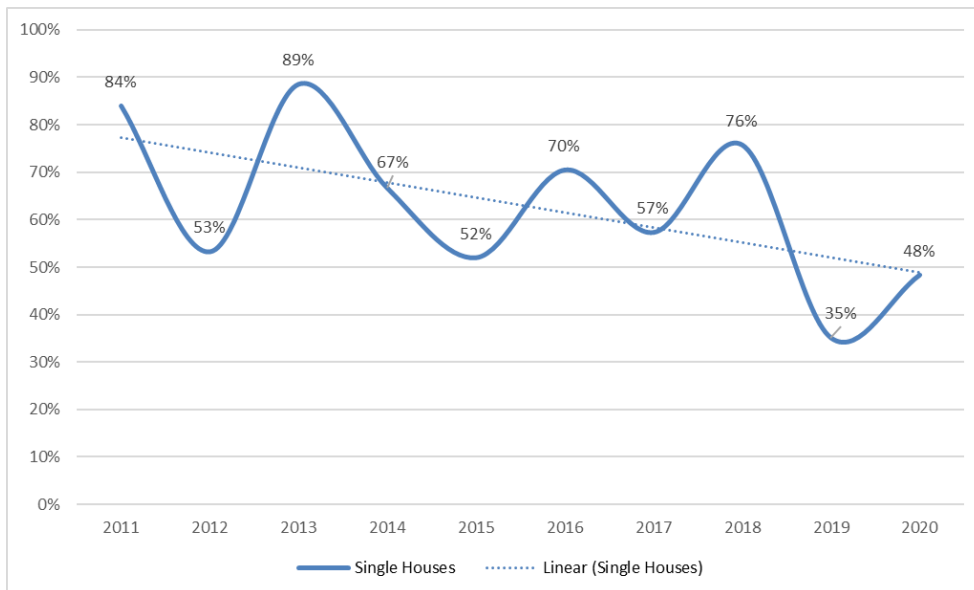

Figure 4.5 Analysis of Historic Completions (in Units) for One-Off Houses in County Longford

Table 4.24: Analysis of Historic Granted Planning Applications (in Units) for One-Off Houses in County Longford

Granted Planning Applications	2006	2007	2008	2009	2010	2011	2012	2013	2014	2015	2016	2017	2018	2019	2020	Total
Houses and Apartments #	515	658	245	309	1	2	2	17	2	6	13	20	44	110	144	2,088
One-Off House #	263	309	207	86	57	35	41	24	19	35	54	76	53	80	74	1,413
Houses and Apartments %	66.2%	68.0%	54.2%	78.2%	1.7%	5.4%	4.7%	41.5%	9.5%	14.6%	19.4%	20.8%	45.4%	57.9%	66.1%	59.6%
One-Off House %	33.8%	32.0%	45.8%	21.8%	98.3%	94.6%	95.3%	58.5%	90.5%	85.4%	80.6%	79.2%	54.6%	42.1%	33.9%	40.4%
Total	778	967	452	395	58	37	43	41	21	41	67	96	97	190	218	3,501

Table 4.25: Analysis of Floor Size of Granted Planning Applications for One-Off Houses in County Longford

Granted Planning Applications	2006	2007	2008	2009	2010	2011	2012	2013	2014	2015	2016	2017	2018	2019	2020	Average
Average floor size of SRD (m ²)	235.73	245.70	268.68	301.50	312.23	281.03	278.80	288.28	252.95	275.03	243.25	255.73	253.80	247.60	269	267.29

Table 4.26: Analysis of Historic Housing Completions (in Units) for One-Off Houses in County Longford

Housing Completions	2011	2012	2013	2014	2015	2016	2017	2018	2019	2020	Total
Houses and Apartments #	8	36	4	18	24	18	32	16	85	63	304
One-Off House #	42	41	31	36	26	43	43	50	46	59	417
Houses and Apartments %	16%	47%	11%	33%	48%	30%	43%	24%	65%	52%	42%
One-Off House %	84%	53%	89%	67%	52%	70%	57%	76%	35%	48%	58%
Total	50	77	35	54	50	61	75	66	131	122	721

4.5 Conclusion

Between 2021 and 2027, this Strategy forecasts a population increase of 3,076 in County Longford. This in turn indicates a total population of 45,800 in 2027 and a total housing target for Longford of 2,568 units over the plan period 2021-2027, the equivalent of 167 units per annum.

It has been determined that 252 of the 2,568 additional anticipated households will not qualify for a mortgage during the plan period. Additionally, these 252 households will not meet the affordability criteria for private rental. Households which are identified as not qualifying for a mortgage and not being able to meet the 'Affordability Criteria' over the plan period are therefore considered to require social (and affordable) housing. This equates to an average of 9.8% of the additional anticipated households or the identified social requirement throughout the plan period is **252 units**.

5 Meeting Housing Requirements in Longford

5.1 Overview

This chapter set out specific information summarising the existing situation about how social housing support is administered by Longford County Council, with the latest existing data, delivery methods and targets set out herein. There are several means available to Longford County Council to meet need for social housing. An overview of how social housing support is currently administered by Longford County Council, including the existing delivery methods and progress against targets is set out in Section 5.5.3.

These mechanisms to deliver social housing will help form the basis of meeting identified social housing need over the plan period. This information therefore informs the development of policy objectives for this Housing Strategy that have been presented in Section 6 as it sets out the existing situation in advance of the implementation of the policy objectives as well the overview of the projected future requirements in relation to housing in County Longford (which have been set out in Section 4.5).

5.2 Social Housing Supply and Demand

5.2.1 Existing Social Housing Needs

The Social Housing Support Need Analysis identifies the latest situation (as of March 2020) in relation to the existing social housing need of County Longford. In March 2020, 933 households were on the social housing waiting list in County Longford as set out in Table 5.1.

With respect to unit type requirements, the greatest demand is for three-bedroom properties which account for 56.5% of the need. This is followed by two-bedroom units (37.2%). The overall requirements and current demand by unit type as well as the specified location within County Longford are detailed in Table 5.1.

It should be noted that the assessed future housing need over the plan period of 252 units is in addition to the existing requirement for 933 households as recorded on the social housing waiting list in March 2020. It should also be noted that whilst 933 households are currently on the social housing waiting list, between 2018 and 2019, the social housing waiting list in County Longford reduced by 8.5%.

Table 5.1: Social Housing Need by Unit Type and Area (March 2020)

Area of Choice	1 Bed	2 Bed	3 Bed	4 Bed	Total Applicants
Ardagh	0	0	0	1	1
Aughnaccliffe	0	9	9	0	18
Ballinalee	0	17	16	0	33
Ballinamuck	0	3	5	1	9
Ballymahon	2	43	63	2	110
Clondra	0	1	1	0	2
Colehill	0	5	4	1	10
Drumlish	0	12	34	6	52
Edgeworthstown	0	35	46	2	83
Granard	0	9	17	2	28
Kenagh	0	14	14	0	28
Killashee	1	3	12	1	17
Killoe	0	1	0	0	1
Lanesboro	2	16	20	1	39
Legan	0	7	6	1	14
Longford	14	165	267	21	467
Newtowncashel	0	0	1	0	1
Newtownforbes	0	7	12	1	20
Longford County Total Number	19	347	527	40	933
Longford County Total %	2%	37.2%	56.5%	4.3%	100%

5.2.2 Meeting Social Housing Demand

5.2.2.1 Overview

Longford County Council will continue to meet their identified social housing provision requirements via a combination of the existing delivery schemes that are in place. Currently, social housing support is administered by the Housing Department within Longford County Council through those mechanisms summarised below and described in further detail thereafter:

- A social rented tenancy in a property owned and managed by the local authority and a tenancy in a property the local authority is managing or has leased from a private owner.
- A social rented tenancy in property owned and managed by an approved housing body (AHB).

- Longford County Council provides accommodation specifically for Travellers and for people with specific housing needs such as older persons, people with disabilities and the homeless etc.
- A tenancy where the local authority arranges short or long-term leases with private landlords for particular properties (i.e. people that are in receipt of rent supplement for 18 months or longer are eligible to apply for this type of accommodation).

5.2.2.2 Social Rental Tenancy from and/or via the Local Authority

This relates to a social rented tenancy in any property that owned and managed by Longford County Council or alternatively, this may relate to any tenancy in a property that Longford County Council is managing or has leased from a private property owner. These can include:

- Construction Projects – This is the construction of properties specifically by Longford County Council.
- Acquisitions - This is the purchase by Longford County Council of a second-hand house on the open market.
- Portfolio Acquisitions – This related to suitable portfolios of vacant properties which can be secured by Longford County Council from financial institutions and investors.
- Turnkeys - Longford County Council buy a new house(s) from a developer, that are ready for a tenant to move into.
- Provision of Social Housing under Part V of the Planning and Development Acts 2000 - While the provision of social housing via traditional Part V mechanism will continue to play a role in the delivery of social housing in County Longford, other delivery channels for social housing are likely to be more significant in terms of their potential to contribute to the social housing targets set out. The statutory context for the provision of social and affordable housing has changed under the Urban Regeneration and Housing Act 2015. The amendments include that there will be a requirement for up to 10% social housing in developments in excess of nine units. The use of cash payments in lieu of social housing provision is no longer allowed. Provision is made for the transfer of completed units on other land not subject to the planning permission to be provided. Provision is also made for the Part V obligation to be fulfilled by developers through long term leasing of properties and rental accommodation availability agreements.
- Buy and Renew - Under this scheme Longford County Council can buy sub-standard properties, which have been vacant for over a year, refurbish them and bring them back into use through the Council's housing stock. The purchase cost plus the cost of refurbishment can't exceed what a comparable property would attain on the private market. This initiative, which complements the Repair & Leasing Scheme, is designed to assist local authorities and AHBs (Approved Housing Bodies) to harness the accommodation potential that exists in certain vacant properties for social housing use.
- Tenant Purchase Scheme: In January 2016, a new scheme for the purchase of existing local authority houses came into effect – The Tenant (Incremental) Purchase Scheme 2016.

5.2.2.3 Social Rental Tenancy from an AHB

This relates to a social rented tenancy in any property that is owned and managed by an AHB. As set out in Section 3.3.5.1, AHBs provide social housing and are formed for the purpose of relieving housing need and the provision and management of housing. They are established by a voluntary management board to benefit the community in which they are based and are approved and funded by the Department of Housing, Planning and Local Government.

Such housing cooperatives (i.e. the AHBs) can provide both social rented housing and/or housing to purchase. AHBs are self-help and jointly owned member/user housing associations or societies. Projects undertaken by an AHB may be in response to the needs of specific communities such as the elderly, people with disabilities, homeless persons or families and single people on low incomes. Some AHBs have also been formed to specialise in meeting a particular housing need whilst others have been developed with broader aims. The specific housing services offered will depend on the aims or concerns of the members, the needs of tenants as well as the financial and other resources available for both capital costs and ongoing management running costs. As set out in Section 3.3.5.1, there are nine AHBs operating in County Longford.

5.2.2.4 Specialist Support Provided by Longford County Council

Longford County Council provides accommodation specifically for individual groups such as travellers and for people with specific housing needs such as people with disabilities and the homeless. The current delivery programmes responding to specific needs include the Refugee Resettlement Programme and the Traveller Accommodation Plan. Under the Refugee Resettlement refugees are being allocated social housing in Longford. The families are part of approximately 4,000 people which the government has committed to receiving through the Irish Refugee Protection Programme. County Councils will continue to work with Central Government and relevant State Agencies Office in responding to its requirements to support refugees as they undergo their resettlement process in Co. Longford.

Under the provisions of the Housing Traveller Accommodation Act 1998, all Local Authorities are required to prepare, adopt and implement a Traveller Accommodation Programme (TAP) to meet the accommodation needs of the county's indigenous Traveller community. The current TAP for Longford County Council sets out the strategy for the provision of Traveller accommodation and support services during 2019-2024. An assessment of the accommodation need was carried out to inform the TAP. This statutory assessment of need assessed all applicants seeking assistance with accommodation. The number of approved Traveller families seeking accommodation is 23. Having regard to this it is considered that a total of 108 units of accommodation should be provided over the five-year programme to cater for the existing demand and projected demand as set out in Table 5.2. The following housing options will be utilised to accommodate this need throughout the plan period for the TAP (i.e. 2019 – 2024):

- Standard Local Authority Housing
- Traveller Voluntary Housing Bodies
- Group Housing
- Long Term Leasing
- Rental Accommodation Scheme
- Housing Assistance Payment Scheme
- Rebuilding Ireland Home Loan.

Table 5.2: Breakdown of Traveller Accommodation Targets in Longford 2019-2024 in Longford

Type	2019/20	2020/21	2021/22	2022/23	2023/24	Total
Transient	0	0	0	0	0	0
Permanent Halting Site	0	0	0	0	0	0
Standard L.A Housing	12	12	12	12	12	60
HAP	6	5	5	4	4	24
RAS/Lease	2	2	2	2	2	10
Voluntary Housing Body	2	2	2	2	2	10
Group Housing	0	0	0	4	0	4
Total	22	21	21	24	20	108

5.2.2.5 Local Authority Support for Leases with Private Landlords

This relates to a tenancy where the local authority arranges short or long-term leases with private landlords for particular properties. Specifically, this applies to people that have been in receipt of rent supplement for 18 months or longer who are deemed eligible to apply for this type of accommodation from Longford County Council. They can receive this support by way of either the Housing Assistance Payment (HAP), the Rental Accommodation Scheme (RAS) or Repair and Lease.

HAP is a scheme under the Housing Miscellaneous Provisions Act 2014 for people who have a long-term housing need and who qualify for social housing support. It is administered by housing authorities and will eventually replace long-term rent supplement (i.e. RAS). The HAP scheme aims to allow all social housing supports to be accessed through the local authorities (i.e. Longford County Council in this instance) in order to enable people to take up full-time employment whilst maintaining their housing support. Under the HAP scheme, the applicant finds appropriate private rented accommodation (within specific caps) and the Local Authority then pays the landlord directly and the tenant pays a rent to the local authority based on the differential rent scheme.

The RAS is an initiative to cater for the accommodation needs of certain persons in receipt of rent supplement, (i.e. who are assessed as having a long-term housing need, normally for more than 18 months). Longford County Council pays rent directly to the accommodation providers on behalf of the tenant (which is a maximum of 92% of the market rent). Longford County Council makes use of the private and voluntary sector to engage in a contractual arrangement that secures medium-long term rented accommodation on behalf of the applicant/tenant.

The Rebuilding Ireland Action Plan for Housing and Homelessness introduced a new scheme, the Vacant Housing Repair and Leasing Initiative (i.e. Repair and Lease). This scheme specifically targets the delivery of social housing and seeks to ensure that existing housing stock is used to the maximum degree possible. The basis of the scheme is that repair and improvement works to suitable vacant properties are funded to bring them up to the standard for rented accommodation and the cost of the works is then deducted from lease payments over an agreed lease term.

5.5.3 Delivery Methods and Targets

It is anticipated that Longford County Council will continue to meet their social housing needs via a combination of these existing delivery schemes (as set out in Section 5.5.2) and through the introduction or greater emphasis of other either existing or recently established schemes and mechanisms. This section assesses different delivery channels available to County Longford and their progress to date in achieving the recent targets in relation to social housing (i.e. as set out in the Rebuilding Ireland: Action Plan for Housing and Homelessness) has been examined.

As set out in Section 2.1.11, Rebuilding Ireland recognises issues around supply and affordability in Ireland’s housing sector and provides a multi-stranded approach to achieve key housing objectives up to 2021. A national commitment to deliver 138,000 additional social housing units during 2016-2021 which equates to 83,760 HAP homes, 3,800 RAS homes and over 50,000 new homes (broken down into 33,617 builds, 6,830 acquisitions and 10,036 leases).

Within County Longford, a target of delivering 309 properties during 2018 – 2021 was set out by Rebuilding Ireland. Additionally, a target of delivering 257 units across all social housing delivery streams was set for 2019 as illustrated in Table 5.3.

Table 5.3: Social Housing Targets for County Longford that have been set out under Rebuilding Ireland

Targets 2018-2021	Targets 2019
-------------------	--------------

Build, Acquisition and Leasing	Build	Acquisition	Leasing	HAP and RAS	All social housing streams
309	76	7	15	159	257

Progress on the delivery of social housing units is documented as part of quarterly updates by the Department of Housing, Planning and Local Government. The most recently available progress update is the annual summary data to the end of 2019 and is documented in Table 5.4. This demonstrates that the total output in County Longford in 2019 was 308 units, which indicates that Longford County Council achieved 120% of its Rebuilding Ireland Target to 2019. This follows 2018 when Longford County Council also exceeded the target by delivering 326 units or 148% of its requirements ²⁷. In total between 2018-2021, 309 units were targeted to be delivered by way of ‘building, acquisition and leasing’. Through 2018-2019, Longford County Council have already delivered 261 units through these mechanisms. Thus, over the course of 2020-2021 only 48 additional units are required to be delivered through ‘building, acquisition and leasing’ mechanisms in order to meet the Rebuilding Ireland targets. This is an encouraging indicator as to Longford County Council’s ability to provide its social housing requirements in line with the aspirations of Rebuilding Ireland.

Table 5.4: Progress on Rebuilding Ireland Social Housing Targets 2019

County Longford to the end of 2019	Total #
All Build Total	87
Acquisition Total	49
Leasing	8
RAS ^[2] & HAP ^[3]	164
Total Output 2019 under Rebuilding Ireland	308 Units Delivered (120% of target)

- 1. New leasing units operational are defined as the number of new leasing units delivered under this scheme in the given period. This program was previously known as long term leasing until 2014.*
- 2. RAS - New transfers is defined as the number of households which have moved from Rent Supplement to RAS in that specific year. It includes households who remained in their existing accommodation and those for whom the LA had to source new properties.*
- 3. HAP - New Households Supported refers to the number of qualified households with an established housing need who are being accommodated under the HAP scheme for that year.*

²⁷ Department of Housing, Planning and Local Government, ‘Details of social housing delivery on a local authority basis for 2019’. Online: <https://rebuildingireland.ie/news/details-of-social-housing-delivery-on-a-local-authority-basis-for-2019/>

6 Policy Objectives to Deliver the Housing Strategy

This section builds on the analysis of housing requirements presented in the HNDA and Housing Strategy. It sets out policy objectives below to guide and deliver new homes of appropriate type and tenure to meet Longford’s housing requirements over the plan period.

Table 6.1: Policy objectives for the Longford Housing Strategy 2021-2027

It is a policy of Longford County Council:	
HO1	To provide new homes to meet expected future housing requirements in the County as identified by the Housing Supply Target. A total of 2,568 new homes shall be provided over the plan period to meet requirements a result of forecast population growth. New homes shall be provided in a planned and coordinated manner in accordance with the aims and policies of the Core Strategy, the RSES, and the National Planning Framework.
HO2	To seek the provision of an appropriate mix of housing types and tenures to ensure homes for communities in towns, villages and rural areas and to meet the needs of people of all incomes and needs.
HO3	To provide for new housing in existing settlements to ensure that settlements grow in a manner that is sustainable, includes provision of sufficient social and economic infrastructure, and to a scale which aligns with the Settlement Hierarchy set out in the Core Strategy.
HO4	To provide new housing in rural areas including one-off homes in accordance with the Development Plan where it meets the social and economic needs of these areas, tackles isolation, and promotes social inclusion.
HO5	To provide housing appropriate to the needs of the elderly (in accordance with the Longford Age Friendly Strategy 2015-2020 and any subsequent strategies), persons with disabilities, lone parents, Travellers, and the homeless. The Council shall support and promote the use of Universal Design principles and life-long adaptability in new housing developments to meet the needs of diverse groups and an aging population.
HO6	To seek high quality of design in all housing development having due regard to Government policy relating to sustainable development, which aims to reduce the demand for travel within existing settlements, and the need to respect and reflect the established character of rural areas.
HO7	To provide social and affordable housing to meet forecast future housing need over the plan period as identified in the HNDA. The Council will endeavour to deliver a further 252 social and affordable housing units over the plan period to meet this forecasted need as resources allow. New units shall be delivered having regard to the aims and policies of the Core Strategy and the needs of

It is a policy of Longford County Council:	
	local communities, including the need to deliver sustainable development, social integration and an appropriate mix of housing types and tenures.
HO8	To make use of a range of delivery mechanisms to provide new social and affordable homes including new builds, acquisitions, renovations and acquisitions of vacant homes, leasing, and housing supports including RAS and HAP.
HO9	To require that 10% of lands zoned for residential use, or for a mixture of residential and other uses, be reserved for social and affordable housing in accordance with the Urban Regeneration and Housing Act 2015, the Planning and Development Act 2000 (as amended) and any future revised Guidance.
HO10	To tackle vacancy and to secure new homes, tackle dereliction and deliver regeneration by bringing vacant sites back into use. This shall be pursued through the application of the vacant site levy in accordance with the Urban Regeneration and Housing Act 2015. The Council shall also endeavour to bring about the timely re-use of vacant Council-owned housing stock.
HO11	To promote the regeneration of town centres through the retention of town centre residential units and through encouraging the reuse of upper floors above commercial premises for residential accommodation.
HO12	To provide appropriate accommodation to meet the needs of the Travelling Community and to secure the implementation of the Longford County Council Traveller Accommodation Programme 2019-2024.
HO13	To support the on-going monitoring and review of the HNDA in accordance with the forthcoming guidance on HNDA methodology to be issued by the Department of Housing, Local Government and Heritage.

Annex 5:

Infrastructure Assessment Report

INFRASTRUCTURE ASSESSMENT REPORT

This copy of the IAR includes the adopted changes and amendments agreed in the Chief Executive's Report on the Proposed Material Amendments to the Longford County Development Plan (adopted 19th October 2021).

Contents Page:

Table of Contents

1. INTRODUCTION.....	3
2. PLANNING POLICY CONTEXT.....	5
3. SETTLEMENT HIERARCHY – ASSET-BASED CRITERIA.....	7
4. METHODOLOGY OF CRITERIA AND ASSESSMENT.....	9
APPENDIX A - INITIAL SIEVE MAPPING EXERCISE.....	13
APPENDIX B – FURTHER ITERATIVE MAPPING.....	23
APPENDIX C: ROADS DEPARTMENT INFRASTRUCTURAL EVALUATION.....	39
APPENDIX D: WATER SERVICES INFRASTRUCTURAL SETTLEMENT ASSESSMENT.....	43
APPENDIX E – SETTLEMENT ASSESSMENTS & MAPPING.....	72
APPENDIX F – SETTLEMENT ZONINGS (RESIDENTIAL & EMPLOYMENT LANDS).....	88
Appendix – F1 Key Town Longford Town:.....	89
Appendix – F2 Self-Sustaining Growth Towns Granard:.....	93
Appendix – F3 Self-Sustaining Towns Ballymahon.....	97
Appendix – F4 Self-Sustaining Towns Edgeworthstown.....	99
Appendix – F5 Self-Sustaining Towns Lanesborough.....	103
Appendix – F6 Towns & Villages Aughnaccliffe.....	105
Appendix – F7 Towns & Villages Ballinalee.....	107
Appendix – F8 Towns & Villages Drumlish.....	109
Appendix – F9 Towns & Villages Keenagh.....	113
Appendix – F10 Towns & Villages Legan.....	115
Appendix – F11 Towns & Villages Newtownforbes.....	117
Appendix – F12 Smaller Villages & Settlements : Abbeyshrule, Ardagh, Ballinamuck & Clondra.....	119
APPENDIX G – REVISIONS TO THE ZONED SITES FOLLOWING THE ADOPTION OF THE CHIEF EXECUTIVE’S REPORT ON THE PROPOSED MATERIAL ALTERATIONS (RESIDENTIAL & EMPLOYMENT LANDS).....	126
Appendix G1 – Revised Further Iteration Plan showing the New Residential & Employment sites (Drumlish).....	132
Appendix G2 – Revised Roads Section Infrastructure Assessment for Drumlish.....	133
Appendix G3 – Revised Water Services Infrastructure Assessment of the sites in Drumlish.....	134
Appendix G4 - Revised Settlement Assessment and Mapping of the zoned lands in Drumlish.....	137

1. INTRODUCTION

This report has been developed in order to provide an assessment of available infrastructure to service the Settlements of County Longford and inform the County Development Plan and the land zoning assessment of the hierarchy of settlements in the Plan

The National Planning Framework (NPF) emphasises the requirement for better linkage between the zoning of land for development and the availability of or investment in infrastructure that is required to facilitate development. The following three National Policy Objectives (NPOs) are relevant:

NPO 72a: Planning authorities will be required to apply a standardised, tiered approach to differentiate between (i) zoned land that is serviced and (ii) zoned land that is serviceable within the life of the plan.

NPO 72b: When considering zoning land for development purposes that require investment in service infrastructure, planning authorities will make a reasonable estimate of the full cost of delivery of the specified services and prepare a report, detailing the estimated cost at draft and final plan stages.

NPO 72c: When considering zoning land for development purposes that cannot be serviced within the life of the relevant plan, such lands should not be zoned for development.

The NPF further states that an Infrastructural Assessment must be aligned with the approved infrastructural investment programme(s) of the relevant delivery agency(ies), or be based on a written commitment by the relevant delivery agency to provide the identified infrastructure within a specified timescale (i.e. within the lifetime of the plan). The Planning Authority may also commit to the delivery of the required and identified infrastructure in its own infrastructural investment programme (i.e. Budgeted Capital Programme) in order to support certain lands for zoning. The Infrastructural Assessment must include a reasonable estimate of the full cost of delivery of the required infrastructure to the identified zoned lands.

Further guidance will be provided by the Department Housing, Planning and Local Government in respect of Infrastructural Assessments in updated Statutory Guidelines that will be issued under Section 28 of the Planning & Development Act 2000 (as amended).

The purpose of this report is therefore to:

- Identify potential sites for residential and employment zoning within the main settlement hierarchy of County Longford.
- Examine the suitability of a site for future development based on NPF objectives, the RSES and the Draft Longford County Development Plan 2021-2027 etc.
- Assess the infrastructure requirements to service each site.

- Assess and weight the planning and serviceability/infrastructural provision for each site to enable a Tier to be assigned, as may be applicable.
- Where sites are identified as Tier 1 or Tier 2 lands, the assessment should clearly identify the likely development services required to support new development and where possible provide an indicative timeframe for delivery i.e. short to medium term or longer term.

It noted from the outset, in terms of reasonable estimate of costs, that Irish Water, has indicated that it does not have resources or capacity to carry out such an exercise and therefore no costings have been provided in terms of water services.

It should be noted that this report forms a working draft of the overall Infrastructure Assessment Report and forms a 'live' document during the development plan process, owing to recommended amendments to land use zonings arising from the public consultation process of the plan, as well as recommendations from prescribed bodies such as the office of the Planning Regulator (OPR), the Eastern and Midland Regional Assembly (EMRA) and the Office of Public Works, among others. Moreover, the Water Services Section and Environment Section of Longford County Council are currently undertaking an assessment of estimated costs for future infrastructure provisions with the aim of providing this estimated costing with the finalised Infrastructure Assessment Report to be inserted into the amended Draft Plan.

The report has been updated and revised following a submission on the Draft Plan by the Office of the Planning Regulator (OPR). The format and structure of the report has changed with the report including mapping showing the combined assessment of the residential and employment lands and presented as T1, T2 and un-serviced lands.

2. PLANNING POLICY CONTEXT

There have been a number of significant developments which will influence future land use zoning in County Development Plans and Local Area Plans. In particular, the National Planning Framework (NPF) sets out a tiered approach for zoning lands as discussed in Section 1 of this report. The following National Policy Objectives are relevant:

- National Policy Objective 72a: *‘Planning authorities will be required to apply a standardised, tiered approach to differentiate between i) zoned land that is serviced and ii) zoned land that is serviceable within the life of the plan’.*
- National Policy Objective 72b: *‘When considering zoning lands for development purposes that require investment in service infrastructure, planning authorities will make a reasonable estimate of the full cost of delivery of the specified services and prepare a report, detailing the estimated cost at draft and final plan stages’.*
- National Policy Objective 72c: *‘When considering zoning land for development purposes that cannot be serviced within the life of the relevant plan, such lands should not be zoned for development’.*

The NPF places an emphasis on the need for compact, smart and sustainable growth and requires 30% of all new housing to be within existing urban footprints (outside of the five cities), thus reducing the amount of greenfield land required to meet future housing requirements.

Moreover, the NPF specifically discusses the prioritising of development lands and states that there are *“many other planning considerations relevant to land zoning beyond the provision of basic enabling infrastructure including overall planned levels of growth, location, suitability for the type of development envisaged, availability of and proximity to amenities, schools, shops or employment, accessibility to transport services etc. Weighing up all of these factors, together with the availability of infrastructure, will assist planning authorities in determining an order of priority to deliver planned growth and development”* (emphasis added).

The NPF further notes that Guidance will be issued under Section 28 of the Planning and Development Act 2000 (as amended) in relation to infrastructural assessments.

Appendix 3 of the NPF provides a methodology for a tiered approach to land zoning as referred to in NPO 72a. The implementation of this tiered approach allows for greater co-ordination between land use zoning and infrastructure availability. Appendix 3 of the NPF provides a description of Tier 1 (Serviced Zoned Land) and Tier 2 (Serviceable Zoned Land) as follows:

Tier 1: Serviced Zoned Land

Land that is able to connect to existing development services i.e. road and footpath access, public lighting, foul sewer drainage, surface water drainage and water supply, for which there is service capacity available.

Tier 2: Serviceable Zoned Land

Land that is not currently sufficiently serviced to support new development but has the potential to become fully serviced within the life of the Plan. The potential for the delivery of the required services and / or capacity to support new development must be identified.

It is therefore appropriate that sustainable planning criteria are used to inform the assessment of each site, in addition to infrastructural criteria, in line with the NPF's requirement of the prioritisation of development land.

In this regard, lands have only been identified for development where they are able to connect to existing development services for which there is service capacity available or has the potential to become fully serviced within the life of the Plan.

3. SETTLEMENT HIERARCHY – ASSET-BASED CRITERIA

Settlement		Population 2016	NEW growth allocation 2016-27	NEW Population Growth to 2027	Remaining Wastewater Capacity (P.E.)	Water capacity (IW submission)	WWTP Future Investment	Connectivity – Transport Infrastructure
Key Town (Density 35-40 units/ha)	Longford Town	10,008	25%	2502	2392	Some headroom available		Very good – Train station, bus services, national road network with good inter-regional links
Self-Sustaining Growth Town (25 units/ha)	Granard	1,096	25%	274	208	Some headroom available		Local bus services, Bus stops x2 with national road network links
Self-Sustaining Towns (25 units/ha)	Ballymahon	1,877	15%	282	-316	-	IW indicate WWTP upgrade planned post-2024	Local bus services, national road network and good regional links to Athlone and Mullingar
	Edgeworthstown	2,072	15%	311	-447	Some headroom available	IW indicate WWTP upgrade planned post-2024	Very good- train station, bus services, national road network, good inter-regional links
	Lanesborough	757	20%	151	-94	Some headroom available		Local bus services, national road network with good links to Longford, Ballymahon and Roscommon
Towns and Villages (20 units/ha)	Aughnaccliffe	177	18%	32	62	Some headroom available		Bus stop x1
	Ballinalee	347	18%	62	350	Some headroom available		Limited – no public transport provision
	Drumlish	931	15%	140	-2	Some headroom available	IW indicate capacity of 150	Bus stop x1
	Keenagh	581	18%	105	436	Some headroom available		Bus stop x1
	Legan	215	16%	34	758	Some headroom available		Limited – no public transport provision
	Newtownforbes	778	18%	140	690	Some headroom available		Bus stop x1
Serviced Rural Villages (15 units/ha)	Abbeysrhole	224	15%	34	183	Some headroom available		Limited – no public transport provision
	Ardagh	210	15%	32	254	Some headroom available		Limited – no public transport provision
	Ballinamuck	232	15%	35	337	Some headroom available		Bus stop x1
	Clondra	449	15%	67	335	Some headroom available		Limited – no public transport provision
Rural Settlement Clusters								
Open Countryside		20,919	3.5%	727				
Total		40,873		4,927				

The table above distils the proposed growth strategy for the county in terms of settlement hierarchy, projected population and housing growth and allocation per settlements and settlement tier, as well identifying some of the critical infrastructural features pertaining to these settlements. Further details on specific infrastructural deficits and requirements for relevant settlements over the plan period will be furnished in the finalised draft Infrastructural Assessment Report, pending final agreement with internal departments and costing/budget requirements.

4. METHODOLOGY OF CRITERIA AND ASSESSMENT

In the absence of Departmental guidance, which is expected to issue under Section 28 of the Planning and Development Act 2000 (as amended) as referred to in the NPF, this Infrastructural Assessment has been developed in accordance with Appendix 3 of the NPF.

The Planning Department undertook a review of the available land supply within the defined study areas of the main settlements of Longford as defined in the Core Strategy. This included the following settlements as defined in the Settlement Hierarchy:

Key Town	Longford Town	
Self-Sustaining Growth Towns	Granard	
Self-Sustaining Towns	Ballymahon Edgeworthstown Lanesborough	
Towns & Villages	Aughnacliffe Ballinalee Drumlish	Keenagh Legan Newtownforbes
Villages & Smaller settlements	Abbeysrule Ardagh	Ballinamuck Clondra

To inform the appropriate zoning of land, the Infrastructure Assessment comprises of quantitative and qualitative research analysis.

The qualitative analysis consists of a template of criteria to gather pertinent information from the relevant departments within Longford County Council. This method is to be used to gain an understanding of underlying conditions and provide insights into infrastructural issues.

The quantitative assessment comprises of an interactive assessment of the subject lands (residential – employment), combining existing and proposed zoning, overlaid with infrastructural mapping depicting key infrastructure elements such as foul sewer, water main, pumping station, roadway, pathway etc. in order to appropriately determine and allocate lands as Tier 1 ('Connected'), or Tier 2 ('Potential Development') and areas of 'No Development'.

This Infrastructural Assessment was conducted on an iterative basis, liaising with the Water Services and Roads Departments of the Council, with additional input from Irish Water in identifying potential shortfall in water supply and wastewater treatment capacities and where targeted investment in upgrading of such infrastructure may likely take place over the plan period, notwithstanding Irish Water's own Strategic Funding Plan.

A critical feature of this process was the overarching requirement to provide for more 'compact growth' forms of future development within our settlements, regardless of scale, whereby a town centre first approach in terms of sequential development was advocated in identifying primary land for development.

The following documents have been included in the IAR which includes the following:

Appendix A: Shows the mapping work undertaken at the pre-draft stage of the Development Plan Review and indicates the assessments undertaken of each settlement and included a review of the indicative amount of serviced lands available. The maps for each settlement indicate the potential development capacities based on the following criteria using advice from Water Services and Irish Water:

- Opportunities for potential development
- Sites where no development is possible
- Connected sites

Appendix B: Shows the mapping work and the identification of potential sites following the initial work undertaken and presented in Appendix A. The maps show the identified potential Residential and Employment lands and includes the overlay of the constrained use layer (potential flooding). These maps were used to inform zoning selections and were then further used in the assessments by Water Services and Roads Section to score each site.

Appendix C: Shows the infrastructure assessment completed by the Roads Section and the scoring applied to each of the sites - New Residential and Employment Sites. The assessments include scores for roads as well as drainage.

Appendix D: Includes the Infrastructure Assessment scoring for the main settlements provided by the Water Services Department and includes water supply and wastewater treatment capacity. This section of the assessment has gone into further detail and assesses the costs of providing the required and identified infrastructure.

Appendix E: Brings the infrastructure assessment reports together and shows the combined scores for the assessments from Roads and Water Services for each settlement. Each settlement is mapped and the zoned lands categorised Tier 1 Serviced, Tier 2 Serviceable and Un-serviced.

Appendix F: Shows the land zonings for each of the settlements.

Appendix G: Shows the revisions to the zoned sites following the adoption of the Chief Executive's Report on the proposed material alterations (Residential and Employment Lands).

Whilst this approach is considered to be in accordance with the overarching principles espoused in the NPF, and particularly in accordance with NPO 3c, there are scenarios in some settlements where more peripheral lands are serviced and more centralised lands are not. Whilst these incidences are infrequent, it remains prudent to develop out these serviced lands irrespective of their location given the levels of investment that have taken place in servicing such lands to begin with.

All selected sites within the settlements were identified and analysed against Infrastructure capacity in terms of:

- Water supply
- Wastewater capacity
- Drainage, extent of SuDS requirements and flood risk
- Roads and transportation
- Level of conformance to and ability to contribute to the achievement of Strategic Outcomes of the NPF (principally fulfilling compact growth); and
- Compliance with emerging/Draft Core Strategy with respect to settlement hierarchy and interrelated quantum of population and housing growth and resultant land requirements to accommodate projected growth.

The identified sites were afforded a planning and serviceability weighting (Score of 100 to 0) to assess the overall suitability for zoning within the Draft Longford County Development Plan 2021-2027. The weighting applied to the sites is represented by a traffic light system and ranges from:

Tier Determination Range			
High	Tier 1	100-67	Serviced
Medium	Tier 2	66-33	Serviceable
Low		32-0	No Development/Un-serviced and Unserviceable within Plan lifetime

In the case of lands identified as falling within the ‘high’ level of serviceability rating a green colour was applied which equates to Tier 1 lands in accordance with the NPF tiered approach to zoning. Such lands are serviced land, comprising of lands that are able to connect to existing development services for which there is service capacity available and therefore be able to accommodate new development. In such instances the site achieves sustainable planning criteria also.

Where lands were deemed to have a ‘medium’ level of serviceability rating an orange/light red colour was applied. These lands can be described as serviceable land, comprising lands that are not currently sufficiently serviced to support new development but have the potential to become fully serviced within the life of the Plan

or where there are planned infrastructure upgrades. In such instances the sites were considered to achieve a moderate status on sustainable planning criteria also.

In the event that lands demonstrated a 'low' level of serviceability they were excluded from consideration in forming the designation of zonings for the plan area. There are major infrastructural deficiencies and/or these sites achieved a poor status on sustainable planning criteria. These lands would be classed as 'No Development' and excluded from further assessment.

The findings of both the qualitative and quantitative assessments have informed an evidence-based assessment of each site. As a result of this assessment it is clear that, for a range of infrastructural reasons, some sites are better placed to deliver employment and residential use in the short to medium term (Tier 1 lands).

APPENDIX A - INITIAL SIEVE MAPPING EXERCISE

The maps presented in this section of the report are based on the previous County Development Plan 2015-2021 and show the land-use zonings and the areas identified for potential development.

These assessments of settlements in the County were undertaken with colleagues from Water Services and Irish Water and was undertaken in March 2020 and informed the drafting and development of the Draft County Development Plan 2021-2027 and the accompanying land-use zonings.

For each settlement the maps identify those areas:

- Potential development
- No development
- Sites that are connected

The mapping exercise was used to inform the identification of potential development sites for Residential and Employment uses within the settlements of the County.

Longford Town Initial Infrastructure Assessment

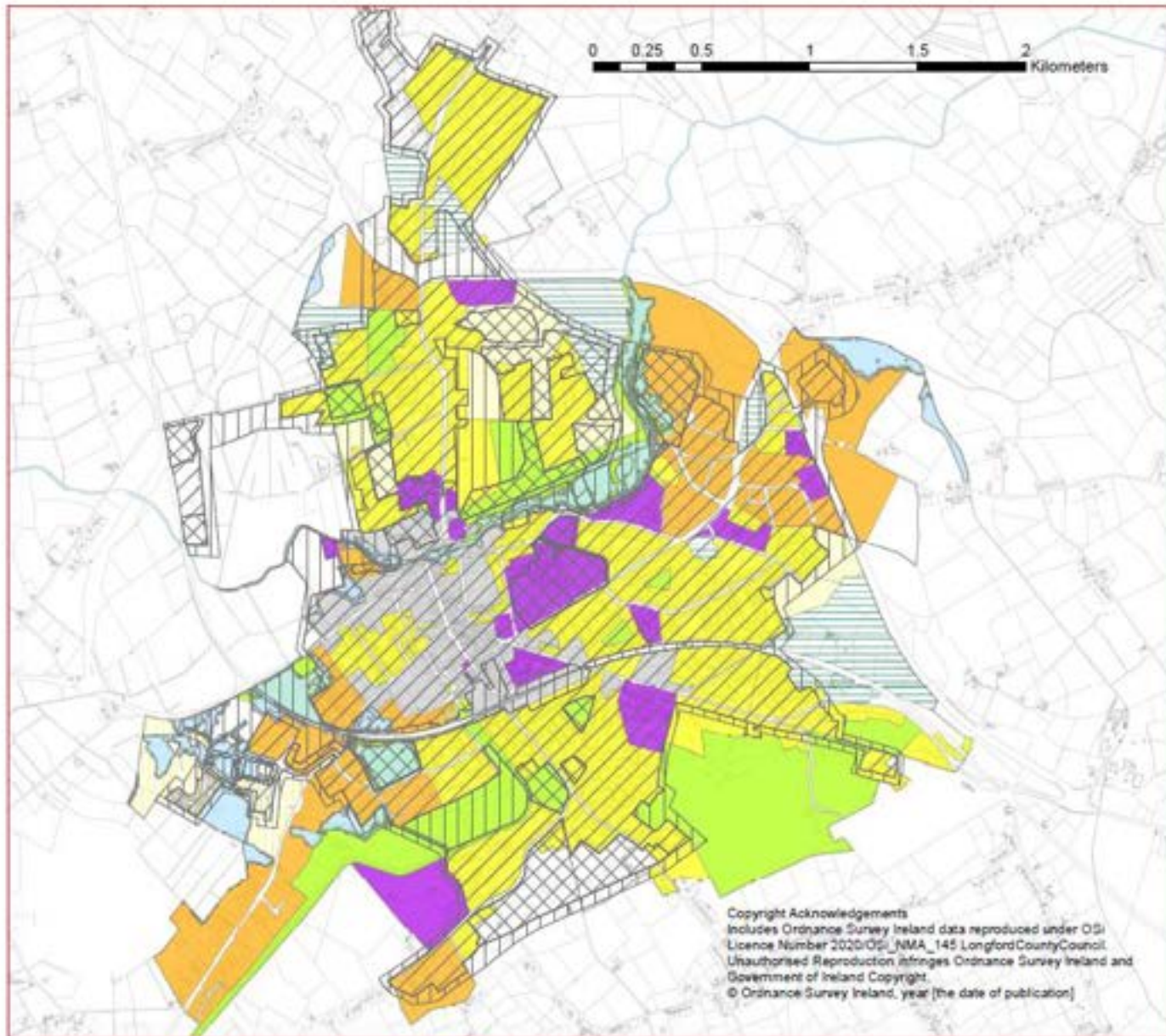

Granard
Initial Infrastructure Assessment

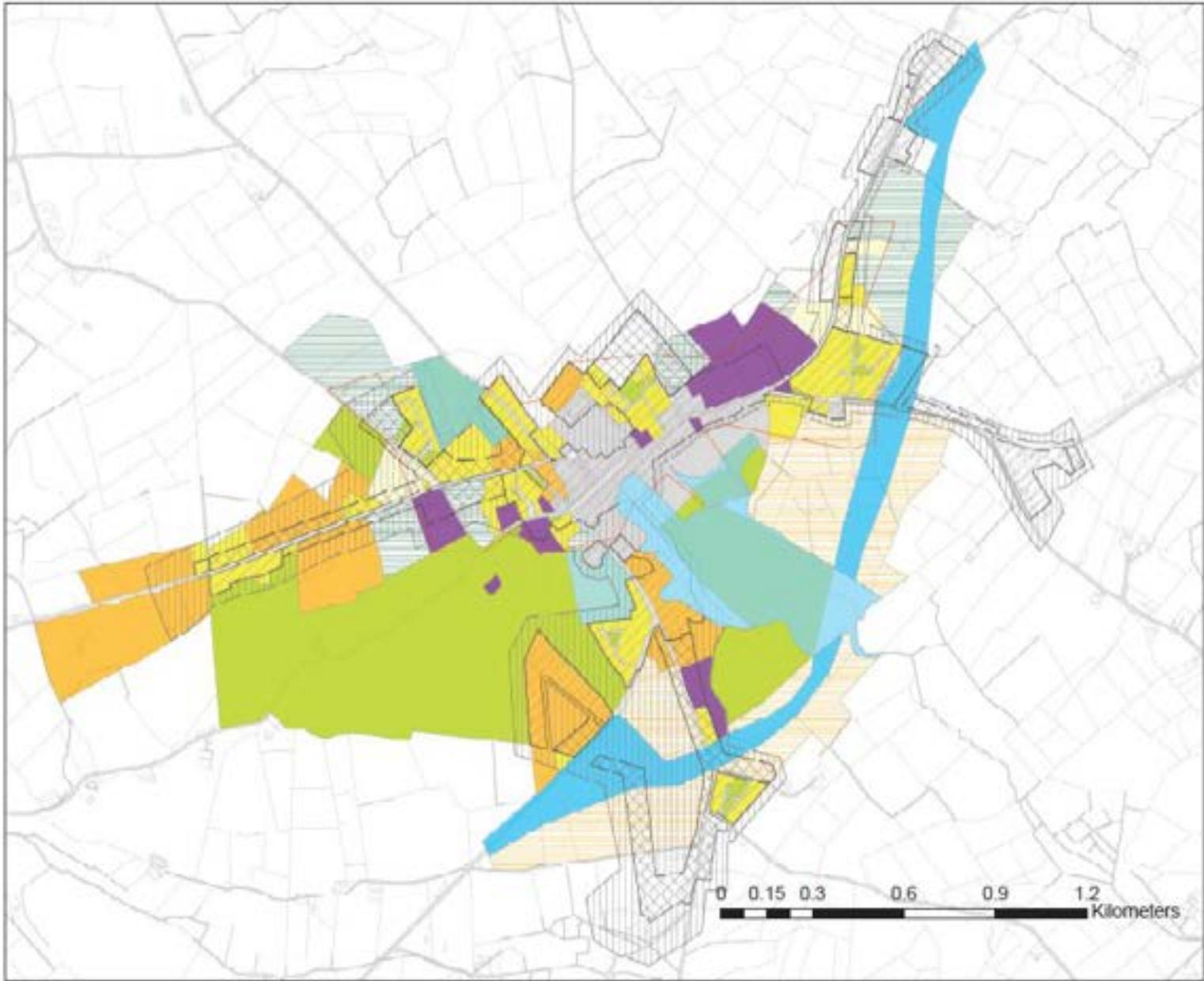

Legend

- Longford Settlement Flood Zone (2010)
- Concluded
- Potential Development
- No Development
- County Longford (2010) Settlements

Granard

- All other values

Appendix B

- Industrial/Commercial/Warehousing
- New Residential
- Recreation/Amenity & Green Space
- Residential
- Social/Community/Education
- Strategic Industrial Reserve
- Strategic Residential Reserve
- Tourism
- Town Core
- Transport & Utility Objective



Ballymahon Initial Infrastructure Assessment

Legend

-  Potential Development
-  No Development
-  Connected
-  Longford Settlement Flood Zones 2004/10
-  County Longford CSO Settlements
- Ballymahon_polygon**
-  -all other values-
- Appendix B**
-  Industrial/Commercial/Warehousing
-  New Residential
-  Recreation/Amenity & Green Space
-  Residential
-  Residential/Community Services/Care
-  Site Remediation Objective
-  Social/Community/Public Utility
-  Strategic Residential Reserve
-  Train Corridor



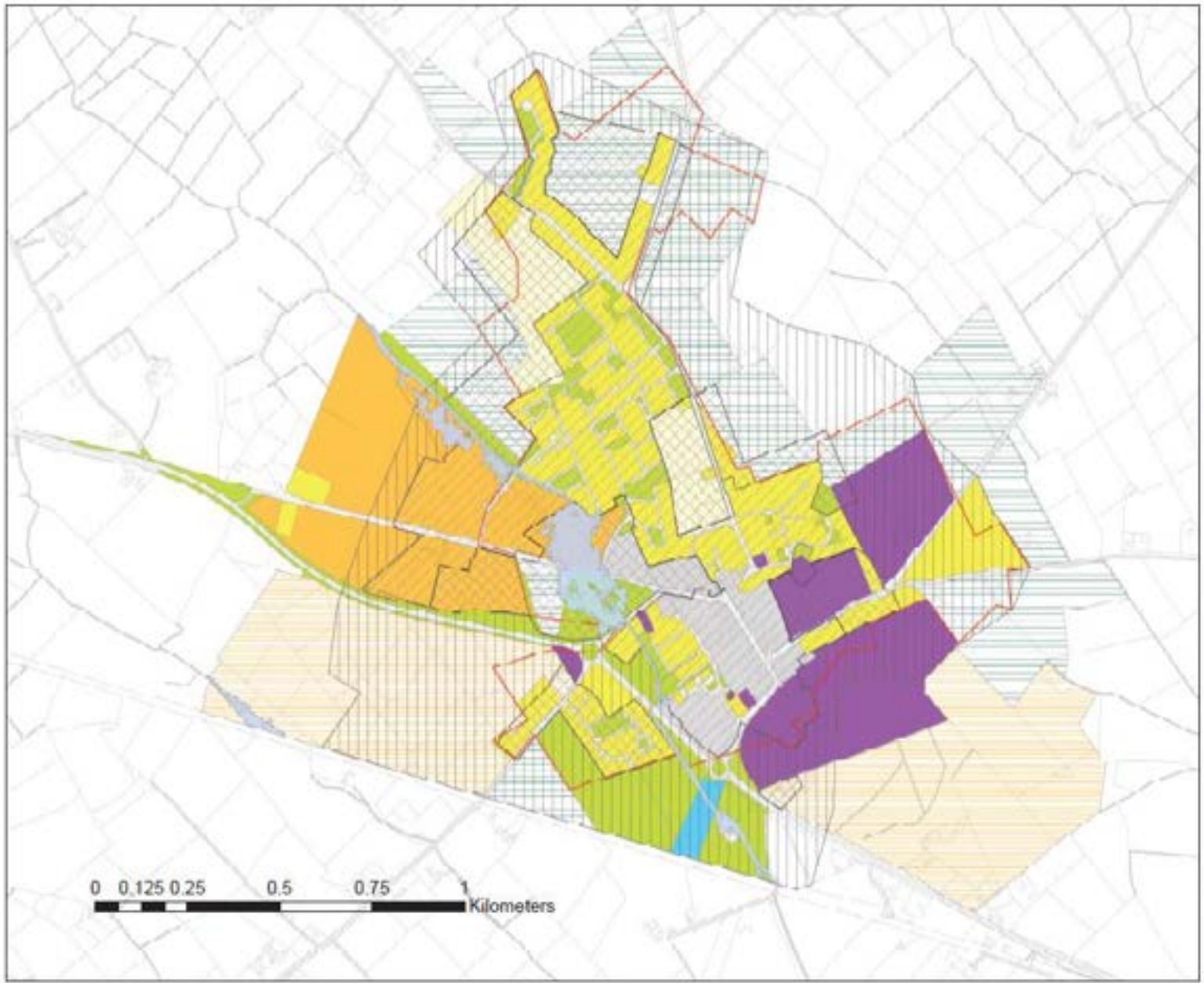

**Edgeworthstown
Initial Infrastructure**

Legend

- Longford Settlement Prior Zones 2010
- Potential Development
- No Development
- Committed
- County Longford CEO Settlements
- Edgeworthstown polygon
- not other values

Appendix B

- Industrial/Commercial/Warehousing
- New Residential
- Recreation/Leisure & Green Space
- Residential
- Social/Community/Education
- Strategic Industrial Reserve
- Strategic Residential Reserve
- Town Core
- Transport & Utilities Infrastructure



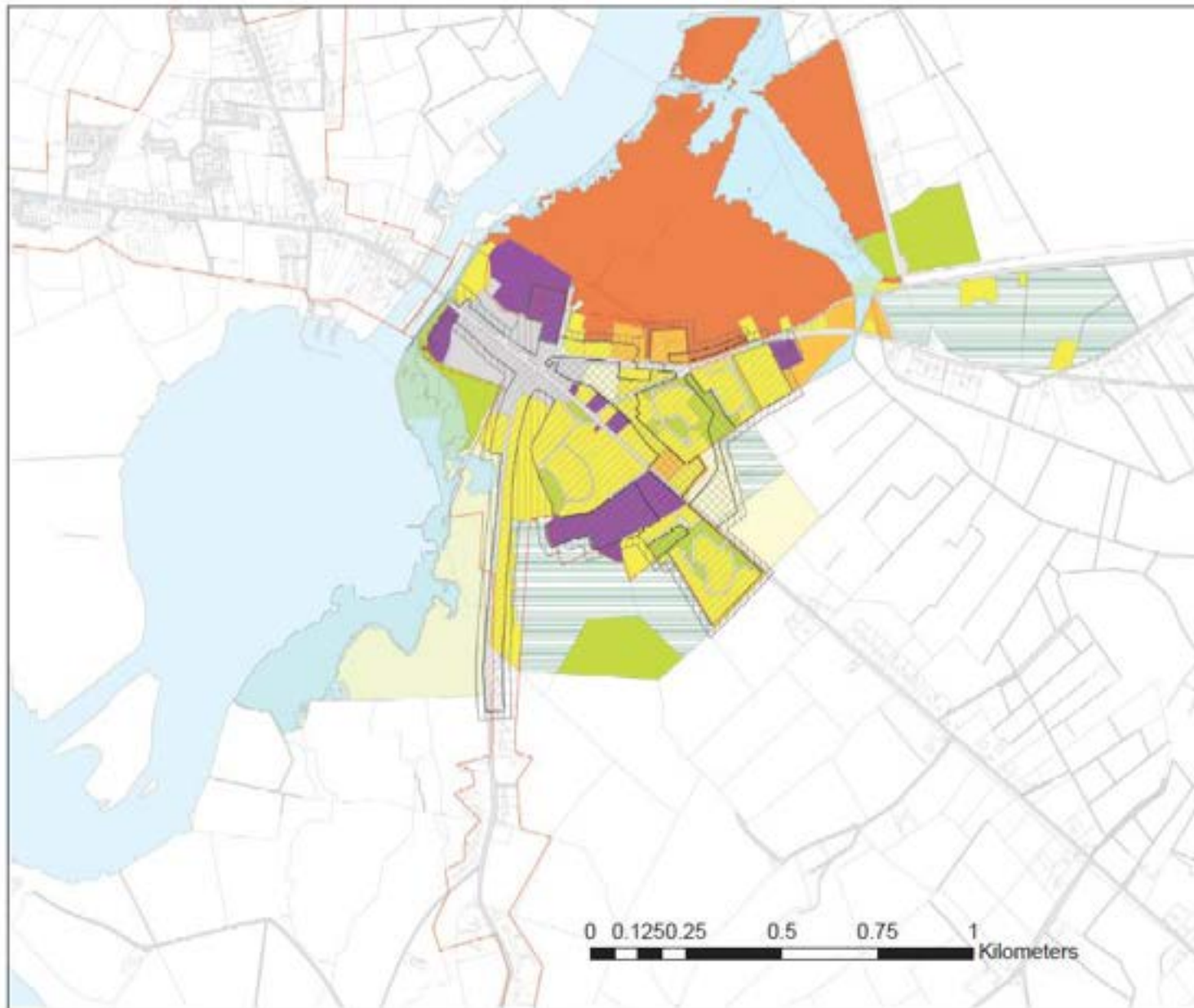

Lanesborough Initial Infrastructure



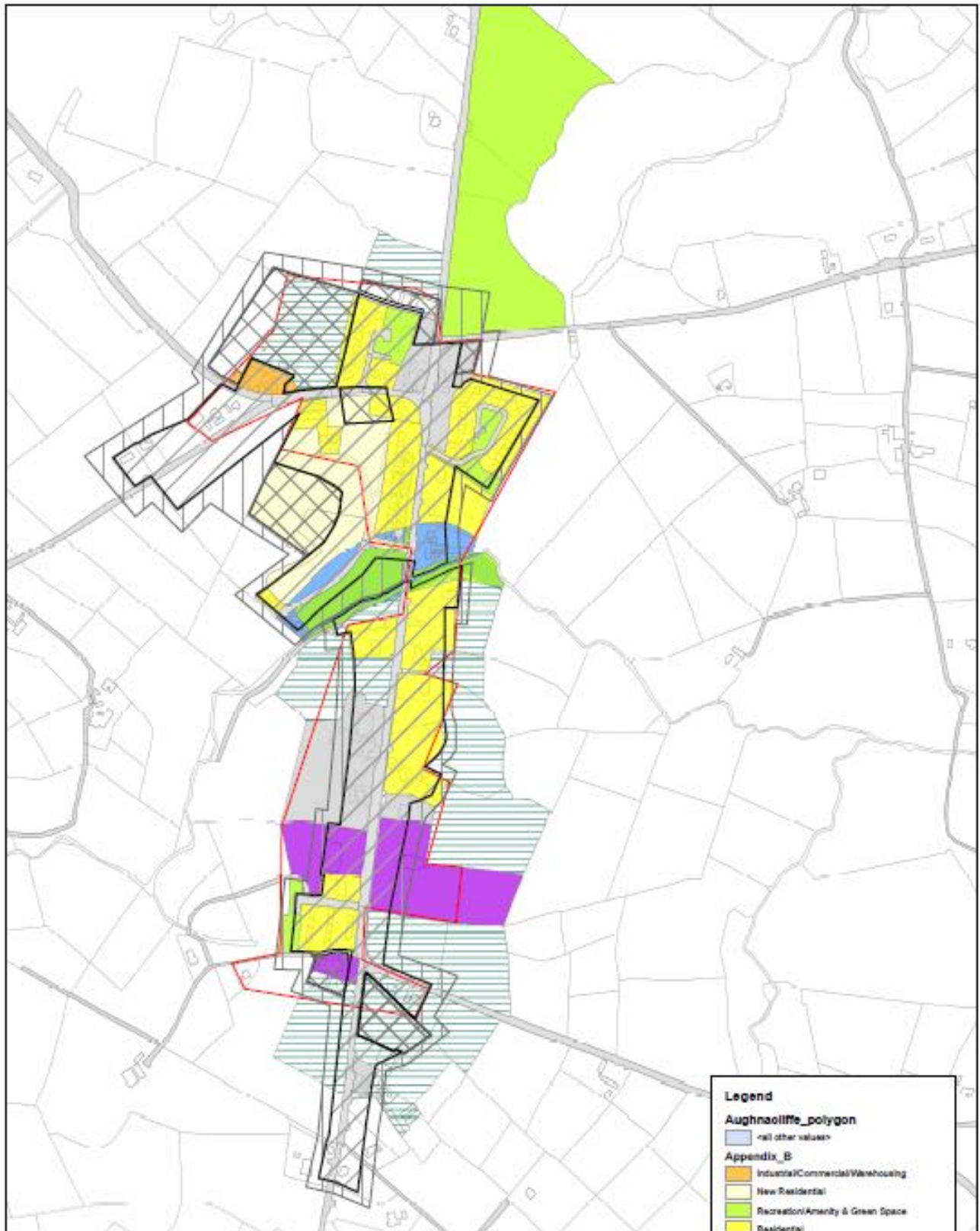

Aughnaclyffe
Initial Infrastructure Assessment



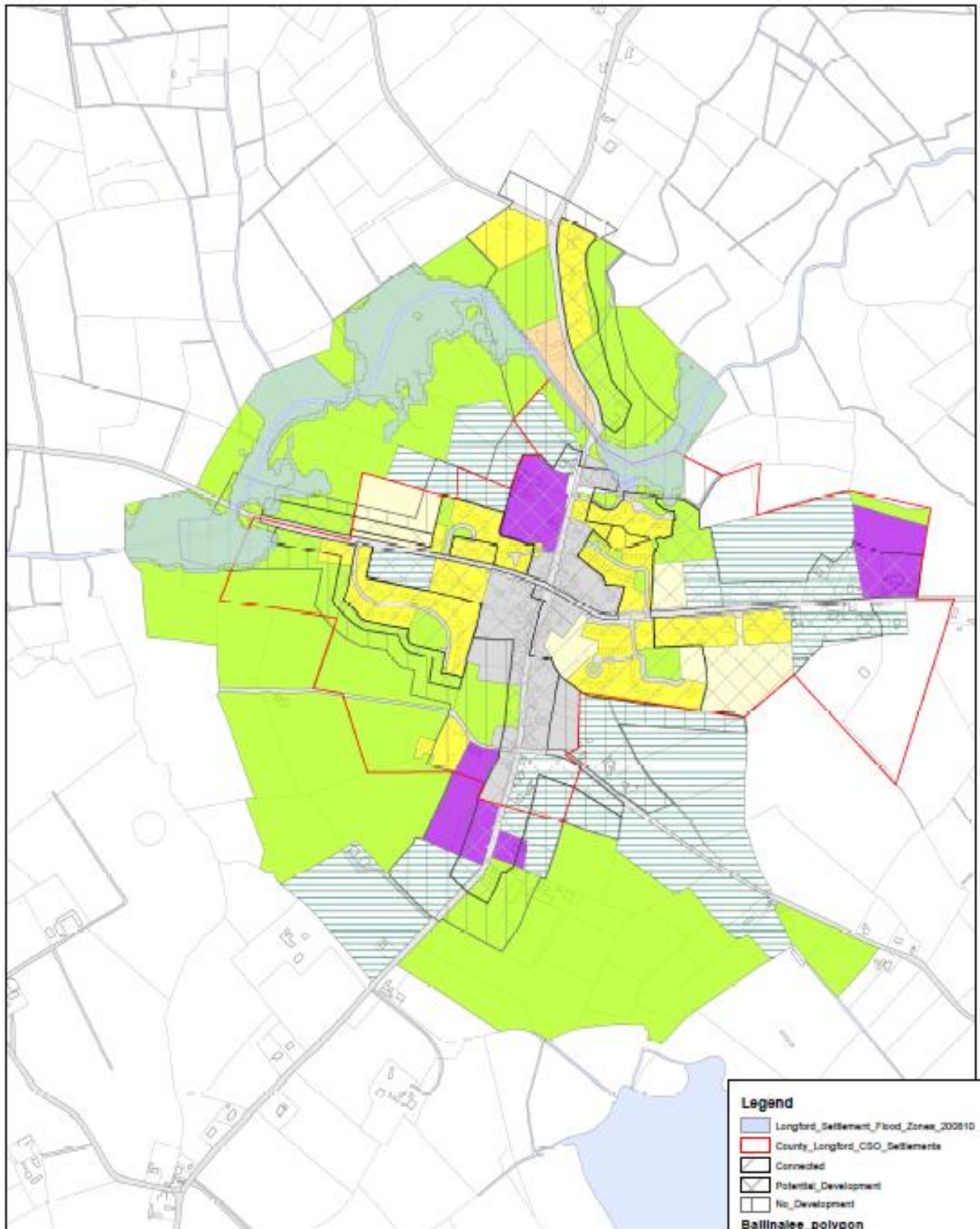

Ballinalee
Initial Infrastructure Assessment



Legend

- Longford Settlement Flood Zones_200810
- County Longford CSO Settlements
- Connected
- Potential Development
- No Development
- Ballinalee_polygon**
- all other urban
- Appendix_B**
- Light Industrial/Commercial/Service
- New Residential
- Recreation/Amenity & Green Space
- Residential
- Social/Community/Education
- Strategic Residential Reserve
- Town Core

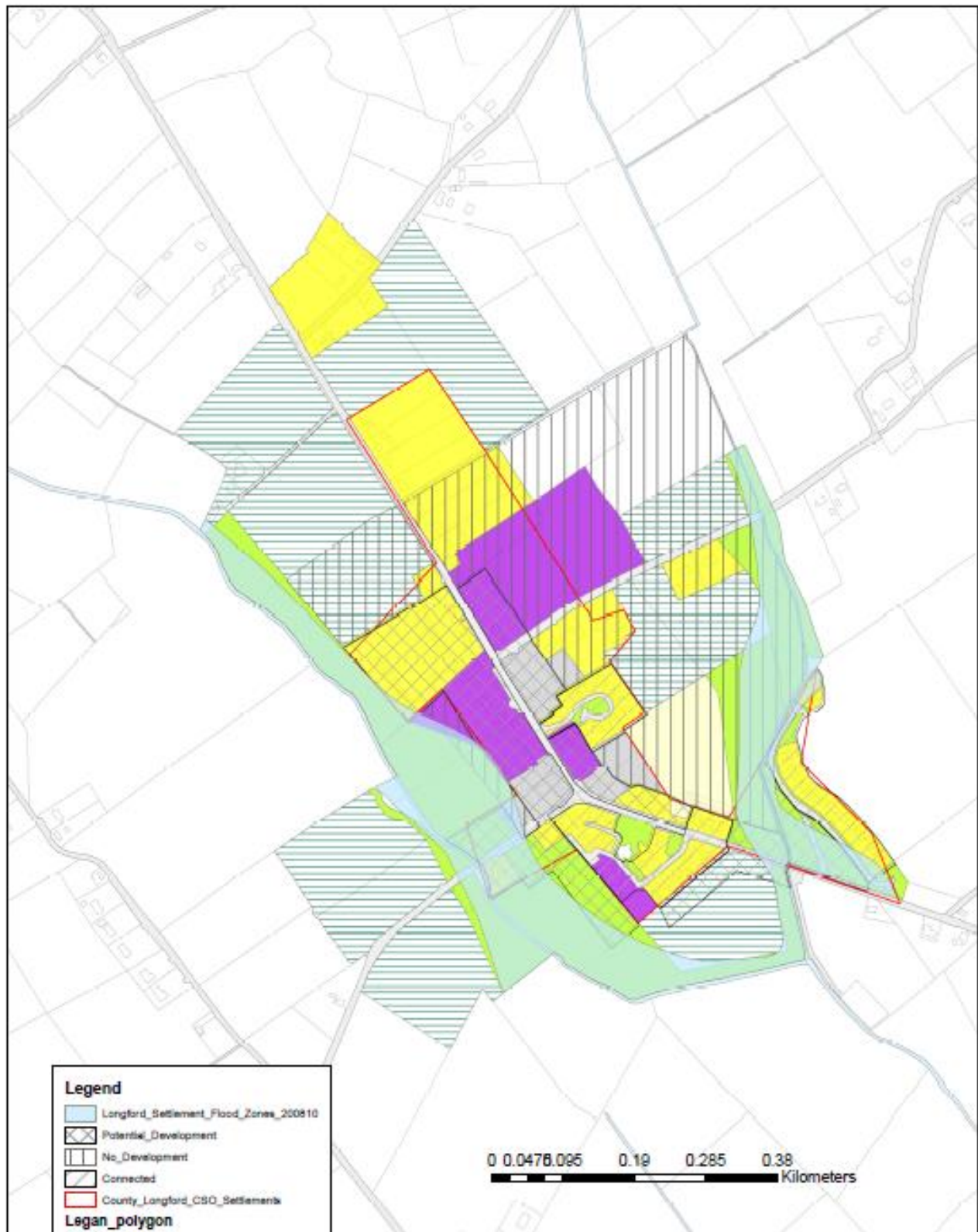

**Legan
Initial Infrastructure Assessment**



Newtownforbes Initial Infrastructure Assessment

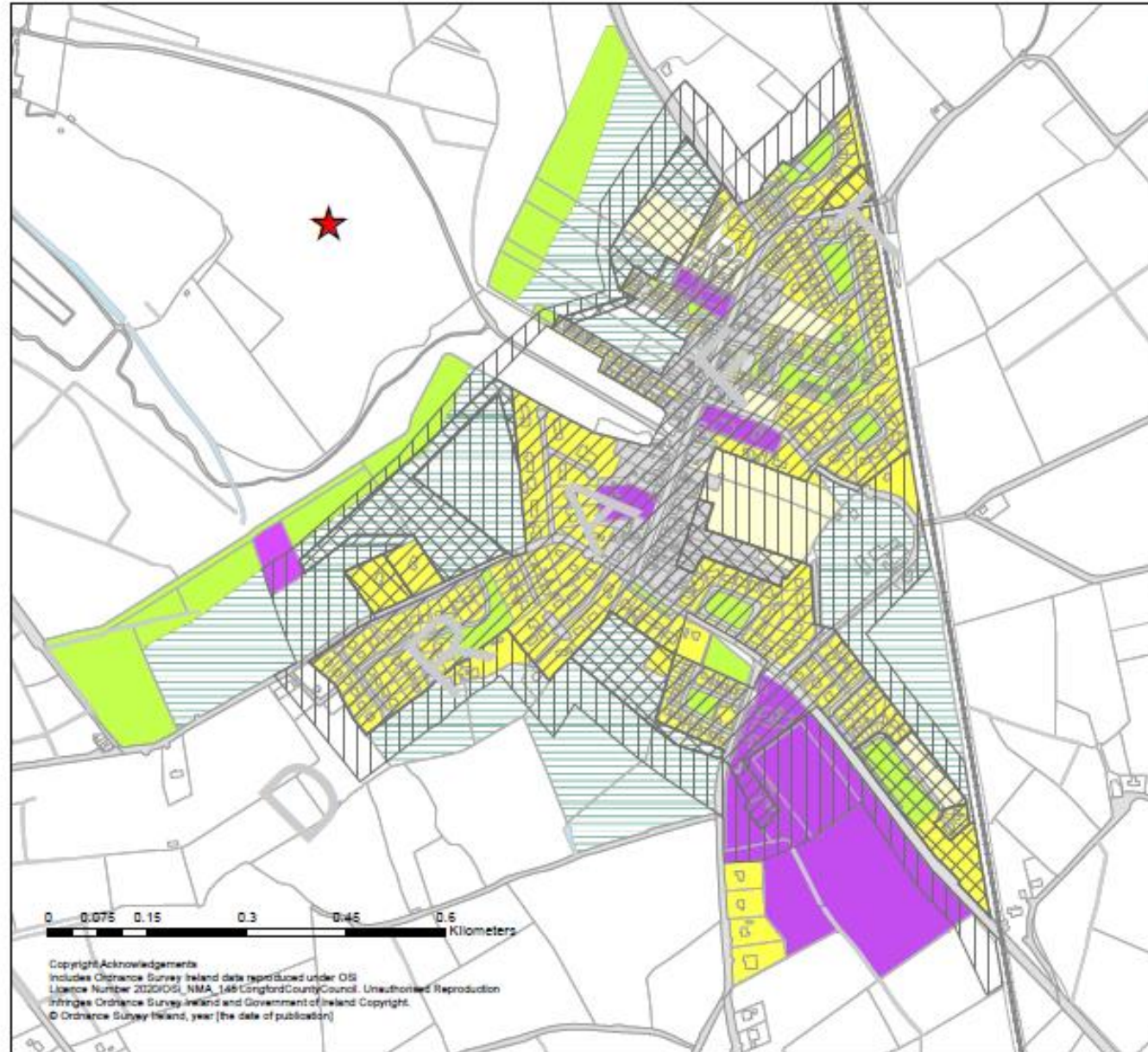

APPENDIX B – FURTHER ITERATIVE MAPPING

The following settlement maps show the proposed residential and employment lands proposed for inclusion in the Draft Plan and represent the zoned lands on which the Infrastructure Assessment is based.

The settlement plans show the residential and employment lands and are coded with a reference number – R1, R2 etc for residential sites; E1, E2 etc for employment sites.

The number and coding of the settlement areas is used in the infrastructure assessments provided by the Roads Section (refer to Appendix C) and Water Services (refer to Appendix D).

The maps in addition also have constrained use mapped which highlights the areas of the settlements at risk of flooding.

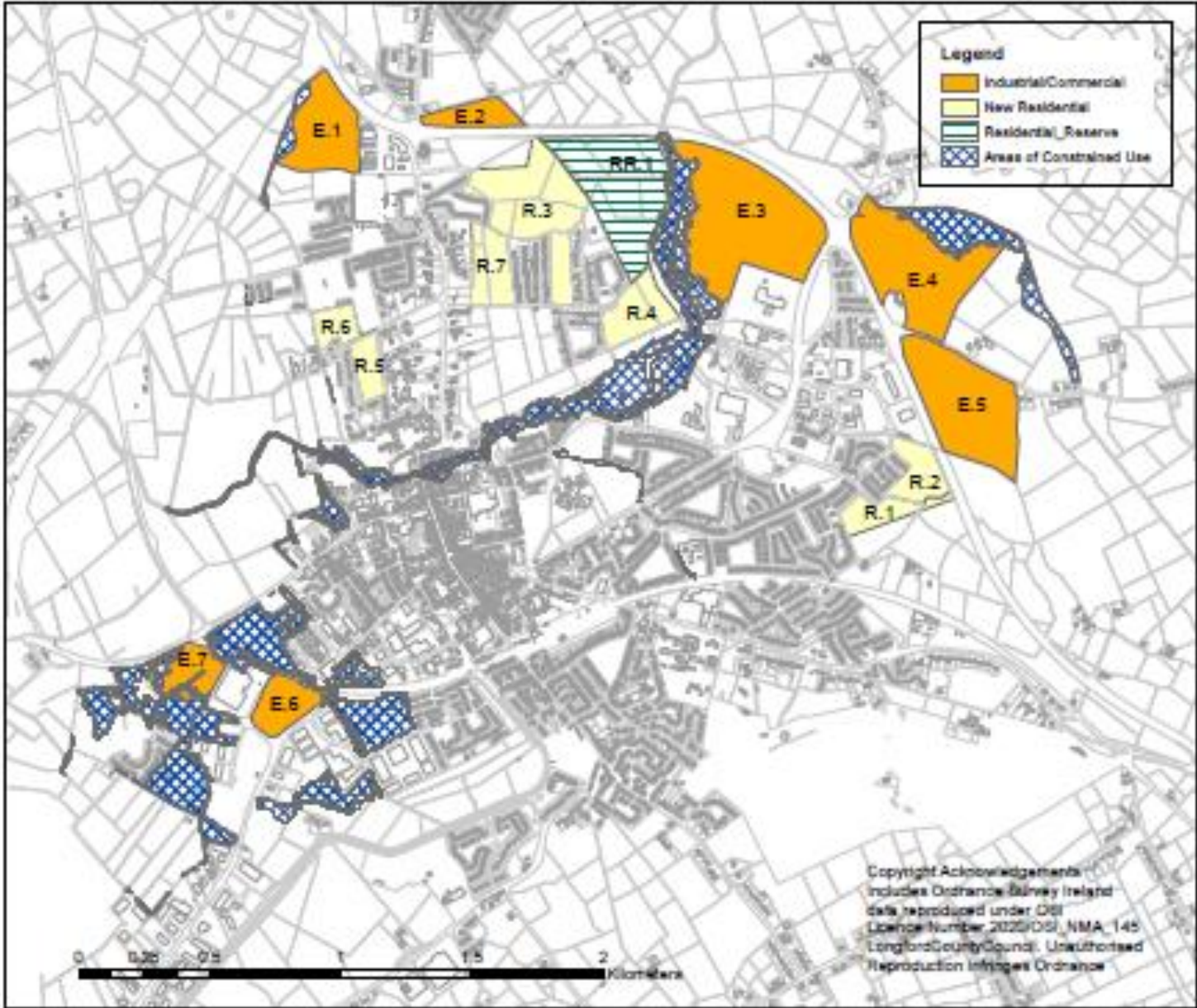

Longford Town
 Infrastructural Assessment-
 Further Iteration



Copyright Acknowledgements
 Includes Ordnance Survey Ireland data reproduced under OSI
 Licence Number 2020/OSI_NMA_145 Longford County Council. Unauthorised Reproduction
 infringes Ordnance Survey Ireland and Government of Ireland Copyright
 © Ordnance Survey Ireland, year 2021

Granard Infrastructural Assessment- Further Iteration

Legend

- Industrial/Commercial/Warehousing
- New Residential
- Strategic Industrial Reserve
- Areas of Constrained Use

Notes:

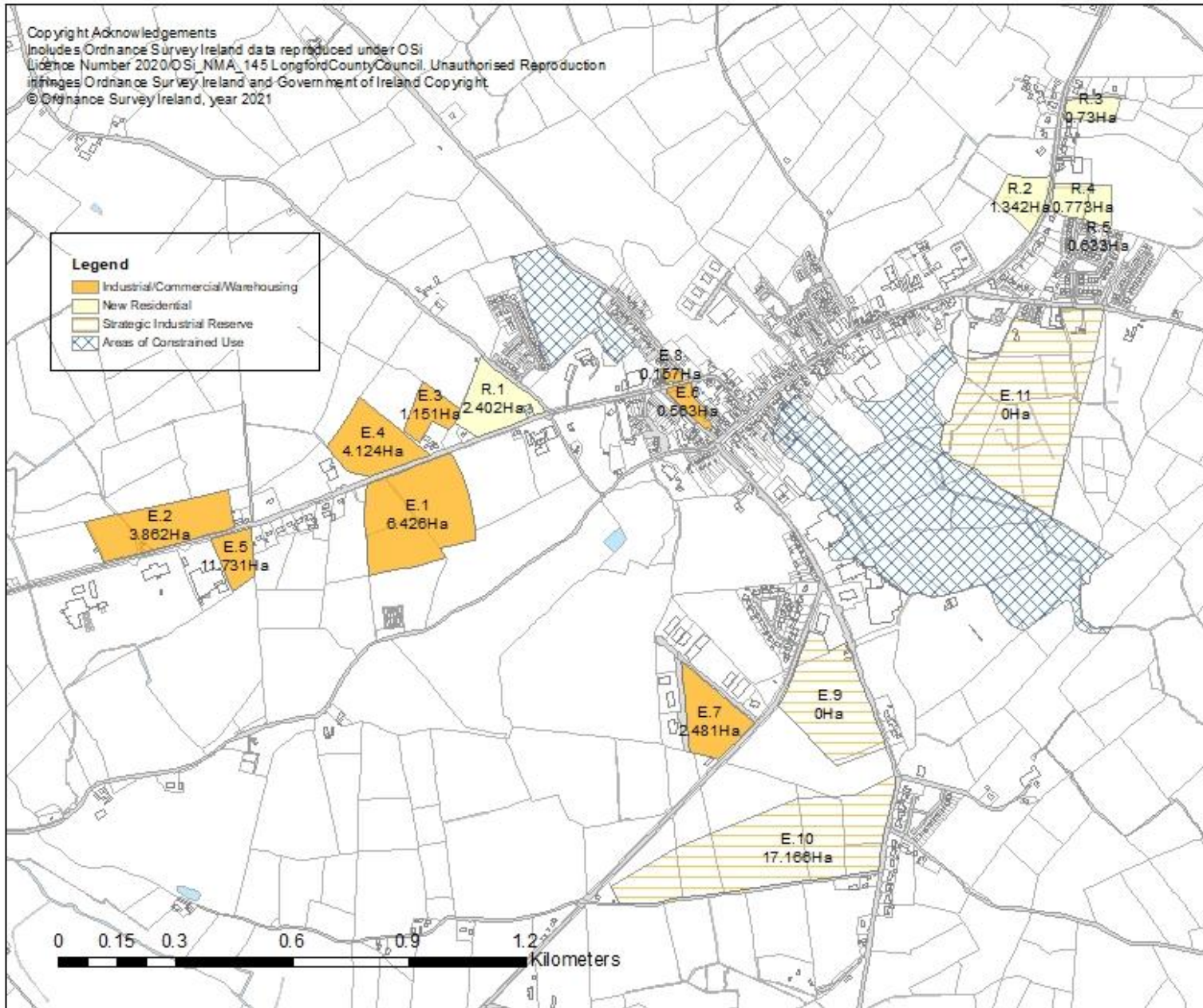

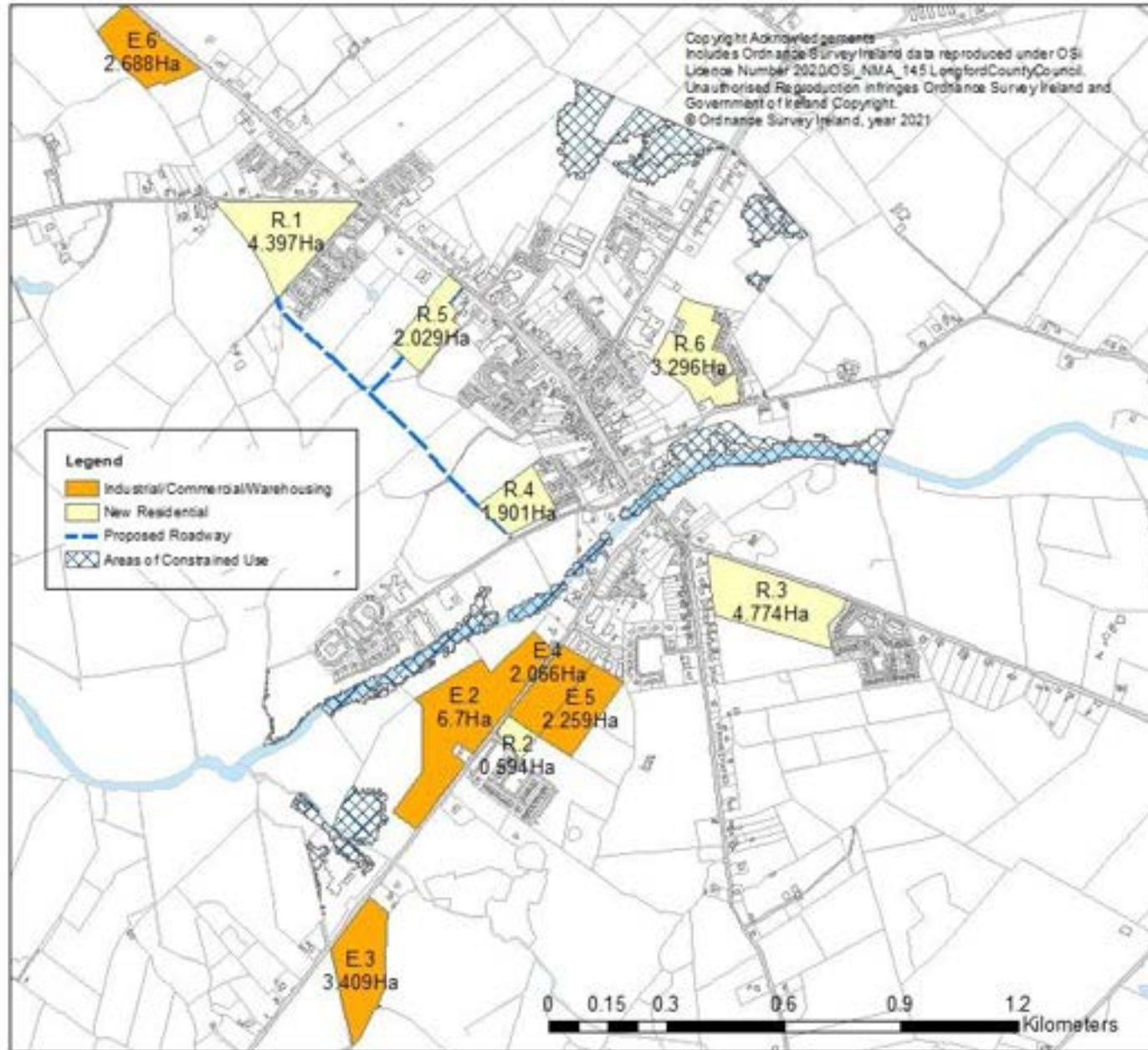

Ballymahon Infrastructural Assessment- Further Iteration

Notes:



Copyright Acknowledgements
 Includes Ordnance Survey Ireland data reproduced under
 OSI
 Licence Number 2020/OSI_NMA_145
 Longford County Council. Unauthorised Reproduction
 infringes Ordnance Survey Ireland and Government of
 Ireland Copyright.
 © Ordnance Survey Ireland, year 2021

Edgeworthstown Infrastructural Assessment- Further Iteration

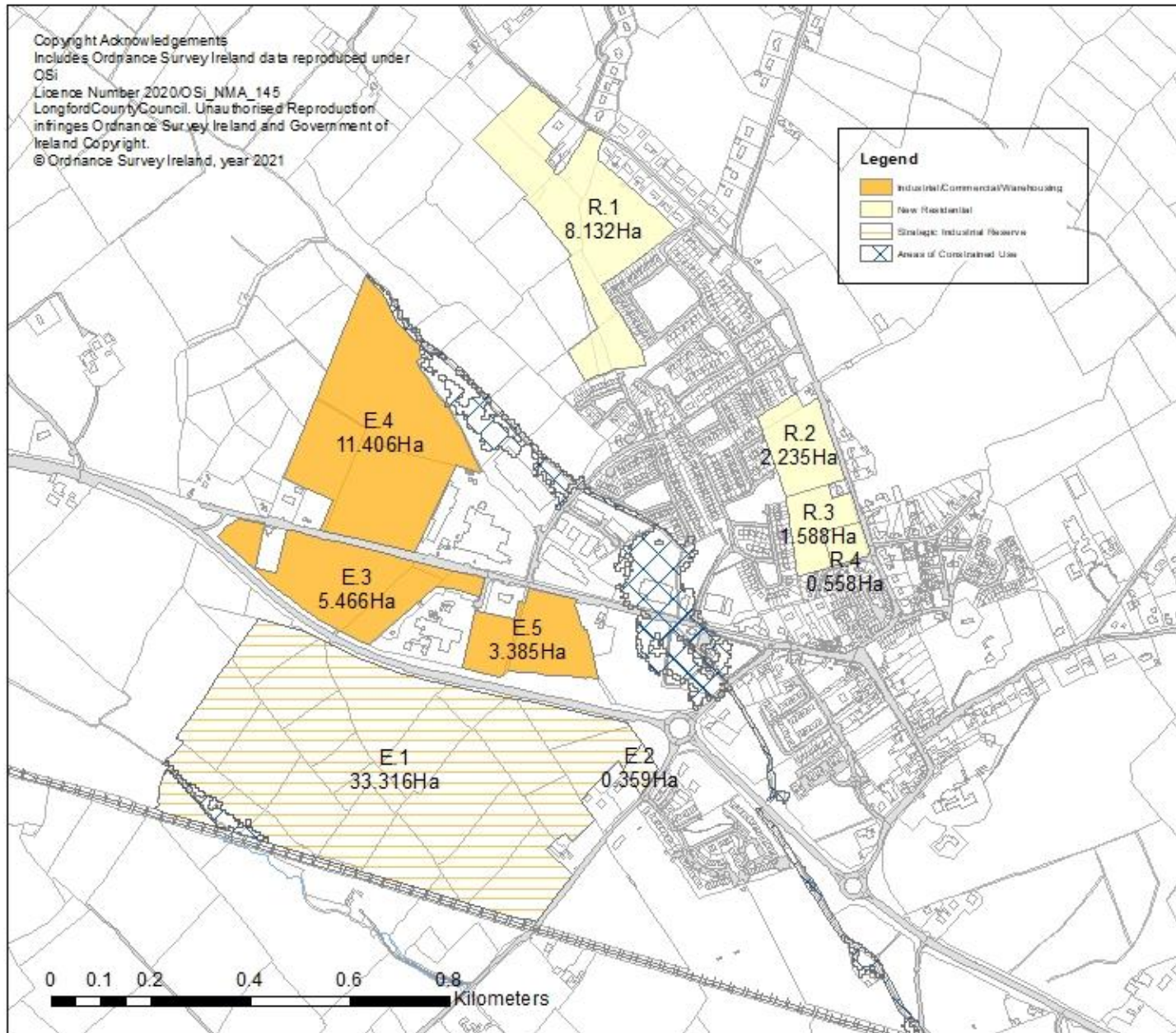

Notes:



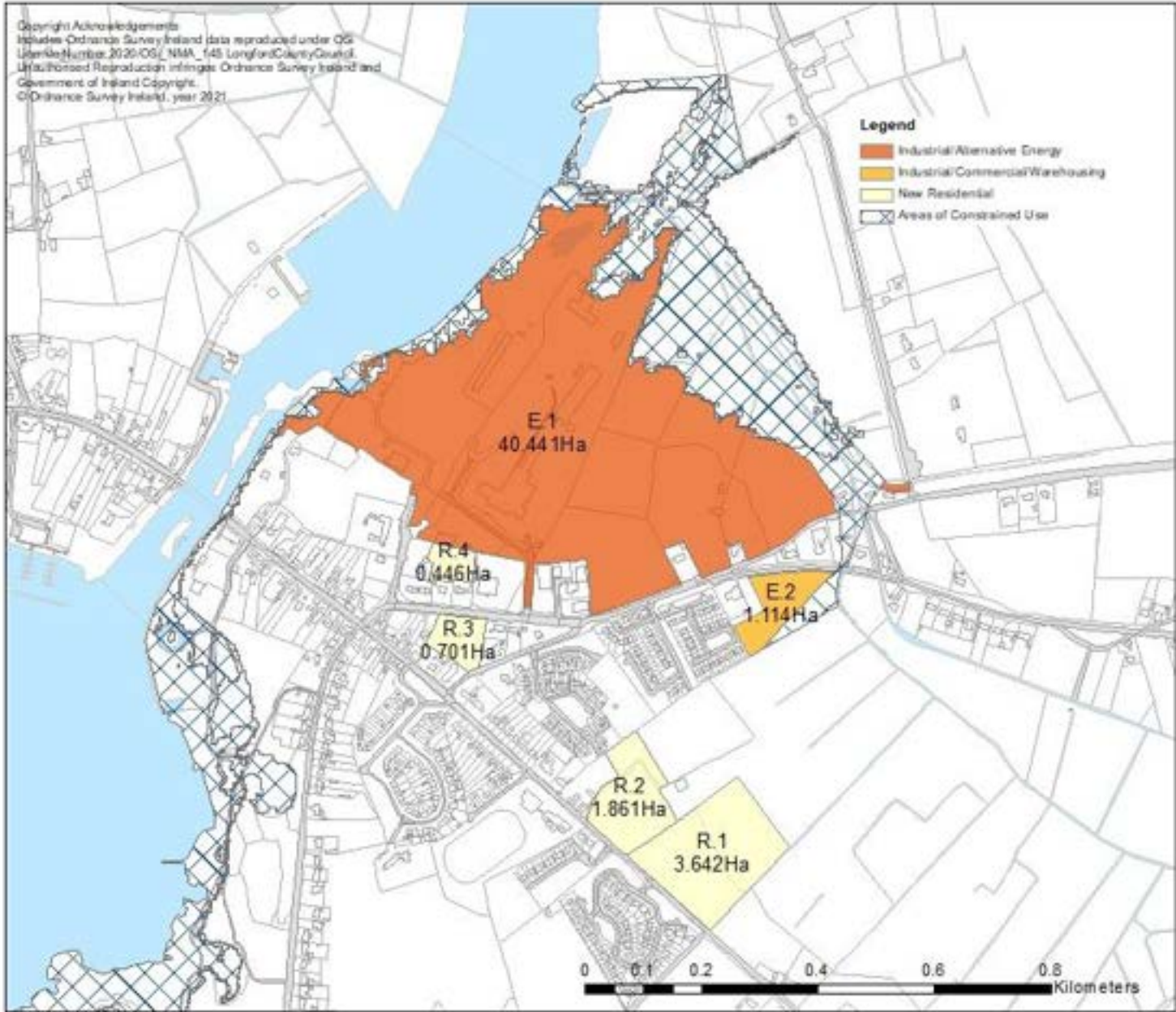

Lanesborough Infrastructural assessment- further iteration

Notes:



Copyright Acknowledgements
Includes Ordnance Survey Ireland data reproduced under OSI
Licence Number 2020/OSI_NMA_145 LongfordCountyCouncil
Unauthorized reproduction infringes Ordnance Survey Ireland and
Government of Ireland Copyright.
© Ordnance Survey Ireland, year 2021

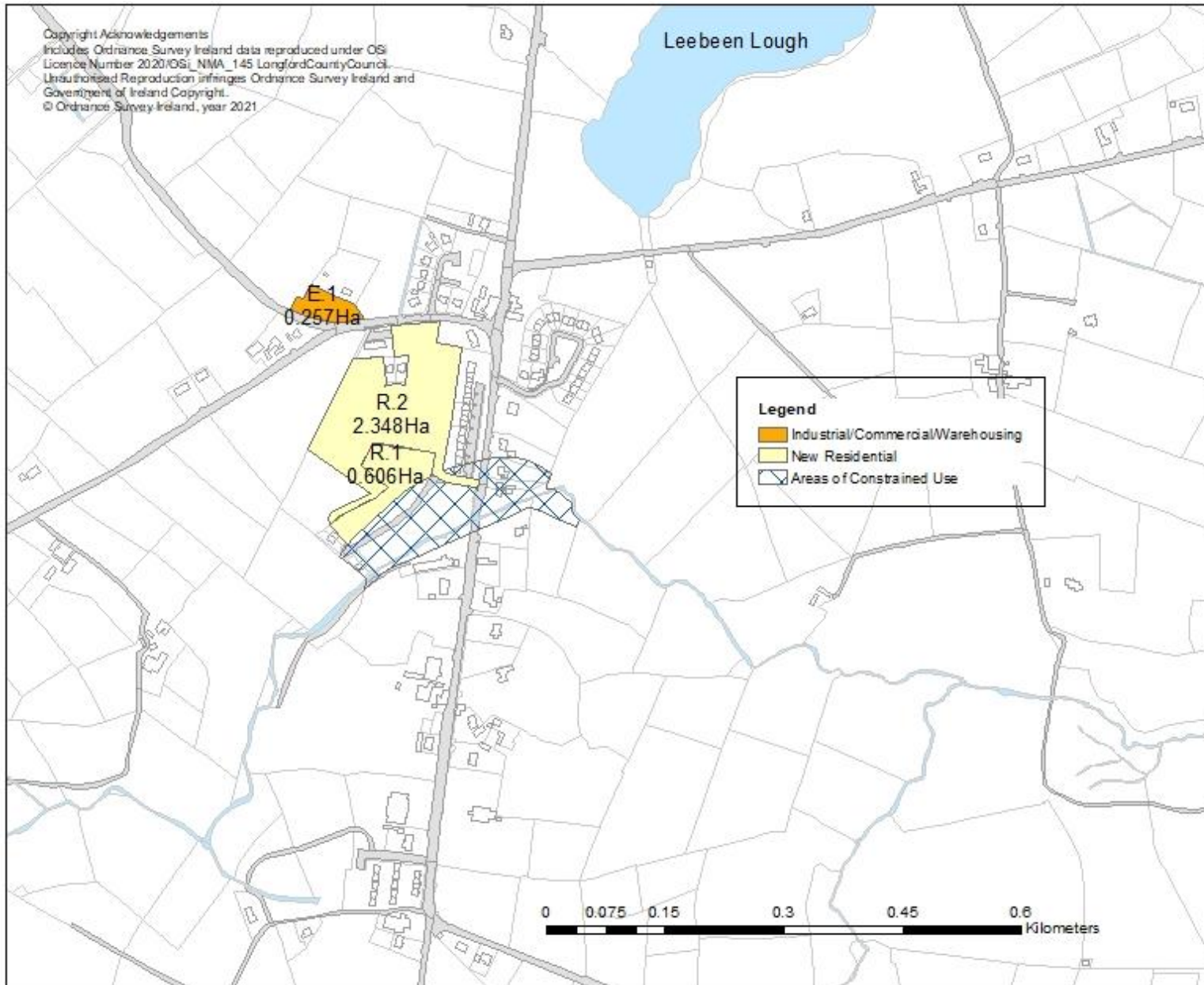

Aughnaclyffe Infrastructural Assessment- Further Iteration

Notes:



Ballinalee
 Infrastructural assessment-
 Further Iteration

Copyright Acknowledgements:
 Includes Ordnance Survey Ireland data reproduced under OS
 Licence Number 2020-OS/NMA_145 LongfordCountyCouncil.
 Unauthorized reproduction infringes Ordnance Survey Ireland and
 Government of Ireland Copyright.
 © Ordnance Survey Ireland, year 2021

Notes:

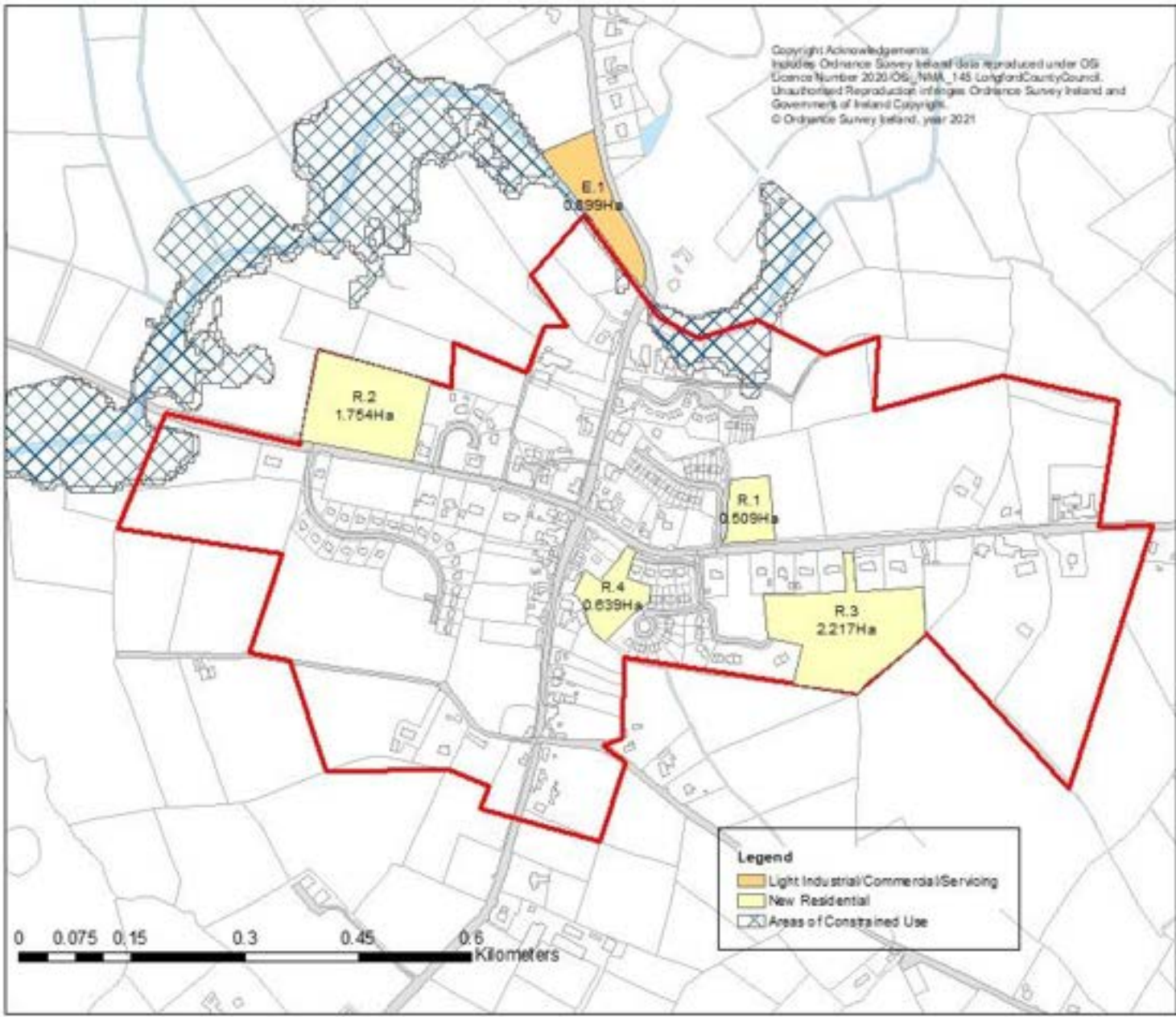

Copyright Acknowledgements
 Includes Ordnance Survey Ireland data reproduced under
 OSI
 Licence Number 2020/OSI_NMA_145
 Longford County Council. Unauthorised Reproduction
 infringes Ordnance Survey Ireland and Government of
 Ireland Copyright.
 © Ordnance Survey Ireland, year 2021

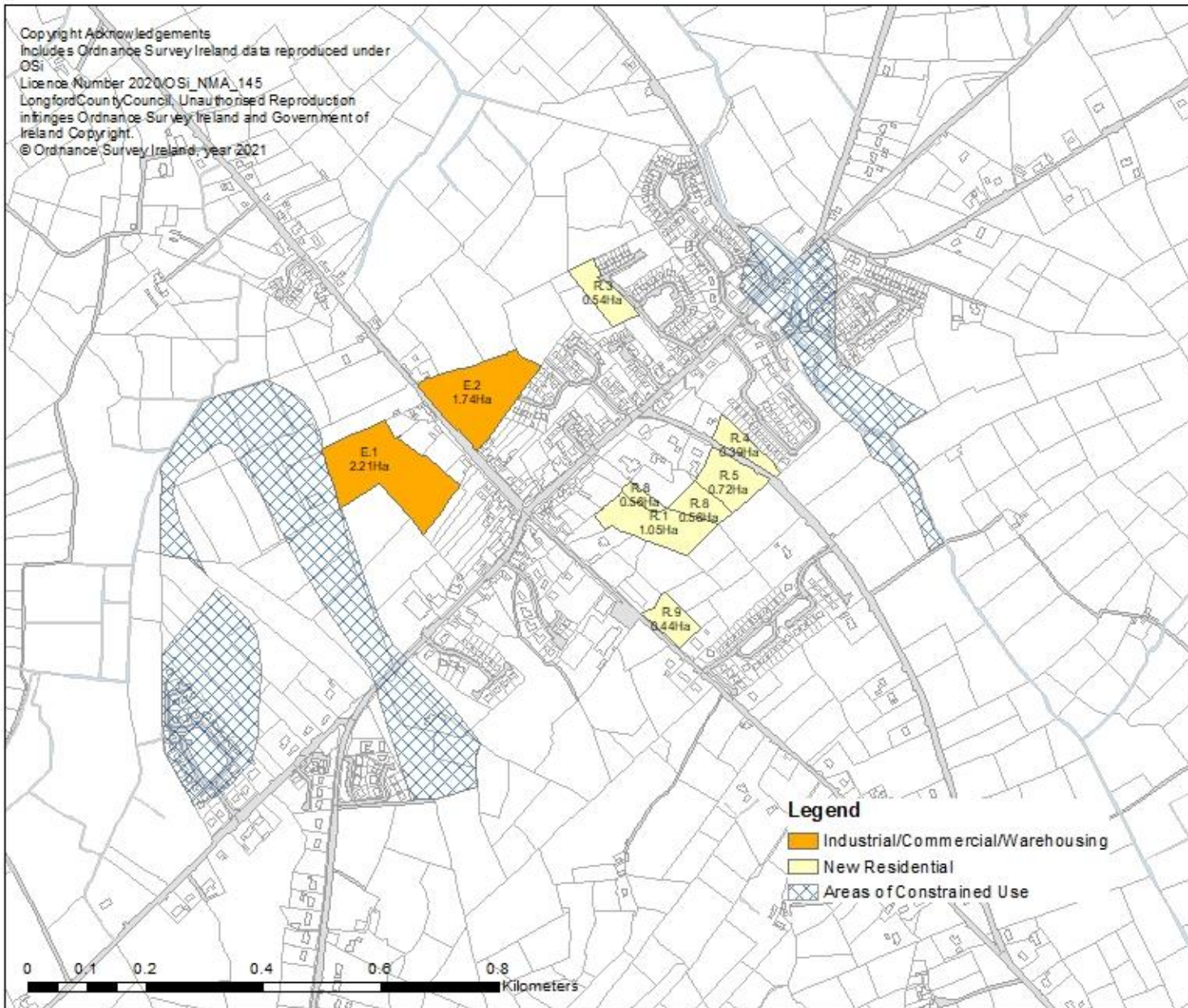

Drumlish Infrastructural assessment- Further Iteration

Notes:



Copyright Acknowledgements
Includes Ordnance Survey Ireland data reproduced under OSI
Licence Number 2020/05/NMA, 145 Longford County Council. Unauthorised Reproduction
infringes Ordnance Survey Ireland and Government of Ireland Copyright.
© Ordnance Survey Ireland, year 2021

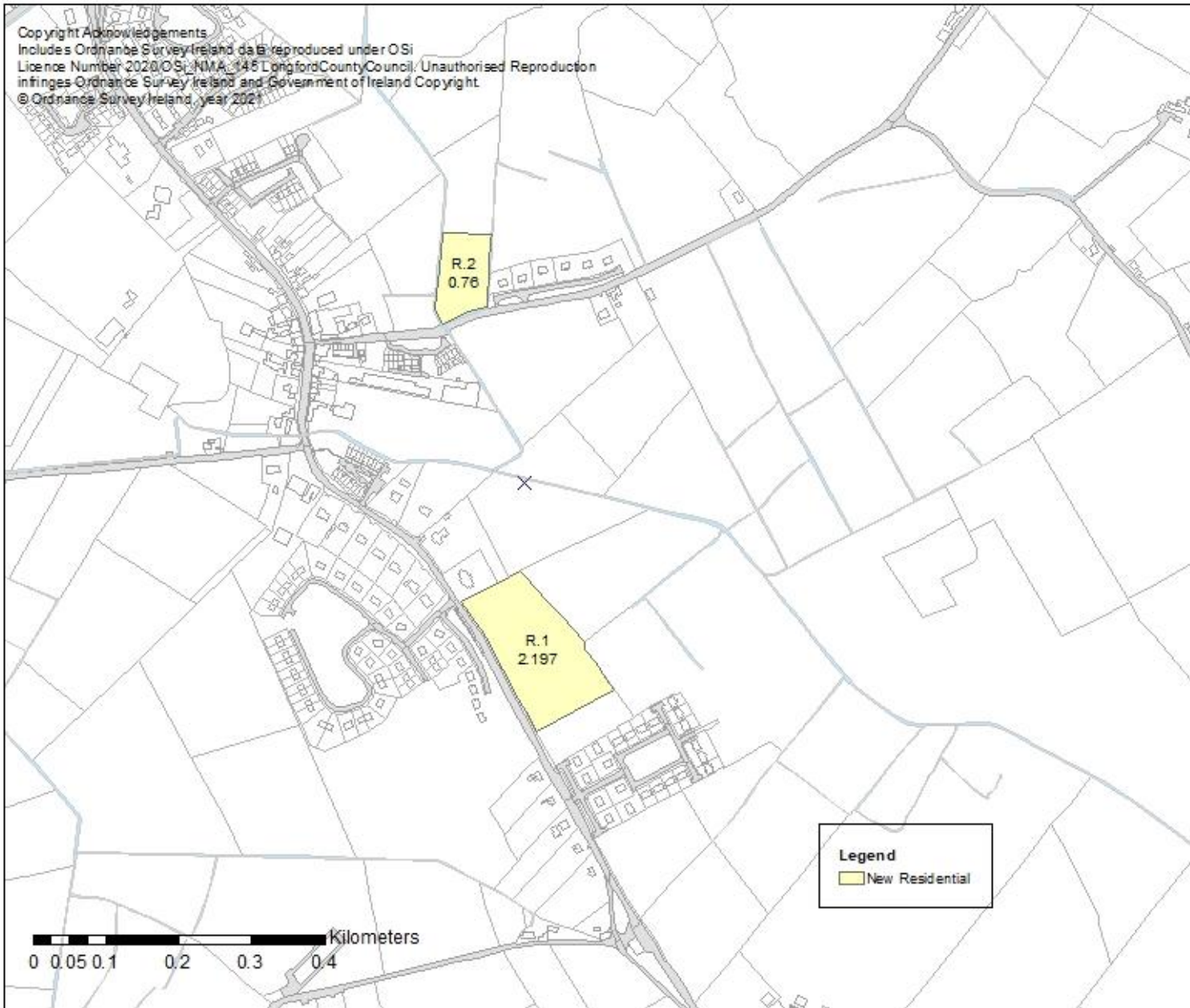

Keenagh Infrastructural Assessment- Further Iteration

Notes:



Copyright Acknowledgements
Includes Ordnance Survey Ireland data reproduced under OSI
Licence Number 2020/O SI_NMA_145 Longford County Council.
Unauthorised reproduction infringes Ordnance Survey Ireland and
Government of Ireland Copyright.
© Ordnance Survey Ireland, year 2021

Legan Infrastructural assessment- Further Iteration

Notes:

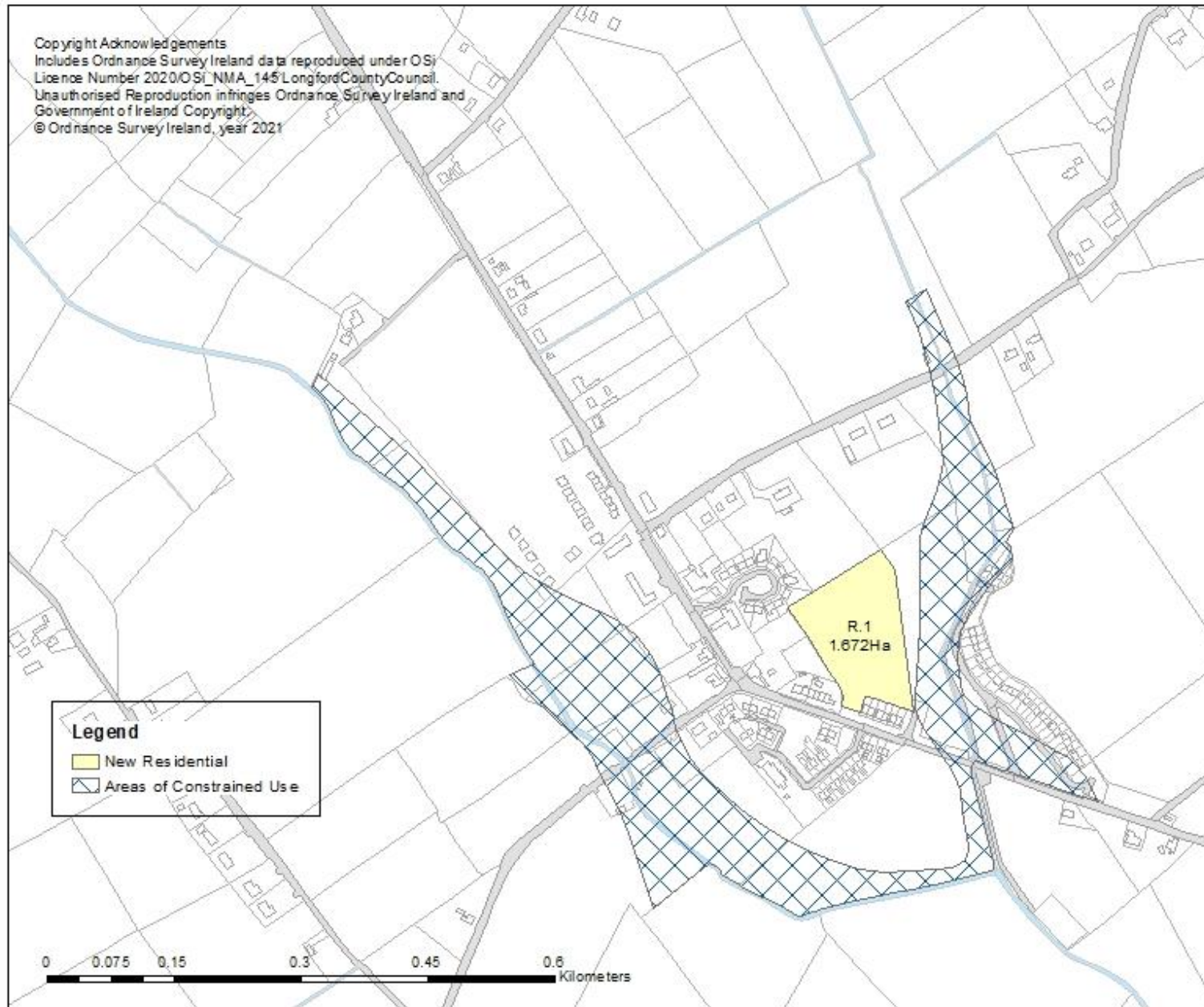

Newtownforbes Infrastructural Assessment- Further Iteration

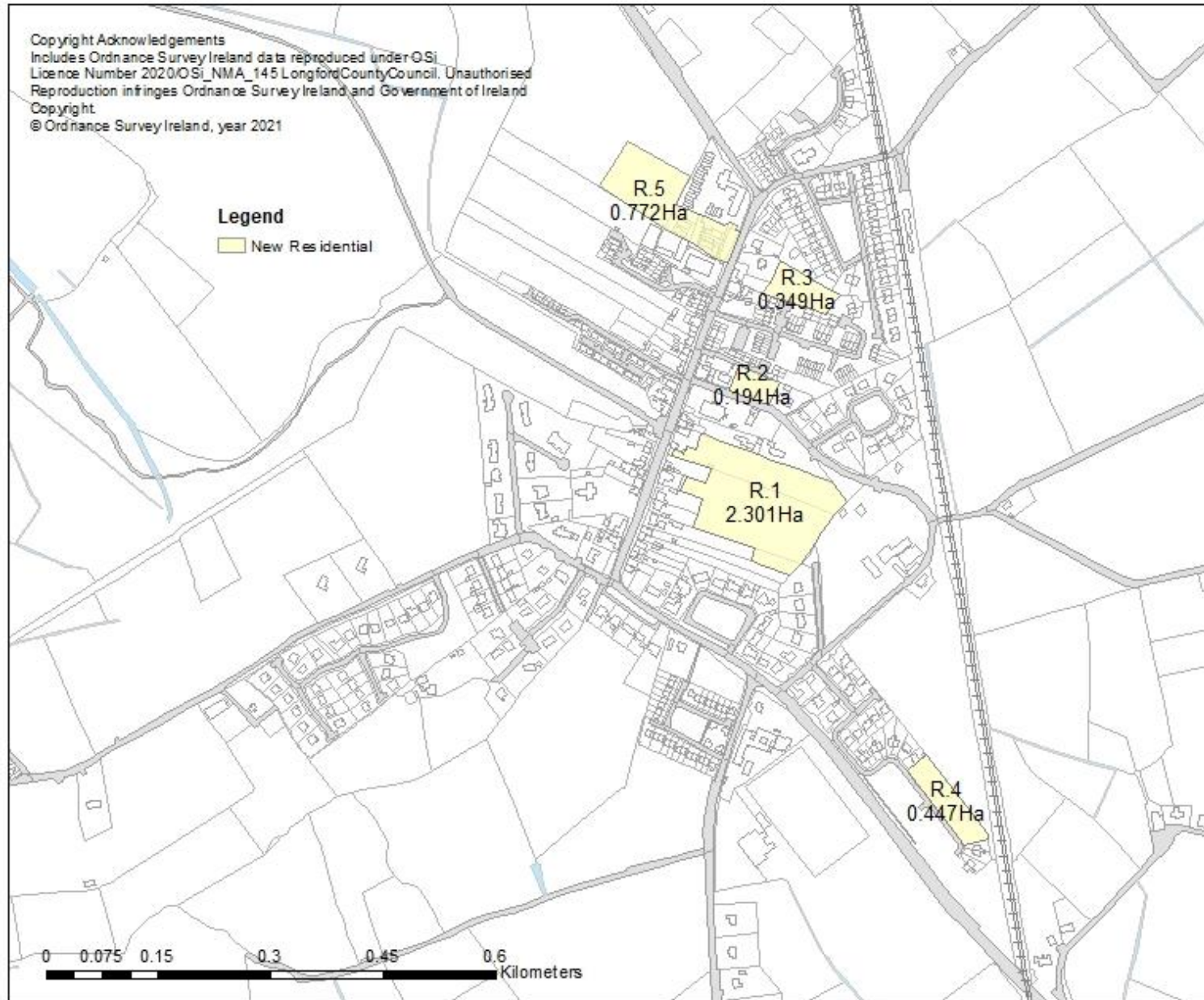

Notes:



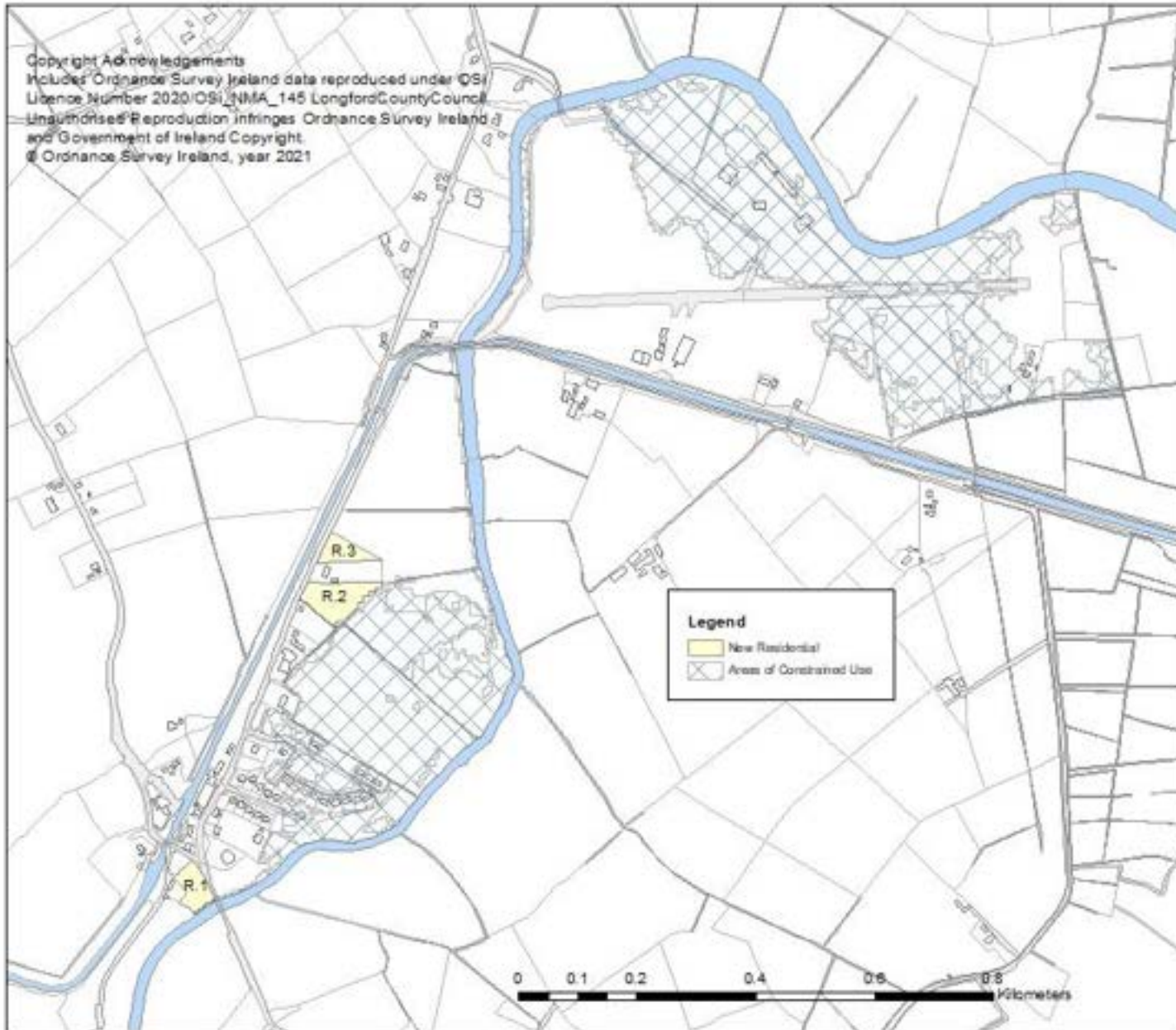

Abbeyshrule Infrastructural assessment- Further Iteration

Notes



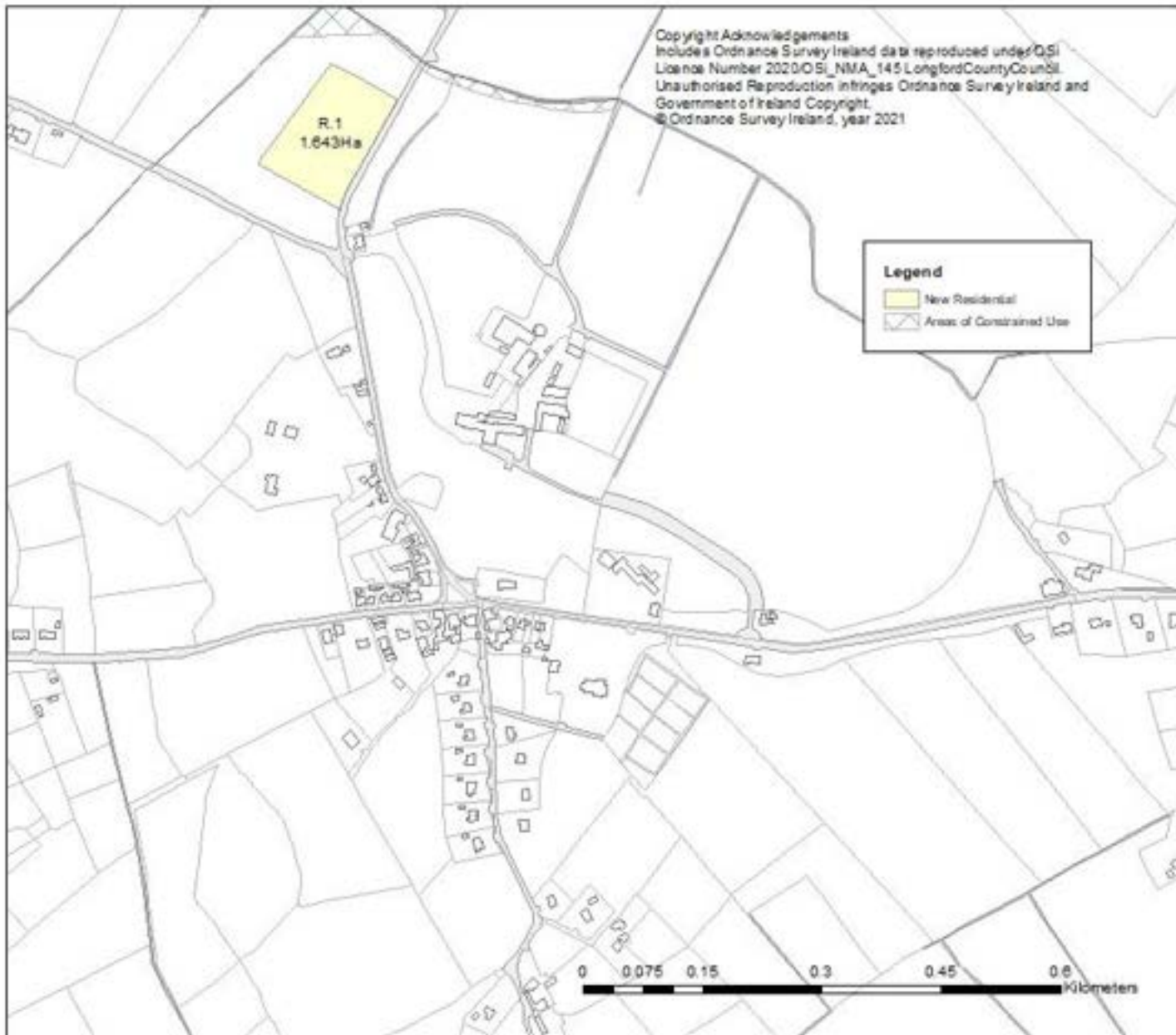

Ardagh Infrastructural assessment- Further Iteration

Notes



Ballinamuck Infrastructural assessment- Further Iteration

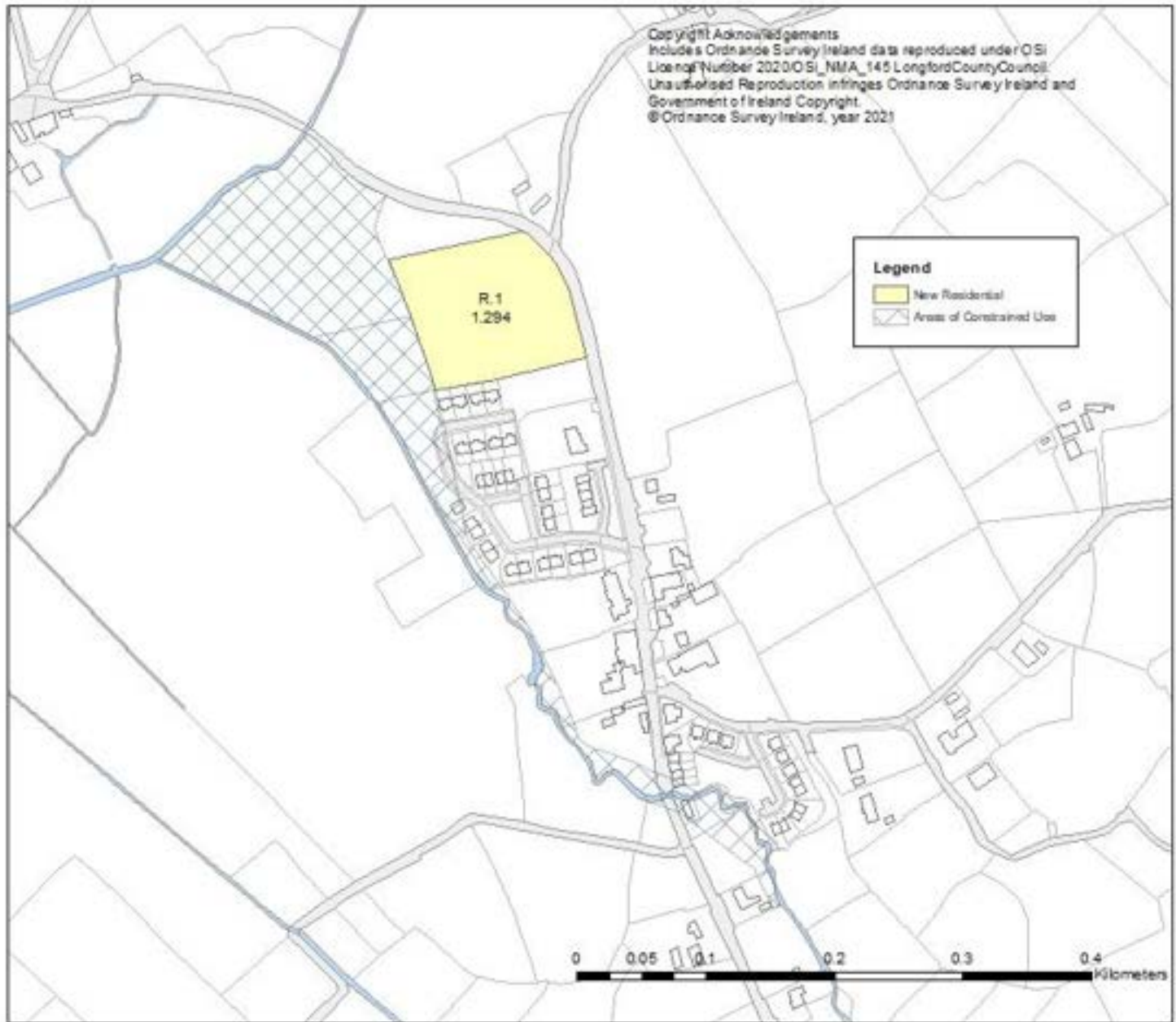

Notes



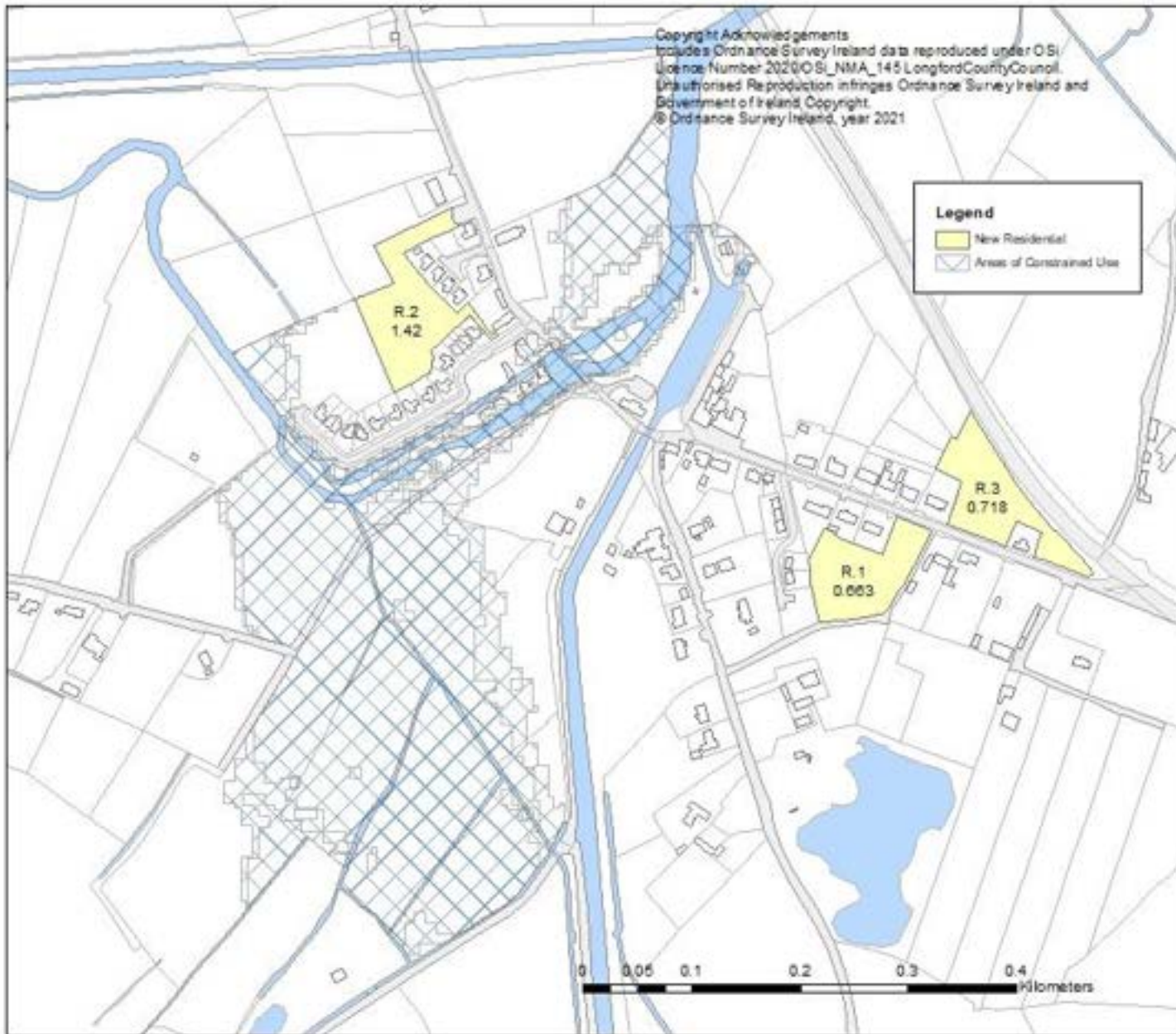

Clonra Infrastructural assessment- Further Iteration

Notes



APPENDIX C: ROADS DEPARTMENT INFRASTRUCTURAL EVALUATION

The following tables show the Roads infrastructure assessment results for each of the main settlements including Longford Town, Granard, Ballymahon, Edgeworthstown, Lanesborough and Drumlish and the associated zoned lands.

The assessment is presented as a number indexed out of 100 and has been evaluated on the available road network, pavements, lighting and other infrastructure in the locality, along with the required works to create a safe access to the site. The assessment also includes an assessment of the zoned lands based on the drainage and flooding of the area.

The assessment has not included details about proposed road improvements, junction realignments and information concerning local road accidents and other matters

The review also does not include an assessment of the costs involved in servicing the zoned lands in respect of roads and drainage, rather it provides an indication of the serviceability of the lands as of January to March 2021.

LONGFORD TOWN

HOUSING LANDS		R1	R2	R3	R4	R5	R6	R7	RR1
CRITERIA	WEIGHTING								
ROADS	100	100	90	50	100	90	80	80	50
DRAINAGE	100	80	80	90	90	90	80	90	60

EMPLOYMENT LANDS		E1	E2	E3	E4	E5	E6	E7
CRITERIA	WEIGHTING							
ROADS	100	50	50	50	50	50	100	100
DRAINAGE	100	50	50	80	80	50	70	70

GRANARD TOWN

HOUSING LANDS		R1	R2	R3	R4	R5
CRITERIA	WEIGHTING					
ROADS	100	100	100	100	100	70
DRAINAGE	100	50	50	50	50	50

EMPLOYMENT LANDS		E1	E2	E3	E4	E5	E6	E7	E8	SIR - E9	SIR - E10	SIR - E11
CRITERIA	WEIGHTING											
ROADS	100	100	100	100	100	100	100	100	100	100	100	100
DRAINAGE	100	50	50	50	50	50	30	100	30	50	50	80

BALLYMAHON

HOUSING LANDS		R1	R2	R3	R4	R5	R6
CRITERIA	WEIGHTING						
ROADS	100	100	100	100	100	100	60
DRAINAGE	100	80	50	10	50	50	80

EMPLOYMENT LANDS		E1	E2	E3	E4	E5	E6
CRITERIA	WEIGHTING						
ROADS	100	100	100	100	100	100	100
DRAINAGE	100	50	50	50	50	50	50

EDGEWORTHSTOWN

HOUSING LANDS		R1	R2	R3	R4
CRITERIA	WEIGHTING				
ROADS	100	100	100	100	100
DRAINAGE	100	50	50	50	50

EMPLOYMENT LANDS		SIR - E1	SIR - E2	E3	E4	E5
CRITERIA	WEIGHTING					
ROADS	100	0	50	100	100	100
DRAINAGE	100	50	50	50	50	50

LANESBOROUGH

HOUSING LANDS		R1	R2	R3	R4
CRITERIA	WEIGHTING				
ROADS	100	100	100	65	65
DRAINAGE	100	50	50	30	40

EMPLOYMENT LANDS		E1	E2
CRITERIA	WEIGHTING		
ROADS	100	100	70
DRAINAGE	100	50	50

DRUMLISH

HOUSING LANDS		R1	R2	R3	R4	R5	R6	R7
CRITERIA	WEIGHTING							
ROADS	100	100	100	100	100	100	80	100
DRAINAGE	100	50	50	50	50	50	80	75

EMPLOYMENT LANDS		E1
CRITERIA	WEIGHTING	
ROADS	100	100
DRAINAGE	100	80

APPENDIX D: WATER SERVICES INFRASTRUCTURAL SETTLEMENT ASSESSMENT

The following tables show the infrastructure assessment results produced by the Water Services Section of the Council, for each of the settlements and the associated zoned lands.

The assessment is presented as a number indexed out of 100 and has been based on the available capacity within the wastewater treatment network of each settlement. The assessment provides an indicative assessment given the available information as of January to March 2021.

The assessment has sought to identify the estimates of costs for servicing sites within the settlements, these costs are rough estimates and indicative only given available information at the time of the assessment and should not be used for any other purposes except for as to give an estimate of costs for servicing the sites only.

The assessment identifies specific settlements with known capacity constraints which includes the settlements of Ballymahon, Edgeworthstown, Lanesborough and Drumlish.

WASTEWATER INFRASTRUCTURE

Wastewater treatment infrastructure headroom assessment.

The following overview details the designed treatment plants in the key settlements with the PE (person equivalent) Design, the actual PE currently using the facility and the calculated PE available capacity and headroom allowing for a 10% variation. The identified headroom is therefore presented with figures highlighted in green showing available headroom, or – no capacity and constraints highlighted in red.

Infrastructure assessment

Wastewater infrastructure

		PE design	source	PE actual		PE available	% range	Headroom
							10	
1	Longford Town	20000	EPA license	15,608	PE 2020 AER	4392	2,000	2392
2	Granard	3200	EPA license	2,672	PE 2020 AER	528	320	208
3	Ballymahon	2125	EPA license	2,359	PE 2020 AER	-234	213	-447
4	Edgeworthstown	2700	EPA license	2,746	PE 2020 AER	-46	270	-316
5	Lanesborough	1600	EPA license	1,534	DBO Dec2020 report	66	160	-94
6	Aughnaccliffe	400	EPA COA	298	DBO Dec2020 report	102	40	62
7	Ballinalee	600	EPA COA	190	DBO Dec2020 report	410	60	350
8	Drumlisk	1200	EPA COA	1,082	PE 2020 AER	118	120	-2
9	Keenagh	1000	EPA COA	464	LD 2020 records	536	100	436
10	Legan	1000	EPA COA	142	LD 2020 records	858	100	758
11	Newtownforbes	1800	EPA license	930	PE 2020 AER	870	180	690
12	Abbeyshrule	300	EPA COA	87	DBO Dec2020 report	213	30	183
13	Ardagh	300	EPA COA to be applied for	17	DBO Dec2020 report	284	30	254
14	Ballinamuck	500	EPA COA	113	LD 2020 records	387	50	337
15	Clondra	600	EPA COA	206	DBO Dec2020 report	395	60	335

WASTEWATER INFRASTRUCTURE SUMMARY BY SETTLEMENT AND LANDS ZONED

The following table provides a summary of the scores for each of the settlements and the identified residential/housing lands and the employment/industrial lands.

WASTEWATER INFRASTRUCTURE REFER TO SETTLEMENT MAPS FOR ZONING LOCATION											
DOMESTIC	R1	R2	R3	R4	R5	R6	R7	R8			
LONGFORD TOWN	89	89	88	86	69	29	48	32			
GRANARD	72	72	72	68	58						
BALLYMAHON	13	48	25	38	41	40					
EDGEWORTHSTOWN	40	38	38	35							
LANESBOROUGH	46	50	38								
AUGHNACLIFFE	80	79									
BALLINALEE	82	84	76	66							
DRUMLISH	61	29	59	66	87	16	61				
KEENAGH	91	86									
LEGAN	94										
NEWTOWNFORBES	86	70	70	73	83						
ABBEYSHRULE	68	33	4								
ARDAGH	98										
BALLINAMUCK	76										
CLONDRA	20	69									
NON-DOMESTIC	E1	E2	E3	E4	E5	E6	E7	E8	E9	E10	E11
LONGFORD TOWN	31	44	54	43	39	47	45				
GRANARD	39	24	39	43	18	18	43	18		43	
BALLYMAHON		24	9	34	34	13					
EDGEWORTHSTOWN	21	29	28	28	28						
LANESBOROUGH	3	19									
AUGHNACLIFFE	97										
BALLINALEE	96										
DRUMLISH	24										
KEENAGH											
LEGAN											
NEWTOWNFORBES											
ABBEYSHRULE											
ARDAGH											
BALLINAMUCK											
CLONDRA											

Wastewater Cost Assessments for each settlement:

The following table(s) presented are considered (calculated) and provide a reasonable estimate for the full cost of delivery of the wastewater services and the amount is provided as a per unit cost with reference to:

- The headroom capacity in the existing network, pump stations and the wastewater treatment plant (from data currently available as of March 2021).
- Distance to the connection point on the existing service network.
- Potential number of units (housing or commercial (wet or dry)).

For each of the main settlement areas, including Longford Town, Granard, Ballymahon, Edgeworthstown and Lanesborough a detailed cost assessment has been undertaken for the zoned lands (residential or employment); for each zoning a percentage score has been assigned. The percentage score is used to identify the approximate cost for the required wastewater infrastructure upgrade for each area.

- Residential lands sites at 100% = low cost estimated at €4,000 per unit, which ranges to 0% = a high cost at €16,000. Certain zoned lands may be assigned an expensive cost, where the amount is determined to be far greater than €16,000.
- Employment lands sites scored at 100% are considered low cost estimated at €4,000, which ranges to 0% and considered a high cost at €100,000. Certain zoned lands may be assigned an expensive cost, where the amount is determined to be far greater than €100,000.

In all circumstances the figures are identified as broad estimates of potential costs. For any potential development a detailed assessment of available services and estimated costs should be undertaken by the Developer and in consultation with Irish Water in respect of wastewater and water supply, prior to any potential development and at pre-application.

LONGFORD TOWN:

		LONGFORD TOWN									
		Longford D0060									
Residential lands	R1	R2	R3	R4	R5			Residential lands			
good %		96	96	93	93	63			100%	4,000	
network	30m road new 100m upgrade	50m road new 100 upgrade	380 green 380 upgrade	200 green 200 upgrade	580 green 580 upgrade	PS possible			0%	16,000	
SPS		0	0	0	0	300			expensive	>16,000	
WWTP		0	0	0	0	0					
Employment lands	E1	E2	E3	E4	E5	E6			Employment lands		
ready %		30	51	50	31	34	41			100%	4,000
network	400 m green	no public road connect	200m road upgrade	connect 1/2 only	200m upgrade road PS 500 rising	280m road			0%	100,000	
SPS	PS 400rising WWTP UPGRADE 300m		0	0	PS 300 rising N4		0			expensive	>100,000
WWTP	main upgrade		0	0	0	0	0				

GRANARD

		Granard D0187												
Residential lands		R1	R2	R3	R4	R5								
good %			50	51	52	48	45							
network	50m upgrade road		30m road new	10m road new	60m road new	80m road new								
SPS			0	0	0	0	0							
WWTP	wwtp upgrade 200m upgrade green			0	0	0	0							
Employment lands		E1	E2	E3	E4	E5	E6	E7	E8	E9	E10	E11		
ready %			30	18	29	30	20	6	30	expensive	27	31	26	
network	connect 1/2		300m new road	60m road new	road crossing	connect 1/2 only	300 upgrade network	connect	300 upgrade network	400 upgrade network	connect	400 upgrade network		
SPS			0 SPS 300 rising									0 PS 800 rising		
WWTP	wwtp upgrade 200m upgrade green			0								0	0	



BALLYMAHON

	Ballymahon D0096								
Residential lands	R1	R2	R3	R4	R5	R6	R7	R8	
good %	expensive		15 expensive		7	8	13	12	10
network	75m network upgrade 75m new road		200m net upgrade, 350 0 new road athlone PS		180m new 0 road		60m new 0 road	next to R6	
SPS	new pump station /900 gravity wwtp upgrade 150m network upgrade		250m new 0 road	auburn upgrade		ballymulvey 0 upgrade		ballymulvey upgrade 30m 0 green	
WWTP			0	0	0	0	0	0	0
Employment lands	E1	E2	E3	E4	E5	E6			
ready %		1	2 expensive		8	8	7		
network	350m new road	200m new road new +upgrade athlone rd	new 750 +upgrade athlone rd	0 road crossing upgrade athlone rd	no public access 100 m new green	connect			
SPS	new +upgrade athlone rd sps 300 wwtp upgrade 150m network upgrade	athlone rd sps 300	sps	sps	upgrade athlone rd sps		0		
WWTP			0	0	0	0	0	0	

EDGEWORTHSTOWN

		EDGEWORTHSTOWN Edgeworthstown D0098						
Residential lands	R1	R2	R3	R4			Residential lands	
good %		19	17	10	expensive		100%	4,000
network	45m new green	2*20m road upgrade	120m upgrade	150m upgrade			0%	16,000
SPS		0	0	0	0		expensive	>16,000
	wwtp upgrade 600m green upgrade network 100m road crossing							
WWTP			0	0	0			
Employment lands	E1	E2	E3	E4	E5	Employment lands		
ready %		11	20	21	21	21	100%	4,000
network		0	0	0	0	0	0%	100,000
SPS		0	0	0	0	0	expensive >100,000	
	wwtp upgrade 600m green upgrade network 750 road crossing							
WWTP			0	0	0	0		

LANESBOROUGH

	LANESBORO		Ballyleague D0220	
Residential lands	R1	R2	R3	
good %		20	20	14
network	250m network upgrade	70m reroute upgrade	120m upgrade	
SPS		0	0	0
WWTP	wwtp upgrade 750m network upgrade		0	0
Employment lands	E1	E2		
ready %		3	27	
network	new ps required stream	100 new road		
SPS	new ps required ESB		0	
WWTP	wwtp upgrade 750m network upgrade		0	

Residential lands	
100%	4,000
0%	16,000
expensive	>16,000

Employment lands	
100%	4,000
0%	100,000
expensive	>100,000

BALLYMAHON – DETAILED ASSESSMENT RESIDENTIAL LANDS:

INFRASTRUCTURE ASSESSMENT		25/ha	67000	34090	20660	22590	26880		
Settlement	BALLYMAHON	43970	5940	47740	19010	20290	32960		
Water supply zone	Abbeyshrule 3 MI/day	13,333							
Agglomeration	Ballymahon D0096	4.397	0.594	4.774	1.901	2.029	3.296		
Residential lands		R1	R2	R3	R4	R5	R6	R7	R8
Wastewater	headroom	- 447	13	48	25	38	41	40	
Employment lands		E1	E2	E3	E4	E5	E6	E7	E8
Wastewater		#DIV/0!	24	9	34	34	13		
See Zoning Maps for reference number			6.7	3.409	2.066	2.259	2.688		
Report, detailing the estimated cost at draft plan stage									

RESIDENTIAL LANDS				R1	R2	R3	R4	R5	R6	R7	R8
Required services	150	network	150m network upgrade			200m net upgrade, 350 new road		180m new road		60m new road	next to R6
		SPS	new pump station /900 gravity			athlone PS upgrade, 250m new road	auburn upgrade		ballymulvey upgrade		ballymulvey upgrade 30m green
		WWTP		wwtp upgrade 150m network upgrade 1/2 road							
CONNECTION	3929			353610	58935	392900	157160	157160	216095	0	0
extra on connection	442	IW		0	0	0	0	0	0	0	0
NETWORK				49191.176	1323.5294	238823.53	39529.412	39529.412	4852.9412	12000	3000
Network upgrade	350	roads section		75		200					
Network new road	200			75		350		180		60	
150 Network upgrade green	200			39.705882	6.6176471	44.117647	17.647059	17.647059	24.264706	0	0
Network new green	100										30
PUMP				337500	0	52000	49500	0	52000	0	0
SCADA	14000	bs Tobin reports				1	1		1		1
valve chamber	4000					1	1		1		
variable speed	12500					1	1		1		
benching	2500					1	1		1		1
Atex pump replace	13000					1	1		1		
discharge +vent	3500					1	1		1		
recertification electric	2500					1			1		1
rising main	250		350								
Pump Station new	250000	urn quotes 2	1								
WWTP upgrade per 100	1.4	2100000		555882	92647	617647	247059	247059	339706	0	0
	2.7	2100000	918	243	40.5	270	108	108	148.5	0	0
NETWORK+SPS+WWTP	sum total	4279110		1,296,184	152,906	1,301,371	457,248	443,748	612,654	12,000	3,000
size land parcel estimate	g water DMA m2			310*270/2	71*56	357*110	154*133	189*104	206*136	242*102/2	170*94
housing density estimate	Dammit repo number			102	8	72	70	32	70	30	30
	25 dwellings/ha m2			43970	5940	47740	19010	20290	32960	12342	15980
	=(13+10+6+6)*8*(1+(15green+5schif pump			42370	5940	46140	17410	20290	31360	12342	15980
	406 m2/ dwelling			108	15	118	47	50	81	30	39
	1095.12 m2/ dwelling			40	5	44	17	19	30	11	15
	=(11+8+11+6)*(6+14+6)*(1+(15 road 2/3 1/3 spl			66	12	93	37	39	64	24	31
	9 dwellings/ha 50:50 split			74	10	81	32	34	56	21	27
340	added dwelling PE	918	chosen nu	90	15	100	40	40	55	0	0
	cost % figure in table										
	4000 100										
	8000 67		-121								
	12000 33		-118								
	16000 0		-121								
	Costs per unit			14,402	10,194	13,014	11,431	11,094	11,139		
	Score to table			13	48	25	38	41	40		
	=-Deficit/+headroom	- 1,365		Plant needs upgrade							

BALLYMAHON – DETAILED ASSESSMENT EMPLOYMENT LANDS:

EMPLOYMENT LANDS			E1	E2	E3	E4	E5	E6
Required services	150	network	350m new road	200m new road		road crossing	no public access 1	connect
		SPS	new +upgrade athlone rd sps 300	new +upgrade athlone rd sps 300	new 750 +upgrade athlone rd sps	upgrade athlone rd sps	upgrade athlone rd sps	upgrade moygh rd sps
		WWTP	wwtp upgrade 150m network upgrade 1/2 road					
CONNECTION	3929		0	78580	39290	23574	27503	31432
extra on connection	442		0	0	0	0	0	0
NETWORK			7000	51764.706	5882.3529	3529.4118	14117.647	4705.8824
Network upgrade	350							
Network new road	200		350	200				
150 Network upgrade green	200		0	58.823529	29.411765	17.647059	20.588235	23.529412
Network new green	100						100	
PUMP			494500	507000	582000	42000	42000	402000
SCADA	14000		1	1	1	1	1	1
valve chamber	4000		1	1	1			1
variable speed	12500		1	1	1	1	1	1
benching	2500		1	1	1			1
Atex pump replace	13000		1	1	1	1	1	1
discharge +vent	3500		1	1	1			1
recertification electric	2500		1	1	1	1	1	1
rising main	250		770	820	1120			400
Pump Station new	250000		1	1	1			1
WWTP upgrade per 100	0.6	9000000	0	352941	176471	105882	123529	141176
10	9000000	510	0	200	100	60	70	80
NETWORK+SPS+WWTP	sum total	3319879	564500	990,286	803,643	174,986	207,150	579,314
size land parcel estimated		m2	224*300	103*330+15	166*240/2	230*80	230*90	90*250
trade density estimated	Number	number	15	4	50	8	20	6
5	trades/ha	m2	67200	67000	34090	20660	22590	26880
=(45)*30*(1+(15green	trades/ha	if pump	65600	65400	32490	19060	20990	25280
2025			33	33	17	10	11	13
10385	m2/ trade		6	6	3	2	2	3
=(100)*67*(1+(15 green	m2/ trade	2/3 1/3 spl	24	24	12	7	8	10
1	trades/ha	50:50 split	20	20	10	6	7	8
51 added PE trade	510	chosen nu	0	20	10	6	7	8
cost % figure in table								
4000	100							
8000	67	-121						
30000	33	-647						
100000	0	-2121						
Costs per unit			#DIV/0!	49,514	80,364	29,164	29,593	72,414
Score to table			#DIV/0!	24	9	34	34	13
added PE total	1428							
=-Deficit/+headroom	- 1,875		Plant needs upgrade					

EDGEWORTHSTOWN – DETAILED ASSESSMENT RESIDENTIAL LANDS:

INFRASTRUCTURE ASSESSMENT		333160	3690	54660	114060	33850
Settlement	EDGEWORTHSTOWN	81320	22350	15880	5680	
Water supply zone	Lough Forbes / Abbeyshrule	13,333				
Agglomeration	Edgeworthstown D0098	8.132	2.235	1.588	0.568	
Residential lands		R1	R2	R3	R4	
Wastewater	headroom - 316	40	38	38	35	
Employment lands		E1	E2	E3	E4	E5
Wastewater		21	29	28	28	28
See Zoning Maps for reference number						
Report, detailing the estimated cost at draft plan stage						

RESIDENTIAL LANDS			R1	R2	R3	R4	
Required services	775	network	45m new green	2*20m road upgrade	120m upgrade	120m upgrade	reroute upgrade
		SPS					
		WWTP	wwtp upgrade 600m green upgrade network 20m road crossing				
CONNECTION	3929		550060	157160	117870	39290	0
extra on connection	442	IW	0	0	0	0	0
NETWORK			67204.545	27272.727	18954.545	10318.182	0
Network upgrade	250	roads section	12.727273	3.6363636	2.7272727	0.9090909	
Network new road	200			50			
600 Network upgrade green	150		381.81818	109.09091	81.818182	27.272727	
Network new green	100		67.5		60	60	
PUMP			0	0	0	0	0
		Jacobs Tobin reports					
SCADA	14000						
valve chamber	4000						
variable speed	12500						
benching	2500						
Atex pump replace	13000						
discharge +vent	3500						
recertification electric	2500						
rising main	250						
Pump Station new	250000	iburn quotes 2019					
WWTP upgrade per 100	1	1500000	954545	272727	204545	68182	0
	2.7	1500000	594	378	108	81	27
NETWORK+SPS+WWTP		sum total	2488130	1,571,810	457,160	341,370	117,790
size land parcel estimating water DMA fit	m2		512*175+280*	192*134	139*134	71*62	
housing density estimate Dammit report	number		160	45	30	10	
23 dwellings/ha	m2		81320	22350	15880	5680	
=(11+10+11+6)*8*(1+(15green+5school if pump			81320	22350	15880	5680	0
440.8 m2/ dwelling			184	51	36	13	0
2046.33 m2/ dwelling			40	11	8	3	0
=(23+9+15+6)*(9+19+5)*(1+(15 road+1 2/3 1/3 split			136	37	27	10	0
5 dwellings/ha	50:50 split		112	31	22	8	0
220 added dwelling PE	594	chosen numk	140	40	30	10	0
cost % figure in table							
4000 100							
8000 67		-121					
12000 33		-118					
16000 0		-121					
Costs per unit			11,227	11,429	11,379	11,779	#DIV/0!
Score to table			40	38	38	35	#DIV/0!
=-Deficit/+headroom	- 910						Plant needs upgrade

EDGEWORTHSTOWN – DETAILED ASSESSMENT EMPLOYMENT LANDS:

EMPLOYMENT LANDS			E1	E2	E3	E4	E5
Required services	600	network					
	750	SPS	newPS				
		WWTP	wwtp upgrade 600m green upgrade network 750 road crossing				
CONNECTION	3929		196450	3929	39290	78580	19645
extra on connection	442		0	0	0	0	0
NETWORK			375000	7500	96802.326	193604.65	48401.16
750 Network upgrade	750		436.04651	8.7209302	87.209302	174.4186	43.60465
Network new road	200		-545.058	-10.9012			
600 Network upgrade green	450		348.83721	6.9767442	69.767442	139.53488	34.88372
Network new green	100						
PUMP			875000	0	0	0	0
SCADA	14000						
valve chamber	4000						
variable speed	12500						
benching	2500						
Atex pump replace	13000						
discharge +vent	3500						
recertification electric	2500						
rising main	250		2500				
Pump Station new	250000		1				
WWTP upgrade per 100	1.5	2500000	1308140	26163	261628	523256	130814
10	2250000	860	500	10	100	200	50
NETWORK+SPS+WWTP sum total		4184202.1	2754589.5	37,592	397,720	795,440	198,860
size land parcel estimating water DMA fit		m2	657*400	52*62	344*162	277*377	111*83+148*171
trade density estimated Dammit report		number		42	1	10	20
	2	trades/ha		333160	3690	54660	114060
		m2		331560	3690	54660	114060
=(45)*65*(1+(15green+20 parking+15rc if pump				76	1	12	26
4387.5		m2/ trade		6	0	1	2
51770		m2/ trade		53	1	9	18
=(200)*167*(1+(15 green+25 parking+12/3 1/3 split				41	0	7	14
0		trades/ha		50:50 split			
86 added PE trade	860	chosen numk	50	1	10	20	5
cost % figure in table							
4000	100						
8000	67	-121					
30000	33	-647					
100000	0	-2121					
Costs per unit			55,092	37,592	39,772	39,772	39,772
Score to table			21	29	28	28	28
added PE total	1454						
=-Deficit/+headroom	- 1,770						
							Plant needs upgrade

GRANARD – DETAILED ASSESSMENT RESIDENTIAL LANDS

INFRASTRUCTURE ASSESSMENT			64260	38620	11510	41240	17300							
Settlement	GRANARD		24020	13420	7300	7730	6330							
Water supply zone	Lough Kinale	1 MI/day	31,111											
Agglomeration	Granard D0187		2.402	1.342	0.73	773	0.633							
Residential lands			R1	R2	R3	R4	R5							
Wastewater	headroom	208	72	72	72	68	58							
Employment lands			E1	E2	E3	E4	E5	E6	E7	E8	E9	E10	E11	
Wastewater			39	24	39	43	18	18	43	18	#DIV/0!	43	#DIV/0!	
See Zoning Maps for reference number report, detailing the estimated cost at draft plan stage														

RESIDENTIAL LANDS			R1	R2	R3	R4	R5
description required ser	200	network	140 up	190 up	50 up	190 up	
		SPS					abbeylara rd up
		WWTP					
CONNECTION	3929		314320	196450	98225	98225	78580
extra on connection	442	IW	0	0	0	0	0
NETWORK			35000	23750	12500	23750	0
Network upgrade	250	roads section	140	95	50	95	
Network new road	200						
Network upgrade green	150						
Network new green	100						
PUMP			0	0	0	0	42000
		Jacobs Tobin reports					
SCADA	14000						1
valve chamber	4000						
variable speed	12500						1
benching	2500						
Atex pump replace	13000						1
discharge +vent	3500						
recertification electric	2500						1
rising main	250						
Pump Station new	250000	burn quotes 2019					
WWTP upgrade per 100	0.4	600000	240000	150000	75000	75000	60000
	2.7	600000	540	216	135	67.5	67.5
NETWORK+SPS+WWTP sum total		1522800	589,320	370,200	185,725	196,975	180,580
size land parcel estimating water DMA 1m2			266*191/2	113*113	53*155	85*78	61*93
housing density estimation Dammit report number			75	40	3	20	20
46 dwellings/ha m2			24020	13420	7300	7730	6330
=(11+8+6)*(7.5)*(1+(15 road+1 school) if pump			24020	13420	7300	7730	4730
219.375 m2/ dwelling			109	61	33	35	29
371.2 m2/ dwelling			65	36	20	21	17
=(12+11+9)*8*(1+(15green+5school+2/3 1/3 split			95	53	29	30	25
27 dwellings/ha 50:50 split			87	49	20	28	23
200 added dwelling PE	540	chosen num	80	50	25	25	20
cost % figure in table							
4000	100						
8000	67	-121					
12000	33	-118					
16000	0	-121					
Costs per unit			7,367	7,404	7,429	7,879	9,029
Score to table			72	72	72	68	58
=-Deficit/+headroom	-	332					
							Plant needs upgrade

LANESBOROUGH – DETAILED ASSESSMENT RESIDENTIAL LANDS:

INFRASTRUCTURE ASSESSMENT			404000	11140		
Settlement	LANESBOROUGH		36420	18610	7010	4460
Water supply zone	Lanesboro 2 2 MI/day		4444			
Agglomeration	Ballyleague D0220		3642	1861	0.701	0.446
Residential lands			R1	R2	R3	R4
Wastewater	headroom	- 94	46	50	38	16
Employment lands			E1	E2	E3	E4
Wastewater			3	19		
See Zoning Maps for reference number report, detailing the estimated cost at draft plan stage						

RESIDENTIAL LANDS			R1	R2	R3	R4
description required serv	750	network	250m network upgrade	70m reroute upgrade	120m upgrade	110+60m upgrade
		SPS				new PS
		WWTP	wwtp upgrade 750m network upgrade			
CONNECTION	3929		235,740	117,870	58,935	19645
extra on connection	442	IW	0	0	0	0
NETWORK			62,500	17,500	30,000	42500
Network upgrade	250	roads section	250	70	120	170
Network new road	200					
Network upgrade green	150					
Network new green	100					
PUMP			0	0	0	0
SCADA	14000	bs Tobin reports				
valve chamber	4000					
variable speed	12500					
benching	2500					
Atex pump replace	13000					
discharge +vent	3500					
recertification electric	2500					
rising main	250					
Pump Station new	250000	urn quotes 2019				
WWTP upgrade per 100	0.4	580827	327,273	163,636	81,818	8100
Water DI	2.7	600000	297	162	81	40.5
Commit re		NETWORK+SPS+WWTP sum total	1165517	625,513	299,006	170,753
size land parcel estimated		m2	512*175+281	192*134	139*134	
housing density estimated		number	160	45	30	
	25	dwellings/ha	36420	18610	7010	4460
	=+(13+10+6+6)*8*(1+(15green+5sch if pump		36420	18610	7010	4460
	406	m2/ dwelling	83	42	16	10
	1095.12	m2/ dwelling	18	9	3	2
	=+(11+8+11+6)*(6+14+6)*(1+(15 road 2/3 - 1/3 spl		61	31	12	7
	5	dwellings/ha	50	26	10	6
110	added dwelling PE	297	chosen nu	60	30	15
	cost % figure in table					
	4000	100				
	8000	67	-121			
	12000	33	-118			
	16000	0	-121			
	Costs per unit		10,425	9,967	11,384	14,049
	Score to table		46	50	38	16
	=-Deficit/+headroom	- 391				
			Plant needs upgrade			

LANESBOROUGH – DETAILED ASSESSMENT EMPLOYMENT LANDS:

EMPLOYMENT LANDS			E1	E2	
Required services	750	network	new ps required street	100 new road	
		SPS	new ps required ESB		
		WWTP	wwtp upgrade 750m network upgrade		
CONNECTION	3929		58,935	3,929	
extra on connection	442		0	0	
NETWORK			-	-	
Network upgrade	250				
Network new road	200				
0 Network upgrade green	150				
Network new green	100				
PUMP			500,000	0	
SCADA	14000				
valve chamber	4000				
variable speed	12500				
benching	2500				
Atex pump replace	13000				
discharge +vent	3500				
recertification electric	2500				
rising main	250		1000		
Pump Station new	250000		1		
WWTP upgrade per 100	0.6	900000	843750	56250	
10	900000	160	150	10	
NETWORK+SPS+WWTP sum total	1462864	1,402,685	60,179		
size land parcel estimated	m2		580*180+43(209*77/2		
trade density estimated	Number	number	42	1	
6 trades/ha	m2		404400	11140	
=(35)*30*(1+(15green	trades/ha	if pump	402800	11140	
1575			257	7	
57427.5	m2/ trade		7	0	
=(90)*95*(1+(15 green	m2/ trade	2/3 1/3 spl	174	5	
0 trades/ha		50:50 split	132	4	
16 added PE trade	160	chosen nu	15	1	
cost % figure in table					
4000	100				
8000	67	-121			
30000	33	-647			
100000	0	-2121			
Costs per unit			93,512	60,179	
Score to table			3	19	
added PE total	457				
=-Deficit/+headroom	- 551			Plant needs upgrade	

AUGHNACLIFFE – DETAILED ASSESSMENT RESIDENTIAL LANDS:

INFRASTRUCTURE ASSESSMENT			2570			
Settlement	AUGHNACLIFFE		6060	23480		
Water supply zone	Smear	1 MI/day	4444			
Agglomeration	Aughnaclyffe A0535		0.606	2.348		
Residential lands			R1	R2	R3	R4
Wastewater	headroom	62	80	79	#DIV/0!	#DIV/0!
Employment lands			E1	E2	E3	E4
Wastewater			97	#DIV/0!		
See Zoning Maps for reference number report, detailing the estimated cost at draft plan stage						

RESIDENTIAL LANDS			R1	R2		
description required services	network	40m up	160m upgrade			
	SPS					
	WWTP					
CONNECTION	3929		15,716	58,935		
extra on connection	442	IW	0	0	0	
NETWORK			10,000	40,000		
Network upgrade	250	roads section	40	160		
Network new road	200					
Network upgrade green	150					
Network new green	100					
PUMP			0	0	0	
SCADA	14000	bs Tobin reports				
valve chamber	4000					
variable speed	12500					
benching	2500					
Atex pump replace	13000					
discharge +vent	3500					
recertification electric	2500					
rising main	250					
Pump Station new	250000	urn quotes 2019				
WWTP upgrade per 100	0	0	-	-		
Water D	2.7	0	51	10.8	40.5	
mit re	NETWORK+SPS+WWTP	sum total	124651	25,716	98,935	
size land parcel estimated	m2		107*43	128*100		
housing density estimated	number		10	28		
	23 dwellings/ha	m2	6060	23480		
=(11+10+11+6)*8*(1+(15green+5scif pump			6060	23480		
440.8	m2/ dwelling		14	53		
2046.33	m2/ dwelling		3	11		
=(23+9+15+6)*(9+19+5)*(1+(15 roa2/3 1/3 spl			10	39		
5 dwellings/ha	50:50 split		8	32		
19	added dwelling PE	51	chosen nl	4	15	
	cost % figure in table		half	half		
	4000	100				
	8000	67	-121			
	12000	33	-118			
	16000	0	-121			
	Costs per unit		6,429	6,596	#DIV/0!	#DIV/0!
	Score to table		80	79	#DIV/0!	#DIV/0!
	=-Deficit/+headroom	11				Plant needs upgrade

AUGHNACLIFFE – DETAILED ASSESSMENT EMPLOYMENT LANDS:

EMPLOYMENT LANDS			E1			
Required services		network	road crossing	100 new road		
		SPS				
		WWTP				
CONNECTION	3929			4,371		
extra on connection	442			1		
NETWORK				0		
Network upgrade	250					
Network new road	200					
0 Network upgrade green	150					
Network new green	100					
PUMP				0		
SCADA	14000					
valve chamber	4000					
variable speed	12500					
benching	2500					
Atex pump replace	13000					
discharge +vent	3500					
recertification electric	2500					
rising main	250					
Pump Station new	250000					
WWTP upgrade per 100	0	0		0		
	10	0	10	10		
NETWORK+SPS+WWTP sum total		4371		4,371		-
size land parcel estimated		m2		36*62		
trade density estimated	Number	number		1		
	6 trades/ha	m2		2570		
=(35)*30*(1+(15green	trades/ha	if pump		2570		
1575				2		
57427.5	m2/ trade			0		
=(90)*95*(1+(15 green	m2/ trade	2/3 1/3 spl		1		
0	trades/ha	50:50 split		1		
1 added PE trade	10	chosen nu		1		
cost % figure in table						
	4000	100				
	8000	67	-121			
	30000	33	-647			
	100000	0	-2121			
Costs per unit				4,371	#DIV/0!	#DIV/0!
Score to table				97	#DIV/0!	#DIV/0!
added PE total	61					
=-Deficit/+headroom	1					Plant needs upgrade

BALLINALEE – DETAILED ASSESSMENT EMPLOYMENT LANDS:

EMPLOYMENT LANDS			E1			
Required services	750	network	new ps required street	100	new road	
		SPS	new ps required ESB			
		WWTP	wwtp upgrade	750m	network upgrade	
CONNECTION	3929			8,742		
extra on connection	442			2		
NETWORK				0		
Network upgrade	250					
Network new road	200					
0 Network upgrade green	150					
Network new green	100					
PUMP				0		
SCADA	14000					
valve chamber	4000					
variable speed	12500					
benching	2500					
Atex pump replace	13000					
discharge +vent	3500					
recertification electric	2500					
rising main	250					
Pump Station new	250000					
WWTP upgrade per 100	0	0		843750		
	10	0	20	150		
NETWORK+SPS+WWTP sum total		8742		1,402,685		
size land parcel estimated		m2		190*45		
trade density estimated	Number	number		15		
	2 trades/ha	m2		8990		
=+(35)*30*(1+(15green	trades/ha	if pump		8990		
1575				2		
57427.5	m2/ trade			0		
=+(90)*95*(1+(15 green	m2/ trade	2/3 1/3 spl		1		
0	trades/ha	50:50 split		1		
2 added PE trade	20	chosen nu		2		
cost % figure in table						
3900	100					
8000	67	-124				
30000	33	-647				
100000	0	-2121				
Costs per unit				4,371	#DIV/0!	#DIV/0!
Score to table				96	#DIV/0!	#DIV/0!
added PE total	250					
=-Deficit/+headroom	100					Plant needs upgrade

DRUMLISH – DETAILED ASSESSMENT RESIDENTIAL LANDS:

INFRASTRUCTURE ASSESSMENT			58840	11140					
Settlement	DRUMLISH		15490	3130	10300	3890	7140	19600	2750
Water supply zone	Lough Forbes	7 MI/day	31111						
Agglomeration	Drumlish D0489		1.549	0.313	1.03	0.389	0.714	1.96	0.275
Residential lands			R1	R2	R3	R4	R5	R6	R7
Wastewater	headroom	- 2	61	29	59	66	87	16	61
Employment lands			E1	E2	E3	E4	E5	E6	E7
Wastewater			24	#DIV/0!					
See Zoning Maps for reference number			5.884						
report, detailing the estimated cost at draft plan stage									

RESIDENTIAL LANDS			R1	R2	R3	R4	R5	R6	R7	
Required services	network		90road upgrade	140m road upgrade	90m road upgrade	110+60m upgrade			40m road upgrade	
Residential lands	SPS					new PS		Barrow upgrade /350m		
	WWTP		Capacity Upgrade wwtp							
CONNECTION		3929	137,515	31,432	98,225	39290	58935	176805	27503	
extra on connection	IW	442	0	0	0	0	0	0	0	
NETWORK			22,500	35,000	22,500	0	0	35000	22500	
Network upgrade	roads section	250	90	140	90	170			90	
Network new road		200								
Network upgrade green		150								
Network new green		100						350		
PUMP			0	0	0	0	0	350000	0	
SCADA	bs Tobin reports	14000								
valve chamber		4000								
variable speed		12500								
benching		2500								
Atex pump replace		13000								
discharge +vent		3500								
recertification electric		2500								
rising main		250						400		
Pump Station new	urn quotes 2019	250000						1		
WWTP upgrade per 100		0.4 431298.6	144,828	33,103	103,448	41379	24300	72900	11340	
Water D		2.7 600000	391.5	94.5	21.6	67.5	27	40.5	121.5	
mit r	NETWORK+SPS+WWTP	sum total	1488504	304,843	99,535	224,173	80669.31	83235	634705	61343
size land parcel estimated	m2		206*53	48*43	119*86	129*36	94*75	125*120	59*47	
housing density estimated	number		35	4	28	16	15	36	6	
	29 dwellings/ha	m2	15490	3130	10300	3890	7140	19600	2750	
+=(12+8+4)*10*(1+(15green+5school+10lif pump			15490	3130	10300	3890	7140	18000	2750	
348 m2/ dwelling			45	9	30	11	21	56	8	
737.1 m2/ dwelling			21	4	14	5	10	27	4	
+=(12+8+9+6)*(3+12+3)*(1+(15 road+1 sc2/3- 1/3 spl			37	7	24	9	17	46	7	
14 dwellings/ha	50:50 split		33	7	22	8	15	41	6	
145 added dwelling PE	297	chosen nt	35	8	25	10	15	45	7	
cost % figure in table										
3900	100									
8000	67	-124								
12000	33	-118								
16000	0	-121								
Costs per unit			8,710	12,442	8,967	8,067	5,549	14,105	8,763	
Score to table			61	29	59	66	87	16	61	
=-Deficit/+headroom	- 394									
			Plant needs upgrade							

DRUMLISH – DETAILED ASSESSMENT EMPLOYMENT LANDS:

EMPLOYMENT LANDS			E1						
Required services		network							
Employment Lands		SPS							
		WWTP							
CONNECTION	3929		78,580						
extra on connection	442		0						
NETWORK			0						
Network upgrade	250								
Network new road	200								
0 Network upgrade green	150								
Network new green	100								
PUMP			0						
SCADA	14000								
valve chamber	4000								
variable speed	12500								
benching	2500								
Atex pump replace	13000								
discharge +vent	3500								
recertification electric	2500								
rising main	250								
Pump Station new	250000								
WWTP upgrade per 100	0.6	900000	900000						
10	900000	200	200						
NETWORK+SPS+WWTP sum total		978580	978,580						
size land parcel estimated		m2	300*200						
trade density estimated	Number	number	15						
5 trades/ha		m2	58840						
+=(45)*30*(1+(15green		trades/ha	if pump	58840					
2025			29						
10385	m2/ trade		6						
+=(100)*67*(1+(15 gree	m2/ trade	2/3 1/3 spl	21						
1	trades/ha	50:50 split	17						
20 added PE trade	200	chosen nu	20						
cost % figure in table									
3900	100								
8000	67	-124							
30000	33	-647							
100000	0	-2121							
Costs per unit			48,929	#DIV/0!	#DIV/0!	#DIV/0!	#DIV/0!	#DIV/0!	#DIV/0!
Score to table			24	#DIV/0!	#DIV/0!	#DIV/0!	#DIV/0!	#DIV/0!	#DIV/0!
added PE total	592								
=-Deficit/+headroom	-	594							Plant needs upgrade

KEENAGH – DETAILED ASSESSMENT RESIDENTIAL LANDS:

INFRASTRUCTURE ASSESSMENT					
Settlement	KEENAGH		27990	17570	
Water supply zone	Lough Forbes	7 MI/day	31111		
Agglomeration	Ballyleague D0220		2799	1757	
Residential lands			R1	R2	R3
Wastewater	headroom	- 94	91	86	#DIV/0!
Employment lands			E1	E2	E3
Wastewater			#DIV/0!	#DIV/0!	
See Zoning Maps for reference number					
report, detailing the estimated cost at draft plan stage					

RESIDENTIAL LANDS			R1	R2	
Required services		network	Clough Dillon Upgrade	Clough Ree well upgrade	
		SPS			
		WWTP			
CONNECTION	3929		196,450	117,870	
extra on connection	442	IW	0	0	
NETWORK			0	0	
Network upgrade	250	roads section			
Network new road	200				
Network upgrade green	150				
Network new green	100				
PUMP			52000	52000	
SCADA	14000	bs Tobin rep	1	1	
valve chamber	4000		1	1	
variable speed	12500		1	1	
benching	2500		1	1	
Atex pump replace	13000		1	1	
discharge +vent	3500		1	1	
recertification electric	2500		1	1	
rising main	250				
Pump Station new	250000	urn quotes 2019			
WWTP upgrade per 100	0	0	0	0	
Water Demand	2.7	600000	216	135	81
Permit re	NETWORK+SPS+WWTP sum total		418320	248,450	169,870
size land parcel estimated		m2	130*120	250*105	
housing density estimated		number	30	25	
	29 dwellings/ha	m2	27990	17570	
=(12+8+4)*10*(1+(15green+5school+10		if pump	26390	15970	
348	m2/ dwelling		80	50	
737.1	m2/ dwelling		38	24	
=(12+8+9+6)*(3+12+3)*(1+(15 road+1 sc		2/3 1/3 spl	66	42	
14	dwellings/ha	50:50 split	59	37	
80	added dwelling PE	216	chosen nu	50	30
	cost % figure in table				
	3900	100			
	8000	67	-124		
	12000	33	-118		
	16000	0	-121		
	Costs per unit		4,969	5,662	
	Score to table		91	86	#DIV/0!
	=-Deficit/+headroom	220			Plant needs upgrade

LEGAN – DETAILED ASSESSMENT RESIDENTIAL LANDS:

INFRASTRUCTURE ASSESSMENT				
Settlement	LEGAN		16720	
Water supply zone	Abbeyshrule	3 MI/day	13333	
Agglomeration	Ballyleague D0220		1672	
Residential lands			R1	R2
Wastewater	headroom	758	94	#DIV/0!
Employment lands			E1	E2
Wastewater			#REF!	#REF!
See Zoning Maps for reference number				
Report, detailing the estimated cost at draft plan stage				

RESIDENTIAL LANDS			R1		
Required services		network	85 along 15 cross upgrade		
		SPS			
		WWTP			
CONNECTION	3929			137,515	
extra on connection	442	IW		0	
NETWORK				25,000	
Network upgrade	250	roads section		100	
Network new road	200				
Network upgrade green	150				
Network new green	100				
PUMP				0	
SCADA	14000	bs Tobin reports			
valve chamber	4000				
variable speed	12500				
benching	2500				
Atex pump replace	13000				
discharge +vent	3500				
recertification electric	2500				
rising main	250				
Pump Station new	250000	turn quotes 2019			
WWTP upgrade per 1000 PE	0	0		-	
Water DI	2.7	0	94.5	94.5	
Commit re	NETWORK+SPS+WWTP	162515	162515	162,515	
size land parcel estimated		m2		130*120	
housing density estimated		number		30	
	29 dwellings/ha	m2		16720	
=(12+8+4)*10*(1+(15green+5school+10business		if pump		16720	
	348 m2/ dwelling			48	
	737.1 m2/ dwelling			23	
=(12+8+9+6)*(3+12+3)*(1+(15 road+1 school+1		2/3 1/3 spl		40	
	14 dwellings/ha	50:50 split		35	
35	added dwelling PE	95	chosen nu	35	
	cost % figure in table				
	3900	100			
	8000	67	-124		
	12000	33	-118		
	16000	0	-121		
	Costs per unit			4,643	#DIV/0!
	Score to table			94	#DIV/0!
	=-Deficit/+headroom	664			Plant needs upgrade

NEWTOWNFORBES – DETAILED ASSESSMENT RESIDENTIAL LANDS:

INFRASTRUCTURE ASSESSMENT							
Settlement	NEWTOWNFORBES		23010	1940	3490	4470	7720
Water supply zone	Lough Forbes	7 MI/day	31111				
Agglomeration	Newtownforbes		2.301	0.194	0.349	0.447	0.772
Residential lands			R1	R2	R3	R4	R5
Wastewater	headroom	690	86	70	70	73	83
Employment lands			E1	E2	E3	E4	E5
Wastewater			#REF!	#REF!			
See Zoning Maps for reference number							
Report, detailing the estimated cost at draft plan stage							

RESIDENTIAL LANDS			R1	R2	R3	R4	R5	
Required services		network	180m new road	60m road	50 new	50 upgrade	80m reroute	
		SPS				Cluain doire	upgrade	
		WWTP						
CONNECTION	3929		157,160	117,870	58,935	19645	0	
extra on connection	442	IW	0	0	0	0	0	
NETWORK			66,000	17,500	30,000	42500	0	
Network upgrade	250	roads section	120	60	50		80	
Network new road	200		180		50			
80 Network upgrade green	150						80	
Network new green	100							
PUMP			0	0	0	26500	0	
SCADA	14000	bs Tobin reports					1	
valve chamber	4000						1	
variable speed	12500							
benching	2500						1	
Atex pump replace	13000							
discharge +vent	3500						1	
recertification electric	2500						1	
rising main	250							
Pump Station new	250000	urn quotes 2019						
WWTP upgrade per 100	0	0	0	0	0	0	0	
Water D	2.7	0	197.1	108	10.8	16.2	21.6	40.5
mit re	NETWORK+SPS+WWTP sum total		448817	223,160	30,716	46,071	57932	90935
size land parcel estimated	m2		193*120	58*33	80*39	135*32	200*46+93*33	
housing density estimated	number		60	45	30			
32 dwellings/ha	m2		23010	1940	3490	4470	7720	
=(11+10+4+6)*7*(1+(15green+5school+1	if pump		23010	1940	3490	2870	7720	
315 m2/ dwelling			73	6	11	14	25	
1832 m2/ dwelling			13	1	2	2	4	
=(15+4+8+6+15+6)*(4+13+6+8)*(1+(15rc	2/3 1/3 spl		53	4	8	10	18	
5 dwellings/ha	50:50 split		43	4	6	8	4	
73 added dwelling PE	197	chosen nu	40	4	6	8	15	
cost % figure in table								
3900 100								
8000 67		-124						
12000 33		-118						
16000 0		-121						
Costs per unit			5,579	7,679	7,679	7,242	6,062	
Score to table			86	70	70	73	83	
=-Deficit/+headroom	493						Plant needs upgrade	

ABBEYSHRULE – DETAILED ASSESSMENT RESIDENTIAL LANDS:

INFRASTRUCTURE ASSESSMENT					
Settlement	ABBEYSHRULE		3230	5910	2910
Water supply zone	Ballymahon	3 MI/day	31111		
Agglomeration	Abbeysrule		2.301	0.194	0.349
Residential lands			R1	R2	R3
Wastewater	headroom	183	68	33	4
Employment lands			E1	E2	E3
Wastewater			#REF!	#REF!	
See Zoning Maps for reference number					
Report, detailing the estimated cost at draft plan stage					
RESIDENTIAL LANDS			R1	R2	R3
Required services		network	75m new	260m new	140m new
		SPS		PS Upgrade	PS Upgrade
		WWTP			
CONNECTION	3929		19,645	39,290	19,645
extra on connection	442	IW	0	0	0
NETWORK			20,000	65,000	50,000
Network upgrade	250	oads section	80	260	200
Network new road	200				
Network upgrade green	150				
Network new green	100				
PUMP			0	16000	8000
SCADA	14000	bs Tobin reports		0.667	0.333
valve chamber	4000			0.667	0.333
variable speed	12500				
benching	2500				
Atex pump replace	13000				
discharge +vent	3500			0.667	0.333
recertification electric	2500			0.667	0.333
rising main	250				
Pump Station new	250000	urn quotes 2019			
WWTP upgrade per 100	0	0	0	0	0
Water D	2.7	0	54	13.5	27
mit re					
NETWORK+SPS+WWTP sum total		237580	39,645	120,290	77,645
size land parcel estimated		m2	86*76	152*108	215*91
housing density estimated		number	20	15	25
23 dwellings/ha		m2	3230	5910	2910
=(11+10+11+6)*8*(1+15green+5school+if pump			3230	4310	1310
440.8 m2/ dwelling			7	13	7
2046.33 m2/ dwelling			2	3	1
=(23+9+15+6)*(9+19+5)*(1+(15 road+1 s 2/3 1/3 spl			5	10	5
5 dwellings/ha		50:50 split	4	8	4
20 added dwelling PE	54	chosen nu	5	10	5
cost % figure in table					
3900 100					
8000 67		-124			
12000 33		-118			
16000 0		-121			
Costs per unit			7,929	12,029	15,529
Score to table			68	33	4
=-Deficit/+headroom	129				Plant needs upgrade

APPENDIX E – SETTLEMENT ASSESSMENTS & MAPPING

The following maps show the lands zoned and include a table providing the combined assessment and appropriate tiering and colour coding of the zoned sites in each of the settlements.

The assessment has sought to combine the assessments that have been undertaken from Water Services in respect of wastewater treatment and Roads Section in respect of the roading infrastructure and identified areas of drainage and flooding.

The assessment identifies the lands according to a colour coding using a simplified traffic light system. The assessments have combined the previous into a combined overview for the settlement. The sites are coded as follows:

LAND ZONING CODING		
Score	Tier	Colour
100-67	1	Green
66-34	2	Yellow
33-0	No Development	Red

Longford Town Infrastructural Assessment- Further Iteration

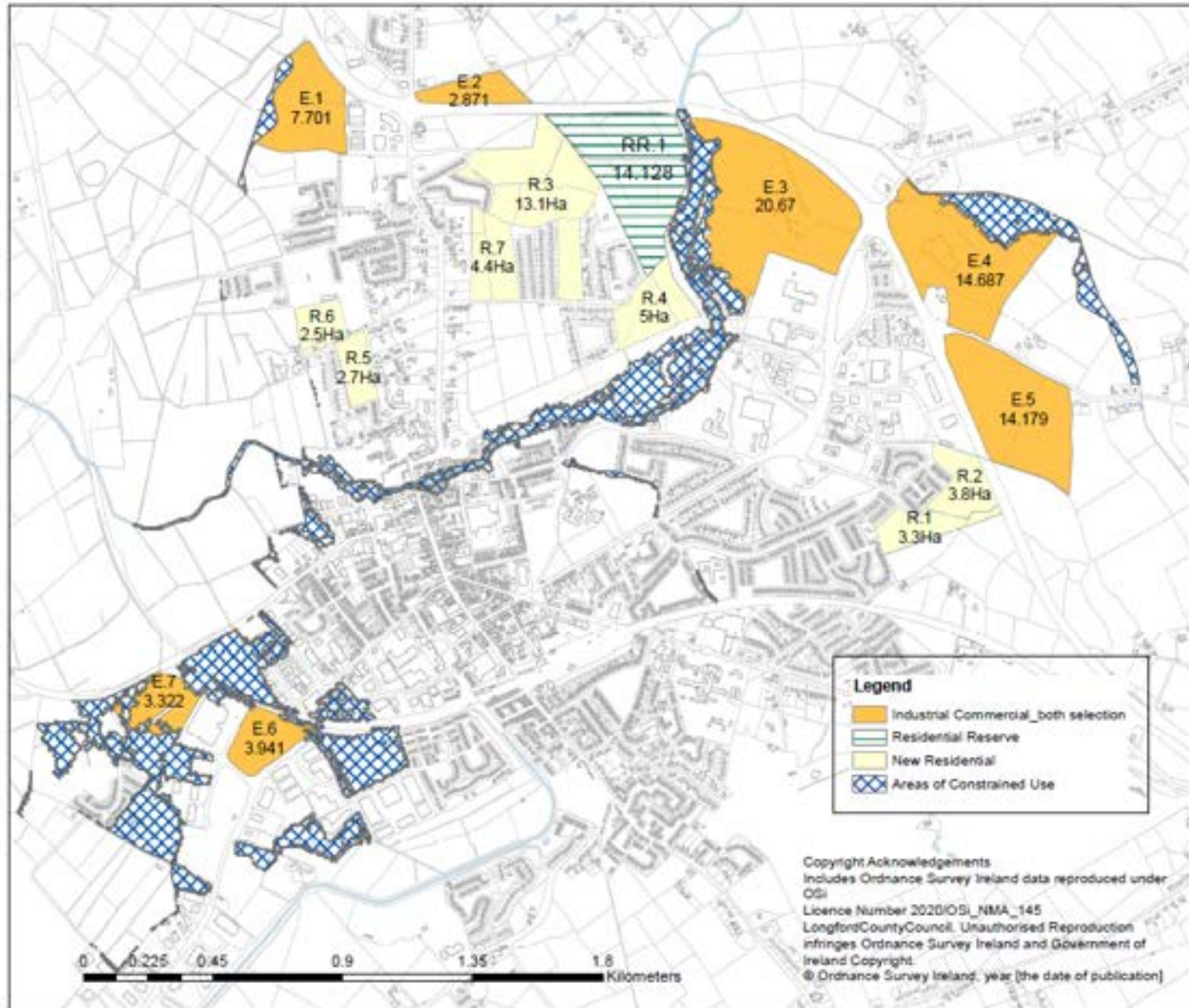

Residential Zonings	Tier-1—Green	Tier-2—Amber	No-Development—Red
R1	■	■	■
R2	■	■	■
R3	■	■	■
R4	■	■	■
R5	■	■	■
R6	■	■	■
R7	■	■	■
RR1	■	■	■

Employment Zonings	Tier-1—Green	Tier-2—Amber	No-Development—Red
E1	■	■	■
E2	■	■	■
E3	■	■	■
E4	■	■	■
E5	■	■	■
E6	■	■	■
E7	■	■	■



Copyright Acknowledgements
 Includes Ordnance Survey Ireland data reproduced under OSI
 Licence Number 2020/OSI_NMA_145 LongfordCountyCouncil. Unauthorised Reproduction
 infringes Ordnance Survey Ireland and Government of Ireland Copyright.
 © Ordnance Survey Ireland, year 2021

Legend

- Industrial/Commercial/Warehousing
- New Residential
- Strategic Industrial Reserve
- Areas of Constrained Use

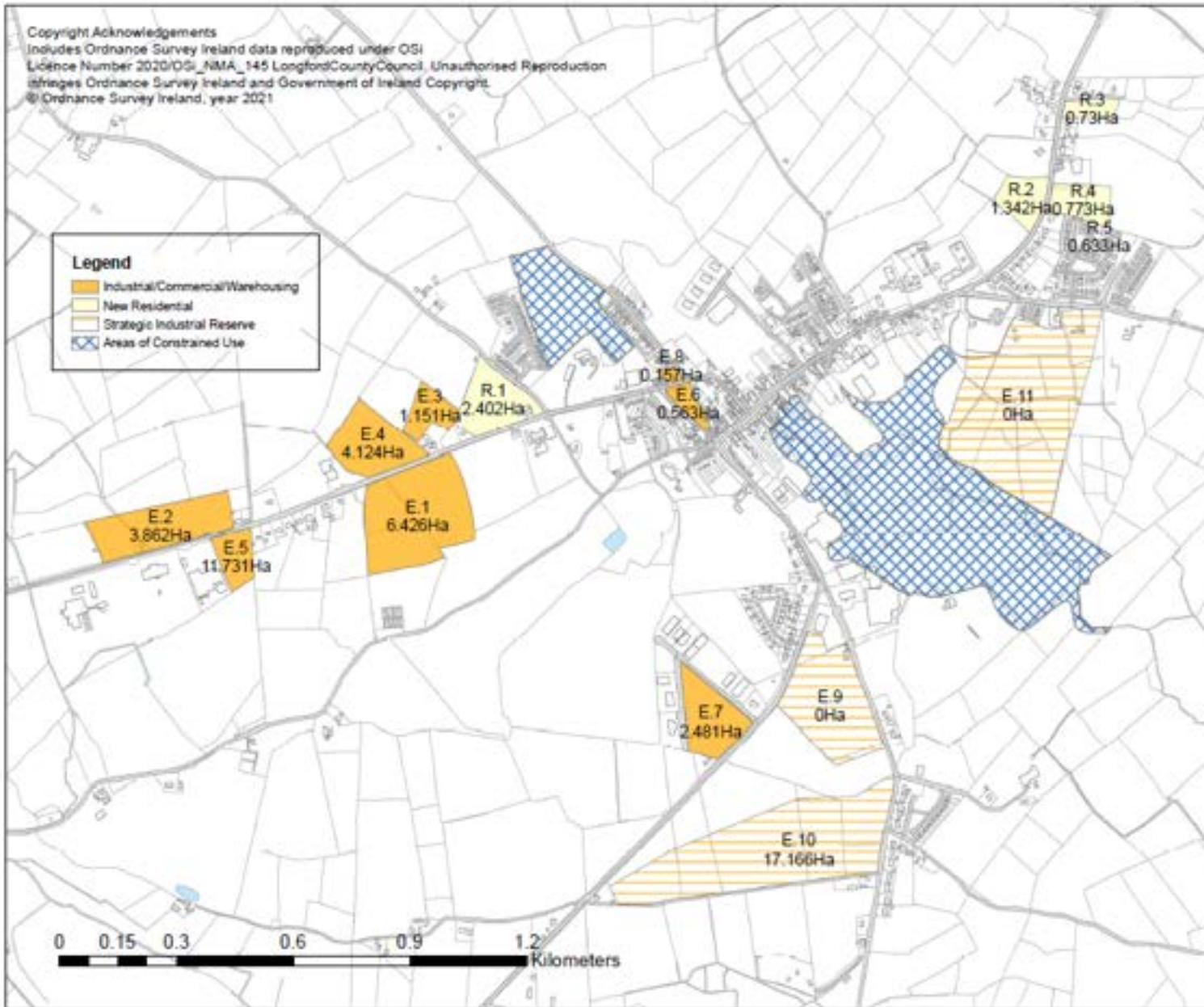

Granard Infrastructural Assessment- Further Iteration

Residential Zonings	Tier 1 – Green Tier 2 – Amber No Development - Red
R1	
R2	
R3	
R4	
R5	

Employment Zonings	Tier 1 – Green Tier 2 – Amber No Development - Red
E1	
E2	
E3	
E4	
E5	
E6	
E7	
E8	
E9	
E10	
E11	



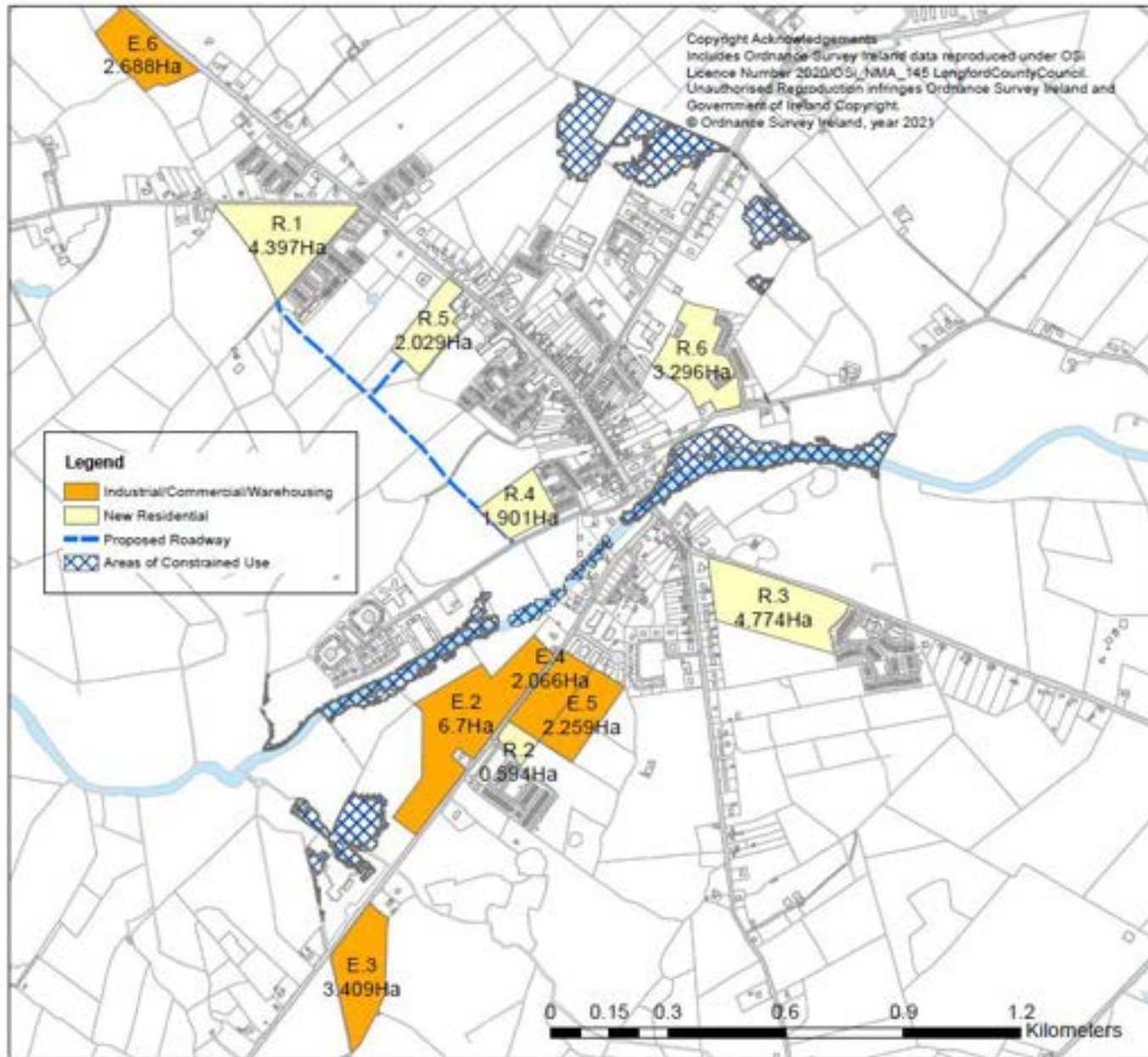

Ballymahon Infrastructural Assessment- Further Iteration

Residential Zonings	Tier 1 – Green Tier 2 – Amber No Development - Red
R1	Red
R2	Amber
R3	Red
R4	Amber
R5	Amber
R6	Amber

Employment Zonings	Tier 1 – Green Tier 2 – Amber No Development - Red
E1	Green
E2	Red
E3	Red
E4	Amber
E5	Amber
E6	Red



Copyright Acknowledgements
 Includes Ordnance Survey Ireland data reproduced under
 OSi
 Licence Number 2020/OSi_NMA_145
 LongfordCountyCouncil. Unauthorised Reproduction
 infringes Ordnance Survey Ireland and Government of
 Ireland Copyright.
 © Ordnance Survey Ireland, year 2021

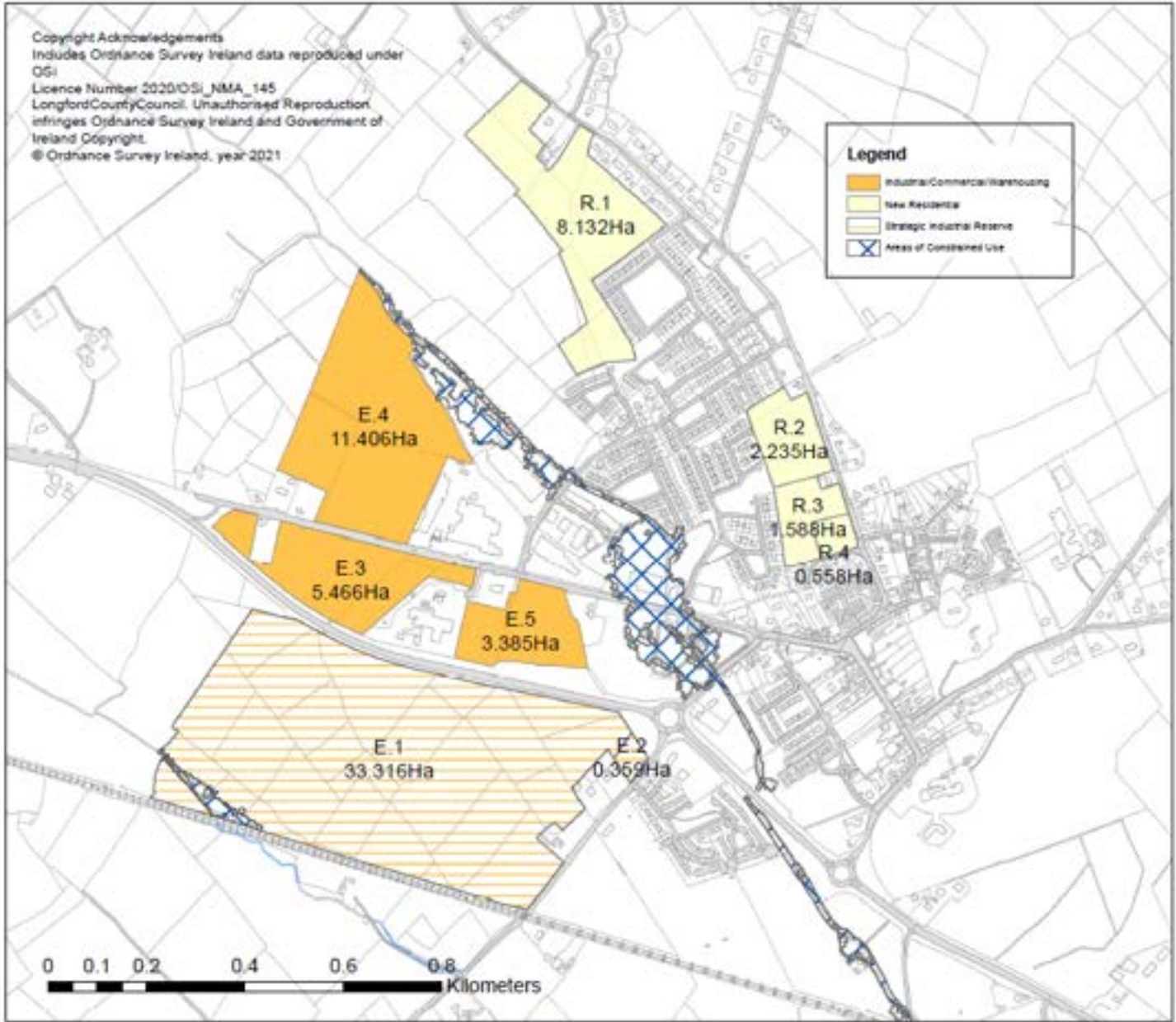

Edgeworthstown Infrastructural Assessment- Further Iteration

Residential Zonings	Tier 1 – Green Tier 2 – Amber No Development - Red
R1	Amber
R2	Amber
R3	Amber
R4	Amber

Employment Zonings	Tier 1 – Green Tier 2 – Amber No Development - Red
E1	Red
E2	Red
E3	Red
E4	Red
E5	Red



Copyright Acknowledgements
 Includes Ordnance Survey Ireland data reproduced under OS
 Licence Number 2020/03_NMA_145 LongfordCountyCouncil
 Unauthorised Reproduction infringes Ordnance Survey Ireland and
 Government of Ireland Copyright
 © Ordnance Survey Ireland, year 2021

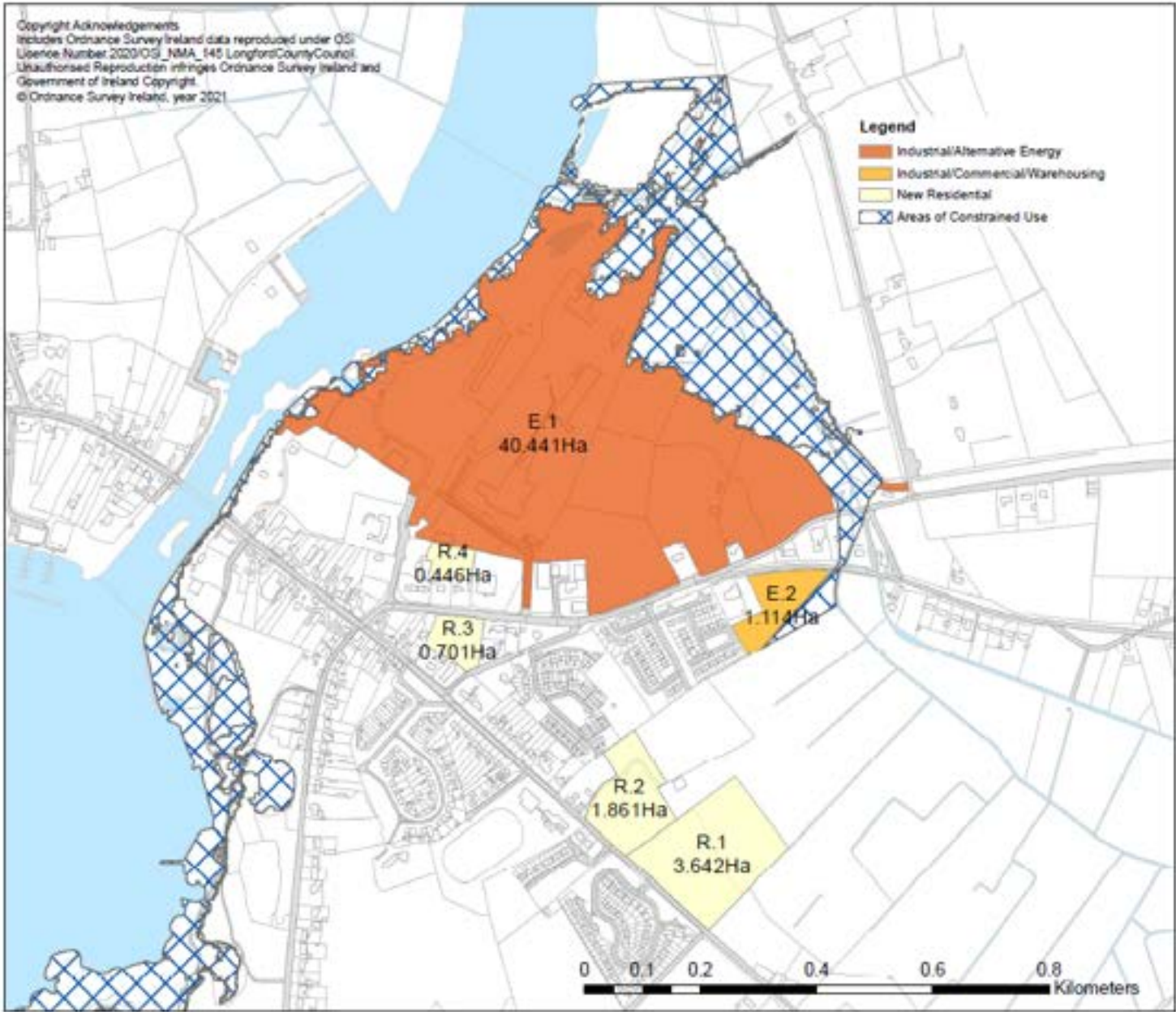

Lanesborough Infrastructural assessment- further iteration

Residential Zonings	Tier 1 – Green Tier 2 – Amber No Development - Red
R1	Amber
R2	Amber
R3	Amber
R4	Amber

Employment Zonings	Tier 1 – Green Tier 2 – Amber No Development - Red
E1	Red
E2	Red



Copyright Acknowledgements
 Includes Ordnance Survey Ireland data reproduced under OS
 License Number 2020/OS_NMA_145 Longford County Council.
 Unauthorised Reproduction Infringes Ordnance Survey Ireland and
 Government of Ireland Copyright.
 © Ordnance Survey Ireland, year 2021

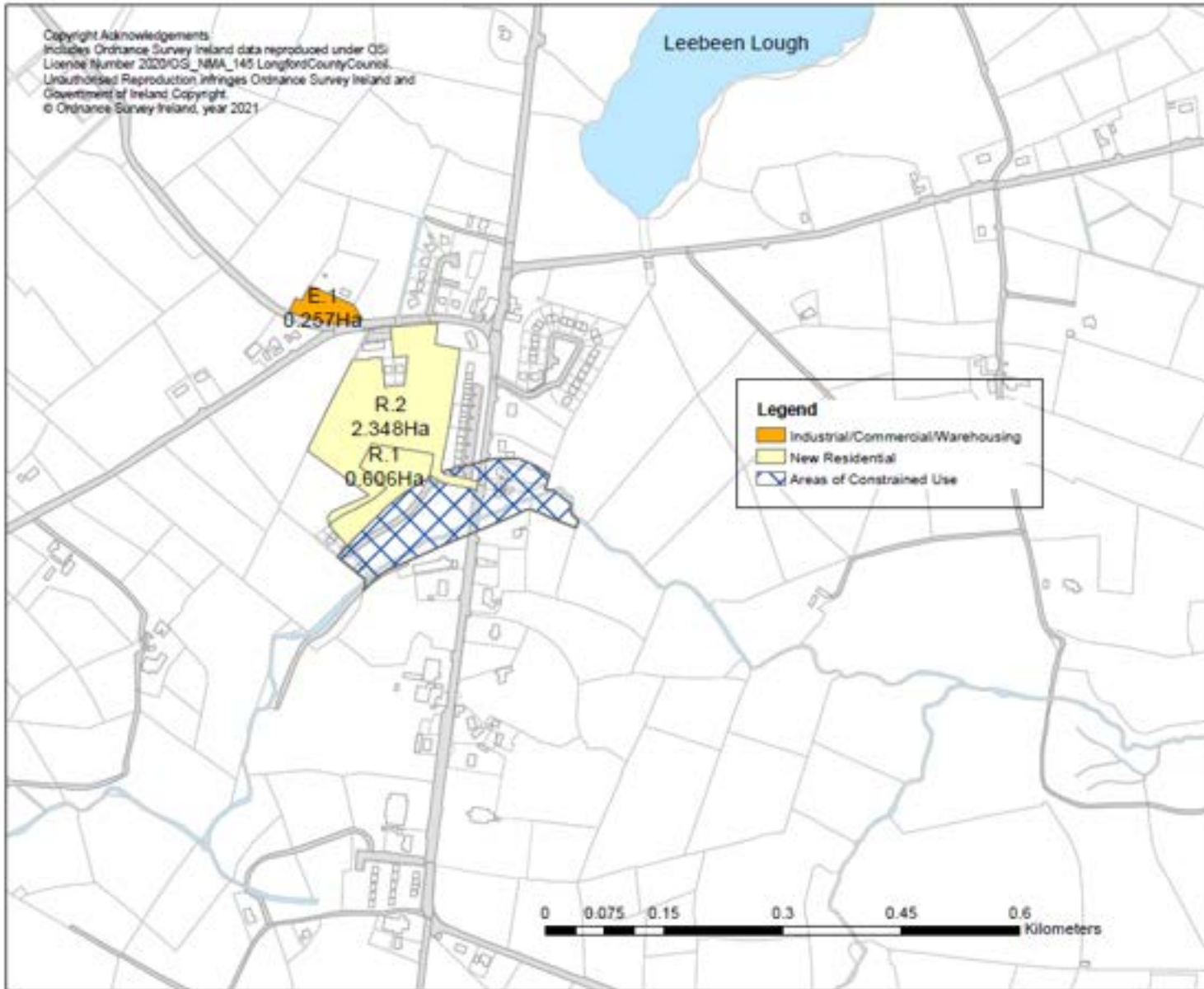

Aghnaccliffe Infrastructural Assessment- Further Iteration

Residential Zonings	Tier 1 – Green Tier 2 – Amber No Development - Red
R1	
R2	

Employment Zonings	Tier 1 – Green Tier 2 – Amber No Development - Red
E1	



Ballinalee Infrastructural assessment- Further Iteration

Copyright Acknowledgements
 Includes Ordnance Survey Ireland data reproduced under OS
 Licence Number 2020/OG_NWA_145 Longford County Council
 Unauthorised reproduction infringes Ordnance Survey Ireland and
 Government of Ireland Copyright.
 © Ordnance Survey Ireland, year 2021

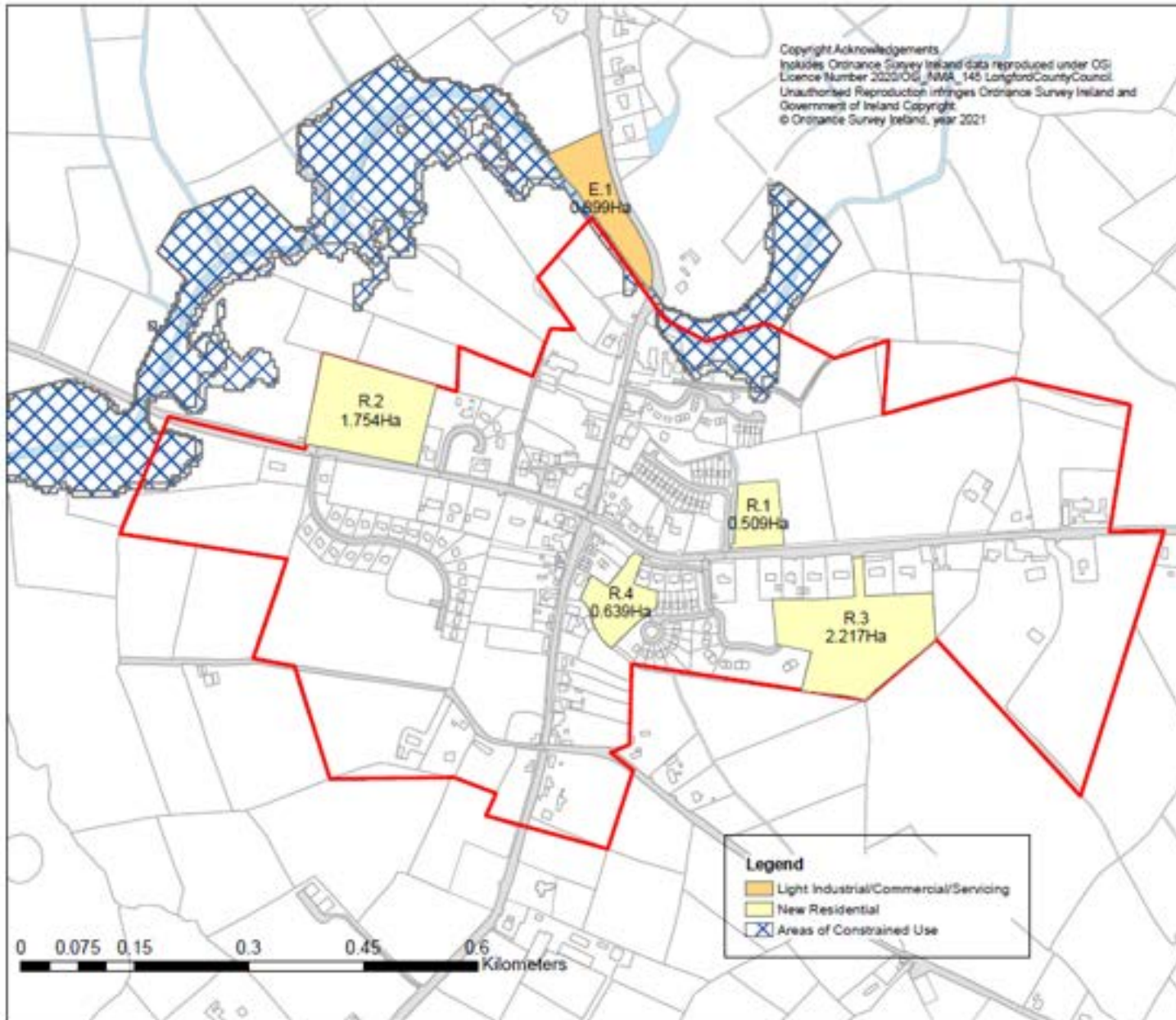

Residential Zonings	Tier 1 – Green Tier 2 – Amber No Development - Red
R1	
R2	
R3	
R4	

Employment Zonings	Tier 1 – Green Tier 2 – Amber No Development - Red
E1	



Copyright Acknowledgements
 Includes Ordnance Survey Ireland data reproduced under
 ODI
 Licence Number 2020/OSI_NMA_145
 LongfordCountyCouncil. Unauthorised Reproduction
 infringes Ordnance Survey Ireland and Government of
 Ireland Copyright.
 © Ordnance Survey Ireland, year 2021

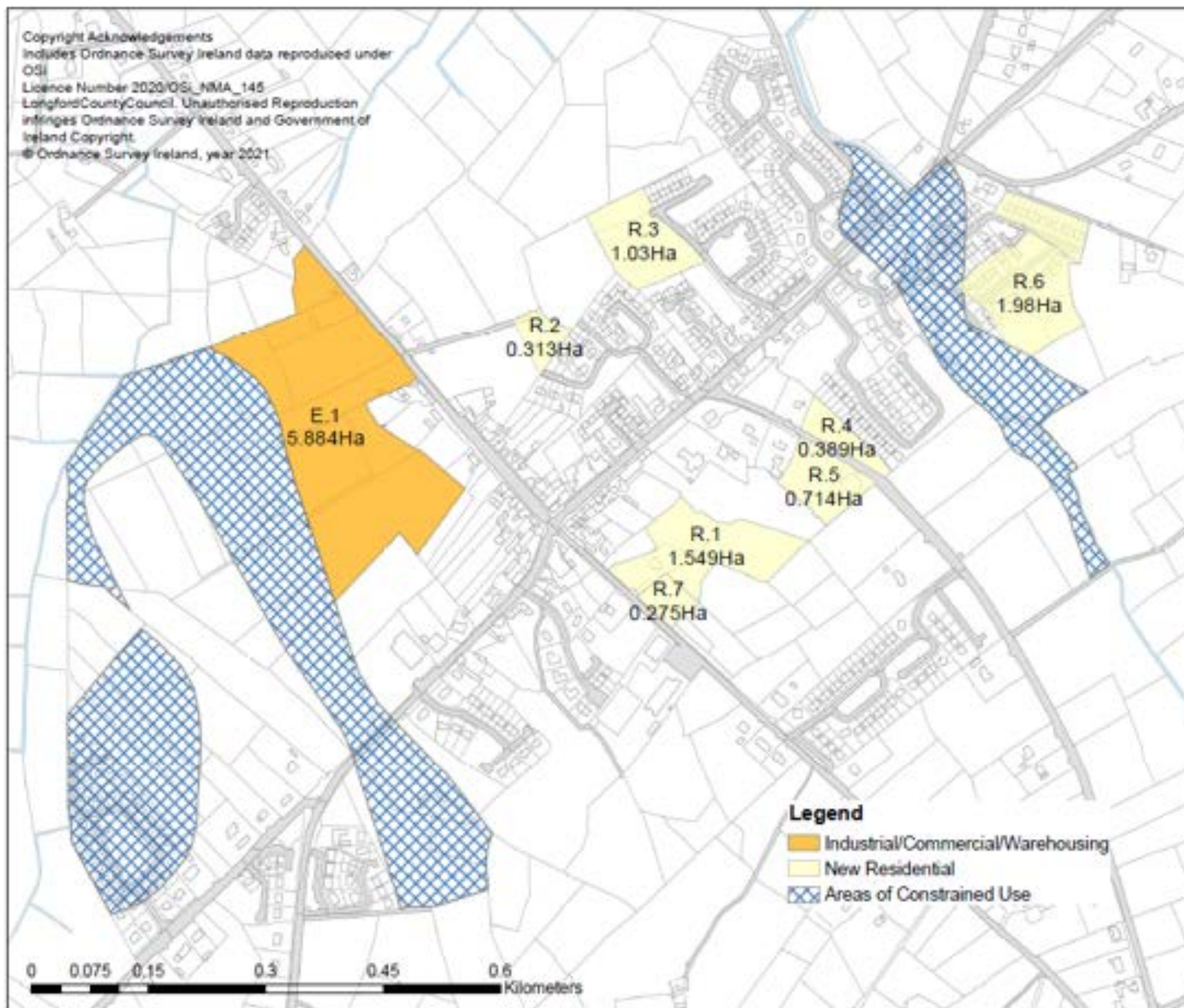

Drumlish Infrastructural assessment- Further Iteration

Residential Zonings	Tier 1 – Green Tier 2 – Amber No Development - Red
R1	Red
R2	Red
R3	Amber
R4	Green
R5	Green
R6	Red
R7	Amber

Employment Zonings	Tier 1 – Green Tier 2 – Amber No Development - Red
E1	Red

Legend

- Industrial/Commercial/Warehousing
- New Residential
- Areas of Constrained Use



Copyright Acknowledgements
 Includes Ordnance Survey Ireland data reproduced under OSI
 Licence Number 2020/OSI/NMA/145 Longford County Council. Unauthorised reproduction
 infringes Ordnance Survey Ireland and Government of Ireland Copyright.
 © Ordnance Survey Ireland, year 2021

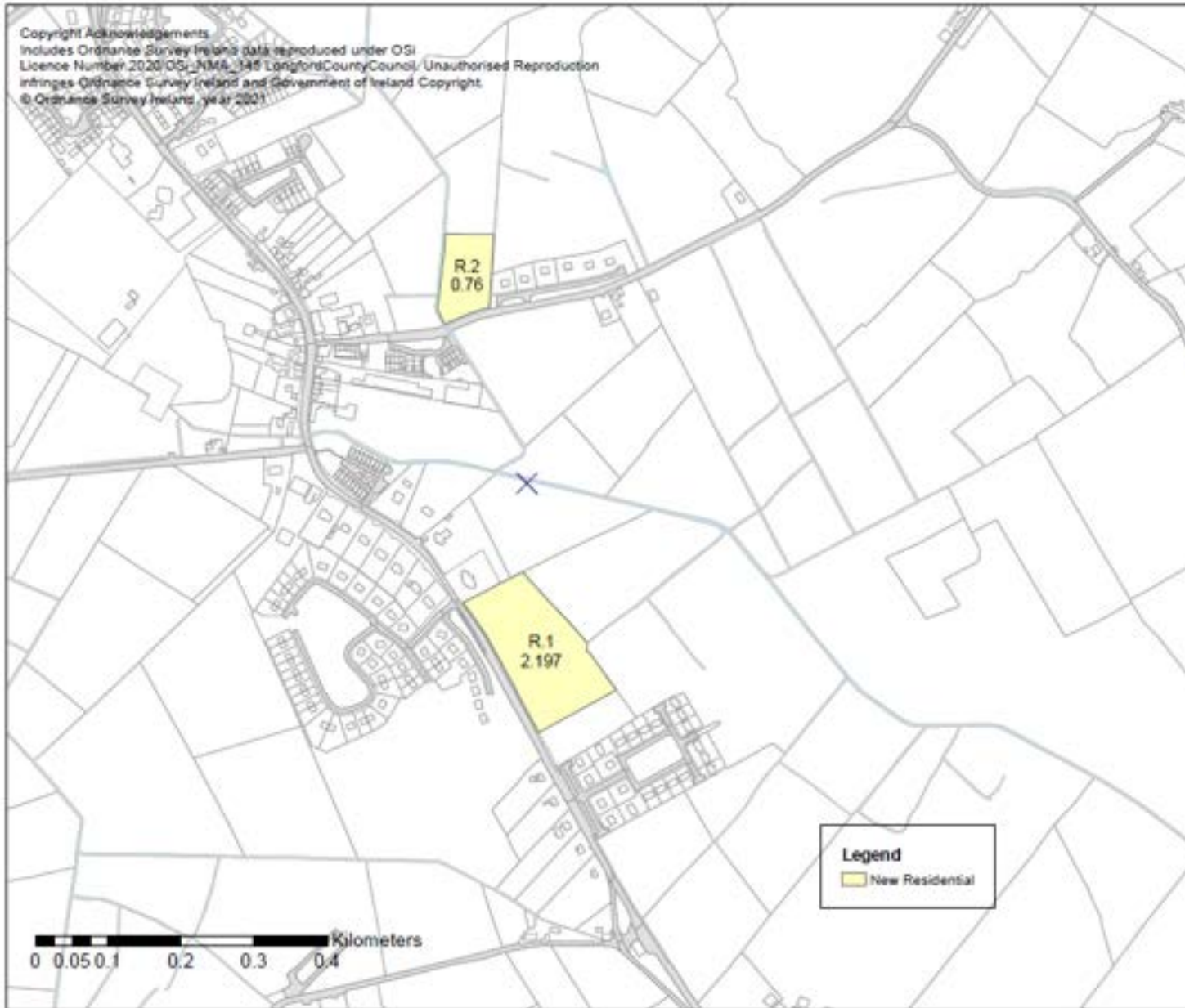

Keenagh Infrastructural Assessment- Further Iteration

Residential Zonings	Tier 1 – Green Tier 2 – Amber No Development - Red
R1	
R2	



Copyright Acknowledgements
 Includes Ordnance Survey Ireland data reproduced under OSI
 Licence Number 2020/OSI_NMA_148 Longford County Council.
 Unauthorised reproduction infringes Ordnance Survey Ireland and
 Government of Ireland Copyright.
 © Ordnance Survey Ireland, year 2021

Legan Infrastructural assessment- Further Iteration

Residential Zonings	Tier 1 – Green Tier 2 – Amber No Development - Red
R1	

Legend

- New Residential
- Areas of Constrained Use





Copyright Acknowledgements
 Includes Ordnance Survey Ireland data reproduced under OSI
 Licence Number 2020/OSI_NMA_145 LongfordCountyCouncil. Unauthorised
 Reproduction infringes Ordnance Survey Ireland and Government of Ireland
 Copyright.
 © Ordnance Survey Ireland, year 2021

Legend

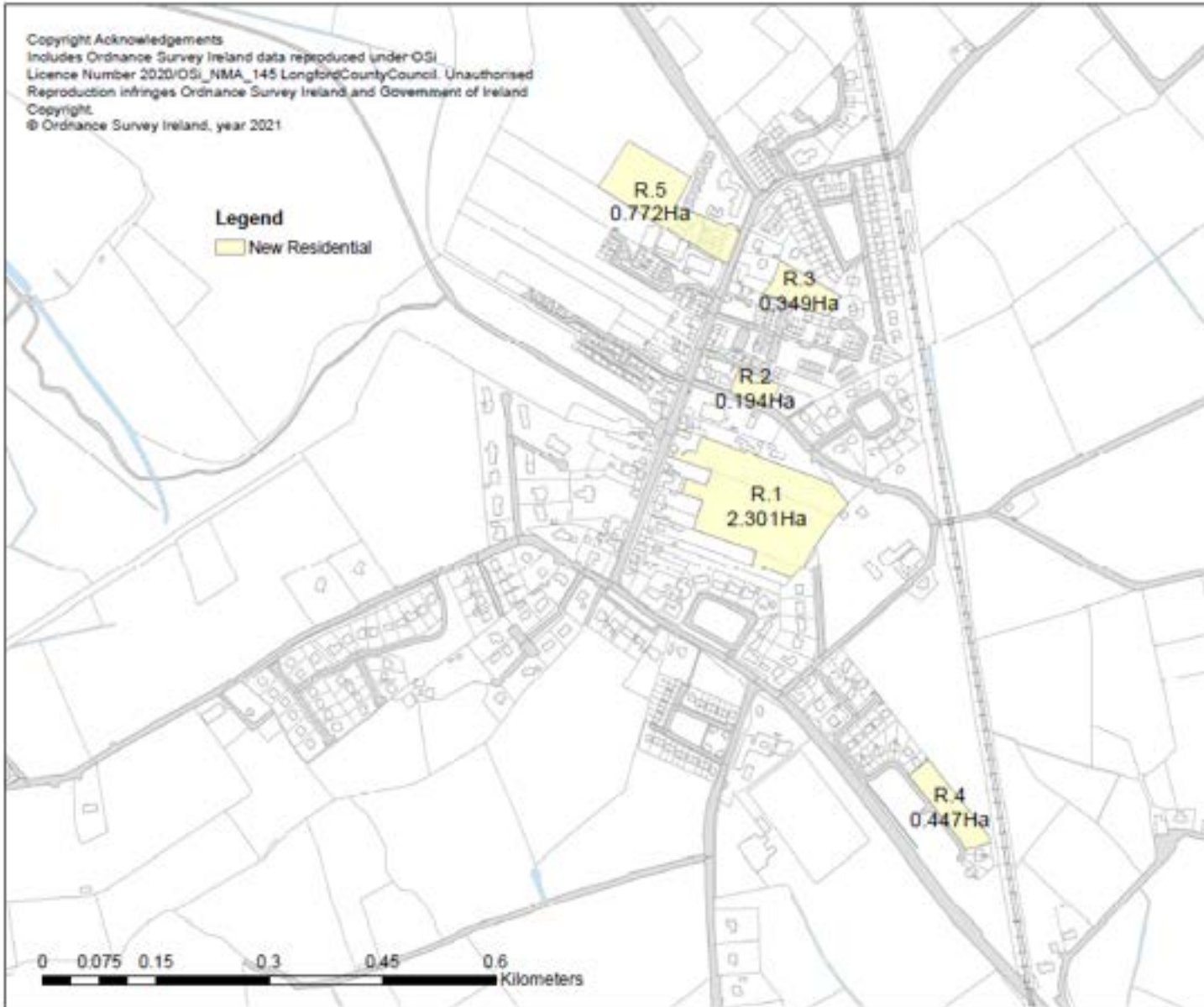
 New Residential

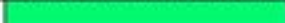

**Newtownforbes
 Infrastructural Assessment-
 Further Iteration**

Residential Zonings	Tier 1 – Green Tier 2 – Amber No Development - Red
R1	
R2	
R3	
R4	
R5	



Copyright Acknowledgements
 Includes Ordnance Survey Ireland data reproduced under OSI
 Licence Number 2020/OSI_NMA_145 LongfordCountyCouncil.
 Unauthorised reproduction infringes Ordnance Survey Ireland
 and Government of Ireland Copyright.
 © Ordnance Survey Ireland, year 2021

Abbeyshrule Infrastructural assessment- Further Iteration

Residential Zonings	Tier 1 – Green Tier 2 – Amber No Development - Red
R1	
R2	
R3	

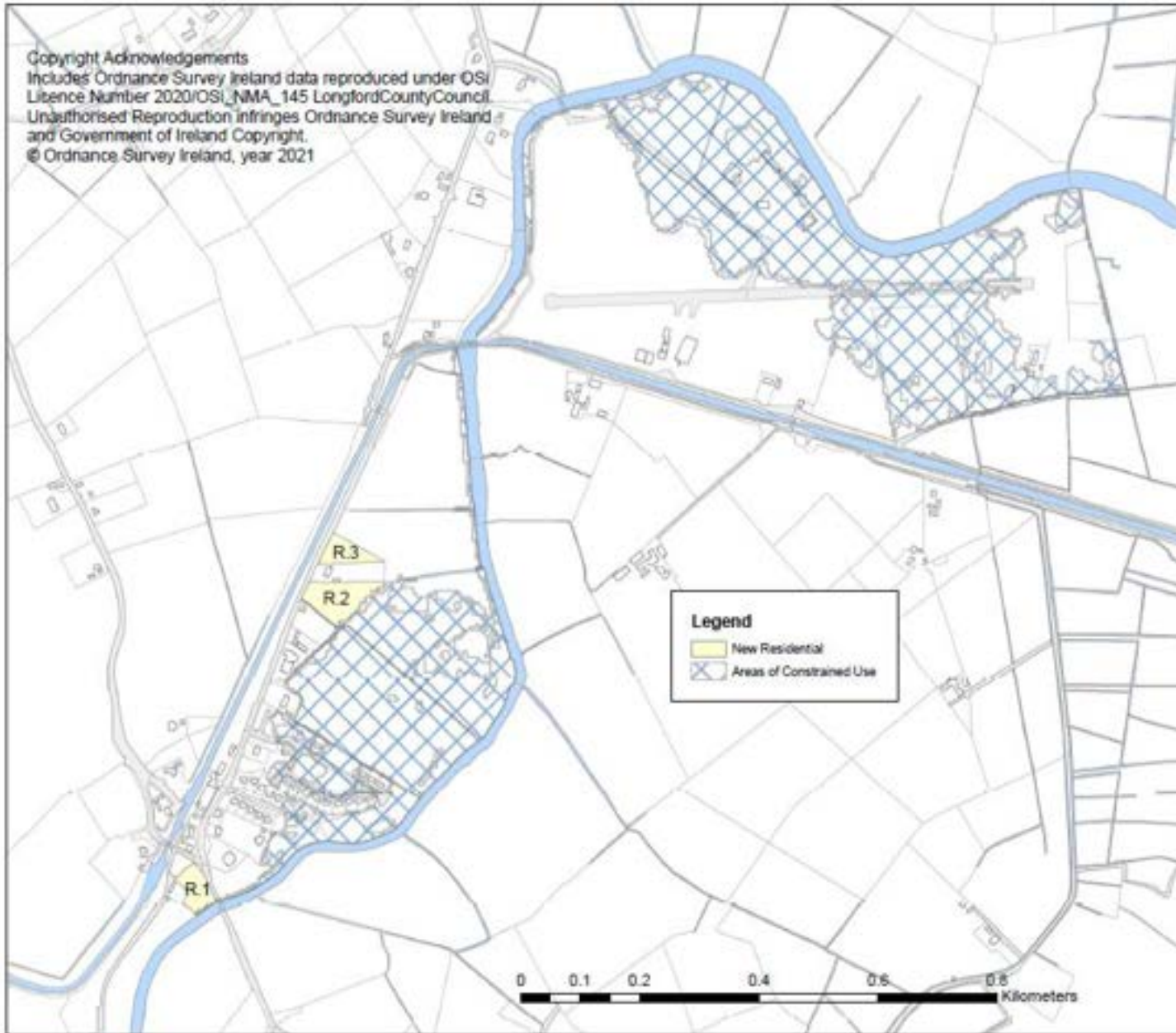

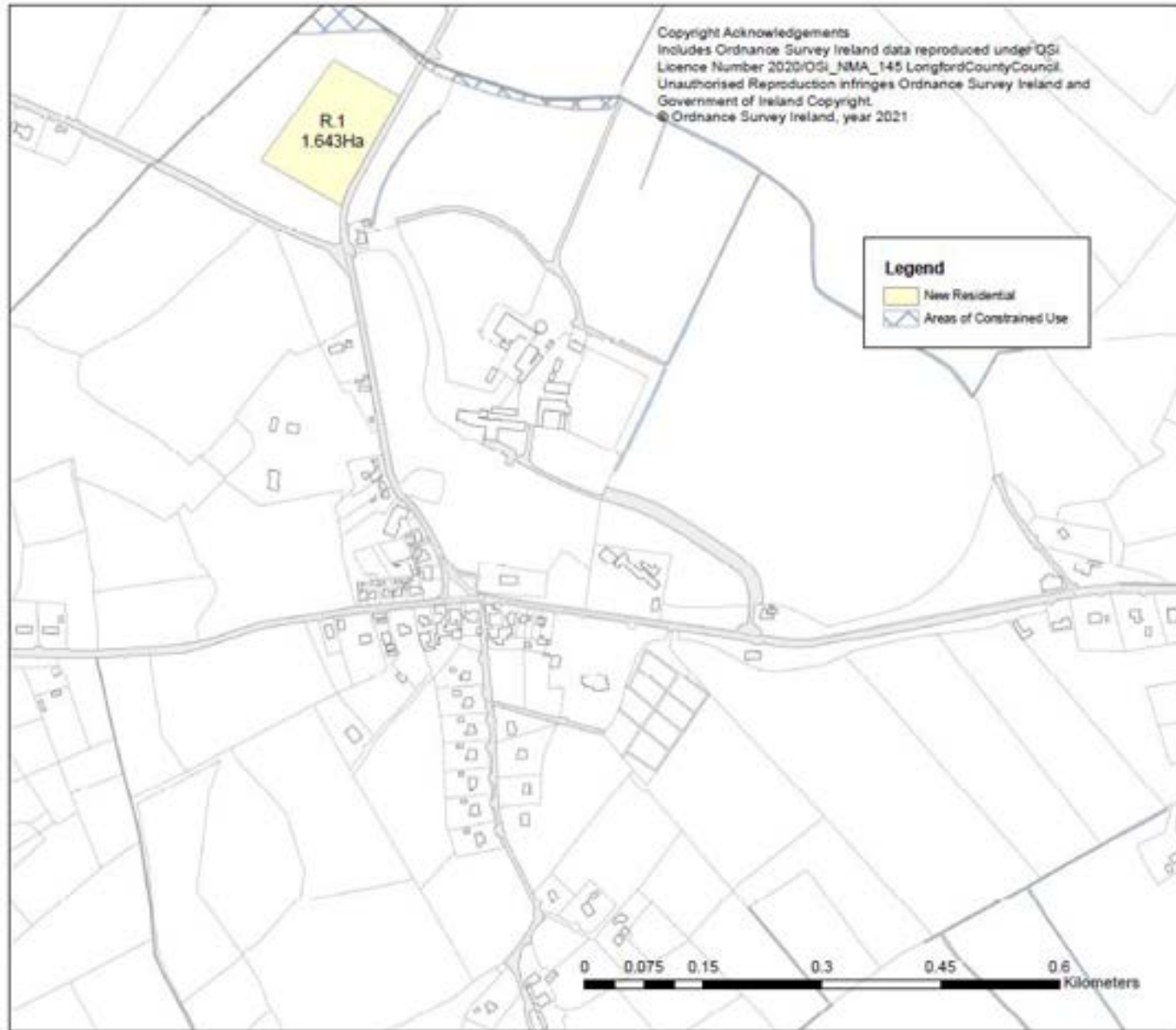

Ardagh Infrastructural assessment- Further Iteration

Residential Zonings	Tier 1 – Green Tier 2 – Amber No Development - Red
R1	

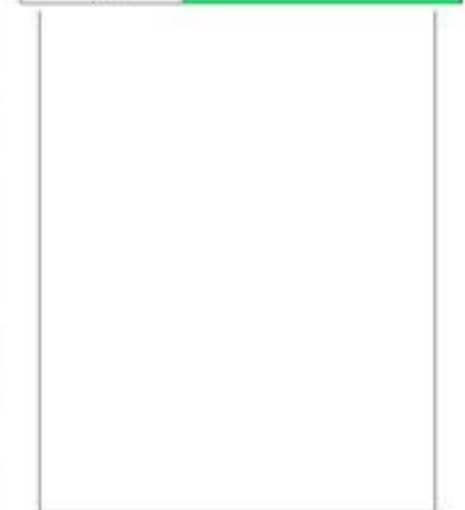

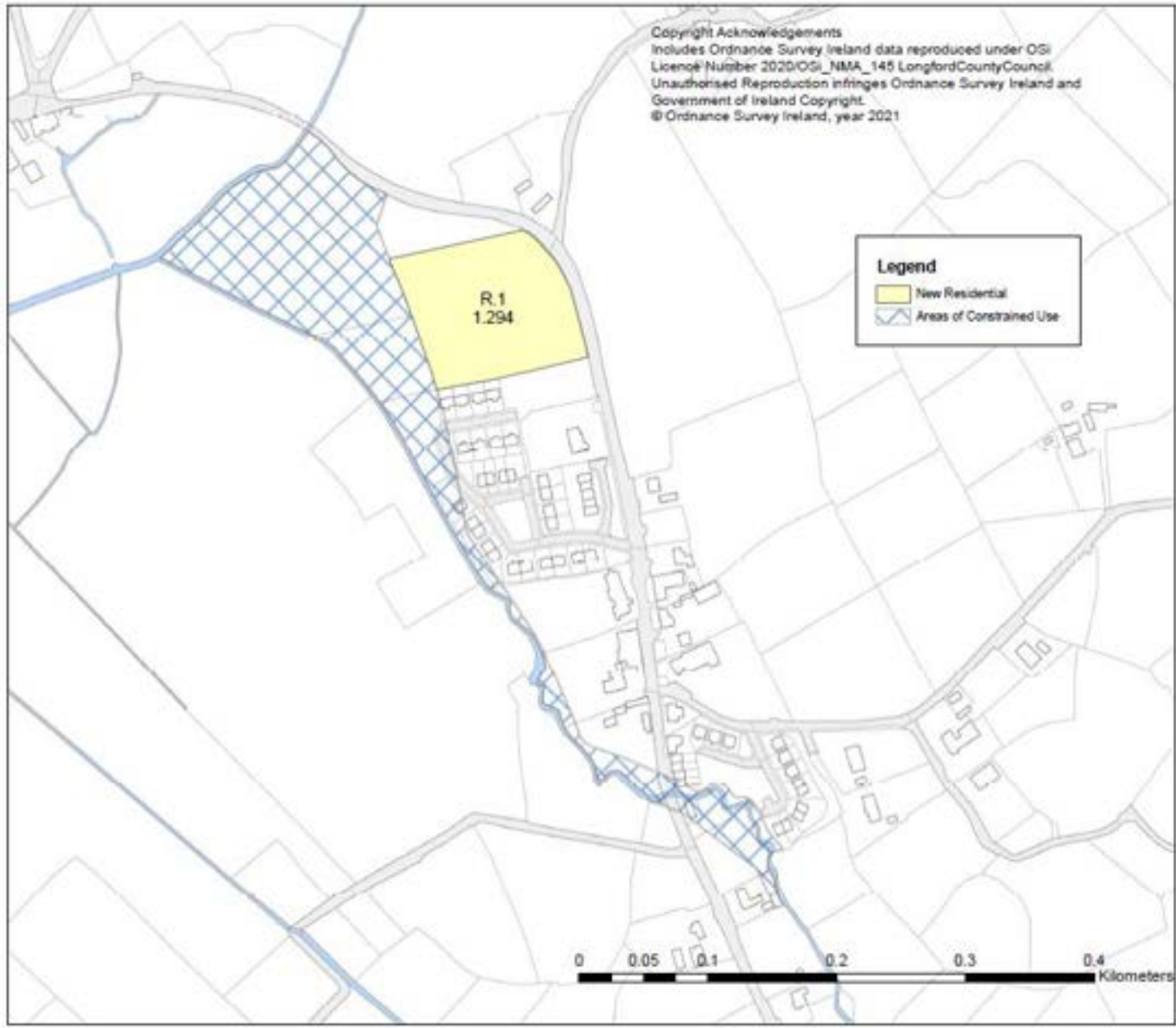

Ballinamuck Infrastructural assessment- Further Iteration

Residential Zonings	Tier 1 – Green Tier 2 – Amber No Development - Red
R1	



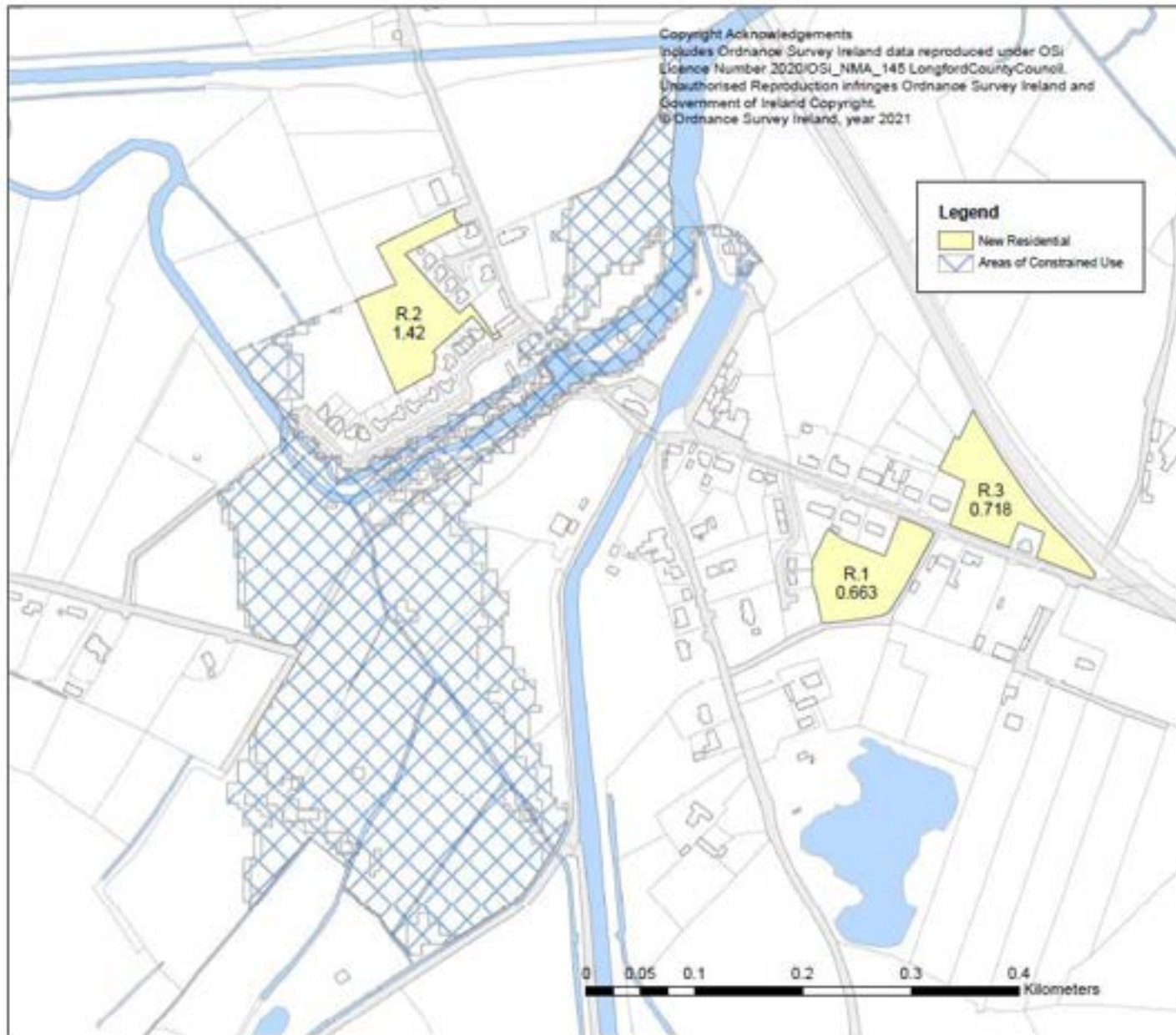

Clonra Infrastructural assessment- Further Iteration

Residential Zonings	Tier 1 – Green Tier 2 – Amber No Development - Red
R1	
R2	
R3	



APPENDIX F – SETTLEMENT ZONINGS (RESIDENTIAL & EMPLOYMENT LANDS)

The lands zoned for residential and employment lands have been assessed according to the infrastructure available to service the sites. The lands identified as being serviced are identified in the following settlement plans.

The background and preliminary background information used in the iterative process of assessing the settlements and the identified sites are included in the preceding appendices.

The revised settlement land-use zonings have been informed by the Submission from the OPR and EMRA which requested that the zoning of lands be informed by an Infrastructure Assessment, flood zonings, and alignment with and consideration of National Planning Policy especially in respect of compact growth and the aim of delivering growth within establishment settlements and within their defined CSO settlement boundaries. The settlements are presented according to the settlement hierarchy.

Key Town	Longford Town	
Self-Sustaining Growth Towns	Granard	
Self-Sustaining Towns	Ballymahon Edgeworthstown Lanesborough	
Towns & Villages	Aughnaccliffe Ballinalee Drumlish	Keenagh Legan Newtownforbes
Villages & Smaller settlements	Abbeyshrule Ardagh	Ballinamuck Clondra

The following maps and plans show the proposed land-use zoning changes for the main settlements and these should be read in conjunction with the previous appendices and assessments:

Appendix – F1 Key Town Longford Town:

The land-use zonings for Longford Town have been revised in accordance with this Infrastructure Assessment framework and the resulting land-use zoning plan for Longford is presented below.

The settlement maps presented in the initial Draft County Development Plan 2021-2027 were based on the current County Development Plan 2015-2021 and the initial infrastructure assessment undertaken in early 2020 (January to April) and informed the review of the land-use zonings for the key settlements and the drafting of the County Development Plan 2021-2027.

Following the Public Consultation on the Draft Longford County Development Plan 2021-2027 and the review of Submissions and Observations received during the consultation period (27th October 2020 until 18th January 2021) the land use zoning plans for the settlements were revised and the Further Iteration Plans are included in this report under Appendix C (produced during the period December 2020 to March 2021).

An additional review of the Infrastructure Assessment Report was undertaken following the development of the Chief Executive's Report on the Submissions received, specifically the submissions from the OPR and EMRA as well as other thematic and area specific submissions. Therefore, the quantum of lands zoned new residential and industrial / commercial / warehousing have been reduced. The revised zoning map identifies and presents a more sustainable and compact form of development reflecting the CSO boundary of the town and core principle of the NPF.

The Further Iteration of the Infrastructure Assessment, the inclusion of the flood risk zonings and the CSO settlement boundary has highlighted specific areas that are subsequently identified as undevelopable and or constrained, lacking the infrastructure required to service the lands, or lands at high risk of flooding. The subsequent settlement plan Longford Proposed Material Amendments (June 2021) identifies those sites where land-use zonings have been amended/revised and the changes identified.

Of specific note are the amendments to the zonings to the north and east of the Longford town and the N4 national road. Additional changes are located along the river Camlin in the centre of Longford, as well as lands to the south-west and south of the town. Part of these lands are identified to be constrained uses and impacted by flood issues.

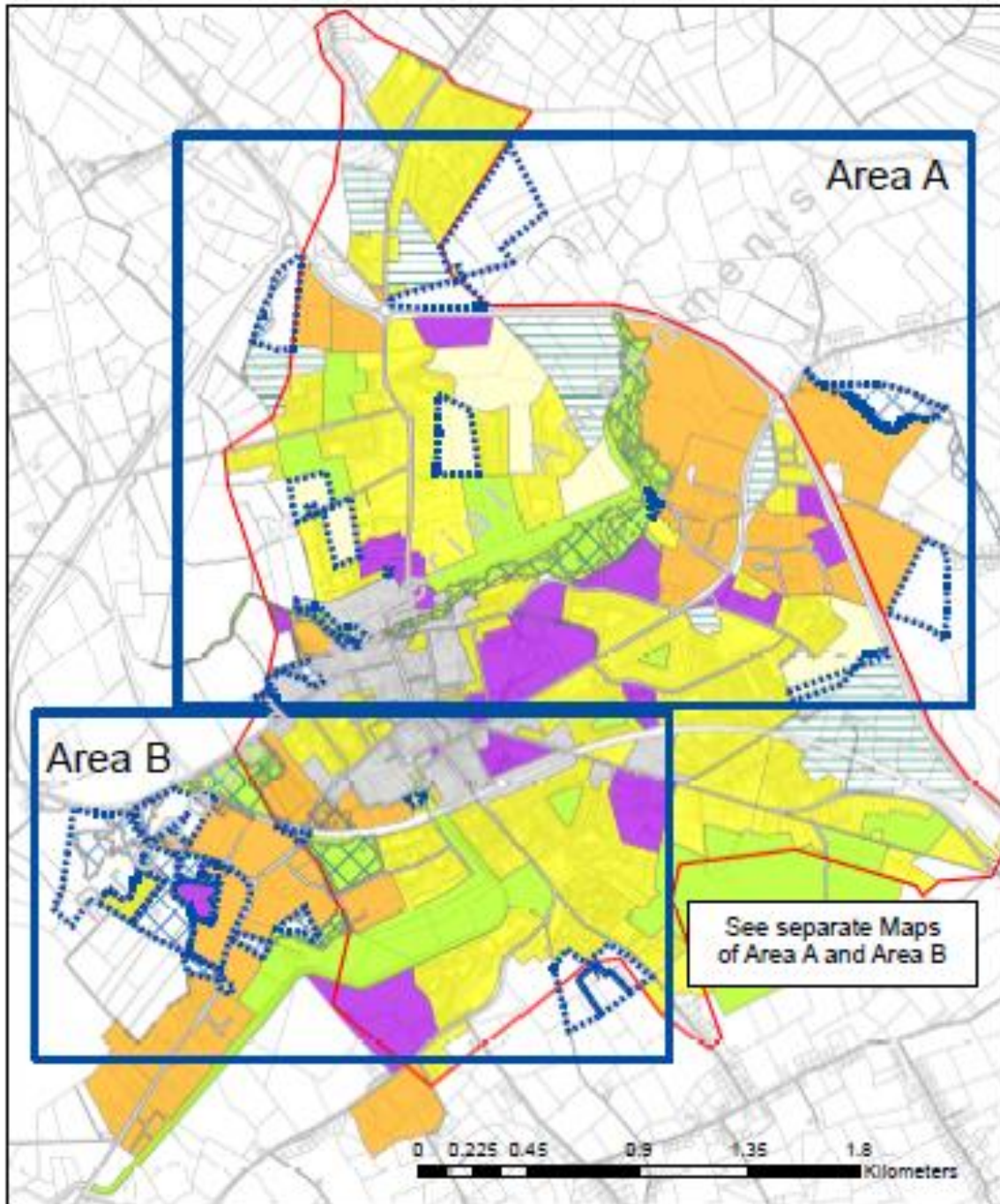

Longford Town
 Proposed Material Amendments
 Outline of Area A & Area B
 County Development Plan 2021-2027



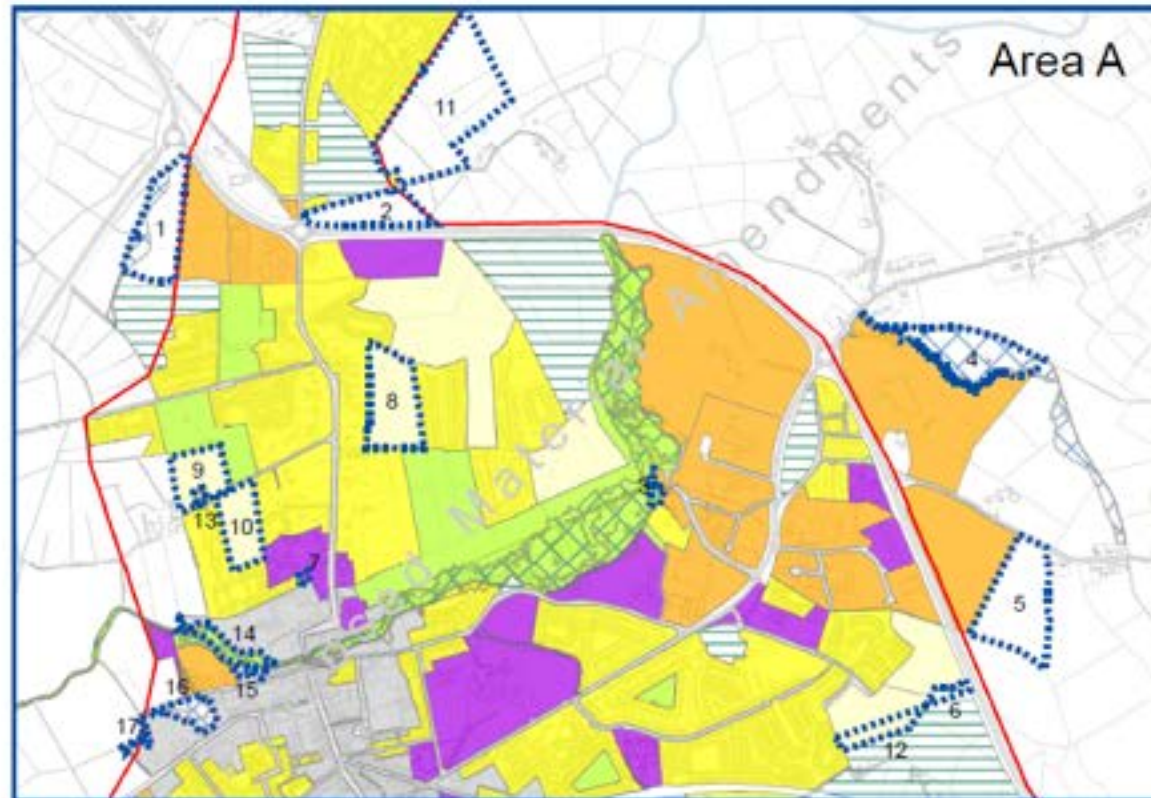

Copyright Acknowledgements
 Includes Ordnance Survey Ireland data reproduced under OLI Licence Number 2020-011_1204_141 Longford County Council. Unauthorised reproduction infringes Ordnance Survey Ireland and Government of Ireland Copyright.
 © Ordnance Survey Ireland, year the date of publication



Longford Town Proposed Material Amendments



Zoning Changes - Area A

Draft Plan Zoning in Draft Plan	Alteration Amended Zoning	Parcel No. Area on Map
Industrial/Commercial/Warehousing		
	No Zoning	1
	No Zoning	2
	Recreational/Amenity/Green Space	8
	No Zoning	4
	No Zoning	5
New Residential		
	Residential Reserve	6
Residential		
	Social/Community/Education/Public Utility	7
Residential Reserve		
	New Residential	9
	New Residential	10
	No Zoning	11
	New Residential	12
	Residential	13
Town Core		
	No Zoning	14
	No Zoning	15
	No Zoning	16
	No Zoning	17

Longford Town
Proposed Material Amendments
County Development Plan 2021-2027

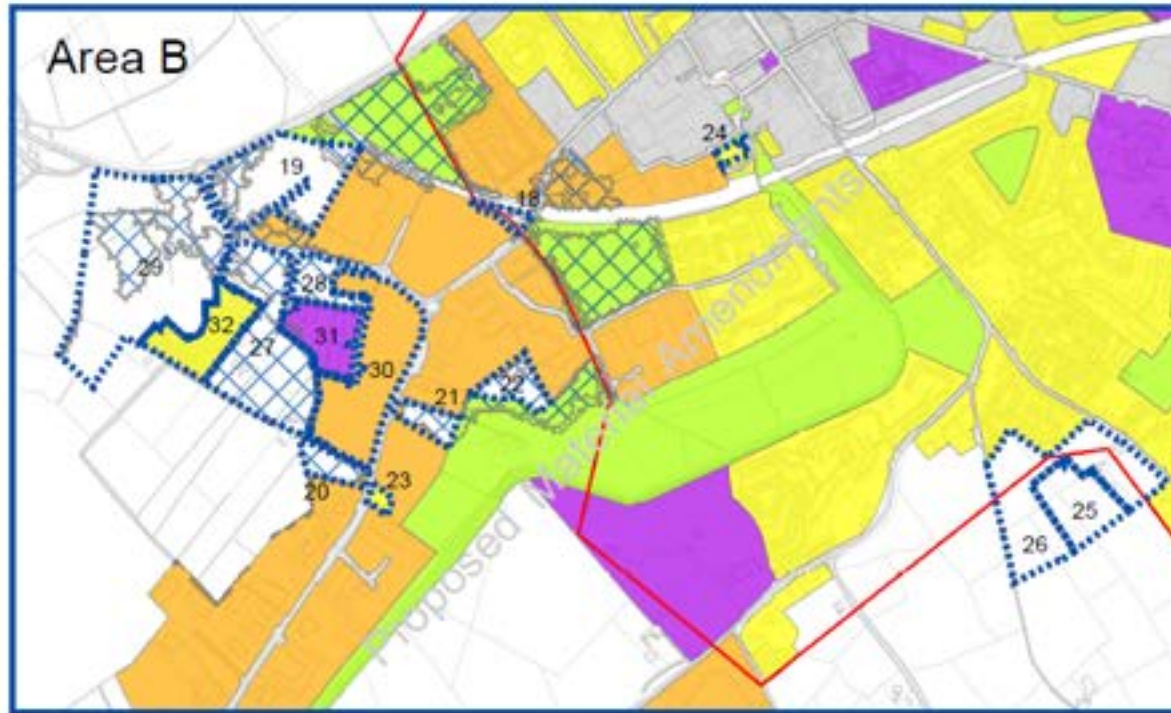

Legend

- Changed Zoning
- Areas of Constrained Land Use
- CSO Settlement Boundary
- Town Core
- Industrial/Commercial/Warehousing
- Recreational/Amenity/Green Space
- New Residential
- Residential
- Social/Community/Education/Public Utility
- Strategic Residential Reserve



Copyright Acknowledgements
Includes Ordnance Survey Ireland data reproduced under
OS
Licence Number 2020/OSI_NMA_145
Longford County Council. Unauthorised Reproduction
infringes Ordnance Survey Ireland and Government of



Zoning Changes - Area B

Draft Plan Zoning in Draft Plan	Alteration Amended Zoning	Parcel/No Area on Map
Industrial/Commercial/Warehousing		
No Zoning	No Zoning	18
No Zoning	No Zoning	19
No Zoning	No Zoning	20
No Zoning	No Zoning	21
No Zoning	No Zoning	22
Residential	Residential	23
Residential	Residential	24
Recreation/Amenity/Green Space		
No Zoning	No Zoning	25
Residential Reserve		
No Zoning	No Zoning	26
Site Resolution Objective		
No Zoning	No Zoning	27
No Zoning	No Zoning	28
No Zoning	No Zoning	29
Industrial/Commercial/Warehousing	Industrial/Commercial/Warehousing	30
Social/Community/Education/Public Utility	Social/Community/Education/Public Utility	31
Residential	Residential	32

Appendix – F2 Self-Sustaining Growth Towns Granard:

The land-use zonings for Granard Town have been revised in accordance with the Infrastructure Assessment framework and the resulting land-use plan for the settlement is presented below.

The settlement maps presented in the initial Draft County Development Plan 2021-2027 were based on the current County Development Plan 2015-2021 and the initial infrastructure assessment undertaken in early 2020 and informed the review of the land-use zonings for the key settlements and the drafting of the County Development Plan 2021-2027.

Following the Public Consultation on the Draft Longford County Development Plan 2021-2027 and the review of Submissions and Observations received during the consultation period (27th October 2020 until 18th January 2021) the land use zoning plans for the settlements were revised and the Further Iteration Plans are included in this report under Appendix C (produced during the period December 2020 to March 2021). An additional review of the Infrastructure Assessment Report was undertaken following the development of the Chief Executive's Report on the Submissions received, specifically the submissions from the OPR and EMRA as well as other thematic and area specific submissions.

The Infrastructure Assessment, the inclusion of the flood risk zonings and the CSO settlement boundary has highlighted specific areas that are subsequently identified as undevelopable and or constrained, lacking the infrastructure required to the service the lands, or lands at high risk of flooding. The subsequent settlement plan identifies those sites where land-use zonings have been amended/revised and the changes identified. The revised zoning map for Granard identifies a more sustainable and compact form of development reflecting the CSO boundary of the town and core principle of the NPF, the EMRA RSES and Submission of the OPR on the Draft Plan.

The quantum of lands zoned new residential and industrial/commercial/warehousing have been reduced within Granard. Within Granard significant areas of land have been revised and the land-use maps showing zone 'A' west of the town and zone 'B' east present the proposed amendments.

In the Granard area 'A' large areas of land have been de-zoned from industrial/commercial/warehousing, in particular those areas outside of the CSO settlement boundary and along the regional and national roads. The revised zoning plan presents a more compact form of development. Granard Area 'B' to the east of the town a significant number of amendments are indicated reflecting the constrained land-use (flooding) issues and the identified CSO boundary. Lands beyond this boundary have been de-zoned accordingly.

Copyright Acknowledgements
 Includes Ordnance Survey Ireland data reproduced under OSI
 Licence Number 2020/OS_NMA_145 Longford County Council.
 Unauthorised reproduction infringes Ordnance Survey Ireland and
 Government of Ireland Copyright.
 © Ordnance Survey Ireland, year [the date of publication]

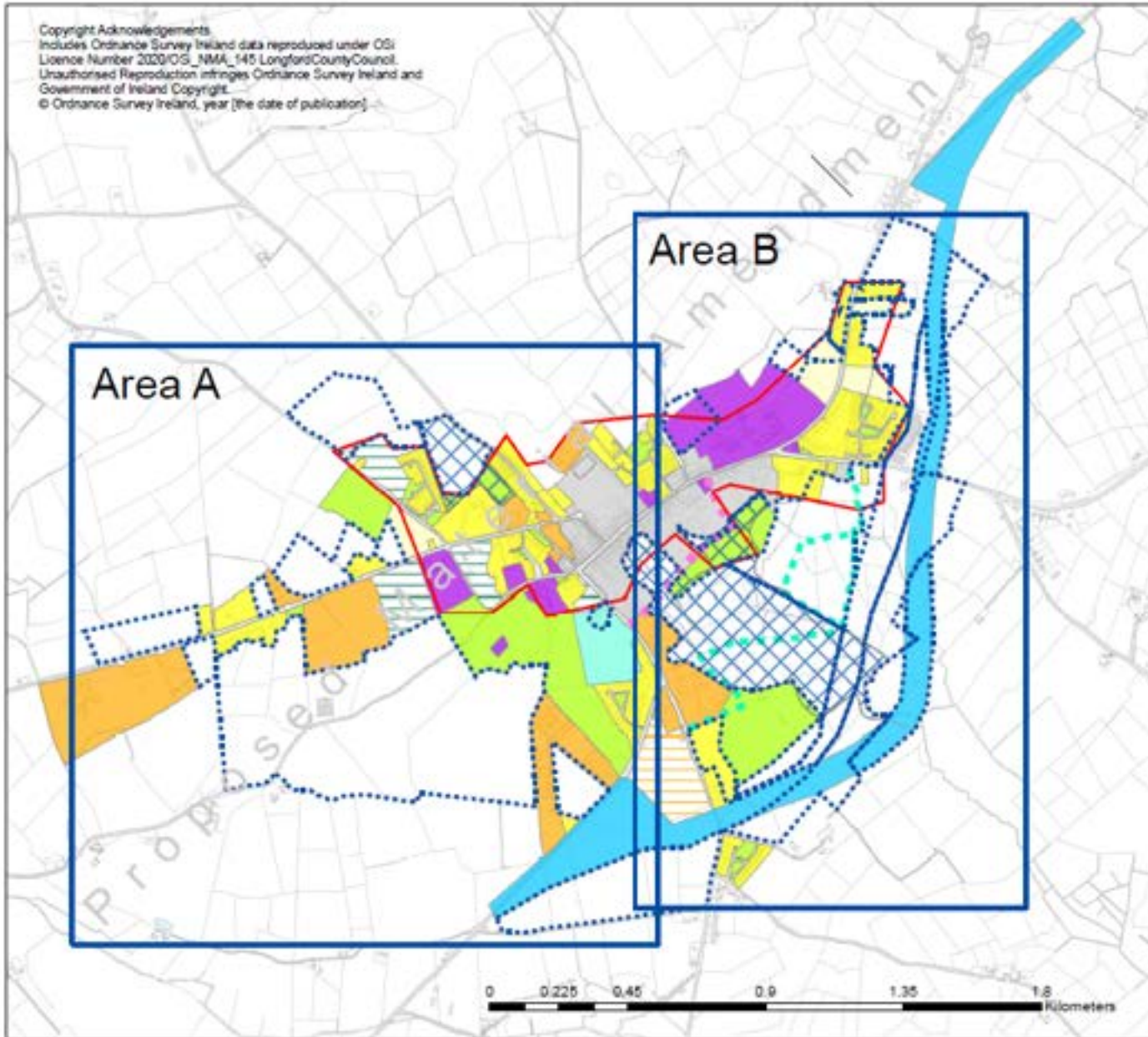

Granard Proposed Material Amendments Area A & Area B

County Development Plan 2021-2027

Legend

- Changed Zoning
- Areas of Constrained Land Use
- CSO Settlement Boundary
- Industrial/Commercial/Warehousing
- New Residential
- Recreation/Amenity/Green Space
- Reservation Objective
- Residential
- Social/Community/Education/Public Utility
- Strategic Industrial Reserve
- Strategic Residential Reserve
- Tourism
- Town Core
- Amenity Walkway
- Proposed Service Road Granard

See separate Maps
 of Area A and Area B



Granard
Proposed Material Amendments
County Development Plan 2021-2027

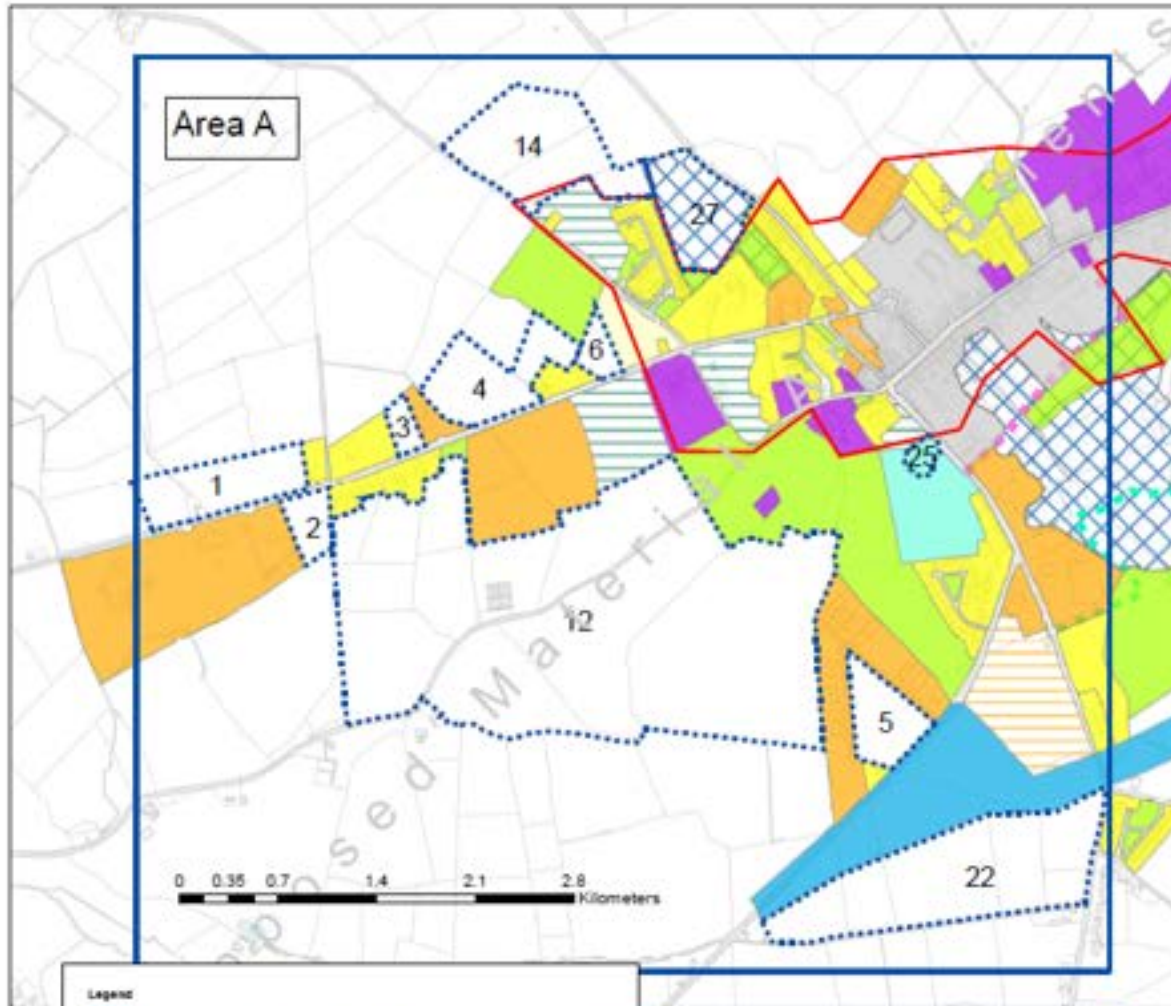
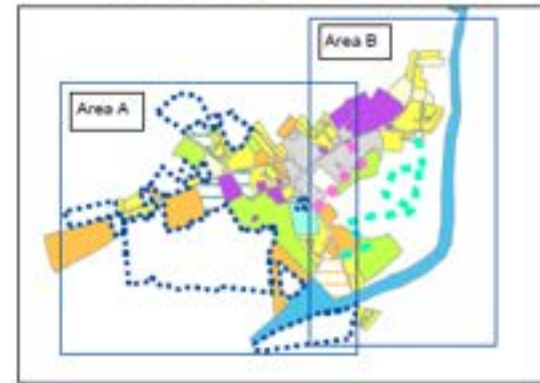

Legend

- Changed Zoning
- CDD Settlement Boundary
- Areas of Constrained Land Use
- Industrial/Commercial/Warehousing
- New Residential
- Recreation/Amenity/Green Space
- Reservation Objective
- Residential
- Social/Community/Education/Public Utility
- Strategic Industrial Reserve
- Strategic Residential Reserve
- Tourism
- Town Core
- Amenity Walkway
- Proposed Service Road Grant

Copyright Acknowledgements
Includes Ordnance Survey Ireland data reproduced under OS Licence Number 2020/001_A184_148 Longford County Council. Unauthorised reproduction infringes Ordnance Survey Ireland and Government of Ireland Copyright. © Ordnance Survey Ireland, year (the date of publication)



Zoning Changes

Draft Plan: Zoning in Draft Plan	Alteration: Amended Zoning	Parcel No: Area on Map
Industrial/Commercial/Warehousing		
No Zoning	No Zoning	1
No Zoning	No Zoning	2
No Zoning	No Zoning	3
No Zoning	No Zoning	4
No Zoning	No Zoning	5
New Residential		
No Zoning	No Zoning	6
Recreation/Amenity/Green Space		
No Zoning	No Zoning	27
Recreational/Amenity/Green Space		
No Zoning	No Zoning	12
Residential Reserve		
No Zoning	No Zoning	14
Strategic Industrial Reserve		
No Zoning	No Zoning	22
Town Core		
Tourism	Tourism	25

Granard
Proposed Material Amendments - Area B
County Development Plan 2021-2027

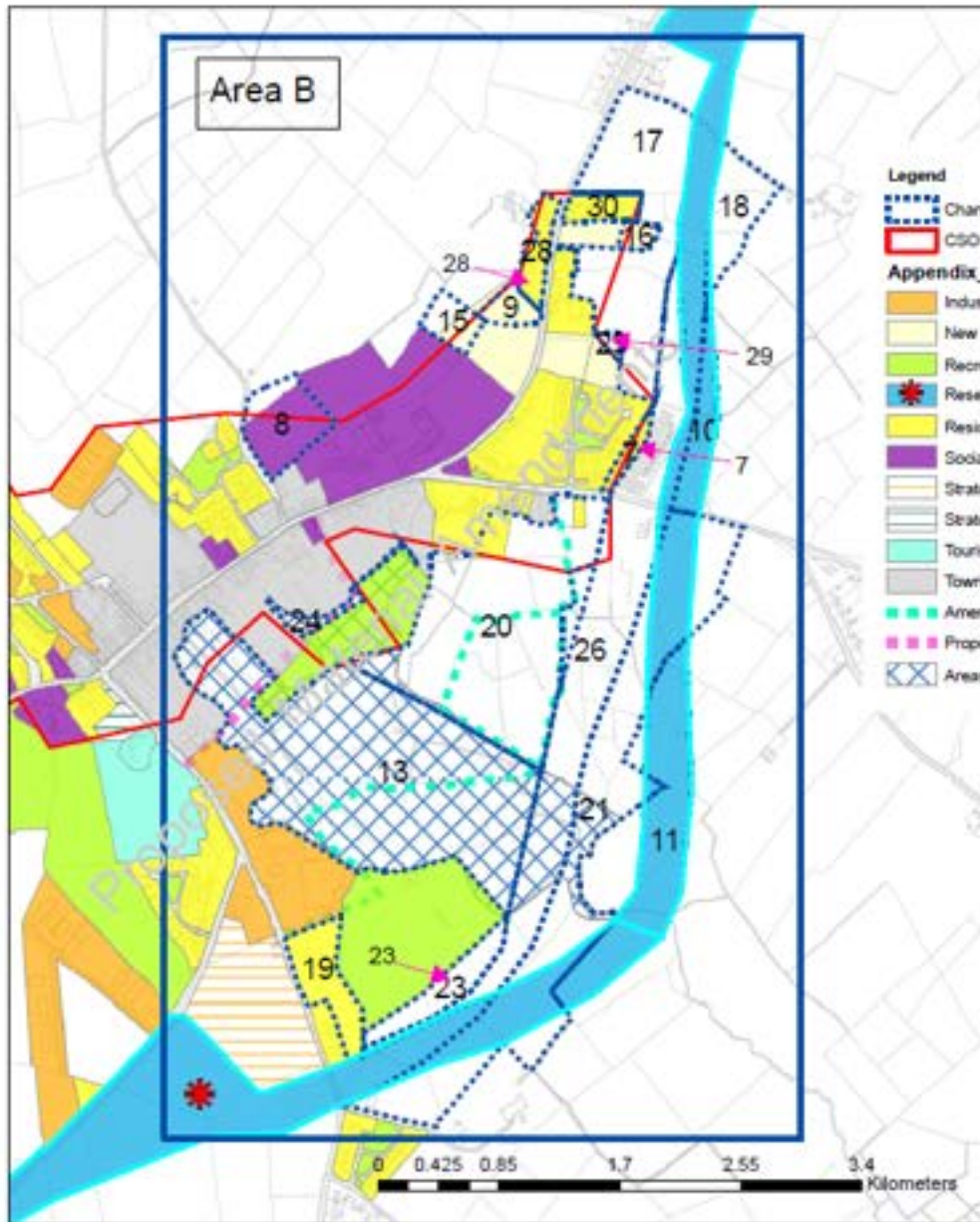

Copyright Acknowledgements
Includes Ordnance Survey Ireland data
reproduced under OSL
Licence Number 2020/00_NIMA_145
Longford County Council. Unauthorised
Reproduction infringes Ordnance Survey Ireland
and Government of Ireland Copyright.
© Ordnance Survey Ireland, year the date of
publication.

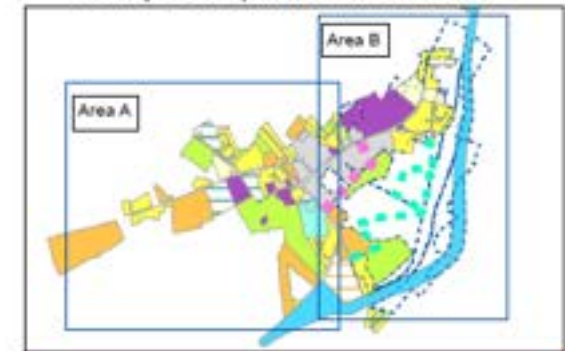

Zoning Changes - Area B

Draft Plan: Zoning in Draft Plan	Alteration Amended Zoning	Parcel No. Area on Map
New Residential		
Residential		7
No Zoning		29
No Zoning		
New Residential		9
Reserved Objective		10
Reserved Objective		11
Residential		28
Recreational/Town Core/Industrial		
No Zoning		13
Social/Community/Education/Public Utility		
Residential		19
Strategic Industrial Reserve		
Social/Community/Education/Public Utility - No Zoning		8
No Zoning & Residential		20
No Zoning & Transport & Utility Objective		21
No Zoning		23
Strategic Residential Reserve		
New Residential & No Zoning		15
New Residential		16
No Zoning		17
No Zoning		18
Residential		30
Town Core		
No Zoning		24
Transport & Utility Objective		
No Zoning		26
Amenity Walkway - New Transport & Utility Objectives - New position for proposed road		

Appendix – F3 Self-Sustaining Towns Ballymahon

The land-use zonings for Ballymahon has been revised in accordance with the Infrastructure Assessment framework and the resulting land-use plan for the settlement is presented below.

The settlement maps presented in the initial Draft County Development Plan 2021-2027 were based on the current County Development Plan 2015-2021 and the preliminary infrastructure assessment undertaken in early 2020 which informed the review of the land-use zonings for the key settlements and the drafting of the County Development Plan 2021-2027.

Following the Public Consultation on the Draft Longford County Development Plan 2021-2027 and the review of Submissions and Observations received during the consultation period (27th October 2020 until 18th January 2021) the land use zoning plans for the settlements were revised and the Further Iteration Plans are included in this report under Appendix C (produced during the period December 2020 to March 2021). An additional review of the Infrastructure Assessment Report was undertaken following the development of the Chief Executive's Report on the Submissions received, specifically the submissions from the OPR and EMRA as well as other thematic and area specific submissions.

The Infrastructure Assessment, the inclusion of the flood risk zonings and the CSO settlement boundary has highlighted specific areas that are subsequently identified as undevelopable and or constrained, lacking the infrastructure required to the service the lands, or lands at high risk of flooding. The revised settlement plan identifies those sites where land-use zonings have been amended/revised and the changes identified. The subsequent zoning map for Ballymahon identifies a more sustainable and compact form of development reflecting the CSO boundary of the town and core principle of the NPF, the EMRA RSES and Submission of the OPR on the Draft Plan.

The quantum of lands zoned new residential and industrial/commercial/warehousing have been reduced within Ballymahon significant areas of land have been revised and lands re-zoned. The settlement has significant infrastructure capacity issues which have been identified and as a consequence the quantum of residential and industrial/commercial/warehousing lands zoned within the town settlement have been significantly reduced. The revised zoning plan presents a more compact form of development, with proposed new residential development located within the defined CSO settlement boundary following the principle of compact growth and sustainable urban development. Significant areas to the south of the town, the north and east of the town have been de-zoned.

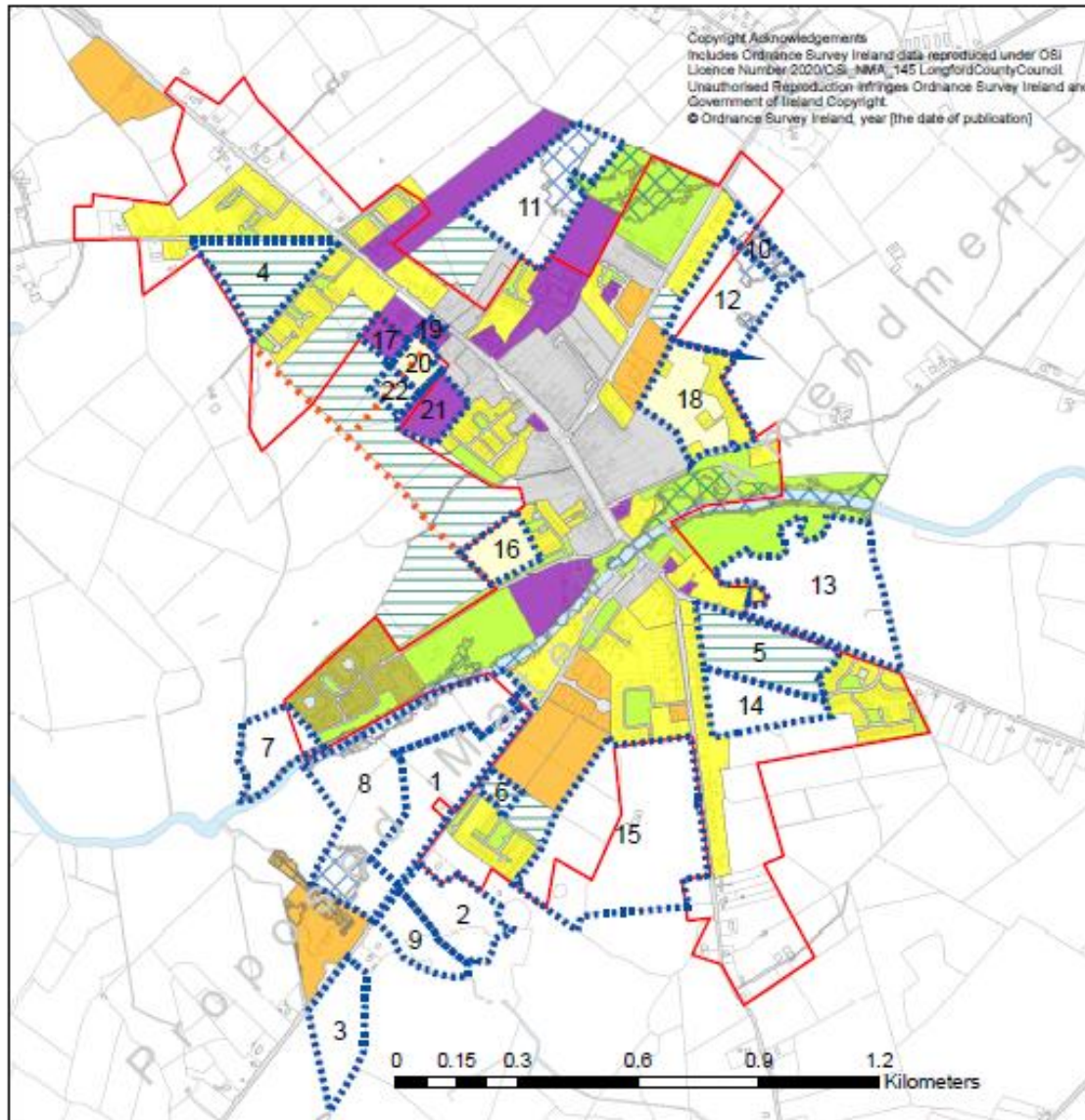

Ballymahon Proposed Material Amendments County Development Plan 2021-2027

- Legend
- Changed Zoning
 - Industrial/Commercial/Warehousing
 - New Residential
 - Recreation/Amenity & Green Space
 - Residential
 - Residential/Community Services/Med. Centre
 - Social/Community/Education/Public Utility
 - Strategic Residential Reserve
 - Town Core
 - CSO Settlement Boundary
 - Areas of Constrained Land Use
 - Proposed Roadway

Zoning Changes		
Draft Plan: Zoning in Draft Plan	Alteration: Amended Zoning	Parcel No: Area on Map
Industrial/Commercial/Warehousing	No Zoning	1 - 3
New Residential	Strategic Residential Reserve	4 - 6
Recreation/Amenity/Green Space	No Zoning	7 - 10
Residential Reserve	No Zoning	11 - 15
	New Residential	16
	Social/Community/Education/Public Utility	17
Site Resolution Objective	Residential & New Residential	18
Town Core	Social/Community/Education/Public Utility	19, 21
	New Residential	20
	Strategic Residential Reserve	22
	Proposed Roadway	



Appendix – F4 Self-Sustaining Towns Edgeworthstown

The land-use zonings for Edgeworthstown has been revised in accordance with the Infrastructure Assessment framework and the resulting land-use plan for the settlement is presented below.

The settlement maps presented in the initial Draft County Development Plan 2021-2027 were based on the current County Development Plan 2015-2021 and the preliminary infrastructure assessment undertaken in early 2020 which informed the review of the land-use zonings for the key settlements and the drafting of the County Development Plan 2021-2027.

Following the Public Consultation on the Draft Longford County Development Plan 2021-2027 and the review of Submissions and Observations received during the consultation period (27th October 2020 until 18th January 2021) the land use zoning plans for the settlements were revised and the Further Iteration Plans are included in this report under Appendix C (produced during the period December 2020 to March 2021). An additional review of the Infrastructure Assessment Report was undertaken following the development of the Chief Executive's Report on the Submissions received, specifically the submissions from the OPR and EMRA as well as other thematic and area specific submissions.

The Infrastructure Assessment, the inclusion of the flood risk zonings and the CSO settlement boundary have identified areas that are constrained and lacking the infrastructure required to the service the lands, or lands at high risk of flooding. The subsequent settlement plans (Area A west and Area B east) identifies those sites where land-use zonings have been amended/revised and the changes identified.

The quantum of lands zoned new residential and industrial/commercial/warehousing have been reduced. The revised zoning map identifies a more sustainable and compact form of development reflecting the CSO boundary of the town and core principle of the NPF, the EMRA RSES and Submission of the OPR on the Draft Plan.

Within Edgeworthstown significant areas of land have been revised and lands re-zoned. The settlement has significant infrastructure capacity issues, especially in relation to wastewater which have been identified and as a consequence the quantum of residential, residential reserve and industrial/commercial/warehousing and reserve lands zoned within the town settlement have been significantly reduced. Significant areas within Area A to the north, west and south of the town have been de-zoned. Significant lands within the Area B (east) have also been re-zoned including lands to the north, east and south of the town.

Edgeworthstown
Proposed Material Amendments
County Development Plan 2021-2027

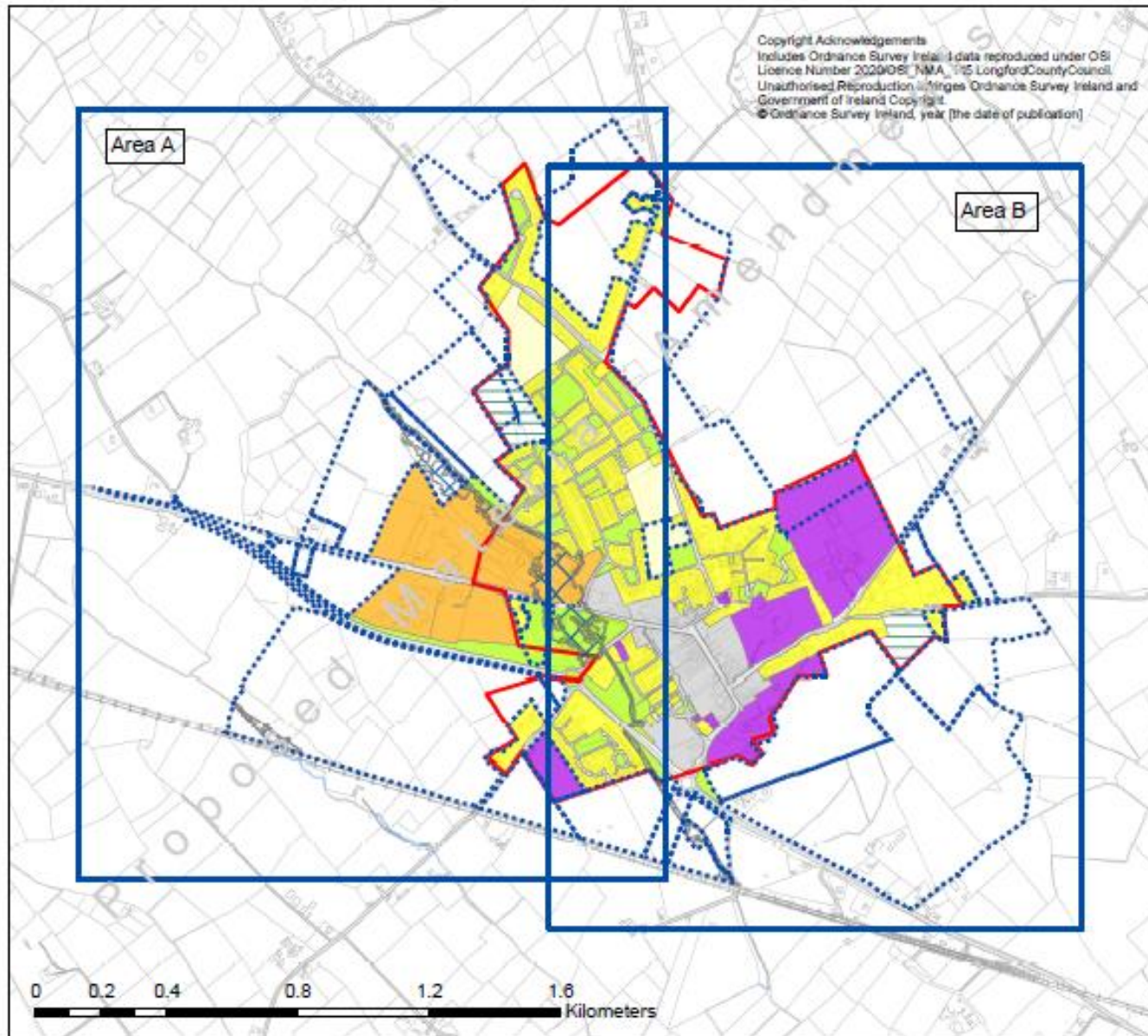

Legend

- Changed Zoning
- Areas of Constrained Land Use
- CSO Settlement Boundary
- Industrial/Commercial/Warehousing
- New Residential
- Recreation/Amenity/Green Spaces
- Residential
- Social/Community/Education/Public Utility
- Strategic Residential Reserve
- Town Core

See separate Maps
of Area A and Area B



Edgeworthstown Proposed Material Amendments County Development Plan 2021-2027

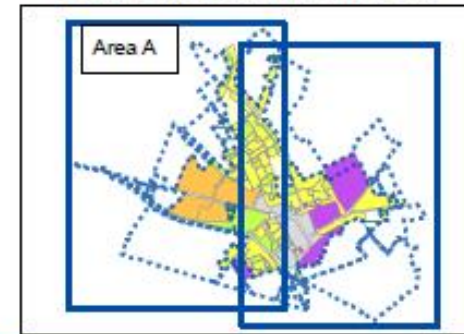
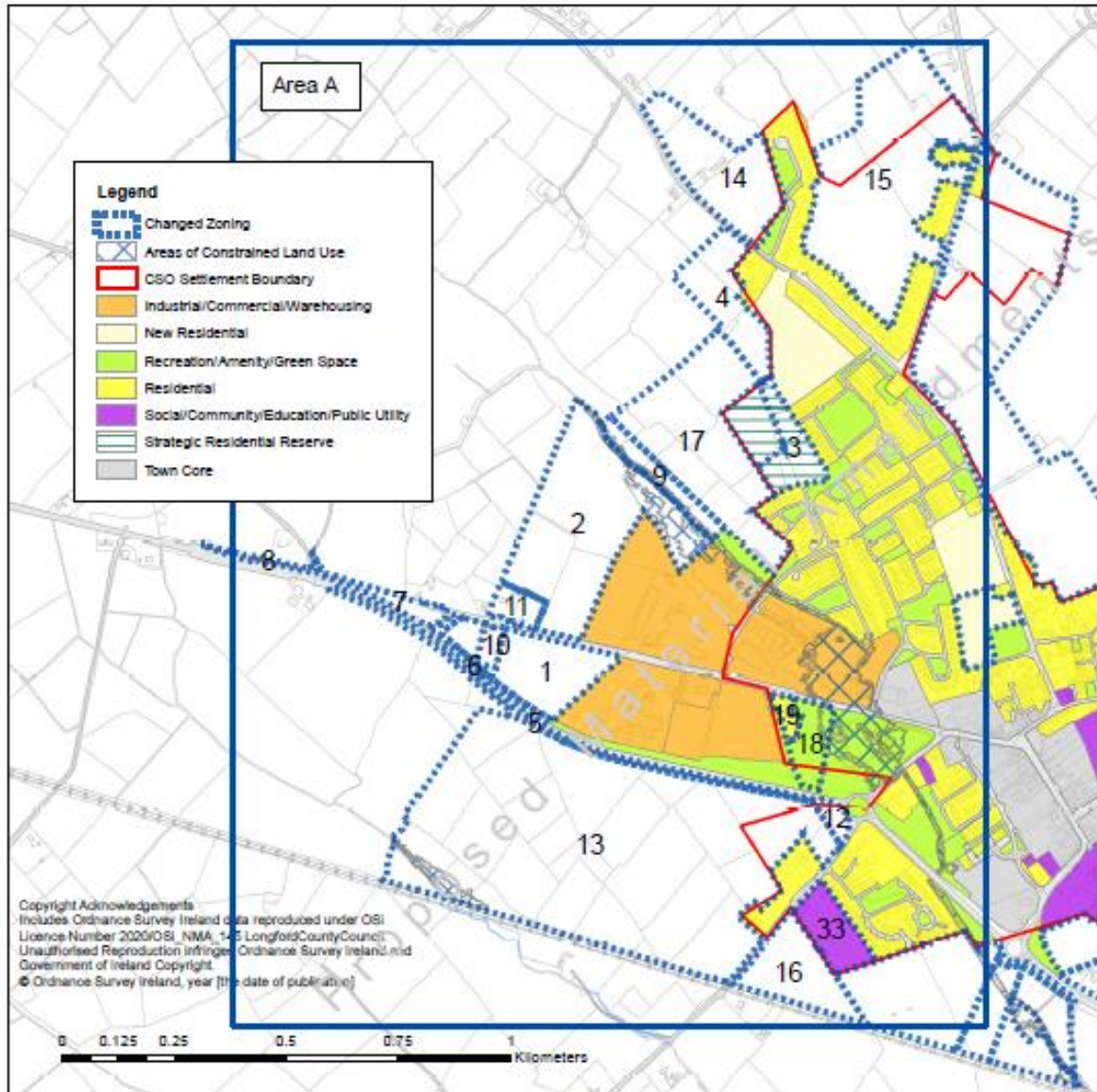

Changed Zoning		
Draft Plan: Zoning in Draft Plan	Alteration: Amended Zoning	Parcel No. Area on Map
Industrial/Commercial/Warehousing	No Zoning	1, 2
New Residential	Strategic Residential Reserve	3
	No Zoning	4
Recreational/Amenity/Green Space	No Zoning	5 - 9
	Social/Community/Education/Public Utility	33
Residential	No Zoning	10, 11
Social/Community/Education/Public Utility	No Zoning	12
Strategic Industrial Reserve	No Zoning	13
Strategic Residential Reserve	No Zoning	14 - 17
	Recreational/Amenity/Green Space	18
	Residential	19



Edgeworthstown
Proposed Material Amendments
County Development Plan 2021-2027

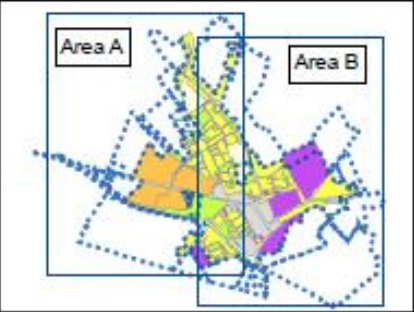
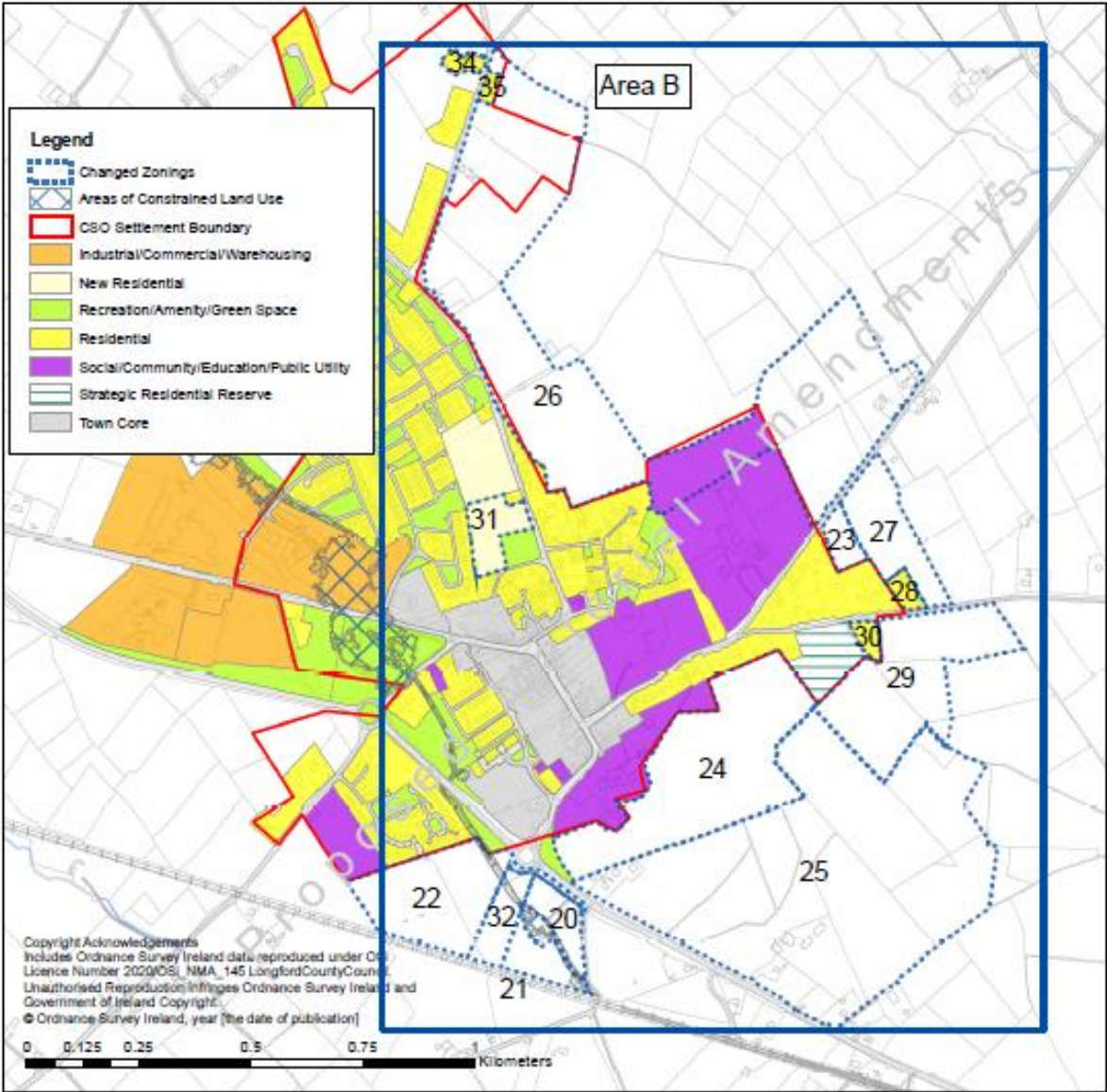

Changed Zoning		
Draft Plan: Zoning in Draft Plan	Alteration: Amended Zoning	Parcel No.: Area on Map
Recreational/Amenity/Green Space	No Zoning	20 - 22
Residential	No Zoning	23
Social/Community/Education	No Zoning	24
Strategic Industrial Reserve	No Zoning	25
Strategic Residential Reserve	Residential	24, 26, 30, 32
	Social/Community/Education/Public Use/No Zoning	26
	No Zoning	27, 29
Transport and Utilities Infrastructure	No Zoning	31
	No Zoning	32



Appendix – F5 Self-Sustaining Towns Lanesborough

The land-use zonings for Lanesborough has been revised in accordance with the Infrastructure Assessment framework and the resulting land-use plan for the settlement is presented below.

The settlement maps presented in the initial Draft County Development Plan 2021-2027 were based on the current County Development Plan 2015-2021 and the preliminary infrastructure assessment undertaken in early 2020 which informed the review of the land-use zonings for the key settlements and the drafting of the County Development Plan 2021-2027.

Following the Public Consultation on the Draft Longford County Development Plan 2021-2027 and the review of Submissions and Observations received during the consultation period (27th October 2020 until 18th January 2021) the land use zoning plans for the settlements were revised and the Further Iteration Plans are included in this report under Appendix C (produced during the period December 2020 to March 2021). An additional review of the Infrastructure Assessment Report was undertaken following the development of the Chief Executive's Report on the Submissions received, specifically the submissions from the OPR and EMRA as well as other thematic and area specific submissions.

The Infrastructure Assessment, the inclusion of the flood risk zonings and the CSO settlement boundary have identified areas that are constrained and lacking the infrastructure required to the service the lands, or lands at high risk of flooding. The subsequent settlement plan identifies those sites where land-use zonings have been amended/revised and the changes identified.

The quantum of lands zoned new residential and industrial/commercial/warehousing have been reduced. The revised zoning map identifies a more sustainable and compact form of development reflecting the CSO boundary of the town and core principle of the NPF, the EMRA RSES and Submission of the OPR on the Draft Plan.

Within Lanesborough significant areas of land have been revised and lands re-zoned and or de-zoned. Significant areas to the north, east and south of the town have been de-zoned in particular lands which were zoned Strategic Residential Reserve. Proposed new residential lands are now located within the existing CSO boundary.

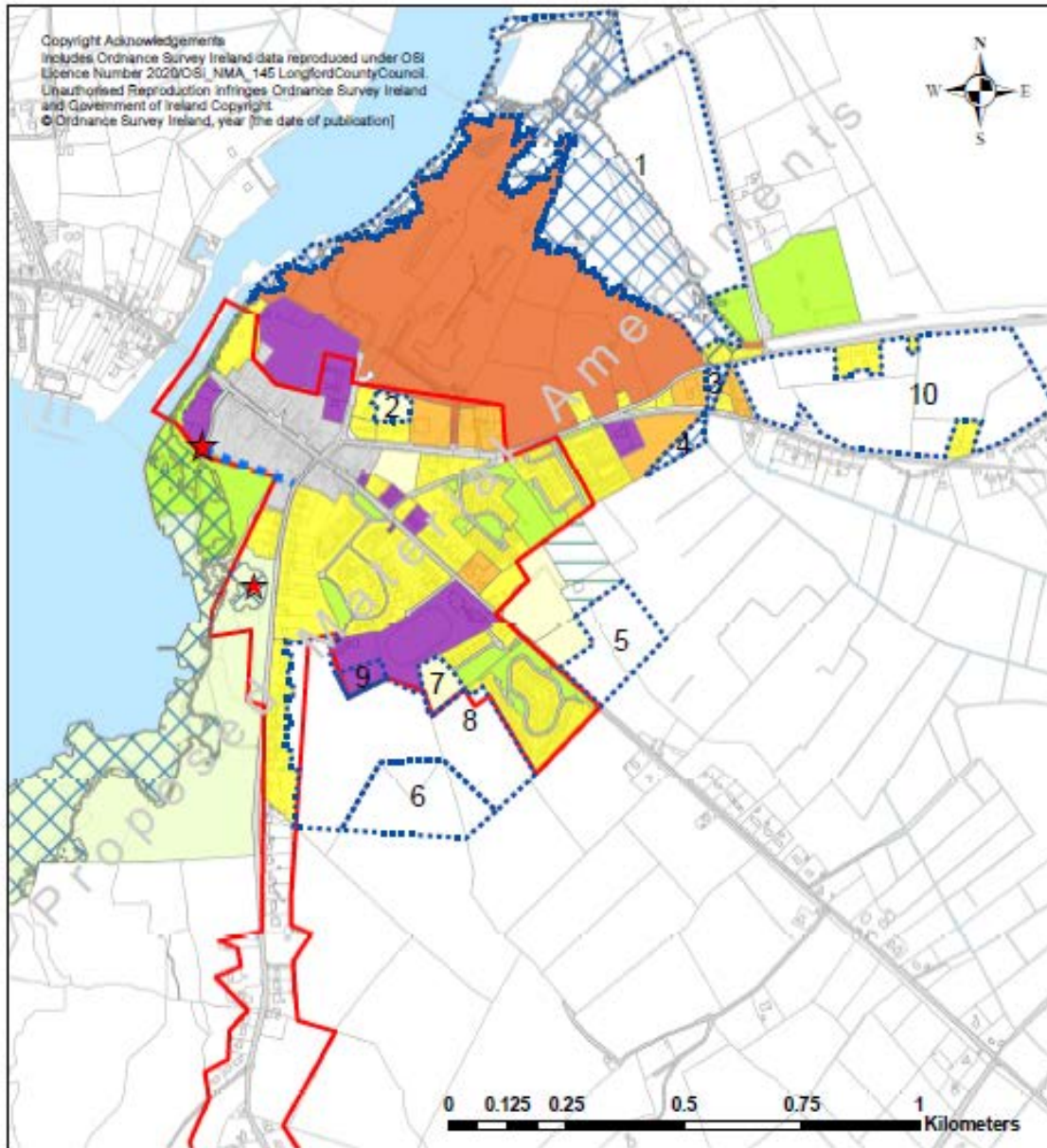

Lanesborough Proposed Material Amendments County Development Plan 2021-2027

Legend

- Changed Zoning
- Areas of Constrained Land Use
- Proposed Road - New
- CDO Settlement Boundary
- Industrial/Alternative Energy
- Industrial/Commercial/Warehousing
- New Residential
- Protected Area/Passive Amenity
- Recreation/Amenity/Green Space
- Residential
- Social/Community/Education/Public Utility
- Strategic Residential Reserve
- Town Core
- Tourism Objective/URDF Funded Projects - New

Zoning Changes		
Draft Plan: Zoning in Draft Plan	Alteration: Amended Zoning	Parcel No: Area on Map
Industrial/Alternative Energy		
	No Zoning	1
	New Residential	2
Industrial/Commercial/Warehousing		
	No Zoning	3
	No Zoning	4
New Residential		
	No Zoning	5
Recreational/Amenity/Green Space		
	No Zoning	6
Residential		
	New Residential	7
Strategic Residential Reserve		
	No Zoning	8
	Social/Community/Education/Public Utility	9
	No Zoning	10

Tourism Objective/URDF Funded Projects - New

Proposed Road - New

Appendix – F6 Towns & Villages Aughnaclyffe

The land-use zonings for Aughnaclyffe has been revised in accordance with the Infrastructure Assessment framework and the resulting land-use plan for the settlement is presented below.

The settlement maps presented in the initial Draft County Development Plan 2021-2027 were based on the current County Development Plan 2015-2021 and the preliminary infrastructure assessment undertaken in early 2020 which informed the review of the land-use zonings for the key settlements and the drafting of the County Development Plan 2021-2027.

Following the Public Consultation on the Draft Longford County Development Plan 2021-2027 and the review of Submissions and Observations received during the consultation period (27th October 2020 until 18th January 2021) the land use zoning plans for the settlements were revised and the Further Iteration Plans are included in this report under Appendix C (produced during the period December 2020 to March 2021). An additional review of the Infrastructure Assessment Report was undertaken following the development of the Chief Executive's Report on the Submissions received, specifically the submissions from the OPR and EMRA as well as other thematic and area specific submissions.

The Infrastructure Assessment, the inclusion of the flood risk zonings and the CSO settlement boundary have identified areas that are constrained and lacking the infrastructure required to service the lands, or lands at high risk of flooding. The subsequent settlement plan identifies those sites where land-use zonings have been amended/revised and the changes identified

The quantum of lands zoned new residential and industrial/commercial/warehousing have been reduced. The revised zoning map identifies a more sustainable and compact form of development reflecting the CSO boundary of the town and core principle of the NPF, the EMRA RSES and Submission of the OPR on the Draft Plan.

Within Aughnaclyffe large areas of land have been revised and lands re-zoned and or de-zoned. The revised zoning plans presents a more compact form of development, with proposed new residential development located within the defined CSO settlement boundary following the principle of compact growth and sustainable urban development.

Significant areas to the north, lands to the west, the east and the south of the town have been revised. The amount of lands zoned Strategic Residential Reserve have been reduced.

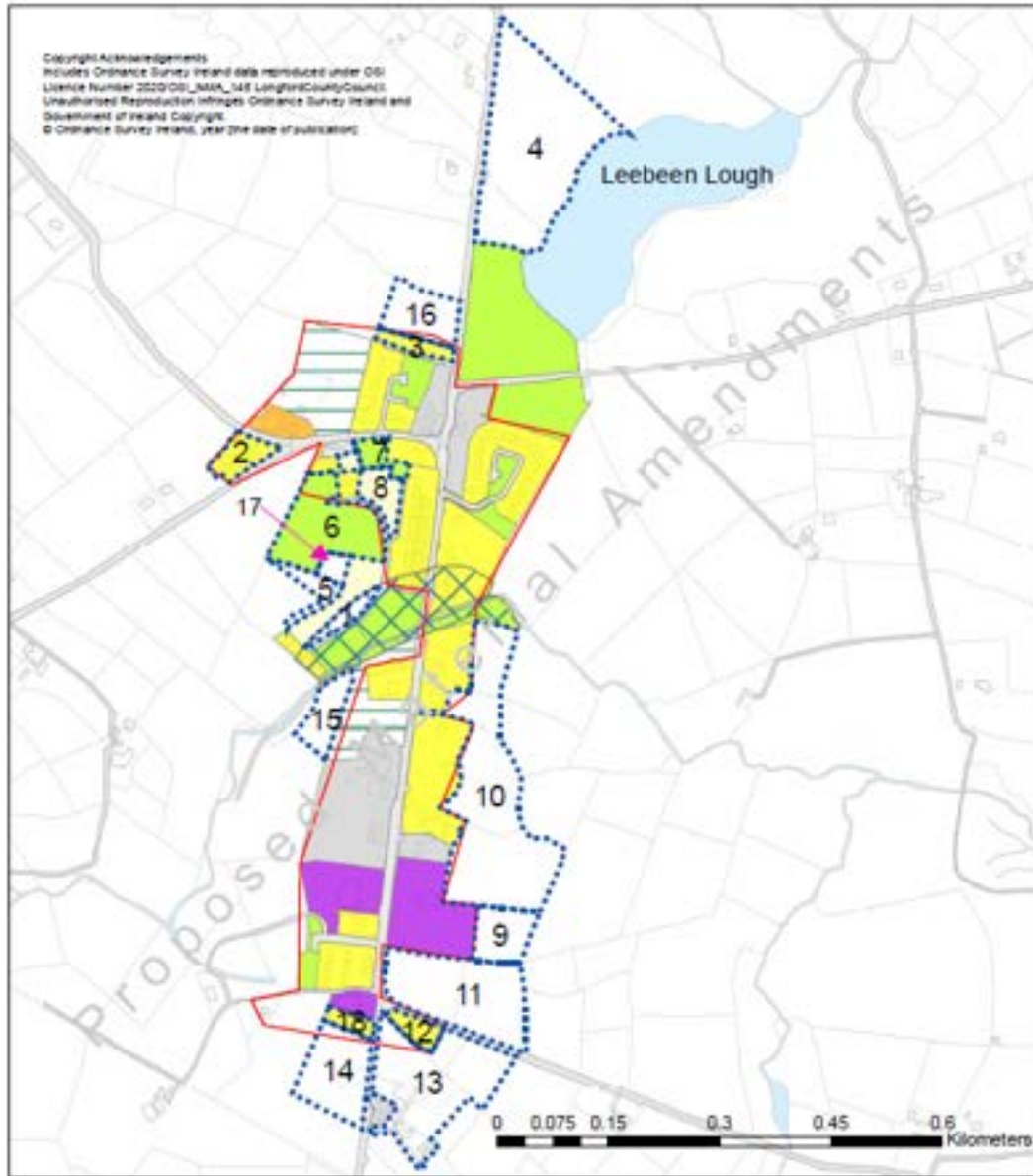

Aghnaclyffe Proposed Material Amendments County Development Plan 2021-2027

Legend

- Changed Zoning
- CDO Settlement Boundary
- Areas of Constrained Land Use
- Industrial/Commercial/Warehousing
- New Residential
- Recreation/Amenity/Green Space
- Residential
- Social/Community/Education/Public Utility
- Strategic Residential Reserve
- Town Core

Changed Zoning

Draft Plan: Zoning in Draft Plan	Alteration: Amended Zoning	Parcel No.: Area on Map
New Residential		
	No Zoning	1, 17
No Zoning		
	Residential	2, 3
Recreational/Amenity/Green Space		
	No Zoning	4
Site Resolution Objective		
	No Zoning	5
	Recreational/Amenity/Green Space	6, 7
	New Residential	8
Social/Community/Education/Public Utility		
	No Zoning	9
Strategic Residential Reserve		
	No Zoning	10, 11, 13, 14, 15, 16
	Residential	12
	Residential	18



Appendix – F7 Towns & Villages Ballinalee

The land-use zonings for Ballinalee has been revised in accordance with the Infrastructure Assessment framework and the resulting land-use plan for the settlement is presented below.

The settlement maps presented in the initial Draft County Development Plan 2021-2027 were based on the current County Development Plan 2015-2021 and the preliminary infrastructure assessment undertaken in early 2020 which informed the review of the land-use zonings for the key settlements and the drafting of the County Development Plan 2021-2027.

Following the Public Consultation on the Draft Longford County Development Plan 2021-2027 and the review of Submissions and Observations received during the consultation period (27th October 2020 until 18th January 2021) the land use zoning plans for the settlements were revised and the Further Iteration Plans are included in this report under Appendix C (produced during the period December 2020 to March 2021). An additional review of the Infrastructure Assessment Report was undertaken following the development of the Chief Executive's Report on the Submissions received, specifically the submissions from the OPR and EMRA as well as other thematic and area specific submissions.

The Infrastructure Assessment, the inclusion of the flood risk zonings and the CSO settlement boundary have identified areas that are constrained and lacking the infrastructure required to the service the lands, or lands at high risk of flooding. The subsequent settlement plan identifies those sites where land-use zonings have been amended/revised and the changes identified.

The quantum of lands zoned new residential and industrial/commercial/warehousing have been reduced. The revised zoning map identifies a more sustainable and compact form of development reflecting the CSO boundary of the town and core principle of the NPF, the EMRA RSES and Submission of the OPR on the Draft Plan.

Within Ballinalee significant areas of land have been revised and lands re-zoned and or de-zoned. The revised zoning plan presents a more compact form of development, with proposed new residential development located within the defined CSO settlement boundary following the principle of compact growth and sustainable urban development.

Significant areas to the north identified as constrained use have been de-zoned, further lands to the west and east and to the south have also been revised. The quantum of lands zoned as Strategic Residential Reserve and Recreation/Amenity/Green Space lands have been de-zoned.

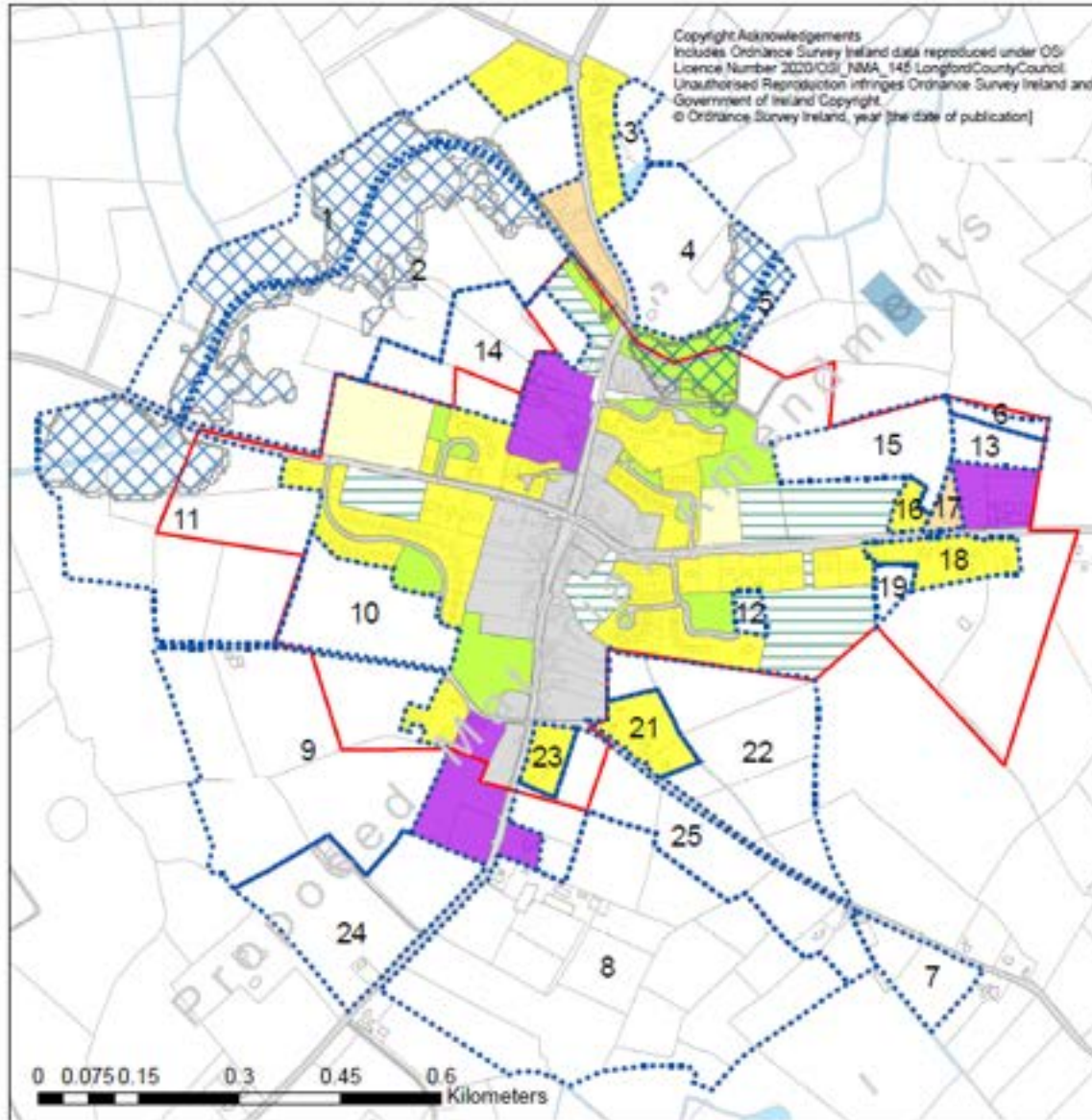

Ballinalee Proposed Material Amendments County Development Plan 2021-2027

- Legend**
- Changed Zoning
 - Areas of Constrained Land Use
 - COO Settlement Boundary
 - Light Industrial/Commercial/Service
 - New Residential
 - Recreation/Amenity/Green Space
 - Residential
 - Social/Community/Education/Public Utility
 - Strategic Residential Reserve
 - Town Core

Changed Zoning		
Draft Plan: Zoning in Draft Plan	Alteration: Amended Zoning	Parcel No.: Area on Map
Recreational/Amenity/Green Space		
	No Zoning	1 - 11
Residential		
	Strategic Residential Reserve	12
Social/Community/Education/Public Utility		
	No Zoning	13
Strategic Residential Reserve		
	No Zoning	14, 15, 19, 22, 24, 25
	Residential	16, 18, 21, 23
	Light Industrial/Commercial/Service	17



Appendix – F8 Towns & Villages Drumlish

The land-use zonings for Drumlish has been revised in accordance with the Infrastructure Assessment framework and the resulting land-use plan for the settlement is presented below.

The settlement maps presented in the initial Draft County Development Plan 2021-2027 were based on the current County Development Plan 2015-2021 and the preliminary infrastructure assessment undertaken in early 2020 which informed the review of the land-use zonings for the key settlements and the drafting of the County Development Plan 2021-2027.

Following the Public Consultation on the Draft Longford County Development Plan 2021-2027 and the review of Submissions and Observations received during the consultation period (27th October 2020 until 18th January 2021) the land use zoning plans for the settlements were revised and the Further Iteration Plans are included in this report under Appendix C (produced during the period December 2020 to March 2021). An additional review of the Infrastructure Assessment Report was undertaken following the development of the Chief Executive's Report on the Submissions received, specifically the submissions from the OPR and EMRA as well as other thematic and area specific submissions.

The Infrastructure Assessment, the inclusion of the flood risk zonings and the CSO settlement boundary have identified areas that are constrained and lacking the infrastructure required to the service the lands, or lands at high risk of flooding. The subsequent settlement plan identifies those sites where land-use zonings have been amended/revised and the changes identified.

The quantum of lands zoned new residential and industrial/commercial/warehousing have been reduced. The revised zoning maps identifies a more sustainable and compact form of development reflecting the CSO boundary of the town and core principle of the NPF, the EMRA RSES and Submission of the OPR on the Draft Plan.

Within Drumlish significant areas of land have been revised and lands re-zoned and or de-zoned. The revised zoning plans (Area A – west) (Area B- east) presents a more compact form of development, with proposed new residential development located within the defined CSO settlement boundary following the principle of compact growth and sustainable urban development.

Map zoned Area A (west) identifies significant areas to the north identified as constrained use have been de-zoned, further lands to the west and east and to the south have also been revised. Additional existing residential lands have been included. **Map zoned Area B (east)** identifies large areas as constrained use, and significant lands have been de-zoned which had been previously zoned as Strategic Residential Reserve; in particular those located around the periphery of the settlement and outside of the CSO boundary.

Drumlish
Proposed Material Amendments
County Development Plan 2021-2027

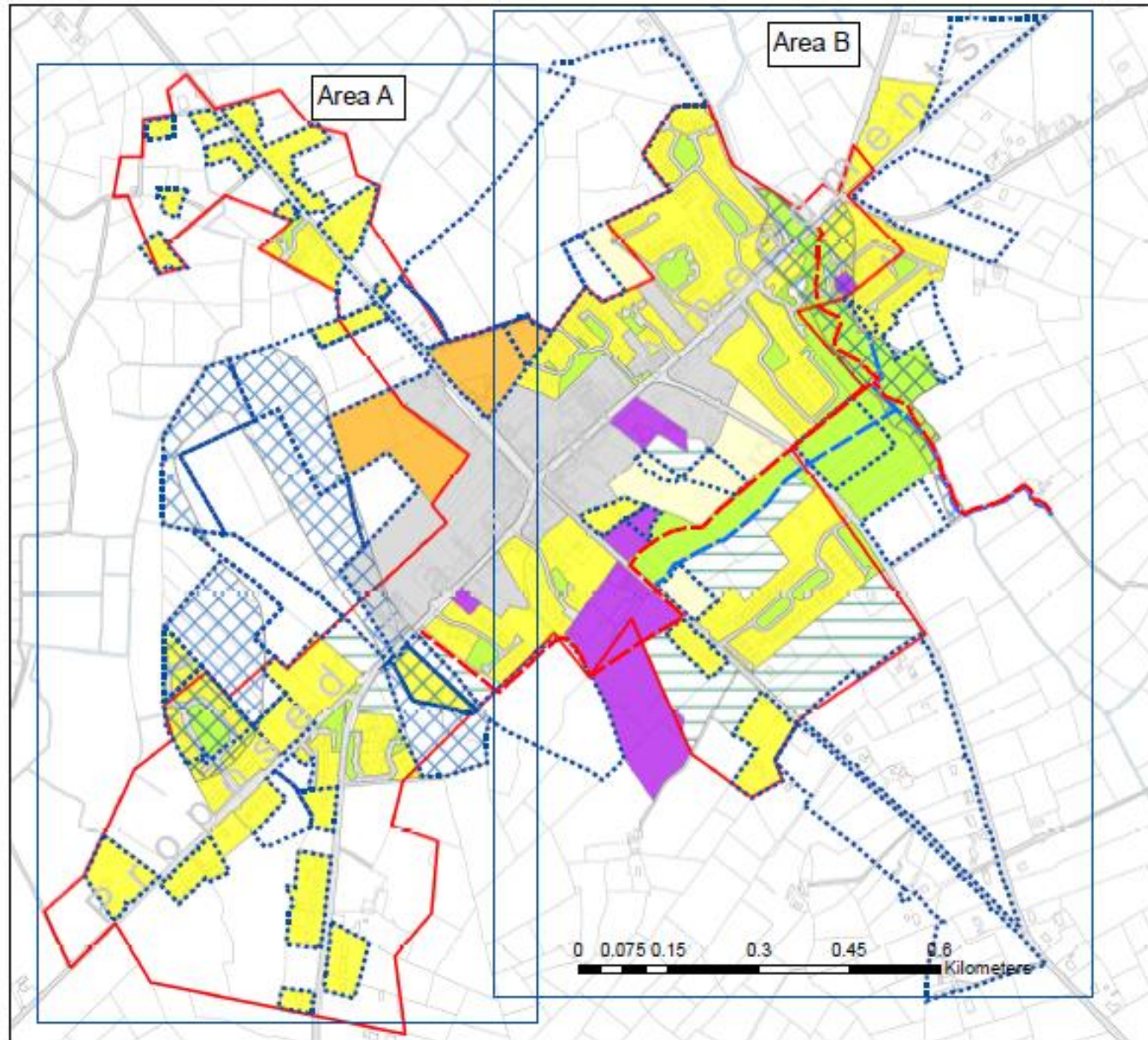

Legend

- Changed Zoning
- Industrial/Commercial/Warehousing
- New Residential
- Recreation/Amenity/Green Space
- Residential
- Social/Community/Education/Public Utility
- Strategic Residential Reserve
- Town Core
- Walkway
- Bridle Path
- CSO Settlement Boundary
- Areas of Constrained Land Use

See separate Maps
of Area A and Area B

Copyright Acknowledgements
Includes Ordnance Survey Ireland data reproduced under OSI
License Number 2020/OSI_NMA_145 Longford County Council.
Unauthorized reproduction infringes Ordnance Survey Ireland and
Government of Ireland Copyright.
© Ordnance Survey Ireland, year [the date of publication]



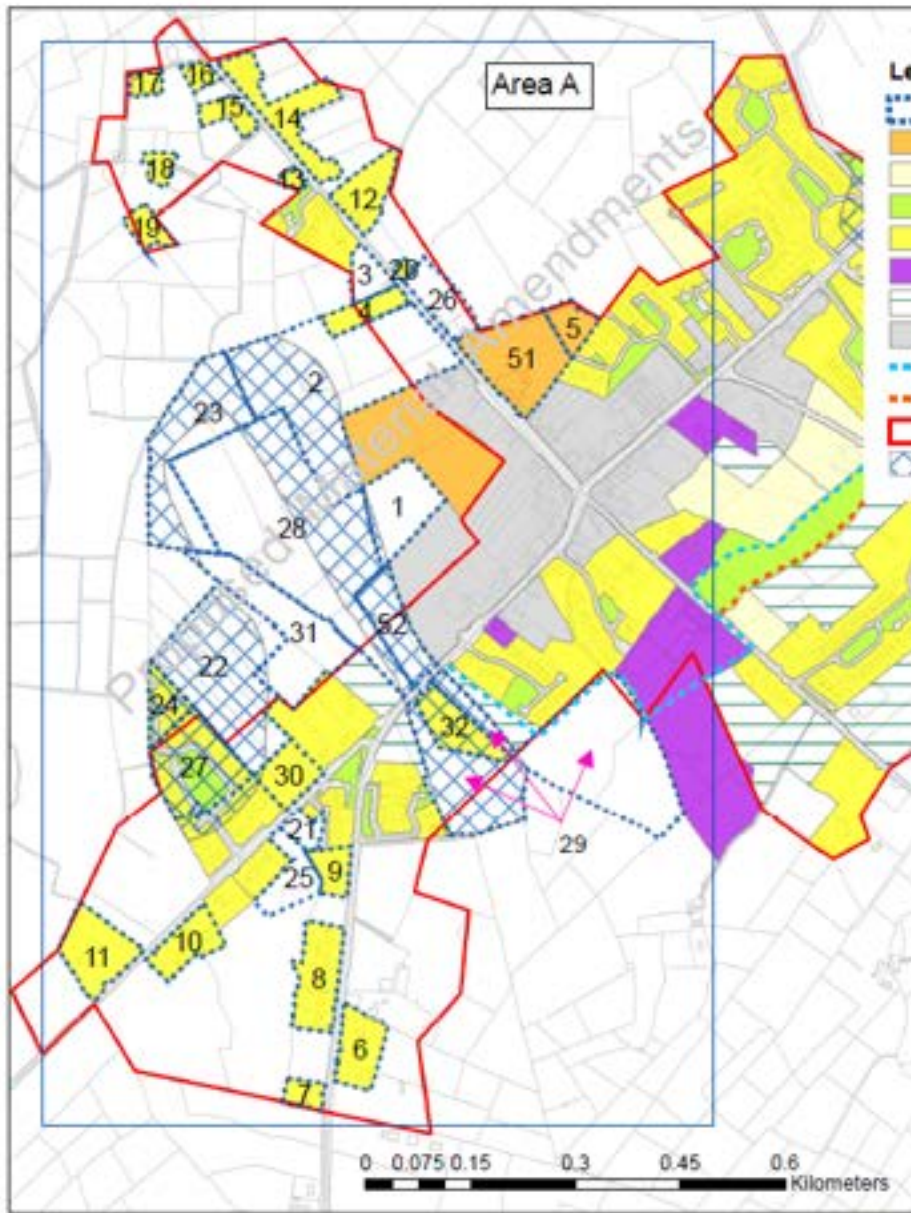

Drumlish Proposed Material Amendments County Development Plan 2021-2027

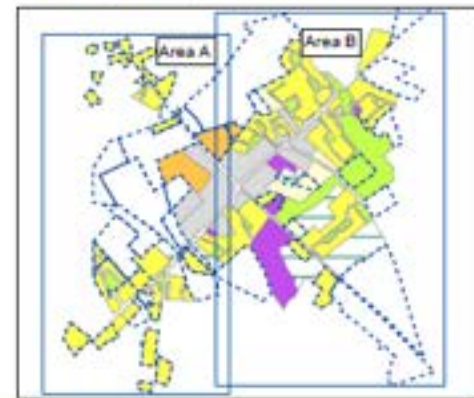

Zoning Changes		
Draft Plan Zoning in Draft Plan	Attention Amended Zoning	Parcel No: Area on Map
Industrial/Commercial/Warehousing		
No Zoning		1 - 3
Residential		4
New Residential		
	Industrial/Commercial/Warehousing	5
No Zoning		
	Residential	6 - 20
Recreational/Amenity/Green Space		
	No Zoning	21
	No Zoning	22 - 25
	Residential	24
Residential		
	No Zoning	25 - 26
Site Resolution Objective		
	Residential	27
Strategic Industrial Reserve		
	No Zoning	28
Strategic Residential Reserve		
	No Zoning	29, 31
	Residential	30, 32
Town Core		
	Industrial/Commercial/Warehousing	31
	No Zoning	32

Walkway (Amended) Bridle Path (New)

Drumlish
Proposed Material Amendments
County Development Plan 2021-2027

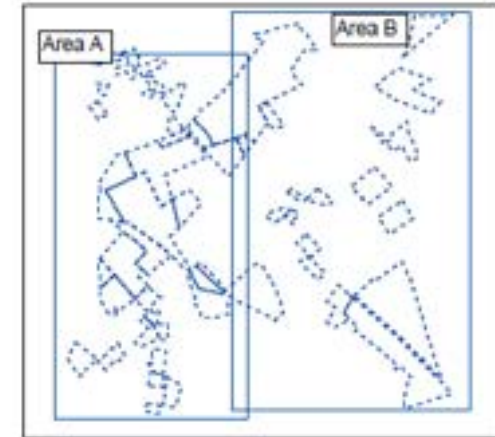
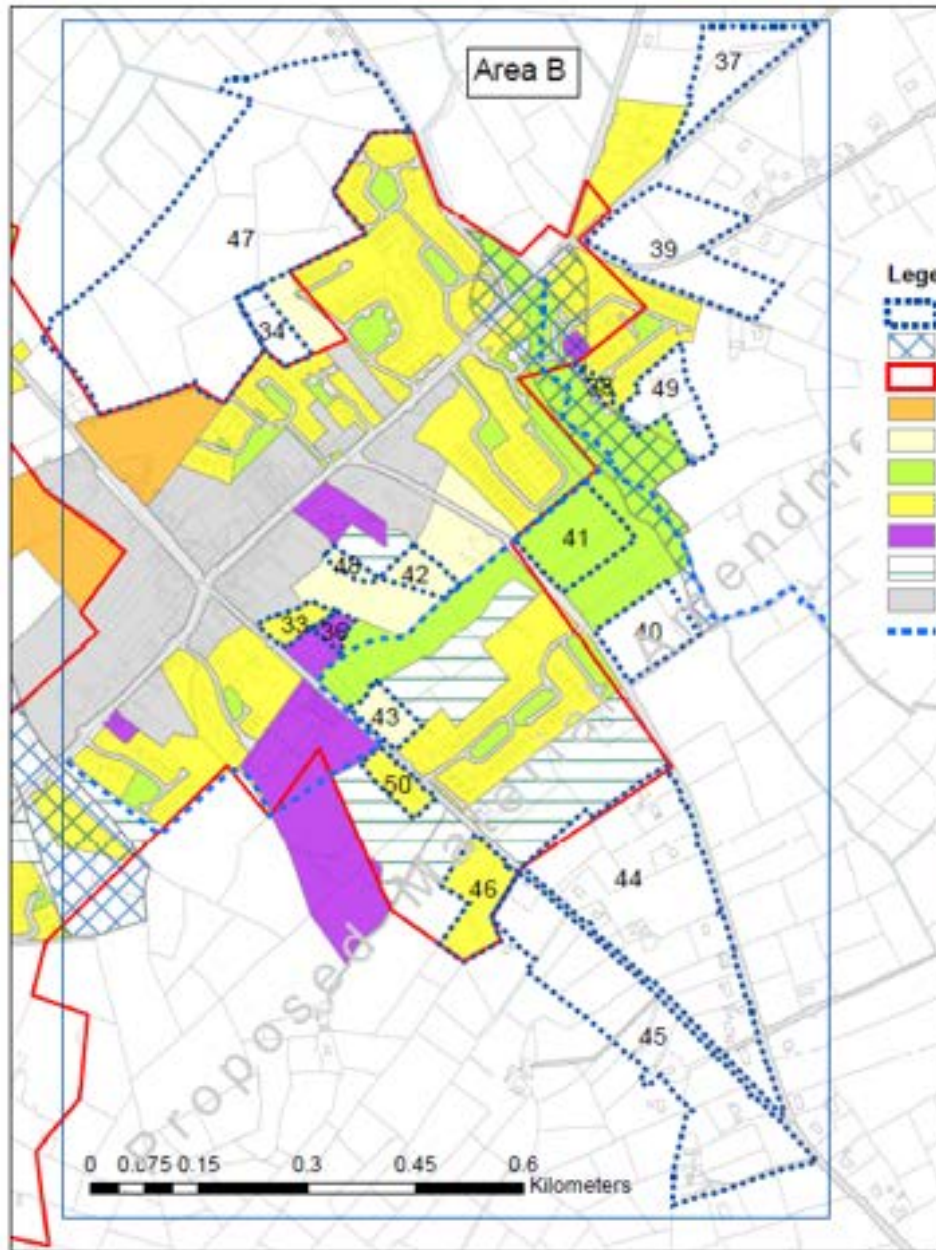

Zoning Changes - Area B

Draft Plan Zoning in Draft Plan	Alteration Amended Zoning	Parcel No. Area on Map
New Residential		
Residential		33
No Zoning		34
Social/Community/Education/Public Utility		36
Recreational/Amenity/Green Space		
No Zoning		37
Residential		38
Strategic Residential Reserve		
No Zoning		39, 40, 44, 45, 47, 49
Recreational/Amenity/Green Space		41
New Residential		42, 43, 48
Residential		46, 50

Walkway
 Bridle Path

Copyright Acknowledgements includes Ordnance Survey Ireland data reproduced under OSL Licence Number 2020-001, JMM, 145 Longford County Council. Unauthorised reproduction infringes Ordnance Survey Ireland and Government of Ireland Copyright. © Ordnance Survey Ireland, year 2021



Appendix – F9 Towns & Villages Keenagh

The land-use zonings for Keenagh has been revised in accordance with the Infrastructure Assessment framework and the resulting land-use plan for the settlement is presented below.

The settlement maps presented in the initial Draft County Development Plan 2021-2027 were based on the current County Development Plan 2015-2021 and the preliminary infrastructure assessment undertaken in early 2020 which informed the review of the land-use zonings for the key settlements and the drafting of the County Development Plan 2021-2027.

Following the Public Consultation on the Draft Longford County Development Plan 2021-2027 and the review of Submissions and Observations received during the consultation period (27th October 2020 until 18th January 2021) the land use zoning plans for the settlements were revised and the Further Iteration Plans are included in this report under Appendix C (produced during the period December 2020 to March 2021). An additional review of the Infrastructure Assessment Report was undertaken following the development of the Chief Executive's Report on the Submissions received, specifically the submissions from the OPR and EMRA as well as other thematic and area specific submissions.

The Infrastructure Assessment, the inclusion of the flood risk zonings and the CSO settlement boundary have identified areas that are constrained and lacking the infrastructure required to the service the lands, or lands at high risk of flooding. The subsequent settlement plan identifies those sites where land-use zonings have been amended/revised and the changes identified.

Within Keenagh the quantum of lands zoned new residential and industrial/commercial/warehousing have been reduced, large areas of land have been revised and lands re-zoned and or de-zoned. The revised zoning plan presents a more compact form of development, with proposed new residential development located within the defined CSO settlement boundary following the principle of compact growth and sustainable urban development.

Significant areas to the north, to the south west and east have been revised and lands de-zoned identified as constrained use have been de-zoned, further lands to the west and east and to the south have also been revised. The quantum of lands zoned for Strategic Residential Reserve zoned lands have been de-zoned and New Residential lands zoned within the CSO boundary.

Keenagh Proposed Material Amendments County Development Plan 2021-2027

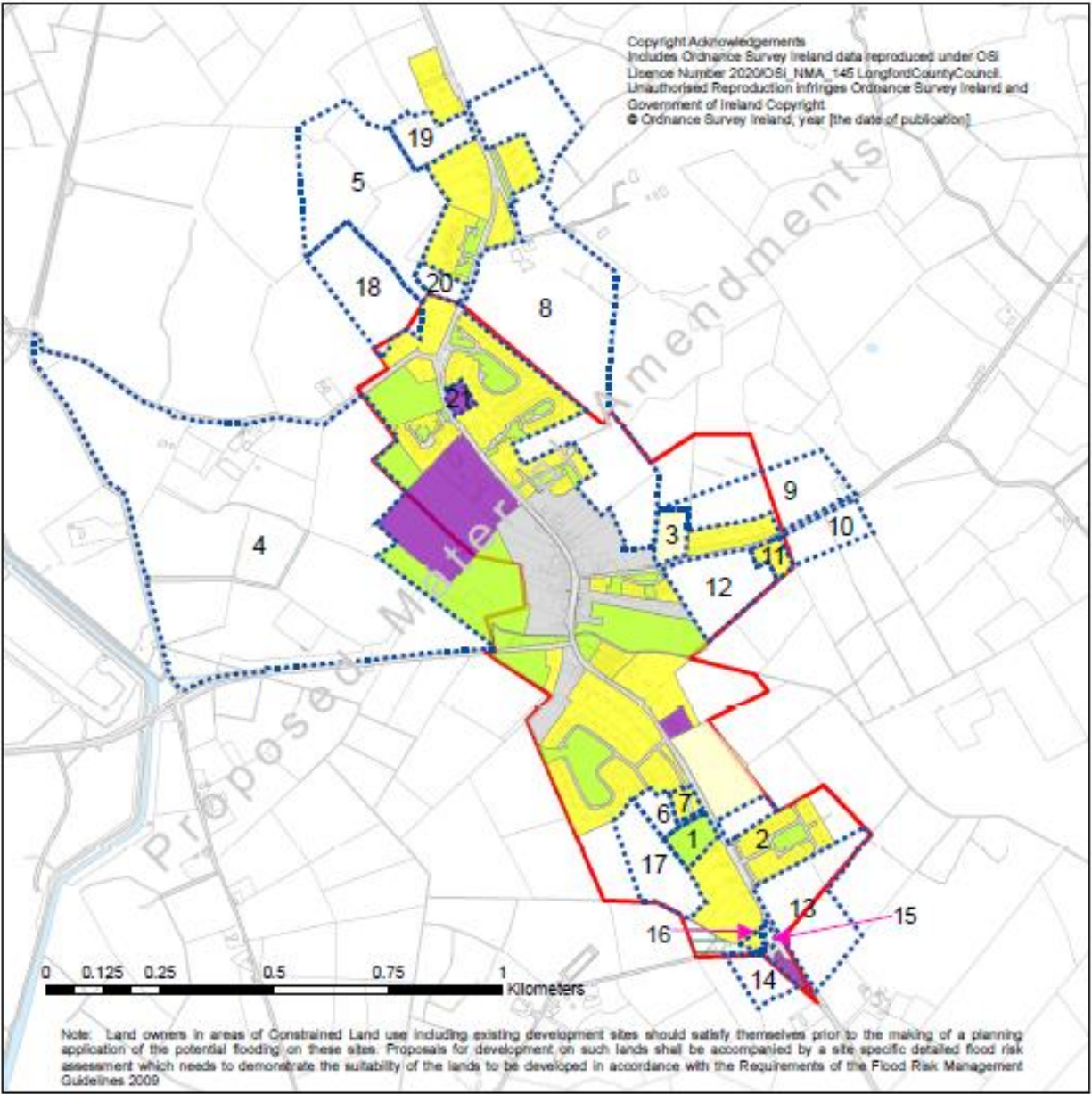

- Legend**
- Changed Zoning
 - Areas of Constrained Land Use
 - CSO Settlement Boundary
 - New Residential
 - Recreation/Amenity & Green Space
 - Residential
 - Social/Community/Education/Public Utility
 - Strategic Residential Reserve
 - Town Core

Zoning Changes		
Draft Plan: Zoning in Draft Plan	Alteration: Amended Zoning	Parcel No: Area on Map
New Residential		
	No Zoning	2
Recreational/Amenity/Green Space		
	No Zoning	4
	No Zoning	5
Residential		
	Social/Community/Education/Public Utility	21
Site Resolution Objective		
	Recreation/Amenity/Green Space	1
	No Zoning	6
	Residential	7
Strategic Residential Reserve		
	New Residential	3
	No Zoning	8 - 10, 12 - 19
	Residential	11, 16
Town Core		
	No Zoning	20



Appendix – F10 Towns & Villages Legan

The land-use zonings for Legan has been revised in accordance with the Infrastructure Assessment framework and the resulting land-use plan for the settlement is presented below.

The settlement maps presented in the initial Draft County Development Plan 2021-2027 were based on the current County Development Plan 2015-2021 and the preliminary infrastructure assessment undertaken in early 2020 which informed the review of the land-use zonings for the key settlements and the drafting of the County Development Plan 2021-2027.

Following the Public Consultation on the Draft Longford County Development Plan 2021-2027 and the review of Submissions and Observations received during the consultation period (27th October 2020 until 18th January 2021) the land use zoning plans for the settlements were revised and the Further Iteration Plans are included in this report under Appendix C (produced during the period December 2020 to March 2021). An additional review of the Infrastructure Assessment Report was undertaken following the development of the Chief Executive's Report on the Submissions received, specifically the submissions from the OPR and EMRA as well as other thematic and area specific submissions.

The Infrastructure Assessment, the inclusion of the flood risk zonings and the CSO settlement boundary have identified areas that are constrained and lacking the infrastructure required to the service the lands, or lands at high risk of flooding. The subsequent settlement plan identifies those sites where land-use zonings have been amended/revised and the changes identified.

The quantum of lands zoned new residential and industrial/commercial/warehousing have been reduced. The revised zoning maps identifies a more sustainable and compact form of development reflecting the CSO boundary of the town and core principle of the NPF, the EMRA RSES and Submission of the OPR on the Draft Plan.

Within Legan significant areas of land have been revised and lands re-zoned and or de-zoned. The revised zoning plan presents a more compact form of development, with proposed new residential development located within the defined CSO settlement boundary following the principle of compact growth and sustainable urban development.

Significant areas to the north, to the south west and east have been revised and lands de-zoned identified as constrained use have been de-zoned, further lands to the west and east and to the south have also been revised. The quantum of the lands zoned Strategic Residential Reserve have been de-zoned.

Legan
Proposed Material Amendments
 County Development Plan 2021-2027

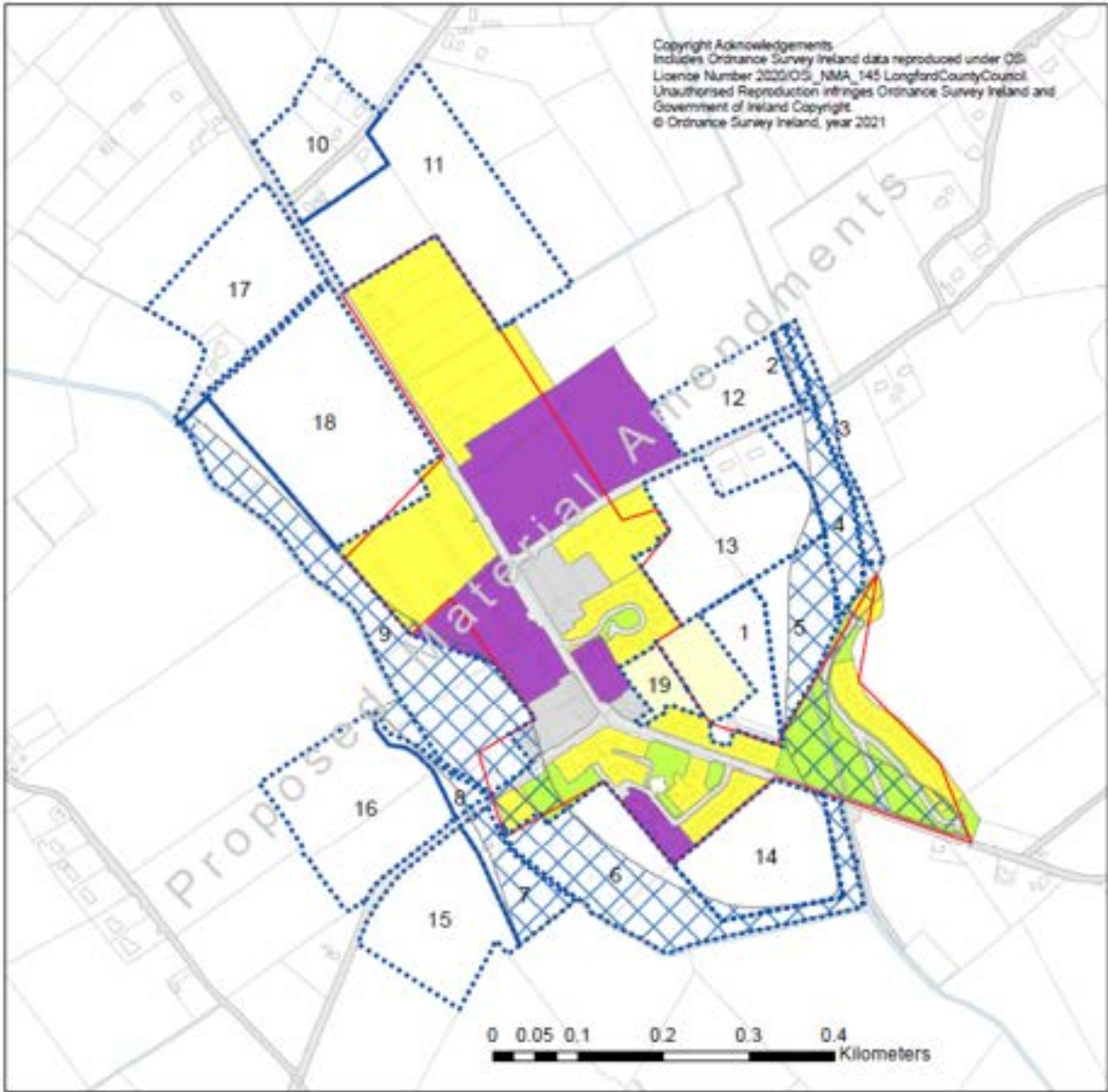

Legend

- Changed Zoning
- CSO Settlement Boundary
- Areas of Constrained Land Use
- New Residential
- Recreation/Amenity/Green Space
- Residential
- Social/Community/Education/Public Utility
- Town Core

Zoning Changes		
Draft Plan: Zoning in Draft Plan	Alteration: Amended Zoning	Parcel No: Area on Map
New Residential	No Zoning	1
Recreation/Amenity/Green Space	No Zoning	2 - 9
Strategic Residential Reserve	No Zoning	11 - 18
Town Core	New Residential	19



Appendix – F11 Towns & Villages Newtownforbes

The land-use zonings for Newtownforbes has been revised in accordance with the Infrastructure Assessment framework and the resulting land-use plan for the settlement is presented below.

The settlement maps presented in the initial Draft County Development Plan 2021-2027 were based on the current County Development Plan 2015-2021 and the preliminary infrastructure assessment undertaken in early 2020 which informed the review of the land-use zonings for the key settlements and the drafting of the County Development Plan 2021-2027.

Following the Public Consultation on the Draft Longford County Development Plan 2021-2027 and the review of Submissions and Observations received during the consultation period (27th October 2020 until 18th January 2021) the land use zoning plans for the settlements were revised and the Further Iteration Plans are included in this report under Appendix C (produced during the period December 2020 to March 2021). An additional review of the Infrastructure Assessment Report was undertaken following the development of the Chief Executive's Report on the Submissions received, specifically the submissions from the OPR and EMRA as well as other thematic and area specific submissions.

The Infrastructure Assessment, the inclusion of the flood risk zonings and the CSO settlement boundary have identified areas that are constrained and lacking the infrastructure required to the service the lands, or lands at high risk of flooding. The subsequent settlement plan identifies those sites where land-use zonings have been amended/revised and the changes identified.

The quantum of lands zoned new residential and industrial/commercial/warehousing have been reduced. The revised zoning maps identifies a more sustainable and compact form of development reflecting the CSO boundary of the town and core principle of the NPF, the EMRA RSES and Submission of the OPR on the Draft Plan.

Within Newtownforbes significant areas of land have been revised and lands re-zoned and or de-zoned. The revised zoning plan presents a more compact form of development, with proposed new residential development located within the defined CSO settlement boundary following the principle of compact growth and sustainable urban development.

Significant areas to the north, to the west and east have been revised and lands de-zoned identified as constrained use have been de-zoned, further lands to the west and east and to the south have also been revised. The quantum of lands zoned Strategic Residential Reserve have been de-zoned. New residential development sites have been reduced and located within the defined CSO boundary.

Copyright Acknowledgements
 Includes Ordnance Survey Ireland data reproduced under OSI
 Licence Number 2006/OSI_NMA_145 LongfordCountyCouncil.
 Unauthorised Reproduction Infringes Ordnance Survey Ireland and
 Government of Ireland Copyright.
 © Ordnance Survey Ireland, year [the date of publication]

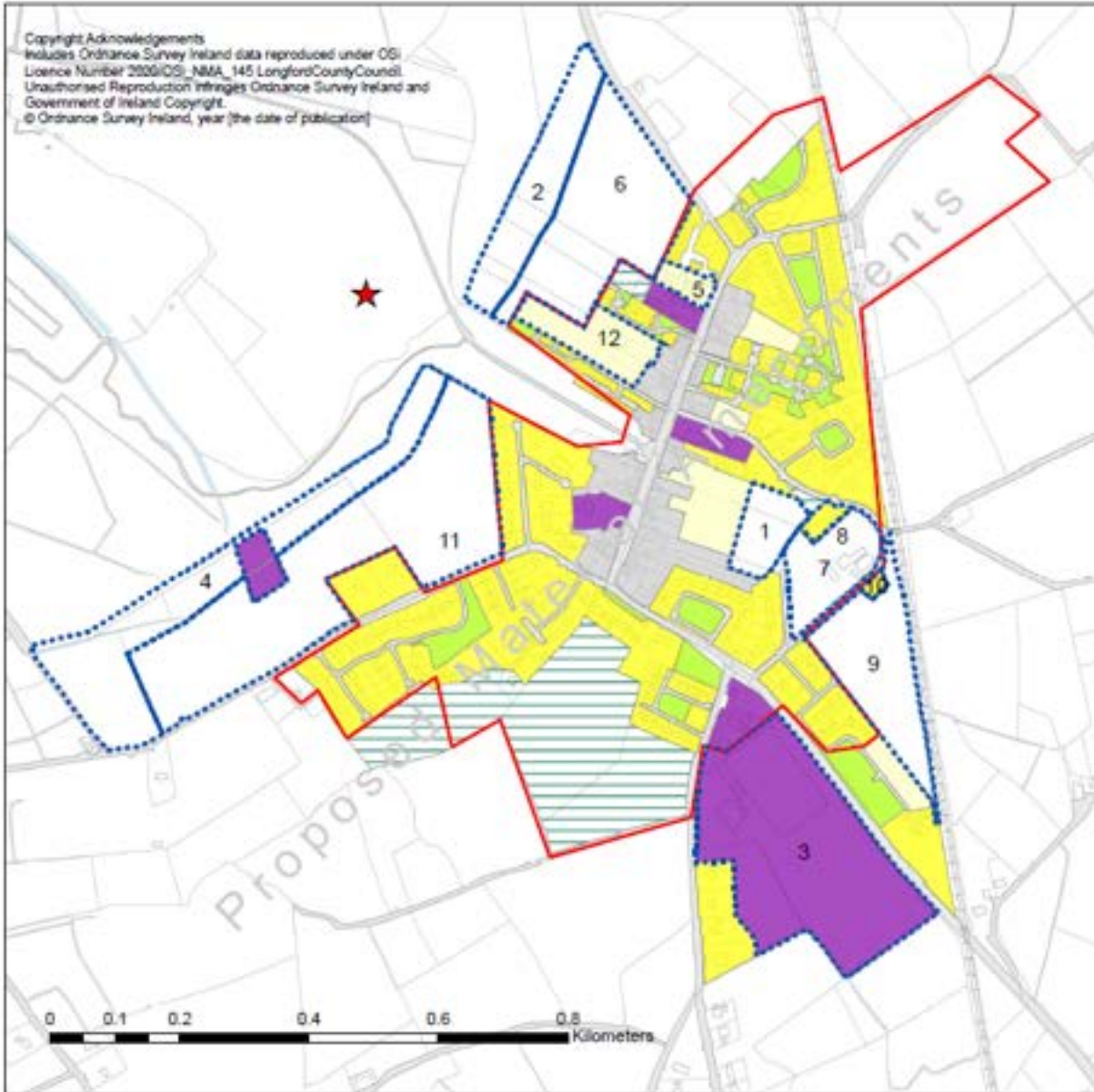

Newtownforbes Proposed Material Amendments County Development Plan 2021-2027

Legend

- Changed Zoning
- Areas of Constrained Land Use
- CSO Settlement Boundary
- New Residential
- Recreation/Amenity/Green Space
- Residential
- Social/Community/Education/Public Utility
- Strategic Residential Reserve
- Town Core
- Tourism & Events

Zoning Changes		
Draft Plan: Zoning in Draft Plan	Alteration: Amended Zoning	Parcel No: Area on Map
New Residential	No Zoning	1
	Residential	12
Recreation/Amenity/Green Space	No Zoning	2, 4
	Social/Community/Education/Public Utility	3
	Residential	11
Social/Community/Education/Public Utility	No Zoning	5
	New Residential	5
Strategic Residential Reserve	No Zoning	6, 7, 8, 11
	Residential	8
	Residential	10
	New Residential	12



Appendix – F12 Smaller Villages & Settlements : Abbeyshrule, Ardagh, Ballinamuck & Clondra

The following settlements and their land-use zonings have been reviewed and revised according to the CSO boundary, constrained land use and the submissions from the OPR and EMRA requesting more compact growth.

- Abbeyshrule
- Ardagh
- Ballinamuck
- Clondra

Copyright Acknowledgements
 Include Ordnance Survey Ireland data reproduced under OSI
 Licence Number 2020/OSI_NMA_145 Longford County Council
 Unauthorised Reproduction infringes Ordnance Survey Ireland and
 Government of Ireland Copyright.
 © Ordnance Survey Ireland, year (the date of publication)

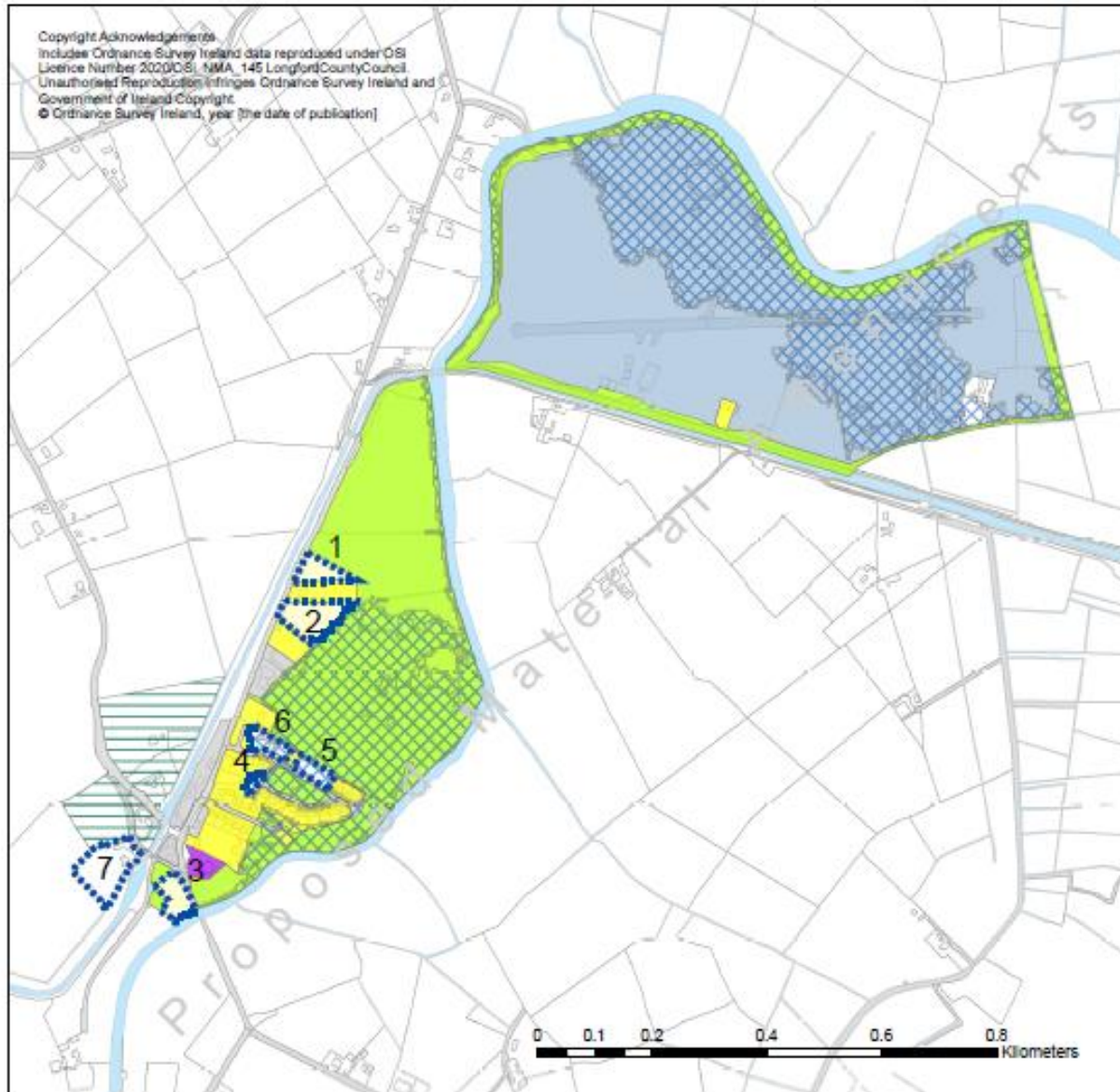

Abbeyshrule Proposed Material Amendments County Development Plan 2021-2027

Legend

- Zone Changes selection
- Areas of Constrained Land Use
- CSO Settlement Boundary
- Airport Development Objective
- New Residential
- Recreation/Amenity/Green Space
- Residential
- Social/Community/Education/Public Utility
- Strategic Residential Reserve
- Town Core

Zoning Changes		
Draft Plan: Zoning in Draft Plan	Alteration: Amended Zoning	Parcel No: Area on Map
Recreation/Amenity/Green Space		
	New Residential	1
	New Residential	2
	New Residential	3
Residential		
	No Zoning	4
	No Zoning	5
	No Zoning	6
Strategic Residential Reserve		
	No Zoning	7



Ardagh
Proposed Material Amendments
County Development Plan 2021-2027

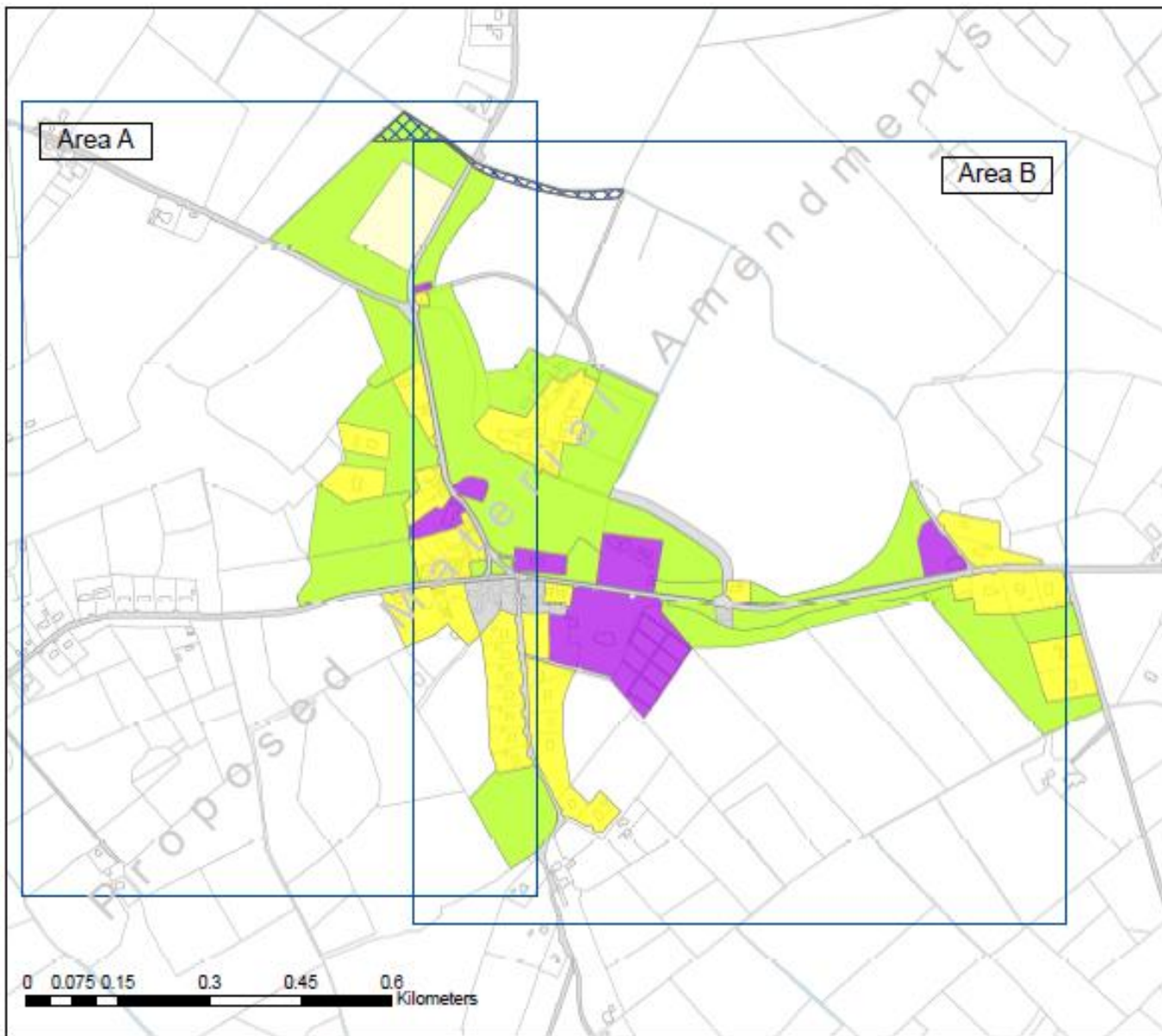

Legend

- Changed Zoning
- New Residential
- Recreation/Amenity/Green Space
- Residential
- Social/Community/Education/Public Utility
- Strategic Residential Reserve
- Tourism
- Town Core
- CSO Settlement Boundary
- Areas of Constrained Land Use

See separate Maps
of Area A and Area B

Copyright Acknowledgements
Includes Ordnance Survey Ireland data reproduced under OSI
Licence Number 2020/OSI_NMA_145 LongfordCountyCouncil.
Unauthorised Reproduction infringes Ordnance Survey Ireland and
Government of Ireland Copyright.
© Ordnance Survey Ireland, year [the date of publication]



Ardagh
Proposed Material Amendments
County Development Plan 2021-2027

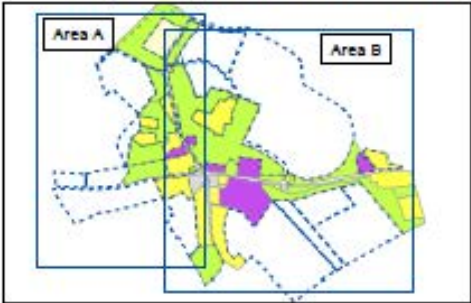
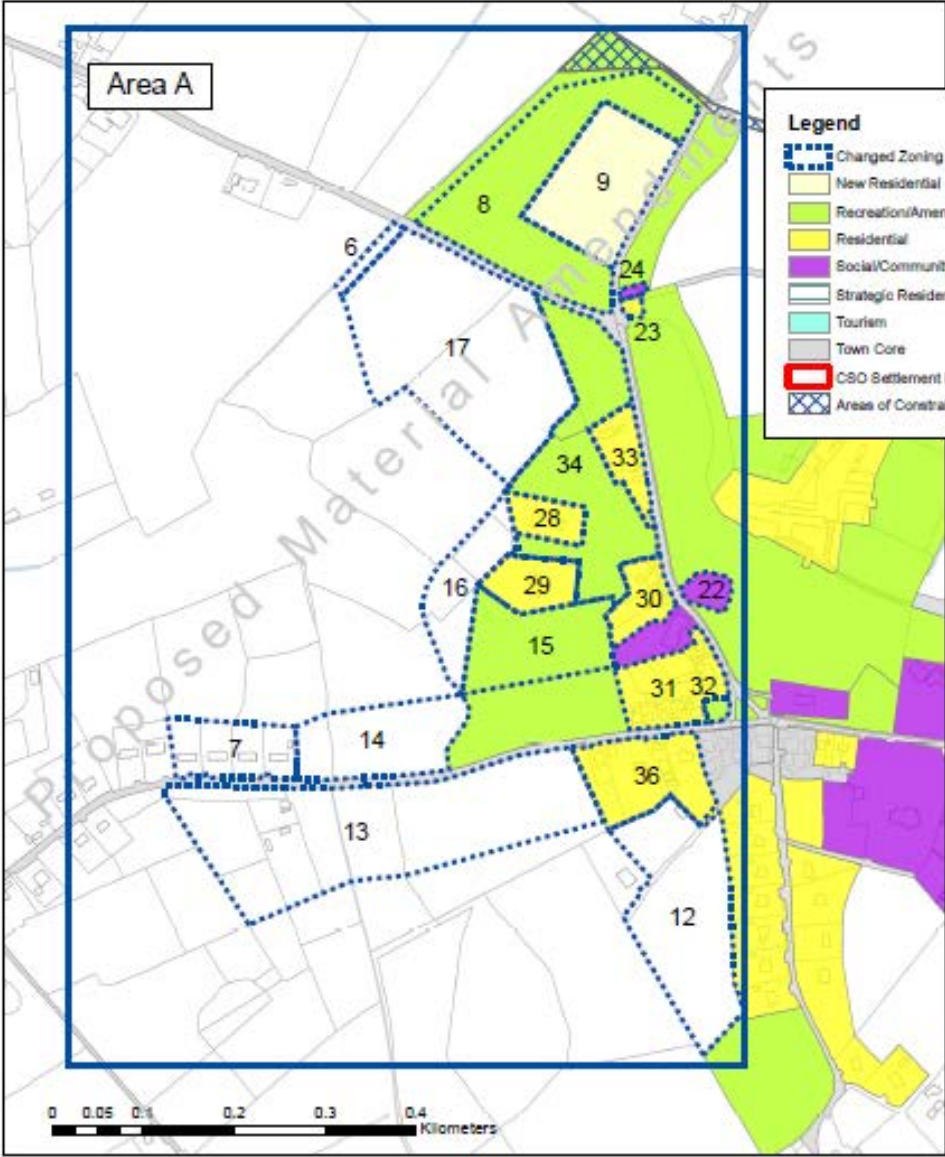

Changed Zoning		
Draft Plan: Zoning in Draft Plan	Alteration: Amended Zoning	Parcel No.: Area on Map
Recreational/Amenity/Green Space		
	No Zoning	6
Residential		
	No Zoning	7
Strategic Residential Reserve		
	Recreational/Amenity/Green Space	8, 15
	New Residential	9
	No Zoning	12, 13, 14, 16, 17
Tourism		
	Social/Community/Education/Public Utility	22, 24
	Residential	23
Town Core		
	Residential	28 - 31, 33, 36
	Recreational/Amenity/Green Space	32, 34

Copyright Acknowledgements
Includes Ordnance Survey Ireland data reproduced under
ODL
Licence Number 2020/ODI_NMA_145
Longford County Council. Unauthorised Reproduction
Infringes Ordnance Survey Ireland and Government of
Ireland Copyright
© Ordnance Survey Ireland, year [the date of publication]



Ardagh
Proposed Material Amendments
County Development Plan 2021-2027

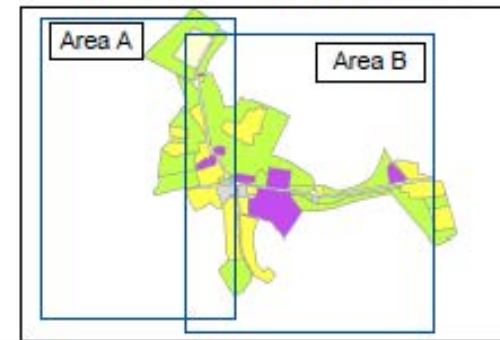
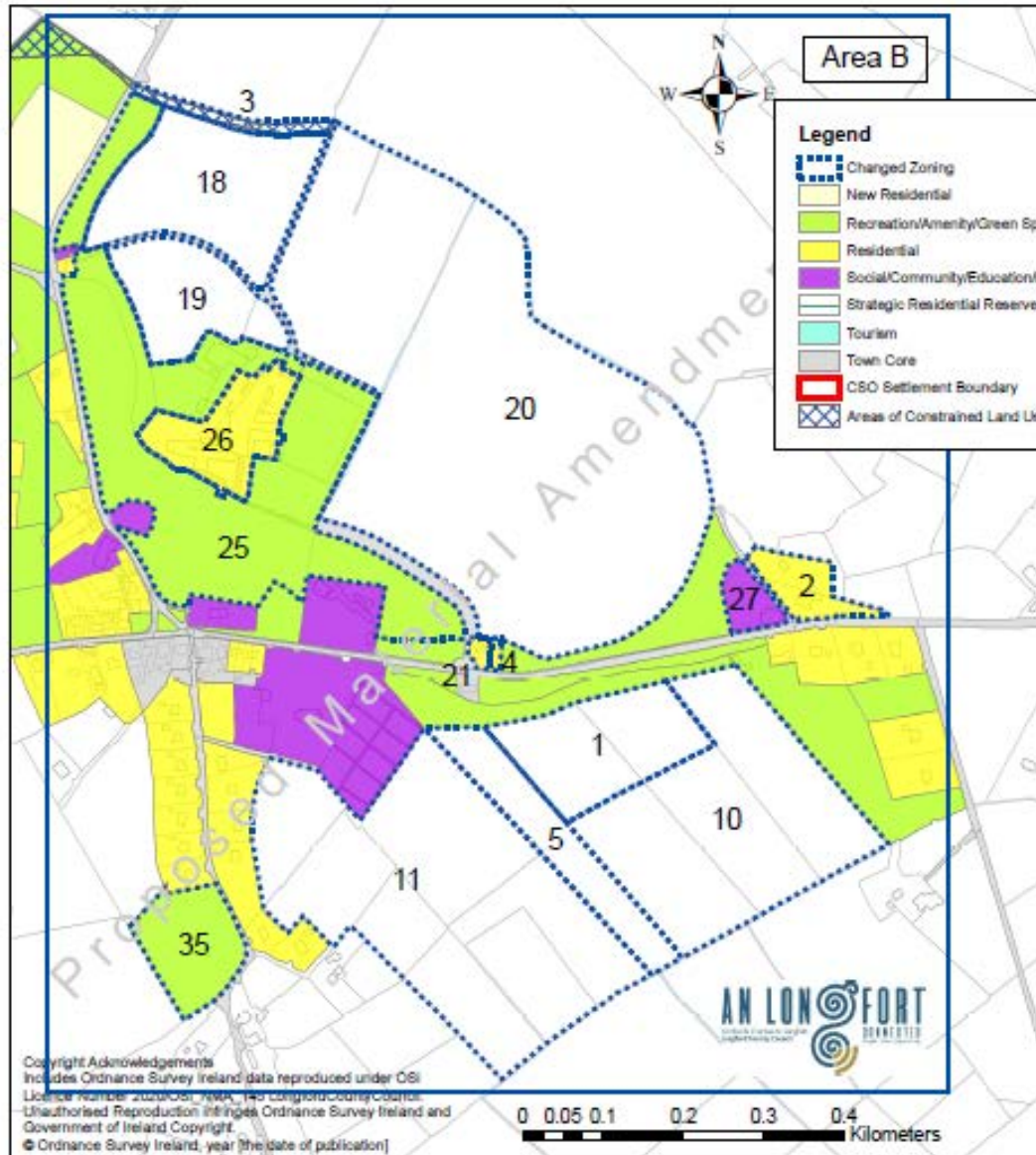

Changed Zoning

Draft Plan: Zoning in Draft	Alteration: Amended Zoning	Parcel No: Area on Map
New Residential		
	No Zoning	1
No Zoning		
	Residential	2
Recreational/Amenity/Green Space		
	No Zoning	3
	Residential	4
	No Zoning	5
Strategic Residential Reserve		
	No Zoning	10
	No Zoning	11
	Recreational/Amenity/Green Space	35
Tourism		
	No Zoning	18
	No Zoning	19
	No Zoning	20
	Residential	21
	Recreational/Amenity/Green Space	25
	Residential	26
Town Core		
	Social/Community/Education	27

Ballinamuck Proposed Material Amendments County Development Plan 2021-2027

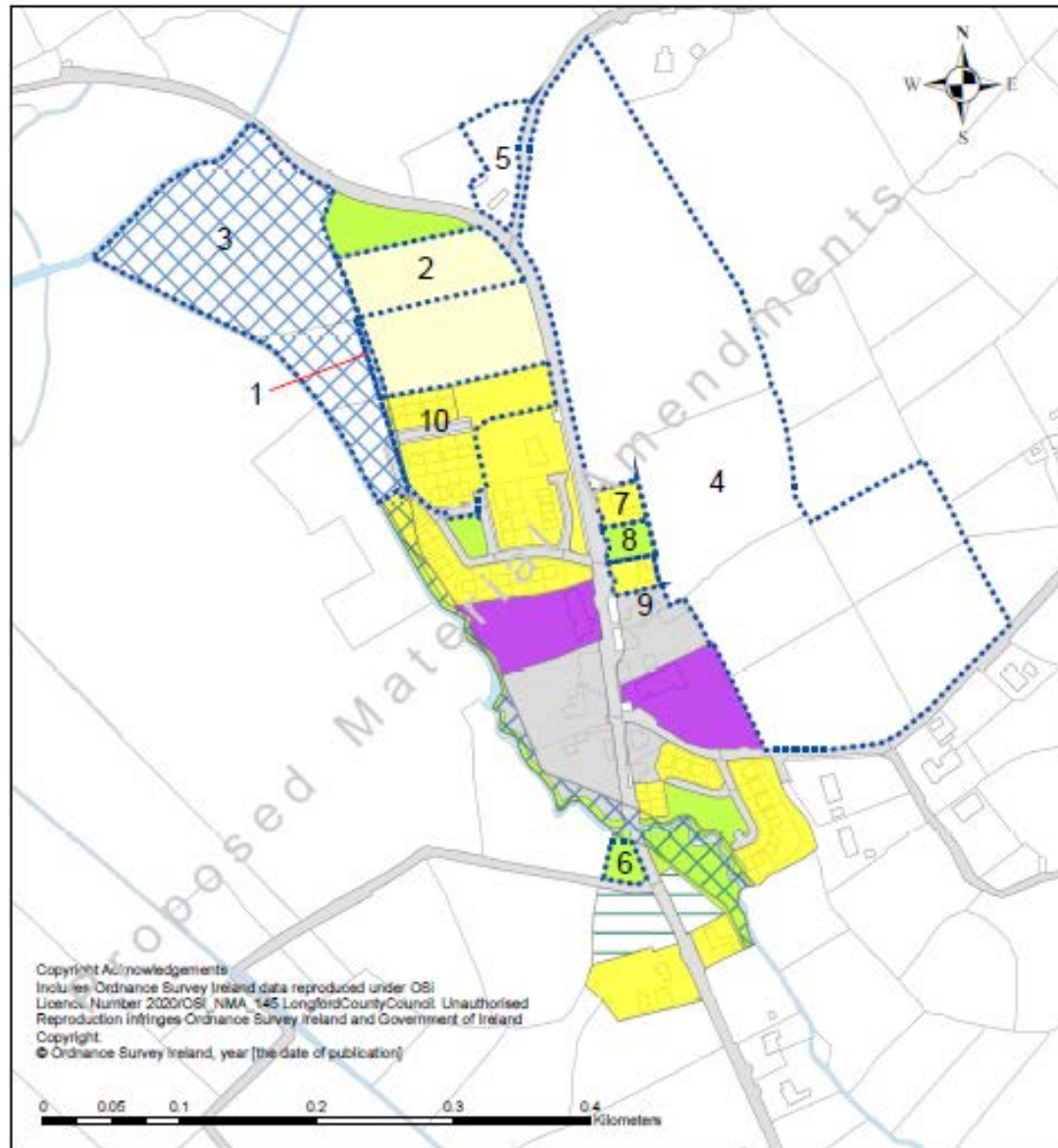

Copyright Acknowledgements
Includes Ordnance Survey Ireland data reproduced under OSI
Licence Number 2020/OSI NMA 145 Longford County Council. Unauthorised
Reproduction infringes Ordnance Survey Ireland and Government of Ireland
Copyright.
© Ordnance Survey Ireland, year [the date of publication]

Legend

- Changed Zoning
- New Residential
- Recreation/Amenity/Green Space
- Residential
- Social/Community/Education/Public Utility
- Strategic Residential Reserve
- Town Core
- COO Settlement Boundary
- Areas of Constrained Land Use

Zoning Changes

Draft Plan: Zoning in Draft	Alteration: Amended Zoning	Parcel No: Area on Map
New Residential		
	No Zoning	1
	Residential	10
Recreational/Amenity/Green Space		
	New Residential	2
	No Zoning	3
Strategic Residential Reserve		
	No Zoning	4
	No Zoning	5
	Recreational/Amenity/Green Space	6
Town Core		
	Residential	7
	Recreational/Amenity/Green Space	8
	Residential	9



Clondra
 Proposed Material Amendments
 County Development Plan 2021-2027

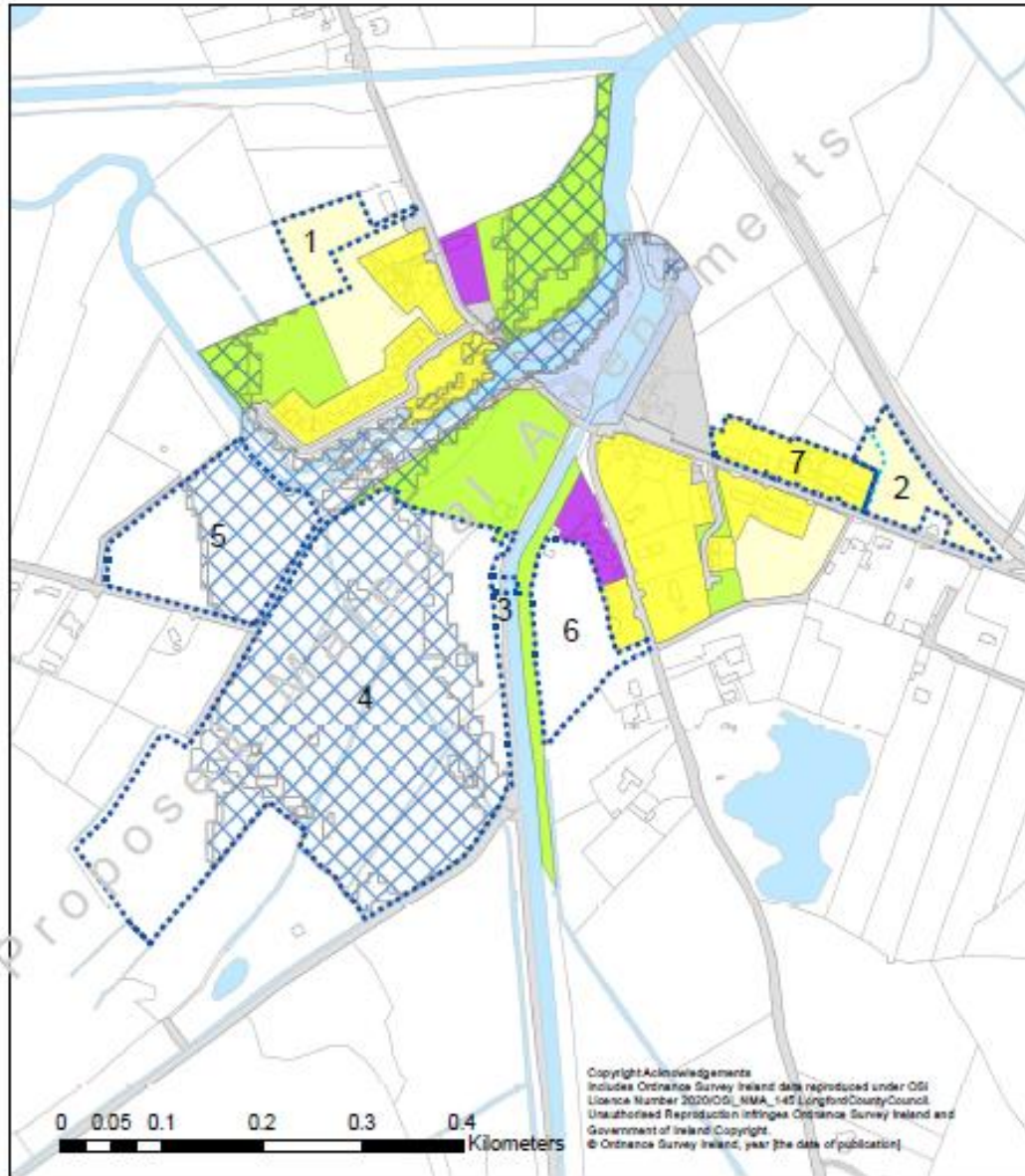

Legend

- Changed Zoning
- Canal Redevelopment Area
- New Residential
- Recreation/Amenity/Green Space
- Residential
- Social/Community/Education/Public Utility
- Town Core
- Proposed Road
- CSD Settlement Boundary
- Areas of Constrained Land Use

Zoning Changes

Draft Plan: Zoning in Draft Plan	Alteration: Amended Zoning	Parcel No: Area on Map
No Zoning		
	New Residential	1
	New Residential	2
	Residential	7
Pedestrian Bridge		
	No Zoning	3
Tourism		
	No Zoning	4
	No Zoning	5
	No Zoning	6



APPENDIX G – REVISIONS TO THE ZONED SITES FOLLOWING THE ADOPTION OF THE CHIEF EXECUTIVE’S REPORT ON THE PROPOSED MATERIAL ALTERATIONS (RESIDENTIAL & EMPLOYMENT LANDS)

The following information identifies the revisions made to the land zonings following the adoption of the Chief Executive Report produced for the Material Amendments of the County Development Plan 2021-2027.

Ballymahon

The Chief Executives Report on the proposed Material Alterations referenced the de-zoning of lands zoned Strategic Residential Reserve R1 and R3. Both sites were scored Red No Development in the IAR and have been de-zoned in the final version of the Longford County Development Plan 2021-2027.

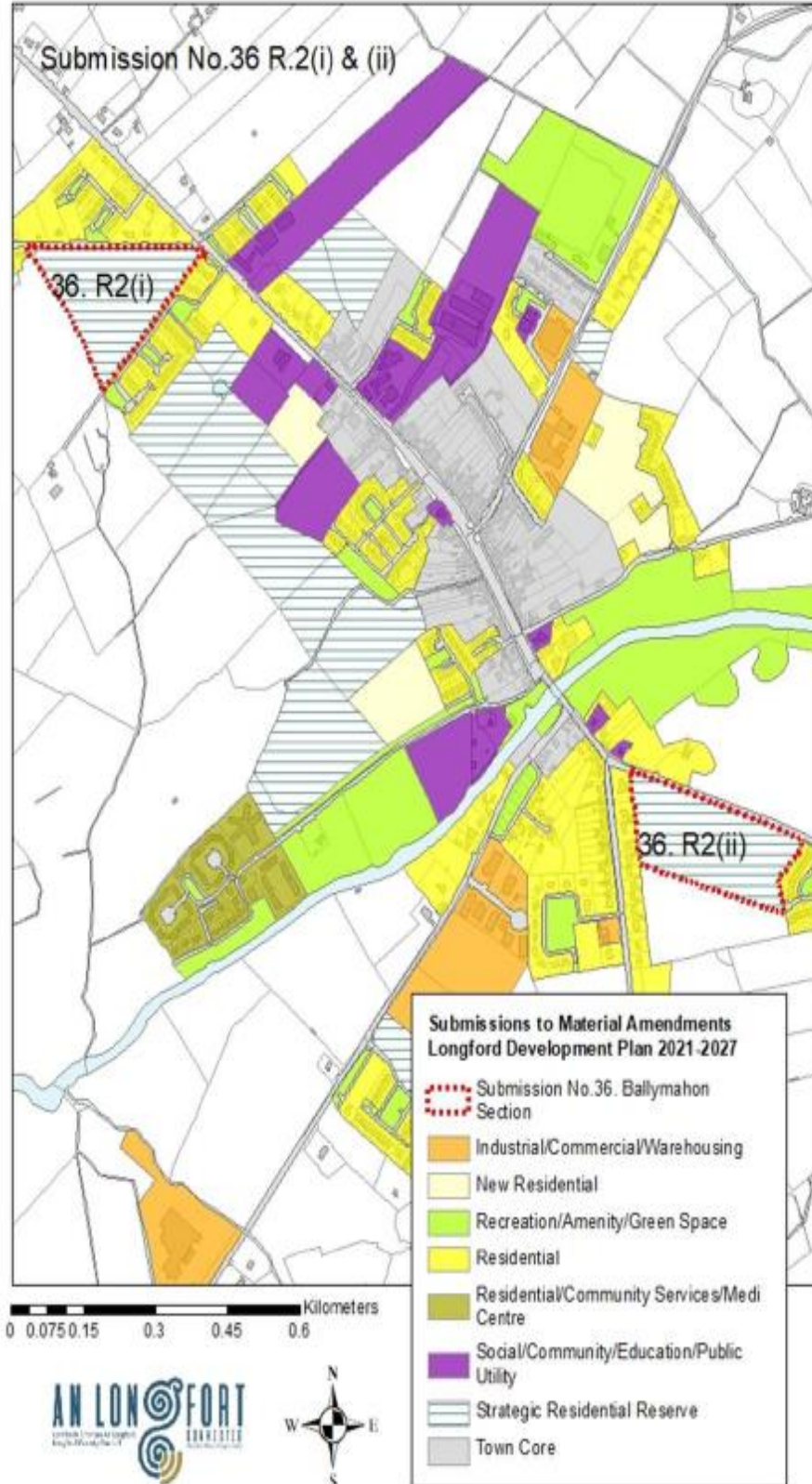

Abbeyshrule

The Chief Executives Report on the proposed Material Alterations referenced the de-zoning of lands in areas of constrained use (lands affected by flooding). The lands zoned R1 (land pocket 19 on the attached plan) are reduced in size as reflected in the attached map along the south-east edge of the site.

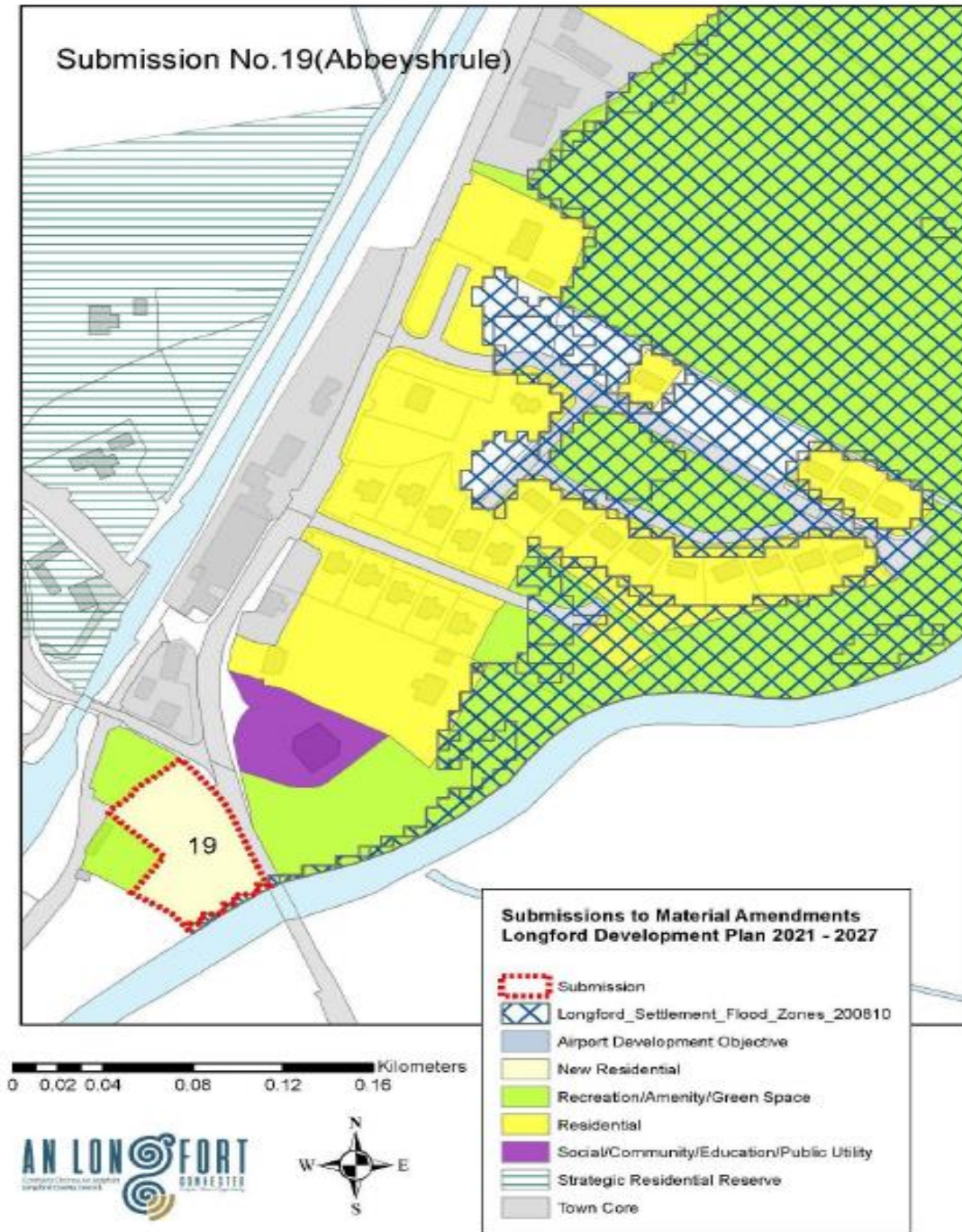

Ballinamuck

The Chief Executives Report on the proposed Material Alterations referenced the de-zoning of lands in areas of constrained use (lands affected by flooding). The lands zoned Town Centre have been revised – the revisions do not impact the findings of the infrastructure assessment report for the settlement as these lands are already developed. However, the settlement maps used in the report have been revised to take account of the areas of constrained use.

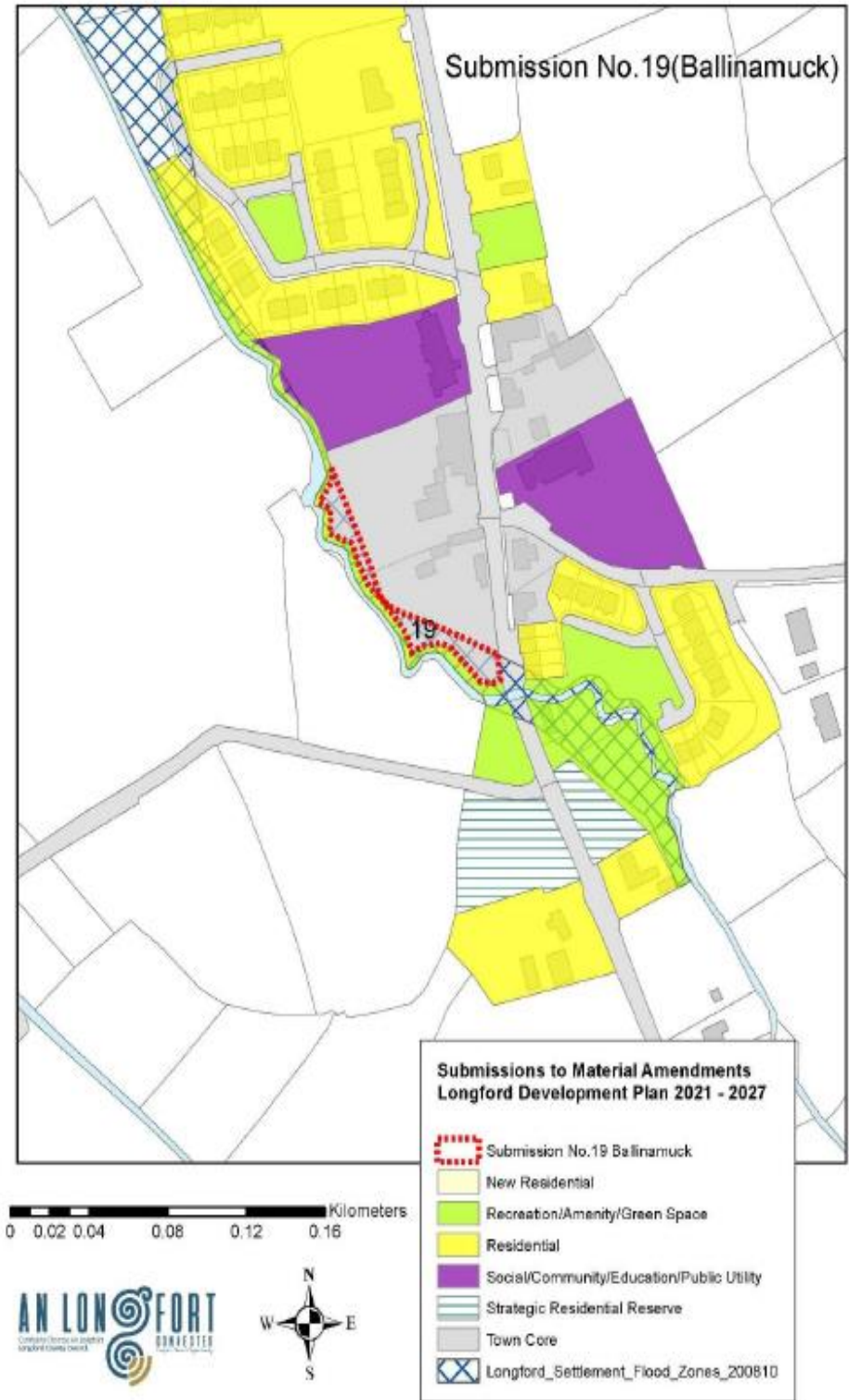

Clondra

The Chief Executives Report on the proposed Material Alterations referenced the de-zoning of new residential lands in areas of constrained use (lands affected by flooding). This amendment was included in the original report and the lands were removed from the infrastructure assessment of the site and the settlement. The lands impacted are shown on the attached map and are to the west of the site no.1.

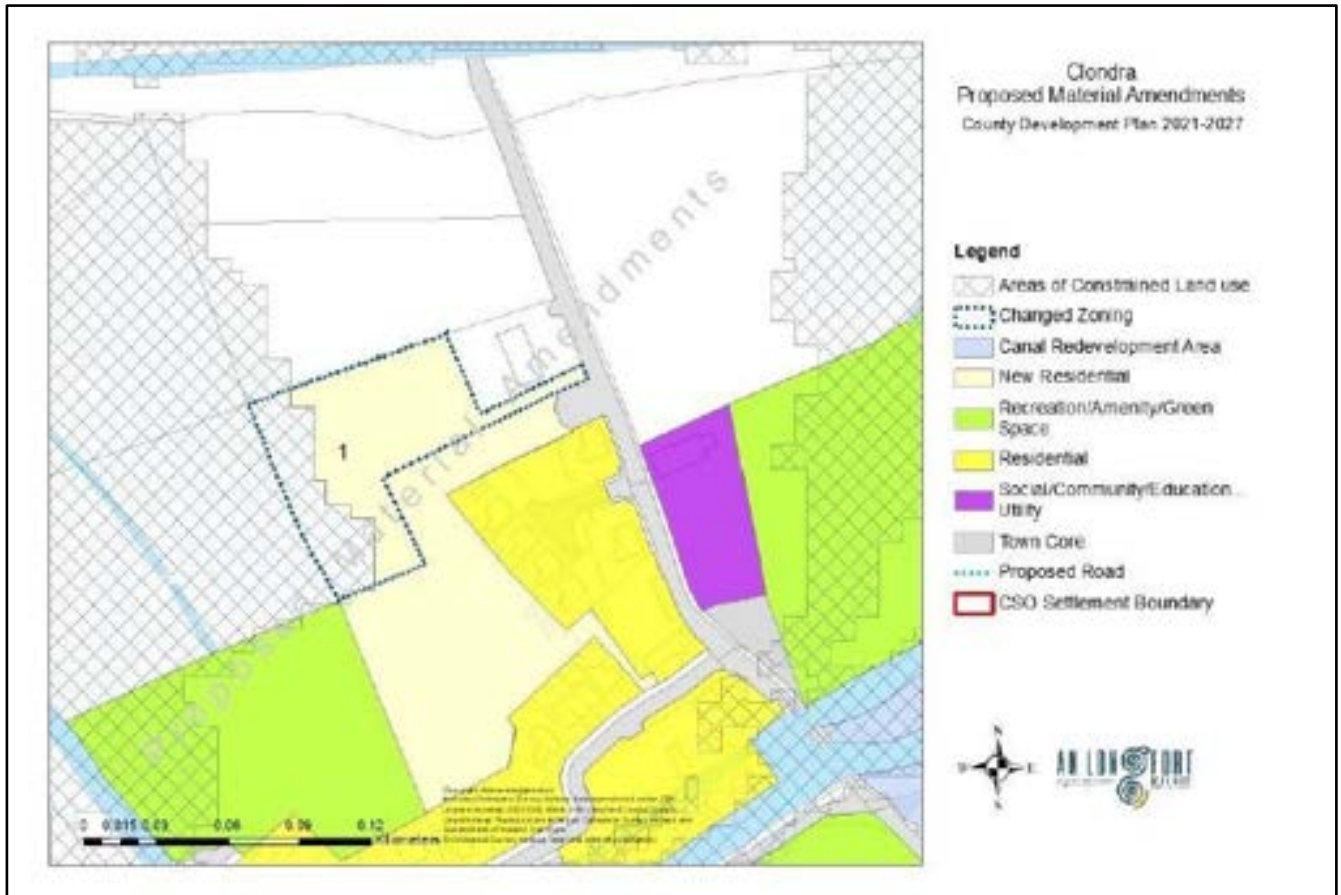

Drumlish

The Chief Executive Report on the proposed Material Alterations included a revised land zoning plan for the Drumlish Settlement. This plan included a revised zoning of new residential sites and an amendment to the employment lands zoned in Drumlish.

Following the adoption of the Chief Executives Report an infrastructure assessment of the revised lands has been included into the report. This includes the following:

- **Appendix G1** – Revised further iteration plan showing the lands zoned new residential and employment.
- **Appendix G2** – Revised Roads Section assessment of the lands zoned new residential and employment.
- **Appendix G3** – Revised Water Services assessment of the lands zoned new residential and employment.
- **Appendix G4** – Revised settlement assessment and mapping of the zoned lands.

Appendix G1 – Revised Further Iteration Plan showing the New Residential & Employment sites (Drumlish)

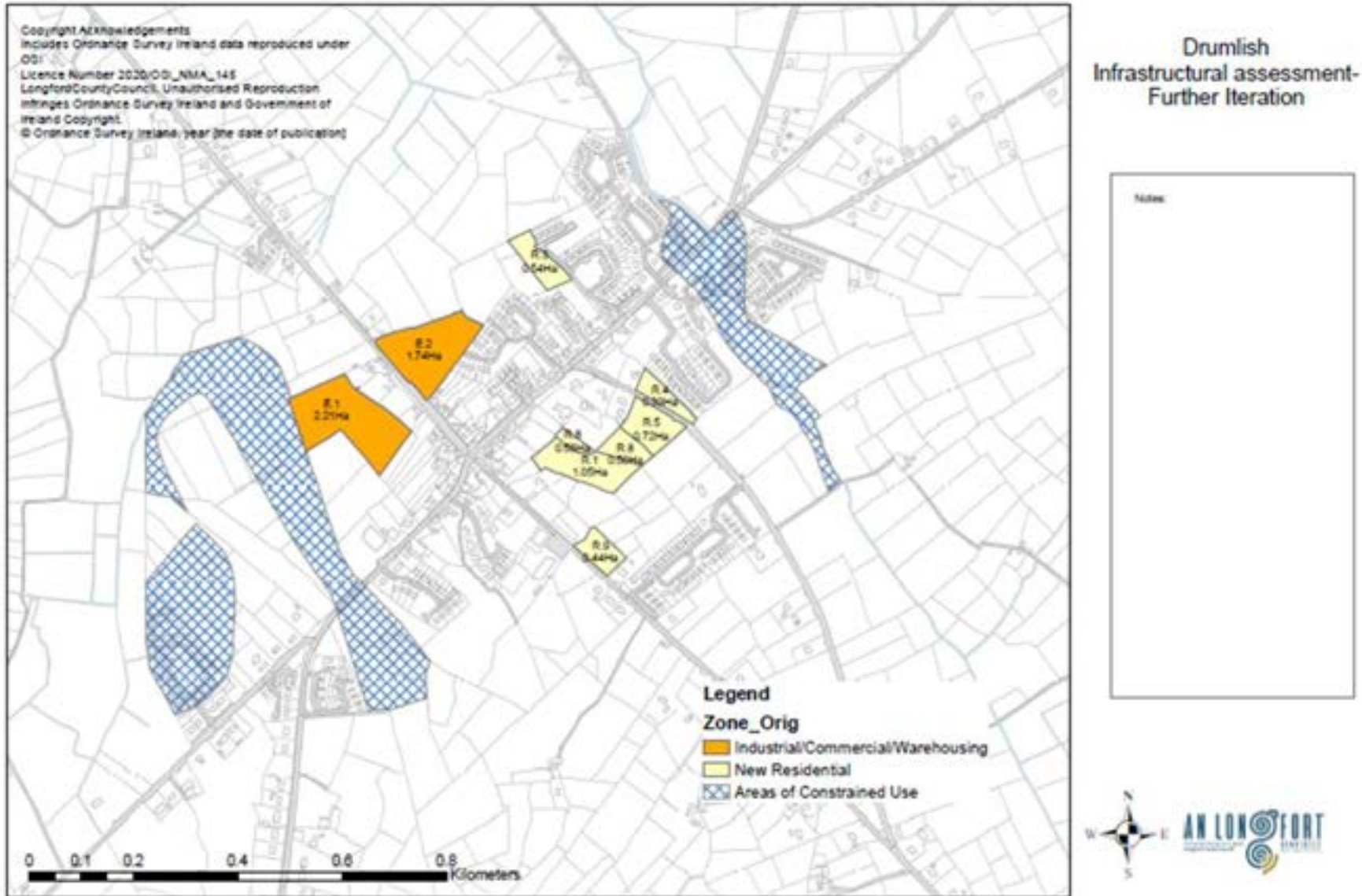

Appendix G2 – Revised Roads Section Infrastructure Assessment for Drumlish

The tables below indicate the zoned lands updated to reflect the revised zoned map as adopted in Oct 2021.

HOUSING LANDS		R1	R2	R3	R4	R5	R6	R7	R8	R9
CRITERIA	WEIGHTING									
ROADS	100	100		100	100	100			50	100
DRAINAGE	100	50		50	50	50			50	50

EMPLOYMENT LANDS		E1	E2
CRITERIA	WEIGHTING		
ROADS	100	100	100
DRAINAGE	100	80	80

Appendix G3 – Revised Water Services Infrastructure Assessment of the sites in Drumlish

The following table provides a summary of the scores for Drumlish and the identified residential/housing lands and employment/industrial lands.

DRUMLISH – DETAILED WATER / WASTEWATER ASSESSMENT

INFRASTRUCTURE ASSESSMENT			58840	11140								
Settlement	DRUMLISH		15490		10300	3890	7140	19600	2750			
Water supply zone	Lough Forbes	7 MI/day	31111									
Agglomeration	Drumlish D0489		1,549		1.03	0.389	0.714	1.96	0.275			
Residential lands			R1	R2	R3	R4	R5	R6	R7	R8	R9	
Wastewater	headroom	- 2	61		35	66	87			11	68	
Employment lands			E1	E2	E3	E4	E5	E6	E7	E8	E9	
Wastewater			24	24								
See Zoning Maps for reference number report, detailing the estimated cost at draft plan stage			5,884									
RESIDENTIAL LANDS			R1	R2	R3	R4	R5	R6	R7	R8	R9	
Required services	network		90road upgrade	40um road upgrade	90um road upgrade	110+60um upgrade				40um road upgrade		
Residential lands	SPS					new PS		Barrow upgrade /350m				
	WWTP		Capacity Upgrade wwtp									
CONNECTION		3929	137,515	31,432	98,225	39,290	58,935					
extra on connection	IW	442	0	0	0	0	0	0				
NETWORK			22,500	35,000	22,500	0	0					
Network upgrade	roads section	250	90	140	90	170						
Network new road		200										
Network upgrade green		150										
Network new green		100										
PUMP			0	0	0	0	0					
SCADA	jobs Tobin reports	14000										
valve chamber		4000										
variable speed		12500										
benching		2500										
Atex pump replace		13000										
discharge +vent		3500										
recertification electric		2500										
rising main		250										
Pump Station new	turn quotes 2019	250000										
WWTP upgrade per 1000 PE	0.4	431298.621	144,828	33,103	103,448	41,379	24,300					
drinking water DMA figures 2.7	600000	391.5	94.5	21.6	67.5	27	40.5					
NETWORK+SPS+WWTP	sum total	1488503.62	304,843	99,535	224,173	80,669.31	83,235					
size land parcel estimated	m2		206*53	48*43	119*86	129*36	94*75					
housing density estimated	number		35	4	28	16	15					
	29 dwellings/ha	m2	15490	3130	10300	3890	7140					
=+(12+8+4)*10*(1+(15green+5school+10business+15road)/100)												
	if pump		15490	3130	10300	3890	7140					
	348 m2/ dwelling		45	9	30	11	21					
	737.1 m2/ dwelling		21	4	14	5	10					
=+(12+8+9+6)*(3+12+3)*(1+(15road+1 school+1 business)/100)												
	2/3 1/3 split		17	7	24	5	17					
	14 dwellings/ha	50:50 split	33	7	22	8	15					
93 added dwelling PE	297	chosen numl	35	8	25	10	15			0	0	
cost % figure in table												
3900	100											
8000	67	-124										
12000	33	-118										
16000	0	-121										
Costs per unit			8,710		8,967	8,067	5,549			5,549	8,067	
Score to table			61		58	66	87			11	68	
-Deficit/+headroom	- 394		Plant needs upgrade									

EMPLOYMENT LANDS			E1	E2	
Required services		network			
Employment Lands		SPS			
		WWTP			
CONNECTION					
	3929				
extra on connection	442		0	0	
NETWORK					
			0	0	
Network upgrade	250				
Network new road	200				
0 Network upgrade green	150				
Network new green	100				
PUMP					
			0	0	
SCADA	14000				
valve chamber	4000				
variable speed	12500				
benching	2500				
Atex pump replace	13000				
discharge +vent	3500				
recertification electric	2500				
rising main	250				
Pump Station new	250000				
WWTP upgrade per 1000 PE		0.6 900000	900000	900000	
	10	900000	200	200	200
NETWORK+SPS+WWTP			sum total	978580	978,580 978,580
size land parcel estimated		m2	300*200	300*200	
trade density estimated Number		number	15	15	
	5 trades/ha	m2	58840	58840	
+=(45)*30*(1+(15green+20 parking+15road)/100)		trades/ha	if pump	58840	58840
	2025			29	29
	10385	m2/ trade		6	6
+=(100)*67*(1+(15 green+25 parking+15 road)/100)		m2/ trade	2/3 1/3 split	21	21
	1 trades/ha		50:50 split	17	17
40 added PE trade		200		20	20
cost % figure in table					
	3900	100			
	8000	67	-124		
	30000	33	-647		
	100000	0	-2121		
Costs per unit				48,929	48,929
Score to table				24	24
added PE total		592			
=-Deficit/+headroom		- 594			Plant needs upgrade

Appendix G4 - Revised Settlement Assessment and Mapping of the zoned lands in Drumlish

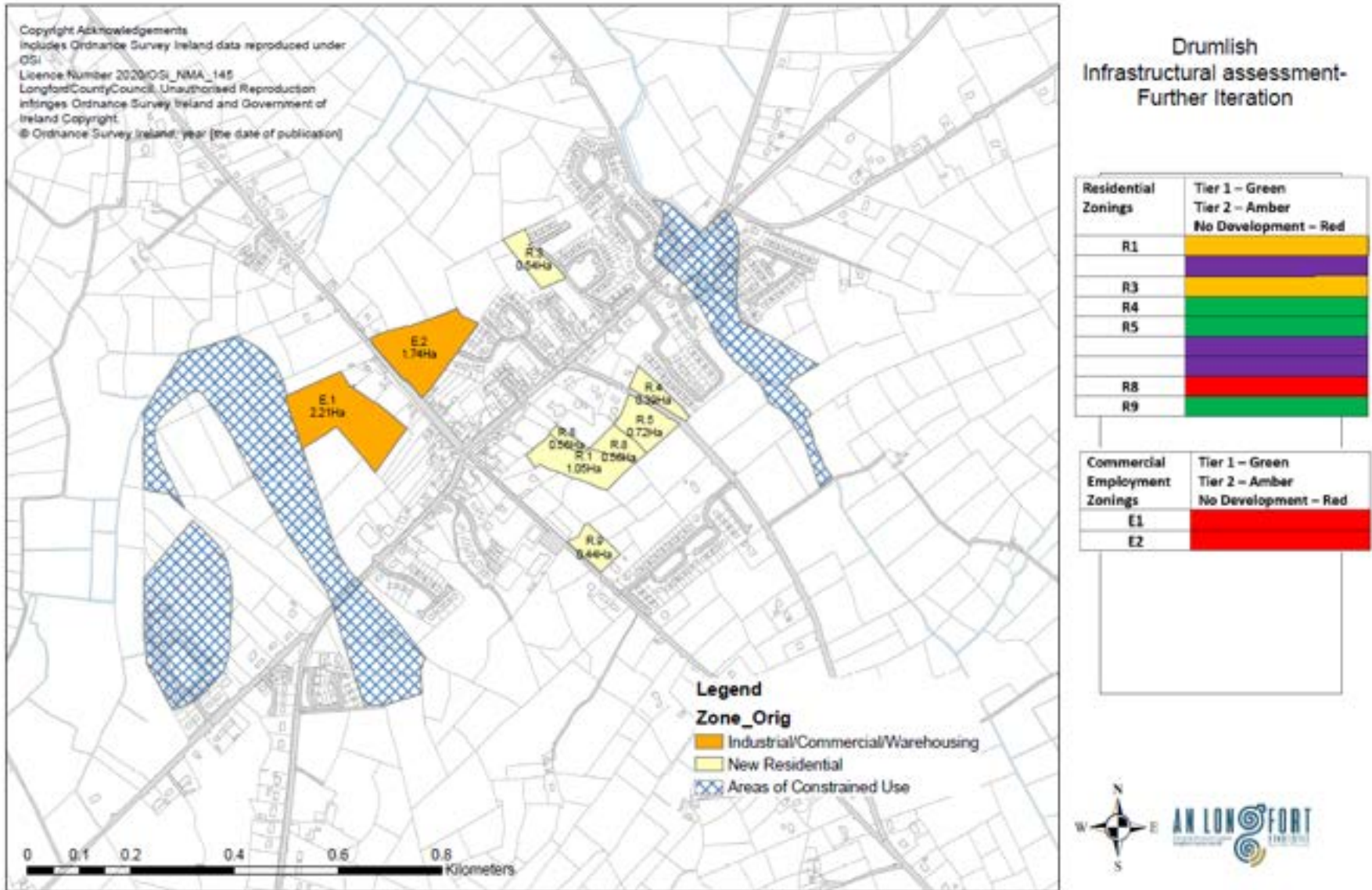

Annex 6:

**Settlement Asset Based Criteria
Table**

Settlement	Scale (Population size and rate of increase/decrease between 1996-2016) where data provides for comparison. Longford County – (30,166 - 40,873) = +35.5%	FAC Medium Population Projection Year 2027 (and rate of change from 2016)	Function	Infrastructure: (Wastewater, water supply, broadband connectivity)	Human Capital (Level of education, skillset of labour force)	Placemaking (Public realm spaces, connectivity of spaces, residential and employment densities)	Enterprise Ecosystem (Formation rates for new businesses, growth of existing businesses – scale-ups, numbers of employment in types of sector)	Connectivity (Transport infrastructure, urban and rural transport options)	Natural Capital (Open space and green infrastructure provisions, environmental and ecologically sensitive sites, flood extents)
Longford Town	6,984 - 10,008 (43% increase)	12,389 (+23.8%)	Jobs to Resident Workforce Ratio = 1.596. Note: The average ratio of jobs to resident workers in the Eastern and Midland Regional Assembly area is 0.86. Main employment, administrative and retail	<u>Wastewater</u> 20,000 PE (Collected PE = 17,623 – 2,377 PE Remaining Capacity). <u>Broadband</u> Settlement serviced by 100% High-Speed Fibre Broadband Coverage	<u>5 Primary Schools</u> 1,208 places enrolled 2019/2020 <u>1 Special School</u> 29 places enrolled 2019/2020 <u>3 Post-Primary School</u> 1,401 places enrolled 2019/2020	A number of formal and informal public and communal spaces and public realm features associated with the settlement, notably the Albert Reynolds Peace Park and the Royal Canal amenity features. Good pedestrian connectivity. Vehicular connectivity	Labour Force participation rate = 60.2%. Unemployment rate = 19.6% based on 2016 Census. Jobs to Resident Workforce Ratio = 1.596. Note: The average ratio of jobs to resident workers in the Eastern and Midland Regional Assembly area is 0.86.	Good public transport links available, including Irish Rail services, Bus Éireann local and national services. Good walking connectivity throughout and around the settlement. Recognised deficiency in dedicated cycle lanes.	A number of formal and informal green spaces and key amenity features present, most notably, the Albert Reynolds Peace Park and the Royal Canal, with ecological corridor linkages throughout. Nearest Natura 2000 site is approx. 3km west of town centre (Brown

			centre in County Longford with a high level of public transport services and connectivity within local, regional and national settings.				Key employment industries within the settlement include manufacturing, commerce and trade and professional services which together, make up of the 15,172 total number of persons at work in Longford Town based on the 2016 Census.		Bog SAC – Site Code: 002346).
Edgeworths town	737 - 2,072 (181% increase)	2,606 (+25.8%)	Second largest settlement in population terms. Good level of social and community infrastructure such as schools, library, sports grounds. High-level of public transport connectivity owing to Irish Rail station	<u>Wastewater</u> 2,700 PE (Collected PE = 2,656 – 44 PE remaining capacity) <u>Broadband</u> Settlement serviced by 99% High-Speed Fibre Broadband Coverage	<u>2 Primary Schools</u> 404 places enrolled 2019/2020		Jobs to Resident Workforce Ratio = 0.735.		

			and proximity to N4 route. <u>Commuter Trips</u> <u>Ratio between jobs and resident workers</u> <u>Retail Hierarchy</u>						
Ballymahon	790 - 1,877 (138% increase)	2,341 (+24.7%)	<u>Commuter Trips</u> <u>Ratio between jobs and resident workers</u> <u>Retail Hierarchy</u>	<u>Wastewater</u> 2,125 PE (Collected PE = 2,622) <u>Broadband Settlement</u> serviced by 93%-96% High-Speed Fibre Broadband Coverage	<u>1 Primary School</u> 355 places enrolled 2019/2020 <u>2 Post-Primary Schools</u> 1,079 places enrolled 2019/2020		Jobs to Resident Workforce Ratio = 0.817.		
Lanesborough - Ballyleague	984 - 1,454* (48% increase)	N/A	<u>Commuter Trips</u> <u>Ratio between jobs and resident workers</u>	<u>Wastewater</u> 3,200 PE (Collected PE = 2,191 – 1,009 PE Remaining Capacity)	<u>2 Primary Schools</u> 165 places enrolled 2019/2020		Jobs to Resident Workforce Ratio = 0.646.		

			<u>Retail Hierarchy</u>		<u>1 Post-Primary School</u> 193 places enrolled 2019/2020 **				
Granard	1,173 – 1,096*** (-0.06% decrease) CSO Settlement defined population (2016) = 816	1,003 (+22.9% in CSO defined Settlement population)	<u>Commuter Trips</u> <u>Ratio between jobs and resident workers</u> <u>Retail Hierarchy</u> Strong rural-urban interdependencies are a feature of the Region, with positive correlations between rural economic performance and regional accessibility.	<u>Wastewater</u> 3,200 PE (Collected PE = 1,775 – 1,425 PE Remaining Capacity). <u>Broadband Settlement</u> serviced by 100% High-Speed Fibre Broadband Coverage	<u>1 Primary School</u> 190 places enrolled 2019/2020 <u>2 Post-Primary School</u> 731 places enrolled 2019/2020		Jobs to Resident Workforce Ratio = 2.353.		
Abbeyshrule	224 (Small Area - 2016 Census)	N/A	<u>Commuter Trips</u>	<u>Wastewater</u> 300 PE (Collected PE = 85 – 215 PE	-				

			<u>Ratio between jobs and resident workers</u> <u>Retail Hierarchy</u>	Remaining Capacity). Broadband Settlement identified for planned fibre broadband deployment					
Ardagh	471 (2 no. Small Areas – 2016 Census)	N/A	<u>Commuter Trips</u> <u>Ratio between jobs and resident workers</u> <u>Retail Hierarchy</u>	<u>Wastewater</u> 450 PE (Collected PE = 58 – 392 PE Remaining Capacity).	<u>1 Primary School</u> 221 places enrolled 2019/2020				
Aughnaccliffe	177 (2016)	223 (+25.98%)	<u>Commuter Trips</u> <u>Ratio between jobs and resident workers</u> <u>Retail Hierarchy</u>	<u>Wastewater</u> 300 PE – unknown collection and headroom PE	<u>1 Primary School</u> 113 places enrolled 2019/2020				
Ballinamuck	232 (Small Area - 2016 Census)	N/A	<u>Commuter Trips</u> <u>Ratio between jobs and resident workers</u>	<u>Wastewater</u> 500 PE (Collected PE = 64 – 436 PE Remaining Capacity).	<u>1 Primary School</u> 87 places enrolled 2019/2020				

			<u>Retail Hierarchy</u>						
Ballinalee	347 (2016 Census)	441 (+27%)	<u>Commuter Trips</u> <u>Ratio between jobs and resident workers</u> <u>Retail Hierarchy</u>	<u>Wastewater</u> 600 PE (Agglomeration = 194 PE 2018)	<u>1 Primary School</u> 149 places enrolled 2019/2020				
Clondra	202 (Small Area - 2016 Census)	N/A	<u>Commuter Trips</u> <u>Ratio between jobs and resident workers</u> <u>Retail Hierarchy</u>	<u>Wastewater</u> 600 PE (Collected PE = 158 – 442 PE Remaining Capacity).	<u>1 Primary School</u> 97 places enrolled 2019/2020				
Drumlish	274 – 931 (240% increase)	1,173 (+26%)	<u>Commuter Trips</u> <u>Ratio between jobs and resident workers</u> <u>Retail Hierarchy</u>	<u>Wastewater</u> 1,200 PE (Collected PE = 1,005 – 195 PE Remaining Capacity)	<u>1 Primary School</u> 230 places enrolled 2019/2020				
Keenagh	223 – 581 (161% increase)	732 (+26%)	<u>Commuter Trips</u>	<u>Wastewater</u> 1,000 PE (Collected PE =	<u>1 Primary School</u>				

			<u>Ratio between jobs and resident workers</u> <u>Retail Hierarchy</u>	692 – 308 PE Remaining Capacity)	167 places enrolled 2019/2020				
Legan	215	260 (+20.9%)	<u>Commuter Trips</u> <u>Ratio between jobs and resident workers</u> <u>Retail Hierarchy</u>	<u>Wastewater</u> 1,000 PE (Collected PE = 192 – 808 PE Remaining Capacity)	<u>1 Primary School</u> 45 places enrolled 2019/2020				
Newtownforbes	470 – 778 (66% increase)	965 (+19.3%)	<u>Commuter Trips</u> <u>Ratio between jobs and resident workers</u> <u>Retail Hierarchy</u>	<u>Wastewater</u> 1,800 PE (Collected PE = 976 – 824 PE Remaining Capacity)	<u>1 Primary School</u> 363 places enrolled 2019/2020				

Annex 7:

Rural Design Guidelines

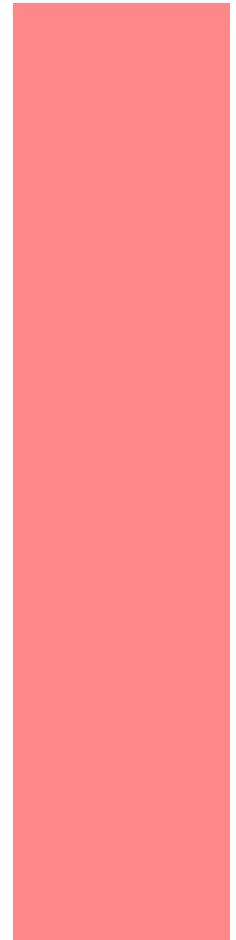

**Rural Design Guidance
For Residential
Developments in Rural
County Longford**

<u>INTRODUCTION.....</u>	<u>IV</u>
<u>STAGE 1 - BASIC CONCEPTS.....</u>	<u>V</u>
NEED TYPE	IV
LONGEVITY AND ADAPTABILITY	IV
SUSTAINABILITY.....	IV
BUDGET	V
<u>STAGE 2 - SITE SELECTION.....</u>	<u>VI</u>
<u>STAGE 3 – SITE LAYOUT</u>	<u>VIII</u>
ACCESS AND ROADSIDE FRONTAGE.....	IX
LANDSCAPING	XIV
<u>STAGE 4 – DETAILED HOUSE DESIGN.....</u>	<u>XV</u>
SHAPE AND FORM	XV
ANNEXES AND GARAGES.....	XVI
MATERIALS AND FINISHES.....	XVI
WINDOWS	XVIII
DOORS AND PORCHES.....	XIX
EXTERNAL FINISHES	XXI
ROOFS	XXI

INTRODUCTION

This guidance document is not intended as a set of rigid, prescriptive rules to which all new development must adhere, but a guiding set of principles that will act as an aid to potential developers, particularly in the early stages of the planning process.

Longford County has a unique and strong identity and character. One of the principal aims of this guide is to retain and strengthen this character for the benefit of its population and future generations. This does not mean that the countryside should be static or decline, it simply means that care should be exercised in the location and siting of developments in the Countryside.

This document has been compiled in the form of sections that follow a logical sequence in the establishment of a dwelling, from concept phase onto location and through to layout and detailed house design.

Photographs are provided throughout to illustrate points made in the text. These photos are from the National Inventory of Architectural Heritage for County Longford and as such, have a particular significance for the County.

It should be noted that pre-planning meetings are always advised in the case of applications for the development of houses in rural County Longford to discuss potential issues and prevent delays in the planning process once initiated.

STAGE 1 - BASIC CONCEPTS

The basic requirements of the end user should be considered prior to the drawing up of detailed plans for the development of a dwelling in rural County Longford. It is recommended that the potential applicant engage the services of a suitably qualified professional at this stage.

These requirements will have significant implications for the location, design, layout and appearance of the finished dwelling and should be carefully considered. They will include, but are not limited to, the following issues:

Need Type

There are many categories of home owner and the house location, siting and design should be chosen to reflect this need. These include owners with young families, empty-nesters, holiday homeowners, home-office users and those with sheltered housing requirements. The category of user should be reflected in the design process.

Longevity and Adaptability

Consideration should be given to the ability of the dwelling to accommodate the changing needs of a household, thereby allowing a family to reside in it over a lifetime, changing and adapting as needs be.

Sustainability

This incorporates the concepts outlined above, combined with location, siting, choice of building materials and finishes and the use of design initiatives and technology to reduce dependence on fossil fuels.

The location of the dwelling in relation to places of work, education, recreation and other activities is a consideration, as is the siting of the dwelling to achieve maximum shelter from prevailing winds and rain while benefiting from solar energy.

Choice of materials is important in terms of the sustainability of their production methods, how they are delivered from their place of manufacture and their inherent sustainability, i.e. how well do they wear and can they be repaired/maintained.

The use of alternative energy sources such as solar cells, geothermal solutions and wind energy should be considered at this point as it is much more efficient for these elements to be integrated into the overall house design rather than attempt to retrofit at a later date.

Budget

Transport, fuel requirements, decoration and furnishing, boundary and surface treatments are some of the many details that contribute to the ongoing development costs that may be hidden at the preliminary stages.

STAGE 2 - SITE SELECTION

Careful site selection can address many issues that could otherwise prove costly and time consuming to resolve at a later time in the design process. Developments should be integrated into and work with the landscape as opposed to dominating it, for example, sites with natural screening and shelter provided by hedgerows, trees and topography should be utilised to reduce the impact of the proposal in the wider landscape and preserve privacy.

Site selection with a view towards the utilisation of natural features will also reduce the need for costly earthworks and landscaping and increase the sustainability of the project (see *Site Layout* and *Landscaping* Sections in *Stage 3*).

The potential for the development to benefit from passive heat and solar energy through appropriate orientation should also be maximised, an important consideration at site selection stage.

Road safety is an important concern. Sites with poor access/sightlines or those that require the removal of significant amounts of roadside hedgerow should be avoided. New accesses onto National roads are generally not permitted.



Site selection that maximises the use of existing features will help to create an appropriate backdrop for a development, providing visual integration with its setting, privacy and shelter.



Hedgerows, ditches and other established roadside boundaries are important landscape elements that significantly contribute to the visual amenity and biodiversity of an area.

The availability of services for the site should be considered as part of the site selection process and included in the budgeting phase. The visual impact of service/access provision can sometimes be greater than that of the development itself, i.e. overhead wiring, access roads cutting through contours, masts and aerials for T.V./broadband connection.

At this stage, potential applicants should consult the Longford County Development Plan for potential locational issues in terms of landscape

vulnerability, which can include areas of archaeological, ecological and visual sensitivity. Other areas such as infrastructural study corridors and areas of known aquifer vulnerability may be best avoided.

STAGE 3 – SITE LAYOUT

A well considered site layout will maximise the benefits of choosing the appropriate site as outlined above. The layout will need to accommodate all aspects of the development, including domestic effluent disposal, site services and access.

Existing site features such as topography and landcover, farm buildings, walls etc. should be used to maximise privacy, screening and shelter. Avoid breaking the skyline in elevated areas as this adds significantly to visual impact.

The proposed dwelling should be located away from areas prone to flooding, where the water table is close to the surface or where drainage appears sluggish, as indicated by ground conditions such as seasonal ponding, poaching by livestock and a visual inspection of dominant vegetation types.

Developments should be carefully located on sloping sites to minimise cut and fill requirements.

Care should be taken to avoid vulnerable features such as wells and watercourses and potentially sensitive archaeological areas.

Maximising passive solar gain is an important element of the site layout process. Generally, glazing should be minimised on northern elevations to conserve heat and maximised on southern facades to capture solar gain (this issue will be addressed further in *Stage 4 – House Design*).

Access and Roadside Frontage

The majority of dwellings in rural County Longford are located along public roadsides. Traditionally, these dwellings were located on the roadside edge, many at a 90 angle, sometimes with outbuildings opposite, creating a street-like relationship with the carriageway.

The advent of high speed vehicles and the necessary accompanying road safety standards has abolished this practice in the development of new dwellings.



Dwellings now tend to be set-back, with a large front lawn, running parallel to the road frontage with the original boundary treatment removed and a straight tarmacadam driveway cutting across contours from the entrance back to the dwelling.

Driveways and entrances create a significant visual impact, particularly in upland areas and roadsides with well established hedgerows and a high level of visual enclosure.

Access roads should be inobtrusively located and designed to follow, as opposed to cut across, land contours. Driveway design should incorporate surface water drainage provisions to prevent run-off on to adjacent roadways and subsequent surface damage.



A combination of sympathetic boundary treatment, good site selection and appropriate driveway design enhances an attractive rural setting.

Hard surfaces and parking areas should be screened from view where possible, preferably to the rear of the building(s).

Accesses and front boundary treatments should aim to minimise removal of existing hedgerows, ditches and stone walls, which are often significant contributors to the character and biodiversity of a rural area. The maintenance of the hedgerow at a suitable height or the

relocation of the proposed entrance to a more appropriate position should be considered above removal.



Whitewashed, barrel-style piers with stone wall splays on each side form an attractive entranceway commonly seen in rural areas.

Where removal is unavoidable, sensitive set-back replacement should be carried out to reflect the original treatment and retain the boundary as a functioning wildlife corridor where possible.

Proposed new boundary treatments and accesses should take cognisance of traditional practice in the area and aim to enhance, rather than detract from the existing roadside

character.

Care should be taken at design stage to ensure adequate sightlines are achieved by maintaining wall and vegetation below 1.2m for required distances



There are a broad range of traditional entrance treatments in County Longford, some of which are pictured here.



Stone walls are commonly used, into which features and detailing have often been inserted to add interest and break monotony. Backplanting with vegetation and/or the use of native climbing species can be used to soften the effect of a development from the roadside.



Pedestrian gates were once a common and attractive feature of front boundary walls that have waned in popularity as vehicles have become more prolific.





Painted wrought iron gates and associated steps, piers and stiles are recognisable features throughout the rural area that create interest and variety in frontage treatments. Front boundary walls, where blockwork is used, should always be plastered/rendered and/or painted and capped.

Landscaping

The primary purpose of landscaping in these guidelines is to link the proposed dwelling with its surrounding countryside. As discussed in previous sections, mature trees and hedgerows on or adjacent to the site should be retained where possible.



Additional planting should utilise native species indigenous to the area in order to help the proposal blend effectively. Large expanses of “pool table” lawns, edged with exotic species and highly visible against surrounding agricultural landscapes, should be avoided. Plant groupings should form organic shapes and soften building lines from external view points.

Planting of shelter belts using species indigenous to the local area can be useful in buffering high winds, creating shelter from driving rain and shade from strong sunshine, as well as increasing the privacy of dwelling and its attendant spaces.



The promotion of biodiversity and retention of wildlife corridors is an important consideration, particularly in or adjacent to protected habitats or other ecologically sensitive areas. Block planting of suitable native woodland species can address these issues.



Earthworks such as cut and fill should aim for gentle, natural looking slopes (Diagram 1.) rather than truncated shelf-like projections with an artificial appearance (Diagram 2.).

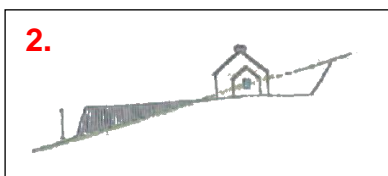

Excavated material should be spread to mould with and softly curve around the original contours. Additional planting should be utilised to further soften the outline of the dwelling against face of the cut, thereby blending the development into the hillside.

Excavated material should be spread to mould with and softly curve around the original contours. Additional planting should be utilised to further soften the outline of the dwelling against face of the cut, thereby blending the

STAGE 4 – DETAILED HOUSE DESIGN

House design should be a detailed response to the specific conditions of the site, combined with the basic concepts identified at *Stage 1*.

Shape and form

Simple shapes work best in the Countryside. New developments should take their cues from the vernacular architecture that exists in the area. Bulky forms should be avoided or mitigated where possible by appropriate roof design and detailing (see Diagram) – long plans may prove a suitable alternative.



The roof profile, chimney positioning, porch detailing and window treatment on the house opposite emphasises horizontal bulk and is at odds with traditional proportions and appearance.

Simple amendments such as those illustrated opposite successfully address the balance and create a dwelling much more in keeping with County Longford vernacular building tradition

Simple, clean roof lines are preferable to fussy complicated shapes. Pitches should generally fall in the range of 40°-45°.

Proportions are particularly important in rural situations in terms of visual impact. Care should be taken to preserve vertical emphasis on the front or visible elevation, and maintaining a high solid to void ratio (i.e. more wall than opening).

Distinctions are generally not made between single and two-storey dwellings, except where there are potential privacy/overlooking issues, where the dwelling is proposed in an elevated area and/or where the construction of a particular type prevails.



The labourer's cottage, pictured left, is a distinctive feature of Longford's rural environment and but one example of vernacular building type. These dwellings were constructed from the 1880's on and many remain in existence today, particularly in the south and east of the County and in the vicinity of the Canal.

These dwellings consist of a simple plan with the bedroom contained in the attic space. Simple roof profiles and horizontally emphasised proportions dominate the appearance.

Annexes and Garages



The above picture illustrates how annexes and extensions were addressed in their traditional form. The annexes are clearly subordinate to the main body of the dwelling, which maintains a stand alone presence and a distinct vertical emphasis in its proportions.

Annexes such as conservatories, sun-rooms and garages should appear as forms similar but subordinate to the main form of the dwelling. Materials used should reflect those of the main dwelling.

Garages should generally be separate from the main dwelling or appear so through appropriate setback

Outbuildings were commonly grouped around the main dwelling, creating a courtyard or street-like enclosure or grouping of buildings. This clustering effect is more desirable than the establishment of large, stand alone double garage structures that compete with the main dwelling for visual dominance.

Materials and finishes

Traditionally, natural and locally sourced materials were favoured in dwelling construction. Traditional building forms, materials and detailing were designed as a response to local climatic conditions, reducing exposure to the elements and thereby minimising heat loss and water ingress.

Natural and traditional materials such as wood and stone also facilitate repair rather than replacement, e.g. uPVC versus wooden windows and doors, an important consideration in the sustainability of a development.

Modern materials and heating methods have allowed a greater range of finishes and detailing, many of which can look incongruous and ill-suited to countryside situations.

In addition to visual considerations, the need for sustainable building solutions would point towards the use of locally sourced products that reduce dependence on fossil fuels in terms of their manufacture, transport and longevity.

Building features and finishes more suited to warmer climates, such as balconies and open arched porches, will be discouraged.

Natural, locally sourced stone will be considered as a finish material where appropriate, however, the use of reconstituted concrete cladding and other artificial cladding materials will be discouraged.

Windows

Painted hardwood finishes are favoured above uPVC and aluminium finishes, both in terms of appearance and sustainability.



Horizontally emphasised windows should be avoided, as should fussy uPVC glazing, particularly where sub-divided by internal glazing bars.



The windows pictured here illustrate traditional forms that exist in rural County Longford, many of which lend themselves to modern interpretation in terms of proportion and scale.



The use of plaster banding and reveals further defines the feature and creates interest. Note how division and sub-division are used to maintain a vertical emphasis in each case.

Doors and Porches

Doors should be simply designed and comprise a minimum of materials. Glazing should be restricted to the upper half of the door. Patio type or double doors should be avoided on the front elevation of the dwelling



Porches and recessed doors were traditionally used to combat adverse weather conditions. Porches can also be used as a design feature to turn corners and create active frontage on two sides of a dwelling.



Fanlights and slit windows are often used to allow light in to hallways and entrance areas, usually with decorative effects such as stained glass and mullions.



The use of brightly painted hardwood doors can be a useful device for adding a splash of colour in to an otherwise neutral façade, with attractive results.

External finishes

The external finishes of a dwelling are particularly important in terms of its compatibility and ability to harmonise with the surrounding landscape. Painted nap plaster or rough/wet dash finishes are appropriate in this setting, as are coloured renders.



The use of brightly painted doors and windows can be used to brighten up a render finish

Large expanses of red and/or yellow brick are not appropriate in rural County Longford as they are not locally sourced, have not been traditionally used as a finish material and are more appropriate to urban locations. In certain circumstances and locations, and depending on the design of the dwelling, the limited use of brick as a detailing material only may be considered.

Dry dash finishes are difficult to maintain and have a tendency to leach minerals, leaving permanent and unsightly vertical streaks down external walls, and, as such, are not encouraged.

Roofs

As discussed at *Stage 3*, roofs should be simply designed. This also follows for roofing materials which should be blue or blue/black slate or tile, with a matte or semi-matte finish. Ridge tiles should generally be of the same colour as the main roofing material, except in certain areas where terracotta/painted ridges are part of the vernacular.



Pitched or hipped roofs are generally acceptable. Extensions or garages/outbuildings should have a similar roofing material of a similar pitch. Half-hips, dutch gables and mansard roofs are generally not acceptable (with the exception of Ardagh village and surrounds, where half-hipped roofs are established by tradition).



The roof and roofing material is an important element in the visual impression of a dwelling, particularly in terms of how the bulk of the building is articulated. Traditional rural built forms were long in plan and appearance. Pitches are usually set between 40° - 45°.



Hipped roofs can be utilised to reduce the visual bulk of square plan houses, an effect that is negated where chimneys are placed at either gable end.



Chimneys are important visual features in a dwelling and should be located on the ridge line where possible, particularly in the case of hipped roofs, or located to the rear. The traditional style chimneys illustrated above are all substantial structures and read as strong design elements. Thin, insubstantial chimney structures should be avoided.

Care should be taken to create an overall design response at roof level. Aerials, satellite dishes and other receivers should be screened from view where possible.

CONTEMPORARY HOUSE DESIGN

Whilst it is evident from the aforementioned design guidance that consideration must be given to the existing and traditional built heritage of County Longford, there is also a growing desire to build homes that reflect advances in technology and fulfil the needs of modern lifestyles. Successful contemporary design in Longford will be measured by how well these objectives are met.

Design proposals of this nature should provide 21st century architecture that is innovative, sustainable, environmentally conscious and firmly of its time and place. Proposals should not seek to replicate, mimic or imitate, but fuse new building technologies and styles with the built character of what has gone before, interpreting traditional in the contemporary context.

Contemporary and inventive design is a welcome addition to the rural countryside. However, given that successful contemporary design is site specific, original and inventive, it is difficult to be prescriptive. In this regard proposals should be expertly and sensitively handled. Accordingly, it is strongly advised to engage the services of a skilled architect and consult with the Local Authority at pre-planning stage.



Contemporary rural house (left) granted planning permission at Mollyglass, Co. Longford. Credit; CAST Architecture. Photo sourced from

<http://castarchitecture.ie/?project=rural-house-ii-longford>

Contemporary extension (below) at Newcastle Demesne, Ballymahon, Co. Longford. Credit; ODOS Architects. Photo sourced from

http://www.e-architect.co.uk/images/jpgs/ireland/ballymahon_house_o010310_rh3.jpg



Annex 8:

Shopfront Design Guidelines

Design Guidance

SHOPFRONTS

Longford County Council - Planning Department
August 2019



1 Introduction

2 Policy Context

- 2.1. Local
- 2.2. Regional
- 3.3. National

3 Process

- 3.1. Works Requiring Planning Permission
- 3.2. Initial Design Considerations
- 3.3. Pre-Planning Design Advice
- 3.4. Making an Application

4 Shop Front Elements

5 Guidelines

G1. Proportion

- A. Doors/Access
- B. Windows
- C. Stall Riser
- D. Fascia

G2. Materials & Colour

- A. Materials
- B. Colour

G3. Outlook

- A. Active Frontage
- B. Security

G4. Signage

- A. Typology
- B. Lettering
- C. Lighting

G5. Projections

- A. Hanging & Projecting Signs
- B. Awnings

A well-designed shopfront should respect both the building itself and the character of its street. Good design is positive for the overall appearance of the streetscape, ensuring a high-quality retail environment which is more attractive to shoppers, visitors, and opportunities for inward investment. These guidelines aim to strike a balance between encouraging best practice in shopfront design, while facilitating creativity and expression, and shall apply to all retail units as defined under Use Class 1 and 2 (inclusive of restaurants, cafes, bars and takeaways), Part 4 of the Planning and Development Regulations 2001 (as amended).

All designs should adhere to Building Regulations to ensure that they are in line with space, design and accessibility standards.

This document is based on planning policies set out at local, regional and national level.

2.1. Local

Longford County Development Plan (CDP) 2015-2021

- Policy ECON 13
'Development Standards – Building Layout & Design';
- Policy ARCH 5
'Architectural Heritage';
- Appendix 13
'Shop Front Design Guidelines';
- Annex 2
'Retail Strategy'.

County Longford Local Economic & Community Plan (LECP) 2016 – 2022.

Longford Town & Environs Local Area Plan (LAP) 2016 - 2022.

2.2. Regional

Eastern and Midland Regional Assembly (EMRA) – Regional Spatial & Economic Strategy (RSES) 2019-2031

- Regional Policy Objective 6.12 & 6.13
'Town Centre Renewal'
- Regional Policy Objectives 9.11 & 9.12
'Healthy Placemaking'.

2.3. National

National Planning Framework (NPF) 2040

- National Policy Objective 4
'Making Stronger Urban Places'
- National Policy Objective 6
'Making Stronger Urban Places'
- National Policy Objective 11
'Making Stronger Urban Places'
- National Policy Objective 13
'Making Stronger Urban Places'
- National Policy Objective 17
'Planning for Diverse Rural Places'

3.1. Works Requiring Planning Permission

- New shopfront;
- Any alternation to an existing façade shopfront which materially affects the appearance of a shopfront (e.g. removing the stall riser, installing another door, installing security grills or shutters, etc.);
- 'Change of use' from shop to any other use aside from 'Residential' where the limitations apply.
- Works to a Protected Structure;
- Works which will materially affect the character of an Architectural Conservation Area (ACA).

On matters relating to advertisement signage, the applicant is advised to review 'Section 2, Part 2, Article 6, Exempt Development – Advertisements' of the current Planning and Development Regulations 2001 (as amended) for such developments considered exempt.

3.2. Design Considerations

- Is the host building a Protected Structure?
- Is the host building located in an Architectural Conservation Area (ACA)?
- What are the qualities and proportion of the rest of the building?
- Does the building have a distinctive architectural style or character (e.g. Georgian)?
- How would a shopfront fit into the host façade/ streetscape?

Longford County Council (LCC) will always encourage the retention, conservation or restoration of period shopfronts. However, where a new shopfront is deemed appropriate by the Local Authority, the new shopfront shall have regard to the design guidance as set out in this document.

3.3. Pre-Planning Design Advice

Longford County Council hold regular pre-planning information meetings with perspective applicants. Interested parties will have the opportunity to meet a planner or architect who can broadly advise them about their proposal. The dates of the meeting are agreed in advance by appointment only.

3.4. Making an Application

- Application Form;
- Fee;
- A Site location Plan to a scale of 1:1000 with site outlined in red;
- An existing elevation of the shopfront and the host building together with adjoining properties;
- Drawing of the shopfront, plans, sections and elevations at a scale of 1:50, showing relationship to host building;
- Joinery or stone detail to 1:10 or 1:5;
- Details of shutters, housing, materials and fittings;
- Specification for signs and materials;
- Shopfront finish;
- Illumination design;
- Photographs of the existing shopfront and adjoining premises;
- Aspirational photographs representation of the 'look and feel' you would like to achieve.

4 Shop Front Elements

A. Cornice

Area above the fascia, either decorative or plain;

B. Console/Corbel

A decorative or plain element at the top of the pilaster. Its height determines height of fascia;

C. Fascia

Area at the top of the shop front where the shop sign is to be positioned;

D. Fanlight

A fan-like window placed over another window or commonly a doorway;

E. Transom

A horizontal element that forms a division between units of a window or door;

F. Mullion

A vertical element that forms a division between units of a window or door;

G. Pilaster

A vertical dividing element between shops, usually sitting forward of the shop front;

H. Sill

Horizontal element at the bottom of the window frame;

J. Plinth

The base element upon which a column, pedestal or structure rest. Usually resting on the ground;

K. Stall Rises

This is the solid section beneath the window sill;

Shop Number

Street number positioned on the fascia or fanlight;

Projecting Sign

Sign that is at a right angle to the fascia and has the same name on it.

Awning

An external shade that folds or rolls out providing shelter and shade;

Traditional

Modern

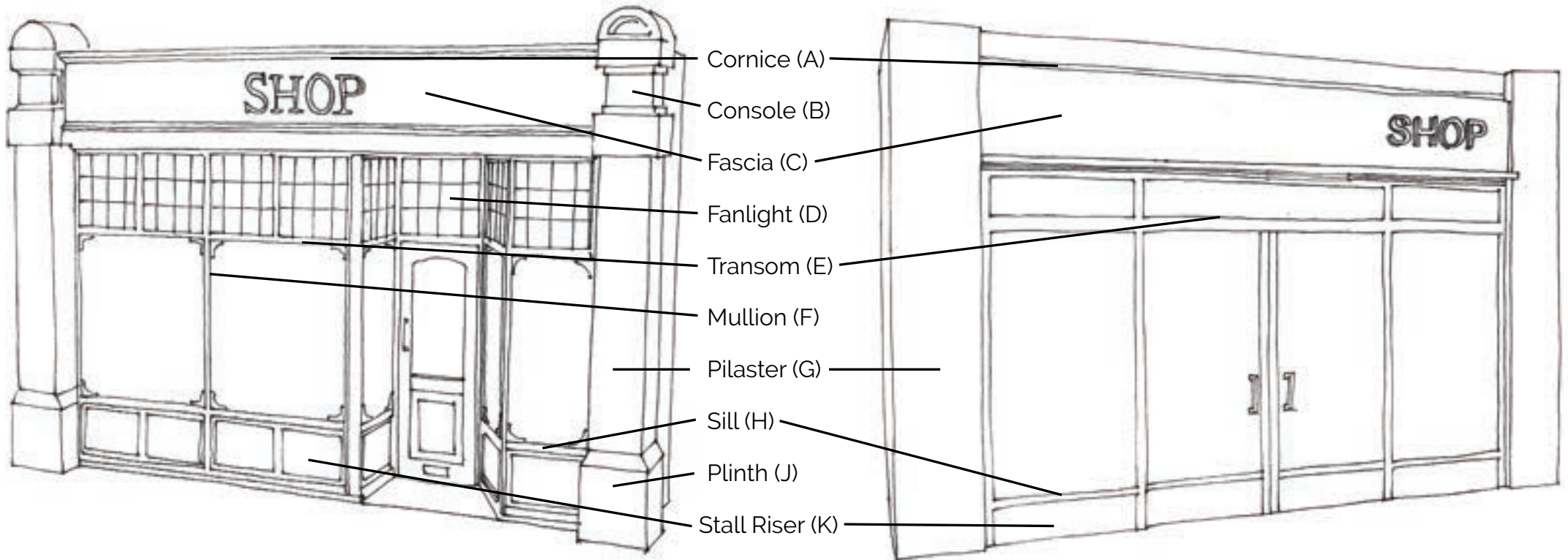

Fig. 1. Shop Front Elements Sketch.



G1. Proportion

Well-proportioned windows and doors help to achieve good shopfront design and create an important first impression. Their size and scale should be proportionate to the openings on the upper floors and it is desirable that they should align with other details of the building such as aligning the stall riser with the height of a plinth.

A. Doors/Access

Recessed doorways create additional interest and should be complimented by a quality surface finish at the threshold. A glass visibility panel is recommended in all new doors and its position and size should be such that wheelchair users and people with disabilities can be seen through it.

All new shopfronts should be designed to make access easier for people with disabilities, the elderly, the very young, people with pushchairs, and the visually impaired. Where possible, level access should be provided. Where this is not possible, raise the pavement level in the vicinity of the doorway or providing a non-slip ramp (gradient between 1:12 & 1:20). Revolving doors and folding doors will generally not be favourably considered.

All new shopfronts should be designed to make access easier for people with disabilities, the elderly, the very young, people with pushchairs, and the visually impaired.

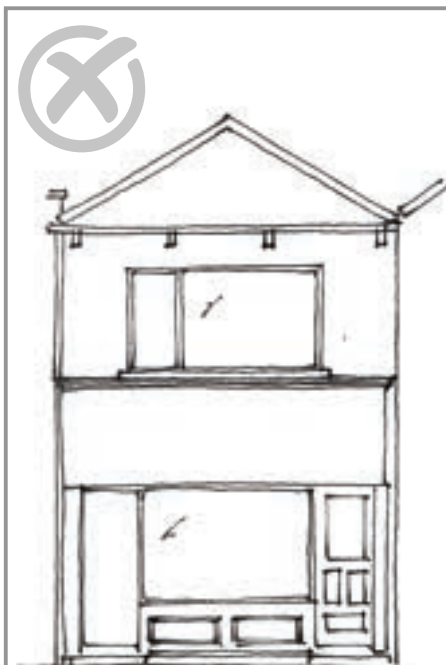

Fig. 2. Proportions.

Some shopfronts incorporate doors to upper floor accommodation. Where existing, this arrangement should be retained, but generally proposals to create such access arrangements will be discouraged. Access to the upper accommodation should preferably be from the rear of the building. Where there is no option but to make a secondary door for access to the upper floor, this door should be an integral part of the shopfront design and should be in keeping with other elements of the shopfront.

B. Windows

Large expanses of glass or completely open shops are usually out of scale with both the street scene and the upper floors of the premises and can create a featureless shopfront. Long runs of horizontal façades should be broken up by vertical divisions or features. Generally, clear glazing should be used, and frosted/tinted/opaque glass only used in circumstances where the overall design concept would warrant the use of such materials. Good examples are occasionally found on windows to public houses. The profusion of stickers/adhesives in shop windows should be avoided.

Generally, clear glazing should be used, and frosted/tinted/opaque glass only used in circumstances where the overall design concept would warrant the use of such materials.



Fig. 3. Vacant retail premises of poor shopfront design, having ground floor window style, size and position not in keeping with upper floor



Fig. 4. Quality materials and finishes, and design and proportion respectful of upper floor window locations.

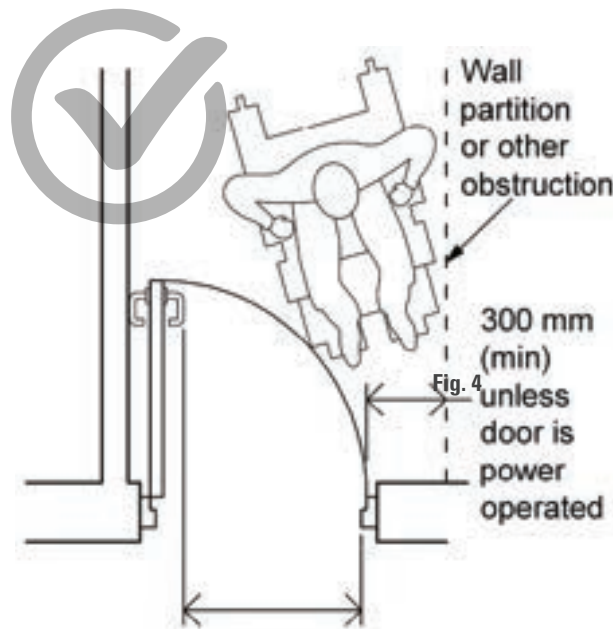

Fig. 5. Effective clear width (Section 1.2, Technical Guidance Document Building Regulations 2010.)

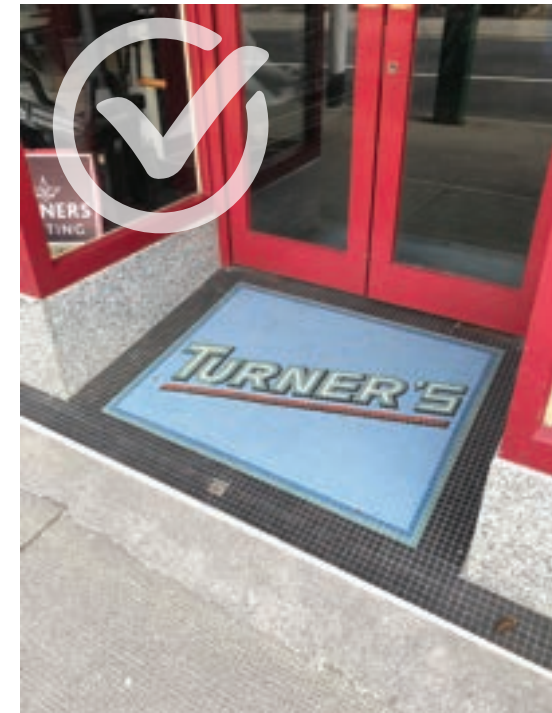

Fig. 6. Recessed doorway with quality threshold finish.



C. Stall Riser

Stall risers focus attention on the window display and raise it up to the shopper's viewpoint. They provide a strong, solid base, protecting the shopfront from damage and giving proportion and character. It is an attractive feature which is traditionally of timber panels, stone or rendered brick, and should be retained and restored. It is desirable to provide a stall riser of at least 400mm to 600mm in height. Timbers should never run directly to the ground - instead a small stone plinth should be provided between the timber and the ground.

Stall risers are often omitted from contemporary designs to maximise the display area or for simplicity of form. The visual success of this is dependent on the use of high-quality materials and detailing, and the omission of a stall riser will therefore only be acceptable where this can be achieved.

D. Fascia

The design of the fascia is a key element of shopfront design and carries the name of the business. In traditional shopfronts the depth of the fascia is quite small. Fascia panels should be proportionate to the size of the building and the length of the shopfront and should not exceed 20% of the overall height of the shopfront to prevent it dominating the façade.

An over deep or shallow fascia can spoil a shopfront. If there is an internal dropped ceiling, existing steel beam or other obstruction, reducing the height of the fascia can be problematic. However, good design by way of the insertion of a sub-fascia, or other design mechanism, can overcome this.

If a shopfront occupies more than one building, the fascia should be subdivided and relate to the individual character of each. Facias extending above the level of first-floor window sills and obscuring architectural details will not be acceptable.

On traditional shopfronts the fascia needs a strong moulding at the top. This should provide a drip detail to protect the fascia from weathering.

Fascia signs should be sensitively positioned across the shopfront and should not:

- Obscure first floor windows or window sills;
- Extend uninterrupted across a number of buildings;
- Cover or ignore any architectural details, such as corbels or pilasters;
- Protrude out from the building further than a depth of 0.25m;
- Form more than 20% of the overall height or surface area of the shopfront; or
- Contain advertisements for other shops or products.

It is desirable to provide a stall riser of at least 400mm to 600mm in height.



Fascia panels should be proportionate to the size of the building and the length of the shopfront and should not exceed 20% of the overall height of the shopfront to prevent it dominating the façade.



Fig. 10. Absence of stall riser framing the shopfront



Fig. 11. No stall riser to shop front, unsympathetic to window positions above, and failure to integrate adjacent doorway into shopfront



Fig. 12. Excessive signage with double fascia.



Fig. 13. Shallow shopfront fascia with unnecessary additional text.



Fig. 14. Original office shopfront with decorative detailing celebrated and retained.

G2. Materials & Colour

A. Materials

The type of material used in a shop front is an important element of the overall design and should take into account the character of the building. Designs should not employ a large number of different materials or use materials that could clash with adjoining premises or the general street scene.

As a general principle, the type and number of materials used should be kept to a minimum, and they should be of high quality, durable and easily maintained. Shiny reflected materials such

as acrylic or plastic, or the use of excessively bright or shocking colour should be avoided. The use of uPVC for windows and doors is to be discouraged. Traditional shopfronts are normally painted softwood, and these can readily be repaired if decayed, and with proper maintenance can last indefinitely. Other materials, such as bronze, cast iron, marble and stone have also had a long tradition in shopfront construction.

If the shop is part of a Protected Structure, then any changes to the shopfront material will require

Planning or Section 57 Declaration approval before works can be undertaken. The current list of Protected Structures in the county are available in the Appendix of the Longford County Development Plan 2015 - 2021 and the Longford Town & Environs Local Area Plan 2016-2022.

Shiny reflected materials such as acrylic or plastic, or lurid colour, in most cases, should be avoided.



Fig. 15. Disproportionate fascia signage over a rigid pattern of polished stone cladding and uPVC window and door framing.



Fig. 16. Solid colour palette, finish and backdrop.



Fig. 17. Plain clour scheme with handpainted lettering.

B. Colour

Colour schemes for historic shopfronts were kept simple, often single coloured, which put the goods of the window display at the centre of attention. Today, colour schemes are often used to make the shopfront itself a form of advertising. Corporate schemes in particular are often imposed without any regard to the design and location, which can contribute to the erosion of the character of an area. Thus, in historically sensitive areas, corporate retailers are expected to modify their standard design and colour scheme where this would be desirable. Walls and stone detailing which have traditionally not been painted should remain undecorated.

- Dark shades of green, grey, blue, red, browns, or black are traditional colours and preferred. Bright shades of yellow, orange and pink are inappropriate;
- Minimalist and monochrome paint combinations combined with the use of a stylish script can result in high-quality schemes. Garish colour combinations should be avoided;
- The change of colour of a shopfront which is part of a Protected Structure may require planning permission.

It is advisable to contact Longford County Council Planning Department to discuss the colour scheme before an application is submitted. Muted paint colours tend to be most appropriate, selected from 'heritage' colour range of paint manufacturers.

Colour schemes for historic shopfronts were kept simple, often single coloured, which put the goods of the window display at the centre of attention.



Fig. 18. Harsh, black and white ground floor public house shop front, contradictory to the softer, more preferred, colour palette of the upper floors.



Fig. 19. Loud and inconsistent colour presentation.



Fig. 20. Lurid colour timber shopfront over decorate original.



Fig. 21. Appropriate ground floor colour sensitively carried through to upper floor quoins, window frames and light fittings.

G3. Outlook

A. Active Frontage

An attractive window display can draw people into the shop from the street and enliven the street scene. Shop window displays should enhance the street scene and reflect the features and proportions of the building's exterior. A shop window display should be maintained at all times.

Where a shop might fall vacant there are opportunities to maintain an attractive window display to improve the look of the shop frontage. This can help to encourage new occupiers to rent the unit and prevent the area from looking run-down and less attractive to potential investors. Efforts should be made to maintain a clean and uncluttered shop window and any visible space behind it. For longer term vacancy it might be

appropriate for the shop front to incorporate window vinyls with artistic or photographic elements or the empty unit might be used for pop-up events (e.g. art exhibitions).

For the avoidance of clutter, externally mounted cabling, wires, trunking will not be permitted on the front façade of the building. Alarm boxes should be carefully located to avoid visual intrusion, and the colour should complement the background.

Obscured windows where a shop is in use, whether as a retail or non-retail use, can create unnecessary, 'dead' frontages to a street. Solid or partly in-filled windows, posters covering the

window or plastic window vinyl will not normally be acceptable in occupied shop units.

The shop window should be the most brightly-lit part of the shopfront. Internal lighting of window displays are helpful for after-hours window shopping and creating an atmosphere of warmth on the street.

For the avoidance of clutter, externally mounted cabling, wires, trunking will not be permitted on the front façade of the building.



Fig. 22. Bland and uninteresting bookmaker shopfront with unsuitable, externally mounted security shutter and shutter box.



Fig. 23. Lively shop front using soft planting to improve the aesthetic.



Fig. 24. Collection of quality materials, finishes and colours combined to convey interest and activity.

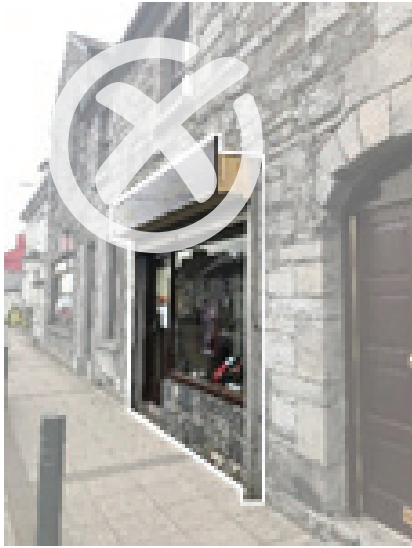

Fig. 25. Projecting roller shutter boxes will not be permitted.



Fig. 26. Externally installed, solid roller shutters will not be permitted.



Fig. 27. Roller shutter guides should be integrated into the shop front in rare cases where externally installed roller shutters are permitted.

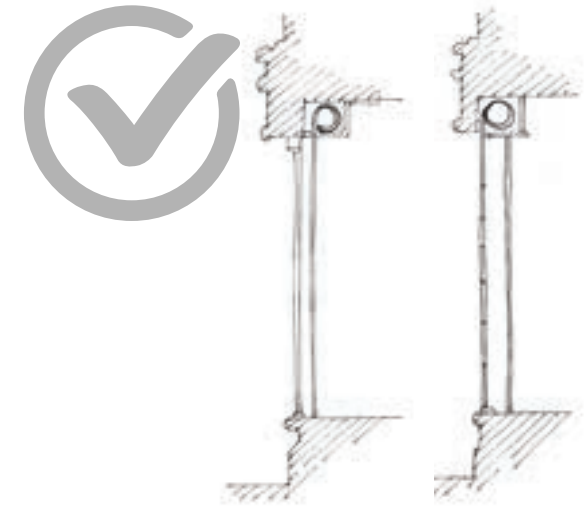

Fig. 27. Where necessary, roller shutters should be located behind external glazing. Open shutters externally are only permitted in exceptional circumstances and when integrated into the shopfront design.

B. Security

It is recognised that shop front security is an important consideration, however if not well designed and integrated it can create a hostile street scene. This can also be the case where shop fronts include blocked out windows and large alarm systems.

Laminated, security glazing should be the first-choice security solution. Sensors on the windows can be linked to an alarm or CCTV for a more comprehensive security system. Internally fitted grilles or mesh shutters are more suitable where toughened security glass is not appropriate.

The installation of externally mounted security shutters requires planning permission.

Detachable, externally-fitted iron grilles, and internal open mesh grilles, which can be fitted behind the glass, are the preferred security shutter options. Open mesh shutters cause less intrusion on the appearance of the building or shopfront, allowing views into the shops after working hours. These have the further advantage of letting light shine onto the street at night, making it more attractive to passers-by. Where security shutters are considered necessary, in cases where the premises in a high-risk area, or is a high-risk business, and if there is evidence from insurers that no other type of shutter would be acceptable for insurance purposes, shutters may be permitted provided they meet the following criteria:

- Incorporated into the shopfront design with guide channels concealed or removable;
- Open grill type, not solid, or perforated;
- Painted or coloured to match the shopfront scheme;
- Housed behind the window display.

Solid, external shutters deaden the street scene and can provide less protection for the shop than toughened security glass.

Laminated, security glazing should be the first-choice solution.

G4. Signage

A. Typology

Signage shall form an integral part of the overall design of the shopfront. Well-designed fascia signage can provide decorative interest and project an image of quality. The signage relating to any commercial ground-floor use shall be contained within the fascia board of the shopfront. Good signage is discreet,

complements the architecture of its background and can enhance the appearance of the shop and streetscape. The common theme in successful contemporary detailing is a restraint in signage size and type. Certain types of business place excessive reliance on the use of signage and advertising to promote their goods and services e.g. fast food outlets and bookmakers.

The common theme in successful contemporary detailing is a restraint in signage size and type.



Fig. 29. Excessive number of stickers on shopfront and façade windows.



Fig. 30. Disproportionate signage scale and with stunted window and door proportions.



Fig. 31. Simple and consistent shop front colour and signage on a quality timber arrangement.



Fig. 32. Overtly large lettering relative to fascia.



Fig. 33. Flat, two-dimensional print lettering on undefined box fascia.



Fig. 34. Simple, clear lettering, complemented with simple, graphic motif.



Fig. 35. Individual and pronounced lettering.



Fig. 36. Etched window lettering for window glazing only.

B. Lettering

Lettering on a fascia sign should be proportionate to the fascia dimensions. The fascia sign should state only the shop name and street number. In some cases, a simple graphic motif may also be appropriate. The choice of lettering can evoke an image and provide decorative interest. The lettering employed shall either be painted on the fascia or consist of individually mounted solid letters on the fascia board. The size of the lettering used should be in proportion to the depth of the fascia board and should not normally exceed 300mm in height. In no case should lettering exceed 400mm. Lettering designs should be kept simple and legible. Lettering or logos shall not be affixed directly to the glazing of any shop

or business windows, other than etched lettering. All sign displays inside the shop should be kept back a minimum distance of 500mm from the glazing. Lettering or logos shall not obstruct the window display and shall not exceed one quarter of the area of the window through which the advertisements are exhibited.

Notwithstanding Schedule 2, Part 2, Article 6, of the Planning and Development Regulations, 2001 (as amended) or any regulations revoking or re-enacting these regulations, all signage and advertisements on a Protected Structure or within an ACA, require planning permission.

The lettering employed shall either be painted on the fascia or consist of individually mounted solid letters on the fascia board. The size of the lettering used should be in proportion to the depth of the fascia board and should not normally exceed 300mm in height.



Fig. 37. Internal flashing signs shall be discouraged and the proliferation of adhesive use.



Fig. 38. Neat strip lighting over individual lettering.

C. Lighting

The brightness and style of illuminated signs should be in keeping with the area in which they are located, thereby minimising light pollution for residents and safety implications for drivers. External lighting of the shopfront will only be considered where it is modest and subtle, and preferably can be concealed

by the fascia or other details of the building. Spotlights supported on projecting brackets will be discouraged. The colouring and intensity of illumination should be complementary to the overall shopfront design and architectural context. Illuminated projecting signs flashing signs in the shop window, and near are illumination around windows unacceptable.

Hand-painted signs or illumination by bracket or wash lighting are preferred to internally illuminated signage.

G5. PROJECTIONS

A. Hanging & Projecting Signs

Projecting signs tend to be bulky, constructed of inappropriate materials, and are frequently internally lit. Too many hanging or projecting signs, installed at varying heights, can erode the appearance and continuity of a street scene. By establishing a standard approach, all shop signage will be visible to potential customers and at an appropriate height and size to be legible. Hanging signs are a traditional feature of shops and can add interest if well designed. Positive consideration may be given to the use of a hanging sign if a building is in multiple occupancy, and the proposed sign would lead to a significant overall reduction in the number

and scale of advertisement structures on or projecting from the face of the building. In this circumstance the following guidelines must be observed:

- Not more than one hanging / projecting sign should be displayed on a building;
- Signs should not be fixed directly to the face of a building but should be fixed by a bracket;
- Projecting signs should be fixed at fascia height adjacent to the access to the upper floors;
- Signs should depict a pictorial feature or symbol illustrating the trade or business

being undertaken and should be as transparent as possible;

- Signs should be individually designed to complement the scale, materials and design of the building;
- Signs should not obscure important features of a building or adjacent building.

Banners and flags are considered to be unsuitable forms of identification and are to be discouraged.

Murals require planning permission, except in circumstances when undertaken in partnership with the local authority

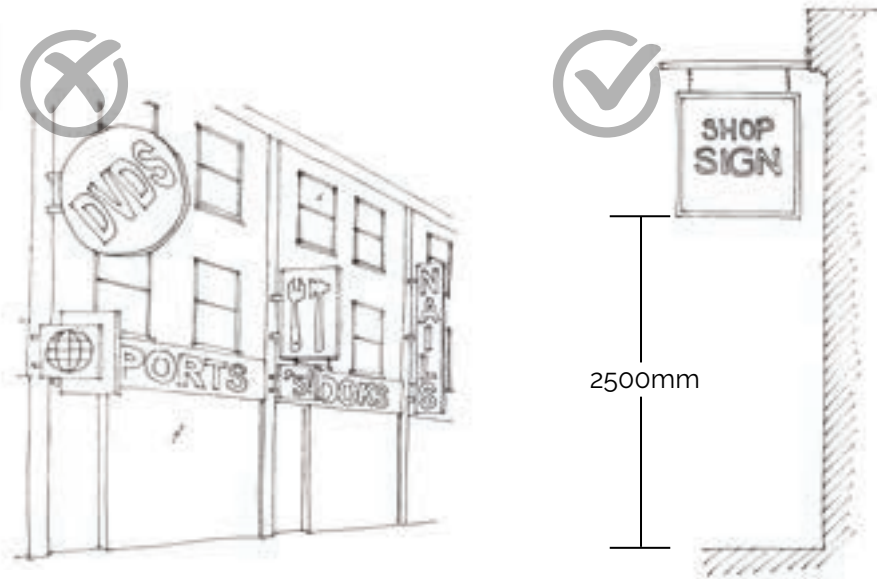

Fig. 39. Poorly placed hanging and projecting signs can create a cluttered and unattractive street scene.

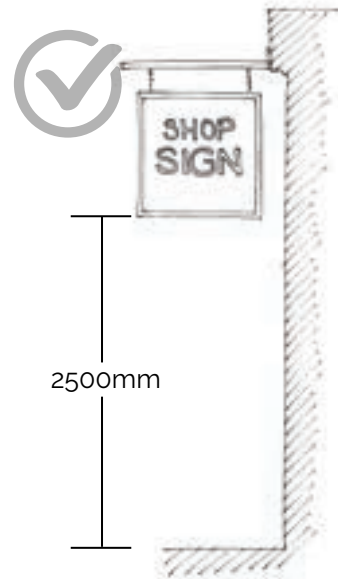

Fig. 40. 2500mm distance of projecting sign from street level.



Fig. 41. Simple, neat and solid contemporary sign projection.



Fig. 42. Mural signage of high artistic quality as a minimum requirement.

B. Awnings

Planning permission is necessary for fixed awnings. Awnings and blinds can be a lively addition to the street scene, provided they are designed as an integral part of the shopfront. Great care is needed in the selection of the style, colour, location and number of canopies and awnings, as they can affect the look of the street and obscure the view of shop fronts. Retractable, open-ended roller awnings are traditional and unobtrusive. If installing a new awning or blind, you should not obscure architectural detail. Continental 'Dutch' canopies and/or those made from shiny materials will not be permitted. Straight canvas canopies with well detailed retractable rollers incorporated into the shopfront will be preferred in most situations. Blind boxes should be integrated into the overall shopfront and preferably flush with the fascia and installed without damaging the detail of the shopfront. Shop names or advertising on the blind may be permitted if appropriate to the overall design of the building and its surroundings.

Each location must be checked to ensure the installation of same does not compromise public safety. All canopies or awnings should be at least 2500mm above the footpath once fully extended; but should not be fixed to the building any higher than ground floor level. A width of at least 0.5m from the outer edge of the canopy or awning to the kerb line should be maintained at all times.

Straight canvas canopies with well detailed retractable rollers incorporated into the shopfront will be preferred in most situations.

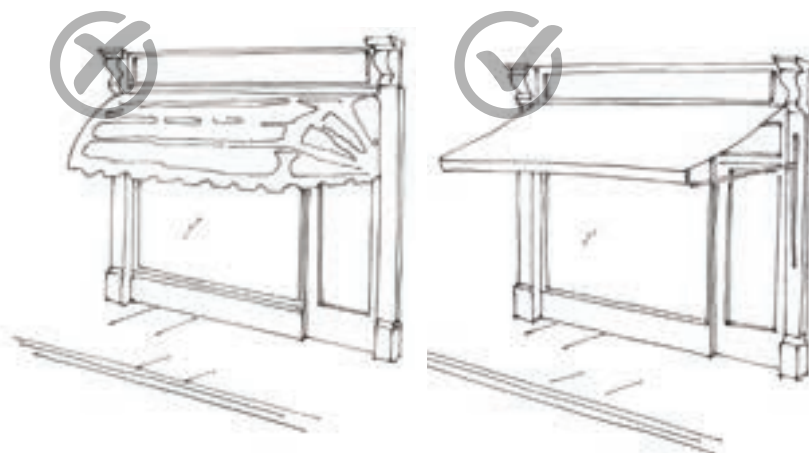

Fig. 43. Preferred awning typologies



Fig. 44. PVC or Dutch type awnings will not be permitted.



Fig. 45. Solid coloured canvas awning with limited text.



Fig. 46. Complementary colourer awning casing to shopfront colour palette.

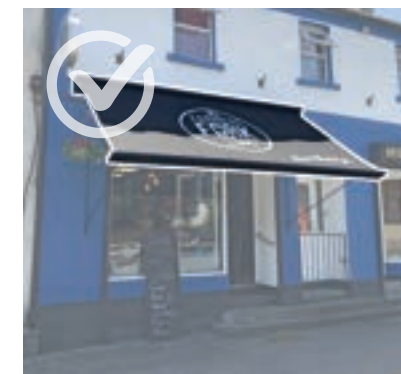

Fig. 47. Open sided awning projection.

References:

Cardiff City Strategic Planning (2011), Shop Fronts and Signage, Supplementary Planning Guidance, Cardiff, UK.

Hackney Environmental Services, Undated, London, UK. 'Shopfront Design Guide', Supplementary Planning Guidance,

London Borough of Hounslow (2013), 'Shop Front Design Guidelines', Supplementary Planning Document, London, UK.

Meath County Council Planning Department (2017), 'Shopfront and Signage Guidelines', Meath County Council, Navan, Meath.

Planning and Economic Development (2013), 'County Kildare Shopfront Guidelines, Section 4 – How to Approach Shopfront Design', Kildare County Council, Kildare.

South Dublin County Council (2014), 'Shopfront Design Guide – 2014', Dublin.

Planning Section
Longford County Council
Great Water Street
Longford Town
Longford
N39 NH56

Email: planning@longfordcoco.ie
Telephone: 043 33 43300
Website: www.longfordcoco.ie

Annex 9:

Retail Strategy

Longford County Retail Strategy 2021-2027



**Planning Department
Aras an Chontae,
Great Water Street,
Longford,
N39 T9K5**

TABLE OF CONTENTS

Executive Summary	i
1 Introduction	1
1.1 Function of the Updated Longford Retail Strategy	1
1.2 Methodology.....	1
1.3 Consideration of Vacancy	2
1.4 Definition of the Retail Typologies	3
1.5 Retail Planning Policy Context	3
1.5.1 National Policy Context	4
1.5.2 Regional Policy Context	6
1.5.3 Local Policy Context	8
1.6 Core Retail Areas	11
2 Retail Trend Analysis and Assessment of Competing Centres.....	13
2.1 Retail Trend Analysis.....	13
2.2 The Changing Nature of Retail Services in Ireland.....	14
2.3 Retail Experience Economy.....	16
2.4 Assessment of Competing Retail Centres.....	17
2.4.1 Introduction.....	17
2.4.2 Competing Centres	18
3 Health Check Analysis	22
3.1 Retail Health Check Analysis of Co. Longford.....	22
3.2 Longford Town.....	22
3.3 Granard.....	26
3.4 Edgeworthstown	28
3.5 Ballymahon.....	30
3.6 Lanesborough	32
3.7 Other Settlements	33
3.8 Summary of Commercial Floorspace Activity Since 2013.....	34
3.9 Healthcheck Conclusions.....	36
4 Projected Floorspace Requirements	38

4.1	Introduction.....	38
4.2	Population of County Longford.....	38
4.3	Expenditure Estimates.....	39
4.4	Turnover and Floorspace Capacity	43
4.5	Additional Retail Floorspace Requirements.....	44
4.6	Additional Retail Floorspace Requirement.....	45
5.	Retail Strategy and Policy Guidance.....	47
5.1	Retail Objectives and Policy Recommendations.....	47
5.2	Retail Strategy Overview.....	47
5.3	Key Retail Principles	48
5.4	Recommended Retail Policy Objectives.....	49
5.5	Criteria for the Assessment of Future Retail Development	53
5.6	Criteria for the Assessment of Different Development Types	54
5.7	Monitoring and Review	55
6.	Conclusion.....	56

EXECUTIVE SUMMARY

The Longford County Retail Strategy 2021-2027 has been compiled as part of the County Development Plan 2021-2027. It represents a re-assessment of the County's previous Retail Strategy 2015-2021 which has been prepared in a period of economic transition marked by moderate growth following the economic recession that characterised the years from 2007-2014.

Whilst this strategy has been prepared in a more positive national economic environment than the previous strategy, it clearly illustrates the on-going impacts which the recession has had on the retail market in the County, as characterised by long-term vacancy levels in many of the County's main retail centres. Moreover, the impact of the Covid-19 pandemic will have a significant bearing on overall economic growth, particularly between 2020 and 2021, which in turn will have implications for future retail expenditure and projected retail floorspace development.

The Covid-19 pandemic and the resultant public health measures introduced over this period, predominantly the three lengthy periods national lockdown restricting multiple retail operations, have also undermined the quantitative and qualitative aspects of the strategy by suspending a substantive element of overall retail activity during the period 2020-2021. At the time of writing, (June 2021) the majority of this substantive sector was beginning to open up again. However, with further emergency public health measures, such as an additional lockdown thereby restricting retail activity once again, cannot be ruled out.

Furthermore, it is anticipated that traditional retail patterns will change significantly post-Covid-19, with an increased demand on online shopping, with more competing land uses, aside from retail, arising in town centres. Consequently, this Retail Strategy should be viewed as an interim strategy in advance of a comprehensive review, post-Covid-19, of the qualitative and quantitative aspects of retail centres within the County.

Notwithstanding this, the Strategy provides notable evidence of the economic resilience of Longford's retailers and its economy, as well as providing the quantitative basis for future retail development in the County over the Plan period.

The purpose of the Longford County Retail Strategy is to ensure that the development of retail floorspace within the County is grounded in an evidence-based framework during its 6-year lifecycle. In this way, the development of additional retail floorspace can be assessed against a set of clearly defined and evidence-based criteria. This will allow for the development of a healthy retailing environment within County Longford addressing high levels of vacancy and economic decline/stagnation in urban centres and reinforcing the vitality of its urban centres facilitating competitiveness in the County and the wider midlands region.

The main findings and recommendations of this retail strategy include:

- Longford Town retains the majority of retail floorspace within the county and remains at the top of the Longford County Retail Hierarchy.
- The findings of healthcheck analysis on each of the main settlements within County Longford indicates that the settlements continue to provide vital services and functions to their residents and their surrounding hinterlands.
- A number of urban streetscape improvement schemes have been proposed for these settlements, as well as funding being secured for their development, which will make a significant contribution to the overall amenity values of the main settlements in the County.
- Despite the resurgence of the national economy in recent years, there remains high levels of vacancy within peripheral areas of the four main settlements of the County.
- The overall vacancy rate within County Longford is currently 9.34%, which is substantively less than the vacancy rate of 17.7% for the County recorded in the previous Retail Strategy 2015-2021, owing to the subsequent occupation of a number of vacant units of large floorplates as well as other premises being the subject of change of use planning permissions from retail to commercial or industrial land uses.
- Of the three retail categories, the proportion of vacancy is highest in the comparison retail floorspace category, with 21.1% of all such floorspace within the County currently vacant.
- Since 2013, only 246.5 square metres of additional retail floorspace has been built.
- Planning permission for a further 2,481 square metres of retail floorspace is due to expire before the 1st of January 2022; if not renewed or implemented prior to expiration.
- 2,036 square metres of floorspace (convenience) is due to expire before the 1st of January 2022, if not renewed or implemented prior to expiration.
- The impact of the Covid-19 pandemic is anticipated to result in a severe drop in economic growth between 2019 and 2020, before recovering rapidly in 2021 with modest growth anticipated in the years thereafter for the duration of the strategy.
- There is a requirement for at least an additional 2,100m² – 3,200m² of convenience, 2,000m² – 2,650m² comparison and 2,200m² – 4,850m² of bulky goods retail floorspace between 2021 and 2027.

1 INTRODUCTION

1.1 Function of the Updated Longford Retail Strategy

The overriding aim of the Retail Strategy is to create the appropriate conditions necessary to foster a healthy and vibrant retail environment in County Longford over the Development Plan period of 2021-2027, in the context of national, regional, and local plans, strategy, policy and guidance. To this end, the Strategy acts as an essential tool in assessing the quantum, scale and type of retail development required over the Longford County Development Plan 2021-2027 period as well as providing the vital evidence base for the relevant policies and objectives contained within Chapter 8: *Economic Development* and Chapter 16: *Development Management Standards* of the Longford County Development Plan 2021-2027 to guide future retail development over the plan period.

1.2 Methodology

This Retail Strategy has been prepared in accordance with the provisions set out in the '*Retail Planning Guidelines for Planning Authorities*', (Department of Environment, Community and Local Government, 2012). The preparation of this strategy has coincided with a period of national economic growth following the sustained economic decline that characterised between the years of 2007-2014. Notwithstanding this, the rate of recovery from this economic crash has not been equitable across the country and has largely been confined to the largest conurbations of the state, most notably within the Greater Dublin Area. However, there is increasing evidence and sentiment that more pronounced growth is now being experienced in areas outside of these locations, including County Longford.

Despite experiencing a period of resurgent growth in recent years, a number of settlements within County Longford still retain long-term vacancy levels of properties within their respective town centres. This level of long-term vacancy coincides with a more general discussion at a national-level regarding the changing nature of town centres in Ireland, where the traditional role of retail is being challenged to offer a greater range of retail choice in terms of functions and accessibility for shoppers. In this regard, there is recognition that the evening and night-time economy has a significant part to play in revitalising town centres and traditional retail cores not just in providing increased accessibility for consumers through later opening hours, but also in providing a more immersive and vibrant experience for consumers and users of town centres throughout the day and evening.

In the backdrop of the preparation of this Retail Strategy, the uncertainty of the exit of the United Kingdom from the European Union remains. Moreover, the impact of the Covid-19 pandemic will have a significant bearing on overall economic growth, particularly between 2020 and 2021, which in turn will have implications for future retail expenditure and projected retail floorspace development.

The Covid-19 pandemic and the resultant public health measures introduced over this period, predominantly the three lengthy periods national lockdown restricting multiple retail operations,

have also undermined the quantitative and qualitative aspects of the strategy by suspending a substantive element of overall retail activity during the period 2020-2021. At the time of writing, (June 2021) the majority of this substantive sector was beginning to open up again. However, with further emergency public health measures, such as an additional lockdown thereby restricting retail activity once again, cannot be ruled out.

Furthermore, it is anticipated that traditional retail patterns will change significantly post-Covid-19, with an increased demand on online shopping, with more competing land uses, aside from retail, arising in town centres. Consequently, this Retail Strategy should be viewed as an interim strategy in advance of a comprehensive review, post-Covid-19, of the qualitative and quantitative aspects of retail centres within the County.

Despite this uncertainty, and the form of future trading arrangements with the UK, retailing remains a fundamental economic function and vital service sector within County Longford.

The applied methodology of this Retail Strategy considers these aspects in detail with the following identified as key objectives of this Retail Strategy:

- Define the retail hierarchy in the County and related retail core boundaries;
- Undertake a health check appraisal of the key retail centres in Longford to ascertain the need for interventions in these areas;
- Identify the broad requirement for additional retail floorspace development in the County over the Development Plan period to support the established settlement hierarchy; and
- Provide guidance on policy recommendations and criteria for the future assessment of retail development proposals over the Development Plan period of 2021-2027.

1.3 Consideration of Vacancy

The preparation of the Longford County Retail Strategy considered retail floorspace vacancy in detail. A survey of existing floorspace in the county was undertaken (between October 2018 and September 2019), which identified a cumulative total of 5,618square metres of vacancy across convenience, comparison and bulky retail categories. This equates to 9.34% of the total retail floorspace in the County. Based on market insights, a frictional vacancy rate of 10% was held across the respective categories to foster competition in the market and the residual total was a factor in the calculated demand model. Identified demand over the plan period was subsequently rationalised on the basis of this vacancy to determine adjusted floorspace requirements. The modelled outputs illustrate that there is an identified need for additional retail floorspace from the beginning of the Plan period in 2021, across convenience, comparison and bulky retail categories.

In undertaking the preparation of this Retail Strategy, Longford County Council has sought to take a proactive approach to addressing the issue of retail floorspace vacancy, while remaining cognisant of its responsibility to facilitate growth in retail and general economic activity within the

County. The Retail Strategy has taken a cumulative approach to depleting vacant floorspace, while accommodating additional floorspace where it is required.

1.4 Definition of the Retail Typologies

Annex 1 of the 2012 Retail Planning Guidelines provides clear guidance on the classification of the two types of retail goods categories, convenience and comparison and defines each category as follows:

Convenience:

This category includes all supermarkets, convenience stores and retail food outlets (excluding fast food takeaways, restaurants, cafes including sandwich bars) serving food, alcoholic and non-alcoholic beverages, tobacco and non-durable household goods.

Comparison:

This list of goods which fall under this category is as follows: clothing and footwear, furniture, furnishings and household equipment (excluding non-durable household goods), medical and pharmaceutical products, therapeutic appliances and equipment, educational and recreation equipment and accessories, books, newspapers and magazines, goods for personal care, goods not elsewhere classified and bulky goods.

Bulky Goods:

While bulky goods category is listed under the classification of comparison floorspace above, it is considered appropriate to make a distinction within the Retail Strategy between pure comparison floorspace and floorspace used for the sale of bulky goods.

The Annex 1 definition includes a list of goods which are considered to fall within the bulky goods category as follows: Goods generally sold from retail warehouses where DIY goods or goods such as flat pack furniture are of such size that they would normally be taken away by car and not be portable by customers travelling by foot, cycle or bus, or that large floorspace would be required to display them e.g. repair and maintenance materials; furniture and furnishings; carpets and other floor coverings; household appliances; tools and equipment for the house and garden; bulky nursery furniture and equipment including perambulators; bulky pet products such as kennels and aquariums; audio-visual, photographic and information processing equipment; catalogue shops and other bulky durables for recreation and leisure. It should be noted that the above classifications are not exhaustive. Bulky goods not mentioned in the above list should be dealt with on their own merits in the context of the definition of bulky goods.

1.5 Retail Planning Policy Context

The following provides an overview of the relevant national, regional and local policy instruments that will influence the future development of the retail sector in the County.

1.5.1 National Policy Context

Project Ireland 2040 - National Planning Framework

The National Planning Framework sets out the Government's high-level strategic plan for the future growth and development of the country out to the year 2040, by which time it is estimated that an extra 1 million people will be living in the country. The NPF sets out a long-term spatial strategy for the country and forms the pinnacle of a hierarchy of spatial plans from which corresponding Regional Spatial and Economic Strategies, County/City Developments Plans and Local Area Plans follow. The NPF sets out a series of shared development goals which are expressed in the NPF as ten National Strategic Outcomes (NSOs) which address a range of development goals.

A key principle underpinning the NPF is that of 'compact growth' which espouses the sustainable growth of compact cities, towns and villages in order to add value and create more attractive places in which people can live and work. In this regard, it is recognised that retail development will be a critical element in providing an appropriate quantum and mix of retail uses which will contribute to and enhance the viability and vitality of urban settlements and their centres.

Retail Planning Guidelines for Planning Authorities (2012)

The Retail Planning Guidelines, published by the Department of the Environment, Community and Local Government (DECLG) in 2012, aim to ensure that the planning system continues to play a key role in supporting competitiveness in the retail sector for the benefit of the consumer in accordance with proper planning and sustainable development. The Guidelines provide a comprehensive retail planning and development framework to guide regional assemblies and planning authorities in the preparation of retail policy objectives for their respective strategies and development plans, as well as guiding An Bord Pleanála and planning authorities in assessing planning applications or appeals. The Guidelines are also a key source of information to retailers and developers in formulating retail development proposals. The Guidelines and accompanying '*Retail Design Manual*' have increased standards in relation to design, access and mobility, signage, landscaping, the creation of place, and town centre integration including fostering a mix of uses.

The Guidelines contain five key policy objectives for retail development:

1. Ensuring that retail development is plan-led;
2. Promoting city/town centre vitality through a sequential approach to development;
3. Securing competitiveness in the retail sector by actively enabling good quality development proposals to come forward in suitable locations;
4. Facilitating a shift towards increased access to retailing by public transport, cycling and walking in accordance with the Smarter Travel Strategy; and
5. Delivering quality urban design outcomes.

The Guidelines emphasise that in order to ensure proper planning and sustainable development, retail development and activity must follow the settlement hierarchy of the State and retail development should be appropriate to the scale and function of the settlement or part of the settlement in which it is located as designated by the NPF, relevant Regional Spatial Economic Strategy and the Core Strategies of Development Plans.

The Guidelines also provide specific guidance for the content and role of Development Plans. The following are key messages from the Guidelines for planning authorities to have regard to in the preparation of Development Plans:

- Development Plans must set out clear evidence-based policies and objectives in relation to retailing in a discrete section of the Plan;
- Joint or multi-authority retail strategies, where required, will guide the preparation of retail policies and objectives in the relevant development plans;
- The need for any additional retail warehousing should be carefully assessed in view of the significant levels of recent provision and potential impacts on vitality and viability of city and town centres;
- At a minimum, Development Plans must:
 - State the elements of their settlement hierarchy in line with the relevant Regional Planning Guidelines (now replaced by Regional Spatial Economic Strategies (RSESs));
 - Outline the level and form of retailing activity appropriate to the various components of the settlement hierarchy in its Core Strategy;
 - Define, by way of a map, the boundaries of the core shopping areas of city and town centres and also location of any district centres;
 - Include a broad assessment (square metres) of the requirement for additional retail floorspace only for those plans in the areas covered by a joint multi-authority retail strategy;
 - Set out strategic guidance on location and scale of retail development to support the settlement hierarchy, including where appropriate identify opportunity sites which are suitable and available, and which match the future retailing needs of the area;
 - Identify sites which can accommodate the needs of modern retail formats in way that maintains the essential character of the shopping area;
 - Include objectives to support action initiatives in city and town centres, such as mobility management measures that both improve accessibility of retail areas, while aiming to develop a pedestrian and cyclist friendly urban environment and vibrant street life;
 - Include public realm interventions aimed at improving the retailing experience through high-quality civic design, provision of attractive street furnishing, lighting and effective street cleaning/business improvement district type initiatives; and

- Identify relevant development management criteria for the assessment of retail developments in accordance with these guidelines.

As referenced above, the Guidelines also advocate strict guidance in relation to the sustainable organisation of retail activity in Ireland to reflect the existing national settlement structure and hierarchy. This retail hierarchy reflects the broad tiers of urban development and recognises that such a system of classification is indicative only, with scope for overlap between the specific retail functions provided in each tier.

Retail Design Manual (2012)

Accompanying the Retail Planning Guidelines (2012) is the Retail Design Manual which outlines the contribution value of high-level design to the future health of town centres and sets out the key principles of urban design which should form the framework for policies to promote quality design in Development Plans and Local Area Plans. Key urban design principles include context and character; access and connectivity; density and mixed uses and includes case studies to demonstrate the application of these principles. Given its function as a complementary document to the Retail Planning Guidelines (2012), the Manual will be particularly relevant in any future retail development and upgrade works to town centres in Longford and most notably in Longford Town which forms the primary retail destination in the County.

1.5.2 Regional Policy Context

Eastern and Midland Regional Spatial and Economic Strategy

The Eastern and Midland Regional Spatial and Economic Strategy (RSES) is the strategic plan and investment framework which provides policy context for the Eastern and Midland Regional Assembly which comprises of the following twelve local authorities: Longford, Westmeath, Offaly, Laois, Louth, Meath, Kildare, Wicklow, Fingal, Dublin City, South Dublin and Dún Laoghaire-Rathdown. The RSES provides a regional expression of the NPF which subsequently gives direction to policy making decisions at a local level through the County Development Plan.

The Eastern and Midland RSES sets out a number of high-level Regional Strategic Outcomes (RSOs) that have been developed having regard to the National Strategic Outcomes set out in the NPF. The RSES sets out a Growth Strategy for the Region in line with the growth identified in the NPF. A key element of in the development of the Growth Strategy is an asset/potential based criteria approach which integrates an evidence-based approach to the identification of suitable settlements within the Region which have the capacity for additional growth. Related to this Growth Strategy is a Settlement Strategy set out in the RSES which identifies a Settlement Hierarchy for the Region and an identification of key growth areas that will see significant development up to 2036 and beyond. In this regard, the RSES sets out the asset-based settlement typology strategy to inform the settlement hierarchies and strategies of each local authority as presented in their respective development plans.

The RSES recognises the importance of the retail sector as a significant employer and economic contributor to the region, as well as its key role in placemaking and creating attractive liveable environments. The RSES also emphasises the significant role retail can play in acting as a significant attraction for consumers as well as providing an accessible environment for other retailers and commercial service providers through the provision of strong mixed use commercial core.

The RSES reinforces the principles for retail development as established in the Retail Planning Guidelines for Planning Authorities 2012, and places emphasis on ensuring that retail development is plan-led with the promotion of town centre vitality through the sequential approach to development and the promotion of good quality development in appropriate locations whilst also facilitating a modal shift and the delivery of quality urban design outcomes.

A key feature of the RSES's retail development policy is its Retail Hierarchy for the Eastern and Midland Regional Assembly area. In this regard, the RSES prescribes five spatial levels of retail centres or functions: Level 1 – Metropolitan Centre (Dublin City Centre); Level 2 – Major Town Centres and County (Principal) Town Centres (including Longford Town); Level 3 – Town and/or District Centres & Sub-County Town Centres (key services towns including Granard); Level 4 – Neighbourhood Centres, Local Centres, Small Towns and Villages; and Level 5 – Corner Shops/Small Villages.

The RSES include the following policy objectives with respect to the retail sector:

RPO 6.9: *EMRA will support the preparation of a Retail Strategy / Strategies for the Region in accordance with the Retail Planning Guidelines for Planning Authorities 2012 to update the retail hierarchy and apply floorspace requirements for the Region.*

RPO 6.10: *Future provisions of significant retail development within the Region shall be consistent with the Retail Planning Guidelines for Planning Authorities 2012 and the retail hierarchy for Region, expressed in the RSES, until such time as this hierarchy is updated.*

The RSES also addresses the need for town centres to maintain and enhance their vitality and vibrancy and refers to the Framework for Town Centre Renewal (Retail Consultation Forum, 2017) which sets out an action plan and a range of suggested supports for town centre renewal which has the potential to support viable and sustainable towns and villages that meet the long term needs of our society, economy and environment. In this regard, the RSES contains the following policy objectives for town centre renewal:

RPO 6.11: *Local Authorities shall include objectives in Development Plan and Local Area Plans supporting emphasis on placemaking for town centres, for example through the inclusion of a Placemaking Strategy for towns and implementation of Town Centre Renewal Plans.*

RPO 6.12: *Local Authorities shall support the preparation of Design Guidelines to provide for improvements in the appearance of streetscapes and for revitalising vacant spaces for example with cost effective, temporary uses that build on the longer-term vision for space.*

RPO 6.13: *EMRA will support the use of targeted financial incentives to re-establish the dominant role of town centres provided for in planning policy to encourage a greater take up of town centre development opportunities for retail, residential, commercial, and leisure uses.*

1.5.3 Local Policy Context

Longford County Development Plan 2021-2027

The Development Plan outlines the spatial development framework for County Longford to develop sustainably over the period 2021-2027 and provides a local expression of national and regional planning policy as reflected in the National Planning Framework and the Eastern and Midland Regional Spatial and Economic Strategy respectively. A critical element of the Development Plan is the Settlement Strategy which provides the geographic framework to guide the location and scale of future development within the County over the plan period and takes cognisance of the regional settlement and retail hierarchies presented in the RSES. An intrinsic feature of this Settlement Strategy is the Settlement Hierarchy which assigns the settlements within County Longford in accordance with the spatial structure and settlements typologies set out in the RSES and categorises areas for development within the County across five tiers as illustrated below:

Longford Town – Key Town
Granard– Self-Sustaining Growth Town
Edgeworthstown, Ballymahon & Lanesborough – Self-Sustaining Towns
Towns and Villages
Rural

Tier 1 – Longford Town – Key Town

Longford Town is identified in the RSES as being a ‘Key Town’ within the region on account of its role as an economically active service town providing employment for its surrounding area as well as being endowed with high-quality transport links and the capacity to act as a regional driver to complement the Regional Growth Centre of Athlone. Its Tier 1 placing is also reflective of the substantial retail and administrative functions on offer in Longford Town, as well as its level of physical as well as social infrastructure which serves a broad, cross-regional hinterland. Accordingly, it is considered that the majority of industrial, commercial, business and retail development will also be channelled to Longford Town.

Tier 2 – Granard - Self-Sustaining Growth Town

Granard has a robust employment base, with a particular focus on manufacturing in the food and agricultural sectors, with the Pat the Baker food manufacturing company and Kiernan Milling both significant employers. In 2016, there were a total of 269 resident workers within Granard, however 633 total jobs were recorded, giving a jobs to resident workers ratio of 2.35; the highest recorded ratio within the regional area. Granard also acts as an important retail centre to its inhabitants and wider hinterland, as reflected in its designation in the RSES as a Level 3 retail centre (Town and/or District Centres & Sub-County Town Centres (Key Service Centres)). Moreover, given its proximity to the Longford-Cavan border, Granard performs as a key service provider and retail centre for a broad hinterland which extends beyond the County boundary.

Tier 3 – Edgeworthstown, Ballymahon and Lanesborough – Self-Sustaining Towns

The settlements of Edgeworthstown, Ballymahon and Lanesborough fulfil critical roles in supporting their respective communities and wider rural areas, and as such, are designated as ‘Self-Sustaining Towns’ within this Settlement Strategy. The settlements of Edgeworthstown and Ballymahon have seen significant growth over the twenty year intercensal period between 1996 and 2016 with their populations increasing by approximately 181% and 138% respectively over this period. Edgeworthstown has a long-established manufacturing and light-industrial base, with particular focus on agri-food and the service sector and also has excellent transport links owing to its proximity to key transport corridors in the form of the N4 and the Sligo-Dublin InterCity rail line. Similarly, Ballymahon has a strong manufacturing and light-industrial base, with a key retail and service-sector standing within the county, with significant growth in tourism-orientated services such as food and drink, hostels, and tourist accommodation which has coincided with the opening of the nearby Longford Forest Center Parcs resort in 2019.

Lanesborough provides an important role in the provision of local-level retailing, social and leisure functions and local services to its wider hinterland. The Development Plan places strong emphasis on the growth of the local economies in Granard and Lanesborough and the development of its vital administrative and social functions to support and complement growth in the region.

Tier 4 – Town and Villages

Aughnaclyffe, Ballinalee, Drumlish, Keenagh, Legan and Newtownforbes

These settlements have unique attributes in terms of natural and/or built heritage and specific cultural and historic associations that require specific designation to protect and enhance their character. Each settlement also has the necessary infrastructure capacity available to accommodate additional growth and to sustain and enhance existing services for the needs of their hinterlands and acting as catalysts for the rural economy of the county.

Tier 5 – Rural

Serviced Rural Villages: Abbeyshrule, Ardagh, Ballinamuck and Clondra.

Rural Settlement Clusters: Abbeylara, Ballycloughan, Ballywillan, Barry, Bunlaghy, Carriboy, Colehill, Coolarty, Cullyfad, Derraghan, Dring, Enybegs, Forgney, Killashee,

Kilnatraun, Legga, Lisryan, Melview, Moydow, Moyne, Mullinalaghta, Newtowncashel, Ratharney, Stonepark and Taghshinny.

Open Countryside

The Settlement Hierarchy acknowledges the importance of rural areas in Longford for sustaining the vitality of rural communities. In terms of the future development of these areas, this strategy places emphasis on maintaining existing rural settlement clusters with a view to the long-term enhancement of existing services and facilities and also the retention and creation of local-level employment opportunities in such small-scale settlements. These locations provide existing social and community infrastructure and services such as schools, shops, post offices, public houses and residential housing. Residential development in these areas will only be permitted at a small-scale, commensurate with existing levels of development and reflective of the character of existing settlements. Small-scale development which will alleviate the pressures for one-off housing in the open countryside will be permitted in these areas.

Longford Retail Hierarchy

The purpose of the retail hierarchy is to indicate the level and form of retailing activity appropriate to the various urban centres in the County. Taking a criteria-based approach enables the Council to protect each centre’s overall vitality and viability, whilst allowing each centre to perform its overall function within the County’s settlement hierarchy. It is the core concept of the retail hierarchy that the principal urban areas (county towns) are supported by key service towns, local service towns and to a lesser extent, smaller villages. As such this retail strategy focuses primarily on the upper levels of the hierarchy. It is important to note that this is not to deter or discourage smaller scale retail development and investment in the smaller villages. Rather, it is important to set a clear hierarchy which identifies where the distribution of new retail floorspace should be delivered and which is appropriate in scale and character to the hierarchical role of the centre.

The Longford County Retail Strategy 2015-2021 contained five tiers of retail hierarchy and was based predominantly on the settlement hierarchy produced as part of the first Longford Core Strategy prepared in 2012, the Retail Planning Guidelines (2012) and the then latest Midland Regional Planning Guidelines, published in 2010.

The retail hierarchy proposed in this Strategy adopts a similar methodology whereby the ranking of each retail centre has taken into account their respective placing within the settlement hierarchy of the County, as outlined in the Core Strategy of the Development Plan, as well as the Retail Hierarchy for the Eastern and Midland Regional Assembly as prescribed in the RSES. In respect of the latter and as referenced previously, the RSES has assigned Longford Town and Granard as Level 2 and Level 3 retail centres respectively in its Retail Hierarchy.

Taking account of the above, the revised Longford County Retail Hierarchy consisting of five tiers has been adopted for inclusion in this Strategy and is set out below:

Hierarchy Level	Retail Hierarchy Settlement Designation	Settlements
-----------------	---	-------------

Tier I	Principal Retail Centre	Longford Town
Tier II	Key Service Centre	Granard
Tier III	Service Centres	Edgeworthstown and Ballymahon
Tier IV	Local Service Centre	Lanesborough
Tier V	Rural Centres and Local Shops	Serviced Rural Villages, Rural Settlement Clusters and the Open Countryside of County Longford

Retail Policies and Objectives Contained Within Longford County Development Plan 2021-2027

The Longford County Development Plan 2021-2027 also contains a number of policies and objectives specific to retail development which were informed by this Retail Strategy and its recommendations. These policies and objectives are outlined below:

1.6 Core Retail Areas

A key policy objective of the Retail Planning Guidelines is the promotion of greater vitality in town centres through the implementation of a sequential approach to the location of all retail development. This ‘sequential approach’ prioritises core areas within town centres over edge-of-centre or out-of-centre locations, which may in some cases, have poorer functional and spatial linkages with the core. This approach recognises the importance of core areas as the most suitable locations for higher order fashion and comparison goods, as they are easily accessible for the majority of the catchment population and also provide a compact and sustainable critical mass of commercial activity and public amenities, thereby reducing the need to travel.

Given its scale and dominance of retail development and uses relative to other settlements in the County, Longford Town is the most pertinent settlement to be subject to a defined core retail area. The assessment of the County’s retail centres carried out under the previous Longford Retail Strategy 2015-2021 recognised the curtailment of retail activity from the commercial core of Longford Town, realised in the most extreme terms by the levels of commercial vacancy experienced in the economic downturn preceding the strategy. Despite the expectation that the levels of commercial vacancy would recede over the period of the previous Retail Strategy, a considerable level of commercial vacancy remains in the town.

Given the level of commercial vacancy within the settlement, coupled with a relative underperforming commercial and retail market, the Core Retail Area of Longford Town remains that which was defined under the previous Retail Strategy, namely the dense clustering of key commercial activities and is bounded by the primary thoroughfares of Main Street to the West and Dublin Street to the South, and by the secondary thoroughfare of Ballymahon Street to the South West. In accordance with the guidance on the location of all new retail activity set out in the Retail

Planning Guidelines, Longford Town's Core Retail Area is to be the focus and preferred location for retail development during the plan period.

Figure 1: Defined Retail Areas of Longford Town

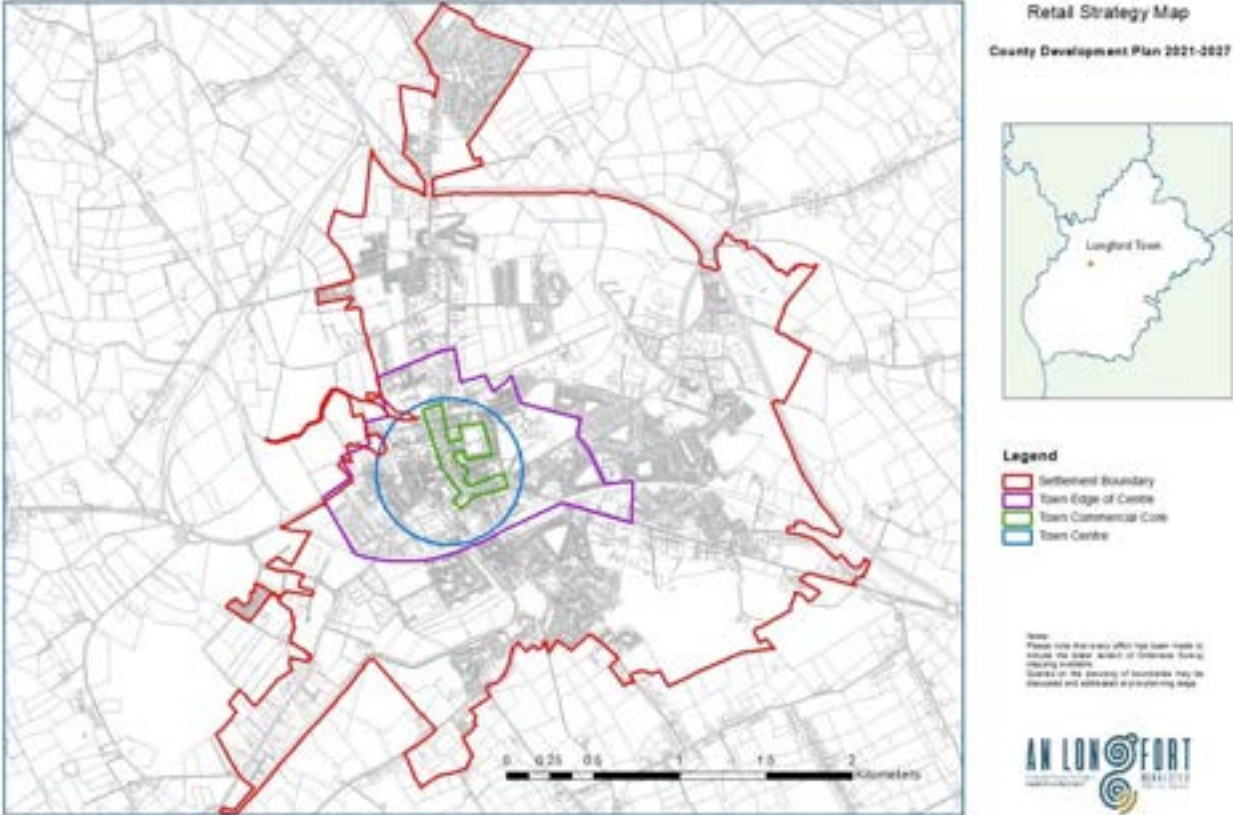

2 RETAIL TREND ANALYSIS AND ASSESSMENT OF COMPETING CENTRES

2.1 Retail Trend Analysis

The retail sector is a vital element of the national, regional and local economy. Nationally there are 280,000 persons employed in the provision of retail services with approximately 72% of employees based outside Dublin¹. Retail is also the biggest contributor to the Irish exchequer, generating 23% of total tax receipts in Ireland and more than twice that of the second largest sector in Ireland². Regionally, many of the largest towns exhibit the broadest retail offer, in keeping with the retail hierarchy set out in the Retail Planning Guidelines 2012. This is not to discount the role of smaller towns and settlements where the provision of retail services is often an essential feature of these communities, fulfilling the important role of providing local goods and services to the population and the surrounding rural hinterlands.

The economic downturn which preceded the previous Longford County Retail Strategy 2015-2021 severely affected the retail sector in Ireland with a 25% drop in sales and job losses in the range of 50,000. A legacy of this economic downturn has been an increase in vacancy rates within many towns and counties, as well as the replacement of higher order comparison and convenience retailing in primary frontage locations with lower order retailing or commercial premises such as bookmakers or takeaways. Furthermore, impacts of the decline in national retail sales and overall economic activity also disproportionately affected independent retailers, many of whom have had higher cost bases than the multiples with which they competed. Such trends have impacted on the attractiveness of many areas as retail destinations and urban environments in general.

Notwithstanding, from an assessment of the pre-Covid-19 pandemic Retail Sales Index, published by the Central Statistics Office (CSO) for May 2019, there has been an increase in the value of national retail sales in comparison with the corresponding months in each of the preceding four years. In May 2019 the adjusted Retail Sales Value index for all retail business excluding motor trades and bars was calculated to be 108.7 (using 2015 as the base year of the index = 100). The adjusted Retail Sales Values for the same month in the preceding years of 2018, 2017, 2016 and 2015 are published as 106.9, 104.8, 101.0 and 97.8. This trend in the retail sector is reflective of the sustained period of gradual economic recovery experienced nationally since the commencement of the economic recovery in 2014.

In terms of the future economic projections, the economic legacy of the Covid-19 pandemic will have immediate effects. It should be noted that the information provided herein is correct at the time of writing and it is recognised that the ongoing global COVID-19 pandemic is subject to change that may affect the national economy. As such, the future GDP growth estimates have been provided to reflect the published data from those sources as outlined herein to reflect the macroeconomic situation as data is limited at this time.

^{1,2} Retailireland.ie. (2018). *Retail in Depth*

The information set out in Table 2.1 collates a number of sources in relation to forecasted GDP growth (and decline) from 2020 onwards.

Table 2.1: Forecasted GDP growth (2020 – 2025)

Source	2020	2021	2022	2023	2024	2025
ESRI Economic Quarterly (March 2020) ³	-7.1%					
ESRI Economic Quarterly (May 2020) ⁴	-10.3%	7.1%				
Central Bank Q2 2020 Bulletin ⁵	-8.3%					
Department of Finance (Feb 2020) ⁶	3.9%	3.0%	2.8%	2.7%	2.7%	2.5%
Department of Finance (April 2020) ⁷	-10.5%	6.0%				
EU Spring 2020 Economic Forecast ⁸	-7.9%	6.1%				
Davys Paper (May 2020) ⁹	-10.3%	7.1%				

Whilst the precise impact of Brexit and the Covid-19 pandemic on the domestic economy remains uncertain, the economic outlook provided by the ESRI would indicate an initial contraction of GDP before a rapid return to moderate level of growth, far removed from the era of boom and bust economic trends that characterised the Celtic Tiger economic era and subsequent recession. This sustainable growth trajectory is also reflected in the retail projections contained in this strategy for County Longford.

2.2 The Changing Nature of Retail Services in Ireland

The challenges the retail sector faces also goes beyond macroeconomic considerations and the potential impacts of Brexit and the Covid-19 pandemic, due to the changing nature of shopping habits. The continued growth of online shopping is mirroring a shift in consumption patterns. Several factors driving growth in this sector include consumers’ appetite for value for money and greater variety, the increased usage of mobile devices, smart home voice assistants, improved

³ <https://www.esri.ie/publications/quarterly-economic-commentary-spring-2020>

⁴ <https://www.esri.ie/publications/quarterly-economic-commentary-summer-2020>

⁵ <https://www.centralbank.ie/publication/quarterly-bulletins/quarterly-bulletin-q2-2020>

⁶ <https://assets.gov.ie/70914/3db3ecde06404a62a369b880a3d7ea23.pdf>

⁷

https://opac.oireachtas.ie/AWData/Library3/Documents%20Laid/pdf/SPU%202020%20Final_300420_171423.pdf

⁸ https://ec.europa.eu/info/business-economy-euro/economic-performance-and-forecasts/economic-forecasts/spring-2020-economic-forecast_en

⁹ <https://static.rasset.ie/documents/news/2020/05/new-econ-forecast-may-27th.pdf>

security and convenience, as well as increased marketing and use of social media promoting online campaigns. A major challenge to the traditional retail format is that from online retailers. In 2017, online sales accounted for just over 12% (€5bn) of the overall retail sales (€40bn) of that year. Significantly for Irish retailers, however, 60% of this online retail trade went to foreign retailer¹⁰.

Global online shopping is likely to increase in market share in the coming years with companies such as Amazon continuously increasing their offering to compete on both a global, national and local level¹¹. Euromonitor International figures recently revealed that Irish shoppers are the fifth biggest internet shoppers on the planet — with €720.10 per capita and €3.3bn spent in total in 2017¹². Euromonitor International, predict that online sales in Ireland could reach just under the €5bn mark by 2022. Increasingly busy lifestyles, broadband penetration, and the rising use of technology in addition to customers’ appetite for value for money and variety will continue to drive the growth of online shopping.

One significant trend which has impacted on the viability of retail services in Irish centres, and especially town centres, has been the drive by retailers to increase the size of floor plates in which they operate, precipitating the move towards out of town shopping centres and retail parks. Out of town or edge of centre retail has become a growing feature of the Irish retail offer since the 1980’s but there has been a significant increase in the number of such centres, as well as their size and scale, since the early 2000’s. These shopping centres and retail parks have become a feature of many urban centres throughout the country, consisting of a mixture of retailers catering to consumer demands for convenience, comparison and bulky goods. The proliferation of out of town shopping centres and retail parks has also coincided with the increasing market presence of large European and UK multinational multiples in the Irish market.

These trends, coupled with the underlying difficult economic conditions which characterised the period between 2007 and 2014, have also contributed to sizeable increases in vacancy rates within town centres, as some retailers close or move to other locations which better meet their requirements. Those that remain are forced to compete for the shrinking market share as the retail attraction of the town diminishes. The provision of parking has become another issue of note, as many towns now impose parking charges which are not applicable in out of town centres. Despite the cap on the size of retail units imposed by the Retail Planning Guidelines 2012, there remains a demand for larger multiple convenience retailers now offering a growing proportion of comparison goods within their stores.

In the case of the larger scale multiples, this move towards the provision of comparison goods reflects the policy of increasing diversification which many are pursuing to obtain a greater market

¹⁰ UCD Smurfit School, *Consumer Market Monitor – Q4 2017* (2017)

¹¹ PWC (2018). [online] Available at: <https://www.pwc.ie/publications/2018/retail-consumer-report-2018.pdf>

¹² Irish Examiner (2018). Fivefold Increase in Online Shopping Since 2007. p.11

share. These multiples are continuing to broaden the range of comparison goods which are available from their stores. This is reflected in the retail market share in Ireland which is dominated by three multiples: Dunnes Stores, SuperValu and Tesco which collectively make up approximately two thirds of the Irish convenience retail market¹³. All three retailers have become increasingly involved in the comparison market over the last decade.

Table 2.2: Multiples share of the Irish convenience market (Source: Kantar Worldpanel, September 2019)

Retailer	Market Share (%)
Dunnes Stores	22.2
Tesco	21.4
SuperValu	21.4
Aldi	12.5
Lidl	11.9
Other Outlets	10.6

The anticipated increases in online sales may have a significant impact on the future demand for retail floorspace in the medium to longer term. Some industry experts predict that the need for larger convenience/comparison stores will subside as an upward trend in home deliveries gathers pace. At present, a large proportion of the main high street convenience retailers offer online shopping with home delivery as an alternative to in-store shopping, with many multiple retail chains giving increasing priority to online aspects of their retail offer. Moreover, the UK market has seen the introduction of exclusively online convenience retailers without any physical stores of their own such as Ocado. More recently, the world’s largest e-commerce marketplace, Amazon, has launched its own online convenience retail brand, Amazon Fresh in the UK, US, Germany and Japan. Whilst none of these exclusively online convenience retail services are in operation in Ireland, it remains clear that online convenience retailing is a burgeoning service with the potential to radically change the traditional retailing landscape and provide for increased demand for storage and distribution facilities.

2.3 Retail Experience Economy

The changing nature of retail is not just confined to the physical infrastructure and the means of trade transactions. Increasingly, retail analysts and economists have referred to the increasing importance of the ‘experience economy’ for retail. In this regard, a growing trend in the retail evolutionary processes have guided economic value from commodities to goods and services to a point where consumer empowerment via technology has upset the traditional power differential between the retailer and the consumer to a stage where customers now expect more. This ‘experience economy’ goes beyond the physical aesthetics of the retail offer in terms of urban design and quality of environment and relies on the behavioural aspects of the consumer.

¹³ Kantar Worldpanel (2019), *Grocery Market Share* - September 2019

Whilst the principle of the ‘experience economy’ relies on the behavioural aspects of the customer, analysts have identified four key factors determining a customer’s shopping experience:

1. Environment – encompassing the overall atmosphere and ease of transactions.
2. Education – referring to the participation of events driven by consumers’ desire to improve knowledge/skills (e.g. demos, product advice and how-to information).
3. Escapism – encapsulates the desire to seek changes in one’s daily routine.
4. Entertainment – captures the activities designed to influence desire of products/brands (e.g. exhibitions and live events).

2.4 Assessment of Competing Retail Centres

2.4.1 Introduction

The retail industry is highly competitive and Longford’s location relative to national transport linkages is a primary consideration in this regard. Two National Primary Routes, the N4 and the N5, which connect the West and East Coasts, converge on the County, in addition to the rail line linking Sligo to Dublin. The presence of these infrastructural links, which have undergone significant upgrades in the last decade, has made the urban centres of the Greater Dublin Area much more accessible than was previously the case. It is now possible to travel between Longford Town and Dublin City Centre in 82 minutes by car and 110 minutes by train, while the travel times from Longford to retail centres such as the Liffey Valley Centre or the Blanchardstown Centre by car can be as little as 74 minutes.

A summary table of the various distances and travel times between the main urban centres of Longford and those which they compete with is presented below.

Table 2.3: Summary table of distances and travel times by road between the main urban centres of County Longford and the main urban and retail centres which they compete¹⁴.

		Longford	Granard	Edgeworthstown	Ballymahon
Athlone Town Centre	Distance	41.9km	53.1km	40.6km	21.4km
	Time	48min	54min	42min	26min
Blanchardstown Centre	Distance	117km	111km	102km	109km
	Time	1hr 18min	1hr 17min	1hr 5min	1hr 15min
Cavan Town Centre	Distance	52.1km	29km	41.3km	60.1km
	Time	52min	33min	43min	58min
Dublin City Centre	Distance	119km	118km	105km	109km
	Time	1hr 24min	1hr 22min	1hr 11min	1hr 21min
Dundrum Town Centre	Distance	129km	123km	115km	121km
	Time	1hr 43min	1hr 42min	1hr 34min	1hr 42min
Liffey Valley Retail Park	Distance	109km	109km	96km	99km
	Time	1hr 14min	1hr 12min	1hr	1hr 11min
Mullingar	Distance	43km	43km	26km	30km
	Time	37min	35min	24min	26min
Sligo Town Centre	Distance	89km	106km	100km	96.9km
	Time	1hr 10min	1hr 30min	1hr 20min	1hr 30min

¹⁴ Travel times and distances taken from Google Maps.

Table 2.4: Summary table of travel times by road between the urban centres of County Longford which feature rail links and the available competing centres served by the same rail lines¹⁵.

	Longford	Edgeworthstown
Dublin City Centre	1hr 52min	1hr 35min
Mullingar	30min	18min
Sligo	1hr 25min	1hr 35min

2.4.2 Competing Centres

In evaluating the retail alternatives which currently exist within easy access to the main settlements of County Longford, such as the Liffey Valley Shopping Centre and Retail Park, Dublin City Centre, Athlone or Mullingar, it is clear that these regional retail attractors are amongst the biggest competition to the existing retail offer in the County.

Liffey Valley Shopping Centre

Liffey Valley Shopping Centre is anchored by M&S and Dunnes Stores and offers a range of national multiples, including Carraig Donn, Easons and Lifestyle Sports, as well as large international comparison multiples such as Coast, H&M, Oasis, River Island and Topshop. The adjacent retail park includes Argos, B&Q, Carpet Right and Halfords, all of which would be classified as being within the bulky goods retail category. In addition to the retail offering, there are also other leisure amenities available, including a large multi-screen cinema as well as numerous restaurants and eateries.

Unlike many of the more recent out of town retail parks which have been developed in the last number of years, there are no large convenience multiples located within this complex, although M&S does provide a convenience offer. An extension of 10,500sqm has been completed in recent years and provides accommodation for a Penneys store as well as six restaurants over three floors and a reconfiguration of the existing VUE Cinema.

Blanchardstown Centre

The Blanchardstown Centre is recognised as one of the primary retail locations in the wider Dublin Region, and due to its location only a short distance from the M50, is easily accessible to people travelling from County Longford. As with Liffey Valley, the Blanchardstown Centre offers an abundance of free parking spaces within an extensive shopping centre and retail park complex.

The shopping centre offers several large multiples, both Irish and international, and includes some of the largest department stores within the country such as Penneys, Debenhams and Marks & Spencers. As with the Liffey Valley Shopping Centre, it also plays host to a range of both Irish (including Dunnes Stores, Easons, Lifestyle Sports and Newbridge Silverware) and internationally (French Connection, Oasis, River Island and Zara) based multiples. In addition, within the retail park there are a variety of convenience, comparison and bulky goods category retailers, including Harvey Norman, Mothercare, Next, and Mr. Price. This substantial retail offering is further

¹⁵ Timetable and rail travel information current as of 21/03/2019, as obtained from Irish Rail website.

reinforced by a wide range of other amenities including a multi-screen cinema, a theatre, a bowling alley and leisure complex, restaurants and eateries, a hotel and a library.

Dublin City Centre

The retail offering of Dublin City Centre, in keeping with its position at the top of the national retail hierarchy (as set out within the Retail Planning Guidelines 2012), is the largest within the country. As with both Liffey Valley and the Blanchardstown Centre, the improvements in infrastructural linkages have enhanced the attraction of the city as a shopping destination to wider catchments across the country. The retail offering, which is located throughout several large shopping centres (including the Ilac Centre, the Jervis Centre and the St. Stephen's Green Shopping Centre), as well as shopping districts (such as the Grafton Street and Henry Street areas) features a number of large department stores as well as flagship stores of many national and international comparison retailers.

Unlike the free parking provided in competing out-of-centre or suburban centres such as the Liffey Valley Shopping Centre and the Blanchardstown Centre, parking is not free and can be relatively expensive. However, it is notable that this element does not undermine the attraction of Dublin City Centre as a retail destination given its significant modal choice and frequency of public transport, including regular train services from Longford Town and Edgeworthstown to and from Dublin City Centre to Connolly and Pearse Street Stations, as well as direct bus links from Longford Town to Dublin by public and private operators.

Athlone

The town of Athlone is considered to be one of the primary shopping destinations within the Midland Region. Boasting a healthy and vibrant town centre, Athlone offers significant competition to retailers operating in the urban centres of County Longford. The opening of the Athlone Towncentre shopping centre in 2007 supplemented the strong retail offer already in existence at Golden Island Shopping Centre. In addition, there is a sizeable retail park located on the periphery of the town on the Old Dublin Road which serves as a location to support a number of retail warehouse type operations providing a range of goods from the convenience, comparison and bulky retail categories. The town offers a mixture of free and pay parking facilities, which offer substantial choice for those travelling by car, and there is a dedicated bus route which operates between Longford Town and the centre of Athlone on a daily basis.

The retail offer of the town itself is located within quite a compact area, with both shopping centres located within or close to the commercial core of the town. Amongst the retailers who operate from the town are comparison retailers, Barratts, Next, Zara and Oasis, with most of the convenience retailers also having a substantive presence within the town. Athlone also has a number of discount foodstores such as Mr.Price which is located in an edge-of-centre location. There are also a number of bulky goods stores including B&Q, Ganlys and Homevalue, all of which are all located in out-of-centre locations near the N6 Athlone Bypass.

Mullingar

Mullingar, like Athlone, is easily accessible from County Longford owing to the presence of the N4 road and the Irish Rail Intercity railway line between Longford Town, Edgeworthstown and Mullingar. There are a sizeable number of national and international multiples in Mullingar including Dunnes Stores and Tesco. The Harbour Place shopping centre located in the Town Centre was developed in the mid 1990's and hosts the aforementioned Dunnes Stores in addition to a number of national and international multiples, these including Carraig Donn, Boots and Holland & Barrett. Like Athlone, the retail offering in Mullingar has increased by way of the Fairgreen Shopping Centre in 2005 and mainly hosts comparison offering. Although Mullingar's convenience, comparison and bulky goods retail offering is slightly smaller than Athlone, Mullingar still represents a significant alternative to shopping in Longford.

Other Competing Centres

The **Dundrum Town Centre**, which first opened in 2005, is Ireland's largest shopping centre extending to approximately 125,000 sq.m of retail floorspace spread across over 130 stores. Unlike its competitors, the Liffey Valley or Blanchardstown Shopping Centres, Dundrum is slightly less accessible from County Longford, owing to its location approximately 1.5km from the Ballinteer exit off the M50 motorway.

Cavan Town also offers competition to retailers located in the north of County Longford, such as Granard. The Church Street and Main Street shopping area of the town includes a number of national and internal convenience and comparison retailers such as Carphone Warehouse, Dunnes Stores, Tesco, Boots, Easons and Clarks, as well as a large number of independent comparison retailers. In addition, to the substantial retail offering of the town centre itself, there are a number of retail parks which accommodate a number of large-scale comparison and bulky goods retailers, with most of the main convenience multiples having a presence in the town also.

Sligo Town's location relative to centres in Longford means that retail competition only really extends itself to those people who are travelling to Sligo for other purposes, who may subsequently conduct their retail business there. Sligo Town currently features town shopping centres, both of which are centrally located within the town. There are also several retail parks, located on the edge of the town at Carraroe and Cleveragh.

Carrick-On-Shannon also offers competition to retailers located in the north and west of County Longford, including those in Longford Town, owing to its accessibility along the N4 National Route. The town comprises of two distinct areas, physically separated by the River Shannon with the southwest bank comprising the Cortober area within the jurisdiction of Roscommon County Council and the northeast side within Leitrim County Council jurisdiction. Out of centre retail parks are in-situ on the western and eastern ends of the town, with the bulk of the town's main street shopping area comprising of several independent convenience and comparison retailers. There

is also a strong presence of tourism-related commercial uses and a good quality urban design environment with amenity spaces fronting onto the River Shannon.

3 HEALTH CHECK ANALYSIS

3.1 Retail Health Check Analysis of Co. Longford

Retailing and the provision of retail services is one of the primary functions of any urban settlement. The Retail Planning Guidelines clearly highlight how the concepts of vitality and viability are central in maintaining and enhancing town centres. As defined in Retail Planning Guidelines “*vitality is a measure of how buoyant a centre is, whilst viability refers to the commercial well-being of a town*”. The degree to which the ‘health’ of a town centre can be measured depends on a number of factors however the Retail Planning Guidelines provide general direction as to the fundamental factors which include the following:

- **Attractions** – these underpin a town and comprise the range and diversity of shopping and other activities which draw in customers and visitors.
- **Accessibility** – successful centres used to be accessible to the surrounding catchment area via a good road network and public transport facilities, and to encompass good linkages between car parks, public transport stops and the various attractions within the centre.
- **Amenity** – a healthy town centre should be a pleasant place to be in. It should be attractive in terms of environmental quality and urban design, it should be safe, and it should have a distinct identity or image.
- **Action** – to function effectively as a viable commercial centre, things need to happen. Development and improvement projects should be implemented efficiently; there should be regular and effective cleaning and maintenance and there should be co-ordinated town centre management initiatives to promote the continued improvement of the centre.

This health check analysis has been undertaken to evaluate the retail functions of the main urban settlements of Co. Longford, assessing the attraction, accessibility and amenity of each centre with the aim of making evidence-based recommendations regarding future actions for their improvement. These actions will be formulated to reinforce the existing retail offering within each of the towns, and where possible expand it, through the suggestion of issues to be addressed or measures to be continued or extended.

3.2 Longford Town

Longford Town is the primary settlement and largest population centre within County Longford. Centrally located within the County, and having the advantage of excellent quality local, regional and national linkages, the town has become a settlement of regional importance. The value of the town and the support function which it provides to its residents as well as those of its hinterland has been recognised within both a national and regional context. The Retail Planning Guidelines have defined the town as a Level 3 settlement, assigning it the role of providing a retail support at a sub-regional level¹⁶. The importance of the town within a local and regional context has also

¹⁶ Retail Planning Guidelines for Planning Authorities (2012), Section 2.2.3, page 11.

been recognised in the Eastern and Midland Regional Spatial and Economic Strategy, which has defined the town as being a ‘Key Town’ within its settlement strategy, which has subsequently been reflected in the Core Strategy of the Longford County Development Plan 2021-2027.

Attraction

In defining the attraction of Longford Town, its location is a key strength, both within the context of the County and in terms of its infrastructural linkages beyond the County. Due to its location within the national infrastructure network, there is a high volume of passing traffic, which brings with its vital retail expenditure inflow. The variety and diversity of the retail offer is much greater than that available in other settlements in the County across convenience, comparison and bulky goods retail categories.

Each of the main convenience multiples has a presence within the town. Tesco operates from a commercial core of the town, within the Longford Centre shopping centre. Planning permission was granted for a substantial redevelopment of this site in 2010, however this permission subsequently expired in 2017 without any development taking place. Other multiples such as Dunnes Stores, SuperValu, Lidl and Aldi operate stores on the periphery of the town centre, while a number of small and medium scale convenience retailers operate from stores in and around the town.

Comparison retailers within Longford Town are, for the most part, clustered into two main areas, namely the commercial core of the town and the N4 Axis Retail Park on the northern edge of the town. The commercial core of the town is dominated by a number of independent comparison retailers alongside a number of multiples including Boots, Sports Direct and Dealz. The N4 Axis Retail Park features a variety of retailers in both comparison and bulky goods categories in addition to a number of restaurants. The remaining comparison retail floorspace within the town is located within a series of small district centres within the periphery of the town.

Accessibility

Longford is strategically located within the national transportation network, with the town forming an important interchange on the East-West road network, giving excellent access to the town from the immediate hinterland and adjoining regions.

Accessibility within the town itself has been improved in recent years with the opening of the N5 Longford Bypass, which now diverts all through traffic directly onto the N4 to the north-west of the town. This has seen the removal of a substantial amount of traffic congestion and has eased both vehicular access and pedestrian permeability throughout the main commercial core of the town. This easing has been very beneficial to the town centre and the retailers who operate within it.

The provision of car parking within the town is good, with a number of both public and private car parks located at various locations in and around the town centre and periphery, all of which operate an hourly tariff system. There is also on street parking available throughout, and which is

also subject to hourly tariffs. Free car parking is available at a number of car parks located in more peripheral locations within town.

The remain some problems which can impact on the accessibility of the town and cause periodic congestion. Delivery and service vehicles accessing the various premises within the town only have access to a small number of loading bays, in particular on Main Street and Ballymahon Street, which can result in issues of double parking on occasion and can cause congestion.

Amenity

Longford is an attractive town, with a mature streetscape which features a variety of buildings of differing size, age and character. The amenity of its commercial core has benefited from the completion of the N5 Longford Bypass, which removed heavy volumes of traffic from the town centre. The streetscape of the town has retained its local character, with a range of traditional shopfronts serving to maintain the town's distinctive identity. Architecturally, the town showcases a range of vernacular style buildings reflecting the historic nature of the town such as the Courthouse, Church of Ireland, Connolly Barracks, St. Mel's Cathedral as well as distinct residential characters areas of Battery Road and St. Mel's Terrace.

Amenity and landscaping measures are ongoing throughout the town as part of an overall regeneration of the urban environment, with specific public realm redevelopments identified for the Market Square/Harbour View, Grafton Court/Longford Shopping Centre and the Royal Canal Basin. A significant element of the overall regeneration vision for the town is that of the Camlin Quarter Urban Design and Economic Framework which sets out a guide for the future economic and development potential of the Camlin Quarter which measures 22ha and encompasses Great Water Street, Little Water Street, Connolly Barracks, Richmond Street, the Camlin River and the western end of the Albert Reynolds Peace Park. Within this Quarter are a number of landmark buildings such as the Riverside Shopping Centre, buildings associated with Connolly Barracks complex and the 'Provider's' Building, all of which are currently vacant. It is envisaged that the Framework will act as a major catalyst for the regeneration of this area of Longford Town and bring enhanced amenity features for visitors and inhabitants.

Assessment

The Health Check Assessment indicates that Longford Town has a relatively good mix of comparison and convenience retailing with a number of national and international multiples well represented, along with a number of well-established independent local retailers. The town also provides for an adequate level of financial institutions and service providers throughout. Notwithstanding the above, as per retail surveys conducted, there is approximately 8,800m² of vacant retail space in Longford Town. The levels of decline in comparison retailing witnessed in the previous Retail Strategy over the period 2007-2013 remains, albeit at a significantly reduced rate for the period 2013-2019, especially in the peripheral parts of the town and on the northern end of Main Street, where longstanding vacancy is particularly problematic. In addition, many previously higher order comparison and convenience retailing in primary frontage locations has

been replaced with lower order retailing or commercial premises such as bookmakers or takeaways with a proliferation of such low order uses in some areas.

A number of areas within the town have been identified for regeneration and urban renewal. These include areas and properties within the Camlin Quarter. In this regard, the Camlin Quarter Urban Design and Economic Framework sets out the principles and envisaged scope of redevelopment for this area with the hope that this framework will act as a major catalyst for the overall regeneration of this area. In addition to the Camlin Quarter area, there is significant scope for the redevelopment of the brownfield 'Townspark' area which features a high proportion of commercial vacancy. Moreover, the site of the Longford Shopping Centre, and associated surface car park, affords a significant redevelopment opportunity. Whilst planning permission for a previous redevelopment scheme of this site has since lapsed with no development taking place, the redevelopment of this site remains a key element to the overall regeneration of Longford Town, given its central location and existing linkages with the core retail area to the west.

The general quality of the public realm and streetscape within the town centre is good, although the continuing trend of long-term vacancy rates does raise substantial concerns that dereliction is becoming a rising issue in some areas of the town. Similarly, while the overall amenity of the town remains at a good level, there is still capacity for improvement, especially in the provision of pedestrian linkages and related infrastructure as well as deficiencies in the overall connectivity of the urban street structure.

A brief assessment of rental asking prices for retail units within the town illustrates that location is a key factor with asking prices varying from €121 to €361 per m² per annum for shop units. The sale price varies from between €370 and €2,000 per m². A similar assessment of the rental asking prices for retail units show that prices can vary from €34.44 to €166.68 per m² per annum¹⁷.

Action Plan:

The health check has identified a number of key areas in Longford Town which require action. These are listed below:

- Further develop the primary and secondary shopping frontages for Longford Town, thereby better consolidating the Main Street, Dublin Street and Ballymahon Street (primary shopping frontages) in addition to better defining the role of adjoining streets (secondary shopping frontage).
- Identify and develop a sustainable use for the former Connolly Barracks site.
- Address vacancy levels to both the Longford Town Shopping Centre and the northern section of Main Street.
- Develop a coherent functionality between the Longford Town Shopping Centre, the southern part of Bridge Street, the northern section of Main Street and the remainder of

¹⁷ Information taken from analysis of published retail property prices available on Daft.ie on 16/09/2019.

the town centre including Main Street, Ballymahon Street, Dublin Street and New Street to provide an easily identifiable commercial core.

- Improve the accessibility to and attractiveness of Market Square for both pedestrians and shoppers in addition to achieving higher order retail in this area.
- Identify any vacant sites/gap sites/backlands which can be used for the provision of uses ancillary to retail, i.e. parking.
- Prepare Shopfront Design Guidelines to encourage creating attractive frontages appropriate to their setting.
- Increase the number of electric vehicle (EV) charging points in the town centre and retail centre car parks; and
- The preparation of environmental enhancement plans to allow for increased footfall throughout the town centre.

3.3 Granard

Located in the north-east of the County, Granard is the fourth largest urban settlement in County Longford, with a range of shops, public houses, community facilities and services and social infrastructure. The Longford County Development Plan 2021-2027 Core Strategy identifies Granard as a ‘Self-Sustaining Town’ within the County’s Settlement Hierarchy. Granard acts as an important driver for local economies in the area, with a number of industries located within the town which have generated significant employment opportunities. The importance of its retail function for its rural hinterland is also recognised in the RSES wherein Granard is designated as a Level 3 Retail Centre – ‘Town and/or District Centres & Sub-County Town (Key Service Centre)’. Whilst its position as a third-level settlement within the Settlement Hierarchy is reflective of a number of elements ranging from historic population trends to physical and social infrastructure, Granard is positioned as a second tier Retail Centre within this Strategy. This is reflective of the important retail function and services it provides for its broad rural hinterland and population catchment to the north-east of the County (and the neighbouring counties of Cavan and Westmeath).

Attraction

In order to establish the attraction of Granard, it is necessary to examine its key defining characteristics. Having a traditional linear townscape, Granard’s Main Street is defined by its terraces of 19th -20th century mixed commercial premises. In this context, vernacular-style shop frontages add a distinct sense of character and ambience at street level. This simple urban morphology is further complemented by a rich built and archaeological heritage. The motte to the south west of Main Street, which is classified as a National Monument in State Guardianship, is a notable historical feature which is visually prominent from the entirety of Main Street. Notwithstanding, due to its location on the N55 national secondary route and its strategic role as a local and regional connector, Granard’s attractive urban character is undermined by large volumes of heavy vehicular through traffic, which significantly impacts upon both local vehicular and pedestrian circulation, and public safety. This traffic congestion, in addition to high levels of

haphazard on-street parking, negatively impacts on the quality, capacity and character of the town's core public realm.

Granard possesses a dynamic and diverse selection of local shops, cafes, pubs and leisure facilities to attract people into the town centre. The settlement's retail offer is clustered around the commercial core of Main Street and is typically dominated by retail service provision, such as cafes and pubs, convenience retail in the form of local grocery shops and specialist retail, including florists and hardware stores. There are few instances of the comparison or bulky goods retail categories in Granard and a limited offer of convenience multiples, with only the SuperValu supermarket chain having a presence on Main Street within the town core. A cursory examination of the commercial retail unit market in Granard has revealed that there is availability in the market throughout the settlement with concentrated levels of unit availability in streets adjacent to the commercial core, such as Barrack Street.

Accessibility

Granard benefits significantly from its strategic location on national road infrastructure, with the N55 that passes through the town forming an important link in the north-south transportation network as it passes through the midlands. This has allowed the town to develop as a gateway between the north midlands and the north-west, connecting Longford to the settlements of Cavan and Dundalk as well as the wider road network of Northern Ireland. The road connections between Granard and its surrounding hinterland are also relatively good, enabling it to fulfil its role as key service town, enhancing the growth of its rural hinterland. However, it is also inadequately served by public transport, and as it is car dominated, does not cater to more vulnerable road users, including cyclists.

Amenity

While Granard possesses an attractive town centre in terms of its improved environmental quality and vernacular urban character, its amenity to potential customers and service providers is greatly undermined by its congested core, lack of permeability, pedestrian safety issues and poor provision of amenity related infrastructure such as pedestrian crossings, high quality street furniture and passive recreation space. Granard has also benefitted from funds secured under State supported streams such as the Town and Village Renewal and in particular, the Rural Regeneration and Development Fund (RRDF) where €2.87m funding was secured for the development of a heritage and amenity park located adjacent to the historic Granard motte. It is envisaged that this project, along with other urban improvement schemes initiated in recent years such as the redevelopment of the Granard Buttermarket and public realm, will act as catalysts for more longer-term improvements to the urban environment and overall amenity in the town.

Assessment

The retail offering of Granard remains in keeping with its position within the Longford County Retail Hierarchy, with a diverse mixture of retail outlets and general service provision. The accessibility and amenity of the town continues to be impacted upon by the presence of high

volumes of vehicular traffic passing through the town. There is also evidence of long-term vacancy levels in units at the north-eastern end of Main Street and leading onto Barrack Street, and from the town centre to Market Street. Such levels of longstanding vacancy inevitably impact on the overall vitality and viability of the town.

An evaluation of the retail rental market in the town indicates that the average retail asking prices for retail units equates to €91 per m² per annum for shop units¹⁸.

Action Plan

This health check has identified a number of key areas in Granard which require action. These are listed below:

- Implement measures to better manage and control traffic circulation and street parking.
- Put in place improved pedestrian crossings and infrastructure.
- Identify any vacant sites/gap sites/backlands which can be used for the provision of retail/facilities ancillary to retail, i.e. parking.
- Direct the provision of future retail development within the town into the existing commercial core of the Main Street and encouraging active frontages that adequately address and engage with this historic streetscape.
- Implement the provision of the longstanding road objective to provide a relief road to bypass the town along the N55 thereby diverting road freight volumes away from the town centre and improving its overall environment.
- Develop more coherent traffic/movement management systems within the town centre for road, pedestrian and cycle users, with a particular emphasis on the junction of Main Street and Market Street.

3.4 Edgeworthstown

The location of Edgeworthstown, on the eastern side of the County, along with the presence of two important national road linkages have long defined the town's attraction, accessibility and amenity. As a result, the town itself has developed to become a strategic interchange in the national road network and serves as a gateway to County Longford for those travelling from the east. The Longford County Development Plan 2021-2027 Core Strategy identifies Edgeworthstown as a 'Self-Sustaining Growth Town' within the County's Settlement Hierarchy.

Attraction

As with Longford Town, the location of Edgeworthstown is a key strength, with the N4 national primary and N55 national secondary routes both passing through the town. This has allowed it to take advantage of the high volume of passing trade, and to offer a mixture of services which become tailored to the needs of both local residents and those who are just passing through. The

¹⁸ Based on information gathered from local auctioneer knowledge of the retail market within the town (16/09/2019)

layout of the town is dominated by the Main Street which is orientated primarily on an East West axis and was formally part of the N4 national primary route.

There is a diverse mixture of convenience and comparison retail units located within the town in addition to a small amount of retail warehousing, located on the western periphery of the town. The retail offer of town is complimented by a range of other services including pubs, cafes, hairdressers and restaurants. There is a heavy concentration of retail activities within the core of the town, located along Dublin Street, Main Street and Pound Street, while there is a small concentration of bulky goods retail units located along the Longford Road. The majority of the retail premises within the town appear to be well kept, although vacancy does appear to be higher in more peripheral areas.

Accessibility

Edgeworthstown is very accessible, located as it is on an important interchange between the N4 national primary route, which links Dublin and the east of the country with the counties of Leitrim, Mayo, Sligo and Roscommon, and the N55, which connects the midlands to the north-west. As well as this road linkage, there is also a rail service which operates between Dublin and Sligo, and which is located just to the south of the town. Car parking within the town centre is restricted to on-street parking.

Amenity

The amenity of Edgeworthstown is dominated by its location within the national road network, with the town forming an important interchange between the N4 and the N55. The N55, which links Cavan Town to Athlone, carries a high volume of HGV traffic, all of which passes through the centre of the town, with negative impacts on amenity.

The streetscape of the town is attractive and is dominated by a largely traditional urban fabric and built form, which includes a mixture of stone front and plaster rendered buildings of various ages and functions. Many recent additions to the building stock of the town have taken place on the western periphery of the town.

Assessment

The retail offering which currently exists in Edgeworthstown is of sufficient quality and variety to continue to satisfy the role of a Strategic Town, as designated in the Settlement Hierarchy of the County Longford. There is also potential for further retail growth within the town, which reduce the vacancy rates within the more peripheral parts of the town. While the presence of the N55 does create some problems, it is also a key strength for the town. Enhancements to the pedestrian linkages and general amenity of the town could bring about substantial benefits and alleviate the negative impacts of the N55 while retaining its benefits. The retail offer is characterised by convenience food stores in the form of SuperValu and Costcutter, with a small number of specialist independent comparison retailers also, typically along Main Street of the town.

There is notable evidence of longstanding vacancy amongst some of the units within the town, particularly along the periphery of the town centre in particular the former Hotel Edgeworth and the former Ulster Bank. In respect of the latter building, there are currently plans to utilise this building as an Innovation Hub for the town with hot-desk and remote working facilities proposed to bring this substantial and architecturally significant building back in to use. Notwithstanding, there are plans in place to develop a community library within the town centre, along with further public realm improvement works along Main Street also. It is envisaged that this scheme will act as a catalyst for more longer-term improvements to the urban environment and overall amenity in the town.

Action Plan

This health check has identified a number of key areas in Edgeworthstown which require action. These are listed below:

- Environmental enhancement plans to allow for increased footfall throughout the town.
- Take measures to improve the public realm and pedestrian linkages in the town centre.
- Look to minimise the impact of the N55 on the amenity of the town.

3.5 Ballymahon

Located to the south of the County, Ballymahon is situated between the larger settlements of Athlone and Longford Town. In this context, the urban centre provides for important residential, retail, social and leisure functions. Under the Settlement Hierarchy of the previous Longford County Development Plan 2015-2021, the town was classified as a ‘Local Service Town’. However, owing to the exceptional growth, in population terms the town has experienced between the intercensal period of 2011 to 2016 where the town recorded a population increase of approximately 20% during this period. Further developments in recent years within the town and nearby, such as the Longford Wood Center Parcs site, have further enhanced the profile of the town. As a result, Ballymahon has been designated as a ‘Self-Sustaining Growth Town’ within the Settlement Hierarchy of the Longford County Development Plan 2021-2027.

Attraction

Ballymahon exhibits a traditional linear market town structure, with its commercial activity being predominantly clustered around a compact urban core centred on Main Street. The broad width of this central thoroughfare, relative to the height of the mixed commercial buildings which front onto it, combine to give Main Street a distinctive and spacious character. The quality of the streetscape and the associated public realm in Ballymahon is also good, with many traditional shopfronts still intact. There is also a generous provision of pedestrian infrastructure such as crossings and street furniture. The settlement is situated adjacent to the River Inny to the east of Lough Ree, which gives the locality its unique topographical character.

Ballymahon possess a good range of retail outlets and services relative to its size, with a variety of small cafes, pubs, grocery and specialist independent retailers. There appears to be very few incidences of national or international retail multiples within the settlement, which consists

generally of independent retailers. Moreover, there is a significant night time economy in Ballymahon with a number of restaurants, pubs and a hotel in operation.

Accessibility

Ballymahon is served by a relatively good road network which includes the N55 national secondary route from Athlone to Cavan and the R392 regional route. However, the town is relatively poorly served by public transport facilities and is heavily reliant on car-based access in comparison to some of the other settlements within the County. There is a generous amount of car parking on the Main Street, owing to its wide streetscape typically seen of a market town environment. The town experiences high volumes of traffic passing through both the N55 and R392, particularly at the north-western end of Main Street/R392 owing to associated school traffic with the Vocational School, Mercy Secondary School and St. Matthew's National School located within this vicinity. The town has been the subject of a review of infrastructural and urban design requirements which has identified improved traffic management measures at the junctions of the N55 and R392 north and south of the River Inny. Further plans for improving pedestrian and cycling permeability within the town centre are also in place, as well as measures to better utilise backland areas of Main Street to accommodate car parking thereby improving accessibility within the town.

Amenity

Overall, Ballymahon exhibits relatively high levels of public amenity and a high-quality townscape and is able to provide a good mixture of retail services to residents and passers-by alike. It also features a good quality and well-maintained public realm, in addition to high standards of vehicular management and pedestrian infrastructure. As discussed previously, there are currently plans in place to provide public realm upgrade improvement works along the Main Street/R392 road section of the town, as well as the provision of a more coordinated traffic and parking management system to serve Ballymahon. Moreover, further plans are at an advanced stage to develop cycling and pedestrian links to amenity features within the wider vicinity of the settlement. It is envisaged that these measures will further enhance the amenity value of Ballymahon and its town centre.

Assessment

The compact nature of the urban core of Ballymahon, and the presence of the N55, which passes through a substantial part of the town core, has been a key economic strength for the town, and has helped to sustain retail activity. Planned infrastructural improvements in the form of junction upgrades to the N55 and R392 routes north and south of the River Inny, together with pedestrian/cycling and public realm improvements to the Main Street/R392 town centre will also lead to significant enhancements of the urban environment of the town. In terms of the dynamism of its commercial market at present, there are a number of retail units currently available for rent particularly in the town's Main Street, with rental prices ranging between €61 and €208 per m² per annum for shop units¹⁹.

¹⁹ Information taken from analysis of published retail property prices available on Daft.ie on 16/09/2019.

Action

This health check has identified a number of key areas in Ballymahon which require action. These are listed below:

- Implement measures to improve public realm, pedestrian infrastructure and quality of streetscape.
- Manage traffic congestion and implement traffic calming.
- Continue to proactively manage car parking, circulation and public realm in the town centre.
- Improve access to the town core by non-vehicular modes of transport.

3.6 Lanesborough

Lanesborough is defined as a ‘Self-Sustaining Town’ within the settlement hierarchy of the Longford County Development Plan 2021-2027, whose functions include providing important local level retail, social, leisure and service function to its broad hinterland.

Attractiveness

Located on the eastern bank of the River Shannon at the northern perimeter of Lough Ree, the settlement of Lanesborough is characterised by a linear core urban form, known locally as ‘Main Street’, which had developed perpendicular to the adjacent river, rising gradually away from it. The townscape is defined predominantly by a non-uniform building line. The Main Street also features a high percentage of residential structures. Lanesborough offers its community a limited mix of retail services such as convenience retail, cafes, pubs and other commercial services, distributed intermittently along Main Street. A second key defining feature is its narrow and inconsistent public realm, which is dominated by car parking, heavy traffic flows and poor-quality hard landscaping, features which all conspire to make this urban centre inhospitable to pedestrians. Lanesborough offers its community a limited mix of retail services such as limited convenience retail, pubs, specialist shops and service retail, which are often not clustered together and distributed intermittently along Main Street.

Accessibility

Lanesborough, which is located adjacent to one of the main bridging points on the River Shannon, is well connected to its wider region by the N63 national secondary route which links Longford to Roscommon and also to the R392 regional road which links the town to Mullingar. As a result, the town is subject to regular traffic congestion, impacting on poor circulation within its commercial core.

Amenity

The presence of high levels of poorly managed on-street car parking, heavy vehicular congestion, poor sightlines and access/egress arrangements and the poor provision of pedestrian facilities, all conspire to significantly undermine the amenity value of this settlement for the local community. In addition, the townscape possesses a very poor relationship with the River Shannon, with the

buildings located on the lower reaches of Main Street failing to adequately utilise or respond to this important local amenity. Future plans and projects for the settlement include the provision of an interpretative centre on the eastern banks of the River Shannon to showcase the tourism offering in the region and public realm improvement works to Main Street.

Assessment

As with the example of Ballymahon, the presence of a high volume of passing traffic is an important strength for Lanesborough. The town itself has retained its functionality and continues to support a range of important support services which can be availed of by the residents of Lanesborough and its surrounding rural hinterland.

Action

This health check has identified a number of key areas in Lanesborough which require action. These are listed below:

- Implement measures to improve public realm, pedestrian infrastructure and quality of streetscape.
- Manage traffic congestion and implement traffic calming.
- Continue to proactively manage car parking, circulation and public realm in the town centre.
- Improve access to the town core by non-vehicular modes of transport.

3.7 Other Settlements

Newtownforbes

Newtownforbes is designated as a *'Town and Village'* settlement (Level 3 settlement tier) within the settlement hierarchy of the Longford County Development Plan 2021-2027. Located to the north west of Longford Town, Newtownforbes plays a critical role in sustaining the viability of local rural communities by providing essential services such as housing, lower level retail and important social facilities that allow for local growth. Located along the N4 national primary route, the settlement is well connected to the wider region and also to its immediate rural environs via the local route L1005. Newtownforbes has a distinctive rural village character with good quality public realm and limited provision of local services and convenience retail. It also possesses good provision of car parking, a general lack of vehicular congestion and safe pedestrian access. In terms of its amenity, Newtownforbes' Main Street features a number of intermittent green spaces attached to institutional and community buildings.

Action

The health check has identified a number of key areas in Newtownforbes which require action. These are listed below:

- Continue to proactively manage car parking, circulation and public realm

- Ensure a good provision of convenience and local service retail is maintained going forward.
- Identify public realm improvements such as painting schemes, window displays, planting, as well as improvements to pedestrian and cycling permeability/mobility within the town centre.

Drumlish

Drumlish is also designated as a ‘*Town and Village*’ settlement within the settlement hierarchy of the Plan and provides housing, local level retail and social facilities to its dependant rural communities, thereby acting as a local growth centre for the rural economy. The settlement of Drumlish is clustered around a central crossroads and is served by the R198 regional route which links it to Longford Town to the South. This rural village has retained much of its charm and is characterised by high-quality public realm and the limited provision of local convenience and service retail. It also possesses good provision of well managed on-street car parking, a general lack of vehicular congestion and a safe pedestrian environment.

Action

The health check has identified one key area in Drumlish which require action. These are listed below:

- Continue to proactively manage car parking, circulation and public realm in the town centre.

3.8 Summary of Commercial Floorspace Activity Since 2013

The previous Longford County Retail Strategy 2015-2021 was prepared in 2013 and 2014 and followed a period of significant economic decline which characterised local and national economies for much of the period between 2007 and 2014. Against this economic landscape, the previous Retail Strategy identified a total vacant floorspace of approximately 10,745m², which represented 17.73% of the total retail floorspace for the county, and comprised of 2,275m² convenience; 2,172m² comparison; and 6,298m² bulky goods floorspace vacancies.

In line with national trends, Longford has experienced a stagnation in retail construction activity since 2013, particularly in comparison and bulky retail floorspace provision. Evidence of this inactivity is provided in the analysis of the quantum of planning applications permitted and subsequently advanced in the intervening period, which is set out in Table 3.1 below.

It is noted that there has been a significant reduction in submitted applications for retail development since the previous Retail Strategy was prepared in 2013, with approximately 3,736m² of retail development being permitted since 2013 including permissions granted for extension of duration applications for retail development previously permitted prior to 2013. However, only a small quantum of actual additional retail development has commenced since 2013 (approximately 246.5m²). It is also worth noting that the majority of retail floorspace

commenced/deliver since 2013 has been in the convenience category (approximately 84% of total retail development since 2013). As a result, there has been little change in the baseline figure for total retail floorspace within the County over and above that which was used in the formulation of the existing retail strategy for the County.

Moreover, it is also noted that two thirds (approximately 67%) of the permitted floorspace since 2013 will have expired by 1st January 2022 if not renewed or implemented.

Table 3.1: Outline of all permitted, commenced and outstanding retail development planning permissions since 2013.

Granted and Commenced Retail Developments since 2013				
Retail Category	Permitted	Commenced	Expired or considered to be expired	Due to Expire by 01/01/2022
Total Convenience	2,446.5m ²	208m ²	-	2,036m ²
Total Comparison	1,265.3m ²	38.5m ²	-	445m ²
Total Bulky	-	-	-	-
Total	3,711.8m²	246.5m²		2,481m²

In addition to the limited growth in retail floorspace, activity since 2013 has also been characterised by a marginal decrease in total vacancy rates in the County, further emphasising the stagnation that the market within County Longford has been experiencing in the period since the preparation of the previous Retail Strategy. As illustrated in Table 3.2, a total of 5,618.94m² of retail floorspace is currently vacant across the County (16.54% of total). Table 3.3 summaries existing levels of retail floorspace in County Longford, taking account of development activity and existing levels of recorded vacancy across the County.

Table 3.2: Summary of all existing vacancy (2020) by retail category.

Total Vacancy by Retail Category	
Floorspace Category	m ²
Total Vacant Convenience Floorspace	1,087.00
Total Vacant Comparison Floorspace	1,435.62
Total Vacant Bulky Floorspace	3,096.32
Total Vacant Floorspace	5,618.94

Table 3.3: Summary of all existing retail floorspace, including 2013 and 2019 baseline figures and the vacancy rate for 2019, by retail category.

Baseline Assessment of Retail Floorspace 2019

	2013 Baseline (m ²)	Development Activity 2013-2019 (m ²)	2019 Baseline (m ²)	Total Vacancy (m ²)	Floorspace in use (m ²)	Available Floorspace in use (%)
Convenience	13,239.40	+208	13,447.40	1,087.00	12,360.40	91.92%
Comparison	11,247.46	-693.46	10,554.00	1,435.62	9,118.38	86.40%
Bulky	36,130.00	0	36,130.00	3,096.32	33,033.68	91.43%
Total	60,616.60	-485	60,131.00	5,618.94	54,512.06	90.66%

3.9 Healthcheck Conclusions

Retail provision is a key component of town centres and provides a major contribution to their vitality and viability. According, the retention of retail as a core function within a town centre remains a key element for any urban settlement. The health check analysis was carried out during a period of national economic recovery, however a quantitative assessment of retail floorspace within the County reveals a relatively stagnated retail development market when compared with similar assessments conducted for the previous Retail Strategy.

Overall, the results of the healthcheck analysis appear to indicate that, in spite of obvious and substantial difficulties in retail sector over the last 6 years relating to vacancy rates an underdeveloped market, the main settlements in County Longford continue to provide the necessary retail services required by their communities. Longford Town remains the most important retail centre within the County and is the location for the majority of the retail floorspace within both the comparison and bulky goods retail categories. It is also the chosen location for the larger convenience multiples, who, with the exception of SuperValu, have chosen the town as their sole operations within the County. All of the other settlements within the County continue to fulfil their ancillary roles to the primary centre, supporting their local communities and surrounding hinterlands, in keeping with respective positions within both the settlement and retail hierarchies.

Vacancy levels account for just over 16% of the total retail floorspace within centres across County Longford. This level of vacancy reinforces concerns expressed under health check appraisals carried out for the previous Retail Strategy. It is imperative that those retail units which are vacant at present are not allowed to become derelict. In this regard, the Council has identified a number of actions required, as well as presently undertaking a number of initiatives, aimed at addressing these issues for the identified retail centres.

In tandem with a number of policy initiatives, urban design principles and planning guidance established elsewhere within the Longford County Development Plan 2021-2027, this suite of planning policy measures will seek to arrest any further decline of town centres through targeted, site specific approaches and to improve the overall quality of environment of our urban centres as well as improving and enhancing retail provision within our identified retail centres. Underlying this approach will be cognisance of the retail hierarchy established in this Retail Strategy and ensuring that the future development of retail in these towns will not have an adverse impact on the primacy of Longford Town and in keeping with the existing scale and character of these respective settlements.

4 PROJECTED FLOORSPACE REQUIREMENTS

4.1 Introduction

This section establishes the future retail floorspace requirements for County Longford within the convenience, comparison and bulky goods retail categories, as specified within the Retail Planning Guidelines 2012. The assessment below has been produced having regard to existing floorspace capacity and projections on future demand for retail services within the County and takes account of identified levels of vacancy detailed in Section 3. This will ensure that future retail and other development in town centres will absorb existing vacancy which may otherwise hamper the vitality and viability of centres.

In brief, the following methodology has been used to define the future retail floorspace requirements for Co. Longford:

- Undertake an estimate of the population at base year and design year.
- Estimate the available expenditure per capita for each of the retail categories (convenience, comparison and bulky goods) at the base year and design year.
- Compile a projection of the total available expenditure in the base year and design year for residents of County Longford allow for assumed expenditure inflows and outflows.
- Undertake a projection of the likely increase of available expenditure which will support the provision of additional floorspace.
- Estimate the likely average turnover of new floorspace in convenience, comparison and bulky goods retail categories.
- Estimate the capacity for additional floorspace within each of the three retail categories, taking account of the existing vacancy rates and planning permissions.

4.2 Population of County Longford

The population of Longford has demonstrated substantial growth since 1996 with the most sizeable increases occurring since 2002. An analysis of census figures between 2002 and 2016 reveals that the population of the County expanded from 31,068 to 40,873, representing an increase of some 31.56% over this fourteen-year period. Whilst the inter-censal period of 2011-2016 was characterised by significant economic contraction across the country, the population of County Longford still maintained a steady increase, albeit not to the same extent as the preceding period from 2002 to 2011.

The starting point in any assessment of future floorspace requirements is projected population growth over the plan period. In this regard, future population forecasts for the County are presented in the Department of Housing, Planning and Local Government (DHPLG) publication, *'Implementation Roadmap for the National Planning Framework'*, and subsequently retained in the Eastern and Midland RSES, and provide for a population range with 20% variation for targets years of 2026 and 2031.

Taking the upper level of the population forecast range for each of the target years, the population of the County is expected to increase by 4,627 persons between 2016 and 2026 and increasing by a further 1,500 persons during the period from 2026 to 2031. Using these population forecasts, the Core Strategy of the Longford County Development Plan 2021-2027 has provided an overall population allocation for the County up to the year 2027 thereby coinciding with the plan period. This equates to a total County population growth of 4,927 to the year 2027, with the vast majority of this additional population growth to be accommodated within the settlements of Longford Town, Granard, Edgeworthstown, Ballymahon and Lanesborough. The level of envisaged population growth within Longford Town means that it should be the primary location for the majority of additional retail floorspace forecast to emerge over the plan period.

Population projections for the county for 2021 (the first year of the Longford County Development Plan 2021-2027), 2026 (population target year), 2027 (the final year of the Longford County Development Plan 2021-2027) and 2031 (population target year) are presented in Table 4.1 below and have regard to the figures contained within Longford County Council’s Core Strategy and Housing Strategy over the period of the Longford County Development Plan 2021-2027.

Table 4.1: Recorded Populations and Population Projections for County Longford

2011	2016	2021	2026	2027	2031
39,000	40,873	43,187	45,500	45,800	47,000

4.3 Expenditure Estimates

The expenditure analysis upon which the subsequent floorspace turnover calculations are formulated, have been projected using figures derived from a number of Central Statistics Office (CSO) sources including the Annual Services Inquiry, the County Incomes and Regional GDP 2015 and the Retail Sales Index.

Per capita spend on an annual basis from 2016 to 2030²⁰ has been established using the population projections outlined above in addition to the expenditure projections which will be outlined below and from the latest available historic figures for the change in the retail economy (CSO Retail Sales Index) up until the year 2018. The projection of future per capita spend for County Longford thereafter has been based upon an assumed range of per capita growth (and decline) percentages derived from a number of sources in relation to forecasted GDP growth (and decline) from 2020 onwards, as identified in Table 2.1 above which ranges between -9.4%% and 6.4% per annum for both convenience and comparison goods from 2020 onwards. This perceived volatility stems from the economic repercussions of the Covid-19 pandemic, largely over the years

²⁰ Using the latest available CSO County Incomes and Regional GDP data (23/09/2019), to include for the remaining 2 years of the existing plan, the 6-year operational period of this strategy, plus 3 additional years, as specified within the Retail Planning Guidelines 2012.

2020-2021, as discussed previously, before returning to more sustainable growth patterns for the remainder of the strategy period. The forecasted per capita spend estimates for convenience and comparison retail in County Longford over this period is set out in Table 4.2 below.

Table 4.2: Determination of Per Capita Spend on Convenience and Comparison Retail for County Longford (2016-2030)

Determination of Per Capita Spend on Convenience and Comparison Retail Expenditure					
		Annual Growth Rate (%)		Per Capita Spend (€)	
		Convenience	Comparison	Convenience	Comparison
Year					
2016	Per Capita Spend - Nationally	-	-	€3,987	€3,604
2016	Per Capita Spend - Adjusted for County Longford (National Index = 100; Longford Index = 85)	85	85	€3,389	€3,063
2017	Per Capita Spend - County Longford	3.9	3.9	€3,521	€3,182
2018	Per Capita Spend - County Longford	3.2	3.2	€3,634	€3,284
2019	Per Capita Spend - County Longford	3.2	3.2	€3,750	€3,389
2020	Per Capita Spend - County Longford	-9.4	-9.4	€3,398	€3,071
2021	Per Capita Spend - County Longford	6.4	6.4	€3,615	€3,267
2022	Per Capita Spend - County Longford	2.8	2.8	€3,716	€3,359
2023	Per Capita Spend - County Longford	2.7	2.7	€3,817	€3,449
2024	Per Capita Spend - County Longford	2.5	2.5	€3,912	€3,536
2025	Per Capita Spend - County Longford	2.5	2.5	€4,010	€3,624
2026	Per Capita Spend - County Longford	2.5	2.5	€4,110	€3,715
2027	Per Capita Spend - County Longford	2.5	2.5	€4,213	€3,808
2028	Per Capita Spend - County Longford	2.2	2.2	€4,306	€3,891
2029	Per Capita Spend - County Longford	2	2	€4,392	€3,969
2030	Per Capita Spend - County Longford	2	2	€4,479	€4,049

This table also illustrates an adjustment in the per capita spend for County Longford to account for lower average income levels when compared to the national average. The national per capita spend has been calculated based upon the total retail spend (inclusive of VAT) per capita in 2016. The Dublin Region has a higher level of disposable income (118.4 in 2016), which has an effect of inflating the national wages. The average disposable income in the majority of counties is less than 100, with CSO County incomes and Regional GDP 2016 report indicating that the disposable income in County Longford is 15 index points lower than the national average. Therefore, the available per capita retail spend in County Longford in 2016 (base year) for was €3,389 for convenience goods and €3,063 for comparison goods. Using these per capita retail spend projection figures, the total available spend for convenience, comparison and bulky goods, as calculated, is presented in Table 4.3.

Table 4.3: Recorded Populations and Population Projections for County Longford

Longford County Total Available Expenditure - Convenience / Comparison / Bulky Goods							
Year	Population	Convenience Per Capita Spend (€)	Comparison Per Capita Spend (€)	Convenience Total Available Spend (€)	Comparison Total Available Spend (€)	Comparison Total Available Spend - Excluding Bulky Goods (€)	Comparison Total Available Spend - Bulky Goods Only (€)
2016	40,873	€3,389	€3,063	€138,518,597	€125,193,999	€100,155,199	€25,038,800
2017	41,336	€3,521	€3,182	€145,551,124	€131,550,043	€105,240,034	€26,310,009
2018	41,798	€3,634	€3,284	€151,887,598	€137,276,988	€109,821,591	€27,455,398
2019	42,261	€3,750	€3,389	€158,484,313	€143,239,141	€114,591,313	€28,647,828
2020	42,724	€3,398	€3,071	€145,159,885	€131,196,438	€104,957,150	€26,239,288
2021	43,187	€3,615	€3,267	€156,123,893	€141,105,779	€112,884,623	€28,221,156
2022	43,649	€3,716	€3,359	€162,212,288	€146,608,509	€117,286,807	€29,321,702
2023	44,112	€3,817	€3,449	€168,359,119	€152,164,054	€121,731,244	€30,432,811
2024	44,575	€3,912	€3,536	€174,379,373	€157,605,199	€126,084,159	€31,521,040
2025	45,037	€4,010	€3,624	€180,591,406	€163,219,674	€130,575,740	€32,643,935
2026	45,500	€4,110	€3,715	€187,009,164	€169,020,085	€135,216,068	€33,804,017
2027	45,800	€4,213	€3,808	€192,948,246	€174,387,866	€139,510,293	€34,877,573
2028	46,100	€4,306	€3,891	€198,484,765	€179,391,807	€143,513,446	€35,878,361
2029	46,400	€4,392	€3,969	€203,771,951	€184,170,400	€147,336,320	€36,834,080
2030	46,700	€4,479	€4,049	€209,191,231	€189,068,381	€151,254,704	€37,813,676

Table 4.3 above illustrates the projected increases in population, per capita spend in both convenience and comparison goods, and total available spend in all three retail categories from 2016 to 2030. This includes the complete operational lifecycle of the Retail Strategy from 2021 to 2027.

This shows the total available spend for all retail goods growing from approximately €263m in 2016 to a projected €367m at the end of this retail strategy period in 2027 to over €398m in 2030.

Table 4.4 illustrates the adjusted retail spend for County Longford from 2016 to 2030. In adjusting the total available convenience retail spend, it has been projected that approximately 15% of the total annual available spend on convenience goods will be lost to competing centres outside the county, these including those within close proximity to certain parts of the county such as Athlone (South Longford), Mullingar (East Longford) and Cavan (North Longford), and also to the country's top shopping destinations such as Liffey Valley and Blanchardstown. In addition to the outflow referred to above, it has been projected that there will also be inflows of retail spend. This has been estimated to be equivalent to 5% of the total annual available spend on convenience goods in County Longford. This inflow is primarily accounted for by passing trade (N4, N55, N63) and the use of the county's retail offering by residents of neighbouring counties (Westmeath, Cavan, Leitrim and Roscommon).

Table 4.4: Projections of the total available convenience retail spend, as adjusted to account for inflow and outflow.

Total Available Expenditure - Convenience					Total Available Expenditure - Comparison - Non-Bulky Goods					Total Available Expenditure - Comparison - Bulky Goods				
Year	Convenience Total Available Spend (€)	Convenience Total Available Spend Outflow (%)	Convenience Total Available Spend Inflow (%)	Adjusted Convenience Total Available Spend (€)	Year	Comparison (Non-Bulky Goods) Total Available Spend (€)	Comparison (Non-Bulky Goods) Total Available Spend Outflow (%)	Comparison (Non-Bulky Goods) Total Available Spend Inflow (%)	Adjusted Comparison (Non-Bulky Goods) Total Available Spend (€)	Year	Comparison (Bulky Goods) Total Available Spend (€)	Comparison (Bulky Goods) Total Available Spend Outflow (%)	Comparison (Bulky Goods) Total Available Spend Inflow (%)	Adjusted Comparison (Bulky Goods) Total Available Spend (€)
2017	145,551,124	15%	5%	130,996,012	2017	105,240,034	10%	2%	96,820,831	2017	26,310,009	20%	1.5%	21,442,657
2018	151,887,598	15%	5%	136,698,839	2018	109,821,591	10%	2%	101,035,864	2018	27,455,398	20%	1.5%	22,376,149
2019	158,484,313	15%	5%	142,635,881	2019	114,591,313	10%	2%	105,424,008	2019	28,647,828	20%	1.5%	23,347,980
2020	145,159,885	15%	5%	130,643,896	2020	104,957,150	10%	2%	96,560,578	2020	26,239,288	20%	1.5%	21,385,019
2021	156,123,893	15%	5%	140,511,504	2021	112,884,623	10%	2%	103,853,853	2021	28,221,156	20%	1.5%	23,000,242
2022	162,212,288	15%	5%	145,991,059	2022	117,286,807	10%	2%	107,903,863	2022	29,321,702	20%	1.5%	23,897,187
2023	168,359,119	15%	5%	151,523,207	2023	121,731,244	10%	2%	111,992,744	2023	30,432,811	20%	1.5%	24,802,741
2024	174,379,373	15%	5%	156,941,436	2024	126,084,159	10%	2%	115,997,427	2024	31,521,040	20%	1.5%	25,689,647
2025	180,591,406	15%	5%	162,532,265	2025	130,575,740	10%	2%	120,129,680	2025	32,643,935	20%	1.5%	26,604,807
2026	187,009,164	15%	5%	168,308,247	2026	135,216,068	10%	2%	124,398,783	2026	33,804,017	20%	1.5%	27,550,274
2027	192,948,246	15%	5%	173,653,421	2027	139,510,293	10%	2%	128,349,469	2027	34,877,573	20%	1.5%	28,425,222
2028	198,484,765	15%	5%	178,636,289	2028	143,513,446	10%	2%	132,032,370	2028	35,878,361	20%	1.5%	29,240,865
2029	203,771,951	15%	5%	183,394,756	2029	147,336,320	10%	2%	135,549,415	2029	36,834,080	20%	1.5%	30,019,775
2030	209,191,231	15%	5%	188,272,108	2030	151,254,704	10%	2%	139,154,328	2030	37,813,676	20%	1.5%	30,818,146

As with the total available convenience retail spend, the total available comparison and bulky goods retail spend must also be adjusted. In doing so it has been projected that 10% of the total comparison retail spend will be lost to competing centres, but that the inflow of spend will also be much lower, at just 2%. In adjusting the total available bulky retail spend, the outflow lost to competing centres has been projected to be more substantial, at 20%, while the inflow of retail spend has been projected as being just 1.5%.

4.4 Turnover and Floorspace Capacity

This section identifies the turnover and floorspace capacity which will be used to calculate the subsequent minimum additional floorspace requirements over the lifetime of this retail strategy. The defined average turnover rate per square metre of floorspace in each of the three categories has been illustrated in Table 4.5. This methodology uses the total expenditure available within the County for each category and divides it by the amount of existing floorspace within that category.

The resulting figure has been used as the basis for the projection of future floorspace requirements, through a comparison exercise against the projected disposable income which is available within the specific category. The overall 2020 baseline figures indicate that 60.09% of all retail floorspace in the County is of the bulky goods retail category, while convenience and comparison retail floorspace account for 22.36% and 17.55% respectively.

Table 4.5: Current Retail Floorspace Per Retail Category and Estimated Turnover per Square Metre for County Longford

Retail Floorspace for Convenience and Comparison Goods and Turnover							
Retail Floorspace Analysis					Retail Category Turnover		
Retail Category	2020				2020		
	Gross Floor Area (sqm)	Net Floor Area (sqm)	Net Area as a % of Gross Area	Net Area as a % of Overall Total Net Area	Adjusted Total Available Spend	Net Floor Area (sqm)	Turnover Per sqm (€)
Convenience	16,809	13,447	80.00%	22.36	€130,643,896	13,447	€9,715
Comparison - Non-Bulky	13,193	10,554	80.00%	17.55	€96,560,578	10,554	€9,149
Comparison - Bulky	45,163	36,130	90.00%	60.09	€21,385,019	36,130	€592
Overall Total	75,164	60,131	-	100.00	€248,589,494	-	

4.5 Additional Retail Floorspace Requirements

Table 4.6: Outline of the cumulative projected additional retail floorspace requirements per annum, as adjusted for vacancy, from 2019-2030.

Additional Floorspace Requirements for Convenience and Comparison Goods - Adjusted for Vacancy												
Year	Convenience				Comparison - Non-Bulky				Comparison - Bulky			
	Total Annual Cumulative Floorspace Requirement (sqm)	Additional Annual Floorspace Requirement (sqm)	Vacant Floorspace (sqm)	Additional Floorspace Development Requirement (sqm)	Total Annual Cumulative Floorspace Requirement (sqm)	Additional Annual Floorspace Requirement (sqm)	Vacant Floorspace (sqm)	Additional Floorspace Development Requirement (sqm)	Total Annual Cumulative Floorspace Requirement (sqm)	Additional Annual Floorspace Requirement (sqm)	Vacant Floorspace (sqm)	Additional Floorspace Development Requirement (sqm)
2016												
2017												
2018												
2019	14,682		1,087.00		11,523		1,435.62		39,446		3,096.32	
2020	13,447	-1,234	0	-2,321	10,554	-969	2,404.39	0	36,130	-3,316	6,412.74	-9,729
2021	14,463	1,016	0	-1,306	11,351	797	1,607.24	-810	38,859	2,729	0	-7,000
2022	15,027	564	0	-742	11,794	443	0	-367	40,374	1,515	0	-5,485
2023	15,597	569	0	-172	12,241	447	0	79	41,904	1,530	0	-3,955
2024	16,154	558	0	385	12,678	438	0	517	43,403	1,498	0	-2,456
2025	16,730	575	0	961	13,130	452	0	969	44,949	1,546	0	-910
2026	17,324	595	0	1,556	13,597	467	0	1,435	46,546	1,597	0	687
2027	17,874	550	0	2,106	14,029	432	0	1,867	48,024	1,478	0	2,165
2028	18,387	513	0	2,619	14,431	403	0	2,270	49,402	1,378	0	3,543
2029	18,877	490	0	3,108	14,815	384	0	2,654	50,718	1,316	0	4,859
2030	19,379	502	0	3,610	15,209	394	0	3,048	52,067	1,349	0	6,208

The methodology used to identify the future requirements for additional retail floorspace takes account of the existing baseline floorspace figures including actual vacancy and an additional frictional vacancy, the calculated turnover per m² of retail floorspace, and the projected available retail spend. This is replicated across each of the retail categories. The key steps taken as part of the methodology include the following:

- The total cumulative floorspace requirements are calculated for each year using the turnover per sq.m and the available spend for each retail category.
- The baseline floorspace figure from the preceding year is subtracted from the total cumulative floorspace requirement to produce the additional annual floorspace requirement.
- The vacancy rate (as adjusted to allow for a 10% frictional vacancy requirement) is deducted from the additional annual floorspace requirement to define the additional floorspace development requirement, which is the final output of the exercise.

Table 4.6 also illustrates the impact of the forecasted economic decline arising from the Covid-19 pandemic and the effect of an assumed -9.4% decline in retail spend in both convenience and comparison retail spend for the year 2020. This results in a negative requirement for additional retail floorspace in this year across all three categories of retail which, along with existing vacant floorspace across convenience, comparison and bulky goods retail categories, negates the theoretical requirement for additional retail floorspace to cater for projected retail spend until the years 2024 (in the case of convenience retail floorspace development), 2023 (in the case of comparison retail floorspace development) and 2026 (in the case of bulky goods retail floorspace development). However, it should be emphasised that this does not signify that no additional retail development should take place before these respective years, but rather demonstrates the impact of economic volatility on projected retail floorspace development.

4.6 Additional Retail Floorspace Requirement

The initial baseline projections for floorspace requirements for the period to 2030 are set out in Table 4.6 above. These projections have been formulated to include adjustments for existing vacancy levels, as well as a frictional vacancy rate of 10% to ensure vital choice and competition in the market. Having regard to calculated demand, and identified vacancy, including the need to maintain a frictional vacancy rate, there is a requirement to plan for additional retail floorspace over the plan period.

The Retail Planning Guidelines advise that Retail Strategies Should “*assess the broad requirement for additional development over the plan period.... These assessments of future retail requirements are intended to provide **broad guidance** as to the additional quantum of convenience and comparison floorspace provision. They should not be treated in an **overly prescriptive** manner, nor should they serve to inhibit competition*”. For this purpose, it is not the intention of this strategy to present figures as some form of cap on retail permissions in the County, but rather to guide the general scale of overall retail provision.

Significant consideration has also been given to the quality of existing vacant retail floorspace, including the prospective suitability of available floorspace to meet the future needs of retailers in the County. A summary of additional floorspace requirements over the Longford County Development Plan period 2021-2027 for the convenience, comparison non-bulky and comparison bulky categories is set out in Table 4.7 below.

Table 4.7: Summary of additional floorspace requirements over the 2021-2027 period

Additional Floorspace Requirements 2021-2027	
Retail Category	Floorspace (sqm)
Additional Convenience	2,100-3,200
Additional Comparison	2,000-2,650
Additional Bulky	2,200-4,850

5. RETAIL STRATEGY AND POLICY GUIDANCE

5.1 Retail Objectives and Policy Recommendations

This section of the strategy contains key retail objectives to encourage and accommodate future retail development in County Longford. It also sets out criteria for the assessment of future retail proposals, in accordance with the overall aims of the Development Plan and the requirements of the Retail Planning Guidelines (DoECLG) 2012.

5.2 Retail Strategy Overview

It is considered that the majority of future floorspace requirements will be provided within the commercial core of Longford Town, taking account of its role as the Principal Retail Centre in the County, and the fact that approximately 50.7% of the envisaged population growth for the County over the plan period to 2027 is expected to take place within the town environment itself. As detailed in Section 4.2, the latter should precipitate a demand for convenience, comparison and bulky goods floorspace as the plan period progresses.

The focus of concentrating the provision of new retail floorspace within Longford Town underpins the ‘town centre first’ approach as per the Retail Planning Guidelines and will also strengthen the competitiveness of the county as a whole relative to other competing centres thereby reducing outward revenue leakage.

The spatial distribution of new floorspace in Co. Longford will be guided by the County Retail Hierarchy. Issues of location and scale are of paramount importance to the assessment of future retail proposals in the County. An overly prescriptive approach in defining the scale acceptable in different areas could inhibit potential improvements to the vitality and viability of smaller centres. Providing a broad framework for assessment purposes, the guidance in Table 5.1 provides a suitably broad framework for assessment purposes, while allowing sufficient flexibility to be applied on a case-specific basis.

Table 5.2: County Retail Hierarchy

Hierarchy	Settlement Type	County Centre	Appropriate Retail Type
Tier I	Principal Retail Centre	Longford Town	Major convenience and comparison
Tier II	Key Service Centre	Granard	Large to Medium scale convenience and medium scale comparison
Tier III	Service Centres	Edgeworthstown and Ballymahon	Medium scale convenience along with small to medium scale comparison, including tourism-related comparison
Tier IV	Local Service Centre	Lanesborough	Medium scale convenience along with small-scale comparison including tourism-related comparison
Tier V	Rural Centres and Local Shops	Serviced Rural Villages, Rural Settlement Clusters and the Open Countryside of County Longford	Predominantly lower order convenience, but not excluding tourism-related comparison

5.3 Key Retail Principles

Having regard to the information presented above in relation to the health check analysis of the main urban settlements of County Longford and the additional floorspace requirements of the County between 2021 and 2027, a series of recommended key retail principles have been devised. The primary purpose of these key retail principles will be to inform the development of policy objectives which will protect and reinforce existing retail offering and look to develop additional retail services, in keeping with the role of the settlements of County Longford, as prescribed in the Core Strategy and the Eastern and Midland RSES.

Specifically, these principles will look to inform policies that will:

- I. Ensure that the retail needs of the County's residents are provided for as much as possible within the County, whilst taking cognisance of the Regional Retail and Settlement Hierarchy as established in the Eastern and Midland RSES;
- II. Ensure that County Longford possesses a clear policy framework that will inform both the conception and assessment of retail development proposals and help to guarantee that the strategic and local convenience and comparison retailing needs of the County are met;
- III. Maintain, and where possible, enhance the existing competitiveness of the County's main centres by facilitating the development of additional retail floorspace where it can be clearly established that such development will result in tangible improvements to the retail offering of the County;
- IV. Encourage reductions in floorspace vacancy, taking account of suitability, obsolescence, and the identification of alternative uses for existing vacant floorspace within the urban centres of the County;
- V. Facilitate the regeneration of areas with scope for improvement or where there may be a high level of vacancy, obsolescence or emerging issues of dereliction, subject to the provisions of the Sequential Test;
- VI. Maintain an appropriate mix of uses and protect night-time amenities in town centre locations whilst taking cognisance of the central tenet of 'compact growth' as espoused in the National Planning Framework in targeting a greater proportion of future residential development within or close to built up areas.
- VII. Engage with the relevant stakeholders and incentivise to ensure that the environmental attractiveness of town/local centres is enhanced; and
- VIII. Address the issue of retail expenditure leakage out of the County to competing centres by looking to develop the retail offering in the County within key retail sectors where this leakage occurs.

In following these principles, the goal of the Longford County Retail Strategy 2021-2027 will be to encourage the development of a healthy, vibrant and sustainable retail environment within the urban centres of County Longford.

5.4 Recommended Retail Policy Objectives

Having regard to the objectives which have been outlined above, the following retail policy objective recommendations are provided and take cognisance of national and regional planning policy as well as the assessment presented in this Retail Strategy. These policy recommendations are intended to inform retail-specific policies presented in Chapter 8: *Economic Development* and Chapter 16: *Development Management Standards* of the Longford County Development Plan 2021-2027, thereby forming an integral component of the strategic policy framework which will ensure that all development within the County is carried out in keeping with the ideals of sustainable development.

The recommended retail policy objectives outlined below have been created with the aim of supporting the expansion of the retail offering of County Longford in a sustainable manner, whilst also seeking to develop urban environments that support an appropriate mix of uses which sustain town centres and enhance their vitality and viability and the overall quality of life of our urban places. The policy objective recommendations outlined below have been formulated with the aim of supporting the expansion of the retail offering of County Longford in a sustainable manner. Therefore, these policy objective recommendations have been designed to encourage the reuse, renewal and regeneration of vacant floorspace where possible. This approach aligns with national and regional planning policy in seeking to secure more compact and sustainable growth of our urban environments focussing on the reuse and redevelopment of previously developed 'brownfield' land and existing buildings.

Notwithstanding this key policy emphasis, where the reuse or adaptation of vacant floorspace would have a negative impact upon a retailer's ability to compete, the construction of new retail floorspace would be permissible. Any application for the development of additional retail floorspace would require a detailed assessment to ensure that it is in keeping with the proper planning and sustainable development of the area within which it is proposed and provided that it can satisfy the relevant criteria as established within this Retail Strategy, the Longford County Development Plan 2021-2027 and the Retail Planning Guidelines.

Policy Objective Recommendation 1: It is the policy of the Council to ensure that all retail development permitted accords with the relevant requirements and criteria as established within the Retail Planning Guidelines for Planning Authorities 2012 and the Longford County Retail Strategy 2021-2027.

Policy Objective Recommendation 2: It is the policy of the Council to guide retail development where practical and viable in accordance with the framework provided by the Sequential Approach to enable the vitality and viability of existing town and village centres to be sustained and strengthened.

Policy Objective Recommendation 3: It is the policy of the Council to permit retail development of a size and scale which is appropriate to the level of the town/settlement area, including its population, as defined within the County Retail Hierarchy. This policy will aim to consolidate and reinforce all existing retail enterprises within the County and permit the development of additional retail floorspace where such development is deemed to be appropriate by Longford County Council.

Policy Objective Recommendation 4: When bringing forward proposals for the creation of new retail floorspace, the Council will require applicants to undertake an assessment of the quality and suitability of existing and available floorspace in the County relative to the circumstances of their proposals.

Policy Objective Recommendation 5: It is the policy of the Council to discourage new retail development if they would either by themselves or cumulatively in conjunction with other developments seriously damage the vitality and viability of existing retail existing retail centres within the County. This policy is aimed at protecting the existing vitality and service provision of the towns, and particularly the town centres, of County Longford by preventing the development of retail enterprises in inappropriate locations or at a scale which would have a negative impact on retail competition within the County.

Policy Objective Recommendation 6: When assessing retail planning applications, it will be Council policy to have regard to the findings of the capacity assessment contained in the Longford County Retail Strategy 2021-2027, including the ability to counteract expenditure leakage. The onus will be on any applicant to demonstrate in a Retail Impact Assessment that the proposed floorspace is appropriate, having regard to the quantum of floorspace required within that specific urban centre or settlement, in addition to evidencing all other relevant variables as specified within the Retail Planning Guidelines.

Policy Objective Recommendation 7: It is the policy of the Council to encourage, in the first instance, developments which promote and protect the Longford Town Core Shopping Area as the primary location for high order comparison and large-scale convenience retail development in the County, subject to the criteria of the Retail Planning Guidelines 2012. In principle, this will not preclude the consideration of proposals in locations where mitigating and robustly justified special circumstances apply.

Policy Objective Recommendation 8: It is the policy of the Council to promote the reuse of vacant retail floorspace. Where no viable retail use can be sustained, alternative uses will be assessed on their own merits against the requirements of the proper planning and sustainable development of the areas within which they are located. This policy will be used to ensure that all proposals for the reuse of existing retail floorspace can be evaluated and the proportion of vacancy can be reduced. In addition, the identification and introduction of alternative uses for vacant retail floorspace will reduce the possibility of such floorspace falling derelict.

Policy Objective Recommendation 9: It is the policy of the Council to look to encourage the consolidation of other non-retail-based services within the town centres of the County utilising existing vacant retail floorspace where necessary. This policy will aid in enhancing the vitality of town centres, encouraging them to maintain their role as employment locations in addition to reducing the proportion of vacant retail floorspace and recognising the value which non-retail uses can contribute to the local economy through the provision of employment and general economic benefit.

Policy Objective Recommendation 10: It is the policy of the Council to continue to improve the public realm of urban centres through the encouragement of high-quality civic design, including but not limited to the provision of attractive street furniture, lighting and effective street cleaning. In addition, the introduction of business improvement district type initiatives to the principal settlements of County Longford will be evaluated to establish the contribution that such proposals could make to the viability and vitality of town centres within the County.

Policy Objective Recommendation 11: It is the policy of the Council to undertake measures to improve the accessibility of town centres by developing a pedestrian and cyclist friendly environment, which improves safety and limits traffic congestion where possible. A particular focus of this policy will be the development of additional pedestrian crossings where necessary within Longford Town centre, as well as other settlements within the County where high volumes of vehicular traffic can be seen to inhibit pedestrian movement.

Policy Objective Recommendation 12: It is the policy of the Council to encourage and facilitate retail innovation, where appropriate, to help diversify the County's retail profile and offer. Where possible, this retail innovation should be directed towards existing urban centres and settlements in the first instance but will not preclude the development of retail enterprises in other locations, where the retail innovation in question cannot be sustained within any alternative location. Such development proposals will be assessed on their own merits and must satisfy the assessment criteria of the Retail Planning Guidelines.

Policy Objective Recommendation 13: It is the policy of the Council to require a Retail Impact Assessment to be carried out for development proposals in the following general circumstances:

- a) Proposals featuring greater than 1,000m² of net floorspace for both convenience and comparison type developments in the four main towns;
- b) Proposals featuring greater than 500m² of net retail floorspace for both convenience and comparison type developments in district towns and other settlements;
- c) Or where the Planning Authority considers the development may impact on the vitality and viability of a town centre.

The Retail Impact Assessment shall include, at minimum, the criteria set out in the Retail Planning Guidelines 2012 and should demonstrate how the proposed development:

- Supports the overall strategy for town centres as set out in the development plan and not materially
- diminish the prospect of attracting private sector investment into one or more town centres;
- Does not cause an adverse impact on one or more town centres, either singly or cumulatively with recent developments or other outstanding planning permissions, sufficient to undermine the quality of the centre or its role in the economic and social life of the community;
- Does not diminish the range of activities and services that a town centre can support;
- Does not cause an increase in the number of vacant properties in the primary retail area that is likely to persist in the long term; and,
- Ensures a high standard of access both by public transport, foot and private car so that the proposal is easily accessible by all sections of society.

Policy Objective Recommendation 14: It is the policy of the Council to protect and enhance the amenities and character of town centres in accordance with the principles of proper planning and sustainable development. The Council will encourage the further improvement and development of commercial, service, social and cultural functions which its town and village centres perform while ensuring the protection of the important heritage and architectural quality of their streetscapes. This will apply to the skyline, shop fronts and advertising structures.

Policy Objective Recommendation 15: It is the policy of the Council to identify under-utilised and obsolete areas for potential renewal and to encourage and facilitate the re-use and regeneration of derelict land and buildings in the county's main towns, villages and smaller centres. The Council will use its statutory powers, where appropriate, to facilitate this and will consider such buildings and lands for inclusion in the Register of Derelict Sites or the Vacant Sites Register.

Policy Objective Recommendation 16: It is the policy of the Council to align, as far as practicable, new retail development with existing and proposed public transport infrastructure and services and encourage access by foot and cycling to reduce the dominance of private car access. Where multiple private car parking of four or more spaces is a feature of any new retail development, developers will be required to provide at least 25% of the total car parking provision for electric vehicles (EVs) including associated charging units, ducting and ancillary infrastructure. Retail development incorporating car parking under spaces will be required to provide at least one EV car parking space including associated charging units, ducting and ancillary infrastructure.

Policy Objective Recommendation 17: It is the policy of the Council to have regard to the principles provided in the Shopfront and Signage Design Guidelines 2021-2027, prepared by Longford County Council and included in Annex 6 of the Longford County Development Plan

2021-2027, and the Retail Design Manual 2012 (Department of Arts, Heritage and the Gaeltacht) in the assessment of any retail development.

5.5 Criteria for the Assessment of Future Retail Development

All applications for significant retail development should be assessed against a range of relevant criteria. The Retail Planning Guidelines for Planning Authorities (2012) provide the main principles for assessing new retail proposals. The Guidelines state that the main planning considerations for retail development include:

1. Location (site selection);
2. Suitability of use (land use zoning and specific policies/objectives);
3. Size and scale (impact, form and design); and
4. Accessibility (access and servicing arrangements).

The Sequential Test

All applications for retail developments at edge-of-centre or out-of-centre locations will be subject to the sequential test, where the following applies:

The Retail Planning Guidelines state that *“the order of priority for the sequential approach is to locate retail development in the city/town centre (and district centre if appropriate), and only to allow retail development in edge-of-centre or out-of-centre locations where all other options have been exhausted. Where retail development in an edge-of-centre site is being proposed, only where the applicant can demonstrate satisfactorily to the planning authority that there are no sites or potential sites including vacant sites/units within a town centre or within a designated district centre that are (a) suitable (b) available and (c) viable, can an edge-of-centre site be considered.*

Where retail development on an out-of-centre site is being proposed, only in exceptional circumstances where the applicant can demonstrate satisfactorily to the planning authority that there are no sites or potential sites either within the centre of a town or designated district centre or on the edge of the town centre that are (a) suitable (b) available and (c) viable, can that out-of-centre site be considered”.

Retail Impact Assessments:

Retail Impact Assessments will be required for significant retail development where due to its scale and/or location, it may impact on the vitality and viability of centres. These assessments will be prepared in accordance with the current Retail Planning Guidelines, which requires an applicant to address the following criteria and demonstrate whether or not the proposal would:

- Support the long-term strategy for city/town centres as established in the development plan, and not materially diminish the prospect of attracting private sector investment into one or more such centres;

- Have the potential to Increase employment opportunities and promote economic regeneration;
- Have the potential to increase competition within the area and thereby attract further consumers to the area;
- Respond to consumer demand for its retail offering and not diminish the range of activities and services that a centre can support;
- Cause an adverse impact on one or more centres, either singly or cumulatively with recent developments or other outstanding planning permissions (which have a realistic prospect of implementation) sufficient to undermine the quality of the centre or its wider function in the promotion and encouragement of the arts, culture, leisure, public realm function of the town centre critical to the economic and social life of the community;
- Cause an increase in the number of vacant properties in the primary retail area that is likely to persist in the long term;
- Ensure a high standard of access both by public transport, foot and private car so that the proposal is easily accessible by all sections of society; and/or
- Link effectively with an existing city/town centre so that there is likely to be commercial synergy.

Traffic and Transport Assessment

A Traffic and Transport Assessment (TTA) may be required for retail developments over a particular threshold (100m²), as set out in the Traffic Management Guidelines 2003, and the Traffic Transport Assessment Guidelines 2007.

A TTA must examine the transport impacts of a proposed development, incorporating any subsequent measures necessary to ensure roads, junctions and other transport infrastructure in the vicinity of the development are adequate to accommodate the proposed development without causing additional delays to existing and future traffic. More importantly, TTA is also important in demonstrating how a proposed retail development incorporates sustainable travel modes.

5.6 Criteria for the Assessment of Different Development Types

Large Convenience Stores

The Retail Planning Guidelines set a 3,000m² retail floorspace cap on food store development outside the four Dublin Authority areas, and the cities of Cork, Limerick/Shannon, Galway and Waterford. This strategy absorbs this requirement, which applies to new stores as well as to extensions to existing retail premises.

Retail Parks and Retail Warehouses

Retail warehouse complexes generally comprise an agglomeration of retail warehouses grouped around a common car park selling mainly bulky household goods. There is an expectation that most of the goods purchased can be transported off-site by the customer and because of this they are generally located on the edge or outside of the built-up urban area.

The key consideration in determining the distribution of floorspace is defining the appropriate and sustainable location for such retail activities. In accordance with the Retail Planning Guidelines there should be a presumption against the further development of out-of-centre retail parks and a preference for sites in or adjacent to town centres to ensure the potential for linked trips and commercial synergy. Key criteria for the assessment of retail warehouse applications include both the scale and design of the development, appropriate vehicular access and the quantitative need for such development. The Retail Planning Guidelines state that individual retail units should not be less than 700sq.m and not more than 6,000sq.m in size. These figures are gross floor area, including storage, garden centres etc. It is essential that the range of goods sold is restricted by planning conditions to bulky household items as those defined within the Retail Planning Guidelines such as household appliances, furniture and furnishings. The proportion of non-bulky goods should be limited to 20% should be clearly delineated on planning application drawings.

Local Shops

Local shops play a vital role in catering for the daily or causal needs of nearby residents or of those passing by. Primarily convenience outlets, they provide a readily accessible service for basic goods, especially for the less mobile members of communities.

Where appropriate, local shops shall be recognised in the relevant parts of the Development Plan, with ample provision for the establishment of other neighbourhood shops and services made in the zoning of additional land for residential development, where necessary.

Retailing and Motor Fuel Stations

Local shops attached to petrol filling stations are a growing sector of the retail market. However, the size of the shop associated with any petrol filling station should take account of the fact that large shops can attract additional custom, large numbers of cars can cause disruption and the preferred location for retailing is in town centres. The Retail Planning Guidelines state that when the size of such retail units is in excess of 100m² the sequential approach should apply.

5.7 Monitoring and Review

The Retail Planning Guidelines advise planning authorities to regularly monitor trends in their areas, and update retail policies and strategies as appropriate. The council acknowledges that the retail sector is one of the most dynamic sectors in the economy and that trends, influences and information can change over time. The Council is therefore committed to monitoring the contents of this strategy to ensure that:

- I. The Retail Strategy and its baseline data are kept as up to date as possible;
- II. Mechanisms that are in place to monitor the progress of the strategy are appropriate and fit for purposes over its lifetime; and
- III. The Council can intervene in a positive and timely manner through a variation to the Development Plan in order to address changing circumstances, as considered necessary.

6. CONCLUSION

The Longford County Retail Strategy 2021-2027 has been prepared for Longford County Council in accordance with the requirements of the Retail Planning Guidelines, 2012. The policy recommendations formulated as part of this Retail Strategy will form a key input into the overall planning policy framework

In compiling this Retail Strategy, due regard has been had to the most up-to-date information regarding population growth projections, the prevailing economic outlook, current retail trends and retail sales information. This has been used to provide a firm basis on which to inform future policy direction with the aim of enhancing and developing the retail offering of Co. Longford including the principal settlement Longford Town, other main settlements to smaller settlements, prioritizing the vibrancy of the town centre including its redevelopment and revitalisation where possible.

Annex 10:

Mid Shannon Wilderness Park



Mid Shannon Wilderness Park



Donall Mac An Bheatha, Senior Planner.

Sean Savage, GIS Officer,

Sylvia Smith, Technician.

Longford County Council, September 2013. (Report reviewed and updated 2020)

Contents

1.	Introduction	3
1.1	Mid Shannon Wilderness Park	3
1.2	Bord Na Móna and Cut Away Bogs	3
1.3	Tourism and Biodiversity	4
2.	Future of the Longford Bogs	4
2.1	Draft National Peatlands Strategy 2014	4
2.2	Bord Na Móna Bogs	6
	Map 1 Bord na Móna Bogs. Map 2: Longford/Roscommon Bogs and Shannon	6
2.3	Corlea Archaeological Project	7
3.	Mid Shannon Wilderness Park - Major Tourism Initiative	9
3.1	Amenity Potential of Mid Shannon Wilderness Park	10
	Map 3: Potential Mid Shannon Wilderness Park	12
	Map 4: Potential Walking Cycling Routes in Mid Shannon Wilderness Park	13
4.	An Ecotourism Project	14
4.1	Biodiversity	15
4.2	Nature conservation and biodiversity corridors	16
5.0	Timeframe for Mid Shannon Wilderness Park	17

1. Introduction

1.1 Mid Shannon Wilderness Park

The Mid Shannon area of Longford in the Republic of Ireland is a little known lake, river, forest and bog area that supports a rich and diverse range of flora and fauna, archaeological monuments and traditional cultural practices. This report sets out a proposal to develop a Mid Shannon Wilderness Park in County Longford.

The Park will be located between the Royal Canal and Lough Ree on the River Shannon. Much of the land involved is in State ownership. The development of such a large amenity park in Longford would provide the Midlands and Ireland with a major tourism attraction of international importance.

The development of a Mid Shannon Wilderness Park in Longford will combine existing natural amenity areas. These areas include Lough Ree, the Rivers Shannon, Inny and Camlin, the Royal Canal, Newcastle Wood and other forests and the future rehabilitated Bord na Móna bogs. All of these amenity areas are in very close proximity to each other and can be developed and combined to create the Wilderness Park. The Park would be developed in partnership between the various owners particularly Bord na Móna, local communities and Longford County Council.



Pic 1: Mid Shannon Wilderness Park, Lough Ree from Athlone looking North.

1.2 Bord Na Móna and Cut Away Bogs.

Bord na Móna has now completed its peat extraction work on the Longford and Roscommon bogs and has begun to plan for their future use. This will include carrying out rehabilitation work to create semi natural landscapes which will produce potentially valuable amenity lands. It is now proposed for existing local communities and Longford County Council to partner with Bord na Móna and collaborate in developing new amenity

uses for the cutaway bogs. This will not conflict with any future intention of Bord na Móna and its potential future use of the bogs. The amenity use of the rehabilitated bogs can be compatible with any future use for the bogs such as renewable energy projects.

1.3 Tourism and Biodiversity

The Mid Shannon Wilderness project aims to strengthen the integration of tourism and natural heritage, and to reconcile tourism development with conservation of biodiversity. It aims to secure environmental protection and sustainable visitor management through the creation of an innovative methodology that is of value to local communities. In European terms, the objective is to improve the environmental performance of the area and promote strategic integrated planning approaches for improving the use of land.

The aim of the project is to contribute to Ireland's and EU biodiversity objectives through the integration of tourism and biodiversity. The project will support the EU's promotion of sustainable, responsible and high-quality tourism. The project will also stimulate a heritage community within its local partnership and enrich the heritage of the area. Finally, it will support the European landscape convention through the tourism conservation actions carried out on the fragile landscape of the area.



Pic No. 2 Typical Longford Mixed Bogland.

2. Future of the Longford Bogs.

2.1 Draft National Peatlands Strategy 2014

The recently published Draft National Peatlands Strategy 2014, produced by the National Parks and Wildlife Service advocates the following partnership approach:

'NPS V 16 Responsible management of peatlands will require collaboration and partnership between land-owners, communities, public authorities, commercial organizations and non-governmental organizations. This Strategy aims to ensure that appropriate supports, structures, funding mechanisms and regulatory frameworks are in place to allow such partnership to develop.'



Pic. 3 Bord na Móna Bog

The following after use principles for cut away bogs are set down by the Draft Strategy:

NPS P 13 Bord na Móna will continue to assess and evaluate the potential of the company's land bank, using a land use review system. The assessment will help prepare a set of evidence based management plans for the various areas of peatland. These plans will also inform its cutaway bog rehabilitation programme.

NPS P 14 The policy of Bord na Móna is not to open up any undrained new bogs for peat production.

NPS P 15 Lands identified by Bord na Móna as having high biodiversity value and/or priority habitats will be reserved for these purposes as the principal future land use.

NPS P 16 Generally, Bord na Móna cutaway bogs that flood naturally will be permitted to flood unless there is a clear environmental and/or economic case to maintain pumped drainage.

NPS P 17 An examination of all publicly owned lands and privately owned cutaway will be undertaken with a view to identifying appropriate uses, which will aim to harness their potential to contribute to Ireland's environmental, ecological and economic wealth, with particular emphasis on mitigating carbon losses.

NPS P 18 In deciding on the most appropriate after use of cutaway peatlands, consideration shall be given to encouraging, where possible, the return to a natural functioning peatland ecosystem. This will require re-wetting of the cutaway peatlands which may lead in time to the restoration of the peatland ecosystem.

NPS P 19 Environmentally, socially and economically viable options should be analysed to plan the future use of industrial cutaway peatlands, in conjunction with limiting factors as outlined in Bord na Móna's Strategic Framework for the Future Use of Peatlands.

NPS P 22 The work of Bord na Móna, Coillte and the Irish Peatlands Conservation Council in developing ecologically rich futures for cutaway and formerly forested bogs will be developed. Such areas can bring new tourism and recreation attractions to the midlands and the west.

The use of the Longford Bogs for amenity purposes as part of the Mid Shannon Wilderness Park among other potential uses clearly ties in with the above principles.

2.2 Bord Na Móna Bogs

Longford contains a large portion of bogs many of which are owned by Bord Na Mona.



Map 1 Bord na Móna Bogs.



Map 2: Longford/Roscommon Bogs and Shannon

It is envisaged that overtime as the cutaway bogs are worked out one of the options under consideration by Bord na Móna is that certain bog areas would return to a natural type environment. These natural environment areas could then, in association with Lough Ree and the Shannon, the Royal Canal, and River Inny etc, form part of a proposed Mid Shannon Wilderness Park. The use of the bogs for other purposes such as renewable energy can be achieved in a compatible manner. The large national resource that the Bord na Mona Bogs are can continue to be developed to provide employment and wealth creation opportunities in the national and local interest including for tourism and amenity purposes.



Pic 4: Rehabilitated and re-colonised bog.

As well as the rehabilitated bogs, rivers and lakes, existing facilities and attractions can be utilized to enhance the attractiveness of the Mid Shannon Wilderness Park. Facilities such as the Corlea Visitors Centre, the ISPCA Animal Refuge, Commons North Park at Lanesborough, Barley Harbour, Newcastle House and wood, Clondra Harbour and Strokestown House etc. already exist and only require a minor amount of refocusing to fit into the broader picture of presenting and creating the Park.

As the Nation Peatland Strategy has recommended the future responsible management of peatlands will require collaboration and partnership between land-owners, communities, public authorities, commercial organizations and non-governmental organizations. The Mid Shannon Wilderness Park aims to ensure that the involvement and co-operation of local communities, Longford County Council and Bord na Móna are in place to allow such partnership to develop.

2.3 Corlea Archaeological Project

There is now a proposal to develop a new Corlea Archaeological and Biodiversity Project. This can be added to in time with the Royal Canal Walking/Cycling Route and the Mid Shannon Wilderness Park to provide the various communities and villages of South Longford with wonderful amenity facilities and tourism infrastructure. It will also encourage visitors to the area especially of the walking and cycling variety. This will help the area to build a more sustainable ecotourism base which will in turn provide economic benefits to the area.



Pic. 5 Corlea Visitor Centre.

Keenagh Community Group now has the agreement of Bord na Móna to develop approximately 12 acres of cutaway bog near Corlea Centre for a recreated Archaeological Iron age type settlement and to present the developing Biodiversity of a rehabilitated cutaway bog. This area has its own existing car park and shall be initially linked back to the centre and Keenagh by a dedicated walking route along the public road. This project will be developed in 2014/5. An important aspect of the proposal is that it be delivered in a very cost effective manner requiring minimal resources in input from the various bodies involved.

The above proposed walking trails and the Corlea Centre have the potential to be linked with the adjoining Royal Canal in the period 2014/15. This will facilitate boating, walking and cycling visitors coming from Dublin and the East and travelling to the West via Longford and the Shannon to visit both Longford and the Corlea Centre.



Pic. 6+ 7: Boating, Walking and Cycling on the Royal Canal.

As the portion of bog immediately adjoining the Corlea Project site is worked out and rehabilitated by Bord na Móna it is hoped to develop an additional area of bog with a direct link back to the Corlea Centre. This would provide dedicated walking trails through the bog presenting the developing biodiversity. It is expected that a portion of the low lying bog shall be re-watered and colonized with appropriate native plants, birds and fish. The timetable for this portion of the project to be achieved is expected to be between 2020-2025.



Pic. 7: Biodiversity of a Bog.

Corlea Project Update July 2020 – the project is substantially complete.

Keenagh Community Group in 2014 got the agreement of Bord na Móna to develop approximately 70 acres of cutaway bog near Corlea Trackway Centre for a restored and developing area of rich Biodiversity and rehabilitated cutaway bog.

In 2018 Corlea Archaeological and Biodiversity Project was officially opened. This now consists of 100 acres of cut away from renatured, a greenway developed connected with the Royal Canal greenway to give national access thus providing the various communities and villages of South Longford with a wonderful amenity facility and tourism infrastructure.

It has already begun to attract visitors to the area especially of the walking and cycling variety. This is helping the area to build a more sustainable ecotourism base which will in turn provide economic benefits to the area.

3. Mid Shannon Wilderness Park - Major Tourism Initiative.

The project has a wide ranging scope, benefiting visitors to the area, local communities, schools as well as improving the wider tourism attractions of Longford and the Midlands. The Corlea proposal is a stand-alone project that represents a first step in a broader development proposal for the gradual conversion of parts of the cutaway bogs in Longford to Biodiversity Parks. These emerging Biodiversity Parks could then be linked with the Shannon, Lough Ree and the Royal Canal to create a Mid Shannon Wilderness Park.



Pic. 8: Lough Ree wilderness.

When the bogs have been worked out by Bord na Móna over the next 10/20 years one of the options under consideration is that they be used as Nature and Biodiversity locations. The existing bog rail tracks could then be utilized as additional walking/cycling tracks to increase the network through the emerging Mid Shannon Wilderness Park (See below) linking with the ISPCA Animal Refuge at Derryglogher and on to Lough Ree at Lanesborough and Newtowncashel. Indeed, it may also be possible to link a walking/cycling route from Dublin through Longford and across the Shannon to Strokestown, Roosky and on to Westport and Sligo.



Pic. 9: Bord Na Móna bridge at Lanesborough.

3.1 Amenity Potential of Mid Shannon Wilderness Park

The development of the Royal Canal as a primary Walking/Cycling route from Dublin through Longford to the West can connect in with routes across the cutaway bogs and the Shannon to the Mayo and Sligo roads. The crossing of the Shannon could use the existing Bord Na Móna rail bridge at Lanesborough which would provide a traffic free crossing point. Indeed, it is possible to Link Dublin through to Roscommon via the Royal Canal in a completely vehicular traffic free environment. This would create a major piece of amenity infrastructure across the Midlands of international importance.



Pic. 10: Boating on the Royal Canal.



Pic. 11: Fishing and Horse riding.



Pic. 12: Walking on the bogs and boating on Lough Ree.

The opening up and development of the Mid Shannon area as proposed above would facilitate the promotion of Tourism and Recreation activities in the area. The usage of the beautiful natural amenities of the area such as lake, river, wood and bog would increase. The level of activity and visitors to the area would increase and this in turn would create local enterprises and additional employment in South Longford.

Mid Shannon Wilderness Park

Mid Shannon Wilderness Park including Lough Ree, the Shannon, the Bogs and the Royal Canal.



Map 3: Potential Mid Shannon Wilderness Park

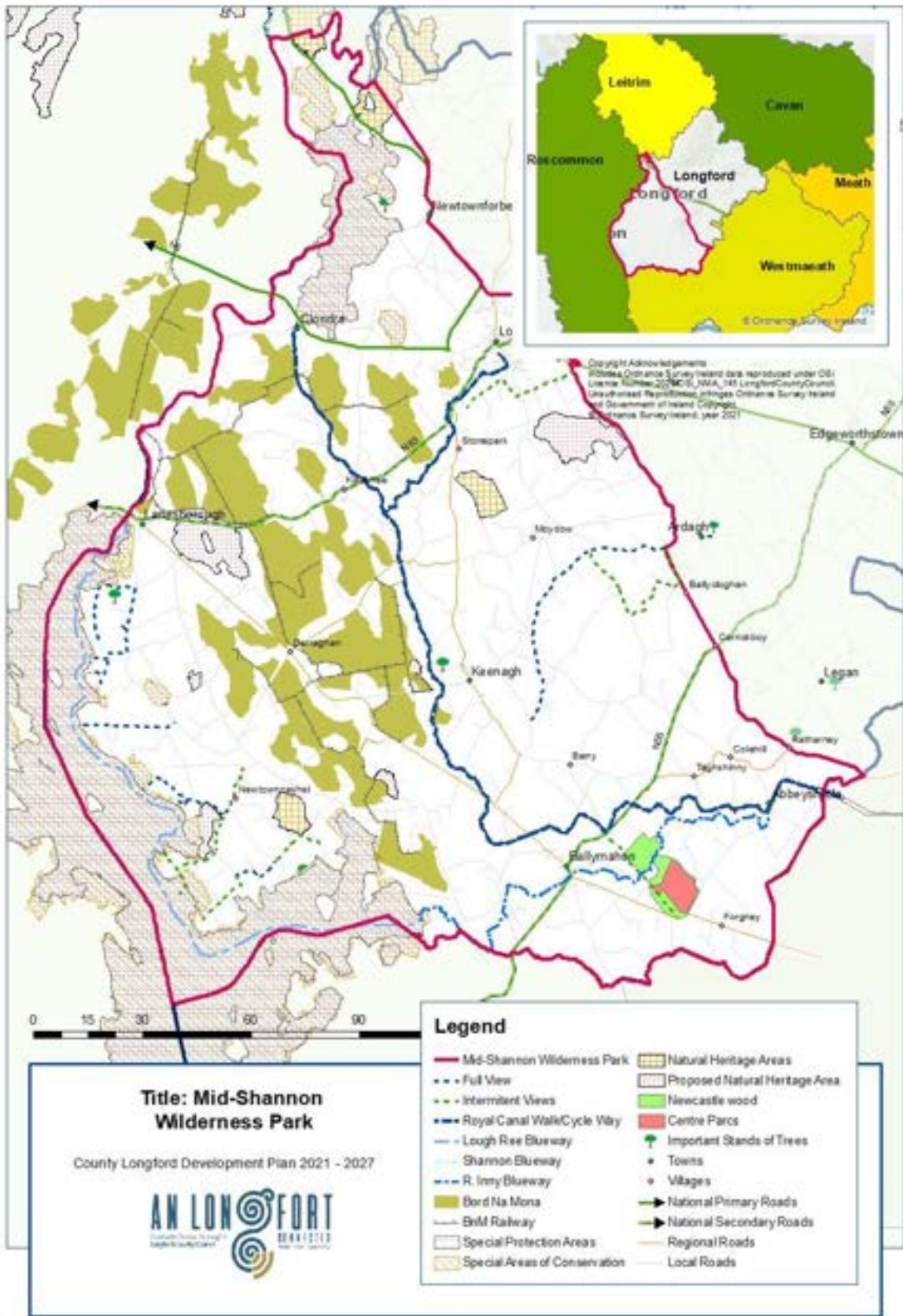

Map 4: Potential Walking Cycling Routes in Mid Shannon Wilderness Park.

The development of the Mid Shannon Wilderness Park in Longford would provide a major amenity and tourism facilities for the Midlands. The plans for the Park and the Corlea project will be sympathetic with any future uses and the conservation and biodiversity action plan of Bord na Móna. It is also intended to develop these projects in a sustainable manner bearing in mind the rich cultural and natural heritage resources of the area. The principles of Ecotourism providing for a destination with a set of standards based on sound environmental practices highlighting all that the region and its people has to offer will guide the development of the project.



Pic. 13: Forest Walks

4. An Ecotourism Project

It is intended to use the principles of Ecotourism in the development of the Mid Shannon Wilderness Park and the Corlea Project. There is an established criterion which must be met in order to qualify for the ecotourism label. These cover a wide range of practices in eight key components of ecotourism as follows:

- Environmentally sustainable practices
- Natural area focus
- Interpretation and Education
- Contributing to Conservation
- Benefiting local Communities
- Visitor Satisfaction
- Responsible Marketing and Communication
- Cultural Awareness and Respect

The Mid Shannon Wilderness Park and the Corlea Project will incorporate these principles. By meeting and possibly exceeding the above, the project will indicate its dedication to educating the visitor and tourist about the native natural world and local culture. This environmentally innovative and socially responsible project will have a very positive impact on the environment and local communities.



Pic. 14: Amenity Sign Boards for Wilderness Park

4.1 Biodiversity

Biodiversity specifically relates to the diversity of habitats, species and genetic diversity of species in the world around us from insects in the soil, to extensive woodlands, to the animals that inhabit them. Since the 1990s, Bord na Móna has adopted a programme of enhancement of biodiversity which has become closely linked to the after-use and rehabilitation of cutaway bogs.

The Corlea proposal follows the Bord na Móna programme in utilizing this proposed portion of cutaway bog to allow for the rehabilitation and re-colonisation of the bog. Re-colonisation of the bogs following peat production leads to establishment of a mosaic of habitats and species, some of which are considered rare and restricted in distribution in Ireland. The Corlea Project shall present the history of the development of the bogs, the rehabilitation programme and the developing biodiversity resource as educational tours to the visiting public.



Pic 15: Typical Bord na Móna rehabilitated and re-colonised Bogs.

The proposed biodiversity trail will tell the story of Irish peatland's past, present and future possibilities. The cutaway bogs around Corlea which have been harvested by Bord na Móna for energy since the 1940s can be established as unique and welcoming habitats for a wide range of flora. The trail will also go through rejuvenating peat land and woodland areas of the Park and cover topics such as peat land formation, woodland ecology, native plants and animals, renewable energy and animal and plant identification.

Vital to enhancing our national biodiversity resource is the wise use and management of cutaway bogs and related lands, and creating awareness of the local, national and regional value of biodiversity of peatlands.



Pic 16: Typical rehabilitated bogs with scrub, heather and rushes.

4.2 Nature conservation and biodiversity corridors

In recent years Bord na Móna has been attempting to give due care to nature conservation and to retaining biodiversity corridors within their national bog network to sustain important refuges for peatland flora and fauna. This is a key requirement of Article 10 of the Habitats Directive. Rehabilitation of the cutaway bogs generally involves measures to accelerate re-vegetation, through activities such as drain blocking to create wetlands, and other targeted practices such as tree planting.





Pic 17: Flora and Fauna

Rehabilitation allows for the expansion of biodiversity back onto the bogs and the creation of diverse and valuable wildlife reserves. It is envisaged that, overtime, as the cutaway bogs are worked out that they will be properly managed to return to a natural type environment and may form part of a proposed Mid Shannon Wilderness Park.



Pic 18: Re-watered cut away bog by Bord na Móna

5.0 Timeframe for Mid Shannon Wilderness Park

The following time frame is proposed to deliver the various projects related to the development of the Mid Shannon Wilderness Park. Over the next ten years it is hoped to deliver various elements of the project building up to the final achievement

Table 1. Timeframe for projects.

Timetable	Project	Status
2014	Corlea Visitor Centre existing. Lough Ree and Royal Canal existing	Complete
2014/2015	Corlea Archaeological & Biodiversity Project	Complete
2015/2016	Corlea link with the Royal Canal	Complete
2015/2020	Project link across the bog top the Corlea Centre	Complete
2015/2020	Local communities to take responsibility for the local area of Bog in association with Longford County Council	Complete
2015/2018	Royal Canal walking / cycling route connecting Dublin to Clondra	Complete
2015/2030	Mid Shannon Wilderness Park	To be completed



**'I will arise and go now, for always night and day
I hear lake water lapping with low sounds by the shore;
While I stand on the roadway, or on the pavements gray,
I hear it in the deep heart's core. '**

Lake Isle of Innisfree, W. B. Yeats.

Annex 11:

Landscape Character Assessment

ANNEX 11: LANDSCAPE CHARACTER ASSESSMENT

Please note the Landscape Character Assessment was prepared as part of the Longford County Development Plan 2015-2021. Any references within the document, pertaining to the previous Development Plan, National Spatial Strategy and previous Regional Planning Guidelines are superseded by the Longford County Development Plan 2021-2027 Chapter 14 Landscape Character Assessment.

The Landscape Character Assessment remains the valid document for the assessment of landscape within the County. The County Development Plan 2021-2027 in Chapter 14 Landscape Character includes a Policy Objective reference CPO 14.2; to review and update the Landscape Character Assessment of the County during the lifetime of the Plan in the context of updated population figures and to include the latest national and regional guidance as indicated below:-

<i>CPO14.2</i>	<i>Review in the context of a regional approach to landscape assessment, the County Landscape Character Assessment following publication of statutory guidelines for Planning Authorities on local Landscape Character Assessments, as outlined in the National Landscape Strategy 2015-2025.</i>
----------------	---

Table of Contents

1.	INTRODUCTION AND CONTEXT	5
1.1	Scope	5
1.1.1	Purpose and Aims	5
1.1.2	Stakeholder Input	6
1.2	Methodology	6
1.2.1	Desk Study	6
1.2.2	Field Survey	6
1.3	Current Landscape Policies	6
1.3.1	National Spatial Strategy	6
1.3.2	Midland Regional Planning Guidelines	7
1.3.3	Longford County Development Plan 2015-2021	9
1.3.4	Conclusion	10
2.	LANDSCAPE CHARACTER	11
2.1	County Overview	11
2.1.1	Landform	11
	(a) Topography	12
	(b) Geology and Soils	12
	(c) Drainage patterns	16
2.1.2	Landcover	17
2.1.3	Human Influence	18
	(a) Settlement pattern	18
	(b) Agriculture	19
	(c) Forestry	20
	(d) Archaeology	21
	(e) Culture	21
2.2	Landscape Character Units	22
	Landscape Unit 1 – Northern Drumlin Lakeland	24
	Location and Physical Characteristics	24
	Landcover	24
	Topography	24
	Geology/Soils	25
	Drainage patterns	25
	Human Influence	25
	Settlement pattern	25
	Transport and Communications	26
	Agriculture.	26
	Industry and services	26
	History, Archaeology and Culture	27
	Recreation and Amenity	27
	Landscape Sensitivity	27
	Threats	27
	Opportunities	27
	Policy Responses	27
	Landscape Unit 2 – Northern Upland	28
	Location and Physical Characteristics	28
	Landcover	28
	Topography	29
	Geology/Soils	29
	Drainage patterns	29
	Human Influence	29

	Settlement pattern	29
	Transport and Communications	30
	Agriculture.	30
	Industry and services	31
	History, Archaeology and Culture	31
	Recreation and Amenity	32
	Landscape Sensitivity	32
	Threats	32
	Opportunities	32
	Policy Responses	32
	Landscape Unit 3 – Shannon Basin/Lough Ree	33
	Location and Physical Characteristics	33
	Landcover	33
	Topography	33
	Geology/Soils	34
	Drainage patterns	34
	Human Influence	34
	Settlement pattern	34
	Transport and Communications	35
	Agriculture.	35
	Industry and services	35
	History, Archaeology and Culture	35
	Recreation and Amenity	36
	Landscape Sensitivity	36
	Threats	36
	Opportunities	36
	Policy Responses	36
	Landscape Unit 4 – Central Corridor	37
	Location and Physical Characteristics	37
	Landcover	37
	Topography	37
	Geology/Soils	38
	Drainage patterns	38
	Human Influence	38
	Settlement pattern	38
	Transport and Communications	38
	Agriculture.	38
	Industry and services	39
	History, Archaeology and Culture	39
	Recreation and Amenity	39
	Landscape Sensitivity	39
	Threats	39
	Opportunities	39
	Policy Responses	40
	Landscape Unit 5 – Inny Basin	41
	Location and Physical Characteristics	41
	Landcover	41
	Topography	41
	Geology/Soils	41
	Drainage patterns	41
	Human Influence	42
	Settlement pattern	42
	Transport and Communications	42

	Agriculture.	42
	Industry and services	42
	History, Archaeology and Culture	42
	Recreation and Amenity	42
	Landscape Sensitivity	42
	Threats	43
	Opportunities	43
	Policy Responses	43
	Landscape Unit 6 – Peatlands	44
	Location and Physical Characteristics	44
	Landcover	44
	Topography	44
	Geology/Soils	44
	Drainage patterns	44
	Human Influence	45
	Settlement pattern	45
	Transport and Communications	45
	Agriculture.	46
	Industry and services	46
	History, Archaeology and Culture	46
	Recreation and Amenity	46
	Landscape Sensitivity	46
	Threats	47
	Opportunities	47
	Policy Responses	47
	Landscape Unit 7 – Open Agricultural	48
	Location and Physical Characteristics	48
	Landcover	48
	Topography	48
	Drainage patterns	49
	Human Influence	49
	Settlement pattern	49
	Transport and Communications	50
	Agriculture.	51
	Industry and services	51
	History, Archaeology and Culture	51
	Recreation and Amenity	51
	Landscape Sensitivity	51
	Threats	51
	Opportunities	51
	Policy Responses	52
2.3	Identification of Visual Units	53
2.4	Identification of Image Units	53
3.	LANDSCAPE VALUES	54
4.	LANDSCAPE SENSITIVITY	55
	APPENDIX 1	56

1. INTRODUCTION AND CONTEXT

This document has been prepared with reference to the Draft Landscape and Landscape Assessment Guidelines for Local Authorities as issued by the Department of the Environment in June 2000¹ (hereinafter referred to as “the guidelines”). As the guidelines are still in draft format, extensive study was carried out into the area of character assessment, and this document draws heavily on recent works throughout the country and the UK. The publication “Landscape Character Assessment – Guidance for England and Scotland”, released by the Countryside agency and Scottish Natural Heritage was used extensively due to its compatibility with the draft guidelines.

An emphasis on landscape *Character* was maintained in the formulation of this assessment. Character represents the individuality of an area based on its particular combination of features and elements. This approach contrasts with the evaluation method, which rates one particular landscape against another.

In order to formulate an effective development management and policy-making tool, the scope of the assessment must first be defined.

1.1 Scope

1.1.1 Purpose and Aims

One of the primary aims of the completed assessment is to inform the policy formulation and decision-making process in relation to the siting, design and material content of new developments.

This process is interlinked with policy documents at a national regional and local level and it is an aim of this assessment to translate the essence of these documents into a workable local context, including the following:

- National Spatial Strategy
- Government Guidelines on sustainable rural housing, location and siting of windfarms,
- mobile phone antennae and support structures, quarries etc.
- Midland Regional Planning Guidelines
- Longford County Development Plan
- Longford County Heritage Plan
- Local Area Plans and Village Policy Statements

While it is an accepted fact that the landscape is not a static entity, the level and direction of change, which is deemed acceptable over a period of time, must be

¹ It is recognised that during the statutory plan preparation period, revised guidelines were issued in June 2014 by the Department of Arts, Heritage and the Gaeltacht entitled “A Draft National Landscape Strategy for Ireland 2014 – 2024”. However, in line with the statutory requirements of the Planning and Development Act 2000 (as amended) it was not within the scope of the prescribed timeframes to facilitate the consideration of these revised guidelines at that point in the County Development Plan process.

ascertained in order to facilitate effective and efficient development control and environmental maintenance systems.

The methodology involved in this process will produce a clear, concise and transparent background for landscape preservation, conservation and enhancement policies for the county, through the use of existing material such as soil data, landcover information and hydrological sensitivity. This will be combined with information from the public, such as the areas and places within the County that form the building blocks of its unique identity and existing policy at all levels throughout the planning process.

1.1.2 Stakeholder Input

The aim of this assessment is to identify, and attempt to quantify, the landscape attributes that make Longford unique. As such, stakeholder input is a basic element of this document.

1.2 Methodology

1.2.1 Desk Study

The initial investigation involved study of available material on the natural factors that influence the landscape. This included information on geology, landform, drainage, soils, landcover and vegetation. Cultural factors such as land use, settlement patterns and the change over time of these factors were also studied and mapped. This resulted in the landscape character types and areas in the following chapters.

1.2.2 Field Survey

The landscape types and areas derived from the desk study were then analysed in the field, whereby aesthetic and perceptual aspects, perceived character and individual condition and potential sensitivity were assessed.

These components were then classified, resulting in maps defining character types and areas, which are then described, and the key characteristics of each area identified.

1.3 Current Landscape Policies

This section details the various national and local policies that relate to the landscape at present.

1.3.1 National Spatial Strategy

The NSS refers to the Midlands as a rural area that is changing and calls for policy responses that support communities where agriculture is under stress through promoting diversification in enterprise, local services and tourism. Reference is made to the protection of landscape, water resources and habitats in order to support this policy response.

Conservation of cultural identity is an important element in the development of rural areas and includes the protection of natural and other heritage resources.

Rural areas are considered in terms of a national resource, including natural environment, landscape and natural heritage, which are essential to underpin strengthened rural economies and the national economy. Resources referred to are agricultural land, water resources forestry and landscape quality.

In relation to the broad strategy for the Midlands region, the NSS identifies the rural areas to the south of Longford and north of Granard as rural areas with strong potential for diversification. The area to the north of Longford and north and east of Ballymahon is identified as having village strengthening and rural area opportunities. The central area, taking in Longford and Edgeworthstown, is defined as a broad national transport corridor.

The importance of unspoilt landscapes and inland waterway networks in the Midlands region and the accessibility of these areas to Dublin is recognised in terms of its future potential to complement the agricultural sector with additional tourism and recreational activity. The potential for the worked out bogs to be utilised in the production of wind energy with ancillary manufacturing servicing and development activities is also noted.

1.3.2 Midland Regional Planning Guidelines

The following is the vision for the Midlands region upon which the policy framework contained in the guidelines is based:

By 2022, the Midland Region will be a successful, sustainable and equitable region full of opportunities for its expanded population achieved through:

- *Enhancing the critical mass of the region by combining the strengths of the linked gateway of Athlone, Tullamore and Mullingar, as envisaged in the NSS with those of the principal towns of Longford and Portlaoise.*
- *Developing the full potential of rural areas in the region in a manner that is compatible with the strengthening of the urban structure of the region.*
- *Offering a distinctive lifestyle rooted in a high quality living environment, rich in heritage and landscape value.*
- *Harnessing the central geographical location of the region at the “heart” of Ireland with more interregional links than any other region in Ireland, to build a strategically focused network of transport and communications links.*
- *Ensuring that the natural environment of the region such as water quality, landscape, and biodiversity is protected, maintained, and enhanced, where appropriate, as a basis for future sustainable development in the region.*

The vision outlined above relates strongly to the landscape of the area as both an entity where the functions required to drive the region take place and also a strong element of the culture and identity of the region that sets it apart from other areas in the Country.

Chapter 3 deals with the development of rural areas in the region and Section 2 of the guidelines outlines the strategic goals and Planning Considerations for the Region.

Goal 11 is of particular relevance in terms of the development of rural areas and landscape implications:

To develop and market a distinctly unique image and identity for the region that will attract investment and economic activity to the region.

The development of the image of the region as the heart of Ireland, an area with a high quality of life in a relatively unspoilt environment, will rely on the continued protection and enhancement of valuable natural resources (such as agricultural land, and amenities such as the lakes, rivers, canals, bogs and uplands) and the built heritage of the region. The preservation of the environmental integrity, water and air quality and the visual environment, will play an important role in maintaining this image which is vital for the attraction of investment and population growth.

Longford County is located in the northern development area as defined by the guidelines, for which the following specific development proposal has been included

Focused promotion and marketing of the natural heritage and cultural resources of the area and its associated high quality of life, which is vital for its development and a valuable contribution towards the identity of the region as a whole.

The following common spatial issues are relevant to the development of landscape policy and are outlined in Section 7:

Environmental Issues

The midlands have specific environmental advantages that can be brought together in order to foster a unique green image for the region. The recommendations under each issue aim to promote and strengthen awareness of the high quality of life that exists in the region and how this can be maintained in tandem with enhanced economic growth.

Agriculture

The future development of agriculture in the region should take cognisance of the following issues:

- *Existing strong agricultural areas should be prioritised for development in this sector.*
- *Diversification of agriculture should be promoted to revitalise the social and economic climate in rural communities, particularly in areas of marginal land.*
- *Targeted promotion of agricultural activities should take place in areas where conditions are best suited for individual specialities, e.g. arable farming in the south, cattle fattening enterprises in central area etc. Land that is agriculturally important should be protected from inappropriate development.*
 - o *Industrial development should be promoted in appropriate rural areas.*
 - o *Environmentally sustainable agricultural practices should be promoted.*

Waterways

Policy should be formulated in relation to inland waterways, taking account of the following issues:

- *The leisure and amenity potential of the inland waterways of the region should be investigated and promoted where appropriate, particularly in line with the tourism industry.*

- *Re-opening of canals and connections between them should be prioritised as a major element in the identity and tourism potential of the region.*

Bogland

The following issues should be considered:

- *Alternative uses for cutaway and cutover boglands should be investigated, particularly in relation to the alternative and renewable energy industries.*
- *The prominence of boglands in the social, economic and cultural development of the region and as a defining element in its identity should be recognised and promoted.*

Forestry

The following issues should be considered in formulating forestry policies:

- *Deciduous forestry should be promoted as an alternative land use in suitable areas of land, particularly in areas of agricultural decline.*
- *The amenity and leisure and other spin-off industrial potential of forestry should be promoted in tandem with afforestation or re-afforestation plans.*

Natural and Built Heritage

In summary, to capitalise on the heritage assets of the region, the following issues should be considered:

- *Common heritage themes should be utilised to promote and market an identity for the region, for its internal population and in terms of the tourist industry.*
- *Heritage elements should be protected through a co-ordinated effort between all four planning authorities to ensure consistency of approach.*

Extractive Industries

Extractive industries are based on a finite resource that needs to be managed in a sustainable manner, taking account of the following aspects:

- *Extractive industry should be monitored in line with best practice Guidelines issued by the industry.*
- *The importance of the aggregates industry to ensure an adequate supply of aggregates to implement infrastructure under the NDP is acknowledged, as is the requirement to protect this non-renewable resource.*

1.3.3 Longford County Development Plan, 2015-2021

The County Development Plan outlines several landscape policies in relation to landscape, which are mainly contained in Section 6. Additional policy areas including the settlement strategy at Section 2.1.6 and rural areas at 2.1.6.5 and 3.2.2 also outline policies in relation to landscape and environmental protection.

Section 3.2.2 relates to sustainable rural policy, including the aims of minimising the negative impacts of development on agriculture and the landscape and minimising the spread of urban generated rural housing around existing pressure areas and sensitive landscapes.

Policy WS6 contains policy to restrict and curtail development in areas of known aquifer vulnerability.

Annex 3 refers to the proposed design guidelines – it is proposed that this landscape character assessment will inform the formulation of the design guidelines; therefore, the preparation of both documents should be carried out in tandem. It should be noted design guidelines have also been prepared and are in form.

Section 3.2.2.1, policy HOU RUR 1 deals with the suitability of a development in terms of the sensitivity of the rural area.

Policies HOU RUR 2, 3 and 4 deals with the sustainability of rural houses based on those who intend to reside in them.

Section 4.5 deals with tourism policy, which includes the extension of amenities, water based and walking in particular. Several areas are listed as base locations for the utilisation of specific natural resources while protecting them from unacceptable degradation as a result of their usage.

Chapter 6 states that the planning Authority will control development in protected areas – scenic views and prospects, ridge lines, broad zones of the lakes, European sites- where this has the potential for negative impacts on the scenic, heritage and cultural assets of the County.

Chapter 6 deals with environment and amenities and issues such as sustainability, prevention of pollution, litter, conservation and protection of heritage and amenities and recreational amenities. Sections 6.1 and 6.2 are possibly of most relevance to this document. The chapter covers policy on the conservation and preservation of monuments, Archaeological, architectural and heritage objects, flora, fauna and wildlife habitats, landscapes and inland waterways, geology, gardens and parks. European sites are listed in section 6.2.2. of the Plan.

1.3.4 Conclusion

The policies outlined above set a clear and positive framework for the protection and enhancement of landscapes in County Longford and the natural resources, cultural heritage and social identity that lies within and arises from them.

2. LANDSCAPE CHARACTER

Character can be defined as a distinct, recognisable and consistent pattern of elements in the landscape that makes one landscape different from another. Landscape character assessments differ from landscape evaluations in that they attempt to *classify* landscapes on their individuality rather than defining one as better as or worse than another.

Landscape can be defined as embracing all that is visible when looking across an area or areas of land. Longford County has a varied and diverse landscape for its small physical size. The upland areas of the northern county contrast sharply with the gently undulating pastoral land of the south and south east, the flat clear views over the Shannon wetlands to the river to the west, Lough Ree to the south-west, and the acres of boglands, wetlands and woodlands throughout the County.

The landscape of the County is not only important in the attraction of tourists, as has been the major emphasis on landscape preservation in the recent past. The distinctive topography, landcover and landscape elements of the County lend its population and communities a sense of identity and belonging. The aim of landscape character assessment is to identify the elements of the landscape which create this uniqueness and the extent to which it is possible to alter these landscapes before unacceptable consequences arise. The following are examples of such consequences:

- Unacceptable degradation of environmental quality, as in the case of pollution of potable water supplies/fish kills etc.
- Loss of irreplaceable archaeological artefacts.
- Loss or fragmentation of important natural habitats.
- Irreparable damage to architectural heritage.
- Privatisation of access to lakes, rivers, heritage items and scenic areas.
- Visual destruction of important areas that are recognised as fundamental elements in the identity of the county.

The guidelines propose that all Local Authorities classify the landscapes in their area according to their character, values and sensitivity. The character is defined as a product of landform and landcover, including vegetation and land-use.

Every act of development changes a landscape. This change can be positive, neutral or negative. It is government policy that in deciding for or against development that the appropriateness of that development within the given landscape context, as defined by this landscape character assessment, be considered.

2.1 County Overview

2.1.1 Landform

Landform is concerned with the spatial and formal arrangement of landscape components as a natural product of geological and geomorphological history.

(a) Topography

The topography of the County can be roughly divided into three types; flat wetlands in the basins of the Shannon and Lough Ree to the south and southwest, the Inny to the northeast and central peatland areas of the County.

The north and northwest is characterised by typical drumlin topography, with the southeast distinguished by the gently undulating limestone pastureland of the Irish Central Plain.

(b) Geology and Soils

Much of the underlying geology of the County is predominantly carboniferous limestone. Ordovician and Silurian shales intrude to the northeast. The bedrock geology of the County is illustrated in greater detail in the accompanying geology map. However, there is no absolute data on the drift/surface geology that occurs within the County. The Geological Survey Ireland (GSI) hopes to conduct a full study of the County, including details on the surface geology, which will be available in 2009-2010. This data will allow for a more detailed characterisation and description of the evolution of landscape character within the County.

A layer of glacial till overlies this geology and has been moulded in places to form Drumlins. This geology results in moderately well drained clay loam soils over much of the County, with bands of poorly drained clay loam and an associated fringe of poorly drained silting clay loams with inter drumlin peats to the north of the county.

To the west of the county lie vast expanses of basin peat with some marshland. Some of the lands adjacent to Lough Ree are comprised of shallow, well-drained loams.

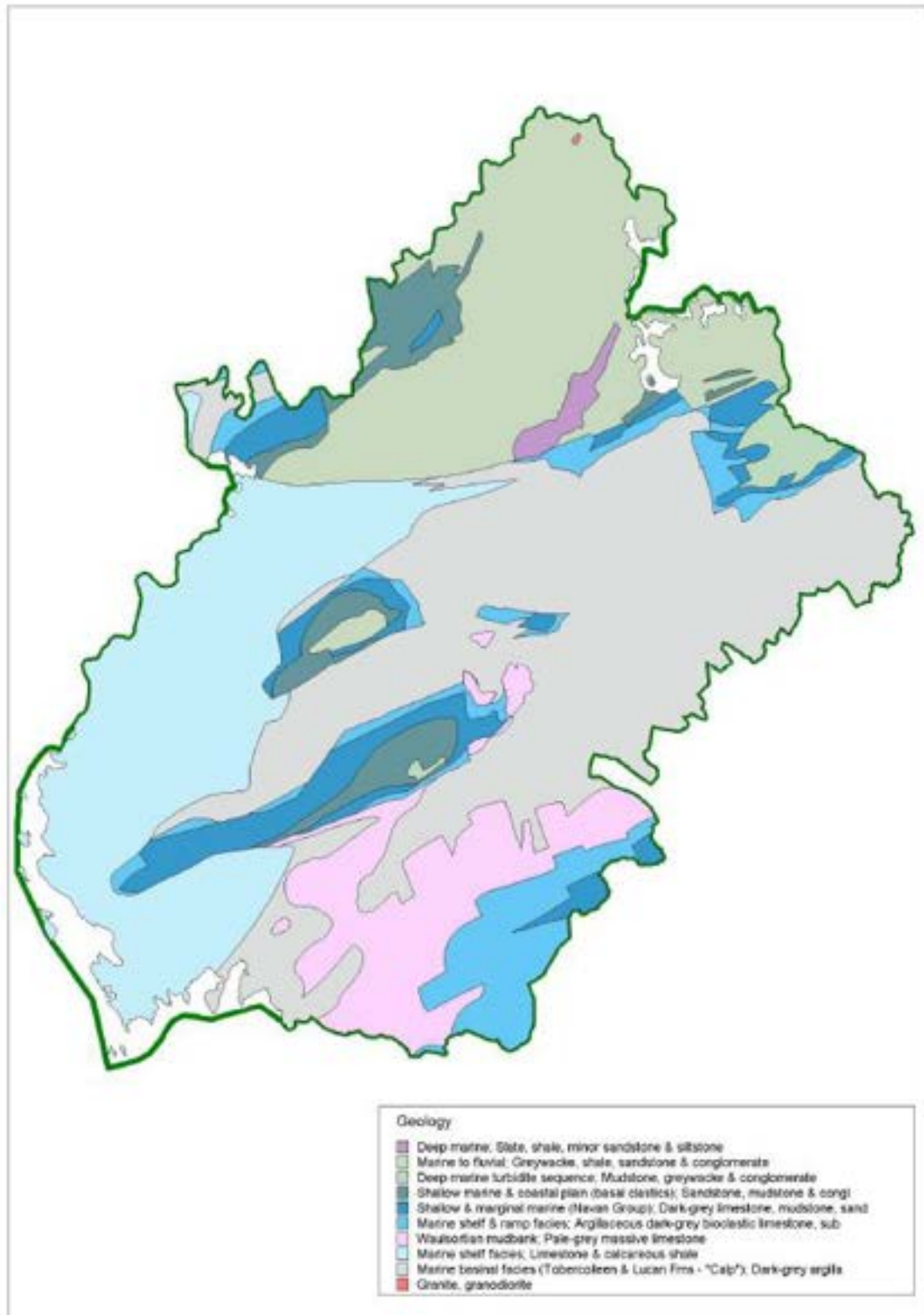

Bedrock Geology of County Longford (Source GSI)

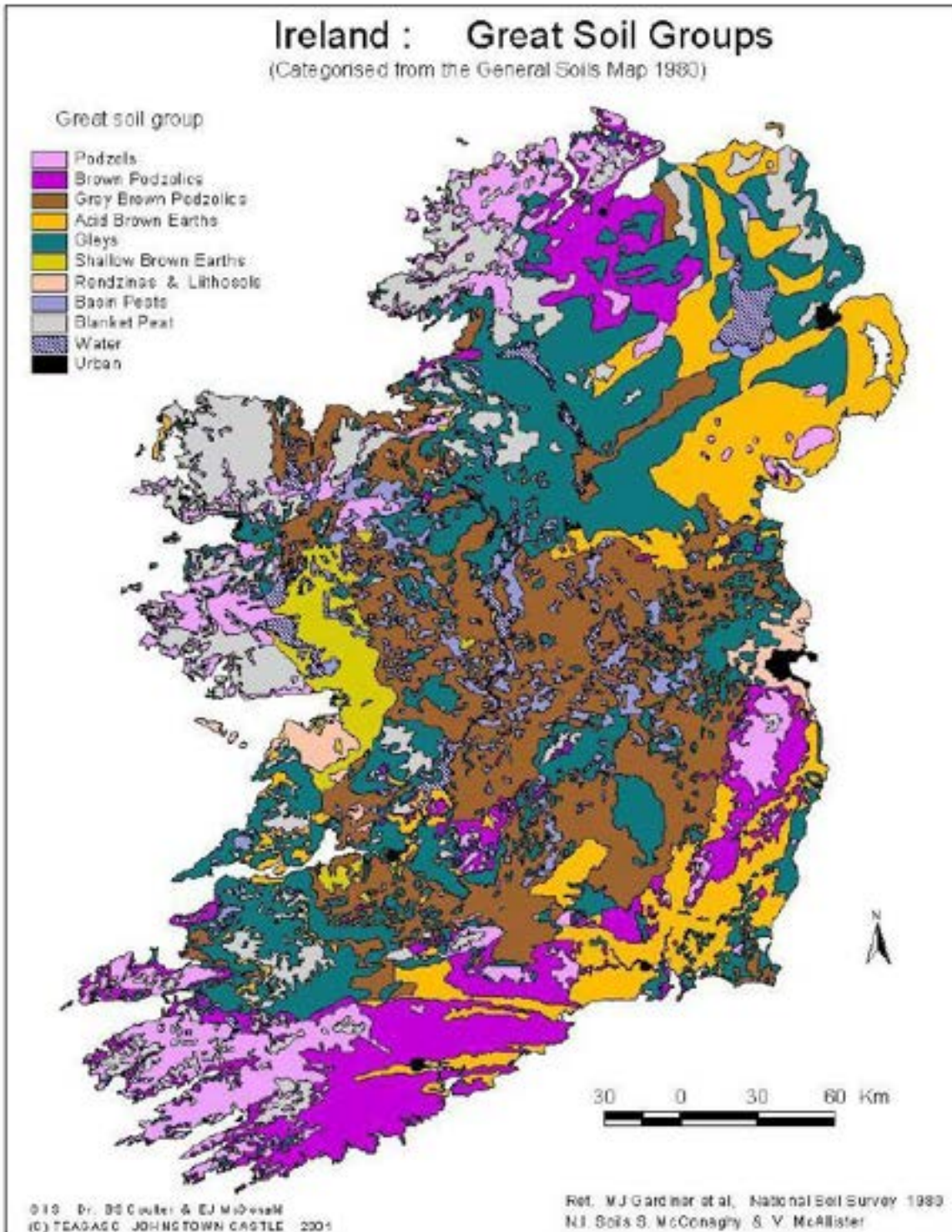

Soil types have an extensive influence on the environment of the County, dictating the landcover and land use and the extent of both. All aspects of life are influenced either directly or indirectly by soil types, including settlement patterns, transport routes, communications infrastructure, location of archaeological deposits and economic activity. Soils represent an important and non-renewable natural resource.

Longford County can broadly be categorised into three areas for classification under the great soil groups. The north of the County (the area mainly above the 100m contour) is mainly composed of gley soils, while a broad strip of basin peats runs diagonally from mid/north west to south east. Pockets of gleys and basin peats abound throughout the County. The remainder of the soils are broadly classified as grey brown podzolics. The map shown on the previous page indicates illustratively the soil groups that can be found within the County.

Gley soils are heavy, poorly drained soils not given to arable cultivation without extensive drainage and artificial enrichment. This is reflected in the pattern of agricultural activity in the northern section of the County, which tends to have smaller, more fragmented landholdings with extensive farming practices.

Landspreading of farm effluent and application of fertilisers in these areas is a delicate balance, given the poor permeability of the soil and the proliferation of waterbodies in this area, many of which are protected as European Sites and vulnerable to eutrophication through excessive nitrate run-off from land.

Threats to surface water are further increased through the poor viability of these smaller farm units as permission is sought for dwelling sites to augment farm incomes and the soil's poor percolation characteristics render them unsuitable in the most part for conventional septic tank methods of domestic effluent disposal. These problems are consistently highlighted by the Northern Regional Fisheries Board in submissions on planning applications in the area.

Due to their relatively poor agricultural characteristics, a substantial portion of these soils has been subject to afforestation, with substantial and long-term visual impacts. The forestry industry has now turned toward the use of more productive soils. The implications of this trend have yet to become apparent, but it may include the proliferation of non-managed exotic monoculture forestry tracts in previous permanent pasture regions and large areas of acidified soils.

The peat soils of the County have been harvested in antiquity, yet only on an industrial scale over the last few decades. The large scale harvesting of peat has an inordinate visual impact, given the flat nature of the landscape in which it is found and, as such, the visibility of the operation and its results over large distances.

The method of harvesting also contributes to the visual impact with large mounds of plastic covered milled peat glinting in the sunlight for kilometres and large amounts of airborne particulates being generated and dispersed during dry weather.

The biggest single environmental impact of peat harvesting is its subsequent burning to generate electricity and heat, instantaneously releasing CO₂ that has remained locked inside this carbon sink for thousands of years and contributing to the global greenhouse effect. The power station at Lanesboro in the west of the County, operated by ESB and Bord na Mona, also abstracts water from the Shannon for use as a coolant. This water is then returned to the river at a substantially higher temperature, impacting on the flora and fauna of the river system at this point.

The re-use of cut-away bog is an important issue that has yet to be addressed, that may have wide-ranging implications across a broad range of environmental sectors. This is also true of the power station itself, due for decommissioning in the next two decades.

Grey brown podzolics are more suited to agricultural practice, reflected in the number of larger landholdings and intensive farming, particularly dairying, where these soils exist. These areas exhibit a distinct landscape character, typified in the “Goldsmith Country” of the southeast County, where verdant rolling pastures predominate, with intermittent stands of mature trees and crumbling demesne walls.

Mapping of geology, in particular the drift geology, in the Longford area is poor to date.

(c) Drainage patterns

Most of County Longford is situated in the Shannon basin and lies along the north eastern shore of Lough Ree. The northern section of the County lies within the Erne catchment to the southwestern shores of Lough Gowna. The major Rivers in the County are the Camlin, which drains the midsection of the County and meets the Shannon at Clondra and the Inny, which runs along most of the southeastern county boundary to enter Lough Ree south of Ballymahon. The map overleaf shows the River Basin Districts.



Numerous lakes dot the northern section of the County, the largest of which is Lough Gowna, forming the boundary with Cavan. The north-western boundary of the County is formed by a string of lakes along the Leitrim border.

2.1.2 Landcover

Landcover in County Longford can be broadly categorised into several areas as indicated in the thematic map shown below (based on Teagasc and Corine data).

As can be seen, the dominant landcover category is dry grassland, which indicates the continued importance of agriculture in the landscape. The interspersed bog and fen, much of which is cutover and reclaimed, also represents a significant element in the landscape.

2.1.3 Human Influence

(a) Settlement pattern

The current County Development Plan, 2009-2015, identifies forty-one (41) designated settlements, which are relatively evenly dispersed throughout the County between north and south. There appears to be a current trend towards more dispersed forms of rural settlement. It is a stated aim of this character assessment to evaluate the ability of certain landscapes to absorb such settlement forms and inform policy decisions accordingly.



The population of Longford has been subject to devastating changes since famine times which had a dramatic impact on the settlement pattern of the County. Between 1841 and 1996 Longford County lost a staggering 74% of its population (from 115,491 to 30,166).²

² "North Leinster" Casey C. Rowan A., 1993 Penguin

This historical trend of depopulation would appear to be reversing, with a modest 3% population growth between 1996 and 2002 being followed by a more substantial 10% growth up to 2006. Census 2011 results show that Longford's population has continued to grow strongly since Census 2006, increasing by 4,609 persons to 39,000 persons. This represents an increase of 13.5% per cent over the 5 year intercensal period. The implications of this growth on the landscape are inevitable, not just at a County level but also on a national one, as demands for accommodation, transport and communications and other modern essentials spiral upwards.

Several major architectural phases are represented in County Longford, indicating the length and intensity of settlement within the County. The following are some examples:

- Prehistoric: Corlea Bog trackway, Flint implements at Lough Kinale
- Early Christian/Celtic Churches: St. Mels, Ardagh, St. Diarmuids, Inchcleraun Island
- Medieval: Chancel Church and Augustinian monastery, Inchcleraun, Abbeysrule,
- Abbeylara, All Saints Priory, Saints Island, Clondra Abbey, Rathcline castle, Castlerea, Elfeet, Mornin.
- 16th/18thc: Castle Forbes (built 1628, rebuilt after fire 19thc) Water garden, Rathcline Castle, Market house, Longford
- 18th/19thc: Ledwithstown house, Ardagh Glebe, Castle Cor, St. Johns Church, Longford, Kilcommock (ruin), Courthouse, Longford, Clock tower, Keenagh, Coolamber Manor, Carriglass Manor, Ballymacormack COI, Newtownforbes COI, Ballinalee COI, Killoe COI, Forgney COI, Ardagh COI, Ballymahon COI, Keenagh COI, Edgeworthstown COI, Taghshinny RCC, Newtowncashel RCC, Lanesboro RCC, Market house Ballymahon.
- Victorian: St. Mels Cathedral, Longford, St. Mel's Diocesan Seminary, Longford, St. Mary's Granard, Edgeworthstown RCC, Longford and Edgeworthstown Railway Stations, Bank of Ireland, Longford, Ulster bank, Longford, rebuilding of Castle Forbes.

It should be noted that the presence of these features might not accurately illustrate the age of a particular settlement but rather the static nature of development in a particular area.

Significant work has been carried out by the Department of the Environment, Community and Local Government in the identification of architectural structures of merit throughout the County through the preparation of the National Inventory of Architectural Heritage. This inventory is invaluable in the augmentation of the list of protected structures for the County, a process to be carried out in tandem with the preparation of the new County Development Plan.

(b) Agriculture

While the agricultural industry remains an important element in the national and local economy, it is extremely vulnerable to global changes and EU policy reform. The habitats map illustrated above indicates the dominance of agricultural land in a County context. Substantial changes in the maintenance and management of agricultural land will therefore have an inordinate visual impact at this level.

Recent changes in agricultural practices have led to trends toward enlargement in the more fertile, south eastern areas of the County, while fragmentation has occurred in the less profitable drumlin landscapes of the northern County, as farmers strive to maximise farm income from smaller, less fertile tracts of land. Farm fragmentation often occurs in the form of selling of half-acre sites for houses along road frontages. This coupled with the fact that the land in these areas is amongst the poorest in the county, the most elevated and visible, the least efficient in terms of the disposal of domestic effluent and require the removal of substantial sections of hedgerows for access purposes, the potential for landscape impact is particularly high.

Grant aid and legislation are major factors in the determination of farming practices throughout the County. Schemes such as the Rural Environmental Protection Scheme promote environmentally sensitive practices and are taken up to a greater degree throughout the County. Habitat identification and conservation, hedgerow replacement and maintenance and watercourse protection are some of the measures introduced relating to landscape.

The introduction of the nitrates regulations, in tandem with grant aided schemes for the construction of farm buildings and effluent storage, have the potential to create a significant visual impact throughout the County. The number of planning applications for slatted sheds increased significantly during this period. These regulations also place limits on livestock numbers on land which may influence vegetation growth, particularly in marginal areas where poaching is a particular problem over the winter period.

(c) Forestry

The development of forestry has a significant impact on the landscape of the County, particularly as areas chosen tend to be marginal and elevated, two factors that can equate with the most scenic areas of the County. The most familiar landscape impact of forestry is the use of non-native species planted in strong geometric patterns in elevated areas that create a stark and artificial impression when viewed from a distance. Attempts have been made to address this issue through guidelines adopted by the industry in new planting, such as careful mix of species, particularly along forest edges and maintenance of the harvest to minimise negative visual impacts.



Areas of Forestry within the County

However, there are several more subtle ways in which forestry can influence the perception of landscape. The slow and steady growth of trees can lead to the gradual and therefore imperceptible loss of views and prospects that might otherwise have been framed or enhanced by judicious and well planned planting.

(d) Archaeology

Proposals to include Archaeological landscapes have been included in submissions to the County Development Plan. As can be seen from the following map which illustrates the Record of Monuments and Places, the County is rich in archaeological heritage, particularly in the Granard area.

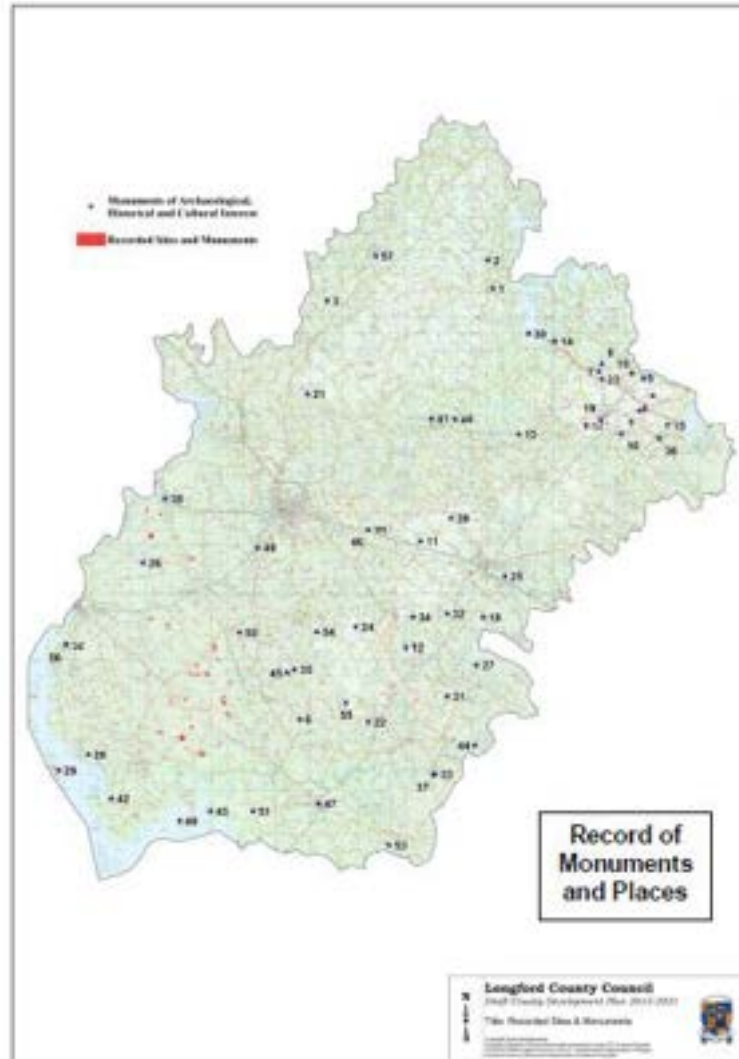

Record of Monuments and Places

It is proposed that the Council engage in consultation with the relevant section of the department of the Environment, Community and Local Government in order to designate, protect and promote awareness of this heritage aspect. The DoECLG have proposed the designation of archaeological landscapes, which will cover areas of intense archaeological deposits. It is suggested that any such designation, once complete, should form part of this assessment.

(e) Culture

It is envisaged that the preparation of this document will run in tandem with the preparation of the heritage plan and result in the identification of the cultural elements

that make Longford unique so that these can be protected and or promoted as part of the Council's duties and activities.

Cultural heritage includes landscapes made famous by literary figures, mythological legends and historical events. Festivals, fairs and community activities may also be included, particularly where they have a spatial dimension.

2.2 Landscape Character Units

The Clare Landscape Pilot Study differentiates between Landscape Character types and Landscape character areas. **Landscape character types** (LCT) are defined as landscapes that may occur in many areas throughout the Country and are composed of similar combinations of elements such as topography, geology, drainage and settlement patterns, landcover and use. **Landscape character areas** (LCA) are sections of the County that are treated as a unit in visual and physical terms, and that may consist of several landscape character types.

Landscape Character types in County Longford would include the peatlands/wetlands, Shannon basin and northern uplands. Landscape character areas are the individual representation of a landscape character type, e.g. Begnagh Bog.

Longford is a relatively small County with a low number of well-defined Landscape Character Types. These broadly correlate with Landscape character areas, as they tend to be geographically specific and the predominantly flat nature of the landscape facilitates topographical definition of units. For this reason, it is considered that a landscape character unit, combining both LCA and LCT as defined in the guidelines, is an appropriate method of assessment in this instance.

In broad terms, there are seven basic landscape character units in Longford which are illustrated on the map overleaf (Please also consult Appendix 1 for maps of each area.)

- **Unit 1 – Northern Drumlin Lakeland**
- **Unit 2 – Northern Upland**
- **Unit 3 – Shannon Basin/Lough Ree**
- **Unit 4 – Central Corridor**
- **Unit 5 – Inny Basin**
- **Unit 6 – Peatlands**
- **Unit 7 – Open Agricultural**

A general overview of the County is provided, following which each Character Unit is assessed in turn, providing details on the landform, characteristics, threats and degree of sensitivity of each area.

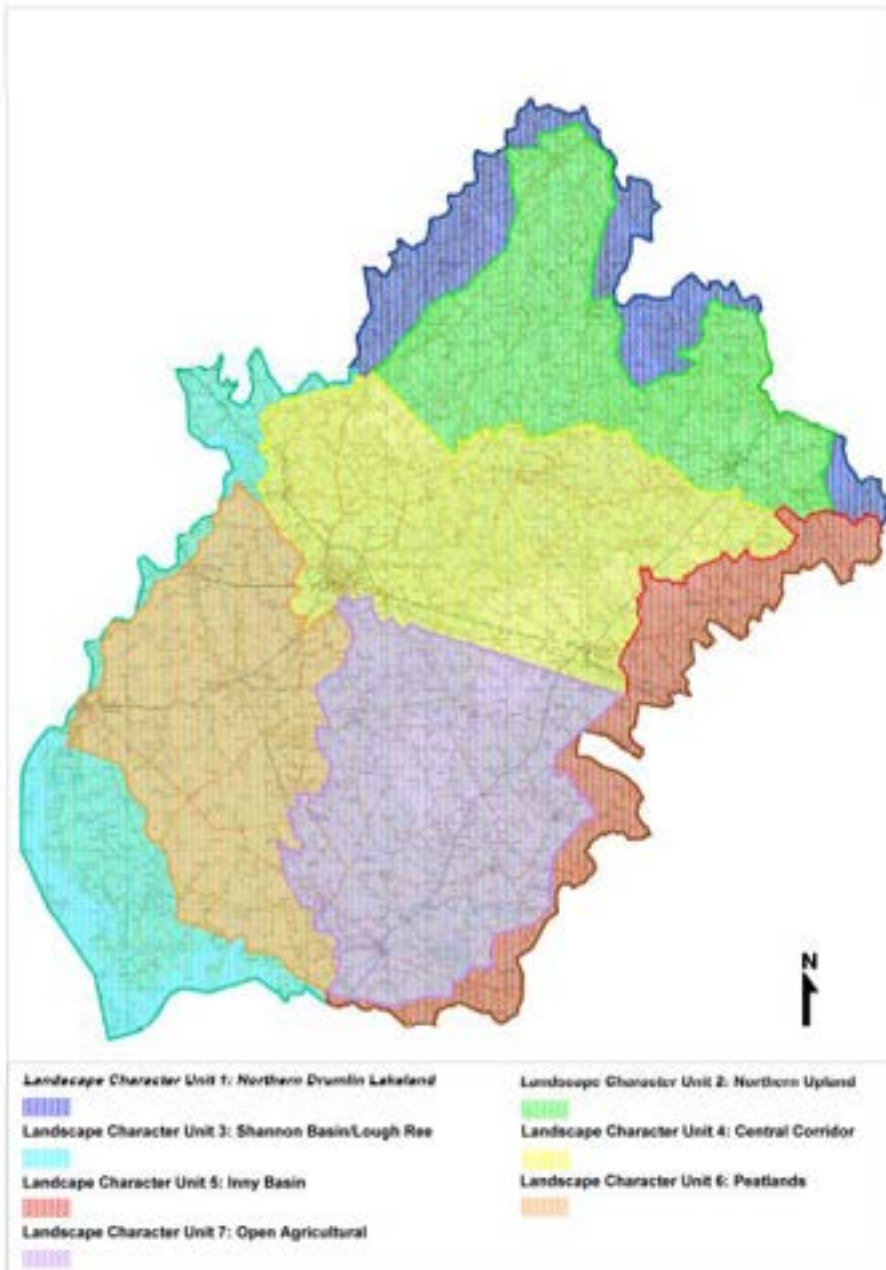

Landscape Unit 1 – Northern Drumlin Lakeland

Location and Physical Characteristics

This area consists of the North West fringe of the County and extends from Drumlish in the west to the County boundary in the north. This landscape unit also includes the areas surrounding Lough Gowna and Lough Kinale in the east of the County (also see map of the area in the context of Longford in Appendix One).

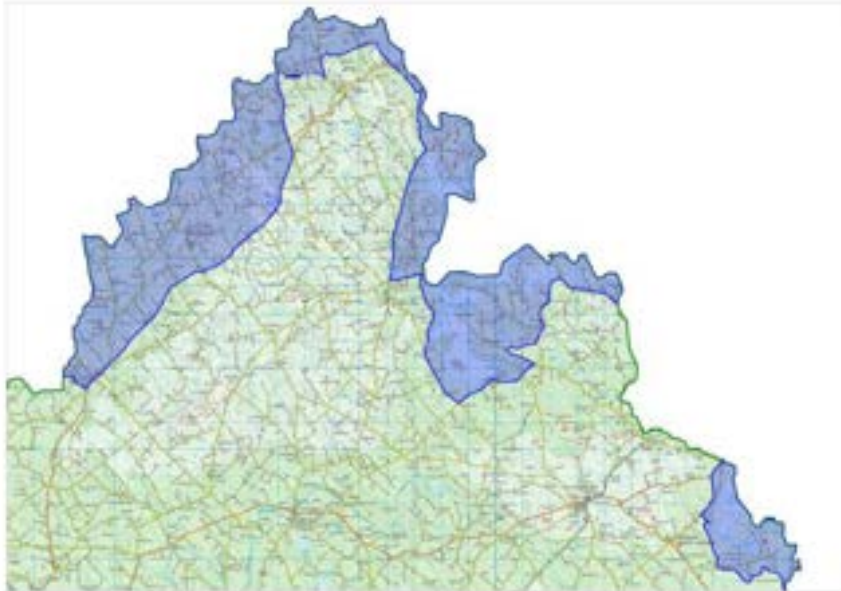

The southern boundary is mainly formed by the R198 Regional route from Longford to Arva, the Aughnacliffe to Enaghan Road and other relevant features such as the 100m contour line.



Lough Sallagh in the North-West fringe of the County

Views are available to the north into Counties Leitrim and Cavan, which more or less mirror the landscape inside the Longford Boundary.

- **Landcover**

Landcover consists of predominantly small agricultural holdings, interspersed with bogland, which becomes more dominant toward the eastern boundary of the unit and lakeland areas that dominate on the western County Boundary.

- **Topography**

The area primarily consists of rolling drumlin landscape, with agricultural land tending to be tightly enclosed and bounded by small but well established hedgerow species, at times permitting limited views of the string of lakes that border the County.



Annagh Lough

- **Geology/Soils**

The soils in this area are predominantly poorly drained gley soils with some peats.

- **Drainage patterns**

Drainage patterns are extremely complex, giving way to peatlands in the valley of the Black River and the vicinity of Annagh Lough. This area type includes the Lough Gowna Complex to the northeast of the County (included in An Foras Forbartha Inventory of Outstanding Landscapes in Ireland, 1977) and Lough Kinale and Derragh Lough in the northeast.



Lough Nabelwy

Drainage is divided between the two major River catchments of the Shannon to the southwest and the Erne to the northeast.

Human Influence

- **Settlement pattern**

The settlement pattern in the area is highly dispersed due to the nature of the topography and its influence on the agricultural practices in the area. Drumlish and Ballinamuck are the only settlements in the area, with the main concentration of development centred on these villages.



Drumlish has seen a substantial level of development over the period of the previous two Development Plan periods relative to its size with a number of recently added housing developments situated within the development boundary.

Ballinamuck has also experienced a level of housing development in recent times but at a much lesser rate to that of Drumlish.

- **Transport and Communications**

The road pattern throughout the area is relatively sparse with an emphasis on north-south communication.

The undulating drumlin nature of the topography of the area is unattractive to mobile telephony infrastructure and other masts/antennae support structures, these preferring the higher ground of the adjacent areas, while retaining strong intervisibility from this area.

- **Agriculture**

Agriculture tends to be extensive and part-time in nature, given the limited capacity of the soils in the area. Farms tend to remain fragmented, which reinforces and perpetuates the patterns of small, tightly packed fields and highly dispersed settlement.

Pylons, Farmullagh



- **Industry and services**

Industrial development in the area is limited given the lack of concentrated settlement and the poor road network.

In common with the majority of rural areas throughout the Country, utility poles and overhead wiring line the roadsides and traverse fields. Two sets of 110 kV electricity lines and their associated pylons enter the County at Farmullagh and Corglass and create a striking landscape impact.

Coarse fishing and angling on the numerous lakes is an important element of the tourist industry in the area.

- **History, Archaeology and Culture**

Known Archaeology in the area is comparatively sparse, with the exception of the islands and shores of Loughs Gowna and Kinale and in the vicinity of Cloonagh and Mullinlaghta to the east of the area. The Black Pig's Dyke, an important linear earthwork, commences at Dring on the southern shores of Lough Gowna and runs down toward Lough Kinale.

The 1798 battlefield and associated sites and monuments are significant culturally important items and are located at and in the vicinity of Ballinamuck.

- **Recreation and Amenity**

The potential for recreational and amenity development in the area is high, given the lakeshore frontage that exists for walking, angling and swimming. The local community has established a swimming pool at Annagh Lough.

Landscape Sensitivity

The sensitivity of much of this landscape can be classified as **LOW to MEDIUM** with some **HIGH** sensitivity in the vicinity of the lakes and designated scenic routes.

Threats

- Loss of inherent character due to altered landscape management practices arising as a result of EU agricultural policy reforms/further decline in agriculture.
- Removal of existing network of hedgerows and boundaries distinctive to the area through farm fragmentation/road frontage and ribbon development.
- Loss of integrity of important historical sites and cultural heritage, such as 1798 battlefield, due to insensitive or poorly located development.
- Agricultural activity and residential development in the vicinity of the lakes threatens water quality and fish stocks.
- Unsympathetic residential or amenity development at lakeshores or within their visual areas.

Opportunities

- Dense field patterns and substantial boundaries provide an enclosed landscape that can accommodate appropriately sited development without major landscape change.
- Opening up of access to lakeshores for amenity purposes.

Policy Responses

- Support appropriate development in areas of population decline.
- Encourage setting back of dwellings into fields retaining existing plot size and boundary treatment.
- Permit hedgerow removal only where necessary for road safety and, where removal is required, encourage replacement with native hedgerow species.
- Encourage access to lakes and watercourses and development of tourist accommodation within or in the vicinity of settlements, while monitoring amenity development /restricting access in environmentally sensitive locations.
- Restrict housing on lakeshores and within their visual areas.

Landscape Unit 2 – Northern Upland

Location and Physical Characteristics

This unit consists of the central northern section of the County, stretching from Drumlish in the west to Moyne in the north, Esker in the south and including the towns of Granard and Abbeylara in the east, up to and including the county boundary with Cavan.

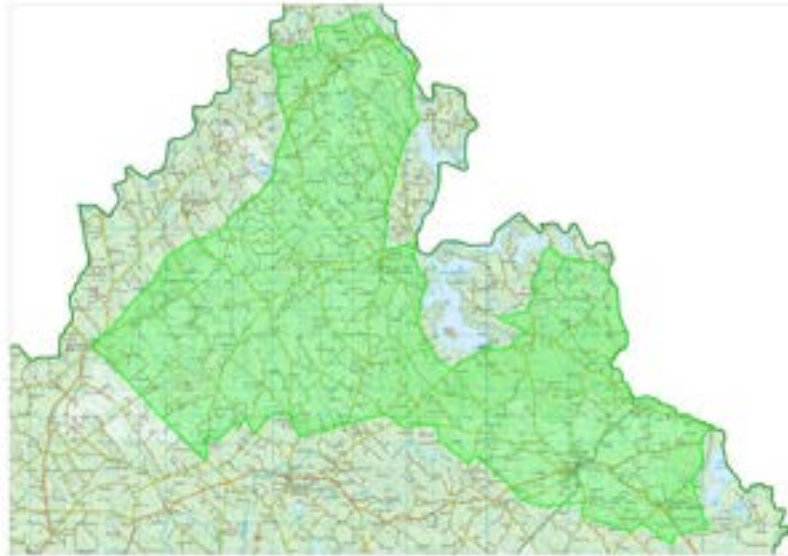

Many of the important views listed in the County Development Plan are located in this landscape unit.

- **Landcover**

Forestry is well established in the area with large coniferous and mixed forestry tracts at Corn Hill, Edenmore and Crott, with smaller pockets scattered throughout the area.



Boggy areas predominate to the western boundary in the lower reaches of the river valleys where drainage becomes sluggish and a transition zone is formed between Landscape units 1 and 2.

- **Topography**

The majority of this unit lies above the 100m contour line to the north of the County and contains Corn Hill, Edenmore and Crott.

Visible from a significant distance, given the flat nature of the surrounding Midland and Border Counties, the highest point is 278m at Corn Hill. There is high intervisibility between this area and other isolated upland areas such as Ardagh Mountain in the south of the County, the Hill of Uisneach in Westmeath and Sliabh Bán in County Roscommon.

- **Geology and Soils**

Predominantly Gley Soils, much of which is in typical drumlin formation.



- **Drainage patterns**

Drainage in the northern section of the unit is dominated by the Lough Gowna Lake complex, which falls under the catchment of the River Erne. The southern portion is drained towards the Shannon via the Camlin and Inny Rivers and their tributaries.

Human Influence

- **Settlement pattern**

The main settlements within this unit are Granard, supported by the villages of Abbeylara, Moyne, Legga, Bunlahy and Aughnacliffe.

While there has been significant activity in terms of planning applications in Granard and environs recently, few of these have been translated into actual development.

Abbeylara, a short distance to the southeast of Granard has also seen significant growth over recent times.

The village of Aughnacliffe (overleaf) and its environs enjoys views over Lough Leebeen and Lough Gowna, a possible factor in the number of development proposals in the area – over 100 dwellings have been granted in the village over the previous two Development Plan periods, a portion of which have been developed. Many of these new developments are highly visible due to the steeply undulating nature of the topography of the village, which provides enclosure to and otherwise linear and ribbon-like settlement pattern.



Moyne and Legga are located to the north of the County near the Cavan border off the R198 regional route, while Bunlahy is located to the south of the area in the vicinity of Ballinalee. These settlements were designated due to their existing level of service provision and/or facilities, such as church, school, and crèche, playing pitches etc., which provide natural congregation areas. Development has yet to become established to any significant degree in these settlements.

Rural housing in the area follows the dense pattern of extensive agriculture and the complex road network, tending to be highly dispersed with some local concentrations.

- **Transport and Communications**

The area is served by an extensive county road network, which is heavily influenced by the elevated topography and associated drainage patterns. Many of these roads are little more than laneways through the hills and valleys and are substandard in width and alignment.

The height of Corn Hill in relation to the surrounding Midland topography has made it an attractive site for the establishment of communications masts, which remain a substantial landscape feature.

A portion of the now disused Cavan railway lies to the east of Abbeylara.

- **Agriculture**

Agriculture in this area tends to be extensive, given the poor soil, drainage and access characteristics, and results in a similar but somewhat less enclosed field pattern than

Landscape Unit 1. This more open feeling in the landscape may also be attributed to the elevated nature of the topography.



- **Industry and services**

Industrial development in the area is limited, with the exception of the Granard area, where the Keirnan Feed factory dominates the landscape for a substantial distance on the approach from Ballinalee. Other industrial developments, including Pat the Baker, are predominantly located within the town where their scale is contained, and their landscape influence is minimal.

The Roadstone Quarry at Moyne (left) exerts a considerable landscape influence over Lough Naback, however, this serves to lessen the influence of the pylons and associated 110kv overhead wiring traversing the unit from east to west at this point.



- **History, Archaeology and Culture**

This landscape area has a particularly high concentration of archaeological heritage, most notably to the eastern side of the unit where the megalithic tombs at Aughnacliffe, the Black Pig's Dyke running from Dring to Lough Kinale, the Abbey at Abbeylara and

the old town at Granardkille are substantial landscape features with important national heritage and mythological associations.

Holy wells are important cultural landscape features and are scattered throughout the eastern section of the unit.

- **Recreation and Amenity**

Mainly confined to sports grounds and GAA pitches.

Landscape Sensitivity

The sensitivity of much of this landscape can be classified as **MEDIUM** to **HIGH**

Threats

- Potential future development of large-scale utility infrastructure in the upland areas.
- Encroachment of forestry onto important upland slopes and interference with designated scenic views.
- Potential loss of material and/or integrity of setting of archaeological features and artefacts.
- Potential loss of character of existing towns and villages.
- Further loss of population in Granard creating settlement pressure in surrounding rural area and historic landscape.
- Encroachment on protected views by dwelling units.

Opportunities

- Towns and villages throughout the unit are capable of accommodating substantial additional development to remove pressure from sensitive areas.
- Potential for further tourism related development, particularly in Granard.

Policy Responses

- The development of coherent countywide framework for large-scale utility infrastructure including identification and designation of permitted and restricted areas.
- The concentration of heritage artefacts and features in the eastern section of this unit may warrant the designation of a specific historic landscape to ensure heightened public awareness and their continued protection.
- Facilitate co-ordination between Coillte/Department of Agriculture Food and the Marine and natural Resources forestry strategies and development Plan Policy.
- Develop identity and character in new developments in towns and villages through the application of area specific design criteria laid out in design guide.
- Protect views and prospects.

Landscape Unit 3 – Shannon Basin/Lough Ree

Location and Physical Characteristics

This unit is located along the western boundary of the County forming the border with Counties Leitrim, Roscommon and Westmeath and taking in the Rivers Shannon, Inny and Rinn and Lough Forbes and Lough Ree.



- **Landcover**

This unit has large amounts of water cover with inland marshes, bogland and tracts of deciduous forestry in the northern section around Lough Forbes. Land cover becomes less diverse travelling south of Lanesboro on the western shores of Lough Ree, with poorly drained agricultural land forming the majority of the landcover in the area.

Relatively small and isolated pockets of bog and marshland create important habitats at Fortwilliam Turlough, Commons North and Portanure, while the Portanure Pine Woods are an important stand of trees on the shores of the lake.

- **Topography**

Lough Ree is interspersed with several small, uninhabited islands and the predominantly flat landscape provides for panoramic vistas across the lake at numerous locations.

Small hills such as those at Newtowncashel, Cullentra and Rathcline (none of which break the 90m contour line) appear much larger in this context and act as punctuation marks in otherwise homogenous topography.

The area around Lough Forbes is relatively inaccessible and visibility limited due to extensive afforestation.

- **Geology**

Much of the geology in the area to the south of Lanesboro is classified as a regionally important aquifer.

The Geological survey of Ireland has classified this area as highly to extremely vulnerable by the Geological survey of Ireland (GSI - see map).

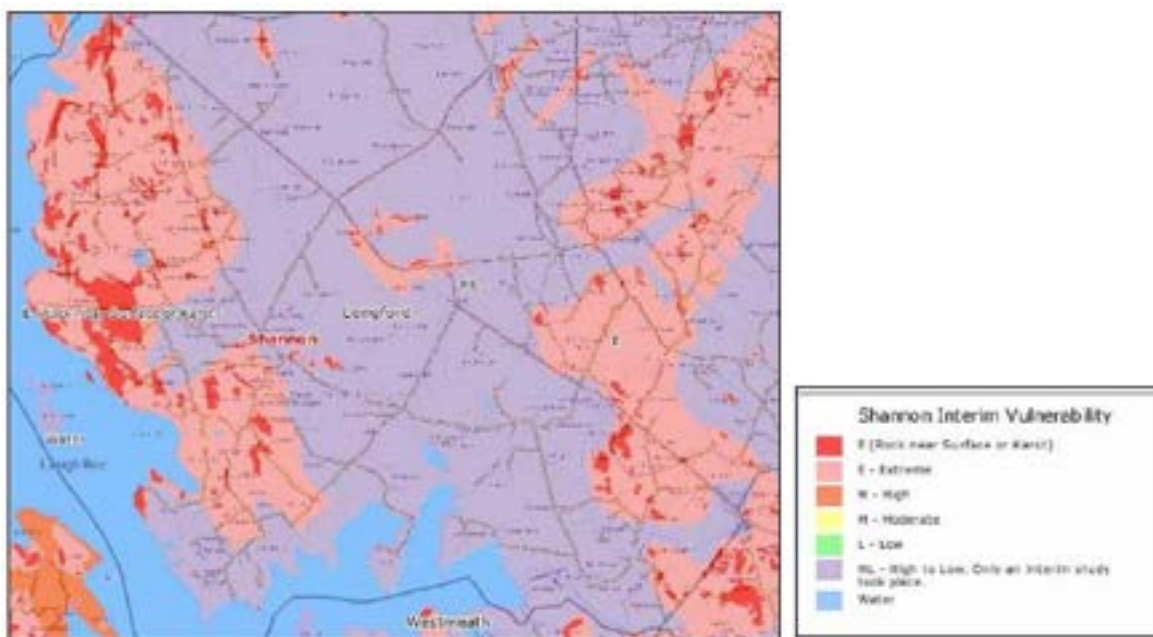

- **Drainage patterns**

The River Shannon enters the northwestern fringe of the County south of Rooskey, where it is joined by the Rinn River in Lough Forbes. Views of the watercourse are limited in this northern section due to a combination of local topographical and landcover characteristics.

The Shannon continues towards Clondra where it is joined by the Camlin River and on towards Lanesboro where it broadens out into Lough Ree. This area is particularly susceptible to flooding.

To the south of the County, the Inny enters Lough Ree via the Owenacharra River.

Human Influence

- **Settlement pattern**

The only significant settlement in the unit is Newtowncashel, a small village located in an elevated position commanding extensive views over the lake. The area has witnessed relatively low levels of development in recent times.

This lack of a defined urban or village structure means that the area is under particular pressure for once-off rural settlement, which is generally dispersed throughout the area, although to a lesser extent than the north of the County.

Some areas of concentrated ribbon development have occurred in the vicinity of adjacent settlements, such as Fisherstown at Clondra and along the Rathcline Road south of Lanesborough.

- **Transport and Communications**

The area is traversed to the north by three of the four national routes that run through the County, the N4 north of Newtownforbes, the N5 at Clondra and the N63 at Lanesborough. The remainder of the road network is relatively sparse except for the southern section and consists of third and fourth-class county roads and supporting networks of lanes and boreens.

- **Agriculture**

Agriculture in the area is, in a similar vein to the majority of the County, extensive in nature. The requirements of the nitrates regulations in terms of effluent storage and the structures required to facilitate these standards, is likely to have significant landscape impact over the coming years.

- **Industry and Services**

Industry and services are limited in the area given the highly dispersed nature of the settlement, however, those that exist have considerable visual impact. These include:

- County Council Water Treatment Plant – Lough Forbes
- Former denim factory (Burlington) at Fisherstown
- Power station at Lanesborough



The former denim factory at Fisherstown is an immense structure (in the region of 29,000m²) the impact of which is reduced given its isolated position, single storey nature and the predominantly flat landscape in which it is situated. The factory is currently occupied by a timber-frame dwelling distribution company.

- **History, Archaeology and Culture**

Castleforbes Demesne is a private estate located to the north of the unit within extensive woodlands.

Extensive early Christian remains are located in the south of the unit and on Saints Island and Inchcleraun.

Waterways corridor study has identified the potential for the discovery of underwater archaeology which is not addressed at present in the County development Plan.

- **Recreation and Amenity**

Access to and awareness of water courses and water bodies tends to be restricted in this area, given the limited road network in the vicinity and landcover barriers such as forestry and wetlands.

Parking and amenity areas have been established at Loughfarm, Bleanavoher and Barley Harbour.

An extensive amenity area has been developed south of Lanesborough, which is extensively used as a walking route by locals and has been zoned for further amenity related uses under the Lanesborough Local Area Plan.

Landscape Sensitivity

The sensitivity of the landscapes in this unit range from **MEDIUM** - along the southeastern border of the unit - to **HIGH** sensitivity - along the shores of the lake, islands, the riverbanks, and in the vicinity of the Aquifer.

Threats

- Pollution of ground and surface water sources from residential or intensive agricultural development.
- Inappropriate development and privatisation of lakeshores and riverbanks.
- Road network insufficient to cater for large numbers of visitors associated with tourism development.
- Loss of important archaeological and architectural features and/or their setting, underwater and lakeside archaeology in particular.
- Proliferation of invasive species – Japanese knotweed, rhododendron, zebra mussel – threatens biodiversity and ecosystem functioning.

Opportunities

- Development of Amenity areas along lakeshore.
- Development of accommodation base within existing village.
- Strong community involvement in village development (Tidy Towns).

Policy Responses

- Restrict development in the vicinity of the lakes and maintain aquifer protection zone for 1km around boreholes at Carrowroe.
- Effluent treatment systems in the vicinity of the lake to have nitrogen and phosphorous cleansing capabilities.
- Prepare Village policy statement for Newtowncashel to include provision for the protection of scenic route.
- Promote appropriate schemes for the control/eradication of invasive species.

Landscape Unit 4 – Central Corridor

Location and Characteristics

This area consists of the centre of the County and includes the settlements of Newtownforbes, Longford Town and Edgeworthstown extending in a northerly direction towards Drumlish in the west and Granard in the east. The southern boundary is mainly formed by the N4 National route from Longford to Mullingar.



- **Landcover**

As with the rest of the County, the main landcover constituent in this unit consists of agricultural pastures. The urban fabric of Longford Town, Edgeworthstown and Newtownforbes also cover extensive areas.

Deciduous and mixed forestry are present in pockets throughout the centre of the unit, notably at Carrickglass and Farraghroe.

- **Topography**

The land in this unit is relatively flat and low-lying, rarely breaking the 100-metre contour line, meaning that trees, field boundaries, buildings and other features generally restrict views over any significant distance.

This is contrasted with areas of distinct demesne type landscapes such as at Moatfarrell/Corbeagh.



View across agricultural landscape at Corbeagh

- **Geology**

Aquifer

- **Drainage patterns**

Drainage is toward the Shannon via a complex network of Rivers and Streams accessing the Camlin River, which is subject to seasonal flooding.

Human Influence

- **Settlement pattern**

The urban network is strongest in this area of the County, with a defined hierarchical system dominated by the settlements of Longford, Edgeworthstown and Newtownforbes, which lie along the main transport routes. Edgeworthstown and Longford exhibit a certain amount of commuter traffic to the Dublin area, but not yet to an economically significant degree.

Ballinalee is located to the northern portion of the unit and has experienced some development in recent times, consolidating the existing settlement within its defined envelope.

A Local Area Plan was prepared for Carrickglass in 2004, adding this area to the list of designated settlements in the County. There is little visibility into the remaining demesne, which is largely contained by mixed tree planting which forms a NHA due to its importance as a habitat. Permission has been granted for over 30 housing units, a retirement village, a hotel, golf course and the refurbishment of the protected manor house. The remaining elements outside of the main demesne walls, particularly the walled garden on the western side of the regional route, and the gates and lodges in the main demesne walls create notable landscape features and a particular atmosphere in the area.

Smaller designated settlements in the area include Kilnatruan on the R194, Enybegs and Coolarty.

Significant pressure exists for “one-off” housing development along the R198 regional route from Longford to Arva and there is an established ribbon development pattern in place in the Clonbalt/Cloonrollagh/Creenagh area. This pattern is repeated at Kilnashee and Cloonagh further north along this route on the approach to Drumlish.

- **Transport and Communications**

The road network is at its most dense at this point given the relatively favourable flat topography of the area. All four national routes (N4 – Dublin/Sligo N5-Longford/Castlebar, N55 Athlone/Cavan, N63-Longford/Roscommon) traverse this Landscape Unit.

The Dublin/Sligo Rail line traverses the County through the Central Corridor. Almost one-third of the planning applications for large-scale communications infrastructure in the County have been made in this area.

- **Agriculture**

Agriculture in this area is well developed in comparison to much of the County, with a wide range of agricultural activity, from large-scale dairying activity to smaller scale extensive uses, particularly to the west of the area.

- **Industry and Services**

The main industrial centre of the County is centred at Longford Town, with major installations at Lisnamuck/Templemichael, Townsparks, Ballymacormack and the Athlone Road.

Edgeworthstown has two large factories, C&D Pet foods and Paul & Vincent.

- **History, Archaeology and Culture**

A wide range of architectural and cultural heritage is present in this area, with the important occupied demesnes of Castleforbes and Carrickglass. Former settlements have left their mark on the landscape at Farraghroe, Corbeagh and Moatfarrell.

- **Recreation and Amenity**

A wide range of recreational facilities are available at Longford Town, including leisure centres and swimming pools, with planning permission granted for additional facilities in the vicinity and at Carrickglass and Edgeworthstown.

The Mall sports complex and walkway through Longford is an important and widely used amenity, augmented by Sli na Sláinte (around Longford bypass) and proposed for further links as part of the Longford Town Development Plan.

The Camlin River is a slow moving river. It holds good stocks of bream, roach and hybrids with some tench to 5lbs. Fishing is into depths of about 5ft to 10ft in normal conditions. There are some good stretches, but these can be difficult to find for first time visiting anglers. Anglers can have good sport here particularly during the early summer months. The Camlin River is part of the Midland Fisheries Group of Shannon Regional Fisheries Board managed waters and requires a fishing permit

There are also a number of GAA and soccer pitches within the Unit and a golf course in Longford Town.

Landscape Sensitivity

The sensitivity of the landscapes in this unit is generally **LOW**. Potential areas of **MEDIUM** to **HIGH** sensitivity exist in the vicinity of protected woodlands, riverbanks and in the vicinity of the Aquifer.

Threats

- Pollution of Groundwater sources in the vicinity of the aquifer to the north of Longford Town.
- Loss/fragmentation of important agricultural land/tree stands and woodlands.
- Continued ribbon development in pressure areas.

Opportunities

- High capacity for absorption of additional development.
- Existing strong urban network upon which settlement strategy can be based.

Policy Responses

- Restriction of development in pressure areas.
- Relaxed restrictions in areas of high capacity.
- Groundwater protection scheme to be installed around potential groundwater supplies.
- Important areas of agricultural land to be identified and protected from further fragmentation.
- Encourage use of existing large-scale communications infrastructure for future proposed developments.

Landscape Unit 5 – Inny Basin

Location and Characteristics

This area is located to the east of the County and forms the border with County Westmeath.

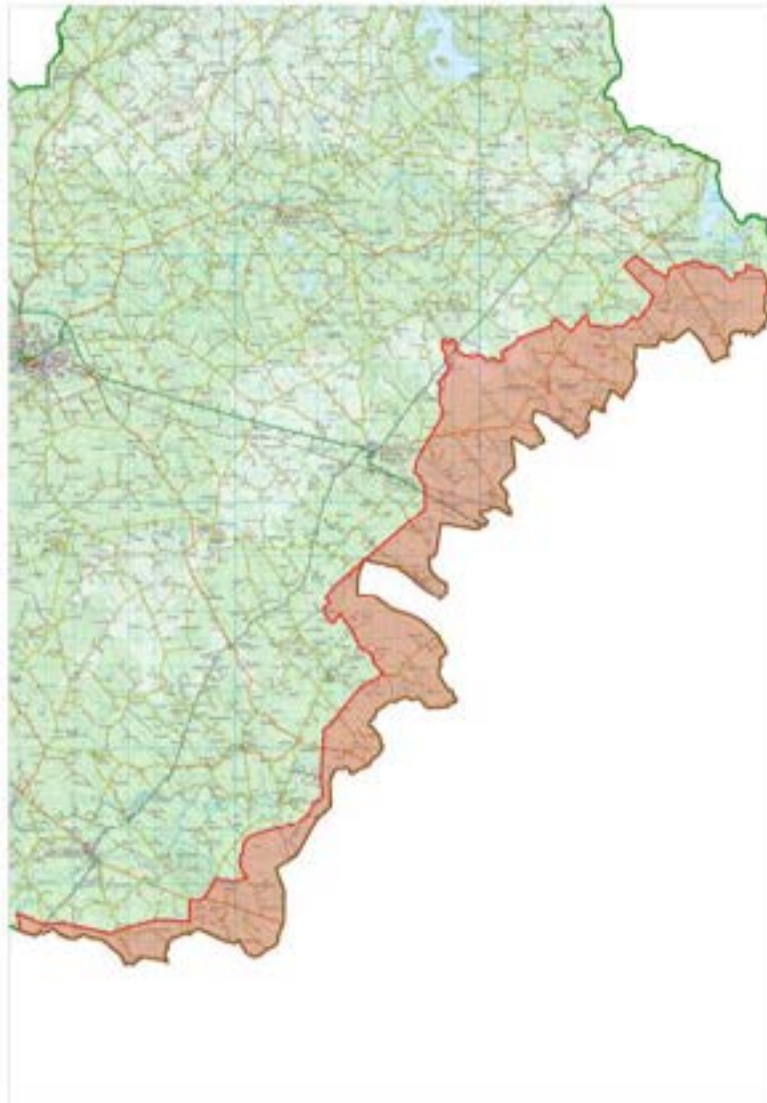

- **Landcover**

The landcover in this area is dominated by peatlands and mixed woodlands interspersed with pastures of varying quality.

- **Topography**

The area maintains a relatively flat and level topography.

- **Drainage patterns**

The Inny River makes its way from Lough Kinale in Unit 1 and follows the County Boundary for a time before veering south into County Westmeath and Lough

Derravarragh. The River re-enters County Longford east of Legan and continues west toward Ballymahon and onto Lough Ree.

The Inny dominates the drainage pattern of the area. Flows tend to be sluggish given the nature of the landcover and topography. There is one seasonal lake to the north of the region, however visibility of the lake and the River from the public road is poor and awareness of these features low, with the possible exceptions of locals and seasoned anglers.

Human Influence

The difficult nature of the terrain has meant that human influence on the landscape of the area has been limited in comparison to other units.

- **Settlement pattern**

There are two designated settlements in this unit, one in the south at Forgney and the other in the North at Lisryan. Settlement is greatest in the areas outlying Legan and Edgeworthstown, while Lisryan in particular has experienced some growth in recent times.

- **Transport and Communications**

The area is roughly bisected between north and south by the N4 and the Dublin-Sligo rail line running parallel. The remainder of the road network in the area is sparse, composed mainly of portions of County roads and small laneways.

- **Agriculture**

Agriculture in the area appears well developed in reclaimed areas.

- **Industry and Services**

There are few industries in the area given the limited road network and unstructured settlement pattern.

Services are generally confined to a local level, such as primary schools, shop, GAA pitch etc. and these facilities are generally located within the two settlements of Forgney and Lisryan.

- **History, Archaeology and Culture**

Coolamber Manor Goldsmith – Forgney Church, Hill, Pallas.

- **Recreation and Amenity**

Mainly confined to local GAA pitches.

Landscape Sensitivity

The sensitivity of the landscapes in this unit are generally **LOW**. Potential areas of **MEDIUM** to **HIGH** sensitivity exist in the vicinity of protected woodlands, riverbanks.

Threats

- Continued depopulation and associated loss of landscape management.

Opportunities

- Existing designated settlements in the area provide potential for population growth.

Policy Responses

- Target growth to existing settlements.
- Encourage provision of facilities to strengthen settlements.
- Facilitate rural housing where appropriate and in accordance with normal planning criteria.

Landscape Unit 6 – Peatlands

Location and Characteristics

This area is located in the west of the County and includes the settlements of Lanesborough and Clondra and extends towards Ballymahon in the south.



- **Landcover**

Located in the western half of the County, this area is dominated by extensive tracts of raised bog interspersed with mixed forestry and areas of scrubby vegetation.

- **Topography**

The topography is notably flat, with the majority of the land lying below the 50m contour line. This, when combined with the limited vegetation cover and extensive peat land cover mean that views are available across wide areas throughout the unit.

- **Drainage patterns**

Drainage patterns in the area are heavily influenced by artificial means employed to retain water levels and prevent inundation of commercial peatlands. The Shannon system is the main natural influence, draining the area via the Camlin, Fallan and Bilberry rivers. Seasonal flooding persists in the northern sector, particularly in the vicinity of the Camlin River.

Human Influence

- **Settlement pattern**

The settlement pattern in this unit tends to be less dispersed and more focussed into the designated towns and villages than other areas, given the difficult nature of the terrain.

The Main settlement in the area is Lanesborough, for which a Local Area Plan has been prepared. Lanesborough is located on the River Shannon at the northern end of Lough Ree and at the junction of the N63 to Roscommon and R392 to Mullingar. Historically an important fording point of the Shannon, Lanesborough declined in strategic importance with the development of Athlone to the south. The Regional Planning Guidelines for the Midlands have recognised this strategic location and role, designating Lanesboro as a local Service town in the urban hierarchy of the region, to provide local level retailing, social and leisure facilities.

Clondra is a small settlement located on the Royal Canal and at the confluence of the Camlin and Shannon Rivers, which is important in terms of its character, scenic quality and tourism potential. Local community interest in the development of the village is high.

Kilashee is a small settlement located on the N63 that has seen substantial residential planning applications under the Rural Renewal Tax Incentive Scheme.

Derraghan consists of a housing estate built by Board na Mona for its workers. Set in the centre of commercial peatlands, the area is distinctive in settlement and landscape terms, given its design, layout and density in relation to its remote location, there has been little development in the vicinity in recent years. The installation of traffic calming signage along the R392 creates an urban effect along an otherwise remote rural setting.

One off development in the area tends be confined to specific pressure areas, for example, Kilmore/Cloonmore and Tullyvrane/Lehery outside Lanesborough.

- **Transport and Communications**

The road network, particularly in the southern section, has been curtailed by the hostile landscape conditions, however communication lines become more complex in the vicinity of Longford and the Royal Canal to the north.

The road pattern around Lanesborough, particularly the R392 that travels east to Ballymahon, is notable due to its straightness and lack of consideration for the topographical features that it traverses. This is a former toll road, constructed in the

18th century and connecting Dublin to the main areas of industrial activity in the Country, at which time, Lanesborough marked the western boundary. The straight road and predominantly flat topography create a distinct and unique landscape experience while travelling across the unit.

The remains of an ancient toher road, constructed of timber, can be seen at Corlea Bog.

The Royal Canal is an important landscape feature, not only due to its heritage associations but also its wider influence on the landscape including features that were built to support it, such as the bridges, towpaths, lock-keepers' cottages and lock gates. Works are ongoing on the opening up of the canal, which will have a considerable impact on how the landscape is perceived throughout the area.

The area is well served by mobile and broadband wireless communications.

- **Agriculture**

Agricultural potential in the area is limited given the nature of the dominant landcover, however, some reclaimed sections of land support large pastoral farming enterprises, particularly in the northern sector.

- **Industry and Services**

The ESB power station at Lanesboro dominates the landscape of the area for a considerable distance, particularly at night time. Much of the industrial development in this unit is planned adjacent to the power station where it is anticipated that the landscape impact will be limited.

- **History, Archaeology and Culture**

The area has a strong industrial history in terms of the historical harvesting of peat and the transport of the finished product along the Royal Canal. The landscape impacts of this history are manifested in the industrial architecture and archaeology that abounds throughout the area.

The Corlea visitor centre interprets an iron-age bog road built across the boglands to the south of the unit. Bord na Mona preserves the boglands in the vicinity in conjunction with the Department of the Environment.

- **Recreation and Amenity**

- Canal/Clondra Harbour
- Longford Town football ground
- Future use of peatlands

Landscape Sensitivity

The visual sensitivity of the landscapes in this unit are generally **LOW**, as their flat nature allows development to be accommodated with minimum screening needed to achieve integration into its surrounds. An exception to this designation is the vicinity of the Royal Canal, where sensitivity is **HIGH**.

In environmental terms, sensitivity can be generally termed **MEDIUM** to **HIGH** due to the limited capacity of the receiving environment to cater for additional effluent loading.

Threats

- Inappropriate development in the vicinity of the Royal Canal.
- Pollution of ground and surface water due to inadequate or malfunctioning effluent treatment systems.

Opportunities

- Existing and potential recreational and amenity development.
- Ability to accommodate development in appropriate areas.

Policy Responses

- Identify appropriate areas for development.
- Develop guidelines for screening and siting measures to facilitate development.

Landscape Unit 7 – Open Agricultural

Location and Characteristics

This area is located in the east of the County and contains twelve settlements including, Ballymahon, Ardagh and Keenagh. The unit extends from below the N4 Longford to Mullingar road towards the southern edge of the County.



- **Landcover**

Located in the southeast of the County, this area contains the most versatile agricultural land in the County and is generally characterised by larger, open fields, interspersed with mature trees. Plantations of deciduous and mixed woodland punctuate the landscape.

- **Topography**

The northern section of the unit contains the most elevated area, including Farnagh Hill and Ardagh (Bawn) and Castlerea Mountain, all of which contain full and/or intermittent scenic views listed for preservation under the County Development Plan.

The southern and eastern sections of the unit consist mainly of gently undulating pastoral land.

- **Drainage patterns**

Drainage in the southern and eastern section of the unit is dominated by the River Inny, which is fed by numerous tributary streams and rivers. The northern section drains toward the Camlin River.

Human Influence

- **Settlement pattern**

This unit has the most developed urban structure of the County, being served by twelve designated settlements. Settlements tend to be established longer than in other units throughout the County and as, such, generally exhibit a strong character, identity and sense of community.

One-off and ribbon development tends to be more pronounced in the northern section of the unit, tapering off to the south where the more agriculturally productive lands are located.

Ballymahon is the largest of the settlements in this unit, having a population in the region of 830 at the last census. The town has its own unique character, with a wide street and strong horizontal and vertical building lines. Good examples of relatively intact Victorian architecture line the eastern end of the Main Street, while the centrally located Courthouse, unfortunately in a poor state of repair, occupies a plaza-like position.

Pressure for development in Ballymahon has been steady over the last number of years with over 800 housing units granted within the settlement envelope. It is therefore likely that the population figure has increased substantially since the census.

A significant number of these applications have translated into completed houses, considerably altering the appearance of the town. The most notable change has been at the Inny Bridge, where the old mill has been refurbished and an additional apartment building constructed within a linear parkland setting along the banks of the River.

A substantial townhouse and apartment development has taken place on the approach from Mullingar, which has significantly altered the appearance of the area where linear one-off development dominated.

Moydow is centrally located within the County and is a small settlement with a nucleus of a church and school. Sporadic development has taken place with permission granted for 18 houses in the vicinity.

Keenagh village, located to the western boundary of the unit, is a well-established settlement in a linear formation, located along the R397. The village has witnessed a substantial level of development over recent Development Plan periods relative to its size. Fortunately, most of these developments have managed to retain a sense of village character and identity in terms of their layout and design, relating strongly to

the street and, by utilising backland and infill sites, maintaining a pedestrian emphasis to the village. A commensurate increase in the level of social and community facilities available will help to ensure the viability and cohesion of village life in this settlement.

Ardagh is a former estate village located to the northern section of the unit. A consistently high performer in the Tidy Towns Competition, the village has a wealth of architectural heritage, which defines the settlement and creates a unique sense of place. Historically important as an Episcopal seat, the central area of the village remains relatively undeveloped and has an Architectural Conservation Area in place.

Abbeyshrule is a small village located on the Royal Canal and the River Inny. The substantial industrial architecture associated with the Canal, the Abbey, associated graveyard and the flat, pastoral environs create the distinctive ambiance of the settlement. Two housing estates are situated in the centre of the village both of which respect the scale and character of the settlement in terms of their layout, density and design.

The designated settlement of Ratharney is located nearby, at the junction of the R399 and R393. Centred on the existing shop and petrol pump (now unfortunately closed) permission has been granted for three additional houses.

Barry, Taghshinny and Colehill are small settlements clustered around a central nucleus, such as a post office in the case of Colehill, schools and pubs in Taghshinny and a “street” containing a shop in the case of Barry. Each is well established with distinctive architecture and features in each case.

Carrickboy and Ballycloughan are located to the east of the unit. Ballycloughan lies 2km south of Ardagh on the R393. The settlement consists of recent single-house development in a linear format centred on the parish church. The use of bright colours, distinctive boundary treatments and sculpture give a village feel to what would otherwise appear as standard ribbon development.

Carrickboy is located approximately 1km further south along the R393 at its junction with the N55. Consisting of a garage, former pub and a handful of houses, there is little to perceptually tie development together as a settlement. The nearby school may have a potential role in the creation of an identity for this village.

Legan is a well-established settlement on the eastern border of the County in the parish of Kilglass. Adjacent to the former Foxhall Glebe, with its important architectural and archaeological remains, the village has developed in a linear fashion with a central nucleus where the majority of recent development has taken place. Facilities in the village are well articulated.

- **Transport and Communications**

The road network in the unit is relatively dense, with the exception of the elevated areas around Ardagh and Castlereagh Mountain. The N55 traverses the unit from northeast to southwest and is served by a network of five regional routes.

The Royal Canal is important as an amenity, a landscape feature and a significant influence on the history, culture, architecture and archaeology of the area. The waterway traverses the southern portion of the unit.

The area contains almost one quarter of the mobile communications infrastructure in the County.

- **Agriculture**

Agriculture exists mainly in the northern section of this unit.

- **Industry and Services**

The majority of industry and services are provided within Ballymahon and these include Scientific Games Worldwide Services Ltd, Kepak and Readymix. It is considered that their respective locations within the town have minimal landscape impact.

- **History, Archaeology and Culture**

This area holds historical and cultural significance with the Irish writer Oliver Goldsmith as he spent time within this area of Longford.

The location of the Royal Canal within this unit also meant that a number of the settlements evolved around the Canal and indeed some of the traditional architecture within this unit is reflective of this.

- **Recreation and Amenity**

The Royal Canal and River Inny provide important amenity and recreation facilities within the unit. The Inny Kayaking Club which is based within Ballymahon has developed over the years and optimises use of this recreational resource.

Abbeyshrule Airport has developed significant aviation facility within the village of Abbeyshrule and is extremely popular with aviators from both Ireland and the UK.

Landscape Sensitivity

Visual sensitivity of the landscapes in this unit are generally **LOW**. An exception to this designation is the vicinity of the Royal Canal, the River Inny, in Upland Areas with designated scenic views, and in proximity to the heritage village of Ardagh where sensitivity is **HIGH**.

Threats

- Inappropriate development within the vicinity of the Royal Canal and River Inny.
- Encroachment of development onto the upland areas with potential interference with designated scenic views.
- Potential loss of character of existing towns and villages including unsympathetic residential developments in areas of high architectural quality, particularly within the heritage village of Ardagh.

Opportunities

- Existing and potential recreational and amenity development, particularly with relation to the River Inny and Royal Canal.
- Existing strong settlement base which has capability to absorb further development.

Policy Responses

- Fast track the formulation of Local Area Plans/ village policy statements throughout the county to create, preserve and enhance village character.
- Promote the development of adequate community and social facilities in smaller villages to maintain character, identity and pedestrian scale.

2.3 Identification of Visual Units

Visual units can be described as areas defined by spatial enclosure and pattern, which are determined, by landform and landcover.

Boundaries of visual units can usually be divided into several or a combination of the following:

- The physical limits of a view or prospect
- The physical limits of a water catchment
- The “gateway” between areas contrasting in their degree of spatial containment

Identification of visual units is a complex process, not least because the visual limits of an area can span several counties.

2.4 Identification of Image Units

Image units are generally composed of landscape areas that are dominated by a major focal point, where a visual field results from the association of this part of the landscape with this feature. Obvious examples of image units in the Longford context would include Ardagh Mountain, Corn Hill and the many lakes, rivers and other waterways throughout the county. These features exert a disproportionately large impact on their surroundings by reason of their size; shape, colour and how they interact with adjacent landscape components.

3.0 LANDSCAPE VALUES

Landscape values can be described as the environmental or cultural benefits, including services and functions that can be derived from various landscape attributes.

The following landscape elements are considered to be important within the County.

Feature	Location	Value
Boglands	Begnagh, Clonard, Kilashee, Commons North, Curry Bog	Aesthetic, ecological, historical, socio-cultural
Rivers	Shannon, Inny, Camlin and associated banks and callows	Aesthetic, ecological, historical, socio-cultural
Lakes	Lough Ree, Lough Gowna, Lough Forbes, and other lakes in the County and associated shores and islands.	Aesthetic, ecological, historical, socio-cultural, religious and mythological
Uplands	Ardagh mountain, Cairn hill	Aesthetic, ecological, historical, socio-cultural, religious and mythological
Archaeological sites, artefacts, structures and objects	Mornin and Castlereagh castles, Abbeylara, Abbeysrule, Saints Island, Inchcleraun, Granard Moat, Granardkille.	Aesthetic, ecological, historical, socio-cultural, religious and mythological
Woodlands	Newtownforbes, Newcastle, Derrycassan, Carriglass, Portanure, Legan.	Aesthetic, ecological, historical.
Architecture	Mill buildings, the Royal Canal and its associated structures, built fabric of towns and villages, churches, courthouses.	Aesthetic, ecological, historical, socio-cultural, religious.

In addition, the importance of existing artefacts etc. contained in the SMR and NHAs, SACs, SPAs and ASIs were emphasised and their continued protection underlined.

4.0 LANDSCAPE SENSITIVITY

The sensitivity of a landscape can be described as the measure of its ability to accommodate change or intervention without suffering unacceptable effects to its character and values.

In order to assess sensitivity, it is necessary to evaluate what development, if any, it is possible to locate within any given area without causing negative impact on the landscape character or values of that area.

Where it is considered that development can be located within a particular area without giving rise to negative impacts, this landscape can be deemed to be of a low sensitivity.

Conversely, an area where development would seriously damage character or damage/eliminate irreplaceable values associated with a landscape, this landscape can be termed highly sensitive.

Areas which are considered as sensitive fall into the following categories:

- Areas, structures artefacts, ruins, objects, views and routes identified as important within the County.
- Areas listed as Natural Heritage Areas and/or Special Protected areas at national level and areas included in the European Communities (Conservation of Wildbirds) (Amendment No.2) Regulations, 1996.
- Views listed for protection in the current County Development Plan, 2015-2021.
- Views/tourist designations on published maps of the County.
- Recognised areas of literary/cultural importance.

APPENDIX 1

Landscape Unit 1: Northern Drumlin Lakeland

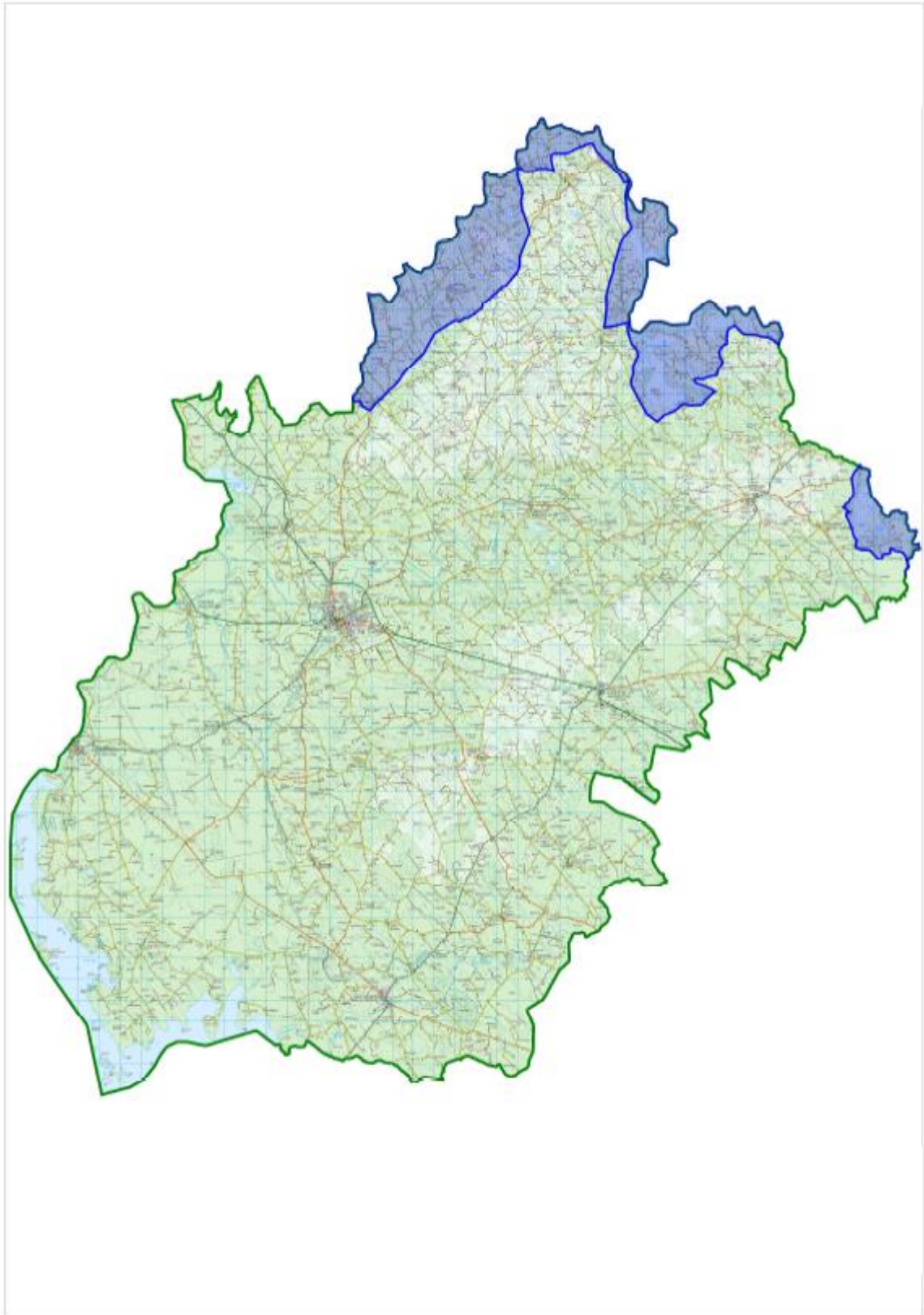

Landscape Unit 2: Northern Upland

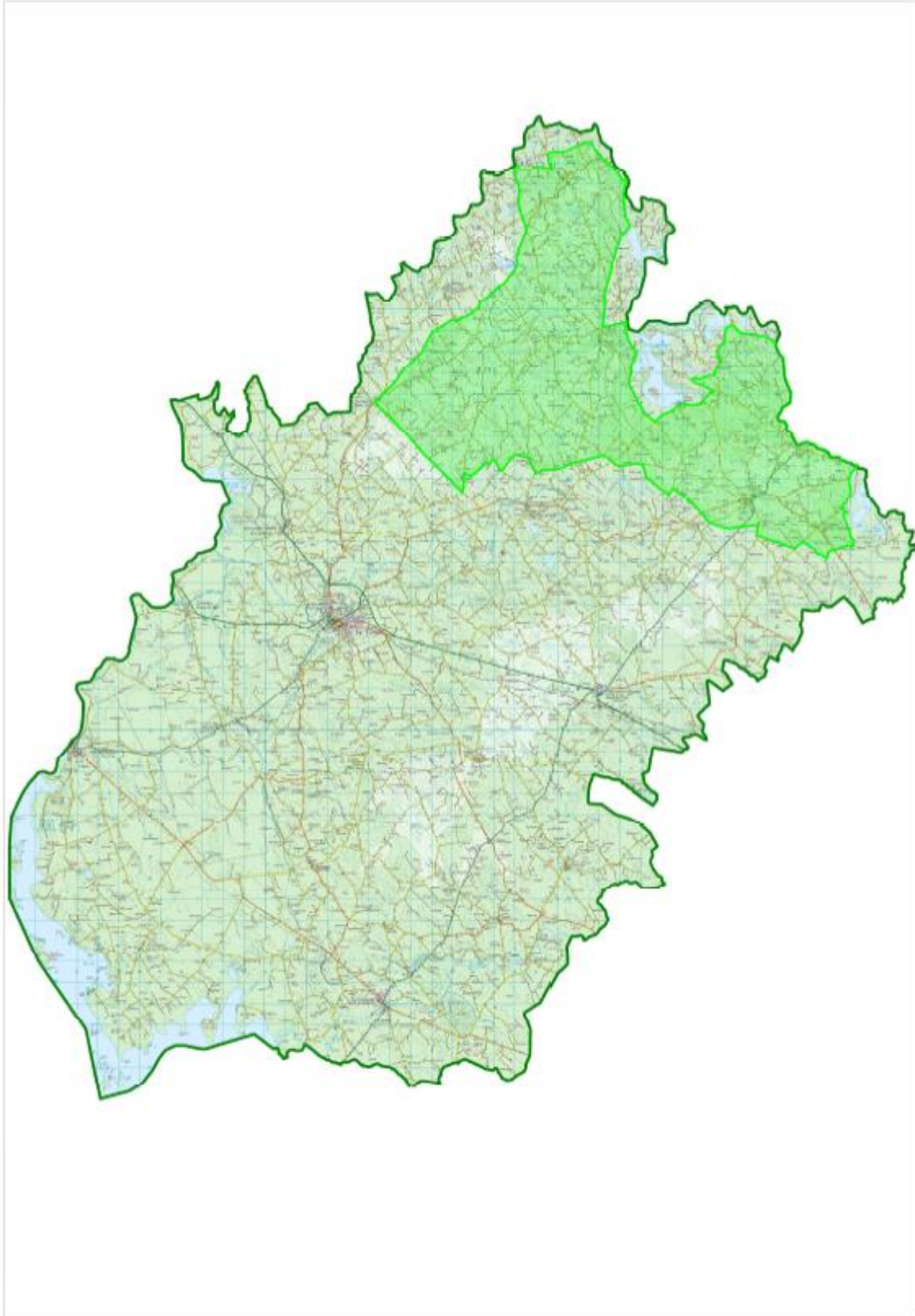

Landscape Unit 3: Shannon Basin / Lough Ree

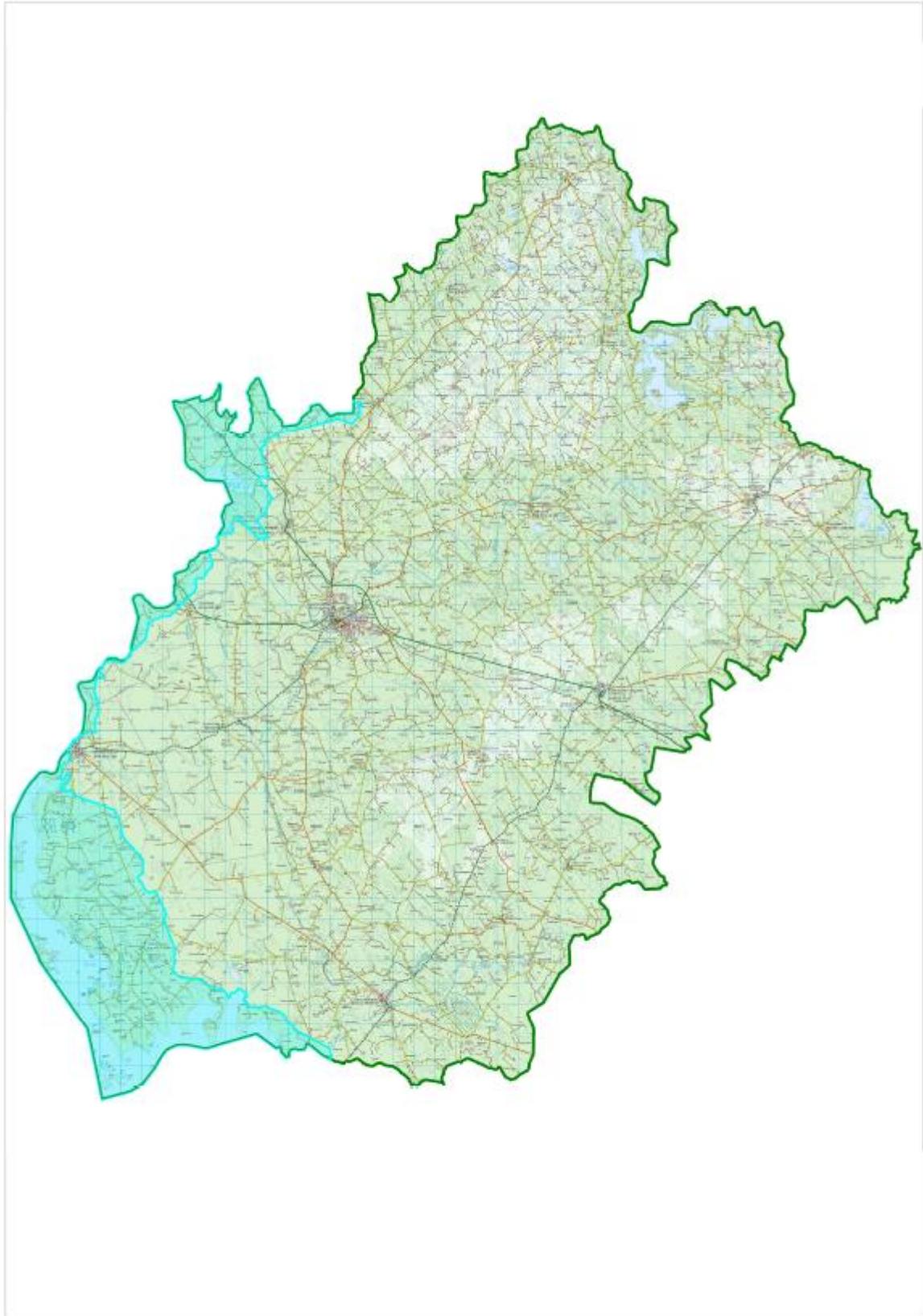

Landscape Unit 4: Central Corridor

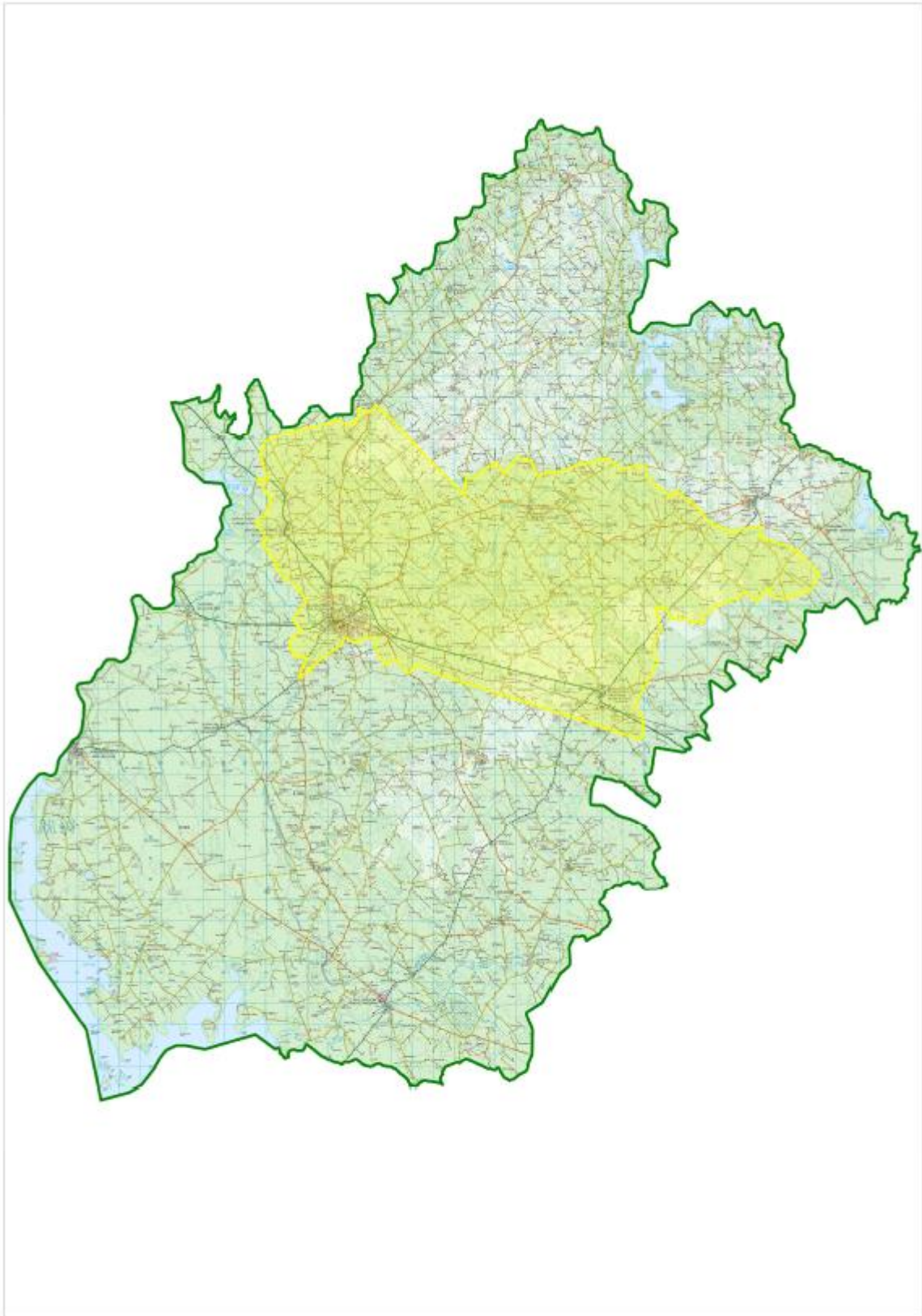

Landscape Unit 5: Inny Basin

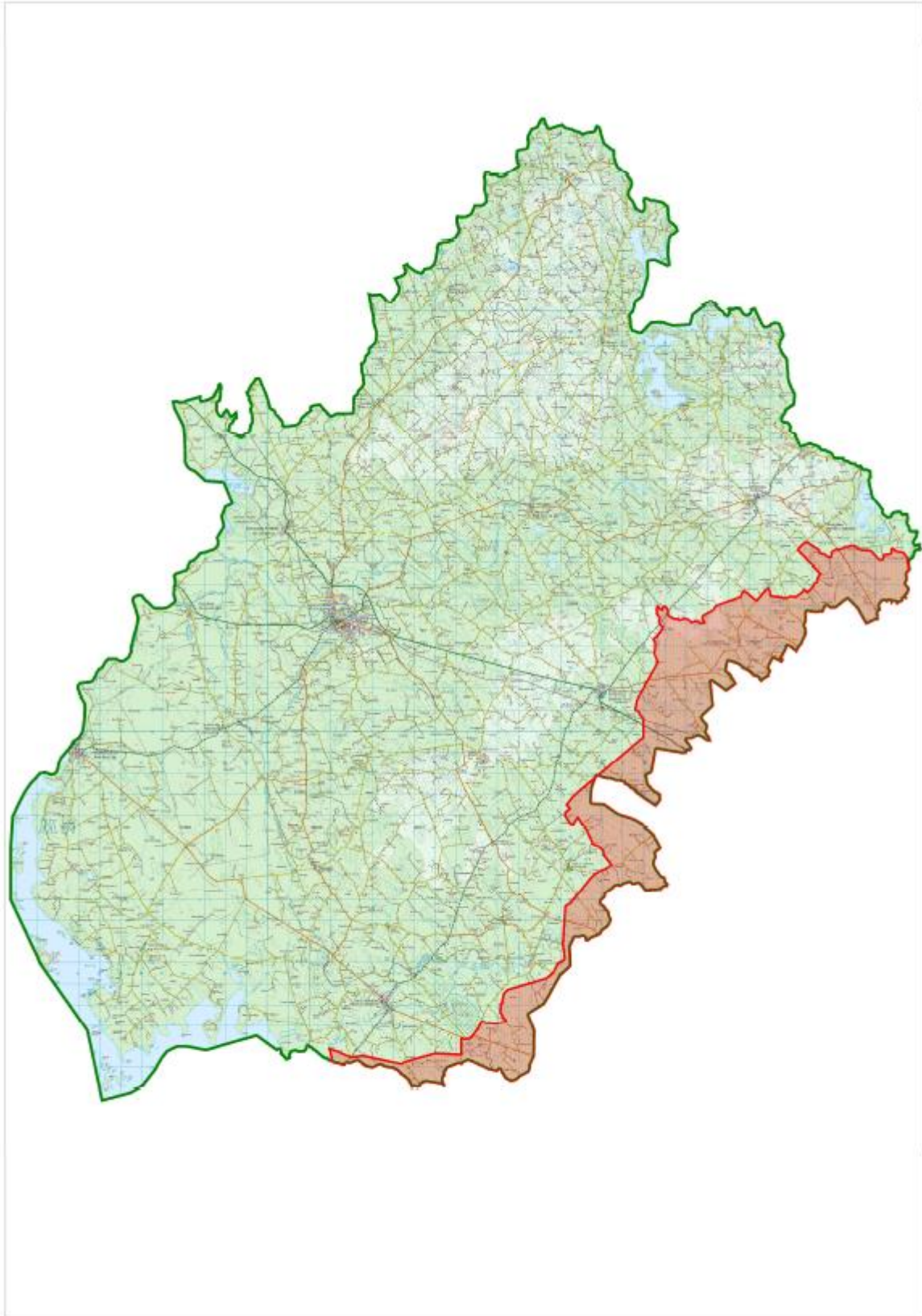

Landscape Unit 6: Peatlands

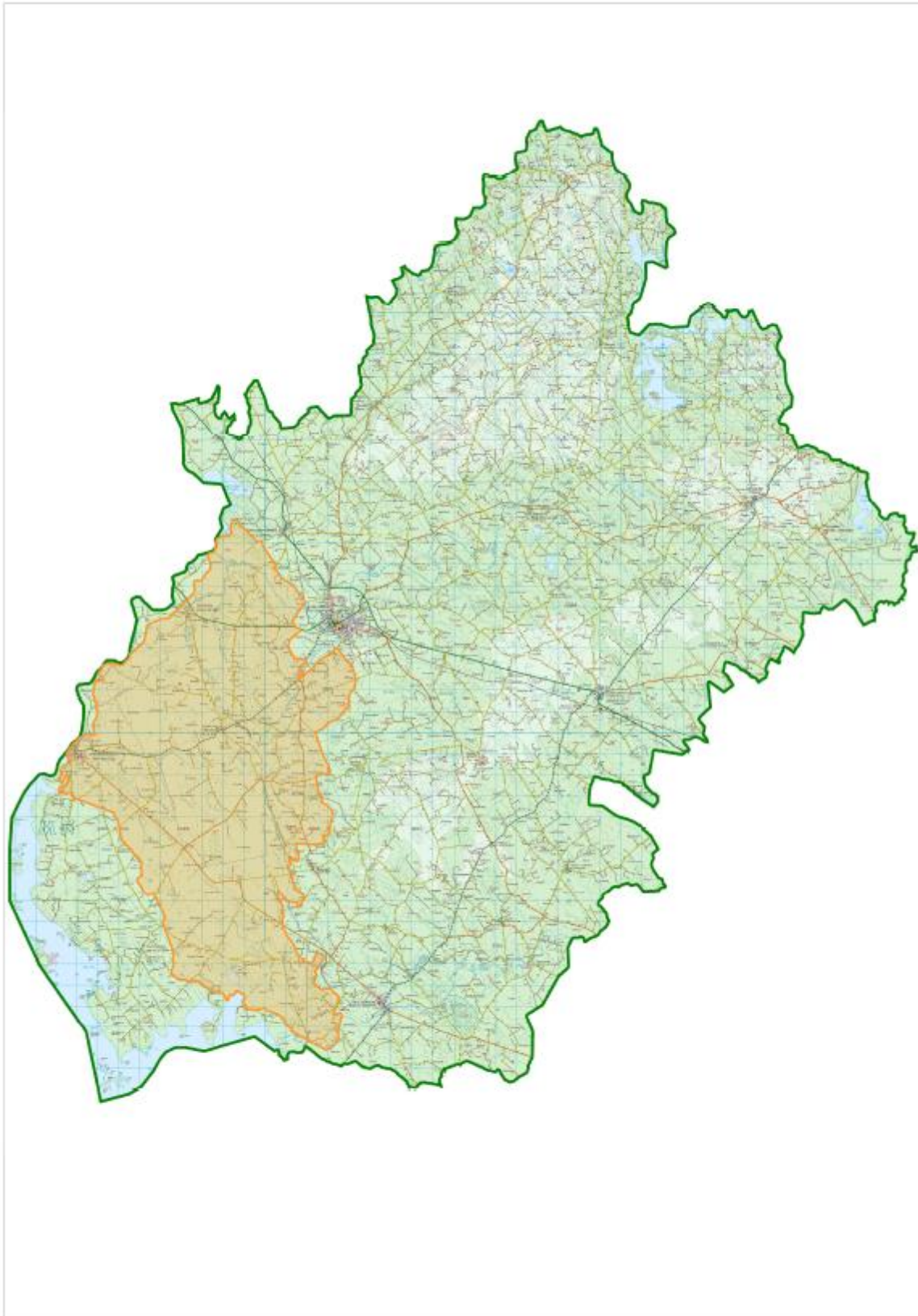

Landscape Unit 7: Open Agricultural

