



PROGRAM AND ABSTRACTS

WORKSHOP ON

**GROUND TRUTH FROM MARS:
SCIENCE PAYOFF FROM A SAMPLE RETURN MISSION**

April 21–23, 2008
Albuquerque, New Mexico

Sponsored by

Lunar and Planetary Institute
NASA Planetary Science Division
NASA Mars Exploration Program
Institute of Meteoritics

Conveners

Charles (Chip) Shearer, *University of New Mexico*
Carl Agee, *University of New Mexico*
David Beaty, *Jet Propulsion Laboratory*

Scientific Organizing Committee

David Bish, *Indiana University*
James Farquhar, *University of Maryland*
John Grotzinger, *California Institute of Technology*
Virgil Lueth, *New Mexico School of Technology*
Chris McKay, *NASA Ames Research Center*
Glenn MacPherson, *Smithsonian Institution*
Doug Ming, *NASA Johnson Space Center*
Dimitri Papanastassiou, *Jet Propulsion Laboratory*
James J. Papike, *University of New Mexico*
Dawn Y. Sumner, *University of California, Davis*
Allan Treiman, *Lunar and Planetary Institute*
David Vaniman, *Los Alamos National Laboratory*

Lunar and Planetary Institute 3600 Bay Area Boulevard Houston TX 77058-1113

LPI Contribution No. 1401

Compiled in 2008 by
LUNAR AND PLANETARY INSTITUTE

The Lunar and Planetary Institute is operated by the Universities Space Research Association under a cooperative agreement with the Science Mission Directorate of the National Aeronautics and Space Administration

Any opinions, findings, and conclusions or recommendations expressed in this volume are those of the author(s) and do not necessarily reflect the views of the National Aeronautics and Space Administration.

Material in this volume may be copied without restraint for library, abstract service, education, or personal research purposes; however, republication of any paper or portion thereof requires the written permission of the authors as well as the appropriate acknowledgment of this publication.

Abstracts in this volume may be cited as

Author A. B. (2008) Title of abstract. In *Workshop on Ground Truth from Mars: Science Payoff from a Sample Return Mission*, p. XX. LPI Contribution No. 1401, Lunar and Planetary Institute, Houston.

This volume is distributed by

ORDER DEPARTMENT
Lunar and Planetary Institute
3600 Bay Area Boulevard
Houston TX 77058-1113, USA
Phone: 281-486-2172
Fax: 281-486-2186
E-mail: order@lpi.usra.edu

Mail orders requestors will be invoiced for the cost of shipping and handling.

ISSN No. 0161-5297

Preface

This volume contains abstracts that have been accepted for presentation at the Workshop on Ground Truth from Mars: Science Payoff from a Sample Return Mission, April 21–23, 2008, Albuquerque, New Mexico.

Administration and publications support for this meeting were provided by the staff of the Publications and Program Services Department at the Lunar and Planetary Institute.

Contents

Program	1
Sample Return from Ancient Hydrothermal Springs <i>C. C. Allen and D. Z. Oehler</i>	7
Scientific Rationale for Consideration of Chemically Altered Meteorites in a Mars Sample Return Mission <i>J. W. Ashley</i>	9
Science Payoff from Noble Gas and Associated Halogen Analysis: Towards a Sample Wish List <i>C. J. Ballentine, R. Burgess, S. Edwards, and J. D. Gilmour</i>	11
OMEGA/Mars Express Feed Forward to MSR <i>J.-P. Bibring</i>	12
Clay Mineralogy as a Guide to Alteration Environments on Mars <i>D. L. Bish and D. T. Vaniman</i>	13
Martian Chronology and Atmospheric Composition: In Situ Measurements Versus Sample Return <i>D. D. Bogard</i>	15
Extremophile Microorganism Communities in Sulfates and Other Sulfur Minerals as Sample Return Target Materials <i>P. J. Boston, M. N. Spilde, D. E. Northup, and P. Todd</i>	17
Interpreting Mars Surface Fluid History Using Minor and Trace Elements in Jarosite: An Example from Post Pit, Nevada <i>P. V. Burger, J. J. Papike, C. K. Shearer, and J. M. Karner</i>	19
Affordable MSR: Constraining Requirements on Sampling and Sample Preservation <i>B. C. Clark</i>	21
Planetary Protection Considerations for Mars Sample Return <i>C. A. Conley</i>	23
Mars Science Laboratory: Science Overview <i>J. A. Crisp, J. P. Grotzinger, A. R. Vasavada, J. S. Karcz, and MSL Science Team</i>	24
Fundamental Importance of Returned Samples to Understanding the Martian Interior <i>D. S. Draper and C. B. Agee</i>	25
Mars Sample Return: Stable Isotope Targets with Return Samples <i>J. Farquhar</i>	27
Identification (or Otherwise) of Martian Carbon in Martian Meteorites <i>M. M. Grady, V. K. Pearson, I. Gilmour, M. A. Gilmour, A. B. Verchovsky, J. Watson, and I. P. Wright</i>	29
Evolution of Water on Mars: Mars Sample Return Considerations for Hydrogen Isotope Measurements <i>J. P. Greenwood</i>	31

Mars Sample Return: The Value of Depth Profiles <i>E. M. Hausrath, A. K. Navarre-Sitchler, J. Moore, P. B. Sak, S. L. Brantley, D. C. Golden, B. Sutter, C. Schröder, R. Socki, R. V. Morris, and D. W. Ming</i>	33
Characterization of Fe-Sulfate Minerals: Preparation for Mars Sample Return <i>B. C. Hyde, P. L. King, M. N. Spilde, and A.-M. S. Ali</i>	35
Mars Sample Return: 20+ Years After the First Mars Sample Return Workshop <i>J. H. Jones</i>	37
Mars Sample Return at 6 Kilometers Per Second: Practical, Low Cost, Low Risk, and Ready <i>S. M. Jones, A. J. G. Jurewicz, R. Wiens, A. Yen, and L. A. Leshin</i>	39
Science Definition of the Mars Science Laboratory Sample Cache <i>J. S. Karcz, D. W. Beaty, C. A. Conley, J. A. Crisp, D. J. Des Marais, J. P. Grotzinger, L. G. Lemke, C. P. McKay, S. W. Squyres, C. R. Stoker, and A. H. Treiman</i>	41
The Implementation of the Mars Science Laboratory Sample Cache <i>J. S. Karcz, M. Cappuccio, A. G. Demo, H. J. Eisen, J. Feldman, K. Gheno, C. E. Kruger, M. Liu, J. H. Reimer, O. Santos, O. E. Serviss, and P. K. Tong</i>	43
Determining Production Rates of Cosmogenic Radioisotopes on Mars <i>Y. Kashiv, M. Paul, and P. Collon</i>	44
Fe-Sulfates on Mars: Considerations for Martian Environmental Conditions, Mars Sample Return and Hazards <i>P. L. King, M. D. Lane, B. C. Hyde, M. D. Dyar, and J. L. Bishop</i>	46
Geochemistry and Astrobiology Science Payoff Using Laser Desorption Fourier Transform Mass Spectrometry (LD-FTMS) Techniques for Mars Sample Return <i>J. M. Kotler, N. W. Hinman, C. D. Richardson, T. McJunkin, and J. R. Scott</i>	48
The Biological Potential of the Northern Plains for Mars Sample Return <i>M. D. Kraft, E. B. Rampe, and T. G. Sharp</i>	49
Encoding of Water-Rock-Atmosphere Interactions in Jarosite: Implications for Mars <i>V. W. Lueth</i>	51
Stable Isotope Characterization of a Terrestrial Kieserite with Comparisons to Other Sulfate Minerals <i>V. W. Lueth, A. R. Campbell, and J. J. Papike</i>	53
Astrobiology with a Groundbreaker Sample Return Mission <i>C. P. McKay</i>	54
Possible Science Priorities for Mars Sample Return <i>MEPAG ND-SAG Team</i>	55
Clay-bearing Rocks in the Mawrth Vallis Region, Mars <i>J. R. Michalski, J.-P. Bibring, F. Poulet, R. Fergason, N. Mangold, D. Loizeau, E. Noe Dobrea, and J. L. Bishop</i>	57
Interpreting and Constraining the Composition and Depositional Environments of Phyllosilicates on Mars <i>R. E. Milliken, J. F. Mustard, B. Ehlmann, J. L. Bishop, S. Murchie, and CRISM Science Team</i>	59

2003 Mars Exploration Rover Mission: Robotic Field Geologists for a Mars Sample Return Mission <i>D. W. Ming</i>	61
Mars Sample Return from Meridiani Planum <i>D. W. Mittlefehldt</i>	63
What We Might Know About Gusev Crater if the Mars Exploration Rover Spirit Mission were Coupled with a Mars Sample Return Mission <i>R. V. Morris</i>	65
Discovery of Diverse Martian Aqueous Deposits from Orbital Remote Sensing <i>S. Murchie, A. McEwen, P. Christensen, J. Mustard, and J.-P. Bibring</i>	66
Hydrated Silicate Minerals and Their Geologic Environments from Orbit <i>J. F. Mustard, S. L. Murchie, B. Ehlmann, R. E. Milliken, J.-P. Bibring, F. Poulet, J. Bishop, E. Noe Dobrea, L. Roach, F. Seelos, and N. K. McKeown</i>	68
Clay Minerals Formation in Impact Induced Hydrothermal Systems: Source of Hydrous Phases on Mars <i>N. Mutik, K. Kirsimäe, and P. Somelar</i>	70
Mars Sample Return: Which Samples and Why <i>C. R. Neal</i>	72
Landing Site Selection for the Mars Science Laboratory and Implications for Mars Sample Return <i>H. E. Newsom, N. L. Lanza, and A. M. Ollila</i>	73
Measurements of Cosmogenic Nuclides In and Their Significance for Samples Returned from Mars <i>K. Nishiizumi, M. W. Caffee, G. F. Herzog, and R. C. Reedy</i>	75
Transition Between Altered and Non-Altered Minerals in Mawrth Vallis and Arabia Terra <i>E. Z. Noe Dobrea, J. L. Bishop, N. K. McKeown, G. Swayze, J. R. Michalski, F. Poulet, J.-P. Bibring, J. F. Mustard, B. L. Ehlmann, R. Arvidson, R. V. Morris, S. Murchie, E. Malaret, C. Hash, and CRISM Team</i>	77
Prospects for Chronological Studies of Martian Rocks and Soils <i>L. E. Nyquist, C.-Y. Shih, and Y. D. Reese</i>	79
Why an “Early” Mars Sample Return: Lessons from Apollo <i>D. A. Papanastassiou</i>	81
Martian Sulfates: Gypsum Crystal Chemistry and Characterization of Two Terrestrial Analogs <i>J. J. Papike, P. V. Burger, J. M. Karner, and C. K. Shearer</i>	83
Fumaroles on Mars: Lessons Learned from the Valley of Ten Thousand Smokes, Alaska <i>J. J. Papike, M. N. Spilde, J. M. Karner, and C. K. Shearer</i>	85
The Importance of an Investigation of the Northern Plains <i>E. B. Rampe, M. D. Kraft, and T. G. Sharp</i>	87
An Experimental Study of Phyllosilicate Modification in Comets During Perihelion Could be Relevant to Ferric Iron-rich Layer Silicate Formation at the Martian Surface <i>F. J. M. Rietmeijer and K. Thiel</i>	89

If We Already have Samples from Mars, Why Do We Need Sample Return Missions? The Importance of Martian Meteorites and the Value of Mars Sample Return <i>C. K. Shearer, L. E. Borg, A. Treiman, and P. King</i>	91
Rock Coatings: Potential Biogenic Indicators <i>M. N. Spilde, P. J. Boston, D. E. Northup, and K. J. Odenbach</i>	93
Boron Isotopic Composition of Igneous Minerals and Secondary Alteration Products in Nakhla <i>L. J. Spivak-Birndorf, M. Wadhwa, and L. B. Williams</i>	95
Using Recent Impact Craters as a Sampling Mechanism for a Mars Sample Return Mission <i>T. D. Swindle, L. L. Tornabene, A. S. McEwen, and J. B. Plescia</i>	97
Meteorites on Mars: Implications for Sample-Return Strategy <i>B. J. Thomson, N. T. Bridges, and M. C. McCanta</i>	99
Two Generations of Carbonate in ALH 84001: Three Oxygen Isotopes and OH <i>J. W. Valley, T. Ushikubo, and N. T. Kita</i>	101
Salt-Hydrate Stabilities and Mars Sample Return Missions <i>D. T. Vaniman, D. L. Bish, and S. J. Chipera</i>	103
Clay Minerals in Returned Samples and Alteration Conditions on Mars <i>M. A. Velbel</i>	105
Highly Siderophile Elements Abundances in SNC Meteorites: An Update <i>R. J. Walker, I. S. Puchtel, A. D. Brandon, and A. J. Irving</i>	107
Magnetic Studies of Returned Samples from Mars <i>B. P. Weiss, I. Garrick-Bethell, and J. L. Kirschvink</i>	109
ChemCam as the Instrument to Select Samples and Enable Mars Sample Return <i>R. C. Wiens, S. Clegg, S. Maurice, and ChemCam Team</i>	111
Honeybee Robotics Sample Acquisition, Transfer and Processing Technologies Enabling Sample Return Missions <i>K. Zacny, G. Paulsen, K. Davis, E. Mumm, and S. Gorevan</i>	112
What Can You Do with a Returned Sample of Martian Dust? <i>M. E. Zolensky and K. Nakamura-Messenger</i>	114

Program

Monday, April 21, 2008
ENABLING SAMPLE RETURN: PRIORITIES, MISSIONS, AND STRATEGIES
8:00 a.m. Alvarado ABC

Chairs: D. W. Ming
A. H. Treiman

Welcome and Introduction

Des Marais D.* MEPAG ND-SAG Team (15 minutes)
Possible Science Priorities for Mars Sample Return [#4037]

Murchie S. * McEwen A. Christensen P. Mustard J. Bibring J.-P. [INVITED] (20 minutes)
Discovery of Diverse Martian Aqueous Deposits from Orbital Remote Sensing [#4035]

Bibring J.-P. * [INVITED] (20 minutes)
OMEGA/Mars Express Feed Forward to MSR [#4061]

Ming D. W. * [INVITED] (20 minutes)
2003 Mars Exploration Rover Mission: Robotic Field Geologists for a Mars Sample Return Mission [#4047]

Crisp J. A. * Grotzinger J. P. Vasavada A. R. Karcz J. S. MSL Science Team [INVITED] (20 minutes)
Mars Science Laboratory: Science Overview [#4016]

Karcz J. S. * Beaty D. W. Conley C. A. Crisp J. A. Des Marais D. J. Grotzinger J. P.
Lemke L. G. McKay C. P. Squyres S. W. Stoker C. R. Treiman A. H. (15 minutes)
Science Definition of the Mars Science Laboratory Sample Cache [#4058]

Shearer C. K. * Borg L. E. Treiman A. King P. (15 minutes)
If We Already have Samples from Mars, Why Do We Need Sample Return Missions? The Importance of Martian Meteorites and the Value of Mars Sample Return [#4004]

Neal C. R. * (15 minutes)
Mars Sample Return: Which Samples and Why [#4026]

Jones J. H. * (15 minutes)
Mars Sample Return: 20+ Years After the First Mars Sample Return Workshop [#4002]

Hausrath E. M. * Navarre-Sitchler A. K. Moore J. Sak P. B. Brantley S. L. Golden D. C. Sutter B.
Schröder C. Socki R. Morris R. V. Ming D. W. (15 minutes)
Mars Sample Return: The Value of Depth Profiles [#4039]

*Denotes speaker

Monday, April 21, 2008
SAMPLE REQUIREMENTS FROM THE
ASTROBIOLOGY POINT OF VIEW
1:30 p.m. Alvarado ABC

Chairs: C. P. McKay
G. J. MacPherson

Steele A. * [INVITED] (20 minutes)

Talk Development of Procedures and Protocols for the Collection and Characterization of Martian Samples. Experience from the Field and Lab

McKay C. P. * [INVITED] (20 minutes)

Astrobiology with a Groundbreaker Sample Return Mission [#4033]

Kraft M. D. * Rampe E. B. Sharp T. G. (15 minutes)

The Biological Potential of the Northern Plains for Mars Sample Return [#4049]

Boston P. J. * Spilde M. N. Northup D. E. Todd P. (15 minutes)

Extremophile Microorganism Communities in Sulfates and Other Sulfur Minerals as Sample Return Target Materials [#4053]

Allen C. C. * Oehler D. Z. (15 minutes)

Sample Return from Ancient Hydrothermal Springs [#4011]

Kotler J. M. * Hinman N. W. Richardson C. D. McJunkin T. Scott J. R. (15 minutes)

Geochemistry and Astrobiology Science Payoff Using Laser Desorption Fourier Transform Mass Spectrometry (LD-FTMS) Techniques for Mars Sample Return [#4054]

Spilde M. N. * Boston P. J. Northup D. E. Odenbach K. J. (15 minutes)

Rock Coatings: Potential Biogenic Indicators [#4045]

Grady M. M. * Pearson V. K. Gilmour I. Gilmour M. A. Verchovsky A. B.

Watson J. Wright I. P. (15 minutes)

Identification (or Otherwise) of Martian Carbon in Martian Meteorites [#4062]

Conley C. A. * [INVITED] (20 minutes)

Planetary Protection Considerations for Mars Sample Return [#4060]

Monday, April 21, 2008
POSTER SESSION
6:00 – 8:00 p.m. Alvarado D

Chairs: C. K. Shearer
C. B. Agee

MEPAG ND-SAG Team

Possible Science Priorities for Mars Sample Return [#4037]

Karcz J. S. Cappuccio M. Demo A. G. Eisen H. J. Feldman J. Gheno K. Kruger C. E.
Liu M. Reimer J. H. Santos O. Serviss O. E. Tong P. K.

The Implementation of the Mars Science Laboratory Sample Cache [#4059]

Jones S. M. Jurewicz A. J. G. Wiens R. Yen A. Leshin L. A.

Mars Sample Return at 6 Kilometers Per Second: Practical, Low Cost, Low Risk, and Ready [#4020]

Thomson B. J. Bridges N. T. McCanta M. C.

Meteorites on Mars: Implications for Sample-Return Strategy [#4043]

Wiens R. C. Clegg S. Maurice S. ChemCam Team

ChemCam as the Instrument to Select Samples and Enable Mars Sample Return [#4032]

Zacny K. Paulsen G. Davis K. Mumm E. Gorevan S.

Honeybee Robotics Sample Acquisition, Transfer and Processing Technologies Enabling Sample Return Missions [#4001]

Kashiv Y. Paul M. Collon P.

Determining Production Rates of Cosmogenic Radioisotopes on Mars [#4055]

Rampe E. B. Kraft M. D. Sharp T. G.

The Importance of an Investigation of the Northern Plains [#4034]

Walker R. J. Puchtel I. S. Brandon A. D. Irving A. J.

Highly Siderophile Element Abundances in SNC Meteorites: An Update [#4015]

Spivak-Birndorf L. J. Wadhwa M. Williams L. B.

Boron Isotopic Composition of Igneous Minerals and Secondary Alteration Products in Nakhla [#4050]

Ashley J. W.

Scientific Rationale for Consideration of Chemically Altered Meteorites in a Mars Sample Return Mission [#4046]

Newsom H. E. Lanza N. L. Ollila A. M.

Landing Site Selection for the Mars Science Laboratory and Implications for Mars Sample Return [#4041]

Fries M. D. Conrad P. G.

Mars Sample Return Priorities in Light of Martian Samples (Meteorites) We Already Have [#4056]

Tuesday, April 22, 2008
SULFATES AS RECORDERS OF MARS NEAR SURFACE PROCESSES
AND THE MER SITES AS FIRST SAMPLE RETURN LOCALITIES
8:00 a.m. Alvarado ABC

Chairs: V. W. Lueth
J. J. Papike

Lueth V. W. * [INVITED] (20 minutes)

Encoding of Water-Rock-Atmosphere Interactions in Jarosite: Implications for Mars [#4040]

Burger P. V. * Papike J. J. Shearer C. K. Karner J. M. (15 minutes)

Interpreting Mars Surface Fluid History Using Minor and Trace Elements in Jarosite: An Example from Post Pit, Nevada [#4010]

King P. L. * Lane M. D. Hyde B. C. Dyar M. D. Bishop J. L. (15 minutes)

Fe-Sulfates on Mars: Considerations for Martian Environmental Conditions, Mars Sample Return and Hazards [#4017]

Hyde B. C. * King P. L. Spilde M. N. Ali A.-M. S. (15 minutes)

Characterization of Fe-Sulfate Minerals: Preparation for Mars Sample Return [#4042]

Lueth V. W. Campbell A. R. Papike J. J. (15 minutes)

Stable Isotope Characterization of a Terrestrial Kieserite with Comparisons to Other Sulfate Minerals [#4027]

Zolensky M. E. * Nakamura-Messenger K. (15 minutes)

What Can You Do with a Returned Sample of Martian Dust? [#4007]

Vaniman D. T. * Bish D. L. Chipera S. J. (15 minutes)

Salt-Hydrate Stabilities and Mars Sample Return Missions [#4025]

Mittlefehldt D. W. * [INVITED] (20 minutes)

Mars Sample Return from Meridiani Planum [#4031]

Morris R. V. * [INVITED] (20 minutes)

What We Might Know About Gusev Crater if the Mars Exploration Rover Spirit Mission were Coupled with a Mars Sample Return Mission [#4048]

Tuesday, April 22, 2008
UNDERSTANDING THE EVOLUTION OF MARS:
CORE, MANTLE, CRUST, SURFACE, AND ATMOSPHERE
1:30 p.m. Alvarado ABC

Chairs: J. Farquhar
D. A. Papanastassiou

Valley J. W. * Ushikubo T. Kita N. T. [INVITED] (20 minutes)
Two Generations of Carbonate in ALH 84001: Three Oxygen Isotopes and OH [#4023]

Greenwood J. P. * (15 minutes)
Evolution of Water on Mars: Mars Sample Return Considerations for Hydrogen Isotope Measurements [#4030]

Farquhar J. * (15 minutes)
Mars Sample Return: Stable Isotope Targets with Return Samples [#4057]

Bogard D. D. * [INVITED] (20 minutes)
Martian Chronology and Atmospheric Composition: In Situ Measurements Versus Sample Return [#4003]

Nyquist L. E. * Shih C.-Y. Reese Y. D. [INVITED] (20 minutes)
Prospects for Chronological Studies of Martian Rocks and Soils [#4014]

Swindle T. D. * Tornabene L. L. McEwen A. S. Plescia J. B. (15 minutes)
Using Recent Impact Craters as a Sampling Mechanism for a Mars Sample Return Mission [#4029]

Papanastassiou D. A. * (15 minutes)
Why an "Early" Mars Sample Return: Lessons from Apollo [#4009]

Draper D. S. * Agee C. B. (15 minutes)
Fundamental Importance of Returned Samples to Understanding the Martian Interior [#4021]

Nishiizumi K. * Caffee M. W. Herzog G. F. Reedy R. C. (15 minutes)
Measurements of Cosmogenic Nuclides In and Their Significance for Samples Returned from Mars [#4028]

Ballentine C. J. Burgess R. Edwards S. Gilmour J. D. * (15 minutes)
Science Payoff from Noble Gas and Associated Halogen Analysis: Towards a Sample Wish List [#4044]

Weiss B. P. * Garrick-Bethell I. Kirschvink J. L. (15 minutes)
Magnetic Studies of Returned Samples from Mars [#4024]

Wednesday, April 23, 2008
HYDROUS MINERALS AS RECORDERS OF FLUID-ATMOSPHERIC EVOLUTION
AND SECONDARY ALTERATION
8:00 a.m. Alvarado ABC

Chairs: D. L. Bish
D. T. Vaniman

Bish D. L. * Vaniman D. T. (15 minutes)

Clay Mineralogy as a Guide to Alteration Environments on Mars [#4022]

Mustard J. F. * Murchie S. L. Ehlmann B. Milliken R. E. Bibring J.-P. Poulet F. Bishop J. Noe Dobrea E. Roach L. Seelos F. McKeown N. K. (15 minutes)

Hydrated Silicate Minerals and Their Geologic Environments from Orbit [#4038]

Milliken R. E. * Mustard J. F. Ehlmann B. Bishop J. L. Murchie S. CRISM Science Team [INVITED] (20 minutes)

Interpreting and Constraining the Composition and Depositional Environments of Phyllosilicates on Mars [#4036]

Michalski J. R. * Bibring J.-P. Poulet F. Fergason R. Mangold N. Loizeau D. Noe Dobrea E. Bishop J. L. [INVITED] (20 minutes)

Clay-bearing Rocks in the Mawrth Vallis Region, Mars [#4018]

Muttik N. * Kirsimäe K. Somelar P. (15 minutes)

Clay Minerals Formation in Impact Induced Hydrothermal Systems: Source of Hydrous Phases on Mars [#4013]

Noe Dobrea E. Z. * Bishop J. L. McKeown N. K. Swayze G. Michalski J. R. Poulet F. Bibring J.-P. Mustard J. F. Ehlmann B. L. Arvidson R. Morris R. V. Murchie S. Malaret E. Hash C. CRISM Team (15 minutes)

Transition Between Altered and Non-Altered Minerals in Mawrth Vallis and Arabia Terra [#4052]

Rietmeijer F. J. M. * Thiel K. (15 minutes)

An Experimental Study of Phyllosilicate Modification in Comets During Perihelion Could be Relevant to Ferric Iron-rich Layer Silicate Formation at the Martian Surface [#4008]

Velbel M. A. * (15 minutes)

Clay Minerals in Returned Samples and Alteration Conditions on Mars [#4019]

SAMPLE RETURN FROM ANCIENT HYDROTHERMAL SPRINGS. Carlton C. Allen¹ and Dorothy Z. Oehler¹. ¹NASA-Johnson Space Center, Houston, TX 77058. carlton.c.allen@nasa.gov, dorothy.z.oehler@nasa.gov

Introduction: Hydrothermal spring deposits on Mars would make excellent candidates for sample return. Molecular phylogeny suggests that life on Earth may have arisen in hydrothermal settings [1-3], and on Mars, such settings not only would have supplied energy-rich waters in which martian life may have evolved [4-7] but also would have provided warm, liquid water to martian life forms as the climate became colder and drier [8]. Since silica, sulfates, and clays associated with hydrothermal settings are known to preserve geochemical and morphological remains of ancient terrestrial life [9-11], such settings on Mars might similarly preserve evidence of martian life. Finally, because formation of hydrothermal springs includes surface and subsurface processes, martian spring deposits would offer the potential to assess astrobiological potential and hydrological history in a variety of settings, including surface mineralized terraces, associated stream deposits, and subsurface environments where organic remains may have been well protected from oxidation.

Previous attempts to identify martian spring deposits from orbit have been general or limited by resolution of available data [12-14]. However, new satellite imagery from HiRISE has a resolution of 28 cm/pixel, and based on these new data, we have interpreted several features in Vernal Crater, Arabia Terra as ancient hydrothermal springs [15, 16].

Spring-like Features: Vernal Crater is a 55-km-diameter, Noachian impact structure, centered at 6°N 355.5°E, in SW Arabia Terra. The features interpreted as spring deposits are light-toned, elliptical structures, ~200m wide by 450 to 550m long, with low relief and apical depressions (Figs. 1-3). They have bright, terraced and asymmetric flanks, double concentric tonal anomalies having circumferential curved faults, and are associated with flat-topped outcrops, river-like channels, and two regional fracture sets. The fracture sets are composed of multiple linear faults that pre-date the mounds. Two prominent spring-like features have been identified and each displays all of the characteristics listed above [15, 16].

Discussion: The spring-like features are interpreted as low mounds, based on enhanced brightness on their western (sun-facing) sides. Neither feature exhibits a detectable shadow in HiRISE imagery, indicating that local slopes do not exceed the sun angle of 34° above the horizon. Each mound has a circular depression, at a location interpreted as the apex.

The martian structures have a striking similarity to terrestrial spring mounds, such as those at Dalhousie, Australia (Fig. 4) [17-19]. Analog features include size,

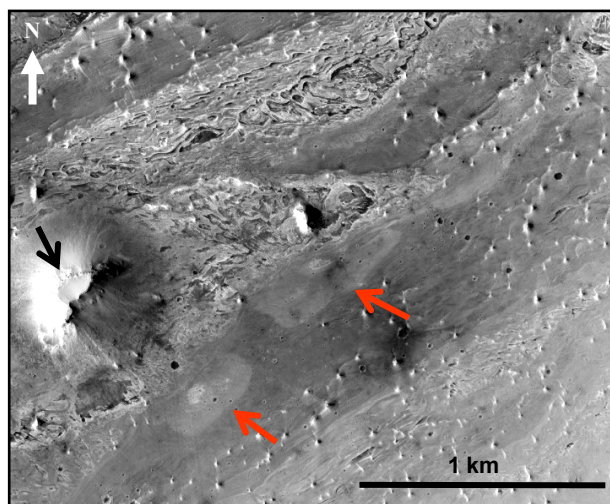

Fig. 1. Spring-like mounds in Vernal Crater, Arabia Terra. Red arrows indicate the elliptical tonal anomalies of the East and West Mounds. Mesa-like outcrop (black arrow). HiRISE image PSP_002812_1855.

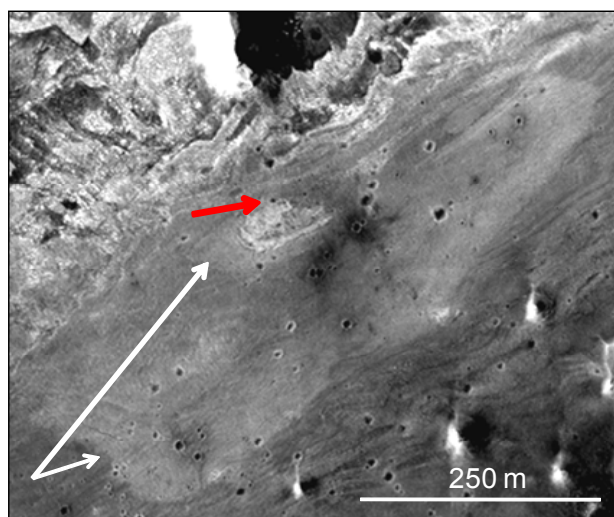

Fig. 2. East mound: inner and outer tonal anomalies (white arrows) and terraced side with apical depression (red arrow). HiRISE image PSP_002812_1855.

shape, tonal anomalies, apical depressions, lateral terraces, asymmetry, and association with river-like channels, mesas, and regional faulting.

The areal density of 5-25 m-diameter craters on each martian mound is approximately 150 per km², suggesting that the two features are roughly contemporaneous, with maximum surface ages of approximately 100 my [20]. This implies that the terraced mounds must be indurated and cemented to have survived millions of years of wind erosion.

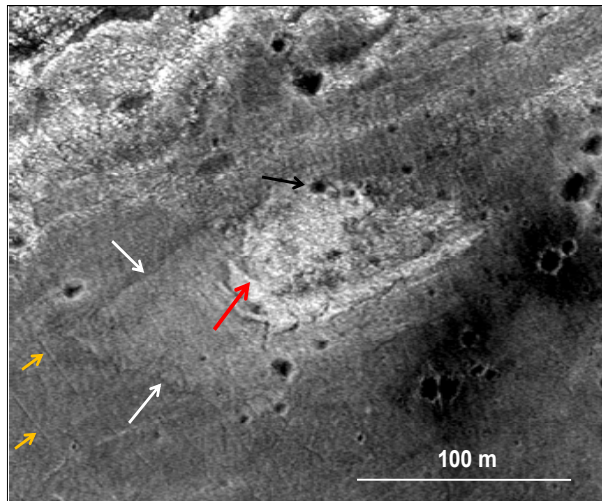

Fig. 3. East mound: inner tonal anomaly (white arrows), bright terrace (red arrow), apical depression (black arrow), linear faults (orange arrows). HiRISE image PSP_002812_1855.

The elliptical shapes of the tonal anomalies and the fact that both mounds display concentric halos suggest that anomaly formation has involved either surface evaporation of pooled liquids (as occurs at Dalhousie) or a subsurface reaction front between fluids and host sediments. Either case implies the past presence of liquid water. This conclusion is supported by the evidence for cementation and by the associated channels that resemble surface rivulets and sapping gullies at Dalhousie [15, 16]. Since liquid water probably has not been stable on the surface of Mars since the late Noachian/Early Hesperian, it is likely that subsurface flow brought comparatively warm waters to colder, shallower settings and that the springs were hydrothermal with respect to local geology.

The composition of the Vernal features is uncertain. Unique mineralogy of the mounds was not detected by CRISM. Spectra from Vernal Crater are dominated by the bright dust that is ubiquitous in Arabia Terra. Nevertheless, the light tone of the mounds is clearly in contrast to surrounding sediments and this suggests that the mounds are composed of a distinctive mineralogy. The persistence of the topography and terracing of the Vernal mounds, despite ubiquitous wind erosion, suggests that these features are indurated, analogous to the cementation observed in terrestrial spring deposits.

Astrobiological Priority for Sample Return:

Identification of ancient thermal springs on Mars is of major importance to astrobiology, as these could be sites where martian life evolved, sought refuge as the climate became colder and drier, and where evidence of that life may be preserved. Carefully selected rock and mineral samples, returned to Earth for detailed laboratory analysis, may provide the first compelling, organic evidence of martian microorganisms.

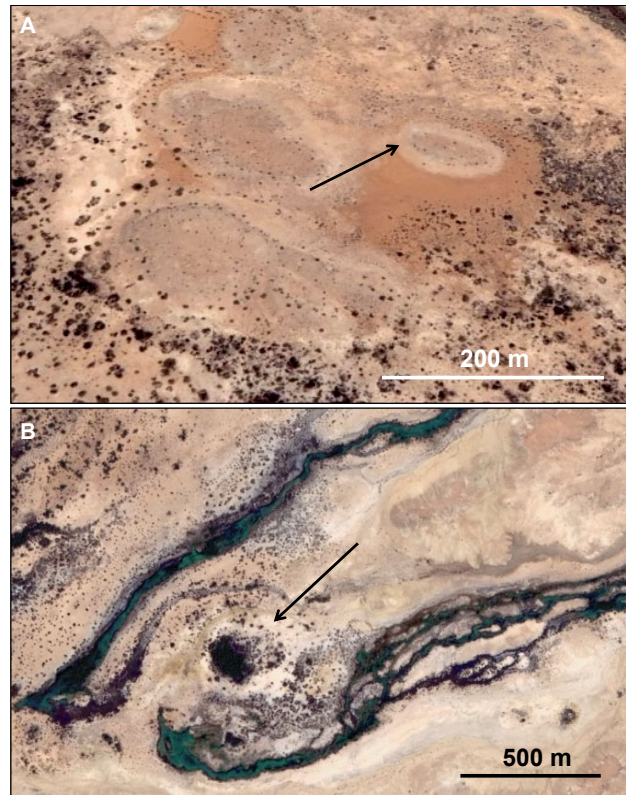

Fig. 4. Spring mounds from the Dalhousie Complex, Australia. A. Elliptical tonal anomalies (arrow). B. Active mound with apical depression (arrow) and associated stream channels. Images from Google Earth.

- References:** [1] C. Blank, *Geobiology* **2**, 1-20 (2004). [2] S. Barion *et al.*, *Biosystems* **87**, 13-19 (2007). [3] K. Stetter, in *Evol. Hydrothermal Ecosystems on Earth (& Mars?)*, Bock & Goode, Eds. (Wiley, NY, 1996), 1-10. [4] M. R. Walter, in *Evol. Hydrothermal Ecosystems on Earth (& Mars?)*, Bock & Goode, Eds. (Wiley, NY, 1996), 112-127. [5] J. Farmer, in *Evol. Hydrothermal Ecosystems on Earth (& Mars?)*, Bock & Goode, Eds. (Wiley, NY, 1996), 273-299. [6] E. Shock, in *Evol. Hydrothermal Ecosystems on Earth (& Mars?)*, Bock & Goode, Eds. (Wiley, NY, 1996), 40-52. [7] S. Grasby, K. Londry, *Astrobiology* **7** (4), 662-683 (2007). [8] A. Knoll, M. Walter, in *Evol. Hydrothermal Ecosystems on Earth (& Mars?)*, Bock & Goode, Eds. (Wiley, NY, 1996), 198-209. [9] S. Cady, J. Farmer, in *Evol. Hydrothermal Ecosystems on Earth (& Mars?)*, Bock & Goode, Eds. (Wiley, NY, 1996), 150-170. [10] J. Parnell *et al.*, *Geology* **33** (5), 373-376. [11] W. Farrand *et al.*, *J. Geophys. Res.* **110**, E05005 (2005). [12] L. Crumpler, *6th Intl. Conf. Mars*, Abs. 3228 (2003). [13] A. Rossi *et al.*, *LPSC XXXVIII*, Abs. 1549 (2007). [14] Oehler, D.Z. & Allen, C.C. *LPSC XXXIX*, Abs. 1949 (2008). [15] Allen, C.C. & Oehler, D.Z., *AbSciCon Abs.* 4053787 (2008). [16] J. Clarke, C. Stoker, *LPSC XXXIV*, Abs. 1504 (2003). [17] M. Bourke *et al.*, *LPSC XXXVIII*, Abs. 2174 (2007). [18] P. Nelson, M. Manga, M. Bourke, J. Clarke, *LPSC XXXVIII*, Abs. 2111 (2007). [19] J. Garvin, S., Sakimoto, J. Frawley, *6th Intl. Conf. Mars*, Abs. 3277 (2003).

SCIENTIFIC RATIONALE FOR CONSIDERATION OF CHEMICALLY ALTERED METEORITES IN A MARS SAMPLE RETURN MISSION. J. W. Ashley^{1,2}. ¹School of Earth and Space Exploration, Mars Space Flight Facility, Arizona State University, Box 871404, Tempe, AZ 85287; ²Minor Planet Research, Inc., Box 19964, Fountain Hills, AZ 85269; james.ashley@asu.edu.

Introduction: Rock materials suspected to have a meteoritic (exogenous) origin have been identified at both Mars Exploration Rover (MER) locations [1], thus demonstrating the ready availability of such material on the martian surface. During the course of nominal mission operations, it is therefore possible (and perhaps even likely) that a roving sample-return spacecraft, or its caching predecessor, would again encounter meteoritic specimens. Providing that the ability to recognize meteorites is at least as feasible as is the case for the MERs, an opportunity for recovery would be at hand.

However, the scientific value of meteorites is traditionally focused on their relevance to the formation and evolution history of the solar system, not the planets upon which they happen to land after ejection from their parent bodies. From this standpoint, we are justified in regarding meteoritic material as a form of contamination for any Mars Sample Return (MSR) mission. However, the mere circumstance of meteoritic material on the surface of Mars provides an alternative way to follow the water through the effects of mineral-water interactions (chemical weathering), and therefore address Mars' climatic history and habitability potential. With a successful sample return, we would have the ability to study through the alteration of materials with well-known starting mineralogies, chemistries (elemental and isotopic), and textures. Conceptually, we have an experiment equivalent to the artificial insertion of an unweathered rock of known character into the Martian surface environment, using it to probe the longer-term behavior of mineral-water interactions at ambient atmospheric pressures and temperatures. Meteorites are in effect control or "witness" [2] samples for the weathering of Mars. A great deal indeed could be learned from their study. Such an approach is particularly applicable to stony meteorites where water migration pathways exist in the form of cleavage planes, grain interstices, and fractures not normally present in iron meteorites.

Background: Meteorite weathering has been studied extensively in several Mars analog environments. Studies of mineral-water interactions have been performed to evaluate nebular and parent body processes, and the negative effects of weathering (i.e. contamination, elemental redistribution, mineralogical alteration, etc.). Unfortunately for cosmochemists, meteorites being dominantly composed of high temperature minerals weather rapidly in the terrestrial environment where pressure-temperature-concentration (*PTX*) conditions are far from the conditions of formation, and where liquid water and oxygen are abundant. However, while constituting a nuisance to the study of meteorites on Earth, low-temperature mineral-water interactions may be a significant extraterrestrial process [e.g. 3]. It has been sug-

gested that meteoritic weathering scenarios in Antarctica may be analogous to low temperature "hydrocryogenic" alteration mechanisms on Mars, in addition to asteroid regoliths and interiors, cometary interiors, and within the surfaces of icy moons of the Jovian planetary systems [4 and 3].



Figure 1. False color MER-B Pancam image collected Sol 1049 showing cobble Ibirama, together with a portion of the Santa Catarina Cobble Field (unofficial name), located along the NNW rim of Victoria Crater, Meridiani Planum, Mars. Santa Catarina was the first member of this field of cobbles to be investigated by rover arm (Instrument Deployment Device) instruments, and is suspected of being a stony-iron meteorite [1]. Other members of this field may be meteoritic by association. Such material is highly sensitized (more so than indigenous basalts) to mineral-water interactions, and would therefore serve well to help assess the subtleties of climatic behavior through laboratory study. Image credits: NASA/JPL/Pancam.

In the process of such studies, much has been learned about mineral-water interactions in low-humidity and low-temperature environments that can be applied to the martian situation. Examples of such elemental redistribution were illustrated in 1988 by [5], where it was determined that rubidium, cobalt, iodine, and calcium may be removed from the interiors of Antarctic chondrites to be concentrated at their surfaces during the production of various evaporite minerals, thereafter to be removed completely by wind erosion. The same was found to be true for carbon [6]. The most obvious indication of Antarctic meteorite weathering is the presence of iron oxide staining [e.g. 7]. The recognized secondary products in Antarctic meteorites include hydrous and anhydrous iron oxides [7] carbonates and sulfates [8, 9, and 5], and amorphous mineraloids with smectitic compositions [4 and 10]. Indeed, [4] recognized that thin films of liquid water can exist at subzero temperatures

that facilitate the elemental migration necessary for typical weathering reactions. In addition, it was empirically determined that Antarctic meteorites exposed to sunlight may have internal temperatures (at depths up to 2.0 cm in some meteorites) that rise as high as 5°C on wind-free days (even when air temperatures remain below 0°C), enabling capillary waters to promote reactions [11]. Moreover, some oxidation reactions have been found to occur in the solid state at low relative humidities [12].

Fully 88 percent of all meteorite falls contain greater or lesser amounts of reduced iron-nickel metal, which will oxidize readily in the presence of even trace amounts of water (liquid or ice, but probably not vapor in most cases). Meteoritic iron is likely to be the most sensitive material to this type of alteration on the surface of Mars. Where weathering intensities might be subtle or undetectable for indigenous rocks, they may be conspicuous in this responsive material. Many meteorites (most of which can be thought of as ultramafic rocks because of their olivine and pyroxene content) are also highly sensitive to silicate alteration. Moreover, many are unequilibrated thermodynamically, adding further to this sensitivity.

Meteoritic Materials in Martian Regolith. As discussed by [13], knowing the contribution of meteoritic materials to Martian soils and sedimentary rock origins, compositions, and weathering scenarios is important to the proper interpretation of geochemical history. [13] further point out that understanding the influx of organic material is necessary for “constraining carbon oxidation rates in support of Martian habitability assessments.” In addition, 1) addressing the mysteries of the titanomagnetite component of the martian dust, 2) assessment of past and present meteoritic flux rates, 3) assigning terrestrial ages to any sizable meteoritic materials for possible determination of sedimentation rates (an idea that should be explored when making sample selections), are important considerations for the study of the meteoritic component to martian regolith materials. For some of these studies, meteoritic material would be regarded as a contaminant; for others, the material is the object of study. In either case, the information is invaluable to the study of Mars conditions and processes.

Our best estimates of the extent of interaction between the Martian surface and the interplanetary medium are currently based on APXS data from both MER-A and MER-B rock and soil targets, and place the amount of contribution at 1 to 3 percent chondritic [13]. However, the authors of this study indicate that other factors could be affecting this estimate, which is based primarily on nickel abundance. Many of the uncertainties are readily avoided when samples are available for laboratory study. For example, laboratory samples of sedimentary rock and soil would allow not only the direct measurement of trace element chemistry at a higher level of accuracy, but also the probing of individual grains on the microscale.

Terrestrial Residence Time. The question of terrestrial residence time will be important for providing constraints on martian weathering behavior. Both cosmogenic stable nuclides and radionuclides are discussed by [14] for

the martian situation. The authors suggest that the ^{10}Be - ^{26}Al - ^{21}Ne isotope system should be useful for determining exposure ages for rocks at Mars’ surface up to 10^6 - 10^7 years b.p. If sufficient spallation/ablation and/or fragmentation had occurred during atmospheric entry (a reasonable assumption), such an age determination should be obtainable up to this maximum for a meteorite sample returned to the laboratory. Determining ages for older exposure histories may be more problematic, but could be possible within the context of contributing stratigraphic, geomorphologic, and/or geochemical factors. It should, however, be noted that a single, highly weathered meteorite would be invaluable even if terrestrial ages cannot be ascertained.

Summary: A valid approach to considering whether meteorites found on Mars would be valuable for the study of martian climatic and habitability history could be summarized with the following: 1) Meteorites are more sensitive to mineral-water interactions (chemical alteration) than most other rock types, and 2) their unaltered “starting” elemental chemistries, isotopic chemistries, mineralogies, and textures are already known. These conditions make exogenic materials ideal witness samples for the study of surface-atmosphere interactions for any planet with an atmosphere. Thus determining the weathering intensity of the meteoritic materials for the purpose of paleoclimatic assessments, is a significant scientific objective served by a meteorite sample return mission.

References: [1] Schröder C. et al. *JGR* (in press). [2] S. Ruff (2008) personal communication. [3] Zolensky and McSween (1988) in *Meteoritics and the Early Solar System*, Univ. of Ariz. Press. [4] J.L. Gooding (1986) *Geochim. Et Cosmochim. Acta.* 50, 2115-2223. [5] M.A. Velbel (1988) *Meteoritics and Planetary Science* 23, 151-159. [6] C.P. Hartmetz et al. (1989) *Meteoritics and Planetary Science* 24, 274-275. [7] J.L. Gooding (1981) *Proc. Lunar Planet. Sci.* 12B, 1105-1122. [8] U.B. Marvin (1980) *Antarct. Jour. U.S.*, 15, 54-55. [9] A.J.T. Jull et al. (1988) *Science* 242, 417-419. [10] J.L. Gooding (1989) in *Smithsonian Contributions to the Earth Sciences*, 28. [11] L. Schultz (1986) *Meteoritics and Planetary Science* 21. [12] V.F. Buchwald and R.S. Clarke (1989) *American Mineralogist* 74, 656-667. [13] A. S. Yen, et al. (2006) *JGR* 11 (E12), doi:10.1029/2006JE002797. [14] Nishiizumi K. and Reedy R.C. (2000) *Concepts and Approaches for Mars Exploration*, abstract #6119.

SCIENCE PAYOFF FROM NOBLE GAS AND ASSOCIATED HALOGEN ANALYSIS: TOWARDS A SAMPLE WISH LIST. C. J. Ballentine, R. Burgess, S. Edwards and J. D. Gilmour, SEAES, University of Manchester, Manchester, M13 9PL, United Kingdom.

Introduction: Noble gases have long played a central role in the development of our understanding of the evolution of the Earth and interactions among mantle, crust and atmosphere. The key to these developments has been the characterization of the isotopic and elemental compositions of the associated reservoirs. Recent work has concluded that the Earth originated with a noble gas component that was isotopically solar. It is thought that the present-day reservoirs evolved from this composition through outgassing, fractionation associated with loss processes and the admixture of decay products of various unstable isotopes[1].

What we know of the martian system is mostly based on analyses of martian meteorites. The story is somewhat similar. There is evidence of a solar composition for at least part of the martian interior[2]. This signature occurs with varying amounts of fission-derived xenon[3]. The isotopic fractionation of xenon in the martian atmosphere[4] is similar to that of the Earth. In contrast to the Earth, however, the martian atmosphere is more radiogenic than its interior, testifying to significant differences between the early histories of volatiles (especially iodine and xenon) on the two planets.

However, there are inherent limitations to our developing understanding imposed by the use of martian meteorites. In addition to the lack of geological context for our investigations, the samples are exposed to cosmic rays for several million years during transit to the Earth. This leads to the production of spallation isotopes depending on the abundance of appropriate target elements. For xenon, this in fact led to the identification of the host phase of the interior component in Nakhla[5]. However, the high concentrations of target elements for He and Ne production mean that the signatures of these elements in martian reservoirs are very poorly constrained.

In addition to helping us define models of martian evolution, noble gas analyses can make other important contributions. The Ar-Ar technique based on decay of ^{40}K to ^{40}Ar will play a significant role in determining absolute ages and calibrating the cratering timescale provided appropriate samples are selected. The Ar-Ar technique requires neutron irradiation, that also allows cosmic ray exposure ages to be determined based on the production of ^{36}Ar from Ca, while noble gas isotopes produced by neutron capture allow relative abundances of the halogens Cl, Br and I to be derived. Thus, noble gas analysis will allow a detailed under-

standing of the volatile evolution of Mars to be developed.

Sample Wish List: Constraining planetary evolution depends on the characterization of planetary reservoirs. To this end, a returned atmospheric sample is crucial to allow both detailed comparison with the heavy element composition understood from martian meteorite analyses (hence addressing atmospheric evolution) and the first tight constraints on the isotopic signatures of the light isotopes. An in situ atmospheric measurement is unlikely to have the required precision (e.g. Viking), but would allow the issue of contamination between sample collection and analysis to be addressed.

Understanding of the martian interior is likely to be best addressed through analysis of igneous rocks. Within 3 m of the surface the cosmic ray flux is greater than that at the Earth's surface. Combined with low erosion rates this suggests deep samples will be required to preserve the signatures of parent reservoirs against overprinting by spallation. The solution is to seek either buried or recently exposed samples, or samples from recent lava flows.

Dating techniques applied to sedimentary rocks tend to yield ambiguous results, thus calibration of the cratering timescale will also require suitable samples of igneous rock. However, the halogen composition of sedimentary rocks deposited from water can potentially play an important role in understanding the history of the parent water body.

Technology: The current state-of-the-art in noble gas mass spectrometry is commercially available multi-collector, electron impact instrumentation and experimental, element specific resonance ionization, time-of-flight instruments for xenon and krypton, all of which are available in Manchester. Detection limits of ~ 1000 atoms are achievable, but for martian samples $10^5 - 10^6$ atoms represent useful sample sizes. For xenon, this corresponds to $\sim 1 \text{ mm}^3$ of the present-day martian atmosphere. Based on analyses of martian meteorites, samples of $\sim 1 \text{ mg}$ are required for characterization of xenon in the interior component. For Ar-Ar and halogen determinations 1-2 mg samples are indicated.

[1]e.g. Ballentine et al. (2005) *Nature* 433 33-38.
[2]Ott U (1988) *GCA* 52 1937-1948 [3]Mathew and Marti (2002) *EPSL* 199, 7-20 [4]e.g. Swindle et al. (1986) *GCA* 1001-1015 [5]Gilmour et al. (2001) *GCA* 65 343-354.

OMEGA/MARS EXPRESS FEED FORWARD TO MSR. J-P. Bibring, Institut d'Astrophysique Spatiale (IAS), Orsay, France (bibring@ias.fr).

Introduction: Following on the pioneering ISM/Phobos and TES/MGS compositional mapping of Mars, OMEGA and HRSC on board Mars Express, coupled to the MERs ground truth, and complemented by CRISM and HIRISE on MRO, have unprecedentedly increased our understanding of the evolution of Mars by coupling compositional data to geomorphological context exhibiting the space and time evolution of the martian environment, at all timescales from geological and climatic to seasonal variations. An important outcome is the very high degree of diversity of the surface, coupled to a high level of preservation, which enables to potentially sample surface material recording most if not all eras constituting the Martian history. There exist a number of areas in which landing would enable collecting samples reflecting this diversity, on a small spatial scale.

Mars uniqueness: Mainly due to its size, sufficiently large (as compared to the Moon) to have been subjected to a high level of internal activity, as traced e.g. by the remnant crustal magnetization, the volcanic features, the fluvial structures, and sufficiently small (as compared to the Earth) not to have suffered global resets, Mars is unique in comparative planetology to exhibit surface terrains enabling potentially to reconstruct the entire history of inner solar system differentiated bodies. A variety of both pristine and altered phases have been identified and mapped in their geological and environmental context, by OMEGA: the cratered crust is characterized by abundant Low Ca Pyroxene (LCP), while the magma outflows are enriched in High Ca pyroxenes (HCP); within the crust, a number of spots show the presence of hydrated phyllosilicates (the discovery of which is one major outcome of the OMEGA investigation); sulfates are found in younger terrains, mostly associated with the Tharsis tectonic event; the reddish and bright soil is dominated by anhydrous ferric oxides (hematite), tracing an alteration without liquid water involved, operating till nowadays. No carbonates have been mapped, which pleads towards an early atmospheric escape. Collecting relevant samples, and analyzing in the lab their elemental, isotopic, mineralogical and molecular constituents, would enable dating and characterizing the processes that took place all along Mars evolution.

Mars habitability: A fundamental outcome of the OMEGA/Mars Express discoveries, confirmed by CRISM/MRO, is the potential for Mars to have har-

bored habitable conditions, very early in its History, as recorded by the presence of hydrated phyllosilicates, in crustal-correlated spots. The relevant era ended rapidly, through a global climatic change likely triggered by the drop of the dynamo, followed by the volcanic building of Tharsis. The areas still preserving this record are not located where optical images would tend to indicate, that is in connection with fluvial structures. On the opposite, they are located within the oldest crustal terrains, in sites exposed through either erosion or impact. The possibility to sample material still preserving the record of the potential emergence of extra-terrestrial life (as biorelics) is a major trigger and stimulus for MSR programmes.

Ready to go MSR: The present knowledge of Mars history, as described by surface structures characterized by their composition, derived from Mars Express and MRO extended mapping, complemented by the MERs, MSL and ExoMars in situ mission, are sufficient to define a scientifically successful MSR with respect to where to go, what to sample, what to measure when returned. There is no need for further characterization, that would justify a new precursor mission. The case will be made, based on the results we will present and discuss, that programmatically, it is just time to go MSR.

CLAY MINERALOGY AS A GUIDE TO ALTERATION ENVIRONMENTS ON MARS. D. L. Bish¹ and D. T. Vaniman², ¹Department of Geological Sciences, Indiana University, 1001 E. 10th St., Bloomington, IN 47405; bish@indiana.edu, ²Los Alamos National Laboratory, MS D462, Los Alamos, NM 87545; vaniman@lanl.gov

Introduction: The possibility of a Mars sample return mission to continue NASA's "Follow the Water" strategy focuses new attention on hydrous environments and the minerals formed in them. In order to understand the evolution of Mars, it is useful to sample assemblages that can provide information on the evolution of the martian atmosphere, the nature of martian surface processes, and the thermal-magmatic evolution of the martian mantle and crust. Orbital and surface-derived data have greatly expanded our understanding of Mars' surface and have shown that hydrous minerals are far more common than previously imagined. Geologists traditionally "read the rocks" to interpret geologic history, and the process involves consideration of textures, assemblages, and mineralogy (and faunal and floral evidence on Earth). The focus of any sample return mission to Mars must be on locales that have the potential to maximize the return of *new* geological information and to provide data that will give us so-called ground-truth information for further interpretation of existing orbital and surface data.

Mars' surface mineralogy holds clues to its hydrologic and geochemical histories and can constrain past alteration processes. Based on early remote IR analyses [1] and Viking XRF results [2], Fe-rich smectites or their degradation products were proposed as major constituents of martian surface soils and dusts. Gooding [3] used thermodynamic data for kaolinite and estimated data for a variety of smectites to conclude that smectites were unstable relative to kaolinite. However, he also concluded that metastable formation and/or preservation could make smectites important constituents of martian dusts and soils. The inference of Fe-rich clay minerals at the martian surface has persisted and clay minerals remain a major component of many surface mineralogic models in the assessment of newer data, *e.g.*, [4] and [5]. There is also abundant evidence for hydrous minerals in the martian regolith, supported by Viking thermal analyses and also indirectly by Mars Odyssey results showing up to 10% H₂O-equivalent H in the upper meter of the surface in equatorial regions. However, these data provide few constraints on the identity of these hydrous minerals.

More definitive data on the mineralogy of Mars [*e.g.*, 5 & 6] show that rock compositions are basaltic to andesitic and contain glass and/or phyllosilicate components. Recent OMEGA and CRISM spectral data suggested the presence of phyllosilicates in several Noachian deposits with a range of Fe, Al, and Mg

bonded to structural OH [*e.g.*, 7, 8, 9, 10]. As discussed by [11], TES fits produce different results for the type-2 martian surface depending on which phyllosilicate and glass spectra are included in the end-member library. In many places, the chemistry of the martian fines is consistent with the presence of altered volcanic material including phyllosilicates, silica, and glass, and recent work [12, 13, & 14] suggested the presence of silica-rich deposits (*e.g.*, opal).

Clay Mineralogy and Alteration Processes on Mars: Mineral alteration and formation on Mars can occur via many paths, including aqueous and vapor [*e.g.*, 15, 16, 17, 18, 19], and interpreting past alteration processes is complex. However, alteration conditions on Mars can be elucidated by an understanding of alteration mineralogy. Depending on conditions, volcanic glass can alter to a variety of mineral assemblages, including zeolites, smectites, kaolin minerals, hydrated volcanic glass, and opaline silica. For example, [18] suggested that amorphous silica, goethite, and kaolinite would form early under acid alteration conditions, whereas zeolites and carbonates would form later under more alkaline conditions. Yen *et al.* [14] suggested that recently observed silica deposits could have formed from hydrothermal alteration or from acidic vapors with small amounts of liquid water. Stability diagrams can shed light on alteration conditions, and Figure 1 shows the sequence from amorphous silica through progressively less siliceous phases as silica activity decreases. The discovery of amorphous silica thus greatly constrains formation conditions.

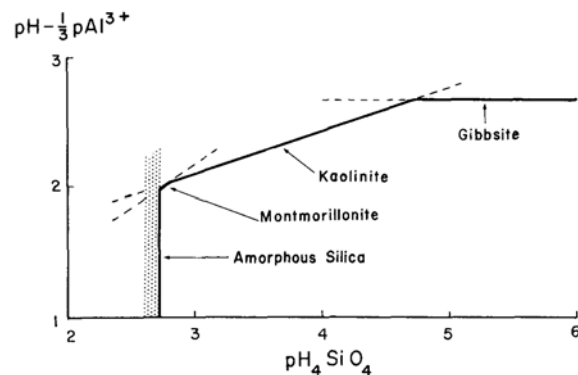

Figure 1. Stability diagram for minerals in the Al₂O₃-SiO₂-H₂O system at 25°C and 1 atm. Solutions are supersaturated with the respective phase to the left of or above the solid line (from [19]). The "p" in axis labels refers to $-\log[]$.

Either smectites or zeolites can form from volcanic ash, depending on conditions, with smectite formation occurring in near- or below-neutral pH conditions and zeolites forming under alkaline conditions. We cannot assume that basaltic volcanic ash will always alter to phyllosilicates. Detection of secondary zeolites would strongly imply the occurrence of alkaline conditions but detection of both smectites and zeolites would indicate a much more persistent and evolved hydrogeologic system. Formation of kaolin minerals would imply a reasonably distinct set of formation conditions. For example, Millot [20] emphasized that kaolin minerals form on Earth most commonly in tropical climates, usually under more-acidic conditions and with high water:rock ratios (well drained). They may also be accompanied by amorphous silica deposits when formed hydrothermally. In addition, they are often accompanied by TiO₂ minerals such as anatase. On Mars, a Ti-Si association has been considered to support acid vapor alteration [14]. Detection of 10Å hydrated halloysite, a more hydrated kaolin mineral, on Mars would imply that the mineral had never experienced dehydration after formation, as hydrated halloysite irreversibly dehydrates to a 7.2Å phase under low-RH conditions. Figure 2 summarizes the relationship between intensity of weathering and resultant mineralogy, with relic micas and chlorites in the least weathered/altered assemblages, smectites and kaolinite as intermediates, and oxides/hydroxides as end stages.

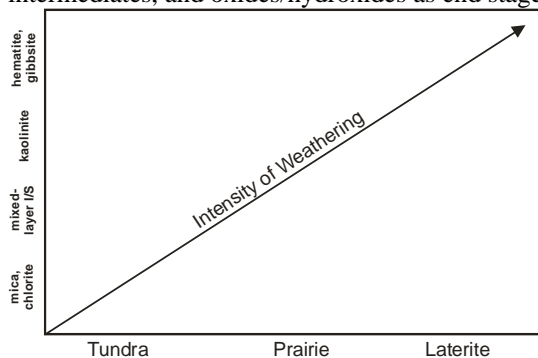

Figure 2. Mineralogy vs. intensity of weathering (modified from [21]).

Additional information on formation conditions can be obtained from experiments. For example, nontronite has been often suggested to occur on Mars; [22] showed that nontronite can form at low temperatures only under *reducing* conditions, where Fe is soluble.

We also have the potential to learn much concerning clay mineral stability from Mars' surface mineralogy. More poorly ordered clay minerals such as smectites and illite/smectites do not occur in old rocks on Earth, and it has often been assumed that these minerals gradually transform to more stable, higher-

temperature phases such as illite, micas, and chlorites. This concept is illustrated in Figure 3, which implies that mixed-layer illite/smectites are not stable over long times even at low temperatures. The discovery of smectites in Noachian terrains [7, 8] has important implications for the long-term stability of clay minerals and suggests an alternative hypothesis, namely that tectonic activity on Earth eventually results in the progressive alteration of low-temperature minerals to higher-temperature assemblages. If the existence of smectites on Mars in rocks older than 3 By is verified, these results will rewrite our understand of clay mineral stability and suggest that, in the absence of (plate) tectonic activity, "metastable" clay minerals may be "stable" for times on the order of the age of our planet.

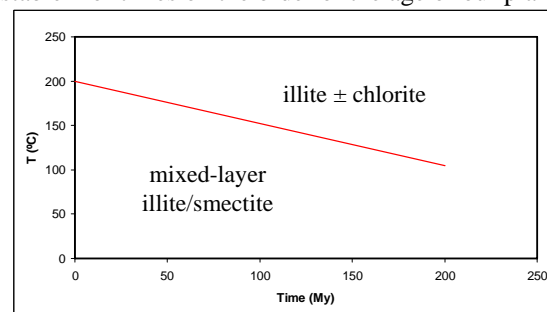

Figure 3. Time-temperature limits on clay minerals (modified from [23]).

References: [1] Hunt G. R. and Salisbury J. W. (1973) *Icarus*, 18, 459-469. [2] Toulmin P. et al. (1977) *JGR*, 82, 4625-4634. [3] Gooding, J. L. (1978) *Icarus* 33, 483-513. [4] Calvin W. M. (1998) *LPS XXIX*, Abstract #1162. [5] Michalski J. R. et al. (2006) *JGR*, 111, E03004. [6] Christensen P. R. et al. (2001) *JGR*, 106, 23823-23871. [7] Bibring J-P. et al. (2006) *Science*, 312, 400-404. [8] Poulet F. et al. (2005) *Nature*, 438, 623-627. [9] Milliken R. E. (2007) *EOS Trans AGU*, 88, Abstract #P12A-02. [10] Bishop J. L. et al. (2007) *EOS Trans AGU*, 88, Abstract #P13D-1559. [11] McSween H. Y. J. et al. (2003) *JGR*, 108, 5135. [12] Michalski J. R. et al. (2005) *Icarus*, 174, 161-177. [13] Ruff S. W. et al. (2007) *EOS Trans AGU*, 88, Abstract #P23A-1097. [14] Yen A. et al. (2007) *EOS Trans AGU*, 88, Abstract #P23A-1095. [15] Gooding J. L. et al. (1992) in *Mars*, 626-651. [16] Banin A. et al. (1997) *JGR*, 102, 13341-13356. [17] Hurowitz J. A. and McLennan S. M. (2007) *EPSL*, 260, 432-443. [18] Zolotov M. Y. and Mironenko M. V. (2007) *JGR-Planets*, 112, E07006. [19] Kittrick J. A. (1969) *Clays & Clay Min*, 17, 157-167. [20] Millot G. (1970) *Geology of Clays*, Springer-Verlag. [21] Velde B. (1985) *Clay Minerals*, Elsevier. [22] Harder H. (1978) *Clays & Clay Min*, 26, 65-72. [23] Velde B. (1992) *Intro. to Clay Minerals*, Chapman & Hall.

Martian Chronology and Atmospheric Composition: In Situ Measurements Versus Sample Return.

Donald D. Bogard, ARES, code KR, NASA, Johnson Space Center, Houston, TX 77058

Overview. I examine two significant issues of martian science from the point of view of in situ measurements by robotic spacecraft versus sample return and analysis in terrestrial labs. (1) To define martian history, ages of geological processes and surface features are required. Estimated ages from surface crater densities have limitations, and the ages measured for martian meteorites cannot be associated with specific martian locales. Whereas returned martian rocks could be accurately dated, some have suggested sending a robotic spacecraft to Mars to measure rock ages using the classical K-⁴⁰Ar technique, considered the easiest to implement. (2) To understand the evolution of the martian atmosphere and its interactions with the surface, requires precise measurements of atmospheric composition. A significant amount of information has derived from measurements by Viking and of martian meteorites. Instrumentation on the Mars Science Lander (MSL) spacecraft to be launched in the near future promises to determine atmospheric composition even more precisely. If MSL is successful, which questions about atmospheric composition will remain and thus will require atmospheric sample return to answer?

Meteorite Ages & Robotic Age Dating. At JSC we have measured ³⁹Ar-⁴⁰Ar ages of many martian meteorites. Essentially all of the shergottites, but not the nakhlites, contain excess ⁴⁰Ar that renders their K-Ar formation ages difficult to measure. We have argued that in many shergottite samples this excess ⁴⁰Ar was not acquired from the martian atmosphere, but is radiogenic ⁴⁰Ar contained in the basaltic magma and incorporated into the meteorites during crystallization. Fig. 1 gives an isochron plot of total K versus total ⁴⁰Ar for nine basaltic shergottites that show similar formation ages of ~170 Myr, as determined by other radiometric techniques. Data with high and very low [K] are feldspathic and pyroxene separates, respectively, and intermediate [K] data are whole rock. Such an isochron is the manner K-Ar data acquired robotically likely would be evaluated. The dashed lines all have the same slope and represent an isochron age of 170 Myr. It is obvious that none of the data are consistent with a K-Ar age as

young as 170 Myr unless comparable amounts of excess ⁴⁰Ar (1-2.5 x10⁻⁶ cm³STP/g) is present in all samples. An analogous isochron plot of JSC data for three depleted shergottites having formation ages of ~470 Myr gives similar results.

A K versus ⁴⁰Ar isochron plot for whole rock and mineral separates of six martian nakhlites is strongly linear and defines a precise (R²=0.9986) isochron age of 1325 ±18 Myr, in excellent agreement with the range in ages obtained on individual nakhlites by other chronometers. Further, because the isochron passes within error of the origin, these nakhlite samples contain essentially no excess ⁴⁰Ar.

The dilemma that would be faced in robotically dating *in situ* these meteorite samples by K-Ar is in knowing whether they did or did not contain excess ⁴⁰Ar. To answer this question clearly would require that a K-⁴⁰Ar isochron be produced from samples possessing sufficiently different [K] so as to define the isochron slope (Fig. 2). If the isochron slope is not defined, the presence or absence of ⁴⁰Ar_{xs} and thus the K-Ar age cannot be determined. Even among six nakhlites, whole rock [K] varies less than a factor of three.

Martian Atmospheric Composition. The SAM FM mass and laser spectrometers aboard MSL have the potential of measuring the isotopic composition of several martian atmospheric species to precisions of ~0.2-1% (P. Mahaffy, pers. comm., 2008). Measurement of lower abundance isotopes is expected to be less precise, yet these isotopes often constitute the most critical data for addressing science questions. Below I list major science questions associated with individual atmospheric species. Assuming that MSL will measure the isotopic abundance of these species to 1%. I then evaluate whether a strong rationale remains for returning to Earth an atmospheric sample of that species.

Xe and Kr. Isotopes of atmospheric Xe are strongly mass fractionated, ~40% across 124-136 amu, probably by early atmospheric loss. Kr composition, however, is close to solar Kr, but may be slightly mass fractionated. Relatively precise measurements of the extent of these

fractionations are required to know the origins (e.g., solar, cometary, planetary) of original Xe and Kr acquired by Mars and of the atmospheric loss processes and timing. Further, the atmosphere contains large relative excesses of ^{129}Xe ($^{129}\text{Xe}/^{132}\text{Xe}=2.6$) from decay of extinct ^{129}I ; likely small relative excesses of $^{80, 82}\text{Kr}$ produced by neutron capture on bromine; fission Xe; and possibly gas produced by cosmic ray reactions. A 1% precision in measuring the total Xe isotopic composition would reasonably define both the fractionation pattern and the amount of excess ^{129}Xe , but would not accurately define the fission and spallation components. The small fractionation in Kr and the presence of neutron components would require precision greater than 1% to accurately define both effects. Thus, a strong case can be made for returning a sample of Kr, and a moderately strong case for returning Xe.

N₂, Ar, Ne Viking measured martian $^{15}\text{N}/^{14}\text{N}$ as 1.62 ± 0.16 that of Earth. This value reflects fractionation during atmospheric loss over time, and is the major science issue associated with atmospheric $^{15}\text{N}/^{14}\text{N}$. Measuring this ratio to 1% would be sufficient for modeling mechanisms of such loss. The $^{38}\text{Ar}/^{36}\text{Ar}$ ratio appears to have been increased by ~25% from the original by atmospheric loss over time, and is known to ~5-10%. Again, knowing this ratio to 1% would satisfy loss models. Because of uncertainties in loss models, it seems unlikely that precision greater than 1% in either $^{14}\text{N}/^{15}\text{N}$ or $^{36}\text{Ar}/^{38}\text{Ar}$ could address the original compositions before loss. The atmospheric $^{40}\text{Ar}/^{36}\text{Ar}$ ratio is $\sim 1800 \pm 10\%$, and represents decay of ^{40}K in the crust and its degassing over time. Measuring this ratio to 1% is probably satisfactory in order to evaluate time evolution of the atmospheric ratio by comparison to older atmosphere trapped in solid samples. No precise measurements exist for Ne, which may be strongly fractionated due to loss. Again, a 1% isotopic precision is probably satisfactory.

CO₂. Viking measured the isotopic composition of C and O in atmospheric CO₂ to ~5-10%. These elements may not be significantly fractionated because of buffering by larger quantities of surface condensates. However, phase transitions and chemical reactions involving these elements produce small isotopic fractionations at the per mill level, and atmospheric CO₂ is likely to

be an important part of these transitions. Thus, isotopic measurements of atmospheric CO₂ more accurate than those likely to be determined by MSL is important for a wide variety of science questions, including, temperatures involved in some reactions.

Minor Reactive Species. It is not apparent that minor, chemically reactive species in the martian atmosphere can be returned to Earth unaltered. Although they address interesting science questions, some of these species may be better measured *in situ*.

In summary, good rationale can be presented for return to Earth of martian atmospheric Kr, Xe, and CO₂, but the arguments are weaker for N₂, Ar, and Ne. This assumes that MSL actually measures these isotopic compositions to 1%. If MSL fails to accomplish this goal, good science rationale exists for measuring all these atmosphere species in terrestrial labs.

Lack of space prevents me from quoting many relevant references, for which I apologize.

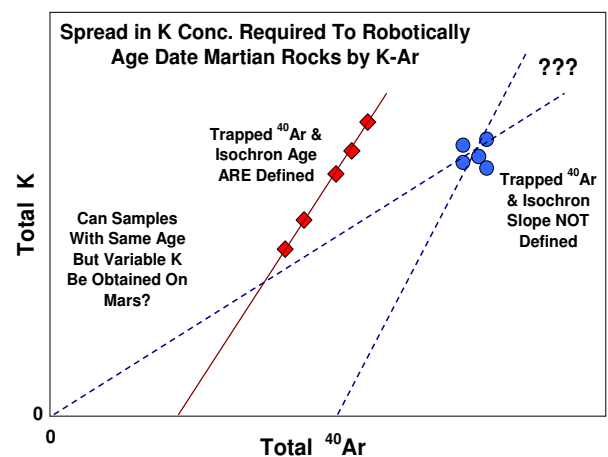
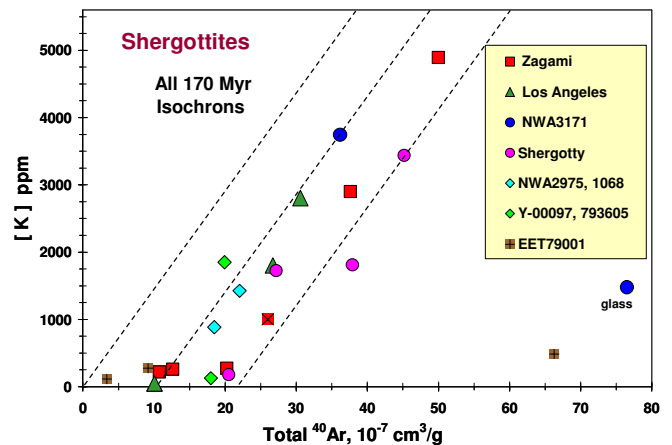

EXTREMOPHILE MICROORGANISM COMMUNITIES IN SULFATES AND OTHER SULFUR MINERALS AS SAMPLE RETURN TARGET MATERIALS. P.J. Boston^{1,2}, M.N. Spilde³, D.E. Northup⁴, and P. Todd⁵. ¹Dept. Earth & Environmental Sci., New Mexico Tech., 801 Leroy Place, Socorro, NM 87801, pboston@nmt.edu, ²National Cave and Karst Research Inst., Carlsbad, NM, 88220, ³Inst. Meteoritics, Univ. New Mexico, Albuquerque, NM 87131, mspilde@unm.edu, ⁴Biol. Dept., Univ. New Mexico, Albuquerque, NM 87131, dnorthup@unm.edu, ⁵TechShot, Inc., Greenville, IN 47124, ptodd@techshot.com

Introduction: The presence of various types of sulfates on the surface of Mars has generated much astrobiological interest in the biological contents of analogous materials on terrestrial arid environments. Numerous active sulfur transforming organisms live in sulfur rich environments in both Earth's surface and subsurface. Our team has studied organisms and their associated mineralogies in several salient environments: 1) a sulfuric acid dominated cave system where the biological activity is integral to the precipitation of sulfates [1] (Fig. 1), 2) microbial communities in a briny sulfur-rich iron mine environment that appear to be mediating the deposit of microcrystalline jarosite (Fig. 2), 3) organisms that utilize copper sulphides producing copper oxides and sulfates as byproducts of that transformation (Fig. 3), and 4) perhaps most saliently, the gypsum fracture microbial communities in the Gypsum Plain area of southeastern NM and west Texas (Fig.4).

The association of sulfate minerals with microbial communities can be seen in the physical proximity of organisms with mineral grains, and in the gradual transformation from amorphous to crystalline phases in the living materials. No transformations occur in killed controls. Such Earth-based microbial communities are of relevance to potential biology and mineralogy of Mars and useful as a comparison to materials that will be considered for collection as part of Sample Return Mission activities.

Methods: We analyze isotopic signatures of C, S, O, and H/D in both mineral and biological components and assess other geochemical biosignatures and bulk chemistry. To study the association of various elements with organisms, we construct elemental maps via electron microprobe of C, S, and other relevant elements. Organisms that are growable are maintained in culture and subjected to an array of experiments including those aimed at inducing the same or similar precipitation of minerals that we see in nature. Lastly, we analyze the DNA of both environmental and cultured samples to determine organism identities, or their closest relatives if they are unknown strains.

Mars Simulation Challenge Experiments: A selection of organism communities isolated from the environments mentioned here have been subjected to between 1 and 5 week simulations of significant Mar-

tian environmental conditions at the TechShot facility in Greenville, Indiana as part of a NIAC-funded (NASA Institute for Advanced Concepts) effort to test Earth organisms under Mars full spectrum sunlight (including UV) at Mars atmospheric pressures and low moisture. A plethora of organisms survived from these trials. Some of the most robust survivors were from the gypsum and other sulfur environments discussed here, including the black lineations seen in Figure 4. Such organisms can be used in ground based simulations of potential target material types that may be encountered on Sample Return.

Conclusion: Numerous microorganisms are involved in processes that either degrade or precipitate sulfates. The biology of these communities can serve as a comparison model for similar Martian minerals and environments. In order to meet the standards of proof for science in Earth extreme environments, we must employ a variety of labor-intensive analyses beyond the foreseeable scope aboard a Mars Sample Return Mission. As a byproduct, we are amassing a library of textures, microbial structures, and mineralogical compositions that can be associated on Earth unequivocally with biological activity. For the purposes of Sample Return Missions, such a field guide of properties can help guide the mission to select samples of potentially great astrobiological significance.

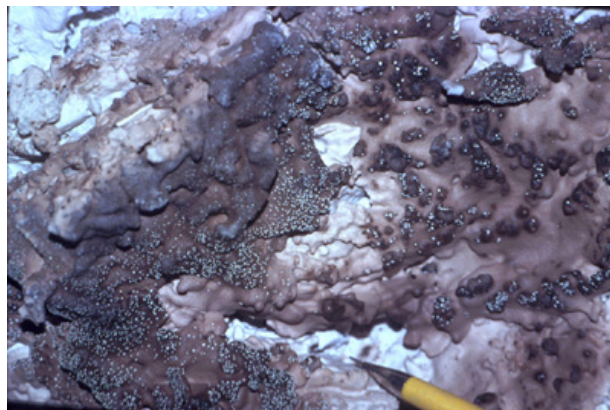

Figure 1: Gypsum paste soaked with sulfuric acid in Cueva de Villa Luz, an active sulfuric acid cave in Tabasco, Mexico. White dots on dark material are microbial colonies growing at pH 1.-2.5. Image courtesy of Kenneth Ingham.

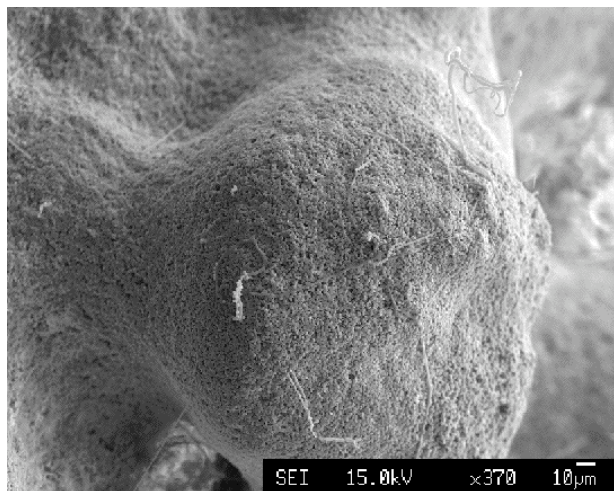

Figure 2: Jarosite and microbial filaments and cell bodies mound up in briny samples from the Soudan Iron Mine in northern Minnesota. SEM by Spilde and Boston.

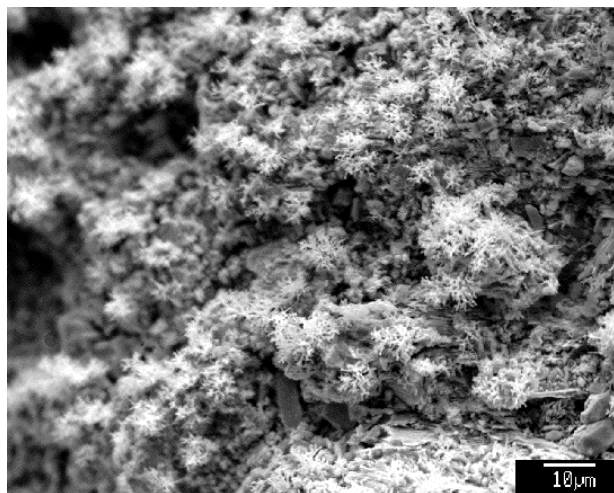

Figure 3: Cellular “bushes” coated with copper oxides derived from copper sulfides. SEM by Spilde and Boston.

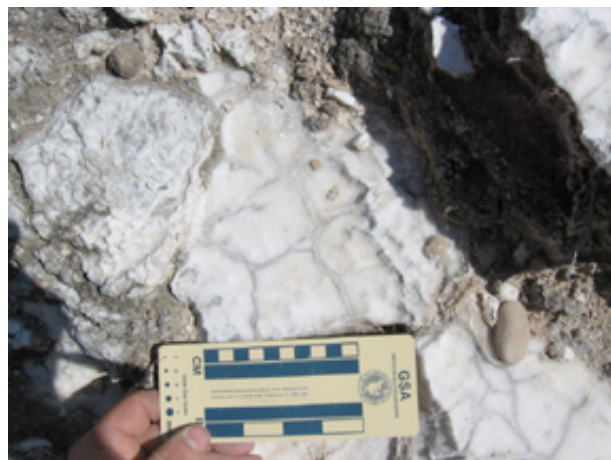

Figure 4: Dark hexagonal lines show gypsum fracture microbial communities in Permian age Gypsum Plain evaporates. These lines could be mistaken for mineral infilling in fractures but are actually densely populated black cyanobacteria, microcolonial fungi, and bacteria. Image by K.W. Stafford.

References:

- [1] Boston, P.J. et al. (2006) *GSA Sp. Pap.* 404, 331-344.

INTERPRETING MARS SURFACE FLUID HISTORY USING MINOR AND TRACE ELEMENTS IN JAROSITE: AN EXAMPLE FROM POST PIT, NEVADA.

P.V. Burger¹, J.J. Papike¹, C.K. Shearer¹, and J.M. Karner¹, ¹Institute of Meteoritics, Department of Earth and Planetary Sciences, University of New Mexico, Albuquerque, New Mexico 87131 (pvburger@unm.edu).

Introduction

Martian jarosite was first identified in a jarosite/hematite rich outcrop at Meridiani Planum by the Opportunity Rover [1]. The utility of jarosite as a recorder of rock-fluid interaction has been discussed by Papike et al. [2,3,4]. Understanding the trace element crystal chemistry of terrestrial jarosite will further our understanding of martian near-surface processes and our ability to better interpret current martian surface data sets. Here, we discuss the morphological characteristics, and major and minor/trace element chemistry of jarosite from Post Pit, NV, and demonstrate its applicability to the martian surface.

Major Element Crystal Chemistry of Jarosite

The general formula for jarosite is $AB_3(XO_4)_2(OH)_6$ [2] where A is a 12-fold coordinated site that can contain monovalent cations such as K, Na, and Rb, divalent cations such as Ca, Pb, Ba, and Sr, and trivalent cations such as the REE. The B position represents an octahedrally coordinated site that usually contains trivalent Fe and Al. The X position represents the tetrahedrally coordinated site and contains many elements including S, P, As, and Mo. The major element chemistry of terrestrial jarosite can be represented within the compositional space defined by alunite ($KAl_3(SO_4)_2(OH)_6$), natroalunite ($NaAl_3(SO_4)_2(OH)_6$), jarosite ($KFe^{3+}_3(SO_4)_2(OH)_6$) and natrojarosite ($NaFe^{3+}_3(SO_4)_2(OH)_6$).

Analytical Parameters

Electron Microprobe – The sample was initially documented using backscattered electron imaging (BSE) at an accelerating voltage of 15 kV and a beam current of 10 nA, using UNM's JEOL 8200 electron microprobe. Wavelength dispersive (WDS) maps were conducted in regions with prominent growth zones, as determined by BSE. Quantitative analyses were conducted using two analytical packages, one for major elements (Fe, K, Na, Al, S) using a 5 μ m beam, and a second package, using a 1 μ m beam, with a 10 nA beam current for minor and trace elements (Ba, Sr, P, V, As, Pb, Cr). Analyses were conducted as traverses across euhedral jarosite grains, parallel to one another, and perpendicular to growth zones, so as to be directly comparable to one another. The remainder of the trace element data discussed here was collected by SIMS and is described by Burger et al. [5].

Results

Sample Description – The Post Pit jarosite thin section is predominantly characterized by a shale host-rock, on which there is fine grained overgrowth of jarosite (Fig. 1a). Several larger (>100 μ m) barite crystals are interspersed throughout this mat. An unidentified Fe-oxyhydroxide occurs at the exterior of the fine grained jarosite. A large, contiguous band of euhedral, zoned jarosite occurs above the Fe-bearing phase. Zoning bands occur on the sub-micron scale.

Major Elements in Jarosite – The average major element composition of Post Pit jarosite falls into the pure endmember jarosite composition field. A representative, stoichiometric analysis is presented in Table 1. Sulfur concentration

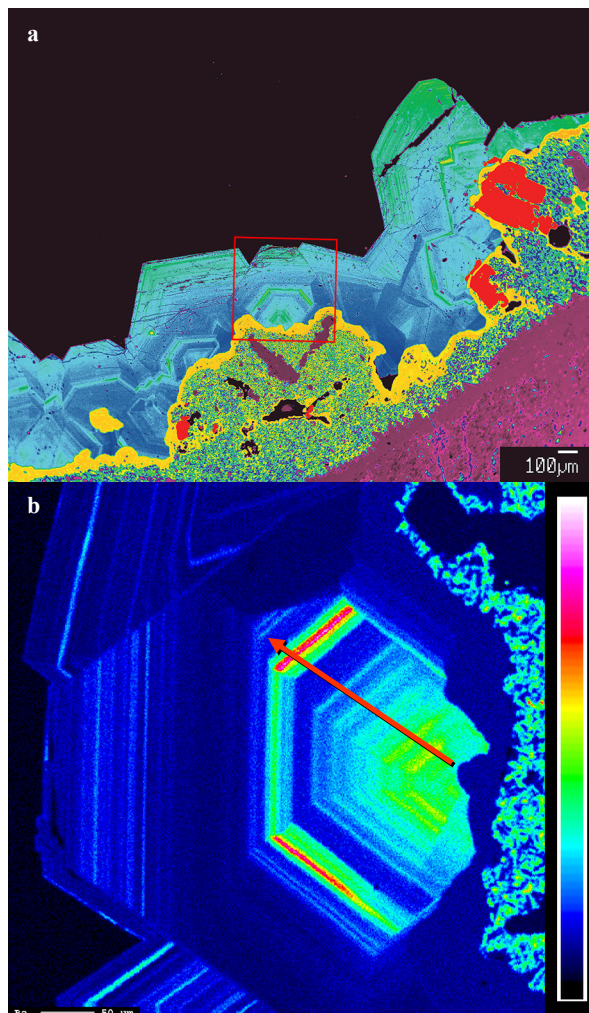

Figure 1. (a) False color BSE of the Post Pit jarosite sample, where purple = shale, blue/green = jarosite, red = barite, yellow = Fe-oxyhydroxide. Figure 1b WDS map outlined in red. (b) WDS map of Ba concentration. Warmer colors indicate higher concentration. Red arrow indicates compositional profile shown in Fig. 2.

averages 1.85 afu, K 0.95 afu, and little (0.01 afu) Na. Fe is the predominant B-site cation, with an average of 2.76 afu, relative to Al, with 0.05 afu. As growth zones occur on the sub-micron scale, major element compositional variation is attenuated by the larger spot size. Nevertheless, major element concentration do show limited variability through the profiles (Fig. 2a). WDS elemental mapping of jarosite crystals reveal subtle differences in the major element composition throughout the jarosite grains.

Minor and Trace Elements in Jarosite – P and Ba have the highest average concentrations, among the minor and trace elements, with 0.08 afu and 0.05 afu, respectively. There is also significant V (0.01 afu) and As (0.01 afu). Average Sr concentration is very low (0.001 afu), but spikes to a high of

0.027 afu. Chromium and Pb are generally below the limit of detection for electron microprobe in this sample.

A Site		B Site		X Site	
<i>Oxide</i>		<i>Oxide</i>		<i>Oxide</i>	
K ₂ O	9.378	Fe ₂ O ₃	46.871	SO ₃	32.010
Na ₂ O	0.028	Al ₂ O ₃	0.636	P ₂ O ₅	0.258
BaO	0.557	V ₂ O ₃	0.235	As ₂ O ₅	0.000
SrO	0.000				
<i>Atoms / Formula Unit</i>		<i>Atoms / Formula Unit</i>		<i>Atoms / Formula Unit</i>	
K	0.991	Fe	2.921	S	1.990
Na	0.005	Al	0.062	P	0.019
Ba	0.019	V	0.016	As	0.000
Sr	0.000				
Total:	1.015	Total:	2.999	Total:	2.009

Table 1. A representative, stoichiometric analysis of Post Pit jarosite.

Discussion

It is apparent from the observations that fluid chemistry plays an important role in determining the trace element composition of jarosite. Crystal morphology alone suggests changing fluid history, as the precipitation of fine grained jarosite and barite is followed by the deposition of Fe-oxyhydroxide. Later conditions again favor jarosite precipitation, but are still dynamic, resulting in the development of growth zones, as seen in the WDS map and composition profiles (Fig. 1b,2). Typically, growth zones in jarosite reflect a change in precipitation from the (K) jarosite endmember to the (Na) natrojarosite endmember [3,4]. Growth zones in Post Pit jarosite are characterized instead by changes in minor and trace element chemistry. This is seen as warmer colors in the Ba WDS map (Fig. 1b) and correspond to a drop in S and K, and an increase in P, Ba, and to a lesser extent, Sr, as seen in the compositional profile (Fig. 2). It appears likely that this occurs through a coupled substitution:

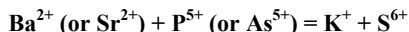

This coupled substitution may be the result of changing fluid chemistry, temperature and/or possibly $f\text{O}_2$. The current data set suggests that V occupies the B crystallographic site, with a valence of 3+. This implies a more reducing environment than is typical for jarosite deposition. Trace element analyses by [5] suggested a negative Ce anomaly in most jarosite samples where Ce is likely 4+ and not easily incorporated into the jarosite structure (Fig. 3); this is not the case with jarosite from Post Pit. Vanadium valence may be a particularly useful tool in recording fluid history if it occupies different crystallographic sites in jarosite, depending on its valence state.

Relevance to Mars Surface Processes – This study illustrates the potential of trace elements in jarosite for fingerprinting the evolution of martian fluids. In addition, Post Pit jarosite reinforces the need for a sample return mission to Mars, as the measurements required to characterize minor and trace element behavior in jarosite are not feasible using current remote sensing or robotic mission techniques.

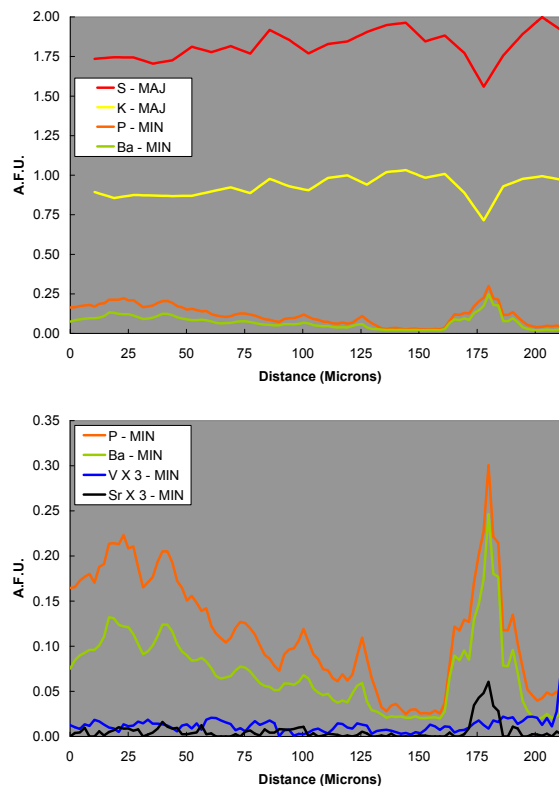

Figure 2. (a) Major element profile conducted across the grain seen in Fig. 1b. A decrease in S and K concentration corresponds to an increase in P, and Ba. (b) Minor element concentration across the same traverse.

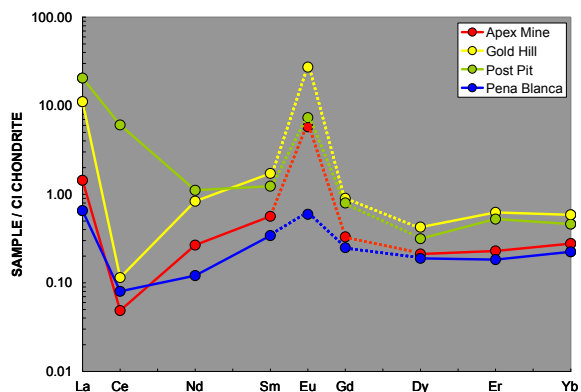

Figure 3. Rare earth element diagram for jarosite from Post Pit and three other locations, after [5].

Acknowledgments

This research was supported by a NASA Cosmochemistry Grant to J.J.P.

References

- [1] Klingelhöfer et al. (2004) *Science*, 306, 1740.
- [2] Papike et al. (2006) *GCA*, 70, 1309.
- [3] Papike et al. (2006) *AmMin*, 91, 1197.
- [4] Papike et al. (2007) *AmMin*, 92, 444.
- [5] Burger et al. (2007) 7th *Inter. Conf. Mars. Abst.* #3244.

AFFORDABLE MSR: CONSTRAINING REQUIREMENTS ON SAMPLING AND SAMPLE PRESERVATION.

B.C. Clark, Institute for Robotic Applications to Science, Littleton, CO 80127, benclark3@comcast.net

Introduction: A Mars sample return (MSR) mission has been a serious objective since at least the 1970's, but has not yet been realized because the expectation value for its cost has exceeded the justification for its need. In the meantime, many of the technologies and mission segments have been demonstrated by other space missions, including the return of space samples using affordable robotic return vehicles. At the same time, the renaissance in new missions to Mars have made discoveries for which MSR is scientifically more important than ever before. Many mission elements remain uncertain, however, such as sample preservation, the ascent vehicle, rendezvous pickup in Mars orbit, and planetary protection. To ultimately achieve an overall affordable MSR, it will be necessary to constrain development and implementation costs of these new elements.

Historical Precedents: The space program began with the most modest of scientific exploration objectives. Indeed, academia at first turned its back for the most part. The van Allen belts were discovered with the crudest form of radiation spectrometer, a few shielded Geiger-Mueller counters. Spatial resolution of most missions to Mars was poor by orders of magnitude compared to the meter- and submeter-scale resolution of images eventually achieved on MGS, MEx, and MRO. Virtually every instrument flown on a space science mission has known limitations in terms of sensitivity, resolution, baseline offsets, cross-coupling and absolute accuracy. Calibrations are mostly ground-based, and there is little independent verification of results by independent means of measurement. Yet, instrument developers are strong, enthusiastic advocates for each mission they propose to become part of, even as they prepare on the drawing boards the next generation instrument that will put to shame all that has gone before it. Clearly, these flight-savvy instrumentation guru's are not hesitant to propose only what they can accomplish, affordably, in order to be selected for the next flight. A "perfect" remote or in situ sensing mission never has and never can be flown, because the instruments are usually behind the state-of-the-art by the time of launch. This has not prevented mission-after-mission, each extending and improving on the discoveries of the last. The instrumentation community has learned its lessons and learned them well.

KISS: For the first MSR to be affordable and remain non-cancelable, it must avoid stumbling blocks. Previous cancellations of major missions by NASA are quickly forgotten, but include such notable cases as Halley/Tempel 2, CRAF, Apollo 18-20, much of the science of ISS, and for a brief while, DAWN. New

lunar science missions became non-existent after Apollo; Mars exploration suffered a great hiatus after Viking. To keep first-MSR as affordable as possible and to assure the likelihood of "staying in the cost box", it must embrace the principle of KISS (keep it simple, son). Once an MSR capability is developed, it will become time to promote improvements and refinements of capabilities, hopefully building extensions on the same hardware and operating plan so as to keep costs of future MSR's competitive. It could be unwise to impose Ultimate MSR capabilities as requirements that should be levied on Initial MSR capabilities.

Sample segregation vs hermetic sealing: Some martian samples might contain volatiles, at least H₂O and possibly some CO₂. Ideally, such samples would be collected at the coldest time of the sol and their temperature maintained at that appropriately cold temperature. Problems in implementing this idealized requirement are manifold. The thermal gradient on Mars is extraordinarily steep from the surface of the soil through the first few centimeters. It is beyond the physical resolution of practical sampling devices and their implementation to take samples from only one temperature zone. Even the soil temperature gradient has never been satisfactorily measured by any mission on Mars and even if so, such gradients would vary dramatically in different specific locations as a function of soil thermal insulation (particle sizes, shapes, compositions; pore spaces; cementation of grains) as well as exposure to solar insolation (e.g., anti-sunward vs pro-solar slopes) and presence or absence of large rocks.

One concern has been that if each and every sample is not individually hermetically sealed, the ones that contain volatiles would release their gases once the sample time-temperature product was high enough, and that this would not only change the mineral phases but also potentially induce artificial alteration of pristine samples. Unfortunately, providing hermetic seals for all samples will impose a significant weight penalty and worse, a set of potentially costly requirements difficult to assure in a dusty, desert environment. Technologies from elastomeric to malleable metals or explosive welding will need to be considered, but application to each and every sample will be the challenge.

The GRS instrument on Odyssey has amply demonstrated the existence of forms of H₂O in soils and sediments at virtually all latitudes on Mars. Some of

this H₂O is thought to be loosely bound, and responds to changes in the temperature-humidity environment on seasonal and even diurnal cycles. Where MgSO₄ is present, adsorbed layers and several mineral hydrated states are possible and laboratory experiments demonstrate the ready conversion between states as a function of environmental fluctuations on times scales of days or sometimes hours [2, 3]. The only way to capture these hydration states and preserve them on the way back to Earth is to seal the samples hermetically (no gas exchange) and keep them at least as cold as that at the time of collection. What, however, does that accomplish. The same sample will in fact have transitioned to other states while on Mars, depending on time of season and/or day/night. Thus, such samples have no canonical state that is representative of their in situ existence. Those minerals just a few mm deeper or shallower will experience different environments, both thermally and in terms of water activity. A “representative” sample may not strictly exist. In other cases, the H₂O may be bound tightly into the mineral structure as OH, such as in smectites, kaolinite and other clay minerals. Release of constitutional OH occurs only at temperatures of several hundreds of deg C, and there is no danger of inadvertent release even if the samples are unsealed.

A potential method of easing these requirements is to provide an in situ DSC/EGA instrument on future missions to measure labile H₂O, but with multiple-use ovens so as to not be limited to 8 samples as with the TEGA instrument on the Phoenix lander. Such an instrument could analyze far more samples than could be sealed and transported back to Earth.

Investigation Centricism: In the “Requirements Flowdown” scheme favored by NASA in justifying missions, science is cast in terms of discipline investigations. For example, “Follow the Water” is a typical investigation theme for Mars exploration. More pragmatically, missions are generally formulated by a combination of science questions and measurement feasibility, embodied in the end as a specific suite of Instruments. Generally, there is no unique isolated one-to-one correspondence between Disciplines and Instruments. Cameras and IR spectrometers, for example, serve multiple purposes to multiple disciplines, ranging from the various subsets of geological to atmospheric sciences.

It is likewise possible to formulate sampling requirements for MSR based on disciplines and specific hypotheses, or to formulate them on the basis of a suite of laboratory instruments that will be brought to bear on the returned samples. One instrument lab often conducts multiple investigations. For example, stepped temperature volatile release can be used to

study everything from the forms of chemical and physically bound H₂O, to organics, to trapped gases.

Many previous sample return missions, from Apollo to Stardust, allocated very small quantities of very specific sub-samples for analysis and then competitively evaluated proposals from various laboratories in part on their ability to squeeze the most science out of the least amount of material consumed or contaminated.

Sample Consumption: For previous sample return missions, only a fraction of the returned material was made available for near-term analysis. The remainder has been kept carefully stored and archived for future analytical capabilities and investigations. Thus, for a nominal 500 g of sample first returned from Mars, perhaps only 100 or 200 g will be available in the proximate future. Assuming the rover-based sampling missions are successful in locating and sampling one dozen (e.g., MER Opportunity at Meridiani) or two dozen (e.g., MER Spirit at Gusev) diverse samples of high priority, there will be as little as 5 or 10 g total per sample type. These quantities are far below that typically requested just for back contamination assessments and for martian toxicity analyses to prepare for human exploration. There will be precious little material for replicate studies, except for micro-analyses. The samples will be far more useful if on the other hand, (1) planetary protection can concentrate on high-likelihood samples, (2) toxicity be derived from the extraordinarily extensive data that will be collected on composition by geochemists and organic chemists, and (3) multi-discipline investigations be carried out in a single laboratory and/or round-robin samples. Atmospheric sampling could be mainly opportunistic, other than perhaps a modest dedicated sampling tube. Instead, future missions could include highly sophisticated mass spectrometers.

MSR vs Mars: Although sample return is essential to advancing our knowledge beyond the intrinsic limitations of all other types of missions, it must be kept in mind that the quantum increase in costs of MSR is in competition with other avenues of investigating the red planet. For example, if MSR indeed turns out to be a 3+ B\$ mission, how will it be justified when the same total expenditure could accomplish any of a number of broad, multiple mission sets. How can MSR be justified compared to having three more MER rovers and two more Phoenix landers, all for the same price and peppered at five intriguing sites on Mars? Or another long-lived MSL with alternative science payload, and one each of MER and PHX? Keeping MSR below 2 B\$ would be a wise move to enhance survivability of the project.

PLANETARY PROTECTION CONSIDERATIONS FOR MARS SAMPLE RETURN. Catharine A. Conley²,
¹Science Mission Directorate 3X63, 300 E St. SW, Washington, DC, 20546; cassie.conley@nasa.gov

Introduction: Regarding planetary protection for Mars Sample Return missions, there are three distinct aspects that must be addressed. The highest priority for any sample return mission must be to protect the Earth from harmful contamination by a returned sample, as dictated by international law, specified in the Outer Space Treaty of 1967. Secondly, the sample must be protected from the environment of Earth, because contamination by terrestrial materials could irretrievably damage the potential for specific scientific investigations to be performed on the returned samples. Finally, the target location from which the samples are collected must be protected from contamination by materials or organisms carried on the spacecraft performing mission activities, which might interfere with future scientific investigation of that target body.

The sources for requirements addressing each of these aspects of planetary protection for Mars Sample Return are the international policy on planetary protection that is maintained by the Committee on Space Research (COSPAR) of the International Council for Science (ICSU), and the individual policies of the national or international space agencies that will perform a sample return mission.

Policy for MSR missions: The planetary protection policies of both COSPAR and NASA assign any mission to return samples from Mars to Category V, Restricted Earth Return. On this category of mission, both COSPAR and NASA policy impose the most stringent restrictions for planetary protection purposes, as described in NASA Requirements Document 8020.12 (The COSPAR policy uses slightly different wording with the same intent):

“the highest degree of concern is expressed by the prohibition of destructive impact upon return, the need for containment throughout the return phase of all returned hardware which directly contacted the target body and/or any unsterilized material from the body, and the need for containment of any unsterilized sample collected and returned to Earth. After the flight mission there is a need to conduct, under strict containment and using the most effective techniques, timely analyses of the unsterilized sample collected and returned to Earth. If any sign of a non-terrestrial replicating entity is found, the returned sample must remain contained unless treated by an effective sterilizing procedure. Category V concerns are reflected in requirements that encompass those for Category IV plus the continued monitoring of related project activities, studies, and research.”

NASA Requirements for MSR missions: In addition to abundant documentation and reporting, specific requirements are imposed by NPD 8020.12 on NASA-led missions to Mars that are assigned to Category V, Restricted Earth Return, as follows:

- a) Unless specifically exempted, the outbound leg of the mission shall meet Category IVb requirements. This provision is intended to avoid "false positive" indications in a life-detection and hazard-determination protocol or in the search for life in the sample after it is returned. A "false positive" could prevent distribution of the sample from containment and could lead to unnecessary increased rigor in the requirements for all subsequent Mars missions.
- b) Unless the sample to be returned is subjected to an accepted and approved sterilization process, the sample container must be sealed after sample acquisition. A redundant, fail-safe containment procedure with a method for verification of its operation before Earth-return shall be required. For unsterilized samples, the integrity of the flight containment system shall be maintained until the sample is transferred to containment in an appropriate receiving facility.
- c) The mission and the spacecraft design must provide a method to "break the chain of contact" with Mars. No uncontained hardware that contacted Mars, directly or indirectly, shall be returned to Earth. Isolation of such hardware from the Mars environment shall be provided during sample container loading into the containment system, launch from Mars, and any in-flight transfer operations required by the mission.
- d) Reviews and approval of the continuation of the flight mission shall be required at three stages: 1) prior to launch from Earth; 2) prior to leaving Mars for return to Earth; and 3) prior to commitment to Earth entry.
- e) For unsterilized samples returned to Earth, a program of life detection and biohazard testing or a proven sterilization process shall be undertaken as an absolute precondition for the controlled distribution of any portion of the sample.

Beyond the overarching requirements given in official NASA documents, a considerable amount of work has been done to define more clearly the planetary protection requirements for individual Mars Sample Return missions. This includes both advice from the Planetary Protection Officer to project planning efforts and reports from the Space Studies Board and other advisory bodies, as well as results from a number of workshops that have been held by NASA and the international community to consider specific aspects of Mars Sample Return.

MARS SCIENCE LABORATORY: SCIENCE OVERVIEW. J. A. Crisp¹, J. P. Grotzinger², A. R. Vasavada¹, J. S. Karcz³, and the MSL Science Team, ¹Jet Propulsion Laboratory, California Institute of Technology, 4800 Oak Grove Dr., Pasadena, CA 91109 USA, ²California Institute of Technology, 1200 E. California Blvd., Pasadena, CA 91125, USA, ³SETI Institute, 515 N. Whisman Rd., Mountain View, CA 94043 USA.

Introduction: The Mars Science Laboratory (MSL) mission is scheduled for launch in the fall of 2009 and operations on Mars beginning the summer of 2010. The high-level scientific goal is to explore and assess quantitatively a local region as a potential habitat for life, past or present. The MSL rover will carry ten scientific instruments and a sample acquisition, processing, and distribution system. The rover instruments and tools will be used to detect and study potential sampling targets with remote and in situ measurements, acquire and deliver samples of rock and soil to the analytical lab instruments for measurement, and observe the environment around the rover. The rover will also have the ability to deposit scooped soil samples containing < 1.5 cm-size rock fragments into a sample cache, providing an option for possible later retrieval by a potential future sample return mission. The primary MSL mission will last one martian year.

Science Objectives: The MSL mission has four primary science objectives. The first is to assess the biological potential of at least one target environment by determining the nature and inventory of organic carbon compounds, searching for the chemical building blocks of life, and identifying features that may record the actions of biologically relevant processes. The second objective is to characterize the geology of the landing region at all appropriate spatial scales by investigating the chemical, isotopic, and mineralogical composition of surface and near-surface materials, and interpreting the processes that have formed rocks and soils. The third objective is to investigate planetary processes of relevance to past habitability (including the role of water) by assessing the long timescale atmospheric evolution and determining the present state, distribution, and cycling of water and CO₂. The fourth objective is to characterize the broad spectrum of surface radiation, including galactic cosmic radiation, solar proton events, and secondary neutrons.

Scientific Investigations: There are ten PI-led scientific investigations on MSL, each related to a single instrument, but the overall scientific goal of assessing present and past habitability will come from using the instruments in an integrated fashion. The instrument investigations have been grouped as follows:

Mast-based remote sensing: Mounted on a mast ~2.2 m above the ground are MastCam, a color wide- and narrow-angle imaging system provided by Malin Space Science Systems (PI: Michael Malin), and

ChemCam, a laser-induced breakdown spectrometer and remote micro-imager provided by Los Alamos National Laboratory (PI: Roger Wiens).

Contact science: On the end of the robotic arm are APXS, an alpha-particle X-ray spectrometer provided by the Canadian Space Agency (PI: Ralf Gellert, Univ. Guelph), and MAHLI, a color hand-lens imager provided by Malin Space Science Systems (PI: Kenneth Edgett).

Analytical laboratory measurements: Located within the main body of the rover are CheMin, which analyzes delivered samples with X-ray diffraction, provided by the Jet Propulsion Laboratory, California Institute of Technology (PI: David Blake, NASA Ames Research Center), and the SAM instrument suite, which contains a gas chromatograph, mass spectrometer, and tunable laser spectrometer, provided by NASA Goddard Space Flight Center (PI: Paul Mahaffy).

Environmental measurements: RAD is a radiation detector provided by Southwest Research Institute (PI: Don Hassler). REMS is a meteorology package (temperature, pressure, winds, and humidity) and UV sensor provided by the Spanish Ministry of Science (PI: Javier Gómez-Elvira, Centro de Astrobiología/INTA-CSIC). DAN is an active neutron spectrometer provided by the Federal Space Agency of Russia (PI: Igor Mitrofanov, Space Research Institute). MARDI is a color, high frame rate descent imager provided by Malin Space Science Systems (PI: Michael Malin).

Science Operations in Support of Sample Caching: The MSL Project Science Group (PSG) will maintain a strategic plan for science operations, including the types of materials to be cached. In tactical day-to-day operations planning, the Science Operations Working Group will select the specific materials for caching and prepare detailed rover activity plans consistent with the PSG's strategic plan.

After identifying one or more rock fragments of interest in the soil and analyzing them as desired, a typical caching operations scenario would likely involve imaging before and after scooping and imaging of the cache opening after delivery to the cache. Several rover instruments (MAHLI, MastCam, Hazcam, Navcam, ChemCam, APXS, SAM, CheMin, as appropriate) could be used to make observations of the rock fragments before scooping or of similar material found in nearby larger rocks.

FUNDAMENTAL IMPORTANCE OF RETURNED SAMPLES TO UNDERSTANDING THE MARTIAN INTERIOR. D. S. Draper and C. B. Agee, Institute of Meteoritics, 1 University of New Mexico, MSC03-2050, Albuquerque, NM 87131, david@draper.name, agee@unm.edu

Introduction: Understanding the formation and evolution of the martian interior is predicated largely on inferences made from the study of martian meteorites. In particular, martian basaltic meteorites (shergottites) have yielded many critical insights regarding the planet's bulk composition, its rapidity of differentiation after accretion, the nature of distinct geochemical reservoirs that remained unmixed until comparatively recent times, and the geologically recent ages of magmatic activity on Mars. They have also provided information that constrains a host of other, nonmagmatic processes. Shearer et al. [this meeting] provided a concise outline of most of these important data.

The mantle sources for martian basalts have been modeled as products of an early magma ocean that differentiated rapidly into two reservoirs [1-5]. These include a reservoir displaying long-term depletions in incompatible trace elements and comparatively reducing oxygen fugacity (fO_2) within a log unit of the iron-wüstite (IW) buffer; and a much more enriched reservoir displaying fO_2 several orders of magnitude more oxidizing. Most workers have concluded that the martian mantle is more Fe-rich than is Earth's; in addition, superchondritic CaO/Al_2O_3 in basaltic meteorite compositions is best explained by early fractionation of (probably majoritic) garnet during magma ocean crystallization. Initially, the enriched reservoir was taken to represent martian crust [4, 6], but we have argued that it can be produced by differentiation within the mantle without the need for a (thus far unsampled) crustal component [5]. Calculated compositions of melts of the depleted mantle, variably mixed with small amounts of the enriched component, appear to account successfully for the mixing trends evident in many types of martian basalt compositional data.

Magma ocean models are based on compositions of the basaltic meteorites. Mars magma ocean models as currently constituted require that all martian basalt source regions be superchondritic with respect to CaO/Al_2O_3 [5]. This is accomplished by invoking fractionation of garnet as an *early* crystallizing phase, sequestering some alumina (garnet crystallization at later stages results in bad mismatches with major and trace element compositions of the meteorites). All subsequent processes of magma ocean crystallization and later melting of the source rocks thus formed are expected not to perturb this ratio [7]. Unlike the case for the Moon, in which most basalts also have superchondritic CaO/Al_2O_3 , plagioclase is not a near-

liquidus phase for likely magma ocean compositions, so garnet is the most likely agent of bringing about the elevation in this ratio, and it is in fact a near-liquidus phase for candidate magma ocean compositions at relevant pressures [7-9]. Good matches to isotopic and trace element data are also obtained in this formulation. In such a model, which assumes that the magma ocean was extensive and planet-wide, it is simply not possible for there to exist mantle lithologies that do not inherit the elevated CaO/Al_2O_3 ratio after early garnet removal.

However, the few measurements by the Mars Exploration Rovers of surface rocks that have been interpreted as basaltic (from Gusev crater) do not have superchondritic CaO/Al_2O_3 [10]. Fig. 1 plots martian basaltic meteorite compositions (data from [11]) for

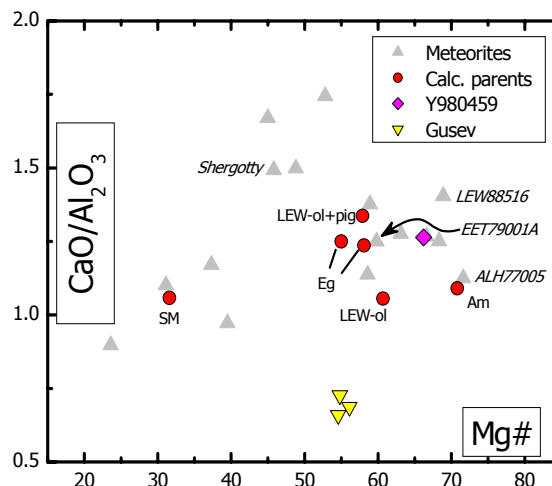

Figure 1. Comparison of martian basaltic meteorites (grey symbols) with Gusev compositions Adirondack, Humphrey, and Mazatzal. See text for discussion

comparison with Gusev data. The Yamato 980459 composition is highlighted, as there is good evidence that it represents a liquid composition [12, 13] and not a crystal accumulate as do almost all the others; if this is true then its composition is of special significance. Also plotted are parental liquid compositions calculated by various authors for Shergotty (SM, [14]), LEW88516 (LEW-ol and LEW-ol+pig assuming olivine and olivine+pigeonite saturation, respectively, [15]), EETA79001 (Eg, [16, 17]), and ALH77005 (Am, [18]). The meteorites for which these parent liquid compositions were estimated are labeled with

their names. This diagram illustrates the consistency of superchondritic $\text{CaO}/\text{Al}_2\text{O}_3$ for martian basaltic meteorites, and that the Gusev compositions are very close to the chondritic value of ~ 0.80 .

At this juncture it is not at all clear whether the reported Gusev compositions actually represent bona fide basalts or whether they instead reflect surface alteration and weathering, which could easily perturb the $\text{CaO}/\text{Al}_2\text{O}_3$ ratio. If those values truly represent the compositions of basalts on the martian surface, then their compositions require that there be mantle source rocks that *do not* have superchondritic $\text{CaO}/\text{Al}_2\text{O}_3$, because no phase involved in either melting or crystallization would fractionate Al from Ca. It is reasonable to assume that melting to produce martian basalts occurs in the mantle at pressures below those where garnet would be a stable residual phase, given that the most primitive martian liquid, Yamato 980459, shows multiple saturation with olivine + low-Ca pyroxene below 2.0 GPa under both anhydrous [19] and volatile-bearing [20] conditions. These phases do not perturb $\text{CaO}/\text{Al}_2\text{O}_3$.

Therefore, basaltic samples returned from the martian surface hold the potential for affecting our understanding of the formation and evolution of the martian interior at the most fundamental level. If basalts with *genuinely magmatic*, chondritic $\text{CaO}/\text{Al}_2\text{O}_3$ are discovered, then the global magma ocean hypothesis for the formation of the martian interior is almost certainly incorrect, and a different process will be required that allows for the formation of at least two different types of mantle source rocks: one with the chondritic ratio, and another with the superchondritic ratio.

How representative are the basaltic meteorites?

There is ample evidence that the martian meteorites represent a biased or skewed sampling of martian igneous lithologies. As has been argued by Irving and coworkers [21, 22], it is likely that the meteorites came from only a few volcanic centers on Mars, possibly all part of Tharsis. For example, the basaltic meteorites' crystallization ages are clustered in three groupings, at ~ 180 Ma, ~ 330 Ma, and ~ 500 - 575 Ma (data summarized in [11]). They also form clusters in certain geochemical parameters, such as the isotopic and incompatible trace element compositions summarized in Fig. 2. Thus it is quite reasonable to suggest that our sampling of the igneous reservoirs on Mars is incomplete. In fact, it is remarkable that the small and limited sample set has allowed such broad inferences to be made about the nature of the martian interior.

If not a magma ocean, then what? If basaltic samples eventually returned from Mars do in fact have chondritic $\text{CaO}/\text{Al}_2\text{O}_3$, largely negating the validity of a model invoking a global, extensive magma ocean,

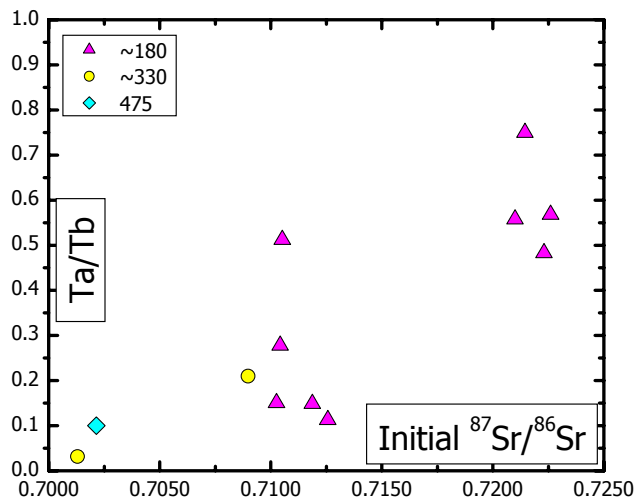

Figure 2. Ta/Tb vs. initial Sr isotopic composition for martian basaltic meteorites of various age ranges. Data summarized in [11].

what sort of model could provide a defensible alternative? One possibility is that a “superplume” early in Mars’ history produced the geochemical reservoirs that are unquestionably reflected in the compositions of the basaltic meteorites. In this view, many processes invoked as occurring in a global magma ocean, and especially early garnet fractionation to impart superchondritic $\text{CaO}/\text{Al}_2\text{O}_3$, may have taken place, but to a more limited extent and only within the plume. Such a feature may operate in a similar fashion to the geophysical models of Kiefer and coworkers [23, 24]. Other mantle regions unaffected by the plume could, at least potentially, retain a chondritic value. Making such a distinction shows that the value of returned basaltic samples would be of critical and fundamental importance in constraining the nature and history of the interior of Mars.

References: [1] Borg, L. E., et al. (1997) GCA 61, 4915. [2] Borg, L. E., et al. (2003) GCA 67, 3519. [3] Herd, C. D. K. (2003) MAPS 38, 1793. [4] Herd, C. D. K., et al. (2002) GCA 66, 2025. [5] Borg, L. and Draper, D. (2003) MAPS 38, 1713. [6] Jones, J. H., et al. (2002) LPI Contribution, Report: 1134 27. [7] Agee, C. B. and Draper, D. S. (2004) EPSL 224, 415. [8] Agee, C. B. and Draper, D. S. (2005) LPS XXXVI abstract #1434. [9] Draper, D. S., et al. (2003) PEPI 139, 149. [10] McSween, H. Y., et al. (2004) Science 305, 842. [11] Meyer, C., Jr., Mars meteorite compendium 2003, pp. 522, NASA Johnson Space Center, Houston, 2003. [12] McKay, G., et al. (2004) LPS XXXV, 2154. [13] Koizumi, E., et al. (2004) LPS XXXV, 1494. [14] Stolper, E. and McSween, H. Y., Jr. (1979) GCA 43, 1475. [15] Harvey, R. P., et al. (1993) GCA 57, 4769. [16] Longhi, J. and Pan, V. (1989) LPS XIX 19, 451. [17] Schwandt, C. S., et al. (2001) LPS XXXII. [18] McSween, H. Y., Jr., et al. (1988) LPS XIX 19, 766. [19] Musselwhite, D. S., et al. (2006) Meteoritics & Planetary Science 41, 1271. [20] Draper, D. S. (2007) LPS XXXVIII, 1447. [21] Irving, A. J., et al. (2005) LPS XXXVI, 1229 [22] Bunch, T. E., et al. (2008) LPS XXXIX, XXXX. [23] Kiefer, W. S. (2003) MAPS 38, 1815. [24] Li, Q. and Kiefer, W. S. (2007) GRL 34, L16203

Mars Sample Return: Stable isotope targets with return samples. J Farquhar, Department of Geology and ESSIC, University of Maryland, College Park, 20742.

Introduction: The return of samples from Mars will provide a unique opportunity to study the present and past environments and surface of Mars. It is inevitable that this effort will be driven by what we already have learned about the atmosphere, surface, and deep planet from studies that use remote sensing techniques, robotic and in-situ techniques, and that derive from the suite of meteorites (SNC) that have been attributed a Martian origin. It is also anticipated that the types of studies that will be undertaken with earth-based techniques on the first return samples will reshape our understanding of the environments and their evolution on Mars and will likely inform further exploration, science, and return sample missions.

Past experience with the Apollo missions has demonstrated that the full importance of these samples and the studies that characterize them will be difficult to gauge, but that the impact on our understanding of Mars, its surface environments, and its evolution are likely to be profound. A number of tests will inevitably be devised as the community gears up for the arrival of such samples and more tests will be developed once they arrive in terrestrial laboratories.

The purpose of this abstract is not to cover all, or even most, of the potential targets for terrestrial-based geochemical investigations of samples from a first (or first few) sample return(s), but to highlight a few questions that could be addressed with return samples using mass spectrometric techniques that focus on light-stable isotopes (H, C, N, O, and S). An undercurrent here will be on approaches used to study samples on Earth, techniques that allow for determination of microscopic variations in isotopic composition, at high precision with rare species, or with minute amounts of sample.

Ground Truth for SNC Meteorites: A sample return will provide ground truth for assertions about the SNC meteorites, which while extremely important in shaping our understanding of Mars comprise a sample set is limited. *The diversity of samples that inform us about the surface environments of Mars will be significantly expanded with return samples.*

The SNC meteorites have been important in shaping our understanding of Mars. These meteorites have been attributed a Martian origin and appear to preserve important information about the chemistry and isotopic variations using a number of compelling lines of evidence that include dynamical considerations associated with delivery from their parent, trapped gases, their young geologic ages, as well as other mineralogical characteristics [1-3]. These meteorites also possess

silicate minerals that have a diagnostic oxygen isotope composition [4, 5]. Silicate minerals from the SNC meteorites are documented to lie on a characteristic mass-fractionation line and the return of samples will provide an important direct measure for the triple oxygen isotope composition of silicate minerals at Mars's surface. Such an exercise will be relevant for evaluating the veracity of hypotheses made about Mars on the basis of data obtained from this suite of samples, and potentially for constraining assimilation or exchange with other Martian surface pools of oxygen.

Other targets for return samples: Among the big questions about Mars are the conditions that prevailed in earlier times in Mars' history. This includes a number of questions and a handful of these might focus on understanding past temperatures and climate, the availability of water in the regolith, an understanding of the nature and variability of atmospheric composition, the transfer of atmospheric signals to the surface and the oxidation of the surface by interactions with atmospheric species.

A number of studies of SNC meteorites have brought Secondary Ion Mass Spectrometry to bear on interpreting the variability of the isotopic composition of phases such as carbonates in the SNC meteorites. These studies have documented variability in stable isotope compositions at small scales and provided important constraints on temperature and fluids that existed in near surface environments.

Determining the hydrogen isotope variations of return samples. Likewise, the hydrogen isotopic composition of SNC meteorites has been demonstrated to be highly evolved as a result of escape processes [6,7]. Investigations using a number of microanalytical and macroanalytical techniques are likely therefore to be a prime target for further investigation of interactions between hydrogen-containing surface pools and deeper planetary reservoirs.

Determination of the temperatures of surface weathering environments using isotope fractionations and clumped isotopes in phases such as carbonate. Recent developments in high precision techniques, techniques that rely on the site occupancy of isotopes, and techniques that provide high spatial resolution and high accuracy and precision will continue to evolve [8-10]. These techniques also provide a way of obtaining information about surface conditions that are unique and valuable for shaping our understanding of the surface evolution of Martian environments.

Determination of the isotopic composition of gases and solid phases in return sample as a measure for

atmospheric composition. The potential exists for preservation of important information about the fractionations between atmospheric species. High-precision measurements of terrestrial atmosphere have proven highly valuable for constraining the types of chemical reactions and chemical pathways that are relevant in the terrestrial element cycles. It is anticipated that similar measurements (such as the carbon isotope fractionation between carbon dioxide and carbon monoxide, or the $^{16}\text{O}/^{17}\text{O}/^{18}\text{O}$ of atmospheric oxygen-possibly carbon dioxide) provide similarly valuable constraints for understanding Mars atmospheric chemistry [11-14].

Determination of the extent to which oxidized species with anomalous ^{17}O have interacted with the silicates during weathering reactions or with water in Martian near surface weathering environments. The presence of an anomalous ^{17}O signal in carbonate and hydrous silicates [15-17] from the SNC meteorites indicates the presence of a pathway for transfer of an atmospheric oxygen signal from the atmosphere into the regolith. The amplitude of the signal may depend on parameters that include the amount of available water and the rates of oxidation of the surface by the atmosphere. The amplitude of this signal is uncertain with the present SNC samples.

Determination of the oxidation pathways that led to the formation of sulfate. Sulfate appears to be a very important feature of Mars surface environments and the indications from the SNC meteorites point to anomalous oxygen and sulfur. This signal suggests an atmospheric oxidation pathway, but the pathway is uncertain in large part because of the paucity of samples with clear signals [17-19]. Return samples have the potential to provide samples that can be used to characterize this signal and therefore to characterize the oxidation pathways and chemistry of sulfur in the Martian atmospheric environment.

Integration of reaction textures and the relationship to isotopic variations. The past decade has seen dramatic improvements in the capabilities of microanalytical techniques, including significant improvements in spatial resolution and precision with SIMS techniques as well as improved capabilities and more widespread use of cutting edge techniques in electron microscopy. The applications and expertise with these techniques will continue to improve and has the potential to provide new types of information and insights into past temperatures, changing conditions, and rates of change.

These examples are but a few of the types of research questions that might be addressed with return samples, or the variety of additional tests that will be devised to understand atmospheric composition, for

textural analysis of samples or even the detection of very rare compounds. Return samples with surface weathering, of soil and sediments, and of atmospheric gases (trapped, adsorbed, or free) have the potential to carry important information about past temperatures of Mars's surface environments, the pathways for oxidation of the Martian regolith, and the presence, composition, and amounts of water in near surface environments.

1. Mcdween, HY. 1994... Meteoritics 29 (6): 757-779.
2. Mcdween, Hy. 1985. Rev Geoph 23 (4): 391-416.
3. Bogard, Dd; Nyquist, Le; Johnson, P. 1984. GCA 48 (9): 1723-1739
4. Clayton, RN; Mayeda, TK. 1996. GCA 60 (11): 1999-2017.
5. Franchi, IA; Wright, IP; Sexton, AS; Pillinger, CT. 1999. MAPS 34 (4): 657-661.
6. Leshin, LA; Epstein, S; Stolper, Em. 1996. Geochimica Et Cosmochimica Acta 60 (14): 2635-2650.
7. Watson, LL; Hutcheon, ID; Epstein, S; Stolper, EM. 1994. Science 265 (5168): 86-90.
8. Eiler, JM Earth And Planetary Science Letters, 262 (3-4): 309-327
9. Valley, JW; Eiler, JM; Graham, CM; Gibson, EK; Romanek, CS; Stolper, EM. 1997. Science 275 (5306): 1633-1638.
10. Eiler, JM; Valley, JW; Graham, CM; Fournelle, J. 2002. Geochimica Et Cosmochimica Acta 66 (7): 1285-1303.
11. Bhattacharya, Sk; Savarino, J; Thiemens, Mh. 2000. Geophysical Research Letters 27 (10): 1459-1462.
12. Eiler, JM; Kitchen, N; Rahn, Ta. 2000. Experimental Constraints On Geochimica Et Cosmochimica Acta 64 (4): 733-746.
13. Thiemens, MH History and applications of mass-independent isotope effects Annual Review Of Earth And Planetary Sciences, 34: 217-262 2006
14. Thiemens, MH Science, 283 (5400): 341-345 JAN 15 1999
- 15.. Romanek, et al. 1994. Nature 372 (6507): 655-657.
16. Farquhar, J; Thiemens, MH; Jackson, T. 1998. Science 280 (5369): 1580-1582.
17. Farquhar, J; Thiemens, MH. 2000. Journal Of Geophysical Research-Planets 105 (E5): 11991-11997.
18. Farquhar, J; Savarino, J; Jackson, TL; Thiemens, MH. 2000. NATURE 404 (6773): 50-52.
19. Farquhar, J; Kim, ST; Masterson, A. 2007. Earth And Planetary Science Letters 264 (1-2): 1-8.

IDENTIFICATION (OR OTHERWISE) OF MARTIAN CARBON IN MARTIAN METEORITES. Monica M. Grady^{1,2}, V. K. Pearson¹, I. Gilmour¹, M. A. Gilmour¹, A. B. Verchovsky¹, J. Watson¹ and I. P. Wright¹; ¹PSSRI, The Open University, Walton Hall, Milton Keynes MK7 6AA, UK, ²Dept. Mineralogy, The Natural History Museum, Cromwell Road, London, SW7 5BD, UK. Contact: m.m.grady@open.ac.uk.

Introduction: One of the goals of current martian exploration is to search for evidence of extinct (or even extant) life. In recent years, this goal has been interpreted as a search for evidence of water on Mars' surface. The success of instrumentation (high resolution cameras and infrared spectrometers) on orbiting spacecraft, coupled with *in situ* data from the MER rovers have revolutionized our understanding of the surface of Mars, the type of rocks and minerals present, and their stratigraphy [1 and subsequent papers]. It is clear that there has been extensive and intensive aqueous action at different periods in Mars' history, and evidence for water is, to all intents and purposes, irrefutable. It is now time to define the next phase in the search for life as a search for regions of habitability on Mars [2]. A search for life could also be seen as a search for carbon, as one of the major assumptions that has been made in the search for life on Mars is that any life present is likely to be carbon-based.

To date, there have been no unambiguous measurements of carbon on Mars' surface. Data from the *Viking* labelled-release experiments were not clear [3]. Although Mars' thin atmosphere is approximately 95% carbon dioxide, and carbonate grains have been identified in dust in the atmosphere [4], predictions of vast carbonate reservoirs [5] have not been verified, and it is now thought that fluid on the surface might have been too acidic for the survival of carbonates [6]. In contrast to observations of the martian surface, measurements on martian meteorites have shown the presence of several different carbon-bearing components, including carbonates [7, 8]. We use data from martian meteorites to estimate the abundance and $\delta^{13}\text{C}$ of organic carbon, primary magmatic carbon and secondary carbonates that might be present on Mars.

Much is known about the behaviour of carbon on Earth as it cycles through the atmosphere, hydrosphere and lithosphere. The biosphere is a fourth carbon reservoir, and its presence influences the fixing and release of carbon in these reservoirs over different time-scales. The overall carbon balance is kept in equilibrium at the surface by a combination of tectonic processes (which bury carbon), volcanism (which releases it) and biology (which mediates it). In contrast, to Earth, Mars currently has no active tectonic system; neither does it possess a significant biosphere. However, these observations might not necessarily have held in the past. By constructing a carbon cycle for

Mars based on the carbon chemistry of martian meteorites, we investigate whether or not there is evidence for a martian biosphere

Analytical techniques: Three separate techniques were used to determine the abundance and isotopic composition of different carbon-bearing components in martian meteorites.

Component identification by stepped combustion.

Carbon-bearing phases are oxidized by incremental heating in an atmosphere of oxygen (stepped combustion). Following purification of the resulting CO_2 , the isotopic composition of the gas is measured by mass spectrometry [9]. An example of the type of data acquired is shown in Figure 1, with the temperature ranges shown over which different carbon-bearing components combust or decrepitate.

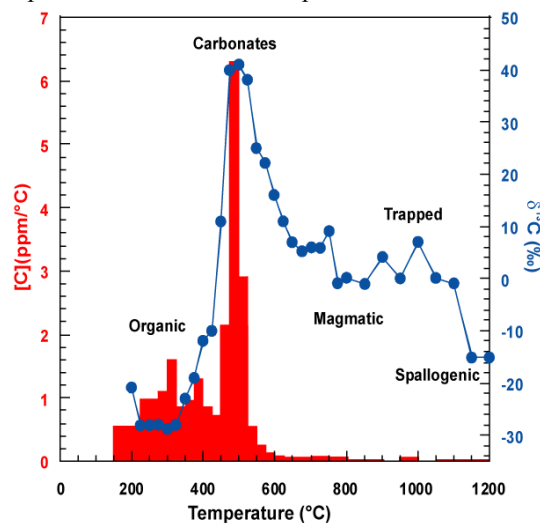
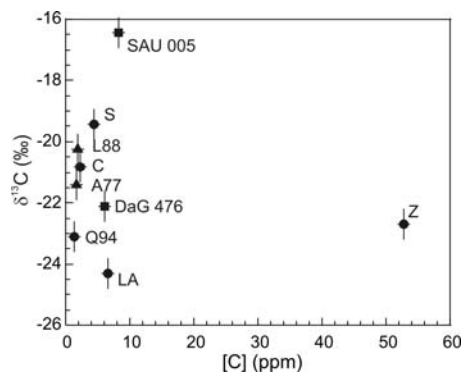

Figure 1: Results from stepped combustion of 4.5mg powdered whole rock ALH 84001. The histogram is carbon abundance in ppm/°C scaled on the left, filled circles are $\delta^{13}\text{C}$, scaled on the right. Errors in $\delta^{13}\text{C}$ are < symbol size.

We have applied this technique to Chassigny and the shergottite sub-groups of martian meteorites, in order to determine an idea of the abundance and isotopic composition of martian primary magmatic carbon [8]. These meteorites were selected because they do not seem to have experienced alteration by fluids in contact with Mars' atmosphere. Results from the study are shown in Figure 2.

Figure 2: Abundance and $\delta^{13}\text{C}$ of magmatic carbon in Chassigny and shergottites. Symbols are shergottite sub-groups: ● – basaltic; ▲ – lherzholitic; ■ – olivine-phyric.



Carbonate determination by acid dissolution.

Analysis of carbonates in martian meteorites is not easy: with the exception of ALH 84001, the carbonates are small, and generally mixed with clay minerals in cracks within primary silicates. It is difficult to analyse carbonates *in situ*, so whole rock meteorites are dissolved in 100% H_3PO_4 , following the method employed for terrestrial carbonates. However, because copious sulphur-bearing species are also generated by this procedure, there are often problems associated with producing pure CO_2 for isotopic analysis. We circumvented this problem by using a gas chromatograph to separate CO_2 from other species, prior to isotope analysis in a Thermo 253 mass spectrometer [10]. Results from analysis of 5 nakhlites are given in Figure 3.

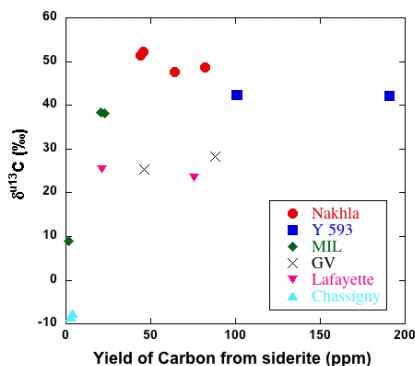

Figure 3: Results from acid dissolution of powdered whole rock nakhlites and Chassigny. Samples of between 30 – 50mg were dissolved in orthophosphoric acid at 72°C.

Organic compound identification by GC-GC-MS (4D TOFMS). A description of this technique and how it is applied to meteorites is given by [11]. Briefly, the technique employs two columns of different polarities in series. The first column, like conventional GC systems, separates compounds on the basis of molecular weight. Following this, specified fractions are passed through a second column and separated on the basis of polarity, detected by TOFMS. The system is sufficiently sensitive that only 1-2mg whole rock meteorite is required for analysis. We have used the technique to characterise organic compounds in carbonaceous chondrites

[12], and now intend to employ it to investigate organic material in martian meteorites in order to determine how much of it is terrestrial contamination and how much is non-terrestrial. Comparison of results with spectra acquired from carbonaceous meteorites will (we hope) enable us to gain an estimate of the population of organics that have been added to Mars from asteroidal and cometary impact, and that which is indigenous to Mars.

Discussion: It is clear from analysis of martian meteorites that carbon-bearing components should be detectable on the surface of Mars by suitable instrumentation. However, the most abundant species present in the igneous rocks that we analysed are carbonates, generally occurring at a level of 50 – 100 ppm. Their elevated $\delta^{13}C$ value ($\sim +50\text{‰}$) distinguishes them from terrestrial carbonates, and is presumed to result from interaction of martian atmospheric CO_2 with groundwater [10]. Magmatic carbon, released by stepped combustion of carbonate-free shergottites, generally occurs at a level of <10 ppm with $\delta^{13}C \sim -22 \pm 2\text{‰}$ [8]. Results for the organic component are in progress.

Summary: Measurement of indigenous martian carbon in martian meteorites is fraught with problems. The samples are contaminated with terrestrial organics, and the abundance of indigenous carbon is very low. Even so, we are still able to produce an inventory of carbon in martian igneous rocks, giving us a handle on the interaction between different carbon-bearing reservoirs on Mars. What is not yet clear is how carbon in the primary igneous rocks will have been transformed or removed by aqueous alteration on Mars' surface. Neither is it clear how conditions on Mars' surface will have sequestered atmospheric CO_2 into secondary clay minerals. Because the amounts of indigenous carbon are so low, it will take detailed analysis of sedimentary and igneous rocks samples returned directly from Mars before we can answer these questions.

Acknowledgements: This research was funded by the STFC. The NHM, UK, AMWG, USA and NIPR, Japan are gratefully acknowledged for samples.

References: [1] Bibring J.-P. (2007) *J. Geophys. Res.*, E112, doi: 10.1029/2007JE002935. [2] Mustard J. (2008) Communication at 18th MEPAG Mtg, Monrovia, CA. [3] Klein H. P. (1978) *Icarus*, 34, 666-674. [4] Bandfield J. L. et al. (2003) *Science*, 301, 1084-1087. [5] Kasting J. B. et al. (1987) *Icarus*, 71, 203-224. [6] Hurowitz J. A. et al. (2006) *J. Geophys. Res.*, E111, doi:10.1029/2005JE002515. [7] Wright I. P. et al. (1992) *Geochim. Cosmochim. Acta*, 56, 817-826. [8] Grady M. M. et al. (2007) *Int. J. Astrobiol.*, 3, 117-124. [9] Yates P. D. et al. (1992) *Chem. Geol.*, 101, 81-91. [10] Grady M. M. et al. (2007) *LPS XXXVIII*, Abstract # 1826. [11] Pearson V. P. et al. (2007) *LPS XXXVIII*, Abstract #1833. [12] Watson J. S. et al. (2005) *LPS XXXVI*, Abstract # 1842.

EVOLUTION OF WATER ON MARS: MARS SAMPLE RETURN CONSIDERATIONS FOR HYDROGEN ISOTOPE MEASUREMENTS. J. P. Greenwood, Dept. of Earth & Environmental Sciences, Wesleyan University, Middletown, CT 06459 USA (jgreenwood@wesleyan.edu).

Introduction: The history of water on Mars, from accretion to an early, putatively warm and wet climate, and then to the present cold and dry epoch, is of the utmost importance for our overall understanding of the Martian climate, prospects for the evolution of life, an understanding of silicate melt generation, and the water content of the mantle. Hydrogen isotopes of water in returned samples from Mars will shed light on this question and must be considered a high priority measurement in the returned samples. Here I outline a simple plan to maximize the scientific return of MSR for hydrogen isotopes.

What we know and don't know regarding D/H of Mars:

D/H and Martian meteorites. Martian meteorites allow us to make measurements under the best possible circumstances in our terrestrial laboratories. They allow us develop instrumentation and methodologies for the measurement of returned Martian samples. New research measuring D/H in Martian meteorites has led to a revolution in our understanding of the evolution of water on Mars [1]. Previous studies found an enormous range in δD in the Martian meteorites [2-8] from terrestrial-like values (as low as $\sim -150\text{‰}$ [5]) up to values measured remotely for the Martian atmosphere ($\sim +4300\text{‰}$ [2]). δD values for ALH 84001, the only sample of ancient Mars, ranged from ~ 0 to $+2000\text{‰}$ [6,7], suggesting a gradual enrichment of D/H of the Martian atmosphere over time, dominated by thermal escape from the top of the Martian atmosphere.

New research on D/H of Martian meteorites upends the current paradigm. A new measurement of δD in apatite of ALH 84001 of $+3000\text{‰}$, 1000‰ higher than any previous measurement in ALH 84001, suggests an early fractionation of D/H and loss of water from Mars, by at least 3.9 Ga, and possibly by 4.5 Ga [1]. The role of thermal escape of water from Mars is thus greatly diminished, with a fractionation of δD of only $\sim 1500\text{‰}$ in the last 4 Ga. Hydrodynamic escape of hydrogen during accretion and an early magma ocean stage is the most likely candidate for enriching D/H on early Mars [9,10].

New measurements of D/H in basaltic shergottites significantly change our understanding of D/H in more recent epochs. As stated above, all previous work on Martian meteorites found a range from terrestrial to Martian atmospheric values for D/H. The new results are higher in D/H with much less variability [1]. The

δD range in basaltic shergottites Los Angeles and Shergotty has a low of $+3500\text{‰}$ with high values for Shergotty of $+4600\text{‰}$. The addition of a Stacked CMOS-type Active Pixel Sensor (SCAPS) detector to a Cameca ims 1270 ion microscope allowed imaging of D/H zonation in mineral grains, and showed a correlation of igneous zonation of fluorine and chlorine with D/H in one apatite grain of Los Angeles (Fig. 1, modified from [1]). This strongly suggests assimilation of a D-enriched component to the Los Angeles magma during apatite crystallization [1]. The D/H zonation is clearly Martian in character (opposite to what would be expected for terrestrial contamination), and its coupling with igneous zonation suggests the preservation of Martian hydrogen isotope zonation in apatite.

The value of D/H of the Martian mantle is also in doubt now. Previous work suggested a δD of $\sim +900\text{‰}$ for the Martian mantle, based on a correlation of δD with H_2O content in Martian meteorite QUE94201 [8]. The new study of D/H in basaltic shergottites [1] sees no correlation between δD and H_2O content, suggesting that this method is inappropriate for determination of Martian mantle δD . The lowest δD value in the new work is $+3000\text{‰}$ for ALH 84001, suggesting that the Martian mantle could have this high value as well [1].

D/H of the Martian atmosphere. Remote measurements of atmospheric D/H on Mars are much more imprecise than measurements made on samples in our terrestrial labs. Modeling results suggest Martian atmospheric D/H can vary by a factor of 2 locally on an annual scale due to current climactic conditions [11], suggesting that significant variation may be found in returned samples able to equilibrate with Martian atmospheric D/H in the present epoch.

Mars Sample Return Strategy: In order to understand the temporal evolution of water on Mars using D/H, we need samples from the different geologic epochs of Mars. We will need sample return from at least two sites on Mars, the ancient heavily cratered terrain, and the younger northern plains. Basaltic samples from these two sites would allow us the possibility to measure D/H in hydrous magmatic minerals, such as apatite, the most common hydrous mineral in the Martian meteorites. This would allow us a chance to determine D/H of the Martian mantle and the temporal evolution of magmatic water on Mars. Of course, conclusive measurement of D/H of the Martian mantle has

yet to be realized in the Martian meteorites, so this a serious caveat [1].

Sedimentary and/or alteration minerals in returned samples from a young and ancient locale on Mars will likely also shed light on the temporal evolution of Martian surface water, as well as the range of D/H possible in the current climactic regime. Highly labile hydrated magnesium sulfates can equilibrate D/H with the Martian atmosphere, apparently on a daily basis [12]. Thus four samples from 2 sites would be considered a minimum for detailed examination of D/H from returned samples from Mars.

Preservation of Martian D/H in returned samples from Mars: We have measured D/H in apatite in the Mojave(?) desert find Martian meteorite Los Angeles, as well as Martian D/H zonation in an apatite grain from this meteorite. Martian D/H systematics have been exquisitely preserved in apatite, even though this meteorite had terrestrial carbonate deposition in rock fractures, which suggests significant interaction with terrestrial water. Thus apatite, a common igneous phosphate mineral on Earth and Mars, will likely preserve its D/H signature during sample return and handling.

Hydrous sulfates present another challenge. D/H of jarosite in Martian meteorite MIL 03346 shows that Martian D/H can be preserved in jarosite from a Martian meteorite [13] but jarosite is a relatively stable sulfate mineral on Mars [14]. Hydrous magnesium sulfates and their ability to exchange D/H during a sample return mission will need careful consideration. Sheet silicates, zeolites, and Martian ice have the same problem, though if samples can be kept frozen and isolated from terrestrial water, measurement of D/H in these phases could be undertaken.

Instrumentation concerns for Mars Sample Return: Secondary Ion Mass Spectrometry (SIMS) will be an important technique for the measurement of trace elements and isotopes in returned samples from Mars. A dedicated ion microscope with a next generation SCAPS detector would be considered essential to Mars sample return, not just for D/H measurement. The power of the SCAPS detector, to visualize 2-D isotope or trace element zonation in a thin-section, will allow us to assess the effects of terrestrial contamination or alteration occurring during the sample return and handling here on Earth for a variety of elements and isotopes. A NanoSims for the measurement of D/H at higher spatial resolution than is capable with a Cameca ims 1280 ion microscope would also be an essential instrument for Mars sample return as well, especially for fine-grained hydrous alteration minerals.

References: [1] Greenwood J. P., Itoh S., Sakamoto N., Vicenzi E., Yurimoto H. (2008) *GRL*, in

press. [2] Watson L. L. et al. (1994) *Science*, 265, 86. [3] Leshin L. A. et al. (1996) *GCA*, 60, 2635. [4] Leshin L. A. (2000) *GRL*, 27, 2017. [5] Gillet P. et al. (2002) *EPSL*, 203, 431. [6] Sugiura N. and Hoshino H. (2000) *Met. Planet. Sci.* 35, 373. [7] Boctor N. Z. et al. (2003) *GCA*, 67, 3971. [8] Leshin L. A. (2000) *GRL*, 27, 2017. [9] Dreibus G. & Wänke H. (1987) *Icarus*, 71, 225. [10] Zahnle K. et al. (1989) *Icarus*, 84, 502. [11] Montmessin F. et al. (2005) *JGR*, 110, doi:10.1029/2004JE002357. [12] Vaniman D. et al. (2004) *Nature*, 431, 663. [13] Vicenzi E. et al. (2008) *LPSC XXXVIII*, abstract #2335. [14] Navrotsky A. et al. (2005) *Icarus*, 176, 250.

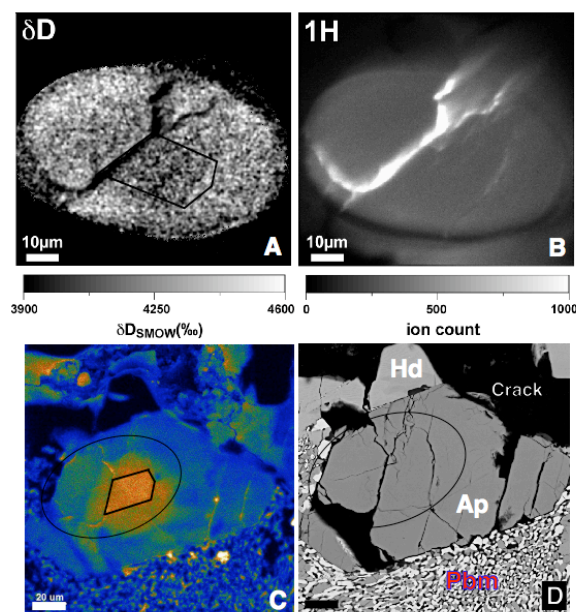

Fig. 1. (A) δD SCAPS image of δD zonation in Los Angeles apatite grain 748-4. Black box outlines area of high fluorine seen in (C). (B) 1H SCAPS image of same grain. (C) Panchromatic CL image of same grain showing igneous zonation pattern. The high CL intensity correlates with high fluorine. Black box outlines highest fluorine intensity and is also shown in (A) The black oval denotes area of SCAPS analysis shown in (A) and (B). (D) BSE image of apatite grain 748-4 showing late-stage crystallization features, such as pyroxferroite breakdown material (PBM), and hedenbergite (Hd). Modified from [1].

MARS SAMPLE RETURN: THE VALUE OF DEPTH PROFILES E.M.Hausrath¹, A.K. Navarre-Sitchler², J. Moore², P.B. Sak³, S.L. Brantley², D.C. Golden¹, B. Sutter¹, C. Schröder¹, R. Socki¹, R.V. Morris¹, D.W. Ming¹,¹ NASA Johnson Space Center, Houston, TX 77058 Elisabeth.M.Hausrath@nasa.gov ²Penn State University, University Park, PA 16802 ³Dickinson College, Carlisle PA, 17013.

Introduction: Sample return from Mars offers the promise of data from Martian materials that have previously only been available from meteorites. Return of carefully selected samples may yield more information about the history of water and possible habitability through Martian history. Here we propose that samples collected from Mars should include depth profiles of material across the interface between weathered material on the surface of Mars into unweathered parent rock material. Such profiles have the potential to yield chemical kinetic data that can be used to estimate the duration of water and information about potential habitats on Mars.

Characteristics of depth profiles:

On Earth, soil-forming processes result in distinct horizons and chemical gradients long studied by soil scientists. Soil-forming processes include transformations from one soil component to another; translocations of material laterally or vertically; additions of material; and loss of material, as by leaching. Soil profiles collected on Mars yield the possibility of additional information into similar soil-forming processes on that planet.

In addition, when depth profiles (through soils or through weathering rinds) are characterized by dissolution of a mineral component, these profiles can be used to study weathering kinetics. When soils can be compared to unaltered parent material, elemental and mineralogical changes can be quantified.

Elemental and mineralogical depth profiles are commonly normalized to an assumed immobile element or mineral to account for non-isovolumetric weathering [1]:

$$\tau_{i,j} = \frac{C_{j,w}}{C_{j,p}} \frac{C_{i,p}}{C_{i,w}} - 1 \quad (\text{Eq. 1})$$

where $\tau_{i,j}$ is the fraction of mobile element or mineral j lost or gained assuming that element or mineral i is immobile (w and p refer to weathered and parent material respectively) and C is the concentration of the immobile and mobile elements or minerals in the parent and weathered materials. An immobile element can be chosen by using the strain of the profile if bulk density is known. Such a normalized dissolution profile commonly has characteristics shown in the schematic dissolution profile, Figure 1. In two profiles formed on basalt and diabase in Hawaii and Virginia, respectively, such normalized profiles reflect differences in climate and mineralogy (Figure 2). The different meteoric precipitation rates likely play an important role in the difference in depletion of the Na-containing plagioclase mineral (Figure 2).

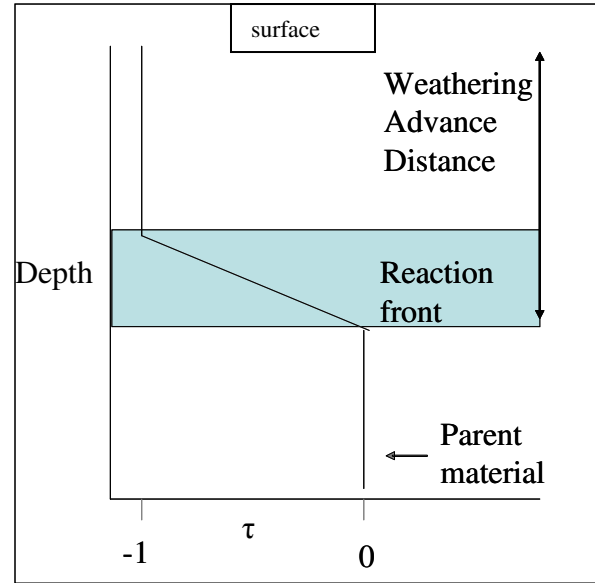

Figure 1. A schematic normalized depth profile from parent material through a weathered surface, showing the reaction front and weathering advance distance.

Kinetic information from depth profiles: Several studies have used chemical/mineral kinetics to study the duration of water on Mars, which is important for the potential habitability of the planet [2-4]. With quantitative chemistry as a function of depth (e.g. Figure 2), information about weathering kinetics can be inferred. Lichtner [5] formulated an analytical solution for the thickness of a reaction front (shown here for a diffusion-dominated front):

$$l = \left(\frac{\phi D}{kA} \right)^{1/2} \quad (\text{Eq. 2})$$

where ϕ = porosity, D = diffusivity, k = the reaction rate constant, and A = the mineral-water interfacial area. This equation is strictly true only for weathering of a single-component, single-phase system characterized by linear kinetics [5]. However, it is more generally true that steeper fronts represent slower weathering rates relative to solute transport than shallow fronts.

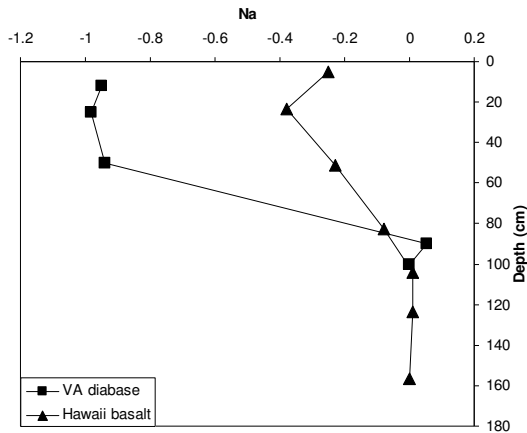

Figure 2. Normalized Na concentrations in soils developed on a diabase in Virginia [6], and a basalt in Hawaii [7]. Na concentrations are normalized to assumed immobile element Ti (Virginia) and Zr (Hawaii). Sodium concentrations are close to parent at depth, and approach a complete loss close to the surface for the Virginia soil, and approximately 40% for the Hawaii soil. These profiles reflect the different climates (MAT=23°C for Hawaii and = 10°C for Virginia, MAP = 180 mm for Hawaii and = 1040mm for Virginia, as well as the different parent materials (diabase for Virginia and basalt for Hawaii). The different precipitation rates likely play a strong role in the different total depletions.

White [8] has used the slope of the weathering gradient (or reaction front) in combination with the weathering advance rate (Figure 1), to calculate surface-area normalized rates from soil profiles using the following equation:

$$R_s = 1000 \frac{\rho_w \omega}{S\beta b_s} \quad (\text{Eq. 3})$$

Here R_s ($\text{mol m}^{-2}\text{s}^{-1}$) is the surface-area normalized weathering rate, ρ_w (g cm^{-3}) is the density of weathered material, S ($\text{m}^2 \text{m}^{-3}$) is the reactive surface area, β (mol mol^{-1}) is the stoichiometric coefficient for the elemental distribution in a mineral, ω (m s^{-1}) is the weathering advance rate, and b_s (kg mol^{-1}) is the weathering gradient. If parameters could be sufficiently constrained, such an equation might yield information about the weathering history on Mars.

In addition to analytical solutions such as equations 2 and 3, numerical models CrunchFlow and FLOTRAN have been used to model weathering profiles on Costa Rica basalts [9], California river terraces [10], and Svalbard basalt and the Mars rock Humphrey [4]. Such models, which incorporate geochemical parameters including mineral dissolution rate constants, solubilities, pore water chemistry, parent mineralogy and secondary products, as well as transport, can allow the calculation of duration of weathering [4]. Although such calculations have been performed for one rock on Mars [4], sample collection and return of one or more depth profiles would allow many more parameters to be constrained and different environments studied.

Alteration of the surfaces of Mars rocks analyzed by the Mars Exploration Rovers has occurred over mm scales [11]. Sample return would allow much more detailed characterization of such minimal alteration. Techniques could include Environmental Scanning Electron Microscopy (ESEM), which would allow samples to be observed without coating. Transmission Electron Microscopy (TEM) would yield mineralogical information at the nanoscale, such as the incipient formation of secondary products. Atomic Force Microscopy (AFM) and X-Ray Photoelectron Spectroscopy (XPS) could yield topographic and chemical data of sample surfaces. High-resolution X-ray computed tomography and neutron scattering could be used to study porosity development due to weathering at μm to nm scale on the surfaces of altered Martian rocks returned to Earth.

Stable isotope measurements on secondary products present in the weathering profile may also yield valuable information about the history of water on Mars. For example, oxygen and hydrogen isotopes in phyllosilicates, and oxygen isotopes in carbonates and Fe-oxides have been measured in depth profiles to yield paleoclimatic information on Earth [12-14]. Such measurements could yield valuable information about water interactions and paleoclimate on Mars. In addition, carbon and oxygen isotopes from carbonates and thermal springs have shown to be useful as biosignatures in some terrestrial settings [15].

Conclusions: Depth profiles yield valuable mineral kinetic and chemical flux information on Earth, and, if collected on Mars and returned to Earth could likely yield similarly important information about Mars weathering and habitability. Since weathering on Mars could have occurred under much more water-limited conditions, and potentially for much shorter time-scales than on Earth, weathering profiles and reaction fronts may be much thinner. Sample return may therefore be ideal to measure these fine-scale weathering profiles. Sample return of depth profiles could also yield valuable information about potential habitats and possible biosignatures on Mars.

References:

- [1] Anderson et al. (2002) *GSAB*, 114, 1143-1158 [2] Stopar J. S. et al. (2006) *GCA*, 70, 6136-6152. [3] Olsen A. A. and Rimstidt J. D. (2007) *American Mineralogist* 92, 598-602. [4] Hausrath E.M. et al. (2008) *Geology*, 36, 67-70 [5] Lichtner P.C. (1988) *GCA*, 52, 143-165. [6] Pavich et al. (1989) USGS Professional paper 1352 [7] Chadwick et al. (2003) *Chemical Geology* 202, 195-223 [8] White A.F.(2002) *Chemical Geology*, 190, 69-89 [9] Navarre-Sitchler et al. in prep [10] Moore et al. in prep for *GCA* [11]Arvidson et al. (2006) *JGR*, 111, doi: 10.1029/2005JE002499 [12] Stern et al., (1997) *GCA*, 61, 731-744 [13] Tabor et al., (2004) *GSAB*, 116, 1280-1293 [14] Tabor and Montanez (2005) *PPP*, 223, 127-146. [15] Socki R.A., et al, (2006) *LPSC XXXVII*, #1014.

Characterization of Fe-sulfate minerals: Preparation for Mars sample return B. C. Hyde¹, P. L. King^{1,2}, M. N. Spilde² and A.-M. S. Ali³ ¹Dept. Earth Sciences, Univ. Western Ontario, London, ON N6A 5B7 Canada. ²Inst. Meteoritics, Univ. New Mexico, Albuquerque, NM 87131 USA. ³Dept. Earth & Planetary Sciences, Univ. New Mexico, Albuquerque, NM 87131 USA.

Introduction: Fe-sulfates have been observed on Mars [e.g. 1] and in martian meteorites [e.g. 2] and will possibly be returned from Mars. The characterization of these minerals will provide information that may be used to calculate depositional environment, fluid and atmospheric interactions (water activity and oxygen fugacity), and formation temperature of salts on Mars [e.g. 3; 4]. However, it is not straightforward to characterize Fe-sulfates for four main reasons: 1) they readily change hydration [5; 6] and oxidation [7] states and such changes may occur during analysis; 2) these minerals may be small (<1-5 μm), making them difficult to analyze even with micro-analytical techniques; 3) we lack standards; and 4) Fe-sulfates contain multi-valent and light elements that are difficult to analyze with traditional techniques (e.g. electron microprobe, EMP). Overcoming analysis issues prior to return of small volumes of martian samples is essential for obtaining knowledge about the surface of Mars. Hence, we are developing methods to analyze ~pure synthetic, fine-grained samples for Fe, S, and light elements (O, C, and N) using bulk and micro-analysis. Knowledge of the light element content is critical for determining the Fe-sulfate type and thus environments on Mars.

Synthesis methods: To synthesize Fe-sulfates, we used ferric sulfate ($\text{Fe}^{3+}_2(\text{SO}_4)_3 \cdot 5\text{H}_2\text{O}$, Acros Organics; 97%), ferrous sulfate ($\text{Fe}^{2+}\text{SO}_4 \cdot 7\text{H}_2\text{O}$, EMD Chemicals; Extra Pure ~100%), sulfuric acid (BDH, 98%) and deionized water. Szomolnokite [$\text{Fe}^{2+}\text{SO}_4 \cdot \text{H}_2\text{O}$] was produced by heating ferrous sulfate to 60 °C for 24 hours. The product was stored in a relative humidity (RH) environment with a saturated MgCl_2 solution (RH= \sim 33%, T=20-25 °C) following [8]. Melanterite [$\text{Fe}^{2+}\text{SO}_4 \cdot 7\text{H}_2\text{O}$] was synthesized by placing ferrous sulfate at RH= \sim 75%, T=20-25 °C using a saturated NaCl solution following [8]. Rhombochase [$\text{HFe}^{3+}(\text{SO}_4)_2 \cdot 4\text{H}_2\text{O}$] was synthesized using a method similar to [9]. A mixture of 9.64 g ferric sulfate, 20.91 mL of deionized water and 5.05 mL of sulfuric acid was left in air for one week. The precipitate was filtered with acetone to remove remaining liquid. Schwertmannite [$\text{Fe}^{3+}_8\text{O}_8(\text{OH})_6(\text{SO}_4)_x \cdot n\text{H}_2\text{O}$] (where $1 \leq x \leq 1.75$) synthesis followed a method similar to that of [10]. Ferric sulfate (1.54 g) was added to 500 mL of deionized water. The solution was mixed at 85 °C for one hour, then filtered and the remaining precipitate was filtered twice more with 100 mL of deionized wa-

ter. The product was left to dry at 60 °C for 24 hours. A mixture of ferricopiapite [fcop, $\text{Fe}^{3+}_{2/3}\text{Fe}^{3+}_4(\text{SO}_4)_6(\text{OH})_2 \cdot 20\text{H}_2\text{O}$] and paracoquimbite [p-coq, $\text{Fe}^{3+}_2(\text{SO}_4)_3 \cdot 9\text{H}_2\text{O}$] was made by deliquescing ferric sulfate at RH= \sim 75%, T=20-25 °C, then solidifying the gel-like substance at RH= \sim 33%, T=20-25 °C. The two minerals may be separated because fcop is bright yellow and p-coq is white/pale yellow.

The melanterite and szomolnokite samples were kept in their RH chambers until analysis. To transport these two samples we sealed them in vials within the RH chamber and placed them in smaller chambers with sponges soaked in saturated salt solutions. The remainder of the samples were kept sealed in glass vials with Teflon/Kapton®/electrical tapes.

Analysis methods: *X-ray Diffraction (XRD) analysis.* The samples were analyzed using a Rigaku Rotaflex RTP 300 RC with a cobalt source at the University of Western Ontario (UWO). Powders were dry-mounted on glass slides and scanned in steps of 0.02° 2 θ from 2° to 82° at a speed of 10°/minute. In total the sample was exposed to lab air for 8 minutes of scan time plus preparation time.

Reflectance infrared (IR) analysis. A Nicolet Nexus 670 FT-IR with a Pike Technologies Automated Diffuse Reflectance attachment was used at UWO to collect biconical reflectance IR data. The samples were sieved to <45 μm ., 2 mg of sample was mixed with 43 mg of KBr and 300 scans were run. Backgrounds were taken before and after each run to ensure that no atmospheric signals were introduced into the spectrum, a dry-air purge chamber was not used because it caused samples to dehydrate.

Electron microprobe (EMP) analysis. EMP analysis used a JEOL 8200 microprobe equipped with wavelength and energy dispersive spectrometers (WDS and EDS) at the University of New Mexico (UNM). Fe-sulfate powders were pressed into discs and C-coated.

Scanning electron microscope (SEM) analysis. SEM analysis used a JEOL 5800LV SEM equipped with an Oxford Analytical ultrathin-window EDS at UNM. Analysis was done in low vacuum (31-45 Pa) using uncoated pressed discs, a 0.15 nA beam current and a 15 kV accelerating voltage. A thin section and a pressed pellet of jarosite from Peña Blanca, New Mexico [11] were used for calibration.

Inductively coupled plasma atomic emission spectroscopy (ICP-AES) and ion chromatography (IC) analysis. A PerkinElmer Optima 5300DV ICP-AES and

Dionex DX500 IC were used for analysis. Samples were run in axial mode for the ICP-AES and the AS9-HC (High Capacity) separation column with Ultra ASRA suppression were used in IC. Fe-sulfates were dissolved in dilute nitric acid and in some cases nitric plus hydrofluoric acid. The dissolved samples were then diluted with deionized water to a volume of 50 mL for initial analysis. The samples were rediluted by 100x to measure Fe and for IC analysis of anion contents.

Bulk C and N analysis. A Costech ECS 4010 elemental analyzer at UNM was used to quantify C and N in the samples. The sample (~5 mg) was combusted and CO₂ and N₂ analyzed with a mass spectrometer.

Results: XRD analysis of the synthetic samples shows the szomolnokite, melanterite and rhomboclase to be single phases. The schwertmannite also contains goethite. The fcop and p-coq samples are dominated by these two phases, but contain other ferric sulfates.

The IR analysis helped confirm the XRD identification of the phases and future work will aim to quantify water contents [e.g. 12].

The EMP WDS analysis showed that there was no measurable accumulation of trace elements in samples synthesized from the 97% pure Fe³⁺₂(SO₄)₃·5H₂O. It was not possible to analyze for O, C or N using WDS or EDS on the EMP due to the C coat, scattering on the rough pellet surface, and the relatively high vacuum.

The SEM allowed for analysis in low vacuum without a C coat and it was possible to analyze for O (C and N were not possible to quantify). Early results show promise, but the work is still in progress. In some cases it seems that dehydration has likely occurred (e.g. melanterite). Table 1 shows the ideal formula for seven fine-grained, powdered samples with

the SEM, ICP-AES and IC results converted to moles and normalized to the ideal formulaic number of Fe atoms. When we have quantified O and H using mass spectrometry it will be possible to calculate exact wt. % values for ICP-AES and IC data rather than ratios.

Bulk N and C analysis showed that N is below detection limits, however, C is present (Table 1).

Conclusions & Implications for Mars Sample

Return: Multiple analysis techniques are required to calibrate and confirm analyses of Fe-sulfate samples, particularly for light element analysis. Future calibration of SEM analysis will provide methods to use these techniques for microanalytical work on samples returned from Mars.

References: [1] Klingelhöfer, G. et al. (2004) *Science*, 306, 1740-1745. [2] Herd, C. D. K. (2006) *LPI Contrib.*, 1331, p.53. [3] King, P. L., and McSween, H. Y. (2005) *JGR*, 110, doi: 10.1029/2005JE002482. [4] Papike, J. J. et al. (2006) *GCA*, 70, 1309-1321. [5] Chou, I-M, et al. (2002), *Am. Min.*, 87, 108-114. [6] Peterson, R. C. and Grant, A. H. (2005), *Can. Min.*, 43, 1171-1181. [7] Jerz, J. K. and Rimstidt, J. D. (2003), *Am. Min.*, 88, 1919-1932. [8] Greenspan, L. (1977), *J. Res. NBS-Phys. & Chem.*, 81A, 89-96. [9] Majzlan, J. et al. (2006) *Eur. J. Mineral.*, 18, 175-186. [10] Loan, M. et al. (2004) *Am. Min.*, 89, 1735-1742. [11] Papike, J. J. (2007) *Am. Min.*, 92, 444-447. [12] Milliken, R. E. and Mustard, J. F. (2005) *JGR*, 110, doi: 10.1029/2005JE002534.

Acknowledgements: Funded by the Canadian Space Agency Space Science Exploration Program (PK) & the Canadian National Science & Engineering Research Council (BH, PK). Paul Burger & Jim Papike are thanked for providing the Peña Blanca jarosite. Nicu-Viorel Atudorei helped with C & N analyses.

	Ideal Moles From Formula				SEM (molar ratio normalized to ideal Fe values) for fine-grained powders pressed into discs. Errors calculated from standard deviation of 7 analyses				ICP-AES/IC (molar ratio normalized to ideal Fe values)			Wt %
	Fe	K	S	O	Fe	K	S	O	Fe	K	S	C
Samples identified as pure phases with XRD												
Szomolnokite	1	0	1	5	1±0.05	0	0.86±0.04	3.98±0.41	1	0	0.93	0.09
Melanterite	1	0	1	11	1±0.05	0	0.87±0.03	4.92±0.25 #	1	0	0.76	0.02
Rhomboclase	1	0	2	12	1±0.03	0	2.33±0.03	10.09±0.70	1	0	2.37	0.04
Samples identified as mixed phases with XRD												
Schwertmannite*	8	0	1-1.75	≥18	8±0.07	0	1.25±0.05	21.03±1.27	8	0	1.56	0.08
fcop ⁺	4.67	0	6	46	-	-	-	-	4.67	0	3.53	0.03
p-coq ⁺	2	0	3	21	-	-	-	-	2	0	3.51	0.03
Natural sample (Ideal values taken from past analysis [11])												
Peña Blanca jar.	2.89	1.07	1.96	13.58	2.89±0.08	0.98±0.02	1.74±0.03	11.76±0.95	2.89	0.91	1.53	0.04

Table 1. Ideal atomic values, SEM and ICP-AES/IC normalized values for major elements. Bulk C analysis in final column. *Contains goethite. ⁺Mixtures dominated by fcop and p-coq respectively. [#]Dehydration of melanterite to szomolnokite in the SEM.

MARS SAMPLE RETURN: 20+ YEARS AFTER THE FIRST MARS SAMPLE RETURN WORKSHOP

J.H. Jones, KR, NASA/JSC, Houston, TX 77058 (john.h.jones@nasa.gov).

Introduction: In the fall of 1987, a Mars sample return workshop was held in Houston, TX. It is fitting, therefore, to compare and contrast one's thinking after such a span of time. Either remarkably or infuriatingly, my own ideas on the subject have changed little, if at all, in those twenty years. Below, I will revisit a 1987 model in light of twenty years of progress in martian investigation.

A Retrospective: Because a keynote speaker had a medical emergency in his family, I was asked to replace him on short notice. My theme then was that we should land on a datable basaltic terrain and return a sample of that terrain, as well as samples of the atmosphere and windblown dust. This scheme had the advantage of simplicity; and simplicity should, in turn, translate into lower cost. Roving and *in situ* analytical capabilities were to be kept to a bare minimum. And the choice of these three sample sets would almost guarantee that good science could be accomplished upon their return to Earth.

My recollection is that other sampling schemes were more ambitious, one of which involved returning km-long drill cores under cryogenic conditions.

Basalt Revisited: The advantage of a moderately fresh basaltic rock over other types of rock or soil is that its age can be determined fairly straightforwardly. With sedimentary and metamorphic rocks, this need not be true. The main scientific goal should have a high probability of being accomplished successfully. It ought to not be difficult to find a sample to return, either. Go to a basaltic terrain and grab almost anything that's lying around. The analytical instrumentation necessary to accomplish this might be as simple as a camera.

What do you get as scientific return from such a sample? If the terrain is chosen carefully, not only will you get the age of the returned basalt, but also the age of the terrain. A terrain that is large enough to have a well-defined crater count will then allow the calibration of the martian cratering record. Very old and very young terrains should be avoided. It is important to get a sample from a middle-aged terrain where the uncertainties in absolute ages are greatest. If successful, the returned sample will not only date its native terrain, but many other martian terrains as well.

In addition, it would be useful to land in an area that we have not visited before. This will add one more data point to our global martian experience.

What are the drawbacks of this plan? How can the mission fail? The simplest way for the mission to fail is if the basalts at this landing site are undatable. The MER experience has shown that many of the rocks that Spirit has encountered have been altered and/or weathered. To the extent that such alteration is pervasive, dating a basaltic crystallization age may not be possible. It is even possible that such alteration is the reason that there are so few old martian meteorites in our collections. One simple means of evaluating the pristinity of a basalt would be to have a RATing tool. If it RATs easily, it's altered.

Therefore, landing sites should be evaluated not only for age and landing safety; they should also be evaluated for the pristinity of their basalts. The presence of dust may make this difficult. Remember that Olympus Mons, the solar system's largest volcano, is invisible to the TESS and THEMIS instruments for just this reason.

To summarize, returning a basaltic sample from a basaltic terrain maximizes simplicity and, therefore, minimizes scientific risk. The successful dating of a rock from a particular terrain has immediate implications for the rest of the planet. Minimizing analytical and roving capabilities minimizes cost.

Windblown Dust Revisited: Based on two data points from Viking, in 1987 I surmised that windblown dust was nearly ubiquitous on Mars. With a few more data points 20 years later, this assumption seems to still be valid. On Earth, layers of dusty material (loess) have been used to estimate the chemical composition of the upper continental crust. In other words, a local sample may have global implications. This may also be true for Mars — perhaps even more so. The chemical compositions of dust or dusty soils at the Viking, Pathfinder, and MER sites were rather similar. It is possible that a returned sample of windblown dust would give a reasonable estimate of the composition of the martian crust.

How can this part of the mission fail? The easiest way would be for a local soil product to be confused with a global average. Morphological evidence should be able to sort these two out. Does it look like a drift? Then it probably is. Nevertheless, it is likely that any sample of windblown dust will have a local component.

To summarize, a windblown sample may well give a global average of the upper crust, and it may well be enriched in alteration/weathering products (e.g., sul-

fates). It should be easy to find at any landing site; we are five for five, so far. Much roving should not be necessary; and the necessary analytical instrumentation may consist of just a camera.

Atmosphere Revisited: Since the first workshop, two notable developments have occurred in refining the composition of the martian atmosphere and martian volatile reservoirs.

(i) It is now recognized that Chassigny contains noble gases that most likely reflect the signature of the martian mantle. For example, the Xe isotopic composition of Chassigny is not significantly different from solar. And, consequently, it is probable that the carbon and hydrogen isotopic compositions of Chassigny also reflect those of the martian mantle.

(ii) Bogard and coworkers have used analyses of martian meteorites to redefine both the $^{40}\text{Ar}/^{36}\text{Ar}$ and the $^{38}\text{Ar}/^{36}\text{Ar}$ ratios of the martian atmosphere. The $^{40}\text{Ar}/^{36}\text{Ar}$ ratio of ~ 1800 is significantly different than the Viking measurement of ~ 3000 ; and the $^{38}\text{Ar}/^{36}\text{Ar}$ ratio is fractionated from that of planetary Ar.

Another improvement in our knowledge of martian atmospheric composition will come from the analyses of the SAM instrument on the Mars Science Laboratory. We should be able to measure the isotopic composition of Ar *in situ*, as well as the oxygen and carbon isotopic composition of CO_2 . We will not be able to measure ^{20}Ne .

It is difficult to envision that a remote analysis of the martian atmosphere will be as accurate or precise as a measurement in a terrestrial lab. Therefore, it seems prudent to return an atmospheric sample as a part of the sample return mission.

Impact of this Mission Design on Astrobiology:

The search for martian life is an exciting aspect of the exploration of Mars; and the sample return mission described above seems to ignore that facet of martian research. However, that is not necessarily true. It is not much of an exaggeration to say that, prior to the MER missions, almost everything we knew about the atmosphere, hydrosphere, and biosphere of Mars came from the study of basaltic martian meteorites — the analysis of martian air by Viking being an obvious exception. Therefore, it is not out of the question that new biological insights will be gained from the return of a basaltic sample.

It may also be true that, if fossilized bacteria exist on Mars, examining windblown dust may be the easiest means of finding them. They are small enough to become windborne and the sampling, as argued above, is global. It is highly probable that the UV radiation environment would destroy any organics in the wind-

blown dust, but that should not affect fossilized materials.

Admittedly, this mission design is not focused on Astrobiology. However, I believe that this is the best strategy. Even if Mars were teeming with life, it is not clear that we would find it on any given sample return mission. Therefore, a mission that focuses on Astrobiology has a diminished chance of scientific success. And as we have seen from the MER Spirit site (i.e., the “basaltic prison”), even a mission that focuses on Astrobiological environments can be risky.

A Recapitulation: Any martian sample return mission will be expensive and risky. A mission that returns a datable basalt, a sample of windblown dust, and a sample of the atmosphere minimizes risk, minimizes cost, and maximizes the scientific return.

We as a scientific community tend to be greedy. We want to return the perfect sample. And to accomplish that, we want to perform a lot of remote analyses and rove 10’s of kilometers in search of that perfect sample. Sadly, the first returned sample will not be perfect. Therefore, we should accept that and simplify the first Mars Sample Return Mission in every way possible.

Mars Sample Return at 6 Kilometers per Second: Practical, Low Cost, Low Risk, and Ready. S. M. Jones¹, A. J. G. Jurewicz², R. Wiens³, A. Yen¹; L. A. Leshin⁴; ¹California Institute of Technology, Jet Propulsion Laboratory, 4800 Oak Grove Drive, Pasadena, CA 91109, ²Arizona State University, Tempe, AZ 85287, ³LANL, Space & Atmospheric Sciences, Los Alamos, NM 87545, ⁴Goddard Space Flight Center, Greenbelt, MD 20771.

Introduction: The technology for a practical sample return is available now. For about 20% of the cost of a complex robotic mission that would return rock and soil samples in, perhaps, fifteen years, we could return samples of atmospheric dust and gases in five years using the SCIM mission concept [1].

SCIM proposes to return samples of both martian dust and atmosphere without ever landing on the martian surface. A robotic mission that doesn't land is low risk with lots of options for contingencies. The small, dispersed solid-portion of the sample SCIM targets is relatively easy to sterilize *in situ*, thereby avoiding planetary protection concerns for the first Mars Sample Return. Moreover, there will be enough martian dust and atmosphere returned to give us an immense science return, providing data for a new, global view of Mars (See Table 1). SCIM can also provide ancillary engineering and chemical data necessary for successfully planning future sample-return missions.

Role in Science/Engineering/Human flight: SCIM will collect and return atmospheric solids that will provide a well-mixed sample of martian crustal components from the hemisphere(s) over which the craft flies. Therefore, we will glean information about weathering, oxidation state, hydration, bulk and trace element chemistry. SCIM atmospheric samples will allow isotope and noble-gas geochemistry to provide constraints on martian history, including primordial and current atmospheric composition, surface-atmosphere interactions, and the degassing history through time. Moreover, we can concurrently collect data on atmospheric and structural parameters for engineering models of landing missions, and health-issues (e.g., Cr⁺⁶) for astronauts without diluting the science return.

Mission design: The SCIM mission design is a venture in flexibility; its exact structure can be modified with respect to the science-goals, institutional partnerships, and the budget at hand.

Basic Mission. The heart of the mission is a high-speed aeropass of Mars with a periapsis below ~45 km, near the equator, at a dusty time of year. Gas is collected when ram-air enters a small opening in the nose; dust is collected as it passes through the rarified bow-wave and impacts aerogel-filled collectors in the body of the spacecraft. The gas and dust collectors are launched in place and require only the removal of simple covers to activate them for the collection processes. After the aeropass, the solar-panels rede-

ploy and the spacecraft resumes cruise configuration. The dust collectors are heated for a few hours to sterilize the samples, eliminating planetary-protection concerns [3], and then stowed for a STARDUST-like return and analysis.

An example Scout-level mission based on the SCIM concept is shown in Fig. 1. This basic mission was designed to collect at least 1000 dust particles of diameter 10 microns or greater, along with millions of smaller particles, and at least one liter of martian atmosphere. For perspective: returning 1000 cometary particles (and no gas) was the goal of the highly-successful STARDUST mission [4], and NASA's prized cosmic dust collection is comprised of only ~250 particles.

Using current Earth-based instrumentation, one thousand 10 micron diameter dust particles would provide sufficient experimental material for many thousands of scientific analyses (Fig. 2). Similarly, the 1 liter atmospheric sample allows for multiple replicate isotopic analyses.

Variations on the basic mission: SCIM can be tailored to various scenarios and even upgraded for increased science return on a higher (but still low-cost) budget. Possible modifications include:

- Non-silicate / non-oxide aerogel and/or 29Si aerogel for analysis or more elements and mineralogical structures
- Passive instrumentation of aeroshell to collect data for CFD and other engineering models
- Double aeropasses to sample both hemispheres
- Rotating collectors/covers to separate dust particles as a function of depth in the atmosphere
- "Piggy-back" probe / small orbiter / camera for collecting remote data in addition to aeropass
- International cooperation: parsing space-craft, dust collector(s), launch vehicle, and "piggy-back" instrument.

We emphasize that SCIM is not intended to replace a future full-scale robotic-landed (or even crewed) mission. Rather, it is a practical near-term step that can provide valuable scientific and engineering data.

References:

[1] Leshin, L. A., et al., (2003) LPS XXXIV Abstract #1288; [2] Jurewicz, A. J., et al., (2002) LPS XXXIII Abstract #1703; [3] Clark, B. C., (2003) LPS XXXIV Abstract #1797; [4] Brownlee, D., et al. (2006) *Sci.*, 314, 1711-1716; [5] Wiens, R. et al, (2003) LPS XXXIV Abstract #1199.

Table 1. SCIM Science Goals are achievable because Martian dust and gas are well mixed below the troposphere; moreover, aerogel capture particles “in-tact” and, after capture, will protect it thermally during the aeropass [2].

- I. Quantitatively characterize the chemical, isotopic, and mineralogical composition of martian crustal materials
- II. Investigate aqueous processing mechanisms that have affected or created martian surface materials
- III. Discover evidence relevant to Mars’ original volatile inventory, hydrologic and atmospheric cycles, and climate evolution
- IV. Provide “ground truth” for past and future remote sensing observations of martian materials
- V. Confirm that martian (SNC) meteorites are indeed samples of Mars

Fig. 1. An example of a SCIM mission architecture for Mars sample collection and return. This design is for an economical (e.g., SCOUT-cost) mission, an expedient, low risk, Mars sample return that addresses global issues and can also be considered “reconnaissance” for robotic-landing or crewed missions [1].

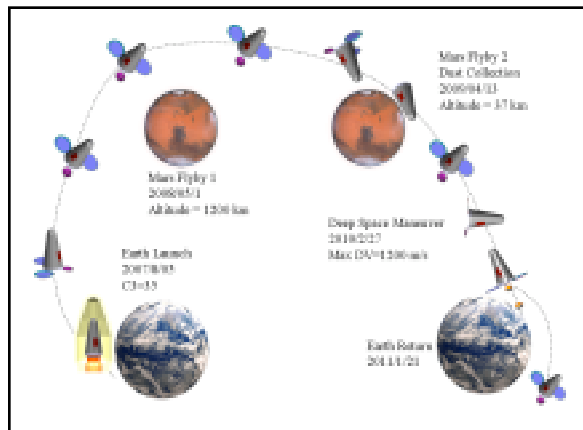
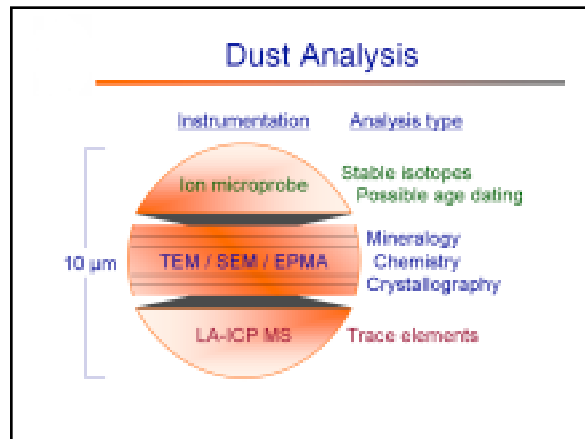

Fig. 2. Scientific importance of dust and atmospheric Samples.

(A) Shows how a 10 micron grain can be allocated for further scientific research after examination using non-destructive analytical techniques. Note: the Mars dust particles could easily be sectioned into multiple pieces and distributed to international laboratories having complementary instrumentation. Accordingly, each returned dust particle will provide material for numerous studies, as per STARDUST [4].



(B) Overview of how the isotopes in a well-mixed martian atmospheric gas sample can be used to probe fundamental questions about martian history [5]. We expect all of these investigations to be addressed with a SCIM 1 liter sample.

Species	Investigation
$^{16}\text{O}/^{17}\text{O}/^{18}\text{O}$	Total volume of water on Mars; Evolution of atmospheric oxygen over time by comparison with SNC silicates and alteration products
$^3\text{H}/^3\text{He}$	Very recent (4×10^4 yr) cryosphere-atmosphere exchange; an indicator of nitrate deposits present on Mars’ surface
$^{210}\text{Po}/^{210}\text{Pb}$	Recent degassing history (past 10^2 yr)
Ne isotopes	Degassing history over past 10^2 yr
$^{39}\text{Ar}/^{39}\text{Ar}$	Degassing history over 4.5×10^7 yr Atmospheric escape history/modeling
$^{40}\text{Ar}, ^{39}\text{Ar}$	Interior processes / early degassing history
$^{86}\text{Kr}, ^{78}\text{Kr}$	Possible constraints on near-surface (paleo-ocean-deposited?) Br, I, from cosmic-ray-induced neutron capture Kr, Xe
$^{22}\text{Ne}, ^{21}\text{Ne}$	U/Pu ratio in Mars’ interior
Kr, Xe isotopes	Formation of Mars from solar nebula; solar nebula processes
DB	Precise composition of present atmosphere; Atmosphere-cryosphere exchange; Atmospheric chemistry & escape processes
$^{13}\text{C}/^{12}\text{C}$	Present atmospheric composition; Atmosphere-cryosphere exchange; Atmospheric chemistry & escape processes
$^{28}\text{Si}/^{29}\text{Si}$	Present atmospheric composition; Balance between degassing and escape; Atmospheric escape processes

SCIENCE DEFINITION OF THE MARS SCIENCE LABORATORY SAMPLE CACHE. J. S. Karcz¹, D. W. Beaty², C. A. Conley³, J. A. Crisp², D. J. Des Marais⁴, J. P. Grotzinger⁵, L. G. Lemke⁴, C. P. McKay⁴, S. W. Squyres⁶, C. R. Stoker⁴, and A. H. Treiman⁷, ¹SETI Institute, 515 North Whisman Road, Mountain View, CA 94043. john.s.karcz@nasa.gov, ²Jet Propulsion Laboratory, California Institute of Technology, 4800 Oak Grove Drive, Pasadena, CA 91109, ³NASA Headquarters, Science Mission Directorate, 3X63, 300 E Street Southwest, Washington, D.C. 20546, ⁴NASA Ames Research Center, Moffett Field, CA 94035, ⁵Division of Geological and Planetary Science, California Institute of Technology, Pasadena, California 91125, ⁶Department of Astronomy, Cornell University, Ithaca, NY 14853, ⁷Lunar and Planetary Institute, 3600 Bay Area Boulevard, Houston, TX 77058

Introduction: In June 2007 NASA proposed the addition of a container for caching samples to the 2009 Mars Science Laboratory (MSL) rover. The cache would provide a potential future Mars Sample Return (MSR) mission with the option of returning a diverse set of previously characterized samples. MSL's capabilities—particularly its broad suite of analytical instruments, traverse endurance of 20 km, and intended lifetime of at least one Martian year—are expected to exceed those of a potential future Mars Sample Return (MSR) rover. We were asked to recommend appropriate scientific objectives for the cache and a minimal set of requirements deemed necessary to reach them.

Constraints on the MSL cache: Factors which were found to have implications for the scientific scope of the cache included: 1) a directive that the cache be minimalist and that it employ MSL's previously planned capabilities without modification, 2) the need for cached samples to tolerate an extended stay on Mars, and 3) a desire that the cache be easily retrievable.

Use of MSL's existing capabilities: Due to the advanced state of MSL's development at the time of the cache's proposed addition, no modifications to the rover's systems to support the cache could be made other than those crucial to its inclusion. Thus, the cache will need to accept samples delivered by MSL's already-planned sample-acquisition systems—a pulverizing drill and a soil scoop. Both systems will be capable of providing powder samples, and the scoop is expected to be able to provide small intact rocks as well.

Tolerance of a long stay: If it is returned, the cache is expected to spend 6–10 years on Mars, well beyond the designed lifetime of MSL. Certain objectives, such as those which would require detailed analysis of volatile gas components of the samples, were thought by our team to be incompatible with such uncontrolled storage. Based on this and the expectation that MSR would retrieve fresh samples in addition to the cache, narrow objectives tolerant to the long stay were chosen. We expect that the cached samples will nevertheless be more broadly valuable.

Ease of retrieval: Easy retrieval of the cache was considered to be important since this may increase the likelihood of its eventual return. As such, the team desired that the cache be compatible with the MSR Orbiting Sample (OS) container and that it only occupy a fraction of the capacity of the OS to leave room for samples that would be freshly obtained by a future MSR mission.

Recommendations:

Scientific Objectives: The cached samples are expected to contribute to each of the high-level goals for sample return identified by the Mars Exploration Program Analysis Group. However, given the constraints described above, our team thought the cached samples would be best suited for one particular objective: investigation of the evolution of the surface and interior of Mars. This aim is the least sensitive to the storage conditions of the samples, particularly to exposure to many years of diurnal thermal cycling.

Sample type: The science-definition team desired that the cache be capable of accommodating both rocks and powders but preferred rocks if accommodating both types was not feasible. (This was found to indeed be the case by the team implementing the cache.)

Cache requirements: We suggested a small set of requirements on the cache intended to—within the constraints above—maximize the attractiveness of the cached samples for later return. These included requirements applicable to the caching of both powder and intact rock samples; however, only those necessary for rocks will be described here. 1) Storage of each sample in separate containers is preferred, but storage of multiple intact rock samples in a common container is considered acceptable *if* 2) the samples are photo-documented using an appropriate MSL imager to aid their re-identification upon return to Earth. Further characterization and analysis is strongly desired whenever possible (using, *e.g.*, ChemCam) but not required. 3) The cache should accommodate at least five (preferably ten or more) independently collected samples. 4) Based on experience from lunar and meteoritic samples, it should accept rocks with masses of at least ~ 3 g to allow extensive petrological analysis. 5)

The materials that will be in direct contact with the samples should be chosen to minimize contamination and should be chosen in consultation with the Curation and Analysis Planning Team for Extraterrestrial Materials (CAPTEM), and 6) samples of those materials should be curated to provide a later reference for understanding contamination of the returned samples, should NASA decide to collect them during a later mission.

THE IMPLEMENTATION OF THE MARS SCIENCE LABORATORY SAMPLE CACHE. J. S. Karcz¹, M. Cappuccio², A. G. Demo², H. J. Eisen³, J. Feldman³, K. Gheno⁵, C. E. Kruger², M. Liu², J. H. Reimer⁶, O. Santos², O. E. Serviss³, P. K. Tong⁵, ¹SETI Institute, 515 North Whisman Road, Mountain View, CA 94043. john.s.karcz@nasa.gov, ²NASA Ames Research Center, Moffett Field, CA 94035, ³Jet Propulsion Laboratory, California Institute of Technology, 4800 Oak Grove Drive, Pasadena, CA 91109, ⁴Lockheed Martin Mission Services, P.O. Box 168, Moffett Field, CA 94035, ⁵Lockheed Martin Space Systems, 3251 Hanover Street, Palo Alto, CA 94304, ⁶ASRC Aerospace Corporation, Moffett Field, CA 94035.

Introduction: We are developing a sample cache for the 2009 Mars Science Laboratory rover. It will be able to accept 5–10 rock samples, each ~ 0.5–1.5 cm across, delivered by MSL's preexisting soil scoop. The samples will be held in a common container designed to allow photo-documentation of the samples over the course of the mission. The design is simple and intended to survive at least ten Earth years on Mars on a presumed-dormant rover. It is intended to allow convenient removal and repackaging, if desired, by a future sample-return rover. Care has been taken to limit contamination of samples by the cache system and to provide means to aid later identification of any contamination which does occur.

Description: The cache will be located at the front of the rover, within the workspace of MSL's arm. The cache will be a passive system, with no moving or electrical parts. It will consist of two components: a sample container and a cradle. The cradle will hold the container to the rover and provide a funnel for delivering samples from the scoop into the container. The container will be removable—tabs holding it into the cradle will bend away when the container is pulled with a predetermined force.

The sample container: The container's geometry (a cylinder 7 cm in diameter and 2.5 cm in height) and mass (200 g full) were chosen for convenient return. It would occupy ~ 40 % of the capacity of recent MSR Orbiting-Sample Container concepts, leaving room for freshly-acquired samples. Samples will be deposited through a top opening. The volume of MSL's scoop is similar to that of the cache, and the scoop, designed to acquire only rock-free soil, has no proven capability to discard any excess soil scooped up with targeted rocks. Therefore the container's sides and face will be meshed to allow soil to fall through in order for the cache to accommodate the desired number of samples. The samples will be uncovered, exposed to the environment for their entire stay on MSL. The top opening will be large to prevent clogging while depositing samples and to allow viewing through the funnel of the cache's contents by the microscopic imager at the end of MSL's arm, the Mars Hand Lens Imager (MAHLI).

Caching operations: The tasks which will comprise each caching event follow from the need to acquire and deliver the sample rocks using a scoop de-



Illustration 1: An oblique view of the cache, looking into the funnel.

signed for soil alone and from the requirement to photo-document the samples. The contents of the cache will be imaged prior to any other operations to assess the volume available and to photo-document previously cached contents from which some soil may have fallen away. Imaging and other feasible characterization of targeted rocks on the ground will be performed prior to acquisition by the scoop. Separation of targeted rocks from incidentally scooped soil may be possible through manipulation of the scoop; if so, this will be done after acquisition. If possible, rocks will be imaged using the HazCams located on the front of the rover while in the scoop. The contents of the container will again be imaged after the samples have been dropped into the cache.

Sample contamination: To limit contamination, few materials will be used to fabricate the cache. Those that will be used, and the cleaning procedures for them, have been chosen based on recommendations from the Curation and Analysis Planning Team for Extraterrestrial Materials (CAPTEM). A copy of the flight cache, witness coupons, and spare materials will be curated on Earth to aid in the future identification of terrestrial contamination. As the container will be open on Mars and the samples exposed, the comparison of the curated materials with the flown cache, if returned, may also provide information on any contamination which occurs during the mission.

DETERMINING PRODUCTION RATES OF COSMOGENIC RADIOISOTOPES ON MARS. Y. Kashiv^{1,2,*}, M. Paul² and P. Collon¹, ¹Department of Physics, The University of Notre Dame (*ykashiv@nd.edu), ²Racah Institute of Physics, The Hebrew University of Jerusalem.

Introduction: Cosmogenic isotopes are produced by nuclear reactions of cosmic rays with atoms in rocks, atmospheres, and the interstellar and interplanetary media. Cosmogenic isotopes produced in rocks on Earth are used mainly to determine erosion rates and rock exposure ages, while those produced in the atmosphere are used in dating, studies of large-scale air circulation, hydrology, geophysics, etc. [1].

Most studies in this area are done with radioactive cosmogenic nuclides, which are measured by the technique of Accelerator Mass Spectrometry (AMS). The choice of isotope to study depends on (a) the problem to study, (b) its half-life, (c) chemical behavior and (d) expected concentration in the samples. Table 1 lists some of the frequently studied cosmogenic radioisotopes, their half-lives and the main elemental targets from which they are produced in rocks.

Table 1: Some frequently studied cosmogenic radioisotopes, their half-lives and main targets in rocks [1,2].

Isotope	Half-life (10 ⁶ yr)	Targets
¹⁰ Be	1.6	O, Mg, Si, Fe
¹⁴ C	0.00573	O, Mg, Si, Ge
²⁶ Al	0.71	Si, Al, Fe
³⁶ Cl	0.3	Fe, Ca, K, Cl
⁴¹ Ca	0.1	Ca, Fe
⁵³ Mn	3.7	Fe
¹²⁹ I	16	Te, Ba, La, Ce

Production rates for a number of cosmogenic radionuclides were measured in terrestrial rocks and in the atmosphere (e.g., [2,3,4]), lunar rocks (e.g., [5,6]) and meteorites (e.g., [5]), and exposure ages were deduced under various models. Models applicable to Martian samples may be simpler due to possibly very long exposure ages and very low erosion rates [7], leading to saturation values for the concentrations of cosmogenic radionuclides (i.e., steady state concentrations, in which production is balanced by decay).

The different composition and pressure of the Martian atmosphere, the lack of current magnetic field on Mars, and the fact that Mars is located farther from the Sun, will result in different cosmogenic production

rates in both Martian surface rocks and the Martian atmosphere.

We propose to measure the production rates of a number of cosmogenic radionuclides in surface rocks, both igneous and sedimentary, and possibly in the atmosphere as well. These production rates will then serve as the reference values for any study using these nuclides in Martian samples.

Studies of the physics and/or chemistry of Mars that could benefit from knowledge of cosmogenic production rates are, for instance, sand transport by winds (aided by determining the exposure ages of rock surfaces that were exposed after long burial times under thick layers of sand), and condensation of atmospheric gasses.

The proposed measurements will be done at the new AMS laboratory at The University of Notre Dame.

Production Rates in Martian Surface Rock:

1. *Igneous rocks.* Both the basaltic rocks of the southern highlands and the andesitic rocks of the northern lowlands [8] offer plenty of elemental targets for the production of all the isotopes in Table 1, with possibly the exception of ¹²⁹I.

2. *Sedimentary rocks.* In terms of elemental targets for the production of the cosmogenic radioisotopes in Table 1, Fe-rich sandstones [9] are similar to the basaltic and andesitic rocks.

3. *Samples.* There are two main requirements for samples of both types of rocks: (a) that they will be of surface layers of rocks, assumed to have been exposed to the atmosphere for a period of time of the order of the measured isotope's half-life, (b) show evidence for as little erosion as possible. The lack of tectonic activity, volcanism and surface liquid water in the recent geologic history of Mars (on the order of the half-lives of the isotopes in Table 1) means that it should be possible to find samples that satisfy the two requirements above.

The required sample size varies from about one milligram of rock for ¹⁰Be and ²⁶Al to a few grams for ¹²⁹I.

Production Rates in the Martian Atmosphere:

Atmospherically produced cosmogenic isotopes on Earth precipitate on the surface with the aerosols they attach to. The lack of liquid water on the surface of Mars (wet sedimentation) and as rain makes measuring atmospherically produced cosmogenic radioisotopes on Mars a challenging task.

Three possible ways that may enable one to determine the atmospheric production rates are: (a) collect samples of atmospheric aerosols [4], (b) sample the ice in the poles, and (c) leaching of surface-deposited aerosols on rocks (if such an environment is found). These types of samples are expected to collect atmospherically produced cosmogenic radioisotopes.

References: [1] Lal D. (1988) *AREPS*, 16, 355-388. [2] Cerling T. E. and Craig H. (1994) *AREPS*, 22, 273-317. [3] Lal D. (1991) *EPSL*, 104, 424-439. [4] Raisbeck G. M. (1983) *Nature*, 301, 690-692. [5] Nishiizumi K. (1983) *Nature*, 305, 611-612. [6] Jull A. J. T. (1998) *GCA*, 62, 3025-3036. [7] Golombek M. P. and Bridges N. T. (2000) *JGR*, 105, 1841-1853. [8] Albee A. L. (2000) *AREPS*, 28, 281-304. [9] Squyres S. W. and Knoll A. H. (2005) *EPSL*, 240, 1-10.

FE-SULFATES ON MARS: CONSIDERATIONS FOR MARTIAN ENVIRONMENTAL CONDITIONS, MARS SAMPLE RETURN AND HAZARDS. P. L. King^{1,2}, M. D. Lane³, B. C. Hyde², M. D. Dyar⁴, and J. L. Bishop⁵, ¹Inst. Meteoritics, Univ. New Mexico, Albuquerque, NM 87131 USA. ²Dept. Earth Science, Univ. Western Ontario, London, ON Canada, ³Planetary Science Institute, Tucson, AZ USA. ⁴Mount Holyoke College, South Hadley, MA USA. ⁵SETI Institute/NASA-Ames Research Center, Mountain View, CA USA.

Introduction: Iron sulfates have been identified in martian meteorites and also in discrete locations on Mars [e.g., 1-4]. Most observations and calculations favor sulfates dominated by Fe³⁺ [Table; 5-7]. Whether significant mass of Fe-sulfates are found in samples returned from Mars will depend on the sampling site.

Fe-sulfates as sensitive indicators of environmental conditions: King and McSween [6] examined Fe-sulfates on Mars and discussed how they may form via either interaction of SO₂ with rocks or from alteration of Fe-sulfides (pyrrhotite). On Earth, Fe³⁺-sulfate assemblages are most common where pyrite or pyrrhotite are oxidized, for example, in ore deposits and acid-mine drainage sites [7]. Fe-sulfate assemblages are sensitive indicators of pH, water activity (*a*H₂O or relative humidity, RH), oxygen activity (*a*O₂), sulfate activity (*a*SO₄) and iron activity (*a*Fe) [6]. Preservation of Fe-sulfates requires a water-limited environment (e.g., cryogenic or arid) like on Mars [6].

To obtain information on environmental variables, it is critical to identify specific *Fe-sulfate suites* (multiple minerals, found together) on Mars. Using visible/near-IR (VNIR-with two data processing methods), thermal IR (TIR), Mössbauer (MB) and alpha-particle X-ray (APX) spectroscopies, Fe-sulfate suites in Gusev Crater were identified as ferricopiapite (ID by 5 methods), coquimbite and fibroferrite (ID with 4 methods), and possibly parabutlerite and rhomboclase (ID with 3 methods) (Table). To constrain the environmental conditions of these minerals on Mars, it is useful to examine ferricopiapite/copiapite stability (Figs. 1-3).

Bulk chemistry of the precipitating solution. Figure 1 shows that solutions in equilibrium with ferricopiapite-coquimbite have F_e2O₃:H₂O:SO₃ = 8-20:52-60:25-32, or if ferricopiapite coexists with coquimbite the solution ratio is 17:54:29.

log_aO₂-log_aH₂O conditions. Figure 2 shows that copiapite is stable over log_aO₂ = -42.4 to -38 and RH ~45 to 80%. Ferricopiapite may co-exist with copiapite at relatively high log_aO₂ and RH (near ii in Fig. 2). Other Fe-sulfates may also co-exist (i and iii in Fig. 2).

pH-p_e conditions. Figure 3 shows that ferricopiapite is stable at extremely low pH (0-1) and oxidizing conditions. The pH limits will change dependent on the co-existing phases (iv and v in Fig. 3).

Containment issues for sample return: Because of their phase relations, to preserve Fe-sulfate minerals it is best to store many of them under controlled condi-

tions, away from oxidizing agents (e.g., air) and high (or low) RH that may cause hydration (or dehydration). For a sample return mission, an economical approach is to seal Fe-sulfate-bearing materials in an airtight, waterproof container on Mars, preferably with an RH/*a*O₂/temperature data logger. If such containment is not possible, then any present Fe-sulfates may form acids that may corrode the sample/holder, or form Fe (oxy)-(hydr)-oxides that may stain the sample/holder.

Hazards of Fe-sulfates: It is not expected that Fe-sulfates will be in sufficient volume to be hazardous; however, precautions should be taken with regard to ingesting, inhaling and handling Fe-sulfates. Most of the hazards associated with Fe-sulfates are related to their high Fe content and capability for acid-production. It is doubtful that sufficient Fe would be ingested to be hazardous [lethal doses are 180-300 mg/kg body weight; 8] and an upper safety limit of 50 mg Fe/day helps limit gastrointestinal irritation (e.g., nausea, vomiting, heartburn, diarrhea, epigastric discomfort) [8]. A more likely hazard is acid production from ingested Fe-sulfates resulting in oral, esophageal, and stomach burns and possible metabolic acidosis [9]. Dermal contact with Fe-sulfates produces irritation and some minerals (e.g. rhomboclase) may cause acid burns to the skin, eyes, and mucous membranes. Inhalation may cause pulmonary dysfunction, likely due to acid burns, and pulmonary fibrosis may occur [9].

References: [1] Lane, M. D. et al. (2008) *Am. Mineral.*, in press. [2] Johnson, J. R. et al. (2007) *Geophys. Res. Lett.*, 34, L13202. [3] Klingelhöfer et al. (2004) *Science*, 306, 1740-45. [4] Vicenzi, E. P. et al. (2007) *LPS XXXVIII*, #2335. [5] Burns, R. G., 1987. *JGR*, 92, 570-574. [6] King, P. L. & McSween Jr., H. Y. (2005) *JGR*, 110, E12S10. [7] Tosca, N. J. & McLennan, S. (2006) *EPSL*, 241, 21-31. [8] Jambor, J. L. et al. (2000) *Rev Mineral. Geochem.*, 40, 303-350. [9] Schümann, K. (2001) *Ann. Nutr. Metab.*, 45, 91-101. [10] Mat. Safety Data Sheet for Fe^{III}-sulfate, Haz. Subst. No. 6311, revised 2005-05-02. [11] Merwin, H.E. & Posnjak, E. (1937) *Am. Mineral.*, 22, 567-571. [12] Jerz, J. K. and Rimstidt, J. D. (2003) *Am. Mineral.* 88, 1919-1932. [13] Majzlan, J. et al. (2006). *Eur. J. Mineral.*, 18, 175-186.

Acknowledgements: Funding for this research was from the Canadian Space Agency Space Science Exploration Program (PLK) and NASA (MDL).

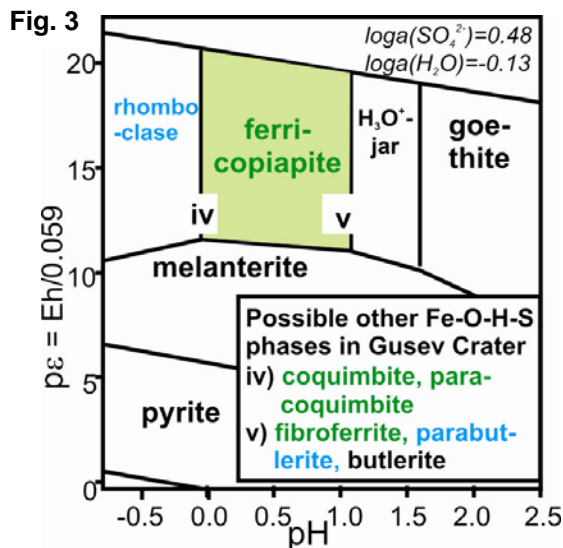
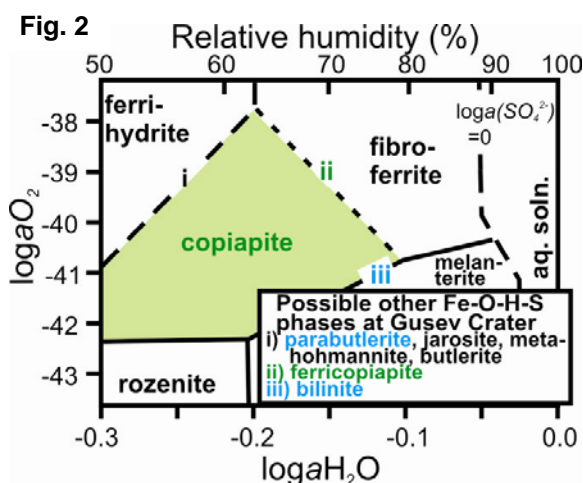
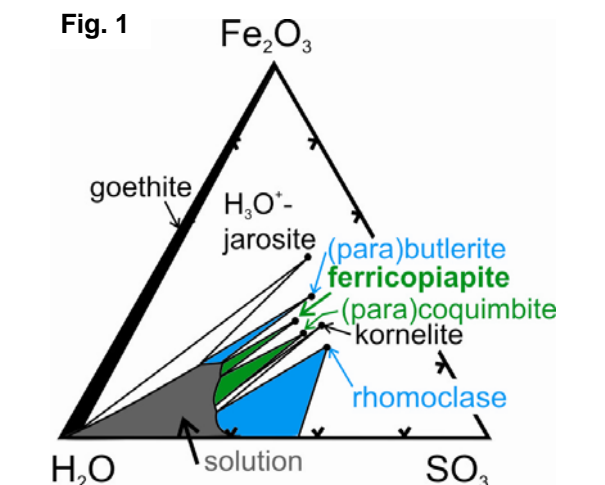

Figure 1: $\text{Fe}_2\text{O}_3\text{-H}_2\text{O-SO}_3$ diagram [modified after 11] showing the stability of different Fe^{3+} -sulfates, goethite and solution.

Figure 2: $\log a\text{O}_2$ versus $\log a\text{H}_2\text{O}$ (or relative humidity) diagram showing the stability ranges of certain Fe-sulfate and Fe-hydroxide minerals and solution [modified after 12]. Other minerals identified with spectroscopic methods may have stability boundaries as postulated (i, ii, iii), but their exact locations have not been calculated yet.

Figure 3: pE versus pH diagram for various Fe-sulfates, pyrite and goethite [modified after 13]. Other minerals identified with spectroscopic methods may have stability boundaries as postulated (iv, v), but their exact locations have not been calculated yet.

Table: Fe-sulfates identified at Gusev Crater, Mars.

Mineral	Ideal Formula	Lane et al. [1] examined PR soil# with APX plus:			Johnson et al. [2] used VNIR† on samples at several Gusev localities	Found on Earth with fcop*
		VNIR†	TIR	MB		
Fe-sulfates identified using at least 4 methods						
Ferricopiapite	$\text{Fe}_{4.6}^{3+}(\text{SO}_4)_6(\text{OH})_2 \cdot 20\text{H}_2\text{O}$	Y	Y	Y	Yell. Tyrone	Y
Coquimbite	$\text{Fe}_{2.2}^{3+}(\text{SO}_4)_3 \cdot 9\text{H}_2\text{O}$	Y	Y	N	W. PR	Y
Paracoquimbite	$\text{Fe}_{2.2}^{3+}(\text{SO}_4)_3 \cdot 9\text{H}_2\text{O}$	Y	Y	N	W. Tyrone, PR	Y
Fibroferrite	$\text{Fe}^{3+}\text{SO}_4(\text{OH}) \cdot 5\text{H}_2\text{O}$	Y	N	Y	Yell. Tyrone, Arad, PR	Y
Fe-sulfates identified using at least 3 methods						
Parabutlerite	$\text{Fe}^{3+}(\text{SO}_4)(\text{OH}) \cdot 2\text{H}_2\text{O}$	n.a.	Y	Y	n.a.	Y
Rhomboclase	$(\text{H}_3\text{O})\text{Fe}^{3+}(\text{SO}_4)_2 \cdot 3\text{H}_2\text{O}$	Y	N	N	Yell. Tyrone, W. Arad	Y
Fe-sulfates identified by at least 1 method						
H_3O^+ jarosite	$\text{H}_3\text{O}^+\text{Fe}_6^{3+}(\text{SO}_4)_4(\text{OH})_{12}$	n.a.	n.a.	n.a.	Yell. Tyrone, Arad	Y
Bilinite	$\text{Fe}^{2+}\text{Fe}_2^{3+}(\text{SO}_4)_4 \cdot 22\text{H}_2\text{O}$	n.a.	Y	N	n.a.	Y
Butlerite	$\text{Fe}^{3+}(\text{SO}_4)(\text{OH}) \cdot 2\text{H}_2\text{O}$	n.a.	n.a.	Y	n.a.	Y
Metahohmannite	$\text{Fe}_2^{3+}(\text{SO}_4)_2\text{O} \cdot 4\text{H}_2\text{O}$	N	N	Y	n.a.	N

#Fe-phosphate also identified in Paso Robles (PR) soil. †VNIR [1] used a pattern-matching technique and VNIR [2] used a spectral database deconvolution technique. *Data on mineral assemblages found with fcop (ferricopiapite) from [8]. Note: Fcop may also be associated with other Fe^{2+} -sulfates (e.g., melanterite, szomolnokite, rozenite), Fe^{3+} - Fe^{2+} -sulfates (e.g., romerite, voltaite), and Fe^{3+} -sulfates (e.g., ferrinatrite, hohmannite, metavoltine, quenstedtite), but these have not been identified at Gusev Crater. Y- definite identification, N- not identified; n.a.- measurement not made; Yell. Tyrone- yellow Tyrone soil; W. PR- white Paso Robles soil; W. Tyrone- white Tyrone soil; W. Arad- white Arad soil, Arad- white and yellow Arad soils.

GEOCHEMISTRY AND ASTROBIOLOGY SCIENCE PAYOFF USING LASER DESORPTION FOURIER TRANSFORM MASS SPECTROMETRY (LD-FTMS) TECHNIQUES FOR MARS SAMPLE RETURN. J.M. Kotler¹, N.W. Hinman¹, C. D. Richardson¹, T. McJunkin², and J.R. Scott². ¹Geosciences Department, University of Montana 32 Campus Drive Missoula, MT 59812, ²Chemical Sciences Idaho National Laboratory 1765 N. Yellowstone Hwy. Idaho Falls, ID 83415.

Introduction: To maximize science payoff, samples returned from Mars need to be analyzed by techniques that will provide inorganic, organic and isotopic chemical information. This will provide planetary scientists the opportunity to understand the evolution of Mars from a geochemical and possibly biochemical perspective. Previous missions have indicated that a variety of geological environments exist on Mars, and sampling strategies should be used that will yield a wide range of geomaterials. Laser desorption Fourier transform mass spectrometry (LD-FTMS) has been used to detect inorganic, biological, and organic chemical signatures associated with different geomaterials. LD-FTMS requires no sample preparation and offers high sensitivity allowing acquisition of spectra with a single laser shot for heterogeneously distributed chemical signatures. Some organic compounds (i.e., polyaromatic hydrocarbons or PAHs) self-ionize and are easily detected¹, but most organic compounds require ionization assistance. Therefore, we are exploring how different minerals assist in ionization, a process called geomatrix-assisted laser desorption/ionization (GALDI)². We have used synthetic, biologically induced, and natural mineral samples to evaluate GALDI using LD-FTMS.

Our focus has been on sulfate minerals, such as jarosite and Na/Mg-sulfate salts, both of which have been found on Mars.^{3,4} Jarosite forms from aqueous solutions and is a biologically induced mineral on Earth⁵. Herein we present results of our characterization of these minerals using GALDI-FTMS.

Results: GALDI-FTMS has revealed the presence of organic matter, including the amino acid glycine, in several jarosite samples from various worldwide locations⁶. Complex cluster ions can form in the gas phase during analysis and systematic studies of isotopic distributions using synthetic jarosites and glycine mixtures (Fig. 1) help identify the original molecules present in the samples⁶. Stearic acid with thenardite (sodium sulfate) used to ascertain the limit of detection (LOD) for GALDI-FTMS. The LOD was estimated to be 3 parts per trillion based on bulk concentrations, corresponding to approximately 7 zeptomoles (10^{-21}) per laser shot. Determining the LOD is complicated by the heterogeneity of the sample (Fig. 2) and evidence that the signal-to-noise ratio (S/N) tends to increase as the concentration of bio/organic compounds decreases relative to the mineral host.

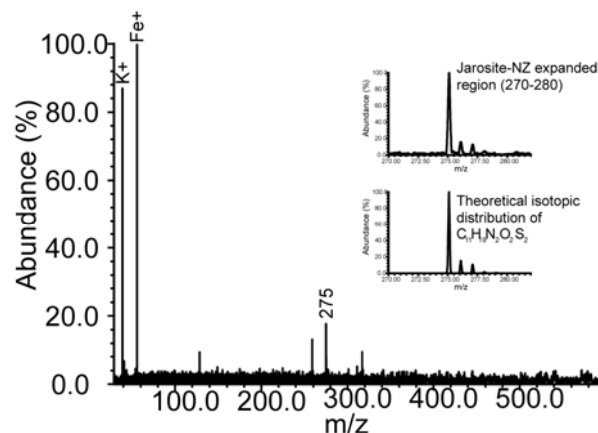

Fig. 1. LD-FTMS spectra of natural jarosite from New Zealand (NZ) and expanded region 270–280 m/z for glycine related ion isotopes.

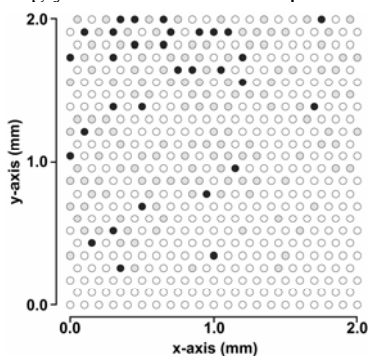

Fig. 2. Two-dimensional map showing heterogeneity of distribution of stearic acid biosignature in thenardite. Gray spots have m/z 390 peaks with S/N of 3 to 10 and black spots have S/N 10 or greater.

Conclusions: GALDI-FTMS offers the opportunity to obtain both geological and biological information simultaneously from a sample with minimal sample disturbance. Future improvements to the instrumentation should be able to provide more accurate isotope ratios, which would be a great asset for acquiring data from heterogeneous samples.

References: [1] Yan, B. et al. (2007) *Talanta*, 72, 634–641. [2] Yan, B. et al. (2007) *Geomicrobiology*, 24, 379–385. [3] Squyres, S.W. et al. (2004) *Science*, 306, 1698–1703. [4] Zhu, M. et al. (2006) *Lunar and Planetary Science XXXVII*. [5] Squyres, S.W. and Knoll, A.H. (2005) *Earth and Plan. Sci. Let.*, 240, 1–10. [6] Kotler, J.M. et al. (2008) *Astrobiology*, in press.

THE BIOLOGICAL POTENTIAL OF THE NORTHERN PLAINS FOR MARS SAMPLE RETURN. M. D. Kraft, E. B. Rampe and T. G. Sharp, Arizona State University, School of Earth and Space Exploration, P.O. Box 1404, Tempe, AZ 85287-1404, United States, mdkraft@asu.edu

Introduction: The principal role of a Mars sample return mission is to address questions that cannot be satisfactorily addressed by robotic missions or remote sensing and that yield the greatest scientific return. The search for life and determining habitability have been major drivers of Mars exploration. Addressing questions concerning biochemical evolution on Mars and the possible evidence for life is challenging a will likely require sample return. The best target location for sample return will be one that addresses multiple possibilities for life as well as major geological and climatic questions about Mars. Here, we suggest the northern plains of Mars may provide the greatest scientific return.

Searching for life on Mars: Phylogenetic studies indicate that the first life on Earth was chemotrophic [1]. If life developed on Mars, it may well have had chemotrophic origins too [2]. Thus, Martian life may have originated and developed in chemically and thermally high-energy subsurface environments, exploiting chemical disequilibria in the presence of groundwater [2,3]. The majority of Martian biomass may have existed in the subsurface [3].

For the purposes of sample return, subsurface environments would be difficult to sample. It has, therefore, been suggested that a good sampling strategy for Mars would be to select samples from hot spring or hydrothermal deposits that connect this potential subsurface biosphere to the surface [3,4]. We agree that hot spring deposits would make good targets for sampling; however, such sites may be quite localized and could be difficult to access due to topography, landing logistics, etc. The likelihood of hydrothermal deposits preserving intact organisms rather than simple fossils is small, particularly if the hydrothermal system is ancient or inactive.

The scientific return of discovering intact, preserved Martian organisms would be far richer than finding only fossil evidence of life [5], although finding Martian fossils would be a truly fantastic and valuable discovery on its own. Intact martian organisms could be preserved in Martian permafrost [5,6]. While it is possible that such biota exist on Mars, it is perhaps more likely that Martian life originated in the much higher energy environments of hydrothermal systems. If so, and if life was short-lived and did not adapt to the environment of icy soils, then organisms would not be present in permafrost. In other words, a lack of life in permafrost—although it may be the best place to

search for extant life and preserved organisms—would not rule out the possibility that life formed elsewhere on Mars.

Thus, an ideal place to search for evidence of life on Mars is a place that has both the potential for preserved (and viable) microorganisms and a place that may preserve fossils from possible (ancient) subsurface ecosystems. The northern plains of Mars is such a place, because it has near-surface permafrost and because it has a link to ancient subsurface hydrothermal systems of Mars.

Sampling the ancient subsurface in the northern plains: The Vastitas Borealis Formation (VBF) is a deposit of sediment formed as a result of flooding from Martian outflow channels by the Late Hesperian and subsequently reworked by periglacial processes [7-9]. The sediment of the VBF was likely derived from ancient crusts eroded from outflow channels. Outflow channels are generally considered to have been carved by water emanating from the subsurface [10]. Little can be known about the residence time of water in the subsurface, but it must have been there prior to the Hesperian. Accounting for all the outflow channels, this subsurface reservoir of water was enormous. This water reservoir, or portions of it, may have hosted a high-energy hydrothermal environment in which chemotrophic life could have formed and been sustained. Through chemical interaction with the mafic and ultramafic hostrock, the water would have had large quantities of dissolved silica. Upon discharge and flooding, sediment derived from ancient Martian crust and the dissolved silica load was carried into the northern lowlands and deposited, perhaps along with a sampling of Mars' subsurface biota. If not preserved as fossils within the derived sediment, it is possible that organism could be fossilized in silica deposits formed from the silica-charged outflow effluent. Thermal Emission Spectrometer (TES) data indicate the presence of high-silica materials in the northern plains. Although the high-silica materials of the northern plains are thought to be derived from geologically recent weathering processes [11-13], Rogers and Christensen (2007) [13] showed that silica-rich materials of the northern plains are mineralogically variable, which may point to multiple geneses of silica-rich materials. Silica preserves ancient fossil microorganisms on Earth. By these arguments, the ancient Martian subsurface and potential fossil organisms may be accessible today in the northern plains.

Preserved organisms and liquid water in the northern plains: The possibility that there are viable organisms in northern plains permafrost, the associated energetics, and rationale behind sampling these materials for life have been discussed previously [6,14]. Discovering viable microorganisms in the northern permafrost hinges first on their existence, and second on whether there has been liquid water present. The possibility that liquid water has existed in the near-surface soils of the northern plains has been presented as well [6,14].

Here, we simply add that some of the high-silica material measured by TES may be direct evidence for liquid water in Martian soils [12]. High-silica surfaces have been observed in TES data for high-latitude surfaces in both hemispheres, indicating that they are linked to more recent Martian climate and orbital changes [11]. The high-silica material in the south and a significant fraction of the silica in the north may be a product of chemical weathering [11-12,15]. Significant redistribution of SiO₂ requires liquid water. Therefore, we argue that there has indeed been liquid water available in the soils of the northern plains, which may have been utilized by organisms. Furthermore, authigenic silica may serve as an additional means of preserving microorganisms and organic material in high-latitude soils.

Conclusions: The northern plains of Mars should be strongly considered for sample return. The plains sediments and soils may contain preserved organisms, but they may also contain fossil evidence for life from the ancient subsurface, sampled and emplaced as a result of outflows and flooding. Thus, the northern plains materials provide a single place to search for multiple occurrences of Martian life. In addition, major questions about Mars' petrologic evolution and weathering/climate history may be addressed via return of northern plains samples (see *Rampe et al.*, this meeting).

References: [1] Pace N. R. (1997) *Science*, 276, 734-740. [2] Shock E. L. (2006) *GCA*, 70(18), Suppl. 1, A598. [3] Jakosky and Shock (1997) [4] Varnes E. S. et al. (2003) *Astrobiology*, 3, 407-414. [5] Smith H. D. and McKay C. P. (2005) *PSS*, 53, 1302-1308. [6] McKay, C. P. et al. (2007) *7th Internat. Conf. Mars*, Abstract #3290. [7] Kreslavsky M. A. and Head J. W. (2002) *JGR*, 107, 5121. [8] Carr M. H. and Head J. W. III (2003) *JGR*, 108, 5042. [9] Tanaka K. (2003) *JGR*, 108 (E4), 8043. [10] Baker V. R. et al. (1992) In *Mars*, Univ. Arizona Press, 493-522. [11] Wyatt M. B. et al. (2004) *Geology*, 32, 645-648. [12] Kraft M. D. et al. (2007) *7th Internat. Conf. Mars*, Abstract #3396. [13] Rogers A. D. and Christensen P. R. (2007) *JGR*, 112, E01003. [14] Jakosky B. M. et al. (2003) *Astrobiology*,

3, 343-350. [15] McLennan S. M. (2003) *Geology*, 31, 315-318.

ENCODING OF WATER-ROCK-ATMOSPHERE INTERACTIONS IN JAROSITE: IMPLICATIONS FOR MARS. V. W. Lueth, New Mexico Bureau of Geology & Mineral Resources, New Mexico Tech, 801 Leroy Place, Socorro, NM 87801, vwluth@nmt.edu

Introduction: The reported existence of jarosite, $\text{KFe}_3(\text{SO}_4)_2(\text{OH})_6$, on Mars provides an exciting opportunity to study water-rock-interactions on the planet's surface. Low pH and a highly oxidizing environment are required for the formation of the mineral. Jarosite can form in a variety of environments ranging from hydrothermal (hypogene) to surface weathering (supergene). Each environment of formation appears to encode a unique stable isotope [1], textural [2], and microchemical signature [3]. In addition, the ability to date the mineral by K/Ar and $^{40}\text{Ar}/^{39}\text{Ar}$ methods [4] allows the opportunity to study the timing of processes responsible for the formation of the mineral.

Stable Isotope Characteristics: The stable isotope values for sulfur, hydrogen and oxygen in both the SO_4 and OH sites can be measured with precision. Individual preparation techniques are required for the determination of $\delta^{34}\text{S}$, $\delta^{18}\text{O}_{\text{SO}_4}$, $\delta^{18}\text{O}_{\text{OH}}$, and δD values.

Sulfur: Sulfur isotope analyses can be used to ascertain origin of the sulfur in jarosite (Fig. 1).

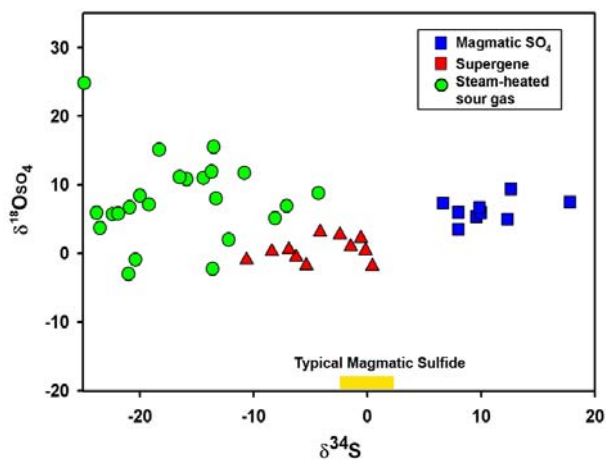

Figure 1 - $\delta^{34}\text{S}$ and $\delta^{18}\text{O}_{\text{SO}_4}$ plot for sulfate minerals from various geological environments. Blue squares represent magmatic gypsum, anhydrite, and alunite. Red triangles are supergene jarosites. Green dots represent jarosites from steam-heated sour gas deposits. All values as ‰ relative to their appropriate standard.

Weathering or supergene types reflect the $\delta^{34}\text{S}$ value of the preexisting sulfide [5,6]. In magmatic systems the value for the precursor sulfide is around 0 ‰ (CDT). If the sulfur in jarosite is derived from H_2S in the hydrothermal environment (steam-heated [1]), it

should reflect the same value as the precursor H_2S unless exchange occurs with aqueous sulfate prior to formation of the jarosite.

Oxygen: Oxygen in the SO_4 site reflects the source of oxygen during oxidation of the sulfide. This value will depend on whether water or air provides the oxygen and if any biogeochemical (microbial) processes are involved. Earlier workers defined an important reference field, the supergene jarosite field (SJSF) [1], for almost all weathering derived jarosites. Jarosites from Lake Tyrell, Australia, are an exception. These samples show significant shifts in both oxygen and hydrogen as a result of equilibration of aqueous sulfate with low pH, highly evaporated water [7]. Hydrothermal jarosites have $\delta^{18}\text{O}_{\text{SO}_4}$ values that typically plot outside the SJSF. Comparison of supergene and hypogene jarosite of similar ages illustrates how oxygen and hydrogen isotopes discriminate between supergene and hypogene jarosite (Fig. 2).

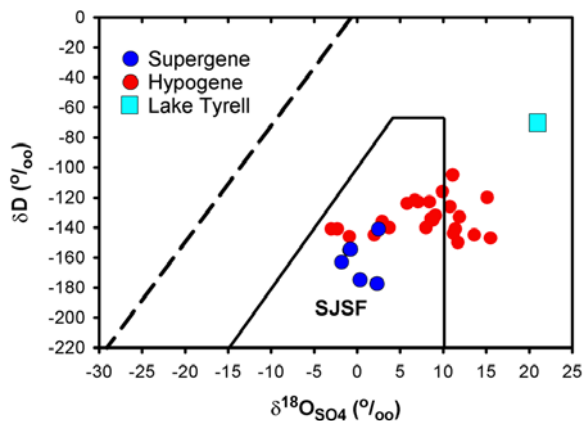

Figure 2 - δD and $\delta^{18}\text{O}_{\text{SO}_4}$ plot for jarosites from various geological environments. Data for Lake Tyrell from [7]. Supergene data from [6] and hypogene data from [4]. See [1] for definition of the SJSF and for additional data for hypogene (steam-heated) and supergene jarosites. Dashed line represent meteoric water line.

Oxygen in the OH site is more complex and reflects the character of the parent fluid, equilibrium exchange processes, and temperature. Most $\delta^{18}\text{O}_{\text{OH}}$ values should plot in a band parallel to the meteoric water line for supergene types. In conjunction with $\delta^{18}\text{O}_{\text{SO}_4}$ it can be used as a single mineral geothermometer [8, 4].

Hydrogen: δD values are controlled by similar processes as those for $\delta^{18}O_{OH}$. Importantly, if equilibrium exchange can be established, both δD and $\delta^{18}O_{OH}$ can be used to infer paleoclimatic conditions. If temperatures can be constrained by other methods, or assumed, the isotopic composition of the water in equilibrium with the jarosite can also be calculated in conjunction with $\delta^{18}O_{SO_4}$.

Texture and Paragenesis: Specific mineral textures, associations, and paragenetic sequences are characteristic of different environments of jarosite formation. Typically jarosite appears within a specific paragenetic sequence that also includes goethite/hematite and gypsum.

Supergene. Jarosite is finely crystalline with the largest crystallites up to approximately 1mm often intermixed with hypogene phases, especially quartz and clays. Jarosite is early in the supergene paragenesis then alters to goethite and gypsum with subsequent weathering. Supergene jarosites are often destroyed at the surface unless fortuitously preserved.

Hypogene. Large crystals (up to 3 cm) or crystalline masses characterize hypogene jarosite occurrences. Common mineral impurities encountered in these samples are other ore/gangue minerals like barite, fluorite, and quartz. The mineral paragenesis is opposite that of supergene environments where hematite (rather than goethite) and gypsum are typically replaced by jarosite sometimes with apatite.

Chemistry: Most jarosites are typically pure end-members, even when both jarosite and natrojarosite occur together. In supergene types, oscillatory banding of jarosite and natrojarosite is common [9]. In hydrothermal types greater solid solution is apparent, consistent with thermodynamic predictions.

Studies correlating trace element compositions to specific geologic/geochemical environments have recently been initiated and may provide a fruitful avenue for characterizing jarosite. A wide variety of trace elements have been shown to be accommodated into the jarosite structure [9]. For example, arsenic is fairly abundant (up to 12,000 ppm) in hypogene steam-heated sour gas type jarosites [4]. Phosphorous, vanadium, and molybdenum have also been documented in jarosite and may be specific to particular types of mineralization.

$^{40}Ar/^{39}Ar$ Geochronology: The chemistry and structure of jarosite allows for reliable age dating [11, 4]. The grain size, contaminants, and composition have significant affect on the analytical spectra (Figure 3). Small crystallite sizes and incorporation of other minerals results in less than optimal age spectra. Poor crystallinity, recoil, Ar loss, and contamination are

endemic to supergene samples. Difficult and sophisticated separation techniques and chemical treatments are required to obtain reliable results. Samples from the surface of Mars will probably require similar types of separation techniques to produce reliable age dates.

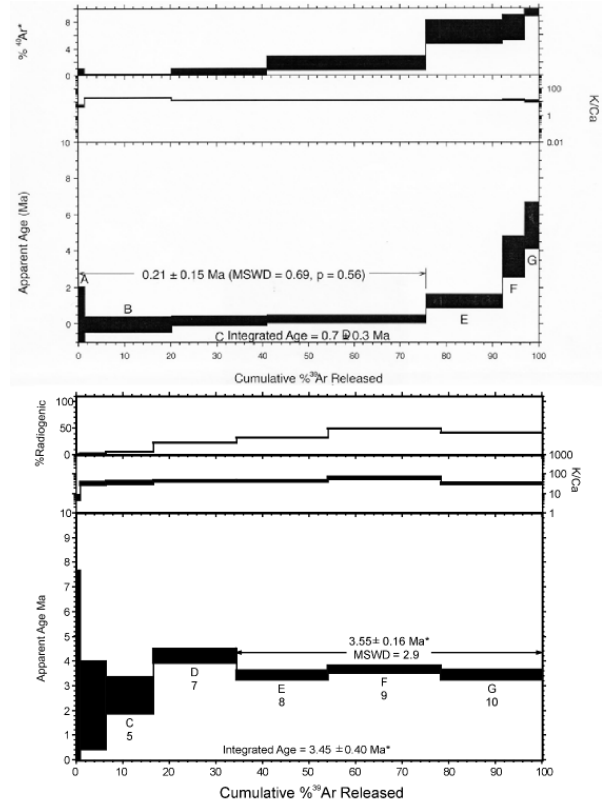

Figure 3 - Comparison of Ar spectra for supergene (top) and hypogene (bottom) jarosites [2]. Note the lower radiogenic yields for supergene types (top most plot) and greater analytical error. The “stepping up” of the apparent age for the supergene jarosite also suggests contamination of the sample by older clays.

Geochemical, geochronological, and stable isotope studies on jarosite from returned samples is a potentially powerful tool for characterizing past water-rock-interactions on the Martian surface.

References: [1] Rye and Alpers, 1997, *USGS OFR* 97-88. [2] Lueth (2006) *LPIC* #1331, p.51. [3] Papike et al. (2007) *Am. Mineral.* 92, 444-447. [4] Lueth, et al. (2005) *Chem. Geol.*, 215, 339-360. [5] Field (1966) *Econ. Geol.* 61, p. 1428-1435. [6] Campbell and Lueth (2008) *Appl. Geochem.* 23, p. 308-319. [7] Alpers et al. (1992) *Chem. Geol.* 96, p. 203-226. [8] Rye and Stoffregen (1995) *Econ. Geol.* 90, p. 2336-2342. [9] Papike et al. (2007) *Am. Min.* 92, p. 444-447. [10] Vasconcelos et al. (1994) *Geochim. Cosmochim Acta* 85, p. 401-420.

STABLE ISOTOPE CHARACTERIZATION OF A TERRESTRIAL KIESERITE WITH COMPARISONS TO OTHER SULFATE MINERALS. V.W. Lueth¹, A.R. Campbell², and J.J. Papike³, ¹New Mexico Bureau of Geology & Mineral Resources, New Mexico Tech, Socorro, NM 87801 (vwlueh@nmt.edu); ²Dept. of Earth & Environmental Sciences, New Mexico Tech, Socorro, NM 87801; ³Institute of Meteoritics, University of New Mexico, Albuquerque, NM 87131

Introduction: Previous missions to Mars have documented that sulfate minerals are important components in the Martian regolith. Kieserite, gypsum, and jarosite are among the sulfate minerals identified and represent an important opportunity to understand water-rock-atmospheric interactions that led to their formation via stable isotope analysis. Here we characterize the stable isotope compositions of a terrestrial kieserite ($\text{MgSO}_4 \cdot \text{H}_2\text{O}$) from Lehrte, Niedersachsen (Lower Saxony), Germany, kindly provided by the Smithsonian Institution. Some nonisotopic analytical results from this same sample were reported earlier [1]. This sample appears to be from Permian evaporates in the Hansa mine area where the Stassfurt bed consists mostly of a kieserite-sylvite-halite assemblage. We then compare the results of the kieserite analysis to gypsum from similar marine environments and speculate on the reliability of kieserite isotopic analyses.

Stable Isotope Analysis: Stable isotopes of sulfur, oxygen (sulfate oxygen only), and hydrogen were run at New Mexico Tech in conjunction with a number of other sulfate minerals (gypsum, barite, and jarosite). Analytical techniques are reported in [2]. Stable isotopes of sulfate oxygen and sulfur were originally performed on similar materials by [3] and are used for discussion.

Sulfur. The average $\delta^{34}\text{S}$ value from replicate analyses of the sample was 11.1 ‰ (CDT), typical of sulfur values for sulfate precipitated from a Permian sea [4]. This result is very close to values published earlier [3] for kieserite samples analyzed from the “Strassfurt” potash seams that ranged between 8.4 to 10.6 ‰ (CDT). Reported sulfur values from other Permian marine evaporites worldwide typically range from 10 to 15 ‰ [4].

Oxygen. An average $\delta^{18}\text{O}_{\text{SO}_4}$ value from replicate analysis was 15.6 ‰, approaching the highest values for Permian ocean water but not unexpected for evaporates precipitating from a restricted marine basin. Permian ocean waters exhibit a wide range of $\delta^{18}\text{O}_{\text{SO}_4}$ values from 10 to 15 ‰ [4]. A comparable $\delta^{18}\text{O}_{\text{SO}_4}$ value of 13.0 ‰ was reported for sulfate from gypsum of the Permian Yeso Fm of equivalent age [5]. Based on these values, the sample accurately reflects the environment from which it precipitated, a restricted marine evaporite basin. Earlier workers [3] published $\delta^{18}\text{O}_{\text{SO}_4}$ values ranging from 7.7 to 10.8‰ for kieserite from the “Strassfurt” potash seams. These values are significantly different from our analysis and low for

published Permian values [4]. They interpreted these values and ranges as a result of exchange with another water (diagenetic?). Exchange with other waters is possible but would require significant changes from the original environment of deposition. Alternatively sulfate reduction and re-oxidation could also result in lower $\delta^{18}\text{O}_{\text{SO}_4}$ values but recognizable changes in sulfur isotope compositions would be expected [6].

Hydrogen. Replicate δD analysis of the kieserite gave values of -71 and -68 ‰ (SMOW). These values are far removed from both modern and ancient ocean waters reported in the literature [7] and probably represent exchange with meteoric water.

Summary: Stable isotope analysis of sulfate minerals provides unique opportunities to understand the origin and perhaps recognize later processes that have affected the minerals. Sulfur isotope values appear quite robust, reflecting the origin of the sulfur in the sulfate – in this case derived from the vast Permian ocean reservoir. In other sulfates, such as gypsum and jarosite, sulfur values reflect their origin from other reservoirs such as oxidation of preexisting sulfide minerals [2] or, in hydrothermal systems, the oxidation of sulfur dioxide [8] or hydrogen sulfide [5]. Sulfate oxygen values also fairly consistently reflect the source of oxygen at the time of oxidation to sulfate – in the case of this kieserite, the Permian marine reservoir. Abiotic variations in sulfate oxygen without changes in sulfur values require low pH, higher temperature, and/or varying solution compositions that require significantly long residence times. Alternatively, bacterially mediated sulfate reduction and re-oxidation are required for significant oxygen isotope exchange that also results in changes in the sulfur values [6]. Hydrogen, in contrast, appears to be readily exchangeable in kieserite and some other sulfates (notably gypsum) but not jarosite [5,8]. The applicability of hydrogen isotopes as a recorder of ancient processes is thus much more problematic in kieserite and gypsum.

References: [1] Papike et al (2007) 7th Intl. Conf. On Mars, # XXXX. [2] Campbell and Lueth (2007) *Appl. Geochem.*, (in press). [3] Wenzel et al. (1986) 4th Working Mtg, Isotopes in Nature, Leipzig, Proceedings, p.669-678. [4] Claypool et al. (1980) *Chem. Geol.* v. 28, p. 199-260. [5] Lueth et al. (2005) *Chem. Geol.*, v. 215, p. 339-360. [6] Alpers et al. (1992) *Chem. Geol.* v. 96, p. 203-226. [7] Sheppard, (1986) *Reviews in Mineralogy*, v.16, p. 165-183. [8] Rye and Alpers (1997) USGS *OFR* 97-88.

ASTROBIOLOGY WITH A GROUNDBREAKER SAMPLE RETURN MISSION C.P. McKay, Space Science Division, NASA Ames Research Center Moffett Field, CA 94035, cmckay@mail.arc.nasa.gov

Introduction: A Mars Sample Return program will be most likely to succeed if it begins with a small mission focused on technology demonstration and then builds to more capable missions over time. Eventually Sample Return Missions must connect in a direct technological and programmatic way with human missions. For the same reason that the first Mars Rover Mission was a small engineering demonstration, the first Mars Sample Return will be an engineering demonstration. It is important however to consider how we can maximize the science return from such an initial mission. The “Groundbreaker” Sample Return Mission is a design for a first sample return mission with limited capability. Essentially the mission returns soil from near the landing site. The notional landing site for Groundbreaker is Meridiani Planum. Here I show that such a mission can provide important advances for Astrobiology.

Astrobiology goals for soil sample: A first soil sample contributes to Astrobiology goals on Mars in the following ways.

1. Light element geochemistry: Of the biogenic elements (C,H, N, O, P, S) and their compounds we have direct measurements only of elemental S in the soil. The important compounds such as nitrates, carbonates, and phosphates are not determined.

2. Weathering history: The martian soil is a product of chemical weathering. It is not just mechanically ground rock. Various hypotheses have been suggested: acid fog (of Cl and S), occasional liquid water even as films, UV and oxidants, extensive liquid water but long ago. The resolution of this question has important implications for the search for organics and understanding the environmental and geological history of Mars.

3. Residual organics: Direct measurements of organics with high sensitivity remains of interest. The Viking GCMS did not detect organics in the soil with an instrumental sensitivity of a few ppb. The appropriate upper limit in the soil may have been much higher. A few ppb of organics, if present purely as microorganisms places a lower limit of cell count only at about 1,000,000 per gram soil. In addition, it is possible that Mars may have refractory organics that would not have been detected at the temperature reached by the Viking ovens (500°C). These refractory organics may be the results of oxidative reactions. Thus laboratory measurements of organics on a returned sample could be of

considerable interest even if the sample was heat sterilized.

4. Iron redox state: Iron may be the key redox element in the martian soil and understanding its mineralogical state will help understand the weathering and oxidative history of the soil.

5. Magnetic fraction: The most interesting aspect of the ALH84001 remains the indication of magnetite of the same shape as biogenic magnetite. The soil of Mars has a large, unexplained, magnetic fractions. Is it of biogenic origin? Studies of the shape and size of the magnetic particles and searches for chains of identical particles could be conducted in laboratories on Earth.

6. Interplanetary dust particles: The surface of Mars has presumably been collecting IDPs, and unlike the moon these are not mixed by micrometeoroid impact.

7. Oxidant: The nature of the oxidant(s) may require in situ investigations but analysis of a returned sample may help rule out some proposed hypotheses (such as high peroxyxynitrate levels).

8. Toxicity of the soil: A soil sample will allow for easy direct determination of any exotic or toxic soil components. This would be directly relevant to future human exploration

POSSIBLE SCIENCE PRIORITIES FOR MARS SAMPLE RETURN. MEPAG ND-SAG TEAM, Correspondence authors: David Des Marais (David.J.DesMarais@nasa.gov), Lars Borg (borg5@llnl.gov), or David W. Beaty (David.Beaty@jpl.nasa.gov.)

Introduction: The return of Martian samples to Earth has long been recognized to be an essential component of a cycle of exploration that begins with orbital reconnaissance and *in situ* surface investigations. Major questions about life, climate and geology would involve answers from state-of-the-art laboratories on Earth. Spacecraft instrumentation could not perform critical measurements such as precise radiometric age dating, sophisticated stable isotopic analyses and definitive life-detection assays. Returned sample studies could respond radically to unexpected findings, and returned materials could be archived for study by future investigators with even more capable laboratories. Unlike Martian meteorites, returned samples could be acquired with known context from selected sites on Mars according to the prioritized exploration goals and objectives.

Scientific Objectives: The ND-MSR-SAG proposed the following 11 high-level scientific objectives for MSR based on the objectives, investigations and priorities described in MEPAG (2006). Determine the chemical, mineralogical, and isotopic composition of the crustal reservoirs of C, N, S and other elements with which they have interacted, and characterize C-, N-, and S-bearing phases down to sub-micron spatial scales in order to document processes that can sustain habitable environments on Mars, both today and in the past. Assess the evidence for pre-biotic processes and/or life on Mars by characterizing the signatures of these phenomena in the form of structure/morphology, biominerals, organic molecular isotopic compositions, and their geologic contexts. Interpret the conditions of Martian water-rock interactions through the study of their mineral products. Constrain the absolute ages of major Martian crustal geologic processes, including sedimentation, diagenesis, volcanism/plutonism, regolith formation, hydrothermal alteration, weathering, and cratering. Understand paleoenvironments and the history of near-surface water on Mars by characterizing the clastic and chemical components, depositional processes, and post-depositional histories of sedimentary sequences. Constrain the mechanisms of early planetary differentiation and the subsequent evolution of the Martian core, mantle, and crust. Determine how the Martian regolith is formed and modified and how and why it differs from place to place. Characterize the risks to future human explorers in the areas of biohazards, material toxicity, and dust/granular materials, and contribute to the assessment of potential *in-situ* resources to aid in establishing a human presence on Mars. For the present-day Martian surface and accessible shallow subsurface environments, determine the state of oxidation as a function of depth, permeability, and other factors in order to interpret the rates and pathways of chemical weathering, and the potential to preserve the chemical signatures of extant life and pre-biotic chemistry. Interpret the initial composition of the Martian atmosphere, the rates and processes of atmospheric loss/gain over geologic time, and the rates and processes of atmospheric exchange with surface condensed species. For Martian climate-modulated polar deposits, determine their age, geochemistry, conditions

of formation, and evolution through the detailed examination of the composition of water, CO₂, and dust constituents, isotopic ratios, and detailed stratigraphy of the upper layers of the surface.

Sample Types: MSR would have its greatest value if the rock samples were collected as suites of samples that represent the diversity of the products of various planetary processes. Martian *sedimentary materials* likely contain a complex mixture of chemical precipitates, volcanic tephra, impact glass, igneous rock fragments, and phyllosilicates. Sediment samples would be needed to achieve definitive measurements of life detection, observations of critical mineralogical and geochemical patterns and occluded trace gases at the submicron scale. Samples of *hydrothermally altered rocks* on Earth provide water, nutrients and chemical energy necessary to sustain microorganisms, and they can preserve fossils in their mineral deposits. Hydrothermal processes substantially affect the mineralogical and volatile composition of the crust and atmosphere. Chemical alteration processes occurring at near-surface ambient conditions (typically < ~20°C) create *low temperature altered rocks* that include, among other things, aqueous weathering, palagonitization and a variety of oxidation reactions. Understanding the conditions under which alteration processes proceed at low temperatures would provide important insight into the near-surface hydrological cycle, and the mass fluxes of volatile compounds. *Igneous rocks* are expected to be primarily lavas and shallow intrusive rocks of basaltic composition. They would be critically important for investigations of the geologic evolution of the Martian surface and interior because their geochemical and isotopic compositions constrain both the composition of mantle source regions as well as the processes that affected magmas during their generation, ascent, and emplacement. *Regolith* samples have recorded interactions between the crust and the atmosphere, the nature of rock fragments, dust and sand particles that have been moved over the surface, H₂O and CO₂ migration between ice and the atmosphere, and processes involving fluids and sublimation. Regolith studies would help to facilitate future human exploration by assessing toxicity and potential resources. *Polar ice* samples would constrain the present and past climatic conditions as well as elucidate cycling of water. Short cores could help to resolve climate variability in the last few 10⁵ to 10⁶ years. *Atmospheric gas* samples would help to document the composition of the atmosphere as well as the processes that influenced its origin and evolution. Trace organic gases, such as methane and ethane, could be analyzed for their abundance, distribution, and their relationship to a potential Martian biosphere. Returned samples of Ne, Kr, CO₂ and CH₄ and C₂H₆ would confer major scientific benefits. Analyses of the chemistry and mineralogy of Martian *dust* would help to elucidate the weathering and alteration history of Mars. Given the global homogeneity of Martian dust, a single sample from anywhere would likely be representative of the planet as a whole. A *depth-resolved suite* of samples should be obtained from depths of cm to

several m within the regolith or from a rock outcrop in order to investigate trends in the abundance of oxidants (e.g., OH, HO₂, H₂O₂ and peroxy radicals) and the preservation of organic matter. **Other sample suites** would include rock breccias that might sample rock types that would otherwise not be available locally, volcanic tephra consisting of fine-grained regolith material or layers and beds possibly delivered from beyond the landing site, and meteorites whose alteration history could be determined and thereby provide insights into Martian climatic history.

Sample Attributes that Affect Science Value:

The following key factors associated with locating, sampling, storing and returning samples could influence strongly their value for achieving MSR science objectives.

1. *Sample size.* A full program of scientific investigations would be expected to require samples of at least 8 g for both rock and regolith. To support the required biohazard testing, each sample should be increased by about 2 g, leading to an optimal sample size of about 10 g. However, textural studies of some types of sample heterogeneities might need one or more larger samples of ~20 g. Material should remain to be archived for future investigations.

2. *Sample encapsulation.* To preserve the scientific usefulness of returned samples, they should not commingle, each sample should be linked uniquely to its documented field context, and rock samples should remain mechanically intact. A smaller number or mass of carefully managed samples would be far more valuable than larger number or mass of poorly managed samples. The encapsulation for at least some of the samples should be airtight to retain volatile components.

3. *Number of samples.* Studies of heterogeneities between samples could provide as much or more information about processes as detailed studies of a single sample. The minimum number of samples needed to address the scientific objectives of MSR would be 26 (20 rock, 3 regolith, 1 dust, 2 gas), in the case of recovery of the MSL cache. These samples would be expected to have a mass of about 350 g, and with sample packaging, the total returned mass would be expected to be about 650 g.

4. *Sample acquisition system.* This system should sample both weathered exteriors and unweathered interiors of rocks, sample continuous stratigraphic sequences of outcrops that might vary in their hardness, relate the orientation of sample structures and textures to those in outcrop surfaces, bedding planes, stratigraphic sequences, and regional-scale structures, and maintain the structural integrity of samples. A mini-corer and a scoop would be the most important collection tools. A gas compressor and a drill would have lower priority but would be needed for specific kinds of samples.

5. *Degree of selectivity of samples and documentation of field context.* The scientific value of MSR would depend critically upon the ability to select wisely the relatively few returned samples from the vast array of materials it would encounter. MSR objectives would probably need at least two kinds of *in situ* observations (color imaging, microscopic imaging), and possibly as many as five (also mineralogy,

elemental analysis and reduced carbon analysis). No significant difference exists in the observations that would be needed for sample selection vs sample documentation. Revisiting a previously occupied site might result in a reduction in the number of instruments that would be carried by MSR.

6. *Sample temperature.* Some key species are sensitive to temperatures exceeding those attained at the surface. Examples include organic material, sulfates, chlorides, clays, ice, and liquid water. MSR's objectives could most confidently be met if the samples would be kept below -20°C, and with less confidence if they would be kept below +20°C. Significant damage, particularly to biological studies, would occur if the samples reach +50°C for 3 hours. Temperature monitoring during return would allow any changes to be evaluated.

7. *Diversity of the returned collection.* The diversity of the suites of returned samples should be commensurate with the diversity of rocks and regolith encountered. This guideline should substantially influence landing site selection and rover operation protocols. It would be scientifically acceptable for MSR to visit only a single landing site, but returning samples from two independent landing sites would be much more valuable.

8. *Surface operations.* In order to collect the suites of rocks indicated by the MSR objectives, the lander should have significant surface mobility, the capability to assess the diversity of surface materials, and the ability to select samples that span that diversity. Depending on the geological character of the landing site, it is expected that a minimum of 6-12 months of surface operation would be needed in order to reconnoiter a site and identify, characterize and collect a set of samples.

9. *Effects of the MSL/ExoMars caches upon MSR planning.* The decision to direct the MSR mission to retrieve the MSL or ExoMars cache conceivably might alter other aspects of the MSR mission. However, given the limitations of the MSL cache, the differences in planetary protection requirements for MSL and MSR, the possibility that the MSR rover might not be able to retrieve the MSL cache, and the potential for MSR to make its own discoveries, the MSR landed spacecraft should have its own capability to characterize and collect at least some of returned samples.

10. *Planetary protection.* A scientifically compelling first MSR mission could be designed without including the capability to access and sample a special region, defined as a region within which terrestrial organisms are likely to propagate. Unless MSR could land pole-ward of 30 degrees latitude, access very rough terrain, or achieve a significant subsurface penetration (e.g. >5 m), MSR would be unlikely to be able to use incremental special regions capabilities. Planetary protection draft test protocols should be updated to incorporate advances in biohazard analytic methodology. The statistical principles that govern mass requirements for subsampling returned samples these analyses should be reassessed.

CLAY-BEARING ROCKS IN THE MAWRTH VALLIS REGION, MARS. J. R. Michalski¹, J.-P. Bibring¹, F. Poulet¹, R. Fergason², N. Mangold³, D. Loizeau³, E. Noe Dobrea⁴, J. L. Bishop⁵, ¹Institut d'Astrophysique Spatiale, Université Paris-Sud, 91405 Orsay, France. ²School of Earth and Space Exploration, Arizona State University. ³Laboratoire IDES-Orsay, Université Paris-Sud, ⁴Jet Propulsion Laboratory, California Institute of Technology, 4800 Oak Grove, Pasadena, CA, 91109. ⁵The SETI Institute, Mountain View, CA 94043.

Introduction: Clay minerals have long been studied in Martian meteorites [1-2], but recent discoveries of vast exposures of phyllosilicates on Mars [3-4] opens a new window into the aqueous history of Mars. Undoubtedly these deposits will be high priority targets for future exploration, including a possible sample return effort. The phyllosilicates, which can accurately be described as clay minerals, occur in geomorphically and mineralogically diverse terrains, suggesting multiple formation mechanisms and various geologic contexts.

In this paper, we describe the mineralogy and geologic context of the largest exposure of clay minerals on Mars: those in the Mawrth Vallis region. We describe the rationale for interpreting these deposits as clay-bearing and report a multi-instrument remote sensing perspective on these deposits. We present the current understanding of how these deposits fit into the global geologic history of Mars, their implications for past habitability, and their value as possible sample return targets.

Mineralogy: The evidence for phyllosilicates on Mars rests on the observation of multiple, correlated spectral absorptions in near infrared ($\lambda = 1-3 \mu\text{m}$) reflectance spectra of certain terrains: 1) a strong $1.9 \mu\text{m}$ hydration feature attributed to mineralogic H_2O , 2) weaker absorptions in the $2.2-2.35 \mu\text{m}$ range attributed to octahedral metal-OH absorptions in clay minerals, and 3) a weaker band sometimes observed near $1.4 \mu\text{m}$ also attributed to octahedral O-H. The occurrence of these features together in the same pixel argues for either a single, expandable TOT clay mineral or a combination of TO clay and another hydrated phase (*e.g.* zeolites). However, the overall spectral shape of these altered terrains that is extracted by spectral ratios compares favorably with the spectral shape of specific clay minerals. The spectral features are confirmed by multiple observations with the OMEGA instrument onboard Mars Express [3-4] and later observations by the CRISM instrument aboard Mars Reconnaissance Orbiter [5].

In the Mawrth Vallis region, the precise placement of the near infrared metal-OH bands and overall spectral shapes suggest the presence of montmorillonite, nontronite, kaolinite, and hydrous silica (similar to opal-A) [6-7]. Nontronite is the most common based on spectral mapping, and the most abundant, based on

spectral modeling. Model results suggest 20-65% contribution from clay minerals in the surface spectra, along with other alteration minerals such as minor silica and ferrihydrite [8]. The spectral models also require a significant component of spectrally neutral material – possibly plagioclase feldspar.

Thermal infrared ($\lambda = 6-30 \mu\text{m}$) spectra do not, however, show evidence for abundant clay minerals in this location [9]. The disagreement between the two datasets with regard to clay mineral detection could be due to a combination of factors: 1) low actual abundances of clays, which are below the detection limit of the TES instrument given its larger spatial footprint or 2) rough surface textures that favor multiple scattering and improve near-infrared detectability, but decrease thermal infrared detectability. Thermal infrared spectra of the altered surfaces are dominated by spectral features of feldspars and amorphous silica. A simple comparison of the spectral shapes of the clay-bearing units and adjacent, dark, basaltic terrains shows that the two are spectrally different and the clay-bearing surfaces are higher in silica content. Comparison of the placement of the major Si-O absorption feature to terrestrial trends [9] suggests the clay-bearing rocks are >60% SiO_2 (wt. %) compared to ~50% SiO_2 for the basaltic surfaces.

Geologic context: The geologic context of clay minerals at each site are interpreted from visible imaging and thermophysical data. In the Mawrth Vallis region, clays are associated with a thick section of ancient, eroded bedrock [10-11]. Detailed geomorphic and stratigraphic [12] studies reveal a complex stratigraphic section with 100s to 1000s of individual layers. The geomorphic diversity (*i.e.* resistance to weathering, surface textures and landforms) among these units suggests a range of lithologies. Some of the clay-bearing layers correspond to resistant, butte-forming units. Others appear unable to form significant topography and contain large cracks/fissures probably related to negative volume change and dessication (Figure 1). No single idea of lithologic context is likely to capture the diversity of the Mawrth Vallis region. However, the environment must have been dynamic in space and/or time to allow for the thick accumulation of such diverse rocks. Because the clays are tied to layering, present over a large area, present throughout a thick section of rocks, interbedded with relatively

clay-rich and clay-poor units, and present along with plagioclase and silica, it seems the most likely geologic context is sedimentary and/or pyroclastic. In either case, geomorphic relationships show that the clay-bearing rocks were deeply eroded early in Mars history and the clays were already in place at this point.

Implications: The close association of the clay mineralogy to ancient, eroded, layered rocks of probable sedimentary origin [10-11] suggests that these deposits could provide a window into the aqueous sedimentary processes in the earliest history of the Solar System. The neutral pH conditions implied by the preponderance of smectite clays could be compatible with the formation of pre-biotic chemistry on Mars as it is understood on Earth [13]. Combined geomorphic and spectroscopic studies provide constraints on the lithologic context of the clays, but questions remain about the lithology of the clay-bearing units.

Lithologic classification is a function of both the mineralogy and texture of a rock and to understand the lithology of these clay-bearing rocks, we must acquire more information. Based on all available data, the altered rocks in the Mawrth Vallis region have a bulk mineralogy of feldspar + Fe-smectite + silica + ferrihydrite \pm montmorillonite \pm kaolinite, but how these minerals are distributed at the sub-pixel level is not known. Are the minerals partitioned among different layers? Do the clay minerals occur as cements around grains of feldspars and other phases? Are the clays clastic and if so, what is their provenance? Is the silica in these rocks present as primary volcanic glass or secondary cement and vein fill? What accessory phases have escaped detection? Are carbonates present

in these rocks and if so, do they hold a clue to the early atmospheric composition and pressure on Mars?

Conclusions: Clay-bearing deposits on Mars are likely to be visited by upcoming landed missions such as the Mars Science Laboratory and/or ExoMars landers. Results from these missions will solidify our understanding of the geologic context of certain clay deposits. Pending the outcome of these missions, it may make sense to collect clay-bearing rocks during a sample return mission because these deposits almost certainly contain a range of particles of distal sources along with authigenic secondary minerals. Through detailed analysis of these deposits, it may be possible to date a range of processes on Mars, search for isotopic signatures of an ancient martian hydrosphere and atmosphere, and search for chemical clues of early organic processes.

References: [1] Treiman, A. H., et al. (1993), *Meteoritics*, 28, 86-97. [2] Bridges, J.C. et al. (2001), *Space Sci. Rev.*, 96(1-4): 365-392. [3] Poulet, F. et al. (2005) *Nature* 438, 623-627. [4] Bibring, J.-P. et al. (2006), *Science*, 312, 400-404. [5] Mustard, J. et al., (2007), *7th Mars Conf.*, #3240. [6] Bishop, J. L. et al. (2007) *EOS Trans. AGU*, Abstract #P13D-1559. [7] Noe Dobreá, E. et al. (2008), *LPSC XXXIX*, #1077. [8] Poulet, F. et al. (2007), *Eos Trans., AGU*, 88(52), abstract # P11E-07. [9] Michalski, J. et al. (in prep), *Icarus*. [10] Loizeau, D. et al. (2007), *JGR*, 112, (E8), E08S08. [10] Michalski, J. and E. Noe Dobreá (2007), *Geology*, 35; no. 10; 951-954. [12] Loizeau, D. et al. (in prep). [13] Chevrier, V. et al., (2007), *Nature*, 448, 60-63.

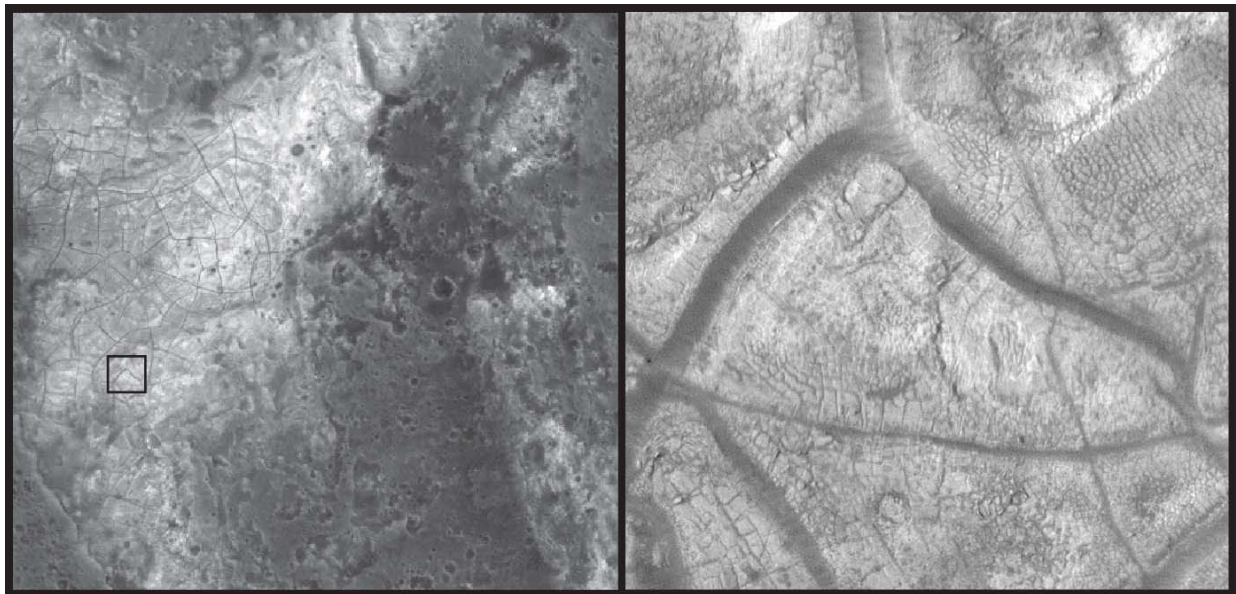

Figure 1: MOC image M1800673 (at left) showing the “polygons” sub-unit of the light-toned, clay-bearing unit in the Mawrth Vallis region. OMEGA detects nontronite and ferrihydrite in this deposit [7]. The MOC image is 3 km across. The inset shows the location of HiRISE image PSP_001454_2030 (at right), which reveals the morphology of two scales of fractures present in this unit. The question remains open as to whether the cracks are related to desiccation of smectites in these rocks.

INTERPRETING AND CONSTRAINING THE COMPOSITION AND DEPOSITIONAL ENVIRONMENTS OF PHYLLOSILICATES ON MARS. R. E. Milliken¹, J. F. Mustard², B. Ehlmann², J. L. Bishop³, S. Murchie⁴ and the CRISM Science Team. ¹Jet Propulsion Lab/Caltech, 4800 Oak Grove Dr., Pasadena, CA 91109 (Ralph.Milliken@jpl.nasa.gov); ²Dept. Geological Sciences, Brown Univ., Providence, RI 02912; ³SETI Institute/ NASA-ARC, Mountain View, CA, 94043; ⁴Applied Physics Lab., Laurel, MD.

Introduction: The identification of phyllosilicates on Mars from visible-near infrared spectra acquired by the OMEGA [1-2] (on ESA's Mars Express [3]) and CRISM (on NASA's MRO spacecraft [4]) spectrometers has revolutionized the way we view aqueous alteration and the role of water-rock interaction on the surface and within the crust. The largest areal exposure of phyllosilicate-rich strata are found in the Mawrth Vallis region, followed by Nili Fossae. While the former consists of thick sequences of strata dominated by Mg/Fe and Al-bearing smectites [1,5], the latter hosts a much more diverse assemblage of phyllosilicates which occur in units that appear stratified or more massive at HiRISE resolution [6,7]. Spectra of the Noachian-aged units in the Nili Fossae region are consistent with the presence of illite, muscovite, kaolinite, chlorite, and various smectites [6,7].

In addition to the Mawrth and Nili regions, phyllosilicates have also been detected in alluvial-fluvial and deltaic environments such as Holden, Eberswalde, Ritchey, and Jezero crater. Spectra of these phyllosilicates are most consistent with Fe/Mg-bearing smectites [8]. Finally, hundreds to thousands of localized exposures of phyllosilicate-bearing material have been identified throughout the ancient Noachian crust of the southern highlands, in Noachian-aged units on the plains surrounding Valles Marineris, and in the walls of Valles Marineris.

The preponderance of phyllosilicate detections and their spatial distribution across the planet suggests aqueous alteration of the predominantly basaltic crust has been an important and widespread geologic process on Mars. In order to fully understand these implications in the context of Mars sample return, we must first understand the methods and uncertainties associated with detections of specific phyllosilicates, the possible formation mechanisms for these types of phyllosilicates, and the geologic/depositional setting in which they are found on Mars.

Spectral Identification of Phyllosilicates: The visible-near infrared wavelength range of OMEGA and CRISM (~3 – 5 μm) includes several H₂O and OH⁻ related absorption features observed in phyllosilicates. Absorptions centered at ~3 and ~1.9 μm are caused by the fundamental stretching and combination stretch+bend vibration modes of H₂O, respectively. It is worth noting that many phyllosilicates do not contain H₂O in their structure (i.e. kaolinite), thus these spectral features may not be present in all phyllosilicate deposits on Mars.

Furthermore, loss of H₂O from phyllosilicates that do have water in their structure, such as H₂O in the interlayer sites of nontronite and montmorillonite, will cause the 1.9 μm absorption to decrease in strength and possibly disappear from the spectrum [9].

The relationship between relative humidity, the amount of H₂O in interlayer sites, and the strength of the 1.9 μm absorption are such that H₂O-bearing smectite deposits may not exhibit this spectral feature under certain martian surface conditions [9]. However, the same does not hold true for structural OH⁻. Therefore, the spectral identification of phyllosilicates on Mars has relied heavily on the detection of metal-OH vibrational absorptions between ~2.1 – 2.7 μm , often in conjunction with the H₂O absorptions described above. The position of the metal-OH absorption(s), where the metal is commonly Al, Mg, and/or Fe for phyllosilicates, is strongly dependent on the relative proportions of these cations in the octahedral sites. Al-rich clay minerals such as montmorillonite or beidellite exhibit an Al-OH absorption centered near 2.2 μm , whereas Mg/Fe-rich phyllosilicates (e.g. nontronite, saponite, or hisingerite) exhibit absorptions centered near ~2.28-2.31 μm .

The position, width, and number of absorption bands in the ~2.1 – 2.7 μm region are diagnostic of specific phyllosilicates in many cases, but there are caveats. Cation substitution is common in naturally forming phyllosilicates on Earth, and the same is undoubtedly true for Mars. For instance, a nontronite with Mg substitution may have absorption bands centered at wavelengths similar to bands observed in saponite, yet one is dioctahedral (nontronite) and the other trioctahedral (saponite). The absorptions discussed here are measurements of vibrations of molecular bonds and their interactions with a crystal structure, whereas identifying a mineral is an interpretation. Therefore, caution must be used when claiming the detection of a specific mineral, especially when attempting to discriminate between minerals for which cations and crystal structure may be similar.

It is important to consider that reflectance spectra acquired by spacecraft are commonly compared directly to laboratory reflectance spectra acquired under idealized or non Mars-like conditions. Variations in particle size (rock versus powder), impurities, interaction with other minerals in an intimate mixture (which can affect the continuum slope of spectra), humidity, grain shape and orientation, surface texture, and many other effects can cause absorption bands to decrease in strength, shift position (if not corrected for the continuum slope), and

possibly be masked, all of which can lead to misidentification of a specific mineral if not taken into consideration. These complexities also make it difficult to derive accurate mineral abundances. Though the lower detection limit of phyllosilicates from OMEGA and CRISM data is likely near ~5 wt. %, promising new results have shown that some phyllosilicate deposits may have as much as ~60 wt. % smectite [10].

It is also worth noting that spectra of phyllosilicates that are similar in the near-infrared often differ at visible wavelengths, especially if transition metals are present in octahedral sites. Different phyllosilicates also exhibit variations in emissivity spectra at thermal wavelengths [11]. Therefore, the most accurate identification of specific phyllosilicates on Mars will likely come from integrating the data that exist for all wavelengths (e.g. OMEGA, CRISM, TES). Such integration may prove especially useful for discriminating between well-crystalline and poorly-crystalline (XRD amorphous) phases from orbit [12].

Formation and Depositional Environments: Despite the uncertainties associated with interpreting the presence of specific minerals using spectroscopic techniques, OMEGA and CRISM spectra of the locations discussed above are most consistent with the presence of phyllosilicates. Furthermore, there is great diversity in the spectral signatures of these deposits and we are confident that we have detected Al-bearing and Mg/Fe-bearing phyllosilicates. The latter are more spatially extensive than the former, and TES emissivity spectra suggest many of the source regions for these phyllosilicates are basaltic in composition and have significant amounts of pyroxene and plagioclase. However, the greater abundance of Fe/Mg-bearing phyllosilicates suggests preferential dissolution and removal of Mg and Fe from olivine and pyroxene relative to Al from plagioclase during chemical weathering [13]. Therefore, many of the phyllosilicates on Mars may represent environments characterized by low water-rock ratios. In addition, though kaolin minerals are a common weathering product of volcanic materials on Earth and often represent high water-rock ratios or extensive flushing of fluids, kaolin minerals have been identified in only a few locations on Mars [6,7].

The predominance of Fe/Mg-bearing phyllosilicates over Al-bearing phyllosilicates is often in contrast to morphologic features indicative of extensive and long-lasting surface flow of water (e.g. Fe/Mg, not Al, smectites are the dominant hydrated phase in the Eberswalde delta). It is clear that to maximize the information gained from sample return we must first attempt to place the phyllosilicate locations and surrounding strata in a proper geologic context. Though the morphology of deltaic environments suggests high water-rock ratios and extensive aqueous alteration of local materials, for

instance, it cannot be ruled out that the clay minerals detected in these environments were simply transported to these locations and not formed *in situ*.

The majority of phyllosilicates on Earth occur as alteration products of weathered crust, and any property of the primary material that leads to an increased rate of alteration (e.g. increased surface area in highly fractured bedrock) has the potential to produce an increase in phyllosilicate production. Most phyllosilicate-bearing deposits on Mars occur in impact-fractured ancient Noachian terrains. However, some phyllosilicate deposits have been observed in Hesperian deposits, thus it is important to avoid the pitfalls of 'guilt by association' when attempting to place ages on secondary minerals, which may have originally formed long before or long after the deposition of strata in which they are found. In this context, it becomes clear that spectral data must be combined with high-resolution visible imagery to differentiate between phyllosilicate *formation* and *depositional* environments on Mars.

The abundance of clay minerals will undoubtedly be an important factor when choosing a phyllosilicate-bearing location for a sample return mission. In this regard, it helps to be guided, but by no means limited, by our terrestrial experience. Lacustrine and deltaic settings are attractive for finding clay-rich deposits, but these deposits often exhibit weaker phyllosilicate spectral signatures than non-deltaic regions such as Mawrth Vallis and Nili Fossae. Such differences may be a result of particle size (outcrops of intact mudstones or shales may exhibit weaker spectral features than an altered basalt with fine clays sprinkled throughout), but such complex problems require detailed laboratory studies to improve existing spectral mixing models.

The science goals of sample return should lead the landing site selection process, and in order to choose the best site for those goals we must first have a clear understanding of the different geologic environments and their implications for the evolution of Mars. Mars sample return is an ambitious goal, and it is imperative that we continue to integrate detailed field and laboratory studies with analysis of spacecraft data to maximize the contribution that orbital spectroscopic techniques have for placing mineral detections in their appropriate geologic context.

References: [1] Poulet, F. et al. (2005), *Nature*, 438; [2] Bibring et al. (2005), *Science*, 307; [3] Bibring, J. et al. (2004) ESA SP; [4] Murchie, S. et al. (2007), *JGR*, 112; [5] Michalski, J. and E. Dobreá (2006), *Geology*, 35(10), 951-954; [6] Mustard, J. et al. (2008), this conference; [7] Ehlmann, B. et al. (2007), 7th Mars Conf., #3270; [8] Milliken et al. (2007), 7th Mars Conf., #3282; [9] Milliken, R. and J. Mustard (2005) *JGR*, 110, E12001; [10] Poulet, F. et al. (2007) Fall AGU, P11E-07; [11] Michalski, J. et al. (2006) *JGR*, 111, E03004; [12] Tosca, N. et al (2008) 39th LPSC, #1745; [13] Burns, R. (1993), *GCA*, 57, 4555-4574.

2003 MARS EXPLORATION ROVER MISSION: ROBOTIC FIELD GEOLOGISTS FOR A MARS SAMPLE RETURN MISSION. D. W. Ming, NASA Johnson Space Center, Mail Code KX, Houston, TX 77058 (douglas.w.ming@nasa.gov).

Introduction: The Mars Exploration Rover (MER) Spirit landed in Gusev crater on Jan. 4, 2004 and the rover Opportunity arrived on the plains of Meridiani Planum on Jan. 25, 2004. The rovers continue to return new discoveries after 4 continuous Earth years of operations on the surface of the red planet. Spirit has successfully traversed 7.5 km over the Gusev crater plains, ascended to the top of Husband Hill, and entered into the Inner Basin of the Columbia Hills. Opportunity has traveled nearly 12 km over flat plains of Meridiani and descended into several impact craters.

Spirit and Opportunity carry an integrated suite of scientific instruments and tools called the Athena science payload. The Athena science payload consists of the 1) Panoramic Camera (Pancam) that provides high-resolution, color stereo imaging, 2) Miniature Thermal Emission Spectrometer (Mini-TES) that provides spectral cubes at mid-infrared wavelengths, 3) Microscopic Imager (MI) for close-up imaging, 4) Alpha Particle X-Ray Spectrometer (APXS) for elemental chemistry, 5) Mössbauer Spectrometer (MB) for the mineralogy of Fe-bearing materials, 5) Rock Abrasion Tool (RAT) for removing dusty and weathered surfaces and exposing fresh rock underneath, and 6) Magnetic Properties Experiment that allow the instruments to study the composition of magnetic martian materials [1].

The primary objective of the Athena science investigation is to explore two sites on the martian surface where water may once have been present, and to assess past environmental conditions at those sites and their suitability for life. The Athena science instruments have made numerous scientific discoveries over the 4 plus years of operations. The objectives of this paper are to 1) describe the major scientific discoveries of the MER robotic field geologists and 2) briefly summarize what major outstanding questions were not answered by MER that might be addressed by returning samples to our laboratories on Earth.

Spirit in Gusev crater: Aqueous alteration in Gusev crater ranges from minor alteration on the surfaces and interiors of rocks and within the regolith on the basaltic plains, to highly altered outcrops and rocks in the Columbia Hills including the Inner Basin [2-5]. Some outcrops and rocks in the Columbia Hills appear to be extensively altered as suggested by their relative “softness” as compared to crater floor basalts, high $\text{Fe}^{3+}/\text{Fe}_T$ ratios, iron mineralogy dominated by nanophase Fe^{3+} oxides, hematite, and goethite, and high Br, S, and Cl concentrations in rock interiors exposed by

grinding with the RAT [2,3]. The discovery of goethite in Columbia Hills rocks is very important to understanding the history of water in Gusev crater, because this mineral can only form in the presence of water, in contrast to hematite that can form by either aqueous or non-aqueous processes [2]. MB measurements also detected the presence of a ferric-sulfate in the Paso Robles class surface soils [2,6]. Observations by Mini-TES suggest that the sulfate is hydrated [7]. The extreme mineralogical and chemical compositions of Paso Robles class soils very strongly implicate aqueous processes that involved the movement of liquid water (highly acidic) through the host material [3,6].

Nanophase Fe-oxides (npOx) are also detected by the MB in soils and rocks at Gusev crater [2]. The mineralogy of npOx phases is not known but these phases may contain $\text{H}_2\text{O}/\text{OH}$; however, the concentration of Fe associated with npOx increases as the concentration of S+Cl increases, showing that npOx is an alteration product [8,2].

Recently, deposits of amorphous silica (>90% SiO_2) have been discovered around Home Plate located in the Inner Basin of the Columbia Hills [9]. These deposits appear to have formed under hydrothermal conditions associated with volcanic deposits in the Columbia Hills [9,10].

Water has played a significant role in the alteration of rocks and soils in the Columbia Hills. The occurrence of goethite, ferric sulfate, and amorphous silica alone suggests that liquid water was involved in their formation. The pervasively altered materials in the Columbia Hills outcrops and rocks may have formed by low-temperature and/or hydrothermal aqueous alteration of basaltic rocks, volcanoclastic materials, and/or impact ejecta by solutions that were rich in acid-volatile elements; although high pH solutions cannot be ruled out in the formation of amorphous silica deposits.

Opportunity on Meridiani Planum: The occurrence of jarosite, other sulfates (e.g., Mg- and Ca-sulfates), and hematite along with siliciclastic materials in outcrops of sedimentary materials at Meridiani Planum are strong indicators of aqueous processes [11-14]. Jarosite can only form by aqueous processes under very acidic conditions; *i.e.*, acid-sulfate weathering conditions. Hematite occurs as small particles (below MI resolution of $\sim 30 \mu\text{m}/\text{pixel}$) embedded within the outcrop, as spherules (average size around 4 μm) embedded in the Meridiani outcrop, and a lag deposit where the hematite has physically weathered out of the

outcrop and concentrated at the surface. The hematite-rich spherules have been interpreted to be concretions that have formed in the outcrop during a complex diagenetic history, as suggested by episodes of cementation and recrystallization, formation of the hematite-rich spherules, and dissolution and formation of crystal mold vugs in outcrops [13].

Squyres *et al.* [11] suggested that the outcrops formed when ancient Meridiani once had abundant acidic groundwater, arid and oxidizing surface conditions, and occasional liquid flow on the surface. Another hypothesis is that regional heating caused a release of sulfide-rich hydrothermal waters that formed pyrite-rich deposits, and the subsequent aqueous oxidation of these deposits formed the sulfates and hematite in Meridiani outcrops [15]. McCollum and Hynke [16] and Knauth *et al.* [17] have suggested that the aqueous alteration occurred during flows induced by volcanic and impact base surges, respectively.

Mars Sample Return (MSR): The robotic field geologists of MER have been highly successfully in advancing our knowledge about aqueous processes on the surface of Mars; however, questions remain unanswered about the mineralogy, chemistry, and formation conditions of many materials encountered by the rovers. Mars samples returned to our laboratories may be the only way to answer some of these unresolved questions, although future robotic missions (2007 Mars Phoenix Scout, 2009 Mars Science Laboratory) may address some of these unanswered questions.

Several unresolved questions are briefly presented here (Table 1), but detailed accounts of these unresolved MER questions and the merits of MSR are presented elsewhere in this volume [18,19]. Several unresolved questions focus on the mineralogy of phases encountered by MER. No doubt, detailed mineralogy could be thoroughly described by the plethora of analytical instruments available in our terrestrial laboratories. Mineralogical identification of these phases would significantly enhance our understanding of their formation processes. Additional constraints on their formation conditions and ages could be obtained by detailed isotopic analyses that can only be performed with high precision in our terrestrial laboratories (e.g., light isotopes, noble gases, stable isotopes, etc.).

MER landing sites for a MSR Mission? No doubt, a debate will rage through the planetary science community on where to land the first and subsequent MSR missions. The MER landing sites have several key advantages over other landing sites. First and foremost, the MER landing sites have been characterized by robotic field geologists for over 4 Earth years. These sites provide a substantial advantage over other sites in understanding the geology of a MSR mission

to Gusev or Meridiani. Another advantage is that MER provided convincing evidence for phases that have formed under the influence of liquid water, which directly addresses NASA's Mars Exploration goal of "follow the water." There is always the possibility that a new site may not readily provide materials that have formed in the presence of liquid water.

There are however several disadvantages of returning to a MER site with a MSR mission. Orbiters (e.g., Mars Express, MRO) have identified many interesting sites on Mars that may have experienced previous episodes of liquid water. Could more be learned about aqueous processes on Mars by going to one of these sites and returning samples? Another confounding problem about returning to an MER site such as Gusev crater is that it might be difficult to acquire representative samples that were identified by Spirit. Will MSR have a rover and the instrumental capability to find important samples? These are questions that the Mars scientific community will have to evaluate over the coming years.

References: [1] Squyres, S. W., *et al.* (2003) *JGR*, **108**, doi:10.1029/2003JE002121. [2] Morris, R.V., *et al.* (2006) *JGR*, **111**, doi:10.1029/2005JE002584. [3] Ming, D.W., *et al.* (2006) *JGR*, **111**, doi:10.1029/2005JE002560. [4] McSween, H.Y., *et al.* (2006) *JGR*, **111**, doi:10.1029/2006JE00247. [5] Squyres, S.W., *et al.* (2007) *Science*, **316**, 738. [6] Yen, A.S., *et al.* (2008) *JGR* (in press). [7] Ruff, S.W., *et al.* (2007) *JGR*, **112**, E02002, doi:10.1029/2007JE002891. [8] Yen, A.S., *et al.* (2005) *Nature*, **436**:49-54. [9] Squyres, S.W., *et al.* (2008) *Science*, submitted. [10] Morris, R.V., *et al.* (2008) *LPSC 39*, #2208. [11] Squyres, S.W., *et al.*, (2006) *Science*, **313**, 1403. [12] Clark, B.C., *et al.*, (2005) *EPSL*, **240**, 73. [13] McLennan, S.M., *et al.* (2005) *EPSL*, **30**, 95. [14] Morris, R.V., *et al.* (2006) *JGR*, **111**, doi:10.1029/2006JE002791. [15] Zolotov, M.Y., & Shock, E.L. (2005) *JGL*, **32**, doi:10.1029/2005FL024253. [16] McCollum, T.M. and B. M. Hynke (2005) *Nature*, **438**, 1129. [17] Knauth, L.P., *et al.* (2005) *Nature* **438**, 1123. [18] Morris, R.V. (2008), *MSR Workshop*, this volume. [19] Mittlefehldt, D.W. (2008), *MSR Workshop*, this volume.

Table 1. Unresolved questions at the MER landing sites that could be addressed by a MSR mission.

Gusev crater
What is the mineralogy of npOx in soils and dust?
Did npOx form by aqueous processes?
What is the ferric sulfate mineralogy in some soils?
Are phyllosilicates present in some altered rocks?
What is the mineralogy S, Cl, & Br in soils & rocks?
How did amorphous silica form?
What is/was the habitability potential at Gusev?
Meridiani Planum
What is the mineralogy of Ca and Mg sulfates?
What is the mineralogy of siliciclastic sediments?
How were the sediments emplaced?
Do sediments harbor signs of ancient life?
What is/was the habitability potential at Meridiani?

MARS SAMPLE RETURN FROM MERIDIANI PLANUM. David W. Mittlefehldt, Astromaterials Research Office, NASA-Johnson Space Center, Houston, Texas, USA (david.w.mittlefehldt@nasa.gov).

Introduction: The NASA Mars Exploration Program has four main goals: (i) determine if life ever arose there, (ii) understand the processes and history of its climate, (iii) determine the evolution of its surface and interior, and (iv) prepare for human exploration of Mars [1]. These goals are embodied in the NASA Mars exploration strategy “Follow the Water.” Current Mars exploration tactics for lander missions build on knowledge gained by prior orbital investigations; the science rationale for choosing landing sites is based on the current best interpretation of the geology. A future Mars sample return mission will greatly exceed in cost typical lander missions because of the need to design for return to Earth and the infrastructure needed on Earth to curate and process the samples safely and cleanly. Because of this added cost burden, expectations for science return are higher. There must be some prospect that the returned samples will allow for testing higher level hypotheses relevant to NASA’s goals. Site selection must be based on knowledge gained from prior *in situ* measurements to enhance the prospects for successfully meeting these goals. I will argue that Meridiani Planum should be that site.

Geology of Meridiani Planum: Meridiani Planum is a low-relief terrain with few craters in the central portion of Sinus Meridiani [2]. Orbital thermal emission spectrometry showed that the plains have a significant cover of hematite, posited to have formed from aqueous solutions [3, 4]. The rocks of Meridiani Planum form a nearly horizontally layered sequence perhaps 800 meters thick, of which the hematite-rich units are only a portion [2, 5]. Although prior to *in situ* investigation the rocks were thought to be volcanoclastic [5], the Mars Exploration Rover Opportunity has shown that the outcrops in its immediate vicinity are sedimentary [6]. This is inferred to hold for the entire section in Meridiani Planum [2]. The rocks investigated by Opportunity represent only about 1% of the section and are near its top [2]; they are among the youngest sediments in the section, and are interpreted to be Late Noachian or Early Hesperian in age [2, 5].

Opportunity and Meridiani Sediments: The ~7 meter sedimentary section investigated by Opportunity is interpreted to be a sequence of wind and water transported clastic materials [6-8]; the synopsis here (Figure 1) is from [7]. The lower unit consists of cross-bedded sandstones interpreted to be fossil eolian dunes. Above this lies an eolian sand sheet composed of fine-scale planar-laminated to low-angle-stratified sandstones. The boundary between the lower and middle

units is an eolian deflation surface indicating a period of erosion. The top of the middle unit is defined by a zone of diagenetic recrystallization. The upper unit consists in part of eolian sand sheet sediments and in part of interdune playa lake sediments showing sedimentary structures indicative of water transport.

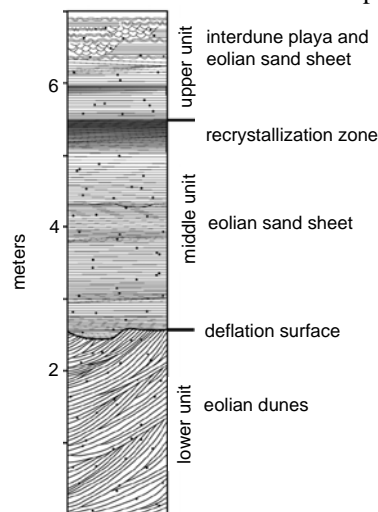

Figure 1. Interpretive sedimentary section investigated by Opportunity, after [7]. The black dots represent the ubiquitous diagenetic hematitic concretions.

The mineralogy of the sediments has been constrained by Mössbauer spectrometry and miniature thermal emission spectrometry (Mini-TES). The iron mineralogy is dominated by hematite, jarosite, an unidentified ferric phase (Fe₃D₃) and pyroxene, with a very small amount of olivine [9]. Mini-TES spectra for light-toned outcrops also demonstrate the presence of jarosite and hematite, and identify Mg- and Ca-bearing sulfates, Al-rich opaline silica, plagioclase feldspar, and possibly nontronite [10]. (Mini-TES spectra are on natural rock surfaces, while Mössbauer spectra are from rock interiors exposed by grinding – the two data sets are not on equivalent materials.)

The sediments in Meridiani Planum are interpreted to have been derived from muds from an evaporating playa lake [11]. The muds were composed of primary igneous minerals, siliciclastic alteration materials and evaporite minerals. Desiccation of the playa lake exposed the surface to wind erosion allowing sand-sized dried mud particles to be transported by wind to the site of deposition. These grains form the framework of the Meridiani rocks that were subsequently affected by diagenesis.

Meeting NASA Science Goals with Meridiani Sediments: The fourth goal listed above is more connected to engineering requirements for human missions than to Mars science. It can be addressed probably equally well by samples from just about any site on Mars, and will not be discussed here.

Determine if life ever arose on Mars. Orbital [3, 4] and *in situ* [6-12] investigation of Meridiani Planum provide a compelling case for aqueous processes having occurred at this site, including the likelihood that standing pools of water once existed on the surface [7, 8]. Thus, rocks returned from Meridiani Planum hold a strong potential for harboring signs of past life, if it ever existed. Examination of samples by electron microbeam techniques to search for microfossils and biogenic mineralization, and by geochemical analysis to search for organic chemical and isotopic fractionations diagnostic of biological activity can test for past (or extant) life. These analyses might best be done on cores intercepting playa lake sediments below the current erosion surface as this would minimize the chance that Mars' current environment has degraded the evidence.

Understand the processes and history of climate on Mars. Clear signs of aqueous activity by ground water and standing water at Meridiani Planum require that the climate was different at the time of deposition and diagenesis. Although some constraints can be placed on the nature of the diagenetic solutions from the mineralogy and chemistry determined *in situ* [11, 12], these data lack the precision and completeness that can be achieved by laboratory study. Examination of returned rocks will allow for complete characterization of mineralogy, mineral compositions and compositional zoning, textural context, and bulk chemical and stable isotopic composition that will allow for much more detailed and precise modeling of fluid evolution. This would certainly be true for the post-depositional diagenesis process. If later diagenesis did not completely overprint the evidence, it may be possible to elucidate the chemistry of the standing waters in which the sediments of the upper unit were deposited. These waters were in contact with the atmosphere, and the compositions of minerals derived from them may thus yield more direct information on the ancient Mars atmosphere and climate. Returned samples will thus allow for greater fidelity of models with nature. A major advance, however, would be to determine absolute ages for this climatic period. This can be accomplished by radiometric age dating of key minerals. Jarosite, formed by aqueous alteration, is amenable to K-Ar (and possibly Ar-Ar) dating to yield its formation age [13], and dating by other radiometric techniques may also be feasible [14].

Determine the evolution of the surface and interior of Mars. In addition to addressing climatic issues, Meridiani sediments would yield important new insights into the evolution of the surface and interior of Mars. Pyroxene and plagioclase are significant components of the outcrops, and they and olivine are components of the younger eolian bedforms [9, 10, 15]. These phases likely are remnants of primary crustal igneous rocks. Their preservation demonstrates that chemical weathering was not 100% effective, opening the door for investigations of the evolution of the surface and interior. One outcome would be determination of the chronology of the development of the crust. Some accessory phases concentrate the parent nuclides of radiometric chronometers. Zircon and baddeleyite concentrate U and individual grains can be dated using microbeam techniques [16, 17]. By using laser extraction techniques, Ar-Ar dating of individual major mineral grains can be done [18]. These techniques would yield information on the chronology of formation of the crust that was altered and eroded to provide the Meridiani sediments. The assemblage and mineral compositions of remnant igneous grains can be used to infer the nature of the crust supplying the detritus [19]. Terrestrial experience [16, 20] shows that by using the full panoply of modern microbeam analytical instrumentation, details of the formation of Mars' ancient crust may be discovered, even if that crust no longer exists.

References: [1] Johnson J. R. et al. (2008) *Mars Science Goals, Objectives, Investigations, and Priorities*, <http://mepag.jpl.nasa.gov/reports/index.html>. [2] Edgett K. S. (2005) *Mars I*, 5. [3] Christensen P. R. et al. (2000) *JGR-Planets* 105, 9623. [4] Christensen P. R. et al. (2001) *JGR-Planets* 106, 23873. [5] Hynek B. M. et al. (2002) *JGR-Planets* 107, 5088. [6] Squyres S. W. et al. (2004) *Science* 306, 1709. [7] Grotzinger J. P. et al. (2005) *EPSL* 240, 11. [8] Squyres S. W. et al. (2006) *Science* 313, 1403. [9] Morris R. V. et al. (2006) *JGR-Planets* 111, E12S15. [10] Glotch T. D. et al. (2006) *JGR-Planets* 111, E12S03. [11] McLennan S. M. et al. (2005) *EPSL* 240, 73. [12] Clark B. C. et al. (2005) *EPSL* 240, 95. [13] Keith W. J. et al. (1979) *USGS Prof. Pap.* 1124-C, C1. [14] Papike J. J. et al. (2006) *GCA* 70, 1309. [15] Glotch T. D. & Bandfield J. L. (2006) *JGR-Planets* 111, E12S06. [16] Pidgeon R. T. & Nemchin A. A. (2006) *Precam. Res.* 150, 201. [17] Herd C. D. K. et al. (2007) *LPS XXXVIII*, #1664. [18] Walton E. L. et al. (2007) *M&PS* 42, A159. [19] Piper D. J. W. et al. (2007) *Can. J. Earth Sci.* 44, 665. [20] Valley J. W. et al. (2005) *Contrib. Min. Pet.* 150, 561.

WHAT WE MIGHT KNOW ABOUT GUSEV CRATER IF THE MARS EXPLORATION ROVER SPIRIT MISSION WERE COUPLED WITH A MARS SAMPLE RETURN MISSION. R. V. Morris, Astromaterials Research Office, NASA Johnson Space Center, Houston, TX 77058 (richard.v.morris@nasa.gov).

Introduction: The science instruments on the Mars Exploration Rover (MER) Spirit have provided an enormous amount of chemical and mineralogical data during more than 1450 sols of exploration at Gusev crater. The Mössbauer (MB) instrument identified 10 Fe-bearing phases at Gusev Crater: olivine, pyroxene, ilmenite, chromite, and magnetite as primary igneous phases and nanophase ferric oxide (npOx), goethite, hematite, a ferric sulfate, and pyrite/marcusite as secondary phases [e.g., 1,2,3]. The Miniature Thermal Emission Spectrometer (Mini-TES) identified some of these Fe-bearing phases (olivine and pyroxene), non-Fe-bearing phases (e.g., feldspar), and an amorphous high-SiO₂ phase near Home Plate. Chemical data from the Alpha Particle X-Ray Spectrometer (APXS) provided the framework for rock classification, chemical weathering/alteration, and mineralogical constraints. APXS-based mineralogical constraints include normative calculations (with Fe³⁺/Fe_T from MB), elemental associations, and stoichiometry (e.g., 90% SiO₂ implicates opalline silica).

If Spirit had cached a set of representative samples and if those samples were returned to the Earth for laboratory analysis, what value is added by Mars Sample Return (MSR) over and above the mineralogical and chemical data provided by MER?

In situ analysis on Mars versus MSR: The sampling strategy employed by MER is to present the instrument to the sample. That is, samples are analyzed in situ with little or no sample preparation, except as provided by the Rock Abrasion Tool (RAT), the Magnetic Properties Experiment, and the churning action of the rover wheels. Some sample preparation was provided by natural processes on Mars, e.g., size sorting of soil particles by the wind. MSR opens two doors that are not possible with in situ analysis: (1) a wide variety of analytical techniques can be employed that are not possible or practical for in situ analysis (e.g., isotopic analysis, high-resolution scanning and transmission electron microscopy (SEM/TEM) with elemental analysis capability, electron microprobe analysis; high-resolution X-ray diffraction (XRD)); (2) pre-analysis sample preparation (e.g., thin sections, phase separation by density, magnetic properties and hand picking, and selective dissolution). In the next sections, we give a few examples of the value added by a MSR of a hypothetical cache made by the Spirit rover.

Nanophase ferric oxide: This Fe³⁺-bearing alteration product is ubiquitous in basaltic soils, and its molar abundance correlates with both S and Cl. Its composition is not well constrained by MER and could be any combination of the following Fe³⁺ alteration products found in terrestrial environments: superparamagnetic hematite and goethite, ferrihydrite, schwertmannite, iddingsite, and the nano-scale particles found in palagonitic tephra. With MSR, the sample preparation and analytical techniques employed to identify these phases on Earth can be used (e.g., sedimentation and selective dissolution followed by XRD and SEM/TEM). We might learn that the form of npOx on Mars is not present on the Earth.

Age dating: MSR of Adirondack, Irvine, Barnhill, and other basaltic rock classes would permit age dating of igneous events by isotopic analysis of whole rocks and mineral separates. This type of analysis was not possible with the MER instruments and it is unlikely that a Mars robotic mission will house a high-precision stable isotope mass spectrometer.

Thin Sections: Thin sections of Gusev rocks (including alteration rinds) can be made and analyzed by standard optical and electron beam microscopy on samples returned to the Earth. For example, is the rind on the rock Mazatzal accretionary or derived from the rock. What is the elemental composition of the igneous minerals, and are they zoned and have exsolution? Is magnetite always present as a primary mineral? What is the thin-section evidence for the origin of the high-SiO₂ phase [4].

Analysis of soil particles: Selection and analysis of individual soils particles is possible with samples returned to Earth. Such particles, for example, may represent new igneous lithologies and may be concentrations of specific alteration phases (e.g., sulfates), permitting analysis of their mineralogical, chemical composition and isotopic.

Summary: Samples returned to the Earth will permit analyses that are not possible in situ because of instrumental and/or sample preparation constraints, thereby extending our knowledge of the martian surface composition and the processes the form and modify it

References: [1] Morris, R.V., *et al.* (2006) *JGR*, **111**, doi:10.1029/2005JE002584. [2] Ming, D.W., *et al.* (2006) *JGR*, **111**, doi:10.1029/2005JE002560. [3] Squyres, S.W., *et al.* (2007) *Science*, **316**, 738. [4] Squyres, S.W., *et al.* (2008) *Science*, submitted.

DISCOVERY OF DIVERSE MARTIAN AQUEOUS DEPOSITS FROM ORBITAL REMOTE SENSING.

S. Murchie¹, A. McEwen², P. Christensen³, J. Mustard⁴, J.-P. Bibring⁵, and the CRISM, HiRISE, THEMIS, and OMEGA Teams, ¹Applied Physics Lab., Laurel, MD (scott.murchie@jhuapl.edu), ²U. of Arizona, Tucson, AZ, ³Arizona State U., Tempe, AZ, ⁴Brown U., Providence, RI, ⁵Institute d'Astrophysique Spatial (IAS), Orsay, France.

Summary: Over the past decade the occurrence, types, and geologic settings of aqueous minerals have been investigated by Mars-orbital spectral mapping instruments using an increasingly expanded wavelength range and higher spatial resolution (TES, THEMIS, OMEGA, and CRISM). Each has complemented previous investigations by re-imaging sites having spectral evidence for aqueous minerals, except using broader wavelength coverage and/or higher resolution. Each has also found previously unrecognized evidence for new aqueous minerals. HiRISE has provided sub-meter resolution images of the mineral occurrences and revealed their physical geology in unprecedented detail. There is clear evidence for at least eight types of deposits each with a distinct combination of mineral and structural features. These diverse deposits likely represent multiple depositional environments recording different phases of the history of water on Mars, and their *in situ* investigation promises significant new insights.

Layered Phyllosilicates. The phyllosilicates detected by OMEGA at Nili Fossae and Mawrth Vallis [1], when observed at high resolution, have discrete, commonly polygonally fractured layers with a stratified composition [2]. At Mawrth Vallis (Fig. 1) an erosion-resistant deposit typically overlies a sequence of Al-rich clays, probably montmorillonite, on top of Fe/Mg-rich clays. Eroded remnants extend over a region 700x900 km in size, suggesting a formerly more extensive deposit [3]. In Nili Fossae, Fe/Mg-rich clays dominate a diverse suite of alteration products [4]. Possible origins include alteration of volcanic ash or impact ejecta, subaerial weathering of basaltic regolith, or aqueous sedimentation of transported clays [5].

Deep Noachian Phyllosilicates: These occur in ejecta, walls, and central peaks of several-kilometer and larger diameter craters in the highland plateau (Fig. 2), in massifs of eroded highlands, and in the walls of Valles Marineris [2]. A variety of phyllosilicate mineral groups are indicated by their spectral signatures, with chlorite and saponite common, especially in highland craters. In Nili Fossae some localities exhibit zeolite, muscovite, or hydrated silica, and there is evidence for mineral "provinces" [6]. In general the mineralogy suggests a low level of alteration, but locations with the latter phases may have experienced higher temperatures or a more active hydrology. Based on CRISM global mapping, the current estimate is that there are 5000-10,000 exposures exceeding 1 km in extent.

Phyllosilicate-containing Intracrater Fans. MRO observations of highland intra-crater fans [e.g. 7,8] have revealed that typically the lower portions of the fans exhibit parallel bedding and an enhanced content of phyllosilicate (Fig. 3). Spectrally, the phyllosilicate is consistent with outcrops of deep or layered phyllosilicate in the drainage basins, and may have originated in the uplands rather than having formed *in situ* in the

fans. MRO results are consistent with sorting of fines and deposition in a lacustrine environment [9, 10].

Glowing Terrain. "Glowing terrain" was identified in THEMIS data based on thermal infrared properties indicating a significant content of minerals having an emissivity $\ll 1.0$. The geologically most reasonable candidate is chloride salt in excess of 25% mass fraction, consistent with the deposits' location typically in closed basins, sometimes at the terminus of inflowing channels [11]. CRISM has not yet detected non-chloride salts in the glowing terrain, but HiRISE images (Fig. 4) show distinct color properties, fine layering, and intense polygonal fracturing.

Meridiani-type Layered Deposits. These layered, etched, gray hematite- and sulfate-bearing deposits were investigated *in situ* by MER/Opportunity [12,13]. A wide variety of MRO data shows that compositional and sedimentary features characteristic of the landing site also typify etched terrain extending over 300,000 km². The material has near-horizontal parallel beds having different erodibilities, with layers that are not deformed by extensive faulting or folding (Fig. 5). Discrete beds have enhanced signatures of mono- and polyhydrated sulfates [13,14] and hematite [12,13].

Valles-Type Layered Deposits. High-resolution MRO data show that Valles Marineris interior layered deposits (ILDs) have features that distinguish them from Meridiani-type layered deposits, despite also containing sulfates and hematite. In western Candor Chasma the deposits are extensively folded and faulted (Fig. 6) [15]. Narrow color bands forming low ridges are interpreted as mineralization by fluid flow along fractures [16]. Spectral signatures of sulfate are much more pervasive than in Meridiani, and sulfate mineralogy is interlayered on a tens-of-meters scale with evidence for kieserite, polyhydrated Fe- or Mg-sulfates, and gypsum. Some of the layers appear well-indurated, whereas others - typically with a strong monohydrated sulfate signature - are friable and erode into yardangs and dune-forming material [17,18].

Hydrated Silica Deposits. A major discovery by MRO is the widespread occurrence of hydrated silica in light-toned layered deposits on the Hesperian-aged plains surrounding Valles Marineris (Fig. 7) [19]. The light-toned deposits in some places are eroded into yardangs, and in others display inverted channels suggesting eolian erosion of fluvial deposits. Discrete layers have a broad, shallow 2.2- μm absorption distinct from that in phyllosilicates, but matching hydrated silica. The shape and center of the band, and strengths and positions of accompanying bands at 1.4 and 1.9 μm , indicate a variety of forms including altered glass, opal, and chalcedony. Other layers exhibit absorptions due to Fe sulfates. The relationship of the hydrated silica to high-Si deposits found by MER/Spirit [20] is unknown.

North Polar Gypsum Deposits. High-resolution MRO observations (Fig. 8) of the Amazonian gypsum deposit in the north polar erg [21] surprisingly suggest that gypsum is concentrated in dunes, especially at the crests [22]. Morphology of the erg (friable, sandy dark material interlayered with light, polygonally fractured resistant layers) strongly resembles the basal unit [23], except reworked by wind. MRO's observations of the erg have not yet revealed a gypsum source region.

References: [1] F. Poulet et al., *Nature*, 438, 623, 2005. [2] J. Mustard et al., submitted to *Nature*, 2008. [3] E. Noe Dobrea et al., *LPSC 39*, 1077, 2008. [4] B. Ehlmann et al., 7th Mars Conf., 3270, 2007. [5] D. Loizeau et al., *J. Geophys. Res.*, 112, doi:10.1029/2006JE002877, 2007. [6] B. Ehlmann et al. *LPSC 39*, 2326, 2008. [7] M. Malin and K. Edgett, *Science*, 290, 227, 2001. [8] M. Malin and K. Edgett, *Science*, 302, 1931, 2003. [9] J. Grant et al., 7th Mars Conf., 3229, 2007. [10] B. Ehlmann et al., submitted to *Nature Geosciences*, 2008. [11] M. Osterloo et al., 7th Mars Conf., 3269, 2007. [12] S. Squyres et al., *Science*, 306, 1698, 2004. [13] R. Arvidson et al. *J. Geophys. Res.*, 111, doi:10.1029/2006JE002728, 2006. [14] S. Wiseman et al., 7th Mars Conf., 3111, 2007. [15] C. Okubo et al., in prep., 2008. [16] C. Okubo et al., *Science*, 315, 983, 2007. [17] S. Murchie et al., 7th Mars Conf., 3238, 2007. [18] L. Roach et al., 7th Mars Conf., 3223, 2007. [19] R. Milliken et al., *LPSC 39*, 2025, 2008. [20] S. Squyres et al., submitted to *Science*, 2008. [21] Y. Langevin et al., *Science*, 307, 1584, 2005. [22] L. Roach et al., *LPSC 38*, 1970, 2007. [23] K. Herkenhoff et al., *Science*, 317, 1711, 2007.

ence, 290, 227, 2001. [8] M. Malin and K. Edgett, *Science*, 302, 1931, 2003. [9] J. Grant et al., 7th Mars Conf., 3229, 2007. [10] B. Ehlmann et al., submitted to *Nature Geosciences*, 2008. [11] M. Osterloo et al., 7th Mars Conf., 3269, 2007. [12] S. Squyres et al., *Science*, 306, 1698, 2004. [13] R. Arvidson et al. *J. Geophys. Res.*, 111, doi:10.1029/2006JE002728, 2006. [14] S. Wiseman et al., 7th Mars Conf., 3111, 2007. [15] C. Okubo et al., in prep., 2008. [16] C. Okubo et al., *Science*, 315, 983, 2007. [17] S. Murchie et al., 7th Mars Conf., 3238, 2007. [18] L. Roach et al., 7th Mars Conf., 3223, 2007. [19] R. Milliken et al., *LPSC 39*, 2025, 2008. [20] S. Squyres et al., submitted to *Science*, 2008. [21] Y. Langevin et al., *Science*, 307, 1584, 2005. [22] L. Roach et al., *LPSC 38*, 1970, 2007. [23] K. Herkenhoff et al., *Science*, 317, 1711, 2007.

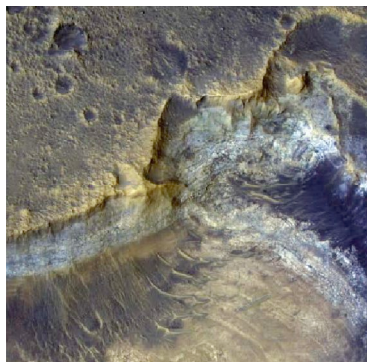

Fig. 1. HiRISE image of Noachian layered clays (type location, Mawrth Vallis). The light-colored materials are clay-bearing.

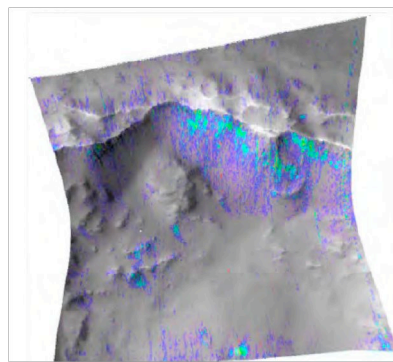

Fig. 2. CRISM image of massive phyllosilicate (in blue) excavated and exposed in a crater wall (type location, Tyrrhena Terra).

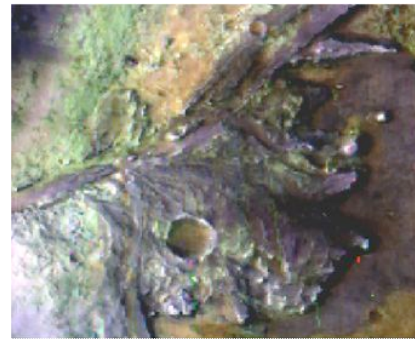

Fig. 3. CRISM IR false color image of an intra-crater fan. Green material in the base of the fan is phyllosilicate-bearing (type location, Jezero crater).

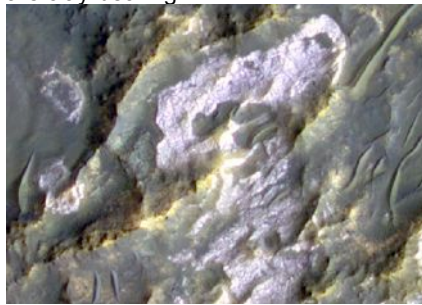

Fig. 4. HiRISE image of the polygonally fractured surface of glowing terrain. Thermal IR properties are consistent with a high chloride content (type location, Terra Sirenum).



Fig. 5. HiRISE image of sulfate- and gray hematite-bearing, horizontally layered, largely undeformed deposits (type location, Terra Meridiani).

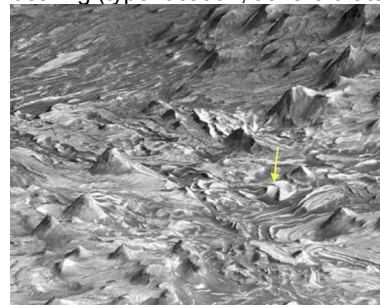

Fig. 6. HiRISE image of sulfate- and gray hematite-bearing layered, faulted, folded deposits in Valles Marineris (type location, Candor Chasma). Oblique projection using digital topography.

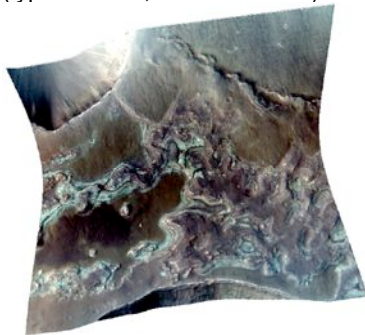

Fig. 7 (left). CRISM IR false color image of thin, light-toned layered deposits on the plateau around Valles Marineris. Discrete layers contain hydrated silica and jarosite (type location, Sinai Planum).

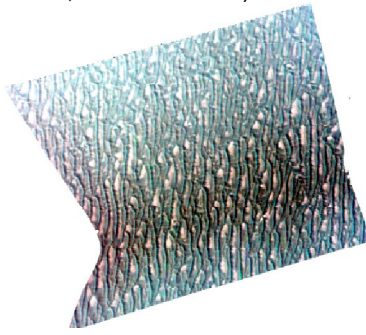

Fig. 8 (right). CRISM IR false color image of gypsum-rich dunes in the north polar erg (type location, Olympia Undae).

HYDRATED SILICATE MINERALS AND THEIR GEOLOGIC ENVIRONMENTS FROM ORBIT J. F. Mustard¹, S. L. Murchie², B. L. Ehlmann¹, R. E. Milliken³, J-P. Bibring⁴, F. Poulet⁴, J. Bishop⁵, E. Noe Dobrea³, L. Roach¹, F. Seelos², N. K. McKeown⁶ ¹Dept. of Geological Sciences, Box 1846, Brown University, Providence, RI 02912 John_Mustard@brown.edu, ²JHU/Applied Physics Laboratory, Laurel, MD 20723, ³JPL-CalTech, ⁴IAS, University of Paris, Orsay, France. ⁵SETI Institute/ NASA-ARC, Mountain View, CA, 94043, ⁶University of Calif., Santa Cruz, CA, 95064.

Introduction: Phyllosilicate minerals were first definitively identified on Mars from orbit by the OMEGA (Observatoire pour la Mineralogie, L'Eau, les Glaces et l'Activité) instrument on board Mars Express [1, 2]. Global mapping showed that sheet silicates are widespread but largely found in terrains of Noachian age. Phyllosilicate formation requires moderate to high pH and high water activity [3]. A major hypothesis presented by Bibring et al. [4] is that the conditions necessary for phyllosilicate formation were specific to the Noachian, the earliest era in Mars' history.

High spatial resolution, precision pointing, and nested observations of imaging instruments (Context Imager (CTX), Compact Reconnaissance Imaging Spectrometer for Mars (CRISM), and the High Resolution Imaging Science Experiment (HiRISE)) on the Mars Reconnaissance Orbiter (MRO) provide enhanced capabilities to analyze surface mineralogy across the planet and determine the nature and geologic setting of phyllosilicate deposits. Findings from MRO on the diversity of phyllosilicates, associated hydrated minerals, and their geologic setting are described here. Along with [5, 6] we discuss implications for aqueous alteration processes on early Mars. Herein, we focus on well-exposed crustal phyllosilicate environments as potential terrains to be sampled by MSR to establish the conditions of phyllosilicate formation.

Mineralogy of Crustal Phyllosilicate Terrains: Particular phyllosilicate minerals can be identified based on the cation-OH pairing, which can be distinguished using infrared spectroscopy (Fig. 1; see [6]). Two principle classes of phyllosilicate minerals exist on the Mars surface: Al-phyllosilicates and, the more common and spatially dominant, Fe/Mg-phyllosilicates. OMEGA identified the smectites nontronite (Fe-rich), saponite (Mg-rich), and montmorillonite (Al-rich), along with the Fe-rich chlorite chamosite [2]. The increased spatial and spectral resolution of CRISM has revealed an increased diversity of phyllosilicate minerals: kaolinite (Al-rich), illite or muscovite (K-rich), and Mg-rich chlorites (Fig. 1).

CRISM data also show regions with phyllosilicate-bearing units typically have additional alteration minerals. Hydrated silicates such as opal, altered glass, and zeolite, specifically analcime, have also been mapped by CRISM associated with phyllosilicate bearing terrains [7]. Iron oxides are also present [8, 9]. Sulfates are notably absent as are all metamorphic facies typical

of elevated P/T conditions ($T > 300$ C) such as prehnite, pumpellyite, epidote, and talc.

A new class of hydrated silicate has been identified with CRISM data [10]. This is characterized by absorption near 2.2 μm and commonly has associated 1.4 and 1.9 μm bands. This 2.20-2.25 μm band is distinct from that observed with Al-OH phyllosilicates such as montmorillonite in that the absorption is broader and centered at longer wavelengths. These spectral characteristics are consistent with hydrated silica glasses such as opal or volcanic glass.

Mineral Assemblages: With CRISM we find that the spatial distribution of these diverse alteration minerals has a high degree of spatial coherency. Within the most well exposed crustal phyllosilicate deposits, we see, in effect, different "provinces" of alteration where some of these minerals are found and not others. Nili Fossae has at least two distinct provinces, one in the immediate vicinity of the fossae with patchy kaolinite-bearing rock units overlying Fe/Mg smectite bearing rock units. All alteration minerals lie beneath a mafic cap rock extending over a region of thousands of square kilometers. In contrast, west of the fossae and east of Antoniadi crater, Fe/Mg smectite, chlorite, zeolite, and hydrated silica are more common, exposed within heavily cratered terrain [7, 8]. Mawrth Vallis presents a distinctly different regional phyllosilicate view: Fe/Mg-smectite is pervasive and is frequently covered by smaller patches of montmorillonite, kaolinite, opal, mica or mixtures of these. [9, 11, 12, 13]. As CRISM coverage builds we are expecting further distinct provinces of alteration minerals to be identified.

Stratigraphic setting: Bibring et al. [4] showed that phyllosilicate-bearing terrains were strongly associated with Noachian-aged units, but did not detail the implied formation environments represented by these phyllosilicate units. Subsequent analyses [5] define three broad categories of phyllosilicate settings: phyllosilicates in layered deposits, massive units, and in fluvial-lacustrine units such as fans. In many regions multiple environments are observed. For example, in the Nili Fossae Region, massive, layered, and delta deposits with phyllosilicate minerals are observed.

Across the southern highlands, many small outcrops of phyllosilicate, numbering in the thousands are observed, commonly associated with impact craters [14]. Phyllosilicates appear to have been excavated or exposed from deep-seated environments and are found

in the ejecta, walls and central peaks of impact craters as well as in outcrops near the base of cliff walls in Valles Marineris. We have estimated depths of excavation of 4-7 km. A possible explanation is that alteration processes extended to deep within the crust [cite Parmentier abstract?].

Discussion: The CRISM data show a wide range of sheet silicates that occur in diverse geologic settings, apparently from deep crustal to near surface environments. The association of these minerals with Noachian-aged terrains does not require Noachian age of formation and more work is needed to stratigraphically date these deposits. Specifically, the nature of the contact with overlying units (unconformable vs. gradational) and the stratigraphy of phyllosilicate-bearing units with respect to unaltered mafic units will be assessed using combined CRISM-CTX-HiRISE observations.

Nevertheless, it is apparent that sheet silicates are critical indicators of environmental conditions on early Mars. Both altered materials and unaltered precursor materials in phyllosilicate-rich terrains are important targets to consider for sample return. A sample from phyllosilicate terrains would be a great asset for determining the timing and geochemical environment of

alteration. A key point as planning for MSR progresses is that all phyllosilicate-bearing terrains are not equal. MRO data show distinct phyllosilicate settings and mineralogies whose diversity must be better understood in order to establish the geologic environment being investigated and to best target a sample return mission.

References: [1] Bibring J-P. et al, *Science* v307, 1576-1581 (2005). [2] Poulet F. et al., *Nature*, v438, 623-627 (2005). [3] Velde B. in *Origin and Mineralogy of Clays* (ed. B. Velde), Springer, Berlin (1995). [4] Bibring J-P. et al. *Science*, v312, 400-404 (2006). [5] Murchie, S. L., et al., (this meeting) (2008). [6] Milliken, R. E., et al., this meeting (2008). [7] Ehlmann B. et al. 7th Mars Conference (2007). [8] Ehlmann, B. et al., 2008, LPSC 39, #2326. [9] Bishop, J. et al., 2008, LPSC 39, #2124. [10] Milliken, R. E., et al., Opaline Silica in (Geologically?) Young Deposits on Mars (submitted) *Science* (2008). [11] Wray, J. et al., 2007, 7th Mars Conference, #3119. [12] McKeown, N. et al., 2008, LPSC 39, #1400. [13] Noe Dobrea, E., et al., (2008). [14] Mustard, J. F. et al., Hydrated Silicate Minerals on Mars Observed by the CRISM Instrument on MRO (submitted) *Nature* (2008).

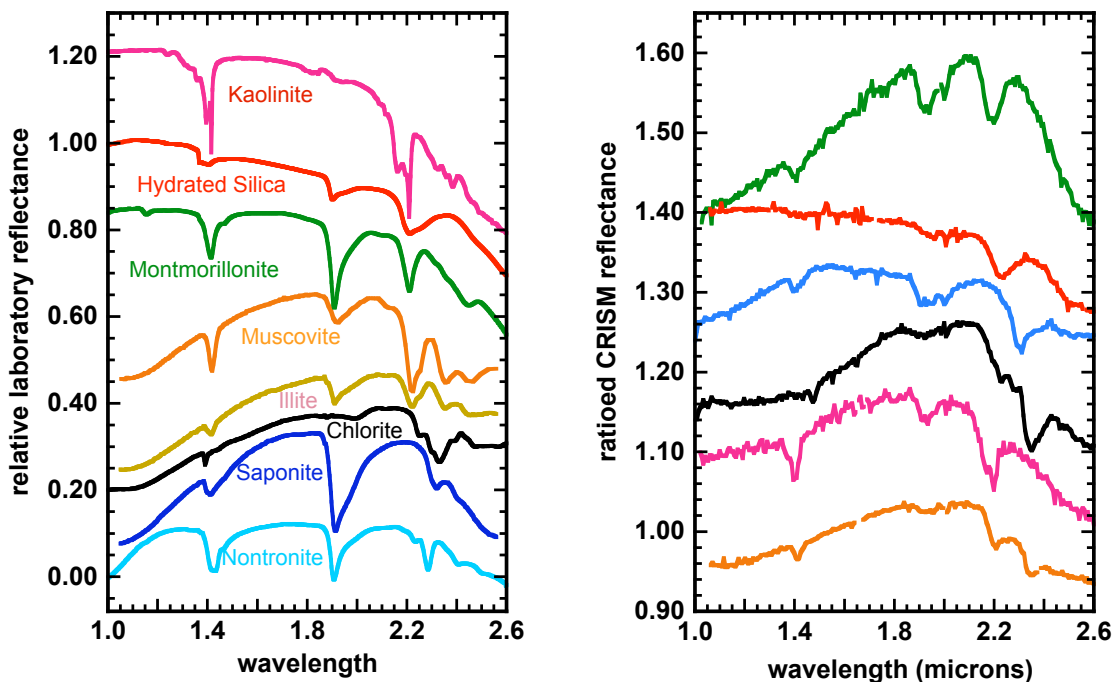

Figure 1. Laboratory spectra (left panel) of pure minerals and CRISM spectra (right panel) showing absorption features diagnostic of phyllosilicate minerals. The colors of spectra in the left panel are tied to the colors of spectra in the right panel to show the mineral identification. The laboratory spectra are offset for clarity. The CRISM spectra are ratios of a spectrum showing a mineral feature to one that is spectrally neutral to remove common artefacts due to imperfect atmospheric removal and instrumental effects.

CLAY MINERAL FORMATION IN IMPACT INDUCED HYDROTHERMAL SYSTEMS: SOURCE OF HYDROUS PHASES ON MARS. N. Muttik¹, K. Kirsimäe² and P. Somelar³, ¹Department of Geology, University of Tartu, Vanemuise 46, 51014 Tartu, Estonia, nele.muttik@ut.ee, ²Department of Geology, University of Tartu, Vanemuise 46, 51014 Tartu, Estonia, kalle.kirsimae@ut.ee, ³Department of Geology, University of Tartu, Vanemuise 46, 51014 Tartu, Estonia, peeter.somlear@ut.ee.

Introduction: Clays are water-rich phyllosilicates that form by hydrous alteration of primary (magmatic/metamorphic) silicate minerals and require presence of water in liquid and/or vapor form. The composition, structure and morphology of clay minerals depend on number of environmental parameters – temperature, fluid composition/amount, pH, Eh etc. This makes clays useful and important indicators for reconstruction of environments of the past [1]. Moreover, clay mineral surfaces are suggested as possible sites for prebiotic reactions and origin of life on Earth [2].

Except for Earth and supposedly Europa and by recent discoveries Encladeus the water in Solar system occurs, if at all, mostly in waterice form. There are evidences of past and geologically rather recent water activity on Mars, but even there the water has been frozen for most of the geological time and evidences of (hydrous) chemical weathering are scarce [3]. Consequently, the clay mineral formation on terrestrial type planets others than Earth is probably of very limited character. Only recently the remote sensing experiments on the Mars Express space-craft identified clay minerals (nontronite and montmorillonite) on Mars in terranes of Noachian age [4, 5]. This proves the hydrous type of chemical weathering, at least in the earliest stages of Martian history.

Impact induced hydrotherms: Environments favorable for clay formation can be locally generated in frozen rocks at any point of the geological history by endogenic processes as volcanism, which can initiate melting of (permafrost) ice and formation of hydrotherms. Apart from volcanism the hydrothermal systems result also form meteorite impacts where strong differential temperatures generated by an impact can initiate the water circulation provided that the water/ice is present at the site. Evidences of impact-induced hydro-thermal (IHT) activity have been found at number of terrestrial craters [e.g. 6, 7], and it is suggested for impact craters on Mars as well [8, 9]. The impact cratering is a far more common process in Solar system than the volcanism and, consequently, the possible impact induced hydrothermal systems in crater structures formed into water (incl. water-ice) containing targets are of much higher frequency compare to the volcanic hydrotherms. Moreover, at the large impact craters the IHT systems that are volumetrically an order of magnitude larger, compared to volcanic hydrotherms, can be generated [10]. This makes the

impact structures interesting targets for clay studies in extraterrestrial environments.

Structure and evolution of IHT:

The terrestrial IHT systems differ from the most known volcanic (both terrestrial and deep-sea) hydrotherms in many aspects – spatial structure, temperature history, fluid flow characteristics and chemistry, size etc.

Spatial configuration of impact-induced hydrothermal (IHT) system (-s) depends evidently on the presence and dimensions of the impact melt sheet. In the large multi-ring impacts, where the initially impermeable melt-sheet covers entire peak ring-basin area as well as partly the space between the peak-ring and final crater ring the IHT develops initially in the annular trough between the peak ring and final crater rim with the fluid venting through faults in the crater modification zone. In the small-to-medium scale craters without significant melting the IHT forms in and around the central high [11], which is heated up during shock-wave passage and decompression. Also, an additional thermal impulse into the crater area can be provided by the stratigraphic uplift and shear heating during the formation of the central peak, and the rapid unloading of the target basement.

Likewise, the life-times of the IHT vary significantly with the crater size depending on the amount of melting and governing mode of heat transport. In large terrestrial structures, as Sudbury, the formation of IHT is in most part of the crater inhibited for $\sim 10^5$ years by the low permeability of rock an/or melt and the first period of cooling is mainly determined by the least effective, i.e. conductive heat removal mechanism. Consequently, the time needed for the system to cool below the 90°C is in the range of 0.22-3.2 Ma depending on the surface permeability [10]. In structures with limited melting the IHT is formed shortly after the impact and the cooling is governed mainly by convective heat transport leading to more rapid temperature decrease, which is two-three orders of magnitude less [11].

The cooling of impact is characterized by exponential temperature evolution with fast temperature drop in the beginning of the cooling and long and slow temperature decrease down to ambient conditions during rest of the time. Other important characteristic of IHT is the irreversible temperature drop without reactiva-

tion episodes during the evolution of the system that are possible in volcanic environments

The range of the temperature variation in the space and time results in specific secondary paragenetic mineral associations. Initial high temperature conditions when the temperature drop is the fastest are recorded mainly in silicate mineral assemblages whose narrow equilibrium state allows rather precise mapping of the thermal aureole.

The assemblage and geochemical characteristics of the hydrothermal minerals in terrestrial IHT systems vary within a narrow interval of pH and suggest weakly alkaline and near neutral environments (pH 6-8) as the result of anion-hydrolysis of the mainly aluminosilicate composition rocks and impact derived impact-melts/glasses.

The longest period of the impact cooling occurs at temperatures below 300(350) °C and as a consequence the dominant hydrothermal assemblage in impact structures is of clay mineral – zeolite – calcite – (pyrite) composition. The impact-induced hydrothermal formations exhibit commonly two main zones of alteration: moderate-temperature (chlorite – anhydrite zone) and low-temperature (smectite(smectite-illite) – zeolite - carbonate zone) facies, which crystallization temperatures can be estimated from stability of hydrothermal phases in modern geothermal fields to be 350–180 and 200–50 °C, respectively [7].

Also, it must be noted that the impact process provides large amount of vitrified, amorphous glasses and impact melts that are easily transformed into hydrous clay phases by postimpact weathering and/or diagenetic and metamorphic processes.

Implication for Martian environments: In contrast to largely differentiated Earth's crust, the possible Martian target rocks are petrologically primitive basic rocks that are rich in Mg and Fe, and considerably lower in Si, Al and alkalis. This implies specific alteration mineralogy and alteration sequences. The closest Earth based analogies are impacts into basalt or amphibolite-facies basic rock. These impact-induced systems are characterized by Fe-smectite (saponite), corrensite and chlorite type mineralization at the expense of primary pyroxene-amphibole minerals and volcanic glasses. However, the low rock/water ratio, negligible O₂ and high (-er) CO₂ fugacity on Mars would suggest high saline fluids with untypically to IHT-s acidic alteration, that, first, would result in fast self-sealing of fluid conduits by Ca/Mg/Fe-carbonate/sulphate precipitation and, secondly, strong hydrolysis resulting in abnormally Fe-rich smectite and halloysite mineralogies. However, distribution of the alteration intensity (i.e. clay abundance) within the terrestrial craters suggest that in the absence of significant erosion the sup-

posedly clay rich zones are not exposed at the surface and the clay identification by remote and/or surface exploration is difficult. Nevertheless, the impact-hydrothermal clays can be searched in structures which central part is excavated by a later impact event.

References:

- [1] Velde, B. (ed) (1995) *Origin and Mineralogy of Clays* Springer, 335 p. [2] Ferris J.P. et al. (1996) *Nature* 381, 59. [3] Morris, R.V. et al. (2004) *Science* 305, 833–836. [4] Bibring, J. -P. et al. (2005) *Science* 307, 1576–1581. [5] Poulet, F. et al. (2005) *Nature* 438, 623–627. [6] Versh, E. et al. (2005) *MAPS* 40, 3-19. [7] Naumov, M (2005) *Geofluids* 5, 165-184. [8] Newsom, H.E. (1980) *Icarus* 44, 207–216. [9] Allen et al. (1982) *J Geophysical Research* 87, 10083-10101. [10] Abramov, O. and Kring, D. A. (2004) *JGR* 109, E10007. [11] Jöeleht, A. et al. (2005) *MAPS* 40, 21-33.

MARS SAMPLE RETURN: WHICH SAMPLES AND WHY. C. R. Neal¹, ¹Dept. of Civil Eng. & Geological Sciences, University of Notre Dame, Notre Dame, IN 46556, USA, neal.1@nd.edu.

Introduction: With NASA making a decision to launch a sample return mission to Mars by 2020, there is much development that needs to be done so we are ready to meet this deadline. The Curation and Analysis Planning Team for Extraterrestrial Materials (CAPTEM) produced papers 1998 and 2000 [1,2] that documented the challenges involved in returning samples from Mars to Earth and keeping them in their pristine condition. There is a tendency to consider that this sample return opportunity will be the only one so we should return the best samples to determine if life ever evolved on the red planet and whether the climate was ever much thicker, warmer, and wetter than at present. In order to achieve this, the sample return mission should be “Christmas-treed” with instruments to identify each sample through extensive analyses on the surface. Then, once these samples are collected they have to be maintained in their pristine state during the long return journey to Earth. However, in this time of modest budgets, such a sample return mission will probably be cost-prohibitive, especially if the samples are collected over an extended period by a rover. Therefore, it is time to re-examine this scenario and to see if sample return will yield significant scientific return for a mission that is less than “perfect”.

From orbital and surface observations, it is apparent that igneous, volcanoclastic, and sedimentary materials are present on the Martian surface. All tell a part of the story regarding the evolution of Mars and this story will be unraveled best through study in Earth-based laboratories. However, the samples that are studied here on Earth must remain unchanged since collection on Mars. So how tolerant are the different types of samples to different environmental conditions that will be encountered during sampling, storage, take off from Mars, return to Earth, re-entry and landing, and finally curation?

Materials. The previous work published in 2000 [2] gave recommendations on the type of materials that would be acceptable from a sample containment standpoint, noting that (as far as possible within mission constraints) only pure, homogeneous materials should be used for components that come into contact with the samples.

- ◆ Low-Zn aluminum (i.e., not the 7000 series alloys) - the 6061 alloys (i.e., alloyed with Mg and Si) are acceptable;
- ◆ Low sulfur stainless steel that contains no molybdenum and is compatible with electropolishing and passivating in nitric acid;
- ◆ Titanium alloys should be as pure as feasible given

the required physical and metallurgical properties;

- ◆ Unplasticized Teflon that would impart organic contamination recognizable as non-biogenic;
- ◆ Tungsten carbide used for the drill bits should be pure WC and sample contamination documented through drilling experiments on Earth.

It is important that flight spares be created of all components that contact the samples and that these spares be stored for subsequent analysis to document homogeneity and purity.

Mineral Stability. The compositions of the various minerals now known to be present at the Martian surface will, in some cases, pose challenges in returning them to Earth and keeping them in their pristine state. For example, clay minerals and hydrated sulfates contain loosely bound water (+/- hydroxyl) molecules that could be dislodged due to temperature and pressure fluctuations. For example, clay minerals can dehydrate between 300-500 K. While this may not seem to be as great a loss, being able to measure the pristine $\delta^{18}\text{O}$ and $\delta^2\text{H}$ of these waters could shed light on the Martian hydrologic cycle. Differential dehydration during collection, storage and transport of samples containing clay minerals will fractionate the isotopic signatures. For Jarosite, dehydration from the hydronium site occurs at 260°C and dehydroxylation occurs between 450-480°C [3]. For other hydrated sulfates, temperature and relative humidity determined the stability of a given phase. Hexahydrite ($\text{MgSO}_4 \cdot 6\text{H}_2\text{O}$) forms from Epsomite ($\text{MgSO}_4 \cdot 7\text{H}_2\text{O}$) at 16-20°C at relative humidities <60%. Kieserite ($\text{MgSO}_4 \cdot \text{H}_2\text{O}$) forms from Hexahydrite as relative humidity drops below 20-45% [4,5]. Hexahydrite dehydrates rapidly (≤ 24 hours) to a variety of secondary products (Starkeyite: 4 H_2O ; Sanderite: 2 H_2O ; Kieserite: 1 H_2O) at 75°C [6]. Such changes would radically affect H and O isotope compositions especially if the sample cache was not sealed. However, igneous rocks and minerals would certainly be tolerant of moderate fluctuations in temperature without much change in their pristine state.

Sample Containment: As the samples will be contained for a relatively long period, the container should not compromise sample integrity. In addition, temperature control could be important for preserving sensitive biologic/sedimentary chemical signatures. If Teflon is to be used, it should be PFA or FEP and applied as a baked-on coat to the metal of the sample container, rather than a separate insert. This protocol reduces the number of parts to be manipulated, and the possibility that the sleeve could come loose, preventing sample insertion, is avoided. Mixing of samples is considered

LANDING SITE SELECTION FOR THE MARS SCIENCE LABORATORY AND IMPLICATIONS FOR MARS SAMPLE RETURN. H. E. Newsom¹, N. L. Lanza¹, and A. M. Ollila¹. ¹Institute of Meteoritics, MSC03 2050, University of New Mexico, Albuquerque 87131.

Introduction: The scientific success of a Mars Sample Return (MSR) mission will be greatly enhanced by returning well characterized materials from several outcrops on Mars. This is important for a wide spectrum of studies, ranging from understanding habitable environments to finding materials suitable for geochronology. The possibility of sending an MSR to a site previously studied during the extensive mission of the Mars Science Laboratory (MSL) is therefore attractive. This becomes even more so given the likelihood of serious financial constraints on the MSR mission, which may limit the duration and scope of a sampling rover associated with MSR. MSL can contribute to a future sample return mission by 1) exploring and defining interesting targets for future sampling and return from that site, and 2) collecting a sample cache, as planned for the MSL rover and probably the ExoMars mission. There are a number of important considerations involving the selection of landing sites for these precursor missions that could substantially influence the success of an MSR mission to one of these sites.

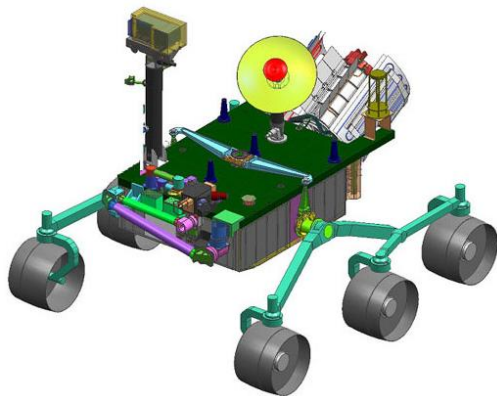

Fig. 1.Diagram of the Mars Science Laboratory, which will contain a sample cache for potential return to Earth by an MSR mission. From JPL/NASA.

Sample return missions to sites already studied – There are a number of obvious advantages and some potential disadvantages to having the MSR mission return to a previously studied site, with or without a sample cache. Being able to revisit outcrops that in-situ study has identified and characterized will greatly enhance the probability of returning significant samples. The alternative of providing an MSL class rover for a new MSR site may be unaffordable. There are some disadvantages to revisiting sites as well. Visiting a previously studied site increases the potential that a site could have biological or biochemical contamination from the prior investigation. This could be minimized by sampling for return portions of outcrops at some distance from the areas earlier investigated.

Types of landing sites – There are several classes of landing sites under consideration for MSL. These sites fall into several types relevant to MSR:

1. Landing sites with prime targets in the landing site ellipse.
2. Go-to landing sites with prime targets in terrains surrounding the landing site ellipse. For go-to sites the rover must travel to reach the prime sites.
3. Go-to landing sites with prime targets in terrains outside the landing site ellipse, but only on restricted azimuths from the center of the ellipse .

Clearly, the landing sites where the prime targets are located in the landing site ellipse are the most suitable as candidate sites for future MSR. In contrast, the go-to sites are problematic for MSR if the available landing site ellipses are far from the science targets. The situation may be improved if the MSR

ellipses are smaller than the MSL ellipse. Also, if a cache is present the MSL or ExoMars rover will need to be accessible at the end of its mission, which is discussed further below.

Location of landing sites and MSR - Other considerations for landing sites relevant to MSR include the latitude of the landing site. This could greatly affect the potential for returning a cache. Sites at high latitudes are not favorable for operations during a significant part of the martian year. Therefore, there may be problems with scheduling an MSR mission to coincide with the warm part of the martian year at a given site.

Sample Cache issues – The collection of a sample cache by the MSL and ExoMars rover has the advantages of allowing recovery of samples from areas that would probably not be accessible to the rover on an MSR mission. However, a sample cache can result in cross contamination of samples within the cache. In addition, the cache may be subject to contamination from the rover that collects the cache, as well as from the rover that collects the cache for the return.

The presence of a sample cache may also influence the operation of the rovers. Returning to the original landing site will be very undesirable. Such a plan could impact the nature of an extended mission for some of the science targets that require long traverses from the landing site ellipse. The identification of possible sample return ellipses at the ends of the planned science traverses at go-to sites would certainly enhance their desirability in this regard, especially if there was good science to do during an extended mission at these locations. Otherwise, following the prime mission, there will be real or perceived pressure to drive back to the landing site with no substantial extended mission.

Mars Science Laboratory landing sites and MSR – There are currently six final sites under consideration for MSL. These sites have different implications for an MSR mis-

sion. The near equatorial Miyamoto Crater site is the most benign in terms of environmental conditions and may have important science outcrops within the landing site ellipse. There are also good targets for an extended mission outside of the nominal ellipse. A north Meridiani site has been retained for landing site safety issues, but may be less interesting scientifically. The northern Nili Fossae and two southern sites, Eberswalde and Holden are go-to sites (less so for Eberswalde) and have many issues including low winter temperatures. The Mawrth Vallis site has potential for interesting materials in or close to the landing site ellipse, but is relatively far north and may also have low temperatures for part of the martian year.



Fig. 2. Possible configuration of the European Space Agency's ExoMars rover. From ESA.

Conclusions – The selection of landing sites for rover missions prior to MSR will have an important bearing on the potential scientific success of the Mars Sample Return mission. Discovery of interesting materials at these sites in locations accessible to sample return missions will provide additional enthusiasm for an MSR mission.

MEASUREMENTS OF COSMOGENIC NUCLIDES IN AND THEIR SIGNIFICANCE FOR SAMPLES RETURNED FROM MARS. K. Nishiizumi¹, M. W. Caffee², G. F. Herzog³, and R. C. Reedy⁴, ¹Space Sciences Laboratory, 7 Gauss Way, University of California, Berkeley, CA 94720-7450, USA (kuni@ssl.berkeley.edu), ²Department of Physics, Purdue University, West Lafayette, IN 47907, USA (mcaffee@purdue.edu), ³Department of Chemistry, Rutgers University, Piscataway, NJ 08854-8087, USA (herzog@rutchem.rutgers.edu), ⁴Institute of Meteoritics, University of New Mexico, Albuquerque, NM 87131, USA (rreedy@unm.edu)

Introduction: Sample return missions enable the use of state-of-the-art scientific equipment and techniques in labs on terra firma to investigate extraterrestrial samples. The Genesis and Stardust missions are excellent examples of the scientific yield made possible by sample return. The availability of even a small amount of sample allows complementary multiple techniques to be applied to the same sample and in many instances duplicate measurements can also be made. The importance of sample return for Martian chronology in particular was reviewed [1].

Cosmogenic nuclides (CNs) are produced by cosmic-ray nuclear interactions with target nuclei in rocks, soils, ice, and the atmosphere. CNs have been widely used for the investigation of solar system matter for several decades [e.g., 2]. Concentrations of stable nuclides, such as ³He, ²¹Ne, and ³⁸Ar, may grow monotonically over time as the target material is exposed to cosmic rays. The concentrations of cosmogenic radionuclides, such as ¹⁰Be, ²⁶Al, and ¹⁴C also build up with exposure time but reach saturation values after several half-lives.

Especially since the advent of accelerator mass spectrometry (AMS), CNs in terrestrial samples have been routinely used to study the timing of glaciation, surface erosion rates, subduction rates, and atmospheric and ocean circulation [e.g., 3]. CNs on Mars will be able to answer questions about crater ages, cosmic-ray exposure ages, erosion rates of rocks and surface materials, tectonic events, and deposition rates of sediments and/or volatiles. The concentrations of cosmogenic stable nuclides give the integrated exposure time of the target rock/mineral, and the activities of radionuclides give recent records of exposure for times up to a few half-lives.

Cosmogenic Nuclides on Mars: Unhindered by either a substantial atmosphere or a planetary magnetic field, galactic cosmic rays (GCR) readily reach the Martian surface at a rate much higher rate than on Earth. The CN production rates and depth profiles on the Martian surface are similar to those on the Moon, even after taking into account the average Martian atmospheric depth of ~15 g/cm², which removes mainly the much lower-energy solar cosmic rays. The production rates of various CNs on Mars have been calculated using the LAHET Code System that has been well tested using a database of CN observations in lunar, meteoritic, and terrestrial samples. These results show

that the production rates of CN on Mars are 3 orders of magnitude higher than those on the Earth's surface and similar to those in meteorites and lunar samples. Consequently many CNs should be measurable in Martian surface samples.

The applications of CNs on Mars will be similar to terrestrial applications related to landscape evolution that include: erosion and exposure histories (glaciation, floods, landslides, and faults); ages of impact craters; deposition or ablation rates of soils and icecaps; and ages of young volcanic eruptions. On Mars, the determination of 'modern' steady state erosion rates of bedrock surfaces may give information on long-term erosion rates of the surface. The histories of aeolian dust and layered terrains near the poles can also be studied. The use of multiple CNs will be required to constrain exposure histories of Martian surface samples.

Table 1. Selected cosmogenic nuclides made on Mars.

Nuclide	Half-life (yr)	Major targets
⁵⁴ Mn	0.855	Fe
²² Na	2.61	Mg, Si
⁶⁰ Co	5.27	Co
¹⁴ C	5,730	O
⁴¹ Ca	1.04x10 ⁵	Fe, Ca
⁸¹ Kr	2.3x10 ⁵	Sr, Y, Zr
³⁶ Cl	3.01x10 ⁵	Cl, K, Ca, Fe
²⁶ Al	7.05x10 ⁵	Mg, Al, Si
¹⁰ Be	1.36x10 ⁶	C, O, Mg, Si
⁵³ Mn	3.7x10 ⁶	Fe
¹²⁹ I	1.57x10 ⁷	Te, Ba, REE
³ He	Stable	O, Mg, Si, Fe
²⁰⁻²² Ne	Stable	Mg, Si
^{36, 38} Ar	Stable	Ca, Fe
¹⁵⁰ Sm	Stable	¹⁴⁹ Sm
¹⁵⁸ Gd	Stable	¹⁵⁷ Gd

Some CNs of particular promise for unraveling the histories of Martian surfaces are listed in Table 1 along with their half-lives and the major target elements from which production occurs. They are often used in combination with one another. For example, the ²¹Ne-¹⁰Be-²⁶Al combination is a powerful one for solving complex exposure histories of both terrestrial surface morphologies and histories of meteorites. However, given the present detection methods and limits these important CNs can only be measured in returned samples.

Issues Addressed by Measurements of Cosmogenic Nuclides: An important objective of Martian

chronology studies is to construct a timeline for the evolution of the planet.

Absolute age of impact craters. At present, the absolute chronology of Mars is based on scaling a cratering rate established for the Moon by dating of returned lunar samples. However, uncertainties of the scaling relation create large uncertainties on Martian chronology [e.g., 4]. Absolute age measurements of a few critical craters would permit calibration of a long-term cratering flux rate on Mars and its use as a planet-wide dating tool. Based on results for meteorites (asteroidal) and lunar samples, we anticipate that Martian surface materials have been exposed to cosmic rays for only a small fraction of the age of the solar system. Ejection by an impact is one mechanism (volcanism and surface erosion or ablation are others) for excavating deeplying material, and thereby starting the cosmic-ray clock. The exposure ages of impact ejecta provide an absolute determination of a crater's age (e.g., South Ray and North Ray Craters on the Moon and Meteor Crater on Earth). Analogous information for a Martian crater would provide a crucial, absolute calibration point for relative terrain ages obtained by crater counting.

Surface exposure ages and erosion rates. The Martian surface is also modified by wind, flood, glaciation, and landslides. CN concentrations and ratios reveal the timing and rate of such events. Micrometeorite milling erodes lunar samples at rates of ~mm/Myr. Wind-blown dust particles also erode (and may bury) surface features. Erosion rates on Mars are not well constrained, but will fall naturally out of modeling calculations, where they appear as necessary parameters in the deconvolution of CN depth profiles and activity ratios.

Regolith gardening. The rate of gardening (overturn and mixing by meteorite impact) in a regolith can be inferred by comparing the depth profiles of CNs in short cores [5]. Deeper-scale gardening processes can be deduced by comparing the depth profiles of CNs that are produced by thermal neutron capture but have different half-lives. Good candidates for such measurement are radioactive ^{41}Ca , ^{60}Co , and stable $^{156,158}\text{Gd}$ and ^{150}Sm . The study of Martian ^{14}C has been proposed as a way to probe the nature of atmosphere-regolith interactions [6]. However, the Martian atmosphere is thin so production of ^{14}C from soil nitrogen, and perhaps even oxygen could complicate any interpretation [7]. Nevertheless, ^{14}C will be produced and deposited on surface materials and its presence is potentially a tracer for chemical reactions occurring in the regolith.

Ice cap evolution. Ratios and concentrations of two or more CNs with different half-lives measured in rock fragments in the ice cap will provide average ice accumulation or sublimation rates. CNs in ice will also constrain ice transport histories.

Sampling Requirements for Mars Sample Return:

Sample Size. Although masses needed for measurement of CNs vary for the nuclides listed in Table 1, meteoritic and lunar samples weighing 10-100 mg usually suffice. For micrometeorites, we have measured ^{10}Be and ^{26}Al in individual particles weighing ~10 μg [8]. Noble gas measurements in cosmic spherules have been reported [e.g., 9]. However, measurements of ^{129}I , ^{41}Ca , or ^{14}C in samples of less than 1 mg are impossible with the present detection limits. With current technology, the most promising approach for small samples will be to measure the cosmogenic noble gases and the radionuclides ^{36}Cl , ^{26}Al , ^{10}Be , and ^{53}Mn . Although we do not know how much mass early Mars sample return missions will bring back, the amounts may will almost certainly be smaller than the Apollo missions returned. A few tens of μg of sample would enable us to measure 3-4 CNs with less than 10-20% uncertainty, although the precision will depend on the specific exposure history of the material. If a larger sample is available, measurements of both stable and radioactive CNs could be made for samples taken from depths of up to ~3 m depending on the details of the irradiation. At greater depths, the production of CNs is likely to have been too small to measure.

Sample handling. Cosmic ray exposure geometry is needed to calculate exposure histories. Documentation of the sample setting before, during, and after sampling will be required. The documentation of Apollo astronauts is a good model. The irradiation of the samples during the return trip to Earth raises additional complications [10]. Large solar particle events and GCR particles could produce short-lived radionuclides such as ^{54}Mn , ^{22}Na , and ^{60}Co at levels comparable to those present at the time of sample collection. As massive shielding of the return capsule is not feasible, and would increase rates for GCR-induced reactions, some means for monitoring the production of CNs should be included in the design of the mission.

Acknowledgments: This work was supported by NASA Cosmochemistry Program grants.

References: [1] Doran P. T. et al. (2004) *Earth Sci. Rev.*, 67, 313-337. [2] Reedy R. C. et al. (1983) *Annu. Rev. Nucl. Part. Sci.*, 33, 505-537. [3] Tuniz C. et al. (1998) Accelerator Mass Spectrometry; Ultrasensitive Analysis for Global Science. CRC Press. [4] Hartmann W. K. and Neukum G. (2001) *Space Sci. Rev.*, 96, 165-194. [5] Langevin Y. et al. (1982) *JGR*, 87, 6681-6691. [6] Jakosky B. M. et al. (1996) *JGR*, 101, 2247-2252. [7] Masarik J. and Reedy R. C. (1997) *LPS, XXVIII*, 881-882. [8] Nishiizumi K. et al. (2007) *LPS, XXXIII*, #2129. [9] Olinger C. T. et al. (1990) *EPSL*, 100, 77-93. [10] Gooding J. L. (1990) *NASA Technical Memorandum Series, NASA-TM-4148*, 242.

TRANSITION BETWEEN ALTERED AND NON-ALTERED MINERALS IN MAWRTH VALLIS AND ARABIA TERRA. E. Z. Noe Dobrea¹, J.L. Bishop², N.K. McKeown³, G. Swayze⁴, J.R. Michalski⁵, F. Poulet⁵, J.-P. Bibring⁵, J.F. Mustard⁶, B.L. Ehlmann⁶, R. Arvidson⁷, R.V. Morris⁸, S. Murchie⁹, E. Malaret¹⁰, C. Hash¹⁰, and the CRISM Team. ¹ Calif. Inst. Tech./JPL, 4800 Oak Grove Drv, Mail Stop 183-501, Pasadena-CA-91109 (eldar@caltech.edu); ² SETI Institute/NASA-ARC, Mountain View, CA; ³ UCSC, Santa Cruz, CA; ⁴ USGS, Denver, CO; ⁵ IAS, Univ. of Paris, Orsay, France; MD, ⁶ Brown University, Providence, RI; ⁷ Washington University, Saint Louis, MO 63130; ⁸ NASA-JSC, Houston, TX; ⁹ APL, Laurel, MD ¹⁰ ACT, Inc. Herndon, VA 20170

Introduction: There are two primary objectives that a sample return mission to another planet should accomplish: 1) return samples that will allow us to answer key questions about a planet's geological history, and 2) return a set of samples that can be considered "characteristic" of a planet's surface in order to understand the planet's current geological state. In the case of Mars, there are a few outstanding questions that will greatly benefit from a sample return mission.

One aspect that is of particular interest to understanding the geological history of Mars is constraining the time period and style in which aqueous alteration occurred. The identification of phyllosilicates by the OMEGA team [*e.g.*, 1, 2] and recent observations by the Compact Reconnaissance Imaging Spectrometer for Mars (CRISM) of the Noachian highlands on Mars provide strong support to the idea that there was a period of significant aqueous alteration on Mars, and that the strata associated with this time period have been since overlain by unaltered materials such as lava flows and airfall dust and/or ash. Determining the age and alteration style of the strata associated to the alteration period, as well as the age of the contact between the altered and unaltered materials will provide definitive measurements that will allow us to address the question of the duration and chronology of aqueous alteration on Mars.

Phyllosilicate exposures on Mars: The two largest exposures of phyllosilicates observed on Mars are located on the plains around Mawrth Vallis [1,3] and in the region around Nili Fossae [4,5]. Smaller exposures have also been identified scattered throughout the highlands of Terra Tyrhena [6], some portions of Arabia Terra [7], Eridania Basin [8], and Meridiani Planum [9]. Although numerous hypothesis have been suggested regarding the formation of these phyllosilicates-bearing units, there is one thread of observation that appears to be common to all these units: they all appear to have been exhumed or excavated from under a layer or layers of unaltered (sometimes mafic) material. This observation, coupled to the global distribution of the observed phyllosilicates, suggests that aqueous alteration was a globally-active process early in Martian history. However, we still do not know long this period

lasted, whether it was a continuous or cyclic event, or what was the geologic context in which the alteration took place. In this work, we focus on the phyllosilicates observed in the Mawrth Vallis and Arabia Terra Region because they present mineralogies and landforms that may allow us to address at least some of these unknowns.

Mawrth Vallis: The largest exposure of phyllosilicates on Mars occurs on the plains surrounding Mawrth Vallis, where phyllosilicates are detected over a continuous area of roughly 200 x 300 km [*e.g.*, 1,3,10]. The phyllosilicate units are observed to underlie a ~100 m thick layer of competent (*i.e.*, cliff forming), boulder-shedding dark material which drapes unconformably over the clay-bearing units [11] and forms a cap rock. This material is spectrally featureless and contrasts starkly with lighter-toned underlying material, which presents absorptions diagnostic of hydrated silicates. At least three different types of phyllosilicates have been found in this region (Fe/Mg-smectites, Al-smectites, and Kaolinite-group phyllosilicates) [12,13,14]. These minerals appear spatially distinct at CRISM resolutions (~20 m/pixel), and are typically associated with either light-toned, finely layered units or massive layered units that show a variety of distinct surface textures. Fe/Mg smectites (identified by absorptions around 1.4, 1.9, and ~2.3 μm) are typically found at the bottom of the stratigraphic sequence, and appear to be spatially the most abundant (14). Sandwiched between the Fe/Mg smectites-bearing units and the overlying dark unit is a unit that displays spectral absorptions at 1.4, 1.9, and ~2.2 μm . The specific band-center and shape of the 2.2- μm band can be used to discern between Al smectites and hydrated glasses, such as Opal-A. Comparisons of CRISM and OMEGA spectra of these units to laboratory spectra of phyllosilicates and hydrated glasses present in volcanic ashes suggest that this unit contains both of these mineralogical candidates. The exact spatial distribution of these minerals is still being studied.

Arabia Terra: Ongoing spectral studies of western Arabia Terra have also identified the presence of hydrated minerals in small (~10 km) localized areas [7]. Mineralogically and stratigraphically, these hydrates are very similar to those observed in

the Mawrth Vallis region, up to 500 km away: Light-toned and layered Fe/Mg smectite-bearing units are overlaid by a unit which interpreted contain hydrated glass, which is in turn overlaid by a dark, spectrally featureless unit (Figure 1). Each of these units is morphologically similar to those observed around Mawrth Vallis, suggesting that the alteration process that formed the hydrated minerals in the Mawrth Vallis region were not constrained only that region, and that it may have been part of the same processes that produced the altered minerals that have been identified in the Nilli Fossae and Terra Tyrhena region.

Relevance to a sample return mission: At least some of the samples collected by a sample return mission should be expected to be characteristic of the planet as a whole, and should allow us to obtain general information about its geological history. Data being returned by OMEGA and CRISM strongly suggest that aqueous alteration was a global process at some point in Martian history, and that after this process ended, additional unaltered materials were deposited on top of the altered units. It would therefore seem necessary that samples representative of both the alteration period (or periods) non-alteration period(s) be returned. As such, it is important to identify locales where a boundary between these two periods is well defined.

In the Arabia Terra/Mawrth Vallis region, the stratigraphic transition from an upper layer of unaltered material, to a middle layer that appears to contain hydrated glass, to a lower layer that contains Fe/Mg bearing smectites strongly suggests that the middle layer is an alteration front, and that it defines a boundary between a period of aqueous alteration and a subsequent period of no alteration. Additionally, the smectites-bearing units in this region are in many cases layered down to the limit of resolution (~50 cm in HiRISE data). Return of both altered and unaltered samples from such a region would allow us to constrain the age at which aqueous alteration processes became less significant, as well as constrain the degree of aqueous activity at different time periods, based on samples return from the different layers that could be sampled.

References: [1] Poulet, F., *et al.* (2005) *Nature*, 438, 632-627. [2] Bibring J-P. *et al.*, *Science* v307, 1576-1581 (2005). [3] Noe Dobrea, E.Z. and Michalski J.R. (2006) *AGU Fall 2006*, #P23D-0091. [4] Mustard *et al.*, (2007) *J. Geoph. Res.* 112, E8. [5] Mangold *et al.* (2007) *J. Geoph. Res.* 112, E8. [6] Pelkey *et al.* (2007) *LPSC 38* # 1338. [7] Noe Dobrea *et al.* (2008) *LPSC 39* # 1077. [8] Noe Dobrea *et al.*, (2007) *2nd MSL Landing Site Workshop*. [9] Ehlmann

B. *et al.* 7th Mars Conference (2007). [10] Loizeau D. *et al.* (2007) *JGR*, 112. [11] Michalski, J.R. and Noe Dobrea, E.Z., (2007) *Geology*, 35, pp. 951-954. [12] Ehlman [13] Bishop J. L. *et al.* (2008) *LPSC 39*, [14] McKeown N. K. *et al.* (2008) *LPSC 39*.

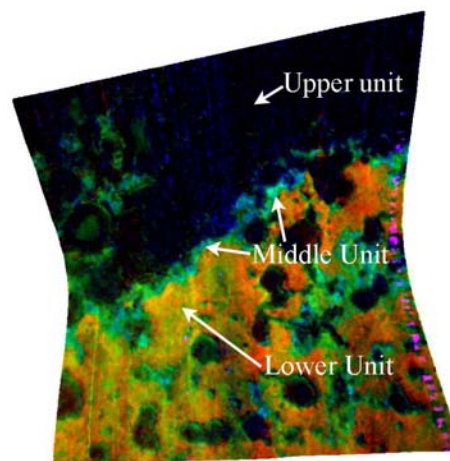

Figure 1: (B) Color composite of parameters maps for FRT8838, where R: D2300 (2.3 μ m feature [7]), G: OLINDEX (ferrous index), B: BD2210 (2.21 μ m feature). In this figure, Fe/Mg smectites appear as red/yellow, hydrated glass and/or Al phyllosilicates appear as blue, and featureless units appear as black.

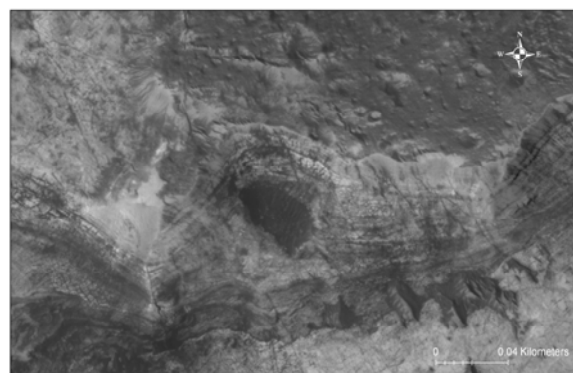

Figure 2: HiRISE view of layered light-toned outcrops overlaid by a darker cratered unit in the Mawrth Vallis region. North is up and sun is from the lower left.

PROSPECTS FOR CHRONOLOGICAL STUDIES OF MARTIAN ROCKS AND SOILS. L. E. Nyquist¹, C-Y. Shih², and Y. D. Reese³, ¹Mail Code KR, NASA Johnson Space Center, Houston, TX 77058, laurence.e.nyquist@nasa.gov, ²Mail Code JE-23, ESCG/Jacobs Sverdrup, P.O. Box 58477, Houston, TX 77058, chy.shih@nasa.gov, ³Mail Code JE-23, ESCG/Muniz Engineering, Houston, TX 77058, young.reese@nasa.gov.

Introduction: Chronological information about Martian processes comes from two sources: Crater-frequency studies and laboratory studies of Martian meteorites. Each has limitations that could be overcome by studies of returned Martian rocks and soils.

Chronology of Martian volcanism: The currently accepted chronology of Martian volcanic surfaces relies on crater counts for different Martian stratigraphic units [1]. However, there is a large inherent uncertainty for intermediate ages near ~2 Ga ago. The effect of differing preferences for Martian cratering chronologies [1] is shown in Fig. 1.

Stöffler and Ryder [2] summarized lunar chronology, upon which Martian cratering chronology is based. Fig. 2 shows a curve fit to their data, and compares to it a corresponding lunar curve from [3]. The radiometric ages of some lunar and Martian meteorites as well as the crater-count delimiters for Martian epochs [4] also are shown for comparison to the crater-frequency curves. Scaling the Stöffler-Ryder curve by a Mars/Moon factor of 1.55 [5] places Martian shergottite ages into the Early Amazonian to late Hesperian epochs, whereas using the lunar curve of [3] and a Mars/Moon factor ~1 consigns the shergottites to the Middle-to-Late Amazonian, a less probable result. The problem is worsened if a continually decreasing cratering rate since 3 Ga ago is accepted [6]. We prefer the adjusted Stöffler-Ryder curve because it gives better agreement with the meteorite ages (Fig. 3).

Comparing Fig. 3 and Fig. 1 gives dramatically different impressions of Martian chronology. For example, assuming that suitable habitats for flowering Martian life are most likely to have existed in the Noa-

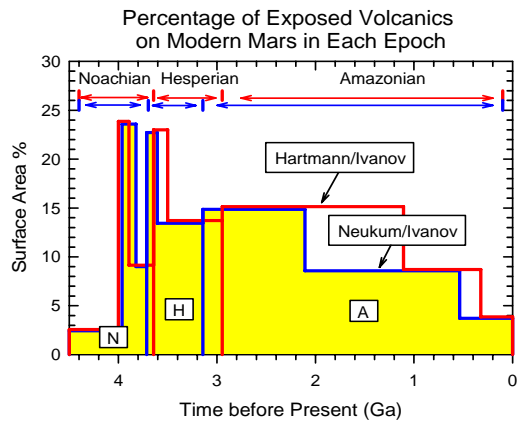

Figure 1. Age distributions for volcanic surface units on Mars using the dating systems of Hartmann/Ivanov (red) and Neukum/Ivanov (blue). From Fig. 15 of [1].

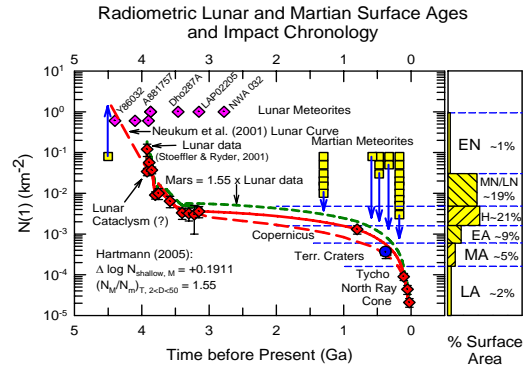

Figure 2. Lunar cratering frequency curve constructed from data summarized by [2] compared to that of Neukum et al. [3] and the ages of some lunar and Martian meteorites. chian, the revised chronology of Fig. 3 doubles the corresponding time interval from ~4.5 to ~3.5 Ga ago to ~4.5 to ~2.5 Ga ago. Dating Martian basalts returned from known locations would remove the uncertainty on the Moon/Mars scaling factor, and thus on the time interval most conducive to emergence of Martian life.

Chronology of aqueous activity: Crater-frequency chronologies require counting craters within areas with statistically significant numbers of craters. However, the search for Martian life within a returned Martian sample will be done on a micro-scale, as for carbonates in the Martian meteorite ALH 84001 [7]. If a positive result is obtained, chronological methods will need to be tailored to the specific habitat in which evidence is found. For the ALH 84001 carbonates, chemical zoning in carbonate globules resulted in radiogenic parent/daughter elemental fractionation that

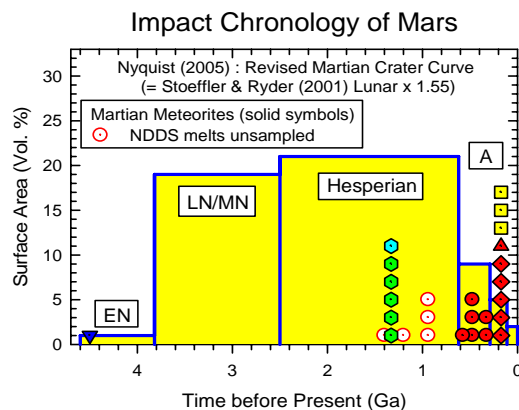

Figure 3. Martian meteorite ages compared to the age distribution of Martian volcanic surface units using a modified Martian crater-frequency curve = (Stöffler-Ryder) x 1.55.

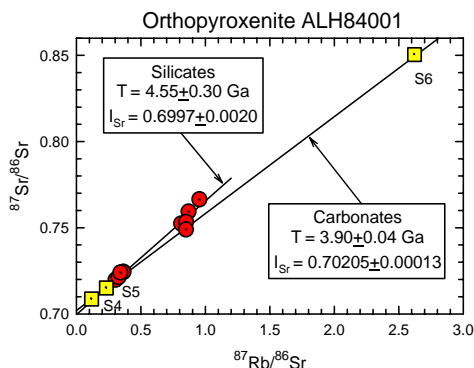

Figure 4. Rb-Sr isochrons for carbonates and host silicates in ALH 84001. Data from Borg et al. [8].

was exploited to determine the carbonate age (Fig. 4).

It is likely that the first Martian sample will be selected to contain evidence of past water. Sulfates are observed from orbit [9] and are present at the Opportunity landing site in Meridiani Planum [10]. To investigate the type of parent/daughter elemental fractionation expected for Martian sulfates, we measured the Rb/Sr ratios of gypsum, kieserite, and jarosite terrestrial analogs courtesy of R. Morris.

Two hypothetical scenarios are illustrated in Fig. 5. For sulfates developed on bedrock of basaltic shergottite composition and 180 Ma old, K-jarosite with $^{87}\text{Rb}/^{86}\text{Sr} \sim 1.0$ would allow determination of a “precipitation age” as low as ~ 10 Ma, assuming a single event, or several events closely spaced in time. For ancient terrain (Fig. 5, bottom), a precise age would be expected even in the absence of K-jarosite. In case of apparent protracted sulfate precipitation, individual phases with contemporaneous sulfates would be sought. Ages also would be obtained by additional techniques, for example, laser $^{40}\text{Ar}/^{39}\text{Ar}$ dating [11]. Concordant ages by two or more techniques would verify the reliability of the chronometry.

Isotopic tracers for regolith components: Void-filling glasses in EET 79001 (“Lithology C”) contain Martian atmospheric gases and S-bearing globules that likely are vestiges of impact-molten Martian regolith [12]. Variations in Sr-isotopic composition observed for lithology C compared to the igneous lithologies A and B [13] probably reflect the presence of “exotic” Ca sulfides and sulfates in the Martian regolith [12]. Such regolith components are expected as a result of aeolian transport. The ultimate origin of non-mass-dependent S-isotopic fractionation in Martian sulfides may be photolysis in the Martian atmosphere [14]. Isotopic studies of returned Martian regolith could distinguish regolith components of differing origins.

Epilog: Here we avoided conclusions about Martian geochemical evolution from studies of “Martian” meteorites, emphasizing instead topics relevant to the

“life” goal of Martian exploration, for which the meteoritic evidence is fragmentary. Nevertheless, a high-priority goal of MSR should be acquiring evidence to rule definitively for or against the Martian meteorite hypothesis, and to acquire igneous rocks whose analysis will complement the meteorite data. Very high analytical precision appears to be required to address some issues of Martian isotopic evolution, as has been demonstrated for meteorites (e.g., [15]). Similar or better precision should be possible for returned rock samples devoid of shock effects.

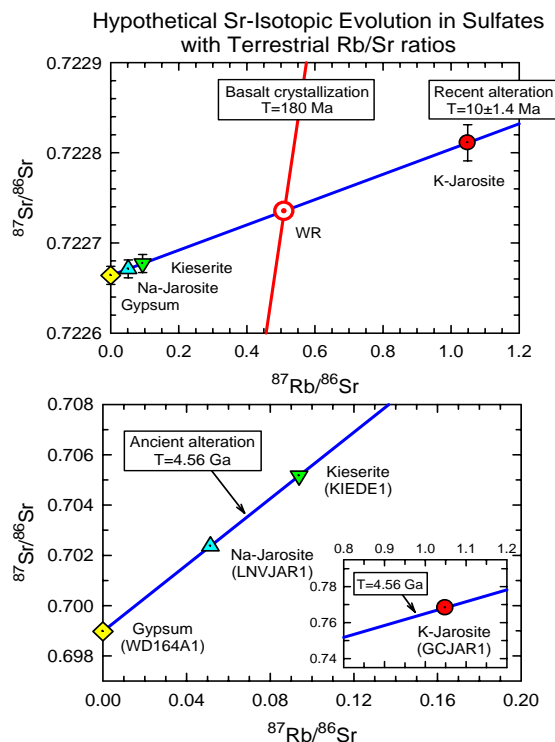

Figure 5. Hypothetical Sr-isotopic evolution in young (top) and ancient (bottom) Martian sulfates using Rb/Sr measured for terrestrial analogues.

- References:** [1] Hartmann W. K. and Neukum G. (2001) *Space Sci. Rev.* 96, 165-194. [2] Stöffler D. and Ryder G. (2001) *Space Sci. Rev.* 96, 9-54. [3] Neukum G. et al. (2001) *Space Sci. Rev.* 96, 55-86. [4] Tanaka K. L. (1986) *PLPSC17, JGR 91*, 139-158. [5] Hartmann W. K. (2005) *Icarus 174*, 294-320. [6] Quantin C. (2007) *Icarus 186*, 1-10. [7] McKay D. S. et al. (1996) *Science 273*, 924-930. [8] Borg L. E. et al. (1999) *Science 286*, 90-94. [9] Bibring J.-P. (2005) *Science 307*, 1576-1581. [10] Squyres S. W. et al. (2004) *Science 306*, 1709-1714. [11] Vasconcelos P. M. et al. (1994) *GCA 58*, 401-420. [12] Rao M. N. et al. (1999) *GRL 26*, 3265-3268. [13] Nyquist et al. (1986) *LPS XVII*, 624-625. [14] Farquhar J. (2000) *Nature 404*, 50-52. [15] Debaille V. et al. (2007) *Nature 450*, 525-528. [16] Nyquist L. E. et al. (2005) *LPS XXXVI*, Abstract #1374.

WHY AN “EARLY” MARS SAMPLE RETURN: LESSONS FROM APOLLO. D. A. Papanastassiou, Science Division, Jet Propulsion Laboratory, California Institute of Technology, MS 183-335, 4800 Oak Grove Drive, Pasadena, CA 91109-8099, Dimitri.A.Papanastassiou@jpl.nasa.gov.

Introduction: The return of samples by the Apollo astronauts permitted the culling of a plethora of scientific expectations and predictions, which were en vogue, prior to sample return. Many of these expectations about the Moon were not confirmed by the analysis of returned samples. Neither the expectations of a very primitive surface of the Moon, nor of a very young surface and ages, based on observed crater-size frequency curves proved to be correct. The surface of the moon was not primitive, but was in part covered with intermediate-age lava flows, although without evidence of volcanic craters. Some of the physical-chemical processes on the surface of the Moon, such as glass formation and isotope fractionation due to escape of volatilized materials from the Moon were not anticipated. In a similar fashion, mechanical properties of the lunar soil and soil gardening processes were not well known. Certainly, predictions of significant “sinking” in the lunar soil were not correct.

Discussion: One of the main characteristics of science on Apollo samples was the infusion of physicists, chemists, and geologists into the new field of interdisciplinary planetary sciences and the wholesale development of advanced analytical techniques and laboratory instrumentation. These techniques were later applied to terrestrial work and to meteorite research, including Martian meteorites, and have led to major advances. Many of the analytical techniques, which we now take for granted, were developed during and shortly after Apollo, as the result of key science investigations of Apollo samples. I review several such key developments:

Age Dating. The crater size frequency curves could not have “guessed” the actual age distribution of rocks on the lunar surface, which reaches a steep peak at 4.0 Ga ago, with mare basalts essentially limited in age between 3.9 and 3.0 Ga ago. The recalibrated crater size frequency spectrum, based on Apollo sample ages, now peaks either at ~4.0 Ga (according to the Terminal Lunar Cataclysm hypothesis) or is a very steeply increasing curve at ~4.0 Ga, which prevents the identification of earlier surfaces and events. Analytical capabilities for age dating were developed in anticipation of the return of lunar samples and also as the result of the returned samples: a) isotope dating prior to Apollo included the introduction of new high precision (0.01 to 0.005%) isotope ratio determinations and their application to Rb-Sr dating; this success subsequently led to commercial instruments for similarly high precision isotope ratios, introduced in the late 70s; b) the ⁴⁰Ar-

³⁹Ar technique was improved and applied extensively to lunar samples. It was established as a reliable technique, least subject to artifacts from Ar diffusion and ³⁹Ar recoil loss (from fine-grained, interstitial phases, during sample activation in a neutron reactor), when used for the measurement of plagioclase mineral separates from mare basalts; c) in response to the very high U/Pb ratios on the Moon and the low ²⁰⁴Pb abundances, sufficiently low-blank techniques were developed for U-Th-Pb only after the end of the Apollo missions. These techniques enabled mare basalt dating and the work on highland breccias and anorthosites, which established the nature of the parentless, mobilized, radiogenic Pb on the Moon and led to the Terminal Lunar Cataclysm hypothesis; d) the Sm-Nd technique was developed well after the Apollo missions, but to a large extent based on the earlier development of rare earth element chemical separations and solid source mass spectrometry techniques for Gd (and then Sm), developed on meteorites, in full anticipation of secondary neutron capture effects in the returned lunar samples. The Sm-Nd technique has revolutionized lunar, other extraterrestrial, and terrestrial sample dating and the development of fundamental planetary evolution models. This was clearly recognized by the 1986 Crafoord Prize award, in geosciences; e) during Apollo, the rough concentrations of platinum group elements (mostly Ir, with Re measurements being scarce, due to blanks) were obtained by neutron activation. The development of the Re-Os technique, in the early ‘90s, long after the Apollo missions, has permitted the precise measurement of Re and Os systematics and the identification of well-defined exotic meteorite components on the lunar surface and in lunar breccias, as a function of the time of their formation.

Cosmic Ray Irradiation effects. The measurement of cosmic ray irradiation effects used established and improved sensitivity techniques and addressed the range of exposure ages on the lunar surface, which was larger than typical exposure ages of chondritic meteorites. Detailed depth profiles in rocks (including in rocks with documented orientation on the lunar surface) were obtained. In addition, regolith gardening processes were studied as a function of depth down to 2.5 m using thermal and epithermal secondary neutron capture in Gd and Sm isotopes with large neutron capture cross sections. The deposition of meter-thick ejecta, without subsequent disturbance for ~0.5 Ga was established. Based on the results on the first missions, it was even possible to design, qualify for (hu-

man) space flight, and fly an in situ secondary neutron detector, the neutron probe, which was returned to Earth for the nuclear track measurements. The techniques for Gd and Sm also led directly to Sm-Nd dating, as addressed above.

Micrometeorite Bombardment and Glass formation. The presence of glass in the Apollo 11 returned samples was a complete surprise, and a source of some fun and wonder, in finding glass, glass spheres and dumbbells, hollow glass spheres, plus micro meteorite craters on the various glasses, termed “zap pits”. By contrast, we now fully expect the formation of glass and agglutinates on an airless planetary surface, exposed to micrometeorite bombardment. However, at the time, the formation of glass as well as the reduction of Fe by the solar-wind hydrogen in Fe-bearing silicates, which resulted in darkening of Fe-bearing minerals and the overall modification of their spectroscopic signatures in the VIS-NIR were important for orbital science. This required a substantial recalibration of the spectroscopy of the surfaces of airless bodies and substantial improvements.

For stable isotopes, the earliest recognition of isotopically heavy oxygen and then silicon (as well as small effects for Ca, in weak acid leaches of soils) on the surfaces of lunar soil grains also established a new process of isotope fractionation on airless surfaces, presumably through meteorite and cosmic ray bombardment, accompanied by preferential gravitational loss of the lighter isotopes.

Lessons for Mars: The case of Mars is admittedly more complicated than the lunar case, because of the presence of water, of an atmosphere, and an expected magmatic evolution that is potentially less restricted in time than the lunar case. But precisely because of extensive data from orbital and in situ missions, it is imperative that ground truth be obtained through returned samples. Much of the complexity envisioned on the surface of Mars dictates the need for a more complex sampling process for returned samples than, for example, a simple grab-and-go mission that can be used for the Moon. However, any proposed complexity of sample collection techniques for a Mars sample return mission would need to address the quality of instruments, available to characterize samples prior to their return and the complexity of sample collection techniques. It would be a mistake to expect to do extensive, in situ instrument-based field work on Mars, prior to selecting samples for return. Based on our experience with Apollo, our ability to characterize complex samples, in situ, in the potential presence of igneous, sedimentary, and altered rocks, and in the presence of wind-blown fine materials is limited. It would make sense to seek diversity of rocks in the returned samples through the

collection of different components based on relatively simple characterization (visual and IR spectroscopy), and field location. It is good to remember that even for Apollo 11, a contingency sample was quickly obtained and then returned. It was from this contingency sample that rather major conclusions of lunar evolution were drawn, including the observation of anorthositic fragments (interpreted as evidence of a lunar-wide anorthositic crust) and a granitic fragment (dubbed Lunny Rock 1) which allowed the identification of a Rb-Sr model age much older than the age of the local basalts, and close to the age of the solar system. Arguably, this fragment was a harbinger of the KREEP-rich component on the lunar surface, recognized primarily based on Apollo 14 samples and its extent on the lunar surface, later, by orbital data.

Conclusion: This long list of achievements indicates the importance of returned samples, the recognition of new processes, based on analysis of returned samples, and our distinct lack of anticipation of processes on the surface of another planet from orbital and in situ data. It is also important to keep in mind that, even an “early” proposed Mars sample return mission, e. g., by 2020, would be more than 12 years in the future and sufficiently distant for further significant analytical instrument developments in terrestrial laboratories. Such improvements will certainly come in surface science, following the developments fueled by the GENESIS and STARDUST missions and returned samples (and funded by NASA SRLIDAP). Certainly, improved sensitivity would be in order, for all investigations, since any sample collection, returned from Mars, would be considerably smaller (by a factor of about 1000) than the amount of materials returned by Apollo.

Acknowledgement: This review and perspective is based on innumerable published results, by a myriad of investigators, over decades. A formal reference list is not possible. It is hoped that those who participated in these developments will fondly remember their effort and excitement. The Apollo generation blossomed nearly forty years ago. It is time for a Mars return sample generation to blossom and interact with the extensive work based on orbital and in situ science, already in hand and ongoing. Copyright 2008 California Institute of Technology. Government sponsorship acknowledged.

MARTIAN SULFATES: GYPSUM CRYSTAL CHEMISTRY AND CHARACTERIZATION OF TWO TERRESTRIAL ANALOGS. J.J. Papike, (jpapike@unm.edu), P.V. Burger, J.M. Karner, and C.K. Shearer, Institute of Meteoritics, Department of Earth and Planetary Sciences, University of New Mexico, Albuquerque, New Mexico 87131

INTRODUCTION: Gypsum, along with kieserite and jarosite, are the most positively identified sulfates on Mars. Large gypsum sand dunes exist near the north pole of Mars (Fishbaugh et al. [1]) and bear similarities to the gypsum sand dunes near White Sands, New Mexico (Langford [2]). We use a sample from White Sands as a terrestrial analog of evaporitic gypsum and gypsum samples from the precious metal deposit at Goldfield, Nevada (Vikre et al. [3]; Papike et al. [4]) as a terrestrial analog of hydrothermal gypsum. We will review gypsum crystal chemistry and present new EMP and SIMS analyses for the two terrestrial gypsum suites.

CRYSTAL CHEMISTRY: The crystal structure information is derived from a neutron diffraction refinement by Cole and Lancucki [5]. We present the crystal structure illustrations (Figure 1a,b) in space group C2/c with cell dimensions $a = 5.67$, $b = 15.20$, and $c = 6.53$ Å. The beta angle is 118.6 degrees. The formula units $\text{CaSO}_4 \cdot 2\text{H}_2\text{O}$ per unit cell, $Z = 4$. Thus there are 4 Ca, 4 S, 16 O, and 8 H_2O groups per unit cell. Figure 1a (projection down the c-axis) shows the C-centered nature of the unit cell and all symmetrically distinct atoms. There are three symmetrically independent oxygen atoms O(I), O(II), and O(W) and two symmetrically independent hydrogen atoms H(I) and H(II). The Ca and S atoms are in special positions and sit on 2-fold axes (Figure 1b). The important 8-coordinated Ca-site has 8 ligands, 6 oxygen atoms and 2 oxygen atoms in H_2O groups. The mineral Churchite, $\text{REE}^{3+}\text{PO}_4 \cdot 2\text{H}_2\text{O}$, is isostructural with gypsum and may suggest a charge-balancing mechanism for the incorporation of REEs and Y, namely REE-P for Ca-S. Although most gypsum is of nearly stoichiometric end-member composition there can be significant Sr substitution. The partition coefficient for Sr gypsum/fluid is ~ 0.5 (Kushnir [6]) but has a range of values from 0.2 - 0.7. **EMP ANALYSES:** Analyses presented in Table 1 were performed on a JEOL 8200 EMP at the Department of Earth and Planetary Sciences/Institute of Meteoritics, University of New Mexico. The EMP is equipped with five wavelength dispersive (WD) X-ray spectrometers and an ultrathin-window energy dispersive spectrometer. Heating under the electron beam and resulting volatilization of H_2O and S are a major concern during analysis of gypsum. Optimum conditions for WD analysis of major and minor elements were determined to be a 1 nA beam current and a 30 μm spot size at 15kV. We normalized the data to 6 oxygens per formula. We cannot analyze

for H with the electron microprobe, but the stoichiometry we determine for these samples argues for 2 H_2O groups.

SIMS ANALYSES: SIMS analyses were conducted using an oxygen beam with a 10 kV primary accelerating voltage, 20 nA beam current, and a -75 volt offset in order to minimize isobaric interferences. Ion yield was calibrated using ^{44}Ca ; Ca concentration had been independently determined using the EMP. Elements were individually calibrated using two in-house apatite standards, Durango and ORNL. Barium analyses are based solely on the NIST 610 synthetic glass standard. The SIMS data are presented in Table 2 and illustrated (chondrite normalized) in Figures 2a, b. Although the REEs are in low concentration, mainly below one times chondrite, the pattern shapes are remarkably similar. Figure 2a shows the REE patterns for 5 different White Sands gypsum grains and Figure 2b compares the average REEs for White Sands grains with the REEs for the two Goldfield samples. These REE concentrations are significantly lower than those measured in gypsum from martian meteorite Nakhla by Bridges and Grady [7] who found REE concentrations up to 100 times chondrite. The Ba concentration are also low, below 2 ppm. Strontium concentrations are higher and variable, Goldfield 200-300 ppm and White Sands 1000-3000 ppm. If we assume a D_{Sr} of 0.5 then the solutions that precipitated the gypsum, now found in the White Sand dunes, contained 2000 to 6000 ppm or between 0.2 and 0.6 wt.% Sr. These variations likely reflect different stratigraphic positions in the Permian evaporitic Yeso source formation located in the San Andres Mountains located in SW New Mexico [2]. **ACKNOWLEDGEMENTS:** We thank Laura Crossey, UNM, for the White Sands sample and Peter Vikre, USGS, for the Goldfield samples. This research was supported by a NASA Cosmochemistry grant to JJP.

REFERENCES: [1] Fishbaugh et al. (2007) JGR, 112, EO7002. [2] Langford (2003) Quaternary International, 104, 31-39. [3] Vikre et al. (2005) USGS Open-File Report 2005-1258. [4] Papike et al. (2006) Am. Min., 91, 1197-1200. [5] Cole and Lancucki (1973) Acta Cryst. B30, 921-929. [6] Kushnir (1982) GCA, 46, 433-446. [7] Bridges and Grady (2000) EPSL, 176, 267-279.

Figure 1 a.

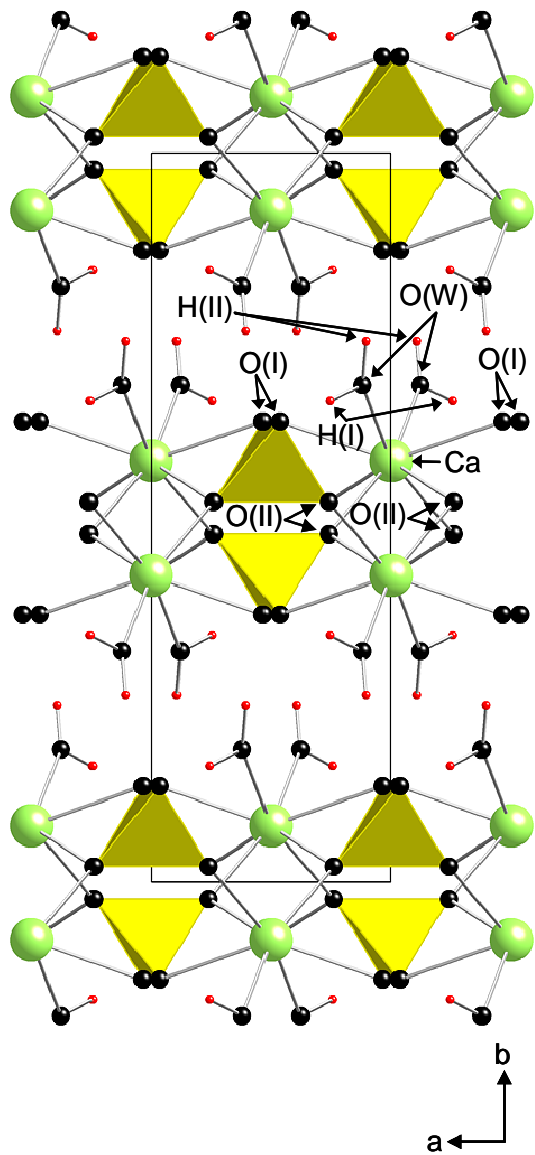

Figure 1 b.

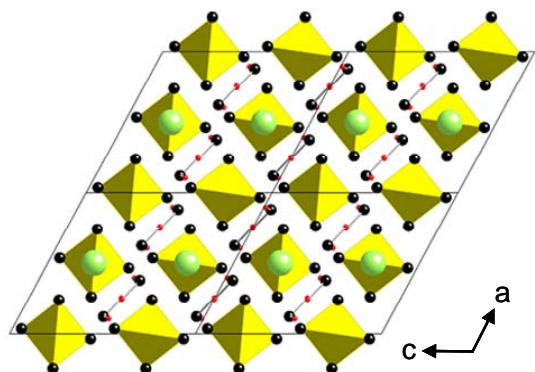

Figure 2a, b. REE patterns for gypsum.

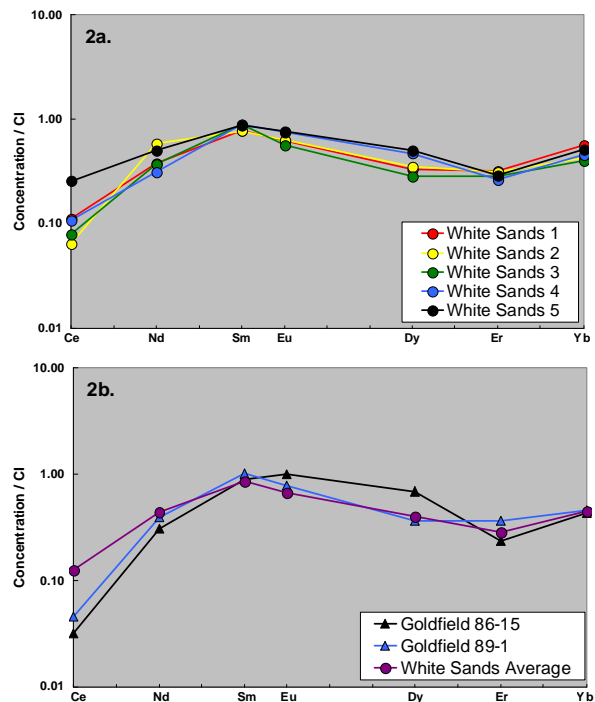

Table 1. EMP analyses of gypsum

Probe point	ws-12	ws-15	ws-18	ws-20	89-1,2	89-1,10	89-1,14	89-1,19	86-15,7	86-15,14
SrO	0.19	b.d.	0.18	0.16	b.d.	b.d.	0.07	b.d.	0.08	0.09
SO ₂	44.69	45.0	45.3	46.0	46.6	46.1	46.2	46.5	45.6	44.8
Na ₂ O	0.03	b.d.	0.07	b.d.	b.d.	0.06	0.06	b.d.	b.d.	b.d.
Fe ₂ O ₃	b.d.	b.d.	0.22	0.10	b.d.	0.06	b.d.	0.05	b.d.	b.d.
CaO	34.12	33.8	33.7	33.3	32.6	32.7	32.8	32.4	33.2	33.6
MgO	0.11	b.d.	b.d.	b.d.	b.d.	b.d.	b.d.	b.d.	0.09	0.07
K ₂ O	0.03	0.05	b.d.	b.d.	b.d.	0.04	0.04	b.d.	b.d.	b.d.
Al ₂ O ₃	0.29	b.d.	b.d.	b.d.	b.d.	b.d.	0.08	b.d.	b.d.	0.06
BaO	b.d.	b.d.	0.03	b.d.	b.d.	b.d.	0.08	b.d.	0.12	0.13
(H ₂ O) [*]	20.54	21.2	20.5	20.4	20.8	21.0	20.7	21.1	20.9	21.2
(Total)	100	100	100	100	100	100	100	100	100	100
Cations based on 6 oxygens										
Sr	0.00	0.00	0.00	0.00	0.00	0.00	0.00	0.00	0.00	0.00
S	0.97	0.97	0.99	1.00	1.00	0.99	1.00	1.00	0.99	0.97
Na	0.00	0.00	0.00	0.00	0.00	0.00	0.00	0.00	0.00	0.00
Fe ³⁺	0.00	0.00	0.00	0.00	0.00	0.00	0.00	0.00	0.00	0.00
Ca	1.06	1.04	1.05	1.03	1.00	1.01	1.01	0.99	1.03	1.04
Mg	0.00	0.00	0.00	0.00	0.00	0.00	0.00	0.00	0.00	0.00
K	0.00	0.00	0.00	0.00	0.00	0.00	0.00	0.00	0.00	0.00
Al	0.01	0.00	0.00	0.00	0.00	0.00	0.00	0.00	0.00	0.00
Ba	0.00	0.00	0.00	0.00	0.00	0.00	0.00	0.00	0.00	0.00
H	3.98	4.07	3.96	3.94	3.98	4.02	3.97	4.02	4.02	4.09
Total	6.04	6.09	6.01	5.97	5.98	6.02	5.99	6.02	6.04	6.10

b.d. = below detection
 *Calculated by difference from assumed 100% sum

Table 2. SIMS analyses of gypsum.

Sample	Sr ppm	Ba ppm	Ce ppm	Nd ppm	Sm ppm	Eu ppm	Dy ppm	Er ppm	Yb ppm
WS Avg.	1597.47	0.91	0.14	0.36	0.22	0.06	0.15	0.07	0.12
GF 86-15	219.78	0.06	0.04	0.25	0.23	0.10	0.27	0.06	0.11
GF 89-1	290.01	0.08	0.05	0.33	0.26	0.08	0.14	0.09	0.11

FUMARoles ON MARS: LESSONS LEARNED FROM THE VALLEY OF TEN THOUSAND SMOKES, ALASKA. J.J. Papike, (jpapike@unm.edu), M.N. Spilde, J.M. Karner, and C.K. Shearer. Institute of Meteoritics, Department of Earth and Planetary Sciences, University of New Mexico, Albuquerque, New Mexico 87131

INTRODUCTION: During June 6-8, 1912, a new vent (Novarupta) near Katmai in the Aleutian Range of Alaska released the largest volcanic eruption of the century and the largest rhyolitic eruption in 20 centuries. The volcanic tephra includes rhyolitic, dacitic, and basaltic compositional types. Spectacular fumaroles developed in the ash-flow sheet prompting Robert F. Griggs to name it the Valley of Ten Thousand Smokes (VTTS). For a brief review and references see Papike, 1992 [1]. We have analyzed a cross-sectional suite of samples outward from a fumarolic vent conduit into unaltered dacitic tuff [See Spilde et al., 1993 [2] for details]. The ash-flow deposit in VTTS ranges from a few meters in the lower valley 20 km from the vent to ~200 km near the vent. The hot ash fell into the valley that contained rivers, snow and ice. The flash vaporized H₂O sources mixed with the volcanic gases derived from the degassing tephra. This vapor streaming formed a variety of “rootless” fumaroles in the valley. Rootless refers to the fact that the fumaroles are not sited over the volcanic source. We feel strongly that this same process has, almost certainly, occurred on Mars over time with hot basaltic pyroclastics falling on martian H₂O and CO₂ ice. We suggest that this process formed some of the sulfates, sheet silicates, and amorphous SiO₂ deposits found on Mars.

RESULTS AND DISCUSSION: Samples J-O were taken sequentially outward from the vent wall toward less altered tuff (Figure 1). The phase identifications were conducted using XRD, EMP, and analytical TEM methods [2]. Original fumarole temperatures were as high as 645 °C but most fumaroles died out in 30 years. In this abstract we emphasize the fumarolic alteration of plagioclase and pyroxene (Figures 2a, 2b, 3a, and 3b). In slightly altered tephra, plagioclase compositions >An₇₃ are not observed, the more calcic portions of the phenocrysts having been replaced by amorphous silica. With increasing proximity to the fumarole conduit, progressively more sodic parts of the phenocrysts have disappeared. Adjacent to the fumarole, plagioclase >An₄₄ has been removed because of the increased solubility of albitic feldspar in chloride-rich fluids as a function of increasing temperature. On a submicrometer scale, a zonal sequence of replacement phases has developed at the interface between unaltered and altered feldspar. A thin leached surface layer (<500 Å), depleted in Al, Na, and Ca but highly enriched in Si and Cl is always present. In altered phenocrysts away from the vent, a

zone <5000 Å thick of amorphous Al-bearing silica is present, locally containing secondary Al-rich smectite crystals. Closer to the fumarole, smectite is absent, and a zone of impure amorphous silica occurs. Extensive alteration of pyroxene phenocrysts only occurs close to the fumarole conduit, where replacement develops along fractures parallel to (100). A narrow leached zone (200-300 Å), depleted in Mg and Ca, is present at the alteration interface, and halloysite is present locally as a secondary precipitate. The alteration of both plagioclase and pyroxene occurred when the fumarolic system cooled significantly (<300 °C) and was dominated by Si-rich, Cl bearing fluids with pH <2.5.

IMPLICATIONS FOR MARS: Certainly the sulfates, sheet silicates, and silica-enriched amorphous phases on Mars formed by a variety of processes. However, we predict with confidence, that some of these phases formed by processes described in this abstract. We will probably know soon, roughly by 2010, the significance of sheet silicates occurring at the MSL landing site. One possibility is that most are hydrothermal, fumarolic.

REFERENCES: [1] Papike (1992) GCA, 56, 1429-1449. [2] Spilde et al. (1993) Am. Min., 78, 1066-1081.

ACKNOWLEDGMENTS: This research was funded by a NASA/ Cosmochemistry grant to JJP, which we gratefully acknowledge.

Figure 1. Schematic map showing the locations of samples J-O in dacite rich ash-flow tuff in the region of the fossil fumarole conduit. The relative abundance of crystalline phases in the alteration zones are noted in the legend.

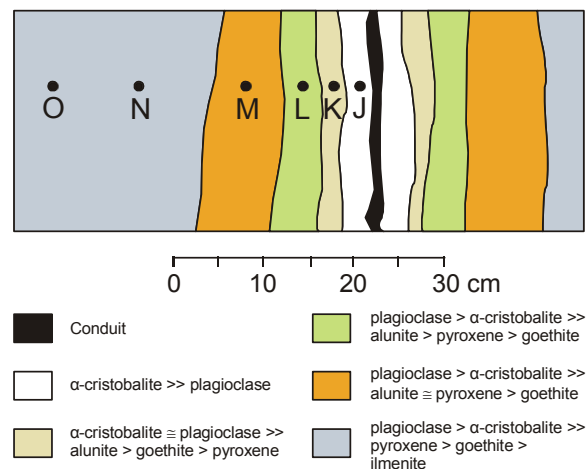

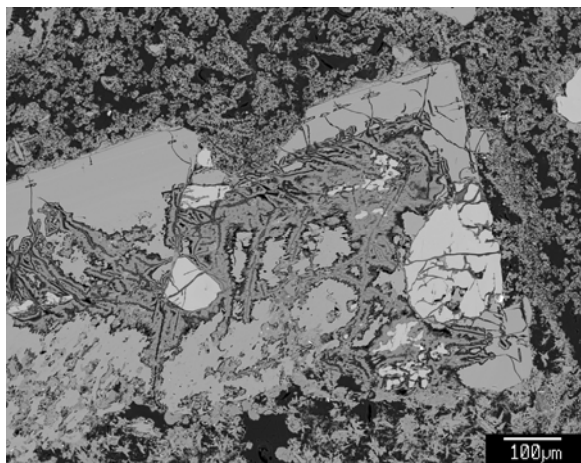

Figure 2a. BSE image of partially altered plagioclase (light gray) in which the calcic core has been replaced by amorphous SiO₂ (dark gray).

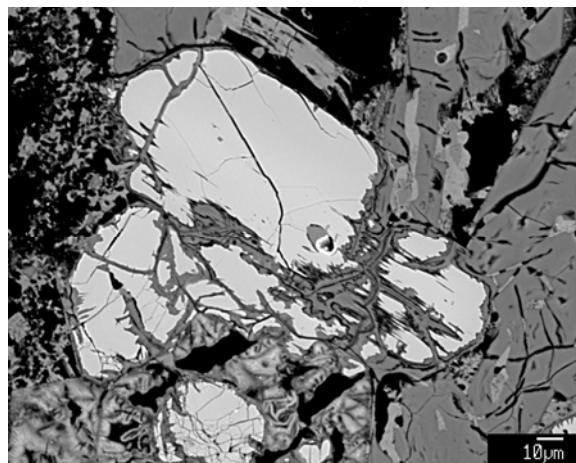

Figure 3a. BSE image of partially altered hypersthene (upper light gray grain) and augite (lower light gray grain). The hypersthene grain shows crystallographic control of the alteration.

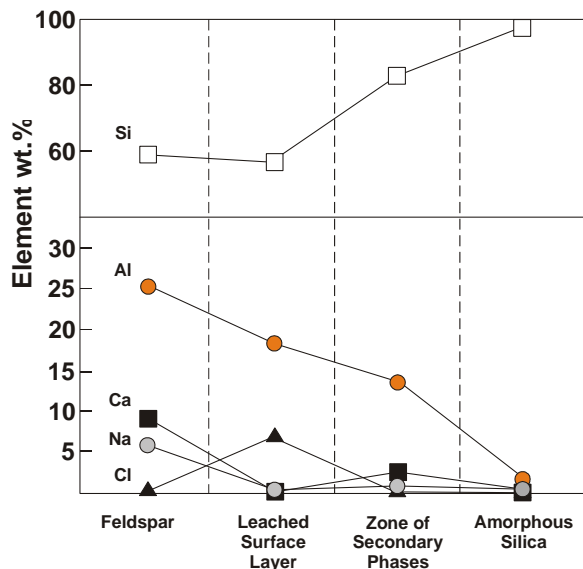

Figure 2b. Normalized element concentrations illustrating the compositional variations that occur in a traverse from plagioclase into the leached surface layer and subsequent layers of amorphous Al-bearing silica and pure silica (TEM analytical data).

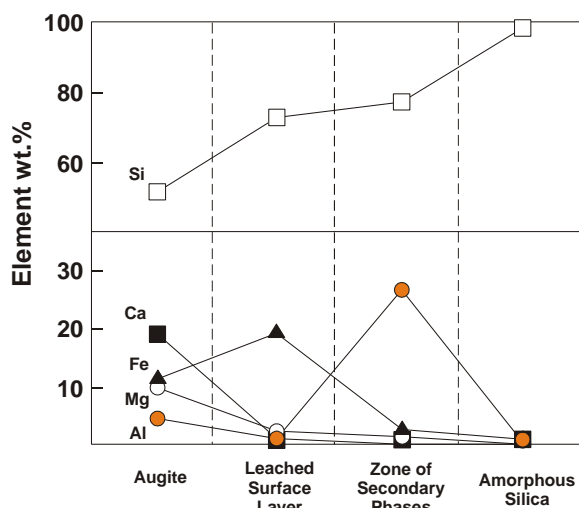

Figure 3b. Normalized element concentrations illustrating the compositional variations that occur in a traverse from unaltered augite into the alteration zone, which consists of three distinct layers (TEM analytical data). The leached layer adjacent to the augite is depleted in Ca and Mg. The second layer consists of secondary phases that have precipitated from the fluid phase, and the outer zone is composed of amorphous silica.

THE IMPORTANCE OF AN INVESTIGATION OF THE NORTHERN PLAINS. E. B. Rampe¹, M. D. Kraft¹, and T. G. Sharp¹, ¹Arizona State University School of Earth and Space Exploration, P.O. Box 1404 Tempe, AZ 85287-1404, Liz.Rampe@asu.edu.

Introduction: Thermal infrared (TIR) spectral models of low-albedo areas of the martian surface show a broad, global-scale compositional dichotomy in which the low latitudes are dominated by pyroxene and plagioclase and high latitudes are composed of plagioclase and a high-silica phase [1-3]. Initially, the high-silica phase was identified as primary volcanic glass [1], so basalt dominated low latitudes (termed surface type 1, or ST1) and andesite dominated mid to high latitudes (surface type 2, or ST2). However, spectral similarities between volcanic glass and silicate chemical weathering products led others to suggest the presence of alteration phases at ST2 [4-8] so that the compositional dichotomy was a result of chemical weathering of ST2. The nature of the high-silica phase is still unknown and its composition has important implications for the history of liquid water on the martian surface. For example, while evidence supporting the presence of weathering products over volcanic glass is growing, if glass is present, it suggests a lack of liquid water at high latitudes because glass is highly susceptible to aqueous alteration. Additionally, it necessitates an igneous origin for the compositional dichotomy, rather than chemical weathering. However, if alteration products are present in the northern plains, the nature of the alteration products can elucidate details of the history of liquid water on the surface, such as amount of liquid water present and duration of wet conditions, pH of the solution, minerals being weathered, and mechanisms for soil development. Research has also shown that alteration phases can affect igneous mineralogic interpretations from remote sensing measurements [5-7,9-13]. Therefore, a sample return mission to the northern plains is important for explaining the compositional dichotomy and the petrologic evolution of the surface.

Evidence for Water in the Northern Plains: The identification of volcanic glass in TIR spectral models from the martian surface [1,14] is evidence for a lack of liquid water in the northern plains. However, there is a wealth of evidence from Mars for a possibly habitable environment in which liquid water existed. For example, gullies, proposed to be formed by melt water from snow and/or ice, are widespread at mid to high latitudes [15-21]. Mantled terrains, attributed to the presence of surface ice and/or permafrost, are also prevalent in these regions [22-24], and the Vastitas Borealis Formation has been suggested to have formed by permafrost-related activities [25]. GRS data also show high levels of hydrogen, attributed to near-surface water ice [26].

GRS and TES analyses support the formation of a silica-rich rind or coating on ST2 because derived chemistry from TES shows a higher SiO₂ content for ST2 than ST1, while GRS data show essentially no change between ST1 and ST2 SiO₂ abundances. This is attributed to a difference in sampling depth, where TES samples the upper tens of microns so that the weathering rind/coating has a large effect on derived chemistry and GRS samples the upper tens of cm so that the weathering rind/coating does not affect derived chemistry [27].

Interpretations from Remote Sensing Experiments: It has been suggested that chemical alteration of the martian surface resulted in the formation of amorphous to poorly crystalline aluminosilicates, rather than crystalline clay minerals [5-7,28]. Our research is concerned with the ways in which chemical weathering and authigenic phases affect remote sensing measurements and interpretations. We have presented research on TIR and visible near-infrared (VNIR) spectra of natural weathering rinds of Columbia River basalts (CRBs), synthetic silica coatings on basalt, and TIR spectra and spectral models of physical mixtures of igneous and alteration phases [5-7,9-13].

Our research shows that TIR spectra and spectral models are greatly affected by relatively small amounts of weathering, while VNIR spectra are not. For example, TIR spectral models of CRB weathering rinds identify significant amounts of glass and/or clay minerals [6,9-10]. These materials are not present in the rinds (igneous minerals and poorly-crystalline, Si-Al-Fe-enriched phases are the only phases present), and their identification in spectral models increases the derived silica content of the surfaces. This is apparent in spectral models of ST1 vs. ST2, where ST1 models have lower silica than ST2 [1-3]. VNIR spectra of CRB rinds are brighter than fresh surfaces, but do not contain absorptions to indicate a greater extent of weathering [6]. VNIR data from the northern plains of Mars also do not contain absorptions that indicate chemical weathering [29,30]. Additionally, TIR spectra and spectral models of silica-coated basalt slabs show that thin coatings (~1 μm) have a large effect on the underlying basalt spectrum. Linear deconvolution modeling, a linear least squares algorithm used to interpret martian surface mineral abundances from TIR spectra, is unsuccessful for silica-coated basalts [7]. However, VNIR spectra of silica-coated basalt particulates do not show evidence for thin silica coatings [11].

Our research also shows that the presence of alteration phases can affect the interpreted igneous mineral abundances from TIR spectra. TIR spectral models of CRB weathering rinds indicate a higher plagioclase-to-pyroxene ratio than is actually present in the rocks [13]. TIR spectral models of physical mixtures of one or two basaltic igneous minerals and a secondary silicate (silica or smectite clay) also show the presence of a secondary silicate can affect how we interpret primary igneous mineralogy. The presence of silica in a 1:1 wt% mixture of plagioclase and pyroxene cause an increase in the interpreted plagioclase-to-pyroxene ratio from spectral models, while smectite causes a decrease [12]. With the mounting evidence for chemical weathering in the northern plains, plans for sample return missions must include samples from the northern plains.

What a Sample from the Northern Plains Can Tell Us:

There are two important questions that such a sample can help us answer: 1) How did the martian surface evolve petrologically? 2) What is the history of liquid water in the northern plains and was the area habitable?

Although research by us and others has helped explain the effects of chemical weathering on remote sensing interpretations of igneous mineral abundances, the effects are still not completely understood. Rampe et al. (2007) suggested that if amorphous silica is present, it may mask the identification of pyroxene in TIR spectral models. Consequently, TIR models from ST1 contain pyroxene while models from ST2 do not [1-3], possibly indicating silica is present in ST2 and obscuring the observation of pyroxene. If a sample is returned from the northern plains, we can determine igneous mineral abundances to compare to TIR spectral models and investigate whether apparent ST1 and ST2 compositional differences are due to igneous variability, disparities in authigenic phase abundances, or a combination of the two. This information will help constrain the petrologic history of the crust.

To characterize the alteration phases and determine the igneous minerals that are chemically altering, we must have a hand sample for analysis. In the rocks of the northern plains, where liquid water is limited, alteration phases are expected to be amorphous or poorly crystalline [5-7,9-12,28], and therefore require microscopy, such as transmission and scanning electron microscopy, for their characterization. The types of secondary alteration phases present and the igneous minerals that are dissolving to produce alteration phases can tell us how much liquid water was present, the duration of liquid water, and the pH of the solution. Since soil develops from the alteration of rocks, understanding the phases within the weathering rinds will help explain soil formation processes on Mars.

A major goal of a sample return mission is to target a habitable area with the hopes of finding evidence for life. Martian data and analog studies support the presence of liquid water in the northern plains. It has been proposed that near-surface environments in the northern plains may have been and still may be able to support chemoautotrophic microbes [31,32]. Martian data and analog studies also support the presence of amorphous silica in the northern plains. On Earth, the oldest microfossils are preserved in silica (chert) [33], rather than clay-rich sedimentary rocks, as are present in the Noachian highlands. The northern plains are a prospective place to find evidence for life because of its habitability and potential for microfossil preservation.

References: [1] Bandfield J. L. et al. (2000) *Science*, 287, 1626–1630. [2] Bandfield J. L. (2002) *JGR*, 107, E6. [3] Rogers A. D. and Christensen P. R. (2007) *JGR*, 112, E01003. [4] Wyatt M. B. and McSween H. Y. (2002) *Nature*, 417, 263-266. [5] Michalski J. R. et al. (2005) *Icarus*, 174, 161-177. [6] Michalski J. R. (2006) *EPSL*, 248, 822-829. [7] Kraft M. D. et al. (2003) *GRL*, 30, 24. [8] Ruff S. W. (2004) *Icarus*, 168, 131-143. [9] Michalski J. R. et al. (2005) *LPS XXXV*, Abstract #1188. [10] Kraft M. D. et al. (2005) *LPS XXXV*, Abstract #1376. [11] Kraft M. D. et al. (2007) *Sev. Intl. Conf. Mars*, Abstract #3396. [12] Rampe, E. B. et al. (2007) *Sev. Intl. Conf. Mars*, Abstract #3242. [13] Kraft M. D. et al. (2006) *GCA*, 70, A335. [14] Ruff S. W. et al. (2006) *JGR*, 111, E12S18. [15] Malin M. C. and Edgett K. S. (2001) *JGR*, 106, 23,429-23,570. [16] Lee P. et al. (2001) *LPS XXXII*, Abstract #1809. [17] Hartmann W. K. (2002) *LPS XXXIII*, Abstract #1904. [18] Christensen P. R. (2003) *Nature*, 422, 45-48. [19] Head J. W. et al. (2007) *LPS XXXVIII*, Abstract #1617. [20] Morgan G. A. et al. (2007) *LPS XXXVIII*, Abstract #1656. [21] Levy, J. S. et al. (2007) *LPS XXXVIII*, Abstract #1728. [22] Kreslavsky M. A. and Head J. W. (2002) *GRL*, 29, 15. [23] Mustard J. F. et al. (2001) *Nature*, 412, 411-414. [24] Kostama V. P. et al. (2006) *GRL*, 33, L11201. [25] Tanaka K. L. et al. (2003), *JGR*, 108, E4. [26] Boynton W. V. (2002) *Science*, 297, 81-85. [27] Wyatt M. B. and McSween H. Y. (2007) *LPS XXXVII*, Abstract #2258. [28] McLennan S. M. (2003) *Geology*, 31, 315-318. [29] Mustard J. F. et al. (2005) *Science*, 307, 1594-1597. [30] Poulet F. et al. (2007) *JGR*, 112, E08S02. [31] Jakosky B. and Shock E. L. (1998) *JGR*, 103, 19,359-19,364. [32] Kraft M.D. et al. (2008), *this meeting*. [33] Schopf J. W. and Packer B. M. (1987) *Science*, 237, 70-73.

AN EXPERIMENTAL STUDY OF PHYLLOSILICATE MODIFICATION IN COMETS DURING PERIHELION COULD BE RELEVANT TO FERRIC IRON-RICH LAYER SILICATE FORMATION AT THE MARTIAN SURFACE. Frans J. M. Rietmeijer¹ and Klaus Thiel², ¹Department of Earth and Planetary Sciences, MSC03-2040, University of New Mexico, Albuquerque, NM 87131-0001, USA; fransjmr@unm.edu, ²Department of Nuclear Chemistry, University of Köln, D-50674 Köln, Germany (klaus.thiel@uni-koeln.de).

Introduction: The variety of layer silicates identified at the Martian surface [1] prompted us to introduce the notion that exposure to solar radiation could be an agent for chemical modification of phyllosilicates during weathering of a wide variety of rock types exposed at the Martian surface and of phyllosilicates in permafrost-like soils leading to formation of Fe-rich layer silicates and lower K₂O contents in micas.

The KOSI team applied periods of simulated insolation to dust-ice mixtures of natural Mg-rich silicates, including “olivine” and “montmorillonite” fractions, graphite, charcoal, water and CO₂ ices at -196°C to simulate the physical processes at the surface of an active comet nucleus during perihelion, *e.g.* dust production rates and size distributions, by [2,3]. A transmission electron microscope study of the KOSI-2 experiment found an abundance of Fe-rich layer silicates that were not present in the starting material [4] suggesting hydrocryogenic dust modification. Iron for the chemically modified layer silicates was probably extracted from low-iron layer silicates in the starting material via $(\text{Fe}^{2+} + \text{OH}^-) = (\text{Fe}^{3+} + \text{O}^{2-}) + \frac{1}{2}\text{H}_2$ [4]. Layer silicates on Mars occur in regions characterized by (1) Fe/Mg-smectite (no montmorillonite), (2) Fe-rich clays, *incl.* nontronite (Fe-smectite) and chamosite (Fe-rich chlorite) and (3) montmorillonite [1]. Smectite and chlorite as the products of chemical weathering may have formed in a globally homogenous dust layer on Mars [5]. The surprising chemical reactivity observed in the Viking Lander biology experiments could have been due to catalytic action by smectite-illite clay minerals [6].

KOSI-2 Observations: A mixture of ~10% minerals (Table 1) and ~90% water ice was exposed to simulated sunlight to create the conditions during four perihelion passages (Fig. 1). The 002-basal spacing

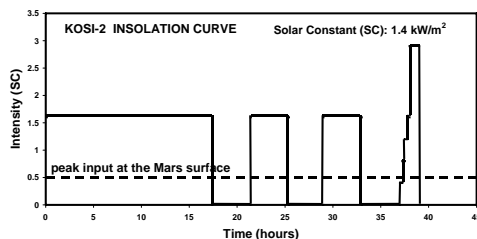

Figure 1: Energy input for four simulated perihelion passages of a comet in the KOSI-2 experiment [7].

Table 1: Mineral impurities in “olivine” and “montmorillonite” fractions of the KOSI-2 experiment (water ice only). The silicate fraction was a mixture of ~90% “olivine” and ~10% “montmorillonite” [7]. Silicates of the starting material in bold italics were found in the TEM study [4].

“Olivine fraction”	
84-91 %	<i>Forsterite (Fo94)</i>
5-11 %	<i>Enstatite (Fs94)</i>
1.7-2.2 %	<i>Chlorite</i>
1.0-1.5 %	<i>Serpentine</i>
0.1-0.4 %	Talc
0.5 %	Spinel
“Montmorillonite fraction”	
93 %	<i>Montmorillonite</i>
3 %	<i>Feldspar</i>
2 %	Muscovite
1 %	<i>Quartz</i>
1 %	Cristobalite

values [4] and chemical compositions indicate that Fe³⁺ is the only iron species in the layer silicates. Phyllosilicates in the starting materials have low Fe₂O₃ contents for both Mg-rich and Mg-poor compositions (Fig 2a; black dots), including natural mica (red open circles).

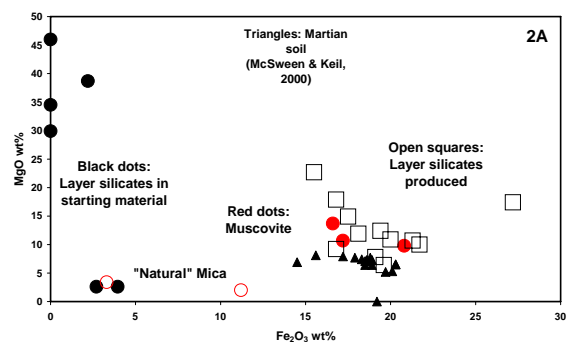

Figure 2A: Fe₂O₃ vs. MgO (wt%) in KOSI starting material (black dots) and modified layer silicates (open squares). KOSI-2 muscovite (solid red dots) is presumably Fe-enriched muscovite from the starting material by comparison with “natural” mica compositions (open red circles). Martian soil compositions [5] are for reference only (solid triangles).

The KOSI-2 Fe-rich muscovite (red dots) suggests it is chemically modified muscovite. This seems plausible as they are among the cluster of Fe-rich chlorite and smectite but we cannot be entirely sure yet. The Fe_2O_3 content of modified KOSI phyllosilicates and the Martian soil are similar. The MgO contents of the Martian soil overlap with the former. The Al_2O_3 content of the modified layer silicates is higher than the Martian soil (Fig. 2b).

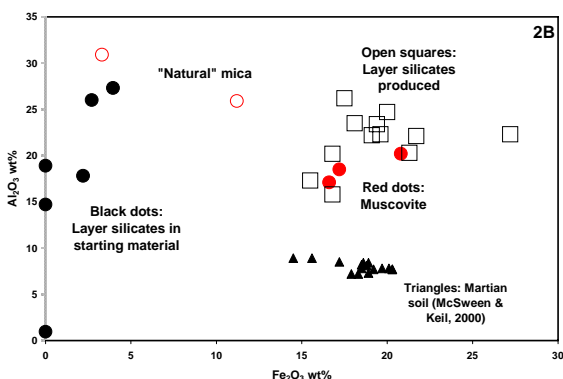

Figure 2B: Fe_2O_3 vs. Al_2O_3 (wt%); same symbols as [2A].

This difference is certainly related to the high Al_2O_3 content of the KOSI-2 starting materials but not inconsistent with “illite” in EETA79001 [6] that suggests that high- K_2O phyllosilicates (mica) existed near the Martian surface. The KOSI-2 starting material included muscovite (Table 1) that is significantly more Fe-rich than typical terrestrial mica. The K_2O contents of “natural” mica and KOSI-2 muscovite are comparable (Fig. 3). The decreasing K_2O values in this KOSI-2 muscovite show a trend consistent with the smectite-illite model [6] to Fe-rich K-bearing smectite and chamosite (Fig. 3; open squares).

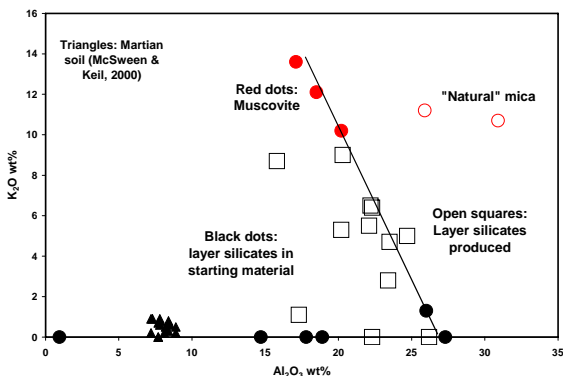

Figure 3: Al_2O_3 vs. K_2O (wt%) in KOSI starting and modified layer silicates, *incl.* KOSI-2 muscovite, and “natural” mica and Martian soil compositions. Symbols are identical to those used in Figure 2. The solid line could be a mixing line between muscovite and montmorillonite and beidel-

lite in the starting materials for the trend of KOSI-produced Fe-rich phyllosilicates, *incl.* chamosite (Fe-chlorite).

Periods of simulated solar radiation caused iron oxidation and iron enrichment in chlorite (chamosite), smectite (nontronite) and muscovite (mica), and concomitant changes in the $(\text{OH}^-)/\text{O}^{2-}$ ratios. It is unclear whether dehydroxylation [4] involved chemical transport at hydrocryogenic conditions or whether it was an entirely intra-crystalline process. As magnesium from layer silicates in the starting material had to be removed probably in solution it seems plausible that hydrocryogenic conditions existed, but so far we have not found pure-MgO or other Mg-rich precipitates in the KOSI-2 experiment.

The processes involved coupled substitutions:

- (1) $\text{Fe}^{3+}(\text{vi}) + 2\text{Al}^{3+}(\text{iv}) + \text{K}^+(\text{interlayer}) = 3\text{Mg}^{2+}(\text{vi}) + \text{Si}^{4+}(\text{iv})$, and for decreasing K_2O contents
- (2) $\text{Fe}^{3+}(\text{vi}) + \text{Al}^{3+}(\text{iv}) = 2\text{K}^+(\text{interlayer}) + \text{Si}^{4+}(\text{iv})$.

Discussion and Conclusions: KOSI-2 showed that a non-traditional geological process caused chemical modification of phyllosilicates in a dirty-ice mixture. What are the implications for layer silicates on Mars assuming solar radiation is an effective process:

- (1) Fe oxidation and Fe enrichment of layer silicates,
- (2) Mg-mobilization,
- (3) Decreasing K-contents from mica to chamosite
- (4) Potentially IR-detectable variability in $(\text{OH}^-)/\text{O}^{2-}$ ratios and correlated increases in the Fe^{3+} content to trace aging of Fe-rich phyllosilicates,
- (5) Dehydroxylation leading to amorphous serpentine [8] and smectite dehydroxylates that are common metastable compounds [9], and
- (6) Geological processing at the Martian surface of these metastable compounds with the basic metal-oxide/ SiO_2 ratios of phyllosilicate minerals [10].

We discussed the KOSI results in a ‘Martian context’ but with an understanding that lower solar radiation as a cause of chemical modification of phyllosilicates at Martian surface conditions throughout time remains to be fully assessed by future controlled experiments.

References: [1] Poulet F. et al. (2005) *Nature*, 438, 623-627. [2] Thiel K. et al. (1991) *Geophys. Res. Lett.*, 18, 281-284. [3] Grün E. et al., (1993) *Geophys. Res. Lett.*, 98, 15091-15104. [4] Rietmeijer F. J. M. and Thiel K. (1995) *LPS XXVI*, 1167-1168. [5] McSween, Jr. H. Y. and Keil K. (2000) *Geochim Cosmochim. Acta*, 64, 2155-2166. [6] Gooding J. L. (1992) *Icarus*, 99, 28-41. [7] Thiel K. et al. (1990) *Proc. LPSC*, 20, 389-399. [8] MacKenzie K. J. D. and Meinhold R. H. (1994) *Amer. Mineral.*, 79, 43-50. [9] Rietmeijer F.J.M. et al. (2004) *Meteoritics Planetary Science*, 39, 723-746. [10] Rietmeijer F. J. M. et al. (2007) on-line doi:10.1016/j.icarus.2007.11.022

If we already have samples from Mars, why do we need sample return missions? The importance of martian meteorites and the value of Mars Sample Return. C.K. Shearer¹, L.E. Borg², A. Treiman³ and P. King¹. ¹Institute of Meteoritics, University of NM, Albuquerque, NM 87131 (cshearer@unm.edu) ²Institute of Geophys. and Planetary Phys, Lawrence Livermore National Laboratory, Livermore, CA, 94550; ³Lunar and Planetary Institute, Houston, TX 77058.

Introduction: Approximately 40 unpaired meteorites are acknowledged as samples derived from Mars. The total mass of these samples exceeds 84 kg. All of them have an igneous origin and formed by the crystallization of basaltic magmas on or near the martian surface. With such a large mass in hand, why is it critical to return an additional 0.5 to 1.0 kg of material from Mars? Here we focus upon: (1) what has been learned from martian meteorites; (2) questions suggested by, but not answered by, the meteorites; and (3) what questions, crucial to the exploration and understanding of Mars, cannot be answered by the martian meteorites and therefore require sample return.

Knowledge from the martian meteorites: Within this abstract format it is not our goal to present all of the fundamental insights derived from martian meteorites. Instead, we list several important findings from martian meteorite studies.

Mars is active!: The relatively young ages of many martian meteorites indicate that Mars was a dynamic planet in the recent past, capable of igneous processes, specifically melting of the martian mantle [1-4]. The young ages further indicate that igneous processes are probably active on Mars today.

Mars differentiated early: Radiogenic isotope studies of martian meteorites show that Mars differentiated rather quickly (within ~25 Ma of solar system formation) and that the products of this early differentiation did not remix for most of its history [3-7]. This early differentiation is consistent with the presence of a magma ocean, comparable to that inferred for the Moon [3-8].

Mars is complex: Some chemical features of the martian basalts (e.g., K/La, Fe/Mn, O isotopes) link them to a common parent body. The array of shergottite compositions implies that they were derived by mixing of two distinct sources produced during the early stages of martian differentiation [3-8]. The superchondritic Ca/Al of many of the martian basalts suggests that they may have been derived from (magma ocean) cumulates that experienced the removal of garnet prior to their formation [8]. Estimates of the crystallization conditions of martian basalts implies that the martian mantle may be under a range of f_{O_2} conditions from IW+1 to more oxidizing conditions [7,9,10].

Mars has "groundwater": Most of the martian meteorites contain complex assemblages of water-deposited

minerals, and many of these clearly formed on Mars [i.e. 11,12]. The water-deposited minerals include: smectite; Fe-O-H phases; Fe-Mg-Ca carbonates; Ca, Mg, and K-Fe sulfates; Na & K chlorides; Ca & Mg-Fe phosphates; and amorphous material. Ages of these assemblages range from ~3.9 – 0.1 Ga, proving that Mars had "groundwater" through most of its history [13]. S isotope data ($\delta^{34}S$ and ^{33}S depletions) and large ^{17}O excesses imply that this water came from (or interacted strongly with) the Mars' atmosphere [14-17]. Alteration phases in the martian meteorites provided a first glimpse of phases that could be stable at or near the martian surface.

Composition & evolution of the martian atmosphere and hydrosphere: Noble gases, N_2 , and CO_2 trapped in impact-produced glass not only confirmed that these meteorites were from Mars, but provided constraints on the composition and dynamics of the martian atmosphere [i.e. 12,18,19]. The $\delta^{13}C$ data from martian meteorites provide insights into the martian carbon cycle [20]. The D/H in apatite relative to atmospheric D/H has been used to suggest early H_2O escape from a wetter Mars [21].

Questions posed by martian meteorites:

How abundant are H and C in the martian basalts and mantle? The martian basalts contain only parts per million of indigenous magmatic H and C. Were their parent magmas (and thus mantle) so poor in H and C, or were these (and other) volatile elements lost on eruption or after crystallization?

Is martian magmatism essentially basaltic in composition? All martian meteorites are derived from basaltic magmas. Does this imply that all martian magmatism is a product of mantle melting followed by crystallization under fairly anhydrous conditions? Alternatively, does Mars produce all sorts of igneous rocks, and the martian meteorites are only a limited sample?

What is the composition of the martian crust? The Moon illustrates an example of a planetary crust which is essentially a product of basaltic magmatism. Based on the martian meteorites, is such a model for the composition and evolution of the crust valid for Mars or does the martian crust exhibit a greater range of compositional diversity (e.g. andesites)?

How did Mars' geochemical reservoirs remain isolated? Martian meteorites are derived from several distinct sources that have remained isolated for ~4.5

Ga. If these sources are in the mantle, how could they remain isolated in the face of convection and plumes? On the other hand, if these sources represent the mantle and crust, how is the crust produced?

Do low-T phases in martian meteorites preserve evidence of alteration processes on Mars? Do some salt minerals in martian meteorites result from terrestrial contamination? Have microbeam analyses of stable isotopes in hydrous minerals been affected by terrestrial contamination?

Is there evidence for martian biology in the martian meteorites? A claim that martian meteorites contain signs of ancient martian life has been vigorously debated, and mostly rejected [i.e. 22,10]. It is not clear, what markers martian biota might have left in rocks destined to be meteorites, and whether those markers could be preserved.

The value of Mars Sample Return:

The martian meteorites present a biased view of Mars: Orbital and surface missions have revealed that Mars' surface is far more diverse than was imagined only a decade ago. This indicates that Mars has a plethora of distinct environments, each of which is characterized by different samples types, with different potential scientific returns. For example, the meteorite collection does not contain samples representative of clays identified from orbit [23] or Br- or Si-rich samples identified by rovers [24]. Most of the lithologies encountered by orbital and surface missions on the martian surface are not in the meteorite collection because they are extremely fragile and do not survive the impact process that would launch them into space. These fragile samples record processes on the surface or in the shallow martian crust that reflect the activity of water. These lithologies potential represent abodes which were hospitable to life.

Geologic context: Although the data derived from martian meteorites paints a general picture of martian planetary evolution and development, it would be significantly more valuable if the data could be placed within a geologic context. Although dates reflecting crystallization or alteration can be tied to a specific sample or groups of samples, they cannot be related to the evolution and alteration of a particular martian terrain or placed within the context of planetary scale events. For example, geologic context is required in order to determine cratering rates and develop accurate crater density chronology. Thus, returned samples that are placed within a geologic context (local-, regional-, and planetary-scale) will provide a means of dating events on the martian surface, as well as constraining the regional extent of mineralogical and geochemical features, thereby more precisely establishing the overall history of Mars.

Ground truth: Sample return should not be viewed as a terminal mission in the exploration of Mars. Ground truth offered by sample return provides insights into the reinterpretation of data gathered by previous orbital and surface missions. Orbital and surface observations allow sample data to be placed in a planetary-scale context. "New Views of the Moon" [25] illustrates the scientific dynamics among orbital, surface, and sample observations in better understanding a planetary body. Further, ground truth enables the implementation of much more complex orbital and surface missions in the future.

Follow the Waters: Both orbital and surface missions have demonstrated that water has a central role in shaping the martian surface and perhaps the evolution of the martian crust. However, the history of water on Mars and its evolving role in shaping the martian crust have not been extracted from these observations. These previous missions have identified numerous lithologies that upon sampling will provide insights into fluid characteristics, sources of fluids, interactions with environments of biologic activity, and history-duration of fluid activity. Samples returned from Mars will potentially preserve more of the fragile secondary alteration phases used to track aqueous processes. Importantly, returned samples may be analyzed with a greater variety of analytical techniques than possible on the surface of Mars by rovers or remotely with orbiters.

Search for life: The initial "groundbreaking" sample return mission will probably not return samples that directly answer the question of whether or not life flourished on Mars. Because life and the history of life is inextricably connected with the physical factors of its environment, the study of Mars as a possible home for life is more likely the prudent scientific investigation for an initial sample return mission.

References: [1] Shih et al. (1982) GCA 46, 2323-2344. [2] Wooden et al. (1982) LPSC XIII, 879-880. [3] Borg et al. (1997) GCA 61, 4915-4931 [4] Symes et al. (2007) GCA 71, in press. [5] Borg L. et al. (2005) GCA 69, 5819-5830 [6] Borg et al., (2003) GCA 67, 3519-3536 [7] Herd et al. (2002) GCA 66, 2025-2036. [8] Borg and Draper (2003) MAPS 38, 1713-1731. [9] Wadhwa (2001) Science, 292, 1527-1530. [10] Shearer et al. (2008) MAPS, in press. [11] Gooding et al. (1988) GCA 52,909-915. [12] McSween. and Treiman (1998) Chapter 6 in Reviews in Mineral, vol. 36. [13] Borg and Drake (2005) JGR. 110, E12S03. [14] Shearer et al. (1996) GCA 60, 2921-2926. [15] Greenwood et al. (2000) EPSL 184, 23-35. [16] Farquhar and Thiemens (2000) JGR 105, 11991-11997. [17] Farquhar et al., (2000) Nature 404, 50-52. [18] Bogard and Johnson (1983) Science 221, 651-654. [19] Becker and Pepin (1984) EPSL 69, 225-242. [20] Goreva et al. (2003) LPSC XXXIV, abst.# 1987. [21] Leshin (2000) GRL 27, 2017-2020. [22] McKay et al. (1996) Science 273, 924-930. [23] Poulet et al., (2005) Nature 438, 623-628. [24] Gellert et al. (2006) JGR 11, E02S05. [25] Jolliff et al. (eds) (2006) New Views of the Moon, 772pp.

ROCK COATINGS: POTENTIAL BIOGENIC INDICATORS. M.N. Spilde¹, P.J. Boston², D.E. Northup³ and K.J. Odenbach⁴, ¹Inst. of Meteoritics, Univ. of New Mexico, Albuquerque, NM 87131, mspilde@unm.edu; ²Dept. of Earth & Environmental Sci., NM Tech, Socorro, NM, 87801; ³Biology Dept, UNM, Albuquerque, NM 87131; ⁴Ohio State Univ., Plant Pathology Dept., Columbus, OH

Introduction: Many Mars surface rocks, photographed by the Mars Exploration Rovers, appear to have shiny, dark coatings. These coatings resemble terrestrial rocks covered with rock varnish. In arid terrestrial regions, this hard, dark coating (also called desert varnish) is manganese-rich and also contains sheet silicates and widely varying levels of silica. Desert varnish has long been linked to simple bacteria and fungi [1,2], but unequivocal proof of a biogenic origin has yet to be shown. Both bacteria and fungi have been isolated from desert varnish, and manganese-oxidizing microorganisms such as *Bacillus*, *Pedomicrobium*, *Cremonium*, *Cladosporium*, *Penicillium*, and *Verticillium* are among them [3]. The microbes remove metal particles from atmospheric dust and fog, oxidize them, and then build up layers and layers of varnish, with phyllosilicates acting as "glue". Researchers have speculated that the manganese-oxides may aid microorganisms by acting as ultraviolet screens [1, 3, 4] or may facilitate radiation resistance, which has been shown for cyanobacteria [5].

Analysis of martian rocks by Spirit and Opportunity has shown that they have a remarkable geological diversity and that many have undergone substantial chemical (hydrous) alteration [7]. Furthermore a type of "case-hardening" of the outer surface of some rocks has been observed [8]; certainly the Rock Abrasion Tool (RAT) has shown thick weathering rinds with significant chemical differences between the inner composition and the outer surface of some rocks [9].

Analysis Methods: Samples of desert varnish on numerous types of rock substrates were collected at sites throughout the southwestern United States, including Mojave Desert area, California; Hanksville, Utah; Socorro and Carlsbad, New Mexico. Samples were imaged in a JEOL 5800LV scanning electron microscope and quantitatively analyzed on a JEOL 8200 electron microprobe. Samples were aseptically collected for culturing and for DNA analysis; both natural and cultured samples were extracted, PCR amplified, and sequenced. Fungal DNA was analyzed using 18S and bacterial DNA analyzed using 16S primers.

Results: Microprobe analysis of samples from the Socorro, NM region yielded lead in percent levels. Anthropogenic lead is usually present in ppm levels in desert varnish but is much higher at Socorro due to lead smelters that operated there at the end of the 19th century. Importantly, the lead acts as a tracer in our samples to reveal a variable rate of varnish growth. While many samples exhibit high lead concentrations

at the outer surface, others contained lead at some distance under the surface, yielding growth rates as high as 30 μm per millenia. Varnish from rock surfaces occasionally wetted by runoff exhibited the highest lead concentration at the greatest distance under the surface. Our results indicate that rock varnish grows at different rates, depending on the rock surface environment, growing fastest where occasionally wetted and slowest where constantly dry. On the other hand, the sample exposed to the most water run off had the lowest lead level presumably attributable to fluid removal of atmospherically deposited lead.

DNA analysis of samples indicates that a diverse microbial community is associated with desert varnish, in agreement with the findings of many other workers. Imaging and DNA analysis of cultures reveals that manganese is sequestered into distinct features by several types of fungi. Likewise fungi can rapidly colonize rock surfaces, even these exposed to constant sun and receiving only occasional water.

Discussion: Chemical analysis of martian meteorites has revealed that Mars boasts more manganese and iron than Earth. Seasonal fogs on the red planet could moisten the rocks with enough water to sporadically supply resident organisms [6]. Thus manganese- or other metal-rich rock coatings may hold implications for Martian biogenic origin of similar rock coatings. Likewise, our work has shown that a microbial community associated with rock coatings can be present deep under the surface of porous rocks where they are protected from radiation and desiccation. In this case, the metal-oxides produced by the community help to produce a case hardening effect that acts as sunscreen and desiccation retardant for the microbial communities.

Implications for Mars Sample Return: If biogenic signatures are present in rock coatings, abrasive (RAT) tools for in situ analysis will very likely destroy such delicate and three dimensional evidence. Therefore the return of samples, especially cores samples that include rock coatings and underlying substrate, is essential to understanding the origin of such coatings.

References: [1] Krumbein W.E. and Jens K. (1981) *Oecologia*, 50, 25-38; [2] Dorn, R. I. & Oberlander, T. M. (1981) *Science*, 213, 1245-1247; [3] Tebo et al. (2004) *Ann. Review Earth & Planetary Sci.*, 32, 287-328; [4] Gorbushina, A. (2003) *Astrobiology*, 3, 543-554; [5] Daly et al. (2004) *Science*, 306, 1025-1028; [6] Dorn R.I. (2006) Ch 8: Rock Varnish In *Chemical Sediments and Landscapes*, Nash, DJ & McLaren SJ,

eds. ; [7] Bibring et al. (2006) *Science* 313, 1899-1901; [8] Famer J. (2005) *GSA Abstracts with Programs*, 37, 512; [9] Squyres et al. (2006) *Science*, 213, 1403-1407

Figure 1. Electron micrographs taken from the surface of non-varnished rocks. A) MCF in a pit on the surface of a sample from a blasted road cut. Scale bar = 20 μm . B) MCF in a surface pit from a naturally weathered

sample. Scale bar = 10 μm . C) BSE image of incipient varnish in image B above. MCF appear dark while incipient rock varnish (Fe- and Mn-rich) is light. Scale bar = 200 μm . D) Close up on incipient varnish in lower center of image C. Scale bar = 100 μm . E) EDS manganese map on the same area as image C above. F) Varnish colonies deep in surface-exposed pore. Scale bar = 10 μm .

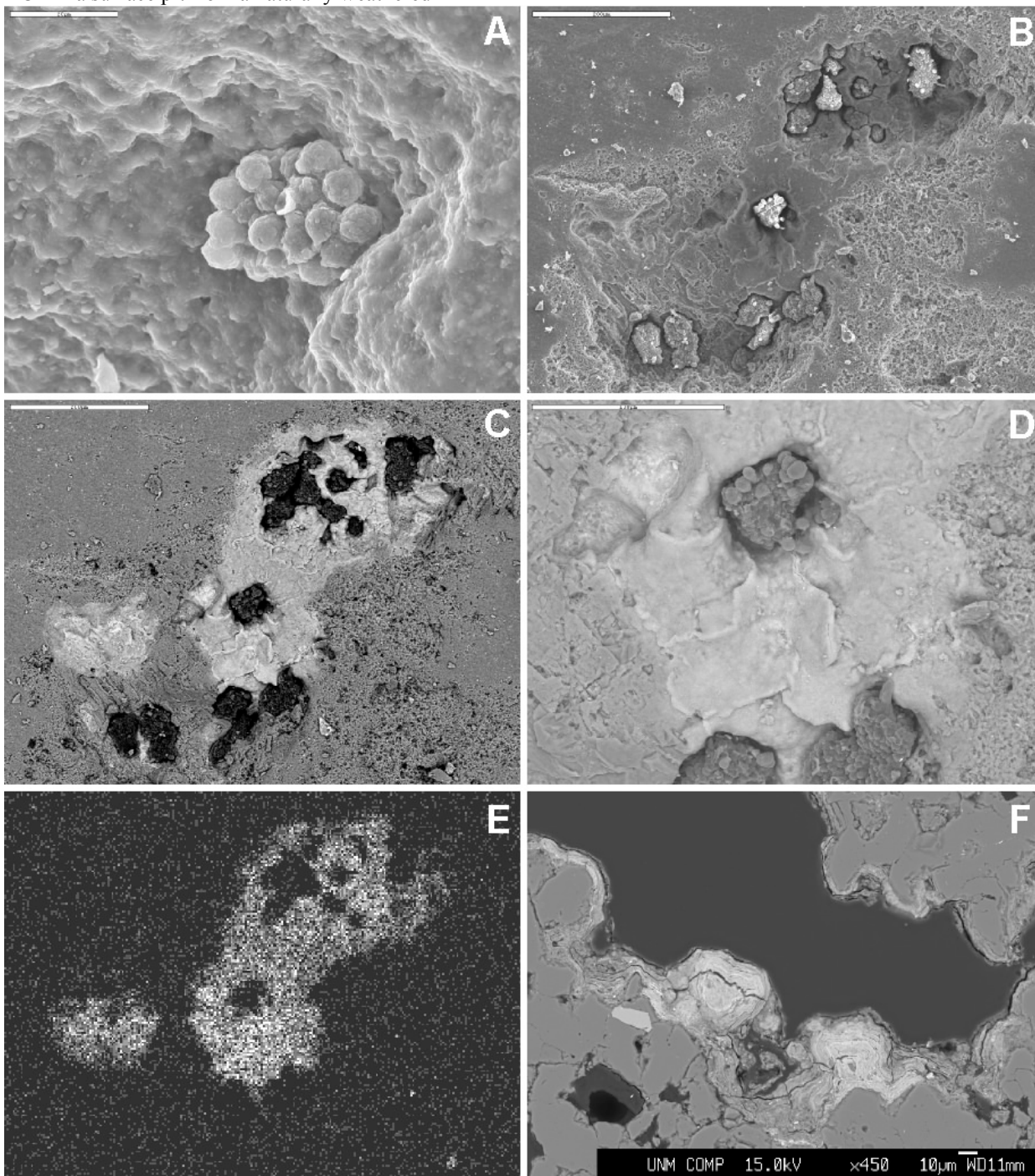

BORON ISOTOPIC COMPOSITION OF IGNEOUS MINERALS AND SECONDARY ALTERATION PRODUCTS IN NAKHLA. L. J. Spivak-Birndorf¹, M. Wadhwa¹ and L. B. Williams¹, ¹School of Earth and Space Exploration, Arizona State University, Tempe, AZ 85287-1404. Lev.Spivak-Birndorf@asu.edu

Introduction: Understanding the role of water in the evolution of the crust of Mars is an important problem in planetary science. Large deposits of aqueous alteration minerals, including phyllosilicates, have recently been detected on the martian surface using remote sensing techniques [1-3]. Martian meteorites also host a variety of secondary minerals that can provide insights into aqueous alteration processes in the martian crust ([4]; and references therein). The nakhlites are among the most aqueously altered martian meteorites and contain relatively abundant (~1-3 vol.%) secondary mineral assemblages known as iddingsite [5]. Constraints on the timing, temperatures and chemical composition of near-surface martian fluids that formed iddingsite in the nakhlites have previously been determined from petrologic and geochemical studies of these secondary phases [4-13].

Boron is relatively soluble and can be readily mobilized in aqueous fluids [14]. The utility of B isotopes for tracing fluid-rock interactions has been demonstrated by several recent studies [15-19]. Boron can adsorb to reactive clay surfaces, including those in the interlayers, during interaction with fluids and the in early stages of diagenesis [16, 17]. Boron is also incorporated into the tetrahedral sites in clay minerals during diagenesis [20]. Clay minerals can therefore preserve information about the chemistry of fluids from which they formed [19]. Boron isotope fractionation during these processes is thought to be controlled by the preference of each B isotope for a different coordination state [21]. The heavier isotope, ¹¹B, prefers to be in trigonal coordination, while the lighter isotope, ¹⁰B, prefers tetrahedral coordination [21]. The fractionation of B isotopes during incorporation into and adsorption onto clay minerals is strongly temperature dependent [19]. As such, if the temperature of the altering fluids and the ¹¹B/¹⁰B ratio of the secondary phases are known, the B isotopic composition of these fluids can be estimated.

There are currently very limited data on the B isotopic compositions of the martian meteorites [22,23]. Furthermore, there are no reported B isotopic measurements of igneous minerals in the nakhlites. In an effort to better constrain the B isotopic compositions of the various (silicate and aqueous fluid) reservoirs on Mars, we present ¹¹B/¹⁰B measurements of iddingsite, pyroxene, and a magmatic inclusion in an olivine grain in Nakhla. Quantifying the various B isotopic reservoirs of Mars is an important step toward understanding the martian geochemical cycle of B and what it can

tell us about the aqueous alteration of the martian crust.

Samples and Analytical Methods: A description of our analytical methods is provided in [23]. Most of the B isotopic measurements of iddingsite were made on a thick section of Nakhla, including all of the post-NH₄Cl exchange analyses [23]. Subsequent to these analyses, the Nakhla thick section was re-polished and two additional thin sections were prepared from it. One of these thin sections was characterized by optical microscopy to identify iddingsite and various igneous minerals. This thin section was ultrasonicated in 1.82% mannitol solution to remove surface contaminant B as previously described [23] and was then gold-coated immediately following this cleaning procedure. The B isotopic compositions of igneous phases (augites and a glassy melt inclusion in olivine) and several areas of iddingsite were measured in the polished gold-coated thin section using the Cameca IMS 6f ion microprobe at Arizona State University (ASU).

Results: The $\delta^{11}\text{B}$ values measured in various mineral phases in Nakhla are shown in Fig. 1. No significant differences in the ¹¹B/¹⁰B ratio were found between different areas of iddingsite analyzed by us in the thick section and the thin section. As such, our previously reported iddingsite data obtained on the Nakhla thick section [23] are presented together with the results of the new measurements of iddingsite on the thin section (solid red symbols in Fig. 1). For comparison, the $\delta^{11}\text{B}$ values measured in iddingsite after the NH₄Cl exchange procedure to remove interlayer B [23] are also shown (open red symbols in Fig. 1). The average $\delta^{11}\text{B}$ of Nakhla iddingsite before ($-5.4 \pm 1.0\text{‰}$) and after ($-5.7 \pm 2.8\text{‰}$) the NH₄Cl exchange are identical within errors ($\pm 1\sigma_{\text{mean}}$). The large errors and considerable scatter in the B isotopic compositions of pyroxene are the result of the low B concentrations ($< \sim 1\text{ppm}$) in this phase. However, the average $\delta^{11}\text{B}$ value for Nakhla pyroxene ($-4.5 \pm 3.0\text{‰}$) is also indistinguishable from that of iddingsite within errors. The magmatic inclusion has a higher B content than the pyroxene, but an identical $\delta^{11}\text{B}$ value within error ($-4.4 \pm 2.5\text{‰}$).

Discussion: The identical B isotopic compositions measured in pyroxenes and a magmatic inclusion in olivine of Nakhla are consistent with a lack of isotopic fractionation between crystals and melt during the formation of igneous rocks [15]. The enrichment of B in the magmatic inclusion relative to pyroxene is also consistent with the incompatible behavior of B in igneous systems [14]. The $\delta^{11}\text{B}$ value of igneous miner-

als in Nakhla is somewhat higher than that reported for igneous minerals in other martian meteorites [22] and may indicate heterogeneity in the B isotopic compositions of martian magmas.

In our previous report, we suggested that the similarity of the $^{11}\text{B}/^{10}\text{B}$ ratios of exchangeable interlayer and tetrahedrally bound B in Nakhla iddingsite could be the result of similar coordination of B in the fluid and minerals (i.e., both tetrahedral) [23]. The speciation and coordination of B in aqueous fluids is pH dependent, with predominately tetrahedrally coordinated B (i.e., present in the fluid as $\text{B}(\text{OH})_4^-$ species) at higher pH [21]. Therefore, it is likely that the pH of the fluids that formed nakhlite iddingsite was somewhat alkaline.

The similarity of B isotopic compositions in primary igneous and secondary alteration phases in Nakhla can also provide insight into the aqueous processing of the crust of Mars. This similarity suggests that the B in iddingsite is derived primarily from the dissolution of the igneous phases, as has been suggested for other trace elements [10]. The similarity of the B isotopic compositions of the igneous minerals, trapped interlayer fluids and iddingsite in Nakhla suggests that no resolvable isotopic fractionation of B occurred during the alteration of this meteorite. If the relatively low-temperature ($<150^\circ\text{C}$; [4-7]) fluids that altered Nakhla had a low pH, fractionation of B isotopes would be expected between these various phases due to the isotopic preference of different aqueous B species. The lack of such fractionation effects suggests that the fluids that altered Nakhla (1) had a relatively high pH and (2) derived their B predominantly from dissolution of the local igneous mineral assemblage.

References: [1] Poulet F. et al. (2005) *Nature* 438, 623-627. [2] Bibring J. -P. et al. (2006) *Science* 312, 400-404. [3] Chevrier V. et al. (2007) *Nature* 448, 60-63. [4] Leshin L. A. and Vicenzi E. (2006) *Elements* 2, 159-164. [5] Bridges J. C. et al. (2001) *Sp. Sci. Rev.* 96, 365-392. [6] Gooding J. L. et al. (1991) *Meteoritics* 26, 134-143. [7] Treiman A. H. et al. (1993) *Meteoritics* 28, 86-97. [8] Leshin L. A. et al. (1996) *GCA* 60, 2635-2650. [9] Gillet Ph. et al. (2002) *EPSL* 203, 431-444. [10] Treiman A. H. and Lindstrom D. J. (1997) *JGR* 102, 9153-9163. [11] Swindle T. D. et al. (2000) *MAPS* 35, 107-115. [12] Shih C. -Y. et al. (1998) *LPS XXXIX*, Abstract #1145. [13] Misawa K. et al. (2003) *LPS XXXIV*, Abstract #1556. [14] Leeman and W. P. and Sisson V. B. (1996) *Rev. Min.* 33, 645-708. [15] Hervig R. L. et al. (2002) *Am. Min.* 87, 769-774. [16] Williams L. B. and Hervig R. L. (2002) *Am. Min.* 87, 1564-1570. [17] Williams L. B. et al. (2001) *GCA* 65, 1769-1782. [18] Williams L. B. et al. (2001) *Chem. Geol.* 174, 445-461. [19] Williams L. B. and Hervig R.

L. (2005) *GCA* 69, 5705-5716. [20] Spivack A. J. et al. (1987) *GCA* 51, 1939-1949. [21] Palmer M. R. and Swihart G. H. (1996) *Rev. Min.* 33, 709-744. [22] Chaussidon M. and Robert F. (1999) *LPS XXX*, Abstract #1592. [23] Spivak-Birndorf L. J. et al. (2008) *LPS XXXIX*, Abstract #1904.

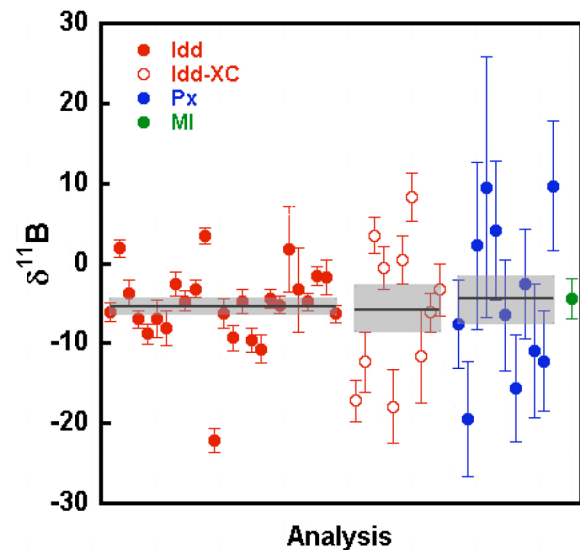

Figure 1. B isotope compositions measured in Nakhla iddingsite (Idd and Idd-XC), pyroxene (Px) and a magmatic inclusion (MI). For iddingsite, closed symbols are pre- NH_4Cl exchange and open symbols are post-exchange. Each data point represents an analysis on a single spot and errors are in-run $\pm 1\sigma_{\text{mean}}$. Solid horizontal lines are averages of all analyses on a particular phase and grey boxes are $\pm 1\sigma_{\text{mean}}$ errors for each of these average values.

USING RECENT IMPACT CRATERS AS A SAMPLING MECHANISM FOR A MARS SAMPLE RETURN MISSION. T. D. Swindle^{1,3}, L. L. Tornabene¹, A. S. McEwen¹, and J. B. Plescia², ¹Lunar and Planetary Laboratory, University of Arizona, Tucson AZ 85721 USA, ²Applied Physics Laboratory, Johns Hopkins University, 11100 Johns Hopkins Road, Laurel MD 20723 USA, ³tswindle@u.arizona.edu.

Introduction: Recent impact craters, several of which have been identified by the presence of extensive ray systems, provide a natural tool for breaking up and extracting samples from identifiable geological units and putting them in an easily accessible deposit. Hence they provide logical targets for an early sample return mission.

The goals that would be pursued are the absolute ages of particular surfaces, the connection between remote sensing and the composition and petrology of particular lava flows, and perhaps the connection of specific craters with the well-studied martian meteorites. Determining the age or other properties of a specific crater is not a first-order goal. Rather, the crater would provide a large quantity of more-easily-sampled material from a known geologic unit.

Martian rayed craters: Although craters with extensive visible rays have long been known on many Solar System bodies, most notably the Moon, the first identification of a Martian rayed craters has only come in recent years [1, 2].

The Martian rayed craters have been discovered not because of their visual albedo, but because of distinctions in their thermal infrared signature, as measured from orbit by TES and THEMIS (Fig. 1). The low-thermal-inertia (fine-grained) material that is visible in the IR produces rays that also contain clusters of secondary craters when examined at optical wavelengths [2, 3].

The first discovered was Zunil (Fig. 2), a 10-km crater with with IR discernable rays extending ~800-900 km [2, 3] and $\sim 10^8$ secondary craters of 10 m diameter or more extending as far as ~1600 km [4]. In addition, it probably produced $\sim 10^{10}$ rock fragments ≥ 10 cm, and even more at the slightly smaller sizes ideal for robotic sampling.

Four more definite and three probable rayed craters were discovered by [3], and yet another (now the largest known rayed crater system) was recently identified [5]. Most, though not all, of these craters are on rather young surfaces, late Hesperian or Amazonian, in the vicinity of either Elysium or Tharsis. In fact, there may be specific conditions required that make intact lava flows prime candidates to either form rays or to render them detectable [3]. Clearly, this is not a problem if the goal is to learn about Martian volcanism.

Science goals: Geochronology is an attractive objective for a sample return mission, because the questions of when processes occurred and how long they

took are key to understanding the evolution of Mars. In addition, geochronology is an area in which the power of terrestrial laboratories far exceed proposed in situ techniques. Carefully targeted in situ measurements could prove useful [6], but will never approach the precision and multiple-system redundancy of laboratory measurements [7]. Two areas that would be key to unraveling Martian chronology would be determining the age of a very young lava surface and providing a point in the “middle” of Mars’ history (e.g., Hesperian). Either (though not both) is possible with the selection of the proper rayed crater. Either would provide a calibration point with chronologies based on crater counts, perhaps helping determine the importance of secondary cratering in crater counts [2] and potentially providing a source for some of the Martian meteorites.

Since the rayed craters are among the youngest craters on Mars, and possess rays including numerous secondaries formed from high-speed ejecta (>1 km/s), they are likely candidate source craters for Martian meteorites [2, 3]. If, in fact, a source crater is sampled, that has the advantage of tying the vast amount of information acquired on the Martian meteorites to a specific location, providing valuable geologic context for the best characterized Martian samples to date. If the crater sampled is not a source crater for Martian meteorites, knowing the age and state of preservation of the crater may provide some clues to which craters may be source craters, and still provides a calibration point for the Martian crater production function.

Most of the rayed craters are on fairly extensive lava flows, extensive enough that they are identifiable in orbital data. Knowing the composition and mineralogy of the rocks from surface samples would provide a crucial comparison point for spectral data obtained from orbit, if not too dusty.

Note that the ideal sampling locations to take advantage of these craters would probably not be within the craters themselves. In some cases, the ground is rough, but a more serious problem is that many of them contain ponded deposits that might be impact melt. While perfect for dating a crater, such impact melt would destroy much of the information about the pre-crater geology. Nor would a sample from a ray itself or a distant cluster of secondary craters be ideal. The thermal signature of the rays themselves is produced by fine-grained material, perhaps only skin deep. Meanwhile, much of the fragmented material in

or around a secondary crater would be from the terrain in which the secondary crater, not the primary, formed. Rather, optimal sampling would probably be within about one crater radius from the crater rim, where unmelted ejecta would still be abundant, such that it would provide a source of material with the composition, petrology and crystallization age of the previous surface that is not highly shocked, but any local rock either excavated by ejecta or sampled by some other mechanism would have a clear genetic relationship with the surface in which the crater formed.

Perhaps, though, the only Mars sample return missions for the next several decades will be from ancient and perhaps geochronologically complex regions, such that the ages determined by any or all isotopic systems will be difficult to tie to a particular surface. If so, one or more of these craters might be a natural location for an in situ geochronology mission [8], where the lower precision would be compensated by the confidence in what is being dated by the age(s) obtained.

Specific craters: As illustrations of the kinds of regions that could be studied with such a mission, we give more details about several of the rayed craters. Crater diameters are given in parentheses.

Zunil (10.1 km), the first rayed crater discovered, and perhaps the youngest, is located on one of the youngest surfaces on Mars, in Cerberus Fossae, home of some of the most recent volcanic and fluvial activity on Mars [2, 9].

Tomini (7.4 km) is located 1250 southwest of Elysium Mons, in a Hesperian-aged unit, near an Amazonian-age unit [3].

Zumba (3.3 km) is also Hesperian-aged, on a series of lava flows originating from Arsia Mons [3]. The yet-unnamed crater (15 km) recently discovered is on the flanks of Elysium Mons, in a lower Amazonian unit. Any of these could provide an important calibration point for the crater-based chronologies near the Hesperian/Amazonian boundary, and each has its advantages. For example, Zumba would provide a sample of material from the Tharsis Rise.

As well as the rayed craters, other relatively fresh craters would have similar advantages, although some might be too old to be candidates to for Martian meteorite source craters. For example, Hale Crater (120 x 150 km) is an Amazonian-aged crater on a terrace of the Argyre basin that appears to have triggered fluvial activity. A carefully-targeted mission to Hale could potentially address both the age of Hale and of Argyre, as well as providing material that could be used to study a relatively recent fluvial episode.

Hence fresh craters, particularly rayed craters, would be a logical target for a geologically valuable sample return to Mars.

References: [1] McEwen A. et al. (2003) *Lunar Planet. Sci.*, 34th, Abstract #2040; [2] McEwen A. S. et al. (2005) *Icarus*, 176, 351-381; [3] Tornabene L. L. et al. (2006) *J. Geophys. Res.*, 111, E10006; [4] Preblich B. S. et al. (2007) *J. Geophys. Res.*, 112(E5), E05006; [5] Tornabene L. L. et al. (2008) *Lunar Planet. Sci.*, 39th, Abstract #2180; [6] Doran P. T. et al. (2004) *Earth Sci. Rev.*, 67, 313-337; [7] Nyquist L. E. et al. (2001) *Space Sci. Rev.*, 96, 105-164; [8] Swindle T. D. et al. (2004) *Meteorit. Planet. Sci.*, 39, A102; [9] Plescia J. B. (2003) *Icarus*, 164, 79-95;

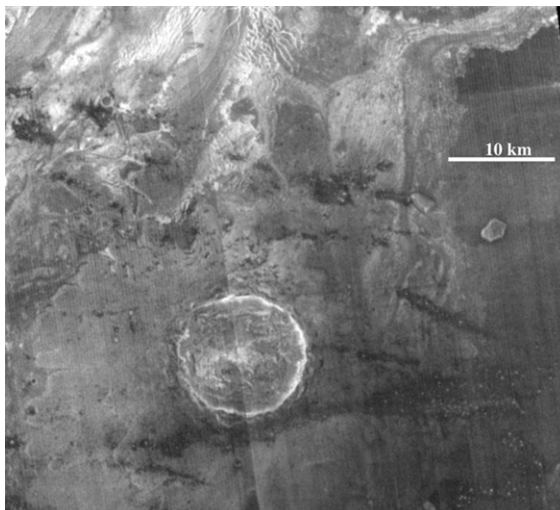

Fig. 1: Part of a mosaic of THEMIS IR images (night-time) of the Athabasca Valles region, showing dark (relatively cool) streaks (Zunil rays) with bright (warmer) spots (interiors of larger Zunil secondaries). The scene is ~50 km wide; located SE of Athabasca Valles. North is up. From [2].

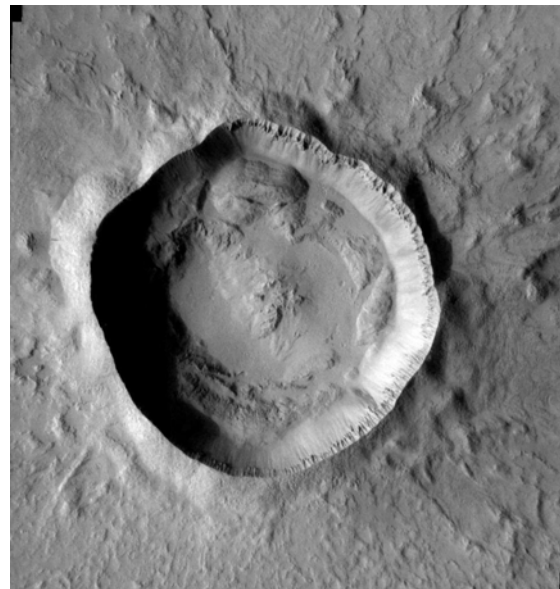

Fig. 2: Zunil crater (diameter 10.1 km), at 7.7°N, 166°E. North is up. From THEMIS visible image V09818024.

METEORITES ON MARS: IMPLICATIONS FOR SAMPLE-RETURN STRATEGY B. J. Thomson¹, N. T. Bridges¹, and M. C. McCanta², ¹Jet Propulsion Laboratory, California Institute of Technology, ²California Institute of Technology. (bthomson@jpl.nasa.gov)

Introduction: The recent discovery of at least 3 iron-nickel meteorites on the surface of Mars [e.g., 1-3] highlights the importance of exogenic material in planetary surface evolution. Because iron meteorites represent but a small fraction (~5%) of the total population of terrestrial meteoritic debris, the question arises as to the whereabouts of the remainder of the meteorite population, *i.e.*, the chondrites, achondrites, and stony-irons (which are about 86%, 8%, and 1%, respectively, of the terrestrial non-cometary bolide population [4]). The high Ni content of Martian soil [5] indicates an average of 1-3% contamination from meteoritic debris (confirming previous estimates [e.g., 6]). Here we estimate the meteorite population that may be archived on the Martian surface and discuss potential recognition criteria. Retrieving exogenic material (meteorites) from the Martian surface is unlikely to be a principal aim of the proposed sample return program. Therefore, a coherent sampling strategy must be employed to determine the origin of potential samples prior to their acquisition.

Terrestrial meteorites inform us of a fundamental disparity in the type abundance of meteorites recognized on the ground (finds) as opposed to the rarer events where meteoritic debris is actually observed to fall from the sky (falls). In the former category, the percentage of iron meteorites vastly exceeds their observed abundance in the latter [4]. This overrepresentation of irons in finds is due to a combination of ease of recognition, preferential preservation, and greater resistance to fragmentation in passage through the Earth's atmosphere and surface impact processes. Observations of asteroid populations [e.g., 7] and the relatively unbiased Antarctic micrometeorite collections [8] have confirmed the view that the type abundance of falls more accurately reflects the type distribution of meteorite parent bodies than do the finds.

Martian finds: The twin Mars Exploration Rovers (MER) have been continuously operating in excess of 4 Earth years. Through Sol 1170, the total distance traversed by Spirit and Opportunity is 6.2 km and 10.3 km, respectively. Assuming that each rover can nominally collect remotely sensed data on targets within an effective radius ~15 m, the cumulative area explored is about 0.5 km², representing less than 7×10^{-9} of the Martian surface. Yet even in this limited area, at least 3 distinct rocks have been recognized whose characteristics are consistent with iron meteorites (dubbed “Heat

Shield”, “Zhong Shan”, and “Allan Hills”). Initially recognized by their unique spectral properties, these bodies have bland visible, near-infrared, and thermal infrared spectra that lack absorption features due to mafic minerals or other silicates, sulfates, or carbonates [9, 10]. Surfaces textures are generally pitted, and overall rock shapes tend to be sub-rounded to rounded (Fig. 1). APXS (Alpha Particle X-ray Spectrometer) measurements of the rock Heat Shield indicate a Ni abundance of ~7% [11], and Mössbauer analyses indicate that ~94% of its Fe is in the form of the iron-nickel mineral kamacite [12], both of which are consistent with the interpretation of Heat Shield as an iron meteorite. Interestingly, the extremely low ferric iron content ($\text{Fe}^{3+}/\text{Fe}_{\text{Total}} < 0.06$) suggests minimal surface weathering [12]. Since native Fe is not a common igneous or volcanic product, its presence on a planetary surface is a likely indicator of an exogenic process (*i.e.*, impact delivery).



Figure 1. Pancam mosaic of “Heat Shield” rock, an iron-nickel meteorite at the Opportunity site (Sol 346).

An even rarer find at the Opportunity site is the pebble “Barberton,” which may be a mesosiderite [3, 5, 12], a stony-iron meteorite. Stony-irons comprise ≤1% of terrestrial falls [4].

Atmospheric passage: The presence of an atmosphere both helps and hinders the survival of incoming meteorites. Thermal stresses due to the friction of passing atmospheric gasses heat up and ablate the outer surface layers of a bolide, and induced mechanical stresses can fracture and fragment incoming mate-

rial. But atmospheric processes also serve to decelerate incoming projectiles, thus allowing them to reach the surface at terminal velocity rather than at cosmic velocity (>2 km/s).

Using the relative percentage of iron meteorites known from falls on the Earth as a guide, the percentage of iron bolides at the top of Earth's atmosphere is about 5% [4]. Although the total flux of incoming bolides at Mars is greater than the flux at the Earth by about a factor of about 2 (due to Mars' closer proximity to the asteroid belt) [13], one can assume that the same relative proportions of irons to stones is applicable to the top of the Martian atmosphere. So for every incoming iron bolide, this suggests ~ 19 incoming stony bolides. The survival rate of incoming projectiles through the thin Martian atmosphere has been estimated for vertical ($\theta=90^\circ$) [14], inclined ($\theta=45^\circ$) [15], and vertical to oblique ($\theta=0-90^\circ$) [16] entry trajectories. The results from these studies indicate that upwards of 10% of the incoming meteorites may make it to the surface (either intact or in a fragmented state). The survival rates for irons and stones are different and model-dependant [*e.g.*, 14-16] – irons are more susceptible to ablation due to their higher thermal conductivities, while they are also more likely to resist fragmentation and survive a high-velocity collision with the surface without shattering. For simplicity, assuming the same survival rate for irons and stones, the discovery of 3 iron meteorites on the Martian surface suggests 30 incoming iron bolides and 570 incoming stony bolides. Therefore, on the order of 60 stony meteorites should be present in the area thus far examined by the rovers.

Implications and potential recognition criteria: Recognizing this predicted suite of stony meteorites hidden among normal (endogenic) rocks on the Martian surface will be a challenging task. Fortunately, several characteristics of stony meteorites may facilitate their recognition. A universal trait of terrestrial meteorites is a fusion crust—a low albedo, charred outer layer—resulting from frictional heating during atmospheric passage. The ability to abrade the outer surface layer of a rock with the RAT (Rock Abrasion Tool) would facilitate recognition of a fusion crust. Abraded or broken surfaces of ordinary chondrites might reveal the presence of chondrules (but only in

low petrologic grade meteorites). Fusion crusts would also have spectral signatures corresponding to silicate glass. Atmospheric passage also shapes the outer surface layers of meteorites in the form of regymplitic surface textures. Finally, if potential meteorites were analyzed with the APXS, ChemMin, or ChemCam instrument suites, they would exhibit distinctive chemical signatures. For example, a rock with a high elemental carbon abundance would be a strong carbonaceous chondrite candidate.

Importance for proposed sample return: Low erosion rates on Mars imply that fallen meteorites will be long-lived surface components. Accidentally returning a meteorite sample from Mars would hamper efforts to calibrate the relative Martian chronology, and would contribute no information about endogenic processes. Alternatively, meteorites or impactites might be interesting targets to sample due to their potential to archive paleo-atmospheres [17] or due to their potential to provide additional insight to the period of heavy impact bombardment in the inner Solar System. In either case, there is a clear need to develop sample protocols that would allow us to distinguish potential meteorites before surface samples are acquired.

References: [1] Arvidson R. E. & Squyres S. W. (2005) *Eos Trans. AGU*, 86(18), abstract P31A-02. [2] Rodionov D. S. et al. (2005) *Geophys. Res. Abs.*, 7, abstract #10242. [3] Schröder C. et al. (2006) *Met. Planet. Sci.*, 41, abstract #5285. [4] McSween H. Y., Jr. (1999), *Meteorites and their Parent Bodies*, 310. [5] Yen A. S. et al. (2006) *JGR*, 111, E12S11. [6] Flynn G. J. & McKay D. S. (1990) *JGR*, 95, 14497-14509. [7] Bus S. J. & Binzel R. P. (2002) *Icarus*, 158, 146-177. [8] Taylor S. et al. (2000) *Met. Planet. Sci.*, 35, 651-666. [9] Christensen P. R. (2005) *AGU Spring Meet.*, abstract P31A-04. [10] Bell J. F. (2005) *Eos Trans. AGU*, 86(18), abstract P31A-03. [11] Yen A. S. et al. (2005) *Geophys. Res. Abs.*, 7, abstract #09861. [12] Morris R. V. et al. (2006) *JGR*, 111, E12S15. [13] Ivanov B. A. (2001) *Space Sci. Rev.*, 96, 87-104. [14] Bland P. A. & Smith T. B. (2000) *Icarus*, 144, 21-26. [15] Popova O. et al. (2003) *Met. Planet. Sci.*, 38, 905-925. [16] Chappelow J. E. & Sharpton V. L. (2006) *Icarus*, 184, 424-435. [17] Delano J. W. (1988) *Works. Mars Sample Return Sci.*, 63-64.

TWO GENERATIONS OF CARBONATE IN ALH84001: THREE OXYGEN ISOTOPES AND OH.

J.W. Valley¹, T. Ushikubo¹, and N.T. Kita¹, ¹Department of Geology & Geophysics, University of Wisconsin, Madison, WI 53706, valley@geology.wisc.edu

Introduction: Analysis by ion microprobe can provide accurate and precise stable isotope ratios (± 0.1 -1‰) of pg to ng samples at 1-10 μm -scale in grain mount or thin section [1]. These capabilities cannot be matched by instruments on Mars, although robotic sample selection is important.

ALH84001: Secondary carbonate minerals in the Martian meteorite, ALH84001, have been intensely studied and variously interpreted. Several textural forms have been described including concentrically zoned “globules” (or concretions) with distinctive white magnesite rims, and “clots” of relatively homogeneous ankerite intergrown with glass and orthopyroxene (see [2]). The apparent continuum of Ca-Mg-Fe composition varying from near calcite to magnesite, has led some workers to conclude that all textures formed by a single process, however [2] shows that compositions are not continuous if Mn is considered and that $\delta^{18}\text{O}$, measured *in situ* from 30 micron spots by CAMECA 4f ion microprobe, also correlates to texture (Fig. 1). Thus, there are at least two populations of carbonate. Globules were interpreted to form by aqueous precipitation at 20-190°C while clots may have formed by shock melting of globules [2].

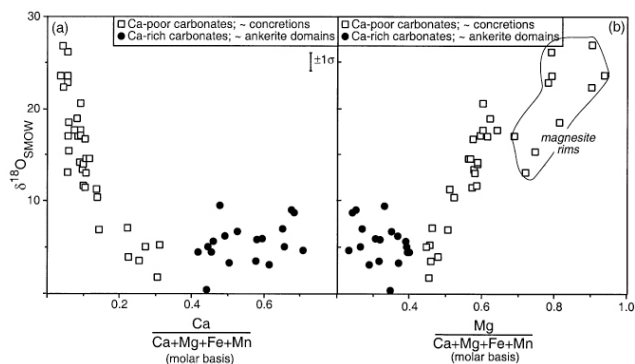

Fig. 1. Carbonates in ALH84001. Globules, $X_{\text{Ca}} < 0.2$, have variable $\delta^{18}\text{O}$ from 3 to 27‰. Carbonate clots, $X_{\text{Ca}} > 0.4$ have $\delta^{18}\text{O}$ mostly from 3-7‰. [2]

Three oxygen isotopes have been measured by several studies of bulk silicate samples in Martian meteorites and consistently yield $\Delta^{17}\text{O} \sim 0.3$ [3]. Bulk analyses of carbonates have also yielded $\Delta^{17}\text{O}$ values above the Terrestrial Fractionation line ($\Delta^{17}\text{O}=0$), but values average 0.8 ± 0.05 ‰, indicating that carbonates precipitated from fluids that exchanged with the Martian atmosphere and that the atmosphere is not in exchange

equilibrium with the silicate crust, attesting to the absence of plate tectonics and seafloor hydrothermal processes on Mars [4]. There have not been previous *in situ* analyses of $\Delta^{17}\text{O}$ in Martian meteorites, in part because accuracy and precision were not sufficient to distinguish values from Earth from those on Mars, or Martian silicates from Martian carbonates.

Three-Oxygen Isotopes by Ion Microprobe: The CAMECA IMS-1280 yields improved accuracy and precision for *in situ* analysis of $\delta^{18}\text{O}$ and $\delta^{17}\text{O}$ with a 15 μm spot [5]. After each analysis, ^{16}OH was measured to correct for tailing under ^{17}O (12-20ppm of ^{16}OH). A series of carbonate standards were run to calibrate instrumental mass fractionation (IMF). SIMS analyses of carbonate were bracketed by analyses of orthopyroxene from ALH84001 ($\delta^{18}\text{O}=4.99$, $\Delta^{17}\text{O}=0.32$ [3]); IMF in opx averages 0.03 ± 0.13 permil ($n=40$, $1\text{se}=0.02$ ‰). Analyses were also made of terrestrial zircons, which were bracketed by analysis of the KIM-5 zircon standard ($\delta^{18}\text{O}=5.09$, $\Delta^{17}\text{O}=0$).

Results: Zircon analyses demonstrate the accuracy and precision of these *in situ* three oxygen isotope data. Values of $\Delta^{17}\text{O}$ are 0 (by definition) ± 0.11 (1sd, $N=28$, $1\text{se}=0.02$ ‰) for KIM-5 and -0.05 ± 0.12 for 44 zircons with ages from 4.0 to 4.35 Ga (Fig. 2).

Values of $\delta^{18}\text{O}$ range from 2.3 to 6.0 for carbonate in clots (Fig. 2b) and 13.9 to 24.6 in globules (Fig. 2a). As seen in previous studies, $\delta^{18}\text{O}$ in globules increases with XMg [2]. Values of $\Delta^{17}\text{O}$ average 0.46 ± 0.20 (1sd) for clots, 0.61 ± 0.36 for ankeritic domains of globules, and 0.96 ± 0.16 for magnesite-rich domains including rims.

Discussion:

Terrestrial zircons. The detrital Hadean zircons are the only terrestrial materials that are similar in age to silicates and carbonates in ALH84001. There is no significant difference in $\Delta^{17}\text{O}$ between KIM-5 which represents oxygen from the Earth’s mantle at ~ 0.1 Ga and the $\Delta^{17}\text{O}$ of Jack Hills (Western Australia) detrital zircons, which preserve values of oxygen isotope ratio from magmas that were contaminated by supracrustal oxygen at > 4 Ga in the Hadean [7]. Thus there is no evidence in these data for a secular trend in $\Delta^{17}\text{O}$ on Earth for the mantle, crust, or hydrosphere.

Martian carbonates. Figs. 2 shows that the new *in situ* analyses of three oxygen isotopes from the Martian meteorite, ALH84001, are clearly distinct in $\Delta^{17}\text{O}$ from those for terrestrial samples, proving that carbon-

ates did not originate on Earth. The average for all samples is close to that reported for bulk analyses [4]. The data are consistent with heterogeneity of ~ 0.5 permil in $\Delta^{17}\text{O}$ within and among carbonates in ALH84001. This hypothesis is supported by the bulk

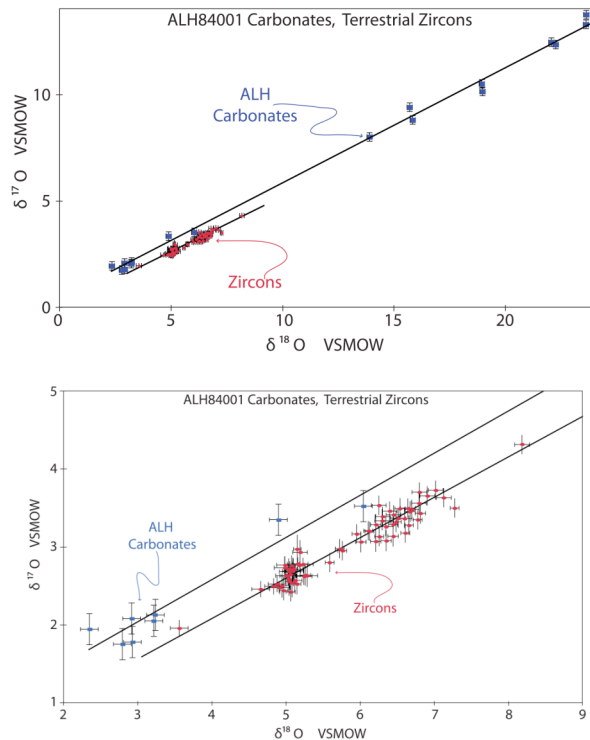

Fig. 2. In situ ion microprobe analyses of $\delta^{17}\text{O}$ vs. $\delta^{18}\text{O}$ VSMOW in carbonates from globules ($\delta^{18}\text{O} > 13$) and clots ($\delta^{18}\text{O} < 6$) in ALH84001 (large blue squares) and from terrestrial zircons (small red triangles). Zircons with $\delta^{18}\text{O}$ near 5 are the standard, KIM-5. All values above 6 permil are >4.0 Ga detrital zircons from the Jack Hills. **2a.** shows all data. **2b.** enlargement showing only data for carbonate clots in ALH84001 and zircons.

data [4] that equal the average of our new in situ analyses. If carbonates are variable, this would confirm the hypothesis that there are multiple generations of carbonate formation with globules formed by low temperature aqueous precipitation [2].

Water in Martian carbonates. Bulk analysis of Martian meteorites shows significant H_2O contents with elevated D/H. In situ analysis of δD in ALH84001 carbonates yields values from +182 to 2092 permil, but the $60\mu\text{m}$ spot size was too large to test for zonation [8]. High D/H is confirmed by micro

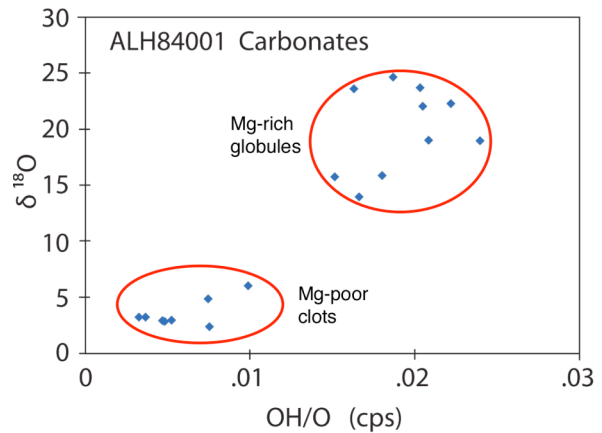

Fig. 3. Ion microprobe analysis of $\delta^{18}\text{O}$ VSMOW vs. count rate on OH normalized to oxygen for carbonates in ALH84001. Carbonate globules ($\delta^{18}\text{O} > 13$) contain significantly more OH than clots ($\delta^{18}\text{O} < 6$).

analysis of bulk samples of carbonate, and leaching experiments suggest that the main carrier of H in globules is hydromagnesite [9]. Figure 3 shows that H is concentrated in the Mg-rich globules ($\delta^{18}\text{O} > 13$) over the relatively Mg-poor clots ($\delta^{18}\text{O} < 6$). Ion imaging of individual analysis pits shows that H is homogeneously distributed over the $15\mu\text{m}$ domains analyzed, ruling out late hydrous alteration along cracks. These observations show that the water in carbonate globules is largely Martian in origin and concentrated in the white rims probably as hydromagnesite. The lower water content of ankeritic clots is consistent with dehydration due to impact melting of hydrous low-T globules.

References: [1] Page, FZ, Ushikubo, T, Kita, NT, Riciputi, LR, Valley, JW (2007) *Am. Mineral.*, 92, 1772-1775. [2] Eiler, JM, Valley, JW, Graham, CM, and Fournelle, J (2002) *Geochem. Cosmochim. Acta*, 66, 1285-1303. [3] Clayton RN and Mayeda TK (1996) *Geochim. Cosmochim. Acta*, 60, 1999-2017. [4] Farquhar J, Thiemens MH, and Jackson T (1998) *Science*, 280, 1580-1582. [5] Valley JW, Ushikubo, T, and Kita NT (2007) *LPS 38 Abstract #1147*. [6] Spicuzza MJ, Day JMD, Taylor LA, and Valley JW (2007) *LPS 38 Abstract #2025*. [7] Cavosie AJ, Valley JW, Wilde SA, and EIMF (2005) *Ear. Plan. Sci. Lett.* 235, 663-681. [8] Sugiura N and Hoshino H (2000) *Meteoritics & Plan. Sci.* 35, 373-380. [9] Eiler JE, Kitchen N, Leshin L and Straussberg M (2002) *Meteoritics & Plan. Sci.* 37, 395-405.

SALT-HYDRATE STABILITIES AND MARS SAMPLE RETURN MISSIONS. D. T. Vaniman¹, D. L. Bish², and S. J. Chipera³, ¹Group EES-6, MS D462, Los Alamos National Laboratory, Los Alamos, NM 87545 (vaniman@lanl.gov), ²Department of Geological Sciences, Indiana University, 1001 E 10th St., Bloomington, IN 47405, ³Chesapeake Energy Corp., 6100 N. Western Ave., Oklahoma City, OK 73118.

Salts on Mars: Early evidence from Viking for salts on Mars [1] has been reinforced by subsequent orbital [2] and landed [3] missions. Clark [4] first laid out the role of hygroscopic salts in martian hydrogeology. Salt hydrates on Mars can include structural OH (e.g., K-jarosite $\text{KFe}^{3+}_3(\text{OH})_6(\text{SO}_4)_2$ with OH at corners shared between FeO_6 octahedra), structural H_2O (e.g., hexahydrate $\text{MgSO}_4 \cdot 6\text{H}_2\text{O}$ with H_2O oxygens in octahedral coordination with Mg), and H_2O in independent sites (e.g., epsomite $\text{MgSO}_4 \cdot 7\text{H}_2\text{O}$ with the 7th H_2O extrapolyhedral). In general, only salt hydrates with H_2O in independent sites may dehydrate and rehydrate reversibly. The other structures are usually destroyed by dehydration, with loss of mineral information concerning formation environment and with release of H_2O that may react with other phases, possibly condensing on and dissolving soluble constituents. Recent work on several sulfate hydrates is summarized here.

Ca-sulfates. $\text{CaSO}_4 \cdot n\text{H}_2\text{O}$ occurs as gypsum ($n=2$) anhydrite ($n=0$), and bassanite ($n \approx 0.5$). Gypsum has H_2O molecules in 25% of the apices of 8-fold polyhedra containing Ca, the other 75% shared by oxygens of SO_4 tetrahedra. Bassanite, in contrast, has chains of SO_4 tetrahedra around channels containing H_2O . With slow dehydration of bassanite, H_2O can be removed almost entirely, producing “soluble” anhydrite. Aggressive complete dehydration with heating produces “insoluble” anhydrite with Ca- SO_4 -Ca chains in an orthorhombic structure. All three Ca-sulfate forms might occur on Mars. Gypsum and insoluble anhydrite should be stable under most conditions of collection and sample return; in the presence of H_2O ice, bassanite can regain water and may fully rehydrate to gypsum but the process is slow (e.g., $\sim 10^3$ hours at -2°C).

Mg-sulfates. The Mg-sulfate system has highly variable values of n in the formula $\text{MgSO}_4 \cdot n\text{H}_2\text{O}$, with common values of 7 (epsomite), 6 (hexahydrate), and 1 (kieserite). Chipera and Vaniman [5] point out the propensity for multiple metastable forms under dehydration. In addition, at low $p\text{H}_2\text{O}$, amorphous forms appear with low values of n dependent at least in part on temperature of dehydration [6].

Recent work in the Mg-sulfate system has led to the recognition that a phase long suspected to have 12 waters of hydration is in fact an 11-hydrate [7]; discovery of this phase on Earth and suggestions that it may occur in cold, icy environments on Mars are re-

flected in the new mineral name “meridianiite” [8]. This new mineral has SO_4 tetrahedra and Mg in octahedral coordination with H_2O oxygens, between sheets of H_2O , and it can not survive above 275 K. Clearly, only a very ambitious refrigerated sample system could return such a sample to Earth. A mission to return such material would probably be a component of one designed to collect and return H_2O ice, not likely in the near term.

Fe-sulfates. Acid systems on Mars can produce ferric sulfate salts [9]. Jarosite is the only confirmed Fe-sulfate mineral on Mars, determined by Mössbauer. Jarosite is quite resilient because of the lack of H_2O molecules and strong linkage by OH of corner-sharing octahedra. Other Fe-sulfates are not so durable [10]. Coquimbite ($\text{Fe}_2(\text{SO}_4)_3 \cdot 9\text{H}_2\text{O}$) has independent H_2O and dehydration on heating to 30°C produces an amorphous product that does not rehydrate. Kornelite ($\text{Fe}_2(\text{SO}_4)_3 \cdot 7\text{H}_2\text{O}$) behaves similarly. Botryogen ($\text{MgFe}(\text{SO}_4)_2(\text{OH}) \cdot 7\text{H}_2\text{O}$) becomes amorphous at comparably low temperatures and also will not reversibly rehydrate, but changes into a solid crust. Even modest heating of these H_2O -bearing ferric sulfates can be destructive, and degradation products can produce both cemented solids and viscous liquids [11].

Mixed-cation sulfates. Experiments [12] with the mixed-cation sulfates blödite ($\text{Na}_2\text{Mg}(\text{SO}_4)_2 \cdot 4\text{H}_2\text{O}$), kainite ($\text{MgSO}_4 \cdot \text{KCl} \cdot 2.75\text{H}_2\text{O}$), and polyhalite ($\text{K}_2\text{Ca}_2\text{Mg}(\text{SO}_4)_4 \cdot 2\text{H}_2\text{O}$) show that all are likely stable at Mars surface conditions. The least stable is kainite, which above $\sim 60^\circ\text{C}$ at low $p\text{H}_2\text{O}$ may form a yet uncharacterized phase [12]. These three mixed-cation salts should be stable under conditions of sample collection and return if maintained at $\leq 50^\circ\text{C}$.

Other salts. Sulfate salts dominate in both orbital and surface data from Mars. However, APXS data leave little doubt that halides are also present. Chloride hydrates could include antarcticite ($\text{CaCl}_2 \cdot 6\text{H}_2\text{O}$), bischofite ($\text{MgCl}_2 \cdot 6\text{H}_2\text{O}$) [see ref. 13], and tachyhydrite ($\text{CaMg}_2\text{Cl}_6 \cdot 12\text{H}_2\text{O}$). Thus the sulfates described above only hint at the salt hydrate complexity that may be present on Mars.

Case Histories of Stability Problems in Extra-terrestrial Samples: Lunar and meteorite samples have been subject to concern over which features are native and which may be products of terrestrial alteration. This is particularly the case for meteorite finds where the sample is known to have been subjected to

terrestrial weathering, but even strict sample collection, transmittal, and storage protocols can lead to alteration.

Lunar experience. Goethite (FeO(OH)) “rust” observed in Apollo 16 rocks stimulated great interest but was eventually found to have formed by hydration-oxidation of lawrencite (FeCl₂) after collection [14]. This is but one example of problems unstable salts can cause. Such problems may be exacerbated if samples from different depths, or collected at different seasons, are stored together. For hydrous silicates (e.g., smectites) water release may be nondestructive, but salts can dissolve or alter with exchange of very little water.

Meteorite experience. Epsomite is observed as a hydrous phase in primitive CII chondrites and has been cited as evidence of late-stage oxidation of the CII parent body [15]. However, there is strong evidence that epsomite formed in these meteorites after they were placed in humid terrestrial museums [16].

Implications for Mars sample return: Many salt hydrates might not be returned to Earth unmodified unless efforts are made to preserve Mars conditions of temperature and pH₂O [17]. Freezing samples from point of collection to processing for analysis on Earth would help maintain unstable hydrates but would be difficult, costly, and not foolproof – exchange of H₂O vapor between samples may still occur. Some samples collected at equatorial to mid latitudes may be desiccated and for these samples exceptional preservation may be unnecessary. Much is uncertain and a sequential approach to sample return is warranted.

Start easy, with equatorial sample return. Shallow regolith and rock surfaces from equatorial regions are likely to be desiccated, for mineral water loss under summer midday temperatures is more effective and rapid than rehydration at nighttime or winter conditions when frost is present. Sample return from higher latitudes where ground ice is present will not only present challenges with possible unstable salt hydrates but also with rover or lander operations at very cold temperatures, as well as the logistics of landing and departure at high latitude.

Analyze in situ. Sample analysis *in situ* will provide baseline determination of mineralogy, composition, and fabric against which later observations on Earth can be compared. This is recognized by MEPAG [18] in recommendations allowing for a sample analysis system of ~50 kg on the lander or rover. Active analysis systems have their own challenges and the analytical tools should avoid or minimize heating samples above maximum site temperature.

Plan ahead for on-planet sample holding. Temperatures on the lander or rover may affect salt hydrate preservation. For example, the heat of an equatorial

summer plus heat produced by the RTG on the 2009 MSL rover can raise the sample cache to 50 °C. Insulation or shading of the sample container might prevent temperature from rising so high, but thermal design constraints and consequences need careful evaluation.

Store separately. Samples collected at summer from an exposed rock surface may, if contained with samples collected from frost-coated regolith at winter, undergo H₂O vapor exchange with deleterious effects (e.g., loss of interlayer H₂O from smectite leading to chloride salt deliquescence). Separate containerization of each collected sample can minimize such effects.

Chill while in transit. Current sample return considerations do not anticipate active refrigeration on the return spacecraft, with an upper temperature constraint of 50 °C [18]. Design to keep temperature as low as possible should be considered, and active refrigeration should be evaluated in trade studies.

Process in an appropriate environment. Avoidance of elevated temperature as samples are processed, allocated, and analyzed will be important for at least some splits of the returned material. It may sufficient to first examine a chilled split for physical alteration (deliquescence, solution, etc.) and get a baseline as-received mineral analysis before other splits are processed and allocated.

Analyze with vigilance. Analytical results that produce unexpected evidence of H₂O exchange between minerals, suspicious mineral morphologies, and dissolution/precipitation features should be scrutinized to determine whether such features may be artifacts.

References: [1] Toulmin P., III et al. (1977) *J. Geophys. Res.* 82, 4625-4634. [2] Gendrin A. et al. (2005) *Science* 307, 1587-1591. [3] Rieder R. et al. (2004) *Science* 306, 1746-1749. [4] Clark B. (1978) *Icarus* 34, 645-665. [5] Chipera S. and Vaniman D. (2007) *Geochim. Cosmochim. Acta* 71, 241-250. [6] Vaniman D. and Chipera S. (2006) *Am. Min.* 91, 1628-1642. [7] Peterson R. and Wang R. (2006) *Geology* 34, 957-960. [8] Peterson R. et al. (2007) *Am. Min.* 92, 1756-1759. [9] Tosca N. et al. (2005) *Earth Planet. Sci. Lett.* 240, 122-148. [10] Hasenmueller E. and Bish D. (2005) *LPS XXXVI*, Abstract #1164. [11] Chipera S. et al. (2007) *LPS XXXVIII*, Abstract #1409. [12] Bish D. and Scanlan M. (2006) *LPS XXXVII*, Abstract #1011. [13] Zolotov et al. (2004) *LPS XXXI*, Abstract #1465. [14] Taylor L. et al. (1973) *Proc. 4th LSC*, 829-839. [15] Zolensky M. et al. (1993) *Geochim. Cosmochim. Acta* 57, 3123-3148. [16] Gounelle M. and Zolensky M. (2001) *Meteor. Planet. Sci.* 36, 1321-1329. [17] Vaniman D. et al. (2004) *Nature* 431, 663-665. [18] MacPherson G. et al. (2002) Groundbreaking MSR (<http://mepag.jpl.nasa.gov/reports/index.html>).

CLAY MINERALS IN RETURNED SAMPLES AND ALTERATION CONDITIONS ON MARS. Michael A. Velbel, Department of Geological Sciences, 206 Natural Science Building, Michigan State University, East Lansing, MI 48824-1115, velbel@msu.edu.

Introduction: A Mars Sample Return Mission will further understanding of the geologic history of Mars, by enabling direct study of surficial materials. The history of chemical interactions between Mars' crustal materials and the planet's fluid envelopes are recorded in igneous and sedimentary materials presently exposed on Mars' surface. The known history of vigorous surficial fluvial and aeolian activity on Mars suggests that much of the surficial material available on the surface of Mars has been modified by exogenic processes involving physical and/or chemical interactions with Mars' atmosphere, and with any hydrosphere which existed at different times during Mars' natural history. However, the extent of any chemical/mineralogical alteration, the relative importance of physical and chemical processes, the timing of any chemical alteration that may have occurred, and what information the surficial materials contain about the chemical history of Mars' surface and atmosphere are all matters of continuing research interest.

Orbiter and lander/rover studies of Mars' surface have identified and provided preliminary characterization of a range of surficial materials available for sampling, including igneous and sedimentary rocks, possible volcanoclastic/pyroclastic rocks, and unconsolidated sediment. Some surfaces expose unaltered anhydrous silicates (militating against extensive interactions with water), but most results (including studies of Mars meteorites) indicate at least minor aqueous alteration of exposed surface materials.

Clay minerals form by deuteric and hydrothermal alteration of igneous parent materials; weathering of any parent-rock type; and diagenesis of sediments (including volcanoclastics). This contribution reviews what can be determined about mineral-environment interactions from the study of the clay-mineral products of mineral-water interactions, emphasizing low-temperature surface phenomena (weathering).

Rock and mineral weathering. During weathering, primary rock-forming minerals react with solutions and/or volatiles. Reactants (minerals and mobile species) are consumed through processes governed by interactions among structure, composition, surface properties, and solute composition (the latter itself influenced by the history of the solution, including its origin and other reactions the solution participated in prior to arriving at the current reaction site). Weathered regoliths produced by weathering reactions contain residual primary rock-forming minerals (remnant

reactants), secondary minerals, and solutions and/or volatiles of altered composition. On Earth, clays formed by weathering vary with the interplay between (1) the dissolution kinetics of primary minerals that release silica and cations to solutions and (2) the leaching intensity of the weathering environment.

In many situations of interest, the solutions left the system long ago, and it is from the surviving solids that we infer the former processes [1-5]. Although reactant and product solutions and volatiles may no longer exist, considerable insight into their nature, abundance, and properties can be achieved by examining the reactant and product minerals. The compositional and textural relationships among reactants and products record mineral stability and elemental mobility, which in turn result from the thermodynamics and kinetics of reactions in the weathering system (including its volatiles). Even on Earth, where high temperatures and abundant water facilitate relatively rapid kinetics (at least in comparison with present conditions on Mars), the mechanisms of weathering reactions often prevent the attainment of thermodynamic equilibrium. Most naturally weathered materials therefore represent various intermediate stages between unaltered parent materials and the ultimate weathering products.

Multiple analytical methods are required to identify, characterize, and reconstruct weathering factors, processes, and conditions (including atmospheric composition and the solute characteristics of any liquid water) that may have existed when the weathering reactions took place in these transitional materials. Some analyses can be performed *in situ*, but the complete array of methods available in terrestrial laboratories is not readily transported off-planet. Also, robotic missions are constrained to use instruments that were available when the mission was designed. As the Stardust mission recently reminded us [6,7], sample-return missions allow use of the instrumental state-of-the-art available at sample return and thereafter.

What do clay minerals tell us about alteration conditions? For most of Mars' natural history, Martian environments of aqueous alteration (surface and shallow subsurface environments like those sampled by Mars meteorites) were likely characterized by low fluid-rock ratios, negligible leaching, and highly reactive (mafic) parent materials. Weathering in such systems may resemble the earliest stages of weathering of terrestrial mafic volcanic rocks. Rapid reaction rates of the mafic silicates and negligible leaching produce

conditions more similar to closed-system conditions than in most other terrestrial weathering environments. Consequently, much analysis of Mars-surface mineralogy assumes that thermodynamic equilibrium adequately describes parent-product mineral relationships of weathered planetary surface materials [8-10]. However, metastability (not thermodynamic equilibrium) is common in low-temperature mineral-water systems, so observations of kinetically controlled textures and mineral associations are more likely than thermodynamic modeling to detect evidence of processes and reaction paths [1-5].

Elemental transfer during alteration. Unlike whole-landscape (orbiter) and whole-sample (lander/rover) mineral and chemical data, returned samples will allow a variety of observations at spatial scales comparable to those at which chemical mineral-water interaction processes operate. These include textures at the interfaces between reactant and product minerals (that preserve information about the geochemical kinetics of the reactions; [11]); compositions (structural formulae, trace elements, isotopes) of reactant and product minerals and genetically related reactant-product assemblages; and compositional relations of products with mineral phases elsewhere in the regolith/landscape other than the local "parent mineral".

Structural relationships between naturally weathered chain-silicates and their alteration products indicate that the T-O-T (tetrahedral-octahedral-tetrahedral) "I-beams" of the chain silicates are transformed with minimal rearrangement of bonds into 2:1 T-O-T sheets [5,12-15]. While these structural relationships are well understood, less is known about compositional aspects of these reactions. Where primary- and secondary-mineral compositions are known from electron microprobe analyses, (isovolumetric) pseudomorphic replacement of primary chain-silicates by secondary sheet-silicates requires export of some elements and import of others. For example, one recent case study finds that clinopyroxene weathering to smectite conserved Si in the conversion of pyroxene to clay, lost Mg, and required import of Fe from faster-weathering Fe-bearing minerals nearby [16]. On Earth, leaching removes those elements overabundant in parent minerals relative to products; on Mars such mobile products may not have moved far in those cases where there was little water to carry them. Recent studies of within-regolith redistribution of major mineral-forming elements during terrestrial weathering [16] will serve as a model for future studies of major-, minor-, and trace-element redistribution at various spatial scales during clay-mineral formation in both terrestrially and extraterrestrially weathered rocks.

Primary-mineral corrosion textures and clay-mineral textures. Olivine subjected to terrestrial weathering of Mars-meteorite finds corrodes in the same manner as terrestrially weathered terrestrial olivine [17] and small-scale corrosion features on weathered terrestrial chain-silicates resemble features in Mars meteorites [18], indicating that insight from terrestrial weathering of mafic silicates is transferable to interpreting the alteration of silicates in samples from Mars.

Pyroxene surfaces are unaffected by relative humidity changes during sample handling and examination [11,16], whereas the smectite formed as the weathering product of the same pyroxene is strongly modified by environmental excursions during sample handling [16]. Preservation of clay-mineral textures in returned Mars samples will be challenging; like other hydrous phases, variations in temperature and relative humidity will drive hydration-dehydration and changes in the volumes and textures of hydrous phases. Corrosion and replacement textures at the surfaces of anhydrous igneous minerals (including contacts with alteration products and exposed surfaces) will be much less vulnerable to modification by the sample recovery-return process. Compositional attributes of clays are more robust than textures and will better survive sample return.

References: [1] Nahon D. B. (1991) *Introduction to the Petrology of Soils and Chemical Weathering*: 313 p. [2] Berner E. K. and Berner R. A. (1996) *Global Environment: Water, Air, and Geochemical Cycles*, 376 p. [3] Delvigne J. (1998) *Can. Mineral. Spec. Publ.* 3. [4] Lasaga A. C. (1998) *Kinetic Theory in the Earth Sciences*, 811 p. [5] Taylor G. and Eggleton R. A. (2001) *Regolith Geology and Geomorphology*, 375 p. [6] Brownlee D. et al. (2006) *Science*, 314, 1711-1716. [7] Zolensky et al. (2006) *Science*, 314, 1735-1739. [8] Gooding J. L. (1978) *Icarus*, 33, 483-513. [9] Gooding J. L., Arvidson R. E. and Zolotov, M. Yu. (1992) in Kieffer H. H. et al. (eds.) *Mars*, p. 626-651. [10] Chevrier & al. (2007) *Nature*, 448, 60-63. [11] Velbel M. A. (2007) In Mange M. and Wright D., (eds.) *Heavy Minerals in Use, Developments in Sedimentology* 58, 113-150. [12] Eggleton R. A. (1975) *Amer. Mineral.*, 60, 1063-1068. [13] Cole W. F. and Lancucki C. J. (1976) *Clays and Clay Minerals*, 24, 79-83. [14] Eggleton R. A. and Boland J. N. (1982) *Clays and Clay Minerals*, 30, 11-20. [15] Banfield J. F. and Barker W. W. (1994) *GCA*, 58, 1419-1429. [16] Velbel M. A. and Barker W. W. (in press) *Clays and Clay Minerals*. [17] Velbel M. A. (2008) *LPS XXXIX*, Abstract #1905. [18] Velbel M. A. et al. (2007) *Meteoritics & Planet. Sci.*, 42, A156.

HIGHLY SIDEROPHILE ELEMENT ABUNDANCES IN SNC METEORITES: AN UPDATE. R.J. Walker¹, I.S. Puchtel¹, A.D. Brandon², and A.J. Irving³. 1 – University of Maryland, College Park, MD 20742 (rjwalker@geol.umd.edu, 2 – NASA, JSC, Houston, TX 77058, 3 – University of Washington, Seattle, WA 98195

Introduction. Highly siderophile elements (HSE: Re, Os, Ir, Ru, Rh, Pd, Pt, and Au) strongly partition into metal relative to silicates. As such, their abundances in planetary mantles were strongly affected by core formation. The moderate abundances of HSE in the terrestrial mantle have been explained as a consequence of one of several processes. Some have advocated that HSE abundances in the mantle were established by metal-silicate equilibration at the base of a deep magma ocean where metal-silicate distribution coefficients may have been appropriate (sufficiently low) to account for the present mantle abundances [1,2]. Others argued that continued accretion postdated the final stages of terrestrial core segregation and that the accumulation of late accreted materials increased the HSE abundances from very low immediately following completion of core segregation, to their current moderate levels [3,4].

Constraining the abundances of HSE in the mantles of other inner solar system bodies may help to distinguish between the early planetary processes that had the largest effect on the HSE budgets of the planetary mantles. Unfortunately, comparisons are difficult. The abundances of HSE in the lunar mantle have been highly problematic to constrain because of the lack of direct samples of the lunar mantle, the paucity of lunar ultramafic rocks (which are most useful for characterizing HSE abundances in mantle sources), and the likely complex stratigraphy of the lunar mantle. Nonetheless, several recent studies have concluded that HSE abundances in the lunar mantle are much (~20x) lower than in the terrestrial mantle, and may be in chondritic relative abundances [5-6]. These conclusions, however, remain tenuous.

Here, we report new HSE data for two lherzolitic shergottites and eight basaltic shergottites as a means of placing additional constraints on the HSE inventory of the martian mantle. This study is complementary to our ongoing study of the Re-Os isotopic systematics of SNC meteorites [7,8]. The SNC suite offers some distinct advantages for studying HSE in the martian mantle compared to studying existing lunar samples in our inventory for understanding the lunar mantle. Most notable is the substantial proportion of ultramafic samples (lherzolites) and basalts with relatively high MgO among the SNC suite. Although these rocks are not direct samples of the martian mantle, their HSE abundances likely more closely record mantle abundances compared to more evolved materials. Several previous studies have reported HSE

abundances in martian SNC meteorites that are generally similar to abundances in terrestrial rocks with the same MgO [9,10]. Based largely on the study of ultramafic samples, the implication has been that the concentrations of the HSE in the martian mantle are roughly comparable to their concentrations in the terrestrial mantle.

Methods. Rhenium, Os, Ir, Ru, Pt, and Pd concentration data were determined for the following SNC meteorites: SaU094, SaU008, ALH77005, EET79001 (lithology A), NWA1195, NWA1068, Dhofar019, LEW88516, Y980459, and DaG476. Because of previous problems interpreting the Re-Os isotopic systematics of DaG476 [7], and desert SNC meteorites in general [8], we have begun a series of experiments to assess effects on HSE (and Os isotopes) resulting from desert weathering. In addition to two bulk samples (one with a pristine appearance and the other with visible alteration), we also analyzed a magnetic separate, a leachate (liberated from the rock using acetic acid) and the leach residue.

As with our previous work on SNC and lunar samples, the SNC meteorite samples were equilibrated with spikes and digested in Carius tubes @270°C using a mixture of nitric and hydrochloric acids. For the latest analytical campaign, blanks for Re, Os, Ir, Ru, Pt, and Pd averaged 1.1, 0.15, 0.39, 0.57, 27, and 9.1 pg, respectively. The effects of chemical blank on individual results varied from negligible for most elements in most samples to ~50% for Re in the magnetic separate of DaG476. Osmium concentrations (and isotopic compositions [8]) were determined by negative thermal ionization mass spectrometry. The remaining HSE were analyzed by inductively coupled plasma mass spectrometry. Accuracy of these measurements was monitored via periodic interspersal and analysis of spiked solutions of known isotopic compositions. In most cases, accuracy and precision of all concentrations except Re are estimated to be ±3%.

Results. Several observations are worthy of note. First, concentrations of the HSE in the meteorites are generally within the range of concentrations previously reported for SNC meteorites. The concentrations are also similar to those in terrestrial peridotites and picrites which have MgO extending over a comparable range. An exception to this is Y980459 which has an HSE pattern shape that is similar to that for NWA1195, but with substantially higher HSE content (Fig. 1). Second, all samples except Dhofar019 are characterized by broadly flat chondrite-normalized

HSE patterns that are depleted in Re relative to other HSE (Fig. 1). This result suggests that during the production of these lavas Re was either similarly compatible to the other HSE, or was lost from surface flows due to volatility, as has been observed for some terrestrial lavas. Finally, results for DaG476 indicate that HSE are evidently present in substantial quantities in phases that can be easily dissolved via a mild leach. This suggests that HSE patterns of desert meteorites must be interpreted with caution.

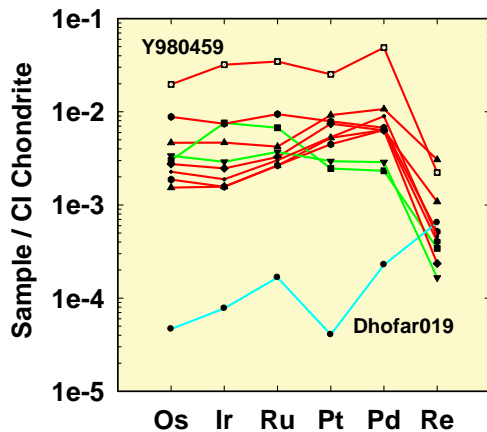

Figure 1. C1 chondrite-normalized HSE patterns for whole rock lherzolitic (green) and basaltic (red) shergottites. Dhofar019 and Y980459 are labeled.

Synthesis. These results, coupled with previously published data, indicate that the martian mantle sampled by shergottites contains similar abundances of the HSE to the terrestrial mantle. Further, the relatively unfractionated chondrite-normalized patterns for

higher MgO samples, together with the broadly chondritic initial $^{187}\text{Os}/^{188}\text{Os}$ ratios [7,8], provide evidence that the HSE are in chondritic relative abundances in the martian mantle source regions. These conclusions, if correct, would be difficult to explain via magma ocean models which may require a unique set of circumstances (p, T, $f\text{O}_2$) to account for the abundances of some HSE in the terrestrial mantle. Thus, these observations seemingly favor late accretionary models for the HSE in both the terrestrial and martian mantles. If late accretion was the mechanism that controlled the HSE abundances, however, it is remarkable that the additions to Earth and Mars were so proportionally similar and mixed so well within the respective mantle sources.

Acknowledgments. This work was supported by NASA grant NNX07AM29G to RJW.

References. [1] Murthy R. (1991) *Science* **253**, 303 [2] Drake M. (2000) *GCA* **640**, 2363 [3] Chou E. (1978) *Proc. 9th Lunar Planet. Sci. Conf.* 219 [4] Morgan et al. (2001) *MAPS* **36**, 1257 [5] Walker R.J. et al. (2004) *EPSL* **224**, 399 [6] Day J.M.D. et al. (2007) *Science* **315**, 217 [7] Brandon A.D. et al. (2000) *GCA* **64**, 4083 [8] Brandon A.D. et al. (2008), this meeting [9] Warren P.H. and Kallemeyn G.W. (1996) *MAPS* **31**, 97 [10] Kong P. et al. (1999) *GCA* **63**, 1865 [11] Walker R.J. et al. (2002) *LPSC XXXIII*, 1042.

Table 1. HSE data (in ng/g) for lherzolitic and basaltic shergottites. Listed in order of decreasing MgO (in wt. %)

Sample	Wgt. (g)	MgO	Re	Os	Ir	Ru	Pt	Pd
<i>Lherzolitic Shergottite</i>								
ALH77005	0.14	28.0	0.156	1.377	3.366	4.386	2.130	1.319
LEW88516	0.09	24.0	0.076	1.546	1.291	2.413	2.559	1.636
<i>Basaltic Shergottite</i>								
SaU008	0.18	20.5	0.496	0.702	0.698	1.719	4.555	3.625
SaU094	0.18	20.5	1.399	2.129	2.071	2.743	7.968	6.075
NWA1195	0.88	19.3	0.237	4.046	3.304	6.119	6.831	3.837
Y980459	0.08	~19	1.020	8.985	14.24	22.49	21.87	27.76
DaG476 (altered)	0.08	~19	0.211	1.041	0.836	1.957	4.614	5.094
DaG476 (fresh)	0.10	~19	0.265	1.562	1.031	1.808	3.154	3.489
DaG476 (magnetic)	0.02	~19	0.048	0.483	0.462	78.04	4.687	3.098
DaG476 (residue)	0.08	~19	0.367	3.986	3.230	4.758	4.240	3.404
DaG476 (leachate)	0.02	~19	0.429	0.954	0.419	1.205	2.887	2.996
EET79001 (lith A)	0.17	~16.5	0.107	1.261	1.095	2.127	6.443	3.586
NWA1068	0.19	16.6	0.186	0.858	0.695	1.725	3.881	3.614
Dhofar019	0.34	14.6	0.296	0.021	0.034	0.108	0.035	0.129

MAGNETIC STUDIES OF RETURNED SAMPLES FROM MARS. B. P. Weiss¹, I. Garrick-Bethell¹, and J. L. Kirschvink², ¹Department of Earth, Atmospheric and Planetary Sciences, Massachusetts Institute of Technology, 54-814, 77 Massachusetts Avenue, Cambridge, MA 02139, bpweiss@mit.edu, ²Division of Geological and Planetary Sciences, California Institute of Technology, 170-25, 1200 E. California Blvd., Pasadena, CA 91125.

Introduction: Although Mars today has no global dipole magnetic field, the twin discoveries of crustal magnetic anomalies in the ancient southern cratered terrane by the Mars Global Surveyor [1] and 4 billion year old remanent magnetization in Martian meteorite ALH 84001 [2] suggest that Mars had a core dynamo during the Noachian epoch. Knowledge of the timing and intensity of the Martian field is critical for understanding the thermal evolution of the Martian core, the possibility of an early period of plate tectonics, and the history of atmospheric loss on Mars. Because the crustal anomalies are sufficiently intense to deflect or focus incoming particle radiation, knowledge of the crustal magnetization pattern may also be important for locating possible human settlements.

Science from magnetic studies: When magnetic minerals crystallize, cool, or are aqueously deposited in presence of a magnetic field, their magnetic moments tend to align themselves in the direction of the local magnetic field and become magnetized with a magnitude that scales with the field intensity. Therefore, paleomagnetic studies of rocks yield two main pieces of information: the *intensity* and the *direction* of ancient fields. Because the original orientations of Martian meteorites on Mars are unknown, all paleomagnetic studies to date on Martian materials have only been able to measure the field paleointensity. *In situ paleomagnetic studies of Mars rocks and analyses of returned Martian samples afford the critical advantage of (a) knowing the geologic context of the samples and (b) providing the first opportunity to get paleodirectional information on Martian fields.*

Paleodirectional data. We regard paleodirectional data as the most important product to be gained from returned samples. Such information can be used for three very important investigations: 1) confirming that ancient magnetic fields were due to a core dynamo, 2) characterizing the temporal behavior of the Martian dynamo (reversal frequency and secular variation) and 3) chronicling local and planetary scale tectonic evolution (motion of the crust and/or mantle with respect to the background field).

1. While it is generally believed that an ancient dynamo once operated on Mars, it is not known for certain if magnetic fields observed from orbit were produced by impact processes [3] or a core dynamo. In extremely old or altered geologic units, it may be very difficult to determine if the magnetization is due to one effect by a combination of both effects. If the

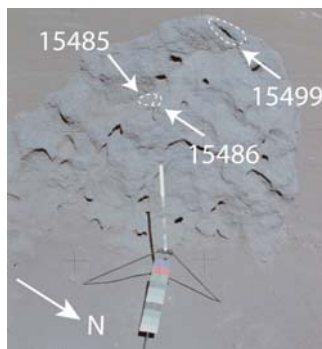

Fig. 1. Gnomon used to orient Apollo 15 samples 15485, 15486 and 15499 extracted from a boulder at Dune Crater. The gnomon rod points to vertical and its shadow can be used to determine geographic north.

paleofields were generated by impacts, then rocks of similar

ages would likely have random magnetization directions. However, rocks magnetized by an axial geocentric dynamo like that of the Earth should have average magnetization that points to either spin pole with inclination given by a characteristic latitudinal dependence. Discovery of such an effect would by itself be revolutionary in proving Mars had a dynamo. Only when the field generating mechanism is established can one proceed to investigations 2 and 3.

2. If one assumes that a crustal block was originally magnetized in the direction specified by a Mars-centric axial dipole, then the measured magnetization direction in an oriented sample from a known site can be used to infer the secular variation and reversal frequency of the field. These data can constrain the nature of core convection, the mechanism of field generation, and possibly the age of any solid inner core.

3. The same dataset can be used to test the hypothesis that Mars has experienced plate tectonics and/or local crustal tectonics. A properly designed study could even also locate the paleorotational axes of the planet. For example, it has long been thought that the formation of Tharsis resulted in true polar wander (TPW) which moved the center of mass of this edifice to the equator where it now lies [4]. Paleomagnetic investigations coupled with other forms of geochronometry would be able to test this hypothesis and place constraints on the timing and rate of this motion. Post-Tharsis TPW has recently been invoked as a mechanism for disrupting the elevation of putative shoreline features on the North Polar Basin [5]; elevation differences along these features have been the major evidence against their interpretation of shorelines. Paleomagnetic study of *in situ* or returned oriented Martian samples is one of the few mechanisms capable of testing the TPW/shoreline hypothesis.

Paleointensity data. Paleomagnetic studies of returned samples can also provide a wealth of informa-

tion concerning the cooling history of the planet by monitoring the strength of the Martian dynamo versus time. This information can also be used to determine when the planet had a dynamo and when it decayed, which will give more information about the mechanism generating the dynamo and planetary thermal evolution. A strong dynamo may have also provided protection from solar wind destruction of the Martian atmosphere and radiation protection for any primitive life.

Ideal samples and sampling strategy. *The ideal targets for paleomagnetic studies are oriented samples taken from coherent bedrock with well-defined paleohorizontal indicators.* Samples should be orientated with respect to present true north and vertical before they are removed from the outcrop. An established method from the Apollo missions for orienting samples is to photograph the sample in the same field of view as a gnomon (Fig. 1). A gnomon is a tripod and sun compass with a freely rotating gimbaled bar that always points toward true vertical (such that sample inclination can be inferred) and whose shadow can be used for obtaining geographic declination [6]. A similar device could be affixed to a sampling arm on a rover.

The ideal lithologies for paleomagnetic investigations are bedded basalts because of their high magnetization intensity, excellent fidelity for recording paleodirectional and paleointensity information, and the simple process by which they become magnetized. Sediments (both siliclastic and chemical) would also be very useful for paleomagnetic studies, but they are less favorable than basalts because of their relatively weaker magnetization, tendency to record a magnetization direction shallower than the true direction (particularly for claystones), and the lack of robust absolute paleointensity techniques for sediments. For either rock type, the samples should be collected from units with identifiable stratigraphy, bedding, layering, or other paleodirection indicators. This will greatly facilitate determining how the orientation of the unit has changed since the time of magnetization.

Landing site. The choice of the landing site is critical. Impact melts and regions heated by impacts should be avoided because they will likely have been demagnetized or remagnetized by impact processes (which may generate strong fields [3]). The samples ideally should be unshocked and unweathered. Interesting sites are the high crustal magnetic anomaly localities (which likely record an ancient dynamo) and bedrock outcrops at Meridiani [7] and Gusev [8] (which afford the possibility of sequence stratigraphy).

Sampling strategy. It is advisable to either collect multiple samples from each stratigraphic level with a coring device or to drill a long core perpendicular to

the stratigraphic sequence. Multiple samples afford the possibility of determining the temporal behavior of the field and can be averaged to obtain statistically meaningful aggregate properties of the geomagnetic field. Using a coring device also ensures that orientation can be reconstructed in the laboratory. For basalts, a minimum mass of 0.03 cm^3 per sample would be measurable with modern superconducting rock magnetometers. Sedimentary samples might require one or more orders of magnitude more sample mass (depending on the lithology). The drill used to collect the cores should ideally be made from nonmagnetic materials to avoid contaminating weakly magnetized rocks.

Sample handling requirements. There are two main sample storage requirements for this investigation: 1) samples should ideally not be heated above ambient Martian (or at least terrestrial) temperatures and 2) samples should not be exposed to magnetic fields greater than 10 microtesla and ideally no greater than ~ 0.1 microtesla. The latter requirement can be easily fulfilled if the samples are shielded inside of a high magnetic permeability container for the return trip to Earth. Because Apollo samples were not returned in magnetically shielded containers, part of their magnetic record was overprinted by spacecraft magnetic fields [9]. On Earth, samples should be stored in a magnetically shielded environment to prevent the acquisition of viscous remanent magnetization in the Earth's field.

In situ magnetic field measurements: While not required for analysis of returned samples, measurements of the local magnetic field with a magnetometer could provide useful information about the large-scale magnetization of the unit being sampled. This information would help interpret the magnetization of sample cores. For example, if several bedrock localities sampled 500 m apart are found to have similar magnetization directions, it would be helpful to know if a similar ambient magnetic field direction is observed between sites at km scales. If the directions were found to be similar, it would greatly strengthen the case for a homogenous field produced by a core dynamo.

References: [1] Acuna M. et al. (1999) *Science*, 284, 790-793. [2] Weiss B. P. et al. (2002) *EPSL* 201, 449-463. [3] Crawford D.A. and Schultz P.H. (1993) *Int. J. Impact. Eng.* 14, 205-216. [4] Melosh H.J. (1980) *Icarus*, 44, 745-751. [5] Perron J.T. et al. (2007) *Nature*, 447, 840-843. [6] Allton J.H. (1989) *Catalog of Apollo Lunar Surface Geological Sampling Tools and Containers* (NASA, Houston) 97 pp. [7] Squyres S.W. et al. (2006) *Science*, 313, 1403-1407. [8] Squyres S.W. et al. (2007) *Science*, 316, 738-742. [9] Pearce G.W. and Strangway D. W. (1972) in *Apollo 16 Preliminary Science Report* (NASA Spec. Pub. SP-315) 7-55 to 7-58.

CHEMCAM AS THE INSTRUMENT TO SELECT SAMPLES AND ENABLE MARS SAMPLE RETURN R.C. Wiens¹, S. Clegg¹, S. Maurice², and the ChemCam team; ¹Los Alamos National Laboratory (Los Alamos, NM 87545 USA; rwuens@lanl.gov, sclegg@lanl.gov), ²Centre d'Etude Spatiale des Rayonnements (31028 Toulouse Cedex 4, France; Maurice@cesr.fr)

Introduction: Mars Sample Return will utilize laboratory instruments to investigate Mars samples from known locations with precisions not obtainable with in-situ instruments on Mars. However, given the return sample limitations, it is imperative that the most revealing samples are returned. Sample caches on MSL and/or ExoMars are planned to be used for collecting desirable samples. If MSR does not pick up these caches, some analytical instrumentation will be required to determine the best samples to return. This instrument or instrument suite should minimally provide elemental abundances including those of astrobiological importance (e.g., H, C, N, O) and mineral identification. However, in-situ instruments should be minimized to avoid complexity and cost increases to MSR. For this reason, a single instrument with widely ranging capabilities and minimal sample handling/processing needs would be the best option. Here we suggest ChemCam or a ChemCam-like instrument as the best option.

ChemCam is an active remote sensing instrument suite being built for MSL [1,2]. It uses laser pulses to remove dust and to profile through weathering coatings of rocks up to 9 m away. Laser-induced breakdown spectroscopy (LIBS) obtains emission spectra of materials ablated from the samples in electronically excited states over an analysis spot < 1 mm in diameter at the focal point of the incident laser beam. A great advantage of LIBS is its sensitivity to H, C, N, O, Li, Be, and B as well as the heavier elements. The light elements are critically important to searching for samples of astrobiological interest, and are not detected by most in-situ techniques. LIBS analyses are rapid, requiring only several minutes to point at the target, focus, and shoot. ChemCam also includes a remote micro-imager (RMI) to provide context images of the target. The RMI has a field of view of 20 mrad (20 cm @ 10 m) and a resolution of ~80 μ rad (< 1 mm @ 10 m).

A key feature in suggesting ChemCam as the instrument to enable Mars Sample Return is its versatility. The small analysis footprint allows ChemCam to act as a contact instrument when samples are within the workspace of the rover's sample arm. Because of this, the MSL mission planning calls for ChemCam to operate during drive sols, remote sensing sols, and during contact sols. Another important feature is the combined imaging and chemical analyses. The RMI resolution is more than an order of magnitude better than that of PanCam, and is within a factor of three of the Microscopic Imager. At this resolution, the microscopic texture of the rocks becomes visible.

ChemCam is a collaboration between NASA and CNES. ChemCam's cost to NASA is under \$9M, a small fraction of the cost of many instruments.

References: [1] Maurice S., Wiens R., Manhès G., Cremers D., et al. (2005) *Lunar Planet. Sci. XXXVI*, 1735. [2] Wiens R., Maurice, et al. (2005) *Lunar Planet. Sci. XXXVI*, 1580.

HONEYBEE ROBOTICS SAMPLE ACQUISITION, TRANSFER AND PROCESSING TECHNOLOGIES ENABLING SAMPLE RETURN MISSIONS. K. Zacny, G. Paulsen, K. Davis, E. Mumm, and S. Gorevan. Honeybee Robotics Spacecraft mechanisms Corporation, New York, NY, ¹zacny@honeybeerobotics.com.

Introduction: In the last decade, Honeybee Robotics Spacecraft Mechanism Corporation has developed numerous sampling acquisition processing and sample transport devices. This abstract and conference presentation or a poster will detail each system with particular emphasis on design, performance, testing, results, and TRL level.

The Mini Corer: The Miniature Rock Coring and Rock Core Acquisition and Transfer System (Mini-Corer) was designed, built, and tested for the NASA's Mars Sample Return Athena Payload, scheduled for launch in 2003 [1]. It is a rover belly-mounted system and acquires rock cores for in-situ examination, and for caching for sample return Figure 1. The Mini-Corer weighs 2.7 kg (not including pitch-translate system) and its dimensions are 29.8 cm x 14.51 cm x 9.64 cm.



Figure 1. An engineering model of Mini-Corer was installed on JPL's field test rover, FIDO, to facilitate basic mission operations testing (see arrow). The Mini-Corer mass is 2.7 kg and the Mini-Corer box dimensions are 29.8 cm x 14.51 cm x 9.64 cm. This model currently resides at JPL.[2]

The Mini-Corer can obtain a 25 mm long and 8 mm in diameter core in strong basalt (compressive strength of 100 MPA) in less than six minutes while consuming fewer than 10 watt-hours of power. The Mini-Corer's carbide cutting teeth penetrate 30 cm in basalt at a penetration rate of more than 20 cm/hr (Figure 2).

The Mini-Corer can autonomously break off and retain the core. An internal pushrod is used to eject the core. This same pushrod is used to stabilize the target rock during the initial coring.

The Mini-Corer is also designed with a quick-change bit acquisition capability. Using the same quick-change subsystem, the Mini-Corer drill can be commanded to acquire a soil acquisition end effector for soil sampling.

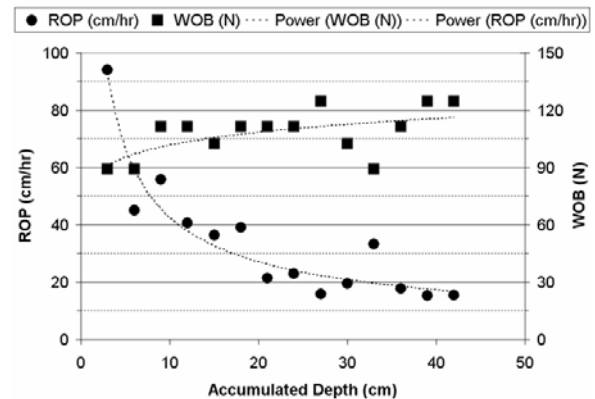

Figure 2. Rate of Penetration (ROP) and Wight on Bit (WOB) vs. Accumulated Depth for a single bit in 100 MPa Keweenaw Basalt. [2]

The Coring Abrading Tool (CAT): The integrated coring and abrading tool (CAT), is a hybrid of Honeybee's existing Rock Abrasion Tool (RAT) and Mini-Corer (MC) designs (Figure 3). The Rock Abrasion Tool is a TRL 9 instrument that is currently operating onboard of the Mars Exploration Rovers.

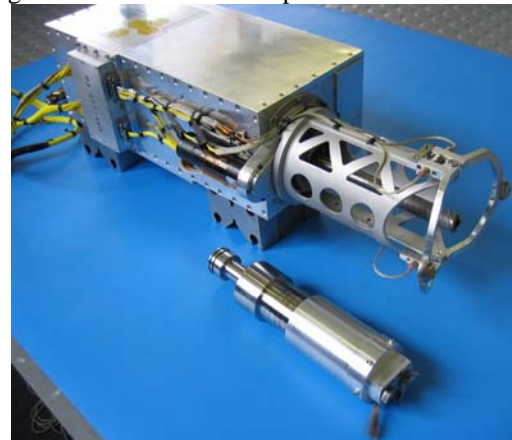

Figure 3. Corer Abrade Tool (CAT) can acquire rock cores and abrade rocks. It weighs less than 4 kg and is designed to be arm mounted.

The CAT is an arm-mounted, stand-alone device, requiring no additional arm actuation once positioned and preloaded. This instrument is capable of autonomously acquiring, retaining, and transferring cores 8 mm in diameter and up to 100 mm long of solid and unconsolidated material. In addition to coring, this

system is also capable of abrading and brushing rock surfaces and changing out bits and end-effectors autonomously. Shown in Figure 1, the CAT weighs less than 4 kg, and can penetrate 100 MPa basalt rock with only 120 Newton of preload (the actual Weight on Bit was less). The CAT was extensively tested in a vacuum chamber (under simulated Mars atmospheric conditions) and it is currently at TRL of 6.

The Sample Acquisition and Transfer Mechanism (SATM) drill: The SATM is a 1-meter class drill system that features sample handling abilities and sample return containers (Figure 4). A prototype was developed and successfully tested to validate the performance requirements for the NASA ST/4 Champollion mission goals. The SATM was designed to acquire samples at 20 cm and at one meter below the surface with little or no cross-contamination. Depending on the scientific sampling needs, the system can accommodate sample volumes ranging from 0.1-1.0 cc.

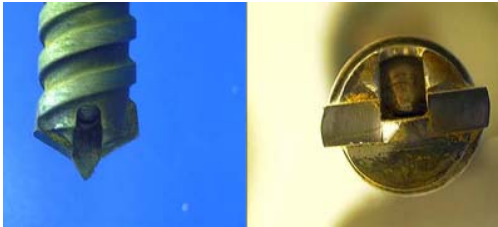

Figure 4: Detail of Sampling Tip (Door Closed) of the Sample Acquisition and Transfer Mechanism (SATM) drill.

The Mechanized Sample Handler (MeSH): The MeSH is a miniature centralized sample preparation station that could be mounted on an MSL-class (large) rover.



Figure 5. The Mechanized Sample Handler (MeSH).

The MeSH capabilities include three main subsystems: a rock crusher, a sieving/shaking mechanism, and a portioning/distribution system. The MeSH is designed to receive a variety of sample types (loose regolith, pebbles and small rock cores) from a variety of sampling devices, crush a sample and distribute powdered samples to a variety of instruments.

MeSH's rock crusher uses compression and attrition to reduce rock cores from a solid core to a very fine powder. The sieving/shaking mechanism sorts fine powder samples into two size categories, both targeted to be below 150 microns. The portioning/distribution system takes the sieved sample and makes an aliquot (or small portion) of it. The aliquot is then passed off to one of several instrument inlet ports.

The Sample Manipulation System (SMS): The SMS as shown in Figure 6 was developed for the Sample Analysis at Mars (SAM) Instrument aboard the Mars Science Laboratory (MSL). The goal of the SMS is to precisely position a sample from the sample inlet device to pyrolysis ovens [3].

The main design driver for the SMS is precise, autonomous manipulation of 74 sample cups to multiple interfaces. The SMS positions each sample cup below any interface to within 0.71 millimeters of true position and delivers up to 1330 Newtons to create a hermetic seal between the sample cup and pyrolysis oven. The high sensitivity of the spectrometers require the SMS to be very clean and also capable of sealing the sample cups from the outside environment during Assembly, Test, Launch, Transit, and Surface Operations while it is not executing an experiment.

The SMS is a first generation flight system that was flight qualified and delivered to Goddard Space Flight Center (GSFC) in November 2007.



Figure 6. The Sample Manipulation System was developed for Mars Science Laboratory Sample Analysis at Mars instrument. It has 74 cups that transfer a sample to a pyrolysis oven and make a hermetic seal with the oven.

References: [1] Myrick T. et al. (2000) LPSC XXXI, Abstract #6105. [2] Zacny K. et al. (2008) Astro. J. [3] Kennedy T. et al. (2006) Optimization of a Mars Sample Manipulation System Through Concentrated Functionality, AIAA Space 2006.

WHAT CAN YOU DO WITH A RETURNED SAMPLE OF MARTIAN DUST?

M.E. Zolensky and K. Nakamura-Messenger; Astromaterials Research and Exploration Science, NASA Johnson Space Center, Houston, TX 77058 USA (michael.e.zolensky@nasa.gov).

Stardust PET: A major issue that we managed to successfully address for the Stardust Mission was the magnitude and manner of preliminary examination (PET) of the returned samples [1], which totaled much less than 1 mg. Not since Apollo and Luna days had anyone faced this issue, and the lessons of Apollo PET were not extremely useful because of the very different sample masses in this case, and the incredible advances in analytical capabilities since the 1960s. After *considerable* discussion with the Curation and Analysis Planning Team for Extraterrestrial Materials we finally all agreed that we would make the 9 month long sample PET as comprehensive as possible, and to also be as inclusive as reasonable with respect to the PET team. We divided the PET effort into six parallel and interrelated efforts: (1) Bulk Composition, (2) Mineralogy and Petrology, (3) Organics, (4) Optical Properties, (5) Isotopes, and (6) Small Craters in Aluminum. All qualified scientists were invited to join any number of these groups, provided they met some minimal background requirements and agreed to group publication all PET results in *Science* (see Brownlee et al., 2006 [1] and all the adjacent papers). Initially we limited PET participation to PhDs with prior experience with analysis of astromaterials. As the effort progressed these rules were relaxed to permit new techniques to be employed and new expertise to be involved. An attractive result of this exercise was the entry of numerous new groups into the astromaterials field and the formation of very powerful new collaborations.

The PET was designed to proceed from the least invasive analyses through marginally destructive ones, and finally to some completely destructive procedures, to maximize the data harvest from minimal sample mass [2]. Thus we began many analysis trees using synchrotron X-ray fluorescence (SXRf), synchrotron tomography (SCT), and/or scanning

transmission X-ray microscopy (STXM) of entire keystone tracks, before actually removing individual grains from the tracks for analysis. These analyses enabled us to focus later characterization efforts on the most interesting captured grains, that would then be removed from the aerogel. We did not always have the time to follow this incremental analytical protocol during PET, but it was a model we followed whenever possible. For these separated grains we usually performed Vis-IR spectroscopy before proceeding to ultramicrotomy, isotopic, mineralogic or organic analyses of sections of grains. Table 1 lists the most commonly applied analytical techniques for nanogram-sized astromaterials, along with their relative, general level of sample destructiveness (modified after [2]). The techniques actually applied to Stardust samples during PET are underlined. Considering the short time (9 months) available for sample PET the range of applied analyses is remarkable, reflecting the value of the returned samples and the depth and dedication of the sample community. When we began to test silica aerogel as a capture media for cometary coma grains in the mid-1980s, the list of available analytical techniques was far shorter than what it is today, and the roster of nanogram-sized sample analysts in the astromaterials community was far smaller. A principal value of a returned sample over what may be accomplished remotely is that the samples can be reanalyzed as new techniques are developed and new ideas and hypotheses are proposed. As long as we continue to take good care of dust-sized samples, we can expect far more and improved analyses to be made of them in the coming decades.

References: [1] Brownlee et al. (2006) *Science* **314**, 1711-1716; [2] Zolensky et al. (2000) *Meteoritics and Planetary Science* **35**, 9-29.

Table 1. A Lengthy But Not Exhaustive Summary of Analytical Techniques Available for Nanogram-sized Samples; Analyses Performed During Stardust PET are Underlined

<u>Technique</u>	<u>Destructiveness</u>
Imaging	
<u>Light-Optical Techniques</u>	non-destructive
<u>Scanning Electron Microscopy/ Energy Dispersive Spectrometry</u>	non-destructive
<u>Synchrotron Tomography</u>	non-destructive
<u>Transmission/Analytical Electron Microscopy</u>	partially
<u>Scanning Transmission X-Ray Microscopy</u>	partially
Atomic Force Microscopy	partially
Force Spectroscopy	partially
Holographic Low-Energy Electron Diffraction	partially
<u>SIMS Ion Imaging</u>	destructive

Table 1 continued

<u>Technique</u>	<u>Destructiveness</u>
Bulk and Mineral Compositional Analyses	
Microparticle Instrumental Neutron Activation Analysis	non-destructive
<u>Synchrotron X-ray Fluorescence</u>	non-destructive
XRF Tomography	non-destructive
<u>Scanning Transmission X-ray Microscopy</u>	non-destructive
<u>Micro Raman Spectroscopy</u>	non-destructive
<u>Electron Microprobe Analysis</u>	partially
<u>Proton Induced X-ray Emission</u>	partially
<u>X-ray Spectroscopy</u>	partially
<u>Secondary Ion Mass Spectrometry (incl the Nano persuasion)</u>	destructive
<u>Time-of-Flight Secondary Ion Mass Spectrometry</u>	destructive
Laser Ablation Microprobe- Inductively Coupled Plasma-Mass Spectrometry	destructive
Double Focusing Secondary Ion Mass Spectrometry	destructive
Resonance Ion Mass Spectrometry	destructive
Thermal Ionization Mass Spectrometry	destructive
Organic Analyses	
<u>Micro Raman Spectroscopy</u>	non-destructive
Fluorescence	non-destructive
<u>Electron Energy-Loss Near Edge Structure</u>	partially
<u>Scanning Transmission X-Ray Microscopy</u>	partially
<u>Transmission and Reflectance IR-Vis Spectroscopy</u>	partially
<u>Optically- and Acoustically-Excited Phonon Spectroscopy</u>	partially
<u>Time-of-Flight Secondary Ion Mass Spectrometry</u>	destructive
<u>Chromatography</u>	destructive
<u>Secondary Ion Mass Spectrometry (incl the Nano persuasion)</u>	destructive
<u>Stepped Combustion and Static Mass Spectrometry</u>	destructive
<u>Two-Stage Laser Desorption/Laser Multiphoton Ionization Mass Spectrometry</u>	destructive
Noble Gas and Sample Exposure History	
Solar Flare Track Analysis	partially
Double-Focusing Mass Spectrometer	destructive
Age Dating	
Laser Ablation Mass Spectrometry	destructive
Mineralogy and Atomic Structure	
<u>Synchrotron X-ray Diffraction</u>	non-destructive
<u>X-ray Absorption Spectroscopy</u>	non-destructive
<u>Transmission IR-Vis Spectroscopy</u>	non-destructive
<u>Micro Raman Spectroscopy</u>	non-destructive
<u>Transmission Electron Microscopy</u>	partially
<u>Electron Energy-Loss Near Edge Structure</u>	partially
Atomic Force Microscopy	partially
<u>Electron Energy Loss Spectroscopy</u>	partially
<u>Extended X-ray Absorption Fine Structure</u>	partially
<u>X-ray Absorption Near-edge Structure</u>	partially
<u>IR-Vis Reflectance Spectroscopy</u>	partially
Cathodoluminescence Microscopy and Spectroscopy	partially
Physical Properties	
Density Measurements	non-destructive
Atomic Force Spectroscopy	partially
Magnetic Force Microscopy	partially

Notes

Notes
