

CATALOGO & FERRAMENTA UTENSILI

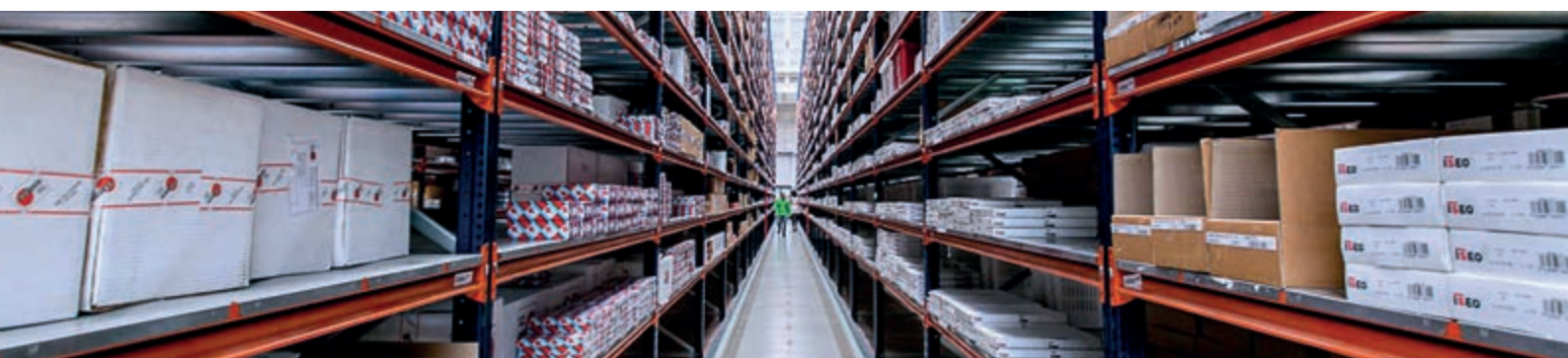

BENVENUTI NELLA NOSTRA AZIENDA



LA NOSTRA STORIA

M&T investe nello sviluppo e creazione di una nuova piattaforma E-Commerce, moderna sia nella veste grafica che nelle funzionalità messe a disposizione di agenti e clienti. 1° Compleanno del Laboratorio unifiche cilindri (servizio in crescita), inoltre è l'anno in cui nasce la pagina Instagram M&T.

Un nuovo concept-store: un punto vendita all'interno della nuova sede, con merce sempre nuova e corsi di formazione tenuti dai migliori fornitori in modo continuativo. Inoltre nascono: la pagina Facebook "Malfatti&Tacchini", <https://m.facebook.com/MalfattiTacchini/>, dove si condividono conoscenze, si pubblicano notizie e foto evento della nostra azienda. I clienti, lo staff M&T, gli esperti, possono commentare e parlarsi su web

L'obiettivo n°1 è stimolare la crescita della propria clientela tramite:
Introduzione nuove merceologie
Nuovi servizi di assistenza
Nuove formule di consulenza commerciale
Nuovi canali distributivi

Primo evento aziendale importante: "M&T DAY" con 25 fornitori protagonisti

Creazione di una seconda base logistica ad Ossonera per la gestione di articoli pesanti e voluminosi

Bresso: un nuovo magazzino di oltre 3.000 mq e nuovi uffici per 500 mq

Il Commendatore del Lavoro Pietro Tacchini e in signor Gino Malfatti avviano e sviluppano velocemente l'attività di ingrosso orientata a servire il canale dettaglio ferramenta su tutto il territorio nazionale

M&T compie 110 anni di attività, per l'occasione viene organizzato un grosso evento con la presenza di oltre 80 fornitori presso gli East End Studios di Milano.

Aprire la nuova sede di Paderno Dugnano, atto finale della riorganizzazione delle attività logistiche, voluta dal Dott. Tacchini, con l'introduzione della radiofrequenza 7.000 mq di magazzino - 1.500 mq di uffici Facile accesso viabilistico, in prossimità di importanti arterie di scorrimento - ampia area parcheggio riservata alla clientela Nuova aula di formazione attrezzata dedicata a clienti e rete agenti

Secondo evento aziendale: "M&T DAY", ancora più importante, poiché si festeggiano i 100 anni di attività, con ben 65 fornitori e una grande premiazione, con "I miti degli italiani". Nello stesso anno si registra il fatturato record

Il magazzino di Ossonera cresce a 5.000 mq Le referenze arrivano a 27.000 Le distribuzioni in esclusiva sono: Kerakoll, Ferm 25 agenti, 1.600 clienti. La copertura è ormai nazionale, con un'area di forza in: Lombardia - Piemonte - Veneto

Michele Tacchini viene nominato presidente ASSOFERMET. Durante i sei anni di presidenza sviluppa importanti relazioni e progetti in ambito nazionale e internazionale

La famiglia Tacchini acquisisce il 100% della Società

Nasce a Milano la Malfatti & Tacchini importatrice di ferramenta e utensileria



CONTATTACI

Per contattarci comporre il numero di telefono sottoindicato e seguire le istruzioni vocali con gli interni desiderati.



02 66502261-62

AMMINISTRAZIONE: interno 202 oppure 216

BANCO: interno 214 oppure 243

ASSISTENZA WEB: interno 210 oppure 232

SPEDIZIONI/ORDINI: interno 220 oppure 222

UFFICIO VENDITE: interno 213



AMMINISTRAZIONE: amministrazione@tacchini.info - amministrazione2@tacchini.info

BANCO: banco@tacchini.info

LABORATORIO TECNICO: ufficiotecnico@tacchini.info

ASSISTENZA WEB: marketing@tacchini.info

SPEDIZIONI/ORDINI: spedizioni@tacchini.info

UFFICIO VENDITE: commerciale@tacchini.info



CHAT TECNICA **WHATSAPP®**

334 2993500

ORARI CHAT: 8.30-12.30 | 13.30-17.30



malfattitacchini@tacchini.info

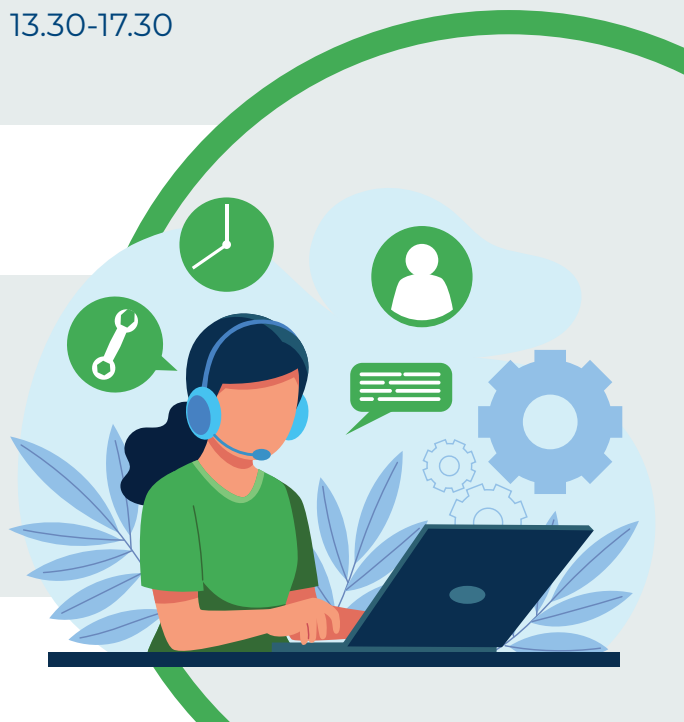

” UTILIZZIAMO
SCHEMI
COLLAUDATI
PER
**CRESCERE
INSIEME** “

dal 1971

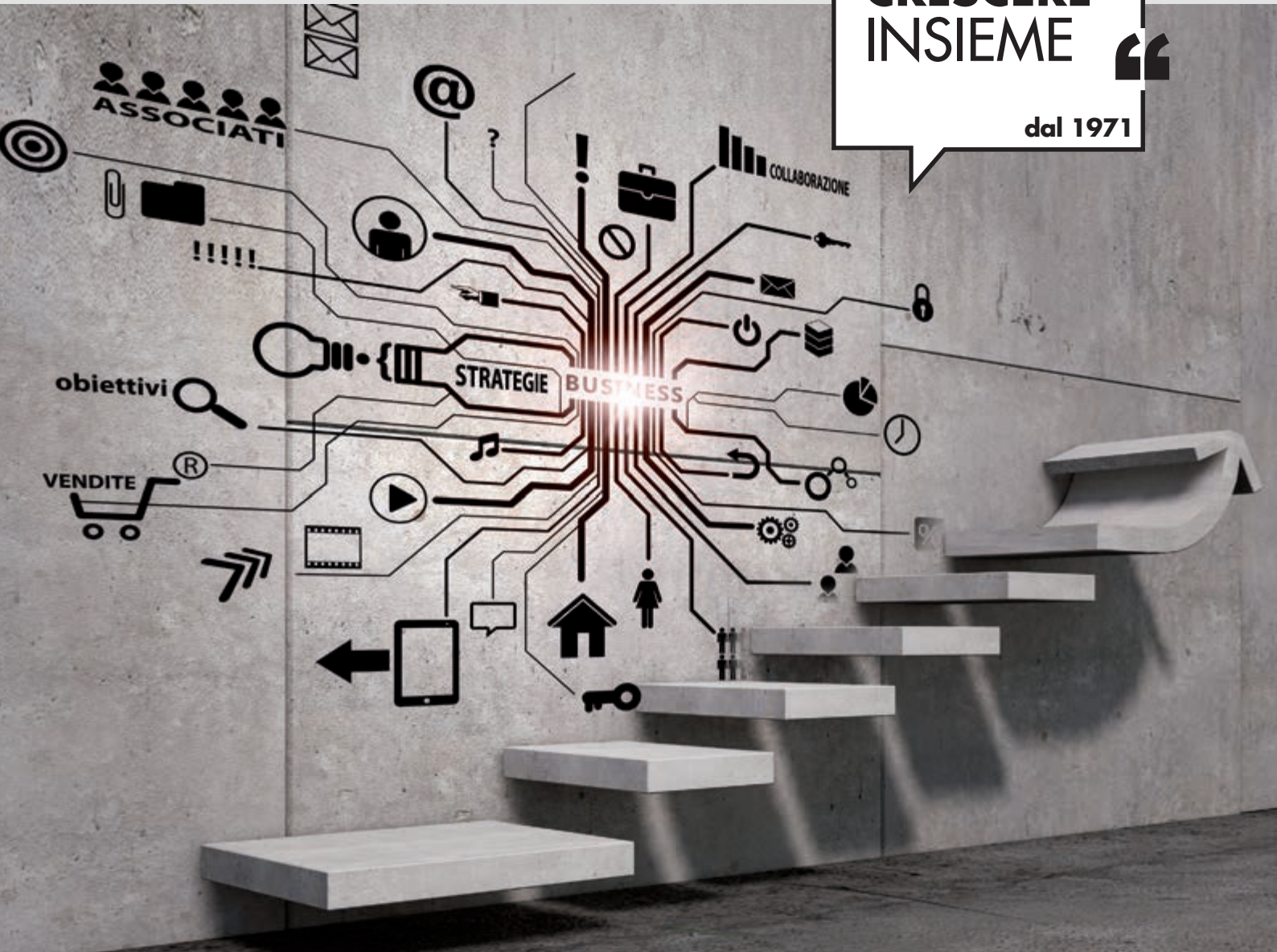

Corradini Luigi spa | Eurogross srl | Fabrizio Ovidio Ferramenta spa | Franzinelli Vigilio srl | Malfatti & Tacchini srl | Perrone & C. snc | Raffaele spa | Viglietta Guido & C. sas | Viridex srl

9 grossisti associati
210 milioni di € di fatturato sviluppato
140.000 mq. di strutture coperte
60.000 referenze gestite
220 agenti di vendita
20.000 clienti dettaglianti sul territorio nazionale

GIeFFE
gruppo grossisti ferramenta

[www.gruppogieffe.com]

**Malfatti
& Tacchini**
ferramenta dal 1908

Chiedi al tuo agente Malfatti & Tacchini
di essere contattato per avere un
preventivo per l'arredo
del tuo negozio



MONGUZZI
ARREDAMENTI MODULARI COMPONENTI

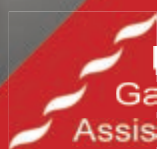

Consulenza nella ricerca del giusto equilibrio tra funzionalità ed estetica
Progettazione personalizzata per una migliore esperienza d'acquisto
Garanzia del migliore allestimento per incrementare le vendite
Assistenza post vendita

Tegometalli
Service center

MONGUZZI LUIGI & C SAS - Via della Valle 5 - 20841 Carate Brianza (MB)
Tel. 0362 903357 - Fax 0362 905121 - monguzzi@monguzzi.it
www.monguzzi.it - www.facebook.com/monguzziarredamenti

MONGUZZI

Tegometalli

SERVICE CENTER

- ARREDI MODULARI componibili
- PROGETTAZIONE personalizzata
- SCAFFALATURA
- GANCI E SISTEMI ESPOSITIVI
- COMUNICAZIONE



RAL 9001



RAL 9006



RAL 7015

140 | 380

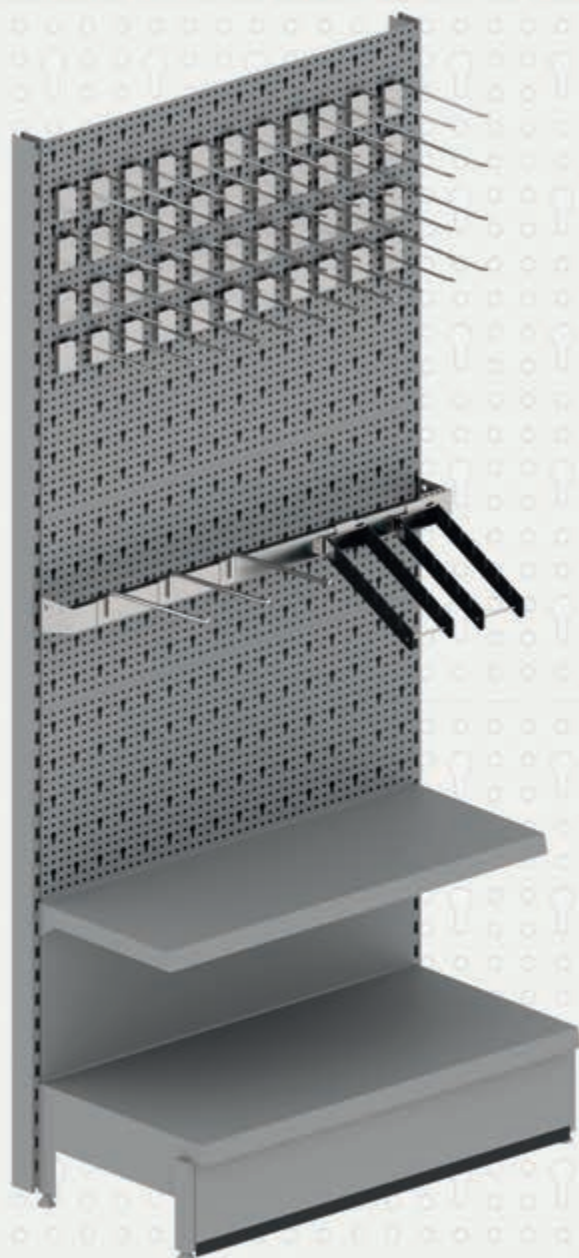
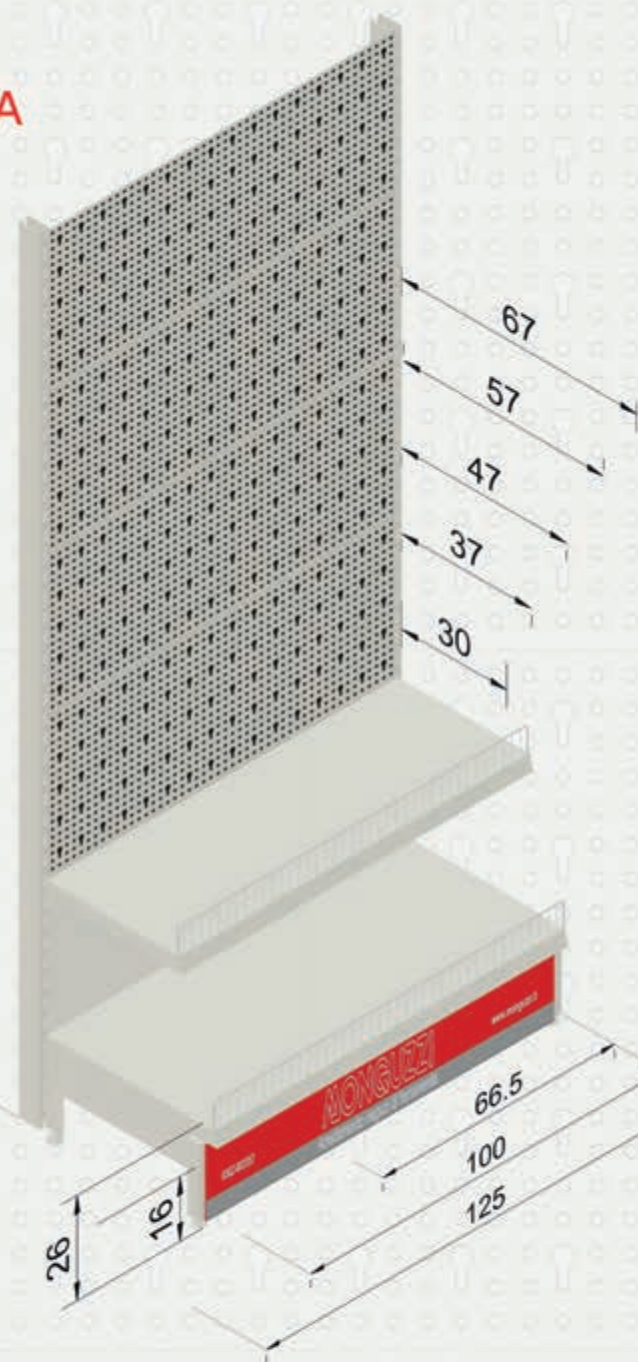

CHIEDI AL TUO AGENTE
MALFATTI & TACCHINI DI ZONA
DI ESSERE CONTATTATO
PER AVERE UN PREVENTIVO

Malfatti
& Tacchini
ferramenta dal 1908



**SE I NOSTRI NEGOZI SONO LE NOSTRE VITE
ASSOFERMET È LA NOSTRA CASA**

UNISCITI A NOI

RAPPRESENTIAMO TUTTA LA CATENA DISTRIBUTIVA DELLA FERRAMENTA



ASSOFERMET
FERRAMENTA

Abbiamo condiviso come te gli stessi pensieri e le stesse preoccupazioni e, senza che lo sapessi, abbiamo lavorato anche per te in questi difficili anni. Il nostro intervento a livello istituzionale ha permesso a più di **34.000 negozi** con i suoi **94.000 dipendenti** di continuare a lavorare e a prosperare diventando un punto di riferimento per migliaia di famiglie italiane. Per questi motivi vogliamo ora coinvolgerti in prima persona nell'ASSOCIAZIONE che è stata al tuo fianco, creando una apposita sezione: **dettaglianti di ferramenta**. Avrai a disposizione informazioni, report e rassegne del settore, oltre a webinar gratuiti online organizzati anche da Confcommercio e molto altro ancora. Chiedi informazioni ai nostri uffici o scrivi a assofermet@assofermet.it

UNISCITI A NOI

RAPPRESENTIAMO TUTTA LA CATENA DISTRIBUTIVA DELLA FERRAMENTA

ASSOFERMET FERRAMENTA raggruppa sul territorio nazionale i commercianti di distribuzione della ferramenta. L'ASSOCIAZIONE è il punto di incontro di grossisti di distributori e di dettaglianti di diverse dimensioni: un pool di imprese capace di rappresentare la forza della ferramenta ed utensileria italiana nell'intera filiera di settore. Come fattore di aggregazione ASSOFERMET FERRAMENTA affianca le imprese associate, nella convinzione che idee conoscenze e informazioni sono sempre più il valore differenziale della competitività; L'ASSOCIAZIONE garantisce anche attraverso un continuo e proficuo scambio di saperi assistenza costante in molteplici campi aziendali. Nell'ambito della tutela istituzionale e della rappresentanza nazionale e internazionale, ASSOFERMET FERRAMENTA aderisce a Edra (European-DIY Retail Association) e IHA (International Hardware Association).



ASSOFERMET
FERRAMENTA

ASSOFERMET – CONFCOMMERCIO IMPRESE PER L'ITALIA
20129 Milano | Via G. Gozzi n. 1 | Telefoni +39.02.76008807 | 76008824
fx +39.02.7810271 P.IVA 07480820963 | www.assofermet.it | assofermet@assofermet.it | assofermet@pec.it

ASSOFERMET - FERRAMENTA

“ Assofermet Ferramenta raggruppa sul territorio nazionale i commercianti di distribuzione della ferramenta. L'associazione è il punto di incontro di **grossisti**, di **distributori** e di **dettaglianti** di diverse dimensioni con un fatturato stimato in più di 9 miliardi di euro all'anno; è rivolta anche ad altri importanti settori della filiera: un pool di imprese capace di rappresentare la forza della **ferramenta ed utensileria italiana** nell'intera filiera di settore. ”



E-COMMERCE E ORDINI ONLINE

Scopri subito il nostro nuovo sito E-Commerce B2B



WWW.MALFATTITACCHINIGROUP.IT

1. RICERCA SEMPLIFICATA

Ricerca i tuoi prodotti all'interno delle nostre:
25.000 referenze / 300 fornitori / 17 macro-categorie e relative sotto-categorie

2. SCHEDE PRODOTTO

Accedi comodamente alle schede prodotto contenenti tutti i dettagli e stampale con un click

3. STOCK IN TEMPO REALE

Consulta lo stock in tempo reale

4. INVIO ORDINE SEMPLIFICATO

Invia i tuoi ordini in pochi click

5. RESI MERCE

Effettua resi merce aprendo un ticket dall'area dedicata (resi soggetti a termini e condizioni)

6. CONSEGNA RAPIDA

Consegna in 12/48h a seconda della zona



MalfattiTacchini



MalfattiTacchini



MalfattiTacchini



DROPSHIPPING

Vendere un prodotto al proprio cliente finale appoggiandosi alla logistica M&T.



WWW.MALFATTITACCHINIGROUP.IT



1. La Ferramenta invia l'ordine a M&T (tramite E-Commerce M&T) inserendo l'indirizzo del proprio cliente finale.

2. M&T elaborerà l'ordine tramite la propria logistica.

3. M&T provvederà alla spedizione dell'ordine all'indirizzo del cliente finale (inserito in fase ordine).

4. Il Cliente finale riceverà entro 24/48h la merce ordinata.



MalfattiTacchini



MalfattiTacchini



MalfattiTacchini



SIAMO SEMPRE CON VOI...



WWW.MALFATTITACCHINIGROUP.IT

CON UN AGENTE DI ZONA SPECIALIZZATO DEDICATO

Oltre 40 agenti su tutto il territorio nazionale

CON UN'EQUIPE DI TECNICI ESPERTI

Supporto tecnico per l'identificazione e l'acquisto di prodotti

AREA CLIENTE ON-LINE IN CONTINUO SVILUPPO

Investiamo costantemente nello sviluppo della nostra piattaforma E-Commerce per fornire e aggregare più dati possibili... tutto a portata di click H24

...PER FACILITARE LA VOSTRA QUOTIDIANITA'!



MalfattiTacchini



MalfattiTacchini



MalfattiTacchini



I NOSTRI BRAND

NUOVI BRAND INSERITI



	DUPLICATRICI, CHIAVI, RADIOCOMANDI	PAG. 1-177
	FISSAGGI, COLLANTI, SILICONI	PAG. 178-225
	ACCESSORI PER TAPPARELLE E PERSIANE	PAG. 226-243
	CATENACCI, CERNIERE, ACC. PER CANCELLI	PAG. 244-288
	LASTRINE, PIASTRE E MENSOLE	PAG. 289-306
	CATENE E FUNI	PAG. 307-319
	ANTINFORTUNISTICA	PAG. 320-335
	UTENSILI	PAG. 336-426
	ELETTROUTENSILI	PAG. 427-483
	MATERIALE ELETTRICO	PAG. 484-512
	ARTICOLI PER LA CASA	PAG. 513-557
	MANIGLIE, POMOLI, ACC. PER MOBILI	PAG. 558-599
	RUOTE	PAG. 600-606
	CASSETTE POSTALI	PAG. 607-615
	GIARDINAGGIO E IDRAULICA	PAG. 616-640



INDICE ALFABETICO

A	
ABBIGLIAMENTO DA LAVORO	321-325
ACCENDIFUOCO	518-519
ACCESSORI IMBIANCHINO	410-411
ACCESSORI RICAMBIO PER FORBICI POTATURA	618-619
ACCESSORI SMARTPHONE/TABLET	503-505
ADATTATORI CIVILI	490-493
ADATTATORI DA VIAGGIO	492-493
ADATTATORI INDUSTRIALI BLU	493-494
ADATTATORI INDUSTRIALI ROSSI	495
ADATTATORI TV	497-498
ADDITIVO PER MOTORI	545
AERATORI PER FINESTRE	556
AEROGRAFI	422
AFFILACOLTELLI	537
ALBERI FLESSIBILI CON MANDRINI	469
ALBERI PER FRESE A TAZZA	473
ALZAIMMONDIZIA	517
ANCORANTI CHIMICI	212-213
ANELLI BRONZO NAUTICA	314
ANELLI PER CHIAVI	1
ANELLI PER TENDE	554
ANELLI PER TENDE DOCCIA	554
ANTIMUFFA	513
ANTIURTO PER MANIGLIE	550
ANTIZANZARE	521
APRICANCELLO SOLO	25
ARCHETTI E SEGNETTI	367,399-400
AREATORI PER RUBINETTI	634
ARGANI	404
ARGANO PER TAPPARELLA	234
ARIA SPRAY	513
ARIASANA	513
ARMADI DA GIARDINO	517
ARMADI PORTA IMMONDIZIA	517
ARMADIETTO PRONTO SOCCORSO	610
ASPIRATORI E ASPIRACENERE	435
ASSI DA STIRO	526
ASTA DI SICUREZZA ARSENIO	239
ASTE SNODATE PER ANTE	576
ASTE TELESCOPICHE	623
ATTACAGLIE PER PENSILI	572
ATTACAGLIE PER QUADRI	548-549

ATTACCHI FLESSIBILI	636-637
ATTAK	216-217
AURICOLARI SMARTPHONE/TABLET	504
AVVIATORI E MANTENITORI CARICA	480
AVVITATORI	427-428
AVVOLGICAVI	488-489
AVVOLGITORI PER TAPPARELLE	227-229
B	
BACCHETTE PER TENDE	553
BACHECHE	611
BANDELLE FORATE	291
BANDELLE PER PERSIANE	237
BARRE PER PENSILI	571
BASETTE FASCETTE CABLAGGIO	188
BASI PER CERNIERE	588
BATTENTI DI ARRESTO	278-279
BATTERIE DURACELL	499-503
BATTERIE E CARICABATTERIE	428-429
BLINDY E ACCESSORI	241
BLINDY SBARRA	241
BLOCCA MARTELLINE	559
BLOCCADISCHI	542
BLOCCATAPPARELLE	232-234
BLOCCO PERSIANE	239-240
BOCCHETTE PER MANIGLIE	565-566
BOCCHETTE PER MOBILI	581-582
BOMBOLE CO2/ARGON	483
BORCHIE COPRIVITI	183-184
BORSE PORTAUTENSILI	402
BOSTIK 99	219
BOSTIK SUPERCHIARO	219
BOTTONI MAGNETICI	575
BRACCI REGOLABILI PER INFISSI	255
BUCHELTERE	612-613
BUSSOLE	371,389-390
C	
CACCIAVITI	385-386
CACCIAVITI CERCAFASE	363
CACCIAVITI PRECISIONE	386
CALIBRI	424
CALOTTE	226
CAMICE DA LAVORO	335
CAMPANELLO SENZA FILI	538

INDICE ALFABETICO



CANCANI A VITE	554	CATENACCIO DI SICUREZZA PER PERSIANE	239
CANNELLI A GAS	421	CATENACCIO PER PERSIANE	239-240
CANTONALI DI RINFORZO	292	CATENE ANTIFURTO ASTRAL/ILSA	538-540
CANTONALI PER PERSIANE	237	CATENE DECORATIVE	308-309
CARDINI PER CANCELLI	275-277	CATENE GENOVESI	307
CARDINI PER PERSIANE	237	CATENE PER PORTE	550
CARICABATTERIE	479-480	CATENELLE PER CHIAVI	4
CARICATORI SMARTPHONE/TABLET	503	CAVALLOTTI CON MANIGLIA	295
CARIGLIONI	272-273	CAVALLOTTI PER CREMONESI	255
CARRELLI ESTENSIBILI	404	CAVETTI STENDIBIANCHERIA	523
CARRELLI IBFM PER SCORREVOLI	284-285	CAVI ANTICADUTA	277-278
CARRELLI OMGE PER SCORREVOLI	282-288	CAVI ANTIFURTO	540-542
CARRELLI PIATTAFORME	404	CAVI PER BATTERIA	543
CARRELLI PIEGHEVOLI	404	CAVI SMARTPHONE/TABLET	504-505
CARRELLI PORTATUBO IRRIGAZIONE	624-625	CAVO SCART	498
CARRUCOLE CON GANCIO	314	CAZZUOLE	404-405
CARRUCOLE PER BASCULANTI	242	CENTRALINA PER TAPPARELLE	235
CARTA ASCIUGATUTTO	515	CERNIERE	257-272
CARTUCCE GAS	421	CERNIERE A BISCOTTO	260
CASELLARI POSTALI	610-611	CERNIERE INCASSO	260-262
CASSETTE BUSSOLE KRINO	391-392	CERNIERE INOX	271-272
CASSETTE EMERGENZA	612	CERNIERE PER MOBILI	260-262,585-587
CASSETTE INSERTI PER AVVITATORI/BITS	394	CERNIERE PER MOBILI SALICE	585-588
CASSETTE METALLO PORTAUTENSILI	371	CERNIERE PER VASISTAS	257
CASSETTE PER AVVOLGITORI	229	CESOIE PER LAMIERE	367,376
CASSETTE PORTA PUBBLICITÀ	609-610	CESOIE PER LATTONIERI	367,376
CASSETTE PORTACHIAVI	611-612	CHIAVE A NASTRO	370
CASSETTE PORTAUTENSILI	402-403	CHIAVE MULTIUSO UNIVERSALE A CROCE	246
CASSETTE PORTAVALORI	612	CHIAVI A BRUGOLA	392-393
CASSETTE POSTALI	607-608	CHIAVI A CATENA PER FILTRO OLIO	545
CASSETTE PRONTO SOCCORSO	610	CHIAVI A CROCE AUTO	370,389
CATENA BIANCA E ROSSA	309	CHIAVI A IMPRONTA MOIA	389
CATENACCI A CANNONE	248-249	CHIAVI A PIPA	370,388
CATENACCI A LEVA	244,253-254	CHIAVI A RULLINO	369,388
CATENACCI A SALDARE	251,254-255	CHIAVI A T SNODATE	370,388-389
CATENACCI A TRAVERSO	248-250	CHIAVI A TUBO ASTRAL	388
CATENACCI INOX	256	CHIAVI A TUBO GIEFFE/MUNDIAL	369
CATENACCI PER CANCELLI	244-245	CHIAVI AUTO	50-80
CATENACCI PER TAPPARELLE	248	CHIAVI CADORINE SILCA	148,160-162
CATENACCI PORTALUCCHETTO	251-253,256	CHIAVI COMBinate	368-369,387-388
CATENACCI QUADROTTO	255	CHIAVI COMBinate A CRICCHETTO	369,388
CATENACCI VERTICALI	244,249,253-254	CHIAVI DOPPIA MAPPA, POMPA SILCA	148-177
CATENACCIO A CREMAGLIERA	248	CHIAVI FISSE	368,386-387



INDICE ALFABETICO

CHIAVI PASSEPARTOUT SILCA	147-148,163-165
CHIAVI PER CASSETTE POSTALI	613
CHIAVI PER CAVI ANTIFURTO ILSA	542-543
CHIAVI PER MANDRINI	469
CHIAVI PER MOBILI	582,584-585
CHIAVI PER SMERIGLIATRICI	458
CHIAVI PER TAVELLINI	245-246
CHIAVI PIATTE SILCA	91-135
CHIAVI PIATTE SILKY	28-29
CHIAVI PIATTE SLIM	29
CHIAVI PIATTE ULTRALITE	29
CHIAVI PIATTE UNIVERSALI	28
CHIAVI POLIGONALI	368-369,387
CHIAVI PUNZONATE SILKY	29
CHIAVI PUNZONATE SLIM	29
CHIAVI PUNZONATE, TUBOLARI SILCA	138-146
CHIAVI SPILLO SILCA	136-137
CHIAVI SVITATUTTO (JOKER)	393
CHIAVI TE-MH	41-49
CHIAVI TORX	392-393
CHIODI PER QUADRI	550
CHIUDIPIORTA	552-553
CHIUSURE A LEVA	246-247
CHIUSURE MAGNETICHE	574
CILINDRI PER CASSETTE POSTALI	614
CILINDRO PER CARIGLIONI	273
CINGHIE CON CRICCHETTO	317-318
CINTINI PER TAPPARELLE	232-233
COLLA A CALDO	417-418
COLLANTI ATTACK	216-217
COLLANTI BOSTIK	219
COLLANTI PATTEX	217-219
COLLANTI VINAVIL	219
COLLE PER TOPI	520
COLTELLI DA TASCA	537
COLTELLI INNESTO	621
COLTELLI OPINEL	536-537
COMPRESSORI	435
CONVERTER	480
COORDINATI PER PORTE	593-599
COPRI MACCHIA SPRAY	415
COPRIANGOLI	255
COPRIAVVOLGITORI COTTALI/GHIDINI	546

COPRICHIAVE	1
COPRINTERRUTORI	546-547
COPRISCARPE VISITATORI	335
CORDE ELASTICHE	525
CREME LAVAMANI	514-515
CREMONESI GHIDINI	558-562
CREMONESI PER FINESTRE	567-569
CRICCHETTI MAGNETICI	573-575
CRICCHETTI REGGISPINTA	574
CRICCHETTI REVERSIBILI PER BUSSOLE	370-371,390
CRICCHETTI SOPRALUCE	247
CUCITRICI	418
CUFFIA MONOUSO	335
CUFFIE E TAPPI ANTIRUMORE	332
CUSCINETTI A SFERA	270
CUSCINETTI PER TAPPARELLE	230
CUSCINETTI RICAMBIO PER BASCULANTI	242
CUTTER	397-398
D	
DADI RAGNO E BUSSOLE	576
DEGHIACCIANTE	545
DETERGENTI PER AUTO	546
DETERGENTI SANIFICANTI	513-515
DIAVOLINA	519
DISCHI DIAMANTATI	448
DISCHI E FOGLI ABRASIVI	449-455
DISCHI LAMELLARI	449
DISCHI TAGLIO E SBAVO	449
DISCHI TAGLIO LEGNO	448-449
DISGORGANTI LIQUIDI (MELT)	514
DISSUASORI PER VOLATILI PLURISPILLO	623
DOCLETTE	633
DOPPIMETRI LEGNO	423-424
DUPLICATRICI SILCA E ACCESSORI	31-35
DURACELL	499-503
E	
EASY SCAN SILCA	15
ELASTICI	525-526
ELETTRODI	482-483
ELETTROPOMPE AD IMMERSIONE	631
ELETTROSEGA EINHELL	617
ESCHE PER TOPI	520

INDICE ALFABETICO



F	
FARETTI	506
FASCE DI SOLLEVAMENTO	316-317
FASCETTE CABLAGGIO	188
FASCETTE STRINGITUBO	187
FELTRINI ADESIVI	555-556
FELTRO ASSORBENTE	225
FERMALIBRI	554
FERMAPERSIANE	238-239
FERMAPORTE	551-552
FERMAPORTE A PEDALE	552
FERMATAPPARELLE	230
FERMATOVAGLIE	555
FERMI PER PERSIANE	237-238
FERRI E GIOCHI GHIDINI	566-567,599
FERROGLIERE PER CRICCHETTI	247-248
FILI MULTIUSO	523-524
FILIERE	393
FILM ESTENSIBILE	225
FILM IMBALLO	225
FILO ANIMATO PER SALDATRICI	483
FILTRI PER SEMI-MASCHERA BLS	334-335
FISSATRICI	419-420
FLESSIBILI DOCCIA	634
FLESSOMETRI	422-423
FORALASTRE	479
FORBICI ELETTRICISTA	367
FORBICI ERBA (A BATTERIE)	619
FORBICI LAVORO/MULTIUSO	537-538
FORBICI PER POTATURA	617-618
FORNELLI DA CAMPEGGIO	421
FRATTAZZI	405-406
FRENAFILETTI ALCA	219
FREQUENZIMETRO COPY CONTROL	12
FRESE A TAZZA AL MANGANESE MARTIN	472
FRESE A TAZZA HSS	472-474
FRESE A TAZZA IMPACT	475
FRESE A TAZZA PER LEGNO	476-477
FRESE A TAZZA WIDIA	475
FRESE ASSORTITE KRINO	475-476
FRESE CONICHE PER FERRO	469-472
FRESE DIAMANTE	470
FRESE PER CERNIERE	478-479

FRESE ROTATIVE SAGOMATE	477-479
FRUSTE MESCOLATORE	437
FUNI ACCIAIO	318-319
FUSIBILI	481
G	
GAMBETTE PER MOBILI	576-577
GANCETTI MULTIUSO	548
GANCI A S	308
GANCI CURVI A VITE	185-186
GANCI FERMAPERSIANE	240
GANCI INOX ADESIVI	555
GANCI MACELLAIO	555
GANCI PER BICI E MULTIUSO	304-306
GANCI PER PANNELLI FORATI	305-306
GANCI PER QUADRI	549
GANCI PER TAPPARELLE	231-232
GANCI PER TENDE	553-554
GANCI ROMA	550
GEL LAVAMANI	514
GENERATORI DI CORRENTE	435
GETTACARTE	557
GHIERE PER SMERIGLIATRICI	458
GIRAMASCHI	393
GIRATUBI	365,375-376
GIRAVITI (MUNDIAL)	362-363
GIRAVITI (STANLEY)	385
GOLFARI	310-311
GRAFFATRICI	418-419
GRASSO	220-222
GREMBIULE MONOUSO	335
GRIGLIE DI AEREAZIONE	556
GRILLI	310-311
GUANTI DA LAVORO	320-321
GUIDACINGHIE	230-231
GUIDE OMGE PER SCORREVOLI	283,286,288
GUIDE PER CASSETTI OMGE/METAL STYLE	588-592
GUSCI AUTO	40
GUSCI E TASTINI	81-90
I	
IDROPULTRICI	630
IGIENIZZANTI (PER AUTO)	223
INCONTRI PER CATENACCI	255
INSERTI PER AVVITATORI/BITS	395-396



INDICE ALFABETICO

INSETTICIDA	519-522
IRRORATORI DA GIARDINO	626
K	
KIT ARIA COMPRESSA	422
KIT CENTRALINA TAPPARELLA	235
KIT COMPRESSORE	421
KIT CUTTER PRECISIONE	394
KIT GUIDE PORTE SCORREVOLI	588
KIT RIPARA BICICLETTE	545
KIT RIPARAZIONE SMARTPHONE	394
KIT SCORREVOLE CON/SENZA SERRATURA	588
L	
LAME PER CUTTER	398-399
LAME PER SEGHE A GATTUCCIO	444-445
LAME PER SEGHE CIRCOLARI E RIDUZIONI (FREUD)	445-448
LAME PER SEGHETTI	401
LAME PER SEGHETTI ALTERNATIVI	442-444
LAME PER TAGLIABULLONI	376
LAME PUK	401
LAME SEGHETTI POTATURA	622
LAME SEGONCINI	622
LAME TAGLIABORDI	616
LAME TRAFORO	401
LAMPADE	511
LAMPADE PORTATILI	510
LAMPADINE	505-510
LAMPADINE ALOGENE PER AUTO	543-544
LANCE IRRIGAZIONE	626
LANCE TELESCOPICHE	630
LANE METALLICHE	452
LASTRINE AD ANGOLO	291-295
LASTRINE DIRITTE	289-291
LASTRINE E SUPPORTI DI GIUNZIONE PER PILASTRI	296-297
LEGABAGAGLI	525-526
LENTE DI INGRANDIMENTO	531
LETTERE/NUMERI OTTONE	614
LEVERINI	377
LEVIGATRICI	433-434
LIME E RASPE	378-382
LIME ROTATIVE PER FERRO	471
LIMITATORE DI APERTURA	239-240,594
LIMITATORI DI APERTURA PORTE BLINDATE	594
LIQUIDI PER LAVAVETRI	545-546

LIQUIDI PER RADIATORI	546
LIVELLE	426
LIVELLE LASER	425
LUBRIFICANTI SPRAY	219-222
LUCCHETTI AD ARCO PER BICI	542
LUCIDATRICI PER AUTO E ACCESSORI	435-436
LUMINARIE	511
LUMINO VOTIVO	511
M	
MAGLIE RAPIDE DI GIUNZIONE	316
MANDRINI	467-469
MANICI TELESCOPICI	623
MANIGLIA PER BASCULANTI	242
MANIGLIA VITALIA	564
MANIGLIE AD INCASSO	581,584
MANIGLIE BRIXIA	563
MANIGLIE CORNO	562-563
MANIGLIE DA BLOCCO	272
MANIGLIE ERIKA	564
MANIGLIE GABRY	561-562
MANIGLIE INCASSO	280
MANIGLIE LADY	560-561
MANIGLIE LINEA CALÌ	564-565
MANIGLIE MILENA	558-560
MANIGLIE MINNY	564
MANIGLIE PER CANCELLI	279-280
MANIGLIE PER CASSE	583
MANIGLIE PER FINESTRE	564-565
MANIGLIE PER MOBILI METAL STYLE	577-579
MANIGLIE ROMA	564
MANIGLIE SHARK	564
MANIGLIE SOTTOLASTRA	582-583
MANIGLIE VEGA	570
MANIGLIONI FERRO E ACCESSORI	281
MARCATORE SPRAY	415
MARTELLETTO TRAFORO	377
MARTELLI CARPENTIERE	377
MARTELLI E MAZZETTE	376-377
MARTELLI TESTA GOMMA	377
MARTELLINE GHIDINI	558-564
MARTELLINE LINEA CALÌ	564-565
MARTELLINE PER BASCULANTI	241
MASCHERE PER SALDARE	481

INDICE ALFABETICO



MASCHERINE BLS	333-335
MASCHI	393
MASTICE RIPARAGOMME BICICLETTE	544-545
MECCHIE	382
MEDAGLIA PER INCISIONI	9
MELT	514
MICROFRESE ROTATIVE	471-472
MISCELATORI ELETTRICI	437
MISCELATORI IDRAULICA	631-632
MISCELATORI PER TRAPANI	437
MISURATORI CONSUMO CORRENTE	512
MISURATORI LASER	424-425
MOLE SMERIGLIO	455-456
MOLLE APPENDIPIATTI	550
MOLLE FERMASCOPIA	555
MOLLE FERMATOVAGLIE	555
MOLLE SPINGIPORTA	552-553
MOLTIPLICATORI INDUSTRIALI BLU	495
MORSE	385
MORSETTI	383
MORSETTI CARCANO-BETA	309-310
MORSETTI ISOLATI	498
MORSETTI PER MASSA	482
MOSCHETTONI POMPIERE	314-316
MOSCHETTONI PORTACHIAVI	2-3
MOSTRINE PER PORTE	595-597
MOTORI PER TAPPARELLE E ACCESSORI	234-236
MULTIMETRI DIGITALI	425
MULTIPRESE CIVILI	484-487
N	
NASTRI ADESIVI	223-224
NASTRI SEGNALETICI	225,333
NASTRI TEFLON	639
NASTRI VELCRO PER ZANZARIERE	528
NASTRO ISOLANTE	225
NEON CIRCOLARE	509
NOTTOLINO LIBERO/OCCUPATO	552
NUMERI CIVICI E LETTERE OTTONE	614-615
O	
OCCHIALI DA LETTURA	531-536
OCCHIALI DI PROTEZIONE	332-333
OCCHIALI A VITE	185
OCCHIALI FILETTATI	186

OLIATORI	421
OLIO PER MOTORE	545
OLIO PER MOTOSEGHE	617
ORGANIZER ARTPLAST	403
ORGANIZER STANLEY	402
ORLI SOTTOVITE	184
P	
PALANCHINI	377
PALETTI PER CANCELLI A SALDARE	244-245
PARACOLPI	551
PARAFREDDO	530
PARASPIFFERI	530-531
PARASPIGOLI	554
PASSACAVI SCRIVANIA	575
PASTA LAVAMANI	514-515
PASTA SALDA	436
PATTINI ROTATIVI OMGE	288
PATTUMIERE	517
PELLI SCAMOSCIATE	545
PENNARELLI SNOWMAN	412-413
PENNE INCISIONE	436
PENNELLI	410-411
PERNI DI FISSAGGIO PER TRAPANI	457
PEZZE RIPARAGOMME BICICLETTE	544-545
PIALLE FALEGNAME	384
PIASTRE GUIDACANCELLO	279
PIASTRINE FORATE	295-296
PIASTRINE FORATE CON OCCHIOLO	296
PIATTAFORME ACCIAIO	404
PIEDINI PER MOBILI	576
PILE DURACELL/PROXE	499-503
PILETTE PER LAVELLO	636
PINZA AUTOBLOCCANTE	365,376
PINZE CAPICORDA	375
PINZE FERMAPORTA	550
PINZE FUSTELLATRICI	366,374
PINZE PER ANELLI	366,374
PINZE PER CAVI BATTERIA	543
PINZE PER OCCHIELLI	374
PINZE PER TENDE	554
PINZE POLIGRIPH	373-374
PINZE PORTAELETTRODI	482
PINZE PUNZONATRICI	367



INDICE ALFABETICO

PINZE RUBINETTI	640	PROFILI METALLICI E LASTRE	297-299
PINZE SPELAFILI	367,374-375	PROFILI OMGE PER SCORREVOLI	282,284
PINZE UNIVERSALI	365,371-374	PROGRAMMATORI GIORNALIERI E SETTIMANALI	512
PISTOLE AD ARIA	421	PROIETTORI LED	510-511
PISTOLE GONFIAGGIO	421-422	PROLUGHE TV	496-497
PISTOLE INCOLLATRICI	416-417	PROLUNGHE LINEARI	487-488
PISTOLE IRRIGAZIONE	626-627	PROTEZIONE CONTRO GLI INSETTI VAPE	521-522
PISTOLE PER SCHIUME POLIURETANICHE	214	PULEGGE	226-227
PISTOLE SILICONE	415-416	PUNTA HSS (ATTACCO 1/4")	428
PISTONI PER ANTE	575	PUNTE ELICOIDALI MARTIN	466
PLACCA PER BASCULANTI	242	PUNTE FORSTNER	478-479
PLACCHE BUCALLETTERE	612	PUNTE PER VETRO	463-464
PLACCHE COPRIAVVOLGITORI	229	PUNTE PILOTA	473,475
PLAFONCINI E PENNELLESSE	410-411	PUNTE SUPER DD	466
PLAFONIERE LED	510	PUNTE TRAPANO HSS	459-463
PLATORELLI	457-458	PUNTE TRAPANO PER LEGNO	466-467
POLVERE ANTI-FORMICHE	522	PUNTE TRAPANO SDS	464-465
POMOLI PER MOBILI	579-581,583-584	PUNTE TRAPANO WIDIA	463
POMOLI PER PORTE	569-571,593,597-599	PUNTERUOLI	383
POMOLINI PER CILINDRI	571,593	PUNTI PER FISSATRICI	418-420
POMPA UNIVERSALE PER TRAPANI	469	PUNTO LUCE	511
POMPE A PRESSIONE	629-630	PUNZONI	378
POMPE A SPALLA	629-630	Q	
POMPE AD IMMERSIONE	631	QUADRI E GIOCHI PER MARTELLINE	566-567,599
PORTA ROTOLI CARTA	515	QUARZI PER RADIOCOMANDI	12
PORTABITI	547-548	R	
PORTACHIAVI	2-9	RABOT GESSATORE	406
PORTACHIAVI MULTIUSO	5-8,9	RACCOGLIPOLVERE PER TRAPANI	469
PORTADISPENSER GEL IGIENIZZANTE	518	RACCORDERIA GIARDINAGGIO	627-629
PORTAETICHETTE	1	RACCORDERIA IDRAULICA	637-639
PORTAINSERI MAGNETICI	395-396	RADIATORI AD OLIO	529
PORTALAMPADA	498	RADIOCOMANDI	10-24
PORTAPUNTE TRAPANO	458	RADIOCOMANDI AUTO	26-27,36
PORTATUBO IRRIGAZIONE (AGRATI)	624	RADIOCOMANDI ORIGINALI	15-25
POSACENERE	557	RAMPINI A VITE	184
POWER BANK SMARTPHONE/TABLET	504	RAMPINI PER FINESTRE	186
POZZETTI PER CATENACCI	256-257	RASCHIA GHIACCIO	545
PRESE CIVILI	490	RASCHIETTI E LAME DI RICAMBIO	409
PRESE INDUSTRIALI BLU	493	RASPE ROTATIVE	476-477
PRESE INDUSTRIALI ROSSE	495-496	RASTRELLO	623
PRESE TELECOMANDATE	512	REDANCE	314
PRESE TV	497-498	REGGIMENSOLE	299-304
PROFILI IN PVC	297	REGGIPIANI	573

INDICE ALFABETICO



REGGISPECCHIO	575	SCALPELLI MURATORE	378
REGGITUBO ARMADIO	572-573	SCARPE DA LAVORO	326-332
RICEVITORE RADIO UNIVERSALE	13	SCHIUME POLIURETANICHE	213-214
RIDUTTORI DI PRESSIONE	483	SCOPE PER FOGLIE	622
RIDUTTORI PER RULLI TAPPARELLA	226-227	SEGACCI	401-402
RIMUOVI TUTTO	513	SEGHE A GATTOCCIO	432-433
RIPARA BICI	544-545	SEGHE A NASTRO	433
RIVETTATRICI	362,418	SEGHE CIRCOLARI	433
RIVETTI	186-187	SEGHETTI ALTERNATIVI	432-433
ROMPIGETTO	635	SEGHETTI POTATURA	621
RONDELLE ALZAPORTA	270	SEGONCINI	621
ROSETTE GHIDINI	565	SEMI-MASCHERA BLS	334-335
ROTELLE METRICHE	424	SERIE CACCIAVITI E INSERTI	391-394
ROTOLI ZANZARIERE	528	SERIE CHIAVI A BRUGOLA	392-393
ROTOLO ASCIUGATUTTO	515	SERIE CHIAVI TORX	392
ROTOLO CARTA BIADESIVA	225	SERRATURE A GANCIO PER CANCELLI	282
ROTOLO PLASTICA BIADESIVA	225	SERRATURE PER MOBILI	585
RUBINETTI A SFERA	625-626	SET ACCESSORI PORTE BLINDATE	570
RUBINETTI MONOFORO	631-632	SFERE PER POLTRONE	600
RULLI IMBIANCHINO	411-412	SGABELLI	527
RULLI OTTAGONALI TELESCOPICI	226	SGORGANTI MELT	514
RULLI OTTOGONALI LISCI	226	SGORGANTI PER TUBI	514
RULLI STELLATI	226	SHAMPOO PER AUTO	546
RULLO DI RINVIO	232	SIFONI (LIRA)	635
RUOTE ANTIFORATURA	606	SILICONI E SIGILLANTI	214-216
RUOTE AVO-VALSECCHI	600-606	SMALTI SPRAY	413-415
RUOTE PER CANCELLI	273-275	SMERIGLIATRICI ANGOLARI	431-432
RUOTE PER CARRIOLA	606	SMERIGLIATRICI COMBinate	432
RUOTE PNEUMATICHE	606	SMUFFER	513
S		SNODO PER ANTE	575
SACCHI PER IMMONDIZIA	515-517	SOFFIATORI (PER FOGLIE)	617
SACCO PORTAFOGLIE	623	SOFFIONI DOCCIA	632
SALDATORI A GAS	420	SPADINI AUTO SILCA	26-27
SALDATORI E PIROGRAFI	436	SPAGNOLETTA AGB	239
SALDATRICI	480-481	SPATOLE CON MANICO	407
SALISCENDI DOCCIA REGOLABILE	633-634	SPATOLE DENTATE	407
SALVIETTE UMDIFICATE LAVAMANI	514	SPATOLE PER CARROZIERE	407
SANITIZZANTE	514	SPAZZOLA RASCHIA GHIACCIO	545
SCAFFALI E ACCESSORI COSMET	517-518	SPAZZOLE PER UTENSILI ELETTRICI	437-441
SCALE	526-528	SPAZZOLE SLIM	408
SCALPELLI E PUNTE SDS	467	SPAZZOLE SPID	408
SCALPELLI ELETTRICISTA	378	SPAZZOLE TERGICRISTALLI PER AUTO	544
SCALPELLI FALEGNAME	377-378	SPILLI BATTISCOPA	184



INDICE ALFABETICO

SPINE CIVILI	489	TAGLIAUNGHIE	536
SPINE INDUSTRIALI BLU	493	TAMPONE GOMMA PER FOGLI ABRASIVI	454
SPINE INDUSTRIALI ROSSE	495-496	TAMPONI E CUFFIE	456-457
SPINE TV	497-498	TAPPETI PER AUTO	544
SPINGIPORTA	552-553	TARGETTES	248
SPIONCINI DIGITALI PER PORTE	594-595	TASSELLATORI	429-430
SPIONCINI PER PORTE	594-595	TASSELLI ACCIAIO	194-195,202-209
SPIRALE MEMORY PER BLOCCADISCHI	542	TASSELLI ANCORINE	198-200
SPRAY ANTIAGGRESSIONE	521	TASSELLI BLISTER	210
SPRAY ARIA COMPRESSA	513	TASSELLI CARTONGESSO	197-198
SPRAY FUGHE GAS	223	TASSELLI CHIMICI E ACCESSORI	212-213
SPRAY IGIENIZZANTE	223,513-514,515	TASSELLI FERMAPORTA	551
SPRAY LUCIDA CRUSCOTTI AUTO	545	TASSELLI GHISA	209
SPRAY PULISCI LENTI OCCHIALI	536	TASSELLI GOMMA	211-212
SPRAY PULITORE VETRO CAMINETTO	519	TASSELLI LEGNO	382-383
SPRAY PULITORI AUTO	545	TASSELLI NYLON	188-197
SPRAY RIMUOVI SILICONE	223	TASSELLI OTTONE	203
SPRAY RINNOVA SANITARI	513	TASSELLI PONTEGGI	191
SPUGNE ABRASIVE	451-452	TASSELLI SANITARI	200-201
SQUADRE FALEGNAME	383-384	TAVELLINI	245-246
STAGNO	436	TAVELLINI PER INCONTRO	550
STARTER PER LAMPADE	505	TELI COPRITUTTO	225
STAZIONI METEO	512	TENAGLIE	364-365,374
STENDIBIANCHERIA	522,526	TENDINASTRO	224
STICK COLLA A CALDO	417-418	TENDITORI	311-313
STRETTOI	370	TERMOCONVETTORI	529
STUFE	530	TERMOOFFIATORI	434-435
STURALAVANDINI	640	TESTA MH-TA	29
SUPPORTI AUTO SMARTPHONE/TABLET	504	TESTER DIGITALI	425
SUPPORTI CORRIMANO	547	TIRAFILI STENDIBIANCHERIA	523
SUPPORTI PER TAPPARELLE	230,236	TIRANTI PER BASCULANTI	242
SVASATORI HSS	471	TORCE	510
SVETTATOI E ACCESSORI	620-621	TRABATTELLI	528
T		TRACCIALINEE	424
TAGLIABALSA	398	TRACCIATORE SPRAY	415
TAGLIABORDI	616	TRANSPALLET	404
TAGLIABULLONI	364,376	TRANSPONDER SILCA	30
TAGLIACORNICI	383	TRAPANI	427-429
TAGLIAERBA EINHELL	616	TRAPPOLE PER TOPI	520-521
TAGLIAPIASTRELLE CIRCOLARE	479	TRECCE PER VENEZIANE E RILOGHE	525
TAGLIASIEPI ELETTRICI	616-617	TRIVELLINI	383
TAGLIASIEPI MANUALI	619	TROLLEY PIEGHEVOLE	404
TAGLIATUBI	368,375,639	TROLLEY PORTAUTENSILI	402-403

INDICE ALFABETICO



TRONCARAMI	619-620
TRONCATRICI	433
TRONCHESI	364-366,372-373
TRONCHESI MANI	536
TUBI CARICO LAVATRICE	639
TUBI COMPRESSORE	422
TUBI FLESSIBILI IDRAULICA	636-637
TUBI GAS	639
TUBI GOFLEX	636
TUBI IRRIGAZIONE	624
TUBI PER ARMADI	573
TUBI SCARICO LAVATRICE	639
TUBO LED	505
TUTA MONOUSO	335
U	
UTENSILI BETA	336-362
UTENSILI GIARDINO	623
UTENSILI MULTIFUZIONE	435
UTENSILI MUNDIAL	362-371
V	
VA VIENI A RULLO	255
VALIGETTE KRINO	391-392
VALVOLE A SFERA	625-626
VAPE	521-522
VAPORIZZATORI	629
VENTILATORI	528-529
VENTOSE	575
VENTOSE CON GANCIO	1
VETRI PER MASCHERE SALDATORE	482
VETRINI PER CASSETTE POSTALI	613-614
VINAVIL	219
VITI	178-183
VITI AUTOFIETTANTI	181-183
W	
WD-40	219-221
Z	
ZANCHE STENDIBIANCHERIA	522
ZANZARIERE	528
ZAPPETTE (GIEFFE)	623
ZINCANTI SPRAY	223







**DUPLICATRICI
CHIAVI
RADIOCOMANDI**

SFOGLIA LA CATEGORIA

















<p>&M900</p> <p>ANELLO per chiavi in acciaio nichelato -</p> <p>90004920 - Colore Ø20 - - conf. 100 - € 0,06</p> <p>90004925 - Colore Ø25 - - conf. 100 - € 0,06</p> <p>90004930 - Colore Ø30 - - conf. 100 - € 0,09</p> <p>90004938 - Colore Ø38 - - conf. 100 - € 0,18</p> 	<p>&M900</p> <p>Conf. 72 pz. ANELLO per chiavi in acciaio nichelato assortiti -</p> <p>90004950 - - conf. 1 - € 10,30</p> 
<p>&M900</p> <p>Conf. 200 pz. PORTAETICHETTE Givolare -</p> <p>90004530 - - conf. 1 - € 24,52</p> 	<p>&M900</p> <p>Conf. 200 pz. PORTAETICHETTE Givolare con finestra apribile -</p> <p>90004529 - - conf. 1 - € 37,28</p> 
<p>&M900</p> <p>Barattolo da 70 pezzi TARGHETTA SEGNANO- ME 74 x 38 a finestra con anello tipo grande colori assortiti -</p> <p>90004526 - - conf. 1 - € 37,08</p> 	<p>&M900</p> <p>Conf. 130 pz. PORTAETICHETTE Giganti -</p> <p>90004532 - - conf. 1 - € 45,32</p> 
<p>&M900</p> <p>Conf. 100 pz. PORTAETICHETTE a doppio guscio givolare -</p> <p>90004531 - - conf. 1 - € 34,58</p> 	<p>&M900</p> <p>PORTAETICHETTE con anello assortite -</p> <p>90004510 - - conf. 100 - € 0,12</p> 
<p>&M900</p> <p>Conf. 200 pz. VENTOSE con gancio -</p> <p>90004533 - - conf. 1 - € 23,40</p> 	<p>&M900</p> <p>PORTAETICHETTE givolare -</p> <p>90004511 - Colore bianche - - conf. 100 - € 0,12</p> <p>90004512 - Colore nere - - conf. 100 - € 0,12</p> <p>90004513 - Colore rosse - - conf. 100 - € 0,12</p> <p>90004514 - Colore verdi - - conf. 100 - € 0,12</p> <p>90004515 - Colore blu - - conf. 100 - € 0,12</p> <p>90004516 - Colore arancio - - conf. 100 - € 0,12</p> 
<p>&M900</p> <p>Conf. 200 pz. COPRICHIAVE VUOTO colori assortiti -</p> <p>90004983 - - conf. 1 - € 7,36</p> 	<p>&M900</p> <p>Conf. 200 pz. COPRICHIAVE PIENO colori assortiti -</p> <p>90004984 - - conf. 1 - € 10,62</p> 



<p>&M900</p> <p>PORTACHIAVE a pallina corda colori vari - 90004978 - - conf. 15 - € 3,70</p> 	<p>&M900</p> <p>PORTACHIAVE a pallina squadre calcio - 90004979 - - conf. 15 - € 3,70</p> 
<p>&M900</p> <p>MOSCHETTONE ALLUMINIO Grande Lunghezza 61 mm Colori assortiti - 90004877 - - conf. 20 - € 1,24</p> 	<p>&M900</p> <p>PORTACHIAVI PALLA BILIARDO NERA - 90004870 - - conf. 16 - € 1,86</p> 
<p>&M900</p> <p>ESPOSITORE PORTACHIAVI ASSORTITI 210 pezzi Modelli: 10 pz Remove Before 12 pz Superhero 15 pz Treccia calcio 15 pz Eco-Cocco 15 pz Treccia Corda 18 pz Emoticon 15 pz Teschio 5 pz Fast Food 15 pz Coccinella 25 pz Cappucci fantasy 20 pz Pallina corda 10 pz All-Star 20 pz Moschetto- ne alluminio 15 pz Unicornio - 90004900 - - conf. 1 - € 587,10</p> 	<p>&M900</p> <p>PORTACHIAVI REMOVE BEFORE - 90004872 - - conf. 10 - € 3,00</p> 
<p>&M900</p> <p>PORTACHIAVI SUPERHERO - 90004873 - - conf. 12 - € 5,16</p> 	<p>&M900</p> <p>PORTACHIAVI FAST FOOD - 90004874 - - conf. 10 - € 3,70</p> 
<p>&M900</p> <p>PORTACHIAVI CAPPUCCI FANTASY - 90004875 - - conf. 25 - € 1,04</p> 	<p>&M900</p> <p>PORTACHIAVI ALL STAR - 90004876 - - conf. 10 - € 3,70</p> 
<p>&M900</p> <p>PORTACHIAVI BLISTER SUPEREROE Personaggi assortiti tra: Hulk; Captain America; The Flash; Thor; Spider Man; Superman; Batman; Iron Man; The Joker. - 90004878 - - conf. 1 - € 7,00</p> 	<p>&M900</p> <p>MOSCHETTONE ALLUMINIO Grande - 90033851 - - conf. 10 - € 2,00</p> 



<p>&M900</p> <p>MOSCHETTONE PORTACHIAVI colori assortiti: verde, arancio, blu, giallo, azzurro, grigio, rosso -</p> <p>90004972 - Colore mini - - conf. 24 - € 1,04</p> <p>90004973 - Colore piccolo - - conf. 24 - € 1,14</p> 	<p>&M900</p> <p>MOSCHETTONE PORTACHIAVI con givolare colori assortiti: verde, arancio, blu, giallo, azzurro, grigio, rosso -</p> <p>90004974 - Colore medio - - conf. 24 - € 1,54</p> <p>90004975 - Colore grande - - conf. 24 - € 1,96</p> 
<p>&M900</p> <p>MOSCHETTONE Alluminio mod. 050 colori vari -</p> <p>90004976 - - conf. 70 - € 1,24</p>  	<p>munkees</p> <p>MOSCHETTONE MOD. OSSO Non adatto alla scalata -</p> <p>464MU3258 - - conf. 1 - € 5,90</p> 
<p>&M900</p> <p>MOSCHETTONE PORTACHIAVI cinturino MS 370 -</p> <p>90004977 - - conf. 24 - € 2,58</p> 	<p>&M900</p> <p>PORTACHIAVI BILIARDO Assortiti -</p> <p>90004864 - - conf. 15 - € 1,86</p> 
<p>&M900</p> <p>PORTACHIAVI TESCHIO -</p> <p>90004871 - - conf. 15 - € 3,10</p> 	<p>&M900</p> <p>PORTACHIAVI EMOTICON -</p> <p>90004860 - - conf. 18 - € 3,10</p> 
<p>&M900</p> <p>PORTACHIAVI UNICORNO -</p> <p>90004861 - - conf. 15 - € 3,10</p> 	<p>&M900</p> <p>PORTACHIAVI COCCINELLE -</p> <p>90004862 - - conf. 15 - € 3,10</p> 
<p>&M900</p> <p>PORTACHIAVI TRECCIA CALCIO -</p> <p>90004980 - - conf. 12 - € 3,50</p> 	<p>&M900</p> <p>PORTACHIAVI TRECCIA CORDA -</p> <p>90004866 - - conf. 15 - € 4,32</p> 



&T900

PORTACHIAVI ECO-COCCO -

90004868 -
- conf. 15 - € 3,92



&T900

PORTACHIAVI TRECCIA CALCIO -

90004869 -
- conf. 15 - € 3,92



&T900

PORTACHIAVI TRECCIA CORDA CALCIO Assortiti -

90004867 -
- conf. 12 - € 4,32



&T540

ESPOSITORE CARTONE VUOTO 15 ganci Misura 280x540x150 mm -

540ESPO -
- conf. 1 - € 40,00



ESAURITO

&T900

PORTACHIAVI ITALIA -

90004882 -
- conf. 15 - € 4,00



&T900

CATENELLA per chiavi serpente tonda nichelata -

90004962 -
- conf. 12 - € 5,16



&T900

CATENELLA per chiavi maglia vittoria -

90004961 -
- conf. 12 - € 6,80



&T900

CATENELLA per chiavi maglia Groumet Lusso nichelata -

90004963 -
- conf. 12 - € 3,70



&T900

CATENELLA per chiavi maglia Groumet colorata -

90004964 -
- conf. 12 - € 2,88



&T900

CATENELLA per chiavi trucker Pesante Nichelata -

90004992 -
- conf. 12 - € 4,32



munkees

PORTACHIAVI MUNKEES MOD. STEGOSAURO
Con funzione apri bottiglie -

464MU3482 -
- conf. 1 - € 5,90



TRUE UTILITY

GIRAVITE MINI-DRIVER TRUE UTILITY Funzioni: cacciavite con 4 inserti (Philips e taglio - contenuti nel corpo) Scanalatura per una maggiore leva e forza di avvitamento Clip di aggancio -









464TU231 -
- conf. 1 - € 8,50















	<p>ESPOSITORE VUOTO 18 PZ. TRUE UTILITY Espositore da banco, consente l'esposizione di 3 set da 6 utensili Dimensioni espositore: 250X320 mm Espositore vuoto prodotti non inclusi -</p> <p>464TUESP03 - - conf. 1 - € 11,80</p>		<p>TORCETTA LED NANOLITE TRUE UTILITY Torcetta a LED da 5 mm Funzionamento con 4 batterie Interruttore ON/OFF, Luminosità lampadina 4 Lumen Consumo 0,22 Watt LED Resistente all'acqua Lunghezza 36 mm Tascabile In dotazione: 3 set completi di batterie -</p> <p>464TU285 - - conf. 1 - € 8,50</p>
	<p>TORCETTA 3 LED COMPACT MICROLITE TRUE UTILITY 3 LED Tascabile o agganciabile al portachiavi in alluminio, lavorato in cromo temperato luminosità lampadina 5 Lumen a LED consumo 0,22 Watt a LED Resistente all'acqua Lunghezza 48 mm Batterie incluse -</p> <p>464TU283 - - conf. 1 - € 8,50</p>		<p>PORTA CHIAVI CASHSTASH TRUE UTILITY Capsula porta-contanti di emergenza Compatto e impermeabile Capsula in alluminio e acciaio Inox Anello per chiavi 10 mm Lunghezza 45 mm -</p> <p>464TU241 - - conf. 1 - € 8,50</p>
	<p>FORCIBI MULTIUSO SCIXORS+ TRUE UTILITY Funzioni: apribottiglie, cacciavite, forbice a lama dritta e seghettata. Perno di sgancio rapido In acciaio inossidabile con attacco a sgancio rapido Lunghezza 76 mm -</p> <p>464TU238 - - conf. 1 - € 10,64</p>		<p>PORTACHIAVI GANCIO A CLIP TRUE UTILITY Permette di organizzare le chiavi grazie alla clip con sistema di aggancio a molle In alluminio anodizzato Misura 51x10 mm -</p> <p>464TU903 - - conf. 1 - € 6,44</p>
	<p>PORTACHIAVI GANCIO A CLIP TRUE UTILITY Permette di organizzare le chiavi grazie alla clip con sistema di aggancio a molle In alluminio anodizzato Misura 34x10 mm -</p> <p>464TU904 - - conf. 1 - € 5,36</p>		<p>PORTACHIAVI MULTIUSO 6 UTENSILI TRUE UTILITY Portachiavi 4 chiavi Apribottiglie Limetta per unghie Taglierino Clip aggancio Cacciavite Materiale acciaio Inox -</p> <p>464TU900 - - conf. 1 - € 20,50</p>
	<p>PORTACHIAVI CON CHIUSURA TRUE UTILITY Perno portachiavi fino ad un massimo di 4 Realizzato in vera pelle con moschettone -</p> <p>464TU901 - - conf. 1 - € 16,18</p>		<p>PORTACHIAVI CON CHIUSURA TRUE UTILITY Perno portachiavi fino ad un massimo di 4 Realizzato in vera pelle con moschettone -</p> <p>464TU902 - - conf. 1 - € 12,94</p>
	<p>ESPOSITORE VUOTO 36 PZ. TRUE UTILITY Espositore autoportante da banco, consente l'esposizione di 6 set da 6 utensili Dimensioni espositore: H400 x L300 x P230 mm Espositore vuoto prodotti non inclusi -</p> <p>464TUESP06 - - conf. 1 - € 16,80</p>		<p>PORTACHIAVI MUNKEES COLTELLINO Pieghevole -</p> <p>464MU2524 - - conf. 1 - € 7,90</p>















<p>munkees</p> <p>PORTACHIAVI MUNKEES MICRO COLTELLINO In acciaio inossidabile Pieghevole Misura 42 mm. -</p> <p>464MU2525 - - conf. 1 - € 7,90</p> 	<p>ESPOSITORE 36 PZ PORTACHIAVI OPINEL Colori assortiti N 4 -</p> <p>414004PCECO36 - - conf. 1 - € 379,00</p>  <p style="color: red; font-size: 2em; transform: rotate(-15deg); opacity: 0.5;">ESAURITO</p>
<p>munkees</p> <p>PORTACHIAVI MUNKEES TORCETTA LED CON MOSCHETTONE -</p> <p>464MU1076 - - conf. 1 - € 5,90</p> 	<p>munkees</p> <p>PORTACHIAVI MUNKEES TORCETTA LED CON MOSCHETTONE Colori assortiti -</p> <p>464MU1078 - - conf. 1 - € 4,70</p> 
<p>munkees</p> <p>PORTACHIAVI LUCE Con 6 led -</p> <p>464MU1082 - - conf. 1 - € 5,90</p> 	<p>munkees</p> <p>PORTACHIAVI MUNKEES TORCETTA LED CON FUNZIONI BUSSOLA, TERMOMETRO E COMPASSO -</p> <p>464MU1084 - - conf. 1 - € 5,90</p> 
<p>munkees</p> <p>PORTACHIAVI MUNKEES CON BUSSOLA E TERMOMETRO CON MOSCHETTONE -</p> <p>464MU3135 - - conf. 1 - € 4,70</p> 	<p>munkees</p> <p>PORTACHIAVI MUNKEES MOSCHETTONE MULTIFUNZIONE In acciaio inossidabile Apribottiglie Chiave esagonale Cacciavite a taglio -</p> <p>464MU3203 - - conf. 1 - € 5,90</p> 
<p>munkees</p> <p>MOSCHETTONE MOD. CUORE Non adatto alla scalata -</p> <p>464MU3221 - - conf. 1 - € 5,90</p> 	<p>munkees</p> <p>PORTACHIAVI MUNKEES MOSCHETTONE CON BUSSOLA Colori assortiti -</p> <p>464MU3228 - - conf. 1 - € 4,70</p> 
<p>munkees</p> <p>MOSCHETTONE MUNKEES CON PORTABOTTIGLIE Non adatto alla scalata -</p> <p>464MU3241 - - conf. 1 - € 5,90</p> 	<p>munkees</p> <p>PORTACHIAVI MUNKEES CON MOSCHETTONE Colori assortiti -</p> <p>464MU3262 - - conf. 1 - € 4,70</p> 















<p>munkees</p> <p>PORTACHIAVI MUNKEES MOSCHETTONE FOR- GED Colori assortiti -</p> <p>464MU3275 - - conf. 1 - € 4,70</p> 	<p>munkees</p> <p>MOSCHETTONE MUNKEES MOD. DRAGO -</p> <p>464MU3285 - - conf. 1 - € 5,90</p> 
<p>munkees</p> <p>PORTACHIAVI MUNKEES MOD. LUCERTOLA Con funzione apri bottiglie -</p> <p>464MU3411 - - conf. 1 - € 5,90</p> 	<p>munkees</p> <p>PORTACHIAVI MUNKEES APRIBOTTIGLIA Colori assortiti -</p> <p>464MU3413 - - conf. 1 - € 4,70</p> 
<p>munkees</p> <p>PORTACHIAVI MUNKEES MOD. LISCA PESCE Con funzione apri bottiglie -</p> <p>464MU3428 - - conf. 1 - € 5,90</p> 	<p>munkees</p> <p>PORTACHIAVI MUNKEES MOD. PINGUINO Con funzione apri bottiglie -</p> <p>464MU3430 - - conf. 1 - € 5,90</p> 
<p>munkees</p> <p>PORTACHIAVI MUNKEES MOD. LABRADOR Con funzione apri bottiglie -</p> <p>464MU3455 - - conf. 1 - € 5,90</p> 	<p>munkees</p> <p>PORTACHIAVI MUNKEES MOD. GATTO Con funzione apri bottiglie -</p> <p>464MU3460 - - conf. 1 - € 5,90</p> 
<p>munkees</p> <p>PORTACHIAVI MUNKEES APRIBOTTIGLIA PIRANHA Colori assortiti -</p> <p>464MU3478 - - conf. 1 - € 4,70</p> 	<p>munkees</p> <p>PORTACHIAVI MUNKEES MOD. TARTARUGA Con funzione apri bottiglie -</p> <p>464MU3484 - - conf. 1 - € 5,90</p> 
<p>munkees</p> <p>PORTACHIAVI MUNKEES MOD. CALCIATORE Con funzione apri bottiglie -</p> <p>464MU3490 - - conf. 1 - € 5,90</p> 	<p>munkees</p> <p>PORTACHIAVI MUNKEES APRIBOTTIGLIA GIO- CATORE BASKET Colori assortiti -</p> <p>464MU3491 - - conf. 1 - € 4,70</p> 



<p>munkees</p> <p>PORTACHIAVI MUNKEES MOD. SNOWBOARDER Con funzione apri bottiglie -</p> <p>464MU3495 - - conf. 1 - € 5,90</p> 	<p>munkees</p> <p>PORTACHIAVI MUNKEES MOD. CICLISTA Con funzione apri bottiglie -</p> <p>464MU3527 - - conf. 1 - € 5,90</p> 
<p>munkees</p> <p>PORTACHIAVI MUNKEES PALLINA IN CORDA PARACORD Colori assortiti -</p> <p>464MU6460 - - conf. 1 - € 4,70</p> 	<p>&M 900</p> <p>PORTACHIAVI ZODIACALE CON LUCE LED Segni zodiacali assortiti -</p> <p>90004881 - - conf. 12 - € 6,00</p> 
<p>TRUE UTILITY</p> <p>UTENSILE MULTIUSO CLIP TOOL TRUE UTILITY Funzioni: pinza, coltello, lima, cacciavite croce, apribottiglie, clip di aggancio In acciaio Inox e alluminio di alta qualità -</p> <p>464TU192 - - conf. 1 - € 12,76</p> 	<p>TRUE UTILITY</p> <p>PINZA MULTIUTENSILE In acciaio inox 11 strumenti Pinze ad ago, tronchesi a molla cacciavite a stella, cacciavite medio e piccolo apri bottiglia, apriscatole, coltello sega, punteruolo e lima In confezione di plastica -</p> <p>464TU194 - - conf. 1 - € 14,50</p> 
<p>TRUE UTILITY</p> <p>MULTIUSO MINI MULTI 11 strumenti Pinze e tronchesi, cacciaviti, forbici, sega e apribottiglie, cutter e lime In confezione di plastica -</p> <p>464TU195 - - conf. 1 - € 12,20</p> 	<p>TRUE UTILITY</p> <p>UTENSILE MULTIUSO CLIP-STICK TRUE UTILITY Funzioni: forcicine, coltellino, cacciavite, apribottiglie, clip di aggancio In acciaio Inox e alluminio di alta qualità -</p> <p>464TU198 - - conf. 1 - € 10,64</p> 
<p>TRUE UTILITY</p> <p>MULTIUSO SCARAB TRUE UTILITY 6 strumenti Pinze a becchi mezzotondi, spelafili seghettati, cacciavite Phillips, coltello e lima In confezione di plastica -</p> <p>464TU204 - - conf. 1 - € 12,20</p> 	<p>TRUE UTILITY</p> <p>MULTIUSO NAIL CLIP KIT 5 strumenti Tagliaunghie, lima, cacciavite, forbici, coltello In confezione di plastica -</p> <p>464TU215 - - conf. 1 - € 9,70</p> 
<p>TRUE UTILITY</p> <p>PORTACHIAVI A LENTE D'INGRANDIMENTO In vetro In confezione di plastica -</p> <p>464TU234 - - conf. 1 - € 7,70</p> 	<p>TRUE UTILITY</p> <p>MULTIUTENSILE AVVOLGI CHIAVE 8 strumenti In acciaio inossidabile Cacciavite per occhiali, cacciavite medio e grande, pinzette, tagliafilo, apribottiglia, apriscatole e detergente per unghie In confezione di plastica -</p> <p>464TU247 - - conf. 1 - € 7,70</p> 



<p>TRUE UTILITY</p> <p>PORTACHIAVI CAVATAPPI In acciaio inossidabile Barra da 4 mm In confezione di plastica -</p> <p>464TU248 - - conf. 1 - € 7,70</p> 	<p>TRUE UTILITY</p> <p>PORTACHIAVI CON PENNA TELESCOPICA E GOMMINO TOUCHSCREEN TRUE UTILITY In confezione di plastica -</p> <p>464TU257B - - conf. 1 - € 9,70</p> 
<p>TRUE UTILITY</p> <p>PORTACHIAVI CON ACCENDINO TRUE UTILITY Ricaricabile In confezione di plastica -</p> <p>464TU262 - - conf. 1 - € 8,70</p> 	<p>TRUE UTILITY</p> <p>PORTACHIAVI CON TORCIA LED TRUE UTILITY 25 lumen In confezione di plastica -</p> <p>464TU307 - - conf. 1 - € 11,50</p> 
<p>TRUE UTILITY</p> <p>COLTELLO SMARTKNIFE TRUE UTILITY Funzioni: apribottiglie, cacciavite, taglia cinture, coltello e taglierino clip di aggancio Lunghezza lama 55 mm In acciaio inox e alluminio di alta qualità -</p> <p>464TU573 - - conf. 1 - € 15,96</p> 	<p>TRUE UTILITY</p> <p>MULTIUTENSILE APRI-BOTTIGLIE CON LAMA TRUE UTILITY Lama da 3 cm In confezione di plastica -</p> <p>464TU577 - - conf. 1 - € 9,70</p> 
<p>TRUE UTILITY</p> <p>ESPOSITORE VUOTO 60 PZ. TRUE UTILITY Espositore autoportante da banco, consente l'esposizione di 10 set da 6 utensili Dimensioni espositore: H400 x L490 x P230 mm Espositore vuoto prodotti non inclusi -</p> <p>464TUESP10 - - conf. 1 - € 25,20</p> 	<p>&M 900</p> <p>PORTACHIAVI MARINI Assortiti -</p> <p>90004863 - - conf. 15 - € 3,10</p> 
<p>&M 900</p> <p>PORTACHIAVI CANI Tipologie assortite -</p> <p>90004879 - - conf. 10 - € 5,00</p> 	<p>&M 900</p> <p>PORTACHIAVI GATTI Tipologie assortite</p> <p>90004880 - - conf. 10 - € 5,00</p> 
<p>&M 900</p> <p>MOSCHETTONE SIMPLEX Mod. 745 ferro nichelato -</p> <p>90033857 - Colore 70 - - conf. 20 - € 0,52 90033858 - Colore 80 - - conf. 20 - € 0,68 90033859 - Colore 90 - - conf. 20 - € 1,10 90033861 - Colore 100 - - conf. 10 - € 1,10</p> 	<p>ALCA</p> <p>MEDAGLIA Per incisioni Finitura nichelata Ø 25 mm</p> <p>783AVK401080 - - conf. 50 - € 0,78</p> 

I MAGNIFICI 5

IL SUPERPOTERE NELLE TUE MANI

BANDY
-ONE



OTTO
-C



SMILE
-CB



SWING
-CE



SMART
-QCD4













MADE IN ITALY

bandbsnc.it



www.malfattitacchinigroup.it



 <p>RADIOCOMANDO SMILE CARBON 2 canali Frequenza: 433 Mhz Rolling Code, Codici fissi in autoapprendimento -</p> <p>23010202 - Frequenza 433 Mhz Rolling Code e Codice fisso - Colore BLU - Canali 2 Modello RADIOCOMANDO SMILE - conf. 10 - € 26,86</p> <p>23010205 - Frequenza 433 Mhz Rolling Code e Codice fisso - Colore BIANCO - Canali 2 Modello RADIOCOMANDO SMILE - conf. 10 - € 26,86</p> <p><i>segue...</i></p>	<p><i>continua...</i></p> <p>23010207 - Frequenza 433 Mhz Rolling Code + Codice fisso - Colore VERDE - Canali 2 Modello RADIOCOMANDO SMILE - conf. 10 - € 26,86</p> <p>23010203 - Frequenza 433 Mhz Rolling Code e Codice fisso - Colore NERO - Canali 2 Modello RADIOCOMANDO SMILE - conf. 10 - € 26,86</p>
 <p>RADIOCOMANDO SWING 2 canali Frequenza: 868 Mhz Rolling Code + Codici fissi in autoapprendimento -</p> <p>23010208 - Frequenza 868 Mhz Rolling-Code e Codice fisso - Colore BIANCO - Canali 2 Modello RADIOCOMANDO SWING - conf. 10 - € 26,86</p>	 <p>RADIOCOMANDO OTTO 2 Canali Frequenza: 433 Mhz Rolling Code, Codici fissi in autoapprendimento Colori assortiti -</p> <p>23010209 - Frequenza 433 Mhz Rolling Code e Codice fisso - Colore Assortiti - Canali 2 Modello RADIOCOMANDO OTTO - conf. 1 - € 23,26</p>
 <p>RADIOCOMANDO BANDY ONE 4 Canali Frequenza: 868+433 Mhz Rolling Code, Codici fissi in autoapprendimento -</p> <p>23010210 - Frequenza 868+433 Mhz Rolling Code e Codice fisso - Colore BIANCO - Canali 4 Modello BANDY-ONE - conf. 10 - € 30,76</p>	 <p>RADIOCOMANDO BANDY ONE 4 Canali UNIVERSALE Duplicazione con autoapprendimento a partire da 10 cm. - Codice Fisso</p> <p>23010701 - Frequenza 433,92 + 868 Mhz Codice fisso - Colore Bianco - Canali 4 Modello Bandy-one - conf. 10 - € 28,64</p>
 <p>RADIOCOMANDO NL/CARTY-R 4 Canali Multi-frequenza Rolling Code + Codice Fisso Compatibilità estesa Segnale amplificato -</p> <p>23010713 - Frequenza 433,92 + 868 MHz - Colore Bianco - Canali 4 Modello Radiocomando Carty R - conf. 1 - € 27,82</p>	 <p>RADIOCOMANDO SMART QCD4 4 Canali TX4 Rolling Code 433 Mhz Doppia frequenza in autoapprendimento -</p> <p>23010211 - Frequenza 433 Mhz Rolling Code e Codice fisso - Colore VERDE - Canali 4 Modello RADIOCOMANDO SMART - conf. 10 - € 32,86</p>
 <p>RADIOCOMANDO 4 TASTI Colori assortiti Codice fisso -</p> <p>900SM15B - Frequenza 433,92 Mhz - Colore Bianco/Nero - Canali 4 Modello Radiocomando - conf. 10 - € 10,10</p> <p>900SM15G - Frequenza 433,92 Mhz - Colore Giallo/Nero - Canali 4 Modello Radiocomando - conf. 10 - € 10,10</p> <p>900SM15N - Frequenza 433,92 Mhz - Colore Nero - Canali 4 Modello Radiocomando - conf. 10 - € 10,10</p> <p><i>segue...</i></p>	 <p><i>continua...</i></p> <p>900SM15NE - Frequenza 433,92 Mhz - Colore Nero/Giallo - Canali 4 Modello Radiocomando - conf. 10 - € 10,10</p> <p>900SM15R - Frequenza 433,92 Mhz - Colore Rosso/Nero - Canali 4 Modello Radiocomando - conf. 10 - € 10,10</p>
 <p>RADIOCOMANDO J.FIVE Frequenza fissa 433.92 MHz -</p> <p>900I112 - Frequenza 433.92 MHz - Canali 2 - conf. 1 - € 10,10</p> <p>900I114 - Frequenza 433.92 MHz - Canali 4 - conf. 1 - € 11,40</p>	 <p>RADIOCOMANDO SMILE CARBON 2 canali Duplicazione con autoapprendimento -</p> <p>23010300 - Frequenza 433,92 Mhz - Colore Blu - Canali 2 Modello Radiocomando Smile - conf. 10 - € 27,48</p> <p>23010302 - Frequenza 433,92 Mhz - Colore Arancione - Canali 2 Modello Radiocomando Smile - conf. 10 - € 27,48</p> <p>23010303 - Frequenza 433,92 Mhz - Colore Bianco - Canali 2 Modello Radiocomando Smile - conf. 10 - € 27,48</p> <p><i>segue...</i></p>



 <p>continua... 23010305 - Frequenza 433,92 Mhz - Colore Verde - Canali 2 Modello Radiocomando Smile - conf. 10 - € 27,48</p> <p style="color: red; font-size: 2em; transform: rotate(-15deg); opacity: 0.5;">ESAURITO</p>	 <p>RADIOCOMANDO SMILE 2 canali Duplicazione con autoapprendimento - 23010280 - Frequenza 433,92 Mhz - Colore Blu trasparente - Canali 2 Modello Radiocomando Smile - conf. 10 - € 26,52 23010281 - Frequenza 433,92 Mhz - Colore Nero - Canali 2 Modello Radiocomando Smile - conf. 10 - € 26,52 segue...</p>
 <p>continua... 23010282 - Frequenza 433,92 Mhz - Colore Arancione fluo - Canali 2 Modello Radiocomando Smile - conf. 10 - € 26,52 23010283 - Frequenza 433,92 Mhz - Colore Bianco - Canali 2 Modello Radiocomando Smile - conf. 10 - € 26,52 23010284 - Frequenza 433,92 Mhz - Colore Giallo trasparente - Canali 2 Modello Radiocomando Smile - conf. 10 - € 26,52 segue...</p>	 <p>continua... 23010285 - Frequenza 433,92 Mhz - Colore Verde trasparente - Canali 2 Modello Radiocomando Smile - conf. 10 - € 26,52 23010287 - Frequenza 433,92 Mhz - Colore Azzurro fluo - Canali 2 Modello Radiocomando Smile - conf. 10 - € 26,52 23010288 - Frequenza 433,92 Mhz - Colore Giallo Fluo - Canali 2 Modello Radiocomando Smile - conf. 10 - € 26,52 segue...</p>
 <p>continua... 23010289 - Frequenza 433,92 Mhz - Colore Trasparente - Canali 2 Modello Radiocomando Smile - conf. 10 - € 26,52 23010290 - Frequenza 433,92 Mhz - Colore Rosso trasparente - Canali 2 Modello Radiocomando Smile - conf. 10 - € 26,52 23010291 - Frequenza 433,92 Mhz - Colore Arancio trasparente - Canali 2 Modello Radiocomando Smile - conf. 10 - € 26,52 segue...</p>	 <p>continua... 23010286 - Frequenza 433,92 Mhz - Colore Rosa trasparente - Canali 2 Modello Radiocomando Smile - conf. 10 - € 26,52 23010292 - Frequenza 433,92 Mhz - Colore Azzurro trasparente - Canali 2 Modello Radiocomando Smile - conf. 10 - € 26,52</p>
 <p>RADIOCOMANDO SWING 2 canali Duplicazione con autoapprendimento - Codice fisso 23010600 - Frequenza 433,92 Mhz - Colore Nero - Canali 2 Modello Radiocomando Swing - conf. 10 - € 26,52</p>	 <p>RADIOCOMANDO EKO 2 canali Duplicazione con autoapprendimento - Codice fisso 23010650 - Frequenza 433,92 Mhz - Colore Bianco - Canali 2 Modello Radiocomando Eko - conf. 10 - € 20,70 23010651 - Frequenza 433,92 Mhz - Colore Rosso - Canali 2 Modello Radiocomando Eko - conf. 10 - € 20,70 23010652 - Frequenza 433,92 Mhz - Colore Blu - Canali 2 Modello Radiocomando Eko - conf. 10 - € 20,70 segue...</p>
 <p>continua... 23010653 - Frequenza 433,92 Mhz - Colore Nero - Canali 2 Modello Radiocomando Eko - conf. 10 - € 20,70</p>	 <p>RADIOCOMANDO NL/BAD 3 canali Duplicazione con autoapprendimento - Codice fisso Resistente alla pioggia Colori assortiti - 23010500 - Frequenza 433,92 Mhz - Colore Assortiti - Canali 3 Modello Radiocomando Bad - conf. 1 - € 18,88</p>
 <p>RADIOCOMANDO BANDY CD4 4 Canali UNIVERSALE Duplicazione con autoapprendimento Codice fisso - Colori assortiti 23010700 - Frequenza 433,92 Mhz - Colore Assortiti - Canali 4 Modello Radiocomando Bandy CD4 - conf. 10 - € 28,64</p>	 <p>RADIOCOMANDO SMART CD4 4 canali UNIVERSALE Duplicazione con autoapprendimento Codice fisso - Colori assortiti 23010620 - Frequenza 433,92 Mhz - Canali 4 Modello Radiocomando Smart CD4 - conf. 10 - € 26,52</p> <p>Modello precedente → </p>



 <p>RADIOCOMANDO NL/CARTY-CD4 4 Canali Per codici standard fino a 400 bit Frequenza 433.92+868 mHz - Codice fisso</p> <p>23010711 - Frequenza 433,92 Mhz - Colore Nero - Canali 4 Modello Radiocomando Carty - CD4 - conf. 1 - € 28,64</p> <p>23010710 - Frequenza 433,92 Mhz - Colore Bianco - Canali 4 Modello Radiocomando Carty - CD4 - conf. 1 - € 28,64</p>	 <p>RADIOCOMANDO NL/CARTY-ONE 4 Canali Dual per codici standard - Codice fisso Colore bianco -</p> <p>23010712 - Frequenza 433,92 + 868 Mhz - Colore Bianco - Canali 4 Modello Radiocomando Carty - one4 - conf. 1 - € 30,76</p>
 <p>RADIOCOMANDO ROX QUARZATO/433 4 canali UNIVERSALE Duplicazione con autoapprendimento Quarzo da ordinare a parte -</p> <p>23010630 - Frequenza 433,92 Mhz + Quarzo - Colore Nero - Canali 4 - conf. 10 - € 35,64</p>	 <p>RADIOCOMANDO 2 Canali Mod. NL/BOSS-QC2-9 Duplicazione con autoapprendimento Completo di quarzo -</p> <p>23010540 - Colore Blu - Quarzo 30.900 - Canali 2 Modello Radiocomando Boss - conf. 1 - € 29,28</p> <p>23010541 - Colore Nero - Quarzo 30.900 - Canali 2 Modello Radiocomando Boss - conf. 1 - € 29,28</p>
 <p>RADIOCOMANDO 2 Canali Mod. NL/BOSS-QC2-8 Duplicazione con autoapprendimento Completo di quarzo -</p> <p>23010530 - Colore Blu - Quarzo 30.875 - Canali 2 Modello Radiocomando Boss - conf. 1 - € 29,28</p> <p>23010531 - Colore Nero - Quarzo 30.875 - Canali 2 Modello Radiocomando Boss - conf. 1 - € 29,28</p>	 <p>RADIOCOMANDO QUARZATO 2 Canali Mod. SMART-QC2 Duplicazione con autoapprendimento Completo di quarzo -</p> <p>23010400 - Colore Azzurro - Quarzo 30.875 - Canali 2 Modello Radiocomando Smart - conf. 1 - € 27,36</p> <p>23010401 - Colore Azzurro - Quarzo 30.900 - Canali 2 Modello Radiocomando Smart - conf. 1 - € 27,36</p>
 <p>RADIOCOMANDO BANDY QC2 QUARZATO 2 Canali Duplicazione con autoapprendimento Quarzo da ordinare a parte -</p> <p>23010702 - Colore Assortiti - Canali 2 - conf. 10 - € 30,76</p>	 <p>RADIOCOMANDO BABY 2 canali Duplicazione con autoapprendimento - Codice fisso</p> <p>23021350 - Frequenza 433,92 Mhz - Colore Rosso - Canali 2 Modello Radiocomando Baby - conf. 1 - € 16,06</p>
 <p>QUARZO Per radiocomandi quarzati -</p> <p>23010102 - Quarzo 26.720 - conf. 5 - € 1,92</p> <p>23010101 - Quarzo 26.995 - conf. 5 - € 1,92</p> <p>23010103 - Quarzo 27.545 - conf. 5 - € 1,92</p> <p>23010115 - Quarzo 27.745 - conf. 5 - € 1,92</p> <p>23010104 - Quarzo 29.700 - conf. 5 - € 1,92</p> <p>segue...</p>	 <p>continua...</p> <p>23010105 - Quarzo 29.800 - conf. 5 - € 1,92</p> <p>23010106 - Quarzo 29.875 - conf. 5 - € 1,92</p> <p>23010116 - Quarzo 30.075 - conf. 5 - € 1,92</p> <p>23010114 - Quarzo 30.155 - conf. 5 - € 1,92</p> <p>23010107 - Quarzo 30.545 - conf. 5 - € 1,92</p> <p>segue...</p>
 <p>continua...</p> <p>23010108 - Quarzo 30.875 - conf. 5 - € 1,92</p> <p>23010109 - Quarzo 30.900 - conf. 5 - € 1,92</p> <p>23010110 - Quarzo 30.925 - conf. 5 - € 1,92</p> <p>23010111 - Quarzo 33.100 - conf. 5 - € 1,92</p> <p>23010112 - Quarzo 40.665 - conf. 5 - € 1,92</p> <p>23010113 - Quarzo 40.685 - conf. 5 - € 1,92</p>	 <p>FREQUENZIMETRO COPY CONTROL Visualizza, compara, tara, accorda, verifica, apprende, copia e trasmette il segnale da un radiocomando ad un altro. -</p> <p>23010030 - Modello Copy control new - conf. 1 - € 339,48</p>



 <p>RICEVITORE RADIO UNIVERSALE RX1 Mono-locale in autoapprendimento Freq. 433,92 Mhz Permette di telecomandare le serratura elettrica o il cancello.. Si può inserire nel portafrutto dello stesso pulsante apriporta/cancello esistente. Radiocomandi non inclusi -</p> <p>23010010 - Modello Radioricevitore per serrature elettriche - conf. 1 - € 42,86</p> <p>23010011 - Modello Radioricevitore per cancelli - conf. 1 - € 42,86</p>	 <p>RADIOCOMANDO JANE TOP 01 4 canali Duplica radiocomandi a cod. fisso con frequenza 433-868 mHz e una serie di codici rolling. Autogenera codici fissi random/univoci a frequenza 433-848 mHz Soft touch Made in Italy Colore bianco lucido antistriscio -</p> <p>590JT01 - Frequenza 433-868 MHz Rolling-code - Colore Bianco - Canali 4 Modello Radiocomando Jane top - conf. 1 - € 38,60</p>
 <p>RADIOCOMANDO JANE TOP 02 4 canali Duplica radiocomandi a cod. fisso con frequenza 433-868 mHz e una serie di codici rolling. Autogenera codici fissi random/univoci a frequenza 433-848 mHz Soft touch Made in Italy Colore bianco lucido antistriscio -</p> <p>590JT02 - Frequenza 433-868 MHz Rolling-code - Colore Bianco - Canali 4 Modello Radiocomando Jane top - conf. 1 - € 38,60</p>	 <p>RADIOCOMANDO PRIME TOP Compatibile con la maggior parte dei radiocomandi a cod. fisso con frequenza 433-868 mHz e una serie di codici rolling. Made in Italy Colori Assortiti -</p> <p>590PT4 - Frequenza 433-868 MHz ROLLING-CODE - Colore ASSORTITI - Canali 4 Modello RADIOCOMANDO PRIME TOP - conf. 1 - € 29,90</p>
 <p>RADIOCOMANDO PRIME F 4 canali Copia in autoapprendimento codici fissi con frequenza 433.92 MHz Autogenera codici fissi random/univoci a frequenza 433.92 MHz Made in Italy Colori assortiti -</p> <p>590JF12V - Frequenza 433,92 Mhz - Colore Assortiti - Canali 4 Modello Radiocomando Prime F 12V - conf. 0 - € 21,00</p>	 <p>RADIOCOMANDO JANE V Duplicazione con autoapprendimento Batteria litio 3V (CR2032) Soft touch Made in Italy Colori assortiti -</p> <p>590JV4 - Frequenza 260 Mhz a 868 Mhz - Colore Assortiti - Canali 4 Modello Radiocomando Jane variabile - conf. 1 - € 32,46</p>
 <p>RADIOCOMANDO JANE F Duplicazione con autoapprendimento Batteria litio 3V (CR2032) Soft touch Made in Italy Colori assortiti -</p> <p>590JF2 - Frequenza 433,92 Mhz - Colore Assortiti - Canali 2 Modello Radiocomando Jane fisso - conf. 1 - € 31,18</p> <p>590JF4 - Frequenza 433,92 Mhz - Colore Assortiti - Canali 4 Modello Radiocomando Jane fisso - conf. 1 - € 31,18</p>	 <p>RADIOCOMANDO JANE Q Duplicazione con autoapprendimento per frequenze da 26 a 40 Mhz Batteria litio 12V Soft touch Made in Italy Colori assortiti Quarzo da ordinare a parte -</p> <p>590JQ2 - Colore Assortiti - Canali 2 Modello Radiocomando Jane quarzato - conf. 1 - € 33,32</p> <p>590JQ4 - Colore Assortiti - Canali 4 Modello Radiocomando Jane quarzato - conf. 1 - € 33,32</p>
 <p>RADIOCOMANDO JANE Q 2T-8 Duplicazione con autoapprendimento Batteria litio 12V Soft touch Made in Italy Colori assortiti Completo di quarzo -</p> <p>590JQ28 - Colore Assortiti - Quarzo 30.875 - Canali 2 Modello Radiocomando Jane quarzato - conf. 1 - € 36,28</p>	 <p>RADIOCOMANDO JANE Q 2T-9 Duplicazione con autoapprendimento Batteria litio 12V Soft touch Made in Italy Colori assortiti Completo di quarzo -</p> <p>590JQ29 - Colore Assortiti - Quarzo 30.900 - Canali 2 Modello Radiocomando Jane quarzato - conf. 1 - € 36,28</p>
 <p>MINI-RICEVITORE RXJF2C Codice fisso Frequenza 433.92 MHz che si abbina ai radiocomandi JANE F e tutti i radiocomandi a codice HT12. Comando a distanza per automazioni, accensione luce, tapparelle, tende ecc. Tutte le operazioni di programmazione e configurazione de canali avvengono tramite l'unico tasto presente nella scheda elettronica -</p> <p>590RXJF2C - Frequenza 433,92 Mhz - Modello mini ricevitore per jane F - conf. 1 - € 80,20</p>	 <p>RADIOCOMANDO CHARGER TX EGOWAY Caricatore da accendisigari per cellulare con radiocomando integrato. Colore nero Frequenza: 280 a 868 MHz - Codice fisso + Rolling code</p> <p>778CHTXM - Frequenza Multifrequenza - Rolling-code - Colore Nero - Canali 4 Modello Caricatore auto - conf. 1 - € 45,00</p> <p>AD ESAURIMENTO</p>

newCopy-Control

soluzione evoluta per radiocomandi



• nuovo design

• nuovo display
più funzionale

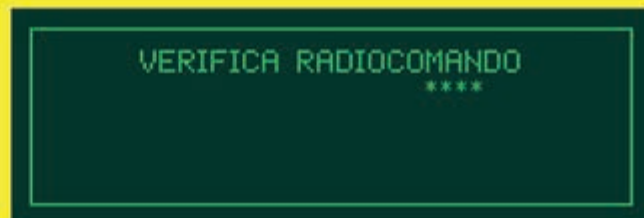

• funzioni principali:

- Identificazione codice Rolling Code
- Trasferimento codice
- **Controllo BIT**
- Frequenzimetro
- Taratura radiocomandi
- Verifica copiatura
- Analizzatore di spettro

MADE IN ITALY

bandbsnc.it

www.malfattitacchinigroup.it

Una **grande tecnologia** in continua evoluzione
al servizio dei **professionisti**.

























ITALFILE[®]
MADE IN ITALY



italfile.it

www.malfattitacchinigroup.it



 <p>RADIOCOMANDO FISSO AIR4L Frequenza 433,92 Mhz Codice fisso e Rolling Code -</p> <p>783RKE10021 - Frequenza 433,92 Mhz Rolling-code - Colore Bianco/Grigio - Canali 4 Modello Radiocomando Air 4L - conf. 1 - € 21,22</p> <p>783RKE10022 - Frequenza 433,92 Mhz Rolling-code - Colore Bianco/Celeste - Canali 4 Modello Radiocomando Air 4L - conf. 1 - € 21,22</p> <p>segue...</p> 	 <p>continua...</p> <p>783RKE10023 - Frequenza 433,92 Mhz Rolling-code - Colore Bianco/Rosso - Canali 4 Modello Radiocomando Air 4L - conf. 1 - € 21,22</p> <p>783RKE10024 - Frequenza 433,92 Mhz Rolling-code - Colore Bianco/Marrone - Canali 4 Modello Radiocomando Air 4L - conf. 1 - € 21,22</p> <p>783RKE10025 - Frequenza 433,92 Mhz Rolling-code - Colore Bianco/Beige - Canali 4 Modello Radiocomando Air 4L - conf. 1 - € 21,22</p> 
 <p>RADIOCOMANDO QUARZATO AIR4Q -</p> <p>783RKE20007 - Frequenza Tra 27 e 40,685 Mhz - Colore Bianco/Rosso - Canali 4 Modello Radiocomando Air 4Q - conf. 1 - € 35,44</p> <p>783RKE20008 - Frequenza Tra 27 e 40,685 Mhz - Colore Bianco/Grigio - Canali 4 Modello Radiocomando Air 4Q - conf. 1 - € 35,44</p> <p>783RKE20009 - Frequenza Tra 27 e 40,685 Mhz - Colore Bianco/Nero - Canali 4 Modello Radiocomando Air 4Q - conf. 1 - € 35,44</p> 	 <p>SET. 5 PZ ASSORTITI RADIOCOMANDI AIR4L Frequenza: 433,92 Mhz Codice fisso e Rolling Code -</p> <p>783RKE10000 - Frequenza 433,92 Mhz - Colore Assortiti - Canali 4 Modello Radiocomando Air 4L - conf. 1 - € 105,88</p> 
 <p>SET. 5 PZ ASSORTITI RADIOCOMANDI AIR4 V64 Frequenza: 433,92+868 Mhz Codice fisso e Rolling Code Aggiornamento tecnologico che migliora il prodotto aumentandone il raggio d'azione +25% e velocizza il processo di copia -</p> <p>783RKE15400 - Frequenza 433,92 + 868 MHz ROLLING-CODE - Colore ASSORTITI - Canali 4 Modello RADIOCOMANDO AIR4 V64 - conf. 1 - € 181,30</p> 	 <p>RADIOCOMANDO FISSO VARIABILE AIR4 V64 Frequenza: 433,92+868 Mhz Codice fisso e Rolling Code Aggiornamento tecnologico che migliora il prodotto aumentandone il raggio d'azione +25% e velocizza il processo di copia -</p> <p>783RKE15421 - Frequenza 433,92 + 868 MHz ROLLING-CODE - Colore ANTRACITE/BIANCO - Canali 4 Modello RADIOCOMANDO AIR4 V64 - conf. 1 - € 36,26</p> <p>segue...</p> 
 <p>continua...</p> <p>783RKE15422 - Frequenza 433,92 + 868 MHz ROLLING-CODE - Colore AZZURRO/BIANCO - Canali 4 Modello RADIOCOMANDO AIR4 V64 - conf. 1 - € 36,26</p> <p>783RKE15423 - Frequenza 433,92 + 868 MHz ROLLING-CODE - Colore ROSSO/BIANCO - Canali 4 Modello RADIOCOMANDO AIR4 V64 - conf. 1 - € 36,26</p> <p>783RKE15424 - Frequenza 433,92 + 868 MHz ROLLING-CODE - Colore TORTORA/BIANCO - Canali 4 Modello RADIOCOMANDO AIR4 V64 - conf. 1 - € 36,26</p> <p>segue...</p> 	 <p>continua...</p> <p>783RKE15425 - Frequenza 433,92 + 868 MHz ROLLING-CODE - Colore BEIGE/BIANCO - Canali 4 Modello RADIOCOMANDO AIR4 V64 - conf. 1 - € 36,26</p> 
 <p>SET. 5 PZ ASSORTITI RADIOCOMANDI AIR4V PLUS 128 Frequenza: 433,92+868 Mhz Radiocomando fisso e rolling variabile Air V Plus 128 in abbinato a Easy Scan Plus e Air4 Remote Programming Software potrà duplicare radiocomandi originali a 128 bit. -</p> <p>783RKE25200 - Frequenza 433,92 + 868 MHz ROLLING-CODE - Colore ASSORTITI - Canali 4 Modello RADIOCOMANDO AIR4V PLUS 128 - conf. 1 - € 195,00</p> 	 <p>RADIOCOMANDO FISSO VARIABILE AIR4V PLUS 128 Frequenza: 433,92+868 Mhz Radiocomando fisso e rolling variabile Air V Plus 128 in abbinato a Easy Scan Plus e Air4 Remote Programming Software potrà duplicare radiocomandi originali a 128 bit. -</p> <p>783RKE25221 - Frequenza 433,92 + 868 MHz ROLLING-CODE - Colore ANTRACITE/BIANCO - Canali 4 Modello RADIOCOMANDO AIR4V PLUS 128 - conf. 1 - € 39,00</p> <p>segue...</p> 
 <p>continua...</p> <p>783RKE25222 - Frequenza 433,92 + 868 MHz ROLLING-CODE - Colore AZZURRO/BIANCO - Canali 4 Modello RADIOCOMANDO AIR4V PLUS 128 - conf. 1 - € 39,00</p> <p>783RKE25223 - Frequenza 433,92 + 868 MHz ROLLING-CODE - Colore ROSSO/BIANCO - Canali 4 Modello RADIOCOMANDO AIR4V PLUS 128 - conf. 1 - € 39,00</p> <p>segue...</p> 	 <p>continua...</p> <p>783RKE25224 - Frequenza 433,92 + 868 MHz ROLLING-CODE - Colore TORTORA/BIANCO - Canali 4 Modello RADIOCOMANDO AIR4V PLUS 128 - conf. 1 - € 39,00</p> <p>783RKE25225 - Frequenza 433,92 + 868 MHz ROLLING-CODE - Colore BEIGE/BIANCO - Canali 4 Modello RADIOCOMANDO AIR4V PLUS 128 - conf. 1 - € 39,00</p> 



 <p>EASYSKAN PLUS SILCA Duplicazione facile e veloce grazie all'autoapprendimento del codice, al riconoscimento automatico delle frequenze e alla semplice procedura di programmazione, duplicare i radiocomandi Air4 Plus è facile e veloce. Tecnologia NFC Alimentazione 2 batterie AA ricaricabili in dotazione o tramite USB -</p> <p>783D746776ZB - Modello Easy Scan Plus - conf. 1 - € 878,00</p> <p>783D747834ZB - Frequenza Software - - conf. 1 - € 338,00</p>	 <p>RADIOCOMANDO ORIGINALE ACM Mod. AC/1621351 2 canali -</p> <p>23020054 - Frequenza 433,92 Mhz Rolling-code - Canali 2 Modello Radiocomando Acm AC/1621326 - conf. 1 - € 29,70</p>
 <p>RADIOCOMANDO ORIGINALE ALLDUCKS/DUCATI Mod. A/6204 4 canali -</p> <p>23020060 - Frequenza 433,92 Mhz Rolling-code - Canali 4 Modello Radiocomando ALLDUCKS A/6204 - conf. 1 - € 44,14</p>	 <p>RADIOCOMANDO ORIGINALE ALLMATIC Mod. AL/12005380 3 canali -</p> <p>23020152 - Frequenza 433,92 Mhz Rolling-code - Canali 3 Modello Radiocomando ALLMATIC AL/12005380 - conf. 1 - € 27,16</p>
 <p>RADIOCOMANDO ORIGINALE ALLMATIC Mod. AL/12005372 4 canali -</p> <p>23020153 - Frequenza 433,92 Mhz Rolling-code - Canali 4 Modello Radiocomando ALLMATIC AL/12005372 - conf. 1 - € 28,42</p>	 <p>RADIOCOMANDO ORIGINALE APRIMATIC Mod. AP/41905-004 4 canali -</p> <p>23020205 - Frequenza 433,92 Mhz Rolling-code - Canali 4 Modello Radiocomando aprimatic ap/41905-004 - conf. 1 - € 34,58</p>
 <p>RADIOCOMANDO ORIGINALE AVIDSEN Mod. AV/104257 4 canali -</p> <p>23020220 - Frequenza 433,92 Mhz Rolling-code - Canali 4 Modello Radiocomando avidsen av/114253 - conf. 1 - € 31,82</p>	 <p>RADIOCOMANDO ORIGINALE BENINCA Mod. B/9863066 4 canali -</p> <p>23020252 - Frequenza 433,92 Mhz Rolling-code - Canali 4 Modello Radiocomando beninca b/9863066 - conf. 1 - € 37,34</p>
 <p>RADIOCOMANDO ORIGINALE BENINCA Mod. B/9863106 2 canali -</p> <p>23020254 - Frequenza 868 Mhz Rolling-code - Canali 2 Modello Radiocomando beninca b/9863106 - conf. 1 - € 36,50</p>	 <p>RADIOCOMANDO ORIGINALE BENINCA Mod. B/9863173 2 canali Rolling code sui codici 128 bit e 78 bit -</p> <p>23020255 - Frequenza 433,92 Mhz Rolling-code - Canali 2 Modello Radiocomando beninca b/9863173 - conf. 1 - € 28,22</p>
 <p>RADIOCOMANDO ORIGINALE BFT MITTO Mod. BF/D111904 2 Canali -</p> <p>23020301 - Frequenza 433,92 Mhz Rolling-code - Canali 2 Modello Radiocomando bft mitto bf/d111904 - conf. 1 - € 32,68</p>	 <p>RADIOCOMANDO ORIGINALE BFT MITTO Mod. BF/D111906 4 Canali -</p> <p>23020302 - Frequenza 433,92 Mhz Rolling-code - Canali 4 Modello Radiocomando bft mitto bf/d111906 - conf. 1 - € 38,62</p>



 <p>RADIOCOMANDO ORIGINALE BALLAN Mod. BA/10444083 3 Canali -</p> <p>23020320 - Frequenza 433,92 Mhz Rolling-code - Canali 3 Modello Radiocomando bft ballan ba/10444083 - conf. 1 - € 51,14</p> <p>23020321 - Frequenza 433.92 Mhz - Canali 3 Modello Radiocomando bft ballan ba/10444148 - conf. 1 - € 52,60</p> <p>Modello precedente →</p>	 <p>RADIOCOMANDO ORIGINALE CAME Mod. CA/001AT02EV 2 canali -</p> <p>23020410 - Frequenza 433,92 Mhz Rolling-code - Canali 2 Modello Radiocomando came ca/001at02 - conf. 1 - € 52,60</p> <p>Modello precedente →</p>
 <p>RADIOCOMANDO ORIGINALE CAME Mod. CA/001AT04EV 4 canali -</p> <p>23020402 - Frequenza 433,92 Mhz Rolling-code - Canali 4 Modello Radiocomando came ca/001at04 - conf. 1 - € 47,52</p> <p>Modello precedente →</p>	 <p>RADIOCOMANDO ORIGINALE CAME Mod. CA/001TOP-862EV 2 canali -</p> <p>23020409 - Frequenza 868 Mhz Codice fisso - Canali 2 Modello Radiocomando came ca/001top-862ev - conf. 1 - € 46,14</p> <p>Mod. duplicabile con Sandy One</p> <p>Modello precedente →</p>
 <p>RADIOCOMANDO ORIGINALE CAME Mod. CA/001TOP-432EE 2 canali -</p> <p>23020406 - Frequenza 433,92 Mhz Codice fisso - Canali 2 Modello Radiocomando came ca/001top-432ee - conf. 1 - € 32,76</p> <p>Mod. duplicabile con Smile, Baby, Swing, Eka</p> <p>Modelli precedenti →</p>	 <p>RADIOCOMANDO ORIGINALE CAME Mod. CA/001TOP-434EE 4 canali -</p> <p>23020407 - Frequenza 433,92 Mhz Codice fisso - Canali 4 Modello Radiocomando came ca/001top-434ee - conf. 1 - € 51,50</p> <p>Mod. duplicabile con Smile, Baby, Swing, Eka</p> <p>Modelli precedenti →</p>
 <p>RADIOCOMANDO CAME 4 Canali -</p> <p>23020411 - Frequenza ROLLING CODE - Colore AZZURRO/BIANCO - Canali 4 Modello RADIOCOMANDO CAME TOPD4RBS - conf. 1 - € 47,40</p> <p>23020412 - Frequenza 433/868 MHZ - Colore AZZURRO/NERO - Canali 4 Modello RADIOCOMANDO CAME TOPD4FBS - conf. 1 - € 47,40</p>	 <p>RADIOCOMANDO ORIGINALE CARDIN Modello C/TXQ449200 2 canali -</p> <p>23020457 - Frequenza 433,92 Mhz Rolling-code - Canali 2 Modello radiocomand.cardin c/txq449200 - conf. 1 - € 29,28</p> <p>Modello precedente →</p>
 <p>RADIOCOMANDO ORIGINALE CARDIN Modello C/TXQ449400 4 canali -</p> <p>23020458 - Frequenza 433,92 Mhz Rolling-code - Canali 4 Modello radiocomand.cardin c/txq449400 - conf. 1 - € 33,10</p> <p>Modello precedente →</p>	 <p>RADIOCOMANDO ORIGINALE CARDIN Mod. C/ TRS435400 4 canali -</p> <p>23020453 - Frequenza 433,92 Mhz Rolling-code - Canali 4 Modello Radiocomando cardin c/trs435400 - conf. 1 - € 35,64</p>
 <p>RADIOCOMANDO ORIGINALE CARDIN Mod. C/ TXQ486200 2 canali -</p> <p>23020454 - Frequenza 868 Mhz Rolling-code - Canali 2 Modello Radiocomando cardin c/txq486200 - conf. 1 - € 34,58</p> <p>Modello precedente →</p>	 <p>RADIOCOMANDO ORIGINALE CARDIN Mod. C/ TXQ486400 4 canali -</p> <p>23020455 - Frequenza 868 Mhz Rolling-code - Canali 4 Modello Radiocomando cardin c/txq486400 - conf. 1 - € 35,64</p> <p>Modello precedente →</p>





 <p>RADIOCOMANDO ORIGINALE CARDIN Mod. C/ TRS435200 2 canali -</p> <p>23020452 - Frequenza 433,92 Mhz Rolling-code - Canali 2 Modello Radiocomando cardin c/trs435200 - conf. 1 - € 30,34</p>	 <p>RADIOCOMANDO ORIGINALE CASIT Mod. CS/ ERTS4C 4 canali -</p> <p>23020502 - Frequenza 433,92 Mhz Rolling-code - Canali 4 Modello Radiocomando casit cs/erts21rq - conf. 1 - € 35,64</p> <p>Modello precedente →</p>
 <p>RADIOCOMANDO DEA Mod. DE/GT12 2 canali Frequenza: 433.920 Mhz -</p> <p>23020554 - Frequenza 433.920 Mhz - Canali 2 Modello RADIOCOMANDO DEA DE/GT12 - conf. 1 - € 40,32</p>	 <p>RADIOCOMANDO ORIGINALE ZEN Mod. ZEN 4 4 Canali Può lavorare come Rolling code sui codici 128 bit e 64 bit SOSTITUISCE ZEN 4 -</p> <p>23020603 - Frequenza 433,92 Mhz Rolling-code - Canali 4 Modello Radiocomando ditec zen 4 - conf. 1 - € 34,38</p> <p>Modello precedente →</p>
 <p>RADIOCOMANDO ORIGINALE ZEN Mod. ZEN 4/C 4 Canali SOSTITUISCE NAGOL 4/C -</p> <p>23020604 - Frequenza 433,92 Mhz Codice fisso - Canali 4 Modello Radiocomando ditec zen 4c - conf. 1 - € 36,28</p> <p>Mod. duplicabile con Smile, Swing 433 Modello precedente →</p>	 <p>RADIOCOMANDO ORIGINALE ELVOX Mod. EV/ ETR5 2 canali -</p> <p>23020620 - Frequenza 433,92 Mhz Rolling-code - Canali 2 Modello Radiocomando elvox ev/etr5 - conf. 1 - € 49,40</p> <p>Modello precedente →</p>
 <p>RADIOCOMANDO ORIGINALE ERONE Mod. E/ ERONE-AM 2 canali -</p> <p>23020652 - Frequenza 433,92 Mhz Rolling-code - Canali 2 Modello Radiocomando erone e/erone-am - conf. 1 - € 27,36</p>	 <p>RADIOCOMANDO ORIGINALE ERONE Mod. E/ ERONE-FM 2 canali -</p> <p>23020653 - Frequenza 433,92 Mhz Rolling-code - Canali 2 Modello Radiocomando erone e/erone-fm - conf. 1 - € 30,12</p>
 <p>RADIOCOMANDO ORIGINALE ERONE Mod. E/ S2TR2641-E2 2 canali -</p> <p>23020654 - Frequenza 433,92 Mhz Rolling-code - Canali 2 Modello Radiocomando erone e/s2tr2641-e2 - conf. 1 - € 27,36</p>	 <p>RADIOCOMANDO ORIGINALE ERONE Mod. E/ S2TR2681-E2 2 canali -</p> <p>23020655 - Frequenza 868 Mhz Rolling-code - Canali 2 Modello Radiocomando erone e/s2tr2681-e2 - conf. 1 - € 32,46</p> <p>Modello precedente →</p>
 <p>RADIOCOMANDO ORIGINALE EXTEL Mod. EX/750530 4 canali -</p> <p>23020630 - Frequenza 433,92 Mhz Rolling-code - Canali 4 Modello Radiocomando extel ex/750530 - conf. 1 - € 51,14</p>	 <p>RADIOCOMANDO FAAC Modello FC/787007 2 canali -</p> <p>23020711 - Frequenza 433,92 Mhz Rolling-code - Canali 2 Modello Radiocomando faac fc/787007 - conf. 1 - € 35,22</p>



 <p>RADIOCOMANDO ORIGINALE FAAC Mod. FC/787008 4 Canali - 23020702 - Frequenza 433,92 Mhz Rolling-code - Canali 4 Modello Radiocomando faac fc/787008 - conf. 1 - € 41,38</p>	 <p>RADIOCOMANDO ORIGINALE FAAC Mod. FC/7870071 2 Canali - 23020703 - Frequenza 433,92 Mhz Rolling-code - Canali 2 Modello Radiocomando faac fc/7870071 - conf. 1 - € 35,22</p>
 <p>RADIOCOMANDO ORIGINALE FAAC Mod. FC/7870081 4 Canali - 23020705 - Frequenza 433,92 Mhz Rolling-code - Canali 4 Modello Radiocomando faac fc/7870081 - conf. 1 - € 41,38</p>	 <p>RADIOCOMANDO ORIGINALE FAAC Mod. FC/787452 4 Canali - 23020708 - Frequenza 433,92 Mhz Rolling-code - Canali 4 Modello Radiocomando faac fc/787456 - conf. 1 - € 24,18</p>
 <p>RADIOCOMANDO FAAC Modello FC/787009 2 canali - 23020709 - Frequenza 868 Mhz Rolling-code - Canali 2 Modello Radiocomando faac fc/787009 - conf. 1 - € 35,22</p>	 <p>RADIOCOMANDO ORIGINALE FAAC Mod. FC/7870091 2 Canali - 23020704 - Frequenza 868 Mhz Rolling-code - Canali 2 Modello Radiocomando faac fc/7870091 - conf. 1 - € 35,22</p>
 <p>RADIOCOMANDO ORIGINALE FAAC Mod. FC/7870101 4 Canali - 23020706 - Frequenza 868 Mhz Rolling-code - Canali 4 Modello Radiocomando faac fc/7870101 - conf. 1 - € 41,38</p>	 <p>RADIOCOMANDO ORIGINALE FAAC Mod. FC/787010 4 Canali - 23020707 - Frequenza 868 Mhz Rolling-code - Canali 4 Modello Radiocomando faac fc/787010 - conf. 1 - € 41,38</p>
 <p>RADIOCOMANDO ORIGINALE FAAC 2 canali Modello: 787471 Frequenza: 315 - 23020710 - Modello Radiocomando faac fc/787471 - conf. 1 - € 43,50</p>	 <p>RADIOCOMANDO ORIGINALE FADINI Birio Mod. FA/8613 2 canali - 23020760 - Frequenza 868 Mhz Rolling-code - Modello Radiocomando fadini fa/8613 - conf. 1 - € 43,08</p>
 <p>RADIOCOMANDO ORIGINALE FADINI Mod. FA/8615 4 canali - 23020754 - Frequenza 868 Mhz Rolling-code - Canali 4 Modello Radiocomando fadini fa/8615 - conf. 1 - € 44,78</p>	 <p>RADIOCOMANDO ORIGINALE FADINI Siti Mod. FA/6313 2 canali - 23020761 - Frequenza 433,92 Mhz Rolling-code - Canali 2 Modello Radiocomando fadini fa/6313 - conf. 1 - € 43,08</p>













 <p>RADIOCOMANDO ORIGINALE FADINI Mod. FA/6315 4 canali -</p> <p>23020755 - Frequenza 433,92 Mhz Rolling-code - Canali 4 Modello Radiocomando fadini fa/6315 - conf. 1 - € 42,02</p>	 <p>RADIOCOMANDO ORIGINALE FADINI Modello FA/5313 4 Canali -</p> <p>23020757 - Frequenza 868 Mhz Rolling-code - Colore Verde - Canali 4 Modello Radiocomando fadini fa/5313gl - conf. 1 - € 38,20</p> <p>23020758 - Frequenza 868 Mhz Rolling-code - Colore Nero - Canali 4 Modello Radiocomando fadini fa/5313sl - conf. 1 - € 38,20</p> <p>segue...</p>
<p>continua...</p>  <p>23020759 - Frequenza 868 Mhz Rolling-code - Colore Giallo - Canali 4 Modello Radiocomando fadini fa/5313yl - conf. 1 - € 38,20</p>	 <p>RADIOCOMANDO ORIGINALE FADINI Mod. FA/7113SL 4 canali Frequenza 433 Mhz -</p> <p>23022103 - Frequenza 433,92 Mhz Rolling-code - Canali 4 Modello Radiocomando fadini fa/7113sl - conf. 1 - € 37,34</p>
 <p>RADIOCOMANDO ORIGINALE GIBIDI Mod G/AU03000 4 canali -</p> <p>23020801 - Frequenza 433,92 Mhz Rolling-code - Canali 4 Modello Radiocomando gbd g/au03000 - conf. 1 - € 29,06</p>	 <p>RADIOCOMANDO ORIGINALE GENIUS Mod. GE/6100330 2 canali -</p> <p>23020802 - Frequenza 433,92 Mhz Rolling-code - Canali 2 Modello Radiocomando genius ge/6100330 - conf. 1 - € 35,22</p>
 <p>RADIOCOMANDO ORIGINALE GENIUS Mod. GE/6100331 4 canali -</p> <p>23020803 - Frequenza 433,92 Mhz Rolling-code - Canali 4 Modello Radiocomando genius ge/6100331 - conf. 1 - € 41,80</p>	 <p>RADIOCOMANDO ORIGINALE GENIUS Mod. GE/6100334 4 canali -</p> <p>23020804 - Frequenza 433,92 Mhz Rolling-code - Canali 4 Modello Radiocomando genius ge/6100334 - conf. 1 - € 31,62</p>
 <p>RADIOCOMANDO ORIGINALE GENIUS Mod. GE/6100332 2 canali -</p> <p>23020807 - Frequenza 868 Mhz Rolling-code - Canali 2 Modello Radiocomandogenius kilo ge/6100332 - conf. 1 - € 33,94</p>	 <p>RADIOCOMANDO ORIGINALE GENIUS Mod. GE/6100333 4 canali -</p> <p>23020808 - Frequenza 868 Mhz Rolling-code - Canali 4 Modello Radiocomandogenius kilo ge/6100333 - conf. 1 - € 35,86</p>
 <p>RADIOCOMANDO ORIGINALE GT ALARM Mod. GT/2320 2 canali -</p> <p>23020852 - Frequenza 433,92 Mhz Rolling-code - Canali 2 Modello Radiocomando gt alarm gt/2320 - conf. 1 - € 52,20</p>	 <p>RADIOCOMANDO ORIGINALE HORMAN Mod. H/436751 4 canali Luce blu rolling code Luce rossa codice fisso -</p> <p>23020904 - Frequenza 868 Mhz Rolling-code - Canali 4 Modello Radiocomando horman h/436751 - conf. 1 - € 83,02</p>















 <p>RADIOCOMANDO ORIGINALE HORMAN ECO-STAR Mod. H/437681 2 canali -</p> <p>23020905 - Frequenza 433,92 Mhz Rolling-code - Canali 2 Modello Radiocomando horman h/437681 - conf. 1 - € 51,76</p>	 <p>RADIOCOMANDO ORIGINALE JCM Mod. JC/GO 2 canali -</p> <p>23020952 - Frequenza 868 Mhz Rolling-code - Canali 2 Modello Radiocomando jcm jc/go - conf. 1 - € 36,92</p>
 <p>RADIOCOMANDO ORIGINALE KEY AUTOMATION Mod. KE/900TXB-42R 4 canali Colori assortiti -</p> <p>23021002 - Frequenza 433,92 Mhz Rolling-code - Canali 4 Modello Radiocomandokey autom. ke/900kplay4r - conf. 1 - € 30,48</p> <p><small>Modello precedente</small> → </p>	 <p>RADIOCOMANDO ORIGINALE KING GATE Mod. K/STYLO4 4 canali -</p> <p>23021052 - Frequenza 433,92 Mhz Rolling-code - Canali 4 Modello Radiocomando king gate k/stylo4 - conf. 1 - € 32,88</p>
 <p>RADIOCOMANDO ORIGINALE LABEL Mod. LA/R03001 3 canali -</p> <p>23021102 - Frequenza 433,92 Mhz Rolling-code - Canali 3 Modello Radiocomando label la/r03001 - conf. 1 - € 33,10</p>	 <p>RADIOCOMANDO ORIGINALE LIFE Mod. L/1AT0030013 2 canali -</p> <p>23021152 - Frequenza 433,92 Mhz Rolling-code - Canali 2 Modello Radiocomando life l/1at0030013 - conf. 1 - € 38,40</p>
 <p>RADIOCOMANDO ORIGINALE LIFE Mod. L/1AT0040013 4 canali -</p> <p>23021153 - Frequenza 433,92 Mhz Rolling-code - Canali 4 Modello Radiocomando life l/1at0040013 - conf. 1 - € 41,16</p>	 <p>RADIOCOMANDO ORIGINALE LIFE Mod. L/1AT0090002 2 canali -</p> <p>23021154 - Frequenza 433,92 Mhz Rolling-code - Canali 2 Modello Radiocomando life l/1at0090002 - conf. 1 - € 35,86</p>
 <p>RADIOCOMANDO ORIGINALE LIFE Mod. L/1AT0100002 4 canali -</p> <p>23021155 - Frequenza 433,92 Mhz Rolling-code - Canali 4 Modello Radiocomando life l/1at0100002 - conf. 1 - € 38,40</p>	 <p>RADIOCOMANDO ORIGINALE MARANTEC Mod. M/64173 2 canali -</p> <p>23021202 - Frequenza 868 Mhz Codice fisso - Canali 2 Modello Radiocomando marantec m/64173 - conf. 1 - € 42,22</p> <p><small>Modello precedente</small> →  <small>Mod. duplicabile con Standby One</small></p>
 <p>RADIOCOMANDO ORIGINALE MHOUSE Mod. NC/GTX4 4 canali -</p> <p>23021302 - Frequenza 433,92 Mhz Rolling-code - Canali 4 Modello Radiocomando mhouse nc/gtx4 - conf. 1 - € 46,90</p> <p><small>Modello precedente</small> → </p>	 <p>RADIOCOMANDO ORIGINALE MOOVO Mod. NC/MT4G 4 canali -</p> <p>23021303 - Frequenza 433,92 Mhz Rolling-code - Canali 4 Modello Radiocomando moovo nc/mt4g - conf. 1 - € 44,98</p>



 <p>RADIOCOMANDO ORIGINALE NICE Mod. NC/ FLO2R 2 Canali GUSCIO NERO -</p> <p>23021324 - Frequenza 433,92 Mhz Rolling-code - Canali 2 Modello Radiocomando nice nc/flo2r - conf. 1 - € 31,80</p>	 <p>RADIOCOMANDO ORIGINALE NICE Mod. NC/ FLO4R 4 canali GUSCIO NERO -</p> <p>23021325 - Frequenza 433,92 Mhz Rolling-code - Canali 2 Modello Radiocomando nice nc/flo4r - conf. 1 - € 35,22</p>
 <p>RADIOCOMANDO NICE - ERA FLOR Rolling code 2 Canali -</p> <p>23021326 - Frequenza 433.92 MHz - Colore Nero - Canali 2 - conf. 1 - € 31,80</p>	 <p>RADIOCOMANDO ORIGINALE NICE Mod. NC/ ON2FM Linea Opera 2 canali -</p> <p>23021323 - Frequenza 868 Mhz Rolling-code - Canali 2 Modello Radiocomando nice nc/on2efm - conf. 1 - € 44,78</p>
 <p>RADIOCOMANDO ORIGINALE NICE Mod. NC/ INTI 2 canali -</p> <p>23021304 - Frequenza 433,92 Mhz Rolling-code - Colore Nero - Canali 2 Modello Radiocomando nice nc/inti2 - conf. 1 - € 33,10</p> <p>23021305 - Frequenza 433,92 Mhz Rolling-code - Colore Rosso - Canali 2 Modello Radiocomando nice nc/inti2r - conf. 1 - € 33,10 segue...</p>	<p>continua...</p> <p>23021306 - Frequenza 433,92 Mhz Rolling-code - Colore Blu - Canali 2 Modello Radiocomando nice nc/inti2b - conf. 1 - € 33,10</p> <p>23021307 - Frequenza 433,92 Mhz Rolling-code - Colore Verde - Canali 2 Modello Radiocomando nice nc/inti2g - conf. 1 - € 33,10</p> <p>23021308 - Frequenza 433,92 Mhz Rolling-code - Colore Giallo - Canali 2 Modello Radiocomando nice nc/inti2y - conf. 1 - € 33,10 segue...</p>
 <p>continua...</p> <p>23021309 - Frequenza 433,92 Mhz Rolling-code - Colore Lilla - Canali 2 Modello Radiocomando nice nc/inti2l - conf. 1 - € 33,10</p>	 <p>RADIOCOMANDO ORIGINALE NICE Mod. NC/ ON2E 2 canali -</p> <p>23021319 - Frequenza 433,92 Mhz Rolling-code - Canali 2 Modello Radiocomando nice nc/on2e - conf. 1 - € 34,58</p>
 <p>RADIOCOMANDO ORIGINALE NICE Mod. NC/ ON4E 4 canali -</p> <p>23021310 - Frequenza 433,92 Mhz Rolling-code - Canali 4 Modello Radiocomando nice nc/on4e - conf. 1 - € 41,16</p>	 <p>RADIOCOMANDO ORIGINALE NICE Mod. NC/ SM2 2 canali -</p> <p>23021311 - Frequenza 433,92 Mhz Rolling-code - Canali 2 Modello Radiocomando nice nc/sm2 - conf. 1 - € 37,28</p>
 <p>RADIOCOMANDO ORIGINALE NICE Mod. NC/ SM4 4 canali -</p> <p>23021312 - Frequenza 433,92 Mhz Rolling-code - Canali 4 Modello Radiocomando nice nc/sm4 - conf. 1 - € 39,96</p>	 <p>RADIOCOMANDO ORIGINALE NICE Mod. NC/VR 2 canali -</p> <p>23021313 - Frequenza 433,92 Mhz Rolling-code - Canali 2 Modello Radiocomando nice nc/vr - conf. 1 - € 35,22</p> <p>Modello precedente →</p>



 <p>RADIOCOMANDO ORIGINALE NICE Mod. NC/BT2K Quarzo Frequenze: 30,875 Mhz 40,685 Mhz 2 canali -</p> <p>23021315 - Quarzo 30.875 - Canali 2 Modello Radiocomando nice nc/bt2k - conf. 1 - € 46,68</p> <p><small>Mod. duplicabile con QC2 - R08 QC2</small></p>	 <p>RADIOCOMANDO ORIGINALE NICE Mod. NC/P6 6 canali Per tende, tapparelle e impianti climatici Gestisce fino a 6 gruppi di automazioni differenti -</p> <p>23021320 - Frequenza 433,92 Mhz Rolling-code - Canali 6 Modello Radiocomando nice nc/p6 - conf. 1 - € 86,36</p>
 <p>RADIOCOMANDO ORIGINALE NICE Mod. NC/ERG01 3 tasti Telecomando per Tende e Tapparelle Supporto muro incluso -</p> <p>23021321 - Frequenza 433,92 Mhz Rolling-code - Canali 3 Modello Radiocomando nice nc/ergo1 - conf. 1 - € 64,28</p>	 <p>RADIOCOMANDO ORIGINALE NICE Mod. NC/WM002G Telecomando per Tende e Tapparelle Gestisce fino a 2 gruppi di automazioni differenti -</p> <p>23021322 - Frequenza 433,92 Mhz Rolling-code - Modello Radiocomando nice nc/wm002g - conf. 1 - € 57,08</p>
 <p>RADIOCOMANDO ORIGINALE NOVOFERM Mod. NO/MT00690 2 canali -</p> <p>23021430 - Frequenza 433,92 Mhz Rolling-code - Canali 2 Modello Radiocomando novoferm no/mt00690 - conf. 1 - € 70,44</p>	 <p>RADIOCOMANDO ORIGINALE NORMSTHAL CRAWFORD Mod. N/N002592-00-00 4 canali -</p> <p>23021402 - Frequenza 433,92 Mhz Rolling-code - Canali 4 Modello Radiocomando Normsthal n/n002592-00- - conf. 1 - € 80,84</p>
 <p>RADIOCOMANDO ORIGINALE PRASTEL Mod. PR/MPSTP2E 2 canali -</p> <p>23021502 - Frequenza 433,92 Mhz Rolling-code - Canali 2 Modello Radiocomando prastel pr/mpstp2e - conf. 1 - € 30,34</p>	 <p>RADIOCOMANDO ORIGINALE PRASTEL Mod. PR/TC4E 4 canali -</p> <p>23021503 - Frequenza 433,92 Mhz Rolling-code - Canali 4 Modello Radiocomando prastel pr/tc4e - conf. 1 - € 38,40</p>
 <p>RADIOCOMANDO ORIGINALE PRASTEL Mod. PR/TC4S 4 canali -</p> <p>23021505 - Frequenza 868 Mhz Rolling-code - Canali 4 Modello Radiocomando prastel pr/tc4s - conf. 1 - € 38,40</p>	 <p>RADIOCOMANDO ORIGINALE PROGET Mod. PRO/BUGGYF 2 canali -</p> <p>23021552 - Frequenza 433,92 Mhz Rolling-code - Canali 2 Modello Radiocomando proget pro/buggyf - conf. 1 - € 24,62</p> <p><small>Modello precedente</small></p>
 <p>RADIOCOMANDO ORIGINALE PUJOL Mod. P/P9EMIS0240 3 canali -</p> <p>23021602 - Frequenza 433,92 Mhz Rolling-code - Canali 3 Modello Radiocomando pujol p/p9emis0240 - conf. 1 - € 28,00</p>	 <p>RADIOCOMANDO ORIGINALE RIB Mod. R/ACG6056 2 canali -</p> <p>23021652 - Frequenza 433,92 Mhz Codice fisso - Canali 2 Modello Radiocomando rib r/acg6056 - conf. 1 - € 32,88</p>



 <p>RADIOCOMANDO ORIGINALE RIB Mod. R/ACG6054 4 canali - 23021653 - Frequenza 433,92 Mhz Codice fisso - Canali 4 Modello Radiocomando rib r/acg6054 - conf. 1 - € 34,58</p>	 <p>RADIOCOMANDO ORIGINALE SEA Mod. SE/23110400 2 canali - 23021702 - Frequenza 433,92 Mhz Rolling-code - Canali 2 Modello Radiocomando sea se/23110400 - conf. 1 - € 37,14</p>
 <p>RADIOCOMANDO ORIGINALE SEA Mod. SE/23110405 4 canali - 23021703 - Frequenza 433,92 Mhz Rolling-code - Canali 4 Modello Radiocomando sea se/23110405 - conf. 1 - € 39,04</p>	 <p>RADIOCOMANDO ORIGINALE SEA Mod. SE/23110410 2 canali - 23021704 - Frequenza 868 Mhz Rolling-code - Canali 2 Modello Radiocomando sea se/23110410 - conf. 1 - € 37,98</p>
 <p>RADIOCOMANDO ORIGINALE SEA Mod. SE/23110415 4 canali - 23021705 - Frequenza 868 Mhz Rolling-code - Canali 4 Modello Radiocomando sea se/23110415 - conf. 1 - € 40,10</p>	 <p>RADIOCOMANDO ORIGINALE SEA Mod. SE/23110472 2 canali - 23021706 - Frequenza 433,92 Mhz Rolling-code - Canali 2 Modello Radiocomando sea se/23110472 - conf. 1 - € 38,62</p>
 <p>RADIOCOMANDO ORIGINALE SEA Mod. SE/23110477 4 canali - 23021708 - Frequenza 433,92 Mhz Rolling-code - Canali 4 Modello Radiocomando sea coccin. se/23110477 - conf. 1 - € 40,32</p>	 <p>RADIOCOMANDO ORIGINALE SEA Mod. SE/23110481 2 canali - 23021707 - Frequenza 868 Mhz Rolling-code - Canali 2 Modello Radiocomando sea se/23110481 - conf. 1 - € 38,62</p>
 <p>RADIOCOMANDO ORIGINALE SEAV Mod. SV/BEHAPPY-868 2 canali - 23021753 - Frequenza 868 Mhz Rolling-code - Canali 2 Modello Radiocomando seav sv/behappy-868 - conf. 1 - € 46,90</p>	 <p>RADIOCOMANDO ORIGINALE SEAV Mod. SV/BEHAPPY 2 canali - 23021752 - Frequenza 433,92 Mhz Rolling-code - Canali 2 Modello Radiocomando seav sv/behappy - conf. 1 - € 28,00</p>
 <p>RADIOCOMANDO ORIGINALE SERAI Mod. SR/OG-28 2 canali - 23021802 - Frequenza 433,92 Mhz Codice fisso - Canali 2 Modello Radiocomando serai sr/og-28 - conf. 1 - € 41,60</p>	 <p>RADIOCOMANDO ORIGINALE SERAI Mod. SR/OG-82 2 canali Duplicabile con Bandy One - 23021804 - Frequenza 433,92 Mhz Codice fisso - Canali 2 Modello Radiocomando serai sr/og-82 - conf. 1 - € 52,40</p>



 <p>RADIOCOMANDO ORIGINALE SOMFY-TELIS Mod. SF/1810630 1 canale Supporto muro incluso -</p> <p>23021830 - Frequenza 433,92 Mhz Rolling-code - Canali 1 Modello Radiocomando somfy-telis sf/1810630 - conf. 1 - € 72,56</p>	 <p>RADIOCOMANDO ORIGINALE SOMFY-TELIS Mod. SF/1810631 4 canali Supporto muro incluso -</p> <p>23021831 - Frequenza 433,92 Mhz Rolling-code - Canali 4 Modello Radiocomando somfy-telis sf/1810631 - conf. 1 - € 96,54</p>
 <p>RADIOCOMANDO ORIGINALE SOMMER Mod. SO/4020 4 canali -</p> <p>23021855 - Frequenza 868 Mhz Rolling-code - Canali 4 Modello Radiocomando sommer 4ch so/4020 - conf. 1 - € 40,74</p>	 <p>RADIOCOMANDO SOMMER Mod. SO/4018 4 Canali -</p> <p>23022104 - Frequenza 868 Mhz - Canali 4 Modello Radiocomando sommer SO/4018 - conf. 1 - € 41,60</p>
 <p>RADIOCOMANDO ORIGINALE SOMMER Mod. SO/4013 4 canali -</p> <p>23021856 - Frequenza 433,92 Mhz Rolling-code - Canali 4 Modello Radiocomando sommer 4ch so/4013 - conf. 1 - € 40,74</p>	 <p>RADIOCOMANDO ORIGINALE SOMMER Mod. SO/4014 2 canali -</p> <p>23021852 - Frequenza 433,92 Mhz Rolling-code - Canali 2 Modello Radiocomando sommer so/4014 - conf. 1 - € 65,40</p> <p>Modello precedente →</p>
 <p>RADIOCOMANDO ORIGINALE SOMMER Mod. SO/4026 2 canali -</p> <p>23021853 - Frequenza 868 Mhz Rolling-code - Canali 2 Modello Radiocomando sommer so/4026 - conf. 1 - € 31,82</p>	 <p>RADIOCOMANDO ORIGINALE STAGNOLI Mod. ST/AV221 2 canali -</p> <p>23021902 - Frequenza 433,92 Mhz Rolling-code - Canali 2 Modello Radiocomando stagnoli st/av221 - conf. 1 - € 35,00</p>
 <p>RADIOCOMANDO ORIGINALE TAU Mod. TA/K-SLIM-RP 2 canali -</p> <p>23021952 - Frequenza 433,92 Mhz Rolling-code - Canali 2 Modello Radiocomando tau ta/k-slim-rp - conf. 1 - € 27,58</p>	 <p>RADIOCOMANDO ORIGINALE TAU Mod. TA/T-4RP 4 canali -</p> <p>23021953 - Frequenza 433,92 Mhz Rolling-code - Canali 4 Modello Radiocomando tau ta/t-4rp - conf. 1 - € 30,76</p>
 <p>RADIOCOMANDO TELECO Mod. TL/TVTxE868A02 2 canali -</p> <p>23022002 - Frequenza 868 Mhz Rolling-code - Canali 2 Modello Radiocomando Teleco tl/tvtxe868a02 - conf. 1 - € 34,58</p> <p>Modello precedente →</p>	 <p>RADIOCOMANDO ORIGINALE TELECO Mod. TL/TVTxE868A04 4 canali -</p> <p>23022003 - Frequenza 868 Mhz Rolling-code - Canali 4 Modello Radiocomando Teleco tl/tvtxe868a04 - conf. 1 - € 35,86</p> <p>Modello precedente →</p>



 <p>RADIOCOMANDO ORIGINALE TELECO Mod. TL/ TXR434A02 2 canali -</p> <p>23022004 - Frequenza 433,92 Mhz Rolling-code - Canali 2 Modello Radiocomando Teleco tl/txr434a02 - conf. 1 - € 40,10</p>	 <p>RADIOCOMANDO ORIGINALE TELECO Mod. TL/ TAK868C02 2 canali -</p> <p>23022005 - Frequenza 868 Mhz Rolling-code - Canali 2 Modello Radiocomando Teleco tl/tak868c02 - conf. 1 - € 34,58</p>
 <p>RADIOCOMANDO ORIGINALE TELECO Mod. TL/ TAK868C04 4 canali -</p> <p>23022006 - Frequenza 868 Mhz Rolling-code - Canali 4 Modello Radiocomando Teleco tl/tak868c04 - conf. 1 - € 37,34</p>	 <p>RADIOCOMANDO ORIGINALE TELCOMA Mod. T/ NOIRE2E 2 canali TASTI GRIGI -</p> <p>23022052 - Frequenza 433,92 Mhz Rolling-code - Canali 2 Modello Radiocomando telcoma t/noire2e - conf. 1 - € 32,88</p> <p>Modello precedente →</p>
 <p>RADIOCOMANDO ORIGINALE TELCOMA Mod. T/ NOIRE4E 4 canali TASTI GRIGI -</p> <p>23022053 - Frequenza 433,92 Mhz Rolling-code - Canali 4 Modello Radiocomando telcoma t/noire4e - conf. 1 - € 37,14</p> <p>Modello precedente →</p>	 <p>RADIOCOMANDO ORIGINALE TELCOMA Mod. T/ EDGE2 2 canali TASTI AZZURRI -</p> <p>23022054 - Frequenza 433,92 Mhz - Canali 2 Modello Radiocomando telcoma t/edge2 - conf. 1 - € 32,88</p> <p>Mod. duplicabile Smile, Baby, Swing, Eko</p>
 <p>RADIOCOMANDO ORIGINALE TELCOMA Mod. T/ EDGE4 4 canali TASTI AZZURRI -</p> <p>23022055 - Frequenza 433,92 Mhz - Canali 4 Modello Radiocomando telcoma t/edge4 - conf. 1 - € 38,40</p> <p>Mod. duplicabile con Smile, Baby, Swing, Eko</p>	 <p>RADIOCOMANDO ORIGINALE TELCOMA Mod. T/ FM402E 2 canali TASTI VERDI -</p> <p>23022056 - Frequenza 433,92 Mhz Rolling-code - Canali 2 Modello Radiocomando telcoma t/fm402e - conf. 1 - € 35,44</p> <p>Modello precedente →</p>
 <p>RADIOCOMANDO ORIGINALE VDS Mod. V/E010 3 canali -</p> <p>23022102 - Frequenza 433,92 Mhz Rolling-code - Canali 3 Modello Radiocomando vds v/e010 - conf. 1 - € 29,06</p>	 <p>APRICANCELLO SOLO 1CONTROL PER SMARTPHONE CONTROLLO TRAMITE APP GRATUITA Bluetooth LE 4.0 Compatibile con iPhone e Android. Può azionare fino a 4 cancelli o garage. Distanza di funzionamento da 15 a 20 mt. Non necessita di connessione internet. Resistente agli agenti atmosferici -20°C / +50°C. Compatibile con la maggior parte dei radiocomandi in commercio (rolling code compresi). Funziona con 2 batterie 1,5V tipo C (include). Non serve accenderlo. Dimensioni prodotto: 39 x 102 x 134 mm -</p> <p>90102035 - Modello Apricancello solo - conf. 1 - € 146,88</p>
 <p>APRICANCELLO PER SMARTPHONE 1 Control SOLO Dispositivo elettronico Consente l'azionamento a distanza radiocomandata, attraverso lo smartphone. E' possibile condividere l'utilizzo con altri utenti. Può controllare fino a 4 diverse automazioni radiocomandate. L'App "1 Control Solo" è gratuita ed è scaricabile dagli Store per iPhone e Android. PRO: Con batterie FILO: Con alimentatore -</p> <p>90102036 - Modello Apricancello solo pro - conf. 1 - € 216,30</p> <p>90102037 - Modello Apricancello solo Filo - conf. 1 - € 269,86</p>	



RADIOCOMANDI AUTO UNIVERSALI PRIMA SERIE

783CIRFH1
- conf. 1 - € 62,40

783CIRFH3
- conf. 1 - € 82,00

783CIRFH4
- conf. 1 - € 82,00

783CIRFH6
- conf. 1 - € 75,60

783CIRFH7
- conf. 1 - € 82,00

783CIRFH12
- conf. 1 - € 81,00



TESTA FLIP CON ADATTATORE SPADINO ESCLUSO - Nera

783FHPTA
- conf. 1 - € 16,80



SPADINI PER RADIOCOMANDI AUTO UNIVERSALI PRIMA SERIE

1°

Codice	Prezzo
783BW9FH	€ 7,00
783CY24FH	€ 7,00
783DAT17FH	€ 7,00
783DH5RFH	€ 7,00
783DWO4RFH	€ 7,00
783DWO5FH	€ 7,00
783FO10FH	€ 7,00
783FO21FH	€ 7,00
783GT10FH	€ 7,00
783HON58RFH	€ 7,00
783HON70FH	€ 7,00
783HU100FH	€ 7,00
783HU101FH	€ 7,00
783HU133RFH	€ 7,00
783HU56RFH	€ 7,00
783HU66FH	€ 7,00
783HU71FH	€ 7,00
783HU83FH	€ 7,00
783HU87RFH	€ 7,00
783HYN10FH	€ 7,00
783HYN14FH	€ 7,00
783HYN14RFH	€ 7,00
783HYN15FH	€ 7,00
783HYN6FH	€ 7,00
783HYN7RFH	€ 7,00
783KIA3RFH	€ 7,00
783KW16FH	€ 7,00
783MAZ24RFH	€ 7,00

Codice	Prezzo
783MIT11RFH	€ 7,00
783MIT8FH	€ 7,00
783NE72FH	€ 7,00
783NE73FH	€ 7,00
783NE75FH	€ 7,00
783NSN11FH	€ 7,00
783NSN14FH	€ 7,00
783NSN19FH	€ 7,00
783SIP16FH	€ 7,00
783SIP22FH	€ 7,00
783SSY3FH	€ 7,00
783SZ11FH	€ 7,00
783SZ11RFH	€ 7,00
783SZ12FH	€ 7,00
783SZ17RFH	€ 7,00
783TOY40FH	€ 7,00
783TOY41RFH	€ 7,00
783TOY43FH	€ 7,00
783TOY43RFH	€ 7,00
783TOY46RFH	€ 7,00
783TOY47FH	€ 7,00
783TOY48FH	€ 7,00
783TOY49FH	€ 7,00
783VAC102FH	€ 7,00
783VA6FH	€ 7,00
783YH35RFH	€ 7,00
783ZD24RFH	€ 7,00



























 <p>RADIOCOMANDI AUTO UNIVERSALI SECONDA SERIE</p> <p>783CIRFH13 – SENZA TRANSPONDER – conf. 25 – € 27,80</p> <p>783CIRFH13T – CON TRANSPONDER – conf. 25 – € 34,40</p> <p>783CIRFH14 – SENZA TRANSPONDER – conf. 25 – € 27,80</p> <p>783CIRFH14T – CON TRANSPONDER – conf. 25 – € 34,40</p> <p>783CIRFH15 – SENZA TRANSPONDER – conf. 25 – € 27,80</p> <p><i>segue...</i></p>	 <p><i>continua...</i></p> <p>783CIRFH15T – CON TRANSPONDER – conf. 25 – € 34,80</p> <p>783CIRFH16 – SENZA TRANSPONDER – conf. 25 – € 27,80</p> <p>783CIRFH16T – CON TRANSPONDER – conf. 25 – € 34,80</p>
---	--

SPADINI PER RADIOCOMANDI AUTO UNIVERSALI SECONDA SERIE 2°

Codice	Prezzo
783CY24CH	€ 7,00
783DAT17CH	€ 7,00
783DWO5CH	€ 7,00
783FO21CH	€ 7,00
783FO26CH	€ 7,00
783FO38RCH	€ 7,00
783GM45CH	€ 7,00
783HON58RCH	€ 7,00
783HON66CH	€ 7,00
783HU100CH	€ 7,00
783HU101CH	€ 7,00
783HU116CH	€ 7,00
783HU133RCH	€ 7,00
783HU43CH	€ 7,00
783HU46CH	€ 7,00
783HU46FH	€ 7,00
783HU66CH	€ 7,00
783HU83CH	€ 7,00
783HYN14CH	€ 7,00
783HYN14RCH	€ 7,00
783HYN6CH	€ 7,00
783HYN7RCH	€ 7,00

Codice	Prezzo
783MAZ24RCH	€ 7,00
783MIT11RCH	€ 7,00
783MIT8CH	€ 7,00
783NE72CH	€ 7,00
783NE73CH	€ 7,00
783NSN14CH	€ 7,00
783NSN19CH	€ 7,00
783PO1RCH	€ 7,00
783SIP22CH	€ 7,00
783SSY3CH	€ 7,00
783TOY40CH	€ 7,00
783TOY43CH	€ 7,00
783TOY43RCH	€ 7,00
783TOY47CH	€ 7,00
783TOY48CH	€ 7,00
783TOY49CH	€ 7,00
783VAC102CH	€ 7,00
783VA2CH	€ 7,00
783VA2FH	€ 7,00
783VA6CH	€ 7,00
783YM28CH	€ 7,00



  <p>CHIAVI PIATTE UNIVERSALI</p> <p>783UL048 – Silca UL048 – 3 SP DX – conf. 100 – € 0,52</p> <p>783UL049 – Silca UL049 – 3 SP SX – conf. 100 – € 0,52</p> <p>783UL050 – Silca UL050 – 5 SP DX – conf. 100 – € 0,34</p> <p>783UL051 – Silca UL051 – 5 SP SX – conf. 100 – € 0,34</p> <p>783UL052 – Silca UL052 – 4 SP DX – conf. 100 – € 0,34</p> <p>segue...</p>	  <p>continua...</p> <p>783UL053 – Silca UL053 – 4 SP SX – conf. 100 – € 0,34</p> <p>783UL054 – Silca UL054 – 6 SP DX – conf. 100 – € 0,68</p> <p>783UL055 – Silca UL055 – 6 SP SX – conf. 100 – € 0,54</p> <p>783UL056 – Silca UL056 – 3 SP RID DX – conf. 100 – € 0,46</p> <p>783UL057 – Silca UL057 – 3 SP RID SX – conf. 100 – € 0,46</p> <p>segue...</p>
  <p>continua...</p> <p>783UL058 – Silca UL058 – 5 SP RID DX – conf. 100 – € 0,34</p> <p>783UL059 – Silca UL059 – 5 SP RID SX – conf. 100 – € 0,34</p> <p>783UL060 – Silca UL060 – 4 SP RID DX – conf. 100 – € 0,46</p> <p>783UL061 – Silca UL061 – 4 SP RID SX – conf. 100 – € 0,46</p>	  <p>CHIAVI PIATTE SILKY</p> <p>783UL050DZ – Silca UL050DZ – 5 SP DX ASS. – conf. 100 – € 0,86</p> <p>783UL050DZ1 – Silca UL050DZ1 – 5 SP DX NEW COL. ASS. – conf. 100 – € 0,86</p> <p>783UL050DZ21 – Silca UL050DZ – 5 SP DX ROSSO – conf. 50 – € 0,90</p> <p>783UL050DZ22 – Silca UL050DZ – 5 SP DX VERDE – conf. 50 – € 0,90</p> <p>783UL050DZ23 – Silca UL050DZ – 5 SP DX BLU – conf. 50 – € 0,90</p> <p>segue...</p>
  <p>continua...</p> <p>783UL050DZ27 – Silca UL050DZ – 5 SP DX VIOLA – conf. 50 – € 0,90</p> <p>783UL050DZ2H – Silca UL050DZ – 5 SP DX ARANCIONE – conf. 50 – € 0,90</p> <p>783UL051DZ – Silca UL051DZ – 5 SP DX ASS. – conf. 100 – € 0,86</p> <p>783UL051DZ21 – Silca UL051DZ – 5 SP SX ROSSO – conf. 50 – € 0,90</p> <p>783UL051DZ22 – Silca UL051DZ – 5 SP SX VERDE – conf. 50 – € 0,90</p> <p>segue...</p>	  <p>continua...</p> <p>783UL051DZ23 – Silca UL051DZ – 5 SP SX BLU – conf. 50 – € 0,90</p> <p>783UL051DZ27 – Silca UL051DZ – 5 SP SX VIOLA – conf. 50 – € 0,90</p> <p>783UL051DZ2H – Silca UL051DZ – 5 SP SX ARANCIONE – conf. 50 – € 0,90</p> <p>783UL052DZ – Silca UL052DZ – 4 SP DX ASS. – conf. 100 – € 0,86</p> <p>783UL052DZ21 – Silca UL052DZ – 4 SP DX ROSSO – conf. 50 – € 0,90</p> <p>segue...</p>
  <p>continua...</p> <p>783UL052DZ22 – Silca UL052DZ – 4 SP DX VERDE – conf. 50 – € 0,90</p> <p>783UL052DZ23 – Silca UL052DZ – 4 SP DX BLU – conf. 50 – € 0,90</p> <p>783UL052DZ27 – Silca UL052DZ – 4 SP DX VIOLA – conf. 50 – € 0,90</p> <p>783UL052DZ2H – Silca UL052DZ – 4 SP DX ARANCIONE – conf. 50 – € 0,90</p> <p>783UL053DZ – Silca UL053DZ – 4 SP SX ASS. – conf. 100 – € 0,90</p> <p>segue...</p>	  <p>continua...</p> <p>783UL054DZ – Silca UL054DZ – 6 SP DX ASS. – conf. 100 – € 0,90</p> <p>783UL058DZ – Silca UL058DZ – 5 SP RID DX ASS. – conf. 100 – € 0,86</p> <p>783UL058DZ1 – Silca UL058DZ1 – 5 SP RID DX NEW COL. ASS. – conf. 100 – € 0,86</p> <p>783UL059DZ – Silca UL059DZ – 5 SP RID SX ASS. – conf. 100 – € 0,90</p> <p>783AGB1RDZ – COLORI ASSORTITI – conf. 100 – € 0,90</p> <p>segue...</p>
  <p>continua...</p> <p>783CB6DZ – COLORI ASSORTITI – conf. 100 – € 0,90</p> <p>783CS204DZ – COLORI ASSORTITI – conf. 100 – € 0,90</p> <p>783CS206DZ – COLORI ASSORTITI – conf. 100 – € 0,90</p> <p>783CS7DZ – COLORI ASSORTITI – conf. 100 – € 0,90</p> <p>783FM090DZ – COLORI ASSORTITI – conf. 100 – € 0,90</p> <p>segue...</p>	  <p>continua...</p> <p>783IE6DZ – COLORI ASSORTITI – conf. 100 – € 0,90</p> <p>783MER8DZ – COLORI ASSORTITI – conf. 100 – € 0,90</p> <p>783OC074DZ – COLORI ASSORTITI – conf. 100 – € 0,90</p> <p>783PF092DZ – COLORI ASSORTITI – conf. 100 – € 0,90</p> <p>783PF092SDZ – COLORI ASSORTITI – conf. 100 – € 0,90</p> <p>segue...</p>
  <p>continua...</p> <p>783VI080DZ – COLORI ASSORTITI – conf. 100 – € 0,90</p> <p>783VI081DZ – COLORI ASSORTITI – conf. 100 – € 0,90</p> <p>783VI082DZ – COLORI ASSORTITI – conf. 100 – € 0,90</p> <p>783VI084DZ – COLORI ASSORTITI – conf. 100 – € 0,90</p> <p>783VI086DZ – COLORI ASSORTITI – conf. 100 – € 0,90</p> <p>segue...</p>	  <p>continua...</p> <p>783WA1RDZ – COLORI ASSORTITI – conf. 100 – € 0,90</p> <p>783WE1DZ – COLORI ASSORTITI – conf. 100 – € 0,90</p> <p>783YA31DZ – COLORI ASSORTITI – conf. 100 – € 0,90</p>



 <p>CHIAVI PUNZONATE SILKY</p> <p>783AGB5DZ – COLORI ASSORTITI – conf. 25 – € 2,80</p> <p>783AGB8DZ – COLORI ASSORTITI – conf. 25 – € 2,80</p> <p>783AGB9DZ – COLORI ASSORTITI – conf. 25 – € 2,80</p> <p>783CB97DZ – COLORI ASSORTITI – conf. 25 – € 2,80</p> <p>783CS62DZ – COLORI ASSORTITI – conf. 25 – € 2,80</p> <p>segue...</p> 	 <p>continua...</p> <p>783CS70DZ – COLORI ASSORTITI – conf. 25 – € 2,80</p> <p>783IE26DZ – COLORI ASSORTITI – conf. 25 – € 2,80</p> 
 <p>CHIAVI PIATTE SLIM – Spessore ridotto Teste originali per profili – Conf. colori assortiti</p> <p>783UL050SLSL – Silca UL050SLSL – conf. 100 – € 0,98</p> <p>783UL051SLSL – Silca UL051SLSL – conf. 100 – € 0,98</p> <p>783UL052SLSL – Silca UL052SLSL – conf. 100 – € 0,98</p> <p>783UL053SLSL – Silca UL053SLSL – conf. 100 – € 0,98</p> <p>783UL058SL – Silca UL058SL – conf. 100 – € 0,98</p> <p>segue...</p> 	 <p>continua...</p> <p>783AGB1RSL – Silca AGB1RSL – conf. 100 – € 0,98</p> <p>783CB6ASL – Silca CB6ASL – conf. 100 – € 0,98</p> <p>783CS204ASL – Silca CS204ASL – conf. 100 – € 0,98</p> <p>783CS206ASL – Silca CS206ASL – conf. 100 – € 0,98</p> <p>783CS7NSL – Silca CS7NSL – conf. 100 – € 0,98</p> <p>segue...</p> 
 <p>continua...</p> <p>783FM090SL – Silca FM090SL – conf. 1 – € 0,98</p> <p>783FM1ASL – Silca FM1ASL – conf. 100 – € 0,98</p> <p>783IE6ASL – Silca IE6ASL – conf. 100 – € 0,98</p> <p>783MER1SL – Silca MER1SL – conf. 100 – € 0,98</p> <p>783MER8SL – Silca MER8SL – conf. 100 – € 0,98</p> <p>segue...</p> 	 <p>continua...</p> <p>783OC074SL – Silca OC074SL – conf. 100 – € 0,98</p> <p>783PF092SL – Silca PF092SL – conf. 100 – € 0,98</p> <p>783PF092SSL – Silca PF092SSL – conf. 1 – € 0,98</p> <p>783PF2SL – Silca PF2SL – conf. 100 – € 0,98</p> <p>783SM1SL – Silca SM1SL – conf. 100 – € 0,98</p> <p>segue...</p> 
 <p>continua...</p> <p>783VI080SL – Silca VI080SL – conf. 100 – € 0,98</p> <p>783VI082SL – Silca VI082SL – conf. 100 – € 0,98</p> <p>783VI084NSL – Silca VI084NSL – conf. 100 – € 0,98</p> <p>783VI086NSL – Silca VI086NSL – conf. 100 – € 0,98</p> <p>783WA1RSL – Silca WA1RSL – conf. 100 – € 0,98</p> <p>segue...</p> 	 <p>continua...</p> <p>783WA2RSL – Silca WA2RSL – conf. 100 – € 0,98</p> <p>783YA226SL – Silca YA226SL – conf. 100 – € 0,98</p> <p>783YA31SL – Silca YA31SL – conf. 100 – € 0,98</p> <p>783YA6SL – Silca YA6SL – conf. 100 – € 0,98</p> 
 <p>CHIAVI SLIM PUNZONATE Teste originali per profili – Conf. colori assortiti</p> <p>783AGB5SL – Silca AGB5SL – conf. 25 – € 3,40</p> <p>783AGB8SL – Silca AGB8SL – conf. 25 – € 3,40</p> <p>783CB97SL – Silca CB97SL – conf. 50 – € 3,40</p> <p>783CS146SL – Silca CS146SL – conf. 25 – € 3,40</p> <p>783IE15SL – Silca IE15SL – conf. 50 – € 3,40</p> 	 <p>CHIAVI PIATTE ULTRALITE in titanio ultra leggera e resistente – Testa A</p> <p>783UL050U60 – COLORI ASSORTITI – conf. 100 – € 1,52</p> <p>783UL050U61 – ROSSO – conf. 50 – € 1,52</p> <p>783UL050U62 – VERDE – conf. 50 – € 1,52</p> <p>783UL050U63 – BLU – conf. 50 – € 1,52</p> <p>783UL050U64 – GIALLO – conf. 50 – € 1,52</p> <p>segue...</p> 
 <p>continua...</p> <p>783UL050U67 – VIOLA – conf. 50 – € 1,52</p> 	 <p>MEZZA TESTA MH-TA</p> <p>783MHTA – conf. 1 – € 8,80</p> 



DUPLICATRICI-CHIAVI-RADIOCOMANDI

Codice	Foto	Descrizione	Prezzo	Supporto clonazione
783C00777		T3 TRAN.TEX.FIX 4C GLASS	€ 22,20	Diagnostico
783C00907		T4 TRAN.TEX.FIX 4C WEDGE	€ 22,20	Diagnostico
783C01166		T6 TRAN.MEG.CRY.ID48 GLASS	€ 14,80	Diagnostico
783C02835		T10 TRAN.PH.CRY.ID42 WEDGE	€ 16,20	Diagnostico
783C01312		T8 TRAN.TEX.CRY.ID64 WEDGE	€ 22,20	Diagnostico
783C01701		TRAN.PH.CRY.ID40 WEDGE T12	€ 15,40	Diagnostico
783C01889		TRAN.PH.CRY.ID46 WEDGE T14	€ 21,00	Diagnostico
783C02042		T16 TRAN.TEX.CRY.ID60 WEDGE	€ 22,20	Diagnostico
783C02214		T17 TRAN.TEX.CRY.ID63 WEDGE	€ 22,20	Diagnostico
783C02504		T18 TRAN.TEX.CRY.ID65 WEDGE	€ 22,20	Diagnostico
783C02505		T19 TRAN.TEX.CRY.ID61 WEDGE	€ 22,20	Diagnostico
783C02708		T21 TRAN.TEX.CRY.ID62 WEDGE	€ 22,20	Diagnostico
783C02748		T22 TRAN.TEX.CRY.ID69 WEDGE	€ 22,20	Diagnostico
783C02825		T23 TRAN.MEG.CRY.ID48 A3 GLASS	€ 14,80	Diagnostico
783C02826		T24 TRAN.MEG.CRY.ID48 A1 GLASS	€ 14,80	Diagnostico
783C02836		TRAN.PH.CRY. T25 ID41 WEDGE	€ 15,40	Diagnostico
783C02838		T26 TRAN.MEG.CRY.ID48 A4 GLASS	€ 14,80	Diagnostico
783C02888		T27 TRAN.SOKYMAT.CRY.8E GLASS	€ 29,40	Diagnostico
783C02892		TRAN.PH.CRY.4W WEDGE T28	€ 15,40	Diagnostico
783C02899		T29 TRAN.PH.CRY.ID45 WEDGE	€ 16,20	Diagnostico
783C02900		T30 TRAN.PH.CRY.4M WEDGE	€ 16,20	Diagnostico
783C02952		T31 TRAN.TEX.CRY.ID67 WEDGE	€ 22,20	Diagnostico
783C02953		T32 TRAN.PH.CRY.ID46 WEDGE	€ 22,20	Diagnostico
783C03403		TRAN.MEG.CRY.MAGIC WR T33	€ 14,00	Rw4 – anche Diagnostico
783C03620		TRANSPONDER IN VETRO T48	€ 30,80	Rw4 – anche Diagnostico
783C104902		TRAN.PHILIPS CRYPTO-3 T49C	€ 27,00	Rw4 – anche Diagnostico
783C03771		TRAN.T39 TEX.CRY.HYN-KIA WEDGE	€ 22,40	Diagnostico
783C03799		TRAN.T41 TEX.CRY.FORD WEDGE	€ 25,20	Diagnostico
783C03800		TRAN.PH.CRY.MULTI WEDGE T50	€ 25,20	Rw4
783C03927		MULTITRANSP. GTI WEDGE CRYPTO	€ 37,14	Rw4 – anche Diagnostico
783C03980		TRAN.TEX.CRY.T80+ CLON.WEDGE	€ 25,20	Rw4
783C04114		TRAN.TEXAS CRY.AES128 T128C	€ 26,60	Rw4











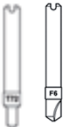













  <p>DUPLICATRICE CHIAVI MECCANICA REKORD Per chiavi piatte per cilindro e auto e chiavi a croce. Motore monofase a 1 velocità 50Hz-60Hz Fresa HSS Lunghezza massima di cifratura 43 mm Dimensioni 330x430x270 mm Peso 19 Kg -</p> <p>783D833000ZB - - conf. 1 - € 3.769,26</p>	  <p>DUPLICATRICE CHIAVI MECCANICA BRAVO II PROFESSIONAL Per chiavi piatte per cilindro e auto e chiavi a croce. Motore a 1 velocità 50Hz Fresa HSS Dimensioni 400x520x400 mm Peso 21,5 Kg -</p> <p>783D832450ZB - - conf. 1 - € 5.847,06</p>
  <p>DUPLICATRICE CHIAVI MECCANICA BRAVO II W-MAX Per la duplicazione di chiavi per serrature a cilindro (sia porte che auto) e chiavi a croce. Motore a 2 velocità 50Hz Fresa HSS Dimensioni 400x520x400 mm Peso 22,5 Kg -</p> <p>783D832470ZB - - conf. 1 - € 7.285,40</p>	  <p>DUPLICATRICE CHIAVI AUTOMATICA POKER PRO Per la riproduzione di: chiavi piatte a cifratura singola e doppia, sia ad uso residenziale che per veicoli, chiavi a croce con profilo a "x". Macchina: 24V d.c - 5.5 Amp - 130W Alimentatore: 90/264V a.c - 50/60 Hz - 220W Motore fresa: 24V d.c Fresa: U01W in metallo duro con rivestimento Velocità fresa: 1860 giri/min Morsetti: girevoli a 4 fasce Movimenti: su 2 assi (con boccole speciali) azionati da motori passo-passo Dimensioni: 318x413x340 mm Peso: 16 Kg -</p> <p>783D851467ZB - - conf. 1 - € 8.976,88</p>
  <p>DUPLICATRICE CHIAVI MECCANICA FASTBIT Per la riproduzione di chiavi a mappa, doppia mappa (maschio e femmina), a pompa e chiavi con fermo centrale Motore monofase 1 velocità 50/60Hz Fresa HSS con rivestimento in TiN Lunghezza massima di cifratura 42 mm Dimensioni 400x460x300 mm Peso 15,4 Kg -</p> <p>783D844063ZB - - conf. 1 - € 4.598,98</p>	  <p>DUPLICATRICE CHIAVI OMNIA 650RPM Per chiavi a mappa e doppia mappa (maschio e femmina), con fermo centrale e chiavi a pompa in ottone Motore monofase a 1 velocità 50Hz Fresa HSS Velocità utensile 650 giri/min Dimensioni 395x550x320 mm Peso 32 Kg -</p> <p>783D845200ZB - - conf. 1 - € 7.697,78</p>
  <p>DUPLICATRICE CHIAVI MECCANICA OMNIA W-MAX Per la riproduzione di chiavi a mappa, doppia mappa (maschio e femmina), con fermo centrale e posteriore, chiavi a pompa, chiavi a gorges adattabili e chiavi con tagli verticali. Carrello per tagli verticali, calibro estraibile, illuminazione led, morsetto a movimento libero. Motore monofase 1 velocità Alimentazione: 230V - 50 Hz Fresa: metallo duro -</p> <p>783D844535ZB - - conf. 1 - € 10.368,34</p>	  <p>DUPLICATRICE MECCANICA MATRIX EVO S Garantisce prestazioni di elevata qualità e precisione nella riproduzione di chiavi punzonate con cifratura piana, chiavi con cifratura tipo laser e chiavi tipo Fichet.</p> <p>783D851471ZB - - conf. 1 - € 6.621,30</p>
  <p>DUPLICATRICE CHIAVI MECCANICA MATRIX EVO Per riproduzione di chiavi punzonate piane o inclinate, chiavi con cifratura tipo laser, chiavi tipo Fichet® Motore monofase 1 velocità 50/60Hz Fresa HSS Dimensioni 310x400x470 mm Peso 24,6 Kg -</p> <p>783D837497ZB - - conf. 1 - € 7.530,36</p>	  <p>DUPLICATRICE CHIAVI MECCANICA MATRIX PRO S Garantisce prestazioni di elevata qualità e precisione nella riproduzione di chiavi punzonate con cifratura piana, chiavi con cifratura tipo laser, chiavi tipo Fichet e chiavi tubolari con quattro sedi dedicate ad un'ottimale posizionamento. -</p> <p>783D851470ZB - - conf. 1 - € 7.692,70</p>
  <p>DUPLICATRICE CHIAVI MECCANICA MATRIX PRO Per la riproduzione di chiavi punzonate con cifratura piana o inclinata, chiavi con cifratura tipo laser, chiavi tubolari e chiave tipo Fichet® Motore monofase 1 velocità 50/60Hz Fresa HSS Dimensioni 310x400x470 mm Peso 24,6 Kg -</p> <p>783D837496ZB - - conf. 1 - € 8.657,84</p>	  <p>DUPLICATRICE ELETTRONICA FUTURA PRO Per chiavi piatte, a croce, laser e punzonate, sia residenziali che automotive. Motore 24V dc 50/60Hz Fresa HSS con rivestimento TiCN Dimensioni 318x413x522 mm Peso 20 Kg -</p> <p>783D847000ZB - - conf. 1 - € 21.804,80</p>



 <p>DUPLICATRICE CHIAVI ELETTRONICA FUTURA PRO ENGRAVING Per chiavi piatte, a croce, laser e punzonate, sia residenziali che automotive. Con le ganasce e il fresino in dotazione è inoltre possibile effettuare incisioni su chiavi, portachiavi, piccole medaglie e targhette di metallo e alluminio ultralite Motore 24V dc 50/60 Hz Frese HSS con rivestimento TiCN Frese in dotazione 01D - 01LW - 18DW (per incisione) Dimensioni 318x413x522 mm Peso 20 Kg -</p> <p>783D849055ZB - - conf. 1 - € 22.389,28</p>	 <p>DUPLICATRICE CHIAVI ELETTRONICA FUTURA PRO UNLIMITED La macchina oltre ad avere le caratteristiche della Futura pro Engraving è dotata di una valigetta di alluminio che contiene una serie di accessori e utensili dedicati all'automotive: Morsetto 03R per chiavi Ford Adattatore B6 per chiavi Simplex Ganaschia 04J per chiavi BMW e Mercedes Ganaschia 19J per chiavi Audi, Ford e Volvo Ganaschia 56J, 57J per chiavi VAG Fresini 02LW e 06LW -</p> <p>783D851721ZB - - conf. 1 - € 25.430,80</p>
 <p>MACCHINA DUPLICATRICE ELETTRONICA F400 Per cifrare chiavi piatte Fresa in metallo duro (widia) a 80 denti Display da 10" integrato touch screen con inclinazione Lavora in modalità stand-alone Compatibile con SKP Pro Connessione alla rete locale 4 porte USB Porte HDMI per collegare schermi esterni Alimentazione: 100-240V - 50/60Hz Dimensioni: 502x740x680 mm Peso: 54 Kg -</p> <p>783D8A3850ZB - - conf. 1 - € 40.000,00</p>	 <p>MACCHINA DUPLICATRICE ELETTRONICA F600 Per cifrare e incidere chiavi piatte Fresa in metallo duro (widia) a 80 denti Display da 10" integrato touch screen con inclinazione Connessione alla rete locale Lavora in modalità stand-alone Compatibile con SKP Pro 4 porte USB Porta HDMI per il collegamento di schermi esterni Alimentazione: 100-240V - 50/60Hz Dimensioni: 502x740x680 mm Peso: 58,6 Kg -</p> <p>783D8A3545ZB - - conf. 1 - € 50.000,00</p>
 <p>MACCHINA DUPLICATRICE ELETTRONICA F900 Con processo di alimentazione, incisione, cifratura e scarico di chiavi piatte Fresa in metallo duro (widia) a 80 denti Display da 10" integrato touch screen con inclinazione Lavora in modalità stand-alone Compatibile con SKP Pro Connessione alla rete locale 4 porte USB Porte HDMI per collegare schermi esterni Incisione automatica su entrambi i lati Alimentazione: 100-240V - 50/60Hz Dimensioni: 921x740x680 mm Peso: -Con alimentatore 87,7 Kg -Senza alimentatore 61,7 Kg -</p> <p>783D8A3064ZB - - conf. 1 - € 70.000,00</p>	 <p>DUPLICATRICE ELETTRONICA IDEA Per la riproduzione a codice e a copia di chiavi mappa e doppia mappa, pompa e chiavi a fermo centrale Motore monofase a 1 velocità 50Hz Dimensioni: 500x500x420 mm Peso: 46,4 Kg -</p> <p>783D826680ZB - - conf. 1 - € 32.064,00</p>
 <p>DUPLICATRICE ELETTRONICA TRIAX PRO Per la decodifica e la cifratura a codice o da originale di chiavi laser e punzonate e per l'incisione di chiavi, portachiavi e piccole medaglie. Motore brushless 48V - 200W 50/60Hz Frese W500 in metallo duro W101 in metallo duro W146 in metallo duro Dimensioni 450x600x510 mm Peso 51,5 Kg -</p> <p>783D845960ZB - - conf. 1 - € 39.021,92</p>	 <p>KIT RW4 PLUS + MBOX + U-SNOOP Dispositivo di clonazione chiavi auto</p> <p>783D754554ZB - - conf. 1 - € 4.285,64</p>
 <p>SMART PRO Dispositivo per la programmazione di chiavi trasponder, prossimità, radiocomandi auto. Schermo touch screen da 10 pollici. Batteria: agli ioni di litio Li-Ion ricaricabile tramite veicolo o cavo di alimentazione Spazio archiviazione: 32 GB SSD Porte esterne: USB tipo A e B, jack per cuffie, connettore cavo OBD Dimensioni: 322x203x68 mm Peso: 2,9 Kg -</p> <p>783D846799AD - - conf. 1 - € 7.637,74</p>	 <p>TASTATORE PER MACCHINA DUPLICATRICE MATRIX SILCA -</p> <p>783D739972ZB - Mod. T1 - Per Cisa - - conf. 1 - € 44,60</p> <p>783D740389ZB - Mod. T6 - Per Titan - - conf. 1 - € 44,60</p> <p>783D740341ZB - Mod. T13 - Per Dom - - conf. 1 - € 44,60</p> <p>783D740349ZB - Mod. T20 - Per Dierre - - conf. 1 - € 44,60</p> <p>783D740357ZB - Mod. T28 - Per Securemme - - conf. 1 - € 44,60</p> <p>segue...</p>
 <p>continua...</p> <p>783D740367ZB - Mod. T39 - Per Agb - Iseo - - conf. 1 - € 44,60</p> <p>783D740370ZB - Mod. T42 - Per Azbe - Corni - Mul.t.lock - Mottura - Resa - - conf. 1 - € 44,60</p> <p>783D740372ZB - Mod. T44 - Per Dierre - - conf. 1 - € 44,60</p> <p>783D740375ZB - Mod. T47 - Per Agb - Iseo - - conf. 1 - € 44,60 (su ordinazione)</p> <p>783D740384ZB - Mod. T55 - Per Securemme - - conf. 1 - € 44,60</p> <p>783D740342ZB - Mod. T70 - Per Mottura - - conf. 1 - € 44,60</p>	 <p>TASTATORE T12A PER MACCHINA DUPLICATRICE MATRIX SILCA -</p> <p>783D740339ZB - Mod. T12A - Per Mul-t-lock - - conf. 1 - € 49,20</p>



 <p>TASTATORI PER MACCHINA DUPLICATRICE HSS Modelli: Matrix</p> <p>783D742533ZB – Mod. T72 – Per Titan – – conf. 1 – € 46,20</p> <p>783D740467ZB – Mod. F6 – Per Titan – – conf. 1 – € 63,20</p> <p>783D740451ZB – Mod. F47 – conf. 1 – € 63,20 (su ordinazione)</p> 	 <p>TASTATORE 01T PER MACCHINA DUPLICATRICE FUTURA SILCA –</p> <p>783D942565ZR – Mod. 01T – Per Futura pro – – conf. 1 – € 74,00</p> <p>783D942866ZR – Mod. 02T – Per Futura pro – – conf. 1 – € 44,00</p> <p>783D943910ZR – Mod. 03T – Per Futura pro – – conf. 1 – € 37,60</p> 
 <p>TASTATORE 04TT Per macchina Triax Pro –</p> <p>783D946383ZR – Mod. 04TT – Per Triax pro – – conf. 1 – € 50,60</p> 	 <p>FRESINI PER MACCHINA DUPLICATRICE MATRIX SILCA –</p> <p>783D740406ZB – Mod. F12A – Per Mul-t-lock – – conf. 1 – € 72,60</p> <p>783D740410ZB – Mod. F13 – Per Dom – – conf. 1 – € 63,20</p> <p>783D740419ZB – Mod. F20 – Per Dierre – – conf. 1 – € 72,60</p> <p>783D740430ZB – Mod. F28 – Per Securemme – – conf. 1 – € 63,20</p> <p>783D740442ZB – Mod. F39 – Per Agb – Iseo – – conf. 1 – € 63,20</p> <p><i>segue...</i></p> 
 <p><i>continua...</i></p> <p>783D740446ZB – Mod. F42 – Per Tesa – Azbe – Corni – Mul-t-lock – Mottura – – conf. 1 – € 72,60</p> <p>783D740448ZB – Mod. F44 – Per Dierre – – conf. 1 – € 72,60</p> <p>783D740461ZB – Mod. F55 – Per Securemme – – conf. 1 – € 63,20</p> <p>783D740483ZB – Mod. F70 – Per Mottura – – conf. 1 – € 72,60</p> <p>783D742530ZB – Mod. F72 – Per Titan – – conf. 1 – € 77,60</p> 	 <p>FRESA PER MACCHINA DUPLICATRICE FUTURA SILCA –</p> <p>783D742867ZB – Mod. 01D – Per Cisa – – conf. 1 – € 60,40</p> <p>783D743671ZB – Mod. 02L – Per Dierre New Power – Meroni – – conf. 1 – € 60,40</p> <p>783D743673ZB – Mod. 02D – Per Securemme – – conf. 1 – € 60,40</p> <p>783D743674ZB – Mod. 03D – Per Keso – Vachette – – conf. 1 – € 60,40</p> <p><i>segue...</i></p> 
 <p><i>continua...</i></p> <p>783D743746ZB – Mod. 04D – Per Mul-t-lock – – conf. 1 – € 60,40</p> <p>783D744353ZB – Mod. 06D – Per Titan – – conf. 1 – € 60,40</p> <p>783D742606ZB – Mod. 01L – – conf. 1 – € 67,42</p> <p>783D743672ZB – Mod. 03L – Per FUTURA – – conf. 1 – € 60,40</p> <p>783D747004ZB – Mod. F14D – Per Mottura Champions – Securemme K22 – K64 – – conf. 1 – € 60,40</p> 	 <p>FRESA PER MACCHINA DUPLICATRICE –</p> <p>783D709238ZB – Mod. W101 – – conf. 1 – € 145,20</p> <p>783D711604ZB – Mod. W129 – – conf. 1 – € 145,20</p> <p>783D726050ZB – Mod. W274 – Per Titan – – conf. 1 – € 141,20</p> <p>783D736794ZB – Mod. W300 – conf. 1 – € 141,20</p> <p>783D744273ZB – Mod. W326 – Per EVVA – – conf. 1 – € 168,80</p> 
 <p>FRESINO W122 PER MACCHINA DUPLICATRICE QUATTROCODE Per cilindro Atra New Power –</p> <p>783D709242ZB – Mod. W105 – Per Abus – Cisa – Kaba 8 – – conf. 1 – € 101,00</p> <p>783D709243ZB – Mod. W106 – Per Iseo – Agb – Kyr – – conf. 1 – € 101,00</p> <p>783D709482ZB – Mod. W114 – Per Honda – Fiat – Evva – Ics – Meroni – – conf. 1 – € 145,20</p> <p><i>segue...</i></p> 	 <p><i>continua...</i></p> <p>783D710424ZB – Mod. W122 – Dierre New Power – – conf. 1 – € 141,20</p> <p>783D710569ZB – Mod. W124 – Per Dom – Corbin – – conf. 1 – € 202,00</p> <p>783D722580ZB – Mod. W138 – Per Mottura Champions – – conf. 1 – € 101,00</p> 
 <p>SET ADATTATORE FIAM PER MACCHINA DUPLICATRICE OMNIA SILCA Adattatori per chiavi art. 5F115 – 5F117 – 5F119 – 5F121</p> <p>783D722498ZB – Mod. Adattatore – Per Fiam – – conf. 1 – € 446,00</p> 	 <p>SET ADATTATORI per chiavi Dom –</p> <p>783D710026ZB – Per Dom – – conf. 1 – € 65,80</p> 



 <p>GANASCIA PER MACCHINA DUPLICATRICE FUTURA PRO SILCA Per: Audi, Ford, Porsche, Seat, Skoda, Volkswagen -</p> <p>783D744023ZB - Mod. 19j - Per Audi - Ford - Porsche - Seat - Volkswagen - - conf. 1 - € 232,00</p> 	 <p>GANASCIA PER MACCHINA DUPLICATRICE FUTURA PRO SILCA -</p> <p>783D743256ZB - Mod. 04j - Per Bmw - - conf. 1 - € 222,00</p> <p>783D743261ZB - Mod. 05j - Per Abus - - conf. 1 - € 232,00</p> <p>783D743262ZB - Mod. 06j - Per Abus - - conf. 1 - € 222,00</p> <p>783D743269ZB - Mod. 09j - Per Dom - Corbin - - conf. 1 - € 256,00</p> <p>783D743270ZB - Mod. 10j - Per Dom - Corbin - - conf. 1 - € 268,00 segue...</p> 
 <p>continua...</p> <p>783D743278ZB - Mod. 11j - Per Iseo - - conf. 1 - € 268,00</p> <p>783D743341ZB - Mod. 13j - Per Securemme - - conf. 1 - € 278,00</p> <p>783D744017ZB - Mod. 18j - Per Securemme - - conf. 1 - € 348,00</p> <p>783D744487ZB - Mod. 40j - Per Dom - Corbin - - conf. 1 - € 418,00</p> <p>783D744489ZB - Mod. 41j - Per Dom - Corbin - - conf. 1 - € 372,00</p> 	 <p>ADATTATORE FIAM T2 Per chiavi 5FI5 - 5FI7 - 5FI9</p> <p>783D727165ZB - - conf. 1 - € 338,00</p> 
 <p>SET ADATTATORI MATRIX</p> <p>783D722724ZB - Per Cisa - conf. 1 - € 504,00</p> <p>783D741910ZB - Mod. A35 - Per Securemme K5 - conf. 1 - € 786,00</p> 	 <p>FRESA HSS A SEGNETTO MOD. SG1 Dimensioni 80x1,5x22 mm Per duplicatrici Opera III - Opera IV Targa 2000 - Tech3 Technica -</p> <p>783D700080ZB - - conf. 1 - € 80,80</p> 
 <p>FRESA HSS PER DUPLICATRICE Dimensioni 80x1,5x22 mm Per duplicatrici Omnia - Omnia 650rpm Omnia Max - Omnia W Max -</p> <p>783D741777ZB - Per Omnia - - conf. 1 - € 80,80</p> 	 <p>FRESA METALLO DURO A SEGNETTO MOD. PL1.25 Dimensioni 100x1,5x22 mm Per duplicatrici Idea - Prisma Laser -</p> <p>783D726023ZB - - conf. 1 - € 562,00</p> 
 <p>FRESA PER MACCHINA DUPLICATRICE SILCA -</p> <p>783D742607ZB - Mod. 01F - Per Futura - - conf. 1 - € 146,20 - AD ESAURIMENTO</p> <p>FRESA PER MACCHINA DUPLICATRICE FUTURA PRO SILCA</p> <p>783D747276ZB - Mod. 01F - Per Futura PRO - - conf. 1 - € 146,20</p> 	 <p>FRESA A DISCO Per chiavi piatte Ø 80x5x16 HSS-CO -</p> <p>60526125001 - - conf. 1 - € 130,80</p> 
 <p>FRESA A DISCO Per chiavi D.M. 3 tagli Ø 80x1,5x22 HSS-CO -</p> <p>60526125010 - - conf. 1 - € 130,80</p> 	 <p>FRESA A DISCO Per chiavi D.M. WIDIA Ø 80x1,5 foro Ø 22 HSS-CO -</p> <p>90172015 - - conf. 1 - € 182,00</p> 



FRESA HSS PRISMATICA MOD. P01 Dimensioni 80x5x16 mm Per duplicatrici Bravo Evolution Bravo Professional Bravo Maxima - Bravo W-Max Bravo Sofer Bravo Bd Evolution Bravo Japan - Bravo Max Japan Bravo III - Poker Plus Poker S - Rekord Rekord Brazil - Rekord Sofer -

783D700875ZB -
- conf. 1 - € 121,00



SPAZZOLA TYNEX Per chiavi Ø 80x11 foro Ø 10 -

90172055 -
- conf. 1 - € 33,20



SPAZZOLA ACCIAIO Per chiavi Ø 75x11 foro Ø 10 -

90172050 -
- conf. 1 - € 8,20



**PER L'ACQUISTO DI MACCHINE DUPLICATRICI
CHIEDI INFORMAZIONI AL TUO AGENTE DI ZONA.
DISPONIBILI FORMULE DI PAGAMENTO AGEVOLATE E FINANZIAMENTI.**



Inizia una nuova era.

È TEMPO DI DIVENTARE **Pro**



MYKEYS
Pro

Tutte le informazioni,
video tutorials, step-by-step
guides e molto altro
in un'unica piattaforma.



IT IS TIME TO BECOME **Pro**

www.mykeyspro.com



 <p>RADIOCOMANDO AUTO 3 bottoni Per modelli: Jeep: Cherokee (fino al 2019)</p> <p>783CY24P21 - - conf. 1 - € 54,00</p> 	 <p>RADIOCOMANDO AUTO FORD 3 bottoni Frequenza 433 MHz Per modelli: Fiesta, Focus, Fusion, Mondeo, Turneo Connect</p> <p>783FO21R10 - Frequenza 433 Mhz - - conf. 1 - € 54,00</p> 
 <p>RADIOCOMANDO AUTO OPEL 2 bottoni Frequenza 433,29 Mhz Per modelli Opel: Chevrolet-Daewoo Aveo (fino al 2011) Chevrolet-Daewoo Cruze (fino al 2008) Chevrolet-Daewoo Orlando (fino al 2015) Chevrolet-Daewoo Spark (fino al 2015) Opel Vauxhall Adam (fino al 2013) Opel Vauxhall Astra (fino al 2009) Opel Vauxhall Cascada (fino al 2013) Opel Vauxhall Corsa (fino al 2014) Opel Vauxhall Insignia (fino al 2017) Opel Vauxhall Mokka (fino al 2012) Opel Vauxhall Zafira (fino al 2013)</p> <p>783HU100AR02 - - conf. 1 - € 54,00</p> 	 <p>RADIOCOMANDO AUTO OPEL 2 bottoni Frequenza 433,92 AM Per modelli: Opel Corsa (fino al 2012)</p> <p>783HU100AR12 - - conf. 1 - € 48,40</p> 
 <p>RADIOCOMANDO AUTO OPEL 3 bottoni Frequenza 433,92 MHz Per modelli: - Cruze (fino al 2014) - Orlando (fino al 2015) - Astra (fino al 2015) - Insignia (fino al 2017)</p> <p>783HU100R01 - - conf. 1 - € 84,00</p> 	 <p>RADIOCOMANDO AUTO OPEL 2 bottoni Frequenza 433,92 MHz Per modelli: Aveo Cruze Orlando Spark Adam Astra Cascada Corsa e Insignia Mokka Zafira</p> <p>783HU100R02 - - conf. 1 - € 84,00</p> 
 <p>RADIOCOMANDO AUTO 3 bottoni Per modelli: Opel: Astra (fino al 2016)</p> <p>783HU100R23 - - conf. 1 - € 50,20</p> 	 <p>RADIOCOMANDO AUTO 3 bottoni Per modelli: C-max Focus Galaxy Mondeo Ranger S-max Tourneo Connect Transit Connect</p> <p>783HU101AR24 - - conf. 1 - € 51,80</p> 
 <p>RADIOCOMANDO AUTO FORD 3 bottoni Frequenza 433 MHz Per modelli: B-Max, C-Max, EcoSport, Fiesta, Focus, Galaxy, Kuga, Mondeo, S-Max</p> <p>783HU101R10 - Frequenza 433 MHz - - conf. 1 - € 54,00</p> 	 <p>RADIOCOMANDO AUTO FORD - 3 bottoni</p> <p>783HU101R15 - - conf. 1 - € 76,80</p> 
 <p>RADIOCOMANDO AUTO BMW Per modelli: Serie 1 Serie 3 Serie 5 Serie 6 X1 X5 X6 Z4</p> <p>783HU131RS05 - - conf. 1 - € 92,40</p> 	 <p>RADIOCOMANDO AUTO 2 bottoni Per modelli: Suzuki, Fiat e Opel: Sedici (fino al 2014) Agila (fino al 2014) Grand Vitara (fino al 2013) Splash (fino al 2015) Swift (fino al 2010) SX4 (fino al 2012)</p> <p>783HU133RR18 - - conf. 1 - € 50,20</p> 



  <p>RADIOCOMANDO AUTO 2 bottoni Per modelli: Fiat Opel Vauxhall Suzuki</p> <p>783HU133RR19 - - conf. 1 - € 50,20</p>	  <p>RADIOCOMANDO AUTO VOLVO 5 bottoni Frequenza 433,92 MHz Per modelli: - S60 - S80 - V40 - V60 - V70 - XC60 - XC70</p> <p>783HU152S16 - - conf. 1 - € 116,20</p>
  <p>RADIOCOMANDO AUTO 5 bottoni Per modelli: Land Rover: Freelander 2 (fino al 2012)</p> <p>783HU188S16 - - conf. 1 - € 94,40</p>	  <p>RADIOCOMANDO AUTO 3 bottoni Per Ford</p> <p>783HU198P14 - - conf. 1 - € 110,60</p>
  <p>RADIOCOMANDO AUTO 3 bottoni Per Ford ID47 433Mhz</p> <p>783HU198P15 - - conf. 1 - € 110,60</p>	  <p>RADIOCOMANDO AUTO 3 bottoni Per modelli: Mini: Cabrio (fino al 2015) Clubman (fino al 2014) Countryman (fino al 2016) Coupe' (fino al 2014) Hatchback (fino al 2013) Paceman (fino al 2016) Roadster (fino al 2011)</p> <p>783HU200S22 - - conf. 1 - € 57,40</p>
  <p>RADIOCOMANDO AUTO VOLKSWAGEN 3 bottoni Frequenza: 434 AM Per modelli: Passat (fino al 2011) Passat (fino al 2014) Passat CC (fino al 2012)</p> <p>783HU66S20 - - conf. 1 - € 92,40</p>	  <p>RADIOCOMANDO AUTO 3 bottoni Per modelli: Hyundai Per modelli: IX35 (dal 2013 al 2015) Tucson (dal 2013 al 2015)</p> <p>783KIA8P28 - - conf. 1 - € 78,80</p>
  <p>RADIOCOMANDO AUTO 3 bottoni Per modelli: Mazda Per modelli: 6 (dal 2012 al 2020) CX-5 (dal 2012 al 2017) MX-5 (dal 2015 al 2020)</p> <p>783MAZ25RP31 - - conf. 1 - € 89,80</p>	  <p>RADIOCOMANDO AUTO 2 bottoni Per modelli: Mazda Per modelli: 2 (dal 2014 al 2020) 3 (dal 2013 al 2019) 6 (dal 2012 al 2020) CX-3 (dal 2015 al 2020) CX-5 (dal 2012 al 2020)</p> <p>783MAZ25RP32 - - conf. 1 - € 89,80</p>
  <p>RADIOCOMANDO AUTO NISSAN 3 bottoni Frequenza 433,92 MHz Per modelli: Qashqai - X-Trail</p> <p>783NSN14P01 - - conf. 1 - € 110,60</p>	  <p>RADIOCOMANDO AUTO NISSAN 2 bottoni Frequenza 433,92 MHz Per modelli: - Pulsar C13 - Qashqai - X-Traili</p> <p>783NSN14P04 - - conf. 1 - € 110,60</p>



 <p>RADIOCOMANDO AUTO NISSAN 2 bottoni Frequenza: 433 AM Per modelli: Nissan: Cabstar (fino al 2013) Micra (fino al 2010) Navara (fino al 2015) Note (fino al 2013) NV200 (fino al 2013) Pathfinder (fino al 2014) Qashqai (fino al 2014) Tiida (fino al 2013) Maxity (fino al 2013)</p> <p>783NSN14R14 - - conf. 1 - € 72,80</p>	 <p>RADIOCOMANDO AUTO DACIA, NISSAN E RENAULT 3 bottoni - Frequenza 433 FM Per modelli: Dacia: Dokker (fino al 2013) Duster (fino al 2013) Lodgy (fino al 2013) Logan (fino al 2013 e 2016) Sandero (fino al 2013 e 2016) Per marca Fiat: Talento Per marca Nissan: Micra NV300 Pulsar (fino al 2016) Qashqai (fino al 2016) X-trail (fino al 2017) Per marca Opel Vauxhall: Vivaro (fino al 2014) Per marca Renault: Trafic (fino al 2019) Twingo Fortwo</p> <p>783RNN01R11 - - conf. 1 - € 77,00</p>
 <p>RADIOCOMANDO AUTO RENAULT 3 bottoni Frequenza 433 AM Per modelli: Dacia: Sandero (fino al 2008) Per marca Nissan: Interstar (fino al 2010) Primastar (fino al 2014) Per marca Opel Vauxhall: Movano (fino al 2010) Vivaro (fino al 2014) Per marca Renault: Clio 2 (fino al 2008) Clio 3 (fino al 2010) Kangoo (fino al 2017) Master (fino al 2010) Master (fino al 2017) Trafic (fino al 2014) Twingo (fino al 2010) Wind (fino al 2012)</p> <p>783RNR01 - - conf. 1 - € 72,80</p>	 <p>RADIOCOMANDO AUTO FIAT 3 bottoni Frequenza 433 MHz Per modelli: 500 - Grande Punto - Mito - Ypsilon - Nemo - 500 (fino al 2011) - Doblo</p> <p>783SIP22R01 - - conf. 1 - € 88,20</p>
 <p>RADIOCOMANDO AUTO FIAT 3 bottoni Frequenza 433 MHz Per modelli: Giulietta - Juniper - Relay - 500L - Bravo - Ducato 3/4 - Daily - Delta - Musa - Ypsilon - Boxer</p> <p>783SIP22R07 - - conf. 1 - € 88,20</p>	 <p>RADIOCOMANDO AUTO RENAULT 4 bottoni Frequenza 433,92 MHz Per modelli: Clio IV (fino al 2012) - Captur (fino al 2013) - Symbol (fino al 2013)</p> <p>783VA150S13 - - conf. 1 - € 127,40</p>
 <p>RADIOCOMANDO AUTO RENAULT 4 bottoni Frequenza 433,92 MHz Per modelli: Grand Scenic 3 (fino al 2009) - Laguna 3 (fino al 2007) - Megane 3 (fino al 2009) - Scenic 3 (fino al 2009)</p> <p>783VA150S15 - - conf. 1 - € 116,20</p>	 <p>RADIOCOMANDO AUTO RENAULT 3 bottoni Frequenza: 433 AM Per modelli: Grand Scenic 2 (fino al 2008) Megane 2 (fino al 2008) Scenic 2 (fino al 2008)</p> <p>783VA150S19 - - conf. 1 - € 53,20</p>
 <p>RADIOCOMANDO AUTO 2 bottoni Per modelli: Renault: Espace (fino al 2006) Laguna (fino al 2007) Vel Satis (fino al 2005)</p> <p>783VA150S21 - - conf. 1 - € 50,20</p>	 <p>RADIOCOMANDO AUTO 3 bottoni Per modello: - Smart Fortwo (fino al 2016)</p> <p>783VA2AR13 - SILCA VA2 - - conf. 1 - € 48,40</p>
 <p>RADIOCOMANDO AUTO 4 bottoni Per modelli: Renault: Espace 5 (dai 2015) Megane 4 (dai 2015) Scenic 4 (dai 2015) Talisman (dai 2015)</p> <p>783VA2P26 - - conf. 1 - € 82,60</p>	 <p>RADIOCOMANDO AUTO 3 bottoni Per modelli: Renault, Opel, Nissan: NV400 (fino al 2017) Movano (fino al 2017) Clio 3 (fino al 2012) Kangoo (fino al 2017) Master (fino al 2017) Modus (fino al 2012) Twingo (fino al 2014)</p> <p>783VA2R01 - - conf. 1 - € 54,00</p>



  <p>RADIOCOMANDO AUTO 3 bottoni Per modelli: Citroen, Fiat, Lancia, Peugeot e Toyota: Berlingo (fino al 2014) C2 (fino al 2009) C3 (fino al 2016) C3 Picasso (fino al 2017) C3 Pluriel (fino al 2009) C4 Picasso (fino al 2013) C5 (fino al 2011) C8 (fino al 2014) Dispatch (fino al 2016) DS3 (fino al 2016) Jumpy (fino al 2016) Scudo (fino al 2016) DS3 (fino al 2016) Jumpy (fino al 2016) Scudo (fino al 2016) Ulysse (fino al 2011) Phedra (fino al 2010) 207 (fino al 2012) 307 (fino al 2008) 308 (fino al 2013)</p> <p>783VAR16 - - conf. 1 - € 50,20</p>	  <p>RADIOCOMANDO AUTO 3 bottoni Per modelli: Smart: Fortwo (fino al 2007) Roadster (fino al 2006)</p> <p>783YM23R20 - - conf. 1 - € 37,60</p>
  <p>RADIOCOMANDO AUTO FIAT - 3 bottoni Per modelli: 500X, Jeep</p> <p>783SIP22P36 - - conf. 1 - € 78,80</p>	  <p>RADIOCOMANDO AUTO JEEP COMPASS - 3 bottoni Per modelli: Jeep</p> <p>783SIP22P40 - - conf. 1 - € 78,80</p>
  <p>RADIOCOMANDO AUTO PROXIMITY - 3 bottoni Per modello Hyundai</p> <p>783KIA8R32 - - conf. 1 - € 51,40</p>	  <p>RADIOCOMANDO AUTO PROXIMITY - 3 bottoni Per modello KIA</p> <p>783KIA8R28 - - conf. 1 - € 57,00</p>
  <p>RADIOCOMANDO AUTO - 2 bottoni Per modelli: Nissan: Frontier, Juke, Micra, Navara, Note, NP300, NV200, Tiida</p> <p>783NSN14P30 - - conf. 1 - € 82,00</p>	  <p>RADIOCOMANDO AUTO - 3 bottoni Per modelli: Seat: Alhambra (fino al 2016), Altea (fino al 2015), Ibiza (fino al 2016), Leon (fino al 2013), Mii (fino al 2016), Toledo (fino al 2010) Per modelli Skoda: Citigo (fino al 2016), Fabia (fino al 2014), Octavia (fino al 2013), Rapid (fino al 20016), Roomster (fino al 2015), Roomster Scout (fino al 2015), Superb (fino al 2013), Yeti (fino al 2013)</p> <p>783HU66R09 - - conf. 1 - € 54,00</p>
  <p>RADIOCOMANDO AUTO - 2 bottoni Per modelli: Opel: Corsa, Meriva</p> <p>783HU100R26 - - conf. 1 - € 49,80</p>	  <p>RADIOCOMANDO AUTO 2 bottoni Per modelli: Citroën C1, Peugeot 108, Toyota Aygo (dal 2014 al 2021)</p> <p>783TOY49R25 - - conf. 1 - € 94,00</p>
  <p>CHIAVE SLOT 3 bottoni Per modelli: Mercedes</p> <p>783HU106S23 - - conf. 1 - € 94,00</p>	  <p>RADIOCOMANDO PROXIMITY 3 bottoni Per modelli: Citroen C4 - Peugeot 508 - 3008 - 5008</p> <p>783VAP36 - - conf. 1 - € 83,80</p>



RADIOCOMANDO AUTO 2 bottoni

Per modelli: Citroën C1, Peugeot 107, Toyota Aygo (dal 2005 al 2014)

783VA2R27 -
- conf. 1 - € 57,00



GUSCIO AUTO 3 bottoni

Per modelli: BMW: X1 - X2 X4 (fino al 2018) X5 (fino al 2018) 6-Series (fino al 2018) 5-Series (fino al 2010) X6 (fino al 2019) 4-Series 3-Series (fino al 2019) X3 (fino al 2017)

783HU178RS8 -
- conf. 1 - € 32,00

































GUSCIO AUTO 3 bottoni

Per modelli: Ford: C-Max (fino al 2015) Kuga (fino al 2020) B-Max (fino al 2018) Fiesta (fino al 2012)

783HU198CRS8 -
- conf. 1 - € 23,20

































 8 003 737 808 712 BW9MH / 783 - SILCA PER BMW®  INSERTO CH.TESTA ELETTRONICA 5 pz	 8 003 737 808 620 CY24MH / 783 - SILCA PER CHRYSLER®  INSERTO CH.TESTA ELETTRONICA 5 pz	 8 003 737 808 729 DAT17MH / 783 - SILCA PER SUBARU®  INSERTO CH.TESTA ELETTRONICA 5 pz	 8 003 737 808 7319 DH5RMH / 783 - SILCA PER DAIHATSU®  INSERTO CH.TESTA ELETTRONICA 5 pz	 8 003 737 808 736 DW04RMH / 783 - SILCA PER CHEVROLET-DAEWOO®  INSERTO CH.TESTA ELETTRONICA 5 pz
 8 003 737 808 743 DW05MH / 783 - SILCA PER CHEVROLET-DAEWOO®  INSERTO CH.TESTA ELETTRONICA 5 pz	 8 003 737 807 296 F021MH / 783 - SILCA PER FORD EU®  INSERTO CH.TESTA ELETTRONICA 5 pz	 8 003 737 808 781 GT10MH / 783 - SILCA PER TRW SIPEA®  INSERTO CH.TESTA ELETTRONICA 5 pz	 8 003 737 808 798 HON58RMH / 783 - SILCA PER HONDA®  INSERTO CH.TESTA ELETTRONICA 5 pz	 8 003 737 807 340 HON70MH / 783 - SILCA PER HONDA®  INSERTO CH.TESTA ELETTRONICA 5 pz
 8 003 737 807 357 HU100MH / 783 - SILCA PER HUF®  INSERTO CH.TESTA ELETTRONICA 5 pz	 8 003 737 807 364 HU101MH / 783 - SILCA PER HUF®  INSERTO CH.TESTA ELETTRONICA 5 pz	 8 003 737 808 644 HU133RMH / 783 - SILCA PER HUF®  INSERTO CH.TESTA ELETTRONICA 5 pz	 8 003 737 808 811 HU56RMH / 783 - SILCA PER HUF®  INSERTO CH.TESTA ELETTRONICA 5 pz	 8 003 737 808 828 HU66MH / 783 - SILCA PER HUF®  INSERTO CH.TESTA ELETTRONICA 5 pz

In conformità alle disposizioni legali in vigore relative alle proprietà industriali, informiamo che i marchi o le denominazioni commerciali citate nel nostro documento sono di proprietà esclusiva dei fabbricanti di serrature e degli utilizzatori autorizzati. Questi marchi o denominazioni commerciali sono indicati a titolo di semplice informazione, con lo scopo di riconoscere velocemente a quali serrature le nostre chiavi sono destinate. Questo documento è esclusivamente riservato ai professionisti della riproduzione chiavi che utilizzano i prodotti Silca. / Le illustrazioni e i dati tecnici dei prodotti contenuti nel documento debbono considerarsi indicativi. Silca si riserva il diritto, ferme restando le caratteristiche essenziali dei prodotti, di apportare tutte le modifiche che ritiene necessarie e opportune al fine di migliorare la qualità dei prodotti. Tutti i disegni e le fotografie sono di proprietà di Silca, ogni riproduzione anche parziale, senza autorizzazione scritta di Silca S.p.A. è vietata secondo termini di legge. Per qualsiasi controversia competenti sono gli Uffici Giudiziari dove ha sede l'Azienda Silca S.p.A., con espressa esclusione di qualsiasi altro foro.

































DUPLICATRICI-CHIAVI-RADIOCOMANDI

 8 003737808835 HU71MH / 783 - SILCA PER HUF®  INSERTO CH.TESTA ELETTRONICA 5 pz	 8 003737807371 HU83MH / 783 - SILCA PER HUF®  INSERTO CH.TESTA ELETTRONICA 5 pz	 8 003737808842 HU87RMH / 783 - SILCA PER HUF®  INSERTO CH.TESTA ELETTRONICA 5 pz	 8 003737807388 HYN10MH / 783 - SILCA PER HYUNDAI®  INSERTO CH.TESTA ELETTRONICA 5 pz	 8 003737808866 HYN14MH / 783 - SILCA PER HYUNDAI®  INSERTO CH.TESTA ELETTRONICA 5 pz
 8 003737808651 HYN14RMH / 783 - SILCA PER HYUNDAI®  INSERTO CH.TESTA ELETTRONICA 5 pz	 8 003737807395 HYN15MH / 783 - SILCA PER HYUNDAI®  INSERTO CH.TESTA ELETTRONICA 5 pz	 8 003737807401 HYN6MH / 783 - SILCA PER HYUNDAI®  INSERTO CH.TESTA ELETTRONICA 5 pz	 8 003737807418 HYN7RMH / 783 - SILCA PER HYUNDAI®  INSERTO CH.TESTA ELETTRONICA 5 pz	 8 003737807425 KIA3RMH / 783 - SILCA PER KIA®  INSERTO CH.TESTA ELETTRONICA 5 pz
 8 003737808880 KW16MH / 783 - SILCA PER KAWASAKI®  INSERTO CH.TESTA ELETTRONICA 5 pz	 8 003737807432 MAZ24RMH / 783 - SILCA PER MAZDA®  INSERTO CH.TESTA ELETTRONICA 5 pz	 8 003737807449 MIT11RMH / 783 - SILCA PER MITSUBISHI®  INSERTO CH.TESTA ELETTRONICA 5 pz	 8 003737807456 MIT8MH / 783 - SILCA PER MITSUBISHI®  INSERTO CH.TESTA ELETTRONICA 5 pz	 8 003737807463 NE72MH / 783 - SILCA PER NEIMAN®  INSERTO CH.TESTA ELETTRONICA 5 pz

In conformità alle disposizioni legali in vigore relative alle proprietà industriali, informiamo che i marchi o le denominazioni commerciali citate nel nostro documento sono di proprietà esclusiva dei fabbricanti di serrature e degli utilizzatori autorizzati. Questi marchi o denominazioni commerciali sono indicati a titolo di semplice informazione, con lo scopo di riconoscere velocemente a quali serrature le nostre chiavi sono destinate. Questo documento è esclusivamente riservato ai professionisti della riproduzione chiavi che utilizzano i prodotti Silca. / Le illustrazioni e i dati tecnici dei prodotti contenuti nel documento debbono considerarsi indicativi. Silca si riserva il diritto, ferme restando le caratteristiche essenziali dei prodotti, di apportare tutte le modifiche che ritiene necessarie e opportune al fine di migliorare la qualità dei prodotti. Tutti i disegni e le fotografie sono di proprietà di Silca, ogni riproduzione anche parziale, senza autorizzazione scritta di Silca S.p.A. è vietata secondo termini di legge. Per qualsiasi controversia competenti sono gli Uffici Giudiziari dove ha sede l'Azienda Silca S.p.A., con espressa esclusione di qualsiasi altro foro.



 8 003737807180 NE73MH / 783 - SILCA PER NEIMAN®  INSERTO CH.TESTA ELETTRONICA 5 pz	 8 003737810876 NE75MH / 783 - SILCA PER NEIMAN®  INSERTO CH.TESTA ELETTRONICA 5 pz	 8 003737807470 NSN11MH / 783 - SILCA PER NISSAN®  INSERTO CH.TESTA ELETTRONICA 5 pz	 8 003737807487 NSN14MH / 783 - SILCA PER NISSAN®  INSERTO CH.TESTA ELETTRONICA 5 pz	 8 003737807494 NSN19MH / 783 - SILCA PER NISSAN®  INSERTO CH.TESTA ELETTRONICA 5 pz
 8 003737807517 SIP16MH / 783 - SILCA PER TRW SIPEA®  INSERTO CH.TESTA ELETTRONICA 5 pz	 8 003737807524 SIP22MH / 783 - SILCA PER TRW SIPEA®  INSERTO CH.TESTA ELETTRONICA 5 pz	 8 003737808897 SSY3MH / 783 - SILCA PER SSANGYONG®  INSERTO CH.TESTA ELETTRONICA 5 pz	 8 003737808668 SX9MH / 783 - SILCA PER SIMPLEX®  INSERTO CH.TESTA ELETTRONICA 5 pz	 8 003737808675 SZ11MH / 783 - SILCA PER SUZUKI®  INSERTO CH.TESTA ELETTRONICA 5 pz
 8 003737807531 SZ11RMH / 783 - SILCA PER SUZUKI®  INSERTO CH.TESTA ELETTRONICA 5 pz	 8 003737807548 SZ12MH / 783 - SILCA PER SUZUKI®  INSERTO CH.TESTA ELETTRONICA 5 pz	 8 003737808903 SZ17RMH / 783 - SILCA PER SUZUKI®  INSERTO CH.TESTA ELETTRONICA 5 pz	 8 003737807555 TOY40MH / 783 - SILCA PER TOYOTA®  INSERTO CH.TESTA ELETTRONICA 5 pz	 8 003737807562 TOY41RMH / 783 - SILCA PER TOYOTA®  INSERTO CH.TESTA ELETTRONICA 5 pz

In conformità alle disposizioni legali in vigore relative alle proprietà industriali, informiamo che i marchi o le denominazioni commerciali citate nel nostro documento sono di proprietà esclusiva dei fabbricanti di serrature e degli utilizzatori autorizzati. Questi marchi o denominazioni commerciali sono indicati a titolo di semplice informazione, con lo scopo di riconoscere velocemente a quali serrature le nostre chiavi sono destinate. Questo documento è esclusivamente riservato ai professionisti della riproduzione chiavi che utilizzano i prodotti Silca. / Le illustrazioni e i dati tecnici dei prodotti contenuti nel documento debbono considerarsi indicativi. Silca si riserva il diritto, ferme restando le caratteristiche essenziali dei prodotti, di apportare tutte le modifiche che ritiene necessarie e opportune al fine di migliorare la qualità dei prodotti. Tutti i disegni e le fotografie sono di proprietà di Silca, ogni riproduzione anche parziale, senza autorizzazione scritta di Silca S.p.A. è vietata secondo termini di legge. Per qualsiasi controversia competenti sono gli Uffici Giudiziari dove ha sede l'Azienda Silca S.p.A., con espressa esclusione di qualsiasi altro foro.



DUPLICATRICI-CHIAVI-RADIOCOMANDI

 8 003 737 807 579 TOY43MH / 783 - SILCA PER TOYOTA® INSERTO CH.TESTA ELETTRONICA 5 pz	 8 003 737 807 586 TOY43RMH / 783 - SILCA PER TOYOTA® INSERTO CH.TESTA ELETTRONICA 5 pz	 8 003 737 807 593 TOY46RMH / 783 - SILCA PER TOYOTA® INSERTO CH.TESTA ELETTRONICA 5 pz	 8 003 737 807 609 TOY47MH / 783 - SILCA PER TOYOTA® INSERTO CH.TESTA ELETTRONICA 5 pz	 8 003 737 807 616 TOY48MH / 783 - SILCA PER TOYOTA® INSERTO CH.TESTA ELETTRONICA 5 pz
 8 003 737 807 623 TOY49MH / 783 - SILCA PER TOYOTA® INSERTO CH.TESTA ELETTRONICA 5 pz	 8 003 737 808 682 VA6MH / 783 - SILCA PER VALEO® INSERTO CH.TESTA ELETTRONICA 5 pz	 8 003 737 808 699 VAC102MH / 783 - SILCA PER VACHETTE® INSERTO CH.TESTA ELETTRONICA 5 pz	 8 003 737 808 705 YH35RMH / 783 - SILCA PER YAMAHA® INSERTO CH.TESTA ELETTRONICA 5 pz	 8 003 737 808 941 ZD24RMH / 783 - SILCA PER ZADI® INSERTO CH.TESTA ELETTRONICA 5 pz

In conformità alle disposizioni legali in vigore relative alle proprietà industriali, informiamo che i marchi o le denominazioni commerciali citate nel nostro documento sono di proprietà esclusiva dei fabbricanti di serrature e degli utilizzatori autorizzati. Questi marchi o denominazioni commerciali sono indicati a titolo di semplice informazione, con lo scopo di riconoscere velocemente a quali serrature le nostre chiavi sono destinate. Questo documento è esclusivamente riservato ai professionisti della riproduzione chiavi che utilizzano i prodotti Silca. / Le illustrazioni e i dati tecnici dei prodotti contenuti nel documento debbono considerarsi indicativi. Silca si riserva il diritto, ferme restando le caratteristiche essenziali dei prodotti, di apportare tutte le modifiche che ritiene necessarie e opportune al fine di migliorare la qualità dei prodotti. Tutti i disegni e le fotografie sono di proprietà di Silca, ogni riproduzione anche parziale, senza autorizzazione scritta di Silca S.p.A. è vietata secondo termini di legge. Per qualsiasi controversia competenti sono gli Uffici Giudiziari dove ha sede l'Azienda Silca S.p.A., con espressa esclusione di qualsiasi altro foro.















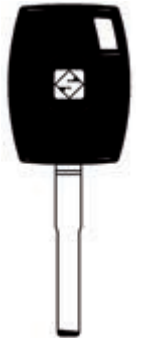















 8 003737855037 BW9TE / 783 - SILCA PER BMW®  CHIAVE TRANSPONDER S/CHIP- C/TAPPO 5 pz	 8 003737841603 CY24TE / 783 - SILCA PER CHRYSLER®  CHIAVE TRANSPONDER S/CHIP- C/TAPPO 5 pz	 8 003737856874 DAT17TE / 783 - SILCA PER SUBARU®  CHIAVE TRANSPONDER S/CHIP- C/TAPPO 5 pz	 8 003737889148 DW04CTE / 783 - SILCA PER CHEVROLET-DAEWOO®  CHIAVE TRANSPONDER S/CHIP- C/TAPPO 5 pz	 8 003737854290 DW04RTE / 783 - SILCA PER CHEVROLET-DAEWOO®  CHIAVE TRANSPONDER S/CHIP- C/TAPPO 5 pz
 8 003737854511 DW05TE / 783 - SILCA PER CHEVROLET-DAEWOO®  CHIAVE TRANSPONDER S/CHIP- C/TAPPO 5 pz	 8 003737889124 DW06BTE / 783 - SILCA PER CHEVROLET-DAEWOO®  CHIAVE TRANSPONDER S/CHIP- C/TAPPO 5 pz	 8 003737839167 F021TE / 783 - SILCA PER FORD (EU)®  CHIAVE TRANSPONDER S/CHIP- C/TAPPO 5 pz	 8 003737841610 GT10BTE / 783 - SILCA PER YAMAHA®  CHIAVE TRANSPONDER S/CHIP- C/TAPPO 5 pz	 8 003737841658 GT15RBTE / 783 - SILCA PER TRW SIPEA®  CHIAVE TRANSPONDER S/CHIP- C/TAPPO 5 pz
 8 003737890014 GT15RTE / 783 - SILCA PER TRW SIPEA®  CHIAVE TRANSPONDER S/CHIP- C/TAPPO 5 pz	 8 003737856867 HON58RTE / 783 - SILCA PER HONDA®  CHIAVE TRANSPONDER S/CHIP- C/TAPPO 5 pz	 8 003737889162 HON65RTE / 783 - SILCA PER HONDA®  CHIAVE TRANSPONDER S/CHIP- C/TAPPO 5 pz	 8 003737841672 HON66TE / 783 - SILCA PER HONDA®  CHIAVE TRANSPONDER S/CHIP- C/TAPPO 5 pz	 8 003737841795 HON70TE / 783 - SILCA PER HUF®  CHIAVE TRANSPONDER S/CHIP- C/TAPPO 5 pz

In conformità alle disposizioni legali in vigore relative alle proprietà industriali, informiamo che i marchi o le denominazioni commerciali citate nel nostro documento sono di proprietà esclusiva dei fabbricanti di serrature e degli utilizzatori autorizzati. Questi marchi o denominazioni commerciali sono indicati a titolo di semplice informazione, con lo scopo di riconoscere velocemente a quali serrature le nostre chiavi sono destinate. Questo documento è esclusivamente riservato ai professionisti della riproduzione chiavi che utilizzano i prodotti Silca. / Le illustrazioni e i dati tecnici dei prodotti contenuti nel documento debbono considerarsi indicativi. Silca si riserva il diritto, ferme restando le caratteristiche essenziali dei prodotti, di apportare tutte le modifiche che ritiene necessarie e opportune al fine di migliorare la qualità dei prodotti. Tutti i disegni e le fotografie sono di proprietà di Silca, ogni riproduzione anche parziale, senza autorizzazione scritta di Silca S.p.A. è vietata secondo termini di legge. Per qualsiasi controversia competenti sono gli Uffici Giudiziari dove ha sede l'Azienda Silca S.p.A., con espressa esclusione di qualsiasi altro foro.





























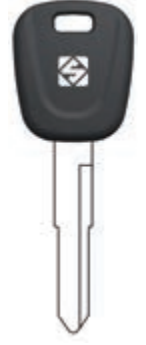

DUPLICATRICI-CHIAVI-RADIOCOMANDI

 8 0 0 3 7 3 7 8 9 7 7 6 1 HU137TE / 783 - SILCA PER HONDA®  5 pz	 8 0 0 3 7 3 7 8 4 1 8 1 8 HU100TE / 783 - SILCA PER HUF®  CHIAVE TRANSPONDER S/CHIP-C/TAPPO 5 pz	 8 0 0 3 7 3 7 8 4 1 8 3 2 HU101TE / 783 - SILCA PER HUF®  CHIAVE TRANSPONDER S/CHIP-C/TAPPO 5 pz	 8 0 0 3 7 3 7 8 4 1 8 5 6 HU133RTE / 783 - SILCA PER NEIMAN®  CHIAVE TRANSPONDER S/CHIP-C/TAPPO 5 pz	 8 0 0 3 7 3 7 8 5 8 8 1 6 HU134TE / 783 - SILCA PER HUF®  CHIAVE TRANSPONDER S/CHIP-C/TAPPO 5 pz
 8 0 0 3 7 3 7 8 5 8 8 2 3 HU136TE / 783 - SILCA PER HUF®  CHIAVE TRANSPONDER S/CHIP-C/TAPPO 5 pz	 8 0 5 2 7 8 2 0 0 5 5 6 0 HU162ATE / 783 - SILCA PER HUF®  5 pz	 8 0 0 3 7 3 7 8 5 5 1 3 6 HU43TE / 783 - SILCA PER HUF®  CHIAVE TRANSPONDER S/CHIP-C/TAPPO 5 pz	 8 0 0 3 7 3 7 8 8 8 8 4 4 HU49RTE / 783 - SILCA PER HUF®  CHIAVE TRANSPONDER S/CHIP-C/TAPPO 5 pz	 8 0 0 3 7 3 7 8 4 1 8 7 0 HU56RTE / 783 - SILCA PER HUF®  CHIAVE TRANSPONDER S/CHIP-C/TAPPO 5 pz
 8 0 0 3 7 3 7 8 4 1 8 9 4 HU66TE / 783 - SILCA PER HUF®  CHIAVE TRANSPONDER S/CHIP-C/TAPPO 5 pz	 8 0 0 3 7 3 7 8 4 1 9 1 7 HU83TE / 783 - SILCA PER HUF®  CHIAVE TRANSPONDER S/CHIP-C/TAPPO 5 pz	 8 0 0 3 7 3 7 8 5 5 0 9 9 HU87RTE / 783 - SILCA PER HUF®  CHIAVE TRANSPONDER S/CHIP-C/TAPPO 5 pz	 8 0 0 3 7 3 7 8 4 1 1 3 9 HYN10TE / 783 - SILCA PER HYUNDAI®  CHIAVE TRANSPONDER S/CHIP-C/TAPPO 5 pz	 8 0 0 3 7 3 7 8 4 1 9 5 5 HYN14TE / 783 - SILCA PER HYUNDAI®  CHIAVE TRANSPONDER S/CHIP-C/TAPPO 5 pz

In conformità alle disposizioni legali in vigore relative alle proprietà industriali, informiamo che i marchi o le denominazioni commerciali citate nel nostro documento sono di proprietà esclusiva dei fabbricanti di serrature e degli utilizzatori autorizzati. Questi marchi o denominazioni commerciali sono indicati a titolo di semplice informazione, con lo scopo di riconoscere velocemente a quali serrature le nostre chiavi sono destinate. Questo documento è esclusivamente riservato ai professionisti della riproduzione chiavi che utilizzano i prodotti Silca. / Le illustrazioni e i dati tecnici dei prodotti contenuti nel documento debbono considerarsi indicativi. Silca si riserva il diritto, ferme restando le caratteristiche essenziali dei prodotti, di apportare tutte le modifiche che ritiene necessarie e opportune al fine di migliorare la qualità dei prodotti. Tutti i disegni e le fotografie sono di proprietà di Silca, ogni riproduzione anche parziale, senza autorizzazione scritta di Silca S.p.A. è vietata secondo termini di legge. Per qualsiasi controversia competenti sono gli Uffici Giudiziari dove ha sede l'Azienda Silca S.p.A., con espressa esclusione di qualsiasi altro foro.













 8 003737855402 HYN17BTE / 783 - SILCA PER HYUNDAI®  CHIAVE TRANSPONDER S/CHIP- C/TAPPO 5 pz	 8 003737856799 HYN17RBTE / 783 - SILCA PER HYUNDAI®  CHIAVE TRANSPONDER S/CHIP- C/TAPPO 5 pz	 8 003737841979 HYN6TE / 783 - SILCA PER HYUNDAI®  CHIAVE TRANSPONDER S/CHIP- C/TAPPO 5 pz	 8 003737841986 HYN7RTE / 783 - SILCA PER HYUNDAI®  CHIAVE TRANSPONDER S/CHIP- C/TAPPO 5 pz	 8 003737890236 ISU5TE / 783 - SILCA PER ISUZU®  CHIAVE TRANSPONDER S/CHIP- C/TAPPO 5 pz
 8 052782007311 KIA10TE / 783 - SILCA PER KIA®  5 pz	 8 003737841993 KIA3RTE / 783 - SILCA PER KIA®  CHIAVE TRANSPONDER S/CHIP- C/TAPPO 5 pz	 8 003737926904 KIA9TE / 783 - SILCA PER KIA®  5 pz	 8 003737842006 KW16TE / 783 - SILCA PER KAWASAKI®  CHIAVE TRANSPONDER S/CHIP- C/TAPPO 5 pz	 8 003737842013 MAZ24RTE / 783 - SILCA PER MAZDA®  CHIAVE TRANSPONDER S/CHIP- C/TAPPO 5 pz
 8 003737839297 MIT11RTE / 783 - SILCA PER MITSUBISHI®  CHIAVE TRANSPONDER S/CHIP- C/TAPPO 5 pz	 8 003737910019 MIT17TE / 783 - SILCA PER MITSUBISHI®  5 pz	 8 003737839303 MIT8TE / 783 - SILCA PER MITSUBISHI®  CHIAVE TRANSPONDER S/CHIP- C/TAPPO 5 pz	 8 003737842020 NE72ATE / 783 - SILCA PER TRW SIPEA®  CHIAVE TRANSPONDER S/CHIP- C/TAPPO 5 pz	 8 003737842037 NE73TE / 783 - SILCA PER NEIMAN®  CHIAVE TRANSPONDER S/CHIP- C/TAPPO 5 pz

In conformità alle disposizioni legali in vigore relative alle proprietà industriali, informiamo che i marchi o le denominazioni commerciali citate nel nostro documento sono di proprietà esclusiva dei fabbricanti di serrature e degli utilizzatori autorizzati. Questi marchi o denominazioni commerciali sono indicati a titolo di semplice informazione, con lo scopo di riconoscere velocemente a quali serrature le nostre chiavi sono destinate. Questo documento è esclusivamente riservato ai professionisti della riproduzione chiavi che utilizzano i prodotti Silca. / Le illustrazioni e i dati tecnici dei prodotti contenuti nel documento debbono considerarsi indicativi. Silca si riserva il diritto, ferme restando le caratteristiche essenziali dei prodotti, di apportare tutte le modifiche che ritiene necessarie e opportune al fine di migliorare la qualità dei prodotti. Tutti i disegni e le fotografie sono di proprietà di Silca, ogni riproduzione anche parziale, senza autorizzazione scritta di Silca S.p.A. è vietata secondo termini di legge. Per qualsiasi controversia competenti sono gli Uffici Giudiziari dove ha sede l'Azienda Silca S.p.A., con espressa esclusione di qualsiasi altro foro.

































DUPLICATRICI-CHIAVI-RADIOCOMANDI

 8 0 0 3 7 3 7 8 3 9 3 1 0 NSN11TE / 783 - SILCA PER NISSAN®  CHIAVE TRANSPONDER S/CHIP- C/TAPPO 5 pz	 8 0 0 3 7 3 7 8 3 9 3 2 7 NSN14TE / 783 - SILCA PER NISSAN®  CHIAVE TRANSPONDER S/CHIP- C/TAPPO 5 pz	 8 0 0 3 7 3 7 8 3 9 3 3 4 NSN19TE / 783 - SILCA PER NISSAN®  CHIAVE TRANSPONDER S/CHIP- C/TAPPO 5 pz	 8 0 0 3 7 3 7 8 6 2 3 5 6 P01RTE / 783 - SILCA PER PROTON®  CHIAVE TRANSPONDER S/CHIP- C/TAPPO 5 pz	 8 0 0 3 7 3 7 8 5 5 0 7 5 SIP16TE / 783 - SILCA PER TRW SIPEA®  CHIAVE TRANSPONDER S/CHIP- C/TAPPO 5 pz
 8 0 0 3 7 3 7 8 4 2 0 4 4 SIP22TE / 783 - SILCA PER TRW SIPEA®  CHIAVE TRANSPONDER S/CHIP- C/TAPPO 5 pz	 8 0 5 2 7 8 2 0 1 1 7 0 7 SSSY2TE / 783 - SILCA PER SSANGYONG®  CHIAVE TRANSPONDER S/CHIP- C/TAPPO 5 pz	 8 0 0 3 7 3 7 8 5 5 0 4 4 SSSY3TE / 783 - SILCA PER SSANGYONG®  CHIAVE TRANSPONDER S/CHIP- C/TAPPO 5 pz	 8 0 0 3 7 3 7 8 8 7 6 3 2 SSSY4RTE / 783 - SILCA PER SSANGYONG®  CHIAVE TRANSPONDER S/CHIP- C/TAPPO 5 pz	 8 0 0 3 7 3 7 8 4 2 0 6 8 SX9TE / 783 - SILCA PER SIMPLEX®  CHIAVE TRANSPONDER S/CHIP- C/TAPPO 5 pz
 8 0 0 3 7 3 7 8 3 9 3 4 1 SZ11RTE / 783 - SILCA PER SUZUKI®  CHIAVE TRANSPONDER S/CHIP- C/GUSCI 5 pz	 8 0 0 3 7 3 7 8 3 9 3 5 8 SZ11TE / 783 - SILCA PER SUZUKI®  CHIAVE TRANSPONDER S/CHIP- C/GUSCI 5 pz	 8 0 0 3 7 3 7 8 3 9 3 6 5 SZ12TE / 783 - SILCA PER SUZUKI®  CHIAVE TRANSPONDER S/CHIP- C/GUSCI 5 pz	 8 0 0 3 7 3 7 8 4 2 0 7 5 SZ17RTE / 783 - SILCA PER SUZUKI®  CHIAVE TRANSPONDER S/CHIP- C/TAPPO 5 pz	 8 0 0 3 7 3 7 8 6 1 4 6 5 SZ22TE / 783 - SILCA PER SUZUKI®  CHIAVE TRANSPONDER S/CHIP- C/TAPPO 5 pz

In conformità alle disposizioni legali in vigore relative alle proprietà industriali, informiamo che i marchi o le denominazioni commerciali citate nel nostro documento sono di proprietà esclusiva dei fabbricanti di serrature e degli utilizzatori autorizzati. Questi marchi o denominazioni commerciali sono indicati a titolo di semplice informazione, con lo scopo di riconoscere velocemente a quali serrature le nostre chiavi sono destinate. Questo documento è esclusivamente riservato ai professionisti della riproduzione chiavi che utilizzano i prodotti Silca. / Le illustrazioni e i dati tecnici dei prodotti contenuti nel documento debbono considerarsi indicativi. Silca si riserva il diritto, ferme restando le caratteristiche essenziali dei prodotti, di apportare tutte le modifiche che ritiene necessarie e opportune al fine di migliorare la qualità dei prodotti. Tutti i disegni e le fotografie sono di proprietà di Silca, ogni riproduzione anche parziale, senza autorizzazione scritta di Silca S.p.A. è vietata secondo termini di legge. Per qualsiasi controversia competenti sono gli Uffici Giudiziari dove ha sede l'Azienda Silca S.p.A., con espressa esclusione di qualsiasi altro foro.

































 8 003737858830 TAT1TE / 783 - SILCA PER TATA®  CHIAVE TRANSPONDER S/CHIP- C/TAPPO 5 pz	 8 003737842082 TOY40BTE / 783 - SILCA PER TOYOTA®  CHIAVE TRANSPONDER S/CHIP- C/TAPPO 5 pz	 8 003737839389 TOY41RTE / 783 - SILCA PER TOYOTA®  CHIAVE TRANSPONDER S/CHIP- C/TAPPO 5 pz	 8 003737839396 TOY43ATE / 783 - SILCA PER TOYOTA®  CHIAVE TRANSPONDER S/CHIP- C/TAPPO 5 pz	 8 003737858793 TOY43RATE / 783 - SILCA PER TOYOTA®  CHIAVE TRANSPONDER S/CHIP- C/TAPPO 5 pz
 8 003737839402 TOY43TE / 783 - SILCA PER TOYOTA®  CHIAVE TRANSPONDER S/CHIP- C/GUSCI 5 pz	 8 003737839419 TOY46RTE / 783 - SILCA PER TOYOTA®  CHIAVE TRANSPONDER S/CHIP- C/GUSCI 5 pz	 8 003737839426 TOY47TE / 783 - SILCA PER TOYOTA®  CHIAVE TRANSPONDER S/CHIP- C/TAPPO 5 pz	 8 003737856843 TOY48BTE / 783 - SILCA PER TOYOTA®  CHIAVE TRANSPONDER S/CHIP- C/TAPPO 5 pz	 8 003737855549 TOY49TE / 783 - SILCA PER TOYOTA®  CHIAVE TRANSPONDER S/CHIP- C/TAPPO 5 pz
 8 003737906999 TOY51TE / 783 - SILCA PER TOYOTA®  5 pz	 8 003737842099 VA2TE / 783 - SILCA PER VALEO®  CHIAVE TRANSPONDER S/CHIP- C/TAPPO 5 pz	 8 003737842105 VAC102TE / 783 - SILCA PER VACHETTE®  CHIAVE TRANSPONDER S/CHIP- C/TAPPO 5 pz	 8 003737842112 YH35RATE / 783 - SILCA PER YAMAHA®  CHIAVE TRANSPONDER S/CHIP- C/TAPPO 5 pz	 8 003737842136 ZD24RTE / 783 - SILCA PER BMW®  CHIAVE TRANSPONDER S/CHIP- C/TAPPO 5 pz

In conformità alle disposizioni legali in vigore relative alle proprietà industriali, informiamo che i marchi o le denominazioni commerciali citate nel nostro documento sono di proprietà esclusiva dei fabbricanti di serrature e degli utilizzatori autorizzati. Questi marchi o denominazioni commerciali sono indicati a titolo di semplice informazione, con lo scopo di riconoscere velocemente a quali serrature le nostre chiavi sono destinate. Questo documento è esclusivamente riservato ai professionisti della riproduzione chiavi che utilizzano i prodotti Silca. / Le illustrazioni e i dati tecnici dei prodotti contenuti nel documento debbono considerarsi indicativi. Silca si riserva il diritto, ferme restando le caratteristiche essenziali dei prodotti, di apportare tutte le modifiche che ritiene necessarie e opportune al fine di migliorare la qualità dei prodotti. Tutti i disegni e le fotografie sono di proprietà di Silca, ogni riproduzione anche parziale, senza autorizzazione scritta di Silca S.p.A. è vietata secondo termini di legge. Per qualsiasi controversia competenti sono gli Uffici Giudiziari dove ha sede l'Azienda Silca S.p.A., con espressa esclusione di qualsiasi altro foro.

































DUPLICATRICI-CHIAVI-RADIOCOMANDI

 8 003 737 708 425 AB57AP / 783 - SILCA PER ABUS®  CHIAVE ACCIAIO 25 pz	 8 003 736 460 584 AB57RAP / 783 - SILCA PER ABUS®  CHIAVE ACCIAIO 25 pz	 8 003 736 460 522 AB58RAP / 783 - SILCA PER ABUS®  CHIAVE ACCIAIO 25 pz	 8 003 736 460 560 AB59RAP / 783 - SILCA PER ABUS®  CHIAVE ACCIAIO 25 pz	 8 003 737 509 800 AB64RAP / 783 - SILCA PER ABUS®  CHIAVE OTTONE 25 pz
 8 003 737 509 817 AB65RAP / 783 - SILCA PER ABUS®  CHIAVE OTTONE 25 pz	 8 003 736 001 039 ABS2 / 783 - SILCA PER ABSA®  CHIAVE ACCIAIO 50 pz	 8 003 736 001 084 ABS3 / 783 - SILCA PER ABSA®  CHIAVE ACCIAIO 50 pz	 8 003 736 003 484 AF16A / 783 - SILCA PER SAFE®  CHIAVE ACCIAIO 50 pz	 8 003 736 003 644 AF3A / 783 - SILCA PER SAFE®  CHIAVE ACCIAIO 50 pz
 8 003 736 003 668 AF3B / 783 - SILCA PER SAFE®  CHIAVE ACCIAIO 50 pz	 8 003 736 003 736 AF4B / 783 - SILCA PER SAFE®  CHIAVE ACCIAIO 50 pz	 8 003 736 003 781 AF4C / 783 - SILCA PER SAFE®  CHIAVE ACCIAIO 50 pz	 8 003 736 003 811 AF4D / 783 - SILCA PER SAFE®  CHIAVE ACCIAIO 50 pz	 8 003 736 003 859 AF4DP / 783 - SILCA PER SAFE®  CHIAVE ACCIAIO 25 pz

In conformità alle disposizioni legali in vigore relative alle proprietà industriali, informiamo che i marchi o le denominazioni commerciali citate nel nostro documento sono di proprietà esclusiva dei fabbricanti di serrature e degli utilizzatori autorizzati. Questi marchi o denominazioni commerciali sono indicati a titolo di semplice informazione, con lo scopo di riconoscere velocemente a quali serrature le nostre chiavi sono destinate. Questo documento è esclusivamente riservato ai professionisti della riproduzione chiavi che utilizzano i prodotti Silca. / Le illustrazioni e i dati tecnici dei prodotti contenuti nel documento debbono considerarsi indicativi. Silca si riserva il diritto, ferme restando le caratteristiche essenziali dei prodotti, di apportare tutte le modifiche che ritiene necessarie e opportune al fine di migliorare la qualità dei prodotti. Tutti i disegni e le fotografie sono di proprietà di Silca, ogni riproduzione anche parziale, senza autorizzazione scritta di Silca S.p.A. è vietata secondo termini di legge. Per qualsiasi controversia competenti sono gli Uffici Giudiziari dove ha sede l'Azienda Silca S.p.A., con espressa esclusione di qualsiasi altro foro.



 AF5A / 783 - SILCA PER SAFE®  CHIAVE ACCIAIO 50 pz	 AF5B / 783 - SILCA PER SAFE®  CHIAVE ACCIAIO 50 pz	 AF5C / 783 - SILCA PER SAFE®  CHIAVE ACCIAIO 50 pz	 AF5D / 783 - SILCA PER SAFE®  CHIAVE ACCIAIO 50 pz	 AF7A / 783 - SILCA PER SAFE®  CHIAVE ACCIAIO 50 pz
 AF7AP / 783 - SILCA PER SAFE®  CHIAVE ACCIAIO 25 pz	 AX1RP / 783 - SILCA PER AXA®  CHIAVE ACCIAIO 25 pz	 AX4RP / 783 - SILCA PER AXA®  CHIAVE ACCIAIO 25 pz	 B111-PT / 783 - SILCA PER GENERAL MOTORS®  CHIAVE TRANSPONDER OTTONE 5 pz	 BA2 / 783 - SILCA PER BASCO®  CHIAVE ACCIAIO 50 pz
 BA2R / 783 - SILCA PER BASCO®  CHIAVE ACCIAIO 50 pz	 BH11 / 783 - SILCA PER BOSCH®  CHIAVE PER CAMION 50 pz	 BH12 / 783 - SILCA PER BOSCH®  CHIAVE ACCIAIO 50 pz	 BH12P / 783 - SILCA PER BOSCH®  CHIAVE ACCIAIO 25 pz	 BH4 / 783 - SILCA PER BOSCH®  CHIAVE ACCIAIO 50 pz

In conformità alle disposizioni legali in vigore relative alle proprietà industriali, informiamo che i marchi o le denominazioni commerciali citate nel nostro documento sono di proprietà esclusiva dei fabbricanti di serrature e degli utilizzatori autorizzati. Questi marchi o denominazioni commerciali sono indicati a titolo di semplice informazione, con lo scopo di riconoscere velocemente a quali serrature le nostre chiavi sono destinate. Questo documento è esclusivamente riservato ai professionisti della riproduzione chiavi che utilizzano i prodotti Silca. / Le illustrazioni e i dati tecnici dei prodotti contenuti nel documento debbono considerarsi indicativi. Silca si riserva il diritto, ferme restando le caratteristiche essenziali dei prodotti, di apportare tutte le modifiche che ritiene necessarie e opportune al fine di migliorare la qualità dei prodotti. Tutti i disegni e le fotografie sono di proprietà di Silca, ogni riproduzione anche parziale, senza autorizzazione scritta di Silca S.p.A. è vietata secondo termini di legge. Per qualsiasi controversia competenti sono gli Uffici Giudiziari dove ha sede l'Azienda Silca S.p.A., con espressa esclusione di qualsiasi altro foro.

































DUPLICATRICI-CHIAVI-RADIOCOMANDI

 8 003736023529 BH4P / 783 - SILCA PER BOSCH® CHIAVE ACCIAIO 25 pz	 8 003736028784 BT2 / 783 - SILCA PER BLAU® CHIAVE ACCIAIO 50 pz	 8 003736028821 BT3 / 783 - SILCA PER BLAU® CHIAVE ACCIAIO 50 pz	 8 003736851542 BW7BP / 783 - SILCA PER NEIMAN® CHIAVE OTTONE 25 pz	 8 003736029910 BW7P / 783 - SILCA PER HUF® CHIAVE ACCIAIO 25 pz
 8 003736042308 CR3RP / 783 - SILCA PER CLAUSOR® CHIAVE ACCIAIO 25 pz	 8 003737442169 CTR1R / 783 - SILCA PER CATERPILLAR® CHIAVE OTTONE 50 pz	 8 003736050655 CY12R / 783 - SILCA PER BRIGGS & STRATTON® CHIAVE ACCIAIO 50 pz	 8 003736785618 CY19P / 783 - SILCA PER YALE® CHIAVE ACCIAIO 25 pz	 8 003736864511 CY24BP / 783 - SILCA PER BRIGGS & STRATTON® CHIAVE OTTONE 25 pz
 8 003736052048 DAT12P / 783 - SILCA PER DATSUN® CHIAVE ACCIAIO 25 pz	 8 003736052321 DAT13P / 783 - SILCA PER NISSAN® CHIAVE ACCIAIO 25 pz	 8 003737705103 DAT17T21 / 783 - SILCA PER SUBARU® CHIAVE TRANSPONDER ALPACCA 1 pz	 8 003736055667 DH4RP / 783 - SILCA PER DAIHATSU® CHIAVE ACCIAIO 25 pz	 8 003737489386 DH4RT4 / 783 - SILCA PER DAIHATSU® CHIAVE TRANSPONDER OTTONE 1 pz

In conformità alle disposizioni legali in vigore relative alle proprietà industriali, informiamo che i marchi o le denominazioni commerciali citate nel nostro documento sono di proprietà esclusiva dei fabbricanti di serrature e degli utilizzatori autorizzati. Questi marchi o denominazioni commerciali sono indicati a titolo di semplice informazione, con lo scopo di riconoscere velocemente a quali serrature le nostre chiavi sono destinate. Questo documento è esclusivamente riservato ai professionisti della riproduzione chiavi che utilizzano i prodotti Silca. / Le illustrazioni e i dati tecnici dei prodotti contenuti nel documento debbono considerarsi indicativi. Silca si riserva il diritto, ferme restando le caratteristiche essenziali dei prodotti, di apportare tutte le modifiche che ritiene necessarie e opportune al fine di migliorare la qualità dei prodotti. Tutti i disegni e le fotografie sono di proprietà di Silca, ogni riproduzione anche parziale, senza autorizzazione scritta di Silca S.p.A. è vietata secondo termini di legge. Per qualsiasi controversia competenti sono gli Uffici Giudiziari dove ha sede l'Azienda Silca S.p.A., con espressa esclusione di qualsiasi altro foro.

































 8 003736064096 DW02 / 783 - SILCA PER DAEWOO®  CHIAVE ACCIAIO 50 pz	 8 003737745345 DW04CT6 / 783 - SILCA PER CHEVROLET-DAEWOO®  CHIAVE TRANSPONDER OTTONE 1 pz	 8 052782005478 DW04RAP / 783 - SILCA PER DAEWOO®  25 pz	 8 003737804592 DW04RT5 / 783 - SILCA PER DAEWOO®  CHIAVE TRANSPONDER OTTONE 1 pz	 8 003737478885 DW04RT6 / 783 - SILCA PER DAEWOO®  CHIAVE TRANSPONDER OTTONE 1 pz
 8 003737740548 DW05RAP / 783 - SILCA PER DAEWOO®  CHIAVE ACCIAIO 25 pz	 8 003737804622 DW05RT5 / 783 - SILCA PER DAEWOO®  CHIAVE TRANSPONDER OTTONE 1 pz	 8 003737804653 DW05T5 / 783 - SILCA PER DAEWOO®  CHIAVE TRANSPONDER OTTONE 1 pz	 8 003737479011 DW05T6 / 783 - SILCA PER DAEWOO®  CHIAVE TRANSPONDER OTTONE 1 pz	 8 003737804684 DW06BT5 / 783 - SILCA PER DAEWOO®  CHIAVE TRANSPONDER OTTONE 1 pz
 8 003737466547 DW06BT6 / 783 - SILCA PER DAEWOO®  CHIAVE TRANSPONDER OTTONE 1 pz	 8 003737486897 ED2 / 783 - SILCA PER EVERGOOD®  CHIAVE ACCIAIO 50 pz	 8 003737487863 ED3R / 783 - SILCA PER EVERGOOD®  CHIAVE ACCIAIO 50 pz	 8 003736070486 FA2P / 783 - SILCA PER FIAT®  CHIAVE ACCIAIO 25 pz	 8 003736069671 FAB1 / 783 - SILCA PER FAAB®  CHIAVE ACCIAIO 50 pz

In conformità alle disposizioni legali in vigore relative alle proprietà industriali, informiamo che i marchi o le denominazioni commerciali citate nel nostro documento sono di proprietà esclusiva dei fabbricanti di serrature e degli utilizzatori autorizzati. Questi marchi o denominazioni commerciali sono indicati a titolo di semplice informazione, con lo scopo di riconoscere velocemente a quali serrature le nostre chiavi sono destinate. Questo documento è esclusivamente riservato ai professionisti della riproduzione chiavi che utilizzano i prodotti Silca. / Le illustrazioni e i dati tecnici dei prodotti contenuti nel documento debbono considerarsi indicativi. Silca si riserva il diritto, ferme restando le caratteristiche essenziali dei prodotti, di apportare tutte le modifiche che ritiene necessarie e opportune al fine di migliorare la qualità dei prodotti. Tutti i disegni e le fotografie sono di proprietà di Silca, ogni riproduzione anche parziale, senza autorizzazione scritta di Silca S.p.A. è vietata secondo termini di legge. Per qualsiasi controversia competenti sono gli Uffici Giudiziari dove ha sede l'Azienda Silca S.p.A., con espressa esclusione di qualsiasi altro foro.



DUPLICATRICI-CHIAVI-RADIOCOMANDI

 8 003736069695 FAB2 / 783 - SILCA PER FAAB®  CHIAVE ACCIAIO 50 pz	 8 003736070226 FAR1R / 783 - SILCA PER FARMA®  CHIAVE ACCIAIO 50 pz	 8 003736070240 FAR2 / 783 - SILCA PER FARMA®  CHIAVE ACCIAIO 50 pz	 8 003736070264 FAR2R / 783 - SILCA PER FARMA®  CHIAVE ACCIAIO 50 pz	 8 003736070332 FAR4R / 783 - SILCA PER FARMA®  CHIAVE ACCIAIO 50 pz
 8 003736073722 F010P / 783 - SILCA PER FORD®  CHIAVE ACCIAIO 25 pz	 8 003736074347 F019P / 783 - SILCA PER CHUBB®  CHIAVE ACCIAIO 25 pz	 8 003736074378 F021P / 783 - SILCA PER TIBBE®  CHIAVE ACCIAIO 25 pz	 8 003737804738 F021T3 / 783 - SILCA PER FORD®  CHIAVE TRANSPONDER ACCIAIO 1 pz	 8 003737346092 F021T7 / 783 - SILCA PER FORD (EU)®  CHIAVE TRANSPONDER ACCIAIO 1 pz
 8 003737688222 F038RT17 / 783 - SILCA PER FORD (USA)®  CHIAVE TRANSPONDER OTTONE 1 pz	 8 003736295575 F040RBP / 783 - SILCA PER FORD®  CHIAVE ACCIAIO 25 pz	 8 003736073494 F0T6 / 783 - SILCA PER HUF®  CHIAVE ACCIAIO 50 pz	 8 003736079861 GHE1 / 783 - SILCA PER GHE®  CHIAVE ACCIAIO 50 pz	 8 003736079878 GHE2 / 783 - SILCA PER GHE®  CHIAVE ACCIAIO 50 pz

In conformità alle disposizioni legali in vigore relative alle proprietà industriali, informiamo che i marchi o le denominazioni commerciali citate nel nostro documento sono di proprietà esclusiva dei fabbricanti di serrature e degli utilizzatori autorizzati. Questi marchi o denominazioni commerciali sono indicati a titolo di semplice informazione, con lo scopo di riconoscere velocemente a quali serrature le nostre chiavi sono destinate. Questo documento è esclusivamente riservato ai professionisti della riproduzione chiavi che utilizzano i prodotti Silca. / Le illustrazioni e i dati tecnici dei prodotti contenuti nel documento debbono considerarsi indicativi. Silca si riserva il diritto, ferme restando le caratteristiche essenziali dei prodotti, di apportare tutte le modifiche che ritiene necessarie e opportune al fine di migliorare la qualità dei prodotti. Tutti i disegni e le fotografie sono di proprietà di Silca, ogni riproduzione anche parziale, senza autorizzazione scritta di Silca S.p.A. è vietata secondo termini di legge. Per qualsiasi controversia competenti sono gli Uffici Giudiziari dove ha sede l'Azienda Silca S.p.A., con espressa esclusione di qualsiasi altro foro.



 8 003736079939 GHE6 / 783 - SILCA PER GHE® CHIAVE ACCIAIO 50 pz	 8 003737804868 GM15T5 / 783 - SILCA PER GENERAL MOTORS® CHIAVE TRANSPONDER OTTONE 1 pz	 8 003736085107 GT10 / 783 - SILCA PER GIOBERT® CHIAVE ACCIAIO 50 pz	 8 003736085206 GT10AP / 783 - SILCA PER GIOBERT® CHIAVE ACCIAIO 25 pz	 8 003736085213 GT10BP / 783 - SILCA PER GIOBERT® CHIAVE ACCIAIO 25 pz
 8 003736519800 GT10BT5 / 783 - SILCA PER GIOBERT® CHIAVE TRANSPONDER S/CHIP- C/TAPPO 5 pz	 8 003736085237 GT10CP / 783 - SILCA PER GIOBERT® CHIAVE ACCIAIO 25 pz	 8 003736085244 GT10DP / 783 - SILCA PER GIOBERT® CHIAVE ACCIAIO 25 pz	 8 003736085282 GT10P / 783 - SILCA PER GIOBERT® CHIAVE ACCIAIO 25 pz	 8 003736345256 GT12AP / 783 - SILCA PER GIOBERT® CHIAVE OTTONE 25 pz
 8 003736085640 GT15RAP / 783 - SILCA PER GIOBERT® CHIAVE ACCIAIO 25 pz	 8 003736854819 GT15RBP / 783 - SILCA PER GIOBERT® CHIAVE OTTONE - BLU 25 pz	 8 003736507685 GT15RBT5 / 783 - SILCA PER GIOBERT® CHIAVE TRANSPONDER S/CHIP- C/TAPPO 5 pz	 8 003737929493 GT15RCP / 783 - SILCA PER GIOBERT® 25 pz	 8 003736351141 GT15RCT5 / 783 - SILCA PER GIOBERT® CHIAVE TRANSPONDER S/CHIP- C/TAPPI 5 pz

In conformità alle disposizioni legali in vigore relative alle proprietà industriali, informiamo che i marchi o le denominazioni commerciali citate nel nostro documento sono di proprietà esclusiva dei fabbricanti di serrature e degli utilizzatori autorizzati. Questi marchi o denominazioni commerciali sono indicati a titolo di semplice informazione, con lo scopo di riconoscere velocemente a quali serrature le nostre chiavi sono destinate. Questo documento è esclusivamente riservato ai professionisti della riproduzione chiavi che utilizzano i prodotti Silca. / Le illustrazioni e i dati tecnici dei prodotti contenuti nel documento debbono considerarsi indicativi. Silca si riserva il diritto, ferme restando le caratteristiche essenziali dei prodotti, di apportare tutte le modifiche che ritiene necessarie e opportune al fine di migliorare la qualità dei prodotti. Tutti i disegni e le fotografie sono di proprietà di Silca, ogni riproduzione anche parziale, senza autorizzazione scritta di Silca S.p.A. è vietata secondo termini di legge. Per qualsiasi controversia competenti sono gli Uffici Giudiziari dove ha sede l'Azienda Silca S.p.A., con espressa esclusione di qualsiasi altro foro.



















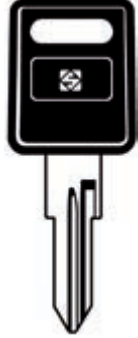











DUPLICATRICI-CHIAVI-RADIOCOMANDI

 8 003736351141 GT15RCT5 / 783 - SILCA PER GIOBERT®  CHIAVE TRANSPONDER S/CHIP- C/TAPPI 5 pz	 8 003737674997 GT15RDP / 783 - SILCA PER ZADI®  CHIAVE ACCIAIO - BLU 25 pz	 8 003736358287 GT15RDT5 / 783 - SILCA PER GIOBERT®  CHIAVE TRANSPONDER S/CHIP- C/TAPPI 5 pz	 8 003736085664 GT15RP / 783 - SILCA PER GIOBERT®  CHIAVE ACCIAIO 25 pz	 8 003736541993 GT15RT2 / 783 - SILCA PER GIOBERT®  CHIAVE TRANSPONDER S/CHIP- C/TAPPO 5 pz
 8 003736085763 GT16AP / 783 - SILCA PER GIOBERT®  CHIAVE ACCIAIO 25 pz	 8 003736085886 GT18RBP / 783 - SILCA PER GIOBERT®  CHIAVE ACCIAIO 25 pz	 8 003736519824 GT18RT5 / 783 - SILCA PER GIOBERT®  CHIAVE TRANSPONDER S/CHIP- C/TAPPO 5 pz	 8 003736086036 GT3 / 783 - SILCA PER GIOBERT®  CHIAVE OTTONE 100 pz	 8 003736086050 GT3R / 783 - SILCA PER GIOBERT®  CHIAVE OTTONE 100 pz
 8 003736086135 GT5AP / 783 - SILCA PER GIOBERT®  CHIAVE ACCIAIO 25 pz	 8 003736086159 GT5BP / 783 - SILCA PER GIOBERT®  CHIAVE ACCIAIO 25 pz	 8 003736086173 GT5CP / 783 - SILCA PER GIOBERT®  CHIAVE ACCIAIO 25 pz	 8 003736086197 GT5EP / 783 - SILCA PER GIOBERT®  CHIAVE ACCIAIO 25 pz	 8 003736086203 GT5FP / 783 - SILCA PER GIOBERT®  CHIAVE ACCIAIO 25 pz

In conformità alle disposizioni legali in vigore relative alle proprietà industriali, informiamo che i marchi o le denominazioni commerciali citate nel nostro documento sono di proprietà esclusiva dei fabbricanti di serrature e degli utilizzatori autorizzati. Questi marchi o denominazioni commerciali sono indicati a titolo di semplice informazione, con lo scopo di riconoscere velocemente a quali serrature le nostre chiavi sono destinate. Questo documento è esclusivamente riservato ai professionisti della riproduzione chiavi che utilizzano i prodotti Silca. / Le illustrazioni e i dati tecnici dei prodotti contenuti nel documento debbono considerarsi indicativi. Silca si riserva il diritto, ferme restando le caratteristiche essenziali dei prodotti, di apportare tutte le modifiche che ritiene necessarie e opportune al fine di migliorare la qualità dei prodotti. Tutti i disegni e le fotografie sono di proprietà di Silca, ogni riproduzione anche parziale, senza autorizzazione scritta di Silca S.p.A. è vietata secondo termini di legge. Per qualsiasi controversia competenti sono gli Uffici Giudiziari dove ha sede l'Azienda Silca S.p.A., con espressa esclusione di qualsiasi altro foro.











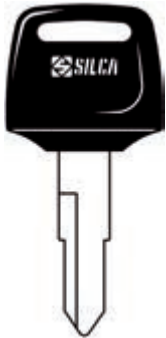





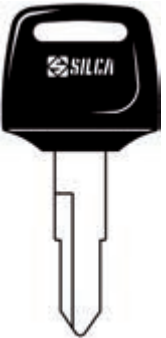



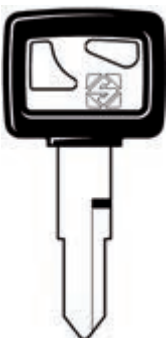

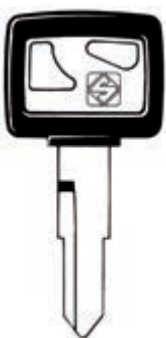







 GT5P / 783 - SILCA PER GIOBERT®  CHIAVE ACCIAIO 25 pz	 GT6RAP / 783 - SILCA PER GIOBERT®  CHIAVE ACCIAIO 25 pz	 GT6RBP / 783 - SILCA PER GIOBERT®  CHIAVE ACCIAIO 25 pz	 GT6RCP / 783 - SILCA PER GIOBERT®  CHIAVE ACCIAIO 25 pz	 GT6REP / 783 - SILCA PER GIOBERT®  CHIAVE ACCIAIO 25 pz
 GT6RFP / 783 - SILCA PER GIOBERT®  CHIAVE ACCIAIO 25 pz	 GT6RP / 783 - SILCA PER GIOBERT®  CHIAVE ACCIAIO 25 pz	 GT7BP / 783 - SILCA PER GIOBERT®  CHIAVE ACCIAIO 25 pz	 GT7P / 783 - SILCA PER GIOBERT®  CHIAVE ACCIAIO 25 pz	 GT8BP / 783 - SILCA PER GIOBERT®  CHIAVE OTTONE 25 pz
 GT8FP / 783 - SILCA PER GIOBERT®  CHIAVE OTTONE 25 pz	 HD1 / 783 - SILCA PER HUDSON®  CHIAVE ACCIAIO 50 pz	 HON10 / 783 - SILCA PER HONDA®  CHIAVE ACCIAIO 50 pz	 HON31AP / 783 - SILCA PER HONDA®  CHIAVE ACCIAIO 25 pz	 HON31BP / 783 - SILCA PER HONDA®  CHIAVE OTTONE 25 pz

In conformità alle disposizioni legali in vigore relative alle proprietà industriali, informiamo che i marchi o le denominazioni commerciali citate nel nostro documento sono di proprietà esclusiva dei fabbricanti di serrature e degli utilizzatori autorizzati. Questi marchi o denominazioni commerciali sono indicati a titolo di semplice informazione, con lo scopo di riconoscere velocemente a quali serrature le nostre chiavi sono destinate. Questo documento è esclusivamente riservato ai professionisti della riproduzione chiavi che utilizzano i prodotti Silca. / Le illustrazioni e i dati tecnici dei prodotti contenuti nel documento debbono considerarsi indicativi. Silca si riserva il diritto, ferme restando le caratteristiche essenziali dei prodotti, di apportare tutte le modifiche che ritiene necessarie e opportune al fine di migliorare la qualità dei prodotti. Tutti i disegni e le fotografie sono di proprietà di Silca, ogni riproduzione anche parziale, senza autorizzazione scritta di Silca S.p.A. è vietata secondo termini di legge. Per qualsiasi controversia competenti sono gli Uffici Giudiziari dove ha sede l'Azienda Silca S.p.A., con espressa esclusione di qualsiasi altro foro.



DUPLICATRICI-CHIAVI-RADIOCOMANDI

 8 003736089877 HON31CP / 783 - SILCA PER HONDA®  CHIAVE ACCIAIO 25 pz	 8 003736089891 HON31P / 783 - SILCA PER HONDA®  CHIAVE ACCIAIO 25 pz	 8 003736089938 HON31RAP / 783 - SILCA PER HONDA®  CHIAVE ACCIAIO 25 pz	 8 003736089976 HON31RCP / 783 - SILCA PER HONDA®  CHIAVE ACCIAIO 25 pz	 8 003736089990 HON31RP / 783 - SILCA PER HONDA®  CHIAVE ACCIAIO 25 pz
 8 003736090477 HON39P / 783 - SILCA PER HONDA®  CHIAVE ACCIAIO 25 pz	 8 003736090514 HON39RP / 783 - SILCA PER HONDA®  CHIAVE ACCIAIO 25 pz	 8 003736090712 HON41P / 783 - SILCA PER HONDA®  CHIAVE ACCIAIO 25 pz	 8 003736090767 HON42AP / 783 - SILCA PER HONDA®  CHIAVE ACCIAIO 25 pz	 8 003737806534 HON58RT5 / 783 - SILCA PER HONDA®  CHIAVE TRANSPONDER OTTONE 1 pz
 8 003737412728 HON58RT6 / 783 - SILCA PER HONDA®  CHIAVE TRANSPONDER OTTONE 1 pz	 8 003736091771 HON61BP / 783 - SILCA PER HONDA®  CHIAVE ACCIAIO 25 pz	 8 003736091788 HON61RBP / 783 - SILCA PER HONDA®  CHIAVE ACCIAIO 25 pz	 8 003736091795 HON62RBP / 783 - SILCA PER HONDA®  CHIAVE ACCIAIO 25 pz	 8 003737673198 HON63FP / 783 - SILCA PER HONDA®  CHIAVE ACCIAIO 25 pz

In conformità alle disposizioni legali in vigore relative alle proprietà industriali, informiamo che i marchi o le denominazioni commerciali citate nel nostro documento sono di proprietà esclusiva dei fabbricanti di serrature e degli utilizzatori autorizzati. Questi marchi o denominazioni commerciali sono indicati a titolo di semplice informazione, con lo scopo di riconoscere velocemente a quali serrature le nostre chiavi sono destinate. Questo documento è esclusivamente riservato ai professionisti della riproduzione chiavi che utilizzano i prodotti Silca. / Le illustrazioni e i dati tecnici dei prodotti contenuti nel documento debbono considerarsi indicativi. Silca si riserva il diritto, ferme restando le caratteristiche essenziali dei prodotti, di apportare tutte le modifiche che ritiene necessarie e opportune al fine di migliorare la qualità dei prodotti. Tutti i disegni e le fotografie sono di proprietà di Silca, ogni riproduzione anche parziale, senza autorizzazione scritta di Silca S.p.A. è vietata secondo termini di legge. Per qualsiasi controversia competenti sono gli Uffici Giudiziari dove ha sede l'Azienda Silca S.p.A., con espressa esclusione di qualsiasi altro foro.















 8 003736430136 HON64RBP / 783 - SILCA PER HONDA® CHIAVE ACCIAIO 25 pz	 8 003737742146 HON66T27 / 783 - SILCA PER HONDA® CHIAVE TRANSPONDER ALPACCA 1 pz	 8 003737693806 HON70T14 / 783 - SILCA PER HONDA® CHIAVE TRANSPONDER OTTONE 1 pz	 8 003737582872 HU100T12 / 783 - SILCA PER HUF® CHIAVE TRANSPONDER ALPACCA 1 pz	 8 003737706995 HU129BP / 783 - SILCA PER HUF® CHIAVE ACCIAIO 25 pz
 8 003737718370 HU133RT12 / 783 - SILCA PER HUF® CHIAVE TRANSPONDER OTTONE 1 pz	 8 003737742276 HU133RT14 / 783 - SILCA PER HUF® CHIAVE TRANSPONDER OTTONE 1 pz	 8 003736092716 HU22P / 783 - SILCA PER HUF® CHIAVE ACCIAIO 25 pz	 8 003736093133 HU32P / 783 - SILCA PER HUF® CHIAVE ACCIAIO 25 pz	 8 003736093584 HU39P / 783 - SILCA PER HUF® CHIAVE OTTONE 25 pz
 8 003736093737 HU43P / 783 - SILCA PER HUF® CHIAVE OTTONE 25 pz	 8 003737806671 HU43T2 / 783 - SILCA PER HUF® CHIAVE TRANSPONDER OTTONE 1 pz	 8 003737351294 HU43T9 / 783 - SILCA PER HUF® CHIAVE TRANSPONDER OTTONE 1 pz	 8 003736093799 HU46 / 783 - SILCA PER HUF® CHIAVE ACCIAIO 50 pz	 8 003737805063 HU46AT5 / 783 - SILCA PER HUF® CHIAVE TRANSPONDER OTTONE 1 pz

In conformità alle disposizioni legali in vigore relative alle proprietà industriali, informiamo che i marchi o le denominazioni commerciali citate nel nostro documento sono di proprietà esclusiva dei fabbricanti di serrature e degli utilizzatori autorizzati. Questi marchi o denominazioni commerciali sono indicati a titolo di semplice informazione, con lo scopo di riconoscere velocemente a quali serrature le nostre chiavi sono destinate. Questo documento è esclusivamente riservato ai professionisti della riproduzione chiavi che utilizzano i prodotti Silca. / Le illustrazioni e i dati tecnici dei prodotti contenuti nel documento debbono considerarsi indicativi. Silca si riserva il diritto, ferme restando le caratteristiche essenziali dei prodotti, di apportare tutte le modifiche che ritiene necessarie e opportune al fine di migliorare la qualità dei prodotti. Tutti i disegni e le fotografie sono di proprietà di Silca, ogni riproduzione anche parziale, senza autorizzazione scritta di Silca S.p.A. è vietata secondo termini di legge. Per qualsiasi controversia competenti sono gli Uffici Giudiziari dove ha sede l'Azienda Silca S.p.A., con espressa esclusione di qualsiasi altro foro.













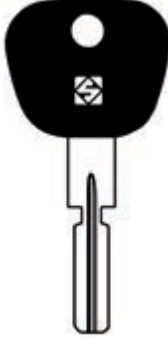













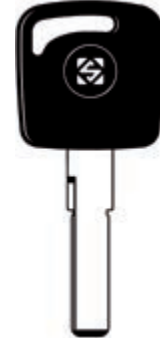



DUPLICATRICI-CHIAVI-RADIOCOMANDI

 8 003736093904 HU46P / 783 - SILCA PER HUF®  CHIAVE ACCIAIO 25 pz	 8 003737439787 HU46T12 / 783 - SILCA PER HUF®  CHIAVE TRANSPONDER OTTONE 1 pz	 8 003737805018 HU46T2 / 783 - SILCA PER HUF®  CHIAVE TRANSPONDER OTTONE 1 pz	 8 003737804981 HU49AT5 / 783 - SILCA PER HUF®  CHIAVE TRANSPONDER OTTONE 1 pz	 8 003736094161 HU49BP / 783 - SILCA PER WITTE®  CHIAVE ACCIAIO 25 pz
 8 003736094185 HU49CP / 783 - SILCA PER HUF®  CHIAVE ACCIAIO 25 pz	 8 003736094222 HU49P / 783 - SILCA PER HUF®  CHIAVE ACCIAIO 25 pz	 8 003737477772 HU49T10X / 783 - SILCA PER HUF®  CHIAVE TRANSPONDER OTTONE 1 pz	 8 003737770750 HU49T28 / 783 - SILCA PER HUF®  CHIAVE TRANSPONDER OTTONE 1 pz	 8 003737806725 HU49T5 / 783 - SILCA PER HUF®  CHIAVE TRANSPONDER OTTONE 1 pz
 8 003736094321 HU50AP / 783 - SILCA PER HUF®  CHIAVE ACCIAIO 25 pz	 8 003737806749 HU56RAT2 / 783 - SILCA PER HUF®  CHIAVE TRANSPONDER OTTONE 1 pz	 8 003736094512 HU56RP / 783 - SILCA PER HUF®  CHIAVE OTTONE 25 pz	 8 003737806763 HU56RT2 / 783 - SILCA PER HUF®  CHIAVE TRANSPONDER OTTONE 1 pz	 8 003737742870 HU56RT30 / 783 - SILCA PER HUF®  CHIAVE TRANSPONDER OTTONE 1 pz

In conformità alle disposizioni legali in vigore relative alle proprietà industriali, informiamo che i marchi o le denominazioni commerciali citate nel nostro documento sono di proprietà esclusiva dei fabbricanti di serrature e degli utilizzatori autorizzati. Questi marchi o denominazioni commerciali sono indicati a titolo di semplice informazione, con lo scopo di riconoscere velocemente a quali serrature le nostre chiavi sono destinate. Questo documento è esclusivamente riservato ai professionisti della riproduzione chiavi che utilizzano i prodotti Silca. / Le illustrazioni e i dati tecnici dei prodotti contenuti nel documento debbono considerarsi indicativi. Silca si riserva il diritto, ferme restando le caratteristiche essenziali dei prodotti, di apportare tutte le modifiche che ritiene necessarie e opportune al fine di migliorare la qualità dei prodotti. Tutti i disegni e le fotografie sono di proprietà di Silca, ogni riproduzione anche parziale, senza autorizzazione scritta di Silca S.p.A. è vietata secondo termini di legge. Per qualsiasi controversia competenti sono gli Uffici Giudiziari dove ha sede l'Azienda Silca S.p.A., con espressa esclusione di qualsiasi altro foro.

































 8 003736094574 HU58AP / 783 - SILCA PER HUF®  CHIAVE ALPACCA 25 pz	 8 003736094550 HU58AP / 783 - SILCA PER HUF®  CHIAVE OTTONE 25 pz	 8 003736231573 HU64P / 783 - SILCA PER HUF®  CHIAVE OTTONE 25 pz	 8 003736231580 HU65AP / 783 - SILCA PER HUF®  CHIAVE OTTONE 25 pz	 8 003737806794 HU66AT5 / 783 - SILCA PER HUF®  CHIAVE TRANSPONDER OTTONE 1 pz
 8 003737344494 HU66AT6 / 783 - SILCA PER HUF®  CHIAVE TRANSPONDER OTTONE 1 pz	 8 003737806824 HU66BT1 / 783 - SILCA PER HUF®  CHIAVE TRANSPONDER OTTONE 1 pz	 8 003737499644 HU66BT15 / 783 - SILCA PER HUF®  CHIAVE TRANSPONDER OTTONE 1 pz	 8 003737745376 HU66BT28 / 783 - SILCA PER HUF®  CHIAVE TRANSPONDER OTTONE 1 pz	 8 003737354844 HU66T10 / 783 - SILCA PER HUF®  CHIAVE TRANSPONDER OTTONE 1 pz
 8 003737494250 HU66T15 / 783 - SILCA PER HUF®  CHIAVE TRANSPONDER OTTONE 1 pz	 8 003737724036 HU66T23 / 783 - SILCA PER HUF®  CHIAVE TRANSPONDER OTTONE 1 pz	 8 003737725743 HU66T24 / 783 - SILCA PER HUF®  CHIAVE TRANSPONDER OTTONE 1 pz	 8 003737731904 HU66T26 / 783 - SILCA PER HUF®  CHIAVE TRANSPONDER OTTONE 1 pz	 8 003737739276 HU66T28 / 783 - SILCA PER HUF®  CHIAVE TRANSPONDER OTTONE 1 pz

In conformità alle disposizioni legali in vigore relative alle proprietà industriali, informiamo che i marchi o le denominazioni commerciali citate nel nostro documento sono di proprietà esclusiva dei fabbricanti di serrature e degli utilizzatori autorizzati. Questi marchi o denominazioni commerciali sono indicati a titolo di semplice informazione, con lo scopo di riconoscere velocemente a quali serrature le nostre chiavi sono destinate. Questo documento è esclusivamente riservato ai professionisti della riproduzione chiavi che utilizzano i prodotti Silca. / Le illustrazioni e i dati tecnici dei prodotti contenuti nel documento debbono considerarsi indicativi. Silca si riserva il diritto, ferme restando le caratteristiche essenziali dei prodotti, di apportare tutte le modifiche che ritiene necessarie e opportune al fine di migliorare la qualità dei prodotti. Tutti i disegni e le fotografie sono di proprietà di Silca, ogni riproduzione anche parziale, senza autorizzazione scritta di Silca S.p.A. è vietata secondo termini di legge. Per qualsiasi controversia competenti sono gli Uffici Giudiziari dove ha sede l'Azienda Silca S.p.A., con espressa esclusione di qualsiasi altro foro.





















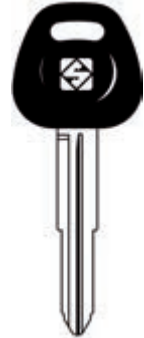









DUPLICATRICI-CHIAVI-RADIOCOMANDI

 8 003737805285 HU66T5 / 783 - SILCA PER HUF®  CHIAVE TRANSPONDER OTTONE 1 pz	 8 003737344487 HU66T6 / 783 - SILCA PER HUF®  CHIAVE TRANSPONDER OTTONE 1 pz	 8 003736370586 HU71P / 783 - SILCA PER HUF®  CHIAVE ALPACCA 25 pz	 8 003736373389 HU72RP / 783 - SILCA PER HUF®  CHIAVE ACCIAIO 25 pz	 8 003737492812 HU83T14 / 783 - SILCA PER HUF®  CHIAVE TRANSPONDER ALPACCA 1 pz
 8 003737604857 HU83T5 / 783 - SILCA PER HUF®  CHIAVE TRANSPONDER ALPACCA 1 pz	 8 003737423472 HU87RT12 / 783 - SILCA PER HUF®  CHIAVE TRANSPONDER OTTONE 1 pz	 8 003737643122 HU87RT18 / 783 - SILCA PER HUF®  CHIAVE TRANSPONDER OTTONE 1 pz	 8 003737805230 HU87RT5 / 783 - SILCA PER HUF®  CHIAVE TRANSPONDER OTTONE 1 pz	 8 003736545373 HU87RT9 / 783 - SILCA PER HUF®  CHIAVE TRANSPONDER S/CHIP-C/TAPPO 5 pz
 8 003736850989 HY11R / 783 - SILCA PER HARLEY DAVIDSON®  CHIAVE OTTONE 50 pz	 8 003736578425 HYN10BP / 783 - SILCA PER HYUNDAI®  CHIAVE ACCIAIO 25 pz	 8 003737489409 HYN10T4 / 783 - SILCA PER HYUNDAI®  CHIAVE TRANSPONDER OTTONE 1 pz	 8 003736506848 HYN11CP / 783 - SILCA PER HYUNDAI®  CHIAVE ACCIAIO 25 pz	 8 052782005461 HYN12CP / 783 - SILCA PER HYUNDAI®  25 pz

In conformità alle disposizioni legali in vigore relative alle proprietà industriali, informiamo che i marchi o le denominazioni commerciali citate nel nostro documento sono di proprietà esclusiva dei fabbricanti di serrature e degli utilizzatori autorizzati. Questi marchi o denominazioni commerciali sono indicati a titolo di semplice informazione, con lo scopo di riconoscere velocemente a quali serrature le nostre chiavi sono destinate. Questo documento è esclusivamente riservato ai professionisti della riproduzione chiavi che utilizzano i prodotti Silca. / Le illustrazioni e i dati tecnici dei prodotti contenuti nel documento debbono considerarsi indicativi. Silca si riserva il diritto, ferme restando le caratteristiche essenziali dei prodotti, di apportare tutte le modifiche che ritiene necessarie e opportune al fine di migliorare la qualità dei prodotti. Tutti i disegni e le fotografie sono di proprietà di Silca, ogni riproduzione anche parziale, senza autorizzazione scritta di Silca S.p.A. è vietata secondo termini di legge. Per qualsiasi controversia competenti sono gli Uffici Giudiziari dove ha sede l'Azienda Silca S.p.A., con espressa esclusione di qualsiasi altro foro.





























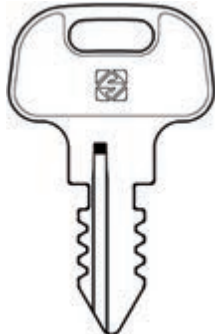

 8 003737672412 HYN13BP / 783 - SILCA PER HYUNDAI®  CHIAVE ACCIAIO 25 pz	 8 003737703130 HYN14RT14 / 783 - SILCA PER HYUNDAI®  CHIAVE TRANSPONDER OTTONE 1 pz	 8 003737705417 HYN14T14 / 783 - SILCA PER HYUNDAI®  CHIAVE TRANSPONDER OTTONE 1 pz	 8 003737704533 HYN15T14 / 783 - SILCA PER HYUNDAI®  CHIAVE TRANSPONDER OTTONE 1 pz	 8 003736095229 HYN3P / 783 - SILCA PER HYUNDAI®  CHIAVE OTTONE 25 pz
 8 003736095434 HYN5RP / 783 - SILCA PER HYUNDAI®  CHIAVE ACCIAIO 25 pz	 8 003736095526 HYN6P / 783 - SILCA PER HYUNDAI®  CHIAVE ACCIAIO 25 pz	 8 003737685313 HYN6T14 / 783 - SILCA PER HYUNDAI®  CHIAVE TRANSPONDER OTTONE 1 pz	 8 003737489423 HYN6T4 / 783 - SILCA PER HYUNDAI®  CHIAVE TRANSPONDER OTTONE 1 pz	 8 003737701754 HYN7RT14 / 783 - SILCA PER HYUNDAI®  CHIAVE TRANSPONDER OTTONE 1 pz
 8 003736578791 HYN9P / 783 - SILCA PER HYUNDAI®  CHIAVE OTTONE 25 pz	 8 003736099340 IM4RP / 783 - SILCA PER IMSA®  CHIAVE ACCIAIO 25 pz	 8 003736103788 KI10R / 783 - SILCA PER KIFERM®  CHIAVE ACCIAIO 50 pz	 8 003736103887 KI13 / 783 - SILCA PER KIFERM®  CHIAVE ACCIAIO 50 pz	 8 003736795884 KIA1RAP / 783 - SILCA PER KIA®  CHIAVE ACCIAIO 25 pz

In conformità alle disposizioni legali in vigore relative alle proprietà industriali, informiamo che i marchi o le denominazioni commerciali citate nel nostro documento sono di proprietà esclusiva dei fabbricanti di serrature e degli utilizzatori autorizzati. Questi marchi o denominazioni commerciali sono indicati a titolo di semplice informazione, con lo scopo di riconoscere velocemente a quali serrature le nostre chiavi sono destinate. Questo documento è esclusivamente riservato ai professionisti della riproduzione chiavi che utilizzano i prodotti Silca. / Le illustrazioni e i dati tecnici dei prodotti contenuti nel documento debbono considerarsi indicativi. Silca si riserva il diritto, ferme restando le caratteristiche essenziali dei prodotti, di apportare tutte le modifiche che ritiene necessarie e opportune al fine di migliorare la qualità dei prodotti. Tutti i disegni e le fotografie sono di proprietà di Silca, ogni riproduzione anche parziale, senza autorizzazione scritta di Silca S.p.A. è vietata secondo termini di legge. Per qualsiasi controversia competenti sono gli Uffici Giudiziari dove ha sede l'Azienda Silca S.p.A., con espressa esclusione di qualsiasi altro foro.

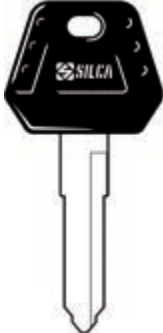

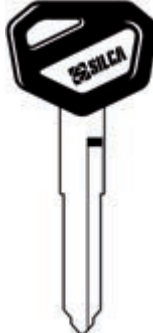





























DUPLICATRICI-CHIAVI-RADIOCOMANDI

 8 0 5 2 7 8 2 0 0 5 4 5 4 KIA3RAP / 783 - SILCA PER KIA®  25 pz	 8 0 0 3 7 3 7 6 9 0 8 4 3 KIA3RT14 / 783 - SILCA PER KIA®  CHIAVE TRANSPONDER OTTONE 1 pz	 8 0 0 3 7 3 7 5 4 2 1 1 1 KIA3RT16 / 783 - SILCA PER KIA®  CHIAVE TRANSPONDER OTTONE 1 pz	 8 0 0 3 7 3 7 8 0 6 9 4 7 KIA3RT5 / 783 - SILCA PER KIA®  CHIAVE TRANSPONDER OTTONE 1 pz	 8 0 0 3 7 3 7 7 3 7 4 3 2 KIA7T14 / 783 - SILCA PER KIA®  CHIAVE TRANSPONDER OTTONE 1 pz
 8 0 0 3 7 3 7 6 9 6 7 8 4 KOM1 / 783 - SILCA PER KOMATSU®  CHIAVE OTTONE 50 pz	 8 0 0 3 7 3 7 8 9 0 9 0 8 KTM1P / 783 - SILCA PER KTM®  CHIAVE OTTONE 25 pz	 8 0 0 3 7 3 7 8 9 0 8 9 2 KTM2RP / 783 - SILCA PER KTM®  CHIAVE OTTONE 25 pz	 8 0 0 3 7 3 7 7 8 8 3 9 7 KUB1R / 783 - SILCA PER KUBOTA®  CHIAVE OTTONE 50 pz	 8 0 0 3 7 3 7 8 5 0 5 2 0 KUB2R / 783 - SILCA PER KUBOTA®  CHIAVE OTTONE 50 pz
 8 0 0 3 7 3 6 1 0 5 2 7 0 KW12P / 783 - SILCA PER KAWASAKI®  CHIAVE ACCIAIO 25 pz	 8 0 0 3 7 3 7 6 6 3 8 9 2 KW14AP / 783 - SILCA PER KAWASAKI®  CHIAVE ACCIAIO 25 pz	 8 0 0 3 7 3 6 1 0 5 3 7 9 KW14P / 783 - SILCA PER KAWASAKI®  CHIAVE ACCIAIO 25 pz	 8 0 0 3 7 3 6 1 0 5 3 9 3 KW15BP / 783 - SILCA PER KAWASAKI®  CHIAVE ACCIAIO 25 pz	 8 0 0 3 7 3 6 4 7 0 3 3 0 KW16CP / 783 - SILCA PER KAWASAKI®  CHIAVE ACCIAIO 25 pz

In conformità alle disposizioni legali in vigore relative alle proprietà industriali, informiamo che i marchi o le denominazioni commerciali citate nel nostro documento sono di proprietà esclusiva dei fabbricanti di serrature e degli utilizzatori autorizzati. Questi marchi o denominazioni commerciali sono indicati a titolo di semplice informazione, con lo scopo di riconoscere velocemente a quali serrature le nostre chiavi sono destinate. Questo documento è esclusivamente riservato ai professionisti della riproduzione chiavi che utilizzano i prodotti Silca. / Le illustrazioni e i dati tecnici dei prodotti contenuti nel documento debbono considerarsi indicativi. Silca si riserva il diritto, ferme restando le caratteristiche essenziali dei prodotti, di apportare tutte le modifiche che ritiene necessarie e opportune al fine di migliorare la qualità dei prodotti. Tutti i disegni e le fotografie sono di proprietà di Silca, ogni riproduzione anche parziale, senza autorizzazione scritta di Silca S.p.A. è vietata secondo termini di legge. Per qualsiasi controversia competenti sono gli Uffici Giudiziari dove ha sede l'Azienda Silca S.p.A., con espressa esclusione di qualsiasi altro foro.

































 8 003737540780 KW17T5 / 783 - SILCA PER DUCATI®  CHIAVE TRANSPONDER OTTONE 1 pz	 8 003736413559 KYM1P / 783 - SILCA PER KYMCO®  CHIAVE ACCIAIO 25 pz	 8 003736427266 KYM1RP / 783 - SILCA PER KYMCO®  CHIAVE OTTONE 25 pz	 8 003737543194 KYM2 / 783 - SILCA PER KYMCO®  CHIAVE ACCIAIO 50 pz	 8 003737645942 KYM2P / 783 - SILCA PER KYMCO®  CHIAVE ACCIAIO 25 pz
 8 003737543217 KYM2R / 783 - SILCA PER KYMCO®  CHIAVE ACCIAIO 50 pz	 8 003737645935 KYM2RP / 783 - SILCA PER KYMCO®  CHIAVE ACCIAIO 25 pz	 8 003737892872 KYM3AP PER KYMCO®  CHIAVE OTTONE 25 pz	 8 003737892872 KYM3AP / 783 - SILCA PER KYMCO®  CHIAVE OTTONE 25 pz	 8 003737892889 KYM3RAP / 783 - SILCA PER KYMCO®  CHIAVE OTTONE 25 pz
 8 003737910934 KYM4AP / 783 - SILCA PER KYMCO®  25 pz	 8 003737910941 KYM4RAP / 783 - SILCA PER KYMCO®  25 pz	 8 003736906518 LAM1P / 783 - SILCA PER LAMBORGHINI®  CHIAVE OTTONE 25 pz	 8 003736505872 LM5P / 783 - SILCA PER LUMA®  CHIAVE ACCIAIO 25 pz	 8 003736111677 LS1 / 783 - SILCA PER LAS®  CHIAVE ACCIAIO 50 pz

In conformità alle disposizioni legali in vigore relative alle proprietà industriali, informiamo che i marchi o le denominazioni commerciali citate nel nostro documento sono di proprietà esclusiva dei fabbricanti di serrature e degli utilizzatori autorizzati. Questi marchi o denominazioni commerciali sono indicati a titolo di semplice informazione, con lo scopo di riconoscere velocemente a quali serrature le nostre chiavi sono destinate. Questo documento è esclusivamente riservato ai professionisti della riproduzione chiavi che utilizzano i prodotti Silca. / Le illustrazioni e i dati tecnici dei prodotti contenuti nel documento debbono considerarsi indicativi. Silca si riserva il diritto, ferme restando le caratteristiche essenziali dei prodotti, di apportare tutte le modifiche che ritiene necessarie e opportune al fine di migliorare la qualità dei prodotti. Tutti i disegni e le fotografie sono di proprietà di Silca, ogni riproduzione anche parziale, senza autorizzazione scritta di Silca S.p.A. è vietata secondo termini di legge. Per qualsiasi controversia competenti sono gli Uffici Giudiziari dove ha sede l'Azienda Silca S.p.A., con espressa esclusione di qualsiasi altro foro.















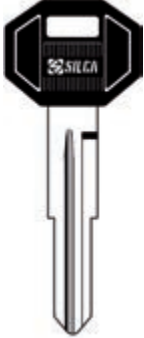













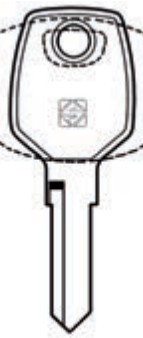

DUPLICATRICI-CHIAVI-RADIOCOMANDI

 8 003736111721 LS11 / 783 - SILCA PER LAS®  CHIAVE ACCIAIO 50 pz	 8 003736563322 LS11R / 783 - SILCA PER LAS®  CHIAVE ACCIAIO 50 pz	 8 003736111769 LS12 / 783 - SILCA PER LAS®  CHIAVE ACCIAIO 50 pz	 8 003736112162 LS16 / 783 - SILCA PER LAS®  CHIAVE ACCIAIO 50 pz	 8 003737805599 MAZ13T5 / 783 - SILCA PER MAZDA®  CHIAVE TRANSPONDER OTTONE 1 pz
 8 003736115606 MAZ16BP / 783 - SILCA PER MAZDA®  CHIAVE ACCIAIO 25 pz	 8 003736413191 MAZ24REP / 783 - SILCA PER MAZDA®  CHIAVE ACCIAIO 25 pz	 8 003737805537 MAZ24RT5 / 783 - SILCA PER MAZDA®  CHIAVE TRANSPONDER OTTONE 1 pz	 8 003736119192 MIT11RAP / 783 - SILCA PER MITSUBISHI®  CHIAVE ACCIAIO 25 pz	 8 003737690898 MIT11RT21 / 783 - SILCA PER MITSUBISHI®  CHIAVE TRANSPONDER OTTONE 1 pz
 8 003737643153 MIT14BT14 / 783 - SILCA PER MITSUBISHI®  CHIAVE TRANSPONDER OTTONE 1 pz	 8 003737805513 MIT14BT5 / 783 - SILCA PER MITSUBISHI®  CHIAVE TRANSPONDER OTTONE 1 pz	 8 003737482721 MIT15AP / 783 - SILCA PER MITSUBISHI®  CHIAVE ACCIAIO 25 pz	 8 003736119253 MIT2P / 783 - SILCA PER MITSUBISHI®  CHIAVE ACCIAIO 25 pz	 8 003736119376 MIT2RP / 783 - SILCA PER MITSUBISHI®  CHIAVE ACCIAIO 25 pz

In conformità alle disposizioni legali in vigore relative alle proprietà industriali, informiamo che i marchi o le denominazioni commerciali citate nel nostro documento sono di proprietà esclusiva dei fabbricanti di serrature e degli utilizzatori autorizzati. Questi marchi o denominazioni commerciali sono indicati a titolo di semplice informazione, con lo scopo di riconoscere velocemente a quali serrature le nostre chiavi sono destinate. Questo documento è esclusivamente riservato ai professionisti della riproduzione chiavi che utilizzano i prodotti Silca. / Le illustrazioni e i dati tecnici dei prodotti contenuti nel documento debbono considerarsi indicativi. Silca si riserva il diritto, ferme restando le caratteristiche essenziali dei prodotti, di apportare tutte le modifiche che ritiene necessarie e opportune al fine di migliorare la qualità dei prodotti. Tutti i disegni e le fotografie sono di proprietà di Silca, ogni riproduzione anche parziale, senza autorizzazione scritta di Silca S.p.A. è vietata secondo termini di legge. Per qualsiasi controversia competenti sono gli Uffici Giudiziari dove ha sede l'Azienda Silca S.p.A., con espressa esclusione di qualsiasi altro foro.



 8 003736119420 MIT3RP / 783 - SILCA PER MITSUBISHI®  CHIAVE ACCIAIO 25 pz	 8 003736119468 MIT4RP / 783 - SILCA PER MITSUBISHI®  CHIAVE ACCIAIO 25 pz	 8 003736119543 MIT6RP / 783 - SILCA PER MITSUBISHI®  CHIAVE ACCIAIO 25 pz	 8 003737504836 MIT8-PT / 783 - SILCA PER MITSUBISHI®  CHIAVE TRANSPONDER OTTONE 5 pz	 8 003736119697 MIT8AP / 783 - SILCA PER MITSUBISHI®  CHIAVE ACCIAIO 25 pz
 8 003736119710 MIT8P / 783 - SILCA PER MITSUBISHI®  CHIAVE ACCIAIO 25 pz	 8 003737640824 MIT8T19 / 783 - SILCA PER MITSUBISHI®  CHIAVE TRANSPONDER OTTONE 1 pz	 8 003737696760 MIT8T21 / 783 - SILCA PER MITSUBISHI®  CHIAVE TRANSPONDER OTTONE 1 pz	 8 003737489454 MIT8T4 / 783 - SILCA PER MITSUBISHI®  CHIAVE TRANSPONDER OTTONE 1 pz	 8 003736120181 MM1 / 783 - SILCA PER MAGNETI MARELLI®  CHIAVE ACCIAIO 50 pz
 8 003736120242 MM1RP / 783 - SILCA PER MAGNETI MARELLI®  CHIAVE ACCIAIO 25 pz	 8 003736564466 MRT1R / 783 - SILCA PER MERIT®  CHIAVE ACCIAIO 50 pz	 8 003736800052 MRT1RP / 783 - SILCA PER MERIT®  CHIAVE ACCIAIO 25 pz	 8 003737700009 MRT2RAP / 783 - SILCA PER MERIT®  CHIAVE OTTONE 25 pz	 8 003736124486 NE10 / 783 - SILCA PER NEIMAN®  CHIAVE ACCIAIO 50 pz

In conformità alle disposizioni legali in vigore relative alle proprietà industriali, informiamo che i marchi o le denominazioni commerciali citate nel nostro documento sono di proprietà esclusiva dei fabbricanti di serrature e degli utilizzatori autorizzati. Questi marchi o denominazioni commerciali sono indicati a titolo di semplice informazione, con lo scopo di riconoscere velocemente a quali serrature le nostre chiavi sono destinate. Questo documento è esclusivamente riservato ai professionisti della riproduzione chiavi che utilizzano i prodotti Silca. / Le illustrazioni e i dati tecnici dei prodotti contenuti nel documento debbono considerarsi indicativi. Silca si riserva il diritto, ferme restando le caratteristiche essenziali dei prodotti, di apportare tutte le modifiche che ritiene necessarie e opportune al fine di migliorare la qualità dei prodotti. Tutti i disegni e le fotografie sono di proprietà di Silca, ogni riproduzione anche parziale, senza autorizzazione scritta di Silca S.p.A. è vietata secondo termini di legge. Per qualsiasi controversia competenti sono gli Uffici Giudiziari dove ha sede l'Azienda Silca S.p.A., con espressa esclusione di qualsiasi altro foro.











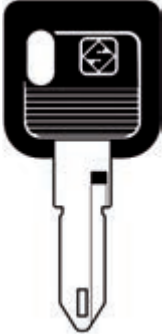



















DUPLICATRICI-CHIAVI-RADIOCOMANDI

 8 003736124912 NE21P / 783 - SILCA PER NEIMAN®  CHIAVE ACCIAIO 25 pz	 8 003736124967 NE23AP / 783 - SILCA PER NEIMAN®  CHIAVE ACCIAIO 25 pz	 8 003736125025 NE23DP / 783 - SILCA PER NEIMAN®  CHIAVE ACCIAIO 25 pz	 8 003736125063 NE23P / 783 - SILCA PER NEIMAN®  CHIAVE ACCIAIO 25 pz	 8 003736125247 NE31 / 783 - SILCA PER NEIMAN®  CHIAVE ACCIAIO 50 pz
 8 003736125407 NE38AP / 783 - SILCA PER NEIMAN®  CHIAVE ACCIAIO 25 pz	 8 003736125469 NE38DP / 783 - SILCA PER NEIMAN®  CHIAVE ACCIAIO 25 pz	 8 003736125483 NE38P / 783 - SILCA PER NEIMAN®  CHIAVE ACCIAIO 25 pz	 8 003736125544 NE40P / 783 - SILCA PER NEIMAN®  CHIAVE ACCIAIO 25 pz	 8 003736125667 NE44 / 783 - SILCA PER NEIMAN®  CHIAVE ACCIAIO 50 pz
 8 003736125858 NE5 / 783 - SILCA PER NEIMAN®  CHIAVE ACCIAIO 50 pz	 8 003736125957 NE51P / 783 - SILCA PER NEIMAN®  CHIAVE ACCIAIO 25 pz	 8 003736126152 NE55AP / 783 - SILCA PER NEIMAN®  CHIAVE ACCIAIO 25 pz	 8 003736126176 NE55DP / 783 - SILCA PER NEIMAN®  CHIAVE ACCIAIO 25 pz	 8 003736126190 NE55FP / 783 - SILCA PER NEIMAN®  CHIAVE ACCIAIO 25 pz

In conformità alle disposizioni legali in vigore relative alle proprietà industriali, informiamo che i marchi o le denominazioni commerciali citate nel nostro documento sono di proprietà esclusiva dei fabbricanti di serrature e degli utilizzatori autorizzati. Questi marchi o denominazioni commerciali sono indicati a titolo di semplice informazione, con lo scopo di riconoscere velocemente a quali serrature le nostre chiavi sono destinate. Questo documento è esclusivamente riservato ai professionisti della riproduzione chiavi che utilizzano i prodotti Silca. / Le illustrazioni e i dati tecnici dei prodotti contenuti nel documento debbono considerarsi indicativi. Silca si riserva il diritto, ferme restando le caratteristiche essenziali dei prodotti, di apportare tutte le modifiche che ritiene necessarie e opportune al fine di migliorare la qualità dei prodotti. Tutti i disegni e le fotografie sono di proprietà di Silca, ogni riproduzione anche parziale, senza autorizzazione scritta di Silca S.p.A. è vietata secondo termini di legge. Per qualsiasi controversia competenti sono gli Uffici Giudiziari dove ha sede l'Azienda Silca S.p.A., con espressa esclusione di qualsiasi altro foro.

































 8 003736126213 NE55P / 783 - SILCA PER NEIMAN®  CHIAVE ACCIAIO 25 pz	 8 003736125872 NE5P / 783 - SILCA PER NEIMAN®  CHIAVE ACCIAIO 25 pz	 8 003736126602 NE66P / 783 - SILCA PER NEIMAN®  CHIAVE OTTONE 25 pz	 8 003737805438 NE66T2 / 783 - SILCA PER NEIMAN®  CHIAVE TRANSPONDER OTTONE 1 pz	 8 003736126701 NE7 / 783 - SILCA PER NEIMAN®  CHIAVE ACCIAIO 50 pz
 8 003736126763 NE71RDP / 783 - SILCA PER NEIMAN®  CHIAVE ACCIAIO 25 pz	 8 003736126794 NE72 / 783 - SILCA PER NEIMAN®  CHIAVE ACCIAIO 50 pz	 8 003737490443 NE72AT14 / 783 - SILCA PER VALEO®  CHIAVE TRANSPONDER OTTONE 1 pz	 8 003737743501 NE72AT29 / 783 - SILCA PER NEIMAN®  CHIAVE TRANSPONDER OTTONE 1 pz	 8 003737805407 NE72AT5 / 783 - SILCA PER VALEO®  CHIAVE TRANSPONDER OTTONE 1 pz
 8 003736126893 NE72DP / 783 - SILCA PER NEIMAN®  CHIAVE ACCIAIO 25 pz	 8 003736126923 NE72FP / 783 - SILCA PER NEIMAN®  CHIAVE ACCIAIO 25 pz	 8 003736126947 NE72KP / 783 - SILCA PER NEIMAN®  CHIAVE ACCIAIO 25 pz	 8 003736127050 NE73DP / 783 - SILCA PER NEIMAN®  CHIAVE ACCIAIO 25 pz	 8 003737512411 NE73T5 / 783 - SILCA PER NEIMAN®  CHIAVE TRANSPONDER S/CHIP- C/TAPPO 5 pz

In conformità alle disposizioni legali in vigore relative alle proprietà industriali, informiamo che i marchi o le denominazioni commerciali citate nel nostro documento sono di proprietà esclusiva dei fabbricanti di serrature e degli utilizzatori autorizzati. Questi marchi o denominazioni commerciali sono indicati a titolo di semplice informazione, con lo scopo di riconoscere velocemente a quali serrature le nostre chiavi sono destinate. Questo documento è esclusivamente riservato ai professionisti della riproduzione chiavi che utilizzano i prodotti Silca. / Le illustrazioni e i dati tecnici dei prodotti contenuti nel documento debbono considerarsi indicativi. Silca si riserva il diritto, ferme restando le caratteristiche essenziali dei prodotti, di apportare tutte le modifiche che ritiene necessarie e opportune al fine di migliorare la qualità dei prodotti. Tutti i disegni e le fotografie sono di proprietà di Silca, ogni riproduzione anche parziale, senza autorizzazione scritta di Silca S.p.A. è vietata secondo termini di legge. Per qualsiasi controversia competenti sono gli Uffici Giudiziari dove ha sede l'Azienda Silca S.p.A., con espressa esclusione di qualsiasi altro foro.

































DUPLICATRICI-CHIAVI-RADIOCOMANDI

 8 0 0 3 7 3 7 3 5 2 6 2 8 NE73T8 / 783 - SILCA PER NEIMAN®  CHIAVE TRANSPONDER OTTONE 1 pz	 8 0 0 3 7 3 6 1 2 7 0 7 4 NE74P / 783 - SILCA PER NEIMAN®  CHIAVE ACCIAIO 25 pz	 8 0 0 3 7 3 7 8 0 6 2 5 1 NE74T5 / 783 - SILCA PER NEIMAN®  CHIAVE TRANSPONDER OTTONE 1 pz	 8 0 0 3 7 3 6 1 2 7 0 9 8 NE75EP / 783 - SILCA PER NEIMAN®  CHIAVE ACCIAIO 25 pz	 8 0 0 3 7 3 7 2 4 3 9 7 1 NE77RDP / 783 - SILCA PER NEIMAN®  CHIAVE ACCIAIO 25 pz
 8 0 0 3 7 3 7 8 0 6 2 7 5 NE77RT2 / 783 - SILCA PER NEIMAN®  CHIAVE TRANSPONDER OTTONE 1 pz	 8 0 0 3 7 3 7 7 4 5 5 4 3 NE78T29 / 783 - SILCA PER NEIMAN®  CHIAVE TRANSPONDER OTTONE 1 pz	 8 0 0 3 7 3 6 1 2 7 9 5 1 NS4 / 783 - SILCA PER HUF®  CHIAVE ACCIAIO 50 pz	 8 0 0 3 7 3 6 1 2 7 5 2 4 NSN11BP / 783 - SILCA PER NISSAN®  CHIAVE ACCIAIO 25 pz	 8 0 0 3 7 3 7 4 3 8 1 2 4 NSN11T13 / 783 - SILCA PER NISSAN®  CHIAVE TRANSPONDER OTTONE 1 pz
 8 0 0 3 7 3 7 8 0 7 1 0 4 NSN11T2 / 783 - SILCA PER NISSAN®  CHIAVE TRANSPONDER OTTONE 1 pz	 8 0 0 3 7 3 7 7 1 4 5 9 4 NSN11T25 / 783 - SILCA PER NISSAN®  CHIAVE TRANSPONDER OTTONE 1 pz	 8 0 0 3 7 3 7 6 6 2 2 0 8 NSN14CP / 783 - SILCA PER NISSAN®  CHIAVE ACCIAIO 25 pz	 8 0 0 3 7 3 7 6 8 6 5 0 1 NSN14T14 / 783 - SILCA PER NISSAN®  CHIAVE TRANSPONDER OTTONE 1 pz	 8 0 0 3 7 3 7 7 1 4 6 2 4 NSN14T25 / 783 - SILCA PER NISSAN®  CHIAVE TRANSPONDER OTTONE 1 pz

In conformità alle disposizioni legali in vigore relative alle proprietà industriali, informiamo che i marchi o le denominazioni commerciali citate nel nostro documento sono di proprietà esclusiva dei fabbricanti di serrature e degli utilizzatori autorizzati. Questi marchi o denominazioni commerciali sono indicati a titolo di semplice informazione, con lo scopo di riconoscere velocemente a quali serrature le nostre chiavi sono destinate. Questo documento è esclusivamente riservato ai professionisti della riproduzione chiavi che utilizzano i prodotti Silca. / Le illustrazioni e i dati tecnici dei prodotti contenuti nel documento debbono considerarsi indicativi. Silca si riserva il diritto, ferme restando le caratteristiche essenziali dei prodotti, di apportare tutte le modifiche che ritiene necessarie e opportune al fine di migliorare la qualità dei prodotti. Tutti i disegni e le fotografie sono di proprietà di Silca, ogni riproduzione anche parziale, senza autorizzazione scritta di Silca S.p.A. è vietata secondo termini di legge. Per qualsiasi controversia competenti sono gli Uffici Giudiziari dove ha sede l'Azienda Silca S.p.A., con espressa esclusione di qualsiasi altro foro.



 8 003737805858 NSN14T5 / 783 - SILCA PER NISSAN®  CHIAVE TRANSPONDER OTTONE 1 pz	 8 003737686204 NSN19T13 / 783 - SILCA PER NISSAN®  CHIAVE TRANSPONDER OTTONE 1 pz	 8 003737705394 NSN19T21 / 783 - SILCA PER NISSAN®  CHIAVE TRANSPONDER OTTONE 1 pz	 8 003736129399 OM1 / 783 - SILCA PER BOSCH®  CHIAVE FERRO 50 pz	 8 003736131408 PF1P / 783 - SILCA PER PREFER®  CHIAVE ACCIAIO 25 pz
 8 003736909175 PO1RT4 / 783 - SILCA PER PROTON®  CHIAVE TRANSPONDER OTTONE 1 pz	 8 003736136205 PW1P / 783 - SILCA PER DOM®  CHIAVE ACCIAIO 25 pz	 8 003737762038 RC5 / 783 - SILCA PER CINA®  CHIAVE ACCIAIO 100 pz	 8 003736138315 R010 / 783 - SILCA PER RONIS®  CHIAVE ACCIAIO 50 pz	 8 003736138339 R010R / 783 - SILCA PER RONIS®  CHIAVE ACCIAIO 50 pz
 8 003736138988 R032R / 783 - SILCA PER RONIS®  CHIAVE ACCIAIO 50 pz	 8 003736844902 R032RP / 783 - SILCA PER RONIS®  CHIAVE OTTONE 25 pz	 8 003736139824 R05R / 783 - SILCA PER RONIS®  CHIAVE ACCIAIO 50 pz	 8 003736140905 RT2P / 783 - SILCA PER ROOTES®  CHIAVE ACCIAIO 25 pz	 8 003736146907 SIP10 / 783 - SILCA PER TRW SIPEA®  CHIAVE ACCIAIO 50 pz

In conformità alle disposizioni legali in vigore relative alle proprietà industriali, informiamo che i marchi o le denominazioni commerciali citate nel nostro documento sono di proprietà esclusiva dei fabbricanti di serrature e degli utilizzatori autorizzati. Questi marchi o denominazioni commerciali sono indicati a titolo di semplice informazione, con lo scopo di riconoscere velocemente a quali serrature le nostre chiavi sono destinate. Questo documento è esclusivamente riservato ai professionisti della riproduzione chiavi che utilizzano i prodotti Silca. / Le illustrazioni e i dati tecnici dei prodotti contenuti nel documento debbono considerarsi indicativi. Silca si riserva il diritto, ferme restando le caratteristiche essenziali dei prodotti, di apportare tutte le modifiche che ritiene necessarie e opportune al fine di migliorare la qualità dei prodotti. Tutti i disegni e le fotografie sono di proprietà di Silca, ogni riproduzione anche parziale, senza autorizzazione scritta di Silca S.p.A. è vietata secondo termini di legge. Per qualsiasi controversia competenti sono gli Uffici Giudiziari dove ha sede l'Azienda Silca S.p.A., con espressa esclusione di qualsiasi altro foro.































DUPLICATRICI-CHIAVI-RADIOCOMANDI

 8 003736146914 SIP10R / 783 - SILCA PER TRW SIPEA®  CHIAVE ACCIAIO 50 pz	 8 003736147065 SIP2 / 783 - SILCA PER TRW SIPEA®  CHIAVE ACCIAIO 50 pz	 8 003737805674 SIP22T5 / 783 - SILCA PER TRW SIPEA®  CHIAVE TRANSPONDER OTTONE 1 pz	 8 003736147089 SIP2AP / 783 - SILCA PER TRW SIPEA®  CHIAVE ACCIAIO 25 pz	 8 003736147126 SIP2DP / 783 - SILCA PER TRW SIPEA®  CHIAVE ACCIAIO 25 pz
 8 003736147171 SIP2P / 783 - SILCA PER TRW SIPEA®  CHIAVE ACCIAIO 25 pz	 8 003736147294 SIP5 / 783 - SILCA PER TRW SIPEA®  CHIAVE ACCIAIO 50 pz	 8 003736147386 SIP9 / 783 - SILCA PER TRW SIPEA®  CHIAVE ACCIAIO 50 pz	 8 003736147393 SIP9R / 783 - SILCA PER TRW SIPEA®  CHIAVE ACCIAIO 50 pz	 8 003737805650 SK22RT1 / 783 - SILCA PER FAB®  CHIAVE TRANSPONDER OTTONE 1 pz
 8 003736149403 SSA1R / 783 - SILCA PER SISPA®  CHIAVE ACCIAIO 50 pz	 8 003736149427 SSA2R / 783 - SILCA PER SISPA®  CHIAVE ACCIAIO 50 pz	 8 003736149441 SSA3R / 783 - SILCA PER SISPA®  CHIAVE ACCIAIO 50 pz	 8 003736149465 SSA4R / 783 - SILCA PER SISPA®  CHIAVE ACCIAIO 50 pz	 8 003736460812 SSA4RAP / 783 - SILCA PER SISPA®  CHIAVE ACCIAIO 25 pz

In conformità alle disposizioni legali in vigore relative alle proprietà industriali, informiamo che i marchi o le denominazioni commerciali citate nel nostro documento sono di proprietà esclusiva dei fabbricanti di serrature e degli utilizzatori autorizzati. Questi marchi o denominazioni commerciali sono indicati a titolo di semplice informazione, con lo scopo di riconoscere velocemente a quali serrature le nostre chiavi sono destinate. Questo documento è esclusivamente riservato ai professionisti della riproduzione chiavi che utilizzano i prodotti Silca. / Le illustrazioni e i dati tecnici dei prodotti contenuti nel documento debbono considerarsi indicativi. Silca si riserva il diritto, ferme restando le caratteristiche essenziali dei prodotti, di apportare tutte le modifiche che ritiene necessarie e opportune al fine di migliorare la qualità dei prodotti. Tutti i disegni e le fotografie sono di proprietà di Silca, ogni riproduzione anche parziale, senza autorizzazione scritta di Silca S.p.A. è vietata secondo termini di legge. Per qualsiasi controversia competenti sono gli Uffici Giudiziari dove ha sede l'Azienda Silca S.p.A., con espressa esclusione di qualsiasi altro foro.













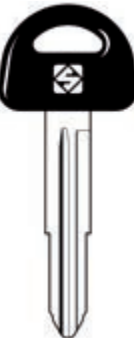















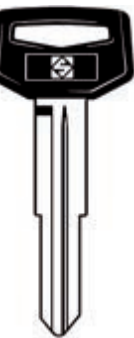

 8 003736149489 SSA4RP / 783 - SILCA PER SISPA®  CHIAVE ACCIAIO 25 pz	 8 003736149502 SSA5 / 783 - SILCA PER SISPA®  CHIAVE ACCIAIO 50 pz	 8 003736149526 SSA5R / 783 - SILCA PER SISPA®  CHIAVE ACCIAIO 50 pz	 8 003736851603 SSA6RP / 783 - SILCA PER SISPA®  CHIAVE OTTONE 25 pz	 8 003736151840 SX6GP / 783 - SILCA PER SIMPLEX®  CHIAVE ACCIAIO 25 pz
 8 003736151857 SX6P / 783 - SILCA PER SIMPLEX®  CHIAVE ACCIAIO 25 pz	 8 003736152069 SX9AP / 783 - SILCA PER SIMPLEX®  CHIAVE ALPACCA 25 pz	 8 003736862494 SX9GP / 783 - SILCA PER SIMPLEX®  CHIAVE ALPACCA 25 pz	 8 003737467254 SX9T14 / 783 - SILCA PER SIMPLEX®  CHIAVE TRANSPONDER ALPACCA 1 pz	 8 003736418608 SX9T5 / 783 - SILCA PER SIMPLEX®  CHIAVE TRANSPONDER S/CHIP- C/TAPPI 5 pz
 8 003737352635 SX9T6 / 783 - SILCA PER SIMPLEX®  CHIAVE TRANSPONDER ALPACCA 1 pz	 8 003736152137 SZ10RP / 783 - SILCA PER SUZUKI®  CHIAVE ACCIAIO 25 pz	 8 003736152229 SZ11RP / 783 - SILCA PER SUZUKI®  CHIAVE ACCIAIO 25 pz	 8 003737640725 SZ11RT18 / 783 - SILCA PER SUZUKI®  CHIAVE TRANSPONDER OTTONE 1 pz	 8 003737489461 SZ11RT4 / 783 - SILCA PER SUZUKI®  CHIAVE TRANSPONDER OTTONE 1 pz

In conformità alle disposizioni legali in vigore relative alle proprietà industriali, informiamo che i marchi o le denominazioni commerciali citate nel nostro documento sono di proprietà esclusiva dei fabbricanti di serrature e degli utilizzatori autorizzati. Questi marchi o denominazioni commerciali sono indicati a titolo di semplice informazione, con lo scopo di riconoscere velocemente a quali serrature le nostre chiavi sono destinate. Questo documento è esclusivamente riservato ai professionisti della riproduzione chiavi che utilizzano i prodotti Silca. / Le illustrazioni e i dati tecnici dei prodotti contenuti nel documento debbono considerarsi indicativi. Silca si riserva il diritto, ferme restando le caratteristiche essenziali dei prodotti, di apportare tutte le modifiche che ritiene necessarie e opportune al fine di migliorare la qualità dei prodotti. Tutti i disegni e le fotografie sono di proprietà di Silca, ogni riproduzione anche parziale, senza autorizzazione scritta di Silca S.p.A. è vietata secondo termini di legge. Per qualsiasi controversia competenti sono gli Uffici Giudiziari dove ha sede l'Azienda Silca S.p.A., con espressa esclusione di qualsiasi altro foro.





















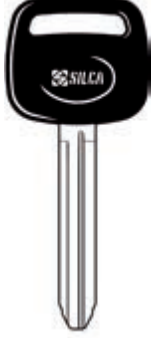







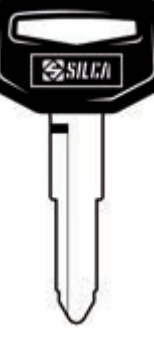

DUPLICATRICI-CHIAVI-RADIOCOMANDI

 8 003737668903 SZ11T18 / 783 - SILCA PER SUZUKI®  CHIAVE TRANSPONDER OTTONE 1 pz	 8 003736152274 SZ12P / 783 - SILCA PER SUZUKI®  CHIAVE ACCIAIO 25 pz	 8 003736852822 SZ14RAP / 783 - SILCA PER SUZUKI®  CHIAVE ACCIAIO 25 pz	 8 003736152397 SZ4P / 783 - SILCA PER SUZUKI®  CHIAVE ACCIAIO 25 pz	 8 003736152458 SZ4RP / 783 - SILCA PER SUZUKI®  CHIAVE ACCIAIO 25 pz
 8 003736152496 SZ5P / 783 - SILCA PER SUZUKI®  CHIAVE ACCIAIO 25 pz	 8 003736152656 SZ8RP / 783 - SILCA PER SUZUKI®  CHIAVE ACCIAIO 25 pz	 8 003736156524 TOY19 / 783 - SILCA PER TOYOTA®  CHIAVE ACCIAIO 50 pz	 8 003736157002 TOY27RP / 783 - SILCA PER TOYOTA®  CHIAVE OTTONE 25 pz	 8 003736157637 TOY36P / 783 - SILCA PER TOYOTA®  CHIAVE ACCIAIO 25 pz
 8 003736845190 TOY37AP / 783 - SILCA PER TOYOTA®  CHIAVE OTTONE 25 pz	 8 003736157736 TOY37P / 783 - SILCA PER TOYOTA®  CHIAVE ACCIAIO 25 pz	 8 003736157873 TOY38RP / 783 - SILCA PER TOYOTA®  CHIAVE ACCIAIO 25 pz	 8 003736157347 TOY3R / 783 - SILCA PER TOYOTA®  CHIAVE ACCIAIO 50 pz	 8 003737489485 TOY40BT4 / 783 - SILCA PER TOYOTA®  CHIAVE TRANSPONDER OTTONE 1 pz

In conformità alle disposizioni legali in vigore relative alle proprietà industriali, informiamo che i marchi o le denominazioni commerciali citate nel nostro documento sono di proprietà esclusiva dei fabbricanti di serrature e degli utilizzatori autorizzati. Questi marchi o denominazioni commerciali sono indicati a titolo di semplice informazione, con lo scopo di riconoscere velocemente a quali serrature le nostre chiavi sono destinate. Questo documento è esclusivamente riservato ai professionisti della riproduzione chiavi che utilizzano i prodotti Silca. / Le illustrazioni e i dati tecnici dei prodotti contenuti nel documento debbono considerarsi indicativi. Silca si riserva il diritto, ferme restando le caratteristiche essenziali dei prodotti, di apportare tutte le modifiche che ritiene necessarie e opportune al fine di migliorare la qualità dei prodotti. Tutti i disegni e le fotografie sono di proprietà di Silca, ogni riproduzione anche parziale, senza autorizzazione scritta di Silca S.p.A. è vietata secondo termini di legge. Per qualsiasi controversia competenti sono gli Uffici Giudiziari dove ha sede l'Azienda Silca S.p.A., con espressa esclusione di qualsiasi altro foro.





























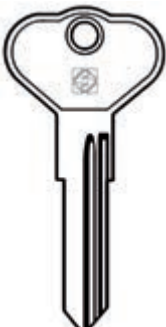

 8 003737489508 TOY41RAT4 / 783 - SILCA PER TOYOTA®  CHIAVE TRANSPONDER OTTONE 1 pz	 8 003736158368 TOY41RP / 783 - SILCA PER TOYOTA®  CHIAVE ACCIAIO 25 pz	 8 003737489515 TOY41RT4 / 783 - SILCA PER TOYOTA®  CHIAVE TRANSPONDER OTTONE 1 pz	 8 003737763349 TOY43AT31 / 783 - SILCA PER TOYOTA®  CHIAVE TRANSPONDER OTTONE 1 pz	 8 003737489522 TOY43AT4 / 783 - SILCA PER TOYOTA®  CHIAVE TRANSPONDER OTTONE 1 pz
 8 003736158443 TOY43P / 783 - SILCA PER TOYOTA®  CHIAVE ACCIAIO 25 pz	 8 003736158528 TOY46RP / 783 - SILCA PER TOYOTA®  CHIAVE ACCIAIO 25 pz	 8 003736802766 TOY47BP / 783 - SILCA PER TOYOTA®  CHIAVE ACCIAIO 25 pz	 8 003737710213 TOY47T16 / 783 - SILCA PER TOYOTA®  CHIAVE TRANSPONDER OTTONE 1 pz	 8 003737489539 TOY47T4 / 783 - SILCA PER TOYOTA®  CHIAVE TRANSPONDER OTTONE 1 pz
 8 003737489546 TOY48BT4 / 783 - SILCA PER TOYOTA®  CHIAVE TRANSPONDER ALPACCA 1 pz	 8 003736158078 TOY4BP / 783 - SILCA PER TOYOTA®  CHIAVE ACCIAIO 25 pz	 8 003736158191 TOY4RBP / 783 - SILCA PER TOYOTA®  CHIAVE ACCIAIO 25 pz	 8 003736158214 TOY4RCP / 783 - SILCA PER TOYOTA®  CHIAVE ACCIAIO 25 pz	 8 003736171145 UNI1 / 783 - SILCA PER UNION®  CHIAVE ACCIAIO 50 pz

In conformità alle disposizioni legali in vigore relative alle proprietà industriali, informiamo che i marchi o le denominazioni commerciali citate nel nostro documento sono di proprietà esclusiva dei fabbricanti di serrature e degli utilizzatori autorizzati. Questi marchi o denominazioni commerciali sono indicati a titolo di semplice informazione, con lo scopo di riconoscere velocemente a quali serrature le nostre chiavi sono destinate. Questo documento è esclusivamente riservato ai professionisti della riproduzione chiavi che utilizzano i prodotti Silca. / Le illustrazioni e i dati tecnici dei prodotti contenuti nel documento debbono considerarsi indicativi. Silca si riserva il diritto, ferme restando le caratteristiche essenziali dei prodotti, di apportare tutte le modifiche che ritiene necessarie e opportune al fine di migliorare la qualità dei prodotti. Tutti i disegni e le fotografie sono di proprietà di Silca, ogni riproduzione anche parziale, senza autorizzazione scritta di Silca S.p.A. è vietata secondo termini di legge. Per qualsiasi controversia competenti sono gli Uffici Giudiziari dove ha sede l'Azienda Silca S.p.A., con espressa esclusione di qualsiasi altro foro.

































DUPLICATRICI-CHIAVI-RADIOCOMANDI

 8 003736171237 UNI11A / 783 - SILCA PER UNION®  CHIAVE ACCIAIO 50 pz	 8 003736173507 UNI8 / 783 - SILCA PER UNION®  CHIAVE ACCIAIO 50 pz	 8 003737494748 VA2T14 / 783 - SILCA PER VALEO®  CHIAVE TRANSPONDER ALPACCA 1 pz	 8 003736174016 VAC102DP / 783 - SILCA PER VACHETTE®  CHIAVE ACCIAIO 25 pz	 8 003736845145 VAC102GP / 783 - SILCA PER VACHETTE®  CHIAVE OTTONE - BLU 25 pz
 8 003737422888 VAC102T1 / 783 - SILCA PER VACHETTE®  CHIAVE TRANSPONDER S/CHIP- C/TAPPO 5 pz	 8 003737754729 VAC102T32 / 783 - SILCA PER VACHETTE®  CHIAVE TRANSPONDER OTTONE 1 pz	 8 003736174092 VAC12 / 783 - SILCA PER VACHETTE®  CHIAVE ACCIAIO 50 pz	 8 003736181731 V010 / 783 - SILCA PER HUF®  CHIAVE ACCIAIO 50 pz	 8 003736181755 V010P / 783 - SILCA PER HUF®  CHIAVE ACCIAIO 25 pz
 8 003736181861 V013 / 783 - SILCA PER HUF®  CHIAVE ACCIAIO 50 pz	 8 003736181885 V013P / 783 - SILCA PER WITTE®  CHIAVE ACCIAIO 25 pz	 8 003736182370 V09P / 783 - SILCA PER WITTE®  CHIAVE ACCIAIO 25 pz	 8 003737715393 WGU1 / 783 - SILCA PER WANGUAN®  CHIAVE ACCIAIO 50 pz	 8 003736845107 W01REP / 783 - SILCA PER WEPOO®  CHIAVE OTTONE 25 pz

In conformità alle disposizioni legali in vigore relative alle proprietà industriali, informiamo che i marchi o le denominazioni commerciali citate nel nostro documento sono di proprietà esclusiva dei fabbricanti di serrature e degli utilizzatori autorizzati. Questi marchi o denominazioni commerciali sono indicati a titolo di semplice informazione, con lo scopo di riconoscere velocemente a quali serrature le nostre chiavi sono destinate. Questo documento è esclusivamente riservato ai professionisti della riproduzione chiavi che utilizzano i prodotti Silca. / Le illustrazioni e i dati tecnici dei prodotti contenuti nel documento debbono considerarsi indicativi. Silca si riserva il diritto, ferme restando le caratteristiche essenziali dei prodotti, di apportare tutte le modifiche che ritiene necessarie e opportune al fine di migliorare la qualità dei prodotti. Tutti i disegni e le fotografie sono di proprietà di Silca, ogni riproduzione anche parziale, senza autorizzazione scritta di Silca S.p.A. è vietata secondo termini di legge. Per qualsiasi controversia competenti sono gli Uffici Giudiziari dove ha sede l'Azienda Silca S.p.A., con espressa esclusione di qualsiasi altro foro.



















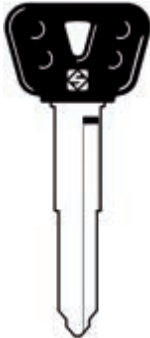











 8 003736190504 W01RP / 783 - SILCA PER WEP00®  CHIAVE OTTONE 25 pz	 8 003736492707 Y160-PT / 783 - SILCA PER CHRYSLER®  CHIAVE TRANSPONDER OTTONE 5 pz	 8 003737699303 Y164-PT / 783 - SILCA PER CHRYSLER®  CHIAVE TRANSPONDER OTTONE 5 pz	 8 003736200333 YH28BP / 783 - SILCA PER YAMAHA®  CHIAVE ACCIAIO 25 pz	 8 003736200340 YH28BP / 783 - SILCA PER YAMAHA®  CHIAVE OTTONE 25 pz
 8 003736200357 YH28P / 783 - SILCA PER YAMAHA®  CHIAVE ACCIAIO 25 pz	 8 003736200432 YH28RP / 783 - SILCA PER YAMAHA®  CHIAVE ACCIAIO 25 pz	 8 003736200517 YH29P / 783 - SILCA PER YAMAHA®  CHIAVE ACCIAIO 25 pz	 8 003736200593 YH29RP / 783 - SILCA PER YAMAHA®  CHIAVE ACCIAIO 25 pz	 8 003736200715 YH30P / 783 - SILCA PER YAMAHA®  CHIAVE ACCIAIO 25 pz
 8 003736200760 YH30RAP / 783 - SILCA PER YAMAHA®  CHIAVE OTTONE 25 pz	 8 003736200777 YH30RBP / 783 - SILCA PER YAMAHA®  CHIAVE ACCIAIO 25 pz	 8 003736200791 YH30RP / 783 - SILCA PER YAMAHA®  CHIAVE ACCIAIO 25 pz	 8 003736200838 YH31RAP / 783 - SILCA PER YAMAHA®  CHIAVE ACCIAIO 25 pz	 8 003736200852 YH31RBP / 783 - SILCA PER YAMAHA®  CHIAVE ACCIAIO 25 pz

In conformità alle disposizioni legali in vigore relative alle proprietà industriali, informiamo che i marchi o le denominazioni commerciali citate nel nostro documento sono di proprietà esclusiva dei fabbricanti di serrature e degli utilizzatori autorizzati. Questi marchi o denominazioni commerciali sono indicati a titolo di semplice informazione, con lo scopo di riconoscere velocemente a quali serrature le nostre chiavi sono destinate. Questo documento è esclusivamente riservato ai professionisti della riproduzione chiavi che utilizzano i prodotti Silca. / Le illustrazioni e i dati tecnici dei prodotti contenuti nel documento debbono considerarsi indicativi. Silca si riserva il diritto, ferme restando le caratteristiche essenziali dei prodotti, di apportare tutte le modifiche che ritiene necessarie e opportune al fine di migliorare la qualità dei prodotti. Tutti i disegni e le fotografie sono di proprietà di Silca, ogni riproduzione anche parziale, senza autorizzazione scritta di Silca S.p.A. è vietata secondo termini di legge. Per qualsiasi controversia competenti sono gli Uffici Giudiziari dove ha sede l'Azienda Silca S.p.A., con espressa esclusione di qualsiasi altro foro.























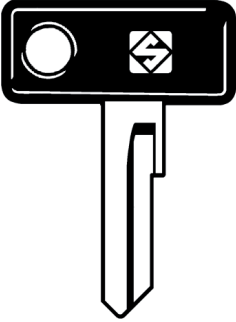







DUPLICATRICI-CHIAVI-RADIOCOMANDI

 8 003 736 200 937 YH33RP / 783 - SILCA PER YAMAHA®  CHIAVE ACCIAIO 25 pz	 8 003 736 200 951 YH34P / 783 - SILCA PER YAMAHA®  CHIAVE ACCIAIO 25 pz	 8 003 736 200 968 YH34RP / 783 - SILCA PER YAMAHA®  CHIAVE ACCIAIO 25 pz	 8 003 737 499 002 YH35 / 783 - SILCA PER YAMAHA®  CHIAVE OTTONE 50 pz	 8 003 737 686 495 YH35BP / 783 - SILCA PER YAMAHA®  CHIAVE ACCIAIO 25 pz
 8 003 737 424 882 YH35R / 783 - SILCA PER YAMAHA®  CHIAVE OTTONE 50 pz	 8 003 737 703 178 YH35RAT22 / 783 - SILCA PER YAMAHA®  CHIAVE TRANSPONDER OTTONE 1 pz	 8 003 736 200 975 YH35RBP / 783 - SILCA PER YAMAHA®  CHIAVE ACCIAIO 25 pz	 8 003 736 201 446 YM15 / 783 - SILCA PER YMOS®  CHIAVE ACCIAIO 50 pz	 8 003 736 201 460 YM15P / 783 - SILCA PER YMOS®  CHIAVE ACCIAIO 25 pz
 8 003 737 804 493 YM15T5 / 783 - SILCA PER YMOS®  CHIAVE TRANSPONDER OTTONE 1 pz	 8 003 736 201 927 YM22AP / 783 - SILCA PER YMOS®  CHIAVE ACCIAIO 25 pz	 8 003 736 201 989 YM23P / 783 - SILCA PER YMOS®  CHIAVE ACCIAIO 25 pz	 8 003 736 202 139 YM28 / 783 - SILCA PER YMOS®  CHIAVE ACCIAIO 50 pz	 8 003 736 202 153 YM28P / 783 - SILCA PER YMOS®  CHIAVE ACCIAIO 25 pz

In conformità alle disposizioni legali in vigore relative alle proprietà industriali, informiamo che i marchi o le denominazioni commerciali citate nel nostro documento sono di proprietà esclusiva dei fabbricanti di serrature e degli utilizzatori autorizzati. Questi marchi o denominazioni commerciali sono indicati a titolo di semplice informazione, con lo scopo di riconoscere velocemente a quali serrature le nostre chiavi sono destinate. Questo documento è esclusivamente riservato ai professionisti della riproduzione chiavi che utilizzano i prodotti Silca. / Le illustrazioni e i dati tecnici dei prodotti contenuti nel documento debbono considerarsi indicativi. Silca si riserva il diritto, ferme restando le caratteristiche essenziali dei prodotti, di apportare tutte le modifiche che ritiene necessarie e opportune al fine di migliorare la qualità dei prodotti. Tutti i disegni e le fotografie sono di proprietà di Silca, ogni riproduzione anche parziale, senza autorizzazione scritta di Silca S.p.A. è vietata secondo termini di legge. Per qualsiasi controversia competenti sono gli Uffici Giudiziari dove ha sede l'Azienda Silca S.p.A., con espressa esclusione di qualsiasi altro foro.

























 8 003737805094 YM28T2 / 783 - SILCA PER YMOS®  CHIAVE TRANSPONDER OTTONE 1 pz	 8 003736202283 YM30P / 783 - SILCA PER YMOS®  CHIAVE OTTONE 25 pz	 8 003737805117 YM30T5 / 783 - SILCA PER YMOS®  CHIAVE TRANSPONDER OTTONE 1 pz	 8 003737701938 YW1P / 783 - SILCA PER YWS®  CHIAVE OTTONE 25 pz	 8 003736204126 ZD10P / 783 - SILCA PER ZADI®  CHIAVE ACCIAIO 25 pz
 8 003736204140 ZD11 / 783 - SILCA PER ZADI®  CHIAVE ACCIAIO 50 pz	 8 003736204171 ZD11P / 783 - SILCA PER ZADI®  CHIAVE OTTONE 25 pz	 8 003736204201 ZD13R / 783 - SILCA PER ZADI®  CHIAVE ACCIAIO 50 pz	 8 003736204225 ZD14RP / 783 - SILCA PER ZADI®  CHIAVE ACCIAIO 25 pz	 8 003736204270 ZD16RP / 783 - SILCA PER ZADI®  CHIAVE ACCIAIO 25 pz
 8 003736204294 ZD17RAP / 783 - SILCA PER ZADI®  CHIAVE ACCIAIO 25 pz	 8 003736470415 ZD18EP / 783 - SILCA PER ZADI®  CHIAVE OTTONE 25 pz	 8 003737585385 ZD18R / 783 - SILCA PER ZADI®  CHIAVE ACCIAIO 50 pz	 8 003736852198 ZD21P / 783 - SILCA PER ZADI®  CHIAVE OTTONE 25 pz	 8 003736494497 ZD22RBP / 783 - SILCA PER ZADI®  CHIAVE ACCIAIO 25 pz

In conformità alle disposizioni legali in vigore relative alle proprietà industriali, informiamo che i marchi o le denominazioni commerciali citate nel nostro documento sono di proprietà esclusiva dei fabbricanti di serrature e degli utilizzatori autorizzati. Questi marchi o denominazioni commerciali sono indicati a titolo di semplice informazione, con lo scopo di riconoscere velocemente a quali serrature le nostre chiavi sono destinate. Questo documento è esclusivamente riservato ai professionisti della riproduzione chiavi che utilizzano i prodotti Silca. / Le illustrazioni e i dati tecnici dei prodotti contenuti nel documento debbono considerarsi indicativi. Silca si riserva il diritto, ferme restando le caratteristiche essenziali dei prodotti, di apportare tutte le modifiche che ritiene necessarie e opportune al fine di migliorare la qualità dei prodotti. Tutti i disegni e le fotografie sono di proprietà di Silca, ogni riproduzione anche parziale, senza autorizzazione scritta di Silca S.p.A. è vietata secondo termini di legge. Per qualsiasi controversia competenti sono gli Uffici Giudiziari dove ha sede l'Azienda Silca S.p.A., con espressa esclusione di qualsiasi altro foro.

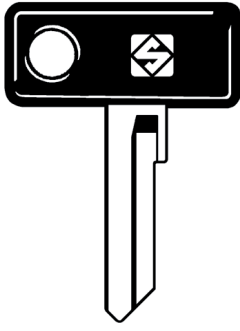

DUPLICATRICI-CHIAVI-RADIOCOMANDI

 8 003737674010 ZD23RBP / 783 - SILCA PER ZADI®  CHIAVE ACCIAIO 25 pz	 8 003736295865 ZD23RCP / 783 - SILCA PER ZADI®  CHIAVE OTTONE - BLU 25 pz	 8 003737805131 ZD23RT5 / 783 - SILCA PER ZADI®  CHIAVE TRANSPONDER OLC T.BLU 1 pz	 8 003737703154 ZD24RAT22 / 783 - SILCA PER ZADI®  CHIAVE TRANSPONDER OTTONE 1 pz	 8 003737637046 ZD24RDP / 783 - SILCA PER ZADI®  CHIAVE ACCIAIO 25 pz
 8 003737805179 ZD24RT5 / 783 - SILCA PER ZADI®  CHIAVE TRANSPONDER OLC T.BLU 1 pz	 8 003737353243 ZD26R / 783 - SILCA PER ZADI®  CHIAVE OTTONE 50 pz	 8 003737431385 ZD28RFP / 783 - SILCA PER ZADI®  CHIAVE OTTONE 25 pz	 8 003737805193 ZD30T5 / 783 - SILCA PER ZADI®  CHIAVE TRANSPONDER OTTONE 1 pz	 8 003736204423 ZD7 / 783 - SILCA PER ZADI®  CHIAVE ACCIAIO 50 pz
 8 003736204454 ZD9 / 783 - SILCA PER ZADI®  CHIAVE ACCIAIO 50 pz	 8 003736204485 ZD9P / 783 - SILCA PER ZADI®  CHIAVE ACCIAIO 25 pz			

In conformità alle disposizioni legali in vigore relative alle proprietà industriali, informiamo che i marchi o le denominazioni commerciali citate nel nostro documento sono di proprietà esclusiva dei fabbricanti di serrature e degli utilizzatori autorizzati. Questi marchi o denominazioni commerciali sono indicati a titolo di semplice informazione, con lo scopo di riconoscere velocemente a quali serrature le nostre chiavi sono destinate. Questo documento è esclusivamente riservato ai professionisti della riproduzione chiavi che utilizzano i prodotti Silca. / Le illustrazioni e i dati tecnici dei prodotti contenuti nel documento debbono considerarsi indicativi. Silca si riserva il diritto, ferme restando le caratteristiche essenziali dei prodotti, di apportare tutte le modifiche che ritiene necessarie e opportune al fine di migliorare la qualità dei prodotti. Tutti i disegni e le fotografie sono di proprietà di Silca, ogni riproduzione anche parziale, senza autorizzazione scritta di Silca S.p.A. è vietata secondo termini di legge. Per qualsiasi controversia competenti sono gli Uffici Giudiziari dove ha sede l'Azienda Silca S.p.A., con espressa esclusione di qualsiasi altro foro.



 8 0 5 2 7 8 2 0 0 1 7 1 5 ARRS8 / 783 - SILCA PER ALFA ROMEO®  1 pz	 8 0 0 3 7 3 7 9 1 3 6 6 9 CY24RS10 / 783 - SILCA PER CHRYSLER®  1 pz	 8 0 0 3 7 3 7 8 6 3 9 0 2 CY24RS2 / 783 - SILCA PER CHRYSLER®  KEY SHELL OTTONE - 2 BOTTONI 1 pz	 8 0 0 3 7 3 7 8 6 3 8 9 6 CY24RS8 / 783 - SILCA PER CHRYSLER®  KEY SHELL OTTONE - 3 BOTTONI 1 pz	 8 0 5 2 7 8 2 0 0 2 0 6 4 DAT17BRS8 / 783 - SILCA PER SUBARU®  1 pz
 8 0 0 3 7 3 7 9 1 2 8 5 3 FORS8 / 783 - SILCA PER FORD®  1 pz	 8 0 0 3 7 3 7 9 1 3 5 0 8 FORSA8 / 783 - SILCA PER FORD®  1 pz	 8 0 0 3 7 3 7 8 8 1 5 6 2 GT10RS1 / 783 - SILCA PER TRW SIPEA®  KEY SHELL OTTONE - 1 BOTTONE 1 pz	 8 0 0 3 7 3 7 8 5 5 6 6 2 GT15RARS1 / 783 - SILCA PER TRW SIPEA®  KEY SHELL OTTONE - 1 BOTTONE 1 pz	 8 0 0 3 7 3 7 8 6 5 1 1 1 GT15RRS1 / 783 - SILCA PER TRW SIPEA®  KEY SHELL OTTONE - 1 BOTTONE 1 pz
 8 0 0 3 7 3 7 8 2 2 0 2 2 HON66RS1 / 783 - SILCA PER HONDA®  KEY SHELL OTTONE - 1 BOTTONE 1 pz	 8 0 0 3 7 3 7 8 2 2 0 4 6 HON66RS2 / 783 - SILCA PER HONDA®  KEY SHELL OTTONE - 2 BOTTONI 1 pz	 8 0 0 3 7 3 7 8 2 2 0 6 0 HON66RS3 / 783 - SILCA PER HONDA®  KEY SHELL OTTONE-2 BOTTONI NO SEDE TRP 1 pz	 8 0 0 3 7 3 7 8 2 2 0 7 7 HON66RS4 / 783 - SILCA PER HONDA®  KEY SHELL OTTONE-2 BOTTONI CON SEDE TRP 1 pz	 8 0 0 3 7 3 7 8 2 2 0 8 4 HON66RS5 / 783 - SILCA PER HONDA®  KEY SHELL OTTONE-3 BOTTONI NO SEDE TRP 1 pz

In conformità alle disposizioni legali in vigore relative alle proprietà industriali, informiamo che i marchi o le denominazioni commerciali citate nel nostro documento sono di proprietà esclusiva dei fabbricanti di serrature e degli utilizzatori autorizzati. Questi marchi o denominazioni commerciali sono indicati a titolo di semplice informazione, con lo scopo di riconoscere velocemente a quali serrature le nostre chiavi sono destinate. Questo documento è esclusivamente riservato ai professionisti della riproduzione chiavi che utilizzano i prodotti Silca. / Le illustrazioni e i dati tecnici dei prodotti contenuti nel documento debbono considerarsi indicativi. Silca si riserva il diritto, ferme restando le caratteristiche essenziali dei prodotti, di apportare tutte le modifiche che ritiene necessarie e opportune al fine di migliorare la qualità dei prodotti. Tutti i disegni e le fotografie sono di proprietà di Silca, ogni riproduzione anche parziale, senza autorizzazione scritta di Silca S.p.A. è vietata secondo termini di legge. Per qualsiasi controversia competenti sono gli Uffici Giudiziari dove ha sede l'Azienda Silca S.p.A., con espressa esclusione di qualsiasi altro foro.



DUPLICATRICI-CHIAVI-RADIOCOMANDI

 8 0 0 3 7 3 7 8 2 2 1 9 0 HON66RS6 / 783 - SILCA PER HONDA®  KEY SHELL OTTONE-3 BOTTONI CON SEDE TRP 1 pz	 8 0 0 3 7 3 7 9 1 3 7 0 6 HU100RS2 / 783 - SILCA PER HUF®  1 pz	 8 0 0 3 7 3 7 9 1 3 7 1 3 HU100RS8 / 783 - SILCA PER HUF®  1 pz	 8 0 0 3 7 3 7 9 1 3 6 7 6 HU101ARS8 / 783 - SILCA PER HUF®  1 pz	 8 0 5 2 7 8 2 0 0 1 7 9 1 HU101BRS8 / 783 - SILCA PER HUF®  1 pz
 8 0 5 2 7 8 2 0 1 3 9 3 0 HU101DRS8 / 783 - SILCA PER HUF®  1 pz	 8 0 5 2 7 8 2 0 0 1 7 2 2 HU131RRS8 / 783 - SILCA PER HUF®  1 pz	 8 0 0 3 7 3 7 8 6 4 5 0 3 HU133RDRS1 / 783 - SILCA PER SILCA®  KEY SHELL OTTONE - 1 BOTTONE 1 pz	 8 0 5 2 7 8 2 0 0 2 0 9 5 HU136RS2 / 783 - SILCA PER HUF®  1 pz	 8 0 5 2 7 8 2 0 0 2 1 0 1 HU136RS8 / 783 - SILCA PER HUF®  1 pz
 8 0 5 2 7 8 2 0 1 3 9 8 5 HU188RS11 / 783 - SILCA PER HUF®  1 pz	 8 0 5 2 7 8 2 0 0 1 7 8 4 HU200ARS8 / 783 - SILCA PER HUF®  1 pz	 8 0 0 3 7 3 7 9 1 2 8 6 0 HU200RS2 / 783 - SILCA PER HUF®  1 pz	 8 0 0 3 7 3 7 8 5 6 3 4 8 HU58RS2N / 783 - SILCA PER HUF®  KEY SHELL OLC-2 BOTTONI NO BATTERY HOLD. 1 pz	 8 0 0 3 7 3 7 9 1 3 7 3 7 HU66APRS / 783 - SILCA PER HUF®  1 pz

In conformità alle disposizioni legali in vigore relative alle proprietà industriali, informiamo che i marchi o le denominazioni commerciali citate nel nostro documento sono di proprietà esclusiva dei fabbricanti di serrature e degli utilizzatori autorizzati. Questi marchi o denominazioni commerciali sono indicati a titolo di semplice informazione, con lo scopo di riconoscere velocemente a quali serrature le nostre chiavi sono destinate. Questo documento è esclusivamente riservato ai professionisti della riproduzione chiavi che utilizzano i prodotti Silca. / Le illustrazioni e i dati tecnici dei prodotti contenuti nel documento debbono considerarsi indicativi. Silca si riserva il diritto, ferme restando le caratteristiche essenziali dei prodotti, di apportare tutte le modifiche che ritiene necessarie e opportune al fine di migliorare la qualità dei prodotti. Tutti i disegni e le fotografie sono di proprietà di Silca, ogni riproduzione anche parziale, senza autorizzazione scritta di Silca S.p.A. è vietata secondo termini di legge. Per qualsiasi controversia competenti sono gli Uffici Giudiziari dove ha sede l'Azienda Silca S.p.A., con espressa esclusione di qualsiasi altro foro.



 8 003737863780 HU66ARS8 / 783 - SILCA PER HUF®  KEY SHELL OTTONE - 3 BOTTONI 1 pz	 8 003737912839 HU66BRS8 / 783 - SILCA PER HUF®  1 pz	 8 003737913720 HU66PRS / 783 - SILCA PER HUF®  1 pz	 8 003737923071 HU66R09 / 783 - SILCA PER HUF®  1 pz	 8 003737822732 HU66RS1 / 783 - SILCA PER HUF®  KEY SHELL OTTONE - 1 BOTTONE 1 pz
 8 003737828529 HU66RS2 / 783 - SILCA PER HUF®  KEY SHELL OTTONE - 2 BOTTONI 1 pz	 8 003737822725 HU66RS8 / 783 - SILCA PER HUF®  KEY SHELL OTTONE - 3 BOTTONI 1 pz	 8 003737833653 HU83ARS2 / 783 - SILCA PER HUF®  KEY SHELL ALPACCA - 2 BOTTONI 1 pz	 8 003737847759 HU83ARS2N / 783 - SILCA PER HUF®  KEY SHELL OLC-2 BOTTONI NO BATTERY CONN. 1 pz	 8 003737833677 HU83BRS8 / 783 - SILCA PER HUF®  KEY SHELL OTTONE - 3 BOTTONI 1 pz
 8 003737847766 HU83BRS8N / 783 - SILCA PER HUF®  KEY SHELL OLC-3 BOTTONI NO BATTERY CONN. 1 pz	 8 003737847773 HU83CRS7 / 783 - SILCA PER HUF®  KEY SHELL OTTONE - 4 BOTTONI 1 pz	 8 003737847780 HU83CRS7N / 783 - SILCA PER HUF®  KEY SHELL OLC-4 BOTTONI NO BATTERY CONN. 1 pz	 8 003737833479 HU83RS2 / 783 - SILCA PER HUF®  KEY SHELL ALPACCA - 2 BOTTONI 1 pz	 8 003737822619 HU87RS2 / 783 - SILCA PER HUF®  KEY SHELL OTTONE - 2 BOTTONI 1 pz

In conformità alle disposizioni legali in vigore relative alle proprietà industriali, informiamo che i marchi o le denominazioni commerciali citate nel nostro documento sono di proprietà esclusiva dei fabbricanti di serrature e degli utilizzatori autorizzati. Questi marchi o denominazioni commerciali sono indicati a titolo di semplice informazione, con lo scopo di riconoscere velocemente a quali serrature le nostre chiavi sono destinate. Questo documento è esclusivamente riservato ai professionisti della riproduzione chiavi che utilizzano i prodotti Silca. / Le illustrazioni e i dati tecnici dei prodotti contenuti nel documento debbono considerarsi indicativi. Silca si riserva il diritto, ferme restando le caratteristiche essenziali dei prodotti, di apportare tutte le modifiche che ritiene necessarie e opportune al fine di migliorare la qualità dei prodotti. Tutti i disegni e le fotografie sono di proprietà di Silca, ogni riproduzione anche parziale, senza autorizzazione scritta di Silca S.p.A. è vietata secondo termini di legge. Per qualsiasi controversia competenti sono gli Uffici Giudiziari dove ha sede l'Azienda Silca S.p.A., con espressa esclusione di qualsiasi altro foro.



DUPLICATRICI-CHIAVI-RADIOCOMANDI

 8 0 5 2 7 8 2 0 1 3 9 6 1 HU92RARS8 / 783 - SILCA PER HUF®  1 pz	 8 0 0 3 7 3 7 8 5 6 3 6 2 HU92RRS2N / 783 - SILCA PER HUF®  KEY SHELL OLC-2 BOTTONI NO BATTERY HOLD. 1 pz	 8 0 0 3 7 3 7 8 5 6 4 0 9 HU92RRS8N / 783 - SILCA PER HUF®  KEY SHELL OLC-3 BOTTONI NO BATTERY HOLD. 1 pz	 8 0 0 3 7 3 7 8 2 2 6 0 2 HURS5 / 783 - SILCA PER HUF®  KEY SHELL - 3 BOTTONI NO SEDE TRP 1 pz	 8 0 0 3 7 3 7 8 5 5 6 8 6 HURSA2 / 783 - SILCA PER HUF®  KEY SHELL - 2 BOTTONI 1 pz
 8 0 0 3 7 3 7 8 3 3 6 2 2 HURSA8 / 783 - SILCA PER HUF®  KEY SHELL - 3 BOTTONI 1 pz	 8 0 0 3 7 3 7 8 5 5 6 9 3 HURSB2 / 783 - SILCA PER HUF®  KEY SHELL - 2 BOTTONI 1 pz	 8 0 0 3 7 3 7 8 5 5 6 5 5 HURSB8 / 783 - SILCA PER HUF®  KEY SHELL - 3 BOTTONI 1 pz	 8 0 0 3 7 3 7 8 6 3 7 7 3 HURSC2 / 783 - SILCA PER HUF®  KEY SHELL - 2 BOTTONI 1 pz	 8 0 0 3 7 3 7 8 6 3 7 6 6 HURSC8 / 783 - SILCA PER HUF®  KEY SHELL - 3 BOTTONI 1 pz
 8 0 0 3 7 3 7 9 2 0 0 2 5 HURSD2 / 783 - SILCA PER HUF®  1 pz	 8 0 0 3 7 3 7 9 1 5 2 3 6 HURSD8 / 783 - SILCA PER HUF®  1 pz	 8 0 5 2 7 8 2 0 1 3 9 0 9 HURSF8 / 783 - SILCA PER HUF®  1 pz	 8 0 0 3 7 3 7 8 8 5 0 1 0 HURSG2N / 783 - SILCA PER HUF®  KEY SHELL - 2 BOTTONI NO BATTERY CONN. 1 pz	 8 0 0 3 7 3 7 8 6 4 5 2 7 HURSG8N / 783 - SILCA PER OPEL-VAUXHALL®  KEY SHELL - 3 BOTTONI NO BATTERY CONN. 1 pz

In conformità alle disposizioni legali in vigore relative alle proprietà industriali, informiamo che i marchi o le denominazioni commerciali citate nel nostro documento sono di proprietà esclusiva dei fabbricanti di serrature e degli utilizzatori autorizzati. Questi marchi o denominazioni commerciali sono indicati a titolo di semplice informazione, con lo scopo di riconoscere velocemente a quali serrature le nostre chiavi sono destinate. Questo documento è esclusivamente riservato ai professionisti della riproduzione chiavi che utilizzano i prodotti Silca. / Le illustrazioni e i dati tecnici dei prodotti contenuti nel documento debbono considerarsi indicativi. Silca si riserva il diritto, ferme restando le caratteristiche essenziali dei prodotti, di apportare tutte le modifiche che ritiene necessarie e opportune al fine di migliorare la qualità dei prodotti. Tutti i disegni e le fotografie sono di proprietà di Silca, ogni riproduzione anche parziale, senza autorizzazione scritta di Silca S.p.A. è vietata secondo termini di legge. Per qualsiasi controversia competenti sono gli Uffici Giudiziari dove ha sede l'Azienda Silca S.p.A., con espressa esclusione di qualsiasi altro foro.



<p>8 003737864534</p> <p>HURSH2N / 783 - SILCA</p> <p>PER HUF®</p>  <p>KEY SHELL - 2 BOTTONI NO BATTERY CONN.</p> <p>1 pz</p>	<p>8 003737822206</p> <p>HYN12RS1 / 783 - SILCA</p> <p>PER HYUNDAI®</p>  <p>KEY SHELL OTTONE - 1 BOTTONE</p> <p>1 pz</p>	<p>8 052782002118</p> <p>KIA8ARS8 / 783 - SILCA</p> <p>PER KIA®</p>  <p>1 pz</p>	<p>8 052782002019</p> <p>KIA8BRS8 / 783 - SILCA</p> <p>PER KIA®</p>  <p>1 pz</p>	<p>8 052782013947</p> <p>KIA8CRS8 / 783 - SILCA</p> <p>PER KIA®</p>  <p>1 pz</p>
<p>8 003737912846</p> <p>KIA8RS8 / 783 - SILCA</p> <p>PER KIA®</p>  <p>1 pz</p>	<p>8 052782013916</p> <p>KIARS8 / 783 - SILCA</p> <p>PER KIA®</p>  <p>1 pz</p>	<p>8 003737913690</p> <p>LDRRS11 / 783 - SILCA</p> <p>PER LAND ROVER®</p>  <p>1 pz</p>	<p>8 003737822282</p> <p>MIT8RS2 / 783 - SILCA</p> <p>PER MITSUBISHI®</p>  <p>KEY SHELL OTTONE - 2 BOTTONI</p> <p>1 pz</p>	<p>8 003737843362</p> <p>NE73ARS1 / 783 - SILCA</p> <p>PER NEIMAN®</p>  <p>KEY SHELL OTTONE - 1 BOTTONE</p> <p>1 pz</p>
<p>8 003737843379</p> <p>NE73BRS1 / 783 - SILCA</p> <p>PER NEIMAN®</p>  <p>KEY SHELL OTTONE - 1 BOTTONE</p> <p>1 pz</p>	<p>8 003737822244</p> <p>NE73RS2 / 783 - SILCA</p> <p>PER NEIMAN®</p>  <p>KEY SHELL OTTONE - 2 BOTTONI</p> <p>1 pz</p>	<p>8 003737855716</p> <p>NE78ARS2N / 783 - SILCA</p> <p>PER NEIMAN®</p>  <p>KEY SHELL OLC-2 BOTTONI NO BATTERY CONN.</p> <p>1 pz</p>	<p>8 003737855723</p> <p>NE78BRS8 / 783 - SILCA</p> <p>PER NEIMAN®</p>  <p>KEY SHELL OTTONE - 3 BOTTONI</p> <p>1 pz</p>	<p>8 003737855747</p> <p>NE78BRS8N / 783 - SILCA</p> <p>PER NEIMAN®</p>  <p>KEY SHELL OLC-3 BOTTONI NO BATTERY CONN.</p> <p>1 pz</p>

In conformità alle disposizioni legali in vigore relative alle proprietà industriali, informiamo che i marchi o le denominazioni commerciali citate nel nostro documento sono di proprietà esclusiva dei fabbricanti di serrature e degli utilizzatori autorizzati. Questi marchi o denominazioni commerciali sono indicati a titolo di semplice informazione, con lo scopo di riconoscere velocemente a quali serrature le nostre chiavi sono destinate. Questo documento è esclusivamente riservato ai professionisti della riproduzione chiavi che utilizzano i prodotti Silca. / Le illustrazioni e i dati tecnici dei prodotti contenuti nel documento debbono considerarsi indicativi. Silca si riserva il diritto, ferme restando le caratteristiche essenziali dei prodotti, di apportare tutte le modifiche che ritiene necessarie e opportune al fine di migliorare la qualità dei prodotti. Tutti i disegni e le fotografie sono di proprietà di Silca, ogni riproduzione anche parziale, senza autorizzazione scritta di Silca S.p.A. è vietata secondo termini di legge. Per qualsiasi controversia competenti sono gli Uffici Giudiziari dove ha sede l'Azienda Silca S.p.A., con espressa esclusione di qualsiasi altro foro.



DUPLICATRICI-CHIAVI-RADIOCOMANDI

 8 003737855730 NE78RS2N / 783 - SILCA PER NEIMAN®  KEY SHELL OLC-2 BOTTONI NO BATTERY CONN. 1 pz	 8 003737822787 NERS5 / 783 - SILCA PER NEIMAN®  KEY SHELL - 3 BOTTONI CON SEDE TRP 1 pz	 8 003737864541 NERSD1N / 783 - SILCA PER NEIMAN®  KEY SHELL - 1 BOTTONE NO BATTERY CONN. 1 pz	 8 003737915540 NSN14ARS2 / 783 - SILCA PER NISSAN®  1 pz	 8 052782002002 NSN14DRS2 / 783 - SILCA PER NISSAN®  1 pz
 8 003737865104 NSN14RS2 / 783 - SILCA PER NISSAN®  KEY SHELL OTTONE - 2 BOTTONI 1 pz	 8 003737865098 NSN14RS8 / 783 - SILCA PER NISSAN®  KEY SHELL OTTONE - 3 BOTTONI 1 pz	 8 052782002057 NSN19BRS8 / 783 - SILCA PER SUBARU®  1 pz	 8 003737855679 SIP22ARS1 / 783 - SILCA PER TRW SIPEA®  KEY SHELL OTTONE - 1 BOTTONE 1 pz	 8 003737912822 SIP22BRS8 / 783 - SILCA PER TRW SIPEA®  1 pz
 8 003737910637 SIP22CRS8 / 783 - SILCA PER TRW SIPEA®  1 pz	 8 003737913645 SIP22ERS8 / 783 - SILCA PER TRW SIPEA®  1 pz	 8 003737913744 SIP22FRS8 / 783 - SILCA PER TRW SIPEA®  1 pz	 8 052782002132 SIP22JRS7 / 783 - SILCA PER SIPEA®  1 pz	 8 052782002149 SIP22JRS8 / 783 - SILCA PER SIPEA®  1 pz

In conformità alle disposizioni legali in vigore relative alle proprietà industriali, informiamo che i marchi o le denominazioni commerciali citate nel nostro documento sono di proprietà esclusiva dei fabbricanti di serrature e degli utilizzatori autorizzati. Questi marchi o denominazioni commerciali sono indicati a titolo di semplice informazione, con lo scopo di riconoscere velocemente a quali serrature le nostre chiavi sono destinate. Questo documento è esclusivamente riservato ai professionisti della riproduzione chiavi che utilizzano i prodotti Silca. / Le illustrazioni e i dati tecnici dei prodotti contenuti nel documento debbono considerarsi indicativi. Silca si riserva il diritto, ferme restando le caratteristiche essenziali dei prodotti, di apportare tutte le modifiche che ritiene necessarie e opportune al fine di migliorare la qualità dei prodotti. Tutti i disegni e le fotografie sono di proprietà di Silca, ogni riproduzione anche parziale, senza autorizzazione scritta di Silca S.p.A. è vietata secondo termini di legge. Per qualsiasi controversia competenti sono gli Uffici Giudiziari dove ha sede l'Azienda Silca S.p.A., con espressa esclusione di qualsiasi altro foro.



 8 003737833660 SIP2RS8 / 783 - SILCA PER TRW SIPEA®  KEY SHELL OTTONE - 3 BOTTONI 1 pz	 8 003737920032 SIPRS8 / 783 - SILCA PER SIPEA®  1 pz	 8 052782001760 SIPRS8 / 783 - SILCA PER SIPEA®  1 pz	 8 003737915250 SIPRSC8 / 783 - SILCA PER TRW SIPEA®  1 pz	 8 003737856379 SX9ARS2 / 783 - SILCA PER SIMPLEX®  KEY SHELL SNI-2 BOTTONI 1 pz
 8 003737822299 SX9RS2 / 783 - SILCA PER SIMPLEX®  KEY SHELL OTTONE - 2 BOTTONI 1 pz	 8 003737856386 SXRSA2 / 783 - SILCA PER SIMPLEX®  KEY SHELL - 2 BOTTONI 1 pz	 8 003737864510 SZ11RDRS1 / 783 - SILCA PER SUZUKI®  KEY SHELL OTTONE - 1 BOTTONE 1 pz	 8 003737843522 SZ11RRS2 / 783 - SILCA PER SUZUKI®  KEY SHELL OTTONE - 2 BOTTONI 1 pz	 8 003737875608 SZ22RS2 / 783 - SILCA PER SUZUKI®  KEY SHELL OTTONE - 2 BOTTONI 1 pz
 8 003737920018 SZRS2 / 783 - SILCA PER SUZUKI®  1 pz	 8 003737822770 TOY40BRS2 / 783 - SILCA PER TOYOTA®  KEY SHELL OTTONE - 2 BOTTONI 1 pz	 8 003737822657 TOY40BRS8 / 783 - SILCA PER TOYOTA®  KEY SHELL OTTONE - 3 BOTTONI 1 pz	 8 003737843515 TOY41RBR8 / 783 - SILCA PER TOYOTA®  KEY SHELL OTTONE - 3 BOTTONI 1 pz	 8 003737833486 TOY41RRS2 / 783 - SILCA PER TOYOTA®  KEY SHELL OTTONE - 2 BOTTONI 1 pz

In conformità alle disposizioni legali in vigore relative alle proprietà industriali, informiamo che i marchi o le denominazioni commerciali citate nel nostro documento sono di proprietà esclusiva dei fabbricanti di serrature e degli utilizzatori autorizzati. Questi marchi o denominazioni commerciali sono indicati a titolo di semplice informazione, con lo scopo di riconoscere velocemente a quali serrature le nostre chiavi sono destinate. Questo documento è esclusivamente riservato ai professionisti della riproduzione chiavi che utilizzano i prodotti Silca. / Le illustrazioni e i dati tecnici dei prodotti contenuti nel documento debbono considerarsi indicativi. Silca si riserva il diritto, ferme restando le caratteristiche essenziali dei prodotti, di apportare tutte le modifiche che ritiene necessarie e opportune al fine di migliorare la qualità dei prodotti. Tutti i disegni e le fotografie sono di proprietà di Silca, ogni riproduzione anche parziale, senza autorizzazione scritta di Silca S.p.A. è vietata secondo termini di legge. Per qualsiasi controversia competenti sono gli Uffici Giudiziari dove ha sede l'Azienda Silca S.p.A., con espressa esclusione di qualsiasi altro foro.



DUPLICATRICI-CHIAVI-RADIOCOMANDI

 8 003737822695 TOY43ARS10 / 783 - SILCA PER TOYOTA®  KEY SHELL OTTONE - 4 BOTTONI ANTIPANICO 1 pz	 8 003737822626 TOY43ARS2 / 783 - SILCA PER TOYOTA®  KEY SHELL OTTONE - 2 BOTTONI 1 pz	 8 003737822718 TOY43ARS7 / 783 - SILCA PER TOYOTA®  KEY SHELL OTTONE - 4 BOTTONI 1 pz	 8 003737822671 TOY43ARS8 / 783 - SILCA PER TOYOTA®  KEY SHELL OTTONE - 3 BOTTONI 1 pz	 8 003737822688 TOY43ARS9 / 783 - SILCA PER TOYOTA®  KEY SHELL OTTONE - 3 BOTTONI ANTIPANICO 1 pz
 8 003737822640 TOY43BRS2 / 783 - SILCA PER TOYOTA®  KEY SHELL OTTONE - 2 BOTTONI 1 pz	 8 003737822664 TOY43BRS8 / 783 - SILCA PER TOYOTA®  KEY SHELL OTTONE - 3 BOTTONI 1 pz	 8 003737865999 TOY43CRS2N / 783 - SILCA PER TOYOTA®  KEY SHELL OLC-2 BOTTONI NO BATTERY HOLD. 1 pz	 8 003737843560 TOY43CRS7N / 783 - SILCA PER TOYOTA®  KEY SHELL OLC-4 BOTTONI NO BATTERY CONN. 1 pz	 8 003737822701 TOY43RS1 / 783 - SILCA PER TOYOTA®  KEY SHELL OTTONE - 1 BOTTONE 1 pz
 8 003737822633 TOY43RS2 / 783 - SILCA PER TOYOTA®  KEY SHELL OTTONE - 2 BOTTONI 1 pz	 8 003737843386 TOY47BRS2 / 783 - SILCA PER TOYOTA®  KEY SHELL OTTONE - 2 BOTTONI 1 pz	 8 003737843492 TOY47BRS8 / 783 - SILCA PER TOYOTA®  KEY SHELL OTTONE - 3 BOTTONI 1 pz	 8 003737828512 TOY48ARS8 / 783 - SILCA PER TOYOTA®  KEY SHELL OTTONE - 3 BOTTONI 1 pz	 8 003737822763 TOY48BRS2 / 783 - SILCA PER TOYOTA®  KEY SHELL OTTONE - 2 BOTTONI 1 pz

In conformità alle disposizioni legali in vigore relative alle proprietà industriali, informiamo che i marchi o le denominazioni commerciali citate nel nostro documento sono di proprietà esclusiva dei fabbricanti di serrature e degli utilizzatori autorizzati. Questi marchi o denominazioni commerciali sono indicati a titolo di semplice informazione, con lo scopo di riconoscere velocemente a quali serrature le nostre chiavi sono destinate. Questo documento è esclusivamente riservato ai professionisti della riproduzione chiavi che utilizzano i prodotti Silca. / Le illustrazioni e i dati tecnici dei prodotti contenuti nel documento debbono considerarsi indicativi. Silca si riserva il diritto, ferme restando le caratteristiche essenziali dei prodotti, di apportare tutte le modifiche che ritiene necessarie e opportune al fine di migliorare la qualità dei prodotti. Tutti i disegni e le fotografie sono di proprietà di Silca, ogni riproduzione anche parziale, senza autorizzazione scritta di Silca S.p.A. è vietata secondo termini di legge. Per qualsiasi controversia competenti sono gli Uffici Giudiziari dove ha sede l'Azienda Silca S.p.A., con espressa esclusione di qualsiasi altro foro.



<p>8 003737822749</p> <p>TOY48BRS8 / 783 - SILCA PER TOYOTA®</p>  <p>KEY SHELL OTTONE - 3 BOTTONI 1 pz</p>	<p>8 003737833639</p> <p>TOYRS8 / 783 - SILCA PER TOYOTA®</p>  <p>KEY SHELL - 3 BOTTONI (RUBBER PAD) 1 pz</p>	<p>8 003737913683</p> <p>TOYRSE2 / 783 - SILCA PER TOYOTA®</p>  <p>1 pz</p>	<p>8 052782013954</p> <p>VA150RS2 / 783 - SILCA PER VALEO®</p>  <p>1 pz</p>	<p>8 052782013923</p> <p>VA150RS7 / 783 - SILCA PER VALEO®</p>  <p>1 pz</p>
<p>8 003737913652</p> <p>VA150RS8 / 783 - SILCA PER VALEO®</p>  <p>1 pz</p>	<p>8 003737843539</p> <p>VA2ARS2N / 783 - SILCA PER VALEO®</p>  <p>KEY SHELL OLC-2 BOTTONI NO BATTERY CONN. 1 pz</p>	<p>8 003737843355</p> <p>VA2BRS2 / 783 - SILCA PER VALEO®</p>  <p>KEY SHELL OTTONE - 2 BOTTONI 1 pz</p>	<p>8 003737833684</p> <p>VA2BRS8 / 783 - SILCA PER VALEO®</p>  <p>KEY SHELL OTTONE - 3 BOTTONI 1 pz</p>	<p>8 003737843546</p> <p>VA2BRS8N / 783 - SILCA PER VALEO®</p>  <p>KEY SHELL OLC-3 BOTTONI NO BATTERY CONN. 1 pz</p>
<p>8 003737843577</p> <p>VA2CRS7 / 783 - SILCA PER VALEO®</p>  <p>KEY SHELL OTTONE - 4 BOTTONI 1 pz</p>	<p>8 003737843553</p> <p>VA2CRS7N / 783 - SILCA PER VALEO®</p>  <p>KEY SHELL OLC-4 BOTTONI NO BATTERY CONN. 1 pz</p>	<p>8 003737863919</p> <p>VA2DRS10 / 783 - SILCA PER VALEO®</p>  <p>KEY SHELL OTTONE - 4 BOTTONI ANTIPANICO 1 pz</p>	<p>8 003737885003</p> <p>VA2DRS8 / 783 - SILCA PER VALEO®</p>  <p>KEY SHELL OTTONE - 3 BOTTONI 1 pz</p>	<p>8 003737913638</p> <p>VA2ERS2 / 783 - SILCA PER VALEO®</p>  <p>1 pz</p>

In conformità alle disposizioni legali in vigore relative alle proprietà industriali, informiamo che i marchi o le denominazioni commerciali citate nel nostro documento sono di proprietà esclusiva dei fabbricanti di serrature e degli utilizzatori autorizzati. Questi marchi o denominazioni commerciali sono indicati a titolo di semplice informazione, con lo scopo di riconoscere velocemente a quali serrature le nostre chiavi sono destinate. Questo documento è esclusivamente riservato ai professionisti della riproduzione chiavi che utilizzano i prodotti Silca. / Le illustrazioni e i dati tecnici dei prodotti contenuti nel documento debbono considerarsi indicativi. Silca si riserva il diritto, ferme restando le caratteristiche essenziali dei prodotti, di apportare tutte le modifiche che ritiene necessarie e opportune al fine di migliorare la qualità dei prodotti. Tutti i disegni e le fotografie sono di proprietà di Silca, ogni riproduzione anche parziale, senza autorizzazione scritta di Silca S.p.A. è vietata secondo termini di legge. Per qualsiasi controversia competenti sono gli Uffici Giudiziari dove ha sede l'Azienda Silca S.p.A., con espressa esclusione di qualsiasi altro foro.

































DUPLICATRICI-CHIAVI-RADIOCOMANDI

 8 0 0 3 7 3 7 9 1 3 6 2 1 VA2ERS8 / 783 - SILCA PER VALEO®  1 pz	 8 0 0 3 7 3 7 8 2 2 0 1 5 VA2RS2 / 783 - SILCA PER VALEO®  KEY SHELL OTTONE - 2 BOTTONI 1 pz	 8 0 0 3 7 3 7 8 5 5 7 0 9 VAC102ARS1 / 783 - SILCA PER VACHETTE®  KEY SHELL OTTONE - 1 BOTTONE 1 pz	 8 0 0 3 7 3 7 8 6 4 5 8 9 VAC102B1N / 783 - SILCA PER VACHETTE®  KEY SHELL OLC-1 BOTTONE NO BATTERY HOLD. 1 pz	 8 0 0 3 7 3 7 8 2 2 7 5 6 VACRS2 / 783 - SILCA PER VACHETTE®  KEY SHELL - 2 BOTTONI 1 pz
 8 0 0 3 7 3 7 8 3 3 5 9 2 VACRSA2 / 783 - SILCA PER VACHETTE®  KEY SHELL - 2 BOTTONI 1 pz	 8 0 0 3 7 3 7 9 1 5 2 4 3 VARSD8 / 783 - SILCA PER VALEO®  1 pz	 8 0 0 3 7 3 7 8 6 4 4 9 7 YM23RS1 / 783 - SILCA PER YMOS®  KEY SHELL OTTONE - 1 BOTTONE 1 pz	 8 0 0 3 7 3 7 8 6 4 1 8 3 YM23RS8 / 783 - SILCA PER YMOS®  KEY SHELL OTTONE - 3 BOTTONI 1 pz	 8 0 0 3 7 3 7 8 9 2 2 1 6 YMRS1 / 783 - SILCA PER YMOS®  KEY SHELL - 1 BOTTONE (RUBBER PAD GIAL.) 1 pz
 8 0 0 3 7 3 7 8 9 2 2 0 9 YMRS8 / 783 - SILCA PER YMOS®  KEY SHELL - 3 BOTTONI (RUBBER PAD) 1 pz				

In conformità alle disposizioni legali in vigore relative alle proprietà industriali, informiamo che i marchi o le denominazioni commerciali citate nel nostro documento sono di proprietà esclusiva dei fabbricanti di serrature e degli utilizzatori autorizzati. Questi marchi o denominazioni commerciali sono indicati a titolo di semplice informazione, con lo scopo di riconoscere velocemente a quali serrature le nostre chiavi sono destinate. Questo documento è esclusivamente riservato ai professionisti della riproduzione chiavi che utilizzano i prodotti Silca. / Le illustrazioni e i dati tecnici dei prodotti contenuti nel documento debbono considerarsi indicativi. Silca si riserva il diritto, ferme restando le caratteristiche essenziali dei prodotti, di apportare tutte le modifiche che ritiene necessarie e opportune al fine di migliorare la qualità dei prodotti. Tutti i disegni e le fotografie sono di proprietà di Silca, ogni riproduzione anche parziale, senza autorizzazione scritta di Silca S.p.A. è vietata secondo termini di legge. Per qualsiasi controversia competenti sono gli Uffici Giudiziari dove ha sede l'Azienda Silca S.p.A., con espressa esclusione di qualsiasi altro foro.

































 1002 / 783 - SILCA PER I.B.F.M.®  CHIAVE PER CASSETTA POSTALE 100 pz	 1003P / 783 - SILCA PER -  CHIAVE PER CASSETTA POSTALE 100 pz	 A303 / 783 - SILCA PER CINA®  CHIAVE OTTONE 50 pz	 AA3 / 783 - SILCA PER  CHIAVE OTTONE 50 pz	 AA5 / 783 - SILCA PER ALA®  CHIAVE ACCIAIO 50 pz
 AA5R / 783 - SILCA PER ALA®  CHIAVE OTTONE 50 pz	 AA6 / 783 - SILCA PER ALA®  CHIAVE ACCIAIO 100 pz	 AA6R / 783 - SILCA PER ALA®  CHIAVE OTTONE 100 pz	 AB10 / 783 - SILCA PER ABUS®  CHIAVE ACCIAIO 100 pz	 AB10R / 783 - SILCA PER ABUS®  CHIAVE ACCIAIO 50 pz
 AB21R / 783 - SILCA PER ABUS®  CHIAVE ACCIAIO 100 pz	 AB23 / 783 - SILCA PER ABUS®  CHIAVE ACCIAIO 50 pz	 AB25R / 783 - SILCA PER ABUS®  CHIAVE ACCIAIO 50 pz	 AB2R / 783 - SILCA PER ABUS®  CHIAVE ACCIAIO 100 pz	 AB35 / 783 - SILCA PER ABUS®  CHIAVE ACCIAIO 100 pz

In conformità alle disposizioni legali in vigore relative alle proprietà industriali, informiamo che i marchi o le denominazioni commerciali citate nel nostro documento sono di proprietà esclusiva dei fabbricanti di serrature e degli utilizzatori autorizzati. Questi marchi o denominazioni commerciali sono indicati a titolo di semplice informazione, con lo scopo di riconoscere velocemente a quali serrature le nostre chiavi sono destinate. Questo documento è esclusivamente riservato ai professionisti della riproduzione chiavi che utilizzano i prodotti Silca. / Le illustrazioni e i dati tecnici dei prodotti contenuti nel documento debbono considerarsi indicativi. Silca si riserva il diritto, ferme restando le caratteristiche essenziali dei prodotti, di apportare tutte le modifiche che ritiene necessarie e opportune al fine di migliorare la qualità dei prodotti. Tutti i disegni e le fotografie sono di proprietà di Silca, ogni riproduzione anche parziale, senza autorizzazione scritta di Silca S.p.A. è vietata secondo termini di legge. Per qualsiasi controversia competenti sono gli Uffici Giudiziari dove ha sede l'Azienda Silca S.p.A., con espressa esclusione di qualsiasi altro foro.















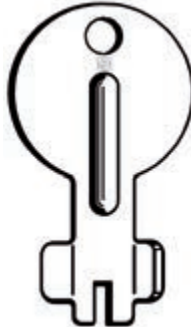

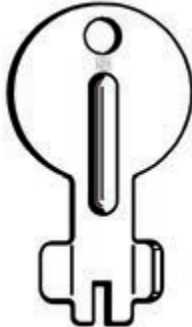













DUPLICATRICI-CHIAVI-RADIOCOMANDI

 8 003736002920 AB36R / 783 - SILCA PER ABUS®  CHIAVE ACCIAIO 100 pz	 8 003736297302 AB37 / 783 - SILCA PER ABUS®  CHIAVE ACCIAIO 50 pz	 8 003736297319 AB37R / 783 - SILCA PER ABUS®  CHIAVE ACCIAIO 50 pz	 8 003736755055 AB38P / 783 - SILCA PER ABUS®  CHIAVE ALPACCA 25 pz	 8 003736002999 AB39 / 783 - SILCA PER ABUS®  CHIAVE ACCIAIO 100 pz
 8 003736003002 AB39R / 783 - SILCA PER ABUS®  CHIAVE ACCIAIO 100 pz	 8 003736297340 AB41R / 783 - SILCA PER ABUS®  CHIAVE ACCIAIO 50 pz	 8 003736755086 AB42R / 783 - SILCA PER ABUS®  CHIAVE ACCIAIO 50 pz	 8 003736461437 AB43 / 783 - SILCA PER ABUS®  CHIAVE OTTONE 100 pz	 8 003736854000 AB43R / 783 - SILCA PER ABUS®  CHIAVE OTTONE 100 pz
 8 003736855090 AB44 / 783 - SILCA PER ABUS®  CHIAVE OTTONE 100 pz	 8 003736868380 AB44R / 783 - SILCA PER ABUS®  CHIAVE ACCIAIO 100 pz	 8 003736494435 AB52 / 783 - SILCA PER ABUS®  CHIAVE OTTONE 100 pz	 8 003737493123 AB63 / 783 - SILCA PER ABUS®  CHIAVE OTTONE 50 pz	 8 003736000940 ABA1 / 783 - SILCA PER BASSETTI®  CHIAVE PER ASCENSORI 100 pz

In conformità alle disposizioni legali in vigore relative alle proprietà industriali, informiamo che i marchi o le denominazioni commerciali citate nel nostro documento sono di proprietà esclusiva dei fabbricanti di serrature e degli utilizzatori autorizzati. Questi marchi o denominazioni commerciali sono indicati a titolo di semplice informazione, con lo scopo di riconoscere velocemente a quali serrature le nostre chiavi sono destinate. Questo documento è esclusivamente riservato ai professionisti della riproduzione chiavi che utilizzano i prodotti Silca. / Le illustrazioni e i dati tecnici dei prodotti contenuti nel documento debbono considerarsi indicativi. Silca si riserva il diritto, ferme restando le caratteristiche essenziali dei prodotti, di apportare tutte le modifiche che ritiene necessarie e opportune al fine di migliorare la qualità dei prodotti. Tutti i disegni e le fotografie sono di proprietà di Silca, ogni riproduzione anche parziale, senza autorizzazione scritta di Silca S.p.A. è vietata secondo termini di legge. Per qualsiasi controversia competenti sono gli Uffici Giudiziari dove ha sede l'Azienda Silca S.p.A., con espressa esclusione di qualsiasi altro foro.



 AB01 / 783 - SILCA PER BONFEDI®  CHIAVE PER ASCENSORI 100 pz	 AB04 / 783 - SILCA PER BONFEDI®  CHIAVE PER ASCENSORI 100 pz	 AF11 / 783 - SILCA PER FIAM®  CHIAVE PER ASCENSORI 100 pz	 AF11 / 783 - SILCA PER FIAM®  CHIAVE PER ASCENSORI 100 pz	 AGB1R / 783 - SILCA PER AGB®  CHIAVE OTTONE 100 pz
 AGB2R / 783 - SILCA PER AGB®  CHIAVE OTTONE 100 pz	 AGB3 / 783 - SILCA PER AGB®  CHIAVE OTTONE 100 pz	 AGB3R / 783 - SILCA PER AGB®  CHIAVE OTTONE 100 pz	 AGE1 / 783 - SILCA PER AGE®  CHIAVE ACCIAIO 50 pz	 AIN1 / 783 - SILCA PER INSUBRIA®  CHIAVE PER ASCENSORI 100 pz
 ALP1 / 783 - SILCA PER ALPHA®  CHIAVE ACCIAIO 100 pz	 ALP4 / 783 - SILCA PER ALPHA®  CHIAVE OTTONE 100 pz	 ALP4R / 783 - SILCA PER ALPHA®  CHIAVE OTTONE 100 pz	 ALP9 / 783 - SILCA PER ALPHA®  CHIAVE OTTONE 100 pz	 ALP9R / 783 - SILCA PER ALPHA®  CHIAVE OTTONE 100 pz

In conformità alle disposizioni legali in vigore relative alle proprietà industriali, informiamo che i marchi o le denominazioni commerciali citate nel nostro documento sono di proprietà esclusiva dei fabbricanti di serrature e degli utilizzatori autorizzati. Questi marchi o denominazioni commerciali sono indicati a titolo di semplice informazione, con lo scopo di riconoscere velocemente a quali serrature le nostre chiavi sono destinate. Questo documento è esclusivamente riservato ai professionisti della riproduzione chiavi che utilizzano i prodotti Silca. / Le illustrazioni e i dati tecnici dei prodotti contenuti nel documento debbono considerarsi indicativi. Silca si riserva il diritto, ferme restando le caratteristiche essenziali dei prodotti, di apportare tutte le modifiche che ritiene necessarie e opportune al fine di migliorare la qualità dei prodotti. Tutti i disegni e le fotografie sono di proprietà di Silca, ogni riproduzione anche parziale, senza autorizzazione scritta di Silca S.p.A. è vietata secondo termini di legge. Per qualsiasi controversia competenti sono gli Uffici Giudiziari dove ha sede l'Azienda Silca S.p.A., con espressa esclusione di qualsiasi altro foro.





























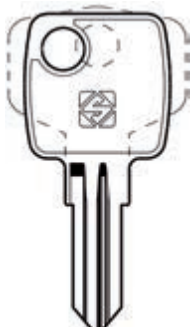

DUPLICATRICI-CHIAVI-RADIOCOMANDI

 8 003737725255 ALU1 / 783 - SILCA PER ALUBOX®  CHIAVE OTTONE 100 pz	 8 003736548602 ARL1 / 783 - SILCA PER AREL®  CHIAVE OTTONE 50 pz	 8 003737643405 ART1 / 783 - SILCA PER ARMSTRONG®  CHIAVE OTTONE 100 pz	 8 003737642705 ART1R / 783 - SILCA PER ARMSTRONG®  CHIAVE OTTONE 100 pz	 8 003736016330 AS1 / 783 - SILCA PER ASIA®  CHIAVE ACCIAIO 100 pz
 8 003736010178 ASS137 / 783 - SILCA PER ASSA®  CHIAVE ACCIAIO 100 pz	 8 003736550131 ASS44 / 783 - SILCA PER ASSA®  CHIAVE ACCIAIO 50 pz	 8 003737245487 AY1 / 783 - SILCA PER ABLOY®  CHIAVE ACCIAIO 50 pz	 8 003736780514 BAI1 / 783 - SILCA PER BASI®  CHIAVE ACCIAIO 50 pz	 8 003736495388 BAS4R / 783 - SILCA PER BASTA®  CHIAVE ACCIAIO 100 pz
 8 003736020887 BE200 / 783 - SILCA PER BETA®  CHIAVE OTTONE 100 pz	 8 003736021433 BE201 / 783 - SILCA PER BETA®  CHIAVE OTTONE 100 pz	 8 003736021938 BE202 / 783 - SILCA PER BETA®  CHIAVE OTTONE 100 pz	 8 003736022508 BE203 / 783 - SILCA PER BETA®  CHIAVE OTTONE 100 pz	 8 003736023048 BE3 / 783 - SILCA PER BETA®  CHIAVE OTTONE 100 pz

In conformità alle disposizioni legali in vigore relative alle proprietà industriali, informiamo che i marchi o le denominazioni commerciali citate nel nostro documento sono di proprietà esclusiva dei fabbricanti di serrature e degli utilizzatori autorizzati. Questi marchi o denominazioni commerciali sono indicati a titolo di semplice informazione, con lo scopo di riconoscere velocemente a quali serrature le nostre chiavi sono destinate. Questo documento è esclusivamente riservato ai professionisti della riproduzione chiavi che utilizzano i prodotti Silca. / Le illustrazioni e i dati tecnici dei prodotti contenuti nel documento debbono considerarsi indicativi. Silca si riserva il diritto, ferme restando le caratteristiche essenziali dei prodotti, di apportare tutte le modifiche che ritiene necessarie e opportune al fine di migliorare la qualità dei prodotti. Tutti i disegni e le fotografie sono di proprietà di Silca, ogni riproduzione anche parziale, senza autorizzazione scritta di Silca S.p.A. è vietata secondo termini di legge. Per qualsiasi controversia competenti sono gli Uffici Giudiziari dove ha sede l'Azienda Silca S.p.A., con espressa esclusione di qualsiasi altro foro.



 BES1 / 783 - SILCA PER BEST®  CHIAVE OTTONE 50 pz	 BK15 / 783 - SILCA PER BKS®  CHIAVE ACCIAIO 50 pz	 BK26 / 783 - SILCA PER BKS®  CHIAVE ACCIAIO 100 pz	 BMB1 / 783 - SILCA PER BMB®  CHIAVE OTTONE 100 pz	 BMB5 / 783 - SILCA PER BMB®  CHIAVE OTTONE 100 pz
 BN2 / 783 - SILCA PER BECCARINI®  CHIAVE OTTONE 50 pz	 BN2R / 783 - SILCA PER BECCARINI®  CHIAVE OTTONE 50 pz	 BT5R / 783 - SILCA PER BLAU®  CHIAVE ACCIAIO 50 pz	 BUR2 / 783 - SILCA PER BURG®  CHIAVE ACCIAIO 50 pz	 BUR24R / 783 - SILCA PER BURG®  CHIAVE ACCIAIO 100 pz
 BUR28R / 783 - SILCA PER BURG®  CHIAVE ACCIAIO 50 pz	 BUR38 / 783 - SILCA PER BURG®  CHIAVE ACCIAIO 100 pz	 CA2 / 783 - SILCA PER CITY®  CHIAVE ACCIAIO 50 pz	 CAB1 / 783 - SILCA PER CAB®  CHIAVE OTTONE 100 pz	 CAB2R / 783 - SILCA PER CAB®  CHIAVE OTTONE 100 pz

In conformità alle disposizioni legali in vigore relative alle proprietà industriali, informiamo che i marchi o le denominazioni commerciali citate nel nostro documento sono di proprietà esclusiva dei fabbricanti di serrature e degli utilizzatori autorizzati. Questi marchi o denominazioni commerciali sono indicati a titolo di semplice informazione, con lo scopo di riconoscere velocemente a quali serrature le nostre chiavi sono destinate. Questo documento è esclusivamente riservato ai professionisti della riproduzione chiavi che utilizzano i prodotti Silca. / Le illustrazioni e i dati tecnici dei prodotti contenuti nel documento debbono considerarsi indicativi. Silca si riserva il diritto, ferme restando le caratteristiche essenziali dei prodotti, di apportare tutte le modifiche che ritiene necessarie e opportune al fine di migliorare la qualità dei prodotti. Tutti i disegni e le fotografie sono di proprietà di Silca, ogni riproduzione anche parziale, senza autorizzazione scritta di Silca S.p.A. è vietata secondo termini di legge. Per qualsiasi controversia competenti sono gli Uffici Giudiziari dove ha sede l'Azienda Silca S.p.A., con espressa esclusione di qualsiasi altro foro.











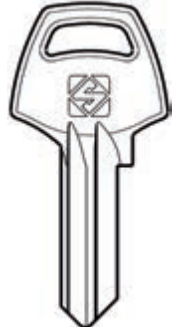









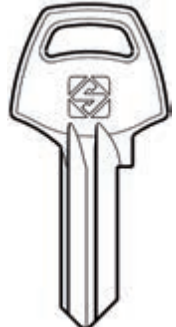







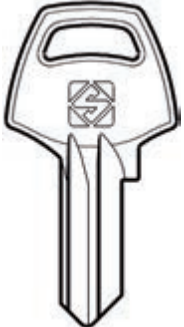

DUPLICATRICI-CHIAVI-RADIOCOMANDI

 8 003736030336 CAF1 / 783 - SILCA PER CAF® CHIAVE OTTONE 100 pz	 8 003736270312 CAF1R / 783 - SILCA PER CAF® CHIAVE OTTONE 50 pz	 8 003736030374 CAF2 / 783 - SILCA PER CAF® CHIAVE OTTONE 100 pz	 8 003736460751 CAX1R / 783 - SILCA PER CASH BOX® CHIAVE OTTONE 100 pz	 8 003737448161 CAX2R / 783 - SILCA PER CASH BOX® CHIAVE ACCIAIO 100 pz
 8 003736031364 CB1 / 783 - SILCA PER CORBIN® CHIAVE OTTONE 100 pz	 8 003737795517 CB101R / 783 - SILCA PER CORBIN® CHIAVE ACCIAIO 100 pz	 8 00373652579 CB15 / 783 - SILCA PER CORBIN® CHIAVE OTTONE 50 pz	 8 00373652586 CB16 / 783 - SILCA PER CORBIN® CHIAVE ACCIAIO 50 pz	 8 00373652609 CB17 / 783 - SILCA PER CORBIN® CHIAVE ACCIAIO 50 pz
 8 003736552623 CB19 / 783 - SILCA PER CORBIN® CHIAVE ACCIAIO 50 pz	 8 003736318557 CB1R / 783 - SILCA PER CORBIN® CHIAVE ACCIAIO 50 pz	 8 003736031906 CB2 / 783 - SILCA PER CORBIN® CHIAVE OTTONE 100 pz	 8 003736031968 CB21 / 783 - SILCA PER CORBIN® CHIAVE OTTONE 100 pz	 8 003736300132 CB29R / 783 - SILCA PER CORBIN(USA)® CHIAVE ACCIAIO 50 pz

In conformità alle disposizioni legali in vigore relative alle proprietà industriali, informiamo che i marchi o le denominazioni commerciali citate nel nostro documento sono di proprietà esclusiva dei fabbricanti di serrature e degli utilizzatori autorizzati. Questi marchi o denominazioni commerciali sono indicati a titolo di semplice informazione, con lo scopo di riconoscere velocemente a quali serrature le nostre chiavi sono destinate. Questo documento è esclusivamente riservato ai professionisti della riproduzione chiavi che utilizzano i prodotti Silca. / Le illustrazioni e i dati tecnici dei prodotti contenuti nel documento debbono considerarsi indicativi. Silca si riserva il diritto, ferme restando le caratteristiche essenziali dei prodotti, di apportare tutte le modifiche che ritiene necessarie e opportune al fine di migliorare la qualità dei prodotti. Tutti i disegni e le fotografie sono di proprietà di Silca, ogni riproduzione anche parziale, senza autorizzazione scritta di Silca S.p.A. è vietata secondo termini di legge. Per qualsiasi controversia competenti sono gli Uffici Giudiziari dove ha sede l'Azienda Silca S.p.A., con espressa esclusione di qualsiasi altro foro.

































 CB3 / 783 - SILCA PER CORBIN®  CHIAVE OTTONE 100 pz	 CB30 / 783 - SILCA PER CORBIN®  CHIAVE OTTONE 100 pz	 CB30R / 783 - SILCA PER CORBIN®  CHIAVE OTTONE 50 pz	 CB31 / 783 - SILCA PER CORBIN®  CHIAVE ACCIAIO 50 pz	 CB38R / 783 - SILCA PER CORBIN(USA)®  CHIAVE OTTONE 100 pz
 CB3R / 783 - SILCA PER CORBIN®  CHIAVE OTTONE 100 pz	 CB4 / 783 - SILCA PER CORBIN®  CHIAVE OTTONE 100 pz	 CB42 / 783 - SILCA PER CORBIN®  CHIAVE ACCIAIO 100 pz	 CB43R / 783 - SILCA PER CORBIN®  CHIAVE OTTONE 100 pz	 CB4R / 783 - SILCA PER CORBIN®  CHIAVE OTTONE 50 pz
 CB5 / 783 - SILCA PER CORBIN®  CHIAVE OTTONE 100 pz	 CB5R / 783 - SILCA PER CORBIN®  CHIAVE OTTONE 50 pz	 CB6 / 783 - SILCA PER CORBIN®  CHIAVE OTTONE 50 pz	 CB6R / 783 - SILCA PER CORBIN®  CHIAVE ACCIAIO 100 pz	 CB7 / 783 - SILCA PER CORBIN®  CHIAVE OTTONE 50 pz

In conformità alle disposizioni legali in vigore relative alle proprietà industriali, informiamo che i marchi o le denominazioni commerciali citate nel nostro documento sono di proprietà esclusiva dei fabbricanti di serrature e degli utilizzatori autorizzati. Questi marchi o denominazioni commerciali sono indicati a titolo di semplice informazione, con lo scopo di riconoscere velocemente a quali serrature le nostre chiavi sono destinate. Questo documento è esclusivamente riservato ai professionisti della riproduzione chiavi che utilizzano i prodotti Silca. / Le illustrazioni e i dati tecnici dei prodotti contenuti nel documento debbono considerarsi indicativi. Silca si riserva il diritto, ferme restando le caratteristiche essenziali dei prodotti, di apportare tutte le modifiche che ritiene necessarie e opportune al fine di migliorare la qualità dei prodotti. Tutti i disegni e le fotografie sono di proprietà di Silca, ogni riproduzione anche parziale, senza autorizzazione scritta di Silca S.p.A. è vietata secondo termini di legge. Per qualsiasi controversia competenti sono gli Uffici Giudiziari dove ha sede l'Azienda Silca S.p.A., con espressa esclusione di qualsiasi altro foro.

































DUPLICATRICI-CHIAVI-RADIOCOMANDI

 8 003736033979 CB70 / 783 - SILCA PER CORBIN®  CHIAVE OTTONE 100 pz	 8 003736756625 CB78R / 783 - SILCA PER CORBIN®  CHIAVE OTTONE 50 pz	 8 003736033993 CB8 / 783 - SILCA PER CORBIN®  CHIAVE OTTONE 100 pz	 8 003736783164 CB80 / 783 - SILCA PER CORBIN®  CHIAVE OTTONE 100 pz	 8 003736783195 CB81 / 783 - SILCA PER CORBIN®  CHIAVE OTTONE 100 pz
 8 003736843578 CB83 / 783 - SILCA PER CORBIN®  CHIAVE OTTONE 100 pz	 8 003736850651 CB84 / 783 - SILCA PER CORBIN®  CHIAVE OTTONE 100 pz	 8 003736350274 CB85 / 783 - SILCA PER CORBIN®  CHIAVE OTTONE 100 pz	 8 003737542333 CB86 / 783 - SILCA PER CORBIN®  CHIAVE OTTONE 50 pz	 8 003737424783 CB88R / 783 - SILCA PER CORBIN®  CHIAVE OTTONE 100 pz
 8 003737424806 CB89R / 783 - SILCA PER CORBIN®  CHIAVE OTTONE 100 pz	 8 003736034013 CB9 / 783 - SILCA PER CORBIN®  CHIAVE OTTONE 100 pz	 8 003737446747 CB90R / 783 - SILCA PER CORBIN®  CHIAVE OTTONE 100 pz	 8 003737641258 CB99R / 783 - SILCA PER CORBIN®  CHIAVE ACCIAIO 100 pz	 8 003736031333 CBR1 / 783 - SILCA PER COBRA®  CHIAVE OTTONE 50 pz

In conformità alle disposizioni legali in vigore relative alle proprietà industriali, informiamo che i marchi o le denominazioni commerciali citate nel nostro documento sono di proprietà esclusiva dei fabbricanti di serrature e degli utilizzatori autorizzati. Questi marchi o denominazioni commerciali sono indicati a titolo di semplice informazione, con lo scopo di riconoscere velocemente a quali serrature le nostre chiavi sono destinate. Questo documento è esclusivamente riservato ai professionisti della riproduzione chiavi che utilizzano i prodotti Silca. / Le illustrazioni e i dati tecnici dei prodotti contenuti nel documento debbono considerarsi indicativi. Silca si riserva il diritto, ferme restando le caratteristiche essenziali dei prodotti, di apportare tutte le modifiche che ritiene necessarie e opportune al fine di migliorare la qualità dei prodotti. Tutti i disegni e le fotografie sono di proprietà di Silca, ogni riproduzione anche parziale, senza autorizzazione scritta di Silca S.p.A. è vietata secondo termini di legge. Per qualsiasi controversia competenti sono gli Uffici Giudiziari dove ha sede l'Azienda Silca S.p.A., con espressa esclusione di qualsiasi altro foro.

































 CC1 / 783 - SILCA PER CORNI®  CHIAVE OTTONE 100 pz	 CC1R / 783 - SILCA PER CORNI®  CHIAVE OTTONE 100 pz	 CC2 / 783 - SILCA PER CORNI®  CHIAVE OTTONE 50 pz	 CC2R / 783 - SILCA PER CORNI®  CHIAVE OTTONE 100 pz	 CC3 / 783 - SILCA PER CORNI®  CHIAVE OTTONE 50 pz
 CC3R / 783 - SILCA PER CORNI®  CHIAVE OTTONE 100 pz	 CC6R / 783 - SILCA PER CORNI®  CHIAVE OTTONE 50 pz	 CE1 / 783 - SILCA PER CES®  CHIAVE ACCIAIO 50 pz	 CE12 / 783 - SILCA PER CES®  CHIAVE ACCIAIO 50 pz	 CE2 / 783 - SILCA PER CES®  CHIAVE OTTONE 50 pz
 CE2X / 783 - SILCA PER CES®  CHIAVE OTTONE 100 pz	 CE3 / 783 - SILCA PER CES®  CHIAVE OTTONE 50 pz	 CE6 / 783 - SILCA PER CES®  CHIAVE OTTONE 100 pz	 CH1 / 783 - SILCA PER CHICAGO®  CHIAVE OTTONE 50 pz	 CH6 / 783 - SILCA PER CHICAGO®  CHIAVE OTTONE 50 pz

In conformità alle disposizioni legali in vigore relative alle proprietà industriali, informiamo che i marchi o le denominazioni commerciali citate nel nostro documento sono di proprietà esclusiva dei fabbricanti di serrature e degli utilizzatori autorizzati. Questi marchi o denominazioni commerciali sono indicati a titolo di semplice informazione, con lo scopo di riconoscere velocemente a quali serrature le nostre chiavi sono destinate. Questo documento è esclusivamente riservato ai professionisti della riproduzione chiavi che utilizzano i prodotti Silca. / Le illustrazioni e i dati tecnici dei prodotti contenuti nel documento debbono considerarsi indicativi. Silca si riserva il diritto, ferme restando le caratteristiche essenziali dei prodotti, di apportare tutte le modifiche che ritiene necessarie e opportune al fine di migliorare la qualità dei prodotti. Tutti i disegni e le fotografie sono di proprietà di Silca, ogni riproduzione anche parziale, senza autorizzazione scritta di Silca S.p.A. è vietata secondo termini di legge. Per qualsiasi controversia competenti sono gli Uffici Giudiziari dove ha sede l'Azienda Silca S.p.A., con espressa esclusione di qualsiasi altro foro.

































DUPLICATRICI-CHIAVI-RADIOCOMANDI

 8 003736040748 CIL1 / 783 - SILCA PER CILA®  CHIAVE OTTONE 100 pz	 8 003736268029 CIL2 / 783 - SILCA PER CILA®  CHIAVE OTTONE 50 pz	 8 003736554535 CIL3 / 783 - SILCA PER CILA®  CHIAVE OTTONE 50 pz	 8 003736040991 CIL5 / 783 - SILCA PER CILA®  CHIAVE OTTONE 100 pz	 8 003736268081 CIL6 / 783 - SILCA PER CILA®  CHIAVE OTTONE 50 pz
 8 003736268104 CIL7 / 783 - SILCA PER CILA®  CHIAVE OTTONE 50 pz	 8 003736041103 CIS1 / 783 - SILCA PER CAS-CISMA®  CHIAVE OTTONE 100 pz	 8 003736041127 CIS2 / 783 - SILCA PER CAS-CISMA®  CHIAVE OTTONE 100 pz	 8 003736041141 CIS3 / 783 - SILCA PER CAS-CISMA®  CHIAVE OTTONE 100 pz	 8 003736041165 CIS4 / 783 - SILCA PER CAS-CISMA®  CHIAVE OTTONE 100 pz
 8 003737797429 CIS4R / 783 - SILCA PER CAS-CISMA®  CHIAVE OTTONE 100 pz	 8 003736271180 CIS5 / 783 - SILCA PER CAS-CISMA®  CHIAVE OTTONE 50 pz	 8 003736271197 CIS7 / 783 - SILCA PER CAS-CISMA®  CHIAVE OTTONE 50 pz	 8 003736554641 CLS242 / 783 - SILCA PER CIELS®  CHIAVE ACCIAIO 50 pz	 8 003736271227 CM1 / 783 - SILCA PER CEMA®  CHIAVE OTTONE 50 pz

In conformità alle disposizioni legali in vigore relative alle proprietà industriali, informiamo che i marchi o le denominazioni commerciali citate nel nostro documento sono di proprietà esclusiva dei fabbricanti di serrature e degli utilizzatori autorizzati. Questi marchi o denominazioni commerciali sono indicati a titolo di semplice informazione, con lo scopo di riconoscere velocemente a quali serrature le nostre chiavi sono destinate. Questo documento è esclusivamente riservato ai professionisti della riproduzione chiavi che utilizzano i prodotti Silca. / Le illustrazioni e i dati tecnici dei prodotti contenuti nel documento debbono considerarsi indicativi. Silca si riserva il diritto, ferme restando le caratteristiche essenziali dei prodotti, di apportare tutte le modifiche che ritiene necessarie e opportune al fine di migliorare la qualità dei prodotti. Tutti i disegni e le fotografie sono di proprietà di Silca, ogni riproduzione anche parziale, senza autorizzazione scritta di Silca S.p.A. è vietata secondo termini di legge. Per qualsiasi controversia competenti sono gli Uffici Giudiziari dove ha sede l'Azienda Silca S.p.A., con espressa esclusione di qualsiasi altro foro.



 CM2 / 783 - SILCA PER CEMA®  CHIAVE OTTONE 100 pz	 CM4 / 783 - SILCA PER CEMA®  CHIAVE OTTONE 50 pz	 CS10 / 783 - SILCA PER CISA®  CHIAVE OTTONE 100 pz	 CS10R / 783 - SILCA PER CISA®  CHIAVE OTTONE 50 pz	 CS119 / 783 - SILCA PER CISA®  CHIAVE OTTONE 50 pz
 CS119R / 783 - SILCA PER CISA®  CHIAVE OTTONE 50 pz	 CS12 / 783 - SILCA PER CISA®  CHIAVE OTTONE 50 pz	 CS120 / 783 - SILCA PER CISA®  CHIAVE OTTONE 50 pz	 CS120R / 783 - SILCA PER CISA®  CHIAVE OTTONE 50 pz	 CS12R / 783 - SILCA PER CISA®  CHIAVE OTTONE 50 pz
 CS13R / 783 - SILCA PER CISA®  CHIAVE ACCIAIO 50 pz	 CS142 / 783 - SILCA PER CISA®  CHIAVE OTTONE 100 pz	 CS14R / 783 - SILCA PER CISA®  CHIAVE OTTONE 50 pz	 CS15 / 783 - SILCA PER CISA®  CHIAVE OTTONE 100 pz	 CS15R / 783 - SILCA PER CISA®  CHIAVE ACCIAIO 50 pz

In conformità alle disposizioni legali in vigore relative alle proprietà industriali, informiamo che i marchi o le denominazioni commerciali citate nel nostro documento sono di proprietà esclusiva dei fabbricanti di serrature e degli utilizzatori autorizzati. Questi marchi o denominazioni commerciali sono indicati a titolo di semplice informazione, con lo scopo di riconoscere velocemente a quali serrature le nostre chiavi sono destinate. Questo documento è esclusivamente riservato ai professionisti della riproduzione chiavi che utilizzano i prodotti Silca. / Le illustrazioni e i dati tecnici dei prodotti contenuti nel documento debbono considerarsi indicativi. Silca si riserva il diritto, ferme restando le caratteristiche essenziali dei prodotti, di apportare tutte le modifiche che ritiene necessarie e opportune al fine di migliorare la qualità dei prodotti. Tutti i disegni e le fotografie sono di proprietà di Silca, ogni riproduzione anche parziale, senza autorizzazione scritta di Silca S.p.A. è vietata secondo termini di legge. Per qualsiasi controversia competenti sono gli Uffici Giudiziari dove ha sede l'Azienda Silca S.p.A., con espressa esclusione di qualsiasi altro foro.

































DUPLICATRICI-CHIAVI-RADIOCOMANDI

 8 003736271401 CS16 / 783 - SILCA PER CISA® CHIAVE OTTONE 50 pz	 8 003737858106 CS163X / 783 - SILCA PER CISA® CHIAVE OTTONE 100 pz	 8 003736268272 CS17 / 783 - SILCA PER CISA® CHIAVE OTTONE 50 pz	 8 003736268289 CS17R / 783 - SILCA PER CISA® CHIAVE OTTONE 50 pz	 8 003736043275 CS18 / 783 - SILCA PER CISA® CHIAVE OTTONE 100 pz
 8 003736043398 CS204 / 783 - SILCA PER CISA® CHIAVE OTTONE 100 pz	 8 003736044319 CS205 / 783 - SILCA PER CISA® CHIAVE OTTONE 100 pz	 8 003736045262 CS206 / 783 - SILCA PER CISA® CHIAVE OTTONE 100 pz	 8 003736046429 CS207 / 783 - SILCA PER CISA® CHIAVE OTTONE 100 pz	 8 003736555129 CS27 / 783 - SILCA PER CISA® CHIAVE OTTONE 50 pz
 8 003736555167 CS28 / 783 - SILCA PER CISA® CHIAVE OTTONE 50 pz	 8 003736555181 CS28R / 783 - SILCA PER CISA® CHIAVE OTTONE 50 pz	 8 003736555204 CS30R / 783 - SILCA PER CISA® CHIAVE OTTONE 50 pz	 8 003736047969 CS31R / 783 - SILCA PER CISA® CHIAVE OTTONE 100 pz	 8 003736555280 CS37 / 783 - SILCA PER CISA® CHIAVE OTTONE 50 pz

In conformità alle disposizioni legali in vigore relative alle proprietà industriali, informiamo che i marchi o le denominazioni commerciali citate nel nostro documento sono di proprietà esclusiva dei fabbricanti di serrature e degli utilizzatori autorizzati. Questi marchi o denominazioni commerciali sono indicati a titolo di semplice informazione, con lo scopo di riconoscere velocemente a quali serrature le nostre chiavi sono destinate. Questo documento è esclusivamente riservato ai professionisti della riproduzione chiavi che utilizzano i prodotti Silca. / Le illustrazioni e i dati tecnici dei prodotti contenuti nel documento debbono considerarsi indicativi. Silca si riserva il diritto, ferme restando le caratteristiche essenziali dei prodotti, di apportare tutte le modifiche che ritiene necessarie e opportune al fine di migliorare la qualità dei prodotti. Tutti i disegni e le fotografie sono di proprietà di Silca, ogni riproduzione anche parziale, senza autorizzazione scritta di Silca S.p.A. è vietata secondo termini di legge. Per qualsiasi controversia competenti sono gli Uffici Giudiziari dove ha sede l'Azienda Silca S.p.A., con espressa esclusione di qualsiasi altro foro.

































 8 003736048195 CS38 / 783 - SILCA PER CISA®  CHIAVE OTTONE 100 pz	 8 003736048218 CS38R / 783 - SILCA PER CISA®  CHIAVE OTTONE 100 pz	 8 003736048317 CS4 / 783 - SILCA PER CISA®  CHIAVE OTTONE 100 pz	 8 003736272347 CS42 / 783 - SILCA PER CISA®  CHIAVE OTTONE 50 pz	 8 003736272354 CS43 / 783 - SILCA PER CISA®  CHIAVE OTTONE 50 pz
 8 003737493062 CS44R / 783 - SILCA PER CISA®  CHIAVE OTTONE 50 pz	 8 003736272392 CS46 / 783 - SILCA PER CISA®  CHIAVE OTTONE 50 pz	 8 003736272408 CS46R / 783 - SILCA PER CISA®  CHIAVE OTTONE 50 pz	 8 003736272415 CS47 / 783 - SILCA PER CISA®  CHIAVE OTTONE 50 pz	 8 003736272422 CS47R / 783 - SILCA PER CISA®  CHIAVE OTTONE 50 pz
 8 003736781337 CS49 / 783 - SILCA PER CISA®  CHIAVE OTTONE 100 pz	 8 003736048416 CS4R / 783 - SILCA PER CISA®  CHIAVE OTTONE 100 pz	 8 003736781344 CS50 / 783 - SILCA PER CISA®  CHIAVE OTTONE 100 pz	 8 003736268296 CS500 / 783 - SILCA PER CISA®  CHIAVE OTTONE 50 pz	 8 003736268319 CS500R / 783 - SILCA PER CISA®  CHIAVE OTTONE 50 pz

In conformità alle disposizioni legali in vigore relative alle proprietà industriali, informiamo che i marchi o le denominazioni commerciali citate nel nostro documento sono di proprietà esclusiva dei fabbricanti di serrature e degli utilizzatori autorizzati. Questi marchi o denominazioni commerciali sono indicati a titolo di semplice informazione, con lo scopo di riconoscere velocemente a quali serrature le nostre chiavi sono destinate. Questo documento è esclusivamente riservato ai professionisti della riproduzione chiavi che utilizzano i prodotti Silca. / Le illustrazioni e i dati tecnici dei prodotti contenuti nel documento debbono considerarsi indicativi. Silca si riserva il diritto, ferme restando le caratteristiche essenziali dei prodotti, di apportare tutte le modifiche che ritiene necessarie e opportune al fine di migliorare la qualità dei prodotti. Tutti i disegni e le fotografie sono di proprietà di Silca, ogni riproduzione anche parziale, senza autorizzazione scritta di Silca S.p.A. è vietata secondo termini di legge. Per qualsiasi controversia competenti sono gli Uffici Giudiziari dove ha sede l'Azienda Silca S.p.A., con espressa esclusione di qualsiasi altro foro.

































DUPLICATRICI-CHIAVI-RADIOCOMANDI

 8 003736268326 CS501 / 783 - SILCA PER CISA®  CHIAVE OTTONE 50 pz	 8 003736268340 CS501R / 783 - SILCA PER CISA®  CHIAVE OTTONE 50 pz	 8 003737273565 CS52X / 783 - SILCA PER CISA®  CHIAVE OTTONE 50 pz	 8 003736048928 CS6 / 783 - SILCA PER CISA®  CHIAVE OTTONE 100 pz	 8 003736431782 CS68 / 783 - SILCA PER CISA®  CHIAVE OTTONE 100 pz
 8 003736048973 CS6R / 783 - SILCA PER CISA®  CHIAVE OTTONE 100 pz	 8 003736272507 CS7 / 783 - SILCA PER CISA®  CHIAVE OTTONE 50 pz	 8 003736049338 CS7R / 783 - SILCA PER CISA®  CHIAVE OTTONE 100 pz	 8 003736049567 CS8 / 783 - SILCA PER CISA®  CHIAVE OTTONE 100 pz	 8 003736517240 CS85 / 783 - SILCA PER CISA®  CHIAVE ACCIAIO 50 pz
 8 003737465267 CS88 / 783 - SILCA PER CISA®  CHIAVE OTTONE 100 pz	 8 003736049581 CS8R / 783 - SILCA PER CISA®  CHIAVE OTTONE 100 pz	 8 003736272590 CS9 / 783 - SILCA PER CISA®  CHIAVE OTTONE 50 pz	 8 003736272606 CS9R / 783 - SILCA PER CISA®  CHIAVE OTTONE 50 pz	 8 003736316713 DEA2 / 783 - SILCA PER DE ANGELI®  CHIAVE ACCIAIO 50 pz

In conformità alle disposizioni legali in vigore relative alle proprietà industriali, informiamo che i marchi o le denominazioni commerciali citate nel nostro documento sono di proprietà esclusiva dei fabbricanti di serrature e degli utilizzatori autorizzati. Questi marchi o denominazioni commerciali sono indicati a titolo di semplice informazione, con lo scopo di riconoscere velocemente a quali serrature le nostre chiavi sono destinate. Questo documento è esclusivamente riservato ai professionisti della riproduzione chiavi che utilizzano i prodotti Silca. / Le illustrazioni e i dati tecnici dei prodotti contenuti nel documento debbono considerarsi indicativi. Silca si riserva il diritto, ferme restando le caratteristiche essenziali dei prodotti, di apportare tutte le modifiche che ritiene necessarie e opportune al fine di migliorare la qualità dei prodotti. Tutti i disegni e le fotografie sono di proprietà di Silca, ogni riproduzione anche parziale, senza autorizzazione scritta di Silca S.p.A. è vietata secondo termini di legge. Per qualsiasi controversia competenti sono gli Uffici Giudiziari dove ha sede l'Azienda Silca S.p.A., con espressa esclusione di qualsiasi altro foro.

































 DM10 / 783 - SILCA PER DOM®  CHIAVE ACCIAIO 50 pz	 DM137 / 783 - SILCA PER DOM®  CHIAVE ACCIAIO 100 pz	 DM14 / 783 - SILCA PER DOM®  CHIAVE OTTONE 50 pz	 DM16 / 783 - SILCA PER DOM®  CHIAVE OTTONE 100 pz	 DM17 / 783 - SILCA PER DOM®  CHIAVE OTTONE 50 pz
 DM1R / 783 - SILCA PER DOM®  CHIAVE ACCIAIO 50 pz	 DM1RP / 783 - SILCA PER DOM®  CHIAVE ACCIAIO 25 pz	 DM39 / 783 - SILCA PER DOM®  CHIAVE OTTONE 50 pz	 DM39R / 783 - SILCA PER DOM®  CHIAVE ACCIAIO 50 pz	 DM4 / 783 - SILCA PER DOM®  CHIAVE ACCIAIO 50 pz
 DM63 / 783 - SILCA PER DOM®  CHIAVE ACCIAIO 100 pz	 DM63R / 783 - SILCA PER DOM®  CHIAVE ACCIAIO 50 pz	 DM8 / 783 - SILCA PER DOM®  CHIAVE ACCIAIO 50 pz	 DN2 / 783 - SILCA PER DIAMOND®  CHIAVE OTTONE 50 pz	 DX1 / 783 - SILCA PER DEXTER®  CHIAVE OTTONE 100 pz

In conformità alle disposizioni legali in vigore relative alle proprietà industriali, informiamo che i marchi o le denominazioni commerciali citate nel nostro documento sono di proprietà esclusiva dei fabbricanti di serrature e degli utilizzatori autorizzati. Questi marchi o denominazioni commerciali sono indicati a titolo di semplice informazione, con lo scopo di riconoscere velocemente a quali serrature le nostre chiavi sono destinate. Questo documento è esclusivamente riservato ai professionisti della riproduzione chiavi che utilizzano i prodotti Silca. / Le illustrazioni e i dati tecnici dei prodotti contenuti nel documento debbono considerarsi indicativi. Silca si riserva il diritto, ferme restando le caratteristiche essenziali dei prodotti, di apportare tutte le modifiche che ritiene necessarie e opportune al fine di migliorare la qualità dei prodotti. Tutti i disegni e le fotografie sono di proprietà di Silca, ogni riproduzione anche parziale, senza autorizzazione scritta di Silca S.p.A. è vietata secondo termini di legge. Per qualsiasi controversia competenti sono gli Uffici Giudiziari dove ha sede l'Azienda Silca S.p.A., con espressa esclusione di qualsiasi altro foro.

































DUPLICATRICI-CHIAVI-RADIOCOMANDI

 8 003736064492 DX1R / 783 - SILCA PER DEXTER®  CHIAVE OTTONE 100 pz	 8 003736267688 DX3 / 783 - SILCA PER DEXTER®  CHIAVE OTTONE 50 pz	 8 003737442633 ED4 / 783 - SILCA PER EVERGOOD®  CHIAVE ACCIAIO 50 pz	 8 003736066076 EK1 / 783 - SILCA PER EUREKA®  CHIAVE OTTONE 100 pz	 8 003736066625 EMK1 / 783 - SILCA PER EMKA®  CHIAVE ACCIAIO 100 pz
 8 003737455312 EMK5 / 783 - SILCA PER EMKA®  CHIAVE ACCIAIO 100 pz	 8 003736558533 ET2 / 783 - SILCA PER ETNA®  CHIAVE OTTONE 50 pz	 8 003736862272 EU10 / 783 - SILCA PER EURO LOCKS®  CHIAVE ACCIAIO 100 pz	 8 003736786608 EU10R / 783 - SILCA PER EURO LOCKS®  CHIAVE ACCIAIO 100 pz	 8 003736863569 EU11R / 783 - SILCA PER EURO LOCKS®  CHIAVE ACCIAIO 50 pz
 8 003737438537 EU12 / 783 - SILCA PER EURO LOCKS®  CHIAVE ACCIAIO 100 pz	 8 003737449854 EU13R / 783 - SILCA PER EURO LOCKS®  CHIAVE ACCIAIO 100 pz	 8 003737509350 EU15 / 783 - SILCA PER EURO LOCKS®  CHIAVE ACCIAIO 100 pz	 8 003737519366 EU16R / 783 - SILCA PER EURO LOCKS®  CHIAVE ACCIAIO 100 pz	 8 003737674546 EU18R / 783 - SILCA PER EURO LOCKS®  CHIAVE ACCIAIO 100 pz

In conformità alle disposizioni legali in vigore relative alle proprietà industriali, informiamo che i marchi o le denominazioni commerciali citate nel nostro documento sono di proprietà esclusiva dei fabbricanti di serrature e degli utilizzatori autorizzati. Questi marchi o denominazioni commerciali sono indicati a titolo di semplice informazione, con lo scopo di riconoscere velocemente a quali serrature le nostre chiavi sono destinate. Questo documento è esclusivamente riservato ai professionisti della riproduzione chiavi che utilizzano i prodotti Silca. / Le illustrazioni e i dati tecnici dei prodotti contenuti nel documento debbono considerarsi indicativi. Silca si riserva il diritto, ferme restando le caratteristiche essenziali dei prodotti, di apportare tutte le modifiche che ritiene necessarie e opportune al fine di migliorare la qualità dei prodotti. Tutti i disegni e le fotografie sono di proprietà di Silca, ogni riproduzione anche parziale, senza autorizzazione scritta di Silca S.p.A. è vietata secondo termini di legge. Per qualsiasi controversia competenti sono gli Uffici Giudiziari dove ha sede l'Azienda Silca S.p.A., con espressa esclusione di qualsiasi altro foro.



 8 003737684262 EU19 / 783 - SILCA PER EURO LOCKS®  CHIAVE ACCIAIO 100 pz	 8 003736257474 EU1R / 783 - SILCA PER EURO LOCKS®  CHIAVE OTTONE 50 pz	 8 003737891400 EU22RP / 783 - SILCA PER EURO LOCKS®  CHIAVE OTTONE 25 pz	 8 003736257498 EU3 / 783 - SILCA PER EURO LOCKS®  CHIAVE OTTONE 50 pz	 8 003736067271 EU4 / 783 - SILCA PER EURO LOCKS®  CHIAVE ACCIAIO 100 pz
 8 003736067295 EU4R / 783 - SILCA PER EURO LOCKS®  CHIAVE ACCIAIO 100 pz	 8 003736067325 EU5R / 783 - SILCA PER EURO LOCKS®  CHIAVE OTTONE 100 pz	 8 003736786639 EU6 / 783 - SILCA PER EURO LOCKS®  CHIAVE ACCIAIO 100 pz	 8 003736303775 EU9 / 783 - SILCA PER EURO LOCKS®  CHIAVE ACCIAIO 50 pz	 8 003736295193 EV10X / 783 - SILCA PER EVVA®  CHIAVE ACCIAIO 100 pz
 8 003737385282 EV69X / 783 - SILCA PER EVVA®  CHIAVE ACCIAIO 50 pz	 8 003737674294 FB36 / 783 - SILCA PER FAB®  CHIAVE OTTONE 100 pz	 8 003736272682 FEB1 / 783 - SILCA PER FEB®  CHIAVE OTTONE 50 pz	 8 003736559073 FEB1R / 783 - SILCA PER FEB®  CHIAVE OTTONE 50 pz	 8 003736070936 FEB2 / 783 - SILCA PER FEB®  CHIAVE OTTONE 100 pz

In conformità alle disposizioni legali in vigore relative alle proprietà industriali, informiamo che i marchi o le denominazioni commerciali citate nel nostro documento sono di proprietà esclusiva dei fabbricanti di serrature e degli utilizzatori autorizzati. Questi marchi o denominazioni commerciali sono indicati a titolo di semplice informazione, con lo scopo di riconoscere velocemente a quali serrature le nostre chiavi sono destinate. Questo documento è esclusivamente riservato ai professionisti della riproduzione chiavi che utilizzano i prodotti Silca. / Le illustrazioni e i dati tecnici dei prodotti contenuti nel documento debbono considerarsi indicativi. Silca si riserva il diritto, ferme restando le caratteristiche essenziali dei prodotti, di apportare tutte le modifiche che ritiene necessarie e opportune al fine di migliorare la qualità dei prodotti. Tutti i disegni e le fotografie sono di proprietà di Silca, ogni riproduzione anche parziale, senza autorizzazione scritta di Silca S.p.A. è vietata secondo termini di legge. Per qualsiasi controversia competenti sono gli Uffici Giudiziari dove ha sede l'Azienda Silca S.p.A., con espressa esclusione di qualsiasi altro foro.

































DUPLICATRICI-CHIAVI-RADIOCOMANDI

 8 003736272705 FEB2R / 783 - SILCA PER FEB® CHIAVE OTTONE 50 pz	 8 003737675314 FEB6R / 783 - SILCA PER FEB® CHIAVE OTTONE 50 pz	 8 003736272712 FF1 / 783 - SILCA PER FF-FACCHINETTI® CHIAVE OTTONE 50 pz	 8 003736071292 FF14 / 783 - SILCA PER FF-FACCHINETTI® CHIAVE OTTONE 100 pz	 8 003736071315 FF15 / 783 - SILCA PER FF-FACCHINETTI® CHIAVE OTTONE 100 pz
 8 003737582261 FF17 / 783 - SILCA PER FF-FACCHINETTI® CHIAVE ACCIAIO 100 pz	 8 003737661614 FF18 / 783 - SILCA PER FF-FACCHINETTI® CHIAVE OTTONE 50 pz	 8 003736071353 FF2 / 783 - SILCA PER FF-FACCHINETTI® CHIAVE OTTONE 100 pz	 8 003736320703 FF8 / 783 - SILCA PER FF-FACCHINETTI® CHIAVE ACCIAIO 50 pz	 8 003736304604 FH9 / 783 - SILCA PER FTH® CHIAVE ACCIAIO 50 pz
 8 003736072350 FI064 / 783 - SILCA PER FIAM® CHIAVE OTTONE 100 pz	 8 003736072435 FI232 / 783 - SILCA PER FIAM® CHIAVE OTTONE 100 pz	 8 003736072459 FI233 / 783 - SILCA PER FIAM® CHIAVE OTTONE 100 pz	 8 003736072473 FI234 / 783 - SILCA PER FIAM® CHIAVE OTTONE 100 pz	 8 003736072497 FI235 / 783 - SILCA PER FIAM® CHIAVE OTTONE 100 pz

In conformità alle disposizioni legali in vigore relative alle proprietà industriali, informiamo che i marchi o le denominazioni commerciali citate nel nostro documento sono di proprietà esclusiva dei fabbricanti di serrature e degli utilizzatori autorizzati. Questi marchi o denominazioni commerciali sono indicati a titolo di semplice informazione, con lo scopo di riconoscere velocemente a quali serrature le nostre chiavi sono destinate. Questo documento è esclusivamente riservato ai professionisti della riproduzione chiavi che utilizzano i prodotti Silca. / Le illustrazioni e i dati tecnici dei prodotti contenuti nel documento debbono considerarsi indicativi. Silca si riserva il diritto, ferme restando le caratteristiche essenziali dei prodotti, di apportare tutte le modifiche che ritiene necessarie e opportune al fine di migliorare la qualità dei prodotti. Tutti i disegni e le fotografie sono di proprietà di Silca, ogni riproduzione anche parziale, senza autorizzazione scritta di Silca S.p.A. è vietata secondo termini di legge. Per qualsiasi controversia competenti sono gli Uffici Giudiziari dove ha sede l'Azienda Silca S.p.A., con espressa esclusione di qualsiasi altro foro.



 FIS3 / 783 - SILCA PER FASEM®  CHIAVE OTTONE 100 pz	 FM090 / 783 - SILCA PER FASEM®  CHIAVE OTTONE 100 pz	 FM1 / 783 - SILCA PER FASEM®  CHIAVE OTTONE 100 pz	 FM2 / 783 - SILCA PER FASEM®  CHIAVE OTTONE 100 pz	 FM5 / 783 - SILCA PER FASEM®  CHIAVE OTTONE 50 pz
 FM6 / 783 - SILCA PER FASEM®  CHIAVE OTTONE 100 pz	 FM7 / 783 - SILCA PER FASEM®  CHIAVE OTTONE 50 pz	 GE1 / 783 - SILCA PER GEGE®  CHIAVE ACCIAIO 100 pz	 GE1X / 783 - SILCA PER GEGE®  CHIAVE OTTONE 50 pz	 GE32 / 783 - SILCA PER GEGE®  CHIAVE ACCIAIO 50 pz
 GL1 / 783 - SILCA PER GLOBE®  CHIAVE ACCIAIO 50 pz	 GL13R / 783 - SILCA PER GLOBE®  CHIAVE OTTONE 100 pz	 GL17R / 783 - SILCA PER GLOBE®  CHIAVE OTTONE 50 pz	 GL3 / 783 - SILCA PER GLOBE®  CHIAVE ACCIAIO 50 pz	 GL6 / 783 - SILCA PER GLOBE®  CHIAVE OTTONE 50 pz

In conformità alle disposizioni legali in vigore relative alle proprietà industriali, informiamo che i marchi o le denominazioni commerciali citate nel nostro documento sono di proprietà esclusiva dei fabbricanti di serrature e degli utilizzatori autorizzati. Questi marchi o denominazioni commerciali sono indicati a titolo di semplice informazione, con lo scopo di riconoscere velocemente a quali serrature le nostre chiavi sono destinate. Questo documento è esclusivamente riservato ai professionisti della riproduzione chiavi che utilizzano i prodotti Silca. / Le illustrazioni e i dati tecnici dei prodotti contenuti nel documento debbono considerarsi indicativi. Silca si riserva il diritto, ferme restando le caratteristiche essenziali dei prodotti, di apportare tutte le modifiche che ritiene necessarie e opportune al fine di migliorare la qualità dei prodotti. Tutti i disegni e le fotografie sono di proprietà di Silca, ogni riproduzione anche parziale, senza autorizzazione scritta di Silca S.p.A. è vietata secondo termini di legge. Per qualsiasi controversia competenti sono gli Uffici Giudiziari dove ha sede l'Azienda Silca S.p.A., con espressa esclusione di qualsiasi altro foro.

































DUPLICATRICI-CHIAVI-RADIOCOMANDI

 8 003736241114 GL7 / 783 - SILCA PER GLOBE® CHIAVE OTTONE 50 pz	 8 003736560352 GL8 / 783 - SILCA PER GLOBE® CHIAVE ACCIAIO 50 pz	 8 003736084698 GS1 / 783 - SILCA PER GIUSSANI® CHIAVE OTTONE 100 pz	 8 003736560390 GS10 / 783 - SILCA PER GIUSSANI® CHIAVE OTTONE 50 pz	 8 003736560413 GS10R / 783 - SILCA PER GIUSSANI® CHIAVE OTTONE 50 pz
 8 003736560437 GS12R / 783 - SILCA PER GIUSSANI® CHIAVE OTTONE 50 pz	 8 003736084827 GS13 / 783 - SILCA PER GIUSSANI® CHIAVE OTTONE 100 pz	 8 003736084841 GS2 / 783 - SILCA PER GIUSSANI® CHIAVE OTTONE 100 pz	 8 003736084865 GS2R / 783 - SILCA PER GIUSSANI® CHIAVE OTTONE 100 pz	 8 003736273221 GS3 / 783 - SILCA PER GIUSSANI® CHIAVE OTTONE 50 pz
 8 003736273238 GS3R / 783 - SILCA PER GIUSSANI® CHIAVE OTTONE 50 pz	 8 003736084926 GS4 / 783 - SILCA PER GIUSSANI® CHIAVE OTTONE 100 pz	 8 003736084933 GS4R / 783 - SILCA PER GIUSSANI® CHIAVE ACCIAIO 100 pz	 8 003736560475 GS6 / 783 - SILCA PER GIUSSANI® CHIAVE OTTONE 50 pz	 8 003736560512 GS8 / 783 - SILCA PER GIUSSANI® CHIAVE OTTONE 50 pz

In conformità alle disposizioni legali in vigore relative alle proprietà industriali, informiamo che i marchi o le denominazioni commerciali citate nel nostro documento sono di proprietà esclusiva dei fabbricanti di serrature e degli utilizzatori autorizzati. Questi marchi o denominazioni commerciali sono indicati a titolo di semplice informazione, con lo scopo di riconoscere velocemente a quali serrature le nostre chiavi sono destinate. Questo documento è esclusivamente riservato ai professionisti della riproduzione chiavi che utilizzano i prodotti Silca. / Le illustrazioni e i dati tecnici dei prodotti contenuti nel documento debbono considerarsi indicativi. Silca si riserva il diritto, ferme restando le caratteristiche essenziali dei prodotti, di apportare tutte le modifiche che ritiene necessarie e opportune al fine di migliorare la qualità dei prodotti. Tutti i disegni e le fotografie sono di proprietà di Silca, ogni riproduzione anche parziale, senza autorizzazione scritta di Silca S.p.A. è vietata secondo termini di legge. Per qualsiasi controversia competenti sono gli Uffici Giudiziari dove ha sede l'Azienda Silca S.p.A., con espressa esclusione di qualsiasi altro foro.

































 GT1 / 783 - SILCA PER GIOBERT®  CHIAVE OTTONE 100 pz	 HF74 / 783 - SILCA PER HÄFELE®  CHIAVE OTTONE 100 pz	 HF74R / 783 - SILCA PER HÄFELE®  CHIAVE ACCIAIO 100 pz	 HF75 / 783 - SILCA PER HÄFELE®  CHIAVE ACCIAIO 100 pz	 HF75R / 783 - SILCA PER HÄFELE®  CHIAVE OTTONE 50 pz
 HG2 / 783 - SILCA PER HUGIN®  CHIAVE OTTONE 50 pz	 HN3 / 783 - SILCA PER HEKNA®  CHIAVE ACCIAIO 50 pz	 HN4 / 783 - SILCA PER HEKNA®  CHIAVE ACCIAIO 50 pz	 HPP1 / 783 - SILCA PER HOPPE®  CHIAVE ACCIAIO 100 pz	 HPP1R / 783 - SILCA PER HOPPE®  CHIAVE OTTONE 100 pz
 HR1 / 783 - SILCA PER HR®  CHIAVE ACCIAIO 50 pz	 HUT1 / 783 - SILCA PER HUNIT®  CHIAVE OTTONE 100 pz	 HW1 / 783 - SILCA PER HUWIL®  CHIAVE OTTONE 50 pz	 HW4 / 783 - SILCA PER HUWIL®  CHIAVE ACCIAIO 50 pz	 HW4R / 783 - SILCA PER HUWIL®  CHIAVE OTTONE 50 pz

In conformità alle disposizioni legali in vigore relative alle proprietà industriali, informiamo che i marchi o le denominazioni commerciali citate nel nostro documento sono di proprietà esclusiva dei fabbricanti di serrature e degli utilizzatori autorizzati. Questi marchi o denominazioni commerciali sono indicati a titolo di semplice informazione, con lo scopo di riconoscere velocemente a quali serrature le nostre chiavi sono destinate. Questo documento è esclusivamente riservato ai professionisti della riproduzione chiavi che utilizzano i prodotti Silca. / Le illustrazioni e i dati tecnici dei prodotti contenuti nel documento debbono considerarsi indicativi. Silca si riserva il diritto, ferme restando le caratteristiche essenziali dei prodotti, di apportare tutte le modifiche che ritiene necessarie e opportune al fine di migliorare la qualità dei prodotti. Tutti i disegni e le fotografie sono di proprietà di Silca, ogni riproduzione anche parziale, senza autorizzazione scritta di Silca S.p.A. è vietata secondo termini di legge. Per qualsiasi controversia competenti sono gli Uffici Giudiziari dove ha sede l'Azienda Silca S.p.A., con espressa esclusione di qualsiasi altro foro.

































DUPLICATRICI-CHIAVI-RADIOCOMANDI

 8 003736561274 ICS1 / 783 - SILCA PER ICSA®  CHIAVE OTTONE 50 pz	 8 003736096417 IE1 / 783 - SILCA PER ISEO®  CHIAVE OTTONE 100 pz	 8 003736273429 IE10 / 783 - SILCA PER ISEO®  CHIAVE OTTONE 50 pz	 8 003736336971 IE12 / 783 - SILCA PER ISEO®  CHIAVE OTTONE 100 pz	 8 003736336988 IE2 / 783 - SILCA PER ISEO®  CHIAVE OTTONE 100 pz
 8 003736097049 IE224 / 783 - SILCA PER ISEO®  CHIAVE OTTONE 100 pz	 8 003736097315 IE225 / 783 - SILCA PER ISEO®  CHIAVE OTTONE 100 pz	 8 003737644013 IE27R / 783 - SILCA PER ISEO®  CHIAVE ACCIAIO 100 pz	 8 003737753562 IE28R / 783 - SILCA PER ISEO®  CHIAVE OTTONE 100 pz	 8 003736097582 IE3 / 783 - SILCA PER ISEO®  CHIAVE OTTONE 100 pz
 8 003737836241 IE31 / 783 - SILCA PER ISEO®  CHIAVE OTTONE 100 pz	 8 003736273863 IE4 / 783 - SILCA PER ISEO®  CHIAVE OTTONE 50 pz	 8 003736561427 IE5 / 783 - SILCA PER ISEO®  CHIAVE OTTONE 50 pz	 8 003736097902 IE6 / 783 - SILCA PER ISEO®  CHIAVE OTTONE 100 pz	 8 003736098022 IE6R / 783 - SILCA PER ISEO®  CHIAVE OTTONE 100 pz

In conformità alle disposizioni legali in vigore relative alle proprietà industriali, informiamo che i marchi o le denominazioni commerciali citate nel nostro documento sono di proprietà esclusiva dei fabbricanti di serrature e degli utilizzatori autorizzati. Questi marchi o denominazioni commerciali sono indicati a titolo di semplice informazione, con lo scopo di riconoscere velocemente a quali serrature le nostre chiavi sono destinate. Questo documento è esclusivamente riservato ai professionisti della riproduzione chiavi che utilizzano i prodotti Silca. / Le illustrazioni e i dati tecnici dei prodotti contenuti nel documento debbono considerarsi indicativi. Silca si riserva il diritto, ferme restando le caratteristiche essenziali dei prodotti, di apportare tutte le modifiche che ritiene necessarie e opportune al fine di migliorare la qualità dei prodotti. Tutti i disegni e le fotografie sono di proprietà di Silca, ogni riproduzione anche parziale, senza autorizzazione scritta di Silca S.p.A. è vietata secondo termini di legge. Per qualsiasi controversia competenti sono gli Uffici Giudiziari dove ha sede l'Azienda Silca S.p.A., con espressa esclusione di qualsiasi altro foro.



 IE7 / 783 - SILCA PER ISEO®  CHIAVE OTTONE 100 pz	 IE8 / 783 - SILCA PER ISEO®  CHIAVE OTTONE 50 pz	 IE9 / 783 - SILCA PER ISEO®  CHIAVE OTTONE 100 pz	 IF6 / 783 - SILCA PER IFAM®  CHIAVE OTTONE 100 pz	 ILF1R / 783 - SILCA PER ILMA FABBRI®  CHIAVE ACCIAIO 50 pz
 IN1 / 783 - SILCA PER ILLINOIS®  CHIAVE ACCIAIO 50 pz	 JC1 / 783 - SILCA PER JUNKUNC®  CHIAVE ACCIAIO 50 pz	 JD1 / 783 - SILCA PER JOHN DEERE®  CHIAVE OTTONE 50 pz	 JM1 / 783 - SILCA PER JPM®  CHIAVE ACCIAIO 50 pz	 JM1R / 783 - SILCA PER JPM®  CHIAVE ACCIAIO 50 pz
 JM2R / 783 - SILCA PER JPM®  CHIAVE ACCIAIO 50 pz	 JR1R / 783 - SILCA PER JUNGHEINRICH®  CHIAVE ACCIAIO 50 pz	 KEY1 / 783 - SILCA PER KEYA®  CHIAVE ACCIAIO 100 pz	 KEY2 / 783 - SILCA PER KEYA®  CHIAVE ACCIAIO 100 pz	 KK1 / 783 - SILCA PER WALLY®  CHIAVE OTTONE 50 pz

In conformità alle disposizioni legali in vigore relative alle proprietà industriali, informiamo che i marchi o le denominazioni commerciali citate nel nostro documento sono di proprietà esclusiva dei fabbricanti di serrature e degli utilizzatori autorizzati. Questi marchi o denominazioni commerciali sono indicati a titolo di semplice informazione, con lo scopo di riconoscere velocemente a quali serrature le nostre chiavi sono destinate. Questo documento è esclusivamente riservato ai professionisti della riproduzione chiavi che utilizzano i prodotti Silca. / Le illustrazioni e i dati tecnici dei prodotti contenuti nel documento debbono considerarsi indicativi. Silca si riserva il diritto, ferme restando le caratteristiche essenziali dei prodotti, di apportare tutte le modifiche che ritiene necessarie e opportune al fine di migliorare la qualità dei prodotti. Tutti i disegni e le fotografie sono di proprietà di Silca, ogni riproduzione anche parziale, senza autorizzazione scritta di Silca S.p.A. è vietata secondo termini di legge. Per qualsiasi controversia competenti sono gli Uffici Giudiziari dove ha sede l'Azienda Silca S.p.A., con espressa esclusione di qualsiasi altro foro.

































DUPLICATRICI-CHIAVI-RADIOCOMANDI

 8 003736307018 LC11 / 783 - SILCA PER LINCÉ® CHIAVE ACCIAIO 50 pz	 8 003736107281 LF10 / 783 - SILCA PER LOWE & FLETCHER® CHIAVE ACCIAIO 50 pz	 8 003736107304 LF10P / 783 - SILCA PER LOWE & FLETCHER® CHIAVE ACCIAIO 25 pz	 8 003736107335 LF11 / 783 - SILCA PER LOWE & FLETCHER® CHIAVE ACCIAIO 100 pz	 8 003736562912 LF11R / 783 - SILCA PER LOWE & FLETCHER® CHIAVE ACCIAIO 50 pz
 8 003736107373 LF12 / 783 - SILCA PER LOWE & FLETCHER® CHIAVE ACCIAIO 50 pz	 8 003736307193 LF13 / 783 - SILCA PER EURO LOCKS® CHIAVE ACCIAIO 50 pz	 8 003736107403 LF14 / 783 - SILCA PER LOWE & FLETCHER® CHIAVE ACCIAIO 50 pz	 8 003736562936 LF16 / 783 - SILCA PER LOWE & FLETCHER® CHIAVE ACCIAIO 50 pz	 8 003736562943 LF16R / 783 - SILCA PER LOWE & FLETCHER® CHIAVE ACCIAIO 50 pz
 8 003736562950 LF17 / 783 - SILCA PER EURO LOCKS® CHIAVE ACCIAIO 50 pz	 8 003736107519 LF19 / 783 - SILCA PER LOWE & FLETCHER® CHIAVE ACCIAIO 50 pz	 8 003736251564 LF2 / 783 - SILCA PER LOWE & FLETCHER® CHIAVE OTTONE 50 pz	 8 003736251564 LF2 / 783 - SILCA PER LOWE & FLETCHER® CHIAVE OTTONE 50 pz	 8 003736107588 LF20 / 783 - SILCA PER LOWE & FLETCHER® CHIAVE ACCIAIO 50 pz

In conformità alle disposizioni legali in vigore relative alle proprietà industriali, informiamo che i marchi o le denominazioni commerciali citate nel nostro documento sono di proprietà esclusiva dei fabbricanti di serrature e degli utilizzatori autorizzati. Questi marchi o denominazioni commerciali sono indicati a titolo di semplice informazione, con lo scopo di riconoscere velocemente a quali serrature le nostre chiavi sono destinate. Questo documento è esclusivamente riservato ai professionisti della riproduzione chiavi che utilizzano i prodotti Silca. / Le illustrazioni e i dati tecnici dei prodotti contenuti nel documento debbono considerarsi indicativi. Silca si riserva il diritto, ferme restando le caratteristiche essenziali dei prodotti, di apportare tutte le modifiche che ritiene necessarie e opportune al fine di migliorare la qualità dei prodotti. Tutti i disegni e le fotografie sono di proprietà di Silca, ogni riproduzione anche parziale, senza autorizzazione scritta di Silca S.p.A. è vietata secondo termini di legge. Per qualsiasi controversia competenti sono gli Uffici Giudiziari dove ha sede l'Azienda Silca S.p.A., con espressa esclusione di qualsiasi altro foro.































 8 003736107601 LF20R / 783 - SILCA PER LOWE & FLETCHER®  CHIAVE ACCIAIO 50 pz	 8 003736107670 LF22 / 783 - SILCA PER LOWE & FLETCHER®  CHIAVE OTTONE 50 pz	 8 003736107687 LF22R / 783 - SILCA PER LOWE & FLETCHER®  CHIAVE ACCIAIO 50 pz	 8 003736107717 LF23R / 783 - SILCA PER LOWE & FLETCHER®  CHIAVE OTTONE 100 pz	 8 003736562998 LF24 / 783 - SILCA PER LOWE & FLETCHER (AU...)  CHIAVE ACCIAIO 50 pz
 8 003736307230 LF27 / 783 - SILCA PER LOWE & FLETCHER (AU...)  CHIAVE ACCIAIO 50 pz	 8 003736107991 LF30R / 783 - SILCA PER LOWE & FLETCHER®  CHIAVE OTTONE 100 pz	 8 003736563063 LF31R / 783 - SILCA PER LOWE & FLETCHER®  CHIAVE ACCIAIO 50 pz	 8 003736108158 LF36 / 783 - SILCA PER LOWE & FLETCHER®  CHIAVE ACCIAIO 50 pz	 8 003736261228 LF37 / 783 - SILCA PER LOWE & FLETCHER®  CHIAVE OTTONE 50 pz
 8 003736108240 LF4 / 783 - SILCA PER LOWE & FLETCHER®  CHIAVE OTTONE 100 pz	 8 003736307315 LF42R / 783 - SILCA PER LOWE & FLETCHER®  CHIAVE ACCIAIO 50 pz	 8 003736261273 LF43R / 783 - SILCA PER LOWE & FLETCHER (AU...)  CHIAVE OTTONE 50 pz	 8 003736371187 LF44 / 783 - SILCA PER LOWE & FLETCHER®  CHIAVE ACCIAIO 100 pz	 8 003736862890 LF45R / 783 - SILCA PER LOWE & FLETCHER®  CHIAVE ACCIAIO 100 pz

In conformità alle disposizioni legali in vigore relative alle proprietà industriali, informiamo che i marchi o le denominazioni commerciali citate nel nostro documento sono di proprietà esclusiva dei fabbricanti di serrature e degli utilizzatori autorizzati. Questi marchi o denominazioni commerciali sono indicati a titolo di semplice informazione, con lo scopo di riconoscere velocemente a quali serrature le nostre chiavi sono destinate. Questo documento è esclusivamente riservato ai professionisti della riproduzione chiavi che utilizzano i prodotti Silca. / Le illustrazioni e i dati tecnici dei prodotti contenuti nel documento debbono considerarsi indicativi. Silca si riserva il diritto, ferme restando le caratteristiche essenziali dei prodotti, di apportare tutte le modifiche che ritiene necessarie e opportune al fine di migliorare la qualità dei prodotti. Tutti i disegni e le fotografie sono di proprietà di Silca, ogni riproduzione anche parziale, senza autorizzazione scritta di Silca S.p.A. è vietata secondo termini di legge. Per qualsiasi controversia competenti sono gli Uffici Giudiziari dove ha sede l'Azienda Silca S.p.A., con espressa esclusione di qualsiasi altro foro.

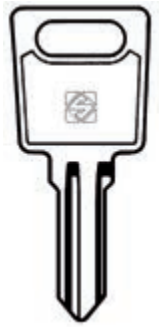

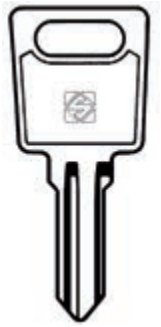





























DUPLICATRICI-CHIAVI-RADIOCOMANDI

 8 003736862845 LF46R / 783 - SILCA PER LOWE & FLETCHER®  CHIAVE ACCIAIO 100 pz	 8 003736307308 LF4R / 783 - SILCA PER LOWE & FLETCHER®  CHIAVE ACCIAIO 50 pz	 8 003736470354 LF54 / 783 - SILCA PER LOWE & FLETCHER®  CHIAVE OTTONE 100 pz	 8 003737587624 LF57 / 783 - SILCA PER LOWE & FLETCHER®  CHIAVE OTTONE 100 pz	 8 003737583176 LF59R / 783 - SILCA PER LOWE & FLETCHER®  CHIAVE ACCIAIO 100 pz
 8 003736108462 LF6 / 783 - SILCA PER LOWE & FLETCHER®  CHIAVE ACCIAIO 100 pz	 8 003737703802 LF61R / 783 - SILCA PER LOWE & FLETCHER®  CHIAVE OTTONE 100 pz	 8 003737928724 LF6R / 783 - SILCA PER LOWE & FLETCHER®  CHIAVE OTTONE 50 pz	 8 003736563155 LF7 / 783 - SILCA PER EURO LOCKS®  CHIAVE ACCIAIO 50 pz	 8 003736563179 LF8 / 783 - SILCA PER EURO LOCKS®  CHIAVE ACCIAIO 50 pz
 8 003737467742 LMA1 / 783 - SILCA PER LAMA®  CHIAVE ACCIAIO 50 pz	 8 003736307711 LP3 / 783 - SILCA PER LIPS®  CHIAVE ACCIAIO 50 pz	 8 003736111776 LS13 / 783 - SILCA PER LAS®  CHIAVE ACCIAIO 50 pz	 8 003736308176 LS13R / 783 - SILCA PER LAS®  CHIAVE ACCIAIO 50 pz	 8 003736112032 LS14 / 783 - SILCA PER LAS®  CHIAVE ACCIAIO 50 pz

In conformità alle disposizioni legali in vigore relative alle proprietà industriali, informiamo che i marchi o le denominazioni commerciali citate nel nostro documento sono di proprietà esclusiva dei fabbricanti di serrature e degli utilizzatori autorizzati. Questi marchi o denominazioni commerciali sono indicati a titolo di semplice informazione, con lo scopo di riconoscere velocemente a quali serrature le nostre chiavi sono destinate. Questo documento è esclusivamente riservato ai professionisti della riproduzione chiavi che utilizzano i prodotti Silca. / Le illustrazioni e i dati tecnici dei prodotti contenuti nel documento debbono considerarsi indicativi. Silca si riserva il diritto, ferme restando le caratteristiche essenziali dei prodotti, di apportare tutte le modifiche che ritiene necessarie e opportune al fine di migliorare la qualità dei prodotti. Tutti i disegni e le fotografie sono di proprietà di Silca, ogni riproduzione anche parziale, senza autorizzazione scritta di Silca S.p.A. è vietata secondo termini di legge. Per qualsiasi controversia competenti sono gli Uffici Giudiziari dove ha sede l'Azienda Silca S.p.A., con espressa esclusione di qualsiasi altro foro.

































 LS14R / 783 - SILCA PER LAS®  CHIAVE ACCIAIO 50 pz	 LS19 / 783 - SILCA PER LAS®  CHIAVE ACCIAIO 50 pz	 LS2 / 783 - SILCA PER LAS®  CHIAVE ACCIAIO 50 pz	 MAR1 / 783 - SILCA PER MARS®  CHIAVE ACCIAIO 50 pz	 MBL1 / 783 - SILCA PER MOBELLA®  CHIAVE OTTONE 100 pz
 MBL1R / 783 - SILCA PER MOBELLA®  CHIAVE OTTONE 100 pz	 MC12 / 783 - SILCA PER MCM®  CHIAVE ACCIAIO 50 pz	 ME5 / 783 - SILCA PER MELSMETALL®  CHIAVE ACCIAIO 100 pz	 ME9 / 783 - SILCA PER MELSMETALL®  CHIAVE ACCIAIO 50 pz	 MER1 / 783 - SILCA PER MERONI®  CHIAVE OTTONE 100 pz
 MER10R / 783 - SILCA PER MERONI®  CHIAVE OTTONE 50 pz	 MER11R / 783 - SILCA PER MERONI®  CHIAVE OTTONE 100 pz	 MER12R / 783 - SILCA PER MERONI®  CHIAVE OTTONE 50 pz	 MER13R / 783 - SILCA PER MERONI®  CHIAVE OTTONE 100 pz	 MER16R / 783 - SILCA PER MERONI®  CHIAVE OTTONE 50 pz

In conformità alle disposizioni legali in vigore relative alle proprietà industriali, informiamo che i marchi o le denominazioni commerciali citate nel nostro documento sono di proprietà esclusiva dei fabbricanti di serrature e degli utilizzatori autorizzati. Questi marchi o denominazioni commerciali sono indicati a titolo di semplice informazione, con lo scopo di riconoscere velocemente a quali serrature le nostre chiavi sono destinate. Questo documento è esclusivamente riservato ai professionisti della riproduzione chiavi che utilizzano i prodotti Silca. / Le illustrazioni e i dati tecnici dei prodotti contenuti nel documento debbono considerarsi indicativi. Silca si riserva il diritto, ferme restando le caratteristiche essenziali dei prodotti, di apportare tutte le modifiche che ritiene necessarie e opportune al fine di migliorare la qualità dei prodotti. Tutti i disegni e le fotografie sono di proprietà di Silca, ogni riproduzione anche parziale, senza autorizzazione scritta di Silca S.p.A. è vietata secondo termini di legge. Per qualsiasi controversia competenti sono gli Uffici Giudiziari dove ha sede l'Azienda Silca S.p.A., con espressa esclusione di qualsiasi altro foro.



















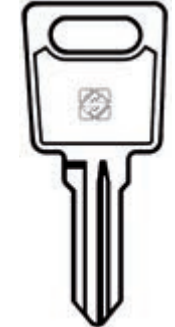











DUPLICATRICI-CHIAVI-RADIOCOMANDI

 8 003736563834 MER17R / 783 - SILCA PER MERONI®  CHIAVE OTTONE 50 pz	 8 003736117334 MER1R / 783 - SILCA PER MERONI®  CHIAVE OTTONE 100 pz	 8 003736117563 MER2 / 783 - SILCA PER MERONI®  CHIAVE OTTONE 100 pz	 8 003736563896 MER21R / 783 - SILCA PER MERONI®  CHIAVE OTTONE 50 pz	 8 003736274167 MER23 / 783 - SILCA PER MERONI®  CHIAVE OTTONE 50 pz
 8 003736117709 MER24 / 783 - SILCA PER MERONI®  CHIAVE OTTONE 100 pz	 8 003736274181 MER27 / 783 - SILCA PER MERONI®  CHIAVE OTTONE 50 pz	 8 003736493728 MER29 / 783 - SILCA PER MERONI®  CHIAVE OTTONE 100 pz	 8 003737609296 MER33R / 783 - SILCA PER MERONI®  CHIAVE OTTONE 100 pz	 8 003737821865 MER34R / 783 - SILCA PER MERONI®  CHIAVE OTTONE 50 pz
 8 003737821919 MER35R / 783 - SILCA PER MERONI®  CHIAVE OTTONE 50 pz	 8 003737695404 MER36 / 783 - SILCA PER MERONI®  CHIAVE OTTONE 100 pz	 8 003737698603 MER37 / 783 - SILCA PER MERONI®  CHIAVE OTTONE 100 pz	 8 003736274198 MER4 / 783 - SILCA PER MERONI®  CHIAVE OTTONE 50 pz	 8 003736117785 MER4R / 783 - SILCA PER MERONI®  CHIAVE OTTONE 100 pz

In conformità alle disposizioni legali in vigore relative alle proprietà industriali, informiamo che i marchi o le denominazioni commerciali citate nel nostro documento sono di proprietà esclusiva dei fabbricanti di serrature e degli utilizzatori autorizzati. Questi marchi o denominazioni commerciali sono indicati a titolo di semplice informazione, con lo scopo di riconoscere velocemente a quali serrature le nostre chiavi sono destinate. Questo documento è esclusivamente riservato ai professionisti della riproduzione chiavi che utilizzano i prodotti Silca. / Le illustrazioni e i dati tecnici dei prodotti contenuti nel documento debbono considerarsi indicativi. Silca si riserva il diritto, ferme restando le caratteristiche essenziali dei prodotti, di apportare tutte le modifiche che ritiene necessarie e opportune al fine di migliorare la qualità dei prodotti. Tutti i disegni e le fotografie sono di proprietà di Silca, ogni riproduzione anche parziale, senza autorizzazione scritta di Silca S.p.A. è vietata secondo termini di legge. Per qualsiasi controversia competenti sono gli Uffici Giudiziari dove ha sede l'Azienda Silca S.p.A., con espressa esclusione di qualsiasi altro foro.

































 8 003736274211 MER5 / 783 - SILCA PER MERONI®  CHIAVE OTTONE 50 pz	 8 003736563957 MER7R / 783 - SILCA PER MERONI®  CHIAVE OTTONE 50 pz	 8 003736117884 MER8 / 783 - SILCA PER MERONI®  CHIAVE OTTONE 100 pz	 8 003736268685 MER9R / 783 - SILCA PER MERONI®  CHIAVE OTTONE 50 pz	 8 003736308893 MF1R / 783 - SILCA PER ME-FA®  CHIAVE ACCIAIO 50 pz
 8 003736118386 MG1 / 783 - SILCA PER MG (MONTI)®  CHIAVE OTTONE 100 pz	 8 003736118485 MG1R / 783 - SILCA PER MG (MONTI)®  CHIAVE OTTONE 100 pz	 8 003736118584 MG2 / 783 - SILCA PER MG (MONTI)®  CHIAVE OTTONE 100 pz	 8 003736118669 MG2R / 783 - SILCA PER MG (MONTI)®  CHIAVE OTTONE 100 pz	 8 003736564039 MG3 / 783 - SILCA PER MG (MONTI)®  CHIAVE OTTONE 50 pz
 8 003736118829 MH2 / 783 - SILCA PER MICHEL-SEAT®  CHIAVE OTTONE 100 pz	 8 003736118843 MH2R / 783 - SILCA PER MICHEL-SEAT®  CHIAVE OTTONE 100 pz	 8 003736118881 MH4 / 783 - SILCA PER MICHEL-SEAT®  CHIAVE OTTONE 100 pz	 8 003736118904 MH4R / 783 - SILCA PER MICHEL-SEAT®  CHIAVE OTTONE 100 pz	 8 003736119918 MI3 / 783 - SILCA PER MORI E.®  CHIAVE OTTONE 100 pz

In conformità alle disposizioni legali in vigore relative alle proprietà industriali, informiamo che i marchi o le denominazioni commerciali citate nel nostro documento sono di proprietà esclusiva dei fabbricanti di serrature e degli utilizzatori autorizzati. Questi marchi o denominazioni commerciali sono indicati a titolo di semplice informazione, con lo scopo di riconoscere velocemente a quali serrature le nostre chiavi sono destinate. Questo documento è esclusivamente riservato ai professionisti della riproduzione chiavi che utilizzano i prodotti Silca. / Le illustrazioni e i dati tecnici dei prodotti contenuti nel documento debbono considerarsi indicativi. Silca si riserva il diritto, ferme restando le caratteristiche essenziali dei prodotti, di apportare tutte le modifiche che ritiene necessarie e opportune al fine di migliorare la qualità dei prodotti. Tutti i disegni e le fotografie sono di proprietà di Silca, ogni riproduzione anche parziale, senza autorizzazione scritta di Silca S.p.A. è vietata secondo termini di legge. Per qualsiasi controversia competenti sono gli Uffici Giudiziari dove ha sede l'Azienda Silca S.p.A., con espressa esclusione di qualsiasi altro foro.













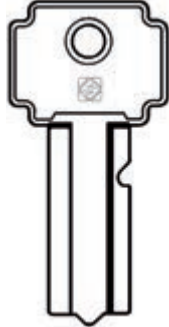

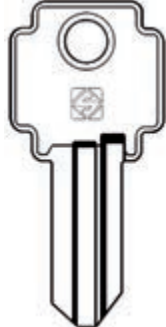



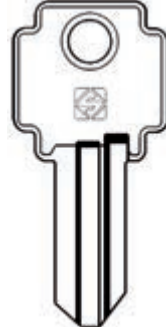

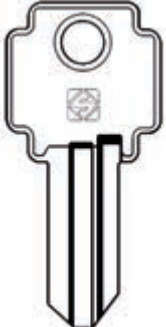









DUPLICATRICI-CHIAVI-RADIOCOMANDI

 8 003736262720 MLM1 / 783 - SILCA PER MLM®  CHIAVE OTTONE 50 pz	 8 003736120099 MLM2 / 783 - SILCA PER MLM®  CHIAVE ACCIAIO 100 pz	 8 003736120372 MN1 / 783 - SILCA PER MONTI-MG®  CHIAVE OTTONE 100 pz	 8 003736120396 MN2 / 783 - SILCA PER MONTI-MG®  CHIAVE OTTONE 100 pz	 8 003736274600 MN2R / 783 - SILCA PER MONTI-MG®  CHIAVE OTTONE 50 pz
 8 003736120433 MN3 / 783 - SILCA PER MONTI-MG®  CHIAVE OTTONE 100 pz	 8 003736120457 MN3R / 783 - SILCA PER MONTI-MG®  CHIAVE OTTONE 100 pz	 8 003736120518 MN5 / 783 - SILCA PER MONTI-MG®  CHIAVE OTTONE 100 pz	 8 003736120532 MN5R / 783 - SILCA PER MONTI-MG®  CHIAVE OTTONE 100 pz	 8 003736120556 MN6 / 783 - SILCA PER MONTI-MG®  CHIAVE OTTONE 100 pz
 8 003736120570 MN6R / 783 - SILCA PER MONTI-MG®  CHIAVE OTTONE 100 pz	 8 003736274679 MN7 / 783 - SILCA PER MONTI-MG®  CHIAVE OTTONE 50 pz	 8 003736274686 MN8 / 783 - SILCA PER MONTI-MG®  CHIAVE OTTONE 50 pz	 8 003736564350 MN8R / 783 - SILCA PER MONTI-MG®  CHIAVE OTTONE 50 pz	 8 003736564374 MN9 / 783 - SILCA PER MONTI-MG®  CHIAVE OTTONE 50 pz

In conformità alle disposizioni legali in vigore relative alle proprietà industriali, informiamo che i marchi o le denominazioni commerciali citate nel nostro documento sono di proprietà esclusiva dei fabbricanti di serrature e degli utilizzatori autorizzati. Questi marchi o denominazioni commerciali sono indicati a titolo di semplice informazione, con lo scopo di riconoscere velocemente a quali serrature le nostre chiavi sono destinate. Questo documento è esclusivamente riservato ai professionisti della riproduzione chiavi che utilizzano i prodotti Silca. / Le illustrazioni e i dati tecnici dei prodotti contenuti nel documento debbono considerarsi indicativi. Silca si riserva il diritto, ferme restando le caratteristiche essenziali dei prodotti, di apportare tutte le modifiche che ritiene necessarie e opportune al fine di migliorare la qualità dei prodotti. Tutti i disegni e le fotografie sono di proprietà di Silca, ogni riproduzione anche parziale, senza autorizzazione scritta di Silca S.p.A. è vietata secondo termini di legge. Per qualsiasi controversia competenti sono gli Uffici Giudiziari dove ha sede l'Azienda Silca S.p.A., con espressa esclusione di qualsiasi altro foro.

































 MN9R / 783 - SILCA PER MONTI-MG®  CHIAVE OTTONE 50 pz	 MP101 / 783 - SILCA PER MP-PLODARI®  CHIAVE OTTONE 100 pz	 MP102 / 783 - SILCA PER MP-PLODARI®  CHIAVE OTTONE 100 pz	 MP103 / 783 - SILCA PER MP-PLODARI®  CHIAVE OTTONE 100 pz	 MP104 / 783 - SILCA PER MP-PLODARI®  CHIAVE OTTONE 100 pz
 MP105 / 783 - SILCA PER MP-PLODARI®  CHIAVE OTTONE 100 pz	 MP230 / 783 - SILCA PER MP-PLODARI®  CHIAVE OTTONE 100 pz	 MS1 / 783 - SILCA PER MASTER®  CHIAVE OTTONE 50 pz	 MS10 / 783 - SILCA PER MASTER®  CHIAVE OTTONE 50 pz	 MS11 / 783 - SILCA PER MASTER®  CHIAVE OTTONE 100 pz
 MS17 / 783 - SILCA PER MASTER®  CHIAVE OTTONE 50 pz	 MS19 / 783 - SILCA PER MASTER®  CHIAVE OTTONE 100 pz	 MS2 / 783 - SILCA PER MASTER®  CHIAVE OTTONE 100 pz	 MS3 / 783 - SILCA PER MASTER®  CHIAVE OTTONE 50 pz	 MS6 / 783 - SILCA PER MASTER®  CHIAVE OTTONE 100 pz

In conformità alle disposizioni legali in vigore relative alle proprietà industriali, informiamo che i marchi o le denominazioni commerciali citate nel nostro documento sono di proprietà esclusiva dei fabbricanti di serrature e degli utilizzatori autorizzati. Questi marchi o denominazioni commerciali sono indicati a titolo di semplice informazione, con lo scopo di riconoscere velocemente a quali serrature le nostre chiavi sono destinate. Questo documento è esclusivamente riservato ai professionisti della riproduzione chiavi che utilizzano i prodotti Silca. / Le illustrazioni e i dati tecnici dei prodotti contenuti nel documento debbono considerarsi indicativi. Silca si riserva il diritto, ferme restando le caratteristiche essenziali dei prodotti, di apportare tutte le modifiche che ritiene necessarie e opportune al fine di migliorare la qualità dei prodotti. Tutti i disegni e le fotografie sono di proprietà di Silca, ogni riproduzione anche parziale, senza autorizzazione scritta di Silca S.p.A. è vietata secondo termini di legge. Per qualsiasi controversia competenti sono gli Uffici Giudiziari dove ha sede l'Azienda Silca S.p.A., con espressa esclusione di qualsiasi altro foro.

































DUPLICATRICI-CHIAVI-RADIOCOMANDI

 8 0 0 3 7 3 6 1 2 2 2 2 2 MS7 / 783 - SILCA PER MASTER®  CHIAVE OTTONE 100 pz	 8 0 0 3 7 3 6 2 5 1 4 4 1 MS8 / 783 - SILCA PER MASTER®  CHIAVE OTTONE 50 pz	 8 0 0 3 7 3 6 1 2 2 3 0 7 MTG1 / 783 - SILCA PER MOTOGARD®  CHIAVE OTTONE 50 pz	 8 0 0 3 7 3 6 1 2 2 3 2 1 MTG1R / 783 - SILCA PER MOTOGARD®  CHIAVE OTTONE 50 pz	 8 0 0 3 7 3 6 5 6 4 6 0 2 NR1R / 783 - SILCA PER -  CHIAVE ACCIAIO 50 pz
 8 0 0 3 7 3 6 1 2 8 3 2 3 OC074 / 783 - SILCA PER OMEC®  CHIAVE OTTONE 100 pz	 8 0 0 3 7 3 6 2 7 5 0 6 5 OC1 / 783 - SILCA PER OMEC®  CHIAVE OTTONE 50 pz	 8 0 0 3 7 3 6 1 2 8 6 0 6 OC236 / 783 - SILCA PER OMEC®  CHIAVE OTTONE 100 pz	 8 0 0 3 7 3 6 1 2 8 6 2 0 OC237 / 783 - SILCA PER OMEC®  CHIAVE OTTONE 100 pz	 8 0 0 3 7 3 6 1 2 8 6 4 4 OC238 / 783 - SILCA PER OMEC®  CHIAVE OTTONE 100 pz
 8 0 0 3 7 3 6 2 7 5 1 3 3 OC239 / 783 - SILCA PER OMEC®  CHIAVE OTTONE 50 pz	 8 0 0 3 7 3 7 6 3 1 2 8 0 OC5 / 783 - SILCA PER OMEC®  CHIAVE OTTONE 100 pz	 8 0 0 3 7 3 7 4 3 9 7 3 2 OJ6R / 783 - SILCA PER OJMAR®  CHIAVE OTTONE 100 pz	 8 0 0 3 7 3 6 5 6 5 0 9 8 OL5 / 783 - SILCA PER OLIVA®  CHIAVE ACCIAIO 50 pz	 8 0 0 3 7 3 6 4 6 4 6 3 6 OMR1R / 783 - SILCA PER O.M.R.®  CHIAVE OTTONE 100 pz

In conformità alle disposizioni legali in vigore relative alle proprietà industriali, informiamo che i marchi o le denominazioni commerciali citate nel nostro documento sono di proprietà esclusiva dei fabbricanti di serrature e degli utilizzatori autorizzati. Questi marchi o denominazioni commerciali sono indicati a titolo di semplice informazione, con lo scopo di riconoscere velocemente a quali serrature le nostre chiavi sono destinate. Questo documento è esclusivamente riservato ai professionisti della riproduzione chiavi che utilizzano i prodotti Silca. / Le illustrazioni e i dati tecnici dei prodotti contenuti nel documento debbono considerarsi indicativi. Silca si riserva il diritto, ferme restando le caratteristiche essenziali dei prodotti, di apportare tutte le modifiche che ritiene necessarie e opportune al fine di migliorare la qualità dei prodotti. Tutti i disegni e le fotografie sono di proprietà di Silca, ogni riproduzione anche parziale, senza autorizzazione scritta di Silca S.p.A. è vietata secondo termini di legge. Per qualsiasi controversia competenti sono gli Uffici Giudiziari dove ha sede l'Azienda Silca S.p.A., con espressa esclusione di qualsiasi altro foro.



 8 003736129771 PC1 / 783 - SILCA PER P.C. (CORTELLEZZI)®  CHIAVE OTTONE 100 pz	 8 003736129917 PC13 / 783 - SILCA PER P.C. (CORTELLEZZI)®  CHIAVE ACCIAIO 100 pz	 8 003736565463 PC18R / 783 - SILCA PER P.C. (CORTELLEZZI)®  CHIAVE OTTONE 50 pz	 8 003736130036 PC2 / 783 - SILCA PER P.C. (CORTELLEZZI)®  CHIAVE OTTONE 100 pz	 8 003736130081 PC3 / 783 - SILCA PER P.C. (CORTELLEZZI)®  CHIAVE OTTONE 100 pz
 8 003736565517 PC3R / 783 - SILCA PER P.C. (CORTELLEZZI)®  CHIAVE OTTONE 50 pz	 8 003736130128 PC4 / 783 - SILCA PER P.C. (CORTELLEZZI)®  CHIAVE OTTONE 100 pz	 8 003736275355 PC6 / 783 - SILCA PER P.C. (CORTELLEZZI)®  CHIAVE OTTONE 50 pz	 8 003736130364 PF070 / 783 - SILCA PER PREFER®  CHIAVE OTTONE 100 pz	 8 003736275393 PF071 / 783 - SILCA PER PREFER®  CHIAVE OTTONE 50 pz
 8 003736130449 PF072 / 783 - SILCA PER PREFER®  CHIAVE OTTONE 100 pz	 8 003736130463 PF073 / 783 - SILCA PER PREFER®  CHIAVE OTTONE 100 pz	 8 003736130487 PF092 / 783 - SILCA PER PREFER®  CHIAVE OTTONE 100 pz	 8 003736130913 PF092S / 783 - SILCA PER PREFER®  CHIAVE OTTONE 100 pz	 8 003736131385 PF1 / 783 - SILCA PER PREFER®  CHIAVE OTTONE 100 pz

In conformità alle disposizioni legali in vigore relative alle proprietà industriali, informiamo che i marchi o le denominazioni commerciali citate nel nostro documento sono di proprietà esclusiva dei fabbricanti di serrature e degli utilizzatori autorizzati. Questi marchi o denominazioni commerciali sono indicati a titolo di semplice informazione, con lo scopo di riconoscere velocemente a quali serrature le nostre chiavi sono destinate. Questo documento è esclusivamente riservato ai professionisti della riproduzione chiavi che utilizzano i prodotti Silca. / Le illustrazioni e i dati tecnici dei prodotti contenuti nel documento debbono considerarsi indicativi. Silca si riserva il diritto, ferme restando le caratteristiche essenziali dei prodotti, di apportare tutte le modifiche che ritiene necessarie e opportune al fine di migliorare la qualità dei prodotti. Tutti i disegni e le fotografie sono di proprietà di Silca, ogni riproduzione anche parziale, senza autorizzazione scritta di Silca S.p.A. è vietata secondo termini di legge. Per qualsiasi controversia competenti sono gli Uffici Giudiziari dove ha sede l'Azienda Silca S.p.A., con espressa esclusione di qualsiasi altro foro.











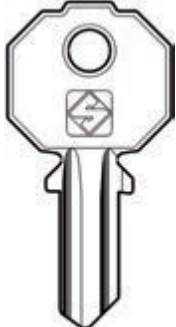



















DUPLICATRICI-CHIAVI-RADIOCOMANDI

 8 003736275676 PF12 / 783 - SILCA PER PREFER® CHIAVE OTTONE 50 pz	 8 003736131576 PF15 / 783 - SILCA PER PREFER® CHIAVE OTTONE 100 pz	 8 003736760837 PF16R / 783 - SILCA PER PREFER® CHIAVE ACCIAIO 50 pz	 8 003736131439 PF1R / 783 - SILCA PER PREFER® CHIAVE OTTONE 100 pz	 8 003736131590 PF2 / 783 - SILCA PER PREFER® CHIAVE OTTONE 100 pz
 8 003736132351 PF208 / 783 - SILCA PER PREFER® CHIAVE OTTONE 100 pz	 8 003736132726 PF210 / 783 - SILCA PER PREFER® CHIAVE OTTONE 100 pz	 8 003736133051 PF211 / 783 - SILCA PER PREFER® CHIAVE OTTONE 100 pz	 8 003736133297 PF212 / 783 - SILCA PER PREFER® CHIAVE OTTONE 100 pz	 8 003736317314 PF214 / 783 - SILCA PER PREFER® CHIAVE ACCIAIO 50 pz
 8 003736565654 PF215 / 783 - SILCA PER PREFER® CHIAVE OTTONE 50 pz	 8 003736131972 PF2S / 783 - SILCA PER PREFER® CHIAVE OTTONE 100 pz	 8 003736133839 PF3 / 783 - SILCA PER PREFER® CHIAVE OTTONE 100 pz	 8 003736133877 PF4 / 783 - SILCA PER PREFER® CHIAVE OTTONE 100 pz	 8 003736133914 PF5 / 783 - SILCA PER PREFER® CHIAVE OTTONE 100 pz

In conformità alle disposizioni legali in vigore relative alle proprietà industriali, informiamo che i marchi o le denominazioni commerciali citate nel nostro documento sono di proprietà esclusiva dei fabbricanti di serrature e degli utilizzatori autorizzati. Questi marchi o denominazioni commerciali sono indicati a titolo di semplice informazione, con lo scopo di riconoscere velocemente a quali serrature le nostre chiavi sono destinate. Questo documento è esclusivamente riservato ai professionisti della riproduzione chiavi che utilizzano i prodotti Silca. / Le illustrazioni e i dati tecnici dei prodotti contenuti nel documento debbono considerarsi indicativi. Silca si riserva il diritto, ferme restando le caratteristiche essenziali dei prodotti, di apportare tutte le modifiche che ritiene necessarie e opportune al fine di migliorare la qualità dei prodotti. Tutti i disegni e le fotografie sono di proprietà di Silca, ogni riproduzione anche parziale, senza autorizzazione scritta di Silca S.p.A. è vietata secondo termini di legge. Per qualsiasi controversia competenti sono gli Uffici Giudiziari dove ha sede l'Azienda Silca S.p.A., con espressa esclusione di qualsiasi altro foro.

































 8 003736134102 PF5S / 783 - SILCA PER PREFER®  CHIAVE OTTONE 100 pz	 8 003736565739 PF6 / 783 - SILCA PER PREFER®  CHIAVE OTTONE 50 pz	 8 003736268807 PF7 / 783 - SILCA PER PREFER®  CHIAVE OTTONE 50 pz	 8 003736268814 PF7S / 783 - SILCA PER PREFER®  CHIAVE OTTONE 50 pz	 8 003736565777 PF8 / 783 - SILCA PER PREFER®  CHIAVE OTTONE 50 pz
 8 003736134577 PF9 / 783 - SILCA PER PREFER®  CHIAVE OTTONE 100 pz	 8 003737670890 PHF15 / 783 - SILCA PER PFAFFENHAIN®  CHIAVE ACCIAIO 50 pz	 8 003736565975 PM1 / 783 - SILCA PER PROMETA®  CHIAVE OTTONE 50 pz	 8 003736136120 PT1 / 783 - SILCA PER NONFANGO®  CHIAVE OTTONE 100 pz	 8 003736136144 PT1R / 783 - SILCA PER NONFANGO®  CHIAVE OTTONE 100 pz
 8 003736566033 PT2 / 783 - SILCA PER POTENT®  CHIAVE OTTONE 50 pz	 8 003736136786 RC1R / 783 - SILCA PER CINA®  CHIAVE ACCIAIO 100 pz	 8 003736760899 RC3R / 783 - SILCA PER CINA®  CHIAVE ACCIAIO 100 pz	 8 003737683395 RC5R / 783 - SILCA PER CINA®  CHIAVE ACCIAIO 100 pz	 8 003737747080 RC6 / 783 - SILCA PER CINA®  CHIAVE OTTONE 100 pz

In conformità alle disposizioni legali in vigore relative alle proprietà industriali, informiamo che i marchi o le denominazioni commerciali citate nel nostro documento sono di proprietà esclusiva dei fabbricanti di serrature e degli utilizzatori autorizzati. Questi marchi o denominazioni commerciali sono indicati a titolo di semplice informazione, con lo scopo di riconoscere velocemente a quali serrature le nostre chiavi sono destinate. Questo documento è esclusivamente riservato ai professionisti della riproduzione chiavi che utilizzano i prodotti Silca. / Le illustrazioni e i dati tecnici dei prodotti contenuti nel documento debbono considerarsi indicativi. Silca si riserva il diritto, ferme restando le caratteristiche essenziali dei prodotti, di apportare tutte le modifiche che ritiene necessarie e opportune al fine di migliorare la qualità dei prodotti. Tutti i disegni e le fotografie sono di proprietà di Silca, ogni riproduzione anche parziale, senza autorizzazione scritta di Silca S.p.A. è vietata secondo termini di legge. Per qualsiasi controversia competenti sono gli Uffici Giudiziari dove ha sede l'Azienda Silca S.p.A., con espressa esclusione di qualsiasi altro foro.

















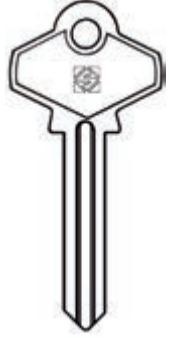













DUPLICATRICI-CHIAVI-RADIOCOMANDI

 8 003737725279 RC6R / 783 - SILCA PER CINA®  CHIAVE OTTONE 100 pz	 8 003736137042 REN1 / 783 - SILCA PER RENZ®  CHIAVE ACCIAIO 100 pz	 8 003736137059 REN1R / 783 - SILCA PER RENZ®  CHIAVE ACCIAIO 100 pz	 8 003736761018 REN3R / 783 - SILCA PER RENZ®  CHIAVE ACCIAIO 100 pz	 8 003736138537 R020 / 783 - SILCA PER RONIS®  CHIAVE ACCIAIO 50 pz
 8 003736138551 R020R / 783 - SILCA PER RONIS®  CHIAVE ACCIAIO 50 pz	 8 003736566231 R021 / 783 - SILCA PER RONIS®  CHIAVE ACCIAIO 50 pz	 8 003736566255 R034 / 783 - SILCA PER RONIS®  CHIAVE ACCIAIO 50 pz	 8 003736566309 R04 / 783 - SILCA PER RONIS®  CHIAVE ACCIAIO 50 pz	 8 003736139572 R044 / 783 - SILCA PER RONIS®  CHIAVE ACCIAIO 100 pz
 8 003736310001 R049 / 783 - SILCA PER RONIS®  CHIAVE ACCIAIO 50 pz	 8 003737588270 R067 / 783 - SILCA PER RONIS®  CHIAVE OTTONE 100 pz	 8 003737588294 R067R / 783 - SILCA PER RONIS®  CHIAVE OTTONE 100 pz	 8 003737527415 R068 / 783 - SILCA PER RONIS®  CHIAVE OTTONE 100 pz	 8 003736566583 SA2 / 783 - SILCA PER SAMSONITE®  CHIAVE ACCIAIO 50 pz

In conformità alle disposizioni legali in vigore relative alle proprietà industriali, informiamo che i marchi o le denominazioni commerciali citate nel nostro documento sono di proprietà esclusiva dei fabbricanti di serrature e degli utilizzatori autorizzati. Questi marchi o denominazioni commerciali sono indicati a titolo di semplice informazione, con lo scopo di riconoscere velocemente a quali serrature le nostre chiavi sono destinate. Questo documento è esclusivamente riservato ai professionisti della riproduzione chiavi che utilizzano i prodotti Silca. / Le illustrazioni e i dati tecnici dei prodotti contenuti nel documento debbono considerarsi indicativi. Silca si riserva il diritto, ferme restando le caratteristiche essenziali dei prodotti, di apportare tutte le modifiche che ritiene necessarie e opportune al fine di migliorare la qualità dei prodotti. Tutti i disegni e le fotografie sono di proprietà di Silca, ogni riproduzione anche parziale, senza autorizzazione scritta di Silca S.p.A. è vietata secondo termini di legge. Per qualsiasi controversia competenti sono gli Uffici Giudiziari dove ha sede l'Azienda Silca S.p.A., con espressa esclusione di qualsiasi altro foro.











 SAR3 / 783 - SILCA PER SARGENT®  CHIAVE OTTONE 50 pz	 SEA5 / 783 - SILCA PER SEAT®  CHIAVE OTTONE 100 pz	 SEA7 / 783 - SILCA PER SEAT®  CHIAVE OTTONE 100 pz	 SF1 / 783 - SILCA PER SAFE®  CHIAVE OTTONE 50 pz	 SG808 / 783 - SILCA PER SHANGHAI®  CHIAVE OTTONE 100 pz
 SG808R / 783 - SILCA PER CINA®  CHIAVE ACCIAIO 100 pz	 SM1 / 783 - SILCA PER SIMECA®  CHIAVE OTTONE 100 pz	 SM1R / 783 - SILCA PER SIMECA®  CHIAVE OTTONE 100 pz	 SS1 / 783 - SILCA PER SIS®  CHIAVE OTTONE 100 pz	 SS10 / 783 - SILCA PER SIS®  CHIAVE OTTONE 100 pz
 SS13 / 783 - SILCA PER SIS®  CHIAVE OTTONE 100 pz	 SS3 / 783 - SILCA PER SIS®  CHIAVE OTTONE 100 pz	 SS3R / 783 - SILCA PER SIS®  CHIAVE OTTONE 50 pz	 SS4 / 783 - SILCA PER SIS®  CHIAVE OTTONE 50 pz	 SS9 / 783 - SILCA PER SIS®  CHIAVE OTTONE 100 pz

In conformità alle disposizioni legali in vigore relative alle proprietà industriali, informiamo che i marchi o le denominazioni commerciali citate nel nostro documento sono di proprietà esclusiva dei fabbricanti di serrature e degli utilizzatori autorizzati. Questi marchi o denominazioni commerciali sono indicati a titolo di semplice informazione, con lo scopo di riconoscere velocemente a quali serrature le nostre chiavi sono destinate. Questo documento è esclusivamente riservato ai professionisti della riproduzione chiavi che utilizzano i prodotti Silca. / Le illustrazioni e i dati tecnici dei prodotti contenuti nel documento debbono considerarsi indicativi. Silca si riserva il diritto, ferme restando le caratteristiche essenziali dei prodotti, di apportare tutte le modifiche che ritiene necessarie e opportune al fine di migliorare la qualità dei prodotti. Tutti i disegni e le fotografie sono di proprietà di Silca, ogni riproduzione anche parziale, senza autorizzazione scritta di Silca S.p.A. è vietata secondo termini di legge. Per qualsiasi controversia competenti sono gli Uffici Giudiziari dove ha sede l'Azienda Silca S.p.A., con espressa esclusione di qualsiasi altro foro.

































DUPLICATRICI-CHIAVI-RADIOCOMANDI

 8 003736761308 SSP1 / 783 - SILCA PER SIS®  CHIAVE ACCIAIO 100 pz	 8 003736312692 STS1 / 783 - SILCA PER STS®  CHIAVE ACCIAIO 50 pz	 8 003736151062 STS2 / 783 - SILCA PER STS®  CHIAVE ACCIAIO 100 pz	 8 003737463669 STS2R / 783 - SILCA PER STS®  CHIAVE ACCIAIO 100 pz	 8 003736851696 STS4 / 783 - SILCA PER STS®  CHIAVE ACCIAIO 100 pz
 8 003736153424 TC1 / 783 - SILCA PER TICINO®  CHIAVE OTTONE 100 pz	 8 003736567405 TC1R / 783 - SILCA PER TICINO®  CHIAVE OTTONE 50 pz	 8 003736312982 TE1 / 783 - SILCA PER TESA®  CHIAVE ACCIAIO 50 pz	 8 003736265028 TE2 / 783 - SILCA PER TESA®  CHIAVE OTTONE 50 pz	 8 003736265042 TE2R / 783 - SILCA PER TESA®  CHIAVE OTTONE 50 pz
 8 003737785037 TE2X / 783 - SILCA PER TESA®  CHIAVE ACCIAIO 50 pz	 8 003736154049 TE6 / 783 - SILCA PER TESA®  CHIAVE ACCIAIO 100 pz	 8 003736846319 TE8XFA / 783 - SILCA PER TESA®  CHIAVE ACCIAIO 50 pz	 8 003736154070 TH1 / 783 - SILCA PER TECUMSEH®  CHIAVE ACCIAIO 50 pz	 8 003736265073 TL1 / 783 - SILCA PER TRI CIRCLE®  CHIAVE OTTONE 50 pz

In conformità alle disposizioni legali in vigore relative alle proprietà industriali, informiamo che i marchi o le denominazioni commerciali citate nel nostro documento sono di proprietà esclusiva dei fabbricanti di serrature e degli utilizzatori autorizzati. Questi marchi o denominazioni commerciali sono indicati a titolo di semplice informazione, con lo scopo di riconoscere velocemente a quali serrature le nostre chiavi sono destinate. Questo documento è esclusivamente riservato ai professionisti della riproduzione chiavi che utilizzano i prodotti Silca. / Le illustrazioni e i dati tecnici dei prodotti contenuti nel documento debbono considerarsi indicativi. Silca si riserva il diritto, ferme restando le caratteristiche essenziali dei prodotti, di apportare tutte le modifiche che ritiene necessarie e opportune al fine di migliorare la qualità dei prodotti. Tutti i disegni e le fotografie sono di proprietà di Silca, ogni riproduzione anche parziale, senza autorizzazione scritta di Silca S.p.A. è vietata secondo termini di legge. Per qualsiasi controversia competenti sono gli Uffici Giudiziari dove ha sede l'Azienda Silca S.p.A., con espressa esclusione di qualsiasi altro foro.

































 TL10 / 783 - SILCA PER TRI CIRCLE®  CHIAVE ACCIAIO 50 pz	 TL6 / 783 - SILCA PER TRI CIRCLE®  CHIAVE OTTONE 50 pz	 TL8 / 783 - SILCA PER TRI CIRCLE®  CHIAVE ACCIAIO 50 pz	 TL9 / 783 - SILCA PER TRI CIRCLE®  CHIAVE OTTONE 50 pz	 TN16X / 783 - SILCA PER TITAN®  CHIAVE ACCIAIO 100 pz
 T030RX / 783 - SILCA PER TOK-WINKHAUS®  CHIAVE ACCIAIO 50 pz	 T052 / 783 - SILCA PER TOK-WINKHAUS®  CHIAVE ACCIAIO 50 pz	 TR12 / 783 - SILCA PER TRIOVING®  CHIAVE OTTONE 50 pz	 TR4 / 783 - SILCA PER TRIOVING®  CHIAVE OTTONE 50 pz	 VAC1 / 783 - SILCA PER VACHETTE®  CHIAVE ACCIAIO 50 pz
 VAC151 / 783 - SILCA PER VACHETTE®  CHIAVE ACCIAIO 100 pz	 VAC1R / 783 - SILCA PER VACHETTE®  CHIAVE ACCIAIO 50 pz	 VAC2 / 783 - SILCA PER VACHETTE®  CHIAVE OTTONE 50 pz	 VAC29 / 783 - SILCA PER VACHETTE®  CHIAVE ACCIAIO 50 pz	 VAC46 / 783 - SILCA PER VACHETTE®  CHIAVE ACCIAIO 100 pz

In conformità alle disposizioni legali in vigore relative alle proprietà industriali, informiamo che i marchi o le denominazioni commerciali citate nel nostro documento sono di proprietà esclusiva dei fabbricanti di serrature e degli utilizzatori autorizzati. Questi marchi o denominazioni commerciali sono indicati a titolo di semplice informazione, con lo scopo di riconoscere velocemente a quali serrature le nostre chiavi sono destinate. Questo documento è esclusivamente riservato ai professionisti della riproduzione chiavi che utilizzano i prodotti Silca. / Le illustrazioni e i dati tecnici dei prodotti contenuti nel documento debbono considerarsi indicativi. Silca si riserva il diritto, ferme restando le caratteristiche essenziali dei prodotti, di apportare tutte le modifiche che ritiene necessarie e opportune al fine di migliorare la qualità dei prodotti. Tutti i disegni e le fotografie sono di proprietà di Silca, ogni riproduzione anche parziale, senza autorizzazione scritta di Silca S.p.A. è vietata secondo termini di legge. Per qualsiasi controversia competenti sono gli Uffici Giudiziari dove ha sede l'Azienda Silca S.p.A., con espressa esclusione di qualsiasi altro foro.

































DUPLICATRICI-CHIAVI-RADIOCOMANDI

 8 003736177512 VI080 / 783 - SILCA PER VIRO®  CHIAVE OTTONE 100 pz	 8 003736178137 VI081 / 783 - SILCA PER VIRO®  CHIAVE OTTONE 50 pz	 8 003736178632 VI082 / 783 - SILCA PER VIRO®  CHIAVE OTTONE 100 pz	 8 003736179189 VI083 / 783 - SILCA PER VIRO®  CHIAVE OTTONE 100 pz	 8 003736179448 VI084 / 783 - SILCA PER VIRO®  CHIAVE OTTONE 100 pz
 8 003736179653 VI085 / 783 - SILCA PER VIRO®  CHIAVE OTTONE 100 pz	 8 003736269019 VI086 / 783 - SILCA PER VIRO®  CHIAVE OTTONE 50 pz	 8 003736180031 VI087 / 783 - SILCA PER VIRO®  CHIAVE OTTONE 100 pz	 8 003736180253 VI088 / 783 - SILCA PER VIRO®  CHIAVE OTTONE 100 pz	 8 003736180277 VI089 / 783 - SILCA PER VIRO®  CHIAVE OTTONE 100 pz
 8 003736325715 VI11 / 783 - SILCA PER VIRO®  CHIAVE ACCIAIO 50 pz	 8 003736337183 VI13 / 783 - SILCA PER VIRO®  CHIAVE OTTONE 100 pz	 8 003736763746 VI14 / 783 - SILCA PER VIRO®  CHIAVE OTTONE 100 pz	 8 003737532365 VI15R / 783 - SILCA PER VIRO®  CHIAVE OTTONE 100 pz	 8 003736278295 VI1R / 783 - SILCA PER VIRO®  CHIAVE OTTONE 50 pz

In conformità alle disposizioni legali in vigore relative alle proprietà industriali, informiamo che i marchi o le denominazioni commerciali citate nel nostro documento sono di proprietà esclusiva dei fabbricanti di serrature e degli utilizzatori autorizzati. Questi marchi o denominazioni commerciali sono indicati a titolo di semplice informazione, con lo scopo di riconoscere velocemente a quali serrature le nostre chiavi sono destinate. Questo documento è esclusivamente riservato ai professionisti della riproduzione chiavi che utilizzano i prodotti Silca. / Le illustrazioni e i dati tecnici dei prodotti contenuti nel documento debbono considerarsi indicativi. Silca si riserva il diritto, ferme restando le caratteristiche essenziali dei prodotti, di apportare tutte le modifiche che ritiene necessarie e opportune al fine di migliorare la qualità dei prodotti. Tutti i disegni e le fotografie sono di proprietà di Silca, ogni riproduzione anche parziale, senza autorizzazione scritta di Silca S.p.A. è vietata secondo termini di legge. Per qualsiasi controversia competenti sono gli Uffici Giudiziari dove ha sede l'Azienda Silca S.p.A., con espressa esclusione di qualsiasi altro foro.

































 8 003736571310 VI2 / 783 - SILCA PER VIRO®  CHIAVE OTTONE 50 pz	 8 003737694865 VI23 / 783 - SILCA PER VIRO®  CHIAVE ACCIAIO 100 pz	 8 003736571334 VI2R / 783 - SILCA PER VIRO®  CHIAVE OTTONE 50 pz	 8 003736180833 VI3 / 783 - SILCA PER VIRO®  CHIAVE OTTONE 100 pz	 8 003736180932 VI3R / 783 - SILCA PER VIRO®  CHIAVE OTTONE 100 pz
 8 003736181038 VI4 / 783 - SILCA PER VIRO®  CHIAVE OTTONE 100 pz	 8 003736278509 VI4R / 783 - SILCA PER VIRO®  CHIAVE OTTONE 50 pz	 8 003736181076 VI5 / 783 - SILCA PER VIRO®  CHIAVE OTTONE 100 pz	 8 003736181175 VI5R / 783 - SILCA PER VIRO®  CHIAVE OTTONE 100 pz	 8 003736571358 VI6 / 783 - SILCA PER VIRO®  CHIAVE OTTONE 50 pz
 8 003736181311 VI7 / 783 - SILCA PER VIRO®  CHIAVE OTTONE 100 pz	 8 003736181342 VI7R / 783 - SILCA PER VIRO®  CHIAVE OTTONE 100 pz	 8 003736181366 VI8 / 783 - SILCA PER VIRO®  CHIAVE OTTONE 100 pz	 8 003736181380 VI8R / 783 - SILCA PER VIRO®  CHIAVE OTTONE 100 pz	 8 003736278592 VI9 / 783 - SILCA PER VIRO®  CHIAVE OTTONE 50 pz

In conformità alle disposizioni legali in vigore relative alle proprietà industriali, informiamo che i marchi o le denominazioni commerciali citate nel nostro documento sono di proprietà esclusiva dei fabbricanti di serrature e degli utilizzatori autorizzati. Questi marchi o denominazioni commerciali sono indicati a titolo di semplice informazione, con lo scopo di riconoscere velocemente a quali serrature le nostre chiavi sono destinate. Questo documento è esclusivamente riservato ai professionisti della riproduzione chiavi che utilizzano i prodotti Silca. / Le illustrazioni e i dati tecnici dei prodotti contenuti nel documento debbono considerarsi indicativi. Silca si riserva il diritto, ferme restando le caratteristiche essenziali dei prodotti, di apportare tutte le modifiche che ritiene necessarie e opportune al fine di migliorare la qualità dei prodotti. Tutti i disegni e le fotografie sono di proprietà di Silca, ogni riproduzione anche parziale, senza autorizzazione scritta di Silca S.p.A. è vietata secondo termini di legge. Per qualsiasi controversia competenti sono gli Uffici Giudiziari dove ha sede l'Azienda Silca S.p.A., con espressa esclusione di qualsiasi altro foro.































DUPLICATRICI-CHIAVI-RADIOCOMANDI

 8 003736181502 VL2R / 783 - SILCA PER V.G.F. VILLATORE®  CHIAVE ACCIAIO 100 pz	 8 003736181632 VL5E / 783 - SILCA PER V.G.F. VILLATORE®  CHIAVE ACCIAIO 100 pz	 8 003736181663 VL5RE / 783 - SILCA PER V.G.F. VILLATORE®  CHIAVE OTTONE 100 pz	 8 003736183773 WA1 / 783 - SILCA PER WALLY®  CHIAVE OTTONE 100 pz	 8 003736184121 WA1R / 783 - SILCA PER WALLY®  CHIAVE OTTONE 100 pz
 8 003736184626 WA2 / 783 - SILCA PER WALLY®  CHIAVE OTTONE 100 pz	 8 003736184893 WA2R / 783 - SILCA PER WALLY®  CHIAVE OTTONE 100 pz	 8 003736185333 WA3 / 783 - SILCA PER WALLY®  CHIAVE OTTONE 100 pz	 8 003736185418 WA4 / 783 - SILCA PER WALLY®  CHIAVE OTTONE 100 pz	 8 003736186668 WE1 / 783 - SILCA PER WELKA®  CHIAVE OTTONE 100 pz
 8 003736187160 WE1R / 783 - SILCA PER WELKA®  CHIAVE OTTONE 100 pz	 8 003736187559 WE2 / 783 - SILCA PER WELKA®  CHIAVE OTTONE 100 pz	 8 003736187900 WE2R / 783 - SILCA PER WELKA®  CHIAVE OTTONE 100 pz	 8 003736188211 WE3 / 783 - SILCA PER WELKA®  CHIAVE OTTONE 100 pz	 8 003736188327 WE3R / 783 - SILCA PER WELKA®  CHIAVE OTTONE 100 pz

In conformità alle disposizioni legali in vigore relative alle proprietà industriali, informiamo che i marchi o le denominazioni commerciali citate nel nostro documento sono di proprietà esclusiva dei fabbricanti di serrature e degli utilizzatori autorizzati. Questi marchi o denominazioni commerciali sono indicati a titolo di semplice informazione, con lo scopo di riconoscere velocemente a quali serrature le nostre chiavi sono destinate. Questo documento è esclusivamente riservato ai professionisti della riproduzione chiavi che utilizzano i prodotti Silca. / Le illustrazioni e i dati tecnici dei prodotti contenuti nel documento debbono considerarsi indicativi. Silca si riserva il diritto, ferme restando le caratteristiche essenziali dei prodotti, di apportare tutte le modifiche che ritiene necessarie e opportune al fine di migliorare la qualità dei prodotti. Tutti i disegni e le fotografie sono di proprietà di Silca, ogni riproduzione anche parziale, senza autorizzazione scritta di Silca S.p.A. è vietata secondo termini di legge. Per qualsiasi controversia competenti sono gli Uffici Giudiziari dove ha sede l'Azienda Silca S.p.A., con espressa esclusione di qualsiasi altro foro.

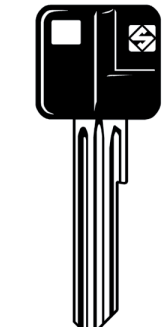

 WE5 / 783 - SILCA PER WELKA®  CHIAVE OTTONE 50 pz	 WE7 / 783 - SILCA PER WELKA®  CHIAVE OTTONE 50 pz	 WE7R / 783 - SILCA PER WELKA®  CHIAVE OTTONE 50 pz	 WK55 / 783 - SILCA PER WILKA®  CHIAVE ACCIAIO 50 pz	 WLC1 / 783 - SILCA PER WINLOCK®  CHIAVE ACCIAIO 100 pz
 YA13 / 783 - SILCA PER YALE®  CHIAVE OTTONE 100 pz	 YA13R / 783 - SILCA PER YALE®  CHIAVE OTTONE 100 pz	 YA14R / 783 - SILCA PER YALE®  CHIAVE OTTONE 100 pz	 YA18 / 783 - SILCA PER YALE®  CHIAVE ACCIAIO 50 pz	 YA18R / 783 - SILCA PER YALE®  CHIAVE ACCIAIO 50 pz
 YA226 / 783 - SILCA PER YALE®  CHIAVE OTTONE 100 pz	 YA227 / 783 - SILCA PER YALE®  CHIAVE OTTONE 100 pz	 YA31 / 783 - SILCA PER YALE®  CHIAVE OTTONE 100 pz	 YA31R / 783 - SILCA PER YALE®  CHIAVE OTTONE 100 pz	 YA39P / 783 - SILCA PER YALE®  CHIAVE ACCIAIO 25 pz

In conformità alle disposizioni legali in vigore relative alle proprietà industriali, informiamo che i marchi o le denominazioni commerciali citate nel nostro documento sono di proprietà esclusiva dei fabbricanti di serrature e degli utilizzatori autorizzati. Questi marchi o denominazioni commerciali sono indicati a titolo di semplice informazione, con lo scopo di riconoscere velocemente a quali serrature le nostre chiavi sono destinate. Questo documento è esclusivamente riservato ai professionisti della riproduzione chiavi che utilizzano i prodotti Silca. / Le illustrazioni e i dati tecnici dei prodotti contenuti nel documento debbono considerarsi indicativi. Silca si riserva il diritto, ferme restando le caratteristiche essenziali dei prodotti, di apportare tutte le modifiche che ritiene necessarie e opportune al fine di migliorare la qualità dei prodotti. Tutti i disegni e le fotografie sono di proprietà di Silca, ogni riproduzione anche parziale, senza autorizzazione scritta di Silca S.p.A. è vietata secondo termini di legge. Per qualsiasi controversia competenti sono gli Uffici Giudiziari dove ha sede l'Azienda Silca S.p.A., con espressa esclusione di qualsiasi altro foro.

















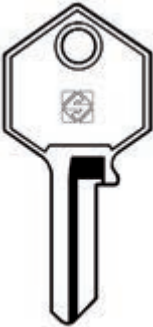

DUPLICATRICI-CHIAVI-RADIOCOMANDI

 8 003736573109 YA4 / 783 - SILCA PER YALE® CHIAVE ACCIAIO 50 pz	 8 003736196513 YA41 / 783 - SILCA PER YALE® CHIAVE OTTONE 100 pz	 8 003736279964 YA6 / 783 - SILCA PER YALE® CHIAVE OTTONE 50 pz	 8 003736198036 YA63 / 783 - SILCA PER YALE® CHIAVE OTTONE 100 pz	 8 003736197688 YA6R / 783 - SILCA PER YALE® CHIAVE OTTONE 100 pz
 8 003736198272 YA7 / 783 - SILCA PER YALE® CHIAVE OTTONE 100 pz	 8 003736573499 YA72 / 783 - SILCA PER YALE® CHIAVE ACCIAIO 50 pz	 8 003736198401 YA7R / 783 - SILCA PER YALE® CHIAVE OTTONE 100 pz	 8 003737246248 YA84 / 783 - SILCA PER YALE® CHIAVE ACCIAIO 50 pz	 8 003737246255 YA84R / 783 - SILCA PER YALE® CHIAVE ACCIAIO 50 pz
 8 003737691826 YA89 / 783 - SILCA PER YALE® CHIAVE ACCIAIO 50 pz	 8 003737701365 YA91 / 783 - SILCA PER YALE® CHIAVE OTTONE 50 pz	 8 003737684279 YAR2 / 783 - SILCA PER YANMAR® CHIAVE ACCIAIO 50 pz	 8 003736202610 YT1 / 783 - SILCA PER YETI® CHIAVE ACCIAIO 100 pz	 8 003736315457 YT13R / 783 - SILCA PER YETI® CHIAVE ACCIAIO 50 pz

In conformità alle disposizioni legali in vigore relative alle proprietà industriali, informiamo che i marchi o le denominazioni commerciali citate nel nostro documento sono di proprietà esclusiva dei fabbricanti di serrature e degli utilizzatori autorizzati. Questi marchi o denominazioni commerciali sono indicati a titolo di semplice informazione, con lo scopo di riconoscere velocemente a quali serrature le nostre chiavi sono destinate. Questo documento è esclusivamente riservato ai professionisti della riproduzione chiavi che utilizzano i prodotti Silca. / Le illustrazioni e i dati tecnici dei prodotti contenuti nel documento debbono considerarsi indicativi. Silca si riserva il diritto, ferme restando le caratteristiche essenziali dei prodotti, di apportare tutte le modifiche che ritiene necessarie e opportune al fine di migliorare la qualità dei prodotti. Tutti i disegni e le fotografie sono di proprietà di Silca, ogni riproduzione anche parziale, senza autorizzazione scritta di Silca S.p.A. è vietata secondo termini di legge. Per qualsiasi controversia competenti sono gli Uffici Giudiziari dove ha sede l'Azienda Silca S.p.A., con espressa esclusione di qualsiasi altro foro.

































 8 003736573567 YT14R / 783 - SILCA PER YETI®  CHIAVE OTTONE 50 pz	 8 003736202641 YT1R / 783 - SILCA PER YETI®  CHIAVE OTTONE 100 pz	 8 003736315501 YT2R / 783 - SILCA PER YETI®  CHIAVE ACCIAIO 50 pz	 8 003736203174 YT3 / 783 - SILCA PER YETI®  CHIAVE ACCIAIO 100 pz	 8 003736315525 YT3R / 783 - SILCA PER YETI®  CHIAVE ACCIAIO 50 pz
 8 003736203297 YT6 / 783 - SILCA PER YETI®  CHIAVE ACCIAIO 100 pz	 8 003736203372 YT8 / 783 - SILCA PER YETI®  CHIAVE ACCIAIO 100 pz	 8 003736203396 YT8R / 783 - SILCA PER YETI®  CHIAVE ACCIAIO 100 pz	 8 003736203433 YT9R / 783 - SILCA PER YETI®  CHIAVE ACCIAIO 100 pz	

In conformità alle disposizioni legali in vigore relative alle proprietà industriali, informiamo che i marchi o le denominazioni commerciali citate nel nostro documento sono di proprietà esclusiva dei fabbricanti di serrature e degli utilizzatori autorizzati. Questi marchi o denominazioni commerciali sono indicati a titolo di semplice informazione, con lo scopo di riconoscere velocemente a quali serrature le nostre chiavi sono destinate. Questo documento è esclusivamente riservato ai professionisti della riproduzione chiavi che utilizzano i prodotti Silca. / Le illustrazioni e i dati tecnici dei prodotti contenuti nel documento debbono considerarsi indicativi. Silca si riserva il diritto, ferme restando le caratteristiche essenziali dei prodotti, di apportare tutte le modifiche che ritiene necessarie e opportune al fine di migliorare la qualità dei prodotti. Tutti i disegni e le fotografie sono di proprietà di Silca, ogni riproduzione anche parziale, senza autorizzazione scritta di Silca S.p.A. è vietata secondo termini di legge. Per qualsiasi controversia competenti sono gli Uffici Giudiziari dove ha sede l'Azienda Silca S.p.A., con espressa esclusione di qualsiasi altro foro.



















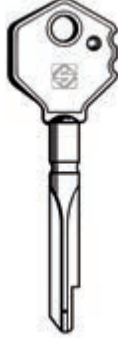









DUPLICATRICI-CHIAVI-RADIOCOMANDI

 8 003736191716 XBW1 / 783 - SILCA PER BURG WACHTER®  CHIAVE A CROCE 25 pz	 8 003737581363 XBW1P / 783 - SILCA PER BURG®  CHIAVE A CROCE DESIGN 25 pz	 8 003736191723 XBW2 / 783 - SILCA PER BURG WACHTER®  CHIAVE A CROCE 25 pz	 8 003737581370 XBW2P / 783 - SILCA PER BURG®  CHIAVE A CROCE DESIGN 25 pz	 8 003736191730 XBW3 / 783 - SILCA PER BURG WACHTER®  CHIAVE A CROCE 25 pz
 8 003737581387 XBW3P / 783 - SILCA PER BURG®  CHIAVE A CROCE DESIGN 25 pz	 8 003737581424 XBW5P / 783 - SILCA PER BURG®  CHIAVE A CROCE DESIGN 25 pz	 8 003737581448 XF1P / 783 - SILCA PER FIAM®  CHIAVE A CROCE DESIGN 25 pz	 8 003736191822 XF2 / 783 - SILCA PER FIAM®  CHIAVE A CROCE 25 pz	 8 003737581462 XF2P / 783 - SILCA PER FIAM®  CHIAVE A CROCE DESIGN 25 pz
 8 003736523050 XIE3 / 783 - SILCA PER ISEO®  CHIAVE A CROCE 25 pz	 8 003737686310 XOC1 / 783 - SILCA PER OMEC®  CHIAVE A CROCE 25 pz	 8 003736219557 XOM2 / 783 - SILCA PER BOSCH®  CHIAVE A SPILLO 50 pz	 8 003736192010 XTF2 / 783 - SILCA PER TUFF®  CHIAVE A CROCE 25 pz	 8 003736192034 XY1 / 783 - SILCA PER YALE®  CHIAVE A CROCE 25 pz

In conformità alle disposizioni legali in vigore relative alle proprietà industriali, informiamo che i marchi o le denominazioni commerciali citate nel nostro documento sono di proprietà esclusiva dei fabbricanti di serrature e degli utilizzatori autorizzati. Questi marchi o denominazioni commerciali sono indicati a titolo di semplice informazione, con lo scopo di riconoscere velocemente a quali serrature le nostre chiavi sono destinate. Questo documento è esclusivamente riservato ai professionisti della riproduzione chiavi che utilizzano i prodotti Silca. / Le illustrazioni e i dati tecnici dei prodotti contenuti nel documento debbono considerarsi indicativi. Silca si riserva il diritto, ferme restando le caratteristiche essenziali dei prodotti, di apportare tutte le modifiche che ritiene necessarie e opportune al fine di migliorare la qualità dei prodotti. Tutti i disegni e le fotografie sono di proprietà di Silca, ogni riproduzione anche parziale, senza autorizzazione scritta di Silca S.p.A. è vietata secondo termini di legge. Per qualsiasi controversia competenti sono gli Uffici Giudiziari dove ha sede l'Azienda Silca S.p.A., con espressa esclusione di qualsiasi altro foro.

































 8 003 737 581 653 XY10P / 783 - SILCA PER YALE®  CHIAVE A CROCE DESIGN 25 pz	 8 003 737 581 530 XY1P / 783 - SILCA PER YALE®  CHIAVE A CROCE DESIGN 25 pz	 8 003 737 581 554 XY2P / 783 - SILCA PER YALE®  CHIAVE A CROCE DESIGN 25 pz	 8 003 737 581 578 XY3P / 783 - SILCA PER YALE®  CHIAVE A CROCE DESIGN 25 pz	 8 003 736 192 096 XY4 / 783 - SILCA PER YALE®  CHIAVE A CROCE 25 pz
 8 003 737 581 592 XY4P / 783 - SILCA PER YALE®  CHIAVE A CROCE DESIGN 25 pz	 8 003 737 581 615 XY5P / 783 - SILCA PER YALE®  CHIAVE A CROCE DESIGN 25 pz	 8 003 737 581 639 XY6P / 783 - SILCA PER YALE®  CHIAVE A CROCE DESIGN 25 pz	 8 003 736 192 126 XY7 / 783 - SILCA PER YALE®  CHIAVE A CROCE 25 pz	 8 003 737 581 691 XZ1BP / 783 - SILCA PER ZEISS IKON®  CHIAVE A CROCE DESIGN 25 pz
 8 003 737 581 738 XZ2AP / 783 - SILCA PER ZEISS IKON®  CHIAVE A CROCE DESIGN 25 pz	 8 003 736 192 218 XZ2B / 783 - SILCA PER ZEISS IKON®  CHIAVE A CROCE 25 pz	 8 003 737 581 752 XZ2BP / 783 - SILCA PER ZEISS IKON®  CHIAVE A CROCE DESIGN 25 pz	 8 003 737 581 776 XZ2CP / 783 - SILCA PER ZEISS IKON®  CHIAVE A CROCE DESIGN 25 pz	

In conformità alle disposizioni legali in vigore relative alle proprietà industriali, informiamo che i marchi o le denominazioni commerciali citate nel nostro documento sono di proprietà esclusiva dei fabbricanti di serrature e degli utilizzatori autorizzati. Questi marchi o denominazioni commerciali sono indicati a titolo di semplice informazione, con lo scopo di riconoscere velocemente a quali serrature le nostre chiavi sono destinate. Questo documento è esclusivamente riservato ai professionisti della riproduzione chiavi che utilizzano i prodotti Silca. / Le illustrazioni e i dati tecnici dei prodotti contenuti nel documento debbono considerarsi indicativi. Silca si riserva il diritto, ferme restando le caratteristiche essenziali dei prodotti, di apportare tutte le modifiche che ritiene necessarie e opportune al fine di migliorare la qualità dei prodotti. Tutti i disegni e le fotografie sono di proprietà di Silca, ogni riproduzione anche parziale, senza autorizzazione scritta di Silca S.p.A. è vietata secondo termini di legge. Per qualsiasi controversia competenti sono gli Uffici Giudiziari dove ha sede l'Azienda Silca S.p.A., con espressa esclusione di qualsiasi altro foro.















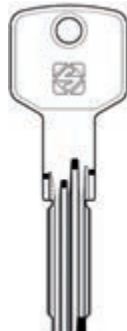















DUPLICATRICI-CHIAVI-RADIOCOMANDI

 8 003736232679 AB40 / 783 - SILCA PER ABUS®  CHIAVE OTTONE 50 pz	 8 003737347549 AB48 / 783 - SILCA PER ABUS®  CHIAVE OTTONE 50 pz	 8 003737740364 AGB5 / 783 - SILCA PER AGB®  CHIAVE OTTONE 50 pz	 8 003737740364 AGB5 / 783 - SILCA PER AGB®  CHIAVE OTTONE 50 pz	 8 003737465755 AGB6 / 783 - SILCA PER AGB®  CHIAVE OTTONE 50 pz
 8 003737478342 AGB7 / 783 - SILCA PER AGB®  CHIAVE OTTONE 50 pz	 8 003737675321 AGB8 / 783 - SILCA PER AGB®  CHIAVE OTTONE 50 pz	 8 003737749275 AGB9 / 783 - SILCA PER AGB®  CHIAVE OTTONE 50 pz	 8 003737602273 APK2R / 783 - SILCA PER APEKS®  CHIAVE OTTONE 50 pz	 8 003737611398 BD22 / 783 - SILCA PER BRICARD®  CHIAVE OTTONE 50 pz
 8 003737609234 BNK1 / 783 - SILCA PER BLINKY®  CHIAVE OTTONE 50 pz	 8 003736535381 CB87 / 783 - SILCA PER CORBIN®  CHIAVE OTTONE 50 pz	 8 003737603102 CB97 / 783 - SILCA PER CORBIN®  CHIAVE OTTONE 50 pz	 8 003737609197 CB98 / 783 - SILCA PER CORBIN®  CHIAVE OTTONE 50 pz	 8 003737638128 CE131 / 783 - SILCA PER CES®  CHIAVE OTTONE 50 pz

In conformità alle disposizioni legali in vigore relative alle proprietà industriali, informiamo che i marchi o le denominazioni commerciali citate nel nostro documento sono di proprietà esclusiva dei fabbricanti di serrature e degli utilizzatori autorizzati. Questi marchi o denominazioni commerciali sono indicati a titolo di semplice informazione, con lo scopo di riconoscere velocemente a quali serrature le nostre chiavi sono destinate. Questo documento è esclusivamente riservato ai professionisti della riproduzione chiavi che utilizzano i prodotti Silca. / Le illustrazioni e i dati tecnici dei prodotti contenuti nel documento debbono considerarsi indicativi. Silca si riserva il diritto, ferme restando le caratteristiche essenziali dei prodotti, di apportare tutte le modifiche che ritiene necessarie e opportune al fine di migliorare la qualità dei prodotti. Tutti i disegni e le fotografie sono di proprietà di Silca, ogni riproduzione anche parziale, senza autorizzazione scritta di Silca S.p.A. è vietata secondo termini di legge. Per qualsiasi controversia competenti sono gli Uffici Giudiziari dove ha sede l'Azienda Silca S.p.A., con espressa esclusione di qualsiasi altro foro.



















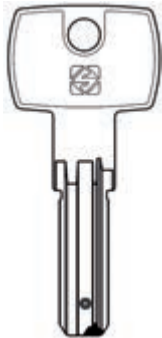











 8 0 0 3 7 3 6 0 4 0 7 2 4 CH9T / 783 - SILCA PER CHICAGO®  CHIAVE TUBOLARE 50 pz	 8 0 0 3 7 3 7 4 3 5 6 8 0 CIS9 / 783 - SILCA PER CAS-CISMA®  CHIAVE OTTONE 50 pz	 8 0 0 3 7 3 7 3 9 0 4 1 5 CS115 / 783 - SILCA PER CISA®  CHIAVE OTTONE 50 pz	 8 0 0 3 7 3 6 5 3 7 3 1 6 CS116P / 783 - SILCA PER CISA®  CHIAVE OTTONE 25 pz	 8 0 0 3 7 3 7 5 9 2 9 2 5 CS139 / 783 - SILCA PER CISA®  CHIAVE OTTONE 50 pz
 8 0 0 3 7 3 7 6 0 2 1 1 2 CS139P / 783 - SILCA PER CISA®  CHIAVE OTTONE 25 pz	 8 0 0 3 7 3 7 5 9 7 6 2 3 CS140 / 783 - SILCA PER CISA®  CHIAVE OTTONE 50 pz	 8 0 0 3 7 3 7 5 9 7 6 3 0 CS141 / 783 - SILCA PER CISA®  CHIAVE OTTONE 50 pz	 8 0 0 3 7 3 7 6 1 1 1 5 2 CS144 / 783 - SILCA PER CISA®  CHIAVE OTTONE 50 pz	 8 0 0 3 7 3 7 6 4 5 8 0 5 CS145 / 783 - SILCA PER CISA®  CHIAVE OTTONE 50 pz
 8 0 0 3 7 3 7 6 7 6 7 7 9 CS146 / 783 - SILCA PER CISA®  CHIAVE OTTONE 50 pz	 8 0 0 3 7 3 6 7 5 7 1 8 9 CS48 / 783 - SILCA PER CISA®  CHIAVE OTTONE 50 pz	 8 0 0 3 7 3 6 4 1 7 1 0 6 CS62 / 783 - SILCA PER CISA®  CHIAVE OTTONE 50 pz	 8 0 0 3 7 3 6 5 3 7 3 3 0 CS62P / 783 - SILCA PER CISA®  CHIAVE OTTONE 25 pz	 8 0 0 3 7 3 7 3 5 4 5 2 3 CS70 / 783 - SILCA PER CISA®  CHIAVE OTTONE 50 pz

In conformità alle disposizioni legali in vigore relative alle proprietà industriali, informiamo che i marchi o le denominazioni commerciali citate nel nostro documento sono di proprietà esclusiva dei fabbricanti di serrature e degli utilizzatori autorizzati. Questi marchi o denominazioni commerciali sono indicati a titolo di semplice informazione, con lo scopo di riconoscere velocemente a quali serrature le nostre chiavi sono destinate. Questo documento è esclusivamente riservato ai professionisti della riproduzione chiavi che utilizzano i prodotti Silca. / Le illustrazioni e i dati tecnici dei prodotti contenuti nel documento debbono considerarsi indicativi. Silca si riserva il diritto, ferme restando le caratteristiche essenziali dei prodotti, di apportare tutte le modifiche che ritiene necessarie e opportune al fine di migliorare la qualità dei prodotti. Tutti i disegni e le fotografie sono di proprietà di Silca, ogni riproduzione anche parziale, senza autorizzazione scritta di Silca S.p.A. è vietata secondo termini di legge. Per qualsiasi controversia competenti sono gli Uffici Giudiziari dove ha sede l'Azienda Silca S.p.A., con espressa esclusione di qualsiasi altro foro.

































DUPLICATRICI-CHIAVI-RADIOCOMANDI

 8 003736537378 CS70P / 783 - SILCA PER CISA®  CHIAVE OTTONE 25 pz	 8 003736785977 DM118 / 783 - SILCA PER DOM®  CHIAVE OTTONE 50 pz	 8 003736512849 DM120 / 783 - SILCA PER DOM®  CHIAVE OTTONE 50 pz	 8 003737442206 DM128 / 783 - SILCA PER DOM®  CHIAVE OTTONE 50 pz	 8 003737602402 DM139 / 783 - SILCA PER DOM®  CHIAVE ALPACCA 50 pz
 8 003736058125 DM24 / 783 - SILCA PER DOM®  CHIAVE OTTONE 50 pz	 8 003736232686 DM55 / 783 - SILCA PER DOM®  CHIAVE OTTONE 50 pz	 8 003736059689 DM58 / 783 - SILCA PER DOM®  CHIAVE OTTONE 50 pz	 8 003736059962 DM64 / 783 - SILCA PER DOM®  CHIAVE ALPACCA 50 pz	 8 003736232693 EC5 / 783 - SILCA PER ELCA®  CHIAVE OTTONE 50 pz
 8 003737671224 EU17 / 783 - SILCA PER EURO LOCKS®  CHIAVE OTTONE 50 pz	 8 003737916639 EV106 / 783 - SILCA PER EVVA®  25 pz	 8 003737916646 EV106R / 783 - SILCA PER EVVA®  25 pz	 8 003737920766 EV107 / 783 - SILCA PER EVVA®  25 pz	 8 003737920759 EV107R / 783 - SILCA PER EVVA®  25 pz

In conformità alle disposizioni legali in vigore relative alle proprietà industriali, informiamo che i marchi o le denominazioni commerciali citate nel nostro documento sono di proprietà esclusiva dei fabbricanti di serrature e degli utilizzatori autorizzati. Questi marchi o denominazioni commerciali sono indicati a titolo di semplice informazione, con lo scopo di riconoscere velocemente a quali serrature le nostre chiavi sono destinate. Questo documento è esclusivamente riservato ai professionisti della riproduzione chiavi che utilizzano i prodotti Silca. / Le illustrazioni e i dati tecnici dei prodotti contenuti nel documento debbono considerarsi indicativi. Silca si riserva il diritto, ferme restando le caratteristiche essenziali dei prodotti, di apportare tutte le modifiche che ritiene necessarie e opportune al fine di migliorare la qualità dei prodotti. Tutti i disegni e le fotografie sono di proprietà di Silca, ogni riproduzione anche parziale, senza autorizzazione scritta di Silca S.p.A. è vietata secondo termini di legge. Per qualsiasi controversia competenti sono gli Uffici Giudiziari dove ha sede l'Azienda Silca S.p.A., con espressa esclusione di qualsiasi altro foro.

































 8 003737916615 EV122 / 783 - SILCA PER EVVA®  25 pz	 8 003737916622 EV122R / 783 - SILCA PER EVVA®  25 pz	 8 003737718097 FAC31 / 783 - SILCA PER FAC®  CHIAVE OTTONE 50 pz	 8 003737345309 FH17R / 783 - SILCA PER FTH®  CHIAVE OTTONE 50 pz	 8 003737611923 FH32 / 783 - SILCA PER FTH®  CHIAVE OTTONE 50 pz
 8 003737611930 FH33 / 783 - SILCA PER FTH®  CHIAVE OTTONE 50 pz	 8 003737611954 FH35 / 783 - SILCA PER FTH®  CHIAVE OTTONE 50 pz	 8 003737611961 FH36 / 783 - SILCA PER FTH®  CHIAVE OTTONE 50 pz	 8 003737609272 FI3R / 783 - SILCA PER FIAM®  CHIAVE OTTONE 50 pz	 8 003737708319 FY1R / 783 - SILCA PER FAYN®  CHIAVE OTTONE 50 pz
 8 003737609364 GF1 / 783 - SILCA PER GRIFO®  CHIAVE OTTONE 50 pz	 8 003737742399 GS17 / 783 - SILCA PER GIUSSANI®  CHIAVE OTTONE 50 pz	 8 003737673914 GVV1R / 783 - SILCA PER GEVY®  CHIAVE OTTONE 50 pz	 8 003736295056 IE14 / 783 - SILCA PER ISEO®  CHIAVE OTTONE 50 pz	 8 003736295063 IE15 / 783 - SILCA PER ISEO®  CHIAVE OTTONE 50 pz

In conformità alle disposizioni legali in vigore relative alle proprietà industriali, informiamo che i marchi o le denominazioni commerciali citate nel nostro documento sono di proprietà esclusiva dei fabbricanti di serrature e degli utilizzatori autorizzati. Questi marchi o denominazioni commerciali sono indicati a titolo di semplice informazione, con lo scopo di riconoscere velocemente a quali serrature le nostre chiavi sono destinate. Questo documento è esclusivamente riservato ai professionisti della riproduzione chiavi che utilizzano i prodotti Silca. / Le illustrazioni e i dati tecnici dei prodotti contenuti nel documento debbono considerarsi indicativi. Silca si riserva il diritto, ferme restando le caratteristiche essenziali dei prodotti, di apportare tutte le modifiche che ritiene necessarie e opportune al fine di migliorare la qualità dei prodotti. Tutti i disegni e le fotografie sono di proprietà di Silca, ogni riproduzione anche parziale, senza autorizzazione scritta di Silca S.p.A. è vietata secondo termini di legge. Per qualsiasi controversia competenti sono gli Uffici Giudiziari dove ha sede l'Azienda Silca S.p.A., con espressa esclusione di qualsiasi altro foro.

































DUPLICATRICI-CHIAVI-RADIOCOMANDI

 IE26 / 783 - SILCA PER ISEO®  CHIAVE OTTONE 50 pz	 IE26P / 783 - SILCA PER ISEO®  CHIAVE OTTONE 25 pz	 KA1 / 783 - SILCA PER KABA®  CHIAVE OTTONE 50 pz	 KA2 / 783 - SILCA PER KABA®  CHIAVE ALPACCA 50 pz	 KA3 / 783 - SILCA PER KABA®  CHIAVE ALPACCA 50 pz
 KA5 / 783 - SILCA PER KABA®  CHIAVE OTTONE 50 pz	 KA7 / 783 - SILCA PER KABA®  CHIAVE ALPACCA 50 pz	 KA8 / 783 - SILCA PER KABA®  CHIAVE ALPACCA 50 pz	 KA9 / 783 - SILCA PER KABA®  CHIAVE OTTONE LUCIDO 50 pz	 KA9 / 783 - SILCA PER KABA®  CHIAVE OTTONE LUCIDO 50 pz
 KE1 / 783 - SILCA PER KESO®  CHIAVE OTTONE 50 pz	 KE11 / 783 - SILCA PER KESO®  CHIAVE ALPACCA 50 pz	 KE13 / 783 - SILCA PER KESO®  CHIAVE ALPACCA 50 pz	 KE2 / 783 - SILCA PER KESO®  CHIAVE ALPACCA 50 pz	 KE3 / 783 - SILCA PER KESO®  CHIAVE OTTONE 50 pz

In conformità alle disposizioni legali in vigore relative alle proprietà industriali, informiamo che i marchi o le denominazioni commerciali citate nel nostro documento sono di proprietà esclusiva dei fabbricanti di serrature e degli utilizzatori autorizzati. Questi marchi o denominazioni commerciali sono indicati a titolo di semplice informazione, con lo scopo di riconoscere velocemente a quali serrature le nostre chiavi sono destinate. Questo documento è esclusivamente riservato ai professionisti della riproduzione chiavi che utilizzano i prodotti Silca. / Le illustrazioni e i dati tecnici dei prodotti contenuti nel documento debbono considerarsi indicativi. Silca si riserva il diritto, ferme restando le caratteristiche essenziali dei prodotti, di apportare tutte le modifiche che ritiene necessarie e opportune al fine di migliorare la qualità dei prodotti. Tutti i disegni e le fotografie sono di proprietà di Silca, ogni riproduzione anche parziale, senza autorizzazione scritta di Silca S.p.A. è vietata secondo termini di legge. Per qualsiasi controversia competenti sono gli Uffici Giudiziari dove ha sede l'Azienda Silca S.p.A., con espressa esclusione di qualsiasi altro foro.

















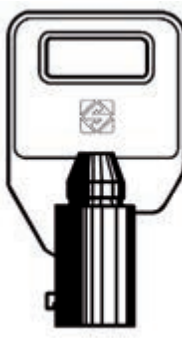



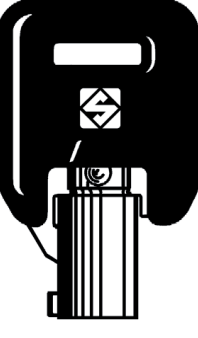



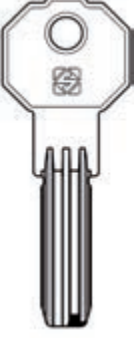





 KE9 / 783 - SILCA PER KESO®  CHIAVE ALPACCA 50 pz	 KLE10R / 783 - SILCA PER KALE®  CHIAVE OTTONE 50 pz	 LC14R / 783 - SILCA PER LINCE®  CHIAVE OTTONE 50 pz	 MER22T / 783 - SILCA PER MERONI®  CHIAVE TUBOLARE 50 pz	 MER25T / 783 - SILCA PER MERONI®  CHIAVE TUBOLARE 50 pz
 MER26T / 783 - SILCA PER MERONI®  CHIAVE TUBOLARE 50 pz	 MER38 / 783 - SILCA PER MERONI®  CHIAVE OTTONE 50 pz	 MER39 / 783 - SILCA PER MERONI®  CHIAVE OTTONE 50 pz	 MG8 / 783 - SILCA PER MG (MONTI)®  CHIAVE OTTONE 50 pz	 MG9 / 783 - SILCA PER MG®  CHIAVE OTTONE 50 pz
 MSL1 / 783 - SILCA PER MASTER LOCK®  CHIAVE OTTONE 50 pz	 MTK12RP / 783 - SILCA PER MULT.LOCK®  CHIAVE ALPACCA 25 pz	 MTK13RAP / 783 - SILCA PER MULT.LOCK®  CHIAVE OTTONE 25 pz	 MTK4RP / 783 - SILCA PER MULT.LOCK®  CHIAVE OTTONE 25 pz	 MTK4RPX / 783 - SILCA PER MULT.LOCK®  CHIAVE OTTONE 25 pz

In conformità alle disposizioni legali in vigore relative alle proprietà industriali, informiamo che i marchi o le denominazioni commerciali citate nel nostro documento sono di proprietà esclusiva dei fabbricanti di serrature e degli utilizzatori autorizzati. Questi marchi o denominazioni commerciali sono indicati a titolo di semplice informazione, con lo scopo di riconoscere velocemente a quali serrature le nostre chiavi sono destinate. Questo documento è esclusivamente riservato ai professionisti della riproduzione chiavi che utilizzano i prodotti Silca. / Le illustrazioni e i dati tecnici dei prodotti contenuti nel documento debbono considerarsi indicativi. Silca si riserva il diritto, ferme restando le caratteristiche essenziali dei prodotti, di apportare tutte le modifiche che ritiene necessarie e opportune al fine di migliorare la qualità dei prodotti. Tutti i disegni e le fotografie sono di proprietà di Silca, ogni riproduzione anche parziale, senza autorizzazione scritta di Silca S.p.A. è vietata secondo termini di legge. Per qualsiasi controversia competenti sono gli Uffici Giudiziari dove ha sede l'Azienda Silca S.p.A., con espressa esclusione di qualsiasi altro foro.

































DUPLICATRICI-CHIAVI-RADIOCOMANDI

 8 003737487900 OC3 / 783 - SILCA PER OMEC®  CHIAVE OTTONE 50 pz	 8 003737487955 OC4 / 783 - SILCA PER OMEC®  CHIAVE OTTONE 50 pz	 8 003737660891 OC6 / 783 - SILCA PER OMEC®  CHIAVE OTTONE 50 pz	 8 003736129894 PC12T / 783 - SILCA PER P.C. (CORTELLEZZI)®  CHIAVE TUBOLARE 50 pz	 8 003736129955 PC15T / 783 - SILCA PER P.C. (CORTELLEZZI)®  CHIAVE TUBOLARE 50 pz
 8 003736760769 PC15TP / 783 - SILCA PER P.C. (CORTELLEZZI)®  CHIAVE TUBOLARE OTTONE 25 pz	 8 003737644037 PF18 / 783 - SILCA PER PREFER®  CHIAVE OTTONE 50 pz	 8 003737771162 PF20 / 783 - SILCA PER PREFER®  CHIAVE OTTONE 50 pz	 8 003737882538 PF22 / 783 - SILCA PER PREFER®  CHIAVE OTTONE 50 pz	 8 003736232723 PN1 / 783 - SILCA PER PERINO PG®  CHIAVE OTTONE LUCIDO 50 pz
 8 003737454919 PT4R / 783 - SILCA PER POTENT®  CHIAVE OTTONE 50 pz	 8 003737603638 PT5RP / 783 - SILCA PER POTENT®  CHIAVE OTTONE 25 pz	 8 003737912587 PT7RAP / 783 - SILCA PER POTENT®  25 pz	 8 003737642149 SCM1R / 783 - SILCA PER SECUREMME®  CHIAVE OTTONE 50 pz	 8 003737671699 SCM2 / 783 - SILCA PER SECUREMME®  CHIAVE OTTONE 50 pz

In conformità alle disposizioni legali in vigore relative alle proprietà industriali, informiamo che i marchi o le denominazioni commerciali citate nel nostro documento sono di proprietà esclusiva dei fabbricanti di serrature e degli utilizzatori autorizzati. Questi marchi o denominazioni commerciali sono indicati a titolo di semplice informazione, con lo scopo di riconoscere velocemente a quali serrature le nostre chiavi sono destinate. Questo documento è esclusivamente riservato ai professionisti della riproduzione chiavi che utilizzano i prodotti Silca. / Le illustrazioni e i dati tecnici dei prodotti contenuti nel documento debbono considerarsi indicativi. Silca si riserva il diritto, ferme restando le caratteristiche essenziali dei prodotti, di apportare tutte le modifiche che ritiene necessarie e opportune al fine di migliorare la qualità dei prodotti. Tutti i disegni e le fotografie sono di proprietà di Silca, ogni riproduzione anche parziale, senza autorizzazione scritta di Silca S.p.A. è vietata secondo termini di legge. Per qualsiasi controversia competenti sono gli Uffici Giudiziari dove ha sede l'Azienda Silca S.p.A., con espressa esclusione di qualsiasi altro foro.



 8 003737747882 SCM3RP / 783 - SILCA PER SECUREMME®  CHIAVE OTTONE 25 pz	 8 003736144835 SCU1 / 783 - SILCA PER SECURITAL®  CHIAVE ZAMA 100 pz	 8 003736145214 SEB2 / 783 - SILCA PER SEA®  CHIAVE ALPACCA 50 pz	 8 003737932134 STD1R / 783 - SILCA PER STANDERS®  50 pz	 8 003736855205 STS5 / 783 - SILCA PER STS®  CHIAVE OTTONE 50 pz
 8 003736855182 STS6 / 783 - SILCA PER STS®  CHIAVE OTTONE 50 pz	 8 003737726191 STU6R / 783 - SILCA PER SATURN®  CHIAVE OTTONE 50 pz	 8 003737444316 TAR16 / 783 - SILCA PER TARONI®  CHIAVE OTTONE 50 pz	 8 003737444323 TAR16R / 783 - SILCA PER TARONI®  CHIAVE OTTONE 50 pz	 8 003737674492 TAR21 / 783 - SILCA PER TARONI®  CHIAVE OTTONE 50 pz
 8 003737670296 TE16 / 783 - SILCA PER TESA®  CHIAVE OTTONE 50 pz	 8 003737745307 TE19 / 783 - SILCA PER TESA®  CHIAVE OTTONE 50 pz	 8 003736154001 TE4 / 783 - SILCA PER TESA®  CHIAVE OTTONE 50 pz	 8 003737374804 TE4R / 783 - SILCA PER TESA®  CHIAVE OTTONE 50 pz	 8 003736154032 TE5 / 783 - SILCA PER TESA®  CHIAVE ALPACCA 50 pz

In conformità alle disposizioni legali in vigore relative alle proprietà industriali, informiamo che i marchi o le denominazioni commerciali citate nel nostro documento sono di proprietà esclusiva dei fabbricanti di serrature e degli utilizzatori autorizzati. Questi marchi o denominazioni commerciali sono indicati a titolo di semplice informazione, con lo scopo di riconoscere velocemente a quali serrature le nostre chiavi sono destinate. Questo documento è esclusivamente riservato ai professionisti della riproduzione chiavi che utilizzano i prodotti Silca. / Le illustrazioni e i dati tecnici dei prodotti contenuti nel documento debbono considerarsi indicativi. Silca si riserva il diritto, ferme restando le caratteristiche essenziali dei prodotti, di apportare tutte le modifiche che ritiene necessarie e opportune al fine di migliorare la qualità dei prodotti. Tutti i disegni e le fotografie sono di proprietà di Silca, ogni riproduzione anche parziale, senza autorizzazione scritta di Silca S.p.A. è vietata secondo termini di legge. Per qualsiasi controversia competenti sono gli Uffici Giudiziari dove ha sede l'Azienda Silca S.p.A., con espressa esclusione di qualsiasi altro foro.











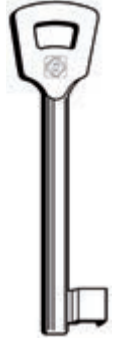







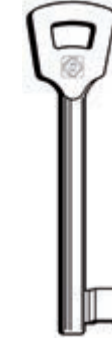











DUPLICATRICI-CHIAVI-RADIOCOMANDI

 8 003736372962 TE7 / 783 - SILCA PER TESA® CHIAVE ALPACCA 50 pz	 8 003736430495 TV2 / 783 - SILCA PER TOVER® CHIAVE ALPACCA 50 pz	 8 003737440295 TV2 PER TOVER® CHIAVE OTTONE 50 pz	 8 003737716901 UC8R / 783 - SILCA PER UCEM® CHIAVE OTTONE 50 pz	 8 003737462891 VI19 / 783 - SILCA PER VIRO® CHIAVE OTTONE 50 pz
 8 003737699747 YA90 / 783 - SILCA PER YALE® CHIAVE OTTONE 50 pz	 8 003736415041 YD7R / 783 - SILCA PER YARD-YARDENI® CHIAVE OTTONE 50 pz	 8 003736493483 ZD25 / 783 - SILCA PER ZADI® CHIAVE OTTONE 50 pz		

In conformità alle disposizioni legali in vigore relative alle proprietà industriali, informiamo che i marchi o le denominazioni commerciali citate nel nostro documento sono di proprietà esclusiva dei fabbricanti di serrature e degli utilizzatori autorizzati. Questi marchi o denominazioni commerciali sono indicati a titolo di semplice informazione, con lo scopo di riconoscere velocemente a quali serrature le nostre chiavi sono destinate. Questo documento è esclusivamente riservato ai professionisti della riproduzione chiavi che utilizzano i prodotti Silca. / Le illustrazioni e i dati tecnici dei prodotti contenuti nel documento debbono considerarsi indicativi. Silca si riserva il diritto, ferme restando le caratteristiche essenziali dei prodotti, di apportare tutte le modifiche che ritiene necessarie e opportune al fine di migliorare la qualità dei prodotti. Tutti i disegni e le fotografie sono di proprietà di Silca, ogni riproduzione anche parziale, senza autorizzazione scritta di Silca S.p.A. è vietata secondo termini di legge. Per qualsiasi controversia competenti sono gli Uffici Giudiziari dove ha sede l'Azienda Silca S.p.A., con espressa esclusione di qualsiasi altro foro.



 10NFHL / 783 - SILCA PER NEMEF®  25 pz	 1NFHL / 783 - SILCA PER NEMEF®  CHIAVE ZAMA 25 pz	 2NFHL / 783 - SILCA PER NEMEF®  CHIAVE ZAMA 25 pz	 3NFHL / 783 - SILCA PER NEMEF®  CHIAVE ZAMA 25 pz	 4NFHL / 783 - SILCA PER NEMEF®  CHIAVE ZAMA 25 pz
 5005C / 783 - SILCA PER PATENT PASSEPARTOUT...  CHIAVE PATENT BRONZATA 25 pz	 5006C / 783 - SILCA PER PATENT PASSEPARTOUT...  CHIAVE PATENT BRONZATA 25 pz	 5007EK / 783 - SILCA PER PATENT PASSEPARTOUT...  CHIAVE PATENT OTTONATA 25 pz	 5008EK / 783 - SILCA PER PATENT PASSEPARTOUT...  CHIAVE PATENT OTTONATA 25 pz	 5601 / 783 - SILCA PER MASCHI E FEMMINE®  CHIAVE CADORINE MASCHIO 25 pz
 5602 / 783 - SILCA PER MASCHI E FEMMINE®  CHIAVE CADORINE MASCHIO 25 pz	 5921 / 783 - SILCA PER MASCHI PER CANCELLE...  CHIAVE CADORINE MASCHIO 25 pz	 5922 / 783 - SILCA PER MASCHI PER CANCELLE...  CHIAVE CADORINE MASCHIO 25 pz	 5922 P / 783 - SILCA PER MASCHI PER CANCELLE...  CHIAVE CADORINE MASCHIO 25 pz	 5922 P1 / 783 - SILCA PER MASCHI PER CANCELLE...  CHIAVE CADORINE MASCHIO 25 pz

In conformità alle disposizioni legali in vigore relative alle proprietà industriali, informiamo che i marchi o le denominazioni commerciali citate nel nostro documento sono di proprietà esclusiva dei fabbricanti di serrature e degli utilizzatori autorizzati. Questi marchi o denominazioni commerciali sono indicati a titolo di semplice informazione, con lo scopo di riconoscere velocemente a quali serrature le nostre chiavi sono destinate. Questo documento è esclusivamente riservato ai professionisti della riproduzione chiavi che utilizzano i prodotti Silca. / Le illustrazioni e i dati tecnici dei prodotti contenuti nel documento debbono considerarsi indicativi. Silca si riserva il diritto, ferme restando le caratteristiche essenziali dei prodotti, di apportare tutte le modifiche che ritiene necessarie e opportune al fine di migliorare la qualità dei prodotti. Tutti i disegni e le fotografie sono di proprietà di Silca, ogni riproduzione anche parziale, senza autorizzazione scritta di Silca S.p.A. è vietata secondo termini di legge. Per qualsiasi controversia competenti sono gli Uffici Giudiziari dove ha sede l'Azienda Silca S.p.A., con espressa esclusione di qualsiasi altro foro.

























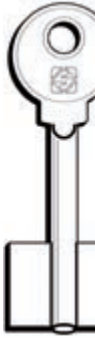





DUPLICATRICI-CHIAVI-RADIOCOMANDI

 8 003736226807 5922 P2 / 783 - SILCA PER MASCHI PER CANCELLE... CHIAVE CADORINE MASCHIO 25 pz	 8 003736226814 5922 P3 / 783 - SILCA PER MASCHI PER CANCELLE... CHIAVE CADORINE MASCHIO 25 pz	 8 003736226838 5922 P5 / 783 - SILCA PER MASCHI PER CANCELLE... CHIAVE CADORINE MASCHIO 25 pz	 8 003736223233 5A2 / 783 - SILCA PER ANTONIOLI® CHIAVE A DOPPIA MAPPA 25 pz	 8 003736223257 5A4 / 783 - SILCA PER ANTONIOLI® CHIAVE A DOPPIA MAPPA 25 pz
 8 003737450812 5A7 / 783 - SILCA PER ANTONIOLI® CHIAVE A DOPPIA MAPPA 25 pz	 8 003736223189 5AT1 / 783 - SILCA PER ATRA® CHIAVE A DOPPIA MAPPA 25 pz	 8 003737661669 5AT11AP / 783 - SILCA PER ATRA® CHIAVE A DOPPIA MAPPA 25 pz	 8 003737887625 5AT13AP / 783 - SILCA PER ATRA® CHIAVE A DOPPIA MAPPA 20 pz	 8 003737503761 5AT1P / 783 - SILCA PER ATRA® CHIAVE A DOPPIA MAPPA 25 pz
 8 003736223202 5AT3 / 783 - SILCA PER ATRA® CHIAVE A POMPA 25 pz	 8 003736765221 5AT5 / 783 - SILCA PER ATRA® CHIAVE A DOPPIA MAPPA 25 pz	 8 003736576575 5AT7 / 783 - SILCA PER ATRA® CHIAVE A DOPPIA MAPPA 25 pz	 8 003736514317 5AT9 / 783 - SILCA PER ATRA® CHIAVE A DOPPIA MAPPA 25 pz	 8 003736223219 5AU1 / 783 - SILCA PER ANTONIOLI® CHIAVE A POMPA 25 pz

In conformità alle disposizioni legali in vigore relative alle proprietà industriali, informiamo che i marchi o le denominazioni commerciali citate nel nostro documento sono di proprietà esclusiva dei fabbricanti di serrature e degli utilizzatori autorizzati. Questi marchi o denominazioni commerciali sono indicati a titolo di semplice informazione, con lo scopo di riconoscere velocemente a quali serrature le nostre chiavi sono destinate. Questo documento è esclusivamente riservato ai professionisti della riproduzione chiavi che utilizzano i prodotti Silca. / Le illustrazioni e i dati tecnici dei prodotti contenuti nel documento debbono considerarsi indicativi. Silca si riserva il diritto, ferme restando le caratteristiche essenziali dei prodotti, di apportare tutte le modifiche che ritiene necessarie e opportune al fine di migliorare la qualità dei prodotti. Tutti i disegni e le fotografie sono di proprietà di Silca, ogni riproduzione anche parziale, senza autorizzazione scritta di Silca S.p.A. è vietata secondo termini di legge. Per qualsiasi controversia competenti sono gli Uffici Giudiziari dove ha sede l'Azienda Silca S.p.A., con espressa esclusione di qualsiasi altro foro.

































 5AU11 / 783 - SILCA PER AUNO®  CHIAVE A DOPPIA MAPPA 25 pz	 5AU13 / 783 - SILCA PER AUNO®  CHIAVE A DOPPIA MAPPA 25 pz	 5AU3 / 783 - SILCA PER ANTONIOLI®  CHIAVE A POMPA 25 pz	 5AU5 / 783 - SILCA PER ANTONIOLI®  CHIAVE A DOPPIA MAPPA 25 pz	 5AU7 / 783 - SILCA PER ANTONIOLI®  CHIAVE OTTONE 25 pz
 5AU9 / 783 - SILCA PER AUNO®  CHIAVE A DOPPIA MAPPA 25 pz	 5BDE1 / 783 - SILCA PER BODE®  CHIAVE A DOPPIA MAPPA 25 pz	 5BDE3 / 783 - SILCA PER BODE®  CHIAVE A DOPPIA MAPPA 25 pz	 5BE1 / 783 - SILCA PER BETA®  CHIAVE A DOPPIA MAPPA 25 pz	 5BE2 / 783 - SILCA PER BETA®  CHIAVE A DOPPIA MAPPA 25 pz
 5BE3 / 783 - SILCA PER BETA®  CHIAVE A DOPPIA MAPPA 25 pz	 5BE5 / 783 - SILCA PER BETA®  CHIAVE A DOPPIA MAPPA 25 pz	 5BL1 / 783 - SILCA PER BMC®  CHIAVE A DOPPIA MAPPA 25 pz	 5BUR1 / 783 - SILCA PER BURG WACHTER®  CHIAVE A DOPPIA MAPPA 25 pz	 5BUR2 / 783 - SILCA PER BURG WACHTER®  CHIAVE A DOPPIA MAPPA 25 pz

In conformità alle disposizioni legali in vigore relative alle proprietà industriali, informiamo che i marchi o le denominazioni commerciali citate nel nostro documento sono di proprietà esclusiva dei fabbricanti di serrature e degli utilizzatori autorizzati. Questi marchi o denominazioni commerciali sono indicati a titolo di semplice informazione, con lo scopo di riconoscere velocemente a quali serrature le nostre chiavi sono destinate. Questo documento è esclusivamente riservato ai professionisti della riproduzione chiavi che utilizzano i prodotti Silca. / Le illustrazioni e i dati tecnici dei prodotti contenuti nel documento debbono considerarsi indicativi. Silca si riserva il diritto, ferme restando le caratteristiche essenziali dei prodotti, di apportare tutte le modifiche che ritiene necessarie e opportune al fine di migliorare la qualità dei prodotti. Tutti i disegni e le fotografie sono di proprietà di Silca, ogni riproduzione anche parziale, senza autorizzazione scritta di Silca S.p.A. è vietata secondo termini di legge. Per qualsiasi controversia competenti sono gli Uffici Giudiziari dove ha sede l'Azienda Silca S.p.A., con espressa esclusione di qualsiasi altro foro.

































DUPLICATRICI-CHIAVI-RADIOCOMANDI

 8 0 0 3 7 3 6 2 2 3 6 0 8 5C11 / 783 - SILCA PER CERUTTI®  CHIAVE A DOPPIA MAPPA 25 pz	 8 0 0 3 7 3 6 2 2 3 6 2 2 5C14 / 783 - SILCA PER CERUTTI®  CHIAVE A DOPPIA MAPPA 25 pz	 8 0 0 3 7 3 6 2 2 3 6 3 9 5C15 / 783 - SILCA PER CERUTTI®  CHIAVE A POMPA 25 pz	 8 0 0 3 7 3 6 2 2 3 6 5 3 5C4 / 783 - SILCA PER CERUTTI®  CHIAVE A DOPPIA MAPPA 25 pz	 8 0 0 3 7 3 6 2 2 3 6 6 0 5C6 / 783 - SILCA PER CERUTTI®  CHIAVE A DOPPIA MAPPA 25 pz
 8 0 0 3 7 3 6 2 2 3 6 7 7 5C8 / 783 - SILCA PER CERUTTI®  CHIAVE A DOPPIA MAPPA 25 pz	 8 0 0 3 7 3 6 2 2 3 6 9 1 5C9 / 783 - SILCA PER CERUTTI®  CHIAVE A DOPPIA MAPPA 25 pz	 8 0 0 3 7 3 6 2 2 3 3 9 4 5CB1 / 783 - SILCA PER CORBIN®  CHIAVE A DOPPIA MAPPA 25 pz	 8 0 0 3 7 3 6 2 2 3 4 0 0 5CB2 / 783 - SILCA PER CORBIN®  CHIAVE A DOPPIA MAPPA 25 pz	 8 0 0 3 7 3 6 8 0 3 5 7 2 5CB3 / 783 - SILCA PER CORBIN®  CHIAVE A DOPPIA MAPPA 25 pz
 8 0 0 3 7 3 6 2 2 3 4 5 5 5CC2 / 783 - SILCA PER CORNI®  CHIAVE A DOPPIA MAPPA 25 pz	 8 0 0 3 7 3 6 2 2 3 4 7 9 5CC4 / 783 - SILCA PER CORNI®  CHIAVE A DOPPIA MAPPA 25 pz	 8 0 0 3 7 3 6 2 2 3 4 8 6 5CPR1 / 783 - SILCA PER CIPIERRE®  CHIAVE A DOPPIA MAPPA 25 pz	 8 0 0 3 7 3 6 3 4 8 8 2 0 5CPR3 / 783 - SILCA PER CIPIERRE®  CHIAVE A DOPPIA MAPPA 25 pz	 8 0 0 3 7 3 6 2 2 3 4 9 3 5CS1 / 783 - SILCA PER CISA®  CHIAVE A DOPPIA MAPPA 25 pz

In conformità alle disposizioni legali in vigore relative alle proprietà industriali, informiamo che i marchi o le denominazioni commerciali citate nel nostro documento sono di proprietà esclusiva dei fabbricanti di serrature e degli utilizzatori autorizzati. Questi marchi o denominazioni commerciali sono indicati a titolo di semplice informazione, con lo scopo di riconoscere velocemente a quali serrature le nostre chiavi sono destinate. Questo documento è esclusivamente riservato ai professionisti della riproduzione chiavi che utilizzano i prodotti Silca. / Le illustrazioni e i dati tecnici dei prodotti contenuti nel documento debbono considerarsi indicativi. Silca si riserva il diritto, ferme restando le caratteristiche essenziali dei prodotti, di apportare tutte le modifiche che ritiene necessarie e opportune al fine di migliorare la qualità dei prodotti. Tutti i disegni e le fotografie sono di proprietà di Silca, ogni riproduzione anche parziale, senza autorizzazione scritta di Silca S.p.A. è vietata secondo termini di legge. Per qualsiasi controversia competenti sono gli Uffici Giudiziari dove ha sede l'Azienda Silca S.p.A., con espressa esclusione di qualsiasi altro foro.













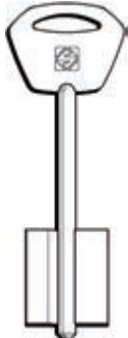















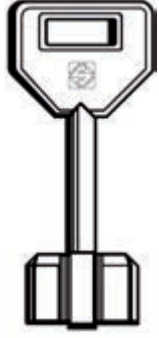

 5CS10P / 783 - SILCA PER CISA®  CHIAVE A DOPPIA MAPPA 25 pz	 5CS12P / 783 - SILCA PER CISA®  CHIAVE A DOPPIA MAPPA 25 pz	 5CS1P / 783 - SILCA PER CISA®  CHIAVE A DOPPIA MAPPA 25 pz	 5CS2 / 783 - SILCA PER CISA®  CHIAVE A DOPPIA MAPPA 25 pz	 5CS2P / 783 - SILCA PER CISA®  CHIAVE A DOPPIA MAPPA 25 pz
 5CS4T / 783 - SILCA PER CISA®  CHIAVE TELESCOPICA - TESTA ZAMA 25 pz	 5CS6P / 783 - SILCA PER CISA®  CHIAVE A DOPPIA MAPPA 25 pz	 5CS8P / 783 - SILCA PER CISA®  CHIAVE A DOPPIA MAPPA 25 pz	 5CT1 / 783 - SILCA PER CONFORTI®  CHIAVE A DOPPIA MAPPA 25 pz	 5CT3 / 783 - SILCA PER CONFORTI®  CHIAVE A DOPPIA MAPPA 25 pz
 5DS1 / 783 - SILCA PER DOMUS®  25 pz	 5EY1 / 783 - SILCA PER ESETY®  CHIAVE A DOPPIA MAPPA 25 pz	 5EY20 / 783 - SILCA PER ESETY®  CHIAVE A DOPPIA MAPPA 25 pz	 5EY22 / 783 - SILCA PER ESETY®  CHIAVE A DOPPIA MAPPA 25 pz	 5EY24 / 783 - SILCA PER ESETY®  CHIAVE A DOPPIA MAPPA 25 pz

In conformità alle disposizioni legali in vigore relative alle proprietà industriali, informiamo che i marchi o le denominazioni commerciali citate nel nostro documento sono di proprietà esclusiva dei fabbricanti di serrature e degli utilizzatori autorizzati. Questi marchi o denominazioni commerciali sono indicati a titolo di semplice informazione, con lo scopo di riconoscere velocemente a quali serrature le nostre chiavi sono destinate. Questo documento è esclusivamente riservato ai professionisti della riproduzione chiavi che utilizzano i prodotti Silca. / Le illustrazioni e i dati tecnici dei prodotti contenuti nel documento debbono considerarsi indicativi. Silca si riserva il diritto, ferme restando le caratteristiche essenziali dei prodotti, di apportare tutte le modifiche che ritiene necessarie e opportune al fine di migliorare la qualità dei prodotti. Tutti i disegni e le fotografie sono di proprietà di Silca, ogni riproduzione anche parziale, senza autorizzazione scritta di Silca S.p.A. è vietata secondo termini di legge. Per qualsiasi controversia competenti sono gli Uffici Giudiziari dove ha sede l'Azienda Silca S.p.A., con espressa esclusione di qualsiasi altro foro.



















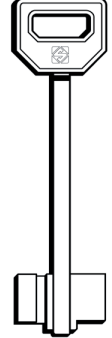

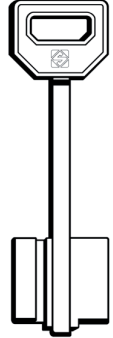









DUPLICATRICI-CHIAVI-RADIOCOMANDI

 8 0 0 3 7 3 6 2 2 3 8 6 8 5EY3 / 783 - SILCA PER ESETY®  CHIAVE A DOPPIA MAPPA 25 pz	 8 0 0 3 7 3 6 6 3 1 2 0 5EY32 / 783 - SILCA PER ESETY®  CHIAVE A DOPPIA MAPPA 25 pz	 8 0 0 3 7 3 7 7 8 5 0 5 1 5EY34 / 783 - SILCA PER ESETY®  CHIAVE A DOPPIA MAPPA 25 pz	 8 0 0 3 7 3 6 2 2 3 8 8 2 5EY5 / 783 - SILCA PER ESETY®  CHIAVE A DOPPIA MAPPA 25 pz	 8 0 0 3 7 3 6 2 2 3 9 7 4 5FAC1 / 783 - SILCA PER FAC®  CHIAVE A DOPPIA MAPPA 25 pz
 8 0 0 3 7 3 6 2 2 3 9 8 1 5FAC3 / 783 - SILCA PER FAC®  CHIAVE A DOPPIA MAPPA 25 pz	 8 0 0 3 7 3 6 2 2 3 9 9 8 5FC1 / 783 - SILCA PER FIAMCA®  CHIAVE A DOPPIA MAPPA 25 pz	 8 0 0 3 7 3 6 2 2 4 0 0 1 5FC4 / 783 - SILCA PER FIAMCA®  CHIAVE A DOPPIA MAPPA 25 pz	 8 0 0 3 7 3 6 2 2 4 0 1 8 5FEB1 / 783 - SILCA PER FEB®  CHIAVE A DOPPIA MAPPA 25 pz	 8 0 0 3 7 3 6 2 2 4 0 2 5 5FEB3 / 783 - SILCA PER FEB®  CHIAVE A DOPPIA MAPPA 25 pz
 8 0 0 3 7 3 6 2 2 4 0 3 2 5FEB5 / 783 - SILCA PER FEB®  CHIAVE A POMPA 25 pz	 8 0 0 3 7 3 6 2 2 4 0 6 3 5FI1 / 783 - SILCA PER FIAM®  CHIAVE A DOPPIA MAPPA 25 pz	 8 0 0 3 7 3 6 2 2 4 0 8 7 5FI13 / 783 - SILCA PER FIAM®  CHIAVE A DOPPIA MAPPA 25 pz	 8 0 0 3 7 3 6 5 0 3 0 3 8 5FI15 / 783 - SILCA PER FIAM®  CHIAVE A DOPPIA MAPPA 25 pz	 8 0 0 3 7 3 6 5 0 4 3 1 8 5FI17 / 783 - SILCA PER FIAM®  CHIAVE A DOPPIA MAPPA 25 pz

In conformità alle disposizioni legali in vigore relative alle proprietà industriali, informiamo che i marchi o le denominazioni commerciali citate nel nostro documento sono di proprietà esclusiva dei fabbricanti di serrature e degli utilizzatori autorizzati. Questi marchi o denominazioni commerciali sono indicati a titolo di semplice informazione, con lo scopo di riconoscere velocemente a quali serrature le nostre chiavi sono destinate. Questo documento è esclusivamente riservato ai professionisti della riproduzione chiavi che utilizzano i prodotti Silca. / Le illustrazioni e i dati tecnici dei prodotti contenuti nel documento debbono considerarsi indicativi. Silca si riserva il diritto, ferme restando le caratteristiche essenziali dei prodotti, di apportare tutte le modifiche che ritiene necessarie e opportune al fine di migliorare la qualità dei prodotti. Tutti i disegni e le fotografie sono di proprietà di Silca, ogni riproduzione anche parziale, senza autorizzazione scritta di Silca S.p.A. è vietata secondo termini di legge. Per qualsiasi controversia competenti sono gli Uffici Giudiziari dove ha sede l'Azienda Silca S.p.A., con espressa esclusione di qualsiasi altro foro.

































 5FI19 / 783 - SILCA PER FIAM®  CHIAVE A DOPPIA MAPPA 25 pz	 5FI21 / 783 - SILCA PER FIAM®  CHIAVE A DOPPIA MAPPA 25 pz	 5FI23P / 783 - SILCA PER FIAM®  CHIAVE A DOPPIA MAPPA - BLU 25 pz	 5FI5 / 783 - SILCA PER FIAM®  CHIAVE A DOPPIA MAPPA 25 pz	 5FI7 / 783 - SILCA PER FIAM®  CHIAVE A DOPPIA MAPPA 25 pz
 5FI9 / 783 - SILCA PER FIAM®  CHIAVE A DOPPIA MAPPA 25 pz	 5FR1 / 783 - SILCA PER FERRAMETALL®  CHIAVE A DOPPIA MAPPA 25 pz	 5HK1 / 783 - SILCA PER HK®  CHIAVE A DOPPIA MAPPA 25 pz	 5ID11 / 783 - SILCA PER IDM®  CHIAVE A DOPPIA MAPPA 25 pz	 5ID13 / 783 - SILCA PER IDM®  CHIAVE A DOPPIA MAPPA 25 pz
 5ID3 / 783 - SILCA PER IDM®  CHIAVE A DOPPIA MAPPA 25 pz	 5ID5 / 783 - SILCA PER IDM®  CHIAVE A DOPPIA MAPPA 25 pz	 5ID7 / 783 - SILCA PER IDM®  CHIAVE A DOPPIA MAPPA 25 pz	 5ID9 / 783 - SILCA PER IDM®  CHIAVE A DOPPIA MAPPA 25 pz	 5IE1 / 783 - SILCA PER ISEO®  CHIAVE A DOPPIA MAPPA 25 pz

In conformità alle disposizioni legali in vigore relative alle proprietà industriali, informiamo che i marchi o le denominazioni commerciali citate nel nostro documento sono di proprietà esclusiva dei fabbricanti di serrature e degli utilizzatori autorizzati. Questi marchi o denominazioni commerciali sono indicati a titolo di semplice informazione, con lo scopo di riconoscere velocemente a quali serrature le nostre chiavi sono destinate. Questo documento è esclusivamente riservato ai professionisti della riproduzione chiavi che utilizzano i prodotti Silca. / Le illustrazioni e i dati tecnici dei prodotti contenuti nel documento debbono considerarsi indicativi. Silca si riserva il diritto, ferme restando le caratteristiche essenziali dei prodotti, di apportare tutte le modifiche che ritiene necessarie e opportune al fine di migliorare la qualità dei prodotti. Tutti i disegni e le fotografie sono di proprietà di Silca, ogni riproduzione anche parziale, senza autorizzazione scritta di Silca S.p.A. è vietata secondo termini di legge. Per qualsiasi controversia competenti sono gli Uffici Giudiziari dove ha sede l'Azienda Silca S.p.A., con espressa esclusione di qualsiasi altro foro.



















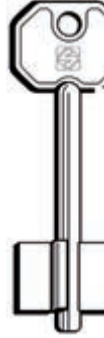











DUPLICATRICI-CHIAVI-RADIOCOMANDI

 8 003737602150 5IE11 / 783 - SILCA PER ISEO®  CHIAVE A DOPPIA MAPPA 25 pz	 8 003736224322 5IE3 / 783 - SILCA PER ISEO®  CHIAVE A DOPPIA MAPPA 25 pz	 8 003736224339 5IE5 / 783 - SILCA PER ISEO®  CHIAVE A POMPA 25 pz	 8 003736224346 5IE7 / 783 - SILCA PER ISEO®  CHIAVE A DOPPIA MAPPA 25 pz	 8 003736224353 5IE9 / 783 - SILCA PER ISEO®  CHIAVE A DOPPIA MAPPA 25 pz
 8 003736224377 5IT3 / 783 - SILCA PER ITAL®  CHIAVE A POMPA 25 pz	 8 003736224391 5IT8 / 783 - SILCA PER ITAL®  CHIAVE A DOPPIA MAPPA 25 pz	 8 003736224483 5JW1 / 783 - SILCA PER JUWEL®  CHIAVE A DOPPIA MAPPA 25 pz	 8 003736224513 5K1 / 783 - SILCA PER KASSEL®  CHIAVE A POMPA 25 pz	 8 003736224490 5KY2 / 783 - SILCA PER KASSEL®  CHIAVE A POMPA 25 pz
 8 003736224506 5KY4 / 783 - SILCA PER KASSEL®  CHIAVE A DOPPIA MAPPA 25 pz	 8 003736490420 5KY6 / 783 - SILCA PER KASSEL®  CHIAVE A DOPPIA MAPPA 25 pz	 8 003736490444 5KY7 / 783 - SILCA PER KASSEL®  CHIAVE A DOPPIA MAPPA 25 pz	 8 003736224599 5LV1 / 783 - SILCA PER LIPS-VAGO®  CHIAVE A DOPPIA MAPPA 25 pz	 8 003736224612 5ME1 / 783 - SILCA PER MELSMETALL®  CHIAVE A DOPPIA MAPPA 25 pz

In conformità alle disposizioni legali in vigore relative alle proprietà industriali, informiamo che i marchi o le denominazioni commerciali citate nel nostro documento sono di proprietà esclusiva dei fabbricanti di serrature e degli utilizzatori autorizzati. Questi marchi o denominazioni commerciali sono indicati a titolo di semplice informazione, con lo scopo di riconoscere velocemente a quali serrature le nostre chiavi sono destinate. Questo documento è esclusivamente riservato ai professionisti della riproduzione chiavi che utilizzano i prodotti Silca. / Le illustrazioni e i dati tecnici dei prodotti contenuti nel documento debbono considerarsi indicativi. Silca si riserva il diritto, ferme restando le caratteristiche essenziali dei prodotti, di apportare tutte le modifiche che ritiene necessarie e opportune al fine di migliorare la qualità dei prodotti. Tutti i disegni e le fotografie sono di proprietà di Silca, ogni riproduzione anche parziale, senza autorizzazione scritta di Silca S.p.A. è vietata secondo termini di legge. Per qualsiasi controversia competenti sono gli Uffici Giudiziari dove ha sede l'Azienda Silca S.p.A., con espressa esclusione di qualsiasi altro foro.

































 5ME3 / 783 - SILCA PER MELSMETALL®  CHIAVE A DOPPIA MAPPA 25 pz	 5M02 / 783 - SILCA PER MOIA®  CHIAVE A DOPPIA MAPPA 25 pz	 5MS1 / 783 - SILCA PER SAFE®  CHIAVE A DOPPIA MAPPA 25 pz	 5MS3 / 783 - SILCA PER SAFE®  CHIAVE A DOPPIA MAPPA 25 pz	 5MS5 / 783 - SILCA PER SAFE®  CHIAVE A DOPPIA MAPPA 25 pz
 5MT10 / 783 - SILCA PER MOTTURA®  CHIAVE A DOPPIA MAPPA 25 pz	 5MT10BP / 783 - SILCA PER MOTTURA®  CHIAVE A DOPPIA MAPPA 25 pz	 5MT12 / 783 - SILCA PER MOTTURA®  CHIAVE A DOPPIA MAPPA 25 pz	 5MT12F / 783 - SILCA PER MOTTURA®  CHIAVE A DOPPIA MAPPA 25 pz	 5MT14 / 783 - SILCA PER MOTTURA®  CHIAVE A DOPPIA MAPPA 25 pz
 5MT16 / 783 - SILCA PER MOTTURA®  CHIAVE A DOPPIA MAPPA 25 pz	 5MT18BP / 783 - SILCA PER MOTTURA®  CHIAVE A DOPPIA MAPPA 25 pz	 5MT19BP / 783 - SILCA PER MOTTURA®  CHIAVE A DOPPIA MAPPA 25 pz	 5MT2 / 783 - SILCA PER MOTTURA®  CHIAVE A DOPPIA MAPPA 25 pz	 5MT21BP / 783 - SILCA PER MOTTURA®  CHIAVE A DOPPIA MAPPA 25 pz

In conformità alle disposizioni legali in vigore relative alle proprietà industriali, informiamo che i marchi o le denominazioni commerciali citate nel nostro documento sono di proprietà esclusiva dei fabbricanti di serrature e degli utilizzatori autorizzati. Questi marchi o denominazioni commerciali sono indicati a titolo di semplice informazione, con lo scopo di riconoscere velocemente a quali serrature le nostre chiavi sono destinate. Questo documento è esclusivamente riservato ai professionisti della riproduzione chiavi che utilizzano i prodotti Silca. / Le illustrazioni e i dati tecnici dei prodotti contenuti nel documento debbono considerarsi indicativi. Silca si riserva il diritto, ferme restando le caratteristiche essenziali dei prodotti, di apportare tutte le modifiche che ritiene necessarie e opportune al fine di migliorare la qualità dei prodotti. Tutti i disegni e le fotografie sono di proprietà di Silca, ogni riproduzione anche parziale, senza autorizzazione scritta di Silca S.p.A. è vietata secondo termini di legge. Per qualsiasi controversia competenti sono gli Uffici Giudiziari dove ha sede l'Azienda Silca S.p.A., con espressa esclusione di qualsiasi altro foro.

































DUPLICATRICI-CHIAVI-RADIOCOMANDI

 8 0 0 3 7 3 6 2 2 4 7 8 0 5MT2F / 783 - SILCA PER MOTTURA®  CHIAVE A DOPPIA MAPPA 25 pz	 8 0 0 3 7 3 6 2 2 4 7 9 7 5MT3 / 783 - SILCA PER MOTTURA®  CHIAVE A DOPPIA MAPPA 25 pz	 8 0 0 3 7 3 7 7 6 7 4 3 9 5MT3BP / 783 - SILCA PER MOTTURA®  CHIAVE A DOPPIA MAPPA 25 pz	 8 0 0 3 7 3 6 2 2 4 8 1 0 5MT5 / 783 - SILCA PER MOTTURA®  CHIAVE A DOPPIA MAPPA 25 pz	 8 0 0 3 7 3 7 7 6 7 4 8 4 5MT5BP / 783 - SILCA PER MOTTURA®  CHIAVE A DOPPIA MAPPA 25 pz
 8 0 0 3 7 3 6 2 2 4 8 4 1 5MT7 / 783 - SILCA PER MOTTURA®  CHIAVE A DOPPIA MAPPA 25 pz	 8 0 0 3 7 3 7 7 6 7 5 4 5 5MT7BP / 783 - SILCA PER MOTTURA®  CHIAVE A DOPPIA MAPPA 25 pz	 8 0 0 3 7 3 6 2 2 4 8 6 5 5MT9 / 783 - SILCA PER MOTTURA®  CHIAVE A DOPPIA MAPPA 25 pz	 8 0 0 3 7 3 7 7 6 7 5 9 0 5MT9BP / 783 - SILCA PER MOTTURA®  CHIAVE A DOPPIA MAPPA 25 pz	 8 0 0 3 7 3 7 8 5 3 7 4 3 5NFHL / 783 - SILCA PER NEMEF®  CHIAVE ZAMA 25 pz
 8 0 0 3 7 3 6 2 2 4 9 1 9 50C1 / 783 - SILCA PER OMEC®  CHIAVE A DOPPIA MAPPA 25 pz	 8 0 0 3 7 3 6 5 3 7 3 9 2 50C3 / 783 - SILCA PER OMEC®  CHIAVE A DOPPIA MAPPA 25 pz	 8 0 0 3 7 3 6 2 2 5 0 2 2 SPE3 / 783 - SILCA PER PROGRES FONTAINE®  CHIAVE A GRUGNO OTTONE LUCIDO 25 pz	 8 0 0 3 7 3 6 2 2 5 0 6 0 SPE5 / 783 - SILCA PER PROGRES FONTAINE®  CHIAVE A GRUGNO OTTONE LUCIDO 25 pz	 8 0 0 3 7 3 6 8 9 7 8 0 9 SPF1 / 783 - SILCA PER PREFER®  CHIAVE A DOPPIA MAPPA 25 pz

In conformità alle disposizioni legali in vigore relative alle proprietà industriali, informiamo che i marchi o le denominazioni commerciali citate nel nostro documento sono di proprietà esclusiva dei fabbricanti di serrature e degli utilizzatori autorizzati. Questi marchi o denominazioni commerciali sono indicati a titolo di semplice informazione, con lo scopo di riconoscere velocemente a quali serrature le nostre chiavi sono destinate. Questo documento è esclusivamente riservato ai professionisti della riproduzione chiavi che utilizzano i prodotti Silca. / Le illustrazioni e i dati tecnici dei prodotti contenuti nel documento debbono considerarsi indicativi. Silca si riserva il diritto, ferme restando le caratteristiche essenziali dei prodotti, di apportare tutte le modifiche che ritiene necessarie e opportune al fine di migliorare la qualità dei prodotti. Tutti i disegni e le fotografie sono di proprietà di Silca, ogni riproduzione anche parziale, senza autorizzazione scritta di Silca S.p.A. è vietata secondo termini di legge. Per qualsiasi controversia competenti sono gli Uffici Giudiziari dove ha sede l'Azienda Silca S.p.A., con espressa esclusione di qualsiasi altro foro.













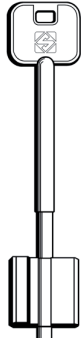













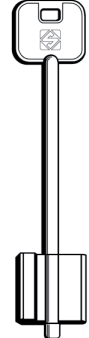



 5PF3 / 783 - SILCA PER PREFER®  CHIAVE A DOPPIA MAPPA 25 pz	 5PT1 / 783 - SILCA PER POTENT®  CHIAVE A DOPPIA MAPPA 25 pz	 5PT10 / 783 - SILCA PER POTENT®  CHIAVE A DOPPIA MAPPA 25 pz	 5PT11 / 783 - SILCA PER POTENT®  CHIAVE A DOPPIA MAPPA 25 pz	 5PT12 / 783 - SILCA PER POTENT®  CHIAVE A DOPPIA MAPPA 25 pz
 5PT13 / 783 - SILCA PER POTENT®  CHIAVE A DOPPIA MAPPA 25 pz	 5PT15 / 783 - SILCA PER POTENT®  CHIAVE A DOPPIA MAPPA 25 pz	 5PT18 / 783 - SILCA PER POTENT®  CHIAVE A DOPPIA MAPPA 25 pz	 5PT2 / 783 - SILCA PER POTENT®  CHIAVE A DOPPIA MAPPA 25 pz	 5PT20 / 783 - SILCA PER POTENT®  CHIAVE A DOPPIA MAPPA 25 pz
 5PT21 / 783 - SILCA PER POTENT®  CHIAVE A DOPPIA MAPPA 25 pz	 5PT22 / 783 - SILCA PER POTENT®  CHIAVE A DOPPIA MAPPA 25 pz	 5PT24 / 783 - SILCA PER POTENT®  CHIAVE A DOPPIA MAPPA 25 pz	 5PT3 / 783 - SILCA PER POTENT®  CHIAVE A DOPPIA MAPPA 25 pz	 5PT5 / 783 - SILCA PER POTENT®  CHIAVE A POMPA 25 pz

In conformità alle disposizioni legali in vigore relative alle proprietà industriali, informiamo che i marchi o le denominazioni commerciali citate nel nostro documento sono di proprietà esclusiva dei fabbricanti di serrature e degli utilizzatori autorizzati. Questi marchi o denominazioni commerciali sono indicati a titolo di semplice informazione, con lo scopo di riconoscere velocemente a quali serrature le nostre chiavi sono destinate. Questo documento è esclusivamente riservato ai professionisti della riproduzione chiavi che utilizzano i prodotti Silca. / Le illustrazioni e i dati tecnici dei prodotti contenuti nel documento debbono considerarsi indicativi. Silca si riserva il diritto, ferme restando le caratteristiche essenziali dei prodotti, di apportare tutte le modifiche che ritiene necessarie e opportune al fine di migliorare la qualità dei prodotti. Tutti i disegni e le fotografie sono di proprietà di Silca, ogni riproduzione anche parziale, senza autorizzazione scritta di Silca S.p.A. è vietata secondo termini di legge. Per qualsiasi controversia competenti sono gli Uffici Giudiziari dove ha sede l'Azienda Silca S.p.A., con espressa esclusione di qualsiasi altro foro.































DUPLICATRICI-CHIAVI-RADIOCOMANDI

 8 0 0 3 7 3 6 2 2 5 1 0 7 5PT11 / 783 - SILCA PER PETTITI®  CHIAVE A DOPPIA MAPPA 25 pz	 8 0 0 3 7 3 6 2 2 5 2 6 8 5R11 / 783 - SILCA PER C.R.®  CHIAVE A DOPPIA MAPPA 25 pz	 8 0 0 3 7 3 6 2 2 5 2 8 2 5R14 / 783 - SILCA PER C.R.®  CHIAVE A DOPPIA MAPPA 25 pz	 8 0 0 3 7 3 6 8 0 3 7 3 2 5R16 / 783 - SILCA PER C.R.®  CHIAVE A DOPPIA MAPPA 25 pz	 8 0 0 3 7 3 6 2 2 5 3 0 5 5R2 / 783 - SILCA PER C.R.®  CHIAVE A DOPPIA MAPPA 25 pz
 8 0 0 3 7 3 6 2 2 5 3 1 2 5R3 / 783 - SILCA PER C.R.®  CHIAVE A DOPPIA MAPPA 25 pz	 8 0 0 3 7 3 6 2 2 5 3 3 6 5R6 / 783 - SILCA PER C.R.®  CHIAVE A DOPPIA MAPPA 25 pz	 8 0 0 3 7 3 6 2 2 5 3 4 3 5R7 / 783 - SILCA PER C.R.®  CHIAVE A POMPA 25 pz	 8 0 0 3 7 3 6 2 2 5 3 5 0 5R9 / 783 - SILCA PER C.R.®  CHIAVE A DOPPIA MAPPA 25 pz	 8 0 0 3 7 3 6 2 2 5 3 7 4 5SAB2 / 783 - SILCA PER SAB®  CHIAVE A DOPPIA MAPPA 25 pz
 8 0 0 3 7 3 6 2 2 5 3 8 1 5SAB4 / 783 - SILCA PER SAB®  CHIAVE A DOPPIA MAPPA 25 pz	 8 0 0 3 7 3 6 2 2 5 3 9 8 5SAB6P / 783 - SILCA PER SAB®  CHIAVE A DOPPIA MAPPA 25 pz	 8 0 0 3 7 3 6 2 2 5 4 2 8 5SAB8P / 783 - SILCA PER SAB®  CHIAVE A DOPPIA MAPPA 25 pz	 8 0 0 3 7 3 6 8 6 1 7 8 7 5SAS1 / 783 - SILCA PER SIAS®  CHIAVE A DOPPIA MAPPA 25 pz	 8 0 0 3 7 3 6 8 6 1 7 6 3 5SAS3 / 783 - SILCA PER SIAS®  CHIAVE A DOPPIA MAPPA 25 pz

In conformità alle disposizioni legali in vigore relative alle proprietà industriali, informiamo che i marchi o le denominazioni commerciali citate nel nostro documento sono di proprietà esclusiva dei fabbricanti di serrature e degli utilizzatori autorizzati. Questi marchi o denominazioni commerciali sono indicati a titolo di semplice informazione, con lo scopo di riconoscere velocemente a quali serrature le nostre chiavi sono destinate. Questo documento è esclusivamente riservato ai professionisti della riproduzione chiavi che utilizzano i prodotti Silca. / Le illustrazioni e i dati tecnici dei prodotti contenuti nel documento debbono considerarsi indicativi. Silca si riserva il diritto, ferme restando le caratteristiche essenziali dei prodotti, di apportare tutte le modifiche che ritiene necessarie e opportune al fine di migliorare la qualità dei prodotti. Tutti i disegni e le fotografie sono di proprietà di Silca, ogni riproduzione anche parziale, senza autorizzazione scritta di Silca S.p.A. è vietata secondo termini di legge. Per qualsiasi controversia competenti sono gli Uffici Giudiziari dove ha sede l'Azienda Silca S.p.A., con espressa esclusione di qualsiasi altro foro.

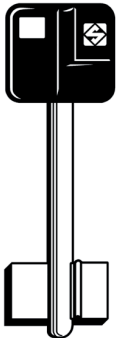

 5SAS5 / 783 - SILCA PER SIAS®  CHIAVE A DOPPIA MAPPA 25 pz	 5SCM10 / 783 - SILCA PER SECUREMME®  CHIAVE A DOPPIA MAPPA OTTONE 25 pz	 5SCM12 / 783 - SILCA PER SECUREMME®  CHIAVE A DOPPIA MAPPA OTTONE 25 pz	 5SCM14 / 783 - SILCA PER SECUREMME®  CHIAVE A DOPPIA MAPPA 25 pz	 5SCM2 / 783 - SILCA PER SECUREMME®  CHIAVE A DOPPIA MAPPA 25 pz
 5SCM4 / 783 - SILCA PER SECUREMME®  CHIAVE A DOPPIA MAPPA 25 pz	 5SCM6 / 783 - SILCA PER SECUREMME®  CHIAVE A DOPPIA MAPPA 25 pz	 5SCM8 / 783 - SILCA PER SECUREMME®  CHIAVE A DOPPIA MAPPA 25 pz	 5SMA1 / 783 - SILCA PER CAM®  CHIAVE A DOPPIA MAPPA 25 pz	 5SR2 / 783 - SILCA PER SERMEC®  CHIAVE A DOPPIA MAPPA 25 pz
 5SR8 / 783 - SILCA PER SERMEC®  CHIAVE A DOPPIA MAPPA 25 pz	 5TSI1 / 783 - SILCA PER TESIO®  CHIAVE A DOPPIA MAPPA 25 pz	 5TSI3 / 783 - SILCA PER TESIO®  CHIAVE A DOPPIA MAPPA 25 pz	 5YA1 / 783 - SILCA PER YALE®  CHIAVE A POMPA 25 pz	 5YA10P / 783 - SILCA PER YALE®  CHIAVE A DOPPIA MAPPA 25 pz

In conformità alle disposizioni legali in vigore relative alle proprietà industriali, informiamo che i marchi o le denominazioni commerciali citate nel nostro documento sono di proprietà esclusiva dei fabbricanti di serrature e degli utilizzatori autorizzati. Questi marchi o denominazioni commerciali sono indicati a titolo di semplice informazione, con lo scopo di riconoscere velocemente a quali serrature le nostre chiavi sono destinate. Questo documento è esclusivamente riservato ai professionisti della riproduzione chiavi che utilizzano i prodotti Silca. / Le illustrazioni e i dati tecnici dei prodotti contenuti nel documento debbono considerarsi indicativi. Silca si riserva il diritto, ferme restando le caratteristiche essenziali dei prodotti, di apportare tutte le modifiche che ritiene necessarie e opportune al fine di migliorare la qualità dei prodotti. Tutti i disegni e le fotografie sono di proprietà di Silca, ogni riproduzione anche parziale, senza autorizzazione scritta di Silca S.p.A. è vietata secondo termini di legge. Per qualsiasi controversia competenti sono gli Uffici Giudiziari dove ha sede l'Azienda Silca S.p.A., con espressa esclusione di qualsiasi altro foro.



























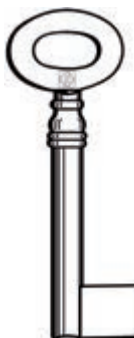

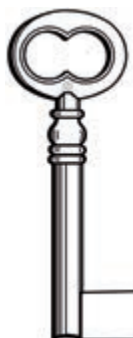

DUPLICATRICI-CHIAVI-RADIOCOMANDI

 8 003736225824 5YA13P / 783 - SILCA PER YALE® CHIAVE A DOPPIA MAPPA 25 pz	 8 003736225831 5YA14P / 783 - SILCA PER YALE® CHIAVE A DOPPIA MAPPA 25 pz	 8 003736225862 5YA18P / 783 - SILCA PER YALE® CHIAVE A DOPPIA MAPPA 25 pz	 8 003736225879 5YA20 / 783 - SILCA PER YALE® CHIAVE A DOPPIA MAPPA 25 pz	 8 003736225886 5YA22 / 783 - SILCA PER YALE® CHIAVE A DOPPIA MAPPA 25 pz
 8 003736225893 5YA4 / 783 - SILCA PER YALE® CHIAVE A POMPA 25 pz	 8 003736225909 5YA6 / 783 - SILCA PER YALE® CHIAVE A DOPPIA MAPPA 25 pz	 8 003736225916 5YA8 / 783 - SILCA PER YALE® CHIAVE A DOPPIA MAPPA 25 pz	 8 003736225923 5YA9P / 783 - SILCA PER YALE® CHIAVE A DOPPIA MAPPA 25 pz	 8 003736225947 5ZM2 / 783 - SILCA PER ZIME® CHIAVE A DOPPIA MAPPA 25 pz
 8 003736574939 6106 / 783 - SILCA PER MASCHI E FEMMINE CO... CHIAVE CADORINE FEMMINA - NERO ANTICO 25 pz	 8 003736576582 6107 / 783 - SILCA PER MASCHI E FEMMINE CO... CHIAVE CADORINE FEMMINA - NERO ANTICO 25 pz	 8 003736804012 6108 / 783 - SILCA PER MASCHI E FEMMINE CO... CHIAVE CADORINE FEMMINA - NERO ANTICO 25 pz	 8 003736765894 6109 / 783 - SILCA PER MASCHI E FEMMINE CO... CHIAVE CADORINE FEMMINA - NERO ANTICO 25 pz	 8 003736458505 6114 / 783 - SILCA PER MASCHI E FEMMINE CO... CHIAVE CADORINE FEMMINA - NERO ANTICO 10 pz

In conformità alle disposizioni legali in vigore relative alle proprietà industriali, informiamo che i marchi o le denominazioni commerciali citate nel nostro documento sono di proprietà esclusiva dei fabbricanti di serrature e degli utilizzatori autorizzati. Questi marchi o denominazioni commerciali sono indicati a titolo di semplice informazione, con lo scopo di riconoscere velocemente a quali serrature le nostre chiavi sono destinate. Questo documento è esclusivamente riservato ai professionisti della riproduzione chiavi che utilizzano i prodotti Silca. / Le illustrazioni e i dati tecnici dei prodotti contenuti nel documento debbono considerarsi indicativi. Silca si riserva il diritto, ferme restando le caratteristiche essenziali dei prodotti, di apportare tutte le modifiche che ritiene necessarie e opportune al fine di migliorare la qualità dei prodotti. Tutti i disegni e le fotografie sono di proprietà di Silca, ogni riproduzione anche parziale, senza autorizzazione scritta di Silca S.p.A. è vietata secondo termini di legge. Per qualsiasi controversia competenti sono gli Uffici Giudiziari dove ha sede l'Azienda Silca S.p.A., con espressa esclusione di qualsiasi altro foro.



 8 003736228702 6507 / 783 - SILCA PER MASCHI E FEMMINE PE...  CHIAVE CADORINE FEMMINA - NERO ANTICO 25 pz	 8 003736804098 6508 / 783 - SILCA PER MASCHI E FEMMINE A ...  CHIAVE CADORINE FEMMINA - NERO ANTICO 25 pz	 8 003736228788 6509 / 783 - SILCA PER MASCHI E FEMMINE A ...  CHIAVE A GORGES FEMMINA - NERO ANTICO 25 pz	 8 003736905887 6511 / 783 - SILCA PER MASCHI E FEMMINE A ...  CHIAVE A GORGES FEMMINA - NERO ANTICO 25 pz	 8 003736577534 6512 / 783 - SILCA PER MASCHI E FEMMINE A ...  CHIAVE A GORGES FEMMINA - NERO ANTICO 25 pz
 8 003736228870 6513 / 783 - SILCA PER MASCHI E FEMMINE A ...  CHIAVE A GORGES FEMMINA - NERO ANTICO 25 pz	 8 003736228900 6605 / 783 - SILCA PER FEMMINE FIRENZE®  CHIAVE CADORINE FEMMINA - NERO ANTICO 25 pz	 8 003736228924 6606 / 783 - SILCA PER FEMMINE FIRENZE®  CHIAVE CADORINE FEMMINA - NERO ANTICO 25 pz	 8 003736765931 6607 / 783 - SILCA PER FEMMINE FIRENZE®  CHIAVE CADORINE FEMMINA - NERO ANTICO 25 pz	 8 003736804173 6608 / 783 - SILCA PER FEMMINE FIRENZE®  CHIAVE CADORINE FEMMINA - NERO ANTICO 25 pz
 8 003736577459 6609 / 783 - SILCA PER FEMMINE FIRENZE®  CHIAVE CADORINE FEMMINA - NERO ANTICO 25 pz	 8 003736804197 6610 / 783 - SILCA PER FEMMINE FIRENZE®  CHIAVE CADORINE FEMMINA - NERO ANTICO 25 pz	 8 003736575028 6611 / 783 - SILCA PER FEMMINE FIRENZE®  CHIAVE CADORINE FEMMINA - NERO ANTICO 25 pz	 8 003737238366 6614 / 783 - SILCA PER FEMMINE FIRENZE®  CHIAVE CADORINE FEMMINA - NERO ANTICO 10 pz	 8 003736229037 6750 / 783 - SILCA PER FEMMINE®  CHIAVE CADORINE FEMMINA 25 pz

In conformità alle disposizioni legali in vigore relative alle proprietà industriali, informiamo che i marchi o le denominazioni commerciali citate nel nostro documento sono di proprietà esclusiva dei fabbricanti di serrature e degli utilizzatori autorizzati. Questi marchi o denominazioni commerciali sono indicati a titolo di semplice informazione, con lo scopo di riconoscere velocemente a quali serrature le nostre chiavi sono destinate. Questo documento è esclusivamente riservato ai professionisti della riproduzione chiavi che utilizzano i prodotti Silca. / Le illustrazioni e i dati tecnici dei prodotti contenuti nel documento debbono considerarsi indicativi. Silca si riserva il diritto, ferme restando le caratteristiche essenziali dei prodotti, di apportare tutte le modifiche che ritiene necessarie e opportune al fine di migliorare la qualità dei prodotti. Tutti i disegni e le fotografie sono di proprietà di Silca, ogni riproduzione anche parziale, senza autorizzazione scritta di Silca S.p.A. è vietata secondo termini di legge. Per qualsiasi controversia competenti sono gli Uffici Giudiziari dove ha sede l'Azienda Silca S.p.A., con espressa esclusione di qualsiasi altro foro.



















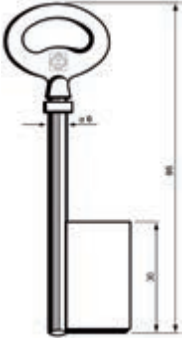

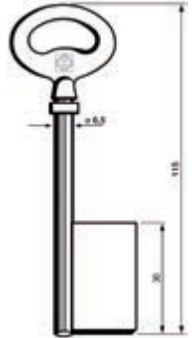





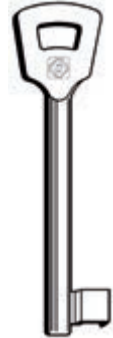



DUPLICATRICI-CHIAVI-RADIOCOMANDI

 8 003736229044 6802 / 783 - SILCA PER FEMMINE PER MOBILI® CHIAVE CADORINE FEMMINA 25 pz	 8 003736229051 6803 / 783 - SILCA PER FEMMINE DA CASSETTO... CHIAVE CADORINE FEMMINA 25 pz	 8 003736853119 6805 / 783 - SILCA PER FEMMINE PER MOBILI® CHIAVE CADORINE FEMMINA - NERO ANTICO 25 pz	 8 003736229075 6806 / 783 - SILCA PER FEMMINE PER MOBILI® CHIAVE CADORINE FEMMINA 25 pz	 8 003736295223 6911V / 783 - SILCA PER NEMEF® CHIAVE CADORINE FEMMINA 25 pz
 8 003736226906 6BDE1 / 783 - SILCA PER BODE® CHIAVE PER CASELLARI 25 pz	 8 003736226913 6BDE2 / 783 - SILCA PER BODE® CHIAVE A MAPPA 25 pz	 8 003736226920 6BDE3 / 783 - SILCA PER BODE® CHIAVE A MAPPA 25 pz	 8 003737551472 6EK1 / 783 - SILCA PER EUREKA® CHIAVE OTTONE LUCIDATA E VERNICIATA 25 pz	 8 003737575744 6EK10 / 783 - SILCA PER EUREKA® CHIAVE OTTONE LUCIDATA E VERNICIATA 25 pz
 8 003737575720 6EK11 / 783 - SILCA PER EUREKA® CHIAVE OTTONE LUCIDATA E VERNICIATA 25 pz	 8 003737551618 6EK12 / 783 - SILCA PER EUREKA® CHIAVE OTTONE LUCIDATA E VERNICIATA 25 pz	 8 003737551519 6EK2 / 783 - SILCA PER EUREKA® CHIAVE OTTONE LUCIDATA E VERNICIATA 25 pz	 8 003737551496 6EK3 / 783 - SILCA PER EUREKA® CHIAVE OTTONE LUCIDATA E VERNICIATA 25 pz	 8 003737575706 6EK4 / 783 - SILCA PER EUREKA® CHIAVE OTTONE LUCIDATA E VERNICIATA 25 pz

In conformità alle disposizioni legali in vigore relative alle proprietà industriali, informiamo che i marchi o le denominazioni commerciali citate nel nostro documento sono di proprietà esclusiva dei fabbricanti di serrature e degli utilizzatori autorizzati. Questi marchi o denominazioni commerciali sono indicati a titolo di semplice informazione, con lo scopo di riconoscere velocemente a quali serrature le nostre chiavi sono destinate. Questo documento è esclusivamente riservato ai professionisti della riproduzione chiavi che utilizzano i prodotti Silca. / Le illustrazioni e i dati tecnici dei prodotti contenuti nel documento debbono considerarsi indicativi. Silca si riserva il diritto, ferme restando le caratteristiche essenziali dei prodotti, di apportare tutte le modifiche che ritiene necessarie e opportune al fine di migliorare la qualità dei prodotti. Tutti i disegni e le fotografie sono di proprietà di Silca, ogni riproduzione anche parziale, senza autorizzazione scritta di Silca S.p.A. è vietata secondo termini di legge. Per qualsiasi controversia competenti sono gli Uffici Giudiziari dove ha sede l'Azienda Silca S.p.A., con espressa esclusione di qualsiasi altro foro.





























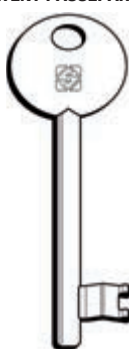

 6EK5 / 783 - SILCA PER EUREKA®  CHIAVE OTTONE LUCIDATA E VERNICIATA 25 pz	 6EK6 / 783 - SILCA PER EUREKA®  CHIAVE OTTONE LUCIDATA E VERNICIATA 25 pz	 6EK7 / 783 - SILCA PER EUREKA®  CHIAVE OTTONE LUCIDATA E VERNICIATA 25 pz	 6EK8 / 783 - SILCA PER EUREKA®  CHIAVE OTTONE LUCIDATA E VERNICIATA 25 pz	 6F21 / 783 - SILCA PER CHIAVI ADATTABILI -...  CHIAVE A GORGES OTTONE LUCIDO 25 pz
 6F30 / 783 - SILCA PER CHIAVI ADATTABILI -...  CHIAVE A GORGES OTTONE LUCIDO 25 pz	 6M37 / 783 - SILCA PER MASCHI A GORGES®  CHIAVE A DOPPIA MAPPA 25 pz	 6M38 / 783 - SILCA PER MASCHI A GORGES®  CHIAVE A DOPPIA MAPPA 25 pz	 6NFHL / 783 - SILCA PER NEMEF®  CHIAVE ZAMA 25 pz	 6P10D / 783 - SILCA PER CORNI®  CH.PATENT PASS.OTTONE VER. 25 pz
 6P10D-1 / 783 - SILCA PER CORNI®  CH.PATENT PASS.OTTONE VER. 25 pz	 6P10S / 783 - SILCA PER CORNI®  CH.PATENT PASS.OTTONE VER. 25 pz	 6P10S-1 / 783 - SILCA PER CORNI®  CH.PATENT PASS.OTTONE VER. 25 pz	 6P1D / 783 - SILCA PER PATENT PASSEPARTOUT...  CH.PATENT PASS.OTTONE NIC. 25 pz	 6P1MP / 783 - SILCA PER PATENT PASSEPARTOUT...  CH.PATENT PASS.OTTONE NIC. 25 pz

In conformità alle disposizioni legali in vigore relative alle proprietà industriali, informiamo che i marchi o le denominazioni commerciali citate nel nostro documento sono di proprietà esclusiva dei fabbricanti di serrature e degli utilizzatori autorizzati. Questi marchi o denominazioni commerciali sono indicati a titolo di semplice informazione, con lo scopo di riconoscere velocemente a quali serrature le nostre chiavi sono destinate. Questo documento è esclusivamente riservato ai professionisti della riproduzione chiavi che utilizzano i prodotti Silca. / Le illustrazioni e i dati tecnici dei prodotti contenuti nel documento debbono considerarsi indicativi. Silca si riserva il diritto, ferme restando le caratteristiche essenziali dei prodotti, di apportare tutte le modifiche che ritiene necessarie e opportune al fine di migliorare la qualità dei prodotti. Tutti i disegni e le fotografie sono di proprietà di Silca, ogni riproduzione anche parziale, senza autorizzazione scritta di Silca S.p.A. è vietata secondo termini di legge. Per qualsiasi controversia competenti sono gli Uffici Giudiziari dove ha sede l'Azienda Silca S.p.A., con espressa esclusione di qualsiasi altro foro.























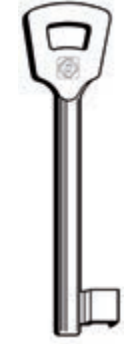







DUPLICATRICI-CHIAVI-RADIOCOMANDI

 8 003737479035 6P1S / 783 - SILCA PER PATENT PASSEPARTOUT...  CH.PATENT PASS.OTTONE NIC. 25 pz	 8 003737484848 6P2D / 783 - SILCA PER PATENT PASSEPARTOUT...  CH.PATENT PASS.OTTONE NIC. 25 pz	 8 003737484664 6P2MP / 783 - SILCA PER PATENT PASSEPARTOUT...  CH.PATENT PASS.OTTONE NIC. 25 pz	 8 003737485531 6P2S / 783 - SILCA PER PATENT PASSEPARTOUT...  CH.PATENT PASS.OTTONE NIC. 25 pz	 8 003737484862 6P3D / 783 - SILCA PER PATENT PASSEPARTOUT...  CH.PATENT PASS.OTTONE NIC. 25 pz
 8 003737485555 6P3S / 783 - SILCA PER PATENT PASSEPARTOUT...  CH.PATENT PASS.OTTONE NIC. 25 pz	 8 003737551632 6P4MP / 783 - SILCA PER MG (MONTI) [®]  CHIAVE OTTONE LUCIDATA E VERNICIATA 25 pz	 8 003737580663 6P8D / 783 - SILCA PER PATENT PASSEPARTOUT...  CH.PATENT PASS.OTTONE VER. 25 pz	 8 003737580687 6P8D-1 / 783 - SILCA PER PATENT PASSEPARTOUT...  CH.PATENT PASS.OTTONE VER. 25 pz	 8 003737580700 6P8D-2 / 783 - SILCA PER PATENT PASSEPARTOUT...  CH.PATENT PASS.OTTONE VER. 25 pz
 8 003737580724 6P8D-3 / 783 - SILCA PER PATENT PASSEPARTOUT...  CH.PATENT PASS.OTTONE VER. 25 pz	 8 003737580748 6P8D-4 / 783 - SILCA PER PATENT PASSEPARTOUT...  CH.PATENT PASS.OTTONE VER. 25 pz	 8 003737580762 6P8S / 783 - SILCA PER PATENT PASSEPARTOUT...  CH.PATENT PASS.OTTONE VER. 25 pz	 8 003737580786 6P8S-1 / 783 - SILCA PER PATENT PASSEPARTOUT...  CH.PATENT PASS.OTTONE VER. 25 pz	 8 003737580809 6P8S-2 / 783 - SILCA PER PATENT PASSEPARTOUT...  CH.PATENT PASS.OTTONE VER. 25 pz

In conformità alle disposizioni legali in vigore relative alle proprietà industriali, informiamo che i marchi o le denominazioni commerciali citate nel nostro documento sono di proprietà esclusiva dei fabbricanti di serrature e degli utilizzatori autorizzati. Questi marchi o denominazioni commerciali sono indicati a titolo di semplice informazione, con lo scopo di riconoscere velocemente a quali serrature le nostre chiavi sono destinate. Questo documento è esclusivamente riservato ai professionisti della riproduzione chiavi che utilizzano i prodotti Silca. / Le illustrazioni e i dati tecnici dei prodotti contenuti nel documento debbono considerarsi indicativi. Silca si riserva il diritto, ferme restando le caratteristiche essenziali dei prodotti, di apportare tutte le modifiche che ritiene necessarie e opportune al fine di migliorare la qualità dei prodotti. Tutti i disegni e le fotografie sono di proprietà di Silca, ogni riproduzione anche parziale, senza autorizzazione scritta di Silca S.p.A. è vietata secondo termini di legge. Per qualsiasi controversia competenti sono gli Uffici Giudiziari dove ha sede l'Azienda Silca S.p.A., con espressa esclusione di qualsiasi altro foro.



 8 003737580823 6P8S-3 / 783 - SILCA PER PATENT PASSEPARTOUT...  CH.PATENT PASS.OTTONE VER. 25 pz	 8 003737580847 6P8S-4 / 783 - SILCA PER PATENT PASSEPARTOUT...  CH.PATENT PASS.OTTONE VER. 25 pz	 8 003737580861 6P9MP / 783 - SILCA PER MP®  CH.PATENT PASS.OTTONE VER. 25 pz	 8 003736766013 7608 / 783 - SILCA PER CORBIN®  CHIAVE CASSAFORTE MASCHIO 25 pz	 8 003736229709 7657 / 783 - SILCA PER SELLA & VALZ®  CHIAVE CASSAFORTE MASCHIO 25 pz
 8 003737853767 7NFHL / 783 - SILCA PER NEMEF®  CHIAVE ZAMA 25 pz	 8 003737853767 7NFHL / 783 - SILCA PER NEMEF®  CHIAVE ZAMA 25 pz	 8 003736230132 8207 / 783 - SILCA PER CONFORTI®  CHIAVE CASSAFORTE FEMMINA 25 pz	 8 003736230149 8208 / 783 - SILCA PER -  CHIAVE CASSAFORTE FEMMINA 25 pz	 8 003736230170 8211 / 783 - SILCA PER -  CHIAVE CASSAFORTE FEMMINA 25 pz
 8 003736230194 8211/2 / 783 - SILCA PER -  CHIAVE CASSAFORTE FEMMINA 25 pz	 8 003736230200 8212 / 783 - SILCA PER -  CHIAVE CASSAFORTE FEMMINA 25 pz	 8 003736230231 8310TA / 783 - SILCA PER TANN®  CHIAVE CASSAFORTE FEMMINA 25 pz	 8 003736230262 8355C / 783 - SILCA PER CONFORTI®  CHIAVE A DOPPIA MAPPA 25 pz	 8 003736230309 8370PA / 783 - SILCA PER PARMA-PAS®  CHIAVE A DOPPIA MAPPA 25 pz

In conformità alle disposizioni legali in vigore relative alle proprietà industriali, informiamo che i marchi o le denominazioni commerciali citate nel nostro documento sono di proprietà esclusiva dei fabbricanti di serrature e degli utilizzatori autorizzati. Questi marchi o denominazioni commerciali sono indicati a titolo di semplice informazione, con lo scopo di riconoscere velocemente a quali serrature le nostre chiavi sono destinate. Questo documento è esclusivamente riservato ai professionisti della riproduzione chiavi che utilizzano i prodotti Silca. / Le illustrazioni e i dati tecnici dei prodotti contenuti nel documento debbono considerarsi indicativi. Silca si riserva il diritto, ferme restando le caratteristiche essenziali dei prodotti, di apportare tutte le modifiche che ritiene necessarie e opportune al fine di migliorare la qualità dei prodotti. Tutti i disegni e le fotografie sono di proprietà di Silca, ogni riproduzione anche parziale, senza autorizzazione scritta di Silca S.p.A. è vietata secondo termini di legge. Per qualsiasi controversia competenti sono gli Uffici Giudiziari dove ha sede l'Azienda Silca S.p.A., con espressa esclusione di qualsiasi altro foro.

































DUPLICATRICI-CHIAVI-RADIOCOMANDI

 8 0 0 3 7 3 6 2 3 0 3 1 6 8372TA / 783 - SILCA PER TANN® CHIAVE CASSAFORTE FEMMINA 25 pz	 8 0 0 3 7 3 6 2 3 0 3 2 3 8373C / 783 - SILCA PER CONFORTI® 25 pz	 8 0 0 3 7 3 6 2 3 0 3 4 7 8385PA / 783 - SILCA PER PARMA-PAS® CHIAVE A DOPPIA MAPPA 25 pz	 8 0 0 3 7 3 6 2 3 0 3 5 4 8388C / 783 - SILCA PER CONFORTI® CHIAVE A DOPPIA MAPPA 25 pz	 8 0 0 3 7 3 6 2 3 0 3 8 5 8405 / 783 - SILCA PER CONFORTI® CHIAVE CASSAFORTE FEMMINA 25 pz
 8 0 0 3 7 3 6 8 6 9 1 6 5 8477ASS / 783 - SILCA PER ASSA® CHIAVE CASSAFORTE FEMMINA 25 pz	 8 0 0 3 7 3 6 8 6 3 6 9 9 8490ASS / 783 - SILCA PER ASSA® CHIAVE CASSAFORTE FEMMINA 25 pz	 8 0 0 3 7 3 6 2 3 0 4 9 1 8614 / 783 - SILCA PER PARMA® CHIAVE CASSAFORTE FEMMINA 25 pz	 8 0 0 3 7 3 6 2 3 0 5 1 4 8615 / 783 - SILCA PER PARMA-PAS® CHIAVE CASSAFORTE FEMMINA 25 pz	 8 0 0 3 7 3 6 2 3 0 5 3 8 8655 / 783 - SILCA PER FUMEO PARMA® CHIAVE CASSAFORTE FEMMINA 25 pz
 8 0 0 3 7 3 6 2 3 0 5 4 5 8656 / 783 - SILCA PER SELLA & VALZ® CHIAVE CASSAFORTE FEMMINA 25 pz	 8 0 0 3 7 3 6 2 3 0 6 7 5 8958/1 / 783 - SILCA PER - CHIAVE CASSAFORTE FEMMINA 25 pz	 8 0 0 3 7 3 6 2 3 0 6 9 9 8972 / 783 - SILCA PER - CHIAVE CASSAFORTE FEMMINA 25 pz	 8 0 0 3 7 3 7 8 5 3 7 7 4 8NFHL / 783 - SILCA PER NEMEF® CHIAVE ZAMA 25 pz	 8 0 0 3 7 3 6 2 3 1 1 6 0 9510 / 783 - SILCA PER MASCHI SERIE SPECIA... CHIAVE CADORINE MASCHIO 25 pz

In conformità alle disposizioni legali in vigore relative alle proprietà industriali, informiamo che i marchi o le denominazioni commerciali citate nel nostro documento sono di proprietà esclusiva dei fabbricanti di serrature e degli utilizzatori autorizzati. Questi marchi o denominazioni commerciali sono indicati a titolo di semplice informazione, con lo scopo di riconoscere velocemente a quali serrature le nostre chiavi sono destinate. Questo documento è esclusivamente riservato ai professionisti della riproduzione chiavi che utilizzano i prodotti Silca. / Le illustrazioni e i dati tecnici dei prodotti contenuti nel documento debbono considerarsi indicativi. Silca si riserva il diritto, ferme restando le caratteristiche essenziali dei prodotti, di apportare tutte le modifiche che ritiene necessarie e opportune al fine di migliorare la qualità dei prodotti. Tutti i disegni e le fotografie sono di proprietà di Silca, ogni riproduzione anche parziale, senza autorizzazione scritta di Silca S.p.A. è vietata secondo termini di legge. Per qualsiasi controversia competenti sono gli Uffici Giudiziari dove ha sede l'Azienda Silca S.p.A., con espressa esclusione di qualsiasi altro foro.



 9706 / 783 - SILCA PER MASCHI®  CHIAVE CADORINE MASCHIO 25 pz	 9NFHL / 783 - SILCA PER NEMEF®  CHIAVE ZAMA 25 pz	 9NFHL / 783 - SILCA PER NEMEF®  CHIAVE ZAMA 25 pz	 A / 783 - SILCA PER ANTONIOLI®  CHIAVE A DOPPIA MAPPA 25 pz	 ACH / 783 - SILCA PER AVA-CHUBB®  CHIAVE A DOPPIA MAPPA 25 pz
 AL / 783 - SILCA PER ANTONIOLI®  CHIAVE A DOPPIA MAPPA 25 pz	 ALL / 783 - SILCA PER ANTONIOLI®  CHIAVE A DOPPIA MAPPA 25 pz	 ALLT / 783 - SILCA PER ANTONIOLI®  CHIAVE A DOPPIA MAPPA 25 pz	 AML / 783 - SILCA PER ANTONIOLI®  CHIAVE A DOPPIA MAPPA 25 pz	 AP / 783 - SILCA PER ANTONIOLI®  CHIAVE A POMPA 25 pz
 APN / 783 - SILCA PER ANTONIOLI®  CHIAVE A POMPA 25 pz	 AUL / 783 - SILCA PER ISEO®  CHIAVE A DOPPIA MAPPA 25 pz	 AUM / 783 - SILCA PER ISEO®  CHIAVE A DOPPIA MAPPA 25 pz	 AUP / 783 - SILCA PER ISEO®  CHIAVE A POMPA 25 pz	 BE / 783 - SILCA PER BETA®  CHIAVE A DOPPIA MAPPA 25 pz

In conformità alle disposizioni legali in vigore relative alle proprietà industriali, informiamo che i marchi o le denominazioni commerciali citate nel nostro documento sono di proprietà esclusiva dei fabbricanti di serrature e degli utilizzatori autorizzati. Questi marchi o denominazioni commerciali sono indicati a titolo di semplice informazione, con lo scopo di riconoscere velocemente a quali serrature le nostre chiavi sono destinate. Questo documento è esclusivamente riservato ai professionisti della riproduzione chiavi che utilizzano i prodotti Silca. / Le illustrazioni e i dati tecnici dei prodotti contenuti nel documento debbono considerarsi indicativi. Silca si riserva il diritto, ferme restando le caratteristiche essenziali dei prodotti, di apportare tutte le modifiche che ritiene necessarie e opportune al fine di migliorare la qualità dei prodotti. Tutti i disegni e le fotografie sono di proprietà di Silca, ogni riproduzione anche parziale, senza autorizzazione scritta di Silca S.p.A. è vietata secondo termini di legge. Per qualsiasi controversia competenti sono gli Uffici Giudiziari dove ha sede l'Azienda Silca S.p.A., con espressa esclusione di qualsiasi altro foro.

































DUPLICATRICI-CHIAVI-RADIOCOMANDI

 8 003736020856 BE2 / 783 - SILCA PER BETA® CHIAVE A POMPA 25 pz	 8 003736020863 BE2P / 783 - SILCA PER BETA® CHIAVE A POMPA 25 pz	 8 003736020191 BEA / 783 - SILCA PER BETA® CHIAVE A DOPPIA MAPPA 25 pz	 8 003736020207 BEAC / 783 - SILCA PER BETA® CHIAVE A DOPPIA MAPPA 25 pz	 8 003736020214 BEC / 783 - SILCA PER BETA® CHIAVE A DOPPIA MAPPA 25 pz
 8 003736020221 BEL / 783 - SILCA PER BETA® CHIAVE A DOPPIA MAPPA 25 pz	 8 003736020238 BELC / 783 - SILCA PER BETA® CHIAVE A DOPPIA MAPPA 25 pz	 8 003736020368 BES / 783 - SILCA PER BETA® CHIAVE A DOPPIA MAPPA 25 pz	 8 003736020375 BESC / 783 - SILCA PER BETA® CHIAVE A DOPPIA MAPPA 25 pz	 8 003736027589 BL / 783 - SILCA PER BMC® CHIAVE A DOPPIA MAPPA 25 pz
 8 003736030282 C / 783 - SILCA PER CERUTTI® CHIAVE A DOPPIA MAPPA 25 pz	 8 003736034075 CC / 783 - SILCA PER CERUTTI® CHIAVE A DOPPIA MAPPA 25 pz	 8 003736034082 CCL / 783 - SILCA PER CERUTTI® CHIAVE A DOPPIA MAPPA 25 pz	 8 003736034099 CCLQ / 783 - SILCA PER CERUTTI® CHIAVE A DOPPIA MAPPA 25 pz	 8 003736040052 CF / 783 - SILCA PER CAF® CHIAVE A DOPPIA MAPPA 25 pz

In conformità alle disposizioni legali in vigore relative alle proprietà industriali, informiamo che i marchi o le denominazioni commerciali citate nel nostro documento sono di proprietà esclusiva dei fabbricanti di serrature e degli utilizzatori autorizzati. Questi marchi o denominazioni commerciali sono indicati a titolo di semplice informazione, con lo scopo di riconoscere velocemente a quali serrature le nostre chiavi sono destinate. Questo documento è esclusivamente riservato ai professionisti della riproduzione chiavi che utilizzano i prodotti Silca. / Le illustrazioni e i dati tecnici dei prodotti contenuti nel documento debbono considerarsi indicativi. Silca si riserva il diritto, ferme restando le caratteristiche essenziali dei prodotti, di apportare tutte le modifiche che ritiene necessarie e opportune al fine di migliorare la qualità dei prodotti. Tutti i disegni e le fotografie sono di proprietà di Silca, ogni riproduzione anche parziale, senza autorizzazione scritta di Silca S.p.A. è vietata secondo termini di legge. Per qualsiasi controversia competenti sono gli Uffici Giudiziari dove ha sede l'Azienda Silca S.p.A., con espressa esclusione di qualsiasi altro foro.

































 CFL / 783 - SILCA PER CAF®  CHIAVE A DOPPIA MAPPA 25 pz	 CFN / 783 - SILCA PER CAF®  CHIAVE A DOPPIA MAPPA 25 pz	 CL / 783 - SILCA PER CERUTTI®  CHIAVE A DOPPIA MAPPA 25 pz	 CLN / 783 - SILCA PER CERUTTI®  CHIAVE A DOPPIA MAPPA 25 pz	 CLQ / 783 - SILCA PER CERUTTI®  CHIAVE A DOPPIA MAPPA 25 pz
 CM / 783 - SILCA PER CERUTTI®  CHIAVE A POMPA 25 pz	 CN / 783 - SILCA PER CERUTTI®  CHIAVE A DOPPIA MAPPA 25 pz	 CNC / 783 - SILCA PER CERUTTI®  CHIAVE A DOPPIA MAPPA 25 pz	 CNCP / 783 - SILCA PER CERUTTI®  CHIAVE A DOPPIA MAPPA 25 pz	 CNP / 783 - SILCA PER CERUTTI®  CHIAVE A DOPPIA MAPPA 25 pz
 CP / 783 - SILCA PER CERUTTI®  CHIAVE A DOPPIA MAPPA 25 pz	 CPC / 783 - SILCA PER CERUTTI®  CHIAVE A POMPA 25 pz	 CPN / 783 - SILCA PER CERUTTI®  CHIAVE A POMPA 25 pz	 CPP / 783 - SILCA PER CERUTTI®  CHIAVE A POMPA 25 pz	 CPV / 783 - SILCA PER CERUTTI®  CHIAVE A POMPA 25 pz

In conformità alle disposizioni legali in vigore relative alle proprietà industriali, informiamo che i marchi o le denominazioni commerciali citate nel nostro documento sono di proprietà esclusiva dei fabbricanti di serrature e degli utilizzatori autorizzati. Questi marchi o denominazioni commerciali sono indicati a titolo di semplice informazione, con lo scopo di riconoscere velocemente a quali serrature le nostre chiavi sono destinate. Questo documento è esclusivamente riservato ai professionisti della riproduzione chiavi che utilizzano i prodotti Silca. / Le illustrazioni e i dati tecnici dei prodotti contenuti nel documento debbono considerarsi indicativi. Silca si riserva il diritto, ferme restando le caratteristiche essenziali dei prodotti, di apportare tutte le modifiche che ritiene necessarie e opportune al fine di migliorare la qualità dei prodotti. Tutti i disegni e le fotografie sono di proprietà di Silca, ogni riproduzione anche parziale, senza autorizzazione scritta di Silca S.p.A. è vietata secondo termini di legge. Per qualsiasi controversia competenti sono gli Uffici Giudiziari dove ha sede l'Azienda Silca S.p.A., con espressa esclusione di qualsiasi altro foro.































DUPLICATRICI-CHIAVI-RADIOCOMANDI

 8 0 0 3 7 3 6 0 4 2 1 8 6 CPX / 783 - SILCA PER CERUTTI®  CHIAVE A POMPA 25 pz	 8 0 0 3 7 3 6 0 4 2 1 9 3 CPXN / 783 - SILCA PER CERUTTI®  CHIAVE A POMPA 25 pz	 8 0 0 3 7 3 6 0 4 2 2 2 3 CQ / 783 - SILCA PER CERUTTI®  CHIAVE A DOPPIA MAPPA 25 pz	 8 0 0 3 7 3 6 0 4 2 3 7 7 CS / 783 - SILCA PER CISA®  CHIAVE A DOPPIA MAPPA 25 pz	 8 0 0 3 7 3 6 0 4 2 3 8 4 CSC / 783 - SILCA PER CISA®  CHIAVE A DOPPIA MAPPA 25 pz
 8 0 0 3 7 3 6 0 4 2 3 9 1 CSCP / 783 - SILCA PER CISA®  CHIAVE A DOPPIA MAPPA 25 pz	 8 0 0 3 7 3 6 0 4 2 4 0 7 CSL / 783 - SILCA PER CISA®  CHIAVE A DOPPIA MAPPA 25 pz	 8 0 0 3 7 3 6 0 4 2 4 1 4 CSLC / 783 - SILCA PER CISA®  CHIAVE A DOPPIA MAPPA 25 pz	 8 0 0 3 7 3 6 0 4 2 4 2 1 CSLCP / 783 - SILCA PER CISA®  CHIAVE A DOPPIA MAPPA 25 pz	 8 0 0 3 7 3 6 0 4 2 4 3 8 CSLP / 783 - SILCA PER CISA®  CHIAVE A DOPPIA MAPPA 25 pz
 8 0 0 3 7 3 6 0 4 2 4 4 5 CSM / 783 - SILCA PER CISA®  CHIAVE A DOPPIA MAPPA 25 pz	 8 0 0 3 7 3 6 0 4 2 4 5 2 CSMC / 783 - SILCA PER CISA®  CHIAVE A DOPPIA MAPPA 25 pz	 8 0 0 3 7 3 6 0 4 2 4 6 9 CSMCP / 783 - SILCA PER CISA®  CHIAVE A DOPPIA MAPPA 25 pz	 8 0 0 3 7 3 6 0 4 2 4 7 6 CSMP / 783 - SILCA PER CISA®  CHIAVE A DOPPIA MAPPA 25 pz	 8 0 0 3 7 3 6 0 4 2 5 0 6 CSP / 783 - SILCA PER CISA®  CHIAVE A DOPPIA MAPPA 25 pz

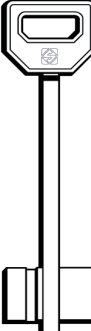
In conformità alle disposizioni legali in vigore relative alle proprietà industriali, informiamo che i marchi o le denominazioni commerciali citate nel nostro documento sono di proprietà esclusiva dei fabbricanti di serrature e degli utilizzatori autorizzati. Questi marchi o denominazioni commerciali sono indicati a titolo di semplice informazione, con lo scopo di riconoscere velocemente a quali serrature le nostre chiavi sono destinate. Questo documento è esclusivamente riservato ai professionisti della riproduzione chiavi che utilizzano i prodotti Silca. / Le illustrazioni e i dati tecnici dei prodotti contenuti nel documento debbono considerarsi indicativi. Silca si riserva il diritto, ferme restando le caratteristiche essenziali dei prodotti, di apportare tutte le modifiche che ritiene necessarie e opportune al fine di migliorare la qualità dei prodotti. Tutti i disegni e le fotografie sono di proprietà di Silca, ogni riproduzione anche parziale, senza autorizzazione scritta di Silca S.p.A. è vietata secondo termini di legge. Per qualsiasi controversia competenti sono gli Uffici Giudiziari dove ha sede l'Azienda Silca S.p.A., con espressa esclusione di qualsiasi altro foro.

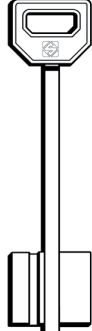

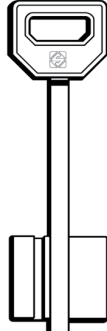
 DS / 783 - SILCA PER FACEF®  CHIAVE A DOPPIA MAPPA 25 pz	 E / 783 - SILCA PER ESETY®  CHIAVE A DOPPIA MAPPA 25 pz	 EL / 783 - SILCA PER ESETY®  CHIAVE A DOPPIA MAPPA 25 pz	 EM / 783 - SILCA PER SECUREMME®  CHIAVE A DOPPIA MAPPA 25 pz	 EN / 783 - SILCA PER ESETY®  CHIAVE A DOPPIA MAPPA 25 pz
 EP / 783 - SILCA PER ESETY®  CHIAVE A POMPA 25 pz	 EPN / 783 - SILCA PER ESETY®  CHIAVE A POMPA 25 pz	 EPP / 783 - SILCA PER ESETY®  CHIAVE A POMPA 25 pz	 EPT / 783 - SILCA PER ESETY®  CHIAVE A POMPA 25 pz	 F / 783 - SILCA PER FIAM®  CHIAVE A DOPPIA MAPPA 25 pz
 FD / 783 - SILCA PER FACEF®  CHIAVE A DOPPIA MAPPA 25 pz	 FQ / 783 - SILCA PER FIAM®  CHIAVE A DOPPIA MAPPA 25 pz	 FQC / 783 - SILCA PER FIAM®  CHIAVE A DOPPIA MAPPA 25 pz	 FQL / 783 - SILCA PER FIAM®  CHIAVE A DOPPIA MAPPA 25 pz	 FQM / 783 - SILCA PER FIAM®  CHIAVE A DOPPIA MAPPA 25 pz

In conformità alle disposizioni legali in vigore relative alle proprietà industriali, informiamo che i marchi o le denominazioni commerciali citate nel nostro documento sono di proprietà esclusiva dei fabbricanti di serrature e degli utilizzatori autorizzati. Questi marchi o denominazioni commerciali sono indicati a titolo di semplice informazione, con lo scopo di riconoscere velocemente a quali serrature le nostre chiavi sono destinate. Questo documento è esclusivamente riservato ai professionisti della riproduzione chiavi che utilizzano i prodotti Silca. / Le illustrazioni e i dati tecnici dei prodotti contenuti nel documento debbono considerarsi indicativi. Silca si riserva il diritto, ferme restando le caratteristiche essenziali dei prodotti, di apportare tutte le modifiche che ritiene necessarie e opportune al fine di migliorare la qualità dei prodotti. Tutti i disegni e le fotografie sono di proprietà di Silca, ogni riproduzione anche parziale, senza autorizzazione scritta di Silca S.p.A. è vietata secondo termini di legge. Per qualsiasi controversia competenti sono gli Uffici Giudiziari dove ha sede l'Azienda Silca S.p.A., con espressa esclusione di qualsiasi altro foro.

































DUPLICATRICI-CHIAVI-RADIOCOMANDI

 8 003736075054 FQN / 783 - SILCA PER FIAM® CHIAVE A DOPPIA MAPPA 25 pz	 8 003736075191 FT500 / 783 - SILCA PER FICHET® CHIAVE OTTONE LUCIDO 25 pz	 8 003736075207 FT500C / 783 - SILCA PER FICHET® CHIAVE OTTONE 25 pz	 8 003736494947 FT510 / 783 - SILCA PER FICHET® CHIAVE OTTONE 25 pz	 8 003736075122 FTN / 783 - SILCA PER FIAM® CHIAVE A DOPPIA MAPPA 25 pz
 8 003736075306 GBZ1 / 783 - SILCA PER GB2® CHIAVE A POMPA 25 pz	 8 003736075313 GBZ1P / 783 - SILCA PER GB2® CHIAVE OTTONE 25 pz	 8 003736079984 GIL / 783 - SILCA PER GIPIS® CHIAVE A DOPPIA MAPPA 25 pz	 8 003736079991 GL / 783 - SILCA PER GMG® CHIAVE A DOPPIA MAPPA 25 pz	 8 003736084582 GP / 783 - SILCA PER GMG® CHIAVE A POMPA 25 pz
 8 003736084599 GPN / 783 - SILCA PER GMG® CHIAVE A POMPA 25 pz	 8 003736096288 IDM / 783 - SILCA PER IDM® CHIAVE A DOPPIA MAPPA 25 pz	 8 003736099609 IPP / 783 - SILCA PER IMSI® CHIAVE A POMPA 25 pz	 8 003736102170 JW20 / 783 - SILCA PER JUWEL® CHIAVE A DOPPIA MAPPA 25 pz	 8 003736102224 JW35 / 783 - SILCA PER JUWEL® CHIAVE A DOPPIA MAPPA 25 pz

In conformità alle disposizioni legali in vigore relative alle proprietà industriali, informiamo che i marchi o le denominazioni commerciali citate nel nostro documento sono di proprietà esclusiva dei fabbricanti di serrature e degli utilizzatori autorizzati. Questi marchi o denominazioni commerciali sono indicati a titolo di semplice informazione, con lo scopo di riconoscere velocemente a quali serrature le nostre chiavi sono destinate. Questo documento è esclusivamente riservato ai professionisti della riproduzione chiavi che utilizzano i prodotti Silca. / Le illustrazioni e i dati tecnici dei prodotti contenuti nel documento debbono considerarsi indicativi. Silca si riserva il diritto, ferme restando le caratteristiche essenziali dei prodotti, di apportare tutte le modifiche che ritiene necessarie e opportune al fine di migliorare la qualità dei prodotti. Tutti i disegni e le fotografie sono di proprietà di Silca, ogni riproduzione anche parziale, senza autorizzazione scritta di Silca S.p.A. è vietata secondo termini di legge. Per qualsiasi controversia competenti sono gli Uffici Giudiziari dove ha sede l'Azienda Silca S.p.A., con espressa esclusione di qualsiasi altro foro.

































 JW40 / 783 - SILCA PER JUWEL®  CHIAVE A DOPPIA MAPPA 25 pz	 JW50 / 783 - SILCA PER JUWEL®  CHIAVE A DOPPIA MAPPA 25 pz	 JW60 / 783 - SILCA PER JUWEL®  CHIAVE A DOPPIA MAPPA 25 pz	 JW70 / 783 - SILCA PER JUWEL®  CHIAVE A DOPPIA MAPPA 25 pz	 JW90 / 783 - SILCA PER JUWEL®  CHIAVE A DOPPIA MAPPA 25 pz
 KC / 783 - SILCA PER YALE®  CHIAVE A DOPPIA MAPPA 25 pz	 KL / 783 - SILCA PER KASSEL®  CHIAVE A DOPPIA MAPPA 25 pz	 KYL / 783 - SILCA PER YALE®  CHIAVE A DOPPIA MAPPA 25 pz	 KYP / 783 - SILCA PER YALE®  CHIAVE A POMPA 25 pz	 MC / 783 - SILCA PER MOIA®  CHIAVE A DOPPIA MAPPA 25 pz
 ML / 783 - SILCA PER MOIA®  CHIAVE A DOPPIA MAPPA 25 pz	 MT / 783 - SILCA PER MOTTURA®  CHIAVE A DOPPIA MAPPA 25 pz	 MT2 / 783 - SILCA PER MOTTURA®  CHIAVE A POMPA 25 pz	 MT2P / 783 - SILCA PER MOTTURA®  CHIAVE A POMPA 25 pz	 MT3 / 783 - SILCA PER MOTTURA®  CHIAVE A POMPA 25 pz

In conformità alle disposizioni legali in vigore relative alle proprietà industriali, informiamo che i marchi o le denominazioni commerciali citate nel nostro documento sono di proprietà esclusiva dei fabbricanti di serrature e degli utilizzatori autorizzati. Questi marchi o denominazioni commerciali sono indicati a titolo di semplice informazione, con lo scopo di riconoscere velocemente a quali serrature le nostre chiavi sono destinate. Questo documento è esclusivamente riservato ai professionisti della riproduzione chiavi che utilizzano i prodotti Silca. / Le illustrazioni e i dati tecnici dei prodotti contenuti nel documento debbono considerarsi indicativi. Silca si riserva il diritto, ferme restando le caratteristiche essenziali dei prodotti, di apportare tutte le modifiche che ritiene necessarie e opportune al fine di migliorare la qualità dei prodotti. Tutti i disegni e le fotografie sono di proprietà di Silca, ogni riproduzione anche parziale, senza autorizzazione scritta di Silca S.p.A. è vietata secondo termini di legge. Per qualsiasi controversia competenti sono gli Uffici Giudiziari dove ha sede l'Azienda Silca S.p.A., con espressa esclusione di qualsiasi altro foro.

































DUPLICATRICI-CHIAVI-RADIOCOMANDI

 8 0 0 3 7 3 6 1 2 2 7 5 8 MT3P / 783 - SILCA PER MOTTURA®  CHIAVE A POMPA 25 pz	 8 0 0 3 7 3 6 1 2 2 7 6 5 MT4 / 783 - SILCA PER MOTTURA®  CHIAVE A POMPA 25 pz	 8 0 0 3 7 3 6 1 2 2 7 7 2 MT4P / 783 - SILCA PER MOTTURA®  CHIAVE A POMPA 25 pz	 8 0 0 3 7 3 6 5 2 4 8 8 0 MT4RP / 783 - SILCA PER MOTTURA®  CHIAVE A POMPA 25 pz	 8 0 0 3 7 3 6 1 2 2 2 8 4 MTF / 783 - SILCA PER MOTTURA®  CHIAVE A DOPPIA MAPPA 25 pz
 8 0 0 3 7 3 6 1 2 2 5 6 7 MTL / 783 - SILCA PER MOTTURA®  CHIAVE A DOPPIA MAPPA 25 pz	 8 0 0 3 7 3 6 1 2 2 5 7 4 MTLF / 783 - SILCA PER MOTTURA®  CHIAVE A DOPPIA MAPPA 25 pz	 8 0 0 3 7 3 6 1 2 2 5 8 1 MTM / 783 - SILCA PER MOTTURA®  CHIAVE A DOPPIA MAPPA 25 pz	 8 0 0 3 7 3 6 1 2 2 5 9 8 MTMF / 783 - SILCA PER MOTTURA®  CHIAVE A DOPPIA MAPPA 25 pz	 8 0 0 3 7 3 6 1 2 2 6 0 4 MTN / 783 - SILCA PER MOTTURA®  CHIAVE A DOPPIA MAPPA 25 pz
 8 0 0 3 7 3 7 7 6 7 6 5 1 MTNBP / 783 - SILCA PER MOTTURA®  CHIAVE A DOPPIA MAPPA 25 pz	 8 0 0 3 7 3 6 1 2 2 6 1 1 MTNC / 783 - SILCA PER MOTTURA®  CHIAVE A DOPPIA MAPPA 25 pz	 8 0 0 3 7 3 7 7 6 7 7 0 5 MTNCBP / 783 - SILCA PER MOTTURA®  CHIAVE A DOPPIA MAPPA 25 pz	 8 0 0 3 7 3 6 1 2 9 6 2 7 P / 783 - SILCA PER PATRONE®  CHIAVE A DOPPIA MAPPA 25 pz	 8 0 0 3 7 3 6 1 3 0 3 4 0 PFM / 783 - SILCA PER POTENT®  CHIAVE A DOPPIA MAPPA 25 pz

In conformità alle disposizioni legali in vigore relative alle proprietà industriali, informiamo che i marchi o le denominazioni commerciali citate nel nostro documento sono di proprietà esclusiva dei fabbricanti di serrature e degli utilizzatori autorizzati. Questi marchi o denominazioni commerciali sono indicati a titolo di semplice informazione, con lo scopo di riconoscere velocemente a quali serrature le nostre chiavi sono destinate. Questo documento è esclusivamente riservato ai professionisti della riproduzione chiavi che utilizzano i prodotti Silca. / Le illustrazioni e i dati tecnici dei prodotti contenuti nel documento debbono considerarsi indicativi. Silca si riserva il diritto, ferme restando le caratteristiche essenziali dei prodotti, di apportare tutte le modifiche che ritiene necessarie e opportune al fine di migliorare la qualità dei prodotti. Tutti i disegni e le fotografie sono di proprietà di Silca, ogni riproduzione anche parziale, senza autorizzazione scritta di Silca S.p.A. è vietata secondo termini di legge. Per qualsiasi controversia competenti sono gli Uffici Giudiziari dove ha sede l'Azienda Silca S.p.A., con espressa esclusione di qualsiasi altro foro.

































 PL / 783 - SILCA PER POTENT®  CHIAVE A DOPPIA MAPPA 25 pz	 PLL / 783 - SILCA PER POTENT®  CHIAVE A DOPPIA MAPPA 25 pz	 PO / 783 - SILCA PER POTENT®  CHIAVE A DOPPIA MAPPA 25 pz	 POL / 783 - SILCA PER POTENT®  CHIAVE A DOPPIA MAPPA 25 pz	 POP / 783 - SILCA PER POTENT®  CHIAVE A POMPA 25 pz
 PP / 783 - SILCA PER MOIA®  CHIAVE A POMPA 25 pz	 PTL / 783 - SILCA PER PATRONE®  CHIAVE A DOPPIA MAPPA 25 pz	 R / 783 - SILCA PER C.R.®  CHIAVE A DOPPIA MAPPA 25 pz	 RF / 783 - SILCA PER C.R.®  CHIAVE A DOPPIA MAPPA 25 pz	 RFO / 783 - SILCA PER C.R.®  CHIAVE A DOPPIA MAPPA 25 pz
 RGC / 783 - SILCA PER R.G.®  CHIAVE A DOPPIA MAPPA 25 pz	 RL / 783 - SILCA PER C.R.®  CHIAVE A DOPPIA MAPPA 25 pz	 RLC / 783 - SILCA PER C.R.®  CHIAVE A DOPPIA MAPPA 25 pz	 RLCR / 783 - SILCA PER C.R.®  CHIAVE A DOPPIA MAPPA 25 pz	 RLN / 783 - SILCA PER C.R.®  CHIAVE A DOPPIA MAPPA 25 pz

In conformità alle disposizioni legali in vigore relative alle proprietà industriali, informiamo che i marchi o le denominazioni commerciali citate nel nostro documento sono di proprietà esclusiva dei fabbricanti di serrature e degli utilizzatori autorizzati. Questi marchi o denominazioni commerciali sono indicati a titolo di semplice informazione, con lo scopo di riconoscere velocemente a quali serrature le nostre chiavi sono destinate. Questo documento è esclusivamente riservato ai professionisti della riproduzione chiavi che utilizzano i prodotti Silca. / Le illustrazioni e i dati tecnici dei prodotti contenuti nel documento debbono considerarsi indicativi. Silca si riserva il diritto, ferme restando le caratteristiche essenziali dei prodotti, di apportare tutte le modifiche che ritiene necessarie e opportune al fine di migliorare la qualità dei prodotti. Tutti i disegni e le fotografie sono di proprietà di Silca, ogni riproduzione anche parziale, senza autorizzazione scritta di Silca S.p.A. è vietata secondo termini di legge. Per qualsiasi controversia competenti sono gli Uffici Giudiziari dove ha sede l'Azienda Silca S.p.A., con espressa esclusione di qualsiasi altro foro.













DUPLICATRICI-CHIAVI-RADIOCOMANDI

 8 0 0 3 7 3 6 1 3 8 0 6 3 RM / 783 - SILCA PER C.R.®  CHIAVE A DOPPIA MAPPA 25 pz	 8 0 0 3 7 3 6 1 3 8 2 4 7 RN / 783 - SILCA PER C.R.®  CHIAVE A DOPPIA MAPPA 25 pz	 8 0 0 3 7 3 6 1 4 0 4 1 7 RP / 783 - SILCA PER C.R.®  CHIAVE A POMPA 25 pz	 8 0 0 3 7 3 6 1 4 0 4 2 4 RPC / 783 - SILCA PER C.R.®  CHIAVE A POMPA 25 pz	 8 0 0 3 7 3 6 1 4 3 0 3 6 S / 783 - SILCA PER SECUREMME®  CHIAVE A DOPPIA MAPPA 25 pz
 8 0 0 3 7 3 6 1 4 4 8 0 4 SB / 783 - SILCA PER SECUREMME®  CHIAVE A DOPPIA MAPPA 25 pz	 8 0 0 3 7 3 6 1 4 4 8 7 3 SD / 783 - SILCA PER SIDERAL®  CHIAVE A DOPPIA MAPPA 25 pz	 8 0 0 3 7 3 6 4 6 4 6 5 0 SDC / 783 - SILCA PER SIDERAL®  CHIAVE A DOPPIA MAPPA 25 pz	 8 0 0 3 7 3 6 1 4 4 8 8 0 SDP / 783 - SILCA PER SIDERAL®  CHIAVE A POMPA 25 pz	 8 0 0 3 7 3 6 1 4 4 9 2 7 SE / 783 - SILCA PER SEA®  CHIAVE A DOPPIA MAPPA 25 pz
 8 0 0 3 7 3 6 1 4 5 3 8 2 SF / 783 - SILCA PER SECUREMME®  CHIAVE A DOPPIA MAPPA 25 pz	 8 0 0 3 7 3 6 1 4 8 4 2 0 SM / 783 - SILCA PER SECUREMME®  CHIAVE A DOPPIA MAPPA 25 pz	 8 0 0 3 7 3 6 1 4 9 2 4 3 SRP / 783 - SILCA PER SERMEC®  CHIAVE A POMPA 25 pz	 8 0 0 3 7 3 6 1 5 3 4 0 0 TC / 783 - SILCA PER TITANO®  CHIAVE A DOPPIA MAPPA 25 pz	 8 0 0 3 7 3 6 1 5 4 4 1 4 TL / 783 - SILCA PER TITANO®  CHIAVE A DOPPIA MAPPA 25 pz

In conformità alle disposizioni legali in vigore relative alle proprietà industriali, informiamo che i marchi o le denominazioni commerciali citate nel nostro documento sono di proprietà esclusiva dei fabbricanti di serrature e degli utilizzatori autorizzati. Questi marchi o denominazioni commerciali sono indicati a titolo di semplice informazione, con lo scopo di riconoscere velocemente a quali serrature le nostre chiavi sono destinate. Questo documento è esclusivamente riservato ai professionisti della riproduzione chiavi che utilizzano i prodotti Silca. / Le illustrazioni e i dati tecnici dei prodotti contenuti nel documento debbono considerarsi indicativi. Silca si riserva il diritto, ferme restando le caratteristiche essenziali dei prodotti, di apportare tutte le modifiche che ritiene necessarie e opportune al fine di migliorare la qualità dei prodotti. Tutti i disegni e le fotografie sono di proprietà di Silca, ogni riproduzione anche parziale, senza autorizzazione scritta di Silca S.p.A. è vietata secondo termini di legge. Per qualsiasi controversia competenti sono gli Uffici Giudiziari dove ha sede l'Azienda Silca S.p.A., con espressa esclusione di qualsiasi altro foro.



 <p>8 003736163409</p> <p>TRL / 783 - SILCA PER 4 TR®</p>  <p>CHIAVE A DOPPIA MAPPA 25 pz</p>	 <p>8 003736163416</p> <p>TRP / 783 - SILCA PER 4 TR®</p>  <p>CHIAVE A POMPA 25 pz</p>	 <p>8 003736183254</p> <p>W / 783 - SILCA PER WELKA®</p>  <p>CHIAVE A DOPPIA MAPPA 25 pz</p>	 <p>8 003736190443</p> <p>WM / 783 - SILCA PER WELKA®</p>  <p>CHIAVE A DOPPIA MAPPA 25 pz</p>	 <p>8 003736198937</p> <p>YC / 783 - SILCA PER YALE®</p>  <p>CHIAVE A DOPPIA MAPPA 25 pz</p>
--	---	---	---	---

In conformità alle disposizioni legali in vigore relative alle proprietà industriali, informiamo che i marchi o le denominazioni commerciali citate nel nostro documento sono di proprietà esclusiva dei fabbricanti di serrature e degli utilizzatori autorizzati. Questi marchi o denominazioni commerciali sono indicati a titolo di semplice informazione, con lo scopo di riconoscere velocemente a quali serrature le nostre chiavi sono destinate. Questo documento è esclusivamente riservato ai professionisti della riproduzione chiavi che utilizzano i prodotti Silca. / Le illustrazioni e i dati tecnici dei prodotti contenuti nel documento debbono considerarsi indicativi. Silca si riserva il diritto, ferme restando le caratteristiche essenziali dei prodotti, di apportare tutte le modifiche che ritiene necessarie e opportune al fine di migliorare la qualità dei prodotti. Tutti i disegni e le fotografie sono di proprietà di Silca, ogni riproduzione anche parziale, senza autorizzazione scritta di Silca S.p.A. è vietata secondo termini di legge. Per qualsiasi controversia competenti sono gli Uffici Giudiziari dove ha sede l'Azienda Silca S.p.A., con espressa esclusione di qualsiasi altro foro.



MUSTAD



TECNOLOGIA DELLE VITI

EN 14592 : 2009
CSTB - PARIS

VITI PROFESSIONALI PER LEGNO LUBRIFICATE LUBEX®



VITI PER LAMIERA



VITI PER EDILIZIA

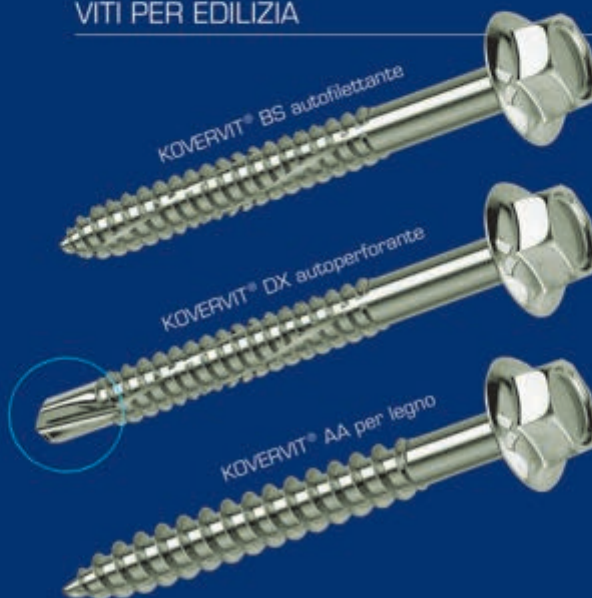

100% MADE IN ITALY

MUSTAD S.p.A. Stabilimenti produttivi: BALANGERO/PINEROLO (TO) - Tel. 0123.346625 - Fax 0123.346041
www.mustad.it - e-mail: commercio@mustad.it



**FISSAGGI
COLLANTI
SILICONI**

SFOGLIA LA CATEGORIA



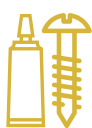

VITE TRUCIOLARE PANELVIT® MUSTAD Testa svasata piana Tutto filetto Bronzata **prezzi al centinaio (es. conf. 5 pz = 500 pz.)**

7052,5X10 – misura 2,5x10 – conf. 5 – € **1,48**
7052,5X12 – misura 2,5x12 – conf. 5 – € **1,48**
7052,5X16 – misura 2,5x16 – conf. 5 – € **1,54**
7052,5X20 – misura 2,5x20 – conf. 5 – € **1,94**
 segue...



continua...

7052,5X25 – misura 2,5x25 – conf. 5 – € **2,30**
7053X10 – misura 3x10 – conf. 5 – € **1,51**
7053X12 – misura 3x12 – conf. 5 – € **1,44**
7053X16 – misura 3x16 – conf. 5 – € **1,51**
7053X18 – misura 3x18 – conf. 5 – € **1,67**
 segue...



continua...

7053X20 – misura 3x20 – conf. 5 – € **1,70**
7053X25 – misura 3x25 – conf. 5 – € **2,10**
7053X30 – misura 3x30 – conf. 5 – € **2,58**
7053X35 – misura 3x35 – conf. 5 – € **3,20**
7053X40 – misura 3x40 – conf. 5 – € **4,06**
 segue...



continua...

7053,5X12 – misura 3,5x12 – conf. 5 – € **1,79**
7053,5X16 – misura 3,5x16 – conf. 5 – € **1,79**
7053,5X18 – misura 3,5x18 – conf. 5 – € **2,02**
7053,5X20 – misura 3,5x20 – conf. 5 – € **2,06**
7053,5X25 – misura 3,5x25 – conf. 5 – € **2,38**
 segue...



continua...

7053,5X30 – misura 3,5x30 – conf. 5 – € **2,74**
7053,5X35 – misura 3,5x35 – conf. 5 – € **3,46**
7053,5X40 – misura 3,5x40 – conf. 5 – € **3,94**
7053,5X45 – misura 3,5x45 – conf. 5 – € **5,66**
7053,5X50 – misura 3,5x50 – conf. 5 – € **6,60**
 segue...



continua...

7054X16 – misura 4x16 – conf. 5 – € **2,36**
7054X18 – misura 4x18 – conf. 5 – € **2,54**
7054X20 – misura 4x20 – conf. 5 – € **2,68**
7054X25 – misura 4x25 – conf. 5 – € **3,00**
7054X30 – misura 4x30 – conf. 5 – € **3,38**
 segue...



continua...

7054X35 – misura 4x35 – conf. 5 – € **4,02**
7054X40 – misura 4x40 – conf. 5 – € **4,36**
7054X45 – misura 4x45 – conf. 5 – € **5,42**
7054X50 – misura 4x50 – conf. 5 – € **5,98**
7054X60 – misura 4x60 – conf. 2 – € **7,90**
 segue...



continua...

7054X70 – misura 4x70 – conf. 2 – € **12,46**
7054,5X20 – misura 4,5x20 – conf. 5 – € **3,60**
7054,5X25 – misura 4,5x25 – conf. 5 – € **3,90**
7054,5X30 – misura 4,5x30 – conf. 5 – € **4,50**
7054,5X35 – misura 4,5x35 – conf. 5 – € **4,88**
 segue...



continua...

7054,5X40 – misura 4,5x40 – conf. 5 – € **5,40**
7054,5X45 – misura 4,5x45 – conf. 2 – € **6,82**
7054,5X50 – misura 4,5x50 – conf. 2 – € **7,26**
7054,5X60 – misura 4,5x60 – conf. 2 – € **8,88**
7054,5X70 – misura 4,5x70 – conf. 2 – € **11,66**
 segue...



continua...

7054,5X80 – misura 4,5x80 – conf. 2 – € **15,34**
7055X20 – misura 5x20 – conf. 5 – € **4,58**
7055X25 – misura 5x25 – conf. 5 – € **5,02**
7055X30 – misura 5x30 – conf. 5 – € **5,84**
7055X35 – misura 5x35 – conf. 5 – € **6,34**
 segue...



continua...

7055X40 – misura 5x40 – conf. 5 – € **6,90**
7055X45 – misura 5x45 – conf. 2 – € **7,70**
7055X50 – misura 5x50 – conf. 2 – € **8,14**
7055X60 – misura 5x60 – conf. 2 – € **10,60**
7055X70 – misura 5x70 – conf. 2 – € **11,46**
 segue...









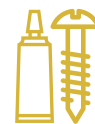





continua...

7055X80 – misura 5x80 – conf. 2 – € **13,26**
7055X90 – misura 5x90 – conf. 2 – € **18,20**
7055X100 – misura 5x100 – conf. 2 – € **21,30**
7055X120 – misura 5x120 – conf. 2 – € **42,98**
7056X40 – misura 6x40 – conf. 2 – € **11,30**
 segue...





 <p>continua... 7056X50 – misura 6x50 – – conf. 2 – € 12,72 7056X60 – misura 6x60 – – conf. 2 – € 14,68 7056X70 – misura 6x70 – – conf. 2 – € 17,08 7056X80 – misura 6x80 – – conf. 2 – € 19,52 7056X90 – misura 6x90 – – conf. 2 – € 21,54 segue...</p>	 <p>continua... 7056X100 – misura 6x100 – – conf. 2 – € 24,70 7056X110 – misura 6x110 – – conf. 1 – € 32,30 7056X120 – misura 6x120 – – conf. 1 – € 34,50 7056X130 – misura 6x130 – – conf. 1 – € 43,12 7056X140 – misura 6x140 – – conf. 1 – € 49,10 segue...</p>
 <p>continua... 7056X160 – misura 6x160 – – conf. 1 – € 71,94 7056X180 – misura 6x180 – – conf. 1 – € 98,30 7056X200 – misura 6x200 – – conf. 1 – € 121,86</p>	 <p>VITE TRUCIOLARE PANELVIT® PF MUSTAD Testa svasata piana Gambo parzialmente filettato Nervature autosvasanti sottotesta Bronzata prezzi al centinaio 705PF3,5X30 – misura 3,5x30 – – conf. 5 – € 2,82 705PF3,5X35 – misura 3,5x35 – – conf. 5 – € 3,56 705PF3,5X40 – misura 3,5x40 – – conf. 5 – € 4,06 705PF3,5X45 – misura 3,5x45 – – conf. 5 – € 5,82 segue...</p>
 <p>continua... 705PF3,5X50 – misura 3,5x50 – – conf. 5 – € 6,80 705PF4X30 – misura 4,0x30 – – conf. 5 – € 3,50 705PF4X35 – misura 4,0x35 – – conf. 5 – € 4,14 705PF4X40 – misura 4,0x40 – – conf. 5 – € 4,48 705PF4X45 – misura 4,0x45 – – conf. 5 – € 5,58 segue...</p>	 <p>continua... 705PF4X50 – misura 4,0x50 – – conf. 5 – € 6,16 705PF4X60 – misura 4,0x60 – – conf. 2 – € 8,14 705PF4X70 – misura 4,0x70 – – conf. 2 – € 12,84 705PF4,5X35 – misura 4,5x35 – – conf. 5 – € 5,04 705PF4,5X40 – misura 4,5x40 – – conf. 5 – € 5,56 segue...</p>
 <p>continua... 705PF4,5X45 – misura 4,5x45 – – conf. 5 – € 7,04 705PF4,5X50 – misura 4,5x50 – – conf. 5 – € 7,48 705PF4,5X60 – misura 4,5x60 – – conf. 2 – € 9,16 705PF4,5X70 – misura 4,5x70 – – conf. 2 – € 12,00 705PF4,5X80 – misura 4,5x80 – – conf. 2 – € 15,80 segue...</p>	 <p>continua... 705PF5X40 – misura 5,0x40 – – conf. 5 – € 7,12 705PF5X45 – misura 5,0x45 – – conf. 5 – € 7,92 705PF5X50 – misura 5,0x50 – – conf. 5 – € 8,40 705PF5X60 – misura 5,0x60 – – conf. 2 – € 10,92 705PF5X70 – misura 5,0x70 – – conf. 2 – € 11,80 segue...</p>
 <p>continua... 705PF5X80 – misura 5,0x80 – – conf. 2 – € 13,66 705PF6X60 – misura 6,0x60 – – conf. 2 – € 13,18 705PF6X70 – misura 6,0x70 – – conf. 2 – € 17,60 705PF6X80 – misura 6,0x80 – – conf. 2 – € 20,12</p>	 <p>VITE TRUCIOLARE PANELVIT® MUSTAD Testa svasata piana Filettatura tagliente e penetrante Trattamento galvanico CHROMITING® 240H Prezzi al centinaio (es. conf. 5 pz = 500 pz.) 705Z2,5X12 – Misura 2,5x12 – – conf. 5 – € 1,32 705Z2,5X16 – Misura 2,5x16 – – conf. 5 – € 1,38 705Z2,5X20 – Misura 2,5x20 – – conf. 5 – € 1,73 705Z2,5X25 – Misura 2,5x25 – – conf. 5 – € 2,02 segue...</p>
 <p>continua... 705Z3X10 – Misura 3x10 – – conf. 5 – € 1,34 705Z3X12 – Misura 3x12 – – conf. 5 – € 1,31 705Z3X16 – Misura 3x16 – – conf. 5 – € 1,33 705Z3X18 – Misura 3x18 – – conf. 5 – € 1,46 705Z3X20 – Misura 3x20 – – conf. 5 – € 1,48 segue...</p>	 <p>continua... 705Z3X25 – Misura 3x25 – – conf. 5 – € 1,84 705Z3X30 – Misura 3x30 – – conf. 5 – € 2,20 705Z3X35 – Misura 3x35 – – conf. 5 – € 2,80 705Z3X40 – Misura 3x40 – – conf. 5 – € 3,62 705Z3X45 – Misura 3x45 – – conf. 2 – € 4,54 segue...</p>

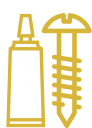

MUSTAD

continua...

705Z3,5X12 - Misura 3,5x12 -
- conf. 5 - € **1,53**

705Z3,5X16 - Misura 3,5x16 -
- conf. 5 - € **1,54**

705Z3,5X18 - Misura 3,5x18 -
- conf. 5 - € **1,73**

705Z3,5X20 - Misura 3,5x20 -
- conf. 5 - € **1,75**

705Z3,5X25 - Misura 3,5x25 -
- conf. 5 - € **1,99**

segue...



MUSTAD

continua...

705Z3,5X30 - Misura 3,5x30 -
- conf. 5 - € **2,34**

705Z3,5X35 - Misura 3,5x35 -
- conf. 5 - € **2,92**

705Z3,5X40 - Misura 3,5x40 -
- conf. 5 - € **3,28**

705Z3,5X45 - Misura 3,5x45 -
- conf. 2 - € **4,92**

705Z3,5X50 - Misura 3,5x50 -
- conf. 2 - € **5,68**

segue...



MUSTAD

continua...

705Z4X16 - Misura 4x16 -
- conf. 5 - € **2,02**

705Z4X18 - Misura 4x18 -
- conf. 5 - € **2,16**

705Z4X20 - Misura 4x20 -
- conf. 5 - € **2,26**

705Z4X25 - Misura 4x25 -
- conf. 5 - € **2,50**

705Z4X30 - Misura 4x30 -
- conf. 5 - € **2,82**

segue...



MUSTAD

continua...

705Z4X35 - Misura 4x35 -
- conf. 5 - € **3,34**

705Z4X40 - Misura 4x40 -
- conf. 5 - € **3,70**

705Z4X45 - Misura 4x45 -
- conf. 2 - € **4,54**

705Z4X50 - Misura 4x50 -
- conf. 2 - € **5,10**

705Z4X60 - Misura 4x60 -
- conf. 2 - € **6,82**

segue...



MUSTAD

continua...

705Z4X70 - Misura 4x70 -
- conf. 2 - € **10,74**

705Z4X80 - Misura 4x80 -
- conf. 2 - € **14,00**

705Z4,5X20 - Misura 4,5x20 -
- conf. 5 - € **3,04**

705Z4,5X25 - Misura 4,5x25 -
- conf. 5 - € **3,28**

705Z4,5X30 - Misura 4,5x30 -
- conf. 5 - € **3,80**

segue...



MUSTAD

continua...

705Z4,5X35 - Misura 4,5x35 -
- conf. 5 - € **4,10**

705Z4,5X40 - Misura 4,5x40 -
- conf. 5 - € **4,46**

705Z4,5X45 - Misura 4,5x45 -
- conf. 2 - € **5,64**

705Z4,5X50 - Misura 4,5x50 -
- conf. 2 - € **6,16**

705Z4,5X60 - Misura 4,5x60 -
- conf. 2 - € **7,54**

segue...



MUSTAD

continua...

705Z4,5X70 - Misura 4,5x70 -
- conf. 2 - € **9,88**

705Z4,5X80 - Misura 4,5x80 -
- conf. 2 - € **13,18**

705Z5X20 - Misura 5x20 -
- conf. 5 - € **3,94**

705Z5X25 - Misura 5x25 -
- conf. 5 - € **4,20**

705Z5X30 - Misura 5x30 -
- conf. 5 - € **4,92**

segue...



MUSTAD

continua...

705Z5X35 - Misura 5x35 -
- conf. 5 - € **5,28**

705Z5X40 - Misura 5x40 -
- conf. 5 - € **5,74**

705Z5X45 - Misura 5x45 -
- conf. 2 - € **6,38**

705Z5X50 - Misura 5x50 -
- conf. 2 - € **6,72**

705Z5X60 - Misura 5x60 -
- conf. 2 - € **8,94**

segue...



MUSTAD

continua...

705Z5X70 - Misura 5x70 -
- conf. 2 - € **9,54**

705Z5X80 - Misura 5x80 -
- conf. 2 - € **11,12**

705Z5X90 - Misura 5x90 -
- conf. 2 - € **15,20**

705Z5X100 - Misura 5x100 -
- conf. 2 - € **18,06**

705C5X120 - Misura 5x120 -
- conf. 1 - € **37,92**

segue...



MUSTAD

continua...

705Z6X40 - Misura 6x40 -
- conf. 2 - € **9,54**

705Z6X50 - Misura 6x50 -
- conf. 2 - € **10,76**

705Z6X60 - Misura 6x60 -
- conf. 2 - € **12,30**

705Z6X70 - Misura 6x70 -
- conf. 2 - € **14,38**

705Z6X80 - Misura 6x80 -
- conf. 2 - € **16,40**

segue...



MUSTAD

continua...

705Z6X90 - Misura 6x90 -
- conf. 2 - € **18,48**

705Z6X100 - Misura 6x100 -
- conf. 2 - € **21,50**

705C6X110 - Misura 6x110 -
- conf. 1 - € **27,98**

705Z6X120 - Misura 6x120 -
- conf. 2 - € **29,36**

705C6X130 - Misura 6x130 -
- conf. 1 - € **36,94**

segue...



MUSTAD

continua...

705Z6X140 - Misura 6x140 -
- conf. 2 - € **43,40**

705C6X150 - Misura 6x150 -
- conf. 1 - € **31,64**

705C6X160 - Misura 6x160 -
- conf. 1 - € **61,74**











705C6X180 - Misura 6x180 -
- conf. 1 - € **74,42**

705C6X200 - Misura 6x200 -
- conf. 1 - € **107,10**









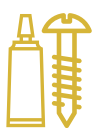

segue...





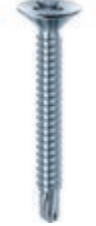
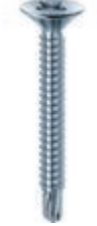

 <p>VITE TRUCIOLARE PANELVIT® INOX MUSTAD Testa svasata piana Tutto filetto prezzi al centinaio (es. conf. 2 pz = 200 pz.)</p> <p>70513X16 – misura 3x16 – – conf. 2 – € 4,10 70513X20 – misura 3x20 – – conf. 2 – € 4,62 70513X25 – misura 3x25 – – conf. 2 – € 5,54 70513X30 – misura 3x30 – – conf. 2 – € 6,84 segue...</p>	 <p>continua...</p> <p>70513,5X16 – misura 3,5x16 – – conf. 2 – € 4,96 70513,5X20 – misura 3,5x20 – – conf. 2 – € 5,36 70513,5X25 – misura 3,5x25 – – conf. 2 – € 6,14 70513,5X30 – misura 3,5x30 – – conf. 2 – € 7,22 70513,5X35 – misura 3,5x35 – – conf. 2 – € 8,50 segue...</p>
 <p>continua...</p> <p>70513,5X40 – misura 3,5x40 – – conf. 2 – € 9,88 70514X16 – misura 4x16 – – conf. 2 – € 6,16 70514X20 – misura 4x20 – – conf. 2 – € 6,50 70514X25 – misura 4x25 – – conf. 2 – € 7,58 70514X30 – misura 4x30 – – conf. 2 – € 8,62 segue...</p>	 <p>continua...</p> <p>70514X35 – misura 4x35 – – conf. 2 – € 9,92 70514X40 – misura 4x40 – – conf. 2 – € 11,38 70514X50 – misura 4x50 – – conf. 1 – € 15,58 70514,5X30 – misura 4,5x30 – – conf. 2 – € 11,06 70514,5X35 – misura 4,5x35 – – conf. 2 – € 12,30 segue...</p>
 <p>continua...</p> <p>70514,5X40 – misura 4,5x40 – – conf. 1 – € 13,78 70514,5X50 – misura 4,5x50 – – conf. 1 – € 18,92 70514,5X60 – misura 4,5x60 – – conf. 1 – € 24,42 70515X30 – misura 5x30 – – conf. 2 – € 14,06 70515X35 – misura 5x35 – – conf. 2 – € 15,86 segue...</p>	 <p>continua...</p> <p>70515X40 – misura 5x40 – – conf. 2 – € 17,70 70515X50 – misura 5x50 – – conf. 1 – € 21,36 70515X60 – misura 5x60 – – conf. 1 – € 25,10 70515X70 – misura 5x70 – – conf. 1 – € 29,78 70515X80 – misura 5x80 – – conf. 1 – € 33,54 segue...</p>
 <p>continua...</p> <p>70516X50 – misura 6x50 – – conf. 1 – € 32,64 70516X60 – misura 6x60 – – conf. 1 – € 36,56 70516X70 – misura 6x70 – – conf. 1 – € 43,36 70516X80 – misura 6x80 – – conf. 1 – € 47,00 70516X100 – misura 6x100 – – conf. 1 – € 57,84</p>	 <p>VITE AUTOFILETTANTE Testa Cilindrica Tutto filetto Zincata Prezzi al centinaio (es. conf. 10 pz = 1000 pz.)</p> <p>705A2,9X9,5 – misura 2,9x9,5 – – conf. 10 – € 1,25 705A2,9X13 – misura 2,9x13 – – conf. 10 – € 1,43 705A2,9X16 – misura 2,9x16 – – conf. 5 – € 1,62 705A3,5X9,5 – misura 3,5x9,5 – – conf. 5 – € 1,53 segue...</p>
 <p>continua...</p> <p>705A3,5X13 – misura 3,5x13 – – conf. 5 – € 1,64 705A3,5X16 – misura 3,5x16 – – conf. 5 – € 1,84 705A3,5X19 – misura 3,5x19 – – conf. 5 – € 2,14 705A3,5X25 – misura 3,5x25 – – conf. 5 – € 2,76 705A3,9X9,5 – misura 3,9x9,5 – – conf. 5 – € 1,81 segue...</p>	 <p>continua...</p> <p>705A3,9X13 – misura 3,9x13 – – conf. 5 – € 2,06 705A3,9X16 – misura 3,9x16 – – conf. 5 – € 2,28 705A3,9X19 – misura 3,9x19 – – conf. 5 – € 2,62 705A3,9X22 – misura 3,9x22 – – conf. 5 – € 3,04 705A3,9X25 – misura 3,9x25 – – conf. 5 – € 3,22 segue...</p>
 <p>continua...</p> <p>705A3,9X32 – misura 3,9x32 – – conf. 5 – € 4,08 705A4,2X13 – misura 4,2x13 – – conf. 5 – € 2,44 705A4,2X16 – misura 4,2x16 – – conf. 5 – € 2,70 705A4,2X19 – misura 4,2x19 – – conf. 5 – € 2,98 705A4,2X22 – misura 4,2x22 – – conf. 5 – € 3,38 segue...</p>	 <p>continua...</p> <p>705A4,2X25 – misura 4,2x25 – – conf. 5 – € 3,58 705A4,2X32 – misura 4,2x32 – – conf. 5 – € 4,56 705A4,2X38 – misura 4,2x38 – – conf. 2 – € 5,78 705A4,8X16 – misura 4,8x16 – – conf. 5 – € 3,86 705A4,8X19 – misura 4,8x19 – – conf. 5 – € 4,22 segue...</p>

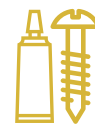

 <p>continua... 705A4,8X25 - misura 4,8x25 - - conf. 5 - € 4,98 705A4,8X32 - misura 4,8x32 - - conf. 2 - € 6,14 705A4,8X38 - misura 4,8x38 - - conf. 2 - € 7,30 705A4,8X50 - misura 4,8x50 - - conf. 2 - € 11,82 705A5,5X25 - misura 5,5x25 - - conf. 2 - € 7,84 segue...</p>	 <p>continua... 705A5,5X32 - misura 5,5x32 - - conf. 2 - € 9,90 705A5,5X38 - misura 5,5x38 - - conf. 2 - € 11,06 705A5,5X45 - misura 5,5x45 - - conf. 2 - € 10,64 705A5,5X50 - misura 5,5x50 - - conf. 2 - € 16,12</p>
 <p>VITE AUTOPERFORANTE E AUTOFIETTANTE DRILLEX® MUSTAD Testa cilindrica Zincata prezzi al centinaio (es. conf. 5 pz = 500 pz.)</p> <p>705D3,5X13 - misura 3,5x13 - - conf. 5 - € 2,96 705D3,5X16 - misura 3,5x16 - - conf. 5 - € 3,10 705D3,5X19 - misura 3,5x19 - - conf. 5 - € 3,40 705D3,5X25 - misura 3,5x25 - - conf. 5 - € 4,10 segue...</p>	 <p>continua... 705D3,9X13 - misura 3,9x13 - - conf. 5 - € 3,44 705D3,9X16 - misura 3,9x16 - - conf. 5 - € 3,60 705D3,9X19 - misura 3,9x19 - - conf. 5 - € 3,92 705D3,9X25 - misura 3,9x25 - - conf. 5 - € 4,62 705D3,9X32 - misura 3,9x32 - - conf. 5 - € 5,42 segue...</p>
 <p>continua... 705D4,2X16 - misura 4,2x16 - - conf. 5 - € 4,24 705D4,2X19 - misura 4,2x19 - - conf. 5 - € 4,58 705D4,2X25 - misura 4,2x25 - - conf. 5 - € 5,40 705D4,2X32 - misura 4,2x32 - - conf. 5 - € 6,38 705D4,2X38 - misura 4,2x38 - - conf. 2 - € 7,64 segue...</p>	 <p>continua... 705D4,8X25 - misura 4,8x25 - - conf. 5 - € 6,92 705D4,8X32 - misura 4,8x32 - - conf. 2 - € 8,34 705D4,8X38 - misura 4,8x38 - - conf. 2 - € 9,32 705D4,8X50 - misura 4,8x50 - - conf. 2 - € 13,66 705D4,8X60 - misura 4,8x60 - - conf. 2 - € 16,06 705D4,8X70 - misura 4,8x70 - - conf. 2 - € 17,48</p>
 <p>VITE AUTOPERFORANTE E AUTOFIETTANTE DRILLEX® MUSTAD Testa Svasata Piana Zincata 100H Prezzi al centinaio (es. conf. 5 pz = 500 pz.)</p> <p>705DP3,5X13 - Misura 3,5x13 - - conf. 5 - € 2,86 705DP3,5X16 - Misura 3,5x16 - - conf. 5 - € 2,96 705DP3,9X16 - Misura 3,9x16 - - conf. 5 - € 3,58 705DP3,9X19 - Misura 3,9x19 - - conf. 5 - € 3,82 segue...</p>	 <p>continua... 705DP3,9X25 - Misura 3,9x25 - - conf. 5 - € 4,50 705DP3,9X32 - Misura 3,9x32 - - conf. 5 - € 5,24 705DP3,9X38 - Misura 3,9x38 - - conf. 5 - € 6,46 705DP4,2X16 - Misura 4,2x16 - - conf. 5 - € 4,02 705DP4,2X19 - Misura 4,2x19 - - conf. 5 - € 4,42 segue...</p>
 <p>continua... 705DP4,2X25 - Misura 4,2x25 - - conf. 5 - € 5,02 705DP4,2X32 - Misura 4,2x32 - - conf. 5 - € 6,00 705DP4,2X38 - Misura 4,2x38 - - conf. 5 - € 7,22 705DP4,8X19 - Misura 4,8x19 - - conf. 5 - € 5,96 705DP4,8X25 - Misura 4,8x25 - - conf. 5 - € 6,60 segue...</p>	 <p>continua... 705DP24,8X32 - Misura 4,8x32 - - conf. 2 - € 8,06 705DP24,8X38 - Misura 4,8x38 - - conf. 2 - € 9,08 705DP24,8X45 - Misura 4,8x45 - - conf. 2 - € 10,96 705DP24,8X50 - Misura 4,8x50 - - conf. 2 - € 12,54 705DP24,8X60 - Misura 4,8x60 - - conf. 2 - € 15,12 705DP24,8X70 - Misura 4,8x70 - - conf. 2 - € 16,98</p>
 <p>VITE AUTOPERFORANTE KOVERVIT® DX MUSTAD Filettatura BS con scanalature automaschianti Punta autoperforante DRILLEX® Testa con chiave esagonale Trattamento galvanico CHROMITING® Prezzi al centinaio (es. conf. 2 pz = 200 pz.)</p> <p>705KDX6,3X20 - Misura 6,3x20 - - conf. 2 - € 14,46 705KDX6,3X25 - Misura 6,3x25 - - conf. 2 - € 14,88 segue...</p>	 <p>continua... 705KDX6,3X30 - Misura 6,3x30 - - conf. 2 - € 15,30 705KDX6,3X35 - Misura 6,3x35 - - conf. 2 - € 16,98 705KDX6,3X40 - Misura 6,3x40 - - conf. 2 - € 17,64 705KDX6,3X50 - Misura 6,3x50 - - conf. 1 - € 18,54 705KDX6,3X60 - Misura 6,3x60 - - conf. 1 - € 19,20 segue...</p>





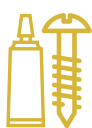









 <p>continua... 705KDX6,3X70 – Misura 6,3x70 – – conf. 1 – € 21,24 705KDX6,3X80 – Misura 6,3x80 – – conf. 1 – € 22,62 705KDX6,3X90 – Misura 6,3x90 – – conf. 1 – € 26,08 705KDX6,3X100 – Misura 6,3x100 – – conf. 1 – € 30,44 705KDX6,3X110 – Misura 6,3x110 – – conf. 1 – € 35,36 segue...</p>	 <p>continua... 705KDX6,3X120 – Misura 6,3x120 – – conf. 1 – € 27,26 705KDX6,3X130 – Misura 6,3x130 – – conf. 1 – € 38,98 705KDX6,3X140 – Misura 6,3x140 – – conf. 1 – € 54,42 705KDX6,3X150 – Misura 6,3x150 – – conf. 1 – € 63,84</p>
 <p>VITE AUTOPERFORANTE KOVERVIT® MUSTAD Trattamento galvanico CHROMITING® Prezzi al centinaio (es. conf. 5 pz = 500 pz.)</p> <p>705DFL4,2X13 – Misura 4,2x13 – – conf. 5 – € 4,92 705DFL4,2X16 – Misura 4,2x16 – – conf. 5 – € 5,02 705DFL4,2X19 – Misura 4,2x19 – – conf. 5 – € 5,26 705DFL4,2X25 – Misura 4,2x25 – – conf. 5 – € 6,38 705DFL4,2X32 – Misura 4,2x32 – – conf. 5 – € 7,70</p>	 <p>VITE AUTOPERFORANTE KOVERVIT® AA MUSTAD Filettatura AA a passo rapido per un avvitatura veloce. Vite temprata e cementata per fissaggi su legno Testa chiave esagonale Tratta- mento galvanico CHROMITING®</p> <p>705KAA6,5X60 – Misura 6,5x60 – – conf. 1 – € 18,72 705KAA6,5X70 – Misura 6,5x70 – – conf. 1 – € 21,58 705KAA6,5X80 – Misura 6,5x80 – – conf. 1 – € 23,60 segue...</p>
 <p>continua... 705KAA6,5X90 – Misura 6,5x90 – – conf. 1 – € 27,14 705KAA6,5X100 – Misura 6,5x100 – – conf. 1 – € 29,06 705KAA6,5X110 – Misura 6,5x110 – – conf. 1 – € 33,50 705KAA6,5X120 – Misura 6,5x120 – – conf. 1 – € 36,02 705KAA6,5X130 – Misura 6,5x130 – – conf. 1 – € 42,90 segue...</p>	 <p>continua... 705KAA6,5X140 – Misura 6,5x140 – – conf. 1 – € 50,20 705KAA6,5X150 – Misura 6,5x150 – – conf. 1 – € 58,82 705KAA6,5X160 – Misura 6,5x160 – – conf. 1 – € 74,86</p>
 <p>VITI AUTOFIETTANTI GETO INFISSI PER MURA- TURA testa piana svasata zincata bianca impronta T-30</p> <p>513TVGS17 – Misura 7,5x52mm – – conf. 100 – € 0,11 513TVGS20 – Misura 7,5x72mm – – conf. 100 – € 0,16 513TVGS29 – Misura 7,5x82mm – – conf. 100 – € 0,17 513TVGS21 – Misura 7,5x92mm – – conf. 100 – € 0,19 segue...</p>	 <p>continua... 513TVGS18 – Misura 7,5x102mm – – conf. 100 – € 0,22 513TVGS22 – Misura 7,5x112mm – – conf. 100 – € 0,24 513TVGS28 – Misura 7,5x122mm – – conf. 100 – € 0,26 513TVGS23 – Misura 7,5x132mm – – conf. 100 – € 0,28 513TVGS24 – Misura 7,5x152mm – – conf. 100 – € 0,32</p>
 <p>VITI AUTOFIETTANTI GETO INFISSO PER MU- RATURA testa cilindrica zincata bianca impronta T-30 Ø 7,5 mm T-15 Ø 5mm</p> <p>513TVGC16 – Misura 7,5x52mm – – conf. 100 – € 0,11 513TVGC10 – Misura 7,5x72mm – – conf. 100 – € 0,16 513TVGC17 – Misura 7,5x82mm – – conf. 100 – € 0,17 513TVGC11 – Misura 7,5x92mm – – conf. 100 – € 0,19 segue...</p>	 <p>continua... 513TVGC18 – Misura 7,5x102mm – – conf. 100 – € 0,22 513TVGC12 – Misura 7,5x112mm – – conf. 100 – € 0,24 513TVGC19 – Misura 7,5x122mm – – conf. 100 – € 0,26 513TVGC13 – Misura 7,5x132mm – – conf. 100 – € 0,28 513TVGC14 – Misura 7,5x152mm – – conf. 100 – € 0,32</p>
 <p>BORCHIA COPRIVITE A PUNTA mod. 648 ottone lucido</p> <p>90026202 – misura 12 – – conf. 200 – € 0,13 90026203 – misura 14 – – conf. 200 – € 0,15 90026204 – misura 16 – – conf. 200 – € 0,17 90026205 – misura 18 – – conf. 200 – € 0,19 90026206 – misura 20 – – conf. 200 – € 0,22</p>	 <p>BORCHIA COPRIVITE A PUNTA Art. 648 ottone nichelato</p> <p>90026207 – misura 12 – – conf. 200 – € 0,14 90026208 – misura 14 – – conf. 200 – € 0,16 90026209 – misura 16 – – conf. 200 – € 0,18 90026210 – misura 18 – – conf. 200 – € 0,21 90026211 – misura 20 – – conf. 200 – € 0,24</p>















<p>MINUTEX</p> <p>BORCHIA COPRIVITE PIANA Art. 647 ottone lucido</p> <p>90026212 - misura 12 - - conf. 200 - € 0,13 90026213 - misura 14 - - conf. 200 - € 0,15 90026214 - misura 16 - - conf. 200 - € 0,17 90026215 - misura 18 - - conf. 200 - € 0,19 90026216 - misura 20 - - conf. 200 - € 0,22</p> 	<p>MINUTEX</p> <p>BORCHIA COPRIVITE PIANA Art. 647 ottone nichelato</p> <p>90026222 - misura 12 - - conf. 200 - € 0,14 90026223 - misura 14 - - conf. 200 - € 0,16 90026224 - misura 16 - - conf. 200 - € 0,18 90026225 - misura 18 - - conf. 200 - € 0,21 90026226 - misura 20 - - conf. 200 - € 0,23</p> 
<p>&M900</p> <p>ORLO SOTTOVITE ferro bronzato</p> <p>90026310 - misura esterna 10mm - misura interna 3,8mm - - conf. 1000 - € 0,02 90026311 - misura esterna 12mm - misura interna 4,3mm - - conf. 1000 - € 0,02 90026312 - misura esterna 14mm - misura interna 5mm - - conf. 1000 - € 0,02 90026313 - misura esterna 16mm - misura interna 6mm - - conf. 1000 - € 0,02</p> 	<p>&M900</p> <p>ORLO SOTTOVITE ferro nichelato</p> <p>90026316 - misura esterna 10mm - misura interna 3,8mm - - conf. 1000 - € 0,02 90026317 - misura esterna 12mm - misura interna 4,3mm - - conf. 1000 - € 0,02 90026318 - misura esterna 14mm - misura interna 5mm - - conf. 1000 - € 0,02 90026319 - misura esterna 16mm - misura interna 6mm - - conf. 1000 - € 0,02</p> 
<p>&M900</p> <p>ORLO SOTTOVITE ferro ottonato</p> <p>90026303 - misura esterna 10mm - misura interna 3,8mm - - conf. 1000 - € 0,02 90026304 - misura esterna 12mm - misura interna 4,3mm - - conf. 1000 - € 0,02 90026305 - misura esterna 14mm - misura interna 5mm - - conf. 1000 - € 0,02 90026307 - misura esterna 16mm - misura interna 6mm - - conf. 1000 - € 0,02</p> 	<p>&M900</p> <p>Busta 100 pz SPILLI BATTISCOPIA Ø 0,7</p> <p>90027620 - Lungh. 20 - - conf. 50 - € 0,24 90027625 - Lungh. 25 - - conf. 50 - € 0,28 90027630 - Lungh. 30 - - conf. 50 - € 0,32</p> 
<p>&M900</p> <p>RAMPINO DIRITTO A VITE IN FERRO Mod. 104 acciaio zincato</p> <p>90032051 - misura 16x30 - Ø filo 2,25 - L.mm. 20 - - conf. 200 - € 0,08 90032052 - misura 16x40 - Ø filo 2,25 - L.mm. 30 - - conf. 200 - € 0,08 90032053 - misura 17x35 - Ø filo 2,50 - L.mm. 25 - - conf. 200 - € 0,08 segue...</p> 	<p>&M900</p> <p>continua...</p> <p>90032054 - misura 17x40 - Ø filo 2,50 - L.mm. 30 - - conf. 200 - € 0,10 90032055 - misura 17x50 - Ø filo 2,50 - L.mm. 40 - - conf. 200 - € 0,10 90032056 - misura 18x40 - Ø filo 3,00 - L.mm. 30 - - conf. 200 - € 0,10 90032057 - misura 18x50 - Ø filo 3,00 - L.mm. 40 - - conf. 200 - € 0,10 segue...</p> 
<p>&M900</p> <p>continua...</p> <p>90032058 - misura 18x60 - Ø filo 3,00 - L.mm. 45 - - conf. 200 - € 0,10 90032059 - misura 19x50 - Ø filo 3,50 - L.mm. 40 - - conf. 200 - € 0,12 90032060 - misura 19x60 - Ø filo 3,50 - L.mm. 45 - - conf. 200 - € 0,14 90032061 - misura 19x70 - Ø filo 3,50 - L.mm. 55 - - conf. 200 - € 0,14 segue...</p> 	<p>&M900</p> <p>continua...</p> <p>90032062 - misura 20x50 - Ø filo 4,00 - L.mm. 35 - - conf. 200 - € 0,12 90032063 - misura 20x60 - Ø filo 4,00 - L.mm. 45 - - conf. 200 - € 0,14 90032064 - misura 20x70 - Ø filo 4,00 - L.mm. 50 - - conf. 200 - € 0,14 90032065 - misura 20x80 - Ø filo 4,00 - L.mm. 60 - - conf. 200 - € 0,16 segue...</p> 
<p>&M900</p> <p>continua...</p> <p>90032066 - misura 21x50 - Ø filo 4,50 - L.mm. 35 - - conf. 200 - € 0,16 90032067 - misura 21x60 - Ø filo 4,50 - L.mm. 45 - - conf. 200 - € 0,18 90032068 - misura 21x80 - Ø filo 4,50 - L.mm. 60 - - conf. 200 - € 0,20 90032069 - misura 21x100 - Ø filo 4,50 - L.mm. 80 - - conf. 200 - € 0,24 segue...</p> 	<p>&M900</p> <p>continua...</p> <p>90032070 - misura 22x80 - Ø filo 5,00 - L.mm. 60 - - conf. 200 - € 0,26 90032071 - misura 22x100 - Ø filo 5,00 - L.mm. 80 - - conf. 200 - € 0,30 90032072 - misura 23x100 - Ø filo 6,00 - L.mm. 80 - - conf. 100 - € 0,38 90032073 - misura 23x120 - Ø filo 6,00 - L.mm. 100 - - conf. 100 - € 0,42</p> 



<p>&M900</p> <p>GANCIO CURVO Art. 103 A VITE IN FERRO acciaio zincato</p> <p>90032151 - misura 16x 30 - Ø filo 2,25 - L.mm. 10 - - conf. 200 - € 0,08</p> <p>90032152 - misura 16x 40 - Ø filo 2,25 - L.mm. 16 - - conf. 200 - € 0,08</p> <p>90032153 - misura 17x 40 - Ø filo 2,50 - L.mm. 16 - - conf. 200 - € 0,08</p> <p>segue...</p> 	<p>&M900</p> <p>continua...</p> <p>90032154 - misura 17x 50 - Ø filo 2,50 - L.mm. 20 - - conf. 200 - € 0,10</p> <p>90032155 - misura 18x 50 - Ø filo 3,00 - L.mm. 16 - - conf. 200 - € 0,10</p> <p>90032156 - misura 18x 60 - Ø filo 3,00 - L.mm. 20 - - conf. 200 - € 0,10</p> <p>90032157 - misura 19x 60 - Ø filo 3,50 - L.mm. 20 - - conf. 200 - € 0,12</p> <p>segue...</p> 
<p>&M900</p> <p>continua...</p> <p>90032158 - misura 19x 70 - Ø filo 3,50 - L.mm. 25 - - conf. 200 - € 0,12</p> <p>90032159 - misura 19x 80 - Ø filo 3,50 - L.mm. 30 - - conf. 200 - € 0,12</p> <p>90032160 - misura 20x 70 - Ø filo 4,00 - L.mm. 25 - - conf. 200 - € 0,12</p> <p>90032161 - misura 20x 80 - Ø filo 4,00 - L.mm. 30 - - conf. 200 - € 0,14</p> <p>segue...</p> 	<p>&M900</p> <p>continua...</p> <p>90032162 - misura 20x100 - Ø filo 4,00 - L.mm. 40 - - conf. 200 - € 0,16</p> <p>90032163 - misura 21x 70 - Ø filo 4,50 - L.mm. 25 - - conf. 200 - € 0,16</p> <p>90032164 - misura 21x 80 - Ø filo 4,50 - L.mm. 30 - - conf. 200 - € 0,18</p> <p>90032165 - misura 21x100 - Ø filo 4,50 - L.mm. 40 - - conf. 200 - € 0,20</p> <p>segue...</p> 
<p>&M900</p> <p>continua...</p> <p>90032166 - misura 22x 80 - Ø filo 5,00 - L.mm. 25 - - conf. 200 - € 0,22</p> <p>90032167 - misura 22x100 - Ø filo 5,00 - L.mm. 35 - - conf. 200 - € 0,26</p> <p>90032168 - misura 22x120 - Ø filo 5,00 - L.mm. 50 - - conf. 200 - € 0,30</p> <p>90032170 - misura 23x140 - Ø filo 6,00 - L.mm. 70 - - conf. 100 - € 0,42</p> 	<p>&M900</p> <p>OCCHIOLO AVITE Art. 100 acciaio zincato</p> <p>90032001 - misura 16x30 - Ø filo 2,25 - L.mm. 12 - - conf. 200 - € 0,08</p> <p>90032002 - misura 16x35 - Ø filo 2,25 - L.mm. 15 - - conf. 200 - € 0,08</p> <p>90032003 - misura 16x40 - Ø filo 2,25 - L.mm. 16 - - conf. 200 - € 0,08</p> <p>segue...</p> 
<p>&M900</p> <p>continua...</p> <p>90032004 - misura 17x30 - Ø filo 2,50 - L.mm. 12 - - conf. 200 - € 0,08</p> <p>90032005 - misura 17x40 - Ø filo 2,50 - L.mm. 18 - - conf. 200 - € 0,08</p> <p>90032006 - misura 17x50 - Ø filo 2,50 - L.mm. 20 - - conf. 200 - € 0,08</p> <p>90032007 - misura 18x40 - Ø filo 3,00 - L.mm. 16 - - conf. 200 - € 0,08</p> <p>segue...</p> 	<p>&M900</p> <p>continua...</p> <p>90032008 - misura 18x50 - Ø filo 3,00 - L.mm. 20 - - conf. 200 - € 0,10</p> <p>90032009 - misura 18x60 - Ø filo 3,00 - L.mm. 24 - - conf. 200 - € 0,10</p> <p>90032010 - misura 19x50 - Ø filo 3,50 - L.mm. 18 - - conf. 200 - € 0,10</p> <p>90032011 - misura 19x60 - Ø filo 3,50 - L.mm. 25 - - conf. 200 - € 0,10</p> <p>segue...</p> 
<p>&M900</p> <p>continua...</p> <p>90032012 - misura 16x70 - Ø filo 3,50 - L.mm. 30 - - conf. 200 - € 0,12</p> <p>90032013 - misura 20x50 - Ø filo 4,00 - L.mm. 18 - - conf. 200 - € 0,10</p> <p>90032014 - misura 20x60 - Ø filo 4,00 - L.mm. 20 - - conf. 200 - € 0,12</p> <p>90032015 - misura 20x70 - Ø filo 4,00 - L.mm. 25 - - conf. 200 - € 0,12</p> <p>segue...</p> 	<p>&M900</p> <p>continua...</p> <p>90032016 - misura 20x80 - Ø filo 4,00 - L.mm. 30 - - conf. 200 - € 0,14</p> <p>90032017 - misura 21x60 - Ø filo 4,00 - L.mm. 20 - - conf. 200 - € 0,14</p> <p>90032018 - misura 21x70 - Ø filo 4,50 - L.mm. 25 - - conf. 200 - € 0,16</p> <p>90032019 - misura 21x80 - Ø filo 4,50 - L.mm. 30 - - conf. 200 - € 0,16</p> <p>segue...</p> 
<p>&M900</p> <p>continua...</p> <p>90032020 - misura 22x70 - Ø filo 5,00 - L.mm. 25 - - conf. 200 - € 0,22</p> <p>90032021 - misura 22x80 - Ø filo 5,00 - L.mm. 30 - - conf. 200 - € 0,24</p> <p>90032022 - misura 22x100 - Ø filo 5,00 - L.mm. 40 - - conf. 200 - € 0,26</p> <p>90032023 - misura 22x120 - Ø filo 5,00 - L.mm. 50 - - conf. 200 - € 0,30</p> <p>segue...</p> 	<p>&M900</p> <p>continua...</p> <p>90032024 - misura 23x80 - Ø filo 6,00 - L.mm. 30 - - conf. 100 - € 0,28</p> <p>90032025 - misura 23x100 - Ø filo 6,00 - L.mm. 40 - - conf. 100 - € 0,32</p> <p>90032026 - misura 23x120 - Ø filo 6,00 - L.mm. 50 - - conf. 100 - € 0,38</p> <p>90032027 - misura 23x140 - Ø filo 6,00 - L.mm. 60 - - conf. 100 - € 0,42</p> <p>segue...</p> 



<p>&M900</p> <p>continua...</p> <p>90032028 - misura 25x120 - Ø filo 7,00 - L.mm. 50 - - conf. 100 - € 0,48</p> <p>90032029 - misura 25x140 - Ø filo 7,00 - L.mm. 60 - - conf. 100 - € 0,52</p> 	<p>&M900</p> <p>OCCHIOLO AVITE CON FILETTATURA METRICA Art 182 con dado acciaio zincato</p> <p>90032231 - Misura 1 - Ø Filo 5 - L.mm 20 - - conf. 200 - € 0,38</p> <p>90032232 - Misura 2 - Ø Filo 5 - L.mm 30 - - conf. 200 - € 0,40</p> <p>90032233 - Misura 3 - Ø Filo 6 - L.mm 35 - - conf. 200 - € 0,42</p> <p>90032234 - Misura 4 - Ø Filo 6 - L.mm 40 - - conf. 200 - € 0,46</p> <p>90032235 - Misura 5 - Ø Filo 6 - L.mm 50 - - conf. 100 - € 0,54</p> <p>segue...</p> 
<p>&M900</p> <p>continua...</p> <p>90032237 - Misura 7 - Ø Filo 8 - L.mm 65 - - conf. 100 - € 0,54</p> 	<p>fischer</p> <p>OCCHIOLO GS PER PONTEGGI Ø occhio 23 12 X 120</p> <p>50080926 - - conf. 25 - € 4,40</p> 
<p>ES</p> <p>VITE CON OCCHIELLO Destra Per tasselli Zincata</p> <p>322501508 - Misura M8 - - conf. 120 - € 0,64</p> 	<p>&M900</p> <p>GANCIO CREDENZA con occhio</p> <p>90032201 - misura 1 - L.mm 25 - mano DX - - conf. 100 - € 0,92</p> <p>90032202 - misura 1 - L.mm 25 - mano SX - - conf. 100 - € 0,92</p> <p>90032203 - misura 1 - L.mm 40 - mano DX - - conf. 100 - € 0,98</p> <p>90032204 - misura 1 - L.mm 40 - mano SX - - conf. 100 - € 0,98</p> <p>90032205 - misura 2 - L.mm 50 - mano DX - - conf. 100 - € 1,06</p> <p>segue...</p> 
<p>&M900</p> <p>continua...</p> <p>90032206 - misura 2 - L.mm 50 - mano SX - - conf. 100 - € 1,06</p> <p>90032207 - misura 2 - L.mm 65 - mano DX - - conf. 100 - € 1,08</p> <p>90032208 - misura 2 - L.mm 65 - mano SX - - conf. 100 - € 1,08</p> <p>90032209 - misura 3 - L.mm 75 - mano DX - - conf. 100 - € 1,12</p> <p>90032210 - misura 3 - L.mm 75 - mano SX - - conf. 100 - € 1,12</p> 	<p>&M900</p> <p>RAMPINO FINESTRA IN FERRO CON OCCHIOLO art 105 acciaio zincato</p> <p>90032221 - misura 20x 80 - Ø filo 4 - L.mm 80 - - conf. 100 - € 0,82</p> <p>90032222 - misura 20x100 - Ø filo 4 - L.mm 100 - - conf. 100 - € 0,86</p> <p>90032224 - misura 21x120 - Ø filo 4,5 - L.mm 120 - - conf. 100 - € 1,00</p> <p>segue...</p> 
<p>&M900</p> <p>continua...</p> <p>90032225 - misura 21x140 - Ø filo 4,5 - L.mm 140 - - conf. 100 - € 1,06</p> <p>90032227 - misura 22x180 - Ø filo 5 - L.mm 180 - - conf. 50 - € 1,62</p> <p>90032228 - misura 22x200 - Ø filo 5 - L.mm 200 - - conf. 50 - € 1,74</p> 	<p>&M900</p> <p>RIVETTI IN ALLUMINIO</p> <p>90070042 - Misura 3,0 x 8 - - conf. 1000 - € 0,02</p> <p>90070043 - Misura 3,0 x 10 - - conf. 1000 - € 0,02</p> <p>90070044 - Misura 3,0 x 12 - - conf. 1000 - € 0,03</p> <p>90070045 - Misura 3,2 x 6 - - conf. 1000 - € 0,02</p> <p>90070046 - Misura 3,2 x 8 - - conf. 1000 - € 0,02</p> <p>segue...</p> 
<p>&M900</p> <p>continua...</p> <p>90070047 - Misura 3,2 x 10 - - conf. 1000 - € 0,03</p> <p>90070048 - Misura 3,2 x 12 - - conf. 1000 - € 0,03</p> <p>90070049 - Misura 3,4 x 7 - - conf. 1000 - € 0,02</p> <p>90070050 - Misura 3,4 x 9 - - conf. 1000 - € 0,03</p> <p>90070052 - Misura 3,4 x 12 - - conf. 500 - € 0,03</p> <p>segue...</p> 	<p>&M900</p> <p>continua...</p> <p>90070053 - Misura 3,4 x 14 - - conf. 500 - € 0,03</p> <p>90070054 - Misura 4,0 x 8 - - conf. 1000 - € 0,02</p> <p>90070055 - Misura 4,0 x 10 - - conf. 1000 - € 0,03</p> <p>90070057 - Misura 4,0 x 12 - - conf. 500 - € 0,03</p> <p>90070058 - Misura 4,0 x 14 - - conf. 500 - € 0,03</p> <p>segue...</p> 



&M900



continua...
90070059 – Misura 4,0 x16 –
 – conf. 500 – € 0,04
90070060 – Misura 4,0 x18 –
 – conf. 500 – € 0,04
90070061 – Misura 4,0 x20 –
 – conf. 500 – € 0,04
90070062 – Misura 4,8 x 8 –
 – conf. 500 – € 0,03
90070063 – Misura 4,8 x10 –
 – conf. 500 – € 0,03
 segue...

&M900



continua...
90070065 – Misura 4,8 x12 –
 – conf. 500 – € 0,04
90070066 – Misura 4,8 x14 –
 – conf. 500 – € 0,04
90070067 – Misura 4,8 x16 –
 – conf. 500 – € 0,05
90070068 – Misura 4,8 x18 –
 – conf. 500 – € 0,06
90070069 – Misura 4,8 x20 –
 – conf. 500 – € 0,06

&M900



RIVETTI IN ALLUMINIO confezione 100 pezzi

90070011 – misura 3,0 x 7 –
 – conf. 10 – € 2,72
90070012 – misura 3,0 x 9 –
 – conf. 10 – € 3,00
90070013 – misura 3,0 x11 –
 – conf. 10 – € 3,22
90070015 – misura 3,2 x 7 –
 – conf. 10 – € 2,82
90070016 – misura 3,2 x 9 –
 – conf. 10 – € 3,10
 segue...

&M900



continua...
90070017 – misura 3,2 x11 –
 – conf. 10 – € 3,34
90070018 – misura 3,4 x 7 –
 – conf. 10 – € 2,72
90070019 – misura 3,4 x 9 –
 – conf. 10 – € 3,06
90070021 – misura 3,4 x12 –
 – conf. 10 – € 3,50
90070022 – misura 3,4 x14 –
 – conf. 10 – € 3,72
 segue...

&M900



continua...
90070025 – misura 4,0 x 11 –
 – conf. 10 – € 3,38
90070026 – misura 4,0 x 12 –
 – conf. 10 – € 3,90
90070027 – misura 4,0 x 14 –
 – conf. 10 – € 4,12
90070028 – misura 4,0 x 16 –
 – conf. 10 – € 4,50
90070032 – misura 4,8 x 9 –
 – conf. 10 – € 4,14
 segue...

&M900



continua...
90070034 – misura 4,8 x 12 –
 – conf. 10 – € 4,56
90070035 – misura 4,8 x 14 –
 – conf. 10 – € 5,52
90070036 – misura 4,8 x 16 –
 – conf. 10 – € 6,08
90070037 – misura 4,8 x 18 –
 – conf. 10 – € 6,88
90070038 – misura 4,8 x 20 –
 – conf. 10 – € 7,50

&M900



FASCETTA STRINGITUBO VITE Nastro H. mm 5

90078700 – misura 7-11 –
 – conf. 100 – € 0,40
90078701 – misura 11-19 –
 – conf. 100 – € 0,40

&M900



FASCETTA STRINGITUBO AVITE Nastro H.mm 8

90078710 – misura 10-18 –
 – conf. 100 – € 0,48
90078711 – misura 14-24 –
 – conf. 100 – € 0,48
90078712 – misura 17-29 –
 – conf. 100 – € 0,48
90078713 – misura 25-37 –
 – conf. 50 – € 0,54
90078714 – misura 25-45 –
 – conf. 50 – € 0,54
 segue...

&M900



continua...
90078715 – misura 33-53 –
 – conf. 50 – € 0,56
90078716 – misura 40-60 –
 – conf. 50 – € 0,56
90078717 – misura 48-69 –
 – conf. 50 – € 0,58
90078718 – misura 63-83 –
 – conf. 50 – € 0,60
90078719 – misura 78-98 –
 – conf. 50 – € 0,64
90078720 – misura 93-113 –
 – conf. 50 – € 0,74

&M900



FASCETTA STRINGITUBO A VITE Nastro H 14mm

90078740 – Misura 14- 22 –
 – conf. 50 – € 0,58
90078741 – Misura 17- 29 –
 – conf. 50 – € 0,60
90078742 – Misura 25- 37 –
 – conf. 50 – € 0,60
90078743 – Misura 25- 45 –
 – conf. 50 – € 0,60
90078744 – Misura 33- 53 –
 – conf. 50 – € 0,62
 segue...

&M900











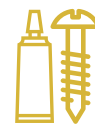



continua...
90078745 – Misura 40- 60 –
 – conf. 50 – € 0,64
90078746 – Misura 48- 68 –
 – conf. 50 – € 0,68
90078747 – Misura 63- 83 –
 – conf. 50 – € 0,68
90078748 – Misura 78- 98 –
 – conf. 50 – € 0,80
90078749 – Misura 93-113 –
 – conf. 50 – € 0,92
 segue...

&M900



continua...
90078750 – Misura 108-128 –
 – conf. 50 – € 1,04
90078751 – Misura 123-143 –
 – conf. 50 – € 1,16
90078752 – Misura 138-158 –
 – conf. 50 – € 1,24
90078753 – Misura 153-173 –
 – conf. 50 – € 1,36
90078754 – Misura 168-188 –
 – conf. 50 – € 1,44



<p>fischer</p> <p>TASSELLO UX nylon</p> <p>50071541 – mod. UX – misura 6x35 R – – conf. 100 – € 0,08 50071543 – mod. UX – misura 8x50 R – – conf. 50 – € 0,12</p> 	<p>fischer</p> <p>TASSELLO UX-S nylon vite truciolare TSP</p> <p>50071547 – misura 5x30 – R S 5 – – conf. 100 – € 0,19 50071548 – misura 6x35 – R S 10 – – conf. 100 – € 0,20 50071550 – misura 8x50 – R S 10 – – conf. 50 – € 0,30</p> 
<p>fischer</p> <p>TASSELLO nylon</p> <p>500500131 – mod. S 4 – – conf. 100 – € 0,06 500500132 – mod. S 5 – – conf. 100 – € 0,06 500500133 – mod. S 6 – – conf. 100 – € 0,06 500500135 – mod. S 8 – – conf. 100 – € 0,10 500500136 – mod. S 10 – – conf. 50 – € 0,17</p> 	<p>fischer</p> <p>TASSELLO BI-MATERIALE DUOPOWER nylon senza vite Combinazione di 2 materiali e 3 modalità di espansione assicura una maggiore capacità di carico, estensione, piegatura e annodamento. Adatto per installazioni passanti e non passanti. Utilizzo: calcestruzzo, mattone pieno/semipieno, cartongesso, pietra, cartongesso</p> <p>500537639 – Ø 5 – Mod. Duopower 5 – – conf. 100 – € 0,07 500537640 – Ø 6 – Mod. Duopower 6 – – conf. 100 – € 0,08 segue...</p> 
<p>fischer</p> <p>continua...</p> <p>500537641 – Ø 8 – Mod. Duopower 8 – – conf. 100 – € 0,12 500537644 – Ø 10 – Mod. Duopower 10 – – conf. 50 – € 0,22</p> 	<p>fischer</p> <p>TASSELLO BI-MATERIALE DUOPOWER S nylon con vite Combinazione di 2 materiali e 3 modalità di espansione assicura una maggiore capacità di carico, estensione, piegatura e annodamento. Adatto per installazioni passanti e non passanti. Utilizzo: calcestruzzo, mattone pieno/semipieno, cartongesso, pietra, cartongesso</p> <p>500537645 – Ø 5 – Mod. Duopower 5 S – – conf. 100 – € 0,18 500537646 – Ø 6 – Mod. Duopower 6 S – – conf. 100 – € 0,20 segue...</p> 
<p>fischer</p> <p>continua...</p> <p>500537647 – Ø 8 – Mod. Duopower 8 S – – conf. 50 – € 0,30 500537648 – Ø 10 – Mod. Duopower 10 S – – conf. 25 – € 0,70</p> 	<p>G&B</p> <p>ESPOSITORE 18 CONFEZIONI TASSELLI BI-FIX Dimensioni: 280x260x160 Contiene le misure: Tassello Bi-Fix BF6-35V con vite 12 pezzi Tassello Bi-Fix BF8-45V con vite 6 pezzi Bi-Fix è il BI-Componente multi-espansione per tutti i materiali edili Tasselli contenuti: 51318125 – 325283 Tassello Bi-Fix BF6-35V con vite n° confezioni 12 pezzi – Quantità 100 (1200 pz) 51318130 – 325284 Tassello Bi-Fix BF8-45V con vite n° confezioni 6 pezzi – Quantità 50 (300 pz)</p> <p>513ESELF35 – – conf. 1 – € 238,00</p> 
<p>G&B</p> <p>TASSELLO BI-FIX Con vite Il BI-componente multi-espansione per tutti i materiali edili</p> <p>51318125 – mod. BF6-35V – Ø foro 6 – ØxL 6X35 – Vite 4.5x40 – conf. 100 – € 0,15 51318130 – mod. BF8-45V – Ø foro 8 – ØxL 8X45 – Vite 5x50 – conf. 50 – € 0,22</p> 	<p>G&B</p> <p>TASSELLI CONDOR Nylon senza bordo</p> <p>513HTC05 – Misura 5x25mm – – conf. 200 – € 0,02 513HTC06 – Misura 6x30mm – – conf. 200 – € 0,02 513HTC08 – Misura 8x40mm – – conf. 100 – € 0,04 513HTC10 – Misura 10x50mm – – conf. 50 – € 0,06</p> 
<p>G&B</p> <p>TASSELLI CONDOR Nylon con bordo</p> <p>513HTCB05 – Misura 5x25mm – – conf. 200 – € 0,02 513HTCB06 – Misura 6x30mm – – conf. 200 – € 0,02 513HTCB08 – Misura 8x40mm – – conf. 100 – € 0,04 513HTCB10 – Misura 10x50mm – – conf. 50 – € 0,06 513HTCB12 – Misura 12x60mm – – conf. 25 – € 0,13</p> 	<p>G&B</p> <p>TASSELLI GL in nylon Senza vite Materiale di ancoraggio: Pietra, Mattone pieno, Mattone vuoto</p> <p>51365001 – Misura 5x25mm – – conf. 200 – € 0,03 51365002 – Misura 6x30mm – – conf. 200 – € 0,03 51365115 – Misura 6x45mm – – conf. 100 – € 0,04 51365003 – Misura 8x40mm – – conf. 100 – € 0,05 51365116 – Misura 8x50mm – – conf. 100 – € 0,06 segue...</p> 

ESPERIENZA E INNOVAZIONE

Offriamo il massimo della qualità
per il vostro lavoro



G&B
FIXING INNOVATION



G&B Fissaggi S.r.l. Italia

Corso Savona, 22 - 10029 Villastellone (TO)
tel. +39 011 961 94 33 - fax +39 011 961 93 82
www.gebfissaggi.com - info@gebfissaggi.com

G&B Fissaggi UK

G&B Fissaggi Vertretung Deutschland

G&B Fissaggi Ibérica

G&B Fissaggi Benelux

G&B Fissaggi France

BI·FIX

la rivoluzione nel fissaggio

il **BI-componente** multi-espansione per tutti i materiali edili

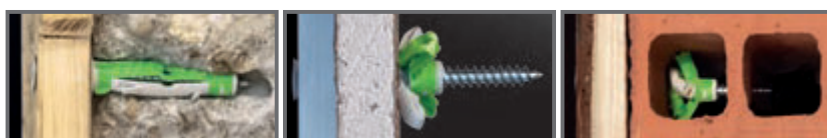
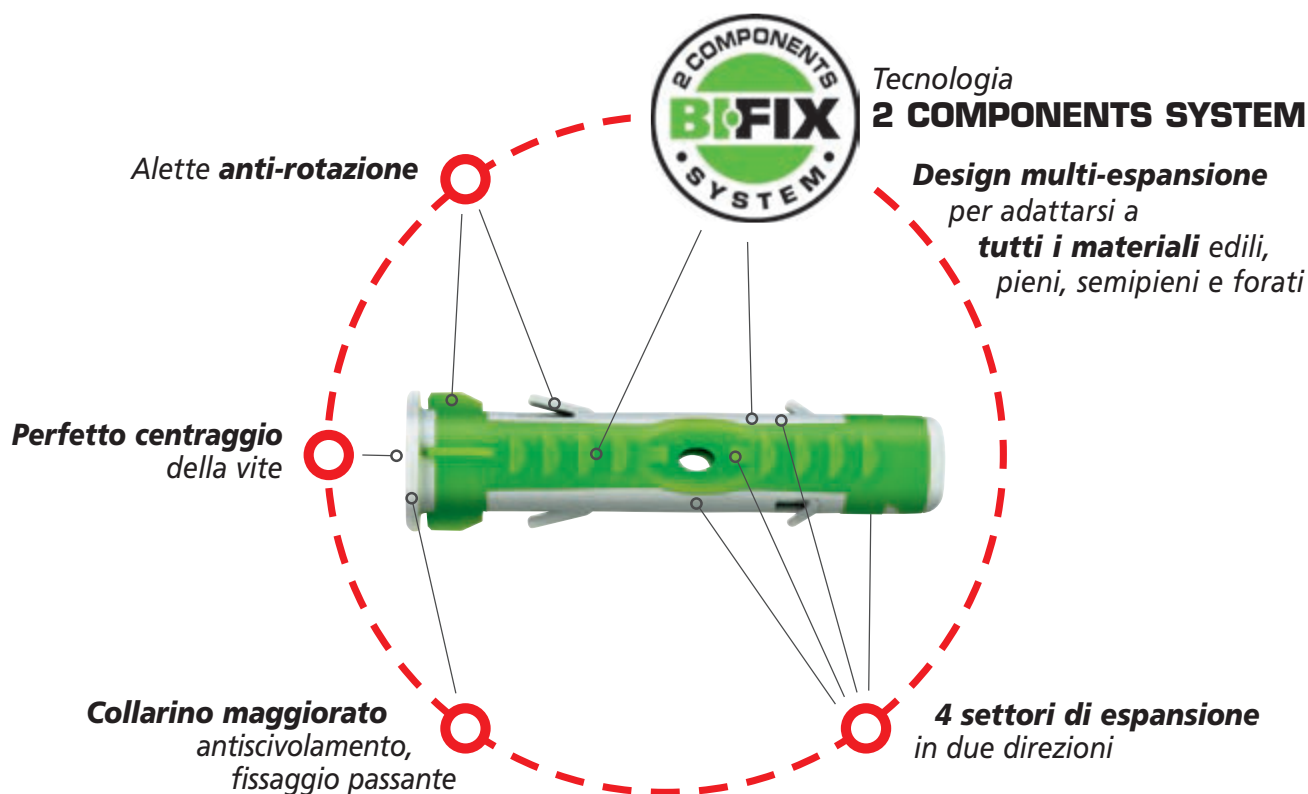

Grazie alla tecnologia **2 materiali** e al **design esclusivo**:

- **Sicurezza** della perfetta installazione
- **Alti valori di carico**
- **1 solo tassello** per tutti i tuoi progetti











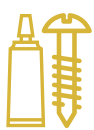















**ESTREMA TENUTA + MASSIMA ADATTABILITA' =
IL FISSAGGIO PERFETTO PER OGNI SITUAZIONE**

























guarda il video

www.gebfissaggi.com









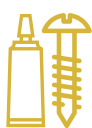





 <p>continua...</p> <p>51365004 - Misura 10x50mm - - conf. 75 - € 0,09</p> <p>51365017 - Misura 12x60mm - - conf. 25 - € 0,20</p> <p>51365018 - Misura 14x70mm - - conf. 25 - € 0,05</p> 	 <p>TASSELLI GL in nylon con vite Materiale di ancoraggio: Pietra, Mattone pieno, Mattone vuoto</p> <p>51365005 - Misura 5x25mm - - conf. 100 - € 0,05</p> <p>51365006 - Misura 6x30mm - - conf. 100 - € 0,06</p> <p>51365119 - Misura 6x45mm - - conf. 100 - € 0,08</p> <p>51365007 - Misura 8x40mm - - conf. 50 - € 0,10</p> <p>51365120 - Misura 8x50mm - - conf. 50 - € 0,14</p> <p>segue...</p> 
 <p>continua...</p> <p>51365008 - Misura 10x50mm - - conf. 50 - € 0,16</p> 	 <p>TASSELLI GL Nylon multiuso con vite T.E mordente e rondella</p> <p>51365064 - Misura 8x40mm - - conf. 50 - € 0,16</p> <p>51365065 - Misura 10x50mm - - conf. 25 - € 0,30</p> <p>51365066 - Misura 12x60mm - - conf. 25 - € 0,46</p> <p>51365067 - Misura 14x70mm - - conf. 20 - € 0,70</p> 
 <p>TASSELLI CONDOR Nylon con bordo con viti truciolari t.p.s. taglio a croce zincate bianche</p> <p>513HTCB55 - Misura 5x25mm - - conf. 100 - € 0,04</p> <p>513HTCB65 - Misura 6x30mm - - conf. 100 - € 0,05</p> <p>513HTCB85 - Misura 8x40mm - - conf. 100 - € 0,08</p> 	 <p>TASSELLI CONDOR Nylon senza bordo con viti truciolari t.p.s. taglio croce zincate bianche</p> <p>513HTC55 - Misura 5x25mm - - conf. 100 - € 0,04</p> <p>513HTC65 - Misura 6x30mm - - conf. 100 - € 0,05</p> <p>513HTC85 - Misura 8x40mm - - conf. 100 - € 0,08</p> 
 <p>TASSELLI NYLON RX</p> <p>90031230 - Misura RX 5x25 - - conf. 200 - € 0,03</p> <p>90031231 - Misura RX 6x30 - - conf. 200 - € 0,03</p> <p>90031232 - Misura RX 8x40 - - conf. 100 - € 0,06</p> <p>90031233 - Misura RX 10x50 - - conf. 50 - € 0,08</p> <p>90031234 - Misura RX 12x60 - - conf. 25 - € 0,16</p> 	 <p>TASSELLI NYLON RX CON VITE</p> <p>90031236 - Misura RX 5x25 - - conf. 100 - € 0,07</p> <p>90031237 - Misura RX 6x30 - - conf. 100 - € 0,06</p> <p>90031238 - Misura RX 8x40 - - conf. 50 - € 0,12</p> <p>90031239 - Misura RX 10x50 - - conf. 50 - € 0,24</p> 
 <p>TASSELLO FU nylon</p> <p>500502345 - mod. FU - misura 6 x 35 - - conf. 100 - € 0,20</p> <p>500502346 - mod. FU - misura 6 x 45 - - conf. 100 - € 0,20</p> <p>50002348 - mod. FU - misura 8 x 50 - - conf. 100 - € 0,26</p> <p>500502350 - mod. FU - misura 10 x 60 - - conf. 50 - € 0,40</p> 	 <p>TASSELLO FU-V nylon con vite</p> <p>500502351 - mod. FU 6 x 35 V - - conf. 100 - € 0,30</p> <p>500502352 - mod. FU 6 x 45 V - - conf. 100 - € 0,36</p> <p>500502353 - mod. FU 8 x 50 V - - conf. 50 - € 0,42</p> <p>500502354 - mod. FU 10 x 60 V - - conf. 25 - € 0,68</p> 
 <p>TASSELLO FU-H nylon Cancano</p> <p>500502363 - mod. FU 6 x 35 H - - conf. 25 - € 1,12</p> <p>500502364 - mod. FU 8 x 50 H - - conf. 25 - € 1,20</p> 	 <p>TASSELLI GBU Nylon con bordo</p> <p>513HGBU06 - Misura 6x40mm - - conf. 200 - € 0,03</p> <p>513HGBU08 - Misura 8x50mm - - conf. 100 - € 0,06</p> <p>513HGBU10 - Misura 10x60mm - - conf. 50 - € 0,10</p> 



  <p>TASSELLI GBU Nylon con bordo con viti t.p.s. taglio croce zincate bianche</p> <p>513HGBUV06 – Misura 6x40mm – – conf. 100 – € 0,06 513HGBUV08 – Misura 8x50mm – – conf. 50 – € 0,12 513HGBUV10 – Misura 10x60mm – – conf. 50 – € 0,24</p>	  <p>TASSELLO S14 ROE PER PONTEGGI in nylon per occhioli GS 12</p> <p>50052161 – mod. S14 ROE 100 – – conf. 25 – € 0,90</p>
  <p>TASSELLO SXRL-WT nylon Prolungato Vite zincata tsp torx Adatto per: calcestruzzo – mattone – pietra naturale Per fissare: porte – finestre – corrimano</p> <p>500506472 – Mod. SXRL 6 XR 60 WT – – conf. 100 – € 0,34 500506473 – Mod. SXRL 8 XR 60 WT – – conf. 50 – € 0,48 500506474 – Mod. SXRL 8 XR 80 WT – – conf. 50 – € 0,56 500506475 – Mod. SXRL 8 XR 100 WT – – conf. 50 – € 0,74 <i>segue...</i></p>	 <p><i>continua...</i></p> <p>500506476 – Mod. SXRL 8 XR 120 WT – – conf. 50 – € 0,88 500506477 – Mod. SXRL 10 XR 80 WT – – conf. 50 – € 0,94 500506478 – Mod. SXRL 10 XR 100 WT – – conf. 50 – € 1,04 500506479 – Mod. SXRL 10 XR 120 WT – – conf. 50 – € 0,98 500506480 – Mod. SXRL 10 XR 140 WT – – conf. 50 – € 1,28 500506481 – Mod. SXRL 10 XR 160 WT – – conf. 50 – € 1,50</p>
  <p>TASSELLI GX-L Nylon con vite T.P.S taglio TORX T30 e T40 vite Ø 5,5 mm cementata vite Ø 7mm acciaio 5.8</p> <p>51397005 – Vite 5,5x85mm – – conf. 50 – € 0,36 51397006 – Vite 5,5x105mm – – conf. 50 – € 0,44 51397007 – Vite 5,5x125mm – – conf. 50 – € 0,52 51397035 – Vite 5,5x145mm – – conf. 50 – € 0,64 <i>segue...</i></p>	 <p><i>continua...</i></p> <p>51397177 – Vite 5,5x175mm – – conf. 50 – € 0,96 51397178 – Vite 5,5x205mm – – conf. 50 – € 1,38 51397008 – Vite 7x85mm – – conf. 50 – € 0,50 51397009 – Vite 7x105mm – – conf. 50 – € 0,56 51397010 – Vite 7x125mm – – conf. 50 – € 0,68 <i>segue...</i></p>
  <p><i>continua...</i></p> <p>51397011 – Vite 7x145mm – – conf. 50 – € 0,74 51397012 – Vite 7x165mm – – conf. 50 – € 0,86 51397013 – Vite 7x205mm – – conf. 25 – € 1,26 51397014 – Vite 7x245mm – – conf. 20 – € 1,74 51397015 – Vite 10x260mm – – conf. 20 – € 1,90</p>	  <p>TASSELLO SXR-VAE nylon Prolungato con vite non premontata antifurto testa a borchia con impronta TX e stellina SXR VAE Adatto per: calcestruzzo – mattone – pietra naturale Per fissare: porte – finestre – corrimano Ridotta profondità di posa</p> <p>500505603 – Misura 10x80 – – conf. 100 – € 1,12 500505604 – Misura 10x100 – – conf. 100 – € 1,26 500505605 – Misura 10x120 – – conf. 100 – € 1,38 <i>segue...</i></p>
  <p><i>continua...</i></p> <p>500505606 – Misura 10x140 – – conf. 100 – € 1,54</p>	  <p>TASSELLI ESPANSIBILI KPD CON VITE Vite TSP Torx Impronta vita 40</p> <p>90031240 – Misura KPD 10/80 – – conf. 50 – € 0,56 90031241 – Misura KPD 10/100 – – conf. 50 – € 0,76 90031243 – Misura KPD 10/140 – – conf. 25 – € 0,94 90031244 – Misura KPD 10/160 – – conf. 25 – € 1,20</p>
  <p>TASSELLO FUR-T Nylon Con vite premontata torx</p> <p>50070110 – misura 8x80 – – conf. 50 – € 1,16</p>	  <p>TASSELLI TURBO JET Nylon con collarino bombato colore grigio RAL 7035 vite a chiodo T.P.S. zincata bianca</p> <p>51393003 – Misura 6x32mm – – conf. 100 – € 0,07</p>









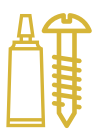





<p>fischer</p> <p>TASSELLO FUR-T Nylon Con vite premontata torx</p> <p>50070111 - misura 8x100 - - conf. 50 - € 1,28</p> 	<p>G&B</p> <p>TASSELLI TURBO JET Nylon con collarino bombato colore RAL 7035 vite a chiodo T.P.S. zincata bianca</p> <p>51393004 - Misura 6x40mm - - conf. 100 - € 0,07</p> 
<p>fischer</p> <p>TASSELLO FUR-T Nylon Con vite premontata torx</p> <p>50070112 - misura 8x120 - - conf. 50 - € 1,44</p> 	<p>G&B</p> <p>TASSELLI TURBO JET Nylon con collarino bombato colore grigio RAL 7035 vite a chiodo T.P.S. zincata bianca</p> <p>51393005 - Misura 6x55mm - - conf. 50 - € 0,08</p> 
<p>fischer</p> <p>TASSELLO FUR-T Nylon Con vite premontata torx</p> <p>50088756 - misura 10x80 - - conf. 50 - € 1,30</p> <p>50088757 - misura 10x100 - - conf. 50 - € 1,42</p> <p>50088760 - misura 10x115 - - conf. 50 - € 1,50</p> <p>50088758 - misura 10x135 - - conf. 50 - € 1,60</p> <p>50088759 - misura 10x160 - - conf. 50 - € 2,60</p> <p>segue...</p> 	<p>fischer</p> <p>continua...</p> <p>50088761 - misura 10x185 - - conf. 50 - € 4,20</p> <p>50088764 - misura 10x200 - - conf. 50 - € 4,40</p> <p>50088762 - misura 10x230 - - conf. 50 - € 5,00</p> 
<p>G&B</p> <p>TASSELLI TURBO JET Nylon con collarino svasato vite a chiodo T.P.S. zincata bianca</p> <p>51393026 - mod. 5x37mm - - conf. 100 - € 0,07</p> <p>51393027 - mod. 5x47mm - - conf. 100 - € 0,07</p> <p>51393028 - mod. 6x32mm - - conf. 100 - € 0,07</p> <p>51393029 - mod. 6x40mm - - conf. 100 - € 0,07</p> <p>51393030 - mod. 6x55mm - - conf. 100 - € 0,08</p> <p>segue...</p> 	<p>G&B</p> <p>continua...</p> <p>51393031 - mod. 6x67mm - - conf. 100 - € 0,09</p> <p>51393032 - mod. 6x80mm - - conf. 50 - € 0,12</p> <p>51393034 - mod. 8x60mm - - conf. 100 - € 0,15</p> <p>51393035 - mod. 8x75mm - - conf. 100 - € 0,17</p> <p>51393036 - mod. 8x100mm - - conf. 50 - € 0,24</p> <p>segue...</p> 
<p>G&B</p> <p>continua...</p> <p>51393037 - mod. 8x120mm - - conf. 50 - € 0,28</p> <p>51393038 - mod. 8x135mm - - conf. 50 - € 0,32</p> 	<p>G&B</p> <p>TASSELLI TURBO Nylon Ø 10 mm con bordo svasato colore grigio RAL 7035 vite T.P.S. zincata bianca</p> <p>51341242 - Misura 10x100 - - conf. 50 - € 0,60</p> <p>51341243 - Misura 10x120 - - conf. 50 - € 0,64</p> <p>51341244 - Misura 10x140 - - conf. 25 - € 0,74</p> 
<p>G&B</p> <p>TASSELLI GX-L Nylon con vite T.E. vite Ø 7mm acciaio 5.8</p> <p>51397126 - Vite 5,5X85mm - Misura 8x80mm - - conf. 50 - € 0,36</p> 	<p>G&B</p> <p>TASSELLI LATER CORNICE Nylon Ø 8mm con vite T.P.S. taglio POZIDRIVE cementata</p> <p>513HTLAU01 - Misura 8X80mm - - conf. 50 - € 0,40</p> 



























 <p>TASSELLI GX-L Nylon con vite T.E. vite Ø 7mm acciaio 5.8</p> <p>51397127 – Vite 5,5x105mm – Misura 8x100mm – - conf. 25 – € 0,42</p> 	 <p>TASSELLI LATER CORNICE Nylon Ø 8mm con vite T.P.S. taglio POZIDRIVE cementata</p> <p>513HTLAU02 – Misura 8x100mm – - conf. 50 – € 0,54</p> 
 <p>TASSELLI GX-L Nylon con vite T.E. vite Ø 7mm acciaio 5.8</p> <p>51397022 – Vite 7x85mm – Misura 10x80mm – - conf. 100 – € 0,54</p> 	 <p>TASSELLI LATER CORNICE Nylon Ø 8mm con vite T.P.S. taglio POZIDRIVE cementata</p> <p>513HTLAU07 – Misura 8x120mm – - conf. 50 – € 0,36</p> 
 <p>TASSELLI GX-L Nylon con vite T.E. vite Ø 7mm acciaio 5.8</p> <p>51397023 – Vite 7x105mm – Misura 10x100mm – - conf. 50 – € 0,62</p> <p>51397024 – Vite 7x125mm – Misura 10x120mm – - conf. 50 – € 0,70</p> <p>51397025 – Vite 7x145mm – Misura 10x140mm – - conf. 50 – € 0,82</p> 	 <p>TASSELLI GX-L Nylon Ø 10mm con vite VAST ANTINTRUSIONE TORX T40 acciaio 5.8 completa di inserto a stella coprivite zincato bianco</p> <p>51397089 – Vite 7x85mm – Misura 10x80mm – - conf. 50 – € 0,60</p> 
 <p>TASSELLI LATER CORNICE Nylon Ø 10mm con vite T.P.S. taglio POZIDRIVE acciaio 5.8</p> <p>513HTLAU04 – Misura 10x80mm – - conf. 50 – € 0,56</p> 	 <p>TASSELLI GX-L Nylon Ø 10mm con vite VAST ANTINTRUSIONE TORX T40 acciaio 5.8 completa di inserto a stella coprivite zincato bianco</p> <p>51397090 – Vite 7x105mm – Misura 10x100mm – - conf. 50 – € 0,68</p> 
 <p>TASSELLI LATER CORNICE Nylon Ø 10mm con vite T.P.S. taglio POZIDRIVE acciaio 5.8</p> <p>513HTLAU08 – Misura 10x100mm – - conf. 50 – € 0,46</p> 	 <p>TASSELLI GX-L Nylon Ø 10mm con vite VAST ANTINTRUSIONE TORX T40 acciaio 5.8 completa di inserto a stella coprivite zincato bianco</p> <p>51397091 – Vite 7x125mm – Misura 10x120mm – - conf. 50 – € 0,82</p> 
 <p>TASSELLI LATER CORNICE Nylon Ø 10mm con vite T.P.S. taglio POZIDRIVE acciaio 5.8</p> <p>513HTLAU10 – Misura 10x120mm – - conf. 50 – € 0,40</p> 	 <p>TASSELLI CASA Nylon</p> <p>513HTS07 – mod. 9x40mm – vite M4X50 – - conf. 150 – € 0,26</p> <p>513HTL07 – mod. 12x45mm – vite M5X55 – - conf. 100 – € 0,30</p> 



<p>fischer</p> <p>TASSELLO N nylon con vite a chiodo Fissaggio veloce a percussione. Adatto a: Pannelli leggeri Lamiere sottili Sottostrutture legno o metallo</p> <p>50098826 - Mod. N 4 x 35/10S - - conf. 100 - € 0,10</p> 	<p>G&B</p> <p>TASSELLI CASA Nylon</p> <p>513HTS04 - mod. 9x40mm - vite M4X35 - - conf. 100 - € 0,26</p> 
<p>fischer</p> <p>TASSELLO N nylon con vite a chiodo Fissaggio veloce a percussione. Adatto a: Pannelli leggeri Lamiere sottili Sottostrutture legno o metallo</p> <p>50048788 - Mod. N 6 x 40/10S - - conf. 100 - € 0,24</p> <p>50048789 - Mod. N 6 x 60/30S - - conf. 100 - € 0,24</p> <p>50048790 - Mod. N 6 x 80/50S - - conf. 100 - € 0,26</p> <p>50048791 - Mod. N 8 x 60/20S - - conf. 100 - € 0,30</p> <p>50050358 - Mod. N 8 x 80/40S - - conf. 50 - € 0,34</p> 	<p>G&B</p> <p>TASSELLI CASA Nylon</p> <p>513HTL04 - mod. 12x45mm - vite M4X35 - - conf. 50 - € 0,34</p> 
<p>fischer</p> <p>TASSELLO N nylon con vite a chiodo Fissaggio veloce a percussione. Adatto a: Pannelli leggeri Lamiere sottili Sottostrutture legno o metallo</p> <p>50050357 - Mod. N 8 x 100/60S - - conf. 50 - € 0,46</p> <p>50050359 - Mod. N 8 x 120/80S - - conf. 50 - € 0,60</p> <p>50050346 - Mod. N 10 x 100/50S - - conf. 50 - € 0,76</p> <p>50050347 - Mod. N 10 X 135/85S - - conf. 50 - € 0,92</p> <p>segue...</p> 	<p>fischer</p> <p>continua...</p> <p>50050348 - Mod. N 10 x 160/110S - - conf. 50 - € 1,24</p> <p>50050335 - Mod. N 10 x 230/180S - - conf. 50 - € 2,80</p> 
<p>fischer</p> <p>TASSELLO SXRL nylon Fissaggio prolungato con vite in acciaio a testa esagonale e impronta TX SXRL-FUS. Adatta a: Mattone pieno Calcestruzzo Blocchi isolam. termico Pannelli pieni cartongesso</p> <p>500522719 - Mod. SXRL 10x80 FUS - - conf. 50 - € 1,04</p> <p>500522720 - Mod. SXRL 10x100 FUS - - conf. 50 - € 1,14</p> 	<p>G&B</p> <p>TASSELLI CASA Nylon</p> <p>513HTS03 - Misura 9x40mm - - conf. 100 - € 0,24</p> <p>513HTL03 - Misura 12x45mm - - conf. 50 - € 0,26</p> 
<p>G&B</p> <p>TASSELLI CASA Acciaio</p> <p>513HT81 - Misura 8X35 mm - Vite M4 - - conf. 100 - € 0,26</p> <p>513HT91 - Misura 9X40 mm - Vite M5 - - conf. 100 - € 0,32</p> 	<p>G&B</p> <p>TASSELLI CASA Acciaio</p> <p>513HT82 - Misura 8X35 mm - Vite M4 - - conf. 100 - € 0,30</p> <p>513HT92 - Misura 9x40 mm - Vite M5 - - conf. 100 - € 0,30</p> 
<p>G&B</p> <p>TASSELLI CASA Mod. CA9-40/1 CA12-45/1 Nylon</p> <p>513HTS01 - Misura 9x40mm - - conf. 100 - € 0,28</p> <p>513HTL01 - Misura 12x45mm - - conf. 50 - € 0,36</p> 	<p>G&B</p> <p>TASSELLI CASA Mod. CA9-40/2 CA12-45/2 Nylon</p> <p>513HTS02 - Misura 9X40mm - - conf. 100 - € 0,30</p> <p>513HTL02 - Misura 12x45mm - - conf. 50 - € 0,36</p> 





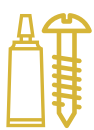



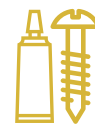





 <p>TASSELLI CASA Nylon Occhielli chiusi 513HTS06 – mod. 9x40mm – vite M4 – – conf. 100 – € 0,32 513HTL06 – mod. 12x45mm – vite M5 – – conf. 50 – € 0,42</p> 	 <p>TASSELLI CASA Nylon 513HTS05 – Misura 9x40mm – – conf. 100 – € 0,32 513HTL05 – Misura 12x45mm – – conf. 50 – € 0,40</p> 
 <p>TASSELLI CASA Acciaio 513HT83 – Misura 8X35mm – Vite M4 – – conf. 100 – € 0,28 513HT93 – Misura 9x40mm – Vite M5 – – conf. 50 – € 0,34</p> 	 <p>TASSELLI CASA Acciaio 513HT84 – Misura 8x35mm – Vite M4 – – conf. 100 – € 0,30 513HT94 – Misura 9x40mm – Vite M5 – – conf. 50 – € 0,36</p> 
 <p>TASSELLI CASA Acciaio 513HT65 – Misura 6x30mm – – conf. 200 – € 0,24 513HT85 – Misura 8x35mm – – conf. 200 – € 0,24 513HT95 – Misura 9x40mm – – conf. 150 – € 0,28</p> 	 <p>Confezine 10 APPENDIQUADRI S 4 S nylon gancio ottonato 500500250 – – conf. 1 – € 4,20</p> 
 <p>TASSELLO SB 9/4 NYLON a vite 500500344 – – conf. 100 – € 0,30</p> 	 <p>TASSELLO SB 9 L 4 NYLON prolungato a vite 500500354 – – conf. 100 – € 0,46</p> 
 <p>TASSELLO SB 9/8 NYLON gancio corto 500500348 – – conf. 100 – € 0,30</p> 	 <p>TASSELLO SB 9 L 8 NYLON prolungato Gancio corto 500500358 – – conf. 100 – € 0,46</p> 
 <p>TASSELLO SB 9/2 NYLON Gancio medio 500500342 – – conf. 100 – € 0,34</p> 	 <p>TASSELLO SB 9/6 NYLON Gancio lungo 500500346 – – conf. 50 – € 0,38</p> 









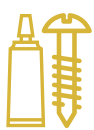





 <p>TASSELLO SB 9/1 NYLON Occhiolo aperto 500500341 - - conf. 100 - € 0,38</p> 	 <p>TASSELLO SB 9/3 NYLON Occhiolo chiuso 500500343 - - conf. 100 - € 0,38</p> 
 <p>TASSELLO SB 9/5 M 4X35 NYLON Viti doppia 500500345 - - conf. 50 - € 0,50</p> 	 <p>TASSELLO NYLON SBN 9/4 Vite 500500394 - - conf. 200 - € 0,34</p> 
 <p>TASSELLO NYLON SBN 9/8 Gancio corto 500500398 - - conf. 200 - € 0,34</p> 	 <p>TASSELLO NYLON SBN 9/1 Occhiolo aperto 500500391 - - conf. 100 - € 0,52</p> 
 <p>TASSELLO NYLON SBN Ø 9/2 Gancio medio 500500392 - - conf. 200 - € 0,36</p> 	 <p>TASSELLO NYLON SB 12/4 a vite 500500364 - - conf. 100 - € 0,44</p> 
 <p>TASSELLO NYLON SB 12 L 4 prolungato a vite 500500374 - - conf. 50 - € 0,60</p> 	 <p>TASSELLO NYLON SB 12/8 Gancio corto 500500368 - - conf. 50 - € 0,40</p> 
 <p>TASSELLO NYLON SB 12 L 8 prolungato Gancio corto 500500378 - - conf. 50 - € 0,60</p> 	 <p>TASSELLO NYLON SB 12/2 Gancio medio 500500362 - - conf. 100 - € 0,44</p> 



<p>fischer</p> <p>TASSELLO NYLON SB 12 L 2 prolungato Gancio medio</p> <p>500500372 - - conf. 50 - € 0,62</p> 	<p>fischer</p> <p>TASSELLO NYLON SB 12/6 Gambo lungo</p> <p>500500366 - - conf. 50 - € 0,50</p> 
<p>fischer</p> <p>TASSELLO NYLON SB 12/1 occhio aperto</p> <p>500500361 - - conf. 50 - € 0,56</p> 	<p>fischer</p> <p>TASSELLO NYLON SB 12/3 occhio chiuso</p> <p>500500363 - - conf. 50 - € 0,54</p> 
<p>fischer</p> <p>TASSELLO NYLON SB 12/5 M 5 x 40</p> <p>50000365 - - conf. 50 - € 0,74</p> 	<p>fischer</p> <p>TASSELLO NYLON SB 12/10 Gancio piatto regolabile</p> <p>500500370 - - conf. 25 - € 1,18</p> 
<p>G&B</p> <p>ANCORANTI GBM/C Acciaio con occhio</p> <p>513TGBMC06 - MOD. 12x42mm - vite M6X50 - - conf. 50 - € 1,24</p> <p>513TGBMC08 - MOD. 14x50mm - vite M8X60 - - conf. 25 - € 1,54</p> <p>513TGBMC10 - MOD. 16x60mm - vite M10X80 - - conf. 20 - € 2,40</p> 	<p>G&B</p> <p>TASSELLI RAPID Nylon autoforante per pareti cartongesso</p> <p>513HRN01 - Misura 16X38mm - - conf. 200 - € 0,09</p> 
<p>G&B</p> <p>TASSELLI RAPID Nylon completo di vite T.P.S. taglio croce zincata bianca Misura vite: 4,5x50 mm</p> <p>513HRNV01 - Misura 16x38mm - - conf. 100 - € 0,13</p> 	<p>fischer</p> <p>TASSELLO GK PER CARTONGESSO 1 inserto per confezione GWK per avvvitamento</p> <p>50052389 - Vite Non inclusa - - conf. 100 - € 0,28</p> 
<p>fischer</p> <p>TASSELLI GKM PER CARTONGESSO autofilet-tante in metallo</p> <p>50024556 - - conf. 100 - € 0,44</p> 	<p>fischer</p> <p>TASSELLO CON VITE GKS Con vite Il tassello più veloce per l'installazione del cartongesso</p> <p>50052390 - Vite Inclusa - - conf. 100 - € 0,50</p> 



<p>fischer</p> <p>TASSELLO FID PER PANNELLI ISOLANTI In- stallazione rapida Avvitamento senza foratura Per fissaggio di: carichi leggeri cassette postali segnaletica</p> <p>50048213 - Mod. FID 50 - - conf. 50 - € 0,84 500510971 - Mod. FID 90 - - conf. 50 - € 1,22</p> 	<p>fischer</p> <p>TASSELLI PD PER CARTONGESSO CON VITE Per pannelli di vari spessori, compresi pannelli con cavità. Garantisce la massima flessibilità</p> <p>50024772 - Modello PD 8 S - Ø Foro 8 mm - Misura Viti 4x40 mm - - conf. 50 - € 0,64 50015936 - Modello PD 10 S - Ø Foro 10 mm - Misura Viti 5 mm - - conf. 50 - € 0,66</p> 
<p>fischer</p> <p>GKW inserto per GK</p> <p>50052393 - - conf. 10 - € 3,50</p> 	<p>fischer</p> <p>TASSELLO PD PER CARTONGESSO S/VITE Adatto per tutti i pannelli con spessore a partire da 6 mm</p> <p>50024771 - foro 8 - - conf. 100 - € 0,24 50015935 - foro 10 - - conf. 100 - € 0,32</p> 
<p>fischer</p> <p>TASSELLI GKM PER CARTONGESSO CON VITE Spessore min fino al primo strato portante 32 mm Attacco utensile PZ2</p> <p>50040432 - Spess. fissabile 12 mm - Dim. vite 4,5x35mm - - conf. 100 - € 0,74 50040434 - Spess. fissabile 27 mm - Dim. vite 4,5x50mm - - conf. 100 - € 0,88</p> 	<p>fischer</p> <p>ELEMENTO DI FISSAGGIO A PERCUSSIONE FIF-S R Misura 8/100 Per sistemi composti di isolamento termico esterno (ETICS) Idoneo per: Calcestruzzo - mattone pieno Blocco pieno in calcestruzzo Mattone semipieno</p> <p>500530530 - - conf. 100 - € 0,72</p> 
<p>fischer</p> <p>TASSELLO DUOBLASE S Con vite Tssello autofo- rante per installazioni facili e veloci su pannelli e lastre di cartongesso</p> <p>500545676 - - conf. 25 - € 0,84</p> 	<p>fischer</p> <p>TASSELLO DUOBLADE Tassello autoforante per installazioni facili e veloci su pannelli e lastre di cartongesso</p> <p>500545675 - - conf. 50 - € 0,50</p> 
<p>fischer</p> <p>TASSELLI HM S PER CARTONGESSO In metallo zincato Con vite metrica</p> <p>500519772 - Misura 5x37 - - conf. 50 - € 0,58 500519774 - Misura 5x52 - - conf. 50 - € 0,62 500519775 - Misura 5x65 - - conf. 50 - € 0,68 500519777 - Misura 6x37 - - conf. 50 - € 0,64 500519778 - Misura 6x52 - - conf. 50 - € 0,76 segue...</p> 	<p>fischer</p> <p>continua...</p> <p>500519782 - Misura 6x65 - - conf. 50 - € 0,78</p> 
<p>fischer</p> <p>ANCORINA DUOTEC In nylon -Ø del foro ridotto (10 mm) ed elemento basculante corto (39 mm) per una facile installazione in cavità strette ed isolate. -Elemento basculante bicomponente rinforzato con fibra di vetro e collare per elevati carichi di trazione e taglio. -Utilizzabile anche come fissaggio ad espansione per fori, in materiali pieni -Facile preassemblaggio, il collare prefissa il tassello senza vite. -E' possibile avvitare e svitare la vite più volte.</p> <p>500540177 - Misura 10 - - conf. 25 - € 0,92</p> 	<p>fischer</p> <p>ANCORINA DUOTEC 10 S + VITE TSP In nylon -Ø del foro ridotto (10 mm) ed elemento basculan- te corto (39 mm) per una facile installazione in cavità strette ed isolate. -Elemento basculante bicomponente rinforzato con fibra di vetro e col- lare per elevati carichi di trazione e taglio. -Uti- lizzabile anche come fissaggio ad espansione per fori, in materiali pieni -Facile preassemblaggio, il collare prefissa il tassello senza vite. -E' possibile avvitare e svitare la vite più volte.</p> <p>500540178 - Misura 10 S - - conf. 25 - € 1,04</p> 

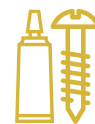







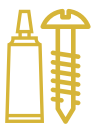





<p>Rapid</p> <p>ANCORINE ACCIAIO art.35 Ø 12 mm. Vite M4/80</p> <p>90031200 – - conf. 100 – € 0,46</p> 	<p>Rapid</p> <p>ANCORINE ACCIAIO art.37 Ø 12 mm. Occhiolo aperto M4</p> <p>90031202 – - conf. 100 – € 0,46</p> 
<p>Rapid</p> <p>ANCORINE ACCIAIO art.38 Ø 12 mm. Occhiolo chiuso M4</p> <p>90031203 – - conf. 100 – € 0,46</p> 	<p>Rapid</p> <p>ANCORINE ACCIAIO art.39 Ø 12 mm. Vite M4/100</p> <p>90031201 – - conf. 100 – € 0,46</p> 
<p>fischer</p> <p>ANCORINE ACCIAIO KD M6 – M8 KD 8 doppio dado</p> <p>500501466 – mod. KD6 – M6 – - conf. 25 – € 1,62 50080178 – mod. KD8 – M8 – - conf. 20 – € 4,40</p> 	<p>fischer</p> <p>ANCORINE ACCIAIO KD4 Con Bussola Ottone</p> <p>500501461 – - conf. 50 – € 0,98</p> 
<p>fischer</p> <p>ANCORINE ACCIAIO KDD 4 Doppio Dado M4</p> <p>500501463 – - conf. 50 – € 1,08</p> 	<p>fischer</p> <p>ANCORINE ACCIAIO KDH 4 Occhiolo aperto</p> <p>500501462 – - conf. 50 – € 0,98</p> 
<p>fischer</p> <p>ANCORINE ACCIAIO KDV 4 Vite e taglio combinato</p> <p>500501469 – - conf. 50 – € 0,96</p> 	<p>fischer</p> <p>ANCORINE ACCIAIO KDO 4 Occhiolo chiuso</p> <p>500501468 – - conf. 50 – € 1,04</p> 
<p>fischer</p> <p>ANCORINE ACCIAIO KDH M6 – KDH M8 con gancio</p> <p>500501467 – mod. KDH6 – M6 – - conf. 20 – € 1,74 50080179 – mod. KDH8 – M8 – - conf. 20 – € 5,60</p> 	<p>K&B</p> <p>ANCORETTE SOFFITTO ANCORA Acciaio DR</p> <p>513HAN11 – Vite M6x100mm – Ø 16 – Modello DR1 – - conf. 25 – € 1,26 513HAN12 – Vite M6x100mm – Ø 16 – Modello DR2 – - conf. 25 – € 1,26 513HAN13 – Vite M8x115mm – Ø 20 – Modello DR3 – - conf. 20 – € 2,40 513HAN14 – Vite M8x100mm – Ø 20 – Modello DR4 – - conf. 20 – € 2,40</p> 



 <p>ANCORETTE SOFFITTO ANCORA Acciaio DE</p> <p>513HAN01 - Vite M4x80mm - Ø 14 - Modello DE1 - - conf. 50 - € 0,50</p> <p>513HAN02 - Vite M4x75mm - Ø 14 - Modello DE2 - - conf. 50 - € 0,52</p> <p>513HAN03 - Vite M4x75mm - Ø 14 - Modello DE3 - - conf. 50 - € 0,54</p> <p>segue...</p> 	 <p>continua...</p> <p>513HAN04 - Vite M4x100mm - Ø 14 - Modello DE4 - - conf. 50 - € 0,56</p> <p>513HAN05 - Vite M4x100mm - Ø 15 - Modello DE5 - - conf. 50 - € 0,50</p> 
 <p>TASSELLO PFS 12 N NYLON Per fissaggi di scaldabagni su murature Particolarmente indicato per applicazioni su mattoni forati Contenuto busta: 2 tasselli PFM 10 N 2 cancani M10</p> <p>500517597 - - conf. 1 - € 3,80</p> 	 <p>FISSAGGIO WD 120 X Per lavabi e orinatoi</p> <p>500538945 - - conf. 50 - € 3,80</p> 
 <p>TASSELLO NYLON SANITARI WB5N Per vasi e bidet con calotta coprivite cromata busta 2 P.z.</p> <p>500501015 - - conf. 10 - € 7,20</p> 	 <p>CONFEZIONE 2 PEZZI SANIFIS SF2 L accessori per il fissaggio laterale per sanitari con calotta bianca tassello 10x50 mm</p> <p>513HSF02L - Misura 10x50mm - - conf. 40 - € 4,60</p> 
 <p>CONFEZIONE 4 PEZZI SANIFIS SF2 Inox A2 accessori per il fissaggio di sanitari a pavimento, con dado cieco M6 (chiave 10) tassello GL Nylon Misura barretta: M6x80mm</p> <p>513HSF02 - Misura 8x40mm - - conf. 4 - € 3,60</p> 	 <p>CONFEZIONE 2 PEZZI SANIFIS SF3 accessori per il fissaggio di sanitari a parete tassello GL Nylon</p> <p>513HSF310 - Misura 10x50mm - - conf. 25 - € 1,36</p> <p>513HSF320 - Misura 12x60mm - - conf. 25 - € 2,40</p> <p>513HSF340 - Misura 14x70mm - - conf. 25 - € 2,40</p> 
 <p>CONFEZIONI 2 PEZZI SANIFIS SF4 accessori per il fissaggio di scaldabagni tassello GL Nylon</p> <p>513HSF410 - Misura 10x50mm - - conf. 50 - € 0,90</p> <p>513HSF412 - Misura 12x60mm - - conf. 50 - € 1,48</p> <p>513HSF414 - Misura 14x70mm - - conf. 50 - € 1,74</p> 	 <p>CONFEZIONE 2 PEZZI SANIFIS SF5 accessori per lavabo con dado in acciaio tassello GL Nylon</p> <p>513HSF510 - Misura 10x50mm - - conf. 25 - € 2,20</p> <p>513HSF520 - Misura 12x60mm - - conf. 25 - € 3,00</p> <p>513HSF540 - Misura 14x70mm - - conf. 25 - € 4,00</p> 
 <p>TASSELLO NYLON SANITARI WDS X Tassello in nylon Fissaggio per scaldabagno, su murature portanti e cassette scaricatrici Kit composto da: 2 Tasselli SX + 2 cancani Espansione a 4 settori del tassello SX Materiali di supporto: Calcestruzzo Mattone pieno e semipieno in laterizio</p> <p>500538951 - Ø 10 mm - - conf. 5 - € 2,80</p> <p>500538952 - Ø 12 mm - - conf. 5 - € 3,20</p> <p>500538953 - Ø 14 mm - - conf. 5 - € 3,60</p> 	 <p>TASSELLO NYLON SANITARI WB2 Per vasi e bidet busta 4 Pz. INOX</p> <p>500501004 - - conf. 10 - € 3,60</p> 



<p>fischer</p> <p>TASSELLO NYLON SANITARI WB4 Per vasi e bidet fissaggio passante</p> <p>500501011 - - conf. 10 - € 5,00</p> 	<p>fischer</p> <p>TASSELLO NYLON SANITARI WD Per lavabi e sanitari a parete busta 2 P.z.</p> <p>500538943 - mod. WD -100 - - conf. 10 - € 3,60 500538946 - mod. WD -140 - - conf. 10 - € 4,80</p> 
<p>fischer</p> <p>TASSELLO NYLON SANITARI WST Per lavabi e sanitari a parete con dado in acciaio M10 Busta 2 pz</p> <p>500538949 - mod. WST -120 - - conf. 10 - € 3,40 500501042 - mod. WST -140 - - conf. 10 - € 4,20</p> 	<p>fischer</p> <p>TASSELLO NYLON SANITARI WD Per lavabi e sanitari a parete busta 2 P.z.</p> <p>500501033 - mod. WD -180 - - conf. 10 - € 8,20 50042911 - mod. WD -230 - - conf. 10 - € 9,40</p> 
<p>fischer</p> <p>TASSELLI THERMAX</p> <p>50045686 - Mod. 8/80 M6 - - conf. 20 - € 5,00 50045692 - Mod. 10/100 M6 - - conf. 20 - € 5,80 50045697 - Mod. 10/100 M8 - - conf. 20 - € 5,80</p> 	<p>fischer</p> <p>COLLARE PESANTE CPT acciaio zincato con vite e tassello</p> <p>500501130 - Mod.CPT 3/8 - - conf. 10 - € 1,32 500501131 - Mod.CPT 1/2 - - conf. 10 - € 1,28 500501132 - Mod.CPT 3/4 - - conf. 10 - € 1,28 500501133 - Mod.CPT 1 - - conf. 10 - € 1,32 500501134 - Mod.CPT 1.1/4 - - conf. 5 - € 1,52 segue...</p> 
<p>fischer</p> <p>continua...</p> <p>500501135 - Mod.CPT 1.1/2 - - conf. 5 - € 1,64 500501136 - Mod.CPT 2 - - conf. 5 - € 1,78 500501137 - Mod.CPT 2.1/2 - - conf. 5 - € 3,60 500501138 - Mod.CPT 3 - - conf. 5 - € 4,00</p> 	<p>fischer</p> <p>COLLARE SCP per PLUVIALI acciaio zincato</p> <p>500501301 - Mod. SCP Ø 80 - - conf. 10 - € 1,90 500501302 - Mod. SCP Ø 100 - - conf. 10 - € 2,20 500501303 - Mod. SCP Ø 120 - - conf. 10 - € 2,40</p> 
<p>fischer</p> <p>COLLARINO in acciaio P/ TUBI</p> <p>500501180 - Ø 10 - - conf. 50 - € 0,42 500501182 - Ø 12 - - conf. 50 - € 0,44 500501184 - Ø 13-14 - - conf. 50 - € 0,48 500501185 - Ø 16 - - conf. 50 - € 0,48 500501186 - Ø 18-19 - - conf. 50 - € 0,50 segue...</p> 	<p>fischer</p> <p>continua...</p> <p>500501187 - Ø 20 - - conf. 25 - € 0,50 500501188 - Ø 22 - - conf. 25 - € 0,52 500501189 - Ø 24 - - conf. 25 - € 0,56 500501190 - Ø 26 - - conf. 25 - € 0,58 500501191 - Ø 28 - - conf. 25 - € 0,60 segue...</p> 
<p>fischer</p> <p>continua...</p> <p>500501192 - Ø 32 - - conf. 20 - € 0,60 500501193 - Ø 32 - - conf. 10 - € 0,68 500501194 - Ø 42 - - conf. 10 - € 0,74 500501195 - Ø 50 - - conf. 10 - € 0,84 500501196 - Ø 60 - - conf. 5 - € 0,98</p> 	<p>CG&B</p> <p>CONFEZIONE 2 PEZZI COLLARE FAST Acciaio collari pesanti in acciaio per tubi completi di vite doppio filetto e tassello GL Nylon Tassello 10x50mm</p> <p>513TFAT01 - Ø 17 - - conf. 50 - € 1,90 513TFAT02 - Ø 21 - - conf. 50 - € 2,00 513TFAT03 - Ø 27 - - conf. 50 - € 2,20 513TFAT04 - Ø 33,5 - - conf. 50 - € 2,20 segue...</p> 

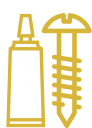

G&B

continua...

513TFAT05 - Ø 42,5 -
- conf. 50 - € 2,40

513TFAT06 - Ø 48 -
- conf. 50 - € 2,40

513TFAT07 - Ø 60 -
- conf. 25 - € 2,80

513TFAT08 - Ø 76 -
- conf. 25 - € 3,60

513TFAT09 - Ø 89 -
- conf. 25 - € 3,80



G&B

CONFEZIONE 2 PEZZI COLLARE TONDO PER PLUVIALI in acciaio zincato verniciato testa di moro completo di tassello GL Nylon Ø 10x60 mm dimensione fascia (spessore per larghezza) 1,5x27 Tassello 10x60mm

51338118 - Ø 80 - Modello CPL-TM 80 -
- conf. 50 - € 3,20

51338119 - Ø 100 - Modello CPL-TM 100 -
- conf. 50 - € 3,20

51338120 - Ø 120 - Modello CPL-TM 120 -
- conf. 50 - € 3,40



G&B

CONFEZIONE 2 PEZZI COLLARE TONDO PER PLUVIALI in acciaio zincato completo di tassello GL Nylon dimensione fascia (spessore per larghezza) 1,5x27mm Tassello 10x60mm

51338114 - Ø 60 - Modello CPL60 -
- conf. 50 - € 2,80

51338115 - Ø 80 - Modello CPL80 -
- conf. 50 - € 2,80

51338116 - Ø 100 - Modello CPL100 -
- conf. 50 - € 2,80

51338117 - Ø 120 - Modello CPL120 -
- conf. 50 - € 3,00



fischer

GAFFETTA in acciaio P/ TUBI

500501170 - Ø 10 -
- conf. 50 - € 0,11

500501171 - Ø 13 -
- conf. 50 - € 0,13

50001172 - Ø 16 -
- conf. 50 - € 0,14

50001173 - Ø 20 -
- conf. 50 - € 0,18

50001174 - Ø 22 -
- conf. 25 - € 0,22



G&B

ANCORANTI DELTA Acciaio con vite T.E 8.8 zincata bianca rondella maggiorata DIN 9021

51333027 - Misura 8X45mm -
- conf. 50 - € 0,26



fischer

GAFFETTA in acciaio P/ TUBI

500501175 - Ø 25 -
- conf. 25 - € 0,24

500501176 - Ø 28 -
- conf. 25 - € 0,28

500501177 - Ø 32 -
- conf. 20 - € 0,32

500501178 - Ø 40 -
- conf. 5 - € 0,68

500501179 - Ø 50 -
- conf. 5 - € 0,74



G&B

ANCORANTI DELTA Acciaio con vite T.E 8.8 zincata bianca rondella maggiorata DIN 9021

51333028 - Misura 8x70mm -
- conf. 50 - € 0,34

51333145 - Misura 8x90mm -
- conf. 50 - € 0,40

51333029 - Misura 10x55mm -
- conf. 50 - € 0,48

51333169 - Misura 10x65mm -
- conf. 50 - € 0,52

51333030 - Misura 10x80mm -
- conf. 50 - € 0,60

segue...



G&B

continua...

51333031 - Misura 10x100mm -
- conf. 50 - € 0,66

51333106 - Misura 10x120mm -
- conf. 30 - € 0,80

51333107 - Misura 12x80mm -
- conf. 25 - € 0,96

51333034 - Misura 12x100mm -
- conf. 25 - € 1,08

51333108 - Misura 12x120mm -
- conf. 25 - € 1,28

segue...



G&B

continua...

51333048 - Misura 14x70mm -
- conf. 25 - € 1,08

51333127 - Misura 14x100mm -
- conf. 20 - € 1,28

51333036 - Misura 16x75mm -
- conf. 20 - € 1,62

51333037 - Misura 16x110mm -
- conf. 15 - € 1,90



G&B

CONFEZIONE 2 PEZZI TASSELLI BRIC BCM Nylon completi di accessori per il fissaggio di sanitari e scaldabagni Misura gancio: 10x95 mm

513HBG01 - Misura 14x72mm -
- conf. 25 - € 2,40



G&B

ANCORANTI DELTA Acciaio con vite T.P.S. 10.09 zincata bianca impronta esagonale e distanziale DIN 7991

513DELP645 - Misura 8X45 MM - Vite M6X45 - Impronta BRUGOLA MM 4 -
- conf. 50 - € 0,34

513DELP860 - Misura 10X60 MM - Vite M8X60 - Impronta BRUGOLA MM 5 -
- conf. 50 - € 0,70

513DELP880 - Misura 10X80 MM - Vite M8X80 - Impronta BRUGOLA MM 5 -
- conf. 50 - € 0,90

segue...



G&B









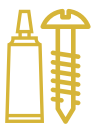













continua...

513DELP1070 - Misura 12X70 MM - Vite M10X70 - Impronta BRUGOLA MM 6 -
- conf. 50 - € 1,72









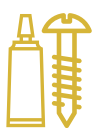





513DELP1010 - Misura 12X100 MM - Vite M10X100 - Impronta BRUGOLA MM 6 -
- conf. 50 - € 1,96

















 <p>CONFEZIONE 2 PEZZI TASSELLI BRIC BCM Nylon completi di accessori per il fissaggio di sanitari e scaldabagni Ø 14 mm</p> <p>513HBT01 - Misura 10x130 - - conf. 25 - € 3,40</p> 	 <p>TASSELLO Ottone Prezzo per scatola da 100 pz.</p> <p>90031301 - Filetto M4 - - conf. 1 - € 11,00</p> <p>90031302 - Filetto M5 - - conf. 1 - € 13,20</p> <p>90031303 - Filetto M6 - - conf. 1 - € 17,40</p> <p>90031304 - Filetto M8 - - conf. 1 - € 28,80</p> <p>90031305 - Filetto M10 - - conf. 1 - € 40,80</p> <p>90031306 - Filetto M12 - - conf. 1 - € 82,00</p> 
 <p>TASSELLI OMEGA Ottone</p> <p>513TT005 - Misura 7x22mm - Vite M5 - - conf. 100 - € 0,15</p> <p>513TT006 - Misura 8x20mm - Vite M6 - - conf. 200 - € 0,17</p> <p>513TT008 - Misura 10x30mm - Vite M8 - - conf. 150 - € 0,32</p> <p>513TT010 - Misura 12x35mm - Vite M10 - - conf. 100 - € 0,48</p> <p>513TT012 - Misura 15x40mm - Vite M12 - - conf. 50 - € 0,96</p> 	 <p>TASSELLO Art.15 Ø 6 mm. vite prolungata acciaio</p> <p>90031075 - - conf. 200 - € 0,28</p> 
 <p>TASSELLO Art.16 vite Ø 6 mm. acciaio</p> <p>90031070 - - conf. 200 - € 0,24</p> 	 <p>TASSELLO Art.17 Ø 6 mm. Gancio corto acciaio</p> <p>90031080 - - conf. 200 - € 0,28</p> 
 <p>TASSELLO Art.18 Ø 6 mm. occhio chiuso acciaio</p> <p>90031090 - - conf. 200 - € 0,30</p> 	 <p>TASSELLO ACCIAIO art.1 Ø 8 mm. Gancio lungo</p> <p>90031104 - - conf. 100 - € 0,30</p> 
 <p>TASSELLO ACCIAIO art.2 Ø 8 mm. Gancio medio</p> <p>90031102 - - conf. 100 - € 0,28</p> 	 <p>TASSELLO ACCIAIO art.3 Ø 8 mm. Gancio corto</p> <p>90031100 - - conf. 100 - € 0,28</p> 
 <p>TASSELLO ACCIAIO art. 4 Ø 8 mm. Occhio aperto</p> <p>90031110 - - conf. 100 - € 0,34</p> 	 <p>TASSELLO ACCIAIO art. 5 Ø 8 mm. Occhio chiuso</p> <p>90031112 - - conf. 100 - € 0,34</p> 









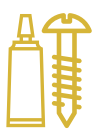





 <p>TASSELLO ACCIAIO art.7 Ø 8 mm. Vite mm.43 90031120 – - conf. 100 – € 0,24</p> 	 <p>TASSELLO ACCIAIO art. 8 Ø 8 mm. Vite sporgenza M5x30 mm 90031122 – - conf. 100 – € 0,46</p> 
 <p>TASSELLO ACCIAIO art. 8B Ø 8 mm. Vite sporgenza M 5x50 mm 90031123 – - conf. 100 – € 0,46</p> 	 <p>TASSELLO ACCIAIO art. 20 Ø 10 mm. gancio corto 90031101 – - conf. 100 – € 0,36</p> 
 <p>TASSELLO ACCIAIO art. 22A Ø 10 mm. Gancio medio 90031103 – - conf. 100 – € 0,38</p> 	 <p>TASSELLO ACCIAIO art. 22B Ø 10 mm. Gancio lungo 90031105 – - conf. 100 – € 0,38</p> 
 <p>TASSELLO ACCIAIO art. 24 Ø 10 mm. Occhio aperto 90031111 – - conf. 100 – € 0,50</p> 	 <p>TASSELLO ACCIAIO art. 25 Ø 10 mm. Occhio chiuso 90031113 – - conf. 100 – € 0,50</p> 
 <p>TASSELLO ACCIAIO art. 20 Ø 10 mm. Vite 90031121 – - conf. 100 – € 0,34</p> 	 <p>TASSELLO ACCIAIO art. 21 Ø 10 mm. Vite sporgenza M 6x30 mm 90031124 – - conf. 100 – € 0,54</p> 
 <p>TASSELLO ACCIAIO art. 21A Ø 10 mm. Vite sporgenza M 6x50 mm 90031125 – - conf. 100 – € 0,54</p> 	 <p>TASSELLI ACCIAIO SR CON GANCIO 90031268 – Misura M6/50 – - conf. 50 – € 1,00 90031269 – Misura M8/55 – - conf. 50 – € 1,18 90031270 – Misura M10/75 – - conf. 25 – € 1,74 90031271 – Misura M12/90 – - conf. 25 – € 3,00</p> 















<p>Rapid</p> <p>TASSELLI ACCIAIO SR CON VITE TE 8.8</p> <p>90031260 – Misura SR M6/55 – – conf. 50 – € 0,68</p> <p>90031261 – Misura SR M8/60 – – conf. 50 – € 0,86</p> <p>90031262 – Misura SR M10/80 – – conf. 25 – € 1,24</p> <p>90031263 – Misura SR M12/90 – – conf. 25 – € 2,20</p> 	<p>Rapid</p> <p>TASSELLI ACCIAIO SR CON OCCHIOLO</p> <p>90031264 – Misura M6/50 – – conf. 50 – € 0,94</p> <p>90031265 – Misura M8/55 – – conf. 50 – € 1,24</p> <p>90031266 – Misura M10/75 – – conf. 25 – € 1,64</p> <p>90031267 – Misura M12/90 – – conf. 25 – € 2,80</p> 
<p>Rapid</p> <p>TASSELLI ACCIAIO AD ESPANSIONE TL Pesanti</p> <p>90031273 – Mod. TL 8/100 – – conf. 50 – € 0,38</p> <p>90031277 – Mod. TL 10/140 – – conf. 50 – € 0,84</p> <p>90031278 – Mod. TL 12/110 – – conf. 50 – € 0,84</p> 	<p>fischer</p> <p>TASSELLO ACCIAIO SBS 8/1 occh. aperto</p> <p>500500401 – – conf. 50 – € 0,50</p> 
<p>fischer</p> <p>TASSELLO ACCIAIO SBS 8/2 Gancio medio</p> <p>500500402 – – conf. 100 – € 0,44</p> 	<p>fischer</p> <p>TASSELLO ACCIAIO SBS 8/3 Gancio chiuso</p> <p>500500403 – – conf. 50 – € 0,48</p> 
<p>fischer</p> <p>TASSELLO ACCIAIO SBS 8x4 vite</p> <p>500500404 – – conf. 100 – € 0,44</p> 	<p>fischer</p> <p>TASSELLO ACCIAIO SBS 8/5 vite doppia M4</p> <p>500500405 – – conf. 50 – € 0,70</p> 
<p>fischer</p> <p>TASSELLO ACCIAIO SBS 8/8 Gancio corto</p> <p>500500408 – – conf. 100 – € 0,44</p> 	<p>fischer</p> <p>TASSELLO ACCIAIO SBS 9/1 Occhiolo aperto</p> <p>500500411 – – conf. 50 – € 0,62</p> 
<p>fischer</p> <p>TASSELLO ACCIAIO SBS 9/2 Gancio medio</p> <p>500500412 – – conf. 100 – € 0,48</p> 	<p>fischer</p> <p>TASSELLO ACCIAIO SBS 9/3 Occhiolo chiuso</p> <p>500500413 – – conf. 50 – € 0,62</p> 









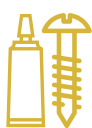





<p>fischer</p> <p>TASSELLO ACCIAIO SBS 9/4 Vite</p> <p>500500414 - - conf. 100 - € 0,48</p> 	<p>fischer</p> <p>TASSELLO ACCIAIO SBS 9/5 vite doppia M6x20</p> <p>500500424 - - conf. 50 - € 0,74</p> 
<p>fischer</p> <p>TASSELLO ACCIAIO SBS 9/5 vite doppia M5x40</p> <p>500500415 - - conf. 50 - € 0,74</p> 	<p>fischer</p> <p>TASSELLO ACCIAIO SBS 9/6 Gancio lungo</p> <p>500500416 - - conf. 50 - € 0,54</p> 
<p>fischer</p> <p>TASSELLO ACCIAIO SBS 9/8 Gancio corto</p> <p>500500418 - - conf. 100 - € 0,48</p> 	<p>fischer</p> <p>TASSELLO ACCIAIO FH II - H Dado Cieco</p> <p>50045055 - FH II-H 10x10 - Lungh. Fissaggio 75 - - conf. 50 - € 3,60 50045057 - FH II-H 10x50 - Lungh. Fissaggio 130 - - conf. 50 - € 4,60 50044906 - FH II-H 12x25 - Lungh. Fissaggio 115 - - conf. 50 - € 6,00 50044907 - FH II-H 12x50 - Lungh. Fissaggio 140 - - conf. 25 - € 6,80 segue...</p> 
<p>fischer</p> <p>continua...</p> <p>50044909 - FH II-H 15x25 - Lungh. Fissaggio 130 - - conf. 25 - € 8,40 50044910 - FH II-H 15x50 - Lungh. Fissaggio 155 - - conf. 25 - € 9,20</p> 	<p>fischer</p> <p>TASSELLO ACCIAIO SBS 9/10 Gancio piatto regol.</p> <p>500500420 - - conf. 50 - € 1,18</p> 
<p>fischer</p> <p>TASSELLO ACCIAIO FA Dado Cieco</p> <p>500500511 - mod.FA FA 8x 70 - tot. 65 - - conf. 25 - € 4,20 500500512 - mod.FA FA 8x 85 - tot. 80 - - conf. 25 - € 6,00 500500515 - mod.FA FA 10x 85 - tot. 75 - - conf. 25 - € 6,40 500500516 - mod.FA FA 10x120 - tot. 110 - - conf. 25 - € 8,60 500500522 - mod.FA FA 12x100 - tot. 85 - - conf. 20 - € 8,20 segue...</p> 	<p>fischer</p> <p>continua...</p> <p>500500523 - mod.FA FA 12x135 - tot. 120 - - conf. 20 - € 10,80 500500526 - mod.FA FA 14x115 - tot. 100 - - conf. 10 - € 15,00 500500527 - mod.FA FA 14x145 - tot. 130 - - conf. 20 - € 18,60</p> 
<p>fischer</p> <p>TASSELLO FBN II in acciaio zincato</p> <p>50040664 - Misura 8/10 - L. Ancor 71 - - conf. 50 - € 0,80 50040669 - Misura 8/20 - L. Ancor 80 - - conf. 50 - € 0,88 50040700 - Misura 8/30 - L. Ancor 90 - - conf. 50 - € 0,98 50040771 - Misura 8/50 - L. Ancor 111 - - conf. 50 - € 1,02 50040783 - Misura 8/100 - L. Ancor 161 - - conf. 20 - € 1,86 segue...</p> 	<p>fischer</p> <p>continua...</p> <p>50040827 - Misura 10/10 - L. Ancor 86 - - conf. 50 - € 1,12 50040851 - Misura 10/20 - L. Ancor 95 - - conf. 50 - € 1,20 50040854 - Misura 10/30 - L. Ancor 105 - - conf. 50 - € 1,30 50040855 - Misura 10/50 - L. Ancor 126 - - conf. 20 - € 1,32 50040931 - Misura 10/70 - L. Ancor 145 - - conf. 20 - € 2,20 segue...</p> 















<p>fischer</p> <p>continua...</p> <p>50040943 – Misura 10/100 – L. Ancor 176 – – conf. 20 – € 2,60</p> <p>50040944 – Misura 10/140 – L. Ancor 216 – – conf. 20 – € 3,80</p> <p>50040950 – Misura 12/10 – L. Ancor 106 – – conf. 20 – € 1,68</p> <p>50044558 – Misura 12/20 – L. Ancor 116 – – conf. 20 – € 1,86</p> <p>50045263 – Misura 12/30 – L. Ancor 126 – – conf. 20 – € 2,20</p> <p>segue...</p> 	<p>fischer</p> <p>continua...</p> <p>50045264 – Misura 12/50 – L. Ancor 146 – – conf. 20 – € 2,20</p> <p>50045266 – Misura 12/100 – L. Ancor 196 – – conf. 20 – € 4,60</p> <p>50045564 – Misura 16/25 – L. Ancor 145 – – conf. 10 – € 3,20</p> <p>50045565 – Misura 16/50 – L. Ancor 170 – – conf. 10 – € 4,80</p> <p>50045566 – Misura 16/80 – L. Ancor 198 – – conf. 10 – € 6,40</p> <p>50045567 – Misura 16/100 – L. Ancor 218 – – conf. 10 – € 7,60</p> 
<p>fischer</p> <p>TASSELLO ACCIAIO ZINCATO FSL Con corpo espandente FSL-S 8.8 GS con vite e testa esagonale e rondella maggiorata</p> <p>500523923 – MOD. 8x60 – – conf. 50 – € 0,64</p> <p>500523924 – MOD. 8x80 – – conf. 50 – € 0,74</p> <p>500523925 – MOD. 8x120 – – conf. 50 – € 0,82</p> <p>500523926 – MOD. 10x65 – – conf. 25 – € 0,90</p> <p>segue...</p> 	<p>fischer</p> <p>continua...</p> <p>500523927 – MOD. 10x85 – – conf. 25 – € 1,00</p> <p>500523928 – MOD. 10x120 – – conf. 25 – € 1,16</p> <p>500523929 – MOD. 12x80 – – conf. 20 – € 1,38</p> <p>500523930 – MOD. 12x100 – – conf. 20 – € 1,46</p> <p>500523931 – MOD. 12x120 – – conf. 20 – € 1,56</p> 
<p>G&B</p> <p>SITA Acciaio TTS filettatura lunga completo di dado e rondella assemblati</p> <p>513TTS96 – Misura 8x65mm – – conf. 150 – € 0,26</p> <p>513TTS05 – Misura 8x75mm – – conf. 100 – € 0,26</p> <p>513TTS06 – Misura 8x95mm – – conf. 100 – € 0,30</p> <p>513TTS26 – Misura 10x70mm – – conf. 70 – € 0,40</p> <p>513TTS08 – Misura 10x90mm – – conf. 50 – € 0,44</p> <p>segue...</p> 	<p>G&B</p> <p>continua...</p> <p>513TTS09 – Misura 10x100mm – – conf. 50 – € 0,50</p> <p>513TTS18 – Misura 10x120mm – – conf. 40 – € 0,54</p> <p>513TTS095 – Misura 10x150mm – – conf. 40 – € 0,70</p> <p>513TTS10 – Misura 12x95mm – – conf. 40 – € 0,68</p> <p>513TTS19 – Misura 12x110mm – – conf. 40 – € 0,74</p> <p>segue...</p> 
<p>G&B</p> <p>continua...</p> <p>513TTS27 – Misura 12x120mm – – conf. 25 – € 0,76</p> <p>513TTS12 – Misura 12x160mm – – conf. 25 – € 1,06</p> <p>513TTS121 – Misura 12x200mm – – conf. 20 – € 1,46</p> <p>513TTS93 – Misura 14x100mm – – conf. 20 – € 1,14</p> <p>513TTS94 – Misura 14x130mm – – conf. 20 – € 1,32</p> <p>segue...</p> 	<p>G&B</p> <p>continua...</p> <p>513TTS28 – Misura 16x110mm – – conf. 20 – € 1,34</p> <p>513TTS120 – Misura 16x125mm – – conf. 10 – € 1,50</p> <p>513TTS20 – Misura 16x145mm – – conf. 10 – € 1,78</p> <p>513TTS1620 – Misura 16x200mm – – conf. 10 – € 2,20</p> <p>513TTS30 – Misura 20x170mm – – conf. 5 – € 3,20</p> 
<p>fischer</p> <p>TASSELLO FBN II SK in acciaio zincato con vite TSP</p> <p>50044917 – – conf. 25 – € 4,80</p> 	<p>G&B</p> <p>SITA GBK CE 7 Acciaio con marcatura CE opzione 7 per calcestruzzo non fessurato completo di dado e rondella assemblati filettatura extralunga</p> <p>51360323 – Misura 8x75mm – Vite M8 – – conf. 100 – € 0,34</p> <p>51360324 – Misura 8x95mm – Vite M8 – – conf. 100 – € 0,38</p> <p>51360325 – Misura 8x115mm – Vite M8 – – conf. 50 – € 0,46</p> <p>51360326 – Misura 10x75mm – Vite M10 – – conf. 70 – € 0,50</p> <p>segue...</p> 
<p>G&B</p> <p>continua...</p> <p>51360327 – Misura 10x90mm – Vite M10 – – conf. 50 – € 0,56</p> <p>51360328 – Misura 10x100mm – Vite M10 – – conf. 50 – € 0,58</p> <p>51360329 – Misura 10x120mm – Vite M10 – – conf. 50 – € 0,66</p> <p>51360332 – Misura 12x100mm – Vite M12 – – conf. 40 – € 0,80</p> <p>51360333 – Misura 12x110mm – Vite M12 – – conf. 40 – € 0,88</p> <p>segue...</p> 	<p>G&B</p> <p>continua...</p> <p>51360334 – Misura 12x120mm – Vite M12 – – conf. 25 – € 0,90</p> <p>51360336 – Misura 12x160mm – Vite M12 – – conf. 25 – € 1,14</p> <p>51360341 – Misura 16x125mm – Vite M12 – – conf. 20 – € 1,72</p> <p>51360342 – Misura 16x145mm – Vite M16 – – conf. 20 – € 1,96</p> <p>51360349 – Misura 16x200mm – Vite M16 – – conf. 10 – € 2,60</p> <p>51360345 – Misura 20x170mm – Vite M20 – – conf. 5 – € 3,60</p> 



<p>fischer</p> <p>TASSELLO ACCIAIO SLM con occhio chiuso</p> <p>500500631 - MOD SLM 6 - - conf. 50 - € 3,40 500500632 - MOD SLM 8 - - conf. 50 - € 4,80 500500633 - MOD SLM 10 - - conf. 25 - € 6,40 500500634 - MOD SLM 12 - - conf. 15 - € 8,80 500500635 - MOD SLM 16 - - conf. 5 - € 15,60</p> 	<p>fischer</p> <p>TASSELLO ACCIAIO SLM con vite T.E.</p> <p>500500621 - mod. SLM 6 - - conf. 50 - € 1,84 500500622 - mod. SLM 8 - - conf. 50 - € 2,40 500500623 - mod. SLM 10 - - conf. 25 - € 4,00 500500624 - mod. SLM 12 - - conf. 20 - € 6,00</p> 
<p>fischer</p> <p>TASSELLO ACCIAIO SLM con gancio forgiato</p> <p>500500641 - mod SLM 6 - - conf. 50 - € 4,20 500500642 - mod SLM 8 - - conf. 50 - € 5,20 500500643 - mod SLM 10 - - conf. 25 - € 7,00 500500644 - mod SLM 12 - - conf. 10 - € 11,00 500500645 - mod SLM 16 - - conf. 5 - € 17,10</p> 	<p>fischer</p> <p>TASSELLO ACCIAIO SLM con batta filettata</p> <p>500500611 - mod. SLM 6 - - conf. 50 - € 3,00 500500612 - mod. SLM 8 - - conf. 50 - € 3,80 500500613 - mod. SLM 10 - - conf. 25 - € 5,20 500500614 - mod. SLM 12 - - conf. 20 - € 8,00 500500615 - mod. SLM 16 - - conf. 10 - € 14,20</p> 
<p>fischer</p> <p>TASSELLO ACCIAIO SLM acciaio</p> <p>500500601 - mod. SLM 6 - - conf. 50 - € 1,38 500500602 - mod. SLM 8 - - conf. 50 - € 1,86 500500603 - mod. SLM 10 - - conf. 25 - € 3,00 500500604 - mod. SLM 12 - - conf. 20 - € 4,40 500500605 - mod. SLM 16 - - conf. 10 - € 8,20 50050557 - mod. SLM 20 - - conf. 5 - € 28,60</p> 	<p>fischer</p> <p>TASSELLO ACCIAIO TAM</p> <p>50090245 - Misura 6 - - conf. 50 - € 1,28 50090246 - Misura 8 - - conf. 50 - € 1,46 50090247 - Misura 10 - - conf. 25 - € 1,96 50090248 - Misura 12 - - conf. 25 - € 2,80</p> 
<p>fischer</p> <p>TASSELLO ACCIAIO TAM - G con gancio</p> <p>50090261 - Misura 6 - - conf. 50 - € 2,40 50090262 - Misura 8 - - conf. 50 - € 3,00 50090263 - Misura 10 - - conf. 25 - € 4,20 50090264 - Misura 12 - - conf. 15 - € 7,60</p> 	<p>fischer</p> <p>TASSELLO ACCIAIO TAM - OD con occhio e distanziale</p> <p>500590266 - mod. TA M100 OD - - conf. 50 - € 5,40</p> 
<p>fischer</p> <p>TASSELLO ACCIAIO TAM-BP con vite di sicurezza</p> <p>50090265 - Misura 8 - - conf. 50 - € 4,40</p> 	<p>fischer</p> <p>TASSELLO ACCIAIO TAM - O occhio chiuso</p> <p>50090257 - Misura 6 - - conf. 50 - € 2,40 50090258 - Misura 8 - - conf. 50 - € 2,80 50090259 - Misura 10 - - conf. 25 - € 4,00 50090260 - Misura 12 - - conf. 15 - € 6,40</p> 
<p>fischer</p> <p>TASSELLO ACCIAIO TAM - T/S con vite e distanziale</p> <p>50090267 - Misura 6/25 - - conf. 50 - € 2,20 50090268 - Misura 8/25 - - conf. 50 - € 2,60 50090269 - Misura 10/28 - - conf. 25 - € 4,00 50090270 - Misura 12/25 - - conf. 20 - € 7,40</p> 	<p>fischer</p> <p>TASSELLO ACCIAIO TAM - S con vite T.E.</p> <p>50090249 - Misura 6 - - conf. 50 - € 1,54 50090250 - Misura 8 - - conf. 50 - € 1,92 50090251 - Misura 10 - - conf. 25 - € 3,20 50090252 - Misura 12 - - conf. 20 - € 4,40</p> 



 <p>ANCORANTI NTR/C Acciaio con occhio stampato dado e rondella DIN 9021 (UNI 6593)</p> <p>513TNTRC06 - Misura 10x45mm - Vite M6X50 - conf. 50 - € 0,92</p> <p>513TNTRC08 - Misura 12x52mm - Vite M8X60 - conf. 25 - € 1,18</p> <p>513TNTRC10 - Misura 15x60mm - Vite M10X75 - conf. 20 - € 1,68</p>	 <p>ANCORANTI NTR/B Acciaio con barra filettata 5.8 dado e rondella DIN 9021 (UNI 6593)</p> <p>513TNTRG06 - Misura 10x45mm - conf. 50 - € 0,98</p> <p>513TNTRG08 - Misura 12x52mm - conf. 25 - € 1,24</p> <p>513TNTRG10 - Misura 15x60mm - conf. 20 - € 2,20</p>
 <p>ANCORANTI NTR/V Acciaio con vite 8.8 T.E. e rondella DIN 9021 (UNI6593)</p> <p>513TNTRV06 - Misura 10x45mm - Vite M6X50 - conf. 50 - € 0,40</p> <p>513TNTRV08 - Misura 12x52mm - Vite M8X60 - conf. 50 - € 0,68</p> <p>513TNTRV10 - Misura 15x60mm - Vite M10X80 - conf. 25 - € 1,08</p> <p>513TNTRV12 - Misura 18x75mm - Vite M12X90 - conf. 20 - € 1,88</p>	 <p>ANCORANTI NTR Acciaio</p> <p>513TNTR06 - Misura 10x45mm - conf. 50 - € 0,24</p> <p>513TNTR08 - Misura 12x52mm - conf. 50 - € 0,28</p> <p>513TNTR10 - Misura 15x60mm - conf. 25 - € 0,36</p> <p>513TNTR12 - Misura 18x75mm - conf. 20 - € 0,66</p>
 <p>ANCORANTI GBM/G Acciaio con gancio stampato</p> <p>513TGBMG06 - MOD. 12x42mm - conf. 50 - € 1,24</p> <p>513TGBMG08 - MOD. 14x50mm - conf. 25 - € 1,58</p> <p>513TGBMG10 - MOD. 16x60mm - conf. 20 - € 2,40</p>	 <p>ANCORANTI GMB Acciaio</p> <p>513TGBM06 - Misura 10x42mm - conf. 50 - € 0,54</p> <p>513TGBM08 - Misura 14x50mm - conf. 50 - € 0,66</p> <p>513TGBM10 - Misura 16x60mm - conf. 25 - € 0,96</p> <p>513TGBM12 - Misura 20x72mm - conf. 20 - € 1,14</p>
 <p>ANCORANTI GBM/V Acciaio con vite 8.8 T.E.</p> <p>513TGBMV06 - Misura 10x42mm - Vite M6X50 - conf. 50 - € 0,66</p> <p>513TGBMV08 - Misura 14x50mm - Vite M8X60 - conf. 50 - € 0,90</p> <p>513TGBMV10 - Misura 16x60mm - Vite M10X80 - conf. 25 - € 1,40</p> <p>513TGBMV12 - Misura 20x72mm - Vite M12X90 - conf. 20 - € 2,20</p>	 <p>TASSELLO GHISA GM</p> <p>500500901 - mod. GM 6 - Lungh. 47 - conf. 50 - € 2,80</p> <p>500500902 - mod. GM 8 - Lungh. 50 - conf. 50 - € 3,20</p> <p>500500903 - mod. GM 10 - Lungh. 60 - conf. 25 - € 4,80</p>
 <p>TASSELLO GHISA GM con barra filettata</p> <p>500500911 - Modello GM 6 - conf. 50 - € 4,12</p> <p>500500912 - Modello GM 8 - conf. 50 - € 5,36</p> <p>500500914 - Modello GM 12 - conf. 20 - € 11,12</p>	 <p>TASSELLO GHISA GM con occhio chiuso</p> <p>500500931 - mod. GM 6 - conf. 50 - € 6,00</p> <p>500500932 - mod. GM 8 - conf. 50 - € 8,20</p> <p>500500933 - mod. GM 10 - conf. 25 - € 11,20</p>
 <p>TASSELLO GHISA GM con vite T.E.</p> <p>500500921 - mod. GM 6 T.E. - conf. 50 - € 3,20</p> <p>500500922 - mod. GM 8 T.E. - conf. 50 - € 4,20</p> <p>500500923 - mod. GM 10 T.E. - conf. 25 - € 6,60</p> <p>500500924 - mod. GM 12 T.E. - conf. 20 - € 10,20</p>	 <p>TASSELLO GHISA GM Con gancio forgiato</p> <p>500500941 - Modello GM 6 - conf. 50 - € 6,18</p> <p>500500942 - Modello GM 8 - conf. 25 - € 8,20</p> <p>500500943 - Modello GM 10 - conf. 25 - € 11,20</p>

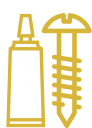

fischer

BLISTER 4 PZ. TASSELLO ACCIAIO TAM-S con vite T.E.

500504572 - Misura 8 -
- conf. 1 - € 9,60



fischer

TASSELLI GKM K PER CARTONGESSO Tassello in metallo Utilizzabile per pannelli in gesso-fibra o cartongesso e con viti legno, autofilettanti o truciolari In blister Blister con 10 fissaggi

500505373 - Dimensioni 75x147mm -
- conf. 20 - € 7,22



fischer

TASSELLI GKMS SK PER CARTONGESSO Utilizzato per pannelli in gesso-fibra o cartongesso e con viti legno, autofilettanti o truciolari In blister Blister con 6 fissaggi e 6 viti Ø 4,5x35 mm

50090917 - Dimensioni 75x147mm -
- conf. 20 - € 7,00



fischer

TASSELLO SB 12 K nylon con accessori

500504463 - mod. SB 12/ 3K - pezzi 4 - tipo occh. Chiuso -
- conf. 20 - € 3,40

500504465 - mod. SB 12/ 5K - pz 4 - tipo vite doppia -
- conf. 20 - € 3,40

500504461 - mod. SB 12 /1K - pz 4 - tipo occh. aperto -
- conf. 20 - € 3,40



fischer

TASSELLO GK K In nylon per cartongesso In blister

500552391 -
- conf. 1 - € 5,36



fischer

TASSELLO GK S K In nylon con vite testa svasata piana per cartongesso In blister

500552392 -
- conf. 1 - € 5,56



fischer

TASSELLO S K nylon IN BLISTER

500504402 - mod. S 5 K - pezzi 35 -
- conf. 20 - € 2,60

500504403 - mod. S 6 K - pezzi 30 -
- conf. 20 - € 2,60

500504404 - mod. S 8 K - pezzi 20 -
- conf. 20 - € 2,60



fischer

TASSELLO SC/K nylon con accessori IN BLISTER

500504430 - mod. S6C/1K - pezzi 8+8 - tipo oc. aperto -
- conf. 20 - € 4,20

500504431 - mod. S6C/2K - pezzi 10+10 - tipo gan. Medio -
- conf. 20 - € 4,20

500504432 - mod. S6C/3K - pezzi 8+8 - tipo oc. chiuso -
- conf. 20 - € 4,20

500504433 - mod. S6C/8K - pezzi 10+10 - tipo gan. Corto -
- conf. 20 - € 4,20



fischer

TASSELLO SX -SK nylon con vite In Blister

500504416 - mod. Sx 5SK - pezzi 20+20 -
- conf. 40 - € 3,60

500504417 - mod. Sx 6SK - pezzi 15+15 -
- conf. 20 - € 3,60

50004418 - mod. SX 8SK - pezzi 10+10 -
- conf. 20 - € 3,60



fischer

RICAMBI PFM 10 K per mensole a scomparsa CPF 14x120 CPF 14x145 CPF 14x170 Blister 4 pz.

500504549 -
- conf. 12 - € 3,40



fischer

RICAMBI PFM 8 K per mensole a scomparsa CPF 10 x 100 CPF 10 x 150 Blister 4 pz.

500504548 -
- conf. 12 - € 3,00



fischer

TASSELLO SB 9 K nylon con accessori Blister 4 pz.

500504445 - mod. SB 9/ 5K - pezzi 4 - tipo vite dado m 4 -
- conf. 20 - € 3,40

500504449 - mod. SB 9/9K - pezzi 4 - tipo gancio piatto -
- conf. 20 - € 3,40





<p>fischer</p> <p>CONFEZIONE INDUSTRIALE TASSELLI SX 6 Contenuto: 1000 Tasselli SX 6 nylon 1000 Viti \emptyset 4,5x40 mm</p> <p>500517656 – – conf. 1 – € 109,20</p> 	<p>fischer</p> <p>CONFEZIONE INDUSTRIALE TASSELLI SX 6 Contenuto: 5000 Tasselli SX 6 nylon</p> <p>500517657 – – conf. 1 – € 126,28</p> 
<p>fischer</p> <p>CONFEZIONE INDUSTRIALE TASSELLI SX 8 Contenuto: 500 Tasselli SX 8 nylon 500 Viti \emptyset 5x50 mm</p> <p>500522890 – – conf. 1 – € 90,80</p> 	<p>fischer</p> <p>CONFEZIONE INDUSTRIALE TASSELLI SX 8 Contenuto: 5000 Tasselli SX 8 nylon</p> <p>500522891 – – conf. 1 – € 246,00</p> 
<p>Rapid</p> <p>TASSELLO GOMMA Art.1 \emptyset 9 con gancio lungo</p> <p>90031004 – – conf. 100 – € 0,30</p> 	<p>Rapid</p> <p>TASSELLO GOMMA Art.2 \emptyset 9 con gancio medio</p> <p>90031002 – – conf. 100 – € 0,30</p> 
<p>Rapid</p> <p>TASSELLO GOMMA Art.3 \emptyset 9 con gancio corto</p> <p>90031000 – – conf. 100 – € 0,28</p> 	<p>Rapid</p> <p>TASSELLO GOMMA Art.4 \emptyset 9 occhio aperto</p> <p>90031006 – – conf. 100 – € 0,34</p> 
<p>Rapid</p> <p>TASSELLO GOMMA Art.4 \emptyset 9 occhio chiuso</p> <p>90031008 – – conf. 100 – € 0,34</p> 	<p>Rapid</p> <p>TASSELLO GOMMA Art.4 \emptyset 9 vite sporg. 30mm</p> <p>90031012 – – conf. 100 – € 0,42</p> 
<p>Rapid</p> <p>TASSELLO GOMMA Art.4 \emptyset 9 vite sporg. 50mm</p> <p>90031013 – – conf. 100 – € 0,42</p> 	<p>Rapid</p> <p>TASSELLO GOMMA Art.7 \emptyset 9 con vite</p> <p>90031010 – – conf. 100 – € 0,26</p> 

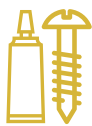

 <p>SUPPORTO A SFERA femmina 90031011 - Ø 12 - con vite - - conf. 20 - € 0,34</p> 	 <p>TASSELLO GOMMA art.21 Ø 12 vite sporg. 30mm 90031014 - - conf. 100 - € 0,52</p> 
 <p>TASSELLO GOMMA art.21A Ø 12 vite sporg. 50mm 90031015 - - conf. 100 - € 0,54</p> 	 <p>TASSELLO GOMMA Art.22 Ø 12 con gancio corto 90031001 - - conf. 100 - € 0,36</p> 
 <p>TASSELLO GOMMA Art. 22A Ø 12 con gancio medio 90031003 - - conf. 100 - € 0,38</p> 	 <p>TASSELLO GOMMA Art. 22B Ø 12 con gancio lungo 90031005 - - conf. 100 - € 0,40</p> 
 <p>TASSELLO GOMMA art.24 Ø 12 occhiolo aperto 90031007 - - conf. 100 - € 0,50</p> 	 <p>TASSELLO GOMMA art.25 Ø 12 occhiolo chiuso 90031009 - - conf. 100 - € 0,50</p> 
 <p>ANCORANTE CHIMICO FIP C 700 HP 410 ml - con 2 beccucci Elevata tixotropia Non contiene stirene Utilizzabile con pistola 930 13 030 50093446 - - conf. 12 - € 13,00</p> 	 <p>ANCORANTE CHIMICO T-BOND 300 ml - con 2 beccucci Elevata tixotropia Non contiene stirene Utilizzabile con pistola per silicone 50093179 - - conf. 12 - € 12,60</p> 
 <p>ANCORANTE CHIMICO PE 300 SF 300 ml miscelatore incluso Idoneo per: mattone pieno, forato, doppio UNI, calcestruzzo Adatto ad ancoraggi che non richiedono certificazioni 500518899 - - conf. 12 - € 8,20</p> 	 <p>ANCORANTE CHIMICO GEB MA 300 Poliesteri per alte prestazioni Formato 300 ml 513CC30 - - conf. 12 - € 7,40</p> 



  <p>GEBOFIX PRO VE-SF CE1 RESINA VINILESTERE Senza stirene per applicazioni con barre filettate e ferri da ripresa su calcestruzzo</p> <p>513CC32 – – conf. 12 – € 11,40</p>	  <p>TASSELLI A RETE FIS H-HK</p> <p>50041900 – Mod. 12X50 – – conf. 50 – € 0,56 50041901 – Mod. 12x85 – – conf. 50 – € 0,62 50041902 – Mod. 16x85 – – conf. 50 – € 0,64 50041905 – Mod. 16x130 – – conf. 50 – € 0,90 50041906 – Mod. 20x85 – – conf. 50 – € 0,78</p>
  <p>TASSELLI FIS- H N A CALZA con 10 beccucci</p> <p>50050470 – Mod. 16x85 – – conf. 20 – € 1,98 50050472 – Mod. 18x85 – – conf. 20 – € 2,20 50050474 – Mod. 20x85 – – conf. 20 – € 2,60</p>	  <p>BUSSOLA RETINATA IN PLASTICA CON FONDELLO DI TENUTA</p> <p>90031400 – Misura 12x80 – Pezzi conf. 100 – – conf. 1 – € 13,40 90031402 – Misura 15x85 – Pezzi conf. 100 – – conf. 1 – € 13,40 90031403 – Misura 15x85 – Pezzi conf. 2000 – – conf. 1 – € 206,00</p>
  <p>BARRA FILETTATA FIS - M acciaio zincato con dado e rosetta punta inclinata a 45°</p> <p>500509124 – Misura 8x110 – – conf. 20 – € 1,56 50009125 – Misura 10x110 – – conf. 20 – € 1,92 500509126 – Misura 10x135 – – conf. 20 – € 2,20 500509127 – Misura 12x115 – – conf. 20 – € 3,20</p>	  <p>TASSELLO CHIMICO con occhio chiuso</p> <p>500507003 – misura M 6 x 50 – – conf. 50 – € 1,20 500507005 – misura M 8 x 60 – – conf. 50 – € 1,84 500507007 – misura M 10 x 70 – – conf. 25 – € 2,40</p>
  <p>BUSSOLA FIS - E Acciaio zincato con filettatura interna</p> <p>50043632 – Misura 11x85 – Filetto M8 – – conf. 10 – € 2,60 50043633 – Misura 15x85 – Filetto M10 – – conf. 10 – € 2,80</p>	  <p>BECCUCCIO MISCELATORE Universale 10 X 93 mm per cartuccia FIP T-BOND, FIS, UPM</p> <p>500509123 – – conf. 10 – € 1,98</p>
  <p>POMPETTA AD ARIA PER PULIZIA FORI</p> <p>50089300 – – conf. 1 – € 52,74</p>	  <p>SCHIUMA poliuretanic universale 1K-750M</p> <p>50009285 – – conf. 12 – € 7,00</p>
  <p>SCHIUMA poliuretanic PUP 1K-750M Universale Per pistole 750 ml</p> <p>500521769 – – conf. 12 – € 7,00</p>	  <p>SCHIUMA poliuretanic manuale PU 1/750 Classe B2 Autoestinguente 750ml</p> <p>50009293 – – conf. 12 – € 10,60</p>

fischer

Oltre ciò che vedi.



Il mondo fischer va oltre ciò che vedi, oltre il prodotto finale che ogni giorno utilizziamo con semplicità e soddisfazione. I laboratori fischer di Ricerca&Sviluppo non si fermano mai, per poter sempre garantire massime prestazioni e sicurezza dei prodotti, anche in caso di sisma.

www.fischeritalia.it

www.facebook.com/fissaggio 

www.youtube.com/fissaggifischer 

fischer 
innovative solutions

www.malfattitacchinigroup.it



SILICONI



COLLANTI

PROFESSIONISTI TRA I PROFESSIONISTI!

SILICONI • SIGILLANTI ACRILICI e BUTILICI • MS POLIMERI
SCHIUME POLIURETANICHE • PRODOTTI ISOLANTI e FONASSORBENTI



AL·CA
TECHNOLOGIES ADHESIVES













Via Stelvio, 312 • 21050 MARNATE (VA) Italy

Tel. 0331 606873 • al.ca@alcasil.com









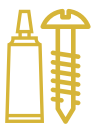



www.alcasil.com

www.malfattitacchinigroup.it









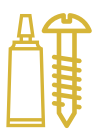

















<p>fischer</p> <p>SCHIUMA poliuretanic 1K - 750 P Classe B2 Autoestinguente Per pistole: 930 13036 - 34 - 32 750ml</p> <p>50009292 - - conf. 12 - € 13,40</p> 	<p>AL·CA</p> <p>SCHIUMA POLIURETANICHE ALCAFOAM MANUALE 750 ml Offre un buon isolamento acustico e termico ed ha una buona presa sui materiali edili.</p> <p>16510SMA0175 - - conf. 12 - € 7,56</p> 
<p>AL·CA</p> <p>SCHIUMA POLIURETANICA AUTOESPANDENTE Formato 750 ml Per pistola</p> <p>16511SPI01750 - - conf. 12 - € 7,32</p> 	<p>AL·CA</p> <p>SCHIUMA POLIURETANICA Formato 750 ml Resistente al fuoco B1</p> <p>16510SMA0275 - - conf. 12 - € 13,02</p> 
<p>AL·CA</p> <p>SIGILLANTE REFRATTARIO ALCASIGIL CALOR-FER Formato 310 ml Mastice a presa rapida inodore per la sigillatura di caminetti, forni, stufe.. sottoposte ad alte temperature 1500°C Resistenti al fuoco Colore nero</p> <p>165601310 - - conf. 6 - € 4,40</p> 	<p>fischer</p> <p>PULITORE "PUR 500" per schiuma poliuretanic e pistola 500 ml.</p> <p>50009286 - - conf. 1 - € 10,20</p> 
<p>AL·CA</p> <p>PULITORE PER SCHIUMA POLIURETANICA Formato 500 ml</p> <p>16520000 - - conf. 12 - € 5,86</p> 	<p>&M 930</p> <p>PISTOLA PER SCHIUMA POLIURETANICA Tripla guarnizione di tenuta teflon Art 3000</p> <p>93013032 - - conf. 1 - € 30,00</p> 
<p>&M 930</p> <p>PISTOLA PER SCHIUMA poliuretanic professionale in metallo - Art. 3 tripla guarnizione in tenuta teflon</p> <p>93013034 - - conf. 1 - € 38,50</p> 	<p>Gieffe gruppo general ferramentas</p> <p>PISTOLA PER SCHIUMA IFE-04B</p> <p>512310850N - - conf. 1 - € 11,60</p> 
<p>Henkel</p> <p>SILICONE TRASPARENTE Silicon 5 Universale 50 ml</p> <p>515576538 - - conf. 12 - € 3,00</p> 	<p>Henkel</p> <p>SILICONE BIANCO Silicon 5 Bagno e cucina 50 ml</p> <p>515584780 - - conf. 12 - € 3,18</p> 









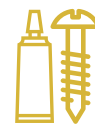





 <p>fischer</p> <p>SILICONE ACETICO SAM 280 – trasparente multituoso A prova di muffa cartuccia 280 ml</p> <p>50009219 – - conf. 25 - € 2,74</p>	 <p>Henkel</p> <p>SILICONE ACETICO a prova di muffa BIANCO 280 ml.</p> <p>515579400 – - conf. 25 - € 3,20</p>
 <p>G&B</p> <p>SILICONE ACETICO GEBOFIL Professionale Trasparente Formato 280 ml Indicato per l'utilizzo su vetro, piastrelle, ceramica, legno verniciato e metalli. Resistente alla muffa, raggi ultravioletti e agenti atmosferici. Non verniciabile.</p> <p>513SIL10 – - conf. 24 - € 3,10</p>	 <p>G&B</p> <p>SIGILLANTE ACRILICO UNIVERSALE GEBOFIL Certificato CE Formato 310 ml Colore bianco Indicato per cartongesso, legno, laterizi, calcestruzzo... Verniciabile</p> <p>513SILAC01 – - conf. 24 - € 1,98</p>
 <p>Henkel</p> <p>SIGILLANTE ACETICO universale trasparente a prova di muffa 280 ml</p> <p>515579399 – - conf. 25 - € 2,96</p>	 <p>Henkel</p> <p>SIGILLANTE SL500 a prova di muffa ideale per sigillatura di materiali non porosi (alluminio, metallo)</p> <p>5151536081 – Misura 300 ml - Colore Nero - - conf. 12 - € 5,20 5151536082 – Misura 300 ml - Colore Marrone - - conf. 12 - € 5,20 5151536083 – Misura 300 ml - Colore Grigio - - conf. 12 - € 5,20</p>
 <p>AL·CA</p> <p>SILICONE ACETICO Formato 280 ml Alcasil SE polimerizza a temperatura ambiente sotto l'azione dell'umidità. Resistente alla muffa Resistente ai raggi UV Applicabile anche su vetro, piastrelle in ceramica, plastiche e la maggior parte delle vernici.</p> <p>16501BI050128 – Colore Bianco - - conf. 24 - € 3,02 16501TR050128 – Colore Trasparente - - conf. 24 - € 3,10</p>	 <p>AL·CA</p> <p>SILICONE ACETICO ALCASIL Formato 280 ml Con ottima elasticità permanente e ottima aderenza su tutti i materiali da costruzione</p> <p>16501BI020128 – Colore Bianco - - conf. 24 - € 3,28 16501NE020128 – Colore Nero - - conf. 24 - € 3,28 16501TR020128 – Colore Trasparente - - conf. 24 - € 3,22</p>
 <p>AL·CA</p> <p>SILICONE ACETICO ALCASIL GASKET Sigillante siliconico monocomponente a polimerizzazione acetica per applicazioni edili e industriali Resistente a alte temperature fino a 300°C</p> <p>16501NE040108 – Formato 80 ml - Colore Nero - - conf. 12 - € 3,80 16501RO040108 – Formato 80 ml - Colore Rosso - - conf. 12 - € 4,00 16501NE040131 – Formato 310 ml - Colore Nero - - conf. 24 - € 6,80</p> <p>segue...</p>	 <p>AL·CA</p> <p>continua...</p> <p>16501RO040131 – Formato 310 ml - Colore Rosso - - conf. 24 - € 7,14</p>
 <p>AL·CA</p> <p>SILICONE NEUTRO ALCASIL NE-S Formato 310 ml Sigillante siliconico neutro alcolico monocomponente a basso modulo con una buona adesione Polimerizza a temperatura ambiente Basso modulo Resistente alla muffa</p> <p>16502BI130131 – Colore Bianco - - conf. 24 - € 4,78 16502GR130231 – Colore Grigio - - conf. 24 - € 4,78 16502NE130131 – Colore Nero - - conf. 24 - € 4,78</p> <p>segue...</p>	 <p>AL·CA</p> <p>continua...</p> <p>16502TM130131 – Colore Testa di moro - - conf. 24 - € 4,72 16502TR130131 – Colore Trasparente - - conf. 24 - € 4,72</p>









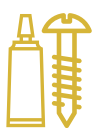





  <p>SILICONE NEUTRO ALCASIL NP Formato 310 ml Sigillante monocomponente neutro con elasticità permanente ed ottima adesione Per materiali da costruzione</p> <p>16502AL140131 – Colore Alluminio – – conf. 24 – € 5,98 16502AN140131 – Colore Antracite – – conf. 24 – € 5,98 16502GR140131 – Colore Grigio – – conf. 24 – € 5,98 16502NC140131 – Colore Noce – – conf. 24 – € 5,98</p>	  <p>SIGILLANTE ACRILICO ALCACRIL Formato 310 ml Sigillante monocomponente plasto-elastico a base di dispersione acrilica per materiali porosi Verniciabile</p> <p>16503BI030131 – Colore Bianco – – conf. 24 – € 2,20 16503GR030131 – Colore Grigio – – conf. 24 – € 2,20</p>
  <p>SIGILLANTE ALCASIGIL FIXAL Formato 290 ml Trasparente Cristallino Adesivo sigillante a base di polimeri MS idridi Adatto per creare giunzioni invisibili tra i vari materiali</p> <p>16505MSTR0129 – – conf. 12 – € 9,66</p>	  <p>SIGILLANTE ADESIVO PATTEX SP 101 Sigillante adesivo Super performante Polimero Flextec Polimerizza in ambiente umido Formato 280 ml L'imballo diventa un espositore</p> <p>5152427201 – Colore Bianco – – conf. 12 – € 10,90 5152427203 – Colore Trasparente – – conf. 12 – € 11,90</p>
  <p>SIGILLANTE ADESIVO PATTEX SP 101 Sigillante adesivo Super performante Polimero Flextec Polimerizza in ambiente umido Formato 280 ml</p> <p>5152024184 – colore Bianco – – conf. 25 – € 11,00 5152024185 – colore Grigio – – conf. 25 – € 11,20</p>	  <p>SIGILLANTE ACRIL ONE Muratura verniciabile non contiene solventi</p> <p>515577500 – Formato 310 ML – Colore BIANCO – – conf. 25 – € 2,90 515577501 – Formato 310 ML – Colore GRIGIO – – conf. 25 – € 2,90</p>
  <p>SIGILLANTE AC 405 ACRIL MURO 300 ml – Bianco Finitura ruvida spatolabile effetto intonaco Adatto a interni ed esterni Sovraverniciabile Ottima adesione a superfici umide e porose.</p> <p>5151536075 – – conf. 25 – € 7,40</p>	  <p>SIGILLANTE SL 620 SERRAMENTI E EDILIZIA Sigillante siliconico neutro Resiste alle muffe, agli agenti atmosferici, ad acidi e basi diluiti, ai raggi UV. Certificato ISO 11600.</p> <p>5151144716 – Misura 300 ml – Colore Trasparente – – conf. 25 – € 6,80 5151536088 – Misura 300 ml – Colore Bianco – – conf. 25 – € 6,90 5151536097 – Misura 300 ml – Colore Marrone – – conf. 12 – € 6,90 5151536099 – Misura 300 ml – Colore Grigio – – conf. 12 – € 6,90</p>
  <p>SIGILLANTE SL 618 SPECCHI 300 ml – Trasparente Sigillante siliconico neutro dotato di alta resistenza ed elevata elasticità ed adesione, ideale per l'incollaggio di specchi</p> <p>5151535859 – – conf. 25 – € 8,40</p>	  <p>ESPOSITORE 12 PEZZI COLLA DEXCYAN Formato 10 gr colla a base di etilcianocrilato Consente l'adesione di una vasta gamma di materiali: metallo, plastiche, cuoio, legno. Velocità di presa medio/alta.</p> <p>16530DEX01001 – – conf. 12 – € 3,88</p>
  <p>BLISTER SUPER ATTAk Classic Gr. 3</p> <p>515579572 – – conf. 24 – € 4,10</p>	  <p>BLISTER SUPER ATTAk Classic Gr. 5</p> <p>515579573 – – conf. 24 – € 6,30</p>



<p>Henkel</p> <p>BLISTER SUPER ATTAK Classic Gr. 10</p> <p>515579712 – – conf. 12 – € 11,70</p> 	<p>Henkel</p> <p>BLISTER SUPER ATTAK EASY BRUSH Gr. 5</p> <p>515579576 – – conf. 12 – € 7,40</p> 
<p>Henkel</p> <p>BLISTER SUPER ATTAK Flex Gel Gr. 3</p> <p>515112597 – – conf. 24 – € 4,90</p> 	<p>Henkel</p> <p>BLISTER SUPER ATTAK PLASTICA Gr. 2 + 4 ml</p> <p>5152047414 – – conf. 12 – € 13,00</p> 
<p>Henkel</p> <p>BLISTER ATTAK VETRO Gr. 3</p> <p>515579550 – – conf. 24 – € 4,70</p> 	<p>Henkel</p> <p>BLISTER SCOLLATUTTO Gel Gr. 5</p> <p>515579552 – – conf. 12 – € 7,00</p> 
<p>Henkel</p> <p>COLLA TANGIT PVC – U Per tubi e raccordi in PVC rigido 125 gr.</p> <p>515298842 – – conf. 12 – € 10,20</p> 	<p>Henkel</p> <p>COLLA DA PARATI METYLAN SICHZELL KLEISTER Forte presa iniziale Miscela senza grumi Per circa 40 m² Formato 125 gr</p> <p>5151697348 – – conf. 1 – € 12,20</p> 
<p>Henkel</p> <p>MILLECHIODI TUBO Blister – 100 Gr. ideale per incollaggio: Cemento, mattoni, pietra, legno, cartongesso</p> <p>515579799 – – conf. 12 – € 7,20</p> 	<p>Henkel</p> <p>MILLECHIODI TUBO 250 Gr. Ideale per incollaggio: Cemento, mattoni, pietra, legno, cartongesso</p> <p>515579803 – – conf. 12 – € 10,40</p> 
<p>Henkel</p> <p>MILLECHIODI CARTUCCIA 400 Gr. Ideale per incollaggio: Cemento, mattoni, pietra, legno, cartongesso</p> <p>515579801 – – conf. 12 – € 12,56</p> 	<p>Henkel</p> <p>MILLECHIODI LEGNO ideale per tutte le applicazioni su legno. Presa in soli 10 '' Prodotto senza Blister</p> <p>5151419729 – Contenuto 100 Gr. – – conf. 12 – € 7,10</p> <p>5151420207 – Contenuto 200 Gr. – – conf. 12 – € 9,80</p> 



<p>Henkel</p> <p>100% REPAIR GEL Adesivo universale in gel - per piccole riparazioni</p> <p>5151683632 - Contenuto 8 gr. - - conf. 12 - € 5,80</p> <p>5151683637 - Contenuto 20 gr. - - conf. 12 - € 10,80</p> 	<p>Henkel</p> <p>PATTEX SPECIAL RESTAURO LEGNO Per riparazione di buchi, crepe e fessure su tutti i tipi di legno Gr 50</p> <p>5151476785 - Colore Chiaro - - conf. 6 - € 6,30</p> <p>5151476786 - Colore Scuro - - conf. 6 - € 6,30</p> 
<p>Henkel</p> <p>PATTEX SPECIAL PELLE Adesivo Pelle abbinata a tutti i tipi di materiale Gr 30</p> <p>5151479391 - - conf. 6 - € 5,00</p> 	<p>Henkel</p> <p>POWER EPOXY ACCIAIO LIQUIDO 2 tubetti da amalgamare Adesivo bicomponente Ripara stucca e salda i metalli Agisce in 5 minuti 2 x 15 Gr</p> <p>5151659549 - - conf. 6 - € 7,20</p> 
<p>Henkel</p> <p>POWER EPOXY ACCIAIO LIQUIDO Siringa che miscela i due prodotti Adesivo bicomponente Ripara stucca e salda i metalli Extraforte Agisce in 5 minuti Gr 35</p> <p>5151479397 - - conf. 6 - € 9,60</p> 	<p>Henkel</p> <p>POWER EXPORY SALDATUTTO Incolla salda e ripara tutti i materiali. Extraforte 2x12 Gr</p> <p>5151659551 - - conf. 6 - € 7,00</p> 
<p>Henkel</p> <p>POWER EPOXY SALDATUTTO MIX Adesivo bicomponente Incolla salda e ripara tutti i materiali. Extraforte Agisce in 5 minuti Gr 28</p> <p>5151478701 - - conf. 6 - € 9,80</p> 	<p>Henkel</p> <p>PATTEX SPECIAL ADESIVO GOMMA Gomma abbinata a tutti i tipi di materiale Gr 30</p> <p>5151479389 - - conf. 6 - € 5,00</p> 
<p>Henkel</p> <p>PATTEX SPECIAL ADESIVO TESSUTO Per jeans, cotone, feltro e adesivi sintetici Trasparente una volta sciuato Gr 20</p> <p>5151479394 - - conf. 6 - € 5,00</p> 	<p>Henkel</p> <p>RIPARATUTTO EXPRESS BARRETTA Con cutter Pasta modellabile Per tutti i materiali Ricostruisce, sigilla e incolla Gr. 48</p> <p>5151863223 - - conf. 12 - € 12,00</p> 
<p>Henkel</p> <p>PATTEX SPECIAL ADESIVO PLASTICA Per tutti i tipi di plastica flessibile e rigida abbinati a tutti i materiali Gr 30</p> <p>5151479384 - - conf. 6 - € 5,00</p> 	<p>Henkel</p> <p>BLISTER MASTICE SUPERCHIARO Superforte incollaggio rapido per tutti i materiali 50 gr.</p> <p>515579228 - - conf. 12 - € 3,30</p> 

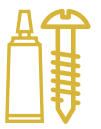

  <p>MASTICE UNIVERSALE PATTEX 125 grammi Ideale per metallo, gomma, pelle, cuoio, legno, plastica, pietra incolla e asciuga in 15 minuti</p> <p>5151419317 - - conf. 12 - € 4,45</p>	  <p>COLLA VINILICA UNIVERSALE Colore Bianca Plasticata Per carta, stoffa, legno</p> <p>5151715109 - Formato 100 gr - - conf. 12 - € 1,80 5151715112 - Formato 250 gr - - conf. 12 - € 3,30 5151715111 - Formato 1 kg - - conf. 12 - € 8,00</p>
  <p>PATTEX VINIL CLASSIC 750 grammi Ideale per tutti i tipi di legno</p> <p>5151419307 - - conf. 6 - € 6,80</p>	  <p>100% COLLA Collante senza solventi Può essere utilizzato su superfici verniciate e non ha problemi con i colori acrilici e vernici in resina alchidica.</p> <p>5151542108 - Formato 50 gr - - conf. 12 - € 7,60 5151542643 - Formato 100 gr - - conf. 12 - € 10,30</p>
  <p>BOSTIK 99 Adesivo universale ad alta resistenza al calore Elastico - spalmabile A presa istantanea Resistente all'umidità e sostanze chimiche Adatto per legno, plastica, metallo, vetroresina, sughero</p> <p>797D2884 - Formato 400 ml - - conf. 12 - € 9,80 797D2885 - Formato 850 ml - - conf. 12 - € 18,20 797D2886 - Formato 1800 ml - - conf. 8 - € 36,60</p>	  <p>BOSTIK SUPERCHIARO Astuccio Adesivo a contatto superforte Ideale per gomma, cuoio, laminati Resistente a calore, umidità e acqua</p> <p>797D2370 - Formato 50 gr - - conf. 24 - € 3,60 797D2356 - Formato 125 gr - - conf. 24 - € 4,80</p>
  <p>BOSTIK SUPERTRASPARENTE Astuccio Adesivo a contatto universale superforte e trasparente</p> <p>797D2352 - Formato 125 gr - - conf. 24 - € 6,20 797D2371 - Formato 50 gr - - conf. 24 - € 4,60</p>	  <p>VINAVIL Formato 100 gr</p> <p>797D0630 - - conf. 10 - € 3,10</p>
  <p>VINAVIL colla vinilica universale</p> <p>797D0604 - Formato 250 gr - - conf. 10 - € 4,80</p>	  <p>VINAVIL NPC 1 Kg</p> <p>797D0610 - - conf. 4 - € 12,40</p>
  <p>DEXLOC FRENAFILETTI 220 Formato 10 ml è un prodotto anaerobico monocomponente adatto alla frenatura di viti e dadi e altre parti filettate contro l'allentamento causato dalle vibrazioni. Il prodotto polimerizza spontaneamente quando si trova in assenza d'aria all'interno di superfici metalliche con poco gioco.</p> <p>16508DEX22010 - - conf. 12 - € 3,88</p>	  <p>LUBRIFICANTE WD40 Formato 100 ml Arresta i cigolii Elimina l'umidità Libera i meccanismi bloccati Pulisce e protegge dalla ruggine Allenta le parti arrugginite</p> <p>83039509 - - conf. 24 - € 3,71</p>



AL MONDO



WD-40, PRODOTTO MULTIFUNZIONE



WD-40 SPECIALIST,



WD-40 SPECIALIST, PRODOTTI MOTO



WD-40 SPECIALIST, PRODOTTI BIKE



OTTIMO LAVORO!

Per maggiori informazioni, visita wd40.it

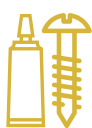

 <p>LUBRIFICANTE WD-40 Arresta i cigolii Elimina l'umidità Libera i meccanismi bloccati Pulisce e protegge dalla ruggine Allenta le parti arrugginite</p> <p>83039302 - Formato 200 ml - - conf. 36 - € 4,24 83039204 - Formato 400 ml - - conf. 24 - € 7,70</p>	 <p>LUBRIFICANTE WD-40 Formato 250 ml. Doppia Posizione Arresta i cigolii Elimina l'umidità Libera i meccanismi bloccati Pulisce e protegge dalla ruggine Allenta le parti arrugginite</p> <p>83039489 - - conf. 30 - € 6,18</p>
 <p>LUBRIFICANTE WD-40 Formato 500 ml. Doppia Posizione Arresta i cigolii Elimina l'umidità Libera i meccanismi bloccati Pulisce e protegge dalla ruggine Allenta le parti arrugginite</p> <p>83039134 - - conf. 6 - € 8,90</p>	 <p>LUBRIFICANTE WD-40 Formato 400 ml Doppia Posizione Arresta i cigolii Elimina l'umidità Allenta i meccanismi bloccati Pulisce e protegge dalla ruggine Sblocca i bulloni e parti arrugginite Non contiene silicone</p> <p>830391048 - - conf. 24 - € 9,20</p>
 <p>LUBRIFICANTE WD-40 Fusto da 5 Litri Arresta i cigolii Elimina l'umidità Libera i meccanismi bloccati Pulisce e protegge dalla ruggine Allenta le parti arrugginite</p> <p>83044506 - - conf. 1 - € 65,52</p>	 <p>SUPER SBLOCCANTE WD-40 Formato 400 ml Azione rapida Formula adatta per: Tutti i metalli e vernici grippaggio - ossidazione Raccomandato per dadi/bulloni, cerniere e chiavistelli</p> <p>83039348 - - conf. 12 - € 12,57</p>
 <p>LUBRIFICANTE WD-40 PER SERRATURE Formato 250 ml Il lubrificante serrature WD-40 SPECIALIST è stato sviluppato appositamente per la manutenzione di tutti i tipi di cilindri Grazie alla sua formula senza grasso nè silicone, penetra per capillarità dentro tutti i micro-meccanismi delle serrature senza sporcarle Assicura una manutenzione preventiva delle parti mobili e protegge durevolmente dalla ruggine anche all'esterno</p> <p>83039308 - - conf. 12 - € 9,20</p>	 <p>DETERGENTE CONTATTI WD-40 Formato 400 ml Asciugatura rapida Formula adatta per metalli - plastiche - gomme Raccomandato per contatti circuiti stampati, stampanti e fotocopiatrici</p> <p>83039368 - - conf. 12 - € 12,57</p>
 <p>LUBRIFICANTE AL SILICONE WD-40 Formato 400 ml Applicazione pulita Resistente a temperature da -35° a +200° Formula adatta per metalli - plastiche gomme - legno Raccomandato per cinghie, guarnizioni valvole e cerniere</p> <p>83039377 - - conf. 12 - € 12,57</p>	 <p>GRASSO BIANCO AL LITIO WD-40 Formato 400 ml Lubrificazione a lunga durata Resistente a carichi elevati Non cola Resistente a temperature da -18° a +145° Per ambienti interni ed esterni Formula raccomandata per: cuscinetti - argani - pistoni - guide di porte - pompe - cardini - cerniere - meccanismi di freno Certificato NSF H2</p> <p>83039391 - - conf. 12 - € 12,57</p>
 <p>GRASSO ADESIVO WD-40 Formato 400 ml Eccellente aderenza alla superficie Resistente alla centrifugazione, acqua, carichi elevati Resistente a temperature da -18° a +145° Formula raccomandata per: catene (anche in movimento) - ingranaggi scoperti - ruote dentate - presse - cesoie - cerniere</p> <p>83039221 - - conf. 12 - € 12,57</p>	 <p>GRASSO SPRAY WD-40 Formato 400 ml Eccellente lubrificazione della superficie Ottima aderenza Resistente all'acqua, non cola Resistente a temperature da -20° a +55° Adatto ad applicazioni con carichi elevati Formula raccomandata per: cardini - viti - guide - rulli - ingranaggi - utensili - cuscinetti - argani - serrande</p> <p>83039217 - - conf. 12 - € 12,57</p>

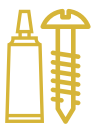

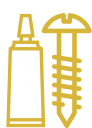

 <p>LUBRIFICANTE SECCO AL PTFE WD-40 Formato 400 ml Lubrificazione secca Non attira polvere, sporco, unto Secca rapidamente Compatibile con tutti i metalli, plastiche e vetro Resistente a temperature da -20° a +250° Formula raccomandata per: guide - perni - punte - elettro utensili - serrature - saliscendi - catene - cavi - cerniere - stampi - rotelle Certificato NSF H2</p> <p>8303939546 - - conf. 12 - € 12,57</p>	 <p>OLIO DA TAGLIO WD-40 Formato 400 ml Limita l'accumulo di calore ed evita l'usura degli utensili Adatta su tutti i metalli Formula raccomandata per: lame - dischi - punte - frese</p> <p>83039109 - - conf. 12 - € 12,57</p>
 <p>LUBRIFICANTE PTFE ALTE PRESTAZIONI WD-40 Formato 400 ml Eccellente lubrificazione Riduce la frizione e l'usura di utensili e attrezzi Compatibile con tutti i metalli, plastiche, vetro, vinile, gomma Resistente a temperature da -20° a +100° Formula raccomandata per: idraulica - elettro utensili - ingranaggi - boccole - guide - verricelli - manovelle Certificato NSF H2</p> <p>8303939746 - - conf. 12 - € 12,57</p>	 <p>SGRASSANTE WD-40 Formato 500 ml Rimuove rapidamente grasso, olio e sporco senza lasciare residui Adatta per superfici come: pavimenti, metalli, plastiche Formula raccomandata per: motori - utensili - macchinari industriali - equipaggiamento nautico</p> <p>8303939246 - - conf. 12 - € 12,68</p>
 <p>LUBRIFICANTE CATENA UNIVERSALE WD-40 BIKE Formato 250 ML La formula al PTFE fornisce un'eccellente lubrificazione sia in condizioni asciutte che umide, riducendo l'attrito e l'usura della catena. Penetra nelle giunture della catena e, dopo l'asciugatura, lascia una pellicola protettiva duratura che aiuta a prevenire la corrosione. Idoneo a molteplici applicazioni, tra cui cambio, cavi e leve. Raccomandato per: catena, cambio, gruppo rapporti, leve, maniglie</p> <p>8303970346 - - conf. 12 - € 9,89</p>	 <p>SGRASSANTE WD-40 BIKE Formato 500 ML A base di solventi, agisce rapidamente per rimuovere grasso, olio e sporco. Agisce al contatto senza lasciare residui e non necessita di risciacquo. Riduce l'usura Raccomandato per: catena, cambio, gruppo rapporti</p> <p>83039704 - - conf. 12 - € 11,33</p>
 <p>LUBRIFICANTE CATENA PER CONDIZIONI ASCIUTTE WD-40 BIKE Formato 100 ML Concepito per condizioni asciutte e polverose. La sua formula contiene PTFE che penetra efficacemente all'interno della catena creando una pellicola lubrificante senza attirare polvere. Riduce l'attrito e l'usura della catena Raccomandato per: catena, cambio, leve</p> <p>83039695 - - conf. 12 - € 11,60</p>	 <p>LUBRIFICANTE CATENA PER CONDIZIONI UMIDE WD-40 BIKE Formato 100 ML Lubrificante catena per condizioni umide è specificamente sviluppato per l'uso della bici in condizioni di umidità e fango. Penetra efficacemente all'interno della catena e fornisce un'eccellente lubrificazione respingendo l'umidità e proteggendo efficacemente dalla corrosione. Riduce l'attrito e l'usura della catena Raccomandato per: catena, cambio, leve</p> <p>83039687 - - conf. 12 - € 9,27</p>
 <p>SBLOCCANTE BIODEGRADABILE W8 Sbloccante otto funzioni: sbloccante, protettivo, lubrificante, idrorepellente, anticongelante, sgrassante, dielettrico, anticorrosivo. Indispensabile per il ripristino di oggetti utilizzati in officina, in casa, in garage, in giardino, nella nautica. Non contiene tricloroetilene. Formato 400 ml</p> <p>469W8S - Formato 400 ml - - conf. 12 - € 5,00</p>	 <p>SUPER SBLOCCANTE Prodotto multiuso con 7 funzioni: sbloccante, protettivo, lubrificante, idrorepellente, anticongelante, sgrassante e dielettrico. Scioglie la ruggine, le incrostazioni e la salsedine. Non contiene tricloroetilene a rispetto dell'ambiente.</p> <p>46981710/02 - Formato 200 ml - - conf. 12 - € 3,31 46981710/04 - Formato 400 ml - - conf. 12 - € 3,97</p>
 <p>EMULSOIL OLIO EMULSIONABILE Trasparente Raccomandato per operazioni convenzionali quali taglio, tornitura e nelle operazioni gravose quali foratura, fresatura, filettatura... Formato 1 L</p> <p>46983050/01 - Formato 1 L - - conf. 16 - € 14,36</p>	 <p>GRASSO 1000°C SPRAY Grasso al rame Lubrifica e assicura la facilità di smontaggio di parti filettate, guarnizioni e flange sottoposti a basse e alte temperature da -30°C a +1000°C Formato 400 ml</p> <p>46985410/04 - - conf. 12 - € 8,03</p>



  <p>GRASSO 700° SPRAY Grasso Alta Temperatura Lubrificante antigrippaggio al bisolfuro di molibdeno che resiste alle temperature sino a 700°C. Per acciaierie, fonderie, officine meccaniche. Formato 400 ml</p> <p>46984110/04 - - conf. 12 - € 6,71</p>	  <p>GRASSO CATENE SPRAY Per la lubrificazione di lunga durata delle catene sottoposte a velocità di rotazione estreme, in particolare per la moto. Lubrificante molto adesivo, incolore, inodore. Formato 400 ml</p> <p>46984010/04 - Formato 400 ml - - conf. 12 - € 6,87</p>
  <p>GRASSO MILLEUSI SPRAY Lubrificante universale adatto per la casa, industria, officina. Lubrifica e protegge senza ossidarsi o alterarsi nel tempo. Buona resistenza al calore Formato 400 ml</p> <p>46983810/04 - - conf. 6 - € 5,10</p>	  <p>LUBRIFICANTE SECCO SPRAY Lubrificante al PTFE che non cola e non macchia. Indicato per giunti, ingranaggi, cerniere... Assicura una lubrificazione ad alte temperature e per lungo termine Formato 400 ml</p> <p>46985210/04 - Formato 400 ml - - conf. 12 - € 6,52</p>
  <p>OLIO TAGLIO SPRAY Rende piu rapida e sicura la lavorazione dei metalli. Può essere impiegato per qualsiasi lavorazione di metalli ferrosi, non ferrosi e relative leghe. Preserva dalla ruggine. Formato 400 ml</p> <p>46983010/04 - Formato 400 ml - - conf. 12 - € 5,67</p>	  <p>OLIO VASELINA Paraffina liquida pura incolore e inerte che protegge gomma, tessuti, pelle, cuoio, legno e metalli. Non si ossida, non irrancidisce e non asciuga. Indicato per macchinari dell'industria tessile. Formato 400 ml</p> <p>46981910/04 - Formato 400 ml - - conf. 12 - € 5,45</p>
  <p>RIATTIVA CONTATTI Espelle l'umidità Indispensabile per riattivare e lubrificare circuiti elettrici e meccanismi vari. Ideale per l'auto, la casa, il lavoro... Non danneggia la plastica e la gomma Utilizzare su impianti non in tensione. Formato 200 ml</p> <p>46982010/02 - Formato 200 ml - - conf. 12 - € 4,32</p>	  <p>SILICONE SPRAY Universale Utilizzabile come lubrificante, come protettivo, distaccante, isolante per impianti elettrici... Effetto idrorepellente. Inodore e invisibile. Formato 400 ml</p> <p>46980410/04 - Formato 400 ml - - conf. 12 - € 4,34</p>
  <p>GRASSO MILLEUSI In tubetto Grasso polivalente filante, dall'aspetto liscio, brillante e discretamente adesivo. Adatto per un uso casalingo, per auto e industria. Idrorepellente Formato 125 ml</p> <p>46983830/125 - - conf. 12 - € 4,53</p>	  <p>GRASSO VASELINA Lubrificante in crema di pura paraffina incolore e inerte per proteggere gomma, metalli, legno, cuoio e tessuto. Specifico per utilizzare attrezzature fitness, macchine utensili, trasmissioni e cerniere. Sigillante non idurente e difficilmente asportabile da acqua e alcool.</p> <p>46981930/125 - Confezione Tubetto - Formato 125 ml - - conf. 12 - € 4,41 46981930/01 - Confezione Barattolo - Formato 0,9 kg - - conf. 12 - € 17,00</p>
  <p>GRASSO NAUTICA In barattolo Al litio di colore bianco contenente ossido di zinco e titanio specifico per la lubrificazione e protezione di tutti meccanismi sottoposti all'azione dell'acqua. Buona stabilità con acqua. Formato 0,9 kg</p> <p>46983930/01 - - conf. 12 - € 21,16</p>	  <p>ANTISLITTANTE CINGHIE SPRAY Può essere utilizzato per qualsiasi tipo di cinghia in gomma, cuoio, tessuto o nylon. Consente un perfetto movimento della cinghia mantenendo costante il sincronismo dei movimenti di trazione. Prolunga la durata della cinghia in quanto penetra nelle porosità, prevenendo tagli e screpolature. Formato 400 ml</p> <p>46983110/04 - Formato 400 ml - - conf. 6 - € 6,77</p>





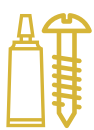



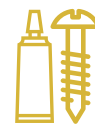







 <p>ACCIAIO INOX SPRAY Ideale per ripristinare e proteggere tutti i materiali in acciaio: attrezzature marine, celle frigorifere, lavelli... Si applica facilmente, essicca rapidamente all'aria formando una pellicola flessibile compatta e resistente. Può essere sopravverniciata. Alta resistenza al calore Formato 400 ml</p> <p>46981810/04 - Formato 400 ml - - conf. 12 - € 7,46</p>	 <p>RICERCA GAS Sistema rapido e sicuro per trovare le perdite di gas nei punti sottoposti a pressioni. Formato 400 ml</p> <p>46981110/04 - Formato 400 ml - - conf. 12 - € 4,34</p>
 <p>ZINCO CHIARO SPRAY Protettivo antiruggine con elevato potere coprente di colore zinco chiaro. Prodotto monocomponente pronto all'uso ad alto contenuto di zinco puro in veicolo sintetico al 98%. Alta resistenza al calore. Formato 400 ml</p> <p>46981310/04 - Formato 400 ml - - conf. 12 - € 5,38</p>	 <p>ZINCOBRIL SPRAY Protettivo antiruggine con con elevato potere coprente di colore zinco brillante. Prodotto monocomponente pronto all'uso ad alto contenuto di zinco puro in veicolo sintetico al 98%. Forma un film elastico resistente a tutti gli agenti atmosferici Alta resistenza al calore Formato 400 ml</p> <p>46981310/04B - Formato 400 ml - - conf. 12 - € 5,67</p>
 <p>ZINCANTE SPRAY Istantaneo FTC-ZS 400 ml Elevata protezione contro la corrosione Ottima aderenza alle superfici metalliche</p> <p>500519660 - - conf. 12 - € 6,20</p>	 <p>ECOCLIMAT SPRAY Ideale per pulire e igienizzare i climatizzatori di auto e per uso civile Contiene principi attivi di soluzione alcolica, La formula schiumosa elimina dai condotti e filtri: sporco, muffe, odori gradevoli... (Non è un disinfettante e sanificante). Formato 400 ml</p> <p>46984710/04 - Formato 400 ml - - conf. 12 - € 7,00</p>
 <p>TOGLI SILICONE SPRAY Elimina tracce di silicone Contiene solventi agrumati Formato 400 ml</p> <p>46982910/04 - Formato 400 ml - - conf. 12 - € 5,38</p>	 <p>NASTRO IMBALLO in polipropilene acrilico Svolgimento morbido e silenzioso Resistente agli ultravioletti Ottima resistenza all'invecchiamento Maggiore resistenza al taglio</p> <p>190990030 - Alt. mm 50 - Lungh. M 66 - Colore Trasp. - - conf. 6 - € 1,88</p> <p>190990035 - Alt. mm 50 - Lungh. M 66 - Colore Avana - - conf. 6 - € 1,88</p>
 <p>NASTRO MASCHERATURA Solvente gomma naturale Alta conformabilità Compatibile con vernici Adesione immediata su superfici irregolari Resistente a solventi Non lascia residui</p> <p>190990005 - Alt. mm 19 - Lungh. M 50 - - conf. 16 - € 1,20</p> <p>190990010 - Alt. mm 25 - Lungh. M 50 - - conf. 12 - € 1,60</p> <p>190990015 - Alt. mm 30 - Lungh. M 50 - - conf. 10 - € 1,80</p> <p>segue...</p>	 <p>continua...</p> <p>190990020 - Alt. mm 38 - Lungh. M 50 - - conf. 8 - € 2,40</p> <p>190990025 - Alt. mm 50 - Lungh. M 50 - - conf. 6 - € 3,40</p>
 <p>NASTRO AMERICANO in polietilene telato Altezza 50 mm Lunghezza 25 m Colore Argento Superfici di utilizzo: pietra, cemento, legna, plastica Impermeabile ultrasensibile Adatto a: riparare, rinforzare e proteggere</p> <p>190990050 - - conf. 6 - € 5,76</p>	 <p>NASTRO BIADIESIVO DPS Altezza 50 mm Lunghezza 25 m Colore bianco</p> <p>190990055 - - conf. 6 - € 4,40</p>



<p>SORAGNI</p> <p>NASTRO PER IMBALLO</p> <p>7719558AVA – Colore Avana – Misura 48mm x 66mt – – conf. 42 – € 1,87</p> <p>7719558TRA – Colore Trasparente – Misura 48mm x 66mt – – conf. 36 – € 1,87</p> 	<p>SORAGNI</p> <p>NASTRO MASKING in carta</p> <p>771902718 – Misura 18mm X 50mt – – conf. 96 – € 0,97</p> <p>771902724 – Misura 24mm x 50mt – – conf. 72 – € 1,29</p> <p>771902730 – Misura 30mm x 50mt – – conf. 60 – € 1,61</p> <p>771902736 – Misura 36mm x 50mt – – conf. 48 – € 1,94</p> <p>771902748 – Misura 48mm x 50mt – – conf. 36 – € 2,60</p> 
<p>SORAGNI</p> <p>NASTRO TELATO USA</p> <p>771920148B – colore Black – – conf. 6 – € 3,86</p> <p>771920148S – colore Silver – – conf. 6 – € 3,86</p> 	<p>SORAGNI</p> <p>BIADESIVO UNIVERSALE</p> <p>7719020 – Misura 48mm x 25mt – – conf. 1 – € 5,16</p> 
<p>ASTRAL</p> <p>TENDINASTRO Corpo metallo manico plastica Con lama retrattile antinfortunistica Made in USA</p> <p>190990045 – – conf. 1 – € 17,60</p> 	<p>Henkel</p> <p>NASTRO TELATO POWER TAPE GRIGIO</p> <p>515579000 – mt. 10 – h/mm. 50 – – conf. 12 – € 8,50</p> <p>515579001 – mt. 25 – h/mm. 50 – – conf. 12 – € 15,00</p> 
<p>Henkel</p> <p>BLISTER NASTRO TELATO POWER TAPE 50mmx5mt</p> <p>515578999 – colore grigio – – conf. 12 – € 6,10</p> <p>515579005 – colore bianco – – conf. 12 – € 6,10</p> <p>515579006 – colore nero – – conf. 12 – € 6,10</p> <p>515579008 – colore verde – – conf. 12 – € 6,10</p> 	<p>Henkel</p> <p>NASTRO BIADESIVO Soffice spessore 1,5mm. 1,5 mt.</p> <p>515578686 – – conf. 12 – € 4,40</p> 
<p>Henkel</p> <p>NASTRO BIADESIVO a basso spessore Traspa- rente 10 mt.</p> <p>515578683 – – conf. 12 – € 2,50</p> 	<p>SORAGNI</p> <p>NASTRO BIADESIVO MAGNUM Forte presa</p> <p>7719075 – Misura 19mm x 1,5mt – – conf. 6 – € 4,32</p> 
<p>Henkel</p> <p>MILLECHIODI NASTRO BIADESIVO Rotolo da 1,5 m Garantisce una super tenuta fino a 120 Kg per rotolo. Adatto per legno, vetro, pietra, materie sintetiche, metallo nonché nylon, PP e PE</p> <p>5151415580 – – conf. 12 – € 7,70</p> 	<p>FAI</p> <p>NASTRO ISOLANTE in PVC</p> <p>90090050 – Colore Rosso – Misura 15x10 – – conf. 10 – € 0,72</p> <p>90090051 – Colore Grigio – Misura 15x10 – – conf. 10 – € 0,72</p> <p>90090052 – Colore Bianco – Misura 15x10 – – conf. 10 – € 0,72</p> <p>90090053 – Colore Nero – Misura 15x10 – – conf. 10 – € 2,02</p> <p>90090054 – Colore Bianco – Misura 19x25 – – conf. 10 – € 1,54</p> <p>segue...</p> 



  <p>continua... 90090055 – Colore Nero – Misura 19x25 – – conf. 10 – € 1,54 90090056 – Colore Bianco – Misura 25x25 – – conf. 8 – € 2,04 90090057 – Colore Nero – Misura 25x25 – – conf. 8 – € 2,04</p>	<p>ASTRAL</p> <p>NASTRO ADESIVO SEGNALETICO in PVC “Per distanziamento” Altezza 50 mm Lunghezza 50 metri Colore bianco</p> <p>190990056 – – conf. 6 – € 4,60</p>  
<p>SORAGNI</p> <p>FILM ESTENSIBILE Trasparente Dimensioni 50 cm Spessore 23 my Peso 2,4 kg</p> <p>771678TRA – – conf. 8 – € 13,62</p> 	<p>SORAGNI</p> <p>FILM ESTENSIBILE Spessore 23 Micron Misura 12,5 cm Lunghezza 110 metri Peso bobina 350 gr</p> <p>771SP676 – – conf. 1 – € 3,08</p> 
<p>SORAGNI</p> <p>ROTOLO CARTA PROTETTIVA con nastro biadesivo</p> <p>771702 – Misura 18cm x 20mt – – conf. 50 – € 1,50 771703 – Misura 30cm x 20mt – – conf. 25 – € 2,20</p> 	<p>SORAGNI</p> <p>ROTOLO DI PLASTICA PROTETTIVA Con nastro biadesivo</p> <p>77170620 – Misura 55cm x 20mt – – conf. 10 – € 1,92 771708 – Misura 140cm x 33mt – – conf. 16 – € 5,94 771711 – Misura 270cm x 16mt – – conf. 5 – € 5,32</p> 
<p>SORAGNI</p> <p>FELTRO ASSORBENTE Standard EU 1x25 metri 200 gr/m²</p> <p>771SP121025 – – conf. 1 – € 25,80</p> 	<p>SORAGNI</p> <p>BOBINA PROFESSIONALE LDPE Trasparente prima scelta 80 Micron 2x20 metri 3 kg</p> <p>771SP726V – – conf. 6 – € 18,74</p> 
<p>SORAGNI</p> <p>TELO IN ALTA DENSITA' HDPE 100 m² – 7 MI-CRON 48 metri 4x25 cm 670 gr</p> <p>771SP744007 – – conf. 20 – € 4,88</p> 	<p>SORAGNI</p> <p>SET 3 TELI HDPE Con prestappo con apertura rapida alta densità Misura 48 m² 300 gr</p> <p>771SP7197S – – conf. 45 – € 2,60</p> 
<p>SORAGNI</p> <p>TELO COPRITUTTO HDPE Con apertura rapida alta densità 4x4 metri 110 gr</p> <p>771SP719007 – – conf. 100 – € 0,90</p> 	<p>SORAGNI</p> <p>TELO COPRITUTTO LDPE Con apertura rapida trasparente/rigenarato 4X4 metri 195 gr</p> <p>771SP716013 – – conf. 70 – € 1,08</p> 

SIMM





ACCESSORI PER TAPPARELLE E PERSIANE





SFOGLIA LA CATEGORIA





 <p>RULLO OTTAGONALE LISCIO PER MOTORIZZATE Spessore 8/10 Ø 60 mm</p> <p>90013705 - Mt. 1,6 - - conf. 8 - € 12,20 90013706 - Mt. 2,2 - - conf. 8 - € 16,80</p> 	 <p>RULLO OTTAGONALE TELESCOPICO PER MOTORIZZATE Con limitatore Ø 60 mm</p> <p>90013709 - - conf. 8 - € 5,80</p> 
 <p>RULLO STELLATO spessore 5/10 Ø 60 - tipo A</p> <p>90013791 - mt. 1,60 - - conf. 8 - € 11,00 90013792 - mt. 2,20 - - conf. 8 - € 15,20</p> 	 <p>CALOTTA IN PVC CON PERNO TONDO Per rullo ottagonale liscio</p> <p>90013710 - - conf. 10 - € 0,68</p> 
 <p>CALOTTA ESTERNA IN FERRO CON PERNO TONDO Per rullo ottagonale liscio 40 mm</p> <p>90013711 - - conf. 10 - € 1,32</p> 	 <p>CALOTTA ESTERNA LUNGA IN FERRO Per rullo ottagonale liscio 60 mm</p> <p>90013712 - - conf. 5 - € 5,76</p> 
 <p>CALOTTA INTERNA REGOLABILE RIVESTITA IN PVC CON PERNO PIENO TORNITO QUADRO 13 MM Ribasso Ø 12 mm Per rullo ottagonale liscio 60 mm</p> <p>90013713 - - conf. 4 - € 5,40</p> 	 <p>CALOTTA regolabile Ø 60 zincata</p> <p>90013389 - Ø 60 - - conf. 5 - € 6,60</p> 
 <p>PULEGGIA CON CALOTTA LISCIA Spessore 7/10 Calotta liscia 60 mm</p> <p>90013720 - Ø 200 - - conf. 4 - € 6,60 90013721 - Ø 220 - - conf. 4 - € 7,20 90013722 - Ø 240 - - conf. 4 - € 7,60</p> 	 <p>RIDUTTORE STANDARD RAPP. 1:2,5 Puleggia Ø 24 cm Calotta liscia 60 mm</p> <p>90013730 - - conf. 1 - € 31,80</p> 
 <p>MOLLA DI RICAMBIO PER COMPACT ALFA Ferro zincato</p> <p>90013785 - - conf. 10 - € 14,62</p> 	 <p>CALOTTA STELLATA con perno</p> <p>90013798 - - conf. 10 - € 1,20</p> 



  <p>PULEGGIA per rullo stellato in ferro</p> <p>90013805 - Ø 200 - - conf. 4 - € 4,54</p> <p>90013806 - Ø 220 - - conf. 4 - € 4,94</p> <p>90013807 - Ø 240 - - conf. 4 - € 6,38</p>	  <p>RIDUTTORE per rullo stellato con supporto</p> <p>90013810 - - conf. 1 - € 25,96</p>
  <p>PULEGGIA PER RULLI IN LEGNO con foro cieco</p> <p>90013830 - Ø 200 - - conf. 4 - € 3,70</p> <p>90013831 - Ø 220 - - conf. 4 - € 4,12</p> <p>90013832 - Ø 240 - - conf. 4 - € 4,94</p>	  <p>RIDUTTORE PER RULLO IN LEGNO Mod. R 100 con supporto</p> <p>90013835 - - conf. 1 - € 25,96</p>
  <p>FORCELLA PER RULLO IN LEGNO 65 mm</p> <p>90013840 - - conf. 10 - € 1,52</p>	  <p>AVVOLGITORE INTERNO INTERASSE UNIVER-SALE Interassi: 130-135-142- 160-165-185 Con placca</p> <p>90014001 - Mt. 6 - - conf. 10 - € 8,00</p> <p>90014002 - Mt. 8 - - conf. 10 - € 9,00</p>
  <p>AVVOLGITORE INTERNO TIPO "MINI" CON PLACCA INOX Metri 4 Interasse foro 114 mm</p> <p>90014010 - - conf. 1 - € 12,40</p>	  <p>AVVOLGITORE PER TAPPARELLA Completo di Placca INTERASSE 125</p> <p>90014015 - Ø 75 - MT. 4 - - conf. 10 - € 4,12</p> <p>90014016 - Ø 85 - MT. 6 - - conf. 10 - € 5,40</p> <p>90014017 - Ø 95 - MT. 8 - - conf. 10 - € 4,94</p>
  <p>AVVOLGITORE Completo di Placca INTERASSE 145</p> <p>90014020 - Ø 75 - Mt. 4 - - conf. 10 - € 4,32</p> <p>90014021 - Ø 85 - Mt. 6 - - conf. 10 - € 4,32</p> <p>90014022 - Ø 95 - Mt. 8 - - conf. 10 - € 5,16</p>	  <p>AVVOLGITORE PER TAPPARELLA Completo di Placca INTERASSE 165</p> <p>90014025 - Ø 75 - mt. 4 - - conf. 10 - € 4,12</p> <p>90014026 - Ø 85 - mt. 6 - - conf. 10 - € 5,40</p> <p>90014027 - Ø 95 - mt. 8 - - conf. 10 - € 6,20</p> <p>90014029 - Ø 115 - mt. 12 - - conf. 10 - € 8,04</p>
  <p>AVVOLGITORE Completo di Placca INTERASSE 185</p> <p>90014030 - Ø 75 - mt. 4 - - conf. 10 - € 5,20</p> <p>90014031 - Ø 85 - mt. 6 - - conf. 10 - € 5,40</p> <p>90014032 - Ø 95 - mt. 8 - - conf. 10 - € 6,20</p> <p>90014033 - Ø 98 - mt. 10 - - conf. 10 - € 6,60</p> <p>90014034 - Ø 115 - mt. 12 - - conf. 10 - € 8,04</p>	  <p>AVVOLGITORE PER TAPPARELLA Completo di Placca INTERASSE 210</p> <p>90014036 - Ø 85 - Metri 6 - - conf. 10 - € 6,20</p> <p>90014037 - Ø 95 - Metri 8 - - conf. 10 - € 6,18</p> <p>90014039 - Ø 115 - Metri 12 - - conf. 10 - € 9,68</p>



<p>SIAMM</p> <p>AVVOLGITORE Completo di Placca mt. 12 INTE-RASSE 256</p> <p>90014049 – – conf. 1 – € 9,68</p> 	<p>SIAMM</p> <p>AVVOLGITORE semincasso mt. 5 completo di placca argento</p> <p>90014060 – – conf. 1 – € 10,30</p> 
<p>SIAMM</p> <p>AVVOLGITORE semincasso mt. 9 completo di placca argento</p> <p>90014061 – – conf. 1 – € 22,60</p> 	<p>SIAMM</p> <p>AVVOLGITORE semincasso mt. 6 DX con placca verniciata nera</p> <p>90014069 – – conf. 1 – € 20,20</p> 
<p>SIAMM</p> <p>AVVOLGITORE semincasso mt. 6 SX con placca verniciata nera Ruota: Ø 68</p> <p>90014070 – – conf. 1 – € 20,20</p> 	<p>SIAMM</p> <p>AVVOLGITORE semincasso mt. 5,5 DX con placca verniciata nera</p> <p>90014065 – – conf. 1 – € 18,54</p> 
<p>SIAMM</p> <p>AVVOLGITORE semincasso mt. 5,5 SX con placca verniciata nera Ruota lato sinistro</p> <p>90014066 – – conf. 1 – € 18,54</p> 	<p>SIAMM</p> <p>AVVOLGITORE semincasso mt. 11 SX con placca verniciata nera</p> <p>90014086 – – conf. 1 – € 31,60</p> 
<p>SIAMM</p> <p>AVVOLGITORE semincasso mt. 11 DX con placca verniciata nera</p> <p>90014085 – – conf. 1 – € 31,60</p> 	<p>SIAMM</p> <p>AVVOLGITORE semincasso mt.9 completo di placca argento Materiale Alluminio</p> <p>90014062 – – conf. 1 – € 19,20</p> 
<p>SIAMM</p> <p>AVVOLGITORE SEMINCASSO CON PLACCA</p> <p>90014076 – Metri 10 – I 200 – A 50 – Placca Crom. – conf. 1 – € 59,00</p>  <p>LISCIA BOMBATA</p>	<p>SIAMM</p> <p>AVVOLGITORE SEMINCASSO Con placca argento Interasse 165</p> <p>90014073 – Metri 6 – Int. 165 – Ø 75 – A 25mm– Placca Bombata – conf. 1 – € 16,80</p> <p>90014074 – Metri 9 – Int. 165 – Ø 75 – A 50 mm– Placca Bombata – conf. 1 – € 23,70</p> <p>90014080 – Metri 5 – Int. 165 – Ø 65 – A 25 mm– Placca Liscia – conf. 1 – € 17,30</p> <p>segue...</p>  <p>LISCIA BOMBATA</p>















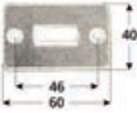
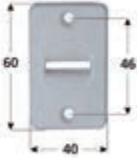





  <p>continua... 90014081 - Metri 8 - Int. 165 - Ø 75 - A 50 mm - Placca Liscia - conf. 1 - € 25,40 90014082 - Metri 11 - Int. 165 - Ø 95 - A 50 mm - Placca Liscia - conf. 1 - € 40,40</p> <p>LISGA BOMBATA</p>	 <p>AVVOLGITORE DA INCASSO COMPLETO - SMALL mt. 4 Con cintino e placca in PVC</p> <p>90014089 - Mt. 4 - - conf. 1 - € 7,82</p> 
 <p>AVVOLGITORE A BANDIERA RICOPERTO Con cintino 6 metri</p> <p>90014091 - Metri 6 - - conf. 1 - € 14,42</p> 	 <p>AVVOLGITORE a bandiera in ferro cromato mt. 6</p> <p>90014092 - - conf. 1 - € 25,60</p> 
 <p>AVVOLGITORE esterno in ferro cromato mt. 6</p> <p>90014095 - - conf. 1 - € 9,28</p> 	 <p>AVVOLGITORE A CASSONETTO CON PULEGGIA Puleggia 180 mm Altezza totale 230 mm</p> <p>90014105 - Mano Dx - - conf. 2 - € 16,00 90014106 - Mano Sx - - conf. 2 - € 16,00</p> 
 <p>PLACCA BIANCA IN PVC PER AVVOLGITORE Interasse universale Bloccaggio a clips</p> <p>90014300 - - conf. 10 - € 1,38</p> 	 <p>PLACCA per avvolgitore INOX</p> <p>90014312 - Int. 125 - - conf. 25 - € 0,94 90014313 - Int. 145 - - conf. 25 - € 0,94 90014314 - Int. 165 - - conf. 25 - € 0,94 90014315 - Int. 185 - - conf. 25 - € 1,08 90014316 - Int. 210 - - conf. 15 - € 1,54 90014317 - Int. 256 - - conf. 15 - € 1,56</p> 
 <p>PLACCA CIECA Materiale: alluminio Larghezza: 60 mm</p> <p>90014301 - Int. 165 - Finitura Argento - - conf. 1 - € 3,50 90014302 - Int. 165 - Finitura Bronzato - - conf. 1 - € 4,12 90014303 - Int. 165 - Finitura Bianco - - conf. 1 - € 3,20 90014304 - Int. 185 - Finitura Argento - - conf. 1 - € 3,50 90014305 - Int. 185 - Finitura Bronzato - - conf. 1 - € 4,32 segue...</p> 	 <p>continua... 90014306 - Int. 185 - Finitura bianco - - conf. 1 - € 3,60</p> 
 <p>CASSETTA per avvolgitore mt. 6 INTERASSE 125</p> <p>90014333 - - conf. 5 - € 3,50</p> 	 <p>CASSETTA PVC Da murare Per avvolgitori</p> <p>90014335 - Metri da 6 - Interasse 165 mm - - conf. 5 - € 3,10 90014336 - Metri da 4 a 8 - Interasse 185 mm - - conf. 5 - € 2,80 90014337 - Metri da 12 - Interasse 185 mm - - conf. 5 - € 4,54</p> 



 <p>FERMA TAPPARELLA CORTO</p> <p>90014351 - Modello Corto - Colore Grigio - - conf. 50 - € 0,24</p> <p>90014352 - Modello Corto - Colore Marrone - - conf. 50 - € 0,24</p> <p>90014353 - Modello Corto - Colore Bianco - - conf. 50 - € 0,24</p> 	 <p>FERMA TAPPARELLA LUNGO</p> <p>90014361 - Modello Lungo - Colore Grigio - - conf. 50 - € 0,28</p> <p>90014362 - Modello Lungo - Colore Marrone - - conf. 50 - € 0,28</p> <p>90014363 - Modello Lungo - Colore Bianco - - conf. 50 - € 0,28</p> 
 <p>SUPPORTO FERMATAPPARELLA ad angolo con paracolpi</p> <p>90014370 - - conf. 15 - € 0,70</p> 	 <p>SUPPORTO a sfera maschio</p> <p>90014381 - - conf. 20 - € 1,36</p> 
 <p>SUPPORTO a sfera Femmina</p> <p>90014382 - - conf. 20 - € 2,48</p> 	 <p>SUPPORTO CON GAMBO FILETTATO M10 PER CUSCINETTO A SFERE Ø 42 MM Da utilizzare con calotte, pulegge, riduttori</p> <p>90014383 - - conf. 10 - € 2,60</p> 
 <p>CUSCINETTO TONDO A SFERE</p> <p>90014384 - Materiale PVC - - conf. 10 - € 0,74</p> <p>90014385 - Materiale Ferro - - conf. 10 - € 1,38</p> 	 <p>CUSCINETTO TONDO AD INCASTRO Ferro zincato</p> <p>90014386 - - conf. 10 - € 1,48</p> 
 <p>SUPPORTO a sfera sfilabile tipo Baveno, con fori</p> <p>90014390 - - conf. 10 - € 2,48</p> 	 <p>SUPPORTO a sfera, con zanca in ferro</p> <p>90014400 - - conf. 10 - € 1,72</p> 
 <p>SUPPORTO a sfera, con zanca per riduttore</p> <p>90014401 - - conf. 5 - € 3,30</p> 	 <p>GUIDA CINGHIA OVALE Ottone lucido</p> <p>447423140001 - Modello Orizzontale - Misura 35x60 - - conf. 10 - € 7,40</p> <p>447423160001 - Modello Verticale - Misura 62x52 - - conf. 10 - € 9,40</p> 



 <p>GUIDACINGHIA orizzontale per tapparella con rulli in plastica</p> <p>90014420 - - conf. 50 - € 0,74</p> 	 <p>GUIDACINGHIA verticale per tapparella con rulli in plastica</p> <p>90014421 - - conf. 50 - € 0,74</p> 
 <p>GUIDACINGHIA DA AVVITARE A 1 FERITOIA Orizzontale Colore bianco Materiale PVC</p> <p>90014422 - - conf. 20 - € 0,88</p> 	 <p>GUIDACINGHIA DA AVVITARE A 1 FERITOIA Verticale Colore bianco Materiale PVC</p> <p>90014423 - - conf. 20 - € 0,88</p> 
 <p>GUIDACINGHIA VERTICALE CON SPAZZOLINO</p> <p>90014424 - Finitura Bianco - - conf. 20 - € 2,60 90014425 - Finitura Marrone - - conf. 20 - € 2,60</p> 	 <p>GUIDACINGHIA ORIZZONTALE CON SPAZZOLINO</p> <p>90014426 - Finitura Bianco - - conf. 20 - € 2,80 90014427 - Finitura Marrone - - conf. 20 - € 2,80</p> 
 <p>GANCIO ATTACCO rullo Mod. H 305</p> <p>90014443 - - conf. 100 - € 0,24</p> 	 <p>GUIDACINGHIA PER CASSONETTI A SCOMPARSA Colore bianco</p> <p>90014428 - - conf. 10 - € 1,88</p> 
 <p>GANCIO attacco stecca ferro zincato Completo di cintino</p> <p>90014440 - - conf. 25 - € 1,70</p> 	 <p>GANCIO INIZIALE per tapparella in ferro</p> <p>90014441 - - conf. 200 - € 0,20</p> 
 <p>GANCIO TERMINALE per tapparella in ferro</p> <p>90014442 - - conf. 100 - € 0,18</p> 	 <p>GANCIO MOBILE per tapparella legno Mod. H 200 Tropicalizzato</p> <p>90014444 - - conf. 100 - € 0,14</p> 



ZAS
EASYHOME



Via Sile, 37/14
CASTELFRANCO V.TO (TV)



0423 724644 - 420401



www.zasrl.com



**FUNI
CAVETTI
ELASTICI
CORDE ELASTICHE
CINTINI PER TAPPARELLE
FASCE SOLLEVAMENTO
CINGHIE ANCORAGGIO
FILI MULTIUSO
CATENE**

















**PROGETTAZIONE
e ALLESTIMENTO
STRUTTURE
ESPOSITIVE
da 1 a 9 mt**





 <p>GANCIO INTERMEDIO per tapparella in legno 42mm. Mod. H 103 Tropicalizzato</p> <p>90014445 - - conf. 100 - € 0,10</p> 	 <p>GANCIO NORMALE per tapparella Tropicalizzato</p> <p>90014446 - - conf. 100 - € 0,20</p> 
 <p>RULLO DI RINVIO pesante R 305</p> <p>90014460 - - conf. 10 - € 1,78</p> 	 <p>BLOCCA TAPPARELLE UNIBLOCK A due elementi per stecche da 9 a 14 mm</p> <p>90014710 - - conf. 4 - € 7,42</p> 
 <p>BLOCCA TAPPARELLE A STECCA CON CODA A TAGLIO</p> <p>90014701 - L 9 - - conf. 4 - € 0,90 90014702 - L 14 - - conf. 4 - € 0,82</p> 	 <p>CINTINO PER TAPPARELLE IN COTONE BICOLORE 18 grammi Larghezza 22 mm</p> <p>885CI1MT55 - Mt. 5,5 mt - - conf. 12 - € 2,52 885CI1MT75 - Mt. 7,5 mt - - conf. 12 - € 3,34 885CI1RT50 - Mt. 50 mt - - conf. 5 - € 15,90</p> 
 <p>CINTINO PER TAPPARELLE IN COTONE BICOLORE 22 grammi Larghezza 22 mm</p> <p>885CI2MT55 - Metri 5,5 mt - - conf. 12 - € 2,78 885CI2MT75 - Metri 7,5 mt - - conf. 12 - € 3,54 885CI2RT50 - Metri 50 mt - - conf. 5 - € 20,04</p> 	 <p>CINTINO PER TAPPARELLE IN COTONE BICOLORE 27 grammi Larghezza 22 mm</p> <p>885CI3MT55 - Mt. 5,5 mt - - conf. 12 - € 3,04 885CI3MT75 - Mt. 7,5 mt - - conf. 12 - € 4,04 885CI3A12 - Mt. 12 mt - - conf. 12 - € 5,80 885CI3RT50 - Mt. 50 mt - - conf. 5 - € 23,26</p> 
 <p>CINTINO PER TAPPARELLE IN COTONE BICOLORE 30 grammi Larghezza 22 mm</p> <p>885CI4MT55 - Metri 5,5mt - - conf. 12 - € 3,60 885CI4MT75 - Metri 7,5mt - - conf. 12 - € 4,78 885CI4RT50 - Metri 50 mt - - conf. 5 - € 27,66</p> 	 <p>CINTINO PER TAPPARELLE IN POLIPROPILENE Bianco 25 grammi Larghezza 22 mm</p> <p>885CI9MT55B - Metri 5,5 mt - - conf. 12 - € 3,12 885CI9MT75B - Metri 7,5 mt - - conf. 12 - € 3,98 885CI9RT50B - Metri 50 MT - - conf. 5 - € 22,08</p> 
 <p>CINTINO STRETTO PER TAPPARELLE IN COTONE BICOLORE Larghezza 17 mm</p> <p>885CI11RT50 - Metri 50 mt - - conf. 5 - € 18,54</p> 	 <p>CINTINO STRETTO E SOTTILE IN POLIPROPILENE PER MONOBLOCCO Grigio Larghezza 18 mm</p> <p>885CI6RT50 - Metri 50 MT - - conf. 5 - € 17,20</p> 















 <p>CINTINO PER TAPPARELLE ANIMATO IN YUTA Larghezza 30 mm</p> <p>885C112RT50 – Metri 50 mt – – conf. 5 – € 23,60</p> 	 <p>CINTINO PER TAPPARELLE IN COTONE BICOLORE 18 grammi</p> <p>512820010N – Metri 5 mt – – conf. 100 – € 1,65 512820020N – Metri 7 mt – – conf. 100 – € 2,28 512820060N – Metri 50 mt – – conf. 20 – € 12,30</p> 
 <p>CINTINO PER TAPPARELLE IN COTONE BICOLORE 27 grammi</p> <p>512820030N – Metri 5,5 mt – – conf. 100 – € 2,40 512820040N – Metri 7,5 mt – – conf. 100 – € 3,30 512820070N – Metri 50 mt – – conf. 20 – € 19,36</p> 	 <p>ROTOLO CINTINO IN POLIPROPILENE PER MONOBLOCCO Larghezza 19 mm Lunghezza 50 metri</p> <p>512820050N – Metri 50 mt – Colore BICOLORE – – conf. 20 – € 12,30 512820080N – Metri 50 mt – Colore GRIGIO – – conf. 20 – € 9,76</p> 
 <p>BLOCCO TAPPARELLE 2+1 OTTAGONALE Art. MTBLOC360-4 Ø 60 mm</p> <p>90013535 – – conf. 4 – € 20,00</p> 	 <p>COPPIA BLOCCATAPPARELLA Fissaggio laterale destro e sinistro Acciaio bronzato Completo di viti</p> <p>70099800 – – conf. 10 – € 9,28</p> 
 <p>COPPIA BLOCCATAPPARELLA sicurblock mod. 606</p> <p>90013400 – – conf. 25 – € 4,90</p> 	 <p>BLOCCATAPPARELLA martelletto “alt” Tipo D ferro zincato</p> <p>90013500 – – conf. 50 – € 1,60</p> 
 <p>BLOCCATAPPARELLA martelletto “alt” tipo C fisso ferro zincato</p> <p>90013501 – – conf. 50 – € 1,30</p> 	 <p>COPPIA BLOCCATAPPARELLA LATERALE wolgi-block senza piastrina</p> <p>90013521 – – conf. 25 – € 1,41</p> 
 <p>COPPIA BLOCCATAPPARELLA ultrablock tipo S bronzato</p> <p>90013524 – – conf. 20 – € 2,76</p> 	 <p>COPPIA BLOCCATAPPARELLA a sporgere tipo B senza piastrina</p> <p>90013525 – – conf. 10 – € 1,96</p> 



  <p>BLOCCATAPPARELLA automatico galletto</p> <p>90013510 - finitura zincato - - conf. 20 - € 2,14</p> <p>90013511 - finitura bronzato - - conf. 20 - € 2,70</p>	 <p>COPPIA BLOCCATAPPARELLA Genioblock automatico</p> <p>90013530 - - conf. 20 - € 10,80</p>
  <p>ARGANO AD ASTA IN ZAMA CON INSERTO</p> <p>90015952 - Peso 20 KG - Rapporto 1:5 - Sezione QUADRO 8 - - conf. 1 - € 31,40</p> <p>90015953 - Peso 25 KG - Rapporto 1:7 - Sezione QUADRO 8 - - conf. 1 - € 31,40</p> <p>90015954 - Peso 35 KG - Rapporto 1:11 - Sezione QUADRO 8 - - conf. 1 - € 31,40</p> <p>segue...</p>	 <p>continua...</p> <p>90015955 - Peso 20 KG - Rapporto 1:5 - Sezione ESAGONO 7 - - conf. 1 - € 31,40</p> <p>90015956 - Peso 25 KG - Rapporto 1:7 - Sezione ESAGONO 7 - - conf. 1 - € 31,40</p> <p>90015957 - Peso 35 KG - Rapporto 1:11 - Sezione ESAGONO 7 - - conf. 1 - € 31,40</p>
  <p>SNODO 45° Placchetta in acciaio inox</p> <p>90015958 - L 250 - Sezione QUADRO 8 - - conf. 1 - € 16,00</p> <p>90015959 - L 250 - Sezione ESAGONO 7 - - conf. 1 - € 17,40</p>	  <p>BLOCCATAPPARELLA GIBLOCK CON ALLARME SONORO Acciaio nero Completo di viti Batteria inclusa Dimensioni: 190 x 20 x 20H</p> <p>461GB01AAN - Art. GB01A - TIPO DX - - conf. 1 - € 120,94</p> <p>461GB01ALAN - Art. GB01AL - TIPO SX - - conf. 1 - € 120,94</p>
  <p>BLOCCATAPPARELLA GIBLOCK Acciaio nero Completo di viti Dimensioni: 190x20x20H</p> <p>461GB01AN - Art. GB01 - Tipo DX - - conf. 1 - € 21,64</p> <p>461GB01LAN - Art. GB01L - Tipo SX - - conf. 1 - € 21,64</p> <p>461GB01PAN - Art. GB01P - Tipo DX + SX - - conf. 1 - € 43,08</p>	  <p>BLOCCATAPPARELLA GIBLOCK ART. GB02 Rostri regolabili Acciaio nero Completo di viti Dimensioni: 320x20x20H</p> <p>461GB02AN - - conf. 1 - € 44,14</p>
  <p>BLOCCA TAPPARELLE GIBLOCK ART. GB02 2 rostri con allarme Acciaio nero Completo di viti Dimensioni: 320x20x20</p> <p>461GB02AAN - - conf. 1 - € 168,04</p>	  <p>MOTORE PER TAPPARELLA ELETTROMECCANICO CON FINE CORSA MECCANICO ECOLOGIC 45N Serie Ø 45 mm Set adattatore per motore da ordinare a parte</p> <p>90013561 - Portata Nm20 - Lungh. 467 - Peso max soll. 35 Kg - - conf. 1 - € 65,72</p> <p>90013562 - Portata Nm30 - Lungh. 537 - Peso max soll. 53 Kg. - - conf. 1 - € 65,72</p> <p>90013564 - Portata Nm50 - Lungh. 537 - Peso max soll. 90 Kg - - conf. 1 - € 67,36</p>
  <p>MOTORE PER TAPPARELLA ELETTROMECCANICO CON FINE CORSA MECCANICO CON RICEVENTE INTERNA PROTEO 45C Serie Ø 45 mm Trasmettitore a 1 canale 433 Mhz incluso Set adattatore per motore da ordinare a parte</p> <p>90013566 - Portata Nm30 - Lungh. 637 - Peso max soll. 53 Kg - - conf. 1 - € 165,40</p> <p>90013569 - Portata Nm50 - Lungh. 637 - Peso max soll. 90 Kg - - conf. 1 - € 171,20</p>	  <p>ARGANO ASTA DA 1,30 MT PER MANOVRA DI SOCCORSO Compatibile con motori per tapparelle con manovra di soccorso</p> <p>90014850 - - conf. 5 - € 24,60</p>



 <p>ANELLO PER MANOVRA DI SOCCORSO Misura 15 cm. Compatibile con motori per tapparelle con manovra di soccorso</p> <p>90014852 – – conf. 5 – € 6,40</p>	 <p>ASTA + ANELLO PER MANOVRA DI SOCCORSO Snodo 90° Compatibile con motori per tapparelle con manovra di soccorso</p> <p>90014851 – – conf. 5 – € 19,36</p>
 <p>MOTORE PER TAPPARELLA ELETTRONICO CON FINE CORSA ELETTRONICO PULSE 45E Serie Ø 45 mm. Trasmettitore a 1 canale 433 Mhz incluso. Set adattatore per motore da ordinare a parte</p> <p>90013571 – Portata Nm30 – Peso max soll. 53 Kg – – conf. 1 – € 228,00</p> <p>90013574 – Portata Nm50 – Peso max soll. 90 Kg – – conf. 1 – € 206,00</p>	 <p>MOTORE PER TAPPARELLA ELETTROMECCANICO CON FINE CORSA MECCANICO ECOLOGIC 59N Lunghezza 599 mm Serie Ø 59 mm. Peso massimo sollevato 145 Kg</p> <p>90013576 – Portata Nm100 – – conf. 1 – € 216,00</p>
 <p>MOTORE PER TAPPARELLA ELETTROMECCANICO CON FINE CORSA MECCANICO ECOLOGIC CON MANOVRA DI SOCCORSO Lunghezza 622,1 mm Serie Ø 45 mm. Peso massimo sollevato 90 Kg</p> <p>90013565 – Portata Nm50 – – conf. 1 – € 238,00</p>	 <p>MOTORE PER TAPPARELLA ELETTROMECCANICO CON FINE CORSA MECCANICO ECOLOGIC - VERSIONE CORTA Lunghezza 375 mm Serie Ø 45 mm. Peso massimo sollevato 35 Kg</p> <p>90013540 – Portata Nm20 – – conf. 1 – € 103,60</p>
 <p>MOTORE PER TAPPARELLA TARGET 50 NM Serie Ø 45 mm. Colore motore: Verde – Ral 6029. Set adattatore per motore da ordinare a parte</p> <p>90013570 – – conf. 20 – € 43,80</p>	 <p>RADIOCOMANDO MULTICANALE</p> <p>90013588 – – conf. 1 – € 52,20</p>
 <p>CENTRALINA con funzione trasmettitore fino a 20 canali programmabili, 3 fine corsa programmabili e rilevamento ostacoli in salita, portata max 50 Nm. Potenza max 300 Watt</p> <p>90013553 – – conf. 1 – € 81,00</p>	 <p>KIT CENTRALINA PER TAPPARELLA Contenuto del kit: Centralina con funzione trasmettitore e pulsante via cavo con collegamento fino a un max di 25 centraline in parallelo. Frequenza 433 MHz. Potenza 1000 W. Misura: 52 x 132 x 23,5 mm. Art. MTR265A-2. Trasmettitore 1 canale. Frequenza 433 MHz. Batteria CR2450. Misura: 135 x 45 x 16 mm. Art. MTR2700-2. Sostituzione cod. 90013587 - 316915</p> <p>90013592 – – conf. 1 – € 99,00</p>
 <p>RADIOCOMANDO MONOCANALE Bidirezionale. Frequenza 433 MHz. Misura: 135 x 45 x 16 mm. Art. MTR2700-2</p> <p>90013557 – – conf. 1 – € 37,60</p>	 <p>ATTUATORE A CATENA ORIO 250 N Elettrico, per finestre a sporgere, vasistas, cupole e abbaini. Funzioni: Corsa selezionabile 240,360 mm. Rampa progressiva di partenza. Controllo potenza su tutta la corsa. Rilassamento organi meccanici dopo ogni fine corsa. Dimensioni: 356 x 56,5 x 33,5 mm. Peso: 845 gr</p> <p>90013585 – Finitura Bianco – – conf. 1 – € 168,40</p> <p>90013586 – Finitura Nero – – conf. 1 – € 168,40</p>



 <p>SET ADATTATORE PER MOTORE adattatore a corona ottagonale da Ø 60 mm</p> <p>90013580 - - conf. 10 - € 1,60</p> 	 <p>SET ADATTATORI PIU' CORONA ROTONDA D78</p> <p>90013582 - - conf. 1 - € 6,40</p> 
 <p>SET ADATTATORI PIU' CORONA ROTONDA D70</p> <p>90013581 - - conf. 1 - € 6,40</p> 	 <p>STAFFA DI FISSAGGIO REGOLABILE Art. MTOSI-TAL-2 Su zanca Per motori Ø 45 mm</p> <p>90013583 - - conf. 1 - € 3,80</p> 
 <p>SUPPORTO PER MOTORE TAPPARELLA Perno quadro 10 mm</p> <p>90013850 - - conf. 5 - € 4,00</p> 	 <p>SUPPORTO PER MOTORE TAPPARELLA Con uscita quadro 10 mm</p> <p>90013852 - - conf. 5 - € 5,80</p> 
 <p>SUPPORTO PER MOTORE TAPPARELLA Perno quadro 10 mm</p> <p>90013853 - - conf. 5 - € 4,00</p> 	 <p>SUPPORTO A PONTE PER MOTORE TAPPARELLA Interasse 48 mm Foro quadro 10 mm</p> <p>90013854 - - conf. 20 - € 1,40</p> 
 <p>SUPPORTO REGOLABILE PER MOTORE TAPPARELLA Foro quadro 10 mm</p> <p>90013866 - - conf. 5 - € 5,76</p> 	 <p>DADO PER GAMBO FILETTATO 10MA PER MOTORE TAPPARELLA Ferro zincato</p> <p>90013867 - - conf. 20 - € 0,12</p> 
 <p>SUPPORTO DA AVVITARE PER MOTORE TAPPARELLA Con appoggio per quadro 10 mm</p> <p>90013871 - - conf. 20 - € 3,70</p> 	 <p>SUPPORTO DA AVVITARE PER MOTORE TAPPARELLA Con appoggio per quadro</p> <p>90013872 - A Q 10 - - conf. 20 - € 4,94 90013873 - A Q 16 - - conf. 20 - € 6,40</p> 



 <p>BANDELLA SAGOMATA Art. 200 Verniciata nera</p> <p>90012950 - L. 200 - - conf. 24 - € 1,66 90012951 - L. 250 - - conf. 24 - € 1,90 90012952 - L. 300 - - conf. 24 - € 2,06</p> 	 <p>BANDELLA PESANTE Art. 20 Verniciata nera</p> <p>90012960 - L. 400 - - conf. 24 - € 5,62 90012961 - L. 500 - - conf. 24 - € 6,58 90012962 - L. 600 - - conf. 24 - € 8,34</p> 
 <p>CANTONALE TORINO Art. 242 Verniciato nero La confezione contiene: 12 mano Dx 12 mano Sx</p> <p>90012800 - - conf. 24 - € 2,76</p> 	 <p>CONTROPIASTRA RINFORZO Art. 2420 Verniciata Nero</p> <p>90012802 - - conf. 24 - € 2,32</p> 
 <p>CANTONALE CENTRALE 3a ANTA Art 2431 Verniciato nero Figura mano DX</p> <p>90012804 - Mano Dx - - conf. 12 - € 4,80 90012805 - Mano Sx - - conf. 12 - € 4,80</p> 	 <p>CANTONALE CENTRALE A "T" - Art. 243 Verniciato nero</p> <p>90012806 - - conf. 24 - € 1,97</p> 
 <p>CARDINE A MURO Art 2 - Ø 12mm. Verniciato nero</p> <p>90012900 - - conf. 24 - € 1,91</p> 	 <p>CARDINE A MURO Art 3 - Ø 14mm. Verniciato nero</p> <p>90012902 - - conf. 24 - € 4,50</p> 
 <p>CARDINE AD AVVITARE spina a levare Art 16 - Ø 12 mm. Verniciato nero</p> <p>90012910 - - conf. 24 - € 2,78</p> 	 <p>CARDINE A LEGNO Art. 8 Spina Ø 12 mm Verniciato nero Dimensioni: 180x23x20 mm</p> <p>90011830 - - conf. 24 - € 2,54</p> 
 <p>CARDINE A LEGNO Art. 10 Spina Ø 14 mm Verniciato nero Dimensioni: 190x45x31 mm</p> <p>90011831 - - conf. 24 - € 4,86</p> 	 <p>FERMO A VITE serie 300 kevlar nero</p> <p>180292 - - conf. 20 - € 1,40</p> 



 <p>FERMO A VITE serie 300 kevlar nero</p> <p>180294 - - conf. 20 - € 1,64</p> 	<p>&T900</p> <p>FERMAPERSIANE Piemonte DESTRO Normale nero 13,5 x 19</p> <p>90013090 - - conf. 10 - € 4,42</p> 
<p>&T900</p> <p>FERMAPERSIANA Piemonte DESTRO lungo nero 13,5 x 25</p> <p>90013092 - - conf. 10 - € 4,72</p> 	<p>&T900</p> <p>FERMAPERSIANE Piemonte SINISTRO normale nero 13,5 x 19</p> <p>90013091 - - conf. 10 - € 4,42</p> 
<p>&T900</p> <p>FERMAPERSIANA Piemonte SINISTRO Lungo nero 13,5 x 25</p> <p>90013093 - - conf. 10 - € 4,72</p> 	<p>&T900</p> <p>FERMAPERSIANA ante esterne con molla DX-SX finitura nero L. 120mm</p> <p>90013085 - - conf. 12 - € 11,34</p> 
<p>&T900</p> <p>FERMAPERSIANA PER CAPPOTTO - nero con fermo a foglia regolabile vite lunga 150mm</p> <p>90013018 - - conf. 40 - € 5,32</p> 	<p>&T900</p> <p>FERMAPERSIANA vite e fermo nero</p> <p>90013012 - - conf. 25 - € 3,90</p> 
<p>&T900</p> <p>FERMAPERSIANA vite e fermo regolabile nero</p> <p>90013013 - - conf. 50 - € 5,26</p> 	<p>&T900</p> <p>FERMAPERSIANA con fermo a foglia regolabile verniciato nero Lunghezza 60 mm</p> <p>90013014 - - conf. 40 - € 5,12</p> 
<p>&T900</p> <p>FERMAPERSIANA con fermo a foglia regolabile per doppia anta verniciato nero Lunghezza 130 mm</p> <p>90013015 - - conf. 25 - € 5,26</p> 	<p>&T900</p> <p>FERMAPERSIANE C/TASSELLO nere</p> <p>90013011 - - conf. 25 - € 3,16</p> 



<p>IBFM</p> <p>FERMAPERSIANA Automatico In resina - nero</p> <p>525638 - - conf. 10 - € 2,06</p> 	<p>IBFM</p> <p>FERMAPERSIANE Automatico Art. 638/T in resina nero</p> <p>525638T - - conf. 10 - € 3,70</p> 
<p>IBFM</p> <p>FERMAPERSIANE TIPO LUNGO Automatico Art. 638/L in resina nero</p> <p>525638L - - conf. 10 - € 9,28</p> 	<p>IBFM</p> <p>FERMAPERSIANA art. 638 / LI in plastica nero</p> <p>525638LI - - conf. 20 - € 2,48</p> 
<p>IBFM</p> <p>SOCCHIUDI FINESTRA in plastica</p> <p>525638B - - conf. 10 - € 3,10</p> 	<p>IBFM</p> <p>LIMITATORE DI APERTURA Art. D15 In ferro</p> <p>525D15DX - Mano DX - - conf. 1 - € 12,20 525D15SX - Mano SX - - conf. 1 - € 12,20</p> 
<p>IBFM</p> <p>POMOLO PER LIMITATORE DI APERTURA Art. D15/PM</p> <p>525D15PMB - Lunghezza Bronzato - - conf. 1 - € 10,22 525D15PMCS - Lunghezza Cromo Satinato - - conf. 1 - € 14,24 525D15PMO - Lunghezza Ottone Lucido - - conf. 1 - € 11,76</p> 	<p>GHIDINI</p> <p>ASTA DI SICUREZZA ARSENIO incontri non compresi</p> <p>50533182080007 - Lunghezza 80 - - conf. 2 - € 30,12 50533182100007 - Lunghezza 100 - - conf. 2 - € 32,98 50533182120007 - Lunghezza 120 - - conf. 2 - € 32,09 50533182140007 - Lunghezza 140 - - conf. 2 - € 34,42</p> 
<p>AGB</p> <p>CATENACCIO DI SICUREZZA Per persiana anta doppia Lunghezza 225 mm Acciaio verniciato nero</p> <p>140H009632393 - - conf. 5 - € 20,00</p> 	<p>AGB</p> <p>SPAGNOLETTA MOD. ABACO Sistema di chiusura per imposte in legno, PVC, alluminio In zama - Spessore standard Finitura Black Powerage ad alta resistenza alla corrosione e raggi UV Funzione di blocco maniglia Vendibile tassativamente ad imballi da 20 pz.</p> <p>140H009031593 - - conf. 20 - € 10,00</p> 
<p>AGB</p> <p>PERNO DI CHIUSURA MOD. ABACO Piastra di chiusura ad angolo per spagnolette</p> <p>140H009012693 - - conf. 20 - € 1,40</p> 	<p>GHIDINI</p> <p>INCONTRO per asta sicurezza Con chiusura</p> <p>50533184500007 - - conf. 20 - € 8,21</p> 



RISCONTRO DI SICUREZZA Per spagnoletta verniciato nero 150 x 27 mm

180290 -
- conf. 10 - € 4,20

DIERRE

GANCIO FERMAPERSIANE

46770100 - Finitura Ottone Lucido - Misura 100 -
- conf. 12 - € 3,20
46770100B - Finitura Bronzata - Misura 100 -
- conf. 12 - € 3,92
46770100CS - Finitura Cromo Satinato - Misura 100 -
- conf. 12 - € 4,32
46770100N - Finitura Nero - Misura 100 -
- conf. 12 - € 3,92
46770120 - Finitura Ottone Lucido - Misura 120 -
- conf. 12 - € 3,70
segue...

DIERRE

continua...

46770120B - Finitura Bronzata - Misura 120 -
- conf. 12 - € 4,32
46770120CS - Finitura Cromo Satinato - Misura 120 -
- conf. 12 - € 4,74
46770120N - Finitura Nero - Misura 120 -
- conf. 12 - € 4,32
46770140 - Finitura Ottone Lucido - Misura 140 -
- conf. 12 - € 4,32
46770140B - Finitura Bronzata - Misura 140 -
- conf. 12 - € 4,94
segue...

DIERRE

continua...

46770140CS - Finitura Cromo Satinato - Misura 140 -
- conf. 12 - € 5,36
46770140N - Finitura Nero - Misura 140 -
- conf. 12 - € 4,94
4677060 - Finitura Ottone Lucido - Misura 60 -
- conf. 12 - € 2,88
4677060B - Finitura Bronzata - Misura 60 -
- conf. 12 - € 3,30
4677060CS - Finitura Cromo Satinato - Misura 60 -
- conf. 12 - € 3,70
segue...

DIERRE

continua...

4677060N - Finitura Nero - Misura 60 -
- conf. 12 - € 3,30
4677080 - Finitura Ottone Lucido - Misura 80 -
- conf. 12 - € 3,10
4677080B - Finitura Bronzata - Misura 80 -
- conf. 12 - € 3,70
4677080CS - Finitura Cromo Satinato - Misura 80 -
- conf. 12 - € 4,12
4677080N - Finitura Nero - Misura 80 -
- conf. 12 - € 3,70

DIERRE

GANCIO FERMAPERSIANE REGOLABILE Ottone Lucido

467120 - Misura 60-140 -
- conf. 12 - € 5,20

Cotali

GANCIO ROMA Di sicurezza per porte

447600900001 - finitura ott. luc. -
- conf. 12 - € 10,78
447600900003 - finitura ott.bronz. -
- conf. 12 - € 11,10

DiSEC

BLOCCO PERSIANE CORTO Art. SCB05 Acciaio nero Completo di viti

461SCB05AN -
- conf. 1 - € 61,54

DiSEC

BLOCCO PERSIANE Art. SCB10 Acciaio nero Completo di viti

461SCB10AN -
- conf. 1 - € 106,72

DiSEC

BLOCCO PERSIANE SP-BLOCK Art. SP01 Perni e pomoli in ottone Molla in acciaio INOX 8 viti e 2 spessori 1 mm inclusi

461SP01FN - Finitura nero -
- conf. 1 - € 68,74

DEFENCE SYSTEM

LIMITATORE APERTURA BLOCK AIR DEFENCE SYSTEM Limita l'apertura di finestre, persiane e portefinestre Realizzato in metallo Lunghezza 19 cm 3 posizioni di apertura

90013004 - Finitura Bronzo -
- conf. 6 - € 7,00
90013005 - Finitura Oro -
- conf. 6 - € 7,00
90013006 - Finitura Nero -
- conf. 6 - € 7,00
90013007 - Finitura Bianco -
- conf. 6 - € 7,00
segue...

DEFENCE SYSTEM

continua...

90013008 - Finitura Cromo Satinato -
- conf. 6 - € 7,00



<p>BLINDY:</p> <p>ESPOSITORE BLINDY PER INFERRIATE</p> <p>90013181 - - conf. 1 - € 108,16</p> 	<p>BLINDY:</p> <p>BLINDY SBARRA estensibile per la blindatura di porte e finestre Conferisce una maggiore tenuta allo scasso di scuretti, persiane. Kit composto da: 1 Blindy Sbarra 2 Ganci blocca anta 2 piastre a muro 2 Blindy Top rinforzo gancio Viteria per installazione</p> <p>90013155 - Misura 500+800 - - conf. 1 - € 56,66</p> <p>90013156 - Misura 700+1200 - - conf. 1 - € 60,36</p> <p>90013157 - Misura 1000+180 - - conf. 1 - € 65,72</p> 
<p>BLINDY:</p> <p>GANCIO BLOCCA ANTA - BLINDY Fissato alla parte centrale degli scuretti, serve a sorreggere Blindy Sbarra</p> <p>90013161 - - conf. 1 - € 6,60</p> 	<p>BLINDY:</p> <p>CONTROPIASTRA CON INNESTO A MURO - BLINDY Doppio utilizzo sia per muro tenero che in presenza di spalla muro in marmo (innesto rivolto verso l'esterno)</p> <p>90013172 - - conf. 1 - € 11,74</p> 
<p>BLINDY:</p> <p>COPPIA ROSTRI BLINDY Adatti alla blindatura di porte e finestre, specifico per scuretti e persiane in qualsiasi materiale (legno, pvc, alluminio)</p> <p>90013150 - - conf. 1 - € 32,54</p> 	<p>BLINDY:</p> <p>COPPIA RINFORZI SBARRA BLINDY TOP Utilizzabile nel caso si installassero ulteriori ganci blocca anta sullo scuro/persiana</p> <p>90013173 - - conf. 1 - € 9,88</p> 
<p>BLINDY:</p> <p>SPESSORE GANCIO BLINDY Utilizzabile per installare il Gancio blocco-anta in presenza di ostacoli da scavalcare (es: aste serrature tripli)</p> <p>90013170 - - conf. 1 - € 12,98</p> 	<p>BLINDY:</p> <p>FISSAGGIO PER MURI A CAPPOTTO BLINDY Utilizzabile per installare la Blindy Sbarra in caso di presenza del cappotto isolante nel muro Permette di ancorarsi al muro in laterizio</p> <p>90013162 - Misura 150 mm - - conf. 1 - € 24,72</p> <p>90013163 - Misura 190 mm - - conf. 1 - € 29,88</p> 
<p>BLINDY:</p> <p>FISSAGGIO SBARRA BLINDY PARK Sistema Brevettato per "parcheggiare" Blindy Sbarra E' sufficiente ruotare la sbarra di 90° e infilare la sbarra nell'apposito supporto. Applicabile al gancio blocca anta utilizzando le stesse viti Applicabile sia a destra che a sinistra Sia su anta singola che doppia anta o ante multiple</p> <p>90013160 - - conf. 1 - € 15,04</p> 	<p>BLINDY:</p> <p>GANCIO BLOCCA ANTA GENOVESE BLINDY Fissato alla parte centrale degli scuretti modello genovese, serve a sorreggere Blindy Sbarra</p> <p>90013164 - - conf. 1 - € 7,82</p> 
<p>VECBS:</p> <p>MARTELLINA nylon - nero per basculante</p> <p>90013211 - - conf. 6 - € 4,80</p> 	<p>IBFM:</p> <p>MARTELLINA REGOLABILE PER BASCULANTI IN ZAMA Colore nero Quadro maniglia 8 mm Misura 96x45</p> <p>525437M - - conf. 15 - € 7,40</p> 



<p>DECAS</p> <p>PLACCA per basculante in abs nero</p> <p>90013214 - Tipo Cilindro tondo - Int. 67 - - conf. 12 - € 2,68</p> <p>90013215 - Tipo Cilindro sagomato - Int. 70 - - conf. 12 - € 2,68</p> 	<p>DECAS</p> <p>CARRUCOLA nylon per basculante su cuscinetti Gola a V</p> <p>90013222 - Ø esterno 80 - Ø 12 - - conf. 6 - € 6,00</p> <p>90013225 - Ø esterno 90 - Ø 15 - - conf. 6 - € 6,20</p> <p>90013226 - Ø esterno 90 - Ø 12 - - conf. 6 - € 6,20</p> <p>90013229 - Ø esterno 100 - Ø 15 - - conf. 6 - € 6,40</p> <p>90013230 - Ø esterno 100 - Ø 12 - - conf. 6 - € 6,40</p> 
<p>DECAS</p> <p>MANIGLIA per basculante Kit 3 pezzi</p> <p>90013220 - - conf. 6 - € 4,40</p> 	<p>DECAS</p> <p>COPPIA TIRANTI per serranda con asola Fune a 49 fili Ø 38 mm Lunghezza 2,5 mt completa di morsetti</p> <p>90013240 - Mt. 2,5 - - conf. 6 - € 11,00</p> <p>90013260 - Mt. 3,0 - - conf. 6 - € 12,78</p> 
<p>DECAS</p> <p>COPPIA TIRANTI per serranda con nipplo Fune a 49 fili Ø 38 mm Lunghezza 2,5 mt completa di morsetti</p> <p>90013241 - Mt. 2,5 - - conf. 6 - € 11,00</p> <p>90013261 - Mt. 3,0 - - conf. 6 - € 12,78</p> 	<p>DiSEC</p> <p>BLOCCO BASCULANTE INOX PROTEZIONE PER GARAGE E SERRANDE Art. MG710 DX - SX 2 chiavi KM0P85 magnetiche incluse</p> <p>461MG710I - - conf. 1 - € 292,80</p> 
<p>DiSEC</p> <p>BLOCCO BASCULANTE INOX PROTEZIONE PER GARAGE E SERRANDE Art. MG700 2 chiavi KM0P85 magnetiche incluse</p> <p>461MG700I - - conf. 1 - € 158,50</p> 	<p>DECAS</p> <p>CUSCINETTO IN ACCIAIO Cuscinetto a sfere 2RS Ø esterno 40 mm Ø foro mozzo 15 mm</p> <p>90013272 - - conf. 6 - € 3,60</p> 
<p>DECAS</p> <p>RULLINO IN NYLON Cuscinetto a sfere ZZ Ø 12 mm</p> <p>90013270 - Ø esterno 40 - - conf. 6 - € 5,00</p> <p>90013271 - Ø esterno 45 - - conf. 6 - € 5,00</p> 	



COME DISTINGUERE UN AVVOLGITORE SEMINCASSO DESTRO DA UNO SINISTRO?

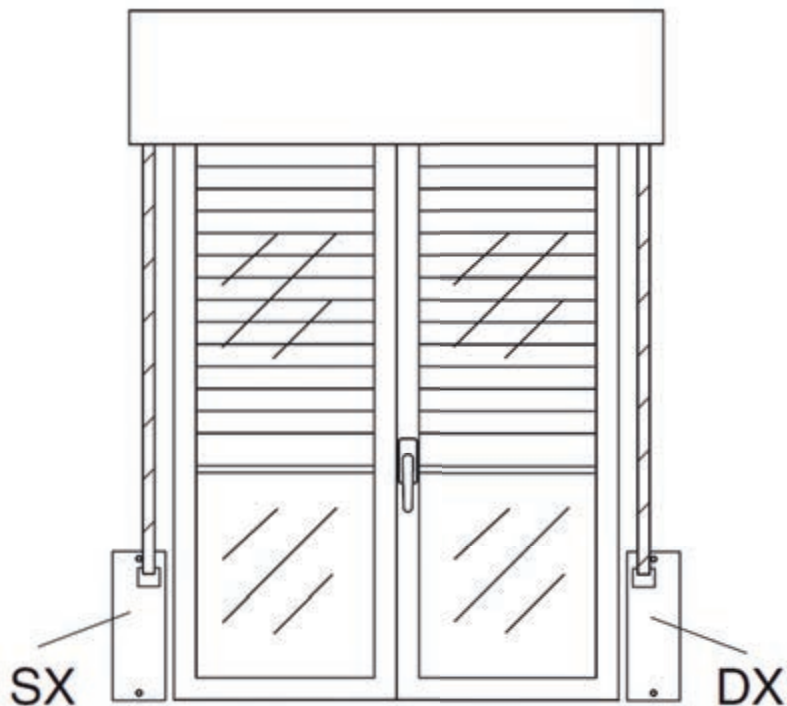

AVVOLGITORI SEMINCASSO SOSTITUITI

ARTICOLI:
 90014065 - 90014069
 90014070 - 90014085
 90014086



**AVVOLGITORI DA UTILIZZARE
 CON CINTINI SOTTILI**

I marchi logotipo riprodotti sono di proprietà delle rispettive Aziende.



Linea Smarthome

con semplicità e comodità le automazioni nella tua casa

Tramite **APP** e gli assistenti vocali [**Alexa** e **Google Home**] potrai comandare e anche programmare con il timer aperture e chiusure in casa. Avrai un feedback direttamente sul tuo smartphone con il controllo di stato delle varie situazioni.

SERIE SMART

Alexa

Google Home

Connector



Motorizzazione per tapparelle,
persiane e Tende da sole
movimentati e regolati da APP



BrueIMotion
divisione di Bruel srl

Via Santa Margherita, 121/123
20861 Brugherio (MB)
tel. +39 039 883 104
fax +39 039 287 84 32

www.brueimotion.com
info@brueimotion.com



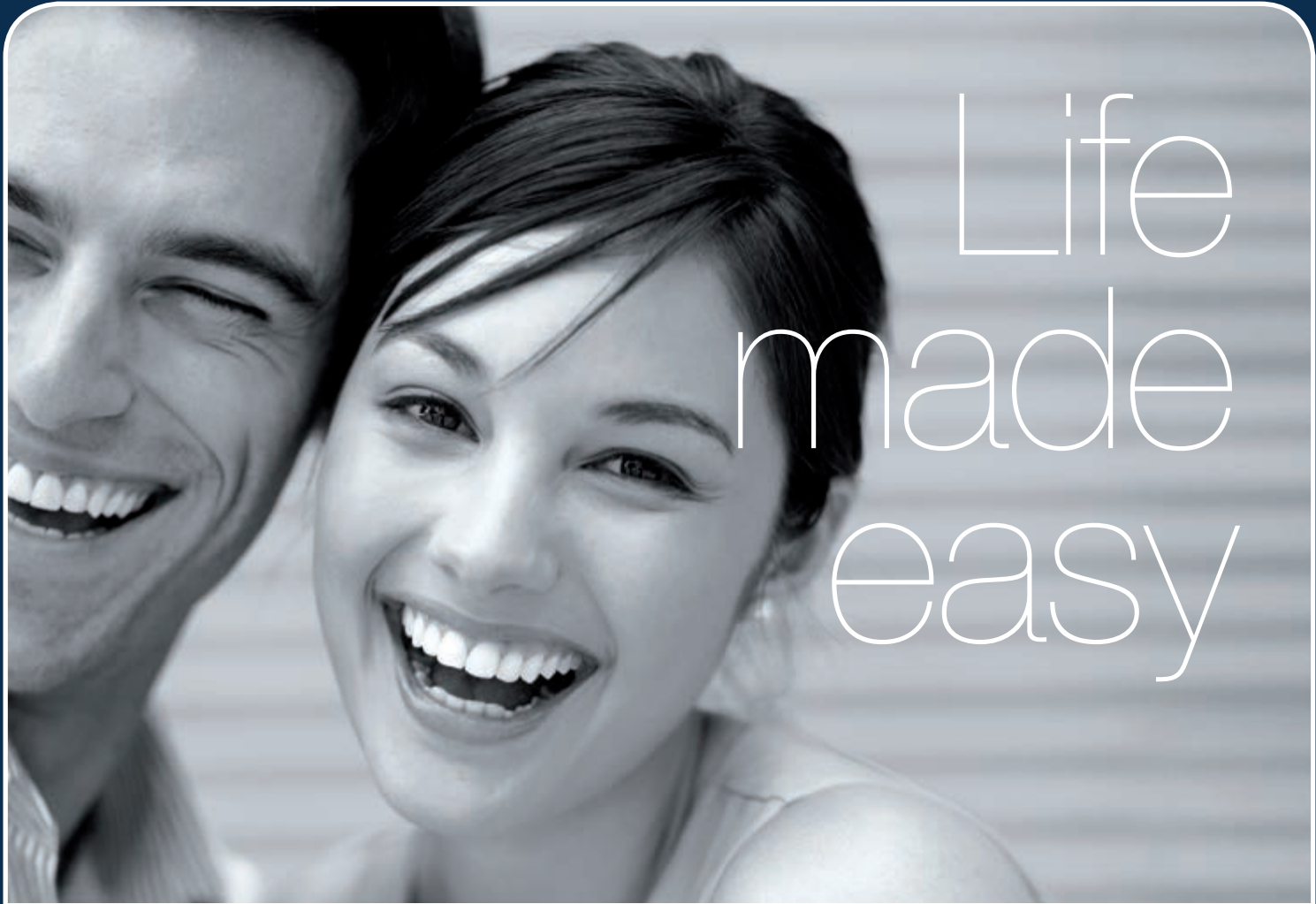

Life made easy

Il gruppo Comunello è costruito su una solida e affidabile base produttiva ben strutturata. Il gruppo si compone di 4 divisioni con il 100% dei prodotti di ciascuna divisione progettato e realizzato in Italia. Questo controllo totale sui processi di produzione garantisce i massimi livelli di qualità.

Comunello è stata fondata nel 1965 e oggi esporta in più di 105 paesi in tutto il mondo.

COMUNELLO
GATE DIVISION

COMUNELLO
AUTOMATION

COMUNELLO
FRAME DIVISION

COMUNELLO
FRAME AUTOMATION

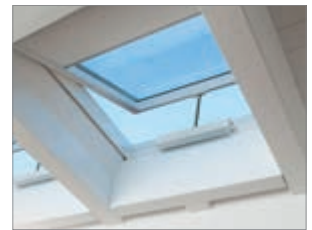

COMUNELLO
THE OPENING COMPANY

F.lli Comunello S.p.A - Via Cassola, 64 - 36027 Rosà (VI) Italy - Tel. +39 0424 585111 Fax +39 0424 533417 - info@comunello.it - www.comunello.com

www.malfattitacchinigroup.it

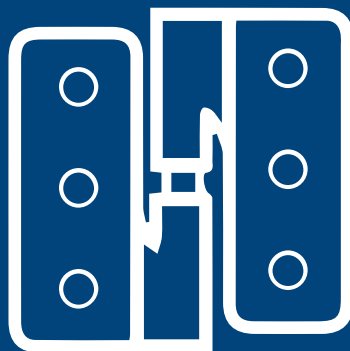

























**CATENACCI
CERNIERE
ACCESSORI PER CANCELLI**

SFOGLIA LA CATEGORIA





 <p>PALETTO INCASSO Modello Ischia 1 rinvio Doppio filetto 6/8 Lunghezza 155 mm zincato</p> <p>77348016 - Larghezza 16 - - conf. 20 - € 12,20</p> <p>77348020 - Larghezza 20 - - conf. 20 - € 12,20</p> 	 <p>CATENACCIO INCASSO Modello Capri 1 rinvio - filetto M8 Misura 160 x 24 mm zincato</p> <p>773488 - - conf. 20 - € 14,80</p> 
 <p>CATENACCIO INCASSO Leva in ottone 1 rinvio - filetto M8 zincato</p> <p>41570516 - Lungh. 155 - Larg. 16 - - conf. 20 - € 7,20</p> <p>41570520 - Lungh. 155 - Larg. 20 - - conf. 20 - € 7,20</p> <p>41570524 - Lungh. 160 - Larg. 24 - - conf. 20 - € 7,20</p> 	 <p>CATENACCIO INCASSO A LEVA Art. 420 1 rinvio - filetto M8 Lunghezza 152 mm zincato</p> <p>525420020T - Larghezza 20 - Canotto post. tondo - - conf. 10 - € 1,94</p> <p>525420024T - Larghezza 24 - Canotto post. tondo - - conf. 10 - € 1,94</p> <p>525420020Q - Larghezza 20 - Canotto post. quadro - - conf. 10 - € 1,94 segue...</p> 
 <p>continua...</p> <p>525420024Q - Larghezza 24 - Canotto post. quadro - - conf. 10 - € 1,94</p> 	 <p>PALETTO INCASSO Modello Duplo doppio rinvio doppio filetto M8 / M10 Misura 197 x 24 mm zincato</p> <p>773490 - - conf. 5 - € 18,40</p> 
 <p>CATENACCIO INCASSO A LEVA doppio rinvio - filetto M8 Misura 200 x 24,5 mm zincato</p> <p>415700 - - conf. 10 - € 9,40</p> 	 <p>CATENACCIO AD INCASSO 16 Zincato</p> <p>415704B16 - Misura 160mm - - conf. 20 - € 2,60</p> <p>415704B20 - Misura 200mm - - conf. 20 - € 2,60</p> <p>415704B24 - Misura 240mm - - conf. 20 - € 3,58</p> 
 <p>PALETTO A LEVA PER SERRAMENTI IN METALLO Acciaio zincato</p> <p>525420024L - Misura 160 - - conf. 10 - € 2,88</p> 	 <p>CATENACCIO INCASSO A LEVA Art. 422 Doppio rinvio - Filetto M8 Misura 195 x 24 zincato</p> <p>525422 - - conf. 10 - € 7,00</p> 
 <p>CATENACCIO VERTICALE per cancelli automatici</p> <p>525418 - Finitura Tropicalizzato - - conf. 6 - € 16,06</p> <p>525918 - Finitura Inox - - conf. 6 - € 25,96</p> 	 <p>PALETTO Modello Ginone ambidestro da saldare leva frizionata Misura 450 mm Corsa 36 mm Acciaio lucido</p> <p>773499 - - conf. 10 - € 17,40</p> 

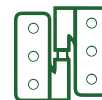

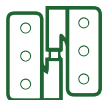

<p>IBFM</p> <p>PALETTO per cancelli in acciaio zincato</p> <p>525410035 – Misura 350 – – conf. 10 – € 3,92</p> <p>525410045 – Misura 450 – – conf. 10 – € 4,54</p> <p>525410060 – Misura 600 – – conf. 10 – € 5,76</p> <p>525410070 – Misura 700 – – conf. 10 – € 6,80</p> 	<p>IBFM</p> <p>PALETTO QUADRO DA SALDARE Art. 8 Pesante In acciaio zincato Punta quadra Larghezza 25</p> <p>525008330 – Misura 330 – – conf. 10 – € 9,28</p> <p>525008600 – Misura 600 – – conf. 10 – € 13,80</p> 
<p>IBFM</p> <p>PALETTO QUADRO DA SALDARE Art. 8/A Pesante In acciaio zincato Punta tonda Larghezza 25</p> <p>525008330A – Misura 330 – – conf. 10 – € 9,88</p> <p>525008600A – Misura 600 – – conf. 10 – € 14,42</p> 	<p>IBFM</p> <p>PALETTO QUADRO DA SALDARE Art. 9 In acciaio zincato Punta quadra Larghezza 25</p> <p>525009130 – Misura 130 – – conf. 15 – € 5,16</p> <p>525009300 – Misura 300 – – conf. 15 – € 6,80</p> <p>525009500 – Misura 500 – – conf. 15 – € 9,88</p> 
<p>IBFM</p> <p>PALETTO QUADRO DA SALDARE Art. 9/A In acciaio zincato Punta quadra Larghezza 25</p> <p>525009130A – Misura 130 – – conf. 15 – € 5,36</p> <p>525009300A – Misura 300 – – conf. 15 – € 7,22</p> <p>525009500A – Misura 500 – – conf. 15 – € 10,30</p> 	<p>MONO-COMPLEMENTI</p> <p>TAVELLINO Quadro 7</p> <p>695860 – Finitura Inox – – conf. 20 – € 3,80</p> <p>695862 – Finitura Zincato – – conf. 20 – € 3,00</p> 
<p>COMUNELLO</p> <p>TAVELLINO Quadro 7 zincato</p> <p>415620 – – conf. 50 – € 3,60</p> 	<p>IBFM</p> <p>TAVELLINO Quadro 7 zincato Art. 21</p> <p>525021 – – conf. 50 – € 2,48</p> 
<p>IBFM</p> <p>TAVELLINO Tipo piccolo Quadro 8 femmina zincato</p> <p>525023P – – conf. 20 – € 5,98</p> 	<p>IBFM</p> <p>CHIAVE MASCHIO PER TAVELLINO Quadro 6-8 in zama Art. 23/A</p> <p>525023A – – conf. 20 – € 2,68</p> 
<p>MONO-COMPLEMENTI</p> <p>CHIAVE PER TAVELLINO Art. 86.3 Quadro 7</p> <p>695863 – – conf. 20 – € 1,16</p> 	<p>COMUNELLO</p> <p>CHIAVE PER TAVELLINO Art. 625 Quadro 7</p> <p>415625Q – – conf. 1 – € 1,74</p> 



<p>COMINELLO</p> <p>CHIAVE PER TAVELLINO Art. 625 Triangolare 415625T - - conf. 1 - € 1,70</p> 	<p>IBFM</p> <p>CHIAVE PER TAVELLINO Quadro 7 in zama Art. 21/AM 525021AM - - conf. 50 - € 1,04</p> 
<p>GEKO</p> <p>CHIAVE UNIVERSALE Multiuso a croce 7916200/90 - - conf. 1 - € 4,86</p> 	<p>CHIUSURE A LEVA Art. 2.00.00 acciaio nichelato 90025400 - - conf. 25 - € 3,40</p> 
<p>CHIUSURE A LEVA Art. 2.00.01 Per Lucchetto acciaio nichelato 90025405 - - conf. 25 - € 3,40</p> 	<p>CHIUSURE A LEVA Art. 2.02.00 acciaio nichelato 90025435 - - conf. 200 - € 0,66</p> 
<p>CHIUSURE A LEVA Art. 2.03.00 acciaio nichelato 90025440 - Finitura Nichelato - - conf. 150 - € 0,80 90025441 - Finitura Inox - - conf. 150 - € 2,60</p> 	<p>CHIUSURE A LEVA Art. 2.03.01 Per Lucchetto acciaio nichelato 90025445 - - conf. 150 - € 0,86</p> 
<p>CHIUSURE A LEVA Art. 2.04.00 acciaio nichelato 90025450 - - conf. 200 - € 0,76</p> 	<p>CHIUSURE A LEVA Art. 2.05.00 regolabile acciaio nichelato zincato 90025460 - - conf. 25 - € 2,60</p> 
<p>CHIUSURE A LEVA Art. 2.05.00 regolabile INOX 90025461 - - conf. 25 - € 8,00</p> 	<p>CHIUSURE A LEVA REGOLABILE Art. 2.05.01 Nichelato 90025455 - - conf. 25 - € 2,80</p> 



 <p>CHIUSURE A LEVA Art. 2.45.00 acciaio nichelato 90025580 – – conf. 200 – € 1,48</p>	 <p>CHIUSURE A LEVA Art. 2.18.00 Regolabile acciaio nichelato 90025510 – – conf. 25 – € 5,00</p>
 <p>CHIUSURE A LEVA Art. 2.06.00 acciaio nichelato 90025470 – – conf. 50 – € 1,70</p>	 <p>CHIUSURE A LEVA Art. 2.06.01 Per Lucchetto acciaio nichelato 90025475 – – conf. 50 – € 1,70</p>
 <p>&M900 CRICCHETTO SOPRALUCE ART. 23 Ottone lucido 60x45x45 90009790 – – conf. 10 – € 2,80</p>	 <p>&M900 INCONTRO PIANO ART. 23/A Per cricchetto Ottone lucido 43x14 90009800 – – conf. 10 – € 0,86</p>
 <p>&M900 INCONTRO AD ANGOLO ART. 23/B Per cricchetto Finitura ottone lucido 24x22x40 90009810 – – conf. 10 – € 0,86</p>	 <p>Cottali CRICCHETTO SOPRALUCE Ottone Lucido 447600220L – – conf. 1 – € 6,66</p>
 <p>COMUNELLO CRICCHETTO SALDARE 415630 – Misura Piccolo – A 65 – B 24 – Finitura zincato – conf. 50 – € 3,00 415635 – Misura Medio – A 73,5 – B 30 – Finitura grezzo – conf. 50 – € 2,20 415640 – Misura Grande – A 85 – B 38 – Finitura grezzo – conf. 25 – € 3,20</p>	 <p>IBFM CRICCHETTO SALDARE Acciaio Scrocco tropicalizzato 525412P – A 53 – B 22 – Tipo piccolo – conf. 25 – € 1,24 525412 – A 68 – B 31 – Tipo medio – conf. 25 – € 1,36 525412G – A 85 – B 38 – Tipo grande – conf. 20 – € 2,48</p>
 <p>AD ESAURIMENTO CRICCHETTO A SALDARE IN FERRO 69554B – A 51,65 – B 21,51 – conf. 20 – € 1,06</p>	 <p>COMUNELLO FERROGLIERA per cricchetto per Art. 630 Misura 38 x 43 mm Finitura grezzo 415645 – – conf. 20 – € 0,88</p>

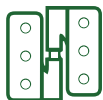

<p>COMINELLO</p> <p>FERROGLIERA per cricchetto per Art. 635 / 640 Misura 67 x 36 mm Finitura grezzo</p> <p>415650 - - conf. 20 - € 0,94</p> 	<p>&M 900</p> <p>TARGETTES ferro verniciato nero</p> <p>90010431 - misura 20 - - conf. 12 - € 1,34 90010432 - misura 25 - - conf. 12 - € 1,38 90010433 - misura 30 - - conf. 12 - € 1,50 90010434 - misura 35 - - conf. 12 - € 1,66 90010435 - misura 40 - - conf. 12 - € 1,68</p> 
<p>&M 900</p> <p>TARGETTES ferro nichelato</p> <p>90010441 - misura 20 - - conf. 12 - € 1,34 90010442 - misura 25 - - conf. 12 - € 1,38 90010443 - misura 30 - - conf. 12 - € 1,50 90010444 - misura 35 - - conf. 12 - € 1,66 90010445 - misura 40 - - conf. 12 - € 1,68</p> 	<p>METAL</p> <p>CATENACCIO Dimensioni: 80x40 mm Materiale ferro Finitura nero</p> <p>64560060805 - - conf. 5 - € 1,02</p> 
<p>&M 900</p> <p>CATENACCIOLO A CANNONE verniciato nero</p> <p>90010251 - misura 60 - - conf. 24 - € 0,70 90010252 - misura 80 - - conf. 24 - € 0,72 90010253 - misura 100 - - conf. 24 - € 0,80 90010254 - misura 120 - - conf. 24 - € 0,76 90010255 - misura 140 - - conf. 24 - € 0,84</p> 	<p>&M 900</p> <p>CATENACCIOLO A CANNONE zincato</p> <p>90010261 - misura 60 - - conf. 24 - € 0,70 90010262 - misura 80 - - conf. 24 - € 0,72 90010263 - misura 100 - - conf. 24 - € 0,80 90010264 - misura 120 - - conf. 24 - € 0,86 90010265 - misura 140 - - conf. 24 - € 1,02</p> 
<p>&M 900</p> <p>CATENACCIO A CREMAGLIERA ART. 221 Ottone lucido</p> <p>90009820 - A 60 - Entrata 35 - - conf. 2 - € 19,00 90009821 - A 80 - Entrata 45 - - conf. 2 - € 19,00</p> 	<p>MONO CERNIERE</p> <p>COPPIA CATENACCI per tapparelle Art. 115 bronzato 110mm.</p> <p>695115 - - conf. 5 - € 11,00</p> 
<p>MONO CERNIERE</p> <p>CATENACCIO TRAVERSO Zincato</p> <p>180215Z08 - Lunghezza 80 - - conf. 10 - € 5,20 180215Z12 - Lunghezza 120 - - conf. 10 - € 5,40 180215Z16 - Lunghezza 160 - - conf. 10 - € 6,00</p> 	<p>MONO CERNIERE</p> <p>CATENACCIO TRAVERSO Art. 82/A Asta 21,5 x 5 mm Larghezza 50 mm tropicalizzato</p> <p>69582A1 - Lunghezza 80 - - conf. 10 - € 2,40 69582A2 - Lunghezza 110 - - conf. 10 - € 2,80 69582A3 - Lunghezza 150 - - conf. 10 - € 3,00</p> 
<p>MONO CERNIERE</p> <p>CATENACCIO TRAVERSO Art. 82/B Asta 15 x 5 mm Larghezza 38,5 mm bronzato</p> <p>69582B1 - Lunghezza 80 - - conf. 10 - € 3,40 69582B2 - Lunghezza 110 - - conf. 10 - € 4,00 69582B3 - Lunghezza 150 - - conf. 10 - € 4,60</p> 	<p>&M 900</p> <p>CATENACCIO Art. 519 ottone lucido</p> <p>90010004 - misura 100 - - conf. 12 - € 3,80 90010005 - misura 120 - - conf. 12 - € 4,40</p> 



&M900

CATENACCIO Art. 620 ottone lucido

- 90010014 - misura 100 -
- conf. 12 - € 6,20
- 90010015 - misura 120 -
- conf. 12 - € 6,60



&M900

CATENACCIOLO A CANNONE Art. 621 ottone lucido

- 90010023 - misura 80 -
- conf. 12 - € 5,20
- 90010025 - misura 120 -
- conf. 12 - € 9,00



IBFM

CATENACCIO A TRAVERSO Art. 30 Asta 13 x 7 mm Larghezza 40 mm tropicalizzato

- 525030080V - Lunghezza 80 -
- conf. 10 - € 3,70
- 525030120V - Lunghezza 120 -
- conf. 10 - € 4,12
- 525030160V - Lunghezza 160 -
- conf. 10 - € 4,54
- 525030200V - Lunghezza 200 -
- conf. 10 - € 5,16



IBFM

CATENACCI TRASVERSALI COMPLETI DI CON-TROPIASTRA ART.30

- 525030080N - Finitura Nero - Lunghezza 80mm -
- conf. 10 - € 4,54
- 525030080Z - Finitura Zincato - Lunghezza 80mm -
- conf. 10 - € 3,70
- 525030120N - Finitura Nero - Lunghezza 120mm -
- conf. 10 - € 4,94



segue...

IBFM

continua...

- 525030120Z - Finitura Zincato - Lunghezza 120mm -
- conf. 10 - € 4,12
- 525030160N - Finitura Nero - Lunghezza 160mm -
- conf. 10 - € 5,36
- 525030160Z - Finitura Zincato - Lunghezza 160mm -
- conf. 10 - € 4,54



segue...

IBFM

continua...

- 525030200N - Finitura Nero - Lunghezza 200mm -
- conf. 10 - € 6,80
- 525030200Z - Finitura Zincato - Lunghezza 200mm -
- conf. 10 - € 5,16



IBFM

CATENACCIO A TRAVERSO Art. 32 Asta 16 x 6 mm Larghezza 40 mm tropicalizzato

- 525032150V - Lunghezza 150 -
- conf. 10 - € 3,20
- 525032200V - Lunghezza 200 -
- conf. 10 - € 3,42
- 525032250V - Lunghezza 250 -
- conf. 10 - € 3,68



IBFM

CATENACCIO VERTICALE Bronzato Con fori e incontro Larghezza 40 mm

- 695142B1 - Lunghezza 150 - Asta Tonda - Ø Asta Ø12x200 -
- conf. 6 - € 6,80
- 695142B2 - Lunghezza 200 - Asta Tonda - Ø Asta Ø12x250 -
- conf. 6 - € 8,40
- 695142B3 - Lunghezza 250 - Asta Tonda - Ø Asta Ø12x300 -
- conf. 6 - € 9,00



segue...

IBFM

continua...

- 695142B4 - Lunghezza 300 - Asta Tonda - Ø Asta Ø12x400 -
- conf. 6 - € 10,80
- 695142BQ1 - Lunghezza 150 - Asta Quadra - Ø Asta Ø12x200 -
- conf. 6 - € 11,20
- 695142BQ2 - Lunghezza 200 - Asta Quadra - Ø Asta Ø12x250 -
- conf. 6 - € 12,00
- 695142BQ3 - Lunghezza 250 - Asta Quadra - Ø Asta Ø12x300 -
- conf. 6 - € 12,80



segue...

IBFM

continua...

- 695142BQ4 - Lunghezza 300 - Asta Quadra - Ø Asta Ø12x400 -
- conf. 6 - € 15,80



IBFM

CATENACCIO VERTICALE Asta tonda Con fori e incontro Larghezza 45 mm

- 6951441 - Finitura Zincato - Lunghezza 150 - Ø Asta Ø15x200 -
- conf. 4 - € 9,80
- 6951442 - Finitura Zincato - Lunghezza 200 - Ø Asta Ø15x288 -
- conf. 4 - € 14,20
- 6951443 - Finitura Zincato - Lunghezza 250 - Ø Asta Ø15x456 -
- conf. 4 - € 15,20



segue...

IBFM

continua...

- 695144B1 - Finitura Bronzato - Lunghezza 150 - Ø Asta Ø15x200 -
- conf. 4 - € 12,80
- 695144B2 - Finitura Bronzato - Lunghezza 200 - Ø Asta Ø15x288 -
- conf. 4 - € 15,60
- 695144B3 - Finitura Bronzato - Lunghezza 250 - Ø Asta Ø15x456 -
- conf. 4 - € 20,40



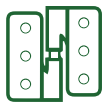

 <p>CATENACCIO A TRAVERSO Art. 76/B Asta 21,5 x 7 mm Larghezza 50 mm bronzato</p> <p>69576B1 - Lunghezza 140 - - conf. 5 - € 8,20 69576B2 - Lunghezza 200 - - conf. 5 - € 10,00 69576B3 - Lunghezza 260 - - conf. 5 - € 11,20</p> 	 <p>CATENACCIO A TRAVERSO Art. 76/A Asta 21,5x7 mm Larghezza 50 mm zincato</p> <p>69576A3 - Lunghezza 260 - - conf. 8 - € 7,20</p> 
 <p>CATENACCIO TRASVERSALE LEGGERO - Mod. 216 Asta tonda Ø 10 mm Larghezza 36 mm bronzato</p> <p>180216080 - Lunghezza 80 - - conf. 10 - € 5,80 180216120 - Lunghezza 120 - - conf. 10 - € 6,60 180216160 - Lunghezza 160 - - conf. 10 - € 8,20 180216200 - Lunghezza 200 - - conf. 10 - € 8,80</p> 	 <p>CATENACCIO TRAVERSO Bronzato</p> <p>695106B1 - - conf. 1 - € 3,80 695106B2 - - conf. 1 - € 4,20</p> 
 <p>CATENACCIO A TRAVERSO LEGGERO Art. 805 Asta 16 x 10,5 mm Larghezza 39,5 mm bronzato</p> <p>41580508 - Lunghezza 80 - - conf. 10 - € 4,20 41580512 - Lunghezza 120 - - conf. 10 - € 4,60 41580516 - Lunghezza 160 - - conf. 10 - € 5,00 41580520 - Lunghezza 200 - - conf. 10 - € 5,60</p> 	 <p>CATENACCIO A TRAVERSO MEDIO Art. 810 Asta 16 x 10,5 mm Larghezza 39,5 mm bronzato</p> <p>41581015 - Lunghezza 150 - - conf. 10 - € 6,80 41581020 - Lunghezza 200 - - conf. 10 - € 7,20 41581025 - Lunghezza 250 - - conf. 10 - € 7,40 41581030 - Lunghezza 300 - - conf. 10 - € 8,60 41581040 - Lunghezza 400 - - conf. 10 - € 10,20</p> 
 <p>CATENACCIO PESANTE ART. 860 Acciaio zincato Asta tonda Ø 16 mm Lunghezza 50 mm</p> <p>415860240 - Lunghezza 240 - Corsa 85 - - conf. 4 - € 23,20</p> 	 <p>CATENACCIO TRASVERSALE Art. 273 Asta 20 x 8 mm Larghezza 49 mm acciaio lucido</p> <p>18027315 - Lunghezza 150 - - conf. 10 - € 16,40 18027320 - Lunghezza 200 - - conf. 10 - € 20,40 18027325 - Lunghezza 250 - - conf. 10 - € 24,80 18027330 - Lunghezza 300 - - conf. 10 - € 22,40</p> 
 <p>CATENACCIO TAURUS PESANTISSIMO Art. 124 Asta 25 x 10 mm Larghezza 56 mm bronzato</p> <p>695124B1 - Lunghezza 340 - - conf. 4 - € 19,60 695124B2 - Lunghezza 460 - - conf. 4 - € 22,60 695124B3 - Lunghezza 570 - - conf. 4 - € 30,20</p> 	 <p>CATENACCIO PORTALUCCHETTO Art. 74/A Zincato</p> <p>69574A1 - Lungh. 160 - Larg. 43 - Asta 22 x 4 - - conf. 5 - € 4,20 69574A2 - Lungh. 210 - Larg. 50 - Asta 22 x 7 - - conf. 5 - € 6,20 69574A3 - Lungh. 260 - Larg. 50 - Asta 22 x 7 - - conf. 5 - € 7,60</p> 
 <p>CATENACCIO MIGNON PORTALUCCHETTO Art. 87 Misura 100 x 40 mm Asta 15 x 2 mm zincato</p> <p>90010274 - - conf. 10 - € 2,40</p> 	 <p>CATENACCIO PORTALUCCHETTO leggero Art. 890 Misura 200 x 45 mm Asta tonda Ø 12 mm Tropicalizzato</p> <p>180890AT20CV - - conf. 10 - € 15,00</p> 

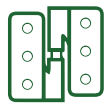



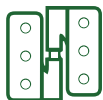





















<p>MINUTEX</p> <p>CATENACCIO MIGNON PORTALUCCHETTO Trasversale Asta tonda Ø 9 mm Largh. 3,5 cm In acciaio</p> <p>90010120 – Misura 70 – Finitura Bronzato – – conf. 12 – € 4,82</p> <p>90010121 – Misura 110 – Finitura Bronzato – – conf. 12 – € 5,38</p> <p>90010122 – Misura 150 – Finitura Bronzato – – conf. 12 – € 5,78</p> <p>90010130 – Misura 70 – Finitura Vern. Bianca – – conf. 12 – € 4,82</p> <p>segue...</p> 	<p>MINUTEX</p> <p>continua...</p> <p>90010131 – Misura 110 – Finitura Vern. Bianca – – conf. 12 – € 5,38</p> <p>90010132 – Misura 150 – Finitura Vern. Bianca – – conf. 12 – € 5,78</p> 
<p>MINUTEX</p> <p>CATENACCIO GIGANTE PORTALUCCHETTO Trasversale Asta tonda Ø 12 mm Largh. 4 cm In acciaio</p> <p>90010140 – Misura 160 – Finitura Bronzato – – conf. 12 – € 7,72</p> <p>90010141 – Misura 210 – Finitura Bronzato – – conf. 12 – € 8,70</p> <p>90010145 – Misura 160 – Finitura Vern. Bianco – – conf. 12 – € 7,72</p> <p>90010146 – Misura 210 – Finitura Vern. Bianco – – conf. 12 – € 8,70</p> 	<p>CATENACCIO PORTALUCCHETTO Art. 1265 a saldare Asta tonda Ø 12 mm Zincato</p> <p>180126515 – Lunghezza 170 – – conf. 10 – € 17,60</p> <p>180126520 – Lunghezza 210 – – conf. 10 – € 21,60</p> 
<p>COMUNELLO</p> <p>CATENACCIO TONDO A SALDARE FINITURA ZINCO</p> <p>41573715 – Lunghezza 150mm – – conf. 20 – € 7,40</p> <p>41573720 – Lunghezza 200mm – – conf. 20 – € 7,60</p> <p>41573725 – Lunghezza 250mm – – conf. 20 – € 8,80</p> <p>41573730 – Lunghezza 300mm – – conf. 20 – € 9,60</p> <p>41573740 – Lunghezza 400mm – – conf. 20 – € 12,00</p> 	<p>CATENACCIO PORTA LUCCHETTO acciaio tropicalizzato</p> <p>180256T15 – A 147 – C 48 – – conf. 5 – € 12,40</p> <p>180256T20 – A 195 – C 74 – – conf. 5 – € 15,60</p> <p>180256T30 – A 318 – C 99 – – conf. 5 – € 18,60</p> 
<p>MINUTEX</p> <p>CATENACCIO PORTALUCCHETTO Art. 110/B Asta tonda Ø 9 mm bronzato</p> <p>695110B1 – Lunghezza 80 – – conf. 10 – € 3,80</p> <p>695110B2 – Lunghezza 110 – – conf. 10 – € 4,40</p> <p>695110B3 – Lunghezza 150 – – conf. 10 – € 5,20</p> 	<p>CATENACCIO PESANTE TRASVERSALE Porta lucchetto zincato</p> <p>180263Z10 – A 115 – B 95 – C 20 – – conf. 6 – € 18,40</p> <p>180263Z15 – A 150 – B 110 – C 40 – – conf. 6 – € 19,60</p> <p>180263Z20 – A 200 – B 135 – C 10 – – conf. 6 – € 18,80</p> 
<p>CATENACCIO PESANTE AUTOMATICO a molla porta lucchetto zincato</p> <p>180263Z20A – A 195 – B 155 – C 40 – – conf. 6 – € 24,00</p> 	<p>CATENACCIO PORTALUCCHETTO Art. 250 Asta tonda Ø 12 mm Larghezza 42,5 mm Bronzato</p> <p>180250150 – Lunghezza 150 – – conf. 10 – € 14,40</p> <p>180250200 – Lunghezza 200 – – conf. 10 – € 17,80</p> <p>180250250 – Lunghezza 250 – – conf. 10 – € 21,00</p> <p>180250300 – Lunghezza 300 – – conf. 10 – € 27,40</p> 
<p>CATENACCIO PORTALUCCHETTO leggero Art. 248 bronzato</p> <p>180248100 – Misura 105 x 30 – Ø asta 10 – – conf. 10 – € 7,40</p> <p>180248150 – Misura 145 x 45 – Ø asta 15 – – conf. 10 – € 9,60</p> 	<p>CATENACCIO PORTALUCCHETTO Art. 122 Asta tonda Ø 12 mm bronzato</p> <p>6951221 – Lunghezza 160 – – conf. 5 – € 7,40</p> <p>6951222 – Lunghezza 210 – – conf. 5 – € 8,60</p> 





<p>COMUNELLO</p> <p>CATENACCIO PORTALUCCHETTO Art. 752 Asta tonda Ø 12 mm Larghezza 43 mm bronzato</p> <p>415752130 – Lunghezza 130 – – conf. 10 – € 9,80 415752145 – Lunghezza 145 – – conf. 10 – € 12,40 415752170 – Lunghezza 170 – – conf. 10 – € 13,80 415752195 – Lunghezza 195 – – conf. 10 – € 15,60</p> 	<p>COMUNELLO</p> <p>CATENACCIO PORTALUCCHETTO ART. 755 Acciaio zincato Asta 25 mm Larghezza 56 mm</p> <p>415755200 – Lunghezza 200 – Corsa 70 – – conf. 4 – € 15,00 415755300 – Lunghezza 300 – Corsa 70 – – conf. 4 – € 19,20 415755400 – Lunghezza 400 – Corsa 100 – – conf. 4 – € 21,60 415755500 – Lunghezza 500 – Corsa 100 – – conf. 4 – € 25,20</p> 
<p>IBFM</p> <p>CATENACCIO PORTALUCCHETTO Art. 15 Asta tonda Ø 9 mm Larghezza 33 mm bronzato</p> <p>525015070B – Lunghezza 70 – – conf. 10 – € 2,40 525015110B – Lunghezza 110 – – conf. 10 – € 2,60 525015150B – Lunghezza 150 – – conf. 10 – € 3,30</p> 	<p>COMUNELLO</p> <p>CATENACCIO PORTALUCCHETTO Art. 760 Asta tonda Ø 14 mm Larghezza 60 mm tropicalizzato</p> <p>415760180 – Lunghezza 180 – – conf. 10 – € 8,80 415760215 – Lunghezza 215 – – conf. 10 – € 10,40 415760270 – Lunghezza 270 – – conf. 10 – € 12,80</p> 
<p>IBFM</p> <p>CATENACCIO PORTALUCCHETTO Art. 63 Asta tonda Ø 12 mm Larghezza 40 mm tropicalizzato</p> <p>525063150 – Lunghezza 150 – – conf. 10 – € 4,32 525063200 – Lunghezza 200 – – conf. 10 – € 4,74</p> 	<p>IBFM</p> <p>CATENACCI TONDI CON PORTALUCCHETTO ART.63</p> <p>525063150N – Finitura Nero – Lunghezza 150mm – – conf. 10 – € 6,60 525063150Z – Finitura Zincato – Lunghezza 150mm – – conf. 10 – € 4,32 525063200N – Finitura Nero – Lunghezza 200mm – – conf. 10 – € 6,80 <i>segue...</i></p> 
<p>IBFM</p> <p><i>continua...</i> 525063200Z – Finitura Zincato – Lunghezza 200mm – – conf. 10 – € 4,74</p> 	<p>IBFM</p> <p>CATENACCIO PORTALUCCHETTO PESANTE Asta tonda ferro verniciato</p> <p>525020180 – Lungh. 180 – Larg. 60 – Asta Ø 13 – – conf. 10 – € 5,76 525020220 – Lungh. 220 – Larg. 60 – Asta Ø 13 – – conf. 10 – € 7,22 525020270 – Lungh. 270 – Larg. 65 – Asta Ø 15 – – conf. 10 – € 9,06 525020320 – Lungh. 320 – Larg. 65 – Asta Ø 15 – – conf. 10 – € 11,34</p> 
<p>COMUNELLO</p> <p>CATENACCIO PORTALUCCHETTO MEDIO Art. 750 tropicalizzato</p> <p>41575010 – Lunghezza 100 – – conf. 10 – € 3,80 41575015 – Lunghezza 150 – – conf. 10 – € 4,80 41575020 – Lunghezza 200 – – conf. 10 – € 6,20</p> 	<p>IBFM</p> <p>CATENACCIO PORTALUCCHETTO MEDIO Art. 36 Asta 16 x 6 mm Larghezza 40 mm zincato</p> <p>525036100 – Lunghezza 100 – – conf. 10 – € 2,48 525036150 – Lunghezza 150 – – conf. 10 – € 3,40 525036180 – Lunghezza 180 – – conf. 10 – € 3,50 525036230 – Lunghezza 230 – – conf. 10 – € 4,32</p> 
<p>IBFM</p> <p>CATENACCIO PORTALUCCHETTO PESANTE Art. 38 Asta 25 x 10 mm Larghezza 57 mm Acciaio zincato</p> <p>525038200 – Lunghezza 200 – – conf. 5 – € 11,74 525038300 – Lunghezza 300 – – conf. 5 – € 14,84</p> 	<p>www.comunello.it</p> <p>CATENACCIO PORTALUCCHETTO TAURUS Art. 125 Asta 25 x 10 mm Larghezza 54 mm zincato</p> <p>6951251 – Lunghezza 340 – – conf. 4 – € 14,80 6951252 – Lunghezza 460 – – conf. 4 – € 17,40 6951253 – Lunghezza 570 – – conf. 4 – € 20,20</p> 

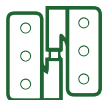

  <p>CATENACCIO NOSTRANO PORTALUCCHETTO tropicalizzato</p> <p>90010381 – misura 200 – – conf. 12 – € 4,32</p> <p>90010382 – misura 250 – – conf. 12 – € 4,60</p> <p>90010383 – misura 300 – – conf. 12 – € 7,02</p>	  <p>CATENACCIO VERTICALE PESANTE 400 BRONZATO</p> <p>415835400 – – conf. 1 – € 17,80</p>
  <p>CATENACCIO VERTICALE smontabile da avvitare asta tonda piastra 105 mm Acciaio zincato</p> <p>525067200A – Lunghezza 200 – – conf. 10 – € 8,44</p> <p>525067300A – Lunghezza 300 – – conf. 10 – € 10,10</p> <p>525067500A – Lunghezza 500 – – conf. 10 – € 13,40</p>	  <p>CATENACCIO VERTICALE Aperto smontabile da saldare asta tonda piastra 105 mm Acciaio zincato</p> <p>525067200C – Lunghezza 200 – – conf. 10 – € 7,00</p> <p>525067300C – Lunghezza 300 – – conf. 10 – € 8,04</p> <p>525067500C – Lunghezza 500 – – conf. 10 – € 10,92</p>
  <p>CATENACCIO VERTICALE ART. 34 Asta 16 x 6 mm Larghezza 40 mm In acciaio tropicalizzato</p> <p>525034150V – Lunghezza 150 – – conf. 10 – € 4,12</p> <p>525034200V – Lunghezza 200 – – conf. 10 – € 4,32</p> <p>525034300V – Lunghezza 300 – – conf. 10 – € 5,36</p>	  <p>CATENACCIO PROFILATO DA AVVITARE ART. 11/A Asta tonda \varnothing 8 Larghezza 20 mm In acciaio verniciato plastificato nero</p> <p>525011150A – Lunghezza 150 – – conf. 15 – € 3,92</p> <p>525011200A – Lunghezza 200 – – conf. 15 – € 4,32</p> <p>525011250A – Lunghezza 250 – – conf. 15 – € 4,74</p>
  <p>CATENACCIO A PULSANTE Art. 300 Asta tonda Larghezza 13 mm acciaio bronzato</p> <p>140D003001222 – Lunghezza 120 – – conf. 20 – € 1,64</p> <p>140D003001522 – Lunghezza 150 – – conf. 20 – € 1,92</p> <p>140D003002022 – Lunghezza 200 – – conf. 20 – € 2,20</p> <p>140D003002522 – Lunghezza 250 – – conf. 20 – € 2,60</p> <p>140D003003022 – Lunghezza 300 – – conf. 20 – € 2,60</p>	  <p>CATENACCIO A LEVA Art. 320 Asta tonda \varnothing 8 mm Larghezza 16 mm acciaio ottonato</p> <p>140D003201503 – Lunghezza 150 – – conf. 20 – € 3,20</p> <p>140D003202003 – Lunghezza 200 – – conf. 20 – € 3,40</p> <p>140D003202503 – Lunghezza 250 – – conf. 20 – € 3,60</p> <p>140D003203003 – Lunghezza 300 – – conf. 20 – € 3,80</p> <p>140D003204003 – Lunghezza 400 – – conf. 20 – € 4,40</p> <p>segue...</p>
  <p>continua...</p> <p>140D003205003 – Lunghezza 500 – – conf. 20 – € 5,00</p> <p>140D003206003 – Lunghezza 600 – – conf. 20 – € 7,60</p>	  <p>CATENACCIO A LEVA Art. 320 Asta tonda \varnothing 8 mm Larghezza 16 mm acciaio bronzato</p> <p>140D003201522 – Lunghezza 150 – – conf. 20 – € 3,00</p> <p>140D003202022 – Lunghezza 200 – – conf. 20 – € 3,20</p> <p>140D003202522 – Lunghezza 250 – – conf. 20 – € 3,40</p> <p>140D003203022 – Lunghezza 300 – – conf. 20 – € 3,60</p> <p>140D003204022 – Lunghezza 400 – – conf. 20 – € 4,20</p> <p>segue...</p>
  <p>continua...</p> <p>140D003205022 – Lunghezza 500 – – conf. 20 – € 5,00</p> <p>140D003206022 – Lunghezza 600 – – conf. 20 – € 7,60</p>	  <p>CATENACCIO VERTICALE Art. 231 Asta tonda \varnothing 9 mm Larghezza 19 mm acciaio bronzato</p> <p>180231200 – Lunghezza 200 – – conf. 20 – € 6,80</p> <p>180231250 – Lunghezza 250 – – conf. 20 – € 7,40</p> <p>180231300 – Lunghezza 300 – – conf. 20 – € 8,00</p> <p>180231400 – Lunghezza 400 – – conf. 20 – € 9,80</p> <p>180231500 – Lunghezza 500 – – conf. 10 – € 11,80</p> <p>segue...</p>



 **continua...**
180231600 - Lunghezza 600 -
 - conf. 10 - € **13,40**
180231800 - Lunghezza 800 -
 - conf. 10 - € **18,20**



AGB **CATENACCIO VERTICALE Art. 338** Asta tonda Ø 9 mm Larghezza 18,5 acciaio bronzato

140D003382022 - Lunghezza 200 -
 - conf. 10 - € **4,20**
140D003383022 - Lunghezza 300 -
 - conf. 10 - € **5,00**
140D003384022 - Lunghezza 400 -
 - conf. 10 - € **6,20**
140D003385022 - Lunghezza 500 -
 - conf. 10 - € **7,20**



 **CATENACCIO A CODA 1/2 PESO Art. 270** acciaio lucido

18027020 - misura 200 -
 - conf. 20 - € **11,80**
18027025 - misura 250 -
 - conf. 20 - € **12,20**
18027030 - misura 300 -
 - conf. 20 - € **13,20**
18027040 - misura 400 -
 - conf. 20 - € **15,40**
18027050 - misura 500 -
 - conf. 20 - € **17,60**



IBFM **CATENACCIO VERTICALE PROFILATO Art. 10** in acciaio zincato Da saldare

525010150 - Lunghezza mm 150 -
 - conf. 15 - € **2,88**
525010200 - Lunghezza mm 200 -
 - conf. 15 - € **3,30**
525010250 - Lunghezza mm 250 -
 - conf. 15 - € **3,50**
525010300 - Lunghezza mm 300 -
 - conf. 15 - € **3,92**
525010400 - Lunghezza mm 400 -
 - conf. 15 - € **4,54**
 segue...



IBFM **continua...**
525010500 - Lunghezza mm 500 -
 - conf. 15 - € **4,94**



IBFM **CATENACCIO VERTICALE PESANTE Art. 13** in acciaio zincato Da saldare

525013200 - Lunghezza 200 -
 - conf. 5 - € **7,00**
525013250 - Lunghezza 250 -
 - conf. 5 - € **7,42**
525013300 - Lunghezza 300 -
 - conf. 5 - € **9,28**
525013400 - Lunghezza 400 -
 - conf. 5 - € **11,12**



COMJNELLO **CATENACCIO A SALDARE Art. 735** Asta 18 x 6 mm Larghezza 22 mm zincato

41573515 - Lunghezza 150 -
 - conf. 10 - € **3,60**
41573520 - Lunghezza 200 -
 - conf. 10 - € **4,00**
41573525 - Lunghezza 250 -
 - conf. 10 - € **4,20**
41573530 - Lunghezza 300 -
 - conf. 10 - € **4,80**
41573540 - Lunghezza 400 -
 - conf. 10 - € **6,00**
 segue...



COMJNELLO **continua...**
41573550 - Lunghezza 500 -
 - conf. 10 - € **6,80**
41573560 - Lunghezza 600 -
 - conf. 10 - € **9,20**
41573580 - Lunghezza 800 -
 - conf. 10 - € **11,40**



COMJNELLO **CATENACCIO A SALDARE PESANTE Art. 745** Asta 25 x 10 mm Larghezza 30 mm Zincato

41574520 - Lunghezza 200 -
 - conf. 6 - € **8,00**
41574525 - Lunghezza 250 -
 - conf. 6 - € **8,80**
41574530 - Lunghezza 300 -
 - conf. 6 - € **9,80**
41574540 - Lunghezza 400 -
 - conf. 6 - € **12,00**
41574550 - Lunghezza 500 -
 - conf. 6 - € **14,80**
 segue...



COMJNELLO **continua...**
41574560 - Lunghezza 600 -
 - conf. 6 - € **21,80**
41574580 - Lunghezza 800 -
 - conf. 6 - € **26,00**



COMJNELLO **CATENACCIO A LEVA MEDIO Art. 720** Asta tonda zincato

41572035 - Lunghezza 350 -
 - conf. 10 - € **4,80**
41572045 - Lunghezza 450 -
 - conf. 10 - € **5,80**
41572060 - Lunghezza 600 -
 - conf. 10 - € **6,60**
41572080 - Lunghezza 800 -
 - conf. 10 - € **9,00**



AGB **CATENACCI A SALDARE Art. 330** Asta quadra Larghezza 18,5 mm tropicalizzato





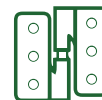



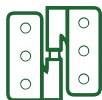















140D003302004 - Lunghezza 200 -
 - conf. 20 - € **3,40**
140D003304004 - Lunghezza 400 -
 - conf. 20 - € **5,20**











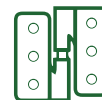





<p>COMJNELLO</p> <p>CATENACCIO A SALDARE Art. 710 Asta 10 x 10 zincato</p> <p>41571013 – Lunghezza 130 – – conf. 10 – € 5,20</p> <p>41571030 – Lunghezza 300 – – conf. 10 – € 7,40</p> <p>41571050 – Lunghezza 500 – – conf. 10 – € 9,80</p> 	<p>COMJNELLO</p> <p>CATENACCIO A SALDARE Art. 712 Asta tonda Ø 10 mm zincato</p> <p>41571213 – Lunghezza 130 – – conf. 10 – € 5,20</p> <p>41571230 – Lunghezza 300 – – conf. 10 – € 7,40</p> <p>41571250 – Lunghezza 500 – – conf. 10 – € 9,80</p> 
<p>COMJNELLO</p> <p>CATENACCIO A SALDARE PUNTA TONDA Ø 14 Art. 716 zincato</p> <p>415716330 – Misura 330 – – conf. 5 – € 10,20</p> <p>415716660 – Misura 660 – – conf. 5 – € 14,80</p> 	<p>INVO</p> <p>CATENACCIO Modello Quadrotto Corsa 40 mm In alluminio acciaio zincato e nylon con chiave</p> <p>77315702553 – Lunghezza 250 – – conf. 1 – € 63,40</p> <p>77315705053 – Lunghezza 500 – – conf. 1 – € 80,60</p> 
<p>INVO</p> <p>CATENACCIO Modello Quadrotto Corsa 40 mm in alluminio acciaio zincato e nylon</p> <p>773157025 – Lunghezza 250 – – conf. 1 – € 38,80</p> <p>773157050 – Lunghezza 500 – – conf. 1 – € 56,00</p> 	<p>INVO</p> <p>BRACCIO REGOLABILE DI APERTURA “ AREA-RE ” acciaio INOX AISI 430 incontro in saviolyte marrone</p> <p>773211 – – conf. 4 – € 37,00</p> 
<p>INVO</p> <p>BRACCIO REGOLABILE PER INFISSI A SPORGERE Modello Marco Inox Misura 250 / 350 mm in acciaio INOX AISI 430 4 posizioni di apertura</p> <p>773617 – – conf. 10 – € 36,20</p> 	<p>INVO</p> <p>BRACCIO ARRESTO SOGLIOLA FERRO Misura 210 mm Int. fori 137 mm in acciaio zincato sganciabile</p> <p>773616 – – conf. 20 – € 15,80</p> 
<p>COMJNELLO</p> <p>COPRIANGOLO quadro zincato</p> <p>41561510 – Misura 10 – A 24 – B 10 – – conf. 50 – € 0,68</p> <p>41561512 – Misura 12 – A 26 – B 12 – – conf. 50 – € 0,72</p> 	<p>AGB</p> <p>CAVALLOTTO PER CREMONESI Foro Ø 14 mm bronzato</p> <p>140E001451402 – – conf. 20 – € 0,38</p> 
<p>INCONTRO PER CATENACCIO acciaio bronzato</p> <p>1802311R – Art. rettang. – – conf. 40 – € 0,88</p> <p>1802311S – Art. semitondo – – conf. 40 – € 0,88</p> 	<p>IBFM</p> <p>ARRESTO PORTA VA-VIENI a rullo regolabile Art. 208</p> <p>52520816100 – Lungh. 100 – Largh. 16 – – conf. 12 – € 5,16</p> <p>52520825120 – Lungh. 120 – Largh. 25 – – conf. 12 – € 6,38</p> 



  <p>ESPOSITORE ALDEGHI ESPOSICUREZZA Dimensioni: 56X34 cm Pezzi: 118 Per maggiori informazioni contattare il proprio agente di zona</p> <p>180ESP1230 - - conf. 1 - € 726,00</p>	  <p>CATENACCIO TRASVERSALE Art. 212IN - Leggero Asta piatta Larghezza 18 mm INOX</p> <p>180212108 - Lunghezza 80 - - conf. 10 - € 7,40 180212110 - Lunghezza 100 - - conf. 10 - € 7,80</p>
  <p>CATENACCIO PORTALUCCHETTO Art. 214I Leggero Misura 100 x 27 mm Asta quadra INOX</p> <p>180214110 - - conf. 10 - € 6,00</p>	  <p>CATENACCIO TRASVERSALE Art. 216I - Leggero Asta tonda Ø 10 mm Larghezza 36 mm INOX</p> <p>180216108 - Lunghezza 80 - - conf. 2 - € 30,00 180216112 - Lunghezza 120 - - conf. 2 - € 37,00</p>
  <p>CATENACCIO VERTICALE leggero Art. 231I Asta tonda Ø 9 mm Larghezza 19 mm INOX</p> <p>180231120 - Lunghezza 200 - - conf. 2 - € 28,60 180231130 - Lunghezza 300 - - conf. 2 - € 35,80 180231150 - Lunghezza 500 - - conf. 2 - € 44,40</p>	  <p>CATENACCIO PORTALUCCHETTO Art. 248I Asta tonda Ø 10 mm Larghezza 36 mm INOX</p> <p>180248110 - misura 100 - - conf. 2 - € 37,40 180248115 - misura 150 - - conf. 2 - € 47,20</p>
  <p>CATENACCIO PORTALUCCHETTO Art. 250I Asta tonda Ø 12 mm Larghezza 42,5 mm INOX</p> <p>180250115 - Lunghezza 150 - - conf. 2 - € 59,00 180250120 - Lunghezza 200 - - conf. 2 - € 67,20</p>	  <p>POZZETTI IN OTTONE per catenacci con tappo e molle INOX</p> <p>18019906 - ØI 6 - ØE 9,5 - - conf. 10 - € 4,40 18019908 - ØI 8 - ØE 12 - - conf. 10 - € 5,00 18019910 - ØI 10 - ØE 14 - - conf. 10 - € 5,40 18019912 - ØI 12 - ØE 16 - - conf. 10 - € 6,40 18019914 - ØI 14 - ØE 18 - - conf. 10 - € 7,40 segue...</p>
  <p>continua...</p> <p>18019918 - ØI 18 - ØE 22 - - conf. 10 - € 8,80 18019920 - ØI 20 - ØE 24 - - conf. 10 - € 9,40 18019922 - ØI 22 - ØE 26 - - conf. 10 - € 9,80</p>	  <p>POZZETTO con tappo e molla in ottone</p> <p>525475006 - ØI 6 - ØE 10 - - conf. 50 - € 2,20 525475008 - ØI 8 - ØE 12 - - conf. 50 - € 2,60 525475010 - ØI 10 - ØE 14 - - conf. 50 - € 2,80 525475012 - ØI 12 - ØE 14 - - conf. 50 - € 3,20 525475014 - ØI 14 - ØE 18 - - conf. 50 - € 3,80 segue...</p>
  <p>continua...</p> <p>525475016 - ØI 16 - ØE 22 - - conf. 50 - € 4,60 525475018 - ØI 18 - ØE 22 - - conf. 50 - € 4,60 525475020 - ØI 20 - ØE 24 - - conf. 50 - € 4,60 525475022 - ØI 22 - ØE 26 - - conf. 50 - € 5,00</p>	  <p>BOCCOLE IN OTTONE per catenacci</p> <p>140D003010801 - ØI 8 - ØE 11 - - conf. 50 - € 1,26 140D003011001 - ØI 10 - ØE 13 - - conf. 50 - € 1,58 140D003011301 - ØI 13 - ØE 16 - - conf. 50 - € 1,66</p>



<p>&M900</p> <p>CONF.50 POZZETTI per porte in ottone</p> <p>90010391 - ØI 6 - ØE 7,5 - - conf. 1 - € 8,20</p> <p>90010392 - ØI 8 - ØE 9,5 - - conf. 1 - € 10,20</p> <p>90010393 - ØI 10 - ØE 11,5 - - conf. 1 - € 12,80</p> <p>90010394 - ØI 12 - ØE 13,5 - - conf. 1 - € 15,80</p> 	<p>COMUNELLO</p> <p>CERNIERA PER VASISTAS</p> <p>41560065 - misura 65 - - conf. 40 - € 2,20</p> <p>41560085 - misura 85 - - conf. 20 - € 2,80</p> 
<p>COMUNELLO</p> <p>COPPIA CERNIERA A COMPASSO - DX-SX per VASISTAS brevettata</p> <p>41560665 - misura 65 - - conf. 40 - € 4,20</p> <p>41560685 - misura 85 - - conf. 25 - € 5,40</p> 	<p>COMUNELLO</p> <p>COPPIA CERNIERA A COMPASSO - DX-SX per VASISTAS brevettata</p> <p>41561265 - misura 65 - - conf. 40 - € 6,60</p> <p>41561285 - misura 85 - - conf. 25 - € 8,00</p> 
<p>CERNIERA STRETTA Art. 120 con perno fisso acciaio zincato</p> <p>180120020 - Pollici ½ - HxL 20x14 - - conf. 24 - € 1,02</p> <p>180120025 - Pollici 1 - HxL 25x19 - - conf. 24 - € 1,02</p> <p>180120030 - Pollici 1¼ - HxL 31,5x23 - - conf. 24 - € 1,06</p> <p>180120035 - Pollici 1¾ - HxL 35x25 - - conf. 24 - € 1,10</p> <p>180120040 - Pollici 1¾ - HxL 38,5x26 - - conf. 24 - € 1,08</p> <p>segue...</p> 	<p>continua...</p> <p>180120045 - Pollici 1½ - HxL 45x28 - - conf. 24 - € 1,26</p> <p>180120050 - Pollici 2 - HxL 50x31 - - conf. 24 - € 1,36</p> <p>180120055 - Pollici 2¾ - HxL 55x32 - - conf. 24 - € 1,44</p> <p>180120060 - Pollici 2¾ - HxL 60x35 - - conf. 24 - € 1,52</p> <p>180120065 - Pollici 2¼ - HxL 65x35 - - conf. 24 - € 1,58</p> <p>segue...</p> 
<p>continua...</p> <p>180120070 - Pollici 2½ - HxL 70x38 - - conf. 24 - € 1,68</p> <p>180120075 - Pollici 3 - HxL 75x41 - - conf. 24 - € 1,76</p> <p>180120080 - Pollici 3¾ - HxL 80x42 - - conf. 24 - € 2,00</p> <p>180120090 - Pollici 3¾ - HxL 90x51 - - conf. 24 - € 2,20</p> <p>180120100 - Pollici 4 - HxL 100x56 - - conf. 24 - € 2,40</p> 	<p>&M900</p> <p>CERNIERA STRETTA con perno fisso acciaio zincato</p> <p>90018201 - pollici 1 - HxL 30X20 - - conf. 50 - € 0,52</p> <p>90018202 - pollici 1¼ - HxL 40X25 - - conf. 50 - € 0,58</p> <p>90018203 - pollici 2 - HxL 50X30 - - conf. 20 - € 0,66</p> <p>90018204 - pollici 2¼ - HxL 65X35 - - conf. 20 - € 0,88</p> <p>90018205 - pollici 3 - HxL 75X40 - - conf. 20 - € 1,08</p> <p>segue...</p> 
<p>&M900</p> <p>continua...</p> <p>90018206 - pollici 3¼ - HxL 90X50 - - conf. 20 - € 1,62</p> <p>90018207 - pollici 4 - HxL 100X55 - - conf. 20 - € 1,62</p> 	<p>CERNIERE QUADRE Art. 121 acciaio zincato con perno in ottone fisso</p> <p>180121020 - pollici ½ - HxL 20x19 - - conf. 24 - € 1,06</p> <p>180121025 - pollici 1 - HxL 25x25 - - conf. 24 - € 1,06</p> <p>180121030 - pollici 1¼ - HxL 31,5x31 - - conf. 24 - € 1,10</p> <p>180121035 - pollici 1¾ - HxL 35x36 - - conf. 24 - € 1,08</p> <p>180121040 - pollici 1¾ - HxL 38,5x39 - - conf. 24 - € 1,18</p> <p>segue...</p> 
<p>continua...</p> <p>180121045 - pollici 1½ - HxL 45x45 - - conf. 24 - € 1,26</p> <p>180121050 - pollici 2 - HxL 50x50 - - conf. 24 - € 1,42</p> <p>180121055 - pollici 2¾ - HxL 55x55 - - conf. 24 - € 1,56</p> <p>180121060 - pollici 2¾ - HxL 60x60 - - conf. 24 - € 1,72</p> <p>180121065 - pollici 2¼ - HxL 65x65 - - conf. 24 - € 1,78</p> <p>segue...</p> 	<p>continua...</p> <p>180121070 - pollici 2½ - HxL 70x70 - - conf. 24 - € 2,00</p> <p>180121075 - pollici 3 - HxL 75x75 - - conf. 24 - € 2,40</p> <p>180121080 - pollici 3¾ - HxL 80x80 - - conf. 24 - € 2,60</p> <p>180121090 - pollici 3¾ - HxL 90x90 - - conf. 24 - € 3,00</p> <p>180121100 - pollici 4 - HxL 100x100 - - conf. 24 - € 3,60</p> 

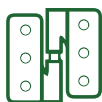

 <p>CERNIERE QUADRE Art. 121 acciaio zincato con perno zincato</p> <p>180121020PZ - Misura 20x18,8 - - conf. 24 - € 0,76</p> <p>180121025PZ - Misura 25x25 - - conf. 24 - € 0,76</p> <p>180121030PZ - Misura 31,5x31,5 - - conf. 24 - € 0,76</p> <p>180121035PZ - Misura 35x36 - - conf. 24 - € 0,86</p> <p>180121040PZ - Misura 38,5x39 - - conf. 24 - € 0,88</p> <p>segue...</p>	 <p>continua...</p> <p>180121045PZ - Misura 45x45 - - conf. 24 - € 0,94</p> <p>180121050PZ - Misura 50x50 - - conf. 24 - € 0,94</p> <p>180121055PZ - Misura 55x55 - - conf. 24 - € 1,12</p> <p>180121060PZ - Misura 60x60 - - conf. 24 - € 1,14</p> <p>180121065PZ - Misura 65x65 - - conf. 24 - € 1,28</p> <p>segue...</p>
 <p>continua...</p> <p>180121070PZ - Misura 70x70 - - conf. 24 - € 1,44</p> <p>180121075PZ - Misura 75x75 - - conf. 24 - € 1,50</p> <p>180121080PZ - Misura 80x80 - - conf. 24 - € 1,88</p> <p>180121090PZ - Misura 90x90 - - conf. 24 - € 1,88</p> <p>180121100PZ - Misura 100x102,5 - - conf. 24 - € 2,60</p>	 <p>&M 900</p> <p>CERNIERA QUADRA con perno fisso tropicalizzata</p> <p>90018221 - pollici 1¼ - HxL 38X38 - N fori 4 - - conf. 50 - € 0,62</p> <p>90018222 - pollici 2 - HxL 51X51 - N fori 6 - - conf. 20 - € 0,70</p> <p>90018223 - pollici 2¼ - HxL 64X62 - N fori 6 - - conf. 20 - € 0,84</p> <p>90018224 - pollici 3 - HxL 76X77 - N fori 6 - - conf. 20 - € 1,30</p> <p>90018225 - pollici 3¼ - HxL 89X86 - N fori 8 - - conf. 20 - € 1,96</p> <p>segue...</p>
 <p>&M 900</p> <p>continua...</p> <p>90018226 - pollici 4 - HxL 100X99 - N fori 8 - - conf. 20 - € 1,92</p>	 <p>METAL</p> <p>CERNIERA SPINA FISSA Finitura zincata</p> <p>6453030ZN - Misura 30x30 - - conf. 10 - € 0,54</p> <p>6454040ZN - Misura 40x40 - - conf. 10 - € 0,60</p> <p>6455050ZN - Misura 50x50 - - conf. 10 - € 0,72</p> <p>6458080ZN - Misura 80x80 - - conf. 10 - € 1,34</p>
 <p>&M 900</p> <p>CERNIERA LUNGA Art. 9533 con perno fisso acciaio zincato</p> <p>90018241 - LxH 60x25 - - conf. 20 - € 0,70</p> <p>90018242 - LxH 70x25 - - conf. 20 - € 0,98</p> <p>90018243 - LxH 80x25 - - conf. 20 - € 0,86</p> <p>90018244 - LxH 100x25 - - conf. 20 - € 1,04</p> <p>90018245 - LxH 125x25 - - conf. 20 - € 1,20</p> <p>segue...</p>	 <p>&M 900</p> <p>continua...</p> <p>90018246 - LxH 140x25 - - conf. 20 - € 1,36</p> <p>90018247 - LxH 180x30 - - conf. 20 - € 2,20</p>
 <p>CERNIERA LUNGA Art. 122 con perno fisso acciaio zincato</p> <p>180122050 - Pollici 2 - LxH 50x22 - - conf. 24 - € 1,34</p> <p>180122060 - Pollici 2¼ - LxH 60x22 - - conf. 24 - € 1,36</p> <p>180122070 - Pollici 2½ - LxH 70x22 - - conf. 24 - € 1,52</p> <p>180122080 - Pollici 3¼ - LxH 80x25 - - conf. 24 - € 1,70</p> <p>180122100 - Pollici 4 - LxH 100x25 - - conf. 24 - € 2,00</p> <p>segue...</p>	 <p>continua...</p> <p>180122120 - Pollici 4½ - LxH 120x28 - - conf. 24 - € 2,40</p> <p>180122140 - Pollici 5¼ - LxH 140x28 - - conf. 24 - € 2,80</p> <p>180122150 - Pollici 6 - LxH 150x32 - - conf. 24 - € 3,00</p> <p>180122160 - Pollici 6¼ - LxH 160x32 - - conf. 24 - € 3,40</p> <p>180122180 - Pollici 7 - LxH 180x35 - - conf. 24 - € 3,60</p> <p>180122200 - Pollici 8 - LxH 200x34 - - conf. 24 - € 4,80</p>
 <p>CERNIERA 1/2 LARGA PESANTE Art. 838 perno fisso acciaio lucido</p> <p>180838030 - pollici 1¼ - HxL 30x28 - - conf. 24 - € 1,08</p> <p>180838038 - pollici 1¼ - HxL 38x35 - - conf. 24 - € 1,08</p> <p>180838044 - pollici 1½ - HxL 44x37 - - conf. 24 - € 1,24</p> <p>180838050 - pollici 2 - HxL 50x40 - - conf. 24 - € 1,36</p> <p>180838057 - pollici 2¼ - HxL 57x43 - - conf. 24 - € 1,52</p> <p>segue...</p>	 <p>continua...</p> <p>180838063 - pollici 2¼ - HxL 63,5x43 - - conf. 24 - € 1,64</p> <p>180838070 - pollici 2½ - HxL 70x50 - - conf. 24 - € 1,92</p> <p>180838075 - pollici 3 - HxL 75x50 - - conf. 24 - € 2,20</p> <p>180838087 - pollici 3¼ - HxL 87x58 - - conf. 24 - € 2,80</p> <p>180838100 - pollici 4 - HxL 100x70 - - conf. 24 - € 3,80</p>



Prodotti per ferramenta professionale e fai da te.

ACCIAIO



LEGNO

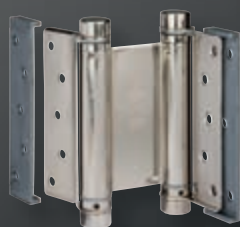

INOX



ARREDO



GIUNZIONI
PER LEGNO



SISTEMI
D'OMBRA



Aldeghi Luigi_{s.p.a}

dal 1930

MADE IN ITALY



Aldeghi Luigi S.p.A.

Stabilimenti - Factories

20872 CORNATE D'ADDA (MB) - ITALY

Via Matteotti, 66

☎ +39 039 692181 📠 +39 039 6929562

23900 LECCO - ITALY

Corso Bergamo 40

www.aldeghi.com • info@aldeghi.com

Sede Legale - Head Office

23900 LECCO - ITALY

Corso Bergamo, 40





Prodotti per
costruzioni in legno



Le tue
idee?
Realizzale con giunzioni
e fissaggi di qualità.

Giunzioni Piane

Giunzioni a 90°

Giunzioni di testa

Giunzioni per pilastri

Giunzioni per usi vari

Giunzioni per travi tonde



Aldeghi Luigi s.p.a

dal 1930

MADE IN ITALY



Aldeghi Luigi S.p.A.

Stabilimenti - Factories

20872 CORNATE D'ADDA (MB) - ITALY

Via Matteotti, 66

☎ +39 039 692181 📠 +39 039 6929562

23900 LECCO - ITALY

Corso Bergamo 40

www.aldeghi.com • info@aldeghi.com

Sede Legale - Head Office

23900 LECCO - ITALY

Corso Bergamo, 40



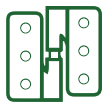

<p>&M900</p> <p><i>continua...</i> 90018406 - pollici 4 - HxL 100x70 - N. Fori 8 - - conf. 24 - € 2,80</p> 	<p>&M900</p> <p>CERNIERA PESANTE Art. 816 perno fisso acciaio zincato</p> <p>90018451 - pollici 1 - HxL 25x50 - - conf. 20 - € 1,28 90018452 - pollici 1¼ - HxL 38x70 - - conf. 24 - € 1,38 90018453 - pollici 2 - HxL 50x95 - - conf. 24 - € 1,78 90018454 - pollici 2¼ - HxL 64x110 - - conf. 24 - € 4,20 90018455 - pollici 3 - HxL 75x140 - - conf. 12 - € 7,60</p> 
<p>&M900</p> <p>CERNIERA OTTONE FRESATA Art. 101 collo piano</p> <p>90018711 - HxL 30x25 - - conf. 24 - € 0,92 90018712 - HxL 30x30 - - conf. 24 - € 1,02 90018713 - HxL 35x30 - - conf. 24 - € 1,12 90018714 - HxL 35x35 - - conf. 24 - € 1,16 90018715 - HxL 40x35 - - conf. 24 - € 1,30 <i>segue...</i></p> 	<p>&M900</p> <p><i>continua...</i> 90018716 - HxL 40x40 - - conf. 24 - € 1,70 90018717 - HxL 50x40 - - conf. 24 - € 1,82 90018718 - HxL 50x50 - - conf. 24 - € 2,88 90018719 - HxL 60x50 - - conf. 24 - € 2,88</p> 
<p>&M900</p> <p>CERNIERA OTTONE FRESATA Art. 102 mezzo collo finitura oro satinato</p> <p>90018723 - HxL 35x35 - - conf. 24 - € 1,52 90018724 - HxL 40x35 - - conf. 24 - € 1,64 90018725 - HxL 40x40 - - conf. 24 - € 1,76 90018726 - HxL 50x40 - - conf. 24 - € 2,20 90018727 - HxL 50x50 - - conf. 24 - € 3,00 <i>segue...</i></p> 	<p>&M900</p> <p><i>continua...</i> 90018728 - HxL 60x50 - - conf. 24 - € 3,60</p> 
<p>&M900</p> <p>CERNIERA A BISCOTTO Art. 105 senza fermo</p> <p>90018041 - Finitura Ottone satinato - - conf. 24 - € 3,40 90018042 - Finitura Ottone bronzato - - conf. 24 - € 3,80</p> 	<p>&M900</p> <p>CERNIERA A BISCOTTO Art. 106 con fermo</p> <p>90018045 - Finitura Ottone satinato - - conf. 24 - € 5,00 90018046 - Finitura Ottone bronzato - - conf. 24 - € 5,60</p> 
<p>METAL</p> <p>CERNIERA A BISCOTTO</p> <p>6454802417 - Finitura Ottonata - Misura 80x31 - - conf. 10 - € 1,18 6454802432 - Finitura Nichelata - Misura 80x31 - - conf. 10 - € 1,04 6454802464 - Finitura Tropicalizzata - Misura 80x31 - - conf. 10 - € 1,00</p> 	<p>METAL</p> <p>CERNIERA COLLO Zincata</p> <p>6454802301 - Misura 40x35 - Collo 10 - - conf. 10 - € 2,40 64548023013 - Misura 40x35 - Collo 13 - - conf. 10 - € 2,60 6454802308 - Misura 40x40 - Collo 8 - - conf. 10 - € 2,60</p> 
<p>METAL</p> <p>CERNIERA PIANA Collo 0 Misura 40x40 Ottone antico</p> <p>6454802203 - - conf. 10 - € 2,60</p> 	<p>METAL</p> <p>CERNIERA CON ASOLA Tonda Collo 0 Misura 40x40 Ottone antico</p> <p>645TONDA40 - - conf. 10 - € 1,60</p> 

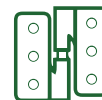



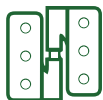



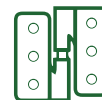





<p>METAL SOLO BASETTA PER CERNIERE Ottone antico</p> <p>64598MG06 - - conf. 10 - € 1,50</p> 	<p>METAL CERNIERA PIANA A giglio Misura 85x53 Colore nero</p> <p>64548033088 - - conf. 10 - € 1,16</p> 
<p>METAL CERNIERA PIANA A GIGLIO Misura 85x52 Colore nero</p> <p>64548033085 - - conf. 10 - € 1,16</p> 	<p>METAL CERNIERA ANUBA Misura 9x12 Colore nera</p> <p>64548098012 - - conf. 10 - € 0,94</p> 
<p>METAL CERNIERA INCASSO 40 Colore brunita</p> <p>6454808405 - - conf. 10 - € 0,82</p> 	<p>METAL CERNIERA INCASSO</p> <p>645INC180T - Finitura Ottonata - Misura 18 MM - conf. 10 - € 1,28</p> <p>645INC18BR - Finitura Bronzata - Misura 18 MM - conf. 10 - € 1,20</p> <p>645INC18NI - Finitura Nichelata - Misura 18 MM - conf. 10 - € 1,22</p> <p>645INC240T - Finitura Ottonata - Misura 24 MM - conf. 10 - € 1,28 segue...</p> 
<p>METAL continua...</p> <p>645INC24BR - Finitura Bronzata - Misura 24 MM - conf. 10 - € 1,20</p> <p>645INC24NI - Finitura Nichelata - Misura 24 MM - conf. 10 - € 1,22</p> 	<p>METAL CERNIERA INCASSO</p> <p>645INC284BR - Finitura BRONZATA - - conf. 10 - € 3,20</p> <p>645INC284OT - Finitura OTTONATA - - conf. 10 - € 3,20</p> 
<p>METAL CERNIERA INCASSO</p> <p>645INC279BR - Finitura Bronzata - - conf. 10 - € 3,00</p> <p>645INC279OT - Finitura Ottonata - - conf. 10 - € 2,80</p> 	<p>METAL CERNIERA INCASSO</p> <p>645INC240BR - Finitura Bronzata - - conf. 10 - € 4,60</p> <p>645INC240OT - Finitura Ottonata - - conf. 10 - € 4,40</p> 
<p>METAL CERNIERA ZANCATA</p> <p>645ZAN80BR - Finitura Bronzata - Misura 80 - - conf. 10 - € 5,20</p> <p>645ZAN80OT - Finitura Ottonata - Misura 80 - - conf. 10 - € 5,00</p> <p>645ZAN105BR - Finitura Bronzata - Misura 105 - - conf. 10 - € 5,20</p> <p>645ZAN105OT - Finitura Ottonata - Misura 105 - - conf. 10 - € 5,00</p> 	<p>METAL CERNIERA ZANCATA</p> <p>645ZAN673BR - Finitura OTTONATA - - conf. 10 - € 5,00</p> <p>645ZAN673OT - Finitura BRONZATA - - conf. 10 - € 4,80</p> 



  <p>CERNIERA ZANCATA</p> <p>645ZANKBR - Finitura Bronzata - - conf. 10 - € 6,60</p> <p>645ZANKOA - Finitura Ottone Antico - - conf. 10 - € 6,60</p> <p>645ZANKOT - Finitura Ottone - - conf. 10 - € 6,60</p>	  <p>CERNIERA FUSA Con asola Colore bronzato</p> <p>6454822404 - Misura 40X37 - - conf. 10 - € 1,90</p> <p>6454822401 - Misura 40X42 - - conf. 10 - € 2,20</p>
  <p>CERNIERA OTTONE FRESATA Art. 103 collo intero finitura oro satinato</p> <p>90018731 - HxL 35x35 - - conf. 24 - € 1,82</p> <p>90018732 - HxL 40x35 - - conf. 24 - € 1,94</p> <p>90018733 - HxL 40x40 - - conf. 24 - € 2,60</p> <p>90018734 - HxL 50x40 - - conf. 24 - € 2,48</p> <p>90018735 - HxL 50x50 - - conf. 24 - € 3,60</p> <p>segue...</p>	  <p>continua...</p> <p>90018736 - HxL 60x50 - - conf. 24 - € 4,00</p>
  <p>CERNIERA INVISIBILE Art. 110 ottone lucido apertura 180°</p> <p>90018121 - Ø 10 - - conf. 12 - € 2,80</p> <p>90018122 - Ø 12 - - conf. 12 - € 2,80</p> <p>90018123 - Ø 14 - - conf. 12 - € 3,40</p> <p>90018124 - Ø 16 - - conf. 12 - € 4,40</p>	  <p>CERNIERA AMERICANA PESANTE PIANA con cuscinetti a sfera pomoli piatti acciaio bronzato</p> <p>18013001 - pollici 3x2¼ - HxL 76x63 - - conf. 2 - € 15,40</p> <p>18013002 - pollici 3¼x3 - HxL 86x76 - - conf. 2 - € 16,40</p> <p>18013003 - pollici 4x3¼ - HxL 101x89 - - conf. 2 - € 17,80</p> <p>18013004 - pollici 5x4 - HxL 127x101 - - conf. 2 - € 36,00</p>
  <p>CERNIERA AMERICANA PESANTE collo intero con cuscinetti a sfera pomoli piatti acciaio bronzato</p> <p>18013101 - pollici 3 - HxL 76x46 - - conf. 2 - € 18,00</p> <p>18013102 - pollici 3¼ - HxL 89x58 - - conf. 2 - € 19,40</p> <p>18013103 - pollici 4 - HxL 101x63 - - conf. 2 - € 21,80</p> <p>18013104 - pollici 5 - HxL 127x68 - - conf. 2 - € 38,40</p>	  <p>CERNIERA PAUMELLES PIANA acciaio bronzato</p> <p>180105080D - HxL 80x50 - mano DX - - conf. 12 - € 7,20</p> <p>180105080S - HxL 80x50 - mano SX - - conf. 12 - € 7,20</p> <p>180105095D - HxL 95x55 - mano DX - - conf. 12 - € 8,00</p> <p>180105095S - HxL 95x55 - mano SX - - conf. 12 - € 8,00</p> <p>180105110D - HxL 110x70 - mano DX - - conf. 12 - € 9,40</p> <p>180105110S - HxL 110x70 - mano SX - - conf. 12 - € 9,40</p>
  <p>CERNIERA A LIBRO PIANA acciaio bronzato</p> <p>180107100D - HxL 100x65 - mano DX - - conf. 12 - € 10,00</p> <p>180107100S - HxL 100x65 - mano SX - - conf. 12 - € 10,00</p> <p>180107120D - HxL 120x70 - mano DX - - conf. 12 - € 12,00</p> <p>180107120S - HxL 120x70 - mano SX - - conf. 12 - € 12,00</p>	  <p>CERNIERA A LIBRO PIEGATA acciaio bronzato</p> <p>180108100D - HxL 100x65 - mano DX - - conf. 12 - € 11,60</p> <p>180108100S - HxL 100x65 - mano SX - - conf. 12 - € 11,60</p> <p>180108120D - HxL 120x70 - mano DX - - conf. 12 - € 13,60</p> <p>180108120S - HxL 120x70 - mano SX - - conf. 12 - € 13,60</p>
  <p>CERNIERA ASE acciaio verniciato nero</p> <p>90025201 - Misura 120 - - conf. 12 - € 1,42</p> <p>90025202 - Misura 140 - - conf. 12 - € 1,46</p> <p>90025203 - Misura 160 - - conf. 12 - € 1,50</p> <p>90025204 - Misura 180 - - conf. 12 - € 1,60</p> <p>90025205 - Misura 200 - - conf. 12 - € 1,74</p> <p>segue...</p>	  <p>continua...</p> <p>90025206 - Misura 220 - - conf. 12 - € 1,82</p> <p>90025207 - Misura 240 - - conf. 12 - € 1,92</p> <p>90025208 - Misura 260 - - conf. 12 - € 2,38</p> <p>90025209 - Misura 280 - - conf. 12 - € 2,42</p> <p>90025210 - Misura 300 - - conf. 12 - € 2,48</p>



 <p>CERNIERE A BANDELLA Acciaio tropicalizzato</p> <p>180740AT250 – misura 250 – – conf. 10 – € 7,20</p> <p>180740AT300 – misura 300 – – conf. 10 – € 7,00</p> <p>180740AT400 – misura 400 – – conf. 10 – € 10,20</p>	 <p>AGB CERNIERA ANUBA Art.. 119 acciaio bronzato</p> <p>140E001190902 – Ø 9 – – conf. 100 – € 0,46</p> <p>140E001191102 – Ø 11 – – conf. 80 – € 0,56</p> <p>140E001191302 – Ø 13 – – conf. 100 – € 0,50</p> <p>140E001191402 – Ø 14 – – conf. 100 – € 0,60</p> <p>140E001191602 – Ø 16 – – conf. 50 – € 0,84</p>
 <p>AGB CERNIERA ANUBA Art. 119 acciaio ottonato</p> <p>140E001190903 – Ø 9 – – conf. 100 – € 0,50</p> <p>140E001191103 – Ø 11 – – conf. 80 – € 0,60</p> <p>140E001191303 – Ø 13 – – conf. 100 – € 0,56</p> <p>140E001191403 – Ø 14 – – conf. 100 – € 0,68</p> <p>140E001191603 – Ø 16 – – conf. 50 – € 0,96</p>	 <p>AGB CERNIERA ANUBA BAROCCO Art. 132 senza segno acciaio bronzato</p> <p>140E001320902 – Ø 9 – – conf. 100 – € 0,74</p> <p>140E001321302 – Ø 13 – – conf. 50 – € 0,92</p> <p>140E001321402 – Ø 14 – – conf. 50 – € 1,06</p>
 <p>AGB CERNIERA ANUBA BAROCCO Art. 132 senza segno acciaio ottonato</p> <p>140E001320903 – Ø 9 – – conf. 100 – € 0,78</p> <p>140E001321303 – Ø 13 – – conf. 50 – € 1,02</p> <p>140E001321403 – Ø 14 – – conf. 50 – € 1,18</p>	 <p>AGB CERNIERA ANUBA BAROCCO Art. 131 con segno acciaio bronzato</p> <p>140E001311102 – Ø 11 – – conf. 40 – € 1,08</p> <p>140E001311302 – Ø 13 – – conf. 50 – € 0,98</p> <p>140E001311402 – Ø 14 – – conf. 50 – € 1,12</p> <p>140E001311602 – Ø 16 – – conf. 50 – € 1,40</p>
 <p>AGB CERNIERA ANUBA BAROCCO Art. 131 con segno acciaio ottonato</p> <p>140E001311103 – Ø 11 – – conf. 40 – € 1,14</p> <p>140E001311303 – Ø 13 – – conf. 50 – € 1,06</p> <p>140E001311403 – Ø 14 – – conf. 50 – € 1,22</p> <p>140E001311603 – Ø 16 – – conf. 50 – € 1,56</p>	 <p>AGB KIT DIMA Ø 14 mm Per installazione cerniere normali il Kit contiene: 2 dime 1 punta 1 fermapunta 1 pernoregistro 1 gancio</p> <p>140E001121401 – Applicazione A battente – – conf. 1 – € 78,20</p> <p>140E001151401 – Applicazione A filo – – conf. 1 – € 78,20</p>
 <p>AGB KIT DIMA Ø 14-16 mm Per installazione cerniere registrabili Mod. Top e 3D il Kit contiene: 2 dime 1 punta Ø 7,5-7,9 mm 1 punta Ø 7,7 mm 2 fermapunte 3 chiavi esagonali 1 inserto per avvitatore.</p> <p>140E001121604 – Applicazione A battente – – conf. 1 – € 119,40</p> <p>140E001151604 – Applicazione A filo – – conf. 1 – € 119,40</p>	 <p>IBFM COPPIA CERNIERE MOLLA TIPO BOMMER Art. 108 ferro bronzato</p> <p>525108029 – Altezza 75 – – conf. 1 – € 17,92</p> <p>525108030 – Altezza 100 – – conf. 1 – € 21,22</p> <p>525108033 – Altezza 125 – – conf. 1 – € 28,02</p> <p>525108036 – Altezza 150 – – conf. 1 – € 37,28</p>
 <p>IBFM COPPIA CERNIERE MOLLA TIPO BOMMER Art.109 Ferro ottonato</p> <p>525109029 – Altezza 75 – – conf. 1 – € 17,92</p> <p>525109030 – Altezza 100 – – conf. 1 – € 21,22</p> <p>525109033 – Altezza 125 – – conf. 1 – € 28,02</p> <p>525109036 – Altezza 150 – – conf. 1 – € 37,28</p>	 <p>IBFM COPPIA CERNIERE MOLLA TIPO BOMMER Art. 114 Inox</p> <p>525114029 – Altezza 75 – – conf. 1 – € 75,20</p> <p>525114030 – Altezza 100 – – conf. 1 – € 100,94</p>

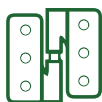

IBFM

COPPIA CERNIERE MOLLA TIPO BOMMER Art. 107 Acciaio nichelato

525107029 - Altezza 75 -
- conf. 1 - € **17,92**

525107030 - Altezza 100 -
- conf. 1 - € **21,22**

525107033 - Altezza 125 -
- conf. 1 - € **28,02**

525107036 - Altezza 150 -
- conf. 1 - € **37,28**



CERNIERA ALI PIANE SENZA FORI acciaio lucido

180122706 - Ø 13,5 - HxL 60x46 -
- conf. 10 - € **5,80**

180122708 - Ø 13,5 - HxL 80x56 -
- conf. 10 - € **6,20**

180122710 - Ø 15 - HxL 100x61 -
- conf. 10 - € **7,20**

180122712 - Ø 18 - HxL 120x66 -
- conf. 10 - € **11,40**



CERNIERA CON COLLO SENZA FORI acciaio lucido

180111906 - Ø 13,5 - HxL 60x60 -
- conf. 10 - € **6,00**

180111908 - Ø 13,5 - HxL 80x69 -
- conf. 10 - € **6,40**

180111910 - Ø 15 - HxL 100x72 -
- conf. 10 - € **7,40**

180111912 - Ø 18 - HxL 120x78 -
- conf. 10 - € **11,60**



AGB

CERNIERA A TAPPO CON 2 ALI perno fisso acciaio lucido

140E002070601 - Ø 10 - misura 60 -
- conf. 20 - € **1,08**

140E002070801 - Ø 12 - misura 80 -
- conf. 20 - € **1,16**

140E002071001 - Ø 13 - misura 100 -
- conf. 20 - € **1,26**

140E002071201 - Ø 15 - misura 120 -
- conf. 20 - € **1,52**

140E002071401 - Ø 16 - misura 140 -
- conf. 20 - € **1,72**



AGB

CERNIERA A TAPPO PESANTE CON 2 ALI perno fisso acciaio lucido

140E002021401 - Ø 18,5 - misura 140 -
- conf. 10 - € **1,96**

140E002021701 - Ø 19,5 - misura 170 -
- conf. 10 - € **3,20**

140E002022001 - Ø 21,5 - misura 200 -
- conf. 10 - € **3,80**



CERNIERA A TAPPO PERNO FISSO acciaio lucido

1801223060 - Ø 12 - Misura 60 -
- conf. 50 - € **1,52**

1801223080 - Ø 12 - Misura 80 -
- conf. 50 - € **1,82**

1801223100 - Ø 14,5 - Misura 100 -
- conf. 50 - € **1,96**

1801223120 - Ø 14,5 - Misura 120 -
- conf. 30 - € **2,60**

1801223140 - Ø 16,5 - Misura 140 -
- conf. 30 - € **3,20**

segue...



continua...

1801223170 - Ø 18 - Misura 170 -
- conf. 20 - € **6,00**

1801223200 - Ø 19,5 - Misura 200 -
- conf. 20 - € **8,00**



IBFM

CERNIERA A TAPPO PERNO FISSO acciaio lucido

525400060 - Ø 12 - Misura 60 -
- conf. 24 - € **0,82**

525400080 - Ø 12 - Misura 80 -
- conf. 24 - € **0,96**

525400100 - Ø 13,5 - Misura 100 -
- conf. 24 - € **1,04**

525400120 - Ø 14,5 - Misura 120 -
- conf. 24 - € **1,42**

525400140 - Ø 16 - Misura 140 -
- conf. 24 - € **1,68**

segue...



IBFM

continua...

525400170 - Ø 17 - Misura 170 -
- conf. 12 - € **2,88**

525400200 - Ø 20 - Misura 200 -
- conf. 12 - € **3,50**



COMUNELLO

CERNIERA A TAPPO perno fisso acciaio lucido

41542006 - Ø 10 - misura 60 -
- conf. 50 - € **1,26**

41542008 - Ø 12 - misura 80 -
- conf. 50 - € **1,34**

41542010 - Ø 13 - misura 100 -
- conf. 50 - € **1,44**

41542012 - Ø 15 - misura 120 -
- conf. 50 - € **1,70**

41542014 - Ø 16 - misura 140 -
- conf. 50 - € **1,78**



COMUNELLO

CERNIERA A TAPPO PESANTE perno fisso acciaio lucido

41542514 - Ø 17,5 - misura 140 -
- conf. 10 - € **2,80**

41542517 - Ø 17,5 - misura 170 -
- conf. 10 - € **2,80**

41542520 - Ø 19,6 - misura 200 -
- conf. 10 - € **3,40**



AGB

FISCE A TAPPO 2 ALI - DESTRA acciaio lucido

140E002030601 - misura 60 -
- conf. 12 - € **1,44**

140E002030801 - misura 80 -
- conf. 12 - € **1,68**

140E002031001 - misura 100 -
- conf. 12 - € **1,88**









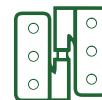







140E002031201 - misura 120 -
- conf. 12 - € **2,20**

140E002031401 - misura 140 -
- conf. 12 - € **2,80**

segue...







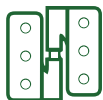



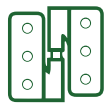















<p>AGB</p> <p>continua...</p> <p>140E002031701 – misura 170 – – conf. 12 – € 5,40</p> <p>140E002032001 – misura 200 – – conf. 12 – € 6,40</p> 	<p>AGB</p> <p>FISCE A TAPPO 2 ALI – SINISTRA acciaio lucido</p> <p>140E002040601 – Misura 60 – – conf. 12 – € 1,44</p> <p>140E002040801 – Misura 80 – – conf. 12 – € 1,68</p> <p>140E002041001 – Misura 100 – – conf. 12 – € 1,88</p> <p>140E002041201 – Misura 120 – – conf. 12 – € 2,20</p> <p>140E002041401 – Misura 140 – – conf. 12 – € 2,80</p> <p>segue...</p> 
<p>AGB</p> <p>continua...</p> <p>140E002041701 – Misura 170 – – conf. 12 – € 5,40</p> <p>140E002042001 – Misura 200 – – conf. 12 – € 6,40</p> 	<p></p> <p>FISCE A TAPPO 2 ALI – DESTRA acciaio lucido</p> <p>180122206D – misura 60 – – conf. 40 – € 1,96</p> <p>180122208D – misura 80 – – conf. 40 – € 2,80</p> <p>180122210D – misura 100 – – conf. 20 – € 3,60</p> <p>180122212D – misura 120 – – conf. 20 – € 4,60</p> <p>180122214D – misura 140 – – conf. 20 – € 7,20</p> 
<p></p> <p>FISCE A TAPPO 2 ALI – SINISTRA acciaio lucido</p> <p>180122206S – misura 60 – – conf. 40 – € 1,96</p> <p>180122208S – misura 80 – – conf. 40 – € 2,80</p> <p>180122210S – misura 100 – – conf. 20 – € 3,60</p> <p>180122212S – misura 120 – – conf. 20 – € 4,60</p> <p>180122214S – misura 140 – – conf. 20 – € 7,20</p> 	<p>IBFM</p> <p>FISCE A TAPPO 2 ALI – DESTRA acciaio naturale</p> <p>525495060DX – Misura 60 – – conf. 20 – € 1,20</p> <p>525495080DX – Misura 80 – – conf. 20 – € 1,22</p> <p>525495100DX – Misura 100 – – conf. 10 – € 1,84</p> <p>525495120DX – Misura 120 – – conf. 10 – € 2,06</p> <p>525495140DX – Misura 140 – – conf. 10 – € 2,88</p> <p>525495160DX – Misura 160 – – conf. 10 – € 3,50</p> 
<p>IBFM</p> <p>FISCE A TAPPO 2 ALI – SINISTRA acciaio naturale</p> <p>525495060SX – Misura 60 – – conf. 20 – € 1,20</p> <p>525495080SX – Misura 80 – – conf. 20 – € 1,22</p> <p>525495100SX – Misura 100 – – conf. 10 – € 1,84</p> <p>525495120SX – Misura 120 – – conf. 10 – € 2,06</p> <p>525495140SX – Misura 140 – – conf. 10 – € 2,88</p> <p>525495160SX – Misura 160 – – conf. 10 – € 3,50</p> 	<p></p> <p>FISCE A TAPPO 2 ALI – DESTRA acciaio lucido</p> <p>180122016D – misura 160 – – conf. 10 – € 10,60</p> <p>180122018D – misura 180 – – conf. 10 – € 12,40</p> <p>180122020D – misura 200 – – conf. 6 – € 14,20</p> 
<p></p> <p>FISCE A TAPPO 2 ALI – SINISTRA acciaio lucido</p> <p>180122016S – misura 160 – – conf. 10 – € 10,60</p> <p>180122018S – misura 180 – – conf. 10 – € 12,40</p> <p>180122020S – misura 200 – – conf. 6 – € 14,20</p> 	<p></p> <p>FISCE 3 ALI LUNGHE perno a levare acciaio lucido</p> <p>1801221110 – Ø 15 – misura 110 – – conf. 20 – € 3,40</p> <p>1801221140 – Ø 18 – misura 140 – – conf. 20 – € 5,80</p> <p>1801221170 – Ø 20 – misura 170 – – conf. 10 – € 8,40</p> <p>1801221200 – Ø 22 – misura 200 – – conf. 6 – € 11,80</p> 
<p>COMUNELLO</p> <p>FISCE A TAPPO 2 ALI – DESTRA acciaio lucido</p> <p>41543006D – misura 60 – – conf. 20 – € 1,56</p> <p>41543008D – misura 80 – – conf. 20 – € 1,90</p> <p>41543010D – misura 100 – – conf. 20 – € 2,60</p> <p>41543012D – misura 120 – – conf. 20 – € 2,80</p> <p>41543014D – misura 140 – – conf. 10 – € 3,60</p> <p>segue...</p> 	<p>COMUNELLO</p> <p>continua...</p> <p>41543017D – misura 170 – – conf. 10 – € 4,40</p> <p>41543020D – misura 200 – – conf. 10 – € 5,80</p> 









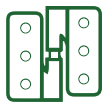

<p>COMJNELLO</p> <p>FISCE A TAPPO 2 ALI - SINISTRA acciaio lucido</p> <p>41543006S - misura 60 - - conf. 20 - € 1,56</p> <p>41543008S - misura 80 - - conf. 20 - € 1,90</p> <p>41543010S - misura 100 - - conf. 20 - € 2,60</p> <p>41543012S - misura 120 - - conf. 20 - € 2,80</p> <p>41543014S - misura 140 - - conf. 10 - € 3,60</p> <p>segue...</p> 	<p>COMJNELLO</p> <p>continua...</p> <p>41543017S - misura 170 - - conf. 10 - € 4,40</p> <p>41543020S - misura 200 - - conf. 10 - € 5,80</p> 
<p>COMJNELLO</p> <p>CERNIERA A GOCCIA acciaio lucido</p> <p>41557004 - Ø 10 - misura 40 - - conf. 40 - € 0,84</p> <p>41557006 - Ø 10 - misura 60 - - conf. 40 - € 0,92</p> <p>41557008 - Ø 13 - misura 80 - - conf. 40 - € 1,02</p> <p>41557010 - Ø 13 - misura 100 - - conf. 40 - € 1,12</p> <p>41557012 - Ø 16 - misura 120 - - conf. 40 - € 1,84</p> <p>41557014 - Ø 16 - misura 140 - - conf. 40 - € 2,20</p> 	<p>COMJNELLO</p> <p>CERNIERA A GOCCIA acciaio lucido</p> <p>180113040 - Ø 10 - misura 40 - - conf. 50 - € 1,58</p> <p>180113060 - Ø 10 - misura 60 - - conf. 50 - € 1,78</p> <p>180113080 - Ø 12 - misura 80 - - conf. 50 - € 2,60</p> <p>180113100 - Ø 14 - misura 100 - - conf. 50 - € 3,80</p> <p>180113120 - Ø 16 - misura 120 - - conf. 30 - € 5,00</p> <p>180113140 - Ø 18 - misura 140 - - conf. 30 - € 7,00</p> 
<p>COMJNELLO</p> <p>CERNIERA A GOCCIA con cuscinetto perno Ø 12 acciaio lucido</p> <p>41549510 - misura 100 - - conf. 16 - € 5,20</p> <p>41549515 - misura 150 - - conf. 16 - € 5,80</p> 	<p>COMJNELLO</p> <p>CERNIERA A GOCCIA PER BLINDATE Con cuscinetto Perno in ferro</p> <p>1801249 - Ø 22 - misura 155 - - conf. 10 - € 13,40</p> 
<p>COMJNELLO</p> <p>CERNIERE PER PORTE A SPINGERE A MOLLA Ø 22X45</p> <p>1801254155DS - Mano Dx - - conf. 10 - € 22,40</p> <p>1801254155SS - Mano Sx - - conf. 10 - € 22,40</p> 	<p>COMJNELLO</p> <p>CERNIERA REGISTRABILE "BORELLONA" da saldare a sezione eccentrica in acciaio lucido perno e rondella in ottone</p> <p>773422 - Misura 120 - - conf. 10 - € 20,00</p> 
<p>COMJNELLO</p> <p>CERNIERA 2 ALI perno a levare acciaio lucido</p> <p>1801228060 - Ø 12 - misura 60 - - conf. 50 - € 0,84</p> <p>1801228080 - Ø 12 - misura 80 - - conf. 50 - € 1,12</p> <p>1801228100 - Ø 14,5 - misura 100 - - conf. 50 - € 1,36</p> <p>1801228120 - Ø 14,5 - misura 120 - - conf. 30 - € 1,86</p> <p>1801228140 - Ø 16,5 - misura 140 - - conf. 30 - € 2,40</p> <p>segue...</p> 	<p>COMJNELLO</p> <p>continua...</p> <p>1801228170 - Ø 18 - misura 170 - - conf. 20 - € 4,00</p> <p>1801228200 - Ø 19,5 - misura 200 - - conf. 20 - € 5,40</p> 
<p>IBFM</p> <p>CERNIERA 2 ALI perno a levare acciaio lucido perno e ranella in acciaio zincato</p> <p>525401060 - Ø 9,5 - Misura 60 - - conf. 24 - € 0,52</p> <p>525401080 - Ø 12 - Misura 80 - - conf. 24 - € 0,58</p> <p>525401100 - Ø 13,5 - Misura 100 - - conf. 24 - € 0,74</p> <p>525401120 - Ø 15 - Misura 120 - - conf. 24 - € 0,94</p> <p>525401140 - Ø 16,6 - Misura 140 - - conf. 24 - € 1,22</p> <p>segue...</p> 	<p>IBFM</p> <p>continua...</p> <p>525401170 - Ø 17,5 - Misura 170 - - conf. 12 - € 2,00</p> <p>525401200 - Ø 22 - Misura 200 - - conf. 12 - € 2,68</p> 



 <p>CERNIERA PER PORTE BLINDATE 2 ALI Ø22x25mm Registrabile con cuscinetto a sfere e rullini</p> <p>1801250150 - - conf. 1 - € 21,80</p>	  <p>CERNIERA 2 ALI perno a levare acciaio lucido</p> <p>140E002060601 - Ø 10 - misura 60 - - conf. 20 - € 0,62</p> <p>140E002060801 - Ø 12 - misura 80 - - conf. 20 - € 0,82</p> <p>140E002061001 - Ø 13 - misura 100 - - conf. 20 - € 0,98</p> <p>140E002061201 - Ø 15 - misura 120 - - conf. 20 - € 1,28</p> <p>140E002061401 - Ø 16 - misura 140 - - conf. 20 - € 1,74</p>
  <p>CERNIERA 2 ALI A SALDARE PESANTE perno a levare acciaio lucido</p> <p>140E002001401 - Ø 18 - misura 140 - - conf. 10 - € 2,20</p> <p>140E002001701 - Ø 19 - misura 170 - - conf. 10 - € 3,00</p> <p>140E002002001 - Ø 21 - misura 200 - - conf. 10 - € 3,80</p>	  <p>CERNIERA A 2 ALI perno a levare acciaio lucido</p> <p>41540206 - Ø 10 - misura 60 - - conf. 40 - € 0,64</p> <p>41540208 - Ø 12 - misura 80 - - conf. 50 - € 0,76</p> <p>41540210 - Ø 13 - misura 100 - - conf. 50 - € 0,92</p> <p>41540212 - Ø 15 - misura 120 - - conf. 40 - € 1,10</p> <p>41540214 - Ø 16 - misura 140 - - conf. 40 - € 1,32</p>
  <p>CERNIERA 2 ALI PESANTE perno a levare acciaio lucido</p> <p>41540514 - Ø 17,5 - misura 140 - - conf. 10 - € 2,20</p> <p>41540517 - Ø 17,5 - misura 170 - - conf. 10 - € 2,40</p> <p>41540520 - Ø 20 - misura 200 - - conf. 10 - € 2,80</p>	  <p>CERNIERA 3 ALI perno a levare acciaio lucido rondella in ottone</p> <p>140E002050801 - Ø 12 - misura 80 - - conf. 20 - € 1,08</p> <p>140E002051001 - Ø 13 - misura 100 - - conf. 20 - € 1,26</p> <p>140E002051201 - Ø 15 - misura 120 - - conf. 20 - € 1,58</p> <p>140E002051401 - Ø 16 - misura 140 - - conf. 20 - € 2,20</p>
 <p>CERNIERA 3 ALI CHIUSE PESANTE con cuscinetto acciaio lucido</p> <p>1801091 - Ø 28 - misura 180 - - conf. 4 - € 27,80</p>	  <p>CERNIERA 3 ALI PESANTE perno a levare acciaio lucido rondella in ottone</p> <p>140E002011401 - Ø 18 - misura 140 - - conf. 10 - € 2,60</p> <p>140E002011701 - Ø 19 - misura 170 - - conf. 10 - € 3,40</p> <p>140E002012001 - Ø 21 - misura 200 - - conf. 10 - € 4,20</p>
  <p>CERNIERA A 3 ALI perno a levare acciaio lucido</p> <p>41541008 - Ø 12 - misura 80 - - conf. 40 - € 1,10</p> <p>41541010 - Ø 13 - misura 100 - - conf. 40 - € 1,24</p> <p>41541012 - Ø 15 - misura 120 - - conf. 40 - € 1,50</p> <p>41541014 - Ø 16 - misura 140 - - conf. 40 - € 1,62</p>	  <p>CERNIERA 3 ALI PESANTE perno a levare acciaio lucido</p> <p>41541514 - Ø 18 - misura 140 - - conf. 16 - € 2,40</p> <p>41541517 - Ø 18 - misura 170 - - conf. 16 - € 2,60</p> <p>41541520 - Ø 20 - misura 200 - - conf. 16 - € 3,20</p>
 <p>CERNIERA A 3 ALI perno a levare acciaio lucido</p> <p>1801229080 - Ø 12 - misura 80 - - conf. 50 - € 1,10</p> <p>1801229100 - Ø 14,5 - misura 100 - - conf. 50 - € 1,62</p> <p>1801229120 - Ø 14,5 - misura 120 - - conf. 30 - € 2,20</p> <p>1801229140 - Ø 16,5 - misura 140 - - conf. 30 - € 2,80</p> <p>1801229170 - Ø 18 - misura 170 - - conf. 20 - € 4,60</p> <p>1801229200 - Ø 19 - misura 200 - - conf. 20 - € 5,80</p>	  <p>CERNIERA 3 ALI perno a levare acciaio lucido perno e ranella acciaio zincato</p> <p>525402080 - Ø 12 - Misura 80 - - conf. 24 - € 0,74</p> <p>525402100 - Ø 13,5 - Misura 100 - - conf. 24 - € 0,88</p> <p>525402120 - Ø 15 - Misura 120 - - conf. 24 - € 1,12</p> <p>525402140 - Ø 16,5 - Misura 140 - - conf. 24 - € 1,32</p> <p>525402170 - Ø 17,5 - Misura 170 - - conf. 12 - € 2,48</p> <p>segue...</p>





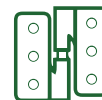



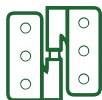

















  <p><i>continua...</i> 525402200 - Ø 20 - Misura 200 - - conf. 12 - € 3,10</p>	  <p>CERNIERE 3 ALI Art. 91B-2 Ala piana 2 corte, 1 lunga Ranelle in Acciaio temperato tropicalizzate 69591B2 - misura 150 - Ø 16 - - conf. 1 - € 6,40</p> <p>AD ESAURIMENTO</p>
  <p>CERNIERA 2 ALI CHIUSE acciaio lucido 1801082 - Ø 28 - misura 97 - - conf. 8 - € 10,60</p>	  <p>CERNIERA 2 ALI CHIUSE con cuscinetto acciaio lucido 1801083 - Ø 28 - misura 100 - - conf. 8 - € 15,00</p>
  <p>CERNIERA HERCULA 2 ALI APERTE rondella in ottone acciaio lucido 140E002081001 - Ø 28 - misura 97 - - conf. 12 - € 5,40</p>	  <p>CERNIERA HERCULA 2 ALI APERTE con cuscinetto acciaio lucido 140E002091001 - Ø 28 - misura 97 - - conf. 12 - € 7,00</p>
  <p>CERNIERA 2 ALI APERTE PESANTE rondella in ottone acciaio lucido 1801080 - Ø 28 - misura 97 - - conf. 8 - € 10,60</p>	  <p>CERNIERE 3 ALI CHIUSE PESANTE acciaio lucido 1801090 - misura 200 - - conf. 4 - € 17,80</p>
  <p>CERNIERA 2 ALI CHIUSE PESANTE con cuscinetto acciaio lucido 1801087 - Ø 28 - misura 180 - - conf. 4 - € 21,20</p>	  <p>CERNIERA 3 ALI APERTE PESANTE acciaio lucido 1801088 - Ø 28 - misura 180 - - conf. 4 - € 18,40</p>
  <p>CERNIERA 3 ALI APERTE PESANTE con cuscinetto acciaio lucido 1801089 - Ø 28 - misura 180 - - conf. 4 - € 28,60</p>	  <p>CERNIERA 3 ALI APERTE rondella in ottone acciaio lucido 525405A - Ø 28 - Misura 180 - - conf. 4 - € 7,62</p>









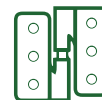





 <p>CERNIERA 2 ALI APERTE PESANTE con cuscinetto acciaio lucido 1801081 - Ø 28 - misura 100 - - conf. 8 - € 15,00</p> 	 <p>CERNIERONA 2 ALI APERTE rondella in ottone 415440 - Ø 28 - misura 98 - - conf. 10 - € 6,60</p> 
 <p>CERNIERONA 2 ALI APERTE con cuscinetto 415445 - Ø 28 - misura 98 - - conf. 10 - € 8,40</p> 	 <p>CERNIERA "MEZZAMAXI" 2 ALI APERTE rondella in ottone 773417 - Ø 28 - misura 90 - - conf. 10 - € 11,60</p> 
 <p>CERNIERA 2 ALI APERTE rondella in ottone acciaio lucido 525403A - Ø 28 - Misura 90 - - conf. 8 - € 4,54</p> 	 <p>CERNIERA 2 ALI CHIUSE PESANTE rondella in ottone acciaio lucido 1801086 - Ø 28 - misura 200 - - conf. 4 - € 16,60</p> 
 <p>CERNIERA 2 ALI APERTE PESANTE acciaio lucido 1801084 - Ø 28 - misura 200 - - conf. 4 - € 16,60</p> 	 <p>CERNIERA HERCULA 2 ALI APERTE rondella in ottone acciaio lucido 140E002101901 - Ø 28 - misura 193 - - conf. 6 - € 8,00</p> 
 <p>CERNIERA HERCULA 2 ALI APERTE con cuscinetto acciaio lucido 140E00211901 - Ø 28 - misura 193 - - conf. 6 - € 9,80</p> 	 <p>CERNIERA HERCULA 3 ALI APERTE rondella in ottone acciaio lucido 140E002121901 - Ø 28 - misura 193 - - conf. 6 - € 9,20</p> 
 <p>CERNIERA HERCULA 3 ALI APERTE con cuscinetto acciaio lucido 140E002131901 - Ø 28 - misura 197 - - conf. 6 - € 12,80</p> 	 <p>CERNIERA 4 ALI CHIUSE PESANTE acciaio lucido 1801094 - Ø 28 - misura 200 - - conf. 4 - € 19,00</p> 



  <p>CERNIERA 4 ALI CHIUSE PESANTE con cuscinetto acciaio lucido</p> <p>1801095 - Ø 28 - misura 207 - - conf. 4 - € 28,00</p>	  <p>CERNIERONA 4 ALI APERTE rondella in ottone perno a levare</p> <p>415480 - Ø 28 - misura 186 - - conf. 4 - € 11,20</p>
  <p>CERNIERONA 4 ALI APERTE con cuscinetto perno a levare</p> <p>415482 - Ø 28 - misura 186 - - conf. 4 - € 17,00</p>	  <p>CERNIERA 4 ALI APERTE PESANTE acciaio lucido con rondella in ottone</p> <p>1801092 - Ø 28 - misura 200 - - conf. 4 - € 19,00</p>
  <p>CERNIERA 4 ALI APERTE PESANTE con cuscinetto acciaio lucido</p> <p>1801093 - Ø 28 - misura 207 - - conf. 4 - € 28,00</p>	  <p>CERNIERA HERCULA 4 ALI APERTE rondella in ottone acciaio lucido</p> <p>140E002141901 - Ø 28 - misura 193 - - conf. 6 - € 9,40</p>
  <p>CERNIERA HERCULA 4 ALI APERTE con cuscinetto acciaio lucido</p> <p>140E002151901 - Ø 28 - misura 193 - - conf. 6 - € 13,00</p>	  <p>RONDELLA ALZAPORTE Conf. 200 pz. in ottone</p> <p>90012401 - Ø 8 - - conf. 1 - € 10,80 90012402 - Ø 9 - - conf. 1 - € 11,40 90012403 - Ø 10 - - conf. 1 - € 13,60 90012404 - Ø 11 - - conf. 1 - € 14,80 90012405 - Ø 12 - - conf. 1 - € 15,40 segue...</p>
  <p>continua...</p> <p>90012406 - Ø 13 - - conf. 1 - € 17,80 90012407 - Ø 14 - - conf. 1 - € 20,00 90012408 - Ø 15 - - conf. 1 - € 24,60</p>	  <p>CUSCINETTO A SFERA</p> <p>41540011 - Ø I 11 - Ø E 19 - Spess. 7,2 - - conf. 20 - € 1,40 41540012 - Ø I 12 - Ø E 20 - Spess. 7,2 - - conf. 20 - € 1,40 41540014 - Ø I 14 - Ø E 22 - Spess. 7,2 - - conf. 20 - € 1,50 41540020 - Ø I 20 - Ø E 32 - Spess. 8,2 - - conf. 20 - € 1,96</p>
  <p>CUSCINETTO A SFERA REGGISPINTA Art. 413 In acciaio zincato e cementato</p> <p>525413008Z - Ø I 8 - Ø E 15 - Spess. 5,6 - - conf. 20 - € 0,58 525413009Z - Ø I 9 - Ø E 15 - Spess. 6 - - conf. 20 - € 0,54 525413010Z - Ø I 10 - Ø E 18 - Spess. 6 - - conf. 20 - € 0,54 525413011Z - Ø I 11 - Ø E 19 - Spess. 6,5 - - conf. 20 - € 0,56 525413012Z - Ø I 12 - Ø E 20 - Spess. 6,5 - - conf. 20 - € 0,56 segue...</p>	  <p>continua...</p> <p>525413013Z - Ø I 13 - Ø E 22 - Spess. 7 - - conf. 20 - € 0,62 525413014Z - Ø I 14 - Ø E 22 - Spess. 7 - - conf. 20 - € 0,56 525413018Z - Ø I 18 - Ø E 26 - Spess. 7,5 - - conf. 20 - € 0,94 525413020Z - Ø I 20 - Ø E 28 - Spess. 7 - - conf. 20 - € 0,94</p>



 <p>CERNIERA STRETTA MOD. 120 INOX perno fisso</p> <p>180120125 - HxL 25x19 - - conf. 24 - € 2,80 180120130 - HxL 30x23 - - conf. 24 - € 2,80 180120140 - HxL 40x26 - - conf. 24 - € 3,00 180120150 - HxL 50x31 - - conf. 24 - € 3,20 180120160 - HxL 60x35 - - conf. 24 - € 5,20 180120180 - HxL 80x42 - - conf. 24 - € 6,80</p>	 <p>CERNIERA QUADRA MOD. 121 INOX perno fisso</p> <p>180121125 - HxL 25x25 - - conf. 24 - € 3,00 180121130 - HxL 30x30 - - conf. 24 - € 3,00 180121140 - HxL 40x40 - - conf. 24 - € 3,20 180121150 - HxL 50x50 - - conf. 24 - € 3,60 180121160 - HxL 60x60 - - conf. 24 - € 6,60 180121180 - HxL 80x80 - - conf. 24 - € 9,00</p>
 <p>CERNIERA Lunga INOX perno fisso Mod. 122</p> <p>1801221080 - LxH 80x31 - - conf. 24 - € 6,00 1801221100 - LxH 100x31 - - conf. 24 - € 7,00 1801221120 - LxH 120x31 - - conf. 24 - € 8,80</p>	 <p>CERNIERA 1/2 LARGA PESANTE MOD. 838 perno fisso INOX</p> <p>180838150 - pollici 2 - HxL 50x40 - - conf. 24 - € 6,60 180838163 - pollici 2¼ - HxL 64x44 - - conf. 24 - € 8,40 180838175 - pollici 3 - HxL 75x51 - - conf. 24 - € 10,80 180838187 - pollici 3¼ - HxL 87x58 - - conf. 24 - € 15,60 180838199 - pollici 4 - HxL 100x70 - - conf. 24 - € 20,20</p>
 <p>CERNIERA 1/2 LARGA PESANTE MOD. 840 perno a levare INOX</p> <p>180840150 - pollici 2 - HxL 50x40 - - conf. 24 - € 7,20 180840163 - pollici 2¼ - HxL 64x44 - - conf. 24 - € 9,00 180840175 - pollici 3 - HxL 75x51 - - conf. 24 - € 11,40 180840187 - pollici 3¼ - HxL 87x58 - - conf. 24 - € 16,20 180840199 - pollici 4 - HxL 100x70 - - conf. 24 - € 21,00</p>	 <p>CERNIERE INOX</p> <p>1808501430 - HXL 40X30 - - conf. 24 - € 5,40 1808501440 - HXL 40X40 - - conf. 24 - € 6,00 1808501640 - HXL 60X40 - - conf. 24 - € 7,60 1808501650 - HXL 60X50 - - conf. 24 - € 8,20 1808501850 - HXL 80X50 - - conf. 24 - € 10,20</p>
 <p>CERNIERA PER ARREDAMENTI NAUTICI INOX</p> <p>180852140 - HxL 40x55 - - conf. 24 - € 7,20</p>	 <p>CERNIERA PER ARREDAMENTI NAUTICI INOX</p> <p>180854140 - HxL 40x70 - - conf. 24 - € 7,60</p>
 <p>FISCE A TAPPO 2 ALI - DESTRA INOX</p> <p>18012221060D - Ø 14,5 - misura 60 - - conf. 10 - € 13,60 18012221080D - Ø 15,5 - misura 80 - - conf. 10 - € 16,20 18012221100D - Ø 17 - misura 100 - - conf. 10 - € 24,20 18012221120D - Ø 17 - misura 120 - - conf. 10 - € 29,20</p>	 <p>FISCE A TAPPO 2 ALI - SINISTRA INOX</p> <p>18012221060S - Ø 14,5 - misura 60 - - conf. 10 - € 13,60 18012221080S - Ø 15,5 - misura 80 - - conf. 10 - € 16,20 18012221100S - Ø 17 - misura 100 - - conf. 10 - € 24,20 18012221120S - Ø 17 - misura 120 - - conf. 10 - € 29,20</p>
 <p>FISCE 3 ALI PER SERRAMENTI perno a levare INOX</p> <p>1801221111 - Ø 15 - misura 110 - - conf. 10 - € 25,00 1801221114 - Ø 18 - misura 140 - - conf. 10 - € 37,40</p>	 <p>CERNIERA A SALDARE perno fisso INOX</p> <p>1801223106 - Ø 12 - misura 60 - - conf. 10 - € 9,00 1801223108 - Ø 12 - misura 80 - - conf. 10 - € 10,60 1801223110 - Ø 14,5 - misura 100 - - conf. 10 - € 14,80 1801223112 - Ø 16,5 - misura 120 - - conf. 10 - € 18,80 1801223114 - Ø 16,5 - misura 160 - - conf. 10 - € 22,80</p>

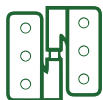



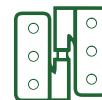









 <p>CERNIERA A 2 ALI perno a levare INOX</p> <p>1801228106 - Ø 12 - misura 60 - - conf. 10 - € 7,60</p> <p>1801228108 - Ø 12 - misura 80 - - conf. 10 - € 9,00</p> <p>1801228110 - Ø 14,5 - misura 100 - - conf. 10 - € 12,40</p> <p>1801228112 - Ø 16,5 - misura 120 - - conf. 10 - € 16,60</p> <p>1801228114 - Ø 16,5 - misura 140 - - conf. 10 - € 20,60</p>	 <p>CERNIERA A 3 ALI perno a levare INOX</p> <p>1801229110 - Ø 14,5 - misura 100 - - conf. 10 - € 14,00</p> <p>1801229112 - Ø 16,5 - misura 120 - - conf. 10 - € 18,00</p> <p>1801229114 - Ø 16,5 - misura 140 - - conf. 10 - € 22,40</p>
 <p>COMUNELLO</p> <p>MANIGLIA DA BLOCCO figura mano destra zincata</p> <p>415660DX - - conf. 20 - € 4,20</p>	 <p>COMUNELLO</p> <p>MANIGLIA DA BLOCCO figura mano sinistra zincata</p> <p>415660SX - - conf. 20 - € 4,20</p>
 <p>MONO-COMPLEMENTI</p> <p>MANIGLIA DA BLOCCO destra 66B.1 nera</p> <p>69566B1 - - conf. 20 - € 3,60</p>	 <p>MONO-COMPLEMENTI</p> <p>MANIGLIA DA BLOCCO sinistra 66B.2 nera</p> <p>69566B2 - - conf. 20 - € 3,60</p>
 <p>GHIDINI</p> <p>MANIGLIA DA BLOCCO "SAP" ambidestra nera</p> <p>50566900000016 - - conf. 12 - € 15,34</p>	 <p>IBFM</p> <p>MANIGLIA DI BLOCCO PER FINESTRE Acciaio zincato</p> <p>525427DX - Lunghezza 130 - Mano Dx - - conf. 10 - € 3,10</p> <p>525427SX - Lunghezza 130 - Mano Sx - - conf. 10 - € 3,10</p>
 <p>COMUNELLO</p> <p>MANIGLIA DA BLOCCO ambidestra zincata</p> <p>415662 - - conf. 20 - € 6,20</p>	 <p>AVVO</p> <p>MANIGLIA "POLENA" NERA PER CHIUSURA TAU 824 impugnatura in alluminio quadro 6</p> <p>7731612 - - conf. 2 - € 43,80</p>
 <p>AVVO</p> <p>CHIUSURA 3 PUNTI TAU Zincata</p> <p>773824 - - conf. 2 - € 55,00</p>	 <p>AVVO</p> <p>CARIGLIONE PER INFISSI STROMBOLI Misura 158 mm Aste esterne 10x10 da saldare o avvitare acciaio zincato corsa 13 mm</p> <p>773571 - - conf. 10 - € 32,60</p>



  <p>CARIGLIONE NUOVA RIVOLI Misura 220 mm corsa mand. superiore 25 mm. corsa mand. inferiore 22,5 mm.</p> <p>773590 - - conf. 5 - € 43,20</p>	  <p>CARIGLIONE NUOVA RIVOLI Misura 220 mm corsa mand. superiore 25 mm. corsa mand. inferiore 22,5 mm. Cilindro sicurezza e 2 chiavi</p> <p>77359052 - - conf. 1 - € 86,00</p>
  <p>CARIGLIONE CAR BREVETTATO Misura 270 mm aste esterne 14x14 con foro portalucchetto</p> <p>415680 - - conf. 5 - € 22,60</p>	  <p>CARIGLIONE CAR BREVETTATO Misura 270 mm con cilindro e 2 chiavi aste esterne 14x14</p> <p>415682 - - conf. 5 - € 35,60</p>
  <p>CARIGLIONE LEO BREVETTATO Misura 200 mm aste esterne 10x10</p> <p>415686 - - conf. 1 - € 18,80</p>	  <p>CARIGLIONE BON Misura 230 mm con cilindro e 2 chiavi</p> <p>415684 - - conf. 1 - € 70,20</p>
  <p>CARIGLIONE STAR PICCOLO Misura 180 x 60 mm per aste esterne zincato tropical Corsa aste 31 mm <i>Figura mano SX</i></p> <p>415690MCD - Mano DX - - conf. 2 - € 45,60 415690MCS - Mano SX - - conf. 2 - € 45,60</p>	  <p>CARIGLIONE STAR GRANDE Misura 240 x 70 mm per aste esterne Zincato tropical Corsa aste 40 mm</p> <p>415694MCD - Mano DX - - conf. 2 - € 55,60 415694MCS - Mano SX - - conf. 2 - € 55,60</p>
  <p>CILINDRO PER CARIGLIONI Per modello Comunello 684 CSM 2000</p> <p>440346 - - conf. 1 - € 14,60</p>	  <p>RUOTA GOLA "V" 1 cuscinetto Acciaio zincato</p> <p>525360040 - Misura 40 - B 12 - port. Kg 20 - - conf. 10 - € 3,30 525360050 - Misura 50 - B 17 - port. Kg 30 - - conf. 10 - € 5,56 525360060 - Misura 60 - B 17 - port. Kg 100 - - conf. 10 - € 6,60 525360070 - Misura 70 - B 20 - port. Kg 150 - - conf. 10 - € 7,62 525360080 - Misura 80 - B 20 - port. Kg 150 - - conf. 10 - € 7,82 segue...</p>
  <p>continua...</p> <p>525360090 - Misura 90 - B 20 - port. Kg 300 - - conf. 10 - € 9,06 525360100 - Misura 100 - B 20 - port. Kg 200 - - conf. 6 - € 9,88 525360120 - Misura 120 - B 20 - port. Kg 200 - - conf. 4 - € 11,94 525360140 - Misura 140 - B 26 - port. Kg 300 - - conf. 2 - € 18,34 525360160 - Misura 160 - B 26 - port. Kg 350 - - conf. 1 - € 24,10 segue...</p>	  <p>continua...</p> <p>525360180 - Misura 180 - B 26 - port. Kg 350 - - conf. 1 - € 31,72 525360200 - Misura 200 - B 26 - port. Kg 350 - - conf. 1 - € 40,38</p>









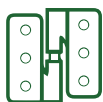



<p>COMJNELLO</p> <p>RUOTA GOLA "V" 1 cuscinetto Acciaio zincato</p> <p>415300V060 - misura 60 - B 16,5 - port. Kg. 100 - - conf. 12 - € 10,80</p> <p>415300V080 - misura 80 - B 20 - port. Kg. 200 - - conf. 10 - € 14,40</p> <p>415300V090 - misura 90 - B 21 - port. Kg. 210 - - conf. 8 - € 14,40</p> <p>415300V100 - misura 100 - B 21 - port. Kg. 220 - - conf. 8 - € 14,60</p> <p>415300V120 - misura 120 - B 21 - port. Kg. 240 - - conf. 6 - € 21,40</p> <p>segue...</p> 	<p>COMJNELLO</p> <p>continua...</p> <p>415300V140 - misura 140 - B 25 - port. Kg. 270 - - conf. 2 - € 28,20</p> <p>415300V160 - misura 160 - B 25 - port. Kg. 290 - - conf. 2 - € 46,80</p> <p>415300V200 - misura 200 - B 25 - port. Kg. 330 - - conf. 2 - € 61,80</p> 
<p>COMJNELLO</p> <p>RUOTA GOLA "V" 2 cuscinetti Acciaio zincato</p> <p>415305V100 - misura 100 - B 28 - port. Kg. 425 - - conf. 8 - € 24,40</p> <p>415305V120 - misura 120 - B 28 - port. Kg. 450 - - conf. 6 - € 29,20</p> <p>415305V140 - misura 140 - B 31 - port. Kg. 550 - - conf. 2 - € 41,20</p> <p>415305V160 - misura 160 - B 33 - port. Kg. 575 - - conf. 2 - € 55,40</p> <p>415305V200 - misura 200 - B 33 - port. Kg. 625 - - conf. 2 - € 80,40</p> 	<p>COMJNELLO</p> <p>RUOTA CON PIASTRE GOLA "V" 1 cuscinetto Acciaio zincato</p> <p>415330V080 - misura 80 - B 16,5 - port. Kg. 180 - - conf. 6 - € 15,80</p> <p>415330V090 - misura 90 - B 21 - port. Kg. 190 - - conf. 6 - € 18,00</p> <p>415330V100 - misura 100 - B 21 - port. Kg. 200 - - conf. 6 - € 18,80</p> <p>415330V120 - misura 120 - B 25 - port. Kg. 220 - - conf. 2 - € 23,00</p> <p>415330V140 - misura 140 - B 25 - port. Kg. 240 - - conf. 2 - € 35,60</p> 
<p>COMJNELLO</p> <p>RUOTA A SUPP. INTERNO GOLA "V" 1 cuscinetto Acciaio zincato</p> <p>415335V080 - misura 80 - B 20 - port.kg. 180 - - conf. 6 - € 15,80</p> <p>415335V090 - misura 90 - B 21 - port.kg. 190 - - conf. 6 - € 17,40</p> <p>415335V100 - misura 100 - B 21 - port.kg. 200 - - conf. 6 - € 19,60</p> <p>415335V120 - misura 120 - B 25 - port.kg. 220 - - conf. 2 - € 25,60</p> <p>415335V140 - misura 140 - B 25 - port.kg. 240 - - conf. 2 - € 31,40</p> 	<p>IBFM</p> <p>RUOTA A SUPP. ESTERNO GOLA "V" 1 cuscinetto Acciaio zincato</p> <p>525386060 - Misura 63 - B 17 - Port. Kg. 75 - - conf. 10 - € 9,28</p> <p>525386080 - Misura 95 - B 20 - Port. Kg. 150 - - conf. 6 - € 10,92</p> <p>525386100 - Misura 105 - B 20 - Port. Kg. 175 - - conf. 4 - € 12,98</p> 
<p>IBFM</p> <p>RUOTA A SUPP. INTERNO GOLA "V" 1 cuscinetto Acciaio zincato</p> <p>525393080 - Misura 80 - B 20 - Port. Kg. 125 - - conf. 4 - € 9,68</p> <p>525393100 - Misura 100 - B 20 - Port. Kg. 150 - - conf. 4 - € 11,74</p> 	<p>COMJNELLO</p> <p>RUOTA GOLA SEMITONDA 1 cuscinetto Acciaio zincato</p> <p>415310060 - misura 60 - B 16,5 - port. Kg. 100 - - conf. 12 - € 10,80</p> <p>415310080 - misura 80 - B 20 - port. Kg. 200 - - conf. 10 - € 14,40</p> <p>415310090 - misura 90 - B 21 - port. Kg. 210 - - conf. 8 - € 14,40</p> <p>415310100 - misura 100 - B 21 - port. Kg. 220 - - conf. 8 - € 14,60</p> <p>415310120 - misura 120 - B 25 - port. Kg. 240 - - conf. 6 - € 21,40</p> <p>segue...</p> 
<p>COMJNELLO</p> <p>continua...</p> <p>415310140 - misura 140 - B 25 - port. Kg. 270 - - conf. 2 - € 28,20</p> <p>415310160 - misura 160 - B 25 - port. Kg. 290 - - conf. 2 - € 46,80</p> <p>415310200 - misura 200 - B 25 - port. Kg. 330 - - conf. 2 - € 61,80</p> 	<p>COMJNELLO</p> <p>RUOTA GOLA SEMITONDA 2 cuscinetti Acciaio zincato</p> <p>415315100 - misura 100 - B 28 - port. Kg. 425 - - conf. 8 - € 24,40</p> <p>415315120 - misura 120 - B 28 - port. Kg. 450 - - conf. 6 - € 29,20</p> <p>415315140 - misura 140 - B 31 - port. Kg. 550 - - conf. 2 - € 41,20</p> <p>415315160 - misura 160 - B 33 - port. Kg. 575 - - conf. 2 - € 55,40</p> <p>415315200 - misura 200 - B 33 - port. Kg. 625 - - conf. 2 - € 80,40</p> 
<p>IBFM</p> <p>RUOTA GOLA SEMITONDA "U" 1 cuscinetto Acciaio zincato</p> <p>525364060 - Misura 60 - B 25 - Port. Kg. 200 - - conf. 10 - € 9,48</p> <p>525364080 - Misura 80 - B 25 - Port. Kg. 300 - - conf. 6 - € 10,92</p> <p>525364090 - Misura 90 - B 25 - Port. Kg. 300 - - conf. 6 - € 12,16</p> <p>525364100 - Misura 100 - B 25 - Port. Kg. 400 - - conf. 6 - € 13,18</p> <p>525364120 - Misura 120 - B 25 - Port. Kg. 400 - - conf. 4 - € 15,86</p> <p>segue...</p> 	<p>IBFM</p> <p>continua...</p> <p>525364140 - Misura 140 - B 26 - Port. Kg. 600 - - conf. 4 - € 18,96</p> <p>525364160 - Misura 160 - B 26 - Port. Kg. 700 - - conf. 1 - € 25,54</p> <p>525364180 - Misura 180 - B 26 - Port. Kg. 700 - - conf. 1 - € 37,28</p> <p>525364200 - Misura 200 - B 26 - Port. Kg. 700 - - conf. 1 - € 44,90</p> 



<p>COMJNELLO</p> <p>RUOTA CON PIASTRE GOLA SEMITONDA 1 cuscinetto Acciaio zincato</p> <p>415332080 - Misura 80 - B 20 - port. kg. 180 - - conf. 6 - € 15,80</p> <p>415332090 - Misura 90 - B 21 - port. kg. 190 - - conf. 6 - € 18,00</p> <p>415332100 - Misura 100 - B 21 - port. kg. 200 - - conf. 6 - € 18,80</p> <p>415332120 - Misura 120 - B 25 - port. kg. 220 - - conf. 2 - € 23,00</p> <p>415332140 - Misura 140 - B 25 - port. kg. 240 - - conf. 2 - € 35,60</p> 	<p>IBFM</p> <p>RUOTA CON SUPPORTO INTERNO Acciaio zincato</p> <p>525392080P - Misura 80 - B 33 - Portata 250 - - conf. 4 - € 10,30</p> <p>525392100P - Misura 100 - B 33 - Portata 300 - - conf. 4 - € 12,36</p> <p>525392120P - Misura 120 - B 33 - Portata 400 - - conf. 4 - € 15,46</p> 
<p>IBFM</p> <p>RUOTA CON SUPPORTO INTERNO Acciaio zincato</p> <p>525392080L - Misura 80 - B 34 - Port. Kg 250 - - conf. 4 - € 13,40</p> <p>525392100L - Misura 100 - B 34 - Port. Kg 300 - - conf. 4 - € 15,46</p> <p>525392120L - Misura 120 - B 34 - Port. Kg 400 - - conf. 4 - € 17,92</p> 	<p>COMJNELLO</p> <p>RUOTA SUPP.INTERNO GOLA SEMITONDA 1 cuscinetto Acciaio zincato</p> <p>415337080 - misura 80 - B 20 - port.kg. 180 - - conf. 6 - € 15,80</p> <p>415337090 - misura 90 - B 21 - port.kg. 190 - - conf. 6 - € 17,40</p> <p>415337100 - misura 100 - B 21 - port.kg. 200 - - conf. 6 - € 19,60</p> <p>415337120 - misura 120 - B 25 - port.kg. 220 - - conf. 2 - € 25,60</p> <p>415337140 - misura 140 - B 25 - port.kg. 140 - - conf. 2 - € 31,40</p> 
<p>IBFM</p> <p>CARDINE INFERIORE Ø 45 con cuscinetto</p> <p>525839P - - conf. 2 - € 12,78</p> 	<p>COMJNELLO</p> <p>CARDINE INFERIORE PICCOLO con cuscinetto</p> <p>41587P - - conf. 4 - € 22,20</p> 
<p>COMJNELLO</p> <p>CARDINE INFERIORE MEDIO con cuscinetto</p> <p>41587M - - conf. 4 - € 25,40</p> 	<p>IBFM</p> <p>CARDINE INFERIORE Ø 50 con cuscinetto</p> <p>525839 - - conf. 2 - € 20,18</p> 
<p>IBFM</p> <p>CARDINE INFERIORE Ø 70 con cuscinetto</p> <p>525849 - - conf. 2 - € 28,22</p> 	<p>COMJNELLO</p> <p>CARDINE INFERIORE GRANDE con cuscinetto</p> <p>41587G - - conf. 2 - € 34,40</p> 
<p>IBFM</p> <p>CARDINE SUPERIORE Ø 45 con cuscinetto regolabile</p> <p>525838P - - conf. 2 - € 12,78</p> 	<p>COMJNELLO</p> <p>CARDINE SUPERIORE PICCOLO con cuscinetto regolabile</p> <p>41586P - R. 50/60 - - conf. 4 - € 30,00</p> 

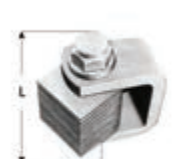











<p>IBFM</p> <p>CARDINE SUPERIORE Ø 50 con cuscinetto regolabile</p> <p>525838 - - conf. 2 - € 20,60</p> 	<p>COMUNELLO</p> <p>CARDINE SUPERIORE GRANDE con cuscinetto regolabile</p> <p>41586G - R 90-105 - - conf. 2 - € 41,20</p> 
<p>IBFM</p> <p>CARDINE SUPERIORE Ø 70 con cuscinetto regolabile</p> <p>525848 - - conf. 2 - € 29,46</p> 	<p>COMUNELLO</p> <p>CARDINE SUPERIORE con cuscinetto</p> <p>41581M22 - Ø 56 - R. 55/95 - - conf. 10 - € 47,80 41581M24 - Ø 60 - R. 65/100 - - conf. 10 - € 59,60</p> 
<p>COMUNELLO</p> <p>CARDINE INFERIORE con cuscinetto reggispinta</p> <p>41582M22 - Ø 56 - R. 55/95 - - conf. 10 - € 51,60 41582M24 - Ø 60 - R. 65/100 - - conf. 10 - € 63,20</p> 	<p>COMUNELLO</p> <p>CARDINE SUPERIORE con cuscinetto perno base quadrata regolabile</p> <p>4158840 - Q. 40 - D 60 - D1 33 - - conf. 2 - € 56,20 4158850 - Q. 50 - D 60 - D1 43 - - conf. 2 - € 60,00 4158860 - Q. 60 - D 70 - D1 53 - - conf. 2 - € 65,60</p> 
<p>COMUNELLO</p> <p>MAXIPERNO INFERIORE</p> <p>4158940 - Ø 40 - D 60 - D1 33 - - conf. 2 - € 37,60 4158950 - Ø 40 - D 60 - D1 43 - - conf. 2 - € 38,80 4158960 - Ø 40 - D 65 - D1 53 - - conf. 2 - € 43,00</p> 	<p>COMUNELLO</p> <p>CARDINE SUPERIORE doppia regolazione</p> <p>41585G - Ø 70 - R. 90/105 - - conf. 2 - € 41,00 41585M - Ø 50 - R. 70/85 - - conf. 4 - € 34,00</p> 
<p>COMUNELLO</p> <p>CARDINE SUPERIORE con piastra a fissare</p> <p>41586PSTG - Ø 70 - R. 90/105 - - conf. 2 - € 63,60</p> 	<p>AVVO</p> <p>CARDINE A SALDARE "PANAREA" regolabile senza sfilare il cancello</p> <p>7733801 - L. 70 - kg. 100 - - conf. 10 - € 18,40 7733802 - L. 83 - kg. 150 - - conf. 10 - € 24,20</p> 
<p>COMUNELLO</p> <p>CARDINE A SALDARE con cavalletto regolabile</p> <p>415100G - B 49 - L. 95 - - conf. 10 - € 13,80 415100P - B 30 - L. 73 - - conf. 20 - € 12,20</p> 	<p>AVVO</p> <p>PIVOT PER CANCELLI "LIPARI"</p> <p>773385 - - conf. 10 - € 27,20</p> 

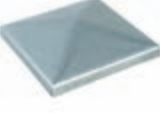
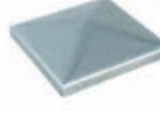

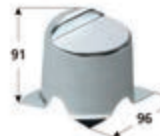
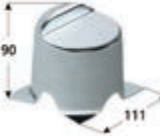
<p>COMJNELLO</p> <p>PERNO SFERICO e piastra a fissare BREVETTATO</p> <p>415105-20 - - conf. 10 - € 17,00</p>	<p>COMJNELLO</p> <p>PERNO INFERIORE BREVETTATO</p> <p>415110-20 - Ø 20 - L 87 - - conf. 20 - € 3,60 415110-24 - Ø 24 - L 99 - - conf. 10 - € 4,40 415110-27 - Ø 27 - L 105 - - conf. 10 - € 8,00</p>
<p>COMJNELLO</p> <p>PIASTRA PER PERNO INFERIORE</p> <p>415115-20 - Ø 20,5 - A 60 - - conf. 20 - € 2,80 415115-24 - Ø 24,5 - A 70 - - conf. 10 - € 4,40 415115-27 - Ø 28,0 - A 70 - - conf. 10 - € 5,80</p>	<p>IBFM</p> <p>CARDINE Regolabile acciaio zincato</p> <p>525425016 - M 16 - A 32 - L 50 - - conf. 1 - € 5,36 525425018 - M 18 - A 35 - L 56 - - conf. 1 - € 5,98 525425020 - M 20 - A 41 - L 75 - - conf. 1 - € 6,38 525425022 - M 22 - A 41 - L 65 - - conf. 1 - € 15,24 525425024 - M 24 - A 47 - L 72 - - conf. 1 - € 10,30</p>
<p>IBFM</p> <p>CARDINE E CUSCINETTO In inox Portata a coppia 1000 Kg</p> <p>525948949 - - conf. 1 - € 241,02</p>	<p>COMJNELLO</p> <p>CARDINE con cavallotto e bussale regolabili</p> <p>415120-M20 - A 37 - L 90 - - conf. 20 - € 7,60 415120-M24 - A 49 - L 100 - - conf. 10 - € 11,40</p>
<p>COMJNELLO</p> <p>CARDINE con ali e bussole regolabile</p> <p>415135-M18 - A 39 - L 85 - - conf. 20 - € 8,00 415135-M22 - A 53 - L 95 - - conf. 10 - € 11,40 415135-M27 - A 60 - L 117 - - conf. 10 - € 21,60</p>	<p>COMJNELLO</p> <p>CARDINE CON CAVALLOTTO Dado regolabile M 20</p> <p>415155-M20 - - conf. 20 - € 11,40</p>
<p>COMJNELLO</p> <p>CARDINE con ali e dado regolabile</p> <p>415160-M18 - A 40 - B 33 - - conf. 20 - € 11,00 415160-M22 - A 47 - B 40 - - conf. 10 - € 14,40</p>	<p>&M 900</p> <p>KIT CAVO ANTICADUTA PER CANCELLI A BATTENTE con accessori Fune Ø 6 Lunghezza 530 mm Finitura zincata</p> <p>90013245 - - conf. 4 - € 11,40</p>
<p>IBFM</p> <p>CAVO ANTICADUTA PER CANCELLI A BATTENTE Fune Ø 6 mm Portata 920 Kg</p> <p>525540520 - Modello Acciaio zincato - Lungh. 500 - - conf. 4 - € 8,86</p>	<p>IBFM</p> <p>CAVETTO ANTICADUTA DI SICUREZZA PER CANCELLI Art. 541</p> <p>525541 - - conf. 1 - € 11,22</p>



<p>DECAS</p> <p>CAVO ANTICADUTA PER CANCELLI A BATTENTE Fune d'acciaio Ø 6 mm</p> <p>90013262 - Finitura Acciaio Zincato - Lunghezza 500 mm - - conf. 1 - € 7,60</p> <p>90013263 - Finitura Acciaio Inox - Lunghezza 500 mm - - conf. 1 - € 12,60</p> <p>90013264 - Finitura Acciaio Zincato - Lunghezza 530 mm - - conf. 1 - € 7,80</p> <p>segue...</p> 	<p>DECAS</p> <p>continua...</p> <p>90013265 - Finitura Acciaio Inox - Lunghezza 530 mm - - conf. 1 - € 13,00</p> <p>90013266 - Finitura Acciaio Zincato - Lunghezza 600 mm - - conf. 1 - € 8,00</p> <p>90013267 - Finitura Acciaio Inox - Lunghezza 600 mm - - conf. 1 - € 13,40</p> <p>90013268 - Finitura Acciaio Zincato - Lunghezza 700 mm - - conf. 1 - € 8,40</p> <p>segue...</p> 
<p>DECAS</p> <p>continua...</p> <p>90013269 - Finitura Acciaio Inox - Lunghezza 700 mm - - conf. 1 - € 14,20</p> 	<p>DECAS</p> <p>TIRANTE DI FISSAGGIO Per cavo anticaduta cancelli a battente M12 X 180 mm</p> <p>90013273 - Finitura Acciaio Zincato - - conf. 4 - € 3,40</p> <p>90013274 - Finitura Acciaio Inox - - conf. 4 - € 9,00</p> 
<p>IBFM</p> <p>COPRIPILASTRO QUADRATO Spessore 1,5 mm in ferro naturale</p> <p>525398030 - Misura 30 - - conf. 5 - € 0,52</p> <p>525398040 - Misura 40 - - conf. 5 - € 0,54</p> <p>525398050 - Misura 50 - - conf. 5 - € 0,58</p> <p>525398060 - Misura 60 - - conf. 5 - € 0,64</p> <p>525398080 - Misura 80 - - conf. 5 - € 0,90</p> <p>segue...</p> 	<p>IBFM</p> <p>continua...</p> <p>525398100 - Misura 100 - - conf. 5 - € 1,30</p> <p>525398120 - Misura 120 - - conf. 5 - € 1,68</p> <p>525398150 - Misura 150 - - conf. 5 - € 3,10</p> <p>525398200 - Misura 200 - - conf. 5 - € 5,76</p> 
<p>COMJNELLO</p> <p>COPRIPILASTRO QUADRATO grezzo</p> <p>415165030 - misura 30 - - conf. 5 - € 0,58</p> <p>415165060 - misura 60 - - conf. 5 - € 0,72</p> 	<p>COMJNELLO</p> <p>BATTENTE D'ARRESTO zincato</p> <p>415170 - - conf. 5 - € 5,40</p> 
<p>IBFM</p> <p>BATTENTE D'ARRESTO Zincato</p> <p>525470 - - conf. 5 - € 4,32</p> 	<p>IBFM</p> <p>BATTENTE D'ARRESTO Da avvitare Acciaio zincato</p> <p>525470V - A 158 - B 45 - - conf. 10 - € 6,60</p> <p>525470VP - A 120 - B 35 - - conf. 10 - € 5,98</p> 
<p>COMJNELLO</p> <p>ARRESTO FINE CORSA zincata</p> <p>415200G - H 98 - - conf. 15 - € 11,20</p> <p>415200P - H 77 - - conf. 30 - € 8,60</p> 	<p>IBFM</p> <p>ARRESTO FINE CORSA Acciaio zincato</p> <p>525471G - H 70 - B 120 - Tipo Grande - - conf. 10 - € 9,88</p> <p>525471P - H 50 - B 80 - Tipo Piccolo - - conf. 10 - € 7,82</p> 



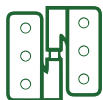

<p>IBFM</p> <p>ARRESTO FINE CORSA Da avvitare Acciaio zincato</p> <p>525476G - H 70 - B 120 - Tipo Grande - - conf. 10 - € 12,98</p> <p>525476P - H 50 - B 80 - Tipo Piccolo - - conf. 10 - € 10,72</p> 	<p>COMJNELLO</p> <p>OLIVA CILINDRICA IN NYLON</p> <p>41523025 - Ø 25 - M 14 - - conf. 20 - € 3,80</p> <p>41523030 - Ø 30 - M 16 - - conf. 20 - € 4,20</p> <p>41523040 - Ø 40 - M 16 - - conf. 20 - € 5,00</p> 
<p>COMJNELLO</p> <p>OLIVA BOMBATA NYLON</p> <p>415235 - Ø 35 - - conf. 4 - € 4,80</p> <p>415240 - Ø 37,5 - - conf. 4 - € 4,80</p> 	<p>IBFM</p> <p>OLIVA BOMBATA IN NYLON Perno ferro zincato</p> <p>525460025 - Ø 25 - - conf. 10 - € 2,68</p> <p>525460030 - Ø 30 - - conf. 10 - € 2,88</p> <p>525460042 - Ø 42 - - conf. 10 - € 3,50</p> 
<p>IBFM</p> <p>MINI PIASTRA GUIDA CANCELLO A 2 rulli - regolazione da 25 a 50 con oliva da 42 acciaio zincato</p> <p>525467/2 - - conf. 1 - € 15,86</p> 	<p>COMJNELLO</p> <p>MINI PIASTRA GUIDA CANCELLO con oliva da 34.5 regolabile - zincata</p> <p>415247 - - conf. 5 - € 18,80</p> 
<p>COMJNELLO</p> <p>PIASTRA GUIDACANCELLO doppia regolazione da 35 - 62 con oliva da 30</p> <p>415255220 - - conf. 10 - € 30,40</p> 	<p>COMJNELLO</p> <p>PIASTRA GUIDACANCELLO doppia regolazione da 62 - 85 con oliva da 40</p> <p>415255350 - - conf. 5 - € 45,00</p> 
<p>IBFM</p> <p>PIASTRA GUIDACANCELLO A 4 rulli - regolabile da 25 a 50 con oliva da 42 acciaio zincato</p> <p>525467/4 - - conf. 12 - € 25,96</p> 	<p>IBFM</p> <p>PIASTRA GUIDACANCELLO Ala lunga A 4 rulli - regolabile da 25 a 50 con oliva da 42 acciaio zincato</p> <p>525467/L - - conf. 1 - € 28,64</p> 
<p>COMJNELLO</p> <p>MANIGLIA IN ZAMA Quadro 8 con vite in testa mec - nero</p> <p>41521025 - Misura quadro 25x35 - - conf. 20 - € 3,60</p> <p>41521040 - Misura quadro 40x50 - - conf. 20 - € 3,60</p> 	<p>COMJNELLO</p> <p>MANIGLIA in Zama con grano Q.8 x25 - 80 mec - nero</p> <p>415211 - - conf. 20 - € 4,40</p> 



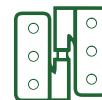





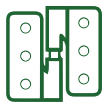









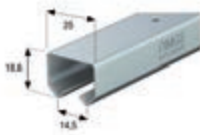





<p>IBFM</p> <p>MANIGLIA in resina Con molla Q8 x 50</p> <p>525536B – Colore Bianco – – conf. 10 – € 7,42</p> <p>525536N – Colore Nero – – conf. 10 – € 7,42</p> 	<p>COMUNELLO</p> <p>MANIGLIA SONIA in alluminio con grano Q.8 x 30 – 50 nera</p> <p>415209 – – conf. 20 – € 23,20</p> 
<p>AVVO</p> <p>MANIGLIA MANON Q8X120 MM Ambidestra con molla premontata</p> <p>77387430 – Tipo Nylon nero – – conf. 2 – € 26,20</p> <p>77387431 – Tipo Metallo p.fuso nero – – conf. 2 – € 42,60</p> 	<p>GHIDINI</p> <p>MANIGLIA LARA con vite in testa</p> <p>50566970000016 – Q. 8x25 – Fin. Nero – – conf. 12 – € 10,37</p> <p>50566970045016 – Q. 8x40 – Fin. Nero – – conf. 12 – € 10,66</p> 
<p>GHIDINI</p> <p>MANIGLIA A ZAMPA Q.8 x 25 spinata mec-nero</p> <p>50566982000016 – – conf. 10 – € 11,52</p> 	<p>GHIDINI</p> <p>MANIGLIA ZAMPA Q8 spinata ottone lucido</p> <p>50549986000001 – – conf. 10 – € 15,41</p> 
<p>IBFM</p> <p>MANIGLIA TIPO RUSTICO Art. 435/TX Quadro 8 x 35-55 In alluminio verniciata nero</p> <p>525435TX – – conf. 10 – € 5,56</p> 	<p>GHIDINI</p> <p>MANIGLIA TORTIGLIONE Q.8 x 25 Con vite in testa mec – nero</p> <p>50566974000016 – – conf. 10 – € 16,42</p> 
<p>AVVO</p> <p>CREMONESE MANON Alluminio</p> <p>773872BI – finitura verniciato bianco – – conf. 4 – € 31,80</p> <p>773872NE – finitura verniciato nero – – conf. 4 – € 31,80</p> 	<p>OMA</p> <p>CREMONESE APPLICARE per aste esterne mezza tonde</p> <p>90009399 – Finitura Ferro vern. nero – – conf. 10 – € 8,10</p> 
<p>COMUNELLO</p> <p>MANIGLIA INCASSO piccola 115 x 52 zincata</p> <p>415270ZP – – conf. 30 – € 3,80</p> 	<p>COMUNELLO</p> <p>MANIGLIA INCASSO grande 200 x 90 zincata</p> <p>415270ZG – – conf. 30 – € 8,80</p> 





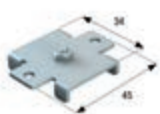



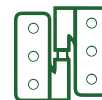

















<p>COMJNELLO</p> <p>MANIGLIONE DIRITTO nero</p> <p>41567715 – misura 15 – – conf. 10 – € 13,20 41567720 – misura 20 – – conf. 10 – € 14,60</p> 	<p>COMJNELLO</p> <p>MANIGLIONE ZANCATO nero</p> <p>41567515 – misura 15 – – conf. 10 – € 13,60 41567520 – misura 20 – – conf. 10 – € 14,60</p> 
<p>COMJNELLO</p> <p>MANIGLIA in Inox Art. 2000 Ø 30 Interasse 350 Altezza 85 Ambidestro Satinato</p> <p>4152000 – – conf. 2 – € 42,64</p> 	<p>COMJNELLO</p> <p>MANIGLIA in Inox Art. 2200 Ø 35 Interasse 350 Altezza 85 Ambidestro Satinato</p> <p>4152200 – – conf. 1 – € 65,52</p> 
<p>COMJNELLO</p> <p>MANIGLIA In Nylon Art. 6400 Ø 35 Interasse 350 Altezza 80 Colore nero</p> <p>4156400 – – conf. 2 – € 22,80</p> 	<p>COMJNELLO</p> <p>MANIGLIA in Nylon Art. 6500 Ø 35 Interasse 350 Altezza 80 Ambidestro Colore nero</p> <p>4156500 – – conf. 1 – € 25,60</p> 
<p>IBFM</p> <p>MANIGLIONE DIRITTO Acciaio vern. nero</p> <p>525482180 – Misura 180 – – conf. 10 – € 5,56 525482230 – Misura 230 – – conf. 10 – € 5,98</p> 	<p>IBFM</p> <p>MANIGLIONE ZANCATO Acciaio vern. nero</p> <p>525483180 – Misura 180 – – conf. 10 – € 6,38 525483230 – Misura 230 – – conf. 10 – € 6,80</p> 
<p></p> <p>MANIGLIA Filo Ø9 ingombro 50mm con piastra stampata in acciaio tropicalizzato</p> <p>180950AT16 – A 160 – B 50 – C 95 – – conf. 10 – € 9,00</p> 	<p>COMJNELLO</p> <p>FISSAGGIO UNIFICATO Art. F2000 Doppio regolabile per profili tubolari</p> <p>415F0018 – – conf. 1 – € 21,00</p> 
<p>COMJNELLO</p> <p>FISSAGGIO SINGOLO Art. F0068 Ad aggancio rapido per profili tubolari</p> <p>415F0068 – – conf. 1 – € 11,60</p> 	<p>COMJNELLO</p> <p>FISSAGGIO UNIFICATO in Inox Art. F1000 Singolo ad aggancio rapido per profili tubolari</p> <p>415F1000 – – conf. 1 – € 7,80</p> 



 <p>FISSAGGIO SINGOLO Per legno</p> <p>415F1400W - - conf. 1 - € 25,20</p> 	 <p>FISSAGGIO UNIFICATO Art. F2000 Doppio per profili tubolari</p> <p>415F2000 - - conf. 1 - € 14,28</p> 
 <p>SERRATURA A GANCIO con cilindro</p> <p>41521550 - E 50 - - conf. 5 - € 37,80 41521560 - E 60 - - conf. 5 - € 37,80</p> 	 <p>SCATOLA COPRISERRATURA</p> <p>41522040 - A 21 - - conf. 20 - € 11,40 41522050 - A 11 - - conf. 20 - € 11,40</p> 
 <p>ROLL-GE 10 Art. 10 PROFILO SUPERIORE 2,5 MT in acciaio zincato con fori 4,5 mm Spessore 1 mm Portata max 25 Kg</p> <p>723100025 - - conf. 1 - € 9,00</p> 	 <p>ROLL-GE 10 Art. 207 PROFILO INFERIORE 2 MT. In acciaio ottonato Spessore 0,5 mm</p> <p>7232070720 - - conf. 2 - € 1,62</p> 
 <p>ROLL-GE 10 Ø 15 - Art. 3 CARRELLO 4 ruote nylon con perno girevole in acciaio portata max: 8Kg</p> <p>7233 - - conf. 50 - € 5,00</p> 	 <p>ROLL-GE 10 Ø 15 - Art. 4 CARRELLO 4 ruote in Delrin Perno M6 portata max: 8 Kg</p> <p>7234 - - conf. 50 - € 5,00</p> 
 <p>ROLL-GE 10 Ø 15 - Art. 12 CARRELLO PIEGATO 2 ruote acciaio Portata max 15 Kg</p> <p>72312 - - conf. 50 - € 3,00</p> 	 <p>ROLL-GE 10 Art. 13 FERMA PORTE Per profilo superiore</p> <p>72313001 - - conf. 10 - € 1,08</p> 
 <p>ROLL-GE 10 Art. 14 STAFFA SOFFITTO In acciaio Per applicazione del profilo superiore</p> <p>72314 - - conf. 10 - € 1,00</p> 	 <p>ROLL-GE 10 Ø 15 - Art. 15 SUPPORTO per applicazione profili a parete</p> <p>72315 - - conf. 10 - € 4,20</p> 





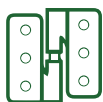



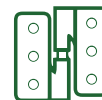

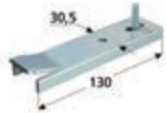

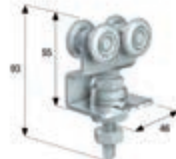

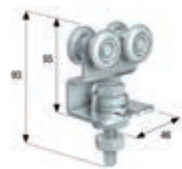









 <p>ROLL-GE 10 Ø 15 – Art. 16 CARRELLO DIRITTO 1 ruota acciaio Portata max 8 Kg</p> <p>72316 – - conf. 10 – € 1,60</p> 	 <p>ROLL-GE 10 Ø 15 – Art. 17 CARRELLO PIEGATO 1 ruota acciaio Portata max 8 Kg</p> <p>72317 – - conf. 50 – € 1,60</p> 
 <p>ROLL-GE 10 Ø 15 – Art. 29 COPPIA GUIDA INFERIORE con bussola ottone rotante Ø 10. La coppia è composta da 1 pezzo destra 1 pezzo sinistra</p> <p>72329 – - conf. 25 – € 3,40</p> 	 <p>ROLL-GE 10 Ø 15 – Art. 123 CARRELLO PIEGATO 1 ruota acciaio Portata max 8 Kg</p> <p>723123 – - conf. 50 – € 3,20</p> 
 <p>ROLL-GE 10 Ø 15 – Art. 125 CARRELLO DIRITTO 1 ruota acciaio Portata max 8 Kg</p> <p>723125 – - conf. 50 – € 2,20</p> 	 <p>ROLL-GE 10 Art. 126 GUIDA Per fissaggio al pavimento In acciaio</p> <p>723126006 – - conf. 10 – € 0,88</p> 
 <p>ROLL-GE 10 Art. 178 PIASTRA SOSPENSIONE In acciaio Per perno M6 Spessore porta min 12 mm</p> <p>723178 – - conf. 10 – € 0,52</p> 	 <p>ROLL-GE 10 Art. 302 GUIDA In acciaio con bussola rotante Ø 10 mm</p> <p>723302006 – - conf. 10 – € 1,00</p> 
 <p>ROLL-GE 10 Art. 303 GUIDA In acciaio con bussola rotante Ø 10 mm</p> <p>723303006 – - conf. 10 – € 1,00</p> 	 <p>ROLL-GE 10 Art. 304 GUIDA LATERALE In acciaio con bussola rotante Ø 10 mm Spessore porta min 16 mm</p> <p>723304006 – - conf. 10 – € 1,14</p> 
 <p>ROLL-GE 10 Ø 15 – Art. 902 CARRELLO 2 ruote in acciaio Portata max 10 Kg</p> <p>723902 – - conf. 50 – € 1,30</p> 	 <p>ROLL-GE 10 Ø 15 – Art. 903 CARRELLO 2 ruota nylon Portata max 8 Kg.</p> <p>723903 – - conf. 50 – € 1,74</p> 



 <p>ROLL-GE 10 Ø 15 – Art. 1042 CARRELLO DIRITTO 1 ruota acciaio Portata max 15 Kg</p> <p>7231042 – - conf. 50 – € 3,00</p> 	 <p>ROLL-GE 10 Ø 15 – Art. 5026 CARRELLO GIREVOLE 2 ruote in acciaio Portata max 10 Kg</p> <p>7235026006 – - conf. 100 – € 5,60</p> 
 <p>ROLL-GE 20 Art. 20 PROFILO SUPERIORE 2,5 MT in acciaio zincato con fori 5,3 mm Spessore 1,5 mm Portata max 100 Kg</p> <p>72320025 – - conf. 1 – € 18,80</p> 	 <p>ROLL-GE 20 Art. 239 PROFILO INFERIORE 2,5 MT In acciaio zincato</p> <p>72323925 – - conf. 1 – € 6,20</p> 
 <p>ROLL-GE 20 Ø 24 – Art. 22 CARRELLO 2 ruote in acciaio Portata max 30 Kg.</p> <p>72322 – - conf. 15 – € 4,20</p> 	 <p>CARRELLO PER PORTE SCORREVOLI 2 CUSCINETTI ART. 338/2 Acciaio zincato</p> <p>5253382 – Ø 25 – - conf. 10 – € 5,16</p> 
 <p>ROLL-GE 20 Ø 24 – Art. 23 CARRELLO 4 ruote acciaio Portata max 40 kg</p> <p>72323 – - conf. 10 – € 6,40</p> 	 <p>CARRELLO PER PORTE SCORREVOLI 4 CUSCINETTI ART. 338/4 Acciaio zincato</p> <p>5253384 – Ø 25 – - conf. 10 – € 7,00</p> 
 <p>ROLL-GE 20 Ø 24 – Art. 24 PARACOLPO fine guida</p> <p>72324 – - conf. 50 – € 1,28</p> 	 <p>ROLL-GE 20 Ø 24 – Art. 25 SUPPORTO A PARETE per profili Art. 20/24</p> <p>72325 – - conf. 30 – € 1,28</p> 
 <p>ROLL-GE 20 Ø 24 – Art. 37 CARRELLO DIRITTO 1 ruota acciaio Portata max 25 Kg</p> <p>72337 – - conf. 50 – € 2,20</p> 	 <p>ROLL-GE 20 Ø 24 – Art. 38 CARRELLO 2 ruote acciaio Portata max 30 Kg.</p> <p>72338 – - conf. 30 – € 4,60</p> 

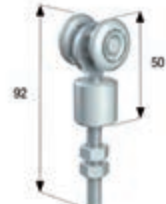

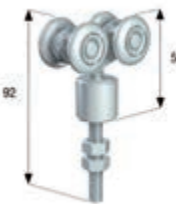





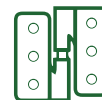

 <p>ROLL-GE 20 Ø 24 – Art. 39 SUPPORTO A PARETE per profili</p> <p>72339 – - conf. 10 - € 2,20</p> 	 <p>ROLL-GE 20 Ø 24 – Art. 40 CARRELLO 4 ruote acciaio-nylon Perno girevole M10 Portata max 45 Kg</p> <p>72340 – - conf. 8 - € 9,20</p> 
 <p>ROLL-GE 20 Ø 24 – Art. 41 CARRELLO 4 ruote acciaio Perno girevole M10 Portata max 45 Kg</p> <p>72341 – - conf. 8 - € 8,40</p> 	 <p>ROLL-GE 20 Ø 24 – Art. 44 CARRELLO 2 ruote acciaio-nylon Perno M8 Spessore porta min 25 mm Portata max 35 Kg</p> <p>72344 – - conf. 15 - € 5,20</p> 
 <p>ROLL-GE 20 Ø 24 – Art. 45 CARRELLO 4 ruote acciaio-nylon Perno M10 Spessore porta min 25 mm Portata max 45 Kg</p> <p>72345 – - conf. 10 - € 7,20</p> 	 <p>ROLL-GE 20 Ø 24 – Art. 48 CARRELLO PIEGATO 1 ruota acciaio-nylon Portata max 25 Kg</p> <p>72348 – - conf. 25 - € 2,20</p> 
 <p>ROLL-GE 20 Ø 24 – Art. 84 CARRELLO 2 ruote in acciaio Portata max 30Kg.</p> <p>72384 – - conf. 30 - € 4,12</p> 	 <p>CARRELLO FISSO 2 CUSCINETTI ART. 330 In acciaio Per portoni scorrevoli</p> <p>525330024 – Ø 24 – A 63 – M 8 – Portata 60 Kg - conf. 40 - € 4,74</p> <p>525330044 – Ø 42 – A 115 – M 12 – Portata 200 Kg - conf. 10 - € 8,24</p> <p>525330054 – Ø 54 – A 152 – M 20 – Portata 400 Kg - conf. 10 - € 13,80</p> 
 <p>ROLL-GE 20 Ø 24 – Art. 85 CARRELLO 4 Ruote acciaio Portata max 40 Kg</p> <p>72385 – - conf. 1 - € 7,42</p> 	 <p>CARRELLO FISSO 4 CUSCINETTI ART. 331 In acciaio Per portoni scorrevoli</p> <p>525331024 – Ø 24 – A 62 – M 8 – Portata 85 Kg - conf. 20 - € 7,62</p> <p>525331044 – Ø 42 – A 115 – M 12 – Portata 450 Kg - conf. 6 - € 13,18</p> <p>525331054 – Ø 54 – A 158 – M 20 – Portata 750 Kg - conf. 10 - € 21,64</p> 
 <p>ROLL-GE 20 Ø 24 – Art. 86 CARRELLO 2 ruote in acciaio Perno girevole M8 Portata max 35 Kg</p> <p>72386 – - conf. 30 - € 6,60</p> 	 <p>ROLL-GE 20 Ø 24 – Art. 87 CARRELLO 4 ruote in acciaio Perno girevole M8 Portata max 45 Kg</p> <p>72387 – - conf. 30 - € 8,44</p> 



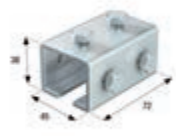



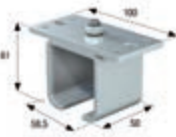

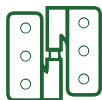















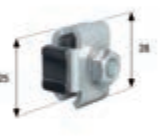

 <p>ROLL-GE 20 Ø 24 – Art. 88 PIASTRA di sospensione rotante</p> <p>72388 – - conf. 1 – € 2,26</p> 	 <p>ROLL-GE 20 Ø 24 – Art. 96 CARRELLO PIEGATO 1 ruota acciaio-nylon Portata max 35 Kg</p> <p>72396 – - conf. 30 – € 3,92</p> 
 <p>ROLL-GE 20 Art. 134 PIASTRA DI SOSPENSIONE In acciaio Per perno M10 Spessore porta min 25 mm</p> <p>723134 – - conf. 10 – € 0,68</p> 	 <p>ROLL-GE 20 Ø 24 – Art. 191 GUIDA INFERIORE Bussola in ottone rotante</p> <p>723191 – - conf. 50 – € 2,80</p> 
 <p>ROLL-GE 20 Ø 24 – Art. 192 GUIDA INFERIORE bussola in ottone rotante</p> <p>723192 – - conf. 50 – € 2,80</p> 	 <p>ROLL-GE 20 Art. 291 GUIDA In acciaio con bussola rotante in ottone Ø 14 mm</p> <p>723291 – - conf. 100 – € 2,40</p> 
 <p>ROLL-GE 20 Ø 24 – Art. 901 CARRELLO 2 ruote in acciaio – nylon Portata max 25Kg.</p> <p>723901 – - conf. 30 – € 3,10</p> 	 <p>ROLL-GE 20 Ø 24 – Art. 1028 CARRELLO DIRITTO 1 ruota in acciaio Portata max 35 Kg</p> <p>7231028 – - conf. 30 – € 3,20</p> 
 <p>ROLL-GE 20 Ø 24 – Art. 1086 CARRELLO 4 ruote in acciaio Portata max 45 Kg</p> <p>7231086 – - conf. 30 – € 5,00</p> 	 <p>ROLL-GE 20 Ø 24 – Art. 1161 CARRELLO DIRITTO 1 ruota acciaio Portata max 35 Kg</p> <p>7231161 – - conf. 50 – € 3,20</p> 
 <p>ROLL-GE 20 Ø 24 – Art. 1222 CARRELLO 2 ruote in Delrin Portata max 20 Kg.</p> <p>7231222 – - conf. 15 – € 4,40</p> 	 <p>ROLL-GE 20 Ø 24 – Art. 1223 CARRELLO 4 ruote in Delrin Portata max 40 Kg.</p> <p>7231223 – - conf. 10 – € 6,40</p> 

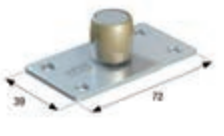

 <p>ROLL-GE 20 Ø 24 – Art. 1233 CARRELLO 2 Ruote in ACCIAIO Portata max 35 Kg</p> <p>7231233 – - conf. 30 – € 3,00</p> 	 <p>ROLL-GE 20 Ø 24 – Art. 1284 CARRELLO 2 ruote in Derlin Portata max 20 Kg.</p> <p>7231284 – - conf. 30 – € 4,00</p> 
 <p>ROLL-GE 20 Ø 24 – Art. 1285 CARRELLO 4 ruote in Derlin Portata max 30 Kg.</p> <p>7231285 – - conf. 20 – € 6,40</p> 	 <p>ROLL-GE 20 Art. 1293 GIUNZIONE PER PROFILO SUPERIORE In acciaio</p> <p>7231293 – - conf. 50 – € 5,80</p> 
 <p>ROLL-GE 20 Art. 1296 BUSSOLA IN OTTONE Ø 14 mm</p> <p>7231296008 – - conf. 100 – € 1,96</p> 	 <p>ROLL-GE 20 Ø 24 – Art. 5013 CARRELLO 2 ruote in acciaio-nylon Perno girevole Portata max 30 Kg</p> <p>7235013 – - conf. 50 – € 4,12</p> 
 <p>ROLL-GE 50 Ø 38 – Art. 52 CARRELLO 2 ruote acciaio Portata max 150 Kg.</p> <p>72352 – - conf. 25 – € 9,28</p> 	 <p>ROLL-GE 50 Ø 38 – Art. 53 CARRELLO 4 ruote acciaio Portata max 200 Kg.</p> <p>72353 – - conf. 12 – € 15,04</p> 
 <p>ROLL-GE 50 Art. 55 PARACOLPO FERMAPORTE per profilo</p> <p>72355 – - conf. 25 – € 2,26</p> 	 <p>ROLL-GE 50 Art. 56 STAFFA A MURARE IN ACCIAIO Per applicazione del profilo superiore</p> <p>72356 – - conf. 50 – € 1,82</p> 
 <p>ROLL-GE 50 Art. 57 PIASTRA DI SOSPENSIONE ROTANTE IN ACCIAIO Spessore min porta 32 mm Per perno M12</p> <p>72357 – - conf. 50 – € 1,86</p> 	 <p>ROLL-GE 50 Art. 58 STAFFA IN ACCIAIO Per applicazione a soffitto del profilo superiore</p> <p>72358 – - conf. 25 – € 7,62</p> 



 <p>ROLL-GE 50 Ø 38 – Art. 78 CARRELLO 2 ruote in acciaio Perno girevole M12 Portata max 160 Kg</p> <p>72378 – - conf. 50 – € 18,74</p> 	 <p>ROLL-GE 50 Ø 38 – Art. 79 CARRELLO 4 ruote acciaio perno girevole Portata max 200 Kg.</p> <p>72379 – - conf. 12 – € 22,66</p> 
 <p>ROLL-GE 50 Ø 38 – Art. 1190 CARRELLO 4 ruote in Delrin Perno M12 Portata max 130 Kg</p> <p>7231190 – - conf. 12 – € 17,00</p> 	 <p>ROLL-GE 150 Ø 24 – Art. 152 CARRELLO PIEGATO 1 ruota acciaio Portata max 20 Kg.</p> <p>723152 – - conf. 25 – € 2,20</p> 
 <p>ROLL-GE 150 Ø 24 – Art. 153 CARRELLO DIRITTO 1 ruota acciaio Portata max 20 Kg.</p> <p>723153 – - conf. 50 – € 2,20</p> 	 <p>ROLL-GE 150 Ø 24 – Art. 154 CARRELLO PIEGATO 1 ruota acciaio Portata max 20 Kg.</p> <p>723154 – - conf. 25 – € 2,20</p> 
 <p>ROLL-GE 150 Ø 24 – Art. 155 CARRELLO DIRITTO 1 ruota acciaio Portata max 20 Kg.</p> <p>723155 – - conf. 25 – € 2,20</p> 	 <p>ROLL-GE 150 Ø 24 – Art. 161 GUIDA INFERIORE in acciaio</p> <p>723161 – - conf. 10 – € 0,88</p> 
 <p>ROLL-GE 150 Ø 24 – Art. 162 FERMAPORTA per profilo con battuta in gomma</p> <p>723162 – - conf. 10 – € 1,08</p> 	 <p>ROLL-GE APO Art. 63 / 70 GUIDA INFERIORE bussola in ottone rotante</p> <p>72363 – Art. 63 – Ø 20 – - conf. 50 – € 3,70 72370 – Art. 70 – Ø 25 – - conf. 50 – € 3,92</p> 
 <p>PATTINI ROTATIVI EGO</p> <p>Mod. 106 7239206 – Mod. 106 – 2 fori - conf. 60 – € 6,80 Mod. 107 7239207 – Mod. 107 – 3 fori - conf. 30 – € 7,62</p>  	 <p>SQUADRETTE REGOLABILI Olive in ottone</p> <p>7239219 – - conf. 40 – € 8,24</p> 

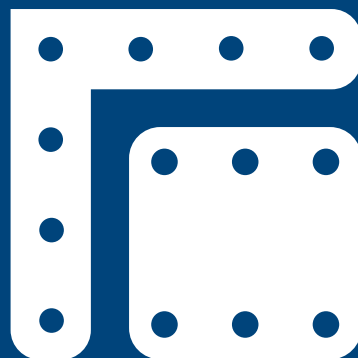











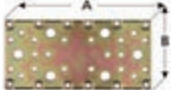







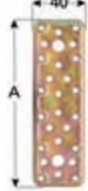



**LASTRINE
PIASTRE
MENSOLE**

SFOGLIA LA CATEGORIA



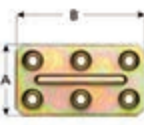













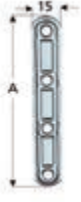









 <p>GIUNZIONI PESANTI DIRITTE STAMPATE Acciaio tropicalizzato</p> <p>180776AT08 – A 80x100 – – conf. 25 – € 2,20 180776AT12 – A 120x100 – – conf. 25 – € 2,80</p> 	 <p>&M 900</p> <p>LASTRINA PIANA STONDATA Art. 510 Tropicalizzata</p> <p>90017442 – A 180 – B 65 – – conf. 25 – € 1,71 90017443 – A 200 – B 90 – – conf. 25 – € 3,10</p> 
 <p>LASTRINA DI GIUNZIONE PESANTE DIRITTA Spessore 2,2 mm Acciaio tropicalizzato</p> <p>180770AT08 – A 80 – B 50 – – conf. 50 – € 1,16 180770AT12 – A 120 – B 50 – – conf. 50 – € 1,56 180770AT16 – A 160 – B 50 – – conf. 25 – € 2,20 180770AT20 – A 200 – B 50 – – conf. 25 – € 2,40</p> 	 <p>LASTRINA DI GIUNZIONE PESANTE DIRITTA Spessore 2,2 mm Acciaio tropicalizzato</p> <p>180772AT18 – A 180 – B 65 – – conf. 25 – € 2,60</p> 
 <p>LASTRINA DI GIUNZIONE PESANTE DIRITTA Spessore 2,2 mm Acciaio tropicalizzato</p> <p>180774AT18 – A 180 – B 90 – – conf. 20 – € 3,60</p> 	 <p>LASTRINA DI GIUNZIONE DIRITTA Spessore 40 mm Tropicalizzata</p> <p>180745AT08 – Ax B 80x100 – – conf. 50 – € 0,94 180745AT16 – Ax B 160x100 – – conf. 25 – € 1,66</p> 
 <p>PIASTRA PIANA Art. 500 spessore 2mm. tropicalizzata</p> <p>90017401 – L 60 – H 40 – – conf. 50 – € 0,42 90017402 – L 80 – H 40 – – conf. 50 – € 0,42 90017403 – L 100 – H 40 – – conf. 50 – € 0,52 90017406 – L 120 – H 60 – – conf. 50 – € 0,86 90017407 – L 140 – H 60 – – conf. 50 – € 0,98 segue...</p> 	 <p>continua...</p> <p>90017411 – L 160 – H 80 – – conf. 50 – € 1,56 90017412 – L 200 – H 80 – – conf. 50 – € 1,88 90017415 – L 240 – H 100 – – conf. 50 – € 2,60</p> 
 <p>LASTRINA DI GIUNZIONE DIRITTA Spessore 2 mm Acciaio zincato</p> <p>180170Z06 – A 60 – B 30 – – conf. 50 – € 0,30 180170Z08 – A 80 – B 30 – – conf. 50 – € 0,32 180170Z10 – A 100 – B 30 – – conf. 50 – € 0,42</p> 	 <p>PIASTRA PESANTE DIRITTA Art. 281 zincata</p> <p>90017060 – Misura 90x40 – – conf. 50 – € 0,42</p> 
 <p>PIASTRINA RETTANGOLARE Spessore 1 mm Acciaio tropicalizzato</p> <p>180162AT735 – Misura 39x70 – – conf. 100 – € 0,70 180162AT750 – Misura 50x70 – – conf. 100 – € 0,82</p> 	 <p>PIASTRINA QUADRA Spessore 1 mm Acciaio tropicalizzato</p> <p>180160AT44 – Misura 40x40 – – conf. 1 – € 0,38 180160AT55 – Misura 50x50 – – conf. 1 – € 0,42</p> 







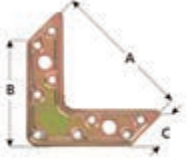



















  <p>PIASTRINA DI GIUNZIONE DIRITTA Spessore 2 mm Larghezza 30 mm</p> <p>90017040 - Misura 40 - - conf. 50 - € 0,15</p> <p>90017041 - Misura 60 - - conf. 50 - € 0,17</p> <p>90017042 - Misura 80 - - conf. 50 - € 0,22</p> <p>90017043 - Misura 100 - - conf. 50 - € 0,24</p> <p>90017044 - Misura 120 - - conf. 50 - € 0,32</p> <p>segue...</p>	  <p>continua...</p> <p>90017045 - Misura 160 - - conf. 50 - € 0,40</p> <p>90017046 - Misura 200 - - conf. 50 - € 0,48</p>
  <p>LASTRINA DI GIUNZIONE DIRITTA Spessore 2,2 mm Acciaio tropicalizzato</p> <p>180748AT06 - A 60 - B 30 - - conf. 100 - € 0,62</p>	  <p>LASTRINA RETTANGOLARE Misura 7x3,5 cm Spessore 1 mm Zincata</p> <p>90016620 - - conf. 100 - € 0,15</p>
  <p>LASTRINA QUADRATA cm. 4x4 zincata</p> <p>90017050 - - conf. 200 - € 0,10</p>	  <p>PIASTRA FORATA DIRITTA Spessore 3 mm Larghezza 40 mm Fori Ø 5 mm e 10,5 mm</p> <p>90017460 - Misura 100 - - conf. 25 - € 0,42</p> <p>90017461 - Misura 140 - - conf. 25 - € 0,54</p> <p>90017462 - Misura 180 - - conf. 25 - € 0,68</p> <p>90017463 - Misura 220 - - conf. 25 - € 0,80</p>
  <p>SQUADRETTA A "T" Art. 502 Tropicalizzata</p> <p>90017431 - A 70 - B 36 - C 16 - - conf. 100 - € 0,42</p>	  <p>LASTRINA DI GIUNZIONE PESANTE A "T" Spessore 2,2 cm Acciaio tropicalizzato</p> <p>180751AT160 - A 160 - B 115 - C 45 - - conf. 10 - € 6,20</p>
  <p>LASTRINA DI GIUNZIONE PESANTE DIRITTA Spessore 2,5 mm Acciaio tropicalizzato</p> <p>180778AT10 - A 100 - B 20 - - conf. 50 - € 0,42</p> <p>180778AT20 - A 206 - B 20 - - conf. 50 - € 0,70</p> <p>180778AT30 - A 312 - B 20 - - conf. 50 - € 1,10</p>	  <p>LASTRINA DI GIUNZIONE PESANTE DIRITTA STAMPATA Spessore 4 mm Acciaio tropicalizzato</p> <p>180767AT100 - A 100 - B 20 - - conf. 25 - € 0,92</p> <p>180767AT200 - A 206 - B 20 - - conf. 25 - € 1,80</p> <p>180767AT300 - A 312 - B 20 - - conf. 25 - € 2,80</p>
  <p>LASTRINA 4 FORI DIRITTA Art. 163 bronzata</p> <p>180163B06 - misura 6 - - conf. 100 - € 0,22</p> <p>180163B08 - misura 8 - - conf. 100 - € 0,26</p> <p>180163B10 - misura 10 - - conf. 100 - € 0,28</p> <p>180163B12 - misura 12 - - conf. 100 - € 0,32</p> <p>180163B14 - misura 14 - - conf. 100 - € 0,36</p>	  <p>LASTRINA 4 FORI DIRITTA Art. 163 Spessore 1,5 mm Acciaio zincato</p> <p>180163Z06 - Misura 6 - - conf. 100 - € 0,20</p> <p>180163Z08 - Misura 8 - - conf. 100 - € 0,22</p> <p>180163Z10 - Misura 10 - - conf. 100 - € 0,24</p> <p>180163Z12 - Misura 12 - - conf. 100 - € 0,26</p> <p>180163Z14 - Misura 14 - - conf. 100 - € 0,30</p>











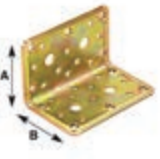







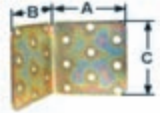

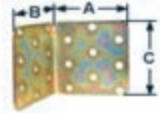



 <p>LASTRINA DIRITTA 4 FORI Art. 165 zincata</p> <p>18016504 – misura 4 – – conf. 100 – € 0,16 18016506 – misura 6 – – conf. 100 – € 0,18 18016508 – misura 8 – – conf. 100 – € 0,20 18016510 – misura 10 – – conf. 100 – € 0,22 18016512 – misura 12 – – conf. 100 – € 0,24 segue...</p> 	 <p>continua...</p> <p>18016514 – misura 14 – – conf. 100 – € 0,28 18016516 – misura 16 – – conf. 100 – € 0,34 18016518 – misura 18 – – conf. 100 – € 0,36 18016520 – misura 20 – – conf. 100 – € 0,44</p> 
 <p>LASTRINE STAMPATE 4 FORI DIRITTE INOX Spessore 1,5 mm Acciaio inossidabile</p> <p>180163106 – Misura 6 – A 61 – – conf. 100 – € 0,72 180163108 – Misura 8 – A 79 – – conf. 100 – € 0,90 180163110 – Misura 10 – A 99 – – conf. 100 – € 1,00 180163112 – Misura 12 – A 119 – – conf. 100 – € 1,16</p> 	 <p>LASTRINA DIRITTA Spessore 2 mm Larghezza 15 mm Zincata</p> <p>90017000 – Misura 4 – – conf. 100 – € 0,08 90017006 – Misura 6 – – conf. 100 – € 0,10 90017007 – Misura 8 – – conf. 100 – € 0,11 90017008 – Misura 10 – – conf. 100 – € 0,13 90017009 – Misura 12 – – conf. 100 – € 0,16 segue...</p> 
 <p>continua...</p> <p>90017010 – Misura 14 – – conf. 100 – € 0,18 90017011 – Misura 16 – – conf. 100 – € 0,22 90017012 – Misura 18 – – conf. 100 – € 0,24 90017013 – Misura 20 – – conf. 100 – € 0,26</p> 	 <p>PIASTRINA DIRITTA FORATA Spessore 4 mm Fori Ø 6 mm</p> <p>90017028 – Misura 200 – – conf. 50 – € 0,70 90017029 – Misura 300 – – conf. 50 – € 1,00</p> 
 <p>PIASTRA DIRITTA FORATA Spessore 2 mm Larghezza 20 mm</p> <p>90017025 – Misura 200 – – conf. 100 – € 0,30 90017026 – Misura 300 – – conf. 100 – € 0,44</p> 	 <p>ATTACCAGLIA STRETTA Spessore 1,8 mm Larghezza 15 mm</p> <p>90017031 – Misura 60 – – conf. 100 – € 0,10 90017032 – Misura 80 – – conf. 100 – € 0,12 90017033 – Misura 100 – – conf. 100 – € 0,14 90017034 – Misura 120 – – conf. 100 – € 0,16</p> 
 <p>LASTRINA TONDA Spessore 1,5 mm Larghezza 19 mm Zincata</p> <p>90017021 – Misura 60 – – conf. 100 – € 0,11 90017022 – Misura 80 – – conf. 100 – € 0,13 90017023 – Misura 100 – – conf. 100 – € 0,15 90017024 – Misura 120 – – conf. 100 – € 0,17</p> 	 <p>BANDELLA FORATA Spessore 0,8 mm Acciaio zincato</p> <p>180733Z25 – A 25 – L 10 mt – – conf. 1 – € 31,20</p> 
 <p>BANDA IN LAMIERA FORATA Atr. 945 acciaio zincato</p> <p>90078650 – largh. 17 mm – Lungh. 10 mt – spessore 0,7 – – conf. 1 – € 10,84</p> 	 <p>LASTRINA AD ANGOLO PESANTE STAMPATA Spessore 2,2 mm Acciaio tropicalizzato</p> <p>180752AT120 – A 120 – B 83 – C 30 – – conf. 10 – € 2,80 180752AT160 – A 160 – B 110 – C 32 – – conf. 10 – € 3,00</p> 













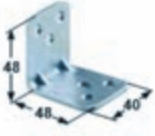

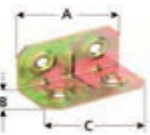





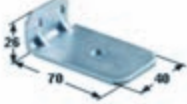



 <p>ANGOLO DI RINFORZO LEGGERO Art. 153 Spessore 1,5 mm Acciaio zincato</p> <p>180153Z4 - HxL 4x4 - - conf. 100 - € 0,40 180153Z5 - HxL 5x5 - - conf. 100 - € 0,46 180153Z6 - HxL 6x6 - - conf. 100 - € 0,48 180153Z7 - HxL 7x7 - - conf. 100 - € 0,58</p> 	 <p>ANGOLI RINFORZO LEGGERI Spessore 1,5 mm Acciaio zincato</p> <p>180155Z33 - Misura 30x30 - - conf. 200 - € 0,46 180155Z44 - Misura 40x40 - - conf. 200 - € 0,58 180155Z55 - Misura 50x50 - - conf. 200 - € 0,62 180155Z66 - Misura 60x60 - - conf. 200 - € 0,76</p> 
 <p>CANTONALE DI RINFORZO LEGGERO Spessore 1,8 mm Larghezza 12 mm</p> <p>90017203 - Misura 30x30 - - conf. 50 - € 0,12 90017204 - Misura 40x40 - - conf. 50 - € 0,13 90017205 - Misura 50x50 - - conf. 50 - € 0,14 90017206 - Misura 60x60 - - conf. 100 - € 0,16</p> 	 <p>ANGOLI RINFORZO PESANTI Spessore 2 mm Acciaio zincato</p> <p>180157Z10 - Misura 10x10 - - conf. 100 - € 1,06 180157Z12 - Misura 12x12 - - conf. 100 - € 1,32 180157Z14 - Misura 14x14 - - conf. 50 - € 1,80 180157Z16 - Misura 16x16 - - conf. 50 - € 2,40 180157Z18 - Misura 18x18 - - conf. 50 - € 2,80 segue...</p> 
 <p>continua...</p> <p>180157Z20 - Misura 20x20 - - conf. 50 - € 4,80</p> 	 <p>CANTONALE DI RINFORZO PESANTE Spessore 2 mm Larghezza 18 mm Zincato</p> <p>90012708 - Misura 80 - - conf. 50 - € 0,32 90012710 - Misura 100 - - conf. 50 - € 0,38 90012712 - Misura 120 - - conf. 50 - € 0,44 90012714 - Misura 140 - - conf. 50 - € 0,48 90012716 - Misura 160 - - conf. 50 - € 0,58 segue...</p> 
 <p>continua...</p> <p>90012718 - Misura 180 - - conf. 50 - € 0,64 90012720 - Misura 200 - - conf. 50 - € 0,76</p> 	 <p>540</p> <p>CONFEZIONE 4 PZ. PIASTRE DI RINFORZO A SQUADRA</p> <p>540214195005 - Tipologia 6pz angoli rinforzo - Misura 3x3 zincato - - conf. 10 - € 2,00 540214195010 - Tipologia 6pz angoli rinforzo - Misura 4x4 zincato - - conf. 10 - € 2,40 540214195015 - Tipologia 4pz angoli rinforzo - Misura 5x5 zincato - - conf. 10 - € 3,20 segue...</p> 
 <p>540</p> <p>continua...</p> <p>540214195020 - Tipologia 4pz angoli rinforzo - Misura 6x6 zincato - - conf. 10 - € 4,00</p> 	 <p>ANGOLI DI RINFORZO LEGGERI STAMPATI INOX Spessore 1,5 mm Acciaio inossidabile</p> <p>180153I44 - A 40 - B 40 - - conf. 100 - € 0,88 180153I55 - A 50 - B 50 - - conf. 100 - € 1,04 180153I66 - A 60 - B 60 - - conf. 100 - € 1,16 180153I77 - A 70 - B 70 - - conf. 100 - € 1,30</p> 
 <p>GIUNZIONI PESANTI Angolo 135° Spessore 2,2 mm Acciaio tropicalizzato</p> <p>180747AT106 - A 80 - B 80 - - conf. 25 - € 1,66</p> 	 <p>LASTRINA DI GIUNZIONE PESANTE ad angolo 135° Spessore 2,2 mm Acciaio tropicalizzato</p> <p>180760AT180 - A 90 - B 90 - C 65 - - conf. 25 - € 3,00</p> 



 <p>GIUNZIONI PESANTI AD ANGOLO STAMPATE Spessore 2,2 mm Acciaio tropicalizzato</p> <p>180777AT44 - A 40 - B 40 - - conf. 25 - € 2,20 180777AT66 - A 60 - B 60 - - conf. 25 - € 2,80</p> 	 <p>LASTRINA DI GIUNZIONE PESANTE ad angolo 90° Spessore 2,2 mm Acciaio tropicalizzato</p> <p>180771AT44 - A 40 - B 40 - C 50 - - conf. 50 - € 1,16 180771AT66 - A 60 - B 60 - C 50 - - conf. 50 - € 1,56 180771AT88 - A 80 - B 80 - C 50 - - conf. 25 - € 2,20 180771AT100 - A 100 - B 100 - C 50 - - conf. 25 - € 2,40</p> 
 <p>LASTRINA DI GIUNZIONE AD ANGOLO Art. 511 Stondata Tropicalizzata</p> <p>90017444 - A 90 - B 90 - C 65 - - conf. 25 - € 1,71 90017445 - A 100 - B 100 - C 90 - - conf. 25 - € 3,10</p> 	 <p>LASTRINA NERVATA AD ANGOLO Art. 512 Stondata Tropicalizzata</p> <p>90017446 - A 90 - B 90 - C 65 - - conf. 25 - € 1,71 90017447 - A 100 - B 100 - C 90 - - conf. 25 - € 3,10</p> 
 <p>PIASTRA PIEGATA Art. 501 Spessore 2 mm Tropicalizzata</p> <p>90017417 - A 40 - B 40 - C 40 - - conf. 50 - € 0,54 90017418 - A 60 - B 60 - C 40 - - conf. 50 - € 0,62 90017421 - A 60 - B 60 - C 60 - - conf. 50 - € 0,86 90017422 - A 80 - B 80 - C 60 - - conf. 50 - € 0,79 90017426 - A 80 - B 80 - C 80 - - conf. 25 - € 1,62 segue...</p> 	 <p>continua...</p> <p>90017429 - A 100 - B 100 - C 100 - - conf. 25 - € 2,54 90017430 - A 120 - B 120 - C 100 - - conf. 25 - € 2,96</p> 
 <p>LASTRINA DI GIUNZIONE PESANTE NERVATA ad angolo 90° Spessore 2,2 mm Acciaio tropicalizzato</p> <p>180773AT99 - A 90 - B 90 - C 65 - - conf. 25 - € 2,60</p> 	 <p>LASTRINA DI GIUNZIONE PESANTE ad angolo 90° Spessore 2,2 mm Acciaio tropicalizzato</p> <p>180775AT99 - A 90 - B 90 - C 90 - - conf. 20 - € 3,60</p> 
 <p>LASTRINA DI GIUNZIONE PESANTE STAMPATA AD ANGOLO Spessore 2,2 mm Acciaio tropicalizzato</p> <p>180746AT44 - A 40 - B 80 - - conf. 50 - € 0,94 180746AT88 - A 80 - B 80 - - conf. 25 - € 1,66</p> 	 <p>GIUNZIONI PESANTI CON CAVA DI REGOLAZIONE Spessore 2,8 mm Acciaio tropicalizzato</p> <p>180750AT090 - A 90 - B 45 - C 50 - - conf. 10 - € 2,20</p> 
 <p>GIUNZIONI A MURARE PER PAVIMENTI Spessore 2,8 mm Acciaio tropicalizzato</p> <p>180754AT200 - A 200 - B 45 - C 50 - - conf. 10 - € 4,80 180754AT300 - A 300 - B 45 - C 50 - - conf. 10 - € 6,60</p> 	 <p>PIASTRINA DI GIUNZIONE AD ANGOLO Spessore 2 mm Larghezza 30 mm</p> <p>90017120 - Misura 2x2 - - conf. 50 - € 0,15 90017121 - Misura 3x3 - - conf. 50 - € 0,17 90017122 - Misura 4x4 - - conf. 50 - € 0,22 90017123 - Misura 5x5 - - conf. 50 - € 0,24 90017124 - Misura 6x6 - - conf. 50 - € 0,32 segue...</p> 



  <p><i>continua...</i> 90017125 - Misura 8x8 - - conf. 50 - € 0,40 90017126 - Misura 10x10 - - conf. 50 - € 0,48</p>	  <p>PIASTRA PESANTE PIEGATA Art. 282 zincata 90017070 - Misura 40x48x48 - - conf. 50 - € 0,42</p>
  <p>PIASTRINA AD ANGOLO 4 FORI Spessore 1 mm Acciaio tropicalizzato 180161AT22 - Ax B 20x20 - C 40 - - conf. 200 - € 0,38 180161AT25 - Ax B 25x25 - C 50 - - conf. 200 - € 0,42</p>	  <p>PIASTRINA PIEGATA spessore 1mm 5 x 2,0 x 2,0 90016630 - - conf. 100 - € 0,13</p>
  <p>PIASTRINA PIEGATA spessore 1mm 4 x 2,2 x 2,2 90016625 - - conf. 100 - € 0,10</p>	  <p>PIASTRA PESANTE A "L" Art. 283 zincata 90017080 - Misura 40x26x70 - - conf. 50 - € 0,42</p>
  <p>LASTRINA DI GIUNZIONE AD ANGOLO Spessore 2 mm Acciaio zincato 180169Z2 - A 20 - B 20 - - conf. 50 - € 0,20 180169Z3 - A 30 - B 30 - - conf. 50 - € 0,24 180169Z4 - A 40 - B 40 - - conf. 50 - € 0,30 180169Z5 - A 50 - B 50 - - conf. 50 - € 0,34</p>	  <p>LASTRINA DI GIUNZIONE PESANTE ad angolo 90° Spessore 2,2 mm Acciaio tropicalizzato 180749AT33 - A 30 - B 30 - C 30 - - conf. 100 - € 0,72</p>
  <p>GIUNZIONE DIRITTA PER LEGNO TONDO Ø 80/100 Acciaio tropicalizzato 180900AT08 - - conf. 1 - € 1,52</p>	  <p>ANGOLARI DI RINFORZO Piegati a 90° Spessore 4 mm Acciaio tropicalizzato 180768AT55 - A 50 - B 50 - - conf. 25 - € 0,94 180768AT10 - A 100 - B 100 - - conf. 25 - € 1,82 180768AT15 - A 150 - B 150 - - conf. 25 - € 2,80</p>
  <p>LASTRINA AD ANGOLO PESANTE angolo 90° Spessore 2,5 mm Acciaio tropicalizzato 180779AT55 - A 50 - B 50 - - conf. 50 - € 0,52 180779AT10 - A 100 - B 100 - - conf. 50 - € 0,86 180779AT15 - A 150 - B 150 - - conf. 50 - € 1,22</p>	  <p>LASTRINA 4 FORI AD ANGOLO Art. 166 Acciaio zincato 18016602 - Misura 2x2 - - conf. 100 - € 0,18 18016603 - Misura 3x3 - - conf. 100 - € 0,20 18016604 - Misura 4x4 - - conf. 100 - € 0,22 18016605 - Misura 5x5 - - conf. 100 - € 0,24 18016606 - Misura 6x6 - - conf. 100 - € 0,28 <i>segue...</i></p>



  <p>continua... 18016607 – Misura 7x7 – – conf. 100 – € 0,32 18016608 – Misura 8x8 – – conf. 100 – € 0,36 18016609 – Misura 9x9 – – conf. 100 – € 0,40 18016610 – Misura 10x10 – – conf. 100 – € 0,46</p>	  <p>LASTRINA 4 FORI AD ANGOLO Art. 164 Spessore 1,5 mm Acciaio bronzato</p> <p>180164B3 – Misura 3X3 – – conf. 100 – € 0,24 180164B4 – Misura 4x4 – – conf. 100 – € 0,28 180164B5 – Misura 5x5 – – conf. 100 – € 0,30 180164B6 – Misura 6x6 – – conf. 100 – € 0,36 180164B7 – Misura 7x7 – – conf. 100 – € 0,36</p>
  <p>LASTRINA 4 FORI AD ANGOLO Art. 164 Acciaio zincato</p> <p>180164Z3 – Misura 3X3 – – conf. 100 – € 0,22 180164Z4 – Misura 4x4 – – conf. 100 – € 0,24 180164Z5 – Misura 5x5 – – conf. 100 – € 0,26 180164Z6 – Misura 6x6 – – conf. 100 – € 0,30 180164Z7 – Misura 7x7 – – conf. 100 – € 0,34</p>	  <p>LASTRINA 4 FORI AD ANGOLO Spessore 2 mm Larghezza 15 mm Zincata</p> <p>90017103 – Misura 3x3 – – conf. 100 – € 0,10 90017104 – Misura 4x4 – – conf. 100 – € 0,11 90017105 – Misura 5x5 – – conf. 100 – € 0,13 90017106 – Misura 6x6 – – conf. 100 – € 0,16 90017107 – Misura 7x7 – – conf. 100 – € 0,18</p> <p><i>segue...</i></p>
  <p>continua... 90017108 – Misura 8x8 – – conf. 100 – € 0,22 90017110 – Misura 10x10 – – conf. 100 – € 0,26</p>	  <p>LASTRINE STAMPATE 4 FORI ANGOLO INOX Spessore 1,5 mm Acciaio inossidabile</p> <p>180164I33 – Misura 3X3 – A 31 – B 31 – – conf. 100 – € 0,74 180164I44 – Misura 4X4 – A 40 – B 40 – – conf. 100 – € 0,92 180164I55 – Misura 5X5 – A 50 – B 50 – – conf. 100 – € 1,10 180164I66 – Misura 6X6 – A 60 – B 60 – – conf. 100 – € 1,22</p>
  <p>SQUADRETTA CON ASOLA Misura 22x28 mm Spessore 2 mm Finitura nichelata</p> <p>90017435 – – conf. 100 – € 0,14</p>	  <p>PIASTRINA PIEGATA Spessore 1,5 mm Larghezza 15 mm</p> <p>90016600 – Misura 17x17 – Finitura Ottonata – – conf. 100 – € 0,11 90016601 – Misura 17x17 – Finitura Bronzata – – conf. 100 – € 0,11 90016605 – Misura 25x25 – Finitura Ottonata – – conf. 100 – € 0,12 90016606 – Misura 25x25 – Finitura Bronzata – – conf. 100 – € 0,12</p>
  <p>LASTRINA AD ANGOLO PER SCHIENALI Spessore 1,5 mm Larghezza 15 mm</p> <p>90016610 – Misura 23,5x34 – Finitura Ottonata – – conf. 100 – € 0,13 90016611 – Misura 23,5x34 – Finitura Bronzata – – conf. 100 – € 0,13</p>	  <p>CAVALLOTTO PIEGHEOLE per maniglia tonda Spessore 2,2 mm Acciaio tropicalizzato</p> <p>180866AT2148 – A 60 – – conf. 50 – € 5,40</p>
  <p>CAVALLOTTO FISSO Per maniglia tonda Spessore 2,2 mm Acciaio tropicalizzato</p> <p>180865AT2125 – A 60 – – conf. 50 – € 4,60</p>	  <p>CAVALLOTTO CON MAGLIA TONDA In acciaio – Saldato Ø filo 8 mm Piastra 60x50x3 Maglia 20x21 Finitura tropicalizzata</p> <p>90015810 – Modello Con anello – – conf. 24 – € 3,30 90015820 – Modello Maglia tonda – – conf. 24 – € 2,80</p>

















<p>MINUTEX</p> <p>PIASTRA FORATA CON OCCHIOLO SALDATO Misura 200x90x3 Foro occhio Ø 35 mm Acciaio tropicalizzato</p> <p>90017458 - - conf. 1 - € 13,78</p> 	<p>SFR</p> <p>PIASTRINA DADO SALDATO Misura 50x50 mm Spessore 3 mm Fori Ø 5 mm</p> <p>90017450 - Dado M8 - - conf. 50 - € 1,14 90017451 - Dado M10 - - conf. 50 - € 1,16 90017452 - Dado M12 - - conf. 50 - € 1,26</p> 
<p>SFR</p> <p>PIASTRA DIRITTA CON OCCHIOLO SALDATO Misura 150x150 mm Spessore 4 mm Fori Ø 11 mm Foro occhio Ø 40 mm</p> <p>90017455 - - conf. 4 - € 18,40</p> 	<p>SFR</p> <p>LASTRINA PORTALUCCHETTO</p> <p>90017150 - Tipo Piccolo - A 47 - B 16,5 - C 35,5 - Spess. 1,8 - conf. 100 - € 0,13 90017151 - Tipo Grande - A 56 - B 21,5 - C 48,5 - Spess. 2 - conf. 100 - € 0,22</p> 
<p>LASTRINA DI GIUNZIONE Piano con tondo Ø 80/100 Spessore 2,2 mm Acciaio tropicalizzato</p> <p>180912AT88 - A 80 - B 80 - - conf. 25 - € 2,60</p> 	<p>GIUNZIONE A 90° PER TONDI Ø80\100 Spessore 2,2 mm Acciaio tropicalizzato</p> <p>180904AT88 - A 80 - B 80 - - conf. 25 - € 2,60</p> 
<p>LASTRINA DI GIUNZIONE AD "U" Per travi inclinate Acciaio tropicalizzato</p> <p>180761AT045 - A 45 - B 44 - C 46 - Spessore 2,2 - conf. 10 - € 2,20 180761AT060 - A 60 - B 80 - C 61 - Spessore 2,5 - conf. 10 - € 6,40 180761AT070 - A 70 - B 80 - C 71 - Spessore 3 - conf. 10 - € 7,80 180761AT090 - A 90 - B 90 - C 91 - Spessore 3 - conf. 10 - € 9,80</p> 	<p>GIUNZIONE DI ESTREMITA' Ali esterne Spessore 2 mm Acciaio tropicalizzato</p> <p>180784AT60 - A 61 - B 100 - - conf. 10 - € 5,40 180784AT80 - A 81 - B 120 - - conf. 10 - € 6,20 180784AT90 - A 91 - B 120 - - conf. 10 - € 6,60 180784AT100 - A 101 - B 140 - - conf. 10 - € 6,80</p> 
<p>GIUNZIONI DI ESTREMITA' Ali esterne Spessore 2 mm Acciaio tropicalizzato</p> <p>180785AT60 - A 61 - B 100 - - conf. 10 - € 5,40 180785AT80 - A 81 - B 120 - - conf. 10 - € 6,20 180785AT90 - A 91 - B 120 - - conf. 10 - € 6,60 180785AT100 - A 101 - B 140 - - conf. 10 - € 6,80</p> 	<p>GIUNZIONI DI ESTREMITA' A LARGHEZZA VARIABILE Spessore 2 mm Acciaio tropicalizzato</p> <p>180786AT100 - B 24,5 - C 100 - - conf. 10 - € 6,40 180786AT140 - B 44,5 - C 140 - - conf. 10 - € 7,40</p> 
<p>SUPPORTO PER PILASTRI Acciaio tropicalizzato</p> <p>180800AT060 - A 62 - B 62 - - conf. 4 - € 30,00 180800AT070 - A 72 - B 72 - - conf. 4 - € 30,00 180800AT090 - A 92 - B 92 - - conf. 4 - € 30,00 180800AT100 - A 102 - B 102 - - conf. 4 - € 30,00</p> 	<p>SUPPORTO PER PILASTRI TONDI Acciaio tropicalizzato</p> <p>180922AT100 - Ø A 102 - BxC 150x150 - - conf. 4 - € 38,60 180922AT120 - Ø A 122 - BxC 150x150 - - conf. 4 - € 38,60 180922AT80 - Ø A 182 - BxC 230x230 - - conf. 4 - € 29,80</p> 



























 <p>SUPPORTO PER PILASTRI AD AVVITARE REGI-STABILE Acciaio tropicalizzato</p> <p>180803AT01 - A 115 - B 31 - C 31 - D 28,5Spess. 2,5 - conf. 12 - € 5,20</p> <p>180803AT00 - A 167 - B 50 - C 38 - D 47Spess. 3 - conf. 8 - € 7,40</p> <p>180803AT03 - A 177 - B 73 - C 46 - D 70Spess. 3 - conf. 8 - € 12,00</p>	 <p>SUPPORTO ANCORAGGIO Registrabile Spessore 5 mm Acciaio tropicalizzato</p> <p>180788AT60 - A 60 / 140 - - conf. 4 - € 31,40</p>
 <p>SUPPORTO ANCORAGGIO Registrabile Spessore 5 mm Acciaio tropicalizzato</p> <p>180938AT60 - A 70 / 150 - - conf. 4 - € 31,40</p>	 <p>SUPPORTI DI ANCORAGGIO REGISTRABILI Misu-re 70x140</p> <p>180789AT90 - - conf. 1 - € 33,00</p>
 <p>PROFILI PVC ANGOLARE Colore bianco</p> <p>1881549/OP - - conf. 30 - € 2,88</p> <p>1881546/OP - Misura 2000x10x10 - - conf. 30 - € 1,26</p> <p>1881547/OP - Misura 2000x15x15 - - conf. 30 - € 1,74</p> <p>1881548/OP - Misura 2000x20x20 - - conf. 30 - € 2,48</p> <p>1881557C/OP - Misura 2000x30x30 - - conf. 30 - € 3,30</p> <p>1881557E/OP - Misura 2000x40x40 - - conf. 30 - € 6,80</p>	 <p>PROFILI PVC ANGOLARE "L" Colore bianco</p> <p>1881550/OP - Misura 2000x20x10 - - conf. 30 - € 1,74</p> <p>1881552/OP - Misura 2000x30x20 - - conf. 30 - € 2,88</p> <p>1881556/OP - Misura 2000x40x10 - - conf. 30 - € 2,88</p>
 <p>PROFILI PVC A "U" Colore bianco</p> <p>188133G/OP - Misura 2600X10X14 - - conf. 30 - € 3,92</p> <p>188133H/OP - Misura 2600X10X21 - - conf. 30 - € 4,74</p>	 <p>PROFILI PVC ANGOLARI Colore bianco</p> <p>1881546B/OP - Misura 1000x10x10 - - conf. 30 - € 0,66</p> <p>1881547B/OP - Misura 1000x15x15 - - conf. 30 - € 0,90</p> <p>1881548D/OP - Misura 1000x20x20 - - conf. 30 - € 1,20</p> <p>1881549D/OP - Misura 1000x25x25 - - conf. 30 - € 1,42</p> <p>1881557C1/OP - Misura 1000x30x30 - - conf. 30 - € 1,68</p> <p>segue...</p>
 <p>continua...</p> <p>1881557E1/OP - Misura 1000x40x40 - - conf. 30 - € 3,50</p> <p>1881557F1/OP - Misura 1000x50x50 - - conf. 30 - € 4,32</p>	 <p>PROFILO PVC ANGOLARE "L" Colore bianco</p> <p>1881550B/OP - Misura 1000x20x10 - - conf. 30 - € 0,90</p> <p>1881551B/OP - Misura 1000x25x20 - - conf. 30 - € 1,30</p> <p>1881552B/OP - Misura 1000x30x20 - - conf. 30 - € 1,40</p> <p>1881556B/OP - Misura 1000x40x10 - - conf. 30 - € 1,48</p>
 <p>PIATTO FERRO Metri 2</p> <p>1882000 - Misura 2000x15x3 - - conf. 7 - € 4,94</p> <p>1882002 - Misura 2000x20x3 - - conf. 7 - € 5,36</p> <p>1882004 - Misura 2000x25x3 - - conf. 7 - € 6,60</p> <p>1882006 - Misura 2000x30x3 - - conf. 7 - € 9,06</p>	 <p>PIATTO FERRO ANGOLARE Metri 2</p> <p>1882018 - Misura 2000x20x20 - - conf. 7 - € 10,30</p> <p>1882020 - Misura 2000x30x30 - - conf. 7 - € 14,84</p> <p>1882022 - Misura 2000x40x40 - - conf. 7 - € 18,54</p>



 <p>ANGOLO FERRO A "L" 1882049 - Misura 20x13x4 - - conf. 7 - € 10,50</p> 	 <p>PROFILI ALLUMINIO ANGOLARE A "L" 188980 - Misura 1000x15x10 - - conf. 10 - € 2,48 188975 - Misura 1000x20x10 - - conf. 10 - € 2,68 188979 - Misura 1000x30x15 - - conf. 10 - € 3,30 188978 - Misura 1000x40x15 - - conf. 10 - € 6,18 188955 - Misura 2000x15x10 - - conf. 10 - € 4,54 segue...</p> 
 <p>continua... 188950 - Misura 2000x20x10 - - conf. 10 - € 4,94 188954 - Misura 2000x30x15 - - conf. 10 - € 5,98 188953 - Misura 2000x40x15 - - conf. 10 - € 11,54</p> 	 <p>CONNETTORE PUNTALE QUADRO ALETTATO Colore nero 1882450 - Misura 20x20 - - conf. 5 - € 1,30 1882451 - Misura 25x25 - - conf. 5 - € 1,52</p> 
 <p>PIATTO FERRO Metri 1 1882000A - Misura 1000x15x3 - - conf. 7 - € 2,68 1882002A - Misura 1000x20x3 - - conf. 7 - € 2,88 1882004A - Misura 1000x25x3 - - conf. 7 - € 3,50 1882006A - Misura 1000x30x3 - - conf. 7 - € 4,94</p> 	 <p>PIATTO ALLUMINIO 188778 - Misura 1000x15x2 - - conf. 10 - € 2,88 188775 - Misura 1000x20x2 - - conf. 10 - € 3,10 188777 - Misura 1000x25x2 - - conf. 10 - € 3,70 188780 - Misura 1000x30x2 - - conf. 10 - € 4,12 188753 - Misura 2000x15x2 - - conf. 10 - € 5,16 segue...</p> 
 <p>continua... 188750 - Misura 2000x20x2 - - conf. 10 - € 5,76 188752 - Misura 2000x25x2 - - conf. 10 - € 6,80 188755 - Misura 2000x30x2 - - conf. 10 - € 7,82</p> 	 <p>LAMIERA ACCIAIO NATURALE STIRATO 188451A - lungh. 500x200 - - conf. 2 - € 6,38</p> 
 <p>BATTISCOPA Mod. Batiplast 2000x65 mm 188170101 - Colore Bianco - - conf. 1 - € 2,60 188170104 - Colore Grigio Scuro - - conf. 1 - € 2,60 188170115 - Colore Nero - - conf. 1 - € 2,60 188170141 - Colore Mogano - - conf. 1 - € 2,60</p> 	 <p>TUBO TONDO FERRO 1882077A - Misura 1000x12 - - conf. 7 - € 4,12 1882083 - Misura 1000x16 - - conf. 7 - € 9,06 1882083A - Misura 1000x16 - - conf. 7 - € 4,94 1882084A - Misura 1000x20 - - conf. 7 - € 5,98 1882077 - Misura 2000x12 - - conf. 7 - € 7,62 1882084 - Misura 2000x20 - - conf. 7 - € 11,12</p> 
 <p>ANGOLO FERRO Metri 1 1882018A - Misura 1000x20x20 - - conf. 7 - € 5,56 1882020A - Misura 1000x30x30 - - conf. 7 - € 7,82 1882022A - Misura 1000x40x40 - - conf. 7 - € 9,68</p> 	 <p>LAMIERA ALLUMINIO BRILLANTE LISCIO 188456A - Dimensioni 500x200x0,5 - - conf. 2 - € 6,80 188476B - Dimensioni 500x500x0,5 - - conf. 2 - € 13,60</p> 















 <p>TUBO QUADRO FERRO</p> <p>1882110A – Misura 1000x20x20 – – conf. 7 – € 7,62 1882110 – Misura 2000x20x20 – – conf. 7 – € 14,22</p> 	 <p>LAMIERA ALLUMINIO NATURALE LISCIO</p> <p>188455A – Misura 500x200x0,5 – – conf. 2 – € 5,76 188455B – Misura 500x400x0,5 – – conf. 2 – € 9,48</p> 
 <p>LAMIERA AL CHICCO DI RISO</p> <p>188457A – Misura 500x200x1,5 – – conf. 2 – € 18,12</p> 	 <p>PROFILO ANGOLARE ALLUMINIO</p> <p>188850 – – conf. 10 – € 4,54 188875 – Misura 1000x10x10 – – conf. 10 – € 2,48 188876 – Misura 1000x15x15 – – conf. 10 – € 2,68 188877 – Misura 1000x20x20 – – conf. 10 – € 3,30 188878 – Misura 1000x25x25 – – conf. 10 – € 3,50 segue...</p> 
 <p>continua...</p> <p>188880 – Misura 1000x30x30 – – conf. 10 – € 3,92 188881 – Misura 1000x40x40 – – conf. 10 – € 7,00 188851 – Misura 2000x15x15 – – conf. 10 – € 5,16 188852 – Misura 2000x20x20 – – conf. 10 – € 6,18 188853 – Misura 2000x25x25 – – conf. 10 – € 6,80 segue...</p> 	 <p>continua...</p> <p>188855 – Misura 2000x30x30 – – conf. 10 – € 7,62 188856 – Misura 2000x40x40 – – conf. 10 – € 13,60</p> 
 <p>TUBO TONDO ALLUMINIO</p> <p>1881112 – Misura 1000x10 – – conf. 10 – € 2,88 1881113 – Misura 1000x12 – – conf. 10 – € 2,88 1881114 – Misura 1000x16 – – conf. 10 – € 3,50 1881116 – Misura 1000x20 – – conf. 10 – € 4,12 1881102 – Misura 2000x10 – – conf. 10 – € 5,36 segue...</p> 	 <p>continua...</p> <p>1881103 – Misura 2000x12 – – conf. 10 – € 5,36 1881104 – Misura 2000x16 – – conf. 10 – € 6,60 1881106 – Misura 2000x20 – – conf. 10 – € 7,82</p> 
 <p>UNGHETTA ALLUMINIO</p> <p>1881071 – Misure 1000x18 – – conf. 10 – € 2,68 1881073 – Misure 1000x25 – – conf. 10 – € 3,10 1881061 – Misure 2000x18 – – conf. 10 – € 4,94 1881063 – Misure 2000x25 – – conf. 10 – € 5,76</p> 	 <p>TUBO A "Q" ALLUMINIO</p> <p>1881190 – Misura 1000x20x20 – – conf. 10 – € 5,16 1881180 – Misura 2000x20x20 – – conf. 10 – € 9,88</p> 
 <p>REGGIMENSOLA IN ACCIAIO STAMPATO verniciatura BIANCA</p> <p>1802522B12 – A 120 – B 83 – Portata 34 Kg – – conf. 10 – € 1,50 1802522B15 – A 145 – B 100 – Portata 25 Kg – – conf. 10 – € 1,76 1802522B20 – A 195 – B 135 – Portata 40 Kg – – conf. 10 – € 2,60 1802522B25 – A 245 – B 165 – Portata 35 Kg – – conf. 10 – € 3,20 1802522B30 – A 295 – B 195 – Portata 39 Kg – – conf. 10 – € 4,60 segue...</p> 	 <p>continua...</p> <p>1802522B35 – A 345 – B 230 – Portata 33 Kg – – conf. 10 – € 5,40 1802522B40 – A 395 – B 260 – Portata 40 Kg – – conf. 10 – € 6,80</p> 



 <p>MENSOLA IN ACCIAIO STAMPATO Bianco con saetta di rinforzo</p> <p>1803522B30 - A 295 - B 195 - S 41 - Portata 150 Kg - conf. 10 - € 5,80 1803522B40 - A 395 - B 260 - S 41 - Portata 180 Kg - conf. 10 - € 9,60 1803522B50 - A 490 - B 320 - S 41 - Portata 170 Kg - conf. 10 - € 12,60</p>	 <p>REGGIMENSOLA IN ACCIAIO STAMPATO verniciatura NERA</p> <p>1802522N12 - A 120 - B 83 - S 31 - Portata 34 Kg - conf. 10 - € 1,50 1802522N15 - A 145 - B 100 - S 31 - Portata 25 Kg - conf. 10 - € 1,76 1802522N20 - A 195 - B 135 - S 36 - Portata 40 Kg - conf. 10 - € 2,60 1802522N25 - A 245 - B 165 - S 36 - Portata 35 Kg - conf. 10 - € 3,20 <i>segue...</i></p>
<p><i>continua...</i></p>  <p>1802522N30 - A 295 - B 195 - S 41 - Portata 39 Kg - conf. 10 - € 4,60 1802522N35 - A 345 - B 230 - S 41 - Portata 33 Kg - conf. 10 - € 5,40</p>	 <p>REGGIMENSOLA IN ACCIAIO STAMPATO verniciatura MARRONE</p> <p>1802522M12 - A 120 - B 83 - S 31 - Portata 34 Kg - conf. 10 - € 1,50 1802522M15 - A 145 - B 100 - S 31 - Portata 25 Kg - conf. 10 - € 1,76 1802522M20 - A 195 - B 135 - S 36 - Portata 40 Kg - conf. 10 - € 2,60 1802522M25 - A 245 - B 165 - S 36 - Portata 35 Kg - conf. 10 - € 3,20 <i>segue...</i></p>
<p><i>continua...</i></p>  <p>1802522M30 - A 295 - B 195 - S 41 - Portata 39 Kg - conf. 10 - € 4,60 1802522M35 - A 345 - B 230 - S 41 - Portata 33 Kg - conf. 10 - € 5,40</p>	 <p>REGGIMENSOLA IN ACCIAIO STAMPATO verniciatura SILVER</p> <p>1802522S12 - A 120 - B 83 - S 31 - Portata 34 Kg - conf. 10 - € 1,50 1802522S15 - A 145 - B 100 - S 31 - Portata 25 Kg - conf. 10 - € 1,76 1802522S20 - A 195 - B 135 - S 36 - Portata 40 Kg - conf. 10 - € 2,60 1802522S25 - A 245 - B 165 - S 36 - Portata 35 Kg - conf. 10 - € 3,20 <i>segue...</i></p>
<p><i>continua...</i></p>  <p>1802522S30 - A 295 - B 195 - S 41 - Portata 39 Kg - conf. 10 - € 4,60 1802522S35 - A 345 - B 230 - S 41 - Portata 33 Kg - conf. 10 - € 5,40</p>	 <p>MENSOLA PER PROFILI IN ACCIAIO STAMPATO Passo cremagliera 32 Zincata</p> <p>1802770AZ25 - A 222 - Portata 90 Kg - conf. 10 - € 3,00 1802770AZ30 - A 272 - Portata 75 Kg - conf. 10 - € 3,80 1802770AZ40 - A 374 - Portata 90 Kg - conf. 10 - € 7,80 1802770AZ4A - A 370 - Portata 40 Kg - conf. 10 - € 5,60</p>
 <p>CREMAGLIERA IN ACCIAIO STAMPATO Passo cremagliera 32 Zincata</p> <p>1802750AZ100 - A 1000 - conf. 10 - € 10,20 1802750AZ198 - A 1980 - conf. 10 - € 18,40</p>	 <p>REGGIMENSOLA NERVATA BIANCA</p> <p>500509672 - misura 100x125 - conf. 20 - € 0,50 500509673 - misura 125x150 - conf. 20 - € 0,60 500509674 - misura 150x200 - conf. 20 - € 0,70 500509675 - misura 200x250 - conf. 20 - € 1,98 500509676 - misura 250x300 - conf. 20 - € 1,34 500509677 - misura 300x350 - conf. 20 - € 1,74</p>
 <p>REGGIMENSOLA NERVATA GRIGIA</p> <p>500501603 - misura 125x150 - conf. 20 - € 0,58 500501604 - misura 150x200 - conf. 20 - € 0,70 500501605 - misura 200x250 - conf. 20 - € 0,94 500501606 - misura 250x300 - conf. 20 - € 1,34 500501607 - misura 300x350 - conf. 20 - € 1,74</p>	 <p>MENSOLE A SCOMPARSA CPF acciaio tropicalizzata</p> <p>50014933 - Foro 12 - Misura 10 X100 - Tipo CPF - conf. 20 - € 2,40 50014934 - Foro 12 - Misura 10 X150 - Tipo CPF - conf. 20 - € 2,48 50014954 - Foro 12 - Misura 12 x 80 - Tipo CPF - conf. 20 - € 2,48 50014930 - Foro 14 - Misura 14 x120 - Tipo CPF - conf. 20 - € 2,60 50014931 - Foro 14 - Misura 14 x145 - Tipo CPF - conf. 20 - € 2,60 <i>segue...</i></p>



<p>fischer</p> <p>continua... 50014932 - Foro 14 - Misura 14 x170 - Tipo CPF - - conf. 20 - € 2,80</p> 	<p>BOLIS ITALIA</p> <p>REGGIMENSOLA A SCOMPARSA in acciaio zincato con tassello a espansione</p> <p>90015400 - M x A 8 x 100 - foro 12 - - conf. 50 - € 1,24 90015401 - M x A 8 x 150 - foro 12 - - conf. 50 - € 1,18 90015408 - M x A 12 x 150 - foro 14 - - conf. 30 - € 2,20 90015409 - M x A 12 x 170 - foro 14 - - conf. 30 - € 2,40</p> 
<p>BOLIS ITALIA</p> <p>REGGIMENSOLA TOSCANIA Effetto rustico bugnato</p> <p>90015021 - L 140 - H 110 - Finitura nero - - conf. 1 - € 5,80 90015022 - L 140 - H 110 - Finitura argento anticato - - conf. 1 - € 5,60 90015023 - L 140 - H 110 - Finitura rame - - conf. 1 - € 5,60 90015024 - L 230 - H 175 - Finitura nero - - conf. 1 - € 7,40 segue...</p> 	<p>BOLIS ITALIA</p> <p>continua... 90015025 - L 230 - H 175 - Finitura argento anticato - - conf. 1 - € 7,20 90015026 - L 230 - H 175 - Finitura rame - - conf. 1 - € 7,20</p> 
<p>MINUTEX</p> <p>REGGIMENSOLA RIPOSTIGLIO Tropicalizzata</p> <p>90015132 - L.cm. 30 - - conf. 6 - € 2,72 90015133 - L.cm. 40 - - conf. 6 - € 3,54 90015134 - L.cm. 50 - - conf. 6 - € 5,16</p> 	<p>MINUTEX</p> <p>REGGIMENSOLA RIPOSTIGLIO Laccata bianca</p> <p>90015135 - L. cm. 30 - - conf. 6 - € 3,88 90015136 - L. cm. 40 - - conf. 6 - € 4,14</p> 
<p>MINUTEX</p> <p>REGGIMENSOLA RIPOSTIGLIO Laccata rosso</p> <p>90015125 - L. cm. 40 - - conf. 6 - € 5,38 90015124 - L. cm. 30 - - conf. 6 - € 3,80</p> 	<p>MENSOLE FORTI montaggio semplice e veloce Acciaio zincato</p> <p>1802576AZ30 - A 295 - B 215 - Portata 300 Kg - - conf. 10 - € 6,20 1802576AZ40 - A 395 - B 279 - Portata 250 Kg - - conf. 10 - € 8,20 1802576AZ50 - A 495 - B 343 - Portata 200 Kg - - conf. 10 - € 10,40</p> 
<p>MENSOLE RIBALTABILE a tre posizioni acciaio zincato</p> <p>1802534Z30 - A 300 - B 200 - H 30 - S 22Portata 200 Kg - conf. 4 - € 20,00 1802534Z40 - A 400 - B 272 - H 36 - S 27Portata 200 Kg - conf. 4 - € 24,60</p> 	<p>BOLIS ITALIA</p> <p>REGGIMENSOLA ROBUSTA Zincata Barra smontabile Portata 35 Kg</p> <p>90015110 - Misura 30 cm - - conf. 6 - € 2,80 90015111 - Misura 40 cm - - conf. 6 - € 3,00 90015112 - Misura 50 cm - - conf. 6 - € 5,00</p> 
<p>MENSOLE EXTRAFORTI mensole di grande portata in acciaio zincato</p> <p>1802576AZ30S - A 295 - B 215 - Portata 400 Kg - - conf. 10 - € 9,60 1802576AZ40S - A 395 - B 279 - Portata 350 Kg - - conf. 10 - € 12,60 1802576AZ50S - A 495 - B 343 - Portata 350 Kg - - conf. 10 - € 17,80</p> 	<p>BOLIS ITALIA</p> <p>REGGIMENSOLA OBELIX Art. 2043</p> <p>90015311 - L. cm. 30 - Colore zincata - - conf. 10 - € 6,42 90015312 - L. cm. 40 - Colore zincata - - conf. 10 - € 8,66 90015313 - L. cm. 50 - Colore zincata - - conf. 10 - € 10,84 90015315 - L. cm. 30 - Colore nera - - conf. 10 - € 6,42 90015316 - L. cm. 40 - Colore nera - - conf. 10 - € 8,56 90015317 - L. cm. 50 - Colore nera - - conf. 10 - € 10,80</p> 



 <p>REGGIMENSOLA PALLADIO</p> <p>90015041 - L x H 140 x 110 - Finitura bianco - - conf. 2 - € 7,86</p> <p>90015042 - L x H 140 x 110 - Finitura argento - - conf. 2 - € 7,80</p> <p>90015043 - L x H 140 x 110 - Finitura cromo - - conf. 2 - € 12,08</p> <p>90015044 - L x H 230 x 180 - Finitura bianco - - conf. 2 - € 11,12</p> <p>90015045 - L x H 230 x 180 - Finitura argento - - conf. 2 - € 10,60</p> <p>90015046 - L x H 230 x 180 - Finitura cromo - - conf. 2 - € 16,64</p> 	 <p>REGGIMENSOLA PIEGHEVOLE colore bianco portata 50 Kg.</p> <p>90015250 - L x H 200 - - conf. 10 - € 5,62</p> <p>90015251 - L x H 300 - - conf. 10 - € 7,02</p> <p>90015252 - L x H 400 - - conf. 10 - € 10,66</p> 
 <p>REGGIMENSOLA PESANTE SENZA SAETTA spessore 3,5 ferro zincato</p> <p>90015051 - Ax B 70x80 - - conf. 40 - € 0,52</p> <p>90015052 - Ax B 70x100 - - conf. 40 - € 0,56</p> <p>90015053 - Ax B 70x120 - - conf. 40 - € 0,60</p> <p>90015054 - Ax B 70x150 - - conf. 40 - € 0,66</p> <p>90015055 - Ax B 70x200 - - conf. 40 - € 0,84</p> 	 <p>MENSOLE SAETTA PESANTI Acciaio zincato</p> <p>1802579Z15 - A 145 - B 100 - C 20 - - conf. 10 - € 2,20</p> <p>1802579Z20 - A 195 - B 100 - C 20 - - conf. 10 - € 2,60</p> <p>1802579Z25 - A 245 - B 100 - C 20 - - conf. 10 - € 2,80</p> 
 <p>SUPERMENSOLA tropicalizzata</p> <p>90015750 - A 18 - B 12 - - conf. 6 - € 3,36</p> <p>90015751 - A 25 - B 15 - - conf. 6 - € 3,82</p> 	 <p>MENSOLA PESANTE Zincata</p> <p>1802577Z06 - A 60 - B 70 - C 20 - - conf. 20 - € 0,84</p> <p>1802577Z08 - A 80 - B 70 - C 20 - - conf. 20 - € 0,90</p> <p>1802577Z10 - A 99 - B 70 - C 20 - - conf. 20 - € 1,02</p> <p>1802577Z12 - A 115 - B 70 - C 20 - - conf. 20 - € 1,10</p> <p>1802577Z15 - A 145 - B 70 - C 20 - - conf. 20 - € 1,22</p> <p>1802577Z20 - A 195 - B 70 - C 20 - - conf. 20 - € 1,54</p> 
 <p>MENSOLA RIBALTABILE IN ACCIAIO STAMPATO Verniciata bianca</p> <p>1802530B30 - A 287 - Portata 32 Kg - - conf. 1 - € 13,00</p> <p>1802530B40 - A 387 - Portata 24 Kg - - conf. 1 - € 15,40</p> 	 <p>MENSOLA IN ACCIAIO STAMPATO CON SAETTA DI RINFORZO Acciaio tropicalizzato</p> <p>1802521AT30 - A 295 - B 195 - S 41 - Portata 150 Kg - conf. 10 - € 6,20</p> <p>1802521AT41 - A 345 - B 230 - S 41 - Portata 165 Kg - conf. 10 - € 8,00</p> <p>1802521AT51 - A 395 - B 260 - S 41 - Portata 180 Kg - conf. 10 - € 10,20</p> <p>segue...</p> 
 <p>continua...</p> <p>1802521AT55 - A 490 - B 320 - S 41 - Portata 170 Kg - conf. 10 - € 12,80</p> 	 <p>REGGIMENSOLA TERMOSIFONI PIATTI Art. 5502 zincata</p> <p>90015702 - - conf. 12 - € 7,36</p> 
 <p>REGGIMENSOLA MALTA per termosifoni</p> <p>90015700 - finitura zincato - Art. 5512 - - conf. 12 - € 6,82</p> <p>90015701 - finitura avorio - Art. 5516 - - conf. 12 - € 10,64</p> 	 <p>FERMAPALO PER ANTENNE acciaio tropicalizzato</p> <p>90012990 - - conf. 25 - € 2,12</p> 



REGGIMENSOLA LEONARDO ricoperta plastica MARRONE *Articolo venduto singolarmente*

- 9001512M - L. cm. 12 -
- conf. 10 - € 0,96
- 9001518M - L. cm. 18 -
- conf. 10 - € 1,15
- 9001524M - L. cm. 24 -
- conf. 10 - € 1,55



REGGIMENSOLA LEONARDO Ricoperta plastica NERA *Articolo venduto singolarmente*

- 9001512N - L.cm. 12 -
- conf. 10 - € 1,01
- 9001518N - L.cm. 18 -
- conf. 10 - € 1,15
- 9001524N - L.cm. 24 -
- conf. 10 - € 1,63



REGGIMENSOLA LEONARDO Ricoperta plastica FRASSINO *Articolo venduto singolarmente*

- 9001512F - L.cm. 12 -
- conf. 10 - € 0,96
- 9001518F - L.cm. 18 -
- conf. 10 - € 1,15
- 9001524F - L.cm. 24 -
- conf. 10 - € 1,55



REGGIMENSOLA LEONARDO Ricoperta plastica ROSSA *Articolo venduto singolarmente*

- 9001512R - L.cm. 12 -
- conf. 10 - € 0,96
- 9001518R - L.cm. 18 -
- conf. 10 - € 1,09
- 9001524R - L.cm. 24 -
- conf. 10 - € 1,55



REGGIMENSOLA LEONARDO Ricoperta plastica BIANCA *Articolo venduto singolarmente*

- 9001512B - L.cm. 12 -
- conf. 10 - € 1,01
- 9001518B - L.cm. 18 -
- conf. 10 - € 1,15
- 9001524B - L.cm. 24 -
- conf. 10 - € 1,63



REGGIMENSOLA BOOMERANG Blister 2 pezzi realizzata in acciaio verniciato a polveri epossidiche due diverse possibilità di utilizzo portata coppia: 30 Kg completa di viti e tasselli

- 90014930 - Finitura Argento -
- conf. 1 - € 7,34
- 90014931 - Finitura Nero -
- conf. 1 - € 7,34
- 90014932 - Finitura Bianco -
- conf. 1 - € 7,34

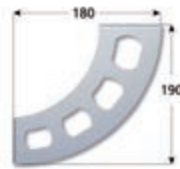

BLISTER 2 PEZZI REGGIMENSOLA LUNA in zama verniciata a liquido regolabile per diversi spessori completa di viti e tasselli **Finitura Argento**

- 90014940 - A 62-84 - D 68 - C 0-22 - P.Kg 20
- conf. 4 - € 17,44
- 90014941 - A 87-123 - D 100 - C 0-36 - P.Kg 50
- conf. 4 - € 20,88



BLISTER 2 PEZZI REGGIMENSOLA LUNA in zama verniciata a liquido regolabile per diversi spessori completa di viti e tasselli **Finitura Nero**

- 90014946 - A 87-123 - D 100 - C 0-36 - P.Kg 50
- conf. 4 - € 20,88



BLISTER 2 pezzi REGGIPIANI A25 x B3-10 x D25 Port. Cp: 20 Kg In ottone verniciato completi di viti e tasselli

- 90014901 - Finitura Argento -
- conf. 4 - € 10,64
- 90014909 - Finitura Cromato -
- conf. 4 - € 11,86



BLISTER 2 PEZZI REGGIMENSOLA GONDOLA realizzata in ABS regolabile per diversi spessori completa di viti e tasselli **Finitura Argento**

- 90014920 - Ax B 76-90x60 - D 3-17 - P.Kg 15 -
- conf. 30 - € 7,50
- 90014921 - Ax B 118-150x90 - D 4-36 - P.Kg 35 -
- conf. 28 - € 12,78



BLISTER 2 PEZZI REGGIMENSOLA GONDOLA realizzata in ABS regolabile per diversi spessori completa di viti e tasselli **Finitura Nero**

- 90014926 - Ax B 118-150x90 - D 4-36 - P.Kg 35 -
- conf. 28 - € 12,78



BLISTER 2 pezzi REGGIMENSOLA GONDOLA A80 x B100 Port. Cp: 50 Kg realizzata in ABS Reg. per diversi spess. completa di viti e tasselli

- 90014910 - Finitura Cromato -
- conf. 20 - € 10,04
- 90014911 - Finitura Nero -
- conf. 20 - € 5,64
- 90014912 - Finitura Bianco -
- conf. 20 - € 5,64
- 90014913 - Finitura Argento -
- conf. 20 - € 5,40





BLISTER 2 Pezzi REGGIPIANI A27 x B10 x D30
Port. Cp: 15 Kg Nylon verniciati completi di viti e tasselli per il montaggio

90014904 - Finitura Ottone -
- conf. 4 - € 3,26
90014905 - Finitura Cromato -
- conf. 4 - € 3,44



GANCIO A SOFFITTO PER BICI Art. 822

90015771 -
- conf. 12 - € 2,90



COPPIA GANCIO BICI Art. 821

90015770 -
- conf. 6 - € 6,16

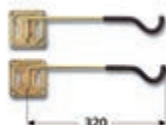

GANCIA SOFFITTO PORTATUTTO Art. 820

90015775 -
- conf. 10 - € 4,56



MENSOLA per bici a parete articolo 823

90015772 -
- conf. 1 - € 11,80



GANCIO PORTABICI in tubo con guaina

90015774 -
- conf. 10 - € 3,40



GANCIO SINGOLO 9 multiuso in tubo piegato e verniciato con guaina in plastica

90015762 -
- conf. 20 - € 2,54



GANCIO SINGOLO 18 multiuso in tubo piegato e verniciato con guaina in plastica

90015764 -
- conf. 10 - € 3,64



GANCIO SINGOLO 29 multiuso in tubo piegato e verniciato con guaina in plastica

90015765 -
- conf. 10 - € 4,12



GANCIO MULTIUSO da applicare a soffitto o al muro in tubo piegato e verniciato con gommino in plastica

90015777 -
- conf. 5 - € 3,02



GANCIO MULTIUSO DA PARETE

1804040AZ150 - A 150 - B 150 - C 90 - Portata 85 Kg
- conf. 1 - € 6,20
1804040AZ250 - A 250 - B 250 - C 120 - Portata 45 Kg
- conf. 1 - € 6,60

























GANCIO A "L" DIRITTO A PARETE

1804030AZ150 - A 120 - B 150 - C 25 - Portata 85 Kg
- conf. 1 - € 5,40
1804030AZ250 - A 120 - B 250 - C 25 - Portata 45 Kg
- conf. 1 - € 5,80

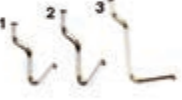







 <p>GANCIO PORTA BICICLETTE da parete ripiegabile 1804110AZ320 - - conf. 10 - € 4,60</p> 	 <p>GANCIO A "L" da soffitto 1804100AZ200 - - conf. 10 - € 6,80</p> 
 <p>GANCIO A "S" Multiuso 1804090AZ170 - - conf. 10 - € 1,60</p> 	 <p>GANCIO RIPIEGABILE Multiuso da parete Acciaio zincato 1804080AZ080 - Misura 80 mm - - conf. 10 - € 6,60 1804120AZ200 - Misura 100mm - - conf. 10 - € 4,20 1804200AZ150 - Misura 150mm - - conf. 10 - € 6,00 1804210AZ200 - Misura 200mm - - conf. 10 - € 5,60</p> 
 <p>DOPPIO GANCIO A "L" da parete 1804070AZ200 - - conf. 10 - € 8,00</p> 	 <p>GANCIO A "U" Doppio da parete Acciaio zincato 1804050AZ180 - Misura 180mm - - conf. 10 - € 7,20 1804050AZ250 - Misura 250mm - - conf. 10 - € 8,20 1804060AZ400 - Misura 400mm - - conf. 10 - € 9,20</p> 
 <p>GANCI FILO DOPPIO Art. 405 in ferro nichelato 90015913 - L.cm. 10 - - conf. 50 - € 0,90 90015914 - L.cm. 15 - - conf. 50 - € 0,98</p> 	 <p>GANCIO FILO SINGOLO Art.401 ferro nichelato 90015910 - Lungh. cm 10 - - conf. 100 - € 0,38 90015911 - Lungh. cm 15 - - conf. 100 - € 0,40 90015912 - Lungh. cm 20 - - conf. 100 - € 0,44</p> 
 <p>GANCIO Per pannelli forati in ferro nichelato 90015904 - mod. 4 - - conf. 100 - € 0,06 90015905 - mod. 5 - - conf. 100 - € 0,08 90015906 - mod. 6 - - conf. 100 - € 0,12</p> 	 <p>GANCIO Per pannelli forati in ferro nichelato 90015901 - mod. 1 - - conf. 100 - € 0,04 90015902 - mod. 2 - - conf. 100 - € 0,06 90015903 - mod. 3 - - conf. 100 - € 0,08</p> 
 <p>GANCIO IN PLASTICA A MOLLA - n° 5 per pannello in nylon nero 90015925 - - conf. 100 - € 0,28</p> 	 <p>GANCIO IN PLASTICA OCCHIELLO GRANDE n° 1 per pannelli forati in nylon nero 90015921 - - conf. 100 - € 0,28</p> 



LASTRINE-PIASTRE-MENSOLE

 GANCIO IN PLASTICA OCCHIELLO PICCOLO - n° 2 per pannello in nylon nero 90015922 - - conf. 100 - € 0,28 	 GANCIO IN PLASTICA CURVO - n° 6 per pannello in nylon nero 90015926 - - conf. 100 - € 0,28 
 GANCIO IN PLASTICA DRITTO - LUNGO - n° 3 per pannello in nylon nero 90015923 - - conf. 100 - € 0,28 	 GANCIO IN PLASTICA DRITTO - MEDIO - n° 7 per pannello in nylon nero 90015927 - - conf. 100 - € 0,28 
 GANCIO IN PLASTICA INCLINATO - n° 4 per pannello in nylon nero 90015924 - - conf. 100 - € 0,28 	 PANNELLO FORATO 100 x 50 senza ganci 90015899 - - conf. 6 - € 24,80 
 ESPOSITORE ALDEGHI ESPOMENSOLE Dimensioni: 56X50 cm Pezzi: 148 Per maggiori informazioni chiedere al proprio agente di zona 180ESP1226 - - conf. 1 - € 862,00 	



CATENE E FUNI

SFOGLIA LA CATEGORIA









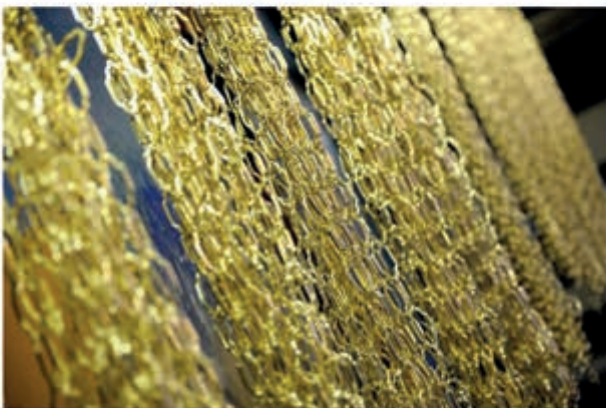



















Scaioli Catene

























since 1958





























 <p>CATENA GENOVESE ZINCATA In Scatola Dimensioni scatola 220x220x190 mm <i>Prezzo a confezione</i></p> <p>190755031 – Metri 150 – N° 11 – Ø mm 1,6 – Carico Kg. 15 – conf. 1 – € 106,60</p> <p>190755034 – Metri 150 – N° 14 – Ø mm 2,2 – Carico Kg. 25 – conf. 1 – € 122,20</p> <p>190755036 – Metri 100 – N° 16 – Ø mm 2,8 – Carico Kg. 40 – conf. 1 – € 108,60 segue...</p> 	 <p><i>continua...</i></p> <p>190755038 – Metri 75 – N° 18 – Ø mm 3,5 – Carico Kg. 125 – conf. 1 – € 111,20</p> <p>190755039 – Metri 60 – N° 19 – Ø mm 4,0 – Carico Kg. 150 – conf. 1 – € 101,60</p> <p>190755040 – Metri 50 – N° 20 – Ø mm 4,5 – Carico Kg. 200 – conf. 1 – € 105,60</p> <p>190755041 – Metri 40 – N° 21 – Ø mm 5,0 – Carico Kg. 250 – conf. 1 – € 97,80 segue...</p> 
 <p><i>continua...</i></p> <p>190755042 – Metri 35 – N° 22 – Ø mm 5,5 – Carico Kg. 300 – conf. 1 – € 106,40</p> <p>190755043 – Metri 30 – N° 23 – Ø mm 6,0 – Carico Kg. 350 – conf. 1 – € 103,80</p> <p>190755044 – Metri 25 – N° 24 – Ø mm 6,5 – Carico Kg. 400 – conf. 1 – € 99,00</p> <p>190755046 – Metri 22 – N° 26 – Ø mm 7,5 – Carico Kg. 520 – conf. 1 – € 117,60 segue...</p> 	 <p><i>continua...</i></p> <p>190755047 – Metri 18 – N° 27 – Ø mm 8,0 – Carico Kg. 630 – conf. 1 – € 113,20</p> <p>190755048 – Metri 15 – N° 28 – Ø mm 9,0 – Carico Kg. 750 – conf. 1 – € 117,00</p> <p>190755050 – Metri 10 – N° 30 – Ø mm 10,0 – Carico Kg. 900 – conf. 1 – € 102,60</p> <p>190755052 – Metri 10 – N° 32 – Ø mm 12,0 – Carico Kg. 1300 – conf. 1 – € 152,20</p> 
 <p>CATENA GENOVESE ZINCATA In Bobina <i>Prezzo a bobina</i></p> <p>190755061 – Metri 150 – N° 11 – Ø mm 1,6 – Carico Kg. 15 – conf. 1 – € 111,24</p> <p>190755064 – Metri 150 – N° 14 – Ø mm 2,2 – Carico Kg. 25 – conf. 1 – € 134,80</p> <p>190755066 – Metri 100 – N° 16 – Ø mm 2,8 – Carico Kg. 40 – conf. 1 – € 119,20 segue...</p> 	 <p><i>continua...</i></p> <p>190755068 – Metri 60 – N° 18 – Ø mm 3,5 – Carico Kg. 125 – conf. 1 – € 95,40</p> <p>190755069 – Metri 50 – N° 19 – Ø mm 4,0 – Carico Kg. 150 – conf. 1 – € 89,80</p> <p>190755071 – Metri 40 – N° 21 – Ø mm 5,0 – Carico Kg. 250 – conf. 1 – € 104,40</p> <p>190755073 – Metri 30 – N° 23 – Ø mm 6,0 – Carico Kg. 350 – conf. 1 – € 110,60 segue...</p> 
 <p><i>continua...</i></p> <p>190755076 – Metri 25 – N° 26 – Ø mm 7,5 – Carico Kg. 520 – conf. 1 – € 139,40</p> <p>190755077 – Metri 22 – N° 27 – Ø mm 8,0 – Carico Kg. 630 – conf. 1 – € 144,60</p> <p>190755078 – Metri 15 – N° 28 – Ø mm 9,0 – Carico Kg. 750 – conf. 1 – € 124,00</p> <p>190755080 – Metri 10 – N° 30 – Ø mm 10,0 – Carico Kg. 900 – conf. 1 – € 108,60 segue...</p> 	 <p><i>continua...</i></p> <p>190755082 – Metri 10 – N° 32 – Ø mm 12,0 – Carico Kg. 1300 – conf. 1 – € 158,40</p> 
 <p>CATENA GENOVESE INOX AISI 316 In Bobina <i>Prezzo a bobina</i></p> <p>190755100 – Metri 50 – N° 13 – Ø mm 2 – Carico Kg. 25 – conf. 1 – € 140,60</p> <p>190755101 – Metri 50 – N° 17 – Ø mm 3 – Carico Kg. 120 – conf. 1 – € 252,00</p> <p>190755102 – Metri 50 – N° 19 – Ø mm 4 – Carico Kg. 160 – conf. 1 – € 446,00 segue...</p> 	 <p><i>continua...</i></p> <p>190755103 – Metri 40 – N° 21 – Ø mm 5 – Carico Kg. 310 – conf. 1 – € 552,00</p> <p>190755104 – Metri 30 – N° 23 – Ø mm 6 – Carico Kg. 350 – conf. 1 – € 548,00</p> <p>190755105 – Metri 22 – N° 27 – Ø mm 8 – Carico Kg. 650 – conf. 1 – € 650,00</p> 
 <p>CATENA GENOVESE In Bobina Prezzo a bobina Lunghezza 10 metri</p> <p>190755405 – – conf. 1 – € 12,60</p> 	 <p>CATENA OVALE In Bobina Prezzo a bobina Lunghezza 30 metri</p> <p>190755311 – – conf. 1 – € 51,80</p> 

























  <p>GANCIO AD ESSE Zincato Vendita a confezione da 5 Kg.</p> <p>190755151 - N 17 - Ø mm 3 - Lunghezza 35 - - conf. 1 - € 37,40</p> <p>190755153 - N 19 - Ø mm 4 - Lunghezza 40 - - conf. 1 - € 31,20</p> <p>190755155 - N 21 - Ø mm 5 - Lunghezza 45 - - conf. 1 - € 28,60</p>	  <p>GANCI AD "S" Nichelati</p> <p>322A154N3 - Dimensioni 30x16 - Misura 3 - - conf. 100 - € 0,13</p> <p>322A154N4 - Dimensioni 38,5x21,5 - Misura 4 - - conf. 100 - € 0,14</p> <p>322A154N5 - Dimensioni 46x26,5 - Misura 5 - - conf. 100 - € 0,22</p>
  <p>CATENELLA GENOVESE Ferro ottonato Vendita a confezione da 25 mt</p> <p>190755011 - Misura 8 - - conf. 1 - € 22,20</p> <p>190755012 - Misura 10 - - conf. 1 - € 19,60</p> <p>190755013 - Misura 12 - - conf. 1 - € 20,40</p> <p>190755014 - Misura 14 - - conf. 1 - € 28,00</p>	  <p>CATENELLA GENOVESE Ferro nichelato Vendita a confezione da 25 mt</p> <p>190755001 - Misura 8 - - conf. 1 - € 22,20</p> <p>190755002 - Misura 10 - - conf. 1 - € 19,60</p> <p>190755003 - Misura 12 - - conf. 1 - € 20,40</p> <p>190755004 - Misura 14 - - conf. 1 - € 28,00</p>
  <p>CATENELLA GENOVESE Art. 301 ottone lucido</p> <p>90029408 - misura 8 - - conf. 25 - € 3,70</p> <p>90029410 - misura 10 - - conf. 25 - € 3,92</p> <p>90029412 - misura 12 - - conf. 25 - € 4,80</p> <p>90029414 - misura 14 - - conf. 25 - € 5,16</p> <p>90029416 - misura 16 - - conf. 25 - € 7,00</p>	  <p>CATENELLA PERLINE In bobina</p> <p>190755200 - Ø mm 3,6 - Conf. mt. 25 - Finitura cromata - - conf. 1 - € 69,00</p> <p>190755201 - Ø mm 3,6 - Conf. mt. 25 - Finitura ottonata - - conf. 1 - € 49,00</p>
  <p>CATENELLA TRANCIATA In bobina</p> <p>190755202 - Ø mm 0,5 - Conf. mt. 20 - Finitura cromata - - conf. 1 - € 65,00</p> <p>190755203 - Ø mm 0,5 - Conf. mt. 20 - Finitura ottonata - - conf. 1 - € 51,30</p>	  <p>CATENELLA OROLOGIO In bobina</p> <p>190755204 - Ø mm 1,3 - Conf. mt. 25 - Finitura ottonata - - conf. 1 - € 34,00</p> <p>190755205 - Ø mm 1,3 - Conf. mt. 25 - Finitura nichelata - - conf. 1 - € 34,00</p>
  <p>CATENELLA GOURMETTE In bobina</p> <p>190755206 - Ø mm 1,2 - Conf. mt. 25 - Finitura ottonata - - conf. 1 - € 29,80</p> <p>190755207 - Ø mm 1,2 - Conf. mt. 25 - Finitura nichelata - - conf. 1 - € 29,80</p> <p>190755208 - Ø mm 2,0 - Conf. mt. 15 - Finitura nera - - conf. 1 - € 29,80</p>	  <p>CATENELLA FORZATINA In bobina</p> <p>190755209 - Ø mm 1,1 - Conf. mt. 25 - Finitura ottonata - - conf. 1 - € 33,00</p> <p>190755551 - Ø mm 1,1 - Conf. mt. 25 - Finitura nichelata - - conf. 1 - € 33,00</p>
  <p>CATENELLA MARTELLATA In bobina</p> <p>190755210 - Ø mm 2,0 - Conf. mt. 10 - Finitura bronzata - - conf. 1 - € 13,20</p> <p>190755211 - Ø mm 2,0 - Conf. mt. 10 - Finitura nera - - conf. 1 - € 13,20</p>	  <p>CATENELLA GENOVESE In bobina</p> <p>190755212 - Ø mm 2,0 - Conf. mt. 10 - Finitura ottonata - - conf. 1 - € 12,60</p> <p>190755213 - Ø mm 2,0 - Conf. mt. 10 - Finitura ramata - - conf. 1 - € 12,60</p> <p>190755214 - Ø mm 2,0 - Conf. mt. 10 - Finitura vern. bianca - - conf. 1 - € 14,80</p>















 <p>CATENELLA OVALE In bobina</p> <p>190755215 - Ø mm 2,0 - Conf. mt. 10 - Finitura ottonata - - conf. 1 - € 12,60</p> 	 <p>CATENA RITORTA In Bobina</p> <p>190755451 - - conf. 1 - € 14,20 190755461 - - conf. 1 - € 46,40 190755462 - - conf. 1 - € 46,40</p> 
 <p>CATENA CATTEDRALE In Bobina Prezzo a bobina Lunghezza 20 metri</p> <p>190755265 - - conf. 1 - € 33,80</p> 	 <p>CATENA METALLO Bianca e Rossa Vendita a confezione da 30 mt</p> <p>190755140 - Ø mm 5 - - conf. 1 - € 163,00</p> 
 <p>CATENA PLASTICA Bianca e Rossa Vendita a confezione da 25 mt</p> <p>190755121 - Ø mm 6 - - conf. 1 - € 29,40 190755122 - Ø mm 8 - - conf. 1 - € 44,40</p> 	 <p>CONFEZIONE MORSETTI IN ACCIAIO ZINCATO BETA ART. 8016 Rispetta analisi di laboratorio e certificati</p> <p>200080160703 - Ø M3 - " 1/8 - Pezzi per confezione 100 - - conf. 1 - € 59,16 200080160705 - Ø M5 - " 3/16 - Pezzi per confezione 50 - - conf. 1 - € 38,28 200080160706 - Ø M6 - " 1/4 - Pezzi per confezione 50 - - conf. 1 - € 41,76 segue...</p> 
 <p>continua...</p> <p>200080160708 - Ø M8 - " 5/16 - Pezzi per confezione 30 - - conf. 1 - € 31,32 200080160710 - Ø M10 - " 3/8 - Pezzi per confezione 30 - - conf. 1 - € 46,98 200080160713 - Ø M13 - " 1/2 - Pezzi per confezione 15 - - conf. 1 - € 33,64</p> 	 <p>MORSETTI CON BASE IN GHISA Sigma by Beta ART. 8516 DIN 741 Zincati</p> <p>200085160003 - Ø 3 - " 1/8 - - conf. 100 - € 0,11 200085160005 - Ø 5 - " 3/16 - - conf. 100 - € 0,14 200085160006 - Ø 6 - " 1/4 - - conf. 100 - € 0,18 200085160008 - Ø 8 - " 5/16 - - conf. 50 - € 0,22 200085160010 - Ø 10 - " 3/8 - - conf. 50 - € 0,42</p> 
 <p>MORSETTI CAVALLOTTO Inox</p> <p>322A54903 - Misura 3-4 - - conf. 30 - € 0,90 322A54905 - Misura 5 - - conf. 25 - € 0,94 322A54906 - Misura 6 - - conf. 25 - € 1,12 322A54908 - Misura 8 - - conf. 20 - € 1,46 322A54910 - Misura 10 - - conf. 20 - € 2,40 322A54912 - Misura 12 - - conf. 20 - € 4,60</p> 	 <p>MORSETTI DIN 741 Corpo in ghisa Cavallotto in acciaio</p> <p>322A00303 - Misura 3 - - conf. 100 - € 0,10 322A00305 - Misura 5 - - conf. 100 - € 0,12 322A00306 - Misura 6 - - conf. 100 - € 0,14 322A00308 - Misura 8 - - conf. 50 - € 0,20 322A00310 - Misura 10 - - conf. 50 - € 0,40 segue...</p> 
 <p>continua...</p> <p>322A00312 - Misura 12 - - conf. 25 - € 0,76</p> 	 <p>MORSETTI A CAVALLOTTO per fune stampati a caldo Corpo e cavallotto in acciaio</p> <p>322A15603 - Misura 3-4 - - conf. 100 - € 0,36 322A15605 - Misura 5 - - conf. 100 - € 0,50 322A15606 - Misura 6 - - conf. 100 - € 0,54 322A15608 - Misura 8 - - conf. 50 - € 0,66 322A15610 - Misura 10 - - conf. 50 - € 1,00 segue...</p> 















 <p>continua... 322A15612 – Misura 12 – – conf. 50 – € 1,42</p> 	 <p>CONFEZIONE GRILLI PER SOLLEVAMENTO DIRITTI BETA ART. 8025 Tipo largo In acciaio al carbonio zincati Rispetta analisi di laboratorio e certificati</p> <p>200080250705 – Ø 5 – " 3/16 – Pezzi per confezione 25 – – conf. 1 – € 35,38</p> <p>200080250706 – Ø 6 – " 1/4 – Pezzi per confezione 25 – – conf. 1 – € 47,56</p> <p>segue...</p>
 <p>continua... 200080250708 – Ø 8 – " 5/16 – Pezzi per confezione 25 – – conf. 1 – € 80,04</p> <p>200080250710 – Ømm 10 – " 42585 – – conf. 1 – € 53,36</p> <p>200080250712 – Ømm 12 – " 42401 – – conf. 1 – € 55,10</p> 	 <p>GRILLI DRITTI ACCIAIO INOX BETA ART. 8225 Inox AISI 316 Rispetta analisi di laboratorio e certificati</p> <p>200082250204 – ØD 4 – " 5/32 – A 8 – WFL kg 50 – conf. 10 – € 3,02</p> <p>200082250205 – ØD 5 – " 3/16 – A 11 – WFL kg 70 – conf. 10 – € 3,32</p> <p>200082250206 – ØD 6 – " 1/4 – A 13 – WFL kg 100 – conf. 5 – € 3,66</p> <p>segue...</p>
 <p>continua... 200082250208 – ØD 8 – " 5/16 – A 17 – WFL kg 250 – conf. 5 – € 5,80</p> <p>200082250210 – ØD 10 – " 3/8 – A 21 – WFL kg 400 – conf. 3 – € 8,42</p> <p>200082250212 – ØD 12 – " 1/2 – A 25 – WFL kg 600 – conf. 3 – € 13,92</p> 	 <p>MORSETTI ACCIAIO INOX BETA ART. 8216 Inox AISI 316 Tipo leggeri Rispetta analisi di laboratorio e certificati</p> <p>200082160203 – Ø F mm 3 – WLF kg 1/8 – T 80 – N 3A mm M3 – conf. 15 – € 2,90</p> <p>200082160204 – Ø F mm 4 – WLF kg 5/32 – T 80 – N 3A mm M4 – conf. 10 – € 3,26</p> <p>200082160205 – Ø F mm 5 – WLF kg 3/16 – T 110 – N 3A mm M5 – conf. 10 – € 3,72</p> <p>segue...</p> 
 <p>continua... 200082160206 – Ø F mm 6 – WLF kg 1/4 – T 120 – N 5A mm M6 – conf. 10 – € 4,12</p> <p>200082160208 – Ø F mm 8 – WLF kg 5/16 – T 210 – N 5A mm M8 – conf. 5 – € 5,52</p> <p>200082160210 – Ø F mm 10 – WLF kg 3/8 – T 240 – N 5A mm M10 – conf. 5 – € 7,60</p> <p>200082160213 – Ø F mm 13 – WLF kg 1/2 – T 300 – N 5A mm M13 – conf. 5 – € 10,68</p> 	 <p>GRILLI DIRITTI TIPO LARGO Sigma by Beta ART. 8524 In acciaio al carbonio zincati Rispetta analisi di laboratorio e certificati</p> <p>200085240005 – B 19 – C 10 – D M5 – WFL kg 40 – conf. 100 – € 0,42</p> <p>200085240006 – B 24 – C 12 – D M6 – WFL kg 90 – conf. 100 – € 0,46</p> <p>200085240008 – B 32 – C 16 – D M8 – WFL kg 180 – conf. 50 – € 0,60</p> 
 <p>MORSETTI ACCIAIO INOX BETA ART. 8216 Inox AISI 316 Tipo leggeri Rispetta analisi di laboratorio e certificati</p> <p>200082160202 – Ø F mm 2 – WLF kg 5/64 – T 80 – N 3A mm M3 – conf. 1 – € 2,84</p> 	 <p>GOLFARI PER SOLLEVAMENTO FEMMINA BETA ART. 8042EZ DIN 582 femmina zincati Rispetta analisi di laboratorio e certificati</p> <p>200080420406 – Ø M6 – WLL kg 90 – F 14 – – conf. 60 – € 1,80</p> <p>200080420408 – Ø M8 – WLL kg 140 – F 20 – – conf. 60 – € 1,80</p> <p>200080420410 – Ø M10 – WLL kg 230 – F 25 – – conf. 50 – € 2,42</p> <p>200080420412 – Ø M12 – WLL kg 340 – F 30 – – conf. 25 – € 3,32</p> <p>segue...</p> 
 <p>continua... 200080420416 – Ø M16 – WLL kg 700 – F 35 – – conf. 15 – € 5,28</p> <p>200080420420 – Ø M20 – WLL kg 1200 – F 40 – – conf. 10 – € 8,02</p> <p>200080420424 – Ø M24 – WLL kg 1800 – F 50 – – conf. 5 – € 15,44</p> 	 <p>GOLFARI PER SOLLEVAMENTO FEMMINA Sigma by Beta ART. 8542 Zincato Rispetta analisi di laboratorio e certificati</p> <p>200085420106 – Ø M6 – Peso Kg 75 – – conf. 250 – € 0,64</p> <p>200085420108 – Ø M8 – Peso Kg 140 – – conf. 200 – € 0,68</p> 



<p>Beta</p> <p>GOLFARI PER SOLLEVAMENTO MASCHIO BETA ART. 8040EZ DIN 580 maschio zincati Rispetta analisi di laboratorio e certificati</p> <p>200080400406 - L min/max M6 - WLF kg 90 - - conf. 60 - € 1,80</p> <p>200080400408 - L min/max M8 - WLF kg 140 - - conf. 60 - € 1,80</p> <p>200080400410 - L min/max M10 - WLF kg 230 - - conf. 50 - € 2,42</p> <p>200080400412 - L min/max M12 - WLF kg 340 - - conf. 25 - € 3,22</p> <p>segue...</p> 	<p>Beta</p> <p>continua...</p> <p>200080400416 - L min/max M16 - WLF kg 700 - - conf. 15 - € 5,28</p> <p>200080400420 - L min/max M20 - WLF kg 1200 - - conf. 10 - € 8,12</p> <p>200080400424 - L min/max M24 - WLF kg 1800 - - conf. 5 - € 15,44</p> <p>200080400433 - Ømm M33 - mm 3,5 - WLL kg 3900 - E mm 54 - conf. 2 - € 44,08</p> 
<p>Beta</p> <p>GOLFARI MASCHIO PER SOLLEVAMENTO Sigma by Beta ART. 8540 Zincato Rispetta analisi di laboratorio e certificati</p> <p>200085400106 - Ø M6 - Peso Kg 75 - - conf. 250 - € 0,64</p> <p>200085400108 - Ø M8 - Peso Kg 140 - - conf. 200 - € 0,68</p> 	<p>GOLFARI FEMMINA Inox</p> <p>322A585B10 - Misura M10 - - conf. 10 - € 5,20</p> 
<p>GOLFARI FEMMINA DIN 582</p> <p>322A056SZ06 - Ø 20 - Misura M6 - - conf. 50 - € 1,22</p> <p>322A056SZ08 - Ø 20 - Misura M8 - - conf. 50 - € 1,22</p> <p>322A056SZ10 - Ø 25 - Misura M10 - - conf. 50 - € 1,60</p> <p>322A056SZ12 - Ø 30 - Misura M12 - - conf. 25 - € 2,40</p> <p>322A056SZ14 - Ø 30 - Misura M14 - - conf. 25 - € 2,40</p> <p>segue...</p> 	<p>continua...</p> <p>322A056SZ16 - Ø 35 - Misura M16 - - conf. 10 - € 3,60</p> <p>322A056SZ18 - Ø 35 - Misura M18 - - conf. 10 - € 3,60</p> <p>322A056SZ20 - Ø 40 - Misura M20 - - conf. 5 - € 5,60</p> <p>322A056SZ22 - Ø 40 - Misura M22 - - conf. 5 - € 5,60</p> <p>322A056SZ24 - Ø 50 - Misura M24 - - conf. 5 - € 9,80</p> 
<p>GOLFARI MASCHI DIN 580 Zincato</p> <p>322A055SZ06 - Misura M6 - - conf. 50 - € 0,90</p> <p>322A055SZ08 - Misura M8 - - conf. 50 - € 0,88</p> <p>322A055SZ10 - Misura M10 - - conf. 50 - € 1,50</p> <p>322A055SZ12 - Misura M12 - - conf. 25 - € 2,40</p> <p>322A055SZ14 - Misura M14 - - conf. 25 - € 2,40</p> <p>segue...</p> 	<p>continua...</p> <p>322A055SZ16 - Misura M16 - - conf. 10 - € 3,60</p> <p>322A055SZ18 - Misura M18 - - conf. 10 - € 3,60</p> <p>322A055SZ20 - Misura 20 - - conf. 5 - € 5,60</p> <p>322A055SZ22 - Misura M22 - - conf. 5 - € 5,60</p> <p>322A055SZ24 - Misura M24 - - conf. 5 - € 9,80</p> 
<p>GRILLO DIRITTO Zincato</p> <p>322S4605 - Misura 5 - - conf. 25 - € 0,86</p> <p>322S4606 - Misura 6 - - conf. 25 - € 1,28</p> <p>322S4608 - Misura 8 - - conf. 25 - € 1,84</p> <p>322S4610 - Misura 10 - - conf. 15 - € 2,20</p> <p>322S4612 - Misura 12 - - conf. 12 - € 3,50</p> <p>segue...</p> 	<p>continua...</p> <p>322S4614 - Misura 14 - - conf. 10 - € 4,40</p> <p>322S4616 - Misura 16 - - conf. 10 - € 6,20</p> <p>322S4618 - Misura 18 - - conf. 5 - € 7,60</p> <p>322S4620 - Misura 20 - - conf. 5 - € 8,80</p> 
<p>Robur</p> <p>TENDITORE a 2 occhi zincato</p> <p>90074514 - M M11 - - conf. 15 - € 5,80</p> 	<p>Beta</p> <p>TENDITORE AD OCCHIO E GANCIO Sigma by Beta ART. 8506 DIN 1480 Rispetta analisi di laboratorio e certificati</p> <p>200085060105 - L min/max 125/173 - WFL kg 25 - - conf. 100 - € 1,26</p> <p>200085060106 - L min/max 173/260 - WFL kg 45 - - conf. 50 - € 1,54</p> <p>200085060108 - L min/max 180/260 - WFL kg 90 - - conf. 30 - € 1,90</p> 



<p>Beta</p> <p>CONFEZIONE TENDITORI AD OCCHIO E GANCIO BETA ART. 8006Z Rispetta analisi di laboratorio e certificati</p> <p>200080060705 - Ø mm M5 - Ø" 3/16 - WFL kg 30 - - conf. 1 - € 73,66</p> <p>200080060706 - Ø mm M6 - Ø" 1/4 - WFL kg 30 - - conf. 1 - € 80,62</p> <p>200080060708 - Ø mm M8 - Ø" 5/16 - WFL kg 20 - - conf. 1 - € 81,78</p> <p>segue...</p> 	<p>Beta</p> <p>continua...</p> <p>200080060710 - Ø mm M10 - Ø" 3/8 - WFL kg 15 - - conf. 1 - € 90,48</p> <p>200080060711 - Ø mm M11 - Ø" 7/16 - WFL kg 15 - - conf. 1 - € 87,36</p> 
<p>Beta</p> <p>TENDITORE A DUE OCCHI Sigma by Beta ART. 8505 DIN 1480 Rispetta analisi di laboratorio e certificati</p> <p>200085050105 - L min/max 120/168 - WFL kg 100 - - conf. 100 - € 1,26</p> <p>200085050106 - L min/max 165/250 - WFL kg 135 - - conf. 50 - € 1,54</p> <p>200085050108 - L min/max 175/255 - WFL kg 250 - - conf. 30 - € 1,90</p> 	<p>Beta</p> <p>CONFEZIONE TENDITORI AD OCCHIO E GANCIO BETA ART. 8006Z Rispetta analisi di laboratorio e certificati</p> <p>200080060106 - Ømm M6 - Ø" 1/4 - WFL kg 45 - L min mm 132 - conf. 1 - € 2,60</p> <p>200080060120 - Ømm M20 - Ø" 3/4 - WFL kg 900 - L min mm 391 - conf. 1 - € 35,38</p> 
<p>Beta</p> <p>CONFEZIONE TENDITORI A DUE OCCHI BETA ART. 8005Z</p> <p>200080050705 - Ø mm M5 - Ø" 42430 - WFL kg 30 - - conf. 1 - € 69,02</p> <p>200080050706 - Ø mm M6 - Ø" 42461 - WFL kg 30 - - conf. 1 - € 75,98</p> <p>200080050708 - Ø mm M8 - Ø" 42491 - WFL kg 20 - - conf. 1 - € 77,72</p> <p>segue...</p> 	<p>Beta</p> <p>continua...</p> <p>200080050710 - Ø mm M10 - Ø" 42585 - WFL kg 15 - - conf. 1 - € 82,94</p> <p>200080050711 - Ø mm M11 - Ø" 42552 - WFL kg 15 - - conf. 1 - € 110,20</p> <p>200080050712 - Ø mm M12 - Ø" 42401 - WFL kg 15 - - conf. 1 - € 129,34</p> <p>200080050125 - Ømm M27 - Ø" 1"1/8 - WFL kg 4000 - L min mm 474 - conf. 1 - € 71,92</p> 
<p>Beta</p> <p>TENDITORI 2 OCCHI ACCIAIO INOX BETA ART. 8205 Inox AISI 316 Rispetta analisi di laboratorio e certificati</p> <p>200082050205 - A mm M5 - B mm 72 - Ø F mm 11 - WFL kg 115 - conf. 10 - € 6,80</p> <p>200082050206 - A mm M6 - B mm 92 - Ø F mm 12 - WFL kg 160 - conf. 5 - € 9,00</p> <p>200082050208 - A mm M8 - B mm 122 - Ø F mm 14 - WFL kg 300 - conf. 5 - € 13,92</p> <p>segue...</p> 	<p>Beta</p> <p>continua...</p> <p>200082050210 - A mm M10 - B mm 150 - Ø F mm 16 - WFL kg 470 - conf. 1 - € 20,78</p> <p>200082050212 - A mm M12 - B mm 201 - Ø F mm 18 - WFL kg 690L minmm 310 - conf. 1 - € 35,96</p> 
<p>Beta</p> <p>TENDITORE A DUE FORCELLE Con canula a tubo inox AISI 316 Art. 8210</p> <p>200082100205 - A mm M5 - B mm 81 - Ø F mm 5 - WFL kg 115L minmm 130 - conf. 1 - € 15,20</p> 	<p>Beta</p> <p>TENDITORE AD OCCHIO E GANCIO Art.8206 inox AISI 316 Rispetta analisi di laboratorio e certificati</p> <p>200082060206 - A mm M6 - B mm 92 - Ø F mm 12 - WFL kg 45L minmm 164 - conf. 1 - € 9,46</p> 
<p>B</p> <p>TENDITORI A DUE GANCI Zincato</p> <p>322S01105 - Misura 5 - - conf. 30 - € 1,76</p> <p>322S01106 - Misura 6 - - conf. 30 - € 1,92</p> <p>322S01108 - Misura 8 - - conf. 20 - € 3,50</p> <p>322S01110 - Misura 10 - - conf. 15 - € 4,12</p> <p>322S01112 - Misura 12 - - conf. 15 - € 6,60</p> <p>segue...</p> 	<p>B</p> <p>continua...</p> <p>322S01114 - Misura 14 - - conf. 10 - € 8,44</p> <p>322S01111 - Misura 11 - - conf. 15 - € 7,00</p> 



CARFER

SINCE
1960















WWW.CARCANO.IT













CARFER

www.malfattitacchinigroup.it















 <p>TENDITORI 2 GANCI Inox</p> <p>322A51005 – Misura M5 – – conf. 50 – € 1,86</p> <p>322A51006 – Misura M6 – – conf. 10 – € 2,40</p> <p>322A51008 – Misura M8 – – conf. 10 – € 4,20</p> <p>322A51010 – Misura M10 – – conf. 10 – € 7,00</p> <p>322A51012 – Misura M12 – – conf. 6 – € 14,00</p>	 <p>TENDITORI OCCHIO GANCIO Inox</p> <p>322A50905 – Misura M5 – – conf. 50 – € 1,86</p> <p>322A50906 – Misura M6 – – conf. 10 – € 2,40</p> <p>322A50908 – Misura M8 – – conf. 10 – € 4,20</p> <p>322A50910 – Misura M10 – – conf. 10 – € 7,00</p> <p>322A50912 – Misura M12 – – conf. 6 – € 14,00</p>
 <p>TENDITORI A 2 GANCI Zincato</p> <p>322A16306 – Misura M6 – – conf. 30 – € 1,76</p> <p>322A16308 – Misura M8 – – conf. 15 – € 2,40</p> <p>322A16310 – Misura M10 – – conf. 10 – € 3,20</p>	 <p>TENDITORI 2 occhi Inox</p> <p>322A50805 – M 122 – Misura M5 – – conf. 5 – € 1,86</p> <p>322A50806 – M 140 – Misura M6 – – conf. 5 – € 2,40</p> <p>322A50808 – M 157 – Misura M8 – – conf. 5 – € 4,20</p> <p>322A50810 – M 182 – Misura M10 – – conf. 5 – € 7,00</p> <p>322A50812 – M 228 – Misura M12 – – conf. 1 – € 14,00</p>
 <p>TENDITORI Occhio/Gancio Zincato</p> <p>322S01005 – M 120 – Misura M5 – – conf. 30 – € 1,66</p> <p>322S01006 – M 143 – Misura M6 – – conf. 30 – € 1,76</p> <p>322S01008 – M 162 – Misura M8 – – conf. 20 – € 2,60</p> <p>322S01010 – M 196 – Misura M10 – – conf. 15 – € 3,68</p> <p>322S01011 – M 207 – Misura M11 – – conf. 15 – € 6,80</p> <p>segue...</p>	 <p>continua...</p> <p>322S01012 – M 223 – Misura M12 – – conf. 15 – € 5,80</p> <p>322S01014 – M 262 – Misura M13 – – conf. 10 – € 7,42</p>
 <p>TENDITORI 2 occhi Zincati</p> <p>322S00905 – M 122 – Misura M5 – – conf. 30 – € 1,66</p> <p>322S00906 – M 140 – Misura M6 – – conf. 30 – € 1,76</p> <p>322S00908 – M 157 – Misura M8 – – conf. 20 – € 2,60</p> <p>322S00910 – M 182 – Misura M10 – – conf. 15 – € 3,60</p> <p>322S00912 – M 197 – Misura M12 – – conf. 15 – € 5,80</p> <p>segue...</p>	 <p>continua...</p> <p>322S00914 – M 228 – Misura M14 – – conf. 10 – € 8,16</p> <p>322S00916 – M 245 – Misura M16 – – conf. 5 – € 12,24</p> <p>322S00920 – M 280 – Misura M20 – – conf. 5 – € 20,76</p>
 <p>TENDITORI DIN 1480 2 occhi</p> <p>322A16106 – Misura M6 – – conf. 30 – € 1,76</p> <p>322A16108 – Misura M8 – – conf. 15 – € 2,40</p> <p>322A16110 – Misura M10 – – conf. 10 – € 3,20</p>	 <p>TENDITORI DIN 1480 Occhio/Gancio</p> <p>322A16206 – Misura M6 – – conf. 30 – € 1,76</p> <p>322A16208 – Misura M8 – – conf. 15 – € 2,40</p> <p>322A16210 – Misura M10 – – conf. 10 – € 3,20</p>
 <p>TIRANTI AD OCCHIO DESTRI NERI Art. 8048</p> <p>200080480120 – ØxLmm M20x160 – F mm 18 – – conf. 1 – € 19,04</p>	 <p>GANCI PER TENDITORI Destra Zincata</p> <p>322S01712 – Misura 12 MA – – conf. 50 – € 2,22</p>



<p>Beta</p> <p>RADANCE ZINCATE BETA ART. 8020 Tipo leggero Acciaio zincato</p> <p>200080200003 - Ømm 2-3 - Smm 0,8 - B mm 20 - Dmm 20 - conf. 50 - € 0,24</p> <p>200080200004 - Ømm 4 - Smm 1,0 - B mm 22 - Dmm 21 - conf. 300 - € 0,24</p> <p>200080200005 - Ømm 5 - Smm 1,0 - B mm 23 - Dmm 24 - conf. 300 - € 0,28</p> <p>segue...</p> 	<p>Beta</p> <p>continua...</p> <p>200080200006 - Ømm 6 - Smm 1,0 - B mm 27 - Dmm 29 - conf. 200 - € 0,28</p> <p>200080200008 - Ømm 8 - Smm 1,2 - B mm 33 - Dmm 33 - conf. 180 - € 0,46</p> <p>200080200010 - Ømm 10 - Smm 1,5 - B mm 40 - Dmm 39 - conf. 100 - € 0,64</p> <p>200080200012 - Ømm 12 - Smm 1,8 - B mm 44 - Dmm 46 - conf. 160 - € 0,84</p> <p>segue...</p> 
<p>Beta</p> <p>continua...</p> <p>200080200014 - Ømm 14 - Smm 2,0 - B mm 49 - Dmm 50 - conf. 100 - € 1,08</p> <p>200080200016 - Ømm 16 - Smm 2,0 - B mm 57 - Dmm 59 - conf. 150 - € 1,50</p> <p>200080200018 - Ømm 18 - Smm 2,5 - B mm 68 - Dmm 69 - conf. 100 - € 2,00</p> <p>200080200020 - Ømm 20 - Smm 3,0 - B mm 78 - Dmm 77 - conf. 70 - € 2,78</p> 	<p>REDANCE In acciaio Inox</p> <p>322A55203 - Misura 3 - - conf. 50 - € 0,22</p> <p>322A55204 - Misura 4 - - conf. 50 - € 0,26</p> <p>322A55205 - Misura 5 - - conf. 50 - € 0,30</p> <p>322A55206 - Misura 6 - - conf. 50 - € 0,34</p> <p>322A55208 - Misura 8 - - conf. 50 - € 0,54</p> <p>322A55210 - Misura 10 - - conf. 50 - € 1,02</p> 
<p>REDANCE PER FUNE Zincate</p> <p>322S09603 - Misura 3 - - conf. 150 - € 0,16</p> <p>322S09604 - Misura 4 - - conf. 150 - € 0,16</p> <p>322S09605 - Misura 5 - - conf. 100 - € 0,18</p> <p>322S09606 - Misura 6 - - conf. 100 - € 0,22</p> <p>322S09608 - Misura 8 - - conf. 50 - € 0,32</p> <p>segue...</p> 	<p>continua...</p> <p>322S09610 - Misura 10 - - conf. 50 - € 0,44</p> <p>322S09612 - Misura 12 - - conf. 50 - € 0,48</p> <p>322S09614 - Misura 14 - - conf. 40 - € 0,78</p> <p>322S09616 - Misura 16 - - conf. 25 - € 1,12</p> <p>322S09618 - Misura 18 - - conf. 25 - € 1,64</p> <p>322S09620 - Misura 20 - - conf. 25 - € 2,40</p> 
<p>Beta</p> <p>REDANCE ACCIAIO INOX BETA ART. 8220 Inox AISI 316 Tipo pesante Rispetta analisi di laboratorio e certificati</p> <p>200082200203 - ØF 3 - D 6 - A 24 - C 10 - conf. 15 - € 1,04</p> <p>200082200204 - ØF 4 - D 6,6 - A 28 - C 11 - conf. 10 - € 1,18</p> <p>200082200205 - ØF 5 - D 8,5 - A 30 - C 13 - conf. 10 - € 1,42</p> <p>200082200206 - ØF 6 - D 10 - A 37 - C 15 - conf. 10 - € 1,62</p> <p>200082200208 - ØF 8 - D 12,5 - A 51 - C 23 - conf. 5 - € 2,52</p> 	<p>540</p> <p>BLISTER 2 PZ. ANELLI IN BRONZO PER NAUTICA Made in Italy</p> <p>540201332027 - Misura 27 - - conf. 10 - € 6,00</p> <p>540201332032 - Misura 32 - - conf. 10 - € 6,00</p> <p>540201332035 - Misura 35 - - conf. 10 - € 6,00</p> 
<p>900</p> <p>CARRUCOLA a gancio ottonata</p> <p>90029225 - Ø 25 - - conf. 24 - € 1,30</p> <p>90029230 - Ø 30 - - conf. 24 - € 1,34</p> <p>90029235 - Ø 35 - - conf. 24 - € 1,48</p> <p>90029240 - Ø 40 - - conf. 24 - € 1,76</p> <p>90029245 - Ø 45 - - conf. 24 - € 1,66</p> <p>segue...</p> 	<p>continua...</p> <p>90029250 - Ø 50 - - conf. 24 - € 2,20</p> <p>90029260 - Ø 60 - - conf. 12 - € 2,68</p> 
<p>MINUTEX</p> <p>CARRUCOLA A GANCIO Ruotain Nylon Ø 50 Con cuscinetto a sfere</p> <p>90029210 - - conf. 12 - € 6,84</p> 	<p>Beta</p> <p>MOSCHETTONI A GANCIO CON SICURA IN ACCIAIO INOX BETA ART. 8250 Inox AISI 316 Rispetta analisi di laboratorio e certificati</p> <p>200082500205 - L 50 - A 25 - ØB 8 - WFL kg 40BF kg 200 - conf. 5 - € 3,96</p> <p>200082500207 - L 70 - A 31 - ØB 12,5 - WFL kg 90BF kg 420 - conf. 5 - € 5,92</p> 













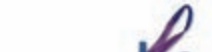

<p>Beta</p> <p>MOSCHETTONI CON GHIERA ACCIAIO INOX BETA ART. 8274G Inox AISI 316 Rispetta analisi di laboratorio e certificati</p> <p>200082740306 - Ø AxL 6x60 - ØC 8,5 - D 6,5 - WFL kg 40 - conf. 5 - € 3,54</p> <p>200082740310 - Ø AxL 10x100 - ØC 15 - D 12 - WFL kg 120 - conf. 1 - € 11,96</p> 	<p>Beta</p> <p>MOSCHETTONI IN ACCIAIO INOX BETA ART. 8274 Inox AISI 316 Rispetta analisi di laboratorio e certificati</p> <p>200082740205 - Ø AxL 5x50 - ØC 8 - D 7 - WFL kg 30 - conf. 10 - € 2,72</p> <p>200082740206 - Ø AxL 6x60 - ØC 8,5 - D 7,5 - WFL kg 40 - conf. 5 - € 2,84</p> <p>200082740208 - Ø AxL 8x80 - ØC 12 - D 10 - WFL kg 75 - conf. 5 - € 4,54 segue...</p> 
<p>Beta</p> <p>continua...</p> <p>200082740210 - Ø AxL 10x100 - ØC 15 - D 13 - WFL kg 120 - conf. 1 - € 7,78</p> 	<p>Beta</p> <p>MOSCHETTONI ZINCATI BETA ART. 8074 DIN 5299 Rispetta analisi di laboratorio e certificati</p> <p>200080740040 - DxL 4x40 - WFL kg 20 - - conf. 100 - € 0,60</p> <p>200080740050 - DxL 5x50 - WFL kg 30 - - conf. 100 - € 0,62</p> <p>200080740060 - DxL 6x60 - WFL kg 40 - - conf. 100 - € 0,68</p> <p>200080740070 - DxL 7x70 - WFL kg 60 - - conf. 50 - € 0,86</p> <p>200080740080 - DxL 8x80 - WFL kg 75 - - conf. 50 - € 1,06 segue...</p> 
<p>Beta</p> <p>continua...</p> <p>200080740090 - DxL 9x90 - WFL kg 100 - - conf. 25 - € 1,42</p> <p>200080740100 - DxL 10x100 - WFL kg 120 - - conf. 25 - € 1,92</p> <p>200080740101 - DxL 11x120 - WFL kg 140 - - conf. 20 - € 2,60</p> <p>200080740102 - DxL 12x140 - WFL kg 140 - - conf. 15 - € 3,66</p> <p>200080740103 - DxL 13x160 - WFL kg 200 - - conf. 10 - € 4,94</p> 	<p>&M 900</p> <p>MOSCHETTONE INOX Pompiere aisi 304</p> <p>90075627 - mm. 120 - - conf. 3 - € 12,90</p> 
<p>B</p> <p>MOSCHETTONI INOX</p> <p>322A530B60 - Misura 60 - - conf. 30 - € 1,26</p> <p>322A530B80 - Misura 80 - - conf. 25 - € 2,60</p> <p>322A530B100 - Misura 100 - - conf. 20 - € 4,40</p> 	<p>B</p> <p>MOSCHETTONI CON GHIERA Zincata</p> <p>322A070060 - Misura 6x60 - - conf. 50 - € 0,64</p> <p>322A070080 - Misura 8x80 - - conf. 25 - € 0,90</p> <p>322A070100 - Misura 10x100 - - conf. 25 - € 1,48</p> 
<p>B</p> <p>MOSCHETTONI Zincati</p> <p>322A068040 - Misura 40 - - conf. 50 - € 0,36</p> <p>322A068050 - Misura 50 - - conf. 50 - € 0,38</p> <p>322A068060 - Misura 60 - - conf. 50 - € 0,44</p> <p>322A068070 - Misura 70 - - conf. 50 - € 0,58</p> <p>322A068080 - Misura 80 - - conf. 50 - € 0,72 segue...</p> 	<p>B</p> <p>continua...</p> <p>322A068090 - Misura 90 - - conf. 10 - € 0,96</p> <p>322A068100 - Misura 100 - - conf. 10 - € 1,18</p> <p>322A068120 - Misura 120 - - conf. 10 - € 1,58</p> <p>322A068140 - Misura 140 - - conf. 10 - € 2,40</p> <p>322A068160 - Misura 160 - - conf. 5 - € 3,80</p> 
<p>B</p> <p>MOSCHETTONI CON ANELLO Zincato</p> <p>322A069040 - Misura 4x40 - - conf. 100 - € 0,50</p> <p>322A069050 - Misura 5x50 - - conf. 100 - € 0,50</p> <p>322A069060 - Misura 6x60 - - conf. 100 - € 0,50</p> <p>322A069080 - Misura 8x80 - - conf. 50 - € 0,86</p> <p>322A069100 - Misura 10x100 - - conf. 25 - € 1,42</p> 	<p>Beta</p> <p>MOSCHETTONI TRAPEZOIDALI Inox AISI 316 Art. 8278</p> <p>200082640212 - B mm 12 - L mm 88 - C mm 12 - WFL kg 60BF kg 440 - conf. 1 - € 10,56</p> <p>200082780208 - Ø A x L mm 8x80 - B mm 45 - C mm 14 - WFL kg 75BF kg 800 - conf. 1 - € 12,18</p> 



<p>Beta</p> <p>MOSCHETTONI ASIMMETRICI Con ghiera inox AISI 316 Art. 8276G</p> <p>200082760306 - Ø A x L mm 6x60 - Ø C mm 8,5 - D mm 9 - WFL kg 40B mm 35 - conf. 1 - € 4,06</p> 	<p>Beta</p> <p>MOSCHETTONI A GANCIO Con girello e sicura inox AISI 316 Art. 8267</p> <p>200082670210 - A mm 10 - L mm 87 - B mm 21 - WFL kg 30BF kg 160 - conf. 1 - € 9,24</p> 
<p>Beta</p> <p>MAGLIE RAPIDE DI GIUNZIONE Zincate Coefficiente di sicurezza:4</p> <p>200080800003 - DxL mm 3,5x36 - Amm 5 - WFL kg 20 - - conf. 100 - € 0,50</p> <p>200080800004 - DxL mm 4x40 - Amm 6 - WFL kg 30 - - conf. 100 - € 0,54</p> <p>200080800005 - DxL mm 5x49 - Amm 6 - WFL kg 50 - - conf. 100 - € 0,64 segue...</p> 	<p>Beta</p> <p>continua...</p> <p>200080800006 - DxL mm 6x57 - Amm 8 - WFL kg 60 - - conf. 100 - € 0,82</p> <p>200080800007 - DxL mm 7x66 - Amm 8 - WFL kg 100 - - conf. 100 - € 1,06</p> <p>200080800008 - DxL mm 8x74 - Amm 11 - WFL kg 140 - - conf. 100 - € 1,24</p> 
<p>Beta</p> <p>MAGLIE RAPIDE Zincate</p> <p>322A06406 - Misura 6 mm - - conf. 100 - € 0,54</p> <p>322A06408 - Misura 8 mm - - conf. 50 - € 0,96</p> <p>322A06410 - Misura 10 mm - - conf. 25 - € 1,60</p> <p>322A06412 - Misura 12 mm - - conf. 20 - € 2,88</p> <p>322A06414 - Misura 14 mm - - conf. 10 - € 5,76</p> <p>322A06416 - Misura 16 mm - - conf. 5 - € 8,66</p> 	<p>Beta</p> <p>FASCE DI SOLLEVAMENTO Nastro piatto a due strati Asole rinforzate Poliestere alta tenacità (PES) H=30</p> <p>200081500020 - L mm 2 - H mm 30 - WLL ton 1 - - conf. 1 - € 12,30</p> <p>200081500030 - L mm 3 - H mm 30 - WLL ton 1 - - conf. 1 - € 15,78</p> <p>200081500040 - L mm 4 - H mm 30 - WLL ton 1 - - conf. 1 - € 20,30 segue...</p> 
<p>Beta</p> <p>continua...</p> <p>200081500050 - L mm 5 - H mm 30 - WLL ton 1 - - conf. 1 - € 23,78</p> <p>200081500060 - L mm 6 - H mm 30 - WLL ton 1 - - conf. 1 - € 27,96</p> 	<p>Beta</p> <p>FASCE DI SOLLEVAMENTO Nastro piatto a due strati Asole rinforzate Poliestere alta tenacità (PES) H=60</p> <p>200081530020 - L 2 - H 60 - Portata 2000 Kg - - conf. 1 - € 21,24</p> <p>200081530030 - L 3 - H 60 - Portata 2000 Kg - - conf. 1 - € 28,90</p> <p>200081530040 - L 4 - H 60 - Portata 2000 Kg - - conf. 1 - € 35,96</p> <p>200081530050 - L 5 - H 60 - Portata 2000 Kg - - conf. 1 - € 43,50</p> <p>200081530060 - L 6 - H 60 - Portata 2000 Kg - - conf. 1 - € 51,04</p> 
<p>Beta</p> <p>FASCE DI SOLLEVAMENTO Nastro piatto a due strati Asole rinforzate Poliestere alta tenacità (PES) H=90</p> <p>200081560020 - L 2 - H 90 - Portata 3000 Kg - - conf. 1 - € 31,90</p> <p>200081560030 - L 3 - H 90 - Portata 3000 Kg - - conf. 1 - € 44,08</p> <p>200081560040 - L 4 - H 90 - Portata 3000 Kg - - conf. 1 - € 55,10</p> <p>200081560050 - L 5 - H 90 - Portata 3000 Kg - - conf. 1 - € 66,12</p> <p>200081560060 - L 6 - H 90 - Portata 3000 Kg - - conf. 1 - € 77,14</p> 	<p>Beta</p> <p>FASCIA CON MINI-CRICCHETTO AD ANELLO BETA ART. 8188C LC 750kg Serraggio ad anello con cricchetto tenditore Cinghia in poliestere 25 mm Cricchetto in acciaio verniciato</p> <p>200081880350 - L 5 mt - - conf. 3 - € 7,36</p> 
<p>USTROPS</p> <p>FASCE DI SOLLEVAMENTO CON ASOLA Colore giallo Portata 3000 kg a tiro diritto</p> <p>782CEDLLC90M2 - Metri 2 metri - Misura 90mm - - conf. 1 - € 23,38</p> <p>782CEDLLC90M3 - Metri 3 metri - Misura 90mm - - conf. 1 - € 23,38</p> <p>782CEDLLC90M4 - Metri 4 metri - Misura 90mm - - conf. 1 - € 29,20 segue...</p> 	<p>USTROPS</p> <p>continua...</p> <p>782CEDLLC90M5 - Metri 5 metri - Misura 90mm - - conf. 1 - € 35,46</p> <p>782CEDLLC90M6 - Metri 6metri - Misura 90mm - - conf. 1 - € 41,36</p> 

















 <p>U STROPS</p> <p>FASCE DI SOLLEVAMENTO CON ASOLA Colore verde Portata 2000 kg a tiro diritto</p> <p>782CEDLLC60M2 – Metri 2 metri – Misura 60mm – conf. 1 – € 11,38</p> <p>782CEDLLC60M3 – Metri 3 metri – Misura 60mm – conf. 1 – € 15,32</p> <p>782CEDLLC60M4 – Metri 4 metri – Misura 60mm – conf. 1 – € 19,30</p> <p>segue...</p>	 <p>U STROPS</p> <p>continua...</p> <p>782CEDLLC60M5 – Metri 5 metri – Misura 60mm – conf. 1 – € 23,38</p> <p>782CEDLLC60M6 – Metri 6 metri – Misura 60mm – conf. 1 – € 27,28</p>
 <p>U STROPS</p> <p>FASCE DI SOLLEVAMENTO CON ASOLA Colore viola Portata 1000 kg a tiro diritto</p> <p>782CEDLLC50M2 – Metri 2 metri – Misura 50mm – conf. 1 – € 7,28</p> <p>782CEDLLC50M3 – Metri 3 metri – Misura 50mm – conf. 1 – € 9,32</p> <p>782CEDLLC50M4 – Metri 4 metri – Misura 50mm – conf. 1 – € 11,42</p> <p>segue...</p>	 <p>U STROPS</p> <p>continua...</p> <p>782CEDLLC50M5 – Metri 5 metri – Misura 50mm – conf. 1 – € 11,44</p> <p>782CEDLLC50M6 – Metri 6 metri – Misura 50mm – conf. 1 – € 15,52</p>
 <p>ES</p> <p>FASCE CON ASOLE TON</p> <p>322C41010300 – M 1 mm – Misura 30x3000 – – conf. 1 – € 14,84</p> <p>322C41010400 – M 1 mm – Misura 30x4000 – – conf. 1 – € 19,10</p> <p>322C41010500 – M 1 mm – Misura 30x5000 – – conf. 1 – € 23,74</p> <p>322C41010600 – M 1 mm – Misura 30x6000 – – conf. 1 – € 27,82</p> <p>322C41020200 – M 2 mm – Misura 60x2000 – – conf. 1 – € 19,46</p> <p>segue...</p>	 <p>ES</p> <p>continua...</p> <p>322C41020300 – M 2 mm – Misura 60x3000 – – conf. 1 – € 27,82</p> <p>322C41020400 – M 2 mm – Misura 60x4000 – – conf. 1 – € 34,86</p> <p>322C41020500 – M 2 mm – Misura 60x5000 – – conf. 1 – € 41,34</p> <p>322C41020600 – M 2 mm – Misura 60x6000 – – conf. 1 – € 47,84</p> <p>322C41030200 – M 3 mm – Misura 90x2000 – – conf. 1 – € 27,82</p> <p>segue...</p>
 <p>ES</p> <p>continua...</p> <p>322C41030300 – M 3 mm – Misura 90x300 – – conf. 1 – € 38,94</p> <p>322C41030400 – M 3 mm – Misura 90x4000 – – conf. 1 – € 50,06</p> <p>322C41030500 – M 3 mm – Misura 90x5000 – – conf. 1 – € 62,66</p> <p>322C41030600 – M 3 mm – Misura 90x6000 – – conf. 1 – € 72,86</p>	 <p>GIEFFE gruppi general ferramenta</p> <p>ESPOSITORE 36 CINGHIE CON FIBBIA Contiene: 9 cinghie da 1,5 m 9 cinghie da 2,5 m 9 cinghie da 3,5 m 9 cinghie da 5 m</p> <p>512130090N – – conf. 1 – € 67,98</p>
 <p>GIEFFE gruppi general ferramenta</p> <p>CINGHIA POLIESTERE CON CRICCHETTO Colore Arancione</p> <p>512130060N – Gancio U – Misura 0,05x9 mt – – conf. 1 – € 19,57</p> <p>512130070N – Gancio JJ – Misura 0,038x6 mt – – conf. 1 – € 10,20</p> <p>512130080N – Gancio JJ – Misura 0,050x9 mt – – conf. 1 – € 23,69</p>	 <p>GIEFFE gruppi general ferramenta</p> <p>CINGHIA POLIESTERE CON TENDITORE A CRICCO Capacità massima di lavoro 700 Kg In blister</p> <p>512130050N – Colore Arancione – Misura 0,025x5 mt – – conf. 1 – € 5,77</p>
 <p>GIEFFE gruppi general ferramenta</p> <p>CINGHIA POLIESTERE CON FIBBIA Autobloccante In blister</p> <p>512130010N – Colore Rosso – Misura 0,025x1,5 mt – – conf. 1 – € 1,85</p> <p>512130020N – Colore Giallo – Misura 0,025x2,5 mt – – conf. 1 – € 2,27</p> <p>512130030N – Colore Blu – Misura 0,025x3,5 mt – – conf. 1 – € 3,09</p> <p>segue...</p>	 <p>GIEFFE gruppi general ferramenta</p> <p>continua...</p> <p>512130040N – Colore Arancione – Misura 0,025x5 mt – – conf. 1 – € 3,71</p>



  <p>CINGHIA CON CRICCHETTO DI ANCORAGGIO E GANCI</p> <p>78250L2000GSP - L min/max 50mmx9mt - WFL kg GSP - Colore Rosso - Portata 2000 kn - conf. 1 - € 21,62</p> <p>78250L2000GT - L min/max 50mmx9mt - WFL kg GT - Colore Arancione - Portata 2000 kn - conf. 1 - € 21,62</p> <p>78250L2500GT - L min/max 50mmx9mt - WFL kg GT - Colore Blu - Portata 2500 kn - conf. 1 - € 24,76</p> <p>segue...</p>	  <p>continua...</p> <p>78250L2500GTA - L min/max 50mmx9mt - WFL kg GT - Colore Arancione - Portata 2500 kn - conf. 1 - € 24,76</p>
  <p>ESPOSITORE 29 PZ. SISTEMI DI ANCORAGGIO BETA ART. 8188/E Fasce in polipropilene Contiene: n.10 ancoraggi 8188F m.1,5 n.10 ancoraggi 8188F m.2,5 n. 6 ancoraggi 8188F m.5 n. 3 ancoraggi 8188C m.5 con cricchetto Dimensioni 34x29x11h cm</p> <p>200081880929 - - conf. 1 - € 103,42</p>	  <p>CONFEZIONE 4 PZ. SISTEMI DI ANCORAGGIO A CRICCHETTO Contiene art. 8180 LC 750kg Nastro in poliesteri ad alta tenacità Cricchetto e gancio in acciaio zincato Dimensioni espositore: 250x200x180 mm</p> <p>200081800704 - L1 250 - L2 3750 - L m 4 - - conf. 1 - € 59,96</p> <p>200081800706 - L1 250 - L2 5750 - L m 6 - - conf. 1 - € 66,96</p>
  <p>CONFEZIONE 4 PZ SISTEMI DI ANCORAGGIO A CRICCHETTO Contiene art. 8181 LC 1000kg Nastro in poliesteri ad alta tenacità Cricchetto e gancio in acciaio zincato Gancio ad uncino Dimensioni espositore: 280x240x230 mm</p> <p>200081810706 - L1 400 - L2 5600 - L m 6 - - conf. 1 - € 85,92</p>	  <p>CRICCHETTO DI ANCORAGGIO per nastro 25 mm con ganci alle estremità Lunghezza 4 mt</p> <p>78225A1A2GAM4 - Misura 25mmx4mt - Gancio GAM - - conf. 1 - € 8,78</p> <p>78225A1A2GT4 - Misura 25mmx4mt - Gancio GT - - conf. 1 - € 9,72</p>
  <p>CINGHIE CON CRICCHETTO 7 pezzi 25 mm x 4 m colore arancione</p> <p>782SAMCR25AOL - - conf. 1 - € 40,36</p>	  <p>CONFEZIONE 10 CINGHIE</p> <p>782SAAPAO1,5L - Misura 25mmx1,5mt - Colore blu - - conf. 1 - € 22,72</p> <p>782SAAPAO2,5L - Misura 25mmx2,5mt - Colore rosso - - conf. 1 - € 25,06</p> <p>782SAAPAO4L - Misura 25mmx4mt - Colore verde - - conf. 1 - € 27,88</p>
  <p>ESPOSITORE DA BANCO 30 pezzi CINGHIE CON FIBBIA 10 cinghie da 25 mm x 1,5 m colore blu 10 cinghie da 25 mm x 2,5 m colore rosso 10 cinghie 25 mm x 4 m colore verde</p> <p>782ESPCART1 - - conf. 1 - € 83,64</p>	  <p>ESPOSITORE DA BANCO 29 Pezzi CINGHIE CON FIBBIA 10 cinghie da 5mm x 1,5 m colore blu 10 cinghie da 25 mm x 2,5 m colore rosso 6 cinghie da 25 mm x 4 m colore verde 3 cinghie 25 mm x 4 m colore arancione</p> <p>782ESPCART5 - - conf. 1 - € 74,56</p>
  <p>FUNE ACCIAIO</p> <p>885FU18A100 - - conf. 1 - € 24,30</p> <p>885FU18A6 - Finitura Acciaio zincato - Misura 1,8mmx6mt - - conf. 1 - € 2,10</p> <p>885FU18A9 - Finitura Acciaio zincato - Misura 1,8x9mt - - conf. 1 - € 2,78</p> <p>885FU24A100 - Finitura Acciaio zincato - Misura 2,40mmx100mt - - conf. 1 - € 32,98</p> <p>segue...</p>	  <p>continua...</p> <p>885FU24A6 - Finitura Acciaio zincato - Misura 2,4mmx6mt - - conf. 1 - € 2,44</p> <p>885FU24A9 - Finitura Acciaio zincato - Misura 2,4mmx9mt - - conf. 1 - € 3,48</p> <p>885FU2A10 - Finitura Acciaio zincato - Misura 2mmx10mt - - conf. 1 - € 2,18</p> <p>885FU2A25 - Finitura Acciaio zincato - Misura 2mmx25mt - - conf. 1 - € 5,26</p> <p>segue...</p>



  <p>continua...</p> <p>885FU3A10 - Finitura Acciaio zincato - Misura 3mmx10mt - - conf. 1 - € 3,58</p> <p>885FU3A25 - Finitura Acciaio zincato - Misura 3mmx35mt - - conf. 1 - € 8,36</p> <p>885FU4A10 - Finitura Acciaio zincato - Misura 4mmx10mt - - conf. 1 - € 5,92</p> <p>885FU4A25 - Finitura Acciaio zincato - Misura 4mmx25mt - - conf. 1 - € 12,50</p> <p>segue...</p>	  <p>continua...</p> <p>885FU5A10 - Finitura Acciaio zincato - Misura 5mmx10mt - - conf. 1 - € 7,12</p> <p>885FU5A25 - Finitura Acciaio zincato - Misura 5mmx25mt - - conf. 1 - € 15,98</p> <p>885FU6A10 - Finitura Acciaio zincato - Misura 6mmx10mt - - conf. 1 - € 9,38</p> <p>885FU6A25 - Finitura Acciaio zincato - Misura 6mmx25mt - - conf. 1 - € 21,18</p> <p>segue...</p>
  <p>continua...</p> <p>885FU8A10 - Finitura Acciaio zincato - Misura 8mmx10mt - - conf. 1 - € 15,62</p> <p>885FU8A25 - Finitura Acciaio zincato - Misura 8mmx25mt - - conf. 1 - € 35,42</p> <p>885FU10A025 - Finitura Acciaio zincato - Misura 10mmx25mt - - conf. 1 - € 61,10</p>	  <p>FUNE ACCIAIO ZINCATA</p> <p>885FU12A50 - Colore Acciaio zincato - Misura 12mmx50mt - - conf. 1 - € 141,92</p> <p>885FU2A100 - Colore Acciaio zincato - Misura 2mmx100mt - - conf. 1 - € 18,40</p> <p>885FU3A100 - Colore Acciaio zincato - Misura 3mmx100mt - - conf. 1 - € 28,84</p> <p>segue...</p>
  <p>continua...</p> <p>885FU4A100 - Colore Acciaio zincato - Misura 4mmx100mt - - conf. 1 - € 41,66</p> <p>885FU5A100 - Colore Acciaio zincato - Misura 5mmx100mt - - conf. 1 - € 54,84</p> <p>885FU6A100 - Colore Acciaio zincato - Misura 6mmx100mt - - conf. 1 - € 73,56</p> <p>885FU8A100 - Colore Acciaio zincato - Misura 8mmx100mt - - conf. 1 - € 125,72</p> <p>segue...</p>	  <p>continua...</p> <p>885FU10A100 - Colore Acciaio zincato - Misura 10mmx100mt - - conf. 1 - € 194,08</p>
  <p>FUNE ACCIAIO INOX</p> <p>885FU2I10 - Misura 2mmx10mt - - conf. 1 - € 8,02</p> <p>885FU2I50 - Misura 2mmx50mt - - conf. 1 - € 33,72</p> <p>885FU3I10 - Misura 3mmx10mt - - conf. 1 - € 13,02</p> <p>885FU3I50 - Misura 3mmx50mt - - conf. 1 - € 65,76</p> <p>885FU4I10 - Misura 4mmx10mt - - conf. 1 - € 21,04</p> <p>segue...</p>	  <p>continua...</p> <p>885FU4I50 - Misura 4mmx50mt - - conf. 1 - € 110,80</p> <p>885FU5I10 - Misura 5mmx10mt - - conf. 1 - € 31,72</p> <p>885FU5I50 - Misura 5mmx50mt - - conf. 1 - € 156,20</p> <p>885FU6I50 - Misura 6mmx50mt - - conf. 1 - € 222,00</p>
  <p>FUNE ANTIGIRO ACCIAIO ZINCATA 133 fili 19x7 mm</p> <p>885FU4G025 - Misura 4mmx25mt - - conf. 1 - € 31,24</p> <p>885FU5G025 - Misura 5mmx25mt - - conf. 1 - € 43,40</p> <p>885FU6G025 - Misura 6mmx25mt - - conf. 1 - € 55,54</p>	

” SIAMO
ATTREZZATI
PER ESSERE SEMPRE
AL TUO
FIANCO

“
dal 1971



Corradini Luigi spa | Eurogross srl | Fabrizio Ovidio Ferramenta spa | Franzinelli Vigilio srl | Malfatti & Tacchini srl | Perrone & C. SNC | Raffaele spa | Viglietta Guido & C. sas | Viridex srl

9 grossisti associati
210 milioni di € di fatturato sviluppato
140.000 mq. di strutture coperte
60.000 referenze gestite
220 agenti di vendita
20.000 clienti dettaglianti sul territorio nazionale

GIEFFE
gruppo grossisti ferramenta

[www.gruppogieffe.com]



ANTINFORTUNISTICA

SFOGLIA LA CATEGORIA





GIEFFE
gruppo general formatura

GUANTO in nitrile N 119

512767848 – Taglia 7 –
– conf. 12 – € 1,06

512767850 – Taglia 8 –
– conf. 12 – € 1,06

512767860 – Taglia 9 –
– conf. 12 – € 1,06

512767880 – Taglia 10 –
– conf. 12 – € 1,06

512767876 – Taglia 11 –
– conf. 12 – € 1,06



GIEFFE
gruppo general formatura

GUANTO nero NL 186-PU

512767800 – Taglia 7 –
– conf. 12 – € 1,06

512767802 – Taglia 8 –
– conf. 12 – € 1,06

512767804 – Taglia 9 –
– conf. 12 – € 1,06

512767806 – Taglia 10 –
– conf. 12 – € 1,06

512NLPUI1 – Taglia 11 –
– conf. 12 – € 1,06



GIEFFE
gruppo general formatura

GUANTO PG 201 R

512767900 – Taglia 8 – Colore Blu –
– conf. 12 – € 5,00

512767910 – Taglia 9 – Colore Giallo –
– conf. 12 – € 5,00

512767920 – Taglia 10 – Colore Rosso –
– conf. 12 – € 5,00

512767930 – Taglia 11 – Colore Nero –
– conf. 12 – € 5,00



GIEFFE
gruppo general formatura

GUANTO IN POLIURETANO BIANCO Guanto in poliuretano con supporti in poliestere Massima leggerezza e traspirabilità Ideali per la manipolazione e assemblaggio di oggetti

51273010N – taglia 07 –
– conf. 12 – € 1,02

51273020N – taglia 08 –
– conf. 12 – € 1,02

51273030N – taglia 09 –
– conf. 12 – € 1,02

51273040N – taglia 10 –
– conf. 12 – € 1,02

segue...



GIEFFE
gruppo general formatura

continua...

51273050N – taglia 11 –
– conf. 12 – € 1,02



Honeywell
THE POWER OF CONNECTED

GUANTO Polytril nitrile Guanto da lavoro per la manipolazione di oggetti delicati in ambienti grassi, umidi o sporchi.

92031025 – taglia 7 –
– conf. 10 – € 4,20

92031026 – taglia 8 –
– conf. 10 – € 4,20

92031027 – taglia 9 –
– conf. 10 – € 4,20

92031028 – taglia 10 –
– conf. 10 – € 4,20



Honeywell
THE POWER OF CONNECTED

GUANTO POLYTRIL FLEX NITRILE Guanto da lavoro per ambienti sia asciutti che umidi

92031029 – Taglia 6 –
– conf. 10 – € 6,00

92031030 – Taglia 7 –
– conf. 10 – € 6,00

92031031 – Taglia 8 –
– conf. 10 – € 6,00

92031032 – Taglia 9 –
– conf. 10 – € 6,00

92031033 – Taglia 10 –
– conf. 10 – € 6,00



Honeywell
THE POWER OF CONNECTED

GUANTO ECO POLIURETANO Colore nero

92031034 – Taglia 6 –
– conf. 10 – € 1,50

92031035 – Taglia 7 –
– conf. 10 – € 1,50

92031036 – Taglia 8 –
– conf. 10 – € 1,50

92031037 – Taglia 9 –
– conf. 10 – € 1,50

92031038 – Taglia 10 –
– conf. 10 – € 1,50

92031039 – Taglia 11 –
– conf. 10 – € 1,50



Honeywell
THE POWER OF CONNECTED

GUANTO VERTIGO Con HPPE SPECTRA con spalmatura in nitrile

92031044 – taglia 6 –
– conf. 10 – € 12,80

92031045 – taglia 7 –
– conf. 10 – € 12,80

92031046 – taglia 8 –
– conf. 10 – € 12,80

92031047 – taglia 9 –
– conf. 10 – € 12,80

92031048 – taglia 10 –
– conf. 10 – € 12,80

segue...



Honeywell
THE POWER OF CONNECTED

continua...

92031049 – taglia 11 –
– conf. 10 – € 12,80



Honeywell
THE POWER OF CONNECTED

GUANTO BLUESAFE Interamente rivestito in nitrile blu Polsino di sicurezza

92031050 – taglia 9 –
– conf. 1 – € 5,20

92031051 – taglia 10 –
– conf. 1 – € 5,20



Honeywell
THE POWER OF CONNECTED

GUANTO in nitrile Senza supporto Cotone flocato Finitura in rilievo Colore verde

92031052 – taglia 7 –
– conf. 12 – € 4,20

92031053 – taglia 8 –
– conf. 12 – € 4,20

92031054 – taglia 9 –
– conf. 12 – € 4,20

92031055 – taglia 10 –
– conf. 12 – € 4,20

92031056 – taglia 11 –
– conf. 12 – € 4,20





<p>Honeywell THE POWER OF CONNECTED</p> <p>GUANTO Triconyl in poliammide Lavorato a maglia leggero Colore bianco</p> <p>92031057 - taglia 6 - - conf. 10 - € 2,20</p> <p>92031058 - taglia 7 - - conf. 10 - € 2,20</p> <p>92031059 - taglia 8 - - conf. 10 - € 2,20</p> <p>92031060 - taglia 9 - - conf. 10 - € 2,20</p> <p>92031061 - taglia 10 - - conf. 10 - € 2,20</p> 	<p>Honeywell THE POWER OF CONNECTED</p> <p>GUANTO DexGrip light in poliammide Cotone, leggero lavorato a maglia Rivestimento in Latex Colore blu rugoso sottile</p> <p>92031062 - taglia 7 - - conf. 10 - € 4,40</p> <p>92031063 - taglia 8 - - conf. 10 - € 4,40</p> <p>92031064 - taglia 9 - - conf. 10 - € 4,40</p> <p>92031065 - taglia 10 - - conf. 10 - € 4,40</p> 
<p>Honeywell THE POWER OF CONNECTED</p> <p>GUANTI Blue Welding Crosta di pelle blu Doppio fiocco di cotone Colore blu</p> <p>92031066 - taglia 9 - - conf. 10 - € 25,20</p> <p>92031067 - taglia 10 - - conf. 10 - € 25,20</p> 	<p>GIEFFE gruppi general ferramenta</p> <p>GUANTO antitaglio DN 198-PU</p> <p>512DNPU07 - Taglia 7 - - conf. 12 - € 5,00</p> <p>512DNPU08 - Taglia 8 - - conf. 12 - € 5,00</p> <p>512763580 - Taglia 9 - - conf. 12 - € 5,00</p> <p>512763582 - Taglia 10 - - conf. 12 - € 5,00</p> <p>512DNPU11 - Taglia 11 - - conf. 12 - € 5,00</p> 
<p>&M930</p> <p>GUANTO Filo Nylon Palma riv. Poliuretano polso elasticizzato Bianco</p> <p>93090067 - Taglia 7 - - conf. 12 - € 2,40</p> <p>93090068 - Taglia 8 - - conf. 12 - € 2,40</p> <p>93090069 - Taglia 9 - - conf. 12 - € 2,40</p> <p>93090070 - Taglia 10 - - conf. 12 - € 2,40</p>  <p>AD ESAURIMENTO</p>	<p>SHOWA</p> <p>GUANTO Showa grip 310 EN 320 + EN 388</p> <p>93090670 - Taglia 9 - - conf. 10 - € 5,40</p> <p>93090671 - Taglia 10 - - conf. 10 - € 5,40</p>  <p>AD ESAURIMENTO</p>
<p>&M930</p> <p>GUANTO Edmond Hhynit 32-015 fodera in cotone rivestito in nitrile adatto al maneggio</p> <p>93090501 - Taglia 7 - - conf. 12 - € 2,40</p> <p>93090502 - Taglia 8 - - conf. 12 - € 2,40</p>  <p>AD ESAURIMENTO</p>	<p>&M930</p> <p>GUANTO TOUCH Utilizzabile con tutti i dispositivi touchscreen Taglia unica 90% Tessuto acrilico 5% Spandex 5% Fibra conduttiva</p> <p>93090040 - - conf. 12 - € 3,80</p> 
<p>COFRA GOOD TO WORK</p> <p>CAPPELLO SHIVER Colore nero</p> <p>413SHINE - - conf. 1 - € 6,80</p>  <p>AD ESAURIMENTO</p>	<p>U-POWER</p> <p>CONFEZIONE 3 MAGLIETTE Mod. Giallo Fluo T-shirt manica corta Confortevole, traspirante e delicata sulla pelle Girocollo a coste Logo ricamato Slim-fit Colore: Giallo Fluo Composizione: 100% COTONE FIAMMATO - 145 gr/m2 NON SI ACCETTANO RESI PER ARTICOLI INDOSSATI E APERTI</p> <p>798195YFM - Taglia M - - conf. 1 - € 36,40</p> <p>798195YFL - Taglia L - - conf. 1 - € 36,40</p> <p>798195YFXL - Taglia XL - - conf. 1 - € 36,40</p> 
<p>U-POWER</p> <p>CONFEZIONE 3 MAGLIETTE Mod. Arancione Fluo T-shirt manica corta Confortevole, traspirante e delicata sulla pelle Girocollo a coste Logo ricamato Slim-fit 3 pezzi Colore: Arancione Fluo Composizione: 100% COTONE FIAMMATO - 145 gr/m2 NON SI ACCETTANO RESI PER ARTICOLI INDOSSATI E APERTI</p> <p>798195OFM - Taglia M - - conf. 1 - € 36,40</p> <p>798195OFL - Taglia L - - conf. 1 - € 36,40</p> <p>798195OFXL - Taglia XL - - conf. 1 - € 36,40</p> 	<p>U-POWER</p> <p>CONFEZIONE 3 MAGLIETTE Mod. Verde Fluo T-shirt manica corta Confortevole, traspirante e delicata sulla pelle Girocollo a coste Logo ricamato Slim-fit Colore: Verde Fluo Composizione: 100% COTONE FIAMMATO - 145 gr/m2 NON SI ACCETTANO RESI PER ARTICOLI INDOSSATI E APERTI</p> <p>798195VFM - Taglia M - - conf. 1 - € 36,40</p> <p>798195VFL - Taglia L - - conf. 1 - € 36,40</p> <p>798195VFXL - Taglia XL - - conf. 1 - € 36,40</p> 



FELPA JUPITER Felpa con cappuccio regolabile Chiusura con zip centrale con serigrafia "U-Power" Tasche ad ingresso obliquo Polsi e fondo a coste elasticizzate Composizione: 70% cotone, 30% poliestere - 310 gr/mq

798EY212BCM - Taglia M - Colore BLACK CARBON - conf. 1 - € 76,24
798EY212BCL - Taglia L - Colore BLACK CARBON - conf. 1 - € 76,24
segue...



continua...
798EY212BCXL - Taglia XL - Colore BLACK CARBON - conf. 1 - € 76,24
798EY212DBM - Taglia M - Colore DEEP BLUE - conf. 1 - € 76,24
798EY212DBL - Taglia L - Colore DEEP BLUE - conf. 1 - € 76,24
798EY212DBXL - Taglia XL - Colore DEEP BLUE - conf. 1 - € 76,24
798EY212AGM - Taglia M - Colore ASPHALT GREY - conf. 1 - € 76,24
segue...



continua...
798EY212AGL - Taglia L - Colore ASPHALT GREY - conf. 1 - € 76,24
798EY212AGXL - Taglia XL - Colore ASPHALT GREY - conf. 1 - € 76,24



FELPA RAINBOW Con zip ed interno in morbido pile con cappuccio Due tasche frontali e una sul petto chiuse con zip Composizione 100% Poliestere **NON SI ACCETTANO RESI PER ARTICOLI INDOSSATI E APERTI**

798174BCS - Taglia S - Colore Black Carbon - conf. 1 - € 61,40
798174BCM - Taglia M - Colore Black Carbon - conf. 1 - € 61,40
798174BCL - Taglia L - Colore Black Carbon - conf. 1 - € 61,40
segue...



continua...
798174BCXL - Taglia XL - Colore Black Carbon - conf. 1 - € 61,40
798174BC2XL - Taglia XXL - Colore Black Carbon - conf. 1 - € 61,40
798174YFS - Taglia S - Colore Yellow Fluo - conf. 1 - € 61,40
798174YFM - Taglia M - Colore Yellow Fluo - conf. 1 - € 61,40
798174YFL - Taglia L - Colore Yellow Fluo - conf. 1 - € 61,40
segue...



continua...
798174YFXL - Taglia XL - Colore Yellow Fluo - conf. 1 - € 61,40
798174YF2XL - Taglia XXL - Colore Yellow Fluo - conf. 1 - € 61,40



PILE NERO BETA ART. 9537N Con zip 100% poliestere

200095370104 - Taglia XL - conf. 1 - € 41,18
200095370105 - Taglia XXL - conf. 1 - € 41,18

AD ESAURIMENTO



GILET MOVER GRIGIO ACCIAIO Gilet 3 tasche anteriori, tasche applicate portaoggetti, dettagli rifrangenti, tripla cucitura Ideale per tutte le stagioni Composizione: 65% Poliestere 35% Cotone twill 250 gr/m² dettagli in contrasto 100% Poliestere canvas **NON SI ACCETTANO RESI PER ARTICOLI INDOSSATI E APERTI**

462160302GS - Taglia S - conf. 1 - € 41,20
462160302GM - Taglia M - conf. 1 - € 41,20
segue...



continua...
462160302GL - Taglia L - conf. 1 - € 41,20
462160302GXL - Taglia XL - conf. 1 - € 41,20



SMANICATO SATURN Resistente, idrorepellente, traspirante e asciuga rapidamente Dotato di due tasche frontali e una sul petto chiuse da una zip Composizione 90% Nylon 10% Spandex **NON SI ACCETTANO RESI PER ARTICOLI INDOSSATI E APERTI**

798181AGS - Taglia S - Colore Grey - conf. 1 - € 67,60
798181AGM - Taglia M - Colore Grey - conf. 1 - € 67,60
798181AGL - Taglia L - Colore Grey - conf. 1 - € 67,60
segue...











continua...
798181AGXL - Taglia XL - Colore Grey - conf. 1 - € 67,60
798181AG2XL - Taglia XXL - Colore Grey - conf. 1 - € 67,60
798181BCS - Taglia S - Colore Black Carbon - conf. 1 - € 67,60
798181BCM - Taglia M - Colore Black Carbon - conf. 1 - € 67,60
798181BCL - Taglia L - Colore Black Carbon - conf. 1 - € 67,60
segue...



continua...
798181BCXL - Taglia XL - Colore Black Carbon - conf. 1 - € 67,60
798181BC2XL - Taglia XXL - Colore Black Carbon - conf. 1 - € 67,60



  <p>SMANICATO UNIVERSE In Softshell con membrana U-Tex che rende il tessuto impermeabile, traspirante e antivento. Comodo e resistente con una fodera interna in micro-fleece fluo. Dotato di due tasche frontali e una sul petto chiuse da una zip. Composizione: 96% Poliestere 4% Spandex Peso 320 gr/m2</p> <p>798FU188BCS – Taglia S – Colore Black Carbon – conf. 1 – € 79,90</p> <p>798FU188BCM – Taglia M – Colore Black Carbon – conf. 1 – € 79,90 segue...</p>	  <p>continua...</p> <p>798FU188BCL – Taglia L – Colore Black Carbon – conf. 1 – € 79,90</p> <p>798FU188BCXL – Taglia XL – Colore Black Carbon – conf. 1 – € 79,90</p> <p>798FU188DBS – Taglia S – Colore Deep Blue – conf. 1 – € 79,90</p> <p>798FU188DBM – Taglia M – Colore Deep Blue – conf. 1 – € 79,90 segue...</p>
  <p>continua...</p> <p>798FU188DBL – Taglia L – Colore Deep Blue – conf. 1 – € 79,90</p> <p>798FU188DBXL – Taglia XL – Colore Deep Blue – conf. 1 – € 79,90</p>	  <p>GIACCA DA LAVORO PLUTON Giacca in tessuto idrorepellente, traspirante e asciuga rapidamente. Due tasche frontali e una sul petto. Cappuccio a scomparsa regolabile. Composizione 90% Nylon 10% Spandex. NON SI ACCETTANO RESI PER ARTICOLI INDOSSATI E APERTI</p> <p>798178AGS – Taglia S – Colore Asphalt Grey – conf. 1 – € 87,40</p> <p>798178AGM – Taglia M – Colore Asphalt Grey – conf. 1 – € 87,40</p> <p>798178AGL – Taglia L – Colore Asphalt Grey – conf. 1 – € 87,40 segue...</p>
  <p>continua...</p> <p>798178AGXL – Taglia XL – Colore Asphalt Grey – conf. 1 – € 87,40</p> <p>798178AG2XL – Taglia XXL – Colore Asphalt Grey – conf. 1 – € 87,40</p> <p>798178BCS – Taglia S – Colore Black Carbon – conf. 1 – € 87,40</p> <p>798178BCM – Taglia M – Colore Black Carbon – conf. 1 – € 87,40</p> <p>798178BCL – Taglia L – Colore Black Carbon – conf. 1 – € 87,40 segue...</p>	  <p>continua...</p> <p>798178BCXL – Taglia XL – Colore Black Carbon – conf. 1 – € 87,40</p> <p>798178BC2XL – Taglia XXL – Colore Black Carbon – conf. 1 – € 87,40</p>
  <p>GIACCA DA LAVORO SPACE Giacca in Softshell con membrana U-Tex che rende il tessuto impermeabile, traspirante e antivento. Inserti in reflex per garantire la massima visibilità. Cappuccio staccabile. Due tasche frontali e una sul petto, due tasche interne e una termosaldata sulla manica. NON SI ACCETTANO RESI PER ARTICOLI INDOSSATI E APERTI</p> <p>798187BCS – Taglia S – Colore Black Carbon – conf. 1 – € 109,40</p> <p>798187BCM – Taglia M – Colore Black Carbon – conf. 1 – € 109,40 segue...</p>	  <p>continua...</p> <p>798187BCL – Taglia L – Colore Black Carbon – conf. 1 – € 109,40</p> <p>798187BCXL – Taglia XL – Colore Black Carbon – conf. 1 – € 109,40</p> <p>798187BC2XL – Taglia XXL – Colore Black Carbon – conf. 1 – € 109,40</p> <p>798FU187DBM – Taglia M – Colore Deep Blue – conf. 1 – € 111,98</p> <p>798FU187DBL – Taglia L – Colore Deep Blue – conf. 1 – € 111,98 segue...</p>
  <p>continua...</p> <p>798FU187DBXL – Taglia XL – Colore Deep Blue – conf. 1 – € 111,98</p> <p>798FU187DBXXL – Taglia XXL – Colore Deep Blue – conf. 1 – € 111,98</p>	  <p>GIACCA SPOCK Giacca ibrida versatile. Chiusura centrale con zip. Cappuccio fisso e regolabile. Polsini elasticizzati. Fodera interna in nylon e micro-pile. Dotata di tre tasche: 2 frontali e 1 sul petto, chiusura zip. Con fondo sagomato. Composizione: 96% poliestere, 4% spandex – 320 gr/mq</p> <p>798FU213BCM – Taglia M – Colore Black Carbon – conf. 1 – € 116,95</p> <p>798FU213BCL – Taglia L – Colore Black Carbon – conf. 1 – € 116,95 segue...</p>
  <p>continua...</p> <p>798FU213BCXL – Taglia XL – Colore Black Carbon – conf. 1 – € 116,95</p> <p>798FU213DBM – Taglia M – Colore Deep Blue – conf. 1 – € 116,95</p> <p>798FU213DBL – Taglia L – Colore Deep Blue – conf. 1 – € 116,95</p> <p>798FU213DBXL – Taglia XL – Colore Deep Blue – conf. 1 – € 116,95 segue...</p>	  <p>continua...</p> <p>798FU213AGM – Taglia M – Colore Asphalt Grey – conf. 1 – € 116,95</p> <p>798FU213AGL – Taglia L – Colore Asphalt Grey – conf. 1 – € 116,95</p> <p>798FU213AGXL – Taglia XL – Colore Asphalt Grey – conf. 1 – € 116,95</p>



GIACCA DA LAVORO BLAZE Giacca in tessuto Softshell, traspirante, imbottita, antivento e idrorepellente Due tasche frontali e una sul petto con chiusura a zip Composizione 96% Poliestere 4% Elastane Membrana TPU **NON SI ACCETTANO RESI PER ARTICOLI INDOSSATI E APERTI**

798113BCS - Taglia S -
- conf. 1 - € 107,00
798113BCM - Taglia M -
- conf. 1 - € 107,00
798113BCL - Taglia L -
- conf. 1 - € 107,00
segue...



continua...
798113BCXL - Taglia XL -
- conf. 1 - € 107,00
798113BC2XL - Taglia XXL -
- conf. 1 - € 107,00



GIUBBOTTO DA LAVORO MIKY In tessuto Softshell, stretch, traspirante, antivento e idrorepellente Due tasche frontali e una sul petto chiuse da zip Cappuccio staccabile Strisce riflettente termo-applicate su busto e braccia Colore Giallo Composizione 96% Poliestere 4% Elastane **NON SI ACCETTANO RESI PER ARTICOLI INDOSSATI E APERTI**

798169YFS - Taglia S -
- conf. 1 - € 97,40
798169YFM - Taglia M -
- conf. 1 - € 97,40
segue...



continua...
798169YFL - Taglia L -
- conf. 1 - € 97,40
798169YFXL - Taglia XL -
- conf. 1 - € 97,40
798169YF2XL - Taglia XXL -
- conf. 1 - € 97,40



GIACCA SOFTSHELL MOD. SAIL DIADORA 3 tasche frontali di cui una sul petto Cappuccio, dettagli rifrangenti Invernale, isolamento termico perfetto Traspirante e resistente al vento 94% poliestere 6% elastene 300 gr Rivestimento TPU **NON SI ACCETTANO RESI PER ARTICOLI INDOSSATI E APERTI**

462159632GM - Colore Grigio - Taglia M -
- conf. 1 - € 76,20
462159632GL - Colore Grigio - Taglia L -
- conf. 1 - € 76,20
segue...



continua...
462159632GXL - Colore Grigio - Taglia XL -
- conf. 1 - € 76,20
462159632GXXL - Colore Grigio - Taglia XXL -
- conf. 1 - € 76,20
462159632BM - Colore Blu - Taglia M -
- conf. 1 - € 76,20
462159632BL - Colore Blu - Taglia L -
- conf. 1 - € 76,20
462159632BXL - Colore Blu - Taglia XL -
- conf. 1 - € 76,20
462159632BXXL - Colore Blu - Taglia XXL -
- conf. 1 - € 76,20



PANTALONE ROCK GRIGIO ACCIAIO In poliestere e cotone twill dotati di elastico in vita, tasche frontali e laterali, tasca portametro e porta martello Dettagli in poliestere antiabrasione e triple cuciture con ginocchiere anti urto Adatti a tutte le stagioni Composizione 65% Poliestere 35% Cotone twill250 gr/m² dettagli in contrasto 100% Poliestere canvas **NON SI ACCETTANO RESI PER ARTICOLI INDOSSATI E APERTI**

462160303GS - Taglia S -
- conf. 1 - € 41,20
segue...



continua...
462160303GM - Taglia M -
- conf. 1 - € 41,20
462160303GL - Taglia L -
- conf. 1 - € 41,20
462160303GXL - Taglia XL -
- conf. 1 - € 41,20



PANTALONE LUNGO DA LAVORO Mod. World Black Pantalone in tessuto U-4 Slim Fit Idrorepellente, traspirante e asciuga rapidamente Dotato di 2 ampie tasche anteriori, Tasca laterale multifunzionale porta utensili, 2 tasche posteriori, 2 tasche chiuse con zip Vita regolabile Carrè posteriore accentuato per la protezione della zona lombare Composizione: 86% NYLON - 14% SPANDEX - 140 gr/m2 **NON SI ACCETTANO RESI PER ARTICOLI INDOSSATI E APERTI**

798189BCM - Taglia M - Colore BLACK CARBON -
- conf. 1 - € 83,20
segue...



continua...
798189BCL - Taglia L - Colore BLACK CARBON -
- conf. 1 - € 83,20
798189BCXL - Taglia XL - Colore BLACK CARBON -
- conf. 1 - € 83,20









PANTALONE DA LAVORO ATOM Idrorepellente, traspirante e asciuga rapidamente. Due tasche anteriori e una laterale Composizione 90% Nylon 10% Spandex **NON SI ACCETTANO RESI PER ARTICOLI INDOSSATI E APERTI**

798145BCS - Taglia S - Colore Black Carbons -
- conf. 1 - € 85,80
798145BCM - Taglia M - Colore Black Carbons -
- conf. 1 - € 85,80
798145BCL - Taglia L - Colore Black Carbons -
- conf. 1 - € 85,80
segue...



continua...
798145BCXL - Taglia XL - Colore Black Carbons -
- conf. 1 - € 85,80
798145BC2XL - Taglia XXL - Colore Black Carbons -
- conf. 1 - € 85,80
798145AGS - Taglia S - Colore Asphalt Grey -
- conf. 1 - € 85,80
798145AGM - Taglia M - Colore Asphalt Grey -
- conf. 1 - € 85,80
798145AGL - Taglia L - Colore Asphalt Grey -
- conf. 1 - € 85,80
segue...



  <p>continua... 798145AGXL – Taglia XL – Colore Asphalt Grey – – conf. 1 – € 85,80 798145AG2XL – Taglia XXL – Colore Asphalt Grey – – conf. 1 – € 85,80</p>	  <p>PANTALONE CORTO DA LAVORO Mod. Mercury Bermuda in tessuto U-4 Slim Fit Idrorepellente, traspirante e asciuga rapidamente Dotato di 2 ampie tasche anteriori, Tasca laterale multi- funzionale porta utensili, 2 tasche posteriori, 2 tasche chiuse con zip Vita regolabile Carré posteriore accentuato per la protezione della zona lombare Composizione: 86% NYLON – 14% SPANDEX – 140gr/m2 NON SI ACCETTANO RESI PER ARTICOLI INDOSSATI E APERTI</p> <p>798196AGM – Taglia M – Colore GREY – – conf. 1 – € 74,80 segue...</p>
  <p>continua... 798196AGL – Taglia L – Colore GREY – – conf. 1 – € 74,80 798196AGXL – Taglia XL – Colore GREY – – conf. 1 – € 74,80 798196AG2XL – Taglia 2XL – Colore GREY – – conf. 1 – € 74,80 798196BCM – Taglia M – Colore BLACK CARBON – – conf. 1 – € 74,80 798196BCL – Taglia L – Colore BLACK CARBON – – conf. 1 – € 74,80 segue...</p>	  <p>continua... 798196BCXL – Taglia XL – Colore BLACK CARBON – – conf. 1 – € 74,80</p>
  <p>BERMUDA CARGO DA LAVORO SUMMER In tela di cotone elasticizzato Due ampie tasche antero- ri e tasca posteriore con velcro Doppio tessuto di rinforzo sulla parte posteriore Composizione 97% Cotone 3% Spandex NON SI ACCETTANO RESI PER ARTICOLI INDOSSATI E APERTI</p> <p>798132BCS – Taglia S – Colore Black Carbon – – conf. 1 – € 42,44 798132BCM – Taglia M – Colore Black Carbon – – conf. 1 – € 42,44 798132BCL – Taglia L – Colore Black Carbon – – conf. 1 – € 42,44 segue...</p>	  <p>continua... 798132BCXL – Taglia XL – Colore Black Carbon – – conf. 1 – € 42,44 798132BC2XL – Taglia XXL – Colore Black Carbon – – conf. 1 – € 42,44 798132GIS – Taglia S – Colore Grey Iron – – conf. 1 – € 42,44 798132GIM – Taglia M – Colore Grey Iron – – conf. 1 – € 42,44 798132GIL – Taglia L – Colore Grey Iron – – conf. 1 – € 42,44 segue...</p>
  <p>continua... 798132GIXL – Taglia XL – Colore Grey Iron – – conf. 1 – € 42,44 798132GI2XL – Taglia XXL – Colore Grey Iron – – conf. 1 – € 42,44</p>	  <p>JEANS CORTO Mod. Havana Tessuto in poliestere per maggior resistenza ad abrasioni e usura Tes- suto elasticizzato tascone porta attrezzi, 2 ampie tasche posteriori, 2 tasche anteriori, Tasca porta metro Anello porta martello Colore: Blu Gram- matura: 330 g/m² Composizione: 70% cotone – 27% poliestere – 3% elasthan</p> <p>413HAV44 – Taglia 44 – – conf. 1 – € 47,40 413HAV46 – Taglia 46 – – conf. 1 – € 47,40 segue...</p>
  <p>continua... 413HAV48 – Taglia 48 – – conf. 1 – € 47,40 413HAV50 – Taglia 50 – – conf. 1 – € 47,40 413HAV52 – Taglia 52 – – conf. 1 – € 47,40 413HAV54 – Taglia 54 – – conf. 1 – € 47,40 413HAV56 – Taglia 56 – – conf. 1 – € 47,40 413HAV58 – Taglia 58 – – conf. 1 – € 47,40</p>	  <p>JEANS BARCELLONA 4 tasche + 1 tascone porta attrezzi Tasca porta metro Anello porta martel- lo Vita regolabile Tessuto elasticizzato</p> <p>413BAR44 – Taglia 44 – – conf. 1 – € 56,20 413BAR46 – Taglia 46 – – conf. 1 – € 56,20 413BAR48 – Taglia 48 – – conf. 1 – € 56,20 413BAR50 – Taglia 50 – – conf. 1 – € 56,20 segue...</p>
  <p>continua... 413BAR52 – Taglia 52 – – conf. 1 – € 56,20 413BAR54 – Taglia 54 – – conf. 1 – € 56,20 413BAR56 – Taglia 56 – – conf. 1 – € 56,20 413BAR58 – Taglia 58 – – conf. 1 – € 56,20</p>	  <p>2 PAIA CALZE GIADY Taglia unica Calza tecnica con tecnologia "Memory size" Plantare in cotone con proprietà ammortizzanti ad effetto cuscinet- to Composizione: 47% Poliestere, 39% Cotone, 12% Poliamide, 2% Elastane NON SI ACCETTA- NO RESI PER ARTICOLI INDOSSATI E APERTI</p> <p>798SK218OF – Colore Arancio Fluo – – conf. 1 – € 17,16 798SK218VF – Colore Verde Fluo – – conf. 1 – € 17,16 798SK218YF – Colore Giallo FLuo – – conf. 1 – € 17,16</p>



www.cofra.it



SUPER
STRETCH



JEMBER V567

245 g/m²

60% cotone - 37% poliestere - 3% elasthan

Pantaloni in tessuto twill composto da fibre elasticizzate che garantiscono massima libertà di movimento.

Vestibilità perfetta per una giornata di lavoro in piena attività.

Colore e forma garantiti anche dopo ripetuti lavaggi.

**FOLLOWS YOUR
MOVEMENTS**





LIGHTTECH

CALZATURE DI SICUREZZA
ULTRALEGGERE

READY
TO FLY



www.cofra.it





Beta



SCARPE IN PELLE SCAMOSCIATA TRAFORATA S1P BETA ART. 7246B Lamina antiperforazione Suola in poliuretano compatto Puntale in acciaio 200J

200072460239 - Taglia 39 -
- conf. 1 - € 46,98
200072460240 - Taglia 40 -
- conf. 1 - € 46,98
200072460241 - Taglia 41 -
- conf. 1 - € 46,98
200072460242 - Taglia 42 -
- conf. 1 - € 46,98
segue...

Beta



continua...
200072460243 - Taglia 43 -
- conf. 1 - € 46,98
200072460244 - Taglia 44 -
- conf. 1 - € 46,98
200072460245 - Taglia 45 -
- conf. 1 - € 46,98
200072460246 - Taglia 46 -
- conf. 1 - € 46,98

Beta



SCARPA S3 RS SRC BETA ART. 7243C Tomaia: pelle idrorepellente Suola: poliuretano bidensità Puntale: Acciaio resistente 200 Joule Antistatica Suola antiscivolo resistente a olii, idrocarburi e solventi Peso 650 gr. Scarpa alta a rapido sfilamento

200072430339 - Taglia 39 -
- conf. 1 - € 47,38
200072430340 - Taglia 40 -
- conf. 1 - € 47,38
200072430341 - Taglia 41 -
- conf. 1 - € 47,38
segue...

Beta



continua...
200072430342 - Taglia 42 -
- conf. 1 - € 47,38
200072430343 - Taglia 43 -
- conf. 1 - € 47,38
200072430344 - Taglia 44 -
- conf. 1 - € 47,38
200072430345 - Taglia 45 -
- conf. 1 - € 47,38
200072430346 - Taglia 46 -
- conf. 1 - € 47,38

COFRA
BORN TO WORK



SCARPA MONTI S3 SRC

413MONTI36 - Taglia 36 -
- conf. 1 - € 79,60
413MONTI37 - Taglia 37 -
- conf. 1 - € 79,60
413MONTI38 - Taglia 38 -
- conf. 1 - € 79,60
413MONTI39 - Taglia 39 -
- conf. 1 - € 79,60
413MONTI40 - Taglia 40 -
- conf. 1 - € 79,60
segue...

COFRA
BORN TO WORK



continua...
413MONTI41 - Taglia 41 -
- conf. 1 - € 79,60
413MONTI42 - Taglia 42 -
- conf. 1 - € 79,60
413MONTI43 - Taglia 43 -
- conf. 1 - € 79,60
413MONTI44 - Taglia 44 -
- conf. 1 - € 79,60
413MONTI45 - Taglia 45 -
- conf. 1 - € 79,60
413MONTI46 - Taglia 46 -
- conf. 1 - € 79,60

COFRA
BORN TO WORK



SCARPE COOL ESD S3 SRC Tomaia: tessuto riciclato misto a poliammide, idrorepellente Fodera Interna: 100% poliestere, tridimensionale, traspirante, assorbente, antiabrasione Soletta: in schiuma di poliuretano Puntale: non metallico in fibra di vetro Lamina: Zero Perforation con bassa resistenza elettrica Consigli d'uso: Logistica, servizi, trasporti, industria leggera, ecc. **Non consigliata per industria pesante ed edilizia**

413COOL36 - Tg. 36 -
- conf. 1 - € 107,80
segue...

COFRA
BORN TO WORK



continua...
413COOL37 - Tg. 37 -
- conf. 1 - € 107,80
413COOL38 - Tg. 38 -
- conf. 1 - € 107,80
413COOL39 - Tg. 39 -
- conf. 1 - € 107,80
413COOL40 - Tg. 40 -
- conf. 1 - € 107,80
413COOL41 - Tg. 41 -
- conf. 1 - € 107,80
segue...

COFRA
BORN TO WORK



continua...
413COOL42 - Tg. 42 -
- conf. 1 - € 107,80
413COOL43 - Tg. 43 -
- conf. 1 - € 107,80
413COOL44 - Tg. 44 -
- conf. 1 - € 107,80
413COOL45 - Tg. 45 -
- conf. 1 - € 107,80
413COOL46 - Tg. 46 -
- conf. 1 - € 107,80

COFRA
BORN TO WORK



SCARPE EXPRESSION S1P SRC Tomaia: tessuto altamente traspirante Fodera interna: 100% poliestere, tridimensionale, traspirante, assorbente e deassorbente, antiabrasione Soletta: realizzata in schiuma di poliuretano Puntale: non metallico in fibra di vetro Lamina: Zero Perforation Consigli d'uso: Logistica, servizi, trasporti, industria leggera, industria microelettronica, settore alimentare. **Non è consigliata per industria pesante ed edilizia**

413EXP36 - Tg. 36 -
- conf. 1 - € 101,60
segue...

COFRA
BORN TO WORK

























continua...
413EXP37 - Tg. 37 -
- conf. 1 - € 101,60
413EXP38 - Tg. 38 -
- conf. 1 - € 101,60
413EXP39 - Tg. 39 -
- conf. 1 - € 101,60
413EXP40 - Tg. 40 -
- conf. 1 - € 101,60
413EXP41 - Tg. 41 -
- conf. 1 - € 101,60
segue...

COFRA
BORN TO WORK



continua...
413EXP42 - Tg. 42 -
- conf. 1 - € 101,60
413EXP43 - Tg. 43 -
- conf. 1 - € 101,60
413EXP44 - Tg. 44 -
- conf. 1 - € 101,60
413EXP45 - Tg. 45 -
- conf. 1 - € 101,60
413EXP46 - Tg. 46 -
- conf. 1 - € 101,60















  <p>VORTIX S1P SRC ESD Scarpe antinfortunistiche basse U-Power linea Red Industry Tomaia: Morbida pelle scamosciata forata, traspirante con inserti in mesh Fodera Interna: a tunnel d'aria traspirante Soletta: Soffice PU espanso Suola: antiabrasione, antiolio, antiscivolo e antistatico Puntale: AirToe Composite</p> <p>7982066638 - Taglia 38 - - conf. 1 - € 73,70</p> <p>7982066639 - Taglia 39 - - conf. 1 - € 73,70</p> <p>segue...</p>	  <p>continua...</p> <p>7982066640 - Taglia 40 - - conf. 1 - € 73,70</p> <p>7982066641 - Taglia 41 - - conf. 1 - € 73,70</p> <p>7982066642 - Taglia 42 - - conf. 1 - € 73,70</p> <p>7982066643 - Taglia 43 - - conf. 1 - € 73,70</p> <p>7982066644 - Taglia 44 - - conf. 1 - € 73,70</p> <p>segue...</p>
  <p>continua...</p> <p>7982066645 - Taglia 45 - - conf. 1 - € 73,70</p> <p>7982066646 - Taglia 46 - - conf. 1 - € 73,70</p>	  <p>NEGAN S1P SRC ESD Scarpe antinfortunistiche basse U-Power linea Red 360 Tomaia: Nylon ultra traspirante e morbida pelle scamosciata, collarino in Lycra e tallonetta anti-shock Puntale: in alluminio Fodera Interna: a tunnel d'aria traspirante Soletta: Soffice PU espanso Suola: Antiperforazione, antiscivolo</p> <p>7982002638 - Tg. 38 - - conf. 1 - € 126,20</p> <p>7982002639 - Tg. 39 - - conf. 1 - € 126,20</p> <p>segue...</p>
  <p>continua...</p> <p>7982002640 - Tg. 40 - - conf. 1 - € 126,20</p> <p>7982002641 - Tg. 41 - - conf. 1 - € 126,20</p> <p>7982002642 - Tg. 42 - - conf. 1 - € 126,20</p> <p>7982002643 - Tg. 43 - - conf. 1 - € 126,20</p> <p>7982002644 - Tg. 44 - - conf. 1 - € 126,20</p> <p>segue...</p>	  <p>continua...</p> <p>7982002645 - Tg. 45 - - conf. 1 - € 126,20</p> <p>7982002646 - Tg. 46 - - conf. 1 - € 126,20</p>
  <p>RYDER S1P SRC ESD Scarpe antinfortunistiche basse U-Power linea Red 360 Tomaia: Nylon ultra traspirante e morbida pelle scamosciata, collarino in Lycra e tallonetta anti-shock Puntale: in alluminio Fodera Interna: a tunnel d'aria traspirante Soletta: Soffice PU espanso Suola: Antiperforazione, antiscivolo</p> <p>7982001638 - Tg. 38 - - conf. 1 - € 126,20</p> <p>7982001639 - Tg. 39 - - conf. 1 - € 126,20</p> <p>segue...</p>	  <p>continua...</p> <p>7982001640 - Tg. 40 - - conf. 1 - € 126,20</p> <p>7982001641 - Tg. 41 - - conf. 1 - € 126,20</p> <p>7982001642 - Tg. 42 - - conf. 1 - € 126,20</p> <p>7982001643 - Tg. 43 - - conf. 1 - € 126,20</p> <p>7982001644 - Tg. 44 - - conf. 1 - € 126,20</p> <p>segue...</p>
  <p>continua...</p> <p>7982001645 - Tg. 45 - - conf. 1 - € 126,20</p> <p>7982001646 - Tg. 46 - - conf. 1 - € 126,20</p>	  <p>SCARPA BASSA NILO S1P TOMAIA: Pelle scamosciata forata FODERA: Tessuto traspirante, assorbente e deassorbente, antiabrasione FUSBETT: Intero, estraibile, antistatico, rivestito in TEXELLE SUOLA: PU Flex-Sole</p> <p>413NIL39 - Tg. 39 - - conf. 1 - € 48,00</p> <p>413NIL40 - Tg. 40 - - conf. 1 - € 48,00</p> <p>413NIL41 - Tg. 41 - - conf. 1 - € 48,00</p> <p>segue...</p>
  <p>continua...</p> <p>413NIL42 - Tg. 42 - - conf. 1 - € 48,00</p> <p>413NIL43 - Tg. 43 - - conf. 1 - € 48,00</p> <p>413NIL44 - Tg. 44 - - conf. 1 - € 48,00</p> <p>413NIL45 - Tg. 45 - - conf. 1 - € 48,00</p> <p>413NIL46 - Tg. 46 - - conf. 1 - € 48,00</p>	  <p>SCARPA ALTA TEVERE S1P TOMAIA: Pelle scamosciata FODERA: Tessuto traspirante, assorbente e deassorbente, antiabrasione FUSBETT: Intero, estraibile, antistatico, rivestito in TEXELLE SUOLA: PU Flex-Sole</p> <p>413TEV39 - Tg. 39 - - conf. 1 - € 51,20</p> <p>413TEV40 - Tg. 40 - - conf. 1 - € 51,20</p> <p>413TEV41 - Tg. 41 - - conf. 1 - € 51,20</p> <p>segue...</p>



  <p>continua... 413TEV42 - Tg. 42 - - conf. 1 - € 51,20 413TEV43 - Tg. 43 - - conf. 1 - € 51,20 413TEV44 - Tg. 44 - - conf. 1 - € 51,20 413TEV45 - Tg. 45 - - conf. 1 - € 51,20 413TEV46 - Tg. 46 - - conf. 1 - € 51,20</p>	  <p>SCARPA PETRI S1 P Tomaia: tessuto BREATHEX con tessitura 3D altamente traspirante e MICRO-TECH Fodera: sany-dry traspirante, antibatterica, assorbente, deassorbente, e antiabrasione Soletta: Cofra soft anatomica, in poliuretano profumato e garantisce l'assorbimento dell'energia di impatto e grip elevato, mentre lo strato superiore lascia piede asciutto e assorbe sudore Suola: PU/TPU Puntale: Aluminium 200J Lamina: non metallica</p> <p>413PET39 - Tg. 39 - - conf. 1 - € 84,88 segue...</p>
  <p>continua... 413PET40 - Tg. 40 - - conf. 1 - € 84,88 413PET41 - Tg. 41 - - conf. 1 - € 84,88 413PET42 - Tg. 42 - - conf. 1 - € 84,88 413PET43 - Tg. 43 - - conf. 1 - € 84,88 413PET44 - Tg. 44 - - conf. 1 - € 84,88 segue...</p>	  <p>continua... 413PET45 - Tg. 45 - - conf. 1 - € 84,88 413PET46 - Tg. 46 - - conf. 1 - € 84,88</p>
  <p>SCARPA RUN S3 DIADORA Calzatura bassa in Nabuk ingrassato, puntale in acciaio 10, 200J, K-sole a passaggio zero, plantare estraibile in EVA termoformata. Suola: Intersuola in PU espanso. Suola in PU compatto antiabrasione. EN: ISO 20345: 2011</p> <p>46215859240 - Taglia 40 - - conf. 1 - € 102,80 46215859241 - Taglia 41 - - conf. 1 - € 102,80 46215859242 - Taglia 42 - - conf. 1 - € 102,80 segue...</p>	  <p>continua... 46215859243 - Taglia 43 - - conf. 1 - € 102,80 46215859244 - Taglia 44 - - conf. 1 - € 102,80 46215859245 - Taglia 45 - - conf. 1 - € 102,80 46215859246 - Taglia 46 - - conf. 1 - € 102,80 46215859247 - Taglia 47 - - conf. 0 - € 102,80</p>
  <p>SCARPA RUN ALTA S3 DIADORA Calzatura alta in Nabuk ingrassato, puntale in acciaio 10, 200J, K-sole a passaggio zero, plantare estraibile in EVA termoformata. Suola: Intersuola in PU espanso. Suola in PU compatto antiabrasione. EN: ISO 20345: 2011</p> <p>46215859337 - Taglia 37 - - conf. 1 - € 110,20 46215859338 - Taglia 38 - - conf. 1 - € 110,20 46215859339 - Taglia 39 - - conf. 1 - € 110,20 segue...</p>	  <p>continua... 46215859340 - Taglia 40 - - conf. 1 - € 110,20 46215859341 - Taglia 41 - - conf. 1 - € 110,20 46215859342 - Taglia 42 - - conf. 1 - € 110,20 46215859343 - Taglia 43 - - conf. 1 - € 110,20 46215859344 - Taglia 44 - - conf. 1 - € 110,20 segue...</p>
  <p>continua... 46215859345 - Taglia 45 - - conf. 1 - € 110,20 46215859346 - Taglia 46 - - conf. 1 - € 110,20</p>	  <p>SCARPA GLOVE S1P DIADORA Calzatura bassa in vitello scamosciato, puntale in alluminio 10, 200 joule. Fodera Air Mesh, K-Sole passaggio zero, plantare in EVA forata. Suola: Intersuola in EVA con film in PU. Battistrada in gomma nitrilica bicolore. EN: ISO 20345: 2011</p> <p>46215695638 - Taglia 38 - - conf. 1 - € 145,20 46215695639 - Taglia 39 - - conf. 1 - € 145,20 46215695640 - Taglia 40 - - conf. 1 - € 145,20 segue...</p>
  <p>continua... 46215695641 - Taglia 41 - - conf. 1 - € 145,20 46215695642 - Taglia 42 - - conf. 1 - € 145,20 46215695643 - Taglia 43 - - conf. 1 - € 145,20 46215695644 - Taglia 44 - - conf. 1 - € 145,20 46215695645 - Taglia 45 - - conf. 1 - € 145,20 segue...</p>	  <p>continua... 46215695646 - Taglia 46 - - conf. 1 - € 145,20 46215695647 - Taglia 47 - - conf. 1 - € 145,20</p>



 <p>SCARPA GLOVE S1P DIADORA COLORE: CAMMELLO Calzatura bassa in vitello scamosciato, puntale in alluminio 10, 200 joule. Fodera Air Mesh, K-Sole passaggio zero, plantare in EVA forata. Suola: Intersuola in EVA con film in PU. Battistrada in gomma nitrilica bicolore. EN: ISO 20345: 2011</p> <p>462156956C38 - Taglia 38 - - conf. 1 - € 136,78</p> <p>462156956C39 - Taglia 39 - - conf. 1 - € 136,78</p> <p>segue...</p>	 <p>continua...</p> <p>462156956C40 - Taglia 40 - - conf. 1 - € 136,78</p> <p>462156956C41 - Taglia 41 - - conf. 1 - € 136,78</p> <p>462156956C45 - Taglia 45 - - conf. 1 - € 136,78</p> <p>462156956C46 - Taglia 46 - - conf. 1 - € 136,78</p> <p>462156956C47 - Taglia 47 - - conf. 1 - € 136,78</p>
 <p>SCARPA GLOVE S1P DIADORA COLORE: ROCCIA LUNARE Calzatura bassa in vitello scamosciato, puntale in alluminio 10, 200 joule. Fodera Air Mesh, K-Sole passaggio zero, plantare in EVA forata. Suola: Intersuola in EVA con film in PU. Battistrada in gomma nitrilica bicolore. EN: ISO 20345: 2011</p> <p>462156956G38 - Taglia 38 - - conf. 1 - € 145,20</p> <p>462156956G39 - Taglia 39 - - conf. 1 - € 145,20</p> <p>segue...</p>	 <p>continua...</p> <p>462156956G40 - Taglia 40 - - conf. 1 - € 145,20</p> <p>462156956G41 - Taglia 41 - - conf. 1 - € 145,20</p> <p>462156956G42 - Taglia 42 - - conf. 1 - € 145,20</p> <p>462156956G43 - Taglia 43 - - conf. 1 - € 145,20</p> <p>462156956G44 - Taglia 44 - - conf. 1 - € 145,20</p> <p>segue...</p>
 <p>continua...</p> <p>462156956G45 - Taglia 45 - - conf. 1 - € 145,20</p> <p>462156956G46 - Taglia 46 - - conf. 1 - € 145,20</p> <p>462156956G47 - Taglia 47 - - conf. 1 - € 145,20</p>	 <p>SCARPA GLOVE II TEXT S1P DIADORA NERO - ESTIVA Calzatura bassa in tessuto rete e vitello scamosciato, puntale in alluminio 10, 200 joule. Fodera Air Mesh, K-Sole passaggio zero, plantare estraibili in EVA forata. Suola: Intersuola in EVA con TPU film protettivo Gomma nitrilica HRO EN: ISO 20345:2011</p> <p>462170236N38 - Taglia 38 - - conf. 1 - € 145,20</p> <p>462170236N39 - Taglia 39 - - conf. 1 - € 145,20</p> <p>segue...</p>
 <p>continua...</p> <p>462170236N40 - Taglia 40 - - conf. 1 - € 145,20</p> <p>462170236N41 - Taglia 41 - - conf. 1 - € 145,20</p> <p>462170236N42 - Taglia 42 - - conf. 1 - € 145,20</p> <p>462170236N43 - Taglia 43 - - conf. 1 - € 145,20</p> <p>462170236N44 - Taglia 44 - - conf. 1 - € 145,20</p> <p>segue...</p>	 <p>continua...</p> <p>462170236N45 - Taglia 45 - - conf. 1 - € 145,20</p> <p>462170236N46 - Taglia 46 - - conf. 1 - € 145,20</p> <p>462170236N47 - Taglia 47 - - conf. 1 - € 145,20</p>
 <p>SCARPA RUN NET AIRBOX MATRYX LOW S1P SRC Calzatura da lavoro con sistema di traspirazione Net Breathing System, tecnologia Airbox con fori di ventilazione laterali e tessuto Matryx 2.0 antiabrasione Suola: PU compatta</p> <p>462176214GN37 - Tg. 37 - - conf. 1 - € 130,60</p> <p>462176214GN38 - Tg. 38 - - conf. 1 - € 130,60</p> <p>462176214GN39 - Tg. 39 - - conf. 1 - € 130,60</p> <p>segue...</p>	 <p>continua...</p> <p>462176214GN40 - Tg. 40 - - conf. 1 - € 130,60</p> <p>462176214GN41 - Tg. 41 - - conf. 1 - € 130,60</p> <p>462176214GN42 - Tg. 42 - - conf. 1 - € 130,60</p> <p>462176214GN43 - Tg. 43 - - conf. 1 - € 130,60</p> <p>462176214GN44 - Tg. 44 - - conf. 1 - € 130,60</p> <p>segue...</p>
 <p>continua...</p> <p>462176214GN45 - Tg. 45 - - conf. 1 - € 130,60</p> <p>462176214GN46 - Tg. 46 - - conf. 1 - € 130,60</p> <p>462176214GN47 - Tg. 47 - - conf. 1 - € 130,60</p>	 <p>SCARPA GLOVE II TEXT S1P DIADORA ROCCIA LUNARE ESTIVA Calzatura bassa in tessuto rete e vitello scamosciato, puntale in alluminio 10, 200 joule. Fodera Air Mesh, K-Sole passaggio zero, plantare estraibili in EVA forata. Suola: Intersuola in EVA con TPU film protettivo Gomma nitrilica HRO EN: ISO 20345:2011</p> <p>462170236G38 - Taglia 38 - - conf. 1 - € 145,20</p> <p>462170236G39 - Taglia 39 - - conf. 1 - € 145,20</p> <p>segue...</p>



**NET
BREATHING
SYSTEM™**

by **GEOX**

AIRBOX
000



- IMPERMEABILITÀ
- TRASPIRABILITÀ
- TERMOREGOLAZIONE NATURALE
- AMMORTIZZAZIONE E MASSIMO COMFORT

U-Power®

Don't worry... be happy!



Nuova linea **RED** **EGO**

55% DI ENERGIA IN PIÙ... 100% DI POSSIBILITÀ IN PIÙ!





LO SANNO ANCHE I BAMBINI

Scopri tutti i modelli sul sito www.u-power.it















 <p>continua... 462170236G40 – Taglia 40 – – conf. 1 – € 145,20 462170236G41 – Taglia 41 – – conf. 1 – € 145,20 462170236G42 – Taglia 42 – – conf. 1 – € 145,20 462170236G43 – Taglia 43 – – conf. 1 – € 145,20 462170236G44 – Taglia 44 – – conf. 1 – € 145,20 segue...</p>	 <p>continua... 462170236G45 – Taglia 45 – – conf. 1 – € 145,20 462170236G46 – Taglia 46 – – conf. 1 – € 145,20 462170236G47 – Taglia 47 – – conf. 1 – € 145,20</p>
 <p>POINT S1P SRC Tomaia: Nylon ultra traspirante Fodera: Wingtex a tunnel d'aria traspirante Puntale: Airtoe Aluminium con membrana traspirante Antiperforazione: soletta antiperforazione tessile "no metal" Coprisottopiede: sottopiede anatomico in soffice poliuretano, traspirante e antibatterico Intersuola: Soffice PU espanso e Infinergy® Battistrada: PU compatto antiabrasione, antiolio, antiscivolo e antistatico</p> <p>7982003635 – Tg. 35 – – conf. 1 – € 113,70 segue...</p>	 <p>continua... 7982003636 – Tg. 36 – – conf. 1 – € 113,70 7982003637 – Tg. 37 – – conf. 1 – € 113,70 7982003638 – Tg. 38 – – conf. 1 – € 113,70 7982003639 – Tg. 39 – – conf. 1 – € 113,70 7982003640 – Tg. 40 – – conf. 1 – € 113,70 segue...</p>
 <p>continua... 7982003641 – Tg. 41 – – conf. 1 – € 113,70 7982003642 – Tg. 42 – – conf. 1 – € 113,70 7982003643 – Tg. 43 – – conf. 1 – € 113,70 7982003644 – Tg. 44 – – conf. 1 – € 113,70 7982003645 – Tg. 45 – – conf. 1 – € 113,70 segue...</p>	 <p>continua... 7982003646 – Tg. 46 – – conf. 1 – € 113,70 7982003647 – Tg. 47 – – conf. 1 – € 113,70</p>
 <p>PUSH S1P SRC Tomaia: Nylon ultra traspirante e morbida Fodera: Wingtex a tunnel d'aria traspirante Puntale: Airtoe Aluminium con membrana traspirante Antiperforazione: soletta antiperforazione tessile "no metal" Coprisottopiede: sottopiede anatomico in soffice poliuretano, traspirante e antibatterico Intersuola: Soffice PU espanso e Infinergy® Battistrada: PU compatto antiabrasione, antiolio, antiscivolo e antistatico</p> <p>7982005639 – Taglia 39 – – conf. 1 – € 113,70 segue...</p>	 <p>continua... 7982005640 – Taglia 40 – – conf. 1 – € 113,70 7982005641 – Taglia 41 – – conf. 1 – € 113,70 7982005642 – Taglia 42 – – conf. 1 – € 113,70 7982005643 – Taglia 43 – – conf. 1 – € 113,70 7982005644 – Taglia 44 – – conf. 1 – € 113,70 segue...</p>
 <p>continua... 7982005645 – Taglia 45 – – conf. 1 – € 113,70 7982005646 – Taglia 46 – – conf. 1 – € 113,70</p>	 <p>YODA S3 SRC Tomaia: Morbida pelle nabuk naturale bottalato idrorepellente Fodera: Wingtex a tunnel d'aria traspirante Puntale: Airtoe Aluminium con membrana traspirante Antiperforazione: soletta antiperforazione tessile "no metal" Coprisottopiede: sottopiede anatomico in soffice poliuretano, traspirante e antibatterico Battistrada: PU compatto antiabrasione, antiolio, antiscivolo e antistatico</p> <p>7982017439 – Taglia 39 – – conf. 1 – € 125,70 segue...</p>
 <p>continua... 7982017440 – Taglia 40 – – conf. 1 – € 125,70 7982017441 – Taglia 41 – – conf. 1 – € 125,70 7982017442 – Taglia 42 – – conf. 1 – € 125,70 7982017443 – Taglia 43 – – conf. 1 – € 125,70 7982017444 – Taglia 44 – – conf. 1 – € 125,70 segue...</p>	 <p>continua... 7982017445 – Taglia 45 – – conf. 1 – € 125,70 7982017446 – Taglia 46 – – conf. 1 – € 125,70</p>



  <p>INFINITY S3 SRC Tomaia: Morbida pelle nabuk naturale bottalato idrorepellente. Fodera: Wingtex a tunnel d'aria traspirante. Soletta: antiperforazione tessile "no metal". Airtoe: Airtoe Aluminium con membrana traspirante. Sottopiede: anatomico in soffice poliuretano, traspirante e antibatterico</p> <p>7981002339 - Taglia 39 - - conf. 1 - € 129,70 7981002340 - Taglia 40 - - conf. 1 - € 129,70 segue...</p>	  <p>continua...</p> <p>7981002341 - Taglia 41 - - conf. 1 - € 129,70 7981002342 - Taglia 42 - - conf. 1 - € 129,70 7981002343 - Taglia 43 - - conf. 1 - € 129,70 7981002344 - Taglia 44 - - conf. 1 - € 129,70 7981002345 - Taglia 45 - - conf. 1 - € 129,70 7981002346 - Taglia 46 - - conf. 1 - € 129,70</p>
  <p>RAPTOR S3 SRC Tomaia: altamente resistente all'abrasione, idrorepellente. Fodera: traspirante. Puntale: senza metallo, 100% della superficie protetta. Antiperforazione: anatomico, antibatterico e traspirante. Battistrada: compatto antiabrasione, antiolio, antiscivolo, antistatico. Adatta all'uso in ambienti umidi, trasporti e logistica.</p> <p>7982037635 - Tg. 35 - - conf. 1 - € 117,78 7982037636 - Tg. 36 - - conf. 1 - € 117,78 segue...</p>	  <p>continua...</p> <p>7982037637 - Tg. 37 - - conf. 1 - € 117,78 7982037638 - Tg. 38 - - conf. 1 - € 117,78 7982037639 - Tg. 39 - - conf. 1 - € 117,78 7982037640 - Tg. 40 - - conf. 1 - € 117,78 7982037641 - Tg. 41 - - conf. 1 - € 117,78 segue...</p>
  <p>continua...</p> <p>7982037642 - Tg. 42 - - conf. 1 - € 117,78 7982037643 - Tg. 43 - - conf. 1 - € 117,78 7982037644 - Tg. 44 - - conf. 1 - € 117,78 7982037645 - Tg. 45 - - conf. 1 - € 117,78 7982037646 - Tg. 46 - - conf. 1 - € 117,78</p>	  <p>SUMMER S1P SRC Tomaia: tomaia in AirNet ultra traspirante. Fodera: Wingtex a tunnel d'aria traspirante. Puntale: Airtoe Aluminium con membrana traspirante. Antiperforazione: soletta antiperforazione tessile "no metal". Battistrada: PU compatto antiabrasione, antiolio, antiscivolo e antistatico. Adatta all'uso in ambienti secchi, trasporti e logistica, laboratori artigianali</p> <p>7982034635 - Tg. 35 - - conf. 1 - € 107,92 7982034636 - Tg. 36 - - conf. 1 - € 107,92 segue...</p>
  <p>continua...</p> <p>7982034637 - Tg. 37 - - conf. 1 - € 107,92 7982034638 - Tg. 38 - - conf. 1 - € 107,92 7982034639 - Tg. 39 - - conf. 1 - € 107,92 7982034640 - Tg. 40 - - conf. 1 - € 107,92 7982034641 - Tg. 41 - - conf. 1 - € 107,92 segue...</p>	  <p>continua...</p> <p>7982034642 - Tg. 42 - - conf. 1 - € 107,92 7982034643 - Tg. 43 - - conf. 1 - € 107,92 7982034644 - Tg. 44 - - conf. 1 - € 107,92 7982034645 - Tg. 45 - - conf. 1 - € 107,92 7982034646 - Tg. 46 - - conf. 1 - € 107,92</p>
  <p>VEROK S1P SRC Tomaia: Nylon ultra traspirante. Fodera: Wingtex a tunnel d'aria traspirante. Puntale: Airtoe Aluminium con membrana traspirante. Antiperforazione: soletta antiperforazione tessile "no metal". Battistrada: PU compatto antiabrasione, antiolio, antiscivolo e antistatico</p> <p>7982021635 - Tg. 35 - - conf. 1 - € 113,70 7982021636 - Tg. 36 - - conf. 1 - € 113,70 7982021637 - Tg. 37 - - conf. 1 - € 113,70 segue...</p>	  <p>continua...</p> <p>7982021638 - Tg. 38 - - conf. 1 - € 113,70 7982021639 - Tg. 39 - - conf. 1 - € 113,70 7982021640 - Tg. 40 - - conf. 1 - € 113,70 7982021641 - Tg. 41 - - conf. 1 - € 113,70 7982021642 - Tg. 42 - - conf. 1 - € 113,70</p>
  <p>ULTRA S1P SRC ESD Tomaia: rete ultra traspirante. Fodera: Wingtex a tunnel d'aria traspirante. Puntale: Airtoe Aluminium con membrana traspirante. Antiperforazione: Save e Flex Plus. Coprisottopiede: Memory in elastopan di Basf. Intersuola: Soffice PU espanso e Infinergy®. Battistrada: PU compatto antiabrasione, antiolio, antiscivolo e antistatico. Calzatura: Natural Comfort 11 Mondopoint</p> <p>7982047635 - Tg. 35 - - conf. 1 - € 111,00 segue...</p>	  <p>continua...</p> <p>7982047636 - Tg. 36 - - conf. 1 - € 111,00 7982047637 - Tg. 37 - - conf. 1 - € 111,00 7982047638 - Tg. 38 - - conf. 1 - € 111,00 7982047639 - Tg. 39 - - conf. 1 - € 111,00 7982047640 - Tg. 40 - - conf. 1 - € 111,00 segue...</p>



 <p>US Power</p> <p>continua... 7982047641 - Tg. 41 - - conf. 1 - € 111,00 7982047642 - Tg. 42 - - conf. 1 - € 111,00 7982047643 - Tg. 43 - - conf. 1 - € 111,00 7982047644 - Tg. 44 - - conf. 1 - € 111,00 7982047645 - Tg. 45 - - conf. 1 - € 111,00 7982047646 - Tg. 46 - - conf. 1 - € 111,00</p>	 <p>CUFFIA antirumore Mod. Hobby non DPI 74050500 - - conf. 5 - € 5,00</p>
 <p>CUFFIA antirumore Livello di attenuazione Medio - Alto EN 352 - 1 74050520 - - conf. 1 - € 10,80</p>	 <p>CUFFIA antirumore professionale livello di attenuazione Alto EN 352 - 1 74050540 - - conf. 1 - € 22,00</p>
 <p>Gieffe gruppo general formica</p> <p>CUFFIE antirumore Mod. B003 tipo economico Confezione: in sacchetto 512730404N - - conf. 60 - € 5,80</p>	 <p>Honeywell THE POWER OF CONNECTOR</p> <p>CUFFIE DI PROTEZIONE ANTIRUMORI MACH 1 SNR Design nuovo e ultra leggero 92031016 - - conf. 1 - € 11,60</p>
 <p>Honeywell THE POWER OF CONNECTOR</p> <p>INSERTI AURICOLARI DI PROTEZIONE LASER LITE La schiuma si espande in modo da adattarsi alla conformazione di qualsiasi condotto uditivo 92031017 - - conf. 200 - € 0,26</p>	 <p>Honeywell THE POWER OF CONNECTOR</p> <p>INSERTI AURICOLARI AD ARCHETTO Pieghevoli 92031041 - - conf. 1 - € 5,60</p>
 <p>Honeywell THE POWER OF CONNECTOR</p> <p>OCCHIALI DI PROTEZIONE HONEYWELL MOD. SVP200 Montatura gialla con lente gialla HDL antigraffio 92031014 - - conf. 1 - € 3,60</p>	 <p>Gieffe gruppo general formica</p> <p>OCCHIALI DI PROTEZIONE MONOLENTE Mod. B501 Trasparenti Confezione: Sacchetto 512730398N - - conf. 12 - € 2,30</p>
 <p>Honeywell THE POWER OF CONNECTOR</p> <p>OCCHIALI DI PROTEZIONE HONEYWELL MOD. POLYSAFE Occhiale indicato per i visitatori, che offre un'ampio campo visivo In policarbonato con ripari laterali integrati e nasello profilato Ventilazione indiretta per evitare l'appannamento 92031015 - - conf. 1 - € 3,80</p>	 <p>Honeywell THE POWER OF CONNECTOR</p> <p>OCCHIALI DI PROTEZIONE HONEYWELL MOD. A700 Design ultraleggero con inserti antiscivolo sulla parte terminale delle stanghette Montatura trasparente Lente in policarbonato monopezzo incolore con trattamento antigraffio Protezione da UV 92031010 - - conf. 1 - € 3,60</p>

















<p>Honeywell THE POWER OF CONNECTOR</p>  <p>OCCHIALI DI PROTEZIONE HONEYWELL MOD. SANTA CRUZ Design classico con campo visivo ampio, grande leggerezza e astine regolabili con meccanismo di blocco Lente in policarbonato monopezzo incolore con trattamento antigraffio Protezione da UV</p> <p>92031011 – – conf. 1 – € 11,00</p>	<p>Honeywell THE POWER OF CONNECTOR</p>  <p>OCCHIALI DI PROTEZIONE HONEYWELL MOD. MILLENNIA 2G Montatura in materiale più morbido e flessibile Elevata protezione di occhi e zigomi. Il design presenta una sporgenza aggiuntiva lungo le sopracciglia per impedire alla polvere di cadere negli occhi.</p> <p>92031013 – – conf. 1 – € 12,60</p>
<p>Honeywell THE POWER OF CONNECTOR</p>  <p>OCCHIALI DI PROTEZIONE HONEYWELL MOD. V-MAXX A mascherina con ventilazione in-diretta creato per resistere alle aggressioni di numerose sostanze chimiche Può essere indossato sopra gli occhiali correttivi Bardature elastiche a regolazione rapida Gli attacchi della bardatura ruotano per facilitare l'utilizzo combinato con gli elmetti di protezione Lente con trattamento antigraffio e antiappannamento Protezione da: gocce, spruzzi, polveri, metalli fusi e solidi incandescenti</p> <p>92031012 – – conf. 1 – € 11,60</p>	<p>OCCHIALI protezione</p> <p>74049800 – – conf. 5 – € 5,80</p> 
<p>OCCHIALI DI PROTEZIONE IN GOMMA</p> <p>74049900 – – conf. 1 – € 5,60</p> 	<p>GIEFFE gruppi general ferramenta</p> <p>OCCHIALI DI PROTEZIONE Mod. Panavision Tipo economico Confezione: sacchetto</p> <p>512730392N – – conf. 1 – € 2,30</p> 
<p>Honeywell THE POWER OF CONNECTOR</p>  <p>ESPOSITORE OCCHIALI HONEYWELL Vuoto</p> <p>92031040 – – conf. 1 – € 10,40</p>	<p>GIEFFE</p> <p>NASTRO SEGNALETICO Bianco-Rosso 200 mt</p> <p>791200/2 – – conf. 12 – € 3,10</p> 
<p>GIEFFE</p> <p>NASTRO SEGNALETICO ADESIVO TELATO Per segnalazioni nel settore industriale. Misura 50x25 metri</p> <p>791180401 – Colore Giallo/Nero – – conf. 18 – € 5,80</p> <p>791180402 – Colore Bianco/Rosso – – conf. 18 – € 5,80</p> 	<p>BLS</p> <p>MASCHERINA BLS 128BW CLASSIC CLASSE FFP2 R D A coppa – Senza valvola Facciale filtrante Riutilizzabile Testato con polvere di Dolomite Testato e certificato in accordo alla norma EN 149:2001+A1:2009 Applicazioni: Per luoghi con particelle solide o liquide non volatili polveri, fumi, nebbie.</p> <p>3018006188 – – conf. 20 – € 1,86</p> 
<p>BLS</p> <p>MASCHERINA BLS 129BW CLASSIC CLASSE FFP2 R D A coppa – Con valvola Facciale filtrante Riutilizzabile Testato con polvere di Dolomite Testato e certificato in accordo alla norma EN 149:2001+A1:2009 Applicazioni: Per luoghi con particelle solide o liquide non volatili polveri, fumi, nebbie.</p> <p>3018006184 – – conf. 15 – € 2,80</p> 	<p>BLS</p> <p>MASCHERINA BLS 226B CLASSIC CLASSE FFP2 NR D A coppa – Con valvola e strato di carboni attivi Facciale filtrante Non riutilizzabile Testato con polvere di Dolomite Testato e certificato in accordo alla norma EN 149:2001+A1:2009 Applicazioni: Per luoghi con particelle solide o liquide non volatili polveri, fumi, nebbie e carboni attivi che serve per bloccare i gas e vapori organici e acidi in concentrazioni inferiori a TLV</p> <p>3018006154 – – conf. 10 – € 3,20</p> 



  <p>MASCHERINA BLS 829 CLASSE FFP2 NR D In confezione singola con possibilità di aprire il dispositivo senza toccare la parte interna Non riutilizzabile Testato con polvere di Dolomite Testato e certificato in accordo alla norma EN 149:2001+A1:2009 Applicazioni: Per luoghi con particelle solide o liquide non volatili: polveri, fumi, nebbie.</p> <p>3018006173 - - conf. 10 - € 2,80</p>	  <p>MASCHERINA BLS 860 CLASSE FFP3 R D Con valvola In confezione singola con possibilità di aprire il dispositivo senza toccare la parte interna Riutilizzabile Testato con polvere di Dolomite Applicazioni: Per luoghi con particelle solide o liquide non volatili: polveri, fumi, nebbie.</p> <p>3018006174 - - conf. 10 - € 6,40</p>
  <p>MASCHERINA BLS Zer0 30 CLASSE FFP3 R D A coppa - Con valvola Facciale filtrante Riutilizzabile Testato con polvere di Dolomite Testato e certificato in accordo alla norma EN 149:2001+A1:2009 Applicazioni: Per luoghi con particelle solide o liquide non volatili: polveri, fumi, nebbie</p> <p>3018006332 - - conf. 10 - € 4,40</p>	  <p>MASCHERINA BLS Zer0 31 CLASSE FFP3 R D A coppa - Con valvola Facciale filtrante Riutilizzabile Testato con polvere di Dolomite Imbustate singolarmente Testato e certificato in accordo alla norma EN 149:2001+A1:2009 Guarnizione interna totale Applicazioni: Per luoghi con particelle solide o liquide non volatili: polveri, fumi, nebbie.</p> <p>3018006340 - - conf. 5 - € 6,40</p>
  <p>MASCHERINA BLS Zer0 30 CLASSE FFP3 R D A coppa - Con valvola Con strato di carboni attivi Facciale filtrante Riutilizzabile Testato con polvere di Dolomite Testato e certificato in accordo alla norma EN 149:2001+A1:2009 Guarnizione interna totale Applicazioni: per luoghi con particelle solide o liquide non volatili: polveri, fumi, nebbie Carbone attivo che serve per bloccare i gas e vapori organici e acidi in concentrazione inferiori al TVL</p> <p>3018006333 - - conf. 10 - € 5,84</p>	  <p>MASCHERINA BLS Zer0 32 CLASSE FFP3 RD A coppa - Con valvola con elastici regolabili Facciale filtrante Dispositivo usa e getta Testato e certificato in accordo alla norma EN 149:2001+A1:2009 Guarnizione interna totale Applicazioni: Per luoghi con particelle solide o liquide non volatili: polveri, fumi, nebbie.</p> <p>3018006398 - - conf. 5 - € 8,20</p>
  <p>PREFILTRO POLVERE BLS 301 P2 Per filtri gas BLS serie 200 e 300 In polipropilene</p> <p>3018011042 - - conf. 16 - € 3,20</p>	  <p>MASCHERINA BLS 502 CLASSE FFP2 A becco Facciale filtrante Imbustato singolarmente Senza valvola Testato e certificato in accordo alla norma EN 149:2001+A1:2009 Applicazioni: Esposizione a particelle solide o liquide non volatili: polveri, fumi, nebbie</p> <p>3018101006 - - conf. 20 - € 1,12</p> <p>AD ESAURIMENTO</p>
  <p>MASCHERA INTERA BLS 5600 Maschere intere riutilizzabili Guarnizione facciale in gomma termoplastica Utilizzate in combinazione con i filtri a connessione a baionetta serie 200 Visore antigraffio, in classe ottica 1 EN 166: permette di avere una visione panoramica senza distorsioni ottiche Testato e certificato in accordo alla norma tecnica armonizzata EN 136:1998 Applicazioni: Protegge da gas/vapori e da particolati tossici Compatibile con filtri Serie BLS 200 - 301</p> <p>3018001083 - - conf. 1 - € 132,40</p>	  <p>SEMIMASCHERA BLS 4400 NEXT Filtri ABEK1P3 R Semimaschere riutilizzabili bifiltro Facciale in silicone Sistema di sgancio/aggancio rapido ed elastici scorrevoli Compatibilità con altri DPI Misura M/L Connessione filtri a baionetta Filtri BLS 222 premontati nel kit Applicazioni: Usata in combinazione con i filtri protegge da gas/vapori organici e inorganici acidi, ammoniaca e polveri</p> <p>3018002073 - - conf. 1 - € 59,60</p>
  <p>SEMIMASCHERINA BLS 4100 NEXT PROTEZIONE A2P2 NR Semimaschere riutilizzabili in silicone Facciale in silicone Sistema di sgancio/aggancio rapido ed elastici scorrevoli Compatibilità con altri DPI Misura M/L Connessione filtri a baionetta Applicazioni: Usata in combinazione con i filtri protegge da gas/vapori organici e polveri Filtri premontati nel kit: BLS 211 e BLS 301</p> <p>3018002072 - - conf. 1 - € 48,40</p>	  <p>COPPIA FILTRI DI RICAMBIO BLS 222 PROTEZIONE ABEK1P3 R Applicazione: Gas e vapori organici, inorganici e acidi Ammoniaca e derivati classe 1 e polvere Connessione a baionetta Compatibile con semimaschere BLS 4400 next e maschere intere BLS 5600 (Art. 3018002073 - 3018001083 3018001083 - 326549)</p> <p>3018011113 - - conf. 8 - € 16,80</p>



  <p>COPPIA FILTRI DI RICAMBIO BLS 211 A2 Protezione da: gas/vapori organici. Connessione a baionetta Compatibile con maschere intere BLS 5600 e semimaschera 4000 Next (Art.3018001083 - 326549 e 3018002072 - 326550)</p> <p>3018011109 - - conf. 8 - € 7,40</p>	  <p>FILTRO DI RICAMBIO BLS 314 CLASSE A1B1E1K1 Con connessione filettata Applicazioni: Anti gas</p> <p>3018011037 - - conf. 16 - € 10,20</p>
  <p>CONFEZIONE 100 PEZZI CUFFIE TONDE MONOUSO Cuffia plissettata tonda in polipropilene non tessuto con bordo elastico Taglia unica Colore Bianco</p> <p>527CUP - - conf. 1</p>	  <p>CONFEZIONE 100 PEZZI COPRISCARPE VISITATORI Monouso in polietilene con elastico di chiusura alla caviglia Colore Blu Dimensioni 40x13 cm Taglia unica</p> <p>527SOVPE - - conf. 1</p>
  <p>CONFEZIONE 5 PEZZI TUTA CON CAPPUCIO Monouso con cappuccio in polipropilene non tessuto, con cerniera frontale elastico alle caviglie, sui polsi e sul cappuccio Utilizzo per lavori di sanificazione e bricolage Colore Bianco</p> <p>527TUTXM - Taglia M - - conf. 1 527TUTXL - Taglia L - - conf. 1 527TUTXXL - Taglia XL - - conf. 1 527TUTXXXL - Taglia XXL - - conf. 1</p>	  <p>CONFEZIONE 100 PEZZI GREMBIULE MONOUSO In polietilene Utilizzi per rispettare le regole di igiene Taglia unica Colore Bianco</p> <p>527GRE02 - - conf. 1</p>
   <p>CONFEZIONE 5 PEZZI CAMICE DA LAVORO In polipropilene non tessuto con chiusura anteriore con velcro colletto a camicia, giromanica Provvisto di 2 tasche esterne Utilizzato per rispettare le regole di igiene e per lavori di sanificazione Colore Bianco</p> <p>527CAMPPXM - Taglia M - - conf. 1 527CAMPPXL - Taglia L - - conf. 1 527CAMPPXXL - Taglia XL - - conf. 1</p>	

**TUTTI HANNO DIRITTO
AD UN LAVORO SICURO.**



NICAMA & KES



**DISPOSITIVI
DI PROTEZIONE
RESPIRATORIA**

**FEEL FREE
TO BREATHE**

blsgroup.com

www.malfattitacchinigroup.it



Beta

Utensili di qualità



www.beta-tools.com

www.malfattitacchinigroup.it















UTENSILI

SFOGLIA LA CATEGORIA





<p>Beta</p> <p>PUNZONI BETA ART. 30</p> <p>200000300020 - Ø 2 - L 125 - - conf. 10 - € 7,38</p> <p>200000300030 - Ø 3 - L 125 - - conf. 10 - € 7,38</p> <p>200000300040 - Ø 4 - L 150 - - conf. 10 - € 9,86</p> <p>200000300050 - Ø 5 - L 150 - - conf. 10 - € 9,86</p> <p>200000300060 - Ø 6 - L 150 - - conf. 10 - € 10,34</p> 	<p>Beta</p> <p>CACCIASPINA BETA ART. 31</p> <p>200000310002 - Ø 2 - L 110 - L 122 - - conf. 10 - € 7,38</p> <p>200000310003 - Ø 3 - L 128 - L 135 - - conf. 10 - € 7,60</p> <p>200000310004 - Ø 4 - L 146 - L 145 - - conf. 10 - € 9,34</p> <p>200000310005 - Ø 5 - L 164 - L 155 - - conf. 10 - € 9,86</p> <p>200000310006 - Ø 6 - L 182 - L 165 - - conf. 5 - € 12,30</p> <p>segue...</p> 
<p>Beta</p> <p>continua...</p> <p>200000310008 - Ø 8 - L 200 - L 180 - - conf. 5 - € 13,12</p> <p>200000310010 - Ø 10 - L 220 - L 195 - - conf. 5 - € 16,48</p> 	<p>Beta</p> <p>BULINI BETA ART. 32</p> <p>200000320100 - Ø 3 - L 100 - L 144 - - conf. 10 - € 6,92</p> <p>200000320125 - Ø 4 - L 125 - L 152 - - conf. 10 - € 8,48</p> <p>200000320150 - Ø 5 - L 150 - L 162 - - conf. 10 - € 10,34</p> <p>200000320160 - Ø 3 - L 150 - L 123 - - conf. 2 - € 56,26</p> 
<p>Beta</p> <p>SCALPELLI PIATTI Art.34 Cromati</p> <p>200000340001 - Lmm 125 - Amm 14,5 - L1mm 45 - Smm 10 - conf. 1 - € 10,44</p> <p>200000340002 - Lmm 150 - Amm 17,0 - L1mm 58 - Smm 12 - conf. 5 - € 13,82</p> <p>200000340003 - Lmm 175 - Amm 21,5 - L1mm 68 - Smm 14 - conf. 5 - € 19,96</p> 	<p>Beta</p> <p>SCALPELLI NERVATI BETA ART. 35</p> <p>200000350001 - L 100 - A 14,5 - - conf. 5 - € 12,18</p> <p>200000350002 - L 125 - A 17 - - conf. 5 - € 13,82</p> <p>200000350003 - L 150 - A 20,5 - - conf. 5 - € 17,06</p> <p>200000350004 - L 200 - A 23 - - conf. 5 - € 26,00</p> <p>200000350005 - L 250 - A 28,5 - - conf. 2 - € 37,70</p> <p>200000350006 - L 300 - A 34 - - conf. 2 - € 50,46</p> 
<p>Beta</p> <p>UGNETTI Art.36 Cromati</p> <p>200000360001 - Lmm 125 - Amm 4 - L1mm 44 - Smm 10 - conf. 5 - € 10,98</p> <p>200000360002 - Lmm 150 - Amm 6 - L1mm 53 - Smm 12 - conf. 5 - € 12,88</p> 	<p>Beta</p> <p>UGNETTI NERVATI Art.37 Cromati</p> <p>200000370001 - Lmm 150 - Amm 6 - L1mm 45 - Smm 18 - conf. 5 - € 19,72</p> <p>200000370002 - Lmm 200 - Amm 8 - L1mm 55 - Smm 22 - conf. 3 - € 28,32</p> 
<p>Beta</p> <p>CHIAVI COMBinate BETA ART. 42</p> <p>200000420005 - mm 5,5x5,5 - L 95 - - conf. 5 - € 8,36</p> <p>200000420006 - mm 6x6 - L 95 - - conf. 5 - € 8,48</p> <p>200000420007 - mm 7x7 - L 105 - - conf. 5 - € 8,54</p> <p>200000420008 - mm 8x8 - L 116 - - conf. 5 - € 8,88</p> <p>200000420009 - mm 9x9 - L 127 - - conf. 5 - € 9,24</p> <p>segue...</p> 	<p>Beta</p> <p>continua...</p> <p>200000420010 - mm 10x10 - L 137 - - conf. 5 - € 9,46</p> <p>200000420011 - mm 11x11 - L 148 - - conf. 5 - € 10,10</p> <p>200000420012 - mm 12x12 - L 158 - - conf. 5 - € 10,22</p> <p>200000420013 - mm 13x13 - L 169 - - conf. 5 - € 10,34</p> <p>200000420014 - mm 14x14 - L 180 - - conf. 5 - € 11,72</p> <p>segue...</p> 
<p>Beta</p> <p>continua...</p> <p>200000420015 - mm 15x15 - L 190 - - conf. 5 - € 12,88</p> <p>200000420016 - mm 16x16 - L 201 - - conf. 5 - € 13,46</p> <p>200000420017 - mm 17x17 - L 212 - - conf. 5 - € 14,16</p> <p>200000420018 - mm 18x18 - L 222 - - conf. 5 - € 14,98</p> <p>200000420019 - mm 19x19 - L 233 - - conf. 5 - € 15,44</p> <p>segue...</p> 	<p>Beta</p> <p>continua...</p> <p>200000420020 - mm 20x20 - L 243 - - conf. 3 - € 17,52</p> <p>200000420021 - mm 21x21 - L 254 - - conf. 3 - € 18,80</p> <p>200000420022 - mm 22x22 - L 264 - - conf. 3 - € 19,26</p> <p>200000420023 - mm 23x23 - L 275 - - conf. 3 - € 20,88</p> <p>200000420024 - mm 24x24 - L 285 - - conf. 3 - € 22,16</p> <p>segue...</p> 















<p>Beta</p> <p>continua...</p> <p>200000420025 - mm 25x25 - L 296 - - conf. 2 - € 23,32</p> <p>200000420026 - mm 26x26 - L 307 - - conf. 2 - € 25,18</p> <p>200000420027 - mm 27x27 - L 317 - - conf. 2 - € 27,38</p> <p>200000420028 - mm 28x28 - L 328 - - conf. 2 - € 28,32</p> <p>200000420029 - mm 29x29 - L 338 - - conf. 2 - € 30,16</p> <p>segue...</p> 	<p>Beta</p> <p>continua...</p> <p>200000420030 - mm 30x30 - L 349 - - conf. 2 - € 31,90</p> <p>200000420032 - mm 32x32 - L 370 - - conf. 2 - € 35,38</p> <p>200000420034 - mm 34x34 - L 391 - - conf. 1 - € 66,70</p> <p>200000420035 - mm 35x35 - L 412 - - conf. 1 - € 71,92</p> <p>200000420036 - mm 36x36 - L 412 - - conf. 1 - € 74,82</p> <p>segue...</p> 
<p>Beta</p> <p>continua...</p> <p>200000420038 - mm 38x38 - L 433 - - conf. 1 - € 82,94</p> <p>200000420041 - mm 41x41 - L 465 - - conf. 1 - € 93,38</p> 	<p>Beta</p> <p>BUSTA VUOTA PER CHIAVI COMBinate Per 42BV6</p> <p>200000420051 - - conf. 1 - € 7,78</p> 
<p>Beta</p> <p>SERIE 9 PZ. CHIAVI COMBinate BETA ART. 42/ SC9I 8-10-11-12-13 14-15-17-19 mm</p> <p>200000420087 - - conf. 1 - € 104,40</p> 	<p>Beta</p> <p>CHIAVI COMBinate BETA ART. 42AS Forchetta e poligonale piegata Cromato</p> <p>200000420108 - " 5/16x5/16 - L 116 - - conf. 2 - € 10,22</p> <p>200000420110 - " 3/8x3/8 - L 137 - - conf. 2 - € 11,32</p> <p>200000420111 - " 7/16x7/16 - L 148 - - conf. 2 - € 11,96</p> <p>200000420113 - " 1/2x1/2 - L 169 - - conf. 2 - € 12,42</p> <p>200000420114 - " 9/16x9/16 - L 180 - - conf. 2 - € 13,58</p> <p>segue...</p> 
<p>Beta</p> <p>continua...</p> <p>200000420119 - " 3/4x3/4 - L 233 - - conf. 2 - € 17,98</p> <p>200000420121 - " 13/16x13/16 - L 254 - - conf. 2 - € 21,70</p> <p>200000420122 - " 7/8x7/8 - L 264 - - conf. 2 - € 22,40</p> <p>200000420124 - " 15/16x15/16 - L 285 - - conf. 2 - € 26,10</p> <p>200000420125 - " 1x1 - L 296 - - conf. 2 - € 27,04</p> <p>segue...</p> 	<p>Beta</p> <p>continua...</p> <p>200000420127 - " 1.1/16x1.1/16 - L 317 - - conf. 2 - € 30,74</p> <p>200000420129 - " 1.1/8x1.1/8 - L 338 - - conf. 2 - € 33,06</p> <p>200000420132 - " 1.1/4x1.1/4 - L 370 - - conf. 2 - € 40,60</p> <p>200000420133 - " 1.5/16x1.5/16 - L 391 - - conf. 1 - € 66,70</p> <p>200000420135 - " 1.3/8x1.3/8 - L 412 - - conf. 1 - € 75,98</p> <p>segue...</p> 
<p>Beta</p> <p>continua...</p> <p>200000420136 - " 1.7/16x1.7/16 - L 412 - - conf. 1 - € 78,88</p> <p>200000420138 - " 1.1/2x1.1/2 - L 433 - - conf. 1 - € 83,52</p> 	<p>Beta</p> <p>SERIE 10 CHIAVI COMBinate Art. 42MP/S10P3 Misure: 7 - 8 - 10 - 11 - 12 13 - 14 - 17 - 19 - 22 mm</p> <p>200000420658 - - conf. 1 - € 111,24</p> 
<p>Beta</p> <p>SERIE 7 CHIAVI COMBinate BETA ART. 42/SP7 Misure: 8-10-11- 13-14-17-19 mm Supporto in materiale plastico Satinato</p> <p>200000420077 - - conf. 1 - € 84,68</p> 	<p>Beta</p> <p>CHIAVI FORCHETTA DOPPIE BETA ART. 55</p> <p>200000550003 - mm 4x5 - L 101 - - conf. 5 - € 5,80</p> <p>200000550006 - mm 5x5,5 - L 101 - - conf. 5 - € 6,62</p> <p>200000550009 - mm 5,5x7 - L 120 - - conf. 5 - € 6,62</p> <p>200000550012 - mm 6x7 - L 120 - - conf. 5 - € 5,22</p> <p>200000550018 - mm 7x8 - L 140 - - conf. 5 - € 6,62</p> <p>segue...</p> 















<p>Beta</p> <p>continua...</p> <p>200000550021 - mm 8x9 - L 140 - - conf. 5 - € 5,34</p> <p>200000550030 - mm 10x11 - L 155 - - conf. 5 - € 5,70</p> <p>200000550033 - mm 10x12 - L 155 - - conf. 5 - € 7,60</p> <p>200000550035 - mm 10x13 - L 170 - - conf. 5 - € 8,36</p> <p>200000550042 - mm 12x13 - L 170 - - conf. 5 - € 6,34</p> <p>segue...</p> 	<p>Beta</p> <p>continua...</p> <p>200000550045 - mm 12x14 - L 170 - - conf. 5 - € 8,60</p> <p>200000550047 - mm 13x14 - L 185 - - conf. 5 - € 9,58</p> <p>200000550054 - mm 14x15 - L 185 - - conf. 5 - € 7,96</p> <p>200000550057 - mm 14x17 - L 189 - - conf. 5 - € 11,08</p> <p>200000550060 - mm 16x17 - L 202 - - conf. 5 - € 9,12</p> <p>segue...</p> 
<p>Beta</p> <p>continua...</p> <p>200000550066 - mm 18x19 - L 220 - - conf. 2 - € 10,86</p> <p>200000550069 - mm 19x22 - L 236 - - conf. 2 - € 14,04</p> <p>200000550075 - mm 20x22 - L 236 - - conf. 2 - € 12,18</p> <p>200000550078 - mm 21x23 - L 245 - - conf. 2 - € 13,00</p> <p>200000550081 - mm 22x24 - L 245 - - conf. 2 - € 15,08</p> <p>segue...</p> 	<p>Beta</p> <p>continua...</p> <p>200000550087 - mm 24x26 - L 262 - - conf. 2 - € 15,56</p> <p>200000550090 - mm 24x27 - L 262 - - conf. 2 - € 16,94</p> <p>200000550096 - mm 25x28 - L 272 - - conf. 2 - € 17,76</p> <p>200000550099 - mm 27x29 - L 284 - - conf. 2 - € 20,08</p> <p>200000550102 - mm 27x30 - L 284 - - conf. 2 - € 23,10</p> <p>segue...</p> 
<p>Beta</p> <p>continua...</p> <p>200000550105 - mm 27x32 - L 297 - - conf. 2 - € 25,06</p> <p>200000550108 - mm 30x32 - L 297 - - conf. 2 - € 22,16</p> <p>200000550114 - mm 32x36 - L 325 - - conf. 1 - € 68,44</p> <p>200000550117 - mm 34x36 - L 325 - - conf. 1 - € 68,44</p> <p>200000550120 - mm 35x38 - L 375 - - conf. 1 - € 75,40</p> <p>segue...</p> 	<p>Beta</p> <p>continua...</p> <p>200000550123 - mm 36x41 - L 375 - - conf. 1 - € 78,88</p> <p>200000550129 - mm 41x46 - L 425 - - conf. 1 - € 91,06</p> <p>200000550132 - mm 46x50 - L 475 - - conf. 1 - € 111,94</p> <p>200000550135 - mm 50x55 - L 500 - - conf. 1 - € 130,50</p> <p>200000550138 - mm 55x60 - L 500 - - conf. 1 - € 138,62</p> 
<p>Beta</p> <p>BUSTA VUOTA PER CHIAVI A FORCHETTA In tela Art.55/BV8</p> <p>200000550159 - - conf. 1 - € 9,86</p> 	<p>Beta</p> <p>SERIE 7 PZ. CHIAVI A FORCHETTA BETA ART. 55/ SP7 Pratico supporto in materiale plastico incluso Misure: 6x7-8x9-10x11-12x13 14x15-16x17-18x19 mm</p> <p>200000550167 - - conf. 1 - € 53,94</p> 
<p>Beta</p> <p>CHIAVI A FORCHETTA DOPPIA Art.55AS Cromate</p> <p>200000550242 - " 11/16x13/16 - Lmm 220 - Amm 39,5 - Almm 41,5Smm 6,5 - conf. 1 - € 14,98</p> 	<p>Beta</p> <p>CHIAVI POLIGONALI DOPPIE CURVE BETA ART. 90</p> <p>200000900006 - mm 6x7 - L 165 - - conf. 5 - € 9,98</p> <p>200000900012 - mm 8x9 - L 180 - - conf. 5 - € 10,68</p> <p>200000900018 - mm 10x11 - L 195 - - conf. 5 - € 11,72</p> <p>200000900021 - mm 10x12 - L 195 - - conf. 5 - € 12,76</p> <p>200000900024 - mm 11x13 - L 215 - - conf. 5 - € 14,16</p> <p>segue...</p> 
<p>Beta</p> <p>continua...</p> <p>200000900027 - mm 12x13 - L 215 - - conf. 5 - € 12,88</p> <p>200000900033 - mm 14x15 - L 230 - - conf. 5 - € 14,16</p> <p>200000900036 - mm 14x17 - L 250 - - conf. 5 - € 17,52</p> <p>200000900039 - mm 16x17 - L 250 - - conf. 5 - € 16,14</p> <p>200000900045 - mm 18x19 - L 265 - - conf. 5 - € 18,68</p> <p>segue...</p> 	<p>Beta</p> <p>continua...</p> <p>200000900048 - mm 19x22 - L 285 - - conf. 3 - € 23,32</p> <p>200000900051 - mm 20x22 - L 285 - - conf. 3 - € 21,58</p> <p>200000900057 - mm 21x23 - L 305 - - conf. 2 - € 24,36</p> <p>200000900063 - mm 24x26 - L 325 - - conf. 2 - € 27,38</p> <p>200000900067 - mm 24x27 - L 325 - - conf. 2 - € 30,16</p> <p>segue...</p> 



<p>Beta</p> <p>continua...</p> <p>200000900070 - mm 25x28 - L 340 - - conf. 2 - € 32,48</p> <p>200000900073 - mm 27x29 - L 355 - - conf. 2 - € 35,38</p> <p>200000900080 - mm 30x32 - L 375 - - conf. 2 - € 40,02</p> <p>200000900088 - mm 32x36 - L 395 - - conf. 1 - € 59,16</p> <p>200000900091 - mm 35x38 - L 415 - - conf. 1 - € 71,34</p> <p>segue...</p> 	<p>Beta</p> <p>continua...</p> <p>200000900094 - mm 36x41 - L 435 - - conf. 1 - € 81,20</p> <p>200000900097 - mm 41x46 - L 460 - - conf. 1 - € 116,58</p> <p>200000900100 - mm 46x50 - L 500 - - conf. 1 - € 153,70</p> 
<p>Beta</p> <p>CHIAVI POLIGONALI CURVE Con attacco per leve di manovra Art.91 Cromate</p> <p>200000910030 - mm 30 - Ømm 48 - Hmm 33,5 - Lmm 200L1mm 565 - conf. 1 - € 63,80</p> <p>200000910041 - mm 41 - Ømm 62 - Hmm 39,5 - Lmm 265L1mm 750 - conf. 1 - € 93,96</p> 	<p>Beta</p> <p>SERIE 9 PZ. CHIAVI MASCHIO ESAGONALI PIEGATE CON ESTREMITA' SFERICA BETA ART. BPC/SC9 Misure: 1,5-2-2,5-3 4-5-6-8-10 mm</p> <p>200000960354 - - conf. 1 - € 45,24</p> 
<p>Beta</p> <p>SERIE 11 PZ. CHIAVI MASCHIO ESAGONALI PIEGATE BETA ART. 96AS/B11 Misure: 3/64-1/16-5/64-3/32-1/8-5/32-3/16-7/32-1/4-5/16-3/8</p> <p>200000960749 - - conf. 1 - € 23,68</p> 	<p>Beta</p> <p>CHIAVE MASCHIO ESAGONALE PIEGATE Art. 96T/AS Con impugnatura di manovra Misura 3/8 Lunghezza 285 mm Ø 12 mm</p> <p>200000960680 - Lmm 285 - L1mm 132 - Ømm 12Tmm 16,0 - conf. 1 - € 26,10</p> 
<p>Beta</p> <p>CHIAVI MASCHIO ESAGONALI PIEGATE BETA ART. 96</p> <p>200000960015 - mm 1,5 - L 45 - L1 15 - - conf. 20 - € 1,02</p> <p>200000960020 - mm 2 - L 50 - L1 17 - - conf. 20 - € 1,08</p> <p>200000960025 - mm 2,5 - L 57 - L1 20 - - conf. 20 - € 1,08</p> <p>200000960030 - mm 3 - L 64 - L1 22 - - conf. 20 - € 1,26</p> <p>200000960035 - mm 3,5 - L 68 - L1 25 - - conf. 20 - € 1,50</p> <p>segue...</p> 	<p>Beta</p> <p>continua...</p> <p>200000960040 - mm 4 - L 72 - L1 28 - - conf. 20 - € 1,58</p> <p>200000960045 - mm 4,5 - L 78 - L1 30 - - conf. 20 - € 1,64</p> <p>200000960050 - mm 5 - L 83 - L1 32 - - conf. 20 - € 1,70</p> <p>200000960060 - mm 6 - L 94 - L1 37 - - conf. 20 - € 2,12</p> <p>200000960070 - mm 7 - L 99 - L1 40 - - conf. 10 - € 2,64</p> <p>segue...</p> 
<p>Beta</p> <p>continua...</p> <p>200000960080 - mm 8 - L 105 - L1 43 - - conf. 10 - € 3,08</p> <p>200000960090 - mm 9 - L 111 - L1 46 - - conf. 10 - € 3,66</p> <p>200000960100 - mm 10 - L 119 - L1 49 - - conf. 10 - € 4,30</p> <p>200000960110 - mm 11 - L 126 - L1 52 - - conf. 10 - € 5,46</p> <p>200000960120 - mm 12 - L 134 - L1 56 - - conf. 10 - € 6,50</p> <p>segue...</p> 	<p>Beta</p> <p>continua...</p> <p>200000960130 - mm 13 - L 142 - L1 62 - - conf. 10 - € 8,30</p> <p>200000960140 - mm 14 - L 151 - L1 69 - - conf. 10 - € 9,70</p> <p>200000960170 - mm 17 - L 174 - L1 79 - - conf. 5 - € 14,98</p> <p>200000960190 - mm 19 - L 196 - L1 88 - - conf. 5 - € 20,88</p> <p>200000960220 - mm 22 - L 216 - L1 100 - - conf. 3 - € 32,48</p> <p>segue...</p> 
<p>Beta</p> <p>continua...</p> <p>200000960240 - mm 24 - L 242 - L1 112 - - conf. 1 - € 42,92</p> <p>200000960270 - mm 27 - L 271 - L1 125 - - conf. 1 - € 58,00</p> <p>200000960312 - mm 32 - L 341 - L1 155 - - conf. 1 - € 101,50</p> 	<p>Beta</p> <p>SERIE 10 PZ. CHIAVI MASCHIO ESAGONALI BETA ART. 96/B10 Misure: 1,5-2-2,5-3-4 5-6-8-10-12 mm</p> <p>200000960380 - - conf. 5 - € 25,64</p> 



UTENSILI

<p>Beta</p> <p>SERIE 8 PZ. CHIAVI MASCHIO ESAGONALI BETA ART. 96/B8 Misure: 2-2,5-3-4-5 6-8-10 mm</p> <p>200000960386 - - conf. 5 - € 18,10</p> 	<p>Beta</p> <p>SERIE 7 PZ. CHIAVI MASCHIO ESAGONALI BETA ART. 96/BG7 Misure: 2,5-3-4-5 6-8-10 mm</p> <p>200000960368 - - conf. 1 - € 34,22</p> 
<p>Beta</p> <p>SERIE 12 PZ. CHIAVI MASCHIO ESAGONALI BETA ART. 96/SC12 Misure: 2-2,5-3-3,5-4 4,5-5-6-7-8-9-10 mm</p> <p>200000960395 - - conf. 1 - € 30,74</p> 	<p>Beta</p> <p>SERIE 9 PZ. CHIAVI MASCHIO ESAGONALI PIEGATE BETA ART. 96/SC9 Misure: 1,5-2-2,5-3 4-5-6-8-10 mm</p> <p>200000960374 - - conf. 1 - € 21,58</p> 
<p>Beta</p> <p>SERIE 6 PZ. CHIAVI MASCHIO ESAGONALE BETA ART. 96/ST6 Misure: 2,5-3-4-5-6-8 mm</p> <p>200000960370 - - conf. 1 - € 14,98</p> 	<p>Beta</p> <p>SERIE 7 PZ. CHIAVI ESAGONALI BETA ART. 96AS/T7 Misure: 3/32-1/8-5/32 3/16-7/32-1/4-5/16</p> <p>200000960740 - - conf. 3 - € 19,96</p> 
<p>Beta</p> <p>CHIAVI MASCHIO ESAGONALI PIEGATE TIPO LUNGO BRUNITE BETA ART. 96L</p> <p>200000960820 - mm 2 - L 99 - L1 15 - - conf. 20 - € 1,36</p> <p>200000960825 - mm 2,5 - L 110 - L1 17 - - conf. 20 - € 1,42</p> <p>200000960830 - mm 3 - L 124 - L1 19 - - conf. 20 - € 1,62</p> <p>200000960835 - mm 3,5 - L 135 - L1 21 - - conf. 20 - € 1,72</p> <p>200000960840 - mm 4 - L 138 - L1 24 - - conf. 20 - € 1,92</p> <p>segue...</p> 	<p>Beta</p> <p>continua...</p> <p>200000960845 - mm 4,5 - L 150 - L1 25 - - conf. 20 - € 2,22</p> <p>200000960850 - mm 5 - L 158 - L1 27 - - conf. 20 - € 2,34</p> <p>200000960860 - mm 6 - L 178 - L1 31 - - conf. 20 - € 2,66</p> <p>200000960870 - mm 7 - L 187 - L1 33 - - conf. 10 - € 3,40</p> <p>200000960880 - mm 8 - L 197 - L1 35 - - conf. 10 - € 4,24</p> <p>segue...</p> 
<p>Beta</p> <p>continua...</p> <p>200000960890 - mm 9 - L 207 - L1 37 - - conf. 10 - € 4,82</p> <p>200000960900 - mm 10 - L 221 - L1 39 - - conf. 10 - € 6,34</p> <p>200000960920 - mm 12 - L 247 - L1 44 - - conf. 10 - € 8,24</p> <p>200000960960 - mm 1,5 - L 79 - L1 13 - - conf. 10 - € 1,72</p> <p>200000960961 - mm 2 - L 84 - L1 15 - - conf. 10 - € 1,86</p> <p>segue...</p> 	<p>Beta</p> <p>continua...</p> <p>200000960962 - mm 2,5 - L 89 - L1 17 - - conf. 10 - € 1,92</p> <p>200000960963 - mm 3 - L 99 - L1 19 - - conf. 10 - € 1,98</p> <p>200000960965 - mm 4 - L 108 - L1 24 - - conf. 10 - € 2,28</p> <p>200000960967 - mm 5 - L 126 - L1 27 - - conf. 10 - € 3,02</p> <p>200000960968 - mm 6 - L 148 - L1 31 - - conf. 10 - € 4,30</p> <p>segue...</p> 
<p>Beta</p> <p>continua...</p> <p>200000960970 - mm 8 - L 168 - L1 35 - - conf. 5 - € 6,16</p> <p>200000960972 - mm 10 - L 187 - L1 39 - - conf. 5 - € 10,56</p> 	<p>Beta</p> <p>SERIE 12 PZ. CHIAVI ESAGONALI BETA ART. 96LC/SP12 Misure: 2-2,5-3-3,5 4-4,5-5-6-7-8-9-10 mm Con supporto</p> <p>200000960336 - - conf. 1 - € 45,12</p> 















<p>Beta</p> <p>CHIAVI MASCHIO ESAGONALI PIEGATE BRUNITE BETA ART. 96N</p> <p>200000960409 - mm 0,9 - L 32 - L1 10 - - conf. 20 - € 0,50</p> <p>200000960413 - mm 1,3 - L 44 - L1 12 - - conf. 20 - € 0,50</p> <p>200000960415 - mm 1,5 - L 46 - L1 15 - - conf. 20 - € 0,54</p> <p>200000960420 - mm 2 - L 51 - L1 17 - - conf. 20 - € 0,56</p> <p>200000960425 - mm 2,5 - L 57 - L1 20 - - conf. 20 - € 0,58</p> <p>segue...</p> 	<p>Beta</p> <p>continua...</p> <p>200000960430 - mm 3 - L 64 - L1 22 - - conf. 20 - € 0,66</p> <p>200000960435 - mm 3,5 - L 68 - L1 25 - - conf. 20 - € 0,80</p> <p>200000960440 - mm 4 - L 72 - L1 28 - - conf. 20 - € 0,90</p> <p>200000960445 - mm 4,5 - L 78 - L1 30 - - conf. 20 - € 1,00</p> <p>200000960450 - mm 5 - L 83 - L1 32 - - conf. 20 - € 1,04</p> <p>segue...</p> 
<p>Beta</p> <p>continua...</p> <p>200000960460 - mm 6 - L 94 - L1 37 - - conf. 20 - € 1,28</p> <p>200000960470 - mm 7 - L 99 - L1 40 - - conf. 10 - € 1,72</p> <p>200000960480 - mm 8 - L 105 - L1 43 - - conf. 10 - € 2,04</p> <p>200000960490 - mm 9 - L 111 - L1 46 - - conf. 10 - € 2,66</p> <p>200000960500 - mm 10 - L 119 - L1 49 - - conf. 10 - € 3,14</p> <p>segue...</p> 	<p>Beta</p> <p>continua...</p> <p>200000960510 - mm 11 - L 126 - L1 52 - - conf. 10 - € 3,90</p> <p>200000960520 - mm 12 - L 134 - L1 56 - - conf. 10 - € 4,76</p> <p>200000960530 - mm 13 - L 142 - L1 62 - - conf. 10 - € 6,28</p> <p>200000960540 - mm 14 - L 151 - L1 69 - - conf. 10 - € 7,14</p> <p>200000960560 - mm 16 - L 165 - L1 72 - - conf. 5 - € 10,68</p> <p>segue...</p> 
<p>Beta</p> <p>continua...</p> <p>200000960570 - mm 17 - L 174 - L1 79 - - conf. 5 - € 11,56</p> <p>200000960590 - mm 19 - L 194 - L1 88 - - conf. 5 - € 15,56</p> 	<p>Beta</p> <p>SERIE 10 PZ. CHIAVI ESAGONALI BETA ART. 96N/ B10 Misure: 1,5-2-2,5-3 4-5-6-8-10-12 mm</p> <p>200000960650 - - conf. 5 - € 17,40</p> 
<p>Beta</p> <p>SERIE 6 PZ. CHIAVI ESAGONALI BETA ART. 96N/ ST6 Misure: 2,5-3-4-5 6-8 mm</p> <p>200000960640 - - conf. 3 - € 10,62</p> 	<p>Beta</p> <p>CHIAVI MASCHIO ESAGONALI PIEGATE BETA ART. 96T Con impugnatura di manovra</p> <p>200000960934 - mm 2 - L 139 - L1 52 - - conf. 5 - € 11,72</p> <p>200000960935 - mm 2,5 - L 153 - L1 55 - - conf. 5 - € 11,72</p> <p>200000960936 - mm 3 - L 153 - L1 55 - - conf. 5 - € 12,30</p> <p>200000960937 - mm 3,5 - L 179 - L1 70 - - conf. 5 - € 12,76</p> <p>200000960938 - mm 4 - L 179 - L1 70 - - conf. 5 - € 12,76</p> <p>segue...</p> 
<p>Beta</p> <p>continua...</p> <p>200000960939 - mm 4,5 - L 200 - L1 84 - - conf. 5 - € 13,12</p> <p>200000960940 - mm 5 - L 200 - L1 84 - - conf. 5 - € 13,12</p> <p>200000960941 - mm 6 - L 221 - L1 103 - - conf. 5 - € 14,98</p> <p>200000960942 - mm 7 - L 236 - L1 106 - - conf. 3 - € 16,48</p> <p>200000960943 - mm 8 - L 255 - L1 117 - - conf. 3 - € 19,04</p> <p>200000960945 - mm 10 - L 285 - L1 132 - - conf. 3 - € 22,04</p> 	<p>Beta</p> <p>SERIE 5 PZ. CHIAVI MASCHIO ESAGONALI PIEGATE BETA ART. 96T/S5P Misure: 2,5-3-4-5-6 mm Con impugnatura di manovra</p> <p>200000960946 - - conf. 1 - € 58,72</p> 
<p>Beta</p> <p>SERIE 8 PZ. CHIAVI TORX BETA ART. 97TX/BG8 Per viti con impronta Torx Misure: T9-T10-T15 T20-T25-T27-T30-T40</p> <p>200000970368 - - conf. 1 - € 44,08</p> 	<p>Beta</p> <p>CHIAVI TORX PIEGATE CON IMPUGNATURA BETA ART. 97TTX</p> <p>200000970708 - Misura T8 - L 139 - L1 52 - - conf. 3 - € 12,18</p> <p>200000970709 - Misura T9 - L 139 - L1 52 - - conf. 3 - € 12,18</p> <p>200000970710 - Misura T10 - L 179 - L1 70 - - conf. 3 - € 12,54</p> <p>200000970715 - Misura T15 - L 179 - L1 70 - - conf. 3 - € 13,58</p> <p>200000970720 - Misura T20 - L 179 - L1 70 - - conf. 3 - € 14,16</p> <p>segue...</p> 















<p>Beta</p> <p>continua...</p> <p>200000970725 – Misura T25 – L 179 – L1 70 – – conf. 3 – € 14,98</p> <p>200000970727 – Misura T27 – L 200 – L1 84 – – conf. 3 – € 16,48</p> <p>200000970730 – Misura T30 – L 200 – L1 84 – – conf. 3 – € 17,06</p> <p>200000970740 – Misura T40 – L 221 – L1 103 – – conf. 3 – € 20,30</p> <p>200000970745 – Misura T45 – L 236 – L1 106 – – conf. 2 – € 23,78</p> <p>200000970750 – Misura T50 – L 255 – L1 117 – – conf. 2 – € 30,16</p> 	<p>Beta</p> <p>SERIE DI 8 CHIAVI MASCHIO PIEGATE Art.97TX/G Per viti con impronta Torx con supporto metallico</p> <p>200000970645 – – conf. 1 – € 56,26</p> 
<p>Beta</p> <p>SERIE 8 PZ. CHIAVI TORX TASCABILE BETA ART. 97TX/ST8 Misure: T9-T10-T15-T20 T25-T27-T30-T40</p> <p>200000970640 – – conf. 1 – € 71,34</p> 	<p>Beta</p> <p>CHIAVI A PROFILO XZN Art.98XZN Cromate</p> <p>200000980006 – Lmm 80 – L1mm 28 – – conf. 1 – € 6,56</p> <p>200000980010 – Lmm 100 – L1mm 36 – – conf. 1 – € 10,92</p> <p>200000980016 – Lmm 140 – L1mm 55 – – conf. 1 – € 25,88</p> 
<p>Beta</p> <p>CHIAVE A SETTORE Con nasello quadro Per ghiere cromate</p> <p>200000990062 – mm 62-65 – Smm 7,0 – Bmm 46,0 – Lmm 242Amm 3,1 – conf. 1 – € 28,32</p> 	<p>Beta</p> <p>CHIAVI COMBINATE A CRICCHETTO REVERSIBILE BETA ART. 142</p> <p>200001420006 – mm 6x6 – L 136 – – conf. 3 – € 18,22</p> <p>200001420007 – mm 7x7 – L 136 – – conf. 3 – € 18,22</p> <p>200001420008 – mm 8x8 – L 136 – – conf. 3 – € 18,80</p> <p>200001420009 – mm 9x9 – L 143 – – conf. 3 – € 20,08</p> <p>200001420010 – mm 10x10 – L 159 – – conf. 3 – € 20,66</p> <p>segue...</p> 
<p>Beta</p> <p>continua...</p> <p>200001420011 – mm 11x11 – L 168 – – conf. 3 – € 21,24</p> <p>200001420012 – mm 12x12 – L 174 – – conf. 3 – € 22,04</p> <p>200001420013 – mm 13x13 – L 180 – – conf. 3 – € 23,78</p> <p>200001420014 – mm 14x14 – L 190 – – conf. 2 – € 24,48</p> <p>200001420015 – mm 15x15 – L 200 – – conf. 2 – € 26,00</p> <p>segue...</p> 	<p>Beta</p> <p>continua...</p> <p>200001420016 – mm 16x16 – L 216 – – conf. 2 – € 28,08</p> <p>200001420017 – mm 17x17 – L 233 – – conf. 2 – € 28,54</p> <p>200001420018 – mm 18x18 – L 239 – – conf. 2 – € 30,74</p> <p>200001420019 – mm 19x19 – L 248 – – conf. 2 – € 31,32</p> <p>200001420022 – mm 22x22 – L 285 – – conf. 1 – € 42,34</p> <p>200001420024 – mm 24x24 – L 325 – – conf. 1 – € 49,30</p> 
<p>Beta</p> <p>SERIE 9 PZ. CHIAVI COMBINATE A CRICCHETTO REVERSIBILE BETA ART. 142/SC9I Misure: 8-10-11-12-13 14-15-17-19 mm Con supporto compatto</p> <p>200001420087 – – conf. 1 – € 226,00</p> 	<p>Beta</p> <p>GIRATUBI MOD. SVEDESE GANASCE PARALLELE A 45° BETA ART. 375</p> <p>200003750032 – L 320 – Ø max " 1" gas – Ø max mm 34 – – conf. 1 – € 51,62</p> <p>200003750041 – L 410 – Ø max " 1"1/2 gas – Ø max mm 49 – – conf. 1 – € 67,86</p> <p>200003750055 – L 550 – Ø max " 2" gas – Ø max mm 60 – – conf. 1 – € 105,56</p> 
<p>Beta</p> <p>SERIE DI PUNTE ELICOIDALI CILINDRICHE Art. 410 In selettore di plastica In acciaio HSS Finitura brunita Ø 1:10 x 0,5 mm</p> <p>200004100418 – – conf. 1 – € 35,96</p> 	<p>Beta</p> <p>SERIE DI MASCHI A MANO Art.430/SP in cassetta M 3,4,5,6,8,10,12</p> <p>200004300201 – – conf. 1 – € 125,28</p> 







<p>Beta</p> <p>CHIAVE A BUSSOLA Con attacco quadro femmina 1/2" bocca esagonale Art. 720L</p> <p>200007200319 - mm 19 - Ømm 28,5 - Lmm 80 - Ø1mm 30Amm 19,0 - conf. 1 - € 22,74</p> 	<p>Beta</p> <p>INSERTI A TAGLIO PER AVVITATORI BETA ART. 861LP Attacco 1/4"</p> <p>200008610005 - SxA 0,5x3 - L 25 - - conf. 10 - € 1,26</p> <p>200008610010 - SxA 0,6x4,5 - L 25 - - conf. 10 - € 1,26</p> <p>200008610015 - SxA 0,8x5,5 - L 25 - - conf. 10 - € 1,26</p> <p>200008610020 - SxA 1x5,5 - L 25 - - conf. 10 - € 1,26</p> <p>200008610025 - SxA 1,2x6,5 - L 25 - - conf. 10 - € 1,26</p> <p>segue...</p> 
<p>Beta</p> <p>continua...</p> <p>200008610030 - SxA 1,6x8 - L 25 - - conf. 10 - € 2,42</p> <p>200008610100 - mm 2 - L 25 - - conf. 10 - € 1,34</p> <p>200008610110 - mm 3 - L 25 - - conf. 10 - € 1,34</p> <p>200008610115 - mm 4 - L 25 - - conf. 10 - € 1,34</p> <p>200008610120 - mm 5 - L 25 - - conf. 10 - € 1,34</p> <p>segue...</p> 	<p>Beta</p> <p>continua...</p> <p>200008610125 - mm 6 - L 25 - - conf. 10 - € 1,34</p> <p>200008610130 - mm 8 - L 25 - - conf. 10 - € 2,02</p> <p>200008610135 - mm 10 - L 25 - - conf. 10 - € 2,66</p> <p>200008610200 - Misura PH0 - L 25 - - conf. 10 - € 1,24</p> <p>200008610205 - Misura PH1 - L 25 - - conf. 10 - € 1,24</p> <p>segue...</p> 
<p>Beta</p> <p>continua...</p> <p>200008610210 - Misura PH2 - L 25 - - conf. 10 - € 1,24</p> <p>200008610213 - Misura PH2L - L 50 - - conf. 10 - € 2,42</p> <p>200008610215 - Misura PH3 - L 25 - - conf. 10 - € 1,24</p> <p>200008610220 - Misura PH4 - L 25 - - conf. 10 - € 3,32</p> <p>200008610300 - Misura PZ1 - L 25 - - conf. 10 - € 1,24</p> <p>segue...</p> 	<p>Beta</p> <p>continua...</p> <p>200008610305 - Misura PZ2 - L 25 - - conf. 10 - € 1,24</p> <p>200008610308 - Misura PZ2L - L 50 - - conf. 10 - € 2,38</p> <p>200008610310 - Misura PZ3 - L 25 - - conf. 10 - € 1,24</p> <p>200008610315 - Misura PZ4 - L 25 - - conf. 10 - € 3,30</p> <p>200008610400 - Misura T6 - L 25 - - conf. 10 - € 1,78</p> <p>segue...</p> 
<p>Beta</p> <p>continua...</p> <p>200008610405 - Misura T7 - L 25 - - conf. 10 - € 1,78</p> <p>200008610410 - Misura T8 - L 25 - - conf. 10 - € 1,78</p> <p>200008610415 - Misura T9 - L 25 - - conf. 10 - € 1,78</p> <p>200008610420 - Misura T10 - L 25 - - conf. 10 - € 1,40</p> <p>200008610425 - Misura T15 - L 25 - - conf. 10 - € 1,40</p> <p>segue...</p> 	<p>Beta</p> <p>continua...</p> <p>200008610430 - Misura T20 - L 25 - - conf. 10 - € 1,40</p> <p>200008610435 - Misura T25 - L 25 - - conf. 10 - € 1,40</p> <p>200008610440 - Misura T27 - L 25 - - conf. 10 - € 1,40</p> <p>200008610445 - Misura T30 - L 25 - - conf. 10 - € 1,40</p> <p>200008610450 - Misura T40 - L 25 - - conf. 10 - € 1,40</p> <p>segue...</p> 
<p>Beta</p> <p>continua...</p> <p>200008610500 - Misura T9 - L 25 - - conf. 10 - € 2,60</p> <p>200008610505 - Misura T10 - L 25 - - conf. 10 - € 2,60</p> <p>200008610510 - Misura T15 - L 25 - - conf. 10 - € 2,60</p> <p>200008610515 - Misura T20 - L 25 - - conf. 10 - € 2,60</p> <p>200008610525 - Misura T27 - L 25 - - conf. 10 - € 2,60</p> <p>segue...</p> 	<p>Beta</p> <p>continua...</p> <p>200008610530 - Misura T30 - L 25 - - conf. 10 - € 2,60</p> <p>200008610535 - Misura T40 - L 25 - - conf. 10 - € 2,60</p> 
<p>Beta</p> <p>INSERTI A BUSSOLA ESAGONALI MAGNETICI PER AVVITATORI BETA ART. 862F Attacco 1/4"</p> <p>200008620405 - mm 5,5 - L 65 - Ø 11 - - conf. 5 - € 6,80</p> <p>200008620406 - mm 6 - L 65 - Ø 11 - - conf. 5 - € 6,80</p> <p>200008620407 - mm 7 - L 65 - Ø 11 - - conf. 5 - € 6,80</p> <p>200008620408 - mm 8 - L 65 - Ø 13 - - conf. 5 - € 6,80</p> <p>200008620410 - mm 10 - L 65 - Ø 15 - - conf. 5 - € 7,38</p> <p>segue...</p> 	<p>Beta</p> <p>continua...</p> <p>200008620412 - mm 12 - L 65 - Ø 18 - - conf. 5 - € 8,12</p> <p>200008620413 - mm 13 - L 65 - Ø 18 - - conf. 5 - € 8,60</p> 



<p>Beta</p> <p>ASTUCCIO 7 INSERTI CHIAVI A BUSSOLA ESA- GONALI MAGNETICI PER AVVITATORI BETA ART. 862F/A7 Attacco 1/4" Misure: 5,5-6-7-8 10-12-13 mm</p> <p>200008620950 - - conf. 1 - € 51,04</p> 	<p>Beta</p> <p>INSERTI A CROCE PHILLIPS PER AVVITATORI BETA ART. 862PH Attacco 1/4"</p> <p>200008620200 - Misura PH1 - L 50 - - conf. 5 - € 3,66 200008620210 - Misura PH3 - L 50 - - conf. 5 - € 3,66 200008620300 - PZ 1 - Lmm 50 - - conf. 5 - € 3,78 200008620305 - PZ 2 - Lmm 50 - - conf. 5 - € 3,78 200008620310 - PZ 3 - Lmm 50 - - conf. 5 - € 3,78</p> 
<p>Beta</p> <p>INSERTI A CROCE POZIDRIV-SUPADRIV PER AVVITATORI BETA ART. 866PZ Attacco 5/16</p> <p>200008660300 - Misura PZ1 - L 32 - - conf. 10 - € 3,14 200008660305 - Misura PZ2 - L 32 - - conf. 10 - € 3,14 200008660310 - Misura PZ3 - L 32 - - conf. 10 - € 3,14 200008660315 - Misura PZ4 - L 38 - - conf. 10 - € 4,76</p> 	<p>Beta</p> <p>RACCORDI PER AVVITATORI BETA ART. 892</p> <p>200008920001 - Quadro 1/4 - Esagonale 5,5 - L 50 - - conf. 5 - € 10,56 200008920002 - Quadro 3/8 - Esagonale 5,5 - L 50 - - conf. 5 - € 15,66 200008920003 - Quadro 1/4 - Esagonale 1/4 - L 50 - - conf. 5 - € 10,56 <i>segue...</i></p> 
<p>Beta</p> <p><i>continua...</i></p> <p>200008920004 - Quadro 3/8 - Esagonale 1/4 - L 50 - - conf. 5 - € 15,66 200008920005 - Quadro 1/4 - Esagonale 5/16 - L 75 - - conf. 5 - € 14,50 200008920006 - Quadro 3/8 - Esagonale 5/16 - L 75 - - conf. 5 - € 21,36</p> 	<p>Beta</p> <p>CHIAVI A BUSSOLA ESAGONALI BETA ART. 900 Attacco 1/4"</p> <p>200009000040 - mm 4 - Ø 6,8 - L 25 - Ø1 11,8A 8,0 - conf. 10 - € 4,18 200009000045 - mm 4,5 - Ø 7,4 - L 25 - Ø1 11,8A 8,0 - conf. 10 - € 4,18 200009000050 - mm 5 - Ø 8 - L 25 - Ø1 11,8A 9 - conf. 10 - € 4,18 <i>segue...</i></p> 
<p>Beta</p> <p><i>continua...</i></p> <p>200009000055 - mm 5,5 - Ø 8,7 - L 25 - Ø1 11,8A 9,0 - conf. 10 - € 4,18 200009000060 - mm 6 - Ø 9,3 - L 25 - Ø1 11,8A 9 - conf. 10 - € 4,18 200009000070 - mm 7 - Ø 10,4 - L 25 - Ø1 11,8A 9,0 - conf. 10 - € 4,18 200009000080 - mm 8 - Ø 11,8 - L 25 - Ø1 12,7A 9,0 - conf. 10 - € 4,18 <i>segue...</i></p> 	<p>Beta</p> <p><i>continua...</i></p> <p>200009000090 - mm 9 - Ø 12,7 - L 25 - Ø1 11,8A 9,0 - conf. 10 - € 4,18 200009000100 - mm 10 - Ø 14,2 - L 25 - Ø1 12A 9 - conf. 10 - € 4,18 200009000110 - mm 11 - Ø 15,8 - L 25 - Ø1 12,5A 10,0 - conf. 10 - € 4,18 200009000120 - mm 12 - Ø 17,2 - L 25 - Ø1 13,5A 10,0 - conf. 10 - € 4,18 <i>segue...</i></p> 
<p>Beta</p> <p><i>continua...</i></p> <p>200009000130 - mm 13 - Ø 18 - L 25 - Ø1 13,5A 10 - conf. 10 - € 4,24 200009000140 - mm 14 - Ø 20 - L 25 - Ø1 15,0A 10,0 - conf. 10 - € 4,30</p> 	<p>Beta</p> <p>RACCORDI CON ATTACCO QUADRO BETA ART. 900/16 Attacco maschio 3/8" Attacco femmina 1/4"</p> <p>200009000814 - L 28 - Ø 13 - - conf. 5 - € 7,26</p> 
<p>Beta</p> <p>PROLUNGHE CON ATTACCO QUADRO BETA ART. 900/... Attacco maschio 1/4" Attacco fem- mina 1/4"</p> <p>200009000818 - L 50 - Ø 11,5 - - conf. 5 - € 9,24 200009000819 - L 100 - Ø 11,5 - - conf. 5 - € 9,46 200009000822 - L 150 - Ø 11,5 - - conf. 5 - € 9,86 200009000823 - L 250 - Ø 11,5 - - conf. 5 - € 14,50 200009000824 - L 350 - Ø 11,5 - - conf. 5 - € 17,52</p> 	<p>Beta</p> <p>SNODO ATTACCO QUADRO BETA ART. 900/25 Attacco 1/4" Maschio/femmina Cromato</p> <p>200009000830 - L 41 - Ø 12,5 - - conf. 4 - € 17,98</p> 

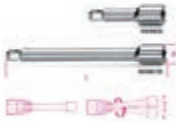

<p>Beta</p> <p>QUADRO MASCHIO BETA ART. 900/42 Attacco 1/4" Con spina scorrevole Cromato</p> <p>200009000854 - L 115 - A 22 - - conf. 3 - € 10,10</p> 	<p>Beta</p> <p>CASSETTA 39 PZ. BETA MINI ART. 900/C39 11 chiavi a bussola esagonali 21 inserti per avvitatori 7 accessori</p> <p>200009000937 - - conf. 5 - € 208,00</p> 
<p>Beta</p> <p>CRICCHETTO REVERSIBILE Con attacco quadro Maschio 1/4" Cromato</p> <p>200009000870 - Lmm 125 - Ømm 25 - Amm 18 - - conf. 0 - € 48,72</p> 	<p>Beta</p> <p>PROLUNGA ANGOLARE BETA ART. 900AN Attacco 1/4" Attacco quadro Maschio/femmina Cromata</p> <p>200009000825 - L 50 - Ø 11,5 - - conf. 2 - € 9,98 200009000826 - L 100 - Ø 11,5 - - conf. 1 - € 10,98 200009000503 - mm 3 - Ømm 12 - Lmm 25 - L1mm 5 - conf. 1 - € 9,00</p> 
<p>Beta</p> <p>CASSETTA 42 CHIAVI BETA EASY ART. 903E/C42 Chiavi a bussola da 1/4" con cricchetto Il kit comprende: 13 chiavi a bussola esagonali, 18 inserti per avvitatori, 4 chiavi maschio esagonale piegate e 7 accessori in cassetta di plastica</p> <p>200009031042 - - conf. 1 - € 71,70</p> 	<p>Beta</p> <p>RACCORDO ATTACCO QUADRO MASCHIO BETA ART. 910/15 Attacco femmina 3/8" Attacco maschio 1/4" Cromato</p> <p>200009100810 - L 30 - Ø 17 - - conf. 5 - € 9,98</p> 
<p>Beta</p> <p>RACCORDO ATTACCO QUADRO FEMMINA BETA ART. 910/16 Attacco femmina 3/8" Attacco maschio 1/2" Cromato</p> <p>200009100814 - L 32 - Ø 18 - - conf. 5 - € 10,44</p> 	<p>Beta</p> <p>PROLUNGHE ATTACCO QUADRO BETA ART. 910/21 ART. 910/22 Attacco 3/8" Cromate</p> <p>200009100822 - L 125 - Ø 17 - - conf. 5 - € 12,30 200009100826 - L 250 - Ø 17 - - conf. 5 - € 16,36</p> 
<p>Beta</p> <p>SNODO ATTACCO QUADRO BETA ART. 910/25 Attacco 3/8" Maschio/femmina Cromato</p> <p>200009100830 - L 54,6 - Ø 19 - - conf. 5 - € 22,40</p> 	<p>Beta</p> <p>QUADRO MASCHIO BETA ART. 910/40 Attacco 3/8" Snodato a T Cromato</p> <p>200009100850 - L 420 - L1 175 - - conf. 3 - € 46,40</p> 
<p>Beta</p> <p>QUADRO MASCHIO BETA ART. 910/42 Attacco 3/8" Con spina scorrevole Cromato</p> <p>200009100854 - L 210 - A 30,5 - - conf. 5 - € 14,62</p> 	<p>Beta</p> <p>QUADRO MASCHIO 3/8" Art. 910/46 Con manovella e impugnatura in metallo cromato</p> <p>200009100862 - Lmm 315 - L1mm 80 - Amm 115 - - conf. 1 - € 28,90</p> 



Beta

CRICCHETTO REVERSIBILE BETA ART. 910/55
Attacco quadro maschio 3/8" Cromato

200009100882 - L 200 - Ø 30 - A 33 -
- conf. 3 - € 52,78



Beta

CHIAVI A BUSSOLA ESAGONALI BETA ART. 910A
Attacco quadro femmina 3/8" Cromate

200009100006 - mm 6 - Ø 9,5 - L 28 - Ø116,7
- conf. 5 - € 6,80
200009100007 - mm 7 - Ø 10,7 - L 28 - Ø116,7
- conf. 5 - € 6,80
200009100008 - mm 8 - Ø 12,1 - L 28 - Ø116,7
- conf. 5 - € 6,80
200009100009 - mm 9 - Ø 13,2 - L 28 - Ø116,7
- conf. 5 - € 6,80
200009100010 - mm 10 - Ø 14,6 - L 29 - Ø116,7
- conf. 5 - € 6,80
segue...



Beta

continua...
200009100011 - mm 11 - Ø 15,8 - L 29 - Ø116,7
- conf. 5 - € 6,80
200009100012 - mm 12 - Ø 17,2 - L 30 - Ø117,7
- conf. 5 - € 7,02
200009100013 - mm 13 - Ø 18,4 - L 31 - Ø117
- conf. 5 - € 7,02
200009100014 - mm 14 - Ø 19,7 - L 32 - Ø117,5
- conf. 5 - € 7,02
200009100015 - mm 15 - Ø 20,9 - L 32 - Ø118
- conf. 5 - € 7,02
segue...



Beta

continua...
200009100016 - mm 16 - Ø 22,2 - L 33 - Ø118,5
- conf. 5 - € 7,90
200009100017 - mm 17 - Ø 23,2 - L 33 - Ø119
- conf. 5 - € 7,90
200009100018 - mm 18 - Ø 24,7 - L 34 - Ø120
- conf. 5 - € 7,90
200009100019 - mm 19 - Ø 25,8 - L 35 - Ø121
- conf. 5 - € 7,90
200009100020 - mm 20 - Ø 27,2 - L 35 - Ø122
- conf. 5 - € 8,48
segue...



Beta

continua...
200009100021 - mm 21 - Ø 28,2 - L 36 - Ø123
- conf. 5 - € 8,48
200009100022 - mm 22 - Ø 29,7 - L 37 - Ø124
- conf. 5 - € 8,60



Beta

PROLUNGHE CON ATTACCHI Art.910AN Quadri
maschio e femmina 3/8" angolari cromate

200009100828 - Lmm 125 - Ømm 17 -
- conf. 1 - € 15,08



Beta

CHIAVI A BUSSOLA MASCHIO ESAGONALI BETA ART. 910PE Attacco quadro femmina 3/8" Cromate Inserti bruniti

200009100490 - mm 3 - Ø 18,5 - L 50 - L1 20
- conf. 5 - € 13,58
200009100492 - mm 4 - Ø 18,5 - L 50 - L1 20
- conf. 5 - € 13,58
200009100494 - mm 5 - Ø 18,5 - L 50 - L1 20
- conf. 5 - € 13,58
200009100496 - mm 6 - Ø 18,5 - L 50 - L1 20
- conf. 5 - € 13,58
segue...



Beta

continua...
200009100497 - mm 7 - Ø 18,5 - L 50 - L1 20
- conf. 5 - € 13,58
200009100498 - mm 8 - Ø 18,5 - L 50 - L1 20
- conf. 5 - € 13,58
200009100500 - mm 10 - Ø 18,5 - L 50 - L1 20
- conf. 5 - € 13,58
200009100519 - Misura T15 - Ø 18,5 - L 50 - L1 20
- conf. 5 - € 17,88
200009100520 - Misura T20 - Ø 18,5 - L 50 - L1 20
- conf. 5 - € 17,88
segue...



Beta

continua...
200009100521 - Misura T25 - Ø 18,5 - L 50 - L1 20
- conf. 5 - € 17,88
200009100522 - Misura T27 - Ø 18,5 - L 50 - L1 20
- conf. 5 - € 17,88
200009100523 - Misura T30 - Ø 18,5 - L 50 - L1 20
- conf. 5 - € 17,88
200009100524 - Misura T40 - Ø 18,5 - L 50 - L1 20
- conf. 5 - € 17,88
segue...



Beta

continua...
200009100106 - mm 6 - Ø 9,5 - L 28 - Ø116,7
- conf. 5 - € 6,80
200009100107 - mm 7 - Ø 10,7 - L 28 - Ø116,7
- conf. 5 - € 6,80
200009100108 - mm 8 - Ø 12,1 - L 28 - Ø116,7
- conf. 5 - € 6,80
200009100109 - mm 9 - Ø 13,2 - L 28 - Ø116,7
- conf. 5 - € 6,80
200009100110 - mm 10 - Ø 14,6 - L 29 - Ø116,7
- conf. 5 - € 6,80
segue...



Beta

continua...
200009100111 - mm 11 - Ø 15,8 - L 29 - Ø116,7
- conf. 5 - € 6,80
200009100112 - mm 12 - Ø 17,2 - L 30 - Ø117,7
- conf. 5 - € 7,02
200009100113 - mm 13 - Ø 18,4 - L 31 - Ø117,0
- conf. 5 - € 7,02
200009100114 - mm 14 - Ø 19,7 - L 32 - Ø117,5
- conf. 5 - € 7,02
200009100115 - mm 15 - Ø 20,9 - L 32 - Ø118,0
- conf. 5 - € 7,02
segue...



Beta













continua...
200009100116 - mm 16 - Ø 22,2 - L 33 - Ø118,5
- conf. 5 - € 7,90
200009100117 - mm 17 - Ø 23,2 - L 33 - Ø119,0
- conf. 5 - € 7,90
200009100118 - mm 18 - Ø 24,7 - L 34 - Ø120,0
- conf. 5 - € 7,90
200009100119 - mm 19 - Ø 25,8 - L 35 - Ø121,0
- conf. 5 - € 7,90
200009100120 - mm 20 - Ø 27,2 - L 35 - Ø122,0
- conf. 5 - € 8,48
segue...





<p>Beta</p> <p>continua...</p> <p>200009100121 - mm 21 - Ø 28,2 - L 36 - Ø1 23,0 - conf. 5 - € 8,48</p> <p>200009100122 - mm 22 - Ø 29,7 - L 37 - Ø1 24,0 - conf. 5 - € 8,60</p> <p>200009100504 - mm 4 - Ø 18 - L 62 - L1 15 - conf. 5 - € 16,36</p> <p>200009100505 - mm 5 - Ø 18 - L 62 - L1 15 - conf. 5 - € 16,36</p> <p>200009100506 - mm 6 - Ø 18 - L 62 - L1 15 - conf. 5 - € 16,36</p> <p>segue...</p> 	<p>Beta</p> <p>continua...</p> <p>200009100507 - mm 7 - Ø 18 - L 62 - L1 15 - conf. 5 - € 16,60</p> <p>200009100508 - mm 8 - Ø 19 - L 62 - L1 15 - conf. 5 - € 16,60</p> <p>200009100510 - mm 10 - Ø 20 - L 62 - L1 15 - conf. 5 - € 16,60</p> <p>200009100512 - mm 12 - Ø 20 - L 62 - L1 15 - conf. 5 - € 16,60</p> <p>200009100472 - PH 2 - Ømm 18,5 - Lmm 48 - L1mm 18 - conf. 1 - € 15,56</p> <p>segue...</p> 
<p>Beta</p> <p>continua...</p> <p>200009100473 - PH 3 - Ømm 18,5 - Lmm 48 - L1mm 18 - conf. 1 - € 15,56</p> <p>200009100474 - PH 4 - Ømm 18,5 - Lmm 48 - L1mm 18 - conf. 1 - € 15,56</p> 	<p>Beta</p> <p>VALIGETTA Art.913A/C30 Con 30 bussole: C910A - da 6 a 24 mm C910AL - da 8 a 14 mm C956E - 16 mm (5/8") e 21 mm (13/16") C910/25 C910/21 - 75 mm C910/22 - 125 mm 913/55</p> <p>200009130960 - - conf. 1 - € 79,94</p> 
<p>Beta</p> <p>CHIAVI A BUSSOLA POLIGONALI LUNGHE BETA ART. 920BL Attacco quadro femmina 1/2" Cromate</p> <p>200009200310 - mm 10 - Ø 14,7 - L 77 - Ø1 21A 12 - conf. 5 - € 18,34</p> <p>200009200312 - mm 12 - Ø 17,8 - L 77 - Ø1 21A 12 - conf. 5 - € 18,34</p> <p>200009200313 - mm 13 - Ø 19,0 - L 77 - Ø1 22A 12 - conf. 5 - € 18,34</p> <p>segue...</p> 	<p>Beta</p> <p>continua...</p> <p>200009200314 - mm 14 - Ø 20,3 - L 77 - Ø1 22A 15 - conf. 5 - € 18,34</p> <p>200009200315 - mm 15 - Ø 21,5 - L 77 - Ø1 22A 15 - conf. 5 - € 18,34</p> <p>200009200316 - mm 16 - Ø 22,8 - L 77 - Ø1 22A 15 - conf. 5 - € 19,50</p> <p>200009200317 - mm 17 - Ø 24,0 - L 77 - Ø1 23A 15 - conf. 5 - € 19,50</p> <p>segue...</p> 
<p>Beta</p> <p>continua...</p> <p>200009200318 - mm 18 - Ø 25,0 - L 77 - Ø1 24A 18 - conf. 5 - € 20,66</p> <p>200009200319 - mm 19 - Ø 26,5 - L 77 - Ø1 25A 18 - conf. 5 - € 20,66</p> <p>200009200321 - mm 21 - Ø 29,0 - L 77 - Ø1 27A 18 - conf. 5 - € 22,98</p> <p>200009200322 - mm 22 - Ø 30,0 - L 77 - Ø1 28A 21 - conf. 5 - € 22,98</p> <p>segue...</p> 	<p>Beta</p> <p>continua...</p> <p>200009200323 - mm 23 - Ø 31,5 - L 77 - Ø1 29A 21 - conf. 5 - € 22,98</p> <p>200009200324 - mm 24 - Ø 32,8 - L 77 - Ø1 30A 24 - conf. 5 - € 26,22</p> <p>200009200327 - mm 27 - Ø 36,5 - L 77 - Ø1 33A 27 - conf. 3 - € 27,38</p> <p>200009200330 - mm 30 - Ø 40,0 - L 77 - Ø1 36A 30 - conf. 3 - € 33,06</p> <p>segue...</p> 
<p>Beta</p> <p>continua...</p> <p>200009200332 - mm 32 - Ø 42,8 - L 77 - Ø1 38A 33 - conf. 3 - € 33,64</p> <p>200009200336 - mm 36 - Ø 48,0 - L 77 - Ø1 41A 34 - conf. 3 - € 54,52</p> 	<p>Beta</p> <p>CHIAVI A BUSSOLA TORX BETA ART. 920FTX Attacco quadro 1/2" Cromate</p> <p>200009200380 - Misura E10 - Ø 13,2 - L 36 - Ø1 21A 6,4 - conf. 5 - € 11,08</p> <p>200009200381 - Misura E12 - Ø 15,0 - L 37 - Ø1 21A 8,0 - conf. 5 - € 11,08</p> <p>200009200382 - Misura E14 - Ø 16,3 - L 37 - Ø1 21A 8,8 - conf. 5 - € 11,08</p> <p>segue...</p> 
<p>Beta</p> <p>continua...</p> <p>200009200383 - Misura E16 - Ø 18,8 - L 37 - Ø1 22A 9,6 - conf. 5 - € 11,08</p> <p>200009200384 - Misura E18 - Ø 20,4 - L 37 - Ø1 22A 11,1 - conf. 5 - € 11,08</p> <p>200009200385 - Misura E20 - Ø 22,9 - L 37 - Ø1 22A 12,7 - conf. 5 - € 11,96</p> <p>200009200387 - Misura E22 - Ø 25,0 - L 37 - Ø1 24A 16,5 - conf. 3 - € 13,92</p> <p>segue...</p> 	<p>Beta</p> <p>continua...</p> <p>200009200388 - Misura E24 - Ø 26,5 - L 40 - Ø1 25A 16,9 - conf. 3 - € 15,78</p> 















<p>Beta</p> <p>CHIAVI A BUSSOLA MASCHIO ESAGONALI BETA ART. 920PE Attacco quadro femmina 1/2" Inserti bruniti Cromate</p> <p>200009200410 - mm 3 - Ø 22,5 - L 58 - L1 20 - conf. 5 - € 14,40 200009200412 - mm 4 - Ø 22,5 - L 58 - L1 20 - conf. 5 - € 14,40 200009200414 - mm 5 - Ø 22,5 - L 58 - L1 20 - conf. 5 - € 14,40 200009200415 - mm 5L - Ø 22,5 - L 100 - L1 62 - conf. 5 - € 15,78</p> <p>segue...</p> 	<p>Beta</p> <p>continua...</p> <p>200009200417 - mm 6 - Ø 22,5 - L 58 - L1 20 - conf. 5 - € 14,40 200009200418 - mm 6L - Ø 22,5 - L 100 - L1 62 - conf. 5 - € 15,78 200009200420 - mm 7 - Ø 22,5 - L 58 - L1 20 - conf. 5 - € 14,40 200009200421 - mm 7L - Ø 22,5 - L 100 - L1 62 - conf. 5 - € 15,78 200009200423 - mm 8 - Ø 22,5 - L 58 - L1 20 - conf. 5 - € 14,40</p> <p>segue...</p> 
<p>Beta</p> <p>continua...</p> <p>200009200424 - mm 8L - Ø 22,5 - L 100 - L1 62 - conf. 5 - € 15,78 200009200428 - mm 10 - Ø 22,5 - L 58 - L1 20 - conf. 5 - € 14,40 200009200429 - mm 10L - Ø 22,5 - L 140 - L1 102 - conf. 5 - € 16,60 200009200432 - mm 12 - Ø 23 - L 58 - L1 20 - conf. 5 - € 16,82 200009200434 - mm 14 - Ø 23 - L 58 - L1 20 - conf. 5 - € 16,82</p> <p>segue...</p> 	<p>Beta</p> <p>continua...</p> <p>200009200437 - mm 17 - Ø 29,5 - L 60 - L1 22 - conf. 5 - € 20,54 200009200439 - mm 19 - Ø 29,5 - L 60 - L1 22 - conf. 5 - € 20,54</p> 
<p>Beta</p> <p>CHIAVI A BUSSOLA A GIRAVITE Art. 920LP Per viti con intaglio Con attacco quadro 1/2" Cromate Inserti bruniti</p> <p>200009200452 - SxA mm 1x5,5 - Ømm 22,5 - Lmm 62 - L1mm 24 - conf. 1 - € 18,10 200009200453 - SxA mm 1,2x6,5 - Ømm 22,5 - Lmm 62 - L1mm 24 - conf. 1 - € 18,10 200009200458 - SxA mm 2x12 - Ømm 22,5 - Lmm 62 - L1mm 24 - conf. 1 - € 18,10</p> 	<p>Beta</p> <p>CHIAVI A BUSSOLA A GIRAVITE Art.920PH Per viti con impronta a croce Philips con attacco quadro 1/2" Cromate Inserti bruniti</p> <p>200009200471 - PH 1 - Ømm 22,5 - Lmm 56 - L1mm 18 - conf. 1 - € 15,90 200009200473 - PH 3 - Ømm 22,5 - Lmm 56 - L1mm 18 - conf. 1 - € 15,90 200009200474 - PH 4 - Ømm 22,5 - Lmm 56 - L1mm 18 - conf. 1 - € 15,90</p> 
<p>Beta</p> <p>CHIAVI A BUSSOLA MASCHIO ESAGONALI BETA ART. 920ME Attacco quadro femmina 1/2" Cromate</p> <p>200009200505 - mm 5 - Ø 21 - L 75 - L1 15,5 - conf. 5 - € 16,94 200009200506 - mm 6 - Ø 21 - L 75 - L1 15,5 - conf. 5 - € 16,94 200009200507 - mm 7 - Ø 21 - L 75 - L1 15,5 - conf. 5 - € 16,94 200009200508 - mm 8 - Ø 21 - L 75 - L1 15,5 - conf. 5 - € 16,94</p> <p>segue...</p> 	<p>Beta</p> <p>continua...</p> <p>200009200510 - mm 10 - Ø 23 - L 75 - L1 15,5 - conf. 5 - € 17,76 200009200512 - mm 12 - Ø 24 - L 75 - L1 15,5 - conf. 5 - € 20,30 200009200514 - mm 14 - Ø 24 - L 75 - L1 15,5 - conf. 5 - € 20,88 200009200517 - mm 17 - Ø 24 - L 75 - L1 15,5 - conf. 5 - € 20,88</p> 
<p>Beta</p> <p>CHIAVI A BUSSOLA MASCHIO TORX BETA ART. 920TX Attacco quadro femmina 1/2" Per viti impronta Torx Inserti bruniti Cromate</p> <p>200009200520 - Misura T20 - Ø 22,5 - L 58 - L1 20 - conf. 5 - € 17,76 200009200521 - Misura T25 - Ø 22,5 - L 58 - L1 20 - conf. 5 - € 17,76 200009200522 - Misura T27 - Ø 22,5 - L 58 - L1 20 - conf. 5 - € 17,76</p> <p>segue...</p> 	<p>Beta</p> <p>continua...</p> <p>200009200523 - Misura T30 - Ø 22,5 - L 58 - L1 20 - conf. 5 - € 17,76 200009200524 - Misura T40 - Ø 22,5 - L 58 - L1 20 - conf. 5 - € 17,76 200009200525 - Misura T45 - Ø 22,5 - L 58 - L1 20 - conf. 5 - € 17,76 200009200526 - Misura T50 - Ø 22,5 - L 58 - L1 20 - conf. 5 - € 17,76</p> <p>segue...</p> 
<p>Beta</p> <p>continua...</p> <p>200009200527 - Misura T55 - Ø 23 - L 58 - L1 20 - conf. 3 - € 23,68 200009200528 - Misura T60 - Ø 23 - L 58 - L1 20 - conf. 3 - € 23,68 200009200535 - Misura T40L - Ø 22,5 - L 120 - L1 82 - conf. 3 - € 22,62 200009200537 - Misura T45L - Ø 22,5 - L 120 - L1 82 - conf. 3 - € 22,62</p> <p>segue...</p> 	<p>Beta</p> <p>continua...</p> <p>200009200539 - Misura T55L - Ø 23 - L 140 - L1 102 - conf. 3 - € 31,90 200009200541 - Misura T70L - Ø 23 - L 120 - L1 82 - conf. 3 - € 31,90</p> 



 	<p>CHIAVI A BUSSOLA MASCHIO XZN BETA ART. 920XZN Attacco quadro femmina 1/2" Per viti impronta XZN Inserti bruniti Cromate</p> <p>200009200560 - Misura M5 - Ø 22,5 - L 58 - L1 20 - conf. 3 - € 18,92</p> <p>200009200561 - Misura M6 - Ø 22,5 - L 58 - L1 20 - conf. 3 - € 18,92</p> <p>200009200562 - Misura M6L - Ø 22,5 - L 100 - L1 62 - conf. 3 - € 21,58</p> <p>segue...</p>	 	<p>continua...</p> <p>200009200563 - Misura M8 - Ø 22,5 - L 58 - L1 20 - conf. 3 - € 18,92</p> <p>200009200564 - Misura M8L - Ø 22,5 - L 100 - L1 62 - conf. 3 - € 21,58</p> <p>200009200565 - Misura M10 - Ø 22,5 - L 58 - L1 20 - conf. 3 - € 19,04</p> <p>200009200566 - Misura M10L - Ø 22,5 - L 100 - L1 62 - conf. 3 - € 21,58</p> <p>segue...</p>
 	<p>continua...</p> <p>200009200568 - Misura M12 - Ø 22,5 - L 58 - L1 20 - conf. 3 - € 19,72</p> <p>200009200569 - Misura M12L - Ø 22,5 - L 100 - L1 62 - conf. 3 - € 22,16</p> <p>200009200571 - Misura M14 - Ø 23 - L 58 - L1 20 - conf. 3 - € 19,72</p> <p>200009200572 - Misura M14L - Ø 23 - L 100 - L1 62 - conf. 3 - € 22,16</p> <p>200009200573 - Misura M16 - Ø 23 - L 58 - L1 20 - conf. 3 - € 24,60</p>	 	<p>RACCORDO ATTACCO QUADRO BETA ART. 920/15 Attacco quadro femmina 1/2" maschio 3/8" cromato</p> <p>200009200810 - Lmm 42 - Ømm 22,0 - conf. 1 - € 11,32</p>
 	<p>RACCORDO ATTACCO QUADRO BETA ART. 920/16 Attacco quadro femmina 1/2" maschio 3/4" Cromato</p> <p>200009200814 - L 46 - Ø 26 - - conf. 1 - € 14,74</p>	 	<p>PROLUNGHE ATTACCO QUADRO BETA ART. 920/20 ART. 920/21 ART. 920/22 Attacco maschio femmina 1/2" Cromate</p> <p>200009200818 - L 75 - Ø 22 - - conf. 5 - € 13,82</p> <p>200009200822 - L 125 - Ø 22 - - conf. 5 - € 16,94</p> <p>200009200826 - L 255 - Ø 22 - - conf. 5 - € 19,04</p>
 	<p>SNODO ATTACCO QUADRO BETA ART. 920/25 Attacco maschio e femmina 1/2" Cromato</p> <p>200009200830 - L 75 - Ø 27 - - conf. 5 - € 27,04</p>	 	<p>QUADRO MASCHIO BETA ART. 920/40 Attacco 1/2" Snodato a T Cromato</p> <p>200009200850 - L 490 - L1 230 - - conf. 2 - € 62,64</p>
 	<p>QUADRO MASCHIO BETA ART. 920/42 Attacco 1/2" Con spina scorrevole Cromato</p> <p>200009200854 - L 305 - A 42 - - conf. 5 - € 18,92</p>	 	<p>QUADRO MASCHIO BETA ART. 920/44 Attacco 1/2" Ad angolo Cromato</p> <p>200009200858 - L 230 - L1 60 - - conf. 3 - € 28,32</p>
 	<p>CRICCHETTO SEMPLICE BETA ART. 920/50 Attacco quadro scorrevole 1/2" Cromato</p> <p>200009200871 - L 275 - Ø 40 - A 42 - - conf. 3 - € 60,32</p>	 	<p>CRICCHETTO REVERSIBILE BETA ART. 920/55LC Attacco quadro maschio 1/2" Locking System Cromato</p> <p>200009200896 - L 275 - Ø 40 - A 43 - - conf. 2 - € 74,24</p>



<p>Beta</p> <p>CRICCHETTO REVERSIBILE Con attacco quadro Maschio 1/2" cromato</p> <p>200009200882 - Lmm 275 - Ømm 40 - Amm 43 - - conf. 1 - € 63,80</p> 	<p>Beta</p> <p>CHIAVI A BUSSOLA ESAGONALI BETA ART. 920A Attacco quadro femmina 1/2" Cromate</p> <p>200009200008 - mm 8 - Ø 12,4 - L 38 - Ø1 21,7A 5,0 - conf. 10 - € 6,86</p> <p>200009200009 - mm 9 - Ø 13,5 - L 38 - Ø1 21,7A 5,0 - conf. 10 - € 6,86</p> <p>200009200010 - mm 10 - Ø 14,9 - L 38 - Ø1 21,7A 6,0 - conf. 10 - € 6,86</p> <p>segue...</p> 
<p>Beta</p> <p>continua...</p> <p>200009200011 - mm 11 - Ø 16,1 - L 38 - Ø1 21,7A 7,0 - conf. 10 - € 6,86</p> <p>200009200012 - mm 12 - Ø 17,5 - L 38 - Ø1 21,7A 8,0 - conf. 10 - € 6,86</p> <p>200009200013 - mm 13 - Ø 18,7 - L 38 - Ø1 21,7A 8,0 - conf. 10 - € 7,14</p> <p>200009200014 - mm 14 - Ø 20,1 - L 38 - Ø1 21,7A 10,0 - conf. 10 - € 7,14</p> <p>segue...</p> 	<p>Beta</p> <p>continua...</p> <p>200009200015 - mm 15 - Ø 21,5 - L 38 - Ø1 22,5A 10,0 - conf. 10 - € 7,14</p> <p>200009200016 - mm 16 - Ø 22,7 - L 38 - Ø1 23,7A 10,0 - conf. 10 - € 8,02</p> <p>200009200017 - mm 17 - Ø 24,1 - L 38 - Ø1 23,1A 10,0 - conf. 10 - € 8,02</p> <p>200009200018 - mm 18 - Ø 25,3 - L 39 - Ø1 24,0A 12,0 - conf. 10 - € 8,02</p> <p>segue...</p> 
<p>Beta</p> <p>continua...</p> <p>200009200019 - mm 19 - Ø 26,6 - L 39 - Ø1 24,0A 12,0 - conf. 10 - € 8,02</p> <p>200009200020 - mm 20 - Ø 27,8 - L 40 - Ø1 25,0A 12,0 - conf. 5 - € 8,76</p> <p>200009200021 - mm 21 - Ø 28,8 - L 40 - Ø1 25,0A 14,0 - conf. 5 - € 8,76</p> <p>200009200022 - mm 22 - Ø 29,9 - L 41 - Ø1 26,0A 14,0 - conf. 5 - € 8,76</p> <p>segue...</p> 	<p>Beta</p> <p>continua...</p> <p>200009200023 - mm 23 - Ø 30,8 - L 42 - Ø1 26,0A 14,0 - conf. 5 - € 10,22</p> <p>200009200024 - mm 24 - Ø 32,2 - L 43 - Ø1 27,0A 16,0 - conf. 5 - € 10,22</p> <p>200009200025 - mm 25 - Ø 33,2 - L 44 - Ø1 27,0A 16,0 - conf. 5 - € 10,22</p> <p>200009200026 - mm 26 - Ø 34,7 - L 45 - Ø1 28,0A 16,0 - conf. 5 - € 10,56</p> <p>segue...</p> 
<p>Beta</p> <p>continua...</p> <p>200009200027 - mm 27 - Ø 36,2 - L 46 - Ø1 29,0A 18,0 - conf. 5 - € 10,56</p> <p>200009200028 - mm 28 - Ø 37,2 - L 47 - Ø1 30,0A 18,0 - conf. 5 - € 10,56</p> <p>200009200029 - mm 29 - Ø 38,6 - L 48 - Ø1 31,0A 18,0 - conf. 5 - € 11,08</p> <p>200009200030 - mm 30 - Ø 40,2 - L 48 - Ø1 32,0A 20,0 - conf. 5 - € 11,08</p> <p>segue...</p> 	<p>Beta</p> <p>continua...</p> <p>200009200032 - mm 32 - Ø 42,3 - L 49 - Ø1 34,0A 22,0 - conf. 5 - € 11,56</p> <p>200009200108 - mm 8 - Ø 12,4 - L 38 - Ø1 21,7 - conf. 10 - € 6,86</p> <p>200009200109 - mm 9 - Ø 13,5 - L 38 - Ø1 21,7 - conf. 10 - € 6,86</p> <p>200009200110 - mm 10 - Ø 14,9 - L 38 - Ø1 21,7 - conf. 10 - € 6,86</p> <p>200009200111 - mm 11 - Ø 16,1 - L 38 - Ø1 21,7 - conf. 10 - € 6,86</p> <p>segue...</p> 
<p>Beta</p> <p>continua...</p> <p>200009200112 - mm 12 - Ø 17,5 - L 38 - Ø1 21,7 - conf. 10 - € 6,86</p> <p>200009200113 - mm 13 - Ø 18,7 - L 38 - Ø1 21,7 - conf. 10 - € 7,14</p> <p>200009200114 - mm 14 - Ø 20,1 - L 38 - Ø1 21,7 - conf. 10 - € 7,14</p> <p>200009200115 - mm 15 - Ø 21,5 - L 38 - Ø1 22,5 - conf. 10 - € 7,14</p> <p>200009200116 - mm 16 - Ø 22,7 - L 38 - Ø1 23,7 - conf. 10 - € 8,02</p> <p>segue...</p> 	<p>Beta</p> <p>continua...</p> <p>200009200117 - mm 17 - Ø 24,1 - L 38 - Ø1 23,1 - conf. 10 - € 8,02</p> <p>200009200118 - mm 18 - Ø 25,3 - L 39 - Ø1 24,0 - conf. 10 - € 8,02</p> <p>200009200119 - mm 19 - Ø 26,6 - L 39 - Ø1 24,0 - conf. 10 - € 8,02</p> <p>200009200120 - mm 20 - Ø 27,8 - L 40 - Ø1 25,0 - conf. 5 - € 8,76</p> <p>200009200121 - mm 21 - Ø 28,8 - L 40 - Ø1 25,0 - conf. 5 - € 8,76</p> <p>segue...</p> 
<p>Beta</p> <p>continua...</p> <p>200009200122 - mm 22 - Ø 29,9 - L 41 - Ø1 26,0 - conf. 5 - € 8,76</p> <p>200009200123 - mm 23 - Ø 30,8 - L 42 - Ø1 26,0 - conf. 5 - € 10,22</p> <p>200009200124 - mm 24 - Ø 32,2 - L 43 - Ø1 27,0 - conf. 5 - € 10,22</p> <p>200009200125 - mm 25 - Ø 33,2 - L 44 - Ø1 27,0 - conf. 5 - € 10,22</p> <p>200009200126 - mm 26 - Ø 34,7 - L 45 - Ø1 28,0 - conf. 5 - € 10,56</p> <p>segue...</p> 	<p>Beta</p> <p>continua...</p> <p>200009200127 - mm 27 - Ø 36,2 - L 46 - Ø1 29,0 - conf. 5 - € 10,56</p> <p>200009200128 - mm 28 - Ø 37,2 - L 47 - Ø1 30,0 - conf. 5 - € 10,56</p> <p>200009200129 - mm 29 - Ø 38,6 - L 48 - Ø1 31,0 - conf. 5 - € 11,08</p> <p>200009200130 - mm 30 - Ø 40,2 - L 48 - Ø1 32,0 - conf. 5 - € 11,08</p> <p>200009200132 - mm 32 - Ø 42,3 - L 49 - Ø1 33,9 - conf. 5 - € 11,56</p> <p>segue...</p> 



<p>Beta</p> <p>continua...</p> <p>200009200833 - L 50 - Ø 22 - - conf. 5 - € 14,74</p> <p>200009200834 - L 125 - Ø 22 - - conf. 5 - € 20,42</p> <p>200009200835 - L 250 - Ø 22 - - conf. 3 - € 28,90</p> <p>200009200836 - L 375 - Ø 22 - - conf. 3 - € 38,86</p> 	<p>Beta</p> <p>SERIE DI 13 CHIAVI A BUSSOLA Art.920B Con attacco quadro femmina 1/2" bocca poligonale cromate da 10 a 22 mm</p> <p>200009200140 - - conf. 1 - € 116,58</p> 
<p>Beta</p> <p>SERIE DI 8 CHIAVI A BUSSOLA Art.920B Con attacco quadro femmina 1/2" bocca poligonale cromate da 23 a 32 mm</p> <p>200009200142 - - conf. 1 - € 96,28</p> 	<p>Beta</p> <p>CHIAVI A BUSSOLA Art.920FTX/L Per viti con profilo Torx con attacco quadro 1/2" tipo lungo Cromate</p> <p>200009200405 - Ømm 22,9 - Lmm 77 - Ø1mm 22,0Amm 12,7 - conf. 1 - € 23,20</p> 
<p>Beta</p> <p>PROLUNGA QUADRO MASCHIO E FEMMINA 1/2"</p> <p>200009200804 - Lmm 135 - Dmm 28 - - conf. 1 - € 58,58</p> 	<p>Beta</p> <p>CHIAVE A BUSSOLA ESAGONALE Art.920MQ/A</p> <p>200009200240 - mm 10 - Dmm 21,5 - Lmm 57 - D1mm 27,5Amm 9 - conf. 1 - € 30,16</p> 
<p>Beta</p> <p>SET CHIAVI A BUSSOLA BETA EASY ART. 923RTX FTX/C16 Contiene: -n°6 chiavi a bussola att. 1/2" con impronta RTX: T20-T25-T27-T30 T40-T45-T50 -n°9 chiavi a bussola att. 1/2" con impronta Torx femmina: E10-E11-E12-E14-E16 E18-E20-E22-E24 In valigetta di plastica</p> <p>200009230944 - - conf. 1 - € 56,86</p> 	<p>Beta</p> <p>CASSETTA 25 CHIAVI A BUSSOLA BETA ART. 923E/C25 Chiavi a bussola esagonali da 1/2" Il kit comprende: -Cricchetto reversibile 1/2" con meccanismo a 72 denti -Chiavi a bussola attacco da 1/2" modelli: 8-9-10-11-12-13-14-15-16-17-18-19-20-21-22-23-24-27-30-32 mm -Snodo da 1/2" con attacco maschio e femmina -Prolunga da 1/2" da 125 mm -Prolunga da 1/2" da 250 mm -Quadro maschio 1/2" con spina scorrevole 250 mm -Valigetta in plastica dimensioni 285x210x84 mm</p> <p>200009231025 - - conf. 1 - € 132,88</p> 
<p>Beta</p> <p>RACCORDO QUADRO BETA ART. 928/15 Attacco femmina 3/4" maschio 1/2" Cromato</p> <p>200009280801 - L 51,5 - Ø 34 - - conf. 5 - € 20,88</p> 	<p>Beta</p> <p>RACCORDO QUADRO BETA ART. 928/16 Attacco femmina 3/4" maschio 1" Cromato</p> <p>200009280807 - L 65 - Ø 34 - - conf. 5 - € 25,18</p> 
<p>Beta</p> <p>PROLUNGHE ATTACCO QUADRO BETA ART. 928/21 ART. 928/22 Attacco maschio femmina 3/4" Cromate</p> <p>200009280815 - L 200 - Ø 34 - - conf. 3 - € 33,06</p> <p>200009280825 - L 380 - Ø 34 - - conf. 3 - € 48,72</p> 	<p>Beta</p> <p>QUADRO SNODATO BETA ART. 928/36A Attacco 3/4" Cromato</p> <p>200009280844 - L 545 - - conf. 1 - € 99,76</p> 















<p>Beta QUADRO SCORREVOLE BETA ART. 928/42 Attacco maschio 3/4" Spina scorrevole Cromato</p> <p>200009280850 - L 450 - A 62,5 - - conf. 3 - € 52,78</p> 	<p>Beta CRICCHETTO REVERSIBILE BETA ART. 928/55 Attacco quadro maschio 3/4" Cromato</p> <p>200009280862 - L 510 - Ø 58 - A 59 - - conf. 2 - € 169,36</p> 
<p>Beta CHIAVI A BUSSOLA ESAGONALI BETA ART. 928A Attacco quadro femmina 3/4" Bocca esagonale Cromate</p> <p>200009280019 - mm 19 - Ø 29,2 - L 50 - Ø1 34 - conf. 5 - € 17,64</p> <p>200009280022 - mm 22 - Ø 31,3 - L 53 - Ø1 34 - conf. 5 - € 17,88</p> <p>200009280023 - mm 23 - Ø 33,3 - L 53 - Ø1 34 - conf. 5 - € 18,22</p> <p>200009280024 - mm 24 - Ø 34,5 - L 53 - Ø1 34 - conf. 5 - € 18,46</p> <p>segue...</p> 	<p>Beta continua...</p> <p>200009280026 - mm 26 - Ø 36,8 - L 55 - Ø1 35 - conf. 5 - € 19,72</p> <p>200009280027 - mm 27 - Ø 38 - L 56 - Ø1 35 - conf. 5 - € 19,72</p> <p>200009280028 - mm 28 - Ø 39 - L 57 - Ø1 35 - conf. 3 - € 20,88</p> <p>200009280029 - mm 29 - Ø 40,2 - L 58 - Ø1 35 - conf. 3 - € 21,24</p> <p>200009280030 - mm 30 - Ø 41,5 - L 58 - Ø1 37 - conf. 3 - € 21,94</p> <p>segue...</p> 
<p>Beta continua...</p> <p>200009280032 - mm 32 - Ø 44,3 - L 60 - Ø1 37 - conf. 3 - € 23,10</p> <p>200009280033 - mm 33 - Ø 45,8 - L 60 - Ø1 37 - conf. 3 - € 24,36</p> <p>200009280034 - mm 34 - Ø 46,8 - L 60 - Ø1 37 - conf. 3 - € 24,60</p> <p>200009280035 - mm 35 - Ø 48,1 - L 62 - Ø1 38 - conf. 3 - € 24,94</p> <p>200009280036 - mm 36 - Ø 49,5 - L 64 - Ø1 38 - conf. 3 - € 24,94</p> <p>segue...</p> 	<p>Beta continua...</p> <p>200009280038 - mm 38 - Ø 52 - L 68 - Ø1 40 - conf. 3 - € 27,38</p> <p>200009280041 - mm 41 - Ø 56 - L 71 - Ø1 40 - conf. 3 - € 30,16</p> <p>200009280046 - mm 46 - Ø 62,3 - L 75 - Ø1 43 - conf. 3 - € 38,28</p> <p>200009280050 - mm 50 - Ø 67,4 - L 80 - Ø1 43 - conf. 3 - € 44,66</p> <p>200009280055 - mm 55 - Ø 73,7 - L 84 - Ø1 48 - conf. 1 - € 55,68</p> <p>200009280060 - mm 60 - Ø 80 - L 87 - Ø1 48 - conf. 1 - € 63,80</p>
<p>Beta CHIAVI A BUSSOLA Art.929 Con attacco quadro femmina 1" Bocca esagonale Cromate</p> <p>200009290036 - mm 36 - Ømm 49,5 - Lmm 65 - Ø1mm 48Amm 26 - conf. 1 - € 37,12</p> 	<p>Beta PROLUNGHE CON ATTACCHI Art. 929/21 Quadri maschio e femmina 1" Cromate</p> <p>200009290815 - Lmm 200 - Ømm 47 - - conf. 1 - € 56,26</p> 
<p>Beta CHIAVI A TUBO DOPPIE POLIGONALI BETA ART. 930 Serie pesante Cromate</p> <p>200009300006 - mm 6x7 - L 100 - Ø 9,5 - Ø1 11,0 - conf. 3 - € 13,82</p> <p>200009300010 - mm 8x9 - L 108 - Ø 12,5 - Ø1 14,0 - conf. 3 - € 17,40</p> <p>200009300014 - mm 10x11 - L 116 - Ø 15,0 - Ø1 16,5 - conf. 3 - € 18,22</p> <p>segue...</p> 	<p>Beta continua...</p> <p>200009300018 - mm 12x13 - L 124 - Ø 17,5 - Ø1 19,0 - conf. 3 - € 21,24</p> <p>200009300023 - mm 14x15 - L 132 - Ø 20,0 - Ø1 21,5 - conf. 3 - € 23,20</p> <p>200009300027 - mm 16x17 - L 140 - Ø 23,0 - Ø1 24,0 - conf. 3 - € 26,68</p> <p>200009300032 - mm 18x19 - L 148 - Ø 25,0 - Ø1 26,5 - conf. 3 - € 29,58</p> <p>segue...</p> 
<p>Beta continua...</p> <p>200009300036 - mm 20x22 - L 156 - Ø 28,0 - Ø1 30,0 - conf. 2 - € 32,48</p> <p>200009300040 - mm 21x23 - L 163 - Ø 29,0 - Ø1 31,5 - conf. 2 - € 34,80</p> <p>200009300044 - mm 24x26 - L 173 - Ø 33,0 - Ø1 35,5 - conf. 2 - € 44,08</p> <p>200009300052 - mm 27x29 - L 191 - Ø 37,0 - Ø1 39,5 - conf. 2 - € 55,10</p> <p>segue...</p> 	<p>Beta continua...</p> <p>200009300056 - mm 30x32 - L 200 - Ø 40,5 - Ø1 43,0 - conf. 2 - € 66,12</p> <p>200009300048 - mm 25x28 - L 182 - Ø 34,5 - Ø1 38 - conf. 2 - € 48,14</p> 















<p>Beta</p> <p>CHIAVI A PIPA BETA ART. 932 Doppie esagonali-poligonali Cromate lucide</p> <p>200009320006 - mm 6x6 - Ø 11,5 - L 110 - Ø1 5,0 - conf. 5 - € 15,44</p> <p>200009320007 - mm 7x7 - Ø 12,5 - L 116 - Ø1 6,0 - conf. 5 - € 15,66</p> <p>200009320008 - mm 8x8 - Ø 13,0 - L 120 - Ø1 6,0 - conf. 5 - € 16,36</p> <p>200009320009 - mm 9x9 - Ø 14,0 - L 125 - Ø1 7,0 - conf. 5 - € 16,94 segue...</p> 	<p>Beta</p> <p>continua...</p> <p>200009320010 - mm 10x10 - Ø 16,5 - L 133 - Ø1 8,0 - conf. 5 - € 17,64</p> <p>200009320011 - mm 11x11 - Ø 17,5 - L 143 - Ø1 8,5 - conf. 5 - € 19,04</p> <p>200009320012 - mm 12x12 - Ø 19,0 - L 148 - Ø1 8,5 - conf. 5 - € 20,42</p> <p>200009320013 - mm 13x13 - Ø 19,5 - L 154 - Ø1 9,5 - conf. 5 - € 21,12 segue...</p> 
<p>Beta</p> <p>continua...</p> <p>200009320014 - mm 14x14 - Ø 21,5 - L 167 - Ø1 10,0 - conf. 5 - € 22,40</p> <p>200009320015 - mm 15x15 - Ø 22,5 - L 182 - Ø1 10,0 - conf. 5 - € 23,68</p> <p>200009320016 - mm 16x16 - Ø 24,5 - L 193 - Ø1 11,0 - conf. 5 - € 24,60</p> <p>200009320017 - mm 17x17 - Ø 26,0 - L 198 - Ø1 12,0 - conf. 5 - € 24,84 segue...</p> 	<p>Beta</p> <p>continua...</p> <p>200009320018 - mm 18x18 - Ø 26,5 - L 215 - Ø1 13,0 - conf. 5 - € 27,16</p> <p>200009320019 - mm 19x19 - Ø 29,0 - L 220 - Ø1 14,0 - conf. 5 - € 29,58</p> <p>200009320021 - mm 21x21 - Ø 30,5 - L 236 - Ø1 16,0 - conf. 3 - € 36,54</p> <p>200009320022 - mm 22x22 - Ø 32,5 - L 250 - Ø1 16,0 - conf. 2 - € 40,02 segue...</p> 
<p>Beta</p> <p>continua...</p> <p>200009320024 - mm 24x24 - Ø 35,0 - L 272 - Ø1 19,0 - conf. 2 - € 47,56</p> <p>200009320027 - mm 27x27 - Ø 39,0 - L 296 - Ø1 21,0 - conf. 2 - € 58,58</p> 	<p>Beta</p> <p>CHIAVI A TUBO DOPPIE ESAGONALI BETA ART. 935 Serie leggera Cromate satinata</p> <p>200009350105 - mm 6x7 - L 100 - Ø 9 - Ø1 10 - conf. 5 - € 8,02</p> <p>200009350111 - mm 8x9 - L 110 - Ø 10 - Ø1 11 - conf. 5 - € 8,60</p> <p>200009350115 - mm 10x11 - L 120 - Ø 14 - Ø1 15 - conf. 5 - € 9,58</p> <p>200009350117 - mm 12x13 - L 130 - Ø 16,5 - Ø1 17,5 - conf. 5 - € 10,86 segue...</p> 
<p>Beta</p> <p>continua...</p> <p>200009350126 - mm 14x15 - L 140 - Ø 19,0 - Ø1 20,0 - conf. 5 - € 12,54</p> <p>200009350128 - mm 16x17 - L 150 - Ø 21,0 - Ø1 22,0 - conf. 5 - € 13,82</p> <p>200009350131 - mm 18x19 - L 160 - Ø 23,0 - Ø1 24,0 - conf. 5 - € 16,36</p> <p>200009350138 - mm 20x22 - L 170 - Ø 26,0 - Ø1 28,0 - conf. 3 - € 19,72 segue...</p> 	<p>Beta</p> <p>continua...</p> <p>200009350141 - mm 21x23 - L 180 - Ø 27,0 - Ø1 29,0 - conf. 3 - € 21,94</p> <p>200009350144 - mm 24x26 - L 190 - Ø 30,0 - Ø1 32,0 - conf. 3 - € 24,94</p> <p>200009350150 - mm 25x28 - L 200 - Ø 31,0 - Ø1 34,0 - conf. 2 - € 27,74</p> <p>200009350153 - mm 27x29 - L 210 - Ø 34,0 - Ø1 36,0 - conf. 2 - € 31,90</p> 
<p>Beta</p> <p>CHIAVI A DOPPIO TUBO ESAGONALI LEGGERE BETA</p> <p>200009350050 - mm 25x28 - L 200 - - conf. 2 - € 25,96</p> 	<p>Beta</p> <p>CHIAVI A PIPA DOPPIE BETA ART. 937 Esagonali-poligonali Cromate</p> <p>200009370006 - mm 6x6 - Ø 11,5 - L 110 - Ø1 5,0A 8,0 - conf. 5 - € 8,60</p> <p>200009370007 - mm 7x7 - Ø 12,5 - L 116 - Ø1 6,0A 9,0 - conf. 5 - € 9,00</p> <p>200009370008 - mm 8x8 - Ø 13,0 - L 120 - Ø1 6,0A 11,0 - conf. 5 - € 9,34 segue...</p> 
<p>Beta</p> <p>continua...</p> <p>200009370009 - mm 9x9 - Ø 14,0 - L 125 - Ø1 7,0A 11,0 - conf. 5 - € 9,86</p> <p>200009370010 - mm 10x10 - Ø 16,5 - L 133 - Ø1 8,0A 13,0 - conf. 5 - € 10,34</p> <p>200009370011 - mm 11x11 - Ø 17,5 - L 143 - Ø1 8,5A 14,0 - conf. 5 - € 10,86</p> <p>200009370012 - mm 12x12 - Ø 19,0 - L 148 - Ø1 8,5A 14,0 - conf. 5 - € 11,96 segue...</p> 	<p>Beta</p> <p>continua...</p> <p>200009370013 - mm 13x13 - Ø 19,5 - L 154 - Ø1 9,5A 16,0 - conf. 5 - € 12,30</p> <p>200009370014 - mm 14x14 - Ø 21,5 - L 167 - Ø1 10,0A 17,0 - conf. 5 - € 13,58</p> <p>200009370015 - mm 15x15 - Ø 22,5 - L 182 - Ø1 10,0A 17,0 - conf. 5 - € 14,98</p> <p>200009370016 - mm 16x16 - Ø 24,5 - L 193 - Ø1 11,0A 20,0 - conf. 5 - € 16,24 segue...</p> 















<p>Beta</p> <p>continua...</p> <p>200009370017 - mm 17x17 - Ø 26,0 - L 198 - Ø1 12,0A 20,0 - conf. 5 - € 16,82</p> <p>200009370018 - mm 18x18 - Ø 26,5 - L 215 - Ø1 13,0A 20,0 - conf. 5 - € 17,18</p> <p>200009370019 - mm 19x19 - Ø 29,0 - L 220 - Ø1 14,0A 22,0 - conf. 5 - € 17,88</p> <p>200009370020 - mm 20x20 - Ø 30,5 - L 222 - Ø1 14,0A 22,0 - conf. 3 - € 20,30</p> <p>segue...</p> 	<p>Beta</p> <p>continua...</p> <p>200009370022 - mm 22x22 - Ø 32,5 - L 250 - Ø1 16,0A 25,0 - conf. 2 - € 23,32</p> <p>200009370030 - mm 30x30 - Ø 42,5 - L 348 - Ø1 23,0A 31,0 - conf. 2 - € 46,40</p> 
<p>Beta</p> <p>CACCIAVITE A PIPA DOPPIA ESAGONALE IMPUGNATURA DI MANOVRA 8X8mm</p> <p>200009410008 - - conf. 1 - € 21,84</p> 	<p>Beta</p> <p>CACCIAVITE A BUSSOLA ESAGONALI BETA ART. 943BX Tipo lungo Cromate</p> <p>200009430003 - mm 4 - L 270 - L1 150 - A1 13,0 - conf. 5 - € 16,02</p> <p>200009430004 - mm 5 - L 270 - L1 150 - A1 14,0 - conf. 5 - € 16,02</p> <p>200009430005 - mm 5,5 - L 270 - L1 150 - A1 12,5 - conf. 5 - € 17,18</p> <p>200009430006 - mm 6 - L 270 - L1 150 - A1 14,5 - conf. 5 - € 17,18</p> <p>segue...</p> 
<p>Beta</p> <p>continua...</p> <p>200009430007 - mm 7 - L 270 - L1 150 - A1 15,5 - conf. 5 - € 18,46</p> <p>200009430008 - mm 8 - L 282 - L1 150 - A1 18,5 - conf. 5 - € 18,46</p> <p>200009430009 - mm 9 - L 282 - L1 150 - A1 19,5 - conf. 5 - € 18,46</p> <p>200009430010 - mm 10 - L 282 - L1 150 - A1 20,5 - conf. 3 - € 20,08</p> <p>200009430011 - mm 11 - L 282 - L1 150 - A1 21,5 - conf. 3 - € 20,08</p> <p>segue...</p> 	<p>Beta</p> <p>continua...</p> <p>200009430012 - mm 12 - L 282 - L1 150 - A1 22,5 - conf. 3 - € 20,08</p> <p>200009430013 - mm 13 - L 282 - L1 150 - A1 23,5 - conf. 3 - € 21,24</p> 
<p>Beta</p> <p>CHIAVIA "T" BETA ART. 950 Esagonali Cromate</p> <p>200009500006 - mm 6 - L 210 - Ø 10,1 - L1 145 - conf. 3 - € 20,88</p> <p>200009500007 - mm 7 - L 212 - Ø 11,2 - L1 145 - conf. 3 - € 20,88</p> <p>200009500008 - mm 8 - L 220 - Ø 12,4 - L1 160 - conf. 3 - € 22,52</p> <p>200009500009 - mm 9 - L 223 - Ø 13,5 - L1 160 - conf. 3 - € 22,52</p> <p>200009500010 - mm 10 - L 230 - Ø 14,9 - L1 160 - conf. 3 - € 24,36</p> <p>segue...</p> 	<p>Beta</p> <p>continua...</p> <p>200009500011 - mm 11 - L 233 - Ø 16,1 - L1 160 - conf. 3 - € 24,36</p> <p>200009500012 - mm 12 - L 240 - Ø 17,5 - L1 175 - conf. 3 - € 27,04</p> <p>200009500013 - mm 13 - L 244 - Ø 19,7 - L1 175 - conf. 3 - € 27,04</p> <p>200009500014 - mm 14 - L 250 - Ø 20,1 - L1 190 - conf. 3 - € 30,16</p> <p>200009500015 - mm 15 - L 254 - Ø 21,5 - L1 190 - conf. 3 - € 31,32</p> <p>segue...</p> 
<p>Beta</p> <p>continua...</p> <p>200009500016 - mm 16 - L 260 - Ø 22,7 - L1 200 - conf. 3 - € 34,80</p> <p>200009500017 - mm 17 - L 264 - Ø 24,1 - L1 200 - conf. 3 - € 35,96</p> <p>200009500019 - mm 19 - L 274 - Ø 26,6 - L1 230 - conf. 3 - € 44,08</p> <p>200009500022 - mm 22 - L 290 - Ø 29,9 - L1 290 - conf. 2 - € 53,36</p> <p>200009500024 - mm 24 - L 300 - Ø 32,2 - L1 320 - conf. 2 - € 60,32</p> 	<p>Beta</p> <p>CHIAVIA "T" BETA ART. 951 Tre estremità maschio esagonali Cromate</p> <p>200009510521 - mm 2 - L 125 - L1 63 - Ø 4,0 - conf. 5 - € 19,04</p> <p>200009510525 - mm 2,5 - L 150 - L1 63 - Ø 4,0 - conf. 5 - € 19,04</p> <p>200009510530 - mm 3 - L 150 - L1 63 - Ø 4,0 - conf. 5 - € 19,04</p> <p>200009510535 - mm 3,5 - L 175 - L1 76 - Ø 5,5 - conf. 5 - € 19,72</p> <p>200009510540 - mm 4 - L 175 - L1 76 - Ø 5,5 - conf. 5 - € 19,72</p> <p>segue...</p> 
<p>Beta</p> <p>continua...</p> <p>200009510545 - mm 4,5 - L 195 - L1 87 - Ø 6,5 - conf. 5 - € 21,58</p> <p>200009510550 - mm 5 - L 195 - L1 87 - Ø 6,5 - conf. 5 - € 21,58</p> <p>200009510560 - mm 6 - L 215 - L1 99 - Ø 8,0 - conf. 5 - € 24,94</p> <p>200009510570 - mm 7 - L 230 - L1 109 - Ø 9,0 - conf. 5 - € 27,04</p> <p>200009510580 - mm 8 - L 250 - L1 122 - Ø 10,0 - conf. 5 - € 27,04</p> <p>segue...</p> 	<p>Beta</p> <p>continua...</p> <p>200009510590 - mm 9 - L 265 - L1 132 - Ø 11,0 - conf. 5 - € 33,64</p> <p>200009510610 - mm 10 - L 280 - L1 142 - Ø 12,0 - conf. 5 - € 33,64</p> <p>200009510620 - mm 12 - L 305 - L1 160 - Ø 15,0 - conf. 3 - € 45,82</p> <p>200009510640 - mm 14 - L 330 - L1 178 - Ø 17,0 - conf. 3 - € 55,10</p> 















<p>Beta</p> <p>SERIE 6 PZ. CHIAVI A "T" ART. 951/S6 Tre estremità maschio esagonali Misure: 2,5-3-4 5-6-8 mm</p> <p>200009510687 - - conf. 1 - € 131,08</p> 	<p>Beta</p> <p>CHIAVI A "T" BETA ART. 952 Bussola esagonale snodata</p> <p>200009520006 - mm 6 - Ø 9,5 - L 395 - - conf. 5 - € 31,90</p> <p>200009520007 - mm 7 - Ø 10,7 - L 395 - - conf. 5 - € 31,90</p> <p>200009520008 - mm 8 - Ø 12,1 - L 395 - - conf. 5 - € 31,90</p> <p>200009520009 - mm 9 - Ø 13,2 - L 395 - - conf. 5 - € 31,90</p> <p>200009520010 - mm 10 - Ø 14,6 - L 400 - - conf. 5 - € 34,80</p> <p>segue...</p> 
<p>Beta</p> <p>continua...</p> <p>200009520011 - mm 11 - Ø 15,8 - L 400 - - conf. 5 - € 34,80</p> <p>200009520012 - mm 12 - Ø 17,0 - L 400 - - conf. 5 - € 34,80</p> <p>200009520013 - mm 13 - Ø 18,7 - L 432 - - conf. 5 - € 37,70</p> <p>200009520014 - mm 14 - Ø 19,7 - L 432 - - conf. 5 - € 37,70</p> <p>200009520015 - mm 15 - Ø 20,9 - L 450 - - conf. 3 - € 45,82</p> <p>segue...</p> 	<p>Beta</p> <p>continua...</p> <p>200009520016 - mm 16 - Ø 22,0 - L 450 - - conf. 3 - € 45,82</p> <p>200009520017 - mm 17 - Ø 23,4 - L 450 - - conf. 3 - € 45,82</p> <p>200009520018 - mm 18 - Ø 24,7 - L 450 - - conf. 3 - € 45,82</p> <p>200009520019 - mm 19 - Ø 26 - L 500 - - conf. 3 - € 56,26</p> <p>200009520020 - mm 20 - Ø 27,4 - L 500 - - conf. 3 - € 56,26</p> <p>segue...</p> 
<p>Beta</p> <p>continua...</p> <p>200009520021 - mm 21 - Ø 28,5 - L 500 - - conf. 3 - € 56,26</p> <p>200009520022 - mm 22 - Ø 29,7 - L 500 - - conf. 3 - € 56,26</p> <p>200009520024 - mm 24 - Ø 32,4 - L 500 - - conf. 3 - € 56,26</p> 	<p>Beta</p> <p>SERIE 7 PZ. CHIAVI A "T" ART. 952/D7 Con bussola esagonale snodata Misure: 7-8-10-12 13-14-17 mm</p> <p>200009520079 - - conf. 1 - € 230,00</p> 
<p>Beta</p> <p>CHIAVI A "T" BETA ART. 953 Maschio esagonale snodato Cromate</p> <p>200009530130 - mm 3 - L 395 - H 5 - - conf. 5 - € 33,06</p> <p>200009530135 - mm 3,5 - L 395 - H 6 - - conf. 3 - € 33,06</p> <p>200009530140 - mm 4 - L 395 - H 6 - - conf. 5 - € 33,06</p> <p>200009530145 - mm 4,5 - L 395 - H 7 - - conf. 3 - € 33,06</p> <p>200009530150 - mm 5 - L 395 - H 7 - - conf. 5 - € 33,06</p> <p>segue...</p> 	<p>Beta</p> <p>continua...</p> <p>200009530160 - mm 6 - L 400 - H 9 - - conf. 5 - € 35,96</p> <p>200009530170 - mm 7 - L 425 - H 10 - - conf. 3 - € 40,02</p> <p>200009530180 - mm 8 - L 425 - H 11 - - conf. 5 - € 40,02</p> <p>200009530200 - mm 10 - L 440 - H 13 - - conf. 5 - € 47,56</p> 
<p>Beta</p> <p>CHIAVI A "T" BETA ART. 957 Bussola snodata Per candele d'accensione Cromate</p> <p>200009570000 - mm - " 16-5/8 - Ø 21,4 - L 275 - - conf. 3 - € 45,82</p> <p>200009570001 - mm - " 20,8-13/16 - Ø 27 - L 275 - - conf. 3 - € 53,94</p> 	<p>Beta</p> <p>CHIAVI A 'T' CON BUSSOLA SNODATA Art.959 per candele di accensione</p> <p>200009590011 - mm - " 20,8 13/16 - Dmm 27 - Lmm 527 - - conf. 1 - € 78,88</p> 
<p>Beta</p> <p>CHIAVI A CROCE mod. 978/979 per dadi ruote</p> <p>200009780001 - 17-19-21-22 MM - conf. 1 - € 66,12</p> <p>200009790001 - 17-19-22-Q M1/2" - conf. 1 - € 66,12</p> 	<p>Beta</p> <p>CHIAVI A CROCE ART. 982 Per dadi ruote camion 24x27x32x3/4 mm</p> <p>200009820001 - - conf. 1 - € 160,08</p> 















<p>Beta</p> <p>PINZETTA A MOLLA BETA ART. 992 Con perno Punte fini dritte arrotondate zigrinate Acciaio inossidabile</p> <p>200009920001 - L 150 - - conf. 5 - € 15,44</p> 	<p>Beta</p> <p>PINZA BECCHI PIATTI LUNGI ZIGRINATI BETA ART. 1008BM Impugnatura bimatereiale</p> <p>200010080036 - L 160 - L1 51,5 - - conf. 3 - € 31,90</p> 
<p>Beta</p> <p>PINZA BECCHI TONDI LUNGI BETA ART. 1010BM Impugnatura bimatereiale</p> <p>200010100036 - L 160 - L1 51,5 - - conf. 2 - € 31,90</p> 	<p>Beta</p> <p>PINZE BECCHI DRITTI BETA ART. 1032 Per anelli elastici di sicurezza Per interni manici ricoperti in PVC</p> <p>200010320013 - L 140x0,9 - Ø 8+12 - - conf. 5 - € 24,72 200010320017 - L 180 - Ø 19+60 - - conf. 5 - € 26,10 200010320021 - L 225 - Ø 40+100 - - conf. 3 - € 32,48 200010320028 - L 300 - Ø 85+200 - - conf. 2 - € 45,82</p> 
<p>Beta</p> <p>PINZE BECCHI DRITTI BETA ART.1032 Per anelli elastici Di sicurezza Per interni manici ricoperti in PVC 140x13</p> <p>200010320014 - Lmm 140x1,3 - Ø mm 12&#247;25 - Ø1mm 1,3 - Amm 20Smm 9 - conf. 1 - € 24,26</p> 	<p>Beta</p> <p>PINZE BECCHI PIEGATI 45° BETA ART. 1033 Per anelli elastici di sicurezza Per interni manici ricoperti in PVC</p> <p>200010330013 - L 140x0,9 - Ø 8+12 - - conf. 5 - € 28,20 200010330017 - L 180 - Ø 19+60 - - conf. 5 - € 28,90 200010330021 - L 225 - Ø 40+100 - - conf. 3 - € 35,96</p> 
<p>Beta</p> <p>PINZE BECCHI PIEGATI 90° BETA ART. 1034 Per anelli elastici di sicurezza Per interni manici ricoperti in PVC</p> <p>200010340013 - L 130x0,9 - Ø 8+12 - - conf. 5 - € 28,20 200010340017 - L 170 - Ø 19+60 - - conf. 5 - € 28,90 200010340021 - L 210 - Ø 40+100 - - conf. 3 - € 35,96 200010340028 - L 290 - Ø 85+200 - - conf. 2 - € 49,88</p> 	<p>Beta</p> <p>PINZE BECCHI DRITTI BETA ART. 1036 Per anelli elastici Per esterni manici ricoperti in PVC</p> <p>200010360013 - L 140x0,9 - Ø 3+10 - - conf. 5 - € 27,38 200010360014 - L 140x1,3 - Ø 10+25 - - conf. 5 - € 26,10 200010360017 - L 175 - Ø 19+60 - - conf. 5 - € 27,50 200010360021 - L 225 - Ø 40+100 - - conf. 3 - € 34,80 200010360028 - L 300 - Ø 85+200 - - conf. 2 - € 54,52</p> 
<p>Beta</p> <p>PINZE BECCHI PIEGATI 45° BETA ART. 1037 Per anelli elastici di sicurezza Per esterni manici ricoperti in PVC</p> <p>200010370013 - L 140x0,9 - Ø 3+10 - - conf. 5 - € 30,16 200010370014 - L 140x1,3 - Ø 10+25 - - conf. 5 - € 28,66 200010370017 - L 175 - Ø 19+60 - - conf. 5 - € 30,16 200010370021 - L 225 - Ø 40+100 - - conf. 3 - € 37,70</p> 	<p>Beta</p> <p>PINZE BECCHI PIEGATI 90° BETA ART. 1038 Per anelli elastici di sicurezza Per esterni manici ricoperti in PVC</p> <p>200010380013 - L 135x0,9 - Ø 3+10 - - conf. 5 - € 30,16 200010380014 - L 135x1,3 - Ø 10+25 - - conf. 5 - € 28,66 200010380017 - L 175 - Ø 19+60 - - conf. 5 - € 30,16 200010380021 - L 220 - Ø 40+100 - - conf. 3 - € 37,70 200010380028 - L 300 - Ø 85+200 - - conf. 2 - € 58,58</p> 
<p>Beta</p> <p>PINZA REGOLABILE Art.1046 Cerniera a crema- gliera sovrapposta manici ricoperti in PVC</p> <p>200010460240 - Lmm 240 - A maxnn 28 - L1mm 33 - Smm 9,0 - conf. 1 - € 38,86</p> 	<p>Beta</p> <p>PINZE REGOLABILI BETA ART. 1048V Verniciate Cerniera chiusa</p> <p>200010480024 - - conf. 1 - € 29,68 200010480215 - L 250 - A max 48 - L1 39 - - conf. 3 - € 48,14 200010480240 - - conf. 1 - € 37,70</p> 



<p>Beta</p> <p>PINZE REGOLABILI AUTOBLOCCANTI BETA ART. 1052 Ganasce concave</p> <p>200010520014 - L 140 - A1 max 22 - - conf. 3 - € 26,92</p> <p>200010520019 - L 190 - A1 max 36 - - conf. 3 - € 30,16</p> <p>200010520024 - L 240 - A1 max 42 - - conf. 3 - € 32,48</p> <p>200010520030 - L 300 - A1 max 55 - - conf. 2 - € 54,52</p> 	<p>Beta</p> <p>PINZE REGOLABILI AUTOBLOCCANTI BETA ART. 1060 Ganasce a forcella</p> <p>200010600020 - LA1 max 200 - A1 max 50 - - conf. 2 - € 42,92</p> <p>200010600028 - LA1 max 280 - A1 max 80 - - conf. 2 - € 55,10</p> 
<p>Beta</p> <p>PINZE REGOLABILI AUTOBLOCCANTI BETA ART. 1062 Ganasce a collo di cigno</p> <p>200010620017 - L 170 - A1 max 50 - - conf. 2 - € 33,64</p> <p>200010620029 - L 290 - A1 max 120 - - conf. 2 - € 44,66</p> <p>200010620046 - L 460 - A1 max 250 - - conf. 1 - € 70,66</p> 	<p>Beta</p> <p>PINZE REGOLABILE AUTOBLOCCANTE BETA ART.1063 Per lattonieri Lunghezza 200 mm</p> <p>200010630021 - - conf. 1 - € 43,50</p> 
<p>Beta</p> <p>TRONCHESI TAGLIENTI DIAGONALI BETA ART. 1082 Manici ricoperti con 2 strati di PVC antiscivolo</p> <p>200010820004 - Lmm 140 - L1mm 20 - mm 1,6 - A mm 25,0Smm 11,0 - conf. 1 - € 25,64</p> <p>200010820036 - L 160 - L1 22 - mm 1,6 - - conf. 3 - € 35,38</p> 	<p>Beta</p> <p>TRONCHESI FRONTALI ART. 1086IN Lunghezza 160 mm</p> <p>200010860017 - - conf. 1 - € 43,48</p> 
<p>Beta</p> <p>TRONCHESI TAGLIENTI FRONTALI BETA ART. 1088BM A grande effetto Impugnatura bimatereiale</p> <p>200010880036 - L 160 - L1 9 - mm 1,6 - - conf. 2 - € 45,24</p> 	<p>Beta</p> <p>CESOIE MOD. AMERICANO BETA ART. 1112 Lame larghe dritte</p> <p>200011120020 - L 200 - L1 50 - S 0,5 - A 26 - conf. 2 - € 26,22</p> <p>200011120025 - L 250 - L1 62 - S 0,8 - A 33 - conf. 2 - € 31,32</p> <p>200011120030 - L 300 - L1 76 - S 1,0 - A 37 - conf. 2 - € 41,18</p> 
<p>Beta</p> <p>CESOIA DOPPIA LEVA DESTROSA BETA ART. 1123 Lame curve</p> <p>200011230020 - L 250 - L1 40 - Inox S 1 - A 24 - conf. 2 - € 35,96</p> 	<p>Beta</p> <p>FORBICI TELEFONISTI BETA ART. 1127 Lame dritte</p> <p>200011270001 - L 150 - L1 35 - - conf. 5 - € 15,66</p> 
<p>Beta</p> <p>FORBICI PER ELETTRICISTI Art.1128BMX Lame in acciaio inossidabile con microdentatura</p> <p>200011280051 - - conf. 1 - € 18,22</p> 	<p>Beta</p> <p>FORBICI PER ELETTRICISTI BETA ART.1128BX Lame dritte in acciaio INOX Con microdentatura Gola tagliafitto Lungh. 145mm</p> <p>200011280055 - - conf. 5 - € 13,20</p> <p>200011280000 - L 145 - L1 50 - - conf. 5 - € 16,02</p> <p>200011280060 - L 145 - L1 50 - A 24 - B 7 - conf. 5 - € 30,08</p> <p>200011280080 - L 155 - L1 55 - mm² 50 - mm² 1+4 - conf. 5 - € 29,58</p> 



<p>Beta</p> <p>FORBICI ELETTRICISTI BETA ART. 1129BM Lame curve Impugnatura bimatereale</p> <p>200011290000 - L 145 - L1 44 - - conf. 5 - € 17,06</p> 	<p>Beta</p> <p>PINZA BECCHI MEZZOTONDI LUNGHISSIMI BETA ART. 1168BM Piegati Zigrinati Impugnatura bimatereale</p> <p>200011680036 - L 160 - L1 54 - mm 1,6 - - conf. 3 - € 35,96</p> 
<p>Beta</p> <p>PINZE UNIVERSALI BETA ART. 1150MQ Cromate lucide</p> <p>200011500098 - L 180 - L1 39 - mm 1,8 - - conf. 1 - € 50,46 200011500036 - L 160 - L1 37 - mm 1,6 - - conf. 3 - € 26,68 200011500038 - L 180 - L1 41 - mm 1,8 - - conf. 3 - € 28,90 200011500040 - L 200 - L1 45 - mm 2,0 - - conf. 3 - € 32,48</p> 	<p>Beta</p> <p>PINZE BECCHI PIATTI LUNGHISSIMI BETA ART. 1162BM Dritti Zigrinati Impugnatura bimatereale</p> <p>200011620036 - L 160 - L1 58 - mm 1,6 - - conf. 3 - € 32,48 200011620040 - L 200 - L1 86 - mm 1,6 - - conf. 3 - € 37,12</p> 
<p>Beta</p> <p>PINZA BECCHI PIATTI LUNGHISSIMI BETA ART. 1164BM Piegati Zigrinati Impugnatura bimatereale</p> <p>200011640036 - L 160 - L1 54 - mm 1,6 - - conf. 3 - € 35,96</p> 	<p>Beta</p> <p>PINZA BECCHI MEZZOTONDI LUNGHISSIMI BETA ART. 1166MQ Dritti</p> <p>200011660096 - L 160 - L1 56 - mm 1,6 - - conf. 1 - € 49,88 200011660036 - L 160 - L1 56 - mm 1,6 - - conf. 3 - € 32,48</p> 
<p>Beta</p> <p>GIRAVITE CROCE POZIDRIV-SUPADRIV BETA ART. 1209PZ Per viti con impronta a croce pozidriv-supadriv Punta nera Cromato</p> <p>200012090003 - Misura PZ1 - L 80 - L1 189 - - conf. 5 - € 5,92 200012090006 - Misura PZ2 - L 100 - L1 220 - - conf. 5 - € 7,72</p> 	<p>Beta</p> <p>GIRAVITE TAGLIO BETA ART. 1201 Per viti a testa con intaglio Punta nera Cromato</p> <p>200012010003 - SxAxL 0,4x2,5x50 - L1 146 - Ø 2,5 - - conf. 5 - € 3,72 200012010006 - SxAxL 0,4x2,5x75 - L1 166 - Ø 2,5 - - conf. 5 - € 3,84 200012010009 - SxAxL 0,5x3x75 - L1 171 - Ø 3,0 - - conf. 5 - € 3,96 segue...</p> 
<p>Beta</p> <p>continua...</p> <p>200012010030 - SxAxL 0,8x4x100 - L1 196 - Ø 4,0 - - conf. 5 - € 4,42 200012010033 - SxAxL 0,8x4x125 - L1 221 - Ø 4,0 - - conf. 5 - € 4,64 200012010036 - SxAxL 0,8x4x150 - L1 246 - Ø 4,0 - - conf. 5 - € 5,06 200012010039 - SxAxL 1,0x5,5x100 - L1 209 - Ø 5,0 - - conf. 5 - € 5,40 segue...</p> 	<p>Beta</p> <p>continua...</p> <p>200012010040 - SxAxL 1,0x5,5x125 - L1 234 - Ø 5,0 - - conf. 5 - € 5,70 200012010042 - SxAxL 1,0x5,5x150 - L1 259 - Ø 5,0 - - conf. 5 - € 5,80 200012010048 - SxAxL 1,2x6,5x100 - L1 220 - Ø 6,0 - - conf. 5 - € 6,38 200012010051 - SxAxL 1,2x6,5x150 - L1 270 - Ø 6,0 - - conf. 5 - € 6,74</p> 
<p>Beta</p> <p>GIRAVITE CROCE PHILLIPS BETA ART. 1202 Per viti con impronta a croce Phillips Punta nera Cromato</p> <p>200012020003 - PHxDxL 0x3x60 - L1 156 - - conf. 5 - € 3,84 200012020006 - PHxDxL 0x3x100 - L1 200 - - conf. 5 - € 4,76 200012020009 - PHxDxL 1x4,5x80 - L1 189 - - conf. 5 - € 4,94 200012020012 - PHxDxL 1x4,5x120 - L1 229 - - conf. 5 - € 5,46 segue...</p> 	<p>Beta</p> <p>continua...</p> <p>200012020018 - PHxDxL 2x6x100 - L1 220 - - conf. 5 - € 6,62 200012020021 - PHxDxL 2x6x150 - L1 270 - - conf. 5 - € 7,26</p> 



<p>Beta</p> <p>GIRAVITE CROCE PHILLIPS NANO BETA ART. 1202N Tipo cortissimo Punta nera Cromato</p> <p>200012020103 - PHxDxL 1x4,5x30 - L1 86,5 - - conf. 3 - € 5,22</p> <p>200012020106 - PHxDxL 2x6x30 - L1 86,5 - - conf. 3 - € 5,52</p> 	<p>Beta</p> <p>SERIE 5 PZ. GIRAVITI EASY BETA ART. 1203/D5 A taglio 3 pz. 3,5x100 - 5,5x150 - 6,5x150 mm A croce 2 pz. PH 1x80 PH 2x100 mm</p> <p>200012030001 - - conf. 1 - € 28,42</p> 
<p>Beta</p> <p>SERIE 6 PZ. GIRAVITI EASY BETA ART. 1203/D6 A taglio 4 pz. 0,4x2,5x60 - 0,5x3x100 - 0,8x4x100 - 1,0x5x125 mm A croce 2 pz. PH 1x4,5x80 PH 2x6x100 mm</p> <p>200012030006 - - conf. 1 - € 29,00</p> 	<p>Beta</p> <p>SERIE 8 PZ. GIRAVITE BETA EASY ART. 1203/d8p 1201 2,5x50 - 3x75 - 4x100 5,5x100 - 6,5x150 mm 1202 PH0x60 - PH1x80 - PH2x100 mm</p> <p>200012030018 - - conf. 1 - € 37,70</p> 
<p>Beta</p> <p>GIRAVITE PRENSILI Art. 1250 per viti a testa con intaglio La guaina in plastica caricata da una molla trattiene la vite sulla lama</p> <p>200012500040 - SxDxL mm 0,6x4x125 - L1mm 225 - - conf. 1 - € 17,64</p> 	<p>Beta</p> <p>SET MICROGIRAVITE BETA ART. 1256/C36-2 Impugnatura bimatereale Prolunga magnetica 36 inserti intercambiabili da 4 mm 1256TX: T3 - T4 - T5 - T6 - T7 T8 - T9 - T10 - T15 1256RTX: T6 - T7 - T8 - T9 - T10 1256LP: 0,8 - 1,2 - 1,5 - 1,8 - 2 - 2,5 - 3 - 3,5 - 4 mm 1256PE: 0,7 - 0,9 - 1,3 - 1,5 - 2 mm 1256PH: PH000 - PH00 - PH0 - PH1 1256PZ: PZ000 - PZ00 - PZ0 - PZ1 1256/20 1256/30</p> <p>200012560100 - - conf. 1 - € 70,18</p> 
<p>Beta</p> <p>MICROGIRAVITE CROCE PHILLIPS BETA ART. 1257PH Per viti con impronta a croce Phillips</p> <p>200012570060 - PH 00 - L 60 - - conf. 5 - € 5,40</p> <p>200012570063 - PH 0 - L 60 - - conf. 5 - € 5,40</p> 	<p>Beta</p> <p>GIRAVITE TAGLIO BETA ART. 1260 Per viti a testa con intaglio</p> <p>200012600003 - SxAxL 0,4x2,5x50 - L1 150 - Ø 2,5 - - conf. 5 - € 5,58</p> <p>200012600006 - SxAxL 0,4x2,5x75 - L1 175 - Ø 2,5 - - conf. 5 - € 5,76</p> <p>200012600009 - SxAxL 0,5x3x75 - L1 175 - Ø 3,0 - - conf. 5 - € 5,86 segue...</p> 
<p>Beta</p> <p>continua...</p> <p>200012600012 - SxAxL 0,5x3x100 - L1 200 - Ø 3,0 - - conf. 5 - € 6,04</p> <p>200012600018 - SxAxL 0,6x3,5x75 - L1 175 - Ø 3,5 - - conf. 5 - € 6,28</p> <p>200012600021 - SxAxL 0,6x3,5x100 - L1 200 - Ø 3,5 - - conf. 5 - € 6,38</p> <p>200012600030 - SxAxL 0,8x4x100 - L1 208 - Ø 4,0 - - conf. 5 - € 7,02 segue...</p> 	<p>Beta</p> <p>continua...</p> <p>200012600033 - SxAxL 0,8x4x125 - L1 233 - Ø 4,0 - - conf. 5 - € 7,26</p> <p>200012600036 - SxAxL 0,8x4x150 - L1 258 - Ø 4,0 - - conf. 5 - € 7,50</p> <p>200012600039 - SxAxL 1x5,5x100 - L1 208 - Ø 5,0 - - conf. 5 - € 8,02</p> <p>200012600040 - SxAxL 1x5,5x125 - L1 233 - Ø 5,0 - - conf. 5 - € 8,12 segue...</p> 
<p>Beta</p> <p>continua...</p> <p>200012600042 - SxAxL 1x5,5x150 - L1 258 - Ø 5,0 - - conf. 5 - € 8,88</p> <p>200012600048 - SxAxL 1,2x6,5x100 - L1 219 - Ø 6,0 - - conf. 5 - € 9,58</p> <p>200012600050 - SxAxL 1,2x6,5x125 - L1 244 - Ø 6,0 - - conf. 5 - € 9,92</p> <p>200012600051 - SxAxL 1,2x6,5x150 - L1 269 - Ø 6,0 - - conf. 5 - € 10,34 segue...</p> 	<p>Beta</p> <p>continua...</p> <p>200012600057 - SxAxL 1,2x8x150 - L1 277 - Ø 8,0 - - conf. 3 - € 12,66</p> <p>200012600060 - SxAxL 1,2x8x200 - L1 327 - Ø 8,0 - - conf. 3 - € 13,12</p> <p>200012600066 - SxAxL 1,6x10x200 - L1 327 - Ø 9,5 - - conf. 3 - € 15,90</p> <p>200012600069 - SxAxL 2x12x250 - L1 377 - Ø 10 - - conf. 3 - € 18,68 segue...</p> 



Beta *continua...*
200012600103 - SxAxL 0,8x4x30 - L1 87 - Ø 4 -
 - conf. 5 - € **7,38**
200012600106 - SxAxL 1,2x6,5x30 - L1 87 - Ø 6 -
 - conf. 5 - € **8,12**



Beta
GIRAVITE CROCE PHILLIPS LUNGO BETA ART. 1262L Per viti con impronta a croce Phillips Tipo lungo Punta nera Cromato
200012620203 - PHxDxL 0x3x300 - L1 400 -
 - conf. 3 - € **10,22**
200012620205 - PHxDxL 1x4,5x300 - L1 400 -
 - conf. 3 - € **12,08**
200012620206 - PHxDxL 1x4,5x400 - L1 508 -
 - conf. 3 - € **14,16**
200012620209 - PHxDxL 2x6x400 - L1 519 -
 - conf. 3 - € **18,22**



Beta
GIRAVITE CROCE PHILLIPS BETA ART. 1262 Per viti con impronta a croce Phillips
200012620003 - PHxDxL 0x3x60 - L1 160 -
 - conf. 5 - € **5,86**
200012620006 - PHxDxL 0x3x100 - L1 200 -
 - conf. 5 - € **6,22**
200012620009 - PHxDxL 1x4,5x80 - L1 188 -
 - conf. 5 - € **7,72**
200012620012 - PHxDxL 1x4,5x120 - L1 228 -
 - conf. 5 - € **8,36**
200012620018 - PHxDxL 2x6x100 - L1 219 -
 - conf. 5 - € **9,46**
segue...



Beta *continua...*
200012620021 - PHxDxL 2x6x150 - L1 269 -
 - conf. 5 - € **10,44**
200012620024 - PHxDxL 3x8x150 - L1 277 -
 - conf. 3 - € **14,04**
200012620027 - PHxDxL 4x10x200 - L1 327 -
 - conf. 3 - € **17,88**
200012620103 - PHxDxL 1x4,5x30 - L1 87 -
 - conf. 5 - € **7,38**
200012620106 - PHxDxL 2x6x30 - L1 87 -
 - conf. 5 - € **8,12**



Beta
SERIE 6 PZ. GIRAVITI BETA ART. 1263/D6 A taglio 4 pz. 0,5x3x75 - 0,8x4x100 - 1x5,5x125 - 1,2x6,5x150 A croce 2 pz. PH 1x4,5x80 - 2x6x100
200012630006 -
 - conf. 1 - € **48,14**



Beta
SERIE 8 PZ. GIRAVITI BETA ART. 1263/D8 A taglio 5 pz. 2,5x50 - 3x75 - 4x100 5,5x25 - 6,5x150 mm A croce 3 pz. PH 0x60 - 1x80 - 2x100
200012630008 -
 - conf. 1 - € **59,74**



Beta
GIRAVITE TAGLIO LAME PARALLELE DA ELETTRICISTA BETA ART. 1264L Per viti con intaglio Tipo lungo
200012640203 - SxDxL 0,5x2,5x200 - L1 300 -
 - conf. 3 - € **8,24**
200012640206 - SxDxL 0,6x3x300 - L1 400 -
 - conf. 3 - € **9,70**
200012640209 - SxDxL 0,8x4x400 - L1 508 -
 - conf. 3 - € **12,66**
200012640215 - SxDxL 1x5x400 - L1 508 -
 - conf. 3 - € **14,16**
200012640218 - SxDxL 1,2x6,5x400 - L1 519 -
 - conf. 3 - € **17,18**



Beta
GIRAVITE TAGLIO BETA ART. 1270 Per viti a testa con intaglio
200012700003 - SxAxL 0,4x2,5x50 - L1 146 -
 - conf. 10 - € **5,16**
200012700012 - SxAxL 0,5x3x100 - L1 196 -
 - conf. 10 - € **5,36**
200012700024 - SxAxL 0,6x3,5x125 - L1 221 -
 - conf. 10 - € **6,40**
200012700027 - SxAxL 0,8x4x75 - L1 171 -
 - conf. 10 - € **6,18**
200012700030 - SxAxL 0,8x4x100 - L1 196 -
 - conf. 10 - € **6,18**
segue...



Beta *continua...*
200012700039 - SxAxL 1x5,5x100 - L1 208 -
 - conf. 10 - € **7,02**
200012700048 - SxAxL 1,2x6,5x100 - L1 216 -
 - conf. 10 - € **9,08**
200012700051 - SxAxL 1,2x6,5x150 - L1 266 -
 - conf. 10 - € **9,70**
200012700054 - SxAxL 1,2x6,5x200 - L1 316 -
 - conf. 10 - € **10,30**
200012700057 - SxAxL 1,2x8x150 - L1 277 -
 - conf. 5 - € **11,54**
segue...



Beta *continua...*
200012700066 - SxAxL 1,6x10x200 - L1 327 -
 - conf. 5 - € **14,42**
200012700045 - SxAxL 1x5,5x200 - L1 308 -
 - conf. 10 - € **9,28**
200012700063 - SxAxL 1,6x10x150 - L1 277 -
 - conf. 5 - € **11,54**



Beta
GIRAVITE NANO BETA ART. 1270N Per viti a testa con intaglio Tipo cortissimo
200012700103 - SxAxL 0,8x4x30 - L1 86,5 -
 - conf. 5 - € **6,60**



Beta
GIRAVITE CROCE PHILLIPS BETA ART. 1272L Per viti con impronta a croce Phillips Tipo lungo
200012720203 - PHxDxL 0x3x300 - L1 395 -
 - conf. 5 - € **11,54**





<p>Beta</p> <p>GIRAVITE CROCE PHILLIPS BETA ART. 1272 Per viti con impronta a croce Phillips</p> <p>200012720003 - PHxDxL 0x3x60 - L1 156 - - conf. 10 - € 5,16</p> <p>200012720009 - PHxDxL 1x4,5x80 - L1 188 - - conf. 10 - € 6,80</p> <p>200012720012 - PHxDxL 1x4,5x120 - L1 228 - - conf. 10 - € 7,02</p> <p>200012720015 - PHxDxL 1x4,5x150 - L1 258 - - conf. 10 - € 7,84</p> <p>200012720023 - PHxDxL 2x6x200 - L1 316 - - conf. 10 - € 11,34</p> <p>segue...</p> 	<p>Beta</p> <p>continua...</p> <p>200012720024 - PHxDxL 3x8x150 - L1 277 - - conf. 5 - € 11,96</p> <p>200012720027 - PHxDxL 4x10x200 - L1 333 - - conf. 5 - € 17,32</p> 
<p>Beta</p> <p>GIRAVITE TAGLIO BETA ART. 1290 Per viti a testa con intaglio Punta nera Cromato</p> <p>200012900009 - SxAxL 0,5x3x75 - L1 171 - Ø 3,0 - - conf. 10 - € 7,26</p> <p>200012900012 - SxAxL 0,5x3x100 - L1 196 - Ø 3,0 - - conf. 10 - € 7,60</p> <p>200012900021 - SxAxL 0,6x3,5x100 - L1 196 - Ø 3,5 - - conf. 10 - € 8,36</p> <p>segue...</p> 	<p>Beta</p> <p>continua...</p> <p>200012900030 - SxAxL 0,8x4x100 - L1 196 - Ø 4,0 - - conf. 10 - € 8,48</p> <p>200012900033 - SxAxL 0,8x4x125 - L1 221 - Ø 4,0 - - conf. 10 - € 8,76</p> <p>200012900036 - SxAxL 0,8x4x150 - L1 246 - Ø 4,0 - - conf. 10 - € 9,24</p> <p>200012900039 - SxAxL 1x5,5x100 - L1 209 - Ø 5,0 - - conf. 10 - € 9,46</p> <p>segue...</p> 
<p>Beta</p> <p>continua...</p> <p>200012900042 - SxAxL 1x5,5x150 - L1 259 - Ø 5,0 - - conf. 10 - € 10,56</p> <p>200012900048 - SxAxL 1,2x6,5x100 - L1 220 - Ø 6,0 - - conf. 10 - € 11,72</p> <p>200012900051 - SxAxL 1,2x6,5x150 - L1 270 - Ø 6,0 - - conf. 10 - € 12,42</p> 	<p>Beta</p> <p>GIRAVITE CROCE PHILLIPS BETA ART. 1292 Per viti con impronta a croce Phillips Punta nera Cromato</p> <p>200012920003 - PHxDxL 0x3x60 - L1 156 - - conf. 10 - € 6,62</p> <p>200012920006 - PHxDxL 0x3x100 - L1 196 - - conf. 5 - € 7,50</p> <p>200012920009 - PHxDxL 1x4,5x80 - L1 189 - - conf. 10 - € 9,12</p> <p>200012920012 - PHxDxL 1x4,5x120 - L1 229 - - conf. 10 - € 10,10</p> <p>segue...</p> 
<p>Beta</p> <p>continua...</p> <p>200012920018 - PHxDxL 2x6x100 - L1 220 - - conf. 10 - € 11,84</p> <p>200012920021 - PHxDxL 2x6x150 - L1 270 - - conf. 10 - € 12,88</p> 	<p>Beta</p> <p>MAZZUOLE BETA ART. 1390 Battenti intercambiabili in materiale plastico Manico in legno</p> <p>200013900022 - D 22 - L 260 - L1 70 - - conf. 5 - € 19,04</p> <p>200013900028 - D 28 - L 280 - L1 85 - - conf. 5 - € 23,68</p> <p>200013900035 - D 35 - L 310 - L1 95 - - conf. 5 - € 31,90</p> <p>200013900045 - D 45 - L 320 - L1 107 - - conf. 4 - € 51,04</p> <p>200013900060 - D 60 - L 380 - L1 128 - - conf. 2 - € 87,00</p> 
<p>Beta</p> <p>PINZA PER CAPICORDA BETA ART. 1602 Per capicorda preisolati Mod. leggero</p> <p>200016020001 - mm² 0,75+6 - - conf. 5 - € 16,02</p> 	<p>Beta</p> <p>PINZA PER CAPICORDA BETA ART. 1603 Per capicorda Non isolati Mod. leggero</p> <p>200016030001 - mm² 1,25+5,5 - - conf. 5 - € 16,02</p> 
<p>Beta</p> <p>MICROMETRI PER ESTERNI Art. 1658 In astuccio rigido di materiale plastico Lettura in centesimi Aste in acciaio temperato</p> <p>200016580075 - Amm 50&#247;75 - Bmm 46 - G mm 0,01 - L min mm 190 - - conf. 1 - € 97,44</p> 	<p>Beta</p> <p>PUNTA PER TRACCIARE BETA ART. 1688 Acciaio temprato</p> <p>200016880020 - L 250 - Ø 2 - - conf. 5 - € 8,76</p> 



professional



Dal 1929 Mundial Alfredo Casartelli s.r.l. produce e distribuisce utensili professionali per **utensileria, industria, autoriparazione, elettrico, idraulica, edilizia**... Qualità, design, innovazione sono caratteristiche della gamma Mundial.



MUNDIAL



Utensileria Alfredo Casartelli **ITALY**

utensili professionali

www.mundial-casartelli.it

professional tools























Mundial Alfredo Casartelli s.r.l. - 22030 Caslino d'Erba (Como) Italy - tel. +39 031 621330 - fax +39 031 622551 - e-mail: mundial@mundial-casartelli.it - www.mundial-casartelli.it

www.malfattitacchinigroup.it











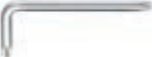
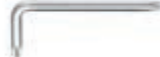

<p>Beta</p> <p>SEGHETTO Art. 1725 archetto in acciaio cromato impugnatura in lega di alluminio</p> <p>200017250001 - Lmm 420 - L1mm 300 - - conf. 1 - € 21,94</p> 	<p>Beta</p> <p>RIVETTATRICE BETA ART. 1741B 4 testine intercambiabili Lunghezza 260 mm</p> <p>200017410000 - - conf. 1 - € 40,02</p> 
<p>Beta</p> <p>RIVETTATRICE BETA ART. 1741U 4 testine intercambiabili Ultracompatta Con regolazione dello sforzo Lunghezza 200 mm</p> <p>200017410450 - - conf. 1 - € 47,56</p> 	<p>Beta</p> <p>CUSCINO SOLLEVATORE BETA ART. 1800/100 (max 135 kg)</p> <p>200018000000 - A 160 - B 150 - S 2+55 - - conf. 3 - € 59,74</p> 
<p>MUNDIAL FEI</p> <p>GIRAVITE PER VITI INTAGLIO MECCANICI In acciaio cromo molibdeno finitura cromata punta nera Durezza HRC 60</p> <p>7080050307 - SxAxL 3,0x75 - - conf. 12 - € 2,70 7080050410 - SxAxL 4,0x100 - - conf. 12 - € 3,96 7080050512 - SxAxL 5,5x125 - - conf. 12 - € 4,40 7080050612 - SxAxL 6,5x125 - - conf. 12 - € 5,72 segue...</p> 	<p>MUNDIAL FEI</p> <p>continua...</p> <p>7080050615 - SxAxL 6,5x150 - - conf. 12 - € 6,05 7080050815 - SxAxL 8,0x150 - - conf. 6 - € 7,98</p> 
<p>MUNDIAL FEI</p> <p>GIRAVITE PER VITI INTAGLIO LAME PARALLELE Acciaio cromo molibdeno</p> <p>7080051310 - SxAxL 3,0x100 - - conf. 12 - € 3,63 7080051415 - SxAxL 4,0x150 - - conf. 12 - € 4,57 7080051515 - SxAxL 5,0x150 - - conf. 12 - € 4,84</p> 	<p>MUNDIAL FEI</p> <p>GIRAVITE PER VITI INTAGLIO - MECCANICI Acciaio cromo vanadio</p> <p>7080055603 - Misura 5,8x38 - conf. 12 - € 3,91</p> 
<p>MUNDIAL FEI</p> <p>GIRAVITE PER VITI CROCE PHILLIPS Acciaio in cromo vanadio Finitura cromata punta nera</p> <p>7080056103 - SxAxL 1x38x4,5 - - conf. 12 - € 3,80</p> 	<p>MUNDIAL FEI</p> <p>GIRAVITE PER VITI CROCE PHILLIPS Acciaio cromo molibdeno finitura cromata punta nera</p> <p>7080052010 - SxAxL 0x100x3,0 - - conf. 12 - € 2,97 7080052108 - SxAxL 1x80x4,5 - - conf. 12 - € 3,91 7080052112 - SxAxL 1x125x4,5 - - conf. 12 - € 4,51 7080052210 - SxAxL 2x100x6,0 - - conf. 12 - € 5,28</p> 
<p>MUNDIAL FEI</p> <p>GIRAVITE PER VITI CROCE POZIDRIV acciaio cromo molibdeno finitura cromata punta nera</p> <p>7080053006 - SxAxL 0x60x3,0 - - conf. 6 - € 2,81 7080053108 - SxAxL 1x80x4,5 - - conf. 12 - € 4,02 7080053210 - SxAxL 2x100x6 - - conf. 12 - € 5,83 7080053315 - SxAxL 3x150x8,0 - - conf. 6 - € 8,20</p> 	<p>MUNDIAL FEI</p> <p>SERIE 7 GIRAVITI Scatola in cartone Contiene: Giravite 3,0x0,5x75 Giravite 4,0x0,8x100 Giraviti 5,5x1,0x100 Giraviti 6,5x1,2x125 Giraviti PH 0x60 -3 Giraviti PH 1x80-4,5 Giraviti PH 2x100-6</p> <p>7080064010 - - conf. 1 - € 31,85</p> 



























  <p>ESPOSITORE 102 PZ GIRAVITI Metallo Contiene: Giravite 3,0x0,5x75 9pz Giravite 4,0x8,0x100 8pz Giravite 5,5x1,0x125 8pz Giravite 6,5x1,2x125 7pz Giravite 8,0x1,2x150 6pz Giravite 3,0x0,5x100 9pz Giravite 4,0x0,8x150 8pz Giravite 5,0x1,0x150 8pz Giravite PH 0x100-3 9pz Giravite PH 1x80-4,5 8pz Giravite PH 2x100-6 7pz Giravite PZ 1x80-5 8pz Giravite PZ 2x100-6 7pz</p> <p>7080066010 - - conf. 1 - € 454,80</p>	 <p>GIRAVITE PER VITI TORX CON FORO Acciaio cromo molibdeno finitura cromata punta nera</p> <p>7080075060 - Misura 6x60 - - conf. 6 - € 3,85</p> <p>7080075070 - Misura 7x60 - - conf. 6 - € 3,85</p> <p>7080075080 - Misura 8x60 - - conf. 6 - € 3,85</p> <p>7080075090 - Misura 9x60 - - conf. 6 - € 4,51</p> <p>7080075100 - Misura 10x80 - - conf. 6 - € 4,62</p> <p>segue...</p>
  <p>continua...</p> <p>7080075150 - Misura 15x80 - - conf. 6 - € 4,62</p> <p>7080075200 - Misura 20x100 - - conf. 6 - € 4,79</p> <p>7080075250 - Misura 25x100 - - conf. 6 - € 5,12</p> <p>7080075270 - Misura 27x100 - - conf. 6 - € 5,12</p> <p>7080075300 - Misura 30x100 - - conf. 6 - € 6,77</p> <p>segue...</p>	  <p>continua...</p> <p>7080075400 - Misura 40x125 - - conf. 6 - € 9,13</p> <p>7080075450 - Misura 45x125 - - conf. 6 - € 9,13</p>
  <p>PORTAINSERTI MAGNETICO Attacco 1/4"</p> <p>7080084010 - Misura 100x117x34 - - conf. 6 - € 6,49</p>	  <p>GIRAVITE ISOLATO 1000volt VDE Per viti intaglio Acciaio cromo vanadio</p> <p>7080090310 - Misura 3,0x0,5x100 - - conf. 6 - € 4,79</p> <p>7080090410 - Misura 4,0x0,8x100 - - conf. 6 - € 5,56</p> <p>7080090512 - Misura 5,5x1,0x125 - - conf. 6 - € 6,66</p>
  <p>GIRAVITE ISOLATO 100 volt VDE Per viti croce phillips</p> <p>7080092110 - Misura 1x100 - - conf. 6 - € 5,61</p> <p>7080092210 - Misura 2x100 - - conf. 6 - € 7,76</p>	  <p>SERIE 5 GIRAVITI ISOLATI 1000 volt VDE Scatola in cartone Contiene: Giraviti 3,0x0,5x100 Giraviti 4,0x0,8x100 Giraviti 5,5x1,0x125 Giraviti PH 1x100 Giraviti PH 2x100</p> <p>7080094010 - - conf. 1 - € 32,78</p>
  <p>ESPOSITORE 144 PZ GIRAVITI In cartone Contiene: Giravite 3x75 24pz Giravite 4x75 24pz Giravite 6x125 24pz Giravite PH 0x60 24pz Giravite PH 1x80 24pz Giravite PH 2x100 24pz</p> <p>7080193010 - - conf. 1 - € 248,16</p>	  <p>GIRAVITE CERCAFASE cromo vanadio Lama isolata</p> <p>7080225410 - Misura 4x0,8x100 - - conf. 12 - € 2,09</p>
  <p>GIRAVITE CERCAFASE cromo vanadio Lama isolata</p> <p>7080232306 - Misura 3x0,5x60 - - conf. 12 - € 1,71</p>	  <p>CHIAVE TRE ESTREMITA' Asta scorrevole maschio esagonali acciaio cromo vanadio finitura cromata punte nere</p> <p>7080344320 - Misura 2,0x65x130 - - conf. 6 - € 9,46</p> <p>7080344325 - Misura 2,5x65x130 - - conf. 6 - € 9,46</p> <p>7080344330 - Misura 3,0x65x150 - - conf. 6 - € 9,57</p> <p>7080344340 - Misura 4,0x90x180 - - conf. 6 - € 10,45</p> <p>segue...</p>















<p>MUNDIAL FE</p> <p>continua... 7080344350 - Misura 5,0x90x180 - - conf. 6 - € 10,78 7080344360 - Misura 6,0x105x215 - - conf. 6 - € 12,32</p> 	<p>MUNDIAL FE</p> <p>CHIAVE PER VITI TORX Acciaio cromo vanadio</p> <p>7080360060 - Misura 6 - - conf. 6 - € 1,10 7080360070 - Misura 7 - - conf. 6 - € 1,10 7080360080 - Misura 8 - - conf. 6 - € 1,10 7080360090 - Misura 9 - - conf. 6 - € 1,10 7080360100 - Misura 10 - - conf. 6 - € 1,54 segue...</p> 
<p>MUNDIAL FE</p> <p>continua... 7080360150 - Misura 15 - - conf. 6 - € 1,65 7080360200 - Misura 20 - - conf. 6 - € 1,87 7080360250 - Misura 25 - - conf. 6 - € 1,98 7080360270 - Misura 27 - - conf. 6 - € 2,09 7080360300 - Misura 30 - - conf. 6 - € 2,15 segue...</p> 	<p>MUNDIAL FE</p> <p>continua... 7080360400 - Misura 40 - - conf. 6 - € 2,20 7080360450 - Misura 45 - - conf. 6 - € 2,75 7080360500 - Misura 50 - - conf. 6 - € 3,08</p> 
<p>MUNDIAL FE</p> <p>SERIE 9 CHIAVI ESAGONALI LUNGHE ESTREMITA' SFERICA Clip in plastica Contiene: 1 pz misura 1,5 1 pz misura 2 1 pz misura 2,5 1 pz misura 3 1 pz misura 4 1 pz misura 5 1 pz misura 6 1 pz misura 8 1 pz misura 10</p> <p>7080351090 - - conf. 1 - € 15,18</p> 	<p>MUNDIAL FE</p> <p>SERIE 6 CHIAVI ESAGONO Contiene Misura: 2 - 2,5 - 3 - 4 - 5 - 6</p> <p>7080356010 - - conf. 1 - € 7,48</p> 
<p>MUNDIAL FE</p> <p>TAGLIABULLONI Acciaio speciale alta resistenza al taglio finitura vernicata impugnatura isolata</p> <p>7080402060 - Misura 600 - - conf. 6 - € 44,33</p> 	<p>MUNDIAL FE</p> <p>MINI TAGLIABULLONI acciaio speciale alta resistenza al taglio finitura vernicata impugnatura in plastica</p> <p>7080404020 - misura 200 - - conf. 6 - € 15,62</p> 
<p>MUNDIAL FE</p> <p>TRONCHESE TAGLIACAVI Per funi acciaio</p> <p>7080407010 - Misura 190 - - conf. 6 - € 26,24</p> 	<p>MUNDIAL FE</p> <p>TRONCHESE Taglio diagonale a leva alta industria Acciaio cromo vanadio Extra finitura lucida</p> <p>7080410016 - Misura 160 - - conf. 6 - € 15,62</p> 
<p>MUNDIAL FE</p> <p>TRONCHESE Taglia diagonale Acciaio cromo vanadio finitura cromata</p> <p>7080412916 - Misura 160 - - conf. 6 - € 12,21</p> 	<p>MUNDIAL FE</p> <p>TENAGLIA PER CEMENTISTI Acciaio finitura verniciata impugnatura plastica</p> <p>7080417025 - Misura 250 - - conf. 6 - € 7,65</p> 





  <p>TENAGLIA Per cementisti extra Acciaio cromo vanadio impugnatura plastica</p> <p>7080420022 - Misura 220 - - conf. 6 - € 11,55</p> <p>7080420025 - Misura 250 - - conf. 6 - € 12,21</p>	  <p>TENAGLIA Per falegnami Acciaio cromo vanadio</p> <p>7080425018 - Misura 180 - - conf. 6 - € 9,68</p>
  <p>PINZA UNIVERSALE Acciaio cromo vanadio finitura cromata</p> <p>7080440918 - Misura 180 - - conf. 6 - € 11,66</p> <p>7080440920 - Misura 200 - - conf. 6 - € 12,87</p>	  <p>PINZA UNIVERSALE a leva alta industria Acciaio cromo vanadio extra finitura lucida</p> <p>7080441018 - Misura 180 - - conf. 6 - € 16,45</p>
  <p>PINZA Becchi mezzotondi con tagliente a leva alta industria Acciaio cromo vanadio extra finitura lucida</p> <p>7080462016 - Misura 160 - - conf. 6 - € 16,72</p>	  <p>PINZA Becchi mezzotondi con tagliente Cromata</p> <p>7080463916 - Misura 170 - - conf. 6 - € 12,05</p>
  <p>PINZA Becchi mezzotondi piegati con tagliente e giratubo Acciaio cromo vanadio finitura cromata</p> <p>7080466916 - Misura 170 - - conf. 6 - € 12,76</p> <p>7080467916 - Misura 200 - - conf. 6 - € 11,88</p>	  <p>PINZA AUTOBLOCCANTE Ganasce concave Acciaio cromo vanadio finitura nichelata</p> <p>7080474025 - Misura 250 - - conf. 2 - € 20,52</p>
  <p>PINZA AUTOBLOCCANTE Ganasce concave Acciaio cromo vanadio finitura nichelata</p> <p>7080478010 - Misura 280 - - conf. 2 - € 27,23</p>	  <p>PINZA PER DADI RUBINETTI finitura lucida impugnatura plastica</p> <p>7080501010 - Misura 250 - - conf. 6 - € 23,38</p>
  <p>GIRATUBO SVEDESE 45° Acciaio cromo vanadio finitura verniciata</p> <p>7080502032 - Ø mm-"1" - L 320 - - conf. 1 - € 28,77</p> <p>7080502040 - Ø mm-"1-1/2" - L 400 - - conf. 1 - € 41,58</p>	  <p>GIRATUBO SVEDESE 90° Acciaio cromo vanadio finitura verniciata</p> <p>7080503030 - Ø mm-"1" - L 300 - - conf. 1 - € 27,89</p> <p>7080503041 - Ø mm-"1-1/2" - L 410 - - conf. 1 - € 40,26</p>















<p>MUNDIAL FE</p> <p>PINZA PER ANELLI ELASTICI ESTERNI Becchi diritti Acciaio cromo vanadio impugnatura plastica</p> <p>7080505018 – Misura 180 – – conf. 6 – € 12,43</p> 	<p>MUNDIAL FE</p> <p>PINZA PER ANELLI ELASTICI ESTERNI Becchi piegati Acciaio cromo vanadio impugnatura plastica</p> <p>7080506017 – Misura 170 – – conf. 6 – € 13,09</p> 
<p>MUNDIAL FE</p> <p>PINZA PER ANELLI ELASTICI INTERNI Becchi diritti Acciaio cromo vanadio impugnatura plastica</p> <p>7080510018 – Misura 180 – – conf. 6 – € 11,88</p> 	<p>MUNDIAL FE</p> <p>PINZA PER ANELLI ELASTICI INTERNI Becchi piegati Acciaio cromo vanadio impugnatura plastica</p> <p>7080511017 – Misura 170 – – conf. 6 – € 12,65</p> 
<p>MUNDIAL FE</p> <p>PINZA PER ELETTRONICA Becchi piatti Acciaio cromo vanadio finitura lucida</p> <p>7080520010 – Misura 120 – – conf. 6 – € 7,15</p> 	<p>MUNDIAL FE</p> <p>PINZA PER ELETTRONICA Becchi tondi</p> <p>7080522010 – Misura 120 – – conf. 6 – € 7,15</p> 
<p>MUNDIAL FE</p> <p>PINZA PER ELETTRONICA Becchi mezzotondi piegati</p> <p>7080524010 – Misura 120 – – conf. 6 – € 7,15</p> 	<p>MUNDIAL FE</p> <p>PINZA PER ELETTRONICA Becchi mezzotondi lunghi</p> <p>7080525010 – Misura 150 – – conf. 6 – € 7,26</p> 
<p>MUNDIAL FE</p> <p>TRONCHESE TAGLIO DIAGONALE Per elettronica</p> <p>7080526010 – Misura 115 – – conf. 1 – € 7,26</p> 	<p>MUNDIAL FE</p> <p>TRONCHESE TAGLIO FRONTALE Per elettricista</p> <p>7080527010 – Misura 115 – – conf. 6 – € 7,26</p> 
<p>MUNDIAL FE</p> <p>PINZA UNIVERSALE Per elettronica con tagliente</p> <p>7080528010 – Misura 120 – – conf. 6 – € 7,26</p> 	<p>MUNDIAL FE</p> <p>PINZA FUSTELLATRICE DOPPIA LEVA Diametro fustelle 2 – 2,5 – 3 – 3,5 – 4 – 5 mm</p> <p>7080553010 – Misura 240 – – conf. 2 – € 18,15</p> 



























<p>MUNDIAL FE</p> <p>PINZA PUNZONATRICE Per assemblaggio doppia leva (una sola mano) Cartongesso</p> <p>7080555030 – Misura 240 – – conf. 2 – € 33,00</p> 	<p>MUNDIAL FE</p> <p>CESOIA DOPPIA LEVA Taglio destro Acciaio cromo vanadio impugnatura isolata</p> <p>7080564010 – Misura 250 – – conf. 2 – € 13,64</p> 
<p>MUNDIAL FE</p> <p>CESOIA DOPPIA LEVA Taglio sinistro Acciaio cromo vanadio impugnatura isolata</p> <p>7080565010 – Misura 250 – – conf. 2 – € 13,64</p> 	<p>MUNDIAL FE</p> <p>CESOIA DOPPIA LEVA Taglio diritto Acciaio cromo vanadio impugnatura isolata</p> <p>7080566010 – Misura 250 – – conf. 2 – € 13,64</p> 
<p>MUNDIAL FE</p> <p>FORBICI PER ELETTRICISTI Bicomponente inox</p> <p>7080683010 – Misura 145 – – conf. 12 – € 10,34</p> 	<p>MUNDIAL FE</p> <p>FORBICI PER ELETTRICISTI Inox</p> <p>7080689010 – – conf. 12 – € 6,60</p> 
<p>MUNDIAL FE</p> <p>PINZA UNIVERSALE ISOLATA 1000 volt VDE Acciaio cromo vanadio finitura cromata</p> <p>7080710018 – Misura 180 – – conf. 6 – € 25,85</p> 	<p>MUNDIAL FE</p> <p>TRONCHESE TAGLIO DIAGONALE ISOLATA 1000 volt VDE Acciaio cromo vanadio finitura cromata</p> <p>7080716016 – Misura 160 – – conf. 6 – € 23,98</p> 
<p>MUNDIAL FE</p> <p>ARCHETTO PROFESSIONALE impugnatura ergonomica Alluminio e acciaio Lama HSS 12”</p> <p>7080593910 – L 12” – – conf. 6 – € 27,89</p> 	<p>MUNDIAL FE</p> <p>ARCHETTO Impugnatura in legno Lama HSS 12”</p> <p>7080595010 – L 12” – – conf. 6 – € 9,90</p> 
<p>MUNDIAL FE</p> <p>ARCHETTO Impugnatura ergonomica Lama HSS 12”</p> <p>7080596010 – L 12” – – conf. 6 – € 12,32</p> 	<p>MUNDIAL FE</p> <p>SPELAFILI AUTOMATICO FRONTALE</p> <p>7080739010 – Misura 175 – – conf. 2 – € 14,85</p> 















<p>MUNDIAL FE</p> <p>TAGLIATUBI RAME E LEGHE LEGGERE mm 32 - 1 1/4"</p> <p>7080772032 - Ø 32 - 1 1/4" - - conf. 2 - € 16,12</p> 	<p>MUNDIAL FE</p> <p>TAGLIATUBI CRICCHETTO Per plastica mm 42 - 1 5/8"</p> <p>7080790042 - - conf. 2 - € 16,06</p> 
<p>MUNDIAL FE</p> <p>TAGLIATUBI PLASTICA AUTOMATICO mm 42 1 5/8"</p> <p>7080792042 - - conf. 2 - € 28,05</p> 	<p>MUNDIAL FE</p> <p>CHIAVE SOTTOLAVABO Reversibile</p> <p>7080796100 - Misura 350 - - conf. 2 - € 20,30</p> 
<p>MUNDIAL FE</p> <p>CHIAVE A FORCHETTA Acciaio cromo vanadio finitura cromata teste lucide</p> <p>7081020067 - Misura 6-7 - - conf. 12 - € 2,59 7081020089 - Misura 8-9 - - conf. 12 - € 2,97 7081020101 - Misura 10-11 - - conf. 12 - € 3,47 7081020103 - Misura 10-13 - - conf. 12 - € 3,74 7081020123 - Misura 12-13 - - conf. 12 - € 3,80 segue...</p> 	<p>MUNDIAL FE</p> <p>continua...</p> <p>7081020137 - Misura 13-17 - - conf. 12 - € 4,62 7081020145 - Misura 14-15 - - conf. 12 - € 4,29 7081020167 - Misura 16-17 - - conf. 12 - € 4,68 7081020189 - Misura 18-19 - - conf. 6 - € 6,11 7081020202 - Misura 20-22 - - conf. 6 - € 6,60 segue...</p> 
<p>MUNDIAL FE</p> <p>continua...</p> <p>7081020213 - Misura 21-23 - - conf. 6 - € 7,92 7081020246 - Misura 24-26 - - conf. 6 - € 9,63 7081020247 - Misura 24-27 - - conf. 6 - € 9,68 7081020258 - Misura 25-28 - - conf. 6 - € 11,28 7081020302 - Misura 30-32 - - conf. 6 - € 14,14</p> 	<p>MUNDIAL FE</p> <p>CHIAVE POLIGONALE Acciaio cromo vanadio finitura cromata teste lucide</p> <p>7081025067 - Misura 6-7 - - conf. 12 - € 3,63 7081025089 - Misura 8-9 - - conf. 12 - € 4,24 7081025101 - Misura 10-11 - - conf. 12 - € 4,84 7081025123 - Misura 10-13 - - conf. 12 - € 5,45 7081025145 - Misura 14-15 - - conf. 12 - € 6,22 segue...</p> 
<p>MUNDIAL FE</p> <p>continua...</p> <p>7081025167 - Misura 16-17 - - conf. 12 - € 6,99 7081025189 - Misura 18-19 - - conf. 6 - € 10,29 7081025202 - Misura 20-22 - - conf. 6 - € 11,61 7081025213 - Misura 21-23 - - conf. 6 - € 13,64 7081025246 - Misura 24-25 - - conf. 6 - € 16,56 segue...</p> 	<p>MUNDIAL FE</p> <p>continua...</p> <p>7081025247 - Misura 24-27 - - conf. 6 - € 16,56 7081025258 - Misura 25-28 - - conf. 6 - € 20,19 7081025302 - Misura 30-32 - - conf. 6 - € 25,08</p> 
<p>MUNDIAL FE</p> <p>CHIAVE COMBINATA Acciaio cromo vanadio finitura cromata teste lucide</p> <p>7081030060 - Misura 6-6 - - conf. 12 - € 2,70 7081030070 - Misura 7-7 - - conf. 12 - € 2,70 7081030080 - Misura 8-8 - - conf. 12 - € 2,97 7081030090 - Misura 9-9 - - conf. 12 - € 3,14 7081030100 - Misura 10-10 - - conf. 12 - € 3,25 segue...</p> 	<p>MUNDIAL FE</p> <p>continua...</p> <p>7081030110 - Misura 11-11 - - conf. 12 - € 3,52 7081030120 - Misura 12-12 - - conf. 12 - € 3,96 7081030130 - Misura 13-13 - - conf. 12 - € 4,07 7081030140 - Misura 14-14 - - conf. 12 - € 4,24 7081030150 - Misura 15-15 - - conf. 12 - € 4,51 segue...</p> 



  <p>continua... 7081030160 – Misura 16-16 – – conf. 12 – € 4,68 7081030170 – Misura 17-17 – – conf. 12 – € 5,17 7081030180 – Misura 18-18 – – conf. 6 – € 6,55 7081030190 – Misura 19-19 – – conf. 6 – € 7,21 7081030200 – Misura 20-20 – – conf. 6 – € 7,81 segue...</p>	  <p>continua... 7081030210 – Misura 21-21 – – conf. 6 – € 8,69 7081030220 – Misura 22-22 – – conf. 6 – € 9,63 7081030230 – Misura 23-23 – – conf. 6 – € 10,89 7081030240 – Misura 24-24 – – conf. 6 – € 11,06 7081030250 – Misura 25-25 – – conf. 6 – € 13,04 segue...</p>
  <p>continua... 7081030260 – Misura 26-26 – – conf. 6 – € 13,31 7081030270 – Misura 27-27 – – conf. 6 – € 14,03 7081030280 – Misura 28-28 – – conf. 6 – € 16,06 7081030290 – Misura 29-29 – – conf. 6 – € 16,89 7081030300 – Misura 30-30 – – conf. 6 – € 16,89 7081030320 – Misura 32-32 – – conf. 6 – € 18,87</p>	  <p>CHIAVE COMBINATA A CRICCHETTO Snodata 72 denti ripresa 5° 7081055080 – Misura 8-8 – – conf. 6 – € 11,61 7081055100 – Misura 10-10 – – conf. 6 – € 12,43 7081055130 – Misura 13-13 – – conf. 6 – € 14,30 7081055170 – Misura 17-17 – – conf. 6 – € 18,81 7081055190 – Misura 19-19 – – conf. 6 – € 20,24</p>
  <p>CHIAVE COMBINATA a cricchetto semplice 7081067080 – Misura 8-8 – – conf. 6 – € 7,04 7081067100 – Misura 10-10 – – conf. 6 – € 7,59 7081067130 – Misura 13-13 – – conf. 6 – € 8,58 7081067170 – Misura 17-17 – – conf. 6 – € 12,21 7081067190 – Misura 19-19 – – conf. 6 – € 13,37</p>	  <p>CHIAVE REGOLABILE Acciaio cromo vanadio finitura cromata impugnatura plastica 7081070020 – Misura 200 – – conf. 2 – € 13,86 7081070025 – Misura 250 – – conf. 2 – € 20,52 7081070030 – Misura 300 – – conf. 2 – € 25,52</p>
  <p>CHIAVE A TUBO DOPPIA Ferro tipo leggero finitura zincata 7081080067 – Misura 6-7 – – conf. 6 – € 1,65 7081080089 – Misura 8-9 – – conf. 6 – € 1,76 7081080101 – Misura 10-11 – – conf. 6 – € 1,82 7081080123 – Misura 12-13 – – conf. 6 – € 1,93 7081080145 – Misura 14-15 – – conf. 6 – € 2,20 segue...</p>	  <p>continua... 7081080167 – Misura 16-17 – – conf. 6 – € 2,31 7081080189 – Misura 18-19 – – conf. 6 – € 2,48 7081080202 – Misura 20-22 – – conf. 6 – € 2,92 7081080246 – Misura 24-26 – – conf. 6 – € 3,36 7081080258 – Misura 25-28 – – conf. 6 – € 3,85 7081080302 – Misura 30-32 – – conf. 6 – € 4,29</p>
  <p>CHIAVE A TUBO DOPPIA Professionale Acciaio cromo vanadio 7081092067 – Misura 6-7 – – conf. 6 – € 2,20 7081092089 – Misura 8-9 – – conf. 6 – € 2,31 7081092101 – Misura 10-11 – – conf. 6 – € 2,81 7081092123 – Misura 12-13 – – conf. 6 – € 3,30 7081092145 – Misura 14-15 – – conf. 6 – € 3,58 segue...</p>	  <p>continua... 7081092167 – Misura 16-17 – – conf. 6 – € 3,96 7081092189 – Misura 18-19 – – conf. 6 – € 5,06 7081092202 – Misura 20-22 – – conf. 6 – € 6,27</p>
  <p>CHIAVE A TUBO In cromo vanadio 512311490N – Misura 6x7 – – conf. 10 – € 1,80 512311500N – Misura 8x9 – – conf. 10 – € 2,00 512311510N – Misura 10x11 – – conf. 10 – € 2,20 512311520N – Misura 12x13 – – conf. 10 – € 2,40</p>	  <p>CHIAVE A BUSSOLA ESAGONO FORO PROFONDO 7080082070 – Misura 7,0x72x150 – – conf. 6 – € 9,90 7080082080 – Misura 8,0x72x150 – – conf. 6 – € 10,67 7080082100 – Misura 10,0x72x150 – – conf. 6 – € 11,33 7080082130 – Misura 13,0x72x150 – – conf. 6 – € 12,71</p>















<p>MUNDIAL FE</p> <p>CHIAVE A PIPA PASSANTE DOPPIA Esagono Poligonale</p> <p>7081098080 - Misura 8-8 - - conf. 6 - € 6,38</p> <p>7081098100 - Misura 10-10 - - conf. 6 - € 6,66</p> <p>7081098130 - Misura 13-13 - - conf. 6 - € 8,69</p> <p>7081098170 - Misura 17-17 - - conf. 6 - € 13,59</p> <p>7081098190 - Misura 19-19 - - conf. 6 - € 15,24</p> 	<p>MUNDIAL FE</p> <p>CHIAVE A "T" Snodata lunga Acciaio cromo vanadio finitura cromata</p> <p>7081150100 - Misura 10 - - conf. 2 - € 27,17</p> <p>7081150130 - Misura 13 - - conf. 2 - € 31,13</p> 
<p>MUNDIAL FE</p> <p>CHIAVE MASCHIO ESAGONALE CON IMPUGNATURA A "T" BICOMPONENTE Acciaio cromo vanadio Finitura cromata</p> <p>7080344020 - Misura 2 - - conf. 6 - € 3,58</p> <p>7080344025 - Misura 2,5 - - conf. 6 - € 3,74</p> <p>7080344030 - Misura 3 - - conf. 6 - € 3,91</p> <p>7080344040 - Misura 4 - - conf. 6 - € 4,35</p> <p>segue...</p> 	<p>MUNDIAL FE</p> <p>continua...</p> <p>7080344050 - Misura 5 - - conf. 6 - € 4,95</p> <p>7080344060 - Misura 6 - - conf. 6 - € 5,72</p> <p>7080344080 - Misura 8 - - conf. 6 - € 6,71</p> <p>7080344100 - Misura 10 - - conf. 6 - € 9,68</p> 
<p>MUNDIAL FE</p> <p>CHIAVE MASCHIO TORX CON IMPUGNATURA A "T"</p> <p>7080344206 - Misura 6 - - conf. 6 - € 3,63</p> <p>7080344207 - Misura 7 - - conf. 6 - € 3,63</p> <p>7080344208 - Misura 8 - - conf. 6 - € 3,63</p> <p>7080344209 - Misura 9 - - conf. 6 - € 3,63</p> <p>7080344210 - Misura 10 - - conf. 6 - € 3,74</p> <p>segue...</p> 	<p>MUNDIAL FE</p> <p>continua...</p> <p>7080344215 - Misura 15 - - conf. 6 - € 3,91</p> <p>7080344220 - Misura 20 - - conf. 6 - € 4,35</p> <p>7080344225 - Misura 25 - - conf. 6 - € 5,23</p> <p>7080344227 - Misura 27 - - conf. 6 - € 5,56</p> <p>7080344230 - Misura 30 - - conf. 6 - € 5,72</p> <p>7080344240 - Misura 40 - - conf. 6 - € 7,65</p> 
<p>MUNDIAL FE</p> <p>CHIAVE A CROCIERA Per ruote</p> <p>7081336179 - Misura 17x19x22x1/2" - - conf. 1 - € 13,20</p> 	<p>MUNDIAL FE</p> <p>STRETTOIO A VITE Acciaio forgiato finitura cromata</p> <p>7081345400 - Misura 400x120 - - conf. 1 - € 44,55</p> <p>7081345500 - Misura 500x120 - - conf. 1 - € 47,41</p> 
<p>MUNDIAL FE</p> <p>CHIAVE A NASTRO Per filtri olio</p> <p>7081360011 - Ø 65-110 - - conf. 1 - € 10,89</p> 	<p>MUNDIAL FE</p> <p>CHIAVE A NASTRO</p> <p>7081364010 - Ø 60-140 - - conf. 1 - € 16,61</p> 
<p>MUNDIAL FE</p> <p>CRICCHETTO REVERSIBILE 1/4" Sgancio rapido</p> <p>7081406010 - Misura 140 - - conf. 2 - € 11,88</p> 	<p>MUNDIAL FE</p> <p>CRICCHETTO DOPPIO 1/4" Femmina esagono per inserti 1/4" maschio quadro per bussolle</p> <p>7081407010 - Misura 100 - - conf. 6 - € 14,58</p> 















<p>MUNDIAL FE</p> <p>CHIAVE BUSSOLA 1/2" bocca esagonale profilo flank drive</p> <p>7081500080 – Misura 8 – – conf. 6 – € 2,86</p> <p>7081500090 – Misura 9 – – conf. 6 – € 2,86</p> <p>7081500100 – Misura 10 – – conf. 6 – € 2,86</p> <p>7081500110 – Misura 11 – – conf. 6 – € 2,86</p> <p>7081500120 – Misura 12 – – conf. 6 – € 2,86</p> <p>segue...</p> 	<p>MUNDIAL FE</p> <p>continua...</p> <p>7081500130 – Misura 13 – – conf. 6 – € 2,97</p> <p>7081500140 – Misura 14 – – conf. 6 – € 2,97</p> <p>7081500150 – Misura 15 – – conf. 6 – € 2,97</p> <p>7081500160 – Misura 16 – – conf. 6 – € 3,19</p> <p>7081500170 – Misura 17 – – conf. 6 – € 3,58</p> <p>segue...</p> 
<p>MUNDIAL FE</p> <p>continua...</p> <p>7081500180 – Misura 18 – – conf. 6 – € 3,58</p> <p>7081500190 – Misura 19 – – conf. 6 – € 3,69</p> <p>7081500200 – Misura 20 – – conf. 6 – € 3,91</p> <p>7081500210 – Misura 21 – – conf. 6 – € 4,46</p> <p>7081500220 – Misura 22 – – conf. 6 – € 4,46</p> 	<p>MUNDIAL FE</p> <p>CRICCHETTO REVERSIBILE 1/2" con sgancio rapido</p> <p>7081505010 – Misura 254 – – conf. 6 – € 39,16</p> 
<p>MUNDIAL FE</p> <p>CRICCHETTO Reversibile 1/2" Sgancio rapido</p> <p>7081506010 – Misura 254 – – conf. 6 – € 21,45</p> 	<p>MUNDIAL FE</p> <p>PROLUNGA 1/2" Acciaio cromo vanadio finitura cromata</p> <p>7081508125 – Misura 125 – – conf. 6 – € 5,78</p> <p>7081508250 – Misura 250 – – conf. 6 – € 9,52</p> 
<p>MUNDIAL FE</p> <p>LEVA A "T" 1/2" Acciaio cromo vanadio finitura cromata</p> <p>7081510010 – Misura 250 – – conf. 6 – € 10,29</p> 	<p>MUNDIAL FE</p> <p>SNODO CARDANICO 1/2" Acciaio cromo vanadio</p> <p>7081512010 – Misura 70 – – conf. 6 – € 12,38</p> 
<p>MUNDIAL FE</p> <p>SERIE 12 BUSSOLE 1/2" + CRICCHETTO + PRO-LUNGA</p> <p>7081542010 – – conf. 6 – € 53,90</p> 	<p>MUNDIAL FE</p> <p>CASSETTA METALLO 5 scomparti Lunga vuota 545x215x225</p> <p>7081764015 – – conf. 1 – € 53,90</p> 
<p>ASTRAL</p> <p>PINZA Elettronica Becchi piatti diritti 125</p> <p>190411302 – – conf. 6 – € 3,10</p> 	<p>M&M 540</p> <p>PINZA MINI UNIVERSALE</p> <p>540600727060 – – conf. 6 – € 3,80</p> 















UTENSILI

 <p>&T540</p>	<p>PINZA BECCHI 1/2 TONDI 540600725030 - - conf. 6 - € 3,80</p>	 <p>ASTRAL</p>	<p>TRONCHESE Elettronica Taglio frontale 105 190411305 - - conf. 6 - € 3,10</p>
 <p>ASTRAL</p>	<p>TRONCHESE Frontale 160 190411110 - - conf. 6 - € 4,54</p>	 <p>ASTRAL</p>	<p>PINZA Telefonica SEMITONDA Curva 160 190411210 - - conf. 6 - € 3,10</p>
 <p>ASTRAL</p>	<p>PINZA Telefonica SEMITONDA Diritta 160 190411200 - - conf. 6 - € 3,10</p>	 <p>&T540</p>	<p>PINZA UNIVERSALE 540600571200 - Misura 200 mm - - conf. 6 - € 5,80</p>
 <p>&T900</p>	<p>PINZA BECCHI PIATTI DIRITTI 90041526 - Misura 160 - - conf. 1 - € 7,80</p>	 <p>&T540</p>	<p>PINZA BECCHI DIRITTI 540600591265 - Misura 160 mm - - conf. 6 - € 3,80</p>
 <p>&T540</p>	<p>PINZA BECCHI 1/2 TONDI 540600591270 - Misura 165 mm - - conf. 1 - € 4,60</p>	 <p>&T540</p>	<p>PINZA BECCHI CURVI 540600601265 - Misura 160 mm - - conf. 1 - € 4,00</p>
 <p>&T540</p>	<p>TRONCHESE LATERALE 540600612000 - Misura 160 mm - - conf. 1 - € 3,80</p>	 <p>&T540</p>	<p>PINZA BECCHI TONDI 540600591275 - Misura 165 mm - - conf. 1 - € 4,60</p>



 <p>&M 540</p> <p>PINZA BECCHI DRITTI 160 mm 540600731100 - - conf. 1 - € 5,60</p>	 <p>&M 540</p> <p>TRONCHESE LATERALE 160 mm 540600732000 - - conf. 1 - € 5,80</p>
 <p>&M 540</p> <p>TRONCHESE FRONTALE 160 mm 540600732100 - - conf. 1 - € 3,80</p>	 <p>&M 540</p> <p>TRONCHESE LATERALE 160 ISOLATO 540600612050 - - conf. 1 - € 4,00</p>
 <p>&M 540</p> <p>PINZA BECCHI DRITTI 1/2 TONDI 540600591277 - - conf. 1 - € 3,00</p>	 <p>&M 540</p> <p>PINZA UNIVERSALE SERIE R/G 540600730160 - Misura 160 mm - - conf. 1 - € 3,00 540600730180 - Misura 180 mm - - conf. 1 - € 3,80 540600730200 - Misura 200 mm - - conf. 1 - € 4,00</p>
 <p>SET 4 MINI PINZE DI PRECISIONE 740PGT405 - - conf. 1 - € 2,88</p>	 <p>Gieffe <small>gruppi generali ferramenta</small></p> <p>PINZA POLIGRIP Misura 250 mm 512311100N - - conf. 10 - € 5,98</p>
 <p>&M 540</p> <p>PINZA POLIGRIPH Doppia cremagliera Manici Isolati Acciaio Cromo Vanadio 540300821000 - Misura 300 - - conf. 10 - € 12,40</p>	 <p>HIT</p> <p>PINZA REGOLABILE CREMAGLIERA 93047026 - Misura 175 MM - Colore ROSSO/ GIALLA - - conf. 1 - € 7,40 93047025 - Misura 240 MM - Colore ROSSO/ NERA - - conf. 1 - € 7,80</p>
 <p>VBW <small>Die Welt der Zangen</small></p> <p>PINZA POLIGRIPH VBW 93031844 - L.mm. 160 - - conf. 5 - € 24,00 93031845 - L.mm. 240 - - conf. 5 - € 24,70 93031846 - L.mm. 300 - - conf. 5 - € 39,80</p>	 <p>&M 540</p> <p>PINZA POLIGRIP 160 mm 540600734250 - - conf. 1 - € 5,00</p>















 <p>KNIPEX</p> <p>PINZA KNIPEX ALLIGATOR</p> <p>93031848 - L.mm. 250 - - conf. 6 - € 37,90</p> <p>93031849 - L.mm. 300 - - conf. 6 - € 51,92</p>	 <p>KNIPEX</p> <p>PINZA KNIPEX COBRA</p> <p>93031842 - L.mm. 250 - - conf. 6 - € 48,00</p> <p>93031843 - L.mm. 300 - - conf. 6 - € 63,24</p>
 <p>&M 540</p> <p>TENAGLIA FALEGNAME</p> <p>540600735180 - Misura 180 - - conf. 1 - € 4,40</p> <p>540600735200 - Misura 200 - - conf. 1 - € 5,00</p>	 <p>KNIPEX</p> <p>TENAGLIA KNIPEX CEMENTISTA</p> <p>93046199 - Misura 200 - - conf. 6 - € 24,92</p> <p>93046200 - Misura 220 - - conf. 6 - € 25,80</p> <p>93046201 - Misura 250 - - conf. 6 - € 28,40</p> <p>93046202 - Misura 280 - - conf. 6 - € 29,60</p> <p>93046203 - Misura 300 - - conf. 6 - € 36,06</p>
 <p>Gieffe <small>gruppo generali ferramenta</small></p> <p>TENAGLIA CEMENTISTA</p> <p>512311160N - Misura 220 mm - - conf. 10 - € 3,84</p> <p>512311170N - Misura 250 mm - - conf. 10 - € 3,96</p> <p>TENAGLIA CEMENTISTA CON MANICO IN PLASTICA</p> <p>512311150N - Misura 200 mm - - conf. 10 - € 3,30</p>	 <p>&M 900</p> <p>PINZA FUSTELLATRICE A REVOLVER 8 posizioni Misure: 1 - 1,5 - 2 2,5 - 3 - 3,5 - 4 - 5</p> <p>90070500 - - conf. 3 - € 12,06</p>
 <p>&M 900</p> <p>PINZA FUSTELLATRICE a 6 punzoni intercambiabili</p> <p>90070502 - - conf. 1 - € 24,10</p>	 <p>&M 900</p> <p>PINZA OCCHIELLI RP05 In blister Manuale Per occhielli da 4 mm 100 occhielli inclusi</p> <p>90070629 - - conf. 1 - € 19,40</p>
 <p>&M 540</p> <p>SUPER PROFESSIONAL PINZA FUSTELLATRICE A REVOLVER Fustelle da: 2-2,5-3-3,5-4-4,5 mm</p> <p>540301041000 - - conf. 10 - € 12,00</p>	 <p>&M 540</p> <p>PINZA PER OCCHIELLI + 100 Occhielli</p> <p>540301080000 - - conf. 6 - € 2,40</p>
 <p>&M 900</p> <p>PINZA PER ANELLI In cromo vanadio per anelli 180 mm</p> <p>90041610 - Becchi Int. dritti - - conf. 1 - € 9,00</p> <p>90041611 - Becchi Int. curvi - - conf. 1 - € 9,00</p> <p>90041613 - Becchi Est. curvi - - conf. 1 - € 9,00</p>	 <p>&M 930</p> <p>PINZA SPELAFILI AUTOMATICA</p> <p>93061210 - - conf. 1 - € 4,20</p>



<p>&M 540</p> <p>PINZA SPELAFILI AUTOMATICA 540306220000 – – conf. 3 – € 4,30</p> 	<p>&M 540</p> <p>PINZA SPELAFILI 160 mm 540600733160 – – conf. 1 – € 4,00</p> 
<p>ASTRAL</p> <p>PINZA SPELAFILI AMERICANA 190411230 – – conf. 1 – € 3,80</p> 	<p>&M 540</p> <p>PINZA AUTOMATICA SPELAFILO REGOLABILE 540306230000 – – conf. 6 – € 1,40</p> 
<p>&M 540</p> <p>PINZE per capicorda isolati 540306240000 – – conf. 6 – € 3,50</p> 	<p>&M 540</p> <p>TAGLIATUBI PER PLASTICA 540601120010 – – conf. 1 – € 9,00</p> 
<p>&M 540</p> <p>TAGLIATUBO SUPER EGO MOD. 701 Fino a 1/8 a 1,1/4 540301090014 – – conf. 1 – € 24,00</p> 	<p>&M 540</p> <p>TAGLIATUBO SUPER EGO MOD. 750 Per plastica 4-63 mm 540301120000 – – conf. 1 – € 25,80</p> 
<p>&M 540</p> <p>TAGLIATUBI 3-35 mm 540601090013 – – conf. 1 – € 19,20</p> 	<p>&M 540</p> <p>TAGLIATUBI 4-30 mm 540601100001 – – conf. 1 – € 7,00</p> 
<p>&M 540</p> <p>GIRATUBI 540600140010 – apertura 1" – – conf. 1 – € 9,98 540600150015 – apertura 1 1/2" – – conf. 1 – € 10,20</p> 	<p>&M 540</p> <p>GIRATUBI STILLSON 540300110300 – Misura 300 MM – 12 pollici – – conf. 4 – € 4,00 540300110450 – Misura 450 MM – 18 pollici – – conf. 4 – € 6,00</p> 















 <p>CHIAVI PER TUBI Mod. 809 Svedese 110809201000 – Misura 1 – - conf. 1 - € 19,80</p>	<p>GIRATUBI "BLITZ" Nero 540300100175 – Misura 175 MM – - conf. 2 - € 5,00 540300100225 – Misura 225 MM – - conf. 2 - € 5,00 540300100270 – Misura 270 MM – - conf. 2 - € 5,80 540300100300 – Misura 300 MM – - conf. 2 - € 5,80</p> 
<p>CESOIA per lattonieri Mod. Americano 90042071 – misura 250 – - conf. 1 - € 7,80</p> 	<p>CESOIA LAMIERA 540604712000 – Taglio Diritto – - conf. 3 - € 5,80 540604713000 – Taglio Destro – - conf. 3 - € 5,80 540604714000 – Taglio Sinistro – - conf. 3 - € 5,80</p> 
<p>PINZA CROMATA ARTICOLATA GRIP Misura 250 mm 540606280000 – - conf. 1 - € 4,00</p> 	<p>PINZA GRIP AUTOBLOCCANTE Ganasce in acciaio al carbonio completamente temprate Misura 175 mm Pollici 7" 512311110N – - conf. 10 - € 4,90</p> 
<p>TAGLIABULLONI HIT 93047010 – misura 300 – - conf. 1 - € 41,00</p> 	<p>LAME DI RICAMBIO TAGLIABULLONI HIT 93047019 – Misura 300 – - conf. 1 - € 19,80 93047020 – Misura 350 – - conf. 1 - € 19,80 93047021 – Misura 450 – - conf. 1 - € 19,80 93047022 – Misura 600 – - conf. 1 - € 21,80 93047023 – Misura 750 – - conf. 1 - € 23,80 93047024 – Misura 900 – - conf. 1 - € 39,80</p> 
<p>LAMA DI RICAMBIO PER TAGLIABULLONI 540604790301 – Misura 300 – - conf. 1 - € 6,20 540604790451 – Misura 450 – - conf. 1 - € 10,80</p> 	<p>MARTELLO Tedesco Manico legno 540306410110 – Grammi 100 – - conf. 6 - € 3,60 540306410210 – Grammi 200 – - conf. 6 - € 4,20 540306410310 – Grammi 300 – - conf. 6 - € 5,00 540306410510 – Grammi 500 – - conf. 6 - € 7,00 540306410810 – Grammi 800 – - conf. 6 - € 9,80 540306410920 – Grammi 1000 – - conf. 6 - € 11,40</p> 
<p>SUPER PROFESSIONAL MARTELLO TEDESCO Manico Fibra 540306415100 – Gr. 100 – - conf. 3 - € 4,00</p> <p>AD ESAURIMENTO</p> 	<p>MARTELLO DA MECCANICO Manico Fibra 93047031 – Gr. 200 – - conf. 1 - € 6,36 93047032 – Gr. 300 – - conf. 1 - € 7,20 93047033 – Gr. 500 – - conf. 1 - € 9,68</p> 







<p>&M540</p> <p>MAZZUOLA TESTA GOMMA Manico in legno</p> <p>540602191200 – Peso 200 gr – Ø 45 – – conf. 1 – € 2,30</p> <p>540602191400 – Peso 400 gr – Ø 50 – – conf. 1 – € 2,60</p> 	<p>HIT</p> <p>MAZZETTA Manico fibra</p> <p>93047034 – Gr. 800 – – conf. 1 – € 11,96</p> <p>93047035 – Gr. 1000 – – conf. 1 – € 13,38</p> 
<p>K</p> <p>MAZZETTA MANICO LEGNO</p> <p>625AM021 – Gr. 1000 – – conf. 3 – € 12,80</p> <p>625AM022 – Gr. 1250 – – conf. 3 – € 14,00</p> 	<p>&M900</p> <p>MAZZETTA OTTAGONALE 1200 Gr</p> <p>900511801200 – – conf. 3 – € 8,60</p> 
<p>HIT</p> <p>SUPER PROFESSIONAL MARTELLINA MALE-PEGGIO Grammi 400</p> <p>540602370410 – – conf. 3 – € 7,80</p> 	<p>&M900</p> <p>MARTELLI FALEGNAME EXTRA G.200 “370”</p> <p>90051121 – – conf. 6 – € 4,40</p> 
<p></p> <p>MARTELLO CARPENTIERE Tipo Spagna – ARIEX Mod 290</p> <p>90051154 – gr. 300 – – conf. 3 – € 7,60</p> <p>90051155 – gr. 400 – – conf. 3 – € 8,20</p> 	<p>ASTRAL</p> <p>SUPER PROFESSIONAL MARTELLO CARPENTIERE CALAMITATO Manico Fibra</p> <p>190522250 – gr. 250 – – conf. 1 – € 10,20</p> <p>190522300 – gr. 300 – – conf. 1 – € 10,20</p> <p>190522400 – gr. 400 – – conf. 1 – € 10,20</p> 
<p>&M900</p> <p>MARTELLETTO per traforo</p> <p>90048016 – – conf. 24 – € 2,80</p> 	<p>&M540</p> <p>PALANCHINO DISARMO cm.60</p> <p>540602160600 – – conf. 6 – € 5,90</p> 
<p>STANLEY</p> <p>SCALPELLO LEGNO DYNAGRIP</p> <p>7880-16-870 – misura 6 – – conf. 2 – € 22,80</p> <p>7880-16-871 – misura 8 – – conf. 2 – € 22,80</p> <p>7880-16-872 – misura 10 – – conf. 2 – € 24,00</p> <p>7880-16-873 – misura 12 – – conf. 2 – € 24,00</p> <p>7880-16-875 – misura 15 – – conf. 2 – € 26,20</p> <p>segue...</p> 	<p>STANLEY</p> <p>continua...</p> <p>7880-16-876 – misura 16 – – conf. 2 – € 26,20</p> <p>7880-16-878 – misura 20 – – conf. 2 – € 27,00</p> <p>7880-16-879 – misura 22 – – conf. 2 – € 27,00</p> <p>7880-16-880 – misura 25 – – conf. 2 – € 30,80</p> 























 <p>SCALPELLO FALEGNAME manico legno</p> <p>90050203 - Misura 8 - Manico Legno - - conf. 4 - € 9,20</p> <p>90050222 - Misura 6 - Manico Plastica - - conf. 1 - € 9,20</p> <p>90050223 - Misura 8 - Manico Plastica - - conf. 1 - € 9,20</p>	 <p>SCALPELLO PUNTA CON PARAMANO 30 cm</p> <p>90051172 - - conf. 1 - € 12,36</p>
 <p>SCALPELLO A PUNTA MURATORE</p> <p>540302120250 - MISURA MM 250 - - conf. 10 - € 3,20</p> <p>540302120300 - MISURA MM 300 - - conf. 10 - € 4,00</p> <p>540302120350 - MISURA MM 350 - - conf. 6 - € 5,40</p> <p>540302120400 - MISURA MM 400 - - conf. 6 - € 6,80</p>	 <p>SCALPELLO PIATTO MURATORE</p> <p>540302130250 - MISURA MM 250 - - conf. 10 - € 3,20</p> <p>540302130300 - MISURA MM 300 - - conf. 10 - € 4,00</p> <p>540302130350 - MISURA MM 350 - - conf. 6 - € 5,40</p> <p>540302130400 - MISURA MM 400 - - conf. 6 - € 6,80</p>
 <p>SCALPELLO PER MECCANICO ESAGONALE</p> <p>540602080125 - L 8x125mm - - conf. 1 - € 4,30</p> <p>540602080150 - L 12x150mm - - conf. 1 - € 4,30</p>	 <p>UNGHIETTA PER MECCANICO 12x150 mm</p> <p>540602082126 - - conf. 1 - € 4,30</p>
 <p>PUNZONE CROMATO Cromo vanadium</p> <p>540602074003 - D 3 - L 125mm - - conf. 1 - € 4,30</p> <p>540602074004 - D 4 - L 125mm - - conf. 1 - € 4,30</p>	 <p>BULINO CROMATO Cromo vanadium</p> <p>540602076009 - D 9 - - conf. 1 - € 4,30</p>
 <p>CACCIA SPINE</p> <p>540602078145 - D 4 - L 145mm - - conf. 1 - € 4,30</p> <p>540602078165 - D 5 - L 165mm - - conf. 1 - € 4,30</p>	 <p>ASTA FERMASTADIE Lunghezza 250 mm</p> <p>90051230 - - conf. 1 - € 10,00</p>
 <p>TRIANGOLO bordo vivo pesante HEAVY TAPER</p> <p>42011070600 - pollici 6 - - conf. 12 - € 10,00</p> <p>42011070800 - pollici 8 - - conf. 12 - € 14,40</p>	 <p>RASPA TONDA taglio mezzodolce</p> <p>90045816 - pollici 6 - - conf. 12 - € 4,80</p> <p>90045817 - pollici 8 - - conf. 12 - € 6,40</p> <p>90045818 - pollici 10 - - conf. 12 - € 7,60</p>















  <p>TRIANGOLO bordo tondo regolare BANDSAW TAPER REGULAR</p> <p>42011010700 – pollici 7 – - conf. 12 – € 47,60</p> <p>42011010800 – pollici 8 – - conf. 12 – € 52,20</p>	  <p>TRIANGOLO bordo tondo pesante BANDSAW TAPER HEAVY</p> <p>42011080700 – Pollici 7 – - conf. 10 – € 14,20</p> <p>42011080800 – Pollici 8 – - conf. 12 – € 18,00</p>
  <p>TRIANGOLI bordo tondo pesante BANDSAW TAPER HEAVY</p> <p>42011100450 – pollici 8 – - conf. 12 – € 7,60</p> <p>42011100500 – pollici 5 – - conf. 12 – € 7,60</p> <p>42011100600 – pollici 6 – - conf. 12 – € 8,20</p> <p>42011100700 – pollici 7 – - conf. 12 – € 8,20</p>	  <p>TRIANGOLO bordo vivo regolare REGULAR TAPER</p> <p>42011000500 – pollici 5 – - conf. 12 – € 8,00</p> <p>42011000800 – pollici 8 – - conf. 12 – € 13,00</p>
  <p>TRIANGOLO bordo vivo sottile SLIM TAPER</p> <p>42011090600 – pollici 6 – - conf. 12 – € 8,00</p> <p>42011090700 – pollici 7 – - conf. 12 – € 9,60</p> <p>42011090800 – pollici 8 – - conf. 12 – € 11,60</p>	  <p>LIMA PIATTA nicholson Lunghezza 250 mm</p> <p>42011171002 – - conf. 12 – € 38,18</p>
  <p>LIMA TONDA ROUND</p> <p>42012501002 – pollici 10 – taglio ¼ d. – - conf. 12 – € 14,40</p> <p>42012500402 – pollici 4 – taglio ¼ d. – - conf. 12 – € 8,80</p> <p>42012500403 – pollici 4 – taglio dolce – - conf. 12 – € 9,20</p> <p>42012500603 – pollici 6 – taglio dolce – - conf. 12 – € 10,00</p> <p>42012500802 – pollici 8 – taglio ¼ d. – - conf. 12 – € 9,80</p> <p>segue...</p>	  <p>continua...</p> <p>42012500803 – pollici 8 – taglio dolce – - conf. 12 – € 10,40</p> <p>42012501003 – pollici 10 – taglio dolce – - conf. 12 – € 14,00</p> <p>42012501202 – pollici 12 – taglio ¼ d. – - conf. 6 – € 17,80</p> <p>42012501203 – pollici 12 – taglio dolce – - conf. 6 – € 18,00</p>
  <p>LIME PIATTE Bordo Tondo Bastard 8^ Nichelata</p> <p>42011171001 – - conf. 12 – € 17,60</p>	  <p>LIMA PIATTA parallela HAND</p> <p>42012100601 – pollici 6 – taglio bast. – - conf. 12 – € 9,60</p> <p>42012100802 – pollici 8 – taglio ¼ d. – - conf. 12 – € 12,78</p> <p>42012101001 – pollici 10 – taglio bast. – - conf. 6 – € 16,60</p>
  <p>LIMA TRIANGOLARE THREE SQUARE</p> <p>42012600501 – pollici 5 – taglio bast. – - conf. 12 – € 6,45</p> <p>42012600601 – pollici 6 – taglio bast. – - conf. 12 – € 11,40</p> <p>42012600602 – pollici 6 – taglio ¼ d. – - conf. 12 – € 11,60</p> <p>42012600603 – pollici 6 – taglio dolce – - conf. 12 – € 14,20</p> <p>42012600802 – pollici 8 – taglio ¼ d. – - conf. 12 – € 15,20</p> <p>segue...</p>	  <p>continua...</p> <p>42012600803 – pollici 8 – taglio dolce – - conf. 12 – € 15,40</p> <p>42012601001 – pollici 10 – taglio bast. – - conf. 12 – € 21,60</p> <p>42012601002 – pollici 10 – taglio ¼ d. – - conf. 12 – € 22,20</p> <p>42012601003 – pollici 10 – taglio dolce – - conf. 12 – € 24,60</p> <p>42012601201 – pollici 12 – taglio bast. – - conf. 12 – € 31,40</p>















  <p>LIMA MEZZATONDA HALFROND</p> <p>42012300601 – pollici 6 – taglio bast. – – conf. 12 – € 15,80</p> <p>42012300801 – pollici 8 – taglio bast. – – conf. 12 – € 17,20</p> <p>42012300401 – pollici 4 – taglio bast. – – conf. 12 – € 15,20</p> <p>42012300402 – pollici 4 – taglio ¼ d. – – conf. 12 – € 15,40</p> <p>42012300403 – pollici 4 – taglio dolce – – conf. 12 – € 16,20</p> <p>segue...</p>	  <p>continua...</p> <p>42012300602 – pollici 6 – taglio ¼ d. – – conf. 12 – € 15,00</p> <p>42012300603 – pollici 6 – taglio dolce – – conf. 12 – € 16,20</p> <p>42012301001 – pollici 10 – taglio bast. – – conf. 6 – € 22,80</p> <p>42012301002 – pollici 10 – taglio ¼ d. – – conf. 6 – € 23,60</p> <p>42012301003 – pollici 10 – taglio dolce – – conf. 6 – € 24,60</p> <p>42012301201 – pollici 12 – taglio bast. – – conf. 6 – € 30,80</p>
  <p>LIMA PIATTA MAGICUT Lunghezza 300 mm - 12"</p> <p>42007941N – – conf. 6 – € 26,98</p>	  <p>LIMA QUADRA SQUARE</p> <p>42012400401 – pollici 4 – taglio bast. – – conf. 12 – € 9,40</p> <p>42012400802 – pollici 8 – taglio ¼ d. – – conf. 12 – € 13,60</p> <p>42012400602 – pollici 6 – taglio ¼ d. – – conf. 12 – € 11,00</p> <p>42012401001 – pollici 10 – taglio bast. – – conf. 6 – € 16,20</p> <p>42012401002 – pollici 10 – taglio ¼ d. – – conf. 6 – € 17,00</p> <p>segue...</p>
  <p>continua...</p> <p>42012401201 – pollici 12 – taglio bast. – – conf. 6 – € 23,00</p> <p>42012401202 – pollici 12 – taglio ¼ d. – – conf. 6 – € 24,80</p>	  <p>RASPA MEZZATONDA HALFROND</p> <p>42013141202 – pollici 12 – taglio ¼ d. – – conf. 6 – € 32,60</p>
 <p>SET 6 LIME assortite piatta parallela piatta a punta mezzatonda – tonda a triangolo – quadra</p> <p>74044920 – – conf. 5 – € 16,60</p>	  <p>LIMA MINI TONDA Lunghezza 150 mm</p> <p>540601973301 – – conf. 1 – € 3,00</p>
  <p>LIMA MINI 1/2 TONDA Lunghezza 150 mm</p> <p>540601973302 – – conf. 1 – € 3,00</p>	  <p>LIMA MINI PIATTA Lunghezza 150 mm</p> <p>540601973300 – – conf. 1 – € 3,00</p>
  <p>LIMA MINI PIATTA A PUNTA Lunghezza 150 mm</p> <p>540601973304 – – conf. 1 – € 1,46</p>	  <p>LIMA TRIANGOLARE Misura 150 mm</p> <p>540601973303 – – conf. 1 – € 3,00</p>















 <p>&M 540</p> <p>LIMA TONDA Appendibile Misura 150 mm</p> <p>540601953106 - Taglio Bastardo - Misura 6" - - conf. 1 - € 2,00</p> <p>540601953108 - Taglio Bastardo - Misura 8" - - conf. 1 - € 3,98</p> <p>540601953206 - Taglio 1/2 dolce - Misura 6" - - conf. 1 - € 2,00</p> <p>540601953208 - Taglio 1/2 dolce - Misura 8" - - conf. 1 - € 3,98</p>	 <p>&M 540</p> <p>LIMA 1/2 TONDA Appendibile</p> <p>540601943106 - Taglio Bastardo - Misura 6" - - conf. 1 - € 3,98</p> <p>540601943108 - Taglio Bastardo - Misura 8" - - conf. 1 - € 3,98</p> <p>540601943208 - Taglio 1/2 dolce - Misura 8" - - conf. 1 - € 3,98</p>
 <p>&M 540</p> <p>LIMA TRIANGOLARE Appendibile</p> <p>540601963106 - Taglio Bastardo - Misura 6" - - conf. 1 - € 2,00</p> <p>540601963108 - Taglio Bastardo - Misura 8" - - conf. 1 - € 3,98</p> <p>540601963206 - Taglio 1/2 dolce - Misura 6" - - conf. 1 - € 2,00</p> <p>540601963208 - Taglio 1/2 dolce - Misura 8" - - conf. 1 - € 3,98</p>	 <p>&M 540</p> <p>LIMA QUADRA Appendibile</p> <p>540601973106 - Taglio Bastardo - Misura 6" - - conf. 1 - € 2,00</p> <p>540601973108 - Taglio Bastardo - Misura 8" - - conf. 1 - € 3,98</p> <p>540601973206 - Taglio 1/2 dolce - Misura 6" - - conf. 1 - € 2,00</p> <p>540601973208 - Taglio 1/2 dolce - Misura 8" - - conf. 1 - € 3,98</p>
 <p>&M 540</p> <p>RASPA 1/2 TONDA Appendibile</p> <p>540601993106 - Taglio Bastardo - Misura 6" - - conf. 1 - € 2,00</p> <p>540601993108 - Taglio Bastardo - Misura 8" - - conf. 1 - € 3,98</p> <p>540601993206 - Taglio 1/2 dolce - Misura 6" - - conf. 1 - € 2,00</p>	 <p>&M 540</p> <p>LIMA PIATTA Appendibile</p> <p>540601933106 - Taglio Bastardo - Misura 6" - - conf. 1 - € 2,00</p> <p>540601933108 - Taglio Bastardo - Misura 8" - - conf. 1 - € 3,98</p> <p>540601933206 - Taglio 1/2 dolce - Misura 6" - - conf. 1 - € 3,98</p> <p>540601933208 - Taglio 1/2 dolce - Misura 8" - - conf. 1 - € 3,98</p>
 <p>ASTRAL</p> <p>LIMA 1/2 TONDA 1/2 DOLCE</p> <p>190450056 - pollici 8" - - conf. 1 - € 6,00</p>	 <p>LIMA/RASPA per legno e ferro</p> <p>74044906 - pollici 6 - L. 150 - - conf. 10 - € 13,40</p> <p>74044908 - pollici 8 - L. 200 - - conf. 10 - € 15,40</p>
 <p>&M 900</p> <p>RASPA PALETTA MEZZATONDA mm. 250</p> <p>90045840 - - conf. 6 - € 7,00</p>	 <p>&M 900</p> <p>RASPA TONDA taglio bastardo</p> <p>90045806 - pollici 6 - - conf. 12 - € 4,40</p> <p>90045809 - pollici 12 - - conf. 12 - € 10,20</p>
 <p>&M 900</p> <p>RASPA calzolaia mm. 200</p> <p>90045830 - - conf. 12 - € 7,00</p>	 <p>&M 900</p> <p>RASPA CABINET taglio mezzodolce</p> <p>90045814 - pollici 12 - L. mm. 300 - - conf. 12 - € 9,40</p>















<p>540</p> <p>SET 10 PZ. LIME AD AGO</p> <p>540606160020 - - conf. 6 - € 2,20</p> 	<p>MECCHIA PROFESSIONALE per legno gambo Ø 6</p> <p>74038450 - Ø 6 - - conf. 3 - € 2,40</p> <p>74038500 - Ø 8 - - conf. 3 - € 2,40</p> <p>74038600 - Ø 10 - - conf. 3 - € 2,60</p> <p>74038700 - Ø 12 - - conf. 3 - € 2,60</p> <p>74038800 - Ø 14 - - conf. 3 - € 2,80</p> <p>segue...</p> 
<p>continua...</p> <p>74038900 - Ø 16 - - conf. 3 - € 2,80</p> <p>74039000 - Ø 18 - - conf. 3 - € 3,00</p> <p>74039100 - Ø 20 - - conf. 3 - € 3,00</p> <p>74039200 - Ø 22 - - conf. 3 - € 3,20</p> <p>74039250 - Ø 24 - - conf. 3 - € 3,40</p> <p>segue...</p> 	<p>continua...</p> <p>74039300 - Ø 25 - - conf. 3 - € 3,60</p> <p>74039320 - Ø 26 - - conf. 3 - € 3,80</p> <p>74039340 - Ø 28 - - conf. 3 - € 4,20</p> <p>74039360 - Ø 30 - - conf. 3 - € 4,40</p> <p>74039400 - Ø 32 - - conf. 3 - € 4,60</p> <p>segue...</p> 
<p>continua...</p> <p>74039420 - Ø 35 - - conf. 3 - € 5,00</p> <p>74039440 - Ø 38 - - conf. 3 - € 5,60</p> 	<p>MECCHIA Professionale regolabile per legno Gambo Ø 10 Ø 22 / 76mm</p> <p>74039480 - - conf. 1 - € 96,00</p> 
<p>ASTRAL</p> <p>MECCHIA PROFESSIONALE per legno gambo Ø 6mm</p> <p>190232006 - Ø 6 - - conf. 10 - € 2,00</p> <p>190232008 - Ø 8 - - conf. 10 - € 2,00</p> 	<p>MECCHIA Professionale regolabile per legno Gambo Ø 6 Ø 15/45mm</p> <p>74039470 - - conf. 1 - € 79,40</p> 
<p>Confezione TASSELLO LEGNO</p> <p>74065500 - Ø 6 - Pz./conf. 100 - - conf. 10 - € 3,20</p> <p>74066000 - Ø 8 - Pz./conf. 60 - - conf. 10 - € 2,60</p> <p>74066500 - Ø 10 - Pz./conf. 40 - - conf. 10 - € 3,00</p> <p>74066600 - Ø 12 - Pz./conf. 30 - - conf. 10 - € 3,00</p> 	<p>Confezione TASSELLO LEGNO In asta lungh. 1000</p> <p>74066800 - Ø 6 - Pz./conf. 100 - - conf. 1 - € 62,40</p> <p>74066810 - Ø 8 - Pz./conf. 100 - - conf. 1 - € 58,00</p> <p>74066820 - Ø 10 - Pz./conf. 100 - - conf. 1 - € 95,40</p> <p>74066830 - Ø 12 - Pz./conf. 50 - - conf. 1 - € 64,00</p> 
<p>Confezione maxi TASSELLO LEGNO</p> <p>74065505 - Ø 6 - Pz./conf. 1000 - - conf. 1 - € 18,60</p> <p>74066005 - Ø 8 - Pz./conf. 1000 - - conf. 1 - € 22,00</p> <p>74066505 - Ø 10 - Pz./conf. 1000 - - conf. 1 - € 36,00</p> <p>74066605 - Ø 12 - Pz./conf. 500 - - conf. 1 - € 32,00</p> 	<p>KIT ASSEMBLAGGIO Punta trapano Ø 10 boc- cola arresto, 4 spine 20 tasselli legno</p> <p>74068300 - - conf. 5 - € 7,40</p> 















 <p>KIT ASSEMBLAGGIO Punta trapano Ø 8 boccola arresto, 4 spine 25 tasselli legno</p> <p>74068200 - - conf. 5 - € 6,60</p>	 <p>KIT ASSEMBLAGGIO Punta trapano Ø 6 boccola arresto, 4 spine 25 tasselli legno</p> <p>74068100 - - conf. 5 - € 5,80</p>
 <p>SPINAA CENTRARE Set 4 pz.</p> <p>74067000 - Ø 6 - - conf. 10 - € 2,00 74067500 - Ø 8 - - conf. 10 - € 2,40 74068000 - Ø 10 - - conf. 10 - € 2,60</p>	 <p>TRIVELLINO per legno</p> <p>74059000 - Ø 2 - - conf. 10 - € 2,80 74059100 - Ø 3 - - conf. 10 - € 2,80 74059200 - Ø 4 - - conf. 10 - € 3,20 74059300 - Ø 5 - - conf. 10 - € 4,20 74059400 - Ø 6 - - conf. 10 - € 6,00</p>
 <p>PUNTERUOLO Lama 100 mm</p> <p>540601591100 - Punta Tonda - - conf. 1 - € 1,32 540301591100 - Punta Quadra - - conf. 1 - € 1,32</p>	 <p>BOCCOLE di arresto per punte: Ø 6 - 8 - 10mm</p> <p>74062000 - - conf. 10 - € 5,40</p>
 <p>MORSETTO per traforo</p> <p>90048012 - misura 50 - - conf. 24 - € 2,80 90048013 - misura 60 - - conf. 24 - € 3,00 90048014 - misura 80 - - conf. 24 - € 3,80 90048015 - misura 100 - - conf. 24 - € 4,20</p>	 <p>MORSETTO</p> <p>540600040101 - - conf. 1 - € 7,00</p>
 <p>MORSETTO A MOLLA Corpo in nylon</p> <p>74095805 - Lunghezza 85 mm - Apertura 30 mm - - conf. 10 - € 1,88 74095807 - Lunghezza 115 mm - Apertura 40 mm - - conf. 10 - € 2,80 74095810 - Lunghezza 175 mm - Apertura 60 mm - - conf. 10 - € 4,40 74095814 - Lunghezza 240 mm - Apertura 70 mm - - conf. 10 - € 5,80</p>	 <p>MORSETTO A MOLLA Kit 4 Mini morsetti Lunghezza 6 cm Apertura 18 mm</p> <p>74095800 - - conf. 1 - € 5,00</p>
 <p>TAGLIACORNICI in ABS angolazione di taglio 45° - 90° - 22,5° capacità di taglio 78 x 120mm</p> <p>7881-20-112 - - conf. 3 - € 25,60</p>	 <p>SQUADRA VOLA FALEGNAME mod. 270</p> <p>90073078 - L.mm. 200 - - conf. 4 - € 9,06 90073079 - L.mm. 300 - - conf. 4 - € 9,62 90073080 - L.mm. 400 - - conf. 4 - € 10,98 90073081 - L.mm. 500 - - conf. 4 - € 12,52</p>



<p>&M 540</p> <p>SQUADRA DA FALEGNAME</p> <p>540303290250 – Misura 250 MM – – conf. 1 – € 2,80</p> <p>540303290300 – Misura 300 MM – – conf. 1 – € 3,20</p> 	<p>&M 540</p> <p>CONF. 4 MATITE FALEGNAME</p> <p>540303355000 – – conf. 12 – € 0,78</p> 
<p>STANLEY</p> <p>FALSA SQUADRA regolabile Lama acciaio 210mm</p> <p>7880-46-825 – – conf. 2 – € 11,60</p> 	<p>&M 930</p> <p>FERRO di ricambio per pialle 93023210 / 215</p> <p>93023211 – per pialla 40 – – conf. 6 – € 6,38</p> <p>93023216 – per pialla 50 – – conf. 6 – € 6,38</p> 
<p>PIALLA IN LEGNO con lama in acciaio piana per rifinitura doppia lama</p> <p>74062500 – MISURA 45 MM – – conf. 1 – € 64,00</p> <p>74062600 – MISURA 48 MM – – conf. 1 – € 79,40</p> 	<p>&M 540</p> <p>PIALLA LEGNO 45 mm</p> <p>540302850045 – – conf. 1 – € 32,40</p> 
<p>&M 540</p> <p>SPONDERUOLA in legno con ferro misura: 30mm</p> <p>540302860027 – – conf. 1 – € 17,20</p> 	<p>STANLEY</p> <p>PIALLA - LIMA SURFORM Lungh.310mm</p> <p>7885-21-122 – – conf. 2 – € 38,00</p> 
<p>STANLEY</p> <p>PIALLETTO RB 5 MULTIUSO pialla / sponderuola a lame intercambiabili Base: 150 mm</p> <p>7880-12-105 – misura 150 – – conf. 2 – € 34,60</p> 	<p>MORSETTO per spinatura con tasselli in legno Ø 6 - 8 - 10mm e 3 spaziatori Conf. Scatola</p> <p>74065000 – – conf. 1 – € 34,20</p> 
<p>&M 540</p> <p>MORSETTO per cornici in alluminio 75mm</p> <p>540301854000 – – conf. 4 – € 7,40</p> 	<p>&M 540</p> <p>MORSETTO FISSO</p> <p>540601860040 – Misura 40 mm – – conf. 1 – € 5,40</p> 



<p>&M 930</p>  <p>MORSA ACCIAIO fissa verde</p> <p>93036095 - misura 80 - - conf. 1 - € 41,00</p> <p>93036096 - misura 100 - - conf. 1 - € 45,12</p> <p>93036097 - misura 125 - - conf. 1 - € 73,96</p> <p>93036098 - misura 150 - - conf. 1 - € 92,50</p>	<p>&M 930</p>  <p>MORSA GHISA FISSA 80 mm</p> <p>93036071 - - conf. 1 - € 18,00</p>
<p>&M 540</p>  <p>MORSA ACCIAIO FISSA ROSSA Misura 80 mm</p> <p>540301870080 - misura mm. 80 - - conf. 1 - € 17,90</p>	<p>Gieffe <small>gruppi general ferramenta</small></p>  <p>MORSA BASE FISSA In acciaio</p> <p>512311680N - misura 100 mm - - conf. 1 - € 34,60</p> <p>512311700N - misura 150 mm - - conf. 1 - € 60,58</p>
<p>STANLEY</p>  <p>SET 6 PZ. GIRAVITI ESSENTIAL Manico in TPR (Termo Poli Rock) impermeabile, ignifugo ed isolante Lama al cromo vanadio indurita con trattamento anticorrosione Contenuto: std 5,5x100 - std 6,5x150 parall. 3x75 - PH 0x50 PH 1x100 - PH 2x100</p> <p>788STHT060208 - - conf. 1 - € 14,60</p>	<p>STANLEY</p>  <p>GIRAVITE ESSENTIAL POZIDRIV Manico in TPR (Termo Poli Rock) impermeabile, ignifugo ed isolante Lama al cromo vanadio indurita con trattamento anticorrosione</p> <p>788STHT160274 - Misura Pz 1x100 - - conf. 1 - € 2,20</p> <p>788STHT160276 - Misura Pz 2x100 - - conf. 1 - € 2,80</p>
<p>STANLEY</p>  <p>GIRAVITE ESSENTIAL PHILLIPS Manico in TPR (Termo Poli Rock) impermeabile, ignifugo ed isolante Lama al cromo vanadio indurita con trattamento anticorrosione</p> <p>788STHT160280 - Misura PH 0x50 - - conf. 1 - € 2,48</p> <p>788STHT160308 - Misura PH 1x100 - - conf. 1 - € 2,20</p> <p>788STHT160335 - Misura PH 2x100 - - conf. 1 - € 2,80</p>	<p>STANLEY</p>  <p>GIRAVITE ESSENTIAL STD. Manico in TPR impermeabile, ignifugo ed isolante Lama al cromo vanadio indurita con trattamento anticorrosione</p> <p>788STHT160389 - misura 5,5x100 - - conf. 1 - € 2,80</p> <p>788STHT160413 - misura 6,5x150 - - conf. 1 - € 2,80</p>
<p>ASTRAL</p>  <p>CACCIAVITE TAGLIO Manico antiscivolo lama cromo molibdeno punta magnetizzata</p> <p>190480006 - misura 4 x 80 - - conf. 10 - € 3,40</p> <p>190480009 - misura 5,5 x 100 - - conf. 10 - € 3,80</p> <p>190480010 - misura 5,5 x 150 - - conf. 10 - € 4,20</p> <p>190480012 - misura 6,5 x 150 - - conf. 10 - € 4,60</p> <p>190480015 - misura 8 x 175 - - conf. 10 - € 6,40</p>	<p>&M 540</p>  <p>GIRAVITE A CROCE POZIDRIVE</p> <p>540606145100 - Misura PZ 1x75 - - conf. 1 - € 2,60</p> <p>540606145110 - Misura PZ 2x200 - - conf. 1 - € 2,60</p> <p>540606230251 - Misura PZ 1x25 - - conf. 1 - € 1,80</p> <p>540606230252 - Misura PZ 2x25 - - conf. 1 - € 1,80</p>
<p>&M 540</p>  <p>GIRAVITE A TAGLIO</p> <p>540606210035 - Misura 6x35 - - conf. 1 - € 1,80</p> <p>540606210100 - Misura 4x100 - - conf. 1 - € 1,80</p> <p>540606210125 - Misura 5x125 - - conf. 1 - € 1,80</p> <p>540606210150 - Misura 6x150 - - conf. 1 - € 1,80</p> <p>540606210175 - Misura 8x175 - - conf. 1 - € 1,80</p> <p>540606210200 - Misura 8x200 - - conf. 1 - € 1,80</p>	<p>KRINO</p>  <p>GIRAVITE 6 PEZZI Contiene: PH1X80 PH2X100 PZ1X80 PZ2X100 4,0X100 6,5X150</p> <p>60565006005 - - conf. 1 - € 18,50</p>



&M 540

SET 6 PEZZI CACCIAVITI 2 pz a croce PH1Z75mm PH2x100mm 4 pz a taglio 4x100mm 5x100mm 6x125mm 8x150mm

540606240000 -
- conf. 1 - € 8,00



&M 540

CACCIAVITE MULTIFUNZIONE 2 lame calamitate Lama 1: Taglio 6/Ph2 Lama 2: Taglio 4/Ph1 Funzione a T

540601720000 -
- conf. 6 - € 3,98



ASTRAL

MAGNETIZZATORE Per cacciaviti

190480275 -
- conf. 24 - € 5,40



STANLEY

SET 6 Pz. CACCIAVITE PRECISIONE Taglio a croce

7882-66-039 -
- conf. 6 - € 11,20



SET 12 CACCIAVITI DI PRECISIONE In acciaio Cromo-Vanadio Mandrino in metallo Manico plastica bimat. Impugnatura ergonomica Esagonali 1,5-2 mm TORX T6-7-8-9 PH 0,00-0,0-0,1 Taglio 1,5-2,5-3 mm

740PGT080 -
- conf. 1 - € 10,92



&M 540

SET. PZ.6 CACCIAVITI PRECISIONE Taglio e croce

540301740000 -
- conf. 12 - € 2,00



&M 540

SET 13 PZ. CACCIAVITI DI PRECISIONE Con lama intercambiabile - in valigetta

540W35767 -
- conf. 1 - € 17,80



&M 930

SET 21 PEZZI CACCIAVITE CHIAVE A BUSSOLA Chiavi inglesi 4.0mm - 4.5mm - 5.0mm - 5.5mm - 6.0mm Cacciaviti a croce N.01 - N.02 Chiave esagonale 1.5mm - 2.0mm - 2.5mm Bussole 3.0mm - 3.5mm - 4.0mm - 4.5mm - 5.0mm Cacciavite a taglio 1.0mm - 1.2mm - 1.8mm - 2.4mm - 3.0mm - 3.5mm

93033021 -
- conf. 6 - € 7,80



&M 540

CACCIAVITE A CRICCHETTO 11 IN 1

540301740010 -
- conf. 1 - € 7,80



ASTRAL

CHIAVE FISSA Cromo Vanadio DIN 3110

190011006 - misura 6-7 -
- conf. 10 - € 1,44

190011008 - misura 8-9 -
- conf. 10 - € 1,64

190011014 - misura 14-15 -
- conf. 10 - € 2,88

190011016 - misura 16-17 -
- conf. 10 - € 3,70

190011018 - misura 18-19 -
- conf. 10 - € 4,32

segue...



ASTRAL

continua...

190011020 - misura 20-22 -
- conf. 10 - € 5,76

190011021 - misura 21-23 -
- conf. 5 - € 6,18

190011024 - misura 24-26 -
- conf. 5 - € 7,62

190011025 - misura 25-28 -
- conf. 5 - € 8,66

190011036 - misura 36-41 -
- conf. 1 - € 17,10



&M 930

SERIE 12 PZ. CHIAVI FORCHETTA DOPPIE

93032500 - Misura 6x7 -
- conf. 1 - € 1,94

93032501 - Misura 8x9 -
- conf. 1 - € 2,00

93032502 - Misura 10x11 -
- conf. 1 - € 2,30













93032503 - Misura 12x13 -
- conf. 1 - € 2,60

93032504 - Misura 14x15 -
- conf. 1 - € 3,00

segue...





<p>&M930</p>  <p><i>continua...</i> 93032505 - Misura 16x17 - - conf. 1 - € 3,60 93032506 - Misura 18x19 - - conf. 1 - € 5,00 93032507 - Misura 20x22 - - conf. 1 - € 6,00 93032508 - Misura 21x23 - - conf. 1 - € 7,00 93032509 - Misura 24x26 - - conf. 1 - € 8,00 <i>segue...</i></p>	<p>&M930</p>  <p><i>continua...</i> 93032510 - Misura 25x28 - - conf. 1 - € 9,00 93032511 - Misura 30x32 - - conf. 1 - € 11,00</p>
<p>&M540</p>  <p>CHIAVE DOPPIA FISSA Ø 32 a 27 540606391030 - - conf. 1 - € 11,00</p>	<p>&M540</p>  <p>SERIE 12 PZ. CHIAVI FISSE DA Ø 6 A 32 MM Cromo vanadio 540306390000 - - conf. 1 - € 27,80</p>
<p>&M540</p>  <p>SERIE 8 PZ. CHIAVI FISSE DA Ø 6 A 22 MM Cromo vanadio 540306380000 - - conf. 2 - € 13,40</p>	<p>ASTRAL</p>  <p>CHIAVE COMBINATA Cromo Vanadio DIN 3110 A 190011106 - misura 6 - - conf. 10 - € 1,00 190011107 - misura 7 - - conf. 10 - € 1,00 190011108 - misura 8 - - conf. 10 - € 1,00 190011109 - misura 9 - - conf. 10 - € 1,00 190011111 - misura 11 - - conf. 10 - € 2,00 <i>segue...</i></p>
<p>ASTRAL</p>  <p><i>continua...</i> 190011112 - misura 12 - - conf. 10 - € 2,00 190011114 - misura 14 - - conf. 5 - € 2,00 190011115 - misura 15 - - conf. 5 - € 2,00 190011116 - misura 16 - - conf. 5 - € 2,00 190011117 - misura 17 - - conf. 5 - € 2,00 <i>segue...</i></p>	<p>ASTRAL</p>  <p><i>continua...</i> 190011118 - misura 18 - - conf. 5 - € 2,98 190011119 - misura 19 - - conf. 5 - € 2,98 190011120 - misura 20 - - conf. 5 - € 2,98 190011122 - misura 22 - - conf. 5 - € 2,98 190011123 - misura 23 - - conf. 5 - € 2,98 <i>segue...</i></p>
<p>ASTRAL</p>  <p><i>continua...</i> 190011125 - misura 25 - - conf. 5 - € 4,58 190011126 - misura 26 - - conf. 5 - € 4,58 190011128 - misura 28 - - conf. 5 - € 6,00</p>	<p>&M540</p>  <p>SERIE 12 PZ. CHIAVI COMBINATE DA Ø 6 A 22 MM Cromo vanadio 540306400000 - - conf. 1 - € 12,16</p>
<p>ASTRAL</p>  <p>CHIAVE POLIGONALE Cromo Vanadio DIN 838 190011206 - misura 6-7 - - conf. 5 - € 2,00 190011208 - misura 8-9 - - conf. 5 - € 2,00 190011210 - misura 10-11 - - conf. 5 - € 2,00 190011212 - misura 12-13 - - conf. 10 - € 2,00 190011214 - misura 14-15 - - conf. 10 - € 3,00 <i>segue...</i></p>	<p>ASTRAL</p>  <p><i>continua...</i> 190011216 - misura 16-17 - - conf. 10 - € 3,00 190011218 - misura 18-19 - - conf. 10 - € 3,00 190011220 - misura 20-22 - - conf. 5 - € 3,00</p>



&M 540

CHIAVE COMBINATA A CRICCHETTO

- 540600483008 – Misura 8 –
– conf. 3 – € 8,80
- 540600483010 – Misura 10 –
– conf. 3 – € 9,60
- 540600483013 – Misura 13 –
– conf. 3 – € 11,00
- 540600483015 – Misura 15 –
– conf. 3 – € 11,60



&M 540

CHIAVE A RULLINO

- 540300071200 – Misura 200 mm –
– conf. 6 – € 6,40



GIEFFE
gruppi general ferramenta

CHIAVE A RULLINO In acciaio forgiato

- 512311640N – misura 10'' –
– conf. 10 – € 8,96
- 512311650N – misura 15'' –
– conf. 10 – € 12,56



GIEFFE
gruppi general ferramenta

CHIAVI PER BOMBOLE GAS 25 mm

- 512311570N –
– conf. 10 – € 2,00



&M 930

CHIAVE A TUBO diritta con foro passante

- 93032730 – misura 6x7 –
– conf. 10 – € 1,14
- 93032731 – misura 8x9 –
– conf. 10 – € 1,18
- 93032732 – misura 10x11 –
– conf. 10 – € 1,32
- 93032733 – misura 12x13 –
– conf. 10 – € 1,50
- 93032734 – misura 14x15 –
– conf. 10 – € 1,70



segue...

&M 930

continua...

- 93032735 – misura 16x17 –
– conf. 10 – € 1,76
- 93032736 – misura 18x19 –
– conf. 5 – € 2,20
- 93032737 – misura 20x22 –
– conf. 5 – € 2,40
- 93032738 – misura 21x23 –
– conf. 5 – € 2,60



&M 540

SERIE 3 CHIAVI A TUBO DIRITTE CON SPINA

- 540300350002 – Misura 6x7 – 8x9 – 10x11 –
– conf. 3 – € 3,80
- 540300350003 – Misura 10x11 – 12x13 – 14x1 –
– conf. 3 – € 4,60
- 540300350004 – Misura 16x17 – 18x19 – 20x2 –
– conf. 3 – € 5,00



&M 540

CHIAVI A TUBO CURVE 4pz Misura 14/19

- 540300340003 –
– conf. 1 – € 8,00



&M 540

CHIAVI A TUBO CURVE A pz Misura 8/13

- 54030034002 –
– conf. 1 – € 7,00



ASTRAL

CHIAVI A TUBO DOPPIE PESANTI – DIRITTE cromo vanadio satinato

- 190011804 – misura 14 x 15 –
– conf. 6 – € 6,00
- 190011806 – misura 18 x 19 –
– conf. 6 – € 7,60
- 190011807 – misura 20 x 22 –
– conf. 6 – € 8,20



&M 930

ASTA DI MANOVRA PER CHIAVI A TUBO

- 93032744 –
– conf. 1 – € 1,82













&M 540

CHIAVE A "T" SNODATA Cromo vanadio satinato

- 540600410010 – Misura 10 –
– conf. 1 – € 9,80





  <p>CHIAVE FISSA In cromo vanadio satinato</p> <p>512311210N - misura 10X11 - - conf. 25 - € 1,84</p> <p>512311220N - misura 12X13 - - conf. 25 - € 2,38</p>	  <p>CHIAVE COMBINATA In cromo vanadio satinato</p> <p>512311330N - misura 10 mm - - conf. 25 - € 2,60</p> <p>512311360N - misura 13 mm - - conf. 25 - € 3,20</p>
  <p>CHIAVE A "T" SNODATA cromo vanadio satinato</p> <p>190011906 - misura 6 - - conf. 5 - € 10,68</p> <p>190011907 - misura 7 - - conf. 5 - € 10,68</p> <p>190011908 - misura 8 - - conf. 5 - € 10,68</p> <p>190011909 - misura 9 - - conf. 5 - € 10,68</p> <p>190011911 - misura 11 - - conf. 5 - € 11,40</p> <p>segue...</p>	  <p>continua...</p> <p>190011912 - misura 12 - - conf. 5 - € 11,40</p> <p>190011914 - misura 14 - - conf. 5 - € 12,48</p> <p>190011915 - misura 15 - - conf. 5 - € 15,00</p> <p>190011916 - misura 16 - - conf. 5 - € 15,00</p> <p>190011917 - misura 17 - - conf. 5 - € 15,00</p> <p>segue...</p>
  <p>continua...</p> <p>190011918 - misura 18 - - conf. 5 - € 15,00</p> <p>190011919 - misura 19 - - conf. 5 - € 18,72</p>	  <p>CHIAVE A CROCE PER AUTO Misura: 17x19x21x22</p> <p>512311470N - - conf. 20 - € 9,84</p>
  <p>CHIAVE A IMPRONTA Con triangolo Per serrature ecologiche</p> <p>690SCHD05812 - - conf. 5 - € 3,70</p>	  <p>BUSSOLA ESAGONALE 1/4" cromo vanadio satinato</p> <p>60564008005 - misura 4 - lunghezza 25 - - conf. 4 - € 2,20</p> <p>60564008010 - misura 4,5 - lunghezza 25 - - conf. 4 - € 2,20</p> <p>60564008015 - misura 5 - lunghezza 25 - - conf. 4 - € 2,20</p> <p>60564008020 - misura 5,5 - lunghezza 25 - - conf. 4 - € 2,20</p> <p>60564008025 - misura 6 - lunghezza 25 - - conf. 4 - € 2,20</p> <p>segue...</p>
  <p>continua...</p> <p>60564008030 - misura 7 - lunghezza 25 - - conf. 4 - € 2,20</p> <p>60564008035 - misura 8 - lunghezza 25 - - conf. 4 - € 2,20</p> <p>60564008040 - misura 9 - lunghezza 25 - - conf. 4 - € 2,20</p> <p>60564008045 - misura 10 - lunghezza 25 - - conf. 4 - € 2,40</p> <p>60564008050 - misura 11 - lunghezza 25 - - conf. 4 - € 2,60</p> <p>segue...</p>	  <p>continua...</p> <p>60564008055 - misura 12 - lunghezza 25 - - conf. 4 - € 2,60</p> <p>60564008060 - misura 13 - lunghezza 25 - - conf. 4 - € 3,00</p> <p>60564008065 - misura 14 - lunghezza 25 - - conf. 4 - € 3,00</p>
  <p>BUSSOLA ESAGONALE 3/8" cromo vanadio satinato</p> <p>60564026005 - misura 7 - lunghezza 28 - - conf. 4 - € 3,40</p> <p>60564026010 - misura 8 - lunghezza 28 - - conf. 4 - € 3,40</p> <p>60564026015 - misura 10 - lunghezza 28 - - conf. 4 - € 3,40</p> <p>60564026020 - misura 11 - lunghezza 28 - - conf. 4 - € 3,40</p> <p>60564026025 - misura 12 - lunghezza 28 - - conf. 4 - € 3,40</p> <p>segue...</p>	  <p>continua...</p> <p>60564026030 - misura 13 - lunghezza 28 - - conf. 4 - € 3,40</p> <p>60564026035 - misura 14 - lunghezza 28 - - conf. 4 - € 3,40</p> <p>60564026040 - misura 15 - lunghezza 28 - - conf. 4 - € 3,60</p> <p>60564026045 - misura 17 - lunghezza 30 - - conf. 4 - € 4,20</p> <p>60564026050 - misura 19 - lunghezza 30 - - conf. 4 - € 4,40</p> <p>segue...</p>



<p>KRINO</p> <p><i>continua...</i> 60564026055 - misura 21 - lunghezza 32 - - conf. 4 - € 4,80 60564026060 - misura 22 - lunghezza 32 - - conf. 4 - € 5,60</p> 	<p>ASTRAL</p> <p>SUPER PROFESIONAL BUSSOLA ESAGONALE 1/2" cromo vanadio satinato</p> <p>190011510 - Misura 10 - - conf. 4 - € 2,00 190011511 - Misura 11 - - conf. 4 - € 2,00 190011512 - Misura 12 - - conf. 4 - € 2,00 190011514 - Misura 14 - - conf. 4 - € 2,00 190011515 - Misura 15 - - conf. 4 - € 2,00 <i>segue...</i></p> 
<p>ASTRAL</p> <p><i>continua...</i> 190011516 - Misura 16 - - conf. 4 - € 2,00 190011518 - Misura 18 - - conf. 4 - € 2,00 190011520 - Misura 20 - - conf. 4 - € 2,00 190011521 - Misura 21 - - conf. 4 - € 2,00 190011522 - Misura 22 - - conf. 4 - € 2,00 <i>segue...</i></p> 	<p>ASTRAL</p> <p><i>continua...</i> 190011523 - Misura 23 - - conf. 4 - € 2,00 190011524 - Misura 24 - - conf. 4 - € 2,00 190011525 - Misura 25 - - conf. 4 - € 4,00 190011526 - Misura 26 - - conf. 4 - € 4,00 190011527 - Misura 27 - - conf. 4 - € 4,00 <i>segue...</i></p> 
<p>ASTRAL</p> <p><i>continua...</i> 190011528 - Misura 28 - - conf. 4 - € 4,00 190011529 - Misura 29 - - conf. 4 - € 4,00 190011532 - Misura 32 - - conf. 4 - € 4,00</p> 	<p>ASTRAL</p> <p>RIDUTTORI PER BUSSOLE</p> <p>190011560 - F. - M. 1/2-3/4 - - conf. 1 - € 5,56 190011561 - F. - M. 1/4-3/8 - - conf. 1 - € 1,92 190011563 - F. - M. 3/8-1/2 - - conf. 1 - € 2,48 190011564 - F. - M. 3/4-1/2 - - conf. 1 - € 8,86</p> 
<p>ASTRAL</p> <p>BUSSOLA ESAGONALE 3/8" Cromo vanadio satinato</p> <p>190011470 - misura 6 - - conf. 4 - € 2,88 190011473 - misura 9 - - conf. 4 - € 2,88 190011480 - misura 16 - - conf. 4 - € 3,10 190011482 - misura 18 - - conf. 4 - € 3,92 190011484 - misura 20 - - conf. 4 - € 4,32</p> 	<p>KRINO</p> <p>BUSSOLA MAGNETICA Attacco 1/4"</p> <p>60563004020 - Misura 7x45 - - conf. 5 - € 2,80 60563004030 - Misura 8x45 - - conf. 5 - € 1,90 60563004040 - Misura 10x45 - - conf. 5 - € 2,20 60563004060 - Misura 13x45 - - conf. 5 - € 2,60</p> 
<p>KRINO</p> <p>SET 6 BUSSOLE MAGNETICHE Ø 5,5 - 6 - 7 - 8 - 10 - 13 mm</p> <p>60563600005 - - conf. 1 - € 9,60</p> 	<p>M&M 540</p> <p>CRICCHETTO REVERSIBILE 1/2" cromo vanadio satinato Manico anatomico bimat.</p> <p>540300483000 - - conf. 6 - € 14,20</p> 
<p>KRINO</p> <p>CRICCHETTO REVERSIBILE cromo vanadio satinato Lunghezza 145 mm</p> <p>60564221005 - Attacco 1/4 - - conf. 2 - € 26,00 60564223005 - Attacco 3/8 - - conf. 2 - € 27,80</p> 	<p>ASTRAL</p> <p>LEVA A T SCORREVOLE cromo vanadio satinato</p> <p>190011454 - Attacco 1/4 - Lungh. 108 - - conf. 2 - € 6,80 190011494 - Attacco 3/8 - Lungh. 165 - - conf. 2 - € 8,86 190011550 - Attacco 1/2 - Lungh. 250 - - conf. 2 - € 12,78</p> 



<p>ASTRAL</p> <p>SNODO cromo vanadio satinato</p> <p>190011455 – Attacco 1/4 – – conf. 2 – € 4,00</p> <p>190011495 – Attacco 3/8 – – conf. 2 – € 4,00</p> <p>190011555 – Attacco 1/2 – – conf. 2 – € 4,00</p> 	<p>ASTRAL</p> <p>CHIAVE PER CANDELA Cromo vanadio</p> <p>190011557 – misura 21 mm – – conf. 1 – € 4,00</p> 
<p>KRINO</p> <p>PROLUNGA cromo vanadio satinato</p> <p>60562173005 – Attacco 1/4 – Lungh. 50 – – conf. 2 – € 3,20</p> <p>60562173010 – Attacco 1/4 – Lungh. 150 – – conf. 2 – € 4,40</p> <p>60562185010 – Attacco 3/8 – Lungh. 150 – – conf. 2 – € 8,40</p> 	<p>ASTRAL</p> <p>PROLUNGA cromo vanadio satinato</p> <p>190011492 – Attacco 3/8 – Lungh. 75 – – conf. 2 – € 5,98</p> <p>190011546 – Attacco 1/2 – Lungh. 250 – – conf. 2 – € 11,34</p> 
<p>ASTRAL</p> <p>CACCIAVITE BUSSOLA Lungh. 125 mm cromo vanadio satinato</p> <p>190011630 – misura 4 – – conf. 2 – € 3,60</p> <p>190011636 – misura 9 – – conf. 2 – € 4,32</p> <p>190011638 – misura 11 – – conf. 2 – € 4,80</p> <p>190011639 – misura 12 – – conf. 2 – € 4,80</p> <p>190011641 – misura 14 – – conf. 2 – € 4,80</p> <p>segue...</p> 	<p>ASTRAL</p> <p>continua...</p> <p>540600380007 – misura 7 – – conf. 2 – € 4,32</p> <p>540600380008 – misura 8 – – conf. 2 – € 4,32</p> <p>540600380010 – misura 10 – – conf. 2 – € 4,80</p> 
<p>ASTRAL</p> <p>CACCIAVITE BUSSOLA Lunghezza 125 mm</p> <p>190011632 – – conf. 1 – € 6,60</p> 	<p>KRINO</p> <p>CASSETTA 108 PZ. CRICCHETTI E BUSSOLE 1/4" E 1/2"</p> <p>60564230030 – – conf. 1 – € 126,60</p> 
<p>KRINO</p> <p>SET 30 PZ. UTENSILI MANUALI IN ASTUCCIO NYLON Il kit comprende: 8 Giraviti – 6 Chiavi fisse 9 Chiavi a brugola esagonali 1 Cacciavite tester 250V 2 Pinze – 1 Chiave a rullino 1 Cutter – 1 Martello manico fibra 1 Flessometro 3 mt 1 Pinza becchi mezzi tondi 1 Nastro isolante nero</p> <p>60564230510 – – conf. 1 – € 68,20</p> 	<p>KRINO</p> <p>VALIGETTA 127 PZ SET BUSSOLE UTENSILI MANUALI 1/4" E 1/2" Utensili manuali, pinze, giraviti, pinza per capicorda, martello, archetto, livella, metro, forbice per elettricista. Valigetta in alluminio Misure: 470x150x360 mm</p> <p>60564230299 – – conf. 1 – € 167,00</p> 
<p>KRINO</p> <p>VALIGETTA 55 PZ ASSORTIMENTO UTENSILI MANUALI, BUSSOLE E ACCESSORI 1/4" E 1/2" Utensili manuali, pinze, giraviti, martello, 6 chiavi combinate. Misura: 350x80x330 mm</p> <p>60564230340 – – conf. 1 – € 73,00</p> 	<p>KRINO</p> <p>VALIGETTA 89 PZ ASSORTIMENTO UTENSILI MANUALI, BUSSOLE E ACCESSORI 1/4" E 1/2" Utensili manuali, pinze, giraviti, martello, archetto, forbice per elettricista, set chiavi maschio, chiavi combinate. Misura: 440x100x350 mm</p> <p>60564230320 – – conf. 1 – € 99,90</p> 



UTENSILI

&M540

CASSETTA CHIAVI A BUSSOLA 17 pezzi cromo vanadium

540300520000 -
- conf. 3 - **€ 5,00**



&M540

CASSETTA CHIAVI A BUSSOLA 40 pezzi cromo vanadium

540300530000 -
- conf. 3 - **€ 9,80**



KRINO

ESPOSITORE 24 PZ. IN PLEXIGLASS CHIAVI A BUSSOLA MAGNETICHE Contenuto: Misura 7 - 6 pz. Misura 8 - 6 pz. Misura 10 - 6 pz. Misura 13 - 6 pz.

60563600016 -
- conf. 1 - **€ 79,20**



KRINO

ESPOSITORE 12 PZ. GIRAVITE NANO 5 IN 1 Lama magnetica 60 mm Phillips 0,1,2,3 Utilizzabile anche su Pozidriv Taglio 6x1

60565006030 -
- conf. 1 - **€ 76,00**



KRINO

ESPOSITORE 12 PZ. GIRAVITE 5 IN 1 5 impronte in un solo giravite CROCE 0 - 1 - 2 - 3 TAGLIO 6 mm Punta magnetica Misura espositore: 180x280x140 mm

60565006035 -
- conf. 1 - **€ 104,40**



KRINO

ESPOSITORE 12 PZ. GIRAVITE A CRICCHETTO REVERSIBILE NANO PH1 - PH2 TAGLIO 6 - 7 mm PZ1 - PZ2 Misura espositore: 200x230x155 mm

60565006045 -
- conf. 1 - **€ 84,00**



&M540

SET 8 PZ. CHIAVI A BRUGOLA 2 - 2,5 - 3 - 4 - 5 - 6 - 8 - 10

540300294000 -
- conf. 1 - **€ 3,20**



540300294000

Set 8 pz. CHIAVE BRUGOLA 1,5 - 2 - 2,5 - 3 - 4 - 5 - 5,5 - 6

74094600 -
- conf. 10 - **€ 3,80**



54094650

Set 10 pz CHIAVE BRUGOLA 1,5 - 2 - 2,5 - 3 - 4 - 5 - 5,5 - 6 - 8 - 10

74094650 -
- conf. 10 - **€ 7,20**



54094700

SET 8 pezzi CHIAVE TORX 9 - 10 - 15 - 20 - 25 - 27 - 30 - 40

74094700 -
- conf. 10 - **€ 6,00**



ASTRAL

CHIAVE TORX CON FORO cromo vanadio Satinato

190011680 - T 6 -
- conf. 10 - **€ 1,68**
190011681 - T 7 -
- conf. 10 - **€ 1,68**
190011682 - T 8 -
- conf. 10 - **€ 1,88**
190011683 - T 9 -
- conf. 10 - **€ 1,88**
190011684 - T 10 -
- conf. 10 - **€ 2,00**
segue...















ASTRAL

continua...

190011687 - T 25 -
- conf. 10 - **€ 2,20**
190011688 - T 27 -
- conf. 10 - **€ 2,30**
190011689 - T 30 -
- conf. 5 - **€ 2,60**
190011694 - T 60 -
- conf. 5 - **€ 12,20**





<p>ASTRAL</p> <p>CHIAVE BRUGOLA cromo vanadio Satinato</p> <p>190011654 – Misura 4 – – conf. 20 – € 0,46</p> <p>190011655 – Misura 4,5 – – conf. 20 – € 0,50</p> <p>190011656 – Misura 5 – – conf. 20 – € 0,62</p> <p>190011660 – Misura 9 – – conf. 10 – € 1,46</p> <p>190011661 – Misura 10 – – conf. 10 – € 1,88</p> <p>segue...</p> 	<p>ASTRAL</p> <p>continua...</p> <p>190011663 – Misura 14 – – conf. 2 – € 6,04</p> <p>190011664 – Misura 17 – – conf. 2 – € 9,40</p> <p>190011665 – Misura 19 – – conf. 2 – € 13,00</p> 
<p>KRINO</p> <p>SET 9 PZ. CHIAVI EXTRA LUNGHE</p> <p>60565101003 – Tipo Esagonali 1,5 a 10 – – conf. 1 – € 13,60</p> <p>60565101013 – Tipo Ball Point 1,5 a 10 – – conf. 1 – € 10,20</p> <p>60565101043 – Tipo Torx TXH10 a TXH50 – – conf. 1 – € 19,20</p> 	<p>KRINO</p> <p>SET 9 PZ. CHIAVI CORTE</p> <p>60565101001 – Tipo Esagonali 1,5 a 10 – – conf. 1 – € 6,20</p> <p>60565101011 – Tipo Ball Point 1,5 a 10 – – conf. 1 – € 6,60</p> <p>60565101041 – Tipo Torx foro 1,5 a 10 – – conf. 1 – € 7,40</p> 
<p>M&T 900</p> <p>KIT 3 PZ. CHIAVE UNIVERSALE SVITA TUTTO JOKER i 54 denti in acciaio ad altissima resistenza si adattano a qualsiasi forma fino a 19 mm, formando una presa a 360° Profondità di aggancio 15 mm Il kit contiene: un cricchetto, una bussola a 54 denti, un inserto per avvitatore Made in U.S.A</p> <p>90040570 – – conf. 1 – € 36,80</p> 	<p>KRINO</p> <p>PORTAFILIERE REGOLABILE</p> <p>6051503001 – Ø mm 25.4 – – conf. 3 – € 6,40</p> <p>6051503002 – Ø mm 38.1 – – conf. 3 – € 8,80</p> 
<p>KRINO</p> <p>GIRAMASCHI ESTENSIBILE</p> <p>6051500101 – n° 1 – – conf. 3 – € 8,20</p> <p>6051500102 – n° 2 – – conf. 3 – € 13,40</p> 	<p>KRINO</p> <p>SERIE 3 MASCHI A MANO HSS</p> <p>6051000103 – Ø 3 – – conf. 5 – € 3,80</p> <p>6051000104 – Ø 4 – – conf. 5 – € 3,80</p> <p>6051000105 – Ø 5 – – conf. 5 – € 4,00</p> <p>6051000106 – Ø 6 – – conf. 5 – € 4,00</p> <p>6051000108 – Ø 8 – – conf. 5 – € 5,00</p> <p>segue...</p> 
<p>KRINO</p> <p>continua...</p> <p>6051000110 – Ø 10 – – conf. 5 – € 6,60</p> <p>6051000112 – Ø 12 – – conf. 3 – € 8,40</p> <p>6051000107 – Ø 7 – – conf. 5 – € 6,40</p> <p>6051000109 – Ø 9 – – conf. 5 – € 8,40</p> 	<p>KRINO</p> <p>GIRAMASCHIO GOODEL SERIE CORTA Art. 15005</p> <p>6051500501 – Gr. n° 1 – M 3 – 5 – Lungh. 62 – – conf. 1 – € 6,00</p> <p>6051500502 – Gr. n° 2 – M 6 – 10 – Lungh. 78 – – conf. 1 – € 7,60</p> 
<p>KRINO</p> <p>GIRAMASCHIO A CRICCHETTO REVERSIBILE In acciaio Serie corta</p> <p>6051501001 – Gr. 1 – – conf. 1 – € 14,00</p> <p>6051501002 – Gr. 2 – – conf. 1 – € 16,80</p> 	<p>KRINO</p> <p>MASCHIO UNICO CON GAMBO RINFORZATO Art. 10174</p> <p>6051017403 – gr. n° 3 – Lungh 56 – – conf. 1 – € 12,80</p> <p>6051017404 – gr. n° 4 – Lungh 63 – – conf. 1 – € 13,00</p> <p>6051017405 – gr. n° 5 – Lungh 70 – – conf. 1 – € 13,20</p> <p>6051017406 – gr. n° 6 – Lungh 80 – – conf. 1 – € 13,60</p> <p>6051017408 – gr. n° 8 – Lungh 90 – – conf. 1 – € 15,00</p> <p>segue...</p> 















 <p>KRINO <i>continua...</i> 6051017410 - gr. n° 10 - Lungh 100 - - conf. 1 - € 17,80</p>	 <p>KRINO ASSORTIMENTO 31 PZ. BITS + PORTA INSERTO MEGNETICO A SGANCIO RAPIDO 60566009005 - - conf. 1 - € 16,40</p>
 <p>KRINO ASSORTIMENTO 26 BITS + GIRAVITE A CRICCHETTO Inserti e bussole 1/4" 60566012006 - - conf. 1 - € 24,60</p>	 <p>KRINO MINI ESPOSITORE 12 SET. INSERTI TORSION Composizione singolo set: 9 inserti + portainserito PH1 - PH2 - PH3 PZ1 - PZ2 - PZ3 TX20 - TX25 - TX30 Misura espositore: 150x40x195 mm 60566005304 - - conf. 1 - € 230,00</p>
 <p>KRINO CASSETTA 138 BITS + BUSSOLE impugnatura cacciavite 60566014015 - - conf. 1 - € 23,00</p>	 <p>STANLEY SET 29 PZ. PORTAINSERTI A CRICCHETTO + BUSSOLE E INSERTI Composto da inserti punte standard, Philips, Torx, esagonali, bussole esagonali, adattatore, giravite portainseriti e cricchetto 7880-54-925 - - conf. 1 - € 20,80</p>
 <p>KIT 18 PZ. CUTTER PRECISIONE Impugnatura bi-materiale antiscivolo con attacco rapido delle lame Contiene: -14 lame assortite -1 cacciavite -1 pinza 740M8790 - - conf. 1 - € 20,40</p>	 <p>KIT 17 PZ. RIPARAZIONE SMARTPHONE E PC Contiene: -1 cacciavite di precisione -1 ventosa per display -2 sollevatori in plastica -1 estrattore di sim card -12 inserti di precisione: Phillips: PH00-PH000 Taglio: 1,2 Torx: T4-T5-T6-T7-T8-T10 Pentalobo: 0,8-2,0 Triangolo: 2,0 740PG17A - - conf. 1 - € 10,50</p>
 <p>KIT 32 INSERTI ASSORITI Con porta inserti magnetico ad attacco rapido e adattatore per bussole 740PG32A - - conf. 1 - € 14,84</p>	 <p>PORTAINSERTI magnetico attacco ch. 1/4 74045200 - - conf. 10 - € 4,60</p>
 <p>BLISTER 2 Pz. INSERTI TORX 74045240 - torx n° T10 - - conf. 10 - € 3,20 74045250 - torx n° T15 - - conf. 10 - € 3,20 74045260 - torx n° T20 - - conf. 10 - € 3,20 74045270 - torx n° T25 - - conf. 10 - € 3,20 74045280 - torx n° T30 - - conf. 10 - € 3,20 74045290 - torx n° T40 - - conf. 10 - € 3,20</p>	 <p>BLISTER 2 Pz. INSERTI BRUGOLA 74045300 - brug. n° 2 - - conf. 10 - € 3,00 74045310 - brug. n° 2,5 - - conf. 10 - € 3,00 74045320 - brug. n° 3 - - conf. 10 - € 3,00 74045330 - brug. n° 4 - - conf. 10 - € 3,00 74045340 - brug. n° 5 - - conf. 10 - € 3,00 74045350 - brug. n° 6 - - conf. 10 - € 3,00</p>















 <p>BLISTER 2 Pz. INSERTI PHILLIPS</p> <p>74045400 – misura PH 1 – pz.x conf. 2 – – conf. 10 – € 2,20</p> <p>74045500 – misura PH 2 – pz.x conf. 2 – – conf. 10 – € 2,20</p> <p>74045600 – misura PH 3 – pz.x conf. 2 – – conf. 10 – € 2,20</p> <p>74045620 – misura PH 4 – pz.x conf. 1 – – conf. 10 – € 3,00</p>	 <p>BLISTER 2 Pz. INSERTI POZIDRIVE</p> <p>74046000 – misura PZ 1 – pz.xconf. 2 – – conf. 10 – € 2,40</p> <p>74046010 – misura PZ 2 – pz.xconf. 2 – – conf. 10 – € 2,40</p> <p>74046030 – misura PZ 4 – pz.xconf. 1 – – conf. 10 – € 3,20</p>
 <p>BLISTER 2 Pz. INSERTI A TAGLIO</p> <p>74045700 – taglio 0,8x4 – – conf. 10 – € 2,80</p> <p>74045800 – taglio 0,8x5 – – conf. 10 – € 2,80</p> <p>74045900 – taglio 1,0x6 – – conf. 10 – € 2,80</p> <p>74045920 – taglio 1,2x7,2 – – conf. 10 – € 2,80</p> <p>74045940 – taglio 1,6x8 – – conf. 10 – € 2,80</p>	 <p>INSERTO LUNGO Taglio 4 Croce PH 1</p> <p>74046100 – – conf. 10 – € 1,78</p>
 <p>INSERTO LUNGO Taglio 5 Croce PH 2</p> <p>74046200 – – conf. 10 – € 1,78</p>	 <p>INSERTO LUNGO Taglio 7,2 Croce PH 3</p> <p>74046250 – – conf. 10 – € 1,78</p>
 <p>SET. 7 Pz. INSERTI PORTAININSERTI 1/4 PH 1 – PH 2 PZ 1 – PZ 2 0,8x4 – 0,8x5</p> <p>74046300 – – conf. 5 – € 11,00</p>	 <p>SET. 7 Pz. INSERTI TORX PORTAININSERTI 1/4 T 10 – T 15 – T20 T 25 – T 30 – T 40</p> <p>74046350 – – conf. 5 – € 12,60</p>
 <p>SET. 10 Pz. INSERTI MISTI PORTAININSERTI 1/4 PH 1 – PH 2 – PH 3 PZ 1 – PZ 2 – PZ 3 0,8x4 – 0,8x5 – 1,0x6</p> <p>74046400 – – conf. 12 – € 16,60</p>	 <p>CONFEZIONE 10 PZ. INSERTI PHILLIPS 1/4" impronta fresata</p> <p>60561043010 – Mod. PH1 – Ø x L 4,5x25 – – conf. 1 – € 5,80</p> <p>60561043020 – Mod. PH2 – Ø x L 6x25 – – conf. 1 – € 5,80</p> <p>60561043030 – Mod. PH3 – Ø x L 6x25 – – conf. 1 – € 5,80</p>
 <p>BLISTER 10 Pz. INSERTO PHILLIPS cromo vanadio 1/4" – Lungh. 25</p> <p>60561048005 – lungh. PH-1 – – conf. 1 – € 7,20</p> <p>60561048025 – lungh. PH-3 – – conf. 1 – € 7,20</p>	 <p>CONFEZIONE 10 PZ. INSERTI TORSION PHILLIPS 1/4" Esclusivo design che permette di disperdere lo sforzo di torsione lungo tutto l'utensile</p> <p>60561058005 – Ø x L 1x25 – – conf. 1 – € 10,00</p> <p>60561058010 – Ø x L 2x25 – – conf. 1 – € 10,00</p> <p>60561058015 – Ø x L 3x25 – – conf. 1 – € 10,00</p>



<p>ASTRAL</p> <p>BLISTER 10 Pz. INSERTI PHILLIPS TITANIO 1/4" - Lungh. 25</p> <p>190480502 - mod. PH-1 - - conf. 1 - € 9,68</p> <p>190480506 - mod. PH-3 - - conf. 1 - € 9,68</p> 	<p>KRINO</p> <p>BLISTER 10 Pz. INSERTI PHILLIPS cromo vanadio 1/4" - Lungh. 50</p> <p>60561056030 - mod. PH-1 - - conf. 1 - € 16,20</p> <p>60561056040 - mod. PH-3 - - conf. 1 - € 17,80</p> 
<p>KRINO</p> <p>CONFEZIONE 5 PZ INSERTI TORSION PHILLIPS 1/4" serie lunga Esclusivo design che permette di disperdere lo sforzo di torsione lungo tutto l'utensile</p> <p>60561059005 - Ø x L 1x50 - - conf. 1 - € 13,60</p> <p>60561059010 - Ø x L 2x50 - - conf. 1 - € 13,60</p> <p>60561059015 - Ø x L 3x50 - - conf. 1 - € 13,60</p> 	<p>KRINO</p> <p>CONFEZIONE 10 PZ. INSERTI POZIDRIV 1/4" impronta fresata</p> <p>60561069010 - Mod. PZ1 - Ø x L 4,5x25 - - conf. 1 - € 6,00</p> <p>60561069020 - Mod. PZ2 - Ø x L 6x25 - - conf. 1 - € 6,00</p> <p>60561069030 - Mod. PZ3 - Ø x L 6x25 - - conf. 1 - € 6,00</p> 
<p>KRINO</p> <p>BLISTER 10 Pz. INSERTO POZIDRIVE cromo vanadio 1/4" - Lungh. 25</p> <p>60561069040 - lungh. PZ 4 - - conf. 1 - € 11,80</p> <p>60561073005 - lungh. PZ-1 - - conf. 1 - € 7,20</p> <p>60561073025 - lungh. PZ-3 - - conf. 1 - € 7,20</p> 	<p>KRINO</p> <p>CONFEZIONE 10 PZ INSERTI TORSION POZIDRIV 1/4" Esclusivo design che permette di disperdere lo sforzo di torsione lungo tutto l'utensile</p> <p>60561083005 - Ø x L 1x25 - - conf. 1 - € 10,00</p> <p>60561083010 - Ø x L 2x25 - - conf. 1 - € 10,00</p> <p>60561083015 - Ø x L 3x25 - - conf. 1 - € 10,00</p> 
<p>KRINO</p> <p>CONFEZIONE 5 PZ INSERTI TORSION POZIDRIV 1/4" serie lunga Esclusivo design che permette di disperdere lo sforzo di torsione lungo tutto l'utensile</p> <p>60561084005 - Ø x L 1x50 - - conf. 1 - € 13,80</p> <p>60561084010 - Ø x L 2x50 - - conf. 1 - € 13,80</p> <p>60561084015 - Ø x L 3x50 - - conf. 1 - € 13,80</p> 	<p>ASTRAL</p> <p>BLISTER 10 Pz. INSERTI POZIDRIVE TITANIO 1/4" - Lungh. 25</p> <p>190480522 - mod. PZ-1 - - conf. 1 - € 10,72</p> <p>190480526 - mod. PZ-3 - - conf. 1 - € 9,68</p> 
<p>KRINO</p> <p>INSERTI POZIDRIVE cromo vanadio 1/4" - Lungh. 50 190480622 - 271880 in blister da 5 pezzi 190480626 - 271908 in blister da 10 pezzi</p> <p>60561082030 - Mod. PZ-1 - - conf. 1 - € 16,20</p> <p>60561082040 - Mod. PZ-3 - - conf. 1 - € 17,80</p> 	<p>KRINO</p> <p>CONFEZIONE 10 PZ INSERTI TORSION TORX 1/4" Esclusivo design che permette di disperdere lo sforzo di torsione lungo tutto l'utensile</p> <p>60561103005 - Ø x L T10x25 - - conf. 1 - € 11,40</p> <p>60561103010 - Ø x L T15x25 - - conf. 1 - € 11,40</p> <p>60561103015 - Ø x L T20x25 - - conf. 1 - € 11,40</p> <p>60561103020 - Ø x L T25x25 - - conf. 1 - € 11,40</p> <p>segue...</p> 
<p>KRINO</p> <p>continua...</p> <p>60561103030 - Ø x L T30x25 - - conf. 1 - € 11,40</p> <p>60561103035 - Ø x L T40x25 - - conf. 1 - € 11,40</p> 	<p>KRINO</p> <p>CONFEZIONE 5 PZ INSERTI TORSION TORX 1/4" serie lunga Esclusivo design che permette di disperdere lo sforzo di torsione lungo tutto l'utensile</p> <p>60561104005 - Ø x L T10x50 - - conf. 1 - € 20,00</p> <p>60561104010 - Ø x L T15x50 - - conf. 1 - € 20,00</p> <p>60561104015 - Ø x L T20x50 - - conf. 1 - € 20,00</p> <p>60561104020 - Ø x L T25x50 - - conf. 1 - € 20,00</p> <p>segue...</p> 



<p>KRINO</p> <p>continua...</p> <p>60561104030 - Ø x L T30x50 - - conf. 1 - € 20,00</p> <p>60561104035 - Ø x L T40x50 - - conf. 1 - € 20,00</p> 	<p>KRINO</p> <p>BLISTER 10 Pz. INSERTI TORX CON FORO cromo vanadio 1/4" - Lungh. 25</p> <p>60561094010 - lungh. T 7 - - conf. 1 - € 10,00</p> <p>60561094015 - lungh. T 8 - - conf. 1 - € 10,00</p> <p>60561094020 - lungh. T 9 - - conf. 1 - € 10,00</p> <p>60561111015 - lungh. T 15 - - conf. 1 - € 13,80</p> <p>60561111025 - lungh. T 25 - - conf. 1 - € 13,80</p> <p>segue...</p> 
<p>KRINO</p> <p>continua...</p> <p>60561111030 - lungh. T 27 - - conf. 1 - € 13,80</p> 	<p>KRINO</p> <p>BLISTER 10 Pz. INSERTO TORX cromo vanadio 1/4" - Lungh. 25</p> <p>60561094000 - lungh. T 5 - - conf. 1 - € 16,40</p> <p>60561094005 - lungh. T 6 - - conf. 1 - € 10,00</p> 
<p>GIEFFE gruppi generali ferramenta</p> <p>CUTTER IN PLASTICA In blister</p> <p>512310210N - lama 9 mm - - conf. 1 - € 0,82</p> <p>512310215N - lama 18 mm - - conf. 1 - € 2,02</p> 	<p>GIEFFE gruppi generali ferramenta</p> <p>CUTTER METALLO Larghezza lama 9 mm In blister</p> <p>512310200N - - conf. 1 - € 2,47</p> 
<p>GIEFFE gruppi generali ferramenta</p> <p>CUTTER BICOMPONENTE A ROTELLA Lama 25 mm In blister</p> <p>512310240N - - conf. 1 - € 3,91</p> 	<p>GIEFFE gruppi generali ferramenta</p> <p>CUTTER METALLO Lama 18 mm In blister</p> <p>512310235N - - conf. 1 - € 4,74</p> 
<p>GIEFFE gruppi generali ferramenta</p> <p>CUTTER AUTOMATICO A 6 lame di 18 mm In blister</p> <p>512310230N - - conf. 1 - € 4,94</p> 	<p>GIEFFE gruppi generali ferramenta</p> <p>CUTTER METALLO A PULSANTE Lama 25 mm In blister</p> <p>512310245N - - conf. 1 - € 7,36</p> 
<p>GIEFFE gruppi generali ferramenta</p> <p>ESPOSITORE CUTTER 24 PZ Cutter XD-86A colori assortiti (giallo, rosso, blu, verde) Dimensioni: 23x34x20</p> <p>512310265N - - conf. 1 - € 49,44</p> 	<p>STANLEY</p> <p>CUTTER materiale sintetico Lama 9 mm</p> <p>7881-10-150 - - conf. 24 - € 3,40</p> 

STANLEY®



**QUALITA', PASSIONE,
ECCELLENZA.**

THE MEASURE OF A PRO™
STANLEY.IT













www.malfattitacchinigroup.it



UTENSILI

<p>STANLEY</p> <p>CUTTER IN METALLO FAT MAX Telaio in alluminio Lama autobloccante</p> <p>7880-10-411 - Lama MM 9 - - conf. 1 - € 8,20</p> 	<p>STANLEY</p> <p>CUTTER materiale sintetico Lama 18 mm</p> <p>7881-10-151 - - conf. 24 - € 7,60</p> 
<p>STANLEY</p> <p>CUTTER AUTOBLOCCANTE Corpo in TPR (Termo Poli Rock) rigido e gomma morbida. Meccanismo autobloccante.</p> <p>788STHT102660 - Lama mm 18 - - conf. 1 - € 9,60</p> 	<p>STANLEY</p> <p>COLTELLI LAMA FISSA Metallo</p> <p>7880-10-590 - - conf. 1 - € 20,00</p> 
<p>M&T 540</p> <p>CUTTER mm. 9</p> <p>540306550000 - - conf. 12 - € 0,62</p> 	<p>ASTRAL</p> <p>CUTTER PESANTE LAMA mm.25</p> <p>190390040 - - conf. 6 - € 3,20</p> 
<p>STANLEY</p> <p>CUTTER IN METALLO FAT MAX Telaio in alluminio Portalama in acciaio Autobloccante Meccanismo spezzalama</p> <p>7880-10-421 - Lama mm 18 - - conf. 1 - € 11,94 7880-10-431 - Lama mm 25 - - conf. 1 - € 18,80</p> 	<p>STANLEY</p> <p>COLTELLO PROFESSIONALE In metallo pressofuso Lama regolabile in 3 posizioni e tagliaspago Pulsante per la sostituzione della lama senza smontare il coltello Sistema Interlock di incastro dei semigusci Serbatoio a scomparsa con lame di ricambio</p> <p>788STHT104790 - - conf. 1 - € 15,20</p> 
<p>STANLEY</p> <p>COLTELLO professionale lega zinco lama fissa 3 lame omaggio</p> <p>7881-10-199 - - conf. 4 - € 11,00</p> 	<p>STANLEY</p> <p>TAGLIABALSA in alluminio Ø 6 mm Lungh. 120mm</p> <p>7880-10-401 - - conf. 12 - € 8,40</p> 
<p>GIEFFE gruppo general tools</p> <p>BLISTER 10 LAME In blister</p> <p>512310270N - lama 9 mm - - conf. 1 - € 0,82 512310275N - lama 18 mm - - conf. 1 - € 1,55 512310280N - lama 25 mm - - conf. 1 - € 3,71</p> 	<p>STANLEY</p> <p>SET. 10 Pz. LAME A SPEZZARE Largh: 25 mm</p> <p>7880-11-325 - lama 25 - - conf. 10 - € 18,40</p> 















<p>STANLEY</p> <p>LAMA DIRITTA ad affilatura acuta</p> <p>7881-11-221 - - conf. 50 - € 0,94</p> 	<p>STANLEY</p> <p>SET. 10 Pz. LAME A SPEZZARE Largh. 9mm</p> <p>7881-11-300 - - conf. 100 - € 0,50</p> 
<p>STANLEY</p> <p>SET. 10 Pz. LAME A SPEZZARE Largh. 18 mm</p> <p>7881-11-301 - - conf. 100 - € 0,68</p> 	<p>ULLMANN</p> <p>LAME TAJIMA KING PER CUTTER Spessore lama 0,4 mm</p> <p>805LK705 - Lama 9 mm - Lunghezza 80 mm - - conf. 100 - € 0,24</p> <p>805LK715 - Lama 18 mm - Lunghezza 100 mm - - conf. 100 - € 0,31</p> 
<p>ULLMANN</p> <p>LAME TAJIMA ROCK HARD BLADE™ Spessore lama 0,7 mm</p> <p>805LCB6520 - Lama 25 mm - Lunghezza 126 mm - - conf. 20 - € 1,44</p> 	<p>ULLMANN</p> <p>LAME TAJIMA PER COLTELLI KING Trapezoidali classiche Misura 60x19x0,61 mm</p> <p>805R726 - - conf. 40 - € 1,38</p> 
<p>STANLEY</p> <p>LAMA AD UNCINO</p> <p>7881-11-802 - - conf. 100 - € 0,94</p> 	<p>STANLEY</p> <p>LAMA trapezio PICCOLA</p> <p>7881-11-908 - - conf. 100 - € 0,50</p> 
<p>STANLEY</p> <p>LAMA trapezio GRANDE</p> <p>7881-11-916 - - conf. 100 - € 0,60</p> 	<p>STANLEY</p> <p>LAMA AD UNCINO profondo</p> <p>7881-11-967 - - conf. 100 - € 1,26</p> 
<p>&M 540</p> <p>SET 10 LAME TRAPEZIO</p> <p>540306531000 - - conf. 12 - € 1,30</p> 	<p>&M 900</p> <p>ARCHETTO MINI manico metallo da 6 mm.</p> <p>90046410 - - conf. 12 - € 2,40</p> 



UTENSILI

<p>&T900</p> <p>ARCHETTO MIGNON In acciaio Manico in legno rosso completo di lama Verniciatura a polvere a forno alta qualità Tondo 6 mm</p> <p>90046400 - - conf. 6 - € 4,40</p> 	<p>&M540</p> <p>ARCHETTO PER TRAFORO Tubolare Altezza 250 mm</p> <p>540303150250 - - conf. 1 - € 3,60</p> 
<p>&T900</p> <p>ARCHETTO PER TRAFORO tubolare</p> <p>90048001 - misura 25 - - conf. 1 - € 6,60 90048002 - misura 30 - - conf. 1 - € 7,00</p> 	<p>&T900</p> <p>ARCHETTO FISSO BLACK completo di lama mod. 107</p> <p>90046211 - - conf. 5 - € 8,20</p> 
<p>&T900</p> <p>ARCHETTO PONY completo di lama mod. 93</p> <p>90046215 - - conf. 12 - € 8,00</p> 	<p>&M900</p> <p>ARCHETTO CANGURO con serbatoio completo di lama mod. 95</p> <p>90046111 - - conf. 5 - € 10,20</p> 
<p>&T900</p> <p>ARCHETTO SUPER impugnatura alluminio completo di lama mod. 96</p> <p>90046105 - - conf. 5 - € 14,60</p> 	<p>BAHCO</p> <p>ARCHETTO PER METALLO Con lama bi-metallica Sandflex da 300 mm - 12" - 24 TPI Peso 510 g Lunghezza 300 mm</p> <p>770319 - - conf. 1 - € 37,26</p> 
<p>BAHCO</p> <p>SEGHETTO BAHCO MOD. 317 Compatto e leggero Telaio in alluminio Adatto a qualsiasi uso Lama 300 mm</p> <p>770317 - - conf. 10 - € 25,10</p> 	<p>GIEFFE gruppi general ferramenta</p> <p>SEGHETTO TIPO PUK "EVO" Pollici 6</p> <p>512311990N - - conf. 10 - € 1,98</p> 
<p>GIEFFE gruppi general ferramenta</p> <p>SEGHETTO TIPO PUK Pollici 6</p> <p>512311980N - - conf. 10 - € 0,90</p> 	<p>&M540</p> <p>SEGONCINO AD ARCO</p> <p>540302980610 - Misura lama 60 cm - - conf. 6 - € 4,20</p> 



 <p>&M 900</p> <p>LAMA PUK per legno Lunghezza 150 mm Per legno dolce, duro o profilato, pannelli di fibre dure, rami, cartone, plastica dolce.</p> <p>90046420 - - conf. 12 - € 0,44</p>	 <p>&M 540</p> <p>PZ. LAMA HS</p> <p>540303100000 - - conf. 1 - € 4,00</p>
 <p>&M 540</p> <p>PZ.2 LAME HSS ORO Misura 300 mm</p> <p>540303090000 - - conf. 6 - € 1,74</p>	 <p>&M 540</p> <p>LAMA RICAMBIO Lunghezza 610 mm</p> <p>540303070024 - - conf. 1 - € 1,40</p>
 <p>KRINO</p> <p>LAMA SEGHETTO BIMETAL HSS-C08% SUPER-FLEX 300x13x0,65 18 denti Lama flessibile adatta ad acciaio Inox, acciai duri e per tutti i metalli</p> <p>60523001100 - - conf. 100 - € 2,20</p>	 <p>&M 900</p> <p>LAMA DA TRAFORO Taifun - per legno</p> <p>90048006 - misura 3 - - conf. 1 - € 1,44</p> <p>90048007 - misura 4 - - conf. 1 - € 1,44</p>
 <p>BAHCO</p> <p>LAMA SEGHETTO Bimetal</p> <p>7703906 - - conf. 100 - € 3,32</p>	 <p>BAHCO</p> <p>LAMA PER ARCHETTO BI-METALLICA Sandflex</p> <p>7703906P - Misura mm. 300 mm - - conf. 1 - € 3,40</p> <p>AD ESAURIMENTO</p>
 <p>STANLEY</p> <p>MINI SEGHETTO IN METALLO FATMAX Struttura in metallo con impugnatura in materiale sintetico, morbido e di grande comfort. Lama bimetallica flessibile da 300 mm a 24 denti/poll Profondità di taglio 37 mm robusta intelaiatura in metallo Lunghezza della lama 250 mm</p> <p>7880-15-211 - - conf. 1 - € 15,20</p>	 <p>&M 540</p> <p>IMPUGNATURA PORTALAME CON LAMA INCLUSA</p> <p>540303110000 - - conf. 6 - € 0,78</p>
 <p>STANLEY</p> <p>SEGACCIO Lama temperata ad induzione per maggior robustezza e durata Impugnatura bi-material con gomma morbida per maggior comfort d'uso In caso di utilizzo prolungato e con guanti. Impugnatura con impronta di direzione</p> <p>7881-20-119 - Misura mm. 380 - - conf. 6 - € 12,40</p>	 <p>&M 540</p> <p>SEGACCIO A DORSO ALTO Lunghezza 300 mm</p> <p>540W77200 - - conf. 1 - € 13,60</p>













<p>&M540</p> <p>SEGACCIO A DORSO Lunghezza 300 mm</p> <p>540W77201 - - conf. 1 - € 10,40</p> 	<p>&M900</p> <p>SEGACCIO MANUALE Lunghezza 400 mm</p> <p>90047202 - - conf. 1 - € 16,48</p> 
<p>&T900</p> <p>SEGACCIO MANUALE Lunghezza 600 mm</p> <p>90047205 - - conf. 1 - € 20,60</p> 	<p>STANLEY</p> <p>ORGANIZER SORT MASTER LIGHT In polipropilene Divisori interni Cerniere laterali Capacità carico: 2,5 kg Dimensioni: 29,5 x 6,5 x 21,5 cm</p> <p>788STST170720 - - conf. 1 - € 12,20</p> 
<p>STANLEY</p> <p>ORGANIZER SORT MASTER JUNIOR Nessun rischio di mischiare il contenuto, grazie alle scanalature ad incasso con il coperchio dei divisori centrali Divisori removibili Pulsante di bloccaggio nel coperchio Può essere utilizzato come unità singola oppure è possibile sovrapporre e agganciare fino a 3 unità Dimensioni 37,5x6,7x29,2</p> <p>788197483 - - conf. 1 - € 13,00</p> 	<p>STANLEY</p> <p>ORGANIZER SORT MASTER Nessun rischio di mischiare il contenuto, grazie alle scanalature ad incasso con il coperchio dei divisori centrali Divisori removibili Pulsante di bloccaggio nel coperchio Dimensioni 43x9x33</p> <p>788194745 - - conf. 1 - € 21,60</p> 
<p>STANLEY</p> <p>BORSA PORTA ATTREZZI 12,5" In nylon 600x600 Den con base rigida in materiale sintetico. Una tasca a rete con chiusura a cerniera e una tasca con chiusura a bottone. Dimensioni 30x25x13 cm</p> <p>7881-93-330 - - conf. 1 - € 21,20</p> 	<p>STANLEY</p> <p>BORSA PORTA ATTREZZI 16" Base rigida Tasche interne ed esterne Tracolla regolabile Tasca frontale con chiusura in velcro Dimensioni 44,7x27,5x23,5</p> <p>788196183 - - conf. 1 - € 30,08</p> 
<p>STANLEY</p> <p>CASSETTA PORTA UTENSILI TOOL BOX Con speciale sistema di apertura/chiusura ad una mano Design innovativo e struttura robusta Vaschetta removibile per i piccoli utensili Organizers nel coperchio per piccola minuteria</p> <p>788179216 - Misura 39,4x22x16,22 - Pollici 16 - - conf. 1 - € 21,60 788179217 - Misura 48,6x26,6x23,6 - Pollici 19 - - conf. 1 - € 32,60 788179218 - Misura 59,5x28,1x26 - Pollici 24 - - conf. 1 - € 44,00</p> 	<p>STANLEY</p> <p>CASSETTA METAL-PLASTIC FATMAX CON VASCHETTA Corpo in metallo molto spazioso Vaschetta Coperchio con scanalatura a "V" per il taglio di assi. Innovativo sistema di alloggiamenti verticali porta-utensili. Grandi cerniere anti ruggine con asola porta lucchetto. Impugnatura ergonomica bi-material.</p> <p>7881-95-615 - - conf. 1 - € 66,00</p> 
<p>STANLEY</p> <p>MOBILE WORKCENTER 3 IN 1 Composto da: Cassetta superiore con cerniera di chiusura in metallo, due organizer nel coperchio, vaschetta estraibile e asola per chiusura a lucchetto; Organizer centrale a 12 scomparti separabili; Elemento base con vano unico Cerniere laterali di aggancio in acciaio Ruote e maniglie per il trasporto Possibilità di agganciare cassetta ed elemento base anche senza l'organizer centrale</p> <p>788170326 - - conf. 1 - € 79,40</p> 	<p>ALPHARD</p> <p>VALIGETTA PORTAMINUTERIA Coperchio trasparente con cerniere 16 scomparti Dimensione: 242x188x37 mm</p> <p>1893300 - - conf. 1 - € 3,34</p> 







 <p>VALIGETTA PORTAMINUTERIA Coperchio trasparente con cerniere 16 vaschette removibili Dimensione: 242x188x37 mm</p> <p>1893300V – - conf. 1 – € 5,40</p>	 <p>VALIGETTA PORTAMINUTERIA CON MANICO Coperchio trasparente con cerniere 9 scomparti Dimensione: 242x188x60 mm</p> <p>1893350 – - conf. 1 – € 4,89</p>
 <p>VALIGETTA PORTAMINUTERIA CON MANICO Coperchio trasparente con cerniere 16 vaschette removibili Dimensione: 242x188x60 mm</p> <p>1893351V – - conf. 1 – € 6,31</p>	 <p>VALIGETTA PORTAMINUTERIA CON MANICO Coperchio trasparente con cerniere Separatori removibili Dimensione: 362x250x85 mm</p> <p>1893500 – - conf. 1 – € 11,03</p>
 <p>VALIGETTA PORTAMINUTERIA CON MANICO Coperchio trasparente con cerniere Vaschette assortite Dimensione: 443x317x107 mm</p> <p>1893710 – - conf. 1 – € 25,94</p>	 <p>VALIGETTA PORTAMINUTERIA CON MANICO Coperchio trasparente con cerniere Separatori removibili Dimensione: 443x317x80 mm</p> <p>1893600 – - conf. 1 – € 15,86</p>
 <p>VALIGETTA PORTAMINUTERIA CON MANICO Coperchio trasparente con cerniere 18 scomparti Dimensione: 360x252x64 mm</p> <p>1893400 – - conf. 1 – € 8,57</p>	 <p>CASSETTIERA PORTAMINUTERIA Cassetti trasparenti Dimensione cassetteria: 192x148x230 mm</p> <p>189501T – N° Cassetti 24 – L 55 – P 130 – H 25 - conf. 1 – € 18,97</p> <p>189511T – N° Cassetti 12 – L 55 – P 130 – H 55 - conf. 1 – € 15,64</p> <p>189512T – N° Cassetti 8 – L 87 – P 130 – H 55 - conf. 1 – € 13,47</p> <p>189514T – N° Cassetti 4 – L 183 – P 130 – H 55 - conf. 1 – € 11,81</p>
 <p>VALIGETTA PORTA TRAPANO Con vano portaminuterie e vano portapunte A 2 chiusure Interno in gommapiuma Dimensione: 400x340x133 mm</p> <p>1892500 – - conf. 1 – € 11,63</p>	 <p>VALIGETTA PORTA UTENSILI In polipropilene Ad 1 chiusura Vaschetta interna removibile</p> <p>1895500 – Pollici 15" – Vano Portaminuterie 2 – L 392 – P 210H 188 - conf. 1 – € 11,61</p> <p>1895600 – Pollici 20" – Vano Portaminuterie 3 – L 500 – P 268H 230 - conf. 1 – € 20,32</p> <p>1895700 – Pollici 23" – Vano Portaminuterie 4 – L 580 – P 280H 250 - conf. 1 – € 23,33</p>
 <p>VALIGETTA PORTA UTENSILI 18 Pollici In polipropilene A 2 chiusure Vaschetta interna removibile Dimensione: 450x238x195 mm</p> <p>1895540 – - conf. 1 – € 13,64</p>	 <p>VALIGETTA CON RUOTE Asse in acciaio Composta da 2 parti indipendenti e complementari. La parte superiore è una valigetta portautensili, mentre il vano inferiore, molto capiente, è adatto per riporre gli elettroutensili. La parte inferiore, se sganciata da quella superiore, è possibile utilizzarla come sgabello. Dimensione: 460x280x665 mm</p> <p>1896700R – - conf. 1 – € 46,56</p>









 <p>CONTENITORE CON INCASTRO Colore Verde</p> <p>189A2 - L 110 - P 160 - H 76 - - conf. 1 - € 1,40</p> <p>189B3 - L 150 - P 240 - H 125 - - conf. 1 - € 3,43</p> <p>189D4 - L 212 - P 360 - H 165 - - conf. 1 - € 7,49</p> <p>189E5 - L 313 - P 504 - H 190 - - conf. 1 - € 14,21</p> <p>189F6 - L 380 - P 610 - H 250 - - conf. 1 - € 35,46</p>	 <p>TROLLEY PIEGHEVOLE A mano Struttura: tubo di acciaio Piede: plastica Dimensioni: 320x234x965 mm (aperto) 455x234 mm (piegato) Piede: 320x234 mm Ruote: 75 mm Capacità di carico: 30 kg</p> <p>512310070N - - conf. 1 - € 13,00</p>
 <p>TROLLEY ESTENSIBILE a mano pieghevole in acciaio Capacità di carico: 60 Kg Diametro ruota: 13,6 cm Altezza maniglia regolabile: da 71 cm a 95 cm Tubo in acciaio con rivestimento a polvere Materiale della ruota: PP</p> <p>512310050N - - conf. 1 - € 33,00</p>	 <p>CARRELLO PIEGHEVOLE A mano Facile da aprire o chiudere in un solo passaggio Con piatto pieghevole Altezza maniglia regolabile: da 76 cm a 100 cm Struttura: in alluminio con parti in acciaio Capacità di carico: 100 kg Piede: plastica Dimensioni: 1000x490x450 mm aperto 700x490x60 mm chiuso Piede: 480x280 mm Ruote: 180 mm</p> <p>512360590 - - conf. 1 - € 55,60</p>
 <p>CARRELLO HEAVY DUTY A mano Con piatto pieghevole Struttura: tubo di acciaio Capacità di carico: 270 kg Piede: acciaio 360 x300 mm Dimensioni: 1150x480x520 mm aperto 1165x435x145 mm chiuso Ruote: 210 mm</p> <p>512360600 - - conf. 1 - € 119,80</p>	 <p>TRANSPALLET TC-PT 2500 Telaio in acciaio saldato alle forche ribassate Timone di sicurezza con leva di azionamento integrata per le principali funzioni: sollevamento, neutra e abbassamento Ritorno automatico del timone in posizione verticale Portata max 2.500 kg Lunghezza forche 1150 mm Larghezza forche 540 mm Diametro rulli di carico 80 mm Diametro ruote del timone 180 mm Peso 62 kg Arrivo prodotto smontato</p> <p>4762022530 - - conf. 1 - € 593,52</p>
 <p>PIATTAFORMA IN ACCIAIO Dimensioni piattaforma: 730 x 480 mm Diametro ruota: 100 mm Materiale ruota: gomma e acciaio Materiale del manico: acciaio Materiale della piattaforma: acciaio con coperchio in pvc Capacità di carico: 150 kg</p> <p>512310030N - - conf. 1 - € 39,00</p>	 <p>PIATTAFORMA IN ACCIAIO Dimensione piattaforma: 910 x 610 mm Diametro ruota: 120 mm Materiale ruota: gomma e acciaio Materiale del manico: acciaio Materiale della piattaforma: acciaio con coperchio in pvc Capacità di carico: 300 kg</p> <p>512310040N - - conf. 1 - € 74,00</p>
 <p>CARRELLO QUADRATO Dimensioni: da 435 mm a 630 mm Capacità di carico: 150kg Corpo in acciaio con copertura antiscivolo 2 freni</p> <p>512310010N - - conf. 1 - € 18,00</p>	 <p>SET 2 CARRELLI MOBILI ESTENSIBILI Con ruote e freno Lunghezza estensione: da 40 cm a 63 cm con coperchio antiscivolo Capacità di carico: 80 Kg</p> <p>512310020N - - conf. 1 - € 13,00</p>
 <p>ARGANO MANUALE Portata 2 tonnellate</p> <p>540301810000 - - conf. 1 - € 26,58</p>	 <p>CAZZUOLINO PUNTA QUADRA Tekna 2000 manico bimatereale</p> <p>19640000 - cm. 12 - - conf. 6 - € 7,86</p> <p>19640001 - cm. 14 - - conf. 6 - € 7,96</p>



























  <p>CAZZUOLA PUNTA QUADRA Tekna 2000 manico bimateriale</p> <p>19640055 - cm. 18 - - conf. 6 - € 11,40</p> <p>19640056 - cm. 19 - - conf. 6 - € 11,52</p> <p>19640057 - cm. 20 - - conf. 6 - € 11,58</p> <p>19640058 - cm. 21 - - conf. 6 - € 11,74</p> <p>19640059 - cm. 22 - - conf. 6 - € 11,92</p>	  <p>CAZZUOLINO PUNTA TONDA Tekna 2000 manico bimateriale</p> <p>19640100 - cm. 12 - - conf. 6 - € 7,86</p> <p>19640101 - cm. 14 - - conf. 6 - € 7,96</p> <p>19640103 - cm. 16 - - conf. 6 - € 8,24</p>
  <p>CAZZUOLA PUNTA TONDA Tekna 2000 manico bimateriale</p> <p>19640155 - cm. 18 - - conf. 6 - € 11,40</p> <p>19640156 - cm. 19 - - conf. 6 - € 11,52</p> <p>19640157 - cm. 20 - - conf. 6 - € 11,58</p> <p>19640158 - cm. 21 - - conf. 6 - € 11,74</p> <p>19640159 - cm. 22 - - conf. 6 - € 11,92</p>	  <p>CAZZUOLINO PUNTA ACUTA Tekna 2000 manico bimateriale</p> <p>19640200 - cm. 12 - - conf. 6 - € 7,86</p> <p>19640201 - cm. 14 - - conf. 6 - € 7,96</p>
  <p>CAZZUOLA PUNTA TONDA STRETTA Tekna 2000 manico bimateriale</p> <p>19640255 - cm. 18 - - conf. 6 - € 11,40</p> <p>19640256 - cm. 19 - - conf. 6 - € 11,52</p> <p>19640257 - cm. 20 - - conf. 6 - € 11,58</p> <p>19640258 - cm. 21 - - conf. 6 - € 11,74</p> <p>19640259 - cm. 22 - - conf. 6 - € 11,74</p>	  <p>CAZZUOLA PUNTA QUADRA Manico in legno non verniciato</p> <p>540304800070 - misura 18 cm - - conf. 1 - € 4,00</p> <p>AD ESAURIMENTO</p>
  <p>CAZZUOLA PUNTA TONDA Manico in legno non verniciato</p> <p>540304800085 - misura 18 cm - - conf. 1 - € 5,80</p> <p>AD ESAURIMENTO</p>	  <p>FRATTEZZO PER STUCCO Manico gomma lama acciaio 28x12</p> <p>19642005 - - conf. 4 - € 12,72</p>
  <p>FRATTEZZO PER COLLA Manico gomma lama acciaio 28 x 12 cm</p> <p>19642037 - Dente 7,5 x 7,5 - - conf. 6 - € 13,28</p> <p>19642039 - Dente 10 x 10 - - conf. 6 - € 12,78</p> <p>19642337 - Dente 12 x 12 - - conf. 4 - € 12,60</p>	  <p>FRATTEZZO PER COLLA Manico bimateriale Lama in acciaio Dimensioni: 36 X 12 cm</p> <p>19642014 - Dente 7,5 X 7,5 - - conf. 12 - € 13,58</p>
  <p>FRATTEZZO Gomma blu rigida base alluminio 21 x 14</p> <p>19642059 - - conf. 4 - € 9,18</p>	  <p>FRATTEZZO GOMMA SPUGNA Cm.21X14</p> <p>19642060 - - conf. 4 - € 9,18</p>



  <p>FRATTAZZO Gomma morbida base alluminio 21 x 14 19642062 - - conf. 4 - € 8,94</p>	  <p>FRATTAZZO GOMMASPUGNA Manico e base in polistirolo anti-urto Colore gomma: Arancio Spessore gomma: 19 mm Impugnatura ergonomica Dimensione: 28 X 14 cm 19642456 - Gomma extra morbida - - conf. 12 - € 11,16 19642457 - Gomma morbida - - conf. 12 - € 11,16</p>
  <p>FRATTAZZO GOMMASPUGNA Manico e base in polistirolo anti-urto Impugnatura ergonomica Dimensione: 21,5 X 13,5 cm 19642459 - Colore Blu - Spessore 14 mm - Gomma Morbida - - conf. 12 - € 9,30 19642460 - Colore Grigio - Spessore 14 mm - Gomma Morbida - - conf. 12 - € 9,30 19642461 - Colore Arancio - Spessore 19 mm - Gomma Extra morbida - - conf. 12 - € 9,54 segue...</p>	  <p>continua... 19642462 - Colore Arancio - Spessore 15 mm - Gomma Morbida - - conf. 12 - € 8,56</p>
  <p>FRATTAZZO GOMMASPUGNA Manico e base in polistirolo anti-urto Impugnatura ergonomica Dimensione: 24 X 10 cm 19642465 - Colore Arancio - Spessore 15 mm - Gomma Morbida - - conf. 12 - € 8,20 19642468 - Colore Blu - Spessore 14 mm - Gomma Morbida - - conf. 12 - € 8,86</p>	  <p>FRATTAZZO PER STUCCO Manico legno 48 x 14 19642080 - - conf. 4 - € 19,96</p>
  <p>FRATTAZZO PER COLLA Manico in legno 19642085 - - conf. 6 - € 22,22 19642087 - Dente 12 x 12 - - conf. 6 - € 22,22 19642086 - Dente 10 x 10 - - conf. 6 - € 22,66</p>	  <p>FRATTAZZO TUTTO IN PLASTICA RIGIDA 19642401 - Misura 44 x 14 - - conf. 24 - € 3,92 19642402 - Misura 42 x 26 - - conf. 12 - € 6,34</p>
  <p>PIALLA PER GESSO 11 lame misura 19644100 - Dimensione 42x6 - - conf. 2 - € 30,80 19644105 - Dimensione 47x7 - - conf. 2 - € 32,42</p>	  <p>RABOT ALLUMINIO Manico in acciaio 8 lame- 45 X 9 19644110 - - conf. 2 - € 26,98</p>
  <p>RASATORE PER INTONACO Dimensione: 255 X 150 mm 19644125 - - conf. 12 - € 11,06</p>	  <p>PIASTRA DI RICAMBIO Dimensione: 255 X 150 mm Per Art. 327159 - 19644125 19648181 - - conf. 15 - € 5,30</p>



 <p>SPATOLA STUCCO PROFESSIONALE Manico legno non verniciato</p> <p>19653981 - cm. 2 - - conf. 12 - € 2,34</p> <p>19653983 - cm. 3 - - conf. 12 - € 2,48</p> <p>19653985 - cm. 4 - - conf. 12 - € 2,50</p> <p>19653987 - cm. 5 - - conf. 12 - € 2,68</p> <p>19653989 - cm. 6 - - conf. 12 - € 2,80</p> <p>segue...</p> 	 <p>continua...</p> <p>19653991 - cm. 7 - - conf. 12 - € 2,90</p> <p>19653993 - cm. 8 - - conf. 12 - € 3,30</p> <p>19653995 - cm. 9 - - conf. 12 - € 3,30</p> <p>19653997 - cm. 10 - - conf. 12 - € 3,72</p> <p>19653999 - cm. 12 - - conf. 12 - € 4,00</p> 
 <p>SPATOLA DENTATA BOSTIK Cm. 20</p> <p>19654004 - Dentatura Piccola - - conf. 12 - € 4,62</p> <p>19654005 - Dentatura Grande - - conf. 12 - € 4,62</p> 	 <p>SPATOLA STUCCO Manico legno verniciato</p> <p>19654070 - cm. 2 - - conf. 12 - € 1,98</p> <p>19654075 - cm. 3 - - conf. 12 - € 2,08</p> <p>19654080 - cm. 4 - - conf. 12 - € 2,26</p> <p>19654085 - cm. 5 - - conf. 12 - € 2,26</p> <p>19654090 - cm. 6 - - conf. 12 - € 2,34</p> <p>segue...</p> 
 <p>continua...</p> <p>19654095 - cm. 7 - - conf. 12 - € 2,48</p> <p>19654100 - cm. 8 - - conf. 12 - € 2,76</p> <p>19654105 - cm. 9 - - conf. 12 - € 3,00</p> <p>19654110 - cm. 10 - - conf. 12 - € 3,14</p> <p>19654115 - cm. 12 - - conf. 12 - € 3,40</p> 	 <p>SPATOLA DENTATA PER BOSTIK</p> <p>19654158 - cm. 4 - - conf. 12 - € 1,33</p> <p>19654159 - cm. 6 - - conf. 12 - € 1,80</p> <p>19654160 - cm. 8 - - conf. 12 - € 2,26</p> <p>19654163 - cm. 10 - - conf. 12 - € 2,52</p> <p>19654165 - cm. 12 - - conf. 12 - € 2,88</p> 
 <p>SPATOLA PER STUCCO INOX Tekna 2000 manico bimateriale</p> <p>19654255 - cm. 6 - - conf. 12 - € 6,60</p> <p>19654257 - cm. 8 - - conf. 12 - € 7,42</p> <p>19654259 - cm. 10 - - conf. 12 - € 8,04</p> 	 <p>SPATOLA STUCCO INOX Manico legno verniciato</p> <p>19654271 - cm. 2 - - conf. 12 - € 4,32</p> <p>19654272 - cm. 3 - - conf. 12 - € 4,32</p> <p>19654273 - cm. 4 - - conf. 12 - € 4,54</p> <p>19654274 - cm. 5 - - conf. 12 - € 4,74</p> <p>19654275 - cm. 6 - - conf. 12 - € 5,00</p> <p>segue...</p> 
 <p>continua...</p> <p>19654276 - cm. 7 - - conf. 12 - € 5,36</p> <p>19654277 - cm. 8 - - conf. 12 - € 5,58</p> <p>19654278 - cm. 9 - - conf. 12 - € 5,98</p> <p>19654279 - cm. 10 - - conf. 12 - € 6,64</p> <p>19654281 - cm. 12 - - conf. 12 - € 7,42</p> 	 <p>SPATOLA PER STUCCO FUSION Lama in acciaio al carbonio Manico bi-materiale in propilene e gomma termoplastica antiscivolo</p> <p>19654233 - Misura 4 - - conf. 12 - € 3,02</p> <p>19654234 - Misura 5 - - conf. 12 - € 3,14</p> <p>19654236 - Misura 7 - - conf. 12 - € 3,34</p> <p>19654238 - Misura 9 - - conf. 12 - € 3,84</p> <p>19654241 - Misura 12 - - conf. 12 - € 4,64</p> 
 <p>SPATOLA PER CARROZZIERI acciaio</p> <p>19654350 - cm. 2 - - conf. 12 - € 0,58</p> <p>19654355 - cm. 4 - - conf. 12 - € 0,80</p> <p>19654360 - cm. 6 - - conf. 12 - € 0,86</p> <p>19654365 - cm. 8 - - conf. 12 - € 1,02</p> <p>19654370 - cm. 10 - - conf. 12 - € 1,11</p> <p>segue...</p> 	 <p>continua...</p> <p>19654375 - cm. 12 - - conf. 12 - € 1,23</p> <p>19654385 - cm. 16 - - conf. 12 - € 1,38</p> <p>19654380 - cm. 14 - - conf. 12 - € 1,26</p> 



UTENSILI

 <p>SPAZZOLA SPID acciaio ottonato 78599090200 - - conf. 24 - € 1,86</p>	 <p>SPAZZOLA SPID "0020" Acciaio INOX 7850020 - - conf. 12 - € 5,40</p>
 <p>SPAZZOLA SPID "0019" Ottone 7850019 - - conf. 12 - € 6,20</p>	 <p>SPAZZOLA SPID "0022" Nylon 7850022 - - conf. 12 - € 5,20</p>
 <p>SPAZZOLA SPID MANICO LUNGO acciaio ottonato 78543030001 - - conf. 10 - € 5,60</p>	 <p>SPAZZOLA A MANO UNIVERSALE 74049700 - - conf. 24 - € 2,20</p>
 <p>SPAZZOLA In ottone 540603875005 - - conf. 12 - € 1,70</p>	 <p>SPAZZOLINA IN NYLON 540603875024 - - conf. 24 - € 2,00</p>
 <p>SPAZZOLINA SLIM Ottone 7851792 - - conf. 12 - € 6,60</p>	 <p>SPAZZOLINA SLIM INOX 7851791 - - conf. 12 - € 6,40</p>
 <p>SPAZZOLINA SLIM Nylon 7851793 - - conf. 12 - € 4,60</p>	 <p>SPAZZOLINA SLIM Acciaio 7851790 - - conf. 12 - € 4,40</p>



 <p>STIK PENNELLO E RASCHIETTO Pennello in acciaio Adatto alla pulizia del brucere</p> <p>7851995 - - conf. 1 - € 7,60</p>	 <p>ASTRAL</p> <p>RASCHIETTO professionale lama 64mm.</p> <p>190390317 - - conf. 6 - € 5,16</p>
 <p>ASTRAL</p> <p>LAME RICAMBIO Lungh. 10 cm per raschietto Set 10 pz.</p> <p>190390331 - - conf. 1 - € 2,20</p>	 <p>GIEFFE gruppi general ferramenta</p> <p>RASCHIETTO IN METALLO In blister</p> <p>512310255N - Misura 20 cm - - conf. 1 - € 6,18</p>
 <p>GIEFFE gruppi general ferramenta</p> <p>10 LAME PER RASCHIETTO di metallo</p> <p>512310260N - - conf. 1 - € 2,68</p>	 <p>GM 930</p> <p>RASCHIETTO Flessibile</p> <p>93058151 - Misura mm 200 - - conf. 10 - € 3,20</p>
 <p>STANLEY</p> <p>RASCHIETTO MULTIUSO in materiale sintetico</p> <p>7881-28-593 - - conf. 20 - € 2,80</p>	 <p>GIEFFE gruppi general ferramenta</p> <p>RASCHIETTO IN PLASTICA In blister</p> <p>512310250N - - conf. 1 - € 1,24</p>
 <p>BAHCO</p> <p>RASCHIETTO PROFESSIONALE 625 Lama triangolare in metallo duro 25mm con fodero incluso</p> <p>770625 - - conf. 5 - € 34,06</p>	 <p>BAHCO</p> <p>RASCHIETTO PROFESSIONALE 650 Lama in metallo duro può montare lama da 65mm.</p> <p>770650 - - conf. 5 - € 33,28</p>
 <p>BAHCO</p> <p>RASCHIETTO PROFESSIONALE LAMA TRIANGO-LARE mm.347</p> <p>770665 - - conf. 1 - € 46,98</p>	 <p>BAHCO</p> <p>LAMA ricambio lungh. 50mm per Art. 440 - 650</p> <p>770442 - - conf. 10 - € 15,62</p>



Industria PENNELLI CERVUS

Via Milano, 218 - 46019 CICOGNARA (Mantova) Italy

Tel. ++39 0375.790204 - Fax ++39 0375.790132

www.pennellicervus.com

info@pennellicervus.com

S/10

PROFESSIONALE



S/20

PROFESSIONALE



Industria PENNELLI CERVUS

Via Milano, 218 - 46019 CICOGNARA (Mantova) Italy

Tel. ++39 0375.790204 - Fax ++39 0375.790132

www.pennellicervus.com













info@pennellicervus.com



730

CLASSICO



<p>BAHCO</p> <p>LAME ricambio triangolari 25 x 25mm per Art. 448 - 625</p> <p>770449 - - conf. 10 - € 14,86</p> 	<p>BAHCO</p> <p>LAMA ricambio Lungh. mm. 65 per Art. 665 - 650 - 450</p> <p>770451 - - conf. 10 - € 17,28</p> 
<p>RADIATORE IN SETOLA BIONDA Manico legno grezzo, resina epossidica, resistente ai solventi Per smalti a solvente, vernici, idropitture, superfici difficili da raggiungere</p> <p>36501020 - Misura 20 - Setola 51 - - conf. 12 - € 2,74</p> <p>36501030 - Misura 30 - Setola 57 - - conf. 12 - € 3,02</p> <p>36501040 - Misura 40 - Setola 57 - - conf. 12 - € 3,72</p> <p>36501050 - Misura 50 - Setola 64 - - conf. 12 - € 4,42</p> <p>segue...</p> 	<p>continua...</p> <p>36501060 - Misura 60 - Setola 64 - - conf. 12 - € 5,46</p> 
<p>RADIATORE Misto setola/poliestere, resina epossidica, manico in legno, resistente ai solventi Per smalti a solvente, vernici, idropitture, ideale per superfici difficili da raggiungere</p> <p>36510740 - Misura 40 - Setola 57 - - conf. 12 - € 2,76</p> <p>36510750 - Misura 50 - Setola 64 - - conf. 12 - € 3,30</p> 	<p>PENNELLO S/20 Mista setola/poliestere, resina epossidica, manico legno, resistente ai solventi Impregnanti, smalti e vernici Spessore 15 mm</p> <p>36502020 - Misura 20 - Setola 51 - - conf. 12 - € 1,92</p> <p>36502030 - Misura 30 - Setola 57 - - conf. 12 - € 2,34</p> <p>36502040 - Misura 40 - Setola 57 - - conf. 12 - € 2,76</p> <p>36502050 - Misura 50 - Setola 57 - - conf. 12 - € 3,42</p> <p>segue...</p> 
<p>continua...</p> <p>36502060 - Misura 60 - Setola 64 - - conf. 12 - € 4,08</p> <p>36502070 - Misura 70 - Setola 64 - - conf. 12 - € 4,92</p> 	<p>PENNELLO S/29 In setola bionda poliestere, manico plastica Impregnanti, smalti a solvente e vernici</p> <p>36502920 - Ø 20 - Lasta 44 - - conf. 12 - € 1,06</p> <p>36502930 - Ø 30 - Lasta 44 - - conf. 12 - € 1,14</p> <p>36502940 - Ø 40 - Lasta 51 - - conf. 12 - € 1,56</p> <p>36502950 - Ø 50 - Lasta 51 - - conf. 12 - € 1,98</p> <p>segue...</p> 
<p>continua...</p> <p>36502960 - Ø 70 - Lasta 57 - - conf. 12 - € 2,64</p> <p>36502970 - Ø 70 - Lasta 57 - - conf. 12 - € 3,12</p> 	<p>VASCHETTA PLASTICA</p> <p>36503902 - Misura 26x34 - - conf. 1 - € 2,92</p> 
<p>PENNELLO SINTEX Plafoniera assicella plastica, manico legno resina epossidica Idropitture e quarzi Superfici semi ruvide e ruvide</p> <p>36505101 - Misura 15 - Setola 85 - - conf. 12 - € 14,40</p> <p>36505102 - Misura 19 - Setola 90 - - conf. 12 - € 18,60</p> <p>36505106 - Misura 7 - Setola 76 - - conf. 12 - € 9,48</p> 	<p>PENNELLO TECHNO 77 In fibra poliestere extra fine, resina epossidica, manico in polipropilene verniciato Per smalti e vernici acriliche superfici lisce e leggermente ruvide</p> <p>36507730 - Misura 30 - Setola 65 - - conf. 12 - € 2,76</p> <p>36507740 - Misura 40 - Setola 65 - - conf. 12 - € 3,36</p> <p>36507750 - Misura 50 - Setola 75 - - conf. 12 - € 4,08</p> <p>36507760 - Misura 60 - Setola 75 - - conf. 12 - € 4,86</p> 



 <p>PENNELLO S/505 PL Plafoncino in fibra di poliestere, manico in plastica Per idropitture ed impregnanti superfici lisce e semi ruvide</p> <p>36550537 - Misura 7 - Setola 64 - - conf. 12 - € 4,80</p> <p>36550510 - Misura 10 - Setola 64 - - conf. 12 - € 5,94</p> <p>36550514 - Misura 14 - Setola 70 - - conf. 12 - € 10,20</p> <p>36550515 - Misura 15 - Setola 76 - - conf. 12 - € 11,94</p>	 <p>PENNELLO 56/S Plafoncino misto sintetico, assicella e manico in plastica Per superfici ruvide e lisce</p> <p>36556414 - Misura 14 - Setola 65 - - conf. 12 - € 8,26</p> <p>36556515 - Misura 15 - Setola 65 - - conf. 12 - € 9,76</p>
 <p>RETINA PLASTICA</p> <p>36570700 - Misura 20 - - conf. 25 - € 1,26</p>	 <p>MANICO PER RULLINO Impugnatura plastica</p> <p>36571801 - Misura 10 - Manico Lungo - - conf. 10 - € 1,58</p> <p>36571802 - Misura 5 - Manico Lungo - - conf. 10 - € 1,58</p>
 <p>RULLINO DI RICAMBIO Per radiatori in filo poliammidico cordato, resistente ai solventi Impregnanti, idropitture, smalti Superficie liscia e leggermente ruvida</p> <p>36571905 - Ø 15 - Misura 5 - - conf. 20 - € 0,88</p> <p>36571911 - Ø 15 - Misura 10 - - conf. 10 - € 0,88</p>	 <p>PROLUNGA PLASTIFICATA</p> <p>36572202 - Misura 1 mt - - conf. 6 - € 5,28</p> <p>36572203 - Misura 2 mt - - conf. 6 - € 6,62</p>
 <p>RULLINO DI RICAMBIO Per radiatori in spugna extra-fine bianca Bassa resistenza ai solventi Smalti e vernici superficie liscia</p> <p>36572705 - Ø 35 - Misura 5 - - conf. 20 - € 0,98</p> <p>36572710 - Ø 35 - Misura 10 - - conf. 10 - € 0,98</p>	 <p>RULLO In tessuto acrilico cordonato Per interno superficie liscia o leggermente ruvida</p> <p>36573323 - Ø 48 - Misura 23 - - conf. 12 - € 6,62</p>
 <p>MANICO DI RICAMBIO T/8 Plastica classico con smussatura</p> <p>36574223 - Misura 23 - - conf. 24 - € 2,44</p>	 <p>RULLO S/730 tessuto poliammide lunga durata, pelo lungo manico ergonomico fisso, resistente ai solventi Per idropitture, quarzi, lavabili per superfici interne/esterne ed intonaci grezzi Lunghezza pelo 23 mm</p> <p>36576323 - Ø 58 - Misura 23 - - conf. 12 - € 10,92</p>
 <p>RULLO In tessuto acrilico cordonato Per interno superficie liscia o leggermente ruvida</p> <p>36573820 - Ø 43 - L.asta 20 - - conf. 1 - € 4,22</p>	 <p>RULLINO DI RICAMBIO Per radiatori in velour, resistente ai solventi Smalti, idropitture, vernici epossidiche superficie liscia</p> <p>36575005 - Ø 15 - Misura 5 - - conf. 20 - € 1,14</p> <p>36575010 - Ø 15 - Misura 10 - - conf. 10 - € 1,14</p>

Chi è il re?

dei marcatori professionali



SNOWMAN[®]
PAINT MARKER

snowman.it



BLUEMAN[®]
INDUSTRIAL MARKERS

blueman-marker.it

MILLER[®]
Scratch Fix[®]

scratchfix.it

RITOCOCCO LEGNO *dal 1970*

Il ritocco per legno superiore per qualità, efficacia e rendimento; è perfetto per mobili, porte, cornici e oggetti in legno pregiato.

Asciuga in pochi secondi ed è resistente all'acqua e all'alcool.



AGISCE COME UN MORDENTE, PENETRA NEL LEGNO MANTENENDO IL DISEGNO NATURALE DELLE VENATURE.

SCRATCH FIX

tratto da 2 a 6 mm

cod. **P1200**

chiaro moro scuro rossiccio medio



01 02 03 04 05

*I COLORI SE PASSATI PIÙ VOLTE
CONSENTONO SFUMATURE PIÙ SCURE*



Niente più graffi!

PUNTA IN FELTRO
DA 4,5 MM
A TAGLIO
DIAGONALE

CORPO
IN ALLUMINIO













IL TAPPO A
PRESSIONE
GARANTISCE LA
CONSERVAZIONE
PER MOLTI ANNI

DISPONIBILE
IN 5 COLORI



linea diretta +39 010 543 201 - vendite@ullmann.it - www.ullmann.it







 <p>RULLO DI RICAMBIO Nylon corto rasato tipo svedese, termosaldato, resistente ai solventi Adatto per interni a superficie liscia</p> <p>36577223 - Ø 48 - Misura 23 - - conf. 12 - € 6,76</p>	 <p>RULLO DI RICAMBIO In microfibra, massimo assorbimento, stesura uniforme, resistente ai solventi Adatto con idropitture e vernici fluide su interni a superficie liscia</p> <p>36577430 - Ø 58 - Misura 23 - - conf. 12 - € 8,38</p>
 <p>PENNARELLO BLUEMAN PUNTOMARK Marcatore permanente Punta in metallo tratto da 1 mm terminale rigido sintetico utile per segnare attraverso i fori Scrive su: Carta, legno, tessuto, gomma, plastica, metallo e vetro</p> <p>805PM051 - Colore Nero - - conf. 12 - € 4,20 805PM052 - Colore Rosso - - conf. 12 - € 4,20 805PM053 - Colore Blu - - conf. 12 - € 4,20</p>	 <p>PENNARELLO PERMANENT SNOWMAN Marcatori permanenti Punta in fibra acrilica da 3,5 mm Tratto da 1 a 3 mm Scrive su: carta, legno, tessuto, gomma, plastica, metallo e vetro</p> <p>805PM101 - Colore Nero - - conf. 12 - € 2,10 805PM102 - Colore Rosso - - conf. 12 - € 2,10 805PM103 - Colore Blu - - conf. 12 - € 2,10</p>
 <p>PENNARELLO PERMANENT SNOWMAN Marcatori permanenti Punta in fibra acrilica con taglio diagonale di 3,7x5 mm Tratto da 1 a 6 mm Scrive su: carta, legno, tessuto, gomma, plastica, metallo e vetro</p> <p>805PM201 - Colore Nero - - conf. 12 - € 2,10 805PM202 - Colore Rosso - - conf. 12 - € 2,10 805PM203 - Colore Blu - - conf. 12 - € 2,10</p>	 <p>PENNARELLO RAPIDOMARK M Marcatori permanenti Inchiostro permanente Colore nero a base di alcool atossico Punta in feltro da 4 mm tratto da 1 a 2 mm Marcano con tratto netto e persistente Scrive su: carta, legno, tessuto, gomma, plastica, metallo e vetro</p> <p>805PM601 - - conf. 12 - € 3,02</p>
 <p>PENNARELLO RAPIDOMARK L Marcatori permanenti Marcatori permanenti Inchiostro permanente Colore nero a base di alcool atossico Punta in feltro da 7 mm tratto da 2 a 3 mm Marcano con tratto netto e persistente Scrive su: carta, legno, tessuto, gomma, plastica, metallo e vetro</p> <p>805PM801 - - conf. 12 - € 4,88</p>	 <p>PENNARELLO PROPAINX XF Ral color Marker professionale per ritoccare scheggiature, graffi e piccole ammaccature. Punta standard arrotondata da 4,5 mm Perfetto su serramenti in alluminio, PVC e su tutte le superfici smaltate</p> <p>805PXFR1013 - Colore Bianco Perla - Ral 1013 - - conf. 12 - € 4,10 805PXFR1021 - Colore Giallo Navone - Ral 1021 - - conf. 12 - € 4,10 805PXFR2004 - Colore Arancio Puro - Ral 2004 - - conf. 12 - € 4,10 segue...</p>
 <p>continua...</p> <p>805PXFR3000 - Colore Rosso Fuoco - Ral 3000 - - conf. 12 - € 4,10 805PXFR3003 - Colore Rosso Rubino - Ral 3003 - - conf. 12 - € 4,10 805PXFR5010 - Colore Blu Genziana - Ral 5010 - - conf. 12 - € 4,10 805PXFR5015 - Colore Blu Cielo - Ral 5015 - - conf. 12 - € 4,10 805PXFR6005 - Colore Verde Muschio - Ral 6005 - - conf. 12 - € 4,10 segue...</p>	 <p>continua...</p> <p>805PXFR6011 - Colore Verde Reseda - Ral 6011 - - conf. 12 - € 4,10 805PXFR7001 - Colore Grigio Argento - Ral 7001 - - conf. 12 - € 4,10 805PXFR7016 - Colore Grigio Antracite - Ral 7016 - - conf. 12 - € 4,10 805PXFR7035 - Colore Grigio Luce - Ral 7035 - - conf. 12 - € 4,10 805PXFR7040 - Colore Grigio Finestra - Ral 7040 - - conf. 12 - € 4,10 segue...</p>
 <p>continua...</p> <p>805PXFR8011 - Colore Marrone Noce - Ral 8011 - - conf. 12 - € 4,10 805PXFR8017 - Colore Marrone Cioccolato - Ral 8017 - - conf. 12 - € 4,10 805PXFR8019 - Colore Marrone Grigio - Ral 8019 - - conf. 12 - € 4,10 805PXFR9001 - Colore Bianco Crema - Ral 9001 - - conf. 12 - € 4,10 805PXFR9003 - Colore Bianco Segnale - Ral 9003 - - conf. 12 - € 4,10 segue...</p>	 <p>continua...</p> <p>805PXFR9005 - Colore Nero Intenso - Ral 9005 - - conf. 12 - € 4,10 805PXFR9006 - Colore Alluminio - Ral 9006 - - conf. 12 - € 4,10 805PXFR9010 - Colore Bianco Puro - Ral 9010 - - conf. 12 - € 4,10 805PXFR9016 - Colore Bianco Traffico - Ral 9016 - - conf. 12 - € 4,10 805PXFR9100P - Colore Bianco Opaco - Ral 90100P - - conf. 12 - € 4,10 segue...</p>



 <p>Ullmann continua... 805PXF950P - Colore Nero Opaco - Ral 9005OP - - conf. 12 - € 4,10</p>	 <p>Ullmann PENNARELLO SCRATCH FIX Ritocco legno Tratto da 2 a 6 mm Perfetto per mobili, porte, cornici e oggetti in legno pregiato. Asciuga in pochi secondi Resistente all'acqua e alcool. I colori se passati più volte, consentono sfumature più scure 805P1201 - Colore Chiaro - - conf. 12 - € 7,60 805P1202 - Colore Moro - - conf. 12 - € 7,60 805P1203 - Colore Scuro - - conf. 12 - € 7,60 segue...</p>
 <p>Ullmann continua... 805P1204 - Colore Rossiccio - - conf. 12 - € 7,60 805P1205 - Colore Medio - - conf. 12 - € 7,60</p>	 <p>Ullmann PENNARELLO PAINT MARKER Punta standard Smalto brillante Scrive su: Metallo, legno, pietra, vetro ceramica, gomma, plastica, PVC, pelle, stoffa e cartone 805P201 - Colore Nero - - conf. 12 - € 2,68 805P202 - Colore Rosso - - conf. 12 - € 2,68 805P203 - Colore Blu - - conf. 12 - € 2,68 805P204 - Colore Verde - - conf. 12 - € 2,68 segue...</p>
 <p>Ullmann continua... 805P205 - Colore Giallo - - conf. 12 - € 2,68 805P214 - Colore Bianco - - conf. 12 - € 2,68</p>	 <p>Eco Service SMALTO SPRAY Acrilico 100% per esterni ed interni Aderisce sulle superfici di legno, metallo, vetro, ceramica... Essicca rapidamente, al tatto in 15 minuti, in 24 ore in profondità Valvola autopulente Formato 400 ml 46990010/001P - Colore NERO LUCIDO - RAL 9005 - - conf. 6 - € 3,58 46990010/002P - Colore BIANCO LUCIDO - RAL 9010 - - conf. 6 - € 3,58 segue...</p>
 <p>Eco Service continua... 46990010/003P - Colore ROSSO FUOCO - RAL 3000 - - conf. 6 - € 3,58 46990010/005P - Colore BLU LUCE - RAL 5012 - - conf. 6 - € 3,58 46990010/006P - Colore MARRONE MOGANO - RAL 8016 - - conf. 6 - € 3,58 46990010/007P - Colore BLU TRAFFICO - RAL 5017 - - conf. 6 - € 3,58 segue...</p>	 <p>Eco Service continua... 46990010/008P - Colore GRIGIO CHIARO - RAL 7035 - - conf. 6 - € 3,58 46990010/009P - Colore BLU - RAL 5010 - - conf. 6 - € 3,58 46990010/010P - Colore GIALLO CADMIO - RAL 1021 - - conf. 6 - € 3,58 46990010/011P - Colore GIALLO CROMO - RAL 1007 - - conf. 6 - € 3,58 segue...</p>
 <p>Eco Service continua... 46990010/012P - Colore VERDE SCURO - RAL 6005 - - conf. 6 - € 3,58 46990010/013P - Colore ROSSO RUBINO - RAL 3003 - - conf. 6 - € 3,58 46990010/014P - Colore ROSA CHIARO - RAL 3015 - - conf. 6 - € 3,58 46990010/015P - Colore VERDE PRIMAVERA - RAL 6002 - - conf. 6 - € 3,58 segue...</p>	 <p>Eco Service continua... 46990010/016P - Colore CIOCCOLATO - RAL 8017 - - conf. 6 - € 3,58 46990010/017P - Colore GRIGIO - RAL 7001 - - conf. 6 - € 3,58 46990010/018P - Colore BIANCO PERLA - RAL 1013 - - conf. 6 - € 3,58 46990010/019P - Colore ARANCIO SANGUE - RAL 2002 - - conf. 6 - € 3,58 segue...</p>
 <p>Eco Service continua... 46990010/020P - Colore ARANCIO - RAL 2004 - - conf. 6 - € 3,58 46990010/021P - Colore MARRONE CHIARO - RAL 8011 - - conf. 6 - € 3,58 46990010/022P - Colore VERDE MENTA - RAL 6029 - - conf. 6 - € 3,58 46990010/023P - Colore VERDE RESEDA - RAL 6011 - - conf. 6 - € 3,58 segue...</p>	 <p>Eco Service continua... 46990010/024P - Colore AZZURRO - RAL 5015 - - conf. 6 - € 3,58 46990010/025P - Colore BLU ZAFFIRO - RAL 5003 - - conf. 6 - € 3,58 46990010/026P - Colore GRIGIO MEDIO - RAL 7032 - - conf. 6 - € 3,58 46990010/027P - Colore ROSSO TRAFFICO - RAL 3020 - - conf. 6 - € 3,58 segue...</p>



























<p> continua... 46990010/028P - Colore AVORIO CHIARO - RAL 1015 - - conf. 6 - € 3,58 46990010/029P - Colore ALLUMINIO - RAL 9006 - - conf. 6 - € 3,58 46990010/030P - Colore NERO OPACO - RAL 9005 - - conf. 6 - € 3,58 46990010/031P - Colore BIANCO OPACO - RAL 9010 - - conf. 6 - € 3,58 segue...</p> 	<p> continua... 46990010/036P - Colore GRIGIO ANTRACITE - RAL 7021 - - conf. 6 - € 3,58 46990010/037P - Colore GRIGIO SCURO - RAL 7016 - - conf. 6 - € 3,58 46990010/044P - Colore GIALLO TRAFFICO - RAL 1023 - - conf. 6 - € 3,58 46990010/047P - Colore ARANCIO PASTELLO - RAL 2003 - - conf. 6 - € 3,58 segue...</p> 
<p> continua... 46990010/050P - Colore LILLA BLUASTRO - RAL 4005 - - conf. 6 - € 3,58 46990010/053P - Colore VERDE SMERALDO - RAL 6001 - - conf. 6 - € 3,58 46990010/054P - Colore BLU TURCHESE - RAL 5018 - - conf. 6 - € 3,58 46990010/055P - Colore VERDE GIALLASTRO - RAL 6018 - - conf. 6 - € 3,58 segue...</p> 	<p> continua... 46990010/057P - Colore MARRONE FANGO - RAL 8003 - - conf. 6 - € 3,58 46990010/062P - Colore VERDE ABETE - RAL 6009 - - conf. 6 - € 3,58 46990010/065P - Colore MARRONE GRIGIO - RAL 8019 - - conf. 6 - € 3,58 46990010/068P - Colore GRIGIO POLVERE - RAL 7037 - - conf. 6 - € 3,58 segue...</p> 
<p> continua... 46990010/072P - Colore NERO SATINATO - RAL 9005 - - conf. 6 - € 3,58 46990010/073P - Colore BIANCO SATINATO - RAL 9010 - - conf. 6 - € 3,58 46990010/074P - Colore VERDE MILITARE - RAL 6003 - - conf. 6 - € 3,58 46990010/077P - Colore ROSSO VINO - RAL 3005 - - conf. 6 - € 3,58</p> 	<p> SMALTO SPRAY Effetto metallico brillante per interni Rapida essiccazione Formato 400 ml</p> <p>46990310/301P - Colore Argento - - conf. 6 - € 4,94 46990310/302P - Colore Oro Pallido - - conf. 6 - € 5,07 46990310/303P - Colore Oro Ducato - - conf. 6 - € 5,88 46990310/304P - Colore Rame - - conf. 6 - € 5,13 46990710/705P - Colore Specchiante Oro - - conf. 6 - € 5,10 segue...</p> 
<p> continua... 46990710/706P - Colore Specchiante Argento - - conf. 6 - € 5,10</p> 	<p> SMALTO SPRAY Acrilico 100% Adatto per esterni ed interni Effetto antico Ferromicaceo Per la decorazione e protezione delle superfici e oggetti Essicca rapidamente al tatto in 15 minuti, in 24 ore in profondità Valvola autopulente Formato 400 ml</p> <p>46990410/401P - Colore Grigio Chiaro - - conf. 6 - € 4,65 46990410/402P - Colore Grigio Forgia - - conf. 6 - € 4,65 46990410/403P - Colore Nero - - conf. 6 - € 4,65 segue...</p> 
<p> continua... 46990410/406P - Colore Grigio - - conf. 6 - € 4,65</p> 	<p> SMALTO SPRAY alte temperature Smalto resistente a temperature continue di 600° C con punte di 800° C Formato 400 ml</p> <p>46990510/501P - Colore Nero Opaco - - conf. 6 - € 6,44 46990510/503P - Colore Bianco - - conf. 6 - € 6,44 46990510/504P - Colore Alluminio - - conf. 6 - € 6,44 46990510/506P - Colore Rosso - - conf. 6 - € 6,44</p> 
<p> SMALTO SPRAY Acrilico 100% Smalto fluorescente per esterni ed interni Rapida essiccazione Formato 400 ml</p> <p>46990110/101P - Colore Giallo - - conf. 6 - € 5,19 46990110/102P - Colore Arancio - - conf. 6 - € 5,19 46990110/103P - Colore Rosso - - conf. 6 - € 5,19 46990110/104P - Colore Verde - - conf. 6 - € 5,19</p> 	<p> SMALTO SPRAY Acrilico 100% Colori speciali Per esterni ed interni Rapida essiccazione Formato 400 ml</p> <p>46990610/601P - Colore Trasparente Lucido - - conf. 6 - € 3,81 46990610/602P - Colore Fondo Ancorante Tras - - conf. 6 - € 4,51 46990610/603P - Colore Bianco Elettrodom. - - conf. 6 - € 3,81 46990610/604P - Colore Fondo Antirug. Grig. - - conf. 6 - € 4,51 segue...</p> 















 <p>continua... 46990610/605P - Colore Trasparente Opaco - - conf. 6 - € 3,81 46990610/607P - Colore Alluminio Ruote - - conf. 6 - € 4,98 46990610/615P - Colore Marrone Scuro Lucido - - conf. 6 - € 3,81 46990610/617P - Colore Fondo Ancorante Bian - - conf. 6 - € 4,51</p>	 <p>MARCATORE Pittura per marcature esterne ed interne Utilizzato nel campo edile, idraulica e nell'impiantistica elettrica Prodotto specifico per tracciare e marcare parcheggi, indicazioni stradali... Alta copertura e resistenza su materiali come sabbia, asfalto, legno, pietra, acciaio, alluminio Con valvola multi direzionale a 360° Formato 500 ml</p> <p>46970910/905 - Colore Fluorescente Arancio - - conf. 4 - € 7,45 46970910/906 - Colore Fluorescente Blu - - conf. 4 - € 7,45 segue...</p>
 <p>continua... 46970910/907 - Colore Fluorescente Fucsia - - conf. 4 - € 7,45 46970910/908 - Colore Fluorescente Giallo - - conf. 4 - € 7,45 46970910/909 - Colore Fluorescente Rosso - - conf. 4 - € 7,45 46970910/910 - Colore Fluorescente Verde - - conf. 4 - € 7,45 46970910/911 - Colore Bianco - - conf. 4 - € 6,29 segue...</p>	 <p>continua... 46970910/912 - Colore Blu - - conf. 4 - € 6,29 46970910/913 - Colore Giallo - - conf. 4 - € 6,29 46970910/914 - Colore Nero - - conf. 4 - € 6,29 46970910/915 - Colore Rosso - - conf. 4 - € 6,29</p>
 <p>TRACCIATORE SPRAY Vernice speciale Specifico per marcature interne ed esterne a lungo termine Utilizzato per la tracciatura nei cantieri, per la marcatura su alberi, per delimitare aree di stoccaggio e parcheggi... Valvola autopulente Rapida essiccazione Formato 400 ml</p> <p>46970810/805 - Colore Rosso - - conf. 6 - € 3,93 46970810/806 - Colore Giallo - - conf. 6 - € 3,93 46970810/807 - Colore Blu - - conf. 6 - € 3,93 segue...</p>	 <p>continua... 46970810/808 - Colore Nero - - conf. 6 - € 3,93 46970810/809 - Colore Bianco - - conf. 6 - € 3,93</p>
 <p>COPRI MACCHIA SPRAY Pittura formulata per coprire diversi tipi di macchie all'interno e all'esterno. Indicata contro macchie di nicotina, olio, vino rosso, caffè, solvente... Valvola multi direzionale a 360° Formato 400 ml</p> <p>46985610/04 - Formato 400 ml - - conf. 6 - € 6,26</p>	 <p>CATRAMIX Vernice nera bituminosa Con proprietà di ancoraggio Utilizzato per impermeabilizzare e proteggere strutture metalliche, lamiere, legno, cemento... Formato 750 ml</p> <p>46961110/750 - - conf. 6 - € 6,50</p>
 <p>G&M 540 PISTOLA PER SILICONE Economica</p> <p>540301820000 - - conf. 1 - € 1,42</p>	 <p>Gieffe gruppo general ferramenta PISTOLA SILICONE A GUSCIO In acciaio Colore blu</p> <p>512310800N - - conf. 1 - € 2,47</p>
 <p>Gieffe gruppo general ferramenta PISTOLA SILICONE A STELO CON FRIZIONE</p> <p>512310820N - - conf. 1 - € 3,28</p>	 <p>Gieffe gruppo general ferramenta PISTOLA SILICONE PROFESSIONALE A STELO</p> <p>512310830N - - conf. 1 - € 6,60</p>



UTENSILI

 <p>PISTOLA SILICONE PROFESSIONALE originale inglese Antigocciolamento Art. 9030</p> <p>93013015 - - conf. 5 - € 9,70</p> 	 <p>PISTOLA SILICONE A GUSCIO In acciaio cromato</p> <p>512310810N - - conf. 1 - € 4,43</p> 
 <p>PISTOLA PER CARTUCCIA CHIMICO Grammi 410 Ø 55</p> <p>512310840N - - conf. 1 - € 11,33</p> 	 <p>PISTOLA PROFESSIONALE COASSIALE In metallo per cartuccia FIP C 700 FIS VT 380C</p> <p>93013030 - - conf. 1 - € 51,84</p> 
 <p>PISTOLA SILICONE A TUBO originale inglese Antigocciolamento Art. 9040</p> <p>93013025 - - conf. 1 - € 43,28</p> 	 <p>PISTOLA A TUBO PER SILICONE YFD-13 In plastica</p> <p>512310845N - - conf. 1 - € 7,80</p> 
 <p>PISTOLA SILICONE Skeleton frame originale inglese Antigocciolamento Art. 9055</p> <p>93013020 - - conf. 2 - € 34,54</p> 	 <p>PISTOLA SILICONE a tubo</p> <p>540301820020 - - conf. 1 - € 3,00</p> 
 <p>PISTOLA INCOLLATRICE Bassa Temperatura 10 W - Ø 8 x 100 Controllo elettronico temperatura Avanzamento automat. dello stick Impugnatura "SOFT GRIP"</p> <p>540306008066 - - conf. 1 - € 4,94</p> 	 <p>PISTOLA INCOLLATRICE Alta Temperatura 40W - Ø 11 X 200 Controllo elettronico temperatura Avanzamento automat. dello stick Impugnatura "SOFT GRIP"</p> <p>540306008060 - - conf. 1 - € 9,48</p> 
 <p>PISTOLA INCOLLATRICE ad alta temperatura 80 Watt batteria ricaricabile autonomia 15 min. tempo ricarica 6 min. impugnatura soft grip 80 Watt Stick Ø 11x200 mm</p> <p>540306008061 - - conf. 1 - € 10,71</p> 	 <p>PISTOLA EG 212 Incollatrice 40 W Estrusione 230 g/ora</p> <p>90070651 - - conf. 1 - € 29,00</p> 



<p>Rapid</p> <p>PISTOLA INCOLLATRICE CG270 CORDLESS Estrusione 350 g/ora Per colla stick Ø 12mm Impiego senza cavo</p> <p>90070652 – – conf. 1 – € 52,40</p> 	<p>Rapid</p> <p>PISTOLA EG 310 Incollatrice 40 W Estrusione 1000 g/ora Heating system per un minor tempo di riscald.</p> <p>90070655 – – conf. 1 – € 100,20</p> 
<p>Rapid</p> <p>PISTOLA INCOLLATRICE EG340 220W PROFESSIONALE Estrusione 1400 g/ora Alte prestazioni Temperatura regolabile 5 posizioni temperatura: 120° – 145° – 170° – 195° – 220° Cavo 2,5 metri Pulsante on/off Per colla stick Ø 12mm</p> <p>90070658 – – conf. 1 – € 218,00</p> 	<p>Rapid</p> <p>PISTOLA INCOLLATRICE PROFESSIONALE Modello EG330 Potenza: 380 W 2 Posizioni di temperatura Estrusione: 1600 gr/h Alte prestazioni</p> <p>90070657 – – conf. 1 – € 212,00</p> 
<p>Henkel</p> <p>PISTOLA INCOLLATRICE ad avanzamento automatico Per incollare carta, plastica, legno, ceramica, tessuti 2 stick colla inclusi</p> <p>74059900 – Watt 20 – Ø stick 7 mm – – conf. 1 – € 9,40 74059920 – Watt 40 – Ø stick 11 mm – – conf. 1 – € 15,40</p> 	<p>PISTOLA TERMOCOLLANTE 2 stick colla inclusi In blister</p> <p>740M8815 – – conf. 1 – € 16,40 740M8845 – – conf. 1 – € 15,80</p> 
<p>Henkel</p> <p>COLLA TRASPARENTE 12X200 Confezione da 1 Kg</p> <p>515243424 – – conf. 5 – € 15,80</p> 	<p>&M 540</p> <p>SET 10 STICK COLLA BIANCHI alta temperatura Ø 11x200 mm</p> <p>540306008254 – – conf. 1 – € 2,66</p> 
<p>&M 540</p> <p>SET 10 STICK COLLA TRASPARENTI alta temperatura Ø 11x200mm</p> <p>540306008256 – – conf. 6 – € 2,45</p> 	<p>&M 540</p> <p>SET 10 STICK COLLA COLORE NERO alta temperatura Ø 11x200mm</p> <p>540306008257 – – conf. 6 – € 2,38</p> 
<p>&M 540</p> <p>SET 10 STICK COLLA TRASPARENTI bassa temperatura Ø 11x200mm</p> <p>540306008268 – – conf. 6 – € 3,28</p> 	<p>SET 12 STICK COLLA PER PISTOLA INCOLLATRICE</p> <p>74060000 – Ø x L 7 x 100 mm – – conf. 10 – € 2,80 74060020 – Ø x L 11 x 100 mm – – conf. 10 – € 4,80</p> 



<p>&M540</p> <p>SET 30 STICKS COLLA BIANCHI alta temperatura Ø 11x200mm</p> <p>540306008258 – – conf. 1 – € 6,16</p> 	<p>&M930</p> <p>SET 36 STICK COLLA M.M 8</p> <p>93013052 – – conf. 1 – € 4,12</p> 
<p>Rapid</p> <p>RIVETTATRICE RP10 In blister Manuale Per rivetti alluminio da 3,2 a 4,8 mm 100 rivetti – chiave e ugelli inclusi</p> <p>90070620 – – conf. 1 – € 34,40</p> 	<p>Rapid</p> <p>RIVETTATRICE MANUALE RP40 MULTI In blister L'ugello Multi si adatta automaticamente a rivetti in alluminio Ø 3,2 – 4,0 – 4,8 mm e INOX Ø 3,2 – 4,0 Misuratore per lamiere e rivetti integrato Calibro per rivetti e punte Impugnatura in morbida gomma Peso 0.54 Kg</p> <p>90070625 – – conf. 1 – € 38,20</p> 
<p>Rapid</p> <p>RIVETTATRICE MANUALE RP100 Sistema di riduzione dello sforzo Press-Less per ridurre l'affaticamento e moltiplicare la potenza Concepita per usi intensivi. Impugnatura in gomma morbida Per rivetti in alluminio da Ø 3,2 e 4 mm Per rivetti Rapid INOXs Ø 4,8 mm Corpo in pressofusione di alluminio Ganasce di strappo in acciaio temperato 5 anni di garanzia</p> <p>90070627 – – conf. 1 – € 48,40</p> 	<p>&M540</p> <p>RIVETTATRICE TIPO GIREVOLE</p> <p>540600771018 – – conf. 3 – € 9,06</p> 
<p>Rapid</p> <p>CUCITRICE UFFICIO Mod. S51 Punti 21/4 2000 punti inclusi</p> <p>90070710 – – conf. 2 – € 25,60</p> 	<p>Rapid</p> <p>CUCITRICE UFFICIO Mod. K1 Punti 24/6 o 26/6 Graffa 40 fogli alla volta</p> <p>90070715 – – conf. 2 – € 51,20</p> 
<p>&M900</p> <p>FISSATRICE SN 112 per punti 5-6-8-10-12 mm. e chiodi 13 mm.</p> <p>90070600 – – conf. 5 – € 20,40</p> 	<p>&M900</p> <p>Conf. 5000 pz PUNTI per fissatrici SN 112 e ROCAMA</p> <p>90070614 – modello 105 – – conf. 5 – € 7,60 90070615 – modello 108 – – conf. 5 – € 8,40 90070616 – modello 110 – – conf. 5 – € 11,20 90070617 – modello 112 – – conf. 5 – € 12,00 90070618 – modello 114 – – conf. 5 – € 12,60</p> 
<p>Rapid</p> <p>CONFEZIONE 2000 PUNTI Per cucitrice S51</p> <p>90070711 – – conf. 10 – € 0,88</p> 	<p>Rapid</p> <p>CONFEZIONE 2000 PUNTI Per cucitrice K1</p> <p>90070716 – – conf. 20 – € 1,88</p> 









  <p>FISSATRICE Rapid R53 Graffe da 4 a 10 90070679 - - conf. 1 - € 38,20</p>	  <p>FISSATRICE Rapid R453 Graffe da 6 a 14 Chiodi da 15 mm 90070680 - - conf. 1 - € 69,60</p>
  <p>PINZATRICE in plastica punte 4-8 mm spess. 0,7 mm 540W74000 - - conf. 1 - € 6,00</p>	  <p>FISSATRICE Rapid R353 Graffe da: 6 a 14 90070681 - - conf. 1 - € 91,80</p>
  <p>FISSATRICE Rapid R23 Graffe: 4-8 mm 90070684 - - conf. 1 - € 62,60</p>	  <p>GRAFFATRICE RAPID R33 graffe 6 - 14 mm 90070688 - - conf. 1 - € 95,80</p>
  <p>GRAFFATRICE MANUALE ALU953 Tecnologia brevettata Powercurve Technology™ per risparmiare fino al 65% dello sforzo Regolazione della potenza con ottimizzazione dello sforzo a 3 livelli Magazzino a doppia funzione per graffe fini e chiodini Corpo in pressofusione di alluminio Parti interne in acciaio temperato Senza rinculo Graffe fini N°53 da 6 a 14 mm Chiodi N°8 da 8 a 15 mm 3 anni di garanzia 90070676 - - conf. 1 - € 71,20</p>	  <p>GRAFFATRICE ELETTRICA E100 Leggera e confortevole ideale per uso casalingo Magazzino a doppia funzione per graffe fini e chiodini Graffe fini N°53 da 6 a 14 mm Chiodi N°8 15 mm 2 anni di garanzia 90070665 - - conf. 1 - € 70,80</p>
  <p>Conf. 2400 pz. GRAFFE Rapid mod. 53 90070696 - - conf. 15 - € 12,20</p>	  <p>GRAFFATRICE RAPID PS101 Graffatrice pneumatica uso leggero Realizzata in robusto alluminio pressofuso leggera ed ergonomica Da usare su tessuti, pelle, falegnameria leggera, rivestimenti, etichettatura e tappezzeria Graffe da 6 a 16 mm Pressione di esercizio max 7 bar Occhiali di protezione - olio lubrificante - 300 graffe incluse Valigia plastica 90070685 - - conf. 1 - € 117,40</p>
  <p>GRAFFE CONF. 5000 Pz. Mod. 13 90070729 - Misura mm 4 - - conf. 10 - € 10,00 90070730 - Misura mm 6 - - conf. 10 - € 10,80 90070731 - Misura mm 8 - - conf. 10 - € 11,60 90070732 - Misura mm 10 - - conf. 10 - € 13,80 90070734 - Misura mm 14 - - conf. 10 - € 17,00</p>	  <p>Conf. 5000 pz. GRAFFE Rapid mod. 53 90070690 - misura 6 - - conf. 10 - € 9,80 90070691 - misura 8 - - conf. 10 - € 10,80 90070692 - misura 10 - - conf. 10 - € 12,60 90070693 - misura 12 - - conf. 10 - € 13,60 90070694 - misura 14 - - conf. 10 - € 15,40 90070695 - misura 16 - - conf. 10 - € 17,20</p>















<p>Rapid</p> <p>CHIODO mod. 300 Rapid 15 mm 90070706 - - conf. 3 - € 11,80</p> 	<p>FISSATRICE PRIMULA 6 Inclusi 1000 punti 6320000107 - - conf. 1 - € 12,56</p> 
<p>FISSATRICE ROCAMA In polipropilene atossico Punti: 105/13 108/13 110/13 6320101027 - Modello Rocama Jr Duo - - conf. 1 - € 41,82</p> 	<p>FISSATRICE SPILLATRICE ROCAMA 10 Con regolatore di potenza Per assemblaggio di telai e cornici Per fissare tappezzeria, ricoperture di divani e mobili Per fissare tutti i tipi di carta e stoffa 6320104110 - - conf. 1 - € 71,68</p> 
<p>FISSATRICE ROCAMA In polipropilene atossico: Punti 150/13 108/13 110/13 6320104501 - Modello Rocama 14 - - conf. 1 - € 67,98</p> 	<p>SPILLATRICE TECNICA Corpo in resina antiurto Leva di manovra in acciaio nichelato Carica inferiore anti inceppamento 6320113086 - Punti 110/10 - - conf. 1 - € 28,02 6320114002 - Punti 114/14 - - conf. 1 - € 36,66</p> 
<p>CONFEZIONE 10000 PUNTI JOLLY ORO 6321001131 - - conf. 1 - € 8,86</p> 	<p>CONFEZIONE 5000 PUNTI FOREST 6321101201 - Punti 105 - - conf. 1 - € 7,00 6321101203 - Punti 108 - - conf. 1 - € 7,82 6321101205 - Punti 110 - - conf. 1 - € 9,88</p> 
<p>CONFEZIONE 5000 PUNTI AP 6321101207 - Punti 112 - - conf. 1 - € 11,12 6321101209 - Punti 114 - - conf. 1 - € 11,94</p> 	<p>&M 900</p> <p>CONFEZIONE 1200 PEZZI GRAFFETTE Acciaio zincato In blister 252A5906 - Misura 6 mm - - conf. 1 - € 7,60 252A5908 - Misura 8 mm - - conf. 1 - € 7,60 252A5910 - Misura 10 mm - - conf. 1 - € 7,60</p> 
<p>KEMPER</p> <p>SALDATORE A CARTUCCIA Art. KE2019 TORNADO Lampada per saldare per cartucce 1120-1120S1 e PL707 Accensione piezo elettrica Fiamma regolabile Impugnatura ergonomica gommata Gancio di sospensione estraibile Sistema di sicurezza antisblocco cartuccia brevettato Misure: 11 x 14,60 x 25,30 cm Peso: 0,51 kg 617KE2019 - - conf. 1 - € 20,80</p> 	<p>KEMPER</p> <p>SALDATORE A CARTUCCIA Art. 770 TORNADO METAL Lampada per saldare per cartucce 1120-1120S1 e PL707 Accensione piezo elettrica Fiamma regolabile Portacartuccia in metallo Impugnatura ergonomica gommata Gancio di sospensione estraibile Sistema di sicurezza antisblocco cartuccia brevettato Misure: 11 x 14,60 x 25,30 cm Peso: 0,68 kg 617770 - - conf. 1 - € 22,60</p> 



 <p>FORNELLO DA CAMPEGGIO A GAS Art. KE2008 Accensione piezo elettrica Fornello portatile per cartuccia mod. 1120-1120S1-PL707 Piattello antivento in acciaio Base in plastica termo-resistente Sistema di sicurezza antisblocco cartuccia brevettato Misure: 12,50 x 21,50 x 12,50 cm Peso: 0,54 kg</p> <p>617KE2008 - - conf. 1 - € 25,20</p>	 <p>CARTUCCIA RICAMBIO Art. 1120S1 Formato 360 ml Cartuccia di butano a forare universale Sistema di sicurezza Stop Gas System Collaudata in base alla normativa EN417</p> <p>6171120S1 - - conf. 36 - € 1,84</p>
 <p>CARTUCCIA RICAMBIO Art. 577 Formato 390 ml Cartuccia di butano Attacco a baionetta Sistema di sicurezza Safety plus Collaudata in base alla normativa EN417</p> <p>617577 - - conf. 1 - € 2,56</p>	 <p>FORNELLO BISTRO' A GAS BUTANO Fornello in alluminio uso esterno per campeggio - Alimentazione a gas butano - Accessori piezo Cartuccia auto sigillante a innesto rapido Consumo gas: 155 g/h Energia termica nominale prodotta: 2,5W Utilizzare cartuccia butano conforme alla normativa EN417 Dimensioni fornello: 350x285x90 mm</p> <p>512930010N - - conf. 1 - € 23,80</p>
 <p>KIT CANNELLO GAS Art. 121960MT10R Cannello per asfaltista Rubinetto in ottone con leva economizzatrice Prolunga tipo M, lunghezza 5 cm Cavalletto di sostegno Bruciatore Ø 60 mm Tubo di 10 mt Regolatore di pressione 0-3 bar Misure: 16 x 72 x 12 cm Peso: 2,44 kg</p> <p>61712196 - - conf. 1 - € 71,00</p>	 <p>KIT SELENA-E" per compressore 1 pistola gonfiaggio 1 tubo - sacchetto raccordi 1 aerografo SELENA 1 pistola nafta 1 pistola soffiaggio</p> <p>90080002 - - conf. 1 - € 68,60</p>
 <p>PISTOLA 25/B1 SOFFIAGGIO ARIA canna corta alluminio</p> <p>90080005 - - conf. 1 - € 9,00</p>	 <p>PISTOLA SOFFIAGGIO ARIA canna lunga Alluminio</p> <p>90080006 - - conf. 1 - € 10,40</p>
 <p>PISTOLA GONFIAGGIO 25/D con manometro in alluminio</p> <p>90080007 - - conf. 1 - € 22,80</p>	 <p>PISTOLA LAVAGGIO Serbatoio 1 lt 26/BT-N</p> <p>90080009 - - conf. 1 - € 31,80</p>
 <p>LANCIA 26/L-R per lavaggio con regolatore passaggio acqua-aria incorporato</p> <p>90080010 - - conf. 1 - € 32,00</p>	 <p>OLIATORE In plastica Canna flessibile 300 gr</p> <p>93013061 - - conf. 1 - € 3,40</p>



 <p>AEROGRAFO SELENA per verniciatura a spruzzo con serbatoio superiore 500gr.</p> <p>90080013 - - conf. 1 - € 39,20</p>	 <p>AEROGRAFO "SELENA" per verniciatura a spruzzo mod. "SELENA-I" con serbatoio inferiore 1000gr.</p> <p>90080015 - - conf. 1 - € 40,40</p>
 <p>GIEFFE gruppi generali ferramenta</p> <p>KIT 5 PEZZI ACCESSORI ARIACOMPRESSA Attacco rapido Contiene: Pistola per soffiaggio Pistola gonfiagomme Pistola lavaggio nebulizzatore Aerografo adatto per ogni tipo di vernice Spirale da 5 mt</p> <p>512330020N - - conf. 1 - € 41,00</p>	 <p>GIEFFE gruppi generali ferramenta</p> <p>AEROGRAFO CON SERBATOIO INFERIORE In alluminio Attacco rapido Ugello 1,8 mm 1 litro</p> <p>512330030N - - conf. 1 - € 23,00</p>
 <p>GIEFFE gruppi generali ferramenta</p> <p>AEROGRAFO CON SERBATOIO SUPERIORE In plastica Attacco rapido Ugello 1,5 mm 0,5 litri</p> <p>512330040N - - conf. 1 - € 30,00</p>	 <p>GIEFFE gruppi generali ferramenta</p> <p>PISTOLA SOFFIAGGIO A CANNA CORTA In alluminio Attacco rapido In blister</p> <p>512330050N - - conf. 1 - € 5,90</p>
 <p>GIEFFE gruppi generali ferramenta</p> <p>PISTOLA DI SOFFIAGGIO A CANNA LUNGA Attacco rapido In alluminio In blister</p> <p>512330060N - - conf. 1 - € 7,66</p>	 <p>GIEFFE gruppi generali ferramenta</p> <p>PISTOLA DI GONFIAGGIO CON MANOMETRO Attacco rapido Manometro: 0-12 bar Valvola di decompressione Tubo flessibile da 400 mm</p> <p>512330070N - - conf. 1 - € 19,80</p>
 <p>GIEFFE gruppi generali ferramenta</p> <p>PISTOLA DI LAVAGGIO ATTACCO RAPIDO Capacità 1 litro</p> <p>512330080N - - conf. 1 - € 21,80</p>	 <p>GIEFFE gruppi generali ferramenta</p> <p>TUBO SPIRALATO PER COMPRESSORE Attacco a baionetta Ø 6x8 mm</p> <p>512330100N - Metri 10 mt - - conf. 1 - € 7,00 512330110N - Metri 15 mt - - conf. 1 - € 9,60</p>
 <p>GIEFFE gruppi generali ferramenta</p> <p>TUBO A SPIRALE PER COMPRESSORE Attacco rapido Ø 6x8 mm</p> <p>512330130N - Metri 10 mt - - conf. 1 - € 11,80 512330140N - Metri 15 mt - - conf. 1 - € 17,70</p>	 <p>STANLEY</p> <p>FLESSOMETRO BI-MATERIAL Cassa in Abs antiurto Clip di aggancio Con espositore da banco</p> <p>7881-30-487 - Mt. 3 - Largh. 12,7 - - conf. 12 - € 3,60 7881-30-497 - Mt. 5 - Largh. 19 - - conf. 12 - € 5,80</p>



<p>STANLEY</p> <p>FLESSOMETRO STANLEY Robusta struttura in plastica Nastro forte e resistente rivestito in polimero Clip di aggancio</p> <p>7881-30-457 - Mt. 8 - Largh. 25 - - conf. 12 - € 12,00</p> 	<p>STANLEY</p> <p>FLESSOMETRO PANORAMIC mt.3 - largh.12,7 Lettura diretta sulla finestrella superiore</p> <p>7880-32-125 - - conf. 4 - € 19,40</p> 
<p>STANLEY</p> <p>FLESSOMETRO TYLON Cassa in Abs Rivestimento in gomma antiscivolo Nastro professionale rivestito con pellicola in mat. plastico Clip di aggancio</p> <p>7881-30-687 - metri 3 - larghezza 12,7 - - conf. 12 - € 6,60 7881-30-697 - metri 5 - larghezza 19 - - conf. 12 - € 12,56</p> 	<p>STANLEY</p> <p>FLESSOMETRO 5 METRI Nastro largh. 19 mm Cassa metallica Nastro rivestito in Mylar Lettura diretta sulla finestrella superiore</p> <p>7880-33-932 - - conf. 6 - € 38,40</p> 
<p>STANLEY</p> <p>FLESSOMETRO POWERLOCK Cassa in materiale sintetico Nastro in acciaio rivestito Mylar Clip di aggancio rivestito Mylar</p> <p>7880-33-191 - Mt. 5 - Largh. 19 - - conf. 6 - € 26,40 7880-33-195 - Mt. 5 - Largh. 25 - - conf. 4 - € 31,80 7880-33-198 - Mt. 8 - Largh. 25 - - conf. 4 - € 39,20 7880-33-238 - Mt. 3 - Largh. 12,7 - - conf. 4 - € 15,40 7880-33-442 - Mt. 10 - Largh. 25 - - conf. 4 - € 46,80</p> 	<p>METRICA MADE TO MEASURE</p> <p>FLESSOMETRO ESPOSITORE TRANSPARENT 12 Pezzi Colori assortiti</p> <p>64889780 - Mt. 5 - Largh. 19 mm - - conf. 1 - € 74,48</p> 
<p>METRICA MADE TO MEASURE</p> <p>FLESSOMETRO TASCABILE Colore Giallo Cassa in ABS Forma ergonomica Bloccaggio e rientro automatico del nastro Nastro smaltato opaco antiriflesso Con clip</p> <p>64838362 - Mt. 2 - Largh. 13 mm - - conf. 12 - € 2,52 64838363 - Mt. 3 - Largh. 16 mm - - conf. 12 - € 2,80 64838365 - Mt. 5 - Largh. 19 mm - - conf. 12 - € 4,06</p> 	<p>METRICA MADE TO MEASURE</p> <p>FLESSOMETRO METRICA RUBBER TOUCH Graduazione e numerazione migliore Speciale gancio mobile con gomma alettata all'interno Nastro rivestito in nylon, antiabrasione, antiacido e antiriflesso Cassa bimatereale rivestita in gomma antiscivolo Rientro del nastro ammortizzato Con clip</p> <p>64838793 - Mt. 3 - Largh. 16 mm - - conf. 12 - € 4,06 64838794 - Mt. 5 - Largh. 19 mm - - conf. 12 - € 5,46 segue...</p> 
<p>METRICA MADE TO MEASURE</p> <p>continua...</p> <p>64838795 - Mt. 5 - Largh. 25 mm - - conf. 6 - € 6,56 64838798 - Mt. 8 - Largh. 25 mm - - conf. 6 - € 10,92</p> 	<p>METRICA MADE TO MEASURE</p> <p>FLESSOMETRO METRICA FLASH Nastro ad effetto fluorescente Graduazione su entrambe le facce: Fronte numerazione orizzontale, fondo fluorescente Retro numerazione verticale, fondo bianco Nastro rivestito in nylon antiabrasione, antiacido e antiriflesso Cassa cromata rivestita in gomma antiscivolo Resistenza alla flessione verticale usando la scala a lettura verticale Con clip</p> <p>64808973 - Mt. 3 - Largh. 16 mm - - conf. 6 - € 10,06 64808974 - Mt. 5 - Largh. 19 mm - - conf. 6 - € 13,72 segue...</p> 
<p>METRICA MADE TO MEASURE</p> <p>continua...</p> <p>64808975 - Mt. 5 - Largh. 25 mm - - conf. 6 - € 15,68 64808978 - Mt. 8 - Largh. 25 mm - - conf. 6 - € 21,00</p> 	<p>vola</p> <p>DOPPIOMETRO LEGNO VOLA mod. LUSO 5 Bianco / giallo</p> <p>90073261 - - conf. 12 - € 2,90</p> 

Buoni STRUMENTI per un buon LAVORO



La misurazione accurata è una delle basi più importanti in qualsiasi lavoro artigianale. Ecco perché è che i professionisti dispongano di strumenti di misurazione sulla cui precisione possono assolutamente fare affidamento. Con qualsiasi tempo, nelle condizioni di cantiere più dure. Strumenti robusti e permanentemente precisi che sono facili da usare. STABILA sviluppa e produce precisamente questi strumenti di misura. Dal 1889.













Scopri di più:

www.stabila.com 

STABILA® 

How true pro's measure













<p>METRICA MADE TO MEASURE</p> <p>DOPPIO METRO In fibra di vetro Graduazione incisa Snodi con doppia molla antiusura e scatto a 90° Non conduttore, lavabile, non graffia la superficie Aste: 10 Lunghezza: 2 metri</p> <p>64818020 - - conf. 12 - € 4,64</p> 	<p>STABILA</p> <p>DOPPIOMETRO IN LEGNO SNODABILE Tipo 717 10 stecche bicolore bianche-gialle Giunzioni in poliammide rinforzati con fibre di vetro Ideale per tracciature continue Classe di precisione III Lunghezza 2 metri</p> <p>7811328 - Mt. 2 - - conf. 10 - € 4,76</p> 
<p>STABILA</p> <p>DOPPIOMETRO IN LEGNO Tipo 617 Snodabile 10 stecche bicolore bianche-gialle Giunzioni in acciaio Classe di precisione III cm/mm Lunghezza 2 metri</p> <p>7811128 - Mt. 2 - - conf. 10 - € 6,71</p> 	<p>METRICA MADE TO MEASURE</p> <p>CALIBRO METRICA TIPO SCUOLA Acciaio inox temperato Scala cromata opaca Bloccaggio a leva 4 funzioni di misura Astuccio in similpelle Scala: 0,05 mm/inch Dimensione: 150 mm</p> <p>64810038 - - conf. 5 - € 14,56</p> 
<p>METRICA MADE TO MEASURE</p> <p>CALIBRO DIGITALE NUMERI GRANDI METRICA In acciaio inox temperato Display con numeri grandi 11 mm 4 funzioni di misura 3 tasti: accensione/spengimento manuale, azzeramento per misure comparative, conversione mm/inch Precisione 0,02 mm Ripetibilità 0,01 mm Alimentazione: pile alcaline 1,5V Custodia in plastica nera</p> <p>64810002LR - A mm 0-155 - B mm 40 - - conf. 1 - € 24,08</p> 	<p>STANLEY</p> <p>ROTELLA METRICA Nastro Fiberglass Largh: 12,7 mm con custodia in ABS Classe precisione III</p> <p>7880-34-295 - mt. 10 - - conf. 6 - € 11,00 7880-34-296 - mt. 20 - - conf. 6 - € 14,20 7880-34-297 - mt. 30 - - conf. 6 - € 23,40</p> 
<p>STANLEY</p> <p>ROTELLA METRICA Nastro Acciaio Largh: 9,5 mm spess: 0,115 mm Classe precisione II</p> <p>7880-34-102 - mt. 10 - - conf. 6 - € 31,60 7880-34-105 - mt. 20 - - conf. 6 - € 41,40</p> 	<p>STANLEY</p> <p>ROTELLA METRICA PowerWinder Telaio aperto Nastro Fiberglass</p> <p>7882-34-772 - mt. 30 - largh. 12,7 - - conf. 2 - € 42,60</p> 
<p>METRICA MADE TO MEASURE</p> <p>ROTELLA Custodia in ABS Resistente agli urti Nastro in fibra di vetro Manovella in metallo</p> <p>64840016SP - Mt. 10 - Largh. 16 mm - - conf. 5 - € 5,84 64840017SP - Mt. 20 - Largh. 16 mm - - conf. 1 - € 7,74</p> 	<p>METRICA MADE TO MEASURE</p> <p>ROTELLA Custodia in ABS Resistente agli urti con impugnatura Nastro in fibra di vetro Custodia a struttura aperta per una migliore pulizia del nastro Manovella in metallo</p> <p>64840057SP - Mt. 50 - Largh. 16 mm - - conf. 1 - € 18,12</p> 
<p>STANLEY</p> <p>TRACCIATORE POWERWINDER Con flacone 113 gr. polvere Blu e livella per fili</p> <p>7880-47-465 - mt. 30 - - conf. 1 - € 20,00</p> 	<p>STANLEY</p> <p>MISURATORE LASER TLM 65 Il modello più semplice e veloce all'uso. Molto compatto e leggero, perfetto per le misurazioni in interni Pulsante unico multifunzione Rilevazione a bordo dello strumento Indicatore livello batteria Portata: da 21 cm a 20 metri Precisione tipica: +/- 3,0 mm Funzioni: distanza, area, volume, misura continua Misurazioni in mm e pollici. La confezione include: batterie</p> <p>788STHT177032 - - conf. 1 - € 84,60</p> 



<p>STANLEY</p>  <p>MISURATORE LASER TLM 99 Portata: da 10 a 30 metri Precisione: +/- 2,0 mm Schermo: a 2 linee Funzioni: distanza, area, volume addizione e sottrazione Ideale per misurazione di base Estremamente facile all'uso</p> <p>788STHT177138 - - conf. 1 - € 139,46</p>	<p>STANLEY</p>  <p>MISURATORE DIGITALE SMART MEASURE PRO Portata 137 metri Precisione ±3% Connettività bluetooth Si sincronizza con l'app e fornisce misurazioni e dati in tempo reale Permette di salvare i files in formato PDF e JPG Misura in m² E' possibile sottrarre aree definite come porte e finestre Rileva altezza, larghezza e area partendo da una foto scattata con smartphone o tablet</p> <p>788STHT177366 - - conf. 1 - € 236,00</p>
<p>METRICA MADE TO MEASURE</p>  <p>MISURATORE LASER METRICA ONE Display retroilluminato su 1 riga Schermo ad alta visibilità Funzione misurazione continua Distanze, superfici, volumi 1 fiala Autospegnimento Funzione sonora Con cinghietta In astuccio <i>*Portata in metri, calcolata secondo luminosità ambientale</i></p> <p>64861120 - Portata 30 m - - conf. 1 - € 67,50</p>	<p>METRICA MADE TO MEASURE</p>  <p>MISURATORE METRICA FLASH 30 Display retroilluminato su 4 righe Schermo nero ad alta visibilità Somma e sottrazione di distanze, superfici e volumi Stelo estraibile per diagonali, 2 fiale Autospegnimento, 99 memorie Filetto 1/4" per attacco treppiede Con cinghietta, in astuccio</p> <p>64861130 - Portata 30 M - - conf. 1 - € 102,06 64861155 - Portata 60 M - - conf. 1 - € 129,34</p>
<p>METRICA MADE TO MEASURE</p>  <p>MISURATORE LASER METRICA FLASH MINI 30 Display retroilluminato su 4 righe Schermo ad alta visibilità Funzione misurazione continua con MAX e MIN Distanze, superfici, volumi 2 funzioni pitagora Somma, sottrazione 10 memorie Autospegnimento Con cinghietta Batteria LI-ION ricaricabile In astuccio <i>*Portata in metri, calcolata secondo luminosità ambientale</i></p> <p>64861110 - Portata 30 m* - - conf. 1 - € 76,96</p>	<p>METRICA MADE TO MEASURE</p>  <p>AUTOLIVELLA FLASH GREEN 360° METRICA Base magnetica e calotta metallica Batterie Ion-Li ricaricabili con cavetto USB Portata: 40 m Portata con ricevitore: 60 m Precisione livellamento: +/- 3 mm/10 m Campo autolivellamento: +/- 4° Potenza laser: Classe II Batterie: 2000 mAh li-ion Dimensioni: 114x66 mm Peso senza batteria: 0,275 Kg</p> <p>64861435 - - conf. 1 - € 199,80</p>
<p>STANLEY</p>  <p>LIVELLA LASER MANUALE DA PARETE Proietta il raggio laser lungo una superficie. Con supporto da parete che consente di girare lo strumento a 360°. Distanza operativa 4,5 mt Batterie incluse</p> <p>788STHT177148 - - conf. 1 - € 36,60</p>	<p>STANLEY</p>  <p>LIVELLA LASER AUTOLIVELLANTE DA PARETE Traccia una linea verticale o orizzontale Ideale per fissare quadri, mensole, scaffali Distanza operativa 6 mt Batterie incluse</p> <p>788STHT177149 - - conf. 1 - € 53,60</p>
<p>STANLEY</p>  <p>LIVELLA LASER AUTOLIVELLANTE CUBIX Traccia una linea a croce Portata 8 mt Precisione ± 0,8 mm/m Include: supporto multidirezionale Quick-Click, batterie</p> <p>788STHT177340 - - conf. 1 - € 79,40</p>	<p>PRÔXE</p>  <p>MULTIMETRO DIGITALE "START" Modello base (standard 830B) Display a 3 1/2 cifre Categoria I 600V 6 funzioni di misura 20 livelli di test Fusibile di protezione Indicatore di "fuori scala" Funzioni di misura: Misura di tensione in corrente continua/alternata Misura di intensità in corrente continua Misura di resistenza Test per diodi - Test transistor</p> <p>753722101 - - conf. 1 - € 8,86</p>
<p>PRÔXE</p>  <p>MULTIMETRO DIGITALE "SUPER" Modello medio Categoria I 600V (IEC 61010) 8 funzioni di misura - 20 livelli di test Auto-azzeramento - Doppio fusibile di protezione Indicatore di "fuori scala" Sonda per misurazione temperatura inclusa Funzioni di misura: Misura di tensione in corrente continua/alternata Misura di intensità in corrente continua Misura di resistenza - Misura di temperatura Test LED - Test per diodi - Test transistor</p> <p>753722102 - - conf. 1 - € 16,68</p>	<p>PRÔXE</p>  <p>MULTIMETRO DIGITALE PROFESSIONALE "TOP" Modello professionale Display a 3 3/4 cifre Categoria III 600V e II - 1000V (IEC 61010) 12 funzioni di misura AUTORANGE (trova in automatico la scala di misura) Indicatore di "fuori scala" Sonda per misurazione di temperatura Funzioni di misura: Misura di tensione e intensità in corrente continua ed alternata Misura in °C e °F - Misura di resistenza Misura di capacità per condensatori Test LED - Diodi - Transistor Test continuità elettrica</p> <p>753722103 - - conf. 1 - € 37,50</p>



<p>STANLEY</p> <p>LIVELLA TORPEDO BASIC 3 bolle - 200mm Corpo in materiale sintetico antiurto scanalato Finestra per lettura superiore Precisione dei piani di lavoro: ± 1 mm/m</p> <p>7880-42-294 - - conf. 6 - € 11,40</p> 	<p>STANLEY</p> <p>LIVELLA TORPEDO MAGNETICA ANTISCHOCK 3 bolle - 230mm corpo in alluminio con estremità e livella superiore rivestita in gomma</p> <p>7880-43-511 - - conf. 6 - € 22,20</p> 
<p>vola</p> <p>LIVELLA TASCABILE mod. 254/MB</p> <p>90073077 - L.mm. 100 - - conf. 25 - € 2,04</p> 	<p>STABILA</p> <p>LIVELLA POCKET PRO MAGNETIC TASCABILE Robusto alloggiamento perpendicolare con nucleo in alluminio e due superfici di misurazione fresate e precise con scanalatura a V per misurazioni orizzontali e verticali su superfici piatte e tonde. Magnete in terre rare</p> <p>78117953 - - conf. 1 - € 20,49</p> 
<p>vola</p> <p>LIVELLA Mod 245 alluminio</p> <p>90073061 - L.mm. 300 - - conf. 3 - € 14,80 90073062 - L.mm. 400 - - conf. 3 - € 15,98 90073063 - L.mm. 500 - - conf. 3 - € 17,42 90073064 - L.mm. 600 - - conf. 3 - € 18,48 90073065 - L.mm. 800 - - conf. 3 - € 21,02 90073066 - L.mm. 1000 - - conf. 3 - € 23,36</p> 	<p>vola</p> <p>LIVELLA Mod 246M alluminio magnetica</p> <p>90073070 - L.mm. 300 - - conf. 2 - € 19,78 90073071 - L.mm. 400 - - conf. 2 - € 20,74 90073072 - L.mm. 500 - - conf. 2 - € 24,92 90073073 - L.mm. 600 - - conf. 2 - € 26,08</p> 
<p>GM540</p> <p>LIVELLA IN ALLUMINIO A 2 BOLLE</p> <p>540303490500 - Misura 500 MM - - conf. 1 - € 3,78 540303490400 - Misura 400 MM - - conf. 1 - € 3,58 540303490600 - Misura 600 MM - - conf. 1 - € 3,98</p> 	<p>STABILA</p> <p>LIVELLA 80 AS Profilo rettangolare in alluminio con nervature di rinforzo Tappi laterali anticivolo Precisione duratura Lunghezza 20 cm</p> <p>78119565 - Lungh. CM 20 - - conf. 1 - € 23,94</p> 
<p>STABILA</p> <p>LIVELLA Modello 70 Strumento di misura leggero e preciso Corpo rettangolare in alluminio</p> <p>7812281 - Mt. 30 - - conf. 1 - € 18,99 7812282 - Mt. 40 - - conf. 1 - € 19,87 7812283 - Mt. 50 - - conf. 1 - € 21,30 7812284 - Mt. 60 - - conf. 1 - € 22,88 7812286 - Mt. 80 - - conf. 1 - € 25,72 segue...</p> 	<p>STABILA</p> <p>continua...</p> <p>7812288 - Mt. 100 - - conf. 1 - € 29,00 7812289 - Mt. 120 - - conf. 1 - € 33,22 7812290 - Mt. 150 - - conf. 1 - € 51,61 7812291 - Mt. 180 - - conf. 1 - € 59,67 7812292 - Mt. 200 - - conf. 1 - € 65,41</p> 
<p>STABILA</p> <p>LIVELLA MAGNETICA Modello 70 M Ottima aderenza agli elementi metallici Corpo rettangolare in alluminio</p> <p>7812872 - Lungh. cm 40 - - conf. 1 - € 42,69 7812143 - Lungh. cm 50 - - conf. 1 - € 43,79 7812874 - Lungh. cm 60 - - conf. 1 - € 44,88 7812875 - Lungh. cm 80 - - conf. 1 - € 57,37</p> 	

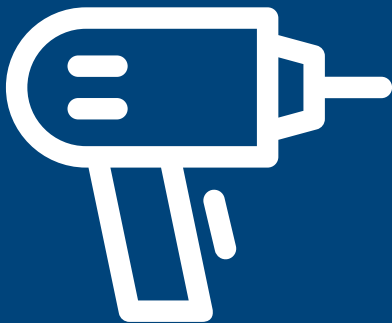

ELETTROUTENSILI

SFOGLIA LA CATEGORIA





**1 BATTERIA.
1000 POSSIBILITÀ.**













POWER X-CHANGE

Visita il sito einhell.it

Einhell Italia   

www.malfattitacchinigroup.it



 <p>Einhell</p> <p>AVVITATORE A BATTERIA TH-CS 12 Li Batteria 12V - 1300 mAh Li-ion Tempo di ricarica 3-5 h Mandrino autoserrante N° Velocità: 1 Rpm (pos 1) 0-400 min Mandrino 10 mm Dimensioni: 198x67x193 mm Peso 1,00 Kg</p> <p>4764513650 - - conf. 1 - € 61,32</p>	 <p>Einhell</p> <p>AVVITATORE A BATTERIA TE-SD 3,6/1 Li Batteria 3,6 V - 1500 mAh - Li-Ion Tempo di ricarica 3-5 h Numero di giri 180 minuto Momento di torsione max 300 Nm Attacco utensile Bit holder Meccanismo di ricarica avanzato Micro-USB Porta inserto magnetico Luce Led Presa antiscivolo Softgrip 10 inserti inclusi Scatola in metallo Peso 0,35 kg</p> <p>4764513501 - - conf. 1 - € 47,40</p>
 <p>Einhell</p> <p>AVVITATORE A BATTERIA TC-CD 18-2 Li 2 Batterie 18V - 1300 mAh Li-ion Tempo di ricarica 3-5 h Mandrino autoserrante Luce Led N° Velocità: 2 Rpm (pos 1) 0-350 min Rpm (pos 3) 0-1250 min Mandrino 10 mm Dimensioni 310x97x293 mm Peso 0,98 Kg</p> <p>4764513820 - - conf. 1 - € 138,36</p>	 <p>Einhell</p> <p>AVVITATORE A BATTERIA TC-CD 18-2 Li-I 2 Batterie 18V 1500 mAh Li-ion Tempo di ricarica 3-5 h Mandrino autoserrante 3 funzioni: avvitare, forare, tassellare Luce Led N° Velocità 2 Rpm (pos 1) 0-350 min Rpm (pos 3) 0-1250 min Mandrino 13 mm Capacità foratura muro 8 mm N° percussioni (vel 1) 0-5250 min N° percussioni (vel 2) 0-18750 min Dimensioni 310x105x290 mm Peso 1,53 Kg Valigetta plastica inclusa</p> <p>4764513825 - - conf. 1 - € 160,32</p>
 <p>M&T 930</p> <p>TRAPANO AVVITATORE POWC1071 Trapano reversibile Mandrino autoserrante: 10 mm Luce led frontale Indicatore stato carica batteria Potenza: 20 V Capacità batteria: 1300 mAh Tipo batteria: Ioni di Litio Dimensione: 19,5 x 7,5 x 22,5 cm Peso: 1,48 kg</p> <p>93047028 - - conf. 1 - € 86,80</p>	 <p>Einhell</p> <p>TRAPANO AVVITATORE A BATTERIA 18V TE-CS 18 Li E-Solo Power X-Change Mandrino autoserrante Luce Led N° Velocità 2 Rpm (pos 1) 0-400 min Rpm (pos 3) 0-1400 min Mandrino 13 mm Dimensioni 223x88x211 mm Peso 1,14 Kg BATTERIA NON INCLUSA</p> <p>4764513870 - - conf. 1 - € 92,88</p>
 <p>Einhell</p> <p>AVVITATORE PER CARTONGESSO A BATTERIA 18 V - TE-DY 18 Li-Solo Ad impulsi Torsione 6 Nm Controllo elettronico velocità Attacco 1/4" Dispositivo antisfondamento BATTERIA NON INCLUSA</p> <p>4764259980 - - conf. 1 - € 107,88</p>	 <p>Einhell</p> <p>AVVITATORE AD IMPULSI A BATTERIA 18V TE-CW 18 Li BL-Brushless-Solo Power X-Change Luce LED Quadro femmina 1/2" Rpm 0-2900 min Peso 1,10 Kg BATTERIA NON INCLUSA</p> <p>4764510040 - - conf. 1 - € 136,44</p>
 <p>Einhell</p> <p>TRAPANO E AVVITATORE A BATTERIA TE-CD 18/2 Li Kit Power X-Change Doppia velocità per avvitare e forare Mandrino autoserrante con blocco mandrino automatico Sostituzione punta istantanea Frizione regolabile Impugnatura ergonomica Luce LED Batteria: 18 V 1500 mAh Li-Ion N° batterie: 2 Durata di ricarica: 1-2 h N° velocità: 2 Momento di torsione: 21 posizioni Mandrino: 10 mm In dotazione: 2 batterie da 1,5 Ah 1 carica batteria Valigetta</p> <p>4764513830 - - conf. 1 - € 183,96</p>	 <p>Einhell</p> <p>TRAPANO AVVITATORE A PERCUSSIONE A BATTERIA 18V TE-CD 18/48 Li-i - Solo Mandrino 13 mm a percussione Torsione 48 Nm BATTERIA NON INCLUSA</p> <p>4764513926 - - conf. 1 - € 100,92</p>
 <p>Einhell</p> <p>TRAPANO AVVITATORE A BATTERIA 18V - TE-CD 18 Li Brushless-Solo Power X-Change Motore senza spazzole, più potenza e maggiore autonomia di lavoro Mandrino 13 mm N° Velocità: 2 Rpm (pos 1) 0-500 min Rpm (pos 3) 0-1800 min Dimensioni: 254x80x215 mm Peso 1,3 kg BATTERIA NON INCLUSA</p> <p>4764513850 - - conf. 1 - € 112,68</p>	 <p>Einhell</p> <p>AVVITATORE A BATTERIA 18V TE-CD 18 Li-i Brushless-Solo Power X-Change Luce Led N° Velocità: 2 Rpm (pos 1) 0-500 min Rpm (pos 3) 0-1800 min Mandrino 13 mm Capacità foratura muro 10 mm N° percussioni (vel 1) 0-8000 min N° percussioni (vel 2) 0-28800 min Dimensioni: 250x215x80 mm Peso 1,9 kg BATTERIA NON INCLUSA</p> <p>4764513860 - - conf. 1 - € 118,68</p>



  <p>SET UTENSILI A BATTERIA 18V TC- TK 18 Li Kit Batteria Power X-Change, -Trapano avvitatore a batteria 18V TC-CD 18/35 Li Regolazione del n° di giri, Led incluso N° giri: 0-550 min-1 -Smerigliatrice angolare a batteria 18V TC-AG 18/115 Li Ingranaggi in alluminio Ø disco: 115 mm N° giri: 8.500 min-1 Profondità taglio max: 28 mm Includo batterie da: 1.5 Ah e 3.0 Ah + caricabatteria rapido</p> <p>4764257238 - - conf. 1 - € 237,36</p>	  <p>TRAPANO AVVITATORE CON PERCUSSIONE A batteria 12V Peak Luce a led automatica, Mandrino autoserrante a ghiera singola, Foratura di: legno, plastica, acciaio, alluminio, mattoni, pannelli di cemento ecc... Foratura metallo: Ø 10mm Foratura alluminio: Ø 12mm Foratura legno: Ø 29mm Apertura mandrino: 0,8 ~ 10 mm Attacco mandrino: 3/8" Batteria: BSL1225M 12V - 2,5 Ah - Li-ion slide Carica batteria: UC12SL (Tempo di carica 37 min) Dimensioni: 181x65x217 mm Peso: 1,2 Kg Accessori in dotazione: Valigetta, 2 batterie, caricabatteria e inserto valigia</p> <p>516DV12DAWF - - conf. 1 - € 270,00</p>
  <p>TRAPANO AVVITATORE CON PERCUSSIONE A batteria 18V Mandrino autoserrante a ghiera unica (blocco alberino), Due velocità meccaniche ed interruttore elettronico, Motore con ventola di raffreddamento, Freno motore elettrico, Luce a led automatica, Impugnatura Soft grip Adatto per forare legno, acciaio e mattone. Apertura mandrino: 2 ~ 13mm Attacco mandrino: 1/2" Batteria: BSL1815 18V - 1,5 Ah - Slide al litio con attacco a slitta Carica batteria: UC18YKSL (Tempo di carica 40 min) Peso: 1,7 Kg Accessori in dotazione: Valigetta, 2 batterie, caricabatteria e inserto</p> <p>516DV18DJLWC - - conf. 1 - € 278,00</p>	  <p>TRAPANO AVVITATORE CON PERCUSSIONE A batteria 18V Motore Brushless Luce led automatica Mandrino autoserrante a ghiera singola 13 mm Apertura mandrino: 2 ~ 13mm Attacco mandrino: 3/8" Batteria: BSL1225M 18V - 3 Ah - Slide al Litio Carica batteria: UC18YFSL (Tempo di carica 37 min) Peso: 1,4 Kg Accessori in dotazione: Valigetta stackable, 2 batterie, caricabatteria e inserto</p> <p>516DV18DDWQ - - conf. 1 - € 361,20</p>
  <p>TRAPANO AVVITATORE CON PERCUSSIONE A batteria 18V Tecnologia Brushless, Mandrino autoserrante a ghiera unica (blocco alberino), Sistema di raffreddamento, Luce a led automatica, Indicatore livello batteria Apertura mandrino: 1,5 ~ 13mm Attacco mandrino: 1/2" Batteria: BSL1850 18V - 5 Ah - Slide al litio Carica batteria: UC18YFSL (Tempo di carica 75 min) Dimensioni: 189x78x253 mm Peso: 2 Kg Accessori in dotazione: Valigetta stackable, 2 batterie, caricabatteria e inserto</p> <p>516DV18DBSLWF - - conf. 1 - € 578,00</p>	  <p>AVVITATORE AD IMPULSI Tecnologia Brushless Meccanismo battente triplo che riduce le vibrazioni e assicura un grande confort, Luce a led con comando automatico o manuale Indicatore livello batteria 4 velocità tramite pulsante: Soft, Normal, Power e Viti autopercoranti Attacco portautensili: 1/4" esagonale innesto rapido Modello Batteria: BSL1850 18V - 5 Ah - Slide al Litio Carica batteria: UC18YFSL (Tempo di carica 75 min) Dimensioni: 127x74x240 mm Peso: 1,6 Kg Accessori in dotazione: Valigetta stackable, 2 batterie, caricabatteria</p> <p>516WH18DBDL2W - - conf. 1 - € 652,00</p>
  <p>PUNTA HSS con attacco esagonale 1/4"</p> <p>74046502 - misura 2 - - conf. 10 - € 2,60 74046503 - misura 3 - - conf. 10 - € 2,80 74046504 - misura 4 - - conf. 10 - € 3,00 74046505 - misura 5 - - conf. 10 - € 3,00</p>	  <p>STARTER KIT Con caricabatterie doppio 3,0 Ah 2 batterie 18V - 3,0 Ah + caricabatterie doppio</p> <p>4764512083 - - conf. 1 - € 202,80</p>
  <p>BATTERIA 18V 5,2 Ah P-X-C Plus 7 in 1 ABS Sistema di gestione attiva della batteria Indicatore di carica a led Soft charging per batterie completamente scariche Voltaggio 18V Capacità batteria 5200 mAh Peso 0.88 kg</p> <p>4764511437 - - conf. 1 - € 132,48</p>	  <p>STARTER KIT Kit batteria e caricabatteria PXC 18V 2,5Ah PXC Starter Kit Utilizzabile con tutti i dispositivi della famiglia Power X-Change Display a led per controllo carica batteria Si ricarica velocemente</p> <p>4764512097 - - conf. 1 - € 40,68</p>
  <p>CARICABATTERIA PXC POWER-X-BOOSTCHARGER 6A Tempi di carica diminuiti Uso universale su tutte le batterie Power X-Change Informazioni sempre aggiornate sullo stato di carica della batteria Tensione 220-240 V 50-60 Hz Tensione di uscita 18V Peso 0.89 kg</p> <p>4764512064 - - conf. 1 - € 69,12</p>	  <p>BATTERIA Tensione batteria 18V Energia della batteria 72 Wh Potenza della batteria 900 W Capacità della batteria 4.0 Ah</p> <p>4764511396 - - conf. 1 - € 90,96</p>



Bosch Elettrotensili Professional e Accessori



Bosch Elettrotensili Professional Italia



boschprofessionaleurope



Elettrotensili, accessori e strumenti di misura professionali Bosch.

It's in your hands. Bosch Professional.



BOSCH



  <p>POWER KIT A Con 2 batterie – 2,5 Ah/36 V BSL36A18 al litio, Attacco a slitta con finestra di raffreddamento + caricabatteria – 5 Ah/18 V UC18YSL3</p> <p>516UC18YSL3WE – - conf. 1 – € 406,00</p>	  <p>POWER KIT C Con 2 batterie – 18V/5 Ah BSL1850C + caricabatteria – 18V/5 Ah UC18YFSL</p> <p>516HKA90408C – - conf. 1 – € 340,00</p>
  <p>TRAPANO A PERCUSSIONE TH-ID 1000 E Regolazione elettronica dei giri con preselettore Selettore foratura/percussione Guida di profondità regolabile in metallo Tensione: 230V 50 Hz Potenza: 1010 W Numero giri: 0-3000 min Numero percussioni: 0-48000 min Mandrino: a cremagliera robusto 1,5 – 13 mm Capacità di foratura nel legno: 32 mm Capacità di foratura nel metallo: 13 mm Capacità di foratura nel muro: 16 mm Dimensione: 320x80x245 mm Peso: 2,12 kg</p> <p>4764259825 – - conf. 1 – € 65,16</p>	  <p>TRAPANO A PERCUSSIONE TC-ID 650 E Regolazione del numero di giri con preselezione Due funzioni: Forare e trapanare a percussione Rotazione a destra e sinistra per forare e avvitare Con asta di profondità in metallo Tensione: 230-240 V 50Hz Potenza: 650 W Numero giri: 0-2800 min Mandrino: autoserrante 1,5 – 13 mm Capacità foratura legno: 25 m Capacità foratura metallo: 10 m Capacità foratura nel muro: 13 mm Dimensioni: 275x71x233 mm Peso: 1,8 kg</p> <p>4764258682 – - conf. 1 – € 45,36</p>
  <p>TRAPANO CON PERCUSSIONE 590 W Regolazione della velocità Impugnatura antiscivolo Foratura acciaio, legno e plastica senza percussione, cemento, mattoni, piastrelle di ceramica, marmo, granito ed altre pietre con percussione. Apertura mandrino: 1,5 ~ 13 mm Ø foro nell'acciaio: 13 mm Ø foro nel legno: 25 mm Ø foro nel calcestruzzo: 16 mm Attacco mandrino: 1/2" Potenza: 590 W Dimensioni: 269x65x180 mm Peso: 1,5 Kg Accessori in dotazione: impugnatura laterale, limitatore profondità e valigetta</p> <p>516DV16VWU – - conf. 1 – € 158,00</p>	  <p>TRAPANO CON PERCUSSIONE 860 W Frizione di sicurezza, Cambio meccanico a 2 velocità: Rotazione e percussione per fori in superfici dure Interruttore elettronico e regolazione dei giri, Mandrino autoserrante Apertura mandrino: 1,5 ~ 13 mm Attacco mandrino: 1/2" Potenza: 860 W Peso: 3 Kg Accessori in dotazione: impugnatura laterale, limitatore profondità e valigetta standard</p> <p>516DV20VDWU – - conf. 1 – € 270,00</p>
  <p>TRAPANO BATTENTE GSB 13 RE 600W Elettronico revers. 2 velocità Mandrino autoserrante 13mm. peso Kg 1,65 in scatola cartone</p> <p>3000601131703 – - conf. 1 – € 159,44</p>	  <p>TRAPANO BATTENTE GSB 1600 RE – 701W Elettronico reversibile Rpm 0 – 3000 Mandrino autoserrante 13mm Foratura max Muratura: Ø 18 mm Calcestruzzo: Ø 16 mm Acciaio: Ø 12 mm Legname: Ø 30 mm Peso 1,9 Kg</p> <p>3000601218101 – - conf. 1 – € 166,86</p>
  <p>TRAPANO A PERCUSSIONE GSB 19-2 RE 850 W Elettronico reversibile 2 Velocità rpm: 0 – 1100 – 3000 Mandrino autoserrante 13 mm Foratura max calcestruzzo: Ø 18 mm acciaio: Ø 13 mm legno: Ø 40 mm Peso: 2,60 Kg in valigia</p> <p>300060117B500 – - conf. 1 – € 296,64</p>	  <p>TRAPANO BATTENTE EASY IMPACT 550 550 W Mandrino autoserrante a doppia bussola Elettronico reversibile Giri a vuoto/min: 3000 Mandrino cremagliera 13mm. peso Kg,1,5 in valigetta</p> <p>3000603126000 – - conf. 1 – € 89,40</p>
  <p>TASSELLATORE 18V Elettropneumatico SDS-Plus Motore Brushless, Dispositivo di sicurezza RFC Frizione di sicurezza meccanica Cambio elettronico Avviamento progressivo Controllo velocità costante Dispositivo Auto-Stop Energia: 1,3 J Peso: 2,3 Kg Accessori in dotazione: Impugnatura laterale, delimitatore di profondità, valigetta stackable Batteria e caricabatteria non inclusi</p> <p>516DH18DPAWP – - conf. 1 – € 758,00</p>	  <p>TASSELLATORE 18V Elettropneumatico Motore Brushless Attacco SDS-Plus con selettore di 3 modalità: solo rotazione, rotazione con percussione e solo percussione. Frizione di sicurezza meccanica Energia: 2,2 J Batteria: BSL1850 18V – 5 Ah – Slide al litio Carica Batteria: UC18YFL Peso: 3x7 Kg Accessori in dotazione: 2 batterie, caricabatteria, protezione batteria, impugnatura laterale, limitatore di profondità e valigetta stackable</p> <p>516DH18DBLWP – - conf. 1 – € 864,00</p>



HIKOKI



MARTELLLO TASSELLATORE 830 W – SDS-Plus
 Frizione di sicurezza, Interruttore elettronico per regolare la velocità, Sistema di prevenzione dei colpi a vuoto di un nuovo selettore manuale. Con 3 modalità di lavoro: rotazione con percussione, solo rotazione o solo percussione con dispositivo VarioLock (per selezionare la posizione dello scalpello) Potenza: 830 W Energia: 2,9 J Peso: 2,8 Kg Accessori in dotazione: Impugnatura laterale, limitatore di profondità e valigetta stackable

516DH26PC2W1 –
 - conf. 1 – € 330,00

HIKOKI



MARTELLLO TASSELLATORE 730 W – SDS-Plus
 Frizione di sicurezza, Interruttore elettronico per regolare la velocità, Sistema di prevenzione dei colpi a vuoto e nuovo selettore manuale. Con 2 modalità di lavoro: rotazione con percussione o solo rotazione. Attacco: SDS-Plus Ø foro nel calcestruzzo: 24 mm Ø foro nell'acciaio: 13 mm Ø foro nel legno: 32 mm Ø foro con punta corona: 50 mm Potenza: 730 W Energia singolo colpo: 1,7 J Dimensioni: 349x75x198 mm Peso: 2,8 Kg Accessori in dotazione: Impugnatura laterale, limitatore di profondità e valigetta

516DH24PG2WS –
 - conf. 1 – € 237,60

HIKOKI



MARTELLLO DEMOLITORE Meccanismo Vario-Lock che permette di regolare gli scalpelli in diverse posizioni, Impugnatura laterale rivestita in elastomeri Demolizione e frantumazione di cemento armato, scanalatura e infissione di pali Attacco: SDS-Max Potenza: 950 W Energia singolo colpo: 7,1 J Dimensioni: 427x103x214 mm Peso: 5,2 Kg Accessori in dotazione: scalpello, impugnatura laterale e valigetta

516H41MB2WS –
 - conf. 1 – € 656,00

HIKOKI



MARTELLLO COMBINATO (perforatore-demolitore) Frizione di sicurezza Alta velocità di rotazione Leve dell'interruttore e del cambio sono situate nella parte superiore Apertura di fori nel cemento armato, Frantumazione di cemento, scanalatura, squadratura Attacco: SDS-Max con innesto rapido Ø foro nel calcestruzzo: 40 mm Ø foro con punta corona: 105 mm Potenza: 1.100 W Energia singolo colpo: 7,1 J Dimensioni: 448x105x255 mm Peso: 7,1 Kg Accessori in dotazione: impugnatura laterale, delimitatore di profondità, grasso e valigetta

516DH40MCWS –
 - conf. 1 – € 690,00

Einhell



MARTELLLO TASSELLATORE E DEMOLITORE A BATTERIA 18V HEROCCO Li-BL-Solo Brushless
 Utilizzabile per forare, tassellare, scalpellare. Il motore senza spazzole offre più potenza e maggiore autonomia Attacco SDS Plus Luce Led Rpm 0-1200 Numero percussioni (velocità 1) 0-5500 min Forza colpo 2,2 J Capacità foratura muro 20 mm Dimensioni: 400x360x120 mm Peso 2,12 Kg **BATTERIA NON INCLUSA**

4764513900 –
 - conf. 1 – € 227,52

Einhell



MARTELLLO TASSELLATORE A BATTERIA 18V TE-HD 18 Li-Solo Power X-Change Tre funzioni avviamento, foratura e foratura a martello anche nel calcestruzzo Mandrino SDS plus Nr giri 1100 min Nr percussioni 5700 min Forza colpo 1,2 J Capacità foratura nel muro 12 mm Dimensioni 266x80x215 mm Peso 1,39 kg **BATTERIA NON INCLUSA**

4764513812 –
 - conf. 1 – € 104,76

Einhell



MARTELLLO TASSELLATORE TH-RH 1600 Con percussione pneumatica Mandrino SDS plus 4 funzioni forare, tassellare, scalpellare con e senza fissaggio Asta di profondità di perforazione a regolazione continua Valigetta inclusa Tensione 230-240V 50Hz Rpm 800 min Nr percussioni 3900 min Forza colpo 4 J Capacità foratura nel muro 32 mm Dimensioni 440x365x130 Peso 5,6 kg

4764258478 –
 - conf. 1 – € 148,68

Einhell



MARTELLLO TASSELLATORE TE-RH 28 5F Controllo elettronico della velocità Regolazione velocità Cinque funzioni: Foratura, avvitaratura, percussione, demolizione fissa e libera Tensione di rete: 220-240V 50 Hz Potenza assorbita: 950 W Numero di giri: 0-1200/0-2600 min Numero percussioni: 0-4500 min Forza percussioni: 3,0 J Capacità di foratura calcestruzzo: 28 mm Mandrino: SDS Plus Peso: 3,8 kg Accessori: Mandrino autoserrante 13 mm

4764257970 –
 - conf. 1 – € 193,80

Einhell



MARTELLLO TASSELLATORE RT-RH 20/1 Controllo elettronico della velocità Quattro funzioni Tensione di rete: 220-240 V - 50 Hz Potenza assorbita: 500 W Numero di giri: 0-1200 min Numero percussioni: 0-5800 min Forza percussioni: 1,6 J Capacità di foratura calcestruzzo: 20 mm Mandrino: SDS Plus Peso: 2,2 kg Con valigetta

4764258491 –
 - conf. 1 – € 116,64

Einhell



TASSELLATORE 4 FUNZIONI CON SET SCALPELLI TH-RH 1600 Testa ingranaggi in alluminio Attacco SDS-Plus Blocco della percussione Tensione 230-240 V 50 Hz Potenza 1.600 W Numero giri 800 min Percussioni/Forza colpo 3.900 min 4,0 J Capacità di foratura 32 mm Peso 5,6 kg Accessori inclusi: Asta di profondità in metallo, tappo anti polvere e pratica valigetta

4763900247 –
 - conf. 1 – € 148,40

Einhell



TASSELLATORI TE-RH 38 E Tassellatore con meccanismo di martello pneumatico Tre funzioni: trapano perforatore, scalpellatore con o senza fissaggio Tensione: 220-240 V 50Hz Potenza: 1050 W Numeri giri a vuoto: 0-500 min Numero percussioni: 0-4100 min Forza colpo: 9 J Attacco utensile: SDS-Max Capacità foratura del muro: 38 mm Dimensioni: 452x133x345

4764257950 –
 - conf. 1 – € 231,48

Einhell



MARTELLLO DEMOLITORE TC-DH 43 Massima potenza grazie alla forza di percussione singola di 43 joule Potenza 1.600 W 1.800 percussioni / min Attacco esagonale, 30 mm Scalpello piatto (400 x 30 mm) Scalpello a punta (400 mm) Peso 14,7 kg

4764139087 –
 - conf. 1 – € 239,88















 <p>Einhell</p> <p>TRAPANO A COLONNA TC-BD 350 Arresto di profondità regolabile per eseguire forature precise Volantino a croce a tre bracci per un effetto leva in qualsiasi momento Velocità a regolazione continua Tensione: 230 V 50 Hz Potenza motore max: 350 W 15 min Numero giri: 580 - 2650 min Attacco mandrino: B16 Diametro punte: 1,5 - 13 mm Profondità di foratura max: 50 mm Dimensioni: 430 x 330 x 225 Peso: 15,1 kg</p> <p>4764250670 - - conf. 1 - € 183,96</p>	 <p>BOSCH Powered for life</p> <p>MARTELLLO TASSELLATORE GBH 2600 DFR 720 Watt - 240 V Con attacco SDS-Plus Peso 2,3 kg</p> <p>3000611254600 - - conf. 1 - € 277,90</p>
 <p>Einhell</p> <p>SMERIGLIATRICE ANGOLARE A BATTERIA 18V AXXIO 18/125 Q Li-BL - Solo Power X-Change Motore senza spazzole Soft Start e protezione di sicurezza Protezione contro i sovraccarichi per una lunga durata Disco da taglio non incluso Diametro disco 125 mm Rpm 8500 min Profondità di taglio 33 mm Peso 1,44 kg BATTERIA NON INCLUSA</p> <p>4764431151 - - conf. 1 - € 130,56</p>	 <p>Einhell</p> <p>SMERIGLIATRICI ANGOLARI A BATTERIA TE-AG 18/115 LI KIT Power X-Change Soft Start e protezione di sicurezza contro l'avvio accidentale Protezione del disco a regolazione rapida Batteria 18V 3000 mAh Tempo di carica 3-5 h Tensione caricatore 200-250 V Diametro disco 115 mm Numero giri a vuoto 8500 min Profondità taglio max 28 mm Peso 1,65 kg Accessori inclusi: caricabatterie rapido e batteria Power X-Change 3,0 Ah</p> <p>4764431119 - - conf. 1 - € 193,80</p>
 <p>Einhell</p> <p>SMERIGLIATRICI ANGOLARI TC-AG 125 Blocco del mandrino Testa porta ingranaggi in metallo Chiave flangiata Tensione 230V 50Hz Potenza 850W Numero giri a vuoto 12000 min Dimensioni 297x95x120 mm Peso 2,1 kg Disco da taglio non incluso</p> <p>4764430619 - Ø disco mm 125 - - conf. 1 - € 54,36</p>	 <p>Einhell</p> <p>SMERIGLIATRICI ANGOLARI TC-AG 115 Blocco del mandrino Testa porta ingranaggi in metallo Chiave flangiata Tensione 230V 50Hz Potenza 500W Numero giri a vuoto 12000 min Dimensioni 297x95x120 mm Peso 1,7 kg Disco da taglio non incluso</p> <p>4764430618 - Ø disco mm 115 - - conf. 1 - € 48,48</p>
 <p>Einhell</p> <p>SMERIGLIATRICI ANGOLARI TE-AG 230/2000 Smerigliatrice angolare a due mani a basse vibrazioni Soft start per un avvio sicuro e la limitazione della corrente di spunto Testa porta ingranaggi in alluminio Cavo lungo 3 m Tensione 230V 50 Hz Potenza 2000W Numero giri a vuoto 6500 min Diametro disco 230 mm Dimensioni 540x140x160 mm Peso 5,4 kg</p> <p>4764430840 - - conf. 1 - € 128,52</p>	 <p>930</p> <p>SMERIGLIATRICE ANGOLARE POWC30100 - 500 W Impugnatura ergonomica Mandrino: M14 Diametro disco: 115 mm Potenza: 500 W</p> <p>93047027 - - conf. 1 - € 40,40</p>
 <p>HiKOKI</p> <p>SMERIGLIATRICE 600 W - ZVRP Resistenza al sovraccarico Ergonomico interruttore laterale Dispositivo ZVRP anti riavvio accidentale e dell'avviamento progressivo Ø del disco: 115 mm Ø foro del disco: 22 mm Attacco alberino filettato: M14 x 2 Potenza: 600 W Velocità a vuoto: 11.500 giri/min Circonferenza impugnatura: 197 mm Dimensioni: 254x130x105 mm Peso: 1,8 Kg Accessori in dotazione: Impugnatura laterale e chiave</p> <p>516G12STAYG - - conf. 1 - € 71,80</p>	 <p>HiKOKI</p> <p>SMERIGLIATRICE 730 W - ZVRP - Disco diamantato Resistenza al sovraccarico Ergonomico interruttore laterale Dispositivo ZVRP anti riavvio accidentale e dell'avviamento progressivo Ø del disco: 115 mm Ø foro del disco: 22 mm Attacco alberino filettato: M14 x 2 Potenza: 730 W Velocità a vuoto: 10.000 giri/min Circonferenza impugnatura: 197 mm Dimensioni: 258x130x105 mm Peso: 1,8 Kg Accessori in dotazione: Impugnatura laterale, disco diamantato e chiave</p> <p>516G12SR4YG - - conf. 1 - € 91,80</p>
 <p>HiKOKI</p> <p>SMERIGLIATRICE 1200 W - ZVRP Sistema di blocco dell'albero Interruttore laterale a slitta Protezione ZVRP evita la ripartenza accidentale dell'utensile. Resistenza al sovraccarico Ø del disco: 115 mm Ø foro del disco: 22 mm Attacco alberino filettato: M14 x 2 Potenza: 1200 W Velocità a vuoto: 11.500 giri/min Circonferenza impugnatura: 197 mm Peso: 2,3 Kg Accessori in dotazione: Impugnatura laterale, disco abrasivo, disco diamantato e chiave</p> <p>516G12SWYW - - conf. 1 - € 161,80</p>	 <p>HiKOKI</p> <p>SMERIGLIATRICE 2000 W Resistenza al sovraccarico Griglie di aspirazione laterale Taglio per cemento sintetico, pietre, mattoni e simili. Ø del disco: 230 mm Ø foro del disco: 22 mm Attacco alberino filettato: M14 x 2 Potenza: 2000 W Velocità a vuoto: 6.600 giri/min Dimensioni: 469x245x82 mm Peso: 5,2 Kg Accessori in dotazione: Impugnatura laterale e chiave</p> <p>516G23STWA - - conf. 1 - € 160,20</p>



 <p>HiKOKI</p> <p>SMERIGLIATRICE A batteria 18V Impugnatura Soft grip, Indicatore livello di carica della batteria, Elevata resistenza al sovraccarico Ø del disco: 115 mm Ø foro del disco: 22 mm Attacco albero filettato: M14 x 2 Velocità a vuoto: 9.300 giri/min Batteria: 18V - Slide al Litio Dimensioni: 306x182x118 mm Peso: 2,1 Kg Accessori in dotazione: Impugnatura laterale, chiave e disco abrasivo Batteria e caricabatteria non inclusi</p> <p>516G18DSL2W2 - - conf. 1 - € 191,40</p>	 <p>HiKOKI</p> <p>SMERIGLIATRICE A batteria 18V Tecnologia Brushless Modalità Auto Mode Protezione contro il riavvio accidentale e anticontraccolpo Ø del disco: 125 mm Ø foro del disco: 22 mm Attacco albero filettato: M14 x 2 Velocità a vuoto: 9.000 giri/min Velocità Auto Mode: 5.500 giri/min a vuoto 9.000 giri/min con carico Batteria: BSL1850 18V - 5 Ah - Slide al Litio Dimensioni: 326x130x135 mm Peso: 2,3 Kg Accessori in dotazione: Impugnatura laterale, chiave, disco abrasivo, 2 batterie, caricabatteria e valigetta stackable</p> <p>516G18DBLWS - - conf. 1 - € 656,00</p>
 <p>BOSCH Invented for life</p> <p>SMERIGLIATRICE ANGOLARE GWS 750 Potenza: 750 W Rpm 11.000 Filettatura dell'albero M14 mole 115 mm Peso 1,8 kg Protezione restart protection impedisce la ripartenza accidentale dell'utensile successivamente ad un'interruzione temporanea della rete elettrica, garantendo la massima sicurezza all'operatore.</p> <p>3000601394000 - - conf. 1 - € 102,80</p>	 <p>BOSCH Invented for life</p> <p>SMERIGLIATRICE ANGOLARE GWS 1000 1.000 W rpm 11.000 Potenza erogata 630 W Filettatura dell'albero M 14 Impugnatura principale dritta Mole 125 mm Peso 2.1 kg</p> <p>3000601828800 - - conf. 1 - € 161,50</p>
 <p>BOSCH Invented for life</p> <p>SMERIGLIATRICE ANGOLARE GWS 1400 1.400 W rpm 11.000 Potenza erogata 820 W Filettatura dell'albero M 14 Mole 125 mm Peso 2.2 Kg</p> <p>3000601824800 - - conf. 1 - € 217,74</p>	 <p>BOSCH Invented for life</p> <p>SMERIGLIATRICE ANGOLARE GWS 24-230 JH 2.400 W rpm 6.500 Filettatura dell'albero M 14 Impugnatura principale Dritto Ø mole 230 mm Peso 5,2 kg</p> <p>300061884M03 - - conf. 1 - € 309,00</p>
 <p>BOSCH Invented for life</p> <p>SMERIGLIATRICE ASSIALE GGS 8CE 750 W rpm 2.500 - 8.000 Ø collare albero 43 mm Ø corpo levigante max 50 mm Peso 1,7 Kg</p> <p>3000601222100 - - conf. 1 - € 681,86</p>	 <p>Einhell</p> <p>SMERIGLIATRICI COMBinate TH-BG 150 Struttura in metallo per una lunga durata Antiscintille per lavorare in sicurezza Tensione 230V Potenza motore max 150W 30 min Dischi abrasivi 150x12,7x16 mm Dimensioni 298x207x210 mm Peso 5,38 kg Accessori inclusi: disco abrasivo a grana grossa e disco a grana fine</p> <p>4764412632 - - conf. 1 - € 64,80</p>
 <p>Einhell</p> <p>GATTUCCI A BATTERIA 18V TE-AP 18 Li-Solo Power X-Change Motore Triathlon (potente, veloce, efficiente) Piattino regolabile per un utilizzo ottimale Oscillazioni: 0-2600 min Altezza oscillazioni: 22 mm Profondità di taglio nel legno: 100 mm Profondità di taglio nel metallo: 6 mm Dimensioni: 410x80x160 mm Peso: 1,62 kg BATTERIA NON INCLUSA</p> <p>4764326300 - - conf. 1 - € 92,04</p>	 <p>Einhell</p> <p>SEGHETTI ALTERNATIVI A BATTERIA 18V TE-JS 18 Li-Solo Power X-Change Con funzione aspirapolvere per una maggiore visibilità Indicatore della linea di taglio Velocità avanzamento 2400 min Altezza 25,4 mm Profondità di taglio nel legno 80 mm Profondità di taglio nella plastica 12 mm Profondità di taglio nel metallo 10 mm Taglio obliquo 47° Dimensioni 235x90x225 mm Peso 1,82 kg BATTERIA NON INCLUSA</p> <p>4764321200 - - conf. 1 - € 92,04</p>
 <p>Einhell</p> <p>SEGHETTI ALTERNATIVI TC - JS 60/1 Cambio lama facile e senza attrezzi Si adatta a diversi tipi di materiale Taglio obliquo, inclinazione 45° Tensione: 220-240 V 50/60 Hz Potenza: 400 W Dimensioni: 283x83x214 mm Peso: 1,73 kg</p> <p>4764321135 - - conf. 1 - € 47,40</p>	 <p>BOSCH Invented for life</p> <p>SEGHETTO Alternativo PST 650 500 W Sistema SDS Prof. taglio: 65mm rpm 3100 peso Kg 1,7 in valigia</p> <p>3000603380003 - - conf. 1 - € 90,44</p>



 <p>BOSCH Invented for life</p> <p>SEGHETTO EASY CUT 50 Tagli dal pieno agevoli senza necessità di preforatura Potenza 370W Assorbimento nominale 500W Rpm 0-7.800 Profondità di taglio in legno 50mm Profondità di taglio in materiale plastico 30 mm Peso 1,6 kg</p> <p>30006033C8000 - - conf. 1 - € 181,28</p>	 <p>HiKOKI</p> <p>SEGHETTO ALTERNATIVO 400 W Impugnatura Soft grip Montato su cuscinetti a sfere, base in acciaio temperato regolabile a 45 gradi, Interruttore elettronico con regolazione del numero di giri. Possibilità di connessione ad un aspiratore esterno. Capacità taglio legno: 65 mm Capacità taglio acciaio: 6 mm Potenza: 400 W Lunghezza corsa lama: 18 mm Angolo taglio max: 45° (dx e sx) Dimensioni: 197x67x195 mm Peso: 1,5 Kg Accessori in dotazione: lama, chiave e paraschegge</p> <p>516FCJ65V3LA - - conf. 1 - € 139,20</p>
 <p>HiKOKI</p> <p>SEGHETTO ALTERNATIVO 705 W Velocità variabile con selettore, Selettore di taglio orbitale in 4 posizioni, Impugnatura soft-grip, Sistema soffiante di pulizia zona taglio, Sistema di aggancio/sgancio lama senza utensili in duralluminio, Base in duralluminio con piastra inferiore in acciaio, Collegabile ad un aspiratore tramite adattatore Raggio min di taglio: 25 mm Potenza: 705 W Lunghezza corsa lama: 26 mm Angolo di taglio max: 45° (dx e sx) Peso: 2,2 Kg Accessori in dotazione: Valigetta, chiave a brugola 4 mm, adattatore aspirazione e lama da taglio per legno</p> <p>516CJ90VAST2W - - conf. 1 - € 256,00</p>	 <p>HiKOKI</p> <p>SEGHETTO ALTERNATIVO FRONTALE Per il taglio di svariati materiali: tubi e profilati d'acciaio, legname vario, piastre in acciaio, alluminio e rame. Regolazione elettronica della velocità, Inserimento e disinserimento della lama senza utensili. Impugnatura frontale Capacità taglio legno: 300 mm Ø taglio tubi acciaio: 130 mm Potenza: 1.010 W Lunghezza corsa lama: 29 mm Dimensioni: 435x90x165 mm Peso: 3,2 Kg Accessori in dotazione: lama, chiave e valigetta</p> <p>516CR13V2WS - - conf. 1 - € 350,00</p>
 <p>Einhell</p> <p>SEGHE A NASTRO TC-SB 200/1 Banco a inclinazione regolabile continua per eseguire tagli obliqui Guida parallela per tagli dritti Regolazione in altezza Guida supportata da cuscinetti Attacco per aspirazione polvere 36 mm Potenza motore 250 W Tensione 220-240 V Rpm 1400 min Escursione 200 mm Lama per sega a nastro 1400x7 mm Nr denti 6/25,4 mm Altezza taglio a 45° 45 mm Altezza taglio 90° 80 mm Dimensioni banco da lavoro 305x305 mm Dimensioni 420x285x720 mm Peso 17,35 kg</p> <p>4764308018 - - conf. 1 - € 261,12</p>	 <p>Einhell</p> <p>SEGHE CIRCOLARI TH-CS 1400/1 Lama HM Regolazione libera della profondità di taglio manuale Regolazione piastra manuale per tagli inclinati Guida parallela per tagli di precisione Tensione 230V 50Hz Potenza 1400W Numero di giri a vuoto 5200 min Lama 190x30 mm Numero denti 24 pezzi Profondità taglio a 45° 45 mm Profondità taglio a 90° 66 mm Dimensioni 355x255x270 mm Peso 4,3 kg</p> <p>4764330937 - - conf. 1 - € 93,96</p>
 <p>Einhell</p> <p>SEGA CIRCOLARE CON BANCHETTO TC-TS 2025/1U Ampliamento del banco Guida angolare per tagli obliqui Aspirazione dei trucioli Lama di precisione in metallo duro, regolabile in altezza e inclinazione Tensione 220-240 V 50Hz Potenza 1800W Potenza motore max 200W Numero giri a vuoto 5000 min Lama 250x30 mm Altezza taglio a 45° - 65 mm, a 90° - 85 mm Dimensioni banco lavoro 563x583 mm Dimensioni 711x624x333 mm Peso 19,24 kg</p> <p>4764340490 - - conf. 1 - € 239,88</p>	 <p>Einhell</p> <p>TRONCATRICE TC-MS 2112 Taglia legno, laminato e plastica Piano di lavoro in alluminio pressofuso Regolazione angolazione per tagli obliqui Tensione 230 V 50 Hz Potenza 1400 W Numero giri a vuoto 5000 min Lama 210x30 mm Larghezza di taglio: -90°x90° (120x55 mm) -90°x45° (80x55 mm) -45°x90° (120x32 mm) -45°x45° (80x32 mm) Dimensione 480x320x290 mm Peso 6,4 kg</p> <p>4764300295 - - conf. 1 - € 138,36</p>
 <p>Einhell</p> <p>TRONCATRICI CON PIANO SUPERIORE TH-MS 2513 T Lama HM Guida parallela e obliqua regolabile Piano girevole della troncatrice regolabile Testa inclinabile a sinistra Attacco per aspirazione 36 mm Tensione 230 V 50 Hz Potenza 1800 W Lama 30x250 mm Numero denti 36 pezzi Dimensioni 545x470x375 mm Peso 13,5 kg</p> <p>4764300345 - - conf. 1 - € 366,00</p>	 <p>HiKOKI</p> <p>SEGA CIRCOLARE 1.010 W Leggera con base d'appoggio in duralluminio, Dispositivo di bloccaggio dell'albero per una rapida sostituzione della lama, Regolazione della profondità di taglio tramite leva posteriore. Taglio di vario tipi di legno Ø lama: 190 mm Ø foro interno lama: 30 mm Profondità di taglio a 90°: 68 mm Profondità di taglio a 45°: 46 mm Potenza: 1.010 W Dimensioni: 291x210x242 mm Peso: 3,6 Kg Accessori in dotazione: lama al widia Ø 190 mm con 40 denti, chiave e guida dritta</p> <p>516C7MFALA - - conf. 1 - € 234,40</p>
 <p>Einhell</p> <p>LEVIGATRICE ROTORBITALE TC-RS 38 E Sistema di regolazione elettronica Rpm Sostituzione rapida carta abrasiva Sacco di raccolta polvere Carta abrasiva Ø 125 mm Potenza 380W Oscillazioni 12000-26000 min Diametro oscillazioni 2 mm Dimensioni 305x188x123 mm Peso 2,00 Kg</p> <p>4764462165 - - conf. 1 - € 59,28</p>	 <p>Einhell</p> <p>LEVIGATRICE ROTORBITALE TE-OS 2520 E Sistema di regolazione elettronica Rpm Sostituzione rapida carta abrasiva Platorello robusto in alluminio Basse vibrazioni grazie al sistema di ammortizzatori Box di raccolta polvere Potenza 250W Oscillazioni 14000-24000 min Diametro oscillazioni 2 mm Superficie levigante 230x115 mm Dimensioni 420x138x240 mm Peso 1,90 Kg</p> <p>4764460620 - - conf. 1 - € 88,92</p>



 <p>Einhell</p> <p>LEVIGATRICE ORBITALE TC-OS 1520 Ideale per levigare superfici piatte Cambio rapido della carta Adatta anche per carta abrasiva Adatto per l'allacciamento all'aspiratore 3 fogli abrasivi inclusi Tensione 230 V 50 Hz Potenza 150 W Oscillazioni 23000 min Diametro oscillazioni: 2 mm Dimensioni 270x100x160 mm Peso 1,1 kg</p> <p>4764460642 - - conf. 1 - € 34,68</p>	 <p>BOSCH Invented for life</p> <p>LEVIGATRICE ROTOORBITALE GEX 125-1 AE 250 W Ø platorello 125 mm rpm 7.500-12.000 Ø 2,5 mm Peso 1,3 Kg</p> <p>3000601387500 - - conf. 1 - € 236,90</p>
 <p>HIKOKI</p> <p>PIALLA 620 W Regolatore della profondità con pomello, Impugnatura Soft grip Piallatura di tavole e pannelli vari in legno Larghezza taglio: 82 mm Profondità max taglio: 2,6 mm Battuta: 9 mm Potenza: 620 W Velocità a vuoto: 17.000 giri/min Dimensioni: 296x165x165 mm Peso: 2,5 Kg Accessori in dotazione: Chiave, guida dritta calibro per montaggio lame</p> <p>516P20SFWA - - conf. 1 - € 204,40</p>	 <p>HIKOKI</p> <p>LEVIGATRICE ROTO-ORBITALE 230 W Levigatura e sverniciatura su vari tipi di legno e metallo, Platorello in velcro circolare forato, Con attacco aspirante e sacco di raccolta Dimensioni platorello: 125 mm Potenza: 230 W Diametro orbita: 3,2 mm Dimensioni: 160x120x145 mm Peso: 1,4 Kg Accessori in dotazione: carta abrasiva e sacco raccogli-polvere</p> <p>516SV13YBWB - - conf. 1 - € 182,80</p>
 <p>HIKOKI</p> <p>LEVIGATRICE ORBITALE 200 W Levigatrice "a delta", per lavori di falegnameria Smerigliatura di superfici varie Con sacco raccogli polvere integrato Impugnatura ergonomica anche per i mancini e Soft grip Platorello in velcro forato Dimensioni carta rettangolare: 110x100 mm Dimensioni carta a delta: 96x96x96 mm Dimensioni platorello: 110x190 mm Potenza: 200 W Ø orbita: 1,5 mm Dimensioni: 230x110x133 mm Peso: 1,2 Kg Accessori in dotazione: carta abrasiva rettangolare, carta abrasiva triangolare e sacco raccogli-polvere</p> <p>516SV12SHWB - - conf. 1 - € 170,00</p>	 <p>HIKOKI</p> <p>LEVIGATRICE ROTO-ORBITALE 350 W Levigatura, finitura e sverniciatura delle superfici in legno e metallo, Regolazione della velocità di rotazione, Pulsante Turbo Boost (per una velocità massima), Impugnatura frontale removibile senza utensili, Platorello in velcro circolare forato, Con raccordo aspirante e sacchetto di raccolta Dimensioni platorello: 150 mm Potenza: 350 W Diametro orbita: 2,8 / 6,2 mm Dimensioni: 388x173x200 mm Peso: 2,5 Kg Accessori in dotazione: carta abrasiva, sacchetto raccogli-polveri, impugnatura frontale e chiave</p> <p>516SV15YCWB - - conf. 1 - € 348,00</p>
 <p>&M 900</p> <p>LEVIGATRICE JOLLY YK85 200 W Orbita: 2 mm Attacco Velcro rpm 15500 Dim. piastra 165x64 peso 1,15 Kg.</p> <p>90086300 - - conf. 1 - € 157,60</p>	 <p>&M 900</p> <p>SUPPORTO IN VELCRO per JOLLY YK85 Autoadesivo</p> <p>90086360 - - conf. 5 - € 5,36</p>
 <p>&M 900</p> <p>FOGLI CARTA ABRASIVA per JOLLY YK75</p> <p>90086346 - misura 80 - - conf. 50 - € 0,54 90086349 - misura 100 - - conf. 50 - € 0,54</p>	 <p>Einhell</p> <p>TERMOSSOFFIATORE TH-HA 2000/1 Pistola ad aria calda a due velocità Protezione anti surriscaldamento Accessori inclusi: sverniciatore e 4 ugelli valigetta plastica Potenza: 2000W Temperatura 350 - 550°C Passaggio aria 300 - 500 L/min Dimensioni 296x85x275 mm Peso 0.68 Kg</p> <p>4764520179 - - conf. 1 - € 35,52</p>
 <p>TERMOSSOFFIATORE Temperatura regolabile Potenza 2000 Watt Temperatura aria: 350-550°C Flusso volumetrico: 300-500 l/min Cavo: 2 mt 5 accessori inclusi Peso 560 gr.</p> <p>740PGPT2000 - - conf. 1 - € 29,88</p>	 <p>HIKOKI</p> <p>TERMOSSOFFIATORE 2000 W Con 2 posizioni per selezionare temperatura e velocità del flusso d'aria, è dotato di un pulsante che consente il veloce raffreddamento della macchina stessa Utile per operazioni di formatura, termorestrizione, rimozione pitture, saldatura ed indurimento Potenza: 2000 W Temperatura flusso d'aria: 1) 450 °C 2) 600 °C Colpo di raffreddamento veloce: 50°C Dimensioni: 245x83x250 mm Peso: 0,6 Kg Accessori in dotazione: ugello tondo, piatto, curvo, con protezione vetro, raschietto e valigetta</p> <p>516RH600TLA - - conf. 1 - € 73,12</p>



 <p>BOSCH Invented for life</p> <p>TERMOUFFIATORE GHG 23-66 Potenza 2.300W Temperatura di lavoro 50-650°C Flusso d'aria 150-500 l/min Peso 0,67 kg</p> <p>30006012A6300 - - conf. 1 - € 282,22</p>	 <p>BOSCH Invented for life</p> <p>TERMOUFFIATORE GHG 20-60 Potenza 2.000W Lunghezza utensile 339,5 mm Temperatura di lavoro 50-630°C Flusso d'aria 150-500 l/min Peso 0,6 kg</p> <p>30006012A6400 - - conf. 1 - € 238,96</p>
 <p>Einhell</p> <p>GENERATORE DI CORRENTE TC-PG 1000 A benzina Motore a miscela due tempi Presa 230 V Facile utilizzo con comando a cavo flessibile Regolazione AVR per la stabilità della potenza d'uscita Interruttore di sovraccarico per proteggere l'apparecchio Telaio portante per proteggere l'utensile Potenza continua: 680 W Potenza max: 800 W (S1 1 Min.) Cilindrata: 63 cc Potenza max: 1,2 kW / 1,65 HP Capacità serbatoio: 4 l Consumo ai 2/3 del carico: ca. 6,6 ore Dimensioni: 430x353x348 mm Peso: 18,8 kg</p> <p>4764152530 - - conf. 1 - € 238,00</p>	 <p>Einhell</p> <p>GENERATORE DI CORRENTE TC-PG 35/ES A benzina Motore a quattro tempi Due prese da 230 V Serbatoio da 15 litri con indicatore di livello per un funzionamento continuo Funzione AVR per una potenza di uscita stabile Con ruote per il trasporto Potenza a 230V: 2600 W - max 2800 W (5 min) Potenza motore max: 4100 W Cilindrata: 208 cc Dimensioni: 610x460x455 mm Peso: 41,9 kg</p> <p>4764152551 - - conf. 1 - € 524,28</p>
 <p>Einhell</p> <p>COMPRESSORI PER AUTO CC-AC 12V Manometro 0-18 bar Alimentazione elettrica 12 V collegamento per presa accendisigari Cavo alimentazione lungo 2,9 m Pistola con tubo alta pressione flessibile e connettore valvola per pneumatici per automobili 3 adattatori supplementari Tensione nominale 12V Pressione d'esercizio max 18 bar Lunghezza del tubo di pressione 450 mm Dimensioni confezione 199x95x141 mm Peso 0,6 kg</p> <p>4762072112 - - conf. 1 - € 17,20</p>	 <p>Einhell</p> <p>COMPRESSORI LUBRIFICATI TC-AC 190/24/8 Tensione di rete: 220 - 240V 50 Hz Potenza assorbita: 1500W S2 15 min Potenza aspirazione: 165 l/min Potenza uscita a 0 bar, 4 bar, 7 bar: 110 l/min, 75 l/min, 55 l/min Capacità serbatoio: 24 l Pressione massima: 8 bar Numero cilindri: 1 Livello di rumore: 97 dB(A) Peso: 20,8 kg</p> <p>4764007325 - - conf. 1 - € 197,76</p>
 <p>Einhell</p> <p>COMPRESSORE TE-AC 270/50/10 Controllo del livello dell'olio mediante vetro spia Grandi indicatori di pressione, facilmente leggibili Grandi ruote e impugnatura per agevolare il trasporto Una vite di scarico della condensa agevola la manutenzione Serbatoio 50 litri Potenza 1.800 W Aspirazione 270 l/min Pressione max 10 bar Serbatoio garantito 10 anni contro la ruggine</p> <p>4764010440 - - conf. 1 - € 389,76</p>	 <p>RIBIMEX</p> <p>ASPIRACENERE Bidone aspiracenere creato per aspirare la cenere fredda dei camini o delle stufe a legna o a pellet Motore 230 V - 50 Hz - 1000 W Filtro intercambiabile con leva di riarmo. Bidone aspiratore 18 l in lamiera laccata con impugnatura per il trasporto. Tubo metallico flessibile 1,10 m + 20 cm lancia.</p> <p>759PRCEN001 - - conf. 1 - € 51,40</p>
 <p>RIBIMEX</p> <p>ASPIRACENERE munito di un pulsante che permette la pulizia del filtro assicurando l'aspirazione continua. Funzione soffiante. Motore 230 V-50 Hz - 1200 W. Filtro HEPA intercambiabile e lavabile. Prefiltro antistatico autoestinguente. Bidone 18 L in metallo laccato Impugnatura per il trasporto. Tubo flessibile metallo 1,30 m e lancia metallica 20 cm. Spazzola orientabile in plastic con setole in nylon. Carrello porta accessori con ruote.</p> <p>759PRCEN012 - - conf. 1 - € 79,98</p>	 <p>Einhell</p> <p>ASPIRATUTTO TC-VC 1815 S Aspiratore solidi e liquidi con funzione di aspirazione e soffiaggio, Serbatoio in acciaio inox Tensione: 220-240V/50Hz Potenza: 1250W Capacità aspirazione max: 180 mbar Volume serbatoio: 15 l Lunghezza e Ø tubo aspiratore: 150 cm e Ø36 mm Lunghezza cavo elettrico: 250 cm Dimensione: 284x287x495 mm Peso: 3 Kg</p> <p>4762342390 - - conf. 1 - € 78,00</p>
 <p>Einhell</p> <p>UTENSILE MULTIFUNZIONE TC-MG 220/1 E Adatto al fai-da-te per levigare, raschiare o segare Attacchi magnetici Potente motore da 220W Accessori inclusi: platorello tringolare, 6 carta vetrata, raschietto, sega a immersione per legno e plastica, adattatore per aspirazione polvere, chiave a brugola Oscillazioni 22000-44000 min Angolazione oscillazione 3.2° Dimensioni carta abrasiva 93x93x93 mm Dimensioni 330x110x90 mm Peso 1,26 kg</p> <p>4764465095 - - conf. 1 - € 59,40</p>	 <p>Einhell</p> <p>LUCIDATRICE/ LEVIGATRICE PER AUTO A BATTERIA 18V CE-CP 18/180 Li E - Solo Tensione 18V Motore senza spazzole Platorello Ø 180 mm Velocità regolabile Cuffie e dischi inclusi BATTERIA NON INCLUSA</p> <p>4762093320 - - conf. 1 - € 174,00</p>



 <p>Einhell</p> <p>LUCIDATRICE PER AUTO CC-PO 90 Tensione: 230 V 50 Hz Potenza: 90W Numero giri: 3700 minuto Platorello: Ø 240 mm Peso: 1,9 kg Con Interruttore On/Off Accessori inclusi: 1 cuffia in cotone, 1 cuffia sintetica</p> <p>4762093173 – - conf. 1 – € 45,36</p>	 <p>Einhell</p> <p>LUCIDATRICE PER AUTO CC-PO 2202/2 E Tensione: 230V 50 Hz Potenza: 1100 W Numero giri: 1000 – 3500 min Platorello: Ø 180 mm Peso: 2,3 kg Con regolazione elettronica Con sblocco albero Con attacco con velcro Accessori inclusi: 1 supporto in gomma piuma, 1 cuffia sintetica, 3 dischi abrasivi (1x60g, 1x80g, 1x120g)</p> <p>4762093265 – - conf. 1 – € 88,08</p>
 <p>Einhell</p> <p>SET CUFFIE E CARTA ABRASIVA Contiene: 2 dischi di carta abrasiva Ø 180 grana 60 2 dischi di carta abrasiva Ø 180 grana 80 2 dischi di carta abrasiva Ø 180 grana 120 2 cuffie 1 sintetica e 1 in cotone 1 tampone in gomma piuma</p> <p>4762093233 – - conf. 1 – € 25,68</p>	 <p>Einhell</p> <p>SET CUFFIE DI RICAMBIO PER LUCIDATRICE CE-CB 18/254 Li 1 Cuffia in panno di cotone 1 Cuffia in materiale sintetico</p> <p>4762093095 – - conf. 1 – € 9,36</p>
 <p>SALDATORE A STILO Potenza: 60W Temperatura: 300°C Cavo: 1,3 mt Accessori inclusi: 2 punte per saldare (curva e dritta) Supporto metallico di sostegno</p> <p>740PGT250 – - conf. 1 – € 15,04</p>	 <p>COOPER</p> <p>SALDATORE WELLER A STILO Dotato di 3 Led Impugnatura ergonomica Completo di: lega saldante aiuto per saldare supporto per saldatore</p> <p>420SP15NEU – W 15 – Gradi max 400 – - conf. 1 – € 41,80 420SP25NEU – W 25 – Gradi max 400 – - conf. 1 – € 42,00 420SP40NEU – W 40 – Gradi max 482 – - conf. 1 – € 48,00 420SP80NEU – W 80 – Gradi max 482 – - conf. 1 – € 56,60</p>
 <p>KIT SALDATORE ISTANTANEO Rapido raggiungimento della temperatura Luce incorporata Potenza: 100W Temperatura: 500°C Cavo: 1,3 mt Accessori inclusi: 3 punte per saldare filo in stagno pasta saldatura Valigetta trasporto</p> <p>740PGT270 – - conf. 1 – € 25,54</p>	 <p>KIT PENNA INCISIONE Con trasformatore</p> <p>740M9220 – - conf. 1 – € 42,40</p>
 <p>KIT PIROGRAFO E SALDATORE 2 livelli di potenza: 15 – 30W Temperatura: 310 – 480°C Cavo: 1,4 mt Impugnatura ergonomica gommata Dotato di base supporto con bracci regolabili e spugnetta 7 accessori per saldare, tagliare, incidere e decorare inclusi</p> <p>740PGT220 – - conf. 1 – € 41,82</p>	 <p>COOPER</p> <p>KIT PIROGRAFO con 15 accessori per la pirografia e il fai da te Contiene: Ferro a cilindro corto da 30W 6 Punta per la pirografia Punta da termoincisione con mandrino portalamo Punta per copia di motivi 3 Punta di marchiatura Appoggiaferro Quaderno di progetti</p> <p>420WHK30EU – - conf. 1 – € 41,40</p>
 <p>&M 900</p> <p>FILLO SALDARE Lonit</p> <p>90075300 – - conf. 25 – € 1,36</p>	 <p>&M 900</p> <p>PASTA STAGNOSALD per saldare 75 Gr</p> <p>90075350 – - conf. 1 – € 1,44</p>

**VUOI LAVORARE
PIÙ FACILMENTE E
CON PIÙ
PRECISIONE?**



CLEPSYDRA
MOD. DEP. - PAT. PEND.



*L'innovativa spazzola per trapano "sagomata", brevetto di SIT
TecnoSpazzole, utile a sverniciare e rimuovere la ruggine da
ringhiere, tubi e tondini*



- + NON "SLITTA" MA "GUIDA"
- + FACILE
- + VELOCE (1/3 DEL TEMPO)
- + SICURA
- + FINITURA OMOGENEA
- + BREVETTO SIT

GUARDA IL VIDEO





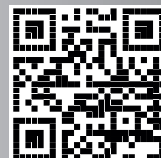









sitbrush.tv/clepsydra



sitbrush.com

www.malfattitacchinigroup.it















 <p>ROCCHETTO FILO PER SALDATURA IN STAGNO CON ANTIOSSIDANTE 40 GR - Ø 1 MM</p> <p>740PGT280 - Composizione 40% SN - 60% Pb - Uso Elettrotecnico - - conf. 1 - € 5,56</p> <p>740PGT285 - Composizione 60% SN - 40% Pb - Uso Elettronica - - conf. 1 - € 7,62</p>	 <p>MISCELATORE ELETTRICO TC-MX 1200 E 1 velocità per miscelare materiali viscosi Regolazione del numero di giri per adattarsi alle diverse esigenze di miscelazione Attacco M14 Agitatore per malta Ø100 incluso Tensione: 220-240 V 50/60 Hz Potenza: 1200 W Numero giri: 0-680 min Dimensioni: 325x325x194 Peso: 2.69 kg</p> <p>4764258545 - - conf. 1 - € 96,00</p>
 <p>MISCELATORE 1200 W Miscelazione colle, vernici e malta Cambio meccanico a 2 velocità Regolazione elettronica di velocità Avviamento progressivo controllato Impugnatura laterali Soft grip Diametro frusta max: 120 mm Attacco frusta: M14 mm Potenza: 1.200 W Peso: 5,4 Kg Accessori in dotazione: frusta da 120 mm</p> <p>516UM12VST2UA - - conf. 1 - € 270,00</p>	 <p>MISCELATORE ELETTRICO POWC6021 - 1050 W Velocità variabile 100-700 giri/min Attacco M14 Frusta 100x500 mm in dotazione</p> <p>93047030 - - conf. 1 - € 107,40</p>
 <p>FRUSTA PER MESCOLATORE</p> <p>512310857N - Misura 60x400x8 - - conf. 1 - € 1,38</p> <p>512310860N - Misura 80x400x8 - - conf. 1 - € 1,52</p> <p>512310865N - Misura 100x600x9 - - conf. 1 - € 2,60</p>	 <p>FRUSTA PER MESCOLATORE Dimensioni 120x600x9</p> <p>512310870N - - conf. 1 - € 7,60</p>
 <p>MISCELATORE PER MALTA</p> <p>74050700 - Ø 80 - L.asta 400 - - conf. 5 - € 12,20</p> <p>74050800 - Ø 100 - L.asta 500 - - conf. 2 - € 19,80</p> <p>74050900 - Ø 120 - L.asta 600 - - conf. 2 - € 21,40</p>	 <p>MISCELATORE vernici - colori smalti - colle</p> <p>74051100 - Ø 60 - L.asta 400 - - conf. 5 - € 13,20</p> <p>74051200 - Ø 80 - L.asta 400 - - conf. 5 - € 14,20</p> <p>74051300 - Ø 100 - L.asta 600 - - conf. 2 - € 22,60</p> <p>74051400 - Ø 120 - L.asta 600 - - conf. 2 - € 22,60</p>
 <p>MISCELATORE vernici - colori smalti - colle 60 x 350</p> <p>74051000 - - conf. 1 - € 3,40</p>	 <p>SPAZZOLA "SIT" "Circolare" Ø gambo 10x28 mm 3/8"x1-1/8" Acciaio steel 0,30 mm Dimensioni: Larghezza 60-50 mm Altezza: 30 mm Sporgenza: 10 mm</p> <p>785880 - - conf. 1 - € 22,20</p>
 <p>SPAZZOLA Circolare filo ottone Ø 75mm gambo Ø 6mm</p> <p>74049000 - - conf. 10 - € 7,40</p>	 <p>SPAZZOLA Circolare DOPPIO Spessore filo acciaio gambo Ø 6mm</p> <p>74047050 - Ø 75 - - conf. 10 - € 4,80</p> <p>74047550 - Ø 100 - - conf. 10 - € 6,20</p>



 <p>SPAZZOLA Circolare filo acciaio gambo Ø 6mm</p> <p>74046850 - Ø 40 - - conf. 10 - € 2,40 74046900 - Ø 50 - - conf. 10 - € 2,40 74047000 - Ø 75 - - conf. 10 - € 3,20 74047500 - Ø 100 - - conf. 10 - € 4,20</p>	 <p>SPAZZOLA Conica filo acciaio Ø 90mm gambo Ø 6mm</p> <p>74046600 - - conf. 10 - € 6,80</p>
 <p>SPAZZOLA "SIT" Circolare RPM 4500 Max in acciaio ottonato</p> <p>785216 - Ø 75 - Modello B G75 - - conf. 12 - € 4,20 785218 - Ø 50 - Modello B G50 - - conf. 12 - € 3,20</p>	 <p>SPAZZOLA "SIT" Circolare "GG63" RPM 15000 Max In acciaio</p> <p>785863 - Ø 60 - - conf. 12 - € 10,00</p>
 <p>SPAZZOLA "SIT" Coniche "C090 G" RPM 6500 Max in acciaio</p> <p>785170 - Ø 95 - - conf. 12 - € 9,20</p>	 <p>SPAZZOLA "SIT" Coniche "C090 G" RPM 6500 Max Inox</p> <p>785941 - Ø 95 - - conf. 12 - € 15,60</p>
 <p>SPAZZOLA "SIT" Circolare "GG102" RPM 10000 Max In Inox</p> <p>785979 - Ø 100 - - conf. 12 - € 17,00</p>	 <p>SPAZZOLA "SIT" Circolare RPM 4500 Max in nylon abrasivo</p> <p>785610 - Ø 75 - Modello B G75A - - conf. 6 - € 11,40 785612 - Ø 100 - Modello B G100A - - conf. 6 - € 13,60</p>
 <p>SPAZZOLA NYLON ARANCIO Gambo Ø 6mm. grana 80mm</p> <p>74049705 - Ø 75 - - conf. 5 - € 7,60 74049715 - Ø 100 - - conf. 5 - € 8,80</p>	 <p>SPAZZOLA NYLON BLU Gambo Ø 6mm. grana 150</p> <p>74049710 - Ø 75 - - conf. 5 - € 7,60 74049720 - Ø 100 - - conf. 5 - € 8,80</p>
 <p>SPAZZOLA "SIT" Circolare "B SP80" RPM 4000 Max in panno SP</p> <p>785402 - Ø 80 - - conf. 6 - € 7,80</p>	 <p>SPAZZOLA Circolare a mazzetti ritorti gambo Ø 6mm</p> <p>74047565 - Ø 75 - - conf. 5 - € 8,40 74047570 - Ø 100 - - conf. 5 - € 9,80</p>



 <p>SPAZZOLA a Tazza filo acciaio gambo Ø 6mm</p> <p>74048000 - Ø 50 - - conf. 10 - € 3,00</p> <p>74048500 - Ø 70 - - conf. 10 - € 3,80</p> <p>74048520 - Ø 85 - - conf. 10 - € 5,20</p>	 <p>SPAZZOLA a Tazza filo ottone Ø 50mm gambo 6mm</p> <p>74049500 - - conf. 10 - € 6,20</p>
 <p>SPAZZOLA NYLON BLU gambo Ø 6mm. grana 80</p> <p>74049725 - Ø 50 - - conf. 5 - € 7,20</p> <p>74049735 - Ø 70 - - conf. 5 - € 8,40</p>	 <p>SPAZZOLA NYLON Gambo 6mm.</p> <p>74049730 - Ø 50 - - conf. 5 - € 7,20</p> <p>74049740 - Ø 70 - - conf. 5 - € 8,40</p>
 <p>SPAZZOLA "SIT" a tazza RPM 4500 Max in nylon abrasivo</p> <p>785614 - Ø 50 - Modello B T50A - - conf. 6 - € 12,40</p> <p>785616 - Ø 75 - Modello B T75A - - conf. 6 - € 14,60</p>	 <p>SPAZZOLA "SIT" a tazza RPM 4500 Max In ottone</p> <p>785200 - Modello B TE50 - Ø 50 - - conf. 12 - € 3,60</p> <p>785660 - Modello TE50 - Ø 50 - - conf. 12 - € 3,20</p>
 <p>SPAZZOLA "SIT" a tazza "TE75" RPM 4500 Max In ottone</p> <p>785202 - Ø 75 - - conf. 12 - € 4,60</p>	 <p>SPAZZOLA "SIT" a tazza RPM 12000 Max</p> <p>785650 - Ø 50 - Modello T50 - - conf. 12 - € 7,40</p> <p>785654 - Ø 65 - Modello T60 - - conf. 12 - € 10,00</p>
 <p>SPAZZOLA Metallica A TAZZA gambo Ø 6x25mm filo in acciaio ondulato ad altissima densità RPM 4500 Max</p> <p>785655 - Art. T70 - - conf. 12 - € 11,20</p>	 <p>PENNELLI "SIT" a tazza RPM 18000 Max Pennelli in acciaio ottonato</p> <p>785209 - Ø 18 - Modello B PE15 - - conf. 12 - € 4,20</p> <p>785210 - Ø 28 - Modello B PE25 - - conf. 12 - € 5,20</p>
 <p>SPAZZOLA "SIT" Pennelli "SP27" RPM 18000 Max</p> <p>785814 - Ø 22 - Modello SP27 - Materiale Acciaio - - conf. 12 - € 5,20</p> <p>785962 - Ø 22 - Modello SP27 - Materiale Inox - - conf. 12 - € 8,20</p>	 <p>SPAZZOLA "SIT" Pennelli "P30" RPM 18000 Max</p> <p>785882 - Ø 35 - - conf. 12 - € 7,60</p>













 <p>SPAZZOLA pennello filo acciaio gambo Ø 6mm</p> <p>74047700 - Ø 16 - - conf. 10 - € 2,80</p> <p>74047800 - Ø 25 - - conf. 10 - € 3,20</p>	 <p>SPAZZOLA NYLON ARANCIO Ø 25 Gambo Ø 6mm. grana 80</p> <p>74049745 - - conf. 5 - € 6,00</p>
 <p>SPAZZOLA NYLON BLU Ø 25 Gambo Ø 6mm. grana 150</p> <p>74049750 - - conf. 5 - € 6,00</p>	 <p>SPAZZOLA fungo filo acciaio gambo Ø 6mm</p> <p>74047820 - Ø mm 30 - - conf. 10 - € 4,40</p> <p>74047840 - Ø mm 40 - - conf. 10 - € 5,40</p>
 <p>SPAZZOLA SCOVOLO filo acciaio Ø 28mm gambo Ø 6mm</p> <p>74047900 - - conf. 10 - € 3,20</p>	 <p>Set 3 Pz. SPAZZOLINE filo acciaio gambo Ø 3mm</p> <p>74047600 - - conf. 10 - € 7,80</p>
 <p>SPAZZOLA Circolare filo acciaio foro Ø 13mm</p> <p>74048580 - Ø 75 - - conf. 10 - € 3,40</p> <p>74048600 - Ø 100 - - conf. 10 - € 4,60</p>	 <p>SPAZZOLA Circolare filo acciaio foro Ø 16mm</p> <p>74048700 - Ø 120 - - conf. 10 - € 11,00</p> <p>74048800 - Ø 150 - - conf. 10 - € 17,80</p>
 <p>SPAZZOLA Circolare filo acciaio Ø 200 foro Ø 20mm</p> <p>74048900 - Spess. 20 - - conf. 5 - € 25,40</p> <p>74048950 - Spess. 40 - - conf. 3 - € 48,00</p>	 <p>SPAZZOLA Conica filo acciaio foro M14</p> <p>74046700 - Ø mm 90 - - conf. 10 - € 7,20</p> <p>74046800 - Ø mm 120 - - conf. 10 - € 8,60</p> <p>74046820 - Ø mm 150 - - conf. 5 - € 12,20</p>
 <p>SPAZZOLA "SIT" Conica "CO90" filo acciaio foro M14 RPM 14000 Max</p> <p>78599090120 - - conf. 12 - € 11,20</p>	 <p>SPAZZOLA "SIT" Circolare "U 115" Ø 115 maz-zetti ritorti foro M14 RPM 15000 Max</p> <p>78599022115 - - conf. 12 - € 20,60</p>







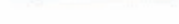
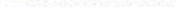







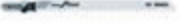

 <p>SPAZZOLA Conica filo acciaio mazzetti ritorti foro M 14</p> <p>74046830 - Ø 100 - - conf. 5 - € 8,80</p> <p>74046840 - Ø 150 - - conf. 5 - € 18,20</p>	 <p>SPAZZOLA "SIT" Conica "CZ95". Ø 95 mazzetti ritorti foro M14 ROM 14000 Max</p> <p>78599090115 - - conf. 12 - € 16,40</p>
 <p>SPAZZOLA a Tazza filo acciaio Foro M 14</p> <p>74048530 - Ø mm 60 - - conf. 10 - € 6,00</p> <p>74048540 - Ø mm 85 - - conf. 10 - € 7,80</p> <p>74048550 - Ø mm 100 - - conf. 5 - € 10,60</p> <p>74048560 - Ø mm 120 - - conf. 5 - € 16,00</p> <p>74048565 - Ø mm 150 - - conf. 5 - € 19,40</p>	 <p>SPAZZOLA a Tazza filo acciaio mazzetti ritorti Foro M14</p> <p>74048570 - Ø mm 65 - - conf. 5 - € 10,00</p> <p>74048575 - Ø mm 85 - - conf. 5 - € 18,80</p> <p>74048576 - Ø mm 100 - - conf. 5 - € 22,20</p> <p>74048577 - Ø mm 120 - - conf. 5 - € 28,40</p>
 <p>SPAZZOLA "SIT" a tazza "TE80" Foro M14 RPM 14000 Max In acciaio ottonato</p> <p>785105 - Ø 80 - - conf. 10 - € 7,80</p>	 <p>SPAZZOLA "SIT" a tazza "C090E" Foro M14 RPM 14000 Max Spazzole coniche con filo ondulato</p> <p>785106 - Ø 90 - - conf. 12 - € 8,40</p>
 <p>SPAZZOLA "SIT" a tazza "TE100" Foro M14 RPM 8500 Max In acciaio ottonato</p> <p>785108 - Ø 100 - - conf. 5 - € 10,00</p>	 <p>SPAZZOLA "SIT" a tazza "TE120" Foro M14 RPM 6600 Max In acciaio ottonato</p> <p>785118 - Ø 120 - - conf. 4 - € 14,80</p>
 <p>SPAZZOLA "SIT" a tazza "TZ70" RPM 14000 Max Spazzola a tazza a mazzetti ritorti</p> <p>785325 - Ø 70 - - conf. 12 - € 12,20</p>	 <p>SPAZZOLA "SIT" a tazza "T80" Foro M 14 RPM 14000 Max</p> <p>78599090150 - - conf. 10 - € 10,60</p>
 <p>SPAZZOLA "SIT" a tazza "TU71" mazzetti ritorti foro M14 RPM 14000 Max</p> <p>78599090105 - - conf. 12 - € 17,60</p>	 <p>SPAZZOLA SIT Metallica a tazza "T" con filo ondulato ad alta resistenza</p> <p>785137 - Art. T100 - Rpm Max 8500 - - conf. 6 - € 21,60</p> <p>785147 - Art. T120 - Rpm Max 6500 - - conf. 6 - € 28,60</p>

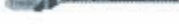











 <p>40 SPAZZOLE assort. in filo acciaio Ottonato 10 pz. art. 469 10 pz. art. 470 10 pz. art. 480 10 pz. art. 485</p> <p>74049600 – - conf. 1 – € 98,20</p>	 <p>Blister 3 pz. LAMA attacco B&D per legno e laminati in cromo vanadio</p> <p>74068700 – denti grossi – L.denti 70 – - conf. 10 – € 3,40</p> <p>74068800 – denti medi – L.denti 70 – - conf. 10 – € 3,80</p> <p>74068900 – denti fini – L.denti 75 – - conf. 10 – € 3,20</p>
 <p>Blister 3 pz LAMA attacco B&D Per legno e laminati in cromo vanadio RETTIFICATA</p> <p>74068910 – denti grossi – L.denti 75 – - conf. 10 – € 5,40</p> <p>74068920 – denti medi – L.denti 75 – - conf. 10 – € 5,40</p> <p>74068950 – denti medi – L.denti 100 – - conf. 10 – € 5,60</p>	 <p>Blister 3 pz LAMA attacco B&D Per legno e laminati Per tagli sagomati in cromo vanadio Denti medi – L.denti 50</p> <p>74072000 – - conf. 10 – € 3,80</p>
 <p>Blister 3 pz. LAMA attacco MAKITA Per legno e laminati per tagli sagomati in cromo vanadio Denti medi – L.denti 50</p> <p>74072200 – - conf. 10 – € 5,20</p>	 <p>Blister 3 pz LAMA attacco BOSCH Per legno e laminati in cromo vanadio</p> <p>74069700 – denti grossi – L.denti 70 – - conf. 10 – € 3,60</p> <p>74069800 – denti medi – L.denti 65 – - conf. 10 – € 3,80</p> <p>74069900 – denti fini – L.denti 60 – - conf. 10 – € 3,40</p>
 <p>Blister 3 pz LAMA attacco BOSCH per legno e laminati in cromo vanadio RETTIFICATA</p> <p>74069910 – denti grossi – L.denti 75 – - conf. 10 – € 5,20</p> <p>74069920 – denti medi – L.denti 75 – - conf. 10 – € 5,20</p> <p>74069950 – denti medi – L.denti 100 – - conf. 10 – € 5,60</p>	 <p>Blister 3 pz. LAMA attacco MAKITA Per legno e laminati in cromo vanadio</p> <p>74071700 – denti grossi – L.denti 70 – - conf. 10 – € 5,00</p> <p>74071800 – denti medi – L.denti 65 – - conf. 10 – € 5,00</p> <p>74071900 – denti fini – L.denti 60 – - conf. 10 – € 5,00</p>
 <p>BOSCH Invented for life</p> <p>Blister 5 pz. LAMA T 119 B per legno e laminati passo 1,9 – 2,3 L. denti 67</p> <p>3002608630037 – - conf. 6 – € 7,82</p>	 <p>Blister 3 pz LAMA attacco BOSCH stretto (tipo vecchio) per legno e laminati in cromo vanadio PROGRESSOR</p> <p>74070700 – denti grossi – L.denti 70 – - conf. 10 – € 6,20</p> <p>74070800 – denti medi – L.denti 65 – - conf. 10 – € 6,20</p>
 <p>BOSCH Invented for life</p> <p>Blister 3 pz. LAMA T 234X per legno leggero, truciolato, panforte, fibra Passo 2,3 – L.denti 91 PROGRESSOR</p> <p>3002608633523 – - conf. 10 – € 18,96</p>	 <p>BOSCH Invented for life</p> <p>Blister 5 pz. LAMA T 144 D per legno e laminati Passo 4–5,2 L.denti 74 rettificati speed</p> <p>3002608630040 – - conf. 6 – € 9,48</p>







<p>BOSCH Invented for life</p> <p>Blister 5 pz. LAMA T 101 A per plexiglas e poli-carbonato Passo 2 – L. denti 74 SPECIAL</p> <p>3002608631010 – - conf. 6 – € 19,78</p> 	<p>BOSCH Invented for life</p> <p>Blister 5 pz. LAMA T 101 B per legno, laminati, panforte, materiale plastico Passo 2,7 – L.denti 74 rettificati CLEAN</p> <p>3002608630030 – - conf. 6 – € 9,48</p> 
<p>BOSCH Invented for life</p> <p>Blister 5 pz. LAMA T 101 D per legno, truciolato, fibra Passo 4-5,2 – L. denti 74 RETTIFICATA</p> <p>3002608630032 – - conf. 6 – € 10,10</p> 	<p>BOSCH Invented for life</p> <p>Blister 5 pz. LAMA T 101 AO per legno – tagli sagomati Passo 1,4 – L. denti 56 CLEAN</p> <p>3002608630031 – - conf. 6 – € 14,22</p> 
<p>BOSCH Invented for life</p> <p>Blister 5 pz. LAMA T 111 C per legno, laminati, truciolato Passo 3 – L. denti 74 BASIC</p> <p>3002608630033 – - conf. 6 – € 6,38</p> 	<p>BOSCH Invented for life</p> <p>Blister 5 pz. LAMA T 301 CD per legno, compensato, truciolato e fibra Passo 3 – L. denti 91 rettificati CLEAN</p> <p>3002608637590 – - conf. 6 – € 24,92</p> 
<p>BOSCH Invented for life</p> <p>Blister 3 pz. LAMA T 123 X per lamiere, tubi, profilati, alluminio Passo 1,2 – 2,6 – L. denti 74 PROGRESSOR</p> <p>3002608638473 – - conf. 6 – € 12,78</p> 	<p></p> <p>Blister 3 pz. LAMA attacco BOSCH per legno e laminati per tagli sagomati in cromo vanadio Denti medi – L.denti 55</p> <p>74072100 – - conf. 10 – € 3,80</p> 
<p>BOSCH Invented for life</p> <p>Blister 5 pz. LAMA T 119 BO per legno, truciolato tagli sagomati Passo 2 – L. denti 56 BASIC</p> <p>3002608630310 – - conf. 6 – € 11,34</p> 	<p></p> <p>Blister 3 LAME HSS attacco B&D per metallo p</p> <p>74068400 – denti grossi – L.denti 45 – - conf. 10 – € 6,40</p> <p>74068500 – denti medi – L.denti 45 – - conf. 10 – € 6,40</p> <p>74068600 – denti fini – L.denti 45 – - conf. 10 – € 6,40</p> <p>74068650 – denti medi – L.denti 70 – - conf. 10 – € 8,40</p> 
<p></p> <p>Blister 3 pz. LAME HSS attacco Bosch largo per metallo</p> <p>74069400 – denti grossi – L.denti 50 – - conf. 10 – € 6,60</p> <p>74069500 – denti medi – L.denti 50 – - conf. 10 – € 6,60</p> <p>74069600 – denti fini – L.denti 50 – - conf. 10 – € 6,60</p> <p>74069650 – denti medi – L.denti 80 – - conf. 10 – € 9,20</p> 	<p></p> <p>Blister 3 pz. LAME HSS per ferro attacco BOSCH stretto (tipo vecchio) L.denti 55</p> <p>74070400 – Denti Grossi – - conf. 10 – € 7,80</p> <p>74070500 – Denti Medi – - conf. 10 – € 7,80</p> <p>74070600 – Denti Fini – - conf. 10 – € 7,80</p> 



 <p>Blister 3 pz. LAME HSS per ferro attacco MAKITA L. denti 55</p> <p>74071400 - Denti grossi - - conf. 10 - € 7,00</p> <p>74071500 - Denti medi - - conf. 10 - € 7,00</p> <p>74071600 - Denti fini - - conf. 10 - € 7,00</p>	 <p>Blister 5 pz. LAMA T 118 A - HSS per lamiera sottili Passo 1,1 - 1,5 - L. denti 67 BASIC</p> <p>3002608631013 - - conf. 6 - € 9,06</p>
 <p>Blister 5 pz. LAMA T 118 B - HSS per lamiere medio spessore Passo 1,9 - 2,3 - L. denti 67 BASIC Lunghezza 92 mm</p> <p>3002608631014 - - conf. 6 - € 9,06</p>	 <p>Blister 5 pz. LAMA T 118 G - HSS per lamiere sottili Passo 0,7 - L. denti 67 BASIC Lunghezza 92 mm</p> <p>3002608631012 - - conf. 6 - € 9,06</p>
 <p>Blister 5 pz. LAMA T 127 D - HSS per lamiere-tubi-profilati Passo 3 - L. denti 74 SPECIAL Lunghezza 100 mm</p> <p>3002608631017 - - conf. 6 - € 10,30</p>	 <p>Blister 5 pz. LAMA T 218 A - HSS per lamiere molto sottili tubi - profilati Passo 1,1 - 1,5 - L. denti 67 BASIC Lunghezza 92 mm</p> <p>3002608631032 - - conf. 6 - € 10,10</p>
 <p>LAME T 227 D - HSS Blister 5 pz Per lamiere 3-15 mm tubi - profilati Passo 3mm - L. denti 74mm Lunghezza 100 mm</p> <p>3002608631030 - - conf. 1 - € 10,30</p>	 <p>Blister 5 pz. LAMA T 318 A - HSS per lamiere - tubi - profilati alluminio Passo 1,2 - L. denti 106 BASIC Lunghezza 132 mm</p> <p>3002608631319 - - conf. 6 - € 19,58</p>
 <p>Blister 5 pz. LAMA T 318 B - HSS per lamiere medio spess. tubi - profilati, alluminio Passo 2 - L. denti 106 BASIC</p> <p>3002608631404 - - conf. 6 - € 19,58</p>	 <p>Blister 5 pz. LAMA T 345 XF - BiM per legno - lamiera - tubi Passo 2,4-5 - L.denti 106 PRO-GRASSOR</p> <p>3002608634994 - - conf. 6 - € 43,26</p>
 <p>Blister 1 pz LAMA in metallo duro attacco Bosch largo per vetro, ceramica e laterizi L. denti 55</p> <p>74072500 - - conf. 1 - € 6,20</p>	 <p>Blister 5 pz. LAMA A GATTUCCIO - S 1122 HF per ferro, legno, pallet, tubi, alluminio Passo 2.6 - Lungh. 225 FLEXIBLE</p> <p>3002608656021 - - conf. 1 - € 41,62</p>















<p>BOSCH Invented for life</p> <p>Blister 5 pz. LAMA A GATTUCCIO S 1122 EF BiM per lamiere sottili, tubi Passo 1,4 - Lungh. 225 FLEXIBLE</p> <p>3002608656020 - - conf. 1 - € 34,60</p> 	<p>BOSCH Invented for life</p> <p>Blister 5 pz. LAMA A GATTUCCIO S 922 BF BiM per lamiere 3-8mm e tubi Passo 1,8 - Lungh. 150 FLEXIBLE</p> <p>3002608656014 - - conf. 1 - € 32,34</p> 
<p>BOSCH Invented for life</p> <p>Blister 5 pz. LAMA A GATTUCCIO S 1531 L per legno grezzo e da costruzione Passo 5 - Lungh. 240 TOP</p> <p>3002608650676 - - conf. 1 - € 40,38</p> 	<p>BOSCH Invented for life</p> <p>Blister 5 pz. LAMA A GATTUCCIO S 644 D per legno, truciolato, MDF, plastica Passo 4,3 Lungh. 150 TOP</p> <p>3002608650673 - - conf. 1 - € 28,42</p> 
<p>BOSCH Invented for life</p> <p>LAME per pialetti diritte in HM 82mm- Conf. 2 pz.</p> <p>3002607000096 - - conf. 1 - € 15,04</p> 	<p>freuri pro</p> <p>LAMA per Legno LP30 Medio N* di denti indicata: per legno naturale lungo vena e trasverso vena</p> <p>479LP30M001 - Ø 125 - spess. 2,4 - Ø foro 20 - n°.denti 24 - conf. 1 - € 32,76</p> <p>479LP30M002 - Ø 130 - spess. 2,4 - Ø foro 20 - n°.denti 24 - conf. 1 - € 32,76</p> <p>479LP30M003 - Ø 140 - spess. 2,4 - Ø foro 20 - n°.denti 24 - conf. 1 - € 41,20</p> <p>segue...</p> 
<p>freuri pro</p> <p>continua...</p> <p>479LP30M004 - Ø 150 - spess. 2,4 - Ø foro 16 - n°.denti 24 - conf. 1 - € 34,00</p> <p>479LP30M005 - Ø 150 - spess. 2,4 - Ø foro 20 - n°.denti 24 - conf. 1 - € 34,00</p> <p>479LP30M006 - Ø 160 - spess. 2,4 - Ø foro 16 - n°.denti 24 - conf. 1 - € 35,02</p> <p>479LP30M007 - Ø 160 - spess. 2,4 - Ø foro 20 - n°.denti 24 - conf. 1 - € 35,02</p> <p>segue...</p> 	<p>freuri pro</p> <p>continua...</p> <p>479LP30M008 - Ø 160 - spess. 2,4 - Ø foro 30 - n°.denti 24 - conf. 1 - € 35,02</p> <p>479LP30M009 - Ø 170 - spess. 2,4 - Ø foro 30 - n°.denti 24 - conf. 1 - € 35,02</p> <p>479LP30M010 - Ø 180 - spess. 2,4 - Ø foro 20 - n°.denti 24 - conf. 1 - € 35,02</p> <p>479LP30M011 - Ø 180 - spess. 2,4 - Ø foro 30 - n°.denti 24 - conf. 1 - € 35,02</p> <p>segue...</p> 
<p>freuri pro</p> <p>continua...</p> <p>479LP30M012 - Ø 184 - spess. 2,4 - Ø foro 16 - n°.denti 24 - conf. 1 - € 35,02</p> <p>479LP30M013 - Ø 190 - spess. 2,4 - Ø foro 16 - n°.denti 24 - conf. 1 - € 35,02</p> <p>479LP30M014 - Ø 190 - spess. 2,4 - Ø foro 20 - n°.denti 24 - conf. 1 - € 35,02</p> <p>479LP30M015 - Ø 190 - spess. 2,4 - Ø foro 30 - n°.denti 24 - conf. 1 - € 35,02</p> <p>segue...</p> 	<p>freuri pro</p> <p>continua...</p> <p>479LP30M016 - Ø 200 - spess. 2,4 - Ø foro 30 - n°.denti 30 - conf. 1 - € 36,06</p> <p>479LP30M017 - Ø 210 - spess. 2,4 - Ø foro 25 - n°.denti 30 - conf. 1 - € 38,32</p> <p>479LP30M018 - Ø 210 - spess. 2,4 - Ø foro 30 - n°.denti 30 - conf. 1 - € 38,32</p> <p>479LP30M019 - Ø 216 - spess. 2,4 - Ø foro 30 - n°.denti 48 - conf. 1 - € 62,84</p> <p>segue...</p> 
<p>freuri pro</p> <p>continua...</p> <p>479LP30M020 - Ø 220 - spess. 2,4 - Ø foro 30 - n°.denti 30 - conf. 1 - € 42,64</p> <p>479LP30M021 - Ø 230 - spess. 2,8 - Ø foro 30 - n°.denti 34 - conf. 1 - € 45,94</p> <p>479LP30M022 - Ø 235 - spess. 2,8 - Ø foro 25 - n°.denti 34 - conf. 1 - € 45,94</p> <p>479LP30M023 - Ø 235 - spess. 2,8 - Ø foro 30 - n°.denti 34 - conf. 1 - € 45,94</p> <p>segue...</p> 	<p>freuri pro</p> <p>continua...</p> <p>479LP30M024 - Ø 240 - spess. 2,8 - Ø foro 30 - n°.denti 36 - conf. 1 - € 49,24</p> <p>479LP30M025 - Ø 250 - spess. 2,8 - Ø foro 30 - n°.denti 40 - conf. 1 - € 53,56</p> 



 <p>LAMA per alluminio LP 80</p> <p>479LP80M001 - Ø 250 - spess. 2,8/2,2 - Ø foro 30 - n°.denti 80 - conf. 1 - € 115,80</p> <p>479LP80M002 - Ø 280 - spess. 2,8/2,2 - Ø foro 30 - n°.denti 64 - conf. 1 - € 78,70</p> <p>479LP80M003 - Ø 300 - spess. 2,8/2,2 - Ø foro 30 - n°.denti 96 - conf. 1 - € 95,58</p> <p>479LP80M004 - Ø 350 - spess. 3,0/2,2 - Ø foro 30 - n°.denti 108 - conf. 1 - € 118,66</p>	 <p>LAMA per Legno LP20 Basso N° di denti indicata: per legno naturale lungo vena</p> <p>479LP20M004 - Ø 150 - spess. 2,4 - Ø foro 16 - n°.denti 12 - conf. 1 - € 25,14</p> <p>479LP20M005 - Ø 150 - spess. 2,4 - Ø foro 20 - n°.denti 12 - conf. 1 - € 25,14</p> <p>479LP20M006 - Ø 160 - spess. 2,4 - Ø foro 16 - n°.denti 12 - conf. 1 - € 25,14 segue...</p>
 <p>continua...</p> <p>479LP20M007 - Ø 160 - spess. 2,4 - Ø foro 20 - n°.denti 12 - conf. 1 - € 25,14</p> <p>479LP20M008 - Ø 160 - spess. 2,4 - Ø foro 30 - n°.denti 12 - conf. 1 - € 25,14</p> <p>479LP20M009 - Ø 170 - spess. 2,4 - Ø foro 30 - n°.denti 12 - conf. 1 - € 25,14</p> <p>479LP20M010 - Ø 180 - spess. 2,4 - Ø foro 20 - n°.denti 12 - conf. 1 - € 25,14 segue...</p>	 <p>continua...</p> <p>479LP20M011 - Ø 180 - spess. 2,4 - Ø foro 30 - n°.denti 12 - conf. 1 - € 25,14</p> <p>479LP20M012 - Ø 184 - spess. 2,4 - Ø foro 16 - n°.denti 12 - conf. 1 - € 28,42</p> <p>479LP20M013 - Ø 190 - spess. 2,4 - Ø foro 16 - n°.denti 12 - conf. 1 - € 28,42</p> <p>479LP20M014 - Ø 190 - spess. 2,4 - Ø foro 20 - n°.denti 12 - conf. 1 - € 28,42 segue...</p>
 <p>continua...</p> <p>479LP20M015 - Ø 190 - spess. 2,4 - Ø foro 30 - n°.denti 12 - conf. 1 - € 28,42</p> <p>479LP20M016 - Ø 200 - spess. 2,4 - Ø foro 30 - n°.denti 16 - conf. 1 - € 31,72</p> <p>479LP20M017 - Ø 210 - spess. 2,4 - Ø foro 25 - n°.denti 16 - conf. 1 - € 34,00</p> <p>479LP20M018 - Ø 210 - spess. 2,4 - Ø foro 30 - n°.denti 16 - conf. 1 - € 34,00 segue...</p>	 <p>continua...</p> <p>479LP20M019 - Ø 216 - spess. 2,4 - Ø foro 30 - n°.denti 24 - conf. 1 - € 39,96</p> <p>479LP20M020 - Ø 220 - spess. 2,4 - Ø foro 30 - n°.denti 16 - conf. 1 - € 36,06</p> <p>479LP20M021 - Ø 230 - spess. 2,8 - Ø foro 30 - n°.denti 20 - conf. 1 - € 38,32</p> <p>479LP20M022 - Ø 235 - spess. 2,8 - Ø foro 25 - n°.denti 24 - conf. 1 - € 37,50 segue...</p>
 <p>continua...</p> <p>479LP20M023 - Ø 235 - spess. 2,8 - Ø foro 30 - n°.denti 24 - conf. 1 - € 41,62</p> <p>479LP20M024 - Ø 240 - spess. 2,8 - Ø foro 30 - n°.denti 24 - conf. 1 - € 41,62</p> <p>479LP20M025 - Ø 250 - spess. 2,8 - Ø foro 30 - n°.denti 24 - conf. 1 - € 42,64</p>	 <p>LAMA per edilizia LP 70</p> <p>479LP70M001 - Ø 300 - spess. 2,8/1,8 - Ø foro 30 - n°.denti 24 - conf. 1 - € 50,26</p> <p>479LP70M002 - Ø 350 - spess. 3,0/2,2 - Ø foro 30 - n°.denti 28 - conf. 1 - € 72,10</p>
 <p>LAMA per Legno LP40 Medio N° di denti indicata: finitura legno naturale lungo e trasverso vena</p> <p>479LP40M006 - Ø 160 - spess. 2,4 - Ø foro 16 - n°.denti 40 - conf. 1 - € 37,28</p> <p>479LP40M007 - Ø 160 - spess. 2,4 - Ø foro 20 - n°.denti 40 - conf. 1 - € 51,00</p> <p>479LP40M008 - Ø 160 - spess. 2,4 - Ø foro 30 - n°.denti 40 - conf. 1 - € 37,28 segue...</p>	 <p>continua...</p> <p>479LP40M009 - Ø 170 - spess. 2,4 - Ø foro 30 - n°.denti 40 - conf. 1 - € 38,32</p> <p>479LP40M010 - Ø 180 - spess. 2,4 - Ø foro 20 - n°.denti 40 - conf. 1 - € 38,32</p> <p>479LP40M011 - Ø 180 - spess. 2,4 - Ø foro 30 - n°.denti 40 - conf. 1 - € 38,32</p> <p>479LP40M012 - Ø 184 - spess. 2,4 - Ø foro 16 - n°.denti 40 - conf. 1 - € 38,32 segue...</p>
 <p>continua...</p> <p>479LP40M013 - Ø 190 - spess. 2,4 - Ø foro 16 - n°.denti 40 - conf. 1 - € 39,34</p> <p>479LP40M014 - Ø 190 - spess. 2,4 - Ø foro 20 - n°.denti 40 - conf. 1 - € 39,34</p> <p>479LP40M015 - Ø 190 - spess. 2,4 - Ø foro 30 - n°.denti 40 - conf. 1 - € 54,80</p> <p>479LP40M016 - Ø 200 - spess. 2,4 - Ø foro 30 - n°.denti 40 - conf. 1 - € 39,34 segue...</p>	 <p>continua...</p> <p>479LP40M017 - Ø 210 - spess. 2,4 - Ø foro 25 - n°.denti 40 - conf. 1 - € 43,68</p> <p>479LP40M018 - Ø 210 - spess. 2,4 - Ø foro 30 - n°.denti 40 - conf. 1 - € 57,40</p> <p>479LP40M019 - Ø 216 - spess. 2,4 - Ø foro 30 - n°.denti 64 - conf. 1 - € 64,28</p> <p>479LP40M020 - Ø 220 - spess. 2,4 - Ø foro 30 - n°.denti 40 - conf. 1 - € 50,88 segue...</p>















 <p>freurit pro</p> <p>continua... 479LP40M021 - Ø 230 - spess. 2,8 - Ø foro 30 - n°.denti 48 - conf. 1 - € 51,92 479LP40M022 - Ø 235 - spess. 2,8 - Ø foro 25 - n°.denti 48 - conf. 1 - € 51,92 479LP40M023 - Ø 235 - spess. 2,8 - Ø foro 30 - n°.denti 48 - conf. 1 - € 51,92 479LP40M024 - Ø 240 - spess. 2,8 - Ø foro 30 - n°.denti 48 - conf. 1 - € 51,92 segue...</p>	 <p>freurit pro</p> <p>continua... 479LP40M025 - Ø 250 - spess. 2,8 - Ø foro 30 - n°.denti 60 - conf. 1 - € 99,60</p>
 <p>freurit pro</p> <p>LAMA per Legno PRO LP 60 479LP60M001 - Ø 250 - spess. 2,8/1,8 - Ø foro 30 - n°.denti 80 - conf. 1 - € 78,70 479LP60M002 - Ø 280 - spess. 2,8/1,8 - Ø foro 30 - n°.denti 64 - conf. 1 - € 78,70 479LP60M003 - Ø 300 - spess. 2,8/1,8 - Ø foro 30 - n°.denti 48 - conf. 1 - € 68,80 segue...</p>	 <p>freurit pro</p> <p>continua... 479LP60M004 - Ø 300 - spess. 2,8/1,8 - Ø foro 30 - n°.denti 72 - conf. 1 - € 86,94 479LP60M005 - Ø 300 - spess. 2,8/1,8 - Ø foro 30 - n°.denti 96 - conf. 1 - € 133,00 479LP60M006 - Ø 305 - spess. 2,8/1,8 - Ø foro 30 - n°.denti 96 - conf. 1 - € 102,80 479LP60M007 - Ø 350 - spess. 3,0/2,2 - Ø foro 30 - n°.denti 54 - conf. 1 - € 79,72 segue...</p>
 <p>freurit pro</p> <p>continua... 479LP60M008 - Ø 350 - spess. 3,0/2,2 - Ø foro 30 - n°.denti 108 - conf. 1 - € 115,78</p>	 <p>freurit pro</p> <p>LAMA per decespugliatore LP17 479LP17MLR3 - Ø 250 - spess. 2,8 - Ø foro 25,4 - n°.denti 20 - conf. 1 - € 41,60</p>
 <p>LAMA PER SEGA CIRCOLARE C.V. Ø 125 - 24 denti Foro Ø 20 2 riduzioni da 16-13</p> <p>74074000 - - conf. 5 - € 8,40</p>	 <p>LAMA SEGA CIRCOLARE C.V. Ø 150 - 24 denti Foro Ø 20 2 riduzioni da 16-13</p> <p>74075000 - - conf. 5 - € 11,60</p>
 <p>LAMA SEGA CIRCOLARE C.V. Ø 125 - 80 denti Foro Ø 20 2 riduzioni da 16-13</p> <p>74074500 - - conf. 5 - € 8,80</p>	 <p>LAMA SEGA CIRCOLARE C.V. Ø 150 - 80 denti Foro Ø 20 2 riduzioni da 16-13</p> <p>74075500 - - conf. 5 - € 12,80</p>
 <p>LAMA SEGA CIRCOLARE C.V. Ø 125 - 16 denti metallo duro Foro Ø 20 con 2 riduzioni da 16-13</p> <p>74075602 - - conf. 1 - € 34,20</p>	 <p>LAMA SEGA CIRCOLARE C.V. Ø 150 - 18 denti metallo duro Foro Ø 20 2 riduzioni da 16-13</p> <p>74075610 - - conf. 1 - € 37,60</p>



























 <p>LAMA Per sega circolare Per il taglio di alluminio E materiali non ferrosi Spessore taglio 2,8/2,0 mm</p> <p>479LP85M002 - Ø 160 - Ø Foro 20 - NØDenti 42 - - conf. 1 - € 53,56</p> <p>479LP85M004 - Ø 190 - Ø Foro 30 - NØDenti 54 - - conf. 0 - € 62,84</p> 	 <p>DISCO DIAMANTATO Corona turbo per materiali edili cemento, laterizi, piastrelle e pietre naturali</p> <p>60503405115 - Ø 115 mm - - conf. 1 - € 10,40</p> <p>60503405230 - Ø 230mm - - conf. 1 - € 41,00</p> 
 <p>DISCO DIAMANTATO Corona continua per materiali edili piastrelle, ceramica e marmo</p> <p>60541130115 - Ø 115 mm - - conf. 1 - € 7,60</p> 	 <p>DISCO DIAMANTATO Per gres porcellanato, ceramica e piastrelle in genere Taglio a secco per tutti i materiali edili difficili da lavorare foro Ø 115 mm</p> <p>60503515115 - Ø 115 mm - - conf. 1 - € 32,76</p> 
 <p>DISCO DIAMANTATO Corona turbo per materiali edili cemento mattoni e piastrelle</p> <p>60541132115 - Ø 115 mm - - conf. 1 - € 8,20</p> <p>60541132230 - Ø 230 mm - - conf. 1 - € 35,80</p> 	 <p>DISCO DA TAGLIO Per fresare, tagliare: legno, PVC e materiali plastici foro Ø 22</p> <p>74041990 - Ø 115 - - conf. 5 - € 7,40</p> <p>74041995 - Ø 230 - - conf. 1 - € 18,80</p> 
 <p>DISCO PIANO taglio ferro Ø 125 foro Ø 13</p> <p>74040600 - Ø 125 - - conf. 10 - € 3,80</p> 	 <p>DISCO PIANO TAGLIO FERRO INOX Foro Ø 22,2 mm HD MF - A46 T-BF</p> <p>90057379 - Ø 115x1,0 - - conf. 50 - € 1,42</p> <p>90057380 - Ø 115x1,6 - - conf. 50 - € 1,42</p> <p>90057381 - Ø 125x1,6 - - conf. 50 - € 1,48</p> <p>90057382 - Ø 230x1,9 - - conf. 25 - € 3,50</p> <p>90057383 - Ø 125x1,0 - - conf. 50 - € 1,48</p> 
 <p>DISCO TAGLIO ferro centro depresso VDMC - C30 R - BF Foro Ø 22,2</p> <p>90057324 - Ø 115x3,2 - - conf. 25 - € 1,34</p> <p>90057325 - Ø 125x3,2 - - conf. 25 - € 1,96</p> <p>90057327 - Ø 230x3,2 - - conf. 25 - € 3,10</p> 	 <p>DISCO SBAVO ferro centro depresso VTMF - A240 - BF Foro Ø 22,2</p> <p>90057329 - Ø 115x6,4 - - conf. 10 - € 2,48</p> <p>90057330 - Ø 125x6,0 - - conf. 10 - € 2,70</p> <p>90057332 - Ø 230x6,8 - - conf. 10 - € 5,54</p> 
 <p>DISCO TAGLIO marmo centro depresso LDMC - C30 R - BF Foro: Ø 22,2</p> <p>90057334 - Ø 115x3,2 - - conf. 25 - € 1,82</p> <p>90057337 - Ø 230x3,2 - - conf. 25 - € 3,92</p> 	 <p>DISCO JOLLY TAGLIO</p> <p>90057888 - Misura 115x1,9x22,23 - Forma C 46 T - BF 41 - - conf. 10 - € 5,00</p> 















<p>GRINDING</p> <p>DISCO TAGLIO FERRO Dimensioni: 230x1,9x22,23 Forma: A 46 T - BF 41</p> <p>90057882 - - conf. 10 - € 5,00</p> 	<p>GRINDING</p> <p>METAL BOX 1 Confezione contiene: 10 PEZZI DISCO PIANO DA TAGLIO PER FERRO</p> <p>90057993 - Misura 115x1,6 - - conf. 1 - € 12,80</p> 
<p>GRINDING</p> <p>DISCO PLATINUM MULTI CUT</p> <p>90057895 - Misura 115x2,5x22,23 - - conf. 1 - € 43,00 90057896 - Misura 230x3,1x22,23 - - conf. 1 - € 95,80</p> 	<p>TAF</p> <p>DISCO Lamellare Zirconio RPM 7000 Max Ø 170 foro Ø 22</p> <p>90057320 - grana 40 - - conf. 10 - € 11,94 90057321 - grana 60 - - conf. 10 - € 11,94 90057322 - grana 80 - - conf. 10 - € 11,94 90057323 - grana 120 - - conf. 10 - € 11,94</p> 
<p>TAF</p> <p>DISCO Lamellare Zirconio RPM 11000 Max Ø 110 foro Ø 22</p> <p>90057310 - grana 40 - - conf. 10 - € 7,00 90057311 - grana 60 - - conf. 10 - € 7,00 90057312 - grana 80 - - conf. 10 - € 7,00 90057313 - grana 120 - - conf. 10 - € 7,00</p> 	<p>GRINDING</p> <p>DISCO LAMELLARE GRINDING Ø 115 x 22 mm Zirconio</p> <p>90057372 - grana 40 - - conf. 10 - € 2,48 90057373 - grana 60 - - conf. 10 - € 2,48 90057374 - grana 80 - - conf. 10 - € 2,48 90057375 - grana 120 - - conf. 10 - € 2,48</p> 
<p>GRINDING</p> <p>DISCO LAMELLARE Misura disco 115x22 60 gr</p> <p>90057990 - - conf. 10 - € 2,78</p> 	<p>GRINDING</p> <p>DISCO LAMELLARE Misura disco 115x22 80 gr</p> <p>90057991 - - conf. 10 - € 2,78</p> 
<p>GRINDING</p> <p>DISCO LAMELLARE Misura disco 115x22 40 gr</p> <p>90057989 - - conf. 10 - € 2,78</p> 	<p>TAF</p> <p>DISCO BIO Lamellare RPM 13200 Max Supporto biodegradabile Ø 115 foro Ø 22 Brevetto TAF</p> <p>90057506 - grana 40 - - conf. 10 - € 2,88 90057508 - grana 60 - - conf. 10 - € 2,88 90057509 - grana 80 - - conf. 10 - € 2,88</p> 
<p>GRINDING</p> <p>DISCO PLATINUM STRIPPER TRADIZIONALE Prodotto in rete di nylon e abrasivo al carburo di silicio Performance più elevata e lunga durata nelle operazioni di sverniciatura e decapaggio Applicazione: Indicati per decapare, rimuovere la ruggine, pulire gomma, materiale plastiche, vernici, legno e cemento Dimensione: 115 x 22,23</p> <p>90057907 - - conf. 5 - € 11,74</p> 	<p>TAF</p> <p>DISCO Fibrato Ø 115 foro Ø 22</p> <p>90057350 - grana 24 - - conf. 25 - € 1,04 90057351 - grana 36 - - conf. 25 - € 0,98 90057352 - grana 50 - - conf. 25 - € 0,96 90057353 - grana 60 - - conf. 25 - € 0,92 90057354 - grana 80 - - conf. 25 - € 0,92 segue...</p> 



 <p>continua... 90057355 - grana 100 - - conf. 25 - € 0,92 90057356 - grana 120 - - conf. 25 - € 0,92</p> 	 <p>DISCO FIBRATO FERRO Abrasivo all'ossido di Alluminio Dimensioni 115x22,23 Supporto in fibra da 0.8mm Per metalli, legno, alluminio, ghisa..</p> <p>90057897 - Grana A 16 - - conf. 1 - € 0,90 90057898 - Grana A 24 - - conf. 1 - € 0,90 90057899 - Grana A 36 - - conf. 1 - € 0,90</p> 
 <p>Blister 6 pezzi DISCO fibrato Ø 100</p> <p>74034610 - grana 60 - - conf. 10 - € 7,80 74034620 - grana 100 - - conf. 10 - € 7,80 74034600 - grana 36 - - conf. 10 - € 7,60</p> 	 <p>Blister 6 pezzi DISCO fibrato Ø 115</p> <p>74034700 - grana 36 - - conf. 10 - € 10,40 74034710 - grana 60 - - conf. 10 - € 10,40 74034720 - grana 100 - - conf. 10 - € 10,40</p> 
 <p>Blister 6 pezzi DISCO fibrato Ø 180</p> <p>74034800 - grana 36 - - conf. 10 - € 16,80 74034810 - grana 60 - - conf. 10 - € 15,00</p> 	 <p>Blister 10 pezzi DISCO Ø 115 attacco VELCRO</p> <p>74034900 - grana 40 - - conf. 10 - € 7,20 74034910 - grana 120 - - conf. 10 - € 6,20 74034920 - grana 240 - - conf. 10 - € 6,20 74034930 - grana assortiti - - conf. 10 - € 6,80</p> 
 <p>Blister 10 pezzi DISCO Ø 125 attacco VELCRO</p> <p>74034955 - grana 40 - - conf. 10 - € 8,20 74034960 - grana 120 - - conf. 10 - € 7,00 74034965 - grana 240 - - conf. 10 - € 7,00 74034970 - grana assortiti - - conf. 10 - € 7,60</p> 	 <p>Blister 6 pezzi DISCO TELA Ø 125mm.</p> <p>74035000 - grana 40 - - conf. 10 - € 5,00 74035100 - grana 80 - - conf. 10 - € 4,60 74035200 - grana 120 - - conf. 10 - € 4,60 74035300 - grana assortiti - - conf. 10 - € 5,00</p> 
 <p>Blister 15 pezzi DISCO CARTA Ø 125mm. sup- porto gr. 160</p> <p>74034000 - grana 50 - - conf. 10 - € 5,80 74034100 - grana 80 - - conf. 10 - € 5,00 74034200 - grana 120 - - conf. 10 - € 4,80 74034300 - grana assortiti - - conf. 10 - € 5,20</p> 	 <p>Blister 10 pezzi DISCO Ø 150 con fori attacco VELCRO</p> <p>74034995 - grana 40 - - conf. 10 - € 12,00 74034996 - grana 80 - - conf. 10 - € 10,40 74034997 - grana 120 - - conf. 10 - € 10,20 74034998 - grana 240 - - conf. 10 - € 10,20 74034999 - grana assortiti - - conf. 10 - € 10,80</p> 
 <p>Blister 5 pezzi DISCO CARTA attacco VELCRO Ø 125</p> <p>3002608605640 - grana 40 - - conf. 6 - € 7,00 3002608605641 - grana 60 - - conf. 6 - € 6,60 3002608605642 - grana 80 - - conf. 6 - € 5,76 3002607018131 - grana 180 - - conf. 6 - € 4,60</p> 	 <p>Blister 10 pezzi DISCO Ø 115 con fori attacco VELCRO</p> <p>74034933 - grana 40 - - conf. 10 - € 7,80 74034935 - grana 80 - - conf. 10 - € 6,60 74034940 - grana 120 - - conf. 10 - € 6,60 74034945 - grana 240 - - conf. 10 - € 6,60 74034950 - grana assortiti - - conf. 10 - € 7,00</p> 



 <p>Blister 10 pezzi DISCO Ø 125 con fori attacco VELCRO</p> <p>74034973 - grana 40 - - conf. 10 - € 8,60</p> <p>74034975 - grana 80 - - conf. 10 - € 7,40</p> <p>74034980 - grana 120 - - conf. 10 - € 7,20</p> <p>74034985 - grana 240 - - conf. 10 - € 7,20</p> <p>74034990 - grana assortiti - - conf. 10 - € 7,80</p>	 <p>DISCO FIBRATO FERRO KFL Abrasivo all'ossido di alluminio Elevata resistenza</p> <p>90057900 - Grana 40 - - conf. 25 - € 0,78</p> <p>90057901 - Grana 50 - - conf. 25 - € 0,78</p> <p>90057902 - Grana 60 - - conf. 25 - € 0,78</p> <p>90057903 - Grana 80 - - conf. 25 - € 0,78</p> <p>90057904 - Grana 100 - - conf. 25 - € 0,78</p> <p>segue...</p>
 <p>continua...</p> <p>90057905 - Grana 120 - - conf. 25 - € 0,78</p>	 <p>ROTORBITALE Misura 115 mm</p> <p>90057973 - Ø 115 - Grana 40 - - conf. 50 - € 0,52</p> <p>90057974 - Ø 115 - Grana 60 - - conf. 50 - € 0,52</p> <p>90057975 - Ø 115 - Grana 80 - - conf. 50 - € 0,52</p> <p>90057976 - Ø 115 - Grana 100 - - conf. 50 - € 0,52</p> <p>90057977 - Ø 115 - Grana 120 - - conf. 50 - € 0,52</p> <p>segue...</p>
 <p>continua...</p> <p>90057978 - Ø 115 - Grana 180 - - conf. 50 - € 0,52</p> <p>90057979 - Ø 125 - Grana 40 - - conf. 50 - € 0,52</p> <p>90057980 - Ø 125 - Grana 60 - - conf. 50 - € 0,52</p> <p>90057981 - Ø 125 - Grana 80 - - conf. 50 - € 0,52</p> <p>90057982 - Ø 125 - Grana 100 - - conf. 50 - € 0,52</p> <p>segue...</p>	 <p>continua...</p> <p>90057983 - Ø 125 - Grana 120 - - conf. 50 - € 0,52</p> <p>90057984 - Ø 125 - Grana 150 - - conf. 50 - € 0,52</p> <p>90057985 - Ø 125 - Grana 180 - - conf. 50 - € 0,52</p>
 <p>Blister 5 pezzi FOGLIO a delta velcro con fori</p> <p>74034830 - grana 40 - - conf. 10 - € 3,20</p> <p>74034835 - grana 60 - - conf. 10 - € 3,00</p> <p>74034840 - grana 80 - - conf. 10 - € 3,00</p> <p>74034845 - grana 120 - - conf. 10 - € 3,00</p> <p>74034850 - grana 240 - - conf. 10 - € 3,00</p>	 <p>GRINDING</p> <p>SOFT ROLL ROTOLO SPUGNA Comodo e pratico imballo ed ogni foglio è pretagliato per facilitare lo strappo e l'utilizzo senza sprechi di abrasivo Dimensioni foglio pretagliato: 115x140 mm</p> <p>90057908 - Misura 115x25 - Grana 120 - - conf. 2 - € 51,50</p> <p>90057909 - Misura 115x25 - Grana 180 - - conf. 2 - € 49,02</p> <p>90057910 - Misura 115x25 - Grana 220 - - conf. 2 - € 49,02</p>
 <p>SPUGNA ABRASIVA</p> <p>90057911 - Grana 80 - - conf. 24 - € 1,12</p> <p>90057912 - Grana 150 - - conf. 24 - € 1,12</p> <p>90057913 - Grana 240 - - conf. 24 - € 1,12</p>	 <p>SPUGNA ABRASIVA all'Ossido di Alluminio o Carburo di Silicio Struttura aperta Impermeabile Per la satinatura del legno alluminio,ottone e per la rimozione di ruggine e piccole imperfezioni sui metalli in genere Misura: 120x280 mm</p> <p>90057914 - Ø Fine - - conf. 10 - € 1,66</p> <p>90057915 - Ø Ultra Fine - - conf. 10 - € 1,66</p> <p>90057916 - Ø Very Fine - - conf. 10 - € 1,66</p>
 <p>24 SPUGNE abrasive per legno Espositore Self Service</p> <p>74033985 - - conf. 1 - € 38,20</p>	 <p>SPUGNA ABRASIVA doppia grana 60/100 per legno</p> <p>74033980 - - conf. 10 - € 3,20</p>





 <p>blister 2 pezzi SPUGNA ABRASIVA per ferro grana 100</p> <p>74033990 – – conf. 10 – € 4,40</p>	 <p>LANA METALLICA GRINWOOL Acciaio, rame, alluminio, ottone, Legno Per la preparazione di superfici e finiture su ogni tipo di materiale Indicata per la satinatura di superfici in Acciaio Inossidabile o anche per la rimozione di pitture e vernici vecchie</p> <p>90057917 – Ø Media – 0 – – conf. 1 – € 3,10 90057918 – Ø Fine – 00 – – conf. 1 – € 3,10 90057919 – Ø Extra Fine – 000 – – conf. 1 – € 3,10</p>
 <p>FOGLI IN TELA FLESSIBILE GF71 Metallo, Acciaio, Alluminio, Legno, Plastica, Cuoio Abrasivo all'Ossido di Alluminio Cosparsione chiusa Elevata flessibilità e resistenza</p> <p>90057920 – Grana 40 – – conf. 25 – € 1,42 90057921 – Grana 60 – – conf. 25 – € 1,38 90057922 – Grana 80 – – conf. 50 – € 1,34 90057923 – Grana 120 – – conf. 50 – € 1,14 segue...</p>	 <p>continua...</p> <p>90057924 – Grana 150 – – conf. 50 – € 1,14 90057925 – Grana 180 – – conf. 50 – € 1,14 90057926 – Grana 220 – – conf. 50 – € 1,14 90057927 – Grana 320 – – conf. 50 – € 1,14</p>
 <p>CARTA LEGGERA GB55 Legno, vernici Abrasivo all'Ossido di Alluminio Cosparsione aperta Misura: 230x280</p> <p>90057928 – Grana 40 – – conf. 25 – € 0,52 90057929 – Grana 60 – – conf. 25 – € 0,42 90057930 – Grana 80 – – conf. 50 – € 0,40 90057931 – Grana 100 – – conf. 50 – € 0,38 90057932 – Grana 120 – – conf. 50 – € 0,38</p>	 <p>FOGLI CARTA IMPERMEABILE GW91 Alluminio, Vernici, Plastica, Marmo, Materiali Compositi Abrasivo al Carburo di Silicio Misura: 230x280</p> <p>90057933 – Grana Sic 150 – – conf. 50 – € 0,48 90057934 – Grana Sic 180 – – conf. 50 – € 0,48 90057935 – Grana Sic 220 – – conf. 50 – € 0,48 90057936 – Grana Sic 320 – – conf. 50 – € 0,48 segue...</p>
 <p>continua...</p> <p>90057937 – Grana Sic 400 – – conf. 50 – € 0,48 90057938 – Grana Sic 600 – – conf. 50 – € 0,48</p>	 <p>ROTOLO CARTA PESANTE ANTISTATICA GE62 Legno, Impiallacciatura massello, Compensato, Poliestere, Lamiera in acciaio, Leghe leggere, Metalli non ferrosi Abrasivo all'Ossido di Alluminio Misura: 120 mm x 50 metri</p> <p>90057939 – Grana 40 – – conf. 1 – € 92,50 90057940 – Grana 60 – – conf. 1 – € 73,14 90057941 – Grana 80 – – conf. 1 – € 66,96 segue...</p>
 <p>continua...</p> <p>90057942 – Grana 100 – – conf. 1 – € 61,80 90057943 – Grana 120 – – conf. 1 – € 58,30 90057944 – Grana 150 – – conf. 1 – € 58,30 90057945 – Grana 180 – – conf. 1 – € 58,30</p>	 <p>ROTOLO CARTA LEGGERA GB55 Legno, Vernici Abrasivo all'Ossido di Alluminio per operazioni manuali non aggressive in genere Misura: 120mm x 50metri</p> <p>90057986 – Grana 40 – – conf. 1 – € 42,64 90057952 – Grana 60 – – conf. 1 – € 30,90 90057953 – Grana 80 – – conf. 1 – € 26,58 90057954 – Grana 100 – – conf. 1 – € 24,72 segue...</p>
 <p>continua...</p> <p>90057955 – Grana 120 – – conf. 1 – € 24,72 90057956 – Grana 150 – – conf. 1 – € 24,72 90057957 – Grana 180 – – conf. 1 – € 24,72 90057958 – Grana 220 – – conf. 1 – € 24,72</p>	 <p>ROTOLO TELA FLESSIBILE GF71 Metallo, Acciaio, Alluminio, Legno, Plastica, Cuoio Abrasivo all'Ossido di Alluminio Misura: 120mm x 5metri</p> <p>90057946 – Grana 40 – – conf. 1 – € 16,28 90057947 – Grana 60 – – conf. 1 – € 15,24 90057948 – Grana 80 – – conf. 1 – € 15,04 90057949 – Grana 100 – – conf. 1 – € 12,98 segue...</p>



  <p>continua... 90057950 - Grana 120 - - conf. 1 - € 12,98 90057951 - Grana 150 - - conf. 1 - € 13,40</p>	 <p>ROTOLO CARTA LEGGERA GB55 Legno, Vernici Abrasivo all'Ossido di Alluminio Misura: 120mm x 5 metri</p> <p>90057959 - Grana 40 - - conf. 10 - € 4,54 90057960 - Grana 60 - - conf. 10 - € 3,92 90057961 - Grana 80 - - conf. 10 - € 3,92 90057962 - Grana 100 - - conf. 10 - € 3,92 segue...</p>
  <p>continua... 90057963 - Grana 120 - - conf. 10 - € 3,92 90057964 - Grana 180 - - conf. 10 - € 3,92 90057965 - Grana 220 - - conf. 10 - € 3,92</p>	  <p>ROTOLO CARTA VELCRATA GE62-V Legno, Vernici, Metallo Abrasivo all'Ossido di Alluminio Misura: 120mm x 25metri</p> <p>90057966 - Grana 40 - - conf. 1 - € 79,32 90057967 - Grana 60 - - conf. 1 - € 71,48 90057968 - Grana 80 - - conf. 1 - € 63,44 90057969 - Grana 100 - - conf. 1 - € 52,94 segue...</p>
  <p>continua... 90057970 - Grana 150 - - conf. 1 - € 52,94 90057971 - Grana 180 - - conf. 1 - € 52,94 90057972 - Grana 240 - - conf. 1 - € 52,94</p>	 <p>Blister 10 Pezzi FOGLIO Carta abrasiva 93x230</p> <p>74035600 - grana 50 - - conf. 10 - € 3,80 74035610 - grana 80 - - conf. 10 - € 3,40 74035620 - grana 120 - - conf. 10 - € 3,20 74035630 - grana assortito - - conf. 10 - € 3,60</p>
  <p>Blister 10 Pezzi FOGLIO Carta abrasiva 115x280</p> <p>74035700 - grana 50 - - conf. 10 - € 5,00 74035710 - grana 80 - - conf. 10 - € 4,00 74035730 - grana assortiti - - conf. 10 - € 4,20</p>	 <p>Blister 3 pezzi NASTRO abrasivo 533 x 75 Per: Bosch, Atlas Copco, Metabo Hitachi, Makita</p> <p>3002608606069 - grana 40 - - conf. 4 - € 9,06 3002608606070 - grana 60 - - conf. 4 - € 8,44 3002608606072 - grana 100 - - conf. 4 - € 7,82 3002608606074 - grana 220 - - conf. 4 - € 7,82 3002608606075 - grana 280 - - conf. 4 - € 8,24 segue...</p>
  <p>continua... 3002608606076 - grana 320 - - conf. 4 - € 7,82</p>	  <p>Blister 3 pezzi NASTRO abrasivo 533 x 75 Per: Bosch, Atlas Copco, Metabo Hitachi, Makita</p> <p>74035735 - grana 40 - - conf. 2 - € 11,00 74035736 - grana 60 - - conf. 2 - € 10,60 74035737 - grana 80 - - conf. 2 - € 10,40 74035738 - grana 100 - - conf. 2 - € 10,20 74035739 - grana 150 - - conf. 2 - € 10,20</p>
  <p>Blister 3 pezzi NASTRO abrasivo 400 x 60 Per: Bosch PSB 60/ 60E</p> <p>3002608606001 - grana 60 - misura 400 x 60 - - conf. 4 - € 6,38 3002608606002 - grana 80 - misura 400 x 60 - - conf. 4 - € 6,18 3002608606003 - grana 100 - misura 400 x 60 - - conf. 4 - € 6,18 3002608606004 - grana 150 - misura 400 x 60 - - conf. 4 - € 6,18 3002608606005 - grana 220 - misura 400 x 60 - - conf. 4 - € 6,00 segue...</p>	  <p>continua... 3002608606006 - grana 280 - misura 400 x 60 - conf. 4 - € 6,20</p>



 <p>Blister 3 pezzi NASTRO abrasivo 410 x 65 Per: Black&Decker, Atlas Copco, Mrtabo, Kress</p> <p>74035740 - grana 40 - - conf. 3 - € 9,20</p> <p>74035745 - grana 60 - - conf. 3 - € 8,60</p> <p>74035750 - grana 80 - - conf. 3 - € 8,60</p> <p>74035755 - grana 100 - - conf. 3 - € 8,60</p> <p>74035757 - grana 150 - - conf. 3 - € 8,60</p>	 <p>Blister 3 pezzi NASTRO abrasivo 510 x 75 Per: Black&Decker</p> <p>74035760 - grana 40 - - conf. 2 - € 10,80</p> <p>74035765 - grana 60 - - conf. 2 - € 10,40</p> <p>74035770 - grana 80 - - conf. 2 - € 10,20</p> <p>74035775 - grana 100 - - conf. 2 - € 10,20</p> <p>74035777 - grana 150 - - conf. 2 - € 10,20</p>
 <p>Blister 3 pezzi NASTRO abrasivo 457 x 75 Per: Black&Decker, Stayer, Skil, Makita</p> <p>74035778 - grana 40 - - conf. 2 - € 10,80</p> <p>74035779 - grana 60 - - conf. 2 - € 10,20</p> <p>74035780 - grana 80 - - conf. 2 - € 10,20</p> <p>74035781 - grana 100 - - conf. 2 - € 10,20</p> <p>74035782 - grana 150 - - conf. 2 - € 10,20</p>	 <p>&M 900</p> <p>FOGLI CARTA ABRASIVA per JOLLY YK85 Attacco velcro</p> <p>90086350 - grana 40 - - conf. 50 - € 0,78</p> <p>90086351 - grana 60 - - conf. 50 - € 0,66</p> <p>90086352 - grana 80 - - conf. 50 - € 0,72</p> <p>90086353 - grana 100 - - conf. 50 - € 0,66</p> <p>90086354 - grana 120 - - conf. 50 - € 0,66</p>
 <p>TAF</p> <p>FOGLI CARTA spaziata corindone 23 x 28</p> <p>90053003 - grana 40 - - conf. 50 - € 0,66</p> <p>90053004 - grana 60 - - conf. 50 - € 0,56</p> <p>90053005 - grana 80 - - conf. 50 - € 0,48</p> <p>90053006 - grana 100 - - conf. 50 - € 0,44</p> <p>90053007 - grana 120 - - conf. 50 - € 0,44</p>	 <p>TAF</p> <p>FOGLI CARTA impermeabile 23 x 28</p> <p>90053008 - grana 150 - - conf. 100 - € 0,82</p> <p>90053009 - grana 180 - - conf. 100 - € 0,76</p> <p>90053010 - grana 220 - - conf. 100 - € 0,72</p> <p>90053011 - grana 320 - - conf. 100 - € 0,72</p> <p>90053012 - grana 400 - - conf. 100 - € 0,72</p> <p>90053013 - grana 600 - - conf. 100 - € 0,72</p>
 <p>TAF</p> <p>FOGLI TELA Corindone 19 x 28</p> <p>90053052 - grana 40 - - conf. 50 - € 1,44</p> <p>90053053 - grana 60 - - conf. 50 - € 1,28</p> <p>90053054 - grana 80 - - conf. 50 - € 1,22</p> <p>90053055 - grana 100 - - conf. 50 - € 1,16</p> <p>90053056 - grana 120 - - conf. 50 - € 1,16</p> <p>segue...</p>	 <p>TAF</p> <p>continua...</p> <p>90053057 - grana 220 - - conf. 50 - € 1,16</p> <p>90053058 - grana 320 - - conf. 50 - € 1,16</p>
 <p>TAMPONE GOMMA per carta abrasiva 125x70</p> <p>74033970 - - conf. 3 - € 9,00</p>	 <p>TAF</p> <p>Mt. 5 MINIROLOLO carta spaziata altezza mm 115</p> <p>90057545 - grana 40 - - conf. 10 - € 8,86</p> <p>90057547 - grana 60 - - conf. 10 - € 7,42</p> <p>90057548 - grana 80 - - conf. 10 - € 6,60</p> <p>90057550 - grana 120 - - conf. 10 - € 6,38</p> <p>90057551 - grana 150 - - conf. 10 - € 6,38</p> <p>segue...</p>
 <p>TAF</p> <p>continua...</p> <p>90057552 - grana 180 - - conf. 10 - € 6,38</p> <p>90057553 - grana 220 - - conf. 10 - € 6,38</p>	 <p>TAF</p> <p>Mt. 50 ROTOLO Carta spaziata altezza mm 115</p> <p>90057555 - grana 40 - - conf. 1 - € 55,62</p> <p>90057557 - grana 60 - - conf. 1 - € 46,14</p> <p>90057558 - grana 80 - - conf. 1 - € 40,18</p> <p>90057560 - grana 120 - - conf. 1 - € 35,02</p> <p>90057561 - grana 150 - - conf. 1 - € 35,02</p>



 <p>Mt. 3 MINIROTOLO Carta VELCRO abrasiva altezza mm 120</p> <p>74035596 - grana 50 - - conf. 2 - € 11,40</p> <p>74035597 - grana 80 - - conf. 2 - € 10,80</p> <p>74035598 - grana 120 - - conf. 2 - € 10,00</p>	 <p>ROTOLO VELCRATO 25 metri CA76V carta spaziata altezza 115 mm</p> <p>90057575 - Grana 40 - - conf. 1 - € 62,42</p> <p>90057577 - Grana 60 - - conf. 1 - € 54,18</p> <p>90057578 - Grana 80 - - conf. 1 - € 50,68</p> <p>90057580 - Grana 100 - - conf. 1 - € 49,64</p> <p>90057583 - Grana 120 - - conf. 1 - € 49,64</p>
 <p>Blister 3 pezzi NASTRO per smerigliatore espansione grane assortite</p> <p>74035798 - - conf. 2 - € 4,20</p>	 <p>Set 45 Pz. assortiti MOLE su perno Gambo Ø 3/6mm.</p> <p>74039700 - - conf. 1 - € 66,00</p>
 <p>SMERIGLIATORE ad espansione Ø 45x30mm. Gambo Ø 6mm.</p> <p>74035796 - - conf. 2 - € 6,60</p>	 <p>MOLA per affilare forbici - lame - coltelli Gambo ch 1/4" Ø 50mm</p> <p>74039500 - - conf. 10 - € 5,20</p>
 <p>MOLE Set 5 Pz. assortiti Ø gambo 3</p> <p>74039800 - - conf. 10 - € 5,60</p>	 <p>Set 5 pz. assortiti MOLE Ø gambo 6</p> <p>74039900 - - conf. 10 - € 8,80</p>
 <p>BLISTER KIT PZ.10 ACCESSORI SMERIGLIATURA ED AFFILATURA</p> <p>740M8230 - - conf. 2 - € 19,80</p>	 <p>Set 100 Mole Assortite su perno gambo Ø 6mm. in espositore Self-Service</p> <p>74039600 - - conf. 1 - € 153,20</p>
 <p>BLISTER KIT PZ.10 ACCESSORI INCISIONE</p> <p>740M8210 - - conf. 2 - € 18,80</p>	 <p>BLISTER KIT PZ.10 ACCESSORI LUCIDATURA E PULITURA</p> <p>740M8250 - - conf. 2 - € 28,40</p>



 <p>BLISTER KIT PZ.10 ACCESSORI TAGLIO 740M8270 - - conf. 2 - € 32,00</p>	 <p>KIT 195 MINI ACCESSORI ASSORTITI Per tagliare, smerigliare, incidere, lucidare ecc. 740PG195A - - conf. 1 - € 21,02</p>
 <p>MOLA ABRASIVA carburo di silicio Ø 75 x 10 foro Ø 13 74040300 - - conf. 1 - € 6,40</p>	 <p>MOLA ABRASIVA corindone grigio 74040000 - Ø 75x10 - Ø foro 10 - - conf. 1 - € 4,80 74040200 - Ø 75x10 - Ø foro 13 - - conf. 1 - € 4,80 74040400 - Ø 100x12 - Ø foro 13 - - conf. 1 - € 8,00 74040450 - Ø 125x15 - Ø foro 16 - - conf. 1 - € 19,80 74040500 - Ø 150x20 - Ø foro 16 - - conf. 1 - € 25,60</p>
 <p>RUOTA a lamelle pannello abrasivo Agressività leggera Ø 150 x 25 foro Ø 32/20mm grana 150 74035970 - - conf. 1 - € 35,40</p>	 <p>RUOTA a lamelle pannello abrasivo Agressività media Ø 150 x 25 foro Ø 32/20 grana 150 74035972 - - conf. 1 - € 39,80</p>
 <p>RUOTA PANNO E TELA Agressività media Gambo Ø 6 mm. grana 150 74035946 - Ø 50x25 - - conf. 5 - € 17,40 74035948 - Ø 75x45 - - conf. 5 - € 26,40 74035950 - Ø 100x50 - - conf. 5 - € 32,60</p>	 <p>RUOTA PANNO E TELA Agressività leggera Gambo 6 mm. grana 150 74035940 - Ø 50x25 - - conf. 5 - € 15,00 74035942 - Ø 75x45 - - conf. 5 - € 21,40 74035944 - Ø 100x50 - - conf. 5 - € 29,00</p>
 <p>CUFFIA Per lucidare con laccio chiusura 74033900 - Ø 140 - - conf. 2 - € 4,80 74033920 - Ø 190 - - conf. 2 - € 6,40</p>	 <p>DISCO feltro Per lucidare 74033925 - Ø 80x10 - Ø foro 13 - - conf. 2 - € 3,60 74033927 - Ø 125x15 - Ø foro 16 - - conf. 2 - € 8,60 74033928 - Ø 150x20 - Ø foro 16 - - conf. 2 - € 15,00</p>
 <p>CUFFIA LANA agnello con velcro 74033922 - Ø 115 - - conf. 2 - € 5,00 74033923 - Ø 125 - - conf. 2 - € 5,80 74033924 - Ø 160 - - conf. 2 - € 8,00</p>	 <p>TAMPONE SPUGNA ricambio con velcro 74033966 - Ø 115 - - conf. 2 - € 5,20 74033967 - Ø 125 - - conf. 2 - € 5,80 74033968 - Ø 160 - - conf. 2 - € 7,20</p>

GRINDING

IL TUO **PARTNER** PIÙ AFFIDABILE,
DA SEMPRE **AL TUO FIANCO**.

La **linea di abrasivi** preferita dagli specialisti di settore.

**MOLE
ABRASIVE**

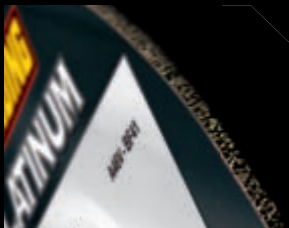

**DISCHI
DIAMANTATI**



**DISCHI LAMELLARI
E DISCHI FIBRATI**



**TESSUTO
NON TESSUTO**



**ABRASIVI
FLESSIBILI**

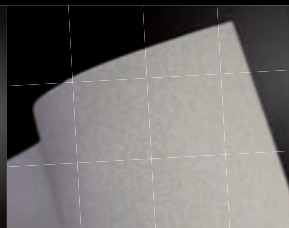

 Grinding Abrasivi

 Grinding Abrasivi

www.grinding.it

www.malfattitacchinigroup.it

www.krino.it

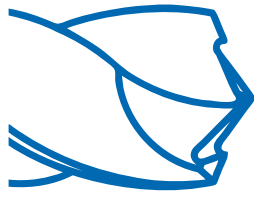

KRINO[®]
CUTTING TOOLS

@KrinoTools

#WeAreKrino





















INNOVATION IS AN ATTITUDE

www.malfattitacchinigroup.it



 <p>TAMPONE SPUGNA ricambio 74033962 - Ø 125 - - conf. 2 - € 5,40 74033964 - Ø 175 - - conf. 2 - € 9,20</p>	 <p>TAMPONE SPUGNA per lucidare Ø 125 gambo Ø 6mm 74033950 - - conf. 1 - € 10,00</p>
 <p>TAMPONE SPUGNA per lucidare Ø 175 foro M 14 74033960 - - conf. 1 - € 14,00</p>	 <p>RUOTA TESSUTO per lucidare Ø 80 gambo Ø 6mm 74033930 - - conf. 2 - € 7,00</p>
 <p>RUOTA TESSUTO per lucidare 74033935 - Ø 100 - Ø foro 20/13 - - conf. 2 - € 6,00 74033940 - Ø 120 - Ø foro 20/16 - - conf. 2 - € 7,00 74033945 - Ø 150 - Ø foro 20/16 - - conf. 2 - € 9,60</p>	 <p>RUOTA lamellare ABRASIVA Gambo 6 mm. grana 80 74035840 - Ø 40x20 - - conf. 10 - € 5,40 74035850 - Ø 50x20 - - conf. 10 - € 6,20 74035860 - Ø 60x40 - - conf. 10 - € 8,80 74035880 - Ø 80x30 - - conf. 10 - € 10,20</p>
 <p>PLATORELLO in nylon BLISTER 74033810 - Ø 100 - Ø foro 10 - - conf. 10 - € 2,80 74033820 - Ø 115 - Ø foro 14 - - conf. 10 - € 3,20 74033822 - Ø 178 - Ø foro 14 - - conf. 10 - € 5,40</p>	 <p>PLATORELLO in nylon SFUSO 74033835 - Ø 115 - Ø foro 14 - - conf. 10 - € 1,88 74033840 - Ø 115 - Ø foro 16 - - conf. 10 - € 1,88 74033845 - Ø 125 - Ø foro 14 - - conf. 10 - € 2,00</p>
 <p>PLATORELLO PER DISCHI IN FIBRA E DISCHI SEMIFLESSIBILI Medio In nylon Attacco M14 90057906 - - conf. 1 - € 14,00</p>	 <p>PLATORELLO IN GOMMA Misura 115 mm 252A2631 - - conf. 1 - € 5,60</p>
 <p>PERNO DI FISSAGGIO 74033500 - Ø 10,0 - perno 6 - - conf. 10 - € 2,60 74033600 - Ø 12,8 - perno 8 - - conf. 10 - € 3,00 74033700 - Ø 22,2 - perno 8 - - conf. 10 - € 4,00</p>	 <p>PLATORELLO in gomma gambo Ø 6 mm Ø 125 3000 RPM 74033800 - - conf. 10 - € 7,00</p>



 <p>PLATORELLO in gomma 3000 RPM Max \varnothing 180 foro \varnothing 14 / 16mm</p> <p>74033805 - - conf. 10 - € 15,40</p>	 <p>PLATORELLO in gomma - Rotoorbitale Attacco velcro - \varnothing 125 mm</p> <p>3002608601061 - Modello Duro - - conf. 10 - € 18,74 3002608601062 - Modello Medio - - conf. 10 - € 18,74 3002608601063 - Modello Morbido - - conf. 10 - € 19,78</p> 
 <p>PLATORELLO ATTACCO VELCRO perno \varnothing 10 foro M14</p> <p>74033880 - \varnothing 115 - - conf. 5 - € 14,20 74033882 - \varnothing 125 - - conf. 5 - € 15,40 74033885 - \varnothing 150 - - conf. 5 - € 21,40</p>	 <p>GHIERA CONICA PER PLATORELLI Collare \varnothing 22</p> <p>74022000 - filetto 8M - - conf. 10 - € 3,20 74022100 - filetto 10M - - conf. 10 - € 3,20 74022200 - filetto 14M - - conf. 10 - € 3,80 74021800 - filetto 14M - - conf. 10 - € 4,60</p>
 <p>GHIERA PIANA PER MOLE A DISCO collare \varnothing 22</p> <p>74022400 - Filetto 8MA - - conf. 10 - € 3,20 74022500 - Filetto 10MA - - conf. 10 - € 3,20 74022600 - Filetto 14MA - - conf. 10 - € 3,80 74021900 - Filetto 14MA - - conf. 10 - € 4,60</p>	 <p>DADO SERRAGGIO PER SMERIGLIATRICI \varnothing 115 a 150</p> <p>3001603340040 - - conf. 1 - € 5,00</p> 
 <p>FLANGIA SERRAGGIO PER SMERIGLIATRICI \varnothing 115 a 150</p> <p>3001605703099 - - conf. 1 - € 5,76</p> 	 <p>CHIAVE DIRITTA Per smerigliatrici angolari</p> <p>3001607950043 - Modello Piccolo - - conf. 1 - € 6,18 3001607950048 - Modello Grande - - conf. 1 - € 5,16</p> 
 <p>CHIAVE SERVIZIO REGOLABILE per ghiera 20 x 35mm</p> <p>74023000 - - conf. 10 - € 9,20 74023100 - - conf. 10 - € 8,20</p>	 <p>CHIAVE SERVIZIO per ghiera 35 mm</p> <p>74022800 - - conf. 10 - € 4,80 74022900 - - conf. 10 - € 3,80</p>
 <p>PORTAPUNTE VUOTO da 19 fori \varnothing 1+10 x 0,5 mm</p> <p>60501016405V - - conf. 1 - € 8,60</p> 	 <p>PORTAPUNTE VUOTO da 25 fori \varnothing 1+13 x 0,5 mm</p> <p>60501016406V - - conf. 1 - € 11,40</p> 



 <p>Serie 19 pz PUNTE HSS RULLATE Art. 10 1 - 10 x 0,5 mm 60501016405 - - conf. 1 - € 15,00</p>	 <p>Serie 19 pz PUNTE HSS RETTIFICATE 1 - 10 x 0,5 mm 60501068401SR - - conf. 1 - € 45,00</p>
 <p>Serie 19 pz PUNTE HSS AL COBALTO Art. 12 1 - 10 x 0,5 mm 60501155401 - - conf. 1 - € 58,20</p>	 <p>Serie 25 pz PUNTE HSS RULLATE Art. 10 1 - 13 x 0,5 mm 60501016406 - - conf. 1 - € 36,00</p>
 <p>Serie 25 pz PUNTE HSS RETTIFICATE 1 - 13 x 0,5 mm 60501068402SR - - conf. 1 - € 81,80</p>	 <p>Serie 25 pz PUNTE HSS AL COBALTO Art. 12 1 - 13 x 0,5 mm 60501155402 - - conf. 1 - € 128,00</p>
 <p>Serie 19 pz. PUNTE HSS TITANIO da 1 a 10 60501170250 - - conf. 1 - € 22,60</p>	 <p>VALIGETTA 116 PZ. PUNTE HSS-G RETTIFICATE Ø 1-10 x 0,5 60501068453 - - conf. 1 - € 256,00</p>
 <p>VALIGETTA 116 PZ. PUNTE HSS-CO 5% COBALTO Ø 1-13 x 0,5 60501155450 - - conf. 1 - € 316,00</p>	 <p>VALIGETTA 116 PUNTE SPEEDMASTER Affilatura speciale a doppia coppia di taglienti con spoglia variabile, coppia di rompitruccioli e scarico in testa 60501229450 - - conf. 1 - € 300,00</p>
 <p>ESPOSITORE 107 PZ. PUNTE SDS-PLUS 4 TAGLIENTI Contenuto espositore: 3 pz. per 16x210 - 12x260 14x260 - 16x260 5 pz. per 5x110 - 5x160 6x210 - 8x210 - 10x210 12x210 - 14x210 - 8x260 10x260 10 pz. per 6x110 - 6x160 8x160 - 10x160 - 12x160 Dimensione espositore: 390x150x225 60503166503 - - conf. 1 - € 726,00</p>	 <p>Selector 19 pz PUNTE HSS WIDIA Miste da 1 a 10 60509001102 - - conf. 1 - € 13,20</p>













<p>KRINO</p> <p>SELECTOR 19 PZ. PUNTE HSS DIN 338 Miste da 1 a 10</p> <p>605010016101 - - conf. 1 - € 14,20</p> 	<p>KRINO</p> <p>PUNTA HSS RULLATA Art.10</p> <p>605010010100 - Ø 1,00 - - conf. 10 - € 0,30 605010010125 - Ø 1,25 - - conf. 10 - € 0,30 605010010150 - Ø 1,50 - - conf. 10 - € 0,30 605010010175 - Ø 1,75 - - conf. 10 - € 0,32 605010010200 - Ø 2,00 - - conf. 10 - € 0,32 segue...</p> 
<p>KRINO</p> <p>continua...</p> <p>605010010225 - Ø 2,25 - - conf. 10 - € 0,32 605010010250 - Ø 2,50 - - conf. 10 - € 0,32 605010010275 - Ø 2,75 - - conf. 10 - € 0,32 605010010300 - Ø 3,00 - - conf. 10 - € 0,32 605010010325 - Ø 3,25 - - conf. 10 - € 0,38 segue...</p> 	<p>KRINO</p> <p>continua...</p> <p>605010010350 - Ø 3,50 - - conf. 10 - € 0,38 605010010375 - Ø 3,75 - - conf. 10 - € 0,40 605010010400 - Ø 4,00 - - conf. 10 - € 0,40 605010010425 - Ø 4,25 - - conf. 10 - € 0,44 605010010450 - Ø 4,50 - - conf. 10 - € 0,44 segue...</p> 
<p>KRINO</p> <p>continua...</p> <p>605010010475 - Ø 4,75 - - conf. 10 - € 0,46 605010010500 - Ø 5,00 - - conf. 10 - € 0,46 605010010525 - Ø 5,25 - - conf. 10 - € 0,52 605010010550 - Ø 5,50 - - conf. 10 - € 0,52 605010010575 - Ø 5,75 - - conf. 10 - € 0,60 segue...</p> 	<p>KRINO</p> <p>continua...</p> <p>605010010600 - Ø 6,00 - - conf. 10 - € 0,60 605010010625 - Ø 6,25 - - conf. 10 - € 0,68 605010010650 - Ø 6,50 - - conf. 10 - € 0,68 605010010675 - Ø 6,75 - - conf. 10 - € 0,80 605010010700 - Ø 7,00 - - conf. 10 - € 0,80 segue...</p> 
<p>KRINO</p> <p>continua...</p> <p>605010010725 - Ø 7,25 - - conf. 10 - € 0,92 605010010775 - Ø 7,75 - - conf. 5 - € 1,14 605010010800 - Ø 8,00 - - conf. 5 - € 1,14 605010010825 - Ø 8,25 - - conf. 5 - € 1,22 605010010850 - Ø 8,50 - - conf. 5 - € 1,22 segue...</p> 	<p>KRINO</p> <p>continua...</p> <p>605010010900 - Ø 9,00 - - conf. 5 - € 1,42 605010010950 - Ø 9,50 - - conf. 5 - € 1,68 605010010975 - Ø 9,75 - - conf. 5 - € 1,86 605010011000 - Ø 10,00 - - conf. 5 - € 1,86 605010011025 - Ø 10,25 - - conf. 5 - € 3,20 segue...</p> 
<p>KRINO</p> <p>continua...</p> <p>605010011050 - Ø 10,50 - - conf. 5 - € 2,26 605010011100 - Ø 11,00 - - conf. 5 - € 2,48 605010011125 - Ø 11,25 - - conf. 5 - € 4,54 605010011150 - Ø 11,50 - - conf. 5 - € 2,80 605010011175 - Ø 11,75 - - conf. 5 - € 4,20 segue...</p> 	<p>KRINO</p> <p>continua...</p> <p>605010011200 - Ø 12,00 - - conf. 5 - € 3,00 605010011225 - Ø 12,25 - - conf. 5 - € 4,60 605010011250 - Ø 12,50 - - conf. 5 - € 3,40 605010011275 - Ø 12,75 - - conf. 5 - € 4,80 605010011300 - Ø 13,00 - - conf. 5 - € 3,60 segue...</p> 
<p>KRINO</p> <p>continua...</p> <p>605010031350 - Ø 13,50 - - conf. 5 - € 7,00 605010031400 - Ø 14,00 - - conf. 5 - € 6,20 605010031450 - Ø 14,50 - - conf. 3 - € 7,62 605010031500 - Ø 15,00 - - conf. 3 - € 8,00 605010031550 - Ø 15,50 - - conf. 3 - € 10,80 segue...</p> 	<p>KRINO</p> <p>continua...</p> <p>605010031600 - Ø 16,00 - - conf. 3 - € 8,80 605010031700 - Ø 17,00 - - conf. 3 - € 12,00 605010031800 - Ø 18,00 - - conf. 3 - € 12,80 605010031900 - Ø 19,00 - - conf. 3 - € 14,80 605010032000 - Ø 20,00 - - conf. 3 - € 17,00</p> 











<p>KRINO</p> <p>PUNTA ELICOIDALE RETTIFICATA HSS-CO AL Cobalto 5%</p> <p>605011450100 - Ø 1,00 - - conf. 10 - € 1,42</p> <p>605011450125 - Ø 1,25 - - conf. 10 - € 1,58</p> <p>605011450150 - Ø 1,50 - - conf. 10 - € 1,42</p> <p>605011450175 - Ø 1,75 - - conf. 10 - € 1,50</p> <p>605011450200 - Ø 2,00 - - conf. 10 - € 1,38</p> <p>segue...</p>	<p>KRINO</p> <p>continua...</p> <p>605011450225 - Ø 2,25 - - conf. 10 - € 1,68</p> <p>605011450250 - Ø 2,50 - - conf. 10 - € 1,44</p> <p>605011450275 - Ø 2,75 - - conf. 10 - € 1,60</p> <p>605011450300 - Ø 3,00 - - conf. 10 - € 1,44</p> <p>605011450325 - Ø 3,25 - - conf. 10 - € 1,98</p> <p>segue...</p>
<p>KRINO</p> <p>continua...</p> <p>605011450350 - Ø 3,50 - - conf. 10 - € 1,80</p> <p>605011450375 - Ø 3,75 - - conf. 10 - € 2,48</p> <p>605011450400 - Ø 4,00 - - conf. 10 - € 2,26</p> <p>605011450425 - Ø 4,25 - - conf. 10 - € 2,80</p> <p>605011450450 - Ø 4,50 - - conf. 10 - € 2,60</p> <p>segue...</p>	<p>KRINO</p> <p>continua...</p> <p>605011450475 - Ø 4,75 - - conf. 10 - € 3,00</p> <p>605011450500 - Ø 5,00 - - conf. 10 - € 2,68</p> <p>605011450525 - Ø 5,25 - - conf. 10 - € 3,60</p> <p>605011450550 - Ø 5,50 - - conf. 10 - € 3,40</p> <p>605011450575 - Ø 5,75 - - conf. 10 - € 4,00</p> <p>segue...</p>
<p>KRINO</p> <p>continua...</p> <p>605011450600 - Ø 6,00 - - conf. 10 - € 3,80</p> <p>605011450625 - Ø 6,25 - - conf. 10 - € 4,80</p> <p>605011450650 - Ø 6,50 - - conf. 10 - € 4,40</p> <p>605011450675 - Ø 6,75 - - conf. 10 - € 5,80</p> <p>605011450700 - Ø 7,00 - - conf. 10 - € 5,40</p> <p>segue...</p>	<p>KRINO</p> <p>continua...</p> <p>605011450725 - Ø 7,25 - - conf. 10 - € 6,40</p> <p>605011450750 - Ø 7,50 - - conf. 5 - € 5,80</p> <p>605011450775 - Ø 7,75 - - conf. 5 - € 7,60</p> <p>605011450800 - Ø 8,00 - - conf. 5 - € 7,00</p> <p>605011450825 - Ø 8,25 - - conf. 5 - € 8,00</p> <p>segue...</p>
<p>KRINO</p> <p>continua...</p> <p>605011450850 - Ø 8,50 - - conf. 5 - € 7,40</p> <p>605011450875 - Ø 8,75 - - conf. 5 - € 9,80</p> <p>605011450900 - Ø 9,00 - - conf. 5 - € 9,00</p> <p>605011450925 - Ø 9,25 - - conf. 5 - € 10,20</p> <p>605011450950 - Ø 9,50 - - conf. 5 - € 9,40</p> <p>segue...</p>	<p>KRINO</p> <p>continua...</p> <p>605011450975 - Ø 9,75 - - conf. 5 - € 11,80</p> <p>605011451000 - Ø 10,00 - - conf. 5 - € 10,80</p> <p>605011451050 - Ø 10,50 - - conf. 5 - € 12,80</p> <p>605011451100 - Ø 11,00 - - conf. 5 - € 14,60</p> <p>605011451150 - Ø 11,50 - - conf. 5 - € 15,80</p> <p>segue...</p>
<p>KRINO</p> <p>continua...</p> <p>605011451200 - Ø 12,00 - - conf. 5 - € 17,40</p> <p>605011451250 - Ø 12,50 - - conf. 5 - € 18,80</p> <p>605011451300 - Ø 13,00 - - conf. 5 - € 20,40</p>	<p>KRINO</p> <p>PUNTA HSSG RETTIFICATA Speedmaster DIN338 Punta con doppio conoide Utilizzabile su: Acciaio INOX Metallo</p> <p>605012200100 - Ø 1 - - conf. 10 - € 1,56</p> <p>605012200150 - Ø 1,5 - - conf. 10 - € 1,56</p> <p>605012200200 - Ø 2 - - conf. 10 - € 1,56</p> <p>605012200250 - Ø 2,5 - - conf. 10 - € 1,58</p> <p>segue...</p>
<p>KRINO</p> <p>continua...</p> <p>605012200300 - Ø 3 - - conf. 10 - € 1,68</p> <p>605012200350 - Ø 3,5 - - conf. 10 - € 1,98</p> <p>605012200400 - Ø 4 - - conf. 10 - € 2,20</p> <p>605012200450 - Ø 4,5 - - conf. 10 - € 2,40</p> <p>605012200500 - Ø 5 - - conf. 10 - € 3,00</p> <p>segue...</p>	<p>KRINO</p> <p>continua...</p> <p>605012200550 - Ø 5,5 - - conf. 10 - € 3,60</p> <p>605012200600 - Ø 6 - - conf. 10 - € 3,80</p> <p>605012200650 - Ø 6,5 - - conf. 10 - € 4,60</p> <p>605012200700 - Ø 7 - - conf. 10 - € 5,40</p> <p>605012200750 - Ø 7,5 - - conf. 5 - € 5,60</p> <p>segue...</p>









  <p>continua...</p> <p>605012200800 - Ø 8 - - conf. 5 - € 7,00</p> <p>605012200850 - Ø 8,5 - - conf. 5 - € 7,60</p> <p>605012200900 - Ø 9 - - conf. 5 - € 8,60</p> <p>605012200950 - Ø 9,5 - - conf. 5 - € 9,40</p> <p>605012201000 - Ø 10 - - conf. 5 - € 10,80</p>	 <p>PUNTA HSS RETTIFICATA extra corta</p> <p>605010940300 - Ø 3,00 - - conf. 10 - € 1,18</p> <p>605010940325 - Ø 3,25 - - conf. 10 - € 1,30</p> <p>605010940350 - Ø 3,50 - - conf. 10 - € 1,30</p> <p>605010940375 - Ø 3,75 - - conf. 10 - € 1,44</p> <p>605010940400 - Ø 4,00 - - conf. 10 - € 1,44</p> <p>605010940500 - Ø 5,00 - - conf. 10 - € 1,70</p>
 <p>PUNTA HSS RETTIFICATA lunga</p> <p>605010960300 - Ø 3,00 - lungh. 100 - - conf. 10 - € 2,40</p> <p>605010960350 - Ø 3,50 - lungh. 112 - - conf. 10 - € 2,60</p> <p>605010960400 - Ø 4,00 - lungh. 119 - - conf. 10 - € 2,60</p> <p>605010960450 - Ø 4,50 - lungh. 126 - - conf. 10 - € 3,40</p> <p>605010960500 - Ø 5,00 - lungh. 132 - - conf. 10 - € 3,20</p> <p>segue...</p>	 <p>continua...</p> <p>605010960525 - Ø 5,25 - lungh. 132 - - conf. 10 - € 4,40</p> <p>605010960550 - Ø 5,50 - lungh. 139 - - conf. 10 - € 4,40</p> <p>605010960575 - Ø 5,75 - lungh. 139 - - conf. 10 - € 4,80</p> <p>605010960600 - Ø 6,00 - lungh. 139 - - conf. 10 - € 4,80</p>
 <p>PUNTA HSS RETTIFICATA</p> <p>605010600100 - Ø 1,00 - - conf. 10 - € 1,16</p> <p>605010600125 - Ø 1,25 - - conf. 10 - € 1,22</p> <p>605010600150 - Ø 1,50 - - conf. 10 - € 1,06</p> <p>605010600175 - Ø 1,75 - - conf. 10 - € 1,00</p> <p>605010600200 - Ø 2,00 - - conf. 10 - € 0,88</p> <p>segue...</p>	 <p>continua...</p> <p>605010600225 - Ø 2,25 - - conf. 10 - € 1,06</p> <p>605010600250 - Ø 2,50 - - conf. 10 - € 0,96</p> <p>605010600275 - Ø 2,75 - - conf. 10 - € 1,22</p> <p>605010600300 - Ø 3,00 - - conf. 10 - € 1,10</p> <p>605010600325 - Ø 3,25 - - conf. 10 - € 1,30</p> <p>segue...</p>
 <p>continua...</p> <p>605010600350 - Ø 3,50 - - conf. 10 - € 1,22</p> <p>605010600375 - Ø 3,75 - - conf. 10 - € 1,42</p> <p>605010600400 - Ø 4,00 - - conf. 10 - € 1,34</p> <p>605010600425 - Ø 4,25 - - conf. 10 - € 1,76</p> <p>605010600450 - Ø 4,50 - - conf. 10 - € 1,60</p> <p>segue...</p>	 <p>continua...</p> <p>605010600475 - Ø 4,75 - - conf. 10 - € 1,80</p> <p>605010600500 - Ø 5,00 - - conf. 10 - € 1,66</p> <p>605010600525 - Ø 5,25 - - conf. 10 - € 2,40</p> <p>605010600550 - Ø 5,50 - - conf. 10 - € 2,40</p> <p>605010600575 - Ø 5,75 - - conf. 10 - € 2,68</p> <p>segue...</p>
 <p>continua...</p> <p>605010600600 - Ø 6,00 - - conf. 10 - € 2,40</p> <p>605010600625 - Ø 6,25 - - conf. 10 - € 3,30</p> <p>605010600650 - Ø 6,50 - - conf. 10 - € 3,00</p> <p>605010600675 - Ø 6,75 - - conf. 10 - € 3,80</p> <p>605010600700 - Ø 7,00 - - conf. 10 - € 3,60</p> <p>segue...</p>	 <p>continua...</p> <p>605010600725 - Ø 7,25 - - conf. 10 - € 4,20</p> <p>605010600750 - Ø 7,50 - - conf. 5 - € 3,80</p> <p>605010600775 - Ø 7,75 - - conf. 5 - € 4,60</p> <p>605010600800 - Ø 8,00 - - conf. 5 - € 4,40</p> <p>605010600825 - Ø 8,25 - - conf. 5 - € 5,80</p> <p>segue...</p>
 <p>continua...</p> <p>605010600850 - Ø 8,50 - - conf. 5 - € 5,40</p> <p>605010600875 - Ø 8,75 - - conf. 5 - € 6,00</p> <p>605010600900 - Ø 9,00 - - conf. 5 - € 5,60</p> <p>605010600925 - Ø 9,25 - - conf. 5 - € 6,60</p> <p>605010600950 - Ø 9,50 - - conf. 5 - € 6,20</p> <p>segue...</p>	 <p>continua...</p> <p>605010600975 - Ø 9,75 - - conf. 5 - € 7,00</p> <p>605010601000 - Ø 10,00 - - conf. 5 - € 6,40</p> <p>605010601025 - Ø 10,25 - - conf. 5 - € 9,00</p> <p>605010601050 - Ø 10,50 - - conf. 5 - € 7,80</p> <p>605010601075 - Ø 10,75 - - conf. 5 - € 10,80</p> <p>segue...</p>















 <p>KRINO</p> <p>continua...</p> <p>605010601100 - Ø 11,00 - - conf. 5 - € 9,40</p> <p>605010601125 - Ø 11,25 - - conf. 5 - € 11,40</p> <p>605010601150 - Ø 11,50 - - conf. 5 - € 10,00</p> <p>605010601175 - Ø 11,75 - - conf. 5 - € 12,60</p> <p>605010601200 - Ø 12,00 - - conf. 5 - € 10,80</p> <p>segue...</p>	 <p>KRINO</p> <p>continua...</p> <p>605010601225 - Ø 12,25 - - conf. 5 - € 13,60</p> <p>605010601250 - Ø 12,50 - - conf. 5 - € 11,80</p> <p>605010601275 - Ø 12,75 - - conf. 5 - € 15,40</p> <p>605010601300 - Ø 13,00 - - conf. 5 - € 12,80</p> <p>605010621350 - Ø 13,50 - - conf. 3 - € 19,00</p> <p>segue...</p>
 <p>KRINO</p> <p>continua...</p> <p>605010621400 - Ø 14,00 - - conf. 3 - € 19,60</p> <p>605010621450 - Ø 14,50 - - conf. 3 - € 21,40</p> <p>605010621500 - Ø 15,00 - - conf. 3 - € 22,60</p> <p>605010621550 - Ø 15,50 - - conf. 3 - € 26,00</p> <p>605010621600 - Ø 16,00 - - conf. 3 - € 27,20</p>	 <p>KRINO</p> <p>PUNTE WIDIA PER MURO</p> <p>605030010300 - Ø 3 - - conf. 10 - € 0,68</p> <p>605030010400 - Ø 4 - - conf. 10 - € 0,68</p> <p>605030010500 - Ø 5 - - conf. 10 - € 0,72</p> <p>605030010600 - Ø 6 - - conf. 10 - € 0,78</p> <p>605030010700 - Ø 7 - - conf. 10 - € 0,88</p> <p>segue...</p>
 <p>KRINO</p> <p>continua...</p> <p>605030010800 - Ø 8 - - conf. 10 - € 0,98</p> <p>605030011000 - Ø 10 - - conf. 10 - € 1,32</p> <p>605030011200 - Ø 12 - - conf. 10 - € 2,20</p> <p>605030011400 - Ø 14 - - conf. 10 - € 3,00</p> <p>605030011500 - Ø 15 - - conf. 10 - € 3,80</p> <p>segue...</p>	 <p>KRINO</p> <p>continua...</p> <p>605030011600 - Ø 16 - - conf. 10 - € 3,80</p> <p>605030010900 - Ø 9 - - conf. 10 - € 1,14</p>
 <p>KRINO</p> <p>PUNTE WIDIA PER MURO lungh. 200</p> <p>605030050600 - Ø 6 - - conf. 6 - € 2,60</p> <p>605030050800 - Ø 8 - - conf. 6 - € 2,80</p> <p>605030050900 - Ø 9 - - conf. 6 - € 3,60</p> <p>605030051000 - Ø 10 - - conf. 6 - € 3,60</p> <p>605030051200 - Ø 12 - - conf. 6 - € 4,40</p> <p>605030051400 - Ø 14 - - conf. 6 - € 5,40</p>	 <p>KRINO</p> <p>PUNTE WIDIA PER MURO codolo ridotto Lungh. 400</p> <p>605030110600 - Ø codolo 6 - - conf. 4 - € 3,00</p> <p>605030110800 - Ø codolo 8 - - conf. 4 - € 3,20</p> <p>605030111000 - Ø codolo 10 - - conf. 4 - € 4,40</p> <p>605030111200 - Ø codolo 12 - - conf. 4 - € 5,00</p> <p>605030111400 - Ø codolo 14 - - conf. 4 - € 6,40</p> <p>segue...</p>
 <p>KRINO</p> <p>continua...</p> <p>605030111600 - Ø codolo 16 - - conf. 4 - € 8,20</p> <p>605030111800 - Ø codolo 18 - - conf. 4 - € 10,60</p> <p>605030112000 - Ø codolo 20 - - conf. 4 - € 13,60</p>	 <p>KRINO</p> <p>PUNTE WIDIA PER MURO Lungh. 600 codolo ridotto</p> <p>605030150800 - Ø 8mm - - conf. 4 - € 6,00</p> <p>605030151000 - Ø 10mm - - conf. 4 - € 7,60</p> <p>605030151200 - Ø 12mm - - conf. 4 - € 8,20</p> <p>605030151400 - Ø 14mm - - conf. 4 - € 10,20</p> <p>605030151600 - Ø 16mm - - conf. 4 - € 13,80</p> <p>segue...</p>
 <p>KRINO</p> <p>continua...</p> <p>605030151800 - Ø 18mm - - conf. 4 - € 17,40</p> <p>605030152000 - Ø 20mm - - conf. 4 - € 20,60</p>	 <p>KRINO</p> <p>PUNTA PER VETRO E CERAMICA A 2 taglianti</p> <p>605031400300 - - conf. 1 - € 4,20</p> <p>605031400400 - Ø 4 - - conf. 1 - € 4,40</p> <p>605031400500 - - conf. 1 - € 4,60</p> <p>605031400600 - Ø 6 - - conf. 1 - € 5,00</p> <p>605031400700 - - conf. 1 - € 5,40</p> <p>segue...</p>















 <p>KRINO</p> <p>continua...</p> <p>605031400800 - Ø 8 - - conf. 1 - € 5,40</p> <p>605031400900 - - conf. 1 - € 6,20</p> <p>605031401000 - - conf. 1 - € 7,80</p> <p>605031401200 - - conf. 1 - € 9,60</p>	 <p>fischer</p> <p>PUNTA CILINDRICA SDX 3K D-C in acciaio rettificata per calcestruzzo muratura con punta in carbonio</p> <p>500530579 - Ø foro 6 - Lung.totale 100 - lung. utile 60 - Ø per elettrout. 5,5 Confezione Blister - conf. 1 - € 3,60</p> <p>500530601 - Ø foro 14 - Lung.totale 150 - lung. utile 85 - Ø per elettrout. 12 Confezione Blister - conf. 1 - € 10,00</p> <p>500530604 - Ø foro 16 - Lung.totale 150 - lung. utile 85 - Ø per elettrout. 14 Confezione Blister - conf. 1 - € 11,40</p> <p>segue...</p>
 <p>fischer</p> <p>continua...</p> <p>500530606 - Ø foro 18 - Lung.totale 160 - lung. utile 105 - Ø per elettrout. 16 Confezione Blister - conf. 1 - € 14,62</p> <p>500530607 - Ø foro 20 - Lung.totale 160 - lung. utile 105 - Ø per elettrout. 18 Confezione Blister - conf. 1 - € 18,34</p> <p>500551327 - Ø foro 10 - Lung.totale 200 - lung. utile 135 - Ø per elettrout. 8 Confezione Tubo plastica - conf. 1 - € 11,12</p> <p>segue...</p>	 <p>fischer</p> <p>continua...</p> <p>500551328 - Ø foro 12 - Lung.totale 200 - lung. utile 135 - Ø per elettrout. 9 Confezione Tubo plastica - conf. 1 - € 11,74</p> <p>500530577 - Ø foro 5 - Lung.totale 85 - lung. utile 50 - Ø per elettrout. 4,6 Confezione Blister - conf. 1 - € 3,20</p> <p>500551326 - Ø foro 8 - Lung.totale 200 - lung. utile 135 - Ø per elettrout. 7 Confezione Tubo plastica - conf. 1 - € 8,66</p>
 <p>fischer</p> <p>PUNTA SDS PLUS II POINTER Acciaio a due taglienti e spirali Per martelli perforatori Adatta al calcestruzzo</p> <p>500503879 - Ø 5x5x110 - - conf. 5 - € 4,60</p> <p>500503914 - Ø 7x50x110 - - conf. 5 - € 6,20</p> <p>500503973 - Ø 10x400x450 - - conf. 5 - € 21,00</p> <p>500504010 - Ø 13x100x160 - - conf. 5 - € 10,40</p> <p>500504031 - Ø 16x150x210 - - conf. 5 - € 14,00</p>	 <p>fischer</p> <p>PUNTE SDS-PLUS IV QUATTRIC Punta in acciaio a 4 taglienti e corpo a 4 spirali di scarico per martelli perforatori</p> <p>500504123 - Ø 6x50x110 - - conf. 1 - € 9,68</p> <p>500504124 - Ø 6x100x160 - - conf. 1 - € 10,72</p> <p>500504132 - Ø 8x50x110 - - conf. 1 - € 10,50</p> <p>500504133 - Ø 8x100x160 - - conf. 1 - € 10,92</p> <p>segue...</p>
 <p>fischer</p> <p>continua...</p> <p>500504134 - Ø 8x150x210 - - conf. 1 - € 12,78</p> <p>500504137 - Ø 10x50x110 - - conf. 1 - € 12,36</p> <p>500504140 - Ø 10x100x160 - - conf. 1 - € 13,18</p> <p>500504141 - Ø 10x150x210 - - conf. 1 - € 15,04</p> <p>500504144 - Ø 12x100x160 - - conf. 1 - € 14,42</p> <p>segue...</p>	 <p>fischer</p> <p>continua...</p> <p>500504145 - Ø 12x150x210 - - conf. 1 - € 17,10</p> <p>500504149 - Ø 12x200x260 - - conf. 1 - € 23,28</p> <p>500504152 - Ø 14x100x160 - - conf. 1 - € 18,54</p> <p>500504153 - Ø 14x150x210 - - conf. 1 - € 23,08</p> <p>500504162 - Ø 18x200x250 - - conf. 1 - € 50,88</p> <p>segue...</p>
 <p>fischer</p> <p>continua...</p> <p>500504163 - Ø 18x400x450 - - conf. 1 - € 59,12</p> <p>500504164 - Ø 20x200x250 - - conf. 1 - € 60,56</p> <p>500504184 - Ø 28x400x450 - - conf. 1 - € 125,46</p> <p>500504186 - Ø 30x400x450 - - conf. 1 - € 133,70</p> <p>500506532 - Ø 16x100x160 - - conf. 1 - € 32,14</p> <p>segue...</p>	 <p>fischer</p> <p>continua...</p> <p>500506533 - Ø 16x150x210 - - conf. 1 - € 35,64</p> <p>500506534 - Ø 16x200x260 - - conf. 1 - € 39,76</p>
 <p>fischer</p> <p>PUNTE SDS-PLUS II POINTER V Punta in acciaio a 2 taglienti con attacco SDS Plus per martelli perforatori</p> <p>500531756 - Ø 5x100x160 - - conf. 1 - € 5,40</p> <p>500531766 - Ø 6x100x160 - - conf. 1 - € 4,80</p> <p>500531767 - Ø 6x150x210 - - conf. 1 - € 5,20</p> <p>500531780 - Ø 8x100x160 - - conf. 1 - € 5,80</p> <p>segue...</p>	 <p>fischer</p> <p>continua...</p> <p>500531782 - Ø 8x200x260 - - conf. 1 - € 9,60</p> <p>500531788 - Ø 9x100x160 - - conf. 1 - € 8,20</p> <p>500531792 - Ø 10x100x160 - - conf. 1 - € 6,80</p> <p>500531794 - Ø 10x200x260 - - conf. 1 - € 9,40</p> <p>500531803 - Ø 12x100x160 - - conf. 1 - € 8,60</p> <p>segue...</p>















 <p>fischer</p> <p>continua...</p> <p>500531805 - Ø 12x200x260 - - conf. 1 - € 12,60</p> <p>500531815 - Ø 14x100x160 - - conf. 1 - € 11,80</p> <p>500531817 - Ø 14x200x260 - - conf. 1 - € 15,20</p> <p>500531822 - Ø 15x100x160 - - conf. 1 - € 12,40</p> <p>500531828 - Ø 16x200x260 - - conf. 1 - € 23,60</p> <p>segue...</p>	 <p>fischer</p> <p>continua...</p> <p>500531804 - Ø 12x150x210 - - conf. 1 - € 10,60</p> <p>500531824 - Ø 15x200x260 - - conf. 1 - € 15,40</p>
 <p>KRINO</p> <p>PUNTE SDS-PLUS 4 TAGLIENTI Corpo della punta in acciaio ad alta resistenza Utilizzabile per calcestruzzo, muro e pietre</p> <p>6050315605110 - Ø 5x110 - - conf. 1 - € 3,40</p> <p>6050315605160 - Ø 5x160 - - conf. 1 - € 3,80</p> <p>6050315606110 - Ø 6x110 - - conf. 1 - € 3,60</p> <p>6050315606160 - Ø 6x160 - - conf. 1 - € 4,20</p> <p>segue...</p>	 <p>KRINO</p> <p>continua...</p> <p>6050315606210 - Ø 6x210 - - conf. 1 - € 5,80</p> <p>6050315608120 - Ø 8x210 - - conf. 1 - € 5,80</p> <p>6050315608160 - Ø 8x160 - - conf. 1 - € 4,40</p> <p>6050315608260 - Ø 8x260 - - conf. 1 - € 6,60</p> <p>6050315608310 - Ø 8x310 - - conf. 1 - € 8,00</p> <p>segue...</p>
 <p>KRINO</p> <p>continua...</p> <p>6050315608460 - Ø 8x460 - - conf. 1 - € 12,00</p> <p>6050315609160 - Ø 9x160 - - conf. 1 - € 4,40</p> <p>6050315610160 - Ø 10x160 - - conf. 1 - € 4,40</p> <p>6050315610210 - Ø 10x210 - - conf. 1 - € 6,20</p> <p>6050315610260 - Ø 10x260 - - conf. 1 - € 6,80</p> <p>segue...</p>	 <p>KRINO</p> <p>continua...</p> <p>6050315610310 - Ø 10x310 - - conf. 1 - € 9,20</p> <p>6050315610460 - Ø 10x460 - - conf. 1 - € 12,20</p> <p>6050315612160 - Ø 12x160 - - conf. 1 - € 5,00</p> <p>6050315612210 - Ø 12x210 - - conf. 1 - € 6,80</p> <p>6050315612260 - Ø 12x260 - - conf. 1 - € 7,20</p> <p>segue...</p>
 <p>KRINO</p> <p>continua...</p> <p>6050315612310 - Ø 12x310 - - conf. 1 - € 11,00</p> <p>6050315612460 - Ø 12x460 - - conf. 1 - € 13,20</p> <p>6050315614210 - Ø 14x210 - - conf. 1 - € 7,60</p> <p>6050315614260 - Ø 14x260 - - conf. 1 - € 8,00</p> <p>6050315614310 - Ø 14x310 - - conf. 1 - € 11,60</p> <p>segue...</p>	 <p>KRINO</p> <p>continua...</p> <p>6050315614460 - Ø 14x460 - - conf. 1 - € 13,00</p> <p>6050315616210 - Ø 16x210 - - conf. 1 - € 9,80</p> <p>6050315616260 - Ø 16x260 - - conf. 1 - € 12,00</p> <p>6050315616310 - Ø 16x310 - - conf. 1 - € 13,40</p> <p>6050315616460 - Ø 16x460 - - conf. 1 - € 14,00</p> <p>segue...</p>
 <p>KRINO</p> <p>continua...</p> <p>6050315618210 - Ø 18x210 - - conf. 1 - € 12,80</p> <p>6050315618310 - Ø 18x310 - - conf. 1 - € 14,00</p> <p>6050315618460 - Ø 18x460 - - conf. 1 - € 16,80</p> <p>6050315620310 - Ø 20x310 - - conf. 1 - € 18,60</p> <p>6050315620460 - Ø 20x460 - - conf. 1 - € 21,60</p> <p>segue...</p>	 <p>KRINO</p> <p>continua...</p> <p>6050315622460 - Ø 22x460 - - conf. 1 - € 24,40</p> <p>6050315624460 - Ø 24x460 - - conf. 1 - € 26,20</p>
 <p>KRINO</p> <p>PUNTA HSS DIN 1869-S1 Extra lunga Misura:120x175mm</p> <p>605010980400 - - conf. 1 - € 11,60</p>	 <p>KRINO</p> <p>PUNTA SDS-PLUS K8 Per trapani A martello Con 4 eliche e 4 taglienti Dimensione 140x160 mm</p> <p>6050315616014 - - conf. 1 - € 6,80</p>



 <p>PUNTE PROLUNGATA SUPER DD – PER MURO con placca al carburo tungsteno Lungh. 600</p> <p>500505385 – Ø x L 6x600 – – conf. 1 – € 18,74</p> <p>500505387 – Ø x L 8x600 – – conf. 1 – € 18,96</p> <p>500505388 – Ø x L 9x600 – – conf. 1 – € 19,36</p> <p>500505389 – Ø x L 10x600 – – conf. 1 – € 20,60</p> <p>500505390 – Ø x L 12x600 – – conf. 1 – € 22,04</p> <p>segue...</p>	 <p>continua...</p> <p>500505391 – Ø x L 14x600 – – conf. 1 – € 25,14</p> <p>500505392 – Ø x L 16x600 – – conf. 1 – € 27,82</p> <p>500505393 – Ø x L 18x600 – – conf. 1 – € 33,58</p> <p>500505394 – Ø x L 20x600 – – conf. 1 – € 41,00</p> <p>500505396 – Ø x L 25x600 – – conf. 1 – € 71,28</p>
 <p>PUNTA PROLUNGATA SUPER DD – PER MURO con placca al carburo di tungsteno Lungh. 400</p> <p>500505349 – Ø 6 – – conf. 1 – € 12,98</p> <p>500505351 – Ø 8 – – conf. 1 – € 14,40</p> <p>500505352 – Ø 9 – – conf. 1 – € 14,62</p> <p>500505353 – Ø 10 – – conf. 1 – € 15,86</p> <p>500505355 – Ø 12 – – conf. 1 – € 17,10</p> <p>segue...</p>	 <p>continua...</p> <p>500505357 – Ø 14 – – conf. 1 – € 18,74</p> <p>500505359 – Ø 16 – – conf. 1 – € 22,46</p> <p>500505361 – Ø 18 – – conf. 1 – € 27,40</p> <p>500505365 – Ø 22 – – conf. 1 – € 41,20</p> <p>500505368 – Ø 25 – – conf. 1 – € 53,60</p>
 <p>PUNTA PROLUNGATA SUPER DD – PER MURO placca al carburo di tungsteno Lungh.250</p> <p>500505330 – Ø 6 – – conf. 3 – € 8,86</p> <p>500505331 – Ø 8 – – conf. 3 – € 9,48</p> <p>500505332 – Ø 10 – – conf. 3 – € 11,34</p> <p>500505333 – Ø 12 – – conf. 3 – € 13,60</p> <p>500505334 – Ø 14 – – conf. 3 – € 15,24</p> <p>segue...</p>	 <p>continua...</p> <p>500505335 – Ø 16 – – conf. 3 – € 18,12</p> <p>500505336 – Ø 18 – – conf. 3 – € 22,66</p> <p>500505337 – Ø 20 – – conf. 3 – € 27,60</p>
 <p>PUNTA SUPER DD – PER MURO placca al carburo di tungsteno</p> <p>500505301 – Ø x L. 3 x 60 – – conf. 10 – € 2,48</p> <p>500505302 – Ø x L. 4 x 75 – – conf. 10 – € 2,68</p> <p>500505303 – Ø x L. 5 x 85 – – conf. 10 – € 2,88</p> <p>500505304 – Ø x L. 6 x 100 – – conf. 10 – € 2,88</p> <p>500505305 – Ø x L. 7 x 100 – – conf. 10 – € 3,50</p> <p>segue...</p>	 <p>continua...</p> <p>500505306 – Ø x L. 8 x 120 – – conf. 10 – € 3,30</p> <p>500505307 – Ø x L. 9 x 120 – – conf. 10 – € 4,12</p> <p>500505308 – Ø x L. 10 x 120 – – conf. 10 – € 4,74</p> <p>500505309 – Ø x L. 11 x 150 – – conf. 6 – € 5,98</p> <p>500505310 – Ø x L. 12 x 150 – – conf. 6 – € 7,22</p> <p>segue...</p>
 <p>continua...</p> <p>500505311 – Ø x L. 13 x 150 – – conf. 6 – € 8,04</p> <p>500505312 – Ø x L. 14 x 150 – – conf. 6 – € 9,80</p> <p>500505313 – Ø x L. 15 x 150 – – conf. 6 – € 9,88</p> <p>500505314 – Ø x L. 16 x 150 – – conf. 6 – € 11,40</p> <p>500505316 – Ø x L. 18 x 160 – – conf. 6 – € 12,78</p> <p>500505318 – Ø x L. 20 x 160 – – conf. 6 – € 16,28</p>	 <p>PUNTE ELICOIDALI CON PLACCHETTA IN HM Per acciai temperati fino HRC 60 manganese per porte blindate – Hardox Punta ottimizzate per forature particolari o impossibili Rivestimento TIN e TISIN</p> <p>638PHM04 – Ø 4 – L1 43 – L2 75 – G/min 2,400 – conf. 1 – € 12,60</p> <p>638PHM05 – Ø 5 – L1 52 – L2 86 – G/min 1,900 – conf. 1 – € 14,40</p> <p>638PHM06 – Ø 6 – L1 57 – L2 93 – G/min 1,500 – conf. 1 – € 15,80</p> <p>638PHM08 – Ø 8 – L1 75 – L2 117 – G/min 1,100 – conf. 1 – € 19,20</p>
 <p>PUNTE PER LEGNO</p> <p>605050010300 – Ø 3 – – conf. 10 – € 0,70</p> <p>605050010400 – Ø 4 – – conf. 10 – € 0,78</p> <p>605050010500 – Ø 5 – – conf. 10 – € 0,82</p> <p>605050010600 – Ø 6 – – conf. 10 – € 1,02</p> <p>605050010800 – Ø 8 – – conf. 10 – € 1,22</p> <p>segue...</p>	 <p>continua...</p> <p>605050011000 – Ø 10 – – conf. 10 – € 1,60</p> <p>605050011200 – Ø 12 – – conf. 10 – € 2,48</p> <p>605050011400 – Ø 14 – – conf. 10 – € 3,70</p> <p>605050011600 – Ø 16 – – conf. 10 – € 4,60</p>















 <p>KRINO</p> <p>PUNTE PER LEGNO serie lunga Lungh. 245</p> <p>605050200600 - Ø 6 - - conf. 5 - € 5,80</p> <p>605050200800 - Ø 8 - - conf. 5 - € 5,80</p> <p>605050201000 - Ø 10 - - conf. 5 - € 6,60</p> <p>605050201200 - Ø 12 - - conf. 5 - € 8,40</p> <p>605050201400 - Ø 14 - - conf. 5 - € 10,00</p> <p>605050201600 - Ø 16 - - conf. 5 - € 11,40</p>	 <p>KRINO</p> <p>PUNTE PER LEGNO serie lunga Lungh. 400</p> <p>605050250600 - Ø 6 - - conf. 5 - € 8,20</p> <p>605050250800 - Ø 8 - - conf. 5 - € 10,40</p> <p>605050251000 - Ø 10 - - conf. 5 - € 10,80</p> <p>605050251200 - Ø 12 - - conf. 5 - € 12,00</p> <p>605050251400 - Ø 14 - - conf. 5 - € 15,00</p> <p>605050251600 - Ø 16 - - conf. 5 - € 17,60</p>
 <p>fischer</p> <p>PUNTA CILINDRICA In acciaio per muratura e calcestruzzo a 4 Taglienti con placca al carburo di tungsteno</p> <p>500545691 - Misura 5X50X85 SDX - - conf. 10 - € 3,40</p> <p>500545692 - Misura 6x60x100 SDX - - conf. 10 - € 3,40</p> <p>500545694 - Misura 8X80X120 SDX - - conf. 10 - € 3,80</p> <p>500545697 - Misura 10X80X120 SDX - - conf. 10 - € 5,40</p> <p>500545699 - Misura 12X90X150 SDX - - conf. 6 - € 8,20</p>	 <p>fischer</p> <p>SET PUNTE CILINDRICHE 5 pezzi SDX 4-5-6-8-10 mm Punta cilindrica D-C in acciaio rettificata per calcestruzzo e muratura con punta al carburo</p> <p>500536606 - - conf. 1 - € 15,60</p>
 <p>fischer</p> <p>SCALPELLO LARGO Ad alte prestazioni con attacco SDS Plus e SDA Max</p> <p>500504279 - - conf. 1 - € 41,60</p>	 <p>BOSCH</p> <p>SCALPELLO Attacco SDS PLUS Lungh. 250mm Largh. tagliente 20mm</p> <p>3002609390394 - - conf. 1 - € 22,86</p>
 <p>BOSCH</p> <p>SCALPELLO Attacco SDS PLUS Lungh. 250mm</p> <p>3002609390576 - - conf. 1 - € 22,86</p>	 <p>BOSCH</p> <p>SCALPELLO Attacco SDS Max Lungh. totale: 400 mm Largh. taglienti: 25 mm</p> <p>3002608690124 - - conf. 1 - € 28,42</p>
 <p>MANDRINO a cremagliera MASCHIO Ø 10 3/8 x 24</p> <p>74078000 - - conf. 1 - € 13,80</p>	 <p>MANDRINO a cremagliera MASCHIO Ø 13 3/8 x 24</p> <p>74078100 - - conf. 1 - € 15,00</p>
 <p>MANDRINO a cremagliera FEMMINA Ø 10 3/8 x 24</p> <p>74078300 - - conf. 1 - € 10,80</p>	 <p>MANDRINO a cremagliera MASCHIO Ø 13 3/8 X 24</p> <p>74078400 - - conf. 1 - € 11,60</p>























 <p>MANDRINO a cremagliera FEMMINA Ø 10 1/2 X 20 74078600 - - conf. 1 - € 10,80</p>	 <p>MANDRINO a cremagliera FEMMINA Ø 13 1/2 X 20 74078700 - - conf. 1 - € 11,60</p>
 <p>MANDRINO A CREMAGLIERA SDS Plus Ø 13 mm 74078701 - - conf. 1 - € 13,80</p>	 <p>MANDRINO a cremagliera MASCHIO Ø 10 Attacco esagonale 1/4" 74078800 - - conf. 1 - € 18,80</p>
 <p>MANDRINO a cremagliera Femmina Con foro interno passante per l'inserimento della vite sinistra di bloccaggio per rotazione destra e sinistra con trapani reversibili Solo rotazione No percussione 6052800120 - Ø Misura 1+10 - Attacco 1/2x20 - L 62 - - conf. 1 - € 12,00 6052800140 - Ø Misura 1,5+13 - Attacco 1/2x20 - L 78 - - conf. 1 - € 12,40</p>	 <p>MANDRINO a cremagliera Attacco SDS Plus Ø 13 mm Solo rotazione No percussione 6052800910 - - conf. 1 - € 14,60</p>
 <p>MANDRINO Senza chiave SDS PLUS Ø 13 74077561 - - conf. 1 - € 18,20</p>	 <p>MANDRINO Senza chiave Con sistema di bloccaggio per elettrotensili portatili reversibili ed a percussione - Attacco 1/2 6052805420 - Ø Misura 1-10 - - conf. 1 - € 20,40 6052805440 - Ø Misura 1,5-13 - - conf. 1 - € 22,00</p>
 <p>MANDRINO autoserrante MASCHIO Ø 10 mm 3/8" x 24 74077300 - - conf. 1 - € 22,80</p>	 <p>MANDRINO autoserrante Femmina Ø 13 mm. 3/8" x 24 74077450 - - conf. 1 - € 26,40</p>
 <p>MANDRINO autoserrante Femmina Ø 10 1/2" x 20 74077500 - - conf. 1 - € 20,60</p>	 <p>MANDRINO autoserrante FEMMINA Ø 13 1/2" X 20 74077550 - - conf. 1 - € 38,60</p>













 <p>MANDRINO PER AVVITATORE 74078850 - - conf. 1 - € 9,40</p>	 <p>MANDRINO AUTOSERRANTE FEMMINA Ø 13 senza chiave 1/2"x20 74077560 - - conf. 1 - € 16,00</p>
 <p>RACCORDO per mandrino SDS Plus 1/2x20 74078900 - - conf. 5 - € 4,40</p>	 <p>CHIAVE per mandrini B&D Ø 10 74079000 - - conf. 10 - € 2,00</p>
 <p>CHIAVE per mandrini B&D Ø 13 universale 74079100 - - conf. 10 - € 2,40</p>	 <p>CHIAVE per mandrini Ø 13 universale 74079200 - - conf. 10 - € 2,40</p>
 <p>CHIAVE per mandrini Ø 16 universale 74079300 - - conf. 5 - € 4,40</p>	 <p>FLESSIBILE con mandrino Ø 8mm. 130 cm. 74055500 - - conf. 1 - € 56,40</p>
 <p>FLESSIBILE con mandrino Ø 8mm. Professionale con cuscinetti a sfera 130cm. 74056000 - - conf. 1 - € 59,60</p>	 <p>RACCOGLI POLVERE per punte da: Ø 4 - 10mm. 74056500 - - conf. 4 - € 4,80</p>
 <p>POMPA Universale per liquidi RPM 3400 per tubi 1/2" Gambo Ø 8 74089000 - - conf. 1 - € 17,60</p>	 <p>ASSORTIMENTO 3 UTENSILI CONICI HSS-G per forare ed allargare lamiere e tubi. Contiene: una fresa GR. 1 - Ø foro da 3 a 14 mm una fresa GR. 2 - Ø foro da 6 a 20 mm una fresa GR. 3 - Ø foro da 16 a 30,5 mm 60501195101 - - conf. 1 - € 134,20</p> 

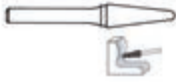

  <p>ASSORTIMENTO 3 FRESE CONICHE A GRADINO HSS-G Contiene: una fresa GR. 2 - Ø foro da 4 a 12 mm una fresa GR. 4 - Ø foro da 4 a 20 mm una fresa GR. 6 - Ø foro da 4 a 20 mm</p> <p>60501259102 - - conf. 1 - € 147,00</p>	  <p>ASSORTIMENTO 6 SVASATORI HSS a 3 tagli Ø svaso mm: 6,3 - 8,3 - 10,4 - 12,4 - 16,5 - 20,5</p> <p>60501270107 - - conf. 1 - € 101,00</p>
  <p>FRESA KERAMASTER Punta diamantata a corona continua Per il taglio del gres, gres porcellanato, gres smaltato, marmo e piastrale standard Scarico laterale per evacuazione carota Doppio scarico per evacuazione detriti</p> <p>605031170600 - Ø 6 - - conf. 1 - € 19,60 605031170800 - Ø 8 - - conf. 1 - € 19,60 605031171000 - Ø 10 - - conf. 1 - € 22,00 segue...</p>	  <p>continua...</p> <p>605031171200 - Ø 12 - - conf. 1 - € 25,80 605031171400 - Ø 14 - - conf. 1 - € 35,00 605211041600 - Ø 16 - - conf. 1 - € 55,80</p>
  <p>ESPOSITORE 30 FRESE KERAMASTER Misure 5-14</p> <p>60503120100 - - conf. 1 - € 776,00</p>	  <p>FRESA CONICA HSS Gambo Ø 10 Ø foro da 0 a 25</p> <p>6050117601 - - conf. 2 - € 24,60</p>
 <p>FRESA CONICA HSS</p> <p>74083500 - Ø gambo 8 - Ø foro da 0 a 25 - - conf. 1 - € 24,80 74083550 - Ø gambo 10 - Ø foro da 6 a 32 - - conf. 1 - € 87,20 74083560 - Ø gambo 10 - Ø foro da 6 a 45 - - conf. 1 - € 153,20</p>	 <p>FRESA A GRADINI HSS</p> <p>74082550 - Ø gambo 6 - Ø foro da 4 a 12 - - conf. 1 - € 27,60 74082600 - Ø gambo 8 - Ø foro da 4 a 20 - - conf. 1 - € 48,00</p>
  <p>FRESA A GRADINI HSS</p> <p>6050118304 - Ø gambo 10 - Ø foro Da 4 a 20 - - conf. 1 - € 36,20 6050118306 - Ø gambo 13 - Ø foro Da 4 a 30 - - conf. 1 - € 80,40 6050118324 - Ø gambo 13 - Ø foro Da 6 a 38 - - conf. 1 - € 127,20</p>	  <p>UTENSILE CONICO HSS</p> <p>6050118001 - Ø gambo 6 - Ø foro Da 3 a 14 - - conf. 2 - € 18,60 6050118002 - Ø gambo 8 - Ø foro Da 6 a 20 - - conf. 2 - € 30,80 6050118003 - Ø gambo 10 - Ø foro Da 16 a 30 - - conf. 2 - € 52,80 6050118004 - Ø gambo 13 - Ø foro Da 26 a 40 - - conf. 2 - € 109,80</p>
 <p>UTENSILE CONICO HSS</p> <p>74080000 - Ø gambo 8 - Ø foro da 4 a 14 - - conf. 1 - € 22,60 74080500 - Ø gambo 8 - Ø foro da 6 a 20 - - conf. 1 - € 36,00 74081000 - Ø gambo 10 - Ø foro da 8 a 20 - - conf. 1 - € 93,80 74082000 - Ø gambo 10 - Ø foro da 20 a 40 - - conf. 1 - € 132,40</p>	 <p>PUNTA/FRESA HSS - per ferro Gambo Ø 6 85mm.</p> <p>74044500 - - conf. 10 - € 3,80</p>

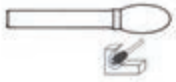
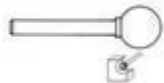

 <p>SVASATORE HSS Gambo Ø 8</p> <p>74084000 - Ø svaso 12 - - conf. 5 - € 13,20</p> <p>74084500 - Ø svaso 16 - - conf. 5 - € 16,20</p> <p>74085000 - Ø svaso 20 - - conf. 5 - € 21,40</p>	 <p>LIMA per ferro cilindrica Gambo Ø 6</p> <p>74042000 - - conf. 10 - € 4,60</p>
 <p>LIMA per ferro conica Gambo Ø 6</p> <p>74042200 - - conf. 10 - € 4,60</p>	 <p>LIMA per ferro cilindrica bombata Gambo Ø 6</p> <p>74042400 - - conf. 10 - € 4,60</p>
 <p>LIMA per ferro sferica Gambo Ø 6</p> <p>74042600 - - conf. 10 - € 4,60</p>	 <p>RASPA per legno svasare Gambo Ø 6</p> <p>74043800 - - conf. 10 - € 4,80</p>
 <p>KRINO MICRO FRESA ROTATIVA CILINDRICA TAGLIO SEMISFERICO In metallo duro HM4 Taglio incrociato per acciaio trattato, acciaio inox, materiali metallici in genere. Vibrazioni ridotte, buona finitura superficiale, ottimi rendimenti. Velocità consigliata: 300+400 m/min.</p> <p>6052602000603 - Ø 3 - - conf. 1 - € 10,20</p>	 <p>KRINO MICRO FRESA ROTATIVA CONICA SFERICA In metallo duro HM4 Taglio incrociato per acciaio trattato, acciaio inox, materiali metallici in genere. Vibrazioni ridotte, buona finitura superficiale, ottimi rendimenti. Velocità consigliata: 300+400 m/min.</p> <p>6052602000703 - Ø 3 - - conf. 1 - € 10,20</p>
 <p>KRINO MICRO FRESA ROTATIVA RAGGIO SFERICO In metallo duro HM4 Taglio incrociato per acciaio trattato, acciaio inox, materiali metallici in genere. Vibrazioni ridotte; buona finitura superficiale, ottimi rendimenti. Velocità consigliata 300+400 m/min</p> <p>6052602000803 - Ø 3 - - conf. 1 - € 10,20</p>	 <p>KRINO MICRO FRESA ROTATIVA A GOCCIA In metallo duro HM4 Taglio incrociato per acciaio trattato, acciaio inox, materiali metallici in genere. Vibrazioni ridotte; buona finitura superficiale, ottimi rendimenti. Velocità consigliata 300+400 m/min</p> <p>6052602000903 - Ø 3 - - conf. 1 - € 10,20</p>
 <p>KRINO FRESE ROTATIVE In metallo duro HM4 Taglio incrociato per acciaio trattato, acciaio inox, materiali metallici in genere. Vibrazioni ridotte, buona finitura superficiale, ottimi rendimenti. Velocità consigliata: 300+400 m/min.</p> <p>6052602000503 - Ø 3 - - conf. 1 - € 10,20</p>	 <p>KRINO MICRO FRESA ROTATIVA CILINDRICA In metallo duro HM4 Taglio incrociato per acciaio trattato, acciaio inox, materiali metallici in genere. Vibrazioni ridotte; buona finitura superficiale, ottimi rendimenti. Velocità consigliata 300+400 m/min</p> <p>6052602000103 - Ø 3 - - conf. 1 - € 10,20</p>















<p>KRINO</p> <p>MICROFRESA ROTATIVA CILINDRICA TAGLIO FRONTALE In metallo duro HM4 Taglio incrociato per acciaio trattato, acciaio inox, materiali metallici in genere. Vibrazioni ridotte, buona finitura superficiale, ottimi rendimenti. Velocità consigliata: 300+400 m/min</p>  <p>6052602000203 - Ø 3 - - conf. 1 - € 10,20</p>	<p>KRINO</p> <p>MICRO FRESA ROTATIVA A FIAMMA In metallo duro HM4 Taglio incrociato per acciaio trattato, acciaio inox, materiali metallici in genere. Vibrazioni ridotte, buona finitura superficiale, ottimi rendimenti. Velocità consigliata: 300+400 m/min.</p>  <p>6052602000403 - Ø 3 - - conf. 1 - € 10,20</p>
<p>KRINO</p> <p>MICRO FRESA ROTATIVA CONICA In metallo duro HM4 Taglio incrociato per acciaio trattato, acciaio inox, materiali metallici in genere. Vibrazioni ridotte, buona finitura superficiale, ottimi rendimenti. Velocità consigliata: 300+400 m/min.</p>  <p>6052602000303 - Ø 3 - - conf. 1 - € 10,20</p>	<p>fischer</p> <p>FRESA DIAMANTATA FC 5 K HS - DI professionale diamantata per piastrelle a Gas</p>  <p>500551346 - Ø 6 - Lung. totale 62 - Ø attacco 8,3 - Tipo di confezione Tubo plastica - conf. 1 - € 22,60</p>
<p></p> <p>TAZZA RINGO HM PER PROTETTORE Con tripla affilatura in grado di forare lamiere in acciaio al manganese delle porte blindate</p>  <p>638RIHM052 - Ø 52 mm - - conf. 1 - € 40,80 638RIHM054 - Ø 54 mm - - conf. 1 - € 40,80 638RIHM057 - Ø 57 mm - - conf. 1 - € 40,80</p>	<p>KRINO</p> <p>FRESA A TAZZA BIMETALLICA HSS-CO 8% "BLU-MOL" Dentatura variabile</p>  <p>6052106501400 - Ø 14 - - conf. 1 - € 11,20 6052106501600 - Ø 16 - - conf. 1 - € 11,20 6052106501700 - Ø 17 - - conf. 1 - € 11,60 6052106501900 - Ø 19 - - conf. 1 - € 11,60 6052106502000 - Ø 20 - - conf. 1 - € 11,60 segue...</p>
<p>KRINO</p> <p>continua...</p>  <p>6052106502100 - Ø 21 - - conf. 1 - € 11,60 6052106502200 - Ø 22 - - conf. 1 - € 12,00 6052106502400 - Ø 24 - - conf. 1 - € 12,40 6052106502500 - Ø 25 - - conf. 1 - € 12,40 6052106502700 - Ø 27 - - conf. 1 - € 12,80 segue...</p>	<p>KRINO</p> <p>continua...</p>  <p>6052106502900 - Ø 29 - - conf. 1 - € 13,20 6052106503000 - Ø 30 - - conf. 1 - € 13,60 6052106503200 - Ø 32 - - conf. 1 - € 14,00 6052106503300 - Ø 33 - - conf. 1 - € 14,60 6052106503500 - Ø 35 - - conf. 1 - € 15,00 segue...</p>
<p>KRINO</p> <p>continua...</p>  <p>6052106503700 - Ø 37 - - conf. 1 - € 15,00 6052106503800 - Ø 38 - - conf. 1 - € 15,60 6052106504000 - Ø 40 - - conf. 1 - € 16,40 6052106504100 - Ø 41 - - conf. 1 - € 16,40 6052106504300 - Ø 43 - - conf. 1 - € 17,20 segue...</p>	<p>KRINO</p> <p>continua...</p>  <p>6052106504400 - Ø 44 - - conf. 1 - € 17,20 6052106504600 - Ø 46 - - conf. 1 - € 17,40 6052106504800 - Ø 48 - - conf. 1 - € 17,80 6052106505100 - Ø 51 - - conf. 1 - € 17,80 6052106505200 - Ø 52 - - conf. 1 - € 18,80 segue...</p>
<p>KRINO</p> <p>continua...</p>  <p>6052106505400 - Ø 54 - - conf. 1 - € 19,00 6052106505700 - Ø 57 - - conf. 1 - € 20,00 6052106505900 - Ø 59 - - conf. 1 - € 20,80 6052106506000 - Ø 60 - - conf. 1 - € 20,80 6052106506400 - Ø 64 - - conf. 1 - € 20,80 segue...</p>	<p>KRINO</p> <p>continua...</p>  <p>6052106506500 - Ø 65 - - conf. 1 - € 23,60 6052106506700 - Ø 67 - - conf. 1 - € 23,60 6052106507000 - Ø 70 - - conf. 1 - € 24,80 6052106507300 - Ø 73 - - conf. 1 - € 25,20 6052106507600 - Ø 76 - - conf. 1 - € 25,80 segue...</p>















 <p>KRINO</p> <p>continua...</p> <p>6052106507900 - Ø 79 - - conf. 1 - € 26,60</p> <p>6052106508300 - Ø 83 - - conf. 1 - € 26,60</p> <p>6052106508600 - Ø 86 - - conf. 1 - € 27,80</p> <p>6052106508900 - Ø 89 - - conf. 1 - € 28,40</p> <p>6052106509200 - Ø 92 - - conf. 1 - € 31,20</p> <p>segue...</p>	 <p>KRINO</p> <p>continua...</p> <p>6052106509500 - Ø 95 - - conf. 1 - € 31,80</p> <p>6052106509800 - Ø 98 - - conf. 1 - € 33,40</p> <p>6052106510200 - Ø 102 - - conf. 1 - € 34,20</p> <p>6052106510500 - Ø 105 - - conf. 1 - € 37,80</p> <p>6052106510800 - Ø 108 - - conf. 1 - € 43,20</p> <p>segue...</p>
 <p>KRINO</p> <p>continua...</p> <p>6052106511100 - Ø 111 - - conf. 1 - € 51,00</p> <p>6052106511400 - Ø 114 - - conf. 1 - € 48,00</p> <p>6052106512100 - Ø 121 - - conf. 1 - € 50,40</p> <p>6052106512700 - Ø 127 - - conf. 1 - € 51,60</p> <p>6052106514000 - Ø 140 - - conf. 1 - € 55,40</p> <p>6052106515200 - Ø 152 - - conf. 1 - € 59,80</p>	 <p>KRINO</p> <p>ALBERO PER SEGHE A TAZZA BIMETAL</p> <p>605210705514B - Art. 5514 - Attacco Ø 6,35 - Ø mm da 14 a 30 - - conf. 1 - € 8,40</p>
 <p>KRINO</p> <p>ALBERO PER SEGHE A TAZZA BIMETAL</p> <p>605210705519B - Art. 5519 - Attacco HEX 8,5 - Ø mm da 14 a 30 - - conf. 1 - € 11,00</p>	 <p>KRINO</p> <p>ALBERO PER SEGHE A TAZZA BIMETAL</p> <p>605210705546B - Art. 5546 - Attacco HEX 8,5 - Ø mm da 32 a 210 - - conf. 1 - € 19,20</p>
 <p>KRINO</p> <p>ADATTATORE PER ALBERI 5514 - 5519</p> <p>60521070300 - - conf. 5 - € 4,40</p>	 <p>KRINO</p> <p>PUNTA PILOTA di ricambio per 5514</p> <p>60521070203 - - conf. 5 - € 4,40</p>
 <p>KRINO</p> <p>PUNTA PILOTA di ricambio per 5519 - 5546</p> <p>60521070202 - - conf. 5 - € 4,40</p>	 <p>KRINO</p> <p>SEGHE A TAZZA BIMETALLICHE HSS a dentatura variabile Taglio professionale per qualsiasi materiale Profondità di foratura 5 mm.</p> <p>60521060016 - Ø mm. 16 - - conf. 1 - € 6,80</p> <p>60521060019 - Ø mm. 19 - - conf. 1 - € 7,40</p> <p>60521060020 - Ø mm. 20 - - conf. 1 - € 7,40</p> <p>60521060022 - Ø mm. 22 - - conf. 1 - € 7,80</p> <p>segue...</p>
 <p>KRINO</p> <p>continua...</p> <p>60521060025 - Ø mm. 25 - - conf. 1 - € 8,20</p> <p>60521060030 - Ø mm. 30 - - conf. 1 - € 9,40</p> <p>60521060032 - Ø mm. 32 - - conf. 1 - € 9,40</p> <p>60521060035 - Ø mm. 35 - - conf. 1 - € 10,80</p> <p>60521060038 - Ø mm. 38 - - conf. 1 - € 10,80</p> <p>segue...</p>	 <p>KRINO</p> <p>continua...</p> <p>60521060040 - Ø mm. 40 - - conf. 1 - € 11,20</p> <p>60521060048 - Ø mm. 48 - - conf. 1 - € 12,60</p> <p>60521060051 - Ø mm. 51 - - conf. 1 - € 13,00</p> <p>60521060057 - Ø mm. 57 - - conf. 1 - € 15,00</p> <p>60521060060 - Ø mm. 60 - - conf. 1 - € 15,20</p> <p>segue...</p>













 <p>KRINO</p> <p>continua...</p> <p>60521060070 - Ø mm. 70 - - conf. 1 - € 18,20</p> <p>60521060083 - Ø mm. 83 - - conf. 1 - € 21,20</p> <p>60521060102 - Ø mm. 102 - - conf. 1 - € 25,40</p>	 <p>fischer</p> <p>FM ADATTATORE 20-30 K Fresa HS-HSS-Co a tazza professionale al cobalto tipo bi-metal</p> <p>500532057 - - conf. 1 - € 19,40</p>
 <p>fischer</p> <p>FRESA A TAZZA FM 20 K HS - HSS - Co professionale al cobalto tipo bi-metal</p> <p>500532061 - - conf. 1 - € 9,00</p>	 <p>fischer</p> <p>FRESA A TAZZA FML al carburo HS-Multi per murature e legno Con adattatore</p> <p>500551362 - Ø FML 60 K - Ø 60 MM - - conf. 1 - € 22,40</p> <p>500551361 - Ø FML 51 K - Ø 51 MM - - conf. 1 - € 19,20</p>
 <p>KRINO</p> <p>FRESA PERFORATRICE A TAZZA - IN HSS RETTIFICATA Per metalli Scarico truciolo laterale e molla di espulsione</p> <p>6052100101200 - Ø 12 - - conf. 1 - € 13,20</p> <p>6052100101300 - Ø 13 - - conf. 1 - € 13,20</p> <p>6052100101400 - Ø 14 - - conf. 1 - € 13,60</p> <p>6052100101500 - Ø 15 - - conf. 1 - € 13,60</p> <p>segue...</p>	 <p>KRINO</p> <p>continua...</p> <p>6052100101600 - Ø 16 - - conf. 1 - € 13,60</p> <p>6052100101700 - Ø 17 - - conf. 1 - € 13,60</p> <p>6052100101800 - Ø 18 - - conf. 1 - € 13,60</p> <p>6052100101900 - Ø 19 - - conf. 1 - € 14,00</p> <p>6052100102000 - Ø 20 - - conf. 1 - € 14,80</p> <p>segue...</p>
 <p>KRINO</p> <p>continua...</p> <p>6052100102100 - Ø 21 - - conf. 1 - € 15,40</p> <p>6052100102200 - Ø 22 - - conf. 1 - € 16,20</p> <p>6052100102300 - Ø 23 - - conf. 1 - € 17,40</p> <p>6052100102400 - Ø 24 - - conf. 1 - € 17,80</p> <p>6052100102500 - Ø 25 - - conf. 1 - € 18,40</p> <p>segue...</p>	 <p>KRINO</p> <p>continua...</p> <p>6052100102600 - Ø 26 - - conf. 1 - € 19,60</p> <p>6052100102700 - Ø 27 - - conf. 1 - € 19,80</p> <p>6052100102800 - Ø 28 - - conf. 1 - € 20,60</p> <p>6052100102900 - Ø 29 - - conf. 1 - € 21,40</p> <p>6052100103000 - Ø 30 - - conf. 1 - € 21,80</p> <p>segue...</p>
 <p>KRINO</p> <p>continua...</p> <p>6052100103100 - Ø 31 - - conf. 1 - € 22,60</p> <p>6052100103200 - Ø 32 - - conf. 1 - € 23,40</p> <p>6052100103300 - Ø 33 - - conf. 1 - € 24,00</p> <p>6052100103400 - Ø 34 - - conf. 1 - € 24,80</p> <p>6052100103500 - Ø 35 - - conf. 1 - € 25,40</p> <p>segue...</p>	 <p>KRINO</p> <p>continua...</p> <p>6052100103600 - Ø 36 - - conf. 1 - € 26,60</p> <p>6052100103700 - Ø 37 - - conf. 1 - € 27,00</p> <p>6052100103800 - Ø 38 - - conf. 1 - € 27,80</p> <p>6052100103900 - Ø 39 - - conf. 1 - € 30,00</p> <p>6052100104000 - Ø 40 - - conf. 1 - € 30,00</p> <p>segue...</p>
 <p>KRINO</p> <p>continua...</p> <p>6052100104100 - Ø 41 - - conf. 1 - € 30,40</p> <p>6052100104200 - Ø 42 - - conf. 1 - € 31,00</p> <p>6052100104300 - Ø 43 - - conf. 1 - € 32,20</p> <p>6052100104400 - Ø 44 - - conf. 1 - € 32,80</p> <p>6052100104500 - Ø 45 - - conf. 1 - € 34,60</p> <p>segue...</p>	 <p>KRINO</p> <p>continua...</p> <p>6052100104600 - Ø 46 - - conf. 1 - € 34,60</p> <p>6052100104700 - Ø 47 - - conf. 1 - € 34,80</p> <p>6052100104800 - Ø 48 - - conf. 1 - € 37,00</p> <p>6052100104900 - Ø 49 - - conf. 1 - € 37,60</p> <p>6052100105000 - Ø 50 - - conf. 1 - € 37,60</p>















 <p>KRINO</p> <p>FRESA A TAZZA IN METALLO DURO per muro Art. 560 a sola rotazione</p> <p>6052101502200 - Ø 22 - M 12 - - conf. 1 - € 20,80</p> <p>6052101502500 - Ø 25 - M 12 - - conf. 1 - € 27,20</p> <p>6052101502700 - Ø 27 - M 12 - - conf. 1 - € 28,20</p> <p>6052101503000 - Ø 30 - M 12 - - conf. 1 - € 28,80</p> <p>6052101503500 - Ø 35 - M 12 - - conf. 1 - € 31,40</p> <p>segue...</p>	 <p>KRINO</p> <p>continua...</p> <p>6052101503800 - Ø 38 - M 12 - - conf. 1 - € 34,60</p> <p>6052101504000 - Ø 40 - M 12 - - conf. 1 - € 37,00</p> <p>6052101504500 - Ø 45 - M 12 - - conf. 1 - € 40,80</p> <p>6052101505000 - Ø 50 - M 12 - - conf. 1 - € 44,00</p> <p>6052101505500 - Ø 55 - M 16 - - conf. 1 - € 53,40</p> <p>segue...</p>
 <p>KRINO</p> <p>continua...</p> <p>6052101506000 - Ø 60 - M 16 - - conf. 1 - € 58,40</p> <p>6052101506500 - Ø 65 - M 16 - - conf. 1 - € 65,80</p> <p>6052101507000 - Ø 70 - M 16 - - conf. 1 - € 70,20</p> <p>6052101508000 - Ø 80 - M 16 - - conf. 1 - € 86,40</p> <p>6052101508500 - Ø 85 - M 16 - - conf. 1 - € 103,00</p> <p>6052101510000 - Ø 100 - M 16 - - conf. 1 - € 139,40</p>	 <p>KRINO</p> <p>PROLUNGA mm. 400 PER FRESE Art. 560 Filetto M16 x 1,5 gambo esagonale Art. 21005 121</p> <p>60521020121 - per frese da55a150 - - conf. 1 - € 42,80</p>
 <p>KRINO</p> <p>PROLUNGA mm. 400 PER FRESE Art. 560 Filetto M12 x 1,25 gambo esagonale Art. 21005 120</p> <p>60521005120 - per frese da22a50 - - conf. 1 - € 28,60</p>	 <p>KRINO</p> <p>FRESA PERFORATRICE A TAZZA "IMPACT" per edilizia</p> <p>6052111003000 - Ø 30 - Lunghezza 75 - - conf. 1 - € 26,36</p> <p>6052111003500 - Ø 35 - Lunghezza 75 - - conf. 1 - € 31,72</p> <p>6052111004000 - Ø 40 - Lunghezza 75 - - conf. 1 - € 34,82</p> <p>6052111105000 - Ø 50 - Lunghezza 75 - - conf. 1 - € 38,94</p> <p>6052111106500 - Ø 65 - Lunghezza 75 - - conf. 1 - € 48,42</p> <p>segue...</p>
 <p>KRINO</p> <p>continua...</p> <p>6052111108000 - Ø 80 - Lunghezza 75 - - conf. 1 - € 71,08</p> <p>6052111109000 - Ø 90 - Lunghezza 75 - - conf. 1 - € 75,80</p> <p>6052111110000 - Ø 100 - Lunghezza 75 - - conf. 1 - € 91,68</p>	 <p>KRINO</p> <p>GAMBO PER FRESE PERFORATRICI A TAZZA "IMPACT" Gambo SDS PLUS</p> <p>60521115504 - M 16 X 2 - lunghezza 100 - - conf. 1 - € 16,06</p> <p>60521115505 - M 16 X 2 - lunghezza 220 - - conf. 1 - € 23,70</p> <p>60521115524 - M 22 X 2,5 - lunghezza 100 - - conf. 1 - € 16,06</p> <p>60521115525 - M 22 X 2,5 - lunghezza 220 - - conf. 1 - € 23,70</p>
 <p>KRINO</p> <p>GAMBO PER FRESE PERFORATRICI A TAZZA "IMPACT" gambo esagonale</p> <p>60521115501 - M 16X2 - lunghezza 100 - - conf. 1 - € 11,94</p> <p>60521115502 - M 16X2 - lunghezza 220 - - conf. 1 - € 17,52</p> <p>60521115521 - M 22X2,5 - lunghezza 100 - - conf. 1 - € 16,06</p> <p>60521115522 - M 22X2,5 - lunghezza 220 - - conf. 1 - € 23,70</p>	 <p>KRINO</p> <p>PUNTA PILOTA PER FRESE IMPACT Ø 8 x 120 mm</p> <p>60521115506 - L.mm 220 - M 22 - - conf. 1 - € 4,32</p>
 <p>KRINO</p> <p>ASSORTIMENTO 59 PZ. FRESE A TAZZA HSS-G Art. 21001 Ø15÷37x2÷38÷50x1 Ripiano adatto a vetrina espositiva piccola codice 60501195710 Articolo in prevendita</p> <p>60501195761 - - conf. 1 - € 1446,00</p>	 <p>KRINO</p> <p>ASSORTIMENTO 47 PZ. FRESE HSS CO 8% BLU-MOL Art 21065 frese x2 Ø16-19-20-21-22-24-25-27-29-30 x1 Ø32-35-37-38-40-41-44-48-51-54-57-60-64-70-76 Art 210705519 6 alberi per seghe 14-30 gambo 8,5 Art. 210705546 6 alberi per seghe 32-210 gambo 8,5 Ripiano adatto a vetrina espositiva piccola codice 60501195710 Articolo in prevendita</p> <p>60501195772 - - conf. 1 - € 674,00</p>



 <p>ASSORTIMENTO 53 PZ. FRESE E UTENSILI CONICI Art. 01180 utensile conico HSS Gr. 1-2-3-4 2 pz. Gr. 5-7-8 1 pz. Art. 01183 utensile a gradini HSS Gr. 2-3-4-5-6-9-24 2 pz. Art. 01185 fresa a svasare HSS Ø4,3 - 5,3 - 6,3 - 7,3 8,3 - 9,4 - 10,4 - 12,4 15 - 16,5 - 20,5 - 25 28 - 31 1 pz. Art. 0117601 fresa conica allargafori HSS 5 pz. Art. 011750600 punta fresa 5 pz. Art. 01188 fresa a sbavare HSS 1 pz. <i>Ripiano adatto a vetrina espositiva grande codice 60501195805</i> Articolo in prevendita</p> <p>60501195859 - - conf. 1 - € 2402,00</p>	 <p>ASSORTIMENTO 82 PZ. FRESE A TAZZA HSS Art. 21001 Ø12+50+55-60 x2 <i>Ripiano adatto a vetrina espositiva grande codice 60501195805</i> Articolo in prevendita</p> <p>60501195861 - - conf. 1 - € 2102,00</p>
 <p>ASSORTIMENTO 32 PZ. FRESE A TAZZA T.C.T. Art. 21040 Ø15+40x1+42-45-48 50-55-60 <i>Ripiano adatto a vetrina espositiva grande codice 60501195805</i> Articolo in prevendita</p> <p>60501195864 - - conf. 1 - € 1524,00</p>	 <p>ASSORTIMENTO 72 PZ. FRESE A TAZZA HSS CO 8% BLU-MOL Art. 21065 fresa a tazza Ø16-17-19-20-21-22-24-25 27-29-30-32-33-35-37-38-40 41-44-46-48-51-54 x2 Ø57-60-64-70-76-79-83-89 92-102 x1 Art. 210705519 albero per seghe 8 pz. Art. 210705546 albero per seghe 8 pz. <i>Ripiano adatto a vetrina espositiva grande codice 60501195805</i> Articolo in prevendita</p> <p>60501195870 - - conf. 1 - € 966,00</p>
 <p>ASSORTIMENTO 24 PZ. FRESE IMPACT EDILIZIA Art. 21110 fresa a tazza impact M16 Ø30-35-40 Art. 21111 fresa a tazza impact M22 Ø50-65-80-90-100 HEX 12 4 pz. SDS 4 pz. Punta 8 pz. <i>Ripiano adatto a vetrina espositiva grande codice 60501195805</i> Articolo in prevendita</p> <p>60521116112 - - conf. 1 - € 582,00</p>	 <p>ASSORTIMENTO 50 PZ. FRESE ROTATIVE HSS Z2+Z3 Art. 26001-26003 Ø6-8-10-12-15 x5 <i>Ripiano adatto a vetrina espositiva grande codice 60501195805</i> Articolo in prevendita</p> <p>60526008501 - - conf. 1 - € 704,00</p>
 <p>SEGA A TAZZA Blister 7 lame da 25 a 62mm Altezza 25mm</p> <p>74073000 - - conf. 3 - € 10,80</p>	 <p>SEGA A TAZZA Blister 7 lame da Ø 25 a 62mm Altezza 50mm</p> <p>74073200 - - conf. 3 - € 12,40</p>
 <p>SEGA A TAZZA Blister 5 lame da Ø 60 a 95mm Altezza 40mm</p> <p>74073500 - - conf. 2 - € 28,40</p>	 <p>RASPA per legno cilindrica Gambo Ø 6</p> <p>74043000 - - conf. 5 - € 4,60</p>
 <p>RASPA per legno conica Gambo Ø 6</p> <p>74043200 - - conf. 5 - € 4,60</p>	 <p>RASPA per legno sferica Gambo Ø 6</p> <p>74043400 - - conf. 5 - € 4,80</p>



 <p>RASPA per legno conica bombata Gambo \varnothing 6 74043600 – – conf. 5 – € 4,80</p>	 <p>RASPA Per legno Gambo \varnothing 6 74044800 – \varnothing inter. 10 – \varnothing ester. 15 – – conf. 5 – € 8,20 74044810 – \varnothing inter. 15 – \varnothing ester. 20 – – conf. 5 – € 9,20 74044820 – \varnothing inter. 20 – \varnothing ester. 25 – – conf. 5 – € 10,00</p>
 <p>RASPA a svasare Attacco esagonale 1/4 74045110 – \varnothing 10 – – conf. 5 – € 5,80 74045120 – \varnothing 13 – – conf. 5 – € 6,80 74045130 – \varnothing 16 – – conf. 5 – € 7,40</p>	 <p>Set 3 pezzi FRESE E RASPE assortite Gambo \varnothing 6 74044600 – – conf. 10 – € 9,80</p>
 <p>Set 6 pezzi FRESE E RASPE assortite Gambo \varnothing 6 74044700 – – conf. 5 – € 23,20</p>	 <p>FRESA sagomata per profilo Tondo interno 45° Gambo 8 – \varnothing 35mm. 74036000 – – conf. 5 – € 8,20</p>
 <p>FRESA sagomata per profilo Tondo esterno 45° Gambo 8 – \varnothing 35mm. 74036100 – – conf. 5 – € 8,20</p>	 <p>FRESA sagomata per profilo concavo Gambo 8 – \varnothing 35mm. 74036200 – – conf. 5 – € 8,20</p>
 <p>FRESA sagomata per profilo convesso Gambo 8 – \varnothing 25mm. 74036300 – – conf. 5 – € 8,20</p>	 <p>FRESA sagomata cilindrica per levigare Gambo 8 – \varnothing 25x22mm. 74036400 – – conf. 5 – € 8,20</p>
 <p>FRESA sagomata per profilo tondo Gambo 8 – \varnothing 25x22mm. 74036450 – – conf. 5 – € 8,20</p>	 <p>FRESA sagomata conica 45° Gambo 8 – \varnothing 35mm. 74036500 – – conf. 5 – € 8,20</p>



 <p>FRESA sagomata per scanalatura Gambo 8 Ø - 35x5mm.</p> <p>74036600 - - conf. 5 - € 8,20</p>	 <p>FRESA sagomata doppia battuta per incastri Gambo 8 Ø 30x22mm.</p> <p>74036700 - - conf. 5 - € 8,20</p>
 <p>FRESA sagomata per intagli Gambo 8 Ø 30x1,5mm.</p> <p>74036800 - - conf. 2 - € 3,60</p>	 <p>FRESA sagomata per intagli Gambo 8 Ø 30x2,5mm.</p> <p>74036900 - - conf. 5 - € 3,60</p>
 <p>FRESA per svasare Gambo Ø 6</p> <p>74037500 - Ø 6 - - conf. 10 - € 2,60 74037600 - Ø 12 - - conf. 10 - € 3,80 74037700 - Ø 16 - - conf. 10 - € 4,20 74037800 - Ø 19 - - conf. 10 - € 5,20</p>	 <p>FRESA sagomata circolare a sega Gambo 8 Ø 45x1,5mm.</p> <p>74037000 - - conf. 5 - € 3,80</p>
 <p>FRESA a dito mortasare Gambo Ø 6</p> <p>74037200 - - conf. 5 - € 4,80</p>	 <p>FRESA per cerniere Gambo Ø 8</p> <p>74037950 - Ø 20 - - conf. 5 - € 6,80 74038000 - Ø 26 - - conf. 5 - € 8,00 74038100 - Ø 30 - - conf. 5 - € 8,60 74038200 - Ø 35 - - conf. 5 - € 10,20 74038300 - Ø 38 - - conf. 5 - € 11,20</p>
 <p>FRESA ad ombrello Gambo Ø 5</p> <p>74037900 - - conf. 10 - € 3,20</p>	 <p>FRESA per cerniere in metallo duro Gambo Ø 8</p> <p>74038400 - Ø 26 - - conf. 2 - € 11,20 74038410 - Ø 30 - - conf. 2 - € 13,00 74038420 - Ø 35 - - conf. 2 - € 19,80</p>
 <p>PUNTA FORSTNER con tagliente Lungh. 90mm</p> <p>74012010 - gambo Ø 8 - Ø 10 - - conf. 1 - € 6,80 74012012 - gambo Ø 8 - Ø 12 - - conf. 1 - € 7,00 74012014 - gambo Ø 8 - Ø 14 - - conf. 1 - € 7,20 74012015 - gambo Ø 8 - Ø 15 - - conf. 1 - € 7,40 74012016 - gambo Ø 8 - Ø 16 - - conf. 1 - € 7,80 segue...</p>	 <p>continua...</p> <p>74012018 - gambo Ø 8 - Ø 18 - - conf. 1 - € 8,40 74012020 - gambo Ø 8 - Ø 20 - - conf. 1 - € 9,00 74012022 - gambo Ø 8 - Ø 22 - - conf. 1 - € 9,20 74012024 - gambo Ø 8 - Ø 24 - - conf. 1 - € 9,40 74012025 - gambo Ø 8 - Ø 25 - - conf. 1 - € 10,00 segue...</p>



Specialisti del fai da te

DIY specialists

DO IT YOURSELF



TELWIN[®]
JOIN THE INNOVATION

Inverter Force: pronti per saldare in ogni occasione!

inverter



FORCE 125 - FORCE 145
VALIGETTA CON ACCESSORI MMA



FORCE 145 - 165 - 195 - 168 MPGE
VALIGETTA CON ACCESSORI MMA



Con gli inverter FORCE saldare è facile, pratico, divertente e i risultati sono sempre eccellenti. Nel catalogo Telwin con oltre 250 prodotti trovi sempre la migliore soluzione per ogni tua esigenza.

www.telwin.com

TELWIN S.p.A. - Via della Tecnica, 3 - 36030 Villaveria (VI) Italy - Tel. +39 0445 858811



TelwinSpa



Telwinspa



telwinspa



 <p>continua... 74012026 - gambo Ø 8 - Ø 26 - - conf. 1 - € 10,40 74012028 - gambo Ø 8 - Ø 28 - - conf. 1 - € 10,80 74012030 - gambo Ø 8 - Ø 30 - - conf. 1 - € 11,20 74012032 - gambo Ø 10 - Ø 32 - - conf. 1 - € 11,60 74012034 - gambo Ø 10 - Ø 34 - - conf. 1 - € 12,20 segue...</p>	 <p>continua... 74012035 - gambo Ø 10 - Ø 35 - - conf. 1 - € 13,40 74012036 - gambo Ø 10 - Ø 36 - - conf. 1 - € 14,40 74012040 - gambo Ø 10 - Ø 40 - - conf. 1 - € 16,60 74012045 - gambo Ø 10 - Ø 45 - - conf. 1 - € 17,80 74012050 - gambo Ø 10 - Ø 50 - - conf. 1 - € 18,80</p>
 <p>FORALASTRA per laminati e metalli da 20 a 123mm Attacco 8mm 74021400 - - conf. 1 - € 24,20</p>	 <p>FORALASTRA per laminati e metalli da 25 a 217mm. Attacco 12mm 74021500 - - conf. 1 - € 27,40</p>
 <p>FORALASTRA per laminati e metalli da 27 a 104mm. Attacco 8mm 74021600 - - conf. 1 - € 14,40</p>	 <p>TAGLIAPIASTRELLE CIRCOLARE punta metallo duro fori da 30 a 80mm 74021700 - - conf. 1 - € 30,40</p>
 <p>CARICABATTERIE Con controllo elettronico delle fasi di carica, interruzione e ripristino automatico Segnala lo stato di carica della batteria tramite LED 790807591 - Modello 6V/12V - - conf. 1 - € 65,56 790807592 - Modello 12V/24V - - conf. 1 - € 85,38</p>	 <p>CARICABATTERIA NEVADA 10 Tensione 12 V Monofase 230 V Potenza 50 Watt Corrente di carica 4 A Per batterie da 25-40 Ah Dim. 95x190x180 Peso Kg. 1,4 790807022 - - conf. 1 - € 74,10</p>
 <p>CARICABATTERIA NEVADA 15 Tensione 12 / 24 V Monofase 230 V Potenza 110 Watt Corrente di carica 6 A (12 V) Corrente di carica 3 A (24 V) Per batterie da 60-115 Ah (12 V) Per batterie da 30-40 Ah (24 V) Dim. 95x190x180 Peso Kg. 2,6 790807026 - - conf. 1 - € 97,78</p>	 <p>CARICABATTERIA ALASKA 150 START Carica batterie e mantenitori con controllo elettronico della corrente di carica, interruzione e ripristino automatico (TRONIC), per accumulatori al piombo a 12V (mod. 150) di motoveicoli, autoveicoli, furgoni, autocarri leggeri. Possibilità di carica normale CHARGE, carica rapida BOOST, carica automatica e mantenimento TRONIC di batterie. Tensione 12 V Monofase 230 V Potenza 220 Watt Corrente di carica 15 A Dim. 200x250x130 Peso Kg. 5 790807576 - - conf. 1 - € 143,22</p>
 <p>CARICABATTERIA LEADER 150 START Tensione 12 V Monofase 230 V Potenza 300 Watt Corrente di carica 14 A 2 posizioni di regolazione Per batterie da 25-250 Ah Dim. 225x290x205 Peso Kg. 6,6 790807505 - - conf. 1 - € 216,00</p>	 <p>CARICABATTERIA LEADER 220 START Tensione 12 - 24 V Monofase 230 V Potenza 0,8 Kw Corrente di carica 20 A 2 Posizioni di regolazione Per batterie da 30 - 400 Ah Dim. 225x290x205 Peso Kg. 9,4 790807530 - - conf. 1 - € 304,00</p>



  <p>CARICABATTERIA E AVVIATORE DYNAMIC 320 START Tensione 12 - 24 V Monofase 230 V Potenza di carica 1 Kw Potenza avviamento 6,4 Kw Corrente di carica 30 A 3 Posizioni di regolazione Per batterie da 20 - 700 Ah Dim. 305x360x630 Peso Kg. 13,9</p> <p>790829316 - - conf. 1 - € 430,00</p>	  <p>CARICABATTERIA E AVVIATORE DYNAMIC 420 START Tensione 12 - 24 V Monofase 230V Potenza carica 1,6 Kw Potenza avviamento 10 Kw Corrente di carica 50 A 4 Posizioni di regolazione Per batterie da 20 - 1000 Ah Dim. 305x360x630 Peso Kg. 16,9</p> <p>790829317 - - conf. 1 - € 502,00</p>
  <p>CARICABATTERIA E AVVIATORE DYNAMIC 520 START Tensione 12 - 24 V Monofase 230V Potenza carica 1,6 Kw Potenza avviamento 10 Kw Corrente di carica 50 A 4 Posizioni di regolazione Per batterie da 20 - 1000 Ah Dim. 365x460x755 Peso Kg. 21</p> <p>790829318 - - conf. 1 - € 588,00</p>	  <p>CARICABATTERIA E AVVIATORE DYNAMIC 620 START Tensione 12-24 V Monofase 230V Potenza carica 2 Kw Potenza avviamento 10 Kw Corrente di carica 70 A 4 Posizioni di regolazione Per batterie da 20 -1550 Ah Dim. 365x460x750 Peso Kg. 25</p> <p>790829308 - - conf. 1 - € 686,00</p>
  <p>CARICABATTERIA E MANTENITORE DI CARICA CE-BC 2 M Tensione 12V Batterie adatte 3 Ah Fino a 60 Ah</p> <p>4761002215 - - conf. 1 - € 36,00</p>	  <p>AVVIATORE PORTATILE DRIVE 9000 - 12V Avviatore portatile d'emergenza multifunzione per moto, auto, camper, etc. È dotato di: -Due uscite USB 1A-2,1A per la carica di dispositivi elettronici (tablet, smartphone, MP3, etc) -Due uscite a 12/19V per l'alimentazione di laptop -Due lampade di emergenza a led Utilizza celle a polimeri di litio Completo di cavi di avviamento, vari connettori per dispositivi mobili, spina accendisigari e alimentatore di rete.</p> <p>790829565 - - conf. 1 - € 177,64</p>
  <p>MANTENITORE DI CARICA INTELLIGENTE PROTETTORE 8 6-12V Con controllo elettronico della corrente di carica, interruzione e ripristino automatico (TRONIC), per accumulatori al piombo a 6/12V di tipo WET, GEL, AGM: SPIRAL/MF, START-STOP. Riconoscimento automatico della tensione di batteria 6/12V segnalazione a led della carica, fine carica protezione cortocircuito uscita o inversione polarità.</p> <p>790807553 - - conf. 1 - € 34,16</p>	  <p>CARICABATTERIA T-CHARGE 12 Tensione 12 - 24 V Monofase 230 V Potenza 55 Watt Controllo elettronico della corrente di carica Corrente di carica 4 A 3 Posizioni di regolazione Per batterie da 2 - 70 Ah Dim. 170x65x35 Peso Kg. 0,6</p> <p>790807560 - - conf. 1 - € 77,66</p>
  <p>CONVERTER 310 CON 2 PORTE USB Convertitore e inverter Ideale per alimentare apparecchiature elettriche (TV, rasoi, computer...) in auto o in camper. Tensione entrata 12V Tensione uscita 230V Potenza 300 W Freq. Uscita: 50 Hz Dim: 172x85x52 Peso: 0,764 Kg Cavo e pinze di collegamento batteria incluse</p> <p>790829444 - - conf. 1 - € 108,80</p>	  <p>AVVIATORE PORTATILE CE-JS 8 Accumolatore di energia e dispositivo di avvio di emergenza compatto Controllo Smart Cell Massima prestazione e durata della batteria Potenza sempre ottimale Doppio controllo della temperatura Illuminazione a led Funzione Power Bank Capacità batterie: 3x2500 mAh Tensione: 12 V Corrente di avviamento: 200-400 A Attacco USB: 5V/2A + 5V/3A Durata della carica: 1,8</p> <p>4761091511 - - conf. 1 - € 134,40</p>
  <p>SALDATRICE MARTE 150 con accessori Monofase 230 V Potenza 2,5 Kw Campo regolaz. 30-100 A. Elettrodi Ø 1,6 - 2,5 mm Dim. 315x175x250 Peso Kg. 11,3</p> <p>790809039 - - conf. 1 - € 159,74</p>	  <p>SALDATRICE INVERTER FORCE 125 con accessori Monofase 230 V Potenza 2,3 Kw Campo regolaz. 10 - 80 A Ciclo di lavoro 50% @ 80 A Elettrodi Ø 1,6 - 2,5 mm Dim. 310x120x225 Peso Kg. 3,6 In scatola cartone</p> <p>790815872 - - conf. 1 - € 208,00</p>



SALDATRICE INVERTER FORCE 145 Completa di maschera TIGER e accessori per la saldatura MMA Monofase 230 v Potenza 3,5Kw Campo regolaz. 10 - 130 A Ciclo di lavoro 60% @ 125 A Elettrodi util. 1,6 - 3,2 Dim.300x225x125 Maschera con filtro di protezione a chiusura manuale 10 DIN Peso 4,5 Kg

790815862 -
- conf. 1 - € 310,00



SALDATRICE INVERTER FORCE 165 Completa di maschera AUTOMATICA e accessori per la saldatura MMA Monofase 230 v Potenza 4,1Kw Campo regolaz. 10 - 150 A Ciclo di lavoro 60% @ 150 A Elettrodi util. 1,6 - 4 Dim. 300x225x125 Maschera con oscuramento automatico 11 DIN Peso Kg. 4,1

790815863 -
- conf. 1 - € 382,00



SALDATRICE INVERTER FORCE 168 MPGE ad elettrodo MMA in corrente continua Raccomandato per motogeneratori Protezioni multiple MPGE Monofase 230 v Potenza 4,1 Kw Campo reg. 10 - 150 A Elettrodi util. 1,6 - 4 Dim. 380x420x170 Peso 5,5 Kg Completa di accessori per la saldatura MMA e valigetta in plastica

790816211 -
- conf. 1 - € 368,00



SALDATRICE INVERTER TECHNOMIG 150 DUAL a filo MIG-MAG/FLUX/BRAZING Utilizzabile su diversi materiali: acciaio, acciaio inox, alluminio **Tecnologia "One-Touch" per regolazione sinergica dei parametri e spessore del materiale da saldare** Con cambio polarità Regolazione lunghezza d'arco 10 curve sinergiche predisposte Protezioni multiple Tensione rete 230 v Potenza 2,8 Kw Campo reg. 20 - 150 A Dim. 460x240x360 Peso 10,1 Kg Completa di accessori: Cavo 10 mmq 1,8 mt Tw160 torcia mig 2 m Colorado 150B pinza di massa 150A

790816085 -
- conf. 1 - € 686,00



SALDATRICE INVERTER TECHNOMIG 180 DUAL a filo MIG-MAG/FLUX/BRAZING Per acciaio, inox, alluminio e saldobrasati **Tecnologia "One-Touch" per regolazione sinergica dei parametri e spessore del materiale da saldare** Con cambio polarità GASMIG-MAG/BRAZING Tensione rete 230 v Potenza 3,8 Kw Campo reg. 20 - 170 A Dim. 460x240x360 Peso 10,8 Kg Accessori compresi: Cavo 16 mmq 1,8 mt Tw180 torcia mig 2,5 m Toledo 250 pinza di massa 250A

790816051 -
- conf. 1 - € 938,00



SALDATRICE INVERTER TECNICA 171/S ad elettrodo MMA/TIG in corrente continua (DC) con innescio a striscio Protezioni multiple Tensione rete 230 v Potenza 4,2 Kw Campo reg. 10 - 150 A Ø elettrodi 1,6 - 4 mm Compatibile con motogeneratori Dim. 380x480x170 Peso 6,6 Kg Completa di accessori: Valigetta plastica Maschera saldatura Pinza portaelettrodi 300A Pinza di massa 250A

790816203 -
- conf. 1 - € 406,00



SALDATRICE INVERTER TECNICA 211/S ad elettrodo MMA/TIG in corrente continua (DC) con innescio a striscio Protezioni multiple Tensione rete 230 v Potenza 5,3 Kw Campo reg. 15 - 180 A Ø elettrodi 1,6 - 4 mm Compatibile con motogeneratori Dim. 380x480x170 Peso 6,7 Kg Completa di accessori: Valigetta plastica Maschera saldatura Pinza portaelettrodi 300A Pinza di massa 250A

790816122 -
- conf. 1 - € 472,00



MASCHERA TRIBE PER SALDATRICI MMA/MIG-MAG TIG>5A Con vetro autoscurante fisso Classe 1/1/1/2 Vetro stato luminoso 3 DIN Vetro stato oscuro 11 DIN Tempo di passaggio chiaro/scuro 0,4 ms Il filtro a cristalli liquidi LCD si oscura automaticamente e ritorna rapidamente allo stato trasparente dopo la saldatura Funzionamento a cella solare Peso 0,41 Kg

790804233 -
- conf. 1 - € 59,50



MASCHERA TIGER PER SALDATRICI MMA/MIG-MAG/TIG Con vetro fisso Vetro DIN:11 Apertura "Lift-up System" Peso 0,47 Kg

790802818 -
- conf. 1 - € 34,72



MASCHERA A CASCO S 800 EN 166 0196 CE

92091200 -
- conf. 1 - € 17,00



MASCHERA 801/R EN 166 F 0068 CE

92091000 -
- conf. 4 - € 13,20



KIT 10 FUSIBILI

790802255 - misura 10A -
- conf. 1 - € 3,72
790802256 - misura 15A -
- conf. 1 - € 3,72
790802257 - misura 20A -
- conf. 1 - € 3,72
790802265 - misura 7,5A -
- conf. 1 - € 3,72





 <p>KIT 20 FUSIBILI 790802258 - misura 30A - - conf. 1 - € 8,68 790802259 - misura 50A - - conf. 1 - € 8,68 790802260 - misura 80A - - conf. 1 - € 8,68</p> 	 <p>VETRI INCOLORI 75 x 98 mm. 1 DIN 0196 CE 92093000 - - conf. 100 - € 0,44</p> 
 <p>VETRI 75 x 98 mm. TONALITA DIN 11 1 DIN 0196 CE 92092000 - - conf. 25 - € 0,84</p> 	 <p>PINZA PORTAELETTRODI PERFECTA 5 Ø Elettrodo Max 3,2-5 mm Portata 250A 92095300 - - conf. 1 - € 26,40</p> 
 <p>PINZA PORTAELETTRODI PARVA 2 Ø Elettrodo Max 2-3,2 mm Portata 150A 92094000 - - conf. 1 - € 13,60</p> 	 <p>PINZA PORTAELETTRODI PERFECTA 3 Ø Elettrodo Max 2,5-4 mm Portata 200A 92095000 - - conf. 1 - € 27,60</p> 
 <p>MORSETTO PER MASSA NEVADA 5 Portata 400A Apertura max morsetto 95 mm 92096200 - - conf. 1 - € 25,80</p> 	 <p>MORSETTO PER MASSA NEVADA 3 Portata 300A Apertura max morsetto 73 mm 92096100 - - conf. 1 - € 13,80</p> 
 <p>MORSETTO PER MASSA NEVADA 2 Portata 200A Apertura max morsetto 58 mm 92096000 - - conf. 1 - € 10,60</p> 	 <p>CAPICORDA 92098000 - A 16 - - conf. 10 - € 2,20 92098300 - A 25 - - conf. 10 - € 2,40</p> 
 <p>CONNETTORI TEXAS 25 60974 - 12 TUV CE 92097000 - mod. maschio - - conf. 10 - € 3,20 92097500 - mod. femmina - - conf. 10 - € 3,80</p> 	 <p>ELETTRODO PER GHISA Ø 2,5 mm. 90087016 - - conf. 50 - € 2,26</p> 



<p>&M 900</p> <p>ELETTRODO PER INOX</p> <p>90087010 - Ø mm. 2 - - conf. 80 - € 0,40</p> <p>90087011 - Ø mm. 2,5 - - conf. 50 - € 0,50</p> 	<p>&M 900</p> <p>ELETTRODO RUTILE</p> <p>90086999 - Ø mm. 1,6 - - conf. 500 - € 0,13</p> <p>90087000 - Ø mm. 2 - - conf. 400 - € 0,10</p> <p>90087001 - Ø mm. 2,5 - - conf. 275 - € 0,11</p> <p>90087002 - Ø mm. 3,25 - - conf. 125 - € 0,26</p> 
<p>TELWIN</p> <p>RIDUTTORE DI PRESSIONE</p> <p>790722119 - Bombola ricaricabile - conf. 1 - € 64,46</p> <p>790722120 - Bombola a perdere - conf. 1 - € 33,48</p>  <p>BOMBOLA A PERDERE</p> <p>BOMBOLA RICARICABILE</p>	<p>TELWIN</p> <p>FILO ANIMATO NO GAS</p> <p>790802145 - Ø 1,2 - kg. 0.8 - - conf. 6 - € 22,32</p> <p>790802146 - Ø 1,2 - kg. 3.0 - - conf. 6 - € 71,88</p> <p>790802179 - Ø 0,9 - kg. 0,8 - - conf. 6 - € 19,84</p> <p>790802181 - Ø 0,8 - kg. 3.0 - - conf. 6 - € 74,36</p> <p>790802188 - Ø 0,9 - kg. 3.0 - - conf. 6 - € 68,18</p> <p>790802208 - Ø 0,8 - kg. 0.8 - - conf. 6 - € 21,08</p> 
<p>TELWIN</p> <p>BOMBOLE a perdere</p> <p>790802038 - art. CO2 - - conf. 1 - € 33,48</p> <p>790802048 - art. Argon - CO2 - - conf. 1 - € 33,48</p> <p>790802050 - art. Argon - - conf. 1 - € 34,72</p> 	

FANTON[®]
FABBRICA MATERIALE ELETTRICO

NOVITÀ
- 2021 -

OPERA **Plus**

**L'unica multipresa da incasso
con DUE PRESE UNIVERSALI
per scatola
tre moduli**





MATERIALE ELETTRICO

SFOGLIA LA CATEGORIA





  MULTIPRESA 3 Posti 2P+T 10A Spina 10A Bianca 47541000 - - conf. 1 - € 10,80	  MULTIPRESA 3 Posti 2P+T Bypass Spina 16A Bianca 47541010 - - conf. 1 - € 13,00
  MULTIPRESA 1+2 POSTI 1 presa 2P+T Bip/Schuko 2 prese 2P+T 16A Bip. Spina 16 A Lunghezza cavo: 1,5 mt Bianco 47542105 - - conf. 1 - € 9,84	  MULTIPRESA 4 Posti 2P+T 16A Bypass senza cavo Bianca 47541022 - - conf. 1 - € 7,58
  MULTIPRESA 4 Posti 2P+T 16A Bypass Shuko senza cavo Bianca 475410130 - - conf. 1 - € 12,90	  MULTIPRESA 4 Posti 2P+T Bip/Schuko Spina 16A 1,5 mt cavo Bianca 475410110 - - conf. 1 - € 16,66
  MULTIPRESA 4 Posti 2P+T Bypass Spina 16A Bianca 47541020 - - conf. 1 - € 13,04	  MULTIPRESA 4 Posti 2P+T 16A bip/st.tedesco cavo 1,5 m Interruttore bipolare luminoso 47547420 - Colore Bianco - - conf. 1 - € 8,34 47547421 - Colore Nero - - conf. 1 - € 8,34
  MULTIPRESA 4 Posti 2P+T Bip/Schuko Spina 16A Interruttore luminoso 1,5 mt cavo 475410100 - Finitura Bianco - - conf. 1 - € 20,60 475410101 - Finitura Nero - - conf. 1 - € 19,18	  MULTIPRESA 4 Posti 2P+T Bip/Schuko Spina 10A Dotata di interruttore di sicurezza on/off e limitatore termico in caso di sovraccarico superiore ai 2300W 4754101004 - - conf. 1 - € 21,68
  MULTIPRESA 4 Posti 2P+T 16A Bip/Schuko Lunghezza cavo 1,5 mt Dotata di interruttore di sicurezza on/off e limitatore termico in caso di sovraccarico superiore ai 2200W 475474204 - - conf. 1 - € 14,70	  MULTIPRESA 4 POSTI 2P+T 16A Bypass Lunghezza cavo 1,5 mt 47547400 - - conf. 1 - € 6,72



<p>FINON</p> <p>MULTIPRESA 6 Posti 2P+T Bip/Schuko Spina 16A Interruttore luminoso 1,5 mt cavo Bianca</p> <p>475410200 - - conf. 1 - € 27,14</p> 	<p>FINON</p> <p>MULTIPRESA 6 Posti 2P+T 16A bip/st.tedesco cavo 1,5 m Interruttore bipolare non luminoso</p> <p>47547430 - Colore Bianco - - conf. 1 - € 10,96 47547431 - Colore Nero - - conf. 1 - € 10,96</p> 
<p>FINON</p> <p>MULTIPRESA 6 Posti 2P+T 16 A Bipasso Lunghezza cavo 1,5 mt</p> <p>47547410 - - conf. 1 - € 8,82</p> 	<p>FINON</p> <p>MULTIPRESA 2+4 Posti 2 Posti 2P+T 16A Bipasso/Schuko 4 Posti 2P+T 16A Bipasso Con interruttore Lunghezza cavo 1,5 mt</p> <p>47549112 - - conf. 1 - € 14,70</p> 
<p>FINON</p> <p>MULTIPRESA 3+6 POSTI 2P+T 16A Con interruttore Lunghezza cavo 1,5 mt</p> <p>47549122 - - conf. 1 - € 20,80</p> 	<p>FINON</p> <p>MULTIPRESA 6 Posti 2P+T Bip/Schuko Spina 16A Interruttore luminoso 1,5 mt cavo Bianca</p> <p>475410300 - - conf. 1 - € 30,82</p> 
<p>FINON</p> <p>MULTIPRESA 4+4 Posti 2P+T 16A Bipasso 250 V Con interruttore Lunghezza cavo 1,5 mt</p> <p>47547440 - - conf. 1 - € 16,80</p> 	<p>FINON</p> <p>MULTIPRESA AD INCASSO Serie Opera Plus Doppia presa precablata 2 prese bipasso italo/tedesche Scatola a 3 moduli 2P+T 16A</p> <p>47542100 - - conf. 1 - € 16,60 47542101 - - conf. 1 - € 16,60</p> 
<p>FINON</p> <p>SCATOLA PER PLACCHE RETTANGOLARI</p> <p>47523955 - - conf. 1 - € 2,40</p> 	<p>Rosi</p> <p>MULTIPRESA 1 presa schuko bivalente 2 prese bivalenti con spina piccola 10A e interruttore limitatore Colore bianca</p> <p>90089014 - - conf. 1 - € 7,60</p> 
<p>Rosi</p> <p>MULTIPRESA 3 prese schuko bivalenti con spina piccola 10A e interruttore limitatore Colore bianca</p> <p>90089015 - - conf. 1 - € 8,00</p> 	<p>FAI</p> <p>MULTIPRESA Art. 8042 Con interruttore Colore bianco Spina: 2P+T - 16 A Prese: 4 universali 2P+T - 10/16 A 8 bivalenti 2P+T - 10/16 A Alveoli: protetti Cavo: H05VV-F 3G1 mm2 Lunghezza cavo: 1,5 mt Corpo: PPL non infiammabile Potenza massima: 2500 W Tensione nominale: 250 Vac</p> <p>90088848 - - conf. 1 - € 11,12</p> 



light UP your creativity

PRESE e MULTIPRESE

L'ampia gamma di spine elettriche e prese con diversi amperaggi e colorazioni sono progettate per i minimi ingombri e sono ideali per comporre in completa autonomia i tuoi cablaggi o le tue lampade. Le multiprese FAI Srl, da tavolo, a vista o nascoste, si prestano ad essere utilizzate in ambienti domestici o professionali, come case o uffici, rappresentando un'ottima soluzione in termini di spazio e ingombro.



light UP your creativity

LAMPADINE LED

I sistemi di illuminazione a led consentono di valorizzare gli ambienti con soluzioni personalizzate dall'elevata efficienza e versatilità di impiego. FAI Srl si presenta sul mercato con una vasta gamma di prodotti a led, con diverse destinazioni d'uso, da quello professionale a quello decorativo. Diverse soluzioni per i tuoi ambienti.



light UP your creativity

PORTALAMPADDE

L'offerta di portalampade FAI Srl si distingue per la vasta gamma di materiali e colorazioni con un buon rapporto qualità-prezzo: dai classici in materiale termoplastico, bakelite o steatite, sino a quelli più raffinati e minimali in porcellana o metallo. Vintage, moderno o minimale... i portalampade FAI Srl si adattano perfettamente a qualsiasi gusto e stile.



Via Martiri della Libertà n. 27 24040 - Misano Gera d'Adda (BG)
Tel. +39 0363 848111 - Tel.+39 0363 848500
info@fai-srl.com - fai-srl.com



ROSI
Energy for You

Produzione materiale elettrico dal 1975

Multiprese *Emilia*

NUOVA GAMMA - SPINA PICCOLA 10A

Nuova gamma di multiprese con spina 10A e limitatore di sicurezza

SPINA
PICCOLA



SPINA A 90° - 10A
Salva spazio



LIMITATORE
Limita l'assorbimento a 2300W



FORO
Pratico per il fissaggio a parete

GAMMA STANDARD

spina 16A e interruttore 2P

SPINA A 90° - 16A
Salva spazio



INTERRUTTORE
2P



FORO
Pratico per il fissaggio a parete



Tutte le **Multiprese** sono disponibili nei colori: ● Nero

Emilia



Bicolor:
Bianco/Grigio

info@rosi.it www.rosi.it

www.malfattitacchinigroup.it



  <p>MULTIPRESA Art. 8161 4 Posti Con interruttore Spina: 2P+T - 16 A Prese: 4 universali 2P+T - 10/16 A Alveoli: protetti Cavo: H05VV-F 3G1 mm2 Lunghezza cavo: 1,5 mt Corpo: PPL non infiammabile Potenza massima: 2500 W Tensione nominale: 250 Vac</p> <p>90088813 - Finitura Bianca - - conf. 1 - € 9,06 90088814 - Finitura Nera - - conf. 1 - € 9,06</p>	  <p>MULTIPRESA 4 prese schuko bivalenti con spina piccola 10A e interruttore limitatore Colore bianca</p> <p>90089016 - - conf. 1 - € 8,60</p>
  <p>MULTIPRESA Art. 8162 5 Posti Con interruttore Spina: 2P+T - 16 A Prese: 5 universali 2P+T - 10/16 A Alveoli: protetti Cavo: H05VV-F 3G1 mm2 Lunghezza cavo: 1,5 mt Corpo: PPL non infiammabile Potenza massima: 2500 W Tensione nominale: 250 Vac</p> <p>90088815 - Finitura Bianca - - conf. 1 - € 9,96 90088816 - Finitura Nera - - conf. 1 - € 9,96</p>	  <p>MULTIPRESA SALVASPAZIO Spina 2P+T 16A 4 prese 10/16A Bypass Potenza max 3500W Lunghezza cavo 1,5 mt</p> <p>90088824 - - conf. 1 - € 8,56</p>
  <p>MULTIPRESA Art. 8019 5 Posti + 2 USB Con interruttore Colore bianco Spina: 2P+T - 16 A Prese: 4 bivalenti 2P+T - 10/16 A 1 universale 2P+T - 10/16 A con interruttore protezione sovraccarico 2 connessioni USB Alveoli: protetti Cavo: H05VV-F 3G1 mm2 Lunghezza cavo: 2 mt Corpo: PPL non infiammabile Potenza massima: 2500 W Tensione nominale: 250 Vac</p> <p>90088840 - - conf. 1 - € 24,66</p>	  <p>MULTIPRESA DA TAVOLO 3 posti 3 porte USB 2 prese 10/16A bypass 1 presa bypass Schuko Lunghezza cavo 1,5 mt Con interruttore</p> <p>90088823 - - conf. 1 - € 24,66</p>
  <p>MULTIPRESA 2+4 POS LATERALE</p> <p>90088849 - - conf. 1 - € 9,86</p>	  <p>MULTIPRESA QUADRATA Art. 8067 6 Posti Con interruttore Colore bianco Spina: 2P+T - 16 A Prese: 6 universali 2P+T - 10/16 A Alveoli: protetti Cavo: H05VV-F 3G1 mm2 Lunghezza cavo: 1,5 mt Corpo: PPL non infiammabile Potenza massima: 2500 W Tensione nominale: 250 Vac</p> <p>90088826 - - conf. 1 - € 9,88</p>
  <p>MULTIPRESA MOBILE 3 Posti Prese bypass 2P+T 10 A Lunghezza cavo: 1,5 mt</p> <p>753722316 - colore Bianco - - conf. 1 - € 5,70</p>	  <p>MULTIPRESA MOBILE 3 Posti Prese bypass 2P+T 10/16A Lunghezza cavo: 1,5 mt</p> <p>753722270 - - conf. 1 - € 6,18</p>
  <p>MULTIPRESA 3 posti Prese bypass 16 A Lunghezza cavo: 1,3 mt</p> <p>753722318 - colore Bianco - - conf. 1 - € 5,80</p>	  <p>MULTIPRESA 4 Posti Prese bypass 2P+T 10/16A Lunghezza cavo: 1,5 mt</p> <p>753722271 - - conf. 1 - € 6,08</p>



<p>PRÔXE</p> <p>MULTIPRESA 4 Posti 2P+T Bip/Schuko 10/16 A Senza interruttore</p> <p>753722272 – Colore Bianca – – conf. 1 – € 9,28</p> 	<p>PRÔXE</p> <p>MULTIPRESA 4 Posti Prese bipasso 2P+T 10/16A Senza cavo</p> <p>753722225 – colore Bianco – – conf. 1 – € 3,60</p> 
<p>PRÔXE</p> <p>MULTIPRESA DA TAVOLO 4 prese bipasso 2P+T 10/16 A 1 presa schuko 10 A 2 porte USB Protezione dal sovraccarico</p> <p>753722337 – Colore Bianco – – conf. 1 – € 21,84</p> 	<p>PRÔXE</p> <p>MULTIPRESA 6 posti presa bipasso/schuko 2P+T 10/16 A con interruttore luminoso bipolare Lunghezza cavo: 1,5 mt</p> <p>753722324 – colore Bianco – – conf. 1 – € 9,80</p> 
<p>PRÔXE</p> <p>MULTIPRESA 6 Posti 2P+T Bip/Schuko 10/16 A Cavo 1,5 mt Con interruttore Disgiuntore di sicurezza</p> <p>753722273 – – conf. 1 – € 9,88</p> 	<p>FINON</p> <p>PROLUNGA Sez. 3x0,75 Presa 2P+T 10A Spina 2P+T 10A Colore nero</p> <p>47592081 – misura mt. 3 – – conf. 1 – € 7,98 47592181 – misura mt. 5 – – conf. 1 – € 11,06</p> 
<p>FINON</p> <p>PROLUNGA Sez. 3x1mm Presa 2P+T 10A Spina 2P+T 10A Colore nero</p> <p>47592121 – misura mt. 3 – – conf. 1 – € 9,14 47592201 – misura mt. 5 – – conf. 1 – € 12,56</p> 	<p>FINON</p> <p>PROLUNGA Sez. 3x0,75 Presa 2p+T 10A Spina 2P+T 10A Colore bianco</p> <p>47592080 – misura mt. 3 – – conf. 1 – € 7,98 47592180 – misura mt. 5 – – conf. 1 – € 11,06</p> 
<p>FINON</p> <p>PROLUNGA Sez. 3x1mm Presa 2P+T 10A Spina 2P+T 10A Colore bianco</p> <p>47592120 – misura mt. 3 – – conf. 1 – € 9,14 47592200 – misura mt. 5 – – conf. 1 – € 12,56</p> 	<p>FINON</p> <p>PROLUNGA LINEARE Presa bipasso italo/tedesca 2P+T 16A 3mm Colore bianco</p> <p>47592650 – Misura mt. 3 – – conf. 1 – € 12,22</p> 
<p>FINON</p> <p>PROLUNGA LINEARE Bipasso Italo/tedesca 2P+T 16A 5mm Colore bianco</p> <p>47592660 – Misura mt. 5 – – conf. 1 – € 18,58</p> 	<p>FAI</p> <p>PROLUNGA Sez. 3x0,75 Art. 8086, 8087 Cavo: H05VV-F 3G0,75 mm² Spina: 2P+T – 10 A Presa: 2P+T – 10 A Alveoli: protetti Tensione nominale: 250 Vac</p> <p>90088855 – Misura mt. 3 – Colore Bianco – – conf. 1 – € 5,78 90088856 – Misura mt. 3 – Colore Nero – – conf. 1 – € 5,78 90088857 – Misura mt. 5 – Colore Bianco – – conf. 1 – € 8,42 90088858 – Misura mt. 5 – Colore Nero – – conf. 1 – € 8,42</p> 



  <p>PROLUNGA Sez. 3x1 mm Art. 8071, 8072 Cavo: H05VV-F 3G1 mm² Spina: 2P+T - 10 A Presa: 2P+T - 10 A Alveoli: protetti Tensione nominale: 250 Vac</p> <p>90088863 - Misura mt. 5 - Colore Bianco - - conf. 1 - € 8,18</p> <p>90088864 - Misura mt. 5 - Colore Nero - - conf. 1 - € 8,18</p> <p>90088865 - Misura mt. 10 - Colore Bianco - - conf. 1 - € 15,64</p> <p>90088866 - Misura mt. 10 - Colore Nero - - conf. 1 - € 15,64</p>	  <p>PROLUNGA Sez. 3x0,75 5 metri Spina: 2P+T 10A Presa: 2P+T 10A</p> <p>753722227 - Colore Bianco - - conf. 1 - € 7,22</p> <p>753722228 - Colore Nero - - conf. 1 - € 7,22</p>
  <p>PROLUNGA Sez. 3x1 mm 5 metri Spina: 2P+T - 10A Presa: 2P+T - 10A</p> <p>753722243 - Colore Bianco - - conf. 1 - € 8,44</p> <p>753722244 - Colore Nero - - conf. 1 - € 8,44</p>	  <p>PROLUNGA Lineare Sez. 3x0,75 mm 3 metri Spina e presa 2P+T 10A</p> <p>753722205 - Colore Bianco - - conf. 1 - € 5,00</p> <p>753722206 - Colore Nero - - conf. 1 - € 5,00</p>
  <p>PROLUNGA Lineare Sez. 3x1 mm 3 metri Spina: 2P+T 10 A Presa: 2P+T 10A</p> <p>753722241 - colore Bianco - - conf. 1 - € 7,00</p> <p>753722242 - colore Nero - - conf. 1 - € 7,00</p>	  <p>PROLUNGA PER RASAERBA 25 metri 3500W</p> <p>90089123 - - conf. 1 - € 35,00</p>
  <p>AVVOLGICAVO "ONDA" 15 metri 4 prese 2P+T 16A bip/st.tedesco Disgiuntore</p> <p>47514610 - Metri 15 - - conf. 1 - € 50,60</p>	  <p>AVVOLGICAVO 25 metri 4 Prese 2P+T Bipasso/ Schuko Sez. 3 x 1,5 mm Spina 16A Disgiuntore</p> <p>47514611 - Metri 25 - - conf. 1 - € 94,20</p>
  <p>AVVOLGICAVO 50 metri 4 Prese 2P+T Bipasso/ Schuko Sez. 3 x 1,5 mm Spina 16A Disgiuntore</p> <p>47514613 - Metri 50 - - conf. 1 - € 161,60</p>	  <p>AVVOLGICAVO INDUSTRIALE Lunghezza 20 metri CE IP44 2 prese 2P+T 16A 220 V CEE blu, 1 presa 2P+T 16A 220 V bip.schuko, 1 spina 2P+T 16A 220 CEE blu, con disgiuntore termico potenza max 230V cavalletto metallico - tamburo termoplastico diametro 26 cm</p> <p>47514620 - Metri 20 - conf. 1 - € 171,00</p>
  <p>AVVOLGICAVO INDUSTRIALE SERIE 4000 IP44 Spina industriale 2x 16A 3P 1x Schuko biv. Potenza 3500W Tensione 230V Disgiuntore termico Supporto metallico in acciaio zincato Cavo 3x2,5</p> <p>Sostituisce l'art. 90089144 del fornitore Rosi</p> <p>90089114 - Mt. 30 - Cavo Ø 3x2,5 - - conf. 1 - € 222,00</p>	  <p>AVVOLGICAVO Cavo: H05VV-F 3G1,5 mm² Spina: 2P+T - 16 A Prese: 4 universali 2P+T - 10/16 A Alveoli: Protetti Disgiuntore termico: presente Materiale custodia: ABS Tensione: 250 Vac Potenza max: 3000 W</p> <p>90088870 - misura mt. 15 MT - - conf. 1 - € 44,46</p> <p>90088871 - misura mt. 25 MT - - conf. 1 - € 66,34</p> <p>90088872 - misura mt. 50 MT - - conf. 1 - € 97,84</p>



  <p>AVVOLGICAVO Prese Schuko 2P+T Bipasso Sez. 3 x 1,0 mm Spina 16A Interruttore di protezione Potenza massima prelevabile a cavo svolto 3500W</p> <p>90088905 – Prese 2 – Metri 5 – – conf. 1 – € 15,82</p> <p>90088910 – Prese 4 – Metri 10 – – conf. 1 – € 23,64</p>	  <p>AVVOLGICAVO 3x1,5 mm 4 Prese 2P + P 16 A 15 metri Con disgiuntore</p> <p>753722315 – Metri 15 – – conf. 1 – € 32,76</p> <p>ESAURITO</p>
  <p>AVVOLGICAVO 3x1,5 mm 4 prese 2P+T 16 A 25 metri Con disgiuntore</p> <p>753722313 – Metri 25 – – conf. 1 – € 49,24</p> <p>AD ESAURIMENTO</p>	  <p>SPINA 2P+T 16A</p> <p>47580020 – colore Bianco – Conf. Scatola – – conf. 5 – € 1,82</p> <p>47580021 – colore Nero – Conf. Scatola – – conf. 5 – € 1,82</p>
  <p>SPINA 2P+T 10A</p> <p>47580010 – colore Bianco – Conf. Scatola – – conf. 5 – € 1,72</p> <p>47580011 – colore Nero – Conf. Scatola – – conf. 5 – € 1,72</p>	  <p>SPINA Art. 8001 2P+T 10A</p> <p>90090001 – Colore Bianco – – conf. 50 – € 0,93</p> <p>90090002 – Colore Nero – – conf. 50 – € 0,93</p>
  <p>SPINA Art. 8002 2P+T 16A</p> <p>90090005 – Colore Bianco – – conf. 50 – € 1,22</p> <p>90090006 – Colore Nero – – conf. 50 – € 1,22</p>	  <p>SPINA RIBASSATA 2P+T 10A</p> <p>47580030 – Colore Bianco – Conf. Scat. – – conf. 5 – € 1,60</p> <p>47580031 – Colore Nero – Conf. Scat. – – conf. 5 – € 1,60</p>
  <p>SPINA RIBASSATA 2P+T 16A</p> <p>47580040 – Colore Bianco – Conf. Scat. – – conf. 5 – € 1,94</p> <p>47580041 – Colore Nero – Conf. Scat. – – conf. 5 – € 1,94</p>	  <p>SPINA RIBASSATA 2P+T 16A</p> <p>753722214 – Colore Nero – – conf. 1 – € 1,38</p>
  <p>SPINA Schuko</p> <p>47580070 – Colore Bianco – Conf. Scat. – – conf. 5 – € 2,86</p> <p>47580071 – Colore Nero – Conf. Scat. – – conf. 5 – € 2,86</p>	  <p>SPINA RIBASSATA HI-PRO Colore nero</p> <p>47580101 – Spina 2P+T 10A – – conf. 25 – € 1,90</p> <p>47580111 – Spina 2P+T 16A – – conf. 25 – € 2,12</p>



<p>FINON</p> <p>PRESA MOBILE HI-PRO 2P+T 10A Colore nero 47581101 - - conf. 25 - € 2,52</p> 	<p>FINON</p> <p>PRESA 2P+T Bipasso 47581000 - Colore Bianco - Conf. Scat. - - conf. 5 - € 2,96 47581001 - Colore Nero - Conf. Scat. - - conf. 5 - € 2,96</p> 
<p>FA</p> <p>PRESA Art. 8004 2P+T 16A Alveoli protetti 90090010 - Colore Bianco - - conf. 50 - € 1,45 90090011 - Colore Nero - - conf. 50 - € 1,45</p> 	<p>PROXE</p> <p>PRESA BIPASSO 2P+T 10/16A 753722218 - Colore Nero - - conf. 1 - € 1,24</p> 
<p>PROXE</p> <p>PRESA 2P+T 10A 753722215 - Colore Bianco - - conf. 1 - € 1,44 753722216 - Colore Nero - - conf. 1 - € 1,44</p> 	<p>FINON</p> <p>ADATTATORE Spina 2P+T 10A Presa Schuko 47582120 - Colore Bianco - Conf. Scat. - - conf. 5 - € 2,50 47582121 - Colore Nero - Conf. Scat. - - conf. 5 - € 2,50</p> 
<p>FINON</p> <p>ADATTATORE Spina 2P+T 16A Bipasso/Schuko 47581050 - Colore Bianco - - conf. 5 - € 4,46 47581051 - Colore Nero - - conf. 5 - € 4,46</p> 	<p>FINON</p> <p>ADATTATORE Spina 2P+16A Presa Schuko 47582130 - Colore Bianco - Conf. Scat. - - conf. 5 - € 2,84 47582131 - Colore Nero - Conf. Scat. - - conf. 5 - € 2,84</p> 
<p>PROXE</p> <p>ADATTATORE TRIPLO 2p+T 10/16 A 2 prese bi- passo 1 presa bipasso/schuko 2P+T 10/16 A 753722303 - Colore Nero - - conf. 1 - € 2,68</p> 	<p>FINON</p> <p>ADATTATORE TRIPLO 2P+T 10A Spina 10A 47582250 - Colore Bianco - - conf. 5 - € 6,40 47582251 - Colore Nero - - conf. 5 - € 6,40</p> 
<p>FINON</p> <p>ADATTATORE TRIPLO 2P+T Bipasso Spina 16A 47582220 - Colore Bianco - - conf. 5 - € 6,84 47582221 - Colore Nero - - conf. 5 - € 6,84</p> 	<p>FINON</p> <p>ADATTATORE SPINA 2P+T 10A DOPPIA PRESA 10/16A ART. 87310 In caso di sovraccarico inter- viene prima dell'interruttore generale evitando il black-out Con interruttore automatico di sovraccarico che superati i 2300W interviene staccando automaticamente la corrente 47587310 - - conf. 1 - € 8,78</p> 



  <p>ADATTATORE TRIPLO 2P+T 10A Spina 10A 47582200 – Colore Bianco – Conf. Scat. – – conf. 5 – € 3,08 47582201 – Colore Nero – Conf. Scat. – – conf. 5 – € 3,08</p>	  <p>ADATTATORE SPINA 2P+T 16A Schuko 3 Spine 47582260 – – conf. 1 – € 8,20</p>
  <p>ADATTATORE SPINA 2P+T 10A Bipasso/Schuko 47582125 – – conf. 1 – € 4,00</p>	  <p>ADATTATORE TRIPLO 2P+T Bipasso 1 Schuko + Bipasso Spina Schuko 47582231 – Colore Nero – – conf. 5 – € 5,60</p>
  <p>ADATTATORE TRIPLO VERTIC. 2P+T Bipasso 1 Schuko+ bipasso Spina 16A BREVETTATO 47582240 – Colore Bianco – – conf. 5 – € 5,70 47582241 – Colore Nero – – conf. 5 – € 5,70</p>	  <p>ADATTATORE TRIPLO 2P+T Bipasso 1 Schuko Spina 16A 47582190 – Colore Bianco – – conf. 5 – € 4,34 47582191 – Colore Nero – – conf. 5 – € 4,34</p>
  <p>ADATTATORE TRIPLO 2P+T 10A 1 Schuko Spina 10A 47582210 – Colore Bianco – Conf. Scatola – – conf. 5 – € 3,88 47582211 – Colore Nero – Conf. Scatola – – conf. 5 – € 3,88</p>	  <p>ADATTATORE TRIPLO 2P+T Bipasso Spina 16A 47582180 – Colore Bianco – Imballo Scatola – – conf. 5 – € 4,68 47582181 – Colore Nero – Imballo Scatola – – conf. 5 – € 4,68</p>
  <p>ADATTATORE Spina Schuko Presa 2P+T Bipasso 47581090 – Colore Bianco – – conf. 5 – € 3,88 47581091 – Colore Nero – – conf. 5 – € 3,88</p>	  <p>ADATTATORE Schuko Spina 2P+T 10A Presa Schuko 16A Alveoli protetti 90090030 – Colore Bianco – – conf. 50 – € 1,54 90090031 – Colore Nero – – conf. 50 – € 1,54</p>
  <p>ADATTATORE Schuko Spina 2P+T 16A Presa Schuko 16A Alveoli protetti 90090035 – Colore Bianco – – conf. 50 – € 1,65 90090036 – Colore Nero – – conf. 50 – € 1,65</p>	  <p>ADATTATORE CON INTERRUITTORE Spina girevole: 2P+T - 16A Presa: 2 bivalenti 2P+T - 10/16A 1 universale 2P+T - 10/16A 2 USB 500 mA - 5 Vdc Alveoli: protetti Corpo: PPL non infiammabile Potenza max: 2500 W Tensione nominale: 250 Vac Art.8017/USB 90088829 – Colore BIANCO – – conf. 1 – € 5,92</p>



  <p>ADATTATORE TRIPLO SALVASPAZIO CON INTERRUTTORE Spina laterale: 2P+T - 16A Prese: 2 bivalenti 2P+T - 10/16A 1 schuko 16A Alveoli: protetti Tensione noinale: 250 Vac Art. 8116/F</p> <p>90088830 - Colore BIANCO - - conf. 1 - € 5,44</p>	  <p>ADATTATORE TRIPLO SALVASPAZIO CON PROTEZIONE DI SOVRACCARICO Spina laterale: 2P+T - 16A Prese: 2 bivalenti 2P+T - 10/16A 1 schuko 16A Alveoli: protetti Tensione nominale: 250 Vac Art. 8117/F</p> <p>90088831 - Colore BIANCO - - conf. 1 - € 6,38</p>
  <p>ADATTATORE TRIPLO 2P+T Bipasso 1 Schuko Spina 10A <i>In caso di sovraccarico interviene automaticamente il limitatore di sicurezza autoripristinabile</i></p> <p>90089010 - Colore Bianco - - conf. 25 - € 6,60</p>	  <p>ADATTATORE TRIPLO 2P+T Bipasso Spina 10A <i>In caso di sovraccarico interviene automaticamente il limitatore di sicurezza autoripristinabile</i></p> <p>90089009 - Colore Bianco - - conf. 25 - € 6,20</p>
  <p>SPINA ULTRA PIATTA Angolatura a 90° Spina: 2P+T - 10A 250 V Spessore: 6 mm</p> <p>90089017 - Colore BIANCO - - conf. 1 - € 3,20 90089018 - Colore NERO - - conf. 1 - € 3,20</p>	  <p>SPINA ULTRA PIATTA Angolatura a 90° Spina: 2P+T - 16A 250 V Spessore: 6 mm</p> <p>90089019 - Colore BIANCO - - conf. 1 - € 3,20 90089020 - Colore NERO - - conf. 1 - € 3,20</p>
  <p>ADATTATORE Spina 2P+T 10A 2 prese bipasso 2P+T 10/16 A 1 presa bipasso/schuko Protezione dal sovraccarico</p> <p>753722340 - Colore Bianco - - conf. 1 - € 6,18</p>	  <p>ADATTATORE TRIPLO USB Spina 2P+T 10A 3 prese 2P+T 10A 2 porte USB - 5V 1A</p> <p>753722321 - - conf. 1 - € 15,46</p>
  <p>ADATTATORE QUADRUPLO PIATTO 2P+T 16 A 4 prese bipasso 2P+T 10/16 A</p> <p>753722295 - Colore Bianco - - conf. 1 - € 3,60 753722296 - Colore Nero - - conf. 1 - € 3,60</p>	  <p>ADATTATORE QUADRUPLO PIATTO 2P+T 10A 4 prese</p> <p>753722306 - Colore Bianco - - conf. 1 - € 3,60 753722312 - Colore Nero - - conf. 1 - € 3,60</p>
  <p>ADATTATORE CARICATORE 3 USB Colore bianco Ingresso 100/240V-50 60Hz Max:4800mA Uscita USB verde: 2,1A Uscita USB rossa: 2,4 A</p> <p>90088825 - - conf. 1 - € 9,20</p>	  <p>SET ADATTATORI Universali da viaggio con custodia rigida</p> <p>47587881 - - conf. 1 - € 18,48</p>



<p>FINON</p> <p>ADATTATORE TRIPLO 3 prese italiane 2P+T 10A 2 prese USB 1,2A Ideale per caricare tutte le apparecchiature elettroniche (smartphone, tablet, ipod, ipad) MADE IN ITALY</p> <p>47587800 - Finitura Bianco - - conf. 1 - € 23,06 47587801 - Finitura Nero - - conf. 1 - € 23,06</p> 	<p>FINON</p> <p>SPINA CEE 220V BLU IP44 2P+T 16A</p> <p>47570100 - - conf. 1 - € 3,46</p> 
<p>FINON</p> <p>PRESA CEE 220V BLU IP44 2P+T 16A</p> <p>47571100 - - conf. 1 - € 6,40</p> 	<p>FINON</p> <p>SPINA CEE 220V BLU IP67 2P+T 16A</p> <p>47570140 - - conf. 1 - € 9,02</p> 
<p>FAI</p> <p>SPINA MOBILE INDUSTRIALE IP44 3P+T 16 A 230 Volt</p> <p>90088873 - - conf. 1 - € 3,64</p> 	<p>FAI</p> <p>PRESA MOBILE INDUSTRIALE IP44 3P+T 16 A 230 Volt</p> <p>90088874 - - conf. 1 - € 5,46</p> 
<p>FINON</p> <p>PRESA CEE 220V BLU IP67 2P+T 16A</p> <p>47571140 - - conf. 1 - € 12,22</p> 	<p>FINON</p> <p>ADATTATORE CEE INDUSTRIALE DUPLEX Spina italiana 2P+T 16A 1 presa bipasso italo/tedesca 2P+T 16A 1 presa 2P+T 16A 200-250v 6h IP44</p> <p>47573010 - - conf. 1 - € 16,10</p> 
<p>Rosi</p> <p>ADATTATORE CEE 220V 3 prese bipasso/schuko Spina blu 2P+T 16A IP20</p> <p>90089095 - - conf. 1 - € 12,60</p> 	<p>FINON</p> <p>SPINA A VITE IP44 16 A</p> <p>47570000 - Colore Blu - Modello 2P+T - - conf. 1 - € 2,68 47570010 - Colore Rossa - Modello 3P+T - - conf. 1 - € 3,88</p> 
<p>FINON</p> <p>PRESA A VITE IP44 16 A</p> <p>47571000 - Colore Blu - Modello 2P+T - - conf. 1 - € 4,34 47571010 - Colore Rossa - Modello 3P+T - - conf. 1 - € 6,02</p> 	<p>FINON</p> <p>ADATTATORE CEE 220V Presa Blu 2P+T 16A Spina 2P+T 16A</p> <p>47573000 - - conf. 1 - € 17,12</p> 



 <p>ADATTATORE INDUSTRIALE Spina 2P+T 16A 200-250V Presa bipasso italo/tedesca 2P+T 16A IP44</p> <p>47573108 - - conf. 1 - € 20,58</p> 	 <p>ADATTATORE CEE 220V Presa 2P+T Bipassa Spina Blu 2P+T 16A</p> <p>47573101 - - conf. 1 - € 19,74</p> 
 <p>CONVERTISPINA OPTIMUS Art. 73020 2P+T 16A 220V Converte la spina degli elettroutensili senza perdere la garanzia Rende sicuro il cantiere grazie alla protezione IP44 Accetta spine sia italiane che tedesche</p> <p>47573020 - - conf. 1 - € 15,30</p> 	 <p>ADATTATORE CEE 220V Presa Blu 2P+T 16A Spina Schuko</p> <p>47573001 - - conf. 1 - € 19,74</p> 
 <p>ADATTATORE CEE 220V 2 Presa 2P+T Bipasso 1 Presa Bip. + Schuko Spina Blu 2P+T 16A</p> <p>47573090 - - conf. 1 - € 17,12</p> 	 <p>ADATTATORE Spina EX 061 BLU Presa POLI V.</p> <p>47573100 - - conf. 4 - € 15,98</p> 
 <p>ADATTATORE CEE 220V 2 Presa Blu 2P+T 16A Spina Blu 2P+T 16A</p> <p>47573110 - - conf. 1 - € 43,36</p> 	 <p>ADATTATORE INDUSTRIALE Spina: 16/A Prese: 2P+T - 16/A CEE Grado protezione: IP20 Tensione: 230 Vac</p> <p>90088875 - - conf. 1 - € 8,40</p> 
 <p>ADATTATORE INDUSTRIALE Spina: 2P+T - 16/A CEE Prese: schuko bipasso Grado protezione: IP20 Tensione: 230 Vac</p> <p>90088878 - - conf. 1 - € 9,60</p> 	 <p>ADATTATORE INDUSTRIALE Spina: 2P+T - 16/A CEE Grado protezione: IP20 Tensione: 230 Vac</p> <p>90088879 - - conf. 1 - € 10,08</p> 
 <p>ADATTATORE INDUSTRIALE Spina: schuko 16/A Prese: 2P+T - 16/A CEE Grado protezione: IP20 Tensione: 230 Vac</p> <p>90088880 - - conf. 1 - € 9,90</p> 	 <p>ADATTATORE INDUSTRIALE Spina: 2P+T - 16/A CEE Prese: 2 16/A bivalente + schuko bipasso Grado protezione: IP20 Tensione: 230 Vac</p> <p>90088881 - - conf. 1 - € 11,00</p> 



 <p>MOLTIPLICATORE CEE 220V 2 Presa Blu 2P+T 16A Spina Blu 2P+T 16A 47573105 – – conf. 2 – € 44,54</p> 	 <p>MOLTIPLICATORE CEE 220V 3 Presa Blu 2P+T 16A Spina Blu 2P+T 16A 47573120 – – conf. 1 – € 53,64</p> 
 <p>MULTIPRESA INDUSTRIALE IP44 2P+T 16 A 230 Volt 90088876 – – conf. 1 – € 19,70</p> 	 <p>MULTIPRESA INDUSTRIALE IP44 3P+T 16 A 230 Volt 90088877 – – conf. 1 – € 25,00</p> 
 <p>SPINA CEE 380V ROSSA IP44 3P+T 16A 47570104 – – conf. 1 – € 5,02</p> 	 <p>PRESA CEE 380V ROSSA IP44 3P+T 16A 47571104 – – conf. 1 – € 7,76</p> 
 <p>PRESA CEE 380V ROSSA IP67 3P+N+T 16A 47571145 – – conf. 1 – € 15,52</p> 	 <p>PRESA CEE ROSSA IP67 3P+T 32A 47571164 – – conf. 1 – € 16,90</p> 
 <p>ADATTATORE CEE 380V Spina Rossa 3P+N+T 16A 1 Presa Blu 2P+T 16A 1 Presa Rossa 3P+T 16A 47573112 – – conf. 1 – € 49,08</p> 	 <p>ADATTATORE CEE 380V 2 Presa Rosse 3P+T 16A Spina Rossa 3P+T 16A 47573111 – – conf. 1 – € 45,64</p> 
 <p>SPINA CEE 380V ROSSA IP44 3P+N+T 16A 47570105 – – conf. 1 – € 6,74</p> 	 <p>SPINA CEE 380V ROSSA IP44 3P+T 32A 47570124 – – conf. 1 – € 8,56</p> 















 SPINA CEE 380V ROSSA IP44 3P+N+T 32A 47570125 - - conf. 1 - € 10,38 	 SPINA CEE 380V ROSSA IP67 3P+T 16A 47570144 - - conf. 1 - € 10,38 
 SPINA CEE 380V ROSSA IP67 3P+N+T 16A 47570145 - - conf. 1 - € 12,32 	 SPINA CEE 380V ROSSA IP67 3P+T 32A 47570164 - - conf. 1 - € 13,58 
 SPINA CEE 380V ROSSA IP67 3P+N+T 32A 47570165 - - conf. 1 - € 14,84 	 PRESA CEE 380V ROSSA IP44 3P+N+T 16A 47571105 - - conf. 1 - € 10,16 
 PRESA CEE 380V ROSSA IP44 3P+T 32A 47571124 - - conf. 1 - € 11,98 	 PRESA CEE 380V ROSSA IP44 3P+N+T 32A 47571125 - - conf. 1 - € 13,58 
 PRESA CEE 380V ROSSA IP67 3P+T 16A 47571144 - - conf. 1 - € 13,36 	 PRESA CEE 380V ROSSA IP67 3P+N+T 32A 47571165 - - conf. 1 - € 19,28 
 PROLUNGA 3 mt. 75 OHM con riduzione 47536020 - - conf. 1 - € 7,40 	 PROLUNGA TV 3 mt. 75 OHM con riduzione 47531020 - - conf. 1 - € 4,20 



  <p>PROLUNGA 3 mt. 75 OHM Spina a 90° con riduzione</p> <p>47531080 – – conf. 1 – € 4,20</p>	  <p>PROLUNGA 5 mt. – 75 OHM con riduzione</p> <p>47531040 – – conf. 1 – € 4,80</p>
  <p>PROLUNGA 2 mt. 75 OHM Spina a 90° con riduzione</p> <p>47531060 – – conf. 1 – € 3,40</p>	  <p>PROLUNGA TV Cavo Coax Spina dritta Ø 9,5 mm Lunghezza cavo 3 mt</p> <p>753722248 – Colore Bianco – – conf. 1 – € 3,40</p>
  <p>SPINA TV Dritta Ø 9,5 Blister 2 pz.</p> <p>47537000 – – conf. 1 – € 3,60</p>	  <p>SPINA+PRESA TV Dritta Ø 9,5</p> <p>47537020 – – conf. 1 – € 3,60</p>
  <p>BLISTER 2 Pz. SPINE TV a squadra</p> <p>47537040 – – conf. 1 – € 3,60</p>	  <p>BLISTER ADATTATORE Triplo TV</p> <p>47537060 – – conf. 1 – € 8,40</p>
  <p>SPINA TV Dritta Ø 9,5</p> <p>47532000 – – conf. 10 – € 0,74</p>	  <p>PRESA TV Dritta Ø 9,5</p> <p>47532020 – – conf. 10 – € 0,80</p>
  <p>SPINA TV a squadra</p> <p>47532040 – – conf. 10 – € 1,08</p>	  <p>ADATTATORE Triplo TV</p> <p>47532060 – – conf. 10 – € 4,20</p>



<p>FINON</p> <p>PRESA COASSIALE A SQUADRA per cavo Ø max 7 mm.</p> <p>47532050 - - conf. 10 - € 1,08</p> 	<p>PRÔXE</p> <p>ADATTATORE TRIPLO TV DA SPINA Ø 9,5 mm a due prese Ø 9,5 mm</p> <p>753722255 - colore Bianco - Conf. Sacchetto - - conf. 1 - € 0,62</p> 
<p>PRÔXE</p> <p>PRESA COASSIALE TV A SQUADRA Ø 9,5 mm per cavo Ø max 6,5 mm</p> <p>753722654 - colore Bianco - Conf. Sacchetto - - conf. 1 - € 0,42</p> 	<p>PRÔXE</p> <p>PRESA ANGOLARE Ø 9,5 mm</p> <p>753722319 - colore Bianco - Conf. Sacchetto - - conf. 1 - € 0,50</p> 
<p>PRÔXE</p> <p>SPINA COASSIALE TV A SQUADRA Ø 9,5 mm per cavo Ø max 6,5 mm</p> <p>753722254 - colore Bianco - Conf. Sacchetto - - conf. 1 - € 0,42</p> 	<p>PRÔXE</p> <p>PRESA COASSIALE TV DRITTA Ø 9,5 mm per cavo Ø max 6,5 mm</p> <p>753722253 - Colore Bianco - Conf. Sacchetto - - conf. 1 - € 0,42</p> 
<p>FINON</p> <p>CAVO "SCART 1,5 mt. 21 poli</p> <p>47531100 - - conf. 1 - € 7,00</p> 	<p>PRÔXE</p> <p>CAVO PER COLLEGAMENTO TV - VIDEO 2 spine scart 21 pin Cavo 1,5 mt.</p> <p>753722251 - Colore Nero - Conf. Cardboard+polybag - - conf. 1 - € 2,58</p> 
<p>FA</p> <p>PORTALAMPADA Attacco E27 Art. 0165 - bianco Art. 0165/N - nero in resina termoindurente Camicia: liscia Tensione nominale: 250 Vac Morsetti: a vite per cavi rigidi o flessibili da 0,5 + 2,5 mm² Fissaggio: con foro filettato M10x1 Ø 40,5 mm</p> <p>90088943 - Colore Bianco - - conf. 10 - € 0,81 90088944 - Colore Nero - - conf. 10 - € 0,56</p> 	<p>FA</p> <p>PORTALAMPADA Attacco E14 Art. 0166 - bianco Art. 0166/N - nero in resina termoindurente Camicia: liscia Tensione nominale: 250 Vac Morsetti: a vite per cavi rigidi o flessibili da 0,5 + 2,5 mm² Fissaggio: con foro filettato M10x1 Ø 27 mm</p> <p>90088941 - Colore Bianco - - conf. 10 - € 0,75 90088942 - Colore Nero - - conf. 10 - € 0,56</p> 
<p>FA</p> <p>MORSETTI ISOLATI Stecca 10 poli Art. 7331, 7332, 7333, 7334 Volanti A cappuccio In policarbonato Corpo: mopen e policarbonato autoestinguente Morsetto: ottone (OT58) Vite serrafilo: frenata Tensione nominale: 450 Vac</p> <p>90088923 - Sezione mm. 2,5 - - conf. 10 - € 1,26 90088924 - Sezione mm. 4 - - conf. 10 - € 1,44 90088925 - Sezione mm. 6 - - conf. 10 - € 1,68 90088926 - Sezione mm. 10 - - conf. 5 - € 2,88</p> 	<p>FA</p> <p>MORSETTI ISOLATI Stecca 12 poli Art. 7400/025, 7400/040, 7400/060 Passanti In policarbonato Corpo: mopen e policarbonato autoestinguente Morsetto: ottone Vite serrafilo: frenata Tensione nominale: 450 Vac</p> <p>90088932 - Sezione mm. 2,5 - - conf. 10 - € 1,12 90088933 - Sezione mm. 4 - - conf. 10 - € 1,24</p> 



NUOVO

DURACELL® OPTIMUM

FINO AL
200% EXTRA DURATA*
EXTRA POTENZA*

PROVA LA NOSTRA POTENZA DI ULTIMA GENERAZIONE

La nuovissima batteria alcalina Duracell Optimum con una nuova formula in grado di fornire fino al **200% di EXTRA DURATA** in alcuni dispositivi o di **EXTRA POTENZA** in altri* ed è disponibile nei formati AA e AAA.



*Offre: Extra Durata rispetto alla Durata Media Minima del test IEC AA 2015 (www.iec.ch) della Fotocamera Digitale O Extra Potenza in una vasta gamma di dispositivi rispetto alla migliore alcalina AA Duracell successiva. I risultati possono variare in base al dispositivo o alle modalità di utilizzo. Per maggiori informazioni: www.Duracell.info.

SCOPRI ANCHE LE NOSTRE BATTERIE SPECIALISTICHE CON TECNOLOGIA BABY SECURE

AIUTA A PREVENIRE LE INGESTIONI













DA OGGI con Bitrex®

LA SOSTANZA PIÙ AMARA AL MONDO CHE RICOPRE LE BATTERIE A MONETA AL LITIO (2016, 2025, 2032) SCORAGGIANDONE L'INGESTIONE DA PARTE DEI BAMBINI



*rispetto alla durata media minima nel test di rendimento secondo lo standard IEC per le batterie a moneta al litio 2032. I risultati possono variare in base al dispositivo e alle modalità di utilizzo.



<p>DURACELL</p> <p>BLISTER 4 PILE OPTIMUM STILO AA 1,5V Alkaline</p> <p>92070786 – – conf. 16 – € 4,56</p> 	<p>DURACELL</p> <p>BLISTER 4 PILE PLUS 100 STILO AA 1,5 Alkaline</p> <p>92070788 – – conf. 20 – € 3,38</p> 
<p>DURACELL</p> <p>BLISTER 4 PILE OPTIMUM MINI STILO AAA 1,5V Alkaline</p> <p>92070787 – – conf. 8 – € 4,56</p> 	<p>DURACELL</p> <p>BLISTER 4 PILE PLUS 100 MINI STILO AAA 1,5 Alkaline</p> <p>92070789 – – conf. 10 – € 3,34</p> 
<p>DURACELL</p> <p>BLISTER 2 PILE PLUS 100 MEZZA TORCIA C 1,5 Alkaline</p> <p>92070790 – – conf. 10 – € 3,34</p> 	<p>DURACELL</p> <p>BLISTER 2 PILE PLUS 100 TORCIA D 1,5 Alkaline</p> <p>92070791 – – conf. 10 – € 4,28</p> 
<p>PRÖXE</p> <p>BLISTER 4 PILE STILO AA – LR6 PROXE SELECTION 1,5V Alkaline Senza mercurio-cadmio</p> <p>753PR1500 – – conf. 10 – € 1,34</p> 	<p>PRÖXE</p> <p>BLISTER 4 PILE MINI STILO AAA – LR03 PROXE SELECTION 1,5V Alkaline Senza mercurio-cadmio</p> <p>753PR2400 – – conf. 10 – € 1,26</p> 
<p>PRÖXE</p> <p>BOX 100 PEZZI PILE MINISTILO AAA LR03 PRID2400 1,5V Alkaline battery</p> <p>753PRID2400 – – conf. 1 – € 25,20</p> 	<p>PRÖXE</p> <p>BOX 100 PEZZI PILE STILO AA LR6 PRID1500 1,5V Alkaline battery</p> <p>753PRID1500 – – conf. 1 – € 26,80</p> 
<p>PRÖXE</p> <p>BLISTER 2 PILE MEZZA TORCIA C – LR14 PROXE SELECTION 1,5V Alkaline Senza mercurio-cadmio</p> <p>753PR1400 – – conf. 6 – € 2,32</p> 	<p>PRÖXE</p> <p>BLISTER 2 PILE TORCIA D – LR20 PROXE SELECTION 1,5V Alkaline Senza mercurio-cadmio</p> <p>753PR1300 – – conf. 6 – € 2,90</p> 



PROXE

BLISTER 1 PILA TRANSISTOR 6LR61 PROXE SELECTION 9V Alkaline Senza mercurio-cadmio

753PR1604 -
- conf. 12 - € 2,00



DURACELL

BLISTER 2 PILE SPECIALI MINI AAAA MN2500 1,5V Alkaline

920394041677 -
- conf. 10 - € 2,40



DURACELL

BLISTER 1 PILA PLUS 100 TRANSISTOR 9V Alkaline

92070792 -
- conf. 10 - € 3,34



DURACELL

BLISTER 1 PILA MN27 12V - Alkaline

92070720 -
- conf. 10 - € 1,38



DURACELL

BLISTER 2 PILE MN9100 1,5V - Alkaline

92070600 -
- conf. 10 - € 2,39



DURACELL

BLISTER 2 PILE MN21 12V - Alkaline

92070700 -
- conf. 10 - € 2,47



SCOPRI ANCHE LE NOSTRE BATTERIE SPECIALISTICHE CON TECNOLOGIA BABY SECURE

AIUTA A PREVENIRE LE INGESTIONI













DA OGGI con Bitrex®

LA SOSTANZA PIÙ AMARA AL MONDO CHE RICOPRE LE BATTERIE A MONETA AL LITIO (2016, 2025, 2032) SCORAGGIANDONE L'INGESTIONE DA PARTE DEI BAMBINI















*rispetto alla durata media minima nel test di rendimento secondo lo standard IEC per le batterie a moneta al litio 2032. I risultati possono variare in base al dispositivo e alle modalità di utilizzo.















<p>DURACELL</p> <p>BLISTER 1 PILA PLUS 100 PIATTA 4,5 Alkaline</p> <p>92070793 – – conf. 10 – € 4,28</p> 	<p>DURACELL</p> <p>BLISTER 1 PILA 123A 3V – Litio</p> <p>92070729 – – conf. 10 – € 4,53</p> 
<p>DURACELL</p> <p>BLISTER 2 PILE 357 / 303 1,5 V – Silver Oxide 11,6x5,4 mm</p> <p>92070711 – – conf. 10 – € 4,33</p> 	<p>DURACELL</p> <p>BLISTER 1 PILA CR2 3V – Litio</p> <p>92070731 – – conf. 10 – € 4,12</p> 
<p>DURACELL</p> <p>BLISTER 2 PILE LR43 1,5V – Alkaline 11,6x4,2 mm</p> <p>92070701 – – conf. 10 – € 1,38</p> 	<p>DURACELL</p> <p>BLISTER 2 PILE LR44 1,5V – Alkaline 11,6 x 5,4mm</p> <p>92070710 – – conf. 10 – € 1,32</p> 
<p>DURACELL</p> <p>BLISTER 2 PILE LR54 1,5V – Alkaline 12 x 3 mm</p> <p>92070705 – – conf. 10 – € 1,38</p> 	<p>DURACELL</p> <p>BLISTER 1 PILA MN11 6V – Alkaline</p> <p>92070699 – – conf. 10 – € 1,40</p> 
<p>DURACELL</p> <p>BLISTER 2 PILA 2016 3V – Litio</p> <p>92070706 – – conf. 10 – € 2,37</p> 	<p>DURACELL</p> <p>BLISTER 2 PILA 2025 3V – Litio</p> <p>92070707 – – conf. 10 – € 2,37</p> 
<p>DURACELL</p> <p>BLISTER 1 PILA 1616 3V – Litio misura: 16x1,6mm</p> <p>92070716 – – conf. 10 – € 1,38</p> 	<p>DURACELL</p> <p>BLISTER 1 PILA 1620 3V – Litio 16 x 2,0mm</p> <p>92070717 – – conf. 10 – € 1,55</p> 



<p>DURACELL</p> <p>BLISTER 2 PILA 2032 3V - Litio</p> <p>92070708 - - conf. 10 - € 2,37</p> 	<p>DURACELL</p> <p>BLISTER 1 PILA 2430 3V - litio misura 24,5x3,1</p> <p>92070718 - - conf. 10 - € 1,96</p> 
<p>DURACELL</p> <p>BLISTER 1 PILA 2450 3V - Litio 24,5x5,1 mm</p> <p>92070719 - - conf. 10 - € 2,06</p> 	<p>DURACELL</p> <p>BLISTER 1 PILA 389/390 1,5V Silver-Oxide 11,6 x 3,5mm</p> <p>92070725 - - conf. 10 - € 3,03</p> 
<p>DURACELL</p> <p>BLISTER 1 PILA 392/384 1,5V - Silver Oxide misura: 7,9x3,6</p> <p>92070727 - - conf. 10 - € 2,16</p> 	<p>DURACELL</p> <p>BLISTER 1 PILA 371/370 1,5V - Silver Oxide misura 9,5x2,1mm</p> <p>92070722 - - conf. 10 - € 2,16</p> 
<p>DURACELL</p> <p>BLISTER 1 PILA 364 1,5V Silver oxide misura: 6,8x2,1mm</p> <p>92070721 - - conf. 10 - € 2,16</p> 	<p>DURACELL</p> <p>BLISTER 1 PILA 376/377 1,5V - Silver - Oxide 6.8 x 2,6mm</p> <p>92070723 - - conf. 10 - € 2,16</p> 
<p>DURACELL</p> <p>BLISTER 1 PILA 399 / 395 1,5V DU - Silver</p> <p>92070728 - - conf. 10 - € 2,39</p> 	<p>DURACELL</p> <p>BLISTER 1 PILA 1220 3V - litio</p> <p>92070715 - - conf. 10 - € 1,69</p> 
<p>DURACELL</p> <p>BLISTER 1 PILA CR1632 3V al litio</p> <p>92071990 - - conf. 10 - € 2,70</p> 	<p>DURACELL</p> <p>BLISTER 1 PILA 3V al litio Batteria specialistica al litio 1/3N adatta all'uso in fotocamere digitali fotocamere a telemetro e dispositivi medicali</p> <p>92070726 - - conf. 10 - € 4,74</p> 



<p>DURACELL</p> <p>BLISTER 6 PILE 10 PR70 – 1,45 V Zinc-Air Per apparecchi acustici misura Ø 5,9x3,6 mm</p> <p>92070090 – - conf. 10 – € 4,55</p> 	<p>DURACELL</p> <p>BLISTER 6 PILE 13 PR48 – 1,45 V Zinc-Air Per apparecchi acustici misura Ø 7,9x5,4 mm</p> <p>92070091 – - conf. 10 – € 4,55</p> 
<p>DURACELL</p> <p>BLISTER 6 PILE 675 PR44 – 1,45 V Zinc-Air Per apparecchi acustici misura Ø 11,6x5,4 mm</p> <p>92070092 – - conf. 10 – € 4,55</p> 	<p>DURACELL</p> <p>BLISTER 6 PILE 312 PR41 – 1,45 V Zinc-Air Per apparecchi acustici misura Ø 8x3,5 mm</p> <p>92070093 – - conf. 10 – € 4,55</p> 
<p>DURACELL</p> <p>BLISTER 2 PILE MINISTILO RICARICABILI AAA – 1,2 V – 750 mAh</p> <p>92070733 – - conf. 10 – € 6,59</p> 	<p>DURACELL</p> <p>BLISTER 2 PILE STILO RICARICABILI AA – 1,2 V – 1300 mAh</p> <p>92070734 – - conf. 10 – € 6,28</p> 
<p>PROXE</p> <p>CARICABATTERIE DURACELL Ricarica sia batterie AA che AAA Cariche in 45 minuti Approssimativamente l'85% della piena carica, quando sono caricate le batterie Duracell 1300mAh AA NiMH; Approssimativamente il 75% della piena carica, quando sono usate le batterie Duracell 750mAh AAA NiMH. Spegnimento automatico Con include batterie 2 AA e 2 AAA</p> <p>7531CEF27EU – - conf. 1 – € 35,90</p> 	<p>GROOVY.</p> <p>ESPOSITORE CON ACCESSORI 68 pezzi Contiene: 4 Supporti Auto 6 Caricatori Auto 2 USB 8 Caricatore 1 USB 6 Caricatore 2 USB 2 Caricatore Wireless 10 Cavo Type-C 10 Cavo Lightning 10 Cavo Micro Usb 2 Power Bank Micro USB+ Type C 2 Power Bank Lightning 8 Auricolari con avvolgi-cuffie</p> <p>511ESP68PCS – - conf. 1 – € 437,56</p> 
<p>GROOVY.</p> <p>CARICATORE WIRELESS Utilizzabile su tutti gli smartphone con dispositivo di carica wireless Sicuro e compatto sicollega alla rete elettrica tramite cavo micro usb non in dotazione Input 5V/1A-2A Output 5V/1A-1,5A max</p> <p>511CARWIREGRS – - conf. 5 – € 9,64</p> 	<p>GROOVY.</p> <p>CARICATORE WIRELESS Art. EP-CW026 Entrata: 5V/1A-2A (max) Uscita: 5V/1A-1,5A (max) Dispositivi compatibili: Apple iPhone 8/8plus/X, Samsung S8/S7/S6/6Edge/6Active/7/8/ Note Edge6/7/8, Google Nexus4/5/6/7, HTC Doid, DNA/HTC 8X, LG G2/G3/GPro.. Si prega sempre di verificare l'integrazione di ricarica wireless sulle caratteristiche tecniche del dispositivo prima dell'acquisto Cavo non incluso</p> <p>511WIRELESSCH – - conf. 5 – € 9,64</p> 
<p>GROOVY.</p> <p>CARICATORE SPINA MURO 4 porte USB Carica simultanea Estrema velocità Carica in serie, funzionale per chi viaggia Input 100-240 Vac 50/60 Hz Output 4,8 A</p> <p>511SPM4USBGRC – Finitura Grigio chiaro – - conf. 5 – € 14,50</p> 	<p>GROOVY.</p> <p>CARICATORE SPINA MURO Presenza di sezionatore protegge da sovratemperatura, sovratensione e sovracorrente Input 100-240 v 50/60 Hz (0,5 A max) 1 porta USB Output 1A/5v 2 porte USB Output 2,4 A/5v</p> <p>511SPM1USBGRC – Finitura Grigio chiaro – Usb 1 – - conf. 5 – € 5,78 511SPM2USBGRC – Finitura Grigio chiaro – Usb 2 – - conf. 5 – € 7,70</p> 



<p>PRÔXE</p> <p>ADATTATORE SPINA 1 PRESA USB - 10A Protezione sovra-tensione e surriscaldamento Input: AC 100-240V 50/60Hz Output: DC 5V 1A</p> <p>753722504 - - conf. 5 - € 4,58</p> 	<p>PRÔXE</p> <p>ADATTATORE SPINA 2 PRESA USB - 10A Protezione sovra-tensione e surriscaldamento Input: AC 100-240V 50/60Hz Output: DC 5V 2,1A</p> <p>753722505 - - conf. 5 - € 5,58</p> 
<p>GROOVY.</p> <p>POWER BANK MICRO USB + TYPE C Utilizzabile per dispositivi con connettore Type-C Ingombro minimo e design ultra sottile Possibilità di utilizzo durante la chiamata Cavo micro USB integrato Adattatore Type-C integrato 4000 Mah Input Dc 5v/1A Output Dc 5v/1A</p> <p>511PWBMICRGRS - - conf. 5 - € 14,50</p> 	<p>GROOVY.</p> <p>POWER BANK APPLE Ingombro minimo e design ultra sottile Possibilità di utilizzo durante la chiamata Ricaricabile con cavo Lightning 4000 Mah</p> <p>511PWBAPPLGRC - - conf. 5 - € 14,50</p> 
<p>GROOVY.</p> <p>POWER BANK 2600 mA</p> <p>511PB2602B - finitura Bianco - - conf. 5 - € 9,60 511PB2602N - finitura Nero - - conf. 5 - € 9,60</p> 	<p>GROOVY.</p> <p>CAVETTO APPLE 1.0A Carica e sincronizza tutti i modelli Apple con connettore Lightning</p> <p>511APPLE1MGRC - Finitura Grigio - Mt 1 - - conf. 5 - € 4,82 511APPLE2MGRC - Finitura Grigio - Mt 2 - - conf. 5 - € 5,78</p> 
<p>GROOVY.</p> <p>AURICOLARI TYPE-C Con avvolgitore Winder per non danneggiare il filo delle cuffie Microfono incorporato Con cavo Type-C</p> <p>511AURICTYGRC - - conf. 5 - € 9,64</p> 	<p>GROOVY.</p> <p>SUPPORTO AUTO PLASTICA 360°</p> <p>511SUPPLAST - - conf. 5 - € 4,82</p> 
<p>GROOVY.</p> <p>AURICOLARI CLASSIC Con avvolgicavo Winder per non danneggiare il filo delle cuffie Microfono incorporato Utilizzabile su tutti i dispositivi con jack di 3.5 mm</p> <p>511AURICLGRS - - conf. 5 - € 6,74</p> 	<p>GROOVY.</p> <p>AURICOLARI SPORT WIRELESS Utilizzabile per dispositivi Android e Apple Resistenza al sudore Suono di alta qualità Microfono incorporato Tempo di accensione 5-7 h</p> <p>511AURICWIRS - - conf. 1 - € 19,90</p> 
<p>GROOVY.</p> <p>CARICATORE AUTO 2 USB Presenza di sezionatore protegge da sovratemperatura, sovratensione, sovracorrente 2 porte USB Input 12-24 VDC Output 2,4 A/5 V</p> <p>511CARAUT2GRS - - conf. 5 - € 6,74</p> 	<p>GROOVY.</p> <p>AURICOLARI WIRELESS Utilizzabile per dispositivi Android e Apple Assenza di fili Design ergonomico Facilità di utilizzo Input 5V Frequenza di trasmissione 20 Hz - 20 Hz Tempo totale di stand-by: 100 Hrs Tempo di ricarica 1 h Batteria auricolare: 50 mAh</p> <p>511AURICWIR - - conf. 1 - € 57,26</p> 



<p>GROOVY.</p> <p>CAVO TYPE-C 1.0A Carica e sincronizza tutti i modelli Android di ultima generazione USB 2.0</p> <p>511TYPEC1MGRC – Finitura Grigio chiaro – Mt 1 – conf. 5 – € 6,74</p> <p>511TYPEC2MGRC – Finitura Grigio chiaro – Mt 2 – conf. 5 – € 7,70</p> 	<p>GROOVY.</p> <p>CAVO MICRO USB 1.0A Carica e sincronizza i dispositivi Android con connettore micro USB Carica macchine fotografiche digitali, rasoi elettrici e molto altro</p> <p>511MICRO1MGRC – Finitura Grigio – Mt 1 – conf. 5 – € 3,86</p> <p>511MICRO2MGRC – Finitura Grigio – Mt 2 – conf. 5 – € 4,82</p> 
<p>BOT LIGHTING</p> <p>LAMPADINA ALOGENA LINEARE Attacco R7S Dimmable Energy Saving</p> <p>310J12079ES – Cons. 120W – Resa 150W – Luce 2900K – Misura 9x79 – conf. 100 – € 2,68</p> <p>310J120ES – Cons. 120W – Resa 150W – Luce 2900K – Misura 9x119 – conf. 100 – € 2,60</p> <p>310J8079ES – Cons. 80W – Resa 100W – Luce 2900K – Misura 9x79 – conf. 100 – € 2,68</p> <p>segue...</p> 	<p>BOT LIGHTING</p> <p>continua...</p> <p>310J80ES – Cons. 80W – Resa 100W – Luce 2900K – Misura 9x119 – conf. 100 – € 2,68</p> <p>310J160ES – Cons. 160W – Resa 200W – Luce 2900K – Misura 9x119 – conf. 100 – € 2,68</p> <p>310J230ES – Cons. 230W – Resa 300W – Luce 2900K – Misura 9x119 – conf. 100 – € 2,68</p> <p>310J400ES – Cons. 400W – Resa 500W – Luce 2900K – Misura 9x119 – conf. 100 – € 2,68</p> 
<p>BOT LIGHTING</p> <p>LED LINEARI R7S 220-240V DIMMERABILE Attacco R7S Vita nominale: 25.000 ore Tempo di avvio: istantaneo</p> <p>310SLD9716X2D – Cons. 15W – Luce 3000K – 2000LM – Fascio 360° Misura 118 X 29 – conf. 1 – € 25,38</p> <p>310SLD9716X3D – Cons. 15W – Luce 4000K – 2000LM – Fascio 360° Misura 118 X 29 – conf. 1 – € 25,38</p> 	<p>BOT LIGHTING</p> <p>LED LINEARI R7S 220-240V Attacco R7S Vita nominale: 15.000 ore Tempo di avvio: istantaneo Non dimmerabile</p> <p>310SLD9610X2 – Cons. 8W – Luce 3000K – 1055LM – Fascio 360° Misura 78 X 29 – conf. 1 – € 14,64</p> 
<p>BOT LIGHTING</p> <p>STARTER NORMALE Tipo ST65 Per lampade fluorescenti lineari da 4W a 65W Misura 26-38 mm Circolari da 22W a 40W</p> <p>310ST65 – conf. 25 – € 0,58</p> 	<p>BOT LIGHTING</p> <p>STARTER Per tubi a Led</p> <p>310LTSTU2 – conf. 25 – € 1,27</p> 
<p>BOT LIGHTING</p> <p>TUBO LED IN VETRO T8 Attacco G13 Vita nominale: 25.000 ore Tempo di avvio: istantaneo Non dimmerabile</p> <p>310LT06092E – Cons. 9W – Resa 18W – Luce 3000K – 900LM – Fascio 250° Misura 600X26 – conf. 25 – € 5,90</p> <p>310LT06093E – Cons. 9W – Resa 18W – Luce 4000K – 900LM – Fascio 250° Misura 600X26 – conf. 25 – € 5,90</p> <p>310LT12182E – Cons. 18W – Resa 36W – Luce 3000K – 1850LM – Fascio 250° Misura 1200X26 – conf. 25 – € 7,96</p> <p>segue...</p> 	<p>BOT LIGHTING</p> <p>continua...</p> <p>310LT12183E – Cons. 18W – Resa 36W – Luce 4000K – 1850LM – Fascio 250° Misura 1200X26 – conf. 25 – € 7,96</p> <p>310LT15242E – Cons. 24W – Resa 58W – Luce 3000K – 2400LM – Fascio 250° Misura 1500X26 – conf. 25 – € 10,38</p> <p>310LT15243E – Cons. 24W – Resa 58W – Luce 4000K – 2400LM – Fascio 250° Misura 1500X26 – conf. 25 – € 10,38</p> 
<p>BOT LIGHTING</p> <p>LAMPADINA AD INCANDESCENZA PER FRIGORIFERI Potenza 15W Attacco E14 Luce calda 2700°K 100 Lumen Misure 58x26 mm</p> <p>310PP15MFR240 – conf. 50 – € 2,08</p> 	<p>BOT LIGHTING</p> <p>LAMPADINA AD INCANDESCENZA PER FORNI Temperatura Max 300° Potenza 15W Attacco E14 Luce calda 2700°K 80 Lumen Misure 48x22 mm</p> <p>310PP15MFF240 – conf. 50 – € 2,08</p> 

BOT LIGHTING

FOR A BRIGHT FUTURE

PER UNA MIGLIORE EFFICIENZA E CONVENIENZA
SOSTITUISCI LA TUA VECCHIA LAMPADINA
CON LE NOSTRE NUOVE SORGENTI LED

Supporter



Serie A
maschile
2019/20



Serie A
femminile
2020



GUARDA L'AMPIA GAMMA DELLE NUOVISSIME STICK LED NEL NOSTRO CATALOGO!



botlighting.it















www.malfattitacchinigroup.it



<p>BOTLIGHTING</p> <p>LAMPADINA ALOGENA MINI CHIARA Attacco G9 Dimmable Energy Saving</p> <p>310JCP33ES - Cons. 33W - Resa 40W - Luce 2900K - Misura 42x14 - conf. 100 - € 2,48</p> <p>310JCP48ES - Cons. 48W - Resa 60W - Luce 2900K - Misura 42x14 - conf. 100 - € 2,48</p> 	<p>BOTLIGHTING</p> <p>LED G9 220-240V ALL-GLASS Attacco G9 Vita nominale: 15.000 ore Tempo di avvio: istantaneo Non dimmerabile</p> <p>310SLD8704X2 - Cons. 4W - Resa 35W - Luce 3000K - 400LM - Fascio 360° Misura 58 X 16 - conf. 1 - € 9,80</p> <p>310SLD8704X3 - Cons. 4W - Resa 35W - Luce 4000K - 400LM - Fascio 360° Misura 58 X 16 - conf. 1 - € 9,80</p> 
<p>BOTLIGHTING</p> <p>LED BISPINA G4 AC/DC 12 V Attacco G4 Vita nominale: 15.000 ore Tempo di avvio: istantaneo Non dimmerabile</p> <p>310SLD8603X2 - Cons. 2,5W - Resa 25W - Luce 2700K - 250 LM - Fascio 360° Misura 46 X 13 - conf. 1 - € 10,38</p> <p>310SLD8603X3 - Cons. 2,5W - Resa 25W - Luce 4000K - 260LM - Fascio 360° Misura 46 X 13 - conf. 1 - € 10,38</p> 	<p>BOTLIGHTING</p> <p>LAMPADINA LED Attacco GU10 Vita nominale: 20.000/15.000 ore Tempo di avvio: istantaneo Non dimmerabile</p> <p>310SLD630742B - Cons. 6,5W - Resa 65W - Luce 3000K - 570LM - Fascio 60° Misura 54x50 - conf. 10 - € 3,92</p> <p>310SLD630743B - Cons. 6,5W - Resa 65W - Luce 4000K - 570LM - Fascio 60° Misura 54x50 - conf. 10 - € 3,92</p> <p>310SLD630752B - Cons. 6,5W - Resa 48W - Luce 3000K - 560LM - Fascio 110° Misura 54x50 - conf. 10 - € 3,92</p> <p>segue...</p> 
<p>BOTLIGHTING</p> <p>continua...</p> <p>310SLD630753B - Cons. 6,5W - Resa 48W - Luce 4000K - 560LM - Fascio 110° Misura 54x50 - conf. 10 - € 3,92</p> <p>310SLD630952B - Cons. 8,3W - Resa 61W - Luce 3000K - 830LM - Fascio 110° Misura 54x50 - conf. 10 - € 5,54</p> <p>310SLD630953B - Cons. 8,3W - Resa 61W - Luce 4000K - 830LM - Fascio 110° Misura 54x50 - conf. 10 - € 5,54</p> <p>310SLD630741B - Cons. 6,5W - Resa 65W - Luce 6500K - 570LM - Fascio 60° Misura 54x50 - conf. 10 - € 5,16</p> 	<p>BOTLIGHTING</p> <p>LAMPADINA LED OLIVA OPALE Attacco E14 Vita nominale: 15.000 ore Tempo di avvio: istantaneo Non dimmerabile</p> <p>310ELD2003X2 - Cons. 3W - Resa 25W - Luce 2700K - 250LM - Fascio 280° Misura 102X35 - conf. 10 - € 2,90</p> <p>310ELD2003X3 - Cons. 3W - Resa 25W - Luce 4000K - 250LM - Fascio 280° Misura 102x35 - conf. 10 - € 2,90</p> <p>segue...</p> 
<p>BOTLIGHTING</p> <p>continua...</p> <p>310ELD2006X2 - Cons. 5,3W - Resa 40W - Luce 2700K - 470LM - Fascio 280° Misura 102X35 - conf. 10 - € 3,02</p> <p>310ELD2006X3 - Cons. 5,3W - Resa 40W - Luce 4000K - 470LM - Fascio 280° Misura 102X35 - conf. 10 - € 3,02</p> <p>310ELD2010X2 - Cons. 7W - Resa 60W - Luce 2700K - 806lm - Fascio 280° Misura 110x38 - conf. 10 - € 4,84</p> <p>segue...</p> 	<p>BOTLIGHTING</p> <p>continua...</p> <p>310ELD2010X3 - Cons. 7W - Resa 60W - Luce 4000K - 806LM - Fascio 280° Misura 110x38 - conf. 10 - € 4,84</p> 
<p>BOTLIGHTING</p> <p>LAMPADINA LED GOCCIA OPALE Attacco E27 Vita nominale: 15.000 ore Tempo di avvio: istantaneo Non dimmerabile</p> <p>310ELD1007X2 - Cons. 5,5W - Resa 40W - Luce 2700K - 470LM - Fascio 240° Misura 102X60 - conf. 10 - € 2,90</p> <p>310ELD1009X2 - Cons. 8W - Resa 60W - Luce 2700K - 806LM - Fascio 240° Misura 102X60 - conf. 10 - € 3,12</p> <p>segue...</p> 	<p>BOTLIGHTING</p> <p>continua...</p> <p>310ELD1009X3 - Cons. 8W - Resa 60W - Luce 4000K - 806lm - Fascio 240° Misura 102X60 - conf. 10 - € 3,12</p> <p>310ELD1012X2 - Cons. 11,5W - Resa 75W - Luce 2700K - 1060LM - Fascio 240° Misura 120X60 - conf. 10 - € 3,82</p> <p>310ELD1012X3 - Cons. 11,5W - Resa 75W - Luce 4000K - 1060LM - Fascio 240° Misura 120X60 - conf. 10 - € 3,82</p> <p>segue...</p> 
<p>BOTLIGHTING</p> <p>continua...</p> <p>310ELD1015X2 - Cons. 13,7W - Resa 100W - Luce 2700K - 1521LM - Fascio 220° Misura 120x60 - conf. 10 - € 4,96</p> <p>310ELD1015X3 - Cons. 13,7W - Resa 100W - Luce 4000K - 1521LM - Fascio 220° Misura 120X60 - conf. 10 - € 4,96</p> <p>310ELD1016X2 - Cons. 14,5W - Resa 121W - Luce 2700K - 1921lm - Fascio 200° Misura 120X60 - conf. 10 - € 13,26</p> <p>segue...</p> 	<p>BOTLIGHTING</p> <p>continua...</p> <p>310ELD1016X3 - Cons. 14,5W - Resa 121W - Luce 4000K - 1921lm - Fascio 200° Misura 120X60 - conf. 10 - € 13,26</p> <p>310ELD1020X2 - Cons. 19W - Resa 150W - Luce 2700K - 2452lm - Fascio 200° Misura 143X67 - conf. 10 - € 13,84</p> <p>310ELD1020X3 - Cons. 19W - Resa 150W - Luce 4000K - 2452lm - Fascio 200° Misura 143X67 - conf. 10 - € 13,84</p> 















<p>BOTLIGHTING</p> <p>LAMPADINA LED GOCCIA OPALE CON SENSO-RE CREPUSCOLARE Attacco E27 Vita nominale: 25.000 ore Tempo di avvio: istantaneo Non dimmerabile Accensione automatica grazie al doppio sensore crepuscolare sul corpo della lampada</p> <p>310LEDSENS10 – Cons. 10W – Resa 75W – Luce 4000K – 1060LM – Fascio 240° Misura 120X60 – conf. 10 – € 14,42</p> 	<p>BOTLIGHTING</p> <p>LAMPADINA LED SFERA OPALE Attacco E14 Vita nominale: 15.000 ore Tempo di avvio: istantaneo Non dimmerabile</p> <p>310ELD3003X2 – Cons. 3W – Resa 25W – Luce 2700K – 250LM – Fascio 240° Misura 78X45 – conf. 10 – € 2,90</p> <p>310ELD3003X3 – Cons. 3W – Resa 25W – Luce 4000K – 250LM – Fascio 240° Misura 78X45 – conf. 10 – € 3,00 segue...</p> 
<p>BOTLIGHTING</p> <p>continua...</p> <p>310ELD3006X2 – Cons. 5W – Resa 40W – Luce 2700K – 470LM – Fascio 240° Misura 78X45 – conf. 10 – € 3,02</p> <p>310ELD3006X3 – Cons. 5W – Resa 40W – Luce 4000K – 510lm – Fascio 240° Misura 78X45 – conf. 10 – € 3,02</p> <p>310ELD3010X2 – Cons. 7,5W – Resa 60W – Luce 2700K – 806lm – Fascio 220° Misura 85X45 – conf. 10 – € 4,84 segue...</p> 	<p>BOTLIGHTING</p> <p>continua...</p> <p>310ELD3010X3 – Cons. 7,5W – Resa 60W – Luce 4000K – 806lm – Fascio 220° Misura 85X45 – conf. 10 – € 4,84</p> 
<p>BOTLIGHTING</p> <p>LAMPADINA LED SFERA OPALE Attacco E27 Vita nominale: 15.000 ore Tempo di avvio: istantaneo Non dimmerabile</p> <p>310ELD3103X2 – Cons. 3W – Resa 25W – Luce 2700K – 250LM Misura 74X45 – conf. 10 – € 2,90</p> <p>310ELD3103X3 – Cons. 3W – Resa 25W – Luce 4000K – 250LM Misura 74X45 – conf. 10 – € 2,90 segue...</p> 	<p>BOTLIGHTING</p> <p>continua...</p> <p>310ELD3106X2 – Cons. 5W – Resa 40W – Luce 2700K – 470LM Misura 74X45 – conf. 10 – € 3,02</p> <p>310ELD3110X2 – Cons. 7,5W – Resa 60W – Luce 4000K – 806LM Misura 84X45 – conf. 10 – € 4,84 segue...</p> 
<p>BOTLIGHTING</p> <p>continua...</p> <p>310ELD3110X3 – Cons. 7,5W – Resa 60W – Luce 4000K – 806LM Misura 84X45 – conf. 10 – € 4,84</p> 	<p>BOTLIGHTING</p> <p>LAMPADINA LED GLOBO 120 OPALE Attacco E27 Vita nominale: 20000 ore Tempo di avvio: istantaneo Non dimmerabile</p> <p>310SLD4115X2B – Cons. 15W – Resa 100W – Luce 2700K – 1521LM – conf. 6 – € 12,92</p> <p>310SLD4121X2B – Cons. 20W – Resa 120W – Luce 2700K – 1900LM – conf. 6 – € 14,42</p> <p>310SLD4121X3B – Cons. 22W – Resa 150W – Luce 4000K – 2452LM – conf. 6 – € 14,42 segue...</p> 
<p>BOTLIGHTING</p> <p>continua...</p> <p>310SLD4115X3B – Cons. 15W – Resa 100W – Luce 4000K – 1521LM – conf. 6 – € 12,92</p> <p>310SLD4122X2B – Cons. 22W – Resa 150W – Luce 2700K – 2452LM – conf. 6 – € 18,34</p> <p>310SLD4122X3B – Cons. 22W – Resa 150W – Luce 4000K – 2452LM – conf. 6 – € 18,34</p> 	<p>BOTLIGHTING</p> <p>LAMPADINA LED OLIVA STICK Attacco E14 Vita nominale: 20.000 ore Tempo di avvio: istantaneo Non dimmerabile</p> <p>310WLD2004X2 – Cons. 4,5W – Resa 40W – Luce 2700K – 470LM – Fascio 360° Misura 97X35 – conf. 10 – € 3,70</p> <p>310WLD2006X2 – Cons. 6W – Resa 60W – Luce 2700K – 806LM – Fascio 360° Misura 97X35 – conf. 10 – € 5,32</p> 
<p>BOTLIGHTING</p> <p>LAMPADINA LED GOCCIA STICK Attacco E27 Tempo di avvio: istantaneo Vita nominale: 15.000 ore Non dimmerabile</p> <p>310WLD1008X2 – Cons. 7W – Resa 60W – Luce 2700K – 806lm – Fascio 360° Misura 104x60 – conf. 10 – € 4,04</p> <p>310WLD1010X2 – Cons. 8W – Resa 75W – Luce 2700K – 1055lm – Fascio 360° Misura 104x60 – conf. 10 – € 5,50</p> <p>310WLD1011X2 – Cons. 10W – Resa 100W – Luce 2700K – 1521lm – Fascio 360° Misura 104x60 – conf. 10 – € 7,28</p> 	<p>BOTLIGHTING</p> <p>LAMPADINA LED SFERA STICK Attacco E14 Vita nominale: 20.000 ore Tempo di avvio: istantaneo Non dimmerabile</p> <p>310WLD3004X2 – Cons. 4,5W – Resa 40W – Luce 2700K – 470lm – Fascio 360° Misura 80x45 – conf. 10 – € 3,70</p> <p>310WLD3006X2 – Cons. 6W – Resa 60W – Luce 2700K – 806LM – Fascio 360° Misura 80X45 – conf. 10 – € 5,32</p> 



<p>BOTLIGHTING</p> <p>LAMPADINA LED SFERA STICK Attacco E27 Vita nominale: 20.000 ore Tempo di avvio: istantaneo Non dimmerabile</p> <p>310WLD3104X2 – Cons. 4,5W – Resa 40W – Luce 2700K – 470lm – Fascio 360° Misura 78x45 – conf. 10 – € 3,70</p> 	<p>BOTLIGHTING</p> <p>LAMPADINA LED FIAMMA STICK Attacco E14 Vita nominale: 20.000 ore Tempo di avvio: istantaneo Non dimmerabile</p> <p>310WLD2004F2 – Cons. 4,5W – Resa 40W – Luce 2700K – 470LM – Fascio 360° Misura 123X35 – conf. 10 – € 3,70</p> 
<p>BOTLIGHTING</p> <p>LAMPADINA LED PICCOLA PERA STICK Attacco E14 Vita nominale: 15.000 ore Tempo di avvio: istantaneo Non dimmerabile</p> <p>310WLD7301X2 – Cons. 1,5W – Resa 15W – Luce 2700K – 140LM – Fascio 360° Misura 55X20 – conf. 10 – € 4,62</p> 	<p>BOTLIGHTING</p> <p>LAMPADINA LED PICCOLA PERA STICK Attacco E14 Vita nominale: 20.000 ore Tempo di avvio: istantaneo Non dimmerabile</p> <p>310WLD7102X2 – Cons. 2W – Resa 25W – Luce 2700K – 250LM – Fascio 360° Misura 63X26 – conf. 10 – € 4,84</p> 
<p>BOTLIGHTING</p> <p>LAMPADINA LED TUBOLARE T20 STICK Attacco E14 Vita nominale: 20.000 ore Tempo di avvio: istantaneo Non dimmerabile</p> <p>310WLD7204X2 – Cons. 4,5W – Resa 40W – Luce 2700K – 470LM – Fascio 360° Misura 90X20 – conf. 10 – € 7,04</p> 	<p>BOTLIGHTING</p> <p>LAMPADINA LED TORTIGLIONE STICK Attacco E14 Vita nominale: 20.000 ore Tempo di avvio: istantaneo Non dimmerabile</p> <p>310WLD2004T2 – Cons. 4,5W – Resa 40W – Luce 2700K – 470LM – Fascio 360° Misura 97X35 – conf. 10 – € 3,70</p> 
<p>BOTLIGHTING</p> <p>LAMPADINA LED TORTIGLIONE STICK SATINATA Attacco E14 Vita nominale: 20.000 ore Tempo di avvio: istantaneo Non dimmerabile</p> <p>310WLD2006T2S – Cons. 6W – Resa 60W – Luce 2700K – 806LM – Fascio 360° Misura 97X35 – conf. 10 – € 5,42</p> 	<p>BOTLIGHTING</p> <p>LAMPADINA FLUORESCENTE OLIVA OPALE Attacco E14</p> <p>310AKS9M27C – Cons. 9W – Resa 38W – Luce 2700K – Misura 110x38 – conf. 10 – € 8,60</p> 
<p>BOTLIGHTING</p> <p>LAMPADINA LED OLIVA FULL LIGHT Vita nominale: 20.000 ore Tempo di avvio: istantaneo Non dimmerabile Classe energetica A++</p> <p>310MLD2006X2 – Attacco E14 – Cons. 6W – Luce 2700K – 806LM – misura 97X35 – conf. 10 – € 5,66</p> 	<p>BOTLIGHTING</p> <p>LAMPADINA LED GOCCIA FULL LIGHT Attacco E27 Vita nominale: 20.000 ore Tempo di avvio: istantaneo Non dimmerabile</p> <p>310MLD1010X2 – Cons. 8W – Resa 75W – Luce 2700K – 1055LM – Fascio 360° Misura 104X60 – conf. 10 – € 6,00</p> <p>310MLD1011X2 – Cons. 10W – Resa 100W – Luce 2700K – 1521LM – Fascio 360° Misura 104X60 – conf. 10 – € 9,80</p> <p>310MLD1016X2 – Cons. 15W – Resa 142W – Luce 2700K – 2300LM – Fascio 360° Misura 126X70 – conf. 10 – € 14,20</p> 
<p>BOTLIGHTING</p> <p>LAMPADINA LED SFERA FULL LIGHT Attacco E14 Vita nominale: 20.000 ore Tempo di avvio: istantaneo Non dimmerabile</p> <p>310MLD3006X2 – Cons. 6W – Resa 60W – Luce 2700K – 806LM – Fascio 360° Misura 80X45 – conf. 10 – € 5,66</p> 	<p>BOTLIGHTING</p> <p>LAMPADINA LED SFERA FULL LIGHT Attacco E27 Vita nominale: 20.000 ore Tempo di avvio: istantaneo Non dimmerabile</p> <p>310MLD3106X2 – Cons. 6W – Resa 60W – Luce 2700K – 806LM – Fascio 360° Misura 78X45 – conf. 10 – € 5,66</p> 



<p>BOTLIGHTING</p> <p>LAMPADINA LED FIAMMA FULL LIGHT Attacco E14 Vita nominale: 20.000 ore Tempo di avvio: istantaneo Non dimmerabile</p> <p>310MLD2006F2 - Cons. 6W - Resa 60W - Luce 2700K - 806LM - Fascio 360° Misura 123X35 - conf. 10 - € 5,66</p> 	<p>BOTLIGHTING</p> <p>LAMPADINA LED TORTIGLIONE FULL LIGHT Attacco E14 Vita nominale: 20.000 ore Tempo di avvio: istantaneo Non dimmerabile</p> <p>310MLD2006T2 - Cons. 6W - Resa 60W - Luce 2700K - 806LM - Fascio 360° Misura 97x35 - conf. 10 - € 5,66</p> 
<p>BOTLIGHTING</p> <p>LAMPADA FLUORESCENTE NEON CIRCOLARE T8 Attacco G10Q</p> <p>310LR222T - Cons. 22W - Luce 4200K - Misura 210X30 - conf. 12 - € 5,76</p> <p>310LR322T - Cons. 32W - Luce 4200K - Misura 305X30 - conf. 12 - € 10,00</p> <p>AD ESAURIMENTO</p> 	<p>FAD</p> <p>LAMPADINA TIPO SFERA A LED E14 Alimentazione: 175-250V Durata 20.000 ore Dimensione: 45X80</p> <p>90090058 - Cons. 5W - Luce 3000K - 470LM - conf. 10 - € 2,24</p> <p>90090059 - Cons. 5W - Luce 4000K - 470LM - conf. 10 - € 2,24</p> <p>90090060 - Cons. 5W - Luce 6000K - 470LM - conf. 10 - € 2,24</p> 
<p>FAD</p> <p>LAMPADINA TIPO SFERA A LED E14 Alimentazione: 175-250V Durata 20.000 ore Dimensione: 45X92</p> <p>90090061 - Cons. 7W - Luce 3000K - 700LM - conf. 10 - € 3,52</p> <p>90090062 - Cons. 7W - Luce 4000K - 700LM - conf. 10 - € 3,52</p> <p>90090063 - Cons. 7W - Luce 6000K - 700LM - conf. 10 - € 3,52</p> 	<p>FAD</p> <p>LAMPADINA TIPO OLIVA A LED E14 Alimentazione: 175-250V Potenza: 5W Durata 20.000 ore</p> <p>90090064 - Cons. 5W - Luce 3000K - 470LM - conf. 10 - € 2,24</p> <p>90090065 - Cons. 5W - Luce 4000K - 470LM - conf. 10 - € 2,24</p> <p>90090066 - Cons. 5W - Luce 6000K - 470LM - conf. 10 - € 2,24</p> 
<p>FAD</p> <p>LAMPADINA TIPO OLIVA A LED E14 Alimentazione: 175-250V Durata 20.000 ore Dimensione: 37X105</p> <p>90090067 - Cons. 6,5W - Luce 3000K - 600LM - conf. 10 - € 3,52</p> <p>90090068 - Cons. 6,5W - Luce 4000K - 600LM - conf. 10 - € 3,52</p> <p>90090069 - Cons. 6,5W - Luce 6000K - 600LM - conf. 10 - € 3,52</p> 	<p>FAD</p> <p>LAMPADINA TIPO BULBO A LED E27 Alimentazione: 175-265V Durata 20.000 ore Dimensione: 60X109</p> <p>90090070 - Cons. 10W - Luce 3000K - 806LM - conf. 10 - € 2,70</p> <p>90090071 - Cons. 10W - Luce 4000K - 806LM - conf. 10 - € 2,70</p> <p>90090072 - Cons. 10W - Luce 6000K - 806LM - conf. 10 - € 2,70</p> 
<p>FAD</p> <p>LAMPADINA TIPO BULBO A LED E27 Alimentazione: 175-265V Potenza: 13,5W Durata 20.000 ore</p> <p>90090073 - Cons. 13,5W - Luce 3000K - 1200LM - conf. 10 - € 3,58</p> <p>90090074 - Cons. 13,5W - Luce 4000K - 1200LM - conf. 10 - € 3,58</p> <p>90090075 - Cons. 13,5W - Luce 6000K - 1200LM - conf. 10 - € 3,58</p> 	<p>FAD</p> <p>LAMPADINA TIPO BULBO A LED E27 Alimentazione: 175-250V Durata 20.000 ore Dimensioni: 60X123</p> <p>90090076 - Cons. 18W - Luce 3000K - 1700LM - conf. 10 - € 7,02</p> <p>90090077 - Cons. 18W - Luce 4000K - 1700LM - conf. 10 - € 7,02</p> <p>90090078 - Cons. 18W - Luce 6000K - 1700LM - conf. 10 - € 7,02</p> 
<p>FAD</p> <p>LAMPADINA TIPO GLOBO A LED E27 Alimentazione: 175-250V Durata 20.000 ore Dimensioni: Ø 95 mm</p> <p>90090079 - Cons. 15W - Luce 3000K - 1300LM - conf. 10 - € 8,54</p> <p>90090080 - Cons. 15W - Luce 4000K - 1300LM - conf. 10 - € 8,54</p> <p>90090081 - Cons. 15W - Luce 6000K - 1300LM - conf. 10 - € 8,54</p> 	<p>FAD</p> <p>LAMPADINA TIPO GLOBO A LED E27 Alimentazione: 175-250V Durata 20.000 ore Dimensioni: Ø 130 mm</p> <p>90090085 - Cons. 3000K - 2700LM - Luce 25W - conf. 10 - € 17,32</p> <p>90090086 - Cons. 4000K - 2700LM - Luce 25W - conf. 10 - € 17,32</p> <p>90090087 - Cons. 6000K - 2700LM - Luce 25W - conf. 10 - € 17,32</p> 



  <p>LAMPADINA TIPO GLOBO A LED E27 Alimentazione: 175-250V Potenza: 18W Durata 20.000 ore Dimensioni: Ø 120 mm</p> <p>90090082 - Cons. 18W - Luce 3000K - 1521LM - - conf. 10 - € 9,58</p> <p>90090083 - Cons. 18W - Luce 4000K - 1521LM - - conf. 10 - € 9,58</p> <p>90090084 - Cons. 18W - Luce 6000K - 1521LM - - conf. 10 - € 9,58</p>	  <p>TORCIA LED IS314 PROLED Materiale ABS Portata 15 mt Autonomia 7 ore 3 AAA non incluse</p> <p>814IS314 - - conf. 1 - € 8,22</p>
  <p>TORCIA LAVORO IS404 TRANSFORMER Materiale ABS Portata 15 m Autonomia 40 ore 3 pile AA/LR6 non incluse</p> <p>814IS404 - - conf. 1 - € 10,28</p>	  <p>TORCIA IMPULSE LED 1W Corpo in ABS e alluminio 1 High Power LED 70 Lumen Portata fino a 85 mt 10 ore di autonomia Con cinturino Resistente agli urti e alle intemperie 2 batterie AA/LR6 Batterie non incluse</p> <p>814IP05 - - conf. 6 - € 8,44</p>
  <p>TORCIA IMPULSE LED 1W Corpo in ABS e alluminio 1 High Power LED 90 Lumen Portata fino a 85 mt 35 ore di autonomia Con cinturino Resistente agli urti e alle intemperie 2 batterie D/LR20 Batterie non incluse</p> <p>814IP06 - - conf. 6 - € 12,16</p>	  <p>PENNA LUMINOSA PENLITE LED In acciaio Portata 6 m Autonomia 6 ore 2 batterie AAA/LR03 non incluse</p> <p>814PENLED05 - - conf. 1 - € 6,16</p>
  <p>TORCIA LED PORTATILE RICARICABILE 5W Antirullo e antiscivolo Batteria al piombo ricaricabile 4V 4Ah Autonomia: 5-20 h Cinghia tracolla inclusa</p> <p>Sostituisce art. 310LED15</p> <p>310LED16 - - conf. 1 - € 33,24</p>	  <p>PLAFONIERA LED TONDA BIANCA - IP20 Attacco in metallo Diffusore in tecnopolimero bianco, Design elegante e ultrasottile, Flusso luminoso uniforme Vita nominale: 25.000 ore Accensione istantanea Non dimmerabile Non adatto per luoghi umidi</p> <p>31054040 - Cons. 12W - Resa 73W - Luce 3000K - 1020LM - Fascio 120° Misura Ø280X60 - - conf. 1 - € 17,76</p> <p>31054042 - - conf. 1 - € 21,56</p>
  <p>PLAFONIERA STAGNA VUOTA - IP65 Per tubi Led, Plafoniera in materiale termoplastico, Fornita senza alimentatore e tubi led Non dimmerabile Adatto per luoghi umidi</p> <p>31053020 - N° TUBI 1 - Misura 86X655X72 - - conf. 1 - € 15,48</p> <p>31053024 - N° TUBI 2 - Misura 86X1265X115 - - conf. 1 - € 32,84</p> <p>31053025 - N° TUBI 2 - Misura 110X1570X60 - - conf. 1 - € 40,84</p>	  <p>PLAFONIERA LED INDUSTRIALE IP65 Potenza 48 W Luce 4000 K Kit di montaggio incluso Dimensione: 1480x96x86 mm</p> <p>90088850 - - conf. 1 - € 63,70</p>
  <p>FARO RICARICABILE A LED Da esterno IP44 Alimentazione 230V 50Hz / 5V-200mA 350 Lumen Potenza 5 W Autonomia 5 ore Durata 30.000 h Dimensioni: 208x144x162 mm</p> <p>814IR6665W - - conf. 1 - € 45,12</p>	  <p>FARO LED MOD. LIGHT PAD Da esterno IP64 6500 K Led con tecnologia SMD Corpo slim Materiale: ABS e alluminio</p> <p>814IS755 - Potenza 30W - Resa 250W - Lumen 2100 - - conf. 1 - € 17,00</p> <p>814IS760 - Potenza 50W - Resa 400W - Lumen 3500 - - conf. 1 - € 25,40</p>



  <p>PROIETTORE LED PADLIGHT3 Da esterno IP65 4000 K Alimentazione 220-240V 50Hz</p> <p>814IS74034K - Lumen 800 - Potenza 10 W - - conf. 1 - € 6,40</p> <p>814IS75534K - Lumen 2400 - Potenza 30 W - - conf. 1 - € 17,20</p> <p>814IS76034K - Lumen 4000 - Potenza 50 W - - conf. 1 - € 27,00</p>	  <p>FARO LED RICARICABILE 20W LED COB MOD. CYCLOP Da esterno - IP65 1200 Lumen - 6500 K Dimensioni 216x183x280 mm Batteria litio 7,4V 4400 mAh Tempo di ricarica 12h Autonomia 3h Funziona mentre è in ricarica Durata 30000h Corpo in alluminio Adattatore 12V e trasformatore inclusi</p> <p>814IR846LED - - conf. 1 - € 93,32</p>
  <p>FARO LED DOB MOD. DENVER Da esterno IP65 Vita nominale: 20.000 ore Corpo in alluminio pressofuso a design curvo nero satinato</p> <p>310DENVER10N - Potenza 12W - LUCE 4000K - 1000LM - FASCIO 120° - Misura 20X152X105 - conf. 1 - € 16,06</p> <p>310DENVER20N - Potenza 20W - LUCE 4000K - 3000LM - FASCIO 120° - Misura 30X232X155 - conf. 1 - € 35,84</p> <p>310DENVER30N - Potenza 36W - LUCE 4000K - 3000LM - FASCIO 120° - Misura 30X232X155 - conf. 1 - € 42,84</p> <p>AD ESAURIMENTO</p>	  <p>PROIETTORE LED SLIM DOB Mod. ORLANDO Da esterno IP65 - IK06 Vita nominale: 30.000 ore Tempo di avvio: istantaneo Tensione: 220-240 V Non dimmerabile Colore: Grigio grafite</p> <p>310ORLANDO30G - Cons. 30W - LUCE 4000K - 3300LM - FASCIO 100° - Misura 186 X 30 X 135 - conf. 1 - € 31,72</p> <p>310ORLANDO50G - Cons. 50W - LUCE 4000K - 5500LM - FASCIO 100° - Misura 242 X 30 X 180 - conf. 1 - € 41,86</p>
  <p>PROIETTORE LED SLIM DA LAVORO IP65 Proiettore portatile, In alluminio pressofuso e vetro temperato, Lunghezza cavo: 1,5 mt con spina standard tedesca Non dimmerabile Adatto per luoghi umidi</p> <p>31056010 - Cons. 30W - Resa 157W - Luce 4000K - 2600LM - Fascio 120° Misura 253X250X170 - conf. 1 - € 53,26</p> <p>31056011 - Cons. 50W - Resa 237W - Luce 4000K - 4200LM - Fascio 120° Misura 292X280X170 - conf. 1 - € 74,82</p>	  <p>LAMPADA OVIDEA LED EVO RICARICABILE ANTIBLACK-OUT IP 20 IRI60EVO 320 Lumen Autonomia 2 - 5 ore Batteria 3.7V 2 Ah Tempo di ricarica 5 - 7 ore Potenza d'illuminazione 4.5 W Luce 6500 K</p> <p>814IR160LED - - conf. 6 - € 35,02</p>
  <p>PUNTO LUCE LED 2 LED 0,5 W Interruttore ON/OFF Luce bianca</p> <p>814IL09LED - - conf. 12 - € 2,68</p>	  <p>LAMPADA Policarbonato con cavo 10 mt. 2 x 0,75</p> <p>47561080 - - conf. 1 - € 16,82</p>
  <p>LAMPADA DA LAVORO Riflettore e gabbia metallica Cavo 10 mt Sezione 2x0,75 mm</p> <p>753722320 - - conf. 1 - € 14,22</p>	  <p>LAMPADA Portatile Al neon 8W con cavo 5 mt. 2 x 0,75</p> <p>47562551 - - conf. 1 - € 21,34</p>
  <p>LUMINARIA Portata 10 Luci Cavo 10+1,5 m H05RN Spina franco/tedesca 2 P 16 A 25 W (a lampadina)</p> <p>47562979 - - conf. 1 - € 62,80</p>	  <p>LUMINO VOTIVO USA E GETTA Batterie incluse</p> <p>814IL01E - - conf. 12 - € 4,54</p>



PRÔXE



PRESA TELECOMANDATA CON TELECOMANDO Per attivare o disattivare a distanza via radio l'alimentazione delle apparecchiature collegate Utile per ridurre il consumo da stand-by degli elettrodomestici **Espandibile fino a 4 prese esclusivamente con Art. 710003**
Telecomando: 4 canali Trasmissione: 30 Mt.
Canale: Cambio tramite selettore (1-4) Potenza massima di utilizzo: 3600 W Batteria: Telecomando 1x A23 12V

753710001 -
- conf. 1 - € 17,10

PRÔXE



MISURATORE CONSUMO DI CORRENTE Misura il consumo di corrente la tensione elettrica e l'intensità dell'elettrodomestico collegato Controlla la potenza massima utilizzata e i tempi di funzionamento. Permette di verificare il costo dell'energia consumata Intervallo di: -Tensione: 190 - 270Vac -Misurazione intensità: 0,02 - 16A -Misurazione potenza: 45 - 4416W Potenza massima di utilizzo: 16A - 3600W Batteria: 2x1,5V - LR44/AG13

753721001 -
- conf. 1 - € 25,54

PRÔXE



PROGRAMMATORE MECCANICO GIORNALIERO Permette la programmazione di un qualsiasi elettrodomestico nel corso delle 24 ore Adatto per lampade, ventilatori, condizionatori, impianti di riscaldamento, lavatrici, lavastoviglie, etc...
Erogazione corrente continua o tramite fascia oraria
Potenza massima di utilizzo: 3500 W

753700001 -
- conf. 1 - € 5,66

PRÔXE



TRE PRESE TELECOMANDATE CON TELECOMANDO Per attivare o disattivare a distanza via radio l'alimentazione delle apparecchiature collegate Utile per ridurre il consumo da stand-by degli elettrodomestici **Espandibile fino a 4 prese esclusivamente con Art. 710001**
Telecomando: 4 canali Trasmissione: 30 Mt.
Canale: Cambio tramite selettore (1-4) Potenza massima di utilizzo: 3600 W Batteria: Telecomando 1x A23 12V

753710003 -
- conf. 1 - € 34,00

PRÔXE



PRESA ELETTRICA WI-FI CON CONTROLLO SMARTPHONE Possibilità di controllo di prese elettriche da remoto Controllabile da più dispositivi Per rete 3G/4G Notifiche status e sistema Funzione timer/countdown App dedicata per IOS/Android Dimensioni: 80x90x55 mm

753710005 -
- conf. 1 - € 27,82

PRÔXE



PROGRAMMATORE SETTIMANALE DIGITALE Con display LCD Consente di programmare il funzionamento di un elettrodomestico collegato nel corso della settimana Fino a 10 programmi ON/OFF selezionabili Funzione di programmazione casuale del timer Adatto per lampade, ventilatori, condizionatori, impianti di riscaldamento, ecc...
Alimentazione: 230Vac - 50Hz Potenza massima di utilizzo: 16A - 3600W Temperature di funzionamento: da -10°C a +40°C

753701007 -
- conf. 1 - € 14,42

PRÔXE



STAZIONE METEO CON SVEGLIA Funzioni: Orologio Calendario (mese, giorno, anno) Funzione di sveglia e snooze Misuratore umidità: dal 20% al 95% Previsione meteo Indicatore delle fasi lunari Batteria: 1 x LR1130 Precisione: ±1,5°C, ±5% Temperatura: 0°C - 70°C o 32°F - 158°F

753725010 -
- conf. 1 - € 14,42



ARTICOLI PER LA CASA

SFOGLIA LA CATEGORIA

















LA GRANDE QUALITÀ ALLA PORTATA DI TUTTI





<p>Henkel</p> <p>ARIASANA KIT Assorbiumidità Con 2 cariche da 450 gr. previene: condensa, muffe e cattivi odori</p> <p>515673932 – - conf. 1 – € 28,00</p> 	<p>Henkel</p> <p>ARIASANA RICARICA 4+1 CLASSIC Previene: Condensa, muffe e cattivi odori 450 gr. cad.</p> <p>515577436 – - conf. 1 – € 16,00</p> 
<p>Henkel</p> <p>ARIASANA AERO 360° Deumidificatore 1 ricarica inodore in omaggio 3 mesi di durata</p> <p>5151680962 – - conf. 1 – € 19,90</p> 	<p>Henkel</p> <p>RICARICA ARIASANA Pastiglia 450 gr. Per Aero 360°</p> <p>5151680958 – Modello lavanda – - conf. 12 – € 6,00 5151680991 – Modello inodore – - conf. 12 – € 6,04</p> 
<p>Henkel</p> <p>2 TAB ARIASANA AEREO 360° Ultra assorbente 2 ricariche per una durata fino a sei mesi Adatte a tutti i kit assorbiumidità per ricariche maggiori o uguali a 450 gr</p> <p>5152277589 – - conf. 12 – € 9,20</p> 	<p>Henkel</p> <p>ESPOSITORE 6 PZ ARIASANA AERO 360 +1 RICARICA Contenuto espositore: 6 kit Ariasana aero 360 1 Ricarica gratis con 1 Tab 450 gr.</p> <p>5152122449 – - conf. 1 – € 113,66</p> 
<p>Henkel</p> <p>SMUFFER PROFESSIONALE Formato 375 ml Dissolvimuffa superattivo ad azione detergente che combatte efficacemente la formazione di alghe, muffe e muschi causati dall'umidità Gradevole fragranza, Dotato di un pratico spruzzatore antigoccia.</p> <p>5152649121 – - conf. 10 – € 7,60</p> 	<p>Eco Service</p> <p>RIMUOVI TUTTO SPRAY Sgrassatore multiuso Scioglie e pulisce catrame, olio, grassi, nastri adesivi, inchiostro... Formato 400 ml</p> <p>46982410/04 – - conf. 1 – € 6,10</p> 
<p>Henkel</p> <p>ARIASANA SPRAY DISINFETTANTE Multiuso, ideale per l'ambiente, le superfici e tessuti d'arredo Formato 150 ml</p> <p>5152369446 – - conf. 12 – € 11,54</p> 	<p>Eco Service</p> <p>RINNOVA SANITARI SPRAY Smalto con speciali resine promotrici Specifico per verniciare e rinnovare oggetti in ceramica e sanitari Formato 400 ml</p> <p>46985810/04 – - conf. 6 – € 7,01</p> 
<p>Eco Service</p> <p>ARIA SPRAY Prodotto a base di propellenti sottopressione Per la rimozione di polvere e corpi estranei. Formato 400 ml</p> <p>46989110/04 – - conf. 12 – € 4,22</p> 	<p>NETTUNA</p> <p>FLACONE SPRAY KILL PLUS 100 ml Igienizza e sanitizza le mani senza usare acqua Non contiene alcool. Neutralizza batteri e virus</p> <p>70700645 – - conf. 1 – € 3,80</p> 



&M920



DETERGENTE SANITIZZANTE A IPOCLORITO DI SODIO Sanitizzante su tutte le superfici CL 131 e' un detergente igienizzante ad elevato contenuto di ipoclorito di sodio, pronto all'uso. Prodotto ad azione detergente e igienizzante contenente tensioattivi non ionici e ipoclorito di sodio, particolarmente indicato per superfici come banchi di lavoro, attrezzature e bagni presenti nelle aree del settore ristorazione e bar. CL131 Trigger 750 ml

92031078 -
- conf. 12 - € 5,00

Eco Service



DISGORGANTE LIQUIDO Per scarichi domestici lenti o ostruiti Elimina facilmente depositi di capelli, residui di cibo... Formato 1L

46961860/01 - Formato 1 L -
- conf. 12 - € 4,44

MELT



DISGORGANTE MELT Formato 750 ml Biodegradabile per oltre il 90% Non intacca plastiche, metalli, acciai, PVC, piombo, guarnizioni in gomma, ferro e non danneggia la flora e la fauna nella fossa biologica e scarichi. Sviluppa un'azione che elimina i depositi. Grazie al suo alto peso raggiunge occlusioni profonde anche in presenza di acqua.

512MELT750 -
- conf. 12 - € 5,40

MELT



DISGORGANTE MELT NO ACID LIQUIDO AD ALTA RESA Formato 1 Litro Formulato basilico ad alta concentrazione Agisce attraverso l'acqua stagnante e mantiene puliti gli scarichi eliminando la fonte dei cattivi odori Sicuro per le tubazioni

512MELT1000 -
- conf. 12 - € 4,60

Spigolli



IDRAULICO FACILE Sgorgante disotturante per scarichi Azione rapida 1000 ml

73005129 -
- conf. 12 - € 5,16

Blumen



SIDOL grazie alla sua formula più cremosa, può rimuovere lo sporco e l'ossido da acciaio, rame, cromo, ottone senza graffiare le superfici e senza lasciare aloni, garantendo una lucidatura impeccabile

255829763 - Formato 150 ml -
- conf. 6 - € 4,72
255829765 - Formato 75 ml -
- conf. 6 - € 3,30

NETTUNG



ESPOSITORE 9 PZ. TUBO SALVIETTE UMIDIFICATE Formato 40 salviette Tubo 15x20 cm Salviette in tessuto non tessuto molto resistenti Leggermente abrasive con solvente naturale ed emollienti Contengono antibatterico Testate secondo gli standard EN1276 e EN12504 Ideale per la rimozione di vernici, smalti, sigillanti, catrame, ruggine, colle, grassi, olio, grafite, inchiostri, coloranti

70700138 -
- conf. 9 - € 8,60

NETTUNG



TUBO SALVIETTE UMIDIFICATE Formato 40 salviette Tubo 15x20 cm Salviette in tessuto non tessuto molto resistenti Leggermente abrasive con solvente naturale ed emollienti Contengono antibatterico Testate secondo gli standard EN1276 e EN12504 Ideale per la rimozione di vernici, smalti, sigillanti, catrame, ruggine, colle, grassi, olio, grafite, inchiostri, coloranti

70700087 -
- conf. 6 - € 8,60

NETTUNG



ESPOSITORE 12 PZ. GEL LAVAMANI Formato 250 ml - 125 lavaggi Con microsferi naturali (pietra pomice) Con solvente specifico per la rimozione di vernici e sericina per pelle morbida pH 6.5 Ideale per la rimozione di vernici, smalti, sigillanti, catrame, ruggine, colle, grassi, olio, grafite, bitume, nero di carbone

70700725 -
- conf. 12 - € 5,60

NETTUNG



GEL LAVAMANI Formato 250 ml - 125 lavaggi Con microsferi naturali (pietra pomice) Con solvente specifico per la rimozione di vernici e sericina per pelle morbida pH 6.5 Ideale per la rimozione di vernici, smalti, sigillanti, catrame, ruggine, colle, grassi, olio, grafite, bitume, nero di carbone

70700676 -
- conf. 18 - € 5,00

NETTUNG



GEL LAVAMANI CON DOSATORE Formato 3000 ml - 750 lavaggi Con microsferi naturali (pietra pomice) Con solvente specifico per la rimozione di vernici e sericina per pelle morbida pH 6.5 Ideale per la rimozione di vernici, smalti, sigillanti, catrame, ruggine, colle, grassi, olio, grafite, bitume, nero di carbone

70700588 -
- conf. 4 - € 25,20

NETTUNG















PASTA LAVAMANI SUPER CONCENTRATA Formato 750 ml - 30 lavaggi Con microsferi sintetiche Arricchita con sericina Per uso frequente pH 9.7 Senza solventi Non ostruisce le tubature Ideale per la rimozione di grasso, olio, lubrificanti, idrocarburi, bitume, nero di carbone, ruggine, grafite

70700671 -
- conf. 12 - € 5,00







 <p>SUPPORTO A MURO TWALL PER CREMA LAVAMANI T-BOX Colore Blu Dimensioni LxHxP 81x180x240 mm Viti e tasselli inclusi</p> <p>70700451 – - conf. 1 – € 12,40</p>	 <p>RICARICA CREMA LAVAMANI T-BAG PER DISPENSER T-BIG Formato 3000 ml – 850 lavaggi Con microsfere naturali Arricchita con emollienti Per uso frequente pH 5.5 Senza solventi Ideale per la rimozione di grasso, olio, lubrificanti, idrocarburi, bitume, nero di carbone, ruggine, grafite</p> <p>70700790 – - conf. 6 – € 16,60</p>
 <p>PASTA LAVAMANI TRADIZIONALE Con microgranuli vegetali e minerali Ideale per la rimozione di tutti i tipi di sporco, meccanici, autoriparatori, metalmeccanici...</p> <p>70700001 – Formato 500 ml – - conf. 24 – € 1,96 70700002 – Formato 1000 ml – - conf. 12 – € 2,84 70700003 – Formato 5000 ml – - conf. 4 – € 10,58</p>	 <p>CREMA LAVAMANI T-BOX CON DOSATORE Formato 5000 ml – 1250 lavaggi Con microsfere naturali Arricchita con emollienti Per uso frequente pH 5.5 Senza solventi Ideale per la rimozione di grasso, olio, lubrificanti, idrocarburi, bitume, nero di carbone, ruggine, grafite</p> <p>70700324 – - conf. 4 – € 30,00</p>
 <p>CREMA LAVAMANI T-BOX CON DOSATORE Formato 3000 ml – 750 lavaggi Con microsfere naturali Arricchita con emollienti Per uso frequente pH 5.5 Senza solventi Ideale per la rimozione di grasso, olio, lubrificanti, idrocarburi, bitume, nero di carbone, ruggine, grafite</p> <p>70700320 – - conf. 4 – € 20,80</p>	 <p>ALCOVIT SANITIZZANTE IDROALCOLICO Sanitizzante per tutte le superfici A base alcolica e con cloruro di benzalconio Prodotto ad azione detergente igienizzante contenente alcool al 71% e cloruro di benzalconio. Il suo utilizzo è indicato per tavoli, banconi, sedie, maniglie porte e per le superfici che possono essere danneggiate dall'ipoclorito di sodio Trigger Formato da 750 ml</p> <p>92031076 – - conf. 12 – € 7,80</p>
 <p>ESPOSITORE POCKET GEL IGIENIZZANTE MANI Contiene 200 blister da 2,8 ml Gel igienizzante in confezioni monodose tascabili Soluzione alcolica al 70% Da utilizzare puro in assenza di acqua Ideale per ristoranti, bar, uffici. Dimensioni: 150x200x100</p> <p>92031089 – - conf. 1 – € 39,80</p>	 <p>PORTAROTOLO MURALE Art.8050 In acciaio zincato Adatto a bobine larghe 30 cm max. Dimensioni 360x310x210 Viti non incluse</p> <p>1458050 – - conf. 1 – € 21,40</p>
 <p>PORTAROTOLO A PAVIMENTO Art.8100 In acciaio zincato Adatto per bobine larghe 30 cm max Bobina carta non inclusa Dimensioni 360x420x890</p> <p>1458100 – - conf. 1 – € 31,88</p>	 <p>2 ROTOLONI ASCIUGATUTTO In ovatta nazionale Peso 2.4 kg</p> <p>93505000 – - conf. 1 – € 16,80</p>
 <p>SACCHI PER IMMUNDIZIA CON MANIGLIE Per raccolta differenziata, antigoccia, eco rigenerati, riciclabili. Per bidoni basculanti da 90 lt.</p> <p>771SP435TR – Misura 72x90cm – Colore TRASPARENTE – Spessore 35µ – N°Sacchi 15Litri 90 – conf. 24 – € 4,10</p>	 <p>SACCHI PER IMMUNDIZIA CON MANIGLIE Per raccolta differenziata, antigoccia, eco rigenerati, riciclabili. Per bidoni portaimmondizie da 110 lt.</p> <p>771SP447TR – Misura 72x110cm – Colore TRASPARENTE – Spessore 70µ – N°Sacchi 10Litri 110 – conf. 12 – € 5,76</p>



























 <p>SACCHI PER IMMUNDIZIA CON MANIGLIE Per raccolta differenziata, antigoccia, eco rigenerati, riciclabili. Per bidoni portaimmondizie da 150 lt.</p> <p>771SP465050 - Misura 95x120 - Colore GIALLO - Spes. 50µ - N°Sacchi 10Litri 150 - conf. 12 - € 5,88</p> 	 <p>SACCHI PER IMMUNDIZIA CON LACCIO per raccolta indifferenziata, antigoccia, eco rigenerati, riciclabili. Per pattumiere con pedale da 45 lt.</p> <p>771SP308018 - Misura 55x65cm - Colore NERO - Spessore 18µ - N°Sacchi 20Litri 45 - conf. 70 - € 1,39</p> 
 <p>SACCHI PER IMMUNDIZIA CON LACCIO per raccolta indifferenziata, antigoccia, eco rigenerati, riciclabili. Per bidoni portaimmondizie da 110 lt.</p> <p>771SP313030 - Misura 72x110cm - Colore NERO - Spessore 30µ - N°Sacchi 10Litri 110 - conf. 40 - € 1,93</p> <p>771SP314030 - Misura 72x110cm - Colore TRASPARENTE - Spessore 30µ - N°Sacchi 10Litri 110 - conf. 40 - € 2,64</p> <p>771SP315050 - Misura 72x110cm - Colore NERO - Spessore 50µ - N°Sacchi 10Litri 110 - conf. 25 - € 2,96</p> 	 <p>SACCHI PER IMMUNDIZIA CON LACCIO per raccolta indifferenziata, antigoccia, eco rigenerati, riciclabili. Per bidoni portaimmondizie da 140 lt.</p> <p>771SP335050 - Misura 90x120cm - Colore NERO - Spessore 50µ - N°Sacchi 10Litri 140 - conf. 16 - € 4,08</p> 
 <p>SACCHI PER IMMUNDIZIA Per calcinacci, antigoccia, riciclabili.</p> <p>771SP490BL - Misura 50x70cm - Colore BLU - Spessore 110µ - N°Sacchi 15Litri 45 - conf. 16 - € 5,60</p> <p>771SP490TR - Misura 40x70cm - Colore TRASPARENTE - Spessore 110µ - N°Sacchi 15Litri 35 - conf. 20 - € 5,50</p> 	 <p>SACCHI PER IMMUNDIZIA CON LACCIO per raccolta indifferenziata, antigoccia, eco rigenerati, riciclabili. Per bidoni portaimmondizie da 180 lt.</p> <p>771SP347070 - Misura 100x130cm - Colore NERO - Spessore 70µ - N°Sacchi 5Litri 180 - conf. 16 - € 4,72</p> 
 <p>SACCHI PER IMMUNDIZIA CON MANIGLIE Per raccolta differenziata, antigoccia, eco rigenerati, riciclabili. Per pattumiere con pedale da 45 lt.</p> <p>771SP408AZ - Misura 55x65cm - Colore AZZURRO - Spessore 18µ - N°Sacchi 15Litri 45 - conf. 60 - € 1,73</p> <p>771SP408GI - Misura 55x65cm - Colore GIALLO - Spessore 18µ - N°Sacchi 15Litri 45 - conf. 60 - € 1,73</p> <p>771SP408TR - Misura 55x65cm - Colore TRASPARENTE - Spessore 18µ - N°Sacchi 15Litri 45 - conf. 60 - € 1,73</p> <p>segue...</p> 	 <p>continua...</p> <p>771SP408VI - Misura 55x65cm - Colore VIOLA - Spessore 18µ - N°Sacchi 15Litri 45 - conf. 60 - € 1,73</p> 
 <p>SACCHI PER IMMUNDIZIA CON MANIGLIE Per raccolta differenziata, antigoccia, eco rigenerati, riciclabili. Per bidoni portaimmondizie da 110 lt.</p> <p>771SP413AZ - Misura 72x110cm - Colore AZZURRO - Spessore 30µ - N°Sacchi 10Litri 110 - conf. 30 - € 2,90</p> <p>771SP413GI - Misura 72x110cm - Colore GIALLO - Spessore 30µ - N°Sacchi 10Litri 110 - conf. 30 - € 2,90</p> <p>771SP413TR - Misura 72x110cm - Colore TRASPARENTE - Spessore 30µ - N°Sacchi 10Litri 110 - conf. 30 - € 2,90</p> <p>segue...</p> 	 <p>continua...</p> <p>771SP413VI - Misura 72x110cm - Colore VIOLA - Spessore 30µ - N°Sacchi 10Litri 110 - conf. 30 - € 2,90</p> 
 <p>SACCHI PER IMMUNDIZIA MAXI - Per grandi dimensioni Ideale per polistirolo</p> <p>771SP485035 - Misura 170x200cm - Colore TRASPARENTE - Spessore 35µ - N°Sacchi 5Litri 500 - conf. 12 - € 6,88</p> 	 <p>SACCO BIO Classico Per umido e organico Per bidoni portaimmondizie 10 lt.</p> <p>771BI42X42 - Misura 42x42cm - Spessore 12µ - N°Sacchi 15 - Litri 10Peso gr. 80 - conf. 60 - € 1,39</p> 



 <p>SACCO BIO Classico Per umido e organico Per bidoni portaimmondizie da 110 lt.</p> <p>771B170X110 - Misura 70x110cm - Spessore 15µ - N°Sacchi 10 - Litri 110Peso gr. 250 - conf. 50 - € 4,22</p> 	 <p>SACCO BIO Con manici Per umido e organico Per pattumiere da 45 lt.</p> <p>771B152X65 - Misura 52x65cm - Spessore 12µ - N°Sacchi 15 - Litri 45Peso gr. 130 - conf. 50 - € 2,60</p> 
 <p>ALZAIMMONDIZIA In lamiera zincata con manico in ferro Dimensioni: 350 x 270</p> <p>90029280 - - conf. 1 - € 8,40</p> 	 <p>PATTUMIERA CON COPERCHIO Con manico autobloccante Dimensione: 235x240x300 mm Formato 10 litri</p> <p>189BS10/M - Colore Marrone - - conf. 1 - € 7,57 189BS10/V - Colore Verde - - conf. 1 - € 7,57</p> 
 <p>ARMADIO BASSO PORTA IMMONDIZIA In polipropilene, materiale ri-ciclabile ed eco-sostenibile Dotato di cerniere in acciaio Ripiano interno regolabile Colore Grigio Dimensione: 1020x370x840 mm</p> <p>189E101/ECO - - conf. 1 - € 92,44</p> 	 <p>ARMADIO In polipropilene Materiale ri-ciclabile ed eco-sostenibile Dotato di cerniere in acciaio Colore bianco</p> <p>189S71/BT - Altezza Basso - Ripiani 1 - L 700 - P 390H 855 - conf. 1 - € 63,97 189S71/TPT - Altezza Alto - Ripiani 3 - L 700 - P 390H 1650 - conf. 1 - € 105,52</p> 
 <p>ARMADIO ALTO PORTASCOPE In polipropilene Materiale ri-ciclabile ed eco-sostenibile Dotato di cerniere in acciaio 3 ripiani più scompartimento unico Colore bianco</p> <p>189S71/PST - L 700 - P 390 - H 1650 - - conf. 1 - € 105,52</p> 	 <p>SCAFFALE In polipropilene Colore Nero</p> <p>189T60/4 - Ripiani 4 - L 600 - P 300 - H 1330 - conf. 1 - € 19,60 189T80/5 - Ripiani 5 - L 800 - P 400 - H 1760 - conf. 1 - € 39,92</p> 
 <p>SCAFFALE A BULLONI 5 ripiani Dimensioni 1000x400 Peso 16,30 kg La lamiera di spessore 5/10 con angolari in 8 pezzi spessore 15/10 30x30 mm da cm 95 giuntabili riposti all'interno della confezione unitamente agli accessori necessari e alle istruzioni per il montaggio. Realizzati nelle versioni a bullone M8 ed incastro Colore grigio scuro PRODOTTO VENDIBILE SOLO IN LOMBARDIA AI CLIENTI SERVITI DA PADRONCINO</p> <p>446ANKT1000B - - conf. 1 - € 81,20</p> 	 <p>KIT 40 BULLONI CON DADO + 4 PIEDINI PRODOTTO VENDIBILE SOLO IN LOMBARDIA AI CLIENTI SERVITI DA PADRONCINO</p> <p>446ANKB4008 - - conf. 1 - € 9,16</p> 
 <p>ANGOLARI "A" 35x35mm In acciaio Preforati per scaffalature Colore grigio martello PRODOTTO VENDIBILE SOLO IN LOMBARDIA AI CLIENTI SERVITI DA PADRONCINO</p> <p>446ANAC1976 - Lunghezza 2 metri - - conf. 4 - € 11,48 446ANAC2508 - Lunghezza 2,5 metri - - conf. 4 - € 14,48 446ANAC3040 - Lunghezza 3 metri - - conf. 4 - € 17,26</p> 	 <p>ANGOLARI "B" 35x55mm In acciaio Preforati per scffalature Colore grigio martello PRODOTTO VENDIBILE SOLO IN LOMBARDIA AI CLIENTI SERVITI DA PADRONCINO</p> <p>446ANAD1976 - Lunghezza 2 metri - - conf. 4 - € 10,58 446ANAD2508 - Lunghezza 2,5 metri - - conf. 4 - € 13,32 446ANAD3040 - Lunghezza 3 metri - - conf. 4 - € 15,86</p> 



  <p>PANNELLI PER SCAFFALATURE METALLICHE In lamiera d'acciaio Colore grigio martellato PRODOTTO VENDIBILE SOLO IN LOMBARDIA AI CLIENTI SERVITI DA PADRONCINO</p> <p>446ANPA0603 – Dimensioni 600x300 – Rinforzi no – Portata 135kg – – conf. 5 – € 7,34</p> <p>446ANPA0604 – Dimensioni 600x400 – Rinforzi no – Portata 140kg – – conf. 5 – € 11,80</p> <p>segue...</p>	  <p>continua...</p> <p>446ANPA065R1 – Dimensioni 600x500 – Rinforzi 1 – Portata 145kg – – conf. 5 – € 16,64</p> <p>446ANPA0803 – Dimensioni 800x300 – Rinforzi no – Portata 125kg – – conf. 5 – € 11,16</p> <p>446ANPA084R1 – Dimensioni 800x400 – Rinforzi 1 – Portata 135kg – – conf. 5 – € 16,54</p> <p>446ANPA085R1 – Dimensioni 800x500 – Rinforzi 1 – Portata 130kg – – conf. 5 – € 19,16</p> <p>segue...</p>
  <p>continua...</p> <p>446ANPA086R2 – Dimensioni 800x600 – Rinforzi 2 – Portata 125kg – – conf. 4 – € 18,40</p> <p>446ANPA10003 – Dimensioni 1000x300 – Rinforzi no – Portata 115kg – – conf. 5 – € 13,28</p> <p>446ANPA104R1 – Dimensioni 1000x400 – Rinforzi 1 – Portata 115kg – – conf. 5 – € 19,64</p> <p>446ANPA105R1 – Dimensioni 1000x500 – Rinforzi 1 – Portata 120kg – – conf. 5 – € 22,86</p> <p>segue...</p>	  <p>continua...</p> <p>446ANPA106R2 – Dimensioni 1000x600 – Rinforzi 2 – Portata 110kg – – conf. 5 – € 28,96</p> <p>446ANPA123R1 – Dimensioni 1200x300 – Rinforzi 1 – Portata 100kg – – conf. 5 – € 14,50</p> <p>446ANPA124R1 – Dimensioni 1200x400 – Rinforzi 1 – Portata 95kg – – conf. 5 – € 22,76</p> <p>446ANPA125R1 – Dimensioni 1200x500 – Rinforzi 1 – Portata 100kg – – conf. 5 – € 26,52</p> <p>segue...</p>
  <p>continua...</p> <p>446ANPA126R2 – Dimensioni 1200x600 – Rinforzi 2 – Portata 100kg – – conf. 4 – € 25,46</p> <p>446ANPA153R1 – Dimensioni 1500x300 – Rinforzi 1 – Portata 80kg – – conf. 5 – € 17,58</p> <p>446ANPA154R1 – Dimensioni 1500x400 – Rinforzi 1 – Portata 75kg – – conf. 5 – € 20,96</p> <p>446ANPA155R1 – Dimensioni 1500x500 – Rinforzi 1 – Portata 80kg – – conf. 4 – € 32,28</p> <p>segue...</p>	  <p>continua...</p> <p>446ANPA156R2 – Dimensioni 1500x600 – Rinforzi 2 – Portata 80kg – – conf. 4 – € 41,00</p>
  <p>PORTADISPENSER A MURO PER FLACONI Diametro contenitore 80 mm</p> <p>64650102 – – conf. 1 – € 6,00</p>	  <p>PIANTANA PER GEL DISPENSER PER FLACONI Può contenere flacone da 500 ml Altezza 1250 mm Diametro contenitore 80 mm</p> <p>64650152 – – conf. 1 – € 49,40</p>
  <p>ACCENDIFUOCO ECO Confezione 72 pezzi Non inquinante, può essere conservato illimitatamente, inodore e non tossico Per accensione di barbecue, stufe e camini</p> <p>32557652 – – conf. 1 – € 3,42</p>	  <p>ACCENDIFUOCO ECO Confezione 100 pezzi Per accensione di barbecue, stufe e camini</p> <p>32515317 – – conf. 1 – € 5,13</p>
  <p>ACCENDIFUOCO LIQUIDO - FIAMMA Formato 1 lt Per accensione di legna e carbone Non emette fumo e odori</p> <p>325095002 – – conf. 1 – € 3,91</p>	  <p>ACCENDIFUOCO DIAVOLINA Confezione 40 cubi Per accensione grill stufe e caminetti</p> <p>92089110 – – conf. 24 – € 2,46</p>

FIREVOLUTION

Come lo accendi il fuoco, oggi?









Se dici accendifuoco, dici

I prodotti per l'accensione si sono evoluti. E tu? Scopri la linea più innovativa di accendifuoco e strumenti per la pulizia e la manutenzione di stufe, caminetti e barbecue su diavolina.eu

DIAVOLINA[®]
FUOCO 

diavolina.eu













<p>DIAVOLINA</p> <p>ACCENDIFUOCO ECOLOGICO DIAVOLINA 28 accensioni Ecologico e pulito</p> <p>92089115 – – conf. 24 – € 1,98</p> 	<p>DIAVOLINA</p> <p>ACCENDIFUOCO ECOLOGICO DIAVOLINA Confezione 100 cubi Con legno certificato FSC</p> <p>92089136 – – conf. 6 – € 6,98</p> 
<p>DIAVOLINA</p> <p>ESPOSITORE 120 PZ. ACCENDIFUOCO DIAVOLINA Confezione singola da 80 cubi</p> <p>92089138 – – conf. 120 – € 4,80</p> 	<p>REDDY</p> <p>ACCENDI FUOCO REDDY Confezione 48 cubi Per caminetti, stufe e barbecue</p> <p>92089131 – – conf. 28 – € 1,10</p> 
<p>REDDY</p> <p>ACCENDI FUOCO ECOLOGICO REDDY Confezione 32 cubi Per camini, stufe e barbecue</p> <p>92089132 – – conf. 32 – € 0,90</p> 	<p>REDDY</p> <p>ESPOSITORE 324 pz. ACCENDI FUOCO REDDY Confezione singola da 48 cubi</p> <p>92089134 – – conf. 1 – € 366,30</p> 
<p>REDDY</p> <p>ESPOSITORE 160 pz. ACCENDI FUOCO ECOLOGICO REDDY Confezione singola da 32 cubi</p> <p>92089135 – – conf. 1 – € 144,00</p> 	<p>DIAVOLINA</p> <p>DIAVOLINA SPAZZACAMINO Formato 270 gr. In polvere Distrugge chimicamente la fuliggine Ideale per stufe e camini Previene gli incendi</p> <p>92089129 – – conf. 12 – € 3,48</p> 
<p>REDDY</p> <p>SUPER VETRO SPRAY 500 ML DIAVOLINA Pulitore per vetri di camini e stufe Rimozione completa di catrame e fuliggine</p> <p>92089133 – – conf. 6 – € 4,80</p> 	<p>DIAVOLINA</p> <p>ACCENDITORE A GAS RICARICABILE DIAVOLINA</p> <p>92089137 – – conf. 18 – € 6,10</p> 
<p>Copyr</p> <p>INSETTICIDA PER VESPE E CALABRONI 600 ml Adatto al trattamento di nidi in modo sicuro Portata getto 4 mt Azione immediata</p> <p>92060050 – – conf. 12 – € 9,80</p> 	<p>Copyr</p> <p>INSETTICIDA PER MOSCHE E ZANZARE 400 ml Per ambienti interni</p> <p>92060052 – – conf. 12 – € 4,32</p> 



 <p>INSETTICIDA PER SCARAFAGGI E FORMICHE 400 ML Uso interno Adatto ad abitazioni e luoghi pubblici o privati</p> <p>92060071 - - conf. 12 - € 4,32</p>	 <p>VAPE EXPERT INSETTI SPRAY CIMICI Formato 300 ml</p> <p>2552019358 - - conf. 12 - € 8,80</p>
 <p>VESPE SPRAY SCHIUMOGENO Permette di eliminare con azione istantanea le vespe e loro nidi ed altri insetti pericolosi quali calabroni. Formato 200 gr</p> <p>255X631002 - - conf. 12 - € 12,40</p>	 <p>VESPE SPRAY NO SCHIUMA Insetticida in formulazione spray pronto all'uso per eliminare vespe e calabroni. Grazie alla speciale valvola che potenzia l'erogazione fino a 5 metri, è possibile il trattamento dei nidi normalmente difficili da raggiungere. Agisce per contatto e la sua buona residualità impedisce il ripopolamento dei luoghi trattati. Da utilizzare su grondaie, cassonetti delle serrande avvolgibili, sotto i davanzali... Formato 750 ml</p> <p>255X631004 - - conf. 12 - € 11,72</p>
 <p>MULTINSETTO Insetticida e acaricida Emulsione acquosa pronta all'uso che esplica la sua azione per ingestione e contatto per il controllo di scarafaggi, formiche, acari della polvere... Formato 500 ml</p> <p>255Y632004 - - conf. 12 - € 10,24</p>	 <p>VAPE MOSCHE E ZANZARE E' un rimedio veloce contro mosche e zanzare. Erogatore bi-direzionale innocuo su piante e fiori, consigliabile spruzzare il prodotto anche su imposte e infissi. Formato 400 ml</p> <p>2552018693 - - conf. 24 - € 4,70</p>
 <p>VAPE SCARAFAGGI E FORMICHE Efficace contro scarafaggi, formiche e altri insetti striscianti. Il suo erogatore bidirezionale permette di concentrare il prodotto nel punto esatto da trattare. Adatto anche per uso domestico Formato 400 ml</p> <p>2552574981 - - conf. 12 - € 9,16</p>	 <p>INSETTICIDA MULTINSETTO Formato 500 ml Per ambienti domestici ed esterni Efficace per settimane contro gli insetti molesti, sia volanti che striscianti. Ottimo contro le cimici, zanzare, mosche, scarafaggi e formiche. Funziona anche per sconfiggere gli acari. La confezione diventa un espositore</p> <p>92031083 - - conf. 12 - € 7,82</p>
 <p>VARAT ESCA FRESCA PER TOPI Formato 150 gr Esca rodenticida pronta all'uso a base della sostanza attiva anticoagulante Brodifacoum, efficace contro il "topolino domestico" La formulazione consiste in una pasta fresca attrattiva. Il prodotto non allerta e non crea sospetti agli altri componenti della popolazione dei roditori.</p> <p>92060015 - - conf. 1 - € 2,80</p>	 <p>COLLA TOPICIDA 135 GR Atossica e non infiammabile Resistente alle alte temperature</p> <p>92060001 - - conf. 25 - € 1,90</p>
 <p>TAVOLETTE COLLANTI Conf. 2 tavolette In fase spalmata Misura tavoletta: 20x17cm Adatta per la cattura di ratti, topi e insetti striscianti</p> <p>92060030 - - conf. 45 - € 3,40</p>	 <p>TRAPPOLA TOPI PICCOLA In ferro</p> <p>90033741 - - conf. 20 - € 1,12</p>



<p>MINUTEX</p> <p>TRAPPOLA TOPI GRANDE In ferro</p> <p>90033742 - - conf. 10 - € 1,81</p> 	<p>DEFENCE SYSTEM</p> <p>ESPOSITORE 18 PZ. SPRAY DIVA 15 ML ANTIAGGRESSIONE AL PEPERONCINO Colori assortiti: rosa, camo, giallo-rosso Prodotto legale conforme al DM 103-2011 Made in Germany Getto a nuvola con portata tra 1 e 3 metri Dispositivo di sicurezza contro attivazione accidentale Non reca danni permanenti alla persona contiene solo Oloresin Capiscum Immobilizza l'aggressore per 30 minuti Libera vendita ai maggiori di anni 16</p> <p>46602057 - - conf. 1 - € 188,28</p> 
<p>DEFENCE SYSTEM</p> <p>ESPOSITORE 9 PEZZI KIT LIBERI DA PUNTURE + 9 PEZZI RICARICA 3 in 1: Pre-puntura, Post-puntura e Protezione solare Flacone 100 ml Sgradito a zanzare, tafani, zecche... Post puntura di insetti, dona una radevole sensazione di sollievo con effetto lenitivo Filtri UV-B: protezione solare In omaggio bracciale con protezione antizanzare Dimensioni: 450x320x210 mm</p> <p>46698202 - - conf. 1 - € 174,60</p> 	<p>Blumen</p> <p>VAPE ELETTROEMANATORE DI PIASTRINE + 10 PIASTRINE Inodore Contro le zanzare comuni e tigre 12 ore di protezione</p> <p>2552019003 - - conf. 12 - € 7,72</p> 
<p>Blumen</p> <p>VAPE 30 PEZZI RICARICA PIASTRINE INVISIBLE Inodore Efficace contro le zanzare comuni e tigre Azione rapida 12 ore di protezione</p> <p>2552019402 - - conf. 36 - € 4,54</p> 	<p>Blumen</p> <p>VAPE ELETTROEMANATORE LIQUIDO + RICARICA CLASSICA Insetticida liquido per uso domestico Protegge dalle zanzare comuni e tigre per 60 notti</p> <p>2552019431 - - conf. 12 - € 11,12</p> 
<p>Blumen</p> <p>VAPE RICARICA LIQUIDA CLASSICA Efficace contro le zanzare comuni e tigre per 60 notti - 36 ml</p> <p>2552018688 - - conf. 30 - € 8,12</p> 	<p>Blumen</p> <p>VAPE ELETTROEMANATORE PIASTRINE SPINA + 10 PIASTRINE Efficace contro le zanzare comuni e tigre Azione rapida 12 ore di protezione</p> <p>2552018927 - - conf. 12 - € 7,34</p> 
<p>Blumen</p> <p>VAPE ELETTROEMANATORE DI PIASTRINE CON FILO + 10 PIASTRINE Efficace contro le zanzare comuni e tigre Azione rapida</p> <p>2552019435 - - conf. 12 - € 8,82</p> 	<p>Blumen</p> <p>VAPE 30 PEZZI RICARICA PIASTRINE Efficace contro le zanzare comuni e tigre Azione rapida 12 ore di protezione</p> <p>2552019649 - - conf. 36 - € 4,36</p> 
<p>Blumen</p> <p>VAPE SPIRALI PROFUMATE Profumazione Assortita: Lavanda, Geranio e Citronella Ogni scatola contiene 10 pezzi</p> <p>2552347754 - - conf. 24 - € 1,97</p> 	<p>Blumen</p> <p>VAPE STRISCIA ATTIRAMOSCHE Contiene 4 pezzi</p> <p>2552019658 - - conf. 24 - € 3,50</p> 



  <p>VAPE ZERO ANTIPUNTURA Formato 100 ml</p> <p>2552575083 – Modello Lozione – – conf. 12 – € 12,12</p> <p>2552580012 – Modello Spay – – conf. 12 – € 12,12</p>	  <p>VAPE DERM SCUDO ATTIVO Formato 100 ml</p> <p>2552575517 – Modello Lozione – – conf. 12 – € 11,42</p> <p>2552580021 – Modello Spray – – conf. 12 – € 10,00</p>
  <p>VAPE DERM SENSIBILE ANTIPUNTURA Formato 100 ml</p> <p>2552574906 – Modello Salviettine – – conf. 12 – € 9,92</p> <p>2552574994 – Modello Lozione – – conf. 12 – € 12,12</p>	  <p>VAPE EXPERT ESCA FORMICHE Contiene 4 pezzi</p> <p>2552018996 – – conf. 12 – € 8,38</p>
  <p>VAPE EXPERT ESCA PER SCARAFAGGI Confezione 4 pezzi</p> <p>2552018994 – – conf. 12 – € 8,38</p>	  <p>VAPE EXPERT OPEN AIR SPRAY Formato 600ml</p> <p>2552019706 – – conf. 12 – € 14,00</p>
  <p>TRAPPOLA PER FORMICHE Prodotto per il controllo delle formiche Elimina l'intera colonia Per uso interno ed esterno Acetamiprid puro 0,1 g Sostanze appetenti e addescanti Formulazione gel</p> <p>255X631101 – – conf. 24 – € 2,98</p>	  <p>POLVERE MICROGRANULARE ANTIFORMICHE Polvere microgranulare antifformiche Composizione: Acetamiprid Idrosolubile Insetticida in polvere arricchito di sostanze attrattive a lunga persistenza. Utilizzabile dentro e fuori casa per il controllo di tutte le specie di formiche, scarafaggi, pilci e ragni. Applicazione tramite tre modalità: impolveramento, nebulizzazione e innaffio. 200 gr</p> <p>255DD01001 – – conf. 12 – € 13,52</p>
  <p>VAPE DERM HERBAL Protegge da punture di zanzare comuni, zanzara tigre, moscerini... Fragranza di citronella e eucalipto Formato 100 ml</p> <p>2552575044 – – conf. 12 – € 10,28</p>	  <p>VAPE PENNA GEL DOPOPUNTURA Lostick gel dona un'immediata sensazione di sollievo Proprietà lenitive, rinfrescanti e idratanti</p> <p>2552572571 – – conf. 12 – € 9,00</p>
  <p>COPPIA ZANCHE Stendibiancheria per balcone</p> <p>90028100 – finitura INOX 304 – – conf. 2 – € 38,00</p> <p>90028101 – finitura Zincato normale – – conf. 4 – € 11,80</p> <p>90028102 – finitura Verniciato bianco – – conf. 4 – € 12,80</p> <p>90028105 – finitura Zincato pieghevole – – conf. 4 – € 10,60</p>	  <p>COPPIA ZANCHE Stendibiancheria per balcone Verniciatura ferromicacea Installazione senza utensili</p> <p>90028106 – Modello Micaceo normale – – conf. 1 – € 16,60</p> <p>90028107 – Modello Micaceo pieghevole – – conf. 1 – € 17,80</p>



























<p>QUAGLIATO</p> <p>BLISTER 4 PEZZI TIRAFILI METALLICI Art. Tendil Per cavo stendibiancheria Fune utilizzabile fino a 6 mm Lunghezza 12 cm</p> <p>748TENDIL - - conf. 1 - € 10,00</p> 	<p>QUAGLIATO</p> <p>BLISTER 4 PEZZI TIRAFILI METALLICI Art. Mini Tendil Per cavo stendibiancheria Fune utilizzabile fino a 6 mm Lunghezza 4,5 cm</p> <p>748MINITENDIL - - conf. 1 - € 10,56</p> 
<p>ZA</p> <p>CAVETTO BIANCO 20 metri Ø 4,5 mm</p> <p>885CA1A0020 - - conf. 1 - € 5,96</p> 	<p>ZA</p> <p>CAVETTO IN ACCIAIO OTTONATO Termoretraibile</p> <p>885CA4A0010 - finitura 4mmx10mt - - conf. 1 - € 2,46 885CA4A0020 - finitura 4mmx20mt - - conf. 1 - € 3,86 885CA5A0020 - finitura 5mmx20mt - - conf. 1 - € 4,90 885CA6A0020 - finitura 6mmx20mt - - conf. 1 - € 8,76</p> 
<p>ZA</p> <p>Bobina 500 mt BIANCO L anima ottonata 3 fili paralleli rivestito con PVC bianco Ø 4,5 mm Lunghezza 500 mt In bobina</p> <p>885CA1A0500 - - conf. 1 - € 111,98</p> 	<p>ZA</p> <p>Bobina 500 mt. CAVETTO STENDIBIANCHERIA SUPERBIANCONE anima zincata 3 mm costruzione a 49 fili (7x7) rivestito in PVC bianco additivato con Biossido di Titanio a 5 mm pieno lunghezza 500 mt con espositore in Omaggio</p> <p>885CA2AZ500 - - conf. 1 - € 316,00</p> 
<p>ZA</p> <p>Box da 16 pz. TIRA TIRA</p> <p>885TT16 - - conf. 1 - € 38,88</p> 	<p>ZA</p> <p>Box da 100 pz BLOCK FIX</p> <p>885BF100 - - conf. 1 - € 34,02</p> 
<p>ZA</p> <p>CAVETTO ACCIAIO OTTONATO Termoretraibile</p> <p>885CA4A0100 - finitura 4mmx100mt - - conf. 1 - € 16,46 885CA5A0100 - finitura 5mmx100mt - - conf. 1 - € 21,00 885CA6A0100 - finitura 6mmx100mt - - conf. 1 - € 29,76 885CA8A0100 - finitura 8mmx100mt - - conf. 1 - € 56,00</p> 	<p>ZA</p> <p>FILO MULTIUSO ZINCATO A CALDO FIORI</p> <p>885FM1A028 - Misura 0,28mmx50gr - - conf. 1 - € 0,70 885FM1A036 - Misura 0,36mmx50gr - - conf. 1 - € 0,70 885FM1A044 - Misura 0,44 mmx50gr - - conf. 1 - € 0,66</p> 
<p>ZA</p> <p>FILO MULTIUSO ZINCATO A CALDO</p> <p>885FM1A080 - Misura 0,80mmx53mt - - conf. 1 - € 1,32 885FM1A100 - Misura 1,00mmx32mt - - conf. 1 - € 1,25 885FM1A120 - Misura 1,20mmx22mt - - conf. 1 - € 1,25 885FM1A150 - Misura 1,50mmx13mt - - conf. 1 - € 1,25 885FM1A200 - Misura 2,00mmx8mt - - conf. 1 - € 1,25 885FM1A250 - Misura 2,50mmx5mt - - conf. 1 - € 1,25</p> 	<p>ZA</p> <p>FILO MULTIUSO ZINCATURA A CALDO</p> <p>885FM1C150 - Misura 1,50mmx50mt - - conf. 1 - € 3,48 885FM1C180 - Misura 1,80mmx50mt - - conf. 1 - € 4,86 885FM1C220 - Misura 2,20mmx50mt - - conf. 1 - € 6,96</p> 



 <p>FILO MULTIUSO ZINCATO A CALDO CON PVC Colore verde</p> <p>885FM2A090 – Misura 0,90mmx33mt – – conf. 1 – € 1,15</p> <p>885FM2A160 – Misura 1,60mmx10mt – – conf. 1 – € 1,15</p> <p>885FM2A220 – Misura 2,20mmx5mt – – conf. 1 – € 1,15</p> <p>885FM2A180 – Misura 1,80mm x7mt – – conf. 1 – € 1,15</p> <p>885FM2A140 – Misura 1,40mmx13mt – – conf. 1 – € 1,15</p> <p>segue...</p> 	 <p>continua...</p> <p>885FM2A110 – Misura 1,10mmx24mt – – conf. 1 – € 1,15</p> 
 <p>FILO MULTIUSO A CALDO ZINCATO CON PVC Colore verde</p> <p>885FM2C200 – Misura 2,00mmx50mt – – conf. 1 – € 5,04</p> <p>885FM2C270 – Misura 2,70mmx50mt – – conf. 1 – € 8,00</p> <p>885FM2D200 – Misura 2,00mmx100mt – – conf. 1 – € 9,72</p> <p>885FM2D270 – Misura 2,70mmx100mt – – conf. 1 – € 14,58</p> 	 <p>FILO MULTIUSO RAME 50 gr</p> <p>885FM3A060 – Misura 0,60mmx20mt – – conf. 1 – € 2,96</p> <p>885FM3A080 – Misura 0,80mmx11mt – – conf. 1 – € 2,96</p> <p>885FM3A100 – Misura 1,00mmx7mt – – conf. 1 – € 2,96</p> 
 <p>FILO MULTIUSO OTTONE 50 gr</p> <p>885FM4A060 – Misura 0,60mmx20mt – – conf. 1 – € 2,44</p> <p>885FM4A080 – Misura 0,80mmx11mt – – conf. 1 – € 2,44</p> <p>885FM4A100 – Misura 1,00mmx7mt – – conf. 1 – € 2,44</p> 	 <p>FILO MULTIUSO INOX 50 gr</p> <p>885FM5A060 – Misura 0,60mmx22mt – – conf. 1 – € 1,63</p> <p>885FM5A080 – Misura 0,80mmx13mt – – conf. 1 – € 1,63</p> <p>885FM5A100 – Misura 1,00mmx8mt – – conf. 1 – € 1,63</p> 
 <p>FILO MULTIUSO RAME</p> <p>540213530010 – Ø mm 1,0 – – conf. 20 – € 2,80</p> 	 <p>FILO ACCIAIO ARMONICO G100</p> <p>90074701 – misura 0,5 – – conf. 1 – € 1,80</p> <p>90074702 – misura 0,7 – – conf. 1 – € 1,80</p> 
 <p>FILO MULTIUSO ARMONICO 100 gr</p> <p>885FM6A100 – Misura 1,00mmx16mt – – conf. 1 – € 3,48</p> 	 <p>ASSORTIMENTO CAVI PLASTIFICATI, FILI, TRECCIE</p> <p>540213620000 – Tipologia Treccia nylon – Misura 5x30 mt – – conf. 1 – € 4,00</p> <p>540213620005 – Tipologia Filo ferro plastific – Misura bianco mt 10 Ø2 mm – – conf. 1 – € 4,00</p> <p>540213620010 – Tipologia Filo ferro plastific – Misura bianco mt 10 Ø3 mm – – conf. 1 – € 4,40</p> <p>segue...</p> 
 <p>continua...</p> <p>540213620018 – Tipologia Filo ferro plastific – Misura mt 10 Ø5 – – conf. 1 – € 2,40</p> <p>540213630003 – Tipologia Cavetto plastificato – Misura mt 2,5 Ø20 – – conf. 1 – € 1,98</p> <p>540213630005 – Tipologia Cavetto plastificato – Misura mt 3 Ø10 – – conf. 1 – € 1,80</p> <p>540213700010 – Tipologia Treccia poliestere – Misura mt 15 Ø50 – – conf. 1 – € 3,00</p> <p>segue...</p> 	 <p>continua...</p> <p>540213700015 – Tipologia Treccia poliestere – Misura mt 15 Ø6 – – conf. 1 – € 6,00</p> <p>540213700020 – Tipologia Treccia poliestere – Misura mt 15 Ø8 – – conf. 1 – € 8,00</p> 



 <p>PIATTINA PLASTIFICATA VERDE Misura 30 mt 885FM7A030 – – conf. 1 – € 1,74</p> 	 <p>TRECCIA VENEZIANA 885PP03B20 – Colore Bianca – Misura 3mmx20mt – – conf. 1 – € 1,87 885PP03G20 – Colore Grigia – Misura 3mmx20mt – – conf. 1 – € 1,87 885PP03M20 – Colore Marrone – Misura 3mmx20mt – – conf. 1 – € 1,87 segue...</p> 
 <p>continua... 885PP03N20 – Colore Nera – Misura 3mmx20mt – – conf. 1 – € 1,87 885PP03R20 – Colore Rossa – Misura 3mmx20mt – – conf. 1 – € 1,87 885PP03V20 – Colore Verde – Misura 3mmx20mt – – conf. 1 – € 1,87 885PP03VS20 – Colore Verde scuro – Misura 3mmx20mt – – conf. 1 – € 1,87</p> 	 <p>TRECCIA Bianca Misura 3mm 885PP03B300 – – conf. 1 – € 19,80</p> 
 <p>RILOGA Misura 2,5 mm 400 mt 885PPR25400 – – conf. 1 – € 24,00</p> 	 <p>RILOGA Misura 2,50mm 20mt 885PPR25B20 – – conf. 20 – € 1,40</p> 
 <p>2 pz RICAMBIO GANCI FERRO Colore nero 885EM1RF – Misura 5/8 mm – – conf. 1 – € 0,66 885EM2RF – Misura 8/10 mm – – conf. 1 – € 0,99</p> 	 <p>2 pz DOPPIO RICAMBIO GANCI FERRO 885EM3RD – – conf. 1 – € 1,16</p> 
 <p>2 PEZZI ELASTICI PIATTI CON GANCIO IN PLASTICA 885EM13E150P – Misura 13mmx1,5 mt – – conf. 1 – € 6,12</p> 	 <p>COPPIA CORDE ELASTICHE Colore blu 512130110N – Misura 0,008x1 mt – – conf. 1 – € 2,27 512130130N – Misura 0,008x1,50 mt – – conf. 1 – € 2,68 512130140N – Misura 0,008x2 mt – – conf. 1 – € 3,09</p> 
 <p>RETE ELASTICA CON GANCI IN FERRO 885EM4E4040 – Misura 40x40cm – Spessore 4mm – – conf. 10 – € 3,98 885EM5E90150 – Misura 90x150cm – Spessore 5mm – – conf. 10 – € 13,56</p> 	 <p>2 PEZZI ELASTICI CON GANCI IN FERRO 885EM8E100F – Misura 8mmx1mt – – conf. 1 – € 1,78 885EM8E150F – Misura 8mmx1,5mt – – conf. 1 – € 2,24 885EM8E200F – Misura 8mmx2mt – – conf. 1 – € 2,56</p> 



ZA

ELASTICO TRADIZIONALE SERIE EASY Colore verde brillante con segnalino

885EM6E100VB - Lunghezza 100 mt - Ø 6 -
- conf. 1 - € 51,00

885EM8E60VB - Lunghezza 60 mt - Ø 8 -
- conf. 1 - € 37,80



colomba

ASSE DA STIRO Modello Venezia Misura:114x36 cm Regolazione altezza in 6 posizioni fino a 95 cm Poggiaferro portacaldaia con inserti in silicone fusto Ø 22 mm Fodera 100% cotone taglia M Colori assortiti Made in Italy

416A122L20W -
- conf. 1 - € 48,60



colomba

ASSE DA STIRO Modello Trento Misura:120x40 cm Regolazione altezza in 6 posizioni fino a 95 cm Poggiaferro portacaldaia con inserti in silicone Barra portagruce Griglia portabiancheria rinforzata fusto ad alta stabilità Ø28 mm Foderina 100% cotone Taglia L Colori assortiti Made in Italy

416A135LV1W -
- conf. 1 - € 65,20



colomba

ASSE DA STIRO Modello Torino Misura:110x32 cm Regolazione altezza 4 posizioni fino a 88 cm Poggiaferro ergonomico Copertina cotone 100% Colori assortiti Made in Italy

416A122L09W -
- conf. 1 - € 33,00



colomba

STENDIBIANCHERIA Modello Milano A torre Ruote per facilitare il trasporto Griglie in acciaio verniciato Antiruggine Made in Italy

416ST1943 - Altezza 3 piani -
- conf. 1 - € 21,40

416ST1944 - Altezza 4 piani -
- conf. 1 - € 27,00



colomba

STENDIBIANCHERIA Modello Napoli In Alluminio Con ali superficie utile per stendere 20 m Griglie in alluminio anodizzato antiruggine Made in Italy

416ST387 -
- conf. 1 - € 30,40



colomba

STENDIBIANCHERIA Modello Palermo Con ali Superficie utile per stendere 18 m Griglie in acciaio verniciato Antiruggine Made in Italy

416ST186 -
- conf. 1 - € 13,80



colomba

STENDIBIANCHERIA Modello Roma In acciaio Inox Con ali Ultraresistente e protezione totale della ruggine Superficie utile per stendere 20 m Ruote antigraffio per facilitarne il trasporto Made in Italy

416ST586 -
- conf. 1 - € 39,60



colomba

SCALA SLIM LIBELLULA Gradini antiscivolo in alluminio estruso Gradini fissati al telaio con rullatura e senza rivetti Ampia piattaforma, piedini antiscivolo Portata 150 kg En 131

416410010N - N°Grad. 3 -
- conf. 1 - € 44,60

416410020N - N°Grad. 4 -
- conf. 1 - € 52,60

416410030N - N°Grad. 5 -
- conf. 1 - € 59,00

416410040N - N°Grad. 6 -
- conf. 1 - € 70,00

segue...



colomba

continua...

416410050N - N°Grad. 7 -
- conf. 1 - € 80,60

416410060N - N°Grad. 8 -
- conf. 1 - € 92,20



colomba

SGABELLO COMPACT In Alluminio Telaio rettangolare 35x20 mm Gradino con tappetino in gomma antiscivolo Portata 150 kg Prodotto a norma EN 14183 certificato TUV-GS

416G110AT2W - N° grad. 2 -
- conf. 1 - € 35,00

416G110AT3W - N° grad. 3 -
- conf. 1 - € 48,20

416G110AT4W - N° grad. 4 -
- conf. 1 - € 66,40



svelt

























SGABELLO STEPPY In acciaio Per uso domestico Ampi gradini piani antiscivolo Sistema di sicurezza anti-chiusura Gradini in acciaio verniciato

784STEPPY02 - N° grad. 2 - H chiusa 83 -
- conf. 1 - € 44,80

784STEPPY03 - N° grad. 3 - H chiusa 106 -
- conf. 1 - € 56,00





  <p>SGABELLO MINISTEP Sgabello pieghevole in plastica Ingombro chiuso 35,5x5,4x32 Piattaforma 22x29 cm Portata 100 Kg Utilizzo domestico e "fai da te" Garanzia 2 anni Conforme al D.Lgs 81/2008</p> <p>784MINISTEP - - conf. 1 - € 13,20</p>	  <p>SGABELLO PIEGHEVOLE Colore rosso Misura 29x22x22 cm</p> <p>512410120N - - conf. 1 - € 7,90</p>
  <p>SGABELLO PIEGHEVOLE Colore grigio Misura 38x22x32 cm</p> <p>512410130N - - conf. 1 - € 11,50</p>	  <p>PIEDINI DI RICAMBIO STEPPY 2/3/4 gradini</p> <p>784STEPPYPIEA - Ricambio Anteriore - - conf. 1 - € 3,40</p> <p>784STEPPYPIEP - Ricambio Posteriore - - conf. 1 - € 3,40</p>
  <p>CONFEZIONE RICAMBI TAMPONI SCALISSIMA Composta da: 2 esterni 2 interni 6 copri aldatura</p> <p>784CONF1040 - - conf. 1 - € 24,60</p>	  <p>SCALETTA BOBO PLUS In alluminio Gradini 80 mm Profilo 50x20 mm Spessore chiuso 16 cm Altezza piattaforma da 0,39 a 0,83 mm Altezza max di lavoro da 2,40 a 2,80 mm Portata Kg 150 Utilizzo domestico Garanzia 2 anni Conforme al D.Lgs. 81/2008 En 131 Testata dal Politecnico di Milano Made in Italy</p> <p>784BOBOPLUS03 - N° grad. 3 - - conf. 1 - € 93,20</p>
  <p>SCALA DOPPIA MAREA LIGHT In alluminio Per utilizzo professionale leggero e domestico Montanti rettangolari ergonomici Gradini ribordati antisdrucciolo Con vaschetta portaoggetti Piattaforma con gancio di sicurezza e cinghie di tenuta. Il ripiano è compreso nel numero gradini</p> <p>784MAREAL03 - N° Grad 3 - H Chiusura 138 mt - - conf. 1 - € 119,20</p> <p>784MAREAL04 - N° Grad 4 - H Chiusura 164 mt - - conf. 1 - € 136,40</p> <p>784MAREAL05 - N° Grad 5 - H Chiusura 189 mt - - conf. 1 - € 148,00</p> <p>segue...</p>	  <p>continua...</p> <p>784MAREAL06 - N° Grad 6 - H Chiusura 214 mt - - conf. 1 - € 165,40</p> <p>784MAREAL07 - N° Grad 7 - H Chiusura 238 mt - - conf. 1 - € 183,20</p> <p>784MAREAL08 - N° Grad 8 - H Chiusura 265 mt - - conf. 1 - € 192,40</p>
  <p>SCALE MAREA In alluminio Profilo maggiorato 50x25 mm Piattaforma zigrinata in polipropilene 30x26 cm Cinghie antiapertura Gradini 80 mm Spessore scala chiusa 15 cm EN131 Testata dal TÜV SUD Conforme al D.Lgs.81/2008 Portata 150 Kg Utilizzo Professionale Garanzia 5 anni Made in Italy Il ripiano è compreso nel numero gradini</p> <p>784MAREAO3R - N° grad. 3 - H chiusa 1,38 mt - - conf. 1 - € 123,40</p> <p>784MAREAO4R - N° grad. 4 - H chiusa 1,64 mt - - conf. 1 - € 142,80</p> <p>segue...</p>	  <p>continua...</p> <p>784MAREAO5R - N° grad. 5 - H chiusa 1,89 mt - - conf. 1 - € 160,40</p> <p>784MAREAO6R - N° grad. 6 - H chiusa 2,14 mt - - conf. 1 - € 175,20</p> <p>784MAREAO7R - N° grad. 7 - H chiusa 2,38 mt - - conf. 1 - € 190,00</p> <p>784MAREAO8R - N° grad. 8 - H chiusa 2,65 mt - - conf. 1 - € 206,00</p>
  <p>SCALE LUXE E3 In tre tronchi trasformabile sia in scala da appoggio, che doppia o zoppa. In alluminio Regolabile su dislivelli Rotelle di scorrimento a muro Dispositivo: -Antiribaltamento del terzo tronco -Antisfilo accidentale -Blocco sfilo oltre l'altezza di sicurezza Pioli ergonomici Inclinati 30x30 mm Altezza a sfilo da 4,95 a 7,30 m Altezza a cavalletto da 2,10 a 3,30 m Chiusa 3,10 m EN131 Testata dal TÜV SUD Conforme al D. Lgs. 81/2008 Portata 150 Kg Garanzia 5 anni Made in Italy</p> <p>784SCNX3040 - N° grad. 9+10+10 - - conf. 1 - € 742,00</p>	  <p>SCALA UNIVERSAL "U3" In alluminio Per uso professionale leggero In tre tronchi trasformabile sia in scala di appoggio che doppia Cinghie di sicurezza Tamponi in gomma antisdrucciolo Numero pioli da 7 a 12 Altezza chiusa da 2 a 3,40 m Altezza cavalletto da 1,88 a 3,25 Altezza a sfilo da 4,24 a 7,88 m</p> <p>784UNIV3X7 - N° grad. 7 - - conf. 1 - € 197,20</p> <p>784UNIV3X9 - N° grad. 9 - - conf. 1 - € 256,00</p>



  <p>SCALE SVELTINA Scala telescopica in acciaio Cerniera manuale dentata Pioli 30 mm Conforme al D.Lgs.81/2008 Portata 100Kg Utilizzo domestico e "fai da te" Garanzia 2 anni Made in Italy</p> <p>784SVELTISS10 - N° grad. 10 - - conf. 1 - € 137,20</p> <p>784SVELTISS8 - N° grad. 8 - - conf. 1 - € 140,60</p>	  <p>SCALA SCALISSIMA In alluminio Con base allargata Uso professionale e hobbistico Funzione scala appoggio o doppia/zoppa</p> <p>784SCALISS06 - N° grad. 6+6 - - conf. 1 - € 226,00</p> <p>784SCALISS08 - N° grad. 8+8 - - conf. 1 - € 248,00</p> <p>784SCALISS10 - N° grad. 10+10 - - conf. 1 - € 280,00</p> <p>784SCALISS12 - N° grad. 12+12 - - conf. 1 - € 366,00</p>
  <p>MAGO S Piccolo trabattello in alluminio Trasformabile in scala doppia Pioli 27x27 mm Profilo 50x20 mm 2 ruote in pvc diametro 100 mm Piano in legno 107x50 cm Peso 12 Kg Portata 100 Kg (1 persona) Utilizzo domestico e "fai da te" Garanzia 3 anni D.Lgs 206/2005 Codice del consumo Made in Italy Misure imballo 175x57x16</p> <p>784MAGOS06 - - conf. 1 - € 238,00</p>	  <p>TRABATTELO CIAO Piccolo trabattello in acciaio Tubo diametro 30 mm 2 ruote in nylon diametro 80 mm Piano in legno 110x52 cm Peso 22 Kg Portata 100 Kg (1 persona) Utilizzo domestico e "fai da te" Garanzia 2 anni D.Lgs. 206/2005 codice del consumo Made in Italy Misure imballo 150x66x12 cm</p> <p>784CIAO010 - - conf. 1 - € 103,00</p>
  <p>ROTOLO ZANZARIERA FIBRA VETRO Colore Grigia Prezzo al metro lineare</p> <p>512210200N - Misura/Metri 0,6x30 - - conf. 30 - € 1,80</p> <p>512210210N - Misura/Metri 0,8x30 - - conf. 30 - € 1,80</p> <p>512210220N - Misura/Metri 1,00x30 - - conf. 30 - € 1,71</p> <p>512210230N - Misura/Metri 1,20x30 - - conf. 30 - € 1,71</p> <p>512210240N - Misura/Metri 1,50x30 - - conf. 30 - € 1,71</p> <p>segue...</p>	 <p>continua...</p> <p>512210250N - Misura/Metri 2,0x30 - - conf. 30 - € 1,80</p> 
  <p>ROTOLO ZANZARIERA ALLUMINIO Prezzo al metro lineare</p> <p>512210300N - Misura/Metri 0,60x30 - - conf. 30 - € 1,90</p> <p>512210310N - Misura/Metri 0,80x30 - - conf. 30 - € 2,38</p> <p>512210320N - Misura/Metri 1,00x30 - - conf. 30 - € 2,84</p> <p>512210330N - Misura/Metri 1,20x30 - - conf. 30 - € 3,42</p> <p>512210340N - Misura/Metri 1,50x30 - - conf. 30 - € 4,38</p>	 <p>ZANZARIERA ESTENSIBILE Per finestre e porte finestre con tapparella Estensibile in entrambe le direzioni In alluminio Bordi con spazzola</p> <p>512210830N - Misura 40x50 cm - AVORIO - - conf. 5 - € 10,00</p> <p>512210860N - Misura 75x100 cm - AVORIO - - conf. 1 - € 15,60</p> <p>512210840N - Misura 40x50 cm - SILVER - - conf. 1 - € 10,40</p> <p>512210855N - Misura 50x75 cm - SILVER - - conf. 1 - € 13,80</p> <p>512210870N - Misura 75x100 cm - SILVER - - conf. 1 - € 20,40</p> 
  <p>ZANZARIERA PER PORTE CON CHIUSURA MAGNETICA Misura 120x250</p> <p>512210710N - Finitura Nero - - conf. 1 - € 9,80</p> <p>512210715N - Finitura Grigio - - conf. 1 - € 9,80</p> <p>512210720N - Finitura Bianco - - conf. 1 - € 9,80</p>	 <p>ZANZARIERA IN POLIESTERE PER PORTA Con velcro Dimensioni 150 x 250 cm</p> <p>512210875N - Colore Nero - - conf. 1 - € 5,80</p> <p>512210885N - Colore Bianco - - conf. 1 - € 5,80</p>  <p>ZANZARIERA IN POLIESTERE PER FINESTRA Con velcro Dimensioni 150 x 180 cm</p> <p>512210915N - Colore Nero - - conf. 1 - € 4,20</p>
  <p>NASTRO BIADESIVO SPECIALE IN VELCRO Per zanzariere in fibra di alluminio Misura 10mmx6,6m</p> <p>512210890N - - conf. 1 - € 4,64</p>	  <p>VENTILATORE A PIANTANA VINTAGE Ø 40 3 Velocità Tasto oscillazione 90° dx/sx Inclinazione 20° alto/basso Altezza regolabile Alimentazione: 220/240V I 50Hz Potenza: 50W Peso: 7500 g Dimensione: 445x1300x402 mm</p> <p>231VP309 - - conf. 1 - € 69,60</p>



  <p>VENTILATORE A PIANTANA ROTATIVO Ø 40 3 Velocità Oscillazione 90° dx/sx Inclinazione regolabile alto/basso Altezza regolabile Base a crociera Alimentazione: 220/240V 50Hz Potenza: 50W Peso: 3200 g Dimensione: 450x1260x475 mm</p> <p>231VP420 - - conf. 1 - € 32,20</p>	  <p>VENTILATORE DA TAVOLO Ø40 3 Velocità Tasto oscillazione 90° dx/sx Inclinazione regolabile alto/basso Alimentazione: 220/240V 50Hz Potenza: 50W Peso: 1840 g Dimensione: 433X428X193 mm</p> <p>231VT412 - - conf. 1 - € 32,60</p>
  <p>VENTILATORE DA PAVIMENTO E MURO ALTA VELOCITÀ 3 Velocità Maniglia per presa Clips avvolgicavo Alimentazione: 220/240V 50Hz Potenza: 100W Peso: 5300 g Dimensione: 540x525x185 mm</p> <p>231VS57 - - conf. 1 - € 82,40</p>	  <p>VENTILATORE DA TAVOLO Ø40 3 velocità Alimentazione 230V/50 Hz Potenza 40W Funzionamento a tasti</p> <p>512910060N - - conf. 1 - € 23,90</p>
  <p>TERMOCONVETTORE K240 Potenza massima 2000W 3 livelli di potenza selezionabili 750/1250/2000W Termostato regolabile Spia di funzionamento Alimentazione 220-240 V - 50Hz</p> <p>512910240N - - conf. 1 - € 52,66</p>	  <p>RADIATORE AD OLIO Con portacavo 9 elementi Potenza massima 2000W 3 livelli di potenza selezionabili 800/1200/2000W Termostato regolabile Spia di funzionamento Funzione anti-surriscaldamento con termo fusibile di protezione Dispositivo antiribaltamento Alimentazione 220-240V - 50Hz</p> <p>512910220N - - conf. 1 - € 75,00</p>
  <p>TERMOCONVETTORE K200 Potenza massima 2000W 3 livelli di potenza 750/1250/2000W Termostato regolabile Appendibile a parete Protezione antisurriscaldamento Alimentazione 220-240V - 50Hz</p> <p>512910200N - - conf. 1 - € 34,00</p>	  <p>TERMOCONVETTORE K190 Potenza massima 2000W 3 livelli di potenza 750/1250/2000W Termostato regolabile con turboventilazione Timer 24H</p> <p>512910190N - - conf. 1 - € 71,00</p>
  <p>TERMOVENTILATORE DA MURO K180 Montaggio a parete Telecomando Funzione ventilazione Termostato di sicurezza Timer 2 livelli di potenza selezionabili 1000/2000W Potenza massima 2000W Alimentazione 220-240V - 50Hz</p> <p>512910180N - - conf. 1 - € 59,80</p>	  <p>TERMOVENTILATORE CERAMICO Design elegante con base oscillante e protezione antisurriscaldamento Potenza massima 1500W 2 livelli di potenza 750/1500W Spia luminosa di funzionamento Con maniglia Alimentatore 220-240V - 50Hz</p> <p>512910150N - - conf. 1 - € 36,80</p>
  <p>TERMOVENTILATORE K140 Con timer 24h e termostato regolabile Potenza massima 2000W 2 livelli di potenza 1000/2000W Funzione ventilazione Interruttore luminoso di funzionamento Alimentazione 220-240V - 50Hz</p> <p>512910140N - - conf. 1 - € 31,40</p>	  <p>TERMOVENTILATORE K120 Con termostato regolabile Potenza massima 2000W 2 livelli di potenza 1000/2000W Funzione ventilazione Interruttore luminoso di funzionamento Alimentazione 220-240V - 50Hz</p> <p>512910120N - - conf. 1 - € 19,20</p>



GIEFFE
gruppi generali forniture



STUFA ALOGENA Design elegante con base oscillante 3 livelli di potenza 400/800/1200 W Interruttore di sicurezza antiribaltamento Alimentazione 220-240 V - 50Hz

512910110N -
- conf. 1 - € 30,40

GIEFFE
gruppi generali forniture



STUFA AL QUARZO Stufa elettrica K100 Due tubi riscaldanti al quarzo Potenza massima 800 W 2 livelli di potenza 400/800 W Interruttore di sicurezza antiribaltamento Con maniglia Alimentazione 220-240V - 50Hz

512910100N -
- conf. 1 - € 14,40

GIEFFE
gruppi generali forniture



STUFA AL CARBONIO Design elegante con base oscillante 2 livelli di potenza 450/900W Interruttore di sicurezza antiribaltamento Alimentazione 220-240V - 50Hz

512910250N -
- conf. 1 - € 46,00

MANGUCCI



PARASPIFFERI SPIIFF CON MOLLA In alluminio Paraspiffero adesivo per base porta con spazzolino in nylon con struttura di regolazione automatica dell'altezza Misura 1 mt

7681576 - Colore Bianco -
- conf. 10 - € 8,20
7681577 - Colore Marrone -
- conf. 10 - € 8,20

M&T 900



PARASPIFFERI PER BLINDATE Larghezza 28 mm Spessore 13 mm accorciabile 8 cm. ogni lato

90005108 - Lungh.cm 81 -
- conf. 10 - € 10,72
90005109 - Lungh.cm 93 -
- conf. 10 - € 11,12
90005110 - Lungh.cm 103 -
- conf. 10 - € 11,12

MANGUCCI



PARASPIFFERI SPIIFF EXTRA In PVC Paraspiffero per base porta con spazzolino in nylon Evita le correnti d'aria e il passaggio di polvere e freddo Misura 1 metro

7681571 - Colore Marrone -
- conf. 25 - € 3,20
7681572 - Colore Trasparente -
- conf. 25 - € 4,00

MANGUCCI



PARASPIFFERI SPIIFF EXTRA Con cavallotto paraspiffero adesivo per base porta con spazzolino in nylon Misura 1 mt

7681570 -
- conf. 25 - € 2,60

MANGUCCI



PARASPIFFERI SOTTOPORTA Misure 950 x 25 mm Risparmio energetico Materiale spugnato Colore grigio

7681579 -
- conf. 10 - € 7,20

MANGUCCI



PARAFREDDO IN COTONE Per porte e finestre Misura 120 cm Fantasie assortite

7681592Y -
- conf. 1 - € 6,20

MANGUCCI



PARASPIFFERI BLACK LINE Autoadesivo in gomma espansa con funzione di antispiffero, isolante termico, isolante acustico, anticondensa, antivibrazioni e paracolpi Colore nero

768152120 - Misura 15x5 mm - Lunghezza 20 metri -
- conf. 10 - € 9,00
768152220 - Misura 20x25 mm - Lunghezza 20 metri -
- conf. 10 - € 12,20
7681526 - Misura 10x5 mm - Lunghezza 20 metri -
- conf. 10 - € 10,40

MANGUCCI



PARASPIFFERI PROFESSIONALE Profilo D In gomma EPDM estrusa Guarnizione adesiva per isolamento termico e acustico di serramenti in legno, alluminio e porte blindate Lunghezza 7,5 metri Misura 9X5 mm

7681550 - Lungh.cm Bianco -
- conf. 10 - € 2,80
7681551 - Lungh.cm Marrone -
- conf. 10 - € 2,80

MANGUCCI



PARASPIFFERI PROFESSIONALE Profilo P In gomma EPDM estrusa Guarnizione adesiva per isolamento termico e acustico di serramenti in legno, alluminio e porte blindate Lunghezza 6 metri Misura 9x5,5

7681540 - Colore Bianco -
- conf. 10 - € 1,96
7681541 - Colore Marrone -
- conf. 10 - € 2,60

ZIPPO

OCCHIALI
DA LETTURA



ZIPPO, Zippo e  sono marchi registrati di proprietà di Zippo Manufacturing Company.

www.malfattitacchinigroup.it

KIT ALASKA

DESIGN ULTIMISSIME TENDENZE MODA, PREZIOSI PINS INCASTONATI
SUL FRONTALE DELLA MONTATURA



Montatura tartaruga chiaro

Montatura tartaruga

Montatura trasparente,
aste tartaruga

Montatura nera

KIT VIRGINIA

IL CLASSICO "MEZZALUNA" IDEALE PER PROFESSIONISTI, AVVOCATI,
NOTAI, MEDICI...



Montatura rossa

Montatura blu

Montatura tartaruga

Montatura verde

KIT OHIO

PONTE IN METALLO, PREZIOSI PINS INCASTONATI NEL FRONTALE DELLA MONTATURA



Montatura rossa, aste nere

Montatura blu, aste nere

Montatura nera

Montatura tartaruga,
aste nere

KIT MINNESOTA

GLI OCCHIALI CLASSICI, UNISEX PER LE PERSONE ELEGANTI



Montatura rossa

Montatura blu

Montatura nera

Montatura tartaruga

kit da 24 occhiali, in 4 colori diversi,
con assortimento ottimale delle diottrie per la vendita.

Aste flessibili, cerniera con meccanismo a molla
per una migliore adattabilità degli occhiali al viso!















  <p>PARASPIFFERI PROFESSIONALE Profilo E In gomma EPDM estrusa Guarnizione adesiva per isolamento termico e acustico di serramenti in legno, alluminio e porte blindate Lunghezza 6 metri Misura 9x4 mm</p> <p>7681530 - Colore Bianco - - conf. 10 - € 2,40</p> <p>7681531 - Colore Marrone - - conf. 10 - € 2,40</p>	  <p>ESPOSITORE 12 LENTI D'INGRANDIMENTO Contiene: 4 pz 2" 5x 4 pz 2,5" 5x 4 pz 3" 3x</p> <p>512660190201 - - conf. 1 - € 25,40</p>
  <p>OCCHIALI DA LETTURA Linea 31Z091-RED</p> <p>89031Z091R100 - Diottria +1.00 - - conf. 1 - € 9,90</p> <p>89031Z091R150 - Diottria +1.50 - - conf. 1 - € 9,90</p> <p>89031Z091R200 - Diottria +2.00 - - conf. 1 - € 9,90</p> <p>89031Z091R250 - Diottria +2.50 - - conf. 1 - € 9,90</p> <p>89031Z091R300 - Diottria +3.00 - - conf. 1 - € 9,90</p> <p>89031Z091R350 - Diottria +3.50 - - conf. 1 - € 9,90</p>	  <p>OCCHIALI DA LETTURA Linea 31Z-B16-RED</p> <p>89031ZB16R100 - Diottria +1.00 - - conf. 1 - € 9,90</p> <p>89031ZB16R150 - Diottria +1.50 - - conf. 1 - € 9,90</p> <p>89031ZB16R200 - Diottria +2.00 - - conf. 1 - € 9,90</p> <p>89031ZB16R250 - Diottria +2.50 - - conf. 1 - € 9,90</p> <p>89031ZB16R300 - Diottria +3.00 - - conf. 1 - € 9,90</p> <p>89031ZB16R350 - Diottria +3.50 - - conf. 1 - € 9,90</p>
  <p>OCCHIALI DA LETTURA Linea 31Z-B20-BDE</p> <p>89031ZB20B100 - Diottria +1.00 - - conf. 1 - € 9,90</p> <p>89031ZB20B150 - Diottria +1.50 - - conf. 1 - € 9,90</p> <p>89031ZB20B200 - Diottria +2.00 - - conf. 1 - € 9,90</p> <p>89031ZB20B250 - Diottria +2.50 - - conf. 1 - € 9,90</p> <p>89031ZB20B300 - Diottria +3.00 - - conf. 1 - € 9,90</p> <p>89031ZB20B350 - Diottria +3.50 - - conf. 1 - € 9,90</p>	  <p>OCCHIALI DA LETTURA Linea 31Z-B20-RDE</p> <p>89031ZB20R100 - Diottria +1.00 - - conf. 1 - € 9,90</p> <p>89031ZB20R150 - Diottria +1.50 - - conf. 1 - € 9,90</p> <p>89031ZB20R200 - Diottria +2.00 - - conf. 1 - € 9,90</p> <p>89031ZB20R250 - Diottria +2.50 - - conf. 1 - € 9,90</p> <p>89031ZB20R300 - Diottria +3.00 - - conf. 1 - € 9,90</p> <p>89031ZB20R350 - Diottria +3.50 - - conf. 1 - € 9,90</p>
  <p>OCCHIALI DA LETTURA Linea 31Z-B21-GRV</p> <p>89031ZB21G100 - Diottria +1.00 - - conf. 1 - € 9,90</p> <p>89031ZB21G150 - Diottria +1.50 - - conf. 1 - € 9,90</p> <p>89031ZB21G200 - Diottria +2.00 - - conf. 1 - € 9,90</p> <p>89031ZB21G250 - Diottria +2.50 - - conf. 1 - € 9,90</p> <p>89031ZB21G300 - Diottria +3.00 - - conf. 1 - € 9,90</p> <p>89031ZB21G350 - Diottria +3.50 - - conf. 1 - € 9,90</p>	  <p>OCCHIALI DA LETTURA Linea 31Z-B22-BLU</p> <p>89031ZB22B100 - Diottria +1.00 - - conf. 1 - € 9,90</p> <p>89031ZB22B150 - Diottria +1.50 - - conf. 1 - € 9,90</p> <p>89031ZB22B200 - Diottria +2.00 - - conf. 1 - € 9,90</p> <p>89031ZB22B250 - Diottria +2.50 - - conf. 1 - € 9,90</p> <p>89031ZB22B300 - Diottria +3.00 - - conf. 1 - € 9,90</p> <p>89031ZB22B350 - Diottria +3.50 - - conf. 1 - € 9,90</p>
  <p>OCCHIALI DA LETTURA Linea 31Z-B22-WHI</p> <p>89031ZB22W100 - Diottria +1.00 - - conf. 1 - € 9,90</p> <p>89031ZB22W150 - Diottria +1.50 - - conf. 1 - € 9,90</p> <p>89031ZB22W200 - Diottria +2.00 - - conf. 1 - € 9,90</p> <p>89031ZB22W250 - Diottria +2.50 - - conf. 1 - € 9,90</p> <p>89031ZB22W300 - Diottria +3.00 - - conf. 1 - € 9,90</p> <p>89031ZB22W350 - Diottria +3.50 - - conf. 1 - € 9,90</p>	  <p>OCCHIALI DA LETTURA Linea 31Z-B25-BLU</p> <p>89031ZB25B100 - - conf. 6 - € 9,90</p> <p>89031ZB25B150 - - conf. 6 - € 9,90</p> <p>89031ZB25B200 - - conf. 6 - € 9,90</p> <p>89031ZB25B250 - - conf. 6 - € 9,90</p> <p>89031ZB25B300 - - conf. 6 - € 9,90</p> <p>89031ZB25B350 - - conf. 6 - € 9,90</p>
  <p>OCCHIALI DA LETTURA Linea 31Z-PR73</p> <p>89031ZPR73100 - Diottria +1.00 - - conf. 1 - € 9,90</p> <p>89031ZPR73150 - Diottria +1.50 - - conf. 1 - € 9,90</p> <p>89031ZPR73200 - Diottria +2.00 - - conf. 1 - € 9,90</p> <p>89031ZPR73250 - Diottria +2.50 - - conf. 1 - € 9,90</p> <p>89031ZPR73300 - Diottria +3.00 - - conf. 1 - € 9,90</p> <p>89031ZPR73350 - Diottria +3.50 - - conf. 1 - € 9,90</p>	  <p>OCCHIALI DA LETTURA Linea 31Z-PR-72</p> <p>89031ZPR72100 - Diottria +1.00 - - conf. 1 - € 9,90</p> <p>89031ZPR72150 - Diottria +1.50 - - conf. 1 - € 9,90</p> <p>89031ZPR72200 - Diottria +2.00 - - conf. 1 - € 9,90</p> <p>89031ZPR72250 - Diottria +2.50 - - conf. 1 - € 9,90</p> <p>89031ZPR72300 - Diottria +3.00 - - conf. 1 - € 9,90</p> <p>89031ZPR72350 - Diottria +3.50 - - conf. 1 - € 9,90</p>



























<p>zippo OCCHIALI DA LETTURA Linea 31Z-PR56</p> <p>89031ZPR56100 - - conf. 6 - € 9,90 89031ZPR56150 - - conf. 6 - € 9,90 89031ZPR56200 - - conf. 6 - € 9,90 89031ZPR56250 - - conf. 6 - € 9,90 89031ZPR56300 - - conf. 6 - € 9,90 89031ZPR56350 - - conf. 6 - € 9,90</p> 	<p>zippo OCCHIALI DA LETTURA Linea 31Z-PR-67</p> <p>89031ZPR67100 - Diottria +1.00 - - conf. 1 - € 9,90 89031ZPR67150 - Diottria +1.50 - - conf. 1 - € 9,90 89031ZPR67200 - Diottria +2.00 - - conf. 1 - € 9,90 89031ZPR67250 - Diottria +2.50 - - conf. 1 - € 9,90 89031ZPR67300 - Diottria +3.00 - - conf. 1 - € 9,90 89031ZPR67350 - Diottria +3.50 - - conf. 1 - € 9,90</p> 
<p>zippo OCCHIALI DA LETTURA Linea 31Z-PR58</p> <p>89031ZPR58100 - - conf. 6 - € 9,90 89031ZPR58150 - - conf. 6 - € 9,90 89031ZPR58200 - - conf. 6 - € 9,90 89031ZPR58250 - - conf. 6 - € 9,90 89031ZPR58300 - - conf. 6 - € 9,90 89031ZPR58350 - - conf. 6 - € 9,90</p> 	<p>zippo OCCHIALI DA LETTURA Linea 31Z-PR74</p> <p>89031ZPR74100 - Diottria +1.00 - - conf. 1 - € 9,90 89031ZPR74150 - Diottria +1.50 - - conf. 1 - € 9,90 89031ZPR74200 - Diottria +2.00 - - conf. 1 - € 9,90 89031ZPR74250 - Diottria +2.50 - - conf. 1 - € 9,90 89031ZPR74300 - Diottria +3.00 - - conf. 1 - € 9,90 89031ZPR74350 - Diottria +3.50 - - conf. 1 - € 9,90</p> 
<p>zippo OCCHIALI DA LETTURA Linea 31Z-PR-70</p> <p>89031ZPR70100 - Diottria +1.00 - - conf. 1 - € 9,90 89031ZPR70150 - Diottria +1.50 - - conf. 1 - € 9,90 89031ZPR70200 - Diottria +2.00 - - conf. 1 - € 9,90 89031ZPR70250 - Diottria +2.50 - - conf. 1 - € 9,90 89031ZPR70300 - Diottria +3.00 - - conf. 1 - € 9,90 89031ZPR70350 - Diottria +3.50 - - conf. 1 - € 9,90</p> 	<p>zippo OCCHIALI DA LETTURA Linea 31Z-PR26</p> <p>89031ZPR26100 - Diottria +1.00 - - conf. 1 - € 9,90 89031ZPR26200 - Diottria +2.00 - - conf. 1 - € 9,90 89031ZPR26300 - Diottria +3.00 - - conf. 1 - € 9,90 89031ZPR26350 - Diottria +3.50 - - conf. 1 - € 9,90</p> 
<p>zippo OCCHIALI DA LETTURA Linea 31Z-PR40</p> <p>89031ZPR40100 - Diottria +1.00 - - conf. 1 - € 9,90 89031ZPR40150 - Diottria +1.50 - - conf. 1 - € 9,90 89031ZPR40200 - Diottria +2.00 - - conf. 1 - € 9,90 89031ZPR40350 - Diottria +3.50 - - conf. 1 - € 9,90</p> 	<p>zippo OCCHIALI DA LETTURA Linea 31Z-PR62</p> <p>89031ZPR62100 - Diottria +1.00 - - conf. 1 - € 9,90 89031ZPR62150 - Diottria +1.50 - - conf. 1 - € 9,90 89031ZPR62200 - Diottria +2.00 - - conf. 1 - € 9,90 89031ZPR62250 - Diottria +2.50 - - conf. 1 - € 9,90 89031ZPR62300 - Diottria +3.00 - - conf. 1 - € 9,90 89031ZPR62350 - Diottria +3.50 - - conf. 1 - € 9,90</p> 
<p>zippo OCCHIALI DA LETTURA Linea 31Z-B3-GRE</p> <p>89031ZB3G100 - Diottria +1.00 - - conf. 1 - € 9,90 89031ZB3G150 - Diottria +1.50 - - conf. 1 - € 9,90 89031ZB3G200 - Diottria +2.00 - - conf. 1 - € 9,90 89031ZB3G250 - Diottria +2.50 - - conf. 1 - € 9,90 89031ZB3G300 - Diottria +3.00 - - conf. 1 - € 9,90 89031ZB3G350 - Diottria +3.50 - - conf. 1 - € 9,90</p> 	<p>zippo OCCHIALI DA LETTURA Linea 31ZPR-68</p> <p>89031ZPR68100 - Diottria +1.00 - - conf. 1 - € 9,90 89031ZPR68150 - Diottria +1.50 - - conf. 1 - € 9,90 89031ZPR68200 - Diottria +2.00 - - conf. 1 - € 9,90 89031ZPR68250 - Diottria +2.50 - - conf. 1 - € 9,90 89031ZPR68300 - Diottria +3.00 - - conf. 1 - € 9,90 89031ZPR68350 - Diottria +3.50 - - conf. 1 - € 9,90</p> 
<p>zippo OCCHIALI DA LETTURA Linea 31Z-PP26</p> <p>89031ZPP26100 - Diottria +1.00 - - conf. 1 - € 9,90</p> 	<p>zippo OCCHIALI DA LETTURA Linea 31Z-PR12</p> <p>89031ZPR12100 - Diottria +1.00 - - conf. 1 - € 9,90 89031ZPR12150 - Diottria +1.50 - - conf. 1 - € 9,90 89031ZPR12200 - Diottria +2.00 - - conf. 1 - € 9,90 89031ZPR12250 - Diottria +2.50 - - conf. 1 - € 9,90 89031ZPR12300 - Diottria +3.00 - - conf. 1 - € 9,90 89031ZPR12350 - Diottria +3.50 - - conf. 1 - € 9,90</p> 



























<p>zippo</p> <p>OCCHIALI DA LETTURA Linea 31Z-PR1A</p> <p>89031ZPR1A100 - Diottria +1.00 - - conf. 1 - € 9,90</p> <p>89031ZPR1A150 - Diottria +1.50 - - conf. 1 - € 9,90</p> <p>89031ZPR1A200 - Diottria +2.00 - - conf. 1 - € 9,90</p> <p>89031ZPR1A250 - Diottria +2.50 - - conf. 1 - € 9,90</p> <p>89031ZPR1A300 - Diottria +3.00 - - conf. 1 - € 9,90</p> <p>89031ZPR1A350 - Diottria +3.50 - - conf. 1 - € 9,90</p> 	<p>zippo</p> <p>OCCHIALI DA LETTURA Linea 31Z-PR64</p> <p>89031ZPR64100 - Diottria +1.00 - - conf. 1 - € 9,90</p> <p>89031ZPR64150 - Diottria +1.50 - - conf. 1 - € 9,90</p> <p>89031ZPR64200 - Diottria +2.00 - - conf. 1 - € 9,90</p> <p>89031ZPR64250 - Diottria +2.50 - - conf. 1 - € 9,90</p> <p>89031ZPR64300 - Diottria +3.00 - - conf. 1 - € 9,90</p> <p>89031ZPR64350 - Diottria +3.50 - - conf. 1 - € 9,90</p> 
<p>zippo</p> <p>OCCHIALI DA LETTURA Linea 31Z-PR60</p> <p>89031ZPR60100 - Diottria +1.00 - - conf. 1 - € 9,90</p> <p>89031ZPR60150 - Diottria +1.50 - - conf. 1 - € 9,90</p> 	<p>zippo</p> <p>OCCHIALI DA LETTURA Linea 31Z-PR24</p> <p>89031ZPR24100 - Diottria +1.00 - - conf. 1 - € 9,90</p> <p>89031ZPR24150 - Diottria +1.50 - - conf. 1 - € 9,90</p> <p>89031ZPR24200 - Diottria +2.00 - - conf. 1 - € 9,90</p> <p>89031ZPR24250 - Diottria +2.50 - - conf. 1 - € 9,90</p> <p>89031ZPR24300 - Diottria +3.00 - - conf. 1 - € 9,90</p> <p>89031ZPR24350 - Diottria +3.50 - - conf. 1 - € 9,90</p> 
<p>zippo</p> <p>OCCHIALI DA LETTURA Linea 31Z-PR30</p> <p>89031ZPR30100 - Diottria +1.00 - - conf. 1 - € 9,90</p> <p>89031ZPR30250 - Diottria +2.50 - - conf. 1 - € 9,90</p> <p>89031ZPR30300 - Diottria +3.00 - - conf. 1 - € 9,90</p> <p>89031ZPR30350 - Diottria +3.50 - - conf. 1 - € 9,90</p> 	<p>zippo</p> <p>OCCHIALI DA LETTURA Linea 31Z-PR47</p> <p>89031ZPR47100 - Diottria +1.00 - - conf. 1 - € 9,90</p> <p>89031ZPR47150 - Diottria +1.50 - - conf. 1 - € 9,90</p> <p>89031ZPR47250 - Diottria +2.50 - - conf. 1 - € 9,90</p> <p>89031ZPR47300 - Diottria +3.00 - - conf. 1 - € 9,90</p> 
<p>zippo</p> <p>OCCHIALI DA LETTURA Linea 31Z-PR9</p> <p>89031ZPR9100 - Diottria +1.00 - - conf. 1 - € 9,90</p> <p>89031ZPR9200 - Diottria +2.00 - - conf. 1 - € 9,90</p> <p>89031ZPR9250 - Diottria +2.50 - - conf. 1 - € 9,90</p> <p>89031ZPR9350 - Diottria +3.50 - - conf. 1 - € 9,90</p> 	<p>zippo</p> <p>OCCHIALI DA LETTURA Linea 31Z-PR61</p> <p>89031ZPR61100 - Diottria +1.00 - - conf. 1 - € 9,90</p> <p>89031ZPR61150 - Diottria +1.50 - - conf. 1 - € 9,90</p> 
<p>zippo</p> <p>OCCHIALI DA LETTURA Linea 31Z-PR31</p> <p>89031ZPR31100 - Diottria +1.00 - - conf. 1 - € 9,90</p> <p>89031ZPR31200 - Diottria +2.00 - - conf. 1 - € 9,90</p> 	<p>zippo</p> <p>OCCHIALI DA LETTURA Linea 31Z-PR1</p> <p>89031ZPR1100 - Diottria +1.00 - - conf. 1 - € 9,90</p> <p>89031ZPR1150 - Diottria +1.50 - - conf. 1 - € 9,90</p> <p>89031ZPR1200 - Diottria +2.00 - - conf. 1 - € 9,90</p> <p>89031ZPR1250 - Diottria +2.50 - - conf. 1 - € 9,90</p> <p>89031ZPR1300 - Diottria +3.00 - - conf. 1 - € 9,90</p> <p>89031ZPR1350 - Diottria +3.50 - - conf. 1 - € 9,90</p> 
<p>zippo</p> <p>ESPOSITORE 24 OCCHIALI DA LETTURA Espo- sitore girevole da banco Dimensioni espositore: 24x24x55 cm Linea 31Z-PD-24M</p> <p>89031ZPD24G - - conf. 1 - € 237,60</p> 	<p>zippo</p> <p>ESPOSITORE 72 OCCHIALI DA LETTURA Esposi- tore girevole da terra Linea 31Z-P-72R</p> <p>89031ZP72R - - conf. 1 - € 712,80</p> 















 <p>OCCHIALI DA LETTURA Modello Alaska Colore Nero</p> <p>545ALASKAN100 - Diottria +1.00 - - conf. 1 - € 9,70</p> <p>545ALASKAN150 - Diottria +1.50 - - conf. 1 - € 9,70</p> <p>545ALASKAN200 - Diottria +2.00 - - conf. 1 - € 9,70</p> <p>545ALASKAN250 - Diottria +2.50 - - conf. 1 - € 9,70</p> <p>545ALASKAN300 - Diottria +3.00 - - conf. 1 - € 9,70</p> <p>segue...</p> 	 <p>continua...</p> <p>545ALASKAN350 - Diottria +3.50 - - conf. 1 - € 9,70</p> 
 <p>OCCHIALI DA LETTURA Modello Alaska Colore Tartaruga chiaro</p> <p>545ALASKAT100 - Diottria +1.00 - - conf. 1 - € 9,70</p> <p>545ALASKAT150 - Diottria +1.50 - - conf. 1 - € 9,70</p> <p>545ALASKAT200 - Diottria +2.00 - - conf. 1 - € 9,70</p> <p>545ALASKAT250 - Diottria +2.50 - - conf. 1 - € 9,70</p> <p>545ALASKAT300 - Diottria +3.00 - - conf. 1 - € 9,70</p> <p>segue...</p> 	 <p>continua...</p> <p>545ALASKAT350 - Diottria +3.50 - - conf. 1 - € 9,70</p> 
 <p>RICARICA SINGOLA OCCHIALI ILLINOIS EL CHARRO Esterno della montatura con effetto visivo e tattile 3D Touch Aste flessibili Con astuccio in ecopelle e cordicella</p> <p>545ILLIN100 - Diottria +1,00 - - conf. 1 - € 13,00</p> <p>545ILLIN150 - Diottria +1,50 - - conf. 1 - € 13,00</p> 	 <p>OCCHIALI DA LETTURA Modello Minnesota Colore Blu</p> <p>545MINNESB100 - Diottria +1.00 - - conf. 1 - € 9,70</p> <p>545MINNESB150 - Diottria +1.50 - - conf. 1 - € 9,70</p> <p>545MINNESB200 - Diottria +2.00 - - conf. 1 - € 9,70</p> <p>545MINNESB250 - Diottria +2.50 - - conf. 1 - € 9,70</p> <p>545MINNESB300 - Diottria +3.00 - - conf. 1 - € 9,70</p> <p>segue...</p> 
 <p>continua...</p> <p>545MINNESB350 - Diottria +3.50 - - conf. 1 - € 9,70</p> 	 <p>OCCHIALI DA LETTURA Modello Minnesota Colore Nero</p> <p>545MINNESN100 - Diottria +1.00 - - conf. 1 - € 9,70</p> <p>545MINNESN150 - Diottria +1.50 - - conf. 1 - € 9,70</p> <p>545MINNESN200 - Diottria +2.00 - - conf. 1 - € 9,70</p> <p>545MINNESN250 - Diottria +2.50 - - conf. 1 - € 9,70</p> <p>545MINNESN300 - Diottria +3.00 - - conf. 1 - € 9,70</p> <p>segue...</p> 
 <p>continua...</p> <p>545MINNESN350 - Diottria +3.50 - - conf. 1 - € 9,70</p> 	 <p>OCCHIALI DA LETTURA Modello Minnesota Colore Rosso</p> <p>545MINNESR100 - Diottria +1.00 - - conf. 1 - € 9,70</p> <p>545MINNESR150 - Diottria +1.50 - - conf. 1 - € 9,70</p> <p>545MINNESR200 - Diottria +2.00 - - conf. 1 - € 9,70</p> <p>545MINNESR250 - Diottria +2.50 - - conf. 1 - € 9,70</p> <p>545MINNESR300 - Diottria +3.00 - - conf. 1 - € 9,70</p> <p>segue...</p> 
 <p>continua...</p> <p>545MINNESR350 - Diottria +3.50 - - conf. 1 - € 9,70</p> 	 <p>OCCHIALI DA LETTURA Modello Minnesota Colore Tartaruga</p> <p>545MINNEST100 - Diottria +1.00 - - conf. 1 - € 9,70</p> <p>545MINNEST150 - Diottria +1.50 - - conf. 1 - € 9,70</p> <p>545MINNEST200 - Diottria +2.00 - - conf. 1 - € 9,70</p> <p>545MINNEST250 - Diottria +2.50 - - conf. 1 - € 9,70</p> <p>545MINNEST300 - Diottria +3.00 - - conf. 1 - € 9,70</p> <p>segue...</p> 















 <p><i>continua...</i> 545MINNEST350 - Diottria +3.50 - - conf. 1 - € 9,70</p> 	 <p>RICARICA SINGOLA OCCHIALI MONTANA EL CHARRO Verniciatura montatura effetto legno Aste flessibili Con astuccio in ecopelle e cordicella</p> <p>545MONT100 - Diottria +1,00 - - conf. 1 - € 13,00</p> 
 <p>OCCHIALI DA LETTURA Modello Ohio Colore Nero</p> <p>545OHIONER100 - Diottria +1.00 - - conf. 1 - € 9,70 545OHIONER150 - Diottria +1.50 - - conf. 1 - € 9,70 545OHIONER200 - Diottria +2.00 - - conf. 1 - € 9,70 545OHIONER250 - Diottria +2.50 - - conf. 1 - € 9,70 545OHIONER300 - Diottria +3.00 - - conf. 1 - € 9,70 <i>segue...</i></p> 	 <p><i>continua...</i> 545OHIONER350 - Diottria +3.50 - - conf. 1 - € 9,70</p> 
 <p>OCCHIALI DA LETTURA Modello Ohio Colore Rosso</p> <p>545OHIOROS100 - Diottria +1.00 - - conf. 1 - € 9,70 545OHIOROS150 - Diottria +1.50 - - conf. 1 - € 9,70 545OHIOROS200 - Diottria +2.00 - - conf. 1 - € 9,70 545OHIOROS250 - Diottria +2.50 - - conf. 1 - € 9,70 545OHIOROS300 - Diottria +3.00 - - conf. 1 - € 9,70 <i>segue...</i></p> 	 <p><i>continua...</i> 545OHIOROS350 - Diottria +3.50 - - conf. 1 - € 9,70</p> 
 <p>OCCHIALI DA LETTURA Modello Virginia Colore Verde</p> <p>545VIRGINV100 - Diottria +1.00 - - conf. 1 - € 9,70 545VIRGINV150 - Diottria +1.50 - - conf. 1 - € 9,70 545VIRGINV200 - Diottria +2.00 - - conf. 1 - € 9,70 545VIRGINV250 - Diottria +2.50 - - conf. 1 - € 9,70 545VIRGINV300 - Diottria +3.00 - - conf. 1 - € 9,70 <i>segue...</i></p> 	 <p><i>continua...</i> 545VIRGINV350 - Diottria +3.50 - - conf. 1 - € 9,70</p> 
 <p>OCCHIALI DA LETTURA Modello Ohio Colore Blu</p> <p>545OHIOBLU100 - Diottria +1.00 - - conf. 1 - € 9,70 545OHIOBLU150 - Diottria +1.50 - - conf. 1 - € 9,70 545OHIOBLU200 - Diottria +2.00 - - conf. 1 - € 9,70 545OHIOBLU250 - Diottria +2.50 - - conf. 1 - € 9,70 545OHIOBLU300 - Diottria +3.00 - - conf. 1 - € 9,70 545OHIOBLU350 - Diottria +3.50 - - conf. 1 - € 9,70</p> 	 <p>OCCHIALI DA LETTURA Modello Virginia Colore Rosso</p> <p>545VIRGINR100 - Diottria +1.00 - - conf. 1 - € 9,70 545VIRGINR150 - Diottria +1.50 - - conf. 1 - € 9,70 545VIRGINR200 - Diottria +2.00 - - conf. 1 - € 9,70 545VIRGINR250 - Diottria +2.50 - - conf. 1 - € 9,70 545VIRGINR300 - Diottria +3.00 - - conf. 1 - € 9,70 <i>segue...</i></p> 
 <p><i>continua...</i> 545VIRGINR350 - Diottria +3.50 - - conf. 1 - € 9,70</p> 	 <p>OCCHIALI DA LETTURA Modello Ohio Colore Tartaruga</p> <p>545OHOTAR100 - Diottria +1.00 - - conf. 1 - € 9,70 545OHOTAR150 - Diottria +1.50 - - conf. 1 - € 9,70 545OHOTAR200 - Diottria +2.00 - - conf. 1 - € 9,70 545OHOTAR250 - Diottria +2.50 - - conf. 1 - € 9,70 545OHOTAR300 - Diottria +3.00 - - conf. 1 - € 9,70 <i>segue...</i></p> 



<p>ioi</p> <p>continua... 545OHOTAR350 - Diottria +3.50 - - conf. 1 - € 9,70</p> 	<p>ioi</p> <p>OCCHIALI DA LETTURA Modello Virginia Colore Tartaruga</p> <p>545VIRGINT100 - Diottria +1.00 - - conf. 1 - € 9,70 545VIRGINT150 - Diottria +1.50 - - conf. 1 - € 9,70 545VIRGINT200 - Diottria +2.00 - - conf. 1 - € 9,70 545VIRGINT250 - Diottria +2.50 - - conf. 1 - € 9,70 545VIRGINT300 - Diottria +3.00 - - conf. 1 - € 9,70 segue...</p> 
<p>ioi</p> <p>continua... 545VIRGINT350 - Diottria +3.50 - - conf. 1 - € 9,70</p> 	<p>ioi</p> <p>OCCHIALI DA LETTURA Modello Virginia Colore Blu</p> <p>545VIRGINB100 - Diottria +1.00 - - conf. 1 - € 9,70 545VIRGINB150 - Diottria +1.50 - - conf. 1 - € 9,70 545VIRGINB200 - Diottria +2.00 - - conf. 1 - € 9,70 545VIRGINB250 - Diottria +2.50 - - conf. 1 - € 9,70 545VIRGINB300 - Diottria +3.00 - - conf. 1 - € 9,70 segue...</p> 
<p>ioi</p> <p>continua... 545VIRGINB350 - Diottria +3.50 - - conf. 1 - € 9,70</p> 	<p>ioi</p> <p>ESPOSITORE 24 OCCHIALI DA LETTURA Espo- sitore girevole da banco Dimensioni espositore: 21x21x53 cm Modello Ohio</p> <p>545KITOHIO24 - - conf. 1 - € 232,80</p> 
<p>ioi</p> <p>ESPOSITORE 24 OCCHIALI DA LETTURA Espo- sitore girevole da banco Dimensioni espositore: 21x21x53 cm Modello Virginia</p> <p>545KITVIRG24 - - conf. 1 - € 232,80</p> 	<p>ioi</p> <p>ESPOSITORE 24 OCCHIALI DA LETTURA Espo- sitore girevole da banco Dimensioni espositore: 21x21x53 cm Modello Minnesota</p> <p>545KITMINN24 - - conf. 1 - € 232,80</p> 
<p>ioi</p> <p>ESPOSITORE 24 OCCHIALI DA LETTURA Espo- sitore girevole da banco Dimensioni espositore: 21x21x53 cm Modello Alaska</p> <p>545KITALASK24 - - conf. 1 - € 232,80</p> 	<p>DEFENCE SYSTEM</p> <p>ESPOSITORE 9 SPRAY LIMPIDALENTE Soluzio- ne vegetale detergente antiappannante Basta nebulizzare sulla superficie delle lenti, frizionare con le dita e pulire con un panno. Panno in micro- fibra incluso nella confezione. Formato 30 ml</p> <p>46643983 - - conf. 1 - € 57,60</p> 
<p>COUPE-ONGLES</p> <p>TAGLIAUNGHIE TRIM Per mani Cartella da 12 pz.</p> <p>41408TRIM12C - - conf. 1 - € 19,98</p> 	<p>OPINEL</p> <p>COLTELLO OPINEL Lama in acciaio al carbonio</p> <p>414111020 - n° lame 2 - - conf. 12 - € 7,22 414111030 - n° lame 3 - - conf. 12 - € 8,20 414111040 - n° lame 4 - - conf. 12 - € 7,82 414111050 - n° lame 5 - - conf. 12 - € 8,80 414113060 - n° lame 6 - - conf. 12 - € 9,68 segue...</p> 



<p>OPINEL</p> <p>continua...</p> <p>414113070 – n° lame 7 – – conf. 12 – € 10,10</p> <p>414113080 – n° lame 8 – – conf. 12 – € 10,30</p> <p>414113090 – n° lame 9 – – conf. 12 – € 12,16</p> <p>414113100 – n° lame 10 – – conf. 6 – € 14,42</p> <p>414113120 – n° lame 12 – – conf. 6 – € 17,92</p> 	<p>OPINEL</p> <p>COLTELLO OPINEL INOX Manico in faggio Richiudibile VIROBLOC dal n°6 al n° 12 Costituito da due parti: una fissa e una scorrevole. Oltre al blocco della lama in posizione aperta (sicurezza d'uso) adesso è possibile bloccare la lama in posizione chiusa (sicurezza di trasporto)</p> <p>4140VRI05 – n° 5 – Lama 60 – – conf. 1 – € 8,62</p> <p>4140VRI06 – n° 6 – Lama 70 – Tipologia Virobloc – – conf. 1 – € 11,00 segue...</p> 
<p>OPINEL</p> <p>continua...</p> <p>4140VRI07 – n° 7 – Lama 80 – Tipologia Virobloc – – conf. 1 – € 11,20</p> <p>4140VRI08 – n° 8 – Lama 85 – Tipologia Virobloc – – conf. 1 – € 11,40</p> <p>4140VRI09 – n° 9 – Lama 90 – Tipologia Virobloc – – conf. 1 – € 13,00</p> <p>4140VRI10 – n° 10 – Lama 100 – Tipologia Virobloc – – conf. 1 – € 16,40 segue...</p> 	<p>OPINEL</p> <p>continua...</p> <p>4140VRI12 – n° 12 – Lama 120 – Tipologia Virobloc – – conf. 1 – € 19,80</p> 
<p>ausonia</p> <p>COLTELLO DA TASCA MOD. WOOD WAVE Lama INOX Manico acciaio INOX con inserti in legno Misura 20 cm</p> <p>19626473 – – conf. 1 – € 22,24</p> 	<p>ausonia</p> <p>COLTELLO DA TASCA MOD. STEALTH Lama INOX teflonata Manico in fibra Misura 20 cm</p> <p>19626238 – – conf. 1 – € 15,88</p> 
<p>Beta</p> <p>ESPOSITORE 10 PZ. COLTELLI BETA ART. 1778SOS/E10 Coltello multifunzione: Taglia cinture di sicurezza Martello frangicristalli Manico in alluminio</p> <p>200017780180 – – conf. 1 – € 310,00</p>  <p>AD ESAURIMENTO</p>	<p>COTE per affilare: falci-coltelli-forbici 230 mm</p> <p>74039540 – – conf. 6 – € 3,60</p> 
<p>Gieffe</p> <p>FORBICI MULTIUSO Titanio Lama inox In blister</p> <p>512340600N – L.mm 5” – – conf. 1 – € 2,16</p> <p>512340610N – L.mm 7” – – conf. 1 – € 2,51</p> <p>512340620N – L.mm 8” – – conf. 1 – € 3,19</p> <p>512340625N – L.mm 9” – – conf. 1 – € 3,81</p> 	<p>Gieffe</p> <p>ESPOSITORE 18 FORBICI Misura forbici: 6 pezzi da 130 mm 6 pezzi da 150 mm 6 pezzi da 210 mm Dimensioni: 250x370x190</p> <p>512340630N – – conf. 1 – € 38,52</p> 
<p>&M 540</p> <p>FORBICI MANICO FIBRA</p> <p>540604608010 – Misura 225 MM – – conf. 1 – € 6,40</p> 	<p>ASTRAL</p> <p>FORBICI PROFESSIONALI Lunghezza 275 mm Lama Inox</p> <p>190404054 – – conf. 1 – € 11,80</p> 



540

FORBICI MULTIUSO Misura 200 mm

540304608000 -
- conf. 1 - € 3,80



ausonia

FORBICI DA LAVORO Nichelate

19613010 - Pollici 4 -
- conf. 1 - € 11,80



ausonia

FORBICI LAVORO LINEA CASA Nichelate Gamba mezza rana Anello rovescio Forgiata a caldo ed affilata a mano

19613015 - Misura 4,5 -
- conf. 1 - € 13,20
19613025 - Misura 5 -
- conf. 1 - € 14,30
19613035 - Misura 5,5 -
- conf. 1 - € 14,96
19613045 - Misura 6,5 -
- conf. 1 - € 16,00



ausonia

FORBICE MERCIAIO STRETTA

19613072 - Misura 4 -
- conf. 6 - € 12,56
19613073 - Misura 4,5 -
- conf. 1 - € 13,66



TRUE UTILITY

ESPOSITORE 6 PZ FIXR - MULTITOOLS 20 STRUMENTI IN 1 TRUE UTILITY Progettato in titanio nero rivestito in acciaio Inox 422 Funzioni: apribottiglie, pulisci cuticole, cacciavite, piccolo cacciavite per occhiali, lama da taglio, spelafili, righello, apri pacchi, lima, chiave per bulloni Clip di aggancio

464TU200 -
- conf. 1 - € 121,32



PROXE

CAMPANELLO SENZA FILI A BATTERIA Campanello con suoneria senza fili a batteria Di facile installazione Dotato di 16 suonerie selezionabili Ideale per abitazioni, negozi, uffici come sistema per accogliere visitatori e di sicurezza Può essere fissato ad una parete tramite gancio o chiodo, oppure semplicemente appoggiato ad un ripiano Trasmissione: Via radio a 433MHz 50 Mt. campo libero Alimentazione: 2 Batterie AA (per suoneria - non incluse) 1 Batteria 23A-12V (per campanello inclusa)

753600016 -
- conf. 1 - € 13,40



ASTRAL

CATENA ANTIFURTO Maglia tonda - zincata ricoperta da guaina in plastica termoretratta

190754010 - Ø mm 4 - Lunghezza 600 -
- conf. 20 - € 2,60
190754013 - Ø mm 4,5 - Lunghezza 800 -
- conf. 15 - € 3,60
190754018 - Ø mm 6 - Lunghezza 600 -
- conf. 10 - € 4,00
190754019 - Ø mm 6 - Lunghezza 800 -
- conf. 10 - € 5,00
190754020 - Ø mm 6 - Lunghezza 1000 -
- conf. 10 - € 6,20
segue...



ASTRAL

continua...

190754021 - Ø mm 6 - Lunghezza 1200 -
- conf. 10 - € 7,00
190754029 - Ø mm 8 - Lunghezza 1000 -
- conf. 5 - € 10,20
190754030 - Ø mm 8 - Lunghezza 1200 -
- conf. 5 - € 12,00



ASTRAL

CATENA ANTIFURTO Maglia quadra - zincata ricoperta da guaina in plastica termoretratta

190754040 - Ø mm 6 - Lunghezza 600 -
- conf. 5 - € 5,20
190754041 - Ø mm 6 - Lunghezza 800 -
- conf. 5 - € 6,60
190754042 - Ø mm 6 - Lunghezza 1000 -
- conf. 5 - € 7,80
190754045 - Ø mm 8 - Lunghezza 900 -
- conf. 5 - € 12,80
190754047 - Ø mm 8 - Lunghezza 1200 -
- conf. 5 - € 17,40
segue...



ASTRAL

continua...

190754048 - Ø mm 8 - Lunghezza 1500 -
- conf. 5 - € 21,20
190754050 - Ø mm 10 - Lunghezza 900 -
- conf. 5 - € 18,20
190754052 - Ø mm 10 - Lunghezza 1200 -
- conf. 4 - € 23,80
190754053 - Ø mm 10 - Lunghezza 1500 -
- conf. 2 - € 28,80
190754055 - Ø mm 10 - Lunghezza 2000 -
- conf. 2 - € 37,40



SIKURO

GUARDIAN













BlocK

UFO 



**la vostra
SICUREZZA
è la nostra
FORZA**

























<p>ASTRAL</p> <p>CATENA ANTIFURTO IN ACCIAIO CEMENTATO Maglia quadra ricoperta da guaina in plastica termoretratta</p> <p>190754070 - Ø mm 6 - Lunghezza 600 - - conf. 5 - € 6,40</p> <p>190754071 - Ø mm 6 - Lunghezza 800 - - conf. 5 - € 8,00</p> <p>190754072 - Ø mm 6 - Lunghezza 1000 - - conf. 5 - € 9,60</p> <p>190754074 - Ø mm 8 - Lunghezza 800 - - conf. 5 - € 14,40</p> <p>segue...</p> 	<p>ASTRAL</p> <p>continua...</p> <p>190754076 - Ø mm 8 - Lunghezza 1000 - - conf. 5 - € 17,60</p> <p>190754077 - Ø mm 8 - Lunghezza 1200 - - conf. 5 - € 21,60</p> <p>190754078 - Ø mm 8 - Lunghezza 1500 - - conf. 5 - € 26,60</p> <p>190754081 - Ø mm 10 - Lunghezza 1000 - - conf. 3 - € 25,20</p> <p>190754082 - Ø mm 10 - Lunghezza 1200 - - conf. 3 - € 30,20</p> <p>segue...</p> 
<p>ASTRAL</p> <p>continua...</p> <p>190754083 - Ø mm 10 - Lunghezza 1500 - - conf. 2 - € 36,80</p> <p>190754085 - Ø mm 10 - Lunghezza 2000 - - conf. 2 - € 48,00</p> 	<p>GIEFFE gruppo general ferramenta</p> <p>CATENA ANTIFURTO Cementata Termo Quadra Rivestita in Pvc</p> <p>512712510N - Ø 6 - Lunghezza 600 - - conf. 1 - € 4,53</p> <p>512712520N - Ø 6 - Lunghezza 800 - - conf. 1 - € 6,18</p> <p>512712530N - Ø 6 - Lunghezza 1000 - - conf. 1 - € 7,21</p> <p>512712540N - Ø 8 - Lunghezza 800 - - conf. 1 - € 11,33</p> <p>512712550N - Ø 8 - Lunghezza 1000 - - conf. 1 - € 14,01</p> <p>segue...</p> 
<p>GIEFFE gruppo general ferramenta</p> <p>continua...</p> <p>512712560N - Ø 8 - Lunghezza 1200 - - conf. 1 - € 16,89</p> <p>512712574N - Ø 10 - Lunghezza 1500 - - conf. 1 - € 29,46</p> 	<p>ILSA</p> <p>CATENA QUADRA CEMENTATA Ex. cod. 190753019 Lucchetto incorporato Misura 8x120</p> <p>523CX756 - - conf. 1 - € 25,44</p> 
<p>ASTRAL</p> <p>CATENA CEMENTATA Rivestita tela Maglia quadra</p> <p>190754090 - Maglia quadra 6 - L. 600 - - conf. 1 - € 10,20</p> <p>190754091 - Maglia quadra 6 - L. 800 - - conf. 1 - € 11,80</p> <p>190754092 - Maglia quadra 6 - L. 1000 - - conf. 1 - € 13,40</p> <p>190754094 - Maglia quadra 8 - L. 800 - - conf. 1 - € 17,00</p> <p>190754096 - Maglia quadra 8 - L. 1000 - - conf. 1 - € 20,20</p> <p>segue...</p> 	<p>ASTRAL</p> <p>continua...</p> <p>190754097 - Maglia quadra 8 - L. 1200 - - conf. 1 - € 24,00</p> <p>190754098 - Maglia quadra 8 - L. 1500 - - conf. 1 - € 29,40</p> <p>190754101 - Maglia quadra 10 - L. 1000 - - conf. 1 - € 28,20</p> <p>190754102 - Maglia quadra 10 - L. 1200 - - conf. 1 - € 32,60</p> <p>190754103 - Maglia quadra 10 - L. 1500 - - conf. 1 - € 39,40</p> <p>190754105 - Maglia quadra 10 - L. 2000 - - conf. 1 - € 49,40</p> 
<p>ASTRAL</p> <p>CATENA CEMENTATA Con lucchetto Rivestita tela Maglia quadra</p> <p>190754112 - Misura 6x600 - - conf. 1 - € 19,40</p> <p>190754113 - Misura 6x800 - - conf. 1 - € 21,00</p> 	<p>ASTRAL</p> <p>CATENA ANTIFURTO Con lucchetto Maglia quadra ricoperta da guaina in plastica termoretratta</p> <p>190754109 - Misura 6x600 - - conf. 5 - € 14,40</p> <p>190754110 - Misura 6x800 - - conf. 5 - € 15,60</p> 
<p>ILSA</p> <p>CATENA A CHIAVE Art. 309821 - Ex cod. 190753062 Art. 309822 - Ex cod. 190753066 Lucchetto corazzato Rivestita tela Maglia quadra Made in Italy</p> <p>523BLOCK610T - Misura cm Ø6x100 - - conf. 1 - € 33,00</p> <p>523BLOCK812T - Misura cm Ø8x120 - - conf. 1 - € 46,66</p> 	<p>ILSA</p> <p>CATENA CEMENTATA A CHIAVE Ex cod. 190753042 Ø6x90cm Maglia Quadra Rivestita Tela</p> <p>52385308 - - conf. 1 - € 15,96</p> 















 <p>CATENA CEMENTATA A COMBINAZIONE Ex cod. 190753044 Ø6X100cm Maglia Quadra Rivestita Tela</p> <p>52385602 - - conf. 1 - € 15,66</p> 	 <p>CATENA CEMENTATA A CHIAVE Ex cod. 190753050 Ø6X100cm Maglia Quadra Rivestita tela con tessuto riflettente Serratura protetta da piastrina antiscasso Chiave Art. 523BK032</p> <p>52385902 - - conf. 1 - € 24,22</p> 
 <p>CATENA CEMENTATA A CHIAVE Ex cod. 190753040 Ø7X100cm Maglia Quadra Catena rivestita in tela Lucchetto rivestito in PVC anti-graffio</p> <p>52385308COVER - - conf. 1 - € 19,14</p> 	 <p>CATENA A CHIAVE Ex cod. 190753002 Ø5X80cm Maglia quadra Rivestita in tessuto Colori assortiti</p> <p>523CX747 - - conf. 1 - € 8,82</p> 
 <p>CATENA A CHIAVE Ex cod. 190753001 Ø3,5X80cm Rivestita PVC</p> <p>52385312 - - conf. 1 - € 5,42</p> 	 <p>CAVO ACCIAIO A CHIAVE Ex cod. 190752103 Ø8x65cm Colori assortiti</p> <p>523304 - - conf. 1 - € 2,56</p> 
 <p>CAVO A CHIAVE Ex cod. 190752105 Ø10X65cm Colori assortiti</p> <p>52386302 - - conf. 1 - € 4,34</p> 	 <p>CAVO ACCIAIO A CHIAVE Ex cod. 190752106 Ø12X80cm</p> <p>52384110 - - conf. 1 - € 4,60</p> 
 <p>CAVO ACCIAIO A CHIAVE Ex cod. 190752109 Ø12X100cm Rivestito in tessuto Colori assortiti</p> <p>523CX4529 - - conf. 1 - € 8,98</p> 	 <p>CAVO ACCIAIO A CHIAVE Ex cod. 190752110 Ø15X80cm Colori assortiti</p> <p>523843521580 - - conf. 1 - € 6,76</p> 
 <p>CAVO ACCIAIO A CHIAVE Ex cod. 190752114 Ø18X80cm</p> <p>52384336 - - conf. 1 - € 9,12</p> 	 <p>CAVO BLINDATO A CHIAVE Ex cod.190752116 Ø18X100cm</p> <p>523CX10818100 - - conf. 1 - € 9,46</p> 



























 	<p>CAVO ACCIAIO A CHIAVE Ex cod. 190752130 Ø25X100cm 523CX491 – – conf. 1 – € 16,18</p>	 	<p>CAVO BLINDATO A CHIAVE Ex cod. 190752120 Ø18X120cm 523CX10918120 – – conf. 1 – € 9,72</p>
 	<p>CAVO BLINDATO A CHIAVE Ex cod. 190752134 Ø22X120 cm 52381704120 – – conf. 1 – € 12,82</p>	 	<p>CAVO ACCIAIO A SPIRALE A CHIAVE Ex cod. 190752311 Ø6X100cm Colori assortiti 5232010SUPP – – conf. 1 – € 3,16</p>
 	<p>CAVO ACCIAIO A SPIRALE A CHIAVE Ex cod. 190752313 Ø8X150cm Colori assortiti 52387302 – – conf. 1 – € 5,86</p>	 	<p>CAVO ACCIAIO A SPIRALE A CHIAVE Ex cod. 190752317 Ø10X120cm Colori assortiti 5238732210120 – – conf. 1 – € 6,78</p>
 	<p>CAVO ACCIAIO A SPIRALE A CHIAVE Ex cod. 190752321 Ø12X150cm 523CX11587120 – – conf. 1 – € 6,30</p>	 	<p>CAVO ACCIAIO A COMBINAZIONE Ex cod. 190752112 Ø15X80cm Colori assortiti 52384617 – – conf. 1 – € 11,08</p>
 	<p>CAVO ACCIAIO A COMBINAZIONE Ex cod. 190752113 Ø12x65cm Completamente rivestito in silicone antigraffio Colori assortiti 523CX4537 – – conf. 1 – € 12,30</p>	 	<p>CAVO ACCIAIO A COMBINAZIONE + CHIAVE CON LUCE LED Ex cod. 190752319 Ø10X120cm 52387605 – – conf. 1 – € 10,20</p>
 	<p>CAVO BLINDATO A COMBINAZIONE Ex cod. 190752118 Ø18X100cm Colori assortiti 52381601 – – conf. 1 – € 12,30</p>	 	<p>CAVO ACCIAIO A COMBINAZIONE Ex cod. 190752132 Ø22X120 cm 52384612 – – conf. 1 – € 17,40</p>



<p>ILSA</p> <p>CAVO CICLO A CHIAVE Ex cod. 190752107 Silicone Ø12x80 cm</p> <p>5238435612 - - conf. 1 - € 9,20</p> 	<p>ILSA</p> <p>CAVO CICLO A CHIAVE Ex cod. 190752101 Ø7X60 cm</p> <p>523N45260 - - conf. 1 - € 17,80</p> 
<p>ASTRAL</p> <p>LUCCHETTO PER SERRANDA 2 chiavi comprese</p> <p>190754114 - MM 65 - Luce 12 - Ø 7 - - conf. 1 - € 9,28 190754115 - MM 90 - Luce 18 - Ø 10 - - conf. 1 - € 11,94</p> 	<p>ILSA</p> <p>BLOCCADISCO UNIVERSALE Ex cod. 190752521 5,5mm Dotato di custodia</p> <p>52393055EB - - conf. 1 - € 11,88</p> 
<p>ILSA</p> <p>BLOCCADISCO MOTO Ex cod. 190752530 Ø 10 mm Dotato di custodia</p> <p>52363055EB - - conf. 1 - € 16,82</p> 	<p>DiSEC</p> <p>BLOCCADISCO MAGNETICO SAFY Serratura anti-picking a chiave magnetica Corpo in alluminio anodizzato Copertura perno in acciaio inox Sensore taglio- Sensore shock programmabile con smartphone Bluetooth LRE (long range extension) fino a 250 m in condizione di allarme Associazione allo smartphone del proprietario Cavo estensibile rinforzato in Kevlar Configurazione sensibilità allarme Configurazione suoneria E-mail & SMS repeater</p> <p>461MG610NE - - conf. 1 - € 233,40</p> 
<p>DiSEC</p> <p>NINO BIKE ALARM Sistema di allarme per biciclette Sorveglia la vostra bicicletta avvisandovi direttamente sullo smartphone in caso di tentato furto. Gestione fino a 6 biciclette</p> <p>461NINOX - - conf. 1 - € 82,76</p> 	<p>ILSA</p> <p>LUCCHETTO AD ARCO Art. 307209 - Ex cod. 190752511 Art. 307210 - Ex cod. 190752515</p> <p>52382103245 - Arco mm 170x245 - - conf. 1 - € 16,52 52382103320 - Arco mm 170x320 - - conf. 1 - € 17,26</p> 
<p>ILSA</p> <p>SPIRALE MEMORY Ex cod. 190752501 Ø4X150cm</p> <p>52387113 - - conf. 1 - € 3,54</p> 	<p>ILSA</p> <p>CHIAVE GREZZA PER LUCCHETTO MONOBLOCCO BK008 Per lucchetto: cod. 523SSU94IS</p> <p>523BK008 - - conf. 1 - € 0,85</p>  <div data-bbox="1037 1646 1524 1720" style="border: 1px solid black; padding: 5px; background-color: #f00; color: white; display: inline-block;">  LUCCHETTO MONOBLOCCO ART. 523SSU94IS </div>
<p>ILSA</p> <p>CHIAVE PER CAVI ASTRAL BIKE Ex cod. 190753355 Per articoli: cod. 523304 cod. 5232010SUPP</p> <p>523K304 - - conf. 10 - € 0,67</p> 	<p>ILSA</p> <p>CHIAVE PER CAVI ASTRAL BIKE Ex cod. 190753360 Per articoli: cod. 5238732210120 cod. 523843521580</p> <p>523BK012D - Profilo Dx - - conf. 10 - € 0,90</p> 



























  <p>CHIAVE PER CAVI ASTRAL BIKE Ex cod. 190753361 Per articoli: cod. 52363055EB cod. 5238435612 cod. 52384336</p> <p>523BK012S – Profilo Sx – – conf. 10 – € 0,90</p>	  <p>CHIAVE PER CAVI ASTRAL BIKE Ex cod. 190753362 Per articoli: cod. 52385902</p> <p>523BK032 – – conf. 10 – € 0,59</p>
  <p>CHIAVE PER CAVI ASTRAL BIKE Ex cod. 190753375 Per articoli: cod. 523CX491</p> <p>523BK024 – – conf. 10 – € 1,08</p>	  <p>CHIAVE PER CAVI ASTRAL BIKE Ex cod. 190753380 Per articoli: cod. 52387302 cod. 52382103245</p> <p>523BK016D – Profilo Dx – – conf. 10 – € 0,90</p>
  <p>CHIAVE PER CAVI ASTRAL BIKE Ex cod. 190753381 Per articoli: cod. 52384110 cod. 52386302</p> <p>523K84110SX – Profilo Sx – – conf. 10 – € 0,90</p>	  <p>CHIAVE PER CATENA Ex cod. 190753363</p> <p>523BK023 – – conf. 1 – € 0,67</p>
  <p>CHIAVE PER CAVI ASTRAL BIKE Ex cod. 190753385 Per articoli: cod. 5238570155 cod. 5238570165</p> <p>523K85701 – – conf. 10 – € 0,64</p>	  <p>CAVI AUTO 10 mm Lunghezza 2,8mt</p> <p>62714691 – – conf. 1 – € 16,90</p>
  <p>CAVI AUTO Lunghezza 2,8mt 10 2,8 mt</p> <p>62716190 – – conf. 1 – € 77,46</p>	  <p>PINZA BATTERIA Manici in plastica</p> <p>90040501 – Lungh. mm 80 – Mod. Rosso – – conf. 10 – € 0,86</p> <p>90040502 – Lungh. mm 80 – Mod. Nero – – conf. 10 – € 0,86</p> <p>90040503 – Lungh. mm 120 – Mod. Rosso – – conf. 10 – € 1,08</p> <p>90040504 – Lungh. mm 120 – Mod. Nero – – conf. 10 – € 1,08</p> <p>90040505 – Lungh. mm 145 – Mod. Rosso – – conf. 10 – € 1,24</p> <p>segue...</p>
  <p>continua...</p> <p>90040506 – Lungh. mm 145 – Mod. Nero – – conf. 10 – € 1,24</p> <p>90040507 – Lungh. mm 180 – Mod. Rosso – – conf. 10 – € 1,38</p> <p>90040508 – Lungh. mm 180 – Mod. Nero – – conf. 10 – € 1,38</p>	  <p>BLISTER 1 LAMPADA ALOGENA Pure Light H4</p> <p>6271180 – – conf. 10 – € 3,92</p>



 <p>BLISTER 1 LAMPADA ALOGENA 55W BOSCH 12V-55W Pure Light H7</p> <p>6271190 - - conf. 10 - € 5,16</p>	 <p>BLISTER 2 LAMPADA ALOGENA P21/5 W</p> <p>6271194 - - conf. 10 - € 2,88</p>
 <p>BLISTER 2 LAMPADA ALOGENA</p> <p>6271201 - - conf. 10 - € 2,88</p>	 <p>BLISTER ALOGENA PUMRE BLISTER Pure Light W1 AF 38</p> <p>6271183 - - conf. 10 - € 2,88</p>
 <p>SET 4 TAPPETI AUTO MOQUETTE</p> <p>62713985 - - conf. 1 - € 8,44</p> <p>AD ESAURIMENTO</p>	 <p>TAPPETO PER AUTO IN GOMMA Rettangolare</p> <p>62715490 - - conf. 1 - € 3,70</p> <p>AD ESAURIMENTO</p>
 <p>SPAZZOLA BOSCH</p> <p>62715009 - Modello AF34 - Misura 340 mm - - conf. 1 - € 15,66</p> <p>62715010 - Modello AF38 - Misura 380 mm - - conf. 1 - € 15,66</p> <p>62715011 - Modello AF40 - Misura 400 mm - - conf. 1 - € 15,66</p> <p>62715012 - Modello AF45 - Misura 450 mm - - conf. 1 - € 15,66</p> <p>62715013 - Modello AF48 - Misura 480 mm - - conf. 1 - € 15,66</p> <p>segue...</p>	 <p>continua...</p> <p>62715014 - Modello AF50 - Misura 500 mm - - conf. 1 - € 15,66</p> <p>62715015 - Modello AF53 - Misura 530 mm - - conf. 1 - € 15,66</p> <p>62715016 - Modello AF55 - Misura 550 mm - - conf. 1 - € 15,66</p> <p>62715017 - Modello AF60 - Misura 600 mm - - conf. 1 - € 15,66</p> <p>62715018 - Modello AF65 - Misura 650 mm - - conf. 1 - € 15,66</p> <p>62715019 - Modello AF70 - Misura 700 mm - - conf. 1 - € 15,66</p>
 <p>SPAZZOLA BOSCH</p> <p>6274707 - Modello 340UC - Misura 340 mm - - conf. 1 - € 5,76</p> <p>6274708 - Modello 400UC - Misura 400 mm - - conf. 1 - € 6,20</p> <p>6274709 - Modello 450UC - Misura 450 mm - - conf. 1 - € 6,20</p> <p>6274710 - Modello 480UC - Misura 475 mm - - conf. 1 - € 6,38</p> <p>6274711 - Modello 500UC - Misura 500 mm - - conf. 1 - € 6,60</p> <p>segue...</p>	 <p>continua...</p> <p>6274712 - Modello 530UC - Misura 530 mm - - conf. 1 - € 7,42</p> <p>6274713 - Modello 550UC - Misura 550 mm - - conf. 1 - € 7,42</p> <p>6274714 - Modello 575UC - Misura 575 mm - - conf. 1 - € 6,60</p> <p>6274715 - Modello 600UC - Misura 600 mm - - conf. 1 - € 7,42</p> <p>6274716 - Modello 650UC - Misura 650 mm - - conf. 1 - € 7,42</p>
 <p>KIT 2 MASTICI RIPARAGOMME BICICLETTA Formato tubetto 10 ml Soluzione vulcanizzante</p> <p>62713021 - - conf. 12 - € 3,10</p>	 <p>KIT 10 PEZZE RIPARAGOMME BICICLETTA 4 pezzi Ø 25 mm 6 pezzi Ø 34 mm</p> <p>62713025 - - conf. 12 - € 2,20</p>















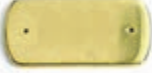



  <p>KIT RIPARAGOMME BICICLETTA Formato tubetto 10 ml Soluzione vulcanizzante 1 raschietto 2 gommini valvola 4 pezze Ø 25 mm 2 pezze 24x35 mm</p> <p>62713023 - - conf. 12 - € 2,68</p>	  <p>CHIAVE A CATENA Per filtro olio</p> <p>93072150 - - conf. 6 - € 2,48</p>
  <p>DEGHIACCIANTE Formato 200 ml</p> <p>62715097 - - conf. 24 - € 1,98</p>	  <p>RASCHIAGHIACCIO CON SPAZZOLA</p> <p>62714823 - - conf. 1 - € 3,92</p>
  <p>PELLE SCAMOSCIATA Piccola</p> <p>62715719 - - conf. 1 - € 7,22</p>	  <p>LINEA NEBULIZZATORI PER AUTO LUBEX Formato 500 ml</p> <p>62710881 - Utilizzo Lucida cruscotti - - conf. 24 - € 2,26 62710882 - Utilizzo Rinnova sedili - - conf. 24 - € 2,26 62710883 - Utilizzo Detergente cerchi - - conf. 24 - € 2,26 62710884 - Utilizzo Detergente vetri - - conf. 24 - € 2,26 62710885 - Utilizzo Nero gomme - - conf. 24 - € 2,26</p>
  <p>LIQUIDO LAVAVETRI LUBEX Formato 5 lt. Liquido per vaschette tergilavavetri</p> <p>6277926 - - conf. 4 - € 2,88</p>	  <p>LIQUIDO PER RADIATORI TAMOIL GRINBLU' Formato 1 lt. -20°C Antigelo Tipo blu</p> <p>627654 - - conf. 12 - € 3,30</p>
  <p>OLIO MOTORE BENZINA-DIESEL LUBEX Minerale 15W40 Unified Plus Per motori benzina e diesel</p> <p>627414 - Formato 4 lt. - - conf. 4 - € 23,90 627415 - Formato 1 lt. - - conf. 12 - € 6,60</p>	  <p>OLIO MOTORE SUPER SYNT BENZINA-DIESEL LUBEX Formato 1 lt. Lubrificante 100% sintetico 5W30 Per motori: benzina, turbobenzina, diesel, turbodiesel, common rail e gas Indicato per auto con filtro antiparticolato</p> <p>6273245 - - conf. 12 - € 7,80</p>
  <p>OLIO MOTORE TOP SYNT BENZINA-DIESEL LUBEX Formato 1 lt. Lubrificante 100% sintetico 5W40 Per motori: benzina, turbobenzina, diesel, turbodiesel, common rail e gas Indicato per auto con filtro antiparticolato</p> <p>6272550 - - conf. 12 - € 7,80</p>	  <p>ADDITIVO PER MOTORI DIESEL COMMON RAIL LUBEX Formato 100 ml Pulisce, protegge e lubrifica il sistema pompa e iniettori Protegge dalla corrosione, migliora lo scorrimento a freddo. Senza cloro</p> <p>62712770 - - conf. 24 - € 2,68</p>



















 <p>SHAMPOO CONCENTRATO PER AUTO LUBEX Formato 0,9 lt. Per lavaggio esterno, elimina lo sporco e lo smog Adatto per qualsiasi tipo di vernice</p> <p>62712774 - - conf. 12 - € 2,26</p>	 <p>LIQUIDO PER RADIATORI Rosso Formato 1l - 35°C Pronto all'uso</p> <p>62712512 - - conf. 12 - € 3,70</p>
 <p>LAVAVETRI Formato 1 lt Vaschette tergi cristalli pronte all'uso</p> <p>62710269 - - conf. 12 - € 2,48</p>	 <p>SMASH LAVAVETRO -15° 2 Litri</p> <p>62716789 - - conf. 1 - € 5,98</p>
 <p>COPRIAVVOLGITORE CLASSIC 278x56mm</p> <p>90013392 - Finitura Ott. Lucido - - conf. 2 - € 14,80</p> <p>90013393 - Finitura Ott. Lucido Sat. - - conf. 2 - € 11,06</p> <p>90013394 - Finitura Ottone Graffiato - - conf. 2 - € 10,76</p> <p>90013395 - Finitura Ott. Cromo Lucido - - conf. 2 - € 13,44</p> <p>90013396 - Finitura Ott. Cromo Sat. - - conf. 2 - € 14,26</p>	 <p>COPRIAVVOLGITORE MINNY 270x55mm</p> <p>50588948800005 - Colore Nero - - conf. 12 - € 5,33</p> <p>50588948800007 - Colore Bianco - - conf. 12 - € 5,33</p>
 <p>COPRIAVVOLGITORE GIOIA 270x56mm Ottone</p> <p>50555448800001 - Finitura Ottone Lucido - - conf. 12 - € 20,56</p> <p>50555448800003 - Finitura Cromo Satinato - - conf. 12 - € 30,68</p> <p>50555448800004 - Finitura Ottone Graffiato - - conf. 12 - € 25,35</p> <p>50555448800007 - Finitura Cromo Lucido - - conf. 12 - € 30,68</p>	 <p>COPRINTERRUTTORE CLASSIC 1 posto</p> <p>90009501 - Finitura Ottone Lucido - - conf. 2 - € 8,64</p> <p>90009511 - Finitura Ottone Satinato - - conf. 2 - € 6,80</p> <p>90009521 - Finitura Ottone Graffiato - - conf. 2 - € 8,64</p>
 <p>COPRINTERRUTTORE CLASSIC 2 posti</p> <p>90009502 - Finitura Ottone Lucido - - conf. 2 - € 8,64</p> <p>90009512 - Finitura Ottone Satinato - - conf. 2 - € 6,80</p> <p>90009522 - Finitura Ottone Graffiato - - conf. 2 - € 8,64</p>	 <p>COPRINTERRUTTORE CLASSIC 3 posti</p> <p>90009503 - Finitura Ottone Lucido - - conf. 2 - € 8,64</p> <p>90009513 - Finitura Ottone Satinato - - conf. 2 - € 6,80</p> <p>90009523 - Finitura Ottone Bronzato - - conf. 2 - € 8,64</p>
 <p>COPRINTERRUTTORE CLASSIC 4 posti</p> <p>90009504 - finitura Ottone Lucido - - conf. 2 - € 11,10</p> <p>90009514 - finitura Ottone Satinato - - conf. 2 - € 12,54</p> <p>90009524 - finitura Ottone Graffiato - - conf. 2 - € 11,72</p>	 <p>COPRINTERRUTTORE CLASSIC 5 posti</p> <p>90009505 - Finitura Ottone Lucido - - conf. 2 - € 11,10</p> <p>90009525 - Finitura Ottone Graffiato - - conf. 2 - € 11,72</p>







 <p>COPRI INTERRUPTORE GIOIA MAGIC 5 Posti 50555448900501 – Finitura Ottone Lucido – – conf. 1 – € 9,40 50555448900503 – Finitura Cromo Satinato – – conf. 1 – € 16,20 50555448900507 – Finitura Cromo Lucido – – conf. 1 – € 16,20</p> 	 <p>COPRI INTERRUPTORE GIOIA MAGIC CIECO 50555448900001 – finitura ott. lucido – – conf. 1 – € 9,00 50555448900002 – finitura ott. satinato – – conf. 1 – € 8,80</p> 
 <p>COPRI INTERRUPTORE GIOIA MAGIC 4 Posti 50555448900401 – Finitura Ottone Lucido – – conf. 1 – € 9,40 50555448900403 – Finitura Cromo Satinato – – conf. 1 – € 16,20 50555448900407 – Finitura Cromo Lucido – – conf. 1 – € 16,20</p> 	 <p>COPRI INTERRUPTORE CLASSIC Cieco 90009510 – Finitura Ottone Satinato – – conf. 2 – € 6,80</p> 
 <p>SUPPORTO QUADRO per corrimano 50549235101000 – finitura ott.bronzato – – conf. 24 – € 6,68 50549235101001 – finitura ott.lucido – – conf. 24 – € 6,52</p> 	 <p>SUPPORTO TONDO FISSO per corrimano 50549235201000 – finitura ott.brun. – – conf. 12 – € 12,27 50549235201001 – finitura ott.lucido – – conf. 12 – € 11,17</p> 
 <p>SUPPORTO TONDO CON VITE per corrimano 50549235251000 – finitura ott.brun. – – conf. 12 – € 18,42 50549235251001 – finitura ott.lucido – – conf. 12 – € 16,56</p> 	 <p>BLISTER 2 Pz. APPENDITUTTO DA PORTA Art. 931 piano con viti 90026753 – – conf. 1 – € 12,56</p> 
 <p>BLISTER 2 Pz. APPENDITUTTO DA PORTA ad incasso Art.930 marrone 90026750 – – conf. 1 – € 12,56</p> 	 <p>BLISTER PORTABITI “PESCIOTTO” in acciaio verniciato portata di 15Kg. bianco 90015951 – – conf. 5 – € 6,30</p> 
 <p>PORTABITI DUMBO in nylon 50588946690005 – finit. nylon nero – – conf. 12 – € 4,54 50588946690007 – finit. nylon bianco – – conf. 12 – € 4,61</p> 	 <p>APPENDIABITO IN ZAMA 645MG40087 – Finitura Oro Lucido – Misura 146x107x45 – – conf. 12 – € 4,74 645MG40088 – Finitura Cromo Opaco – Misura 146x107x45 – – conf. 12 – € 4,74 645MG40090 – Finitura Bronzo Sfumato – Misura 146x107x45 – – conf. 12 – € 5,80 segue...</p> 



  <p><i>continua...</i> 645MG40089 – Finitura Nichel Opaco – Misura 146x107x45 – – conf. 4 – € 5,40 645MG40086 – Finitura Cromo Lucido – Misura 146x107x45 – – conf. 4 – € 5,40</p>	  <p>APPENDIABITI Misura 54x54x34 Materiale Zama 645MG41333 – Finitura Cromo Opaco – – conf. 5 – € 3,00 645MG41335 – Finitura Nero Opaco – – conf. 5 – € 3,00 645MG41336 – Finitura Bianco – – conf. 5 – € 3,00</p>
  <p>APPENDIABITO IN ZAMA 645MG24219 – Finitura Cromo Lucido – Misura 44x32 – – conf. 4 – € 1,76 645MG24221 – Finitura Cromo Opaco – Misura 44x32 – – conf. 4 – € 1,86</p>	  <p>APPENDIABITO IN ZAMA 645MG40085 – Finitura Bronzo Sfumato – Misura 117x119x56 – – conf. 4 – € 5,80 645MG40083 – Finitura Cromo Opaco – Misura 117x119x56 – – conf. 4 – € 5,80 645MG40160 – Finitura Nero Opaco – Misura 117x119x56 – – conf. 4 – € 5,60</p>
  <p>PORTABITO STAR Art. 3.7260 in Zama 44737260BR – Finitura Bronzato – – conf. 12 – € 9,86 44737260CR – Finitura Cromo Lucido – – conf. 12 – € 9,86 44737260CRS – Finitura Cromo satinato – – conf. 12 – € 9,86 44737260OL – Finitura Ottone lucido – – conf. 12 – € 9,86</p>	  <p>GANCIO SPIRALE Art.3.7240 50x95x30 44737240CRS – Finitura Cromo satinato – – conf. 10 – € 4,08 44737240OLV – Finitura Ottone Lucido – – conf. 10 – € 3,08</p>
  <p>GANCIO MULTIUSO In acciaio Misura 62x20 Finitura tropicalizzata 90015790 – Misura 60 – – conf. 50 – € 0,72</p>	  <p>GANCETTO CUCINA Art.6.1014 40x19x50 44761014CR – finitura cromo lucido – – conf. 20 – € 3,08 44761014OLV – finitura ottone lucido – – conf. 20 – € 2,48</p>
  <p>ATTACCAGLIA FISSA ottonata 90026611 – misura 1 – alt. 29 – – conf. 500 – € 0,04 90026612 – misura 2 – alt. 34 – – conf. 250 – € 0,06 90026613 – misura 3 – alt. 38 – – conf. 200 – € 0,10 90026614 – misura 4 – alt. 44 – – conf. 200 – € 0,16</p>	  <p>ATTACCAGLIA SNODATA ottonata 90026660 – misura 0 – A 16 – – conf. 1000 – € 0,02 90026661 – misura 1 – A 20 – – conf. 1000 – € 0,02 90026662 – misura 2 – A 24 – – conf. 1000 – € 0,02 90026663 – misura 3 – A 28 – – conf. 500 – € 0,02 90026664 – misura 4 – A 32 – – conf. 500 – € 0,04 <i>segue...</i></p>
  <p><i>continua...</i> 90026665 – misura 5 – A 40 – – conf. 500 – € 0,04 90026666 – misura 6 – A 49 – – conf. 250 – € 0,08</p>	  <p>BUSTA 10 Pz. ATTACCAGLIA arrotondate N°2 Altezza 29 nichelata 90026591 – misura 1 – A 20 – – conf. 25 – € 0,88 90026593 – misura 3 – A 28 – – conf. 25 – € 0,96</p>



<p>&M900</p> <p>BUSTA 10 Pz. ATTACCAGLIA arrotondate N°2 Altezza 29 nichelata</p> <p>90026602 – – conf. 25 – € 1,16</p> 	<p>&M900</p> <p>BUSTA 2 Pz. ATTACCAGLIE ultrapesanti Altezza 45 nichelate</p> <p>90026608 – – conf. 25 – € 0,88</p> 
<p>&M900</p> <p>Busta 20 Pz. GANCIO BLITZ piccolo</p> <p>90026860 – – conf. 25 – € 1,52</p> 	<p>&M900</p> <p>Busta 10 Pz. GANCIO BLITZ PLUS</p> <p>90026865 – – conf. 25 – € 1,78</p> 
<p>&M900</p> <p>Busta 10 Pz. GANCIO BLITZ GOLD</p> <p>90026866 – – conf. 25 – € 3,50</p> 	<p>&M900</p> <p>Blister 4 pz. GANCIO BLITZ Dekor Sole</p> <p>90026900 – – conf. 25 – € 3,30</p> 
<p>&M900</p> <p>Blister 4 pz. GANCIO BLITZ Dekor Firenze</p> <p>90026910 – – conf. 25 – € 3,30</p> 	<p>&M900</p> <p>Blister 4 pz. GANCIO BLITZ Dekor Loto</p> <p>90026915 – – conf. 25 – € 3,30</p> 
<p>&M900</p> <p>Blister 4 pz. GANCIO BLITZ Dekor Rosa</p> <p>90026920 – – conf. 25 – € 3,30</p> 	<p>&M900</p> <p>Blister 5 pz. GANCIO NYLON A 3 punte</p> <p>90026790 – – conf. 25 – € 1,10</p> 
<p>&M900</p> <p>BUSTA 10 BLITZ MICRO+Tassello ottone</p> <p>90026858 – – conf. 25 – € 1,48</p> 	<p>&M900</p> <p>BUSTA 2 GANCI SINGOLI FOGLIE ferro verniciato Nero altezza 75mm</p> <p>90026711 – – conf. 6 – € 4,74</p> 



&M900

BUSTA 2 GANCI SINGOLI FIORDALISO altezza 75mm ferro verniciato Nero

90026710 -
- conf. 6 - € 5,56



&M900

CHIODI Per quadri Testa ottone

90027761 - misura mm. 20 -
- conf. 1000 - € 0,02
90027762 - misura mm. 25 -
- conf. 1000 - € 0,02
90027763 - misura mm. 30 -
- conf. 1000 - € 0,02



BUSTA 12 CHIODI Testa ottone

90026826 - Misura 25 -
- conf. 10 - € 0,82
90026827 - Misura 25 -
- conf. 10 - € 0,88
90026828 - Misura 25 -
- conf. 10 - € 0,92



&M900

Blister 2 GANCI APPENDIPIATTI in ottone a molla manzoni art. 348

90033725 - N. 1 - Misura 16x19 -
- conf. 5 - € 3,92
90033726 - N. 2 - Misura 19x26 -
- conf. 5 - € 4,12
90033727 - N. 3 - Misura 26x34 -
- conf. 5 - € 4,32
90033728 - N. 4 - Misura 34x44 -
- conf. 5 - € 5,98



&M900

GANCIO APPENDIPIATTI a molla - Ottonato

90033735 - mod. 1 - misura 12x16 -
- conf. 25 - € 0,78
90033736 - mod. 2 - misura 16x25 -
- conf. 25 - € 0,80
90033738 - mod. 4 - misura 32x46 -
- conf. 25 - € 1,08



&M900

ANTIURTO DOPPIO Per maniglie

90011875 -
- conf. 60 - € 0,14



&M900

CATENA di sicurezza per porte

90009720 - finitura ferro nich. -
- conf. 12 - € 2,20
90009721 - finitura ferro ott. -
- conf. 12 - € 2,60
90009722 - finitura ferro bronz. -
- conf. 12 - € 2,60



&M900

PINZA FERMAPORTE ART. 22 60x30x14

90009760 - Finitura Ottone lucido -
- conf. 10 - € 2,40
90009761 - Finitura Ottone bronzato -
- conf. 10 - € 2,60



&M900

GANCIO DI SICUREZZA + INCONTRO ART. 62+62/A Gancio 65x130 Incontro 30x80

90009700 - Finitura Ottone lucido -
- conf. 12 - € 6,00
90009702 - Finitura Ottone bronzato -
- conf. 12 - € 6,40



&M900

TAVELLINO A SCATTO + INCONTRO Tavellino 16x19x50 Incontro 50x16

90009740 - Misura 5 -
- conf. 10 - € 3,40
90009741 - Misura 10 -
- conf. 10 - € 3,40
90009742 - Misura 15 -
- conf. 10 - € 3,40



&M900

TAVELLINO A SCATTO + INCONTRO Tavellino 15x47x55 Incontro 47x15

90009743 - finitura Bronzato -
- conf. 1 - € 3,98



&M900

INCONTRO AD AVVITARE ART 22/B Per pinza fermaporta 14x24x34

90009780 - Finitura Ottone lucido -
- conf. 10 - € 0,86
90009781 - Finitura Ottone bronzato -
- conf. 10 - € 1,04





























<p>&M 900</p> <p>INCONTRO A PIOMBARE ART. 22/A Per pinza fermaporta 45xØ14</p> <p>90009770 – Finitura Ottone lucido – - conf. 10 – € 0,86</p> <p>90009771 – Finitura Ottone bronzato – - conf. 10 – € 1,04</p> 	<p>fischer</p> <p>TASSELLO SB 9/11 NYLON con paracolpo in gomma nero</p> <p>500500351 – - conf. 50 – € 0,80</p> 
<p>fischer</p> <p>TASSELLO SB 9/12 NYLON con paracolpo in gomma nera</p> <p>500500352 – - conf. 50 – € 0,80</p> 	<p>fischer</p> <p>TASSELLO ACCIAIO SBS 9/11 con paracolpo nero</p> <p>500500421 – - conf. 25 – € 1,60</p> 
<p>fischer</p> <p>TASSELLO ACCIAIO SBS 9/12 con paracolpo bianco</p> <p>500500422 – - conf. 25 – € 1,60</p> 	<p>fischer</p> <p>TASSELLO ACCIAIO Con Paracolpo SLM 8 bianco</p> <p>500500651 – - conf. 10 – € 11,20</p> 
<p>fischer</p> <p>TASSELLO ACCIAIO Con paracolpo SLM 8 nero</p> <p>500500652 – - conf. 10 – € 11,20</p> 	<p>&M 540</p> <p>CONFEZIONE 8 PZ. PARACOLPI Misura singolo paracolpo 17x17 mm</p> <p>540213060005 – Colore Bianco – - conf. 10 – € 2,00</p> <p>540213060010 – Colore Noce – - conf. 10 – € 2,00</p> 
<p>fischer</p> <p>PARACOLPO IN NYLON SA 1 N con tasselli e viti Confezione 25 pz</p> <p>500501523 – Colore bianco – - conf. 1 – € 57,60</p> <p>500501526 – Colore marrone – - conf. 1 – € 57,60</p> <p>500501527 – Colore nero – - conf. 1 – € 57,60</p> 	<p>DEFENCE SYSTEM</p> <p>ESPOSITORE 50 PEZZI AMMORTIZZATORE GUMMY BLOCK Ammortizzatore per porte e finestre. Si applica alle cerniere con l'apposito gancio. Evita la chiusura accidentale causata dalle correnti d'aria. Colori assortiti</p> <p>46612500 – - conf. 1 – € 56,00</p> 
<p>IBFM</p> <p>ARRESTO PER PORTA IN ZAMA Art. 263</p> <p>525263C – Finitura Cromo lucido – - conf. 1 – € 3,08</p> <p>525263CS – Finitura Cromo satinato – - conf. 1 – € 3,08</p> <p>525263O – Finitura Ottone – - conf. 1 – € 3,08</p> 	<p>IBFM</p> <p>ARRESTO PER PORTA MAGNETICO Art.264</p> <p>525264C – Finitura Cromo lucido – - conf. 1 – € 4,00</p> <p>525264CS – Finitura Cromo satinato – - conf. 1 – € 4,00</p> <p>525264O – Finitura Ottone – - conf. 1 – € 4,00</p> 



  <p>FERMAPORTE A PEDALE Grande</p> <p>525244 – finitura nero – – conf. 6 – € 7,82</p> <p>525245 – finitura argento – – conf. 6 – € 7,82</p> <p>525246 – finitura oro – – conf. 6 – € 7,82</p> <p>525247 – finitura bronzo – – conf. 6 – € 7,82</p>	  <p>FERMAPORTE A PEDALE Piccolo</p> <p>525240 – finitura bronzo – – conf. 6 – € 4,74</p> <p>525241 – finitura nero – – conf. 6 – € 4,74</p> <p>525242 – finitura argento – – conf. 6 – € 4,74</p> <p>525243 – finitura oro – – conf. 6 – € 4,74</p>
  <p>FERMA ANTE MAGNETICO ART. 262</p> <p>525262 – – conf. 1 – € 10,92</p>	  <p>Cartella 24 Pz. FERMAPORTE CUNEO plastica</p> <p>90011857 – finitura bianco – – conf. 1 – € 5,56</p> <p>90011858 – finitura marrone – – conf. 1 – € 5,56</p>
  <p>Cartella 20 PZ. FERMAPORTE BOERO plastica</p> <p>90011855 – finitura bianca – – conf. 1 – € 7,00</p> <p>90011856 – finitura marrone – – conf. 1 – € 7,00</p> <p>90011859 – Colore Trasparente – – conf. 1 – € 7,00</p>	  <p>REGGIVETRO Ø foro 20 mm In Zama</p> <p>645MG41354 – Finitura Cromo Lucido – – conf. 4 – € 1,90</p> <p>645MG41356 – Finitura Cromo Opaco – – conf. 4 – € 1,90</p>
  <p>REGGIVETRO Ø 28 mm In zama</p> <p>645MG41351 – Finitura Cromo Lucido – – conf. 4 – € 3,00</p> <p>645MG41353 – Finitura Cromo Opaco – – conf. 4 – € 3,00</p>	  <p>CATENACCIO LIBERO / OCCUPATO Acciaio nichelato Art. 37 con chiave</p> <p>525037 – – conf. 6 – € 15,04</p>
  <p>CHIAVISTELLO LIBERO / OCCUPATO Plastica nero per serrature a cilindro sagomato</p> <p>52547/S – – conf. 10 – € 13,40</p>	  <p>NOTTOLINO WC libero/occupato Q,6 – Rosetta nylon nero</p> <p>50588948638005 – – conf. 10 – € 11,95</p>
 <p>SPINGIPORTA TRIUMPH Art. 115 A molla</p> <p>18011521 – N° 1 – A 77 – B 235 – – conf. 2 – € 14,60</p> <p>18011522 – N° 2 – A 101 – B 265 – – conf. 2 – € 16,80</p> <p>18011523 – N° 3 – A 125 – B 300 – – conf. 2 – € 19,40</p> <p>18011524 – N° 4 – A 148 – B 335 – – conf. 2 – € 24,20</p>	  <p>SPINGIPORTA a molla TRIUMPH</p> <p>525091001 – N° 1 – Portata 25 kg – – conf. 4 – € 10,10</p> <p>525091002 – N° 2 – Portata 40 kg – – conf. 4 – € 12,16</p> <p>525091003 – N° 3 – Portata 60 kg – – conf. 4 – € 14,22</p> <p>525091004 – N° 4 – Portata 80 kg – – conf. 4 – € 16,68</p>



 <p>CHIUDIPIORTA A MOLLA Art. 88 in alluminio verniciato per porte fino a kg.40</p> <p>525088A – Finitura Argento – – conf. 4 – € 16,06</p> <p>525088B – Finitura Bianco – – conf. 4 – € 16,06</p> 	 <p>CHIUDIPIORTA MOD. ERCOLE Per chiusura porte fino a H 210 x L 90 cm Max 60 Kg. Spinta regolabile Sgancio facilitato <i>Nessun foro sulla porta grazie alla speciale ruota gommata che scorre silenziosamente sulla porta</i></p> <p>180114CS17D – Finitura Silver – Mano Dx – – conf. 2 – € 19,40</p> <p>180114CS17S – Finitura Silver – Mano Sx – – conf. 2 – € 19,40</p> <p>180114OS17D – Finitura Ottone Sfumato – Mano Dx – – conf. 2 – € 19,40</p> <p>segue...</p> 
 <p>continua...</p> <p>180114OS17S – Finitura Ottone Sfumato – Mano Sx – – conf. 2 – € 19,40</p> <p>180114ZN17D – Finitura Nero – Mano Dx – – conf. 2 – € 19,40</p> <p>180114ZN17S – Finitura Nero – Mano Sx – – conf. 2 – € 19,40</p> 	 <p>FLEXOBRISE 50 Metri con accessori in acciaio ricoperto in plastica</p> <p>90028800 – – conf. 1 – € 56,60</p> 
 <p>Blister 2 Pz BACCHETTA Ottone per tende Ø 7 mm.</p> <p>90028711 – Lungh. 300 – – conf. 25 – € 6,00</p> <p>90028712 – Lungh. 400 – – conf. 25 – € 6,80</p> <p>90028713 – Lungh. 500 – – conf. 25 – € 7,20</p> <p>90028714 – Lungh. 600 – – conf. 25 – € 7,80</p> <p>90028715 – Lungh. 700 – – conf. 25 – € 9,20</p> 	 <p>Busta 2 Pz BACCHETTA TONDA A MOLLA con ventosa in ottone lucido</p> <p>90028654 – Lungh. 400 – – conf. 1 – € 7,60</p> <p>90028655 – Lungh. 500 – – conf. 1 – € 8,20</p> <p>90028656 – Lungh. 600 – – conf. 1 – € 8,80</p> 
 <p>Busta da 2 pz. BACCHETTA TONDA PER TENDE in ferro – Ø 10 ricoperta plastica</p> <p>90028628 – Lungh. 800 – – conf. 15 – € 2,80</p> <p>90028630 – Lungh. 1000 – – conf. 15 – € 3,20</p> 	 <p>Busta da 2 pz. BACCHETTA TONDA PER TENDE in ferro – Ø 7 ricoperta plastica</p> <p>90028622 – Lungh. 400 – – conf. 25 – € 1,00</p> <p>90028623 – Lungh. 500 – – conf. 25 – € 1,16</p> <p>90028624 – Lungh. 600 – – conf. 25 – € 1,30</p> <p>90028625 – Lungh. 700 – – conf. 25 – € 1,48</p> 
 <p>BACCHETTE PIATTE per tende Blister 2 pz</p> <p>90028639 – LUNGH. 400 X 11 – – conf. 1 – € 1,12</p> <p>90028640 – LUNGH. 500 X 11 – – conf. 1 – € 1,26</p> 	 <p>BACCHETTE TONDE per tende Blister 2 pz</p> <p>90028634 – LUNGH. 500 X 7 – – conf. 1 – € 1,40</p> <p>90028636 – LUNGH. 700 x 7 – – conf. 1 – € 1,70</p> 
 <p>GANCIO REGGITENDE in plastica adesivo</p> <p>90028751 – finitura bianco – – conf. 100 – € 0,08</p> <p>90028752 – finitura marrone – – conf. 100 – € 0,08</p> 	 <p>confez.100 pezzi GANCI REGGITENDE IN METALLO per serramenti in alluminio</p> <p>90028740 – Colore Bianco – – conf. 1 – € 17,40</p> <p>90028741 – Colore Marrone – – conf. 1 – € 17,40</p> 



&M900

confez. 100 pezzi GANCI REGGITENDE IN METALLO per serramenti PVC

90028745 - Colore Bianco -

- conf. 1 - € 20,20

90028746 - Colore Marrone -

- conf. 1 - € 20,20



DIERRE

GANCIO per tendaggi in ottone lucido

46716030 - A 30 - B 11 -

- conf. 30 - € 0,64

46716035 - A 35 - B 14 -

- conf. 30 - € 0,94

46716040 - A 40 - B 17 -

- conf. 30 - € 1,26



&M900

CANCANETTO AVITE per bacchetta tende

90028780 - finitura ferro.ott. -

- conf. 200 - € 0,02

90028781 - finitura ferro nich. -

- conf. 200 - € 0,02



&M900

PINZETTA PER BACCHETTE OTTONE Art. 105
Ottone lucido

90028000 -

- conf. 200 - € 0,38



MINUTEX

PINZETTONE per tende Ferro ottonato mod. 5623

90028001 -

- conf. 100 - € 0,25



MINUTEX

PINZETTONE per tende Ferro bronzato mod. 5624

90028002 -

- conf. 100 - € 0,25



&M900

ANELLO Per tenda doccia Ferro zincato

90028350 - misura 48 - misura piccolo -

- conf. 100 - € 0,06

90028360 - misura 56 - misura medio -

- conf. 100 - € 0,08

90028365 - misura 67 - misura grande -

- conf. 100 - € 0,16



&M900

ANELLO Per tenda doccia Ottone nichelato

90028370 - A 48 - misura piccolo -

- conf. 100 - € 0,24

90028380 - A 56 - misura medio -

- conf. 100 - € 0,30



&M900

ANELLO VUOTO Per tende mod. 101 Ottone lucido

90028313 - Ø int- Ø est. 13x18 -

- conf. 200 - € 0,12

90028315 - Ø int- Ø est. 15x20 -

- conf. 200 - € 0,12

90028318 - Ø int- Ø est. 18x23 -

- conf. 200 - € 0,16

90028319 - Ø int- Ø est. 19x25 -

- conf. 200 - € 0,18

90028320 - Ø int- Ø est. 20x27 -

- conf. 200 - € 0,22

segue...



&M900

continua...

90028322 - Ø int- Ø est. 22x30 -

- conf. 200 - € 0,26

90028326 - Ø int- Ø est. 26x36 -

- conf. 100 - € 0,38

90028330 - Ø int- Ø est. 30x39 -

- conf. 100 - € 0,40

90028332 - Ø int- Ø est. 32x44 -

- conf. 100 - € 0,48



&M900

PARASPIGOLI TRASPARENTI PER MOBILI Confezione 60 pz.

90011870 -

- conf. 1 - € 18,54



BOLIS ITALIA

FERMALIBRO in acciaio verniciato a polveri epossidiche Colore: bianco

90014700 - A 195 - B 155 - C 1,2 - D 140

- conf. 20 - € 2,60



TERMOAPPENDINO

Appendino universale con 2 ganci rotondi per termoarredo. Ideoneo per tutti i modelli e marche con tubi orizzontali dal 20 al 26.



Codice	Colore			€
13011	Bianco	1	1	4,50
13012	Trasp.	1	1	4,50
13014	Col. Trasl.	1	1	4,50
13111	Bianco	30	30	3,90 Cad.
13112	Trasp.	30	30	3,90 Cad.
13114	Col. Trasl.	30	30	3,90 Cad.

Disponibile anche:
expo da banco
con 30 pz. sfusi.



Disponibile anche:
expo da banco
scopi 1 posto
con 40 pz. sfusi.

APPENDISCOPA

Appendiscopa in acciaio inox e laccato bianco. Rullini bloccanti in gomma colorata. Modello a 1 - 2 - 3 posti. Fissaggio con bioadesivo o viti.



Colore	Posti	€	Posti	€	Posti	€
Inox Rosso	1	4,20 Cad.	2	21,80 Cad.	3	23,90 Cad.
Inox Giallo	1	4,20 Cad.	2	21,80 Cad.	3	23,90 Cad.
Inox Grigio	1	4,20 Cad.	2	21,80 Cad.	3	23,90 Cad.
Inox Nero	1	4,20 Cad.	2	21,80 Cad.	3	23,90 Cad.
Lacc. B Rosso	1	4,40 Cad.	2	20,80 Cad.	3	22,80 Cad.
Lacc. B Giallo	1	4,40 Cad.	2	20,80 Cad.	3	22,80 Cad.
Lacc. B Grigio	1	4,40 Cad.	2	20,80 Cad.	3	22,80 Cad.
Lacc. B Nero	1	4,40 Cad.	2	20,80 Cad.	3	22,80 Cad.



ULISSE



Tubo estensibile per armadio. Profilo ovale in alluminio. Corredato da supporti laterali. Include le viti per il montaggio. Sviluppa da 800 a 1300 mm.

Codice	mm			€
00128	800-1300	1	15	11,90 Cad.



GETTASIGARETTE

Contenitore ecologico per la raccolta e lo smaltimento di mozziconi di sigaretta. Resistente alle interperie e ai raggi U.V. Non arrugginisce e non scolorisce.

GRANDE DA TERRA

Può essere posizionato ovunque si necessiti di preservare un'aera decorosa e pulita

PICCOLO DA MURO

Può essere applicato su pareti, pali. Ideale presso aree di grande affluenza.



Codice	Conf.		€
10007	1 Pz.	3	99,90 Cad.
10138	1 Pz.	1	49,90 Cad.

TORO

Fermapersiane automatico. Universale e regolabile per tutti i tipi di imposte: alluminio, pvc, legno. Si utilizza su persiane con o senza battuta inferiore. Viti incluse.



Codice	Vite mm	mm		€
52000	6x80	40-55	50	3,00 Cad
52001	6x160	40-55	50	3,80 Cad

250,00 €
iva esclusa

OFFERTA SPECIALE PREZZO NETTO

ESPOSITORE COMPLETO

CHIEDI AL TUO RIVENDITORE TUTTO L'ASSORTIMENTO

STAR PRODUCTS

POWERED BY
DEFENCE SYSTEM



PRIMO ED UNICO SPRAY COPERTO DA POLIZZA R.C. PRODOTTO

Spray antiaggressione al peperoncino.
Bomboletta da 15 ml per la difesa personale.
Libera vendita ai maggiori di 16 anni.



EXPO DA 18 PZ.
COD. 96101



SUPERACCIALE
IN OMIAGGIO

EXPO DA 9+9 PZ.
COD. 98202

Spray contro le punture.
Adatto per il pre e il post puntura.
Durata fino a 8 ore.
Protegge dai raggi UV.



SPRAY 10 ML
IN OMIAGGIO

EXPO DA 9+9 PZ.
COD. 99201

Spray contro le punture.
Adatto per il pre e il post puntura.
Durata fino a 8 ore.
Protegge dai raggi UV.



Limpidante soluzione
vegetale detergente
antiappannante.

EXPO DA 9+9 PZ.
COD. 43989



BIODEGRADABILE

10 SPRAY IN UNO



EXPO DA 12 PZ.
COD. 02175

100% Naturale e biodegradabile,
collaudato e ineguagliato.
Olio universale dalla forma originale,
ideata in Germania 115 anni fa.



 <p>FERMATOVAGLIA Nichelato 40 mm 90024900 - - conf. 50 - € 0,16</p> 	 <p>FERMATOVAGLIA Nichelato 60 mm 90024925 - finitura Nichelato - Modello Alto - - conf. 50 - € 0,62</p> 
 <p>FERMATOVAGLIA Inox 430 40 mm 90024930 - finitura INOX - Modello Standard - - conf. 50 - € 0,50</p> 	 <p>GANCIO INOX MINI adesivo 90026762 - - conf. 200 - € 0,28</p> 
 <p>GANCIO INOX MAXI adesivo 90026761 - - conf. 100 - € 0,50</p> 	 <p>MOLLA FERMASCOPIA INOX 90026765 - N° posti 1 - - conf. 5 - € 3,70 90026766 - N° posti 2 - - conf. 3 - € 11,54</p> 
 <p>MOLLA FERMASCOPIA INOX 3 posti 90026767 - - conf. 3 - € 12,98</p> 	 <p>GANCIO MACELLAIO INOX 90033711 - misura 60 - Ø 3 - - conf. 10 - € 0,41 90033712 - misura 80 - Ø 4 - - conf. 10 - € 0,52 90033713 - misura 100 - Ø 4 - - conf. 10 - € 0,54 90033714 - misura 120 - Ø 5 - - conf. 10 - € 0,76 90033715 - misura 140 - Ø 6 - - conf. 10 - € 1,01 segue...</p> 
 <p>continua... 90033716 - misura 160 - Ø 6 - - conf. 10 - € 1,10 90033717 - misura 180 - Ø 8 - - conf. 10 - € 2,22 90033718 - misura 200 - Ø 9 - - conf. 10 - € 2,74</p> 	 <p>FELTRINI TONDI colore bianco in blister 540213000005 - Ø 18 - Blister pz. 12 - - conf. 20 - € 0,20 540213000010 - Ø 20 - Blister pz. 10 - - conf. 20 - € 0,20 540213000015 - Ø 24 - Blister pz. 8 - - conf. 20 - € 0,20 540213000020 - Ø 28 - Blister pz. 6 - - conf. 20 - € 0,20</p> 
 <p>FELTRINI TONDI colore marrone in blister 540213000030 - Ø 18 - Blister pz. 12 - - conf. 20 - € 0,20</p> 	 <p>FELTRINI QUADRI colore bianco in blister 540213010005 - Dimensioni 25x25 - Blister pz. 8 - - conf. 20 - € 0,20 540213010010 - Dimensioni 30x30 - Blister pz. 6 - - conf. 20 - € 0,20 540213010015 - Dimensioni 35x35 - Blister pz. 4 - - conf. 20 - € 0,20</p> 



&T540

FELTRINI RETTANGOLARI colore bianco in blister

540213020005 - Dimensioni 25x35 - Blister pz. 6 -
- conf. 20 - € 0,20



&T540

FELTRINI RETTANGOLARI Colore bianco In blister

540213020010 - Tipologia 1pz feltrino rettang - Misura 50x100 bianco -
- conf. 1 - € 0,20



&T540

FELTRINI RETTANGOLARI colore marrone in blister

540213020015 - Dimensioni 25x35 - Blister pz. 6 -
- conf. 20 - € 0,20



&T540

ANTISCIVOLO TONDI In blister

540213030005 - Colore Bianco - Ø 18 - Blister pz. 12 -
- conf. 20 - € 0,20

540213030015 - Colore Bianco - Ø 24 - Blister pz. 8 -
- conf. 20 - € 0,20

540213030030 - Colore Nero - Ø 18 - Blister pz. 12 -
- conf. 20 - € 0,20

540213030040 - Colore Nero - Ø 24 - Blister pz. 8 -
- conf. 20 - € 0,20



&T540

ANTISCIVOLO QUADRI In blister

540213040005 - Colore Bianco - Dim. 25x25 - Blister pz. 8 -
- conf. 20 - € 0,20

540213040020 - Colore Nero - Dim. 25x25 - Blister pz. 8 -
- conf. 20 - € 0,20



&T900

Accessorio **PER DOPPI VETRI** 12-24 mm. per installazione aereatore

90033600 - per mod. 130 - Ø 160 -
- conf. 2 - € 11,80

90033601 - per mod. 131 - Ø 200 -
- conf. 2 - € 14,20



RIMPLAST

AEREATORE MAM per finestra Tipo semplice

90033550 - mod. 101 - Ø 120 -
- conf. 3 - € 9,40

90033560 - mod. 105 - Ø 160 -
- conf. 3 - € 13,00

90033570 - mod. 109 - Ø 200 -
- conf. 3 - € 17,60

90033572 - mod. 111 - Ø 240 -
- conf. 3 - € 24,20



RIMPLAST

AEREATORE MAM per finestra Con chiusura

90033551 - mod. 102 - Ø 120 -
- conf. 3 - € 13,00

90033561 - mod. 106 - Ø 160 -
- conf. 3 - € 17,60

90033571 - mod. 110 - Ø 200 -
- conf. 3 - € 22,60

90033573 - mod. 112 - Ø 240 -
- conf. 3 - € 30,00



VECAMCO

GRIGLIA TONDA In plastica con molle e rete

92017000 - Ø 145 -
- conf. 12 - € 3,78

92017010 - Ø 190 -
- conf. 12 - € 5,48

92017020 - Ø 220 -
- conf. 12 - € 6,32



VECAMCO

GRIGLIA QUADRA in plastica con rete fissaggio a vite

92017300 - A 166 - B 166 -
- conf. 12 - € 3,62

92017310 - A 238 - B 238 -
- conf. 12 - € 6,54



VECAMCO

GRIGLIA QUADRA In alluminio fissaggio a vite

92017100 - A 150 - B 150 -
- conf. 10 - € 9,06

92017110 - A 230 - B 230 -
- conf. 10 - € 18,64



VECAMCO

GRIGLIA QUADRA In rame fissaggio a vite

92017200 - A 150 - B 150 -
- conf. 5 - € 11,80

92017210 - A 230 - B 230 -
- conf. 5 - € 21,52





POSACENERE E GETTACARTE Cestello estraibile 300x700x150

64654301 -
- conf. 1 - € 83,80



GETTACARTE A MURO PER ESTERNI Griglia in acciaio INOX Tetto anti-pioggia 360x210x100

64654051 -
- conf. 1 - € 58,10



POSACENERE AMO LA MIA CITTA' Da muro Con cestello estraibile Dimensioni: L230 x H300 x P77 mm

90006259 -
- conf. 1 - € 39,20



AD LucheseDesign

LOGOS

GHIDINI[®]

DAL 1929
MANIGLIE E COORDINATI

Una maniglia espressiva e
scultorea, leggera come
un'ala.



www.ghidini.com



**MANIGLIE
POMOLI
MOBILI**



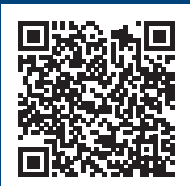









SFOGLIA LA CATEGORIA





 MANIGLIA MILENA Placca Patent ottone lucido 5055744087001 - Placca Q8x70 Ridotta - - conf. 1 - € 26,32 5055744089001 - Placca Q8x90 - - conf. 1 - € 26,32 	 MANIGLIA MILENA Q8x 85 placca YALE ottone lucido 5055744088501 - - conf. 1 - € 26,32 
 MANIGLIA MILENA Q8 Rosetta e Bocchetta PATENT ottone lucido 5055744281501 - - conf. 1 - € 19,92 	 MANIGLIA MILENA Q8 Rosetta e Bocchetta YALE ottone lucido 5055744285501 - - conf. 1 - € 19,92 
 CREMONESE MILENA EZ ottone lucido 5055744406001 - - conf. 2 - € 16,22 	 CREMONESE MILENA EZ+Q7 ottone lucido 5055744407001 - - conf. 2 - € 16,56 
 CREMONESE MILENA Gola lupo centrale ottone lucido 5055744408001 - - conf. 2 - € 19,34 	 MARTELLINA MILENA Q7 ottone lucido 5055744500001 - - conf. 2 - € 14,17 
 MARTELLINA MILENA Q.7 con impugnatura maniglia ottone lucido 5055744550001 - Finitura Ottone lucido - - conf. 2 - € 24,63 5055744550008 - Finitura Ottone satinato - - conf. 2 - € 23,00 	 MARTELLINA DK Q.7 ottone lucido 5055744577001 - - conf. 2 - € 12,15 
 MANIGLIA MILENA Q8x90 Placca PATENT ottone graffiato 5055744089004 - - conf. 1 - € 31,97 	 MANIGLIA MILENA Q8x85 placca YALE ottone graffiato 5055744088504 - Finitura Ottone graffiato - - conf. 1 - € 31,97 



 <p>CREMONESE MILENA EZ ottone graffiato 50555744406004 - - conf. 2 - € 17,81</p>	 <p>CREMONESE MILENA EZ + Q7 ottone graffiato 50555744407004 - - conf. 2 - € 20,31</p>
 <p>CREMONESE MILENA Gola lupo centrale ottone graffiato 50555744408004 - - conf. 2 - € 19,34</p>	 <p>MARTELLINA MILENA Q7 ottone graffiato 50555744500004 - - conf. 2 - € 18,22</p>
 <p>MARTELLINA MILENA DK Q.7 x 40-35 ottone graffiato 50555744577004 - - conf. 2 - € 15,12</p>	 <p>BLOCCA MARTELLINE QUADRO Art. BMAR01B18 Permette l'apertura della martellina SOLO previo pressione sul pulsante 461BMAR01CS - Finitura Cromo Satinato - - conf. 1 - € 23,56</p>
 <p>MANIGLIA MILENA Q8 Rosetta e Bocchetta PATENT ottone graffiato 50555744281504 - - conf. 1 - € 24,14</p>	 <p>MANIGLIA MILENA Rosetta e Bocchetta YALE ottone graffiato 50555744285504 - - conf. 1 - € 24,14</p>
 <p>MANIGLIA MILENA Placca Patent ottone cromo sat. 50555744087003 - Placca Q8x70 Ridotta - - conf. 1 - € 41,91 50555744089003 - Placca Q8x90 - - conf. 1 - € 33,28</p>	 <p>MANIGLIA MILENA Q8 x 85 placca YALE ottone cromo sat. 50555744088503 - - conf. 1 - € 33,75</p>
 <p>MANIGLIA MILENA Q8 Rosetta e Bocchetta PATENT ottone cromo sat. 50555744281503 - - conf. 1 - € 30,11</p>	 <p>MANIGLIA MILENA Q8 Rosetta e Bocchetta YALE ottone cromo sat. 50555744285503 - - conf. 1 - € 30,11</p>

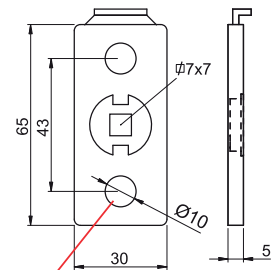
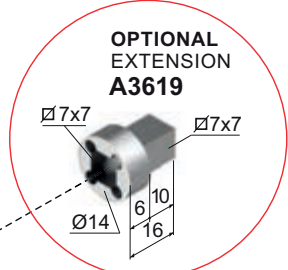
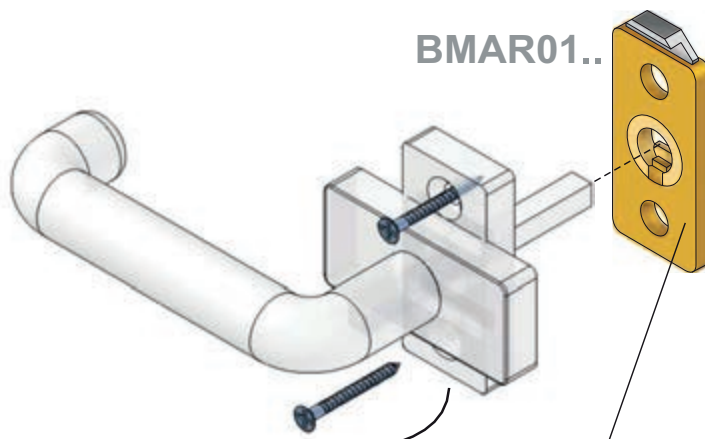
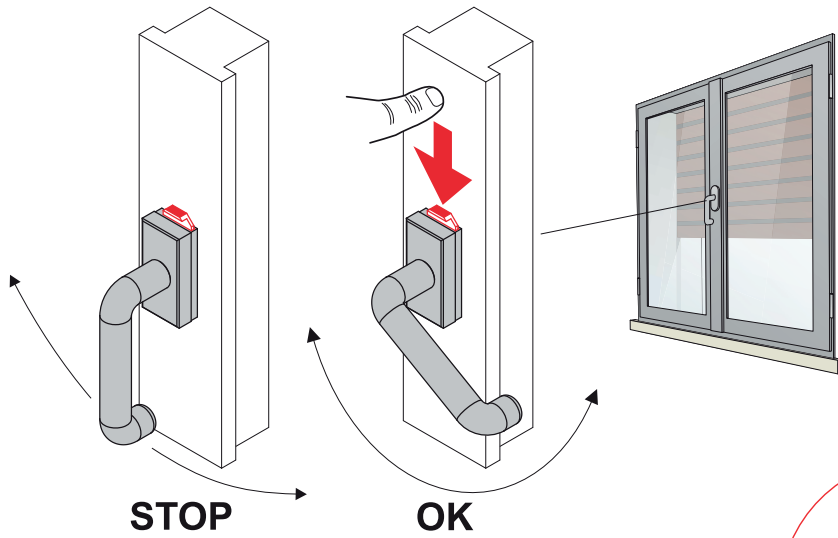

DA MONTARE SU DK ESISTENTI

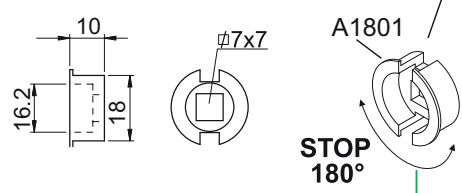

BMAR01B18

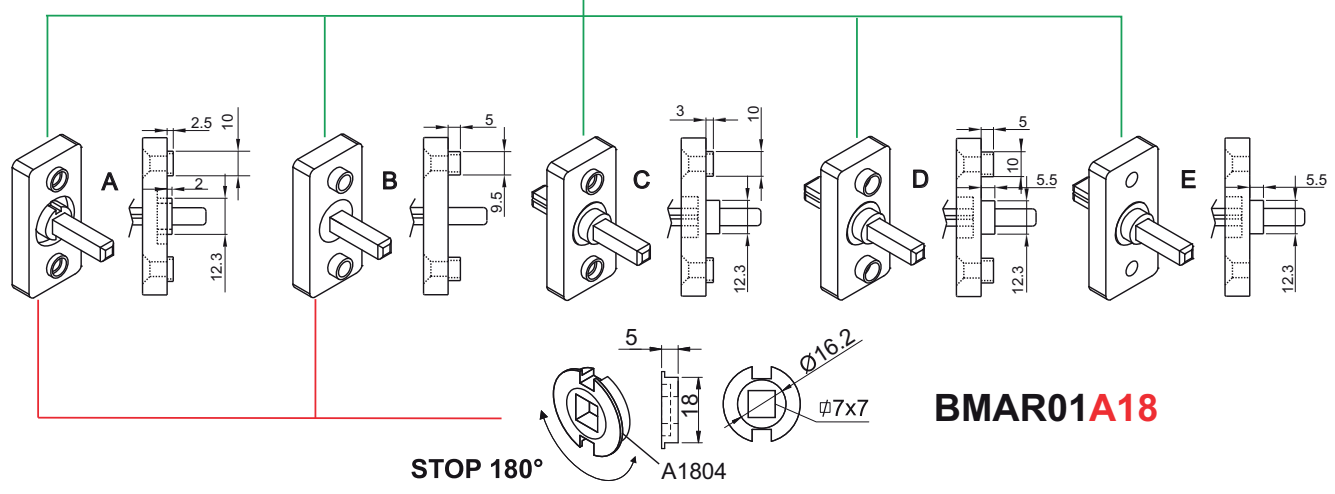

- F6** Cromo satinato
Satin Chrome
- N** Nero
Black
- L** Ottone lucido
Bright Brass
- B** Bronzo
Bronze

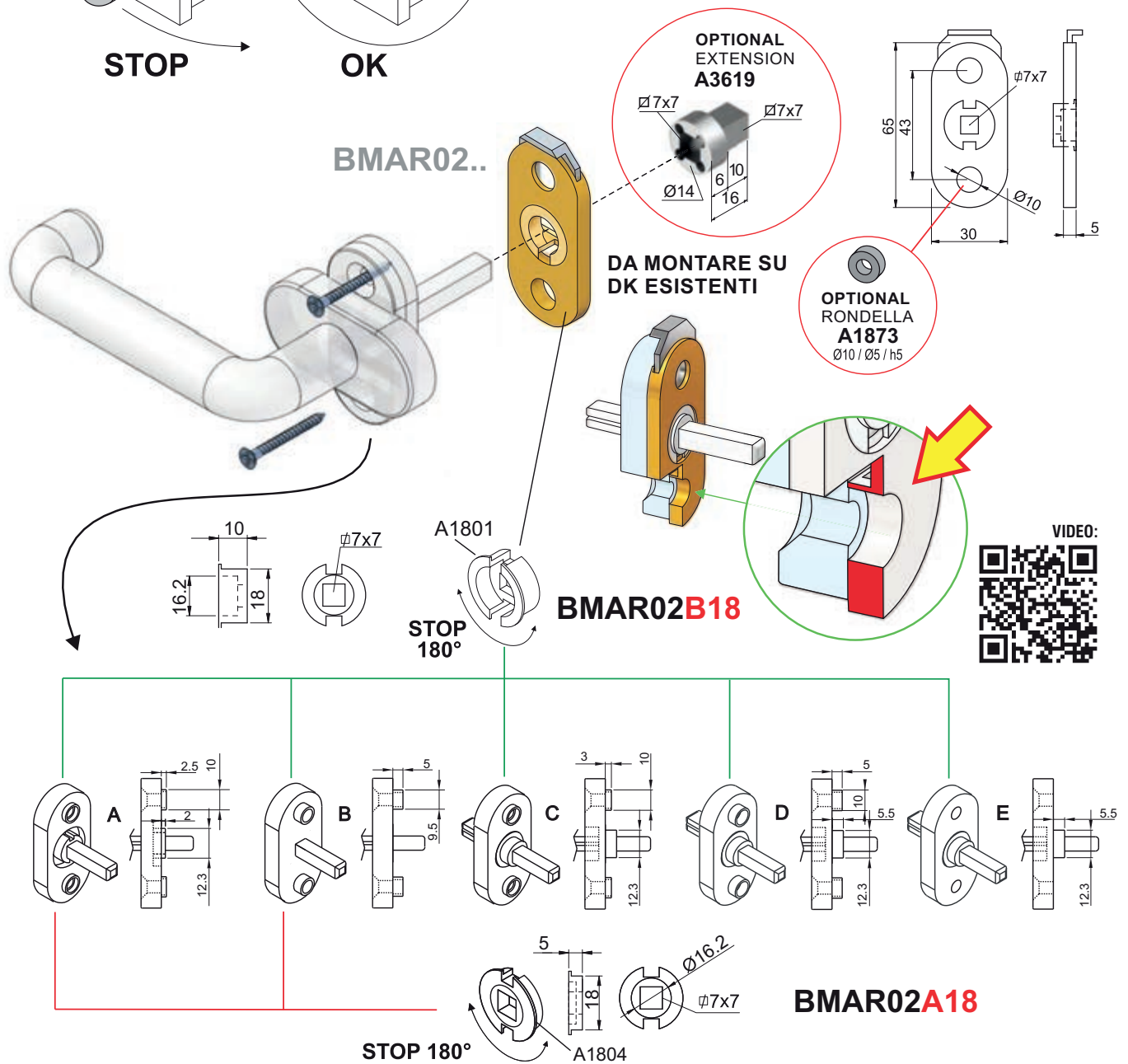
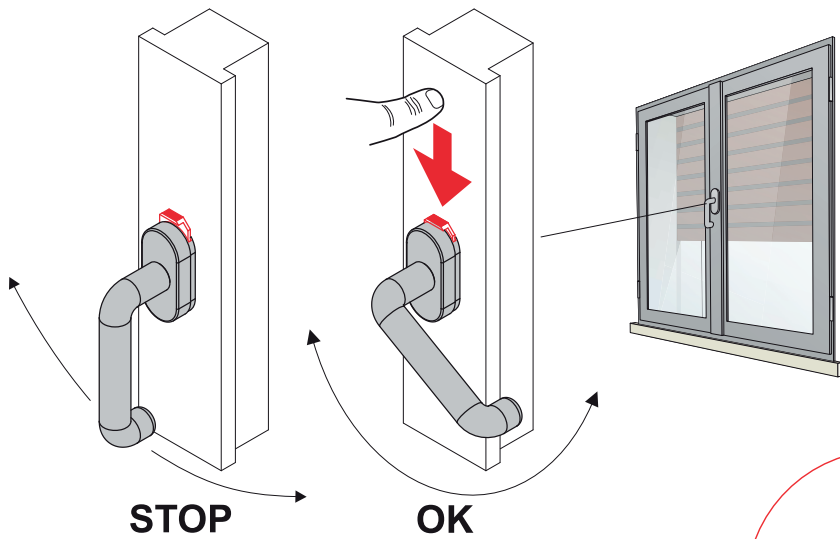

F6 Cromo satinato
Satin Chrome

6 Argento anodizzato
Anodized Silver

N Nero
Black

B Bronzo
Bronze



L Ottone lucido
Bright Brass

9 Oro anodizzato
Anodized Gold









 <p>CREMONESE MILENA EZ ottone cromo sat. 50555744406003 - - conf. 2 - € 22,28</p> 	 <p>CREMONESE MILENA EZ+Q7 ottone cromo sat. 50555744407003 - - conf. 2 - € 22,95</p> 
 <p>MARTELLINA MILENA Q7 ottone cromo sat. 50555744500003 - - conf. 2 - € 19,92</p> 	 <p>MARTELLINA MILENA Q7 DK x 40-35 ottone cromo sat. 50555744577003 - - conf. 2 - € 20,59</p> 
 <p>MANIGLIA LADY Q8 x 90 placca PATENT ottone fumè 50544394089006 - - conf. 4 - € 25,71</p> 	 <p>MANIGLIA LADY Q8 x 85 placca YALE ottone fumè 50544394088506 - - conf. 4 - € 25,71</p> 
 <p>MANIGLIA LADY Q8 Rosetta e Bocchetta PATENT ottone fumè 50544394281006 - - conf. 4 - € 27,82</p> 	 <p>CREMONESE LADY GRAZ ottone fumè 50544394401006 - - conf. 6 - € 13,86</p> 
 <p>CREMONESE LADY GRAZ + Q7 ottone fumè 50544394403006 - - conf. 6 - € 15,27</p> 	 <p>CREMONESE LADY EZ ottone fumè 50544394406006 - - conf. 6 - € 13,86</p> 
 <p>CREMONESE LADY EZ+Q7 ottone fumè 50544394407006 - - conf. 6 - € 15,27</p> 	 <p>CREMONESE LADY Gola Lupo centrale ottone fumè 50544394408006 - - conf. 6 - € 17,00</p> 















 <p>CREMONESE LADY Gola Lupo laterale ottone fumè</p> <p>50544394408106 - - conf. 6 - € 16,60</p> 	 <p>MARTELLINA LADY Q.7 ottone fumè</p> <p>50544394500006 - - conf. 6 - € 19,87</p> 
 <p>MANIGLIA GABRY Placca Patent alluminio bronzato</p> <p>50577400087004 - Placca Q8x70 Ridotta - Finitura Bronzato - - conf. 8 - € 9,22 50577400089004 - Placca Q8x90 - Finitura Bronzato - - conf. 8 - € 9,22</p> 	 <p>MANIGLIA GABRY Q8 X 85 con placca Yale Alluminio bronzato</p> <p>50577400088504 - - conf. 8 - € 9,36</p> 
 <p>MANIGLIA GABRY Q8 con Rosetta e bocchetta Patent Ø 45 alluminio bronzato</p> <p>50577400281004 - - conf. 10 - € 9,43</p> 	 <p>MANIGLIA GABRY Q8 con Rosetta e bocchetta Yale Ø45 alluminio bronzato</p> <p>50577400285004 - - conf. 10 - € 9,70</p> 
 <p>MANIGLIA GABRY Q8 Con Rosetta Ø 45 Quadro lungo 100 mm alluminio bronzato</p> <p>50577400280004 - - conf. 8 - € 9,70</p> 	 <p>CREMONESE GABRY GRAZ alluminio bronzato</p> <p>50577400401004 - - conf. 16 - € 7,12</p> 
 <p>CREMONESE GABRY GRAZ + Q7 alluminio bronzato</p> <p>50577400403004 - - conf. 10 - € 7,33</p> 	 <p>CREMONESE GABRY EZ - scatola alta alluminio bronzato</p> <p>50577400406004 - Modello EZ - - conf. 16 - € 7,82 50577400407004 - Modello EZ+Q7 - - conf. 10 - € 8,44</p> 
 <p>CREMONESE GABRY Gola Lupo centrale alluminio bronzato</p> <p>50577400408004 - - conf. 12 - € 8,27</p> 	 <p>MARTELLINA UNIVERSALE ALOX Quadro Q7 Senza movimento Finitura Bronzata Misura 150x34</p> <p>5057744250004 - - conf. 16 - € 6,40</p> 



 <p>GHIDINI MARTELLINA GABRY impugnatura maniglia Q.7 alluminio bronzato 50577400550004 - - conf. 8 - € 7,37</p>	 <p>GHIDINI MARTELLINA GABRY TN Dkx33 5057740055501 - Finitura Alluminio - - conf. 20 - € 7,92 5057740055504 - Finitura Bronzato - - conf. 20 - € 7,92</p>
 <p>GHIDINI MANIGLIA GABRY Q8x90 Placca Patent Alluminio argento 50577400087001 - Placca Q8x70 Ridotta - Finitura Argento - - conf. 8 - € 9,09 50577400089001 - Placca Q8x90 - Finitura Argento - - conf. 8 - € 9,36</p>	 <p>GHIDINI MANIGLIA GABRY Q8 X 85 con placca Yale Alluminio argento 50577400088501 - - conf. 8 - € 9,09</p>
 <p>GHIDINI MANIGLIA GABRY Q8 con Rosetta e bocchetta Patent Ø45 Alluminio argento 50577400281001 - - conf. 10 - € 9,70</p>	 <p>GHIDINI MANIGLIA GABRY Q8 con Rosetta e bocchetta Yale Ø45 Alluminio argento 50577400285001 - - conf. 10 - € 9,70</p>
 <p>GHIDINI CREMONESE GABRY GRAZ Alluminio argento 50577400401001 - - conf. 16 - € 7,12</p>	 <p>GHIDINI CREMONESE GABRY GRAZ + Q7 Alluminio argento 50577400403001 - - conf. 10 - € 7,44</p>
 <p>GHIDINI CREMONESE GABRY Alluminio argento 50577400406001 - Tipo EZ - - conf. 16 - € 7,94 50577400407001 - Tipo EZ + Q7 - - conf. 10 - € 8,44</p>	 <p>GHIDINI MARTELLINA UNIVERSALE ALOX Quadro Q7 Senza movimento Finitura Argento Misura 150x34 5057744250001 - - conf. 16 - € 6,30</p>
 <p>M&T MANIGLIA CORNO Quadro 8 Senza bocchette 7721644 - - conf. 20 - € 6,50</p>	 <p>M&T MANIGLIA CORNO Quadro 8 Su Placca 7721615/8 - Int. Q8X70 - Lunghezza 190 mm - - conf. 8 - € 11,60 7721635 - Int. Q8X90 - Lunghezza 210 mm - - conf. 8 - € 11,60</p>



 <p>MANIGLIA CORNO Quadro 8 Con rosetta e bocchetta patent</p> <p>7721636 – – conf. 12 – € 11,60</p>	 <p>MARTELLINA CORNO Quadro 7 Placca alta</p> <p>7721608PA – – conf. 20 – € 7,20</p>
 <p>CREMONESE CORNO Con gioco gratz Placca alta</p> <p>7721601PA – – conf. 10 – € 8,10</p>	 <p>CREMONESE CORNO Con gioco gratz + Quadro 7 Placca alta</p> <p>7721602PA – – conf. 5 – € 8,60</p>
 <p>CREMONESE CORNO Con gioco tipo MP Placca alta</p> <p>7721605PA – – conf. 5 – € 8,60</p>	 <p>CREMONESE CORNO Con gioco tipo MP + Quadro 7 Placca alta</p> <p>7721606PA – – conf. 5 – € 9,20</p>
 <p>MANIGLIA BRIXIA In alluminio Quadro 8 Con rosetta e bocchetta patent Ø45 Grano singolo</p> <p>5057743828101 – Finitura Argento – – conf. 10 – € 15,03 5057743828104 – Finitura Bronzata – – conf. 10 – € 10,23</p>	 <p>MEZZA MANIGLIA BRIXIA In alluminio Quadro 8 - Senza quadro Con rosetta Ø50 Con grano</p> <p>5057743833101 – Finitura Argento – – conf. 20 – € 5,95 5057743833104 – Finitura Bronzata – – conf. 20 – € 5,95</p>
 <p>MANIGLIA BRIXIA In alluminio Quadro 8 Con rosetta Ø50 Doppio grano</p> <p>50577438280004 – Finitura BRONZATA – – conf. 8 – € 13,80</p>	 <p>MANIGLIA BRIXIA In alluminio Quadro 8 Con rosetta Ø50 Doppio grano</p> <p>50577438280012 – Finitura OTTONE LUCIDO – – conf. 8 – € 19,70</p>
 <p>MANIGLIA BRIXIA In alluminio Quadro 8 Con rosetta Ø50 Doppio grano</p> <p>50577438280033 – Finitura CROMO SATINATO – – conf. 8 – € 18,74</p>	 <p>MARTELLINA BRIXIA DK</p> <p>5057743855731 – Finitura Argento – – conf. 1 – € 8,15 5057743855734 – Finitura Bronzata – – conf. 1 – € 8,39</p>



























 <p>SECUREMARE</p> <p>KIT 1/2 MANIGLIA ROMA CON ROSETTA E MOLLA Quadro da ordinare a parte</p> <p>7755000CS - Finitura Ottone cromo sat. - conf. 1 - € 15,60 7755000F1 - Finitura Alluminio argento - conf. 1 - € 7,82 7755000F4 - Finitura Alluminio bronzato - conf. 1 - € 7,82 77550000L - Finitura Ottone lucido - conf. 1 - € 15,24</p>	 <p>GHIDINI</p> <p>MARTELLINA ROMA DK Q7 x 40 Con rosetta (con molla) e bocchetta patent Ø50</p> <p>5057732455812 - Finitura Ottone lucido - conf. 1 - € 8,63 5057732455825 - Finitura Cromo satinato - conf. 1 - € 8,63</p>
 <p>GHIDINI</p> <p>MANIGLIA ROMA Quadro 8 Con rosetta (con molla) e bocchetta patent Ø50</p> <p>5057732423112 - Colore Ottone lucido - conf. 1 - € 11,90 5057732423125 - Colore Cromo satinato - conf. 1 - € 11,90</p>	 <p>GHIDINI</p> <p>MANIGLIA SHARK-Z Quadro 8 Con rosetta e bocchetta patent Ø50</p> <p>5056648231512 - Finitura Ottone lucido - conf. 1 - € 25,29 5056648231513 - Finitura Cromo satinato - conf. 1 - € 25,18</p>
 <p>GHIDINI</p> <p>MARTELLINA SHARK-Z DK Q7 X 40</p> <p>5056648055281 - Finitura Cromo satinato - conf. 1 - € 20,16 5056648552812 - Finitura Ottone lucido - conf. 1 - € 15,77</p>	 <p>ASSA ABLOY</p> <p>VITALIA MANIGLIA A CODICE PER PORTE Vitalia è una maniglia innovativa, dotata di codice. La porta rimane sempre chiusa dall'esterno, senza necessità di serrature e chiavi. La maniglia permette l'accesso solo digitando l'apposito codice</p> <p>710D8812H - Mano Dx - mat. INOX - finitura cromo sat. - conf. 1 - € 225,58 710D8812V - Mano Sx - mat. INOX - finitura cromo sat. - conf. 1 - € 225,58</p>
 <p>PM</p> <p>MARTELLINA DK DI SICUREZZA Quadro 7 Con chiave</p> <p>736454090AR - Colore Argento - conf. 50 - € 23,60 736454090BI - Colore Bianco - conf. 50 - € 16,60</p>	 <p>PM</p> <p>MARTELLINA DK PER FINESTRA FILIZ Quadro 7</p> <p>736453890AR - Colore Argento - conf. 50 - € 4,32 736453890BI - Colore Bianco - conf. 50 - € 3,20 736453890BR - Colore Bronzo - conf. 50 - € 4,32</p>
 <p>GHIDINI</p> <p>MANIGLIA ERIKA Q8 R50 Bocchetta per foro chiave non in dotazione</p> <p>5057741023461 - conf. 1 - € 18,00</p>	 <p>GHIDINI</p> <p>MANIGLIA MINNY in coppia Q,8 - in Nylon Rosetta e bocchetta da ordinare a parte</p> <p>50588940208005 - Colore Nero - conf. 8 - € 7,01 50588940208007 - Colore Bianco - conf. 8 - € 7,20</p>
 <p>LINEACALI'</p> <p>MANIGLIA CORNER ZINCAL LINEA CALI' CON ROSETTA PATENT ART. 014 Finitura: Cromo Satinato Dimensioni 45x142 mm Rosetta 45x45 mm</p> <p>626505RB140CCS - conf. 2 - € 40,60</p>	 <p>LINEACALI'</p> <p>MARTELLINA CORNER ZINCAL LINEA CALI' PER FINESTRA CON MOVIMENTO DK SMARTBLOCK Finitura: Cromo Satinato Particolare rosetta che blocca la rotazione della maniglia impedendo al ladro di entrare praticando un foro nel serramento Movimenti: 0° - 90° - 180° (vasistas) Installabile su tutti i tipi di infissi Dimensioni 33x156 mm</p> <p>626505SK742CS - conf. 2 - € 38,40</p>



























 <p>MARTELLINA CORNER ZINCRAL LINEA CALI' PER FINESTRA CON MOVIMENTO DK 4 POSIZIONI Finitura: Cromo Satinato Dimensioni 33x156 mm</p> <p>626505DK742CS - - conf. 2 - € 26,80</p> 	 <p>MANIGLIA GARDA ZINCRAL LINEA CALI' PER FINESTRA CON MOVIMENTO DK SMARTBLOCK Particolare rosetta che blocca la rotazione della maniglia impedendo al ladro di entrare praticando un foro nel serramento. Movimenti: 0° - 90° - 180° (vasistas) Installabile su tutti i tipi di infissi. Dimensioni 33x150 mm</p> <p>626498SK742CS - Finitura Cromo satinato - - conf. 1 - € 31,40</p> <p>626498SK742OL - Finitura Ottone lucido - - conf. 1 - € 30,20</p> 
 <p>CREMONESE / MARTELLINA senza gioco in Nylon</p> <p>50588940400005 - Colore Nero - - conf. 10 - € 6,91</p> <p>50588940400007 - Colore Bianco - - conf. 10 - € 6,91</p> 	 <p>ROSETTA MINNY TONDA In Nylon</p> <p>50588948531005 - Colore Nero - - conf. 16 - € 1,73</p> <p>50588948531007 - Colore Bianco - - conf. 16 - € 1,73</p> 
 <p>BOCCHETTA MINNY TONDA In Nylon</p> <p>50588948631005 - Foto Patent - Colore Nero - - conf. 16 - € 1,73</p> <p>50588948631007 - Foto Patent - Colore Bianco - - conf. 16 - € 1,73</p> <p>50588948635005 - Foto Yale - Colore Nero - - conf. 16 - € 1,73</p> <p>50588948635007 - Foto Yale - Colore Bianco - - conf. 16 - € 1,73</p> 	 <p>PLACCA MINNY In Nylon</p> <p>50588948851005 - Placca Patent 90 - Colore Nero - - conf. 16 - € 3,41</p> <p>50588948851007 - Placca Patent 90 - Colore Bianco - - conf. 16 - € 3,41</p> <p>50588948855005 - Placca Yale 85 - Colore Nero - - conf. 16 - € 3,31</p> <p>50588948855007 - Placca Yale 85 - Colore Bianco - - conf. 16 - € 3,40</p> 
 <p>COPPIA ROSETTE Tonde mm.45 alluminio bronzato</p> <p>50577498531000 - - conf. 50 - € 3,40</p> 	 <p>COPPIA BOCCHETTE GABRY Tonda mm. 45 alluminio bronzato</p> <p>50577498631000 - Foro Patent - - conf. 20 - € 3,17</p> <p>50577498635000 - Foro Yale - - conf. 20 - € 3,40</p> 
 <p>BOCCHETTA Ø 54 mm Alluminio per porte blindate</p> <p>50577048635200 - Foro Yale - Finit. Bronz. - - conf. 50 - € 3,04</p> <p>50577048635224 - Foro Yale - Finit. Cromo Luc. - - conf. 50 - € 5,91</p> <p>50577048635225 - Foro Yale - Finit. Cromo Sat. - - conf. 50 - € 6,77</p> 	 <p>BOCCHETTA Ø 54 mm Alluminio per porte blindate Doppia Mappa</p> <p>50577048637412 - Foro D.M. - Finit. Ottone Luc. - - conf. 50 - € 5,91</p> 
 <p>BOCCHETTA MILENA Tonda Patent Ø 45 x 9 mm Ottone Lucido Vern.</p> <p>50555748631001 - Finitura Ottone lucido - - conf. 50 - € 2,95</p> <p>50555748631008 - Finitura Ottone satinato - - conf. 50 - € 2,95</p> 	 <p>BOCCHETTA MILENA Tonda Yale Ø 45 x 9 mm Ottone Lucido Vern.</p> <p>50555748635001 - Finitura Ottone lucido - - conf. 100 - € 2,99</p> 



  <p>ROSETTA OVALE YALE 73685AR – Colore Argento – – conf. 100 – € 3,20 73685BI – Colore Bianco – – conf. 100 – € 1,44 73685BR – Colore Bronzo – – conf. 100 – € 2,68</p>	  <p>MAGGIORAZIONE Misura: 6x7x20 Ferro 50513280000011 – – conf. 100 – € 0,72</p>
  <p>FERRO CON MOLLA Q8 x105 50513231210570 – – conf. 10 – € 5,33</p>	  <p>FERRO Q8 con intagli per blocco grano 50513230412070 – misura 120 – – conf. 10 – € 1,59 50513230414070 – misura 140 – – conf. 10 – € 1,59 50513230416070 – misura 160 – – conf. 10 – € 1,59</p>
  <p>FERRO ad espansione Q.8x65 50513230500206 – – conf. 4 – € 4,03</p>	  <p>FERRO Q8 CON NIPLEX M10 FOLLE 50513233600170 – Misura 100 – – conf. 10 – € 3,26 50513233610570 – Misura 105 – – conf. 10 – € 3,17 50513233600270 – Misura 110 – – conf. 10 – € 3,17</p>
  <p>GIOCO GRAZ PERNI 50513340200070 – – conf. 10 – € 6,19</p>	  <p>GIOCO GRAZ PERNI Quadro 7 50513340900070 – – conf. 10 – € 6,77</p>
  <p>GIOCO MP 50513340400070 – – conf. 10 – € 6,19</p>	  <p>GIOCO MP Quadro 7 50513340500070 – – conf. 10 – € 6,77</p>
  <p>GIOCO EZ Quadro 7 50513340700070 – – conf. 10 – € 4,67</p>	  <p>GIOCO MARTELLINA Q7 50513350000070 – – conf. 10 – € 5,62</p>











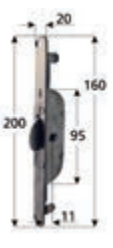
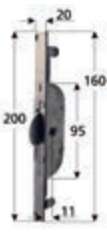

 <p>GIOCO PER ALETTE PIAGATE Finitura zincata 750RG10RZ - - conf. 1 - € 13,80</p> 	 <p>GIOCO PER ALETTE DIRITTE 750RG10RF - - conf. 1 - € 15,80</p> 
 <p>GIOCO DK OVALE Q7x40 con alette 50518340000414 - - conf. 10 - € 5,48</p> 	 <p>GIOCO JOLLY 90009440 - gioco GRAZ - - conf. 10 - € 2,36 90009441 - gioco EZ - - conf. 10 - € 3,30</p> 
 <p>GIOCO EZ 90009442 - - conf. 10 - € 3,50</p> 	 <p>GIOCO GOLA LUPO Laterale 90009447 - - conf. 10 - € 17,90</p> 
 <p>GIOCO CON ALETTE DIRITTE Entrata 7 mm Misura: 114x29,60 Altezza alette: 32 mm 90009445 - - conf. 1 - € 20,82</p> 	 <p>GIOCO CON ALETTE PIEGATE Entrata 7 mm Misura: 114x29,60 Altezza alette: 32 mm 90009446 - - conf. 1 - € 23,98</p> 
 <p>CREMONESE INFILARE GIRO COMPLETO Q.7 Art. 169 B Bronzata 525169B - - conf. 10 - € 10,92</p> 	 <p>CREMONESE INFILARE RZ 1 Giro Q.7 frontale bronzato 90009380 - - conf. 10 - € 15,10</p> 
 <p>CREMONESE INFILARE RZ 1/2 GIRO Q7 frontale bronzato 90009382 - - conf. 10 - € 11,14</p> 	 <p>CREMONESE PER FINESTRE A giro completo 180° Finitura ottone 5251690 - - conf. 10 - € 10,92</p> 













<p>IBFM</p> <p>CREMONESI PER FINESTRA Acciaio lucido Maniglia ottonata</p> <p>525171 - - conf. 10 - € 4,54</p> 	<p>&M900</p> <p>CREMONESE Maniglia in ottone Lunghezza 12,5 cm</p> <p>90009401 - Finitura Ferro luc. imp. ott. - - conf. 10 - € 10,50</p> 
<p>IBFM</p> <p>CREMONESI SPOSTABILI ART. 173</p> <p>525173B - Finitura Bronzato - - conf. 10 - € 6,38 525173F - Finitura Acciaio Lucido - - conf. 10 - € 4,12 525173O - Finitura Ottone - - conf. 10 - € 6,38</p> 	<p>IBFM</p> <p>CREMONESI MIGNON ART. 172</p> <p>525172B - Finitura Bronzato - - conf. 10 - € 4,94 525172F - Finitura Acciaio Lucido - - conf. 10 - € 3,50 525172O - Finitura Ottone - - conf. 10 - € 4,94</p> 
<p>IBFM</p> <p>CREMONESE IN ZAMA Asta Interna Tipo A Con chiave Colore nero</p> <p>525565ZAD - Mano Destra - - conf. 4 - € 25,40 525565ZAS - Mano Sinistra - - conf. 4 - € 25,40</p> 	<p>IBFM</p> <p>CREMONESE IN ZAMA Asta Esterna Tipo B Con chiave Colore nero</p> <p>525565ZBD - Mano Destra - - conf. 4 - € 25,40 525565ZBS - Mano Sinistra - - conf. 4 - € 25,40</p> 
<p>&M900</p> <p>CREMONESE INF. ENT.V.10-20 Bordo Quadro</p> <p>90009384 - - conf. 10 - € 9,00</p> 	<p>&M900</p> <p>CREMONESE INFILARE CHIUSURA ECC Bordo Quadro bronzato</p> <p>90009386 - - conf. 10 - € 9,00</p> 
<p>&M900</p> <p>CREMONESE INFILARE Entrata 17 Bordo Quadro bronzato</p> <p>90009388 - - conf. 10 - € 10,78</p> 	<p>&M900</p> <p>CREMONESE RZ EX 535 entrata 11 - Q.7 frontale 15mm intercambiabile tropicalizzato</p> <p>90009405 - - conf. 4 - € 22,08</p> 
<p>&M900</p> <p>CREMONESE RZ Art. 2000 entrata 11 - Q.7 lungh. chiusura 420mm. lungh. apertura 365mm.</p> <p>90009408 - - conf. 4 - € 25,74</p> 	<p>&M900</p> <p>CREMONESE RZ Art. 2000 entrata 18 - Q.7 lungh. chiusura 420mm. lungh. apertura 365mm.</p> <p>90009409 - - conf. 4 - € 27,00</p> 



<p>&M900</p> <p>CREMONESE RZ Art .2000 entrata 25 – Q.7 lungh. chiusura 420mm. lungh. apertura 365mm.</p> <p>90009410 – – conf. 4 – € 34,90</p> 	<p>&M900</p> <p>CREMONESE RZ Art. 6000 entrata 15 – Q.7 lungh. chiusura 420mm. lungh. apertura 365mm. mano destra</p> <p>90009411 – – conf. 50 – € 32,70</p> 
<p>&M900</p> <p>MINI CREMONESE ADLER entrata 9 – Q.7 frontale 10mm. mano destra</p> <p>90009415 – – conf. 4 – € 36,06</p> 	<p>&M900</p> <p>MINI CREMONESE EX OSMET entrata 11 – Q.7 bordo tondo</p> <p>90009406 – – conf. 4 – € 23,68</p> 
<p>&M900</p> <p>MINI CREMONESE EX OSMET entrata 11 – Q.7 bordo quadro</p> <p>90009407 – – conf. 4 – € 23,68</p> 	<p>GHIDINI</p> <p>POMOLO UNIVERSAL Q8</p> <p>50577486751000 – Ø 55 – Finitura Alluminio Bronzato – – conf. 4 – € 27,74</p> <p>5057748675101 – Ø 55 – Finitura Argento – – conf. 4 – € 27,74</p> <p>50577486771000 – Ø 70 – Finitura Alluminio Bronzato – – conf. 2 – € 41,75</p> <p>5057748677101 – Ø 70 – Finitura Argento – – conf. 3 – € 43,49</p> 
<p>GHIDINI</p> <p>POMOLO MARGHERITA Ø 55 – in coppia Rosetta staccata ottone brunito opaco</p> <p>50544290751000 – – conf. 6 – € 39,46</p> 	<p>GHIDINI</p> <p>POMOLO MILENA in coppia .Q8 ottone lucido</p> <p>50555744751001 – Finitura Ottone lucido – Ø 55 – – conf. 4 – € 55,06</p> <p>50555744771001 – Finitura Ottone lucido – Ø 70 – – conf. 3 – € 61,23</p> 
<p>GHIDINI</p> <p>COPPIA POMOLI CUORE Q8X100 – 2 GRANI Con rosette Ø 54 mm</p> <p>5057200625061 – Finitura Ottone lucido – – conf. 5 – € 28,17</p> <p>5057200625401 – Finitura Argento – – conf. 5 – € 19,00</p> <p>5057200625404 – Finitura Bronzo – – conf. 5 – € 18,92</p> 	<p>Cottali</p> <p>COPPIA POMOLI TRIANGOLO Q8X70 completo di bocchette</p> <p>447191300001 – Materiale Ottone Lucido – – conf. 5 – € 35,00</p> <p>447191300005 – Materiale Ottone Satinato – – conf. 5 – € 36,94</p> <p>447191300007 – Materiale Ottone Cromo Luc. – – conf. 5 – € 44,70</p> <p>447191300032 – Materiale Ottone Cromo Sat. – – conf. 5 – € 44,36</p> <p>447191300076 – Materiale Alluminio Bronzato – – conf. 6 – € 18,48</p> 
<p>Cottali</p> <p>COPPIA POMOLI UOVO Q8 x 70 completo di bocchetta alluminio bronzo</p> <p>447152600001 – Finitura Ott. lucido vern. – Misura Q8x100 – – conf. 1 – € 50,52</p> <p>447191400076 – Finitura Bronzato – Misura Q8x70 – – conf. 6 – € 19,72</p> 	<p>GHIDINI</p> <p>POMOLI PIGNA in coppia</p> <p>5057012810001 – Finitura Argento – Ø Q8X100 – – conf. 8 – € 21,29</p> <p>5057012810004 – Finitura Bronzato – Ø Q8X100 – – conf. 8 – € 21,29</p> <p>505701287001 – Finitura Argento – Ø Q8X70 – – conf. 8 – € 21,29</p> <p>505701287004 – Finitura Bronzato – Ø Q8X70 – – conf. 8 – € 21,29</p> 



 <p>SECUREMMAR</p> <p>KIT POMOLO ROMA Maniglia reversibile uovo con grano M6</p> <p>7755001CS - Colore Ottone cromo sat. - - conf. 1 - € 24,80</p> <p>7755001F1 - Colore Alluminio Argento - - conf. 1 - € 14,40</p> <p>7755001F4 - Colore Alluminio Bronzato - - conf. 1 - € 14,40</p> <p>7755001OL - Colore Ottone Lucido - - conf. 1 - € 24,00</p>	 <p>GHIDINI</p> <p>POMOLO ARIETE spostato Q8 Rosetta bocchetta Yale</p> <p>5055569670260 - - conf. 1 - € 61,92</p>
 <p>GHIDINI</p> <p>POMOLO PIGNA 100mm Q8x45 Bronzato</p> <p>5057200828000 - - conf. 8 - € 21,46</p>	 <p>GHIDINI</p> <p>POMOLO+MANIGLIA MILENA Q8 Rosetta 54 Ottone Cromo Satinato</p> <p>5055574497730 - - conf. 1 - € 60,91</p>
 <p>GHIDINI</p> <p>POMOLO+MANIGLIA MILENA Q8 Rosetta 45 Ottone Cromo Satinato</p> <p>5055574497703 - - conf. 1 - € 60,91</p>	 <p>GHIDINI</p> <p>POMOLO UNIVERSAL con maniglia Q.8 X 70 alluminio bronzo</p> <p>50577400974000 - - conf. 4 - € 21,86</p>
 <p>Cotali</p> <p>SET PER PORTA BLINDATA Art. CPB21968 Pomolo Omega Ø 60 mm Impugnatura Omega Rosetta Ø 50 mm a pressione Ferro nypless 8x100 mm Alluminio argento</p> <p>447CPB219680 - - conf. 1 - € 16,28</p>	 <p>Cotali</p> <p>SET PER PORTA BLINDATA Art. CPB 11161 Set pomolo Ares Ø 65 mm base 56 mm Maniglia Vega Ferro espansione 8x80 mm Ottone lucido verniciato</p> <p>447CPBA21110 - - conf. 1 - € 23,08</p>
 <p>Cotali</p> <p>SET PORTE BLINDATE Art. MA21968 Pomolo Omega Ø60 mm Maniglia Omega con rosetta e bocchetta Ø 50 mm a pressione Ferro espansione 8x80 mm Alluminio argento</p> <p>447CPBSIM219 - - conf. 1 - € 16,28</p>	 <p>GHIDINI</p> <p>POMOLO MILENA con maniglia in folle ottone lucido</p> <p>5055574497700100 - - conf. 1 - € 49,74</p>
 <p>Cotali</p> <p>SET PER PORTE BLINDATE Art. CPB19561 Pomolo Victorian Ø 55 mm con rosetta Ø 45 mm a pressione, 1/2 Karol con rosetta Ø 45 mm a pressione, Ferro fisso nypless 8x100 mm Ottone lucido verniciato</p> <p>447CPB195611 - - conf. 1 - € 23,08</p>	 <p>SECUREMMAR</p> <p>KIT POMOLO ROMA CENTROPORTA Pomolo Ø 63 mm Quadro da ordinare a parte</p> <p>7755020CS - Colore Ottone cromo sat. - - conf. 1 - € 18,40</p> <p>7755020F1 - Colore Alluminio argento - - conf. 1 - € 12,78</p> <p>7755020F4 - Colore Alluminio bronzato - - conf. 1 - € 11,74</p> <p>7755020OL - Colore Ottone lucido - - conf. 1 - € 18,12</p>























 <p>POMOLO UNIVERSAL centroporta alluminio bronzato</p> <p>50577486755500 - Ø 55 - - conf. 8 - € 14,26</p> <p>50577486770500 - Ø 70 - - conf. 6 - € 18,29</p> 	 <p>POMOLO MILENA centroporta ottone lucido</p> <p>50555744755501 - Finitura Ottone lucido - Ø 55 - - conf. 2 - € 30,68</p> <p>50555744770501 - Finitura Ottone lucido - Ø 70 - - conf. 2 - € 37,44</p> 
 <p>POMOLO FISSO Ø mm 70 con vite filetto 8M e dado cieco ottone lucido</p> <p>467150 - - conf. 10 - € 17,40</p> 	 <p>POMOLO ZARA Art. 3.2060 Ø 65 mm con sottosone ed esagono</p> <p>44732060CRS - Finitura Cromo Sat. - - conf. 2 - € 23,76</p> <p>44732060OLV - Finitura Ott.Lucido - - conf. 2 - € 20,78</p> 
 <p>POMOLO GEMINI Art. 3.2000 Ø 43 mm Fissaggio ferro espansione Cromo Satinato</p> <p>44732000CRS - - conf. 6 - € 12,32</p> 	 <p>POMOLO PIPPO centroporta Ø mm.70 In Nylon</p> <p>50588942770005 - Finitura Nero - - conf. 8 - € 15,13</p> <p>50588942770007 - Finitura Bianco - - conf. 8 - € 15,55</p> 
 <p>NOTTOLINO LIMITATORE CON ROSETTA ø 50 Art. 332 Quadro 8x70</p> <p>93504801 - - conf. 10 - € 9,68</p> 	 <p>POMOLO A MEZZALUNA Per cilindri predisposti H40 X L32 mm</p> <p>5055574822871 - IN OTTONE LUCIDO VERNIC - mm 32 X 40 - Tipologia POMOLO - conf. 50 - € 7,92</p> <p>5057704822871 - Finitura ARGENTATO - mm 32 X 40 - Tipologia POMOLO - conf. 50 - € 3,82</p> <p>50577048228900 - Finitura BRONZATA - mm 32 X 40 - Tipologia POMOLO - conf. 50 - € 3,93</p> <p>segue...</p> 
 <p>continua...</p> <p>50577048228912 - Finitura OTTONE LUCIDO - mm 32 X 40 - Tipologia POMOLO - conf. 50 - € 5,86</p> <p>50577048228924 - Finitura CROMO LUCIDO - mm 32 X 40 - Tipologia POMOLO - conf. 50 - € 5,63</p> <p>50577048228925 - Finitura CROMO SATINATO - mm 32 X 40 - Tipologia POMOLO - conf. 50 - € 7,80</p> 	 <p>POMOLO MEZZALUNA per cilindro In zama Finitura Ottone lucido</p> <p>5056674828712 - - conf. 50 - € 2,49</p> 
 <p>POMOLO Art. N6F8 Per cilindri Dimensioni: 40X32 mm Ø 20 mm</p> <p>298N6F8F1 - Finitura ARGENTO - - conf. 10 - € 3,60</p> <p>298N6F8F1S - Finitura ARGENTO SATINATO - - conf. 10 - € 6,80</p> <p>298N6F8F4 - Finitura BRONZATO - - conf. 10 - € 3,60</p> 	 <p>BARRA PER PENSILI Lungh. 2 mt.</p> <p>90017322 - - conf. 10 - € 2,40</p> 

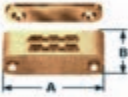

<p> ATTACCAGLIA DOPPIA PER PENSILI PESANTE Spessore 1,5 mm Larghezza 19 mm</p> <p>90017300 - - conf. 200 - € 0,46</p> 	<p> ATTACCAGLIA STAMPATA PER PENSILI Spessore 1,5 mm Larghezza 20 mm</p> <p>90017299 - - conf. 100 - € 0,22</p> 
<p> ATTACCAGLIA REGOLABILE Per barre pensili</p> <p>90017321 - - conf. 100 - € 0,50</p> 	<p> ATTACCAGLIA AD ANGOLO PER MOBILI</p> <p>90017310 - Mano Dx - - conf. 50 - € 0,19 90017311 - Mano Sx - - conf. 50 - € 0,19</p> 
<p> ATTACCAGLIA QUADRA A INSERIMENTO Misura 1,5 mm</p> <p>90017320 - - conf. 100 - € 0,15</p> 	<p> ATTACCAGLIA REGOLABILE Zincata</p> <p>64549015086 - - conf. 10 - € 0,76</p> 
<p> PIASTRINA Ø 32 Q8x25</p> <p>5051332001027 - - conf. 60 - € 3,46</p> 	<p> REGGITUBO PESANTE per tubo ovale</p> <p>90024510 - finitura ottonato - - conf. 20 - € 1,38 90024511 - finitura nichelato - - conf. 20 - € 0,88</p> 
<p> REGGITUBO a 2 punte con fori vite</p> <p>90024500 - Finitura Tropicalizzato - - conf. 100 - € 0,18 90024501 - Finitura Nichelato - - conf. 100 - € 0,22</p> 	<p> REGGITUBO LATERALE PER ARMADI In plastica Per tubo Ø 15 mm</p> <p>90024505 - Finitura Bianco - - conf. 50 - € 0,46 90024506 - Finitura Marrone - - conf. 50 - € 0,46</p> 
<p> REGGITUBO IN ZAMA Dimensioni 60x18 mm Nichelato</p> <p>6454201432C - - conf. 10 - € 0,78</p> 	<p> REGGITUBO IN PLASTICA</p> <p>645REGGIBI - Finitura Bianco - - conf. 10 - € 0,34 645REGGIMA - Finitura Marrone - - conf. 10 - € 0,34</p> 

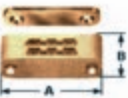

 <p>REGGITUBO IN PLASTICA</p> <p>645REGPABI - Finitura Bianco - - conf. 10 - € 0,10</p> <p>645REGPAMA - Finitura Marrone - - conf. 10 - € 0,10</p> 	 <p>REGGITUBO OVALE APERTO IN ZAMA Regolabile Dimensioni aperto: Ø30x15 mm Cromato</p> <p>64542056Z32 - - conf. 10 - € 4,00</p> 
 <p>TUBO TONDO PER ARMADI Dimensioni Ø18x150 cm</p> <p>64542008F1 - Finitura Bianco - - conf. 10 - € 3,20</p> <p>64542008P1 - Finitura Marrone - - conf. 10 - € 3,20</p> 	 <p>TUBO OVALE PER ARMADI Dimensioni 30 x 15 cm Cromato</p> <p>64542055C15 - - conf. 10 - € 4,40</p> 
 <p>Confezione 100 REGGIPIANI ottone ricoperti in gomma</p> <p>90017556 - finitura bianco - - conf. 1 - € 16,20</p> <p>90017557 - finitura marrone - - conf. 1 - € 16,20</p> <p>90017558 - finitura nero - - conf. 1 - € 12,78</p> 	 <p>MENSOLINA REGGIPIANI IN PLASTICA CON RONDELLA Ø 5 - 6 mm</p> <p>90024490 - Finitura Bianco - - conf. 1000 - € 0,02</p> <p>90024491 - Finitura Marrone - - conf. 1000 - € 0,02</p> 
 <p>CRICCHETTO MAGNETICO PICCOLO Portata 6 Kg.</p> <p>90022101 - Finitura Bianco - Misura 47 mm - - conf. 100 - € 0,34</p> <p>90022102 - Finitura Marrone - Misura 47 mm - - conf. 100 - € 0,34</p> 	 <p>CRICCHETTO MAGNETICO MEDIO Portata 8 kg.</p> <p>90022099 - Finitura Bianco - - conf. 50 - € 0,96</p> <p>90022100 - Finitura Marrone - - conf. 50 - € 0,96</p> 
 <p>CRICCHETTO MAGNETICO GRANDE Portata 12 Kg.</p> <p>90022103 - Finitura Bianco - Misura 87 mm - - conf. 25 - € 1,00</p> <p>90022104 - Finitura Marrone - Misura 87 mm - - conf. 25 - € 1,00</p> 	 <p>CHIUSURA MAGNETICA VAREC Plastica</p> <p>90022377 - Art. UC12 - Ax B 40x12,5 - Attr. 5Kg - Col. Bian. - conf. 12 - € 1,30</p> <p>90022378 - Art. UC14 - Ax B 45x15 - Attr. 7Kg - Col. Bian. - conf. 12 - € 1,56</p> <p>90022379 - Art. UC20 - Ax B 74x16 - Attr. 14Kg - Col. Bian. - conf. 12 - € 4,94</p> <p>segue...</p> 
 <p>continua...</p> <p>90022384 - Art. UC12 - Ax B 40x12,5 - Attr. 5Kg - Col. Marr. - conf. 12 - € 1,30</p> <p>90022385 - Art. UC14 - Ax B 45x15 - Attr. 7Kg - Col. Marr. - conf. 12 - € 1,56</p> <p>90022386 - Art. UC20 - Ax B 74x16 - Attr. 14Kg - Col. Marr. - conf. 12 - € 4,94</p> 	 <p>CRICCHETTO VAREC P2</p> <p>90022410 - Attr. Kg 10 - L 97,5 - Colore Bianco - - conf. 12 - € 4,12</p> <p>90022412 - Attr. Kg 10 - L 97,5 - Colore Marrone - - conf. 12 - € 4,32</p> 



Serviceit

MINUTERIA E
ACCESSORI
PER IL MOBILE
NON STOP



Via Stelvio 6
20822 Seveso (MB) Italy
T. +39 0362 244166
info@serviceit.it

www.serviceit.it

www.malfattitacchinigroup.it

 **METAL**
STYLE

LA PASSIONE
PER I PARTICOLARI



Metal Group Spa
Divisione Metal Style
Viale Europa, 1/3/5 - Cerea (VR) - ITALY
Tel. +39 0442 83777
Email: marketingms@metalstyle.it

www.metalstyle.it













 <p>CRICCHETTO Magnetico</p> <p>640914BI - finitura bianco - - conf. 100 - € 1,08 640914MA - finitura marrone - - conf. 100 - € 1,11</p> 	 <p>CRICCHETTO INCASSO foro Ø 12 mm</p> <p>640909BI - finitura bianco - - conf. 100 - € 1,12 640909MA - finitura marrone - - conf. 100 - € 1,18</p> 
 <p>CRICCHETTO MAGNETICO Bianco</p> <p>640932BI - finitura bianco - - conf. 100 - € 1,57 640932MA - finitura marrone - - conf. 100 - € 1,57</p> 	 <p>CRICCHETTO Magnetico regolabile</p> <p>640925BI - finitura bianco - - conf. 100 - € 1,52 640925MA - finitura marrone - - conf. 100 - € 1,52</p> 
 <p>CRICCHETTO VAREC RMS</p> <p>90022401 - RMS 12 - Attr. Kg 2,5 - Ø 9 - Colore Bianco - conf. 12 - € 1,10 90022402 - RMS 14 - Attr. Kg 4 - Ø 10 - Colore Bianco - conf. 12 - € 1,50 90022405 - RMS 12 - Attr. Kg 2,5 - Ø 9 - Colore Marrone - conf. 12 - € 1,10 90022406 - RMS 14 - Attr. Kg 4 - Ø 10 - Colore Marrone - conf. 12 - € 1,64</p> 	 <p>CRICCHETTO Dimensioni 30x32 mm Bronzato</p> <p>64539085DC - - conf. 10 - € 0,42</p> 
 <p>CHIUSURA MAGNETICA VAREC RP22 Metallo-Rotonda a disco attrazione 3 kg.</p> <p>90022388 - Ø 22 - - conf. 24 - € 1,60</p> 	 <p>CHIUSURA MAGNETICA VAREC RPV Metallo-Rotonda a disco attrazione 1,5 kg.</p> <p>90022393 - Ø 14 - Art. RPV14 - - conf. 12 - € 1,34 90022394 - Ø 22 - Art. RPV22 - - conf. 12 - € 1,82 90022395 - Ø 30 - Art. RPV30 - - conf. 12 - € 4,54</p> 
 <p>CHIUSURA MAGNETICA VAREC Metallo a disco</p> <p>90022420 - Art. RN40 - Attr. Kg 15 - Ø 39 - - conf. 12 - € 7,40 90022425 - Art. RN50A - Attr. Kg 20 - Ø 52 - - conf. 12 - € 13,60</p> 	 <p>SCROCCHETTO a spinta Art. 188 MINI</p> <p>90022106 - finitura bianco - - conf. 50 - € 1,64 90022107 - finitura marrone - - conf. 50 - € 1,92</p> 
 <p>SCROCCHETTO a spinta Art. 180bis</p> <p>90022200 - - conf. 50 - € 2,06</p> 	 <p>CRICCHETTO a rullo - Art. 999</p> <p>640999 - - conf. 100 - € 1,57</p> 



 <p>&M900</p> <p>BOTTONE MAGNETICO In neomidio Senza foro</p> <p>90022210 - Ø 15 - Portata 15 kg - - conf. 28 - € 0,98</p> <p>90022211 - Ø 20 - Portata 30 kg - - conf. 28 - € 1,52</p> <p>90022212 - Ø 25 - Portata 40 kg - - conf. 28 - € 3,40</p> <p>90022213 - Ø 30 - Portata 50 kg - - conf. 28 - € 5,40</p>	 <p>&M900</p> <p>BOTTONE MAGNETICO In neomidio Con foro</p> <p>90022220 - Ø 15 - Portata 15 kg - - conf. 28 - € 1,38</p> <p>90022221 - Ø 20 - Portata 30 kg - - conf. 28 - € 1,86</p> <p>90022222 - Ø 25 - Portata 40 kg - - conf. 28 - € 4,00</p> <p>90022223 - Ø 30 - Portata 50 kg - - conf. 28 - € 8,80</p>
 <p>&M900</p> <p>REGGISPECCHIO 4 ganci Art. esco 202</p> <p>90026000 - finitura ott. nich. - - conf. 100 - € 4,40</p> <p>90026001 - finitura ferro zinc. - - conf. 100 - € 2,20</p>	 <p>&M900</p> <p>CHIUSURA PER ANTE PUSCH LATCH Misura 62 mm</p> <p>90022230 - Finitura Grigio - - conf. 10 - € 2,60</p>
 <p>DIERRE</p> <p>CRICCHETTO 2 SFERE Ottone Lucido</p> <p>46723042 - Misura 42 - - conf. 12 - € 2,40</p> <p>46723050 - Misura 50 - - conf. 12 - € 3,20</p> <p>46723060 - Misura 60 - - conf. 12 - € 3,80</p> <p>46723070 - Misura 70 - - conf. 12 - € 4,60</p>	 <p>SIFA</p> <p>PASSACAPO IN PLASTICA</p> <p>90024520 - Misura Ø 60 - Finitura Bianco - - conf. 50 - € 1,20</p> <p>90024521 - Misura Ø 60 - Finitura Nero - - conf. 50 - € 1,20</p>
 <p>METAL</p> <p>PASSACAPO IN PLASTICA Ø 60 mm</p> <p>64549007F1 - Finitura Bianco - - conf. 20 - € 0,48</p> <p>64549007P1 - Finitura Nero - - conf. 20 - € 0,48</p>	 <p>&M900</p> <p>MINI VENTOSA per ripiani in vetro Art. 216 Ø 20mm</p> <p>90017545 - - conf. 100 - € 0,08</p>
 <p>METAL</p> <p>PISTONE PER ANTE RIBALTABILI Intercambiabile Con attacco anta e fianco Prodotto certificato Lunghezza: 265 mm</p> <p>645XA060FG - Forza 6 kg - - conf. 10 - € 9,28</p> <p>645XA080FG - Forza 8 kg - - conf. 10 - € 9,28</p> <p>645XA100FG - Forza 10 kg - - conf. 10 - € 9,28</p> <p>645XA120FG - Forza 12 kg - - conf. 10 - € 9,28</p>	 <p>METAL</p> <p>SNODO PER ANTE RIBALTABILI Per pensili Ad angolarura variabile</p> <p>645MG21088 - - conf. 1 - € 19,00</p>
 <p>METAL</p> <p>PISTONE INVERSO PER PENSILI Forza: NW 80</p> <p>645XB080FG - - conf. 1 - € 6,80</p>	 <p>&M900</p> <p>PISTONE PER PENSILI</p> <p>90022241 - Modello 100N - - conf. 1 - € 5,16</p> <p>90022242 - Modello 120N - - conf. 1 - € 5,16</p>















<p>MINUTEX</p> <p>ASTA SNODATA con fermo tipo pesante Art. 653 acciaio nichelato</p> <p>90017721 - Misura 15 X 2 - Mano DX - - conf. 24 - € 2,20</p> <p>90017722 - Misura 15 X 2 - Mano SX - - conf. 24 - € 2,20</p> <p>90017723 - Misura 20 X 2 - Mano DX - - conf. 24 - € 2,50</p> <p>90017724 - Misura 20 X 2 - Mano SX - - conf. 24 - € 2,50</p> <p>90017725 - Misura 25 X 2 - Mano DX - - conf. 24 - € 2,58</p> <p>segue...</p> 	<p>MINUTEX</p> <p>continua...</p> <p>90017726 - Misura 25 X 2 - Mano SX - - conf. 24 - € 2,58</p> 
<p>MINUTEX</p> <p>ASTA SNODATA 30 CM con fermo tipo pesante In acciaio zincato Art.653230</p> <p>90017728 - MISURA 15X2 - MANO SX - - conf. 24 - € 2,20</p> 	<p>MINUTEX</p> <p>ASTA SNODATA per cavalletti senza alette Art. 654 acciaio nichelato</p> <p>90017711 - Mis. aperta 15 x 2 - Mano DX - - conf. 48 - € 1,63</p> <p>90017712 - Mis. aperta 15 x 2 - Mano SX - - conf. 48 - € 1,63</p> <p>90017713 - Mis. aperta 20 x 2 - Mano DX - - conf. 48 - € 1,82</p> <p>90017714 - Mis. aperta 20 x 2 - Mano SX - - conf. 48 - € 1,82</p> <p>90017715 - Mis. aperta 25 x 2 - Mano DX - - conf. 48 - € 2,06</p> <p>segue...</p> 
<p>MINUTEX</p> <p>continua...</p> <p>90017716 - Mis. aperta 25 x 2 - Mano SX - - conf. 48 - € 2,00</p> 	<p>DIERRE</p> <p>PIEDINO FISSO ottone lucido</p> <p>46710130 - Ø 30 - filetto M10 - - conf. 25 - € 0,94</p> <p>46710140 - Ø 40 - filetto M10 - - conf. 25 - € 1,26</p> <p>46710150 - Ø 50 - filetto M10 - - conf. 20 - € 1,58</p> <p>46710160 - Ø 60 - filetto M10 - - conf. 10 - € 2,40</p> <p>46710250 - Ø 50 - filetto M12 - - conf. 20 - € 1,88</p> <p>46710260 - Ø 60 - filetto M12 - - conf. 10 - € 2,80</p> 
<p>DIERRE</p> <p>PIEDINI REGOLABILI ottone lucido con foro</p> <p>46710340 - Ø 40 - filetto M10 - - conf. 20 - € 2,40</p> <p>46710450 - Ø 50 - filetto M12 - - conf. 10 - € 3,00</p> <p>46710460 - Ø 60 - filetto M12 - - conf. 10 - € 3,40</p> 	<p>SFA</p> <p>DADO RAGNO A 4 punte</p> <p>90017640 - Attacco M6 - - conf. 200 - € 0,11</p> <p>90017641 - Attacco M8 - - conf. 200 - € 0,15</p> <p>90017642 - Attacco M10 - - conf. 200 - € 0,18</p> 
<p>SFA</p> <p>BUSSOLA IN ACCIAIO ZINCATO CON ESAGONO</p> <p>90017500 - Misura Ø 10x13 - Filettatura M6 - - conf. 500 - € 0,10</p> <p>90017501 - Misura Ø 10x20 - Filettatura M6 - - conf. 500 - € 0,12</p> <p>90017503 - Misura Ø 12x15 - Filettatura M8 - - conf. 500 - € 0,14</p> <p>90017504 - Misura Ø 12x20 - Filettatura M8 - - conf. 500 - € 0,17</p> <p>90017506 - Misura Ø 15x20 - Filettatura M10 - - conf. 500 - € 0,24</p> 	<p>900</p> <p>GAMBA PER MOBILI Quadrata con piedino regolabile acciaio verniciato nero</p> <p>90016000 - Lungh.mm 10 - - conf. 12 - € 4,24</p> <p>90016001 - Lungh.mm 15 - - conf. 12 - € 4,24</p> <p>90016002 - Lungh.mm 20 - - conf. 12 - € 4,76</p> 
<p>METAL</p> <p>PIEDINI PLASTICA Colore nero</p> <p>64510A2100 - Altezza 100 - - conf. 10 - € 0,48</p> <p>64510A2120 - Altezza 120 - - conf. 10 - € 0,50</p> <p>64510A2150 - Altezza 150 - - conf. 10 - € 0,62</p> 	<p>METAL</p> <p>VITE PER FISSAGGIO PIEDINO</p> <p>645VITEPIED - - conf. 50 - € 0,28</p> 















<p>METAL STYLE</p> <p>GANCIO ZOCCOLO PVC 6451006151 - - conf. 10 - € 0,17</p> 	<p>&M 900</p> <p>GAMBA PER MOBILI TONDA piedino regolabile acciaio zincato</p> <p>90017610 - Ø 28 - Lungh. cm 10 - - conf. 4 - € 2,26 90017611 - Ø 28 - Lungh. cm 15 - - conf. 4 - € 2,50 90017651 - Ø 28 - Lungh. cm 12 - - conf. 4 - € 2,34</p> 
<p>&M 900</p> <p>MOLLA DI FISSAGGIO per zoccolino Art. 775 in acciaio zincato</p> <p>90017650 - - conf. 50 - € 0,66</p> 	<p>METAL STYLE</p> <p>MANIGLIA PER MOBILE IN ZAMA</p> <p>645MG23422 - Forza Ottone Lucido - Int. 128 - - conf. 5 - € 2,40 645MG23423 - Forza Cromo Lucido - Int. 128 - - conf. 5 - € 2,20 645MG23425 - Forza Nickel Satinato - Int. 128 - - conf. 5 - € 3,00 645MG23426 - Forza Cromo Opaco - Int. 128 - - conf. 5 - € 2,40</p> 
<p>METAL STYLE</p> <p>MANIGLIA PER MOBILE IN ZAMA</p> <p>645MG23417 - Finitura Ottonato Lucido - Int. 96 - - conf. 5 - € 1,62 645MG23418 - Finitura Cromo Lucido - Int. 96 - - conf. 5 - € 1,52 645MG23420 - Finitura Nickel Satinato - Int. 96 - - conf. 10 - € 1,90 645MG23421 - Finitura Cromo Opaco - Int. 96 - - conf. 5 - € 1,90</p> 	<p>METAL STYLE</p> <p>MANIGLIA PER MOBILE IN ZAMA</p> <p>645MG23341 - Finitura Cromo Lucido - Int. 64 - - conf. 10 - € 1,98 645MG23343 - Finitura Nickel Satinato - Int. 64 - - conf. 10 - € 2,26 645MG23344 - Finitura Cromo Opaco - Int. 64 - - conf. 10 - € 2,26 645MG23345 - Finitura Cromo Lucido - Int. 96 - - conf. 5 - € 2,48 645MG23347 - Finitura Nickel Satinato - Int. 96 - - conf. 5 - € 4,00 segue...</p> 
<p>METAL STYLE</p> <p>continua...</p> <p>645MG23348 - Finitura Cromo Opaco - Int. 96 - - conf. 5 - € 3,30 645MG23349 - Finitura Cromo Lucido - Int. 128 - - conf. 5 - € 3,50 645MG23351 - Finitura Nickel Satinato - Int. 128 - - conf. 5 - € 5,20 645MG23352 - Finitura Cromo Opaco - Int. 128 - - conf. 5 - € 4,32</p> 	<p>METAL STYLE</p> <p>MANIGLIA PER MOBILE IN OTTONE</p> <p>645MG2030 - Finitura Ottone Antico - Misura 84x40 - Int. 64 - - conf. 5 - € 5,36 645MG2035 - Finitura Ottone Antico - Misura 115x49 - Int. 96 - - conf. 5 - € 7,42</p> 
<p>METAL STYLE</p> <p>MANIGLIA PER MOBILE IN ZAMA</p> <p>645MG3835 - Finitura Florence - Misura 81x15 - Int. 64 - - conf. 5 - € 4,94 645MG3847 - Finitura Florence - Misura 115x19 - Int. 96 - - conf. 5 - € 3,70</p> 	<p>METAL STYLE</p> <p>MANIGLIA PER MOBILE IN ZAMA</p> <p>645MG4324 - Finitura Florence - Misura 73x9 - Int. 64 - - conf. 5 - € 2,26 645MG4328 - Finitura Florence - Misura 105x12 - Int. 96 - - conf. 5 - € 3,30 645MG4333 - Finitura Florence - Misura 138x14 - Int. 128 - - conf. 5 - € 4,32</p> 
<p>METAL STYLE</p> <p>MANIGLIA PER MOBILE IN OTTONE</p> <p>645MG4730 - Finitura Florence - Misura 98x20 - Int. 64 - - conf. 5 - € 6,20 645MG4737 - Finitura Florence - Misura 130x20 - Int. 96 - - conf. 5 - € 7,22</p> 	<p>METAL STYLE</p> <p>MANIGLIA PER MOBILE IN ZAMA</p> <p>645MG4198 - Finitura Florence - Misura 100x14 - Int. 64 - - conf. 5 - € 2,26 645MG4203 - Finitura Florence - Misura 140x18 - Int. 96 - - conf. 5 - € 4,12</p> 















<p>METAL STYL</p> <p>MANIGLIA PER MOBILE IN ZAMA</p> <p>645MG23412 – Forza Ottonato Lucido – Int. 64 – – conf. 5 – € 1,90 645MG23413 – Forza Cromo Lucido – Int. 64 – – conf. 5 – € 1,90 645MG23415 – Forza Nichel Satinato – Int. 64 – – conf. 10 – € 2,40 645MG23416 – Forza Cromo Opaco – Int. 64 – – conf. 5 – € 1,90</p> 	<p>METAL STYL</p> <p>MANIGLIA CON PLACCA PER MOBILE IN OTTONE</p> <p>645MG4902 – Finitura Ottone Antico – Misura 89x18 – Int. 64 – – conf. 5 – € 5,36 645MG4904 – Finitura Ottone Antico – Misura 125x22 – Int. 96 – – conf. 5 – € 7,00</p> 
<p>METAL STYL</p> <p>MANIGLIA PER MOBILE IN ZAMA</p> <p>645MG32034 – Finitura Cromo Opaco – Int. 96 – – conf. 5 – € 6,00 645MG32032 – Finitura Cromo Lucido – Int. 96 – – conf. 5 – € 6,60 645MG32033 – Finitura Nickel Satinato – Int. 96 – – conf. 5 – € 8,20 645MG32037 – Finitura Cromo Opaco – Int. 128 – – conf. 5 – € 6,60 segue...</p> 	<p>METAL STYL</p> <p>continua...</p> <p>645MG32035 – Finitura Cromo Lucido – Int. 128 – – conf. 5 – € 7,22 645MG32036 – Finitura Nickel Satinato – Int. 128 – – conf. 5 – € 7,82 645MG32040 – Finitura Cromo Opaco – Int. 160 – – conf. 5 – € 8,00 645MG32038 – Finitura Cromo Lucido – Int. 160 – – conf. 5 – € 9,28 segue...</p> 
<p>METAL STYL</p> <p>continua...</p> <p>645MG32039 – Finitura Nickel Satinato – Int. 160 – – conf. 5 – € 9,68 645MG32041 – Finitura Cromo Lucido – Int. 192 – – conf. 5 – € 10,30 645MG32042 – Finitura Nickel Satinato – Int. 192 – – conf. 5 – € 11,12</p> 	<p>METAL STYL</p> <p>MANIGLIA PER MOBILE IN ZAMA</p> <p>645MG32702 – Finitura Cromo Opaco – Int. 96 – – conf. 5 – € 4,20 645MG32700 – Finitura Cromo Lucido – Int. 96 – – conf. 5 – € 4,20 645MG32705 – Finitura Cromo Opaco – Int. 128 – – conf. 5 – € 4,74 645MG32703 – Finitura Cromo Lucido – Int. 128 – – conf. 5 – € 5,00 645MG32708 – Finitura Cromo Opaco – Int. 160 – – conf. 5 – € 6,38 segue...</p> 
<p>METAL STYL</p> <p>continua...</p> <p>645MG32706 – Finitura Cromo Lucido – Int. 160 – – conf. 5 – € 6,80 645MG35437 – Finitura Cromo Opaco – Int. 192 – – conf. 5 – € 9,06</p> 	<p>METAL STYL</p> <p>MANIGLIA PER MOBILE IN ZAMA</p> <p>645MG23448 – Finitura Cromo Lucido – Int. 128 – – conf. 10 – € 3,30</p> 
<p>METAL STYL</p> <p>MANIGLIA PER MOBILE IN ZAMA</p> <p>645MG23452 – Finitura Cromo Lucido – Int. 96 – – conf. 5 – € 3,10</p> 	<p>METAL STYL</p> <p>MANIGLIA PER MOBILE IN ZAMA</p> <p>645MG23495 – Finitura Ottone lucido – Interasse 128 – – conf. 5 – € 3,30 645MG23498 – Finitura Nickel Satinato – Interasse 128 – – conf. 5 – € 3,92 645MG23503 – Finitura Nickel Satinato – Interasse 96 – – conf. 5 – € 3,60</p> 
<p>METAL STYL</p> <p>MANIGLIA PER MOBILE IN ZAMA</p> <p>645MG23484 – Forza Cromo Opaco – Int. 64 – – conf. 5 – € 2,40 645MG23481 – Forza Cromo Lucido – Int. 64 – – conf. 10 – € 2,68 645MG23489 – Forza Cromo Opaco – Int. 96 – – conf. 5 – € 2,80 645MG23486 – Forza Cromo Lucido – Int. 96 – – conf. 5 – € 4,00 645MG23494 – Forza Cromo Opaco – Int. 128 – – conf. 5 – € 3,40 645MG23491 – Forza Cromo Lucido – Int. 128 – – conf. 5 – € 4,32</p> 	<p>METAL STYL</p> <p>MANIGLIETTA IN CERAMICA BIANCA Art. M01.00.02.02</p> <p>645M010002 – Finitura Ottone vecchio – Int. 96 – – Misura 107x18 – – conf. 5 – € 1,04</p> 



<p>METAL STYLE</p> <p>MANIGLIA IN OTTONE</p> <p>645MG4250 – Finitura Ottone Antico – Misura 77x31 – – conf. 5 – € 3,00</p> <p>645MG4253 – Finitura Ottone Antico – Misura 96x37 – – conf. 5 – € 3,80</p> 	<p>METAL STYLE</p> <p>MANIGLIA IN ZAMA Con fori</p> <p>645MG4344 – Finitura Oro Valenza – Int. 96 – Misura 112x35 – – conf. 5 – € 3,80</p> <p>645MG4345 – Finitura Florence – Int. 96 – Misura 112x35 – – conf. 5 – € 3,60</p> 
<p>METAL STYLE</p> <p>MANIGLIA IN ACCIAIO</p> <p>645MG23722 – Finitura Cromo Lucido – Int. 64 – – conf. 5 – € 2,20</p> <p>645MG41745 – Finitura Bianco Lucido – Int. 64 – – conf. 5 – € 1,96</p> <p>645MG23723 – Finitura Cromo Lucido – Int. 96 – – conf. 5 – € 2,40</p> 	<p>METAL STYLE</p> <p>MANIGLIA</p> <p>645MG41812 – Finitura Bianco – Int. 32 – – conf. 5 – € 2,20</p> <p>645MG41813 – Finitura Cromo Lucido – Int. 32 – – conf. 5 – € 2,20</p> <p>645MG41814 – Finitura Nero – Int. 32 – – conf. 5 – € 2,20</p> <p>645MG41887 – Finitura Ottone Lucido – Int. 32 – – conf. 5 – € 2,40</p> 
<p>METAL STYLE</p> <p>MANIGLIA IN ZAMA</p> <p>645MG35239 – Finitura Cromo Opaco – Int. 96 – – conf. 5 – € 2,80</p> <p>645MG35237 – Finitura Cromo Lucido – Int. 96 – – conf. 5 – € 2,60</p> <p>645MG35242 – Finitura Cromo Opaco – Int. 128 – – conf. 5 – € 3,00</p> <p>645MG35240 – Finitura Cromo Lucido – Int. 128 – – conf. 5 – € 2,60</p> 	<p>METAL STYLE</p> <p>MANIGLIA PER MOBILE IN ZAMA</p> <p>645MG2912 – Finitura Florence – Misura 33x57 – – conf. 5 – € 3,50</p> 
<p>METAL STYLE</p> <p>ANELLO PER MOBILE IN OTTONE</p> <p>645MG2622 – Finitura Ottone Antico – Misura 23x28 – – conf. 5 – € 2,26</p> <p>645MG2626 – Finitura Ottone Antico – Misura 33x39 – – conf. 5 – € 3,00</p> <p>645MG2628 – Finitura Ottone Antico – Misura 40x46 – – conf. 5 – € 3,40</p> <p>645MG2630 – Finitura Ottone Antico – Misura 50x57 – – conf. 5 – € 4,00</p> 	<p>METAL STYLE</p> <p>ANELLO PER MOBILE IN OTTONE Diametro 20 mm</p> <p>645MG2828 – Finitura Ottone Antico – Misura 50x33 – – conf. 5 – € 3,50</p> <p>645MG2829 – Finitura Ottone Antico – Misura 50x44 – – conf. 5 – € 4,40</p> <p>645MG2830 – Finitura Ottone Antico – Misura 50x50 – – conf. 5 – € 4,32</p> 
<p>METAL STYLE</p> <p>MANIGLIA SNODATA CON PLACCA PER MOBILE IN ZAMA</p> <p>645MG2495 – Finitura Florence – Misura 97x33 – Int. 64 – – conf. 5 – € 5,76</p> 	<p>METAL STYLE</p> <p>PENDENTE PER MOBILE IN ZAMA</p> <p>645MG5615 – Finitura Florence – Misura 28x58 – – conf. 5 – € 2,88</p> 
<p>METAL STYLE</p> <p>PENDENTE PER MOBILE IN OTTONE</p> <p>645MG5650 – Finitura Ottone Antico – Misura 18x22 – – conf. 5 – € 4,54</p> <p>645MG5654 – Finitura Ottone Antico – Misura 18x63 – – conf. 5 – € 4,74</p> 	<p>METAL STYLE</p> <p>POMOLO PER MOBILE IN OTTONE</p> <p>645MG6550 – Finitura Ottone Antico – Misura Ø20x18 – – conf. 5 – € 2,48</p> <p>645MG6553 – Finitura Ottone Antico – Misura Ø24x22 – – conf. 5 – € 2,48</p> <p>645MG6556 – Finitura Ottone Antico – Misura Ø27x23 – – conf. 5 – € 4,60</p> <p>645MG6558 – Finitura Ottone Antico – Misura Ø32x25 – – conf. 5 – € 5,98</p> 















<p>METAL</p> <p>POMOLO PER MOBILE IN ZAMA</p> <p>645MG6070 – Finitura Florence – Misura Ø25x21 – conf. 5 – € 2,48 645MG6082 – Finitura Florence – Misura Ø30x23 – conf. 5 – € 2,88</p> 	<p>METAL</p> <p>POMOLO PER MOBILE IN ZAMA</p> <p>645MG6242 – Finitura Florence – Misura Ø25x20 – conf. 10 – € 1,90 645MG6247 – Finitura Florence – Misura Ø30x22 – conf. 10 – € 2,48</p> 
<p>METAL</p> <p>POMOLO PER MOBILE IN ZAMA</p> <p>645MG6511 – Finitura Florence – Misura Ø25x20 – conf. 10 – € 1,90 645MG6515 – Finitura Florence – Misura Ø30x22 – conf. 10 – € 2,48</p> 	<p>METAL</p> <p>POMOLO PER MOBILE IN ZAMA</p> <p>645MG23973 – Finitura Nickel Opaco – Misura Ø20x30 – conf. 10 – € 2,68</p> 
<p>METAL</p> <p>POMOLO PER MOBILE IN ZAMA</p> <p>645MG23977 – Finitura Cromo Lucido – Misura Ø20x25 – conf. 10 – € 2,26 645MG23978 – Finitura Nickel Opaco – Misura Ø20x25 – conf. 10 – € 2,48</p> 	<p>METAL</p> <p>POMOLO PER MOBILE IN ZAMA</p> <p>645MG23981 – Finitura Nickel Opaco – Misura Ø20x22 – conf. 10 – € 1,84</p> 
<p>METAL</p> <p>POMOLO PER MOBILE IN ZAMA</p> <p>645MG23031 – Finitura Cromo Lucido – Ø 20 – conf. 10 – € 1,16 645MG23033 – Finitura Cromo Opaco – Ø 20 – conf. 10 – € 1,38</p> 	<p>METAL</p> <p>POMOLO PER MOBILE IN ZAMA</p> <p>645MG24012 – Finitura Cromo Lucido – Ø 24 – conf. 10 – € 1,36 645MG24015 – Finitura Cromo Opaco – Ø 24 – conf. 10 – € 1,64</p> 
<p>METAL</p> <p>POMOLO PER MOBILE IN ZAMA</p> <p>645MG23885 – Finitura Cromo Lucido – Ø 10 – conf. 10 – € 1,38 645MG23887 – Finitura Cromo Opaco – Ø 10 – conf. 10 – € 1,76</p> 	<p>METAL</p> <p>POMOLO PLASTICA Diametro 32</p> <p>64524PP32BI – Colore Bianco – conf. 10 – € 1,58 64524PP32GR – Colore Grigio – conf. 10 – € 1,70 64524PP32NC – Colore Noce Chiaro – conf. 10 – € 1,26 64524PP32NE – Colore Nero – conf. 10 – € 1,58 64524PP32NS – Colore Noce Scuro – conf. 10 – € 1,26</p> 
<p>METAL</p> <p>POMOLO PLASTICA Diametro 24</p> <p>64524PP24BI – Colore Bianco – conf. 10 – € 0,96 64524PP24GR – Colore Grigio – conf. 10 – € 1,04 64524PP24NC – Colore Noce chiaro – conf. 10 – € 0,96 64524PP24NE – Colore Nero – conf. 10 – € 1,20 64524PP24NS – Colore Noce scuro – conf. 10 – € 0,96</p> 	<p>METAL</p> <p>POMOLO IN CERAMICA BIANCA Art. P04.00.02.02</p> <p>645P040002 – Finitura Ottone vecchio – Misura Ø31 mm x 26 mm – conf. 10 – € 1,00</p> 







<p>METAL STYLE</p> <p>POMOLO CON BUSSOLA IN LEGNO</p> <p>645MG5896 – Finitura Faggio grezzo – Ø Ø30 – – conf. 10 – € 1,72</p> <p>645MG5897 – Finitura Faggio grezzo – Ø Ø38 – – conf. 10 – € 1,90</p> 	<p>METAL STYLE</p> <p>POMOLO CON BUSSOLA IN LEGNO</p> <p>645MG5835 – Finitura Faggio grezzo – Ø Ø30 – – conf. 10 – € 1,66</p> <p>645MG5837 – Finitura Faggio grezzo – Ø Ø38 – – conf. 10 – € 1,86</p> 
<p>METAL STYLE</p> <p>POMOLO IN ZAMA Per mobili</p> <p>645MG6481 – Finitura Ottone antico – Misura Ø25x20 – – conf. 10 – € 1,60</p> <p>645MG6484 – Finitura Ottone antico – Misura Ø30x22 – – conf. 10 – € 2,20</p> 	<p>METAL STYLE</p> <p>POMOLO IN OTTONE</p> <p>645MG38136 – Finitura Ottone Lucido – Ø Ø20 – – conf. 10 – € 2,80</p> <p>645MG38137 – Finitura Cromo Lucido – Ø Ø20 – – conf. 10 – € 3,20</p> <p>645MG38138 – Finitura Nickel Satinato – Ø Ø20 – – conf. 10 – € 3,80</p> <p>645MG38328 – Finitura Cromo Satinato – Ø Ø20 – conf. 10 – € 3,40</p> <p>645MG38139 – Finitura Ottone Lucido – Ø Ø25 – – conf. 10 – € 3,60</p> <p>segue...</p> 
<p>METAL STYLE</p> <p>continua...</p> <p>645MG38140 – Finitura Cromo Lucido – Ø Ø25 – – conf. 10 – € 4,20</p> <p>645MG38141 – Finitura Nickel Satinato – Ø Ø25 – – conf. 10 – € 4,80</p> <p>645MG38217 – Finitura Cromo Satinato – Ø Ø25 – – conf. 10 – € 4,40</p> 	<p>METAL STYLE</p> <p>POMOLO IN OTTONE</p> <p>645MG38157 – Finitura Ottone Lucido – Ø Ø20 – – conf. 10 – € 2,80</p> <p>645MG38158 – Finitura Cromo Lucido – Ø Ø20 – – conf. 10 – € 3,20</p> <p>645MG38747 – Finitura Cromo Satinato – Ø Ø20 – – conf. 10 – € 3,40</p> <p>645MG38159 – Finitura Nickel Satinato – Ø Ø20 – – conf. 10 – € 3,80</p> <p>645MG38160 – Finitura Ottone Lucido – Ø Ø25 – – conf. 10 – € 4,20</p> <p>segue...</p> 
<p>METAL STYLE</p> <p>continua...</p> <p>645MG38239 – Finitura Cromo Satinato – Ø Ø25 – – conf. 10 – € 5,00</p> <p>645MG38162 – Finitura Nickel Satinato – Ø Ø25 – – conf. 10 – € 5,00</p> 	<p>GHIDINI</p> <p>POMOLO GIOIA Ottone Fumè Ø 35</p> <p>5055543073500 – – conf. 14 – € 10,44</p> 
<p>METAL STYLE</p> <p>POMOLO IN ZAMA</p> <p>645MG40077 – Finitura Cromo Lucido – Ø Ø25 – – conf. 10 – € 2,40</p> <p>645MG40079 – Finitura Cromo Opaco – Ø Ø25 – – conf. 10 – € 2,40</p> 	<p>METAL STYLE</p> <p>MANIGLIA PER MOBILE IN ZAMA</p> <p>645MG23994 – Finitura Nickel Satinato – Ø 35 – – conf. 10 – € 3,92</p> <p>645MG23995 – Finitura Cromo Opaco – Ø 35 – – conf. 10 – € 3,70</p> <p>645MG41262 – Finitura Cromo Lucido – Ø 35 – – conf. 6 – € 2,60</p> 
<p>METAL STYLE</p> <p>BOCCHETTA OVALE PER MOBILE IN OTTONE</p> <p>645MG7758 – Finitura Ottone Antico – Misura 22x37 – – conf. 10 – € 1,48</p> <p>645MG7760 – Finitura Florence – Misura 22x37 – – conf. 10 – € 1,86</p> <p>645MG7761 – Finitura Ottone Lucido – Misura 22x37 – – conf. 10 – € 3,20</p> 	<p>METAL STYLE</p> <p>BOCCHETTA PER MOBILE IN ZAMA</p> <p>645MG8059 – Finitura Florence – Misura 97x33 – – conf. 5 – € 2,68</p> 



<p>METAL</p> <p>BOCCHETTA PER MOBILE IN OTTONE</p> <p>645MG7703 – Finitura Florence – Misura 23x34 – - conf. 5 – € 1,64</p> 	<p>METAL</p> <p>BOCCHETTA A ROMBO PER MOBILE IN OTTONE</p> <p>645MG7927 – Finitura Ottone Antico – Misura 25x49 – - conf. 5 – € 1,70</p> 
<p>METAL</p> <p>CHIAVE PER MOBILE IN ZAMA</p> <p>645MG8508 – Finitura Ottone Antico – Misura 29x77 – Gambo 42 – - conf. 5 – € 1,68</p> <p>645MG8509 – Finitura Florence – Misura 29x77 – Gambo 42 – - conf. 5 – € 1,98</p> 	<p>METAL</p> <p>CHIAVE PER MOBILE IN OTTONE</p> <p>645MG8334 – Finitura Florence – Misura 34x71 – Gambo 42 – - conf. 5 – € 3,80</p> 
<p>METAL</p> <p>CHIAVE PER MOBILE IN OTTONE</p> <p>645MG8335 – - conf. 10 – € 3,20</p> 	<p>METAL</p> <p>MANIGLIA IN ACCIAIO</p> <p>645MG22447 – Finitura Inox Spazzolato – Int. 96 – - conf. 5 – € 5,20</p> <p>645MG22448 – Finitura Inox Spazzolato – Int. 128 – - conf. 5 – € 5,60</p> <p>645MG22450 – Finitura Inox Spazzolato – Int. 192 – - conf. 5 – € 7,00</p> 
<p>Cottali</p> <p>MANIGLIETTA LINEA Ø 12 mm INOX Satinato</p> <p>447330101246 – Int. 128 mm – - conf. 12 – € 6,78</p> <p>447330101646 – Int. 160 mm – - conf. 12 – € 8,02</p> 	<p>GHIDINI</p> <p>MANIGLIETTA FISSA Mec-cromata</p> <p>50566912010003 – misura 100 – - conf. 25 – € 3,46</p> <p>50566912012003 – misura 120 – - conf. 25 – € 4,52</p> <p>50566912014003 – misura 140 – - conf. 25 – € 4,75</p> <p>50566912016003 – misura 160 – - conf. 25 – € 5,91</p> 
<p>MINUTEX</p> <p>MANIGLIA imbutita Art.. 699 Ferro zincato</p> <p>90025301 – misura 80 – - conf. 50 – € 0,31</p> <p>90025302 – misura 100 – - conf. 50 – € 0,36</p> <p>90025303 – misura 120 – - conf. 50 – € 0,47</p> <p>90025304 – misura 140 – - conf. 50 – € 0,54</p> <p>90025305 – misura 160 – - conf. 50 – € 0,65</p> 	<p>Cottali</p> <p>MANIGLIETTA PER MOBILI Art. 3.2512 ottone lucido vern.</p> <p>44732510080LV – Lungh. mm 80 – - conf. 50 – € 2,48</p> <p>44732510100LV – Lungh. mm 100 – - conf. 50 – € 2,72</p> <p>44732510120LV – Lungh. mm 120 – - conf. 50 – € 3,08</p> <p>44732510140LV – Lungh. mm 140 – - conf. 50 – € 3,70</p> 
<p>Cottali</p> <p>MANIGLIETTA RIGATA Art. 3.2536.14 ottone lucido vern.</p> <p>447325360LV – Lungh. mm 140 – - conf. 30 – € 7,40</p> 	<p>Cottali</p> <p>MANETTONCINO GECO Art. 3.2695 interasse 125 mm base con viti in vista</p> <p>44732695CRS – Finitura Cromo satinato – - conf. 25 – € 10,48</p> <p>44732695OLV – Finitura Ott. lucido vern. – - conf. 25 – € 9,12</p> 



<p>&M900</p> <p>MANIGLIA LEGNO per mobili frassino Art.4100</p> <p>90016203 - mod. A - Ø 12 - Inter.fori 96 - - conf. 50 - € 2,68</p> <p>90016204 - mod. B - Ø 12 - Inter.fori 64 - - conf. 50 - € 2,24</p> <p>90016205 - mod. C - Ø 11 - Inter.fori 32 - - conf. 50 - € 1,86</p> 	<p>&M900</p> <p>MANIGLIA LEGNO Per Mobili noce scuro Art. 4100</p> <p>90016200 - mod. A - Ø 12 - Inter.fori 96 - - conf. 50 - € 2,68</p> <p>90016201 - mod. B - Ø 12 - Inter.fori 64 - - conf. 50 - € 2,26</p> <p>90016202 - mod. C - Ø 11 - Inter.fori 32 - - conf. 50 - € 1,86</p> 
<p>&M900</p> <p>MANIGLIA SOTTOLAISTRA ottonata</p> <p>90025002 - misura 9 - - conf. 12 - € 1,22</p> <p>90025003 - misura 11 - - conf. 12 - € 1,44</p> 	<p>&M900</p> <p>MANIGLIA AMERICANA ottonata</p> <p>90025006 - misura 9 - - conf. 12 - € 1,58</p> <p>90025007 - misura 11 - - conf. 12 - € 1,88</p> 
<p>&M900</p> <p>MANIGLIA AMERICANA nera</p> <p>90025008 - misura 9 - - conf. 12 - € 1,44</p> <p>90025009 - misura 11 - - conf. 12 - € 1,74</p> 	<p>&M900</p> <p>MANIGLIA SOTTOLAISTRA nera</p> <p>90025004 - misura 9 - - conf. 12 - € 1,16</p> <p>90025005 - misura 11 - - conf. 12 - € 1,34</p> 
<p>amparro</p> <p>POMOLO Per Mobili Finitura oro lucido</p> <p>725015820L - Ø 20 - - conf. 48 - € 2,98</p> <p>725015825L - Ø 25 - - conf. 48 - € 4,08</p> <p>725015830L - Ø 30 - - conf. 48 - € 6,28</p> 	<p>amparro</p> <p>POMOLO Per Mobili Finitura bronzo antico</p> <p>725015820B - Ø 20 - - conf. 48 - € 3,14</p> <p>725015825B - Ø 25 - - conf. 48 - € 4,28</p> <p>725015830B - Ø 30 - - conf. 48 - € 6,60</p> 
<p>amparro</p> <p>POMOLO Per Mobili Finitura oro satinato</p> <p>725016121S - Ø 21 - - conf. 48 - € 3,18</p> <p>725016126S - Ø 26 - - conf. 48 - € 6,94</p> <p>725016132S - Ø 32 - - conf. 48 - € 6,68</p> 	<p>amparro</p> <p>POMOLO Per Mobili Finitura oro lucido</p> <p>725016520L - Ø 20 - - conf. 48 - € 3,18</p> <p>725016525L - Ø 25 - - conf. 48 - € 4,86</p> <p>725016530L - Ø 30 - - conf. 48 - € 7,66</p> 
<p>amparro</p> <p>POMOLO Per Mobili Finitura cromo satinato</p> <p>725016520C - Ø 20 - - conf. 48 - € 4,56</p> <p>725016525C - Ø 25 - - conf. 48 - € 6,48</p> <p>725016530C - Ø 30 - - conf. 48 - € 10,00</p> 	<p>amparro</p> <p>POMOLO Per Mobili Finitura cromo lucido</p> <p>725016520R - Ø 20 - - conf. 48 - € 4,16</p> <p>725016530R - Ø 30 - - conf. 48 - € 9,06</p> 



&T900

POMOLO LEGNO Per mobili bussola in ottone frassino grezzo Art. 101



90016257 - mod. A - Ø 40 -
- conf. 25 - € 0,66
90016258 - mod. B - Ø 35 -
- conf. 25 - € 0,60
90016259 - mod. C - Ø 30 -
- conf. 25 - € 0,54
90016260 - mod. D - Ø 25 -
- conf. 25 - € 0,48

&T900

POMOLO LEGNO Per Mobili bussola in ottone frassino verniciato Art. "101"



90016266 - mod. A - Ø 40 -
- conf. 25 - € 0,92
90016267 - mod. B - Ø 35 -
- conf. 25 - € 0,80
90016268 - mod. C - Ø 30 -
- conf. 25 - € 0,74
90016269 - mod. D - Ø 25 -
- conf. 25 - € 0,66

&T900

POMOLO LEGNO Per Mobili bussola in ottone noce scuro Art. "101"



90016270 - mod. A - Ø 40 -
- conf. 25 - € 0,92
90016271 - mod. B - Ø 35 -
- conf. 25 - € 0,80
90016272 - mod. C - Ø 30 -
- conf. 25 - € 0,74
90016273 - mod. D - Ø 25 -
- conf. 25 - € 0,66

&T900

POMOLO LEGNO Per Mobili bussola in ottone frassino Art. "203"



90016280 - mod. A - Ø 32 -
- conf. 25 - € 0,82
90016281 - mod. B - Ø 28 -
- conf. 25 - € 0,74
90016282 - mod. C - Ø 23 -
- conf. 25 - € 0,64

&T900

POMOLO LEGNO Per Mobili bussola in ottone noce scuro Art. "203"



90016283 - mod. A - Ø 32 -
- conf. 25 - € 0,82
90016284 - mod. B - Ø 28 -
- conf. 25 - € 0,74
90016285 - mod. C - Ø 23 -
- conf. 25 - € 0,64

Cottali

MANIGLIA INCASSO OVALE Ottone Lucido Art. 3.2971 - 3.2972 misure: esterno: 120x33 interno: 75x20



44732971OLV - fori senza foro -
- conf. 25 - € 6,78
44732972OLV - fori con foro -
- conf. 25 - € 6,78

Cottali

MANIGLIETTA INCASSO TONDA Ottone lucido verniciato Art. 3.2701



4473270130OLV - Misura 30x12 -
- conf. 20 - € 4,94
4473270135OLV - Misura 35x12 -
- conf. 20 - € 4,94

amparro

CHIAVI OTTONE PER MOBILI finitura bronzo antico



725002640B0 -
- conf. 25 - € 4,38

amparro

CHIAVI OTTONE PER MOBILI finitura bronzo antico



725001738B0 -
- conf. 25 - € 4,38

amparro

CHIAVI OTTONE PER MOBILI finitura oro



725001738L0 -
- conf. 25 - € 4,16

amparro

CHIAVI OTTONE PER MOBILI finitura oro



725002840L0 -
- conf. 25 - € 4,16

amparro

CHIAVI OTTONE PER MOBILI finitura oro



725001540L0 -
- conf. 25 - € 5,28

IL PIÙ VASTO ASSORTIMENTO DI MANIGLIE

Cottali



TEL. +39 0365 824317
FAX +39 0365 824240
cottali@cottali.it

www.cottali.it

www.malfattitacchinigroup.it

(R)EVOLUTION



Silentia+

Sviluppo tecnologico delle cerniere con sistema decelerante della prima generazione.

I **due deceleratori ad olio silconico** garantiscono un'eccezionale costanza nell'applicazione della forza frenante, assicurando, così, una chiusura perfetta in qualsiasi condizione, ambiente e applicazione.













Silentia+ è dotata dell'**innovativo selettore che ritarda l'azione decelerante** e conferisce la forza frenante in modo ideale ad ogni tipo di anta.



salice.com

SALICE



<p>amparro</p> <p>CHIAVI OTTONE PER MOBILI finitura oro</p> <p>725001842L0 - - conf. 50 - € 6,98</p> 	<p>amparro</p> <p>CHIAVI OTTONE PER MOBILI finitura bronzo antico</p> <p>725002840B0 - - conf. 25 - € 4,38</p> 
<p>amparro</p> <p>CHIAVI OTTONE PER MOBILI finitura bronzo antico</p> <p>725004832B0 - - conf. 25 - € 4,38</p> 	<p>amparro</p> <p>CHIAVI OTTONE PER MOBILI finitura oro</p> <p>725004832L0 - - conf. 25 - € 4,16</p> 
<p>amparro</p> <p>CHIAVI OTTONE PER MOBILI finitura oro</p> <p>725003340L0 - - conf. 25 - € 4,16</p> 	<p>METAL</p> <p>SERRATURA REDOSSO Materiale ferro Destra/Sinistra Dimensione 20 mm Colore nero</p> <p>6453901302 - - conf. 12 - € 2,20</p> 
<p>METAL</p> <p>SERRATURA REDOSSO Destra/Sinistra Finitura ottonato</p> <p>6453909115 - Entrata 15 - - conf. 4 - € 3,00</p> <p>6453909120 - Entrata 20 - - conf. 4 - € 3,00</p> <p>6453909125 - Entrata 25 - - conf. 4 - € 3,00</p> <p>6453909130 - Entrata 30 - - conf. 4 - € 3,00</p> <p>6453909140 - Entrata 40 - - conf. 4 - € 3,80</p> <p>segue...</p> 	<p>METAL</p> <p>continua...</p> <p>6453909150 - Entrata 50 - - conf. 4 - € 3,80</p> 
<p>&M900</p> <p>CERNIERE EASY-ONE applicabile senza incasso</p> <p>90018020 - - conf. 25 - € 1,64</p> 	<p>SALICE</p> <p>CERNIERE SALICE C6A7C99 Collo piano Chiusura automatica Regolazione semplice</p> <p>90018060 - Ø 26 - - conf. 30 - € 1,26</p> <p>Ø26</p> 
<p>SALICE</p> <p>CERNIERE SALICE C6A7L99 Mezzo collo 9 mm Chiusura automatica Regolazione semplice</p> <p>90018065 - Ø 26 - - conf. 30 - € 1,30</p> <p>Ø26</p> 	<p>SALICE</p> <p>CERNIERE SALICE C6A7S99 Collo 17 mm Chiusura automatica Regolazione semplice</p> <p>90018066 - Ø 26 - - conf. 30 - € 1,32</p> <p>Ø26</p> 



<p>SALICE</p> <p>CERNIERE SALICE C9A7C99 Piana Chiusura automatica Regolazione semplice</p> <p>90018080 - Ø 35 - - conf. 10 - € 1,78</p> <p>Ø35</p> 	<p>SALICE</p> <p>CERNIERE SALICE C9A7L99 Mezzo collo 9 mm Chiusura automatica Regolazione semplice</p> <p>90018081 - Ø 35 - - conf. 30 - € 1,92</p> <p>Ø35</p> 
<p>SALICE</p> <p>CERNIERE SALICE C9A7S99 Collo 17 mm Chiusura automatica Regolazione semplice</p> <p>90018082 - Ø 35 - - conf. 30 - € 2,20</p> <p>Ø35</p> 	<p>SALICE</p> <p>CERNIERE SALICE C2A6A99 Apertura 110° Piana Chiusura automatica Doppia regolazione</p> <p>90018067 - Ø 35 - - conf. 30 - € 2,20</p> <p>Ø35</p> 
<p>SALICE</p> <p>CERNIERE SALICE C2A6G99 Mezzo collo 9 mm Chiusura automatica Doppia regolazione</p> <p>90018068 - Ø 35 - - conf. 30 - € 2,40</p> <p>Ø35</p> 	<p>SALICE</p> <p>CERNIERE SALICE C2A7P99 Collo 17 mm Chiusura automatica Doppia regolazione</p> <p>90018069 - Ø 35 - - conf. 30 - € 2,60</p> <p>Ø35</p> 
<p>SALICE</p> <p>CERNIERE SALICE C2A6A66 CON MOLLA Apertura 110° Piana Chiusura libera Doppia regolazione</p> <p>90018053 - - conf. 10 - € 2,80</p> 	<p>SALICE</p> <p>CERNIERE SALICE C2A6G66 Mezzo collo 9 mm Chiusura automatica Doppia regolazione</p> <p>90018054 - - conf. 10 - € 2,80</p> 
<p>SALICE</p> <p>CERNIERE SALICE C2A4A99 SENZA MOLLA Apertura 110° Piana Chiusura libera Doppia regolazione</p> <p>90018050 - Ø 35 - - conf. 30 - € 2,20</p> <p>Ø35</p> 	<p>SALICE</p> <p>CERNIERE SALICE C2A4G99 SENZA MOLLA Mezzo collo 9 mm Chiusura libera Doppia regolazione</p> <p>90018051 - Ø 35 - - conf. 30 - € 2,38</p> <p>Ø35</p> 
<p>SALICE</p> <p>CERNIERE SALICE C2A5P99 SENZA MOLLA Collo 17 mm Chiusura libera Doppia regolazione</p> <p>90018052 - Ø 35 - - conf. 30 - € 2,40</p> <p>Ø35</p> 	<p>SALICE</p> <p>CERNIERE SALICE C2AFA99 Apertura 165° Piana Chiusura automatica Doppia regolazione</p> <p>90018090 - Ø 35 - - conf. 10 - € 6,20</p> <p>Ø35</p> 



<p>SALICE</p> <p>CERNIERE SALICE C2AFG99 Apertura 165° Mezzo collo 9 mm Chiusura automatica Doppia regolazione</p> <p>90018091 - Ø 35 - - conf. 10 - € 6,60</p> <p>Ø35</p> 	<p>SALICE</p> <p>CERNIERE SALICE C2A7M99 Collo 45° Chiusura automatica Apertura 94° Doppia regolazione</p> <p>90018072 - Ø 35 - - conf. 30 - € 4,40</p> <p>Ø35</p> 
<p>SALICE</p> <p>CERNIERE PIANA PER FRIGORIFERO SALICE C2A7F99 Chiusura automatica Regolazione semplice</p> <p>90018070 - Ø 35 - - conf. 30 - € 3,00</p> <p>Ø35</p> 	<p>SALICE</p> <p>CERNIERE SALICE C2A7N99 Controcollo Chiusura automatica Senza base Doppia regolazione</p> <p>90018095 - Ø 35 - - conf. 10 - € 4,40</p> <p>Ø35</p> 
<p>SALICE</p> <p>CERNIERE SALICE CFA7A99 Piana Chiusura automatica Doppia regolazione</p> <p>90018073 - Ø 40 - - conf. 30 - € 3,60</p> <p>Ø40</p> 	<p>SALICE</p> <p>CERNIERE SALICE CFA7G99 Collo 11 mm Chiusura automatica Doppia regolazione</p> <p>90018074 - Ø 40 - - conf. 30 - € 3,80</p> <p>Ø40</p> 
<p>SALICE</p> <p>CERNIERE SALICE CFA7P99 Collo 22 mm Chiusura automatica Doppia regolazione</p> <p>90018075 - Ø 40 - - conf. 30 - € 4,20</p> <p>Ø40</p> 	<p>SALICE</p> <p>SERIE SILENTIA C2AM AD 9 Apertura 155° Piana Con effetto decelerante Anta spessore min. 16 mm Doppia regolazione</p> <p>90018115 - Ø 35 - - conf. 10 - € 10,80</p> <p>Ø35</p> 
<p>SALICE</p> <p>SERIE SILENTIA SALICE C7A6AE9 Apertura 110° Piana Con effetto decelerante Spessore minimo 16 mm</p> <p>90018061 - - conf. 30 - € 4,40</p> 	<p>SALICE</p> <p>SERIE SILENTIA SALICE C7A6PE9 Collo 17 Apertura 110° Con effetto decelerante Spessore minimo 16 mm</p> <p>90018063 - - conf. 30 - € 4,60</p> 
<p>SALICE</p> <p>SERIE SILENTIA SALICE C7A6GE9 Collo 9 Apertura 110° Con effetto decelerante Spessore minimo 16 mm</p> <p>90018062 - - conf. 30 - € 4,40</p> 	<p>SALICE</p> <p>CALIBRO DI PROFONDITA' D7A6 ACYSN 14 mm Per la fresatura di installazione di cerniere Silentia</p> <p>90018116 - - conf. 1 - € 1,36</p> 



SALICE

BASE A CROCE SALICE B2V3H09/15

90018088 – alzo 0 mm. –
– conf. 30 – € 0,24

90018096 – alzo + 2 mm. –
– conf. 30 – € 0,26

90018097 – alzo + 4 mm. –
– conf. 30 – € 0,34



SALICE

BASE A CROCE REG.SALICE B2R3E0 9/15

90018092 – alzo 0mm –
– conf. 300 – € 0,86

90018093 – alzo + 2mm –
– conf. 600 – € 1,06

90018094 – alzo + 4mm –
– conf. 600 – € 1,14

90018104 – alzo + 3mm –
– conf. 600 – € 0,98



SALICE

BASE A SCATTO CROCE SALICE BAV3L09

90018089 –
– conf. 30 – € 0,94



SALICE

BASE A CROCE SALICE B2S3B99B6/15 regolabile
– in zama **solo per Art. 90018095**

90018098 –
– conf. 10 – € 1,08



SALICE

BASE A CROCE SALICE BAR3R Fissaggio codolo ad espansione Titanio Vite di legno

90018058 – Alzo 3 mm –
– conf. 30 – € 1,38



SLV

KIT SCORREVOLE CON SERRATURA Mod. KR1
Composto da: 1 serratura con gancio 2 maniglie tonde Ø 48 mm fissaggio con vite a vista e taglio vite di emergenza ribassato –

90100515 – TIPOLOGIA KIT SCORREVOLE – APPLICAZIONE PER PORTE INTERNE – FORO QUADRO 6 – FINITURA OTTONE LUCIDO E 50 – conf. 1 – € 21,22

90100516 – TIPOLOGIA KIT SCORREVOLE – APPLICAZIONE PER PORTE INTERNE – FORO QUADRO 6 – FINITURA CROMO SATINATO E 50 – conf. 1 – € 24,40



SLV

KIT SCORREVOLE SENZA SERRATURA Mod. KR1
Composto da: 2 maniglie tonde Ø 48 mm fissaggio con vite a vista e taglio vite di emergenza ribassato –

90100510 – TIPOLOGIA KIT SCORREVOLE – APPLICAZIONE PER PORTE INTERNE – FINITURA OTTONE LUCIDO – conf. 1 – € 16,34

90100511 – TIPOLOGIA KIT SCORREVOLE – APPLICAZIONE PER PORTE INTERNE – FINITURA CROMO SATINATO – conf. 1 – € 17,82



OMGE

KIT GUIDA PER PORTE SCORREVOLI Fissaggio al soffitto Scatola completa di profilo superiore in alluminio 2 carrelli con viti e piastre Fermaporte con aggancio Staffa in alluminio con vite per fissaggio binario alla parete Staffa in alluminio Guida a pavimento in nylon Set viti di fissaggio

7231400015 – L.Porta 71-90 – Lungh.Binario 155 – Int.Carrelli 45 – conf. 1 – € 62,00

7231400019 – L.Porta 91-110 – Lungh.Binario 190 – Int.Carrelli 60 – conf. 1 – € 67,00

7231400023 – L.Porta 111-130 – Lungh.Binario 230 – Int.Carrelli 80 – conf. 1 – € 75,60



OMGE

KIT GUIDA PER PORTE SCORREVOLI Fissaggio al soffitto Dotazione: 2 carrelli con viti e piastre Fermaporte con aggancio Staffa in alluminio con vite per fissaggio binario al soffitto Guida a pavimento nylon Set viti di fissaggio

7231401015 – L.porta 71 – 90 – lungh.binario 155 – int.carrelli 45 – conf. 1 – € 68,60

7231401019 – L.porta 91 – 110 – lungh.binario 190 – int.carrelli 60 – conf. 1 – € 75,40

7231401023 – L.porta 111-130 – lungh.binario 230 – int.carrelli 80 – conf. 1 – € 85,40



OMGE

KIT GUIDA PER PORTE SCORREVOLI Con due ammortizzatori

7231399015 – L.Porta 71-90 – Lungh.Binario 155 – Ammortizz. 2 – conf. 1 – € 80,40

7231399019 – L.Porta 91-110 – Lungh.Binario 190 – Ammortizz. 2 – conf. 1 – € 86,40

7231399023 – L.Porta 110-130 – Lungh.Binario 230 – Ammortizz. 2 – conf. 1 – € 94,20



GUIDA A SFERE PER CASSETTO SERIE 351





OMGE

GUIDA A SFERE PER CASSETTO SERIE 351 Fissaggio laterale/orizzontale Estrazione parziale Portata max coppia 40 Kg **La portata massima si riferisce al carico massimo consentito per coppia di guide (550 mm) con montaggio laterale Sezione C = 36 mm** Foratura passo 32 mm Viti Ø 3,5 mm Finitura zincata

72335130 – A 300 – B 185 – C 285 – L 485 – conf. 25 – € 9,60

72335135 – A 350 – B 240 – C 335 – L 570 – conf. 25 – € 10,20

segue...





OMGE

continua...

72335140 - A 400 - B 285 - C 385 - L 685
- conf. 25 - € **10,60**

72335145 - A 450 - B 340 - C 435 - L 790
- conf. 25 - € **11,60**

72335150 - A 500 - B 390 - C 485 - L 890
- conf. 25 - € **12,20**

72335155 - A 550 - B 440 - C 535 - L 990
- conf. 25 - € **12,40**

72335160 - A 600 - B 490 - C 585 - L 1090
- conf. 15 - € **13,40**

segue...

OMGE

continua...

72335165 - A 650 - B 535 - C 635 - L 1185
- conf. 15 - € **14,20**

72335170 - A 700 - B 590 - C 685 - L 1290
- conf. 15 - € **14,60**

GUIDA A SFERE PER CASSETTO SERIE 352

OMGE

GUIDA A SFERE PER CASSETTO SERIE 352
Fissaggio laterale/orizzontale Estrazione parziale
Portata max coppia 15 Kg **La portata massima si riferisce al carico massimo consentito per coppia di guide (400 mm) con montaggio laterale Sezione C = 22,5 mm** Foratura passo 32 mm Viti Ø 3 mm Finitura zincata

72335220 - A 200 - B 126 - C 185 - L 326
- conf. 10 - € **5,00**

72335225 - A 250 - B 177 - C 235 - L 427
- conf. 10 - € **5,80**

segue...

OMGE

continua...

72335230 - A 300 - B 227 - C 285 - L 527
- conf. 10 - € **7,00**

72335235 - A 350 - B 278 - C 335 - L 628
- conf. 10 - € **7,40**

72335240 - A 400 - B 326 - C 385 - L 726
- conf. 10 - € **7,80**

72335245 - A 450 - B 377 - C 435 - L 827
- conf. 10 - € **8,20**

72335250 - A 500 - B 367 - C 485 - L 867
- conf. 10 - € **8,80**

segue...

OMGE

continua...

72335255 - A 550 - B 415 - C 535 - L 965
- conf. 10 - € **9,00**

72335260 - A 600 - B 465 - C 584 - L 1065
- conf. 10 - € **9,40**

GUIDA A SFERE PER CASSETTO SERIE 825

OMGE

GUIDA A SFERE PER CASSETTO SERIE 825
Fissaggio laterale/orizzontale Estrazione totale
Portata max coppia 30 Kg **La portata massima si riferisce al carico massimo consentito per coppia di guide (400 mm) con montaggio laterale Blocco in chiusura Levetta per rimozione cassetto Sezione C = 43,5 mm** Foratura passo 32 mm Viti Ø 3,5 mm Finitura zincata

72382530 - A 300 - B 170 - C 135 - L 605
- conf. 25 - € **14,62**

72382535 - A 350 - B 170 - C 185 - L 705
- conf. 25 - € **12,98**

segue...

OMGE

continua...

72382540 - A 400 - B 220 - C 185 - L 805
- conf. 25 - € **13,80**

72382545 - A 450 - B 224 - C 233 - L 907
- conf. 25 - € **18,20**

72382550 - A 500 - B 270 - C 233 - L 1003
- conf. 25 - € **15,66**

72382555 - A 550 - B 272 - C 285 - L 1107
- conf. 25 - € **16,68**

72382560 - A 600 - B 320 - C 285 - L 1205
- conf. 25 - € **17,72**

OMGE

GUIDA A SFERE PER CASSETTO SERIE 835

OMGE

GUIDA A SFERE PER CASSETTO SERIE 835
Fissaggio laterale/orizzontale Estrazione totale
Portata max coppia 50 Kg **La portata massima si riferisce al carico massimo consentito per coppia di guide (550 mm) con montaggio laterale Blocco in chiusura Sezione C = 55 mm** Foratura passo 32 mm Viti Ø 3,5 mm Finitura zincata

7238350030 - A 300 - B 328 - L 628 -
- conf. 15 - € **23,08**

7238350035 - A 350 - B 375 - L 725 -
- conf. 15 - € **24,92**

segue...

OMGE

continua...

7238350040 - A 400 - B 205 - L 815 -
- conf. 15 - € **26,98**

7238350045 - A 450 - B 475 - L 925 -
- conf. 15 - € **29,04**

7238350050 - A 500 - B 250 - L 1015 -
- conf. 8 - € **32,54**

7238350060 - A 600 - B 300 - L 1235 -
- conf. 8 - € **41,20**

7238350070 - A 700 - B 717 - L 1417 -
- conf. 8 - € **43,26**

7238350080 - A 800 - B 372 - L 1630 -
- conf. 8 - € **48,00**



GUIDA A SFERE PER CASSETTO **SERIE 840**

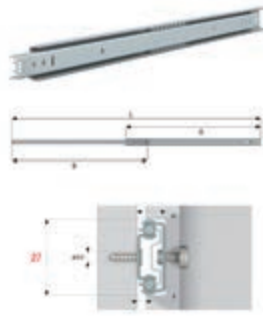

GUIDA A SFERE PER CASSETTO **SERIE 840**

Fissaggio laterale/orizzontale Estrazione parziale Portata max coppia 15 Kg **La portata massima si riferisce al carico massimo consentito per coppia di guide (342 mm) con montaggio laterale Sezione C = 27 mm** Foratura passo 32 mm Viti Ø 3,0 mm Finitura zincata

7238400031 - A 310 - B 231 - L 545 -
- conf. 50 - € **2,68**
7238400034 - A 342 - B 270 - L 609 -
- conf. 50 - € **2,68**
segue...

GUIDA A SFERE PER CASSETTO **SERIE 850**



continua...

7238400040 - A 406 - B 312 - L 718 -
- conf. 50 - € **3,10**
7238400043 - A 438 - B 349 - L 787 -
- conf. 50 - € **3,30**
7238400050 - A 500 - B 404 - L 904 -
- conf. 50 - € **6,40**

GUIDA A SFERE PER CASSETTO **SERIE 850**

Fissaggio al fondo Estrazione parziale Portata max coppia 30 Kg **La portata massima si riferisce al carico massimo consentito per coppia di guide (500 mm) Sezione C = 33,5 mm** Foratura passo 32 mm Viti Ø 3,5 mm Finitura zincata

7238500030 - A 300 - B 175 - L 475 - Ø 3,5
- conf. 25 - € **10,30**
7238500035 - A 350 - B 256 - L 606 - Ø 3,5
- conf. 25 - € **11,34**
7238500040 - A 400 - B 276 - L 676 - Ø 3,5
- conf. 25 - € **11,94**
segue...

continua...

7238500050 - A 500 - B 376 - L 876 - Ø 3,5
- conf. 25 - € **13,40**
7238500055 - A 555 - B 425 - L 980 - Ø 3,5
- conf. 25 - € **13,20**

GUIDA A SFERE PER CASSETTO **SERIE 851**

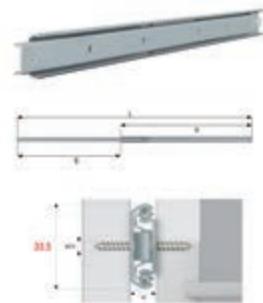

GUIDA A SFERE PER CASSETTO **SERIE 851** Fissaggio laterale/orizzontale Estrazione parziale Portata max coppia 30 Kg **La portata massima si riferisce al carico massimo consentito per coppia di guide (500 mm) con montaggio laterale Sezione C = 33,5 mm** Foratura passo 32 mm Viti Ø 3,5 mm Finitura zincata

7238510030 - A 300 - B 175 - L 475 -
- conf. 40 - € **6,80**
7238510035 - A 350 - B 256 - L 606 -
- conf. 40 - € **7,42**
segue...

continua...

7238510045 - A 450 - B 325 - L 775 -
- conf. 40 - € **9,28**
7238510050 - A 500 - B 375 - L 870 -
- conf. 40 - € **8,24**
7238510055 - A 550 - B 425 - L 975 -
- conf. 20 - € **8,86**
7238510060 - A 600 - B 415 - L 1016 -
- conf. 20 - € **9,48**

GUIDA A SFERE PER CASSETTO **SERIE 860**

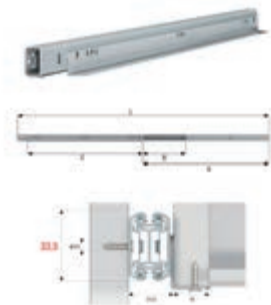

GUIDA A SFERE PER CASSETTO **SERIE 860**









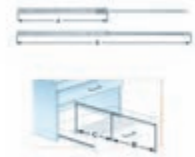

Fissaggio al fondo Estrazione totale Portata max coppia 30 Kg **La portata massima si riferisce al carico massimo consentito per coppia di guide (550 mm) Sezione C = 33,5 mm** Foratura passo 32 mm Viti Ø 3,5 mm Finitura zincata

7238600030 - A 300 - B 120 - C 185 - L 605
- conf. 15 - € **20,80**
7238600035 - A 350 - B 175 - C 191 - L 704
- conf. 15 - € **24,10**
7238600040 - A 400 - B 175 - C 241 - L 816
- conf. 15 - € **24,30**
segue...

continua...

7238600050 - A 500 - B 225 - C 288 - L 1015
- conf. 15 - € **25,14**
7238600060 - A 600 - B 225 - C 390 - L 1195
- conf. 10 - € **26,58**

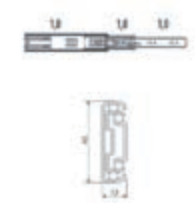
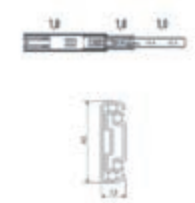

<p>GUIDA A SFERE PER CASSETTO SERIE 870</p>  	<p>GUIDA A SFERE PER CASSETTO SERIE 870 Fissaggio laterale/orizzontale Estrazione parziale Portata max coppia 8 Kg La portata massima si riferisce al carico massimo consentito per coppia di guide (283 mm) con montaggio laterale Sezione C = 17 mm Bloccaggio con vite M4 Foratura passo 32 mm Viti Ø 3 mm Finitura zincata</p> <p>72387019 - A 187 - B 115 - C 182 - L 302 - conf. 10 - € 2,48 72387022 - A 219 - B 125 - C 214 - L 344 - conf. 10 - € 2,68 segue...</p>
<p>OMGE</p> <p>continua...</p> <p>72387025 - A 251 - B 155 - C 246 - L 406 - conf. 10 - € 2,88 72387028 - A 281 - B 179 - C 278 - L 460 - conf. 10 - € 3,10 72387031 - A 315 - B 230 - C 310 - L 545 - conf. 10 - € 3,10 72387034 - A 345 - B 245 - C 342 - L 590 - conf. 10 - € 3,30 72387037 - A 379 - B 250 - C 374 - L 629 - conf. 10 - € 3,70 72387043 - A 430 - B 325 - C 424 - L 755 - conf. 10 - € 4,54</p> 	<p>GUIDA A SFERE PER CASSETTO SERIE 4001</p>  
<p>OMGE</p> <p>GUIDA SU RUOTA IN HOSTAFORM PER CASSETTO SERIE 4001 Fissaggio al fondo/a squadra Estrazione parziale Portata max coppia 25 Kg La portata massima si riferisce al carico massimo consentito per coppia di guide (450 mm) Autochiusura Sezione C = 35 mm Foratura passo 32 mm Viti Ø 3,0 mm Euroviti Ø 6,3 mm Finitura bianca</p> <p>723400125 - A 250 - B 172 - L 422 - - conf. 1 - € 5,20 723400130 - A 300 - B 222 - L 522 - - conf. 1 - € 5,20 segue...</p> 	<p>OMGE</p> <p>continua...</p> <p>723400135 - A 350 - B 272 - L 622 - - conf. 1 - € 5,80 723400140 - A 400 - B 322 - L 722 - - conf. 1 - € 6,00 723400145 - A 450 - B 342 - L 792 - - conf. 1 - € 6,20 723400150 - A 500 - B 392 - L 892 - - conf. 1 - € 6,40 723400155 - A 550 - B 442 - L 992 - - conf. 1 - € 6,80 723400160 - A 600 - B 492 - L 1092 - - conf. 1 - € 7,00</p> 
<p>METAL</p> <p>GUIDA CASSETTI MARRONE</p> <p>645MG39942 - A 250 - - conf. 25 - € 1,62 645MG39943 - A 300 - - conf. 25 - € 1,90 645MG39944 - A 350 - - conf. 25 - € 2,26 645MG39945 - A 400 - - conf. 25 - € 2,48 645MG39946 - A 450 - - conf. 25 - € 2,68 segue...</p> 	<p>METAL</p> <p>continua...</p> <p>645MG39947 - A 500 - - conf. 25 - € 2,88 645MG39948 - A 550 - - conf. 25 - € 2,88 645MG39949 - A 600 - - conf. 25 - € 3,30</p> 
<p>METAL</p> <p>GUIDA PER CASSETTI BIANCA</p> <p>645MG39934 - A 250 - - conf. 25 - € 1,62 645MG39935 - A 300 - - conf. 25 - € 1,90 645MG39936 - A 350 - - conf. 25 - € 2,26 645MG39937 - A 400 - - conf. 25 - € 2,48 645MG39938 - A 450 - - conf. 25 - € 2,68 segue...</p> 	<p>METAL</p> <p>continua...</p> <p>645MG39939 - A 500 - - conf. 25 - € 2,88 645MG39940 - A 550 - - conf. 25 - € 2,88 645MG39941 - A 600 - - conf. 25 - € 3,30</p> 
<p>METAL</p> <p>GUIDA A SFERA PER CASSETTI Estrazione totale non ammortizzata Portata 30 kg Zincata</p> <p>645PK39756 - A 300 - - conf. 15 - € 5,20 645PK39757 - A 350 - - conf. 15 - € 6,00 645PK39758 - A 400 - - conf. 15 - € 6,80 645PK39759 - A 450 - - conf. 15 - € 7,40 645PK39760 - A 500 - - conf. 15 - € 8,00 segue...</p> 	<p>METAL</p> <p>continua...</p> <p>645PK39761 - A 550 - - conf. 15 - € 9,40 645PK39762 - A 600 - - conf. 15 - € 10,20 645PK39763 - A 650 - - conf. 15 - € 11,20 645PK39764 - A 700 - - conf. 15 - € 12,20</p> 



GUIDA A SFERA Estrazione totale ammortizzata
Portata 45 kg Zincata

645FPK39765 - A 300 -
- conf. 15 - € 11,80

645FPK39766 - A 350 -
- conf. 15 - € 12,80

645FPK39767 - A 400 -
- conf. 15 - € 13,60

645FPK39768 - A 450 -
- conf. 15 - € 14,80

645FPK39769 - A 500 -
- conf. 15 - € 16,00

segue...

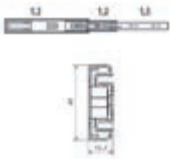

continua...

645FPK39770 - A 550 -
- conf. 15 - € 17,20

645FPK39771 - A 600 -
- conf. 15 - € 19,20

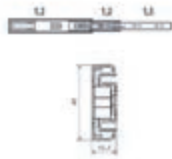

BLOCCA CREMONESE DISEC

CODICE MALFATTI&TACCHINI

461BCRE01BR - BRONZ. € 22,06

461BCRE01CS - CR. SAT. € 22,06

461BCRE01OL - OT. SAT. € 22,06



BCRE01
BLOCCA
CREMONESE

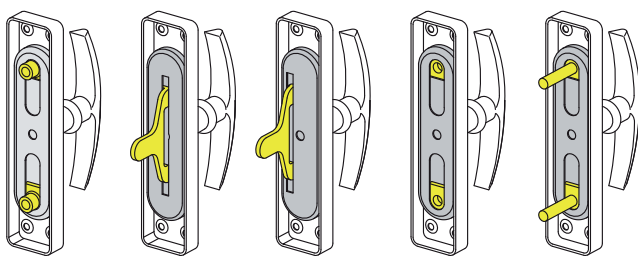
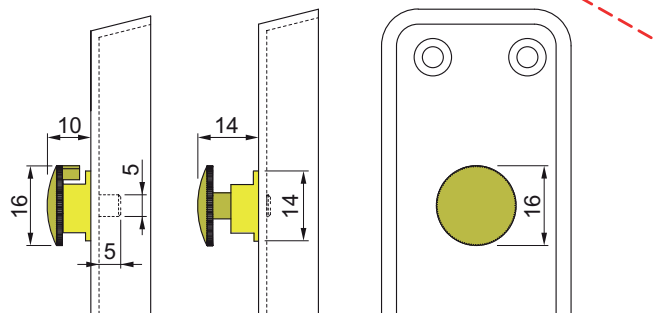

T Cromo satinato
Satin Chrome

B Bronzo
Bronze





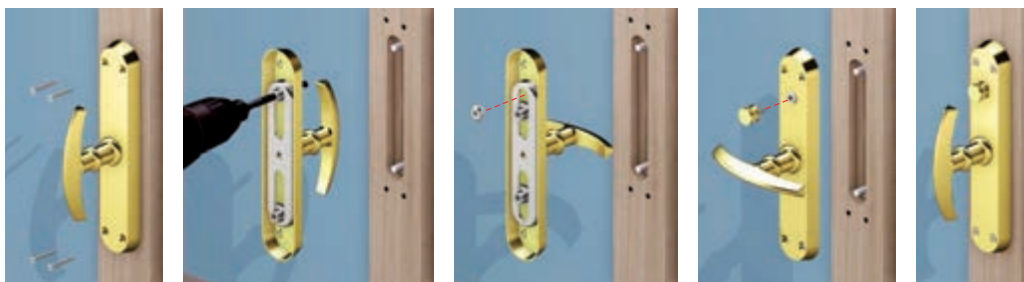

2 PVD Ottone
PVD Brass



VIDEO:





 <p>POMOLO A MEZZALUNA Per cilindri predisposti H40 X L32 mm</p> <p>5055574822871 – IN OTTONE LUCIDO VERNIC – mm 32 X 40 – Tipologia POMOLO – conf. 5 – € 7,92</p> <p>5057704822871 – Finitura ARGENTATA – mm 32 X 40 – Tipologia POMOLO – conf. 5 – € 3,82</p> <p>50577048228900 – Finitura BRONZATA – mm 32 X 40 – Tipologia POMOLO – conf. 5 – € 3,93</p> <p>segue...</p> 	 <p>continua...</p> <p>50577048228912 – Finitura OTTONE LUCIDO – mm 32 X 40 – Tipologia POMOLO – conf. 5 – € 5,86</p> <p>50577048228924 – Finitura CROMO LUCIDO – mm 32 X 40 – Tipologia POMOLO – conf. 5 – € 5,63</p> <p>50577048228925 – Finitura CROMO SATINATO – mm 32 X 40 – Tipologia POMOLO – conf. 5 – € 7,80</p> 
 <p>POMOLO UNIVERSAL Per cilindri predisposti Alluminio</p> <p>50577486818900 – FINITURA ALLUMINIO BRONZATO – TIPOLOGIA POMOLO – conf. 5 – € 5,76</p> <p>50577486818912 – FINITURA OTTONE LUCIDO – TIPOLOGIA POMOLO – conf. 5 – € 7,97</p> <p>50577486818924 – FINITURA CROMO LUCIDO – TIPOLOGIA POMOLO – conf. 5 – € 7,97</p> <p>50577486818925 – FINITURA CROMO SATINATO – TIPOLOGIA POMOLO – conf. 5 – € 9,23</p> 	 <p>POMOLO Art. N6F8 Per cilindri Dimensioni: 40X32 mm Ø 20 mm</p> <p>298N6F8F1 – Finitura ARGENTO – conf. 1 – € 3,60</p> <p>298N6F8F15 – Finitura ARGENTO SATINATO – conf. 1 – € 6,80</p> <p>298N6F8F4 – Finitura BRONZATO – conf. 1 – € 3,60</p> 
 <p>NOTTOLINO LIMITATORE CON ROSETTA Ø 50 Art. 332 – Quadro 8x70</p> <p>298N6F8F1 – conf. 10 – € 9,68</p> 	 <p>POMOLO per cilindro Art. 330</p> <p>93504007 – FINITURA CROMO LUCIDO – TIPOLOGIA POMOLO – conf. 10 – € 9,98</p> <p>93504008 – FINITURA CROMO SATINATO – TIPOLOGIA POMOLO – conf. 10 – € 9,98</p> <p>93504009 – FINITURA OTTONE BRONZATO – TIPOLOGIA POMOLO – conf. 10 – € 9,98</p> <p>93504010 – FINITURA OTTONE LUCIDO – TIPOLOGIA POMOLO – conf. 10 – € 8,48</p> 
 <p>POMOLO per cilindro Art. 330</p> <p>93504011 – FINITURA OTTONE LUCIDO – TIPOLOGIA POMOLO – conf. 10 – € 11,46</p> <p>93504012 – FINITURA CROMO LUCIDO – TIPOLOGIA POMOLO – conf. 10 – € 12,74</p> <p>93504013 – FINITURA CROMO SATINATO – TIPOLOGIA POMOLO – conf. 10 – € 12,74</p> <p>93504014 – FINITURA OTTONE BRONZATO – TIPOLOGIA POMOLO – conf. 10 – € 12,74</p> 	 <p>POMOLO Completo di quadro espansione lunghezza 65</p> <p>192PAA – INTERASSE Alluminio Argento – conf. 1 – € 8,84</p> <p>192PAB – INTERASSE Alluminio Bronzato – conf. 1 – € 8,84</p> <p>192PCL – INTERASSE Ottone Cromo Lucido – conf. 1 – € 11,90</p> <p>192PCS – INTERASSE Ottone Cromo Satinato – conf. 1 – € 11,90</p> <p>192POG – INTERASSE Ottone Graffiato – conf. 1 – € 11,92</p> <p>segue...</p> 
 <p>continua...</p> <p>192POL – INTERASSE Ottone Lucido Vern. – conf. 1 – € 10,68</p> <p>192POS – INTERASSE Ottone Satinato – conf. 1 – € 11,92</p> 	 <p>POMOLO CON MOSTRINA</p> <p>192PMPLSAA – INTERASSE Alluminio Argento – conf. 1 – € 13,20</p> <p>192PMPLSAB – INTERASSE Alluminio Bronzo – conf. 1 – € 13,20</p> <p>192PMPLSCL – INTERASSE Ottone Cromo Lucido – conf. 1 – € 17,78</p> <p>192PMPLSCS – INTERASSE Ottone Cromo Satinato – conf. 1 – € 17,78</p> <p>segue...</p> 
 <p>continua...</p> <p>192PMPLSO – INTERASSE Ottone Lucido – conf. 1 – € 15,60</p> <p>192PMPLSOG – INTERASSE Ottone Graffiato – conf. 1 – € 17,70</p> <p>192PMPLSOS – INTERASSE Ottone Satinato – conf. 1 – € 17,76</p> 	 <p>POMOLO PER LIMITATORE DI APERTURA Art. D15/PM</p> <p>525D15PMB – Lunghezza Bronzato – conf. 1 – € 10,22</p> <p>525D15PMCS – Lunghezza Cromo Satinato – conf. 1 – € 14,24</p> <p>525D15PMO – Lunghezza Ottone Lucido – conf. 1 – € 11,76</p> 



LIMITATORE DI APERTURA Art. D15 In ferro

- 525D15DX - Mano DX -
- conf. 1 - € 12,20
- 525D15SX - Mano SX -
- conf. 1 - € 12,20



SPIONCINO Art. SP Ø 16 mm regolabile da 50 a 80 mm

- 90005039 - finitura cromo satinato -
- conf. 6 - € 5,98
- 90005040 - finitura cromo lucido -
- conf. 6 - € 5,98
- 90005041 - finitura bronzato -
- conf. 6 - € 6,18
- 90005042 - finitura ottone lucido -
- conf. 6 - € 5,36



SPIONCINO Art. SP Ø 16 mm regolabile da 60 a 100 mm

- 90005045 - Finitura Cromo satinato -
- conf. 6 - € 7,22
- 90005047 - Finitura Bronzato -
- conf. 6 - € 7,00
- 90005048 - Finitura Ottone lucido -
- conf. 6 - € 6,80



SPIONCINO SECUREMME Ø 16 mm Serie Diamante a 4 lenti Corpo interno in ottone Vista grandangolare 200°

- 775016BR57 - Finitura Bronzo - Regolazione 57-90 -
- conf. 1 - € 5,98
 - 775016BR60 - Finitura Bronzo - Regolazione 60-110 -
- conf. 1 - € 5,98
 - 775016CS60 - Finitura Cromo Satinato - Regola-
zione 60-110 -
- conf. 1 - € 6,60
- segue...



continua...

- 775016OL60 - Finitura Ottone Lucido - Regola-
zione 60-110 -
- conf. 1 - € 5,98



SPIONCINO ELETTRONICO Mod. E0372 Adatto a porte con spessore da 38-110 mm Foro porta da 14-22 mm Sensore 0,3 Megapixel Schermo 3,2" TFT Dimensioni: 125x68x15 mm Alimentazione: 2 stilo AAA

- 90005075 - FINITURA OTTONE - FUNZIONE VIDEO SENZA - MEGAPIXEL 0.3 - POLLICI 3,2 -
- conf. 1 - € 83,44
- 90005076 - FINITURA CROMO SATINATO - FUN-
ZIONE VIDEO SENZA - MEGAPIXEL 0.3 - POLLICI 3,2 -
- conf. 1 - € 83,44



SPIONCINO ELETTRONICO Mod. E0358 Adatto a porte con spessore da 55-110 mm Foro porta da 14-22 mm Sensore 0,3 Megapixel Schermo 3,5" TFT Dimensioni: 135x85x24,5 mm Alimentazione: 4 stilo AA

- 90005080 - FINITURA OTTONE - FUNZIONE VIDEO SENZA - MEGAPIXEL 0.3 - POLLICI 3,5 -
- conf. 1 - € 130,82
 - 90005081 - FINITURA CROMO SATINATO - FUN-
ZIONE VIDEO SENZA - MEGAPIXEL 0.3 - POLLICI 3,5 -
- conf. 1 - € 130,82
- segue...



continua...

- 90005082 - FINITURA BRONZATO - FUNZIONE VIDEO SENZA - MEGAPIXEL 0.3 - POLLICI 3,5 -
- conf. 1 - € 130,82



SPIONCINO ELETTRONICO Mod. E0399 Adatto a porte con spessore da 38-110 mm Foro porta da 14-22 mm Sensore 0,3 Megapixel Schermo 3,2" TFT Dimensioni: 125x85x18,5 mm Alimentazione: 4 stilo AAA

- 90005090 - FINITURA OTTONE - FUNZIONE VIDEO SENZA - MEGAPIXEL 0.3 - POLLICI 3,2 -
- conf. 1 - € 91,88
 - 90005091 - FINITURA CROMO SATINATO - FUN-
ZIONE VIDEO SENZA - MEGAPIXEL 0.3 - POLLICI 3,2 -
- conf. 1 - € 91,88
- segue...



continua...

- 90005092 - FINITURA BIANCO - FUNZIONE VIDEO SENZA - MEGAPIXEL 0.3 - POLLICI 3,2 -
- conf. 1 - € 91,88



SPIONCINO ELETTRONICO Mod. E0393 Con funzione campanello e scatto automatico di fotografie e video Sensore di movimento Telecamera ad infrarossi con modalità notte Adatto a porte con spessore da 38-110 mm Foro porta da 14-26 mm Sensore 0,3 Megapixel Schermo 4,3" TFT Dimensioni: 139x80x19,8 mm Alimentazione: 4 stilo AA Scheda MicroSD 2 Gb inclusa









- 90005095 - FINITURA OTTONE - FUNZIONE VIDEO CON - MEGAPIXEL 0.3 - POLLICI 4,3 -
- conf. 1 - € 212,18
- segue...







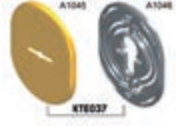











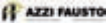



continua...

- 90005096 - FINITURA CROMO SATINATO - FUN-
ZIONE VIDEO CON - MEGAPIXEL 0.3 - POLLICI 4,3 -
- conf. 1 - € 212,18



<p>PRÔXE</p> <p>SPIONCINO ELETTRONICO DIGITALE Adatto a porte con spessore da 40-110 mm Angolo visione: 120° Sensore 0,3 Megapixel Schermo 4,0" TFT Dimensioni: 130x90x15 mm Alimentazione: 2 stilo AAA</p> <p>753365028C - FINITURA SILVER - - conf. 1 - € 78,72 753365029C - FINITURA GOLD - - conf. 1 - € 78,72 753365030C - FINITURA BIANCO - - conf. 1 - € 78,72</p> 	<p>PRÔXE</p> <p>SPIONCINO DIGITALE Compatto Funzione foto Pannello: LCD 3,5" TFT Telecamera: 1.3 Mpx Alimentazione: 3xAAA non include Attacco: 39-62 mm Angolo visione: 120° Dimensione: 96x68x15 mm</p> <p>753365040 - FINITURA ARGENTO - MEGAPIXEL 1,3 - POLLICI 3,5 - conf. 1 - € 101,56</p> 
<p>PRÔXE</p> <p>SPIONCINO WI-FI TUYA 4.3" Adattatori per spioncino porta da 14 e 35 mm Audio bi-direzionale Controllo da remoto tramite smartphone con App TUYA Pannello: LCD 4,3" Risoluzione spioncino: 720p Alimentazione: 5V - 2A Dimensioni LCD: 140x25x98 mm Dimensioni Spioncino: 60x12x60 mm</p> <p>753365050 - - conf. 1 - € 168,56</p> 	<p>Yale</p> <p>SPIONCINO DDV SERIE 500 Visualizzazione immagine molto nitida Facile utilizzo e installazione Spegnimento automatico dopo 10 secondi Può rimpiazzare lo spioncino meccanico senza lavoro aggiuntivo Schermo LCS da 3.2" Telecamera da 0.3 MP con angolo di visione a 105° Foro standard da 14 mm adattabile allo spioncino meccanico Spessore porta 38-110 mm Dimensioni 128x68x15 mm 2 batterie AAA include Colore: argento, ottone ,bianco,nero Certificazione C</p> <p>610450500AR - FINITURA Argento - - conf. 1 - € 125,46 segue...</p> 
<p>Yale</p> <p>continua...</p> <p>610450500OT - FINITURA Ottone - - conf. 1 - € 125,46</p> 	<p>AZZI FAUSTO</p> <p>MOSTRINA Doppia mappa</p> <p>192MDMAA - FINITURA ALLUMINIO ARGENTATO - TIPOLOGIA MOSTRINA - - conf. 1 - € 3,50 192MDMAB - FINITURA ALLUMINIO BRONZATO - TIPOLOGIA MOSTRINA - - conf. 1 - € 3,50 192MDMCL - FINITURA OTTONE CROMO LUCIDO - TIPOLOGIA MOSTRINA - - conf. 1 - € 4,84 segue...</p> 
<p>AZZI FAUSTO</p> <p>continua...</p> <p>192MDMCS - FINITURA OTTONE CROMO SATINATO - TIPOLOGIA MOSTRINA - - conf. 1 - € 4,84 192MDMKSV - FINITURA NICHELATO VERN. SAT. - TIPOLOGIA MOSTRINA - - conf. 1 - € 5,38 192MDMO - FINITURA OTTONE LUCIDO VERN. - TIPOLOGIA MOSTRINA - - conf. 1 - € 4,46 192MDMOG - FINITURA OTTONE GRAFFIATO - TIPOLOGIA MOSTRINA - - conf. 1 - € 5,28 segue...</p> 	<p>AZZI FAUSTO</p> <p>continua...</p> <p>192MDMOS - FINITURA OTTONE SATINATO - TIPOLOGIA MOSTRINA - - conf. 1 - € 5,28</p> 
<p>DiSec</p> <p>MOSTRINA Art. KT037 Per Doppia Mappa</p> <p>461KT037BR - FINITURA ALLUMINIO BRONZATO - MM 85 X 65 - TIPOLOGIA MOSTRINAFORO DOPPIA MAPPA - conf. 1 - € 5,30 461KT037CS - FINITURA CROMO SATINATO - MM 85 X 65 - TIPOLOGIA MOSTRINAFORO DOPPIA MAPPA - conf. 1 - € 8,70 461KT037OL - FINITURA OTTONE LUCIDO - MM 85 X 65 - TIPOLOGIA MOSTRINAFORO DOPPIA MAPPA - conf. 1 - € 6,78</p> 	<p>DiSec</p> <p>KIT MOSTRINA Art. KTE037 In alluminio Per doppia mappa Insacchettati singolarmente</p> <p>461KTE037BR - FINITURA BRONZATO - MM 85 X 65 - TIPOLOGIA MOSTRINAFORO DOPPIA MAPPA - conf. 10 - € 3,90 461KTE037CS - FINITURA CROMO SATINATO - MM 85 X 65 - TIPOLOGIA MOSTRINAFORO DOPPIA MAPPA - conf. 10 - € 2,70 segue...</p> 
<p>DiSec</p> <p>continua...</p> <p>461KTE037OL - FINITURA OTTONE LUCIDO - MM 85 X 65 - TIPOLOGIA MOSTRINAFORO DOPPIA MAPPA - conf. 10 - € 2,70</p> 	<p>CIPPEPPE</p> <p>MOSTRINA PER DOPPIA MAPPA Art. 316 LDMSV Senza viti</p> <p>93504236 - FINITURA OTTONE LUCIDO - INTERASSE FORI MM 64 X 84 - INT. MAN. MOSTRINAINT. PROT. DOPPIA MAPPA - conf. 5 - € 4,88 93504237 - FINITURA CROMO LUCIDO - MM 64 X 84 - TIPOLOGIA MOSTRINAFORO DOPPIA MAPPA - conf. 5 - € 5,72 segue...</p> 

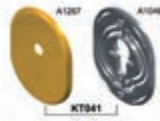

  <p><i>continua...</i> 93504238 – FINITURA CROMO SATINATO – INTERRASSE FORI MM 64 X 84 – INT. MAN. MOSTRINAINT. PROT. DOPPIA MAPPA – conf. 5 – € 5,72 93504239 – FINITURA OTTONE BRONZATO – MM 64 X 84 – TIPOLOGIA MOSTRINA FORO DOPPIA MAPPA – conf. 5 – € 5,72</p>	  <p>MOSTRINA Foro Yale 192MYAA – FINITURA ALLUMINIO ARGENTATO – TIPOLOGIA MOSTRINA – – conf. 1 – € 3,50 192MYAB – FINITURA ALLUMINIO BRONZATO – TIPOLOGIA MOSTRINA – – conf. 1 – € 3,50 192MYCL – FINITURA OTTONE CROMO LUCIDO – TIPOLOGIA MOSTRINA – – conf. 1 – € 4,84 <i>segue...</i></p>
  <p><i>continua...</i> 192MYCS – FINITURA OTTONE CROMO SATINATO – TIPOLOGIA MOSTRINA – – conf. 1 – € 4,84 192MYKSV – FINITURA OTTONE NICHELATO VERN. SAT. – TIPOLOGIA MOSTRINA – – conf. 1 – € 5,38 192MYO – FINITURA OTTONE LUCIDO VERN. – TIPOLOGIA MOSTRINA – – conf. 1 – € 4,46 192MYOG – FINITURA OTTONE GRAFFIATO – TIPOLOGIA MOSTRINA – – conf. 1 – € 5,28 <i>segue...</i></p>	  <p><i>continua...</i> 192MYOS – FINITURA OTTONE SATINATO – TIPOLOGIA MOSTRINA – – conf. 1 – € 5,28</p>
  <p>KIT MOSTRINA Art. KT036 Per Cilindro 461KT036BR – FINITURA ALLUMINIO BRONZATO – MM 85 X 65 – TIPOLOGIA MOSTRINA FORO SAGOMATO – conf. 1 – € 5,30 461KT036CR – FINITURA CROMO LUCIDO – MM 85 X 65 – TIPOLOGIA MOSTRINA FORO SAGOMATO – conf. 1 – € 8,70 <i>segue...</i></p>	  <p><i>continua...</i> 461KT036CS – FINITURA CROMO SATINATO – MM 85 X 65 – TIPOLOGIA MOSTRINA FORO SAGOMATO – conf. 1 – € 8,70 461KT036FN – FINITURA NERO – MM 85 X 65 – TIPOLOGIA MOSTRINA FORO SAGOMATO – conf. 1 – € 6,20 461KT036OL – FINITURA OTTONE LUCIDO – MM 85 X 65 – TIPOLOGIA MOSTRINA FORO SAGOMATO – conf. 1 – € 6,78 <i>segue...</i></p>
  <p><i>continua...</i> 461KT036PVDOL – FINITURA PVD OTTONE LUCIDO – MM 85 X 65 – TIPOLOGIA MOSTRINA FORO SAGOMATO – conf. 1 – € 11,24</p>	  <p>KIT MOSTRINA Art. KTE036 In alluminio Per cilindro Insacchettati singolarmente 461KTE036BR – FINITURA BRONZATO – MM 85 X 65 – TIPOLOGIA MOSTRINA FORO SAGOMATO – conf. 10 – € 3,90 461KTE036CS – FINITURA OTTONE LUCIDO – MM 85 X 65 – TIPOLOGIA MOSTRINA FORO SAGOMATO – conf. 10 – € 2,70 461KTE036OL – FINITURA CROMO SATINATO – MM 85 X 65 – TIPOLOGIA MOSTRINA FORO SAGOMATO – conf. 10 – € 2,70</p>
  <p>MOSTRINA PER CILINDRO SAGOMATO Art. 316 LSV Senza viti 93504230 – FINITURA OTTONE LUCIDO – MM 64 X 84 – TIPOLOGIA MOSTRINA FORO SAGOMATO – conf. 5 – € 4,88 93504231 – FINITURA CROMO LUCIDO – MM 64 X 84 – TIPOLOGIA MOSTRINA FORO SAGOMATO – conf. 5 – € 5,72 93504232 – FINITURA CROMO SATINATO – MM 64 X 84 – TIPOLOGIA MOSTRINA FORO SAGOMATO – conf. 5 – € 5,72 <i>segue...</i></p>	  <p><i>continua...</i> 93504233 – FINITURA OTTONE BRONZATO – MM 64 X 84 – TIPOLOGIA MOSTRINA FORO SAGOMATO – conf. 5 – € 5,72</p>
  <p>KIT MOSTRINA Art. KT041 Per gambo pomolo 461KT041BR – FINITURA ALLUMINIO BRONZATO – MM 85 X 65 – TIPOLOGIA MOSTRINA FORO CODOLO – conf. 1 – € 5,30 461KT041CR – FINITURA CROMO LUCIDO – MM 85 X 65 – TIPOLOGIA MOSTRINA FORO CODOLO – conf. 1 – € 8,70 <i>segue...</i></p>	  <p><i>continua...</i> 461KT041CS – FINITURA CROMO SATINATO – MM 85 X 65 – TIPOLOGIA MOSTRINA FORO CODOLO – conf. 1 – € 8,70 461KT041OL – FINITURA OTTONE LUCIDO – MM 85 X 65 – TIPOLOGIA MOSTRINA FORO CODOLO – conf. 1 – € 6,78 461KT041PVDOL – FINITURA PVD OTTONE LUCIDO – MM 85 X 65 – TIPOLOGIA MOSTRINA FORO CODOLO – conf. 1 – € 11,24</p>



<p>DI SEC</p> <p>KIT MOSTRINA Art. KTE041 In alluminio Per gambo pomolo Insacchettati singolarmente</p> <p>461KTE041BR - FINITURA BRONZATO - MM 85 X 65 - TIPOLOGIA MOSTRINAFORO CODOLO - conf. 10 - € 3,90</p> <p>461KTE041CS - FINITURA CROMO SATINATO - MM 85 X 65 - TIPOLOGIA MOSTRINAFORO CODOLO - conf. 10 - € 2,70</p> <p>461KTE041OL - FINITURA OTTONE LUCIDO - MM 85 X 65 - TIPOLOGIA MOSTRINAFORO CODOLO - conf. 10 - € 2,70</p>	<p>CPIERRE</p> <p>MOSTRINA PER POMOLO Art. 317 LSV Senza viti</p> <p>93504242 - FINITURA OTTONE LUCIDO - MM 64 X 84 - TIPOLOGIA MOSTRINAFORO CODOLO - conf. 5 - € 4,88</p> <p>93504243 - FINITURA CROMO LUCIDO - MM 64 X 84 - TIPOLOGIA MOSTRINAFORO CODOLO - conf. 5 - € 5,72</p> <p>93504244 - FINITURA CROMO SATINATO - MM 64 X 84 - TIPOLOGIA MOSTRINAFORO CODOLO - conf. 5 - € 5,72</p> <p>segue...</p>
<p>CPIERRE</p> <p>continua...</p> <p>93504245 - FINITURA OTTONE BRONZATO - MM 64 X 84 - TIPOLOGIA MOSTRINAFORO CODOLO - conf. 5 - € 5,72</p>	<p>DI SEC</p> <p>KIT MOSTRINA Art. KT089 Foro maniglia Ø 20 mm</p> <p>461KT089BR - FINITURA ALLUMINIO BRONZATO - MM 85 X 65 - TIPOLOGIA MOSTRINAFORO MANIGLIA - conf. 1 - € 8,48</p> <p>461KT089CL - FINITURA CROMO LUCIDO - MM 85 X 65 - TIPOLOGIA MOSTRINAFORO MANIGLIA - conf. 1 - € 11,66</p> <p>segue...</p>
<p>DI SEC</p> <p>continua...</p> <p>461KT089CS - FINITURA CROMO SATINATO - MM 85 X 65 - TIPOLOGIA MOSTRINAFORO MANIGLIA - conf. 1 - € 11,46</p> <p>461KT089OL - FINITURA OTTONE LUCIDO - MM 85 X 65 - TIPOLOGIA MOSTRINAFORO MANIGLIA - conf. 1 - € 9,54</p>	<p>SECUREMMAZ</p> <p>PIASTRINA SERIE T Interna o esterna Foro Ø 46 con supporto plastico Per serrature serie 25 con cuore a doppia mappa e serie 26 Inserto nylon incluso</p> <p>7754300KCS00 - FINITURA CROMO SATINATO - MM 62 X 82 - TIPOLOGIA MOSTRINAFORO PROTETTORE - conf. 1 - € 5,98</p> <p>7754300KOL00 - FINITURA OTTONE LUCIDO - MM 62 X 82 - TIPOLOGIA MOSTRINAFORO PROTETTORE - conf. 1 - € 5,98</p>
<p>SECUREMMAZ</p> <p>KIT 1/2 MANIGLIA ROMA CON ROSETTA E MOLLA Quadro da ordinare a parte</p> <p>7755000CS - Finitura Ottone cromo sat. - conf. 1 - € 15,60</p> <p>7755000F1 - Finitura Alluminio argento - conf. 1 - € 7,82</p> <p>7755000F4 - Finitura Alluminio bronzato - conf. 1 - € 7,82</p> <p>7755000OL - Finitura Ottone lucido - conf. 1 - € 15,24</p>	<p>SECUREMMAZ</p> <p>MANIGLIA OSCILLANTE Loretta in zama Quadro 8 mm ad espansione Ingombro ridotto 10 mm Finitura nera</p> <p>7755210 - TIPOLOGIA MANIGLIA PER EXTENSION - conf. 1 - € 9,98</p>
<p>GHIDINI</p> <p>POMOLI PIGNA in coppia</p> <p>5057012810001 - Finitura Argento - Ø Q8X100 - conf. 8 - € 21,29</p> <p>5057012810004 - Finitura Bronzato - Ø Q8X100 - conf. 8 - € 21,29</p> <p>505701287001 - Finitura Argento - Ø Q8X70 - conf. 8 - € 21,29</p> <p>505701287004 - Finitura Bronzato - Ø Q8X70 - conf. 8 - € 21,29</p>	<p>GHIDINI</p> <p>POMOLO PIGNA 100mm Q8x45 Bronzato</p> <p>5057200828000 - conf. 1 - € 21,46</p>
<p>Cotali</p> <p>COPIA POMOLI UOVO Q8 x 70 completo di bocchetta alluminio bronzo</p> <p>447152600001 - Finitura Ott. lucido vern. - Misura Q8x100 - conf. 6 - € 50,52</p> <p>447191400076 - Finitura Bronzato - Misura Q8x70 - conf. 6 - € 19,72</p>	<p>SECUREMMAZ</p> <p>KIT POMOLO ROMA Maniglia reversibile uovo con grano M6</p> <p>7755001CS - Colore Ottone cromo sat. - conf. 1 - € 24,80</p> <p>7755001F1 - Colore Alluminio Argento - conf. 1 - € 14,40</p> <p>7755001F4 - Colore Alluminio Bronzato - conf. 1 - € 14,40</p> <p>7755001OL - Colore Ottone lucido - conf. 1 - € 24,00</p>



<p>Cotali</p> <p>COPPIA POMOLI TRIANGOLO Q8X70 completo di bocchette</p> <p>447191300001 - Materiale Ottone Lucido - - conf. 5 - € 35,00</p> <p>447191300005 - Materiale Ottone Satinato - - conf. 5 - € 36,94</p> <p>447191300007 - Materiale Ottone Cromo Luc. - - conf. 5 - € 44,70</p> <p>447191300032 - Materiale Ottone Cromo Sat. - - conf. 5 - € 44,36</p> <p>447191300076 - Materiale Alluminio Bronzato - - conf. 6 - € 18,48</p> 	<p>GHIDINI</p> <p>COPPIA POMOLI CUORE Q8X100 - 2 GRANI Con rosette Ø 54 mm</p> <p>5057200625404 - Finitura Bronzo - - conf. 5 - € 18,92</p> 
<p>GHIDINI</p> <p>POMOLO UNIVERSAL Q8</p> <p>50577486751000 - Ø 55 - Finitura Alluminio Bronzato - - conf. 4 - € 27,74</p> <p>5057748675101 - Ø 55 - Finitura Argento - - conf. 4 - € 27,74</p> <p>50577486771000 - Ø 70 - Finitura Alluminio Bronzato - - conf. 2 - € 41,75</p> <p>5057748677101 - Ø 70 - Finitura Argento - - conf. 3 - € 43,49</p> 	<p>GHIDINI</p> <p>POMOLO MILENA in coppia .Q8 ottone lucido</p> <p>50555744751001 - Finitura Ottone lucido - Ø 55 - - conf. 4 - € 55,06</p> <p>50555744771001 - Finitura Ottone lucido - Ø 70 - - conf. 3 - € 61,23</p> 
<p>SECUREMME</p> <p>KIT POMOLO ROMA CENTROPORTA Pomolo Ø 63 mm Quadro da ordinare a parte</p> <p>7755020CS - Colore Ottone cromo sat. - - conf. 1 - € 18,40</p> <p>7755020F1 - Colore Alluminio argento - - conf. 1 - € 12,78</p> <p>7755020F4 - Colore Alluminio bronzato - - conf. 1 - € 11,74</p> <p>7755020OL - Colore Ottone lucido - - conf. 1 - € 18,12</p> 	<p>GHIDINI</p> <p>POMOLO UNIVERSAL centroporta alluminio bronzato</p> <p>50577486755500 - Ø 55 - - conf. 8 - € 14,26</p> <p>50577486770500 - Ø 70 - - conf. 6 - € 18,29</p> 
<p>GHIDINI</p> <p>POMOLO MILENA centroporta ottone lucido</p> <p>50555744755501 - Finitura Ottone lucido - Ø 55 - - conf. 2 - € 30,68</p> 	<p>Cotali</p> <p>POMOLO ZARA Art. 3.2060 Ø 65 mm con sotto-rosone ed esagono</p> <p>44732060CRS - Finitura Cromo Sat. - - conf. 2 - € 23,76</p> <p>44732060OLV - Finitura Ott.lucido - - conf. 2 - € 20,78</p> 
<p>Cotali</p> <p>POMOLO GEMINI Art. 3.2000 Ø 43 mm Fissaggio ferro espansione Cromo Satinato</p> <p>44732000CRS - - conf. 6 - € 12,32</p> 	<p>GHIDINI</p> <p>POMOLO PIPPO centroporta Ø mm.70 In Nylon</p> <p>50588942770005 - Finitura Nero - - conf. 8 - € 15,13</p> <p>50588942770007 - Finitura Bianco - - conf. 8 - € 15,55</p> 
<p>DIERRE</p> <p>POMOLO FISSO Ø mm 70 con vite filetto 8M e dado cieco ottone lucido</p> <p>467150 - - conf. 10 - € 17,40</p> 	



 <p>POMOLO+MANIGLIA MILENA Ottone Cromo Satinato 5055574497730 – - conf. 1 – € 60,91</p> 	 <p>POMOLO UNIVERSAL con maniglia Q,8 X 70 alluminio bronzo 50577400974000 – - conf. 4 – € 21,86</p> 
 <p>SET PER PORTA BLINDATA Art. CPB21968 Pomolo Omega Ø 60 mm Impugnatura Omega Rosetta Ø 50 mm a pressione Ferro nypless 8x100 mm Alluminio argentato 447CPB219680 – - conf. 1 – € 16,28</p> 	 <p>POMOLO MILENA con maniglia in folle ottone lucido 5055574497700100 – - conf. 1 – € 49,74</p> 
 <p>MAGGIORAZIONE Misura: 6x7x20 Ferro 50513280000011 – - conf. 100 – € 0,72</p> 	 <p>FERRO CON MOLLA Q8 x105 50513231210570 – - conf. 10 – € 5,33</p> 
 <p>FERRO Q8 2 tagli+fresatura 50513230412070 – misura 120 – - conf. 10 – € 1,59 50513230414070 – misura 140 – - conf. 10 – € 1,59 50513230416070 – misura 160 – - conf. 10 – € 1,59</p> 	 <p>FERRO ad espansione Q,8x65 50513230500206 – - conf. 4 – € 4,03</p> 
 <p>FERRO Q8 CON NIPLEX M10 FOLLE 50513233600170 – Misura 100 – - conf. 10 – € 3,26 50513233600270 – Misura 110 – - conf. 10 – € 3,17 50513233610570 – Misura 105 – - conf. 10 – € 3,17</p> 	 <p>PIASTRINA Ø 32 Q8x25 5051332001027 – - conf. 60 – € 3,46</p> 

ALL'INTERNO DEL CATALOGO SERRATURE E CATALOGO FERRAMENTA SONO DISPONIBILI ANCHE POMOLI, MOSTRINE E MANIGLIE DELLE SEGUENTI MARCHE: AZZI – CIPIERRE – CISA – COMUNELLO – COTTALI – DIERRE – DISEC – FIAM – IBFM ISEO – MOTTURA – OMEC – OMR/MOIA – BRIALMA – SAVIO – SECUREMME – WELKA

PROXE
Proteggi ciò che ami



**VIDEOSORVEGLIANZA, SICUREZZA
E RISPARMIO ENERGETICO
PENSATI PER LA CASA.**

SCOPRI I NOSTRI PRODOTTI:
WWW.PROXE.IT



CHE VITA DIFFICILE



SENZA LA RUOTA!

UNA PASSIONE DI FAMIGLIA, DA 80 ANNI.

AVO - Aldo Valsecchi S.p.A. rappresenta uno dei marchi storici nella produzione di ruote e supporti "made in Italy". I suoi valori fondamentali sono da sempre qualità, tecnologia e grande attenzione alle esigenze del cliente, per il quale sa trovare le soluzioni più adatte e innovative. Ma il vero fattore vincente è la passione con cui i membri della famiglia Valsecchi guidano l'impresa, un mix di tradizione e di innovazione che l'ha portata a diventare leader del settore in Italia e in Europa.



ALDO VALSECCHI S.p.A. Ruote e Supporti | www.avo.it

made in italy since 1943

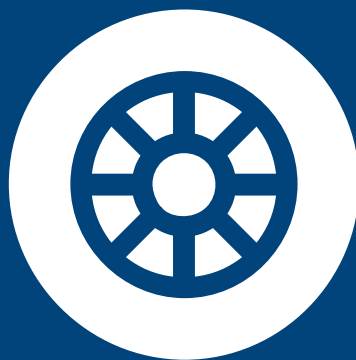

RUOTE

SFOGLIA LA CATEGORIA

















 <p>SFERA PER POLTRONE con Vite mordente Mod. 5007</p> <p>90016020 - Ø 20 - - conf. 24 - € 1,38 90016021 - Ø 25 - - conf. 24 - € 1,62 90016022 - Ø 30 - - conf. 24 - € 2,68</p>	 <p>ROTELLA A SFERA Delrin con adesivo 3M</p> <p>90016043 - Ø 20 - - conf. 24 - € 1,86 90016044 - Ø 25 - - conf. 24 - € 2,26 90016045 - Ø 30 - - conf. 24 - € 3,30</p>
 <p>ROTELLA A SFERA Acciaio con adesivo 3M</p> <p>90016040 - Ø 20 - - conf. 24 - € 1,74 90016041 - Ø 25 - - conf. 24 - € 2,00 90016042 - Ø 30 - - conf. 24 - € 3,10</p>	 <p>SFERA PER POLTRONE con piastra Mod. 5008</p> <p>90016023 - Ø 26 - - conf. 24 - € 1,24 90016024 - Ø 31 - - conf. 24 - € 1,44 90016025 - Ø 36 - - conf. 24 - € 1,82 90016026 - Ø 45 - - conf. 24 - € 2,80</p>
 <p>RUOTA IN GOMMA con perno Art. 210/B zincata</p> <p>813210B - Ø 35 - perno 8M - Alt. 50 - - conf. 24 - € 3,68</p>	 <p>RUOTA IN GOMMA con piastra Art. 210 zincata</p> <p>813210 - Ø 35 - piastra 40x40 - Alt. 50 - - conf. 24 - € 3,68</p>
 <p>ROTELLA GOMMATA mod. 5004 con piastra su sfera</p> <p>90016027 - Ø 27 - - conf. 24 - € 1,52 90016032 - Ø 32 - - conf. 24 - € 1,34</p>	 <p>RUOTA pivotante Art. 168/B in zama con perno cromata</p> <p>813168B8 - Ø 45 - perno 8M - P.Kg. 30 - Alt. 45 - conf. 24 - € 5,84 813168B10 - Ø 55 - perno 10M - P.Kg. 45 - Alt. 58 - conf. 24 - € 7,14</p>
 <p>RUOTA pivotante Art. 168 in zama con piastra cromata</p> <p>81316845 - Ø 45 - piastra 38X38 - P.Kg. 20 - Alt. 58 - conf. 24 - € 5,84 81316855 - Ø 55 - piastra 38X38 - P.Kg. 35 - Alt. 68 - conf. 24 - € 7,14</p>	 <p>RUOTA in gomma Art. 165 supporto in acciaio con piastra cromata</p> <p>81316530 - Ø 30 - piastra 40x40 - P.Kg. 20 - Alt. 52 - conf. 24 - € 5,42 81316540 - Ø 40 - piastra 40x40 - P.Kg. 30 - Alt. 63 - conf. 12 - € 7,14 81316550 - Ø 50 - piastra 47x47 - P.Kg. 40 - Alt. 68 - conf. 12 - € 9,30</p>
 <p>RUOTA in gomma Art. 165/B supporto in acciaio con perno cromata</p> <p>813165B830 - Ø 30 - perno 8M - P.Kg. 20 - Alt. 52 - conf. 24 - € 5,42 813165B1030 - Ø 30 - perno 10M - P.Kg. 20 - Alt. 52 - conf. 24 - € 5,42 813165B840 - Ø 40 - perno 8M - P.Kg. 30 - Alt. 68 - conf. 12 - € 7,14 segue...</p>	 <p>continua...</p> <p>813165B1040 - Ø 40 - perno 10M - P.Kg. 30 - Alt. 63 - conf. 12 - € 7,14 813165B850 - Ø 50 - perno 8M - P.Kg. 40 - Alt. 68 - conf. 12 - € 9,30 813165B1050 - Ø 50 - perno 10M - P.Kg. 40 - Alt. 63 - conf. 12 - € 9,30</p>















  <p>RUOTA DOPPIA INNESTO RAPIDO Art.164N in poliammide Con freno 813164BISN - Ø 50 - Perno M10 - P.Kg. 40 - - conf. 12 - € 1,76</p>	  <p>RUOTA DOPPIA INNESTO RAPIDO Art. 164N in poliammide 813164N50 - Ø 50 - Perno 11x22 - P.Kg. 40 - - conf. 12 - € 1,62</p>
  <p>RUOTA DOPPIA Art. 164 in poliammide 813164B42 - Ø 40 - perno M8 - P.Kg. 20 - - conf. 12 - € 2,37 813164B50 - Ø 50 - perno M10 - P.Kg. 40 - - conf. 12 - € 2,81</p>	  <p>RUOTA DOPPIA Art. 164 in poliammide con piastra 81316442 - Ø 40 - piastra 38x38 - P.Kg. 20 - Alt. 57 - conf. 12 - € 2,37 81316450 - Ø 50 - piastra 39x38 - P.Kg. 40 - Alt. 66 - conf. 12 - € 2,81</p>
  <p>RUOTA POLIAMMIDE Art. 172 rivestita in poliuretano con piastra 81317240 - Ø 40 - piastra 38x38 - P.Kg. 30 - Alt. 50 - conf. 8 - € 5,63 81317250 - Ø 50 - piastra 38x38 - P.Kg. 45 - Alt. 61 - conf. 8 - € 6,70</p>	  <p>RUOTA POLIAMMIDE Art. 172/BISB rivestita in poliuretano con perno e freno 813172BISB40 - Ø 40 - perno 8M - P.Kg. 30 - Alt. 45 - conf. 8 - € 6,05 813172BISB50 - Ø 50 - perno 10M - P.Kg. 45 - Alt. 58 - conf. 8 - € 7,35</p>
  <p>RUOTA POLIAMMIDE Art. 172BIS rivestita in poliuretano con piastra e freno nera 813172BIS40 - Ø 40 - piastra 38x38 - P.Kg. 30 - Alt. 50 - conf. 8 - € 6,05 813172BIS50 - Ø 50 - piastra 38x38 - P.Kg. 45 - Alt. 61 - conf. 8 - € 7,35</p>	  <p>RUOTA POLIAMMIDE Art. 172/B rivestita in poliuretano con perno 813172B40 - Ø 40 - perno 8M - P.Kg. 30 - Alt. 45 - conf. 8 - € 5,63 813172B50 - Ø 50 - perno 10M - P.Kg. 45 - Alt. 58 - conf. 8 - € 6,70</p>
  <p>RUOTA termogomma Art. 300 supporto in acciaio piastra fissa Interasse fori di fissaggio 59x15 813300 - Ø 50 - piastra 70x30 - P.Kg. 20 - Alt. 55 - conf. 20 - € 4,98</p>	  <p>RUOTA termogomma Art. 220/B supporto in acciaio con perno Zincata 813220B40 - Ø x L 40x18 - perno 8M - P.Kg. 15 - Alt. 15 - conf. 20 - € 3,68 813220B50 - Ø x L 50x18 - perno 8M - P.Kg. 20 - Alt. 20 - conf. 20 - € 3,68</p>
  <p>RUOTA termogomma Art. 220 supporto in acciaio con piastra zincata 81322040 - Ø x L 40x18 - piastra 40 x 40 - P.Kg. 15 - Alt. 56 - conf. 20 - € 3,68 81322050 - Ø x L 50x18 - piastra 40 x 40 - P.Kg. 20 - Alt. 66 - conf. 20 - € 3,68 81322060 - Ø x L 60x30 - piastra 100x85 - P.Kg. 150 - Alt. 89 - conf. 8 - € 6,49</p>	  <p>RUOTA rivestita in poliuretano termoplastico Art.173 BIS/B perno girevole e freno 813173BISB075 - Ø 75 - perno 10M - P.Kg. 60 - Alt. 110 - conf. 4 - € 11,26 813173BISB100 - Ø 100 - perno 10M - P.Kg. 65 - Alt. 136 - conf. 4 - € 12,54</p>















 <p>RUOTA rivestita Art. 173/B in poliuretano termoplastico perno girevole</p> <p>813173B075 - Ø 75 - perno 10M - P.Kg. 60 - Alt. 110 - conf. 4 - € 9,09</p> <p>813173B100 - Ø 100 - perno 10M - P.Kg. 65 - Alt. 136 - conf. 4 - € 10,37</p>	 <p>RUOTA rivestita Art. 173/BIS in poliuretano termoplastico perno girevole e freno</p> <p>813173BIS075 - Ø 75 - piastra 70x58 - P.Kg. 60 - Alt. 115 - conf. 4 - € 11,26</p> <p>813173BIS100 - Ø 100 - piastra 70x58 - P.Kg. 65 - Alt. 142 - conf. 4 - € 12,54</p>
 <p>RUOTA rivestita Art. 173 in poliuretano termoplastico piastra girevole</p> <p>813173075 - Ø 75 - piastra 70x58 - P.Kg. 60 - Alt. 115 - conf. 4 - € 9,09</p> <p>813173100 - Ø 100 - piastra 70x58 - P.Kg. 65 - Alt. 142 - conf. 4 - € 10,37</p>	 <p>RUOTA Treki Art. 220CBISB in gomma grigia con perno girevole e freno cromata</p> <p>813220CBISB850 - Ø x L 50x18 - Perno M8 - P. Kg. 20 - Alt. 66 - conf. 12 - € 12,33</p> <p>813220CBISB1050 - Ø x L 50x18 - Perno M10 - P. Kg. 20 - Alt. 66 - conf. 12 - € 12,33</p> <p>813220CBISB1260 - Ø x L 60x23 - Perno M12 - P. Kg. 50 - Alt. 88 - conf. 8 - € 12,77 segue...</p>
 <p>continua...</p> <p>813220CBISB1280 - Ø x L 80x23 - Perno M12 - P. Kg. 60 - Alt. 108 - conf. 4 - € 14,49</p>	 <p>RUOTA Treki in gomma grigia perno girevole cromata art. 220CB</p> <p>813220CB840 - Ø x L 40x18 - Perno M8 - P.Kg. 15 - Alt. 56 - conf. 20 - € 5,42</p> <p>813220CB1040 - Ø x L 40x18 - Perno M10 - P.Kg. 15 - Alt. 56 - conf. 20 - € 5,42</p> <p>813220CB850 - Ø x L 50x18 - Perno M8 - P.Kg. 20 - Alt. 66 - conf. 20 - € 6,05 segue...</p>
 <p>continua...</p> <p>813220CB1050 - Ø x L 50x18 - Perno M10 - P.Kg. 20 - Alt. 66 - conf. 20 - € 6,05</p> <p>813220CB1260 - Ø x L 60x23 - Perno M12 - P.Kg. 50 - Alt. 88 - conf. 8 - € 9,09</p> <p>813220CB1280 - Ø x L 80x23 - Perno M12 - P.Kg. 60 - Alt. 108 - conf. 4 - € 9,74</p>	 <p>RUOTA Treki Art. 220CBIS in gomma grigia con piastra girevole e freno cromata</p> <p>813220CBIS50 - Ø x L 50x18 - Piastra 40x40 - P. Kg. 20 - Alt. 66 - conf. 12 - € 12,33</p> <p>813220CBIS60 - Ø x L 60x23 - Piastra 60x60 - P. Kg. 50 - Alt. 88 - conf. 8 - € 12,77</p> <p>813220CBIS80 - Ø x L 80x23 - Piastra 60x60 - P. Kg. 55 - Alt. 108 - conf. 4 - € 14,49</p>
 <p>RUOTA Treky Art. 220C in gomma grigia con piastra girevole cromata</p> <p>813220C40 - Ø x L 40x18 - Piastra 40x40 - P.Kg. 15 - Alt. 56 - conf. 20 - € 5,42</p> <p>813220C50 - Ø x L 50x18 - Piastra 40x40 - P.Kg. 20 - Alt. 66 - conf. 20 - € 6,05</p> <p>813220C60 - Ø x L 60x23 - Piastra 60x60 - P.Kg. 50 - Alt. 88 - conf. 8 - € 9,09 segue...</p>	 <p>continua...</p> <p>813220C80 - Ø x L 80x23 - Piastra 80x60 - P.Kg. 55 - Alt. 108 - conf. 4 - € 9,74</p>
 <p>RUOTA termogomma Art. 275 supporto in acciaio piastra girevole grigia antimacchia</p> <p>81327550 - Ø x L 50x18 - piastra 60x60 - P.Kg. 55 - Alt. 73 - conf. 12 - € 17,09</p> <p>81327575 - Ø x L 75x24 - piastra 60x60 - P.Kg. 80 - Alt. 101 - conf. 4 - € 27,26</p>	 <p>RUOTA termogomma Art. 275 / BIS con piastra girevole e freno totale grigia antimacchia</p> <p>813275BIS50 - Ø x L 50x18 - Perno 60x60 - P.Kg. 55 - Alt. 73 - conf. 6 - € 21,42</p> <p>813275BIS75 - Ø x L 75x24 - Perno 60x60 - P.Kg. 80 - Alt. 101 - conf. 4 - € 33,54</p>



 <p>RUOTA termogomma Art. 275 / BIS B con perno girevole e freno totale grigia antimacchia</p> <p>813275BISB50 - Ø x L 50x18 - Perno M10 - P.Kg. 55 - Alt. 73 - conf. 6 - € 21,84</p> <p>813275BISB75 - Ø x L 75x24 - Perno M12 - P.Kg. 80 - Alt. 98 - conf. 4 - € 33,96</p>	 <p>RUOTA termogomma Art. 275/B supporto in acciaio con perno girevole grigia antimacchia</p> <p>813275B50 - Ø x L 50x18 - Perno M10 - P.Kg. 55 - Alt. 73 - conf. 12 - € 17,51</p> <p>813275B75 - Ø x L 75x24 - Perno M12 - P.Kg. 80 - Alt. 98 - conf. 4 - € 27,91</p>
 <p>RUOTA in gomma Art. 160/B su mozzo a sfera supporto in acciaio con perno zinco-cromo</p> <p>813160B840 - Ø x L 40x18 - perno 8M - P.Kg. 20 - Alt. 56 - conf. 20 - € 5,63</p> <p>813160B1040 - Ø x L 40x18 - perno 10M - P.Kg. 20 - Alt. 56 - conf. 20 - € 5,63</p> <p>813160B850 - Ø x L 50x18 - perno 8M - P.Kg. 30 - Alt. 66 - conf. 20 - € 6,28</p> <p>segue...</p>	 <p>continua...</p> <p>813160B1050 - Ø x L 50x18 - perno 10M - P.Kg. 30 - Alt. 66 - conf. 20 - € 6,28</p>
 <p>RUOTA in gomma Art. 160 su mozzo a sfera supporto in acciaio con piastra zinco-cromo</p> <p>81316040 - Ø x L 40x18 - piastra 40x40 - P.Kg. 20 - Alt. 56 - conf. 20 - € 5,63</p> <p>81316050 - Ø x L 50x18 - piastra 40x40 - P.Kg. 30 - Alt. 66 - conf. 20 - € 6,28</p>	 <p>RUOTA in gomma Art. 150/B su mozzo a sfera supporto in acciaio con perno cromata</p> <p>813150B1040 - Ø x L 40x18 - perno 10MA - port. Kg. 20 - Alt. 56 - conf. 20 - € 7,35</p> <p>813150B1050 - Ø x L 50x18 - perno 10MA - port. Kg. 30 - Alt. 70 - conf. 12 - € 9,95</p> <p>813150B1060 - Ø x L 60x18 - perno 10MA - port. Kg. 40 - Alt. 70 - conf. 12 - € 11,47</p> <p>segue...</p>
 <p>continua...</p> <p>813150B840 - Ø x L 40x18 - perno 8MA - port. Kg. 20 - Alt. 56 - conf. 20 - € 7,35</p> <p>813150B850 - Ø x L 50x18 - perno 8MA - port. Kg. 30 - Alt. 80 - conf. 12 - € 9,95</p> <p>813150B860 - Ø x L 60x18 - perno 8MA - port. Kg. 40 - Alt. 80 - conf. 12 - € 11,47</p>	 <p>RUOTA in gomma Art. 150 su mozzo a sfera supporto in acciaio piastra girevole cromata</p> <p>81315040 - Ø x L 40x18 - piastra 40x40 - P.Kg. 20 - Alt. 56 - conf. 20 - € 7,35</p> <p>81315050 - Ø x L 50x18 - piastra 47x47 - P.Kg. 30 - Alt. 70 - conf. 12 - € 9,95</p> <p>81315060 - Ø x L 60x18 - piastra 47x47 - P.Kg. 40 - Alt. 80 - conf. 12 - € 11,47</p>
 <p>RUOTA in gomma Art. 155/BIS B supporto in acciaio perno e freno cromata</p> <p>813155BISB060 - Ø x L 60x23 - perno 10M - P. Kg. 60 - Alt. 93 - conf. 8 - € 24,23</p> <p>813155BISB080 - Ø x L 80x23 - perno 10M - P. Kg. 70 - Alt. 115 - conf. 4 - € 26,17</p> <p>813155BISB100 - Ø x L 100x24 - perno 12M - P. Kg. 80 - Alt. 139 - conf. 4 - € 35,05</p> <p>segue...</p>	 <p>continua...</p> <p>813155BISB125 - Ø x L 125x27 - perno 12M - P.Kg. 100 - Alt. 165 - conf. 2 - € 40,66</p>
 <p>RUOTA in gomma Art. 155/BIS con cuscinetto supporto in acciaio piastra girevole e freno cromata</p> <p>813155BIS060 - Ø x L 60x24 - piastra 64x24 - P. Kg. 60 - Alt. 93 - conf. 8 - € 24,23</p> <p>813155BIS080 - Ø x L 80x20 - piastra 64x50 - P. Kg. 70 - Alt. 115 - conf. 4 - € 26,17</p> <p>813155BIS100 - Ø x L 100x24 - piastra 90x70 - P. Kg. 80 - Alt. 139 - conf. 4 - € 35,05</p> <p>segue...</p>	 <p>continua...</p> <p>813155BIS125 - Ø x L 125x27 - piastra 125x27 - P. Kg. 90 - Alt. 165 - conf. 2 - € 40,66</p>



 <p>RUOTA in gomma Art. 155/B con cuscinetto supporto in acciaio perno cromata</p> <p>813155B060 - Ø x L 60x24 - perno 10M - P.Kg. 60 - Alt. 93 - conf. 8 - € 15,79</p> <p>813155B080 - Ø x L 80x20 - perno 10M - P.Kg. 70 - Alt. 115 - conf. 4 - € 17,75</p> <p>813155B100 - Ø x L 100x24 - perno 12M - P.Kg. 80 - Alt. 139 - conf. 4 - € 26,17</p> <p>segue...</p>	 <p>continua...</p> <p>813155B125 - Ø x L 125x27 - perno 12M - P.Kg. 100 - Alt. 165 - conf. 2 - € 31,79</p>
 <p>RUOTA in gomma Art. 155 con cuscinetto supporto in acciaio piastra girevole cromata</p> <p>813155060 - Ø x L 60x24 - piastra 64x50 - P.Kg. 60 - Alt. 93 - conf. 8 - € 15,79</p> <p>813155080 - Ø x L 80x20 - piastra 64x50 - P.Kg. 70 - Alt. 115 - conf. 4 - € 17,75</p> <p>813155100 - Ø x L 100x24 - piastra 90x70 - P.Kg. 80 - Alt. 139 - conf. 4 - € 26,17</p> <p>segue...</p>	 <p>continua...</p> <p>813155125 - Ø x L 125x27 - piastra 90x70 - P.Kg. 100 - Alt. 165 - conf. 2 - € 31,79</p>
 <p>RUOTA in gomma Art. 155/H con cuscinetto supporto in acciaio piastra fissa cromata</p> <p>813155H060 - Ø x L 60x23 - piastra 64x50 - P.Kg. 60 - Alt. 93 - conf. 8 - € 14,93</p> <p>813155H080 - Ø x L 80x23 - piastra 64x50 - P.Kg. 70 - Alt. 115 - conf. 4 - € 17,09</p> <p>813155H100 - Ø x L 100x24 - piastra 90x70 - P.Kg. 80 - Alt. 139 - conf. 4 - € 22,72</p> <p>segue...</p>	 <p>continua...</p> <p>813155H125 - Ø x L 125x27 - piastra 90x70 - P.Kg. 100 - Alt. 165 - conf. 2 - € 28,12</p>
 <p>RUOTA in gomma Art. 90 A e nucleo in materiale termoplastico piastra fissa</p> <p>81390A100 - Ø x L 100x30 - piastra 100x85 - P.Kg. 70 - Alt. 128 - conf. 1 - € 9,51</p>	 <p>RUOTA in gomma Art. 90 e nucleo in materiale termoplastico piastra girevole</p> <p>81390100 - Ø x L 100x30 - piastra 100x85 - P.Kg. 70 - Alt. 128 - conf. 1 - € 12,12</p>
 <p>RUOTA in gomma Art. 80/BIS flange in acciaio piastra girevole e freno</p> <p>81380BIS080 - Ø x L 80x25 - piastra 100x85 - P.Kg. 50 - Alt. 108 - conf. 1 - € 14,49</p> <p>81380BIS100 - Ø x L 100x30 - piastra 100x85 - P.Kg. 70 - Alt. 128 - conf. 1 - € 15,35</p> <p>81380BIS125 - Ø x L 125x37,5 - piastra 115x85 - P.Kg. 100 - Alt. 150 - conf. 1 - € 19,68</p> <p>segue...</p>	 <p>continua...</p> <p>81380BIS140 - Ø x L 140x37,5 - piastra 115x85 - P.Kg. 115 - Alt. 174 - conf. 1 - € 22,49</p> <p>81380BIS160 - Ø x L 160x40 - piastra 140x110 - P.Kg. 150 - Alt. 197 - conf. 1 - € 29,42</p> <p>81380BIS180 - Ø x L 180x50 - piastra 140x110 - P.Kg. 170 - Alt. 225 - conf. 1 - € 32,45</p> <p>81380BIS200 - Ø x L 200x50 - piastra 140x110 - P.Kg. 205 - Alt. 235 - conf. 1 - € 33,31</p>
 <p>RUOTA in gomma Art. 80/A flange in acciaio piastra fissa</p> <p>81380A080 - Ø x L 80x25 - piastra 100x85 - P.Kg. 50 - Alt. 108 - conf. 1 - € 5,63</p> <p>81380A100 - Ø x L 100x30 - piastra 100x85 - P.Kg. 70 - Alt. 128 - conf. 1 - € 6,49</p> <p>81380A125 - Ø x L 125x37,5 - piastra 115x85 - P.Kg. 100 - Alt. 150 - conf. 1 - € 9,95</p> <p>segue...</p>	 <p>continua...</p> <p>81380A140 - Ø x L 140x37,5 - piastra 115x85 - P.Kg. 115 - Alt. 174 - conf. 1 - € 11,26</p> <p>81380A160 - Ø x L 160x40 - piastra 140x110 - P.Kg. 150 - Alt. 197 - conf. 1 - € 16,65</p> <p>81380A180 - Ø x L 180x50 - piastra 140x110 - P.Kg. 170 - Alt. 225 - conf. 1 - € 19,68</p> <p>81380A200 - Ø x L 200x50 - piastra 140x110 - P.Kg. 205 - Alt. 235 - conf. 1 - € 20,12</p>



  <p>RUOTA in gomma Art. 80 flange in acciaio piastra girevole</p> <p>81380080 - Ø x L 80x25 - piastra 100x85 - P.Kg 50 - Alt. 106 - conf. 1 - € 8,21</p> <p>81380100 - Ø x L 100x30 - piastra 100x85 - P.Kg 70 - Alt. 128 - conf. 1 - € 8,86</p> <p>81380125 - Ø x L 125x37,5 - piastra 115x85 - P.Kg 100 - Alt. 151 - conf. 1 - € 11,68</p> <p>segue...</p>	  <p>continua...</p> <p>81380140 - Ø x L 140x37 - piastra 115x85 - P.Kg 115 - Alt. 174 - conf. 1 - € 14,70</p> <p>81380160 - Ø x L 160x40 - piastra 140x110 - P.Kg 150 - Alt. 197 - conf. 1 - € 20,98</p> <p>81380180 - Ø x L 180x50 - piastra 140x110 - P.Kg 170 - Alt. 225 - conf. 1 - € 23,79</p> <p>81380200 - Ø x L 200x50 - piastra 140x110 - P.Kg 205 - Alt. 235 - conf. 1 - € 23,79</p>
  <p>RUOTA TREKI In gomma sintetica Cromata lucida Art. 220CH</p> <p>813220HC100 - Ø x L 100x24 - - conf. 1 - € 10,48</p> <p>813220HC40 - Ø x L 40x18 - - conf. 1 - € 3,89</p> <p>813220HC50 - Ø x L 50x18 - - conf. 1 - € 4,83</p> <p>813220HC60 - Ø x L 60x23 - - conf. 1 - € 6,20</p> <p>813220HC80 - Ø x L 80x23 - - conf. 1 - € 7,56</p>	  <p>RUOTA di ricambio in gomma Art. 112 flange in acciaio Per Art. 80</p> <p>813112080 - Ø x L 80x25 - P.Kg 50 - - conf. 1 - € 2,81</p> <p>813112100 - Ø x L 100x30 - P.Kg 70 - - conf. 1 - € 3,47</p> <p>813112125 - Ø x L 125x37,5 - P.Kg 100 - - conf. 1 - € 4,98</p> <p>813112140 - Ø x L 140x37 - P.Kg 115 - - conf. 1 - € 6,05</p> <p>813112160 - Ø x L 160x40 - P.Kg 150 - - conf. 1 - € 7,79</p> <p>segue...</p>
  <p>continua...</p> <p>813112180 - Ø x L 180x50 - P.Kg 170 - - conf. 1 - € 10,16</p> <p>813112200 - Ø x L 200x50 - P.Kg 205 - - conf. 1 - € 10,37</p>	  <p>RUOTA rivestita Art. 24 in poliuretano piastra e freno nucleo in ghisa con cuscinetto</p> <p>81324080 - Ø x L 80x20 - piastra 100x85 - P.Kg 120 - Alt. 108 - conf. 1 - € 28,33</p> <p>81324100 - Ø x L 100x25 - piastra 100x85 - P.Kg 120 - Alt. 128 - conf. 1 - € 34,61</p> <p>81324125 - Ø x L 125x25 - piastra 115x85 - P.Kg 170 - Alt. 155 - conf. 1 - € 41,54</p> <p>segue...</p>
  <p>continua...</p> <p>81324150 - Ø x L 150x35 - piastra 115x85 - P.Kg 200 - Alt. 181 - conf. 1 - € 50,61</p>	  <p>RUOTA rivestita Art. 22/A in poliuretano piastra fissa nucleo in ghisa con cuscinetto</p> <p>81322A080 - Ø x L 80x20 - piastra 100x85 - P.Kg 120 - Alt. 108 - conf. 1 - € 19,03</p> <p>81322A100 - Ø x L 100x25 - piastra 100x85 - P.Kg 120 - Alt. 128 - conf. 1 - € 24,89</p> <p>81322A125 - Ø x L 125x25 - piastra 115x85 - P.Kg 170 - Alt. 155 - conf. 1 - € 32,00</p> <p>segue...</p>
  <p>continua...</p> <p>81322A150 - Ø x L 150x35 - piastra 115x85 - P.Kg 200 - Alt. 181 - conf. 1 - € 41,75</p>	  <p>RUOTA rivestita Art. 22 in poliuretano piastra girevole nucleo in ghisa con cuscinetto</p> <p>81322080 - Ø x L 80x20 - piastra 100x85 - P.Kg. 120 - Alt. 108 - conf. 1 - € 21,63</p> <p>81322100 - Ø x L 100x25 - piastra 100x85 - P.Kg. 120 - Alt. 128 - conf. 1 - € 27,47</p> <p>81322125 - Ø x L 125x25 - piastra 115x85 - P.Kg. 170 - Alt. 155 - conf. 1 - € 34,61</p> <p>segue...</p>
  <p>continua...</p> <p>81322150 - Ø x L 150x35 - piastra 115x85 - P.Kg. 200 - Alt. 181 - conf. 1 - € 44,77</p>	  <p>RUOTA di ricambio Art. 14 rivestita in poliuretano nucleo in ghisa con cuscinetto Per serie: 22 - 22/A - 24</p> <p>81314080 - Ø x L 80x20 - P.Kg. 150 - - conf. 1 - € 12,54</p> <p>81314100 - Ø x L 100x25 - P.Kg. 200 - - conf. 1 - € 17,51</p> <p>81314125 - Ø x L 125x25 - P.Kg. 250 - - conf. 1 - € 21,63</p> <p>81314150 - Ø x L 150x35 - P.Kg. 400 - - conf. 1 - € 30,07</p>



  <p>RUOTA rivestita Art. 118/BIS A in poliammide piastra fissa in acciaio zinco-cromato Supporti tipo medio</p> <p>813118BISA100 - Ø X L 100x30 - Piastra 100x85 - P.Kg. 37 - Alt. 128 - conf. 1 - € 9,51</p> <p>813118BISA125 - Ø X L 125x40 - Piastra 100x85 - P.Kg. 42 - Alt. 155 - conf. 1 - € 15,58</p> <p>813118BISA80 - Ø X L 80x30 - Piastra 100x85 - P.Kg. 37 - Alt. 108 - conf. 1 - € 8,44</p>	  <p>RUOTA rivestita Art. 118/BIS in poliammide piastra girevole in acciaio zinco-cromato Supporti tipo medio</p> <p>813118BIS100 - Ø X L 100x30 - Piastra 100x85 - P.Kg. 37 - Alt. 128 - conf. 1 - € 13,63</p> <p>813118BIS125 - Ø X L 125x40 - Piastra 100x85 - P.Kg. 42 - Alt. 155 - conf. 1 - € 18,17</p> <p>813118BIS80 - Ø X L 80x30 - Piastra 100x85 - P.Kg. 37 - Alt. 108 - conf. 1 - € 11,68</p>
  <p>RUOTA in poliuretano antifuoratura nucleo in acciaio verniciato grigio</p> <p>81346P - Ø x L 260x85 - P.Kg. 150 - conf. 2 - € 26,61</p>	  <p>RUOTA pneumatica Art. 41 con camera aria nucleo in nylon antiurto</p> <p>81341260 - Ø x L 260x85 - P.Kg. 150 - conf. 2 - € 11,91</p>
  <p>RUOTA PNEUMATICA ANTIFORATURA 350X60</p> <p>81346VTP - conf. 2 - € 51,26</p>	  <p>RUOTA pneumatica Art. 46 VT nucleo in materiale termoplastico</p> <p>81346VT - Ø x L 350x60 - P.Kg. 170 - conf. 1 - € 27,68</p>



CASSETTE POSTALI

SFOGLIA LA CATEGORIA





Dal 1969, Silmec è l'azienda di riferimento nel mercato italiano sul settore della custodia e distribuzione della posta. Utilizziamo solo materie prime fornite dalle principali aziende italiane e concepiamo, giorno dopo giorno, idee e prodotti innovativi in linea con le specifiche esigenze di mercato. Cassette postali, casellari, bacheche ed oggi anche le nuove CASSETTE PER PACCHI: una gamma completa che garantisce durabilità, stile e valore Made in Italy.

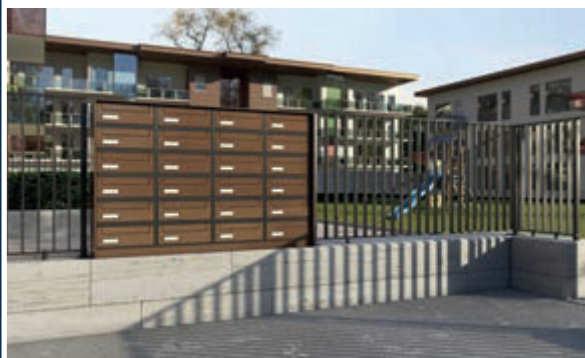

Per i **CASELLARI PERSONALIZZATI** scopri il nostro **CONFIGURATORE** al sito **WWW.SILMEC.COM**



























Silmec Srl - Via San Martino, 3 - CP 57 - 31020 San Zenone degli Ezzelini (TV)

T. +39 0423 968611 - info@silmec.com - www.silmec.com





















  <p>CASSETTA LETTERE INOX – con tetto Dimensioni: 325 x 220 mm Apertura buca lettere : 170x27 mm</p> <p>78010001 – - conf. 1 – € 47,38</p>	  <p>CASSETTA LETTERE INOX – senza tetto Dimensioni: 305 x 220 mm Apertura buca lettere : 210x27 mm</p> <p>78010002 – - conf. 2 – € 41,40</p>
  <p>CASSETTA LETTERE INOX buca lettere oscillante impost. da un lato e porta ritiro dall'altro Dimensioni: 305 x 220 mm Apertura buca lettere : 210x27 mm</p> <p>78010009 – - conf. 2 – € 58,10</p>	  <p>CASSETTA LETTERE INOX – con tetto Dimensioni: 390x250 mm Apertura buca lettere : 215x30 mm</p> <p>78010012 – - conf. 2 – € 72,10</p>
  <p>CASSETTA LETTERE INOX Buca lettere oscillante Impost. da un lato e porta ritiro dall'altro Dimensioni: 365 x 250 mm Apertura buca lettere : 210x27 mm</p> <p>78010014 – - conf. 2 – € 75,40</p>	  <p>CASSETTA RIVISTA INOX Dimensioni: 385 x 275 mm Apertura buca lettere: 240 x 24 mm</p> <p>78010015 – - conf. 2 – € 84,26</p>
  <p>CASSETTA LETTERE con tetto In lamiera verniciata Dimensioni: 325 x 220 mm Apertura buca lettere: 170 x 27 mm</p> <p>7801020101 – Colore Bianco – - conf. 2 – € 37,28 7801020122 – Colore Verde – - conf. 2 – € 37,28 7801020184 – Colore Grigio Ferro – - conf. 2 – € 37,28</p>	  <p>CASSETTA LETTERE senza tetto In acciaio verniciato Dimensioni: 305 x 220 mm Apertura buca lettere: 210 x 27 mm</p> <p>7801020201 – Colore Bianco – - conf. 2 – € 30,28 7801020222 – Colore Verde – - conf. 2 – € 30,28 7801020284 – Colore Nero – - conf. 2 – € 30,28 7801020221 – Colore Giallo – - conf. 2 – € 23,40</p>
  <p>CASSETTA LETTERE EVOLUZIONE In lamiera Con tetto Verniciatura epossidica Dimensioni: 320 x 230 mm</p> <p>90008805 – Colore INOX – - conf. 2 – € 35,80 90008810 – Colore Grigio Antracite – - conf. 2 – € 24,40 90008811 – Colore Verde Etrusco – - conf. 2 – € 24,40 90008812 – Colore Nero – - conf. 2 – € 24,40 <i>segue...</i></p>	  <p><i>continua...</i> 90008813 – Colore Bianco – - conf. 2 – € 24,40 90008814 – Colore Rosso – - conf. 2 – € 24,40</p>
  <p>CASSETTA RIVISTA Lamiera elettrozincata Dimensioni: 385 x 275 mm Apertura buca lettere: 240 x 24 mm</p> <p>7801021521 – Colore giallo – - conf. 1 – € 57,60 7801021522 – Colore verde – - conf. 1 – € 75,80</p>	  <p>CASSETTA LETTERE Ferro zincato in PVC Grigio scuro portina oscillante grigia Dimensioni: 310 x 220 mm Apertura buca lettere: 170x25 mm Sacca multiuso TNT colore blu in omaggio</p> <p>7801035181 – - conf. 1 – € 45,52</p>



  <p>CASSETTA PASSANTE Alluminio Dimensioni: 325 x 240 x 125 mm Apertura buca lettere: 205 x 20 mm</p> <p>7801038072 - - conf. 1 - € 76,22</p>	  <p>CASSETTA LETTERA MOD.2500CT2 Colore nero Acciaio verniciato lucido Dimensioni mm: 200x165x50</p> <p>90008862 - - conf. 1 - € 15,80</p>
  <p>CASSETTE LETTERA MOD.2500CT3 Colore nero Acciaio verniciato lucido Dimensioni mm: 300x200x60</p> <p>90008863 - - conf. 1 - € 17,00</p>	  <p>CASSETTA POSTA RESIDENCE Dimensioni: 410x240x75 mm</p> <p>512810300N - Colore Grigio - - conf. 1 - € 25,00 512810310N - Colore Nero - - conf. 1 - € 25,00 512810320N - Colore Mattone - - conf. 1 - € 25,00 512810330N - Colore Verde - - conf. 1 - € 25,00</p>
  <p>CASSETTA POSTALE OFFICE ACCIAIO INOX Misura: 320x215x105</p> <p>512810350N - - conf. 1 - € 44,70</p>	  <p>CASSETTA LETTERE COMPONIBILE Alluminio Dimensioni: 220x310 mm</p> <p>7801035172 - colore silver - - conf. 2 - € 42,44 7801035173 - colore bronzo - - conf. 2 - € 42,44</p>
  <p>CASSETTA LETTERE ARMONY in ferro art. 2500 armony vulcania Dimensioni: 215 x 300 x 75 mm</p> <p>90008601 - Finitura Silver - - conf. 1 - € 31,20 90008602 - Finitura Bronzo - - conf. 1 - € 31,20</p>	  <p>CASSETTA LETTERE COMPONIBILE Alluminio Dimensioni: 320 x 230 mm</p> <p>7803080172 - Colore Silver - - conf. 1 - € 50,06 7803080273 - Colore Bronzo - - conf. 1 - € 49,86 7803080151 - Colore Oro - - conf. 1 - € 50,40</p>
  <p>CASSETTA POSTALE CAMPAGNOLA Art. 2605 in acciaio verniciato Dimensioni 35x21x7,5 cm</p> <p>90008867 - - conf. 1 - € 24,10</p>	  <p>CASSETTA LETTERE RUSTICA STILE SVIZZERA ferro verniciato nero Dimensioni: 340 x 370 x 85 mm</p> <p>90008510 - - conf. 1 - € 21,80</p>
  <p>CASSETTA INTERNA</p> <p>7801029005 - L.Porta 360 - H.Porta 275 - H.Tot 390 - - conf. 1 - € 71,68 7801029905 - L.Porta 325 - H.Porta 235 - H.Tot 350 - - conf. 1 - € 57,68</p>	  <p>PORTA Alluminio Dimensioni: 400 x 315 mm</p> <p>7801069072 - Colore Silver - - conf. 1 - € 77,46 7801069084 - Colore Grigio ferro - - conf. 1 - € 75,20</p>



  <p>CASSETTA RIVISTA Componibile Alluminio Dimensioni: 370x310x70 mm</p> <p>78010018 - Colore Inox - - conf. 1 - € 80,34</p> <p>7801051881 - Colore Grigio scuro - - conf. 1 - € 61,60</p> <p>7801051882 - Colore Rosso - - conf. 1 - € 61,60</p> <p>7801051883 - Colore Verde - - conf. 1 - € 61,60</p>	  <p>CASSETTA Serenissima Dimensioni: 445 x 327 x 150 mm Apertura buca lettere: 235 x 30 mm</p> <p>78010017 - Colore Inox Satinato - - conf. 1 - € 122,16</p> <p>7801051781 - Colore Grigio scuro - - conf. 1 - € 87,14</p>
  <p>CASSETTA RIVISTA Componibile Alluminio Dimensioni: 370 x 310 mm Apertura buca lettere: 320 x 18 mm</p> <p>7801036172 - Colore silver - - conf. 1 - € 54,38</p> <p>7801036173 - Colore bronzo - - conf. 1 - € 54,38</p>	  <p>CASSETTA POSTALE CITY Per pubblicità Colore nero Misure: 355x260x100 mm</p> <p>512810340N - - conf. 1 - € 19,40</p>
  <p>CASSETTA RIVISTA EVOLUZIONE In lamiera Con tetto Verniciatura epossidica Dimensioni: 370 x 250 mm</p> <p>90008815 - Modello INOX - - conf. 2 - € 47,80</p> <p>90008820 - Modello grigio antracite - - conf. 2 - € 30,00</p> <p>90008821 - Modello verde etrusco - - conf. 2 - € 32,00</p> <p>90008822 - Modello nera - - conf. 2 - € 32,00</p> <p>segue...</p>	  <p>continua...</p> <p>90008823 - Modello bianca - - conf. 2 - € 32,00</p> <p>90008824 - Modello rossa - - conf. 2 - € 32,00</p>
  <p>CASSETTA SC1 alluminio prelievo frontale Silver Dimensioni: 300 x 125 mm Apertura buca lettere: 230 X 20 mm</p> <p>7803010172 - Profondità 200 - - conf. 1 - € 53,76</p> <p>7803010272 - Profondità 280 - - conf. 1 - € 56,24</p> <p>7803010372 - Profondità 335 - - conf. 1 - € 58,72</p>	  <p>CASSETTA SC3 alluminio Silver prelievo posteriore Dimensioni: 300 x 125 mm Apertura buca lettere: 230 X 20 mm</p> <p>7803030172 - Profondità 200 - - conf. 1 - € 60,78</p> <p>7803030272 - Profondità 280 - - conf. 1 - € 63,24</p> <p>7803030372 - Profondità 335 - - conf. 1 - € 65,30</p>
  <p>CASSETTA SC5 alluminio Silver prelievo frontale Dimensioni: 400 x 125 mm Apertura buca lettere: 330 X 20 mm</p> <p>7803050172 - profondità 250 - - conf. 1 - € 69,22</p>	  <p>CASSETTA SC6 alluminio Silver prelievo posteriore Dimensioni: 400 x 125 mm Apertura buca lettere: 330 X 20 mm</p> <p>7803060172 - Profondità 250 - - conf. 1 - € 78,08</p>
  <p>CASSETTA SC7 alluminio Silver prelievo frontale Dimensioni: 300 x 125 mm Apertura buca lettere: 230 X 20 mm componibile</p> <p>7803070172 - Profondità 200 - - conf. 1 - € 53,76</p> <p>7803070272 - Profondità 280 - - conf. 1 - € 56,24</p> <p>7803070372 - Profondità 335 - - conf. 1 - € 58,72</p>	  <p>CASSETTA SC4 alluminio Silver prelievo posteriore Dimensioni: L 300 x H 250 Apertura buca lettere: 230 X 20 mm componibile</p> <p>7803040172 - Profondità 200 - - conf. 1 - € 97,02</p> <p>7803040272 - Profondità 280 - - conf. 1 - € 101,14</p> <p>7803040372 - Profondità 335 - - conf. 1 - € 104,86</p>



CASSETTA SERVIZIO SC4S alluminio Silver a singola faccia ritiro anteriore Dimensioni: L 300 x H 250 mm **componibile**

7803143172 - Profondità 335 -
- conf. 1 - € **101,14**



CASSETTA SERVIZIO SC4S alluminio Silver a doppia faccia ritiro anteriore e posteriore Dimensioni: H 300 x L 250 mm **componibile**

7803143272 - Profondità 335 -
- conf. 1 - € **113,30**



CASSETTA SERVIZIO SC4S Alluminio Dimensioni: 375 x 305 mm Profondità 375 mm Apertura buca lettere: 230 X 20 mm

7803143372 -
- conf. 1 - € **230,72**



CASSETTA SERVIZIO SC4S alluminio Silver vano citofono Passante a doppia faccia ritiro posteriore Dimensioni: 500 x 305 mm Apertura buca lettere: 230 X 20 mm

7803143472 - Profondità 375 -
- conf. 1 - € **393,46**



PORTAPUBBLICITA' ANTRACITE SENZA TETTO In acciaio veniciato epossidico Accessorio indispensabile per ogni abitazione Dimensioni 340x250x50 mm

90008900 -
- conf. 1 - € **19,98**



PORTAPUBBLICITA' ANTRACITE CON TETTO In acciaio veniciato epossidico Grande capienza per pubblicità condominiale Dimensioni 340x350x100 mm

90008905 -
- conf. 1 - € **26,36**



PORTA PUBBLICITÀ BIMETAL MAXI Dimensioni: 375 x 320 mm

7804151684 - Colore Grigio ferro -
- conf. 1 - € **61,60**
780415169001 - Colore Bianco -
- conf. 1 - € **61,60**
780415169007 - Colore Grigio Ral 9007 -
- conf. 1 - € **61,60**



PORTA PUBBLICITÀ BIMETAL Acciaio Dimensioni: 345 x 280 x 80 mm **Sostituisce art. 7804151225**

7804151525 -
- conf. 1 - € **49,40**



PORTA PUBBLICITÀ BIMETAL Dimensioni: 345 x 280 x 80 mm

7804151584 - Colore Grigio ferro -
- conf. 1 - € **45,94**
780415159001 - Colore Bianco -
- conf. 1 - € **45,94**
780415159007 - Colore Grigio Ral 9007 -
- conf. 1 - € **45,94**



ARMADIETTO PRONTO SOCCORSO Vuoto Fissaggio a muro lamiera verniciata

64650001 - Largh. 280 - H 370 - Prof. 130 -
ripiani 1
- conf. 1 - € **40,00**
64650002 - Largh. 280 - H 450 - Prof. 130 -
ripiani 2
- conf. 1 - € **61,20**



CASELLARIO STANDARD SC5V - 3 posti Dimensioni: 375 x 400 mm

7803150372 - Finitura Alluminio - Posti 3 -
- conf. 1 - € **183,34**





CASELLARIO SC5V 4 posti Dimensioni: 500 x 400 mm

7803150472 - Finitura Alluminio - Posti 4 -
- conf. 1 - € **245,14**

















  <p>CASELLARIO SC5V 5 posti Dimensioni: 625 x 400 mm 7803150572 – Finitura Alluminio – Posti 5 – – conf. 1 – € 306,94</p>	  <p>CASELLARIO SC7V 4 posti Lamiera zincata Dimensioni: L 456 x H 330 mm Apertura buca lettere: 220 x 15 mm 7803170417 – Colore Bronzo – – conf. 1 – € 143,18 7803170420 – Colore Silver – – conf. 1 – € 143,18</p>
  <p>CASELLARIO SC7V 5 posti Lamiera zincata Dimensioni: L 564 x H 330 mm Apertura buca lettere: 220 x 15 mm 7803170517 – Colore Bronzo – – conf. 1 – € 179,02 7803170520 – Colore Silver – – conf. 1 – € 179,02</p>	  <p>CASELLARIO SC7V 6 posti Lamiera zincata Dimensioni: L 671 x H 330 mm Apertura buca lettere: 220 x 15 mm 7803170617 – Colore Bronzo – – conf. 1 – € 216,30 7803170620 – Colore Silver – – conf. 1 – € 216,30</p>
  <p>CASELLARIO Art. 2500 CV Finitura Antracite Dimensioni: Altezza 350 mm Profondità 250 mm 90008493 – Lunghezza 360 – Posti 3 – – conf. 1 – € 97,44 90008495 – Lunghezza 600 – Posti 5 – – conf. 1 – € 154,50</p>	  <p>BACHECA PORTAVVISI In bronzo profilo allu- minio anodizzato porta a battente in plexiglass fondo magnetico 7804011154 – misura 290x370x40 – – conf. 1 – € 132,66 7804011254 – misura 550x370x40 – – conf. 1 – € 161,30 7804011354 – misura 550x690x40 – – conf. 1 – € 220,42 7804011454 – misura 750x690x40 – – conf. 1 – € 335,78</p>
  <p>BACHECA PORTAVVISI Finitura argento 7804011152AG – Dimensioni 290x370 – – conf. 1 – € 132,66 7804011252AG – Dimensioni 550x370 – – conf. 1 – € 161,30 7804011352AG – Dimensioni 550x690 – – conf. 1 – € 220,42</p>	  <p>ARMADIETTO PORTACHIAVI Serie Privat Senza portaetichette 64621712B – posti 20 – H 200 – Largh. 160 – prof. 70 – conf. 1 – € 20,20 64621714B – posti 48 – H 300 – Largh. 240 – prof. 70 – conf. 1 – € 25,60</p>
  <p>ARMADIETTO PORTACHIAVI In lamiera Possibi- lità di fissaggio a muro tasselli inclusi Verniciato bianco 512810100N – Posti 20 – Dimensioni 160x200x75 – – conf. 1 – € 10,71 512810110N – Posti 40 – Dimensioni 160x200x75 – – conf. 1 – € 12,98 512810120N – Posti 93 – Dimensioni 240x290x85 – – conf. 1 – € 19,57</p>	  <p>BACHECA PORTACHIAVI Silver profilo in allu- minio anodizzato colore silver fondo in lamiera zincata ricoperta in pvc colore silver brillante 7804021152AG – Dimensioni 290x370 – Posti 24 – – conf. 1 – € 141,72 7804021252AG – Dimensioni 550x370 – Posti 48 – – conf. 1 – € 179,64 7804021352AG – Dimensioni 550x690 – Posti 96 – – conf. 1 – € 257,50</p>
  <p>ARMADIETTO PORTACHIAVI Serie Star Fissag- gio a muro Senza portaetichette 64621751 – posti 100 – H 480 – Largh. 480 – prof. 90 – conf. 1 – € 107,80 64621752 – posti 150 – H 580 – Largh. 480 – prof. 90 – conf. 1 – € 133,00 64621753 – posti 200 – H 440 – Largh. 360 – prof. 150 – conf. 1 – € 149,00</p>	  <p>BACHECA PORTACHIAVI In bronzo profilo in alluminio verniciato colore bronzo-oro fondo in lamiera zincata ricoperta in pvc color verde porta a battente in plexiglass ganci numerati 7804021154 – misura 290x370x40 – posti 24 – – conf. 1 – € 141,72 7804021254 – misura 550x370x40 – posti 48 – – conf. 1 – € 179,64 7804021354 – misura 550x690x40 – posti 96 – – conf. 1 – € 257,50</p>



 <p>ARMADIETTO PORTACHIAVI Serie Star EASY Fissaggio a muro Ganci staccabili Senza portatichette</p> <p>64621762 - posti 80 - H 480 - Largh. 480 - prof. 90 - conf. 1 - € 114,40</p> <p>64621763 - posti 100 - H 580 - Largh. 480 - prof. 90 - conf. 1 - € 138,40</p>	 <p>CASSETTA Portavalori EUROPA 30x24x9 Con portamonete €</p> <p>64625534A - - conf. 1 - € 38,40</p>
 <p>CASSETTE PORTAVALORI A CHIAVE Con portamonete A chiave</p> <p>512810130N - Dimensioni 150x118x80 - - conf. 1 - € 8,86</p> <p>512810140N - Dimensioni 200x160x90 - - conf. 1 - € 10,20</p> <p>512810150N - Dimensioni 250x180x90 - - conf. 1 - € 13,08</p> <p>512810160N - Dimensioni 300x240x90 - - conf. 1 - € 15,45</p>	 <p>CASSETTA Portavalori a chiave</p> <p>64621611B - Mod. 0 - L. 150 - P. 110 - H 70 - conf. 1 - € 17,80</p> <p>64621612A - Mod. 1 - L. 200 - P. 160 - H 90 - conf. 1 - € 20,80</p> <p>64621613A - Mod. 2 - L. 250 - P. 180 - H 90 - conf. 1 - € 22,00</p> <p>64621614A - Mod. 3 - L. 300 - P. 240 - H 90 - conf. 1 - € 24,00</p> <p>64621615A - Mod. 4 - L. 370 - P. 280 - H 90 - conf. 1 - € 32,00</p>
 <p>CASSETTA Portavalori combinazione</p> <p>6462161C2A - Mod. 1 - L. 200 - P. 160 - H 90 - conf. 2 - € 25,60</p> <p>6462161C3A - Mod. 2 - L. 250 - P. 180 - H 90 - conf. 2 - € 27,20</p> <p>6462161C4A - Mod. 3 - L. 300 - P. 240 - H 90 - conf. 2 - € 30,00</p> <p>6462161C5A - Mod. 4 - L. 370 - P. 280 - H 90 - conf. 2 - € 41,80</p>	 <p>SCOMPARTO Per cassette Portavalori per cassetta n°1 200x160mm</p> <p>646216702 - - conf. 2 - € 1,92</p>
 <p>SCOMPARTO Per cassette Portavalori per cassetta n°2 250x180mm</p> <p>646216703 - - conf. 2 - € 2,40</p>	 <p>SCOMPARTO Per cassette Portavalori per cassetta n°3 300x240mm</p> <p>646216704 - - conf. 2 - € 2,60</p>
 <p>SCOMPARTO Per cassette Portavalori per cassetta n°4 370x280</p> <p>646216705 - - conf. 2 - € 6,40</p>	 <p>CASSETTA DI EMERGENZA 120x160x60mm Serratura a chiave cifrata Completa di martelletto zincato con catena</p> <p>64640001 - Cifr. - - - conf. 1 - € 22,20</p> <p>64640001KA - Cifr. KA - - conf. 1 - € 24,60</p>
 <p>PLACCA Bucalettere Dimensioni: 266 x 90 mm</p> <p>78010600 - Colore rame brunito - - conf. 1 - € 31,52</p> <p>7801060053 - Colore alluminio bronzato - - conf. 1 - € 25,96</p> <p>7801060072 - Colore alluminio silver - - conf. 1 - € 25,96</p> <p>7801060084 - Colore grigio ferro - - conf. 1 - € 28,00</p>	 <p>PLACCA Bucalettere Dimensioni: 376 x 90 mm</p> <p>7801065039 - Finitura ottone brunito - - conf. 1 - € 38,00</p> <p>7801065053 - Finitura alluminio bronzato - - conf. 1 - € 28,84</p> <p>7801065072 - Finitura alluminio silver - - conf. 1 - € 28,84</p> <p>7801065084 - Finitura grigio ferro - - conf. 1 - € 31,40</p>



<p>Cottali</p> <p>BUCALETTERE GRAVITY apertura a tirare Dimensioni: 254 x 75 mm Buca 205 x 50 mm Ottone lucido</p> <p>90008980 - - conf. 1 - € 22,18</p> 	<p>Cottali</p> <p>BUCALETTERE VICTORIAN apertura a spinta Ottone lucido</p> <p>90008970 - buca 195 x 40 - L 254 - H 75 - - conf. 1 - € 22,18</p> 
<p>&M900</p> <p>PLACCA Bucalettere apertura a spinta Apertura Buca170x28</p> <p>90008950 - finitura ott. lucido - - conf. 2 - € 14,60 90008951 - finitura ott. nichelato - - conf. 2 - € 15,40 90008952 - finitura ott. antico - - conf. 2 - € 15,60</p> 	<p>SILMEC</p> <p>PLACCA Bucalettere Buca: 245 x 45 mm</p> <p>7801067061 - Colore ottone lucido - - conf. 1 - € 134,94 7801067062 - Colore ottone antico - - conf. 1 - € 134,94</p> 
<p>&M900</p> <p>CHIAVE PER CASSETTA POSTALE 2500 Mod. B e EV Per cassette CT, Evoluzione, Rustiche e Italia</p> <p>90008801 - - conf. 20 - € 0,66</p> 	<p>&M900</p> <p>CHIAVE PER CASSETTA POSTALE 2500 Per modello D per cassette con cilindro taglio SX</p> <p>90008800 - - conf. 20 - € 0,66</p> 
<p>&M900</p> <p>CHIAVE PER CASSETTA POSTALE 2500 Mod. "A e C" Per cassette pressofuse e cassette Armony</p> <p>90008798 - - conf. 20 - € 0,64</p> 	<p>ALGA</p> <p>CHIAVE CASSETTE POSTALI</p> <p>7831002 - - conf. 100 - € 1,08</p> 
<p>ALGA</p> <p>CHIAVE CASSETTE POSTALI</p> <p>7831003P - - conf. 100 - € 1,08</p> 	<p>ALGA</p> <p>CHIAVE FERRO</p> <p>7831003P1 - - conf. 10 - € 1,08</p> 
<p>SILMEC</p> <p>KIT TRAVERSINI alluminio anodizzato Per fissaggio a ringhiera 200 mm</p> <p>78011003 - - conf. 2 - € 8,24</p> 	<p>SILMEC</p> <p>VETRINO PORTANOME per modello 30-700</p> <p>78090005 - - conf. 5 - € 1,14</p> 



  <p>KIT VETRINO PORTANOME Comprende: Sostegno etichetta Vetrino trasparente Targhetta portanome con il marchio Silmec Cornice per vetrino Targhetta in PVC bicolore</p> <p>78090026 - - conf. 1 - € 4,12</p>	  <p>VETRINI PORTANOME 80 x 15 PER SC7</p> <p>78090009 - - conf. 5 - € 1,92</p>
  <p>CILINDRO CROMATO Ø 20 completo di aggancio</p> <p>78090010 - L. 20 - - conf. 5 - € 7,22 78090011 - L. 11 - - conf. 5 - € 7,22</p>	  <p>CILINDRO CROMATO Ø 15mm completo di aggancio</p> <p>78090020 - - conf. 5 - € 7,22</p>
  <p>CILINDRO CASSETTA POSTALE Misura: 17x10mm</p> <p>90008802 - - conf. 1 - € 2,48</p>	  <p>MAGNETI di fissaggio Conf. 4 pz</p> <p>78040904 - - conf. 4 - € 8,86</p>
  <p>COPRIFUGA per placche</p> <p>7801060156 - apert. buca 242x47 - - conf. 1 - € 44,50 7801065156 - apert. buca 352x47 - - conf. 1 - € 49,02</p>	  <p>ACCESSORIO PORTA PUBBLICITÀ Acciaio INOX satinato Da applicare alla cassetta Serenissima mediante viti</p> <p>78011017 - - conf. 1 - € 37,70</p>
  <p>NUMERO CIVICO con chiodo filettato 5MA e tassello 100 mm Ottone lucido verniciato</p> <p>447909450 - Numero 0 - - conf. 1 - € 6,16 447909451 - Numero 1 - - conf. 1 - € 6,16 447909452 - Numero 2 - - conf. 1 - € 6,16 447909453 - Numero 3 - - conf. 1 - € 6,16 447909454 - Numero 4 - - conf. 1 - € 6,16 segue...</p>	  <p>continua...</p> <p>447909455 - Numero 5 - - conf. 1 - € 6,16 447909456 - Numero 6 - - conf. 1 - € 6,16 447909457 - Numero 7 - - conf. 1 - € 6,16 447909458 - Numero 8 - - conf. 1 - € 6,16 447909459 - Numero 9 - - conf. 1 - € 6,16</p>
  <p>LETTERE ALFABETO COMPLETO con pioli 50 mm Ottone lucido verniciato</p> <p>44790910A - Lettera A - - conf. 2 - € 2,72 44790910B - Lettera B - - conf. 2 - € 2,72 44790910C - Lettera C - - conf. 2 - € 2,72 44790910D - Lettera D - - conf. 2 - € 2,72 44790910E - Lettera E - - conf. 2 - € 2,72 segue...</p>	  <p>continua...</p> <p>44790910F - Lettera F - - conf. 2 - € 2,72 44790910G - Lettera G - - conf. 2 - € 2,72 44790910H - Lettera H - - conf. 2 - € 2,72 44790910I - Lettera I - - conf. 2 - € 2,72 44790910J - Lettera J - - conf. 2 - € 2,72 segue...</p>



<p>Cottali</p> <p>ACQR</p> <p>continua...</p> <p>44790910K - Lettera K - - conf. 2 - € 2,72</p> <p>44790910L - Lettera L - - conf. 2 - € 2,72</p> <p>44790910M - Lettera M - - conf. 2 - € 2,72</p> <p>44790910N - Lettera N - - conf. 2 - € 2,72</p> <p>44790910O - Lettera O - - conf. 2 - € 2,72</p> <p>segue...</p>	<p>Cottali</p> <p>ACQR</p> <p>continua...</p> <p>44790910P - Lettera P - - conf. 2 - € 2,72</p> <p>44790910Q - Lettera Q - - conf. 2 - € 2,72</p> <p>44790910R - Lettera R - - conf. 2 - € 2,72</p> <p>44790910S - Lettera S - - conf. 2 - € 2,72</p> <p>44790910T - Lettera T - - conf. 2 - € 2,72</p> <p>segue...</p>
<p>Cottali</p> <p>ACQR</p> <p>continua...</p> <p>44790910U - Lettera U - - conf. 2 - € 2,72</p> <p>44790910V - Lettera V - - conf. 2 - € 2,72</p> <p>44790910W - Lettera W - - conf. 2 - € 2,72</p> <p>44790910X - Lettera X - - conf. 2 - € 2,72</p> <p>44790910Y - Lettera Y - - conf. 2 - € 2,72</p> <p>44790910Z - Lettera Z - - conf. 2 - € 2,72</p>	



m a d e i n i t a l y



UNCONVENTIONAL GARDENING

colore e design per il tuo giardino

WWW.COLOR.GFGARDEN.IT

www.malfattitacchinigroup.it



GIARDINAGGIO E IDRAULICA

SFOGLIA LA CATEGORIA

















 <p>Einhell</p> <p>TAGLIAERBA A BATTERIA GE-CM 18/33 Li Serie Power X-Change Motore brushless (senza spazzole) Indicatore stato carica batteria a 3 Led Caricabatteria incluso Archetto di spinta regolabile e pieghevole Indicazione livello di riempimento del cesto di raccolta Batteria: 18 V 4000 mAh Li-Ion Larghezza di taglio: 330 mm Regolazione altezza taglio: 5 25-65 mm Centralizzato Capacità raccolta: 30 L Diametro ruote anteriori: 150 mm Diametro ruote posteriori: 180 mm Peso: 10,9 Kg Dimensioni: 680x405x360 mm</p> <p>4763413260 - - conf. 1 - € 326,40</p>	 <p>Einhell</p> <p>TAGLIAERBA A BATTERIA GE-CM 18/30 Li 1x3,0Ah Power X-Change Indicazione del livello di carica della batteria Caricabatteria incluso Motore Brushless Einhell con motore elettrico senza spazzole Ruote antiscampo Corpo in plastica resistente agli urti Raccomandato per prati fino a 150 m² di superficie Batteria 18V 3 Ah Li-Ion Numero giri a vuoto 3300 min Regolazione altezza di taglio 3 30-70 mm Diametro taglio 30 cm Capacità raccolta 25 l Peso 9.32 kg</p> <p>4763413155 - - conf. 1 - € 239,40</p>
 <p>Einhell</p> <p>TAGLIAERBA ELETTRICO GC-EM 1032 Scocca in durevole materiale plastico Raccomandato per prati fino a 300 m² di superficie Regolazione altezza di taglio 3 20-60 mm Tensione 220-240V 50Hz Potenza 1000W Numero giri 3500 min Diametro taglio 32 cm Capacità raccolta 30l Peso 8,15 kg</p> <p>4763400257 - - conf. 1 - € 91,20</p>	 <p>Einhell</p> <p>TAGLIAERBA ELETTRICO GC-EM 1536 Motore con Carbon-Power con elevata coppia Sacco raccogliherba con indicatore del livello di raccolta Struttura in plastica resistente Raccomandato per prati fino a 600 m² di superficie Potenza 1500W Tensione 220-240V - 50 Hz Numero giri a vuoto 3400 min Regolazione altezza taglio 5 posizioni 25-65 mm Diametro taglio 36 cm Capacità raccolta 38l Dimensioni 720x450x325 mm Peso 10kg</p> <p>4763400150 - - conf. 1 - € 150,40</p>
 <p>Einhell</p> <p>TAGLIABORDI A BATTERIA GC-CT 18/24 Li P 1x1,5 Ah Power X-Change Indicazione del livello di carica della batteria Inclusi 20 coltelli in plastica Caricabatteria incluso Batteria 18V 1.5 Ah Li-Ion Durata di funzionamento 40 min Tempo ricarica 3-5 h Nr. giri coltello 8500 rpm Larghezza di taglio coltelli 24 cm Lunghezza 180 mm Larghezza 150 mm Altezza 490 mm Peso 1,57 kg</p> <p>4763411102 - - conf. 1 - € 106,80</p>	 <p>Einhell</p> <p>TAGLIABORDI A BATTERIA GC-CT 18/24 Li P 1x2,0 Ah Power X-Change System 2.0Ah Inclusi 20 coltelli in plastica Batteria 18V 2000 mAh Li-Ion Tempo di ricarica 40 min Larghezza di taglio coltelli 24 cm Lunghezza 930 mm Larghezza 160 mm Altezza 490 mm Peso 1,57 kg</p> <p>4763411125 - - conf. 1 - € 143,52</p>
 <p>Einhell</p> <p>TAGLIABORDI ELETTRICI GC-ET 4530 Set Robusto motore elettrico Taglio a doppio filo Testina motorizzata girevole di 180° per il taglio di bordi e per le superfici verticali Testina motorizzata inclinabile in 4 posizioni Impugnatura telescopica Protezione per fiori e piante Tensione 230V 50Hz Potenza 450W Velocità rotazione del rocchetto 8800 rpm Diametro taglio a filo 300 mm Diametro filo 1.4 mm Lunghezza filo 10 m Dimensioni 940x255x140 mm Peso 2,64 kg</p> <p>4763402022 - - conf. 1 - € 75,12</p>	 <p>Einhell</p> <p>LAMA per art. GC-CT 18/24 Li</p> <p>4763405730 - - conf. 1 - € 10,66</p>
 <p>Einhell</p> <p>FORBICI A BATTERIA GC-CG 3,6 Li Per erba e cespugli Lama tagliaerba Lama sfoltirami Cambio lama senza attrezzi Manico telescopico Durata max 60 min Larghezza di lavoro lama taglio 7 cm Larghezza di taglio decespugliatore 10 cm Spessore taglio decespugliatore 8 mm Distanza tra i denti decespugliatore 8 mm Batteria 3.6V 1300 mAh Li-Ion Dimensioni: 900 x 160 x 90 mm Peso 0,69 kg</p> <p>4763410455 - - conf. 1 - € 54,36</p>	 <p>Einhell</p> <p>TAGLIASIEPI A BATTERIA GE-CH 1846 Li-Solo Piccolo e maneggevole Ingranaggi in metallo per una maggiore vita utile Interruttore di sicurezza a 2 mani Copri lama in alluminio Protezione antiurto con sostegno per il montaggio a parete Lama in acciaio tagliato al laser e diamantato Robusta faretra per lo stivaggio e il trasporto Senza batteria e senza caricabatteria Lunghezza barra 520 mm Lunghezza di taglio 46 cm Distanza tra i denti 15 mm Tagli al minuto 2200 min Peso 2 kg Dimensioni 892x180x185 mm</p> <p>4763410642 - - conf. 1 - € 90,96</p>
 <p>Einhell</p> <p>TAGLIASIEPI ELETTRICO GC-EH 6055/1 Lama in acciaio tagliate al laser e rettificata al diamante Robusti ingranaggi in metallo Interruttore di sicurezza Copri lame in alluminio Collettore di taglio Tensione 220-240V 50Hz Potenza 600 W Numero giri a vuoto 1400 min Lunghezza di taglio 55 cm Lunghezza barra 61 cm Distanza tra i denti 26 mm Tagli al minuto 2800 min Dimensione 960x190x190 mm Peso 3,47 kg</p> <p>4763403320 - - conf. 1 - € 101,88</p>	 <p>Einhell</p> <p>TAGLIASIEPI ELETTRICO GC-EH 5747 Doppio interruttore di sicurezza Coltelli a movimento alternato su entrambi i lati Impugnatura supplementare ergonomica Grande protezione per mani Ingranaggi metallici Dispositivo antistrappo per cavo Tensione: 230 V 50 Hz Potenza: 570 W N° giri: 1600 min⁻¹ Lunghezza taglio: 465 mm Lunghezza barra 530 mm Distanza tra i denti: 18 mm Tagli al minuto: 3200 min⁻¹ Peso: 3,1 Kg Dimensioni: 959x110x198 mm</p> <p>4763403742 - - conf. 1 - € 69,40</p>



























 <p>Einhell</p> <p>TAGLIASIEPI ELETTRICO GH-EH 4245 Impugnatura antiscivolo Ampio paramano Copertura lama in alluminio Ingranaggi in metallo di lunga durata Tensione 230V 50Hz Potenza 420W Numero giri a vuoto 1600 min Lunghezza barra 51 cm Lunghezza taglio 45 cm Distanza tra i denti 16 mm Tagli al minuto 3200 min Dimensione 920x175x175 mm Peso 2,5 kg</p> <p>4763403460 - - conf. 1 - € 75,12</p>	 <p>Einhell</p> <p>ELETTROSEGA A BATTERIA GE-LC 36/35 Li-Solo Power X-Change Motore Einhell Brushless elettrico senza spazzole. Barra e catena Oregon Tensione e sostituzione catena senza utensili Protezione anti ritorno e freno immediato della catena. Lubrificazione automatica, grande apertura di riempimento olio Batteria: 2x18 V Li-Ion Lunghezza barra: 35 cm Lunghezza taglio: 33 cm Velocità taglio: 15 m/s Capacità serbatoio olio: 115 ml BATTERIA NON INCLUSA</p> <p>4764501780 - - conf. 1 - € 207,72</p>
 <p>Einhell</p> <p>ELETTROSEGA A CATENA GH-EC 2040 Catena e barra Oregon Tendi e cambio catena manuale Ingranaggi in metallo Perno d'appoggio in metallo Serbatoio olio integrato per lubrificazione automatica Protezione anti ritorno e arresto immediato Tensione 230-240 V 50 Hz Potenza 2000W Numero di giri a vuoto 7800 min Lunghezza barra 406 mm Lunghezza di taglio 375 mm Velocità di taglio 13,5 m/s Capacità serbatoio olio 160 ml Dimensioni 530x215x275 mm Peso 5,45 kg</p> <p>4764501720 - - conf. 1 - € 115,08</p>	 <p>Einhell</p> <p>SOFFIATORE PER FOGLIE A BATTERIA GE-CL 18 Li E-Solo Regolazione della velocità Impugnatura antiscivolo (softgrip) per maggiore comfort e sicurezza Numero di giri a vuoto 12000 min⁻¹ Massima capacità d'aria 105 m³/h Passaggio aria 210 km/h Dimensioni 490x155x182 mm Peso 1,33 kg BATTERIA E CARICATORE NON INCLUSI</p> <p>4763433532 - - conf. 1 - € 52,44</p>
 <p>Einhell</p> <p>SOFFIATORE PER FOGLIE A BATTERIA GE-CL 18 Li-E Batteria Power X-Change, Indicatore di livello batteria con 3 Led, Caricabatteria rapido incluso Regolazione della velocità, Impugnatura antiscivolo (softgrip) per maggiore comfort Batteria: 18V/2000 mAh Li-Ion Tensione caricabatteria: 200-250V/50-60 Hz N° giri a vuoto: 12000 min⁻¹ Massima capacità d'aria: 105 m³/h Passaggio aria: 210 km/h Dimensioni: 490x155x192 mm Peso: 1,73 Kg</p> <p>4763433533 - - conf. 1 - € 125,64</p>	 <p>Einhell</p> <p>SOFFIATORE ASPIRATORE PER FOGLIE ELETTRICO GC-EL 2500 E Selettore aspirazione/soffiaggio Tubo rigido di aspirazione di grandi dimensioni a 2 elementi Regolazione elettronica del numero di giri Sacco di raccolta da 40 L Cinghia di trasporto Tensione 230-240 V 50 Hz Potenza 2500 W Numero di giri a vuoto 7000-13500 min Capacità aspirazione max 650 m³/h Funzione sminuzzatore 10:1 Dimensioni 440x190x335 mm Peso 3,13 kg</p> <p>4763433300 - - conf. 1 - € 62,40</p>
 <p>LUBEX</p> <p>OLIO PER CATENE MOTOSEGHE LUBEX Lubrificante vegetale biodegradabile Per motoseghe ed elettroseghe</p> <p>62712519 - Formato 1 Lt. - - conf. 18 - € 4,12 62712520 - Formato 5 Lt. - - conf. 4 - € 17,30</p>	 <p>LUBEX</p> <p>OLIO SINTETICO GARDEN 2T LUBEX Formato 100 ml Per la miscela di macchine da giardino con motori 2 tempi</p> <p>6279717 - - conf. 24 - € 2,48</p>
 <p>LUBEX</p> <p>GARDEN 4T Formato 0,60 lt 4 tempi</p> <p>6279716 - - conf. 1 - € 5,76</p>	 <p>FELCO</p> <p>FORBICI FELCO 2 Modello Classico controlama ribattuta Misura 215 mm Peso 240 gr.</p> <p>93081202 - - conf. 1 - € 60,00</p>
 <p>FELCO</p> <p>FORBICI FELCO 5 Modello Elementare impugnatura acciaio Misura 225 mm Peso 310 gr.</p> <p>414F05 - - conf. 1 - € 42,40</p>	 <p>FELCO</p> <p>FORBICI FELCO 8 Lunghezza 210 mm Ampiezza taglio 25 mm</p> <p>93081208 - - conf. 1 - € 76,00</p>



























 <p>FELCO FORBICI FELCO 9 Per mancini Ottimizzazione degli sforzi grazie alla testa inclinata e al battente-ammortizzatore Lama e controlama avvitata in acciaio temprato di elevata qualità Misura 210 mm Peso 245 gr.</p> <p>414F09 - - conf. 1 - € 72,10</p>	 <p>FELCO FORBICE FELCO 31 Modello a battente lama in acciaio temprato di elevata qualità e battente regolabile Misura 210 mm Peso 225 gr.</p> <p>414F031 - - conf. 1 - € 66,40</p>
 <p>FELCO FORBICI COGLIUIVA FELCO 300 Lama INOX Testa di taglio tipo lama/controlama Per tagli netti Misura 190 mm Peso 125 gr.</p> <p>414F300 - - conf. 1 - € 21,80</p>	 <p>FELCO FORBICI DA TAGLIO E RACCOLTA FELCO 322 Con impugnatura in acciaio Lama dritta cromata Lunghezza 190 mm</p> <p>414F322 - L 190 mm - - conf. 1 - € 19,60</p>
 <p>GIEFFE gruppi general ferramenta FORBICE ERBA 3 posizioni Manici in alluminio Lame in teflon</p> <p>512220610N - - conf. 1 - € 11,32</p>	 <p>GIEFFE gruppi general ferramenta FORBICE LAMA TEFLON KS-4T</p> <p>512222110N - - conf. 1 - € 10,60</p>
 <p>GIEFFE gruppi general ferramenta FORBICE PESANTE LAME TEFLON KS-8T</p> <p>512222112N - - conf. 1 - € 18,60</p>	 <p>BAHCO FORBICI FLORICOLTURA Adatta per vendemmia e raccolta frutti, ortaggi e fiori. Testa di taglio lunga e sottile con apertura di 40 mm. Misura 190 mm Peso 87 gr. Fornito con fodera</p> <p>770P123-19 - - conf. 1 - € 12,56</p>
 <p>BAHCO FORBICI POTATURA Adatte per un utilizzo generale in giardino. Meccanismo di chiusura con fermaglio in filo di acciaio</p> <p>770P126-19 - Misura 190 mm - Peso 245 gr. - - conf. 1 - € 29,32 770P126-22 - Misura 220 mm - Peso 310 gr. - - conf. 1 - € 36,10</p>	 <p>GIEFFE gruppi general ferramenta LAMA DI RICAMBIO Per KS-4T</p> <p>512222100N - - conf. 1 - € 4,10</p>
 <p>GIEFFE gruppi general ferramenta LAME DI RICAMBIO Per forbice KS-8T</p> <p>512222118N - - conf. 1 - € 5,20</p>	 <p>FELCO LAMA RICAMBIO per felco 2 - 4 - 11</p> <p>90078400 - - conf. 1 - € 23,70</p>























 <p>LAMA RICAMBIO per felco 5 90078405 – – conf. 1 – € 18,74</p> 	 <p>LAMA RICAMBIO per felco 30 90078410 – – conf. 1 – € 17,30</p> 
 <p>BULLONE E DADI per felco 5 90078451 – – conf. 1 – € 8,80</p> 	 <p>BULLONI E DADI per felco 2 90078445 – – conf. 1 – € 14,42</p> 
 <p>BULLONE E DADI per felco 4 90078450 – – conf. 1 – € 8,86</p> 	 <p>MOLLA DI RICAMBIO Per forbice KS-4T 512222108N – – conf. 1 – € 4,12</p> 
 <p>MOLLE RICAMBIO per felco 2 - 4 Kit 2 pezzi 90078435 – – conf. 1 – € 7,42</p> 	 <p>TAGLIAERBA lame temprate autoaffilanti durante l'uso Meccanismo a leva 3 regolazioni di angolazione 770GS-76 – misura 355 mm – – conf. 1 – € 16,94</p> 
 <p>TAGLIASIEPI Per tutti i tipi di siepe Adatto per regolazione frequente delle siepi Misura 660 mm Peso 1115 gr. 770P59-25 – – conf. 1 – € 58,50</p> 	 <p>TAGLIASIEPI Per tutti i tipi di siepe Lame ondulate per il taglio di ramoscelli e steli che tendono a scivolare durante il taglio. Manici in legno Misura 540 mm Peso 1020 gr. 770P57-25-W – – conf. 1 – € 84,48</p> 
 <p>TAGLIASIEPI Per utilizzo intensivo in parchi, vigneti e vivai Taglio rami fino a 10 mm di spessore Misura 570 mm Peso 1085 gr. 770P51-F – – conf. 1 – € 100,48</p> 	 <p>TRONCARAMI Taglio passante Lama stretta e sottile controlama a gancio forgiata Lunghezza 600 mm Peso 960 gr. 770P160-SL-60 – – conf. 1 – € 124,80</p> 















 	TRONCARAMI taglio battente Lungh. 850 mm. 770P173-85 - - conf. 1 - € 145,92	 	FORBICE SIEPI LAMA ONDOLATA Manico fisso 51222340N - - conf. 1 - € 22,24
 	FORBICE SIEPI LAMA ONDOLATA Manico telescopico 51222350N - - conf. 1 - € 29,64	 	TRONCARAMI TAGLIO PASSANTE Manico telescopico 51222330N - - conf. 1 - € 33,26
 	TRONCARAMI TAGLIO PASSANTE Manico fisso 51222320N - - conf. 1 - € 25,66	 	TRONCARAMI LAMA BATTENTE Manico telescopico Con cricchetto 51222310N - - conf. 1 - € 35,16
 	TRONCARAMI LAMA BATTENTE Manico fisso Con cricchetto 51222300N - - conf. 1 - € 29,46	 	TAGLIARAMI A PERTICA 512220612N - - conf. 1 - € 18,47
 	SVETTATOIO lama temprata Taglio Ø 30 770P34-27A - - conf. 1 - € 60,42	 	SVETTATOIO leva a tripla azione Taglio Ø 40 770P34-37 - - conf. 2 - € 101,12
 	LAMA PER P34-37 770R137E - - conf. 1 - € 28,16	 	MOLLE PER SVETTATOIO P/34-27/A 770R427AE - - conf. 1 - € 12,68



 	<p>MOLLE PER SVETTATOIO P/34-37 770R437E - - conf. 1 - € 14,34</p>	 	<p>COLTELLO INNESTO MOD. 3.90 60 Per innesto e potatura Lama acciaio inossidabile 57 mm Impugnatura nylon rosso 414FC39060 - - conf. 1 - € 21,42</p>
 	<p>COLTELLO INNESTO MOD. 3.90 20 Adatto per innesti di rose Lama diritta e scortecciatore Lama acciaio inossidabile 57 mm Impugnatura nylon rosso 414FC39020 - - conf. 1 - € 25,96</p>	 	<p>SEGA PIEGHEVOLE FELCO 600 A taglio tirante Lama 16 cm Acciaio Inox cromato e temprato di alta qualità. Forma conica della lama per un taglio senza inciampi. Manico comodo, antideripante. Misura 350 mm Peso 160 gr. 90078150 - - conf. 1 - € 37,08</p>
 	<p>KIT FELCO Sega Felco 600 + Forbice Felco 2 90078140 - - conf. 1 - € 93,50</p>	 	<p>SEGA PER ASTE TELESCOPICHE Modello PC-330-LH 512222200N - misura 330 mm - - conf. 1 - € 19,80</p>
 	<p>SEGHETTO PIEGHEVOLE CHIUSURA A PULSANTE 512222128N - Modello FA-180-LH - Misura 180 mm - - conf. 1 - € 19,80 512222132N - Modello FA-210-LH - Misura 210 mm - - conf. 1 - € 19,80</p>	 	<p>SEGHETTO PIEGHEVOLE LAMA DIRITTA 512222120N - Modello FRD-150-LH - Misura 150 mm - - conf. 1 - € 15,80 512222124N - Modello FRD-180-LH - Misura 180 mm - - conf. 1 - € 19,00</p>
 	<p>SEGHETTO LAMA CURVA Per impieghi gravosi Modello C-330-LH 512222194N - misura 330 mm - - conf. 1 - € 19,80</p>	 	<p>SEGHETTO CON FODERO LAMA DRITTA 512222162N - Modello JS 240 LH - Misura 240 mm - - conf. 1 - € 23,80 512222166N - Modello JS 300 LH - Misura 300 mm - - conf. 1 - € 25,80</p>
 	<p>SEGACCIO DENTE FINO PER POTATURA DI PRECISIONE Modello GSF-300-SH 512222214N - misura 300 mm - - conf. 1 - € 26,20</p>	 	<p>SEGONCINO TALENT cm. 53 770826832 - - conf. 10 - € 12,36</p>





<p>GIEFFE gruppi general ferramenta</p> <p>LAME DI RICAMBIO</p> <p>512222122N – Modello D-150-LH – Misura 150 mm – – conf. 1 – € 11,00</p> <p>512222126N – Modello FRD-180-LH – Misura 180 mm – – conf. 1 – € 14,20</p> 	<p>GIEFFE gruppi general ferramenta</p> <p>LAME RICAMBIO PER SEGHETTO PIEGHEVOLE CON CHIUSURA A PULSANTE</p> <p>512222130N – Modello FA-180 LH – Misura 180 mm – – conf. 1 – € 13,80</p> <p>512222134N – Modello FA-210 LH – Misura 210 mm – – conf. 1 – € 14,20</p> 
<p>FELCO ferramenta</p> <p>LAMA RICAMBIO PER FELCO 600 Lunghezza: 16 cm Acciaio Inox cromato e temprato di alta qualità forma conica della lama per un taglio senza inciampi</p> <p>90078415 – – conf. 1 – € 29,26</p> 	<p>GIEFFE gruppi general ferramenta</p> <p>LAMA RICAMBIO PER SEGHETTO LAMA CURVA per modello CW-330-LH</p> <p>512222196N – Misura 330 mm – – conf. 1 – € 15,80</p> 
<p>BAHCO gruppi general ferramenta</p> <p>LAMA SEGONCINO PER LEGNO Dentatura continua Adatto sia per legno secco che per legno verde Acciaio bonificato di alta qualità Punta dei denti temprate a induzione ad alta frequenza per prestazioni di lunga durata</p> <p>77051-12 – L. 300 – – conf. 10 – € 9,42</p> <p>77051-21 – L. 533 – – conf. 10 – € 11,96</p> <p>77051-24 – L. 610 – – conf. 10 – € 12,56</p> <p>segue...</p> 	<p>BAHCO gruppi general ferramenta</p> <p>continua...</p> <p>77051-30 – L. 762 – – conf. 10 – € 14,04</p> <p>77051-32 – L. 813 – – conf. 10 – € 14,72</p> <p>77051-36 – L. 914 – – conf. 10 – € 15,62</p> 
<p>BAHCO gruppi general ferramenta</p> <p>LAMA SEGONCINO PER LEGNO Dentatura a castello Adatta per legno verde Acciaio bonificato di alta qualità Punta dei denti temprate a induzione ad alta frequenza per prestazioni di lunga durata</p> <p>77023-21 – L. 530 – – conf. 10 – € 11,96</p> <p>77023-24 – L. 607 – – conf. 10 – € 12,56</p> <p>77023-30 – L. 759 – – conf. 10 – € 13,84</p> <p>77023-32 – L. 810 – – conf. 10 – € 14,72</p> 	<p>BAHCO gruppi general ferramenta</p> <p>LAMA TALENT per segoncino Dentatura continua</p> <p>770ET833-21 – L. 533 – – conf. 10 – € 1,65</p> 
<p>BAHCO gruppi general ferramenta</p> <p>LAMA TALENT per segoncino Dentatura a castello</p> <p>770ET830-24 – L. 610 – – conf. 10 – € 2,02</p> <p>770ET830-28 – L. 711 – – conf. 10 – € 2,28</p> <p>770ET830-30 – L. 762 – – conf. 10 – € 2,20</p> <p>770ET830-32 – L. 813 – – conf. 10 – € 2,40</p> <p>770ET832-21 – L. 533 – – conf. 10 – € 1,69</p> 	<p>GIEFFE gruppi general ferramenta</p> <p>SCOPA FOGLIE In alluminio Regolabile Manico telescopico Lunghezza 82 + 162 mm Numero denti 15</p> <p>512222065N – – conf. 1 – € 16,20</p> 
<p>GIEFFE gruppi general ferramenta</p> <p>SCOPA REGOLABILE 22 denti Attacco conico</p> <p>512220624N – – conf. 1 – € 5,94</p> 	<p>GIEFFE gruppi general ferramenta</p> <p>SCOPA Filo piatto 9 denti Manico in plastica gommata</p> <p>512220644N – – conf. 1 – € 4,91</p> 



























<p>GIeFFe gruppi generali ferramenta</p> <p>RASTRELLO Manico in plastica gommata</p> <p>512220640N - - conf. 1 - € 5,25</p> 	<p>GIeFFe gruppi generali ferramenta</p> <p>RASTRELLO AEREATORE</p> <p>512220654N - - conf. 1 - € 18,86</p> 
<p>GIeFFe gruppi generali ferramenta</p> <p>MANICO TELESCOPICO 3 funzioni</p> <p>51222060N - - conf. 1 - € 19,20</p> 	<p>GIeFFe gruppi generali ferramenta</p> <p>ASTA TELESCOPICA In alluminio rigata con terminale in plastica</p> <p>512223020N - Lunghezza 4,5 mt - Ø 21,25,29 mm - Sezione 3 - - conf. 1 - € 25,78</p> <p>512223040N - Lunghezza 6 mt - Ø 21,25,28,34 mm - Sezione 4 - - conf. 1 - € 32,86</p> <p>512223050N - Lunghezza 8 mt - Ø 21,25,28,34 mm - Sezione 4 - - conf. 1 - € 40,82</p> 
<p>GIeFFe gruppi generali ferramenta</p> <p>ASTA TELESCOPICA In metallo</p> <p>512223070N - Lunghezza 3 mt - Ø 22,25 mm - Sezione 2 - - conf. 1 - € 4,06</p> 	<p>GIeFFe gruppi generali ferramenta</p> <p>TRAPIANTATORE Manico in plastica gommata</p> <p>512220628N - Manico Largo - - conf. 1 - € 4,75</p> <p>512220630N - Manico Stretto - - conf. 1 - € 4,64</p> 
<p>GIeFFe gruppi generali ferramenta</p> <p>ZAPPETTA Lama quadra con tridente Manico in plastica gommata</p> <p>512220636N - - conf. 1 - € 5,44</p> 	<p>GIeFFe gruppi generali ferramenta</p> <p>COLTIVATORE Tridente Manico in plastica gommata</p> <p>512220642N - - conf. 1 - € 4,91</p> 
<p>GIeFFe gruppi generali ferramenta</p> <p>ZAPPETTA Lama cuore con bidente Manico in plastica gommata</p> <p>512220638N - - conf. 1 - € 5,33</p> 	<p>930</p> <p>SACCO PORTAFOGLIE Estensibile da giardino Ideale per raccolta foglie Ø 45 Cm - H. 53 Cm</p> <p>93081170 - - conf. 1 - € 5,98</p>  <p>AD ESAURIMENTO</p>
<p>ASTRAL</p> <p>DISSUASORE PLURISPILLO in acciaio Inox 80 punte Ø 1,3 mm Altezza punta 11 cm Base flessibile da 1 metro sezionabile. Efficacia dissuasione 18 cm</p> <p>190900305 - - conf. 25 - € 5,40</p> 	<p>ASTRAL</p> <p>DISSUASORE PLURIPUNTE In polietilene 40 punte altezza 8 cm Base 50 cm trasparente Efficacia dissuasione 12 cm</p> <p>190900300 - - conf. 100 - € 1,40</p> 



<p>GIEFFE gruppo general farmaceutica</p>  <p>TUBO TRICOALPIN magliato con spirale 5 strati (skin bianco - sottostrato nero - rinforzo spirale in fibra di poliestere) Resistenza allo scoppio 27 bar Inibisce la formazione di alghe Resistenza ai raggi UV Utilizzabile in tutte le stagioni</p> <p>512220170N - Metri 15 - Diametro 5/8" - conf. 1 - € 16,14 512220180N - Metri 25 - Diametro 5/8" - conf. 1 - € 26,88 512220190N - Metri 50 - Diametro 5/8" - conf. 1 - € 53,76 <i>segue...</i></p>	<p>GIEFFE gruppo general farmaceutica</p> <p><i>continua...</i></p> <p>512220200N - Metri 15 - Diametro 3/4" - conf. 1 - € 24,58 512220210N - Metri 25 - Diametro 3/4" - conf. 1 - € 40,92 512220220N - Metri 50 - Diametro 3/4" - conf. 1 - € 81,84 512220230N - Metri 25 - Diametro 1" - conf. 1 - € 66,96 512220240N - Metri 50 - Diametro 1" - conf. 1 - € 133,92</p> 
<p>GIEFFE gruppo general farmaceutica</p>  <p>TUBO TRICOFORT Tubo retinati magliato 6 strati (sottostrato giallo coprente - strato intermedio nero espanso - skin giallo - rinforzo retinato) Resistenza allo scoppio 36 bar Resistenza alla pressione in qualunque condizione d'uso Inibisce la formazione di alghe Resistenza ai raggi UV Utilizzabile in tutte le stagioni</p> <p>512220114N - Metri 15 - Diametro 5/8" - conf. 1 - € 19,18 512220115N - Metri 25 - Diametro 5/8" - conf. 1 - € 31,98 <i>segue...</i></p>	<p>GIEFFE gruppo general farmaceutica</p> <p><i>continua...</i></p> <p>512220116N - Metri 50 - Diametro 5/8" - conf. 1 - € 63,94 512220117N - Metri 15 - Diametro 3/4" - conf. 1 - € 25,98 512220118N - Metri 25 - Diametro 3/4" - conf. 1 - € 43,32 512220119N - Metri 50 - Diametro 3/4" - conf. 1 - € 86,64</p> 
<p>GCE</p>  <p>KIT AQUAPOP Kit per l'irrigazione, composto da tubo estensibile da 5 m a 15 mt, mini-lancia ergonomica con getto a cono regolabile, raccordo aperto e presa rubinetto 1/2. Borsa in plastica per riporre comodamente il kit dopo l'uso</p> <p>50380267600 - Colore Blu - conf. 2 - € 45,60 50380277600 - Colore Fucsia - conf. 2 - € 45,60 50380287600 - Colore Lime - conf. 2 - € 45,60 50380297600 - Colore Tortora - conf. 2 - € 45,60</p>	<p>GCE</p>  <p>KIT AQUAPOCKET Kit di partenza per l'irrigazione, composto da tubo trecciato interno Ø8mm, mini-lancia ergonomica con getto a cono regolabile, raccordo aperto e presa rubinetto 1/2 indoor-outdoor. Borsa in plastica per riporre comodamente il kit dopo l'uso. Lunghezza tubo 10 mt</p> <p>50380267601 - Colore Blu - conf. 2 - € 33,80 50380287601 - Colore Lime - conf. 2 - € 33,80 50380297601 - Colore Tortora - conf. 2 - € 33,80</p>
<p>AGRATI</p>  <p>PORTATUBO MURALE Art.100 In acciaio zincocromato Utile per raccogliere non solo tubo da irrigazione, ma anche cavi elettrici, catene ecc. Struttura particolarmente robusta. Viti non incluse</p> <p>145100IT - conf. 10 - € 15,61</p>	<p>AGRATI</p>  <p>PORTATUBO MURALE CLIPPER Art.110 In polipropilene Colori misti</p> <p>145110IT - conf. 10 - € 3,79</p>
<p>GCE</p>  <p>KIT AVVOLGITUBO MINI CONCEPT READY COMPLETO Portatile o utilizzabile a muro grazie ai supporti a muro (non in dotazione) Completo di 15 mt di tubo, raccordi e lancia a spruzzo Dimensioni: L39 x H28 x P29 cm</p> <p>5035793 - conf. 1 - € 39,20</p>	<p>GCE</p>  <p>CARRELLO PER TUBO EUROTANK Stabile e maneggevole Manico ergonomico in plastica Completo di raccordi portagomma Capacità tubo: 60 mt da 1/2" 50 mt da 5/8" 40 mt da 3/4" Dimensioni L50 x H80 x P36 cm</p> <p>5035729 - conf. 1 - € 30,60</p>
<p>GCE</p>  <p>CARRELLO PER TUBO IDEA In plastica e metallo Pratico e robusto Con ruote e manico telescopico a scomparsa Capacità tubo: 60 mt da 1/2" 50 mt da 5/8" 40 mt da 3/4"</p> <p>5035788 - conf. 1 - € 55,00</p>	<p>AGRATI</p>  <p>AVVOLGITUBO MURALE GIREVOLE Art.130 In acciaio zincato Dotato di staffa che permette la rotazione Portata 50 mt 1/2"</p> <p>145130IT - conf. 1 - € 52,18</p>



  <p>AVVOLGITUBO PORTATILE MURALE Art.131 In lamiera e tubo d'acciaio zincati Portata 50 mt 1/2" Dotato di staffa per applicazione a muro MPR 1175</p> <p>145131IT - - conf. 1 - € 38,22</p>	  <p>CARRELLO AVVOLGITUBO Art.210 Con ruote Adatto a piccole e medie superfici Rullo e telaio in acciaio zincato Portata 50 mt 1/2"</p> <p>145210IT - - conf. 1 - € 45,46</p>
  <p>CARRELLO AVVOLGITUBO BABY CAR Art. 216 Con ruote Adatto a piccole e medie superfici Telaio e dischi rullo in acciaio zincato Dotato di manovella Portata 50 mt 1/2"</p> <p>145216IT - - conf. 1 - € 51,63</p>	  <p>CARRELLO AVVOLGITUBO SEMPLI CAR Art.220 Con ruote Adatto a piccole e medie superfici Telaio e dischi rullo in acciaio zincato Portata 80 m 1/2" Dotato di manovella</p> <p>145220IT - - conf. 1 - € 70,01</p>
  <p>CARRELLO AVVOLGITUBO DROP 60 Art.240 Con ruote Adatto a piccole e medie superfici Telaio in acciaio zincato Rullo robusto polipropilene Portata 60 m 1/2"</p> <p>145240IT - - conf. 1 - € 36,50</p>	  <p>CARRELLO AVVOLGITUBO Art.310 Con ruote Adatto a piccole e medie superfici Rullo e telaio in acciaio zincato Portata 80 m 1/2" 50 m 3/4"</p> <p>145310IT - - conf. 1 - € 63,29</p>
  <p>CARRELLO AVVOLGITUBO Art.315 Con ruote Adatto a medie superfici Rullo e telaio in acciaio zincato Dotato di manovella Portata 110 mt 1/2" 80 mt 3/4"</p> <p>145315IT - - conf. 1 - € 78,53</p>	  <p>CARRELLO AVVOLGITUBO Art.318 Professionale in acciaio verniciato a polvere poliestere atossica Telaio a due portanti per garantire massima robustezza Dotato di manovella Portata 80 mt 3/4"</p> <p>145318IT - - conf. 1 - € 153,29</p>
  <p>RICAMBIO PER CARRELLO AGRATI - PERNO PORTAGOMME G15 Colore nero</p> <p>145MRP1070 - - conf. 1 - € 1,74</p>	  <p>RUBINETTO A SFERA Art. 2510 Portagomma con leva alluminio rossa</p> <p>91013410 - raccordo 3/8" - - conf. 12 - € 10,92</p> <p>91013411 - raccordo 1/2" - - conf. 12 - € 11,60</p> <p>91013412 - raccordo 3/4" - - conf. 7 - € 15,80</p> <p>91013413 - raccordo 1" - - conf. 4 - € 30,20</p>
  <p>VALVOLA A SFERA Art. 2310 leva lunga FEMMINA/FEMMINA</p> <p>91013420 - pollici 3/8" - - conf. 26 - € 6,60</p> <p>91013421 - pollici 1/2" - - conf. 20 - € 9,80</p> <p>91013422 - pollici 3/4" - - conf. 15 - € 13,80</p> <p>91013423 - pollici 1" - - conf. 10 - € 17,92</p> <p>91013424 - pollici 1 3/4" - - conf. 10 - € 27,20</p> <p>segue...</p>	  <p>continua...</p> <p>91013425 - pollici 1 1/4" - - conf. 3 - € 40,78</p> <p>91013426 - pollici 2" - - conf. 2 - € 63,04</p>



&M910

VALVOLA A SFERA Art. 2320 passaggio totale FEMMINA/FEMMINA

- 91013440 - pollici 3/8" -
- conf. 26 - € 6,60
- 91013441 - pollici 1/2" -
- conf. 25 - € 7,42
- 91013442 - pollici 3/4" -
- conf. 20 - € 10,50
- 91013443 - pollici 1" -
- conf. 10 - € 18,34



&M910

VALVOLA A SFERA Art. 2321 passaggio totale MASCHIO/FEMMINA

- 91013430 - pollici 3/8" -
- conf. 26 - € 7,42
- 91013431 - pollici 1/2" -
- conf. 25 - € 7,82
- 91013432 - pollici 3/4" -
- conf. 20 - € 11,54
- 91013433 - pollici 1" -
- conf. 10 - € 19,98



GCE

IRRORATORE SU PUNTALE CONO Statico per piccole aree Portata 23 l/min Superficie irrorata 95 m² Pressione max 4 bar

- 5035619 -
- conf. 8 - € 5,00



GCE

IRRORATORE SU PUNTALE MINI DRIVER Portata 16 l/min Superficie irrorata 450 m² Angolo di irrigazione max 360° Pressione max 4 bar

- 5035616 -
- conf. 12 - € 9,80



GCE

IRRORATORE OSCILLANTE ASTRAL 4 A regolazione continua dell'arco di irradiazione da 20° a 100° - silenzioso Braccio oscillante in plastica a 16 getti Per aree a sezione rettangolare 180 m² Portata 15 l/min Pressione max 4 bar

- 5035669 -
- conf. 6 - € 16,20



GCE

LANCIA A SPRUZZO REGOLABILE a getto diretto erogazione fino a 12 l/min

- 5033405 -
- conf. 6 - € 1,70



GCE

LANCIA GRANDE PORTATA Con regolazione separata dall'intensità del getto

- 5033407 -
- conf. 10 - € 5,80



GIEFFE
gruppi generali ferramenta

LANCIA REGOLABILE 5"

- 512220694N -
- conf. 1 - € 1,46



GCE

LANCIA ERGONOMICA REGOLABILE 3 JET 3 getti disponibili: fisso, ventaglio, cono portata 18 l/min a 4 bar

- 5035527 -
- conf. 8 - € 8,40



GCE

LANCIA ERGONOMICA REGOLABILE 8 JET 8 getti disponibili portata 18 l/min a 4 bar

- 5035528 -
- conf. 8 - € 9,80



GCE

PISTOLA IRRORATRICE 8 JET EASY

- 5033541 -
- conf. 1 - € 12,20















GCE

PISTOLA IRRIGAZIONE MULTIGETTO 5 JET media portata fino a 20 l/min Leva anteriore con dispositivo on/off per apertura ed interruzione del flusso d'acqua













- 5033495 -
- conf. 5 - € 15,60





























<p>GIeFFe gruppi generali ferramenta</p> <p>LANCIA PISTOLA REGOLABILE 512220698N - - conf. 1 - € 6,35</p> 	<p>GIeFFe gruppi generali ferramenta</p> <p>PISTOLA REGOLABILE METALLO GRIP 512220183 - - conf. 1 - € 15,60</p> 
<p>GIeFFe gruppi generali ferramenta</p> <p>LANCIA PISTOLA In acciaio verniciato 512220702N - - conf. 1 - € 6,44</p> 	<p>GIeFFe gruppi generali ferramenta</p> <p>LANCIA PISTOLA REGOLABILE In metallo gom- mato Con grip Leva frontale 512220706N - - conf. 1 - € 15,64</p> 
<p>GIeFFe gruppi generali ferramenta</p> <p>LANCIA PISTOLA REGOLABILE Con grip 7 funzio- ni Leva frontale 512220708N - - conf. 1 - € 11,78</p> 	<p>GCE</p> <p>PRESA per rubinetti attacco 3/4" 5033433 - - conf. 25 - € 1,24</p> 
<p>GCE</p> <p>PRESA per rubinetti attacco 3/4" - 1/2" 5033435 - - conf. 25 - € 1,76</p> 	<p>GCE</p> <p>PRESA per rubinetti attacco 1" 5033432 - - conf. 25 - € 1,28</p> 
<p>GIeFFe gruppi generali ferramenta</p> <p>PRESA Per rubinetto 512220676N - Misura 3/4' - - conf. 1 - € 1,38 512220678N - Misura 1/2' - - conf. 1 - € 1,29</p> 	<p>GCE</p> <p>RACCORDO A 2 MASCHI 5033450 - - conf. 25 - € 1,16</p> 
<p>GCE</p> <p>RACCORDO A 3 MASCHI 5033451 - - conf. 25 - € 2,40</p> 	<p>GCE</p> <p>RACCORDO MASCHIO Filetto 3/4" 5033429 - - conf. 25 - € 0,94</p> 















 RACCORDO DOPPIO 512220680N - - conf. 1 - € 1,06	 RACCORDO PORTAGOMMA AcquaStop 512220682N - Misura 1/2' - - conf. 1 - € 1,79 512220684N - Misura 3/4' - - conf. 1 - € 1,48
 RACCORDO PORTAGOMMA 512220686N - Misura 1/2' - - conf. 1 - € 1,56 512220688N - Misura 3/4' - - conf. 1 - € 1,89	 RACCORDI RIPARATORE 512220690N - Misura 1/2' - - conf. 1 - € 1,52 512220692N - Misura 3/4' - - conf. 1 - € 1,70
 PORTAGOMMA A SCATTO SOFT TOUCH Per tubi da 1/2" e 5/8" 50343042 - Acquastop No - - conf. 50 - € 3,60 50343043 - Acquastop Si - - conf. 50 - € 4,00	 PORTAGOMMA A SCATTO SOFT TOUCH Per tubi da 5/8" e 3/4" 50343044 - Acquastop No - - conf. 50 - € 4,20 50343045 - Acquastop Si - - conf. 50 - € 4,80
 PORTAGOMMA A SCATTO Per tubi da 1/2" e 5/8" 5033020 - - conf. 25 - € 2,80	 PORTAGOMMA A SCATTO Per tubi da 3/4" 5033023 - - conf. 25 - € 3,40
 PORTAGOMMA A SCATTO CON ACQUASTOP Per tubi da 1/2" e 5/8" 5033015 - - conf. 25 - € 3,20	 PORTAGOMMA A SCATTO CON ACQUASTOP Per tubi da 3/4" 5033012 - - conf. 25 - € 3,80
 PORTAGOMMA A SCATTO con rubinetto Per tubi da 1/2" 5033024 - - conf. 5 - € 4,40	 PORTAGOMMA A SCATTO con rubinetto Per tubi da 3/4" 5033029 - - conf. 5 - € 4,80













 <p>GIUNTO RIPARATORE Per tubi da 1/2" e 5/8" 5033439 – - conf. 25 – € 1,76</p> 	 <p>GIUNTO RIPARATORE Per tubi da 3/4" 5033437 – - conf. 25 – € 2,60</p> 
 <p>GIUNTO RIPARATORE IN OTTONE E GOMMA Per tubi da 1/2" e 5/8" 5031439 – - conf. 10 – € 8,60</p> 	 <p>ESPOSITORE DELUXE Pratico e robusto girevole da banco con struttura in metallo a 4 ganci Dimensioni Ø 45 x 54 H Espositore vuoto 503ESP03 – - conf. 1 – € 20,60</p> 
 <p>ESPOSITORE MULTIPRODOTTO Modulare con 4 cassettei Dimensioni 38,5 x 89 x 156 H Espositore vuoto 503ESP07 – - conf. 1 – € 20,60</p> 	 <p>ESPOSITORE MULTIPIANO Dimensioni Ø 40 x 165,5 H Espositore vuoto 503ESP10 – - conf. 1 – € 51,60</p> 
 <p>VAPORIZZATORE SAMBA 1 litro 92099064 – - conf. 20 – € 3,60</p> 	 <p>POMPA A PRESSIONE 2 litri 92099052 – - conf. 9 – € 16,00</p> 
 <p>POMPA A SPALLA Irroratrice a batteria al litio Batteria 12V 8Ah inclusa Capacità 16 litri Pressione 1,5-4 Bar Durata 3-4 h Adatto in particolare per la disinfestazione di particolari colture, piante e fiori da giardino, per la pulizia di luoghi pubblici. Struttura robusta, manopola di controllo, pistone in polipropilene Larghe cinghie per un trasporto facile e confortevole 512250020N – - conf. 1 – € 98,63</p> 	 <p>CARICABATTERIA PER POMPA IRRORATRICE 512250040N – - conf. 1 – € 5,60</p> 
 <p>TAPPO SERBATOIO POMPA IRRORATRICE 512250070N – - conf. 1 – € 1,10</p> 	 <p>KIT LANCIA COMPLETA Asta telescopica da 520 a 910 mm 512250050N – - conf. 1 – € 4,50</p> 



















<p>GIeFFE gruppi generati benzina</p> <p>EROGATORE PER LANCIA POMPE IRRORATRICE</p> <p>512250100N - - conf. 1 - € 0,78</p> 	<p>dimartina</p> <p>POMPA A PRESSIONE MARY Con lancia</p> <p>92099054 - litri 5 - - conf. 1 - € 46,00 92099056 - litri 10 - - conf. 1 - € 66,40</p> 
<p>dimartina</p> <p>POMPA A SPALLA ROSY CON LANCIA</p> <p>92099058 - litri 12 - - conf. 1 - € 89,20 92099060 - litri 16 - - conf. 1 - € 94,60</p> 	<p>dimartina</p> <p>POMPA A SPALLA OLIMPIA 12 CON LANCIA 65 CM Getto regolabile Totalmente ermetica Sgancio rapido delle cinghie Portalanca verticale Stabile anche su piano inclinato Getto fino a 900 cm Pressione 2-5 bar Adatta per superfici di circa 500-1000 m2</p> <p>92099068 - Litri 11,85 - - conf. 1 - € 48,00</p> 
<p>dimartina</p> <p>LANCIA PUNTO Per pompe Mary Getto regolabile Max diametro 60°</p> <p>92099071 - - conf. 12 - € 11,60</p> 	<p>dimartina</p> <p>LANCIA TELESOPICA Per pompe Rosy Lunghhezza massima 1100 mm Getto regolabile Max diametro 60°</p> <p>92099072 - - conf. 1 - € 17,80</p> 
<p>Einhell</p> <p>IDROPULITRICE TC-HP 130 Accensione e spegnimento automatico Attacco per l'acqua con filtro integrale Accessori con attacco rapido Pressione e forza del getto sono regolate dagli ugelli Il prodotto contiene: pistola, tubo flessibile di pressione, lancia, ugello a getto piatto, ugello rotante, spazzola ed un contenitore per detergente Tensione 220-240 V 50Hz Potenza 1500 W Pressione max 130 bar Portata max 390 L/h Lunghezza tubo 5 m Peso 5,1 kg</p> <p>4764140750 - - conf. 1 - € 148,32</p> 	<p>Einhell</p> <p>IDROPULITRICE TE-HP 140 Accensione e spegnimento automatico Attacco per l'acqua con filtro integrale Accessori con attacco rapido Avvolgicavo integrato Pressione e forza del getto sono regolate dagli ugelli Il prodotto contiene: pistola, tubo flessibile di pressione, lancia, ugello a getto piatto, ugello rotante, spazzola, accessorio per pulizia di terrazzi ed un contenitore per detergente Tensione 220-240 V 50 Hz Potenza 1900 W Pressione max 140 bar Portata max 420 L/h Lunghezza tubo 5 m Peso 11,5 kg</p> <p>4764140760 - - conf. 1 - € 259,64</p> 
<p>Einhell</p> <p>IDROPULITRICE TE-HP 170 Accensione e spegnimento automatico Attacco per l'acqua con filtro integrale Accessori con attacco rapido Pressione e forza del getto sono regolate dagli ugelli Il prodotto contiene: pistola, tubo flessibile di pressione, lancia, ugello a getto piatto, ugello rotante, spazzola, accessorio per pulizia di terrazzi ed un contenitore per detergente Tensione 220-240 V 50 Hz Potenza 2300 W Pressione max consentita 170 bar Portata max 440 L/h Lunghezza tubo 10 m Peso 11,65 kg</p> <p>4764140770 - - conf. 1 - € 311,10</p> 	<p>LAVOR</p> <p>IDROPULITRICE FAST EXTRA 140 Acqua fredda Pistola con connessione rapida Lancia intercambiabile Testa ugello ad alta pressione Testa ugello turbo Potenza 140 bar max 420 L/h 1900 W Peso 8 Kg Dimensioni: 27,5x32,5x 44h cm</p> <p>6288109056C - - conf. 1 - € 146,00</p> 
<p>LAVOR</p> <p>IDROPULITRICE DGT 160 PLUS Idropulitrice ad acqua fredda Maniglia avvolgitubo, Controllo digitale con programmi di lavaggio Serbatoio incorporato Potenza 160 bar max 510 L/h 2500W Accessori: Pistola con attacco rapido, lancia attacco rapido, tubo alta pressione da 8 m, patio cleaner L28 ed ugello (ad attacco rapido, a tubo, variojet, eco e chimico</p> <p>62881010050C - - conf. 1 - € 298,00</p> 	<p>LAVOR</p> <p>IDROPULITRICE PLANET 160 WPS Gruppo pompa assiale in alluminio con 3 pistoni in acciaio ad alta resistenza valvola by-pass integrata Il prodotto viene fornito completo di pistola con attacco rapido, tubo 8 mt, lancia porta ugelli con attacco rapido, ugello variojet, ugello tubo e chimico, spazzola rotante e lancia pulisci pavimenti Potenza 2500 W Pressione max consentita 160 bar Portata max 510 L/h Peso 12,5 kg</p> <p>62881100027C - - conf. 1 - € 228,00</p> 



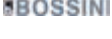











 <p>Einhell</p> <p>POMPE PER ACQUE CHIARE A IMMERSIONE GC-SP 3580 LL Interruttore galleggiante a regolazione continua Attacco per condotti flessibili da 25/38 mm e filettatura esterna da 33,3 mm Gomito 90° 47,8 mm Tensione: 230 V 50 Hz Potenza: 350 W Portata max: 8000 L/h Prevalenza max: 7,5 m Profondità immersione max: 7m Raccordo: 47,8 mm Cavo di alimentazione: 10 m Dimensioni: 222x180x308 Peso: 3.13 kg</p> <p>4764170445 - - conf. 1 - € 79,08</p>	 <p>GIEFFE gruppi general ferramenta</p> <p>ELETTROPOMPA A IMMERSIONE Per acque chiare Potenza: 750 w 13.000 lt/ora Prevalenza 10 m Max profondità 7 m Tensione 230V - 50Hz Impurità aspirabile 5 mm</p> <p>512320200N - - conf. 1 - € 63,40</p>
 <p>GIEFFE gruppi general ferramenta</p> <p>ELETTROPOMPA A IMMERSIONE Per acque scure 13.000 lt/ora Prevalenza 9 m Max profondità 7 m Tensione 230V - 50Hz Impurità aspirabile 25 mm</p> <p>512320210N - Potenza 400w - - conf. 1 - € 51,00 512320220N - Potenza 750w - - conf. 1 - € 63,80</p>	 <p>GIEFFE gruppi general ferramenta</p> <p>ELETTROPOMPA A IMMERSIONE Per lo svuotamento di sentine e piscine Senza interruttore a galleggiante Acque chiare Potenza: 400 w 6.000 lt/ora Prevalenza 6,5 m Max profondità 5 m Tensione 230V - 50Hz Impurità aspirabile 3 mm</p> <p>512320230N - - conf. 1 - € 45,20</p>
 <p>GIEFFE gruppi general ferramenta</p> <p>ELETTROPOMPA A IMMERSIONE Interruttore galleggiante automatico per regolazione livello Potenza: 750 w Per acque chiare e scure 4.500 lt/ora per acque chiare 13.000 lt/ora per acque scure Prevalenza 9 m Max profondità 7 m Tensione 230V - 50Hz Impurità aspirabile 1 mm - 8mm - 35mm</p> <p>512320240N - - conf. 1 - € 66,60</p>	 <p>GIEFFE gruppi general ferramenta</p> <p>ELETTROPOMPA A IMMERSIONE INOX Interruttore galleggiante automatico per regolazione livello Per acque chiare Potenza: 750 w 13.000 lt/ora Prevalenza 10 m Max profondità 7 m Tensione 230V - 50Hz Impurità aspirabile 5mm</p> <p>512320270N - - conf. 1 - € 69,20</p>
 <p>GIEFFE gruppi general ferramenta</p> <p>ELETTROPOMPA A IMMERSIONE INOX Interruttore galleggiante automatico per regolazione livello Per acque scure 13.000 lt/ora Prevalenza 9 m Max profondità 7 m Tensione 230V - 50Hz Impurità aspirabile 25mm</p> <p>512320250N - Potenza 750w - - conf. 1 - € 68,80 512320260N - Potenza 1100w - - conf. 1 - € 77,60</p>	 <p>Einhell</p> <p>POMPA PER ACQUE SCURE GH-DP 3730 Interruttore galleggiante regolabile in altezza Gomito 90° 47,8 mm Tensione 230 V 50 Hz Potenza 370 W Portata max 5 m Profondità immersione max 5 m Raccordo 47,8 mm - 1/2" Cavo di alimentazione 10 m Dimensioni 220x180x400 Peso 4.3 kg</p> <p>4764170471 - - conf. 1 - € 67,08</p>
 <p>GO PLAST</p> <p>MISCELATORE LAVABO</p> <p>508SEI1400000 - - conf. 1 - € 38,12</p>	 <p>GO PLAST</p> <p>MISCELATORE BIDET</p> <p>508SEI1401000 - - conf. 1 - € 38,12</p>
 <p>GO PLAST</p> <p>MISCELATORE MONOFORO CUCINA</p> <p>508SEI1405000 - - conf. 1 - € 31,52</p>	 <p>GO PLAST</p> <p>MISCELATORE CUCINA PARETE</p> <p>508SEI1407000 - - conf. 1 - € 42,44</p>



 <p>MISCELATORE ESTERNO SOLO DOCCIA 508SEI1404000 - - conf. 1 - € 37,50</p> 	 <p>MISCELATORE VASCA DUPLEX 508SEI1402000 - - conf. 1 - € 52,94</p> 
 <p>MISCELATORE AD INCASSO PER DOCCIA 508SEI1403000 - - conf. 1 - € 30,08</p> 	 <p>MONOBLOCCO LAVABO 5087007LB00GL - - conf. 1 - € 34,00</p> 
 <p>MONOFORO LAVABO CUCINA 5087007GLV0GL - - conf. 1 - € 29,26</p> 	 <p>GRUPPO CUCINA PARETE 508700700GL2 - - conf. 1 - € 29,46</p> 
 <p>GRUPPO VASCA DUPLEX 5087007GV00GL - - conf. 1 - € 47,38</p> 	 <p>SOFFIONE A SNODO Corpo cromato 5081403SOFMON - - conf. 1 - € 6,38</p> 
 <p>SOFFIONE DOCCIA OVO-GOM/2 BOSSINI Cromato Autopulente 1 Getto 91019321 - Snodo 1/2" F - - conf. 1 - € 27,80</p> 	 <p>SOFFIONE DOCCIA OVO-KARINA BOSSINI Cromato Autopulente 3 Getti: pioggia, massaggio e pioggia/massaggio Risparmio acqua 91019320 - Snodo 1/2" F - - conf. 1 - € 32,00</p> 
 <p>SOFFIONE DOCCIA Cromato 5 getti Diametro 91 mm 512620420N - - conf. 1 - € 10,58</p> 	 <p>SOFFIONE DOCCIA 1 getto Diametro 70 512620410N - - conf. 1 - € 6,05</p> 



<p>GO PLAST</p> <p>DOCCIA SIMPLY Cromata 1 getto</p> <p>5081401000000 – - conf. 1 – € 2,88</p> 	<p>GO PLAST</p> <p>DOCCIA ARUAL Cromata 3 getto</p> <p>50814015F0000 – - conf. 1 – € 10,72</p> 
<p>GO PLAST</p> <p>DOCCIA AIDAN Cromata 3 getto</p> <p>50814013F0000 – - conf. 1 – € 7,22</p> 	<p>GIEFFE gruppi general ferramenta</p> <p>DOCCETTA IBISCO Cromata 5 getti</p> <p>512620330N – - conf. 1 – € 8,56</p> 
<p>GIEFFE gruppi general ferramenta</p> <p>DOCCETTA GERANIO Cromata 3 getti</p> <p>512620310N – - conf. 1 – € 6,90</p> 	<p>GIEFFE gruppi general ferramenta</p> <p>DOCCETTA PRIMULA Cromata 1 getto</p> <p>512620300N – - conf. 1 – € 5,29</p> 
<p>GIEFFE gruppi general ferramenta</p> <p>DOCCETTA 5 GETTI Con supporto e flessibile</p> <p>512620340N – - conf. 1 – € 15,51</p> 	<p>GIEFFE gruppi general ferramenta</p> <p>DOCCETTA 3 getti con supporto e flessibile</p> <p>512620320N – - conf. 1 – € 13,85</p> 
<p>BOSSINI</p> <p>DOCCIA MIKI 5 GETTI BOSSINI Cromato Auto-pulente 5 Getti: pioggia, misto, pioggia/misto, massaggio, pioggia/massaggio Risparmio acqua Facile pulizia dal calcare</p> <p>91019362 – Snodo 1/2" F – - conf. 1 – € 38,40</p> 	<p>BOSSINI</p> <p>DOCCIA MIKI 3 GETTI BOSSINI Cromato Auto-pulente 3 getti: pioggia, massaggio, pioggia/massaggio Risparmio acqua facile pulizia dal calcare</p> <p>91019361 – Snodo 1/2" F – - conf. 1 – € 26,60</p> 
<p>BOSSINI</p> <p>DOCCIA MIKI 1 GETTO BOSSINI Cromato Facile pulizia dal calcare</p> <p>91019360 – Snodo 1/2" F – - conf. 1 – € 18,00</p> 	<p>GIEFFE gruppi general ferramenta</p> <p>SALISCENDI REGOLABILE IBISCO 5 getti Cromato</p> <p>512620380N – - conf. 1 – € 26,04</p> 



<p>GIEFFE gruppi generali forniture</p> <p>SALISCENDI REGOLABILE GERANIO 3 getti Cromato</p> <p>512620370N - - conf. 1 - € 22,45</p> 	<p>GOPLAST</p> <p>BLISTER SALISCENDI "ECO" Completo di flessibile e doccia monogetto</p> <p>50814028F0000 - - conf. 1 - € 25,14</p> 
<p>GIEFFE gruppi generali forniture</p> <p>SUPPORTO DOCCIA PER DUPLEX in ABS cromo</p> <p>512620455N - - conf. 1 - € 2,70</p> 	<p>GIEFFE gruppi generali forniture</p> <p>BRACCIO DOCCIA Inox Misura 30x10 cm</p> <p>512620450N - - conf. 1 - € 12,33</p> 
<p>GIEFFE gruppi generali forniture</p> <p>FLESSIBILE Cromato Doppia graffatura</p> <p>512620520N - L.cm. 150 - - conf. 1 - € 9,37 512620530N - L.cm. 200 - - conf. 1 - € 11,88</p> 	<p>GIEFFE gruppi generali forniture</p> <p>FLESSIBILE DOCCIA</p> <p>512620490N - Misura 120 cm - - conf. 1 - € 6,19 512620500N - Misura 150 cm - - conf. 1 - € 7,08 512620510N - Misura 200 cm - - conf. 1 - € 7,98</p> 
<p>GOPLAST</p> <p>LACCIO DOCCIA con attacco conico</p> <p>5081425000150 - L.cm. 150 - - conf. 1 - € 3,92 5081425000200 - L.cm. 200 - - conf. 1 - € 4,74</p> 	<p>BOSSINI</p> <p>FLESSIBILE DOCCIA BOSSINI In ottone cromato Doppia aggraffatura 1/2"x1/2" FF Conico</p> <p>91019301 - L 150 - - conf. 1 - € 26,00 91019302 - L 200 - - conf. 1 - € 34,20</p> 
<p>AM910</p> <p>LACCI DOCCIA attacco conico Modello Tex-Sil Tubo interno: gomma EPDM atossica Treccia esterna: tessuto tessile antigraffio con inserto cromato Dado esagonale ch23 Raccordi in ottone aggraffati</p> <p>91014674 - Lungh. 120 mm - - conf. 1 - € 8,20 91014675 - Lungh. 150 mm - - conf. 1 - € 9,00 91014676 - Lungh. 200 mm - - conf. 1 - € 10,40</p> 	<p>GOPLAST</p> <p>AREATORE CROMATO con filtro e reticella per vasca bagno Maschio Ø 28</p> <p>5081335V00000 - - conf. 10 - € 1,24</p> 
<p>GOPLAST</p> <p>AREATORE CROMATO con filtro e reticella Maschio</p> <p>5081335M00000 - - conf. 10 - € 0,74</p> 	<p>GOPLAST</p> <p>AREATORE CROMATO con filtro e reticella Femmina</p> <p>5081335F00000 - - conf. 10 - € 0,74</p> 



<p>&M910</p> 	<p>ROMPIGETTO Art. 2485/S Aereatore doccia con snodo per rubinetti con filettatura maschio - femmina</p> <p>91016100 - - conf. 30 - € 6,00</p>	<p>&M910</p> 	<p>ROMPIGETTO Art. 2790/3S Aereatore doccia con snodo rubinetti senza filettatura cromato Misura 9 cm</p> <p>91016300 - - conf. 20 - € 6,00</p>
<p>&M910</p> 	<p>CANNUCCIA ROMPIGETTO Art. 2790/S Aereatore - doccia per rubinetti senza filettatura Cromato Misura 15 cm</p> <p>91016200 - - conf. 25 - € 5,60</p>	<p>&M910</p> 	<p>CANNUCCIA ROMPIGETTO Art. 2793/S Aereatore - doccia per rubinetti con filettatura Cannuccia bianca Misura 14 cm</p> <p>91016400 - - conf. 20 - € 6,60</p>
<p>&M910</p> 	<p>CANNUCCIA ROMPIGETTO Art. 2796/S Aereatore - doccia per rubinetti con filettatura Cannuccia cromato nero Misura 15 cm</p> <p>91016500 - - conf. 20 - € 7,00</p>	<p>XLIRA</p> 	<p>SIFONE TIPO "SPAZIO 1" Per lavello singolo Senza pilette Completi di raccordi e guarnizioni Attacco per lavastoviglie raccordo 1"-1/2</p> <p>91012910 - - conf. 1 - € 12,98</p>
<p>XLIRA</p> 	<p>SIFONE TIPO "SPAZIO 2" Per doppio lavello Senza pilette Completi di raccordi e guarnizioni Attacco per lavastoviglie raccordo 1"-1/2</p> <p>91012920 - - conf. 1 - € 18,74</p>	<p>XLIRA</p> 	<p>SIFONE TIPO SPAZIO 2 NT Ispezionabile Facilità di montaggio Bianco</p> <p>91012925 - - conf. 1 - € 25,96</p>
<p>XLIRA</p> 	<p>SIFONE TIPO "M" Art. 1433/5 Per doppio lavello Senza pilette Completi di raccordi e guarnizioni Attacco per lavastoviglie raccordo 1"-1/2</p> <p>91012940 - - conf. 1 - € 16,68</p>	<p>XLIRA</p> 	<p>SIFONE TIPO "M" Per lavello singolo Senza pilette Completi di raccordi e guarnizioni Attacco per lavastoviglie raccordo 1"-1/2</p> <p>91012930 - - conf. 1 - € 13,40</p>
<p>XLIRA</p> 	<p>SIFONE TIPO SPAZIO BAGNO Ingombro ridotto Facilità di montaggio Bianco</p> <p>91012950 - - conf. 1 - € 11,94</p>	<p>XLIRA</p> 	<p>PROLUNGA JOLLY CURVA</p> <p>91012970 - pollici 1 1/4" - Ø x L 40x280 - - conf. 6 - € 3,50</p> <p>91012971 - pollici 1 3/4" - Ø x L 32x170 - - conf. 6 - € 3,50</p>



&M 910

PROLUNGA JOLLY DIRITTA

- 91012975 - pollici 1 1/4" - Ø x L 40x340 -
- conf. 10 - € 6,18
- 91012976 - pollici 1 3/4" - Ø x L 32x190 -
- conf. 10 - € 6,38



GOPLAST

TUBO GOFLEX

- 5081000CR0001 - pollici 1" - Ø 26 -
- conf. 5 - € 2,68
- 5081000CR0002 - pollici 1" - Ø 32 -
- conf. 5 - € 2,68
- 5081000TOPCR3 - pollici 1 3/4" - Ø 32 -
- conf. 5 - € 2,68
- 5081000TOPCR5 - pollici 1 1/4" - Ø 40 -
- conf. 5 - € 2,68



XLIRA

PILETTTE PER LAVELLI in ceramica Mod. 2011
Universali in acciaio INOX Complete di guarnizioni
e tappi Raccordo 1-1/2"

- 91012601 -
- conf. 1 - € 6,00



XLIRA

PILETTA BASKET Art. 1945 Ø 90mm 3-1/2" x 1-1/2"

- 91012625 -
- conf. 1 - € 27,20



XLIRA

PILETTA BASKET con troppo pieno Art. 1745
TPR Ø 90mm 3-1/2" x 1-1/2"

- 91012620 -
- conf. 1 - € 36,60



&M 910

GRIGLIETTA LAVELLO INOX

- 91017200 -
- conf. 1 - € 1,00



&M 910

TUBO FLESSIBILE ACCIAIO INOX M. 3/8" - F. 3/8"

- 91018762 - Misura 20 cm -
- conf. 25 - € 3,60
- 91018763 - Misura 25 cm -
- conf. 25 - € 3,80
- 91018764 - Misura 30 cm -
- conf. 25 - € 3,80
- 91018765 - Misura 35 cm -
- conf. 25 - € 4,00
- 91018766 - Misura 40 cm -
- conf. 25 - € 4,20



&M 910

continua...

- 91018768 - Misura 50 cm -
- conf. 25 - € 4,60



&M 910

TUBO FLESSIBILE ACCIAIO INOX M. 3/8" - F. 1/2"

- 91018722 - Misura 20 cm -
- conf. 25 - € 3,60
- 91018723 - Misura 25 cm -
- conf. 25 - € 3,80
- 91018724 - Misura 30 cm -
- conf. 25 - € 3,80
- 91018725 - Misura 35 cm -
- conf. 25 - € 4,00
- 91018726 - Misura 40 cm -
- conf. 25 - € 4,20
- 91018728 - Misura 50 cm -
- conf. 25 - € 4,60



&M 910

TUBO FLESSIBILE ACCIAIO INOX M. 1/2" - F. 3/8"

- 91018712 - Misura 20 cm -
- conf. 25 - € 3,60
- 91018713 - Misura 25 cm -
- conf. 25 - € 3,80
- 91018714 - Misura 30 cm -
- conf. 25 - € 3,80
- 91018715 - Misura 35 cm -
- conf. 25 - € 4,00
- 91018716 - Misura 40 cm -
- conf. 25 - € 4,20
- 91018718 - Misura 50 cm -
- conf. 25 - € 4,60



&M 910

TUBO FLESSIBILE ACCIAIO INOX M. 1/2" - F. 1/2"

- 91018702 - Misura 20 cm -
- conf. 25 - € 3,60
- 91018703 - Misura 25 cm -
- conf. 25 - € 3,80
- 91018704 - Misura 30 cm -
- conf. 25 - € 3,80
- 91018705 - Misura 35 cm -
- conf. 25 - € 4,00
- 91018706 - Misura 40 cm -
- conf. 25 - € 4,20
- 91018708 - Misura 50 cm -
- conf. 25 - € 4,60



&M 910

TUBO FLESSIBILE ACCIAIO INOX F. 3/8" - F. 3/8"













- 91018742 - Misura 20 cm -
- conf. 25 - € 3,60
- 91018743 - Misura 25 cm -
- conf. 25 - € 3,80
- 91018744 - Misura 30 cm -
- conf. 25 - € 3,80
- 91018745 - Misura 35 cm -
- conf. 25 - € 4,00
- 91018746 - Misura 40 cm -
- conf. 25 - € 4,20
- 91018748 - Misura 50 cm -
- conf. 25 - € 4,60



















<p>&M910</p> <p>TUBO FLESSIBILE ACCIAIO INOX F. 3/8" - F. 1/2"</p> <p>91018752 - Misura 20 cm - - conf. 25 - € 3,60 91018753 - Misura 25 cm - - conf. 25 - € 3,80 91018754 - Misura 30 cm - - conf. 25 - € 3,80 91018755 - Misura 35 cm - - conf. 25 - € 4,00 91018756 - Misura 40 cm - - conf. 25 - € 4,20 91018758 - Misura 50 cm - - conf. 25 - € 4,60</p> 	<p>&M910</p> <p>TUBO FLESSIBILE ACCIAIO INOX F.1/2" - F 1/2"</p> <p>91018732 - Misura 20 cm - - conf. 25 - € 3,60 91018733 - Misura 25 cm - - conf. 25 - € 3,80 91018734 - Misura 30 cm - - conf. 25 - € 3,80 91018735 - Misura 35 cm - - conf. 25 - € 4,00 91018736 - Misura 40 cm - - conf. 25 - € 4,20 91018738 - Misura 50 cm - - conf. 25 - € 4,60</p> 
<p>defcom raccomanda</p> <p>RIDUZIONE Zincata Fig. 241</p> <p>46841Z1238 - M Ø F 1/2" - 3/8" - - conf. 10 - € 0,76 46841Z134 - M Ø F 1" - 3/4" - - conf. 10 - € 1,90 46841Z3412 - M Ø F 3/4" - 1/2" - - conf. 10 - € 0,92</p> 	<p>defcom raccomanda</p> <p>PROLUNGA RIDOTTA Zincata Fig. 246</p> <p>46846Z112 - F Ø M 1" - 1/2" - - conf. 10 - € 2,40 46846Z1234 - F Ø M 3/4" - 1/2" - - conf. 10 - € 1,34 46846Z3812 - F Ø M 1/2" - 3/8" - - conf. 10 - € 0,86</p> 
<p>defcom raccomanda</p> <p>PROLUNGA Zincata Fig. 529</p> <p>46829Z1210 - Ø 1/2" - L.mm. 10 - - conf. 10 - € 0,50 46829Z1215 - Ø 1/2" - L.mm. 15 - - conf. 10 - € 0,52 46829Z1220 - Ø 1/2" - L.mm. 20 - - conf. 10 - € 0,58 46829Z1230 - Ø 1/2" - L.mm. 30 - - conf. 10 - € 0,92 46829Z3810 - Ø 3/8" - L.mm. 10 - - conf. 10 - € 0,58 segue...</p> 	<p>defcom raccomanda</p> <p>continua...</p> <p>46829Z3815 - Ø 3/8" - L.mm. 15 - - conf. 10 - € 0,64 46829Z3820 - Ø 3/8" - L.mm. 20 - - conf. 10 - € 0,70 46829Z3830 - Ø 3/8" - L.mm. 30 - - conf. 10 - € 1,02</p> 
<p>defcom raccomanda</p> <p>NIPPLLO Zincato Fig. 280</p> <p>46880Z1 - Ø 1" - - conf. 10 - € 2,60 46880Z12 - Ø 1/2" - - conf. 10 - € 0,88 46880Z34 - Ø 3/4" - - conf. 10 - € 1,34 46880Z38 - Ø 3/8" - - conf. 10 - € 0,82</p> 	<p>defcom raccomanda</p> <p>NIPPLI RIDOTTI Zincata Fig. 245</p> <p>46845Z1238 - M Ø M 1/2" - 3/8" - - conf. 10 - € 0,92 46845Z134 - M Ø M 1" - 3/4" - - conf. 10 - € 2,60 46845Z3412 - M Ø M 3/4" - 1/2" - - conf. 10 - € 1,50</p> 
<p>defcom raccomanda</p> <p>TAPPO MASCHIO esagonale zincato Fig. 292</p> <p>46890Z1 - Ø 1" - - conf. 10 - € 1,74 46890Z12 - Ø 1/2" - - conf. 10 - € 0,60 46890Z34 - Ø 3/4" - - conf. 10 - € 0,88 46890Z38 - Ø 3/8" - - conf. 10 - € 0,60</p> 	<p>defcom raccomanda</p> <p>TAPPO FEMMINA esagonale zincato Fig. 300</p> <p>46830Z1 - Ø 1" - - conf. 10 - € 2,00 46830Z12 - Ø 1/2" - - conf. 10 - € 0,72 46830Z34 - Ø 3/4" - - conf. 10 - € 1,10 46830Z38 - Ø 3/8" - - conf. 10 - € 0,66</p> 
<p>defcom raccomanda</p> <p>MANICOTTO Zincato Fig. 271</p> <p>46827Z12N - Ø F. 1/2" - - conf. 10 - € 0,86 46827Z1N - Ø F. 1" - - conf. 10 - € 1,62 46827Z34N - Ø F. 3/4" - - conf. 10 - € 1,22 46827Z38N - Ø F. 3/8" - - conf. 10 - € 0,84</p> 	<p>&M910</p> <p>RIDUZIONE Ghisa Fig. 241</p> <p>91011011 - M Ø F 1/2" - 3/8" - - conf. 10 - € 1,46 91011013 - M Ø F 1" - 3/4" - - conf. 10 - € 2,20 91011015 - M Ø F 1 3/4" - 3/4" - - conf. 5 - € 3,40 91011017 - M Ø F 1 1/4" - 1" - - conf. 5 - € 3,80 91011018 - M Ø F 1 1/4" - 1 3/4" - - conf. 5 - € 3,80 segue...</p> 



<p>&T910</p> <p><i>continua...</i> 91011019 - M Ø F 2" - 1" - - conf. 2 - € 8,00 91011020 - M Ø F 2" - 1 3/4" - - conf. 2 - € 7,80 91011021 - M Ø F 2" - 1 1/4" - - conf. 2 - € 7,00</p> 	<p>&T910</p> <p>BOCCHETTONE Ghisa Conico Fig. 340</p> <p>91011085 - Ø 1 3/4" - - conf. 2 - € 13,20 91011087 - Ø 2" - - conf. 2 - € 25,40</p> 
<p>&T910</p> <p>MANICOTTO Ghisa Fig. 270</p> <p>91011001 - Ø F 3/8" - - conf. 10 - € 2,00 91011002 - Ø F 1/2" - - conf. 10 - € 1,64 91011004 - Ø F 1" - - conf. 10 - € 3,00 91011005 - Ø F 1 3/4" - - conf. 5 - € 4,60 91011006 - Ø F 1 1/4" - - conf. 5 - € 6,80 91011007 - Ø F 2" - - conf. 5 - € 9,80</p> 	<p>&T910</p> <p>GOMITO Ghisa 90° Femmina / Maschio Fig. 92</p> <p>91011071 - Ø 3/8" - - conf. 10 - € 2,40 91011072 - Ø 1/2" - - conf. 10 - € 1,64 91011073 - Ø 3/4" - - conf. 10 - € 2,60 91011074 - Ø 1" - - conf. 10 - € 4,40 91011075 - Ø 1 3/4" - - conf. 5 - € 7,40 <i>segue...</i></p> 
<p>&T910</p> <p><i>continua...</i> 91011076 - Ø 1 1/4" - - conf. 5 - € 11,20 91011077 - Ø 2" - - conf. 5 - € 14,60</p> 	<p>&T910</p> <p>GOMITO RIDOTTO Ghisa 90° Fig. 90R Ø F. - Ø F.</p> <p>91011051 - Ø F. 1/2" - 3/8" - - conf. 10 - € 2,80 91011052 - Ø F. 3/4" - 1/2" - - conf. 10 - € 3,20 91011053 - Ø F. 1" - 3/4" - - conf. 10 - € 4,80</p> 
<p>&T910</p> <p>GOMITO Ghisa 90° Femmina / Femmina Fig. 90</p> <p>91011061 - Ø 3/8" - - conf. 10 - € 2,20 91011062 - Ø 1/2" - - conf. 10 - € 1,42 91011063 - Ø 3/4" - - conf. 10 - € 2,40 91011064 - Ø 1" - - conf. 10 - € 3,40 91011065 - Ø 1 3/4" - - conf. 5 - € 6,40 <i>segue...</i></p> 	<p>&T910</p> <p><i>continua...</i> 91011066 - Ø 1 1/4" - - conf. 5 - € 10,20 91011067 - Ø 2" - - conf. 5 - € 12,00</p> 
<p>&T910</p> <p>NIPPLIO Ghisa Fig. 280</p> <p>91011041 - Ø 3/8" - - conf. 10 - € 2,80 91011042 - Ø 1/2" - - conf. 10 - € 1,46 91011043 - Ø 3/4" - - conf. 10 - € 1,88 91011044 - Ø 1" - - conf. 10 - € 2,80 91011045 - Ø 1 3/4" - - conf. 5 - € 4,60 <i>segue...</i></p> 	<p>&T910</p> <p><i>continua...</i> 91011046 - Ø 1 1/4" - - conf. 5 - € 5,40 91011047 - Ø 2" - - conf. 5 - € 9,60</p> 
<p>&T910</p> <p>"T" UGUALI Ghisa Fig. 130</p> <p>91011091 - Ø 3/8" - - conf. 10 - € 3,00 91011092 - Ø 1/2" - - conf. 10 - € 1,90 91011093 - Ø 3/4" - - conf. 10 - € 3,40 91011094 - Ø 1" - - conf. 5 - € 5,00 91011095 - Ø 1 3/4" - - conf. 5 - € 8,60 91011096 - Ø 1 1/4" - - conf. 2 - € 13,40</p> 	<p>&T910</p> <p>TAPPO MASCHIO Ghisa Fig. 290</p> <p>91011031 - Ø 3/8" - - conf. 10 - € 1,14 91011032 - Ø 1/2" - - conf. 10 - € 1,14 91011033 - Ø 3/4" - - conf. 10 - € 1,54 91011034 - Ø 1" - - conf. 10 - € 1,70 91011035 - Ø 1 3/4" - - conf. 5 - € 3,40 <i>segue...</i></p> 



<p>&M 910</p> <p>continua... 91011036 - Ø 1 1/4" - - conf. 5 - € 4,00 91011037 - Ø 2" - - conf. 5 - € 7,00</p> 	<p>&M 910</p> <p>TUBO CARICO lavatrice</p> <p>91014101 - Misura 150 cm - - conf. 5 - € 3,20 91014105 - Misura 200 cm - - conf. 5 - € 4,00</p> 
<p>&M 910</p> <p>TUBO SCARICO lavatrice</p> <p>91014111 - Misura 150 cm - - conf. 5 - € 4,00 91014115 - Misura 200 cm - - conf. 5 - € 4,60</p> 	<p>&M 910</p> <p>TUBO GAS 1/2" EN 14800 acciaio INOX AISI316L rivestimento protettivo A NORMATIVA DI LEGGE</p> <p>91015619 - Art. M - F - Lungh. 1000 - - conf. 1 - € 20,80 91015620 - Art. F - F - Lungh. 1000 - - conf. 1 - € 21,40 91015623 - Art. M - F - Lungh. 1500 - - conf. 1 - € 24,80 91015624 - Art. F - F - Lungh. 1500 - - conf. 1 - € 24,80 91015625 - Art. M - F - Lungh. 2000 - - conf. 1 - € 26,40 segue...</p> 
<p>&M 910</p> <p>continua... 91015626 - Art. F - F - Lungh. 2000 - - conf. 1 - € 26,40 91015627 - Art. F - F - Lungh. 3000 - - conf. 1 - € 45,20 91015628 - Art. F - F - Lungh. 4000 - - conf. 1 - € 58,40</p> 	<p>&M 910</p> <p>NASTRO TEFLON ALTA QUALITA Lungh. 12 mt Largh. 12 mm Spess. 0,076 mm</p> <p>91012300 - - conf. 10 - € 0,48</p> 
<p>&M 910</p> <p>NASTRO TEFLON GAS ALTA QUALITA Lungh. 15 mt Largh. 19 mm Spess. 0,20 mm</p> <p>91012301 - - conf. 60 - € 3,00</p> 	<p>Beta</p> <p>UTENSILE SBAVATUBI BETA ART. 345 Corpo in metallo</p> <p>200003450001 - Ø mm - " 3+42 1/8" ÷ 1" 5/8 - L 58 - - conf. 5 - € 28,90</p> 
<p></p> <p>TAGLIATUBO da 1/8" a 1" 1/8 misura 28 mm Per tubi di rame, ottone, plastica e ferro</p> <p>74032800 - - conf. 1 - € 25,20</p> 	<p></p> <p>TAGLIATUBO da 1/8 a 5/8 misura 16 mm Per tubi di rame, ottone, plastica e ferro</p> <p>74031600 - - conf. 1 - € 16,20</p> 
<p></p> <p>TAGLIATUBO da 1/8 a 1" 1/4 misura 32 mm Per tubi di rame, ottone, plastica e ferro</p> <p>74033200 - - conf. 1 - € 26,40</p> 	<p>&M 540</p> <p>PINZA SOTTOLAVELLO Lunghezza asta 25 cm Placchetta appendibile</p> <p>540301000000 - - conf. 1 - € 20,00</p> 



<p>540</p> <p>PINZA RUBINETTI Lunghezza 25 cm</p> <p>540300990000 - - conf. 1 - € 20,00</p> 	<p>ROTELLA di ricambio Universale</p> <p>74033300 - - conf. 10 - € 2,20</p> 
<p>ROTELLA di ricambio per tagliatubi art. 33250</p> <p>74033350 - - conf. 10 - € 6,60</p> 	<p>FRESA Sedi rubinetti 3/8" - 1/2"</p> <p>74021200 - - conf. 2 - € 9,80</p> 
<p>GIEFFE gruppi generali ferramenta</p> <p>STURALAVANDINI A POMPA 430 mm</p> <p>512620070N - - conf. 1 - € 6,39</p> 	<p>GIEFFE gruppi generali ferramenta</p> <p>STURALAVANDINO Indicato per rimuovere ostruzioni dagli scarichi delle docce, lavandini e vasche</p> <p>512620020N - Metri 3,5 - - conf. 1 - € 3,75 512620030N - Metri 5 - - conf. 1 - € 5,15 512620050N - Metri 10 - - conf. 1 - € 10,09</p> 

TERMINI E CONDIZIONI GENERALI DI VENDITA DI MALFATTI & TACCHINI S.r.l.

1. DISPOSIZIONI GENERALI

Malfatti & Tacchini S.r.l. è una società che opera nella commercializzazione di macchine utensili, accessori ed articoli da ferramenta sia di proprio marchio che di altre case produttrici. Le presenti Condizioni, qui di seguito riportate si applicano a tutti i contratti stipulati tra M&T ed i propri Clienti in base ai quali M&T fornisce ai Clienti i prodotti dalla stessa commercializzati.

Qualsiasi accordo integrativo o modificativo delle presenti Condizioni o qualsiasi dichiarazione rilasciata da dipendenti di M&T non avrà efficacia senza conferma scritta rilasciata dal legale rappresentante di M&T o procuratore della stessa munito di idonei poteri

2. INTERPRETAZIONE

2.1. Salvo che il contesto e le circostanze indichino con evidenza altrimenti, si considera che, nelle presenti Condizioni, le seguenti parole e concetti abbiano unicamente i significati di seguito riportati:

M&T: MALFATTI & TACCHINI S.r.l. società con sede in Via Giancarlo Puecher 1 - 20037 Paderno Dugnano (MI), P.IVA 00740240155.

Cliente: società o ditta o altro ente che acquista i prodotti da M&T.

Prodotto/i: i beni prodotti, assemblati, venduti e/o distribuiti da M&T.

Giorno Lavorativo: giorno (diverso da sabato, domenica o festività nazionali) in cui le banche sono aperte al pubblico a Milano.

Ordine: l'ordine del Cliente per l'acquisto dei Prodotti contenuto nel modulo di ordine di acquisto del Cliente o risultante dall'accettazione scritta da parte del Cliente del preventivo di M&T.

Vendita/e: ciascun contratto di vendita concluso tra M&T ed il Cliente, anche tramite rappresentante (ove quest'ultimo sia a ciò facoltizzato per iscritto).

Condizioni: termini e condizioni stabilite in questo documento come modificate nella versione di tempo in tempo vigente.

Contratto: il contratto tra M&T e i suoi Clienti ed i suoi allegati avente ad oggetto la vendita e l'acquisto dei Prodotti.

Catalogo: volume illustrativo dei prodotti M&T.

Evento di Forza Maggiore: avrà il significato indicato nell'articolo 12.

Specifiche: qualsiasi specifica di natura tecnica o relativa all'esecuzione dell'ordine d'acquisto dei Prodotti ulteriore rispetto al catalogo, pattuita per iscritto tra il Cliente e M & T.

Resi: tutti i Prodotti e le merci restituiti mediante la procedura prevista da M&T.

Diritti di proprietà intellettuale: tutti i diritti di proprietà intellettuale ed industriale di M&T, ivi inclusi, senza limitazione alcuna, i diritti relativi ai brevetti per invenzioni, disegni o modelli, modelli di utilità, marchi, loghi, know how, specifiche tecniche, dati, siano stati tali diritti registrati o meno, nonché qualsivoglia domanda o registrazione relativa a tali diritti ed ogni altro diritto o forma di protezione di natura simile o avente effetto equivalente.

3. PRODOTTI

3.1. I Prodotti sono quelli descritti nel catalogo di M&T di tempo in tempo in vigore.

I pesi, le dimensioni, i prezzi, i colori e qualsiasi altra caratteristica e dato, anche di carattere figurativo inseriti nel catalogo, nei listini, nei prospetti, illustrazioni, locandine, offerte nel materiale pubblicitario in genere e/o altri documenti illustrativi di M&T, hanno carattere di indicazioni approssimative e non sono in ogni caso impegnative per M&T.

3.2. I Prodotti potranno essere modificati solo a seguito di Specifica che potrà essere contenuta nel preventivo di M&T o nella conferma d'Ordine ed accettata rispettivamente da M&T stessa o dal Cliente.

3.3. M&T si riserva il diritto di modificare i dati tecnici e costruttivi dei Prodotti in qualsiasi momento e senza obbligo di preavviso al Cliente, ove ciò sia richiesto da qualsiasi applicabile normativa di legge o di regolamento, anche locale, oppure, qualora i Beni siano forniti in conformità ad una Specifica definita da M&T che non incide in modo rilevante sulla loro qualità e rendimento, anche se il Contratto è già stato concluso, definendo diversa Specifica.

3.4. M&T non è tenuta in ogni caso ad apportare alle merci destinate al cliente e già prodotte, o in corso di produzione, le modifiche che siano intervenute successivamente all'ordine.

3.5. Alcuni Prodotti possono essere forniti in imballaggi multipli e in tal caso il Cliente dovrà ordinare i Prodotti in multipli corrispondenti alla dimensione degli imballaggi, come sarà indicata da M&T.

3.6. Il Cliente prende atto che alcuni Prodotti possono richiedere particolare attenzione e vanno adeguatamente custoditi o utilizzati assumendo appropriate precauzioni. Il Cliente si impegna a eliminare o comunque a ridurre al minimo possibile qualsiasi rischio alla salute o sicurezza che possa derivare dai Prodotti anche in assenza di segnalazione espressa di tali rischi da parte di M&T.

4. PREZZI E CONDIZIONI DI PAGAMENTO

4.1. Il prezzo è espresso in Euro ed il prezzo per ogni singolo prodotto è quello indicato nel Catalogo ed è meramente indicativo e potrà pertanto, subire variazioni senza necessità di preventiva informazione al Cliente.

4.2. Salvo diverso accordo scritto tra le parti, la merce sarà fatturata ai prezzi in vigore al momento dell'ordine.

4.3. I prezzi si intendono al netto di Iva, di eventuali imposte e tasse, nonché di tributi, diritti ed oneri fiscali di qualsivoglia specie eventualmente gravanti sul contratto, che restano a carico esclusivo del Cliente.

4.4. Il costo dell'imballaggio è incluso nel prezzo, mentre il costo della spedizione è sempre escluso.

4.5. M&T emetterà fattura a carico del Cliente, contestualmente alla messa a disposizione dei Prodotti al vettore.

4.6. Salvo diverso accordo scritto, il Cliente pagherà la fattura integralmente e con fondi disponibili a M&T entro i termini indicati di volta in volta nella fattura stessa. Il pagamento sarà fatto sul conto corrente bancario indicato per iscritto da M&T. Il termine di pagamento è essenziale.

4.7. In caso di mancato, parziale, ritardato pagamento, fatti salvi gli ulteriori diritti di M&T, su tutte le somme impagate matureranno interessi moratori nella misura di cui al D.lgs 231/2002. E ciò automaticamente e senza necessità di diffida o messa in mora. In aggiunta, M&T avrà il diritto di sospendere la consegna dei Prodotti e di trattenerli in tutto o in parte come

stabilito dall'art. 6.4.. E ciò con riferimento a tutti i contratti in essere tra il Cliente e M&T.

4.8. Il Cliente pagherà qualsiasi somma dovuta ai sensi del Contratto integralmente senza alcuna compensazione, contropotesa, deduzione o trattenuta (fatte salve le deduzioni o trattenute previste dalla legge). M&T potrà in ogni momento, senza pregiudizio di qualsiasi altro diritto alla stessa spettante, compensare anche in via volontaria qualsiasi somma alla stessa dovuta dal Cliente.

5. ORDINI – ACCETTAZIONE E CONFERMA D'ORDINE

5.1. L'Ordine costituisce una proposta di acquisto dei Prodotti in conformità alle presenti Condizioni, che si intendono pertanto lette ed approvate dal Cliente con la trasmissione dell'ordine stesso.

5.2. Il Cliente è tenuto ad assicurare che i dati dell'Ordine e di ogni Specifica applicabile siano completi ed accurati. Nell'ordine deve in particolare essere specificato il codice dell'articolo e le relative quantità. Le quantità minime d'ordine per ciascun prodotto sono indicate nel Catalogo. Ordini non corrispondenti ad esse, o ai loro multipli, verranno automaticamente adeguate da M&T, senza necessità di previa autorizzazione del Cliente.

5.3. Salvo che non sia diversamente pattuito tra le parti, l'ordine deve ritenersi irrevocabile ai sensi e per gli effetti dell'art. 1331 c.c..

5.4. M&T non avrà alcun obbligo di accettare qualsiasi Ordine. L'Ordine si intenderà accettato solamente quando M&T emetterà per iscritto una dichiarazione di conferma dell'accettazione dell'ordine o per fatti concludenti mediante l'esecuzione da parte di M&T dell'Ordine stesso con consegna anche parziale al vettore.

Solo allora il Contratto verrà in esistenza. Nessun Ordine accettato da M&T potrà essere modificato o revocato dal Cliente salvo consenso scritto di M&T. Il Cliente risponderà pienamente nei confronti di M&T per ogni perdita (incluso lucro cessante), costo (incluso il costo del lavoro e dei materiali impiegati), danno, onere e spesa subito o sostenuto da M&T in conseguenza di detta modifica o revoca.

5.5. Fatto salvo quanto al successivo art. 6.6., le tempistiche di evasione dell'Ordine saranno indicate da M&T nella conferma d'Ordine o nel preventivo sottoposto al Cliente.

5.6. Il Contratto costituisce l'intero accordo tra le parti. Il Cliente riconosce fin da ora che non ha fatto e non farà affidamento su qualsiasi dichiarazione, promessa, rappresentazione, assicurazione o garanzia fatta da M&T, o per conto della stessa, che non sia contenuta nel Contratto.

5.7. Campioni, disegni, descrizioni, materiali pubblicitari prodotti da M&T così come ogni descrizione o illustrazione contenuta in cataloghi o brochures hanno la funzione ed il solo scopo di dare una idea approssimativa dei Prodotti negli stessi descritti. Pertanto, gli stessi non formeranno parte del Contratto, né avranno alcuna valenza contrattuale.

5.8. E' espressamente esclusa la facoltà del Cliente di recedere unilateralmente dall'ordine confermato da M&T e comunque dalla Vendita. In caso di revoca, da parte del Cliente dell'ordine confermato da M&T, egli è tenuto in ogni caso a pagare integralmente l'importo relativo ai Prodotti.

5.9. Un preventivo per i Prodotti fornito da M&T non costituirà una offerta. Un preventivo sarà valido solo per un periodo di 30 giorni dalla sua data di emissione, ferma restando

la facoltà di M&T di revocarlo in ogni momento, in particolare nel caso di errori, omissioni o mancanze nelle informazioni fornite dal Cliente.

6. CONSEGNA DEI PRODOTTI E TERMINI DI CONSEGNA

6.1. Le spese di trasporto e spedizione sono a completo carico del Cliente

6.2. M&T si riserva di scegliere il vettore al quale non è tenuto di norma comunicare il valore della merce.

6.3. M&T assicura che:

(a) ogni consegna di Prodotti sarà accompagnata da un documento di trasporto che evidenzierà la data dell'ordine, tutti i dati identificativi del Cliente, di M&T e dell'Ordine, il tipo e la quantità dei Prodotti, istruzioni speciali per la loro custodia, se esistenti, e, qualora l'ordine venga consegnato frazionatamente, il bilancio dei Prodotti ancora da consegnare;

(b) se M&T richiederà al Cliente di restituire alla stessa qualsiasi materiale di imballaggio, ciò sarà chiaramente indicato nel documento di trasporto. Il Cliente renderà detti imballaggi disponibili per il ritiro entro il termine che M&T potrà ragionevolmente chiedere. La restituzione degli imballaggi avverrà a spese di M&T.

6.4. Salvo diverso accordo tra il Cliente e M&T, i Beni saranno consegnati al vettore presso i magazzini o altro luogo determinato da M&T ed inviati al Cliente, con destinazione il luogo di consegna indicato dal Cliente. Salvo quanto diversamente specificato nelle Condizioni, la spedizione sarà regolata secondo le previsioni Incoterms 2010 FCA.

La spedizione avverrà in qualsiasi momento successivo alla data convenuta tra il Cliente e M&T o alla data in cui M&T comunicherà al Cliente che i Prodotti sono pronti.

M&T si riserva il diritto di bloccare la consegna dei Prodotti, anche se già consegnati al vettore, e di trattenere in tutto o in parte i beni stessi qualora il Cliente si renda inadempiente a qualsiasi obbligo di pagamento a favore di M&T alla relativa scadenza o si renda inadempiente di altre obbligazioni nei confronti di M&T, anche con riferimento a contratti differenti da quello che ha ad oggetto i Prodotti interessati dalla consegna.

6.5. La consegna dei Prodotti sarà perfezionata con il completamento della presa in carico dei Prodotti stessi da parte del vettore.

6.6. Qualsiasi data convenuta tra M&T e il Cliente per la consegna è puramente indicativa ed il termine di consegna non è essenziale.

M&T non sarà responsabile per qualsiasi ritardo nella consegna dei Prodotti o mancata consegna dei prodotti stessi che sia causato da Evento di Forza Maggiore o della mancata fornitura da parte del Cliente di adeguate istruzioni per la consegna o di qualsiasi altra istruzione che sia rilevante ai fini della fornitura dei Prodotti.

6.7. Qualora M&T non consegni in via definitiva i Prodotti, la sua responsabilità sarà limitata ai costi e alle spese sostenute dal Cliente per ottenere Prodotti sostitutivi di descrizione e di qualità simile al più basso prezzo di mercato disponibile detratto il prezzo dei Prodotti.

6.8. La spedizione dei Prodotti, così come l'eventuale conferma d'ordine sono comunque subordinate ad ordini effettuati per un importo minimo di Euro 150,00.

7. GARANZIE SUI PRODOTTI

7.1. Tutti i Prodotti M&T sono coperti da garanzia della casa produttrice e dotati di tutte le certificazioni e conformità tecniche necessarie per legge.

Tale garanzia è limitata nel tempo ed opera in relazione all'oggetto venduto, escludendo ogni altra prestazione così come ogni indennizzo e/o risarcimento.

Tale garanzia si applicherà al prodotto che presenti difetti e/o malfunzionamenti non riscontrabili al momento dell'acquisto, purchè il prodotto stesso sia utilizzato correttamente e con la dovuta diligenza e cioè nel rispetto della sua destinazione e di quanto previsto nella eventuale documentazione tecnica, con osservanza puntuale della funzione d'uso propria come descritta nei manuali.

7.2. Le denunce dei vizi devono pervenire per iscritto a M&T entro 8 (otto) giorni da quello di ricevimento della merce.

7.3. M&T farà fronte alla garanzia a propria insindacabile scelta o mediante fornitura sostitutiva o mediante eliminazione dei vizi denunciati o mediante rimborso del prezzo dei Prodotti.

7.4. Il Cliente ha l'obbligo, al momento della ricezione dei prodotti di verificare l'integrità degli stessi e di segnalare sul documento di trasporto eventuali vizi palesi, rotture nell'imballaggio e ogni e qualunque ulteriore circostanza che possa aver danneggiato i Prodotti o pregiudicato il loro esatto funzionamento. La mancata contestazione all'atto della consegna di quanto sopra, farà automaticamente venire meno il diritto di garanzia del Cliente con riferimento a quanto non contestato.

7.5. M&T non sarà tenuta alla garanzia stabilita all'articolo 7.1. nei seguenti casi:

- (a) se il Cliente che effettuata la comunicazione di cui all'articolo 7.2. fa ulteriore uso dei Prodotti;
- (b) se il vizio è risultato dalla mancata osservanza da parte del Cliente di istruzioni scritte o orali di M&T relative alla custodia, installazione, uso e manutenzione dei Prodotti o (se non ve ne sono) delle normali regole di diligenza;
- (c) se il Cliente altera o ripara direttamente i Prodotti senza il consenso scritto di M&T;
- (d) se il vizio deriva dalla normale usura, da danno causato dolosamente o per colpa, negligenza, o custodia o condizioni di lavoro anomali;
- (e) ove terzi, non autorizzati da M&T, siano intervenuti sui Prodotti;

Sono altresì escluse dalla garanzia le forniture di prodotti consumabili, le parti di ricambio fornite anche successivamente o indipendentemente dai Prodotti.

7.6. Qualora M&T stabilisca che i Prodotti per i quali il Cliente ha richiesto la garanzia non sono coperti dalla garanzia stessa, il Cliente rimborserà a M&T tutti i costi sostenuti per indagare sulla richiesta del Cliente e darvi risposta, costi che saranno addebitati sulla base di quelli sostenuti da M&T per la manodopera, i materiali e le ulteriori spese che si saranno resi necessari per le verifiche in ordine alla richiesta di garanzia.

7.6. Fatta eccezione che per gli usi espressamente dichiarati sull'etichetta dei Prodotti, M&T non garantisce che i Prodotti siano adatti a qualsiasi particolare scopo o uso inteso dal Cliente ed è onere del Cliente accettarsi che i Prodotti siano idonei a tale uso.

7.7. Nonostante quanto precede, i Beni forniti da M&T che siano stati acquistati da parte di M&T da un terzo produttore o fornitore non sono coperti da garanzia da parte di M&T, la quale si impegna a cedere al Cliente esclusivamente i diritti di garanzia

ad essa concessi dal terzo produttore o fornitore e purchè detta cessione sia dagli stessi consentita.

8. RESI

8.1. Eventuali resi dei Prodotti potranno essere richiesti nei seguenti casi:

- (a) per prodotti non conformi all'ordinato;
- (b) per errore dell'agente di zona di M&T nell'individuazione del Prodotto;

8.2. Il Cliente, nell'ipotesi in cui intenda effettuare resi di Prodotti dovrà, entro 8 giorni dalla consegna degli stessi, avvisare M&T inviando alla stessa entro il suddetto termine, il modulo resi scaricabile dal sito internet, in cui dovrà essere puntualmente indicato la causale del reso e l'indicazione della fattura di acquisto.

I suddetti resi dovranno essere inviati a M&T, nell'imballo originale.

8.4. Eventuali resi di prodotti verranno in ogni caso accettati da M&T solo se preventivamente concordati ed autorizzati da M&T stessa per iscritto e le relative spese sono interamente a carico del cliente. Effettuato il controllo qualità della casa produttrice, M&T provvederà alla spedizione del prodotto sostituiti e/o riparato.

I resi comunque non autorizzati e/o effettuati con modalità diverse rispetto a quelle concordate non saranno accettati da M&T e saranno restituiti al Cliente mediante spedizione a sue spese.

Non saranno comunque accettati resi di prodotti danneggiati, alterati e/o modificati, parziali e/o fuori catalogo, ordinati appositamente tramite M&T.

9. TRASFERIMENTO DEL RISCHIO DI PERDITA DEI PRODOTTI E RISERVA DI PROPRIETA

9.1. Fermo restando il diritto di M&T di bloccare la consegna dei beni di cui al precedente art. 6.4., il rischio della perdita dei Prodotti si trasferisce a carico del Cliente alla consegna dei Beni al vettore.

9.2. Qualora la spedizione venga ritardata su richiesta del Cliente, il rischio relativo alla merce si trasferisce al Cliente sin dal giorno in cui i Prodotti erano pronti per la spedizione. Nel caso il Cliente rispedisca, per qualsiasi ragione, i Beni oggetto della fornitura a M&T, tutti i costi e i rischi di tale spedizione saranno a carico del Cliente. Lo stesso per i rischi per danni da rotture, trasporto, furto, incendio e rapina, che sono a carico del Cliente, sin dal giorno in cui i Beni erano pronta per la consegna.

9.3. Se il Cliente non provvede al pagamento dei Beni nei termini di cui alla clausola 4.6, M&T potrà in qualsiasi momento richiedere al Cliente, a spese del Cliente, di restituirgli tutti i Prodotti suo possesso che non siano stati rivendicati o incorporati irrevocabilmente in altri prodotti.

10. RISOLUZIONE

10.1. M&T potrà risolvere il Contratto, ai sensi dell'Articolo 1456 del Codice Civile, con effetto immediato e senza alcun obbligo di rispettare un termine, mediante semplice invio al Cliente di raccomandata A/R, qualora si verifichi anche una sola delle seguenti condizioni:

- (a) mancato, parziale, ritardato pagamento di ogni e qualunque somma dovuta dal Cliente a M&T in relazione alle obbligazioni assunte dal Cliente stesso nei confronti di M&T;
- (b) Inadempimento da parte del Cliente delle obbligazioni di cui agli artt. 3.6, 12.1, 12.2;

(c) se il Cliente diventa insolvente, fallisce, è sottoposto a procedura concorsuale, gli viene nominato un amministratore giudiziale, un curatore o un commissario, o sia anche solo proposta una istanza o avviato un procedimento in tal senso;

(d) se il Cliente avvia una negoziazione con tutti o parte dei propri creditori per riscadenziare o ristrutturare i propri debiti o faccia una proposta al fine di ottenere, oppure raggiunga, un concordato o una composizione con i propri creditori;

(e) se il Cliente entra in liquidazione o è proposta una istanza, adottata una delibera o emesso un provvedimento che siano finalizzati alla messa in liquidazione del Cliente;

(f) se un creditore o titolare di diritti di garanzia sottopone a pignoramento o sequestro tutti o parte dei beni del debitore o sia avviato un procedimento per ottenere tali misure;

(g) se si verifica un evento o un procedimento relativamente al Cliente che ai sensi di qualsiasi legge applicabile abbia effetto equivalente o simile a quelli sopra menzionati;

(h) se il Cliente sospende o cessa o intende sospendere o cessare tutta o una parte essenziale della sua attività; -

(i) se la situazione finanziaria del Cliente si deteriora a tal punto da mettere in dubbio la sua capacità di adempiere adeguatamente alle obbligazioni derivanti dal Contratto;

(l) se viene modificata, anche parzialmente, la proprietà del capitale sociale del Cliente.

10.2. La risoluzione del Contratto, a norma del precedente art. 10.1, comporterà l'automatica risoluzione contestuale di tutti i singoli contratti stipulati tra M&T ed il Cliente comunque in essere. Così pure la risoluzione per fatto e colpa del Cliente di un singolo contratto in essere tra M&T e il Cliente comporterà la risoluzione del Contratto e di tutti gli ulteriori contratti in essere tra M&T e il cliente. M&T, potrà peraltro escludere dalla risoluzione specifici contratti comunicando l'eccezione nella lettera di risoluzione inviata al Cliente.

10.3. Senza pregiudizio di altri diritti o rimedi, M&T, anche ai sensi dell'art. 1460 e 1461 c.c., potrà sospendere la fornitura dei Prodotti ai sensi del Contratto o di qualsiasi altro contratto vigente tra M&T e il Cliente se si verifica qualunque caso di inadempimento da parte del Cliente alle obbligazioni assunte oppure le condizioni patrimoniali del Cliente siano diventate tali da porre in pericolo il conseguimento da parte di M&T della controprestazione.

10.4. Alla cessazione del Contratto per qualsiasi ragione o causa, il Cliente pagherà immediatamente a M&T tutte le fatture insolute con gli interessi.

10.5. Gli articoli del Contratto e delle presenti Condizioni che per richiamo espresso, formulazione, senso o contesto sono intesi come destinate a sopravvivere alla risoluzione o cessazione del Contratto continueranno ad avere piena applicazione anche a seguito della cessazione.

11. FORZA MAGGIORE

Nessuna parte sarà responsabile del mancato o ritardato adempimento delle sue obbligazioni ai sensi del Contratto e delle presenti Condizioni se l'inadempimento o il ritardo sono causati da un Evento di Forza Maggiore. Evento di Forza Maggiore è un evento al di fuori del ragionevole controllo della parte e per sua natura imprevedibile o se prevedibile inevitabile, inclusi scioperi, serrate, vertenze lavoristiche (relative alla propria forza lavoro o a quella di terzi), venire meno di fonti energetiche o di trasporti pubblici, atti di Dio, guerra, tumulto, terrorismo, rivolte, interventi di autorità militari o civili, calamità nazionali o internazionali, conflitto armato, contaminazione nucleare

chimica, biologica, boom sonici, esplosioni, collasso di edifici, incendi, alluvioni tempeste, terremoti, naufragi, epidemie o simili eventi, disastri naturali o estreme condizioni meteorologiche avverse, incendio, esplosione, atto doloso di terzi, fallimento di fornitori o subcontraenti. La Parte che desideri avvalersi dell'esenzione di responsabilità per alcuna dei tali circostanze dovrà comunicare all'altra parte senza ritardo il verificarsi della circostanza e la sua cessazione.

12. DISPOSIZIONI GENERALI

12.1. Sarà obbligo del Cliente ottenere e mantenere a proprie spese qualsiasi autorizzazione governativa, consenso, approvazione, registrazione, permesso e licenze di autorità competente per l'esportazione e l'importazione dei Prodotti nonché per il loro commercio, deposito e manutenzione.

12.2. Cessioni e trasferimenti di diritti

(a) M&T può cedere, trasferire, dare in pegno, subappaltare, o disporre in qualsiasi altro modo di tutti i suoi diritti ed obblighi derivanti dal presente Contratto. Il Cliente si impegna a compiere ogni attività e firmare ogni documento che fosse necessario al fine di garantire a M&T l'esercizio dei propri diritti nascenti dal presente articolo

(b) Il Cliente non può cedere, trasferire, dare in pegno, subappaltare o disporre in qualsiasi altro modo dei suoi diritti ed obblighi derivanti dal presente Contratto senza il preventivo consenso scritto di M&T.

12.3. Qualsiasi comunicazione data a una parte ai sensi di o in connessione al presente contratto richiederà la forma scritta e dovrà essere indirizzata, per quanto riguarda M&T, in Via Giancarlo Puecher 1 - 20037 Paderno Dugnano (MI), quanto al Cliente, alla sede legale o amministrativa dello stesso o al diverso indirizzo che lo stesso specificherà per iscritto a M&T con espresso riferimento al presente articolo delle Condizioni. Ogni comunicazione tra le parti dovrà essere inviata per posta elettronica certificata (PEC) o raccomandata con avviso di ricevimento.

12.4. (a) Se una qualsiasi delle previsioni del Contratto o delle Condizioni o singole parti delle stesse fosse o divenisse invalida o priva di efficacia, la stessa si intenderà modificata nella stretta misura necessaria a renderla valida ed efficace; se detta modifica non fosse possibile la previsione o la sua parte oggetto di invalidità o inefficacia si considererà come non apposta. La validità delle restanti previsioni del Contratto e delle Condizioni non sarà pregiudicata da detta cancellazione o modifica.

(b) Se una qualsiasi delle previsioni del Contratto o una sua parte fosse o divenisse invalida o priva di efficacia, le parti negozieranno in buona fede una modifica di detta previsione che sia valida ed efficace e si avvicini il più possibile allo scopo commerciale della previsione originale.

12.5. Qualsiasi rinuncia a diritti o rimedi derivanti dal Contratto o dalle Condizioni, sarà valida ed efficace solo se effettuata per iscritto e non varrà come rinuncia per qualsiasi violazione od inadempimento successivo. L'omissione o il ritardo nel fare valere un diritto o rimedio previsto dal Contratto o dalle Condizioni o dalla legge non rappresenterà una rinuncia a tale diritto o rimedio, nè impedirà o limiterà l'ulteriore esercizio di tale diritto o rimedio. L'esercizio in un caso singolo o in modo parziale di un diritto o rimedio non impedirà né limiterà l'ulteriore esercizio di detto o ulteriore diritto o rimedio.

12.6. Fatta salva diversa previsione delle presenti Condizioni, nessuna modifica del Contratto o delle Condizioni, inclusa l'introduzione di termini e condizioni aggiuntive sarà valida se

non è fatta in forma scritta e sottoscritta da M&T.

13. LEGGE APPLICABILE E FORO ESCLUSIVAMENTE COMPETENTE

13.1. Il Contratto, le Condizioni o qualsiasi disputa e controversia dagli stessi derivanti o connessi, anche relative al loro oggetto, la loro formazione e alla loro interpretazione, incluse le dispute o le rivendicazioni di natura non contrattuale, sono soggette alla legge italiana.

E' espressamente esclusa l'applicazione della Convenzione delle Nazioni Unite sui contratti di compravendita internazionale di merci.

13.2. Le parti convengono irrevocabilmente che qualsiasi disputa e controversia derivante da o connessa al presente Contratto o alle Condizioni, anche relative al loro oggetto, la loro formazione e alla loro interpretazione, incluse le dispute o le rivendicazioni di natura non contrattuale, sarà devoluta all'esclusiva competenza del Foro di Milano.

Ai sensi e per gli effetti degli artt. 1341 e 1342 c.c. il Cliente dichiara di aver fermato la propria particolare attenzione e di approvare specificamente le seguenti condizioni:

Art. 1) rinuncia del Cliente a ogni condizione di contratto diversa dalle Condizioni e necessità di conferma scritta di M&T per l'applicazione di accordi diversi dalle medesime; Art. 5.4.) mancanza dell'obbligo di M&T di accettare l'Ordine; Art. 5.9) non vincolatività dei preventivi.

Art. 3.3) diritto di M&T di modificare la Specifica.

Art. 6.4) trasferimento del rischio di spedizione e facoltà di M&T di sospendere o trattenere la stessa; Art. 6.6) non essenzialità dei termini di consegna e limitazione di responsabilità di M&T e dei rimedi dei rimedi esperibili dal Cliente in caso di ritardo nella consegna; Art. 6.7) limitazione dei rimedi esperibili dal Cliente.

Art. 7) limitazione dei rimedi esperibili dal Cliente e della garanzia e della responsabilità di M&T.

Art. 9) Trasferimento del rischio di perdita: obblighi del Cliente in caso di mancato pagamento a M&T.

Art. 4.1) Facoltà di modifica dei prezzi; Art. 4.4) deroga alle previsioni FCA relativi ai costi di imballaggio; Art. 4.6) Termine di pagamento essenziale; Art. 4.7) facoltà di M&T di sospendere e trattenere la consegna; Art. 4.8) limitazione della possibilità del Cliente di opporre eccezioni e diritto di automatica compensazione di M&T.

Art. 10.1-2) facoltà di M&T di risolvere il Contratto, le Condizioni e altri contratti con il Cliente; Art.10.3) facoltà di M&T di sospendere l'esecuzione di contratti con il Cliente.

Art. 13.1) Legge applicabile.

Art. 13.2) Esclusiva competenza del foro di Milano.

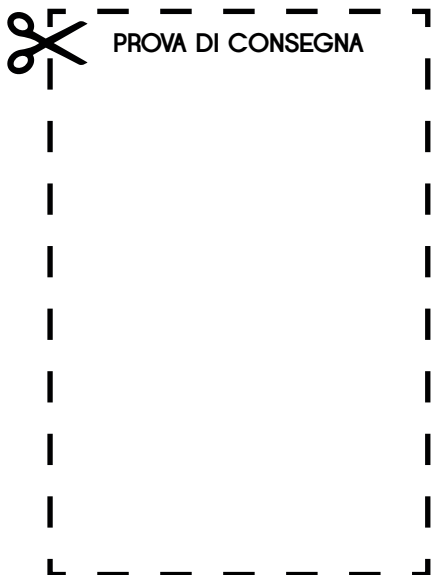



MalfattiTacchini



MalfattiTacchini



MalfattiTacchini



+39 3342993500



PADERNO DUGNANO VIA PUECHER 1 - 20037 (MI)
WWW.MALFATTITACCHINIGROUP.IT | MALFATTITACCHINI@TACCHINI.INFO | T. +39 02 6650 226 1/62

ART. 328232
PREZZO 25,00 €