

LABORATORY GRADE

REMOTE PROGRAMMING SWITCHING MODE DC regulated Power Supplies

SDP Series
SDP – 2210 / 2405 / 2603
User Manual



Table of Contents

1. Important Safety Instructions and Precautions For Use	1
2. Technical Specifications of SDP Series Power Supply	2
3. Introduction	2
4. Control and Indicators	3
5. General Operation Principle	4
5.1 Quick Reference of Keypad Functions	4
5.2 Quick Reference of The Timed and Preset Program	5
6. Operating Instructions	6
6.1 Setting of Operating Mode	7
6.1.1 Enable/Disable Output	7
6.1.2 Lock / Unlock the Keypad and Jog Dial	7
6.1.3 PC Interface RS-232//RS-485 Selection	7
6.1.4 Upper Voltage Limit Setting	8
6.1.5 Output Enable/Disable at Power Up	8
6.2 Basic Operation	8
6.2.1 Setting of Voltage and Current by Jog Dial and UP & DN Key	8
6.2.2 Setting of Voltage and Current Using Keypad	9
6.3 Using the Programming Features	9
6.3.1 Timed Programming	9
6.3.2 Running the Timed Program	11
6.3.3 Preset Programming	11
6.3.4 Selecting Preset	12
7. Maintenance	12
7.1 Recalibration	12
7.1.1 Introduction	12
7.1.2 Installation of calibration software	13
7.1.3 Operating Instructions	13
7.2 Trouble Shooting	13
7.3 In house calibration	13
8. PC Interface Control User Manual	13
8.1 Connect a Signal Power Supply to PC via RS-232	13
8.2 Connect Multiple Power Supply to PC via RS-485	14
8.3 PC Application Software	15
8.3.1 What the Application Software will DO	15
8.3.2 System Requirements	15
8.3.3 Installation of Software	15
8.4 Running the Application Software for RS-232 Interface	15
8.4.1 Start-up the Application Software for RS-232	15
8.4.2 General Operations	17
8.4.3 Data Logging and Setting Windows in Application Software	18
8.4.4 The Time Frame Concept of Data Log	20
8.4.5 Internal Timed Program	21
8.4.6 External Timed Program	22
8.4.7 Internal Preset Memory	23
8.5 Running the Application Software for RS-485 Interface	23
8.5.1 Multi Window Analysis	24
Appendices	
Appendix A -SDP Command Set	27
Appendix B -RS-232 cable and Connection Informations	33
Appendix C -Optional RS-232 to RS-485 Adapter ATR-2485 User Manual	35

All brand or trade names are trademarks or registered trademarks of their respective companies.

1. Important Safety Instructions and Precaution For Use

General Safety Instructions

- Do not use the unit near water.
- Do not install unit near heating sources and heating emitting devices.
- Clean only with dry cloth.
- Do not block the fan ventilation.
- Prevent the power cord from being walked and/or pinched.
- Unplug this unit when not use.
- Unplug this unit during lightning and storms.
- Do not open the cover of the unit during operation.
- Never replace components when the power cable is connected.
- Always disconnect power, discharge circuit and remove external voltage before touching components.
- Only use optional accessories with this unit.
- Please contact qualified service personnel for repair.

Supply Input Range

- The unit is of universal input : 100 - 240 VAC, 50Hz / 60Hz .

Fuses

- For protection of the unit, replace the fuse only with same type and rating of fuse.

Operating environment

The unit is advised be used within the following environment conditions:

- Because to use this unit within the specified ambient temperature range listed in the specification table.
- Because the unit is cooled by natural convection, do not place objects on top to block the convection. Also, user must not to place the unit on or rear any heat emitting devices or use multiple units in stacked configuration. For best result, use the unit in an environment that is as well cross-ventilated as possible.
- At 1KV of fast transient burst environment, the captioned model may have trouble in operation and require user reset.
- At 3V/m radiated immunity environment, the voltmeter may take a reading error +/-2V max. of the captioned model and back to normal operation without the interference.
- Altitude up to 2000M
- Installation category : CAT II
- Pollution degree : 2
- Indoor use only

Precautions For Use

1. The unit has a built-in Tracking O.V.P (Over voltage Protection) features. In the event of output voltage becoming 10% greater than the set value, the O.V.P. will be triggered and the output power will be cut off and >FAULT< warning appears.
When you get this warning , switch off the unit and remove all loading, switch the unit back on again and it should resume normal operation.
In the event this problem persists, the unit must be investigated by your agent.
2. This unit has a buzzer built inside. The buzzer will sound when over temperature/ overload/ over voltage has been triggered.
When you get this warning sound , switch off the unit and remove all loading.
Check your load and output settings.
Allow the unit to cool down for 30 minutes.
If you switch on the unit again, it should resume the normal operation.
In the event of this problem persists, the unit must be investigate by your agent.

Warning!

For Model SDP-2603, the maximum output voltage up to 60Vdc.
It may be hazards to touch metal part of the output terminals.
User must avoid touch live metal part of the output terminals.

2. Technical Specifications of SDP Series Power Supplies

Specifications

Models	SDP-2210	SDP-2405	SDP-2603
Output Voltage:	1-20VDC	1-40VDC	1-60VDC
Output Current:	0-10A	0-5A	0-3.3A
Rated Output Power:	200W		
Ripple & Noise (p-p):	30mVp-p		
Load Regulation:	300mV	200mV	150mV
Line Regulation:	10mV		
Input Voltage:	100 - 240 VAC, 50Hz / 60Hz		
Maximum Input Power:	285W		
Power Factor:	≥0.9		
Display Meter:	4 digits - display LCD Ammeter, Voltmeter and Power meter		
Meter's Accuracy:	(±1% + 5 counts for range V < 5V, I < 0.5A), (±1% + 2 counts for range V ≥ 5V, I ≥ 0.5A).		
LCD Dimension:	48 x 66 (mm)		
Cooling System:	Thermostatic Control Fan		
Operating Temperature:	0- 40°C		
Protection:	-Tracking OVP (Over Voltage Protection), -Current Limiting, -Over Temperature Protection.		
Approvals:	CE EMC -- EN 55011, CE LVD -- EN 61010		
Dimension (WxHxD):	193 x 98 x 215 (mm)		
Weight:	3kg		
Accessory:	-User's Manual, -PC Windows® software, Command Set, LabView® Driver, -RS-232 cable, RS-485 Connector and one 120ohms Resistor		
Optional Accessory:	-RS-232 to RS-485 Adapter ATR-2485		
Remarks:	-Adjustable Upper Voltage limit, -Power Factor Correction.		

Remote Programming Specifications

Communications Interface:	RS-232 (Single Power Supply), and RS-485 (up to 31 Power Supplies).
Remote Programming Functionality:	Full control of power supply functions and data read- back.
Data Logging:	Yes, with supplied software.
Baud Rate:	9600bps

3. Introduction

The SDP series of Programmable Switching Mode Power Supplies are designed for full remote programming with data logging functionality. Up to 31 power supplies can be connected via RS-485. It is ideal for applications which require various groups of output settings and running periods for repetitive tests especially with multiple power supplies.

The front panel allows users to all programming and output settings as a stand alone laboratory power supply.

Full command sets are given in this manual to facilitate the integration of your own control software.

This series of power supplies have obtained the safety approval EN-61010 and EN-55011 EMC approval for scientific , industrial equipment of the CE directives.

Please keep this manual in a safe place and contact your vendor for any special requirement in optional accessories for RS-485.

4. Controls and Indicators

Front Panel

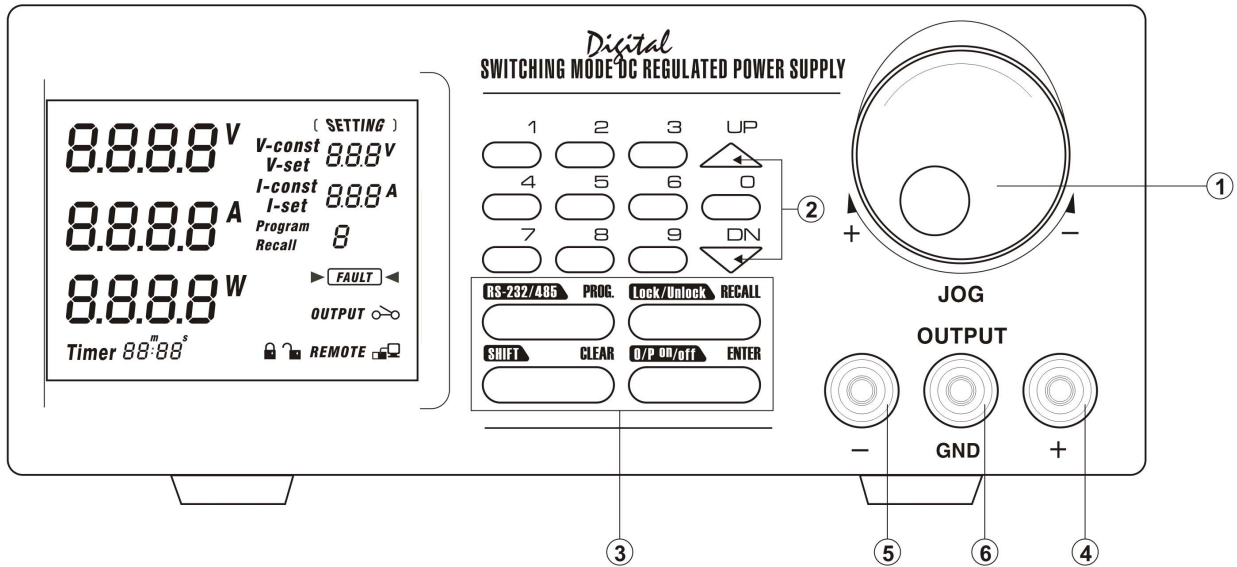

1. JOG DIAL
2. UP & DOWN KEY
3. DUAL FUNCTION CONTROL KEY
4. RED COLOR POSITIVE POLARITY OUTPUT TERMINAL
5. BLACK COLOR NEGATIVE POLARITY OUTPUT TERMINAL
6. GREEN COLOR GROUND TERMINAL (connected to chassis)

Rear Panel

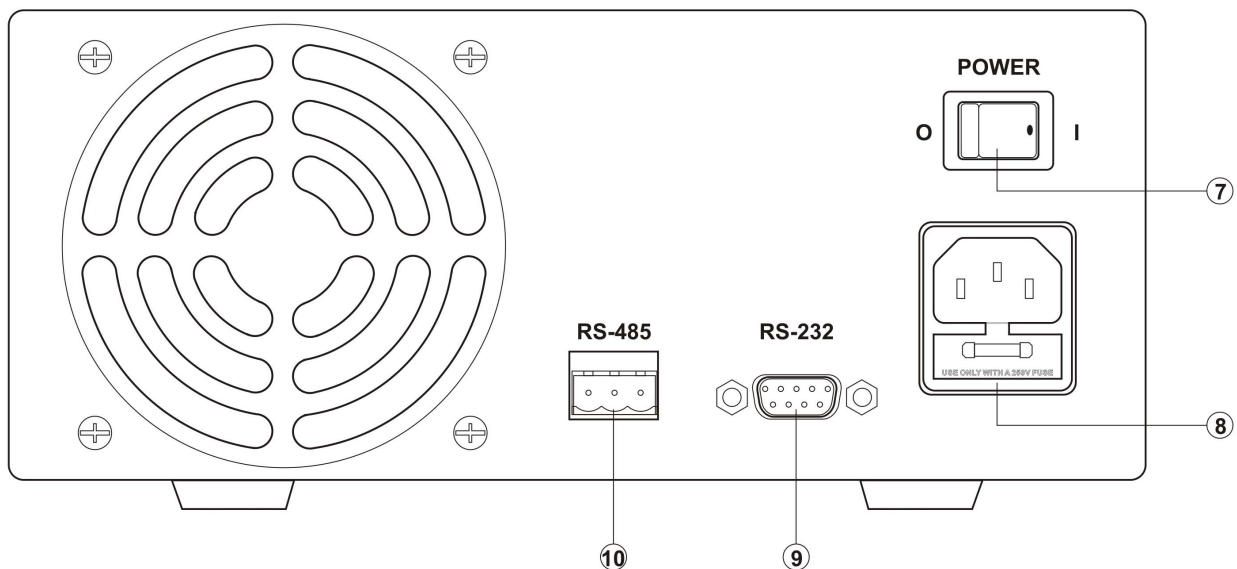

7. POWER SWITCH
8. AC 100-240VAC POWER SOCKET WITH INPUT POWER FUSE
9. RS-232 PORT
10. RS-485 PORT

5. General Operation Principle











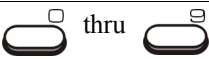



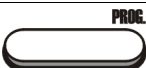
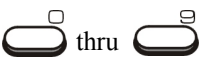







**NOTE: This section contains a condensed overview of the unit.
Read this section to quickly get started.**

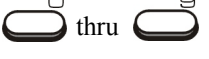





5.1 Quick Reference of Keypad Functions

The front Keypad is organised as follow:

- (1) Number Keys, UP/DOWN Keys and Jog Wheel
- (2) 4 Dual Function Control Keys

The front panel functions are summarized as follow:

Keypad	Function	Section
Number Keys, UP/DOWN Keys and Jog Wheel		
	Press to select numerical values	6.2.2
	Press to ascend the numerical values	6.2.1
	Press to descend the numerical values	6.2.1
Jog Wheel	Rotate to adjust the voltage and current settings	6.2.1
Dual Function Control Keys		
	Press to access alternate function of the control keys	
	Press to terminate any input process and the unit will exit to normal operation	
	Press to use programming features.	5.2
	Use  to recall the timed program	6.3.1
	Use  through  to specify the location of preset program to be stored	6.3.3
	Use  to confirm	
 	Press to enter the PC interface selection menu. You can choose either RS-232 or RS-485	6.1.3
	Use  to select RS-232 or RS-485	
	Use  to confirm the settings	
	Press to recall your stored preset or timed program	
	Use  to recall the timed program	6.3.2
	Use  through  to specify the location of preset program to recall	6.3.4
	Use  to confirm	
 	Press to Lock/Unlock the Keypad and Jog Wheel	6.1.2
	Press to confirm the new settings	
 	Press to Enable/Disable the output	6.1.1

Keypad	Function	Section
	Press to Enable the output at power up	6.1.5
	Press to Disable the output at power up	6.1.5
SPECIAL Function		
	Press to get to the Upper Voltage Limit Setting Use  thru  to input the numerical values Use  to confirm	6.1.4

5.2 Quick Reference of The Timed and Preset Program

The unit can store 10 programs (program number 0-9).

Program 0 is reserved for storing 20 steps (Timed Subprograms).

Program 1 to 9 is for 9 sets of preset voltage and current.

Please refer to Figure 5.2 for the structure.

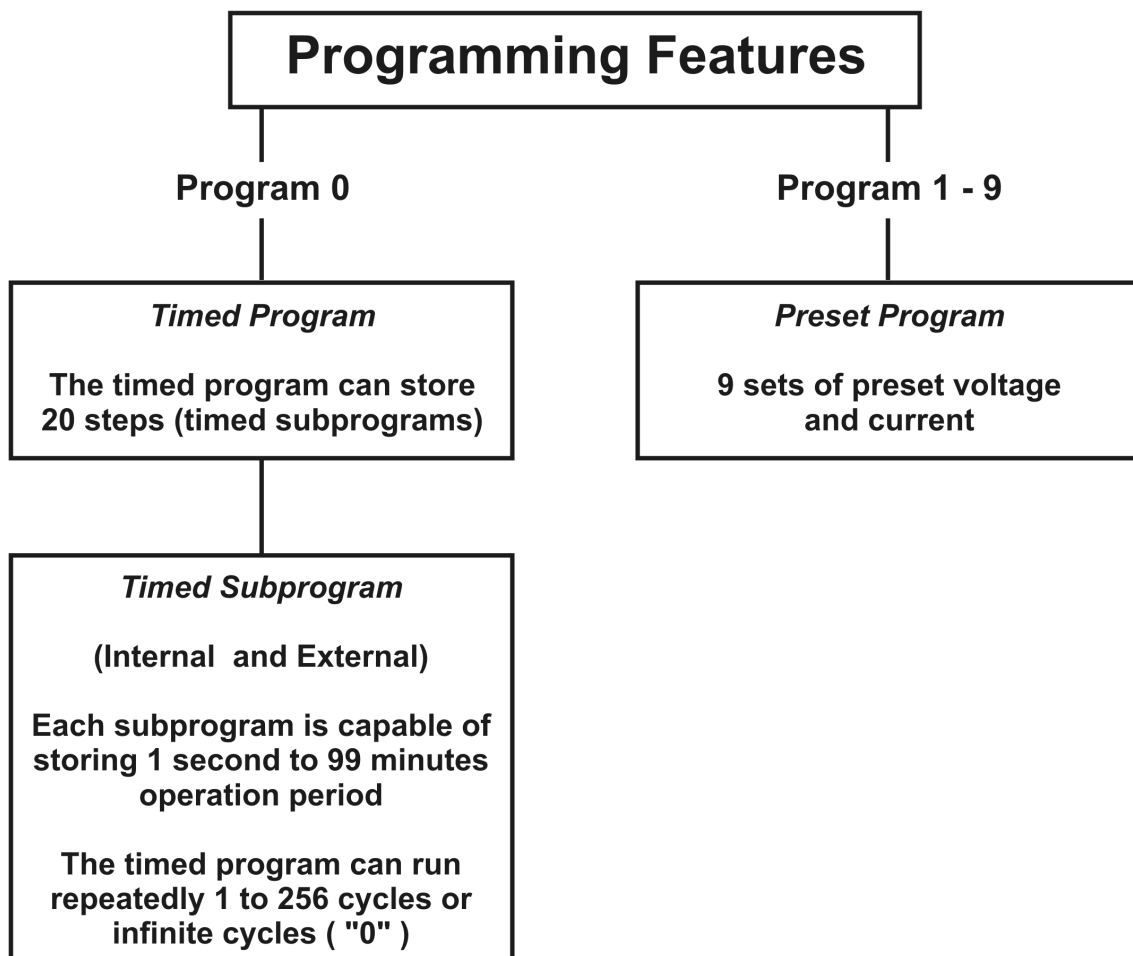

Figure 5.2 Block Diagram of the Programming (Timed and Preset Program)

6. Operating Instructions

NOTE: This section shows how to perform power supply functions using the front panel.

Operations that you can perform are:

6.1 Setting of Operating Mode

- | | |
|---|---------|
| 6.1.1 Enable/Disable Output | Page 9 |
| 6.1.2 Lock/ Unlock the Keypad and Jog Dial | Page 9 |
| 6.1.3 PC Interface RS-232 / RS-4858 Selection | Page 9 |
| 6.1.4 Upper Voltage Limit Setting | Page 10 |
| 6.1.5 Output Enable / Disable at Power Up | Page 10 |

6.2 Basic Operation



- | | |
|---|---------|
| 6.2.1. Setting of Voltage and Current by Jog Dial and UP & DOWN Key | Page 11 |
| 6.2.2 Setting of Voltage and Current by Keypad | Page 11 |

6.3 Using Programming Features





- | | |
|---------------------------------|---------|
| 6.3.1 Timed Programming | Page 12 |
| 6.3.2 Running the Timed Program | Page 13 |
| 6.3.3 Preset Programming | Page 14 |
| 6.3.4 Selecting the Preset | Page 14 |

6.1 Setting of Operating Modes

6.1.1 Enable/Disable Output





	<i>Action</i>	<i>LCD Display</i>	<i>Description</i>
1.	Press 	OUTPUT ○—○	Output ENABLE
2.	Then 	OUTPUT ○—○	Output DISABLE

6.1.2 Lock/ Unlock the Keypad and Jog Dial



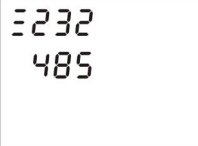

	<i>Action</i>	<i>LCD Display</i>	<i>Description</i>
1.	Press 		Keypad and Jog Dial Locked
2.	Then 		Keypad and Jog Dial UnLocked

6.1.3 PC Interface RS-232/RS-485 Selection

To select RS-232 :



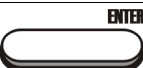

	<i>Action</i>	<i>LCD Display</i>	<i>Description</i>
1.	Press  then 		This will enter into PC Interface RS-232/RS-485 Selection.
2.	Press 		Press this key to select the desired PC Interface In this example, RS-232 is selected
3.	Press 		Press this key to confirm

To select RS-485 :

	<i>Action</i>	<i>LCD Display</i>	<i>Description</i>
1.	Press  then 		This will enter into PC Interface RS-232/RS-485 Selection.
2.	Press 		Press this key to select the desired PC Interface In this example, RS-485 is selected
3.	Press 		Press this key to confirm



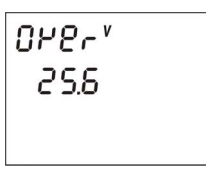

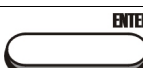

Note : Whenever to terminate the settings of Operation Mode, press “CLEAR” to return to normal operation.

6.1.4 Upper Voltage Limit Setting

	Action	LCD Display	Description
1.	Press   then 		This will enter into Upper Voltage Limit Adjustment. In this example, 25.6V is the present upper voltage limit.
2.	 to 		Use the number key to input your desired voltage
3.	Press 		Press this key to confirm

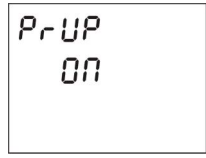





Note : Whenever to terminate the Upper Voltage Limit Setting, press “CLEAR” to return to normal operation.



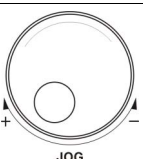

6.1.5 Output Enable/Disable at Power Up

	Action	LCD Display	Description
1.	Press   then 		This will enable the output at power up. i.e. When you switch on the power supply, the output is also ON automatically with last set voltage value.
2.	Press   then 		This will disable the output at power up. i.e. The output will be OFF at next power up. This is the default setting for safety reason !!



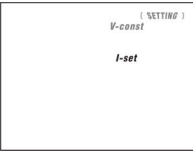



6.2 Basic Operation

6.2.1 Setting of Voltage and Current by Jog Dial and UP & DOWN Key

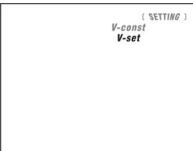
	Action	LCD Display	Description
1.	Press 		Sets Voltage
2.	Rotate  or Press  and 		Rotate or Press  &  Key to set the voltage level.

	Action	LCD Display	Description
3.	Press 		Sets Current
4.	Rotate  OR Press  and 		Rotate the Jog Wheel or Press to set the current.
5.	Press 		Press this key to confirm

6.2.2 Setting of Voltage and Current Using Keypad









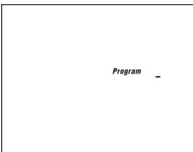





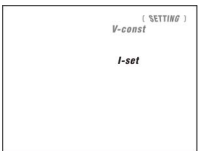

	Action	LCD Display	Description
1.	Press 		Press this key to start on setting voltage. Use number key to set the voltage
2.	Press desired voltage using numbering keypad from  to 		Setting voltage by pressing numbers on Keypad.
3.	Press 		Press this key to start on setting current.
4.	Press desired current using numbering keypad from  to 		Setting current by pressing number on Keypad
5.	Press 		Press Enter to confirm voltage and current settings.

Note : whenever to terminate the settings of voltage and current, press “CLEAR” to return to the normal operation.

6.3 Using the Programming Features

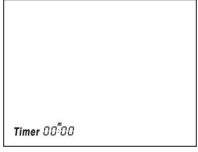



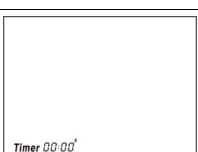
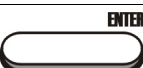
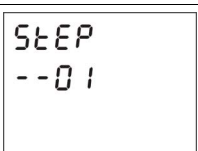
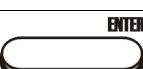



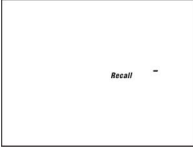

6.3.1 Timed Programming

	Action	LCD Display	Description
1.	Press 		This will use the Programming Feature.

	Action	LCD Display	Description
2.	Press 		This will enter into Timed Programming Mode. There are 0-19 steps (timed subprograms) and the first step is 0.
3.	Press 		Press this key to confirm
4.	 to 		Use the number key to input your desired voltage
5.	Press 		Press this key to confirm the voltage setting.
6.	 to 		Use the number key to input your desired voltage.
7.	Press 		Press this key to confirm the current setting.
8.	 to 		Use the number key to input your desired minutes in the timer.
9.	Press 		Press this key to confirm the minutes setting.
10.	 to 		Use the number key to input your desired seconds in the timer.
11.	Press 		Press this key to confirm the seconds setting. The program will then advance to the next step. i.e. Step 1
12.	Repeat Procedures 4 to 11		You can repeat procedure 4 to 11 for setting the next step. Input zero timer period to terminate the step. For example, if you want the timed program to terminate at step 4, just input zero timer period of step 4.
13.	Press 		Press this key until StEP icon disappears.









Note : whenever to terminate the Timed Program, press “CLEAR” to return to the normal operation.



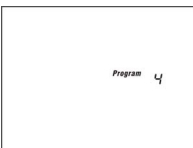

6.3.2 Running the Timed Program

	Action	LCD Display	Description
1.	Press 		This will use the Recall Program Feature.
2.	Press 		This will enter into Recall Timed Program Mode.
3.	Press  or 		Press to check the settings of the steps (timed subprograms)
4.	Press 		Press Enter to confirm
5.	 to 		Use the number key (0-9) to input the number of running cycles You can key in 1-256 cycles. 0000 means the timed program will run infinite cycles.
6.	Press 		Press this key to activate the timed program.



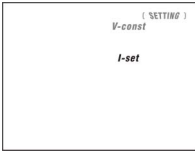

Note : whenever to terminate the Timed Program, press “CLEAR” to return to the normal operation.

6.3.3 Preset Programming

	Action	LCD Display	Description
1.	Press 		This will use the Programming Feature.
2.	 to 		Use the number key (1-9) to select the program number and it will enter into the Preset Programming Mode. In this example, Preset Program Number 4 is selected.
3.	 to 		Use the number key to input your desired voltage.
4.	Press 		Press Enter to confirm the voltage setting.

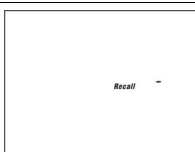
	Action	LCD Display	Description
5.	 to 		Use the number key to input your desired current.
6.	Press 		Press this key to confirm the current setting. The program will then advance to the next Preset. In this example, it will advance Program 5
7.	Repeat Procedures 3 to 6		You can repeat procedure 3 to 6 to change the setting of next preset, otherwise just press enter until Program _ icon disappears.

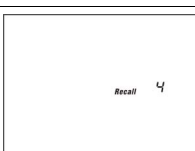
6.3.4 Selecting Preset

	Action	LCD Display	Description
1.	Press 		This will use the Recall Program Feature.
2.	 to 		Use the number key (1-9) to select the program number and it will enter into Recall Preset Mode. In this example, Preset Program Number 4 is selected.
3.	Press 		Press this key to activate the chosen preset number.

Note : whenever to terminate the Preset Program, press “CLEAR” to return to the normal operation.

7. Maintenance

7.1 Recalibration

7.1.1 Introduction

This in-case recalibration is to reduce the difference between the set values and the displayed values on the LCD Display. You only use the recalibration when the difference is greater than 0.1V for voltage or 0.01A for current. The whole recalibration for voltages and current takes less than 15 minutes. It is performed by a proprietary software using regression algorithm. The recalibration software is compatible to window XP, Me, 2000, 98SE, 98.

7.1.2 Installation of the recalibration software

1. In the installation disk, run *Setup.exe* inside the folder of Re-calibration to install the recalibration software.
2. Follow the instructions in the setup program.
3. Finally, a SDP Recalibration icon is created in the Program Menu.

7.1.3 Operation Instruction

1. Ensure your PC is Off, connect RS-232 to serial com. port of your PC and the power supply.
2. On your Power Supply, press [**SHIFT**] key, then quickly press [**RS232/485**] key and select RS-232 followed by [**ENTER**] key.
3. Switch on your PC and run the SDP recalibration software.
4. Follow the instructions shown in the software.

7.2 Trouble Shooting

1. Keypad and jog dial do not work.
Check key lock symbol, if in Lock state, unlock unit by [**SHIFT**] then [**LOCK/UNLOCK**] key. Otherwise switch OFF unit and switch ON again to see if problem persists.
2. No output power
Check output on/off symbol on display. Otherwise, press [**SHIFT**] then [**O/P ON/OFF**].
3. Cannot get high voltage setting within the rated maximum.
Check Upper Voltage Limit setting by [**SHIFT**] then [**0**] key. Reset to rated maximum voltage.
4. *CANCEL* symbol keeps appearing in all keying in operation.
Keying in time not fast enough as only 10 seconds are allowed for data inputing. And 3 seconds for operation mode setting. e.g. lock/unlock,output on/off & etc.
5. *OUT OF RANGE* keeps appearing
 - A. Check if setting is within the rated range.
 - B. If this occurs during voltage setting, please refer to point 3.

7.3 In house calibration

The output can be selected as ON or OFF when power is ON. The default setting of the output is OFF, when power is ON. To change the output status, please go to the SDP software and go to the Tab settings, and select ON/OFF for Output Terminal Status When Power Supply Switch is ON.

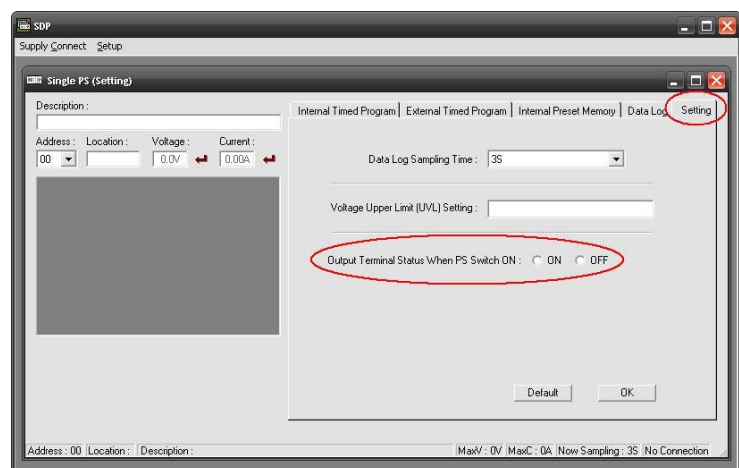

8. PC Interface Control User Manual

This section shows how to connect:

- A single power supply via RS-232 Interface
- 2 or above (up to 31) power supplies via RS-485 Interface

8.1 Connect a Single Power Supply to PC via RS-232

The power supply can be connected to PC via RS-232 as shown in Figure 8.1.

Please use the provided RS-232 connection cable.

The data format is ASCII, no parity bit, 8 data bit, 1 stop bit.

The recommended baud rate is 9600 bps.(Please refer to Appendix B for details)

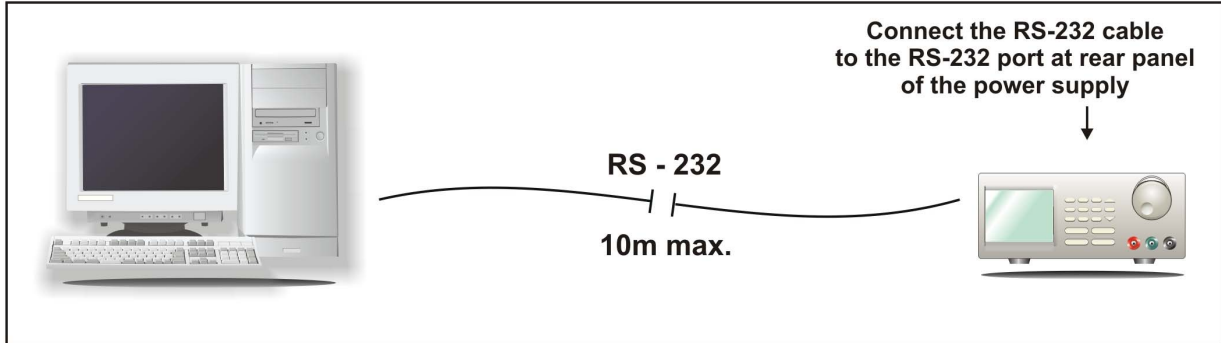

Figure 8.1 Connection between a PC and a Single Power Supply via RS-232.

8.2 Connect Multiple Power Supplies to PC via RS-485

For multiple power supplies, use the RS-485 Interface through the RS-485 port at rear panel of the power supply. Up to 31 power supplies can be connected via RS-485.

You will need a RS-232 to RS-485 Adapter (ATR-2485, Optional Accessory) and the connection shown in Figure 8.2a & 8.2b.

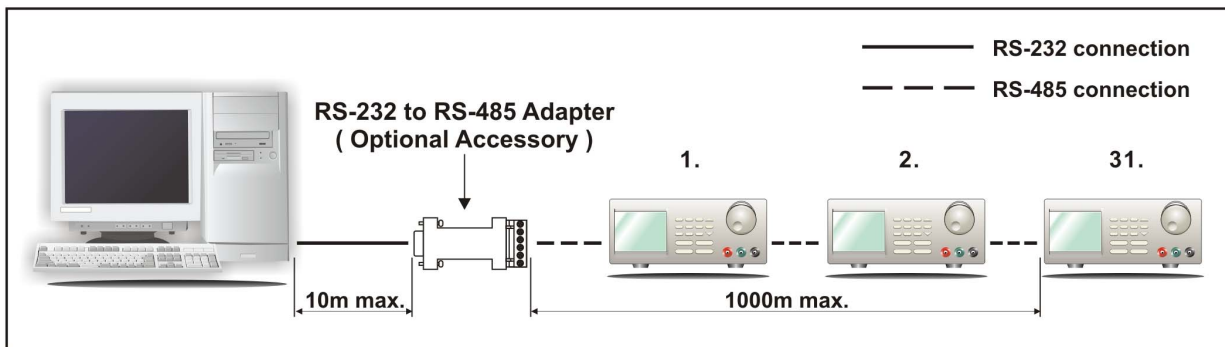

Figure 8.2a. Connection diagram for multiple power supply

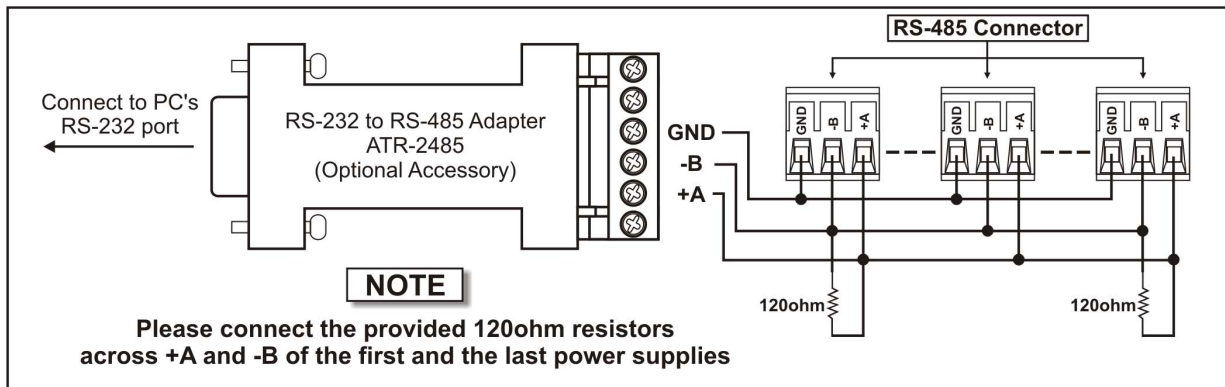

Figure 8.2b. Connection diagram between ATR-2485 Adapter and RS-485 Connectors.

For more informations, please see Appendix B and Appendix C.

8.3 PC Application Software

8.3.1 What the Application Software will Do

The application software can perform:

- Timed Programming;
- Preset Programming;
- Data Logging;
- Voltage, Current and Upper Voltage Limit Settings.

8.3.2 System Requirements

- CPU 450 Mhz or above
- 128 MB Ram
- Min. monitor screen resolution: 800 x 600 pixels.
- Operating systems: Windows[®] XP, ME, 2000, 98SE, 98

All brand or trade names are trademarks or registered trademarks of their respective companies.

8.3.3 Installation of Software

1. Place the provided installation disc in your CD Rom Drive and run *setup.exe*.
2. Follow the instructions in the setup program.

NOTE

During the running of the setup program, you may encounter "VERSION CONFLICT" remarks, ignore it and click "YES" to complete the installation.

3. A SDP icon is created in the Program Menu.

8.4 Running the application software for RS-232 Interface

NOTE

Before running the application software, you must have installed and connected your power supply to the PC using the provided RS-232 cable.

8.4.1 Start-up the Application Software for RS-232

1. Ensure your PC is OFF, connect RS-232 cable to the serial port of your PC and the power supply.
2. On your power supply, press the [SHIFT] key, then quickly press [RS232/485] key and select **RS-232** followed by [ENTER] key.
3. Switch on your PC and run the SDP program.
4. Click on **Setup**, and select the desired COM Port. The default is set at COM 1.



Figure 8.4.1a

5. Click on **Supply Connect**, then click on **Single** in the drop menu.

6. An 'Internal Timed Program' Window will appear as shown in Figure 8.4.1b. Click on the *Data Log* header on top right and a *Data Log* Window as shown in Figure 8.4.1c will appear.

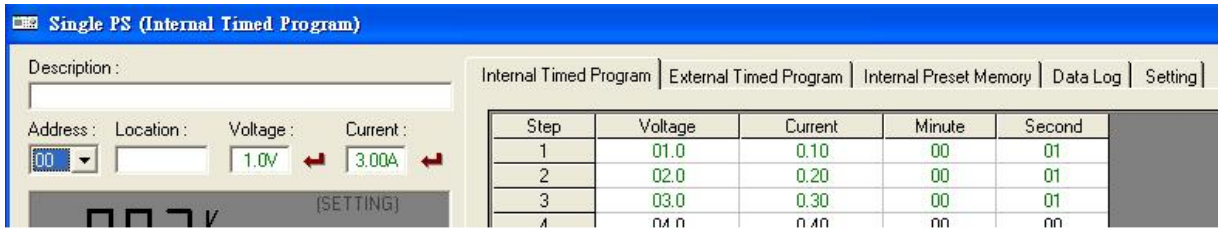

Figure 8.4.1b Internal Timed Program Header.

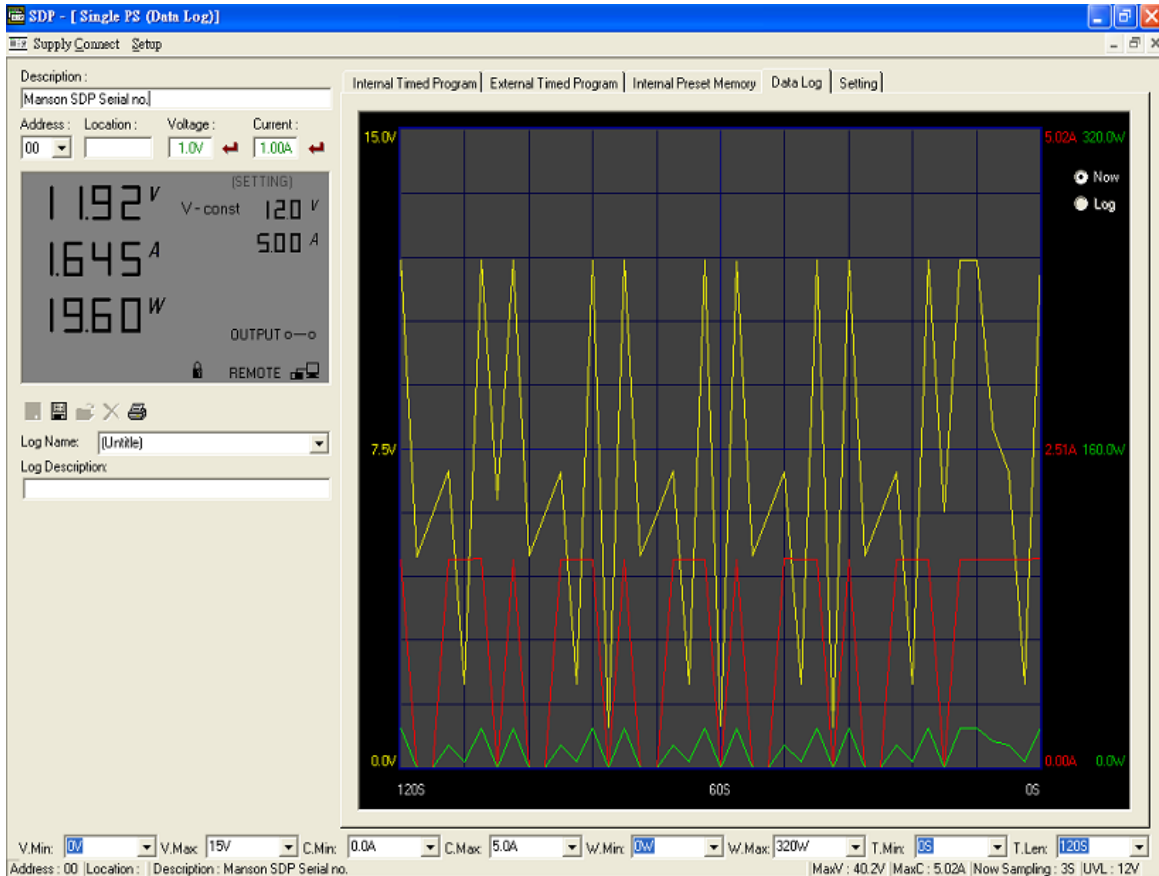

Figure 8.4.1c Data Log Window

Remarks:

When the right bottom corner of the display window shows the UVL value as shows in Figure 8.4.1d, it indicated that the power supply is connected to PC. The power supply is operating normally.



Figure 8.4.1d



Figure 8.4.1e

If it shows **No Connection** as shown in Figure 8.4.1e, check the following:

- A) Go back to *Setup*, check if the correct COM port has been assigned.
- B) Check the power supply if RS-232 has been selected.
- C) Check the RS-232 cable connection.
- D) Check whether the power supply is ON.

8.4.2 General Operations

Please refer to Figure 8.4.2a for the following descriptions.

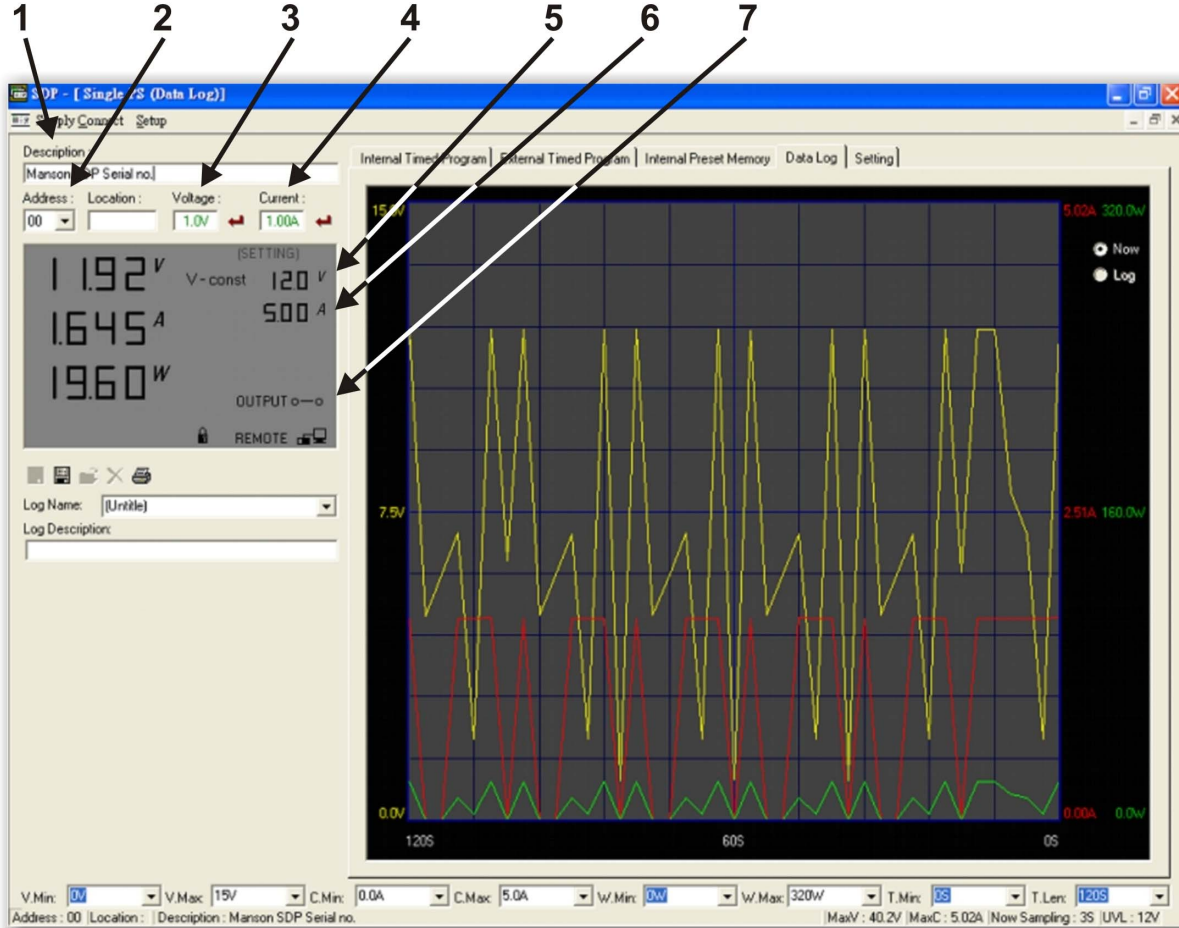

Figure 8.4.2a. General Descriptions

1. Power Supply Description:

manson sdp serial no S2405000

You may click on the assign an identification for your power supply in use. Actually this feature is mainly for multiple power supplies application with RS-485.

2. Address:

00

This function is for multiple power supplies application. Each power supply has a unique address. Ignore this function when using RS-232.

3. Voltage:

V

Enter the desired output voltage with decimal point.

4. Current:

A

Enter the desired current limit with decimal point.

5. & 6. Voltage and Current display on LCD

Alternative way to adjust the Output Voltage and Current,

Left click to increase by 0.1 unit;

Right click to decrease by 0.1 unit.

7. Output

OUTPUT ○○

Left click on icon will switch ON or OFF the output.

8.4.3 Data Logging and Setting Window in Application Software

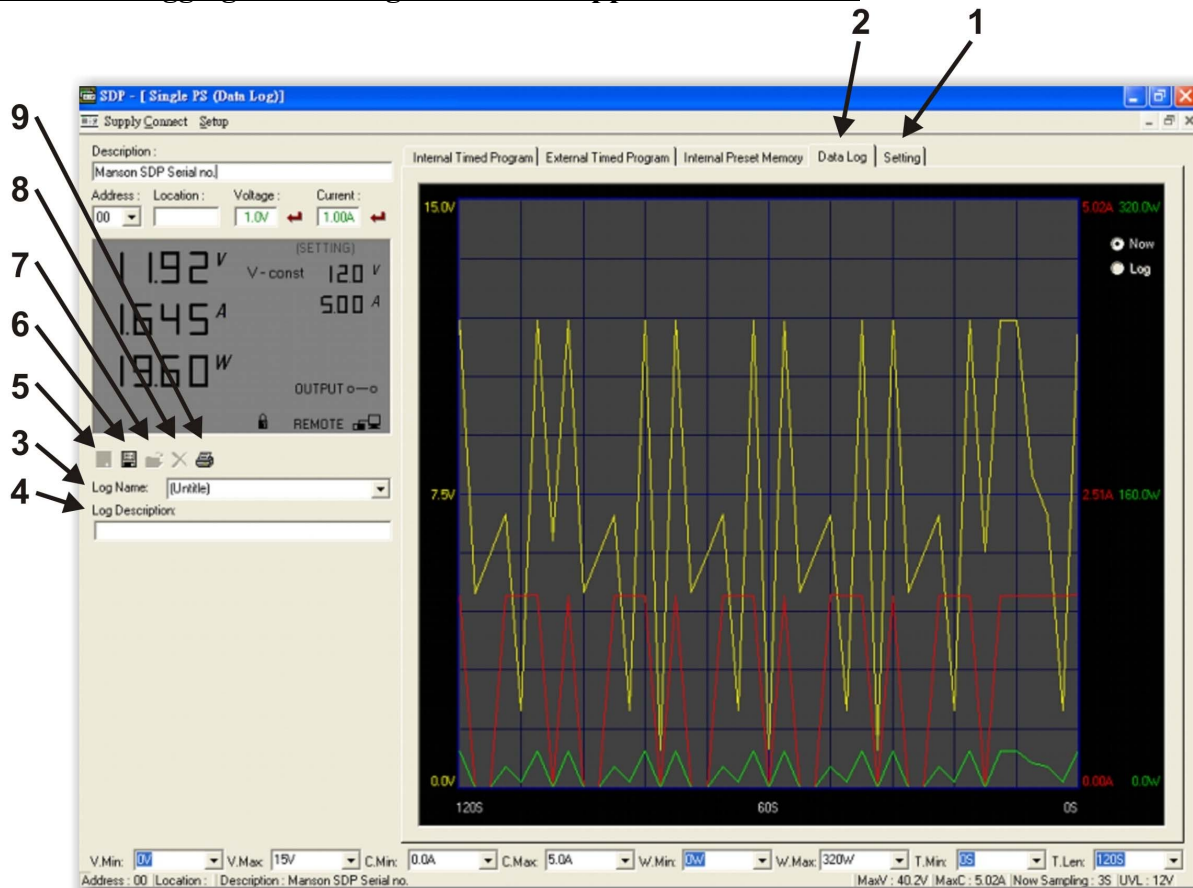

Figure 8.4.3a Data Logging Function for a Single Power Supply

1. Setting Window

In “Setting” Window, the **Data Log Sampling Time**, **Voltage Upper Limit Setting** and the **Output Terminal ON or OFF at next power up** can be set by User.

Data log Sampling Time

You can input your desired sample time from 1 second up or select from the drop menu.

Voltage Upper Limit Setting

You can set your output voltage upper limit value to further safeguard your low voltage applications.

Users also can pre-set the Output On or Off at next power up by selecting the ON or OFF Option.

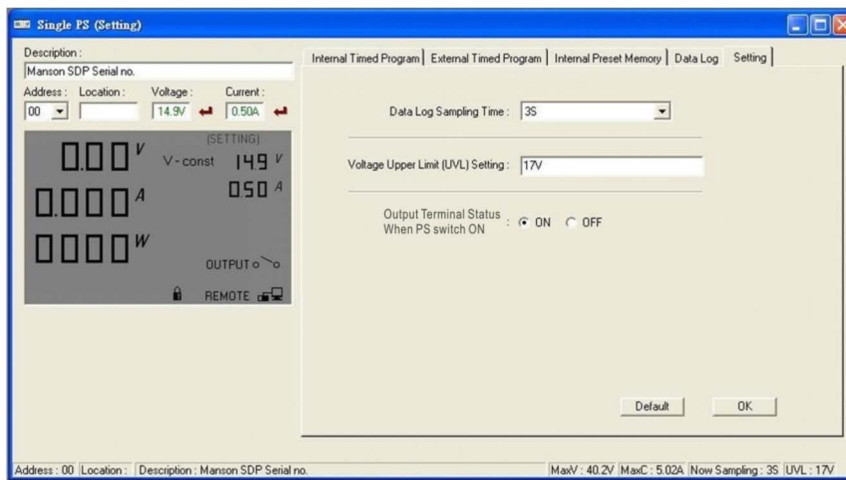

2. Data Log Window

A. You can use the “Data Log” window to view present output data or stored data.

B. All the parameters at the bottom of the window display can be changed by direct entry from the PC (with decimal point) and then confirm by the **Enter** key of the PC, or select the values from respective drop menu.

Parameters at the bottom of the *Data Log* window:

- V Min.----- Minimum Voltage Level.
- V Max.----- Maximum Voltage Level.
- C Min.----- Minimum Current Level.
- C Max. ----- Maximum Current Level.
- W Min. ----- Minimum Power Level in Watt.
- W Max. ----- Maximum Power Level in Watt.

3. Log Name

Untitle ▼

Click cursor on “Untitle”, and type in a name for your log.

4. Log Description

You can type in your detail description of your log.

5. Save Log

- This function (and the icon) becomes effective when a Log Name is entered to replace the “Untitled”.
- Click on it will save the current data onto the PC.
- To retrieve the data, go to the drop menu at (3) *Log Name*.

6. Export to a File of MS Excel “xls” type

Click on this icon will export the collected data (in the *Save Log*) in “xls” format to your PC.

7. Open File Log of “xls type”

Click on this icon will import the collected data in .xls format file to the SDP software.

8. Delete Log

Click on this icon will delete the current log or retrieved log on the display at a current Log Name.

9. Print Log in “xls” Format

8.4.4 The Time Frame Concept of Data Log

The data logging function starts when the software is started running. In figure 8.4.4a, it shows the data log in graphical presentation. The **Time Minimum** and **Time Length** can be set by Users. Both parameters are adjustable so that any time period of the log can be displayed for analysis.

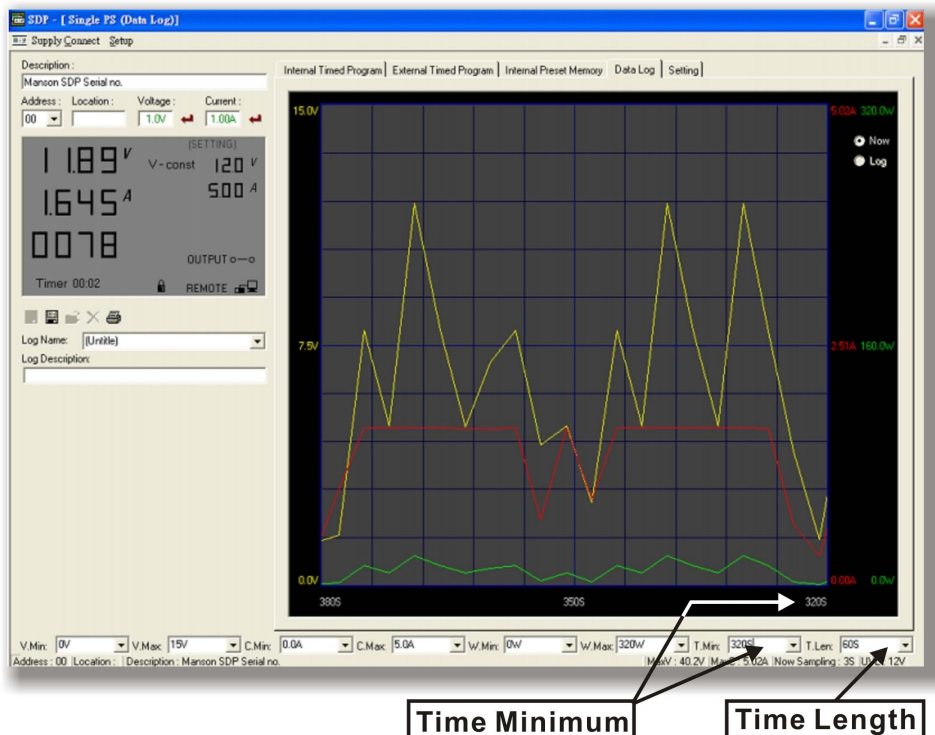
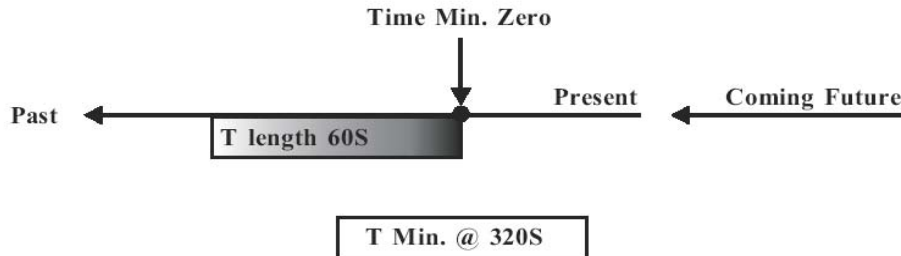

Figure 8.4.4a. The Data Log Window Display

When **T Min** is set to zero second, it means the unit is on real time and the length of time lapsed is on the left hand side of the Time Minimum. **T Len** is the length of time lapsed starting from the Time Minimum.

In the above example, T Min is set to 320 second and T length to 60 second, the display shows the output data starting at 320 seconds ago and ending at the 380 second mark.

Figure 8.4.4b The time frame of Data Log



8.4.5. Internal Timed Program

The PC Interface remote mode really eliminates the tedious process in keying in groups of entries on the power supply. Because all the data are displayed together in the monitor, possibility of wrong entry is greatly reduced. Data of different groups can be classified, stored, exported and retrieved for use at any time.

Furthermore, retrieved data will be in red color if they exceed the preset limits of voltage in Upper Voltage Level or Current Limiting values.

The operation principle of Saving, Exporting, Filing, Deleting and Printing are the same as the Data Log Function.

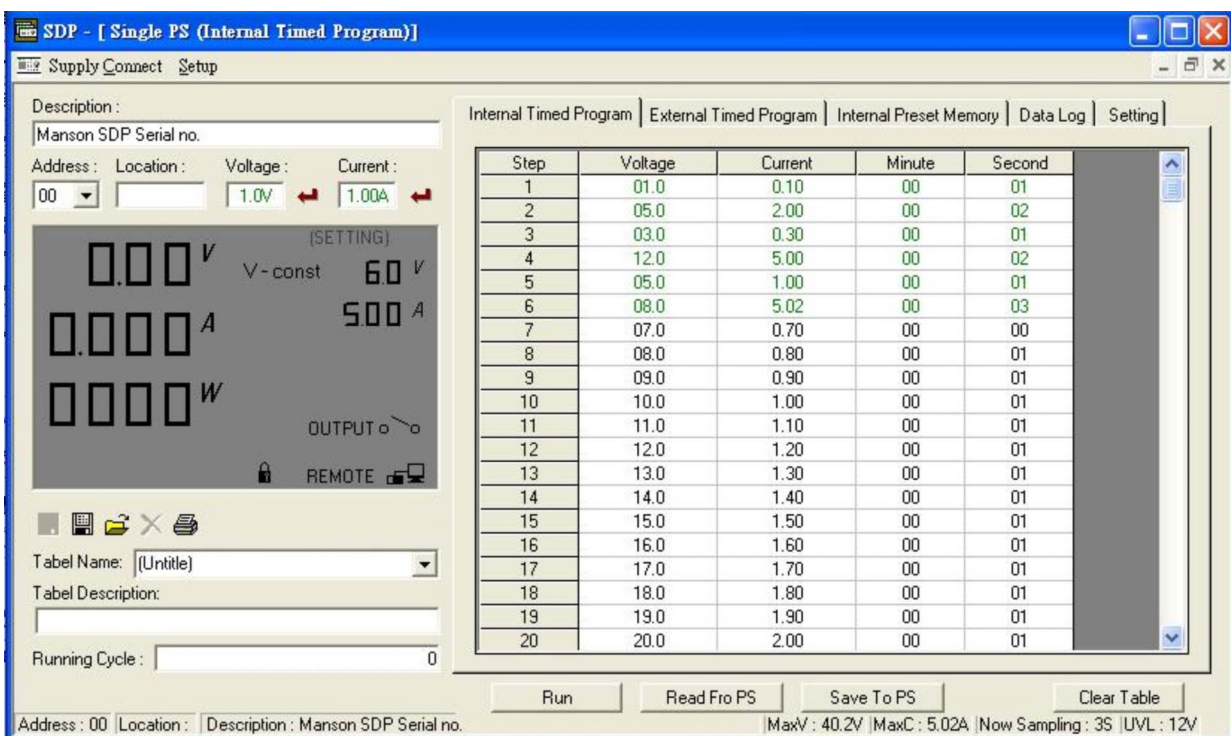
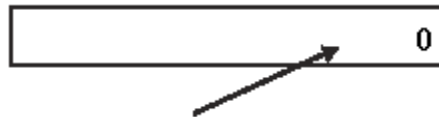

Figure 8.4.5 Internal Timed Program Window

- Clear Table**..... Delete all data in the Display Table and ready for new data entry.
- Save To PS**.....Transfer data from Display Table to the Power Supply.
- Read Fro PS**.....Get data from the Power Supply.
- Run**.....To run the Timed Program

Running Cycle



Enter the number of desired running cycles here. The maximum cycles is infinite as “0” cycle is entered.

***Note: The data must transfer to the power supply before run.

Operation

1. Clear old data in the power supply by first click [**Clear Table**] then click [**Save To PS**].
2. Check if no data in power supply by click [**Read Fro PS**].
3. Enter data in the table using the 'Up Down Left Right' keys of your PC keyboard for new locations
4. Data exceed the rated voltage and current will not be accepted.
5. Voltage exceed set UVL (Upper Voltage Limit) will not be accepted.
6. If retrieved or entered data exceed preset Upper or Lower Limit setting of voltage/ current/time, the data will becomes red in colour.
7. Transfer set data to power supply by clicking [**Save to PS**].
8. Click [**Read Fro PS**] to initiate the [**Run**] Command.
9. Set number of desired [**Running Cycle**] and click [**Run**].

8.4.6 External Timed Program

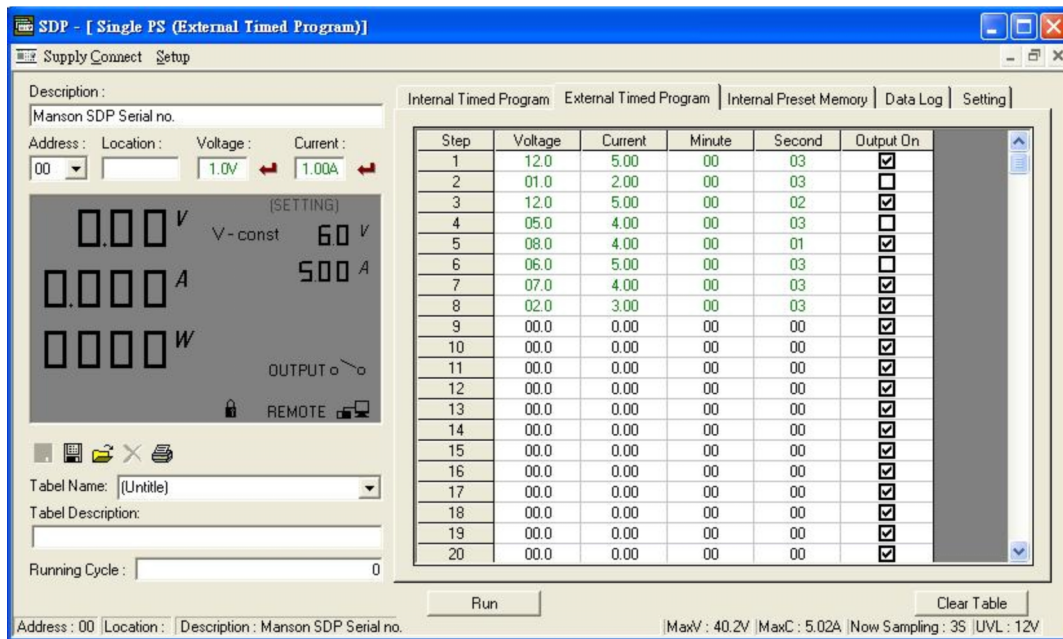

Figure 8.4.6 External Timed Program Window

The above Internal Timed Program is built in with the Power Supply , the External Timed Program is controlled by a remote computer which offer more flexibility and functions.

The operation principle of *External Timed Program* is same as the *Internal Timed Program*. In additional, External Timed Program allows user set the output either ON or OFF by selecting the boxes in the last column.

Output ON/OFF:

1. Output ON Ticked: Output is **ON** for that step
2. Output ON Un-ticked: Output is **OFF** for that step.

Operation Procedure

1. Clear old data in the table, click [**Clear Table**].
2. Enter data in the table using the 'Up Down Left Right' keys of your PC keyboard for new locations.
3. Data exceed the rated voltage and current will not be accepted.
4. Voltage exceed set UVL (Upper Voltage Limit) will not be accepted.
5. If retrieved or entered data exceed preset Upper or Lower Limit setting of voltage/ current/time, the data will becomes red in colour.
6. To run the program, key in the number of desired [**Running Cycle**] at the lower left corner and click [**Run**].
7. Remarks : Do not key in 0 as it will make infinite cycle runs.

8.4.7 Internal Preset Memory

The operation principle is the same as Internal Timed Program. To activate the selected preset values, click on the box of the [**Select**] column then click [**Run**]. If retrieved or entered data exceed present Upper or Lower Limit Setting of voltage/current/time, the colour will become red in colour.

8.5 Running the software using RS-485 Interface

NOTE

Before running the application software, you must have installed and connected your power supplies to the PC via RS-485 as Figure 8.2a and b on page 14

1. On your power supplies, press [**SHIFT**] key, then quickly press [**RS-232/485**] key and select **RS-485** followed by [**ENTER**] key.
2. A 3-digit number will appear. This number is the address assigned to the power supply ad will be used in the software.
3. Using the keypad to key in the address to assign for each power supply. The range is 001 ~ 031 and each of the power supplies requires an unique address.
4. Switch on your PC and run the SDP program.
5. Click on **Setup**, and select the desired COM port. The default is set to COM 1.
6. In the tool bar, Click on **Supply Connect**, then click on Single in the drop menu.
7. An Internal Timed Program Window will appear.
8. By choosing the address in the Address Field (Figure 8.5a) You can input the desired settings for each power supply as given in Section 8.4.2a on page 20.

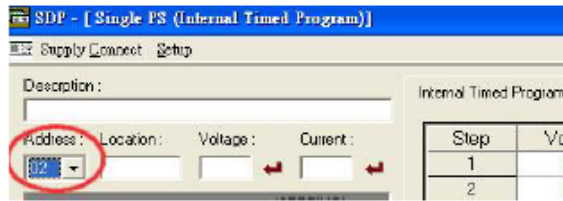

Figure 8.5a Address of each Power Supply.

8.5.1 Multi Window Analysis

1. In the tool bar, Click on **Supply Connect**, then click on **Multi** in the drop Menu.
2. A **Multi Windows** Window (Figure 8.5.1a) will appear.

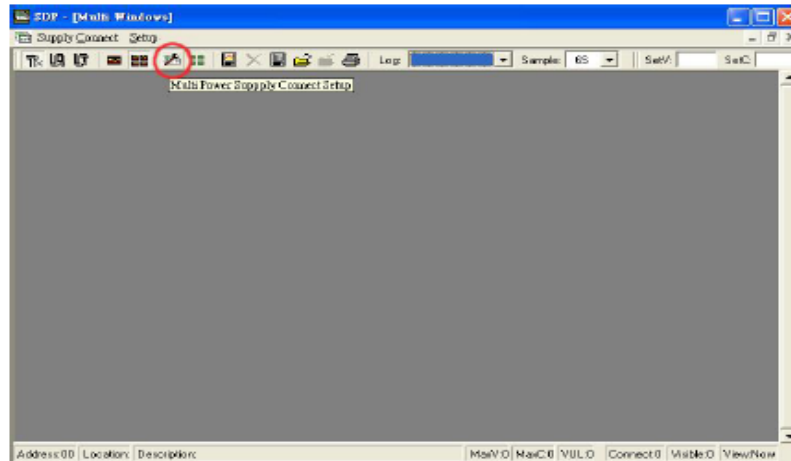

Figure 8.5.1a Multi Window

3. Click on the icon (circled in red in figure 8.5.1a), a **Multi Power Supply Connect Setup** (Figure 8.5.1b) will appear.

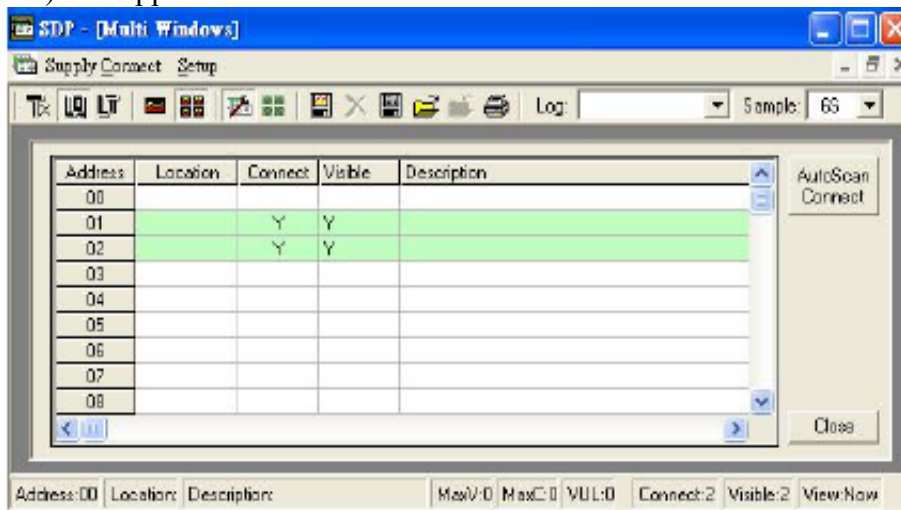

Figure 8.5.1b Multi Power Supply Connect Setup.

4. Click on **AutoScan Connect**, the window will show the connected power supply indicated as “Y” as shown in Figure 8.5.1b.
5. Click on the box along the **Visible** Column to set the desired power supply to be visible in *Multiple Data Log Window*.

6. Users can type in the location and description of the power supplies in the **Location** and **Description** Column.
7. Click on **Close** button (bottom right hand corner) to return to *Multiple Data Log Window*.
8. Remarks:

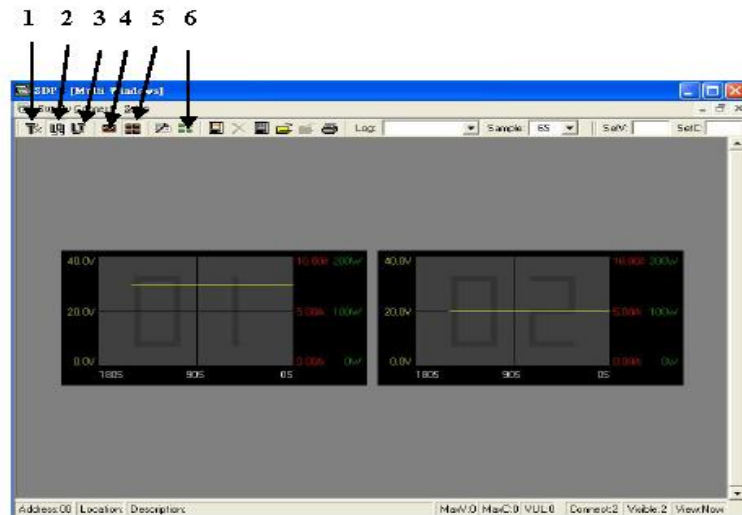

Fig 8.5.1c

(1) Show Digital

One click, it will show the digital readings of all the connected power supplies

(2) Show Log

One click, it will show the data log of all the connected power supplies.

(3) Show Digital and Log

One click, it will show both the data log of all the connected power supplies.



Figure 8.5.1d

You can click on the data log to select the power supply, the data log will highlight in blue and the address bar in the left bottom window will show the selected power supply.

(4) Single Alleyway Display

One click, it will only display the data log of the selected power supply (Figure 8.5.1e). It will disable the icon (2), (3) and (4).

The parameters at the bottom are same as the Data Log Window in RS-232 Interface.

The *All SP* Tick box --- Tick to apply the parameters to all Data Log Window in Multi Alleyway Display.

(5) Multi Alleyway Display

One click, it will display the Data Log and output data of all power supplies. It will activate the icon (2), (3) and (4).

(6) Log Thumbnails Setup

One click, it let user to adjust the window size of the Data log Window in Multi Alleyway Display.

Use the sliders to adjust the height and the width of the Data Log Window.

Scale 4:3 tick box can enable 4:3 screen size for the Data Log Windows.



Figure 8.5.1e



The following tables describes the function on each Icon as shown in figure 8.5.1e.

	<i>Icon</i>	<i>Descriptions</i>
1	Save Log	
2	Delete Log	It can delete the log data in the PC.
3	Export to a file Log of xls type	Click on this icon will export the collected data (in Data Log) in xls format to your PC.
4	Open File Log of xls type	Click on this icon will import the collected data in xls format file to the SDP software.
5	Close File Log of xls type	Click on this icon will close the import xls format file.
6	Print Log	Print Log in xls format.
7	Log	Click on it to select the save log data.
8	Sample	Click on it to select the sampling time.
9	SetV	Click on it and type in to change the voltage setting of the selected power supply.
10	SetC	Click on it and type in to change the current setting of the selected power supply.

APPENDIX A
SDP COMMMAND SET

Remarks in using the Remote Programming Mode

The RS232/485 interface is always ready for connection to PC for remote programming operation . The default setting is RS-232 , however it is recommended to check the status of RS-232/485 setting by using the keypad at the front panel .(see 6.1.3).

The keypad can be disabled by : either pressing  then  or by entering the input command SESS<address> <CR>.

SDP Command Set

{ } - command data, [] - return data, [OK] = "OK", [CR] = 0dh
 ??? = 30h, 30h, 30h, 30h - 39h, 39h, 39h, 39h (4 bytes data)
 ??? = 30h, 30h, 30h - 39h, 39h, 39h (3 bytes data)
 ?? = 30h, 30h - 39h, 39h (2 bytes data)
 <address> 30h, 30h - 3fh, 3fh (2 bytes data).

Bold – Input Command

Italic – Return Data from Power Supply

PS = Power Supply

Command Code & Return Data	Description
Input Command: SESS <address> <CR> Return Data from Power Supply: <i>[OK] [CR]</i>	Disable front panel keypad and make PS to Remote Mode
Input Command: ENDS <address> <CR> Return Data from Power Supply: <i>[OK] [CR]</i>	Enable front panel keypad and make PS to exit Remote Mode
Input Command: CCOM <address> <RS> {000-256} <CR> Return Data from Power Supply: <i>[OK] [CR]</i>	Change RS-232/RS485 <RS> = 0 -> RS-232 <RS> = 1 -> RS-485
Input Command: GCOM <address> <CR> Return Data from Power Supply: <i>[RS] RS485 Address [??] [CR]</i> <i>[OK] [CR]</i>	Get the RS-485 address

Command Code & Return Data	Description
Input Command: GMAX <address> <CR> Return Data from Power Supply: <i>Voltage [???] Current [???] [CR]</i> <i>[OK] [CR]</i>	Get maximum voltage and current of PS
Input Command: GOVP <address> <CR> Return Data from Power Supply: <i>Voltage [???] [CR]</i> <i>[OK] [CR]</i>	Get Upper Voltage Limit of PS
Input Command: GETD <address> <CR> Return Data from Power Supply: <i>Voltage [????] Current [????] [0] [CR]</i> <i>[OK] [CR]</i> <i>Voltage [????] Current [????] [1] [CR]</i> <i>[OK] [CR]</i>	Get Voltage & Current reading from PS PS in CV mode PS in CC mode
Input Command: GETS <address> <CR> Return Data from Power Supply: <i>Voltage [???] Current [???] [CR]</i> <i>[OK] [CR]</i>	Get Voltage & Current Set Value from PS
Input Command: GETM <address> <CR> Return Data from Power Supply: <i>Memory 1 Voltage [???] Current [???] [CR]</i> <i>Memory 2 Voltage [???] Current [???] [CR]</i> <i>Memory 9 Voltage [???] Current [???] [CR]</i> <i>[OK] [CR]</i>	Get All Preset Memory Values from PS
Input Command: GETM <address> location {1-9} <CR> Return Data from Power Supply: <i>Voltage [???] Current [???] [CR]</i> <i>[OK] [CR]</i>	Get Memory from Specific Preset of PS

Command Code & Return Data	Description
<p>Input Command: GETP <address> <CR></p> <p>Return Data from Power Supply:</p> <p><i>Program 00 Voltage [???] Current [???] Minute [??] Second [??] [CR]</i> <i>Program 01 Voltage [???] Current [???] Minute [??] Second [??] [CR]</i> <i>Program 19 Voltage [???] Current [???] Minute [??] Second [??] [CR]</i> <i>[OK] [CR]</i></p>	<p>Get all the Timed Program Memory of PS</p>
<p>Input Command: GETP <address> program {00-19} <CR></p> <p>Return Data from Power Supply:</p> <p><i>Voltage [???] Current [???] Minute [??] Second [??] [CR]</i> <i>[OK] [CR]</i></p>	<p>Get Timed Program Memory from Specific Program of PS</p>
<p>Input Command: GPAL <address> [CR]</p> <p>Return Data from Power Supply:</p> <p><i>Reading voltage [#####] V [ON]</i> <i>Reading current [#####] A [ON]</i> <i>Reading watt [#####] W [ON]</i> <i>Timer minute [#####] second [###] timer [ON] colon [ON] m [ON] s [ON]</i> <i>Setting voltage [###] V-const [ON] V-bar [ON] V [ON]</i> <i>Setting current [###] I-Const [ON] I-bar [ON] A [ON]</i> <i>Program [#] Program [ON] P-bar [ON]</i> <i>SETTING [ON] Key lock [ON] Key open [ON] FAULT [ON] Output on [ON]</i> <i>Output off [ON] Remote [ON] [CR]</i> <i>[OK] [CR]</i></p>	<p>Get LCD Display Information</p>
<p>Input Command: VOLT <address> voltage {000-XXX} <CR></p> <p>Return Data from Power Supply:</p> <p><i>[OK] [CR]</i></p>	<p>Set Voltage Level XXX-Max. Output Rating Voltage = XX.X V Current = X.XX V</p>
<p>Input Command: CURR <address> current {000-XXX} <CR></p> <p>Return Data from Power Supply:</p> <p><i>[OK] [CR]</i></p>	<p>Set Current Level</p>

Command Code & Return Data	Description
Input Command: SOVP <address> voltage {000-XXX} <CR> Return Data from Power Supply: <i>[OK] [CR]</i>	Set Upper Voltage Limit of PS
Input Command: SOUT <address> 1 <CR> Return Data from Power Supply: <i>[OK] [CR]</i>	Disable Output of PS
Input Command: SOUT <address> 0 <CR> <i>Return Data from Power Supply:</i> <i>[OK] [CR]</i>	Enable Output of PS
Input Command: POWW <address> location {1-9}0 <CR> Return Data from Power Supply: <i>[OK] [CR]</i>	Enable the output when switch on the power supply.
Input Command: POWW <address> location {1-9}1 <CR> Return Data from Power Supply: <i>[OK] [CR]</i>	Disable the output when switch on the power supply.
Input Command: PROM <address> location {1-9} Voltage {000-XXX} Current {000-XXX} <CR> Return Data from Power Supply: <i>[OK] [CR]</i>	Set Voltage and Current values of Preset Memory
Input Command: PROP <address> location {00-19} Voltage {000-XXX} Current {000-XXX} Minute {00-99} Second {00-59} <CR> Return Data from Power Supply: <i>[OK] [CR]</i>	Set Voltage, Current and Time period of Timed Program

Command Code & Return Data	Description
Input Command: RUNM <address> location {1-9} <CR> Return Data from Power Supply: <i>[OK] [CR]</i>	Recall Preset Memory 1-9
Input Command: RUNP <address> times {000-256} <CR> Return Data from Power Supply: <i>[OK] [CR]</i>	Run Timed Program (000 = run infinite times)
Input Command: STOP <address> <CR> Return Data from Power Supply: <i>[OK] [CR]</i>	Stop Timed Program

SDP Command Set REV1.2-- 10/2004

APPENDIX B

RS-232 CABLE AND CONNECTION INFORMATION

APPENDIX B RS-232 CABLE AND CONNECTORS INFORMATION

Remark

- The line buffer is assumed to be 16 bytes long.
- The serial asynchronous framing format: no parity bit ,8 data bit, 1 stop bit & bit rate:9600bps

CONNECTORS

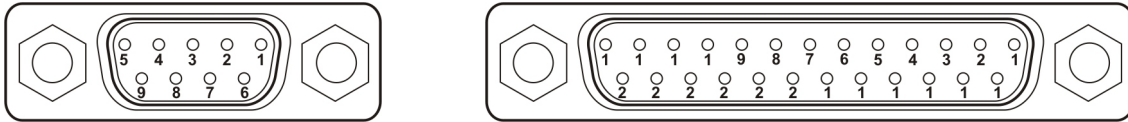

CABLE AND ADAPTOR

Power Supply 9-pin	Computer 9-pin	Power Supply 9-pin	Computer 25-pin
1	1	1	8
2	2	2	3
3	3	3	2
4	4	4	20
5	5	5	7
6	6	6	6
7	7	7	4
8	8	8	5
9	9	9	22

Straight through cable IBM-PC/AT to 25-pin adaptor

PINS ASSIGNMENT AND CONNECTION OF THE POWER SUPPLY

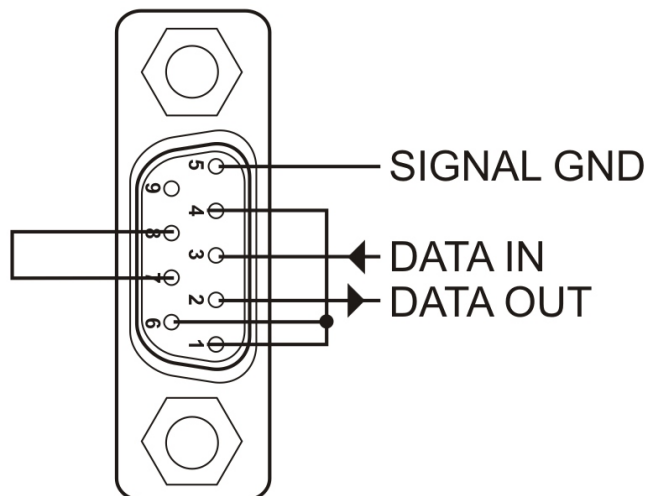

APPENDIX C

OPTIONAL RS-232 to RS-485 Adapter
ATR-2485
User Manual

INTRODUCTION

This Adapter is designed for connecting your PC with RS-232 communication port to HALF-DUPLEX RS-485 interface programmable power supplies (or other equipment). Its transmission length can be up to 1000m.

FEATURES & BENEFITS

- No driver software is needed
- Can directly connected to male RS-232 communication port of your PC

CONTROL AND PIN ASSIGNMENT

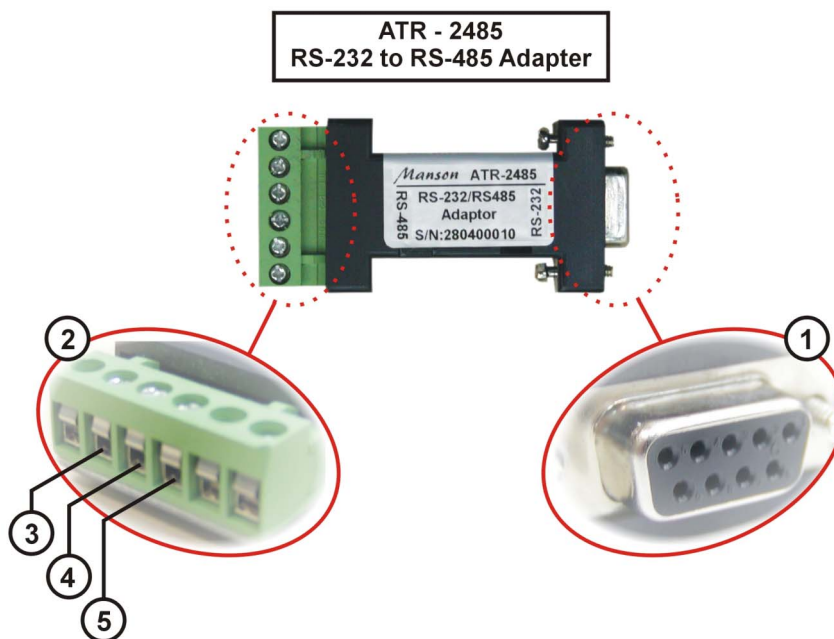

Figure.1

- (1) RS-232 (Connect to the PC communication port)
- (2) RS-485 (Connect to equipment with RS-485 interface)
There are 6 pins, only **A+**, **B-** and **GND** pin are useful.
- (3) Pin **A+**
- (4) Pin **B-**
- (5) Pin **GND**

SPECIFICATIONS

RS-232 side of the adaptor	DB-9 female connector
RS-485 side of the adaptor	3-pin connector - pin 1: RS-485 (+A) pin 2: RS-485 (-B) pin 3: GND
Connection Speed	9600bps
Transmission Length	Up to 1000 m
Dimension	33mm (W) x 17mm (H) x 87mm (D)
Weight	40 g

CONNECTION DIAGRAM

Connect the RS-232 side of ATR-2485 to the PC Communication port.

1. Single Power Supply Connection:

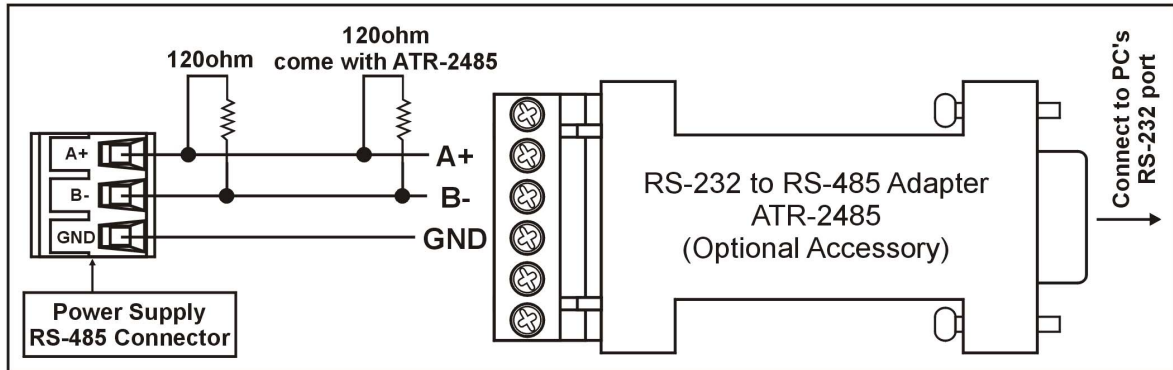

Figure.2

2. 2 or more power supplies connection:

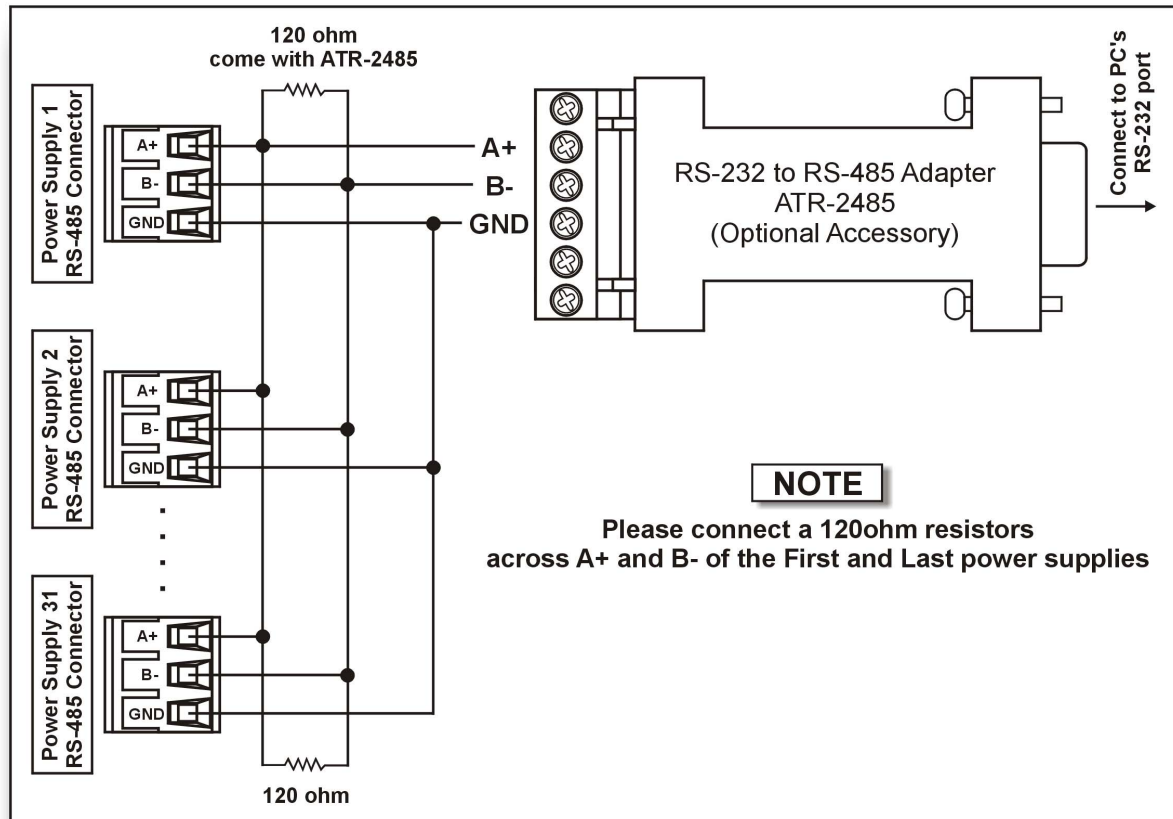

Figure.3