



MARINE PRODUCTS COLLECTION 2021





Testing our products to the highest standards every day.

At Attwood, we make quality our highest priority. We work hard to ensure accurate, consistent, and repeatable data that ensures our products meet industry standards set by the USCG, ABYC, and CE. Our state-of-the-art test lab allows us to re-create the outdoors in a lab-controlled environment. This commitment to quality testing ensures that our products consistently outperform and outlast the competition. Not just in the test lab, but under real-water conditions.

We have proven ourselves as marine industry leaders in product testing and development. Our highly trained lab technicians are passionate about creating quality products. They maintain strict calibration requirements and follow proven test procedures. In addition to maintaining continuous test protocol during the life of our products, we also perform testing for our customers and vendors. With our extensive testing capabilities, you can count on Attwood products being put to the test!

TESTING CAPABILITIES		
Dimensional	Material	Mechanical
Laser Scanner CMM Optical Comparator	Xenon Weathering UVB Exposure Salt Fog Gardner Impact Chemical Exposure Color Matching Tensile/Compression strength Hardness Adhesion	Product Durability Ingress Protection Fluid Flow Fluid Pressure drop Pressure testing (leak, life, strength) Environmental (cycle, shock, soak) Water Intrusion Dust ingress Mechanical Shock Vibration (Random, Sine) Product Dynamic Impact Performance Fatigue Light Intensity/Chromaticity/Cut-off angles (COLREG) Illumination Battery Life

TABLE OF CONTENTS



WATER SYSTEMS & VENTILATION 3

Pumps & Accessories, Thru-Hulls, Drain Plugs, Fittings, Blowers, and Vents



LIGHTING 29

LED & Incandescent Navigation Lighting, Pole Lights, Bases, and Replacement Parts



FUEL 65

EPA Certified & International Portable and Integrated Components



MARINE ACCESSORIES..... 95

Anchoring, Ropes, Fishing, Battery Boxes, Electrical, Paddle Sports, and Trailering



HARDWARE 157

Cleats, Lift Rings, Bow Eyes, Hawse Pipes, Ski Pylons, Bimini Top Hardware, Hatches, Gas Springs, Snap Hooks, and Fastener Kits



SEATING AND PEDESTAL SYSTEMS..... 187

Upholstered Seating & Seating Components, Swivl-Eze™ Seat Pedestals, and Accessories



MOTOR COVERS 219



INDEX 221

Alphabetical and Part Number



LET OUR CATALOG GUIDE YOU...

This catalog will help you select from Attwood's current line of marine products. It is divided into seven sections, as listed in the Table of Contents. Product pages contain the part number and a photograph of each product, along with a complete description and installation guidelines, dimensions, and specifications if applicable.

The products are presented in charts that provide quick comparisons between similar products. Where applicable, dimensional drawings are also included.

Use the catalog as follows:

Product Name _____

Product Description _____
Installation Guidelines _____

Proposition 65 Warning _____

Product Details _____

Part Number _____

Prop 65 warning required (asterix)

Packaging Type Guide

- 7 = Clamshell
- 6 = Blister
- 5 = Poly or Vinyl Bag
- 4 = Individual Carton
- 3/L3 = Skin Pack/Heavy Card
- 2 = Hang Tag
- 1 = Individual UPC label
- PD/ D = PDQ Display

Page note(s) _____

SAHARA MK1 AUTOMATIC BILGE PUMPS

An automatic-switch bilge pump is a requirement for any vessels 20' and over with sleeping accommodations, but is a great convenience for any size boat. The Sahara has everything contained in one compact yet durable package – pump, wire seals, strainer, and **mercury-free** switch – and installs quickly and easily in tight spaces. Pumps include 29" lengths of 16-gauge caulked and tinned copper wire.

* **WARNING** Cancer and Reproductive Harm
– www.P65Warnings.ca.gov (see page 243)

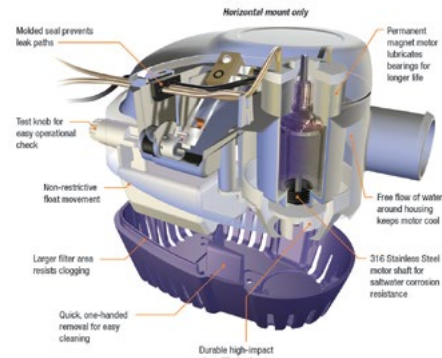

Specifications (Motor Running)

Model No.	Rated Voltage	Design Voltage	Amp Draw	GPH Output @ Design Voltage 13.6 VDC			Max Head	Amp Draw	GPH Output @ Nominal Voltage 12.0 VDC			Max Head	Fuse Size	Hose Size
				0 ft.	3.3 ft.	6.7 ft.			0 ft.	3.3 ft.	6.7 ft.			
S500	12	13.6	1.5	500	350	200	9 ft.	1.2	450	300	190	8 ft.	3-amp	3/4" I.D.
S750	12	13.6	2.8	750	625	450	16 ft.	2.5	660	480	345	12 ft.	5-amp	3/4" I.D.
S750	24	27.2	1.5	750	625	450	16 ft.	1.2	660	480	345	12 ft.	2-amp	3/4" I.D.
S1100	12	13.6	4	1100	973	750	11 ft.	3.4	1070	820	615	9 ft.	6-amp	1-1/8" I.D.
S1100	24	27.2	1.9	1100	973	750	11 ft.	1.4	1070	820	615	9 ft.	3-amp	1-1/8" I.D.

S500 Pump

S500 has plenty of pumping power for most jobs. 500 GPH † at open flow, 350 GPH † at 3.3' head. Draws only 1.5-amps at open flow!

Model No.	Rated Voltage	Hose Size	Wire/ Connector	Bulk Packaging	Prop 65	Aftermarket Packaging	Prop 65
S500	12-volt	3/4" I.D.	29" wire	4505-1	*	4505-7	*
S500 with Stainless Steel Strainer	12-volt	3/4" I.D.	29" wire	4505S1	*	—	—
Stainless Steel Strainer	—	—	—	4236	—	—	—

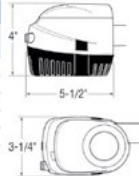

S750 Pump

S750 is sized for larger recreational boats. Our most powerful 3/4"-outlet automatic pump. 750 GPH † at open flow, 625 GPH † at 3.3' head, 3/4" hose outlet.

Model No.	Rated Voltage	Hose Size	Wire/ Connector	Bulk Packaging	Prop 65	Aftermarket Packaging	Prop 65
S750	12-volt	3/4" I.D.	29" wire	4507-1	*	4507-7	*
S750 with Stainless Steel strainer	12-volt	3/4" I.D.	29" wire	4507S1	*	—	—
S750	24-volt	3/4" I.D.	29" wire	4508-1	*	—	—
Stainless Steel Strainer	—	—	—	4236	—	—	—



S1100 Pump

S1100 is our most powerful and efficient automatic pump. High capacity for larger boats and yachts. 1100 GPH † at open flow, 973 GPH † at 3.3' head, 1-1/8" hose outlet.

Model No.	Rated Voltage	Hose Size	Wire/ Connector	Bulk Packaging	Prop 65	Aftermarket Packaging	Prop 65
S1100	12-volt	1-1/8" I.D.	29" wire	4511-1	*	4511-7	*
S1100 with Stainless Steel strainer	12-volt	1-1/8" I.D.	29" wire	4511S1	*	—	—
S1100	24-volt	1-1/8" I.D.	29" wire	4512-1	*	—	—
Stainless Steel Strainer	—	—	—	4236	—	—	—



† Listed GPH is measured at design voltage of 13.6 VDC.





CATEGORY OVERVIEW	4
BILGE PUMPS	5-7
AERATOR PUMPS	8-9
BILGE & FLOAT SWITCHES	10
SHOWER & WASHDOWN SYSTEMS	11-12
BATTERY & HAND OPERATED PUMPS	13
PUMP KITS & ACCESSORIES	14-15
PLUMBING SYSTEM FITTINGS	16
STAINLESS STEEL THRU-HULLS & SCUPPER VALVES FITTINGS	17-19
STAINLESS STEEL CAPPED COMPOSITE THRU-HULLS	20
PLASTIC THRU-HULLS & SCUPPER VALVE FITTINGS	21-22
DRAINS, DRAIN PLUGS & TUBES	23-24
IN-LINE BLOWERS	25
VENTS & COLLECTOR BOXES	26-28



COMPLETE SELECTION

A complete selection of pumps and blowers are available for fishing boats, runabouts, cruisers, yachts, and commercial boats. Attwood pumps and blowers are tested and approved as standard equipment by leading boat manufacturers.

Bilge and Aerator Pumps

The Heavy-Duty 1700 and 2000 bilge pumps have established Attwood into the commercial market with value-loaded industrial-duty features and performance.

The Tsunami series of cartridge style bilge and aerator pumps are engineered for higher performance in the most service friendly design imaginable. Their cartridge style allows quick and easy replacement without the need to remove hoses or mounting bases.

Automatic Bilge Pumps

All boats over 20' long with sleeping accommodations (excluding fold-out cockpit seats) should use automatic bilge pump systems. Non-automatic pumps drawing 12-amps or less can easily convert to automatic operation with an Attwood Automatic Float Switch (part number 4201 or 4202).

Our Sahara Series automatic pumps are available in 500, 750 and 1100 gph capacity models.

Bilge pumps are designed to exhaust standing water only. They are not intended to prevent accumulation of on-board water due to rough weather, hull damage, and/or other unsafe navigational conditions. Note: Bilge and aerator pumps must be lower than the source of water for priming.

Turbo In-Line Blowers

Attwood offers ventilation equipment and accessories featuring the revolutionary, patented Turbo In-Line Blowers for 3" - and 4" -diameter systems. Turbo blowers are the most dependable, efficient, and powerful in-line blowers on the market, designed using aerospace technology. The Turbo line also features the industry's first water-resistant blower models, with durability proven in rigorous moisture tests and years of success in the field. Attwood offers Turbo water-resistant blowers with an unprecedented three-year limited warranty, and a one-year limited warranty for standard models.

Certification, Standards, and Listings - Pumps

All Attwood pumps meet or exceed the following U.S. and international certificates and standards:

- ABYC H-22
- ISO 8846, 8849 Marine
- U.S. Coast Guard Rule, Title 33CFR sections 183.410 and 33CFR 183.425
- NMMA "As Approved Listing"
- CE
- All pumps are marine ignition protected

Certifications, Standards and Listings - Blowers

Attwood in-line blowers meet or exceed the following U.S. and international certificates and standards:

- ABYC-H2; ISO 9097
- U.S. Coast Guard Rules, Title 33 CFR sections 183.410, and 183.610 (b)
- Tested to ANSI/AMCA (210-85) and ANSI/ASHRAE (51-1985) standards
- NMMA "As Approved Listing"
- CE

Choice of Electrical Connectors

Attwood pumps feature several wire attachment styles to adapt to your boat's wiring harness. Standard wire on all pumps are tinned and caulked 16-gauge for butt connection. All pumps ignition protected.

Special connectors are available on special order by contacting your Attwood representative. Minimum order quantity is 250:

- Packard Connector
- Packard Connector, Water-Resistant
- Amp Connector
- Amp Connector, Water-Resistant
- Deutsch Connector
- Quick Silver Connector
- Delphi Connector

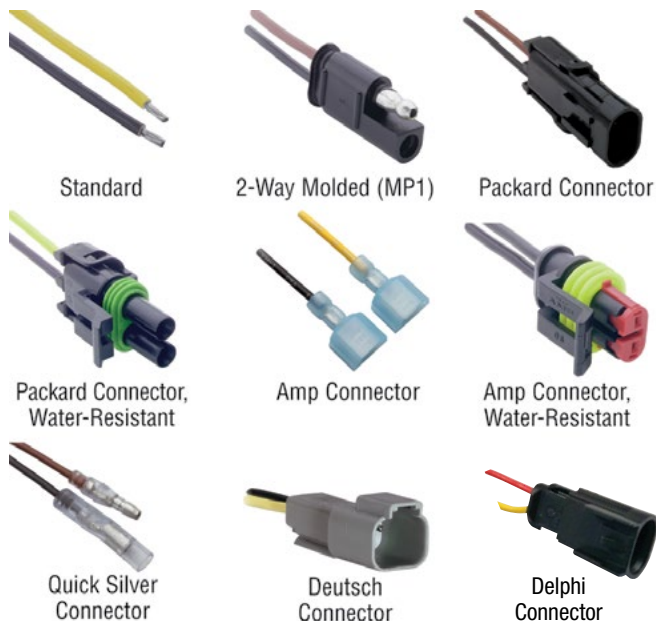

Brown – Positive, Black – Negative, Brown & White – Manual Override

SAHARA MK1 AUTOMATIC BILGE PUMPS

An automatic-switch bilge pump is a requirement for any vessels 20' and over with sleeping accommodations, but is a great convenience for any size boat. The Sahara has everything contained in one compact yet durable package – pump, wire seals, strainer, and **mercury-free** switch – and installs quickly and easily in tight spaces. Pumps include 29" lengths of 16-gauge caulked and tinned copper wire.



* **⚠ WARNING** Cancer and Reproductive Harm
– www.P65Warnings.ca.gov (see page 240)

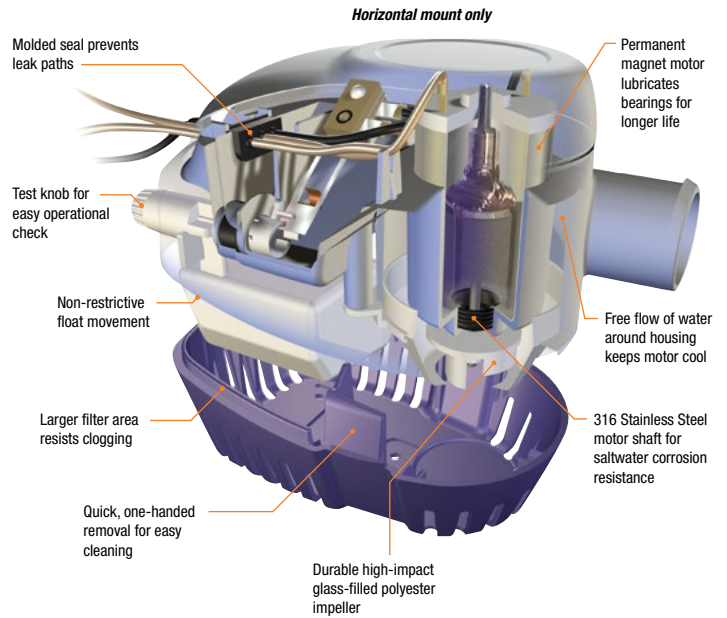

Specifications (Motor Running)

Model No.	Rated Voltage	Design Voltage	Amp Draw	GPH Output @ Design Voltage 13.6 VDC				Max Head	Amp Draw	GPH Output @ Nominal Voltage 12.0 VDC			Max Head	Fuse Size	Hose Size
				0 ft.	3.3 ft.	6.7 ft.	9 ft.			0 ft.	3.3 ft.	6.7 ft.			
S500	12	13.6	1.5	500	350	200	9 ft.	1.2	450	300	190	8 ft.	3-amp	3/4" I.D.	
S750	12	13.6	2.8	750	625	450	16 ft.	2.5	660	480	345	12 ft.	5-amp	3/4" I.D.	
S750	24	27.2	1.5	750	625	450	16 ft.	1.2	660	480	345	12 ft.	2-amp	3/4" I.D.	
S1100	12	13.6	4	1100	973	750	11 ft.	3.4	1070	820	615	9 ft.	6-amp	1-1/8" I.D.	
S1100	24	27.2	1.9	1100	973	750	11 ft.	1.4	1070	820	615	9 ft.	3-amp	1-1/8" I.D.	

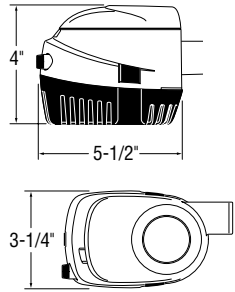

S500 Pump

S500 has plenty of pumping power for most jobs. 500 GPH † at open flow, 350 GPH † at 3.3' head. Draws only 1.5-amps at open flow!

Model No.	Rated Voltage	Hose Size	Wire/ Connector	Bulk Packaging	Prop 65	Aftermarket Packaging	Prop 65
S500	12-volt	3/4" I.D.	29" wire	4505-1	*	4505-7	*
S500 with Stainless Steel Strainer	12-volt	3/4" I.D.	29" wire	4505S1	*	—	—
Stainless Steel Strainer	—	—	—	4236	—	—	—



4505

S750 Pump

S750 is sized for larger recreational boats. Our most powerful 3/4"-outlet automatic pump. 750 GPH † at open flow, 625 GPH † at 3.3' head. 3/4" hose outlet.

Model No.	Rated Voltage	Hose Size	Wire/ Connector	Bulk Packaging	Prop 65	Aftermarket Packaging	Prop 65
S750	12-volt	3/4" I.D.	29" wire	4507-1	*	4507-7	*
S750 with Stainless Steel strainer	12-volt	3/4" I.D.	29" wire	4507S1	*	—	—
S750	24-volt	3/4" I.D.	29" wire	4508-1	*	—	—
Stainless Steel Strainer	—	—	—	4236	—	—	—



4507

S1100 Pump

S1100 is our most powerful and efficient automatic pump. High capacity for larger boats and yachts. 1100 GPH † at open flow, 973 GPH † at 3.3' head. 1-1/8" hose outlet.

Model No.	Rated Voltage	Hose Size	Wire/ Connector	Bulk Packaging	Prop 65	Aftermarket Packaging	Prop 65
S1100	12-volt	1-1/8" I.D.	29" wire	4511-1	*	4511-7	*
S1100 with Stainless Steel strainer	12-volt	1-1/8" I.D.	29" wire	4511S1	*	—	—
S1100	24-volt	1-1/8" I.D.	29" wire	4512-1	*	—	—
Stainless Steel Strainer	—	—	—	4236	—	—	—



4511

† Listed GPH is measured at design voltage of 13.6 VDC.



HEAVY-DUTY BILGE PUMPS



Integrates the highest quality bearings, brushes, alloys and magnets designed to withstand extreme usage cycles. Pump also employs an exclusive shaft and motor compartment, reducing wear and significantly extending pump life. Advanced resin compositions incorporated into exterior to resist chemicals such as engine oil, aggressive detergents and hose plasticisers. Attwood's Heavy Duty Bilge has unsurpassed durability and efficiency in a compact design to ensure electrical energy is converted to the pump rather than excess heat. This pump is fully submersible.

* **WARNING** Cancer and Reproductive Harm
 – www.P65Warnings.ca.gov (see page 240)

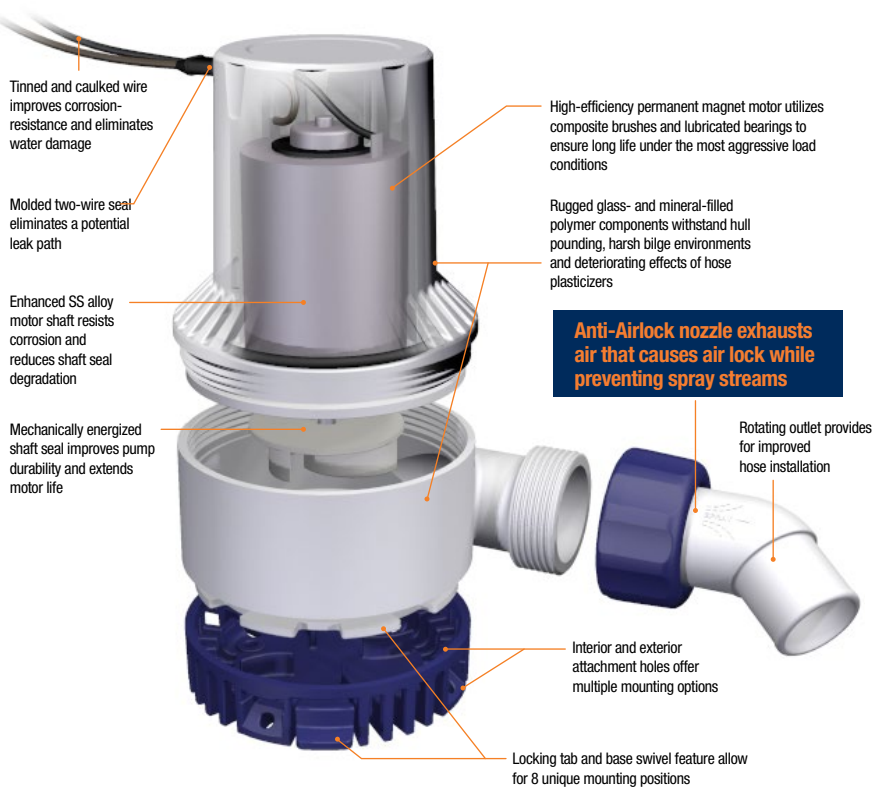

Specifications

Model No.	Rated Voltage	Amp Draw	GPH Output @ Design Voltage 13.6 VDC				GPH Output @ Nominal Voltage 12.0 VDC				Fuse Size	Hose Size	
			0 ft.	3.3 ft.	6.7 ft.	Max Head	Amp Draw	0 ft.	3.3 ft.	6.7 ft.			Max Head
HD1700	12	5.7	1700	1300	950	12 ft.	5.1	1500	1100	800	11 ft.	10-amp	1-1/8" I.D.
HD2000	12	6.6	2000	1600	1230	17 ft.	6	1800	1500	1200	16 ft.	12-amp	1-1/8" I.D.
	24	3.5	2000	1600	1230	17 ft.	2.9	1800	1500	1200	16 ft.	7-amp	1-1/8" I.D.

HD1700 Pump

The perfect upgrade from 1500 GPH rated pumps, especially older, over-rated designs. Delivers a true 1700 GPH at open flow while drawing less than 6-amps.

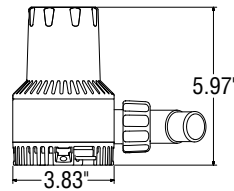

Model No.	Rated Voltage	Wire/ Connector	Bulk Packaging	Prop 65	Aftermarket Packaging	Prop 65
HD1700	12-volt	36" wire	4730-1	*	4730-4	*

HD 1700 Pump with Anti-Airlock nozzle



HD2000 Pump

Attwood's highest capacity bilge pump! Ball-bearing design provides for cooler motor operation and longer life. Delivers over 2000 GPH at open flow while drawing less than 7-amps.

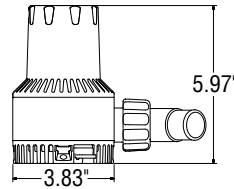

Model No.	Rated Voltage	Wire/ Connector	Bulk Packaging	Prop 65	Aftermarket Packaging	Prop 65
HD2000	12-volt	36" wire	4760-1	*	4760-4	*
	24-volt	36" wire	4770-1	*	4770-4	*

HD 2000 Pump with Anti-Airlock nozzle



TSUNAMI BILGE PUMPS

With their innovative engineering and compact design, Tsunami pumps deliver high output from a small package. We use the most advanced material available, including the best quality bearings and state-of-the-art brushes, alloys and magnets. Our patented shaft seal prevents leaks caused by misalignment and our caulked and tinned wiring eliminates wicking, prevents water damage and resists corrosion.

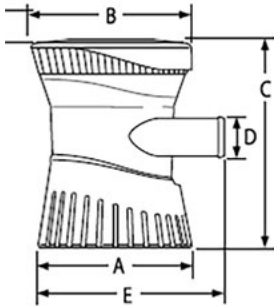

Pump Dimensions

Model No.	A	B	C	D	E
T500	2-3/4"	2-7/8"	3-5/8"	3/4" O.D.	3-1/8"
T800	3-1/8"	3-1/4"	4-3/8"	3/4" O.D.	3-1/2"
T1200	3-1/8"	3-1/4"	4-3/8"	1-1/8" O.D.	3-3/4"

Specifications

Model No.	Rated Voltage	Amp Draw	GPH Output @ Design Voltage 13.6 VDC				GPH Output @ Nominal Voltage 12.0 VDC				Fuse Size	Hose Size	
			0 ft.	3.3 ft.	6.7 ft.	Max Head	0 ft.	3.3 ft.	6.7 ft.	Max Head			
T500	12	1.8	500	400	250	9 ft.	1.4	450	320	160	8 ft.	3-amp	3/4" O.D.
	24	1.3	800	660	510	13 ft.	1.1	760	550	400	11 ft.	2-amp	3/4" O.D.
T800	12	3	800	660	510	13 ft.	2.5	760	550	400	11 ft.	4-amp	3/4" O.D.
	24	1.3	800	660	510	13 ft.	1.1	760	550	400	11 ft.	2-amp	3/4" O.D.
T1200	12	3.5	1200	900	700	11 ft.	3	1100	760	480	9 ft.	5-amp	1-1/8" O.D.
	24	1.5	1200	900	700	11 ft.	1.3	1100	760	480	9 ft.	2-amp	1-1/8" O.D.

Tsunami Bilge Pumps & Accessories

No mounting brackets necessary.

Model No.	Outlet Style	Rated Voltage	Wire/ Connector	Bulk Packaging	Aftermarket Packaging
TSUNAMI BILGE PUMPS					
T500	Barbed - 3/4"	12-volt	29" wire	4606-1	4606-7
	Threaded - 3/4"Δ	12-volt	29" wire	4606TH1	—
T800	Barbed - 3/4"	12-volt	29" wire	4608-1	4608-7
	Threaded - 3/4"Δ	12-volt	29" wire	4608TH1	—
T1200	Barbed - 3/4"	24-volt	29" wire	4609-1	—
	Barbed - 1-1/8"	12-volt	29" wire	4612-1	4612-7
	Barbed - 1-1/8"	24-volt	29" wire	4613-1	—
TSUNAMI REPLACEMENT MOTOR CARTRIDGES					
T500		12-volt	29" wire	—	4620-6
T800		12-volt	29" wire	—	4622-6
T1200		12-volt	29" wire	—	4624-6

ΔThreaded outlet permits the use with 90° fittings or Flow-Rite™ connectors.

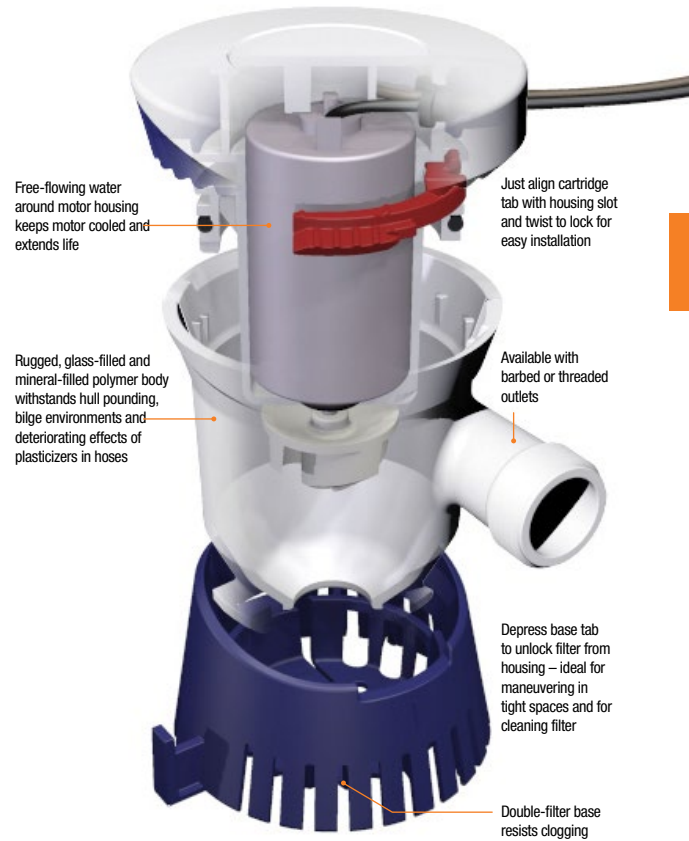

TSUNAMI AERATOR PUMPS

With their innovative engineering and compact design, Tsunami pumps deliver high output from a small package. We use the most advanced material available, including the best quality bearings and state-of-the-art brushes, alloys and magnets. Our patented shaft seal prevents leaks caused by misalignment and our caulked and tinned wiring eliminates wicking, prevents water damage and resists corrosion.

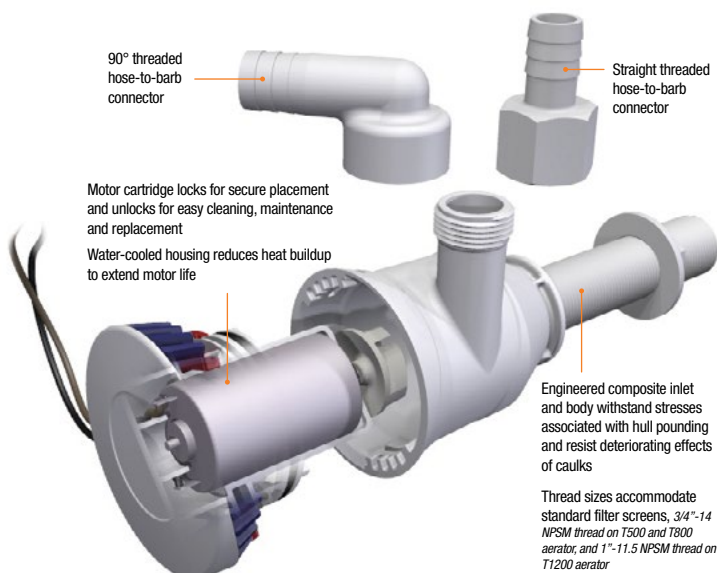

Pump Dimensions

Model	Application	A	B	C	D	E	F	G
T500	Thru-Hull	3-1/2" or 1-1/2"	3" or 1"	3-1/4"	2-7/8"	3-5/8"	3/4-14 NPSM	3/4-14 NPSM
	Seacock	1-1/2"	1"	3-1/4"	2-7/8"	3-5/8"	3/4-14 NPT	3/4-14 NPSM
T800	Thru-Hull	3-1/2" or 1-1/2"	3" or 1"	3-7/8"	3-1/4"	4"	3/4-14 NPSM	3/4-14 NPSM
	Seacock	1-1/2"	1"	3-7/8"	3-1/4"	4"	3/4-14 NPT	3/4-14 NPSM
T1200	Thru-Hull	3-1/2" or 1-1/2"	3" or 1"	4"	3-1/4"	4-7/8"	1-3/8-12 UNF	1-3/8-12 UNF
	Seacock	1-1/2"	1"	4"	3-1/4"	4-7/8"	1-11-1/2 NPT	1-3/8-12 UNF

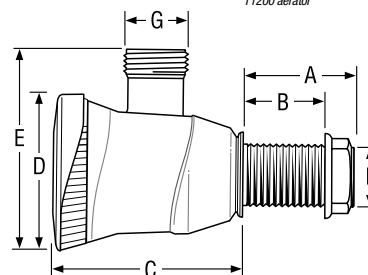

Specifications

Model No.	Rated Voltage	Amp Draw	GPH Output @ Design Voltage 13.6 VDC					GPH Output @ Nominal Voltage 12.0 VDC					Fuse Size	Hose Size
			0 ft.	3.3 ft.	6.7 ft.	Max Head	Amp Draw	0 ft.	3.3 ft.	6.7 ft.	Max Head			
T500	12	1.8	500	440	260	9 ft.	1.4	450	330	160	8 ft.	3-amp	3/4" O.D.	
T800	12	3	800	670	525	9 ft.	2.5	750	555	370	8 ft.	4-amp	3/4" O.D.	
T1200	12	3.5	1200	840	570	9 ft.	3	1140	790	450	8 ft.	5-amp	1-1/8" O.D.	

Tsunami Aerator Pumps & Accessories

No mounting brackets necessary.

Model No.	Inlet Length & Diameter	Outlet Style & I.D. Diameter	Rated Voltage	Wire/ Connector	Bulk Packaging	Aftermarket Packaging
TSUNAMI AERATOR PUMPS						
T500	3-1/2" L x 3/4"	Threaded - 3/4"	12-volt	29" wire	4640-1	4640-7
	1-1/2" L x 3/4"	Threaded - 3/4"	12-volt	29" wire	4641-1	—
	7/8" L x 3/4"	Threaded - 3/4"	12-volt	29" wire used with 3/4" seacock	4643-1	4643-7
T800	3-1/2" L x 3/4"	Threaded - 3/4"	12-volt	29" wire	4650-1	4650-7
	1-1/2" L x 3/4"	Threaded - 3/4"	12-volt	29" wire	4651-1	—
T1200	3-1/2" L x 1-1/8"	Threaded - 1-1/8"	12-volt	29" wire	4660-1	4660-7
	1-1/2" L x 1-1/8"	Threaded - 1-1/8"	12-volt	29" wire	4661-1	—
	7/8" L x 1"	Threaded - 1-1/8"	12-volt	29" wire used with 1" seacock	4663-1	—
TSUNAMI REPLACEMENT MOTOR CARTRIDGES						
T500			12-volt	29" wire	—	4620-6
T800			12-volt	29" wire	—	4622-6
T1200			12-volt	29" wire	—	4624-6



TSUNAMI DUAL OUTLET AERATOR PUMPS

The advantage of the dual outlet is that you can feed multiple applications through a single thru-hull fitting. The Tsunami second outlet is integrated into the pressure chamber, so it looks – and pumps – like part of the aerator. Both of the pump's outlets are engineered for the precise position and angle that will deliver optimum performance.

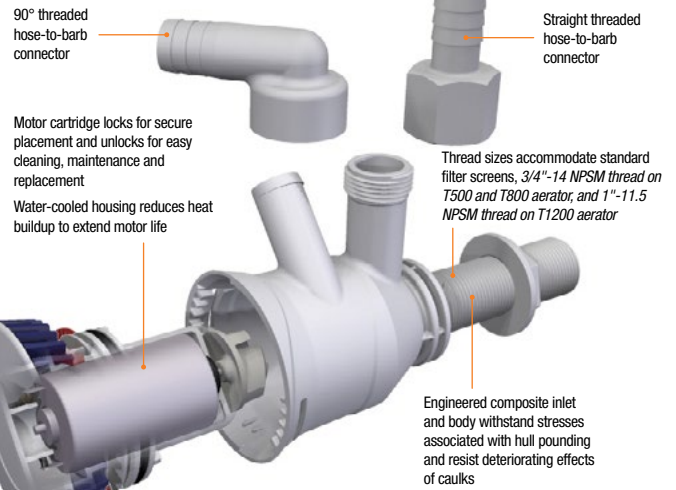

Applications:

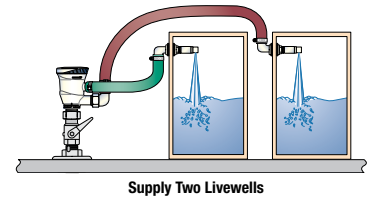
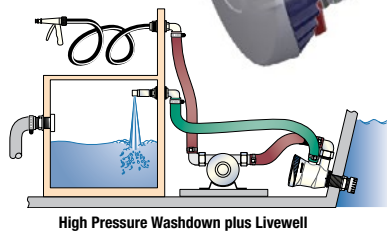
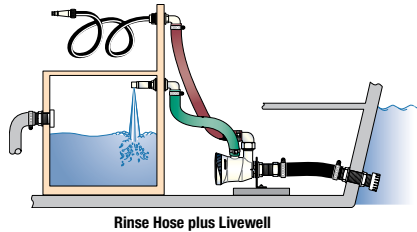

Pump Dimensions

Part No.	Inlet Length	Inlet Dia.	A	B	C	D	E	F	G	H
4672	3-1/2"	3/4"	3-1/4"	3"	4-1/8"	4-1/4"	4"	3/4-14 NPSM	3/4" Barbed .554" I.D.	3/4-14 NPSM .620" I.D.
4670	3/4"	3/4"	1-1/4"	7/16"	4-1/8"	4-1/4"	4"	3/4-14 NPT	3/4" Barbed .554" I.D.	3/4-14 NPSM .620" I.D.

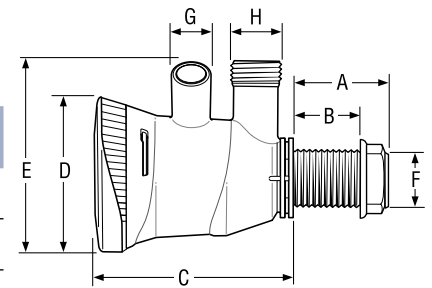

Specifications

Outlet	Amp Draw	GPH Output @ Design Voltage 13.6 VDC					GPH Output @ Nominal Voltage 12.0 VDC					Fuse Size	
		Both Outlets Open					Both Outlets Open						
		0 ft.	3.3 ft.	6.7 ft.	Max Head	0 ft.	Amp Draw	0 ft.	3.3 ft.	6.7 ft.	Max Head		0 ft.
Upper	3.0	750	600	460	13 ft.	880	2.5	670	500	390	11 ft.	770	4-amp
Lower	3.0	750	620	480	13 ft.	880	2.5	690	550	420	11 ft.	770	4-amp

Tsunami Dual Outlet Aerator Pumps & Accessories

No mounting brackets necessary.

Model No.	Inlet Length & Diameter	Rated Voltage	Wire/ Connector	Bulk Packaging	Aftermarket Packaging
TSUNAMI DUAL OUTLET AERATOR PUMPS					
T800	3-1/2" L x 3/4"	12-volt	29" wire	4672-1	4672-7
	7/8" L x 3/4"	12-volt	29" wire, use with 3/4" seacock	4670-1	4670-7
TSUNAMI REPLACEMENT MOTOR CARTRIDGE					
T800		12-volt	29" wire	—	4622-6



S3 SERIES AUTOMATIC BILGE SWITCHES



Incorporates a proprietary Electronic Sensing technology to detect bilge water levels and trigger pump activation and has been engineered to operate in any bilge water mixture consistently without failure. Your pump won't be exposed to continuous cycling as the S3 switch can easily distinguish splashing bilge water, chemicals, sludge build up or foam, and comes equipped with fully sealed electronics that are completely protected from water or chemical damage. For added convenience, the bilge switch can be mounted on the floor of the bilge, directly to a stringer wall, or alongside the basket of the pump without added components or brackets. The S3 Series switch is also directly compatible with all competitive products and free of moving parts that can jam up, break or wear out over time. Marine ignition protected and RoHS compliant.

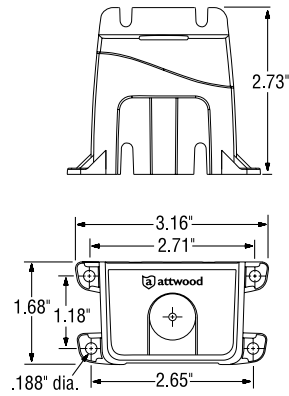

* **⚠ WARNING** Cancer and Reproductive Harm – www.P65Warnings.ca.gov (see page 240)

Description	Max. Pump Amp Draw	Rated Voltage	Wire	Bulk Packaging	Prop 65	Aftermarket Packaging	Prop 65
Switch, White	15A	12-volt	36" wire	4801-1		4801-7	



Automatic Float Switches

Converts bilge pumps to fully automatic operation. Maximum amp draw is 12 amps (at 12-volt D.C.) or 6-amps (at 24-volt D.C.). Features a compact, low-profile design that mounts on any surface from horizontal up to a 24° angle. Incorporates a reliable and affordable mechanical switch that actuates pump motor at 2" water level. Wire leads do not flex or hinge with the float as on some competitive models. Integral cover dampens bilge sloshing to reduce pump cycling, and prevents debris interference. Sealed switch mechanism resists moisture, fume-ignition, and electrical shock. Contains no mercury, which is listed as a health hazard and "Persistent Toxic Substance" in over 26 states. Marine ignition protected and RoHS compliant.

* **⚠ WARNING** Cancer and Reproductive Harm – www.P65Warnings.ca.gov (see page 240)

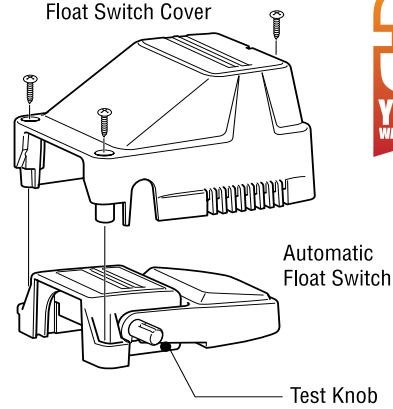

Float Switch with Cover

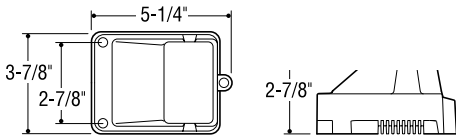

Description	Rated Voltage	Wire/ Connector	Bulk Packaging	Prop 65	Aftermarket Packaging	Prop 65
Float switch with cover	12- and 24-volt CE rated	36" wire	4201-1	*	4201-7	*



Float Switch

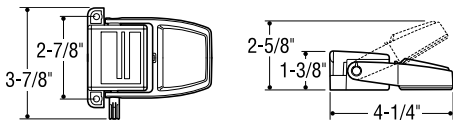

Description	Rated Voltage	Wire/ Connector	Bulk Packaging	Prop 65	Aftermarket Packaging	Prop 65
Float switch	12- and 24-volt CE rated	36" wire	4202-1	*	4202-7	*



Shower Sump Pump Systems

Attwood's shower sump systems deliver the performance you've been asking for. Choose from standard box or large box sizes. Offering fast water flow into and out of sump. The lid snaps in to allow quick installation (and removal for cleaning) and includes a gasket to seal the sump box against overflow. The sump box even includes an air vent to prevent air locks. Meets or exceeds all applicable standards of the ABYC and USCG.

* **⚠ WARNING** Cancer and Reproductive Harm

— www.P65Warnings.ca.gov (see page 240)

Multiple Inlets Can Be Hooked Up to More Than One Drain – Using Different Hose Sizes

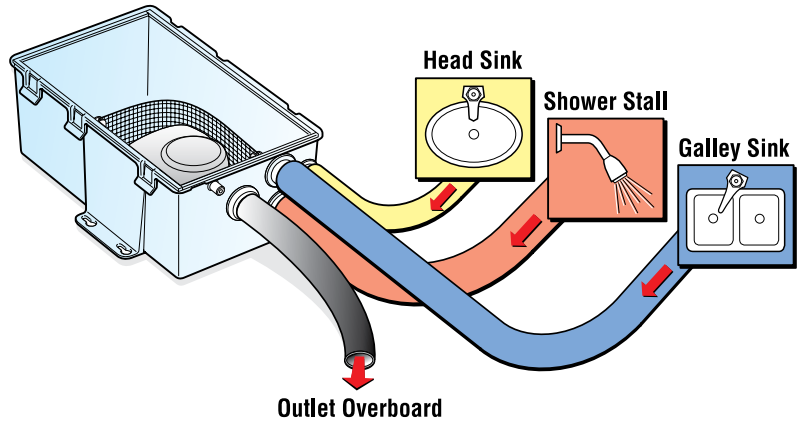

Specifications

Model	Rated Voltage	Fuse Size	Outlet Hose Size
500 GPH	12-volt	3-amps	3/4" I.D.
750 GPH	12-volt	5-amps	3/4" I.D.
750 GPH	24-volt	2-amps	3/4" I.D.

Output Ratings

Model	Amp Draw	GPH Output @ Design Voltage 13.6 VDC			GPH Output @ Nominal Voltage 12.0 VDC		
		0 ft.	3.3 ft.	6.7 ft.	0 ft.	3.3 ft.	6.7 ft.
500 GPH	1.4	420	360	215	385	290	130
750 GPH	2.5	650	500	385	570	420	290

Performance for 24-Volt version is the same (Uses 2 Amp Fuses)

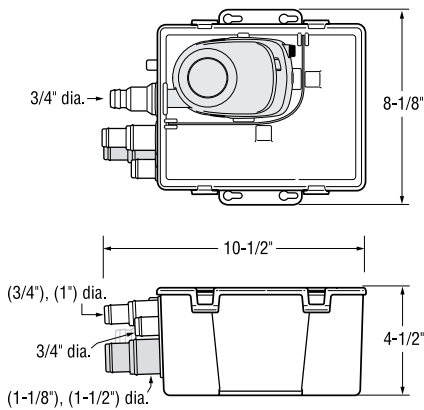
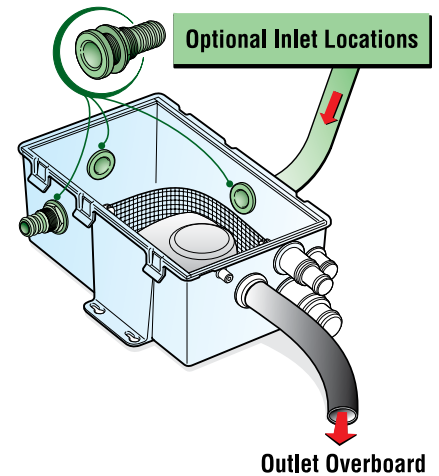

Standard Box

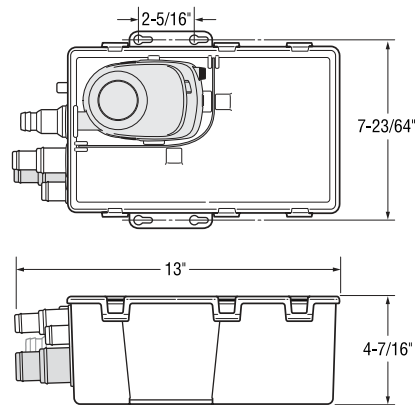

Large Box



4141



4143

Model No.	Rated Voltage	Wire/ Connector	Box Size	Bulk Packaging	Prop 65	Aftermarket Packaging	Prop 65
500 GPH	12-volt	22" wire	Standard	4141-1	*	4141-4	*
750 GPH	12-volt	22" wire	Standard	4142-1	*	—	—
750 GPH	12-volt	22" wire	Large	4143-1	*	4143-4	*
750 GPH	24-volt	22" wire	Large	4144-1	*	—	—
750 GPH	24-volt	22" wire	Standard	4145-1	*	—	—
Lid	—	—	Standard	001001668	*	—	—
Lid	—	—	Large	001001667	*	—	—



Aft-Deck Shower

Install flush in the transom or under the gunwale. Includes hinged cover and replaceable sprayer head. Fixtures are corrosion-resistant. Housing and cover are made of high-impact, UV resistant, engineering-grade plastic and are pre-drilled for six #8 fasteners. Comes with 6' hose, shut-off, and hot/cold mixing controls. Connects to freshwater system for showering.

* **⚠ WARNING** Cancer and Reproductive Harm

– www.P65Warnings.ca.gov (see page 240)

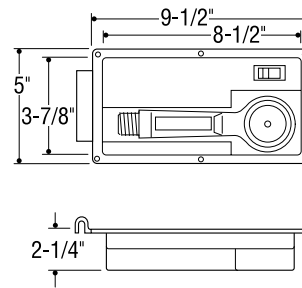

Description	Function	Hose Length	Bulk Packaging	Prop 65	Aftermarket Packaging	Prop 65
Aft-Deck	Hot/cold	6'	4131-1	*	4131-4	*

Cold Water Shower

Install flush in the transom or under the gunwale. Includes hinged cover and replaceable sprayer head. Fixtures are corrosion-resistant. Housing and cover are made of high-impact, UV resistant, engineering-grade plastic and are pre-drilled for six #8 fasteners. Hand-held shower sprayer with 6' hose and shut-off. Connects to freshwater system or self-priming wash-down pump for showering after swimming. Built-in on/off switch for pump.

* **⚠ WARNING** Cancer and Reproductive Harm

– www.P65Warnings.ca.gov (see page 240)

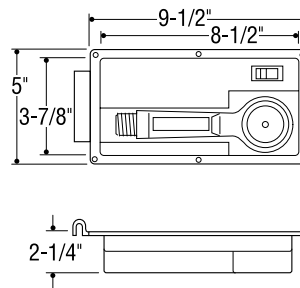

Description	Function	Hose Length	Bulk Packaging	Prop 65	Aftermarket Packaging	Prop 65
Cold Water	On/off switch	6'	4133-1	*	—	65

Self-Priming Washdown Pump

Self-priming pump for cleaning boats, general use, or use as a shower pump. Threaded male inlet and outlet for standard garden hose attachment. Pumps 4 gallons per minute, produces up to 8.5 PSI pressure. Corrosion-resistant plastic housing and impeller, heavy-duty 8-amp 12-Volt D.C. motor. Pump is non-submersible. **Note:** Do not run dry.

* **⚠ WARNING** Cancer and Reproductive Harm – www.P65Warnings.ca.gov (see page 240)



Description	Open Flow GPM	Max Head Pressure	Bulk Packaging	Prop 65	Aftermarket Packaging	Prop 65
Self-priming	4	8.5 PSI	—	*	11574-4	*

Potable Water Pump

This economical, compact pump only delivers drinking water from a water tank to a faucet. Seal allows it to run dry without damage. Made from high-impact plastic. Patented. Inlet and outlet have combination fittings: 3/8" barbs can be removed to accommodate 1/4" NPT fitting. Potable Water Pump is not activated by line pressure. Pump is non-submersible. Note: Mount centrifugal pump so water will flow into the pump.

Caution: Not external ignition protected.

* **⚠ WARNING** Cancer and Reproductive Harm – www.P65Warnings.ca.gov (see page 240)

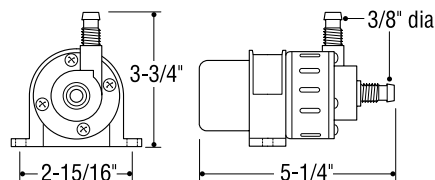

Inlet/Outlet Size	GPH	Max Head	Amp Draw	Fuse Size	Bulk Packaging	Prop 65	Aftermarket Packaging	Prop 65
3/8" barb, or convert to 1/4" NPT	150	16'	1.5	2-amp	6126-1	*	6126-7	*

WATERBUSTER®

PORTABLE PUMP

This submersible pump is a great way to remove unwanted water from boats, pool covers, aquariums and sump pits. Convenient and safe because it needs no electrical cord — runs up to five hours on three alkaline "D" batteries. Excellent for use as a portable pump-out device for paddle boats, inflatables, duck boats, dingies or kayaks, any craft that lacks a hard-wire, permanent electrical system.

- 6-3/8" high x 5-1/4"-diameter
- Pumps up to 200 gallons per hour
- Includes 42" hose with garden hose adapter for adding longer hose
- Lifts water to height of 40"
- **Note:** Not to be used as a permanent bilge pump

Description	GPH Open Flow	GPH 2 ft. Head †	Bulk Packaging	Aftermarket Packaging
Portable Pump	200	125	—	4140-4



4140

Hand-Operated Bilge Pumps

Safely remove unwanted water, or other liquids, from kayaks and other small boats.

* ⚠ **WARNING** Cancer and Reproductive Harm – www.P65Warnings.ca.gov (see page 240)

Description	Bulk Packaging	Prop 65	Aftermarket Packaging	Prop 65
Kayak Hand Bilge Pump, 18"	—		11595-2	*
Hand Bilge Pump, 24", 32" Hose	—		11596-2	*



11595



11596

† 4 ft. maximum head

Bilge Pump Switches

Panel-mounted rocker switches for use with pump that draws 10-amps or less. 1/4" spade terminals. 6-volt through 32-volt D.C. only, 10-amps maximum. Plate is 2-13/16" x 1-7/8". Hole size is 1-1/2" x 7/8".

* **WARNING** Cancer and Reproductive Harm – www.P65Warnings.ca.gov (see page 240)

Caution: Bilge pump switches are not external ignition protected.

Description	Bulk Packaging	Prop 65	Aftermarket Packaging	Prop 65
2-way on/off	—		7615-3	*
3-way auto/off/manual	—		7615A3	*

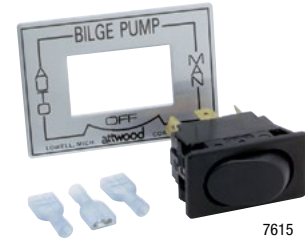

TSUNAMI RECIRQ AERATOR KIT

The Tsunami Recirq Kit recirculates livewell water to keep it cooler and rich in oxygen. This self-contained system feeds a separate aerator spray head and works even while you are underway and cannot use a thru-hull connection. Add this kit to any tank that already has a freshwater fill system. Or use as a backup pump for a fail-safe system.

* **WARNING** Cancer and Reproductive Harm – www.P65Warnings.ca.gov (see page 240)

Recirq Kit includes:

- (1) 500 GPH Tsunami aerator pump with short inlet, threaded outlet
- (1) 4125-1 aerator spray head
- (1) 4232-1 Stainless Steel strainer
- (2) Plastic hose clamps
- (1) 3/4" diameter x 23" long poly hose
- (1) Straight thread-to-barb connector

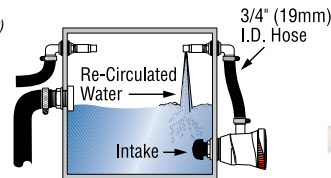

Description	Bulk Packaging	Prop 65	Aftermarket Packaging	Prop 65
T-500 Recirq Livewell Aerator Kit	—		4253-7	*

Bilge Pump Installation Kits

Complete kit to install manual bilge pump with 3/4" I.D. hose outlet.

* **WARNING** Cancer and Reproductive Harm – www.P65Warnings.ca.gov (see page 240)

- (1) 2-way on/off switch with bezel plate
- (1) 3/4" I.D. x 5' corrugated hose
- (1) Thru-hull fitting for 3/4" I.D. hose
- (2) Snap-It hose clamps
- (1) 2-conductor 16-gauge wire, 20' long
- (1) In-line fuse holder with 2-amp fuse

Caution: Bilge pump switches are not external ignition protected.

Description	Hose Size	Bulk Packaging	Prop 65	Aftermarket Packaging	Prop 65
Complete kit (without pump)	3/4" I.D.	—		4116-5	*
Complete kit with Tsunami T-500 bilge pump	3/4" I.D.	—		4614-7	*
6' hose with (2) clamps	3/4" I.D.	—		4199-7	*
6' hose only	1-1/8" I.D.	—		11551-5	*



Aerator Remote Mounting Brackets

For mounting the aerator pump to a base, away from the transom.

* **⚠ WARNING** Cancer and Reproductive Harm

– www.P65Warnings.ca.gov (see page 240)

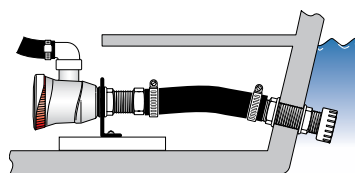

Description	Bulk Packaging	Prop 65	Aftermarket Packaging	Prop 65
1-1/8" Aerator remote mounting bracket	4121-1	*	4121-3	*
3/4" Aerator remote mounting bracket	4122-1	*	4122-3	*

Aerator Spray Heads

For use on livewells that have built-in overflows or recirculating systems.

Adjustable Spray Heads - Mounts on sides of tank. 90° fitting for installation in tight spaces. Rotating head with O-ring adjusts and maintains flow setting. Removable head has an "interference-fit thread design" that will not allow it to vibrate or blow out. Polypropylene construction. Can be installed on tanks with up to 5/8" wall thickness.

Non-Adjustable Spray Heads - Multi-port spray maximizes oxygen level in the livewell. Constructed of ABS plastic.

Double Valve Spray Head - Allows aerating options – one end can be used for freshwater fill, the other end with a recirculating pump. **Single Valve Spray Head** - For output from an aerator pump into the livewell.

* **⚠ WARNING** Cancer and Reproductive Harm

– www.P65Warnings.ca.gov (see page 240)



Description	Hose I.D.	Bulk Packaging	Prop 65	Aftermarket Packaging	Prop 65
ADJUSTABLE SPRAY HEADS					
Aerator spray head	3/4"	4125-1	*	4125-7	*
Aerator spray head w/male connector for Flow-Rite™ Qwik-Lok™ Coupler 3	3/4"	4123-1	*	—	—
NON-ADJUSTABLE SPRAY HEADS					
Aerator spray head, single valve	3/4"	4118A1	*	4118A5	*

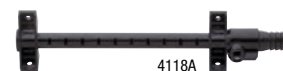

Check Tees

These check tees replace additional connections for RV and marine hookups, providing a combination check valve and tee that allows water to flow in from the dockside connection without filling the tank. Constructed of ABS plastic.

Combination Barbed Fitting - Inlet and outlet both have combination fittings: Comes with 3/8" barbs that can be removed to accommodate 1/4" NPT fitting. 1/2" NPT fitting for dockside water connection.

Combination Barbed Inlet/Threaded Outlet - Inlet has combination fitting: Comes with 3/8" barbs that can be removed to accommodate 1/4" NPT fitting. Outlet is 1/2" NPSM. 1/2" NPT fitting for dockside water connection.

* **⚠ WARNING** Cancer and Reproductive Harm

– www.P65Warnings.ca.gov (see page 240)

Description	Bulk Packaging	Prop 65	Aftermarket Packaging	Prop 65
Combination barbed fitting	6115-1	*	—	—
Combination barbed inlet/threaded outlet	6115A1	*	—	—



Snap-It Hose Clamps

Use on bilge pumps and shower sump systems. Corrosion-resistant plastic.

Note: Clamps are intended for water and waste system hoses only.

Description	Hose O.D.	Hose I.D.	Bulk Packaging	Aftermarket Packaging
Snap-It Hose Clamp	7/8" to 1"	3/4"	9185J1	—



Tees

Three-way 90° fitting. Acetal construction.

* **⚠ WARNING** Cancer and Reproductive Harm – www.P65Warnings.ca.gov (see page 240)

Description	Hose I.D.	Bulk Packaging	Prop 65	Aftermarket Packaging	Prop 65
Tee	3/4"	3892-1	*	—	
Tee	1-1/8" to 1-1/4"	3893-1	*	—	



Straight Connectors

Threaded end fits 3888 drain fitting, A-Series aerator pump outlets and Tsunami threaded outlets. Acetal construction.

3899: Barbed end accommodates 3/4" I.D. hose.

3909: Male end accommodates Flow-Rite™ Qwik-Lok™ Coupler.

* **⚠ WARNING** Cancer and Reproductive Harm – www.P65Warnings.ca.gov (see page 240)

Description	Bulk Packaging	Prop 65	Aftermarket Packaging	Prop 65
Thread-to-Barb 3/4"-14 NPSM and 3/4" I.D. hose fitting. For use with 500-800 GPH pumps	3899-1		3899-3	
Thread-to-Flow-Rite™ Qwik-Lok™ Connector fitting. For use with 500-800 GPH pumps	3909-1		—	
Thread-to-Barb Straight 1-3/8" - 12 UNF thread & 1-1/8" hose fitting For use with 1200 GPH pumps	3902-1	*	3902-3	*



90° Connectors

3890: Threaded female end fits 3888 drain fitting or A-Series aerator pump outlets and Tsunami threaded outlets. Barbed end accommodates 3/4" I.D. hose. Acetal construction.

3900: Threaded end fits A-Series aerator pump outlets and Tsunami threaded outlets. Male end accommodates Flow-Rite™ Qwik-Lok™ Coupler.

3891: Threaded end fits 3889 drain fitting. High-impact plastic. Barbed end accommodates 1-1/8" or 1-1/4" I.D. hose. Acetal construction.

* **⚠ WARNING** Cancer and Reproductive Harm – www.P65Warnings.ca.gov (see page 240)

Description	Bulk Packaging	Prop 65	Aftermarket Packaging	Prop 65
For 3/4"-14 threads and 3/4" I.D. hose. For use with 500-800 GPH pumps	3890-1	*	3890-3	*
Thread-to-Flow-Rite™ Qwik-Lok™ Connector. For use with 500-800 GPH pumps	3900-1	*	—	
For 1-3/8"-12 threads and 1-1/8" or 1-1/4" I.D. hose. For use with 1200 GPH pumps	3891-1	*	—	



STAINLESS STEEL THRU-HULLS & SCUPPER VALVE FITTINGS



Polish your image with these beautiful, durable stainless steel fittings. Each Thru-Hull and Scupper Valve is available with a new silicone gasket and are backed by Attwood's trusted Lifetime Warranty! Why specify plastic parts when these fittings will last the life of the boat?

Rugged Stainless Construction

- Cast from certified Enhanced 316 Stainless Steel alloy for strength and lifetime corrosion-resistance
- We polish all visible areas to a mirror finish, then passivate each part for additional protection
- Thick steel sidewalls withstand continual stress and hose flexing

Faster, Simpler Installation

- A channel under the flange holds a bead of sealant, making it easier to apply a trouble-free seal
- All models have wrench flats or an end notch to hold as a gripping surface. One installer can tighten all connections from inside the hull
- Barbed tail ends provide plenty of room to hold multiple clamps

Stainless Steel Straight Thru-Hulls, Barbed

- Standard Thread model has full-length thread for thick hulls and easy tightening
- Short Thread is a more compact size. Allows installation near corners and in confined areas.

Caution: Stainless Steel Thru-Hull Connectors are designed for installation above the water line only.

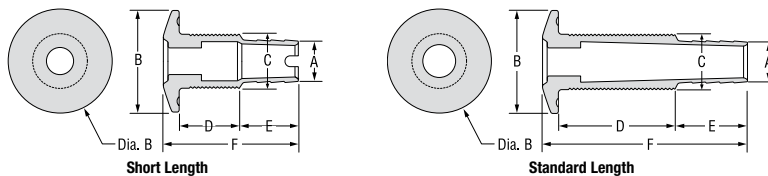

A Hose Size	B Flange Dia.	C Thread O.D.	D Thread Length	E Barb Length	F Total Length	Install. Hole Saw Size	Thread NPSM	Max Hull Thick.	Bulk without Gasket	Aftermarket Packaging
SHORT LENGTH										
5/8" I.D.	1-7/8"	1"	1"	1"	2-1/4"	1-1/8"	3/4"	5/8"	66540-1	66540-3
3/4" I.D.	1-7/8"	1"	1"	1"	2-1/2"	1-1/8"	3/4"	5/8"	66541-1	66541-3
1" I.D.	2-1/4"	1-3/8"	1-1/8"	1"	2-1/2"	1-1/2"	1"	5/8"	66542-1	66542-3
1-1/8" I.D.	2-1/4"	1-3/8"	1-1/4"	1"	2-1/2"	1-1/2"	1"	5/8"	66543-1	66543-3
1-1/4" I.D.	2-1/4"	1-5/8"	1-1/4"	1"	2-5/8"	1-3/4"	1-1/4"	5/8"	66544-1	66544-3
1-1/2" I.D.	3"	1-7/8"	1-1/4"	1-1/2"	3-1/8"	2"	1-1/2"	5/8"	66545-1	66545-3
STANDARD LENGTH										
5/8" I.D.	1-7/8"	1"	2"	1-1/4"	3-3/4"	1-1/8"	3/4"	1-1/16"	66546-1	66546-3
3/4" I.D.	1-7/8"	1"	2"	1-1/4"	3-3/4"	1-1/8"	3/4"	1-5/8"	66547-1	66547-3
1" I.D.	2-1/4"	1-3/8"	2-1/4"	1-1/4"	3-7/8"	1-1/2"	1"	1-3/4"	66548-1	66548-3
1-1/8" I.D.	2-1/4"	1-3/8"	2-3/8"	1-1/4"	3-7/8"	1-1/4"	1"	1-3/4"	66549-1	66549-3
1-1/4" I.D.	2-1/4"	1-5/8"	2-1/2"	1-1/4"	4-1/4"	1-3/4"	1-1/4"	1-7/8"	66550-1	66550-3
1-1/2" I.D.	3"	1-7/8"	2-1/2"	1-1/4"	4-1/8"	2"	1-1/2"	1-7/8"	66551-1	66551-3
2" I.D.	3"	2-3/8"	2-1/2"	1-3/4"	4-5/8"	2-1/2"	1-1/2"	2"	66552-1	—



66540G



66542



66546G



66548

Stainless Steel Straight Thru-Hulls, Threaded



- Unique multi-thread design with NPSM and NPT threads
- Offer generous thread length
- Allows for direct connection to seacocks or pipes

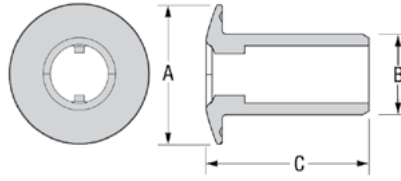

66559



66558G

Caution: Stainless Steel Thru-Hull Connectors are designed for installation above the water line only.

A Flange Dia.	B Thread O.D.	C Total Length	Installation Hole Saw Size	Threads NPSM	Max Hull Thickness	Bulk without Gasket	Aftermarket Packaging
1-7/8"	2-1/8"	2-1/2"	1-1/8"	3/4"	1-5/8"	66559-1	—
2-1/4"	2-1/4"	2-5/8"	1-3/8"	1"	1-3/4"	66561-1	—
3"	2-3/8"	2-3/4"	2"	1-1/2"	1-7/8"	66563-1	—

Stainless Steel 90° Thru-Hulls, Barbed



Allows installation in especially tight spaces.

* **⚠ WARNING** Cancer and Reproductive Harm – www.P65Warnings.ca.gov (see page 240)

Caution: Stainless Steel Thru-Hull Connectors are designed for installation above the water line only.

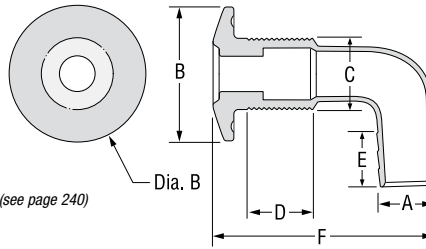

66577

A Hose Size	B Flange Dia.	C Thread O.D.	D Thread Length	E Barb Length	F Total Length	Install. Hole Saw Size	Thread NPSM	Max Hull Thick.	Bulk without Gasket	Prop 65	Aftermarket Packaging
3/4" I.D.	1-7/8"	1"	1-1/2"	3/4"	3-3/8"	1-1/4"	3/4"	1-1/16"	66577-1	—	—
1-1/8" I.D.	2-1/4"	1-3/8"	1-7/8"	3/4"	4-3/8"	1-5/8"	1"	1-1/4"	66579-1	—	—

Stainless Steel Scupper Valves



- The Scupper Flap is tough neoprene rubber with a molded V that fits into the grooved body to reduce backwash
- Fasteners are concealed and corrosion-proof
- Enhanced 316 Stainless Steel Alloy

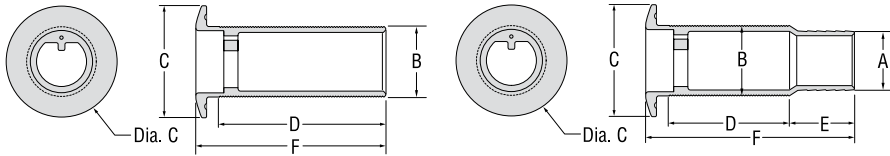

* **⚠ WARNING** Cancer and Reproductive Harm – www.P65Warnings.ca.gov (see page 240)

Caution: Stainless Steel Scupper Valves are designed for installation above the water line only.

A Hose Size	B Thread Dia.	C Flange O.D.	D Thread Length	E Barb Length	F Total Length	Install. Hole Saw Size	Thread NPSM	Max Hull Thick.	Bulk without Gasket	Prop 65	Aftermarket Packaging	Prop 65
THREADED												
—	1-7/8"	3"	3-1/2"	—	3-7/8"	2"	1-1/2"	3"	66565-1	*	—	—
—	2-23/64"	3-5/8"	2-1/2"	—	2-7/8"	2-1/2"	2"	2"	66567-1	*	—	—
BARBED												
1-1/2"	1-7/8"	3"	3-1/2"	1-1/2"	5-1/2"	2"	1-1/2"	3"	66553-1	*	66553-3	*
2"	2-23/64"	3-5/8"	2-1/2"	1-5/16"	4-1/2"	2-1/2"	2"	2"	66555-1	*	—	—
1-1/2"	3"	1-7/8"	2-1/4"	1-1/2"	4-1/2"	2"	1-1/2"	1-3/4"	66557-1	*	—	—
VALVE ACCESSORIES									BULK			
Replacement Flappers for 1-1/2"									66553Kit	*	—	—
Replacement Flappers for 2"									66555Kit	*	—	—



66565



66557G



Stainless Steel Narrow Flange Thru-Hulls

- Consistent exterior appearance throughout range of barb sizes
- Modern styling
- Enhanced 316 Stainless Steel Alloy

Caution: Stainless Steel Thru-Hull Connectors are designed for installation above the water line only.

* **⚠ WARNING** Cancer and Reproductive Harm - www.P65Warnings.ca.gov (see page 240)

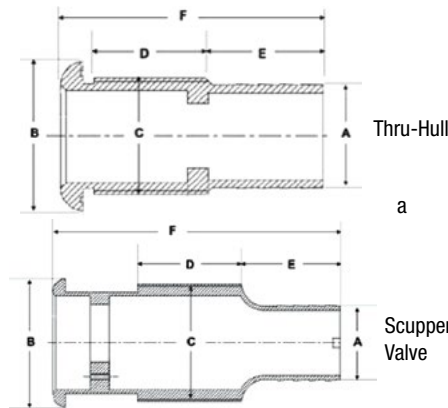

LIFETIME WARRANTY



67555



67556



67551



67553

A Hose Size	B Flange Dia.	C Thread O.D.	D Thread Length	E Barb Length	F Total Length	Install. Hole Saw Size	Thread NPSM	Max Hull Thick.	Bulk without Gasket	Prop 65	Aftermarket Packaging
THRU-HULLS, STANDARD LENGTH											
5/8" I.D.	1-7/10"	1-3/10"	1-2/5"	1-1/8"	3"	1-5/16"	1"	7/8"	67555-1	—	—
3/4" I.D.	1-7/10"	1-3/10"	1-3/10"	1-1/4"	3"	1-5/16"	1"	3/4"	67554-1	—	—
1" I.D.	1-7/10"	1-3/10"	1-2/5"	1-1/8"	3"	1-5/16"	1"	7/8"	67556-1	—	—
1-1/8" I.D.	1-7/10"	1-3/10"	1-1/4"	1-1/8"	2-7/8"	1-5/16"	1"	3/4"	67557-1	—	—
1-1/2" I.D.	2-2/5"	1-7/8"	1-1/2"	1-3/5"	3-2/5"	2"	1-1/2"	1"	67551-1	—	—
2" I.D.	3.13"	2-3/8"	2.93"	2.04"	6.09"	2-7/16"	2"	2.70"	67552-1	*	—
THRU-HULLS, LONG LENGTH											
3/4" I.D.	1-7/10"	1-3/10"	1-1/2"	1-1/8"	4-1/4"	1-5/16"	1"	—	67558-1	—	—
1-1/8" I.D.	1-7/10"	1-3/10"	1-1/2"	1-1/8"	4-1/4"	1-5/16"	1"	—	67561-1	—	—
1-1/2" I.D.	2-2/5"	1-7/8"	1-1/2"	1-7/16"	4-15/16"	2"	1-1/2"	—	67562-1	—	—
SCUPPER VALVE											
1-1/2" I.D.	2-3/5"	1-7/8"	2"	2"	5-3/4"	2-1/8"	1-1/2"	2-3/4"	67553-1	*	—

Stainless Steel Exhaust Thru-Hulls

- Specifically designed for generator and engine exhaust applications
- Features unique, modern styling that is both elegant and functional
- Stainless steel scupper valve and an integrated stainless drip ring
- Enhanced 316 Stainless Steel Alloy

Caution: Stainless Thru-Hull Connectors are designed for installation above the water line only.

* **⚠ WARNING** Cancer and Reproductive Harm – www.P65Warnings.ca.gov (see page 240)

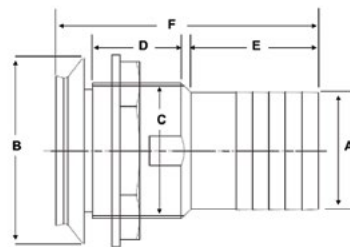

LIFETIME WARRANTY



67581



67582

A Hose Size	B Flange Dia.	C Thread O.D.	D Thread Length	E Barb Length	F Total Length	Install. Hole Saw Size	Thread NPSM	Max Hull Thick.	Bulk without Gasket	Prop 65	Aftermarket Packaging
1-1/2" I.D.	3.18"	2.26"	1.6"	1.97"	4.58"	2.375"	2" – 11-3/4	1.125"	67581-1	*	—
2" I.D.	3.18"	2.26"	1.6"	2.23"	4.58"	2.375"	2" – 11-3/4	1.125"	67580-1	*	—
2-1/2" I.D.	4.60"	3.375"	1.8"	2.75"	5.8"	3.625"	3" – 8	1.5"	67583-1	*	—
3" I.D.	4.60"	3.375"	1.8"	3"	5.8"	3.625"	3" – 8	1.5"	67582-1	*	—

STAINLESS STEEL CAPPED COMPOSITE THRU-HULLS

Designed for the value conscious customer, these fittings provide the look of a Stainless Steel thru-hull at a fraction of the cost

* **⚠ WARNING** Cancer and Reproductive Harm – www.P65Warnings.ca.gov (see page 240)

Corrosion Resistance

Manufactured with high quality stainless steel caps and engineered composite bodies, these thru-hulls are designed to resist degradation as a result of chemical and saltwater exposure.

Consistent Look

To create a uniform look, Attwood has designed its 5/8" thru 1-1/2" barbed thru-hulls with a common exterior surface.

Improved Installation

Always keeping the builder in mind, each fitting incorporates several different types of assembly features that allow for "single operator" installation.

Caution: Stainless Steel Thru-Hull Connectors are designed for installation above the water line only.

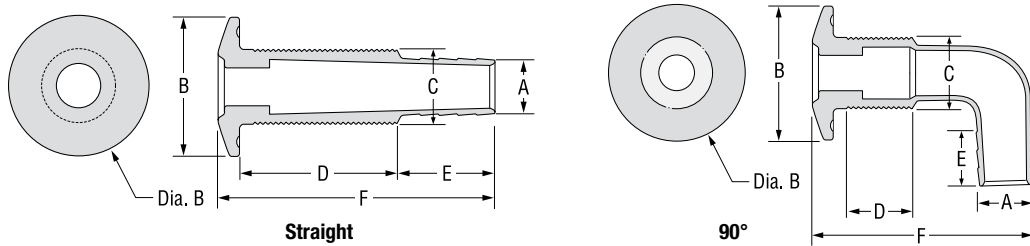

A	B	C	D	E	F	Installation	Max	Bulk	Prop	Aftermarket	Prop
Hose	Flange	Thread	Thread	Barb	Total	Hole Saw	Hull	Packaging	65	Packaging	65
Size	Dia.	O.D.	Length	Length	Length	Size	Thickness				
THRU-HULLS, STRAIGHT											
5/8" I.D.	1-7/8"	1.27"	1.54"	1"	3.39"	1-3/8"	1.30"	68555-1	*	—	
3/4" I.D.	1-7/8"	1.27"	1.54"	1"	3.36"	1-5/16"	1.30"	68554-1	*	—	
1" I.D.	1-7/8"	1.27"	1.54"	1"	3.39"	1-5/16"	1.30"	68556-1	*	—	
1-1/8" I.D.	1-7/8"	1.27"	1.54"	1.3"	3.36"	1-5/16"	1.30"	68557-1	*	—	
1-1/2" I.D.	2-3/8"	1.5"	1.54"	1.6"	3"	1-1/2"	1.40"	68551-1	*	—	
THRU-HULLS, 90°											
5/8" I.D.	1-7/8"	1.27"	1.54"	0.875"	3.48"	1-5/16"	1.30"	68576-1	*	—	
3/4" I.D.	1-7/8"	1.27"	1.54"	1"	3.48"	1-5/16"	1.30"	68577-1	*	—	
1" I.D.	1-7/8"	1.27"	1.54"	1.125"	3.75"	1-5/16"	1.30"	68578-1	*	—	
1-1/8" I.D.	1-7/8"	1.27"	1.54"	1.5"	3.75"	1-5/16"	1.30"	68579-1	*	—	
1-1/2" I.D.	2-3/8"	1.5"	1.54"	1.5"	4.45"	1-1/2"	1.30"	68581-1	*	—	



Thru-Hulls

Made of thermoplastic resins.

* **⚠ WARNING** Cancer and Reproductive Harm – www.P65Warnings.ca.gov (see page 240)

Caution: Plastic Thru-Hull Connectors are designed for installation above the water line only.

Fits Hose Size	Stem Length	Max Hull Thickness	Flange Diameter	Installation Hole Saw Size	Construction	Color	Bulk Packaging	Prop 65	Aftermarket Packaging	Prop 65
5/8" I.D.	3-1/4"	1-1/4"	1-3/4"	1-1/8"	Polypropylene	White	3872-1		3872-3	
Accommodates 7534A (5/8") bailer plug						Black	3872A1		—	
3/4" I.D.	3-1/4"	1-1/4"	1-3/4"	1-1/8"	Polypropylene	White	3873-1		3873-3	
Accommodates 7534A (5/8") bailer plug						Black	3873A1		—	
3/4" I.D.	4"	2"	2"	1-1/16" to 1-1/8"	Acetal	White	3896-1	*	3896-3	*
1-1/8" to 1-1/4" I.D.	3-1/4"	1-1/4"	2-1/4"	1-3/8"	Polypropylene	White	3874-1		3874-3	
Accommodates 7535A (7/8") bailer plug						Black	3874A1		—	
1-1/2" I.D.	3-1/2"	1-1/4"	3"	1-7/8" to 2"	Polypropylene	White	3875-1	*	3875-3	*
Accommodates 7535A (7/8") bailer plug						Black	3875A1	*	—	
2" I.D.	3-1/2"	1-1/4"	3"	1-7/8" to 2"	Polypropylene	White	3845-1	*	—	



3872

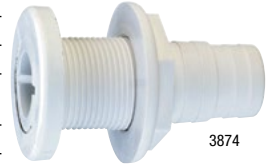

3874



3875

Thru-Transom Thru-Hull Connector

For installation through the transom. Ideal for overflow use in livewell installations. Can be used with the 3876 Scupper Valve in self-bailing applications, or as an exhaust port for a bilge pump. Polypropylene construction.

* **⚠ WARNING** Cancer and Reproductive Harm – www.P65Warnings.ca.gov (see page 240)

Caution: Plastic Thru-Hull Connectors are designed for installation above the water line only.

Fits Hose Size	Stem Length	Max Hull Thickness	Flange Diameter	Installation Hole Saw Size	Color	Bulk Packaging	Prop 65	Aftermarket Packaging	Prop 65
1-1/2" I.D.	5-1/2"	3-1/8"	2-3/4"	2"	White	3875B1	*	—	



3875B

Double Ended Thru-Hull Connector

Double-Ended Thru-Hull provides watertight transition through bulkheads or tanks. 5" overall length. Polypropylene construction.

* **⚠ WARNING** Cancer and Reproductive Harm – www.P65Warnings.ca.gov (see page 240)

Caution: Plastic Thru-Hull Connectors are designed for installation above the water line only.

Fits Hose Size	Max Hull Thickness	Installation Hole Saw Size	Bulk Packaging	Prop 65	Aftermarket Packaging	Prop 65
3/4" I.D.	1-1/8"	1-1/8"	3878-1	*	3878-3	*



3878

90° Thru-Hull Connectors

90° Thru-Hulls are ideal for tight installations, such as livewell overflow drains. Design eliminates hose kinking. Polypropylene construction.

* **⚠ WARNING** Cancer and Reproductive Harm – www.P65Warnings.ca.gov (see page 240)

Caution: Plastic Thru-Hull Connectors are designed for installation above the water line only.

Fits Hose Size	Max Hull Thickness	Flange Diameter	Installation Hole Saw Size	Color	Bulk Packaging	Prop 65	Aftermarket Packaging	Prop 65
3/4" I.D.	1"	1-1/2"	1"	White	3877-1		3877-3	
Accommodates 7533A (1/2") bailer plug					Black	3880-1	*	—
1-1/8" to 1-1/4" I.D.	1-7/8"	2-7/16"	1-5/16"	White	3879-1		3879-3	
Accommodates 7535A (7/8") bailer plug					Black	3870-1	*	—



3877



3879



Scupper Valve

Provides a water exit for boats with self-bailing cockpits. Acetal construction. Accommodates 3875B thru-transom thru-hull connector (screw holes must be drilled for installation.) Diameter: 2-7/8". Use as a replacement valve for 3881 Thru-Transom Scupper.

* **⚠ WARNING** Cancer and Reproductive Harm – www.P65Warnings.ca.gov (see page 240)

Caution: Plastic Thru-Hull Connectors are designed for installation above the water line only.

Description	Bulk Packaging	Prop 65	Aftermarket Packaging	Prop 65
Valve	3876-1	*	3876-3	*



Thru-Transom with Scupper

The rubber flapper opens to drain water out and closes to prevent backwash. Acetal construction. For 1-1/2" I.D. hose.

* **⚠ WARNING** Cancer and Reproductive Harm – www.P65Warnings.ca.gov (see page 240)

Caution: Plastic Thru-Hull Connectors are designed for installation above the water line only.

Description	Dimensions	Max Hull Thickness	Installation Hole Saw Size	Bulk Packaging	Prop 65	Aftermarket Packaging	Prop 65
Thru-transom with scupper	6-1/4" L x 2-7/8" dia.	3-1/8"	2"	3881-1	*	—	
Service Part Kit: Includes outer ring, rubber flapper, four SS screws				3881Kit-1	*	—	



Thru-Hull with Strainer

Thru-hull connector with strainer prevents clogging of the aerator pump. Strainer attaches to threads that extend beyond external retaining nut. Acetal construction.

* **⚠ WARNING** Cancer and Reproductive Harm – www.P65Warnings.ca.gov (see page 240)

Caution: Do not use strainer as a thru-hull connector nut replacement.

Description	Hose Size	Max Hull Thickness	Installation Hole Saw Size	Bulk Packaging	Prop 65	Aftermarket Packaging	Prop 65
Thru-hull with strainer	3/4" I.D.	1-7/16"	1-1/16" to 1-1/8"	3886-1	*	3886-3	*



Mesh Strainer/ Drain Filter

Durable strainers to prevent debris from clogging baitwell drains and aerator pumps. Two types of construction: formed stainless steel wire mesh molded into black PVC plastic base or acetal plastic.

* **⚠ WARNING** Cancer and Reproductive Harm – www.P65Warnings.ca.gov (see page 240)

Caution: Aerator pump must be secured with aerator attachment nut prior to installing strainer.

Description	Thread	Application	Bulk Packaging	Prop 65	Aftermarket Packaging	Prop 65
Stainless Steel mesh	7/8"- 9 UNC2-B	Fits 3877-1 thru-hull	11524-1	*	11524-3	*
	3/4"-14 NPSM	Fits 3/4" aerator inlet and 3886-1 thru-hull	4232-1	*	4232-7	*
Molded plastic	3/4"-14 NPSM	Fits aerator inlet and 3886-1 thru-hull	3885-1	*	3885-3	*



Cockpit Drains

For use with 1-1/2" I.D. hose as part of a self-bailing cockpit system. Features short stem and narrow flange for installing through cockpits. Polypropylene construction.

* **⚠ WARNING** Cancer and Reproductive Harm – www.P65Warnings.ca.gov (see page 240)

Description	Stem Length	Max Hull Thickness	Flange Diameter	Installation Hole Saw Size	Bulk Packaging	Prop 65	Aftermarket Packaging	Prop 65
Drain	3-3/4"	1-1/2"	2-1/8"	1-7/8"	3875C1	*	—	
Drain with screen	4-3/32"	1-7/32"	2-1/8"	1-7/8"	3882-1	*	—	



Drain Fittings

These drain fittings can be used with a hose connector to create a drain. Use 3888 with 3899 or 3890 threaded/hose-to-barb connector. Use 3889 with 3891 threaded/hose-to-barb connector. Acetal construction.

* **⚠ WARNING** Cancer and Reproductive Harm – www.P65Warnings.ca.gov (see page 240)

Description	Dimensions	Max Hull Thickness	Installation Hole Saw Size	Bulk Packaging	Prop 65	Aftermarket Packaging	Prop 65
3/4" diameter	1-1/2"	1-1/8"	1-1/16" to 1-1/8"	3888-1	*	—	
1-1/8" diameter	1-1/2"	1-1/16"	1-7/16" to 1-1/2"	3889-1	*	—	



Drain Cover

Polished stainless steel drain cover can be used for floor drains, vents, or hidden horn openings. Four holes for #6 fasteners.

* **⚠ WARNING** Cancer and Reproductive Harm – www.P65Warnings.ca.gov (see page 240)

Description	Bulk Packaging	Prop 65	Aftermarket Packaging	Prop 65
Stainless Steel, 3-1/4" dia.	66308-1	*	66308-3	*



Drain Plug and Receiver Kit

Molded black plastic with threaded receiver. Molded retaining strap. Includes attaching screws and elastomeric gasket for a watertight fit.

* **⚠ WARNING** Cancer and Reproductive Harm – www.P65Warnings.ca.gov (see page 240)

Description	Bulk Packaging	Prop 65	Aftermarket Packaging	Prop 65
3/4" dia. one piece plug	17209-1	*	17211-3	*



Garboard Drain Plugs

Provides bilge drainage when hauling out. Nut removes with wrench or pliers. Machined, tapered pipe threads ensure watertight plug fit. 3/8" neck depth. Three countersunk holes for #8 fasteners.

* **⚠ WARNING** Cancer and Reproductive Harm – www.P65Warnings.ca.gov (see page 240)

Description	Construction	Bulk Packaging	Prop 65	Aftermarket Packaging	Prop 65
1/2" NPT drain	Cast bronze	7555-1	*	7555-3	*
Replacement plugs, Pair	Brass	9842-1	*	9842-3	*
Replacement plugs, 24 Pair	Brass	—		9842PD1	*
Replacement plugs, 12 Pair (Saltwater Use)	Stainless Steel	—		9844PD2	

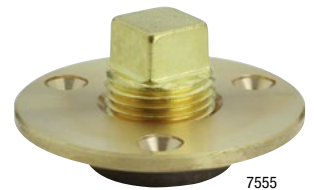

Stainless Steel Garboard Drain Plugs

Threaded removable plug. Retention system keeps plug from getting lost. Large 7/8" (27mm) hole for servicing stern drives. High polished #316 stainless steel reduces corrosion.

* **⚠ WARNING** Cancer and Reproductive Harm – www.P65Warnings.ca.gov (see page 240)

Description	Construction	Bulk Packaging	Prop 65	Aftermarket Packaging	Prop 65
7/8" diameter	Stainless Steel	7557-1	*	7557-7	*
7/8" diameter	Stainless Steel with Gasket	7557G1	*	—	



T-Handle Drain Plugs

For 1" diameter drains. A clockwise turn of the T-handle expands the plug to lock in place; turn counterclockwise to release. Available in brass or stainless steel, with or without chain.

* **⚠ WARNING** Cancer and Reproductive Harm – www.P65Warnings.ca.gov (see page 240)

Description	Bulk Packaging	Prop 65	Aftermarket Packaging	Prop 65
BRASS HANDLE				
Without chain	7526A1	*	7526A7	*
100 units (w/o chain) in battery box display One UPC sheet for use with all 100 units	—	—	7526D1	*
12 units (w/o chain) in PDQ display carton	7526PD1	*	7526D2	*
BRASS PLATED HANDLE				
Without chain	—	—	11592-3	*
STAINLESS STEEL HANDLE				
Without chain	—	—	7518A3	*
12 units (w/o chain) in PDQ display carton	7518PD2	—	7518PD2	—



Snap-Handle Drain Plugs

Snap-handle drain plugs for 1" diameter drains. A clockwise turn of the handle tightens the plug in its tube, and the handle flips down to lock. Available in brass or stainless steel, with or without chain.

* **⚠ WARNING** Cancer and Reproductive Harm – www.P65Warnings.ca.gov (see page 240)

Description	Bulk Packaging	Prop 65	Aftermarket Packaging	Prop 65
BRASS HANDLE				
Without chain	7524A1	*	7524A7	*
With 5" chain	7524B1	*	—	—
75 units (w/o chain), battery box display, one UPC sheet for use with all 75 units	—	—	7524D1	*
12 units (w/o chain) in PDQ display carton	7524PD2	*	7524PD2	*
BRASS PLATED HANDLE				
Without chain	—	—	11591-3	*
24 units (w/o chain) in PDQ display carton	—	—	11586-4	*
STAINLESS STEEL HANDLE				
Without chain	7520A1	*	7520A3	*
12 units (w/o chain) in PDQ display carton	—	—	7520PD2	—



Livewell/Bailer Drain Plugs

Cam-action neoprene plugs snap shut to form stopper for livewells / baitwells. Clockwise turn of the handle tightens plug, lever flips down to lock. Ideal for livewell drains. Brass snaps and plates. **Note:** Not for use with chemicals or fuels.

* **⚠ WARNING** Cancer and Reproductive Harm – www.P65Warnings.ca.gov (see page 240)

Description	Bulk Packaging	Prop 65	Aftermarket Packaging	Prop 65
For 7/16" I.D. thru-hull	—	—	7532A3	*
For 1/2" I.D. thru-hull	7533A1	*	7533A7	*
12 units for 1/2" thru-hull in PDQ display carton	7533PD2	*	7533PD2	*
For 5/8" I.D. thru-hull	7534A1	*	7534A3	*



Drain Tubes

Drain tubes for 1" diameter drain plugs. Use aluminum drain tubes with aluminum-handle drain plugs; use brass tubes with brass-handle plugs and stainless steel plug handles. Tubes have .032" wall thickness.

* **⚠ WARNING** Cancer and Reproductive Harm – www.P65Warnings.ca.gov (see page 240)

Description	Length	Bulk Packaging	Prop 65	Aftermarket Packaging	Prop 65
Brass Drain Tube	1-7/8"	7566AR1	*	—	—
	2-3/8"	7566BG1	*	—	—
	3"	11446-1	*	—	—



TURBO IN-LINE BLOWERS

The first vane axial-flow fan bilge blowers designed using aerospace technology to maximize performance. No other bilge blowers in the industry provide such powerful system output at such low power input in a compact size.

- Patented in-line design – provides ventilation for engine compartments, galleys, bilges, and heads
- System airflow exceeds old-style in-line blowers by as much as 25%
- Draws up to 40% fewer amps, making our Turbo blowers up to four times more efficient than competitive blowers
- Marine ignition protected

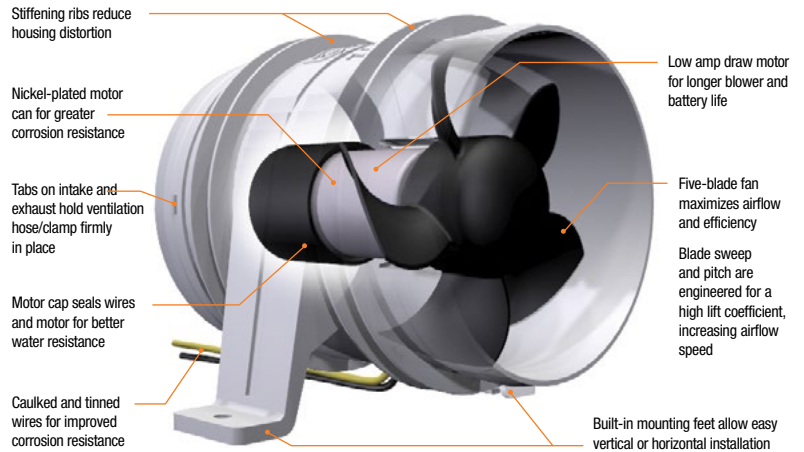

Pump Dimensions

Model No.	A	B	C	D
Turbo 3000	3-5/8"	4-1/2"	5-1/16"	3"
Turbo 4000	4-17/32"	5-1/2"	6-1/16"	4"

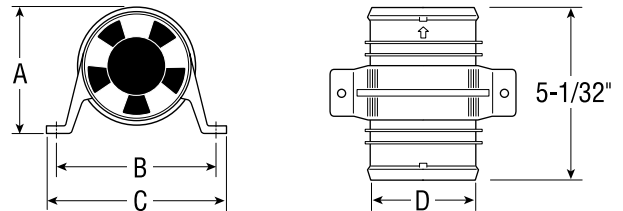

Specifications

Model No.	Rated Voltage	CFM Open Flow	CFM In System*	Current Draw Amps	Fuse Size
Turbo 3000	12-volt nominal	120	90	2.6	4-amp
	13.6-volt design	145	100	3.1	4-amp
Turbo 4000	12-volt nominal	200	100	2.5	5-amp
	13.6-volt design	230	125	2.9	5-amp
	24-volt nominal	200	100	1.5	3-amp
	27.2-volt design	230	125	2.0	3-amp

Turbo 3000 Series

For 3" I.D. ventilation hose. Install with #10 fasteners. Individual carton includes 2 tie straps.

* **⚠ WARNING** Cancer and Reproductive Harm – www.P65Warnings.ca.gov (see page 240)

Model No.	Description	Bulk Packaging	Prop 65	Aftermarket Packaging	Prop 65
Turbo 3000	Standard, 12-volt, White, 1-year Warranty	1731-1	*	1731-4	*
	Water-resistant, 12-volt, White, 3-year Warranty	1733-1	*	1733-4	*



Turbo 4000 Series II

Our 4000 Series II blower system matches air flow of existing in-line blowers at a significantly reduced noise level. For added durability, Attwood incorporates an engineered plastic housing that resists deformation during installation and prevents blade to housing interference. For 4" I.D. ventilation hose. Install with #10 fasteners. Individual carton includes two tie straps.

* **⚠ WARNING** Cancer and Reproductive Harm – www.P65Warnings.ca.gov (see page 240)

Model No.	Description	Bulk Packaging	Prop 65	Aftermarket Packaging	Prop 65
Turbo 4000	Standard, 12-volt, White, 1-year Warranty	1747-1	*	1747-4	*
	Water-resistant, 12-volt, White, 3-year Warranty	1749-1	*	1749-4	*
	Water-resistant, 24-volt, White, 3-year Warranty	1751-1	*	—	—



Note- In system = 3 ft. of duct with one 90° bend, a collector box and louvered vent on discharge side of blower at 13.6 VDC

MAXIMUM EFFICIENCY BLOWERS



WATER SYSTEMS & VENTILATION

25

VENTS & COLLECTOR BOXES

Allwood hull-mounted vents are designed to install by fastening as a complete unit from either inside or outside the hull. Ventilation hose (not included) twists into the bottom of the box to form a raised water barrier. Plastic vents are corrosion-resistant and will not discolor. All collector boxes and vents are designed for intake or exhaust and meet ABYC H-2 cross sectional area requirements.

Stainless Steel Louvered Vent

All-welded #304 Stainless Steel construction with polished finish. Install with #8 fasteners. Requires collector box 1487A for 3" system, or 1487B for 4" system.

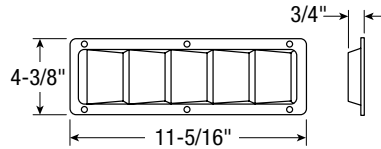

* **⚠ WARNING** Cancer and Reproductive Harm – www.P65Warnings.ca.gov (see page 240)

For use with Collector Box(es)	Dimensions	Bulk Packaging	Prop 65	Aftermarket Packaging	Prop 65
1487A, 1487B	3-1/4" x 10-3/8"	1488-1	*	1488-5	*

Collector Boxes

Collector boxes for use with 1488 stainless steel vent. Available with cut-out for two 3" I.D. wire-supported hoses or one 4" I.D. wire-supported hose. Corrosion-resistant plastic.

* **⚠ WARNING** Cancer and Reproductive Harm – www.P65Warnings.ca.gov (see page 240)

Description	Depth	Installation Hole Saw Size	For Use with Vent(s)	Bulk Packaging	Prop 65	Aftermarket Packaging	Prop 65
For two 3" I.D. hoses	5-9/16"	3-5/8" x 10-3/4"	1488	1487A1	*	—	65



Narrow Stainless Steel Louvered Vents

Suitable for installation on any flat or most contoured hulls. Constructed of all-welded #304 Stainless Steel with a polished finish. Vents for use with 3" I.D. ventilation systems, and require a 1343 collector box. Install with #6 fasteners.

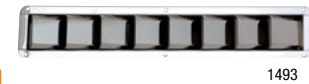
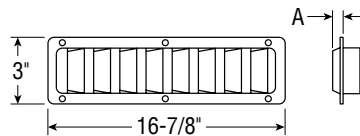

* **⚠ WARNING** Cancer and Reproductive Harm – www.P65Warnings.ca.gov (see page 240)

For use with Collector Box	A Depth	Open Hole Size	Bulk Packaging	Prop 65	Aftermarket Packaging	Prop 65
1343	9/16"	2-1/16" x 15-15/16"	1493-1	*	1493-5	*
1343	1/16"	2-1/16" x 15-15/16"	1499-1	*	1499-5	*



Collector Box

For use with narrow stainless steel vents (1493 or 1499), with two 3" I.D. wire-supported ventilation hoses. Corrosion-resistant plastic.

* **⚠ WARNING** Cancer and Reproductive Harm – www.P65Warnings.ca.gov (see page 240)

Description	Depth	Installation Hole Saw Size	For Use with Vent(s)	Bulk Packaging	Prop 65	Aftermarket Packaging	Prop 65
For two 3" I.D. hoses	4-1/16"	2-7/16" x 16-3/16"	1493, 1499	1343-1	*	—	65



Venturi Vents

Clean, contemporary, louver design. Corrosion-resistant, paintable ABS plastic. For 3" or 4" I.D. ventilation system. Requires 1341 collector box for 3" system, or 1342 for 4" system. Install with #8 fasteners. Sized for installation even on highly-contoured decks.

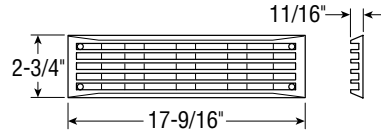

For use with Collector Box	Description	Open Hole Size	Bulk Packaging	Aftermarket Packaging
1341, 1342	Black	2" x 15-3/8"	1494A1	1494A5
	White	2" x 15-3/8"	1494F1	—



Flush Louvered Vents

Canted louvers deflect rain and spray and help conceal the collector box. Installs flush to hull. Drain slots to prevent water accumulation. Black vent is ABS plastic, white vent is ASA plastic. Both are paintable. Install with #8 fasteners. Requires 1341 collector box for 3" system, or 1342 for 4" system.

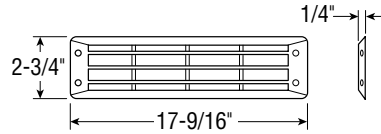

For use with Collector Box	Description	Open Hole Size	Bulk Packaging	Aftermarket Packaging
1341, 1342	Chrome	2" x 15-1/4"	1426-1	1426-5
	Black	2" x 15-1/4"	1423-1	1423-5
	White	2" x 15-1/4"	1425-1	1425-5



Collector Boxes

For use with Venturi, Flush Louvered or Trimline Vents. Corrosion-resistant plastic.

* **WARNING** Cancer and Reproductive Harm – www.P65Warnings.ca.gov (see page 240)

Description	Depth	Installation Hole Saw Size	For Use with Vent(s)	Bulk Packaging	Prop 65	Aftermarket Packaging	Prop 65
For two 3" I.D. hoses	3-7/8"	2-1/16" x 15-9/16"	1494, 1423, 1424, 1425, 1426, 1496A	1341-1	*	—	—
For one 4" I.D. hose	5"	2-1/8" x 15-5/8"	1494, 1423, 1424, 1496A	1342-1	*	—	—



Plastic Louvered Vents

Constructed of paintable, corrosion-resistant ABS plastic with no sharp edges. For 3" I.D. ventilation system with 1345 collector box. Install with #8 fasteners.

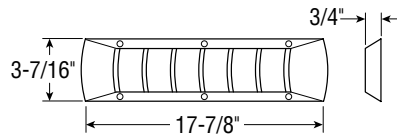

For use with Collector Box	Description	Open Hole Size	Bulk Packaging	Aftermarket Packaging
1345	Chrome Plated	2-1/4" x 16"	1495B1	1495B5
	Black	2-1/4" x 16"	1495A1	—
	Off-White	2-1/4" x 16"	1495-1	—



Collector Box

For use with plastic louvered vent, with two 3" I.D. wire-supported ventilation hoses. Box fastens to vent with screws or pop rivets, then vent fastens to the deck. Corrosion-resistant plastic.

* **WARNING** Cancer and Reproductive Harm – www.P65Warnings.ca.gov (see page 240)

Description	Depth	Installation Hole Saw Size	For Use with Vent(s)	Bulk Packaging	Prop 65	Aftermarket Packaging	Prop 65
For two 3" I.D. hoses	4"	2-7/16" x 16-1/4"	1495	1345-1	*	—	—



Modular Vents

Modular construction to accommodate any ventilation opening size by interlocking two or more center sections. End sections interlock to the center section for a finished appearance. For 4" I.D. ventilation systems using one or more 1348 collector boxes. End sections have two holes for #8 fasteners.

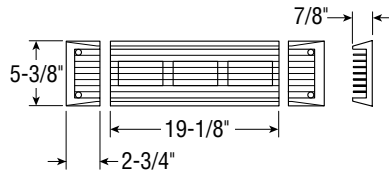

* **⚠ WARNING** Cancer and Reproductive Harm – www.P65Warnings.ca.gov (see page 240)

Description	Color	Open Hole Size	Bulk Packaging	Prop 65	Aftermarket Packaging	Prop 65
Center Sections	White	2-1/2" x 17-3/4"	1438F1	—	—	—
End Sections	White	2-1/2" x 17-3/4"	1439F1	—	—	—

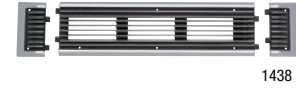

Collector Box

For use with modular vents, with 4" I.D. wire-supported ventilation hose. Corrosion-resistant plastic.

* **⚠ WARNING** Cancer and Reproductive Harm – www.P65Warnings.ca.gov (see page 240)

Description	Depth	Installation Hole Saw Size	For Use with Vent(s)	Bulk Packaging	Prop 65	Aftermarket Packaging	Prop 65
For two 4" I.D. hoses	5"	2-3/4" x 18"	1438, 1439	1348-1	*	—	—



Cowl Ventilator

For use with 3" I.D. wire-supported ventilation hose. Flexible hose flange is screwed onto hose, then vent snaps onto the flange. Vent constructed of chrome-plated zinc. Flange is non-corrosive plastic. Installs with #8 fasteners.

* **⚠ WARNING** Cancer and Reproductive Harm – www.P65Warnings.ca.gov (see page 240)

Description	Installation Hole Size	Bulk Packaging	Prop 65	Aftermarket Packaging	Prop 65
5-5/16" W x 6" L x 2-1/4" H (neck extends 1" below deck)	3-1/4" x 3-1/2"	1364A1	*	1364A3	*



Twist-On Hose Flange

For use with 3" I.D. wire-supported ventilation hose. Hose installs from topside by turning the flange into the hose spiral, passing the hose through the deck hole, then mounting ventilator. No hose clamps needed. Corrosion-resistant plastic. Four holes for required #10 fasteners.

* **⚠ WARNING** Cancer and Reproductive Harm – www.P65Warnings.ca.gov (see page 240)

Description	Installation Hole Size	Bulk Packaging	Prop 65	Aftermarket Packaging	Prop 65
Twist-On Hose Flange, Black	3.5"	1405-1	*	1405-3	*



Storage Vent

Use to vent lockers and storage areas. Provides over six square inches of ventilation opening. Will not accept a ventilation hose. Corrosion-resistant plastic. Two holes for required #6 fasteners.

* **⚠ WARNING** Cancer and Reproductive Harm – www.P65Warnings.ca.gov (see page 240)

Description	Height	Neck	Flange Dia.	Installation Hole Size	Bulk Packaging	Prop 65	Aftermarket Packaging	Prop 65
Black	1-1/16"	5/8"	3-3/16"	3-1/16" to 3-1/8"	1353-1	*	—	—



Clamshell Vent

Provides a seal and splash protection for vent holes, wire and hose openings. Sizes to fit most common applications. Durable 300 series stainless steel construction. Three holes for required #6 fasteners.

Specifications

Vent Width	Size	Max Hole Size	Hose/Wire Max Size	Fasteners Size
1-3/16"	1-9/16" L x 1/2" H	1"	7/16"	#6
2-3/16"	2-1/4" L x 9/16" H	1-1/2"	9/16"	#6

Description	Dimensions	Bulk Packaging	Aftermarket Packaging
Stainless Steel	1-3/16"	66399-1	66399-3
	2-3/16"	66400-1	66400-3





CATEGORY OVERVIEW	30-32
SIDELIGHTS	33-42
ALL-ROUND LIGHT OVERVIEW	43
ALL-ROUND PLUG-IN LIGHTS	44-48
PLUG-IN LIGHT BASES	49-51
ALL-ROUND FOLD-DOWN LIGHTS	52-53
ALL-ROUND FIXED LIGHTS	54
ANCHOR/MASTHEAD LIGHTS	55
TRANSOM LIGHTS	56
BATTERY OPERATED LIGHTS	57
DOCKING LIGHTS	58
UNDERWATER LIGHTS	59-61
UTILITY LIGHTS	62-63
LIGHTING ACCESSORIES & REPLACEMENTS	64



LIGHTING THE WAY

Types of Navigation Lights

This section is divided into four basic types of navigation lights, differentiated by lens color, beam angle (horizontal cut-off angle), and location on the boat. All lights are for 12-volt DC applications only. Styles may vary, but the color, cut-off angle, and location must always comply with the following standards:

Sidelights



Color: Red (port) and/or Green (starboard).

Cut-off: From dead ahead to 112.5° aft on either side of center line (225° total horiz. arc).

Mounting: As far fore as possible.

All-Round Lights



For boats less than 12 meters (39.4 feet). The white all-round light may be used in lieu of a masthead or transom light.

Color: White.

Cut-off: Unbroken arc of 360° on the horizon.

Mounting: As near to the fore and aft centerline as possible.

Anchor/Masthead Lights



Color: White.

Cut-off: Unbroken arc from dead ahead to 112.5° aft on either side of center line (225° total horizontal arc), plus 135° dead astern.

Mounting: Placed over the fore and aft centerline.

Transom Lights



Color: White.

Cut-off: Unbroken horizontal arc of 67.5° each side dead astern (135° total horizontal arc).

Mounting: As far aft as possible.

Certifications, Codes, and Standards

This section provides you with some general information on the selection and installation of navigation lights for pleasure boats of 20 meters (65.6 feet) or less. For details refer to: ABYC A-16, 72 COLREGS, Inland Navigation Rules, U.S. Code of Federal Regulations Title 33 Part IP, or international regulations. The following Attwood navigation lights are NMMA listed and meet 72 COLREGS as noted.



This symbol indicates Attwood navigation lighting products that have been certified according to the latest U.S. Coast Guard regulations.

Model No.	NMMA No.	Meets 72 COLREGS	Meets ISO 19009:2015
3900 Series	91508	YES	NO
5100 Series	91511	YES	NO
5300 Series	91512	YES	NO
5600 Series	2528266	YES	NO
5900 Series	91518	YES	NO
5940 Series	91515	YES	NO
6356D	91420	YES	NO
66382	91425	YES	NO
7100 Series	91520	YES	NO
7200 Series	2456711	YES	NO
7400 Series	2456711	YES	NO
LED Lights			
2500 Series	2515284	YES	NO
NV1002 SERIES (2NM)	2593399	YES	YES
NV1001 SERIES (1NM)	2597456	YES	YES
NV1012 SERIES (2NM)	2593400	YES	YES
NV1011 SERIES (1NM)	2597457	YES	YES
NV2002 SERIES (2NM)	2593401	YES	YES
NV2001 SERIES (1NM)	2597458	YES	YES
NV2012 SERIES (2NM)	2593402	YES	YES
NV2011 SERIES (1NM)	2597459	YES	YES
NV3012 SERIES (2NM)	2593409	YES	YES
NV3011 SERIES (1NM)	2597462	YES	YES
NV4012 SERIES (2NM)	2593410	YES	YES
NV4011 SERIES (1NM)	2597463	YES	YES
NV5012 SERIES (2NM)	2593411	YES	YES
NV5011 SERIES (1NM)	2597464	YES	YES
NV0002P (2NM)	2593407	YES	YES
NV0001P (1NM)	2597460	YES	YES
NV0002S (2NM)	2593408	YES	YES
NV0001S (1NM)	2597461	YES	YES
NV6LC1 SERIES (2NM)	2593403	YES	YES
NV6LC2 SERIES (2NM)	2593404	YES	YES
NV6SP1 SERIES (2NM)	2593405	YES	YES
NV6SP2 SERIES (2NM)	2593406	YES	YES
5530 Series	2459732	YES	NO
5540 Series	2459733	YES	NO
5550 Series	2459733	YES	NO
5580 Series	2501760	YES	NO
7800 Series	2459859	YES	NO
6556 Series	2459860	YES	NO



Boats at Anchor

When anchored in other than designated areas, any boat under 50 meters (164 ft.) must have a 360° white light in view (a single all-round light, a masthead and transom light, or other means).

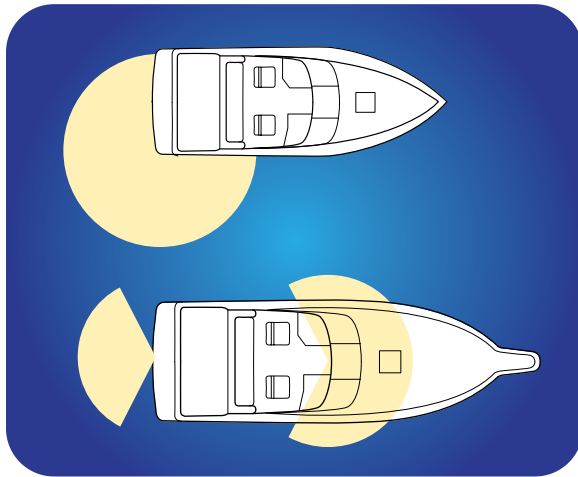

Vertical Separation of Lights

Pole length and location determines light separation. On boats under 12 meters (39.4 feet), the all-round or masthead light must be located a minimum of one meter (39-3/8 inches) above the red-green sidelights. One meter must be the height separation measured from bulb filament centers.

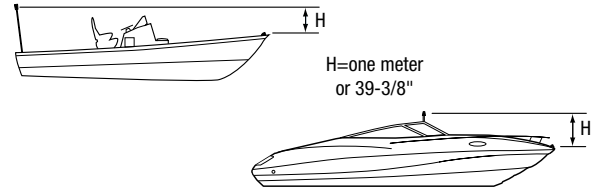

On boats of 12 to 20 meters (39.4 to 65.6 feet), the masthead light must be at least 2.5 meters (8.2 feet) above the gunwale.

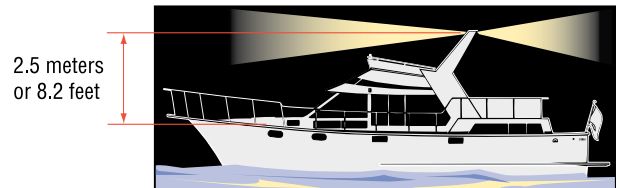

Boats Underway

This section outlines the navigation lighting required according to current U.S. Coast Guard and 72 COLREGS (International Waters) regulations. When underway, the required navigation lights are:

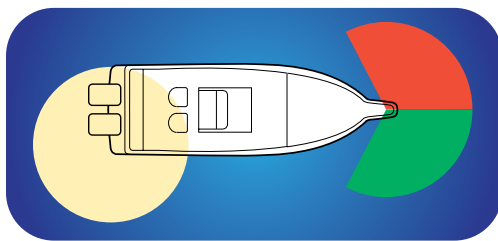

Power-driven boats less than 12 meters (39.4 feet) with max. speed over 7 knots:

- Sidelight pair or combined—1 mile
- All-Round Light—2 mile or Masthead Light—2 mile with Transom Light—2 mile.

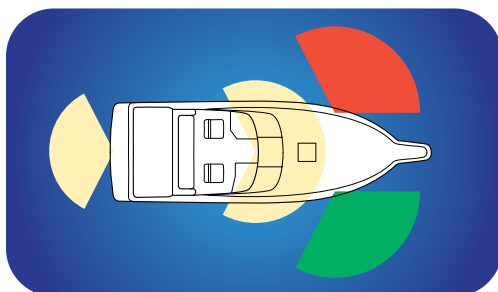

Power-driven boats 12 to 20 meters (39.4 to 65.6 feet):

- Sidelight pair or combined—2 mile
- Masthead Light—3 mile and Transom Light—2 mile.
- All-Round Light may not be used.

Sailboats Under Motor Power:

When under power, sailboats are considered power boats and must operate with power boat lights as previously outlined.

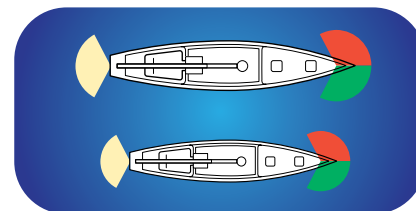

Sailboats less than 7 meters (23 feet) under sail:

- Sidelight pair or combined—1 mile
- Transom Light—2 mile
- Flashlight or lighted lantern.

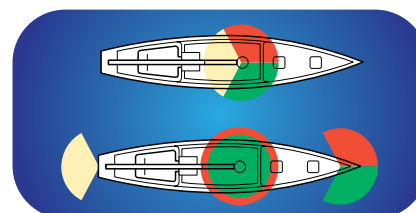

Sailboats 7 to 20 meters (23 to 65.6 feet) under sail:

Three different light configurations may be acceptable:

1. Sidelights & Transom Light.
2. A Sidelight & Transom Light combined in one light (a Tri-Color Light) mounted at or near top of mast.
3. Sidelights & Transom Light, or two All-Round Lights, mounted at or near the top of the mast, the upper light being red and the lower green.

Small, Oar-Driven Boats:

- Sidelight pair or combined—1 mile
- Transom Light—2 mile
- Flashlight or lighted lantern.
- Various other light requirements are outlined in the standards regarding towing, vessels aground, and other special conditions.
- Consult the Inland Navigation Rules, 72 COLREGS, or USCG for details.

WHY ATTWOOD LED?

A New Level of Efficiency

Through the use of proprietary optical design techniques, we've optimized our lens design to harness nearly 90% of all light being generated by the LED. In doing so, our line of LED series navigational lights exceed U.S. Coast Guard requirements with the fewest and lowest watt LEDs of any navigational light manufactured today. Less energy used by navigational lighting means more energy available for powering your boat and enjoying time on the water.

Engineered to Last

As the emerging leader in marine lighting design, Attwood understands the demands of the marine environment. Completely sealed LED units resist water intrusion, electrostatic discharge (during assembly), vibration and ultraviolet light (UV) radiation. Reverse polarity protection has been added to eliminate potential mis-wiring damage during installation. Our LED navigational lighting also features high-quality, electro-polished stainless steel covers designed to resist corrosion in even the most extreme saltwater environments. The result? Style and durability. Most importantly, Attwood lights are built to stand the test of time. Rated for 50,000+ hours of use, you can count on Attwood products to light your way for years to come.



Ready for the Global Market

- EN/ISO 19009:2015
- ABYC A-16
- 1972 COLREGS
- RCD 2013/53/EU
- USG 33 CFR

LED Light Engine

Positioned and sealed inside a lens assembly, the "light engine" serves as the equivalent of an LED (Light Emitting Diode). It can be easily customized to meet the needs of a builder in terms of attachment scheme and overall dimensions.

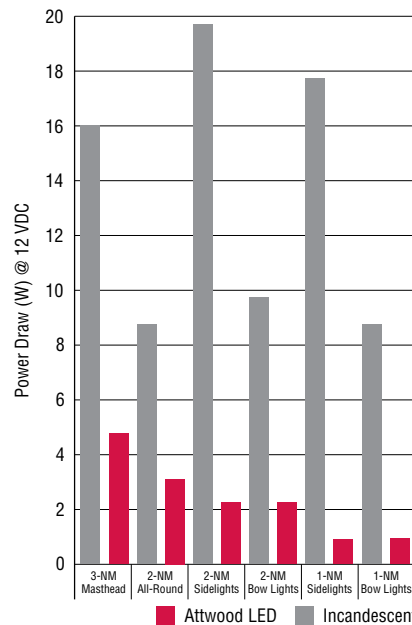
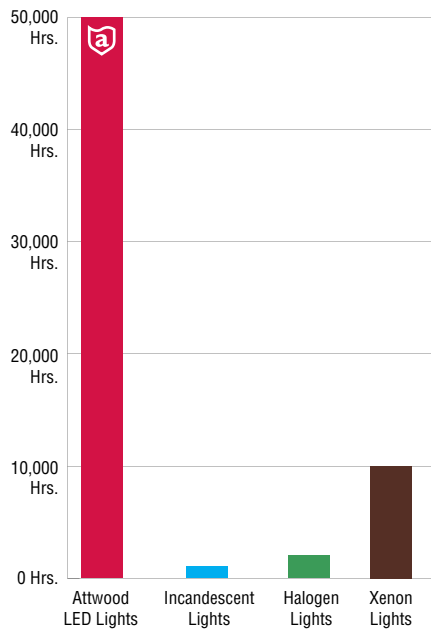

Choice of Electrical Connectors

Attwood lights feature several wire attachment styles to adapt to your boat's wiring harness. Standard wire on all lights are tinned and caulked.

Special connectors are available on special order by contacting your Attwood representative. Minimum order quantity is 250:



Brown – Positive, Black – Negative, Brown & White – Manual Override

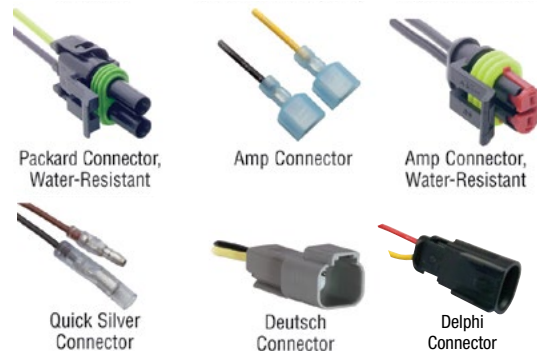

SIDELIGHTS

LED LIGHTARMOR™ LED LIGHTS: 1-MILE / 2-MILE

LightArmor Navigation Lights

LightArmor Navigation Lights have all the characteristics that signifies the premium LightArmor brand: top-quality materials, robust construction, durability, and sleek design.

- * **WARNING** Cancer and Reproductive Harm – www.P65Warnings.ca.gov (see page 240)
- Meets today's global regulatory requirements, including EN/ISO 19009:2015
- Proprietary modular LED light engine technology
- Design flexibility and ease of installation

LED LIGHTARMOR™ Deck Mount Lights

1-Mile Lights For use on boats up to 39.4 ft (12 m) in length.

Description	Bulk Packaging	Prop 65	Aftermarket Packaging	Prop 65
STAINLESS STEEL				
1-NM, Oval, Bi-Color	NV1001SS-1	*	—	
1-NM, Oval, Red/Green, Pair Sidelights	NV1011SS-1	*	—	
1-NM, Round, Bi-Color	NV2001SS-1	*	—	
1-NM, Round, Red/Green, Pair Sidelights	NV2011SS-1	*	—	
BLACK COMPOSITE				
1-NM, Oval, Bi-Color	NV1001PB-1	*	—	
1-NM, Oval, Red/Green, Pair Sidelights	NV1011PB-1	*	—	
1-NM, Round, Bi-Color	NV2001PB-1	*	—	
1-NM, Round, Red/Green, Pair Sidelights	NV2011PB-1	*	—	

2-Mile Lights For use on boats up to 65.6 ft (20 m) in length.

Description	Bulk Packaging	Prop 65	Aftermarket Packaging	Prop 65
STAINLESS STEEL				
2-NM, Oval, Bi-Color	NV1002SS-1	*	—	
2-NM, Oval, Red/Green, Pair Sidelights	NV1012SS-1	*	—	
2-NM, Round, Bi-Color	NV2002SS-1	*	NV2002SS-7	*
2-NM, Round, Red/Green, Pair Sidelights	NV2012SS-1	*	NV2012SSR-7† / NV2012SSG-7†	*
BLACK COMPOSITE				
2-NM, Oval, Bi-Color	NV1002PB-1	*	—	
2-NM, Oval, Red/Green, Pair Sidelights	NV1012PB-1	*	—	
2-NM, Round, Bi-Color	NV2002PB-1	*	NV2002PB-7	*
2-NM, Round, Red/Green, Pair Sidelights	NV2012PB-1	*	NV2012PBG-7† / NV2012PBR-7†	*

LED LIGHTARMOR™ Vertical Mount Lights

1-Mile Lights For use on boats up to 39.4 ft (12 m) in length.

Description	Bulk Packaging	Prop 65	Aftermarket Packaging	Prop 65
STAINLESS STEEL				
1-NM, Round, Red/Green Pair	NV3011SS-1	*	—	

2-Mile Lights For use on boats up to 65.6 ft (20 m) in length.

Description	Bulk Packaging	Prop 65	Aftermarket Packaging	Prop 65
STAINLESS STEEL				
2-NM, Round, Red/Green Pair	NV3012SS-1	*	NV3012SSG-7† / NV3012SSR-7†	*
2-NM, Elliptical, Red/Green Pair	NV4012SS-1	*	NV4012SSG-7† / NV4012SSR-7†	*
2-NM, Oval, Red/Green Pair	NV5012SS-1	*	—	
BLACK COMPOSITE				
2-NM, Oval, Red/Green Pair	NV5012PB-1	*	—	

† Red/Green Sidelights packaged separately for aftermarket.

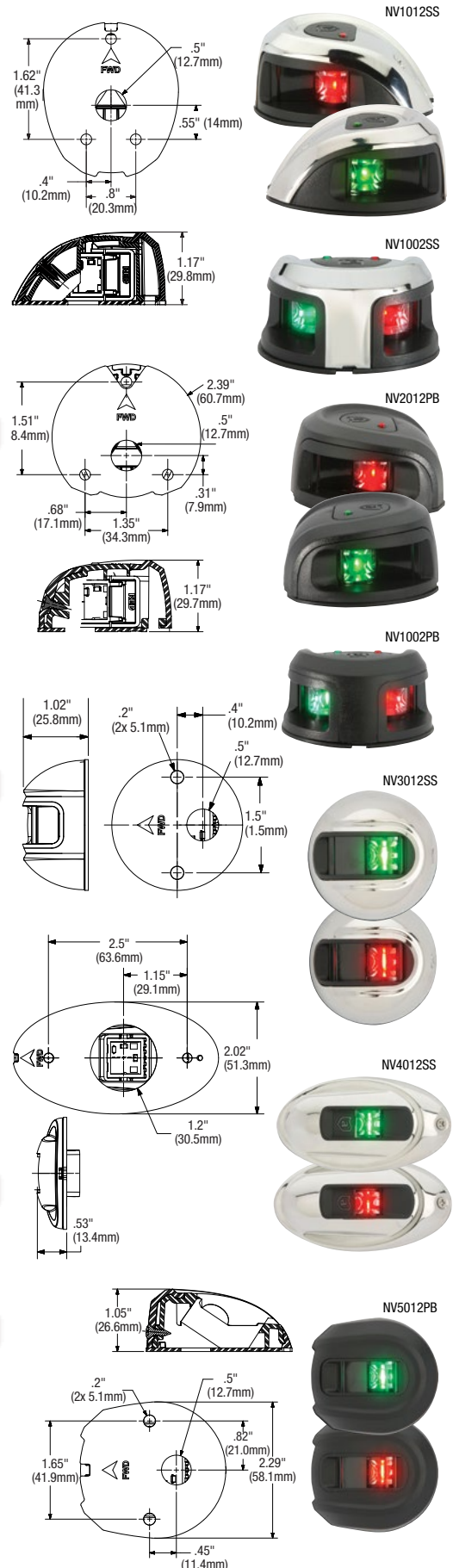

QUASAR 3100 SERIES

2-MILE SIDELIGHTS

Quasar lights are intelligently designed for easier installation, maintenance, and efficient light output. For use on boats up to 65.6 ft. (20 meters).

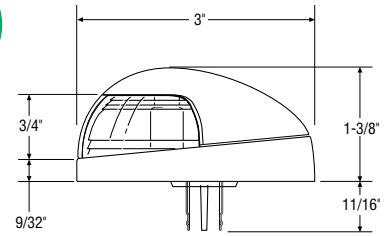
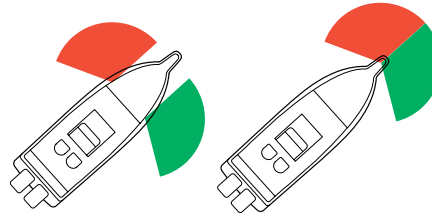

- Smooth contour prevents lines from snagging on housing
- Available in a variety of finishes
- Lens resin color (red/green) tuned to maximum sensitivity of the human eye for optimum visibility
- Single external stainless steel lock screw attaches cover to base, permits easy disassembly for servicing
- Stainless steel electrical contacts will not corrode
- Attaches directly to deck with concealed #10 fasteners – or to one of the Sidelight Snap-On Bases (3300 Series)
- 1/4-inch stainless steel contacts or 7-inch hard wire leads for connection to 12-volt DC power supply
- Includes 8-watt festoon bulb

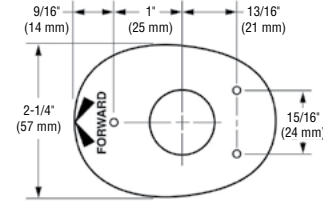

Bi-Color Combination, Deck Mount

2 NM
USCG

2-mile, 225° light visibility.

* **WARNING** Cancer and Reproductive Harm – www.P65Warnings.ca.gov (see page 240)

Description	Socket	Aftermarket Packaging	Prop 65
Black	7" wire lead	3120-7	*
White	7" wire lead	3121-7	*
HIPP / Chrome (Black Base)	7" wire lead	3123-7	*



3120

Red/Green Pair, Deck Mount

Each light provides 2-mile, 112.5° light visibility. Works well with 1/4-inch Quick-Connect Snap-on Base to speed installation.

* **WARNING** Cancer and Reproductive Harm – www.P65Warnings.ca.gov (see page 240)

2 NM
USCG

Description	Socket	Bulk Packaging	Prop 65	Aftermarket Packaging	Prop 65
Black	1/4" quick connect	3130-1	*	—	
	7" wire lead	3150-1	*	3150R7† / 3150G7†	*
HIPP / Chrome (Black Base)	1/4" quick connect	3133-1	*	—	
	7" wire lead	3153-1	*	3153R7† / 3153G7†	*



3153G7



3153R7

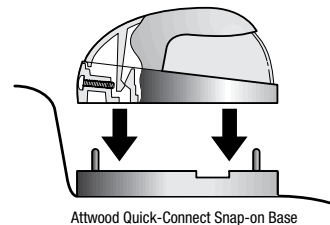

Attwood Quick-Connect Snap-on Base

† Red/Green Sidelights packaged separately for aftermarket.



PULSAR 5040 SERIES

1-MILE SIDELIGHTS

Bayonet lock design secures lens and cover to base. Includes a 9-Watt (#906) wedge base lamp and 7-inch wire leads for connection to 12-volt DC power supply. Installs directly to deck with two #10 fasteners. Cover and lens conceal installation fasteners and seal water out of lamp and hull. For use on boats up to 39.4 ft. (12 meters). 1-mile, 225° light visibility.

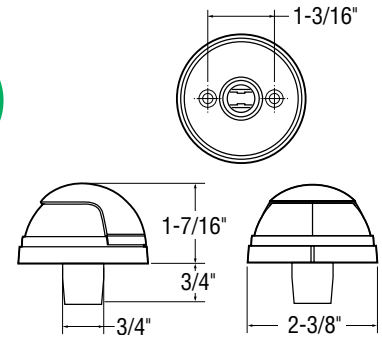
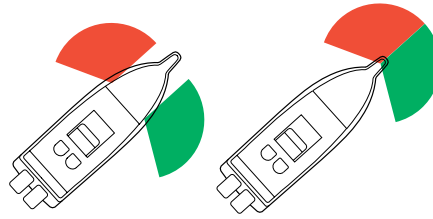

Bi-Color Combination, Deck Mount

* **WARNING** Cancer and Reproductive Harm – www.P65Warnings.ca.gov (see page 240)

1 NM
USCG

Description	Bulk Packaging	Prop 65	Aftermarket Packaging	Prop 65
Black	—		5045-7	*



5045

Red/Green Pair, Deck Mount

Each light provides 1-mile, 112.5° light visibility. Includes a 9-Watt (#906) wedge base lamp.

* **WARNING** Cancer and Reproductive Harm – www.P65Warnings.ca.gov (see page 240)

1 NM
USCG

Description	Bulk Packaging	Prop 65	Aftermarket Packaging	Prop 65
Black	5040-1	*	5040R7† / 5040G7†	*
Stainless Steel	5040SS1	*	—	



5040G



5040R

Red/Green Pair, Raised Base

Ideal for use where light must be elevated for visibility above rails and carpeting.

Each light provides 1-mile, 112.5° light visibility. For use on boats up to 39.4 ft.

(12 meters). Includes a 9-Watt (#906) wedge base lamp.

* **WARNING** Cancer and Reproductive Harm – www.P65Warnings.ca.gov (see page 240)

1 NM
USCG

Description	Bulk Packaging	Prop 65	Aftermarket Packaging	Prop 65
Black	—		5080R7† / 5080G7†	*



5080G



5080R

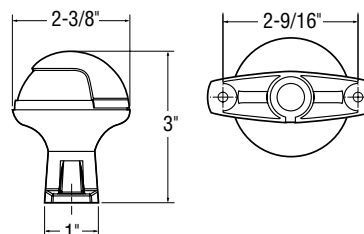

† Red/Green Sidelights packaged separately for aftermarket.

STAINLESS STEEL 3800 SERIES 2-MILE SIDELIGHTS

Attwood's 2-Mile Stainless Steel Sidelights are made with a rugged 316 stainless steel cover for outstanding resistance to impact and corrosion. For use on boats up to 65.6 ft. (20 meters).

- Smooth contour prevent lines from snagging on housing
- A single external stainless steel lock screw attaches cover to base, permits easy disassembly for servicing
- Stainless steel electrical contacts will not corrode
- Cover design and integral gasket seal out water and make installation and maintenance simple
- Includes efficient, high-output 10-watt bayonet lamp
- Tinned 7-inch wire leads make it easier to make a permanent, corrosion-resistant connection

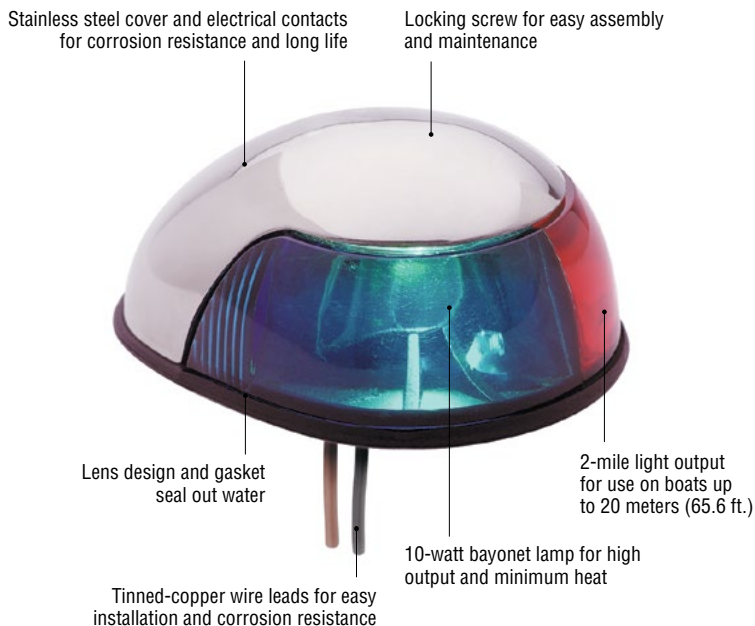
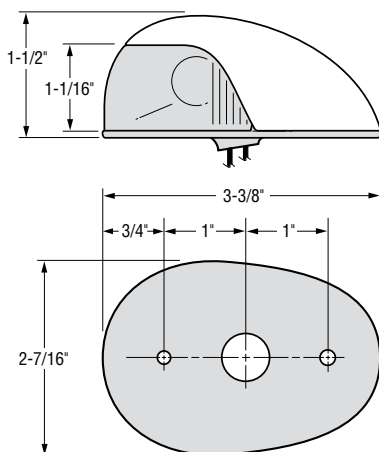
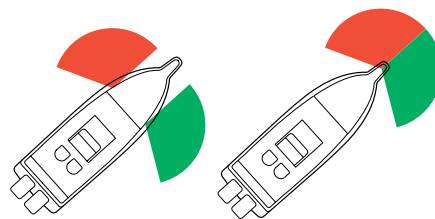

Bi-Color Combination, Deck Mount

2-mile, 225° light visibility.

* **WARNING** Cancer and Reproductive Harm – www.P65Warnings.ca.gov (see page 240)

2 NM
USCG



3810

Description	Rated Voltage	Bulk Packaging	Prop 65	Aftermarket Packaging	Prop 65
Stainless Steel	12-volts	3810-1	*	3810-7	*

Red/Green Pair, Deck Mount

Each light provides 2-mile, 112.5° light visibility.

* **WARNING** Cancer and Reproductive Harm – www.P65Warnings.ca.gov (see page 240)

2 NM
USCG



3820G



3820R

Description	Rated Voltage	Bulk Packaging	Prop 65	Aftermarket Packaging	Prop 65
Stainless Steel	12-volts	3820-1	*	3820R† / 3820G†	*

† Red/Green Sidelights packaged separately for aftermarket.



VERTICAL MOUNT

3800 SERIES

2-MILE SIDELIGHTS

Visibility, Style, and Durability

- Clean, contoured shape blends into hull making the light less noticeable and providing an integrated look with the boat
- Choice of cover colors includes: black, white, or 316 stainless steel
- Rugged stainless steel internal components for corrosion-free performance
- 2-mile output for boats to 20 meters (65.6 ft.)
- Tinned 7-inch wire leads make a permanent, corrosion-resistant connection

Contoured Styling

Matches the 3800 Series 2-Mile Horizontal Mount Sidelights. Provides builders with a family styling for navigation lights between different model offerings.

Durable Construction

The one-piece lens and full-perimeter gasket design make the light virtually waterproof when properly installed. Durable plastic or stainless steel helmet provides rugged protection to the lens and lamp. Internal electrical contacts are stainless steel, so corrosion is not a problem—even in saltwater.

Simple Installation, Small Footprint

Just remove one screw to detach the helmet, and install the base directly to vertical surfaces. Small size makes it simple to install in confined areas. Typical Installation requires: (3) #10 stainless steel screws of length suitable for deck material.

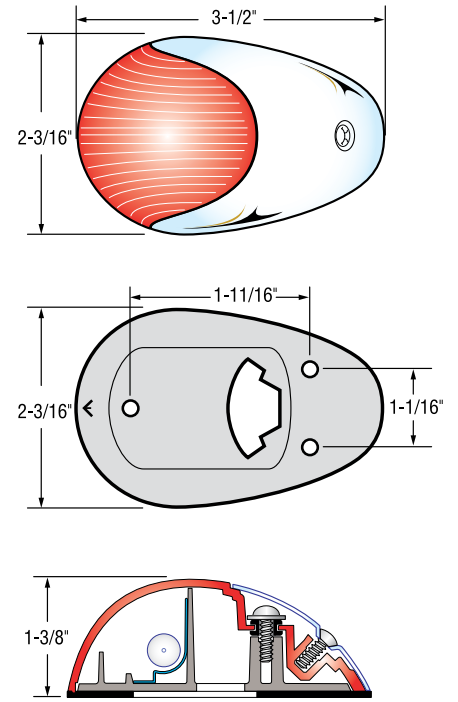
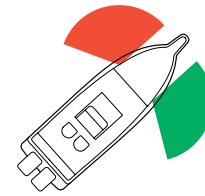
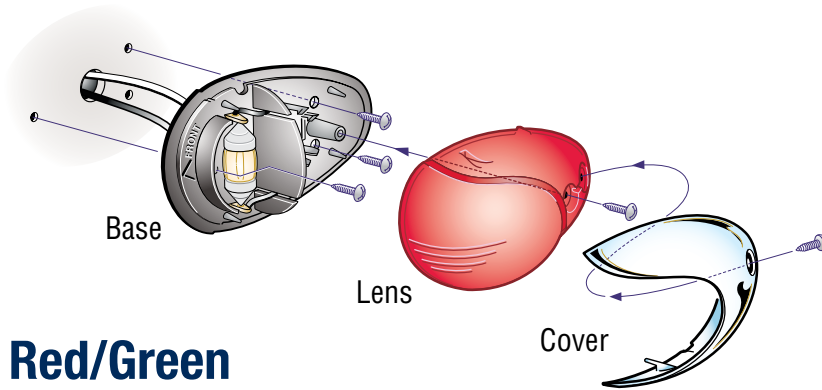

Red/Green Sidelights, Pair

Each light provides 2-mile, 112.5° light visibility.

* **WARNING** Cancer and Reproductive Harm – www.P65Warnings.ca.gov (see page 240)

2 NM
USCG

Description	Rated Voltage	Bulk Packaging	Prop 65	Aftermarket Packaging	Prop 65
Black Plastic	12-volts	3830-1	*	—	
Stainless Steel	12-volts	3838-1	*	3838R† / 3838G†	*



† Red/Green Sidelights packaged separately for aftermarket.



STAINLESS STEEL

66000 SERIES

1-MILE SIDELIGHTS

Constructed of corrosion-resistant 304 stainless steel, these lights provide 1-mile visibility for power boats up to 39.4 ft. (12 meters). Lights include rubber gasket lens seal for enhanced internal corrosion resistance. Includes one 7.5-watt lamp. For connection to 12-volt DC power supply.

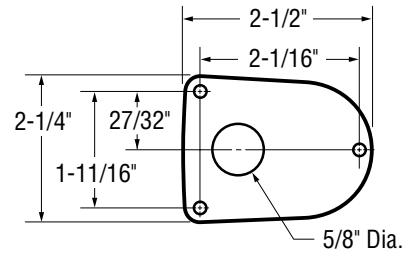
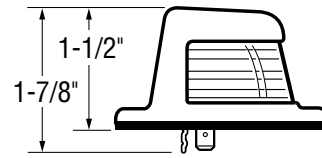
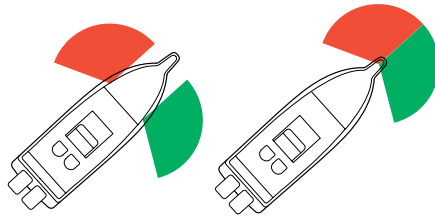

Bi-Color Combination, Deck Mount

Installs with three #6 mounting fasteners (not included). Provides 1-mile, 225° light visibility.

* **WARNING** Cancer and Reproductive Harm – www.P65Warnings.ca.gov (see page 240)

Description	Bulk Packaging	Prop 65	Aftermarket Packaging	Prop 65
Stainless Steel	—		66318-7	*



66318

1 NM
USCG

Red/Green Pair, Deck Mount

Installs with three #6 mounting fasteners (not included). Each light provides 1-mile, 112.5° light visibility.

* **WARNING** Cancer and Reproductive Harm – www.P65Warnings.ca.gov (see page 240)

Description	Socket	Bulk Packaging	Prop 65	Aftermarket Packaging	Prop 65
Stainless Steel	7" wire lead	—		66319R† / 66319G †	*



66319R

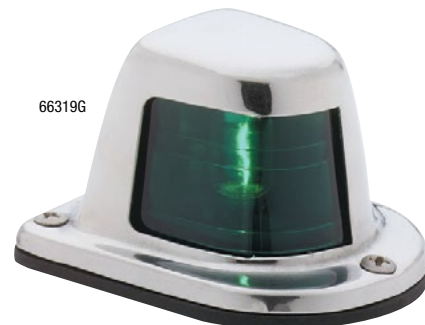

66319G

1 NM
USCG

† Red/Green Sidelights packaged separately for aftermarket.



ZAMAK

6300 SERIES

1-MILE SIDELIGHTS

These die-cast ZAMAK sidelights with Perma-Plate® finish provide 1-mile visibility for power boats up to 39.4 ft. (12 meters). Mounts on decks or gunwales with external screws. Includes 7.5-watt lamp and 7-inch hard wire leads for 12-volt DC electrical connection.

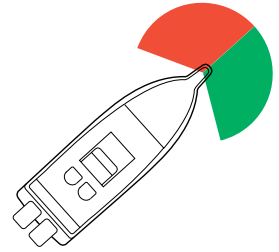

Bi-Color Combination, Deck Mount

Housing completely encases socket. Installs with two #8 fasteners (not included). Provides 1-mile, 225° light visibility.

* **⚠ WARNING** Cancer and Reproductive Harm – www.P65Warnings.ca.gov (see page 240)



6375D6

Description	Bulk Packaging	Prop 65	Aftermarket Packaging	Prop 65
Chrome-Plated ZAMAK	—		6375D6	*

POLE-MOUNTED PLUG-IN SIDELIGHTS

LED LIGHTARMOR™ Bi-Color Navigation Pole Lights

LightArmor Stowaway Pole Lights have all the characteristics that signifies the premium LightArmor brand: top-quality materials, robust construction, durability, and sleek design. Available with task light option.

* **WARNING** Cancer and Reproductive Harm – www.P65Warnings.ca.gov (see page 240)

- Meets today's global regulatory requirements, including EN/ISO 19009:2015
- Proprietary modular LED light engine technology
- 2-mile visibility
- Design flexibility and ease of installation

NOTE: locking collar design is compatible only with LightArmor Plug-In Bases

LightArmor Bi-Color Pole Lights

Series	Use with Light Base
NV6LC1, NV6SP1	910R2, 901V2, 910T2, 2520*, 911339*, 911370*

LightArmor Bi-Color Pole Lights with Task Light

Series	Use with Light Base
NV6LC2, NV6SP2	910R3, 901V3, 910T3, 2530*

* When locking collar is removed.

Description	Pole Length	Bulk Packaging	Prop 65	Aftermarket Packaging	Prop 65
2-Pin, Locking Collar Pole	10" Straight	NV6LC1-10-1	*	—	—
	12" Straight	NV6LC1-12-1	*	—	—
	14" Straight	NV6LC1-14-1	*	NV6LC1-14-7	*
	16" Straight	NV6LC1-16-1	*	—	—
	10" Angled	—	—	NV6LC1-10A7	*
	14" Angled	—	—	NV6LC1-14A7	*
2-Pin, Standard Pole	10" Straight	NV6SP1-10-1	*	—	—
	12" Straight	NV6SP1-12-1	*	—	—
	14" Straight	NV6SP1-14-1	*	—	—
	16" Straight	NV6SP1-16-1	*	—	—
3-Pin, Locking with Task	10" Straight	NV6LC2-10-1	*	NV6LC2-10-7	*
	14" Straight	NV6LC2-14-1	*	NV6LC2-14-7	*
3-Pin, Standard with Task	10" Straight	NV6SP2-10-1	*	—	—
	14" Straight	NV6SP2-14-1	*	—	—

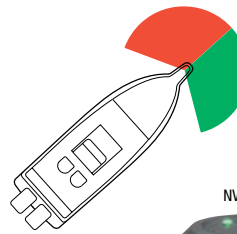

2 NM
USCG

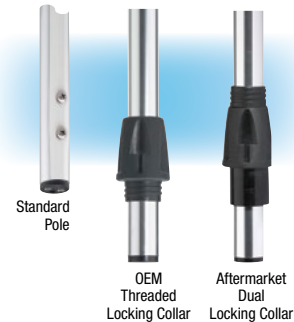

LIGHTARMOR™
Plug-In Bases
See pages 49-51

LED LIGHTARMOR™ Bi-Color Fast Action Navigation Lights

Premium LED lights with a flexible, impact-resistant composite pole make these perfect for anglers and hunters to maneuver through low-hanging obstacles. The subtle, glare-free black matte finish complements many of today's boat designs.

* **WARNING** Cancer and Reproductive Harm – www.P65Warnings.ca.gov (see page 240)

- ISO 19009:2015 Certified
- Impact-resistant polycarbonate lens
- Water resistant
- Corrosion/UV resistant
- LED light engines last for 50,000 hours
- 5-year warranty

Description	Pole Length	Bulk Packaging	Prop 65	Aftermarket Packaging	Prop 65
2-Pin, Locking Collar Pole	10"	NV6LC1-10BP1	*	—	—
	12"	NV6LC1-12BP1	*	—	—
	14"	NV6LC1-14BP1	*	NV6LC1-14BP7	*
3-Pin, Locking Collar Pole	14"	NV6LC2-14BP1	*	NV6LC2-14BP7	*



NAVIGATION: LED PLUG-IN SIDELIGHTS



PULSAR 5090 SERIES

1-MILE SIDELIGHTS

Attwood offers a variety of durable, stowaway, combination pole-mounted sidelights for bow mounting. Each features an anodized aluminum pole that raises the light head for visibility above trolling motors, anchors, or other equipment on the bow. When not in use, lights can be removed from base and stowed, so they won't interfere with fishing or anchoring.

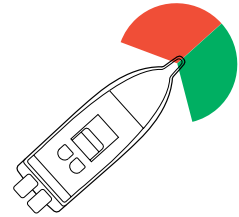

Bi-Color Stowaway

1-mile, 225° light visibility for boats up to 39.4 ft. (12 meters). Includes 9-watt wedge base lamp.

* **⚠ WARNING** Cancer and Reproductive Harm – www.P65Warnings.ca.gov (see page 240)

Series	Use with Light Base
5091, 5092	910R2, 901V2, 910T2, 2520‡, 911339*, 911370*

‡When locking collar is removed.

1 NM
USCG

Description	Pole Length	Bulk Packaging	Prop 65	Aftermarket Packaging	Prop 65
2-Pin Locking-Collar Pole	10" Straight	5092-10T1	*	5092-10-7	*
	12" Straight	5092-12T1	*	—	—
	12" Straight, Black	5092-12TB1	*	—	—
	14" Straight	5092-14T1	*	5092-14-7	*
	16" Straight	5092-16T1	*	—	—
	20" Straight	5092-20T1	*	—	—
2-Pin Standard Pole	10" Angled	5091-10-1	*	5091-10-7	*
	12" Angled	5091-12-1	*	—	—
	14" Angled	5091-14-1	*	5091-14-7	*



Bi-Color Stowaway with Task Light

Based on the same great design of the original Pulsar™ Bi-Color Pole Light, the Task Light also gives you a narrow beam work light. It features a durable rubber "push-on" switch and a micro bulb. Attwood's Task Light output is ten times brighter than competitive models, giving today's fishermen the tools they need for serious nighttime fishing.

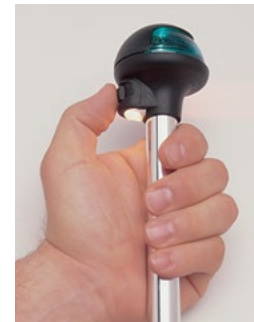
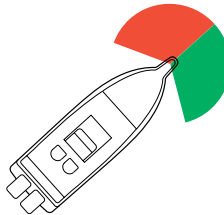

5095

Provides one-mile, 225° bi-color (red/green) light visibility for boats up to 39.4 ft. (12 meters). Lamps included: 9-watt wedge-base lamp for navigation and separately-wired 5,000 hour, non-replaceable task light lamp.

* **⚠ WARNING** Cancer and Reproductive Harm – www.P65Warnings.ca.gov (see page 240)

Series	Use with Light Base
5095	910R3, 901V3, 910T3, 2530*

*When locking collar is removed.

1 NM
USCG

Description	Pole Length	Bulk Packaging	Prop 65	Aftermarket Packaging	Prop 65
3-Pin Locking-Collar Pole	10" Straight	5095-10T1	*	5095-10-7	*
3-Pin Standard Pole	10" Straight	5098-10-1	*	—	—



2500 SERIES HORN & LIGHT BASE

Ideal solution for today's fishing boat market. Combining both horn and light base components into one integrated module, Attwood's assembly is compact, robust, and easy to install. The acoustic technology provides a louder, more effective, and higher quality sounding product than current industry offerings. Attwood's patent pending water management system efficiently controls water inrush and eliminates the need for a sound reducing cloth at the horn mouth.

Exceptional Sound Quality

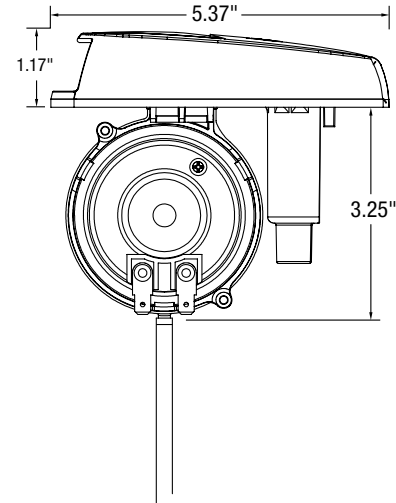
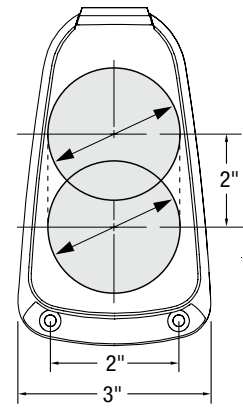
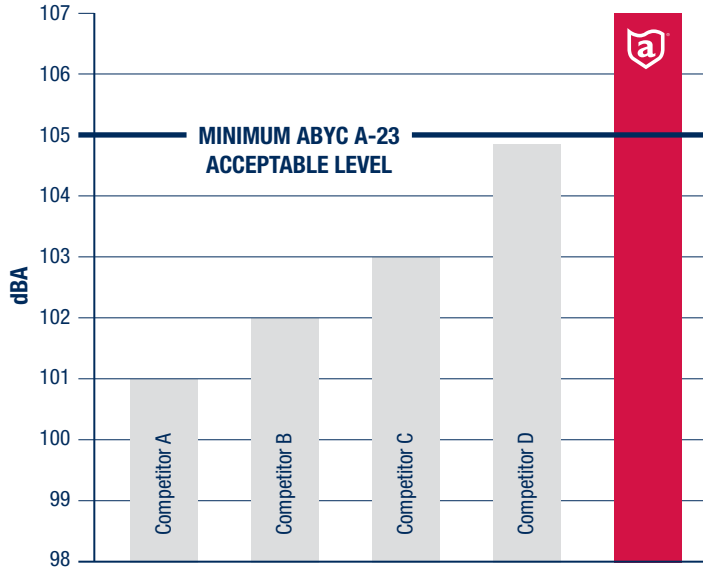

Durable

- Stainless mesh won't tear or puncture like cloth fabric.
- Water management system prevents common horn failures.
- Rubber base cover is flexible to avoid damage if kicked or stepped on.
- Withstands 2500 lb. standing load.
- Horn uses a make/break disc diaphragm to produce a quality tone (The main competitor uses a piezoelectric horn to produce a buzzer sound).

2520 / 2530



2500 Series Horn & Light Base with Suggested Attwood Pole Lights

* ⚠️ **WARNING** Cancer and Reproductive Harm – www.P65Warnings.ca.gov (see page 240)

Description	Pole Length	Bulk Packaging	Prop 65	Aftermarket Packaging	Prop 65
HORN & LIGHT BASE					
2-Wire	—	2520-1	*	—	—
3-Wire	—	2530-1	*	—	—
SUGGESTED ATTWOOD POLE LIGHTS					
2-Pin, Standard Pole	10" Straight	NV6SP1-10-1	*	—	—
	12" Straight	NV6SP1-12-1	*	—	—
	14" Straight	NV6SP1-14-1	*	—	—
	16" Straight	NV6SP1-16-1	*	—	—
3-Pin, Standard with Task	10" Straight	NV6SP2-10-1	*	—	—
	14" Straight	NV6SP2-14-1	*	—	—
2-Pin, Standard Incandescent	10" Straight	5097-10-1	*	—	—

Shown with
LIGHTARMOR
LED Bi-color
Pole Light



PLUG-IN ALL-ROUND LIGHT OVERVIEW

Attwood offers a selection of durable, stowaway, pole-mounted lights. Plug-in pole lights are available in socket styles to fit most Attwood's 2- and 3-pin bases, and competitive brands of bases when the 2- or 3-pin locking-collar pole is specified.

POLE LIGHT SELECTION

Simply choose the style of light head and lens you need and select the pole style to fit your existing base. Or select a matching base best suited to your installation location. *Black pole option available upon request.*



LOCKING-COLLAR POLE WITH UNIVERSAL FIT

Locking-collar poles offer universal fit allowing customers to use them with a wide variety of Attwood 2- and 3-pin straight or angled bases. They also work as replacements in competitive bases, including Perko® brand bases.



STANDARD POLE

Standard pole is used on Attwood all-round, masthead, transom, and bi-color pole lights. Fits all Attwood standard (non-locking-collar) 2- and 3-pin contact bases.

OR

2-MILE ALL-ROUND LIGHTS

Attwood all-round lights offer 2-mile, 360° visibility and are suitable on boats up to 39.4 feet (12 meters). Power vessels less than 39.4 feet may show a single all-round light in lieu of a separate masthead and stern light. Attwood all-round lights are available in a variety of head, pole, and base styles to fit most boats and installation locations. On boats under 12 meters, the all-round light is the most important navigation light because it can be seen by others from any direction.

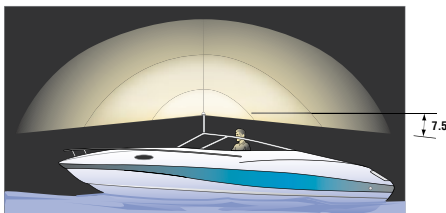

- LED ANTI-GLARE
- ANTI-GLARE LIGHTS
- FROSTED GLOBE LIGHTS

Attwood offers a choice of all-round lights — Anti-Glare and Frosted Globe. Select the head, pole, and base style that best suit your installation location and eliminate driver glare.

Traditional and LED Anti-Glare Lights

Attwood's Anti-Glare All-Round light goes beyond current regulations to reduce the danger of on-board glare. The precision lens focuses the light beam to the horizon where it's needed—360° without diffusion—keeping it out of the driver's field of view. It allows the operator to see while being sure the boat is seen. The bottom aperture eliminates glare by cutting off the light beam at 7.5° below horizontal, so it's out of the driver's view. Above horizontal, the lens shines a continuous arc of light—allowing improved visibility even when the boat is pitching in rolling seas. The Articulating Anti-Glare Light makes it even easier to eliminate glare. The patented articulating head adjusts from 15° fore to 15° aft to fit all base angles and typical deck installations.

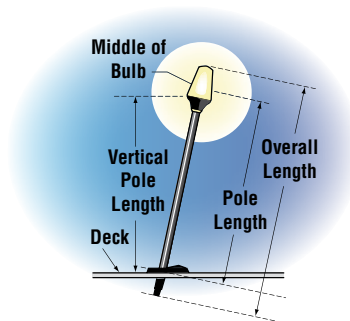

Frosted Globe Lights

Attwood's standard Frosted Globe All-Round light is also available. Offering 360° visibility.

One meter or 39-3/8"

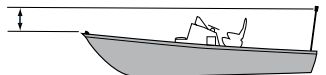

One-Meter Regulation

All-round light must be a minimum of one meter (39-3/8") above the red/green sidelights on boats under 12 meters (39.4 ft.). One meter must be the height separation measured from bulb filament centers.

Note: Frosted globe pole lights may be used with straight and angled bases. Unarticulated anti-glare pole lights must be selected to match the appropriate straight or angled base.



Perko® is a registered trademark of Perko, Inc.





LIGHTARMOR™ Fast Action All-Round Navigation Lights

Premium LED lights with a flexible, impact-resistant composite pole make these perfect for anglers and hunters to maneuver through low-hanging obstacles. The subtle, glare-free black matte finish complements many of today's boat designs.

* **⚠ WARNING** Cancer and Reproductive Harm – www.P65Warnings.ca.gov (see page 240)

- ISO 19009:2015 Certified
- Impact-resistant polycarbonate lens
- Water resistant
- Corrosion/UV resistant
- Light head adjusts 15° fore to 15° aft
- LED light engines last for 50,000 hours
- 5-year warranty

Description	Pole Length	Bulk Packaging	Prop 65	Aftermarket Packaging	Prop 65
All-Round Light	24"	5530-24BP1	*	5530-24BP7	*
	30"	5530-30BP1	*	—	—
	36"	5530-36BP1	*	5530-36BP7	*
	42"	5530-42BP1	*	5530-42BP7	*
	48"	5530-48BP1	*	—	—
	54"	5530-54BP1	*	5530-54BP7	*
	60"	5530-60BP1	*	—	—



5530



Threaded Locking Collar fits securely with LightArmor Plug-In Light Bases





LIGHTARMOR™ All-Round Articulating Light

- USCG certified. Provides 2-mile 360° visibility for boats up to 39.4 ft (12m)
- LightArmor™ All-Round navigation engine
- 30% lighter than earlier Attwood all-round lights
- Exclusive condensation management increases visibility
- Exclusive anti-glare engine preserves night vision
- Shock-, corrosion-, and water-proof electronics
- Durable, anodized aluminum pole
- Articulating head for use in all applications
- Strong locking-collar secures light in harsh marine conditions
- Standard 2-pin
- Compatible with Attwood and popular bases
- Operating range = 10.5 VDC - 14.4 VDC
- Over 50,000 hour life
- 5-year warranty

* **WARNING** Cancer and Reproductive Harm – www.P65Warnings.ca.gov (see page 240)

Series	Use with Light Base
5530	910R2, 901V2, 910T2, 2520‡, 911339‡, 911370‡

‡When locking collar is removed.

Description	Pole Length	Bulk Packaging	Prop 65	Aftermarket Packaging	Prop 65
2-Pin Locking-Collar Pole	12"	5530-12T1	*	—	—
	24"	—	—	5530-24A7	*
	36"	—	—	5530-36A7	*
	42"	5530-42T1	*	5530-42A7	*
	48"	5530-48T1	*	5530-48A7	*
	54"	5530-54T1	*	5530-54A7	*
	54", Black	5530-54TB1	*	—	—
	60"	5530-60T1	*	5530-60A7	*
	66"	5530-66T1	*	—	—

2 NM
USCG



LIGHTARMOR™ All-Round Folding Pole Light

- USCG certified. Provide 2-mile, 360° visibility for boats up to 39.4 feet (12 m)
- LightArmor™ All-Round navigation engine
- 30% lighter than earlier Attwood all-round lights
- Exclusive condensation management increases visibility
- Exclusive anti-glare engine preserves night vision
- Shock-, corrosion-, and water-proof electronics
- Durable, anodized aluminum pole
- Standard 2-pin
- Compatible with Attwood and popular bases
- Operating range = 10.5 VDC - 14.4 VDC
- Over 50,000 hour life
- 5-year warranty

* **WARNING** Cancer and Reproductive Harm – www.P65Warnings.ca.gov (see page 240)

Series	Use with Light Base
5540, 5570	910R2, 901V2, 910T2, 2520‡, 911339‡, 911370‡

‡When locking collar is removed.

Description	Pole Length	Bulk Packaging	Prop 65	Aftermarket Packaging	Prop 65
2-Pin Locking-Collar Pole	54"	5540-54T1	*	5540-54A7	*
	60"	5540-60T1	*	—	—
	72"	5540-72T1	*	—	—
	84"	5540-84T1	*	—	—
2-Pin Standard Pole	60"	5570-60-1	*	—	—
	72"	5570-72-1	*	—	—

2 NM
USCG

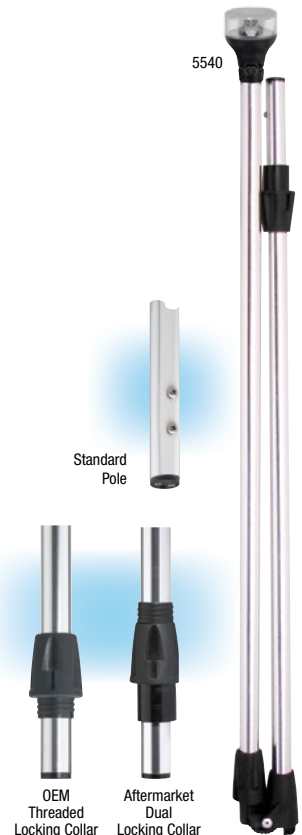

Incandescent All-Round Articulating Anti-Glare Light

Attwood's Anti-Glare lights are a great improvement over conventional all-round lights. They focus light at the horizon and above, not in the driver's eyes.

The bottom aperture reduces glare at 7.5° below horizontal. Above horizontal, the lens shines a continuous arc of light in rolling seas. The patented articulating head adjusts from 15° forward to 15° aft. Simply align the lens to the horizon and tighten the adjustment screw. Makes the boat more visible to taller craft such as freighters and commercial vessels.

The All-Round Articulating Anti-Glare Light simplifies inventory for builders and retailers, since one light fits most angles and installations. The locking-collar pole allows installation in 95% of existing bases — Attwood models as well as competitive bases such as Perko® brand, which simplifies installation for consumers.

* **WARNING** Cancer and Reproductive Harm – www.P65Warnings.ca.gov (see page 240)

Perko® is a registered trademark of Perko, Inc.



5330

2 NM
USCG



Series	Use with Light Base
5330	910R2, 901V2, 910T2, 2520* 911339*, 911370*

* When locking-collar is removed.

Description	Pole Length	Bulk Packaging	Prop 65	Aftermarket Packaging	Prop 65
2-Pin Locking-Collar Pole	42"	5330-42T1	*	5330-42-7	*
	48"	—	*	5330-48-7	*
	54"	5330-54T1	*	—	—
	60"	5330-60T1	*	—	—
	72"	5330-72T1	*	—	—

Incandescent All-Round Folding Pole Light

All-round lights must be at least one meter above sidelights, which requires a longer pole light that is difficult to store for some boats. Attwood's All-Round Folding Pole light solves this problem. It has all the features of the patented Articulating Anti-Glare Light, plus one great advantage — the removable pole folds in half for easy storage.

The mid-point hinge is a corrosion-resistant, glass-filled composite. Wiring is sheathed at the hinge for trouble-free operation.

* **WARNING** Cancer and Reproductive Harm – www.P65Warnings.ca.gov (see page 240)



5340

2 NM
USCG



Series	Use with Light Base
5340	910R2, 901V2, 910T2, 2520* 911339*, 911370*

* When locking-collar is removed.

Description	Pole Length	Bulk Packaging	Prop 65	Aftermarket Packaging	Prop 65
2-Pin Locking-Collar Pole	42"	5340-42T1	*	—	—
	48"	5340-48T1	*	5340-48-7	*
	54"	5340-54T1	*	5340-54-7	*
	60"	5340-60T1	*	—	—
	72"	5340-72T1	*	—	—
	84"	5340-84T1	*	—	—



Incandescent All-Round Anti-Glare Light, Straight Pole

Anti-glare lens focuses light beam to reduce glare in driver's eyes. Straight Pole with locking-collar is adaptable to most 90° competitive bases. 9-watt wedge-base lamp is commonly available in auto, marine, and convenience stores.

* **⚠ WARNING** Cancer and Reproductive Harm – www.P65Warnings.ca.gov (see page 240)

Series	Use with Light Base
5320	910R2, 901V2, 910T2, 2520‡ 911339‡, 911370‡

‡When locking collar is removed.

Description	Pole Length	Bulk Packaging	Prop 65	Aftermarket Packaging	Prop 65
2-Pin Locking-Collar Pole	20"	5320-20T1	*	—	—
	42"	5320-42T1	*	—	—
	48"	5320-48T1	*	—	—
	54"	5320-54T1	*	—	—
	54", Black	5320-54TB1	*	—	—
	60"	5320-60T1	*	—	—
	60", Black	5320-60TB1	*	—	—
	72"	5320-72T1	*	—	—

2 NM
USCG

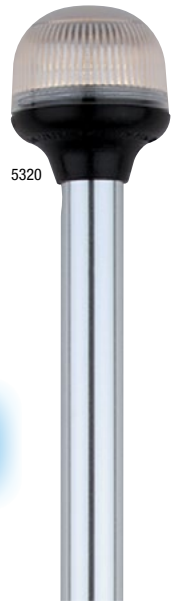

5320



OEM Threaded Locking Collar

Incandescent All-Round Anti-Glare Light, Angled Pole

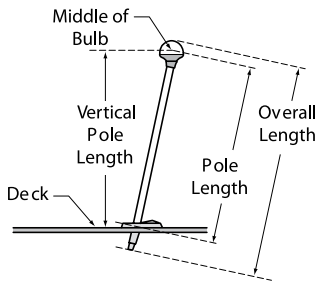

Angled (12°) pole model features either a locking-collar or a standard Attwood 2-pin pole. Poles are constructed of 3/4-inch diameter aluminum. Lens threads off for easy lamp replacement. Includes commonly available 9-watt wedge-base lamp.

* **⚠ WARNING** Cancer and Reproductive Harm – www.P65Warnings.ca.gov (see page 240)

Series	Use with Light Base
5300, 5310	910R2, 901V2, 910T2, 2520‡ 911339‡, 911370‡

‡When locking collar is removed.

Description	Pole Length	Bulk Packaging	Prop 65	Aftermarket Packaging	Prop 65
2-Pin Locking-Collar Pole	66"	5310-66T1	*	—	—
2-Pin Standard Pole	60"	5300-60-1	*	—	—
	72"	5300-72-1	*	—	—

2 NM
USCG



5310, 5300



Standard Pole



OEM Threaded Locking Collar

Incandescent All-Round Frosted Globe Light

Provides 2-mile, 360° illumination for boats up to 65.6 ft. (20 m). Includes 9-watt wedge-base lamp.

* **WARNING** Cancer and Reproductive Harm – www.P65Warnings.ca.gov (see page 240)

Series	Use with Light Base
5100, 5110	910R2, 901V2, 910T2, 2520‡ 911339‡, 911370‡

‡When locking collar is removed.

Description	Pole Length	Bulk Packaging	Prop 65	Aftermarket Packaging	Prop 65
2-Pin Locking-Collar Pole	24"	—	—	5110-24-7	*
	30"	—	—	5110-30-7	*
	36"	—	—	5110-36-7	*
	42"	—	—	5110-42-7	*
	48"	—	—	5110-48-7	*
	54"	—	—	5110-54-7	*
2-Pin Standard Pole	24"	5100-24-1	*	—	—
	36"	5100-36-1	*	—	—
	48"	5100-48-1	*	—	—
	54"	5100-54-1	*	—	—
	54"	5100-54-1	*	—	—

2 NM
USCG



Incandescent Telescoping Pole Light

Stores easily in less space than a conventional All-Around light and can be removed quickly from any Attwood pole light base. Aluminum pole telescopes from 26-inches to 42-inches. Provides 2-mile, 360° illumination for boats up to 65.6 ft. (20 m). Includes 12-watt lamp.

* **WARNING** Cancer and Reproductive Harm – www.P65Warnings.ca.gov (see page 240)

Description	Pole Length	Bulk Packaging	Prop 65	Aftermarket Packaging	Prop 65
Telescoping Pole Lights	26" - 42"	—	—	5610-48-7	*

2 NM
USCG

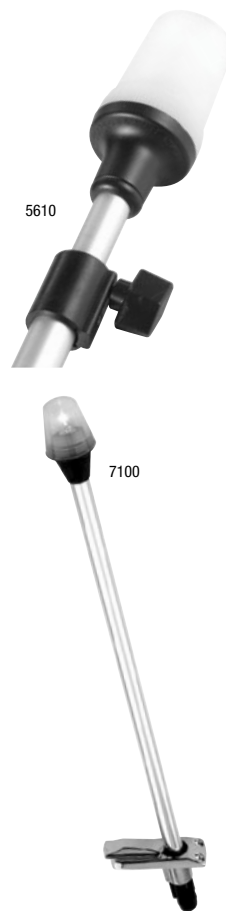

Incandescent Stowaway Light with Plug-In Base

Swivel cover on base protects the socket when light is stowed. Base extends just 3-inches below deck. 4-inch L x 1-5/8-inch W x 1-3/8 inch-dia. Provides 2-mile, 360° illumination for boats up to 65.6 ft. (20 m). Includes 911339 base and 9-watt wedge-base lamp. Three countersunk holes for #10 fasteners.

* **WARNING** Cancer and Reproductive Harm – www.P65Warnings.ca.gov (see page 240)

Description	Pole Length	Bulk Packaging	Prop 65	Aftermarket Packaging	Prop 65
2-Pin Standard Pole with 911339 Base	24"	—	—	7100A7	*
	30"	—	—	7100B7	*
	36"	—	—	7100C7	*

2 NM
USCG

LIGHTARMOR™ PLUG-IN BASES

LIGHT ARMOR Plug-In Light Bases are designed for premium performance, durability, and attractive styling that helps them stand out. This combination of intelligent design and engineering make them worthy of the Light Armor name.

They're a Sure Fit

The threaded design feature fits perfectly with the threaded locking collar now offered across the entire line of Attwood pole lights. This unique system ensures a tight and secure fit that prevents annoying rattling while underway or trailering.

Plenty of Style Choices

The upgraded styling and appearance comes in three popular shapes and a range of material finishes, including Composite, 316 Stainless Steel, and Stainless Steel Overmold, that are sure to appeal to everyone.

Other Key Features

- Unique cover design ensures that the cover stays in place
- Low-profile prevents water from pooling on the top surface
- 2-and 3-pin options



910V SERIES:
RECTANGLE

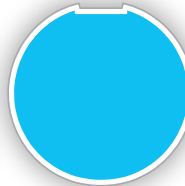

LIGHTARMOR™
PLUG-IN BASES

910R SERIES:
ROUND



910T SERIES:
TEARDROP

Aftermarket packaging includes an OEM Threaded Locking Collar to retrofit existing pole lights.



LIGHTARMOR™ 910V Series Rectangle Base

Classic rectangle design is available in Black Composite and 316 Stainless Steel.

* **WARNING** Cancer and Reproductive Harm – www.P65Warnings.ca.gov (see page 240)

Light Base	Use with Pole Light
910V2	LED Anti-Glare: 5530 and 5540 Series Bi-Color: NV6LC1, 5092, and 5091 Series Frosted Globe: 5110 Series Anti-Glare: 5310, 5320, 5330, and 5340 Series
910V3	Bi-Color: NV6LC2 and 5095 Series

Description	Bulk Packaging	Prop 65	Aftermarket Packaging	Prop 65
2-PIN LIGHT BASE				
Black Composite Cover	910V2PB-1	*	910V2PB-7	*
316 Stainless Steel	910V2SS-1	*	910V2SS-7	*
3-PIN LIGHT BASE				
Black Composite Cover	910V3PB-1	*	910V3PB-7	*
316 Stainless Steel	910V3SS-1	*	910V3SS-7	*



LIGHTARMOR™

910R Series Round Base

Round base is available in Black Composite, and 306 Stainless Steel Overmold (black and white).

* **⚠ WARNING** Cancer and Reproductive Harm – www.P65Warnings.ca.gov (see page 240)

Light Base	Use with Pole Light
910R2	LED Anti-Glare: 5530 and 5540 Series Bi-Color: NV6LC1, 5092, and 5091 Series Frosted Globe: 5110 Series Anti-Glare: 5310, 5320, 5330, and 5340 Series
910R3	Bi-Color: NV6LC2 and 5095 Series

Description	Bulk Packaging	Prop 65	Aftermarket Packaging	Prop 65
2-PIN LIGHT BASE				
Black Composite Cover	910R2PB-1	*	910R2PB-7	*
Overmold 306 Stainless Steel Black Cover	910R2PSB-1	*	910R2PSB-7	*
Overmold 306 Stainless Steel White Cover	910R2PSW-1	*	—	
3-PIN LIGHT BASE				
Black Composite Cover	910R3PB-1	*	910R3PB-7	*
Overmold 306 Stainless Steel Black Cover	910R3PSB-1	*	910R3PSB-7	*
Overmold 306 Stainless Steel White Cover	910R3PSW-1	*	—	



LIGHTARMOR™

910T Series Teardrop Base

Elegant teardrop base is available in Black Composite, and 306 Stainless Steel Overmold (black and white).

* **⚠ WARNING** Cancer and Reproductive Harm – www.P65Warnings.ca.gov (see page 240)

Light Base	Use with Pole Light
910T2	LED Anti-Glare: 5530 and 5540 Series Bi-Color: NV6LC1, 5092, and 5091 Series Frosted Globe: 5110 Series Anti-Glare: 5310, 5320, 5330, and 5340 Series
910T3	Bi-Color: NV6LC2 and 5095 Series

Description	Bulk Packaging	Prop 65	Aftermarket Packaging	Prop 65
2-PIN LIGHT BASE				
Black Composite Cover	910T2PB-1	*	910T2PB-7	*
Overmold 306 Stainless Steel Black Cover	910T2PSB-1	*	910T2PSB-7	*
Overmold 306 Stainless Steel White Cover	910T2PSW-1	*	—	
3-PIN LIGHT BASE				
Black Composite Cover	910T3PB-1	*	910T3PB-7	*
Overmold 306 Stainless Steel Black Cover	910T3PSB-1	*	910T3PSB-7	*
Overmold 306 Stainless Steel White Cover	910T3PSW-1	*	—	



Square 2-Pin Base for Straight Poles

2-pin base for traditional-style Attwood pole lights, constructed of nylon. Hinged cover snaps closed to keep dirt and water out when light is stowed. Socket is keyed to prevent incorrect insertion of pole lights. Four countersunk holes for installation of fasteners. Includes 7-1/2-inch hard wire leads for connection to 12-volt DC power supply.

* **⚠ WARNING** Cancer and Reproductive Harm – www.P65Warnings.ca.gov (see page 240)

- **Dimensions:** 2-1/4-inches x 1-3/4-inches. 1-1/4-inch diameter installation hole size.
- Contacts are nickel-plated to resist corrosion and multi-crimped for durability.
- Wire leads are tinned for corrosion-resistance.

Light Base	Use with Pole Light
911370	LED Anti-Glare: 5570 Series Bi-Color: 5091 Series Frosted Globe: 5100 Series Anti-Glare: 5300 Series

Description	Bulk Packaging	Prop	Aftermarket Packaging	Prop
2-Pin, Black	911370-1	*	—	65



Vertical Mount with Pin Contacts for Straight Poles

Can be mounted on flat windshield frame and includes a “V” adapter for mounting on angled windshield frame. Also for use as a transom mount in open utility boats. Black plastic with hinged lid that closes to keep dirt and water out when stowed away. Two holes for #8 screws. Includes 7-1/2-inch hard wire leads for connection to 12-volt DC power supply.

* **⚠ WARNING** Cancer and Reproductive Harm – www.P65Warnings.ca.gov (see page 240)

- **Dimensions:** 4-1/4-inches x 1-1/2-inches x 1-1/8-inches.
- Contacts are nickel-plated to resist corrosion and multi-crimped for durability.
- Wire leads are tinned for corrosion-resistance.

Light Base	Use with Pole Light
911370	LED Anti-Glare: 5570 Series Bi-Color: 5091 Series Frosted Globe: 5100 Series Anti-Glare: 5300 Series

Description	Bulk Packaging	Prop	Aftermarket Packaging	Prop
2-Pin, Black	911490-1	*	—	65



Oval 2-Pin Base for Angled Pole

This resilient 2-pin base is used for angled pole lights with locking-collars. Ideal for installation in close quarters, such as narrow gunwales or deck areas. Narrow base has a soft rubber cover with a gasket to seal the socket.

* **⚠ WARNING** Cancer and Reproductive Harm – www.P65Warnings.ca.gov (see page 240)

- Contacts are nickel-plated to resist corrosion and multi-crimped for durability.
- Wire leads are tinned for corrosion-resistance.

Light Base	Use with Pole Light
91022	Frosted Globe: 5110 Series Anti-Glare: 5310, 5330 and 5340 Series LED Anti-Glare: 5530 and 5540 Series Bi-Color: 5091 Series

Description	Bulk Packaging	Prop	Aftermarket Packaging	Prop
2-Pin, Black	91022-1	*	91022-7	*



Rectangle 2-Pin Base for 12° Angled Pole

Swivel cover protects the socket when light is stowed away. Socket is keyed to prevent incorrect insertion of pole light. Three countersunk holes for installation fasteners. Includes 7-1/2-inch hard wire leads for connection to 12-volt DC power supply.

* **⚠ WARNING** Cancer and Reproductive Harm – www.P65Warnings.ca.gov (see page 240)

- **Dimensions:** 4-inches x 1-5/8-inches. 1-3/8-inch dia. installation hole size.
- Contacts are nickel-plated to resist corrosion and multi-crimped for durability.
- Wire leads are tinned for corrosion-resistance.

Light Base	Use with Pole Light
911339	Frosted Globe: 5110 Series Anti-Glare: 5300 Series Bi-Color: 5091 Series

Description	Bulk Packaging	Prop	Aftermarket Packaging	Prop
2-Pin, ZAMAK	911339-1	*	911339-7	*





ALL-ROUND FOLD-DOWN LIGHTS WITH LIGHTARMOR™ BASES

All Attwood All-Round Fold-Down Navigation Lights include a durable, easy-to-use, easy-to-install, LightArmor™ Fold-Down Base.

- Robust design provides easy, single-handed cam-lock operation
- Built to last in harsh marine environments



LIGHTARMOR
ZAMAK Base



LIGHTARMOR
Stainless Steel Base



LIGHTARMOR
Black Composite Base

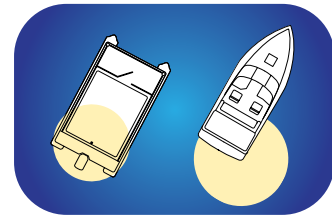
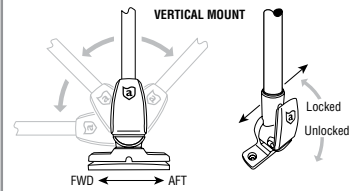
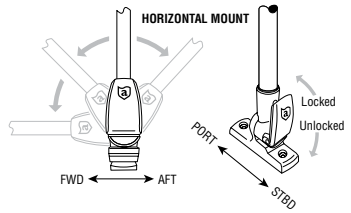

LIGHTARMOR™ All-Round Fold Down Navigation Lights

2 NM
USCG

- USCG certified
- Provides 2-mile, 360°, illumination for boats up to 39.4 ft. (12m)
- Operating range = 10.5 VDC - 14.4 VDC
- LightArmor™ All-Round navigation light engine
- 30% lighter light engine than earlier Attwood all-round lights
- Exclusive condensation management increases visibility
- Exclusive anti-glare engine preserves night vision
- Shock-, corrosion- and water-proof electronics
- Durable, anodized aluminum pole
- Articulating head for use in all applications
- Includes new LightArmor™ Fold-Down Base
- Over 50,000 hour life

* **WARNING** Cancer and Reproductive Harm – www.P65Warnings.ca.gov (see page 240)



**LED Articulating
Anti-Glare**

Draws 20% less power than traditional all-round lights

5550 Series

Description	Pole Length	Bulk Packaging	Prop 65	Aftermarket Packaging	Prop 65
LED ANTI-GLARE LIGHTS					
ZAMAK base—Horizontal Mount	12" Aluminum Pole	5550-12Z1	*	—	
	24" Aluminum Pole	5550-24Z1	*	—	
	30" Aluminum Pole	5550-30Z1	*	—	
	36" Aluminum Pole	5550-36Z1	*	—	
Stainless steel base—Horizontal Mount	12" Aluminum Pole	5550-S12-1	*	—	
	18" Aluminum Pole	5550-S18-1	*	—	
	24" Aluminum Pole	5550-S24-1	*	—	
	30" Aluminum Pole	5550-S30-1	*	—	
	36" Aluminum Pole	5550-S36-1	*	—	
	42" Aluminum Pole	5550-S42-1	*	—	
Composite base; Black—Horizontal Mount	12" Aluminum Pole	5550-P12-1	*	—	
	20" Aluminum Pole	5550-P20-1	*	—	
	24" Aluminum Pole	5550-P24-1	*	—	
Composite base; Black—Horizontal Mount with Adaptor	12" Aluminum Pole	—		5557-P12A7	*
	12" Plastic; Black Pole	—		5558-P12A7	*
	20" Aluminum Pole	—		5550-PA20-7	*
Composite base; Black Vertical Mount	12" Aluminum Pole	5551-P12-1	*	—	
Composite base; Black—Vertical Mount with Adaptor	20" Aluminum Pole	—		5551-PA20-7	*
ALL-ROUND ADAPTOR					
Rail Mount Adaptor, Black Composite		913670-1	*	—	
Rail Mount Adaptor, Stainless Steel		913671-1	*	—	

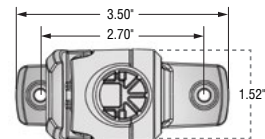

HORIZONTAL COMPOSITE BASE

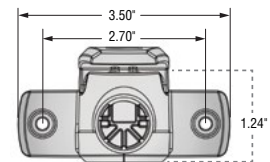

VERTICAL COMPOSITE BASE

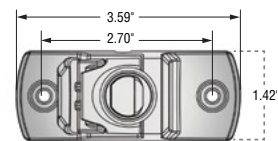

STAINLESS STEEL BASE



□ All Aftermarket Packaged lights include Rail Mount Adaptor

NAVIGATION: ALL-ROUND LED FOLD-DOWN LIGHTS



Incandescent All-Round Fold-Down Lights With Bases LIGHTARMOR™

All Attwood All-Round Fold-Down Navigation Lights include a new durable, easy-to-use, easy-to-install, LightArmor™ Fold-Down Base.

- Robust design provides easy, single-handed cam-lock operation
- Built to last in harsh marine environments



LIGHTARMOR
ZAMAK Base



LIGHTARMOR
Stainless Steel Base



LIGHTARMOR
Black Composite Base

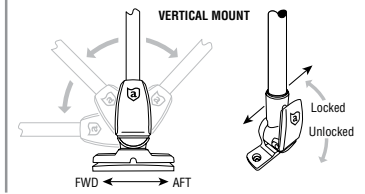
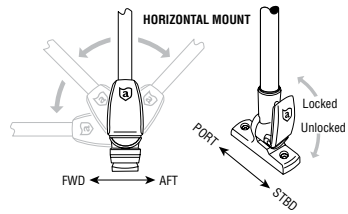

- Provides 2-mile, 360°, illumination for boats up to 39.4 ft. (12m)
- Incandescent All-Round navigation light engine
- Shock-, corrosion- and water-proof electronics
- Durable, anodized aluminum pole
- Anti-glare lens preserves night vision

- USCG certified
- Assembled with Attwood's new LIGHTARMOR bases
- Black composite cam-lock base
- Stainless steel cam-lock base
- Zamak knob-style base



* **WARNING** Cancer and Reproductive Harm – www.P65Warnings.ca.gov (see page 240)

Description	Pole Length	Bulk Packaging	Prop 65	Aftermarket Packaging	Prop 65
GLOBE STYLE LIGHTS					
Composite Base; Black–Horizontal Mount	12" Aluminum	5120-P12-1	*	—	
ZAMAK Base–Horizontal Mount	36" Aluminum	5120-36Z1	*	—	
ANTI-GLARE LIGHTS					
ZAMAK Base–Horizontal Mount	24" Aluminum	5350-24Z1	*	—	
	30" Aluminum	5350-30Z1	*	—	
	36" Aluminum	5350-36Z1	*	—	
Composite Base; Black–Horizontal Mount with Adaptor	12" Aluminum	—		5350-PA12-7 □	*
	12" Black Plastic	—		5358-P12-7 □	*
	20" Aluminum	—		5350-PA20-7 □	*
Composite Base; Black–Vertical Mount	12" Aluminum	5351-P12-1	*	—	
ANTI-GLARE LIGHTS					
Rail Mount Adaptor, Black Composite		913670-1	*	—	
Rail Mount Adaptor, Stainless Steel		913671-1	*	—	



Frosted Globe
Include 9-watt wedge base lamp.
5100 Series

Articulating Anti-Glare
Include 9-watt wedge base lamp.
5350 Series

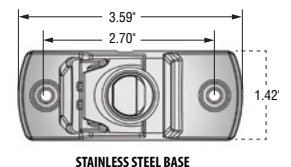
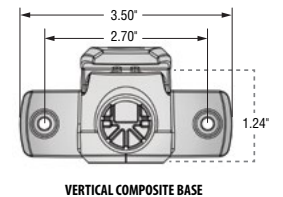
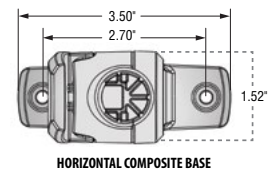

□ All Aftermarket Packaged lights include Rail Mount Adaptor

Incandescent All-Round Fixed Base Pole Lights

Two-mile, 360° light visibility for use on boats up to 39.4 ft. (12 m). Fixed base for use on pontoons, hard tops, and radar arches. 2-1/2-inches long x 1-inch wide. Installs with (2) required #10 fasteners. Includes 9-watt wedge base lamp.



2 NM
USCG



Frosted Globe

* **⚠ WARNING** Cancer and Reproductive Harm – www.P65Warnings.ca.gov (see page 240)

Description	Pole Length	Bulk Packaging	Prop 65	Aftermarket Packaging	Prop 65
Frosted Globe Style	8" aluminum	—	—	5122-08-7	*

LED LIGHTARMOR™ Waketower All-Round Light

Compact size designed for installation on a wakeboard tower, radar arch, hard top, poling platform, tuna tower, or other fixed structure. Direct LED replacement for Attwood's incandescent 5940 series. For pleasure craft up to 39.4 ft (12 m).

* **⚠ WARNING** Cancer and Reproductive Harm – www.P65Warnings.ca.gov (see page 240)

- Two-mile, 360° visibility
- Fully sealed electronics
- Tab release

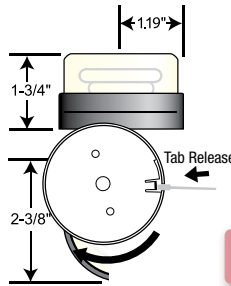

2 NM
USCG



5580



5580-03

Description	Bulk Packaging	Prop 65	Aftermarket Packaging	Prop 65
6" Wire Leads	5580-1	—	5580A7	—
12" Wire Leads, No Sleeve	5582-1	*	—	—
16" Wire Leads	5581-1	—	—	—
Replacement Base	5580-03	*	—	—

Incandescent All-Round Deck Mounted Lights

7-inch leads for connection to 12-volt DC power supply. Bayonet lock secures lens and cover to base and provides easy lamp replacement. Includes a 9-watt wedge base lamp. Installs directly to deck with two required #10 fasteners.

* **⚠ WARNING** Cancer and Reproductive Harm – www.P65Warnings.ca.gov (see page 240)

Raised Base

3-inch high raised base is ideal for mounting above obstructions, such as rails and hardware. Notch in rear of mounting base provides passage for wire leads.

Deck Mount

Light mounts flush, making it ideal for installation atop the tow piece on ski or wakeboard boat towers.

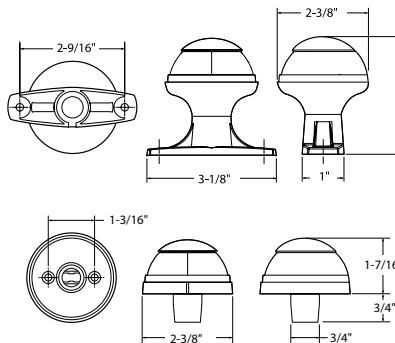

2 NM
USCG



5980



5940

Description	Bulk Packaging	Prop 65	Aftermarket Packaging	Prop 65
3" Raised Base, Black	5980-1	*	—	—
Deck Mount, Black	5940-1	*	5940-7	*



LED LIGHTARMOR™ Anchor/Masthead Lights

Attwood is proud to introduce one of the most innovative navigational lighting products available today. Achieving 3NM of 360 degree visibility, while drawing a fraction of the power of traditional incandescent lights, Attwood's 3NM LightArmor™ LED Masthead/Anchor light is one of the first of its kind. Constructed of corrosion resistant composites with stainless steel accents, this product was designed for harsh coastal marine environment.

* **WARNING** Cancer and Reproductive Harm –
www.P65Warnings.ca.gov (see page 240)

- USCG certified for boats up to 65' (20m)
- Provides 3-mile, 360° illumination
- Light Armor Anchor/Masthead navigation light engine
- Shock-, corrosion- and water-proof electronics
- Durable, anodized aluminum pole
- Includes new **LIGHTARMOR™** Fold-Down Base
 - Cam-lock bases include integrated wire-management
 - Easy, single-handed cam-lock operation
 - Stainless steel
- Over 50,000 hour life
- 5-year warranty

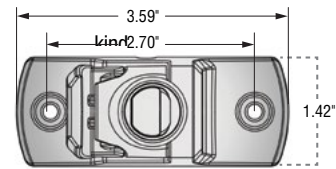

STAINLESS STEEL BASE

7812

3 NM
USCG

LIGHTARMOR™
Stainless Steel
Horizontal Base

Description	Rated Voltage	Pole Length	Bulk Packaging	Prop 65	Aftermarket Packaging	Prop 65
Stainless Steel - Horizontal Mount	12-volt	12" Aluminum	7812-S-1	*	7812-S-7	*
	12-volt	24" Aluminum	7824-S-1	*	—	—
	12-volt	36" Aluminum	7836-S-1	*	—	—
	12-volt	42" Aluminum	7842-S-1	*	—	—
ZAMAK - Horizontal Mount	12-volt	12" Aluminum	7812Z1	*	—	—

Incandescent Anchor/Masthead Lights

Three-mile, 360° light visibility for use on boats up to 65.6 ft. (20 meters). Assembly includes new **LIGHTARMOR™** bases.

* **WARNING** Cancer and Reproductive Harm
www.P65Warnings.ca.gov (see page 240)

- Robust and easy to use
- Freshwater and saltwater compatible
- Simple, one-piece lens is sealed from water
- Concealed, protected wiring at the base
- Uses two festoon-style 8-watt lamps
- Typical installation requires (2) #10 stainless steel screws of length suitable for deck or rail material
- Will collapse and not break if accidentally hit

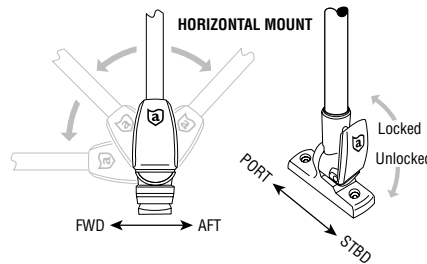

3 NM
USCG



ZAMAK base

Composite base

For base dimensions see page 52

Description	Base	Rated Voltage	Pole Length	Bulk Packaging	Prop 65	Aftermarket Packaging	Prop 65
Horizontal Mounted with rail adaptor	Composite;	12-volt	12" aluminum	—	—	7201-P-7	*
	Black	12-volt	20" aluminum	—	—	7202-P-7	*
Rail Mount Adaptor for Fold-Down light base	Black	—	—	913670-1	*	—	—
	Composite	—	—	913671-1	*	—	—
	Stainless Steel	—	—	913671-1	*	—	—



913671

913670

LED 3-Mile Transom Light

For pleasure craft up to 164 ft. (50m) in length. Creating 135 degrees of light at 3-mile of visibility. A truly unique design, Attwood's transom light includes a luxurious electropolished stainless cover that is both durable and great looking. Easy-to-install surface mount design utilizes a snap feature to eliminate exposed fasteners. Three-inch diameter.

- One of the thinnest lights available— 1/2-inch height
- Compatible with both Attwood and Perko® mounting holes

3 NM
USCG

Description	Bulk Packaging	Aftermarket Packaging
Stainless Steel	6556-1	6556-7



6556

Incandescent Transom Light

Light provides 2-mile, 135° transom visibility for pleasure craft up to 164 ft. (50 m) in length. 304 stainless steel with a plastic body and watertight lamp socket. Round transom light body is translucent, so it shines on both sides of a bulkhead! Can be used to light an interior compartment and may also be used as a cockpit courtesy light. Rubber gasket seals lens and body to mounting surface. Includes (2) stainless steel #10 screws.

* **⚠ WARNING** Cancer and Reproductive Harm – www.P65Warnings.ca.gov (see page 240)

- 7.5 watts at 12-volt DC
- Vertical, flush mount
- Patented design

2 NM
USCG

Description	Dimensions	Bulk Packaging	Prop 65	Aftermarket Packaging	Prop 65
Round	3" dia.	—		6356D7	
Rectangular	4-11/16"L x 2-11/16"H x 2"D	—		66382-7	*



6356D



66382

BATTERY OPERATED LIGHTS

For nighttime operation of small boats and tenders without 12-volt electrical systems. These lights are not intended to meet U.S. Coast Guard regulations. Not for use on boats that can exceed speeds of seven knots.

LED Portable Navigation Light Kit

Be seen and be safe with these compact and portable LED navigation lights. All new portable navigation lights are more durable, easier to use, and include Attwood's strongest mounting and pole configurations. Ideal for personal water craft, camping, and hunting. Kit includes red/green LED bow light, white LED stern light, quick-release mounts, pole, and hardware.

* **WARNING** Cancer and Reproductive Harm – www.P65Warnings.ca.gov (see page 240)

- Water-resistant bow and stern navigation lights
- Attwood's most durable, portable LED navigation light engines
- Sealed electronics, built to last in harsh conditions
- Sealed, shock-proof composite housing
- Shatter-proof polycarbonate lens
- 150+ hour run-time on three AAA batteries (not included)
- New telescoping and threaded poles
- New heavy-duty C-clamp and kayak pad mounting options

Description	Finish	Pole Style	Mounting Style	Bulk Packaging	Prop 65	Aftermarket Packaging	Prop 65
Clamp-On LED Light Kit	Marine Gray	Threaded	C-Clamp	—		14190-7	*
	Real Tree® Max-5 Camouflage	Threaded	C-Clamp	—		14191-7	*
	Marine Gray	Telescoping	C-Clamp	—		14194-7	*
	Real Tree® Max-5 Camouflage	Telescoping	C-Clamp	—		14195-7	*
Deck Mount LED Light Kit	Marine Gray	Telescoping	Optional screw-down or adhesive pad	—		14192-7	*
	Real Tree® Max-5 Camouflage	Telescoping	Optional screw-down or adhesive pad	—		14193-7	*
All-Craft Portable Navigation Light Kit	Marine Gray	Threaded	C-Clamp, screw-down or adhesive pad	—		14196-7	*
	Real Tree® Max-5 Camouflage	Threaded	C-Clamp, screw-down or adhesive pad	—		14197-7	*



LED Multi-Function Sport Light

Durable, water-resistant, multi-purpose light can be used as a bright 300 fixture lumen flood light or 50 lumen red beam for improved night vision. Also has a UV mode for charging fishing lures and line. Ideal for fishing, boating, hunting, camping and more. Features four mounting options and 360° rotation. Includes an adapter for use with Attwood rod holder mount. Requires six AA batteries (not included).

* **WARNING** Cancer and Reproductive Harm – www.P65Warnings.ca.gov (see page 240)

Description	Bulk Packaging	Prop 65	Aftermarket Packaging	Prop 65
Multi-Purpose Light, marine gray	—		14185XFS-7	*
Multi-Purpose Light, camouflage	—		14187XFS-7	*



LED Docking Lights

- Light draws a fraction of the power while producing a brighter output. 5 watts at 12-volt DC each. Transmits light in a much broader pattern as opposed to a narrow beam generated by today's competitors.
- At less than 1-inch thick, the lights are designed to be mounted directly to the surface of the hull with only a small hole for wiring. Requires (3) #8 stainless steel Phillips Head screws (not included).
- Attwood LED technology keeps the light cool to the touch.
- Backed by a 5-year warranty, Attwood's LED docking lights are designed with the most extreme conditions in mind. Attwood uses only the highest grade stainless and aluminum components to ensure the product will be resistant to corrosion.
- To ensure the light is watertight, all electrical components are fully sealed.
- Attwood's simple one-piece cover allows for the ultimate in customization.
- 4-inch lead wires

Attwood LED Docking Light vs. Halogen Current Draw (Amps)

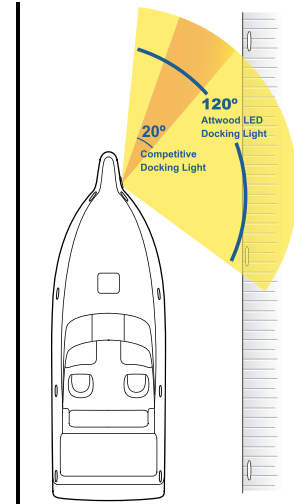
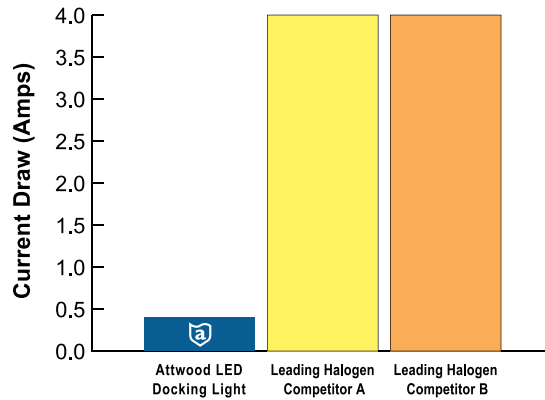

* **WARNING** Cancer and Reproductive Harm – www.P65Warnings.ca.gov (see page 240)

Description	Dimensions	Bulk Packaging	Prop 65	Aftermarket Packaging	Prop 65
Stainless Steel Bezel, White LED, Pair	4-1/8" H x 8-1/8" W x 3/4" D	6521SS1	*	—	
Stainless Steel Bezel, White LED, Pair	1.2" H x 4.5" W x 2.8" D	6522SS1	*	6522SS7	*
Black Powder Coat Bezel, White LED, Pair	1.2" H x 4.5" W x 2.8" D	6523BK1	*	6523BK7	*



LED LIGHTARMOR™ Underwater Lights

Introducing LightArmor™ Underwater Lights from Attwood, a new line of premium surface-mount LED lights that are engineered to be the brightest and most durable lights in the industry. Like all LightArmor™ products, they're technically advanced, built to perform in the harshest marine environments, and backed by an industry-leading 5-year warranty.

- 12- and 24-volt DC systems
- Intelligently engineered for strength and durability
- Exclusive Heat-Sync Cooling System with Active Overheat Protection
- Resistant to corrosion, chemicals, and UV damage
- Extreme impact-resistant lens
- 3 ft. sheathed wire
- Reverse polarity protection
- Fully-sealed waterproof electronics
- Simple installation with minimal mounting hardware
- Low-profile design
- Electro-polished 316 stainless steel cover (Optional for OEM)
- CE certified

Three popular sizes - 4.0-inch, 5.0-inch, 6.0-inch

Three vibrant colors - Sapphire Blue, Intense White, Tactical Green

Two performance levels - High Performance (HP), Extreme High Performance (HPX)

Note: All Light Armor Underwater lights MUST BE MOUNTED UNDER WATER LINE. Only work underwater.



Outshining the Competition.

LIGHTARMOR Underwater Lights are the brightest on the market.

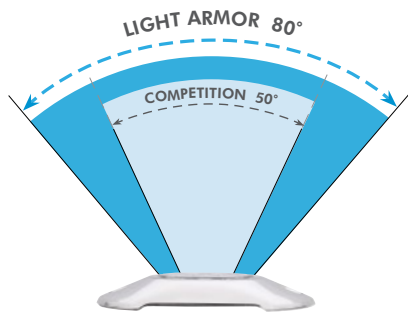

Projection Intensity vs. Competitor

Resistant to corrosion, chemicals, and UV damage

Simple installation with minimal mounting hardware

Extreme impact-resistant lens

Low-profile design

3' sheathed wire

Heat sink cooling system with active overheat protection

Reverse polarity protection

Fully-sealed waterproof electronics

Electro-polished 316 stainless steel cover (included in retail packaging; installation optional)

* ⚠ **WARNING** Cancer and Reproductive Harm – www.P65Warnings.ca.gov (see page 240)

NOTE: Bulk packaging **does not** include covers and aftermarket packaging **does** include covers.

Description	Color	Fixture Lumens*	Current Draw at 13.6- Volts	Current Draw at 24 Volts	Bulk Packaging	Prop 65	Aftermarket Packaging	Prop 65
High Performance (HP)								
4.0 HP - 4" length, 3 LED	Sapphire Blue	800	0.32	0.16	65UW03B-1	*	65UW03B-7	*
	Tactical Green		0.36	0.18	—	—	65UW03G-7	*
	Intense White		0.64	0.32	65UW03W-1	*	65UW03W-7	*
5.0 HP - 5" length, 6 LED	Sapphire Blue	1,350	0.66	0.33	—	—	65UW06B-7	*
	Tactical Green		0.71	0.36	—	—	65UW06G-7	*
	Intense White		1.26	0.63	—	—	65UW06W-7	*
6.0 HP - 6" length, 12 LED	Sapphire Blue	1,650	1.32	0.66	65UW12B-1	*	65UW12B-7	*
	Intense White		2.52	1.26	—	—	65UW12W-7	*
Extreme High Performance (HPX)								
4.0 HPX - 4" length, 3 LED	Sapphire Blue	1,350	0.64	0.32	—	—	66UW03B-7	*
5.0 HPX - 5" length, 6 LED	Sapphire Blue	2,750	1.30	0.65	66UW06B-1	*	66UW06B-7	*
	Tactical Green		1.40	0.70	66UW06G-1	*	66UW06G-7	*
	Intense White		2.46	1.23	66UW06W-1	*	—	—
6.0 HPX - 6" length, 12 LED	Sapphire Blue	5,000	2.59	1.30	66UW12B-1	*	66UW12B-7	*
	Intense White		4.50	2.25	66UW12W-1	*	66UW12W-7	*
Optional Covers - For OEM only (Aftermarket packaged product includes 316 Stainless Steel Cover)								
4.0 HP/HPX Cover	Stainless Steel	—	—	—	65UW03CVSS-1	*	—	—
5.0 HP/HPX Cover	Stainless Steel	—	—	—	65UW06CVSS-1	*	—	—
6.0 HP/HPX Cover	Stainless Steel	—	—	—	65UW12CVSS-1	*	—	—



Sapphire Blue
65UW03B



Tactical Green
65UW03G



Intense White
65UW03W

DIMENSIONS

Model	Color	Length (A)	Width (B)	Distance Between Mounting Holes (C)	Diameter of Wiring Hole (D)	Installed Product Height (E)	Wire Collar Depth (F)
4.0 HP	Sapphire Blue	4.00"	2.15"	3.25"	.56"	.56"	.30"
	Tactical Green						
	Intense White						
4.0 HPX	Sapphire Blue	5.00"	2.15"	4.25"	.56"	.56"	.30"
	Tactical Green						
	Intense White						
5.0 HP	Sapphire Blue	6.00"	2.35"	5.25"	.56"	.56"	.30"
	Tactical Green						
	Intense White						
5.0 HPX	Sapphire Blue	6.00"	2.35"	5.25"	.56"	.56"	.30"
	Tactical Green						
	Intense White						
6.0 HP	Sapphire Blue	6.00"	2.35"	5.25"	.56"	.56"	.30"
	Tactical Green						
	Intense White						
6.0 HPX	Sapphire Blue	6.00"	2.35"	5.25"	.56"	.56"	.30"
	Tactical Green						
	Intense White						

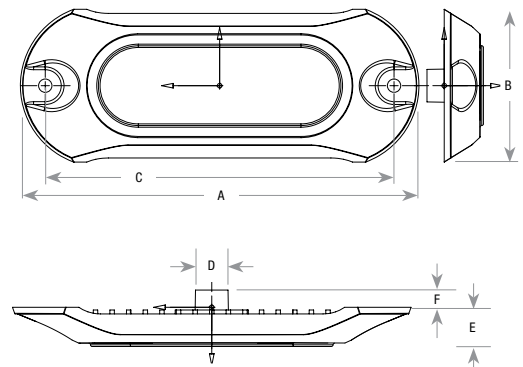

LED Underwater Lights, 3-Inch Series

Lights are 3/4-inch wide and are perfect for surface mounting on rails, transoms, and swim platforms. These LED lights exceed the output of comparable halogen lights, while using 20% of the power. Lights stay cool to the touch and eliminate the burn hazard that halogen lighting can present. Fully potted electronics and stainless steel housing allow for interior and exterior mounting – even underwater! Rated for 50,000+ hours of life.

* **⚠ WARNING** Cancer and Reproductive Harm –

www.P65Warnings.ca.gov (see page 240)

- 1.5 watts at 12-volt DC

Description	LED Color	Bulk Packaging	Prop 65	Aftermarket Packaging	Prop 65
Horizontal Mount	White	—	—	6343SS7	*
Vertical Mount	White	6344SS1	*	—	—



6343

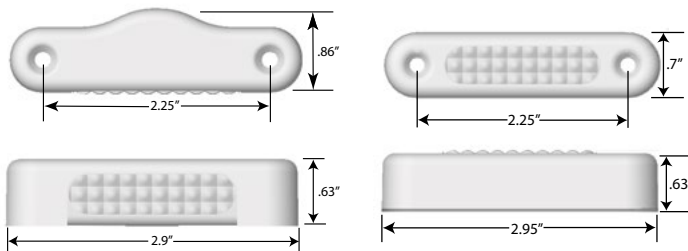

LED UTILITY LIGHTS

INTERIOR/EXTERIOR

LED Round Interior / Exterior Lights

These LED lights exceed the output of comparable halogen lights while using 20% of the power. Lights stay cool to the touch and eliminate the burn hazard that halogen lighting can present. Fully potted electronics and stainless steel housing allow for interior and exterior mounting. Rated for 50,000+ hours of life. Additional LED colors and bezel finishes are available upon request.

* **WARNING** Cancer and Reproductive Harm – www.P65Warnings.ca.gov (see page 240)

For 12-volt DC systems

- Easy installation with minimal intrusion

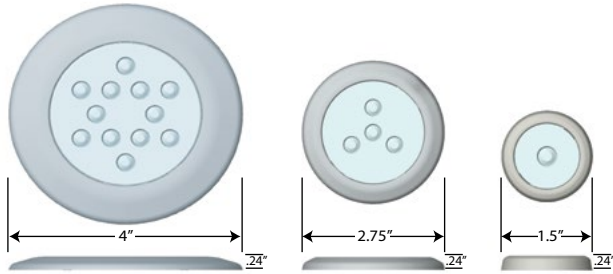

6320W



6320B



6342

Description	LED Color	Bulk Packaging	Prop 65	Aftermarket Packaging	Prop 65
4" ROUND INTERIOR LIGHT, 3 WATTS @ 12 VDC					
Stainless Steel Bezel	White	6340SS1	*	6340SS7	*
	Warm White + Red	6348SS1	*	—	—
Satin Nickel Finish	Warm White	6345SN1	*	—	—
2.75" ROUND INTERIOR LIGHT, 1.8 WATTS @ 12 VDC					
Stainless Steel Bezel White	White	—	—	6341SS7	*
	Warm White	6346SS1	*	—	—
Black Plastic Bezel	White	6320B1	*	—	—
	Amber	6321B1	*	—	—
White Plastic Bezel	White	6320W1	*	6320W7	*
	Blue	6323W1	*	6323W7	*
1.5" ROUND COURTESY LIGHT, 1.1 WATTS @ 12 VDC					
Stainless Steel Bezel	White	6342SS1	*	6342SS7	*



LED Mini Courtesy Lights

Attwood's 1-inch Mini LED Courtesy Lights offer excellent performance in an affordable package. Designed to be installed with just a hole saw, the Mini's rubber grommet eliminates fasteners and allows for quick and easy installation. Comes with fully sealed electronics; performs in almost any interior or exterior application.

* **⚠ WARNING** Cancer and Reproductive Harm – www.P65Warnings.ca.gov (see page 240)

- Compact
- Water-and shock-resistant
- 50,000 hours of life

Description	Color	Bulk Packaging	Prop 65	Aftermarket Packaging	Prop 65
Rubber Grommet, Black	White	6317-1	*	—	
	Blue	6319-1	*	—	



6317

LED Micro Lights

Industry leading light output in an extremely compact package. With electropolished stainless covers and fully sealed electronics. Attwood Micro Lights perform through the harshest conditions. Can be used in rod storage boxes without risk of water damage, under hardtops, or even mounted to rails.

* **⚠ WARNING** Cancer and Reproductive Harm – www.P65Warnings.ca.gov (see page 240)

- .66 watts at 12-volt DC

Description	Color	Bulk Packaging	Prop 65	Aftermarket Packaging	Prop 65
Stainless Steel Bezel, Vertical Mount	White	6350W1	*	6350W7	*
	Blue	6350B1	*	6350B7	*
Stainless Steel Bezel, Horizontal Mount	White	6351W1	*	—	
	Blue	6351B1	*	—	
	Green	6351G1	*	—	

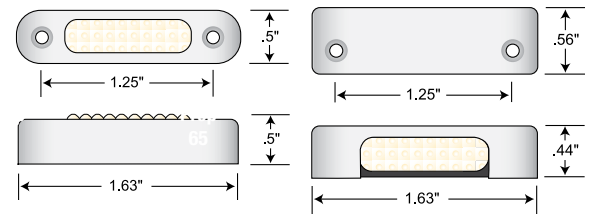

6350



LED Utility Lights

These versatile, surface-mount LED Utility Lights put bright light where you need it.

* **⚠ WARNING** Cancer and Reproductive Harm – www.P65Warnings.ca.gov (see page 240)

- Water-resistant
- 12-VDC
- Less than 1 Amp draw

Description	Bulk Packaging	Prop 65	Aftermarket Packaging	Prop 65
4" Utility Light, 6 white LED's	—		6355W7	
6" Utility Light, 12 white LED's	—		6354W7	*
8" Utility Light, 18 white LED's	—		6353W7	*



6353W7



6354W7

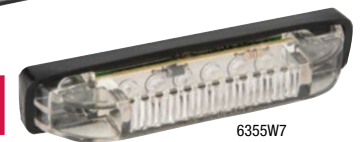

6355W7

ACCESSORIES: NAVIGATION LIGHT REPLACEMENT PARTS

QUASAR Quick-Connect Snap-On Bases

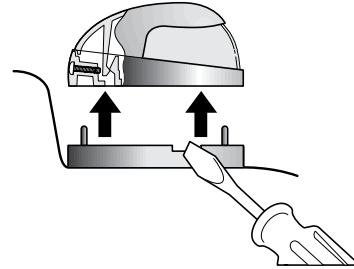
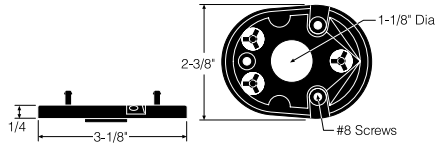

This ingenious base makes Quasar sidelights even easier to install and maintain! Base is 1/4-inch high, designed for contoured decks. Base attaches to the deck with screws, then the Quasar light simply snaps on or off.

Quasar lights are listed on page 34.

Description	Bulk Packaging	Aftermarket Packaging
Snap-on base, 1/4" high Black	3300-1	—



Pole Light Storage Clips

New design holds larger (3/4-inch) diameter anti-glare pole lights. Resilient plastic clip holds standard 3/4-inch-diameter poles. Ideal for storing and protecting plug-in pole lights when mounted in engine wells or lockers. Installs with one #8 fastener.

* **⚠ WARNING** Cancer and Reproductive Harm – www.P65Warnings.ca.gov (see page 240)

Dimensions	Description	Bulk Packaging	Prop 65	Aftermarket Packaging	Prop 65
2" L x 1-1/2" H	Black	7571-1	*	7571L7	*





FUEL

EPA CERTIFIED PORTABLE FUEL SYSTEMS OVERVIEW	66
EPA CERTIFIED PORTABLE FUEL TANKS	67
EPA CERTIFIED PORTABLE FUEL COMPONENTS	68-72
FUEL FITTINGS	73-77
EPA CERTIFIED INTEGRATED FUEL SYSTEMS OVERVIEW	78-80
EPA CERTIFIED INTEGRATED FUEL COMPONENTS	81-86
ACCESSORIES	87-90
NON EPA CERTIFIED / INTERNATIONAL PORTABLE FUEL COMPONENTS	91
NON EPA CERTIFIED / INTERNATIONAL INTEGRATED FUEL COMPONENTS	92-94



FUEL



EPA CERTIFIED PORTABLE FUEL SYSTEMS

YOUR COMPREHENSIVE TANK-TO-ENGINE SOLUTION

As a result of EPA regulations to reduce evaporative emissions, portable fuel systems are now manufactured to prevent fuel vapor from escaping into the atmosphere. These EPA compliant systems are sealed and unable to vent as in the past, causing pressure build up in the tank that rarely occurred prior to these regulations.

In addition, each component within the system adds potential restriction to fuel flow. As fuel restriction levels rise, engine performance is affected. In some cases, complete failure can occur.

Attwood's EPA Certified Portable Fuel System components are designed specifically to handle the problems caused by pressure build-up and fuel restriction inherent in today's closed EPA compliant systems.

With Attwood's systems, your engine will perform properly and valuable fuel will stay in the tank where it belongs. Attwood's systems were developed, with leading engine manufacturers, to ensure optimum, reliable performance on the water. That's the performance you'd expect from the industry leader in marine fuel systems and accessories.



ATTWOOD HAS ENGINEERED THE INDUSTRY'S ONLY COMPREHENSIVE EPA CERTIFIED FUEL TANK-TO-ENGINE SOLUTION.

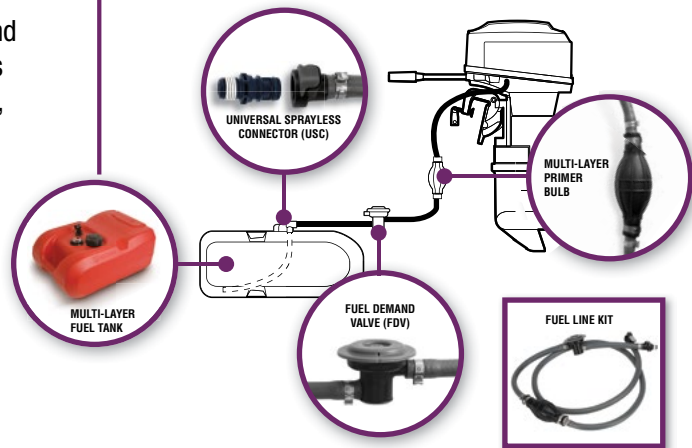

EPA CERTIFIED PORTABLE FUEL TANKS

Attwood fuel tanks are tested to meet EPA, CARB and ABYC/NMMA requirements for portable marine fuel tanks. The tanks have industry leading fuel flow performance and are designed and manufactured for safety and durability in harsh marine conditions.

- Proven automotive-grade multi-layer construction withstands the pressure build-up associated with closed systems
- Engineered for harsh conditions, temperature extremes and abuse
- Injection molded interfaces eliminate leaks
- Automatic vacuum valve in cap eliminates the need for manual vent
- Compatible with 1/4" NPT fuel fittings
- Built-in 5% ullage for fuel expansion

High-strength 1/4" NPT universal pick-up tube
Compatible with all marine and off-road engines

Injection molded interfaces ensure leak proof performance

Available with easy-to-read gauge

High-strength ergonomic handle

Tethered/ratcheting cap with high-flow automatic vacuum valve

Built-in strap channel

Additional capacity for fuel additives

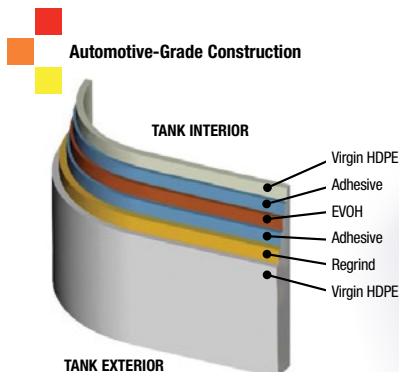

CATEGORY OVERVIEW



PORTABLE FUEL TANKS



EPA Certified multi-layer tank with industry leading fuel flow performance. Designed around the EPA and California Air Resources Board (CARB) regulations. Features an ergonomic design, an optional gauge and a tethered self sealing cap with audible click.

* **⚠ WARNING** Cancer and Reproductive Harm – www.P65Warnings.ca.gov (see page 240)

- Automatic Vacuum Valve ensures proper fuel flow and eliminates the need for manual vent and operator adjustment
- Low-permeation tank virtually eliminates fuel evaporation and fuel loss
- Compatible with 1/4" NPT fuel fittings
- Ethanol and alcohol compatible
- EPA & CARB Certified

3-Gallon Fuel Tanks

EPA/CARB COMPLIANT 3-gallon fuel tank is perfect for use with small outboards.

Description	Dimensions			Aftermarket Packaging	Prop 65
	Length	Width	Height		
3-gallon, without gauge	16.6"	11.45"	7.3"	8803LP2	*
3-gallon, with gauge	16.6"	11.45"	7.3"	8803LPG2	*
3-gallon, without gauge, single-pack	16.6"	11.45"	7.3"	8803LP2S	*
3-gallon, with gauge, single-pack	16.6"	11.45"	7.3"	8803LPG2S	*



8803LP



8803LPG



6-Gallon Fuel Tanks

EPA/CARB COMPLIANT 6-gallon fuel tank adapts to virtually any outboard engine.

Description	Dimensions			Aftermarket Packaging	Prop 65
	Length	Width	Height		
6-gallon, without gauge	19.82"	13.50"	9.16"	8806LP2	*
6-gallon, with gauge	19.82"	13.50"	9.16"	8806LPG2	*
6-gallon, without gauge, single-pack	19.82"	13.50"	9.16"	8806LP2S	*
6-gallon, with gauge, single-pack	19.82"	13.50"	9.16"	8806LPG2S	*



8806LP



8806LPG



12-Gallon Fuel Tanks

EPA/CARB COMPLIANT 12-gallon fuel tank is ideal for pontoon boats where more fuel capacity is needed.

Description	Dimensions			Aftermarket Packaging	Prop 65
	Length	Width	Height		
12-gallon, without gauge	22.75"	14.25"	14.47"	8812LP2	*
12-gallon, with gauge	22.75"	14.25"	14.47"	8812LPG2	*
12-gallon, low-profile, without gauge*	24.00"	18.00"	11.61"	8812LLP2	*
12-gallon, low-profile, with gauge*	24.00"	18.00"	11.61"	8812LLPG2	*



8812LP



8812LPG



Attwood fuel tank gauges are easy-to-read, accurate and durable.



8812LLP

EPA CERTIFIED FUEL TANKS



PRIMER BULBS



Attwood's multi-layer primer bulbs provide the absolute best combination of performance, reliability, safety and compliance to ensure your experience on the water is easier and safer to enjoy. Our exclusive three-layer design resists collapsing and hardening and ensures high output in temperatures ranging from 18°F to 122°F. Includes high-efficiency check valves with Viton O-rings for improved sealing. Assembled with the same components as Mercury and Quicksilver.

* **⚠ WARNING** Cancer and Reproductive Harm – www.P65Warnings.ca.gov (see page 240)

- Exclusive three-layer construction provides the best spring-back during priming and excellent resistance to collapse during high-flow engine operation
- Premium materials give the absolute best combination of performance and reliability:
 - No cracking/hardening over time
 - Low permeation for EPA/CARB compliance
 - Excellent priming in extreme cold and hot environments
 - Zero chance of material delamination as seen by some competitor's products
- New high-performance check valve O-rings provide 30% improved priming while keeping optimized flow during engine use (20 to 35% better than spring-loaded designs)
- EPA and CARB certified

Description	Bulk Packaging	Prop 65	Aftermarket Packaging	Prop 65
3/8" I.D. Hose	—		93038LP7	*
5/16" I.D. Hose	—		93516LP7	*
1/4" I.D. Hose	—		93014LP7	*

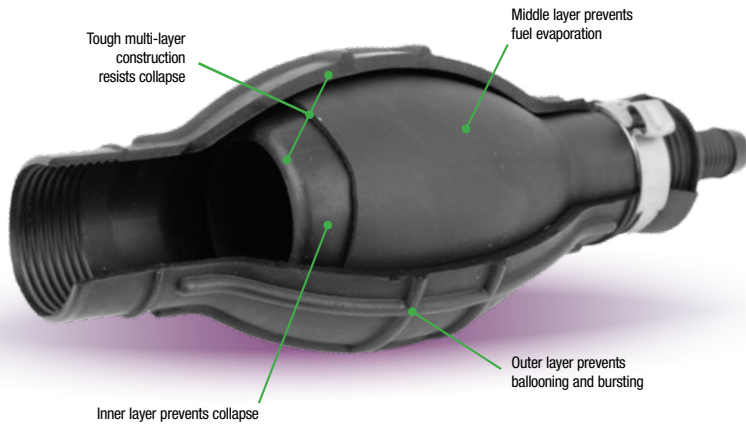

Engineered hose barsbs for leak-free performance

93516LP

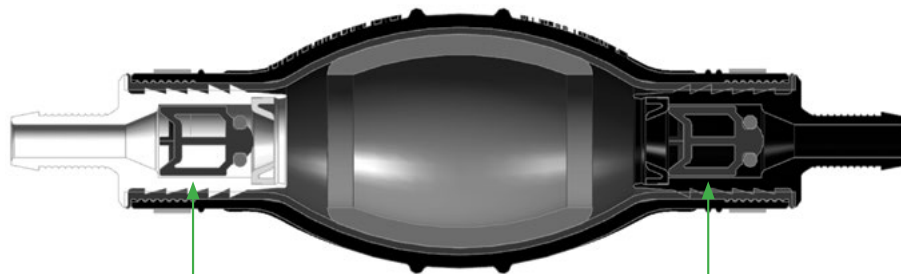

New, high-performance check valves with O-Rings provide 30% faster priming during start-up and high flow when running (20 to 35% better than spring-loaded designs)





FUEL DEMAND VALVE

Attwood's exclusive Fuel Demand Valve eliminates engine flooding and spillage by preventing pressurized fuel from reaching the engine. The valve ensures that fuel is supplied to the engine only when demanded during start up or engine operation. Designed in partnership with OEM engine manufacturers, Attwood's Fuel Demand Valve is compatible with all OEM engine brands.

- Prevents engine flooding and fuel spillage due to pressurized fuel
- Allows only the amount of fuel requested by the engine and prevents a pressurized "slug" of fuel from reaching engine
- Made of high-strength composite material designed to withstand the harsh marine environment
- Compatible with 3/8" and 5/16" fuel hose
- Installs between the fuel tank and the primer bulb
- Low vacuum restriction helps ensure proper engine function during startup and engine operation (less than 2kPa at 125 liters/hour)
- Built-in manual override
- Compatible with Ethanol blended fuels



Specifications

Operating Temp	Storage Temp	Operating Input Pressure	Flow Performance	Hose Size	Manual Override
-20°C to 80°C (-4°F to 176°F)	-40°C to 80°C (-40°F to 176°F)	138 kPa (20 psi) protected for 276 kPa	125 L/H (33 GPH) at <2 kPa (10")	8 mm – 10 mm (5/16" – 3/8")	Yes
Description			Bulk Packaging	Aftermarket Packaging	
In-Line Fuel Demand Valve			8M0044687	9300FDV7	

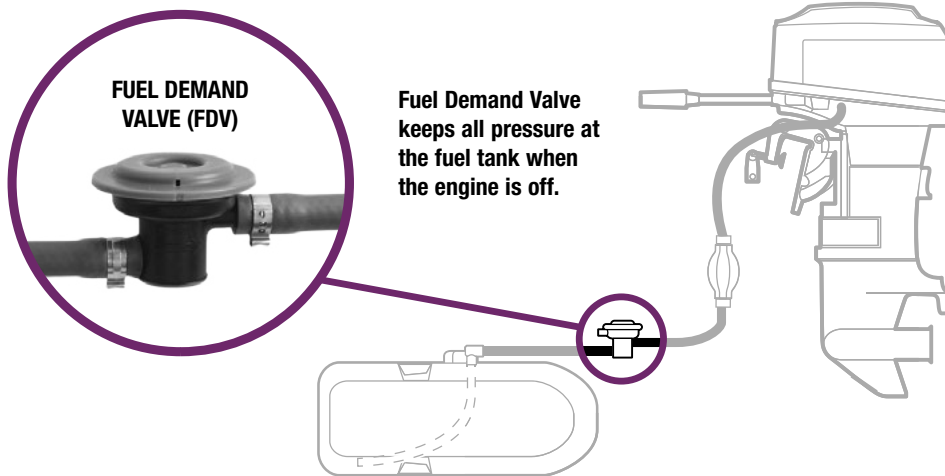

UNIVERSAL SPRAYLESS CONNECTOR (USC)

The Universal Sprayless Connector is a safe way to eliminate the spraying of fuel when connecting and disconnecting pressurized fuel hoses during fueling or maintenance. This unique component helps keep the fuel in the tank where it belongs. Includes male and female connectors for use with all standard marine fuel tanks – 1/4" in (6.4 mm) NPT fittings.

* **⚠ WARNING** Cancer and Reproductive Harm – www.P65Warnings.ca.gov (see page 240)

- Attwood's Universal Sprayless Connector replaces traditional tank fittings and eliminates spray when connecting or disconnecting fuel fittings
- High strength body engineered to withstand the harsh marine environment
- Female hose fitting compatible with 3/8" and 5/16" fuel lines
- Male fitting fits all standard 1/4" NPT fittings
- Male and female connectors include check valves that automatically close upon disconnecting
- High fuel flow fitting (less than .25kPa restriction at 50 liters/hour)
- Compatible with Ethanol blended fuels
- Compatible with all OEM brand engines
- Meets all EPA and CARB requirements
- Pre-applied fuel-grade thread sealant prevents fuel leaks



WINNER OF THE 2011
IBEX INNOVATION AWARD

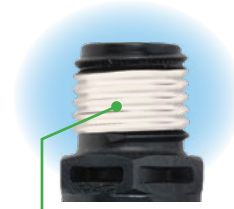

**PRE-APPLIED
FUEL-COMPATIBLE
THREAD SEALANT**



Description	Bulk Packaging	Prop 65	Aftermarket Packaging	Prop 65
Universal Sprayless Connector – Male and Female w/Thread Sealant	—		8838US6	*
Universal Sprayless Connector – Hose Female, 5/16"–3/8"	001008200	*	8838HF6	*
Universal Sprayless Connector – Tank Male, 1/4" NPT w/Thread Sealant	001008199	*	8838TM6	*
Universal Sprayless Connector – Hose Male, 5/16"–3/8"	001011094	*	8838HM6	*



Fuel Line Kits

Attwood's low-permeation Fuel Line Kits set the standard in performance, safety and value. They include Attwood's award-winning Universal Sprayless Connector (hose and tank fittings with thread sealant), multi-layer low-permeation Primer Bulb and low-permeation fuel line. Fuel Demand Valve is optional.



- Multi-Layer Primer Bulb with new High-Performance Check Valve & O-Ring: Provides 30% faster priming during start-up and 20-35% higher running flow than competitive designs
- Ethanol Resistant Fuel Line: Eliminates inner-layer delamination seen by others
- Fuel Demand Valve (if equipped): Prevents engine flooding by restricting pressurized fuel from reaching the engine
- Universal Sprayless Tank Fitting: Enables a safe, gas-free experience at every connection

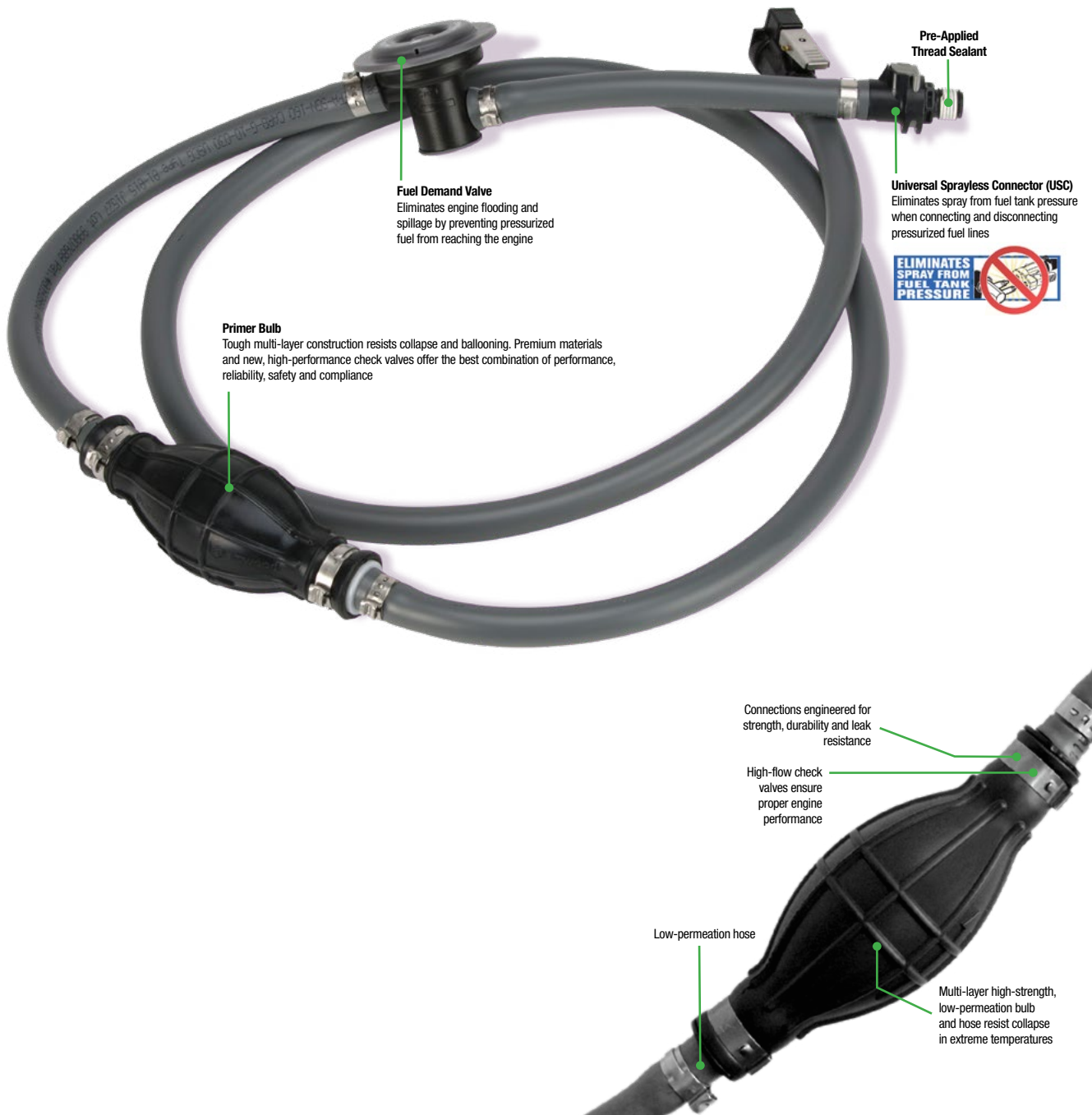

EPA CERTIFIED PORTABLE FUEL COMPONENTS



Fuel Line Kits



* **⚠ WARNING** Cancer and Reproductive Harm – www.P65Warnings.ca.gov (see page 240)

Engine	END FITTING					Primer Bulb	Fuel Demand Valve	Aftermarket Packaging	Prop 65
	Length	Diameter	Includes Tank Fitting	Includes Hose Fitting Tank End	Includes Hose Fitting Engine End				
UNIVERSAL BRAND ENGINES AND TANKS									
Universal	6'	5/16"	None	None	None	Multi-layer / Low-Permeation	No	951606ULP7	*
Universal	6'	3/8"	8838TM6	8838HF6	None	Multi-layer / Low-Permeation	No	93806UUS7	*
Universal	6'	3/8"	8838TM6	8838HF6	None	Multi-layer / Low-Permeation	Yes	93806UUSD7	*
Universal	12'	3/8"	8838TM6	8838HF6	None	Multi-layer / Low-Permeation	No	93812UUS7	*
Universal	12'	3/8"	8838TM6	8838HF6	None	Multi-layer / Low-Permeation	Yes	93812UUSD7	*
Universal	6'	3/8"	None	None	None	Multi-layer / Low-Permeation	No	93806ULP7	*
Universal	6'	3/8"	None	None	None	Multi-layer / Low-Permeation	Yes	93806UFDV7	*
Universal	12'	3/8"	None	None	None	Multi-layer / Low-Permeation	No	93812ULP7	*
MERCURY BRAND ENGINES AND TANKS									
Mercury	6'	3/8"	8838TM6	8838HF6	8896LP6	Multi-layer / Low-Permeation	No	93806MUS7	*
Mercury	6'	3/8"	8838TM6	8838HF6	8896LP6	Multi-layer / Low-Permeation	Yes	93806MUSD7	*
Mercury Pre-1998	6'	3/8"	8838TM6	8838HF6	8893-6	Multi-layer / Low-Permeation	No	93806AUS7	*
JOHNSON BRAND ENGINES AND TANKS									
Johnson / Evinrude	6'	3/8"	8838TM6	8838HF6	8889LP6	Multi-layer / Low-Permeation	No	93806EUS7	*
Johnson / Evinrude	6'	3/8"	8838TM6	8838HF6	8889LP6	Multi-layer / Low-Permeation	Yes	93806EUSD7	*
Johnson / Evinrude	6'	3/8"	None	8889LP6	8889LP6	Multi-layer / Low-Permeation	No	93806ELP7	*
YAMAHA BRAND ENGINES AND TANKS									
Yamaha	6'	3/8"	None	8896LP6	8896LP6	Multi-layer / Low-Permeation	No	93806YLP7	*
Yamaha	6'	3/8"	8838TM6	8838HF6	8896LP6	Multi-layer / Low-Permeation	No	93806YUS7	*
HONDA BRAND ENGINES AND TANKS									
Honda	6'	3/8"	8838TM6	8838HF6	8900-6	Multi-layer / Low-Permeation	No	93806HUS7	*



FUEL TANK AND HOSE FITTINGS



Attwood fuel tank fittings and hose fittings are suitable for use with leaded, unleaded, ethanol blended and alcohol-blended fuels. Unless otherwise specified, threaded fittings have 1/4" male NPT threads; barbed fittings fit 3/8" I.D. hose. Clamps are not included. Use thread sealant on all threads.

* **⚠ WARNING** Cancer and Reproductive Harm – www.P65Warnings.ca.gov (see page 240)

Fitting	Description	Material Construction	Mates to	Notes	Aftermarket Packaging	Prop 65
MERCURY/MARINER BRAND ENGINES AND TANKS						
1/4" NPT Thread	Tank Male	Brass	8890LP6	Mercury Tank Fitting	8873-6	*
3/8" Barb	Hose Female	Acetal	8873-6	Mercury Tank Fitting	8890LP6	
3/8" Barb	Hose Female	Acetal		Mercury Engine End	8896LP6	
1/4" NPT Thread	Twist-lock Tank Female	Nylon	14532-6	w/90° Elbow, 2-Piece	8882-6	*
1/4" NPT Thread	Twist-lock Tank Female	Die-cast Zinc	14532-6	w/90° Elbow, 1-Piece	14530-6	*
3/8" Barb	Twist-lock Hose Male	Die-cast Zinc	8882-6, 14530-6		14532-6	*
JOHNSON/EVINRUDE/OMC BRAND ENGINES AND TANKS						
1/4" NPT Thread	Tank Male	Brass	8889LP6, 88FHE516-6		8883-6	*
5/16" Barb	Hose Female	Acetal	8883-6	Tank or Engine End	88FHE516-6	
3/8" Barb	Hose Female	Acetal	8883-6	Tank or Engine End	8889LP6	*
YAMAHA BRAND ENGINES AND TANKS						
1/4" NPT Thread	Tank Male	Brass	8896LP6, 88FHY516-6		8897-6	*
5/16" Barb	Hose Female	Acetal	8897-6	Tank or Engine End	88FHY516-6	
3/8" Barb	Hose Female	Acetal	8897-6	Tank or Engine End	8896LP6	
HONDA BRAND ENGINES AND TANKS						
1/4" NPT Thread	Tank Male	Chrome-plated Brass	8902-6	90HP+ (Large Bore)	8901-6	*
3/8" Barb	Hose Female	Chrome-plated Brass	8901-6	90HP+ (Large Bore)	8902-6	*
3/8" Barb	Hose Female	Acetal		Engine End	8900-6	*
CHRYSLER BRAND ENGINES AND TANKS						
1/4" NPT Thread	Tank Male	Chrome-plated Brass	8884-6		14509-6	*
3/8" Barb	Hose Female	Chrome-plated Brass	14509-6		8884-6	*
SUZUKI BRAND ENGINES AND TANKS						
1/4" NPT Thread	Tank Male	Chrome-plated Brass	88FTS014-6	Under 75HP (Small Bore)	14509-6	*
3/8" Barb	Hose Female	Chrome-plated Brass	14509-6	Under 75HP (Small Bore)	88FTS014-6	*



Fuel Tank and Hose Fittings

* **⚠ WARNING** Cancer and Reproductive Harm – www.P65Warnings.ca.gov (see page 240)



Fitting	Description	Material Construction	Mates to	Notes	Bulk Packaging	Aftermarket Packaging	Prop 65
UNIVERSAL FITTINGS AND ADAPTERS							
1/4" NPT x 1/4" NPTF	90° Elbow	Brass			—	8887-6	*
1/4" NPT x 5/16" Barb	Male Thread, Hose Barb	Brass			—	88FBM101-6	*
1/4" NPT x 3/8" Barb	Male Thread, Hose Barb	Brass			—	14540-6	*
3/8" NPT x 3/8" Barb	Male Thread, Hose Barb	Aluminum			—	88FBMA102-6	
1/4" NPT x 3/8" Barb	Male Thread, Anti-Siphon Valve	Aluminum			—	88FAS014-6	
3/8" NPT x 3/8" Barb	Male Thread, Anti-Siphon Valve	Aluminum			—	88FAS038-6	
3/8" Hose Mender	In-line Fuel Splice Kit	Brass		Includes (2) Stainless Steel Hose Clamps	—	11822-6	*
5/16" Hose Mender	In-line Fuel Splice Kit	Brass		Includes (2) Stainless Steel Hose Clamps	—	11823-6	*
1/4" Hose Mender	In-line Fuel Splice Kit	Brass		Includes (2) Stainless Steel Hose Clamps	—	11824-6	*



Fuel Tank and Hose Fittings

*  **WARNING** Cancer and Reproductive Harm – www.P65Warnings.ca.gov (see page 240)

Prop 65 MERCURY



* 8838US6



* 8873



* 8890LP



* 8896LP



* 8882



* 14530



* 14534



* 14532

Prop 65 JOHNSON



* 8883



* 88FHE516



* 8889LP

Prop 65 YAMAHA



* 8897



* 88FHY516



* 8896LP

Prop 65 HONDA



* 8901



* 8902



* 8900

Always use thread sealant when assembling threaded fittings.



Fuel Tank and Hose Fittings

*  **WARNING** Cancer and Reproductive Harm – www.P65Warnings.ca.gov (see page 240)

Prop
65

CHRYSLER



* 14509



* 8884

Prop
65

SUZUKI



* 14509



* 88FTS014

Prop
65

UNIVERSAL



* 8887



* 88FBM101



* 14540



* 88FBMA102



* 88FAS014



* 88FAS038



* 11822/ *11823/ *11824

Always use thread sealant when assembling threaded fittings.

Fuel Tank Valves: Shut Off & Multiple Draw



TANK VALVES: THREE-WAY & SHUT OFF

Description	Bulk Packaging	Aftermarket Packaging
Shut-off valve Brass: ¼" NPT x ¼" NPTF	—	88FV200-6



88FV200

CARBON CANISTER FUEL SYSTEMS



Carbon canister systems utilize an engineered charcoal canister to reduce hydrocarbons entering the atmosphere. Other components of a carbon canister system are designed to ensure the tank fills to the proper level every time without spit-back or well-back. All Attwood carbon

canister systems are designed to ensure liquid fuel or water does not reach the canister and are compatible with Jerry Can and marine nozzle refueling.

Direct Fill Carbon Canister Fuel System

- Single 1 psi overpressure relief safety valve built into the caps
- Automatic nozzle shutoff 4-10 gpm
- Anti-backout feature prevents accidental removal
- Reduced number of system components

Remote Fill Carbon Canister Fuel System

- Dual 1 psi overpressure relief safety valves built into the deck fill caps
- Automatic nozzle shutoff 4-18 gpm

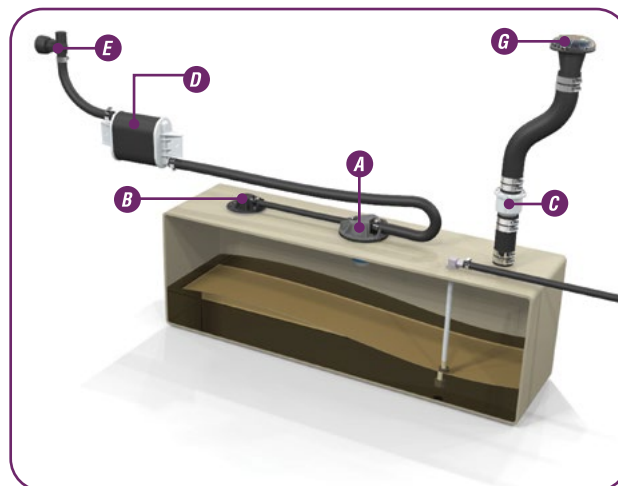
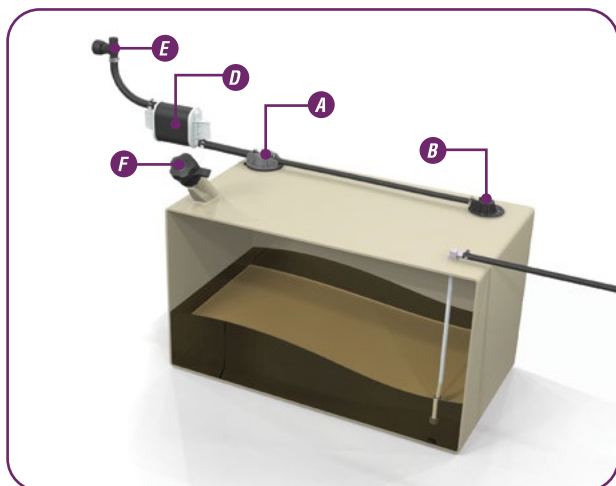

- A Fill Limit Vent Valve
- B Grade Valve
- C Inlet Control Valve
- D Carbon Canister

- E P-Trap
- F Direct Fill Unit
- G Deck Fill Unit

VAPORTEC

EPA CERTIFIED INTEGRATED FUEL SYSTEMS



PRESSURE RELIEF FUEL SYSTEMS

Pressure relief systems are designed with automatic diurnal emission control and overpressure relief safety valves built into the cap of the fill. The overpressure relief safety valves are engineered to release pressure above 1 psi. The high-flow vacuum valves allow fresh air to enter the fuel tank to replace the fuel being consumed by the engine. Other components of a pressure relief system are designed to

ensure the tank fills to the proper level every time without spit-back or well-back. All Attwood pressure relief systems are designed to ensure water does not enter the fuel tank and are compatible with Jerry Can and marine nozzle refueling.

Direct Fill Pressure Relief Fuel System

- Dual 1 psi diurnal emission control and overpressure relief safety valves built into the cap
- Dual high-flow vacuum valves ensure maximum make-up air flow with minimum vacuum restriction
- Automatic nozzle shutoff 4-10 gpm
- Anti-backout feature prevents accidental removal
- Reduced number of system components

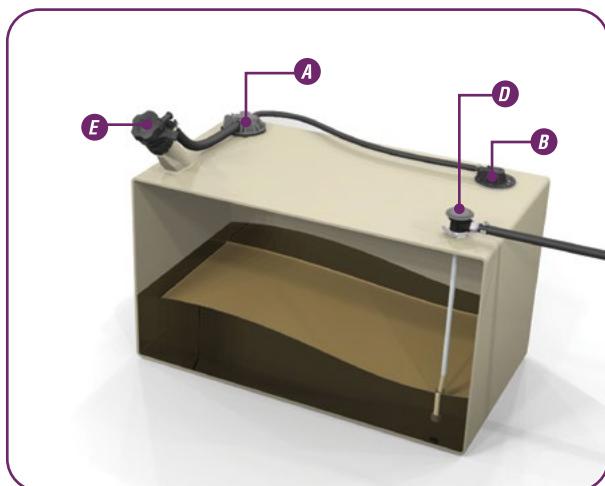

- A** Fill Limit Vent Valve
- B** Grade Valve
- C** Inlet Control Valve

Remote Fill Pressure Relief Fuel System



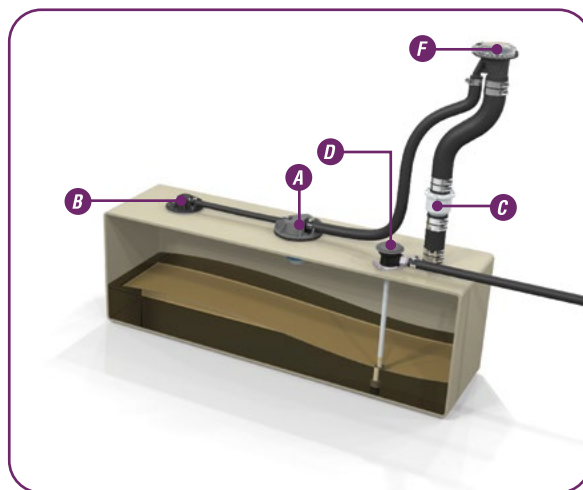







- Dual 1 psi diurnal emission control and overpressure relief safety valves built into the cap
- Triple high-flow vacuum valves ensure maximum make-up air flow (compatible with high HP applications)
- Automatic nozzle shutoff 4-18 gpm



- D** Fuel Demand Valve
- E** Direct Fill Unit (Includes Inlet Control Valve)
- F** Deck Fill Unit

DIURNAL FUEL SYSTEM COMPONENTS



		Carbon Canister Direct Fill	Carbon Canister Remote Fill	Pressure Relief Direct Fill	Pressure Relief Remote Fill
Carbon Canister Deck Fills 			See Page 81		
Carbon Canister Direct Fill 	See Page 82				
Pressure Relief Deck Fills 					See Page 84
Pressure Relief Direct Fill 			See Page 89		
Inlet Control Valve 			See Page 86		See Page 86
Fill Limit Vent Valve 	See Page 86	See Page 86	See Page 86	See Page 86	See Page 86
Grade Valve 	See Page 86	See Page 86	See Page 86	See Page 86	See Page 86
Carbon Canister 	See Page 83	See Page 83			
Integrated Fuel Demand Valve 			See Page 84		See Page 84
P-Trap 	See Page 82	See Page 82			



INTEGRATED FUEL COMPONENTS EPA CERTIFIED



Deck Fills For Carbon Canister Systems

- Essential component of VaporTec and SecureStop
- Dual 1 psi overpressure relief safety valves built into the cap
- Automatic nozzle shutoff 4-18 gpm
- Hinged audible click cap meets EPA requirements
- ISO 10088 and CE compliant
- Meets CARB 13 CCR 2235 and ISO 13331 nozzle mating and retention standards
- Designed and tested to prevent water from entering the fuel system
- Compatible with Ethanol blended fuels
- Fits 1-1/2" fill hose

* **⚠ WARNING** Cancer and Reproductive Harm – www.P65Warnings.ca.gov (see page 240)



Y1 Flat cap

Scalloped cap

Description	Body	Cap Material	Cap Design	Bulk Packaging	Prop 65	Aftermarket Packaging	Prop 65
Deck Fill for Carbon Canister	Straight	Black Plastic	Scalloped	99DFCCSB1	*	99DFCCSB1S	*
		White Plastic	Scalloped	99DFCCSW1	*	—	
		Chrome	Scalloped	99DFCCSZ1	*	99DFCCSZ1S	*
		Stainless Steel	Scalloped	99DFCCSS1	*	—	
		Stainless Steel	Y1 Flat	99DFCCSSY1-1	*	—	
	Angled	Black Plastic	Scalloped	99DFCCAB1	*	99DFCCAB1S	*
		White Plastic	Scalloped	99DFCCAW1	*	—	
		Chrome	Scalloped	99DFCCAZ1	*	99DFCCAZ1S	*
		Stainless Steel	Scalloped	99DFCCAS1	*	—	
		Stainless Steel	Y1 Flat	99DFCCASY1-1	*	—	



Low Profile Deck Fills For Carbon Canister Systems

- Essential component of VaporTec and SecureStop
- Stainless steel construction
- Exclusive overpressure relief valve that is protected by a waterproof screen to eliminate the possibility of water entering the system
- 4-18 gpm refueling when used in an Attwood fuel system
- Flip-up tethered cap for ease of use
- Red dots indicate visual closure for EPA standards
- ISO 10088 and CE compliant
- Compatible with Ethanol blended fuels
- Fits 1-1/2" fill hose

* **⚠ WARNING** Cancer and Reproductive Harm – www.P65Warnings.ca.gov (see page 240)

Description	Body	Bulk Packaging	Prop 65	Aftermarket Packaging	Prop 65
Low Profile Deck Fill for Carbon Canister	Straight	99DFCCLPSS1	*	—	
	Angled	99DFCCLPAS1	*	—	



Direct Fill for Carbon Canister Systems

- Essential component of VaporTec and SecureStop
- Single 1 psi overpressure relief safety valve built into cap
- Anti-backout feature prevents accidental removal
- Automatic nozzle shutoff 4-10 gpm
- Reduced number of components in the system
- Includes ratcheting tethered cap
- Compatible with Attwood's carbon canister architecture
- ISO 10088 and CE compliant
- Meets CARB 13 CCR 2235 and ISO 13331 nozzle mating and retention standards
- Compatible with Ethanol blended fuels
- Fits 1-1/2" fill hose

* **⚠ WARNING** Cancer and Reproductive Harm – www.P65Warnings.ca.gov (see page 240)



99TDF100-1

Description	Bulk Packaging	Prop 65	Aftermarket Packaging	Prop 65
Carbon Canister Direct Fill	99TDF100-1	*	—	

90° P-Trap Fuel Tank Vents

These vents help prevent water from entering the fuel tank, yet allow air to vent freely, during normal sea conditions and washdowns. This eliminates the need for an anti-siphon loop in the vent hose. For 5/8" I.D. hose. Meets ABYC standard. The arrows in this cross-section show the baffled route that water would have to travel in order to reach the fuel vent hose. Compatible with Ethanol blended fuels.

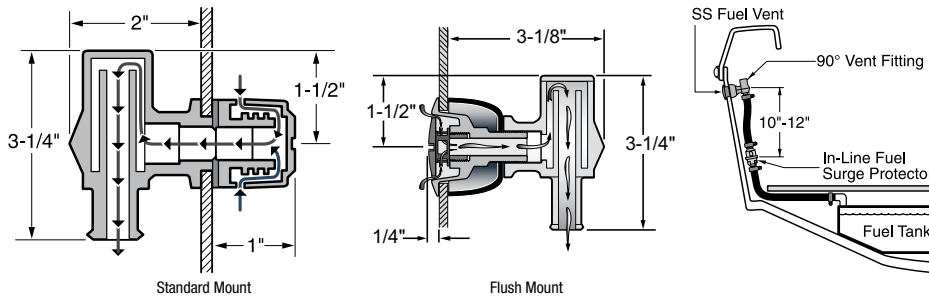

1670

* **⚠ WARNING** Cancer and Reproductive Harm – www.P65Warnings.ca.gov (see page 240)

Description	Maximum Hull Thickness	Installation Hole Size	Style	Bulk Packaging	Prop 65	Aftermarket Packaging	Prop 65
Standard Mount - 5/8" I.D. Hose	9/16"	3/4"	Black with black vent head	1670-1	*	1670-3	*
			Black with stainless steel trim cover	66419-1	*	66419-3	*
Replacement covers for Standard Mount	—	—	For 1670	911526-1	*	—	
			For 66419	911528-1	*	—	
Flush Mount - 5/8" I.D. Hose	1"	1-3/8"	Black with stainless steel vent head	1674-1	*	1674-6	*
Replacement Spacer for Flush Mount	1/4" - 1/2"	—	For 1674	911507-1	*	—	
			For 1674	911508-1	*	—	



1674



Carbon Canisters

- Fits 5/8" vent hose
- Can be mounted in any orientation using brackets provided
- Compatible with Ethanol blended fuels
- Low permeation shell reduces overall system emissions
- Carbon Canister for Engine Compartment models feature a pre-installed composite heat-shield for easy installation



* **⚠ WARNING** Cancer and Reproductive Harm – www.P65Warnings.ca.gov (see page 240)

Description	EPA RATING		CARB RATING		Dimensions Length Width Height	Bulk Packaging	Prop 65	Aftermarket Packaging	Prop 65
	Trailerable Vessel Capacity	Non-trailerable Vessel Capacity	Trailerable Vessel Capacity	Non-trailerable Vessel Capacity					
SUB COMPACT									
Brackets OEM Installed	28 Gal.	44 Gal.	22.4 Gal.	44 Gal.	11.6" x 5.04" x 4.01"	99CC035-1	*	—	
Carbon Canister for Engine Compartment	28 Gal.	44 Gal.	22.4 Gal.	44 Gal.	11.68" x 4.08" x 5.68"	99CC035HSA1	*	—	
COMPACT									
Brackets OEM Installed	70 Gal.	110 Gal.	56 Gal.	110 Gal.	Refer to Horizontal/Vertical	99CC045-1	*	99CC045-1S	*
Brackets Pre-installed Horizontal Orientation	70 Gal.	110 Gal.	56 Gal.	110 Gal.	11.6" x 5.04" x 4.01"	99CC045H1	*	—	
Brackets Pre-installed Vertical Orientation	70 Gal.	110 Gal.	56 Gal.	110 Gal.	10.48" x 3.05" x 5.50"	99CC045V1	*	—	
Carbon Canister for Engine Compartment	70 Gal.	110 Gal.	56 Gal.	110 Gal.	11.68" x 4.08" x 5.68"	99CC045HSA1	*	—	
STANDARD									
Brackets OEM Installed	220 Gal.	350 Gal.	176 Gal.	350 Gal.	Refer to Horizontal/Vertical	99CC085-1	*	—	
Brackets Pre-installed Horizontal Orientation	220 Gal.	350 Gal.	176 Gal.	350 Gal.	17.22" x 5.04" x 4.01"	99CC085H1	*	—	
Carbon Canister for Engine Compartment	220 Gal.	350 Gal.	176 Gal.	350 Gal.	17.74" x 4.08" x 5.68"	99CC085HSA1	*	99CC085HSA1S	*
LARGE VESSEL									
Brackets OEM Installed	420 Gal.	660 Gal.	*N/A	*N/A	Refer to Horizontal/Vertical	99CC150-1	*	99CC150-1S	*
Heat Shield for Large Vessel Carbon Canister	420 Gal.	660 Gal.	*N/A	*N/A	25.61" x 4.08" x 5.68"	99CC150HS1	*	—	

* CARB allows use of 2 canisters assembled in series to match/exceed needed capacity. Contact Attwood Customer Service for more information.



Deck Fills for Pressure Relief Systems

- Essential component of VaporTec and SecureStop
- Dual 1 psi diurnal emission control overpressure relief safety valves
- Triple high-flow vacuum valves ensure maximum make-up air flow with minimum vacuum restriction
- Designed and tested to prevent water from entering the fuel system
- Automatic nozzle shutoff 4-18 gpm
- Hinged audible click cap meets EPA requirements
- ISO 10088 and CE compliant
- Meets CARB 13 CCR 2235 and ISO 13331 nozzle mating and retention standards
- Designed and tested to prevent water from entering the fuel system
- Compatible with Ethanol blended fuels
- Fits 1-1/2" fill hose and 5/8" vent hose



* **⚠ WARNING** Cancer and Reproductive Harm – www.P65Warnings.ca.gov (see page 240)



Y1 Flat cap



Scalloped cap



99DFPVSZ1



99DFPVASY1-1

Description	Body	Cap Material	Cap Design	Bulk Packaging	Prop 65	Aftermarket Packaging	Prop 65
Deckfill for Pressure Relief System	Straight	Black Plastic	Scalloped	99DFPVSZ1	*	—	—
		Chrome	Scalloped	99DFPVSZ1	*	—	—
		Stainless Steel	Scalloped	99DFPVSZ1	*	—	—
		Stainless Steel	Y1 Flat	99DFPVSSY1-1	*	—	—
	Angled	Black Plastic	Scalloped	99DFPVAB1	*	—	—
		Chrome	Scalloped	99DFPVAZ1	*	—	—
		Stainless Steel	Scalloped	99DFPVAS1	*	—	—
		Stainless Steel	Y1 Flat	99DFPVASY1-1	*	—	—

Fuel Demand Valve

The integrated fuel demand valve, used in conjunction with integrated fuel systems eliminates pressurized fuel from reaching fuel distribution lines and your engine and ensures that fuel is provided to the engine on demand rather than as a result of pressure in the tank. Additional features include:

- Compatible with Ethanol blended fuels
- Eliminates the need for rigid fuel distribution lines in pressure relief systems (per ABYC H-24.15.9)

* **⚠ WARNING** Cancer and Reproductive Harm – www.P65Warnings.ca.gov (see page 240)

Specifications

Operating Temp	Storage Temp	Operating Input Pressure	Flow Performance	Hose Size	Manual Override
-20°C to 80°C (-4°F to 176°F)	-40°C to 80°C (-40°F to 176°F)	138 kPa (20 psi) protected for 276 kPa (40 psi) pressure spike	125 L/H (33 GPH) at <2 kPa (10" gasoline)	8 mm – 10 mm (5/16" – 3/8")	Yes

Description	Bulk Packaging	Prop 65	Aftermarket Packaging	Prop 65
Integrated Fuel Demand Valve (IFDV)	99IFDV00-1	*	—	—
Base for Aluminum Tank	99DVA02-1	*	—	—
Pick-Up Tube Barb with O-Ring 3/8"	99DVB01-1	*	—	—
Pick-Up Tube Barb with O-Ring 1/2"	99DVB02-1	*	—	—
IFDV Installation Clip	99DVC01-1	*	—	—
IFDV Plug Cap with Seal	99DVP03-1	—	—	—
Plastic Tank Compression Nut	99DVP04-1	*	—	—
Heat Shield	99IFDVHS1	—	—	—
Single Flange Base for Plastic Tank	99DVP05-1	*	—	—



99IFDV00



Direct Fill for Pressure Relief Systems



- Essential component of VaporTec and SecureStop
- Dual high-flow vacuum valves ensure maximum make-up air flow with minimum vacuum restriction
- Dual 1 psi diurnal emission control and overpressure relief safety valves
- Anti-backout feature prevents accidental removal
- Automatic nozzle shutoff 4-10 gpm
- Reduced number of components in the system
- Includes ratcheting tethered cap
- Performs automatic shut-off function when used with an Attwood system
- EPA certified
- ISO 10088 and CE compliant
- Meets CARB 13 CCR 2235 and ISO 13331 nozzle mating and retention standards
- Compatible with Ethanol blended fuels
- Fits 1-1/2" fill hose and 5/8" vent hose

* **⚠ WARNING** Cancer and Reproductive Harm – www.P65Warnings.ca.gov (see page 240)

Description	Bulk Packaging	Prop 65	Aftermarket Packaging	Prop 65
Pressure Relief Direct Fill	99TDFPV100-1	*	—	—
Replacement Tether	99TDF120-1	—	—	—
Replacement Cap	99TDFPV110-1	*	—	—

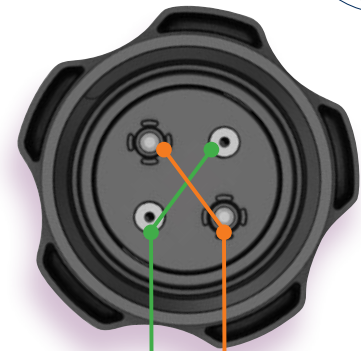

Dual 1 psi diurnal emission control and overpressure relief safety valves

Dual high-flow vacuum valves ensure maximum make-up air flow



Inlet Control Valve

- Essential component of VaporTec and SecureStop
- Built-in overpressure relief compatibility
- ISO 10088 and CE compliant
- Guaranteed 18 gallons per minute fuel flow during filling
- Compatible with 1-1/2" fill hose
- Compatible with Ethanol blended fuels
- Can be oriented between 0°–90° in line with fuel flow

* **⚠ WARNING** Cancer and Reproductive Harm – www.P65Warnings.ca.gov (see page 240)

Description	Bulk Packaging	Aftermarket Packaging
Inlet Control Valve	99ICV000-1	—
ICV Heat Shield	99ICV000HS2	—



99ICV000

Fill Limit Vent Valves

- Essential component of VaporTec and SecureStop
- Sets the full level of fuel in the tank
- Prevents liquid fuel from reaching the carbon canister or vent system during vessel operation, trailering and storage
- Compatible with Ethanol blended fuels and plastic and aluminum tanks
- Passes all USCG CFR 33 and ABYC H-24 fire test requirements and CARB and EPA requirements
- Integrated high-performance gasket included
- Assembly Guide aligns the FLV and gasket with tank for faster installation

* **⚠ WARNING** Cancer and Reproductive Harm – www.P65Warnings.ca.gov (see page 240)

Description	Shut-off Height	Bulk Packaging	Prop 65	Aftermarket Packaging	Prop 65
Fill Limit Vent Valve with GRV Communication	0.8"	99FLB080-1	*	—	
	1.00"	99FLB100-1	*	—	
	1.40"	99FLB140-1	*	—	
	1.70"	99FLB170-1	*	—	
	2.30"	99FLB230-1	*	—	
	3.30"	99FLB330-1	*	—	
Fill Limit Vent Valve without GRV Communication	1.40"	99FLA140-1	*	—	
	1.70"	99FLA170-1	*	—	
	2.30"	99FLA230-1	*	—	
	3.30"	99FLA330-1	*	—	



99FLB230

Grade Valve

- Essential component of VaporTec and SecureStop
- When used in conjunction with a fill limit vent valve, allows proper venting when the fuel tank is in unusual angles
- Prevents liquid fuel reaching the carbon canister and vent system during vessel operation, trailering and storage
- Integrated impact protection feature
- Compatible with Ethanol blended fuels
- Passes all USCG CFR 33 and ABYC H-24 fire test requirements

* **⚠ WARNING** Cancer and Reproductive Harm – www.P65Warnings.ca.gov (see page 240)

Description	Bulk Packaging	Prop 65	Aftermarket Packaging	Prop 65
Grade Valve	99GVP000-1	*	—	
Grade Valve Tank Gasket	99GVG000-1		—	



99GVP000

99GVG000



ACCESSORIES FOR PORTABLE AND INTEGRATED FUEL SYSTEMS

Motor Well Boot

Motor well boot provides organized, covered pass-thru for control cables, wires, or fuel lines. Split side allows for installation without disconnecting controls. Includes tie for secure fit. Black rubber, UV-resistant construction with polypropylene attachment gasket ring.

* **⚠ WARNING** Cancer and Reproductive Harm – www.P65Warnings.ca.gov (see page 240)

Description	Bulk Packaging	Prop 65	Aftermarket Packaging	Prop 65
For 4"-diameter opening	—		12820-5	*



Fuel Tank Strap Sets

1"-wide white nylon web strap with zinc-plated carbon steel snap and quick-release buckle. Includes metal foot-man securing loops and screws.

Description	Bulk Packaging	Aftermarket Packaging
48" long for 3-6 gallon tanks	—	11526-3
72" long for 12-gallon tanks	—	11512-3



Filter Funnels

Fine mesh screen filters out most foreign matter. Lightweight floating polyethylene plastic.

Description	Bulk Packaging	Aftermarket Packaging
Short rigid, with handle	14582-1	—
Long flexible, with handle	14580-1	—



Portable Fuel Tank Cap with Tether

High-flow valve exceeds OEM engine fuel flow requirements. Ratchets to ensure proper seal. For 0-350 HP engines. Compatible with 8803LP/8806LP/8812LP/8812LLP Series portable fuel tanks.

* **⚠ WARNING** Cancer and Reproductive Harm – www.P65Warnings.ca.gov (see page 240)

Description	Bulk Packaging	Prop 65	Aftermarket Packaging	Prop 65
Standard 2-1/4" Neck	—		88TC06-7	*



SpillBuster™

Eliminate messy and potentially dangerous spills with this versatile spout that easily attaches to your oil and fluid bottles. On/off valve controls liquid flow. SpillBuster fits 1-quart, 1-gallon, and most 5-quart bottles. Removable cap seals shut.

Description	Bulk Packaging	Aftermarket Packaging
SpillBuster spout	—	14584D1



14584D1

Fuel/Water Separator Assembly & Filter

With Double Seal. Universal 3/8" (.85cm) ports.

Description	Bulk Packaging	Aftermarket Packaging
Universal Fuel/Water Separator Fits all 2 and 4 cycle engines. 10 Micron Filter and bracket included. Replaces Mercury 35-60494A4. Includes 2 brass plugs.	—	11840-7
Fuel/Water Separator 10 Micron Replacement for: Mercury 35-60494-1, Aqua Power 6031, GLM 24940, Sierra 18-78250, SMI 15494, Valmar 52113, Marpac 7-0872	—	11841-4



11840



11841

Outboard Fuel Filter

Disposable high-flow in-line fuel filters work with most outboard motors. Protects carbureted engines by trapping pollutants. Clear body allows visual inspection. High strength, impact resistant, and shatter resistant construction. Best to replace during winterize or spring start-up for optimum results.

* **⚠ WARNING** Cancer and Reproductive Harm – www.P65Warnings.ca.gov (see page 240)

Description	Bulk Packaging	Prop 65	Aftermarket Packaging	Prop 65
Outboard Fuel Filter for 3/8" lines	—		12562-6	
Universal In-Line Fuel Filter (1/4", 5/16", 3/8")	—		11820-7	



12562



11820

Fuel/Oil Mixing Bottle

Allows the addition of the exact amount of oil required for a 2 cycle engine. Oil level marks are in gallons and litres. Determines ratios for 100:1, 50:1, 24:1 and 10:1 mixes. Wide mouth, quart size bottle.



11873

Description	Bulk Packaging	Aftermarket Packaging
Oil to Gas Mixing Container	—	11873-1

Fuel Hose for Below Deck

Low-permeation, fiber-reinforced fuel line designed to prevent kinking and hardening. Compatible with Ethanol blended fuels. For use in below deck applications.

* **⚠ WARNING** Cancer and Reproductive Harm – www.P65Warnings.ca.gov (see page 240)



9368

Description	Length	Bulk Packaging	Prop 65	Aftermarket Packaging	Prop 65
Fuel supply hose for 5/16" (A1-15)	250 ft.	9368A1	*	—	—

Hydro-Stabilizer

Gives outboards and sterndrives a performance boost, improving both stability and handling. The Hydro-Stabilizer out-performs ordinary flat hydrofoils by reducing drag when the hull goes on plane. Installs on a large variety of motor styles and sizes and includes stainless steel bolts and lock nuts. Wings constructed of black molded plastic. The Hydro-Stabilizer quickly puts the boat on plane and helps pull skiers out of the hole faster. Even at lower RPMs, it keeps the boat on plane. The wings provide a smoother, more stable ride and reduces prop cavitation in turns.

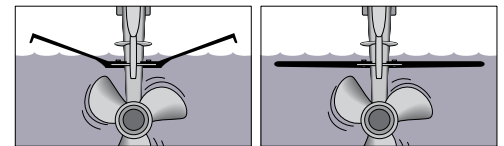

Hydro-Stabilizer

Ordinary Hydrofoil

Description	Bulk Packaging	Aftermarket Packaging
For outboards and stern drives 50 horsepower and above	—	9400-7
For outboards under 50 horsepower	—	9401-7



9400

Outboard Motor Safety Cable

Prevents loss of small outboard engines. Clear vinyl-coated, heavy-duty steel cable. Has a loop on one end, and includes a snap hook on the other end. 3/32" diameter, 50" long.

* **⚠ WARNING** Cancer and Reproductive Harm – www.P65Warnings.ca.gov (see page 240)

Description	Bulk Packaging	Prop 65	Aftermarket Packaging	Prop 65
3/32" dia. x 50" long	—	—	11664-3	*



11664

High-Speed Oil Change Pump

Quickly extract up to 5 quarts of oil from boats, vehicles, lawn mowers, etc. in under 8-minutes. Durable construction. No power or batteries required. Change the oil through the engine dipstick tube. Tank has locking handle, and cap for the hose.

* **⚠ WARNING** Cancer and Reproductive Harm – www.P65Warnings.ca.gov (see page 240)

Description	Bulk Packaging	Prop 65	Aftermarket Packaging	Prop 65
Heavy-Duty Pump—5 quart	—		88EP06-4	*



88EP06

Gear Lube Pump

For use with 32 oz. gear lube bottles. The pump fits any outboard or sterndrive to provide universal fit. Includes one Yamaha® adapter.

* **⚠ WARNING** Cancer and Reproductive Harm – www.P65Warnings.ca.gov (see page 240)

Description	Bulk Packaging	Prop 65	Aftermarket Packaging	Prop 65
Gear Lube Pump	—		11891D7	*



11891

Universal Motor Flushers

Quickly flushes away salt, sand, silt, and alkali to prevent clogging and corrosion. The flusher attaches easily to an ordinary garden hose. Self-adjusting clamping yoke fits most domestic or imported I/O's and outboards. Molded cups deliver fresh water from a garden hose to flush the cooling system through side intakes on the lower unit.

Note: Do not use full flow from hose.

* **⚠ WARNING** Cancer and Reproductive Harm – www.P65Warnings.ca.gov (see page 240)

Description	Bulk Packaging	Prop 65	Aftermarket Packaging	Prop 65
Round with plastic body	—		9372-2	
Round with metal body	—		16205-2	*
Rectangular motor flusher with metal body	—		16207-2	
Universal dual water feed with metal body	—		16208-7	



9372

16205

16207

16208

PORTABLE FUEL COMPONENTS INTERNATIONAL (NOT FOR USE IN THE U.S.)



Fuel Line Kits

For use with portable fuel tanks and popular outboard engines. Made to the highest quality standards.

* **⚠ WARNING** Cancer and Reproductive Harm – www.P65Warnings.ca.gov (see page 240)

Engine	END FITTING					Primer Bulb	Fuel Demand Valve	Aftermarket Packaging	Prop 65
	Length	Diameter	Tank Fitting	Fits Attwood Tank Fitting	Engine Fitting				
UNIVERSAL BRAND ENGINES AND TANKS									
Universal	6'	3/8"	None	N/A	None	Standard	No	93806UI7	*
MERCURY BRAND ENGINES AND TANKS									
Mercury	6'	3/8"	8890LP6	8873-6	8894LP6	Standard	No	93806MI7	*
JOHNSON BRAND ENGINES AND TANKS									
Johnson / Evinrude	6'	3/8"	8889LP6	8883-6	8889LP6	Standard	No	93806EI7	*
YAMAHA BRAND ENGINES AND TANKS									
Yamaha	6'	3/8"	8896LP6	8897-6	8896LP6	Standard	No	93806YI7	*

Primer Bulbs

For easy replacement on any portable fuel line. Alcohol resistant, suitable for use with leaded and non-leaded fuels. Double check valve for quick priming and unrestricted flow. Non-corrosive, galvanized hose clamps. Strong and durable.

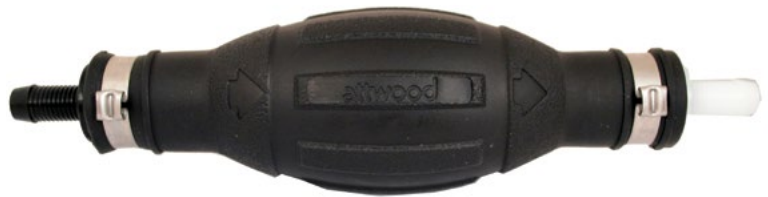

* **⚠ WARNING** Cancer and Reproductive Harm – www.P65Warnings.ca.gov (see page 240)

Description	Bulk Packaging	Aftermarket Packaging	Prop 65
3/8" I.D Hose — For International Markets	—	93038I7	*
5/16" I.D Hose — For International Markets	—	93516I7	*



INTEGRATED FUEL COMPONENTS NOT FOR USE WITH EPA CERTIFIED SYSTEMS



Vented Deck Fills

Attwood's plastic vented deck fills incorporate an industry first patent-pending waterproof screen that eliminates the possibility of water entering a boat's fuel system, while also allowing your boat's engine to breathe freely. These deck fills exceed the ISO 10088 standard for minimum required venting area and meet all ABYC and US Coast Guard safety standards for marine fuel systems. Attwood's unique design includes an integral tank vent with flame arrestor and anti-surge technology. CE certified to ISO 10088 enabling sales world wide.

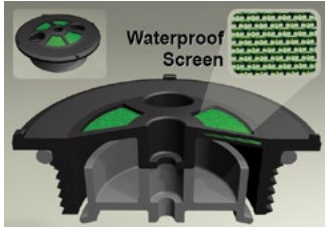

Features:

- Integrated patent-pending waterproof screen eliminates the possibility of water entering your boat's fuel system
- Attwood's unique design includes an integral tank vent with flame arrestor and anti-surge technology, preventing fuel from escaping into the environment
- Engineered body designed for extreme strength
- Choose from oval or round, straight or angled configurations
- Round caps available in plastic, chrome or stainless steel to fit virtually any application and budget
- Stainless steel beaded chain to prevent loss of round Gasoline, Diesel and Water caps
- ISO symbols for Gasoline, Diesel, Water and Waste are located on top of the cap
- Deck plate key is included with gasoline fill
- Fits standard 1-1/2" fuel fill hose and 5/8" vent hose
- Requires (4) #8 screws

* **⚠ WARNING** Cancer and Reproductive Harm – www.P65Warnings.ca.gov (see page 240)

Description	Material	Imprint	Cap Design	Bulk Packaging	Prop 65	Aftermarket Packaging	Prop 65
OVAL VENTED DECK FILLS							
Straight	Black Plastic	Gasoline	Scalloped	99210GB1	*	—	
Angled	Black Plastic	Gasoline	Scalloped	99211GB1	*	—	
ROUND VENTED DECK FILLS							
Straight	Black Plastic	Gasoline	Scalloped	99200GB1	*	—	
	Stainless Steel	Gasoline	Scalloped	99200GS1	*	—	
		Diesel	Scalloped	99200DS1	*	—	
		Water	Scalloped	99200WS1	*	—	
	Chrome	Gasoline	Scalloped	99200GZ1	*	—	
Angled	Black Plastic	Gasoline	Scalloped	99201GB1	*	—	
		Stainless Steel	Gasoline	Scalloped	99201GS1	*	—
	Stainless Steel	Diesel	Scalloped	99201DS1	*	—	
		Water	Scalloped	99201WS1	*	—	
		Chrome	Gasoline	Scalloped	99201GZ1	*	—
Water	Scalloped	99201WZ1	*	—			
	ROUND WASTE DECK FILLS						
Straight	Stainless Steel	Waste	Scalloped	99202WS1	*	—	
	Chrome-plated Zinc	Waste	Scalloped	99202WZ1	*	—	
Angled	Stainless Steel	Waste	Scalloped	99202AWS1	*	—	
		Waste	Y1	99202AWSY1-1	*	—	

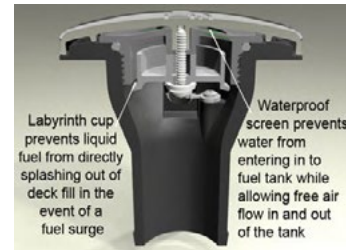

99210GB



99200GS



Y1 Flat cap



Scalloped cap

NON EPA CERTIFIED INTEGRATED FUEL COMPONENTS



1-1/2" Deck Fills, Enhanced 316 Stainless Steel Alloy

For 1-1/2" I.D. hose. Deck fills available with imprint to specify GASOLINE, DIESEL, WATER, or WASTE. Highly-polished finish. Flush cap is slotted for separate key and features an O-ring that seals the cap watertight. Cap is attached by a stainless steel beaded chain. 3-1/4" long fill neck. Key sold separately. 66126 waste model has internal threads for pump-out nozzle. Use for vessels with built-in holding tanks. Note: Requires a bonding wire to prevent sparking when nozzle is inserted on gas and diesel models per USCG and ABYC H-24 requirements.

* **⚠ WARNING** Cancer and Reproductive Harm – www.P65Warnings.ca.gov (see page 240)

Specifications

Part No.	Fill Neck Length	Installation Hole Size	Flange Size	Hose Size	Fastener Size
66406, 66407, 66408	3-1/4"	1-7/8"	3"	1-1/2" I.D.	#10
66126	3-1/4"	2-1/4"	3-1/2"	1-1/2" I.D.	#10

Description	Bulk Packaging	Prop 65	Aftermarket Packaging	Prop 65
"Gasoline" imprint with Red Color Code (Not for use with EPA Certified systems)	66446C1	*	66406-5	*
"Water" imprint with Blue Color Code	66408C1	*	—	—
"Waste" imprint with Black Color Code	66126C1	*	—	—
Replacement key	66060-1	—	—	—
Replacement cap and chain†	—	—	66074-3	—
Replacement cap and chain only for 66126	—	—	66061-3	—



66446C



2" Deck Fills, Enhanced 316 Stainless Steel Alloy

For 2" I.D. hose. These deck fills are both imprinted and color-coded to specify either GASOLINE or DIESEL. Highly-polished finish. Flush cap is slotted for separate key and features an O-ring that seals the cap watertight. Cap is attached by a stainless steel, beaded chain. Long neck accommodates thick deck laminations. Key sold separately. Note: Requires a bonding wire to prevent sparking when nozzle is inserted on gasoline and diesel models per USCG and ABYC H-24 requirements.

* **⚠ WARNING** Cancer and Reproductive Harm – www.P65Warnings.ca.gov (see page 240)

Specifications

Fill Neck Length	Installation Hole Size	Flange Size	Hose Size	Fastener Size
3-1/4"	2-1/4"	3-1/2"	2" I.D.	#10

Description	Bulk Packaging	Prop 65	Aftermarket Packaging	Prop 65
"Gasoline" imprint with Red Color Code (Not for use with EPA Certified systems)	66411C1	*	—	—
"Diesel" imprint with Green Color Code	66412C1	*	—	—
Replacement key	66060-1	*	—	—
Replacement cap and chain	—	—	66061-3	*



66411

† Replacement for 66406, 66407, 66408 and 66408C1 only

FUEL VENTS



Enhanced 316 Stainless Steel Alloy Flush-Mount Fuel Vents

On the exterior, they have a smooth edge over the competition. Unlike some others, there is no protruding cap to cause damage — or be damaged by — hull bumps and scrapes. Cap unscrews with hex head wrench for easy cleaning of filter and pressure testing of entire fuel system. These vents now include two silicone gaskets.



66031



66032

* **⚠ WARNING** Cancer and Reproductive Harm – www.P65Warnings.ca.gov (see page 240)

Description	Hose Size	Maximum Hull Thickness	Installation Hole Size	Bulk Packaging	Prop 65	Aftermarket Packaging	Prop 65
Straight Vent	5/8" I.D.	7/8"	1-3/8"	66031-1		66031-3	
90° Vent	5/8" I.D.	7/8"	1-3/8"	66032-1	*	66032-3	*

Enhanced 316 Stainless Steel Alloy Fuel Vents

Stainless steel vents with spark-proof screen holes.

* **⚠ WARNING** Cancer and Reproductive Harm – www.P65Warnings.ca.gov (see page 240)

Description	Hose Size	Maximum Hull Thickness	Installation Hole Size	Bulk Packaging	Prop 65	Aftermarket Packaging	Prop 65
Straight Vent	5/8" I.D.	1/2"	7/8"	66004-1	*	—	
90° Vent	5/8" I.D.	1/2"	7/8"	66023-1		—	

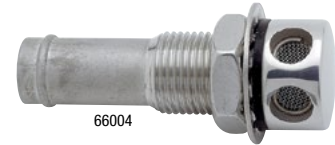

66004



66023

Polypropylene Fuel Vents

Patented splash-resistant, corrosion-resistant polypropylene.

* **⚠ WARNING** Cancer and Reproductive Harm – www.P65Warnings.ca.gov (see page 240)

Description	Color	Hose Size	Maximum Hull Thickness	Installation Hole Size	Bulk Packaging	Prop 65	Aftermarket Packaging	Prop 65
Straight Vent	Black	5/8" I.D.	7/8"	3/4"	1607-1	*	1607-3	*



1607





ANCHORING & MOORING EQUIPMENT	96-101
MARINE ROPES & CORDAGE	102-109
FISHING ROD HOLDERS & ACCESSORIES	110-117
MARINE MAINTENANCE PRODUCTS	118
INTERIOR & BOATING ACCESSORIES	119-127
ELECTRICAL ACCESSORIES	128-135
PADDLESPORTS & ACCESSORIES	136-142
TRAILERING PARTS & ACCESSORIES	143-156



ANCHORING AND MOORING EQUIPMENT

Mushroom Anchors

Mushroom anchors are an economical solution for light-weight boats. The wide-area mushroom cup provides sufficient holding power in mud and weed bottoms.

* **⚠ WARNING** Cancer and Reproductive Harm – www.P65Warnings.ca.gov (see page 240)

- Gray cast iron
- Large, steel eye
- Available coated with aluminum-painted finish or black PVC-coated finish

Description		Bulk Packaging	Prop 65	Aftermarket Packaging	Prop 65
Aluminum - Painted	8 lbs.	9941-1	*	—	
	10 lbs.	9942-1	*	—	
	15 lbs.	9943-1	*	—	
Black PVC-coated	8 lbs.	9941B1	*	—	
	10 lbs.	9942B1	*	—	
	15 lbs.	9943B1	*	—	



Navy Anchors

Navy anchors combine weight with flukes to dig in and hold firmly in sand and mud. The reverse action of the shank allows quick retrieval of a fouled anchor. High-quality, gray iron casting available with aluminum-painted or black PVC-coated finish.

* **⚠ WARNING** Cancer and Reproductive Harm – www.P65Warnings.ca.gov (see page 240)

Description		Bulk Packaging	Prop 65	Aftermarket Packaging	Prop 65
Aluminum - Painted	10 lbs.	9933-1	*	—	
	15 lbs.	9934-1	*	—	
	20 lbs.	9935-1	*	—	
Black PVC-coated	10 lbs.	9933B1	*	—	
	15 lbs.	9934B1	*	—	
	20 lbs.	9935B1	*	—	



River Anchors

River anchors catch and hold river bottoms where mud, rocks, stumps, and brush are present. Flukes act like a grappling hook to snag rocks or other objects. Gray, cast iron with a large, steel eye and black PVC-coated or aluminum-painted finish.

* **⚠ WARNING** Cancer and Reproductive Harm – www.P65Warnings.ca.gov (see page 240)

Description		Bulk Packaging	Prop 65	Aftermarket Packaging	Prop 65
Aluminum - Painted	8 lbs.	9944-1	*	—	
	15 lbs.	9948-1	*	—	
	18 lbs.	9946-1	*	—	
Black PVC-coated	8 lbs.	9944B1	*	—	
	12 lbs.	9945B1	*	—	
	15 lbs.	9948B1	*	—	
	18 lbs.	9946B1	*	—	



Note- All Bulk Packed anchors include ID label with UPC number/bar code.

PENETRATING FLUKE ANCHORS

Penetrating fluke anchors dig into mud, sand, or gravel and stow flat. Pivoting flukes rotate downward into bottom. Excellent weight-to-holding power ratio compared to cast anchors. All Attwood penetrating anchors are manufactured of hot dip galvanized steel for corrosion resistance and strength. The assembly is arc-welded steel that maintains consistent fluke-to-shank angles, ensuring quick penetration and a firm hold.

* **⚠ WARNING** Cancer and Reproductive Harm – www.P65Warnings.ca.gov (see page 240)

Solid Shank Penetrating Anchors

Solid shank for durability and strength.

Specifications

Part No.	A	B	C	D
9955-1	22.25"	18.38"	12.20"	10.0"
9956-1	28.18"	21.0"	14.50"	11.0"
9957-1	32.0"	24.0"	16.50"	12.0"

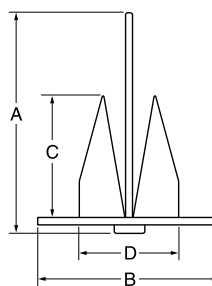

Size	Bulk Packaging	Prop 65	Aftermarket Packaging	Prop 65
#8	9955-1	*	—	
#13	9956-1	*	—	
#18	9957-1	*	—	

Slip-Ring Penetrating Anchors

Feature a slip-ring shank for easy retrieval of a snagged anchor.

* **⚠ WARNING** Cancer and Reproductive Harm – www.P65Warnings.ca.gov (see page 240)

Specifications

Part No.	A	B	C	D
9960-1	13.85"	11.50"	8.75"	8.0"
9961-1	16.35"	13.25"	8.88"	8.88"
9962-1	19.85"	14.25"	9.50"	10.0"
9963-1	21.85"	21.0"	12.0"	12.0"

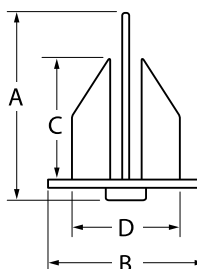

Size	Bulk Packaging	Prop 65	Aftermarket Packaging	Prop 65
#5	9960-1	*	—	
#7	9961-1	*	—	
#10	9962-1	*	—	
#13	9963-1	*	—	

Grapnel Folding Anchors

Ideal four-fluke anchor for personal watercraft (PWC), small craft, and dinghies. Heavily galvanized, malleable iron. Folds up easily for storage. Lockable in opened or closed position.

* **⚠ WARNING** Cancer and Reproductive Harm – www.P65Warnings.ca.gov (see page 240)

Size	Bulk Packaging	Prop 65	Aftermarket Packaging	Prop 65
3 lbs.	11964-1	*	—	
5 lbs.	11966-1	*	—	
7.5 lbs.	11968-1	*	—	



Grapnel Anchor System

3.5 lb. anchor will hold your PWC, canoe, dinghy, kayak, or float tube in mud, sand, gravel, and rock. Includes 25 ft. of rope, marker buoy, giant snap hook, anchor, and durable, nylon storage case that protects your boat from scratches.

* **⚠ WARNING** Cancer and Reproductive Harm – www.P65Warnings.ca.gov (see page 240)

Description	Bulk Packaging	Prop 65	Aftermarket Packaging	Prop 65
Grapnel Anchor System	—	*	11969-4	*



Note- All Bulk Packed anchors include ID label with UPC number/bar code.



Anchor Chains and Shackle

For use on penetrating anchors. Anchor lead chain holds down anchor shanks, in order to keep anchor flat. Increases holding strength, especially in strong currents, high winds, and coastal waters. Protects line from chafing on sharp rocks. These anchor chains include a welded, oversized link on each end for easy installation and anchor attachment.



13753-7

Description	Dimensions	Bulk Packaging	Prop 65	Aftermarket Packaging	Prop 65
Hot dip galvanized with 2 shackles	1/4" x 4'	—		13753-7	

Lift 'n Lock Anchor Control

Easy-to-use anchor lift and pulley system supports anchors up to 20 pounds with 1/2-inch diameter line (sold separately).

* **⚠ WARNING** Cancer and Reproductive Harm – www.P65Warnings.ca.gov (see page 240)

Deluxe Anchor Control

- High-impact, reinforced nylon
- Stainless steel shafts
- Easy pull-up, lock, and release

Standard Anchor Control

- Economical zinc-plated, steel anchor lift
- Nylon pulley system
- Steel sheave controls anchor from any position



13702

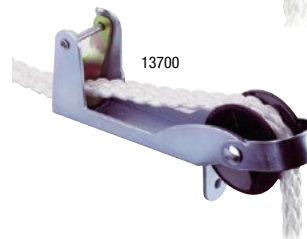

13700

Description	Bulk Packaging	Prop 65	Aftermarket Packaging	Prop 65
Deluxe—Anchor Lift 'n Lock	—		13702-4	*
Standard—Anchor Lift 'n Lock	—		13700-7	*

Anchor Lift System

This convenient system drops the anchor at the turn of a button and stores it in the anchor mount housing when not in use. Constructed of heavy-gauge steel with a durable powder coated finish and mounts on the bow or stern corners most boats. Features self-lubricating nylon wheels. Capacity for 100 ft. of 3/16-inch line (Anchor Line and Pulley System sold separately).

* **⚠ WARNING** Cancer and Reproductive Harm

www.P65Warnings.ca.gov (see page 240)



13710



2908

2906



Description	Bulk Packaging	Prop 65	Aftermarket Packaging	Prop 65
Anchor Lift System	—		13710-4	*
Tiller Line Pulley	2906-1	*	—	
3/16" x 100' Braided line for lift system	—		117553-7	



117553

Anchor Buoy

One-piece, heavy-duty construction uses premium marine-grade vinyl for softness, pliability, and superior durability. Built-in UV inhibitors help maintain high-visibility, fluorescent orange color. MicroGuard® technology further protects from rotting, mold, and mildew.

* **⚠ WARNING** Cancer and Reproductive Harm – www.P65Warnings.ca.gov (see page 240)

Description	Bulk Packaging	Prop 65	Aftermarket Packaging	Prop 65
Buoy, 9"	—		9350-4	*



9350

Anchor Ring & Rope

Assists in anchor retrieval. Designed to lift anchor systems up to 80 lbs. where 10 feet or more of anchor chain is used. Lifting capacity based on anchor buoy size. Buoy sold separately.

Description	Bulk Packaging	Prop 65	Aftermarket Packaging	Prop 65
Anchor Ring with rope	—		9351-2	



9351

Note- All Bulk Packed Chains/Shackles include ID label with UPC number/bar code



SOFTSIDE FENDERS

Attwood SoftSide fenders come with a lifetime guarantee against chalking, splitting, marring, deflating, and crushing. All SoftSide fenders are made in the U.S.A. and resistant to UV and fading. Soft to the touch and easy on hulls, consumers trust the Attwood name in fenders.

SoftSide Oval Mooring Fenders

Molded from a lightweight polymeric material that is soft to the touch, and easy on hulls, and resistant to UV, chalking, splitting, and crushing. Double-molded eye ends for extra strength. Seamless one-piece construction. Oval shape and ribbed sides resist rolling against hull.

* **⚠ WARNING** Cancer and Reproductive Harm – www.P65Warnings.ca.gov (see page 240)

- Sold in a display carton for easy display
- Guaranteed for life against splitting or bursting

Description	Color	Bulk Packaging	Prop 65	Aftermarket Packaging	Prop 65
4"-dia. x 16" L	White	—		9354D1	
	Blue	—		9354BD1	
5"-dia. x 22" L	White	—		9355D1	
5"-dia. x 22" L, 2-Pack	White	—		93552P2	
5"-dia. x 22" L, PDQ	Blue	—		9355BD1	
6"-dia. x 24" L	White	—		9356D1	
	Blue	—		9356BD1	
8"-dia. x 28" L	White	—		9358-1	
	Blue	—		9358B1	

Description	Dimensions	Mounting Pattern	Bulk Packaging	Prop 65	Aftermarket Packaging	Prop 65
Pontoon Fender	8 1/2" x 16 1/2" x 10"	Strap	—		93536-1	*



93552P2



Pontoon Fender
93536



Note - All Bulk Packed fenders include ID label with UPC number/bar code.

SoftSide Dock Fenders

Molded from a lightweight polymeric material that is soft to the touch, easy on hulls, and resistant to UV, chalking, splitting, and crushing. Seamless one-piece construction.

- Sold in a PDQ display carton for easy retail display
- Guaranteed for life
- Made in the U.S.A.

Description	Dimensions	Mounting Pattern	Bulk Packaging	Aftermarket Packaging
12" x 12" Corner Dock Fender	11 3/4" x 11 3/4" x 4 1/2" Fits 90° angle"	Four 5/16" holes	—	93531-1
Straight-Edge Dock Fender	18" x 3 1/2" x 4 1/2"	Three 5/16" holes	—	93532-1
Slide-On Post Dock Fender	7" diam. x 15" height Fits up to 2 3/8" O.D. Post"	Four 5/16" holes	—	93533-1
Round Corner Dock Fender	7" diam. x 15" height Fits 90° angle"	Six 5/16" holes	—	93534-1
Long-Edge Dock Fender	45" x 8 1/2" x 6"	Four 5/16" holes	—	93537-1

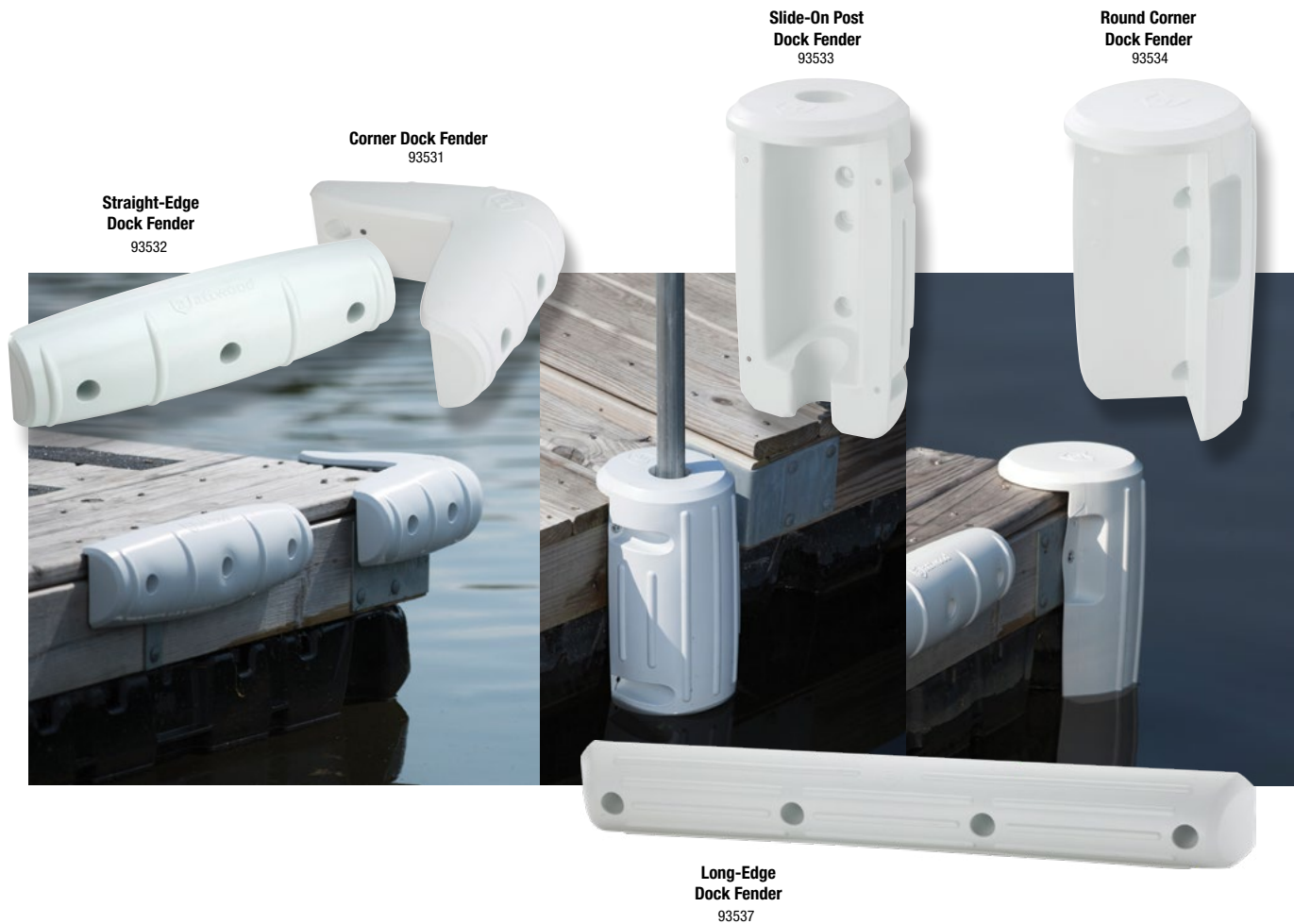

Note- All Bulk Packed fenders include ID label with UPC number/bar code.

ANCHORING AND MOORING EQUIPMENT

100 MARINE ACCESSORIES



Fold-Down Dock Cleats

Ideal for small boats and watercraft. Cleats simply fold-down when not in use and flip back up when it comes time to tie off. Low-profile, fold-down design keeps cleat clear of dock traffic. Marine-grade aluminum protected with corrosion-resistant finish. Easy to install on all dock types with (2) standard 3/8-inch carriage bolts (not included).

Description	Color	Bulk Packaging	Aftermarket Packaging
6" Fold-Down Cleat	White	—	12048-4
8" Fold-Down Cleat	White	—	12049-4



12048

Mooring Snubber Kit

This flexible snubber stretches to absorb shock and protect boats, cleats, and lines from the strain of wind and water. The resilience of the snubber can be adjusted to conditions by increasing or decreasing the amount of line wrapped around it. Includes snubber and 20 ft. of solid braided multifilament polypropylene dock line.

* **⚠ WARNING** Cancer and Reproductive Harm – www.P65Warnings.ca.gov (see page 240)

Description	Thickness	Length	Color	Bulk Packaging	Prop 65	Aftermarket Packaging	Prop 65
Mooring Snubber Kit	3/8"	20 ft.	Blue	—		11730-7	



11730

Mooring Fender Lock Kit

Quickly and easily install or move fenders when mooring. Simply tie fender line onto key and insert key into lock. Includes (2) flush-mount stainless steel mounting plates and (2) stainless steel keys. Fasten with (2) #10 fasteners. Accepts up to 1/2-inch rope.

* **⚠ WARNING** Cancer and Reproductive Harm – www.P65Warnings.ca.gov (see page 240)

Description	Bulk Packaging	Prop 65	Aftermarket Packaging	Prop 65
2" W x 1" H, Set	—		11575-3	*



11575

Boat Hook

Telescoping adjustment collar has molded ribbing – easy to grip and twist for length adjustment, even when wet. High-quality 6061-T6 aluminum tubing with marine finish and rubber vinyl grips. Hook includes non-marring polyethylene tips.

* **⚠ WARNING** Cancer and Reproductive Harm – www.P65Warnings.ca.gov (see page 240)

Description	Bulk Packaging	Prop 65	Aftermarket Packaging	Prop 65
Extends 3-1/2' to 5-1/2'	—		11150-5	*
Extends 3-1/2' to 8'	—		11180-5	*



11180

MARINE ROPES & CORDAGE

Attwood offers a complete line of anchor and mooring products with the premium performance and quality that boaters have come to expect. Our rope products are packaged to look great, while meeting the sustainability and functional requirements demanded by our retail customers.

ROPE MATERIALS

NYLON

Nylon is recognized in the marine industry for its inherent strength, durability, and versatility. Its elasticity allows it to manage the sudden shock loads that would break ropes constructed from other materials, making it a leading choice for anchor and dock lines. Nylon is also abrasion resistant and will last much longer than natural fiber ropes.

Made from multifilament fibers that are light and heat stabilized, nylon rope is also resistant to rot, oils, gasoline, grease, marine growth, and most chemicals.

Benefits

- Strength
- Elasticity enables stretching and reduced breakage
- Resistant to UV light, rot, abrasion, mildew, oils, gasoline, and marine growth
- High wet strength

POLYPROPYLENE

Polypropylene offers high strength-to-weight performance and is available in many construction methods using monofilament fibers, which are smooth and velvety, and multifilament fibers. Both fiber types are UV stabilized to provide resistance against fading and degradation. Waterproof polypropylene ropes float and are also resistant to rot, oils, gasoline, and most chemicals.

Benefits

- Economical and versatile
- Resistant to UV light, rot, abrasion, mildew, oils, gasoline, and marine growth
- Floatable

ATTWOOD ROPE CONSTRUCTION TYPES



Twisted

- Splicable
- Economical construction
- The most common construction type for general purpose rope



Solid Braided

- Resists rotating underload
- Strong, soft, and light-weight construction
- Ideal for use in pulleys, guides, and blocks
- Resists unraveling when cut

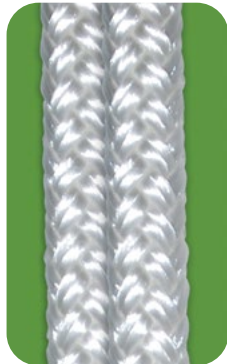

Double Braided

- Braid over braid construction (two ropes combined into one rope)
- Splicable
- Does not hockle, kink, or rotate underload
- Excellent shock absorption and elasticity



Diamond Braided

- High quality construction
- Tight interlacing of yarns
- Stiffer than solid braided rope



Hollow Braided

- Diamond braid construction with hollow center
- Easiest type construction to splice

ANCHOR LINES

Attwood offers anchor lines in different materials and construction types. Our twisted nylon construction is strong, hangs straight, and resists kinking. It can also be spliced, making it a favorite for the seasoned boater. Solid braided nylon lines are stable round cords that will not flatten out and will maintain a soft hand and flexibility throughout its life. We also offer a complete line of polypropylene anchor lines that are sure to meet the needs of any boater.

Premium Nylon Anchor Line

Available with Snap Hook or Thimble

Description	Thickness	Length	Color	Bulk Packaging	Aftermarket Packaging
Twisted nylon line with hook	3/8"	50 ft.	White	—	11707-7
Twisted nylon line with thimble	3/8"	100 ft.	White	—	11734-1
		150 ft.	White	—	11708-1
		200 ft.	White	—	11716-1
	1/2"	100 ft.	White	—	11709-1



11707



11709

Solid Braided MFP Anchor Line

Available with Spring Hook or Thimble

Description	Thickness	Length	Color	Bulk Packaging	Aftermarket Packaging
MFP line with spring hook	3/8"	50 ft.	White	—	11723-7
			Red	—	11736-7
			Blue	—	11741-7
			Black	—	11742-7
MFP line with thimble	3/8"	100 ft.	White	—	11724-1



11723

11724

Hollow Braided Polypropylene Anchor Line

Available with Snap Hook or Thimble

Description	Thickness	Length	Color	Bulk Packaging	Aftermarket Packaging
Polypropylene with snap hook	1/4"	50 ft.	White	—	11714-2
Polypropylene with spring hook	3/8"	50 ft.	Blue/White	—	11725-2
			1/4"	100 ft.	Blue/White



11714



11725



DOCK LINES

Attwood has a selection of dock lines to meet all boater needs for securing their boat to a dock or to other boats when rafting. Whether in nylon or polypropylene, we have dock lines in the most popular sizes and styles. Our nylon dock lines are the strongest and most durable lines available, plus they are resistant to the degradation effects of UV rays.

Our polypropylene dock lines are floatable. All Attwood dock lines are pre-spliced at one end.



3-Strand Twisted Nylon



Double Braided Nylon



Braided MFP



Hollow Braided Polypropylene

Premium 3-Strand Twisted Nylon Dock Line

Thickness	Length	Color	Bulk Packaging	Aftermarket Packaging
3/8"	10 ft.	White	—	11711-7
	15 ft.	White	—	11705-7
1/2"	15 ft.	White	—	11706-7
	20 ft.	White	—	11733-7
	25 ft.	White	—	11715-7



Premium Double Braided Nylon Dock Line

* **WARNING** Cancer and Reproductive Harm – www.P65Warnings.ca.gov (see page 260)

Thickness	Length	Color	Bulk Packaging	Aftermarket Packaging
3/8"	15 ft.	Gold/White	—	11701-7
		White	—	117601-7
		Blue	—	117603-7
		Black	—	117604-7
20 ft.		Gold/White	—	117563-7
		White	—	117605-7
		Blue	—	117607-7
		Black	—	117608-7
25 ft.		Gold/White	—	117564-7
		White	—	117680-7
		Black	—	117681-7



(Continued on next page)



Premium Double Braided Nylon Dock Line

(Continued)

* **⚠ WARNING** Cancer and Reproductive Harm – www.P65Warnings.ca.gov (see page 240)

Thickness	Length	Color	Bulk Packaging	Prop 65	Aftermarket Packaging	Prop 65
1/2"	15 ft.	Gold/White	—		117565-7	
		Gold/White	—		117566-7	
		White	—		117614-7	
	25 ft.	Black	—		117617-7	
		Gold/White	—		117567-7	
	30 ft.	Black	—		117621-7	
Gold/White		—		117684-7		
5/8"	35 ft.	Gold/White	—		117525-7	*



Gold/White



White



Red



Blue



Black



Braided MFP Dock Line

Description	Thickness	Length	Color	Bulk Packaging	Aftermarket Packaging
Double Braided	3/8"	15 ft.	Blue	—	11702-7
			Black	—	11703-7
Solid Braided	3/8"	15 ft.	White	—	11737-7
			Red	—	11749-7
			Blue	—	11750-7
			Black	—	11752-7

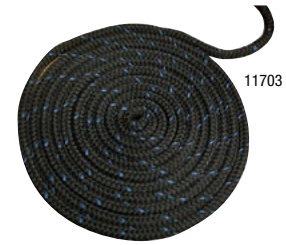

Mooring Snubber Kit

This flexible snubber stretches to absorb shock and protect boats, cleats, and lines from the strain of wind and water. The resilience of the snubber can be adjusted to conditions by increasing or decreasing the amount of line wrapped around it. Includes snubber and 20 ft. of solid braided multifilament polypropylene dock line.

Description	Thickness	Length	Color	Bulk Packaging	Aftermarket Packaging
Mooring Snubber Kit	3/8"	20 ft.	Blue	—	11730-7



Hollow Braided Polypropylene Dock Line

- 15 ft. of hollow, braided polypropylene dock line
- All our polypropylene dock lines are floatable and pre-sliced at one end

Thickness	Length	Color	Bulk Packaging	Aftermarket Packaging
3/8"	15 ft.	Blue/White	—	11728-2



Expandable Dock Mooring Line

- Absorbs shock by stretching from 4 ft. to 5.5 ft.
- Convenient and easy to use -- eliminates excess lines
- Perfect for multiple boat tie ups
- Hollow-braid polyethylene line and shock cord construction

Description	Length	Color	Bulk Packaging	Aftermarket Packaging
Expandable Dock Line	4 ft.	Black	—	11729D5



Launch Line

- Solid braid MFP line includes spring hook and handy foam grip
- Easy to handle floatable line that dries quickly
- UV Resistant
- Helps assist or steer your boat when launching or loading

Thickness	Length	Color	Bulk Packaging	Aftermarket Packaging
5/16"	30 ft.	Blue	—	11732-7



FENDER LINES

Attwood Fender Lines are constructed of double braided or 3-strand twisted nylon for strength, flexibility, and durability. These premium lines feature a professionally spliced eye and are available in a range of diameters, lengths, and colors. Our Fender Lines will not be damaged by oil, grease, gasoline, mildew, or most chemicals.

Double Braided Fender Lines

Description	Thickness	Length	Color	Bulk Packaging	Aftermarket Packaging
Double Braided Nylon, pair	1/4"	5 ft.	White	—	11843-7
		6 ft.	White	—	11971-7



UTILITY ROPES

We have just the unique rope product and accessory that are always practical and valuable for the many uses around the boat, marina and home.

Braided Polypropylene Utility Line

- Multi color offering
- 75 foot offering comes in PDQ retail display of four ropes
- 25 foot offering comes in PDQ retail display of three ropes

Thickness	Length	Color	Bulk Packaging	Aftermarket Packaging
3/8"	25 ft.	Multi	—	11704-2



Hollow Braided Polypropylene Utility Line

Thickness	Length	Color	Bulk Packaging	Aftermarket Packaging
5/16"	50 ft.	Blue	—	11713-2
1/4"	40 ft.	Yellow	—	11710-2
	50 ft.	Yellow	—	11720-2
	100 ft.	Blue	—	11721-2



Diamond Braided Polypropylene Utility Line

- Great for miscellaneous uses around the boat, home, and marina
- Neon multi-color offering

Thickness	Length	Color	Bulk Packaging	Aftermarket Packaging
1/8"	45 ft.	Neon Multi	—	11700-2



11700

Camouflage Cord Utility Line

- Great for hunting, fishing, boating, and camping
- 75 foot offering comes in PDQ retail display of four ropes

Description	Thickness	Length	Color	Bulk Packaging	Aftermarket Packaging
Diamond Braided MFP Camo Cord	1/8"	50 ft.	Camo	—	11717-2
		100 ft.	Camo	—	11718-2
	1/4"	50 ft.	Camo	—	11719-2



11717

Twisted Nylon Utility Line

Thickness	Length	Color	Bulk Packaging	Aftermarket Packaging
1/4"	50 ft.	White	—	11726-2



11726

Solid Braided Nylon Rope

Thickness	Length	Color	Bulk Packaging	Aftermarket Packaging
3/16"	100 ft.	White	—	117553-7



117553

Diamond Braided Nylon Rope

Thickness	Length	Color	Bulk Packaging	Aftermarket Packaging
1/4"	50 ft.	White	—	117561-2



117561

Winch Ropes

Durable winch ropes available in braided nylon and twisted polypropylene. For winches rated up to 1,200 lbs.

Thickness	Length	Material	Color	Bulk Packaging	Aftermarket Packaging
3/8"	20 ft.	Twisted Polypropylene	Black	—	11739-2



11739

Marine Bungee Cord Pack

Ideal for boat covers and general use.

- High tensile strength steel hooks with protective coating
- Contains: (8) 24" White, (6) 30" Blue, (2) 42" Yellow and (2) Adjustable Hooks for Customizing Length

Description	Length	Color	Bulk Packaging	Aftermarket Packaging
18 Piece Assortment	Multi	Multi	—	11712-7



11712

Flat Bungee Set

5-piece set includes 12", 15", 25", 35" and 45" premium flat bungees with plastic encapsulated hooks. Individual colors.

Description	Length	Color	Bulk Packaging	Aftermarket Packaging
5-Piece Assortment	Multi	Multi	—	11753-7



11753

MARINE ROPE ACCESSORIES

Rope Wraps

Wrap around and hold your ropes, cords, hoses, and more.

Description	Bulk Packaging	Aftermarket Packaging
Three (3) 1" x 12" straps, with sewn in hook-and-loop fasteners	—	11792-6



11792

FISHING ROD HOLDERS & ACCESSORIES

The Fishing Leader!

- Make Attwood your fishing source
- Now, more than ever, Attwood is your best source for adjustable rod holders and interchangeable mounts. We think you'll agree — Attwood's comprehensive selection has you covered for all types of rod holders!

Pro Series Rod Holders



Designed for use with bait casting and spinning reels. Heavy-duty, deep-tooth gear lock securely holds rod holder in mounting base.

* **WARNING** Cancer and Reproductive Harm –

www.P65Warnings.ca.gov (see page 240)

Description	Color	Bulk Packaging	Prop 65	Aftermarket Packaging	Prop 65
with Combo Mount	Black	—		5010-4	*

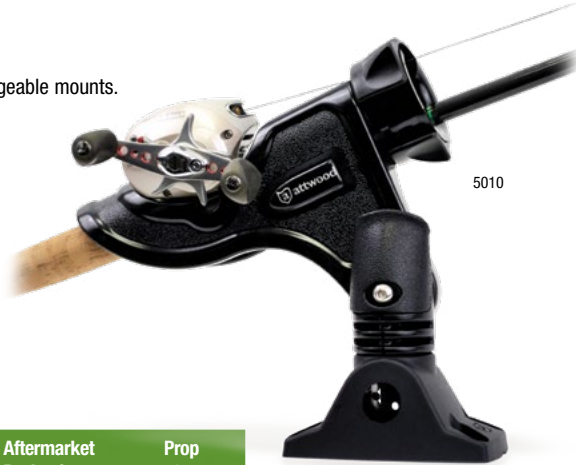

5010

Heavy-Duty Adjustable Rod Holders



Designed for use with bait casting and spinning reels. Features an ergonomic design and easy-to-find rapid-release latch. The large, easy-grip lock-nut offers an easy 180° vertical adjustment range for a variety of rod tip height settings.

Description	Color	Bulk Packaging	Aftermarket Packaging
with Combo Mount	Black	—	5009-4
	White	—	5009W4
with Flush Mount	Black	—	5014-4



5009

2-In-1 Non-Adjustable Rod Holders

Features fixed vertical angle to optimize rod positioning. Smaller size is perfect for medium and light action gear. Rod throat opening fits most standard and ultra-light rods up to 1-3/16-inches diameter. Locking ring fits spinning reel handle shanks up to 7/16-inch diameter. Available as a double-pack.

Description	Color	Bulk Packaging	Aftermarket Packaging
with Side Mount, Pair	Black	—	RH-4646



Includes Side Mount

Note - 2-In-1 Bulk Packed Rod Holders include ID label with UPC number/bar code



Heavy-Duty Rod Holder Extensions

For use with all Attwood mounts including combo mount, Attwood standard side mounts, and other leading rod holder mounts. Complete with all necessary hardware to mount to round or square 7/8-inch to 1-1/4-inch diameter rail.



Description	Bulk Packaging	Aftermarket Packaging
Black Extension	—	5016-3



5016 Heavy Duty Rod Holder Extension

5012 Heavy Duty Rail Mount

Heavy-Duty Rail Mount

For use with the Heavy-Duty Combo Mount. Complete with all necessary hardware to mount to rails from 3/4-inch to 1 1/4-inch width.



Description	Bulk Packaging	Aftermarket Packaging
Black Mount	—	5012-7

Heavy-Duty Combo Mounts

The combo rod holder mount allows for mounting in multiple configurations. This new design offers an improved fit with positive lock for secure rod holder mounting. Can be mounted on side or top of gunwale. Compatible with all Attwood and other leading rod holder mounting patterns.



Description	Bulk Packaging	Aftermarket Packaging
Black Mount	—	5011-7

5012/5011 Heavy Duty Combo Mount & Rail Mount

Flush Mounts

Mounts flush to gunwale or deck. Easy-open cover conceals fasteners and elastomeric liner seals water out. When closed the low profile, smooth, contoured design avoids snagging lines.

Description	Bulk Packaging	Aftermarket Packaging
Black Mount	—	5022-7



5022

Heavy-Duty Clamp-On Rod Holder Mount

Heavy-duty adaptor clamp easily mounts rod holder to gunwale or transom. Ideal for aluminum fishing boats and pontoons. Works together with Attwood's Heavy-Duty Combo Mount and other Attwood fishing accessories. Mounting hardware included.

Description	Bulk Packaging	Aftermarket Packaging
Gunwale/Transom Rod Holder Clamp	—	5030-4



5030-4



Clamp-On Rod Holder

Versatile Clamp-On Rod Holder features wide adjustability and a universal clamp design that allows easy mounting to gunwales, transoms, and rails. Constructed of powder coated steel for durability and long life.

* **⚠ WARNING** Cancer and Reproductive Harm – www.P65Warnings.ca.gov (see page 240)

Description	Color	Bulk Packaging	Prop 65	Aftermarket Packaging	Prop 65
Clamp-On Rod Holder	Black	—		5031D1	*



5031

Mini Rigger Kit

A complete package to start downrigger fishing. Attwood's Mini Rigger Kit bring controlled-depth trolling capabilities to boats of all size. Kit includes Heavy-Duty Combo Mount for multiple mounting configurations, heavy-duty and easy to use professional line release, swivel head pulley to respond to line movements, 100 ft. of stainless steel line, 4 lb. cannonball weight, and an easy grip handle.

* **⚠ WARNING** Cancer and Reproductive Harm – www.P65Warnings.ca.gov (see page 240)

Description	Bulk Packaging	Prop 65	Aftermarket Packaging	Prop 65
Mini Rigger with Harness	—		9709-7	*



9709

Lure Rack

The lure rack holds up to 25 lures, plus a fillet knife and pliers. Has slots for fillet knives.

* **⚠ WARNING** Cancer and Reproductive Harm – www.P65Warnings.ca.gov (see page 240)

Description	Bulk Packaging	Prop 65	Aftermarket Packaging	Prop 65
Lure Rack	—		11848-4	*



11848

Sure-Grip Steel Rod Holders & Mounting Bases

Attwood's line of Sure-Grip Steel Rod Holders are the perfect complement to our molded Pro-Series and Heavy-Duty Adjustable rod holders. They are designed for drift fishing, pan fishing, crappie, and more. Make Attwood your single source for all types of rod holders!

The 3/8-inch diameter coated steel rod is tough, strong, and corrosion-resistant. UV-resistant plastic coating protects the rod butt and handle. Stainless steel exposed stem and wing nut offer years of corrosion-resistant use.

Attwood Sure-Grip mounting bases fit a variety of mounting surfaces including rails. Constructed of extruded aluminum.

* **⚠ WARNING** Cancer and Reproductive Harm – www.P65Warnings.ca.gov (see page 240)

Description	Bulk Packaging	Prop 65	Aftermarket Packaging	Prop 65
SURE-GRIP STEEL ROD HOLDERS				
5° Angle, 4" S.S. Stem & Wing Nut, For horizontal rod position, includes 5071 mounting base	—		5060-3	
5° Angle, 8" S.S. Stem & Wing Nut, For horizontal rod position with added clearance, includes 5071 mounting base	—		5061-3	*
25° Angle, 4" S.S. Stem & Wing Nut, For drifting or trolling	Includes 5071 mounting base	—	5062-3	*
	Includes a pair of rod holders and 5071 mounting bases	—	—	
45° Angle, 4" S.S. Stem & Wing Nut, For trolling, includes 5071 mounting base	—		5063-3	*
SURE-GRIP MOUNTING BASES				
Side mount base, fits gunwale or rail	—		5070-3	
Flush base, fits 2" flat surfaces	—		5071-3	
Flat rail base, fits square rail	—		5072-7	
Clamp-on rail base, fits round rail up to 7/8" -dia.	—		5074-3	

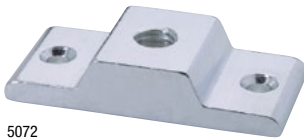

ROD HOLDERS

Stainless Steel Flush Mount Rod Holders

Atwood Stainless Steel Rod Holders answer the need for the finest in finish, function, and durability. The holders are available in 30°, 15°, and 0° configurations in standard 2-inch diameter or in the robust 2-1/4-inch diameter Big Game Series. All Stainless Steel Rod Holders have these outstanding features, including optional custom-casting or electrolytic etching of your logo in the flange. Contact your Atwood representative for details.

* **⚠ WARNING** Cancer and Reproductive Harm – www.P65Warnings.ca.gov (see page 240)



Description	Flange Shape	End Type	Color	Bulk Packaging	Prop 65	Aftermarket Packaging	Prop 65
CLOSED END - 2" DIAMETER X 9" LENGTH							
30°	Rod Holder	Round	Closed	Black	66470-1	*	66470-7
0°	Rod Holder	Round	Closed	Black	66471-1	*	66471-7
STANDARD SERIES - 2" DIAMETER X 7-1/2" LENGTH							
30°	Rod Holder	Oval	Open	Black	66362-1	*	66362-7 ▽
				White	66362W1	*	66362W7 ▽
	Cap Gasket	Black	1478-1	*	—		
		White	1478W1	*	—		
15°	Rod Holder	Oval	Open	Black	66363-1	*	66363-7 ▽
				White	66363W1	*	66363W7 ▽
	Cap Gasket	Black	1477-1	*	—		
		White	1477W1	*	—		
0°	Rod Holder	Oval	Open	Black	66364-1	*	66364-7 ▽
				White	66364W1	*	66364W7 ▽
	Cap Gasket	Black	1476-1	*	—		
		White	1476W1	*	—		



Closed End

Closed End Base Polished end has drainage opening for 14-18 NPT fitting

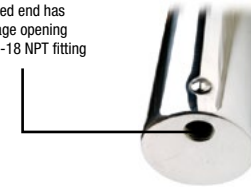

Standard/Big Game Series'

▽ Includes Cap Gasket



Hybrid Rod Holder

10-inch long ABS plastic tube with stainless steel cap.

* **⚠ WARNING** Cancer and Reproductive Harm – www.P65Warnings.ca.gov (see page 240)

Description	Bulk Packaging	Prop 65	Aftermarket Packaging	Prop 65
ABS plastic with Stainless Steel cap, 30° angle	6450-1	*	—	
ABS plastic with Stainless Steel cap, 0° angle	6451-1	*	6451-7	*



Plastic Rod Holders

Durable plastic construction. No liner needed. Holder is angled at 30° for proper rod tip tension. Installation hole size: 2-1/2 inch diameter. Flange has three holes for 1/4 inch screws. Accommodates standard rod grip sizes under 1-1/2 inch diameter.

Description	Color	Bulk Packaging	Aftermarket Packaging
ABS plastic	Black	12701-1	12701-5
ABS plastic, 8 piece Display	White	—	12703D1
ABS plastic, closed end	Black	12704-1	—



12703D1

Stainless Steel Clamp-On Rod Holder

304 stainless steel with black composite liner. Can be used on vertical or horizontal rails.

Adjustable for rails 7/8-inch to 1-inch diameter. 9-inch length, 1-3/4-inch inside diameter tube.

* **⚠ WARNING** Cancer and Reproductive Harm – www.P65Warnings.ca.gov (see page 240)

Description	Bulk Packaging	Prop 65	Aftermarket Packaging	Prop 65
Stainless Steel	—		66970-7	*



66970

ROD STORAGE

PVC Rod Holder Storage

Durable white PVC tube side mounts with molded out area to accommodate standard rod grip sizes up to 1-3/4-inches. 9-inches long.

* **⚠ WARNING** Cancer and Reproductive Harm – www.P65Warnings.ca.gov (see page 240)

Description	Bulk Packaging	Prop 65	Aftermarket Packaging	Prop 65
PVC Rod Holder Storage	—		12708-2	*



12708

Boat Deck Rod Holder Set

Mounts rod and reel combo to deck of the boat. Prevents rod and reel from bouncing out of boat while traveling. Holds up to five rods.

* **⚠ WARNING** Cancer and Reproductive Harm – www.P65Warnings.ca.gov (see page 240)

- Set includes: (1) 10-inch (25 cm) strap for the handle end of the rods, (1) 6-inch (15 cm) strap for the tips and stainless steel mounting hardware.



Description	Bulk Packaging	Prop 65	Aftermarket Packaging	Prop 65
Deck Rod Holder Set	—		12760-7	*



12760

Vertical Mount Rod Holder

- Mounts vertically in application to hold 5-6 rods horizontally
- Molded rubber inserts secure rod butt and tip
- Holds in a crisscross manner, allowing storage of more rods in a smaller space

* **⚠ WARNING** Cancer and Reproductive Harm – www.P65Warnings.ca.gov (see page 240)

Description	Bulk Packaging	Prop 65	Aftermarket Packaging	Prop 65
Vertical Mount, Rod Holder Set	—		12761-7	*



12761

Rod Storage Holder

Holds up to three fishing rods. Closed-cell foam insert protects rod. Mounts vertically or horizontally. 8-3/4 inches L x 2-1/2 inches W.

Description	Bulk Packaging	Aftermarket Packaging
Black ABS frame, black foam	—	12750-6



12750

FISHING NETS

Fold-N-Stow Fishing Nets

Fold down for convenient and compact storage or extend for added reach with Attwood's line of Fold-N-Stow Fishing Nets. A flip of the handle opens and locks the net into place. Easily pull back the trigger and the net collapses down into a stowable size. Constructed of durable, knot-free netting.

* **⚠ WARNING** Cancer and Reproductive Harm – www.P65Warnings.ca.gov (see page 240)



Description	Dimensions At Full Extension	Bulk Packaging	Prop 65	Aftermarket Packaging	Prop 65
Small Folding Net, Ideal for Trout Fishing	24" L x 12.5" W x 10" D	—		12772-2	*
Medium Folding Net, Ideal for a Variety of Applications	47" L x 16" W x 16" D	—		12773-2	*
Large Folding Net, Ideal for Heavy Duty Applications	81" L x 27" W x 27" D	—		12774-2	

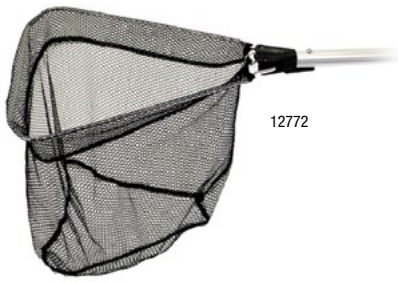

12772

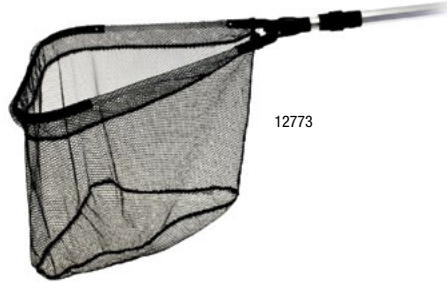

12773



12774

SpillBuster™

Eliminate messy and potentially dangerous spills with this versatile spout that easily attaches to your oil and fluid bottles. On/off valve controls liquid flow. SpillBuster fits 1-quart, 1-gallon, and most 5-quart bottles. Removable cap seals shut.

Description	Bulk Packaging	Aftermarket Packaging
SpillBuster spout	—	14584D1



14584D1

Deluxe Deck Brush Kit

Kit includes:

- Soft brush with squeegee end for gentle, scratch-free cleaning
- Telescoping aluminum pole with flow-through design has water on/off switch and comfortable foam grips
- Nylon boat hook attachment

* **⚠ WARNING** Cancer and Reproductive Harm – www.P65Warnings.ca.gov (see page 240)

Description	Bulk Packaging	Prop 65	Aftermarket Packaging	Prop 65
Deck Brush Kit	—		11807-2	*



11807

Spiral Watering Hose

- 3/4 inch end fittings
- Easy to store. No tangles, always kink-free.
- Weatherproof

* **⚠ WARNING** Cancer and Reproductive Harm – www.P65Warnings.ca.gov (see page 240)

Description	Bulk Packaging	Prop 65	Aftermarket Packaging	Prop 65
3/8" I.D. x 25' Long	—		11871-7	*



11871

Prop Wrench Kit

Offers multiple sockets to fit from 17/32-inch to 1-1/4-inch, allowing consumers to service multiple props. Built of durable composite.

* **⚠ WARNING** Cancer and Reproductive Harm – www.P65Warnings.ca.gov (see page 240)

Description	Bulk Packaging	Prop 65	Aftermarket Packaging	Prop 65
Wrench with up to 1-1/16 inch prop nuts	—		11370-7	*

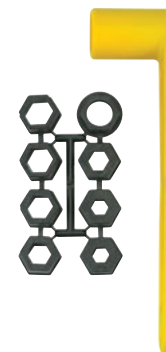

11370

Pontoon Replacement Latch

This durable lock set is a complete replacement kit for your pontoon's gate latch. Universal sizing fits square frames of 1, 1-1/8, and 1-1/4 inch on both left- and right-hinged gates. Secure closure stabilizes gate and prevents inward swinging. Includes mounting hardware for quick and easy installation.

Description	Bulk Packaging	Aftermarket Packaging
Universal Replacement Gate Latch. 8-1/2" x 9-1/2" x 5-1/2"	—	11404-6



11404

INTERIOR & BOATING ACCESSORIES

Soft Grip Steering Wheel

Ideal steering wheel for bass boats, sport boats, and runabouts. Patented design provides a comfortable, and firm grip. Contemporary styling with soft, black PVC outer rim and high-impact, one-piece plastic inner core. Resists UV rays to prevent fading. Soft Grip is non-magnetic so it will not interfere with compass readings. 3-3/8 inches deep dish. Fits all standard 3/4-inch tapered shafts and conforms to ABYC P-22 and ISO 8848.

- * **⚠ WARNING** Cancer and Reproductive Harm – www.P65Warnings.ca.gov (see page 240)
- 8314 NMMA “As Approved”: 090070; CE Certificate WATT005
- 8315 NMMA “As Approved”: 090071; CE Certificate WATT004

Description	Center Cap	Bulk Packaging	Prop 65	Aftermarket Packaging	Prop 65
13"-diameter rim	Black plastic	—		8315-4	*



Tiller Line Pulleys

Non-magnetic 300 series stainless steel body and strap with plastic sheave for wire rope tiller lines. Pulley strap included. Meets ABYC Standard P-18. Swivel pulley rotates 360° on vertical axis. Open eye design for easy installation. Simply mount the strap and attach the pulley. Shrouded body design keeps tiller line in sheave track.

- * **⚠ WARNING** Cancer and Reproductive Harm – www.P65Warnings.ca.gov (see page 240)

Description	Overall Length	Sheave Groove Dia.	Bulk Packaging	Prop 65	Aftermarket Packaging	Prop 65
Swivel	4"	2"	2906-1	*	2906-3	*



Pulley System

Ideal for use in guiding anchor lines and more.

- * **⚠ WARNING** Cancer and Reproductive Harm – www.P65Warnings.ca.gov (see page 240)

Description	Bulk Packaging	Prop 65	Aftermarket Packaging	Prop 65
Pulley System	—		2908-6	*



Tiller Line Clamp

Two screws lock plates together to hold tiller lines in place. Die-cast ZAMAK with chrome finish.

- * **⚠ WARNING** Cancer and Reproductive Harm – www.P65Warnings.ca.gov (see page 240)

Description	Bulk Packaging	Prop 65	Aftermarket Packaging	Prop 65
For 3/16" to 1/4" dia. line	—		8043-3	*



Standard Glove Box

Plastic box and door are light-weight, yet sturdy. Door opens and closes easily on a stainless steel hinge pin and locks with a marine locking latch.

* **⚠ WARNING** Cancer and Reproductive Harm – www.P65Warnings.ca.gov (see page 240)

Door Dimensions	Inside Dimensions	Installation Hole Size
13-3/4" L x 5-1/2" H	11-3/4" L x 4" H x 6-5/8" D	12" L x 4-1/4" H

Description	Bulk Packaging	Prop 65	Aftermarket Packaging	Prop 65
Black	2638-1	*	—	—



2638

Letter & Number Kit

- 3-inch, waterproof vinyl, pressure-sensitive labels
- Resists fuel, fading, and scratches
- Kit contains: Four of each letter and number, plus twelve dashes totaling 148 pieces
- Meets USCG guidelines



* **⚠ WARNING** Cancer and Reproductive Harm – www.P65Warnings.ca.gov (see page 240)



14142

Description	Bulk Packaging	Prop 65	Aftermarket Packaging	Prop 65
White, 148 pieces	—	—	14141-7	*
Black, 148 pieces	—	—	14142-7	*

Rope Ladder

White, five-step boarding ladder. Sturdy 11-3/4 inch blow molded steps. Textured step surface for sure footing. Steps connected by a nylon rope with top loop that quickly secures to cleat or railing.

* **⚠ WARNING** Cancer and Reproductive Harm – www.P65Warnings.ca.gov (see page 240)

Description	Bulk Packaging	Prop 65	Aftermarket Packaging	Prop 65
Rope Ladder	—	—	11865-4	*



11865

BOAT HORNS & SAFETY PRODUCTS

Hidden Horn Kit

Mounts below deck, behind dash, or behind console. Meets ABYC standards for boats up to 16.4 ft. (5 meters), and USCG standards for boats up to 39.4 ft. (12 meters). Heavy-duty marine construction. For 12-volt DC systems only.

* **⚠ WARNING** Cancer and Reproductive Harm – www.P65Warnings.ca.gov (see page 240)

Description	Bulk Packaging	Prop 65	Aftermarket Packaging	Prop 65
3" L x 3 1/4" W x 1 3/4" D	—		11477-3	*

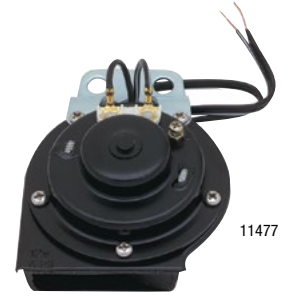

11477

Hidden Horn

Low profile drop-in horn with grills. Design allows easy installation. Easily retrofitted. Comes with black and white cover. 12-volt DC. ABYC compliant with A-16 standards.



Description	Bulk Packaging	Aftermarket Packaging
Drop-In Hidden Horn, includes black and white cover	—	11478-7



11478

Air Horns

Perfect for boating, sporting events, camping, and bicycles.

* **⚠ WARNING** Cancer and Reproductive Harm – www.P65Warnings.ca.gov (see page 240)

Description	Bulk Packaging	Prop 65	Aftermarket Packaging	Prop 65
Single Pack Air Horns				
1.5 oz.	—		118090-7	*
3.5 oz.	—		118091-7	*
8 oz.	—		118092-7	*
Refill Packs				
8 oz. Refill	—		118089-7	



118091

Bellow Signal Horn

Lung-powered horn does not use CO2, Freon, or batteries. Designed for personal protection and safety on land and on water. Meets U.S. Coast Guard Rule 33 (Annex III) and Federal/EPA regulations.

Description	Bulk Packaging	Aftermarket Packaging
8" H x 3 1/2" W	2460-1	2460-7



2460



PORTABLE LIGHTING

Portable Spot Light

Compact 5-watt LED spot light can be stored most anywhere on the boat. Light output is 400 fixture lumens with 50,000 hours of life. Tough thermoplastic construction in safety yellow/black. Includes a 12-volt “cigarette-style” adaptor plug with fuse.

* **WARNING** Cancer and Reproductive Harm – www.P65Warnings.ca.gov (see page 240)

Description	Bulk Packaging	Prop 65	Aftermarket Packaging	Prop 65
Compact Spot Light w/10' power cord	—		11794-7	*



11794



Portable Light Kit

Be seen and be safe with these compact and portable LED navigation lights. All new portable navigation lights are more durable, easier to use, and include Attwood's strongest mounting and pole configurations. Ideal for personal water craft, camping, and hunting. Kit includes red/green LED bow light, white LED stern light, quick-release mounts, pole, and hardware.

* **WARNING** Cancer and Reproductive Harm – www.P65Warnings.ca.gov (see page 240)

- Water-resistant bow and stern navigation lights
- Attwood's most durable, portable LED navigation light engines
- Sealed electronics, built to last in harsh conditions
- Sealed, shock-proof composite housing
- Shatter-proof polycarbonate lens
- 150+ hour run-time on three AAA batteries (not included)
- New telescoping and threaded poles
- New heavy-duty C-clamp and kayak pad mounting options

Description	Finish	Pole Style	Mounting Style	Bulk Packaging	Prop 65	Aftermarket Packaging	Prop 65
Clamp-On LED Light Kit	Marine Gray	Threaded	C-Clamp	—		14190-7	*
	Real Tree® Max-5 Camouflage	Threaded	C-Clamp	—		14191-7	
	Marine Gray	Telescoping	C-Clamp	—		14194-7	*
	Real Tree® Max-5 Camouflage	Telescoping	C-Clamp	—		14195-7	*
Deck Mount LED Light Kit	Marine Gray	Telescoping	Optional screw-down or adhesive pad	—		14192-7	*
	Real Tree® Max-5 Camouflage	Telescoping	Optional screw-down or adhesive pad	—		14193-7	*
All-Craft Navigation LED Light Kit	Marine Gray	Threaded	C-Clamp, screw-down and adhesive pad	—		14196-7	*
	Real Tree® Max-5 Camouflage	Threaded	C-Clamp, screw-down and adhesive pad	—		14197-7	*



14190

BOW

STERN



14191

BOW

STERN



BOATERS SAFETY ACCESSORIES

Bailer Safety Kit

Kit Includes: waterproof emergency flashlight, bailer with easy-grip handle, 50 ft. marine rope with float, Pealess flat safety whistle with lanyard, and seamless "O" Ring.

* **⚠ WARNING** Cancer and Reproductive Harm – www.P65Warnings.ca.gov (see page 240)

Description	Bulk Packaging	Prop 65	Aftermarket Packaging	Prop 65
5-Piece Kit	—		11830-2	*



11830

Whistles—Ball & Flat

- A perfect signal whistle for attaching to life vests
- Lanyard included

Description	Dimensions	Bulk Packaging	Aftermarket Packaging
Plastic Ball Type	2-1/4" x 3/4"	—	11866-6
Plastic Flat Type	1-7/64" x 2-51/64" x 5/16"	—	11829-6



11866



11829

Floating Key Buoy

- Water resistant
- Cover snaps tight for storage of small items
- Distinctive orange top for easy visibility

Description	Bulk Packaging	Aftermarket Packaging
Floating Key Buoy	—	11875-7



11875

Key Floats

Prevent loss of keys when dropped overboard. Three colors: orange, white and blue, with Attwood logo.

* **⚠ WARNING** Cancer and Reproductive Harm – www.P65Warnings.ca.gov (see page 240)

Description	Bulk Packaging	Prop 65	Aftermarket Packaging	Prop 65
PDQ Carton, 24-Piece	—		11889D1	*



11889

Telescoping Paddle

- Compact for easy storage
- Telescopes to 42" (1.06m)
- High impact plastic blade with corrosion-resistant aluminum pole

* **⚠ WARNING** Cancer and Reproductive Harm – www.P65Warnings.ca.gov (see page 240)

Description	Bulk Packaging	Aftermarket Packaging	Prop 65
Paddle, telescoping - 3.5'	—	11828-1	
Paddle, telescoping - 4.5'	—	11826-1	*



11826-1
11828-1



MIRRORS

Note: In some states and provinces, ski mirrors of a certain size/dimension, and/or an onboard observer may be required. Check local requirements.

Wide View Ski Mirror

For installation on windshields 1/2-inch to 1-inch thick (or thinner with customer's own spacer). Provides extra-wide mirror for safe visibility. Molded plastic frame, polished convex mirror, and adjustable base (up-and-down or side-to-side, then secures in desired location). Includes Allen wrench.

* **⚠ WARNING** Cancer and Reproductive Harm – www.P65Warnings.ca.gov (see page 240)



13065

Description	Bulk Packaging	Prop 65	Aftermarket Packaging	Prop 65
11-3/4" W x 4" H, Adjustable	—		13065-4	*

Chrome Ski Mirror

Universal mount installs on dash or windshield. Shatterproof, 180° convex mirror eliminates blind spots. Mirror is compact and constructed of lightweight, chrome plated ZAMAK. Mirror adjusts to any position up-and-down or side-to-side, then secures in desired location.

* **⚠ WARNING** Cancer and Reproductive Harm – www.P65Warnings.ca.gov (see page 240)



9083

Description	Dimensions	Max. Windshield Thickness	Bulk Packaging	Prop 65	Aftermarket Packaging	Prop 65
Perma-Plate®, Adjustable	7-5/16" W x 2-1/2" H	3/4"	—		9083-7	*
Chrome-plated, Adjustable	7" W x 3-1/4" H	1"	—		13055-4	*



13055

Clamp-On Ski Mirror

Universal mount fits up to 1/2-inch thick window frames and adjusts easily to meet most boat applications. Curved mirror provides a wide field of view. Soft touch mounting clamps protect windows and frames. Zinc plated hardware and powder coated shaft assembly.

* **⚠ WARNING** Cancer and Reproductive Harm – www.P65Warnings.ca.gov (see page 240)

Description	Dimensions	Max. Windshield Thickness	Bulk Packaging	Prop 65	Aftermarket Packaging	Prop 65
Clamp-On Ski Mirror, Universal Mount		1/2"	—		13066-7	*



13066

DRINK HOLDERS

LED Stainless Steel Drink Holders



Convenient and stylish LED drink holder makes it easy to see in low-light conditions. The vibrant 35 Lumen interior light ring comes in blue and white to complement all boat interiors. 12 VDC.

* **⚠ WARNING** Cancer and Reproductive Harm – www.P65Warnings.ca.gov (see page 240)

Description	Dimensions	LED Color	Bulk Packaging	Prop 65	Aftermarket Packaging	Prop 65
LED Stainless Steel Drink Holder	3.2" D x 3.6"-dia.	Blue	11786B-1	*	11786B-7	*
LED Stainless Steel Drink Holder	3.2" D x 3.6"-dia.	White	11786W-1	*	11786W-7	*



Molded Plastic Gimbaled Drink Holders

Self-leveling drink holders with slot for coffee cup handle. For boats, cars, and RVs. Molded plastic. Includes gimbaled surface-mounting bracket. Self-draining.

* **⚠ WARNING** Cancer and Reproductive Harm – www.P65Warnings.ca.gov (see page 240)

Description	Color	Bulk Packaging	Prop 65	Aftermarket Packaging	Prop 65
4" H x 4-3/8" W	White	—		11631-4	
	Black	—		11635-4	*



Recessed Drink Holders

Available in sizes for a variety of cans, bottles, and glasses. Each has holes for self-draining.

Description	Dimensions	Bulk Packaging	Aftermarket Packaging
Regular, Black	1-7/8" D x 3"-dia.	11787-1	—
Deep, Black	2-7/8" D x 3"-dia.	11788-1	—
Large, Black	3-1/8" D x 3-3/4"-dia.	11789-1	—
Large, White	3-1/8" D x 3-3/4"-dia.	—	11789WD1
Large, Stainless Steel	3-1/8" D x 3-3/4"-dia.	11845-1	—



Formed Wire Gimbaled Drink Holders

Formed, chrome-plated steel drink holders are ideal for boats, cars, and RVs. Includes a gimbaled surface-mounting bracket that keeps drinks level to prevent spills. Includes mounting screws.

* **⚠ WARNING** Cancer and Reproductive Harm – www.P65Warnings.ca.gov (see page 240)

Description	Bulk Packaging	Prop 65	Aftermarket Packaging	Prop 65
Standard, ideal for 12-ounce cans	—		11670-4	*
Large, with slot for mug handle, includes cooler	—		11672-4	*



Fold-Up Drink Holders

Two easy-to-use, fold-up designs. Holds coffee mugs with a handle, 12-ounce cans, or drink insulators. Mount quickly and easily on boats or RVs. On dual-ring models, flip the small ring up to hold small drinks; for large drinks, flip the small ring down and use the large ring. When not in use, flip ring(s) down and close the cover for convenient storage. 7/8-inch closed depth. Four holes for #10 screws.

* **⚠ WARNING** Cancer and Reproductive Harm – www.P65Warnings.ca.gov (see page 240)

Description	Color	Bulk Packaging	Prop 65	Aftermarket Packaging	Prop 65
Dual Ring	Polycarbonate construction 4-5/8" H x 4-9/16" W x 4-3/4" D	—		2445-7	
		2449-1		2449-7	
Single Rigid Ring	Molded ABS plastic 3-7/8" H x 3-3/4" W	—		11654-3	*

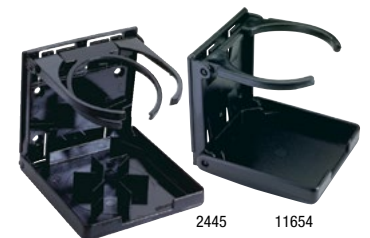

STORAGE CADDIES

Storage caddies keep your boat organized. Easy-to-mount suction cups stay secure, even in rough conditions. Caddies can be mounted in back or on the bottom and can be permanently attached with screws. Non-corrosive white plastic.

Cockpit Caddy

Great organizer for fishing gear and personal items. Has slots for fillet knife, pliers, and over 22 lures.

* **⚠ WARNING** Cancer and Reproductive Harm – www.P65Warnings.ca.gov (see page 240)

Description	Bulk Packaging	Prop 65	Aftermarket Packaging	Prop 65
Cockpit Caddy	—		11849-2	*



11849

Cruiser Caddy

Large storage space holds personal items and a beverage. Has slots for three lures and space for handled mug.

* **⚠ WARNING** Cancer and Reproductive Harm – www.P65Warnings.ca.gov (see page 240)

Description	Bulk Packaging	Prop 65	Aftermarket Packaging	Prop 65
Cruiser Caddy	—		11851-2	*



11851

Safety Orange Boater's Box

Keep your maps, electronics, and other equipment safe while on the water.

- Perfect for use on the boat, at the dock, at home, or in the field
- The lift out tray is great for organizing small items and the flip-up lid provides easy access to your stored items
- Flip latch provides a secure method to keep your belongings safe

Description	Bulk Packaging	Aftermarket Packaging
Safety Orange	—	11834-1



11834

Cooler Mounting Kit

- Cooler corners stay put with straps to prevent injury or boat and cooler damage
- Quick disconnect strap design
- Corrosion resistant
- Fastens with #8 screws



14137

Description	Bulk Packaging	Aftermarket Packaging
Cooler Mounting Kit	—	14137-7

Dry Case Personal Storage

Heavy duty case protects personal gear and electronics. Waterproof up to 80 ft. Strong locking clasp and hinges. Includes carrying lanyard.

Description	Dimensions	Bulk Packaging	Aftermarket Packaging
Dry Case—Large	7-1/4" x 4-3/4" x 1-5/8"	—	11896-1



11896

Heavy-Duty Dry Bags

Heavy-duty, 500 denier PVC fabric construction in safety yellow with black accented components. Strong over-molded carry handle and lower draw straps for maximum compression.

* **⚠ WARNING** Cancer and Reproductive Harm – www.P65Warnings.ca.gov (see page 240)

Description	Bulk Packaging	Prop 65	Aftermarket Packaging	Prop 65
Dry Bag—40 Liter	—		11894-2	*
Dry Bag—20 Liter	—		11897-2	*



11894

ELECTRICAL ACCESSORIES

Battery Boxes

Meet ABYC standard E-10 and U.S. Coast Guard Specification Number 183.420 as an OEM-installed battery hold-down system. Polypropylene construction for total acid resistance. Hold-down straps resist 350 lbs. of force, nearly four times the USCG requirement. Drop tested in temperatures ranging from -20°F to +120°F. Mounting hardware included.

* **⚠ WARNING** Cancer and Reproductive Harm – www.P65Warnings.ca.gov (see page 240)

Small Battery Box

For smaller batteries like Series 16 and those used in jet skis, power lawn, and garden equipment.

Vented black battery box (5-7/8 inch maximum battery block height, 7-7/8 inch maximum battery height with terminals).



9082



9065

Standard Battery Box

Vented and non-vented battery box for standard size, Series 24 batteries (8-3/16 inch maximum battery block height, 10-1/8 inch maximum battery height with terminals).

Note: 9069 cover is non-vented and is not for marine use.

- Four cable openings, enlarged to .55 inch-diameter
- Larger handles with rolled edges
- Instructions molded inside cover



9067

Power Guard 27 Battery Box

Vented black battery box for Series 27 batteries (8-1/2 inch maximum battery block height, 10-1/2 inch maximum battery height with terminals).

- Four cable openings, enlarged to .55 inch-diameter
- Larger handles with rolled edges
- Instructions molded inside cover



9084

Large Battery Box

Vented black battery box for larger applications (7-15/16 inch maximum battery block height, 9-3/4 inch maximum battery height with terminals).

Power Box, F27 Series

- LED battery level indicator with one-touch test button
- Heavy duty non-corrosive black plastic box
- Hold-down strap included
- 12-volt DC accessory adapter port with 10-amp fuse built-in
- External terminals

Battery Box Description	Battery Series	Dimensions with Lid Installed		Strap Length	Color/Style	Bulk Packaging	Prop 65
		Inside Dim. (L x W x H)	Outside Dim. (L x W x H)				
Small	U1	10-5/8" x 7" x 10-1/8"	11" x 7-1/2" x 8-3/4"	40"	Black, vented	9082-1	*
Standard	24/24M/24F	10-5/8" x 7" x 10-1/8"	14" x 9-5/8" x 10-5/8"	40"	Black, vented	9065-1	*
					Black, non-vented	9069-1	
Power Guard 27	27/27F/27M	13-1/16" x 6-15/16" x 10-1/2"	16-7/8" x 9-5/8" x 10-7/8"	40"	Black, vented	9067-1	*
Large	29/31	15-7/16" x 6-15/16" x 9-3/4"	18-3/4" x 9-1/4" x 10-1/4"	38"	Black, vented	9084-1	
Power Box	27F	—	—	44"	Black	9076-1	*



9076

Battery Tray with Straps

A simple-to-install battery holder that fits into limited spaces. For batteries up to 10-1/2 inches in height. Provide simple installation for changing or replacing batteries. The polypropylene hold-down strap has a positive locking, quick-disconnect buckle. Molded base mounts with four #10 panhead fasteners.

* **⚠ WARNING** Cancer and Reproductive Harm – www.P65Warnings.ca.gov (see page 240)

Description	Inside Dimensions	Battery Series	Bulk Packaging	Prop 65	Aftermarket Packaging	Prop 65
24 Series	7" L x 11" W	24/24M	—		9092-5	*
27 Series	12-3/8" L x 7-1/8" W	27/27M	—		9093-5	*
29/31 Series	12-7/8" L x 7" W	29/31	9099-1	*	9099-5	*



Heavy-Duty Battery Trays

Made of non-corrosive black plastic. Includes adjustable height crossbar and stainless steel retaining bolts. Meet ABYC Standard E-10 and U.S. Coast Guard requirements. Install with #10 fasteners.

* **⚠ WARNING** Cancer and Reproductive Harm – www.P65Warnings.ca.gov (see page 240)

Description	Inside Dimensions	Battery Series	Bulk Packaging	Prop 65	Aftermarket Packaging	Prop 65
24 Series	10-7/16" L x 6-7/8" W	24/24M	9096-1	*	9096-5	*
27 Series	12" L x 6-7/8" W	27/27M	9095-1	*	9095-5	*
29/31 Series	13-1/16" L x 6-7/8" W	29/31	9094-1	*	9094-5	*



Heavy-Duty Adjustable Battery Trays

Made of heavy-duty, non-corrosive, black plastic, this tray extends up to 9.5-inches, making it ideal for taller batteries. Includes adjustable-height crossbar and (2) retaining bolts. Contains no metal parts to corrode and no webbing straps to fade. Ergonomic nuts and bolts easily secure batteries. Meet ABYC Standard E-10 and USCG requirements.

- Rust-proof tray adjusts from 7 – 9.5-inches for taller batteries
- Meets ABYC Standard E-10 and US Coast Guard requirements
- Made in the USA

* **⚠ WARNING** Cancer and Reproductive Harm – www.P65Warnings.ca.gov (see page 240)

Description	Inside Dimensions	Battery Series	Bulk Packaging	Prop 65	Aftermarket Packaging	Prop 65
24 Series Battery Tray	10-5/8" x 6-3/4"	24/24M/24F	9097-1	*	9097-5	*
27 Series Battery Tray	12-1/8" x 6-3/4"	27/27M/27F	9098-1	*	9098-5	*



Adjustable Battery Trays*

Heavy-duty, non-corrosive black plastic. Includes adjustable-height crossbar and two retaining bolts. Meets ABYC Standard E-10 and U.S. Coast Guard requirements. Patented design. Install with #10 fasteners.

* **⚠ WARNING** Cancer and Reproductive Harm – www.P65Warnings.ca.gov (see page 240)

Description	Inside Dimensions	Battery Series	Bulk Packaging	Prop 65	Aftermarket Packaging	Prop 65
24 Series Battery Tray	10-5/8" x 7-1/4" x 8-1/2"	24/24M	9090-1	*	9090-5	*
27 Series Battery Tray	12-5/8" x 7-1/4" x 8-1/2"	27/27M	9091-1	*	9091-5	*



Battery Box Hold-Down Straps and Hardware

Straps are woven polypropylene with firm-grip buckles and are completely resistant to battery acid. Kit includes (4) #8, 3/4-inch screws and two footman clamps.

* **⚠ WARNING** Cancer and Reproductive Harm – www.P65Warnings.ca.gov (see page 240)

Description	Fits Battery Box(es)	Bulk Packaging	Prop 65	Aftermarket Packaging	Prop 65
Medium strap kit, 40"	9065, 9065A, 9067, 9082, 9069	9013-1	*	9013-3	*
Medium strap only, 40"	9065, 9065A, 9067, 9082, 9069	9014-1		9014-3	
Long strap kit, 54"	9084	—		9013A3	*
Long strap only, 54"	9084	9014A1		9014A3	
Mounting hardware only	—	9006-1	*	—	



Battery Maintenance Charger

Fully-automatic on-board charger provides a 1.5-amp maintenance charge. Designed to maintain 12-volt batteries. Water-resistant with safety features, such as short circuit connection and reverse polarity protection. LED status indicators.

* **⚠ WARNING** Cancer and Reproductive Harm – www.P65Warnings.ca.gov (see page 240)

Description	Specifications	Bulk Packaging	Prop 65	Aftermarket Packaging	Prop 65
On-Board Battery Charger	1.5-amp, 12-volts, 1 bank operation	—		11900-4	*



Battery Charger

Dual rated 12- and 6-volt battery charger can be used for all of your marine, automotive, RV, and sport applications. The charger is compact and perfect for your bench, garage, or shop use. LED indicators let you know that your battery is fully charged. Overcharge, short circuit, and reverse polarity protection provide years of worry-free use.

* **⚠ WARNING** Cancer and Reproductive Harm – www.P65Warnings.ca.gov (see page 240)

Description	Bulk Packaging	Prop 65	Aftermarket Packaging	Prop 65
12 / 6-volt, 6-amp / 2-amp Battery Charger	—		11901-4	*



Polarized/Wing Nut Battery Terminals

Lead terminals with wing nuts and cadmium-plated bolts. Clamps are stamped with negative (-) or positive (+) sign.

* **⚠ WARNING** Cancer and Reproductive Harm – www.P65Warnings.ca.gov (see page 240)

Description	Bulk Packaging	Prop 65	Aftermarket Packaging	Prop 65
Negative and positive, set	—	*	14215-6	*



Battery Clips

Quick-connect battery clips for 12-volt electrical accessories. 10-amp rated, copper-plated construction with red and black handle grips. For use with wire up to 10-gauge.

* **⚠ WARNING** Cancer and Reproductive Harm – www.P65Warnings.ca.gov (see page 240)

Description	Bulk Packaging	Prop 65	Aftermarket Packaging	Prop 65
Battery Clip Set, 10-amp	—		14258-6	*
Battery Clip, Individual, Black	14258B1	*	—	
Battery Clip, Individual, Red	14258R1	*	—	



4-Way Battery Selector Switch

Single-pole, triple-throw switch permits four connection modes: battery one, battery two, two batteries in parallel, or both off. Rated for 300-amps continuous at 6-volt DC and 150-amps continuous at 12-volt DC. For 6-volt to 32-volt D.C. systems. Includes alternator field circuit disconnect to prevent surges. Selector has positive click positions. Bakelite housing with copper washers, brass terminals, and brass nuts. Install with #10 screws.

Description	Bulk Packaging	Aftermarket Packaging
5-1/2" dia. x 2-3/4" deep	—	14230-3



Battery Switch

Compact and heavy-duty battery switch with removable control knob to deter theft. 12-50-volts DC / 200-amps continuous / 300-amps intermittent / on-off-separate. For use with one battery.

- Ergonomic grips
- Removable walls for easy installation and access

Description	Bulk Packaging	Aftermarket Packaging
Battery Switch 12- to 50-volt DC, on/off	—	14233-7



Dual Battery Selector Switch

Compact and heavy-duty battery switch with removable control knob to deter theft. 12-volts DC - Off / 1 / 1+2 / 2 12-volts DC / 220-amps continuous / 400-amps 5 min intermittent / off. For use with up to two batteries.

- Ergonomic grips
- Removable walls for easy installation and access

Description	Bulk Packaging	Aftermarket Packaging
Battery Switch 12-volt DC, off/1/1+2/2	—	14234-7



ATO/ATC Fuse Holder

Watertight, extra heavy-duty, and weatherproof. For use with fuses up to 30-amps. 12-gauge wire leads for easy hook-ups. Fuse not included.

* **WARNING** Cancer and Reproductive Harm – www.P65Warnings.ca.gov (see page 240)

Description	Wire Size	Bulk Packaging	Prop 65	Aftermarket Packaging	Prop 65
ATO/ATC Fuse holder, 30-amp	12-gauge	—	65	14348-6	*

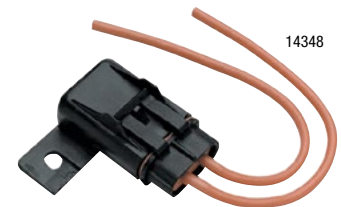

Toggle Switches, Plastic Handle

Black, thermoplastic body with nylon mounting stem. Neoprene toggle seal. These toggle switches have silver contacts and 1/4-inch spade terminals. Rated for 5-amp load and 15-amp inductive load. For 12-volts DC only. Not external ignition protected. Includes a nickel-plated brass backup hex nut and thermoplastic, knurled face nut.

* **⚠ WARNING** Cancer and Reproductive Harm – www.P65Warnings.ca.gov (see page 240)

On/Off/On Switches: For bilge pump, speed selector, or light that requires two power settings.

Single-pole, double-throw contacts.

Installation Hole Size	Overall Dimensions	Depth Behind Panel	*Max. Panel Thickness
1/2"-dia.	1-3/8" L x 3/4" W"	1-1/2"	1/4"

*Dimension using backup nut; 3/16-inch without backup nut.

Description	Bulk Packaging	Prop 65	Aftermarket Packaging	Prop 65
On/off/on switch	—		14386-3	*

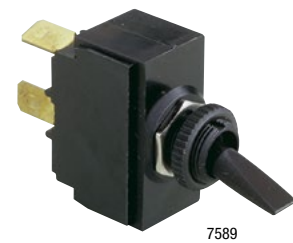

7589

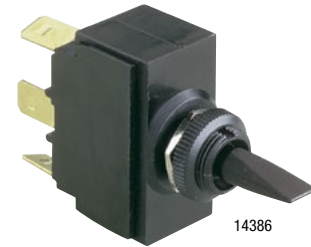

14386

Toggle Switches, Metal Handle

These metal toggle switches have 1/4-inch spade terminals. Rated for 10-amps, 12-volts DC only. Plastic body and housing with metal toggle and ring. Not external ignition protected.

* **⚠ WARNING** Cancer and Reproductive Harm – www.P65Warnings.ca.gov (see page 240)

On/Off Switches: Single-pole, single-throw contact. For lights, bilge pumps, or blowers.

On/Off/On Switches: For bilge pump, speed selector, or light that requires two power settings.

Single-pole, double-throw contacts.

Installation Hole Size	Overall Dimensions	Depth Behind Panel	Max. Panel Thickness
3/8"-dia.	1-1/8" L x 5/8" W"	1-3/8"	1/4"

Description	Bulk Packaging	Prop 65	Aftermarket Packaging	Prop 65
On/off switch	—		14253-3	*
On/off/on switch	—		14255-3	*

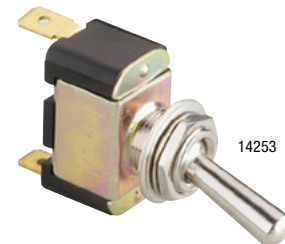

14253

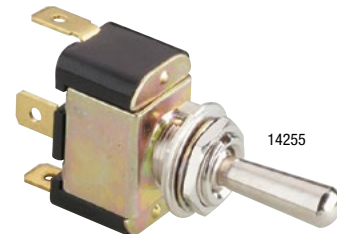

14255

Push/Pull Switches

These switches have large easy-to-pull handles. They are commonly used for operating lights. 3/4 inch-diameter chrome-plated knob with brass case. Includes screw terminals for connection without a wire lug. For 12-volts DC only. Not external ignition protected.

* **⚠ WARNING** Cancer and Reproductive Harm – www.P65Warnings.ca.gov (see page 240)

Two-position Switch, Off/On: For operating one set of lights or another accessory.

Three-position Switch, Off/On/On: For operating running lights and anchor lights separately.

Description	Installation Hole Size	Overall Dimensions	Depth Behind Panel	Max. Panel Thickness	Bulk Packaging	Prop 65	Aftermarket Packaging	Prop 65
Two-position	3/8"-dia.	3-1/8" L x 1-1/4" W	1-1/2"	1"	7563-1	*	7563-6	*
Three-position	3/8"-dia.	3-1/4" L x 1-1/2" W	2"	1"	7594-1	*	7594-3	*



7563

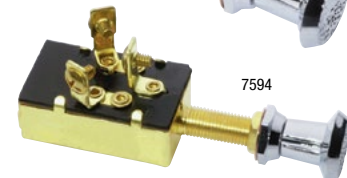

7594

Heavy-Duty Trolling Motor Connectors

Use these connectors for quick, convenient connections between an electric trolling motor and a power source. 6 inch-long wire harnesses with butt connectors.

* **⚠ WARNING** Cancer and Reproductive Harm –

www.P65Warnings.ca.gov (see page 240)

Female Receptacle

Female receptacle has weather cover and small face plate for flat surface mount. Two holes for #8 fasteners.

Male Plug

Male plug has wing-tabs for easy installation and removal.

Plate Dimensions	Depth Behind Panel	Installation Hole Size
2-9/16" W x 1-3/4" H	2-1/4"	1-1/8"-dia.



Description	Wire Size	Volts	Bulk Packaging	Prop 65	Aftermarket Packaging	Prop 65
Female receptacle, boat side	3-Wire	10-gauge	12/24V	—	7648-7	*
	2-Wire	8-gauge	12V	—	14366-6	
Male plug, motor side	3-Wire	10-gauge	12/24V	—	7647-7	*
	2-Wire	8-gauge	12V	—	14365-6	
Male/Female Kit	3-Wire	10-gauge	12/24V	—	7622-7	*

Medium-Duty Trolling Motor Connectors

Use these molded rubber connectors for quick easy connections between an electric trolling motor and the power source. 5-inch long harness with butt connectors. Receptacle (14350) includes weather cover and small face plate for flat surface mount. 10-gauge wire. For 12-volts DC only. Two holes for #8 fasteners.

Plate Dimensions	Depth Behind Panel	Installation Hole Size
2-1/2" W x 1-3/4" H	2-3/4"	1-1/8"-dia.

Description	Wire Size	Bulk Packaging	Aftermarket Packaging
Female receptacle, boat side	10-gauge	—	14350-3
Male plug, motor side	10-gauge	—	14352-3



Trolling Motor Quick Connect

Safe and easy quick disconnect system. For use where a plug and socket cannot be used. Heavy-duty, 10-gauge connector, 22-inches long. Replaces battery clips.

Description	Wire Size	Bulk Packaging	Aftermarket Packaging
2-Connector Kit	10-gauge	—	14367-6



12-Volt USB Adapters/Chargers new

It's easy to add the convenience of using and charging electronic devices on any boat. Compatible with mobile devices and marine equipment. For ¼ inch USB blade connections. Protected against reverse polarity, thermal overload, and short circuiting.

* **⚠ WARNING** Cancer and Reproductive Harm – www.P65Warnings.ca.gov (see page 240)

Description	Bulk Packaging	Prop 65	Aftermarket Packaging	Prop 65
12V Adapter + Dual USB Charger	14262-1	*	14262-6	*
12V Power Adapter + Digital Voltmeter	14263-1	*	14263-6	*
12V 4-in-1 Power Panel with Battery Charge Display	14264-1	*	14264-6	*
Dual USB Adapter	14268-1	*	14268-6	*



Boat Kill Switch Key Set

- Includes seven keys to fit Johnson, Evinrude, Mercury, Yamaha, Suzuki, Tohatsu and Honda kill switches
- Swivel snap hook prevents tangles
- Rust resistant stainless steel crimps
- Corrosion proof

Description	Bulk Packaging	Aftermarket Packaging
Kill switch keys and lanyard	—	7591-6



12-Volt Marine Outlet

Marine quality 12-volt outlet is designed for replacing or adding outlets in your boat, RV or camper.

* **⚠ WARNING** Cancer and Reproductive Harm – www.P65Warnings.ca.gov (see page 240)

Description	Bulk Packaging	Prop 65	Aftermarket Packaging	Prop 65
Surface Mount, 12-Volt, Outlet	—		11862-6	*



Battery Adapter

Brass and plastic accessory plug for use directly with the battery. 150 watts. Comes with 3 ft. of wire, 12-amps, 12-volts.

* **⚠ WARNING** Cancer and Reproductive Harm – www.P65Warnings.ca.gov (see page 240)

Description	Bulk Packaging	Prop 65	Aftermarket Packaging	Prop 65
Battery Adapter, 12 volt	—		11861-6	*



Circuit Breakers

A circuit breaker is an automatically operated electrical switch designed to protect an electrical circuit such as your trolling motor, or anything else electrical in your boat, from damage caused by overload or a short circuit.

* **⚠ WARNING** Cancer and Reproductive Harm – www.P65Warnings.ca.gov (see page 240)

Description	Bulk Packaging	Prop 65	Aftermarket Packaging	Prop 65
60-amp Breaker	Manual Reset with Ring Terminals	—	14372-7	
50-amp Breaker	Manual Reset	—	7623-7	*
	Auto Reset with Ring Terminals	—	14371-6	*
40-amp Breaker	Auto Reset with Ring Terminals	—	14370-6	*

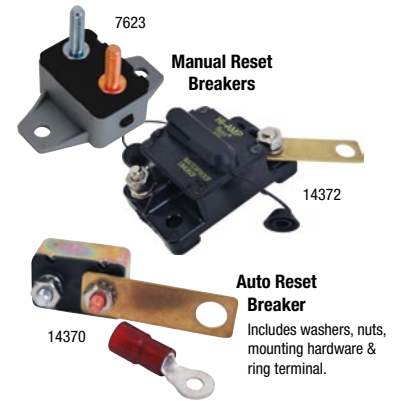

Copper Wire

Stranded copper core is flexible for easy installation and allows the most current for quick starting. PVC insulation in the wire is resistant to cracking, abrasion, weather, oil, and acids.

* **⚠ WARNING** Cancer and Reproductive Harm – www.P65Warnings.ca.gov (see page 240)

Description	Bulk Packaging	Prop 65	Aftermarket Packaging	Prop 65
8-ga. Red/Black, 20', set	—		14361-5	*



Transducer Mounting Plate

- Mounts easily with only two screws
- Easy to adjust, add, or replace transducers.
- Marine-grade polymer plate will not warp, corrode, or be affected by UV rays.

Description	Bulk Packaging	Aftermarket Packaging
Transducer mounting plate and hardware	—	94110-5



Quick-Release Trolling Motor Mate Mounting Plate

For use with MinnKota® wireless trolling motors: AutoPilot, Grip Glide, Powerdrive, Terrova, RipTide ST and RipTide SP models

- Unique design eliminates tarp damage
- Easy on / easy off mounting – removes in seconds
- Exclusive locking feature
- Marine grade powder coat finish

Description	Bulk Packaging	Aftermarket Packaging
Motor mate mounting plate and hardware	—	94100-4



PADDLESPORTS ACCESSORIES

Canoe Paddles

Aluminum Paddles

Heavy aluminum and rugged plastic construction. Ergonomic grip design. Poly-protective shaft grip.

* **⚠ WARNING** Cancer and Reproductive Harm – www.P65Warnings.ca.gov (see page 240)

Wooden Paddles

Economical and lightweight. Palm grip. Varnish finish.

Description	Bulk Packaging	Prop 65	Aftermarket Packaging	Prop 65
ALUMINUM PADDLES				
4 ft. Length	11764-1	*	—	
4 ft. Length (Camouflage Green Blade)	11759-1	*	—	
5 ft. Length	11765-1	*	—	
WOODEN PADDLES				
2-1/2 ft. Length	11760-1		—	
4 ft. Length	11761-1		—	
5 ft. Length	11762-1	*	—	



11759

11764 / 11765

11760 / 11761 / 11762

Stand-Up Paddle Board (SUP) Paddle

Paddle easily adjusts from 55-inches to 82-inches allowing families to share a SUP board. Constructed of heavy-gauge aluminum and engineered plastic components. Durable aluminum shaft with cupped 10° blade for increased efficiency and performance. Glass-filled ABS blade construction for long-term durability.

* **⚠ WARNING** Cancer and Reproductive Harm – www.P65Warnings.ca.gov (see page 240)

- Blade color – white
- Black, polypropylene grip
- Designed and engineered in the USA

Description	Bulk Packaging	Prop 65	Aftermarket Packaging	Prop 65
SUP Paddle	—		11772-1	*



11772

Kayak Paddles

* **⚠ WARNING** Cancer and Reproductive Harm – www.P65Warnings.ca.gov (see page 240)

Straight-Blade Paddles

Heavy aluminum and rugged plastic construction. Two-piece breakdown design is ideal for storage and compact transport. Drip rings included. Soft foam grips.

Asymmetrical Paddles

Asymmetrical spoon blade paddles are designed to increase efficiency of stroke performance and reduce noise and blade flutter in the water. Made from heavy-duty aluminum and engineered plastic construction. Two-piece breakdown design with multiple angle positions that allow for customization for each paddler.

Description	Bulk Packaging	Prop 65	Aftermarket Packaging	Prop 65
STRAIGHT KAYAK PADDLES				
7 ft. Length	11763-1	*	—	
ASYMMETRICAL KAYAK PADDLES				
7 ft. Length	11768-2	*	—	
7-1/2 ft. Length	11766-1	*	—	



Vibrant Asymmetrical Paddles

Unique blade shape increases stroke efficiency and minimizes flutter in the water. The combination of performance and vibrant colors create an expressive kayaking experience. Paddle angles can be adjusted when attached together for a more customized stroke based on skill level for both left and right-hand users.

* **⚠ WARNING** Cancer and Reproductive Harm – www.P65Warnings.ca.gov (see page 240)

- Graphics and vibrant color on each blade
- Tested for performance and durability
- Stay dry with pre-attached drip rings

Description	Color	Bulk Packaging	Prop 65	Aftermarket Packaging	Prop 65
7 ft. Length	Orange-Red & White-Gray	—		11756-2	*
7-1/2 ft. Length	White-Koi Blue & Key Lime	—		11757-2	*
Adjustable, 7 ft. – 7-1/2 ft.	Black	—		11758-2	*



Telescoping Paddle

- Compact for easy storage
- Telescopes to 42" (1.06m)
- High impact plastic blade with corrosion-resistant aluminum pole

* **⚠ WARNING** Cancer and Reproductive Harm – www.P65Warnings.ca.gov (see page 240)



11826-1
11828-1

Description	Bulk Packaging	Prop 65	Aftermarket Packaging	Prop 65
Paddle, telescoping - 3.5'	—		11828-1	
Paddle, telescoping - 4.5'	—		11826-1	*

Paddle Clips

Secures paddles for freeing up both hands or resting from paddling. Fits 1-inch diameter shafts.

Description	Bulk Packaging	Aftermarket Packaging
Paddle Clips, 1" diameter	—	11780-6



11780

Kayak Handle Replacement Set

Tough but comfortable, designed kayak carry handles for replacement on most kayak types and brands. The contoured grip makes carrying your kayak easier and more comfortable. Easy installation. Durable, black plastic and strong, braided rope.

Description	Bulk Packaging	Aftermarket Packaging
Kayak Handle Replacement Set, package of two	—	11944-7



11944

Oarlock Shanks

Made from heavy-gauge steel with a bright zinc finish. Adjustable and very easy to install; no holes to drill, clamp-on easily. One pair.

Description	Bulk Packaging	Aftermarket Packaging
1/2" Shank, Pair	—	9146-6



9146

Oarlock Sockets

These heavy-duty sockets are made of heavy gauge steel designed to provide years of rugged use. The unique angle design allows for secure attachment to the boat that can outlast most original equipment sockets. One pair.

Description	Bulk Packaging	Aftermarket Packaging
1/2" Socket, Pair	—	9149-6



9149

Paddle Lanyards

Use the Standard Lanyard's sturdy clip or the Premium's velcro strap to secure your paddle and prevent dropping it overboard. Coiled bungee cord allows for advanced paddling with easy stowage.

* **⚠ WARNING** Cancer and Reproductive Harm – www.P65Warnings.ca.gov (see page 240)

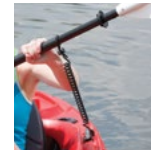

Description	Bulk Packaging	Prop 65	Aftermarket Packaging	Prop 65
Standard	—		11909-7	*
Gear Accessory Leash, 36"	—		11912-5	*



Rescue Line Throw Bag

50 ft. of 3/8-inch floating polypropylene line for water rescues. High visibility red bag with wide, yellow reflective strip for improved visibility in low light conditions.

* **⚠ WARNING** Cancer and Reproductive Harm – www.P65Warnings.ca.gov (see page 240)

Description	Bulk Packaging	Prop 65	Aftermarket Packaging	Prop 65
Rescue Line Throw Bag, 50 ft.	—		11808-2	*



Hand-Operated Bilge Pumps

Safely remove unwanted water, and other liquids from kayaks and other small boats.

* **⚠ WARNING** Cancer and Reproductive Harm – www.P65Warnings.ca.gov (see page 240)

Description	Bulk Packaging	Prop 65	Aftermarket Packaging	Prop 65
Kayak Hand Bilge Pump, 18"	—		11595-2	*
Hand Bilge Pump, 25", 32" Hose	—		11596-2	*



Kayak Foot Braces

Lightweight design fits both sit-in and sit-on-top style kayaks. Trigger lock design allow for easy adjustment. Tracks use a universal mounting hole pattern. One pair. Mounting hardware not included.

* **⚠ WARNING** Cancer and Reproductive Harm – www.P65Warnings.ca.gov (see page 240)

Description	Bulk Packaging	Prop 65	Aftermarket Packaging	Prop 65
15" Length, pair	11940-1		11940-2	*



Kayak Skirt

Keep water out of the kayak with this universal-fit spray skirt made with polyurethane-coated 210 Denier nylon. Dual-side adjustability and PVC-sealed seams. Mesh bag included.

Description	Bulk Packaging	Aftermarket Packaging
Kayak Skirt, Universal (up to 40" long and 22" wide opening)	—	11776-5



11776

Kayak Cockpit Cover

Universal-fit cover made with 210 Denier nylon. Has a 3/16-inch shock cord border and black, polypropylene clips.

Description	Bulk Packaging	Aftermarket Packaging
Kayak Cockpit Cover, Universal (up to 40" long and 22" wide opening)	—	11775-5



11775

Sit-On-Top Kayak Seat

Attwood's adjustable kayak seat provides a padded seat cushion and ample back support. Universal sizing for all sit-on-top kayaks. Four adjustable straps for a custom fit. Quick-drying, UV-resistant fabric with corrosion-resistant hardware. Durable nylon covering with additional storage bag on back of seat.

Description	Bulk Packaging	Aftermarket Packaging
Foldable, clip-on kayak seat - Black	—	11778-2



11778

Deck Plates

Allow addition of storage options to your canoe, kayak, or small boat. Screw out design. High-impact ABS plastic is durable, rugged, and weather-resistant.

* **WARNING** Cancer and Reproductive Harm – www.P65Warnings.ca.gov (see page 240)

Description	Color	Fastener Quantity	Bulk Packaging	Prop 65	Aftermarket Packaging	Prop 65
4"-dia.	White	#8 fasteners (6)	12790-1	*	12790-3	*
	Black	#8 fasteners (6)	12791-1	*	—	—
6"-dia.	White	#8 fasteners (6)	12792-1	*	—	—
	Black	#8 fasteners (6)	12793-1	*	—	—
8"-dia.	White	#8 fasteners (6)	12794-1	—	—	—



12793

12794



30° Rod Holder

Ideal for kayak use. Closed end keeps water out. ABS plastic construction. Flush mounts easy with three ¼-inch screws (not included).

Description	Bulk Packaging	Aftermarket Packaging
30° Rod Holder, closed end	—	12704-2



12704

PADDLESPORTS HARDWARE

Pad Eyes

All pad eyes are pre-drilled with two mounting holes.

* **⚠ WARNING** Cancer and Reproductive Harm – www.P65Warnings.ca.gov (see page 240)

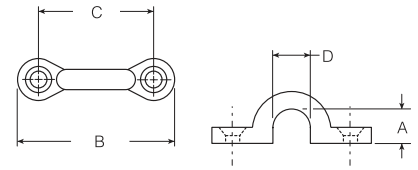

Description	A	B	C	D	Fastener Quantity	Bulk Packaging	Prop 65	Aftermarket Packaging	Prop 65
Cast Stainless Steel	3/8"-diameter	1-7/8" long	1-3/8"	1/2"	#10 fasteners (2)	66105-1		66105-3, four	
Stamped Stainless Steel	5/16"-diameter	1-1/8" long	3/4"	5/16"	#6 fasteners (2)	—		12955L3, pair	*
Chromed bronze	5/16"-diameter	1-7/8" long	1-3/8"	1/2"	#10 fasteners (2)	12988-1	*	—	
White Nylon	5/16"-diameter	1-7/8" long	1-7/16"	5/16"	#10 fasteners (2)	—		10603-3	*
Black Nylon	5/16"-diameter	1-7/8" long	1-7/16"	5/16"	#10 fasteners (2)	—		10604-3	



Nylon Cleats

Ideal for tying off an anchor or for temporary docking. Includes (2) strong 4-inch lightweight cleats. Pre-drilled for #12 screws.

Description	Bulk Packaging	Aftermarket Packaging
Nylon Cleats, set	—	11783-7



Zig-Zag Cleats

Makes a great primary cleat on kayaks, canoes, fishing boats and pontoons. Also good as a utility cleat on docks, piers, trailers, and more. 4-inch model handles rope up to 1/2-inch diameter. 3-inch and 3-1/2 inch models handle rope up to 3/8-inch diameter. One pair.

* **⚠ WARNING** Cancer and Reproductive Harm – www.P65Warnings.ca.gov (see page 240)

Description	Bulk Packaging	Prop 65	Aftermarket Packaging	Prop 65
Zinc Plated, Pair	—		11950-6	*
			11951-6	*
Black Nylon, Pair	—		11926-7	*



Zig-Zag Fender Hanger

No need for knots in your fender lines. Keeps fenders in place with a simple system. Put line over rail and weave it through the zig-zag teeth.

Description	Bulk Packaging	Aftermarket Packaging
Fender Hanger, pair w/ 4' fender lLines	—	11952-7



PADDLESPORTS TRANSPORTATION & STORAGE

Canoe Car-Top Carrier Kit

Simple, convenient kits for carrying canoes and small boats on car roof. Includes four supporting foam blocks that snap on boat's gunwale and help prevent scratches on car top. Two straps with adjusting buckles and clips. Includes 20 ft. of polypropylene rope and S-hooks to secure bow and stern to bumpers. Straps are sturdy poly web with vinyl-coated clips.

* **WARNING** Cancer and Reproductive Harm – www.P65Warnings.ca.gov (see page 240)

Description	Bulk Packaging	Prop 65	Aftermarket Packaging	Prop 65
Car-Top Universal Canoe Carrier Kit	—		11437-7	*



11437

Kayak Car-Top Carrier Kit

Simple, convenient kits for carrying kayaks on car roof. Includes two supporting foam blocks to support kayak and help prevent scratches on car top. Two straps with adjusting buckles and clips. Straps are sturdy poly web with vinyl-coated clips.

* **WARNING** Cancer and Reproductive Harm – www.P65Warnings.ca.gov (see page 240)

Description	Bulk Packaging	Prop 65	Aftermarket Packaging	Prop 65
Car-Top Kayak Carrier Kit	—		11438-7	*



11438

Kayak Roof Rack – J Style

Easy to install kayak carrier mounts securely and safely to most standard and aftermarket roof rack cross bars. J-style design allows for easy loading and unloading of kayaks. Durable powder-coated steel construction holds up to 120 lbs. Foam rubber protection pads and detailed instructions included.

Description	Bulk Packaging	Aftermarket Packaging
Kayak Roof Rack Carrier Kit	—	11441-4



11441

Kayak/Canoe Cart

Haul your kayak easier than ever with Attwood's new Kayak/Canoe Cart, now with premium wheels! Enhanced large diameter wheels cannot deflate, simplifying transport over uneven terrain. Cart easily disassembles to fit into most kayak hitches. Holds up to 100 lb. loads.



Description	Bulk Packaging**	Aftermarket Packaging
Kayak & Canoe Cart	—	11930-4



11930

Kayak Hoist System

Complete hoist system for kayaks, canoes, bikes, ladders, and more. Hooks and locking mechanisms safely hold up to 120 lbs. Easy lifting pulley system and 2-inch wide webbing hang straps. Includes all mounting hardware.

Description	Bulk Packaging	Aftermarket Packaging
Kayak Hoist System	—	11953-4



11953

TRAILERING PARTS & ACCESSORIES

Trailer Guide Lights

Trailer guide lights aid in backing and maneuvering trailers at boat ramps and in tight areas. Waterproof, bright red, LED lights make it easy to identify trailer angle and position, even in low light conditions. Mount to trailer frame or guidepost with corrosion-resistant aluminum and steel mounting. Mounting hardware not included.

Description	Bulk Packaging	Aftermarket Packaging
Trailer Guide Light Assembly	27" L x 1/4" dia.	14066-7



14066

Submersible Trailer Light Kit

Complete kit includes a pair of 8-function stop/tail/turn lights, wiring harness, and license plate bracket. Applicable to trailers under 80-inches wide. Ideal for utility, snowmobile, camping, motorcycle, and boat trailers. Design conforms to applicable US FMVSS and Canadian CMVSS safety standards.

* **⚠ WARNING** Cancer and Reproductive Harm – www.P65Warnings.ca.gov (see page 240)

Description	Bulk Packaging	Prop 65	Aftermarket Packaging	Prop 65
Submersible Kit	—		14060-7	*



14060

Low-Profile Submersible Trailer Light Kit

Low profile for trailers over 80-inches wide. The complete kit includes (2) multi-function lamps, wiring harness, license plate bracket, and mounting hardware. Ideal replacement lights for most boat trailers. Conforms to applicable U.S. FMVSS and Canadian CMVSS safety standards.

* **⚠ WARNING** Cancer and Reproductive Harm – www.P65Warnings.ca.gov (see page 240)

Description	Bulk Packaging	Prop 65	Aftermarket Packaging	Prop 65
Low-Profile Submersible Trailer Light Kit	—		14063-7	*



14063

Submersible LED Trailer Light Kit

Complete kit includes (2) multi-functional (stop/tail/turn) submersible LED trailer lights, license plate bracket, wiring harness, and installation hardware. For use with trailers under 80-inches wide. Conforms to applicable U.S. FMVSS and Canadian CFMVSS standards.

* **⚠ WARNING** Cancer and Reproductive Harm – www.P65Warnings.ca.gov (see page 240)

Description	Bulk Packaging	Prop 65	Aftermarket Packaging	Prop 65
Submersible LED Light Kit	—		14065-7	*



14065

LED Low-Profile Trailer Light Kit

Complete kit includes (2) multi-functional (stop/tail/turn) submersible low-profile LED trailer lights, license plate bracket, wiring harness, and installation hardware. Ideal replacement or upgrade for most trailers. Conforms to applicable U.S. FMVSS and Canadian CFMVSS standards.

* **⚠ WARNING** Cancer and Reproductive Harm – www.P65Warnings.ca.gov (see page 240)

Description	Bulk Packaging	Prop 65	Aftermarket Packaging	Prop 65
Low-profile LED Light Kit	—		14064-7	*



14064



Trailer Wiring Harness/Connectors

The most popular 4-way flat wiring harness kit for vehicles and trailers. Copper-stranded, color-coded wire and plastic molded terminals with four-prong trailer plug or vehicle socket. Both ends have 18-inch plug wire and 48-inch socket wire.

* **⚠ WARNING** Cancer and Reproductive Harm – www.P65Warnings.ca.gov (see page 240)

Description	Bulk Packaging	Prop 65	Aftermarket Packaging	Prop 65
18" plug and 48" socket	—		7663-5	*



14017

Complete Trailer Wiring Kit

Kit Includes: (1) Receptacle and harness, 4 ft. (1.2 m), (1) plug and harness, 25 ft. (7.6 m), (4) blue quick connectors and (8) trailer wire attachment clips.

* **⚠ WARNING** Cancer and Reproductive Harm – www.P65Warnings.ca.gov (see page 240)

Description	Bulk Packaging	Prop 65	Aftermarket Packaging	Prop 65
Complete Wiring Kit	—		7621-7	*



7621

Trailer Light Circuit Testers

The light indicators on this inline circuit tester show which circuit (tail lights, ground, left-or-right signal) is having problems.

Description	Bulk Packaging	Aftermarket Packaging
Circuit Tester, Inline	—	14133-6



14133

Trailer Safety Chain

Connects the trailer tongue to the trailer hitch on the towing vehicle for security and safety. Meets SAE specifications. Welded, solid steel with bright zinc-plated finish and hooks at both ends. Two chains required per trailer.

Description	Specifications	Bulk Packaging	Aftermarket Packaging
Class II Safety Chain with Spring Clips	51" L x 1/4" dia.	—	11011-7

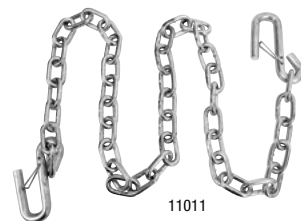

11011

Coupler Locking Pin

Quick connect and disconnect, to keep coupler from accidentally disengaging. Fits 2-inch and 3-inch couplers. Pin fits through coupler release handle to provide security and safety.

* **⚠ WARNING** Cancer and Reproductive Harm – www.P65Warnings.ca.gov (see page 240)

Description	Bulk Packaging	Prop 65	Aftermarket Packaging	Prop 65
Solid zinc-plated steel, 2-1/4" W x 1-5/8" L	—		11029-6	*

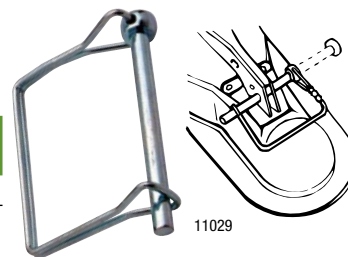

11029

Coupler Security Lock

For maintenance-free trailer security. While this lock is in place, coupler cannot be used. Solid brass with rust-proof stainless steel shackle pin. Includes two keys.

* **⚠ WARNING** Cancer and Reproductive Harm – www.P65Warnings.ca.gov (see page 240)

Description	Dimensions		Bulk Packaging	Prop 65	Aftermarket Packaging	Prop 65
	Shank Length	Diameter				
Coupler Security Lock	5/8"	1/4"	—		12044-6	*



12044

Trailer Tongue Lift Handle

- Convenient handle for maneuvering trailer tongue
- Mounts easily to most trailer couplers

Description	Bulk Packaging	Aftermarket Packaging
Lift Handle	—	11130-7



Non-Skid Pads

Precision 6-inch x 12-inch die-cut pads are simple to install on trailers, boats, and docking for additional safety. Rugged anti-slip surface is 100-grade coarse grit. A proven adhesive ensures long-lasting performance.

Description	Bulk Packaging	Aftermarket Packaging
Non-Skid Pads, pair	—	6260-4



Pontoon Storage Blocks

Great for fall and winter pontoon storage. Stable design keeps pontoon hull dry and off the ground. High-density, engineered composite protects pontoon surface. Conveniently stack together when not in use. Each block holds 4,000 lb. capacity. Lightweight and easy to use. Will not absorb moisture.

* **⚠ WARNING** Cancer and Reproductive Harm – www.P65Warnings.ca.gov (see page 240)

Description	Bulk Packaging	Prop 65	Aftermarket Packaging	Prop 65
Pontoon Storage Blocks Set of 4	—		11401-4	*



Fold-Up Trailer Jacks

Fits 3-inch x 5-inch tongue. Swings up and out of the way. Corrosion-resistant, zinc-plated steel tubing. Swing-up jack has a convenient sidewind handle and a tough 6-inch diameter polypropylene wheel.

* **⚠ WARNING** Cancer and Reproductive Harm – www.P65Warnings.ca.gov (see page 240)

Description	Travel Lift	Lift	Bulk Packaging	Prop 65	Aftermarket Packaging	Prop 65
1000 lbs. capacity, single wheel	10"	24"	—		11127-4	*
1500 lbs. capacity, dual wheel	12"	26"			11126-4	*



Trailer Winches

Many factors affect the capacity of a winch in pulling a boat. As a rule of thumb, winches may be used to trailer boats up to two times the winch capacity. For example, a 1200-lb. capacity winch may be used to load boats up to 2,400-lbs.

* **⚠ WARNING** Cancer and Reproductive Harm – www.P65Warnings.ca.gov (see page 240)

Caution: Attwood winches are not intended for use as hoists; for lifting, supporting, or transporting people; nor for lifting loads over people.



Dual Drive Winch—2,000 pound

Dual drive enhances the pulling capacity by distributing the load equally to two sets of gears. Eliminates frame torque. 2,000-lb. load capacity with 4.1:1 gear ratio. Three-position pawl provides forward, neutral, and reverse operations. Black EDC finish. Molded, textured roller grip. Includes 2-inch x 20 ft. nylon web strap with zinc-plated snap hook.

Single Drive Winch—1,200 pound

Solid gear construction with precise gear tooth engagement. 1,200-lb. load capacity with 4.1:1 gear ratio. Three position pawl provides forward, neutral, and reverse operations. Black EDC finish. Molded, textured roller grip. Includes 20 ft. nylon web strap with zinc-plated snap hook.

Description	Type	Gear Ratio	Bulk Packaging	Prop 65	Aftermarket Packaging	Prop 65
2000 lb. with 2" W x 20' L nylon strap	Dual	4.1:1	—		11195-4	*
1200 lb. with 2" W x 20' L nylon strap	Single	4.1:1			11149-4	*

See tie downs on Pages 157-159 for replacement winch straps, cable and rope.



Trailer Winch Straps

Winch straps, cables, and ropes are available to fit most winches, loads, and applications. A complete selection of winch products to meet every customer need and a variety of price points.

Selecting a winch strap, rope, or cable: NMMA, SAE, and BIA Standards require the minimum breaking strength of winch cable, rope, strap, and hook be at least 1.5 times the rated straightline pull of the winch. For example, if a winch rope has a breaking strength of 1,500 lbs., it can only be used on winches rated up to 1,000 lbs. All Attwood winch cables, ropes, and straps are rated for the winch on which they can be installed. Winch ropes, strap, and cable should have a minimum of four (4) complete wraps around the winch drum in the most extended position for launching or retrieving the boat.

You can depend on Attwood winch straps. They're easy to install and prevent tangling on winch drum. Built to be strong and durable. UV-resistant webbing with a special, heavy-duty, forged steel, snap hook. The extra-long throat is designed for easier attachment to bow eyes on boats. Two strap-end styles are available for easy, secure attachment to the winch drum. Rated for winches up to 2,000 lbs.

Webbing: Polyester webbing is one of the finest web strap materials available. Polyester does not stretch and offers excellent resistance to ultraviolet degradation from sunlight.

Strap-End Styles: Two styles available (1) Cut-End, and (2) Sewn-Loop End.

Hook: Heavy-duty, forged, zinc-plated steel snap hook. Spring-loaded closure for secure attachment. Extra-long throat for easy attachment.

Description	Length	Bulk Packaging	Aftermarket Packaging
Cut-end	15 ft.	11136-1	11136-7
	20 ft.	11137-1	11137-7
	25 ft.	11138-1	11138-7
Sewn-loop end	15 ft.	11141-1	11141-7
	20 ft.	11147-1	11147-7
	25 ft.	11153-1	11153-7



11141



11136

Winch Ropes

Poly Winch Ropes

Twisted polypropylene 3/8-inch diameter winch rope is economical, versatile, and easily spliced. Resistant to rot and mildew and is UV stabilized. For winches rated up to 1,200 lbs., not intended for other uses

Description	Color	Bulk Packaging	Prop 65	Aftermarket Packaging	Prop 65
POLY WINCH ROPE					
3/8" x 20' Long	Black	—		11739-2	



11739



BOW STOPS & ROLLERS

Road-ready bow stops, rollers, and roller brackets provide protective support for your boat's hull while it's on the trailer, and allow easier launching, centering, and retrieval of the boat. This assortment includes rollers, bow stops, and steel roller brackets. Rollers and bow stops are available in polymer or rubber.

Rubber Rollers	Polymer Rollers
Non-marring prime rubber compound	Will not mark or discolor your boat
Economically priced	Resist cuts and abrasions
Original equipment replacements for most trailers	Have superior durability to outlast ordinary rollers

Bow Stops, Rubber

Molded rubber stops. Each is pre-drilled with 3/8-inch or 1/2-inch diameter hole.

* **WARNING** Cancer and Reproductive Harm – www.P65Warnings.ca.gov (see page 240)

Dimensions	Hole I.D.	Bulk Packaging**	Prop 65	Aftermarket Packaging	Prop 65
2" x 2"	3/8"	11200-1	*	—	—
3" x 3"	1/2"	11201-1	*	—	—
4" x 4"	1/2"	11202-1	*	—	—



Bow Rollers, Polymer

Non-marring, resilient bow protection. Smooth finish helps boat roll easily into place. Impervious to sunlight, chemicals, and fuels.

Description	Dimensions	Hole I.D.	Bulk Packaging**	Aftermarket Packaging
Bow Roller	3" O.D. x 3" L	1/2"	11881-1	—
Bow Roller	4" O.D. x 4" L	1/2"	11880-1	—
Bow Roller w/ Bells	3-1/2" O.D. x 4" L	1/2"	11857-1	—



Bow Rollers, Rubber

Durable protective molded rubber bow rollers.

* **⚠ WARNING** Cancer and Reproductive Harm – www.P65Warnings.ca.gov (see page 240)

Description	Outside Diameter	Shaft Diameter	Bulk Packaging	Prop 65	Aftermarket Packaging	Prop 65
3" length	3"	1/2"	11205-1	*	—	
4" length	3-1/2"	1/2"	11209-1	*	—	



Spool/Keel Rollers, Polymer

Smooth, non-marring, resilient protection. Impervious to sunlight, chemicals & fuels. Fits 1/2-inch diameter shafts.

Dimensions	Outside Diameter	Bulk Packaging	Aftermarket Packaging
Spool/Keel Roller	4"	11315-1	—
	5"	11317-1	—
Keel Roller	8"	11319-1	—



Keel Rollers, Heavy-Duty Rubber

These durable, protective rollers are for heavy-duty use. Molded rubber over a steel tube with nylon end inserts. The gradual inward taper and "V" cut eases loading and launching of heavier boats. Plastic inserts are included to protect from mounting hardware damage.

* **⚠ WARNING** Cancer and Reproductive Harm – www.P65Warnings.ca.gov (see page 240)

Dimensions	Shaft Diameter	Bulk Packaging	Prop 65	Aftermarket Packaging	Prop 65
8" length	5/8"	11215-1	*	—	
10" length	5/8"	11216-1	*	—	
12" length	5/8"	11217-1	*	—	



Spool/Keel Rollers, Light-Duty Rubber

Durable and protective. Molded rubber with nylon inserts. 3-inch outside diameter.

* **⚠ WARNING** Cancer and Reproductive Harm – www.P65Warnings.ca.gov (see page 240)

Dimensions	Shaft Diameter	Bulk Packaging	Prop 65	Aftermarket Packaging	Prop 65
4" length	5/8"	11210-1	*	—	
5-1/4" length	5/8"	11211-1	*	—	



Adjusting Rollers, Rubber

For use with automatic adjusting roller systems. Molded rubber. Smooth surface has steel insert; ribbed surface has nylon insert.

* **⚠ WARNING** Cancer and Reproductive Harm – www.P65Warnings.ca.gov (see page 240)

Description	Dimensions	Shaft Diameter	Bulk Packaging	Prop 65	Aftermarket Packaging	Prop 65
Smooth	4-1/4" L x 4-3/8" dia.	3/4"	11230-1	*	—	



Roller Panel Brackets

Cross-member panel brackets are available for a variety of roller sizes. Long mounting slot allows adjustment. Brackets are pre-drilled with 5/8-inch-diameter holes for roller mount. Zinc-plated or galvanized steel.

* **⚠ WARNING** Cancer and Reproductive Harm – www.P65Warnings.ca.gov (see page 240)

Dimensions Width Between Holes	Slots Size	Width Between Slots	Bulk Packaging	Prop 65	Aftermarket Packaging	Prop 65
4-1/4"	2-1/2"	2-3/8"	11252-1	*	—	
8-1/4"	3"	5-1/2"	11254-1	*	—	

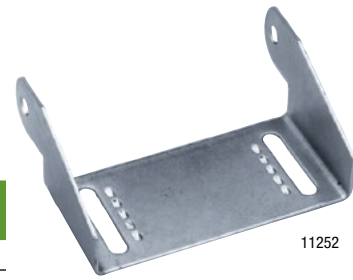

11252

Bunk Brackets

For mounting bunks. Slotted for vertical adjustments. Mounts with 1/2-inch (1.27 cm) bolt. 11-gauge galvanized steel.

Length	Width	Bulk Packaging	Aftermarket Packaging
8"	2"	11363-1	—
10"	2"	11364-1	—



11363

Swivel Bolster Brackets

Heavy 11-gauge galvanized steel that is slotted for vertical adjustment. Non slip dimples for secure hold. 3.5-inch wide angle bracket pivots for angled or flat mounting of 2-inch x 6-inch bunk or bolster boards. Complete with nut and bolt for angle bracket. Mounts with 1/2-inch bolt.

Size	Assembled	Bulk Packaging	Aftermarket Packaging
8"	9"	11360-1	—
10"	11"	11361-1	—
12"	13"	11362-1	—



11360

Roller Panel Spool/Keel Bracket Roller Assemblies

Complete spool/keel bracket and roller assembly. Mounts to trailer cross roller assemblies. Formed, zinc-plated steel panel bracket with 1/2-inch-wide slot for adjustment.

* **⚠ WARNING** Cancer and Reproductive Harm – www.P65Warnings.ca.gov (see page 240)

Description	Included Parts	Bulk Packaging	Prop 65	Aftermarket Packaging	Prop 65
Spool/keel	11210 roller and 11252 bracket	—		11220-3	*



11220



Keel Mounting Bracket

One piece roller bracket with 5-inch slot for vertical adjustment. Mounts with 1/2-inch bolt and is designed to be used with a 5/8-inch roller shaft.

Size	Slot Center	Bulk Packaging*	Aftermarket Packaging
5"	2-3/4"	11370-1	—
10"	8-3/16"	11371-1	—
12"	10-1/8"	11372-1	—

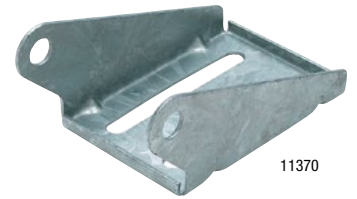

Roller Shaft Sets

Roller shafts and matching pal nuts secure shaft in place on roller. Shaft and nuts are solid zinc-plated steel.

* **⚠ WARNING** Cancer and Reproductive Harm – www.P65Warnings.ca.gov (see page 240)

Description	Length	Roller Size	Bulk Packaging	Prop 65	Aftermarket Packaging	Prop 65
5/8" dia.	6-3/8"	5-1/4"	—	—	11282-3	*
	9-1/4"	8"	—	—	11283-3	*
	11-1/4"	10"	—	—	11284-3	*
	13-1/2"	12"	—	—	11285-3	*



Pal Nuts

5/8-inch zinc plated pal nuts to be used with 5/8-inch roller shafts.

Description	Bulk Packaging	Aftermarket Packaging
Set of 8	—	11368-3



Trailer Bunk Padding

12 ft. long roll of durable, weather-resistant polypropylene marine carpet material. Easy to cut and custom fit. Protects hull; eases loading and launching. Charcoal color; acrylic backing grips surface of trailer bunk boards or cradle. No excessive fuzz, static-free. Made for minimal water retention.

Description	Bulk Packaging	Aftermarket Packaging
8" wide	—	11246-1
12" wide	—	11247-1



Boat Trailer Guide Protectors



Boat Trailer Guide Protectors simply slide over existing trailer guide posts to help protect boat from scratches and impact. These protectors not only protect your boat but enhance the look too. Made of closed-cell polyurethane foam with nylon cloth covers. Sold in pairs.

* **WARNING** Cancer and Reproductive Harm – www.P65Warnings.ca.gov (see page 240)

I.D.	Length	Color	Bulk Packaging	Prop 65	Aftermarket Packaging	Prop 65
2"	36"	Black	—		105693BK	*
2-1/2"	36"	Black	—		105694BK	*
		Forest Green	—		105694FG	*
		Navy	—		105694NV	*
		Red	—		105694RD	*
		Royal	—		105694RB	*
		Silver	—		105694SV	*
48"	36"	Black	—		105695BK	*
		Forest Green	—		105695FG	*
		Navy	—		105695NV	*
		Red	—		105695RD	*
		Royal	—		105695RB	*
		Silver	—		105695SV	*
60"	36"	Black	—		105696BK	*
		Forest Green	—		105696FG	*
		Navy	—		105696NV	*
		Red	—		105696RD	*
		Royal	—		105696RB	*
		Silver	—		105696SV	*



Black



Navy



Royal Blue



Forest Green



Red



Silver



10569_SV

U-Bolt Style Tire Carrier

Square-bend U-bolt with bracket mounts tire on tongue or trailer frame. The frame must be between 2-inch x 2-inch square to 3-1/2-inch x 4-inch rectangular in size. Fits 4- or 5-lug hole rims. Extra-long 8-1/2-inch shaft fits 8-inch to 15-inch tires.

* **WARNING** Cancer and Reproductive Harm – www.P65Warnings.ca.gov (see page 240)

Description	Bulk Packaging	Prop 65	Aftermarket Packaging	Prop 65
Zinc-plated steel	—		11090-3	*



11090

(Padlock not included.)

HubMate Wheel Bearing Protectors and Covers

HubMate bearing protectors replace dust cap in the wheel hub. The accessible grease fitting allows you to add grease without disassembling. Positive grease pressure keeps water and dirt out. Automatically lubricates, reducing wear and prolonging bearing life. Covers are custom-fitted PVC.

* **WARNING** Cancer and Reproductive Harm – www.P65Warnings.ca.gov (see page 240)

Description	Bulk Packaging	Prop 65	Aftermarket Packaging	Prop 65
1.98" Outer Hub I.D.—Stainless Steel	—		11110-7	*



11110



Transom Savers

We've got you covered

A lifted outboard puts hundreds of foot-pounds of pressure on the transom, especially during trailering.

* **⚠ WARNING** Cancer and Reproductive Harm
 – www.P65Warnings.ca.gov (see page 240)

Protect your boat and engine

- Support the cantilevered weight of the motor
- Stabilize engine and steering mechanism when trailering

The Attwood Difference

- Tough components — You'll get long life from our adjustable toggles with replaceable rubber pads
- Innovation — Our shock absorbing spring-loaded transom saver, is designed to reduce damaging effects of road shock. Works great for motors with hydraulic trim/tilt



Composite Head



Heavy-Duty Head



Roller Bracket

All Aftermarket parts include both the Roller and Trailer Mount brackets



Trailer Mount Bracket

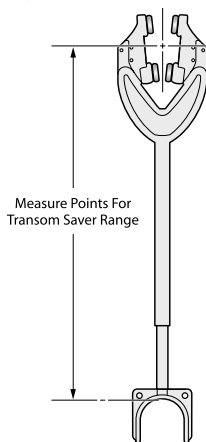

SP-400-RB



SP-4000-ADJ-RB



SP-421-RB

Shock Absorbing Spring

Description	Head Type	Mounting Bracket	Bulk Packaging	Prop 65	Aftermarket Packaging	Prop 65
ADJUSTABLE TRANSOM SAVERS						
23"-35"	Composite	Roller	400-R	*	—	
		Trailer Mount	400-B	*	—	
		Roller/Trailer Mount	—		SP-400-RB	*
HEAVY DUTY TRANSOM SAVERS						
24"-36"	Heavy Duty	Roller	4000-ADJ	*	—	
		Trailer Mount	4000-ADJ-B	*	—	
		Roller/Trailer Mount	—		SP-4000-ADJ-RB	*
32"-44"	Heavy Duty	Roller	424-ADJ	*	—	
		Roller/Trailer Mount	—		SP-424-ADJ-RB	*
44"-56"	Heavy Duty	Roller	436-ADJ	*	—	
		Roller/Trailer Mount	—		SP-436-ADJ-RB	*
SHOCK ABSORBING TRANSOM SAVERS						
27"-36"	Heavy Duty	Roller/Trailer Mount	—		SP-421-RB	*
31"-40"	Heavy Duty	Roller/Trailer Mount	—		SP-429-RB	*
Replacement Parts						
Bolt on Bracket for Attwood Transom Savers			—		SP-402	*
Replacement Rubber Shocks for Heavy-Duty Head			—		SP-410	*
Replacement Toggle for Heavy-Duty Head			—		SP-416	*

Adjustable Transom Saver

Innovative design fits most trailers. Unique angle adjustment (patent pending) from 0-inch to 36-inch with 12-inch increments. Heavy-duty rubber pads and steel construction. Corrosion-resistant, black finish.

* **⚠ WARNING** Cancer and Reproductive Harm – www.P65Warnings.ca.gov (see page 240)

Description	Head Type	Mounting Bracket	Bulk Packaging	Prop 65	Aftermarket Packaging	Prop 65
36"-60"	Heavy Duty	Trailer Mount	460-ADJ	*	—	



Lock N' Stow™

- Locks outboard motor in forward position while trailering, greatly reducing the damaging effects of road shock
- Doesn't tie engine's lower-unit to trailer, eliminating excessive pressure on hydraulic seals and scuff marks
- Small compact mount can be easily stored in just about any boat compartment
- Constructed of black powder-coated steel with stainless steel pins

Description	Bulk Packaging	Aftermarket Packaging
Fits: OMC, Bombardier 1989 to present, 100HP and up	—	10309
Fits: Mercury engines 200 OptiMax, 255 OptiMax, 225HP EFI, 250HP EFI	—	10107
Fits: Mercury engines 135 OptiMax, 150 OptiMax, 175 OptiMax, 75HP-200HP EFI	—	10108



10107



10309

TIE-DOWN STRAPS

Quick-Release Transom Tie-Down Straps

When properly secured to transom eyes and trailer, transom straps reduce vertical and lateral movement to safely secure the boat to the trailer. They also reduce bouncing of the boat on the trailer pads or rollers. Available in 2-inch width for larger trailerable boats and 1 inch width for lighter boats.

* **⚠ WARNING** Cancer and Reproductive Harm – www.P65Warnings.ca.gov (see page 240)

Webbing: Strong webbing. Resists rot, oils, gasoline, and most chemicals.

Buckle: Quick-Release (Over-Center) buckle. Strong and secure, yet easy to use. Quicktightening. Cinch tight and secure by depressing buckle handle. Release by lifting the buckle handle.

Hook: Vinyl-Coated S-Hook to prevent scratching boat or trailer finish. Corrosion-resistant. Heavy-gauge.

Special Features: Protective pad behind buckle to prevent marring and scratches on gel coat and painted surfaces. Hook-N-Loop closure secures the buckle handle in the locked position.



Quick-Release Buckle with Hook-N-Loop Closure



15230

Description	Length	Bulk Packaging	Prop 65	Aftermarket Packaging	Prop 65
2" Wide, sold in pairs	2 ft.	15230-1	*	15230-7	*
	3 ft.	15231-1	*	15231-7	*
	4 ft.	15232-1	*	15232-7	*
	5 ft.	15233-1	*	15233-7	*
	6 ft.	15234-1	*	15234-7	*

Bow Strap

Bow straps secure the bow of the boat to the forward trailer member or tongue, and restricts vertical and backward movement of the boat on the rollers or pads. Reduces load on winch and winch strap. Use bow straps with transom or gunwale straps to provide a complete, secure tie-down system.

* **⚠ WARNING** Cancer and Reproductive Harm – www.P65Warnings.ca.gov (see page 240)

Webbing: Web fiber is strong and has excellent elasticity to absorb sudden shock loads. Resistant to abrasion, rot, oils, gasoline, grease, and many other chemicals.

Buckle: Cam buckle with push-button release. Quick and easy to use. Springloaded lock secures the web strap. Zinc-alloy plated finish. Sewn web end prevents the strap from pulling out of the buckle.

Hook: Contains one vinyl-coated S-Hook for attachment to bow eye. Vinyl coating prevents scratching boat or trailer finish. Corrosion-resistant. Heavy gauge.

Special Features: Strap end contains a sewn-loop to create an adjustable, slip harness for attachment to trailer tongue or frame.

Description	Length	Bulk Packaging	Prop 65	Aftermarket Packaging	Prop 65
1" Wide	3 ft.	15240-1	*	15240-7	*



15240

3-Point Tie-Down Strap

3-Point Tie-Downs secure the transom of personal watercraft to the trailer with one strap. The strap contains three S-hooks; the two, sewn end hooks attach to trailer and the single, "free-floating" hook attaches quickly and easily to the stern of the PWC.

* **⚠ WARNING** Cancer and Reproductive Harm – www.P65Warnings.ca.gov (see page 240)

Webbing: Web fiber is strong and has excellent elasticity to absorb sudden shock loads. Resistant to abrasion, rot, oils, gasoline, grease, and many other chemicals.

Buckle: Cam buckle with push-button release. Quick and easy to use. Spring-loaded lock secures the web strap. Zinc-alloy plated finish. Sewn web end prevents the strap from pulling out of the buckle.

Hook: Contains three, vinyl-coated S-Hooks to protect the finish of the boat and trailer. Floating S-Hook allows for easy installation.

Description	Length	Bulk Packaging	Prop 65	Aftermarket Packaging	Prop 65
1" Wide	94"	15241-1	*	15241-7	*



15241

Quick-Release Gunwale Straps

Gunwale straps secure the entire aft section of the boat over the gunwale to the trailer and restrict vertical movement while on the road.

* **⚠ WARNING** Cancer and Reproductive Harm – www.P65Warnings.ca.gov (see page 240)

Webbing: Strong webbing. Resists rot, oils, gasoline, and most chemicals.

Buckle: Quick-Release (Over-Center) buckle. Strong and secure, yet easy to use.

Quick tightening. Cinch tight and secure by depressing buckle handle. Release by lifting the buckle handle.

Hook: J-Hook with snap-closure for secure, easy attachment. Electrostatic Discharge Coating (EDC) finish to prevent corrosion. Heavy gauge.

For ratchet straps used in gunwale applications, see the General Purpose Utility Strap section below.

Description	Length	Bulk Packaging	Prop 65	Aftermarket Packaging	Prop 65
2" Wide	10 ft.	15220-1	*	15220-7	*
	13 ft.	15221-1	*	15221-7	*
	16 ft.	15222-1	*	15222-7	*
	20 ft.	15223-1	*	15223-7	*

15220



General Purpose Tie-Down Straps

General purpose straps are designed for a variety of applications. Use to secure cargo, motorcycles, bicycles, boats, and other loads. Available in a variety of lengths and styles.

* **⚠ WARNING** Cancer and Reproductive Harm – www.P65Warnings.ca.gov (see page 240)

Webbing: Excellent elasticity to absorb sudden shock loads. Resistant to abrasion, rot, oils, gasoline, grease, and many other chemicals.

Buckle: Easy-to-operate ratchet handle cinches and locks the web strap. Quick release; resists jamming from side loads. Zinc-alloy plated finish. Sewn web end prevents the strap from pulling out of the buckle.

Hook: J-Hook with snap-closure for secure, easy attachment. Electrostatic Discharge Coating (EDC) to prevent corrosion. Heavy gauge.

Description	Length	Bulk Packaging	Prop 65	Aftermarket Packaging	Prop 65
1" Wide ratchet	18 ft.	15201-1	*	15201-7	*

15201

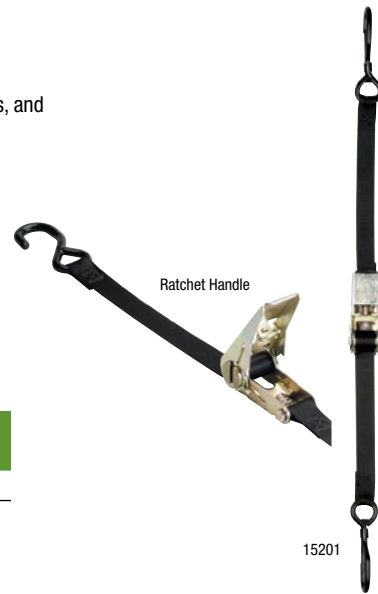



CLEATS & ACCESSORIES	158-162
LIFT RINGS	163
BOW EYES & HAWSE PIPES	164
HAND RAILS	165
WATER SKI HARDWARE	166-167
BIMINI STYLE CONVERTIBLE TOP ACCESSORIES	168-171
HINGES	172-174
SWIVEL HASPS	174
HATCH & DOOR LOCKS	175
HANDLES	176
HATCH HARDWARE	177
HOOKS	178-179
OARLOCKS	179
FASTENER KITS	179
GAS SPRINGS & ACCESSORIES	180-186



CLEATS & ACCESSORIES



Neat Cleat

The Neat Cleat design offers what you've been asking for — a retractable cleat with a thin profile that installs easily on narrow gunwales.

- Beautiful, strong and durable – each stanchion is a 7/8" rod of solid Enhanced 316 Stainless Steel alloy
- Cleats stay up when pulled
- Backed by a lifetime warranty against corrosion

Installation is simple and quick – just drill twice with an appropriate size hole saw. Drainage receptacles (included) capture moisture and send it to the bilge via pitot tubing (not included). Attwood recommends using only stainless steel fasteners for stainless steel hardware.

* **WARNING** Cancer and Reproductive Harm –

www.P65Warnings.ca.gov (see page 240)

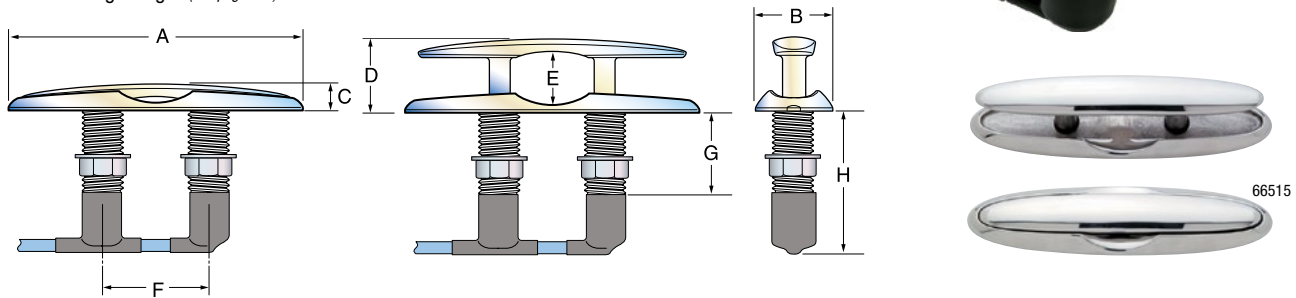
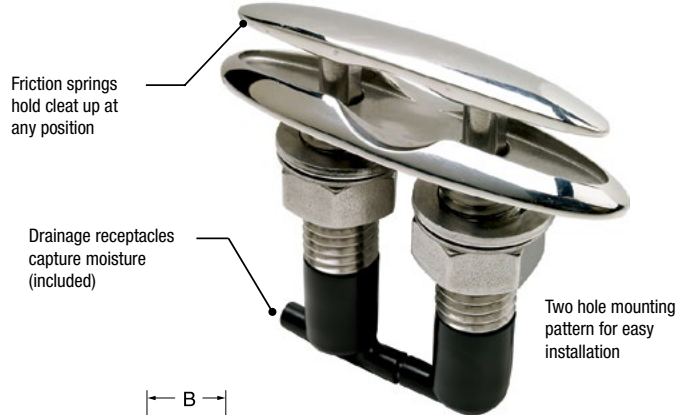

A	B	C	D	E	F	G	H	Installation		Bulk Packaging	Prop 65	Aftermarket Packaging	Prop 65
Total Length	Total Width	Above Deck Lowered	Above Deck Raised	Line Opening	Between Stanchions	Thread Length	Install. Depth	Hole Saw Size	Max. Hull Thickness				
NEAT CLEAT													
4-1/2"	1-5/16"	1/2"	1-5/8"	1-1/4"	1-3/4"	1-3/4"	3-1/8"	1"	1"	66515-1	*	66515-7	*
6"	1-1/2"	1/2"	1-5/8"	1-1/4"	2-1/4"	1-3/4"	3-1/8"	1"	1"	66517-1	*	66517-7	*
8"	1-15/16"	3/4"	2"	1-3/8"	2-13/16"	2-1/4"	3-3/4"	1"	1-1/2"	66519-1	*	—	—
10"	2-7/16"	13/16"	2-5/8"	1-5/8"	3-1/2"	2-7/8"	5-1/4"	1"	1-1/2"	66538-1	*	—	—

Neat Cleat Accessories

* **WARNING** Cancer and Reproductive Harm – www.P65Warnings.ca.gov (see page 240)

Description	Bulk Packaging	Prop 65	Aftermarket Packaging	Prop 65
BACKING PLATES				
For 4-1/2" Neat Cleat	66529-1	—	—	—
For 6" Neat Cleat or Combo Cleat	66531-1	—	—	—
For 8" Neat Cleat or Combo Cleat	66533-1	—	—	—
SPACERS				
For 6" Neat Cleat or Combo Cleat	66617-1	*	—	—



For our Stainless Steel Thru-Hulls and Scuppers see Pages 17-20.



Flush Cleats

This cleat recesses flush to the deck for a clean, contemporary look at an affordable price. Two mounting styles include an exclusive stud-mounted cleat (patented). Water-resistant cleat recesses into cast body, and is captured with lubricated seals. Durable, enhanced cast 316 Stainless Steel construction and simple design assures long-life and dependable operation.

* **⚠ WARNING** Cancer and Reproductive Harm – www.P65Warnings.ca.gov (see page 240)

Easy Installation

- Includes backing plate
- Enhanced 316 Stainless Steel Alloy

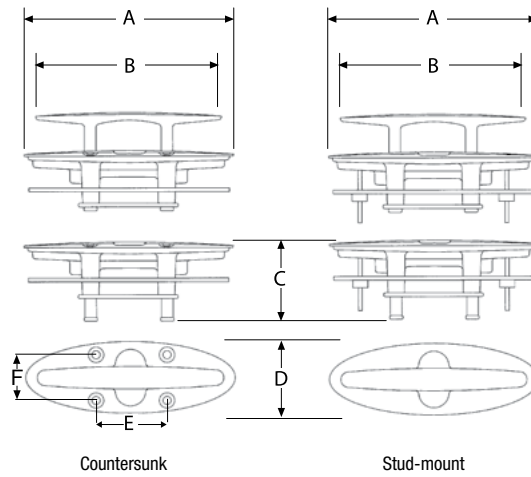

LIFETIME WARRANTY



Description	A	B	C	D	E	F	Fastener Quantity	Bulk Packaging	Prop 65	Aftermarket Packaging	Prop 65
COUNTERSUNK*											
4-1/2" Cleat	5-1/4"	4-1/2"	3-1/8"	2"	1-5/8"	1-7/16"	#10 fasteners (4)	66510-1	*	66510-7	*
6" Cleat	7"	6"	3-1/3"	2"	1-7/8"	1-21/32"	1/4" fasteners (4)	66514-1	*	66514-7	*
8" Cleat	8-1/2"	7-3/4"	3-7/8"	2-13/16"	3-1/2"	2-1/8"	1/4" fasteners (4)	66522-1	*	—	—
STUD-MOUNT*											
4-1/2" Cleat	5-1/4"	4-1/2"	3-1/8"	2"	—	—	—	66512-1	*	—	—
6" Cleat	7"	6"	3-1/3"	2-3/8"	—	—	—	66516-1	*	66516-7	*
8" Cleat	8-1/2"	7-3/4"	3-7/8"	2-13/16"	—	—	—	66524-1	*	—	—

* Countersunk models: Fasteners not included. Stud mount: Fasteners are included.



Folding Cleat

This Enhanced 316 Stainless Steel construction folding cleat locks down to the flush position when not in use, or easily flips up and locks in place when needed. Contemporary look for an economical price. Available with (flush-mount) and without (stud mount) visible holes for mounting.

* **⚠ WARNING** Cancer and Reproductive Harm – www.P65Warnings.ca.gov (see page 240)

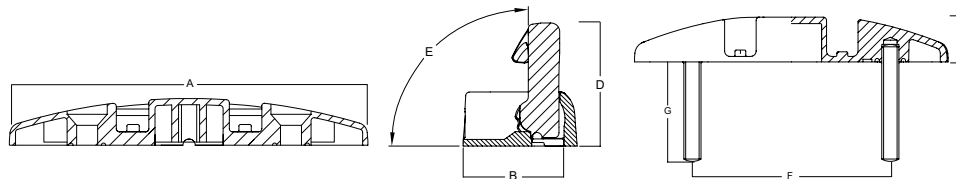

LIFETIME WARRANTY

Description	A	B	C	D	E	F	G	Fasteners Included	Fastener(s) Required	Bulk Packaging	Prop 65	Aftermarket Packaging	Prop 65
FLUSH MOUNT													
4-1/2" Cleat			Closed Position Height	Open Position Height	90°	Between Stan-chions	Thread Length	No		66586-1	*	—	—
STUD MOUNT													
4-1/2" Cleat					90°			Yes		66588-1	*	—	—
6" Cleat					90°			Yes		66589-1	*	—	—



Whitley Cleats

The innovative Whitley Cleat is an Attwood exclusive! The unique, offset design is inspired by contemporary Euro styles. Yet, for all its good looks, this sturdy cleat exceeds ABYC strength standards!

* **WARNING** Cancer and Reproductive Harm –

www.P65Warnings.ca.gov (see page 240)

- Polished stainless finish provides an attractive, premium appearance for the finest boats
- Alloy is certified Enhanced 316 Stainless Steel. Acid and rinsing baths remove surface contaminants and produce a mirror-finish hydrous oxide film. Backed by a Lifetime Warranty against corrosion
- Stud mounting leaves no exposed fasteners to collect water or dirt
- Stainless steel locking nuts and washers are supplied to fit the concealed stainless steel studs



LIFETIME WARRANTY

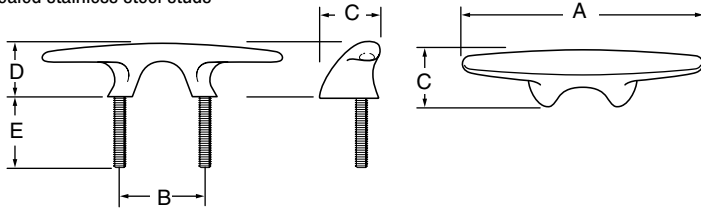

Description	A	B	C	D	E	Stud Size	Bulk Packaging	Prop 65	Aftermarket Packaging	Prop 65
6-1/2" long	6-1/2"	2-13/16"	1-1/2"	1-1/2"	2"	5/16" x 18	66062-1	*	—	—
8-1/2" long	8-1/2"	2-15/16"	2"	1-7/8"	2-1/2"	3/8" x 16	66063-1	—	—	—
10-1/2" long	10-1/2"	3-3/16"	2-15/16"	2-3/16"	3"	7/16" x 14	66064-1	—	—	—

Contemporary Cleats

These beautiful cleats have a modern look and are priced to compete. The clean lines and well-defined surfaces are in tune with styling of today's boats. Thick stanchions offer hearty appearance and performance. Enhanced 316 Stainless Steel alloy. Guaranteed for life. Stainless locking nuts and washers included.

* **WARNING** Cancer and Reproductive Harm –

www.P65Warnings.ca.gov (see page 240)

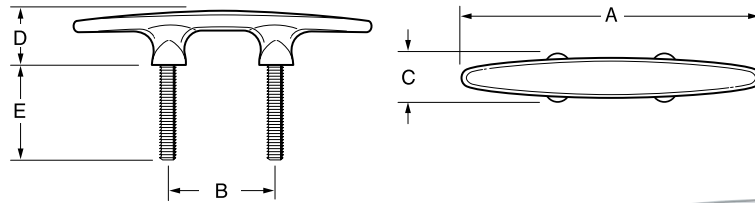

Description	A	B	C	D	E	Stud Size	Bulk Packaging	Prop 65	Aftermarket Packaging	Prop 65
6" long	6"	2-1/4"	1"	1-3/16"	2"	5/16" x 18	66054-1	*	—	—
8" long	8"	2-13/16"	1-15/16"	1-3/8"	2-1/2"	7/16" x 14	66055-1	—	—	—
10" long	10"	3-5/8"	1-11/16"	1-13/16"	3"	7/16" x 14	66056-1	—	—	—



Stud Mount Herreshoff Cleat

This cleat features the classic look of a traditional Herreshoff design plus all the advantages of a stud mount installation. Enhanced 316 Stainless Steel alloy. Guaranteed for life. Stainless locking nuts and washers included.

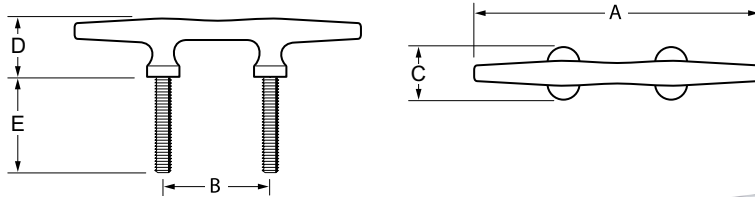

Description	A	B	C	D	E	Stud Size	Bulk Packaging	Aftermarket Packaging
4" long	4"	1-3/16"	9/16"	1"	1-1/4"	1/4" x 20	66334-1	—
6" long	6"	2-1/4"	7/8"	1-1/4"	1-3/4"	1/4" x 20	66335-1	—
8" long	8"	2-7/8"	1-3/16"	1-1/2"	2"	5/16" x 18	66336-1	—



Herreshoff Cleats

Classic Herreshoff style cleat provides traditional styling, easy line tie-off, and corrosion resistance. Made of Enhanced 316 Stainless Steel alloy. Four holes for required fasteners.

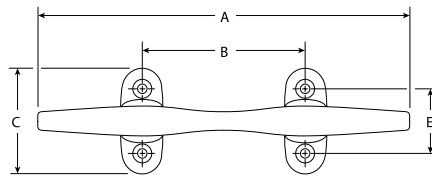

LIFETIME WARRANTY

Description	A	B	C	D	E	Fastener Quantity	Bulk Packaging	Aftermarket Packaging
5" long	5"	2-9/64"	1-1/2"	1-1/8"	1"	#10 fasteners (4)	66398-1	—
6" long	6"	2-1/4"	1-7/8"	1-1/4"	1-9/64"	1/4" fasteners (4)	66009-1	66009L6
8" long	8"	2-27/32"	2-3/16"	1-1/2"	1-11/32"	1/4" fasteners (4)	66010-1	66010L3
10" long	10"	3-3/4"	2-11/16"	1-7/8"	11-1/16"	5/16" fasteners (4)	66011-1	66011-3
12" long	12"	3-7/8"	2-3/4"	2-3/16"	1-15/16"	5/16" fasteners (4)	66012-1	—



Heavy-Duty Herreshoff Cleats

This heavy-duty Herreshoff is a wider, taller, and heavier version of the standard Herreshoff cleat. Made of Enhanced 316 Stainless Steel alloy. Four holes for required fasteners.

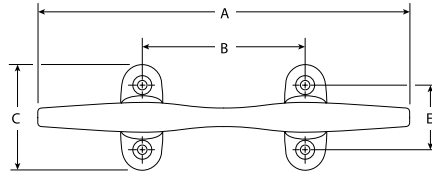

LIFETIME WARRANTY

Description	A	B	C	D	E	Fastener Quantity	Bulk Packaging	Aftermarket Packaging
8" long	8"	2-9/64"	1-1/2"	1-1/8"	1"	#10 fasteners (4)	66110-1	66110-3
10" long	10"	2-1/4"	1-7/8"	1-1/4"	1-9/64"	1/4" fasteners (4)	66111-1	66111-3
12" long	12"	2-27/32"	2-3/16"	1-1/2"	1-11/32"	1/4" fasteners (4)	66112-1	—



Fender Cleat

Stainless steel. Easily secure fenders to your boat with a simple lift of this retractable cleat. Durable, enhanced cast 316 Stainless Steel construction and simple design assures longlife and dependable operation. Small 3-1/2" design.

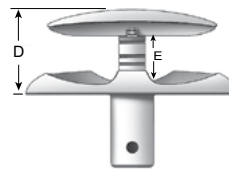
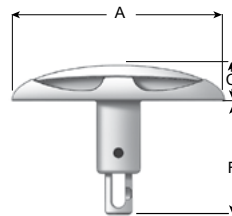

LIFETIME WARRANTY

* **WARNING** Cancer and Reproductive Harm – www.P65Warnings.ca.gov (see page 240)

A	B	C	D	E	F	Hole Distance	Bulk Packaging	Prop 65	Aftermarket Packaging	Prop 65
Total Length	Total Width	Above Deck Lowered	Above Deck Raised	Max. Line Opening	Install. Depth					
3-1/2"	1-3/16"	9/16"	1-3/8"	3/4"	1-7/8"	1-11/16"	66502-1	*	—	



66502



(Not for use for mooring, towing or lifting.)

Chrome-Plated Zinc Cleats

These studded cleats have a modern look and are priced to compete. The clean lines and well-defined surfaces are in tune with styling of today's boats. Thick stanchions offer hearty appearance and performance.

* **WARNING** Cancer and Reproductive Harm –

www.P65Warnings.ca.gov (see page 240)

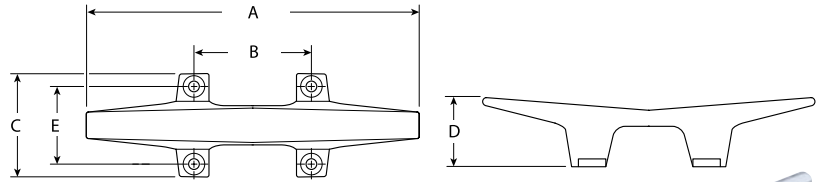

Description	A	B	C	D	E	Fastener Quantity	Bulk Packaging	Prop 65	Aftermarket Packaging	Prop 65
4-1/2" long	4-1/2"	1-11/16"	1-5/8"	1-1/16"	1-3/16"	#8 fasteners (4)	6244-1	*	6244-6, pair	*
6" long	6"	2-7/32"	2-3/32"	1-11/32"	1-1/2"	#10 fasteners (4)	6245-1	*	12009-3 6245-6, pair	*



Cast Aluminum Cleats

Cast aluminum cleats, available in 4 popular sizes. Ideal for small boats and docks. Two holes for required fasteners.

* **WARNING** Cancer and Reproductive Harm –

www.P65Warnings.ca.gov (see page 240)

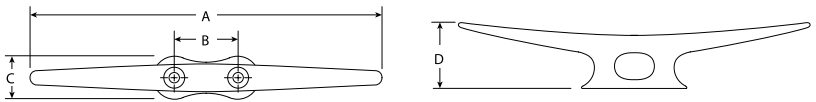

Description	A	B	C	D	Fastener Quantity	Bulk Packaging	Prop 65	Aftermarket Packaging	Prop 65
4-1/2" long, closed base	4-1/2"	2-7/32"	3/4"	1-1/2"	1/4" fasteners (2)	12120-1	*	12121-3	*
6" long, closed base	6"	1-3/8"	7/8"	1-13/32"	1/4" fasteners (2)	12124-1	*	12125-3	*
8" long, open base	8"	1-1/2"	1-1/16"	1-3/4"	1/4" fasteners (2)	12126-1	*	12127-3	*



Cast Iron Cleats

Cast iron dock cleat with galvanized finish, available in 2 popular sizes. Two holes for required fasteners.

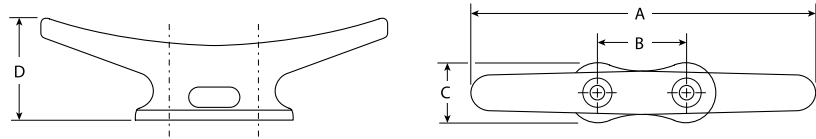

Description	A	B	C	D	Fastener Quantity	Bulk Packaging	Aftermarket Packaging
6" long	6"	1-3/8"	7/8"	1-3/16"	1/4" fasteners (2)	—	12100L3
8" long	8"	1-7/8"	1-1/8"	1-5/8"	3/8" fasteners (2)	12102-1	12102L3



Nylon Cleats

Corrosion-resistant light weight cleats. Two holes for required fasteners.

* **WARNING** Cancer and Reproductive Harm –

www.P65Warnings.ca.gov (see page 240)

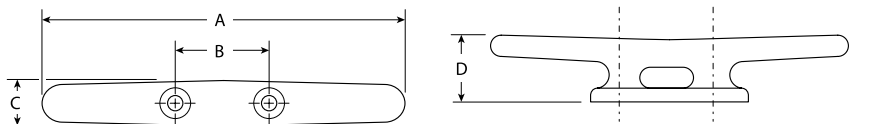

Description	A	B	C	D	Fastener Quantity	Bulk Packaging	Prop 65	Aftermarket Packaging	Prop 65
5" long	5-1/16"	1-29/64"	23/32"	1-1/64"	#12 fasteners (2)	12110-1	*	12111L3	*
6-1/2" long	6-13/32"	1-21/32"	13/16"	1-7/32"	#12 fasteners (2)	12112-1	*	12113L3	*
8" long	7-15/16"	1-51/64"	15/16"	1-3/8"	1/4" fasteners (2)	12114-1	*	12115L3	*



LIFT RINGS



Lift Ring

Attwood's stern-mounted lift ring provides heavy-duty strength for boats lifted by davits, cranes or shore stations. Lifts a maximum vertical load of 12,000 lbs. Installs with 1/2" countersunk stainless steel screws and washers, which must be through-bolted with locking washers or locking nuts.

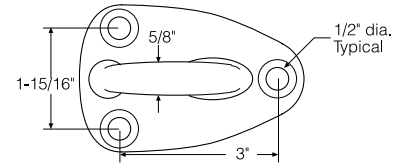
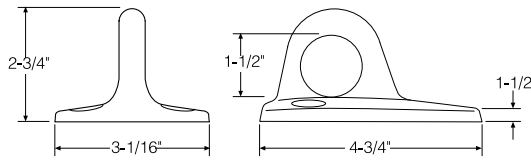

Warning: Lift rings are designed to lift a boat only when fastened to the boat structure. The maximum lifting load figures listed were determined by applying a test load in the direction of the eye shank axis, with the shank fixed in an immovable testing device. Listed lifting loads are for reference only.

Description	Bulk Packaging	Aftermarket Packaging
Stainless steel lift ring	66120-1	—



Flush Lift Rings

Flush lift ring with 3/4" I.D. handle fits most hatches, cabinets, and drawers. Maintains a flush appearance, neatly recessed for safety. Pre-drilled with four holes for required fasteners.

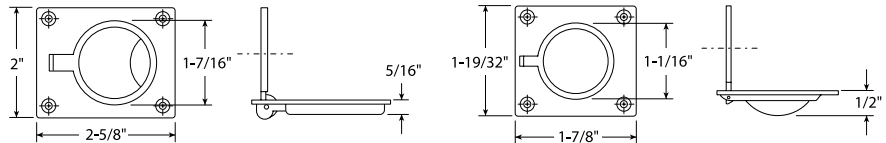

* **WARNING** Cancer and Reproductive Harm – www.P65Warnings.ca.gov (see page 240)

Description	Flange Size	Fastener Quantity	Bulk Packaging	Prop 65	Aftermarket Packaging	Prop 65
Brass	1-7/8" L x 1-1/2" W	#6 fasteners (4)	—	—	3326-3	*



Large Flush Lift Ring, Brass

Large lifting ring allows a full grip. Provides strength for lifting large and heavy hatch covers. Flush appearance, neatly recessed for safety. Chrome-plated brass. Pre-drilled with four holes for #6 fasteners.

* **WARNING** Cancer and Reproductive Harm – www.P65Warnings.ca.gov (see page 240)

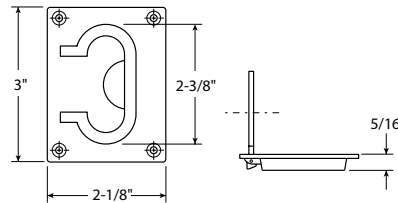

Description	Flange Size	Handle Size	Fastener Quantity	Bulk Packaging	Prop 65	Aftermarket Packaging	Prop 65
Brass	3" L x 2-1/4" W	2" L x 3/4" I.D. ring	#6 fasteners (4)	—	—	3325-3	*



BOW EYES

Bow Eyes, Stainless Steel

Bow eyes have twin shanks to prevent twisting. These rugged bow eyes, when transom-mounted can function as a ski tow.

Not to be used for lifting.

* **⚠ WARNING** Cancer and Reproductive Harm –
www.P65Warnings.ca.gov (see page 240)

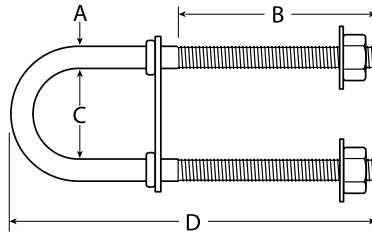

A	B	C	D	Face Plate Dimensions	Pull Strength (lbs.)	Bulk Packaging	Prop 65	Aftermarket Packaging	Prop 65
WITH PLATED NUTS AND WASHERS									
5/16"-dia.	3/8"-16 x 2-7/16"	1-1/16"	4-3/8"	2-1/2" x 9/16"	6,000	3396-1	*	3396-3	*
7/16"-dia.	1/2"-13 x 3-1/4"	1-9/16"	5-5/8"	2-3/4" x 3/4"	12,000	3392-1	*	3392-3	*
WITH STAINLESS STEEL NUTS AND WASHERS									
5/16"-dia.	3/8"-16 x 2-7/16"	1-1/16"	4-3/8"	2-1/2" x 9/16"	6,000	66263-1	*	—	—
7/16"-dia.	1/2"-13 x 3-1/4"	1-9/16"	5-5/8"	2-3/4" x 3/4"	12,000	66261-1	*	66261L3	*
7/16"-dia.	1/2"-13 x 3-1/4"	1-9/16"	5-5/8"	3-1/2" x 1-3/4"	12,000	66262-1	*	—	—

HAWSE PIPES

Enhanced 316 Stainless Steel alloy Hawse Pipes reduce deck and rope chafing when attaching dock lines to cleats mounted inside the cockpit. Available in a variety of shapes and sizes for different installation locations.

Double-Sided Oval Hawse Pipe

Enhanced 316 Stainless Steel alloy Hawse Pipe. Two-piece construction provides a finished appearance for cock-pit and gunwale installation. For 1-1/2" minimum deck thickness.

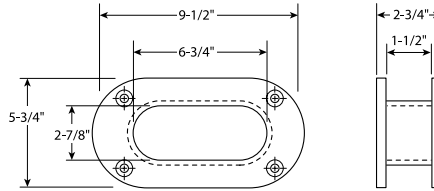

Description	Fastener Quantity	Bulk Packaging	Aftermarket Packaging
Opening Size: 6-3/4" long x 2-7/8" wide	#10 fasteners (4)	66224-1	—

Oval Hawse Pipes

Our most popular-sized Hawse Pipes. Available in two opening and flange sizes to fit your installation. Four holes for required #10 fasteners. Enhanced 316 Stainless Steel alloy.

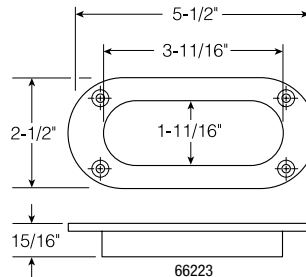

Description	Fastener Quantity	Bulk Packaging	Aftermarket Packaging
Opening Size: 3-11/16" x 1-11/16" wide	#10 fasteners (4)	66223-1	66223-3

Rope/Deck Pipe

Use as an access lid to anchor chain and rope storage lockers. Cover is hinged and spring-loaded to stay shut without rattling. Cover can be locked in open position. Enhanced 316 Stainless Steel alloy.

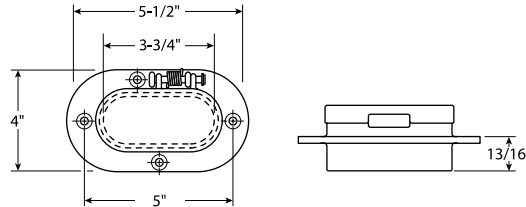

Description	Installation Hole Size	Fastener Quantity	Bulk Packaging	Aftermarket Packaging
Opening Size: 3-3/4" x 2-3/8"	4-1/8" long x 2-3/4" oval	#10 fasteners (4)	66008-1	—



HAND RAILS

Handrails, Stainless Steel

* **⚠ WARNING** Cancer and Reproductive Harm – www.P65Warnings.ca.gov (see page 240)
 Exceed all ABYC H-41 requirements for Hand Rails. Standard and Flared configurations available.

Description	Length	Bulk Packaging	Prop 65	Aftermarket Packaging	Prop 65
Flared	9"	66HRD09-1	*	—	
	12"	66HRD12-1	*	—	
	18"	66HRD18-1	*	—	
Standard	9"	66HR09-1	*	—	
	12"	66HR12-1	*	—	
	24"	66HR24-1	*	—	

Flared



Standard

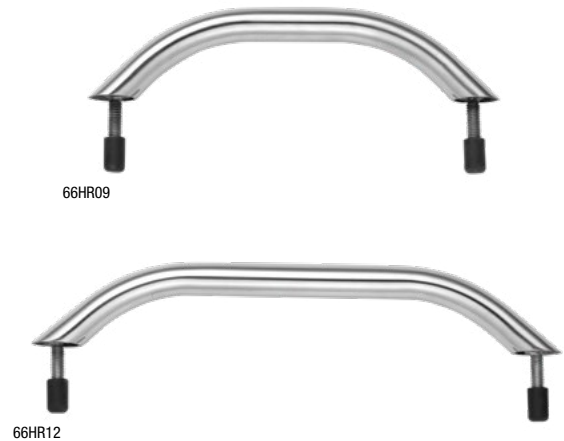

WATER SKI HARDWARE

Flush Mount Ski Tow

This Enhanced 316 Stainless Steel alloy Ski Tow mounts flush to the transom and has no exposed fasteners. Offers a clean look and prevents snags. The elliptical hook accepts up to 5/8" tow line, but rises only 1/2" outward and blends perfectly with the circular body. Easy to install by drilling one 2-1/8" diameter hole with a hole saw. The wide flange covers a bead of sealant and large aluminum backing plate provides solid holding. Backing plate and stainless locking nuts included. Exceeds American Water Ski Association standards for strength. Patented. Backed by a limited lifetime warranty against corrosion.

* **WARNING** Cancer and Reproductive Harm – www.P65Warnings.ca.gov (see page 240)

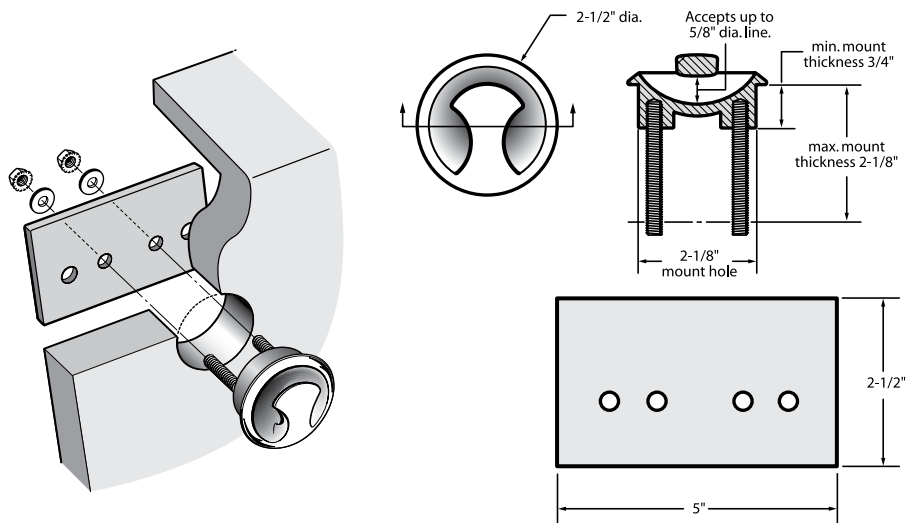

LIFETIME
WARRANTY

LIFETIME
WARRANTY



66448

Description	Bulk Packaging	Prop 65	Aftermarket Packaging	Prop 65
Stainless Ski Tow with 2-1/2" x 5" backing plate	66448-1	*	—	—

Ski Tows

Constructed of 304 Stainless Steel for corrosion-resistance, these tows are ideal for PWC's, I/O's, and inboard ski boats. All welded seams are smoothed and the surface has a highly polished finish. Stainless steel mounting washers and nuts included. A wide, welded-on mounting ring meets the hull so no exterior mounting plate is needed. Exceeds American Water Ski Association standards.

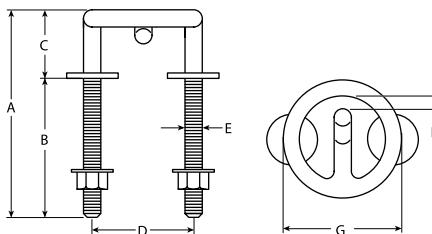

LIFETIME
WARRANTY



66449

Description	A	B	C	D	E	F	G	Bulk Packaging	Aftermarket Packaging
2-1/2" Ring diameter	4-1/2"	3"	1"	2-1/8"	3/8"	3/8"	2-1/2"	66450-1	—
3-1/2" Ring diameter	6"	3-13/16"	2"	3"	1/2"	7/16"	3-1/2"	66451-1	—
2-1/2" Ring diameter, short shank	2-7/8"	1-1/2"	1-5/16"	2-1/8"	3/8"	3/8"	2-1/2"	66449-1	—



66450,
66451

Ski Pylons

The Attwood Difference

- Our heavy duty tow products will pull you anywhere you want to go
- We offer a wide range of configurations for swivel heads, posts, and bases
- Our towing products offer advanced features for durability and quality performance
- The Pro-Swivel has a 360° rotational head with a nylon bushing for smooth slalom pulling

* **⚠ WARNING** Cancer and Reproductive Harm – www.P65Warnings.ca.gov (see page 240)

DO NOT use Ski Pylons to pull any recreational equipment that is tied to the tow rope such as water tubes, aquaplanes, wakeboards, etc.



Pro-Swivel Head
with Through Bolt Clevis



96008



Description	Post Dia.	Post Height	Post Base	Arm Dia.	Arm Length	Arm Base	Bulk Packaging	Prop 65	Aftermarket Packaging	Prop 65
FIXED HEIGHT										
Stainless	1-1/4"	36"	2' x 4" Below Deck	1"	33"-56"	Perm. thru deck	9436-S	*	—	
Steel	1-1/4"	43"	2' x 4" Below Deck	1"	33"-56"	Perm. thru deck	9433-S	*	—	
	2"	45"	6" Dia. SS	1"	33"-56"	Rem. Clev. Pin	923-009	*	—	
	1-1/2"	23"	2' x 4" SS Base	1"	33"-56"	Rem. Clev. Pin	922-ADJ-S	*	—	
		29"	3/4" Pin Base	1"	33"-56"	Rem. Clev. Pin	903-008-T-S	*	—	
		45"	6" Dia. SS	1"	33"-56"	Rem. Clev. Pin	903-009-S	*	—	
ADJUSTABLE HEIGHT										
Stainless	2"	34"-58"	6" Dia. SS	1"	33"-56"	Rem. Clev. Pin	923-009-ADJ	*	SP-923-009-ADJ	*
Steel	1"	28"-33"	Nylon Flush Mnt.	1"	33"-56"	Nylon Flush Mount	96008	*	SP-96008	*
		35"-52"	Nylon Flush Mnt.	1"	33"-56"	Nylon Flush Mount	—		SP-96009	*



6" Diameter
Stainless Steel Base
952



Glass Filled Nylon
Flush Mount
827



Deck Clevis
SP-910 Deck Clevis Set

Ski Pylon Replacement Parts

* **⚠ WARNING** Cancer and Reproductive Harm – www.P65Warnings.ca.gov (see page 240)

Description	Bulk Packaging	Prop 65	Aftermarket Packaging	Prop 65
Threaded Base, Polished Stainless Steel, 6" Diameter	—		952	*
Quick Release Pin with Chain	—		827	*
Deck Clevis, Set	—		SP-910	*
Hardware Kit for Ski Pylons	—		SP-930	*



Hardware Kit
SP-930

BIMINI STYLE CONVERTIBLE TOP ACCESSORIES

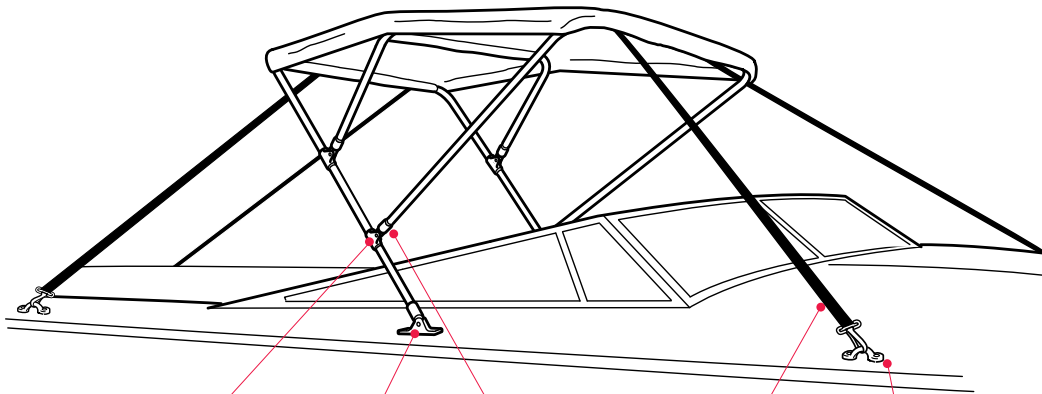

Jaw Slide



Deck Hinge



Top Cap—
Outside Eye End



Top Straps



Pad Eye

STAINLESS STEEL BIMINI TOP FITTINGS

Enhanced 316 Stainless Steel alloy fittings for corrosion-resistant support system of bimini tops. "Heavy-duty" versions are available for larger top applications.

Deck Hinges



These deck hinges feature a flat base for deck mounting and have two holes for #10 fasteners. Stainless steel pin is springloaded for easy top removal.

Description	Base Dimensions	Fastens to Bimini Bow Top Cap with:	Bulk Packaging	Aftermarket Packaging
Straight base	2-1/4" x 11/16"	1/4"-20 removable screw	66104-1	—

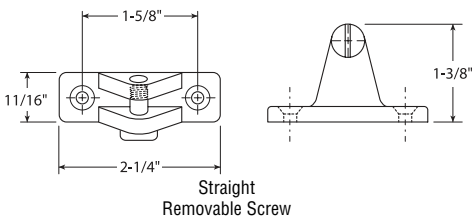
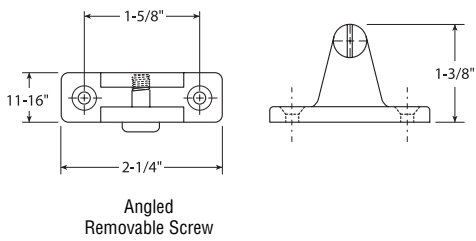
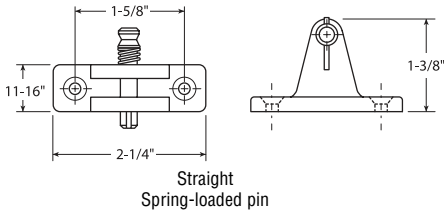

** -3 = Skin Pack



NYLON BOAT FITTINGS

Replacement Bimini Top fittings constructed of high impact, injection molded nylon with stainless steel nuts and bolts.

Angle Hinge

Two holes for required #10 fasteners. With removable 1/4"-20 screw.

* **⚠ WARNING** Cancer and Reproductive Harm – www.P65Warnings.ca.gov (see page 240)

Dimensions	Color	Bulk Packaging	Prop 65	Aftermarket Packaging	Prop 65
2-1/2" L x 5/16" W	Black	—		10610-3	*
	White	—		10600-3	*



Jaw Slide

For 3/4" round tubing.

* **⚠ WARNING** Cancer and Reproductive Harm – www.P65Warnings.ca.gov (see page 240)

Tubing Size	Color	Bulk Packaging	Prop 65	Aftermarket Packaging	Prop 65
3/4" round	White	—		10602-3	
7/8" round	Black	—		10613-3	*
	White	—		10612-3	*



Outside Eye

Accommodates 1/4" bolt for connection to base or top slide.

* **⚠ WARNING** Cancer and Reproductive Harm – www.P65Warnings.ca.gov (see page 240)

Tubing Size	Color	Bulk Packaging	Prop 65	Aftermarket Packaging	Prop 65
3/4" round	White	—		10601-3	*
7/8" round	White	—		10611-3	



Inside Eye, for 1" Square Tubing

Tubing Size	Color	Bulk Packaging	Aftermarket Packaging
1" square	Black	—	10620-3



Bimini Top Slider Kits

Provides slide adjustment for convenient use and storage of bimini top frames.

* **⚠ WARNING** Cancer and Reproductive Harm – www.P65Warnings.ca.gov (see page 240)

Description	Color	Bulk Packaging	Prop 65	Aftermarket Packaging	Prop 65
Slide, top bracket White	White	—		10622-3	
Right deck hinge Black	Black	—		10623-3	*
Left deck hinge Black	Black	—		10624-3	*

Bimini Style Convertible Top Straps

1"-wide polyweb straps to replace lost or damaged top straps. Includes rust-resistant stainless steel spring snap hook and non-marring bow adjusting buckle.

* **⚠ WARNING** Cancer and Reproductive Harm – www.P65Warnings.ca.gov (see page 240)

Description	Color	Bulk Packaging	Prop 65	Aftermarket Packaging	Prop 65
62" long	Black	—		10627-7	*
	White	—		10628-7	*
78" long	Black	—		10629-7	*
	White	—		10630-7	*
96" long	Black	—		10634-7	*
	White	—		10633-7	*



Tethered 1/4" Spring-Loaded Clevis Pin

For use with Attwood deck or rail mounted bimini top hinge fittings that use removable 1/4" spring-loaded clevis pins. This handy 1/4" spring-loaded clevis pin with lanyard allows the pin to be tethered to prevent loss of the pin when removed from the bimini top deck or rail hinge fitting.

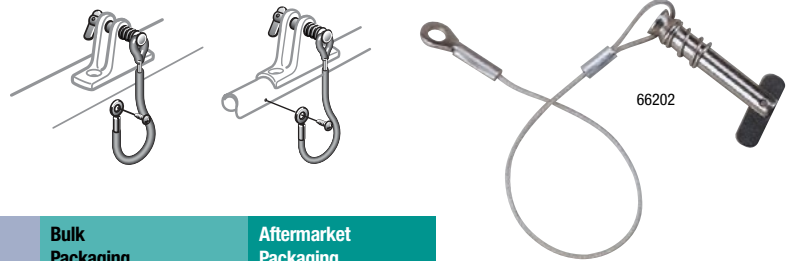

Description	Use With Attwood Deck or Rail Hinge	Bulk Packaging	Aftermarket Packaging
Removeable tethered 1/4" Spring-loaded clevis pin	66160, 66200 66220, 66383	66202-1	66202-3

Eye Straps

All eye straps are pre-drilled with two mounting holes.

* **⚠ WARNING** Cancer and Reproductive Harm – www.P65Warnings.ca.gov (see page 240)

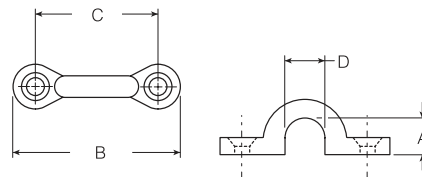

Description	A	B	C	D	Fastener Quantity	Bulk Packaging	Prop 65	Aftermarket Packaging	Prop 65
Cast Stainless Steel	3/8"-diameter	1-7/8" long	1-3/8"	1/2"	#10 fasteners (2)	66105-1		—	
Stamped Stainless Steel	5/16"-diameter	1-1/8" long	3/4"	5/16"	#6 fasteners (2)	—		12955L3, pair	*
	1/2"-diameter	1-7/16" long	15/16"	7/16"	#10 fasteners (2)	—		12957L3, pair	*
	3/4"-diameter	2-1/4" long	1-3/4"	11/16"	#10 fasteners (2)	—		12959L3, pair	*
Chromed bronze	5/16"-diameter,	1-7/8" long	1-3/8"	1/2"	#10 fasteners (2)	12988-1	*	12989-3, single	*
White Nylon	5/16"-diameter	1-7/8" long	1-7/16"	5/16"	#10 fasteners (2)	—		10603-3	*
Black Nylon	5/16"-diameter	1-7/8" long	1-7/16"	5/16"	#10 fasteners (2)	—		10604-3	



HINGES

CAST STAINLESS STEEL HINGES

These hinges are cast from enhanced 316 stainless steel. They combine a great eurostyle look with a polished finish. Available in stud or countersunk mounting styles, these hinges look attractive on any vessel! Hinges are mirror polished to the highest specification in the industry and passivated to enhance surface finish and corrosion-resistance. The hinge pin design allows lid to open a full 180°.

Round Hinge, Cast Stainless Steel

Smooth, full round plate design.

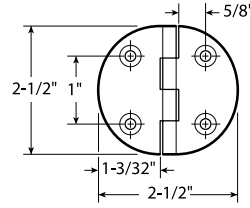

LIFETIME WARRANTY



66240

Description	Fastener Quantity	Bulk Packaging	Aftermarket Packaging
Counter-sunk	#12 fasteners (4)	66240-1	—

FLUSH HINGES

The unique double stud design of these hinges allows for a flush installation while still providing a full 180° swing. This makes them the perfect hinge for lazzerette or fish box covers in the cockpit sole.

Flush Hinge, Round End, Stamped Stainless Steel

Our widest flush, 2-pin hinge. Six holes for required fasteners. Made of solid stamped stainless steel to provide years of maintenance free service.

* **WARNING** Cancer and Reproductive Harm –

www.P65Warnings.ca.gov (see page 240)

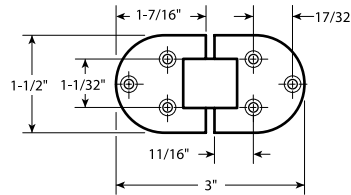

66237

Description	Fastener Quantity	Bulk Packaging	Prop 65	Aftermarket Packaging	Prop 65
Counter-sunk	#8 fasteners (6)	66237-1	*	66237-3	*

Flush Hinge, Square End, Stamped Stainless Steel

Square end 2-pin hinge with radiused corners. Six holes for required fasteners. Made of solid stamped stainless steel to provide years of maintenance free service.

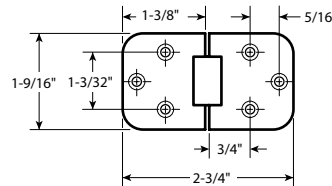

66239

Description	Fastener Quantity	Bulk Packaging	Aftermarket Packaging
Counter-sunk	#8 fasteners (6)	66239-1	66239-3

Strap Hinges, Stainless Steel

Durable stainless steel strap hinges, available in standard or reverse strap styles.

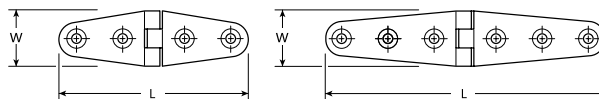

LIFETIME WARRANTY



66025

66434

66026

* **WARNING** Cancer and Reproductive Harm –

www.P65Warnings.ca.gov (see page 240)

Description	Strap Type	Dimensions	Fastener Quantity	Bulk Packaging	Prop 65	Aftermarket Packaging	Prop 65
CAST STAINLESS STEEL							
Four holes	Standard	4" W x 1" L	#10 screws	66025-1	*	66025-3	*
	Reversed	4-1/8" W x 1-1/16" W	#10 screws	66434-1	—	—	—
Six holes	Standard	6" W x 1-1/16" L	#10 screws	—	—	66026-3	—

Butt Hinge, Stainless Steel

Strap hinge design with rounded ends.

Description	Fastener Quantity	Dimensions	Bulk Packaging	Aftermarket Packaging
Cast Stainless Steel	#10 fasteners (4)	1-1/2" x 1-1/2"	66163-1	—



Butt Hinge, Chrome-Plated Zinc

Mounting holes are widely spaced for easy installation.

* **⚠ WARNING** Cancer and Reproductive Harm – www.P65Warnings.ca.gov (see page 240)

Description	Dimensions	Fastener Quantity	Bulk Packaging	Prop 65	Aftermarket Packaging	Prop 65
Rounded	2-7/8" x 1-1/2"	#8 fasteners (6)	12000	*	—	—



Door Hinges, Stainless Steel

Durable cast stainless steel door hinges, available in a variety of lengths.

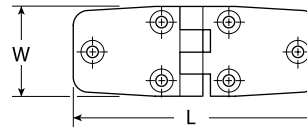

Description	Dimensions	Fastener Quantity ∞	Bulk Packaging	Aftermarket Packaging
CAST STAINLESS STEEL				
Six holes	3" L x 1-1/2" W	#10 fasteners	66028-1, pair	66028-3, pair
	4" L x 1-1/2" W	#10 fasteners	66029-1, pair	66029-3, pair



Door Hinges, Short Side, Stainless Steel

Durable cast stainless steel door hinges, available in a variety of lengths.

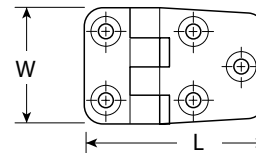

Description	Strap Type	Dimensions	Fastener Quantity	Bulk Packaging	Aftermarket Packaging
Stamped Stainless Steel	Standard	2-13/16" L x 1-1/2" W	#8 fasteners (5)	66391-1	—

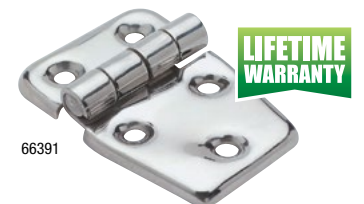

∞ Pin on top

Take-Apart Motor Box Hinge, Non-Locking

For use on motor box or hatch cover. Take apart feature allows removal of cover for engine service or bilge access.

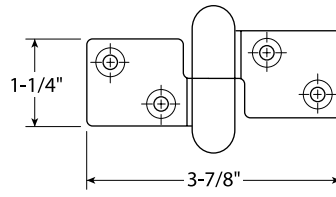

1329

* **WARNING** Cancer and Reproductive Harm – www.P65Warnings.ca.gov (see page 240)

Description	Open Size	Fastener Quantity	Bulk Packaging	Prop 65	Aftermarket Packaging	Prop 65
Brass	4" x 2"	#10 fasteners (4)	1329-1	*	—	

HATCH HINGES

For use on flush hatch covers to prevent cover from folding all the way backward. Cover remains upright when open. Hatch hinges feature a quick-release pin with safety ring so hatch can be completely removed without unscrewing the base.

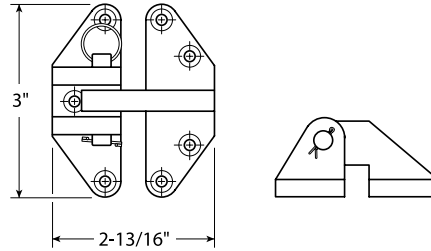

LIFETIME WARRANTY



66027

Hatch Hinge, Stainless Steel

Description	Open Size	Fastener Quantity	Bulk Packaging	Aftermarket Packaging
Cast Stainless Steel	3-1/2" x 1-3/8"	#10 fasteners (4)	66027-1	66027-3

SWIVEL HASPS

For storage compartments that need to be securely locked. Ideal for lockers, cupboards, chests, and hatch doors.

Swivel Hasps, Stainless Steel

Accommodates padlocks with 1/4" dia. or smaller shackle. Swivel eye turns to secure the hasp and keep the compartment shut, even without use of a padlock. Stamped stainless steel construction with chrome finish.

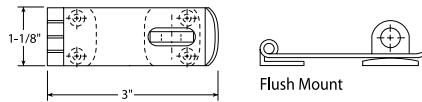

66423

Description	Closed Size	Fastener Quantity	Bulk Packaging	Aftermarket Packaging
Flush mount	3" x 1-1/8"	#8 fasteners (4)	66423-1	—



HATCH & DOOR LOCKS

Padlock Eye Clamps

For use on tackle, bait, and ice boxes that require draw-down pressure-tight seal. Also for hatch or motor box clamps. Accommodates padlocks with 1/4"-diameter or smaller shackle. Flush mount model 2012 has no exposed mounting screws. Chrome finish. Rugged, secure locking device with easy-to-use flip handle.

Description	Closed Size	Fastener Quantity	Bulk Packaging	Aftermarket Packaging
Flush mount	4-1/4" x 1-1/2"	#8 fasteners (4)	2012A1	2012A3



2012A

Slam Latches

Round slam latches fits up to 7/8" door thickness. Made of UV stable and corrosion resistant materials. Include stainless steel mounting hardware.

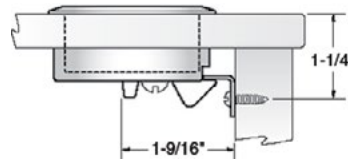

Description	Bulk Packaging	Aftermarket Packaging
Stainless Steel	66832-1	—



66832

Pontoon Replacement Latch

This durable lock set is a complete replacement kit for your pontoon's gate latch. Universal sizing fits square frames of 1, 1-1/8, and 1-1/4 inch on both left- and right-hinged gates. Secure closure stabilizes gate and prevents inward swinging. Includes mounting hardware for quick and easy installation.

Description	Bulk Packaging	Aftermarket Packaging
Universal Replacement Gate Latch. 8-1/2" x 9-1/2" x 5-1/2"	—	11404-6



11404

HANDLES

Vinyl Grab Handles

Streamlined with a molded, hinged, built-in fastener cover system, an Attwood exclusive. A unique, grab handle that looks and works great on runabouts, fishing boats, jet boats, and RV's. Clean styling, shaped to fit your hand for a secure grip. This one-piece design eliminates the problem of loose caps which pop off over time and become lost. The covers are hinged on the base of the handle and are pushed closed after securing the mounting fasteners. Strong, polypropylene inner core with a molded vinyl cover withstands harsh marine environments. Install via thru-bolting or wood screws.

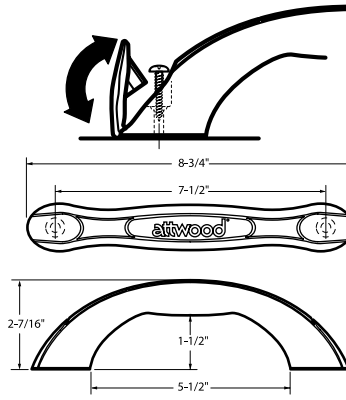

* **⚠ WARNING** Cancer and Reproductive Harm –

www.P65Warnings.ca.gov (see page 240)

Description	Fastener Quantity	Bulk Packaging	Prop 65	Aftermarket Packaging	Prop 65
White	#12 fasteners (2)	2050-1		2050-5	
Moon Rock	#12 fasteners (2)	2052-1	*	—	
Gray	#12 fasteners (2)	2053-1		2053-5	
Black	#12 fasteners (2)	2054-1		2054-5	



2050

Flexible Grab Handles

Flexible grab handles for flush, flexible mounting. They can be mounted to a variety of irregular surfaces and angles on swim platforms, cockpits and companionways. Constructed from soft polypropylene webbing over a semi-rigid core. Available with or without an over-molded grip. Because of the soft, pliable webbing in these handles and the absence of any sharp edges, they are safe in areas where occupants might impact them. They meet the ABYC H-41 standard for

strength: "withstand a load of 400 lbs. in any direction." All materials are non-corrosive, UV stable and mildew-resistant.

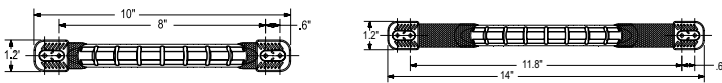

Description	Fastener Quantity	Bulk Packaging	Aftermarket Packaging
Flexible grab handle w/over-molded grip	#12 fasteners (4)	2061-1	2061-5
Flexible grab handle w/over-molded grip, extended	#12 fasteners (4)	2080-1	—



2061



2080

HATCH HARDWARE

Flush Hatch Pulls

The new low profile flush hatch pull is an easy access handle for installation in lids, doors, compartments, and hatches. Handle is easy to grip, even with gloved hands. Made of glass filled propylene with black textured finish.

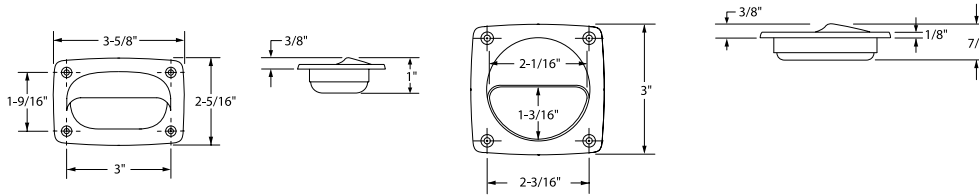

2027



2028

Description	Fastener Quantity	Bulk Packaging	Aftermarket Packaging
Rectangular	#6 fasteners (4)	2027-1	2027-7
Round	#6 fasteners (4)	2028-1	—

Deck Plate/Inspection Port

For inspection and general access to valves and deck vents. Easy opening, screw-out design—no tools required. High impact ABS plastic with textured surface. Durable, rugged, weather-resistant. Flange is pre-drilled with six holes.

* **WARNING** Cancer and Reproductive Harm – www.P65Warnings.ca.gov (see page 240)

Description	Color	Fastener Quantity	Bulk Packaging	Prop 65	Aftermarket Packaging	Prop 65
4"-dia.	White	#8 fasteners (6)	12790-1	*	12790-3	*
	Black	#8 fasteners (6)	12791-1	*	12791-3	*
6"-dia.	White	#8 fasteners (6)	12792-1	*	12792-5	*
	Black	#8 fasteners (6)	12793-1	*	12793-5	*
8"-dia.	White	#8 fasteners (6)	12794-1	*	—	—



12793



12794

Hatch Lift Spring, Stainless Steel

Deflecting spring holds hatch or motor box open, bends to close. Stainless steel, flush mounting.

Description	Fastener Quantity	Bulk Packaging	Aftermarket Packaging
7/16"-dia. x 8-3/4"	#8 fasteners (2)	12460-1	12461-3

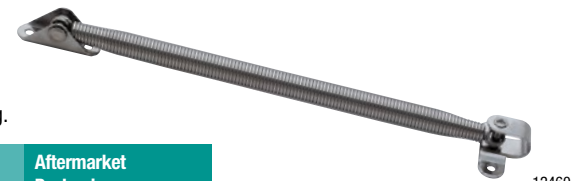

12460



HOOKS

Chain Link

For easy connection of anchor rope thimbles to anchor chain. Available in rugged stainless steel or zinc-plated steel construction material.

* **⚠ WARNING** Cancer and Reproductive Harm – www.P65Warnings.ca.gov (see page 240)

Description	Diameter	Length	Maximum Safe Load ∇	Bulk Packaging	Prop 65	Aftermarket Packaging	Prop 65
Stainless Steel	5/16"	2-7/8"	3,000 lbs.	—	—	12891L3	—
	3/8"	3-1/4"	4,000 lbs.	—	—	12889L3	*
Zinc-Plated Steel	7/32"	2-1/4"	1,000 lbs.	—	—	12355-3	*
	5/16"	3"	2,000 lbs.	—	—	12357-3	*



12891

Marine Carabiner

Spring-loaded closure.

* **⚠ WARNING** Cancer and Reproductive Harm – www.P65Warnings.ca.gov (see page 240)

Description	Length	Ring Diameter	Maximum Safe Load ∇	Bulk Packaging	Prop 65	Aftermarket Packaging	Prop 65
Stainless Steel	2-1/2"	1/4"	350 lbs.	12412-1	—	—	—
	3-1/8"	5/16"	575 lbs.	—	—	12415L3	—
Zinc-Plated Steel	2-1/2"	1/4"	300 lbs.	—	—	12303-3	*
	3-1/2"	3/8"	600 lbs.	—	—	12305-3	*
	3-1/8"	5/16"	700 lbs.	—	—	7651-3	—



12415

Utility Snap Hook

Zinc-plated steel with spring-loaded closures.

Description	Length	Ring Diameter	Maximum Safe Load ∇	Bulk Packaging	Aftermarket Packaging
Light-duty	4"	1/4"	500 lbs.	—	7653L3
Heavy-duty	4"	5/8"	2,500 lbs.	—	7640-3
Heavy-duty	4-1/4"	5/8"	2,500 lbs.	—	12261L3



7653

7640



12261

∇ Maximum safe load is approximately half of maximum load or break strength. Do not exceed maximum safe load. Do not use in applications where life or limb is at risk.

Eye Snap Hooks

With spring-loaded closure, for a variety of uses.

* **⚠ WARNING** Cancer and Reproductive Harm – www.P65Warnings.ca.gov (see page 240)

Description	Closed Eye	Throat	Length	Eye Diameter	Maximum Safe Load [∇]	Bulk Packaging	Prop 65	Aftermarket Packaging	Prop 65
Fixed Eye	Chrome-Plated Zinc	3/8"	3-1/4"	1"	200 lbs.	—		12319-3	
Swivel Eye	Chrome-Plated Brass	1/2"	3"	5/8"	200 lbs.	—		3460-3	*



12319

3460

Clamp-On Oarlocks

Zinc-plated steel resists rust. Oarlock fastens securely to oar with one adjustable bolt, no drilling required.

* **⚠ WARNING** Cancer and Reproductive Harm – www.P65Warnings.ca.gov (see page 240)

Description	Bulk Packaging	Prop 65	Aftermarket Packaging	Prop 65
Shank 1/2"-dia. x 2"	—		9146-3	*



9146

FASTENER KITS

Handy kits contain a variety of the most commonly used stainless steel fasteners for marine projects. Fasteners are designed for installation of most Attwood products.

Deluxe Fastener Kit

A variety of wood screws, machine screws, hex nuts, and washers sizes #6 through #10 in a compartmented, see-through plastic case with snap-close lid.

Description	Includes	Bulk Packaging	Aftermarket Packaging
Deluxe fastener kit	134 pieces	—	12152-3



12152

[∇] Maximum safe load is approximately half of maximum load or break strength. Do not exceed maximum safe load. Do not use in applications where life or limb is at risk.



GAS SPRINGS & ACCESSORIES

Attwood is partnered with Stabilus®, the world's leading supplier of gas springs and related products with over 100,000,000 units in the field. All Attwood springs are made with bio-degradable no hazard to water grade oil (WGK), making them the marine industry's most environmentally friendly gas springs. All springs pass ASTM B117, Attwood salt spray and a 30,000 cycle lifecycle test. Attwood springs come with support to ensure the proper spring for your specific application, including: marine, industrial, agricultural, pharmaceutical, food processing, and medical. Available in 6mm, 8mm and 10mm configurations between 10–200 lbs.

Ni-Slide Series

Attwood's widest selection of configurations and lengths. The industry's proven leader in value, quality and durability.

Stainless Steel Series

Attwood INOX Stainless Steel Series. Stainless steel shell and rod ensure corrosion-resistance and up to 30% lower cost than traditional stainless springs. All stainless steel series springs come with high-strength, corrosion-proof composite end fittings.

* **⚠ WARNING** Cancer and Reproductive Harm – www.P65Warnings.ca.gov (see page 240)

OEM Gas Springs

Length (inches)				Ni-Slide Series			Stainless Standard Series		
Extended	Compressed	Stroke	End Fitting Type	Available Output Force	Bulk Part No.	Prop 65	Available Output Force	Bulk Part No.	Prop 65
6 x 15 - 6MM ROD x 15MM CYLINDER									
6.50	4.90	1.60	6.3mm Dia. Blade	10-60	SL4-XX-1◇	*	—	—	—
7.50	5.25	2.25	10mm Socket	10-60	SL11-XX-1◇	*	10-70	ST11-XX-1◇	*
10.00	7.00	3.00	10mm Socket	10-60	SL10-XX-1◇	*	10-70	ST10-XX-1◇	*
12.04	8.46	3.58	10mm Socket	10-60	SL15-XX-1◇	*	10-70	ST15-XX-1◇	*
15.00	9.50	5.50	10mm Socket	10-60	SL13-XX-1◇	*	10-70	ST13-XX-1◇	*
17.20	10.20	7.00	10mm Socket	10-60	SL16-XX-1◇	—	—	—	—
20.00	12.00	8.00	10mm Socket	10-60	SL14-XX-1◇	—	10-70	ST14-XX-1◇	*
8 x 18 - 8MM ROD x 18MM CYLINDER									
7.50	5.25	2.25	10mm Socket	20-120	SL31-XX-1◇	—	20-120	ST31-XX-1◇	*
10.00	7.00	3.00	10mm Dia. Blade	20-120	SL1-XX-1◇	—	—	—	—
10.00	7.00	3.00	10mm Socket	20-120	SL30-XX-1◇	—	20-120	ST30-XX-1◇	*
10.50	7.50	3.00	10mm Socket	20-120	SL32-XX-1◇	—	20-120	ST32-XX-1◇	*
12.04	8.46	3.58	10mm Socket	20-120	SL35-XX-1◇	*	20-130	ST35-XX-1◇	*
15.00	9.50	5.50	10mm Dia. Blade	20-120	SL2-XX-1◇	—	—	—	—
15.00	9.50	5.50	10mm Socket	20-120	SL33-XX-1◇	*	20-150	ST33-XX-1◇	*
17.20	10.20	7.00	10mm Socket	20-120	SL36-XX-1◇	*	20-150	ST36-XX-1◇	*
20.00	12.00	8.00	10mm Dia. Blade	20-120	SL3-XX-1◇	*	—	—	—
20.00	12.00	8.00	10mm Socket	20-120	SL34-XX-1◇	*	20-150	ST34-XX-1◇	*
23.00	13.12	9.87	10mm Socket	30-120	SL38-XX-1◇	—	—	—	—
26.30	16.10	10.20	10mm Socket	20-120	SL37-XX-1◇	—	20-150	ST37-XX-1◇	*
10 x 22 - 10MM ROD x 22MM CYLINDER									
20.20	12.30	7.90	13mm Socket	30-240	SL20-XX-1◇	—	30-200	STX20-XX-1◇	*
20.20	12.30	7.90	10mm Socket	—	—	—	30-200	ST20-XX-1◇	*
26.30	16.10	10.20	10mm Socket	30-180	SL25-XX-1◇	—	—	—	—
26.97	15.20	11.77	10mm Socket	30-180	SL26-XX-1◇	*	30-200	ST26-XX-1◇	*
28.00	16.50	11.50	10mm Socket	30-180	SL27-XX-1◇	—	—	—	—
30.91	17.13	13.78	10mm Socket	30-180	SL28-XX-1◇	*	—	—	—
36.30	21.10	15.20	13mm Socket	30-180	SL29-XX-1◇	—	30-200	STX29-XX-1◇	*
36.30	21.10	15.20	10mm Socket	—	—	—	30-200	ST29-XX-1◇	*



Composite / Metal End Fitting (Ni-Slide)



NEW All Composite End Fitting (Stainless Steel)



Ball Socket Stainless Steel 13mm Ball Socket



Blade End

◇ To complete the part number, replace XX with the desired available output force 10-200 (lbs.)
(Example: SL14-10-1 = 10 lbs. output force, ST26-180-1 = 180 lbs. output force)

Aftermarket Gas Springs

Popular replacement gas springs and mounting brackets for the aftermarket. Attwood has taken the guess-work out of deciding which gas springs and mounting brackets to offer your marine and RV customers. Packaged in see-through hanging packages, gas springs and mounting brackets can be plan-o-grammed together to provide an attractive one-stop display for convenient customer selection. Additional packaged gas spring sizes and output forces are available. Ask your Attwood sales rep or customer service associate for details.

*  **WARNING** Cancer and Reproductive Harm – www.P65Warnings.ca.gov (see page 240)

Length (inches)		Stroke	End Fitting Type	Standard Output Force (lbs)	Ni-Slide Series Aftermarket Packaging	Prop 65	Stainless Standard Series Aftermarket Packaging	Prop 65
Extended	Compressed							
6 x 15 - 6MM ROD x 15MM CYLINDER								
10	7	3	10mm Socket	40	SL10-40-5		ST10-40-5	*
15	9.5	5.5	10mm Socket	20	SL13-20-5		—	
15	9.5	5.5	10mm Socket	60	SL13-60-5		ST13-60-5	
17.2	10.2	7	10mm Socket	30	SL16-30-5		—	
20	12	8	10mm Socket	20	SL14-20-5		ST14-20-5	
20	12	8	10mm Socket	30	SL14-30-5		ST14-30-5	*
20	12	8	10mm Socket	40	SL14-40-5		ST14-40-5	
20	12	8	10mm Socket	50	—		ST14-50-5	
20	12	8	10mm Socket	60	SL14-60-5		ST14-60-5	
8 x 18 - 8MM ROD x 18MM CYLINDER								
7.5	5.25	2.25	10mm Socket	20	SL31-20-5		ST31-20-5	
7.5	5.25	2.25	10mm Socket	30	SL31-30-5		ST31-30-5	
7.5	5.25	2.25	10mm Socket	40	SL31-40-5		ST31-40-5	
10	7	3	10mm Diameter Blade	20	SL1-20-5		—	
10	7	3	10mm Diameter Blade	40	SL1-40-5		—	
10	7	3	10mm Socket	20	SL30-20-5		ST30-20-5	*
10	7	3	10mm Socket	40	SL30-40-5		ST30-40-5	*
10	7	3	10mm Socket	60	SL30-60-5		ST30-60-5	
10.5	7.5	3	10mm Socket	20	SL32-20-5		ST32-20-5	
10.5	7.5	3	10mm Socket	30	SL32-30-5		ST32-30-5	
12.04	8.46	3.58	10mm Socket	20	SL35-20-5		ST35-20-5	
12.04	8.46	3.58	10mm Socket	30	SL35-30-5		ST35-30-5	
12.04	8.46	3.58	10mm Socket	40	SL35-40-5		ST35-40-5	
12.04	8.46	3.58	10mm Socket	50	SL35-50-5		ST35-50-5	
15	9.5	5.5	10mm Diameter Blade	40	SL2-40-5		—	
15	9.5	5.5	10mm Socket	20	SL33-20-5		ST33-20-5	
15	9.5	5.5	10mm Socket	30	SL33-30-5		ST33-30-5	
15	9.5	5.5	10mm Socket	40	SL33-40-5		ST33-40-5	
15	9.5	5.5	10mm Socket	50	SL33-50-5		ST33-50-5	
15	9.5	5.5	10mm Socket	60	SL33-60-5		ST33-60-5	
17.2	10.2	7	10mm Socket	20	SL36-20-5		ST36-20-5	
17.2	10.2	7	10mm Socket	30	SL36-30-5		ST36-30-5	
17.2	10.2	7	10mm Socket	40	SL36-40-5		ST36-40-5	
17.2	10.2	7	10mm Socket	50	SL36-50-5		ST36-50-5	
17.2	10.2	7	10mm Socket	60	SL36-60-5		ST36-60-5	
17.2	10.2	7	10mm Socket	70	SL36-70-5		ST36-70-5	
17.2	10.2	7	10mm Socket	80	SL36-80-5	*	ST36-80-5	
17.2	10.2	7	10mm Socket	90	SL36-90-5		ST36-90-5	
20	12	8	10mm Diameter Blade	60	SL3-60-5	*	—	
20	12	8	10mm Socket	20	SL34-20-5		ST34-20-5	
20	12	8	10mm Socket	30	SL34-30-5		ST34-30-5	
20	12	8	10mm Socket	40	SL34-40-5		ST34-40-5	
20	12	8	10mm Socket	50	SL34-50-5		ST34-50-5	
20	12	8	10mm Socket	60	SL34-60-5		ST34-60-5	
20	12	8	10mm Socket	80	SL34-80-5		ST34-80-5	
20	12	8	10mm Socket	90	SL34-90-5	*	ST34-90-5	
20	12	8	10mm Socket	120	SL34-120-5		ST34-120-5	

Threaded Studs

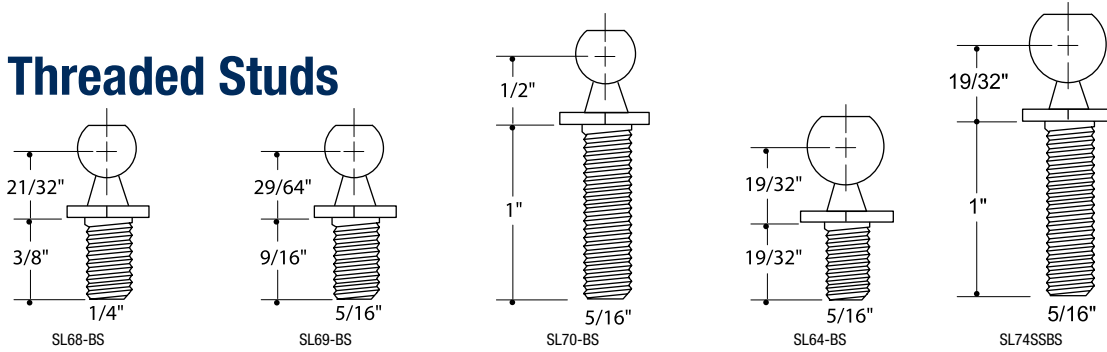

Used as an alternative to mounting brackets, threaded studs can be mounted directly to hatches or other mounting surfaces in applications where the mounting surface is made of metal or another material with the strength to withstand the forces of a gas spring attachment point

Choice of Attachment Points and Finish

Threaded studs are available with “Ball” or “Blade” gas spring attachment points, and a choice of materials, including zinc plated steel, or stainless steel.

* **WARNING** Cancer and Reproductive Harm – www.P65Warnings.ca.gov (see page 240)

Finish	Length	Bulk Packaging	Prop 65	Aftermarket Packaging	Prop 65
WITH 10MM BALL END					
Zinc Plated	3/8"	SL68-BS-1	*	—	
	9/16"	SL69-BS-1	*	—	
	1"	SL70-BS-1	*	—	
Stainless Steel	3/4"	SL75-SSBS-1	*	—	
	9/16"	SL69SSBS-1		—	
WITH 13MM BALL END					
Zinc Plated	19/32"	SL64-BS-1	*	—	
Stainless Steel	19/32"	SL64SSBS-1	*	—	
	1"	SL74SSBS-1	*	—	



MOUNTING BRACKETS

Mounting Brackets are used as attachment points for gas springs on hatches and other mounting surfaces where:

- Mounting surface material is not strong enough to support direct attachment of gas spring using a threaded stud
- The angle and position of the attachment point requires the need for a mounting bracket

Choice of Pem Attachment Ball Pem Points and Finish

Mounting brackets are available with Blade Pem or Ball Pem gas spring attachment points, and a choice of materials and finishes, including zinc-plated steel (with or without black painted finish), stainless steel, or aluminum.

* **WARNING** Cancer and Reproductive Harm – www.P65Warnings.ca.gov (see page 240)

Aftermarket Mounting Brackets

Bracket Series No.	Style	Pem Type	Mounting Holes	Pem Direction	Finish	Aftermarket Packaging	Prop 65
SL40	Flat	Ball 10mm	2	Forward	Stainless Steel	SL40SSP3-7	*
SL50	90°	Ball 10mm	2	Forward	Stainless Steel	SL50SSP3-7	*

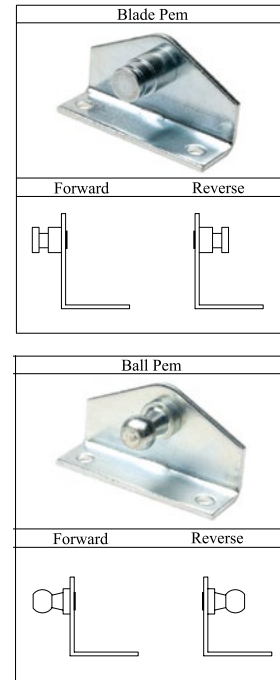

OEM Mounting Brackets

SL3H Bracket

* **⚠ WARNING** Cancer and Reproductive Harm – www.P65Warnings.ca.gov (see page 240)

Finish	Pem Direction	Pem Type	Bulk Packaging	Prop 65
Stainless Steel	Forward	Ball 10mm	SL3HSSP3-1	*

SL3H

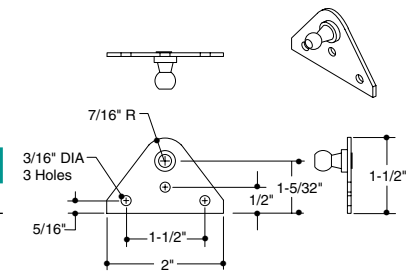

SL40 Bracket

* **⚠ WARNING** Cancer and Reproductive Harm – www.P65Warnings.ca.gov (see page 240)

Finish	Pem Direction	Pem Type	Bulk Packaging	Prop 65
Zinc-Plated	Forward	Ball 10mm	SL40P3-1	*
Black Painted	Forward	Ball 10mm	SL40BP3-1	*
Stainless Steel	Forward	Ball 10mm	SL40SSP3-1	*
Stainless Steel, Black Painted	Forward	Ball 10mm	SL40SSBP3-1	*

SL40

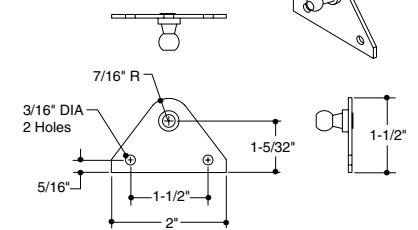

SL46 Bracket

* **⚠ WARNING** Cancer and Reproductive Harm – www.P65Warnings.ca.gov (see page 240)

Finish	Pem Direction	Pem Type	Bulk Packaging	Prop 65
Zinc-Plated	Reverse	Ball 10mm	SL46P3R-1	*
Stainless Steel	Forward	Ball 10mm	SL46SSP3-1	*
	Reverse	Ball 10mm	SL46SSP3R-1	*

SL46

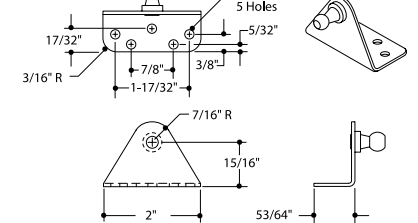

SL44 Left-Hand Crescent Bracket

* **⚠ WARNING** Cancer and Reproductive Harm – www.P65Warnings.ca.gov (see page 240)

Finish	Pem Direction	Pem Type	Bulk Packaging	Prop 65
Zinc-Plated	Forward	Ball 10mm	SL44P3-1	*
	Reverse	Ball 10mm	SL44P3R-1	*
Black Painted	Reverse	Ball 10mm	SL44BP3R-1	*
Stainless Steel	Forward	Ball 10mm	SL44SSP3-1	*

SL44

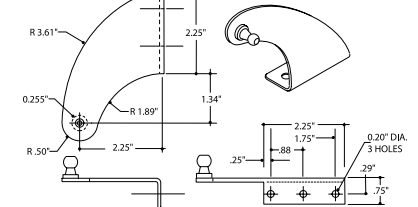

SL48 Right-Hand Crescent Bracket

* **⚠ WARNING** Cancer and Reproductive Harm – www.P65Warnings.ca.gov (see page 240)

Finish	Pem Direction	Pem Type	Bulk Packaging	Prop 65
Zinc-Plated	Forward	Ball 10mm	SL48P3-1	*
Black Painted	Reverse	Ball 10mm	SL48BP3R-1	*
Stainless Steel	Forward	Ball 10mm	SL48SSP3-1	*

SL48

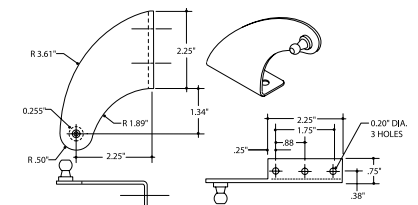

Note: Bracket dimensions are the same with all "Pem" options. Dimensional drawings are shown with "Ball Pem" option.



SL50 Bracket

* **⚠ WARNING** Cancer and Reproductive Harm – www.P65Warnings.ca.gov (see page 240)

Finish	Pem Direction	Pem Type	Bulk Packaging	Prop 65
Zinc-Plated	Forward	Ball 10mm	SL50P3-1	*
	Reverse	Ball 10mm	SL50P3R-1	*
Black Painted	Forward	Ball 10mm	SL50BP3-1	*
	Reverse	Ball 10mm	SL50BP3R-1	*
Stainless Steel	Forward	Ball 10mm	SL50SSP3-1	*
	Reverse	Ball 10mm	SL50SSP3R-1	*
Stainless Steel (3 holes)	Forward	Ball 10mm	SL50SSP3SB-1	*

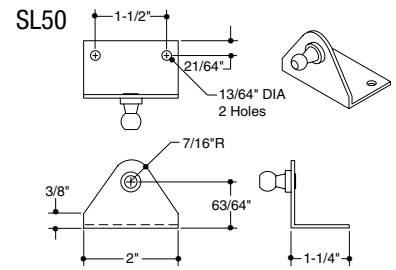

SL513H Bracket

* **⚠ WARNING** Cancer and Reproductive Harm – www.P65Warnings.ca.gov (see page 240)

Finish	Pem Direction	Pem Type	Bulk Packaging	Prop 65
Zinc-Plated	Forward	Ball 10mm	SL513HP3-1	*
	Reverse	Ball 10mm	SL513HP3R-1	*
Black Painted	Reverse	Ball 10mm	SL513HBP3R-1	*

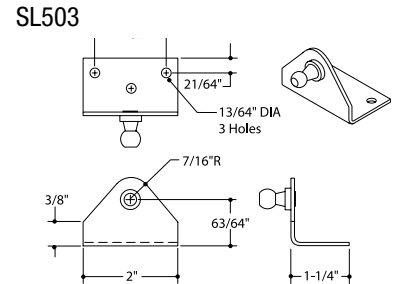

SL514H Bracket

* **⚠ WARNING** Cancer and Reproductive Harm – www.P65Warnings.ca.gov (see page 240)

Finish	Pem Direction	Pem Type	Bulk Packaging	Prop 65
Stainless Steel	Forward	Ball 10mm	SL514HSSP3-1	*

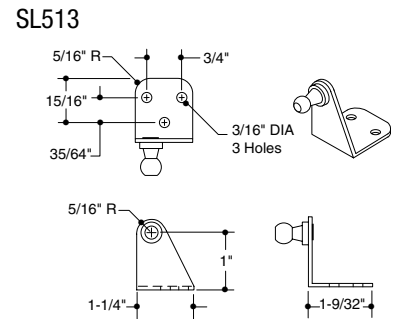

SL52 Bracket

* **⚠ WARNING** Cancer and Reproductive Harm – www.P65Warnings.ca.gov (see page 240)

Finish	Pem Direction	Pem Type	Bulk Packaging	Prop 65
Zinc-Plated	Forward	Ball 10mm	SL52P3-1	*
	Reverse	Ball 10mm	SL52P3R-1	*
Stainless Steel	Forward	Ball 10mm	SL52SSP3-1	*
	Reverse	Ball 10mm	SL52SSP3R-1	*

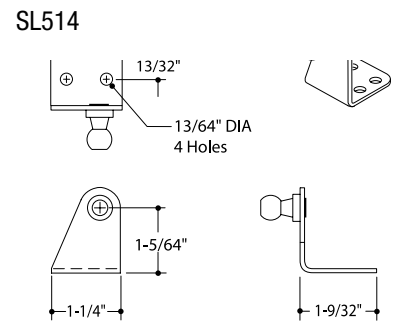

SL54 Bracket

* **⚠ WARNING** Cancer and Reproductive Harm – www.P65Warnings.ca.gov (see page 240)

Finish	Pem Direction	Pem Type	Bulk Packaging	Prop 65
Stainless Steel	Forward	Ball 10mm	SL54SSP3-1	*

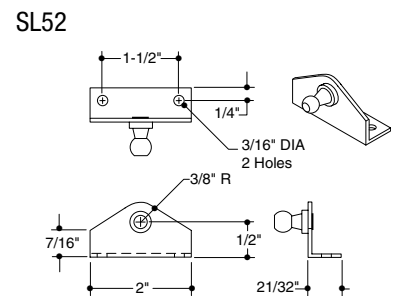
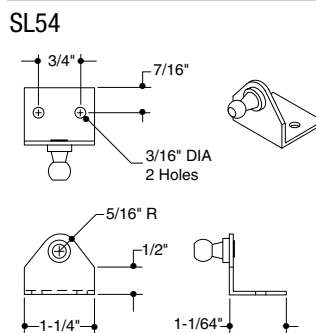

Note: Bracket dimensions are the same with all "Pem" options. Dimensional drawings are shown with "Ball Pem" option.



SL57 Bracket

* **⚠ WARNING** Cancer and Reproductive Harm – www.P65Warnings.ca.gov (see page 240)

Finish	Pem Direction	Pem Type	Bulk Packaging	Prop 65
Zinc-Plated	Forward	Ball 10mm	SL57P3-1	*
Stainless Steel	Reverse	Ball 10mm	SL57SSP3R-1	*

SL57

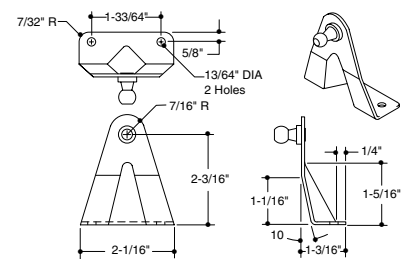

SL58 Bracket

* **⚠ WARNING** Cancer and Reproductive Harm – www.P65Warnings.ca.gov (see page 240)

Finish	Pem Direction	Pem Type	Bulk Packaging	Prop 65
Black Painted	Forward	Ball 10mm	SL58BP3-1	*
	Reverse	Ball 10mm	SL58BP3R-1	*
Stainless Steel	Forward	Ball 10mm	SL58SSP3-1	*
	Reverse	Ball 10mm	SL58SSP3R-1	*
Stainless Steel, Black Painted	Reverse	Ball 10mm	SL58SSBP3R-1	*

SL58

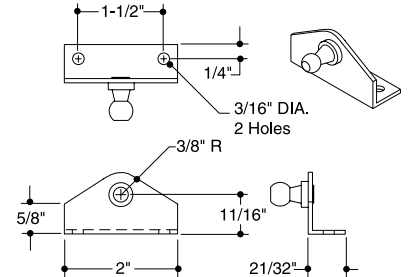

SL61 & SL63 Bracket

* **⚠ WARNING** Cancer and Reproductive Harm – www.P65Warnings.ca.gov (see page 240)

Finish	Pem Direction	Pem Type	Bulk Packaging	Prop 65
Stainless Steel	Forward	Ball 13mm	SL63SSBS-1	*
	Reverse	Ball 13mm	SL61SSBS-1	*

SL61 & SL63

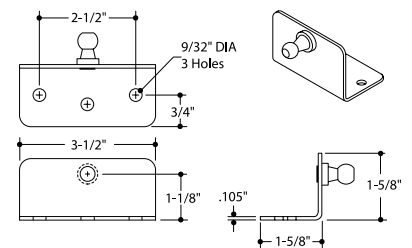

Note: Bracket dimensions are the same with all "Pem" options. Dimensional drawings are shown with "Ball Pem" option.

SL62 Bracket

* **⚠ WARNING** Cancer and Reproductive Harm – www.P65Warnings.ca.gov (see page 240)

Finish	Pem Direction	Pem Type	Bulk Packaging	Prop 65
Stainless Steel	Forward	Ball 13mm	SL62SSBS-1	*

SL62

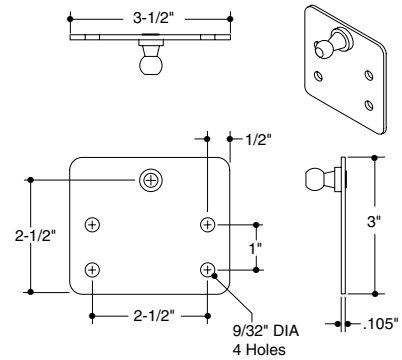

SL65 Bracket

* **⚠ WARNING** Cancer and Reproductive Harm – www.P65Warnings.ca.gov (see page 240)

Finish	Pem Direction	Pem Type	Bulk Packaging	Prop 65
Zinc-Plated	Forward	Ball 10mm	SL65P3-1	*
Black Painted	Forward	Ball 10mm	SL65BP3-1	*
Stainless Steel	Forward	Ball 10mm	SL65SP3-1	*

SL65

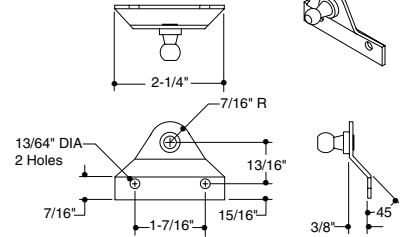

SL72 Bracket

* **⚠ WARNING** Cancer and Reproductive Harm – www.P65Warnings.ca.gov (see page 240)

Finish	Pem Direction	Pem Type	Bulk Packaging	Prop 65
Stainless Steel	Forward	Ball 10mm	SL72SSBS-1	*

SL72

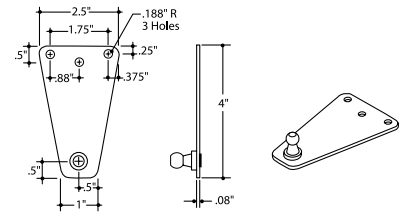

SL76 Bracket

* **⚠ WARNING** Cancer and Reproductive Harm – www.P65Warnings.ca.gov (see page 240)

Finish	Pem Direction	Pem Type	Bulk Packaging	Prop 65
Stainless Steel	Forward	Ball 10mm	SL76SSP3-1	*
	Reverse	Ball 10mm	SL76SSP3R-1	*

SL76

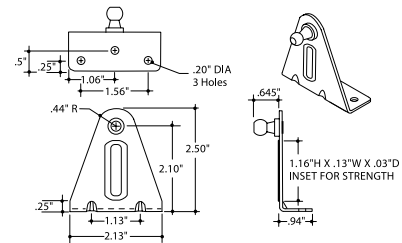

SL77 Bracket

* **⚠ WARNING** Cancer and Reproductive Harm – www.P65Warnings.ca.gov (see page 240)

Finish	Pem Direction	Pem Type	Bulk Packaging	Prop 65
Zinc-Plated	Forward	Ball 10mm	SL77P3-1	*

SL77

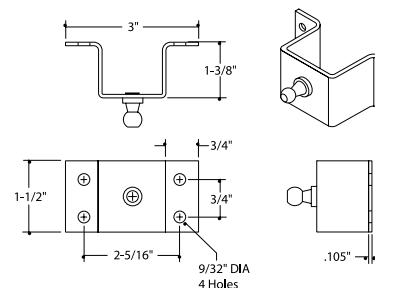

Note: Bracket dimensions are the same with all "Pem" options. Dimensional drawings are shown with "Ball Pem" option.





ABYC SEATING REQUIREMENTS 188

SEATING OVERVIEW 189-192

AERGO 193-194

AVENIR SPORT & AVENIR 195-196

CENTRIC X 197-198

CENTRIC SEATING COMPONENTS 199-200

ATTWOOD CLASSIC 201

VENTURE 202

PROFORM 203

FISHING SEATS 204

278 SERIES PEDESTAL SYSTEMS 205-206

238 SERIES 2-3/8" 207-209

LAKESPORT 238 SERIES 210-211

WEDGE 2" & 2-3/8" 212

LOCK 'N-PIN 3/4" PIN 213-215

PEDESTAL ACCESSORIES 216-218



**SEATING SYSTEMS
& PEDESTALS**

SWIVL-EZE® EXCEEDS THE HIGHEST STANDARDS



The American Boat & Yacht Council has established rigorous safety codes for seating hardware. Swivl-Eze welcomes these standards because we know seating is the critical interface between a boating passenger and a safe and comfortable boat. We exceed ABYC standards to ensure the strength and safety of every Swivl-Eze product.

ABYC REQUIREMENTS REFERENCE GUIDE

To make specifying simple, we've created an easy visual coding system. Throughout this catalog, each code shows the rating applied to individual hardware.



= Operator (Used at the helm/driver position)



= Non-Operator (Not to be used at the helm/driver position)



= Not to be used at the helm/driver position for speeds not to exceed 5 mph

ABYC H31 SEAT STANDARDS

Go to attwoodmarine.com for updated requirements.

GENERAL REQUIREMENTS FOR ALL SEAT TYPES. (AO, AN, B)

- 31.6.1 Provided with a means to prevent unintentional detachment
- 31.8.7 Withstand static load of 450 lbs.
- 31.8.13.1 Adjustable height seats must withstand vertical dynamic test

SPECIFIC REQUIREMENTS BASED ON SEAT TYPE (Catalog reference code)

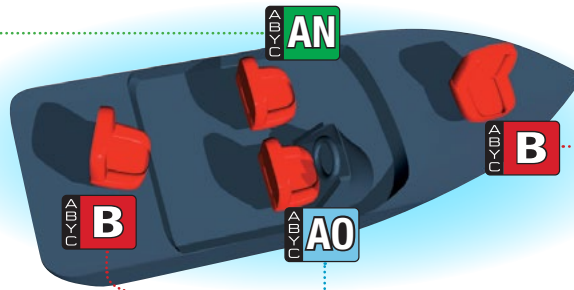

TYPE A: NON-OPERATOR

(Not to be used at the helm/driver position)

- 31.7.3 Swivel locking mechanism must sustain torque of 30 ft. lbs.
- 31.3 A seat designed for occupancy while the vessel is underway at any speed
- 31.7.1 Employ a locking mechanism for each plane or axis of movement
- 31.7.4 Seats with fore/aft adjustment must sustain static load of 300 lbs. for 3 minutes in mid position
- 31.7.5 Seats with a vertical adjustment feature shall have a positive locking mechanism
- 31.8.3 Sustain 10 impacts of 225 lbs.



TYPE A: OPERATOR

(Used at the helm/driver position)

- 31.7.6.1 Must have positive locking swivels which withstand 150 ft. lbs. of torque
- 31.7.6.2 All seats interchangeable with the operator's seat must meet the requirements of this section
- 31.3 A seat designed for occupancy while the vessel is underway at any speed
- 31.7.1 Employ a locking mechanism for each plane or axis of movement
- 31.7.4 Seats with fore/aft adjustment must sustain static load of 300 lbs. for 3 minutes in mid position
- 31.7.5 Seats with a vertical adjustment feature shall have a positive locking mechanism
- 31.8.3 Sustain 10 impacts of 225 lbs.



TYPE B

(Not to be used at the helm/driver position)

- 31.3 A seat designed for occupancy only at boat speeds not exceeding five miles per hour
- 31.8.3 Sustain dynamic loads at 1/2 the velocity required for Type A seats

EXCEPTIONS:

- 31.2.1 ABYC H31 standards do not apply to canoes, kayaks, sailboats, inflatables, race boats, tiller steered boats and boats rated for less than 10 horsepower or manual propulsion



FIND A MATCH FOR EVERY BOATER'S STYLE OF COMFORT

Attwood introduces award-winning seating innovations, year after year. As the Attwood seating group grows, you can find the right seating style for every type of recreational boating, and every type of customer.

BUCKET SEATING

For cruisers, runabouts, deck boats, and pontoon boats



Aergo

- Designed to be comfortable in any seating position
- Includes our 4-G Mesh SAS suspension



Avenir™

- Outstanding support, luxury, and styling
- Exclusive SAS™ Quad-Spring™ suspension offers unequalled shock absorption and comfort



Molded Bucket Seat

- Made from high-impact plastic
- Comfortable, ergonomic design

FOLDING SEATS

For all fishing boats and pontoon boats



Centric X

- Enhanced core for strength and durability
- Updated pattern styling
- Available with standard or premium accent colors



Attwood Classic

- One-hand open/close feature
- Pinch-less hinge
- Available in white, camouflage, or gray



Venture™

- The best ergonomic contouring for cool comfort, with or without upholstery
- Patented no-pinch folding hinge



Low Back Fold Down Fishing Seats

- High impact plastic frame and aluminum hinges
- UV resistant
- Easy to clean vinyl



Padded Flip Boat Seats

- Thick and comfortable padding
- Compact and lightweight

CASTING SEAT

For all fishing boats and pontoon boats

- Offers support and comfort for long-term use
- Made with marine-grade vinyl
- Works with any casting seat application



Aftermarket Seating Offering

Seat Name	Part Number	Color
Aergo (p. 193)	98966BK-2	Bright White/Black
	98966BL-2	Bright White/Blue
	98966BW-2	Bright White/Bright White
	98966RD-2	Bright White/Red
	98967OW-2	Off White/Off White
	98968BK-2	Gray/Black
Avenir (p. 195)	98437BK-2	Off White/Black
	98437OW-2	Off White/Off White
	98438BL-2	Bright White/Blue
	98438BW-2	Bright White/Bright White
	98438GY-2	Bright White/Gray
	98438RD-2	Bright White/Red
	98439BK-2	Gray/Black
	98439GY-2	Gray/Gray
Molded Bucket (p. 204)	98390GY	Gray
Centric X (p. 197)	97S03BK-2	Gray/Black
	97S03BL-2	Gray/Blue
	97S03RD-2	Gray/Red
	97S04BE-2	Beige/Beige
	97S05BK-2	Black/Black
	97S05RD-2	Black/Red
	97SMAX4-2	Camo
Classic (p. 201)	98386-2	Two-Tone Gray
	98387-2	Camouflage
	98388-2	White
Venture (p. 202)	97100-001-2	White
	97100-005-2	Gray
	97100-006-2	Olive
Proform (p. 203)	7012-004-4	Gray/Blue
	7012-101-4	White/White
	7012-102-4	White/Blue
	7012-103-4	White/Red
	7012-104-4	Gray/Red
	7012-105-4	White/Gray
	7012-504-4	Gray/Gray
Low-Back Fold Down Fishing Seats (p. 204)	98395CAMO	Camo
	98395GY	Gray
	98395WH	White
Padded Flip Boat Seats (p. 204)	98391GNMX	Green
	98391GY	Gray
Casting (p. 204)	98505CA	Camo
	98505GY	Gray
	98505WH	White

OEM Seating Offering

Seat/Kit Name	Part Number	Material
Aergo (p. 194)	98961-1	Plastic/Foam
	98963-1	Plastic/Foam
	98990-1	Plastic/Foam
	98991-1	Plastic/Foam
Avenir (p. 196)	98201-1	Plastic
	98202-1	Plastic
	98203-1	Plastic
	98204-1	Plastic
	7060-1	Plastic
	7040-1	Plastic
	ATT103	Foam
	ATT101	Foam
	ATT102	Foam
	ATT109	Foam
	ATT110	Foam
Centric X (p. 198-200)	98900-1	Plastic
	98908-1	Plastic
	98910-1	Plastic
	ATT200-1	Foam
	ATT2005-1	Foam
	ATT210-1	Foam
	98100-1	Plastic
	98120-1	Plastic
	7009-1	Plastic
	7006-1	Plastic
	98124	Plastic
	ATT001	Foam
	ATT008	Foam
	ATT009	Foam
	ATT016	Foam
	ATT002	Foam
ATT007	Foam	
Classic (p. 201)	98386-2	Gray Vinyl
	98387-2	Camo Poly
	98388-2	White Vinyl
Venture (p. 202)	97100-001-1	White Plastic
	97100-005-1	Gray Plastic
	97100-006-1	Olive Plastic
Proform (p. 203)	7012-101-1	White Plastic/Vinyl
	7012-004-1	Gray Plastic/Blue Vinyl
	7012-504-1	Gray Plastic/Vinyl
	7022-101-1	White Plastic/Vinyl
	7020-001-1	White Plastic
	7015-001-1	White Plastic

THE FACTORS OF SEATING COMFORT

What makes a seat comfortable? The answer becomes complex as boating becomes more specialized and boaters more sophisticated. As your seating expert, Attwood stays ahead of design trends. In the columns below we list the universal and specialized comfort factors you should look for in any seat you choose.

UNIVERSAL FACTORS

Contouring

- The seat's backrest follows the natural curve of the spine
- An upward curve at the back of the seat pan rotates the pelvis forward and properly positions the lumbar region
- A rounded front ("waterfall") edge reduces pressure on the thighs



Venture Fishing Seat is contouring in it's purest form

Backrest Angle

- The seat relieves pressure by shifting upper body weight to the backrest, while not reducing support. This is done by angling the seat and seat mount
- Optimal seat pan-to-backrest angle is 95° -105° for passengers, 95° - 100° for drivers

Seat Height

- Pedestal height is critical for comfort and driver's vision. If too low: weight shifts onto the sitting bones. If too high: weight shifts onto back of the thighs and into the spine
- Seat height should be adjustable within a 5" range — 14-1/2" to 19-1/2" above the deck

Proper Dimensions

- Seats should fit a range of body sizes
- Attwood's seats accommodate body frames ranging from small (5th percentile female) to large (95th percentile male)

SPECIALIZED FACTORS

Shock Absorption

- Attwood was the first to create effective shock absorption that isolates the boater's spine from hull pounding. Attwood accomplishes this through our two revolutionary seating suspension systems. Both take a 4G hit without transferring shock to the rider by providing 3-inches of travel for a soft landing without bottoming out.



SAS™ Quad-Spring Suspension



4G Mesh SAS Suspension

Cushioning

- On Attwood seats, the right amount of sculpted foam enhances the comfort and support already designed into the ergonomic contour
- If foam is too thick, the body "swims" without support, and movement is restricted
- If the foam is soft or thin, it "bottoms out," leading to discomfort or injury

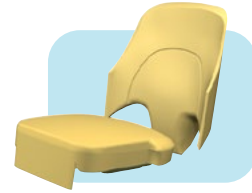

Breathability

- Venture folding fishing seats have ventilated seat back and pan to allow pass-through of air and water for increased comfort

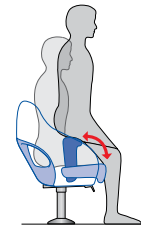

Accessories

- A flip-up bolster can add height and improve the field of vision for maneuvering

SAS SHOCK ABSORBING SYSTEM

SAS and 4G Mesh SAS Suspensions Provide Dynamic Comfort Underway and Static Comfort for Relaxing

Dynamic Comfort

- While underway, both SAS suspension types absorb up to 4Gs of impact from waves and hull pounding.

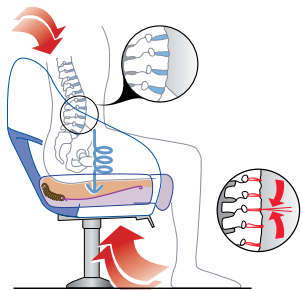

With Suspension
Impact is absorbed by the suspension — not the boater.

Without Suspension
Repeated impact can cause pain and chronic disk injury.

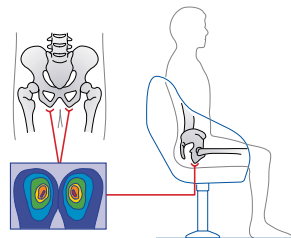

Static Comfort

Even while idle and sitting still, the SAS suspension adjusts to pressure and adds long term comfort.



Conventional Seat
Graphs show that conventional seats allow pressure points and impaired circulation around sharp "sitting bones".



Seat with Suspension
The Attwood suspensions have stretching action to minimize pressure points.

AERGO SEATING

The Aergo seat was definitely designed with comfort in mind. Angled back and cut-out allow the user to get a comfortable back angle in any seating position. Arm cap is angled in to keep arms in seat. The back of the seat is pushed back to allow more seating area in the seat pan. A recessed arm area allows user to swing their leg over the side of the seat when turning to look behind the boat and the flip-up bolster allows additional height when trying to get the boat on plane. Aergo also possesses a feature that you expect in Attwood premium seating, the Mesh SAS Shock Absorbing System that absorbs up to 4Gs of shock.

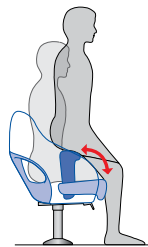

* **⚠ WARNING** Cancer and Reproductive Harm –

www.P65Warnings.ca.gov (see page 240)

Aergo Fully Upholstered Seats

The Aergo seat was designed to be comfortable in any seating position. Features the 4G Mesh SAS shock absorbing system that absorbs up to 4Gs of shock.

* **⚠ WARNING** Cancer and Reproductive Harm – www.P65Warnings.ca.gov (see page 240)

Description	Base Color	Accent Color	Bulk Packaging	Prop 65	Aftermarket Packaging	Prop 65
Aergo Fully Upholstered with Flip-Up Bolster	Off-White	Off-White	—		989670W-2	*
	Bright-White	Black	—		98966BK-2	*
		Blue	—		98966BL-2	*
		Bright-White	—		98966BW-2	*
		Red	—		98966RD-2	*
	Gray	Black	—		98968BK-2	*

Example of a fully upholstered seat.

Aergo Seat Shell Kits

These Aergo Kits contain all the molded foam and plastic in one!

Our 4G Mesh SAS Shock Absorbing System and molded-in armrests give extra functional elements to the design and ergonomic comfort of this seat.

Aergo Kit Components

These kits contain the molded core, pan, and bolster plastic and foam pieces. You can choose either the standard kit, which contains standard bolster foam, or the large bolster kit which has larger bolster foam for added comfort during elevated seating.

* **⚠️ WARNING** Cancer and Reproductive Harm – www.P65Warnings.ca.gov (see page 240)

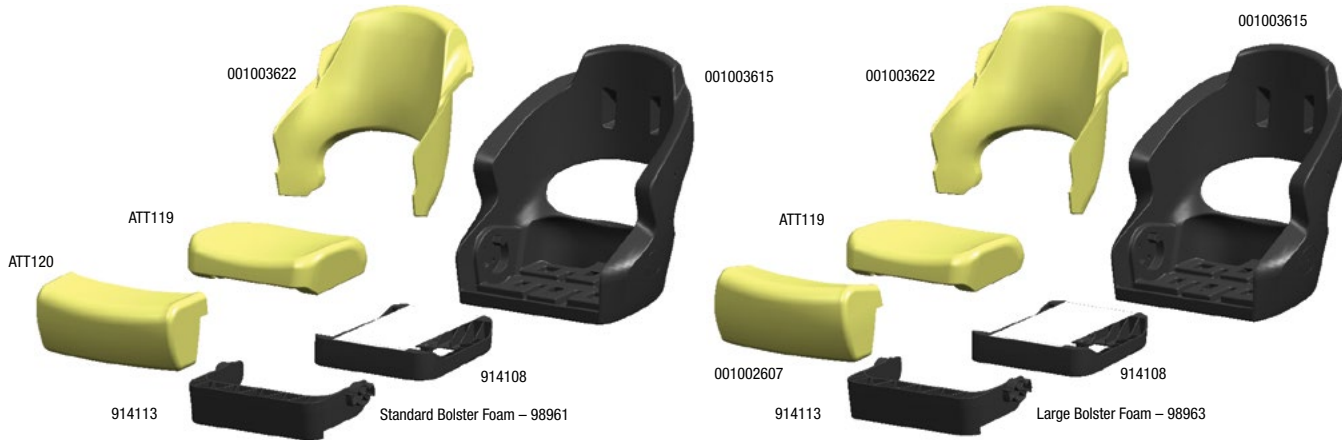

Aergo 240 Kits

Description	Bulk Packaging	Prop 65	Aftermarket Packaging	Prop 65
Aergo 240 Kit with standard bolster	98961-1	*	—	
Aergo 240 Kit with large bolster	98963-1	*	—	



Aergo 220 Kits

Description	Bulk Packaging	Prop 65	Aftermarket Packaging	Prop 65
Aergo 220 Kit with standard bolster	98990-1	*	—	
Aergo 220 Kit with large bolster	98991-1	*	—	

AVENIR™ SPORT SEATING

Avenir Sport is the world's first bolster seat with the award winning, patented SAS shock absorbing system. Avenir Sport features a compact, low profile, sporty styling. It's ideal for smaller cockpits or any application where boater comfort and compact size are important.

Seat Shell and Molded Foam

Work together to provide ergonomic comfort and spinal support.

Arm Contour

Stylish curve supports the arms in a natural, comfortable position.

Flip-Up Bolster

Bolster down creates rounded edge at front of seat and exceeds ABYC H-31 Type A Driver requirements. Up position holds the bolster at a 102° angle with 7" height for improved maneuvering vision or when boat is off plane.



Recessed Bottom Angle

Rounded corners and recessed bottom angle minimize the bottom "footprint." Allows seat to swivel in confined spaces.

No Exposed Hinges

No ugly brackets or fasteners to color-match, pinch, or abrade.

Avenir™ Sport Fully Upholstered Seats

Avenir™ Sport upholstered seats are trimmed out with a deep-tuck backrest, molded polyurethane foam, and marine grade vinyl upholstery. The side cutaway provides lower back ventilation. Seats include corrosion-resistant T-nuts for attachment to seat pedestals.

* **⚠ WARNING** Cancer and Reproductive Harm –

www.P65Warnings.ca.gov (see page 240)

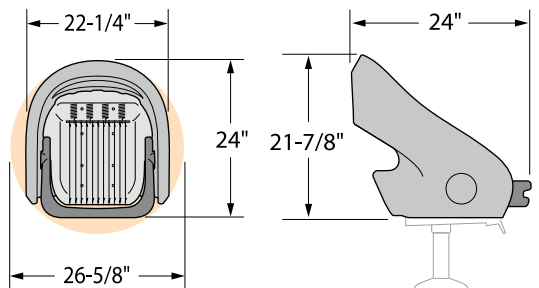

Description	Base Color	Accent Color	Bulk Packaging	Prop 65	Aftermarket Packaging	Prop 65
Avenir Sport Fully Upholstered with Flip-up Bolster	Off-White	Off-White	—		984370W-2	*
		Black	—		98437BK-2	*
	Bright-White	Blue	—		98438BL-2	*
		Bright-White	—		98438BW-2	*
		Gray	—		98438GY-2	*
		Red	—		98438RD-2	*
	Gray	Black	—		98439BK-2	*
		Gray	—		98439GY-2	*



AVENIR™ SPORT & AVENIR™ SEATING COMPONENTS

Avenir molded seating components have just four interlocking parts. This easy-to-install design, along with the universal hole pattern, reduces your upholstery and installation costs. Avenir uses marine-grade materials, a thermoplastic shell, and a stainless steel suspension grid with corrosion proof springs.

These components utilize a shell and backrest upholstery insert which speeds up the upholstery of the seat shell and provide an easy means of adding stylish accent piece with deep-tuck seam. Insert posts snap securely into the seat shell using foolproof clips for a quick and easy assembly.

* **WARNING** Cancer and Reproductive Harm – www.P65Warnings.ca.gov (see page 240)

Complete Kits

Description	Bulk Packaging	Prop 65	Aftermarket Packaging	Prop 65
AVENIR SPORT KITS				
Avenir Sport Kit - Standard Includes: ATT101, ATT102, ATT110, 7034, 7043, 7044	98201-1	—	—	—
Avenir Sport Kit - Lumbar Includes: 7033, ATT101, ATT102, ATT110, 7034, 7043, 7044	98202-1	*	—	—
Avenir Sport Kit - Headrest Includes: 7032, ATT101, ATT102, ATT109, 7034, 7043, 7044	98203-1	*	—	—
AVENIR MIDBACK KIT				
Avenir Midback Kit Includes: 7040-1, 7023, 7041, 7043, 7044, 7060-1, ATT101, ATT102, ATT103	98204-1	*	—	—



Upholstery Trim Rings

Avenir Upholstery Trim Rings provide a finished cap to cover seam where mesh and vinyl meet in ventilation holes at back of seat.

Description	Bulk Packaging	Aftermarket Packaging
AVENIR MIDBACK TRIM RINGS		
Left Side Trim Ring, White Plastic	7060-1	—
Right Side Trim Ring, White Plastic	7040-1	—



Molded Foam Packs

Molded foam packs are contoured specifically to enhance an ergonomic design for maximum comfort and style. Eliminates labor-intensive and costly cut foam and provides a consistent shape that improves the quality of the upholstered seat.

Description	For Use with Component	Bulk Packaging	Aftermarket Packaging
AVENIR MIDBACK FOAM PACKS			
Avenir Midback Backrest Foam	—	ATT103	—
SEAT PAN FOAM PACKS			
SAS Seat Pan	—	ATT101	—
BOLSTER FOAM PACKS			
Flip-up Bolster	—	ATT102	—
AVENIR SPORT FOAM PACKS			
Avenir Sport Backrest with Headrest	—	ATT109	—
Avenir Sport Backrest with Lumbar Option	—	ATT110	—

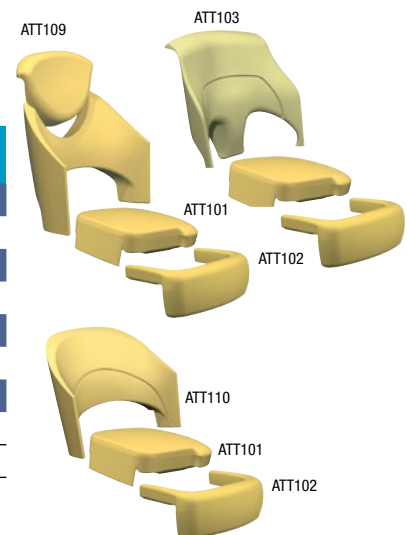

For questions regarding Attwood's most up-to-date seating selections, or for assistance with your seating application, contact your Sales Representative or Attwood Customer Service (616.897.9241)



CENTRIC X **new** SEATING



Centric X now has a stronger and more durable core. The pattern styling is updated with advanced quality vinyls. The acrylic top coat provides anti-stain finish, UV stabilized pigments and is mildew resistant. Choose from standard or premium accent colors. Standard accent colors are the most popular options, or choose from premium accent colors to match specific boat color schemes.

* **⚠ WARNING** Cancer and Reproductive Harm – www.P65Warnings.ca.gov (see page 240)



Seat Pan Designed for Proper Water Drainage



Folds Flat for a Cleaner Look

Description	Base Color	Accent Color	Bulk Packaging	Prop 65	Aftermarket Packaging	Prop 65
Centric X	Gray	Black	—		97S03BK-2	*
		Blue	—		97S03BL-2	*
		Red	—		97S03RD-2	*
	Beige	Beige	—		97S04BE-2	*
	Black	Black	—		97S05BK-2	*
	Black	Red	—		97S05RD-2	*
	Camo	Camo	—		97SMAX4-2	*

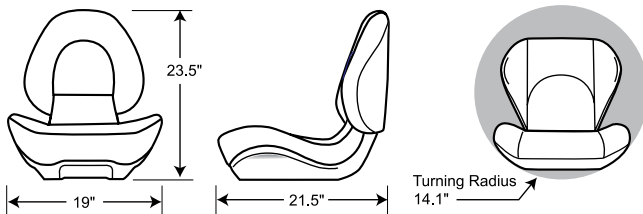

CENTRIC X SEAT COMPONENTS

These sleek, functional, and ergonomically designed seats provide the new look you've been looking for in folding fishing or helm seats! Just choose the base plastic kit that suits your functional needs. Then choose a stylish foam kit and complete your look.

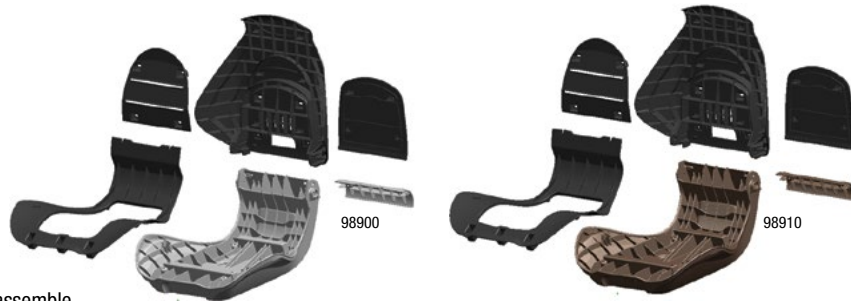

Seat Shell Kits

Centric X seat shell kits contain all plastic components to assemble. Base pieces include corrosion-resistant T-nuts for pedestal attachment. Kits include assembly hardware.

* **⚠ WARNING** Cancer and Reproductive Harm – www.P65Warnings.ca.gov (see page 240)

Description	For Use with Foam Pack	Bulk Packaging	Prop 65	Aftermarket Packaging	Prop 65
Non-SAS, Gray	ATT200-1, ATT205-1, or ATT210-1	98900-1	*	—	
Non-SAS, Dark Gray	ATT200-1, ATT205-1, or ATT210-1	98908-1	*	—	
Non-SAS, Duck	ATT200-1, ATT205-1, or ATT210-1	98910-1	*	—	



Molded Foam Packs

Centric X molded foam kits come in a variety of shapes to fit your individual styling needs.

Description	Bulk Packaging	Aftermarket Packaging
Non-SAS Standard Foam Pack	ATT200-1	—
Non-SAS Flared Headrest Foam Pack	ATT205-1	—
Non-SAS Rounded Headrest Foam Pack	ATT210-1	—

For questions regarding Attwood's most up-to-date seating selections, or for assistance with your seating application, contact your Sales Representative or Attwood Customer Service (616.897.9241)

CENTRIC SEATING COMPONENTS



With all of its features, Centric is surprisingly easy to upholster using our molded foam packs. Centric seat components consist of blow-molded fishing or helm seat cores, injection molded upholstery onserts for the backrest and seat back hinge cover, and molded foam packs.

Seat Core Kits

Centric seat core kits include the seat pan with a choice of Mid-Back and High-Back backrest styles. Each seat includes a separate seatback onsert to cover and protect the hinge. Onsert can be applied and then upholstered over with the rest of the seatback or upholstered separate of the seatback as a means of providing an accent piece. Seat cores include corrosion-resistant T-nuts for attachment to seat pedestals.

Upholstery Onserts

The Upholstery Onserts speed up the upholstery of the backrest and provide an easy means of adding a stylish accent piece with deep-tuck seam. Onsert posts snap securely into seat core using foolproof clips for quick, easy assembly.

* **⚠ WARNING** Cancer and Reproductive Harm – www.P65Warnings.ca.gov (see page 240)

Description	For Use with Foam Packs	Bulk Packaging	Prop 65	Aftermarket Packaging	Prop 65
SEAT CORES AND ONSERTS					
Mid-Back Core, Black	ATT001, ATT002, ATT007	98100-1	*	—	
High-Back Core, Black	ATT007, ATT008	98120-1	*	—	
Mid-Back Onsert	ATT009	7009-1	*	—	
High-Back Onsert	ATT008	7006-1	*	—	
Mid-Back II Onsert	ATT016	98124		—	

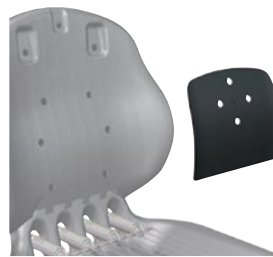

Molded Foam Packs

Molded foam packs are contoured to enhance the ergonomic shape of Centric's seat core for maximum comfort and style. Eliminates labor-intensive and costly cut foam and provides a consistent shape that improves the quality of the upholstered seat. Centric foam packs are offered with a choice of integrated "hook and loop" or "insert" upholstery methods.

Hook and Loop—Joins upholstery seam-to-foam to form a moderate tuck.

Onserts—provide a deep tucked seam depth by using a separate upholstered panel.



ATT001



ATT008



ATT009

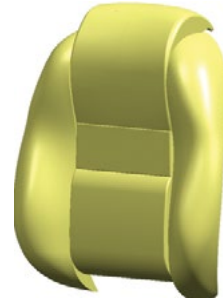

ATT016

Description	For Use with Component(s)	Bulk Packaging	Aftermarket Packaging
BACKREST FOAM PACKS			
Mid-Back, Hook & Loop	98100	ATT001	—
High-Back, w/Onsert	98120, 7006	ATT008	—
Mid-Back, w/Onsert	98100, 7009	ATT009	—
Mid-Back II Foam Pack	98121, 98124	ATT016	—
SEAT PAN FOAM PACKS			
Sport Weight Hook & Loop	98100, 98200, 98120, 98121	ATT002	—
Luxury Weight Hook & Loop	98100, 98200, 98120, 98121	ATT007	—

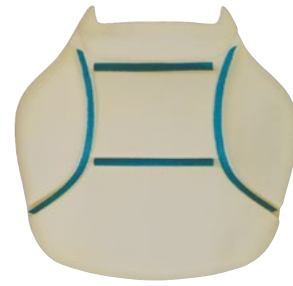

ATT002

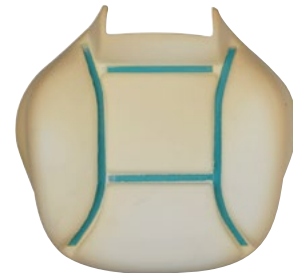

ATT007

For questions regarding Atwood's most up-to-date seating selections, or for assistance with your seating application, contact your Sales Representative or Atwood Customer Service (616.897.9241)

ATTWOOD CLASSIC SEAT

The Attwood Classic Seat delivers the lofty comfort and styling typically associated with OEM seats, but at an attractive retail price. Its ergonomic design and carefully crafted upholstery provide an optimum blend of comfort and support for the active boater and fisherman. Users will appreciate the safety of the integrated pinch-less hinge and the added convenience of the one-hand open and close feature. With its comfort, style, and high-quality materials, it's easy to see why the Classic is the smart choice in seating. Available in Gray, Camouflage, and White.

* **⚠ WARNING** Cancer and Reproductive Harm – www.P65Warnings.ca.gov (see page 240)



98386



98387



98388

Description	Bulk Packaging	Prop 65	Aftermarket Packaging	Prop 65
Classic Seat, Two-Tone Gray, Vinyl	—		98386-2	*
Classic Seat, Camouflage, Polyester	—		98387-2	*
Classic Seat, White, Vinyl	—		98388-2	*

VENTURE FOLDING FISHING SEAT

The Venture folding fishing seat is designed to satisfy the widest possible range of boaters and boat builders. Mounts in any location on bass boats, aluminum fishing boats, fish'n ski, pontoon and deck boats. Its advanced styling distinguishes it from all other seats on the market.

* **⚠ WARNING** Cancer and Reproductive Harm –
www.P65Warnings.ca.gov (see page 240)

Ventilated

Seat back and pan are ventilated to allow pass-through of air and water for increased comfort.

Portability

Venture quickly folds away to allow more room for activity and fishing excitement. Then it can be easily removed and transported using the built-in carry handle.

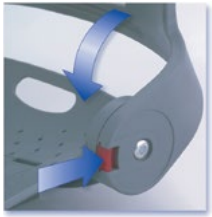

Simple, Pinch-Proof Hinge and Lock
Push-button release automatically locks the seat back in upright sitting position or the folded position for transport.

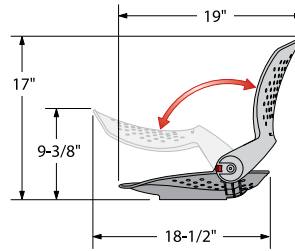
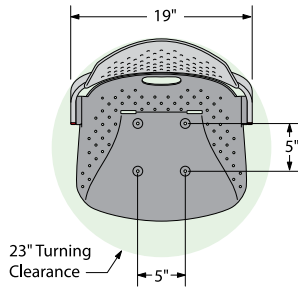

Seat Shell Only

Description	Bulk Packaging	Prop 65	Aftermarket Packaging	Prop 65
Shell Only, White	97100-001-1	*	97100-001-2	*
Shell Only, Medium Gray	97100-005-1	*	97100-005-2	*
Shell Only, Olive	97100-006-1	*	97100-006-2	*

PROFORM SEATING

Molded-In Support

Designed into the contours of the seat back and pan, offering comfort with or without padding.

Molded-In Color

The high-impact polymer is strong and UV stable. Colors have been specially selected to coordinate with boat interiors, trim, carpet and vinyls

Upholstery

Marine grade fabric is UV stable and weather resistant.

Foam Padding

Minimized to reduce cost and water absorption yet provide comfort.

Molded-In Drain Holes

Eliminate standing water; no more “puddle sitting.”



Pinch-Resistant Hinge

Strong enough to withstand impact.



Seat Back Lock

Secures backrest in down position; no more vinyl straps and snaps.



“Waterfall” Front Edge

Gently minimizes pressure behind the knees.

Curved Front Corners

Permit easy, comfortable movement when driving, fishing or relaxing.

PROForm Seats With Upholstered Onserts

Available in a variety of colors, seats include backrest and seat pan onserts upholstered with marine grade vinyl or Cordura 1000 denier nylon that use 1" thick foam for comfort. Onserts are installed with corrosion-resistant screws. Seats include corrosion-resistant T-nuts for attachment to seat pedestals.

* **WARNING** Cancer and Reproductive Harm – www.P65Warnings.ca.gov (see page 240)



7012-101



7012-004



7012-504



7012-104

Description	Bulk Packaging	Prop 65	Aftermarket Packaging	Prop 65
SEATS WITH UPHOLSTERED ONSSERTS				
White PROForm Seat with White upholstered onserts	7012-101-1	*	7012-101-4	*
White PROForm Seat with Blue upholstered onserts	—		7012-102-4	*
White PROForm Seat with Red upholstered onserts	—		7012-103-4	*
White PROForm Seat with Gray upholstered onserts	—		7012-105-4	*
Light Gray PROForm Seat with Blue vinyl upholstered onserts	7012-004-1	*	7012-004-4	*
Light Gray PROForm Seat with Red vinyl upholstered onserts	—		7012-104-4	*
Light Gray PROForm Seat with Gray vinyl upholstered onserts	7012-504-1	*	7012-504-4	*
SEATS WITH UPHOLSTERED ONSSERTS AND OUTER BACK PANEL – FOR MORE FINISHED LOOK				
White PROForm Seat and Outer Back Panel with White vinyl upholstered onserts	7022-101-1	*	—	
PROform ACCESSORIES				
White outer back panel	7020-001-1		—	
White seat with Bosses/Tnuts	7015-001-1		—	



FISHING SEATS

Low-Back Padded Boat Seat

This seat features a high impact plastic frame and aluminum hinges. It is UV and mildew resistant with easy to clean vinyl and a standard seat hole mounting pattern. 7"W x 16"D x 16"H.

* **WARNING** Cancer and Reproductive Harm – www.P65Warnings.ca.gov (see page 240)

Description	Bulk Packaging	Prop 65	Aftermarket Packaging	Prop 65
Low-Back Padded Boat Seat, Gray	—		98395GY	*
Low-Back Padded Boat Seat, White	—		98395WH	*
Low-Back Padded Boat Seat, Camo	—		98395CAMO	*



98395WH



Molded Bucket Seat

This one piece molded plastic boat seat is made from high-impact plastic. Seat includes mounting screws. 18"W x 21"D x 16"H.

* **WARNING** Cancer and Reproductive Harm – www.P65Warnings.ca.gov (see page 240)

Description	Bulk Packaging	Prop 65	Aftermarket Packaging	Prop 65
Molded Boat Seat, Gray	—		98390GY	*



98390GY



Padded Boat Seat

This padded boat seat is a comfortable and convenient addition to your boat's seating. It features thick padding, making your activities comfortable for long periods of time. It's compact and lightweight design makes it easy to transport. 20"W x 17"D x 12"H.

* **WARNING** Cancer and Reproductive Harm – www.P65Warnings.ca.gov (see page 240)

Description	Bulk Packaging	Prop 65	Aftermarket Packaging	Prop 65
Padded Boat Seat, Camo	—		98391GNMX	*
Padded Boat Seat, Gray	—		98391GY	*



Casting Seat

This casting seat is constructed with quality materials and workmanship. Made with marine-grade vinyl, it offers long-term support and comfort. A universal casting seat, it works with any casting seat application. Available in white, gray or camo. 15"W x 11"D x 6" H.

* **WARNING** Cancer and Reproductive Harm – www.P65Warnings.ca.gov (see page 240)

Description	Bulk Packaging	Prop 65	Aftermarket Packaging	Prop 65
Casting Seat, White	—		98505WH	*
Casting Seat, Camo	—		98505CA	*
Casting Seat, Gray	—		98505GY	*



278 SERIES PRODUCTS



STRONG. STABLE. SMOOTH.

Unmatched Strength.

Heavy-duty casting easily supports popular oversized helm seats.

Supreme Stability.

A rigid mount and wider seat interface create ultimate pedestal robustness.

Extra Smooth.

Improved slider motion facilitates easy fore and aft movement. Dampening gas spring on the 278 Air System absorbs impact.



278 Pro System
Fixed Height Pedestal



278 Air System
Adjustable Height Pedestal

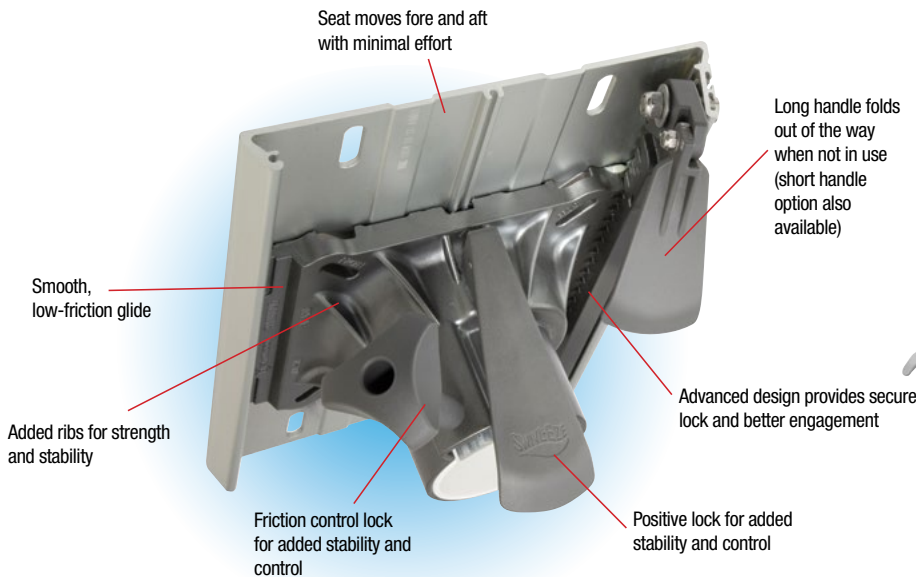

Dimensions of 278 Pro & 278 Air Systems

NOTE: 278 Pro & 278 Air System components are not compatible with other seating systems.

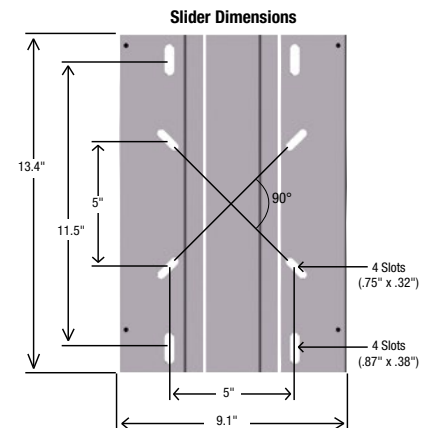
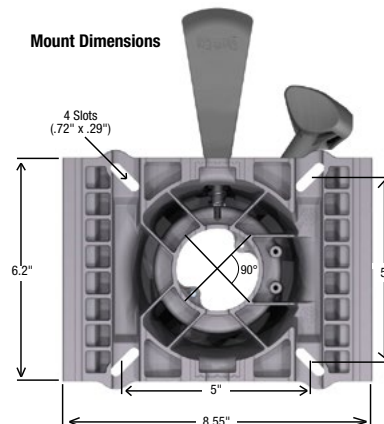
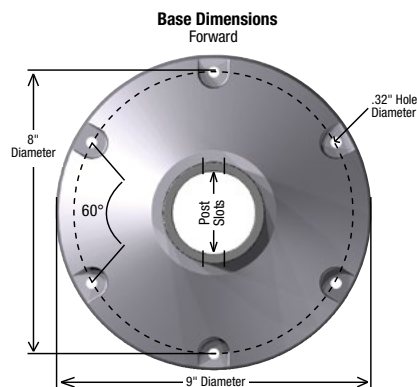
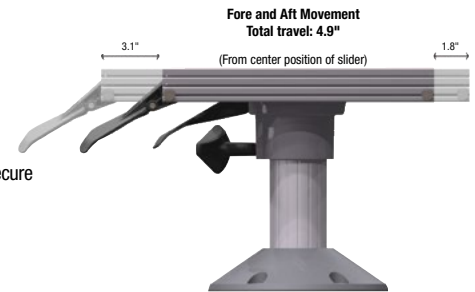

* 5-year warranty applies only to 278 Series products, found on pages 205-206.



* **⚠ WARNING** Cancer and Reproductive Harm – www.P65Warnings.ca.gov (see page 240)

278 Air System (Adjustable Height Pedestal)

Description	ABYC Code	Base Height	Slider Handle	Base Finish	Bulk Packaging	Prop 65
BASES (For total system height, add 1" to the base height.)						
278 Air Pedestal Base, 2.75" Below Deck	AO	9-12"	—	Gray	278AOP0912-BD-1	*
278 Air Pedestal Base	AO	12-15"	—	Gray	278AOP1215-1	*
278 Air Pedestal Base	AO	15-19"	—	Gray	278AOP1519-1	*
278 Air Pedestal Base	AO	19-23"	—	Gray	278AOP1923-1	*
SEAT MOUNTS						
278 Pro Mount, 3 degree	AO	—	—	—	278A03AM-1	*
278 Pro Mount, 0 degree	AO	—	—	—	278A0ZAM-1	*
278 MOUNTS WITH SLIDER						
278 AirGlide Slider, 0 degree	AO	—	Short	—	278A0ZAGS-1	*
278 AirGlide Slider, 0 degree	AO	—	Long	—	278A0ZAGL-1	*
278 AirGlide Slider, 3 degree	AO	—	Short	—	278A03AGS-1	*
278 AirGlide Slider, 3 degree	AO	—	Long	—	278A03AGL-1	*



* **⚠ WARNING** Cancer and Reproductive Harm – www.P65Warnings.ca.gov (see page 240)

278 Pro System (Fixed Height Pedestal)

Description	ABYC Code	Base Height	Slider Handle	Base Finish	Bulk Packaging	Prop 65
278 Pro Pedestal Base, Low Profile	AO	5"	—	Bright	—	
278 Pro Pedestal Base	AO	6"	—	Gray	278A0GY060-1	*
278 Pro Pedestal Base	AO	7"	—	Gray	278A0GY070-1	*
278 Pro Pedestal Base	AO	8"	—	Gray	278A0GY080-1	*
278 Pro Pedestal Base	AO	9"	—	Gray	278A0GY090-1	*
278 Pro Pedestal Base	AO	10"	—	Gray	278A0GY100-1	*
278 Pro Pedestal Base	AO	11"	—	Gray	278A0GY110-1	*
278 Pro Pedestal Base	AO	12"	—	Gray	278A0GY120-1	*
278 Pro Pedestal Base	AO	13"	—	Gray	278A0GY130-1	*
SEAT MOUNTS						
278 Pro Mount, 3 degree	AN	—	—	—	278ANZPM-1	*
278 Pro Mount, 0 degree	AO	—	—	—	278A0ZPM-1	*
278 Pro Mount, 3 degree	AO	—	—	—	278A03PM-1	*
SEAT MOUNTS WITH SLIDER						
278 ProGlide Slider, 3 degree	AO	—	Long	—	278A03PGL-1	*
278 ProGlide Slider, 0 degree	AO	—	Long	—	278A0ZPGL-1	*



AN = For use in all non-helm positions.

AO = For use in helm positions.



238 SERIES 2-3/8" PRODUCTS

238 Series has strength, style and corrosion-resistance:

- Pedestal tubes are hard-anodized aluminum
- All springs are stainless steel
- Bases are bead-blasted (to close aluminum porosity) and clear coated

Smooth movement without wobble

- Slider has gear-tooth lock mechanism; locks solidly, disengages easily
- Slider rides smoothly on acetal linear bearings

Clean style, ergonomic design

- Styling is clean and uncomplicated
- Handles are ergonomically designed to be easy on the hands and easy to reach

Not recommended to interchange with other manufacturers' products

Reinforced polymer handle is thicker for strength and more comfortable grip.

Seat mount mechanism is redesigned. Constant pressure spring provides continuous forward locking pressure.

Cable-actuated height mechanism never needs adjustment.

Linear grooves provide support, reduce wiggle. Acetal linear bearings keep the whole operation smooth and wobble free.

Bead-blasted base finish pounds the aluminum surface and closes up porosity. Proprietary clear-coating improves resistance to scuffing and corrosion.

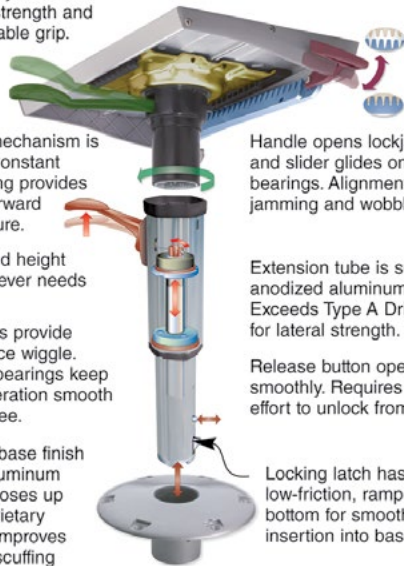

Handle opens lockjaw gears... and slider glides on acetal linear bearings. Alignment tracks eliminate jamming and wobbling.

Extension tube is super-hard anodized aluminum alloy. Exceeds Type A Driver requirements for lateral strength.

Release button operates smoothly. Requires less effort to unlock from base.

Locking latch has low-friction, ramped bottom for smooth insertion into base.

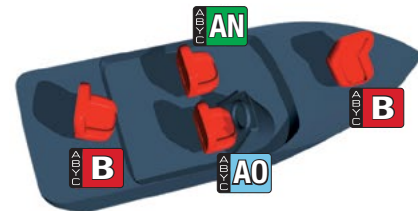
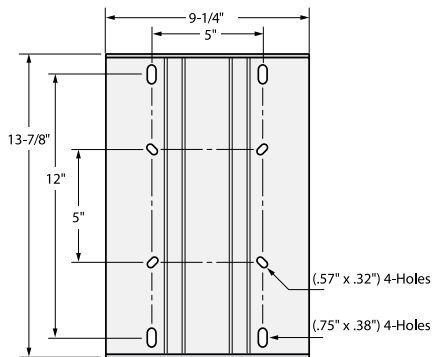

- AO** Blue "AO" = Type A/Operator OK for Helm/Driver position
- AN** Green "AN" = Type A/Non-Operator Not to be used at Helm/Driver position
- B** Red "B" = Type B Slow Speed Not to be used at Helm/Driver position For speeds not to exceed 5 mph



Swivl-Eze 238 Pedestal Kits

Attwood's 2-3/8" pedestal kit is strong, durable, and corrosion resistant. The kit includes a 360 degree swivel seat mount, removable extension post, and 9" base. Available in satin aluminum or Realtree MAX-4 Camouflage.



* **⚠ WARNING** Cancer and Reproductive Harm – www.P65Warnings.ca.gov (see page 240)

Description	ABYC Code	Req. Dia. Mounting Hole	Bulk Packaging	Prop 65	Aftermarket Packaging	Prop 65
BASE PLATE: 9", SEAT MOUNT 5" X 5" ON CENTER						
Pedestal Kit with 9" Satin Post	A0	3"	—		23809-7	*
Pedestal Kit with 11" Satin Post	A0	3"	—		23811-7	*
Pedestal Kit with 13" Satin Post	A0	3"	—		23813-7	*
Pedestal Kit with 15" Satin Post	A0	3"	—		23815-7	*



238 Series Seat Mounts

* **⚠ WARNING** Cancer and Reproductive Harm – www.P65Warnings.ca.gov (see page 240)

Description	ABYC Code	Bulk Packaging	Prop 65	Aftermarket Packaging	Prop 65
SEAT MOUNTS WITHOUT SLIDER					
Stainless Steel, 3° Tilt, Left Handle	A0	238141-1		—	
Stainless Steel, 3° Tilt, Right Handle	A0	238142-1		238142-7	
Plated Steel, 0° Tilt, Left Handle	A0	238150-1		—	
Plated Steel, 3° Tilt, Left Handle	A0	238151-1		—	
Plated Steel, 3° Tilt, Right Handle	A0	238152-1		238152-7	
Plated Steel, 3° Tilt, Forward Handle	A0	238153-1		238153-7	
SEAT MOUNTS WITH ALUMINUM SLIDER					
Plated Steel, 3° Tilt, Right Handle	A0	238162-1		238162-4	*
Plated Steel, 0° Tilt, Right Handle	A0	238164-1		—	

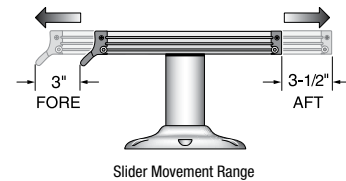

238 Series Pedestals & Extension Posts

* **⚠ WARNING** Cancer and Reproductive Harm – www.P65Warnings.ca.gov (see page 240)

Description	ABYC Code	Bulk Packaging	Prop 65	Aftermarket Packaging	Prop 65
FIXED HEIGHT BELL PEDESTALS (HEIGHT MEASURED FROM DECK TO TOP OF SEAT MOUNT)					
8" Height	AO	238908-1		—	
11" Height	AO	238911-1	*	—	
12" Height	AO	238912-1	*	—	
13" Height	AO	238913-1		—	
15" Height	AO	238915-1		—	
FIXED HEIGHT EXTENSION POSTS (HEIGHT MEASURED FROM DECK TO TOP OF SEAT MOUNT)					
8" Height	AO	238608-1	*	—	
9" Height	AO	238609-1	*	—	
10" Height	AO	238610-1	*	238610-3	*
11" Height	AO	238611-1	*	—	
12" Height	AO	238612-1	*	238612-3	*
13" Height	AO	238613-1	*	238613-3	*
14" Height	AO	238614-1	*	—	
15" Height	AO	238615-1	*	238615-3	*
17" Height	AO	238617-1	*	—	
25" Height	AO	238625-1	*	—	
30" Height	B	238630-1		—	
	B	238630L1		—	
PRO-POLE EXTENSION POSTS** - TYPE "B" (HEIGHT MEASURED FROM DECK TO TOP OF SEAT MOUNT)					
27" Height	B	238027-1		238027-3	
ADJUSTABLE HEIGHT POWER PEDESTALS (HEIGHT MEASURED FROM DECK TO TOP OF SEAT MOUNT)					
13" to 16-1/2" Height	AO	238512-1		238512-4	
19-1/2" to 23" Height	AO	238522-1		238522-4	*



238 Series Socket Bases

Bases are interchangeable between LakeSport 238 Series and 238 Series.

* **⚠ WARNING** Cancer and Reproductive Harm – www.P65Warnings.ca.gov (see page 240)

Description	ABYC Code	Req. Dia. Mounting Hole	Bulk Packaging	Prop 65	Aftermarket Packaging	Prop 65
Aluminum 9" Round, Clear Coat Finish	AO	3"	238312-1		238312-2	
Aluminum 9" D-Shaped, Clear Coat Finish	AO	3"	238322-1		—	
Stainless Steel, 7" x 7", Square, Centered Hole	AO	3"	238333-1	*	—	
Aluminum 9" Cut Both Sides, Clear Coat Finish	AO	3"	238352-1		—	
238 SERIES SOCKET BASE SPLASH GUARD						
Socket Splash Guard, Plastic	AO	—	238300-1		—	

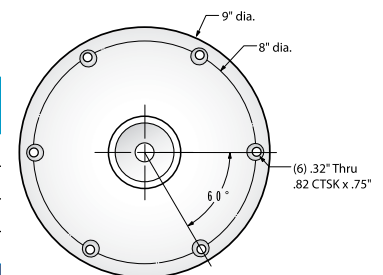

LAKEPORT 238 SERIES PRODUCTS



The Swivl-Eze Difference

- These sturdy 2-3/8" diameter pedestal systems have all the strength and durability you need for years of family fishing enjoyment.
- Hard anodized aluminum pedestal tubes
- Bead blasted finish pounds the aluminum surface and closes up porosity
- All LakeSport™ 238 Series hardware is engineered to exceed ABYC standards

Type A/Operator Models lead the industry with these features:

- Ergonomic positive-locking handle with stainless steel components



- AO** Blue "AO" = Type A/Operator OK for Helm/Driver position
- AN** Green "AN" = Type A/Non-Operator Not to be used at Helm/Driver position
- B** Red "B" = Type B Slow Speed Not to be used at Helm/Driver position For speeds not to exceed 5 mph

LakeSport 2-3/8" Seat Mounts

* **WARNING** Cancer and Reproductive Harm – www.P65Warnings.ca.gov (see page 240)



Description	ABYC Code	Bulk Packaging	Prop 65	Aftermarket Packaging	Prop 65
SEAT MOUNTS WITHOUT SLIDER INSTALLED HEIGHT: 5/8"					
Aluminum, w/ Friction Control, 3° Tilt	AN	818440	*	—	
Aluminum, w/ Friction Control, 3° Tilt	AO	818441	*	818441-3	*
SEAT MOUNTS WITH ALUMINUM SLIDER INSTALLED HEIGHT: 1"					
Aluminum, w/ Friction Control, 3° Tilt	AO	828461	*	—	

LakeSport 2-3/8" Extension Posts

* **WARNING** Cancer and Reproductive Harm – www.P65Warnings.ca.gov (see page 240)

For LakeSport seat mounts only

Description	ABYC Code	Bulk Packaging	Prop 65	Aftermarket Packaging	Prop 65
FIXED HEIGHT EXTENSION POSTS (HEIGHT MEASURED FROM DECK TO TOP OF SEAT MOUNT)					
10" Height, Anodized Finish	AN	238610L1	*	—	
11" Height, Anodized Finish	AN	238611L1	*	—	
13" Height, Anodized Finish	AN	238613L1	*	—	



LakeSport 2-3/8" Seat Pedestals

* **⚠ WARNING** Cancer and Reproductive Harm – www.P65Warnings.ca.gov (see page 240)



Description	ABYC Code	Bulk Packaging	Prop 65	Aftermarket Packaging	Prop 65
HYDRAULIC POWER PEDESTALS W/ SEAT MOUNT (HEIGHT MEASURED FROM DECK TO TOP OF SEAT MOUNT)					
12" – 15" Adjustable Height, Anodized Finish	AO	238813LSM1	*	—	
25" – 32" Adjustable Height, Anodized Finish	B	238833LSM1	*	—	
FIXED HEIGHT BELL PEDESTALS (HEIGHT MEASURED FROM DECK TO TOP OF SEAT MOUNT)					
11" Height	AO	238911L1	*	—	
13" Height	AO	238913L1	—	—	
FIXED HEIGHT BELL PEDESTALS W/ SEAT MOUNT (HEIGHT MEASURED FROM DECK TO TOP OF SEAT MOUNT)					
9" Height	AN	238909LSM1	*	—	
13" Height	AN	238913LSM1	*	—	
16" Height	AN	238916LSM1	*	—	
ADJUSTABLE HEIGHT BELL PEDESTALS W/ SEAT MOUNT, MANUAL (HEIGHT FROM DECK TO TOP OF SEAT MOUNT)					
14"-20" Adjustable Height, Anodized	AN	—	—	2385400	*
12-1/2"-15-1/2" Adj. Height, J-Slot, Anodized	AO	—	—	2385405	*



LakeSport 2-3/8" Socket Bases

Bases are interchangeable between LakeSport 238 Series and 238 Series.

* **⚠ WARNING** Cancer and Reproductive Harm – www.P65Warnings.ca.gov (see page 240)

Description	ABYC Code	Req. Dia. Mounting Hole	Bulk Packaging	Prop 65	Aftermarket Packaging	Prop 65
Aluminum 9" Round, Clear Coat Finish	AO	3"	238312-1		238312-2	
Aluminum 9" D-Shaped, Clear Coat Finish	AO	3"	238322-1		—	
Stainless Steel, 7" x 7", Square, Centered Hole	AO	3"	238333-1	*	—	
Aluminum 9" Cut Both Sides, Clear Coat Finish	AO	3"	238352-1	*	—	
238 SERIES SOCKET BASE SPLASH GUARD						
Socket Splash Guard, Plastic	AO	—	238300-1		—	

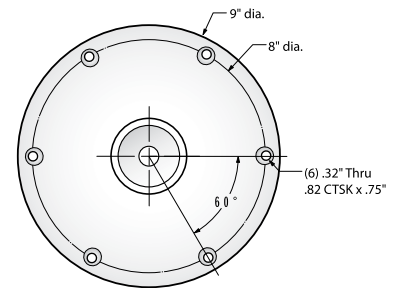

WEDGE 2" & 2-3/8" PRODUCTS



Wedge shaped components slide in for a snug, stable fit

- Type B mounts are not designed to "lock" into post
- Engineered to prevent unintentional detachment

Posts

- Heavy-duty bushing with peripheral bearing system and exclusive "crush ribs" are individually sized for exact fit
- Pedestals come in a few lengths, including patented "J-Slot" adjustable height
- Locking tab positively locks post to base
- Wedge™ bushing locks in with a tight, solid fit
- 2-Point stainless steel riveting strengthens the bushing

Bases

- Strong base design has reinforcing ribs and improved profile to withstand the toughest conditions
- Bead blasting closes aluminum porosity. Brushing process provides long-lasting high-sheen finish

Not recommended to interchange with other manufacturers' products



Blue "AO" = Type A/Operator OK for Helm/Driver position



Green "AN" = Type A/Non-Operator Not to be used at Helm/Driver position



Red "B" = Type B Slow Speed Not to be used at Helm/Driver position For speeds not to exceed 5 mph

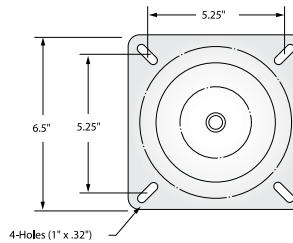

Wedge 2" Seat Mounts

* **WARNING** Cancer and Reproductive Harm – www.P65Warnings.ca.gov (see page 240)

Description	ABYC Code	Installed Height	Bulk Packaging	Prop 65	Aftermarket Packaging	Prop 65
Cast Aluminum, Black E-Coat Steel, 3° Tilt	B	3"	—		SP-18914	*

Wedge 2" Extension Posts

* **WARNING** Cancer and Reproductive Harm – www.P65Warnings.ca.gov (see page 240)

Description	ABYC Code	Bulk Packaging	Prop 65	Aftermarket Packaging	Prop 65
2" FIXED HEIGHT POSTS					
11" Satin Anodized	B	—		SP-28911	*
13" Satin Anodized	B	—		SP-28913	*



Wedge 2-3/8" Extension Posts

* **WARNING** Cancer and Reproductive Harm – www.P65Warnings.ca.gov (see page 240)

Description	ABYC Code	Bulk Packaging	Prop 65	Aftermarket Packaging	Prop 65
2-3/8" ADJUSTABLE HEIGHT POSTS - POWER PEDESTALS (W / INTEGRAL SEAT MOUNT)					
14" - 20" Satin Anodized	B	—		SP-37904	*
24" to 30" Satin Anodized	B	—		SP-37914	*

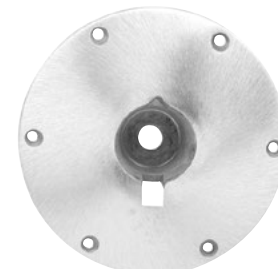

Wedge 2" Base Plates

* **WARNING** Cancer and Reproductive Harm – www.P65Warnings.ca.gov (see page 240)

Description	ABYC Code	Req. Dia. Mounting Hole	Depth Below Deck	Bulk Packaging	Prop 65	Aftermarket Packaging	Prop 65
9" Round, Brushed Aluminum	A0	3.25"	2"	—		SP-68914	*



LOCK'N-PIN 3/4" PIN PRODUCTS



Swivl-Eze is the #1 supplier of 3/4" pin seating hardware. Here's why:

- The 3/4" system gives you outstanding economical performance
- The design is proven by decades of experience
- Posts are available as fixed, manually adjustable or power adjustable
- Seat mounts, posts and bases are available in steel, aluminum or stainless steel

The Swivl-Eze Difference

- The patented Lock'N-Pin system leads the industry in safety
- Lock'N-Pin prevents unintentional detachment for seat mounts, posts and bases
- Lock'N-Pin products exceed ABYC Standard H31.6.1

Not recommended to interchange with other manufacturers' products



Blue 'AO' = Type A/Operator OK for Helm/Driver position



Green 'AN' = Type A/Non-Operator Not to be used at Helm/Driver position



Red 'B' = Type B Slow Speed Not to be used at Helm/Driver position For speeds not to exceed 5 mph

Lock'N-Pin 3/4" Pedestal Packages

Includes Brushed aluminum post, black E-coated seat mount with Spring & Base Plate.

* **WARNING** Cancer and Reproductive Harm – www.P65Warnings.ca.gov (see page 240)

Description	ABYC Code	Post	Seat Mount	Base Plate	Bulk Packaging	Prop 65	Aftermarket Packaging	Prop 65
11" Post, 7"x7" SS Base Plate, Non-Threaded	B	2114	1002	67739	—	—	97739	*
11" Post, 7"x7" SS Base Plate, Threaded	B	2114-T	1002	67739-T	—	—	97739-T	*
13" Post, 7"x7" SS Base Plate, Threaded	B	2134-T	1002	67739-T	—	—	97739-T	*
Brushed Aluminum Finish Kit, 11" Post, 7"x7" Aluminum Base Plate, Non-Threaded	B	2114	1002	67749	—	—	97749-7	*
Camouflage Finish Kit, 11" Post, 7"x7" Aluminum Base Plate, Non-Threaded	B	2114	1002	67749	—	—	97749C-7	*



97749-7

97749C-7

Lock'N-Pin 3/4" Pin Seat Mounts

* **WARNING** Cancer and Reproductive Harm – www.P65Warnings.ca.gov (see page 240)

Description	ABYC Code	Installed Height	Bulk Packaging	Prop 65	Aftermarket Packaging	Prop 65
Black E-Coated, 3° Tilt, 2-3/4" Steel Pin, w / Spring	B	2"	1002	*	SP-1002	*
Black E-Coated, 3° Tilt, 2-1/2" Steel Pin	B	1"	1002-S	*	—	—
All Stainless Steel, 3° Tilt, 2-3/4" Stainless Steel Pin	B	1"	1002-SS	*	—	—
Cast Aluminum, 3° Tilt, 3" Stainless Steel Pin	B	1"	1063	*	—	—



1002



1002-SS

Swivl-Eze 075 Pedestal Kits

Take the confusion out of buying pedestals with these convenient 3/4" pin kits. Kits include seat mount, post and 7" x 7" base. Simply choose the appropriate post height and finish.

Attwood's 3/4" pin kit is corrosion resistant, features a 360 degree swivel, a shock absorbing spring, and a removable pin post. Lock'N-Pin technology features an all steel pin, increasing pedestal strength and durability. Available in brushed aluminum or Realtree MAX-4 camouflage.

* **WARNING** Cancer and Reproductive Harm – www.P65Warnings.ca.gov (see page 240)

Description	ABYC Code	Bulk Packaging	Prop 65	Aftermarket Packaging	Prop 65
BASE PLATE: 7" x 7", SEAT MOUNT 5-1/4" X 5-1/4" ON CENTER Add 3" to post height to get total height, measured from deck to seat					
13" Brushed Aluminum Post	B	—	—	97750-7	*
13" Realtree MAX-4 Camouflage Post	B	—	—	97750C-7	*

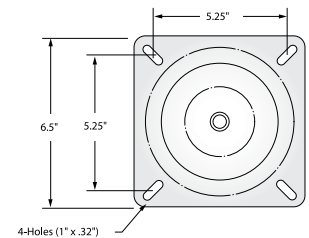

Lock'N-Pin 3/4" Pin Posts



* **WARNING** Cancer and Reproductive Harm – www.P65Warnings.ca.gov (see page 240)

Description	ABYC Code	Bulk Packaging	Prop 65	Aftermarket Packaging	Prop 65
FIXED HEIGHT POSTS					
6" Hgt, 1.5" Dia., Brushed Aluminum, Non-Threaded, Steel Pin	B	2064	*	—	
11" Hgt, 1.5" Dia., Brushed Aluminum, Non-Threaded, Steel Pin	B	2114	*	SP-2114	*
11" Hgt, 1.5" Dia., Brushed Aluminum, Threaded, Steel Pin	B	2114-T	*	SP-2114-T	*
13" Hgt, 1.5" Dia., Brushed Aluminum, Non-Threaded, Steel Pin	B	2134	*	SP-2134	*
13" Hgt, 1.5" Dia., Brushed Aluminum, Threaded, Steel Pin	B	2134-T	*	SP-2134-T	*
13" Hgt, 1.5" Dia., Brushed Aluminum, Non-Threaded, SS Pin	B	2134-SS	*	—	
13" Hgt, 1.5" Dia., Brushed Aluminum, Threaded, SS Pin	B	2134-T-SS	*	—	
13" Hgt, 1.5" Dia., Polished SS, Offset Post 6", Threaded, SS Pin	B	7153-T-SS	*	SP-7153-T-SS	*
16" Hgt, 1.5" Dia., Brushed Aluminum, Non-Threaded, Steel Pin	B	2164	*	SP-2164	*
16" Hgt, 1.5" Dia., Brushed Aluminum, Threaded, Steel Pin	B	2164-T	*	SP-2164-T	*
24" Hgt, 1.5" Dia., Brushed Aluminum, Pro-Post, Non-Threaded, Steel Pin	B	2244	*	SP-2244	*
ADJUSTABLE HEIGHT POSTS - MANUAL					
25"-31" Hgt, 1.5" Dia., Brushed Alum., Pro-Post, Non-Thread, Steel Pin	B	2244-ADJ		SP-2244-ADJ	*
25"-31" Hgt, 1.5" Dia., Brushed Alum., Pro-Post, Threaded, Steel Pin	B	2244-ADJ-T		SP-2244-ADJ-T	*
ADJUSTABLE HEIGHT POSTS - POWER PEDESTALS W/ INTEGRAL SEAT MOUNTS					
14"-17" Hgt, 1.77" Dia., Brushed Aluminum, Non-Threaded, Steel Pin	B	3004	*	SP-3004	*
14"-17" Hgt, 1.77" Dia., Brushed Aluminum, Threaded, Steel Pin	B	3004-T	*	SP-3004-T	*
24"-30" Hgt, 1.77" Dia., Brushed Alum., Pro-Post, Non-Thread., Steel Pin	B	3204	*	SP-3204	*
24"-30" Hgt, 1.77" Dia., Brushed Alum., Pro-Post, Threaded, Steel Pin	B	3204-T	*	SP-3204-T	*
24"-30" Hgt, 1.77" Dia., Brushed Alum., Pro-Post, Threaded, SS Pin	B	3204-T-SS	*	—	
ADJUSTABLE HEIGHT POSTS - POWER PEDESTALS FOR USE WITH 3/4" PIN SEAT MOUNTS					
15"-18" Hgt, 1.77" Dia., Brushed Aluminum, Non-Threaded, Steel Pin	B	3004-R	*	SP-3004-R	*
15"-18" Hgt, 1.77" Dia., Brushed Aluminum, Threaded, Steel Pin	B	3004-R-T	*	SP-3004-R-T	*
15"-18" Hgt, 1.77" Dia., Brushed Aluminum, Threaded, SS Pin	B	3004-R-T-SS	*	—	
24"-30" Hgt, 1.77" Dia., Brushed Aluminum, Non-Threaded, Steel Pin	B	3204-R	*	SP-3204-R	*
24"-30" Hgt, 1.77" Dia., Brushed Aluminum, Threaded, Steel Pin	B	3204-R-T	*	SP-3204-R-T	*
24"-30" Hgt, 1.77" Dia., Brushed Aluminum, Threaded, SS Pin	B	3204-R-T-SS	*	—	



2114-T

2114



7153-T-SS



3204-T

3004-R

2134-SS

2244-ADJ-T



Lock'N-Pin 3/4" Pin Bases

* **⚠ WARNING** Cancer and Reproductive Harm – www.P65Warnings.ca.gov (see page 240)



Description	ABYC Code	Req. Dia. Mounting Hole	Depth Below Deck	Bulk Packaging	Prop 65	Aftermarket Packaging	Prop 65
ZINC PLATED STEEL							
6" x 8", Non-Threaded, Bronze Bushing	B	2.75"	2.5"	6682	*	—	
6" x 8", Threaded, Bronze Bushing	B	2.75"	3.5"	6682-T	*	—	
7" x 7", Non-Threaded, Acetal Bushing	B	2.75"	2.5"	67729	*	—	
7" x 7", Threaded, Acetal Bushing	B	2.75"	3.5"	67729-T	*	SP-67739-T	*
ALUMINUM							
7" x 7", Non-Threaded, Acetal Bushing, Clear Coat	B	3.5"	2.5"	67749		SP-67749	
STAINLESS STEEL FINISH WITH STEEL LIP TUBE							
3" x 4", Non-Threaded, Acetal Bushing	B	1.5"	2.5"	63439	*	—	
4" x 8", Non-Threaded, Acetal Bushing	B	1.5"	2.5"	64839	*	SP-64839	*
4" x 8", Non-Threaded, Bronze Bushing	B	1.5"	2.5"	6483	*	—	
4" x 8", Threaded, Bronze Bushing	B	1.5"	3.7"	6483-T	*	—	
6" x 8", Non-Threaded, Acetal Bushing	B	2.75"	2.5"	66839	*	SP-66839	*
6" x 8", Threaded, Bronze Bushing	B	2.75"	3.7"	6683-T	*	—	
6" x 12", Dual Socket, Threaded, Bronze Bushing	B	2.75"	3.7"	66123-T	*	—	
7" x 7", Non-Threaded, Acetal Bushing	B	2.75"	2.5"	67739	*	SP-67739	*
7" x 7", Non-Threaded, Bronze Bushing	B	2.75"	2.5"	6773	*	—	
7" x 7", Threaded, Bronze Bushing	B	2.75"	3.5"	6773-T	*	—	
7" x 7", Threaded, Bronze Bushing, Unfinished	B	2.75"	3.7"	6773-T-U	*	—	
7" x 7", Offset Hole, Non-Threaded, Acetal Bushing	B	2.75"	2.5"	67739-SC	*	—	
ALL STAINLESS STEEL							
4" x 4", Non-Threaded, Acetal Bushing	B	1.5"	2.5"	64439-SS	*	—	
4" x 4", Polished, Threaded, Bronze Bushing	B	2.75"	3.7"	6443-T-P-SS	*	—	
7" x 7", Non-Threaded, Acetal Bushing	B	2.75"	2.5"	67739-SS	*	—	

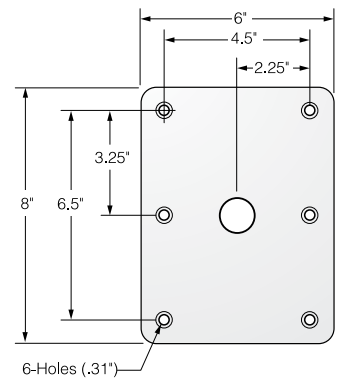
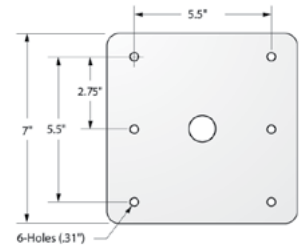

67729



67739-SC



67749



67739-SS



66839



67739



64839



6773



ACCESSORIES

PEDESTALS, SWIVELS & ADAPTERS



Swivl-Eze has the boating experience to deliver all the accessories you want:

- Seating accessories for retrofitting and improving
- Adapters to change a post installation or swivel location
- Table mounts to make boating more convenient and enjoyable

Pedestals

Little on price, big on performance

- Exceptional durability
- Reinforced welded joints
- Black powder coated for a long lasting finish

Description	Bulk Packaging	Aftermarket Packaging
Pedestal, 7"	—	90720
Pedestal, 13"	—	91320
Adjustable Pedestal, 11-1/2" - 17-1/2"	—	91320-ADJ



90720



91320



91320-ADJ

Seat Swivels

Description	Bulk Packaging	Aftermarket Packaging
Zinc Plated, 0° Tilt, 4-Way Locking	1872	—
Black Powder Coated, 0° Tilt, 6-1/4" (10 p/Box)	—	17720
Black Powder Coated, 3° Tilt, 7" (10 p/Box)	—	17721



17720



1872



Seat Mounts

Bench Style Seat Mounts

- Great for mounting seats in jon boats
- Constructed of quality aluminum.

Clamp-On Boat Seat Swivel

- Adjusts from 7-1/2" - 18"
- Black powder coated swivel
- Fits most seat hole patterns

* **⚠ WARNING** Cancer and Reproductive Harm – www.P65Warnings.ca.gov (see page 240)

Description	Bulk Packaging	Prop 65	Aftermarket Packaging	Prop 65
BENCH STYLE SEAT MOUNTS				
Bench Style Kit: Seat Plate an 15" Rails	—		SP-15900	*
Bench Style Seat Plate Only	—		SP-15100	
Bench Style 30" Rails Only	—		SP-15200	*
CLAMP-ON BOAT SWIVEL				
Boat Swivel	—		15700-3	



SP-15900



15700

Quick Disconnect Seat Mount

Allows for easy attachment and removal of boat seats for ease in storage and care. Produced from durable engineered plastic and coated structural steel frame for years of use. Easy to install and use, mounts directly to existing seats and standard pedestals. Perfect for Jon boats, fishing boats, pontoons and more.

* **⚠ WARNING** Cancer and Reproductive Harm – www.P65Warnings.ca.gov (see page 240)

Description	Bulk Packaging	Prop 65	Aftermarket Packaging	Prop 65
Quick Disconnect Seat Mount, fits 6-1/4" (15.9 cm) swivel and plates	—		11602D1	*
Quick Disconnect Seat Mount, fits 7" (17.8 cm) swivel and plates	—	*	11603D1	*



11602D1



11603D1

Deck Slide

- Mounts directly to the boat deck
- 1-5/8" total height
- Constructed of strong aluminum
- Convenient front control operation

* **⚠ WARNING** Cancer and Reproductive Harm – www.P65Warnings.ca.gov (see page 240)

Description	Bulk Packaging	Prop 65	Aftermarket Packaging	Prop 65
Deck Mounted Seat Slide	815000	*	—	



815000

Swivl-Offset

Need more room to maneuver? The 6" Swivl-Eze offset allows additional seat clearance in any position.

* **⚠ WARNING** Cancer and Reproductive Harm – www.P65Warnings.ca.gov (see page 240)

Description	Bulk Packaging	Prop 65	Aftermarket Packaging*	Prop 65
Swivl-Offset	—		7062-3	*



Table Top Mount System

* **⚠ WARNING** Cancer and Reproductive Harm – www.P65Warnings.ca.gov (see page 240)

Description	Bulk Packaging	Prop 65	Aftermarket Packaging	Prop 65
Brushed aluminum post with tension knob. Threaded for use in base. 25"	17525	*	—	
6" diameter round stainless steel base, threaded. Flush mounts to deck. Low profile.	—		952	*



Pedestal Pin Post Adapter

Converts 1.77" bases to accept 3/4" posts

* **⚠ WARNING** Cancer and Reproductive Harm – www.P65Warnings.ca.gov (see page 240)

Description	Bulk Packaging	Prop 65	Aftermarket Packaging	Prop 65
Adapter	—		SP-14000	*





CUSTOM-FIT MOTOR COVERS 220

MOTOR COVERS



CUSTOM-FIT MERCURY® MOTOR COVERS

Show-Off Your Engine ...While You Keep it Under Cover

Custom-fit motor covers feature the Mercury logo in brilliant white against a black background. These covers protect and fit perfectly to the motors unique pattern, showing off your Mercury pride on the water and road.

* **⚠ WARNING** Cancer and Reproductive Harm –
www.P65Warnings.ca.gov (see page 240)

Constructed of 2-Ply Laminated Polyester

- The outer shell is tough, abrasion-resistant polyester
- Acrylic coating keeps the cover waterproof and UV-resistant
- The inside lining is a soft, non woven polyester backing that provides a cushioned barrier around the engine cowling
- A 1-inch polyweb strap in the bottom hem cinches the cover tight. Includes quick-release buckle for fast tightening and removal

*Note: Construction and shape of cover may vary due to different engine styles.
Mercury motor covers fit model year 2000 and newer engines.*

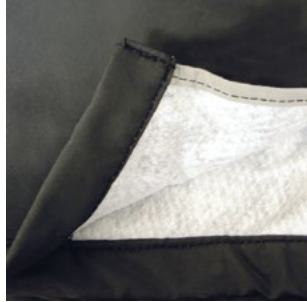

Verado Only



All Others

Engine Description	Engine Size	Bulk Packaging	Prop 65	Aftermarket Packaging	Prop 65
4-Stroke	8-9.9HP	—		105682	*
4-Stroke	15HP, 20HP	—		105683	*
4-Stroke EFI	25HP, 30HP	—		105676	*
4-Stroke EFI	40HP, 50HP, 60HP	—		105651	*
Optimax 1.5L	75HP, 90HP, 115HP, 125HP	—		105635	*
Optimax 2.5L	135HP, 150HP, 175HP	—		105636	*
2-Stroke 2.5L V-6 EFI	150HP, 200HP	—		105637	*
2.5L V-6 Carb	150HP, 200HP				
4-Stroke 1.7L	75HP, 90HP, 115HP				
2-Stroke	75HP, 90HP				
Optimax 3.0L	200HP, 225HP, 250HP	—		105638	*
2-Stroke 3.0L EFI	200HP, 225HP, 250HP				
Verado 4-Cylinder	135HP, 150HP, 175HP, 200HP	—		105648	*
Verado	200HP, 225HP, 250HP, 275HP, 300HP	—		105639	*
150 4-Stroke	150HP	—		105762	*
2.1L	75HP-115HP	—		105777	*
Verado Racing 400R	400HP	—		105782	*





INDEX

BY PART NUMBER	222-231
ALPHABETICAL	232-235



INDEX

BY PART NUMBER

	PART NO	PAGE NO	PART NO	PAGE NO	PART NO	PAGE NO
827.....	818441.....	210	10623-3.....	170	11285-3.....	151
952.....	828461.....	210	10624-3.....	170	11315-1.....	149
1002.....	1001667.....	11	10627-7.....	171	11317-1.....	149
1063.....	1001668.....	11	10628-7.....	171	11319-1.....	149
1872.....	2385400.....	211	10629-7.....	171	11360-1.....	150
2064.....	2385405.....	211	10630-7.....	171	11361-1.....	150
2114.....	5091-10-1.....	41	10633-7.....	171	11362-1.....	150
2134.....	5091-10-7.....	41	10634-7.....	171	11363-1.....	150
2164.....	5091-12-1.....	41	11011-7.....	144	11364-1.....	150
2244.....	5091-14-1.....	41	11029-6.....	144	11368-3.....	151
3004.....	5091-14-7.....	41	11090-3.....	152	11370-1.....	151
3204.....	5092-10-7.....	41	11110-7.....	152	11370-7.....	118
4236.....	5095-10-7.....	41	11126-4.....	145	11371-1.....	151
6483.....	5097-10-1.....	42	11127-4.....	145	11372-1.....	151
6682.....	5098-10-1.....	41	11130-7.....	145	11401-4.....	145
6773.....	5122-08-7.....	54	11136-1.....	147	11404-6.....	118, 175
10107.....	001008199*.....	70	11136-7.....	147	11437-7.....	142
10108.....	001008200*.....	70	11137-1.....	147	11438-7.....	142
10309.....	001011094*.....	70	11137-7.....	147	11441-4.....	142
12000.....	1002-S.....	213	11138-1.....	147	11446-1.....	24
17525.....	1002-SS.....	213	11138-7.....	147	11477-3.....	121
17720.....	105693BK.....	152	11141-1.....	147	11478-7.....	121
17721.....	105694BK.....	152	11141-7.....	147	11512-3.....	87
63439.....	105694FG.....	152	11147-1.....	147	11524-1.....	22
64839.....	105694NV.....	152	11147-7.....	147	11524-3.....	22
66839.....	105694RB.....	152	11149-4.....	146	11526-3.....	87
67729.....	105694RD.....	152	11150-5.....	101	11551-5.....	14
67739.....	105694SV.....	152	11153-1.....	147	11574-4.....	12
67749.....	105695BK.....	152	11153-7.....	147	11575-3.....	101
90720.....	105695FG.....	152	11180-5.....	101	11586-4.....	24
91320.....	105695NV.....	152	11195-4.....	146	11591-3.....	24
96008.....	105695RB.....	152	11200-1.....	148	11592-3.....	24
97739.....	105695RD.....	152	11201-1.....	148	11595-2.....	13, 139
98124.....	105695SV.....	152	11202-1.....	148	11596-2.....	13, 139
105635.....	105696BK.....	152	11205-1.....	149	11602D1.....	217
105636.....	105696FG.....	152	11209-1.....	149	11603D1.....	217
105637.....	105696NV.....	152	11210-1.....	149	11631-4.....	125
105638.....	105696RB.....	152	11211-1.....	149	11635-4.....	125
105639.....	105696RD.....	152	11215-1.....	149	11654-3.....	125
105648.....	105696SV.....	152	11216-1.....	149	11664-3.....	89
105651.....	10600-3.....	170	11217-1.....	149	11670-4.....	125
105676.....	10601-3.....	170	11220-3.....	150	11672-4.....	125
105682.....	10602-3.....	170	11230-1.....	149	11700-2.....	108
105683.....	10603-3.....	141, 171	11246-1.....	151	11701-7.....	104
105762.....	10610-3.....	170	11247-1.....	151	11702-7.....	106
105777.....	10611-3.....	170	11252-1.....	150	11703-7.....	106
105782.....	10612-3.....	170	11254-1.....	150	11704-2.....	107
815000.....	10613-3.....	170	11282-3.....	151	11705-7.....	104
818440.....	10620-3.....	170	11283-3.....	151	11706-7.....	104
	10622-3.....	170	11284-3.....	151	11707-7.....	103



PART NO	PAGE NO	PART NO	PAGE NO	PART NO	PAGE NO	PART NO	PAGE NO
11708-1.....	103	117607-7.....	104	11849-2.....	126	12127-3.....	162
11709-1.....	103	117608-7.....	104	11851-2.....	126	12152-3.....	179
11710-2.....	107	11761-1.....	136	11857-1.....	148	12261L3.....	178
11711-7.....	104	117614-7.....	105	11861-6.....	134	12303-3.....	178
11712-7.....	109	117617-7.....	105	11862-6.....	134	12305-3.....	178
11713-2.....	107	11762-1.....	136	11865-4.....	120	12319-3.....	179
11714-2.....	103	117621-7.....	105	11866-6.....	123	12355-3.....	178
11715-7.....	104	11763-1.....	137	11871-7.....	118	12357-3.....	178
11716-1.....	103	11764-1.....	136	11873-1.....	89	12412-1.....	178
11717-2.....	108	11765-1.....	136	11875-7.....	123	12415L3.....	178
11718-2.....	108	11766-1.....	137	11880-1.....	148	12460-1.....	177
11719-2.....	108	117680-7.....	104	11881-1.....	148	12461-3.....	177
11720-2.....	107	117681-7.....	104	11889D1.....	123	12562-6.....	88
11721-2.....	107	11768-2.....	137	11891D7.....	90	12701-1.....	115
11722-2.....	103	117684-7.....	105	11894-2.....	127	12701-5.....	115
11723-7.....	103	11772-1.....	136	11896-1.....	127	12703D1.....	115
11724-1.....	103	11775-5.....	140	11897-2.....	127	12704-1.....	115
11725-2.....	103	11776-5.....	140	11900-4.....	130	12704-2.....	140
11726-2.....	108	11778-2.....	140	11901-4.....	130	12708-2.....	116
11728-2.....	106	11780-6.....	138	11909-7.....	139	12750-6.....	116
11729D5.....	106	11783-7.....	141	11912-5.....	139	12760-7.....	116
11730-7.....	101, 106	11786B-1.....	125	11926-7.....	141	12761-7.....	116
11732-7.....	106	11786B-7.....	125	11930-4.....	142	12772-2.....	117
11733-7.....	104	11786W-1.....	125	11940-2.....	139	12773-2.....	117
11734-1.....	103	11786W-7.....	125	11944-7.....	138	12774-2.....	117
11736-7.....	103	11787-1.....	125	11951-6.....	141	12790-1.....	140, 177
11737-7.....	106	11788-1.....	125	11952-7.....	141	12790-3.....	140, 177
11739-2.....	109, 147	11789-1.....	125	11953-4.....	142	12791-1.....	140, 177
11741-7.....	103	11789WD1.....	125	11964-1.....	97	12791-3.....	177
11742-7.....	103	11792-6.....	109	11966-1.....	97	12792-1.....	140, 177
11749-7.....	106	11794-7.....	122	11968-1.....	97	12792-5.....	177
11750-7.....	106	11807-2.....	118	11969-4.....	97	12793-1.....	140, 177
117525-7.....	105	11808-2.....	139	11971-7.....	107	12793-5.....	177
11752-7.....	106	118089-7.....	121	12009-3.....	162	12794-1.....	140, 177
11753-7.....	109	118090-7.....	121	12044-6.....	144	12820-5.....	87
117553-7.....	98, 108	118091-7.....	121	12048-4.....	101	12889L3.....	178
117561-2.....	108	118092-7.....	121	12049-4.....	101	12891L3.....	178
11756-2.....	137	11820-7.....	88	12100L3.....	162	12955L3.....	141, 171
117563-7.....	104	11822-6.....	74	12102-1.....	162	12957L3.....	171
117564-7.....	104	11823-6.....	74	12102L3.....	162	12959L3.....	171
117565-7.....	105	11824-6.....	74	12110-1.....	162	12988-1.....	141, 171
117566-7.....	105	11826-1.....	123, 138	12111L3.....	162	12989-3.....	171
117567-7.....	105	11828-1.....	123, 138	12112-1.....	162	13055-4.....	124
11757-2.....	137	11829-6.....	123	12113L3.....	162	13065-4.....	124
11758-2.....	137	11830-2.....	123	12114-1.....	162	13066-7.....	124
11759-1.....	136	11834-1.....	126	12115L3.....	162	1329-1.....	174
11760-1.....	136	11840-7.....	88	12120-1.....	162	1341-1.....	27
117601-7.....	104	11841-4.....	88	12121-3.....	162	1342-1.....	27
117603-7.....	104	11843-7.....	107	12124-1.....	162	1343-1.....	26
117604-7.....	104	11845-1.....	125	12125-3.....	162	1345-1.....	27
117605-7.....	104	11848-4.....	112	12126-1.....	162	1348-1.....	28



PART NO	PAGE NO	PART NO	PAGE NO	PART NO	PAGE NO	PART NO	PAGE NO
1353-1	28	14348-6	131	15231-7	154	2164-T	214
1364A1	28	14350-3	133	15232-1	154	2244-ADJ	214
1364A3	28	14352-3	133	15232-7	154	2244-ADJ-T	214
13700-7	98	14361-5	135	15233-1	154	238027-1	209
13702-4	98	14365-6	133	15233-7	154	238027-3	209
13710-4	98	14366-6	133	15234-1	154	23809-7	208
13753-7	98	14367-6	133	15234-7	154	23811-7	208
1405-1	28	14370-6	135	15240-1	155	23813-7	208
1405-3	28	14371-6	135	15240-7	155	238141-1	208
14060-7	143	14372-7	135	15241-1	155	238142-1	208
14063-7	143	14386-3	132	15241-7	155	238142-7	208
14064-7	143	1438F1	28	15700-3	217	238150-1	208
14065-7	143	1439F1	28	1607-1	94	238151-1	208
14066-7	143	14509-6	73	1607-3	94	238152-1	208
14133-6	144	14530-6	73	16205-2	90	238152-7	208
14137-7	127	14532-6	73	16207-2	90	238153-1	208
14141-7	120	14540-6	74	16208-7	90	238153-7	208
14142-7	120	14580-1	87	1670-1	82	23815-7	208
14185XFS-7	57	14582-1	87	1670-3	82	238162-1	208
14187XFS-7	57	14584D1	88, 118	1674-1	82	238162-4	208
14190-7	57, 122	1476-1	114	1674-6	82	238164-1	208
14191-7	57, 122	1477-1	114	17209-1	23	238300-1	209, 211
14192-7	57, 122	1478-1	114	17211-3	23	238312-1	209, 211
14193-7	57, 122	1478W1	114	1731-1	25	238312-2	209, 211
14194-7	57, 122	1487A1	26	1731-4	25	238322-1	209, 211
14195-7	57, 122	1488-1	26	1733-1	25	238333-1	209, 211
14196-7	57, 122	1488-5	26	1733-4	25	238352-1	209, 211
14197-7	57, 122	1493-1	26	1747-1	25	238512-1	209
14215-6	130	1493-5	26	1747-4	25	238512-4	209
14230-3	131	1494A1	27	1749-1	25	238522-1	209
1423-1	27	1494A5	27	1749-4	25	238522-4	209
14233-7	131	1494F1	27	1751-1	25	238608-1	209
14234-7	131	1495-1	27	2012A1	175	238609-1	209
1423-5	27	1495A1	27	2012A3	175	238610-1	209
1425-1	27	1495B1	27	2027-1	177	238610-3	209
14253-3	132	1495B5	27	2027-7	177	238610L1	210
1425-5	27	1499-1	26	2028-1	177	238611-1	209
14255-3	132	1499-5	26	2050-1	176	238611L1	210
14258-6	130	15201-1	156	2050-5	176	238612-1	209
14258B1	130	15201-7	156	2052-1	176	238612-3	209
14258R1	130	15220-1	156	2053-1	176	238613-1	209
1426-1	27	15220-7	156	2053-5	176	238613-3	209
14262-1	134	15221-1	156	2054-1	176	238613L1	210
14262-6	134	15221-7	156	2054-5	176	238614-1	209
14263-1	134	15222-1	156	2061-1	176	238615-1	209
14263-6	134	15222-7	156	2061-5	176	238615-3	209
14264-1	134	15223-1	156	2080-1	176	238617-1	209
14264-6	134	15223-7	156	2114-T	214	238625-1	209
1426-5	27	15230-1	154	2134-SS	214	238630-1	209
14268-1	134	15230-7	154	2134-T	214	238630L1	209
14268-6	134	15231-1	154	2134-T-SS	214	238813LSM1	211



PART NO	PAGE NO	PART NO	PAGE NO	PART NO	PAGE NO	PART NO	PAGE NO
238833LSM1	211	3130-1	34	3878-3	21	4199-7	14
238908-1	209	3133-1	34	3879-1	21	4201-1	10
238909LSM1	211	3150-1	34	3879-3	21	4201-7	10
238911-1	209	3150G7	34	3880-1	21	4202-1	10
238911L1	211	3150R7	34	3881-1	22	4202-7	10
238912-1	209	3153-1	34	3881Kit-1	22	4232-1	22
238913-1	209	3153G7	34	3882-1	23	4232-7	22
238913L1	211	3153R7	34	3885-1	22	424-ADJ	153
238913LSM1	211	3204-R	214	3885-3	22	4253-7	14
238915-1	209	3204-R-T	214	3886-1	22	436-ADJ	153
238916LSM1	211	3204-R-T-SS	214	3886-3	22	4505-1	5
2445-7	125	3204-T	214	3888-1	23	4505-7	5
2449-1	125	3204-T-SS	214	3889-1	23	4505S1	5
2449-7	125	3300-1	64	3890-1	16	4507-1	5
2460-7	121	3325-3	163	3890-3	16	4507-7	5
2520-1	42	3326-3	163	3891-1	16	4507S1	5
2530-1	42	3392-1	164	3892-1	16	4508-1	5
2638-1	120	3392-3	164	3893-1	16	4511-1	5
278ANZPM-1	206	3396-1	164	3896-1	21	4511-7	5
278AO3AGL-1	206	3396-3	164	3896-3	21	4511S1	5
278AO3AGS-1	206	3460-3	179	3899-1	16	4512-1	5
278AO3AM-1	206	3810-1	36	3899-3	16	4606-1	7
278AO3PGL-1	206	3810-7	36	3900-1	16	4606-7	7
278AO3PM-1	206	3820-1	36	3902-1	16	4606TH1	7
278AOGY060-1	206	3820G7	36	3902-3	16	4608-1	7
278AOGY070-1	206	3820R7	36	3909-1	16	4608-7	7
278AOGY080-1	206	3830-1	37	4000-ADJ	153	4608TH1	7
278AOGY090-1	206	3838-1	37	4000-ADJ-B	153	4609-1	7
278AOGY100-1	206	3838G7	37	400-B	153	460-ADJ	153
278AOGY110-1	206	3838R7	37	400-R	153	4612-1	7
278AOGY120-1	206	3845-1	21	4116-5	14	4612-7	7
278AOGY130-1	206	3870-1	21	4118A1	15	4613-1	7
278AOP0912-BD-1	206	3872-1	21	4118A5	15	4614-7	14
278AOP1215-1	206	3872-3	21	4121-1	15	4620-6	7, 8
278AOP1519-1	206	3872A1	21	4121-3	15	4622-6	7, 8, 9
278AOP1923-1	206	3873-1	21	4122-1	15	4624-6	7, 8
278AOZAGL-1	206	3873-3	21	4122-3	15	4640-1	8
278AOZAGS-1	206	3873A1	21	4123-1	15	4640-7	8
278AOZAM-1	206	3874-1	21	4125-1	15	4641-1	8
278AOZPGL-1	206	3874-3	21	4125-7	15	4643-1	8
278AOZPM-1	206	3874A1	21	4131-1	12	4643-7	8
2906-1	98	3875-1	21	4131-4	12	4650-1	8
2906-3	119	3875-3	21	4133-1	12	4650-7	8
2908-6	119	3875A1	21	4140-4	13	4651-1	8
3004-R	214	3875B1	21	4141-1	11	4660-1	8
3004-R-T	214	3875C1	23	4141-4	11	4660-7	8
3004-R-T-SS	214	3876-1	22	4142-1	11	4661-1	8
3004-T	214	3876-3	22	4143-1	11	4663-1	8
3120-7	34	3877-1	21	4143-4	11	4670-1	9
3121-7	34	3877-3	21	4144-1	11	4670-7	9
3123-7	34	3878-1	21	4145-1	11	4672-1	9



PART NO	PAGE NO	PART NO	PAGE NO	PART NO	PAGE NO	PART NO	PAGE NO
4672-7	9	5110-54-7	48	5530-54BP1	44	6317-1	63
4730-1	6	5120-36Z1	53	5530-54BP7	44	6319-1	63
4730-4	6	5120-P12-1	53	5530-54T1	45	6320B1	62
4760-1	6	5300-60-1	47	5530-54TB1	45	6320W1	62
4760-4	6	5300-72-1	47	5530-60A7	45	6320W7	62
4770-1	6	5310-66T1	47	5530-60BP1	44	6321B1	62
4770-4	6	5320-20T1	47	5530-60T1	45	6323W1	62
4801-1	10	5320-42T1	47	5530-66T1	45	6323W7	62
4801-7	10	5320-48T1	47	5540-54A7	45	6340SS1	62
5009-4	110	5320-54T1	47	5540-54T1	45	6340SS7	62
5009W4	110	5320-54TB1	47	5540-60T1	45	6341SS7	62
5010-4	110	5320-60T1	47	5540-72T1	45	6342SS1	62
5011-7	111	5320-60TB1	47	5540-84T1	45	6342SS7	62
5012-7	111	5320-72T1	47	5550-12Z1	52	6343SS7	61
5014-4	110	5330-42-7	46	5550-24Z1	52	6344SS1	61
5016-3	111	5330-42T1	46	5550-30Z1	52	6345SN1	62
5022-7	111	5330-48-7	46	5550-36Z1	52	6346SS1	62
5030-4	111	5330-54T1	46	5550-P12-1	52	6348SS1	62
5031D1	112	5330-60T1	46	5550-P20-1	52	6350B1	63
5040-1	35	5330-72T1	46	5550-P24-1	52	6350B7	63
5040G7	35	5340-42T1	46	5550-PA20-7	52	6350W1	63
5040R7	35	5340-48-7	46	5550-S12-1	52	6350W7	63
5040SS1	35	5340-48T1	46	5550-S18-1	52	6351B1	63
5045-7	35	5340-54-7	46	5550-S24-1	52	6351G1	63
5060-3	113	5340-54T1	46	5550-S30-1	52	6351W1	63
5061-3	113	5340-60T1	46	5550-S36-1	52	6353W7	63
5062-3	113	5340-72T1	46	5550-S42-1	52	6354W7	63
5063-3	113	5340-84T1	46	5551-P12-1	52	6355W7	63
5070-3	113	5350-24Z1	53	5551-PA20-7	52	6356D7	56
5071-3	113	5350-30Z1	53	5557-P12A7	52	6375D6	39
5072-7	113	5350-36Z1	53	5558-P12A7	52	64439-SS	215
5074-3	113	5350-PA12-7	53	5570-60-1	45	6443-T-P-SS	215
5080G7	35	5350-PA20-7	53	5570-72-1	45	6450-1	115
5080R7	35	5351-P12-1	53	5580-03	54	6451-1	115
5092-10T1	41	5358-P12-7	53	5580-1	54	6451-7	115
5092-12T1	41	5530-12T1	45	5580A7	54	6483-T	215
5092-12TB1	41	5530-24A7	45	5581-1	54	6521SS1	58
5092-14-7	41	5530-24BP1	44	5582-1	54	6522SS1	58
5092-14T1	41	5530-24BP7	44	5610-48-7	48	6522SS7	58
5092-16T1	41	5530-30BP1	44	5940-1	54	6523BK1	58
5092-20T1	41	5530-36A7	45	5940-7	54	6523BK7	58
5095-10T1	41	5530-36BP1	44	5980-1	54	6556-1	56
5100-24-1	48	5530-36BP7	44	6115-1	15	6556-7	56
5100-36-1	48	5530-42A7	45	6115A1	15	65UW03B-1	60
5100-48-1	48	5530-42BP1	44	6126-1	12	65UW03B-7	60
5100-54-1	48	5530-42BP7	44	6126-7	12	65UW03CVSS-1	60
5110-24-7	48	5530-42T1	45	6244-1	162	65UW03G-7	60
5110-30-7	48	5530-48A7	45	6244-6	162	65UW03W-1	60
5110-36-7	48	5530-48BP1	44	6245-1	162	65UW03W-7	60
5110-42-7	48	5530-48T1	45	6245-6	162	65UW06B-7	60
5110-48-7	48	5530-54A7	45	6260-4	145	65UW06CVSS-1	60



PART NO	PAGE NO	PART NO	PAGE NO	PART NO	PAGE NO	PART NO	PAGE NO
65UW06G-7	60	66202-3	171	66451-1	166	66553Kit	18
65UW06W-7	60	66223-1	164	66470-1	114	66555-1	18
65UW12B-1	60	66224-1	164	66470-7	114	66555Kit	18
65UW12B-7	60	66237-1	172	66471-1	114	66557-1	18
65UW12CVSS-1	60	66237-3	172	66471-7	114	66559-1	18
65UW12W-7	60	66239-1	172	66502-1	161	66561-1	18
66004-1	94	66239-3	172	66510-1	159	66563-1	18
66008-1	164	66240-1	172	66510-7	159	66565-1	18
66009-1	161	66261-1	164	66512-1	159	66567-1	18
66009L6	161	66261L3	164	66514-1	159	66577-1	18
66010-1	161	66262-1	164	66514-7	159	66579-1	18
66010L3	161	66263-1	164	66515-1	158	66586-1	159
66011-1	161	66308-1	23	66515-7	158	66588-1	159
66011-3	161	66308-3	23	66516-1	159	66589-1	159
66012-1	161	66318-7	38	66516-7	159	66617-1	158
66023-1	94	66319G7	38	66517-1	158	6682-T	215
66025-1	172	66319R7	38	66517-7	158	66832-1	175
66025-3	172	66334-1	160	66519-1	158	6683-T	215
66026-3	172	66335-1	160	66522-1	159	66970-7	115
66027-1	174	66336-1	160	66524-1	159	66HR09-1	165
66027-3	174	66362-1	114	66529-1	158	66HR12-1	165
66028-1	173	66362-7	114	66531-1	158	66HR24-1	165
66028-3	173	66362W1	114	66533-1	158	66HRD09-1	165
66029-1	173	66362W7	114	66538-1	158	66HRD12-1	165
66029-3	173	66363-1	114	66540-1	17	66HRD18-1	165
66031-1	94	66363-7	114	66540-3	17	66UW03B-7	60
66031-3	94	66363W1	114	66541-1	17	66UW06B-1	60
66032-1	94	66363W7	114	66541-3	17	66UW06B-7	60
66032-3	94	66364-1	114	66542-1	17	66UW06G-1	60
66054-1	160	66364-7	114	66542-3	17	66UW06G-7	60
66055-1	160	66364W1	114	66543-1	17	66UW06W-1	60
66056-1	160	66364W7	114	66543-3	17	66UW12B-1	60
66060-1	93	66382-7	56	66544-1	17	66UW12B-7	60
66061-3	93	66391-1	173	66544-3	17	66UW12W-1	60
66062-1	160	66398-1	161	66545-1	17	66UW12W-7	60
66063-1	160	66399-1	28	66545-3	17	67551-1	19
66064-1	160	66399-3	28	66546-1	17	67552-1	19
66074-3	93	66400-1	28	66546-3	17	67553-1	19
66104-1	169	66400-3	28	66547-1	17	67554-1	19
66105-1	141, 171	66406-5	93	66547-3	17	67555-1	19
66105-3	141	66408C1	93	66548-1	17	67556-1	19
66110-1	161	66411C1	93	66548-3	17	67557-1	19
66110-3	161	66412C1	93	66549-1	17	67558-1	19
66111-1	161	66419-1	82	66549-3	17	67561-1	19
66111-3	161	66419-3	82	66550-1	17	67562-1	19
66112-1	161	66423-1	174	66550-3	17	67580-1	19
66120-1	163	66434-1	172	66551-1	17	67581-1	19
66123-T	215	66446C1	93	66551-3	17	67582-1	19
66126C1	93	66448-1	166	66552-1	17	67583-1	19
66163-1	173	66449-1	166	66553-1	18	67729-T	215
66202-1	171	66450-1	166	66553-3	18	67739-SC	215



PART NO	PAGE NO	PART NO	PAGE NO	PART NO	PAGE NO	PART NO	PAGE NO
67739-SS	215	7526PD1	24	8838HF6	70, 72	9095-5	129
6773-T	215	7532A3	24	8838HM6	70	9096-5	129
6773-T-U	215	7533A1	24	8838TM6	70, 72	9097-5	129
68551-1	20	7533A7	24	8838US6	70	9098-5	129
68554-1	20	7533PD2	24	8873-6	73	9099-5	129
68555-1	20	7534A1	24	8882-6	73	91022-1	51
68556-1	20	7534A3	24	8883-6	73, 91	91022-7	51
68557-1	20	7555-1	23	8884-6	73	910R2PB-1	50
68576-1	20	7555-3	23	8887-6	74	910R2PB-7	50
68577-1	20	7557-1	23	8889LP6	72, 73, 91	910R2PSB-1	50
68578-1	20	7557-7	23	8890LP6	73, 91	910R2PSB-7	50
68579-1	20	7557G1	23	8893-6	72	910R2PSW-1	50
68581-1	20	7563-6	132	8894LP6	91	910R3PB-1	50
7006-1	191, 199, 200	7566AR1	24	8896LP6	72, 73, 91	910R3PB-7	50
7009-1	191, 199, 200	7566BG1	24	8897-6	73, 91	910R3PSB-1	50
7012-004-1	191, 203	7571-1	64	88EP06-4	90	910R3PSB-7	50
7012-004-4	190, 203	7571L7	64	88FAS014-6	74	910R3PSW-1	50
7012-101-1	191, 203	7591-6	134	88FAS038-6	74	910T2PB-1	50
7012-101-4	190, 203	7594-3	132	88FBM101-6	74	910T2PB-7	50
7012-102-4	190, 203	7615-3	14	88FBMA102-6	74	910T2PSB-1	50
7012-103-4	190, 203	7615A3	14	88FHE516-6	73	910T2PSB-7	50
7012-104-4	190, 203	7621-7	144	88FHY516-6	73	910T2PSW-1	50
7012-105-4	190, 203	7622-7	133	88FTS014-6	73	910T3PB-1	50
7012-504-1	191, 203	7623-7	135	88FV200-6	77	910T3PB-7	50
7012-504-4	190, 203	7640-3	178	88TC06-7	87	910T3PSB-1	50
7015-001-1	191, 203	7647-7	133	8900-6	72, 73	910T3PSB-7	50
7020-001-1	191, 203	7648-7	133	8901-6	73	910T3PSW-1	50
7022-101-1	191, 203	7651-3	178	8902-6	73	910V2PB-1	49
7040-1	191, 196	7653L3	178	8M0044687	69	910V2PB-7	49
7060-1	191, 196	7663-5	144	9006-1	130	910V2SS-1	49
7062-3	218	7812-S-1	55	9013-1	130	910V2SS-7	49
7100A7	48	7812-S-7	55	9013-3	130	910V3PB-1	49
7100B7	48	7812Z1	55	9013A3	130	910V3PB-7	49
7100C7	48	7824-S-1	55	9014-1	130	910V3SS-1	49
7153-T-SS	214	7836-S-1	55	9014-3	130	910V3SS-7	49
7201-P-7	55	7842-S-1	55	9014A1	130	911339-1	51
7202-P-7	55	8043-3	119	9014A3	130	911339-7	51
7518A3	24	818441-3	210	903-008-T-S	167	911370-1	51
7518PD2	24	8315-4	119	903-009-S	167	911490-1	51
7520A1	24	8803LP2	67	9065-1	128	911507-1	82
7520A3	24	8803LP2S	67	9067-1	128	911508-1	82
7520PD2	24	8803LPG2	67	9069-1	128	911526-1	82
7524A1	24	8803LPG2S	67	9076-1	128	911528-1	82
7524A7	24	8806LP2	67	9082-1	128	91320-ADJ	216
7524B1	24	8806LP2S	67	9083-7	124	913670-1	52, 53, 55
7524D1	24	8806LPG2	67	9084-1	128	913671-1	52, 53, 55
7524PD2	24	8806LPG2S	67	9090-5	129	9146-3	179
7526A1	24	8812LLP2	67	9091-5	129	9146-6	138
7526A7	24	8812LLPG2	67	9092-5	129	9149-6	138
7526D1	24	8812LP2	67	9093-5	129	9185J1	16
7526D2	24	8812LPG2	67	9094-5	129	922-ADJ-S	167



PART NO	PAGE NO	PART NO	PAGE NO	PART NO	PAGE NO	PART NO	PAGE NO
923-009	167	9433-S	167	98505GY	190, 204	9948B1	96
923-009-ADJ	167	9436-S	167	98505WH	190, 204	9955-1	97
9300FDV7	69	951606ULP7	72	98900-1	191, 198	9956-1	97
93014LP7	68	9709-7	112	98908-1	191, 198	9957-1	97
93038I7	91	97100-001-1	191, 202	98910-1	191, 198	9960-1	97
93038LP7	68	97100-001-2	190, 202	98961-1	191, 194	9961-1	97
9350-4	98	97100-005-1	191, 202	98963-1	191, 194	9962-1	97
9351-2	98	97100-005-2	190, 202	98966BK-2	190, 193	9963-1	97
93516I7	91	97100-006-1	191, 202	98966BL-2	190, 193	99CC035-1	83
93516LP7	68	97100-006-2	190, 202	98966BW-2	190, 193	99CC035HSA1	83
93531-1	100	977339-T	213	98966RD-2	190, 193	99CC045-1	83
93532-1	100	97739-T	213	98967OW-2	190, 193	99CC045-1S	83
93533-1	100	97749-7	213	98968BK-2	190, 193	99CC045H1	83
93534-1	100	97749C-7	213	98990-1	191, 194	99CC045HSA1	83
93536-1	99	97750-7	213	98991-1	191, 194	99CC045V1	83
93537-1	100	97750C-7	213	99200DS1	92	99CC085-1	83
9354BD1	99	97S03BK-2	190, 197	99200GB1	92	99CC085H1	83
9354D1	99	97S03BL-2	190, 197	99200GS1	92	99CC085HSA1	83
93552P2	99	97S03RD-2	190, 197	99200GZ1	92	99CC085HSA1S	83
9355BD1	99	97S04BE-2	190, 197	99200WS1	92	99CC150-1	83
9355D1	99	97S05BK-2	190, 197	99200WZ1	92	99CC150-1S	83
9356BD1	99	97S05RD-2	190, 197	99201DS1	92	99CC150HS1	83
9356D1	99	97SMAX4-2	190, 197	99201GB1	92	99DFCCAB1	81
9358-1	99	98100-1	191, 199, 200	99201GS1	92	99DFCCAB1S	81
9358B1	99	98120-1	191, 199, 200	99201GZ1	92	99DFCCAS1	81
9368A1	89	98201-1	191, 196	99201WS1	92	99DFCCASY1-1	81
9372-2	90	98202-1	191, 196	99201WZ1	92	99DFCCAW1	81
93806AUS7	72	98203-1	191, 196	99202AWS1	92	99DFCCAZ1	81
93806EI7	91	98204-1	191, 196	99202AWSY1-1	92	99DFCCAZ1S	81
93806ELP7	72	98386-2	190, 191, 201	99202WS1	92	99DFCCLPAS1	81
93806EUS7	72	98387-2	190, 191, 201	99202WZ1	92	99DFCCLPSS1	81
93806EUSD7	72	98388-2	190, 191, 201	99210GB1	92	99DFCCSB1	81
93806HUS7	72	98390GY	190, 204	99211GB1	92	99DFCCSB1S	81
93806MI7	91	98391GNMX	190, 204	9933-1	96	99DFCCSS1	81
93806MUS7	72	98391GY	190, 204	9933B1	96	99DFCCSSY1-1	81
93806MUSD7	72	98395CAMO	190, 204	9934-1	96	99DFCCSW1	81
93806UFDV7	72	98395GY	190, 204	9934B1	96	99DFCCSZ1	81
93806UI7	91	98395WH	190, 204	9935-1	96	99DFCCSZ1S	81
93806ULP7	72	9842-1	23	9935B1	96	99DFPVB1	84
93806UUS7	72	9842-3	23	9941-1	96	99DFPVAS1	84
93806UUSD7	72	9842PD1	23	9941B1	96	99DFPVASY1-1	84
93806YI7	91	98437BK-2	190, 195	9942-1	96	99DFPVAZ1	84
93806YLP7	72	98437OW-2	190, 195	9942B1	96	99DFPVSB1	84
93806YUS7	72	98438BL-2	190, 195	9943-1	96	99DFPVSS1	84
93812ULP7	72	98438BW-2	190, 195	9943B1	96	99DFPVSSY1-1	84
93812UUS7	72	98438GY-2	190, 195	9944-1	96	99DFPVSZ1	84
93812UUSD7	72	98438RD-2	190, 195	9944B1	96	99DVA02-1	84
9400-7	89	98439BK-2	190, 195	9945B1	96	99DVB01-1	84
9401-7	89	98439GY-2	190, 195	9946-1	96	99DVB02-1	84
94100-4	135	9844PD2	23	9946B1	96	99DVC01-1	84
94110-5	135	98505CA	190, 204	9948-1	96	99DVP03-1	84



PART NO	PAGE NO	PART NO	PAGE NO	PART NO	PAGE NO	PART NO	PAGE NO
99DVP04-1	84	NV2011SS-1	33	SL14-60-5	181	SL36-70-5	181
99DVP05-1	84	NV2012PB-1	33	SL14-XX-1	180	SL36-80-5	181
99FLA140-1	86	NV2012PBG-7	33	SL15-XX-1	180	SL36-90-5	181
99FLA170-1	86	NV2012PBR-7	33	SL16-30-5	181	SL36-XX-1	180
99FLA230-1	86	NV2012SS-1	33	SL16-XX-1	180	SL37-XX-1	180
99FLA330-1	86	NV2012SSG-7	33	SL1-XX-1	180	SL38-XX-1	180
99FLB080-1	86	NV2012SSR-7	33	SL20-XX-1	180	SL3HSSP3-1	183
99FLB100-1	86	NV3011SS-1	33	SL2-40-5	181	SL3-XX-1	180
99FLB140-1	86	NV3012SS-1	33	SL25-XX-1	180	SL40BP3-1	183
99FLB170-1	86	NV3012SSG-7	33	SL26-XX-1	180	SL40P3-1	183
99FLB230-1	86	NV3012SSR-7	33	SL27-XX-1	180	SL40SSBP3-1	183
99FLB330-1	86	NV4012SS-1	33	SL28-XX-1	180	SL40SSP3-1	183
99GVG000-1	86	NV4012SSG-7	33	SL29-XX-1	180	SL40SSP3-7	182
99GVP000-1	86	NV4012SSR-7	33	SL2-XX-1	180	SL44BP3R-1	183
99ICV000-1	86	NV5012PB-1	33	SL30-20-5	181	SL44P3-1	183
99ICV000HS2	86	NV5012SS-1	33	SL30-40-5	181	SL44P3R-1	183
99IFDV00-1	84	NV6LC1-10-1	40	SL30-60-5	181	SL44SSP3-1	183
99IFDVHS1	84	NV6LC1-10A7	40	SL30-XX-1	180	SL46P3R-1	183
99TDF100-1	82	NV6LC1-10BP1	40	SL31-20-5	181	SL46SSP3-1	183
99TDF120-1	85	NV6LC1-12-1	40	SL31-30-5	181	SL46SSP3R-1	183
99TDFPV100-1	85	NV6LC1-12BP1	40	SL31-40-5	181	SL48BP3R-1	183
99TDFPV110-1	85	NV6LC1-14-1	40	SL31-XX-1	180	SL48P3-1	183
ATT001	191, 199, 200	NV6LC1-14-7	40	SL32-20-5	181	SL48SSP3-1	183
ATT002	191, 199, 200	NV6LC1-14A7	40	SL32-30-5	181	SL4-XX-1	180
ATT007	191, 199, 200	NV6LC1-14BP1	40	SL32-XX-1	180	SL50BP3-1	184
ATT008	191, 199, 200	NV6LC1-14BP7	40	SL33-20-5	181	SL50P3-1	184
ATT009	191, 199, 200	NV6LC1-16-1	40	SL33-30-5	181	SL50P3R-1	184
ATT016	191, 199, 200	NV6LC2-10-1	40	SL33-40-5	181	SL50SSP3-1	184
ATT101	191, 196	NV6LC2-10-7	40	SL33-50-5	181	SL50SSP3-7	182
ATT102	191, 196	NV6LC2-14-1	40	SL33-60-5	181	SL50SSP3R-1	184
ATT103	191, 196	NV6LC2-14-7	40	SL33-XX-1	180	SL50SSP3SB-1	184
ATT109	191, 196	NV6LC2-14BP1	40	SL34-120-5	181	SL513HBP3R-1	184
ATT110	191, 196	NV6LC2-14BP7	40	SL34-20-5	181	SL513HP3-1	184
ATT200-1	191, 198	NV6SP1-10-1	40, 42	SL34-30-5	181	SL513HP3R-1	184
ATT2005-1	191, 198	NV6SP1-12-1	40, 42	SL34-40-5	181	SL514HSSP3-1	184
ATT210-1	191, 198	NV6SP1-14-1	40, 42	SL34-50-5	181	SL52P3-1	184
NV1001PB-1	33	NV6SP1-16-1	40, 42	SL34-60-5	181	SL52P3R-1	184
NV1001SS-1	33	NV6SP2-10-1	40, 42	SL34-80-5	181	SL52SSP3-1	184
NV1002PB-1	33	NV6SP2-14-1	40, 42	SL34-90-5	181	SL52SSP3R-1	184
NV1002SS-1	33	RH-4646	110	SL34-XX-1	180	SL54SSP3-1	184
NV1011PB-1	33	SL10-40-5	181	SL35-20-5	181	SL57P3-1	185
NV1011SS-1	33	SL10-XX-1	180	SL35-30-5	181	SL57SSP3R-1	185
NV1012PB-1	33	SL11-XX-1	180	SL35-40-5	181	SL58BP3-1	185
NV1012SS-1	33	SL1-20-5	181	SL35-50-5	181	SL58BP3R-1	185
NV2001PB-1	33	SL13-20-5	181	SL35-XX-1	180	SL58SSBP3R-1	185
NV2001SS-1	33	SL13-60-5	181	SL3-60-5	181	SL58SSP3-1	185
NV2002PB-1	33	SL13-XX-1	180	SL36-20-5	181	SL58SSP3R-1	185
NV2002PB-7	33	SL1-40-5	181	SL36-30-5	181	SL61SSBS-1	185
NV2002SS-1	33	SL14-20-5	181	SL36-40-5	181	SL63SSBS-1	185
NV2002SS-7	33	SL14-30-5	181	SL36-50-5	181	SL64-BS-1	182
NV2011PB-1	33	SL14-40-5	181	SL36-60-5	181	SL64SSBS-1	182



PART NO	PAGE NO	PART NO	PAGE NO	PART NO	PAGE NO	PART NO	PAGE NO
SL68-BS-1	182	SP-930	167	ST36-40-5	181		
SL69-BS-1	182	SP-96008	167	ST36-50-5	181		
SL69SSBS-1	182	SP-96009	167	ST36-60-5	181		
SL70-BS-1	182	ST10-40-5	181	ST36-70-5	181		
SL74SSBS-1	182	ST10-XX-1	180	ST36-80-5	181		
SL75-SSBS-1	182	ST11-XX-1	180	ST36-90-5	181		
SP-1002	213	ST13-60-5	181	ST36-XX-1	180		
SP-14000	218	ST13-XX-1	180	ST37-XX-1	180		
SP-15100	217	ST14-20-5	181	STX20-XX-1	180		
SP-15200	217	ST14-30-5	181	STX29-XX-1	180		
SP-15900	217	ST14-40-5	181				
SP-18914	212	ST14-50-5	181				
SP-2114	214	ST14-60-5	181				
SP-2114-T	214	ST14-XX-1	180				
SP-2134	214	ST15-XX-1	180				
SP-2134-T	214	ST20-XX-1	180				
SP-2164	214	ST26-XX-1	180				
SP-2164-T	214	ST29-XX-1	180				
SP-2244	214	ST30-20-5	181				
SP-2244-ADJ	214	ST30-40-5	181				
SP-2244-ADJ-T	214	ST30-60-5	181				
SP-28911	212	ST30-XX-1	180				
SP-28913	212	ST31-20-5	181				
SP-3004	214	ST31-30-5	181				
SP-3004-R	214	ST31-40-5	181				
SP-3004-R-T	214	ST31-XX-1	180				
SP-3004-T	214	ST32-20-5	181				
SP-3204	214	ST32-30-5	181				
SP-3204-R	214	ST32-XX-1	180				
SP-3204-R-T	214	ST33-20-5	181				
SP-3204-T	214	ST33-30-5	181				
SP-37904	212	ST33-40-5	181				
SP-37914	212	ST33-50-5	181				
SP-4000-ADJ-RB	153	ST33-60-5	181				
SP-400-RB	153	ST33-XX-1	180				
SP-402	153	ST34-120-5	181				
SP-410	153	ST34-20-5	181				
SP-416	153	ST34-30-5	181				
SP-421-RB	153	ST34-40-5	181				
SP-424-ADJ-RB	153	ST34-50-5	181				
SP-429-RB	153	ST34-60-5	181				
SP-436-ADJ-RB	153	ST34-80-5	181				
SP-64839	215	ST34-90-5	181				
SP-66839	215	ST34-XX-1	180				
SP-67739	215	ST35-20-5	181				
SP-67739-T	215	ST35-30-5	181				
SP-67749	215	ST35-40-5	181				
SP-68914	212	ST35-50-5	181				
SP-7153-T-SS	214	ST35-XX-1	180				
SP-910	167	ST36-20-5	181				
SP-923-009-ADJ	167	ST36-30-5	181				



INDEX

ALPHABETICAL

A

- Aerator Pumps 8-9
- Anchoring and Mooring Equipment
 - Anchor Chains 98
 - Anchor Control 98
 - Anchors 96-97
 - Shackles 98
 - Storage Clips 64, 138
- Automatic Bilge Pumps, Sahara. 5
- Automatic Bilge Switches, S3 Series . . 10
- Automatic Float Switches 10

B

- Battery Boxes 128
- Battery Terminals. 130
- Battery Trays 129
- Bilge Pump Installation Kits 14
- Bilge Pumps
 - Hand-Operated. 13, 139
 - Heavy-Duty 6
 - Sahara Automatic. 5
 - Tsunami. 7
- Bilge Pump Switches. 14
- Bimini Top Fittings
 - Clevis Pin 171
 - Deck Hinges. 169
 - Eye Straps 171
- Bimini Tops Frames & Accessories 168-171
- Blowers, Turbo In-Line. 25
- Boaters Safety Accessories 121
- Boat Hook 101
- Bow Eyes. 164
- Bow Stops, Rollers & Brackets . . 148-151

C

- Car-Top Carriers 142
- Circuit Breakers 135
- Cleats
 - Cast Iron Cleats. 162
 - Contemporary Cleats. 160

- Flush Cleats 159
- Herreshoff Cleats 160-161
- Neat Cleat. 158
- Nylon Cleats 141, 162
- Whitley Cleats 160
- Zig Zag Cleats. 141

D

- Deck Fills. 81, 84, 92-93
- Deck Rigging Kit 112
- Drain Fittings
 - Cockpit Drains 23
 - Drain Cover 23
 - Drain Plugs 23-24
 - Livewell/Bailer 24
 - Drains 23
 - Drain Tubes 24
- Drink Holders. 125

E

- Electrical Accessories 128-135
- Electrical Switches 135

F

- Fastener Kits 179
- Fenders & Accessories. 99-101
 - Fender Lines 107
- Fishing Nets. 117
- Fishing Rod Holders & Accessories
 - Rod Holders. 110-117
- Float Switches. 10
- Fuel Products
 - Accessories 87-90
 - Carbon Canisters 78-83
 - Fuel Demand Valves. 69
 - Fuel Filters 88
 - Fuel Fittings. 73-77
 - Fuel Line Kits. 71-72, 91
 - Fuel Tanks 66-67
 - Fuel Vents 94
 - Fuel/Water Separator 88

- Funnels 87
- Integrated Fuel Systems. 78-80
- Motor Flushers. 90
- Primer Bulbs 68, 91
- P-Trap Vents. 82
- Universal Sprayless Connector . . . 70
- Vent Valves. 86
- Fuse Holders 131

G

- Gas Springs & Accessories
 - Aftermarket Gas Springs 181
 - Mounting Brackets. 182-186
 - OEM Gas Springs. 180
 - Threaded Studs 182
- Gear Lube Pump 90
- Gunwale Straps 156

H

- Handles. 176
- Hand Pumps
 - High-Speed Oil Change Pump 90
- Handrails 165
- Hatch & Door Locks. 175
- Hatches. 175
- Hatch Hardware. 177
- Hawse Pipes 164
- Heavy-Duty Bilge Pumps. 6
- Hinges 172-174
 - Cast Stainless Steel Hinges 172
 - Flush Hinges 172
 - Hatch Hinges 174
- Hooks
 - Chain Links 178
 - Marine Carabiner 178
 - Utility Snap Hook 178
- Horns 121
- Hose Clamps. 16
- Hydro-Stabilizers 89



I

- In-Line Blower, Turbo 25
- Interior & Boating Accessories . . 126–138

K

- Kayak
 - 30° Rod Holder 140
 - Cockpit Cover 140
 - Deck Plates 140
 - Sit-On-Top Kayak Seat 140
 - Skirt 140
- Kill Switch Keys 134

L

- LED Lighting 43–45, 54–61
- Lighting
 - All-Round Lights 46–48, 52–54
 - Anchor/Masthead Lights . . . 52, 55, 59
 - Battery Operated Lights 57
 - Courtesy Lights 63
 - Docking Lights 58
 - Interior / Exterior Lights 62
 - LightArmor 45–60
 - Micro Lights 63
 - Plug-In Bases 49–51
 - Pole Lights
 - Fold-Down 52–53
 - Folding 46
 - Stowaway 41–42, 48
 - Telescoping 48
 - Sidelights 33
 - Trailer Lights 143–144
 - Transom Light 56
 - Waketower Lights 54
- Lighting Accessories
 - Storage Clips 64
- Livewell Aerator Switch 14
- Locks 144

M

- Maintenance Products 118
- Marine Ropes & Cordiage
 - Anchor Line 103
 - Bungee Cord 109
 - Dock Line 104–106
 - Utility Line 107–108
 - Winch Ropes 109, 147
- Mesh/Strainer Drain Filter 22
- Mirrors 124
- Motor Covers—Custom Fit 220

N

- Navigation Lighting 33–63
- Neat Cleat 158
- Nets, Fishing 117
- Nylon Boat Fittings 170

O

- Oarlocks 179
- OEM Gas Springs 180

P

- Paddles 136–138
- Paddle Sports Accessories . . . 136–142
- Paddlesports Hardware 141
- Paddlesports Transportation & Storage 142
- Plumbing System Fittings 16
- Pulsar Lighting Products 41–42
- Pump Accessories
 - Aerator Remote Mounting Bracket 15
 - Aerator Spray Heads 15
 - Check Tees 15
- Pumps
 - Aerator Pumps 8–9
 - Bilge Pumps 5–7
 - Faucet and Hand Pumps 13
 - Potable Water Pump 12
 - Self-Priming Washdown Pump . . 12
 - WaterBuster Portable Pump 13

R

- Recirq Aerator Kit 14
- Rod Storage 116
- Rollers , Trailering 148–151

S

- S3 Series Automatic Bilge Switch 10
- Safety Products 121–123
- Sahara Automatic Bilge Pumps 5
- Scupper Valve Fittings 17–22
- Seating, Upholstered
 - Aergo Seating Systems 193–194
 - Attwood Classic Seating 201
 - Avenir Sport Seating Systems . . 195–196
- Centric Seating Componets 199
- Centric X Seating Systems 197–199
- Fishing Seats 204
- PROForm Seating Systems 203
- Venture Seating Systems 202
- Seat Pedestals
 - 238 Series 2-3/8" Products . . 207–209
 - 278 Series 205–206
 - ABYC Requirements 188
 - Accessories 216–218
 - Lock'N-Pin 3/4" Pin Products . . 213–215
 - Wedge 2" & 2-3/8" Products . . . 212
- Showers
 - Aft-Deck 12
 - Cold Water 12
- Signal Horns 121
- Ski Pylon Replacement Parts 167
- Ski Tows 166
- Snubbers 101, 106
- SoftSide Mooring & Dock Fenders . . 99–100
- Steering Wheel 119
- Storage 126–127
- Swivel Hasps 174

T

Thru-Hulls	17–22
Tire Carrier	152
Trailer Guide Protectors	152
Trailer Parts & Accessories	
Tie-Downs	154–156
Trailer Jack	145
Trailer Lights	143–144
Trailer Safety Chain	144
Trailer Wiring	144
Winch Cable & Ropes	147
Transom Savers	153
Transom Tie-Down Straps	154–156
Trolling Motor Connectors	133
Tsunami Pumps & Accessories	7–9, 14

U

Underwater Lights	59–61
Universal Sprayless Connector	70
Utility Line	107–108

V

Vents

Clamshell Vents	28
Collector Boxes	26–28
Cowl Ventilator	28
Louvered Vents	26–27
Modular Vents	28
Storage Vent	28
Twist-On Hose Flange	28
Venturi Vents	27

W

WaterBuster Portable Pump	13
Water Ski Hardware	166–167
Wheel Bearing Kits	152
Whistles	123
Winches	146–147



SALES POLICY

Prices

Please refer to the current Attwood price schedule for current prices and policies. Prices apply to standard pack quantities only. Orders will be rounded to the nearest standard pack.

Claims

Attwood products are carefully inspected and packaged to assure that they will reach you in good condition.

Product damage or loss occurring in transit is the responsibility of the carrier. In the event of such loss, you must advise the carrier within 15 days after delivery and secure the carriers notation of damage or shortage in the freight bill. We suggest you file a claim with the carrier immediately thereafter. We will give you all reasonable assistance in tracing shortages and filing claims.

Minimum Order

Individual items must be ordered in assortments which total \$500.00 or more per order to one location. Orders less than \$500.00 will be subject to a \$25.00 handling charge.

Returns

Any Product Return Must Have Prior Return Authorization

Non-Defective Product: Attwood will not accept any non-defective returns, unless due to the fault of Attwood. Non-defective product returns will be subject to a minimum 25% handling charge, or will be returned to the customer at their expense.

Defective Product: Credit will not be issued for defective product without written authorization. Return requests must be mailed to our offices and must include an itemized list of materials to be returned, the reasons for return, and the date and number of the Attwood invoice.

Specifications

Weight and dimensions are subject to variation within reasonable tolerances. All items are subject to design improvement change.

Attwood is a member of the National Marine Manufacturers Association. Where stated, Attwood designs its products to comply with all applicable Federal Regulations and with American Boat and Yacht Council (ABYC) standards. Attwood assures all participants in the National Marine Manufacturers Association (NMMA) boat certification program that, where stated, Attwood products are designed to meet or exceed NMMA recommendations and ABYC standards.

See Next Page For Warranty Information.

To Place An Order Or Inquiry—

Phone: (616) 897-2290 Between 8:00 A.M. And 5:00 P.M. EST
Fax: (616) 897-8358

ATTWOOD LIMITED WARRANTY

Attwood Corporation, 1016 North Monroe, Lowell, Michigan 49331 (“Attwood”) warrants to the first retail purchaser of its products that Attwood will replace or repair the product, at its sole discretion, if any defects in material or workmanship are reported within the applicable warranty periods set out below from the date of the first retail purchase, subject to the remedies, exclusions, and limitations in this Limited Warranty. This limited warranty is effective for all Attwood products purchased after May 1, 2009.

1. **Boat Covers and Tops:** *Attwood will apply the below percentages of the original purchase price of the boat cover as a discount off of the cost of a replacement boat cover for each of the prorated warranty periods set out below.

a. Silver Coat, Road Ready™, Snug Harbor Silver Series, and Custom Boat Covers: 3 years Prorated

<i>From Purchase Date</i>	<i>Discount*</i>	<i>From Purchase Date</i>	<i>Discount*</i>
1st Full Year	100%	3rd Full Year	33%
2nd Full Year	67%		

b. Road Max™ Boat Covers: 4 years Prorated

<i>From Purchase Date</i>	<i>Discount*</i>	<i>From Purchase Date</i>	<i>Discount*</i>
1st Full Year	100%	3rd Full Year	50%
2nd Full Year	75%	4th Full Year	25%

c. Snug Harbor Titanium Series, Road Max™ 600 Boat Covers and Acrylic and Vinyl Bimini Tops: 5 years Prorated

<i>From Purchase Date</i>	<i>Discount*</i>	<i>From Purchase Date</i>	<i>Discount*</i>
1st Full Year	100%	4th Full Year	40%
2nd Full Year	80%	5th Full Year	20%
3rd Full Year	60%		

d. Boaters Best™ Boat Covers: 6 years Prorated

<i>From Purchase Date</i>	<i>Discount*</i>	<i>From Purchase Date</i>	<i>Discount*</i>
1st Full Year	100%	4th Full Year	49%
2nd Full Year	83%	5th Full Year	32%
3rd Full Year	66%	6th Full Year	15%

e. Boaters Best™ Ultimate Boat Covers: 8 years Prorated

<i>From Purchase Date</i>	<i>Discount*</i>	<i>From Purchase Date</i>	<i>Discount*</i>
1st Full Year	100%	5th Full Year	50%
2nd Full Year	88%	6th Full Year	37%
3rd Full Year	75%	7th Full Year	25%
4th Full Year	63%	8th Full Year	12%

2. **Pumps:**

- a. Heavy Duty Bilge Pumps Installed on Recreational/Pleasure Boats**
(Part Numbers 4030, 4040, 4060, 4070): **3 years**
- b. Heavy Duty Bilge Pumps Installed on Commercial Boats** (commercial use is defined as any work or employment related use of the product even if only occasionally used for such purposes)
(Part Number 4030,4040,4060,4070): **1 year**
- c. Sahara Series Automatic Bilge Pumps** (Part Numbers 4505, 4507, 4508, 4511): **3 years**
- d. Tsunami Series Cartridge Bilge and Aerator Pumps** (Part Numbers 4606, 4608, 4609, 4612, 4613, 4620, 4622, 4623, 4624, 4625, 4640, 4650, 4651, 4660, 4661, 4670, 4672): **3 years**

3. Automatic Float Switch (Part Numbers 4201, 4202):	3 years
4. Digital Bilge Switch (Part Numbers 4801, 4802):	3 years
5. Bilge Blowers:	
a. Water-Resistant Turbo Bilge Blowers (Part Numbers 1733, 1743, 1749 and 1751):	3 years
b. Standard (Non Water-Resistant) Turbo Bilge Blowers (Part Numbers 1731, 1741 and 1747) except when used in applications which allow contact with liquids (Exception No. 2):	1 year
6. LED Lights:	5 years
7. Pro-Series Rod Holders: (Part Numbers 5010 and 5010W):	5 years
8. Pro-Series Combo Rod Holder Mounts: (Part Numbers 5011, 5012 and 5016):	3 years
9. Attwood Rod Holders: (Part Numbers 5009 and 5009W):	3 years
10. Attwood Fuel Products:	2 years
11. ZAMAK Hardware, or Perma-Plate Parts:	2 years
12. Attwood Cast Stainless Steel Hardware:	Life of the Boat
13. All other Attwood and Swivl-Eze Brand Products:	1 year

Other Limitations: EXCEPT AS SET FORTH HEREIN, THERE ARE NO OTHER WARRANTIES EITHER EXPRESS OR IMPLIED PROVIDED BY ATTWOOD ON THIS PRODUCT. ALL OTHER WARRANTIES, EXPRESS OR IMPLIED, INCLUDING IMPLIED WARRANTIES OF FITNESS AND MERCHANTABILITY, ARE EXPRESSLY EXCLUDED. ATTWOOD FURTHER DISCLAIMS ANY LIABILITY FOR ECONOMIC LOSS ARISING FROM CLAIMS OF PRODUCT FAILURE, NEGLIGENCE, DEFECTIVE DESIGN, MANUFACTURING DEFECT, FAILURE TO WARN AND/OR INSTRUCT, LACK OF SEAWORTHINESS, AND ANY OTHER THEORY OF LIABILITY NOT EXPRESSLY COVERED UNDER THE TERMS OF THIS LIMITED WARRANTY. TO THE EXTENT REQUIRED BY LAW ANY IMPLIED WARRANTY IS LIMITED TO THE DURATION OF THE RESPECTIVE EXPRESS LIMITED WARRANTIES STATED HEREIN. TO THE EXTENT ALLOWED BY LAW NEITHER ATTWOOD, NOR THE SELLING DISTRIBUTOR SHALL HAVE ANY RESPONSIBILITY FOR LOSS OF USE OF THE PRODUCT OR THE BOAT, LOSS OF TIME, INCONVENIENCE, COMMERCIAL LOSS OR INCIDENTAL AND CONSEQUENTIAL DAMAGES. SOME STATES DO NOT ALLOW LIMITATIONS ON HOW LONG AN IMPLIED WARRANTY LASTS, SO THE ABOVE LIMITATION MAY NOT BE APPLICABLE. SOME STATES DO NOT ALLOW THE EXCLUSION OR LIMITATION OF INCIDENTAL OR CONSEQUENTIAL DAMAGES, SO THE ABOVE LIMITATIONS OR EXCLUSIONS MAY NOT BE APPLICABLE. THIS WARRANTY GIVES THE OWNER SPECIFIC LEGAL RIGHTS, AND THE OWNER MAY ALSO HAVE OTHER RIGHTS WHICH VARY FROM STATE TO STATE. RETAIL CUSTOMERS IN THE EUROPEAN ECONOMIC AREA (EEA) MAY HAVE LEGAL RIGHTS UNDER APPLICABLE NATIONAL LEGISLATION REGARDING THE SALE OF RETAIL GOODS WHICH ARE NOT AFFECTED BY THIS LIMITED WARRANTY. THE RETAIL CUSTOMER'S LEGAL RIGHTS UNDER ANY APPLICABLE NATIONAL LEGISLATION REGARDING THE SALE OF RETAIL GOODS SHALL NOT BE AFFECTED. You can receive information relating to privacy and to this limited warranty in Europe on www.attwoodmarine.com and by contacting Attwood at the address listed on next page.

Sole Remedy: In no event shall any repair or replacement under this Limited Warranty exceed the fair market value of the product as of the date of the owner's claim. THE REMEDY OF REPAIR OR REPLACEMENT OF PARTS OR MATERIALS FOUND TO BE DEFECTIVE IN FACTORY MATERIALS OR WORKMANSHIP COVERED BY THIS LIMITED WARRANTY SHALL CONSTITUTE THE OWNER'S SOLE AND EXCLUSIVE REMEDY AGAINST ATTWOOD FOR ANY CLAIMS WHATSOEVER OF ECONOMIC LOSS RESULTING FROM PRODUCT FAILURE.

Acceptance of any product returned or any refund provided by Attwood shall not be deemed an admission that the product is defective. Products that are replaced become Attwood's property. The terms and conditions contained in this limited warranty may not be modified, altered or waived by any action, inaction, or representations, whether oral or in writing, except upon the express, written authority of a management level employee of Attwood.

Exclusions: This Limited Warranty does not apply to the following items:

1. Any Attwood products used in other applications than on pleasure boats, including but not limited to non-marine use or use on boats which are utilized for racing or commercial purposes, with the exception of the Heavy Duty Bilge Pumps installed on commercial boats (see 1b, above) (Part Numbers 4030,4040,4060,4070).
2. Any non water-resistant Turbo Bilge Blowers (Part Numbers 1731, and 1741) used in applications which allow direct contact with water or other liquids.
3. Due to wind velocity encountered when boats are trailered, only Snug Harbor™ Silver Series, Snug Harbor™ Titanium Series, Silver Coat, Road Ready™, Road Max™, Road Max™ 600, Boaters Best™, Boaters Best™ Ultimate, and Custom boat covers, when properly tied down, are warranted as suitable for use in connection with towing on a trailer. No warranty is extended on any other boat covers when used in connection with a trailered boat.
4. Damage to the boat cover or to any other property or any injury resulting from the failure to properly tie down a boat cover before towing is not covered.
5. Ancillary equipment used or associated with Attwood products, including but not limited to, batteries, fuses, electric light bulbs, lamps, or sealed beam units.
6. Any product damaged by accident, acts of nature, improper installation, unreasonable or improper use, lack of proper maintenance, unauthorized repairs or modifications, abuse, normal wear or tear, or other causes not arising from defects in materials or workmanship.
7. Any expenses involved in the removal, reinstallation, or transportation of the product.
8. Any product damaged by the failure of the owner to use, maintain, or store the product as specified in any instructions.
9. Any boat cover torn or ripped because of forcing the fabric over sharp edges or corners, failing to protect the fabric from sharp objects, or allowing water, snow or ice to pool or puddle on the product.
10. Any boat cover fabric discoloration, or failure due to chemical exposure such as bird droppings, tree sap, gas, and oil or mildew due to water, snow or ice, dirt, leaves, pine needles resting on the product or the product stored while damp.
11. Any defect or repair requiring redesign of the Attwood product, except pursuant to the recall provisions of the United States Federal Boat Safety Act of 1971 or the recall laws of any other foreign jurisdiction.

Owner's Obligations: It is the responsibility of the purchaser to return the product to Attwood at the address below, postage pre-paid, and insured with proof of original purchase including date.

Attwood Corporation
1016 North Monroe
Lowell, Michigan 49331
Phone: 616-897-2290

Internet Address:
www.attwoodmarine.com

CALIFORNIA PROPOSITION 65 OVERVIEW

What is Proposition 65?	Proposition 65 requires businesses to provide warnings to Californians about significant exposures to chemicals that cause cancer, birth defects or other reproductive harm. This enables Californians to make informed decisions about their exposures to these chemicals. Proposition 65 requires California to publish a list of chemicals known to cause cancer, birth defects or other reproductive harm. This list, which must be updated at least once a year, has grown to include approximately 900 chemicals since it was first published in 1987.
What does the warning look like?	 WARNING Cancer and Reproductive Harm – www.P65Warnings.ca.gov
What does a warning mean?	The product number associated with the warning could expose individuals to one or more of the chemicals on the list.
How do I learn more about Proposition 65?	Visit this website to learn more about Proposition 65. https://www.p65warnings.ca.gov/
Where do I find answers related to businesses?	https://www.p65warnings.ca.gov/sites/default/files/art_6_business_qa.pdf



ATTWOOD CORPORATION
1016 NORTH MONROE STREET
LOWELL, MI 49331

PHONE: 616.897.9241

WWW.ATTWOODMARINE.COM

CAT-ATT-2021_PROP65

PARTICIPATING MEMBER OF

