

FMFRP 12-13

Maneuver In War

(Reprint of 1939 Edition)



U.S. Marine Corps

PCN 140 121300 00

DEPARTMENT OF THE NAVY
Headquarters United States Marine Corps
Washington, D.C. 20380-0001

21 December 1990

FOREWORD

1. PURPOSE

Fleet Marine Force Reference Publication (FMFRP) 12-13, *Maneuver in War*, is published to ensure the retention and dissemination of useful information which is not intended to become doctrine or to be published in Fleet Marine Force manuals. FMFRP's in the 12 series are a special category of publications: reprints of historical works which are no longer in print.

2. SCOPE

Formerly published as NAVMC 2796, this reference publication was originally written by Charles Andrew Willoughby. An excellent study on the theory of maneuver with many historical illustrations, it is as applicable today as it was when published in 1939.

3. CERTIFICATION

Reviewed and approved this date.

BY DIRECTION OF THE COMMANDANT OF THE MARINE CORPS



M. P. CAULFIELD

Major General, U.S. Marine Corps
Deputy Commander for Warfighting
Marine Corps Combat Development Command
Quantico, Virginia

DISTRIBUTION: 14012130000

LIST OF ILLUSTRATIONS

	<i>Page</i>
1. Colenso, 15 December 1899	4
2. Bull Run, 18-19 July 1861	5
3. Bull Run, 21 July 1861	6
4. Bull Run, A Modern Solution	7
5. 3d Division Infantry Dispositions, Marne Defense, 15-18 July 1918	8
6. Defense of the Sava, Initial Austrian Dispositions, 29 August 1914	9
7. Defense of the Sava, Austrian Dispositions, 1-6 September 1914	10
8. Defense of the Sava, Austrian Concentrations and Counterattack, 6 September 1914	11
9. Defense of the Suez Canal, 1915	12
10. Position Defense	13
11. Lines of Resistance in a Defense Position	14
12. 3d Division, A.E.F., Marne 1918. Lines of Resistance	15
13. Organization of a Defensive Sector	16
14. 3d Div., A.E.F., Marne, 1918. Organization of Defensive Sectors, 7th and 30th Inf.	17
15. Composite Diagram: Defense of River Lines	18
16. A Turning Movement	19
17. The Battle of Beersheba, 31 October 1917	20
18. The 306th U.S. Inf., St. Juvin, 14 October 1918	21
19. The 4th Bn., 365th Fr. Inf., Cuisy-en-Almont, 20 August 1918	22
20. Co. C, 103d U. S. Inf., A.E.F.; Hill 190, 20 July 1918	23
21. The Maxims of Napoleon	29
22. The Historical Continuity of the Principles of War: 505 B.C.-1936 A.D.	36
23. Maneuver of the First Army: Montdidier, 8-12 August 1918	37
24. First Army Plan. Montdidier, 8 August 1918	37
25. The Battle of Meggido, 19 September 1918	38
26. The Campaigns of Simon Bolivar, 1813-1824	40
27. Cantigny, 28 May 1918	41
28. Structure and Physiognomy of Maneuver	43
29. The Battle of Montdidier, 8-12 August 1918	47
30. The Attack of the French Tenth Army: Villers-Cotteret, 1918	48
31. The Meuse-Argonne Operations, U. S. Forces, 1918	49
32. The Battle of La Fere Champenoise, 9 September 1914	50
33. Operations of the French Fourth Army, 21-22 August 1914	51
34. Montdidier, 8 August 1918. First Army Plan	51
35. First Phase, Second Battle of Guise, 17 October 1918	52
36. Frontages. Combat Density. Historical Evolution	54
37. Frontages, World War: Allied and German Attacks	56
38. Summary of Frontages: Allied and German Attacks	57
39. The Battle of St. Privat, 18 August 1870	61
40. The Maneuver of Eylau, 1807	63
41. Battle of Castiglione, 1796	65
42. Battle of Lutzen, 1813	66
43. March of the German Second Army on Le Mans, 1871	66
44. March of the German First Army to the Ourcq, 1914	67
45. Reversal of Corps Columns	69
46. Crossing of Supply Columns	70
47. The Corps in a Flank March	70
48. A Movement by Echelon	71
49. Routes of the German First Army, 5-8 September 1914	71
50. The 4th Bavarian Division. Longueval. 13 October 1914	72
51. Schematic Chart: Types of Maneuver	74
52. The Campaign of Italy, 1796	76
53. Tannenberg, August 1914: First and Second Phases	77
54. The Battle of the Sha-Ho, 1904	78
55. The Battle of the Ardennes, 1914	79
56. Situation: German First and Second Armies, 4-5 September 1914	80
57. The Capture of Cantigny, 28 May 1918	82
58. The Attack of the 1st and 2d U. S. Divisions, 18-22 July 1918	84
59. West Front, 1914: The Race to the Sea	90
60. Characteristics of Breakthrough Operations	91

LIST OF ILLUSTRATIONS—(Continued)

	<i>Page</i>
61. The Breakthrough at Gorlice—Tarnow: 2-9 May 1915	93
62. The Arras—Soissons Salient, 1917	94
63. The Verdun Salient, 1916	96
64. The Battle of Cambrai: November-December 1917	98
65. The Battle of Fleurus, 1794	100
66. The Battle of Le Mans, 1871	101
67. The Turco-Bulgarian Campaign, 1913	102
68. Cannae and the Marne	104
69. Battle of Cannae: Initial Situation	105
70. Battle of Cannae: The Collision	106
71. The Battle of the Cowpens, 1781	107
72. The Engagement at Tafila, 24 January 1918	108
73. Tannenberg, 1914: First Phase	109
74. The Battle of Leuthen, 5 December 1757	110
75. The Napoleonic Maneuver: Orientation. Location of Battles and Classification of Types	111
76. The Battle of Carabobo, 24 June 1821	113
77a. Army Concentrations: Austro-Prussian War, 1866	115
77b. General Situation to include 27 June 1866	116
78. Location and Plan of Prussian Armies, 1-2 July 1866	117
79. The Battle of Koniggratz, 3 July 1866	118
80. The Defense of Petersburg, 1864	120
81. Orientation Map: France, 1914	122
82. The German Advance, 1914	123
83. General Situation: Chancellorsville, 27 April to May 1863	125
84. The Battle of Chancellorsville, 2 May 1863	126
85. The Battle of Wachau, 16 October 1813	127
86. Distribution of Forces, The Schlieffen Plan, 1905	129
87. Offensive-Defensive: Comparative Evaluation	133
88. Casualties in Attack and Defense, 1915-18	134
89. Napoleonic Wars, 1796-1815	136
90. Orientation Map: The Napoleonic Maneuver	138
91. Schematic Diagram: Maneuver Against the Rear of the Enemy	139
92. Theater of War, Lombardy, 1796	140
93. Austrian Lines of Communications, Lombardy, 1796	141
94. Italy, 1796: Operations 2 April to 8 May	143
95. Theater of War: Northwestern Europe, 1805	144
96. The Campaign of Ulm, 1805	145
97. General Situation of the French Armies, 1806	146
98. The Advance on Jena, 1806	147
99. Eugene in Italy, 1813	148
100. Campaign of Italy, 1796	149
101. Campaign of 1815	150
102. The Maneuver of Eylau, 1807	152
103. The Campaign of Ulm, 1805	153
104. The Battle of Ulm	154
105. The Structure of Battle	155
106. Battle of Allenstein, 1807	157
107. Battle of Wagram, 1809	158
108. Wagram, 1809: MacDonald's Assault	159
109. The Structure of Battle	160
110. The Strategic Advance on Bautzen, 1813	161
111. The Battle of Bautzen, 21 May 1813	162
112. The Battle of Bautzen: Schematic	163
113. The Battle of Ulm, 1805	164
114. The Advance on Jena, 1806	164
115. The Battle of Jena, 1806	165
116. The Maneuver of Eylau, 1807	166
117. The Battle of Eylau, 1807	166
118. Progress of Civil War in Spain, 1936-1939	173
119. The Drive to the Sea, March 1938 to February 1939	174
120. The Operations Against the Sierra Palomera, 5-7 February 1938	175

LIST OF ILLUSTRATIONS—(Continued)

	<i>Page</i>
121. The Operations Against the Sierra De San Just, 23 April-5 May 1938	177
122. The Reduction of the Albentosa Sector, 13 to 22 June 1938	178
123. The Operations in Estremadura, 19-24 July 1938	179
124. The Motorized Advance on Guadalajara	184
125. Conflict of Empire	196
126. The Progress of Japanese Expansion in China from 1895 to 1938	200
127. Sino-Japanese Theater of War	201
128. The War of the Railroads. A Parallel to the Sino-Japanese Conflict	202
129. Operations on the North Front, 1937. Sequence of Events	203
130. Initial Offensive in Hopei, August-September 1937	205
131. Operations on the South Front, Shanghai Nanking, 1937	206
132. The War of the Railroads. A Parallel to the Sino-Japanese Conflict	208
133. Operations Against the Lunghai Corridor, 1938	209
134. The Hsuehou-Tayerchwang Area April 1938	210
135. Tayerchwang, 3 April 1938	211
136. The Japanese Major Offensive: Hsuehou, May 1938	212
137. The Battle of Hsuehou, 15-18 May 1938	213
138. The Advance on Hankow	215
139. The Capture of Hankow	216
140. The Capture of Canton	217
141. Lines of Communications, 1939	218
142. The "Life Line": Lashio-Yunnan	219
143. The 142d Chinese Division, 26 September-16 October 1938	222
144. The 142d Chinese Division 26 September-16 October 1938	223
145. Aviation Performance and Comparative Theaters of War	224
146. The Operations at Nankow Pass, 3-24 August 1937	226
147. Relative Distances in Various Sino-Japanese Campaigns, 1937-1939	227
148. The Partition of Africa, 1880-1930	231
149. The Advance on Adua, 29 February 1896	233
150. Adua, Situation at 10:00 A.M., 29 February 1896	234
151. Relative Colonial Acquisitions, 1880-1914	236
152. Orientation Map, Abyssinia	240
153. Roadnet, Northern Theater of Operations, 1936	242
154. Roadnet, Southern Theater of Operations, 1936	243
155. Organization of Theaters of Operation, 1935	244
156. The Initial Italian Concentration, 1 October 1935	247
157. The Initial Italian Advance, 3-6 October 1935	248
158. The Italian Advance, 26 October-11 November 1935	249
159. Mai Timchet and the Dembeguina Pass, 14-16 December 1935	250
160. General Situation, Northern Theater of Operations, 15 December 1935	251
161. The First Battle of the Tembien, 19-23 January 1936	251
162. Marshal Badoglio's Decisive Maneuver, 10 February-3 March 1936	252
163. The Battle of Amba Aradam, 10-15 February 1936	253
164. The Capture of Amba Alagi, 27, February 1936	254
165. The Second Battle of the Tembien, 27-29 February 1936	255
166. The Attack on Coietza and Af Gaga Pass, 2-3 March 1936	256
167. Starace's Advance on Gondar, 10-31 March 1936	257
168. Ruggero's Advance on Sardo, 6-11 March 1936	259
169. The General Advance on Dessie, 5-14 April 1936	260
170. The Battle of Mai Cieu, 1-3 April 1936	261
171. The Advance on Addis Ababa, 24 April-5 May 1936	262
172. Graziani's Initial Operations, October-November 1935	264
173. The Battle of Ganale Doria, 11-13 January 1936	265
174. The Advance on Neghelli, 15-20 January 1936	266
175. The Advance on Sassabaneh, April 1936	267
176. The Battle of Gianagobo, 15-17 April 1936	268
177. Sassabaneh, Situation 24-25 April 1936	270
178. Sassabaneh, Situation 29-30 April 1936	271
179. The Pursuit to Harrar, 5 May 1936	273
180. Military Roads, Northern Abyssinia	279
181. Fig. 1. Military Roads, Abyssinia, Profiles	282
181. Fig. 2. Military Roads, Abyssinia, Profiles	283

CONTENTS

<i>Chapter</i>		<i>Page</i>
I. THE HISTORICAL BASIS OF MODERN TACTICS		
1.	The Value of Military History	1
2.	Science. Doctrine. Proof	2
3.	The Role of the Historical Example	2
4.	Historical Examples: Five Concrete Cases	3
5.	The Evolution of Modern Tactics	11
II. THE PRINCIPLES OF WAR		
6.	The Codification of Military Knowledge	25
7.	The Historical Continuity of the Principles	26
8.	The Practical Application of the Principles of War	35
III. MASS AND DIRECTION		
9.	Definition of Maneuver	45
10.	The Basic Factors	46
11.	Combination of Directions	46
12.	Preliminary Conditions Affecting Direction	48
13.	Direction in Offensive Combat	50
14.	Distribution of Forces. Frontages	50
15.	Frontages. Combat Density. Historical Evolution	53
16.	Interpretation of Density Table	53
IV. THEORY OF MANEUVER		
17.	The Structure of Battle	58
18.	Decisive Action. Point. Place. Time	60
19.	The Preconceived Maneuver	64
20.	Adaptation of the Preconceived Maneuver	67
V. CENTRAL MANEUVER		
21.	A Schematic Classification of Maneuver	74
22.	Operation on Interior Lines	75
23.	Dislocation: Fragmentation of the Front	77
24.	The Penetration	79
25.	The Breakthrough	89
VI. FLANK MANEUVER		
26.	The Converging Attack	100
27.	The Envelopment	103
28.	The Defensive Maneuver	124
29.	Attack or Defense: Relative Tactical Values	129
VII. THE NAPOLEONIC CONCEPT OF MANEUVER		
30.	A Modern Organization	136
31.	Napoleon's System of Operations	137
32.	The Maneuver against Flank and Rear	138
33.	The Maneuver on Interior Lines	148
VIII. THE NAPOLEONIC CONCEPT OF BATTLE		
34.	The Transition from Maneuver to Battle	152
35.	The Internal Structure of Battle	155
36.	The Execution of the Main Attack	157
37.	The Coordination of the Main and Secondary Attack	159
38.	The Exploitation of the Main Attack	160
39.	Examples of the Napoleonic Method	161
40.	Summary and Conclusions	167
IX. THE SPANISH CIVIL WAR, 1936-1939		
41.	A Political Impasse	172
42.	Chronology of Operations	172
43.	Characteristic Types of Maneuver	175
44.	The Effect of Foreign Intervention	180
45.	Tactics and Technique of the Separate Arms	182

CONTENTS—(Continued)

<i>Chapter</i>		<i>Page</i>
X. THE SINO-JAPANESE WAR		
46.	The Politico-Economic Background	196
47.	Chronology of Operation	199
48.	The Problem of Chinese Supply	217
49.	A Tug-of-War. Guerrillas against Regulars	219
50.	Statistics of Conquest	220
51.	Characteristic Types of Maneuver	221
52.	Tactics and Technique of Separate Arms	223
53.	Future Developments	227
XI. THE ITALO-ETHIOPIAN WAR		
54.	The Evolution of an Aggressor	230
55.	Chronology of Operations	237
56.	The Organization of an Overseas Expedition	239
57.	The Campaign in the North: De Bono and Badoglio	247
58.	The Campaign in the South: Graziana	263
59.	Characteristic Types of Maneuver	271
60.	The Tactics and Technique of the Separate Arms	272
XII. EPILOGUE: THE WAR OF THE FUTURE	286

THE HISTORICAL BASIS OF MODERN TACTICS

1. **THE VALUE OF MILITARY HISTORY.** Napoleon once defined recorded history as "a collection of lies men have agreed upon," but he was quick to make an exception in favor of military history: ". . . tactics, evolutions, the technique of engineers and artillery can be learned from textbooks, but a knowledge of the higher elements of war can only be acquired through a study of military history and through experience itself."¹

The professional value of military historical studies is now so universally acknowledged that army service schools, in this country as well as abroad, habitually maintain extensive courses in military history.

A perfect definition of this value is contained in the "Annual Report of the Chief of Staff, U. S. Army, 1935":

"More than most professions, the military is forced to depend upon intelligent interpretation of the past for signposts charting the future. Devoid of opportunity, in peace, for self-instruction through actual practice of his profession, the soldier makes maximum use of historical record in assuring the readiness of himself and his command to function efficiently in emergency.

"The facts derived from historical analysis, he applies to conditions of the present and the proximate future, thus developing a synthesis of appropriate method, organization and doctrine.

"But the military student does not seek to learn from history the minutia of method and technique. In every age, these are decisively influenced by the characteristics of weapons currently available and by the means at hand, for maneuvering, supplying and controlling combat forces. But research does bring to light those fundamental principles and their combination and application which, in the past, have been productive of success.

"These principles know no limitation of time.² Consequently, the Army extends its analytical interest to the dust-buried accounts of wars long past as well as to those still reeking with the scent of battle. It is the object of the search that dictates the field for its pursuit. Those callow critics who hold that only in the most recent battles are there to be found truths applicable to our present problems have failed utterly to see this.

"They apparently cling to the fatuous hope that in historical study is to be found a complete digest of the science of war rather than simply the basic and inviolable laws of the art of war . . ."

It is significant, indeed, that our highest military authority should devote space and thought to the field of military historical study in an annual report dealing with the activities of the American Army as a whole!

The views of General MacArthur in 1935 are supported by a similar idea expressed by a foreign Chief of Staff, Count Schlieffen, Imperial German Army, in 1905:

For anyone who aspires to become a great commander, there is an open book, called military history, which begins with the hand-to-hand struggle between Cain and Abel and which did not end with the Napoleonic Campaigns.

"Its reading, I must admit, is not always exciting. One has to plow through a mass of uninteresting details! But—one accumulates facts, often encouraging facts! and at the bottom of it all, one arrives at the final realization how it all came about, how it had to happen and may happen again."

The American and German opinions of the professional value of military history are amply confirmed by the current practice in foreign armies to make promotion in grade contingent upon examinations in which military history is a required subject; in the British army, promotion examinations include historical topics, viz: The American Civil War, 1861-1864; The Campaign in Mesopotamia, 1915-1917; The Russo-Japanese War, 1904; Gallipoli, 1915; etc.

¹ Napoleon, *Correspondence*, Vol. XXX, p. 315.

² These principles are traceable from Sun-Tzu (506-496 B. C.), the oldest military treatise on record, to the U. S. War Department *Training Regulations*, No. 10-5, series of 1921.

MANEUVER IN WAR

There are no promotion examinations in the American service, but it is suggestive that a foreign army should list the American Civil War concurrently with purely national subjects.

One can afford to acknowledge the wisdom of Bismarck's cynical comment: "Fools say they learn by experience. I prefer to learn by other people's experience."³

This experience, far wider than the average individual can hope to accumulate for himself, is clearly contained in military history. It is significant that great military thinkers like Napoleon, Clausewitz, Moltke and Foch did not consider the tactical schooling of leaders as the *most important* item of their professional equipment; they esteemed above all an *intellectual training* derived from a comparative study of the past.

2. SCIENCE. DOCTRINE. PROOF. Throughout a military career one is confronted with dogmatic statements, in training, in tactics, in instructional texts.

In the professions, and especially in the sciences, a statement of principle is ordinarily based on a long record of laboratory experimentation. No science worthy of the name would undertake to announce a doctrine without furnishing proof of it by submitting laboratory tests or observations which had led to definite conclusions. This is recognized scientific approach! The military profession, if it lays claim to scientific character, should certainly not be exempted from this procedure.

This thought is by no means original! It is expressed in the *Reveries or Memoirs upon the Art of War* by Count Maurice de Saxe, Field-Marshal of France, 1756. This brilliant eighteenth century commander has this to say:

" . . . War is a science so obscure and imperfect that in general no rules of conduct can be given, reducible to absolute certainties, and custom and prejudice, confirmed by ignorance, are its sole foundation and support . . . All other sciences are established upon fixed principles and rules, while this alone remains destitute . . . The question whether war ought to be styled a trade or a science is very properly thus decided (by the Chevalier Folard): it is a trade for the ignorant and a science for men of genius."

Marshal Saxe's sarcastic comments, one hundred and eighty years ago, have an uncomfortable, modern application. Throughout his career, the soldier-student is confronted with mandatory statements in tactics, training and doctrine, often without explanation of their origin; the dicta are repeated parrot-like and followed as a matter of discipline. Now, when a statement of doctrine, principle or method is combined with an analysis of battle experience, ordinary scientific procedure is observed since the conclusion is supported by proof. It is in this direction that military history, i.e., the professional analysis of operations, can render definite, practical service. Military history represents the laboratory of military science. Field service regulations are the record of battlefield experience expressed in brief terms.

3. THE ROLE OF THE HISTORICAL EXAMPLE. If one accepts this general premise, then the entire field of military instruction is immediately affected, and one can expect that tactical doctrine is susceptible of historical proof; this reasoning lends a special importance to the so-called historical example.

The historical example is a narrative of events of a tactical operation in a continuous *analysis of cause and effect* in order to deduce definite, tactical lessons. Although the field of general historical investigation is enormous and touches upon an immense variety of elements, military history is essentially limited to the development of military factors.

³ Centuries before Bismarck, keen observers have known this: "There are two roads—one through the misfortune of their own, the other through those of others; the former is the most unmistakable, the latter the less painful." (Polybius, *Histories*, Book I, p. 41.)

The historical example is now generally regarded as an indispensable tool of tactical instruction.

Tactical instruction in our service schools roughly follows a certain sequence:

- a. Outline of principles: lecture or conference.
- b. Application of principles: map exercise.
- c. Application of principles on the terrain: field exercise

The pedagogic process is such that military situations under "b" are manipulated, if not forced, to produce certain time-and-space factors; consequently, the conditions are somewhat artificial. The author of the problem is judge, jury, prosecuting attorney and defendant, all in one; the resulting military situation, while smoothly adequate for the particular pedagogic objective of the moment, is rarely true to life; it lacks the vital, rugged characteristics of battlefield situations.

It is obvious that somewhere in the average cycle of instruction, there is a place for *battlefield situations*, for historical examples demonstrating the application of principles in concrete cases in combat, since a statement of principle is incomplete without proof in the form of its historical employment.

A general lecture, conference or map exercise is not wholly convincing unless it is based on the realities of the battlefield; this is simply the inescapable relationship between theory and practice. The element that will bridge the gap is the historical example, which accompanies the presentation of theoretical principles, methods and procedure in tactics. Military history becomes a most effective vehicle of tactical instruction. At one of our important service schools military history is an established subject and takes the form of "historical examples accompanying selected faculty conferences."⁴

The following study on defense of river lines is designed to show the practical application of historical examples in support of current tactical doctrine. The battle action is proof of a principle, applied or violated. Note the organization and sequence of this material, the constant cross reference to established regulations, the continuous study of cause and effect:

1. Definition of principles: grouping by "type of action".
2. Brief outline of selected military operations.
3. The application of "principles" in each operation.
4. Analysis. Deductions. Conclusions.

4. HISTORICAL EXAMPLES: FIVE CONCRETE CASES. *a. River defense: Principles. Methods. Classification.* The basic principles of river defense, including practical methods of execution, are contained in current War Department publications and service-school instructional texts⁵ and permit a broad classification of several types of river defense which involve certain definite tactical dispositions, viz:

⁴ At The Infantry School, Fort Benning, Georgia, the academic committees present basic conferences for each tactical category, viz: "The Rifle Platoon in Attack," "Forms of Attack," "Night Marches," etc.; this type of general conference lends itself peculiarly to the insertion of appropriate historical examples, illustrating the particular type of military operation, viz:

Rifle Platoon in Attack:

1. Co B 47th US Inf: Sergy, July 29-30, 1918.
2. 1st Plat Co B 38th Inf: Aisne-Marne, July 18-22, 1918.
3. 4th Plat Co C 31st Inf: Kazanka, Siberia, July 3, 1919.

Forms of Attack:

1. Envelopment: 157th British Regt: Wadi el Hesi, Nov. 8, 1917.
2. Double envelopment: Arab Irregulars: Tabla, Jan. 25, 1918.
3. Penetration: 28th US Inf: Cantigny, May 28-30, 1918.

Night Marches:

1. Night movements of units of 4th and 7th US Inf: Cierges and Nantillois, Oct. 3, 1918.
2. Night march 2d Bn 28th US Inf: Aisne-Marne Offensive, July 17, 1918.
3. *a.* British and Anzac Bns: Sari Bair, Aug. 6-7, 1915.
- b.* British and Anzac Bns: Chanuk Bair, Aug. 8, 1915.

It should be noted that in view of the special mission of The Infantry School, the military historical studies are held within the limits of operations of the infantry regiment (and lesser included units) and supporting arms, rather than general battle studies, as in the past. This important modification was accomplished in the period of 1936 (Col. Walter C. Short, Asst. Comdt.), 1937 (Col. Charles F. Thompson, Asst. Comdt.), 1938 (Col. Courtney H. Hodges, Asst. Comdt.).

⁵ F. S. R., 1939, Pars. 602-628. Part D, "Defense" pamphlet, C. & G. S. S., 1935. Special Text No. 13, Chap. 8, Army Extension Courses, 1937. The "Digest of Infantry Doctrine," Ft. Benning, Ga., 1936. Training Notes, Infantry School, 1939, Vol. II, Chap. 13.

MANEUVER IN WAR

Case 1: Defense at the water's edge.

The method: (a) The main line of resistance is placed on or near the river bank.

The purpose: (b) The opposite bank and its approaches are held under fire, and the enemy's attempts to cross are frustrated in their beginnings.

The means: (c) To hold the river line, in force, with insufficient reserves destroys the flexibility of defense.

The effect: (d) Holding the river line with inadequate forces leads to a general over-extension with consequent weakness.

Case 2: Defense at the water's edge.

Defense: (a) A river line may be employed as an obstacle in front of a defensive position. L. of R. (b) A river line can be employed as a line of resistance only when its course conforms to the strategical and tactical situation.

Strength: (c) Sufficient forces are available for a strong defense at the river's edge.

Reserve: (d) Sufficient forces for the usual defensive requirements in reserve.

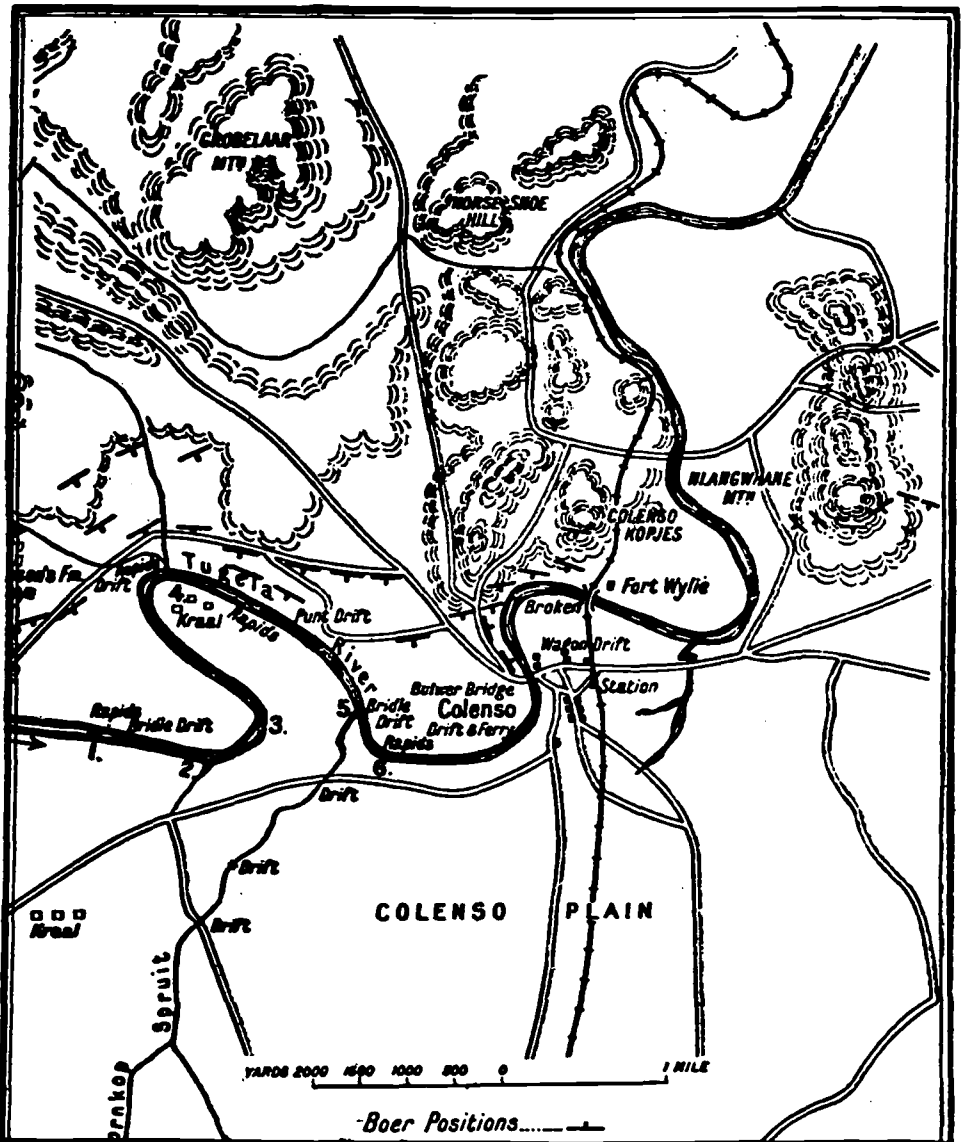

PLATE 1. COLENZO, 15 DECEMBER 1899.

Case 3: Position in Readiness.

Central reserve: (a) It is usually best to hold the mass of the forces in a position in readiness at such distance to the rear that they can intervene at any point where a crossing may be attempted.

Surveillance: (b) The river line is held by relatively weak detachments.

Detachments: (c) Stronger detachments are posted at the most probable points of crossing.

Mission: (d) The mission of the detachments is to discover hostile crossings and prevent the enemy from establishing bridgeheads before the arrival of the main friendly forces.

Case 4: Defense in advance of the river line.

To secure bridgeheads, usually in preparation of a counter-offensive by larger units, or when the river itself must be protected as a line of communications.

b. The application of tactical principles.

Example 1: There are favorable possibilities of "defense at the water's edge" if the point of crossing of the enemy is definitely known or if the local topography clearly limits the points of crossing and the terrain favors the defense.

The British attempt to cross the Tugela River in the battle of Colenso, 15 December, 1899, broke down under the deadly fire of the Boers delivered from a tier of fire trenches along the steep bluffs that dominate the plain of Colenso (Case 1 b).

The Boer War was an eye-opener as regards the effect of small-arms fire combined with concealment. This situation affords a remarkable example of hasty field fortifications, organization of the ground and the employment of tactical localities along the immediate river front.

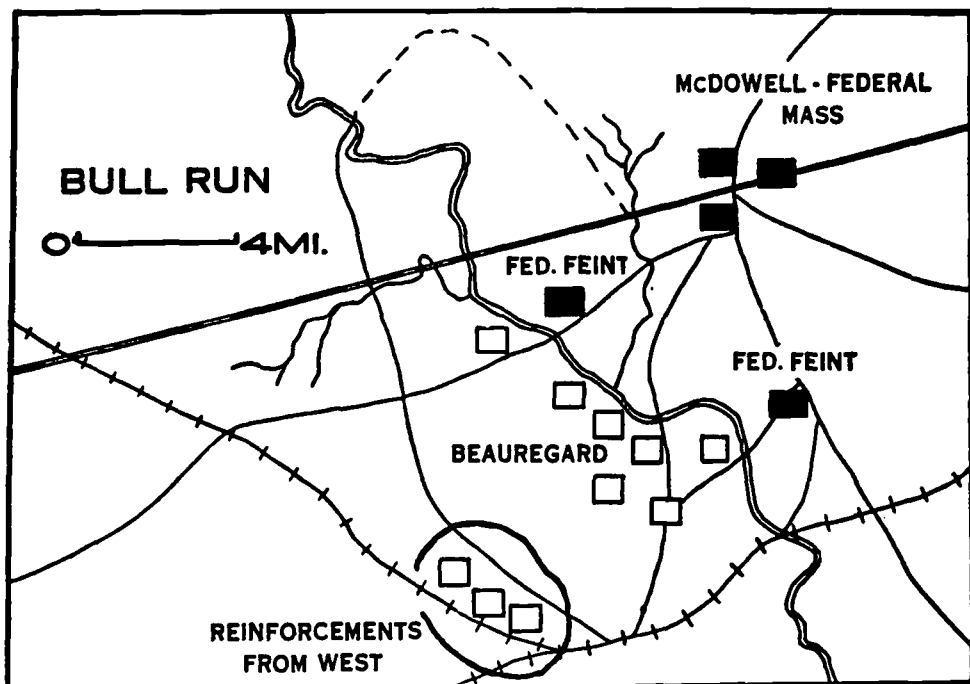

PLATE 2. BULL RUN, 18-19 JULY 1861.

The defensive dispositions of the Boers were practically linear, a hastily organized though shallow position defense as it is understood today. It was effective: the British "attempts to cross were frustrated in their beginning," exactly as indicated in sub-paragraphs (a) and (b), Case 1. The question presents itself at once: why did the British not go around this formidable position? The reason is also a

justification for the linear defense employed here: the Colenso area, astride the British advance for the urgent relief of Ladysmith, was the only locality suitable for a crossing of the Tugela. Here was that rare situation when the point of hostile crossing could be definitely anticipated. Such clear advance information, however, will probably remain the exception rather than the rule.

While the dispositions of the Boer appear to have the sanction of an official text, paragraphs (c) and (d), Case 1, inject an element of doubt and certain limitations. The inherent weakness of the close-in, linear defense, under Case 1, is strikingly evident in the next example:

Example 2: The first battle of Bull Run, 21 July, 1861, is an illustration of a river line improperly held. General Beauregard, the Confederate commander, decided to defend the line of Bull Run Creek; his dispositions fall into the category of "defense at the water's edge" (Case 1). Beauregard placed 5 of his 7½ brigades along the river, thereby committing the bulk of his forces. His line was seven miles long and had a density of 1.8 men per yard of frontage. This is the "cordon" or linear type of defense, which can obviously be pierced or enveloped.

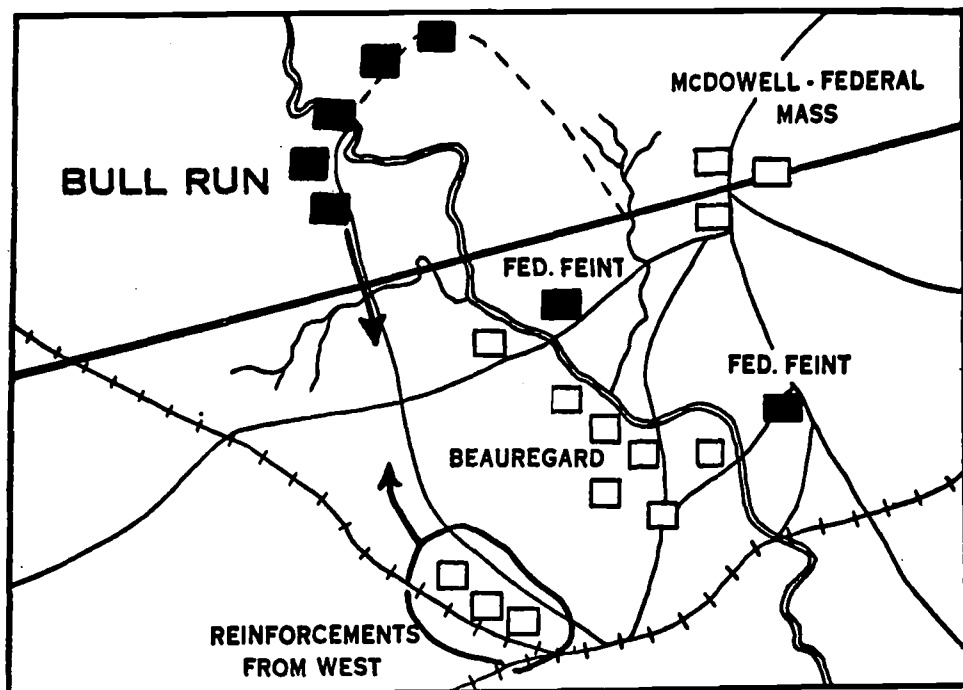

PLATE 3. BULL RUN, 21 JULY 1861.

On the twenty-first, under cover of feint attacks, the bulk of the Federals made a turning movement against the Confederate north flank via Sudley's Springs; the crossing was unopposed, since the bulk of the Confederates was committed elsewhere: 13,000 men lay idle along the creek. The main battle, which developed as a consequence of the Federal envelopment, was fought by Confederate reinforcements which had arrived from the Shenandoah Valley, as a fortunate coincidence.

If the fords had been observed by small detachments while the mass of the Confederate Army was held in a position in readiness (Case 3), a Federal advance via

Sudley's Springs could have been opposed by superior forces, while an advance on the south could have been taken in flank.

Beauregard's dispositions failed in recognizing the point of major crossing of the enemy and opposing it initially. The period prior to a hostile crossing, when the real intentions of the enemy are not fully disclosed, must be regarded as a *readiness phase* in which the tactical means at hand should not be fully committed; when the enemy intentions become unmistakable, then the *readiness phase* merges into a *defense phase*—which is simply a form of combat. Beauregard committed the bulk of his forces during the readiness phase (Case 1 c, d), disregarding the essential requirement of ample reserves (Case 2 c, d).

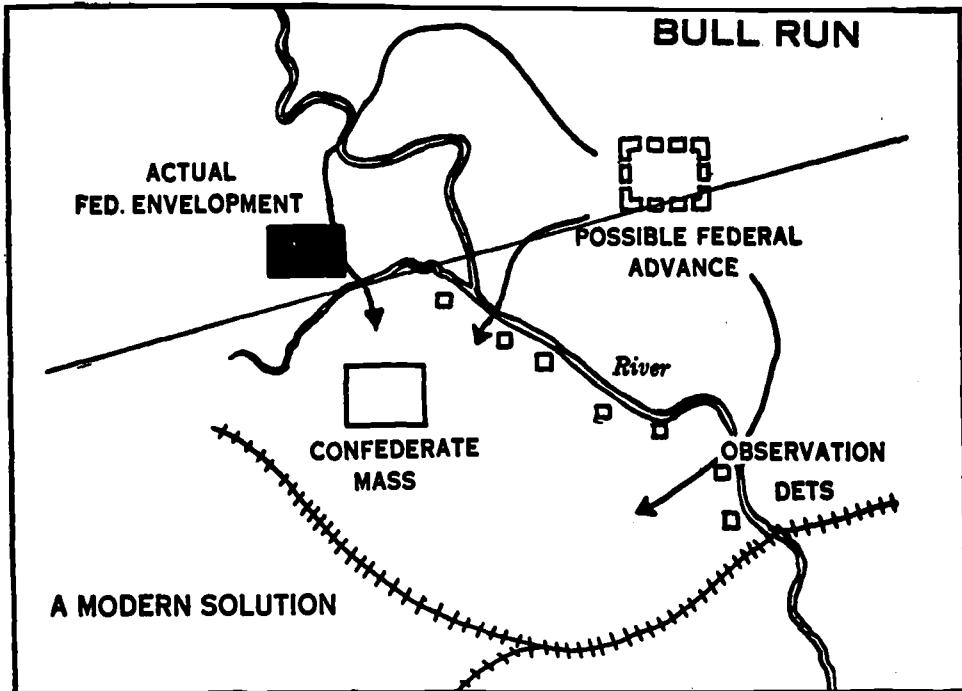

PLATE 4. BULL RUN, A MODERN SOLUTION.

Example 3: The factors that primarily favor defense at the water's edge are shown in Case 2; it may be argued that there is only *one* real factor (Case 2 c), *ample strength*.

The defense of a sector of the Marne River by the 3d U. S. Division, 15 July, 1918, is often quoted as an example of the successful defense of a river line, as an element of a tactical position.

While the river line was actually occupied, the general dispositions of this force followed the prescribed pattern of a heavily organized, defensive sector as practiced on the West Front during 1918; the river became merely an additional obstacle; the whole scheme of defense was influenced by stabilized warfare. As an interior division, there was no necessity for large centralized reserves *in readiness*; ample reserves were available in corps and army; there were 9 divisions on a comparatively narrow front of 18½ miles.

Example 4: The principles and methods listed under Case 3: "Position in readiness," present a type of defense which many authorities regard as practicable for

most situations. In the development of historical examples, proof is sometimes precarious, particularly as regards smaller units. The World War, with its enormous masses on restricted fronts, shows very few instances in which regiments or battalions operated alone; there is a record, however, of a numerically weak infantry division which was employed with such superb skill that it has become a

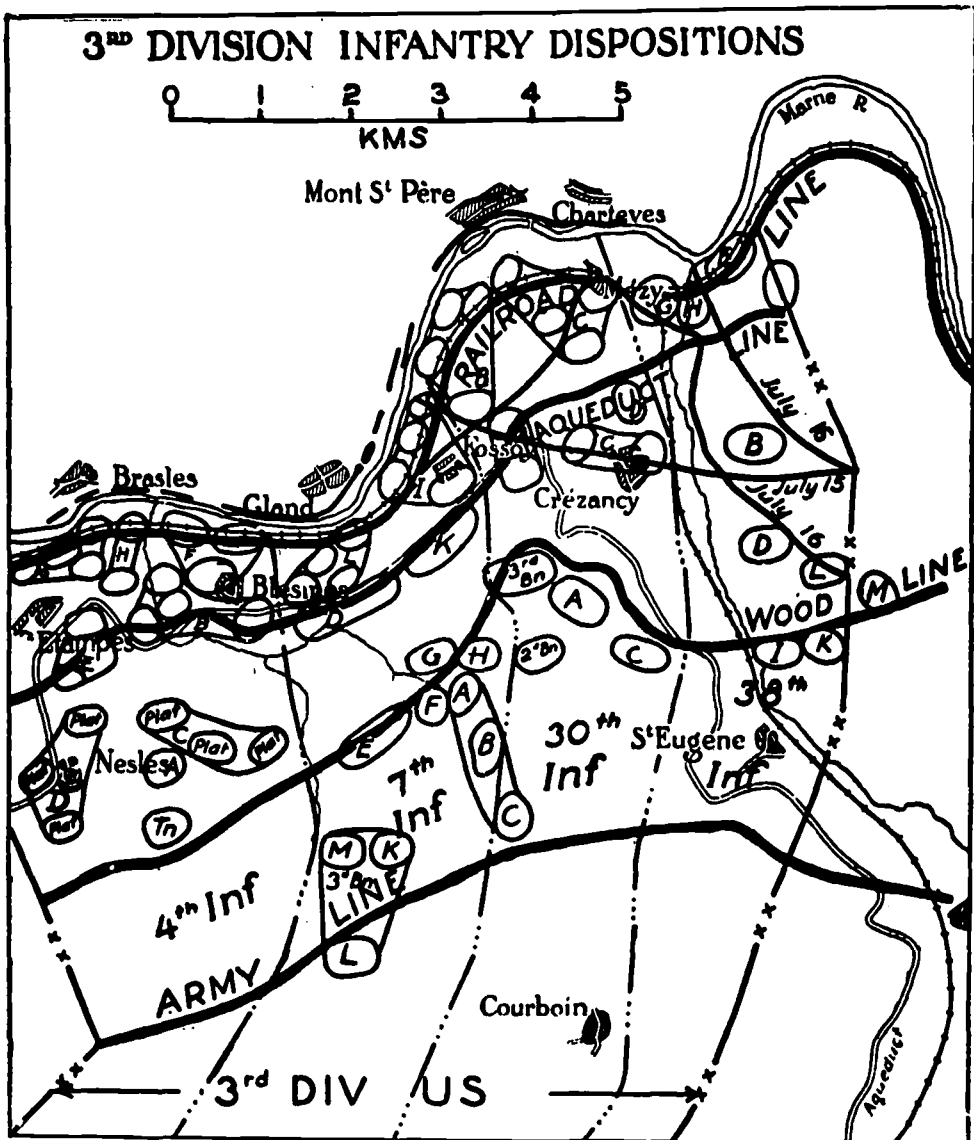

PLATE 5. 3RD DIVISION INFANTRY DISPOSITIONS, MARNE DEFENSE, 15-18 JULY 1918.

veritable classic, in the actual application of every important factor, under Case 3: The defense of the Sava River by the Austrian 29th Infantry Division, 6 September, 1914.

The situation on 29 August showed the bulk of the regular-army units scattered in small detachments along the river, on a front of about 20 miles; this initial disposition falls into the category of "defense at the water's edge." A new commander,

Lt. General Krauss, who arrived at this period, ordered the immediate relief from river duty of all regular-army units and their concentration in a central locality, replacing the river detachments by several battalions of landsturm (3d class troops).

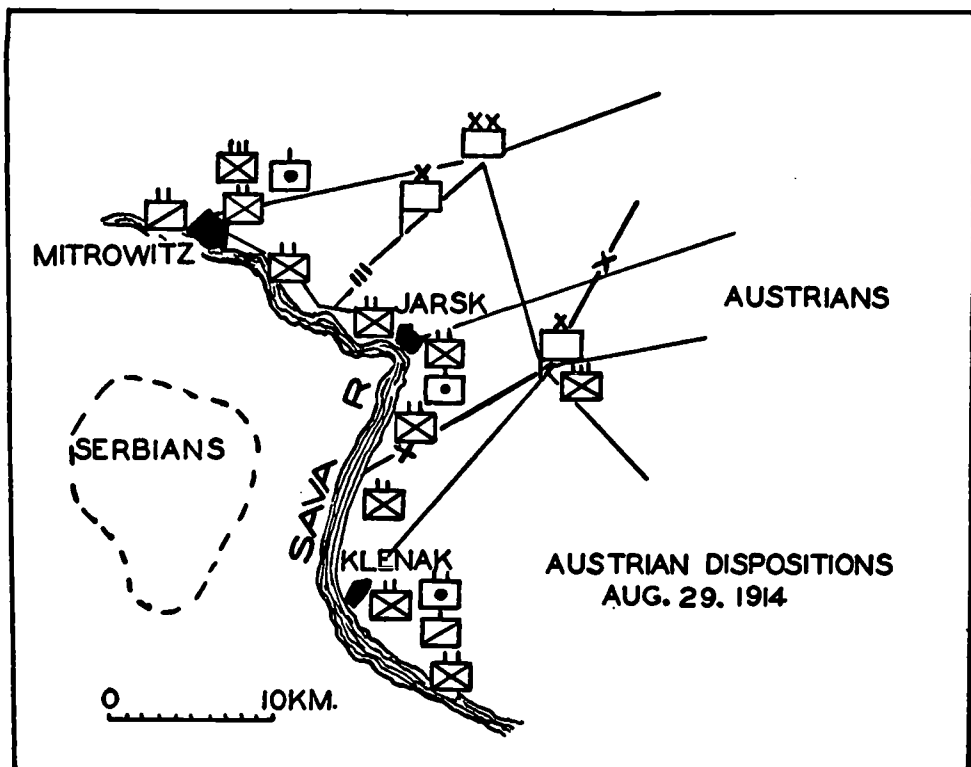

PLATE 6. DEFENSE OF THE SAVA, INITIAL AUSTRIAN DISPOSITIONS, 29 AUGUST 1914.

The division had barely completed its *concentration, in a position of readiness*, when the Serbians forced a crossing east of Mitrowitz on 6 September; their axis of advance ran straight into the Austrian billeting areas! The Austrian commander employed one infantry regiment to hold the enemy frontally, while he made a double envelopment: on the east with one brigade (less one regiment) and on the west with an entire brigade. Counter-attacked on three sides, with a wide river in back, the situation of the Serbians became desperate and finally resulted in their complete defeat that night.

It is important to note that this extraordinary success was made possible only through the prior and timely concentration of the 29th division; only five days before the Serbian crossing, this unit was widely dispersed along the river front. What would have been a likely outcome had the Serbian crossing struck an initially weak sector, on 29 August, composed of only one or two battalions?

In this connection, note the fundamental difference between the dispositions of the Austrians, on the Sava, and the Americans, on the Marne; the former, an *independent* division, in *open warfare*, with plenty of elbow room; the other an *interior* division, with restricted maneuver space, in *stabilized warfare*.

Example 5: The defense on the enemy's side of the river is regarded as excep-

tional, under the special conditions stated in Case 4: The British defense of the Suez Canal, in 1915 and 1916, is a characteristic example.

The British defended, initially, along the west bank of the canal; with this method of "defense at the water's edge," the British repulsed a Turkish crossing, in February 1915.

When Kitchener visited this front, he criticized the British dispositions as a tactical error; he pointed out to the local commander "that instead of defending the canal, the canal was defending him."

This left the canal open to raids, destruction or interruptions; a river line, ordinarily, is incidental to defense, merely an additional obstacle, while the canal represented an important link of British Empire communication and a vulnerable defile. Consequently, the defensive works were pushed to the east, on the Turkish side, at a distance of 12 miles in a series of fortified bridgeheads.

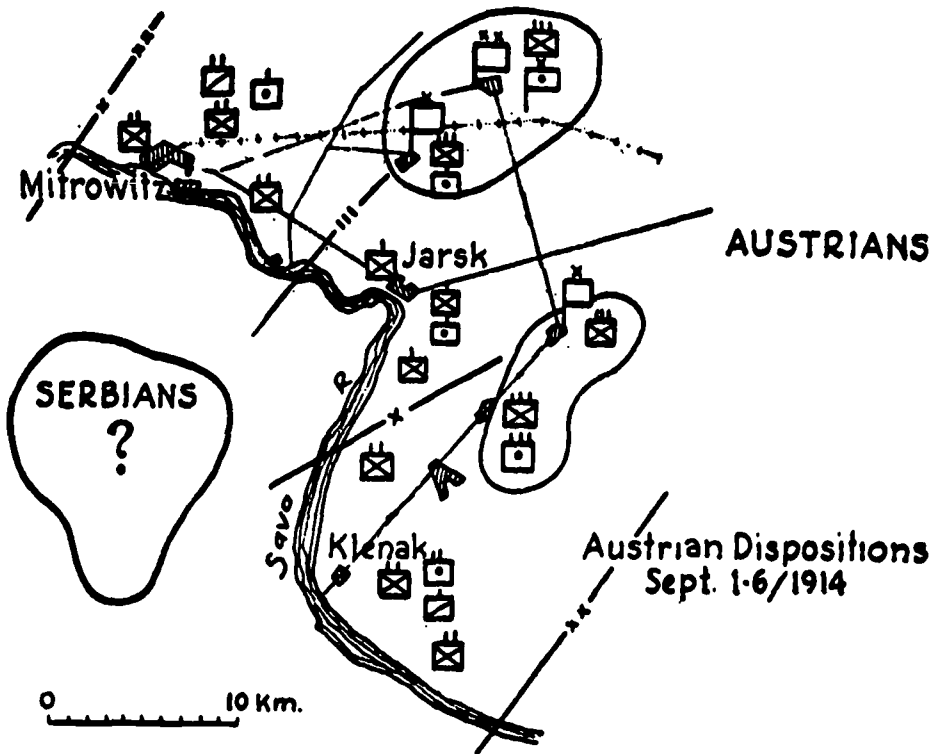

PLATE 7. DEFENSE OF THE SAVA. AUSTRIAN DISPOSITIONS, 1-6 SEPTEMBER 1914.

In summing up lessons, the characteristics of each type of defense are clearly defined in current regulations; the key to a choice between various forms can be found in the extent of front to be covered and the number of troops available, i.e., the ratio of strength to task; an equally important element is the mission: the purpose of the defense.

The problem is not new; it has been neatly stated by two great historical commanders who require neither introduction nor apology—one defines the problem of river defense, while the other suggests a solution:

Frederick the Great: ". . . Nothing is more difficult, almost impossible, than to prevent the passage of a river line, especially if the front is too extended. I should not care to be charged with such a mission."

Napoleon I: ". . . A river is an obstacle which can only delay the enemy for a few days. If you decide to defend it, the only solution is to assemble your troops as a mass and fall upon the enemy before his crossing is completed."

5. THE EVOLUTION OF MODERN TACTICS. a. *The historical origin of tactical principles.* In tracing the application of field service regulations, i.e., "modern doc-

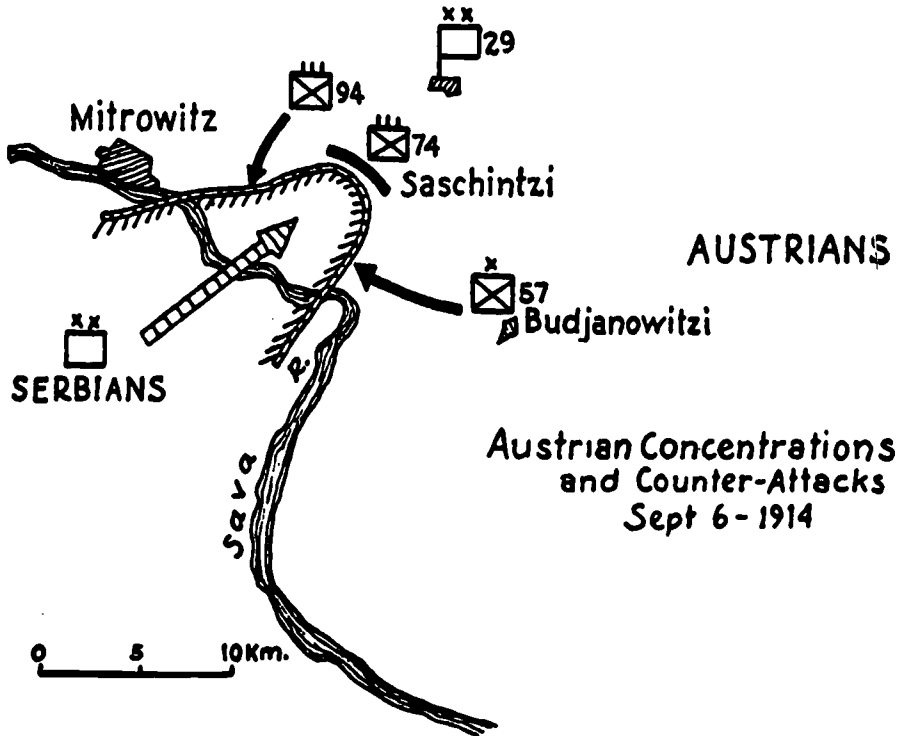

PLATE 8. DEFENSE OF THE SAVA, AUSTRIAN CONCENTRATIONS AND COUNTERATTACK, 6 SEPTEMBER 1914.

trine," in comparatively recent operations, and furnishing unmistakable proof of a natural relationship and interdependence, we have merely applied a common laboratory procedure: the process of analysis and synthesis.

The use of "river defense" as a vehicle is unimportant; the same method can be employed with all tactical categories.

There is nothing complicated or far-fetched in linking the craftsmanship of the soldier with the intellectual process of formulating rules: human knowledge has been empirical in most branches; experience has always been the road to ultimate efficiency.

The intensely practical nature of the military art demands that its methods rest on realities and rational function.

It is equally obvious that military engagements are not fought to establish the accuracy of regulations, but rather that these regulations are an echo of battle experience. In accepting this truism, we have also established the historical basis of modern tactics, in the sense of General MacArthur's classical definition.

Utilizing the known factors in river defense, this relationship can be shown in

comparatively recent military texts.⁶ The generally approved pattern of an organized, defensive position is represented in the following schematic diagrams.

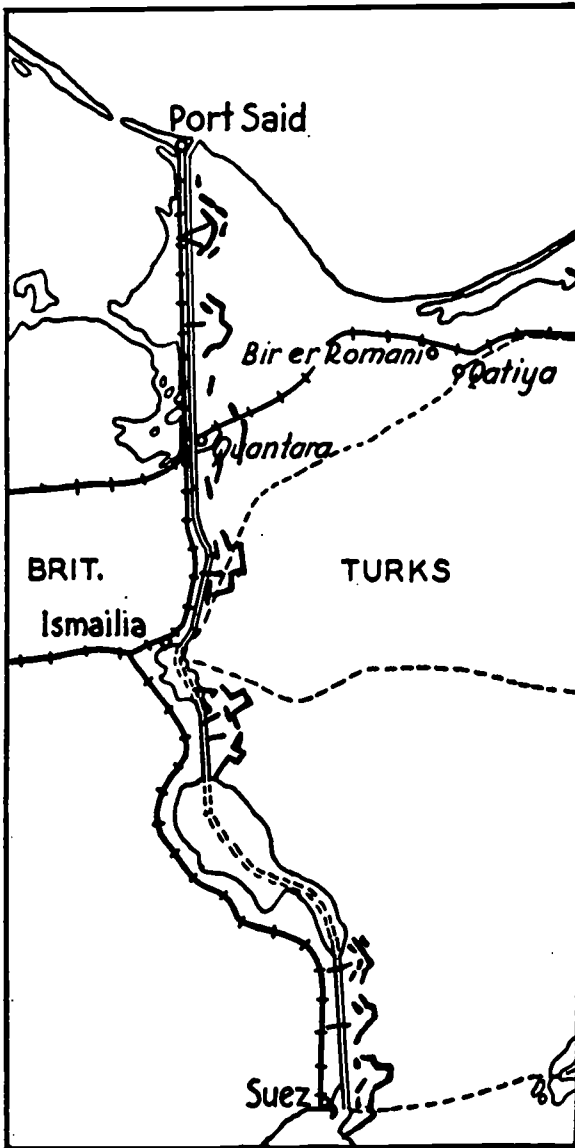

PLATE 9. DEFENSE OF THE SUEZ CANAL, 1915.

Note the depth and sequence of the various successive defensive lines, viz:

	Outpost line of resistance.
Battle position	Main line of resistance.
	Regimental reserve line.
Rear areas	Successive lines.

⁶ Special Text No. 265, Army Extension Course, *Infantry in Defensive Combat*, 1936, Figs. 6 and 8, pp. 18, 20, Chap. II. Training Notes, Infantry School, 1939, Vol. II, Chap. I.

POSITION DEFENSE

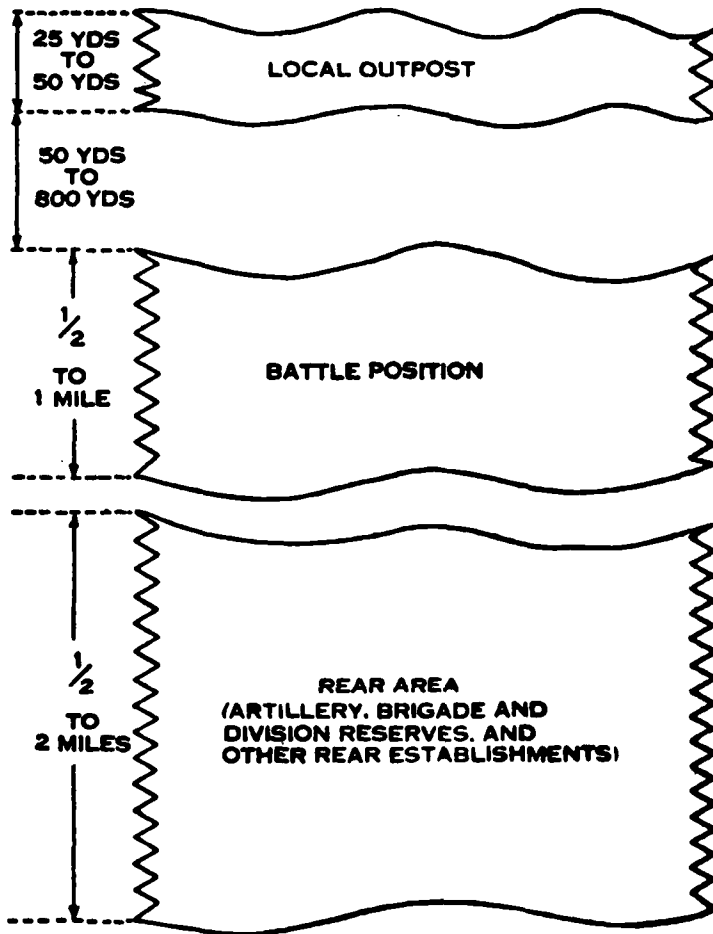

FIGURES GIVEN ARE GUIDES ONLY AND ARE NOT TO BE CONSIDERED AS LIMITS

PLATE 10. POSITION DEFENSE.

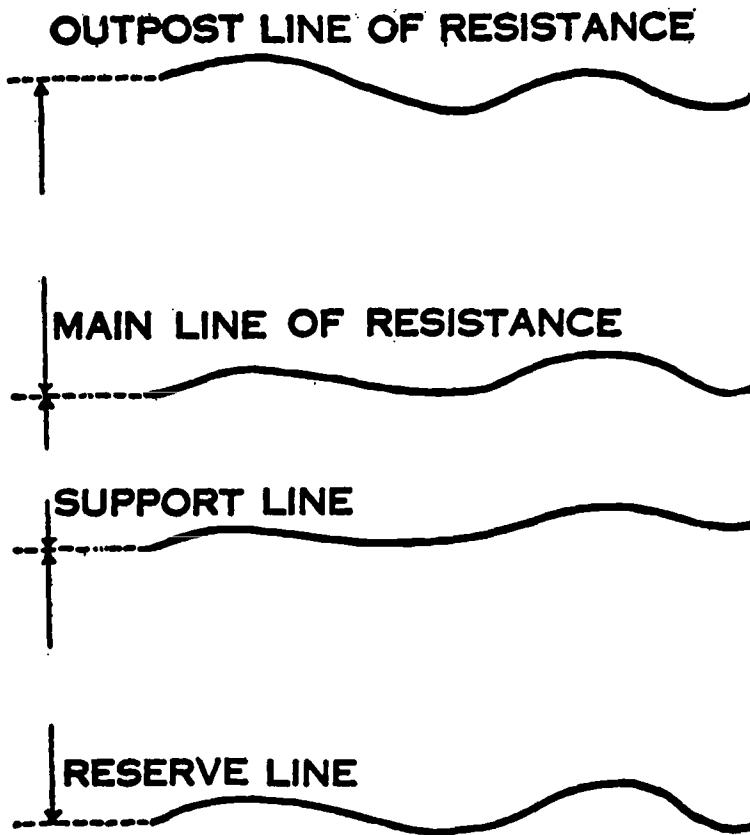

PLATE 11. LINES OF RESISTANCE IN A DEFENSIVE POSITION.

What is this scheme of defense based on? Where was it derived from? Is it a local and recent development? Does it represent the private views of a military instructor? Is it an expression of theory or practical experience? Is it directly derived from battle experience? These are purely rhetorical questions; the answer is inescapable! This tactical scheme of defense, like all military doctrine, rests on the solid basis of history and has stood the test of battle.

Compare the infantry dispositions of the 3d Division ⁷ on the Marne, the framework of this defense, the skeleton of successive defensive lines, with the schematic pattern of this modern text; they are obviously similar and become identical if we adjust the lines of the instructional diagram to the topography of the Marne River; clearly, the schematic figures of the text were influenced by this historical action.

To continue and complete the professional pattern, all that remains is to fill in a regimental sector with combat groups, strongpoints and centers of resistance. The currently accepted design, for a regimental sector, is contained in Fig. 9, S.T. 265, Chap. II, Par. 15.⁸

If this design is transposed to fill in a regimental sector of the 3d Division, one arrives at the actual dispositions of that unit, in its historical defense of the Marne on 15 July, 1918.

The broad concept of defense of river lines is susceptible of similar proof. The

⁷ Plate 5, Par. 4a.

⁸ While obsolescent, the salient features of this text are not likely to disappear.

3RD DIVISION INFANTRY DISPOSITIONS

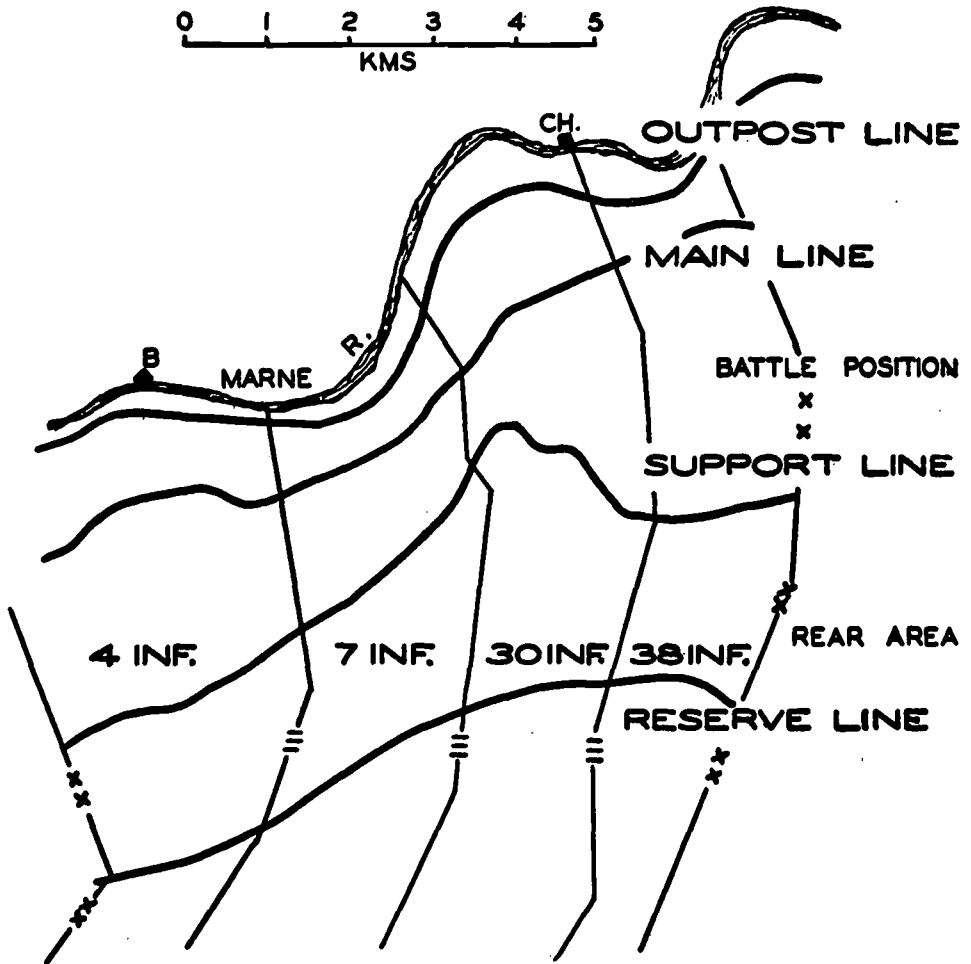

PLATE 12. 3D DIVISION, A.E.F., MARNE 1918. LINES OF RESISTANCE.

sharp demarcation between "defense on the water's edge" and a "position in readiness" has already been developed (Cases 2 and 3).

The historical basis is easily recognizable in a composite diagram: the upper half is based on a diagrammatic figure (Case 3), contained in a comparatively recent instructional text; * the lower half represents the 3d Division on the Marne (Case 2).

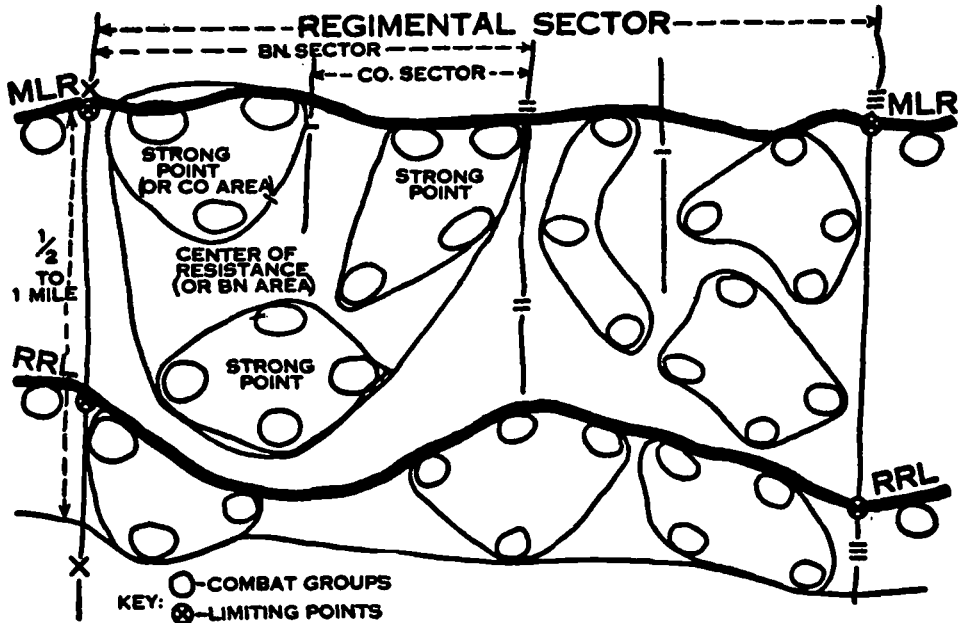

PLATE 13. ORGANIZATION OF A DEFENSIVE SECTOR.

Note and compare the strength and disposition of regiments, battalions and companies:

Conference 1-107-A:

Forward area: 3 rifle companies (1 Bn 1st Inf)
Intermediate position: 3d Bn 1st Inf. & Regtl Hqrs.
Brigade Reserve: 2d Bn 1st Inf; one Bn 2d Inf.
Division Reserve: the 4th Inf.

3d Division A.E.F. Marne 1918: 30th Inf Sector.

Forward area: 1st Bn 30th Inf
Intermediate position: 2d Bn 30th Inf
Brigade Reserve: 3d Bn 30th Inf; 1st Bn 7th Inf.

At first glance, strength and dispositions appear quite similar—except for a highly important circumstance: It is the relative width of the sector, the factors of troop density and of frontage! The composite diagram is drawn to a common scale, a front (width) of 6 miles applies to both halves!

In Conference 1-107-A (Case 3), the regiment occupies a front of 6 miles, with one battalion along the river front, while in the 3d Division A.E.F. (Case 2), there are four regiments abreast on approximately the same frontage, with regimental sectors varying in width from $1\frac{1}{4}$ to 2 miles each. On the Marne, there is an application of mass, power and depth, with regiments in column of battalions, while the scheme of 1-107-A represents a linear disposition, stretched to the limit, a string of detachments in observation along the river front, while relatively heavy reserves are held back in a position of readiness.

* Mimeograph 1-107-A, *Defense of River Lines*, The Infantry School, Ft. Benning, Ga., 1938, and Mimeo. 1-87, 1939.

3RD DIVISION INFANTRY DISPOSITIONS

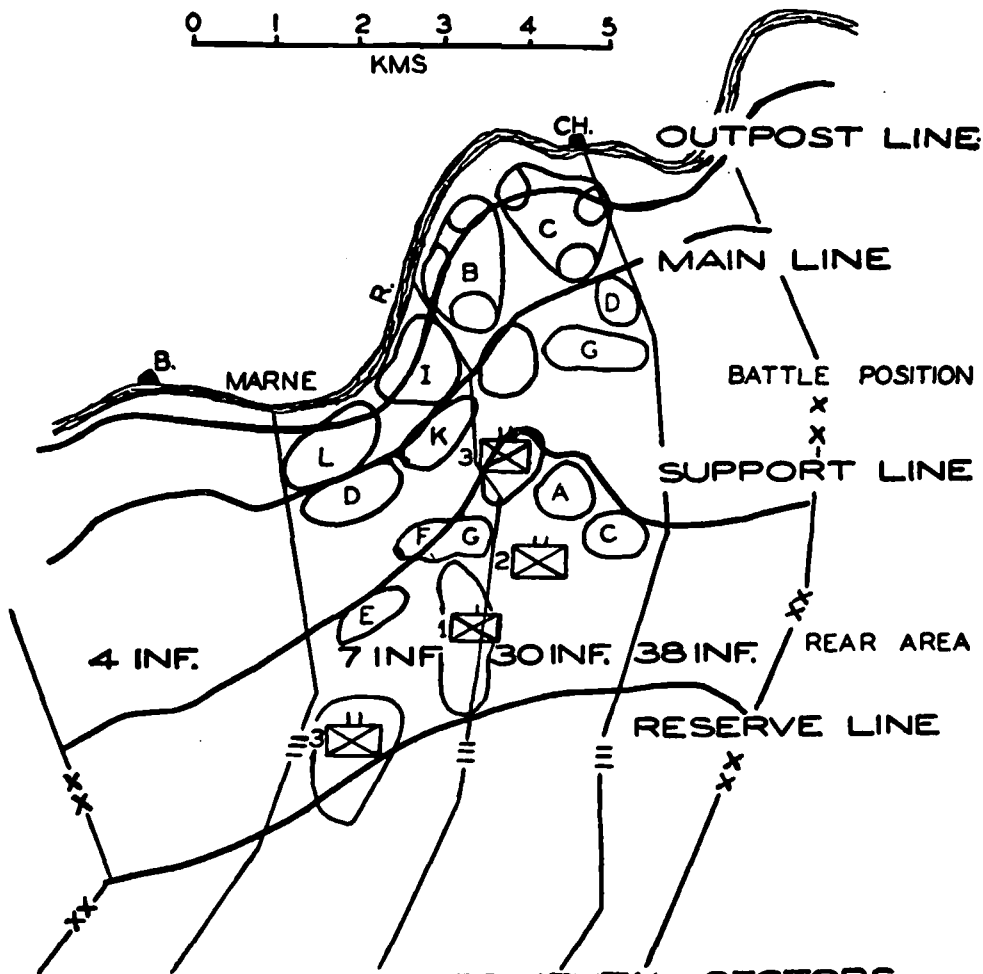

ORGANIZATION OF REGIMENTAL SECTORS

PLATE 14. 3D DIV., AEF, MARNE, 1918. ORGANIZATION OF DEFENSIVE SECTORS, 7TH AND 30TH INF.

From the viewpoint of the individual company or battalion, it may be said that the defense of a river line does not differ materially from a typical sector defense, but from the viewpoint of larger units, the tactical concept is not quite so simple: there is a difference in frontage that cannot be ignored or explained away. For that

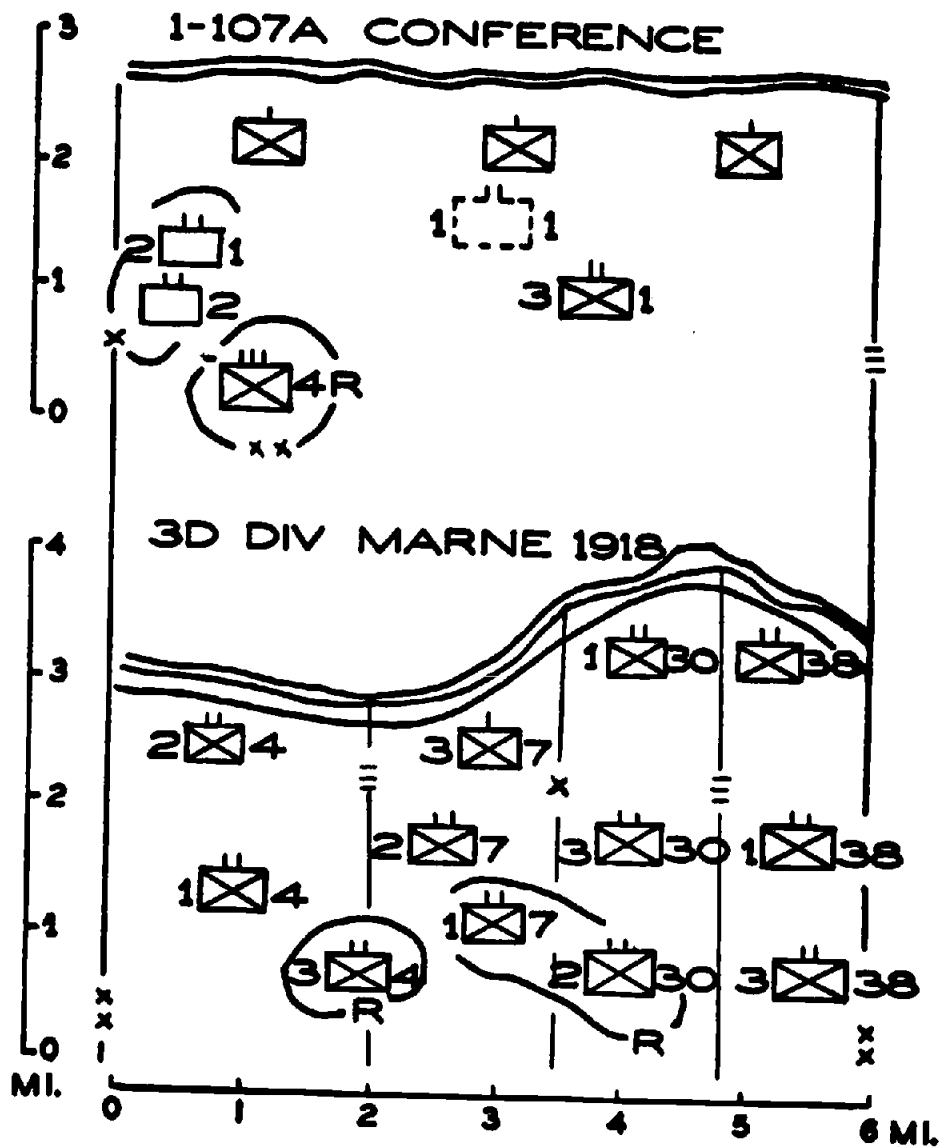

PLATE 15. COMPOSITE DIAGRAM: DEFENSE OF RIVER LINES.

reason, field service regulations classify river defense under "special operations": the variation in frontage suggests the reason; the schematic diagrams reveal it graphically; the texts tell it in plain words.

b. *The relation of large and small units.* In reflecting on the historical evolution of tactics and the formulation of principles and current doctrine, one must face the relation of large and small units; there is considerable confusion. Field

service regulations are primarily concerned with the teamwork of combined arms, within the division or brigade; it can hardly be denied that tactical concepts are not complete except through combined arms; the moment they are limited to a single arm, they become distorted, fragmentary. An isolated infantry garrison, without associated arms, cannot fully realize the potentialities of their armament.

The larger unit operation determines the broad tactical concept; the small unit becomes a cog in a complex machinery with a fixed and monotonous function. The division defends the river line, in a position of readiness; a battalion may find itself along the river, in surveillance or in rear areas as reserve.

Military thought is continually troubled by an apparent conflict in the tactical concepts of "large" and "small" units or a twilight zone between them. Perhaps this is based on an understandable antagonism between "theoretical" and "practical" ideas, engendered by a vague feeling that the average officer, in a peace-time career, will be limited to the workaday problems of small garrisons, in contradistinction to the "highbrows" in staff or large-unit assignments. This feeling is accentuated in the baffling experience of junior officers, in our service schools, who graduate from the exalted map-command of large units to very subordinate assignments, on reporting for duty with troops.

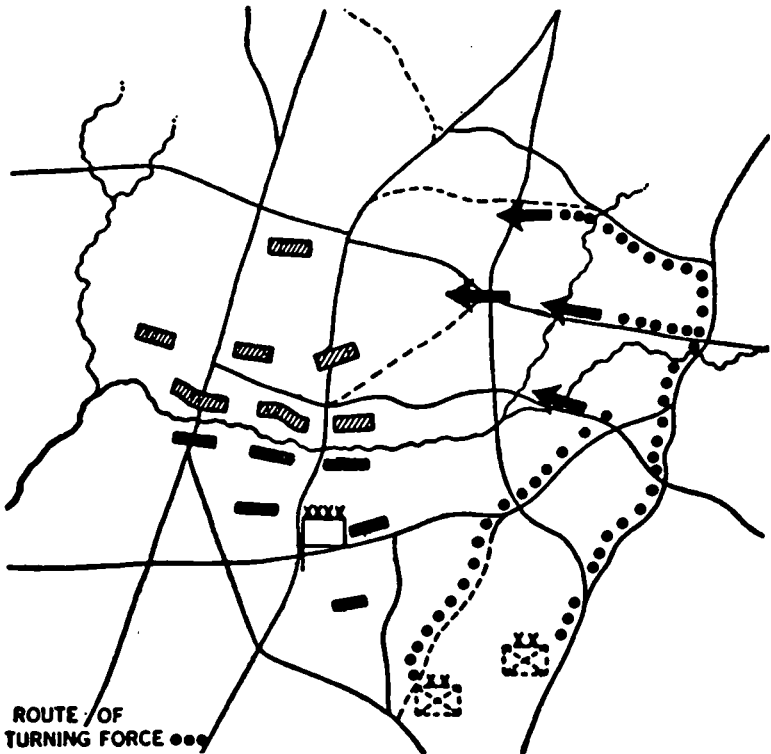

PLATE 16. A TURNING MOVEMENT.

A narrow academic viewpoint will sometimes add to the general confusion, in applying such broad concepts as "principles of war" to small-scale operations: a platoon engaged in enveloping a hostile machine gun which has pinned down a part of it, may conceivably practice "economy of force" with the men who

are immobilized, apply "offensive" and "mass," through the enveloping group and eventually reach the "objective," i.e., the hostile machine gun nest. While intrinsically correct, this phraseology is slightly absurd and strident, as if a discreet whisper were inadvertently magnified by a loudspeaker.

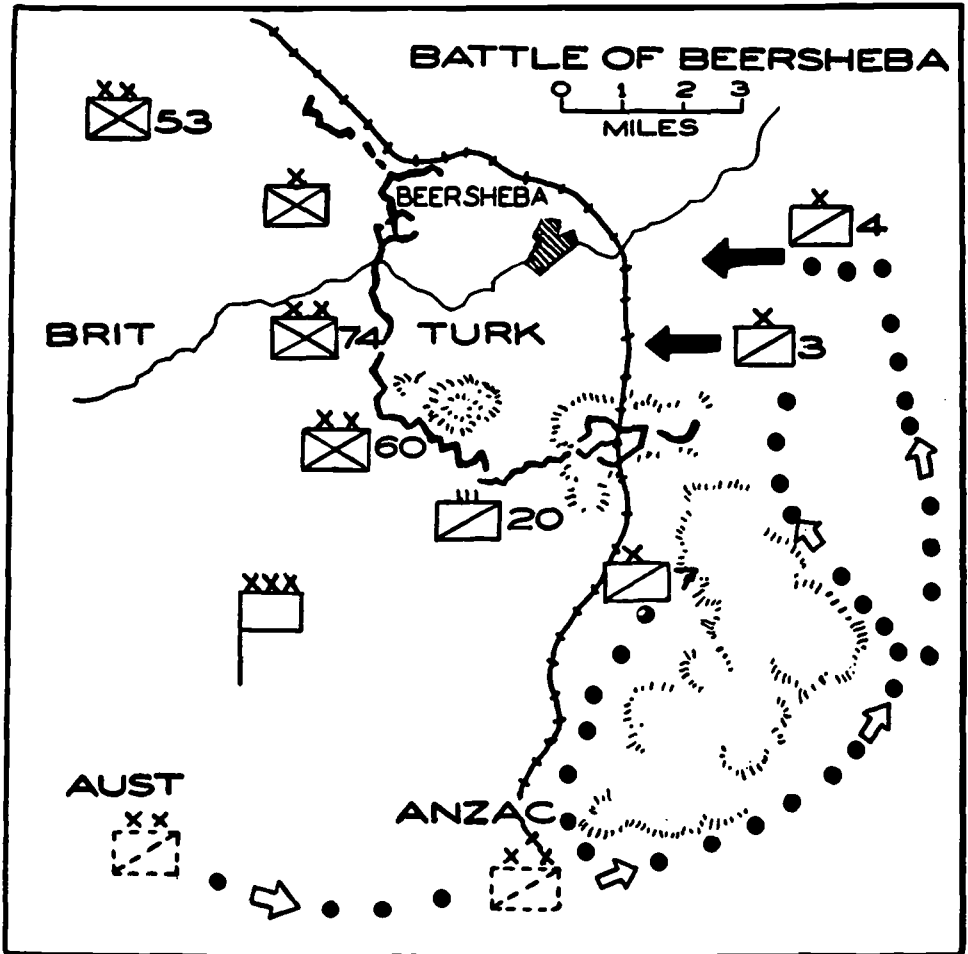

PLATE 17. THE BATTLE OF BEERSHEBA, 31 OCTOBER 1917.

c. *The historical origin of tactical forms.* There can be no real discrepancy in tactical concept between large and small units: the differences, if any, are in execution rather than in principle. There is, in fact, a remarkable coincidence even in tactical form. In the conduct of attack, there is ordinarily no difference predicated on size of unit: a straight left to the jaw, by a flyweight, is delivered in the same manner and for the same purpose as that of a heavyweight, except that the latter carries more force. The envelopment, for example, is essentially the same for the battalion as for the platoon.

This reasoning is applied in four concrete cases, based on a comparatively recent instructional text,¹⁰ in a discussion of the "turning movement":

" . . . Turning movements are operations involving the separation of a command into two forces, one of which engages and holds the enemy while the other, operating beyond

¹⁰ Special Text No. 266, Chap. 7, Par. 28, Army Extension Courses, *Infantry in Offensive Combat*, The Infantry School, Ft. Benning, Ga., 1936. Fig. 35 is shown as Plate 16.

supporting distance, makes a detour so as to strike the hostile flank or rear (Fig. 35). The turning movement should be made over terrain favoring the attacker . . .¹¹

Compare this "schematic pattern" in Plate 16 and the underlying tactical ideas and dispositions with the following concrete battle situations; it will be seen that regardless of size of unit or total numbers engaged, the procedure is identical, from the corps to the company.¹²

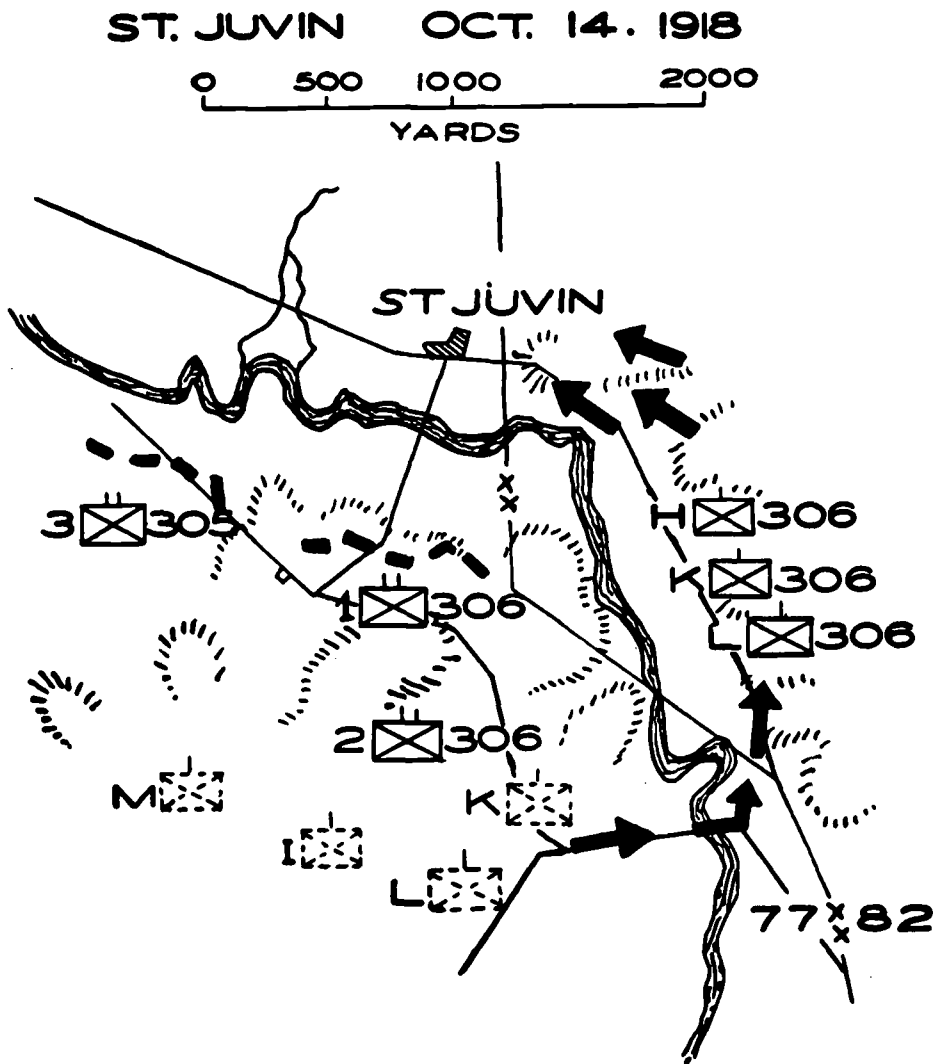

PLATE 18. THE 306TH U. S. INF., ST. JUVIN, 14 OCTOBER 1918.

(1) The operation at Beersheba represents a combination of frontal or holding attack, with a turning movement or envelopment, by cavalry, both coordinated and accurately timed; the attack jumped off, as ordered, on the morning of 31 October.

¹¹ The distinction between turning movements and envelopments is more academic than real; the so-called "wide envelopment" is a turning movement, to all practical purposes.
¹² A comparison of the scheme of maneuver in Fig. 35, i.e. Plate 16, with the troop dispositions and routes at Beersheba indicates a remarkable degree of coincidence. Note the lengthy approach march of some 40 miles by the units charged with the envelopment and surprise attack from the east; in view of the distances involved, an envelopment of this kind could have been executed in the time allotted only by horse cavalry; a modern solution would probably employ mechanized cavalry or motorized infantry.

The frontal attack gained certain objectives by mid-afternoon but slowed down thereafter; the enveloping force also ran into tough going initially and developed, in turn, into a holding attack by dismounted elements with mobile reserves waiting for an opportunity to envelop Beersheba itself. The frontal attack had not succeeded in reaching Beersheba, and it was feared that the retreating Turks would damage the water supply; time was precious; speed became essential; at 3:30 PM the order came: "Take the town before dark. Put Grant straight at it." The 4th Cavalry Brigade, commanded by General Grant, was nearest Beersheba; racing against daylight, Grant decided to attack mounted; he made it; two squadrons of the 12th galloped straight into Beersheba, while the remainder of the attacking force dismounted to clean up isolated Turkish resistance.

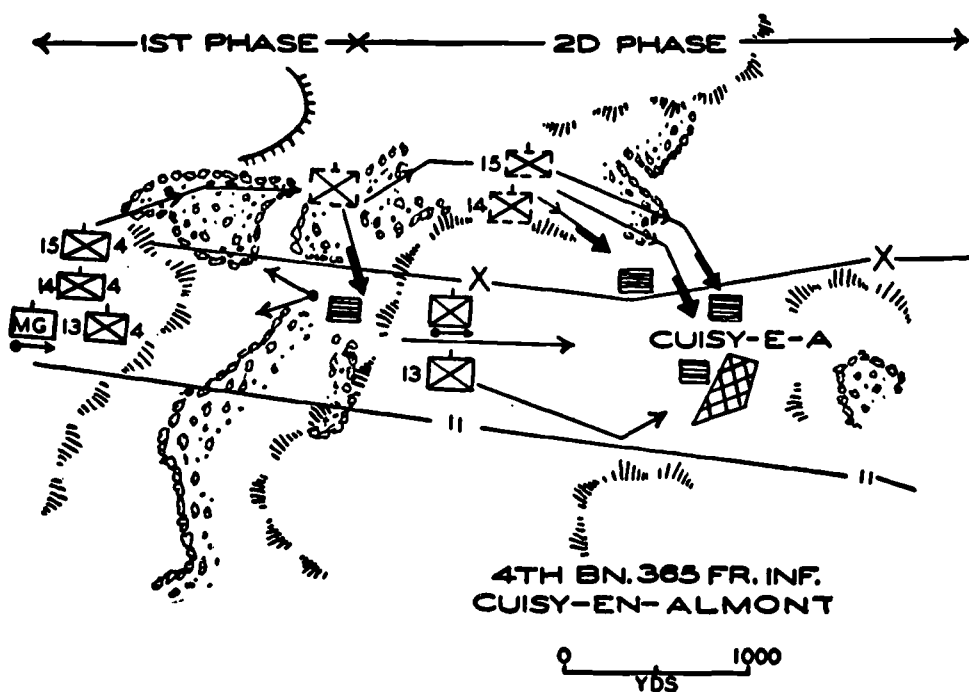

PLATE 19. THE 4TH BN, 365TH FR. INF., CUISY-EN-ALMONT, 20 AUGUST 1918.

(2) On 11 October, the 306th Infantry, a part of the 77th Division, held a line south of the Aire River, in front of St. Juvin. In the continuation of the attack, on the morning of 14 October, this regiment formed initially in column of battalions in the order: 1st Bn., 2d Bn., 3d Bn. The advance of the 1st Battalion was promptly stopped under a withering enemy fire.

In view of the failure of his frontal effort, the resourceful regimental commander ordered an envelopment or turning movement; both remaining battalions were designated as the enveloping force. The immediately available companies, H, K and L, crossed the river and moved north; the leading company entered the town, the others attacked from the hills east of St. Juvin; the enemy was completely surprised. The action of the leading companies had been so successful that the remaining battalion did not have to attack.

It is obvious that the schematic pattern of the "turning movement" was followed in this situation in quite the same manner as at Beersheba; the strength of the

participating units, however, was different—4 divisions, a total of 32,900 on the one hand and a depleted American regiment at St. Juvin of less than 3,000 officers and men.¹³

Size did not affect the tactical idea or method. In the maneuver concept, we find no difference between "large" and "small" units; the factors of surprise, secrecy of movement and objective operated in both instances; the British Corps proceeded on an identical maneuver as this American regiment, and in the concluding examples it will be shown that the analogy can be traced down to still smaller units, i.e., the battalion, company, and platoon.

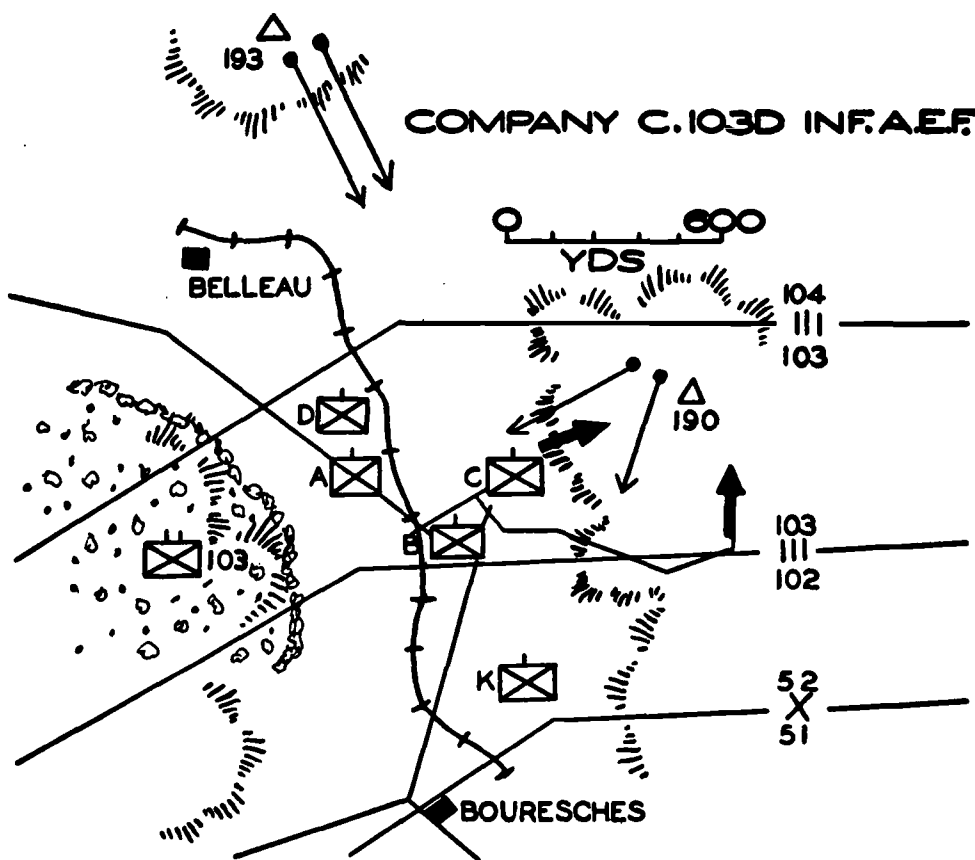

PLATE 20. CO. C 103D U. S. INF, AEF; HILL 190, 20 JULY 1918.

(3 *First phase:* On 20 August, 1918, the 4th Battalion, 365th French Infantry, an interior assault battalion, received orders to attack, in direction of Cuisyen-Almont; an enemy strongpoint containing machine guns was located in the battalion zone of action. The artillery preparation failed to neutralize the enemy. Rather than risk a frontal attack in the face of machine-gun fire, the battalion commander employed the 15th Company (with one platoon M. G., attached) against the flank and rear of the German position; this was an envelopment or turning movement, under cover of a ravine and woods, and was in the zone of

¹³ *British strength:* Desert Mounted Corps: Anzac Mounted Division, 5900; Australian Mounted Division, 4900. XX Corps: 60th Division, 11,600; 74th Division, 11,400.

Turkish strength: Approximately 6000 men, 60 machine guns and 28 field pieces.

the adjacent unit. The enveloping force suffered some casualties but captured the enemy position.

Second phase: After this operation, the village of Cuisy-en-Almont became the next objective; the terrain, however, was flat, open country without cover.

The 15th Company followed by the 14th Company was launched on another envelopment under cover of a draw and woods to the north of Cuisy; the 13th Company was to attack Cuisy from the south, while the Machine Gun Company would operate in the gap, straight to the front, in a combination of fire and movement.

All units moved forward simultaneously; the 14th Company gained contact with the enemy in a holding attack which enabled the 15th Company to continue the envelopment and attack the German right decisively. The attack was entirely successful.

(4) In the afternoon of 20 July, 1918, the 1st Battalion, 103d Infantry, A.E.F., received orders to continue the attack and take Hill 190 northeast of Bouresches; formation: Companies C and D in assault, Companies B and A in support.¹⁴

At 3:00 P. M. the leading companies deployed and started to advance without any artillery preparation, in their particular zone of advance. Hostile fire from the north (Hill 193) and east (Hill 190) stopped the companies on the left. Company C continued to advance under difficulty and was losing men rapidly.

A rear platoon of the company was sent around the right flank to put out of commission a particularly obnoxious machine gun on Hill 190 directly in front. After this gun was eliminated, the advance became easier.

¹⁴ Capt. Arthur E. Burnap, Inf., Personal Experience Report.

THE PRINCIPLES OF WAR

6. THE CODIFICATION OF MILITARY KNOWLEDGE. When General Nathan Bedford Forrest, C.S.A., coined the immortal phrase as his recipe for military success: ". . . to git thar fustest with the mostest men," he also furnished a classical definition of the principles of concentration, objective and movement. When a subordinate asked him what to do in a certain tactical situation and he replied: ". . . Fitum!" he gave an equally clear definition of the principle of the offensive.

With apology to the shades of a very gallant soldier, it is recorded that the General was a trifle careless in orthography and diction; his formal education was lacking, since he early became the sole support of his mother and a large family of children; fortunately, orthography and diction have little to do with ability and character: the poor youth eventually became a successful planter. He grew 1000 bales of cotton in 1861; in 1857 he stopped a lynching and cut down the victim in the face of an angry mob; they knew their man, since he had been tested in several shooting affrays when the odds were heavily against him. He enlisted as a private on 14 June, 1861. In July, he raised a regiment of cavalry, arming and equipping it largely at his own expense; the rest is history: he rose from Colonel to Lieutenant General, C.S.A., to become known as one of the boldest and most resourceful cavalry commanders of the Civil War period; he was wounded four times and had 18 horses killed and 10 others wounded under him.

Here is a first-class soldier who was probably never once conscious of the application of a principle of war, who never attended a military service school but graduated summa-cum-laude from a hundred battlefields.

This comment is no argument against the codification of military science but rather an affirmation of the fact that doctrine is developed on the battlefield by soldiers and reduced to formulas later on; the so-called principles of war are the codification of the methods of the great practitioners of the art of war; one of the greatest, Napoleon I, has expressed this thought repeatedly:

". . . The principles of war are those which have regulated the great captains whose deeds have been handed down to us by history: Alexander, Hannibal, Caesar, Gustaphus Adolphus, Turenne, Prince Eugene and Frederick the Great. The history of these eighty-eight campaigns, carefully written, would be a complete treatise on the art of war; the principles which ought to be followed in offensive and defensive war, would flow from it spontaneously."¹

". . . Read and re-read the Campaigns of Alexander, Hannibal, Caesar, Gustaphus Adolphus, Turenne, Eugene and Ferderick; take them as your model; that is the only way of becoming a great captain, to obtain the secrets of the art of war."²

". . . Caesar's principles were the same as those of Alexander and Hannibal: (a) to keep his forces in junction, (b) not to be vulnerable in any direction, (c) to advance rapidly on important points, to calculate on moral means, the reputation of his army and the fear he inspired and also political means for the preservation of the fidelity of his allies and the obedience of the conquered nation."³

In this quotation one can hardly fail to recognize (a) the principle of concentration, (b) the principle of security and (c) the principle of the objective.

We may as well accept the fact that these "principles" are not recent developments: at the battle of Leuktra (371 B.C.) the Theban Epaminondas applied the *principle of mass* when he concentrated the bulk of his forces against the enemy's weak point; the retreat of Xenophon's ten thousand (401 B.C.) is a classical demonstration of *rear-guard action*; at Arbela (331 B.C.) one finds tactical *penetration*,

¹ Napoleon: *Memoirs*, Vol. II, p. 2.

² Napoleon's "78th Maxim."

³ Napoleon: *Memoirs*, Vol. II, p. 26.

envelopments and *turning movements*; the crossing of the Hydaspes by Alexander (326 B.C.) in a wide turning movement bears a close resemblance to Hooker's crossing of the Rappahannock at Chancellorsville (1863), the movement of Heintzelman's Corps at the first battle of Bull Run (1861) or Napoleon's crossing at the Island of Lobau (1805); Cannae (216 B.C.), as a strategical *double envelopment* and *battle of annihilation*, is a model that is recognizable in the structure of Konigratz (1866), of Tannenberg (1914) and in the initial phases of the Marne Campaign (1914).

What are these principles? Evidence ranging from Sun-Tzu (505-496 B.C.), the oldest military treatise in the world, to the annual "Report of the Chief of Staff, U. S. Army" (1935), apparently indicates that they have always existed and are recognizable and applicable today.

Major General Fuller, British Army, an able military critic, then slightly bewildered, was looking for them in 1909; he found a tell-tale reference in the current edition of British Field Service Regulations:

" . . . the fundamental principles of war are neither very numerous nor in themselves abstruse, but the application of them is difficult . . . "

He complains, however, that the principles were *not listed or defined* in these regulations.

An American student would have had a similar experience had he turned to his own *Field Service Regulations*; in the edition of 1923, he would have found a reference that was practically an echo of the earlier British regulations:

" . . . while the fundamental principles of war are neither very numerous nor complex, their application may be difficult and must not be limited by set rules . . . "

As in the British regulations, the principles were not listed or defined in this particular American text. On further research, however, the student eventually would have encountered the first official American codification of the principles of war in *War Department Training Regulations 10-5* of 23 December, 1921; the principles, for some obscure reason, have not reappeared in training regulations, but local instructional texts in service schools, particularly the Command and General Staff School, Ft. Leavenworth, Kansas, have kept them alive though not entirely intact; a late (1936) Leavenworth version is shown in a later paragraph.

7. THE HISTORICAL CONTINUITY OF THE PRINCIPLES. *a. The American Version of the Principles of War.* In *Training Regulations No. 10-5*, 23 December, 1921, the U. S. War Department lists nine fundamental principles of war deduced from the study of military history. They are:

- The Principle of the Objective.
- The Principle of the Offensive.
- The Principle of Mass.
- The Principle of Economy of Force.
- The Principle of Movement.
- The Principle of Surprise.
- The Principle of Security.
- The Principle of Simplicity.
- The Principle of Cooperation.

These principles are basic and immutable. The great commanders have been guided by them, and success or failure has depended upon the extent and manner of their use. They are not subject to exception. Their proper application constitutes the true measure of military art.

The official character of this list has naturally given great weight to the inter-

pretation of these principles in our times; extracts from the official "definitions" follow:

a. *Discussion.*—a. *The principle of the objective.*—The purpose of a military operation is the attainment of the objective assigned a designated force.

(1) The selection of objectives depends on political, military, and economic conditions, which vary in force and effect; but the following general rules apply:

(a) First, the neutralization or destruction of the opposing military forces. This usually implies the defeat of the enemy's main forces.

(b) Second, the possession of localities which will attain the objective, or contribute thereto.

(3) The objective assigned military forces must be in consonance with the national objective.

b. *The principle of the offensive.*—Offensive action is the only means by which a decision is gained. When successful, the offensive brings victory, while the defensive can only avoid defeat. The only effective way to wage war is to act on the offensive for the purpose of delivering a main blow in a decisive direction. The defensive should be assumed only to assist offensive action elsewhere. Although the offensive confers great advantages, these advantages can be utilized only when the means available are sufficient to provide reasonable chances for success.

c. *The principle of mass.*—The term mass as used here means combat power. Numbers, weapons, tactical skill, fighting ability, resolution, discipline, morale, and leadership all contribute to this power. Success in war is attained by the employment of mass in a main effort.

d. *The principle of economy of force.*—The time and place of the main effort having been determined, men and means are conserved by reducing their employment in other directions.

e. *The principle of movement.*—The term movement as here employed means the maneuver of combat elements.

Movement is most effective when concealed. In many situations movement is made possible only by the effective employment of fire. In applying this principle, time, distance, and means available must be considered.

f. *The principle of surprise.*—Surprise in some form is essential in order to obtain the maximum effect with the minimum loss. Secrecy, rapidity, and preparation are the main factors.

g. *The principle of security.*—Security embraces all measures taken to guard against observation and surprise, to prevent effective hostile interference, and to maintain the power of free action.

h. *The principle of simplicity.*—Simplicity is a relative term. As here used it means that military plans should not provide for complicated movements, that orders should be direct and free from contingencies, that frequent changes of plan are to be avoided, and that unity of command is to be observed.

i. *The principle of cooperation.*—By cooperation is meant the "team-work" of all military persons, towards the accomplishment of a common mission; it can only be attained through coordination. This principle applies to everything that is done in the military service.

g. *Application.*—a. These nine principles comprise the whole art of war. Their application to the preparation for war and the direction of war is called strategy. Their application to specific battles and operations is called tactics.

Like all things monumental in art, in architecture or history, great simplicity of design is the product of evolution; the artless common sense of the principles of war must have been the intellectual property of military leaders of all ages. The most casual review of historical antecedents will support this assumption. The following quotations from important military writers, ranging from Sun-Tzu to Fuller, by no means cover the entire field, but they represent random selections with the sole purpose of establishing an unmistakable historical continuity. Great names were omitted, like Turenne, Wallenstein, Prince Eugene, Comte de Saxe, Montecucculi, Frederick II, merely because other celebrities like Napoleon left more valuable information in their military writings.

b. *Sun-Tzu: The Art of War (505-496 B. C.).* This work is regarded as one of the oldest military treatises in the world.⁴ Consisting of thirteen chapters on the art of war, it became the greatest military classic in the Chinese language and was much esteemed by the Japanese. The exact date of Sun-Tzu's book is uncertain, but it was apparently written during the period 505-496 B.C. Sun-Tzu was a native

⁴ *Sun-Tzu on the Art of War.* The oldest treatise in the world. Translated by Lionel Giles, M. A. Luzac Co., London, 1910. There is also another version, by Captain E. F. Calthrop. John Murray, London, 1908.

of the state of Chi. He became involved in revolutionary activities and fled to the state of Wu; he became the military adviser to Ho-Lu, king of Wu, in whose service he commanded armies and conducted successful campaigns.

Sun-Tzu's work is arranged in thirteen chapters, with a very modern phraseology:

- | | |
|-----------------------------|------------------------------|
| I. Laying Plans. | VIII. Variations of Tactics. |
| II. Waging War. | IX. The Army on the March. |
| III. Attack by Stratagem. | X. Terrain. |
| IV. Tactical Dispositions. | XI. The Nine Situations. |
| V. Energy. | XII. The Attack by Fire. |
| VI. Weak Points and Strong. | XIII. The Use of Spies. |
| VII. Maneuvering. | |

There is some evidence that Napoleon was familiar with Sun-Tzu; at any rate, he had access to de Guignes' translations of the five holy war books of the Chinese; this collection contains the maxims of the leading Chinese commanders who lived between the twelfth century, B.C. and the fifth century, A.D.,—maxims, which even as late as the eighteenth century of our era, every Chinese scholar and officer had to memorize; the "Maxims of Lou-tao" (1150 B.C.) are contained in this collection.

From extracts of Chapters I, II, IV, V and VI of this work, it is easily apparent that several of the so-called *principles of war* are present in their most *characteristic form*, viz:

The Principle of the Objective.

19. In war let your great objective be victory and not a lengthy campaign.⁸
13. The quality of decision is like the well-timed swoop of a falcon which enables it to strike and destroy its victim.⁹
15. Energy may be likened to the bending of a cross-bow; decision to the release of the trigger.⁹

The Principle of the Offensive.⁷

5. Security against defeat implies defensive tactics; ability to defeat the enemy means taking the offensive.

The Principle of Concentration.⁸

14. We can form a single united body, while the enemy must split into fractions; hence, there will be a whole pitted against separate parts, which means that we shall be many against the enemy's few.
15. And if we are thus able to attack an inferior force with a superior one, our opponents will be in dire straits.
29. Military tactics are like unto water: water in its natural course runs away from high places and hastens downward.
So in war, the way to avoid what is strong is to strike what is weak.⁹

The Principle of Mobility.

3. If the campaign is protracted, the resources of the state will not be equal to the strain.⁸
5. Through we have heard of stupid haste in war, cleverness has never been associated with long delays.⁸
6. There is no instance of a country having been benefited by prolonged warfare.⁸
10. In battle, there are not more than two methods of attack: direct and indirect; yet these two in combination give rise to an endless series of maneuvers.⁹
19. Rapidity is the essence of war; take advantage of the enemy's unreadiness.¹⁰

The Principle of Surprise.

18. All warfare is based on deception.¹¹
20. Hold out baits to entice the enemy; feign disorder and crush him.¹¹
24. Attack when he is unprepared; appear when you are not expected.¹²
9. Oh divine art of subtlety and secrecy! through you we learn to be invisible—and hence, hold the enemy's fate in our hands.⁸

The Principle of Coordination.¹³

1. To control a large force is the same in principle as the control of a few men; it is merely a question of subdivision.
2. Fighting with a larger army under your command is nowise different from fighting with a small one: it is merely a question of instituting signs and signals.
21. The deaver combatant looks to the effect of combined energy and does not require too much from individuals.

⁸ Sun-Tzu: Chap. II: Waging War.

⁹ *ibid.*, Chap. V: Energy.

¹⁰ *ibid.*, Chap. IV: Tactical Dispositions.

¹¹ *ibid.*, Chap. VI: Weak Points and Strong.

¹² Par. 29 is clearly a definition of "soft-spot tactics," hailed as a great tactical innovation in 1918.

¹³ Sun-Tzu: Chap. XI: The Nine Situations.

¹⁴ *ibid.*, Chap. I: Laying Plans.

¹⁵ Sun-Tzu: Chap. V: Energy.

c. Napoleon I (1759-1822). For clear definitions and striking applications of the principles of war, one does not ordinarily need to go back further than the days of Napoleon I. In the immense literature on the Napoleonic epoch, nearly every title contains references to the master's precepts; the memoirs of his marshals and close collaborators are a rich mine of information; the most direct and intimate glimpse into the Emperor's workshop, however, is afforded by his *Maxims* and his official and private *Correspondence*; there are 32 volumes of the general correspondence and a reduced edition of 12 volumes, containing selected papers; the preface of the publisher is significant:

Correspondence Militaire de Napoleon 1er, Paris, Plon et Cie, 1876. ". . . There are plenty of books dealing with the art of war. But there is none that can compare in wealth of instruction, in clarity and depth of thought with the masterly correspondence of Napoleon. It contains innumerable lessons; there is not a vague or pointless word; this is the most perfect treatise, in the world, on the science of war and the secret of leading armies to victory . . ."

The following is a tabulation of the *Maxims* in a brief military characterization of their contents:

1. Topographical obstacles; terrain.
2. Plan of campaign. Enemy information and capabilities.
3. Flank protection, strategic advance.
4. Concentration. Armies.
5. Objective in war.
6. Offensive. Advance.
7. Combat readiness.
8. Plans, alternative, based on enemy capabilities.
9. March velocity. Maneuver.
10. Maneuver.
11. Dispersion, effect of, columns within mutual supporting distance.
12. Line of operation. Line of communication.
13. Distance between corps, in advance.
14. Mountain warfare.
15. Objective. Honor. Morale.
16. Frontal attack. Envelopment. Choice of battle area.
18. Counterattack. Offensive.
19. Transit from offensive to defensive.
20. Line of communications (operation), change of.
21. Line of communications. Trains.
22. Camp site, selection of; position of readiness.
23. Counterattack. Enveloping attack.
24. Cantonments. Concentration.
25. Retrograde movements.
26. Dispersion, effect of.
27. Retrograde movements, withdrawal.
28. Dispersion, effect of, concentration.
29. Concentration. Mass.
30. Flank march. Defile.
31. Plan of battle. Planning.
32. Covering force. Security.
33. Defile, passage of. Trains.
34. Intervals. Gaps in the line.
35. Camps. Bivouacs, mutual supporting distance.
36. River crossing, advance to.
37. River crossing, effect of terrain, artillery covering fires.
38. Defense of river line.
39. Turenne, Campaign of 1645. Bridgeheads.
40. Fortresses.
41. Siege operations.
42. Siege operations. Fonquieres theory.
43. Field fortification.
44. Fortresses, defense of.
45. Fortresses, duration of defense.
46. Fortresses, capitulation.
47. Combined arms.
48. Infantry formations.
49. Infantry and cavalry.
50. Cavalry charges.
51. Cavalry in pursuit.
52. Artillery and cavalry; horse artillery.
53. Artillery and infantry.
54. Artillery, battery positions.
55. Supply.
56. Organization, effect of; morale.
57. Officers' corps, lack of.
58. Soldier, qualities of.
59. Soldier, accoutrements.
60. Soldier, pay; length of service.
61. Manifestos. Order of the day.
62. Bivouacs. Tents.
63. Enemy information; evaluation.
64. Unity of command.
65. Councils of war.
66. Commander-in-chief.
67. Capitulation, authorization of.
68. Capitulation, effect of.
69. Surrender, conditions of.
70. Conquered territory, administration.
71. Traitor, general officers.
72. Command responsibilities, C. in C.
73. Commander-in-chief, qualities.
74. Chief of staff, qualities.
75. Chief of artillery, qualities.
76. Outpost commander.
77. Grand tactics, generalship and principles of war, historical.
78. Military history, study of campaigns.
79. Task and means, analysis of.
80. Advance guard, rear guard, duties.
81. Generalship, qualifications.
82. Generalship, source.
83. Generalship, energy.
84. Generalship, effect of hesitancy.
85. Chief of engineers, qualities.
86. Chief of cavalry, qualities.
87. General officer, captured.
88. Dragoons, dispositions.
89. Cavalry, employment of.
90. Cavalry, characteristics.
91. Cavalry, component, variable according to T. of W.
92. Artillery, concentration.
93. Infantry-artillery team.
94. Army, in defensive position.
95. War and opportunity.
96. Reserves, employment of.
97. Detachment, limitations.
98. Siege operations.
99. Fortifications, defense of.
100. Capitulations, rules of.
101. Defensive-offensive, relations of.
102. Turning movement, army.
103. Field fortifications, efficacy of.
104. Passage of armies, no obstacles.
105. Order of battle, circumstances.
106. Flank marches.
107. Pillage, effect of.
108. Enemy prizes.
109. Prisoners of war.
110. Conquered territories, administration of.
111. Geography, influence of.
112. Principles of war, historical application.
113. Naval tactics.
114. Soldier and sailor, comparison.
115. Naval warfare and land operations, comparison of.

As to his maxims, the first 78 were published in Paris in 1830 and were translated into English shortly thereafter; the Maxims from 79 to 115, inclusive, were published at a later date.

A popular edition of the first 78 Maxims is that with annotations and historical examples by General Burnod, in the translation of Lieut. General Sir G. C. d'Aguilar, C. B.; it should be noted that there are slight discrepancies in the sequence of the Maxims, between Burnod's and other editions; e.g., the fifth edition of the Maxims, published by the Librairie Militaire, T. Dumain, Paris, 1874.

The relative frequency of Napoleon's precepts, analogous to the main headings of the W.D. principles' list, would indicate that he regarded the factors of "mass" and "movement" (direction) as the most important:

- Objective: Maxims 1, 5, 15, and 31.
- Offensive: Maxims 6, 18, and 19.
- Mass (Concentration): Maxims 4, 26, 28, 29, 34, 97.
- Surprise: Maxims 2, 8, and 65.
- Security: Maxims 3, 11, 32, and 35.
- Movement (Direction): Maxims 9, 10, 12, 16, 20, 23.

The subsequent, detailed chapters on the Napoleonic concept of maneuver and conduct of battle clearly show the prevalence and decisive importance of "mass" and "direction," when it is considered that his campaigns contain at least twenty-seven clear-cut maneuvers against the flank and rear of his opponents.

These principles run through his correspondence like the "leitmotif" through a Wagnerian opera, viz:

Mass. The first principle of war is never to give battle except with all the troops that can be collected on the field of operations.²²

When you intend to fight a battle collect all your forces; do not omit any of them; a battalion sometimes decides a victory.²⁴

Large detachments should not be made on the eve of battle.²⁵

Direction. An Army ought to have but one line of operations which it must guard carefully and never abandon except from over-ruling necessity.²⁶

Attack vigorously after having observed well where to strike.²⁷

Menace your enemy's flanks, protect your own and be ready to concentrate on the important points.²⁸

Instead of opposing the march of the assailant, front to front, the army ought to place itself on his flanks, ready to cut his line of operations.²⁹

d. Clausewitz (1780-1831). A contemporary of Napoleon, who fought both for and against the Emperor, this Prussian officer wrote a monumental treatise on the theory of war, *Vom Kriege*. Its significance lies in the philosophical character of his views and an extraordinary brilliancy of analysis; he exercised a strong influence upon military literature. In general terms, Clausewitz dissects the phenomena of war, in strategy and tactics, without being quite able or willing to develop a system; his close coordination of theory with battlefield experience as a test, however, is scientifically sound and his influence on German military education has been far-reaching and profound. While he is reluctant to elevate them to the role of "principles," he defines important military "factors," as follows:

Moral Force	Vol. III, Chap. 3
Superiority of Numbers	Vol. III, Chap. 8
The Surprise	Vol. III, Chap. 9
Assembly of Forces in Time	Vol. III, Chap. 11
Assembly of Forces in Space	Vol. III, Chap. 12
Economy of Forces	Vol. III, Chap. 14
Plan of Battle and Objective	App. 2

In Vol. III, Appendix 2, "Summary of Instruction of H. R. H. The Crown

²² Napoleon, *Memoirs*, Vol. III, p. 295.
²⁴ *ibid.*, p. 258.
²⁵ *ibid.*, Vol. II, p. 56.
²⁶ Napoleon, *Maxims*.
²⁷ Letter to Massena, Peninsular War.
²⁸ Napoleon, Peninsular War, Vol. IV, p. 75.
²⁹ Napoleon, *Memoirs*, Vol. II, p. 23.

Prince," Clausewitz finally articulates several principles much as they appear in their current, modern phraseology:

I. General Principles to be observed in war:

- | | |
|------------------------|--|
| Objective | 1. In forming a plan of battle we should have a great objective in view. |
| Offensive | 2. Employ all the forces which we can make available with the utmost energy. |
| Concentration | 3. Concentrate force as much as possible at the point where the decisive blows are to be struck; run the risk of being at a disadvantage at other points; the success at that point will compensate for all defeats at secondary points. |
| Economy of force | |
| Mobility | 4. By rapidity, many measures of the enemy are nipped in the bud; do not lose time. |

Clausewitz was definitely under the influence of the Napoleonic period: he reflects fairly accurately the views of the great master, although many of his critics do not credit him with a complete understanding of the Napoleonic method.

It is apparent that the principles of the *objective*, *concentration* and *economy of force* are fully represented in his writings.

e. MacDougall (1858). Characteristic of the mediocre writings of the post-Napoleonic period, the superintendent of the Royal Military College, Sandhurst, England, published a strategical and tactical text book²⁰ which is nothing more or less than a feeble echo of the views of the great military writers of that age: Napoleon, Jomini, Clausewitz, Archduke Charles of Austria and Napier. The recurrence of the basic principles is unmistakable:

Mass

1. The whole science of war may be briefly defined as the art of placing in the right position, at the right time, a mass of troops greater than your enemy can there oppose to you.
2. To place masses of your army in contact with fractions of your enemy.

Direction

3. To operate as much as possible on the communications of your enemy without exposing your own.
4. To operate always on interior lines.

f. Townshend, 1920: The extraordinary biographical record of the Mesopotamian Campaign,²¹ 1914-1915, by the commander of the ill-fated British-Indian Expeditionary Force must be regarded as an interesting item in the literature on principles of war. He traces the application of the principles in his own troop dispositions in the pitched battles of Kut-al-Amara and Ctesiphon. He derived the principles from Napoleon, Clausewitz, von Moltke, Foch, Frederick, and Jomini.

The coincidence of date with the principles listed in Fuller's *Science of War* is interesting. It is difficult to determine who influenced the other. Fuller's article was published in the *British Army Quarterly* of January 1921, while Townshend's book was also printed in the same year. It is a reasonable presumption that the manuscript was in the hands of the publishers for some time.

Townshend articulates certain principles in direct application to his personal conduct of military operations, viz:

- | | |
|--|-----------|
| 1. The principal objective in strategy | Objective |
| 2. Economy of force | Economy |
| 3. The mass | Mass |
| 4. The strategic offensive | Offensive |
| 5. Rapidity or economy of direction | Direction |
| 6. Security | Security |

The factors of *mass* (3) and *direction* (5) can well be singled out from this list as *basic* and the others as corollaries; *economy of force* (2) is merely a means to

²⁰ *Theory of War*, Lt. Col. P. L. MacDougall, Longman, Brown, Green, Longmans and Roberts, London, 1858.
²¹ *My Campaign*, Major General Charles V. F. Townshend, British Army. The James A. McCann Co., New York, 1920.

create *mass* (3); *offensive* (4) is meaningless without effective *direction* (5) and *security* (6) is an incident of the advance; since *security* (6) is necessary for all military operations, it might be elevated to the dignity of a principle, viz: *mass*, *direction*, *security*.

Other British commentators regard this list as "over-codified" and prefer the trinity: *concentration*, *offensive action* and *security* as "really worthy of the title of principles; all others . . . are only elements in these three . . ."

g. *The British version of the principles of war: Fuller, 1912-1925.* There is considerable evidence that a British military writer, Major General J. F. C. Fuller, is the father of the currently accepted, modern version of the principles of war or at any rate gave them articulate form and wide publicity.

	1912		1921		1925
1	Principle of the objective	1	Objective	1	Direction
2	Principle of mass	2	Offensive	2	Offensive
3	Principle of the offensive	3	Surprise	3	Surprise
4	Principle of security	4	Concentration	4	Concentration
5	Principle of surprise	5	Economy of force	5	Distribution
6	Principle of movement	6	Security	6	Security
		7	Movement	7	Mobility
		8	Cooperation	8	Endurance
				9	Determination

Fuller, who writes with vigor and is a respected name in British military circles, established his professional reputation as the indefatigable proponent of tank employment in the World War, and was Chief of Staff of the initial British tank forces at Cambrai, 1917. In a series of articles and special studies on the "science of war," he attempted to apply the methods of science to the study of war, to discover its elements, its conditions and "principles" and deduce controlling laws of war. This analysis makes Fuller a sort of nineteenth century Clausewitz.

In his *The Foundations of the Science of War* (Hutchinson & Co., London, 1926) and in an article of the same title in the *British Army Quarterly* (Vol. I, January 1921), Fuller traces the evolution of his ideas. He took a paragraph of the British field service regulations (1909) as his point of departure: ". . . the fundamental principles of war are neither very numerous nor in themselves very abstruse but the application of them is difficult . . ."; his own statements are quoted, at some length, since their influence on private and official texts is easily demonstrable:

This idea was excellent, but what were these fundamental principles?

I turned to the correspondence of Napoleon and studied it closely and during 1912 I had come to the conclusion that the principles which had guided Napoleon were as follows:

. . . The Principle of the Objective—the true objective being that point at which the enemy may be most decisively defeated; generally this point is to be found along the line of least resistance.

The Principle of Mass—that is, concentration of strength and effort at the decisive point . . .

The Principle of the Offensive; the Principles of Security, Surprise and Movement, i. e., Rapidity . . .

I had now got six (6) working principles. Whilst at the Staff College (1913), I applied my principles and found them a great help; in the summer of 1917, the C. O. of Aldershot asked me to lecture on the principles; in 1918, my lectures were published.

In 1919, a committee began to rewrite the *British Field Service Regulations* and the chairman said to me: "I believe you have written something on the principles of war. May I have it?"

In 1920 the principles I had laid down were, in a slightly modified form, included in the new edition of the *Field Service Regulations*.

Between August 1922 and January 1923 I wrote a series of fifty lectures on "The Science of War": they were given to the 1923 batch of Staff College students and were based on the following theory: We start with man, and from man extract four (4) elements:

- 1 Mental power Mind Control
- 2 Protective power Protection Stability
- 3 Offensive power Weapons Activity
- 4 Mobile power Movement Cooperation

From these elements, I evolved four elementary principles, namely:

1. From mind: the principle of the *objective*.
2. From protection: the principle of *security*.
3. From weapons: the principle of the *offensive*.
4. From movement: the principle of *mobility*.

I next postulated a law, which I called the "law or the conservation of military energy" and from it extracted four accentuating principles of war, namely:

1. The principle of surprise.
2. The principle of economy of force.
3. The principle of concentration of force.
4. The principle of cooperation.

These principles were of great assistance to me, to work out problems in the physical sphere of war but it was difficult to apply them to mental and moral action; as regards mental action, I devised a coefficient for each and as regards moral action, from "will, morale and fear," I decided three moral principles, namely:

1. The principle of determination.
2. The principle of endurance.
3. The principle of demoralization.

In 1923, having set these lectures together in book form, I submitted them to my friend, Captain B. H. Liddell Hart. I spent such time as I had in 1924 in reconsidering each step in my system. A difficulty I could not avoid was changing the names of some of my old principles which appeared in Vol. II, *Field Service Regulations*, edition of 1924.

- | | |
|---------------------------------------|---------------|
| 1. Maintenance of the objective | Direction |
| 2. Offensive action. | |
| 3. Surprise. | |
| 4. Concentration. | |
| 5. Economy of force | Distribution |
| 6. Security. | |
| 7. Mobility. | |
| 8. Cooperation. | |
| | Endurance |
| | Determination |

I substituted the principle of direction (for objective), which is both more accurate and more general.

For economy of force, I substituted the principle of distribution and exalted economy of force to the position of the law of war.

I scrapped cooperation and introduced two new principles: endurance (8) and determination (9). Though the principles have grown from eight to nine, they can be reduced to three groups, namely, control, resistance and pressure and, finally, to one law: the law of economy of force. Thus the system evolved from six (6) principles in 1912, rose to eight (8) in 1915, to virtually nineteen (19) in 1923, and then descended to nine (9) in 1925, with the added advantage that these nine (9) can be merged into three (3) and these three (3) into one (1) law . . ."

It is curious to note that in his erudite meandering, this able soldier finally emerged with a single law: economy of force, which is pointless taken by itself but becomes rational as the sole means of producing mass at some point. This law is a stilted, codified paraphrase of Forrest's salty comment ". . . to get thar fustest with the mostest men."

Fuller's work as an Anglo-Saxon Clausewitz is obviously meritorious; the nearest American counterpart is a brilliant, abbreviated study by Major Edward S. Johnston, Infantry: "A Science of War," Vol. XIV, June 1934, *The Command and General Staff School Quarterly*, Fort Leavenworth, Kansas.

h. The C. & G.S.S. version, Ft. Leavenworth, Kas. (1936). The Command and General Staff School Press has published a pamphlet, *The Principles of Strategy*, (1936) intended to serve as an instructional text; this is the latest chronological version of the famous principles.

A comparison of the Leavenworth version with the initial list, TR 10-5, War Department, 1921, reveals that the principles of the *objective* and *simplicity* were omitted and that the term: *importance of*, was substituted for the definitive one of: *principle*.

EVOLUTION OF PRINCIPLES: 1921-1936

TR 10-5, W.D. 1921

C&GSS, 1936

The Principles of War

The Principles of Strategy

1. Objective	1. The importance of offensive action
2. Offensive	2. The importance of concentration of combat power
3. Mass	3. The importance of economy of force
4. Economy of force	4. The importance of mobility
5. Movement	5. The importance of surprise
6. Surprise	6. The importance of security
7. Security	7. The importance of cooperation
8. Simplicity	
9. Cooperation	

Following are extracts from the explanatory comments for each principle. There is nothing new or startling in them; as proof of the historical continuity of the principles of war, the Leavenworth version is briefly compared with analogous historical opinions by great captains; the coincidence is striking:

Offensive Action. a. The advantages in the strategic offensive are primarily that the initiative will generally be secured and that surprise will be facilitated . . .

b. Only by the offensive may the initiative be retained and a definite plan followed . . .

Sun-Tzu, 496 B. C. In war let your great objective be victory and not a lengthy campaign. (Chap. IV, Par. 19.)

Security against defeat implies defensive tactics; ability to defeat the enemy means taking the offensive. (Chap. IV, Par. 5.)

To make war was always to attack.

Frederick II, 1756

Napoleon, 1809

Attack vigorously after having observed well when to strike. (Letter to Massena.)

Menace your enemy's flanks; protect your own and be ready to concentrate on the important points. (*Memoirs*, Vol. IV, p. 75.)

The true art of defense consists in knowing how to attack. (Thiers, Vol. VII, p. 361.)

Foch, 1910

A decision by arms is the only judgment that counts, because it is the only one that creates a vanquished or a victor. (*Principles of War*.)

Concentration of Combat Power. a. The largest possible combat power should be concentrated in the area where it can inflict the greatest harm on the enemy; where success is most probable and where, if victorious, success will bring the greatest advantages. Strategically the weakest points of an army are its flanks and rear . . .

c. It must be remembered that the main operation is all important. Success in the main operation will more than compensate for small defeats elsewhere . . .

d. As to the principle of striking an enemy as hard as one can and in the most vulnerable place there can be no question.

Napoleon, 1809

When a commander intends to give battle, he should collect all his forces and overlook none; a battalion sometimes decides the day. (Maxim: XXIX.)

The first principle of war is never to give battle except with all the troops that can be collected on the field of operations. (*Memoirs*, Vol. III, p. 295.)

No detachment should be made on the eve of battle. (Maxim: XXVIII. *Memoirs*, Vol. II, p. 56.)

Sun-Tzu, 496 B. C.

We can form a single united body, while the enemy must split into fractions; hence there will be a whole pitted against separate parts, which means that we shall be many against the enemy's few. (Chap. VI, Par. 14.)

And if we are thus able to attack an inferior force with a superior one, our opponents will be in dire straits. (Chap. VI, Par. 15.)

Economy of Force. a. In order to insure the concentration of combat power the greatest economy of this power must be practiced in carrying out subsidiary missions . . .

Napoleon, 1809

There are many good generals in Europe, but they see too many things; I see only one; masses. I seek to destroy them, knowing well that the accessories will then fall of their own accord.

Grant, 1862

If the main objects of war are gained the lesser ones are sure to follow. (Badeau: *Military History of U. S. Grant*, Vol. I, p. 412.)

Mobility. a. To a large extent war is an affair of movement. The power of rapid movement and of profiting from movement is essential for successful strategy . . .

c. The power to effect more rapid movements than those of the enemy has always been an index of great military leadership and a high standard of efficiency in the troops . . .

Sun-Tzu, 496 B. C.

Rapidity is the essence of war; take advantage of the enemy's unreadiness, make your way by unexpected routes and attack unguarded spots. Though we have heard of stupid haste in war, cleverness has never been associated with long delays. (Chap. II, Par. 3.)

Napoleon, 1809

The strength of an army, like the power in mechanics, is estimated by multiplying the mass by rapidity; a rapid march augments the morale of an army and increases its means of victory. Press on! (Maxim: IX.)

The secret of war is to march twelve leagues, fight a battle, and march twelve more in pursuit. (Napier, Vol. V, p. 155.)

Surprise. a. Surprise is the most deadly of all weapons. The commander is vitally concerned with the problem of bringing it about. Surprise has been the foundation of almost all the grand tactical and strategic combinations of the past as it will be of those to come . . .

b. Surprise is effected by doing the unexpected and thereby creating a situation for which the enemy is unprepared . . .

Sun-Tzu, 496 B. C.

All warfare is based on deception. Hold out baits to the enemy; feign disorder and crush him. Attack him when he is unprepared; appear when you are not expected.

Vegetius,²² 400 A. D.

Dispositions for action must be carefully concealed from the enemy, lest they should counteract them. (Maxim: 33)

It is better to overcome the enemy by surprise than by general actions. (Maxim: 4.)

Those designs are best which the enemy is entirely ignorant of till the moment of execution. (Maxim: 3)

Security. a. Security insures freedom of action. It consists in making provision to guard against surprise, and in disposing protective detachments to guard what is vital in order to allow troops to move or rest undisturbed.

b. Protection from the air and mechanized forces are of the utmost importance.

Napoleon, 1809

The several camps of an army should be placed in such a manner that they may be able to support each other. (*Memoirs*, Vol. III, p. 313.)

An army should keep its columns so united as to prevent an enemy from passing between them with impunity . . . if corps are detached, every precaution should be taken to prevent an attack upon them, in detail. (Maxim: XI)

Cooperation. a. The full power of an army can be exerted only when all its parts combine in action.

b. Cooperation is obtained by clear and well-considered instructions, by constant communication between units, by the intelligence of subordinate leaders in grasping and executing the commander's plans.

Sun-Tzu, 496 B. C.

To control a large force is the same in principle as to control a few men; it is merely a question of subdivision. (Chap. VI, Par. 1.)

Fighting with a large army under your command is nowise different from fighting with a small one: it is merely a question of instituting signs and signals. (Chap. VI, Par. 2.)

8. THE PRACTICAL APPLICATION OF THE PRINCIPLES OF WAR. a. *Application to large units.* The approach to this subject is through a process of synthesis: one examines the finished product, i.e., a battle or campaign that was won or lost, and attempts to trace the progressive effect of "principles" through reconstruction; this procedure comes very close to the modern, so-called "case method"; the recurrence or omission of certain factors may eventually attain the force of law. The majority of situations, in the entire text, are easily susceptible to this treatment, viz:

Principle of the Offensive:

On 8 August, the French First Army attacked in conjunction with the British. Note the attack directions of the French and Canadian Corps.

Principle of the Objective (Direction):

- A The capture of the Mezieres plateau.
- B Continue the attack to seize the Hangest plateau.
- C Attack and capture of Assainvillers.
- B-C Complete encirclement of Montdidier.

²² Vegetius, a Roman military writer of the fourth century, believed to have been a Christian; his principal work, in five books, is entitled *Epitome Institutionum Rei Militaris* and is dedicated to Valentinian II. It treats of the organization of armies, the training of soldiers, etc., and is written in a clear and graceful style. Translations of it have been published in English, French and German.

	Sun-Tzu 505 B. C.	Napoleon 1822	Clausewitz	MacDougall 1858	N. B. Forrest 1864	Townshend 1920	Fuller		TR 10-5 W. D. 1921	C. & G. S. S. 1936
							1912	1925		
1 Objective	Objective	Objective	Mass	Mass	Mass	Objective	Objective	Direction	Objective	Objective
2 Offensive	Offensive	Offensive	Direction	Direction	Direction	Economy of Force	Mass	Offensive	Offensive	Concentration
3 Concentration	Mass	Mass	Concentration		Rapidity	Mass	Offensive	Surprise	Mass	Economy of Force
4 Mobility	Movement	Movement	Economy of Force		Offensive	Offensive	Security	Concentration	Economy of Force	Mobility
5 Surprise	Surprise	Surprise	Mobility			Direction	Surprise	Distribution	Movement	Surprise
6 Coordination	Security	Security				Security	Movement	Security	Surprise	Security
7								Mobility	Security	
8								Endurance	Simplicity	
9								Determination	Cooperation	

DIRECTION - MASS

PLATE 22. THE HISTORICAL CONTINUITY OF THE PRINCIPLES OF WAR: 505 B. C.—1936 A. D.

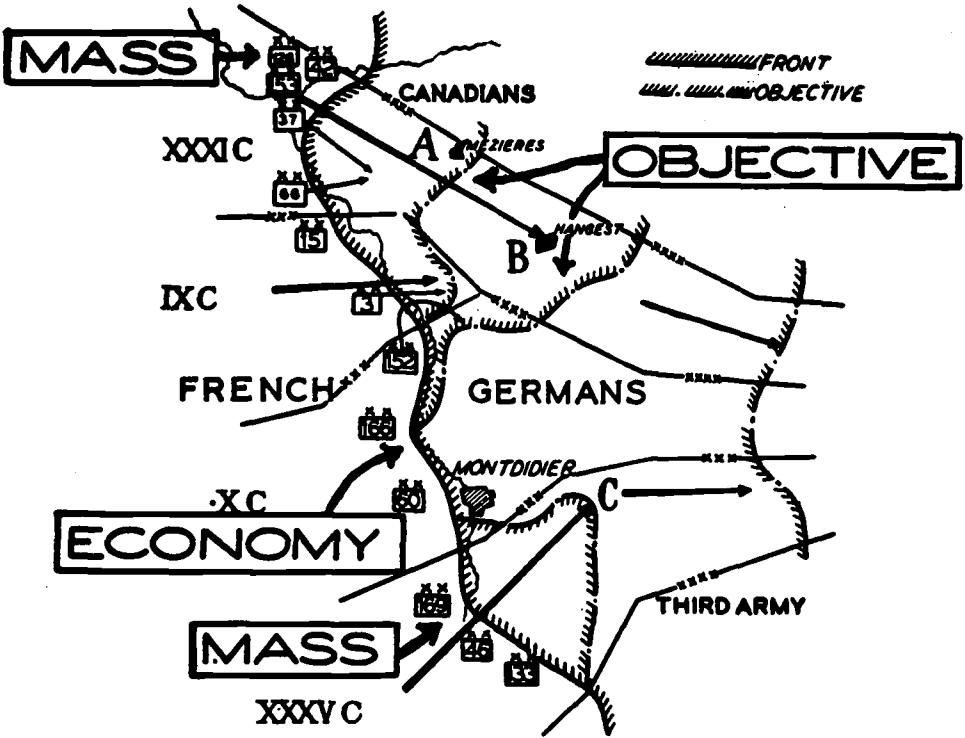

THE PRINCIPLES OF WAR

PLATE 23. MANEUVER OF THE FIRST ARMY: MONTDIDIER, 8-12 AUGUST 1918.

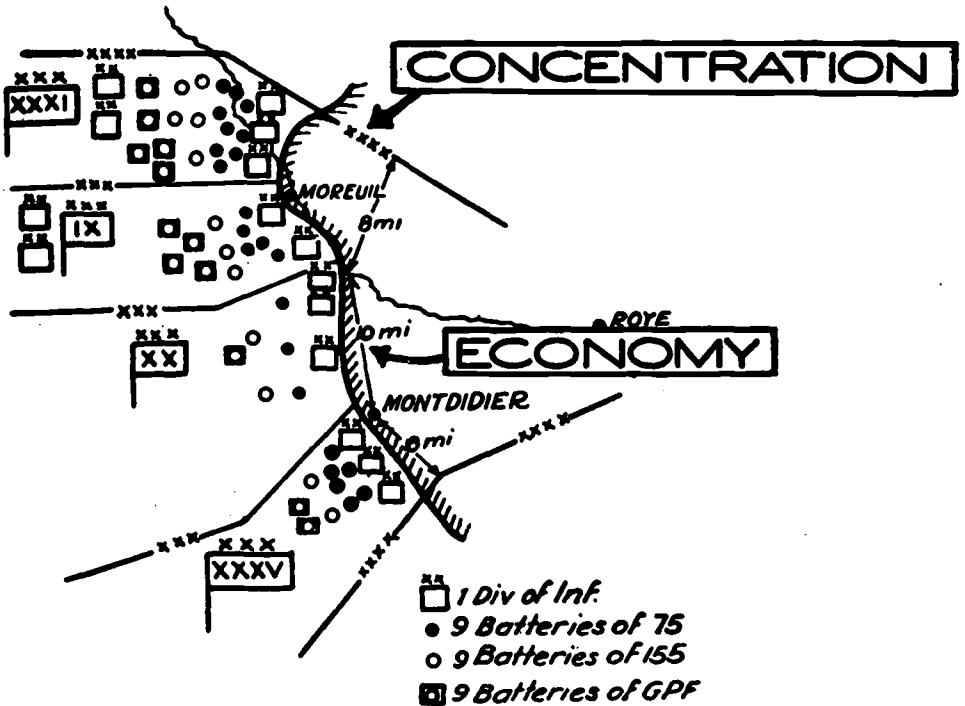

THE PRINCIPLES OF WAR

PLATE 24. FIRST ARMY PLAN. MONTDIDIER, 8 AUGUST 1918.

Principle of Economy of Force:

In the zone of action of the IX Corps: 3 Divisions.
 In the zone of action of the X Corps: 2 Divisions.

Principle of Concentration (Mass):

In the zone of action of the XXXI Corps: 5 Divisions, reinforced.
 In the zone of action of the XXXV Corps: 3 Divisions, reinforced.

Principle of Surprise:

The entry into action of the XXXV Corps was initially slated for 10 August; it was launched a day ahead; the enemy was completely surprised.

The application of certain principles, in the same operation, is further accentuated if *distribution of forces and relative density of weapons* are considered, viz:

Principle of Concentration (Mass.):

On the front of Moreuil, representing about one-third of the Army zone of action, there is a massing of one-half of the infantry and two-thirds of the artillery, i. e., 9 divisions, 126 batteries F.A., 72 batteries Howz., and 72 batteries G.P.F.

Principle of Economy of Force:

On the front west of Montdidier, 3 divisions, 27 batteries F.A., 18 batteries Howz., and 9 batteries of G.P.F. only.

THE PRINCIPLES OF WAR

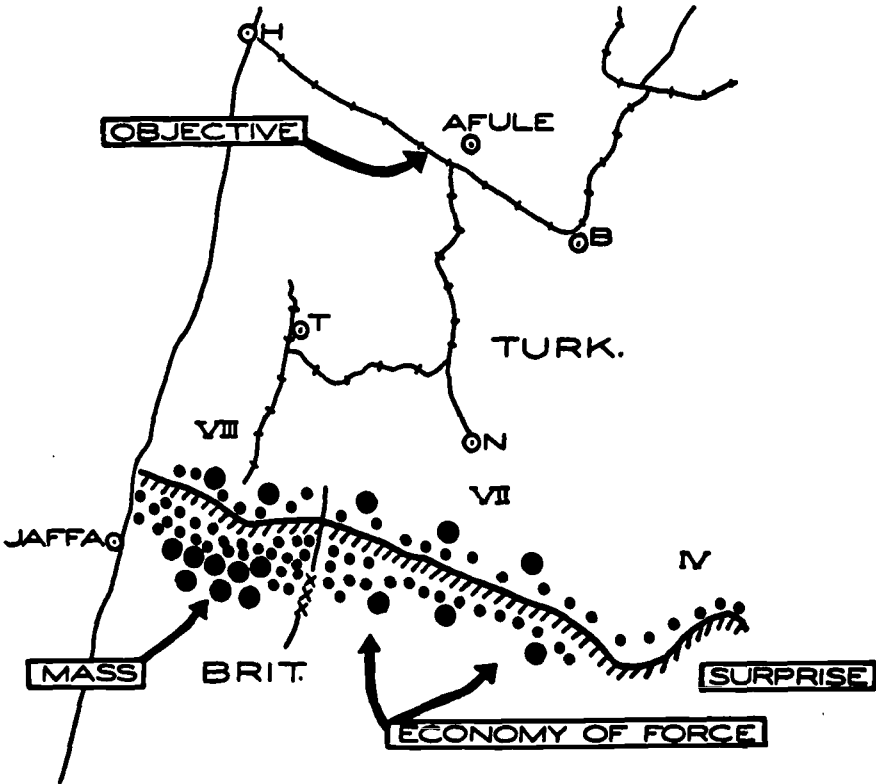

	BRIT	VII	VI	IV	HEDJAZ
SABERS	12000	1000	1000	2000	
RIFLES	57000	8000	9000	9000	6000
GUNS	540	186	82	74	60

RELATIVE TURKISH AND BRITISH STRENGTH

PLATE 25. THE BATTLE OF MEGGIDO, 19 SEPTEMBER 1918.

The operation against the Montdidier salient was probably the turning-point of the war on the West Front; Ludendorff states: ". . . the eighth of August was the black day of the war for the Germany Army." *Mass, direction and surprise* were admittedly the deciding factors or principles.

These factors are recognizable in every major operation of the world-war period; there is another "turning-point" on another front, the battle of Meggido, 19 September, 1918, in the campaign of Palestine. The principles of mass, direction and surprise contributed to the decisive success of the British Expeditionary Force against the remnants of the Turkish army, viz:

Principle of Surprise:

The concentrations on the decisive coastal front were made under cover of darkness; the old camps, in the Jordan valley, remained standing; 15,000 dummy horses were placed along the deserted picket lines; headquarters were maintained and the wireless traffic continued, as usual.

Principle of Concentration (Mass.):

Note the concentration on the prospective "break-through" front: every small dot represents: 1000 infantry; every large dot: 50 field pieces. Allenby concentrated 35,000 infantry and 383 guns on a narrow front of about 15 miles.

Principle of Economy of Force:

The remaining front of about 40 miles was held by only 22,000 rifles and 157 guns.

Principle of the Offensive—Movement—Surprise. Surprise, or placing the attack where it is not expected, or enemy preparations are inadequate, is obviously dependent on speed, i.e., the result of movement.

The American classic, under this heading, is Jackson's Valley Campaign, 1862; it compares easily with the best European pattern.

Range of movement, i.e., distance, is an important factor: the Napoleonic marches have become justly famous in this respect, especially the concentric movement on Ulm, 1805, and the initial advance into Russia, 1812. However, once again there is a brilliant American counterpart to the Napoleonic model—if it does not surpass it, in the vastness of its actual territorial extent—the campaigns of liberation, waged by Simon Bolivar²³ in the period 1813 to 1824, from Venezuela on the Atlantic, to Peru on the Pacific.

The incredible extent of these offensive operations is realized if one compares the size of the United States, superimposed on a map of South America, to the same scale; the net-work of the Bolivarian operations would have covered the United States from New York to San Francisco, approximately 2800 miles as the crow flies—and this took place in 1821, when the area west of the Mississippi was still unexplored territory!

The Campaign of 1813: Tachira—Caracas

The Campaign in Western Venezuela, 1813

The Expeditions of Los Cayos, 1814-1815

The Campaign in Central Venezuela, 1818

The Campaign of Nueva Granada (Colombia), 1819

The Campaign of Carabobo, 1821

The Campaign of Pasto, 1823

The Campaign in Southern Peru, 1824.

b. Application of principles to smaller units. At first glance, it would appear as if the inherent characteristics of the principles of war tend to limit their applica-

²³ General E. Lopez-Contreras: *Simon Bolivar: Conductor de Tropas*. Caracas, Venezuela, 1925.

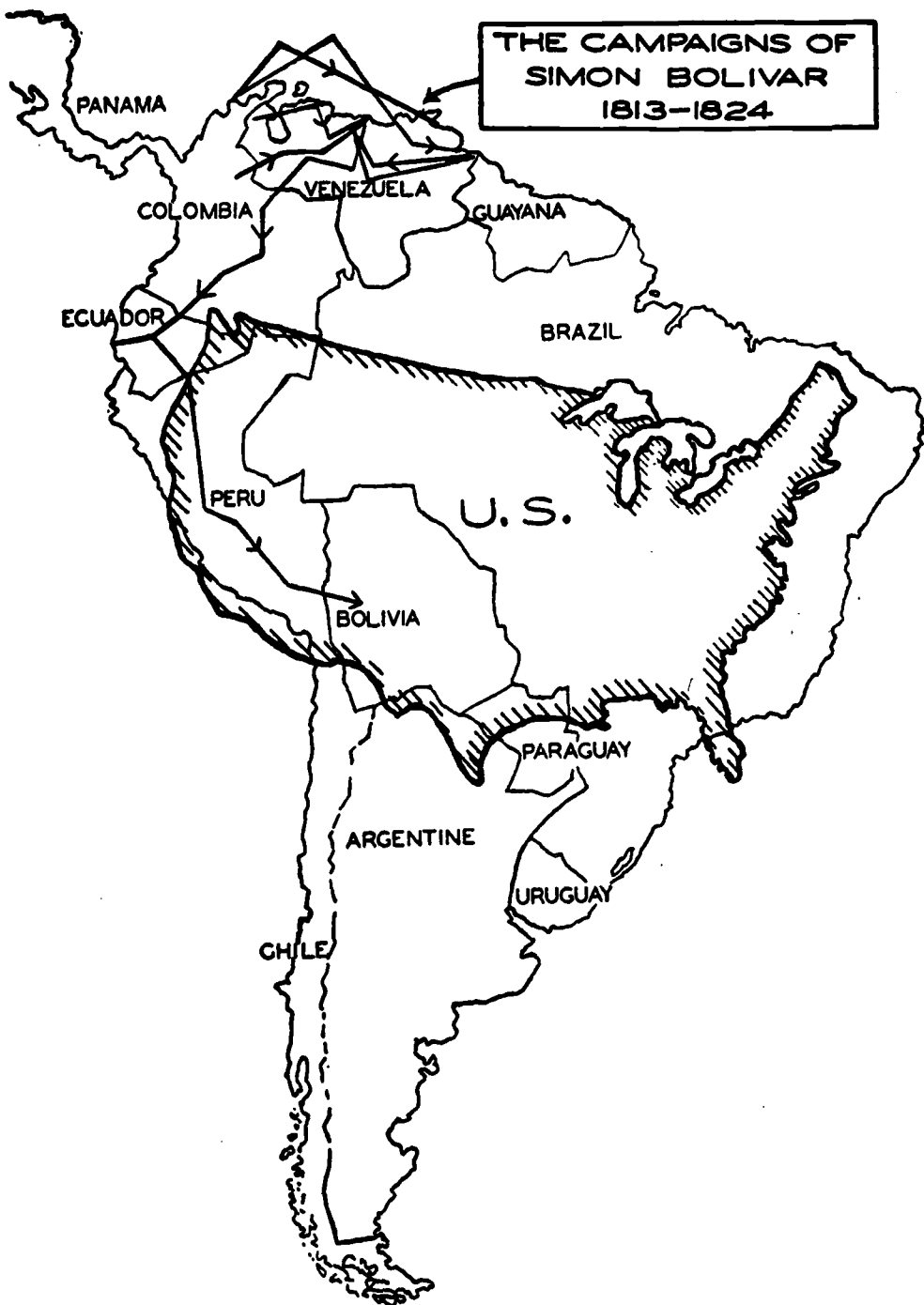

PLATE 26. THE CAMPAIGNS OF SIMON BOLIVAR, 1813-1824.

tion to large units; by dictionary definition, however, a principle is supposed to be of universal application.

It must be recognized that the "principles" remain in force regardless of size of units, but their application, of course, takes a definite tactical form in small-unit operations.³⁴

In this respect, we are naturally influenced by our own war experiences; the stabilized fronts of the World War period accentuated the tactical forms of penetration and breakthrough in which limited objectives, large troop concentrations, rigid boundaries and zones of action became characteristic features; it may as well be recognized that these features are not favorable to free maneuver but rather tend to "corridor fighting."

The historically famous attack on Cantigny, 28 May, 1918, by the 28th Infantry, A.E.F., is a characteristic example of a penetration, in a limited objective attack, as practiced on the West Front on innumerable similar occasions.

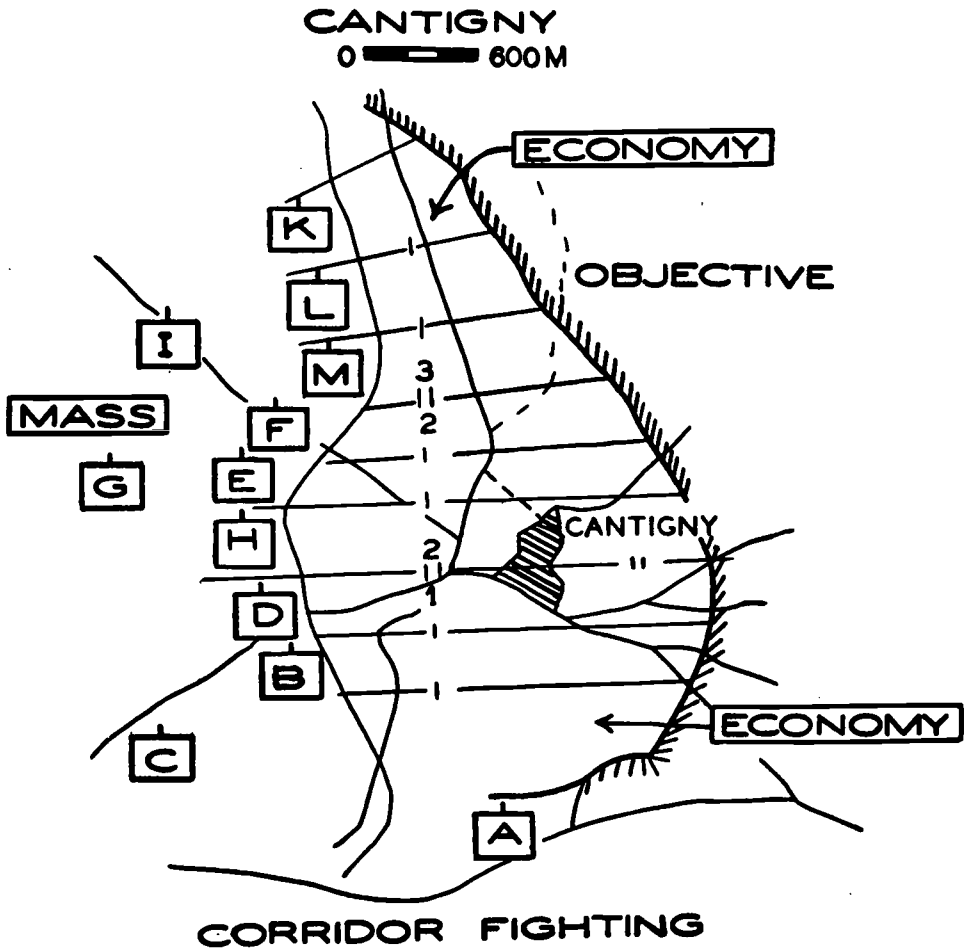

PLATE 27. CANTIGNY, 28 MAY 1918.

³⁴ See Chap. I, Par. 56.

The peculiar tension surrounding this first American attack lent a significance to this operation far beyond its relative military value.

The attack front was about 2200 yards; an entire regiment at war strength (250 men per company) was employed in the assault echelon; the force engaged was probably too large for the mission.

The formation of the regiment was with three battalions abreast, each battalion with three companies in line and one in reserve; one machine gun company had been attached to each battalion; a section of flame throwers and a group of 12 Schneider tanks were furnished by the French.

The artillery support for the attack was markedly strong and consisted of the organic divisional artillery, reinforced by one hundred thirty-two 75-mm guns, thirty-six 155-mm guns, one hundred seventy-eight heavy guns and howitzers and forty trench mortars; two hundred thousand rounds were accumulated for this concentration.

The application of "principles" is recognizable but not as obvious as in the case of larger units.

Concentration—Mass: The relatively narrow front, for an attack with battalions abreast and the density of artillery support (6 guns per yard of front) are expressions of mass.

Economy of Force: The sectors assigned to Cos. A and K, flank companies, are relatively wider than the narrower fronts assigned to Cos. E, F and H, interior companies, which were expected to meet stiffer resistance.

It may be argued, of course, that this formation and type of attack were prescribed in minute detail, by high authority, that there was no opportunity for "maneuver" or scheme of maneuver, or direction other than a head-long collision and that, consequently, it is gratuitous to search for principles.

In this more or less academic dilemma, it is of course desirable to trace a sharp line of demarcation; this is entirely practicable. At present the Army is regarded as the "*fundamental unit of strategic maneuver,*"²⁵ i.e., a conception which involves primarily the *displacement of large units.*

Within the Army, corps and divisions become *units of execution* of the strategic maneuver; their radii of action are more limited than the Army.

In the framework of larger units, the brigade and regiment become mere *tools of execution*, as combat units of relatively limited powers: the radius of action of a division, i.e., its *immediate combat effectiveness*, is limited in width from 6 to 12 miles and in depth to the extreme range of its organic artillery.

This view is confirmed in a recent address²⁶ by the Chief of Infantry: ". . . The larger features of divisional organization lie outside the province of my office . . . Suffice it to say that the general consensus of authoritative opinion seems to favor the organization of the army corps as a unit of definite composition embodying that degree of sufficiency for independent action at present attributed to the division; and the restriction of the division to the role of a purely combat unit.

". . . A number of consequences follow from the generalization of motor transport . . . the army corps of two or three divisions will definitely displace the divisions as the tactically and administratively self-contained unit, capable of independent action. The division becomes a purely tactical unit."

A differentiation between "large" and "small" units is derived from a distinction

²⁵ *Manual for Commanders of Large Units*, Par. 30.

²⁶ Address at C. & G. S. S., Ft. Leavenworth, 5 May 1938.

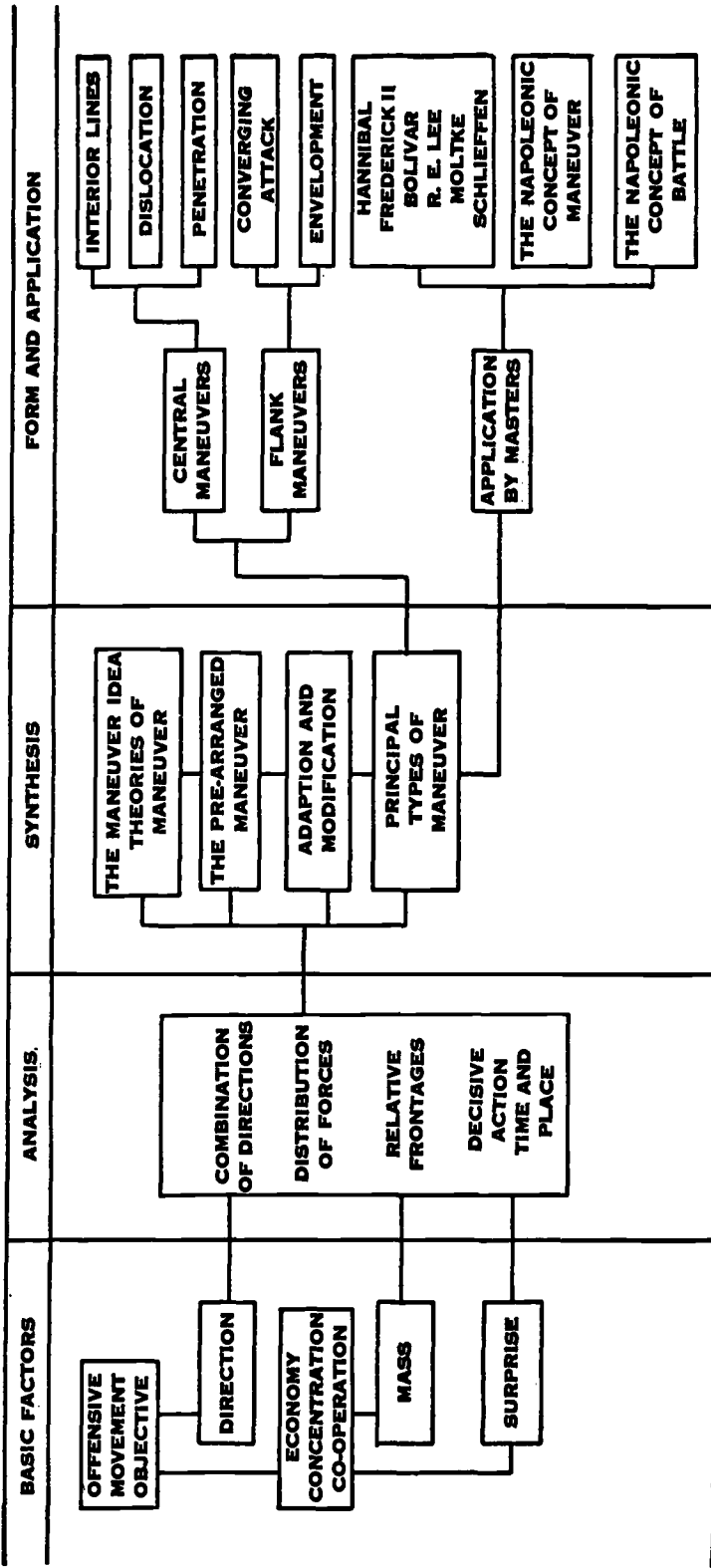

PLATE 28. STRUCTURE AND PHYSIOGNOMY OF MANEUVER.

between "strategical" and "tactical" maneuver: ²⁷ one being maneuver involving *displacement of forces*, the other *concentration of fires*; such a distinction leads to a ready transfer of ideas and terms, viz:

^m *Definition of Tactics:*

There have been many definitions of "tactics," but all of them have failed to include collateral conceptions (supply, sanitation, morale); when the many facets of a military action are considered, we find that tactics cannot be exclusive, but is a composite thing.

It is possible, by historical agreement, to define "tactics" as distinguished from "strategy" and in this approach to a limitation, we may develop the characteristics of tactics, much as in an equation; "x" is determined by eliminations.

Von Bulow 1789, *Geist des neueren Kriegssystem*, defines as "strategic movements those beyond the enemy intelligence"; von Willisen talks of "strategy as the art of combinations and concentrations, tactics the art of combat." Von Clausewitz defines strategy as "employment of combat for war objectives," tactics as "employment of units in combat"; this agrees with Jomini: "l'art de diriger les armees sur les theatres d'operations," and "l'art de diriger les troupes sur les champs de bataille." This presents an important distinction: theater of operations and battlefield respectively, as proper spheres for strategy and tactics.

More recent writers like Blume appear to agree in general: "The field of tactics embraces the employment of military units, in combat, and their control dictated by combat requirements, while strategy is limited to command activities, exclusive of tactics." Von Scherff: "Strategy tell *why*—tactics *how* to fight."

Grand-Duke Karl always speaks of "science of war," (strategy) and "art of war" (tactics). Napoleon and Frederick always refer to strategy as "l'art de guerre."

A very modern, scientific writer, Prof. Dr. Delbruck, has probably exhausted the subject, when he defines "strategy involves the employment of all military means toward reaching a general war objective, while tactics concerns the conduct of troops to and during combat."

Balck: "Strategy is conduct of war; tactics is conduct of troops."

Closely interwoven are ideas (Lemoine, *Tactique Generale*) that strategy, or grand tactics, involve displacement of units, and tactics displacement of fire.

Apparently, tactics is limited to battlefield situations which, in turn, affect troops and units more directly than high command.

In speaking of the tactical employment of troops, tactics appears to be limited to

- (a) troop leading, to and in combat
- (b) dispositions to combine fire and movement
- (c) displacements to produce fire effect.

It is obvious, however, that a successful activity, under each heading, is dependent of many factors, such as (a) morale and physical condition, (b) ammunition supply, (c) leadership.

Principles	Strategical	Tactical
Objective		Target
Offensive	Direction	Fire
Movement		Movement
Concentration	Mass	Relative Frontages
Economy of Force		Troop Density
Cooperation	Plan	Orders
Surprise	Surprise	Surprise
Security	Security	Security
Simplicity	Simplicity	Simplicity

The analysis of military operations, in subsequent chapters, is predicated on the basic conception that it is primarily "mass" and "direction" that determine the physiognomy and structure of maneuver, i.e., military action.

MASS AND DIRECTION

9. DEFINITION OF MANEUVER. *a. Introduction.* In the appraisal of the "maneuver chart," it is well to recall General MacArthur's brilliant views on the real purpose of military historical studies;¹ his main idea and phraseology are repeated in the framework of this study. Note the column *analysis*, i.e., analysis of "those fundamental principles which, in the past, have been productive of success" and *synthesis*, i.e., "facts derived from analysis are applied to the present and future, thus developing a synthesis of appropriate method, organization and doctrine."

As to *application* in concrete historical cases, the whole range of situations, from 213 B. C. to 1914, is a test of yet another precept—that "these principles know no limitation of time." Consequently, this series involves:

- (1) A progressive analysis of maneuver with a view to the definition of basic factors, types, procedure and execution.
- (2) A study of maneuver in the principal campaigns of the nineteenth century.
- (3) A demonstration of the historical continuity of maneuver forms, with emphasis on the efficacy of flank operations.

b. An elusive idea. The preliminary inquiries into this subject have established considerable authority for the predominance of *mass* and *direction* as major elements in the structure of *maneuver*.²

Earlier American military texts³ generally began with a *definition* of the military terms involved.

The sequence of steps⁴ in the ordinary process of military instruction provide for (1) Preparation, (2) Explanation, (3) Demonstration and (4) Application. There is not a service school in the country, in generally following this sequence, that does not virtuously feel that it has reached the acme in pedagogy. These steps are mutually dependent; if one is omitted or unduly enlarged at the expense of another, the educational balance is disturbed.

In most military systems, the element of *explanation* is not always adequate. The military have a professional tendency toward the dogmatic; they bridle at persuasion when coercion is so much simpler.

It is somewhat difficult to develop a clear-cut *definition* of *maneuver* in our military texts. The word "maneuver"—and presumably the idea behind it—flit elusively through the pages of certain War Department texts:⁵

Par. 14: "The form of concentration depends upon . . . the subsequent strategic maneuver."

Par. 17: ". . . He uses strategical reserves to influence the situation by *maneuver* . . ."

Par. 22: ". . . a skillful commander will *maneuver* the enemy out of his position . . . He must keep his command, as a whole, free to maneuver . . ."

Par. 30: ". . . The Army is the fundamental unit of strategical *maneuver* . . ."

Par. 37: ". . . The initial disposition of the Army should conform to the projected maneuver."

Immediately the question suggests itself: What kind of maneuver? How, where and why is it applied?

¹ Chap. I, Par. 1.

² In the considerable literature on modern strategy and tactics, certain authors and titles are outstanding. Von Schlieffen's *Canuar*, C. & G. S. S., Ft. Leavenworth, Kas., 1931; Balck's *Tactics*, translation by Brig. General Walter Krueger, U. S. Army, C. & G. S. S., Ft. Leavenworth, Kas., 1911. Balck has added an important supplementary volume to his original series: *Development of Tactics—World War*, C. & G. S. S., Ft. Leavenworth, Kas., 1922. Of post-war analysis, in French, the brilliant studies of Lemoine and Touchon must be mentioned, in particular Lemoine's *Tactique Generale*, Part III; the important parts of this valuable work are covered in this chapter.

³ *Infantry Drill Regulations*, U. S. Army, edition of 1911; one of the best publications of its kind and time.

⁴ TR 10-3, Sec. IV, Par. 14. War Department.

⁵ *Manual for Commanders of Large Units*.

In *Field Service Regulations*,⁶ there are many references of a general character:

Par. 382: ". . . The effect of surprise is dependent upon rapidity of *maneuver* . . ."

Par. 393: ". . . indicate the points the seizure of which is of especial importance to the *maneuver*."

Par. 426: ". . . terrain often creates advantages for the development of a *maneuver* . . ."

One may presumably be accused of carrying coal to Newcastle in calling for such a definition, but it makes for clear thinking. Lord Gray, the famous British statesman, once said: ". . . Discussion without definition is useless." The only alternative to clear thinking is intellectual arrogance or a sort of semi-religious faith, expecting to pick ideas from nowhere, a naive hope that at the last moment inspiration will descend like the fluttering of Biblical doves.

10. THE BASIC FACTORS. *a. Direction or combination of directions.* Now and then we catch a glimpse of the "type and form" of maneuver, but it is largely a matter of interpretation. There is the tedious job to trace the various factors and component elements that make up the complexity of maneuver—like a mosaic, in which small fragments are assembled until, suddenly, the final pattern is revealed.

In *Field Service Regulations*, we have an important beginning, a prime initial factor, the *factor of direction*:

Par. 434: ". . . The offensive action of every unit is given its *direction* with reference to an axis of attack."

This point is generally confirmed in the *Manual for Commanders of Large Units*:

Par. 36: ". . . The Army Commander receives a general *direction* of advance . . . if corps are diverted from their axis . . . he adopts measures to maintain the mass of the army on its *general direction*."

This factor can be accepted provisionally⁷ as "direction or combination of directions in which the different elements of a unit will act."

b. Distribution of forces. The next factors to examine will be distribution of forces, frontages and depth of formation; under this heading our official language is pretty clear:

Par. 394: "Units are distributed for combat in width and in depth. Units assigned to decisive missions are . . . assigned relatively narrow frontages."

Par. 385: ". . . The necessity for concentrating the greatest possible force at the point of decisive action requires strict economy in the strength of forces assigned to secondary missions . . ."

The idea is variable and could be expressed in still another form, such as: The ratio of offensive effort to the defensive; the sequence and degree of effort during combat; combat or troop density per yard of front; the proportion between troops engaged and troops in reserve. In its final meaning, it aims at the *creation of mass*.

The so-called plan of maneuver is essentially the synthesis of these basic elements: direction and distribution of forces. In analyzing possible combinations and the conditions governing their use, they are examined in three general situations: (1) Offensive against an enemy in position; (2) Offensive against an enemy in movement; (3) Defensive.

11. COMBINATION OF DIRECTIONS. We find a very clear example of "Combination of Direction" against an enemy in position in the Battle of Montdidier, 8 August 1918.

On 8 August, the French First Army attacked in conjunction with the British Army. The plan of the army commander provided for:

1—*A First Phase*: To push at top speed toward the Mezieres—Genonville Plateau, force the passage of the Avre, and obtain a bridgehead for the army.

⁶ Edition of 1923, Chap. IX: Combat.

⁷ It has already been identified as a "principle," Chap. I, Par. 7.

2—*A Second Phase:* To seize the Hangest-en-Santerre Plateau as a threat of encircling Montdidier.

3—*A Third Phase:* To complete the encirclement of Montdidier by an attack of the XXXV Corps in direction: Assainvillers, and to progress rapidly to the east.

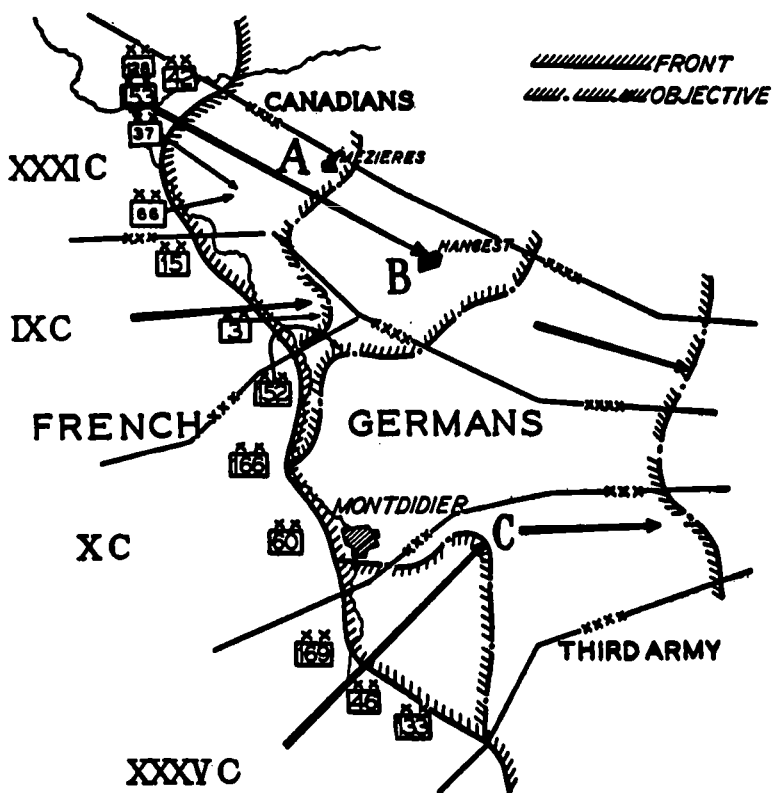

PLATE 29. THE BATTLE OF MONTDIDIER, 8-12 AUGUST 1918.

At 5:05 A. M., 8 August, the XXXI Corps advanced to the attack to the south-east. Four hours later, the IX Corps attacked due east. The entrance into action of the XXXV Corps depended on the capture of the Hangest Plateau; it was initially slated for 10 August. With the attack in the north succeeding beyond expectation, the XXXV Corps was launched a day ahead. The enemy was completely surprised; the "pincers attack" had a decisive success. During the night of 10 August, the Germans evacuated the Montdidier pocket.

Examined from the viewpoint of "combination of direction," the scheme of maneuver of this battle of Montdidier may be considered as a series of attacks practically at right angles:

- ...combined attack of the 37th and 66th Divisions at 7:00 A. M.,
- ...combined attack of the XXXI and IX Corps at 9:00 A. M.,
- ...combined attack of the XXXI and XXXV Corps at 4:00 P. M.

This maneuver is an example of the combination of directions in the domain of an army. However, one frequently finds similar combinations in lower echelons; there are several examples in this same battle of Montdidier, particularly in the maneuver of the 66th and 37th Divisions, or of the 152d and 166th Divisions.

In this situation a very important point is raised: *the continuity of maneuver forms regardless of the size of the unit.* It is as if one applied a magnifying glass to the maneuver procedure of a division, like the 66th for instance (these divisions rarely contained more than 10,000 men). The procedure is thus enlarged to an identical picture representing a corps, such as the IX or XXXI; inversely, the maneuver of the corps is duplicated by divisions and brigades.

12. PRELIMINARY CONDITIONS AFFECTING DIRECTION.

As one reflects on the example just shown, two conditions appear to be necessary in order to affect "combinations of directions"; (1) The enemy front must have *sinuosities*, and (2) The terrain must have a sufficient number of *compartments*.

If the enemy's front were absolutely straight, one would first have to make a breach in it, before attempting a "combination of directions."

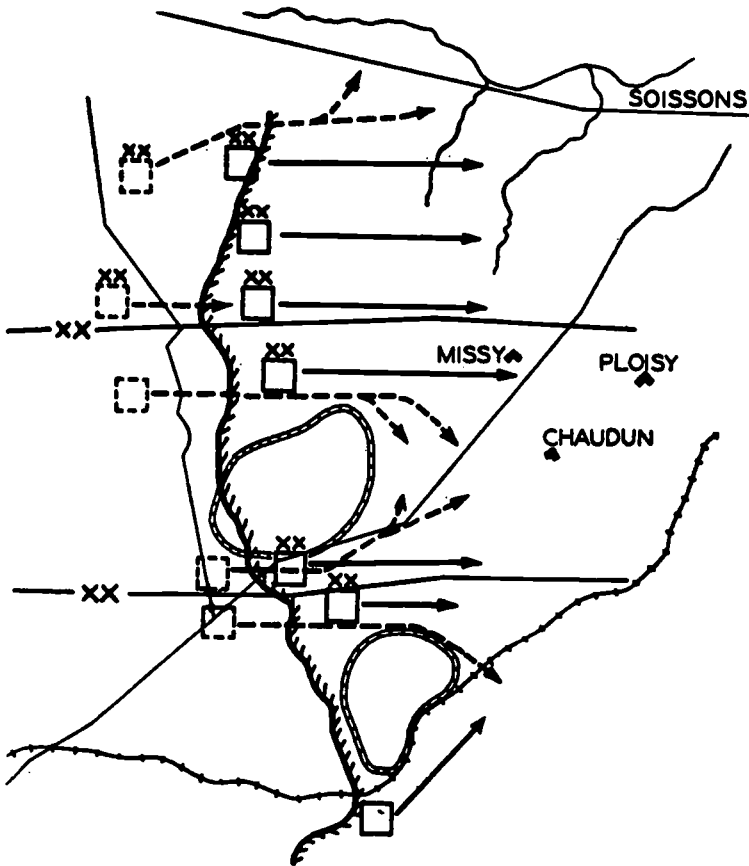

PLATE 30. THE ATTACK OF THE FRENCH TENTH ARMY:
VILLERS-COTTERET, 1918.

As to terrain, it should have a sufficient number of compartments so that converging attacks do not develop on terrain subject to the same system of fires; since one of the movements would come under enfilading fires.

Now, it is quite possible that the enemy may present a comparatively straight (rectilinear) front; in that case, *combination of directions are held in abeyance*, in the beginning, but may be used later on. They appear, therefore, in the form

of direct actions of the troops in first line, combined with encircling movements effected by the troops in rear.

Note the scheme of maneuver of Mangin's Army in the region of Villers-Cotterets, in which the American 1st and 2d Divisions formed the bulk of the forces engaged and distinguished themselves conspicuously.

It is quite obvious that the front-line divisions are intended to drive straight ahead into *open terrain*, while the divisions in second line are making enveloping maneuvers around wooded areas or particularly difficult terrain.

This is a valuable procedure because these enveloping maneuvers, i.e., true "combinations of directions," apply not only to woods or localities but to any terrain, area or zone which presents difficulties of a tactical nature.

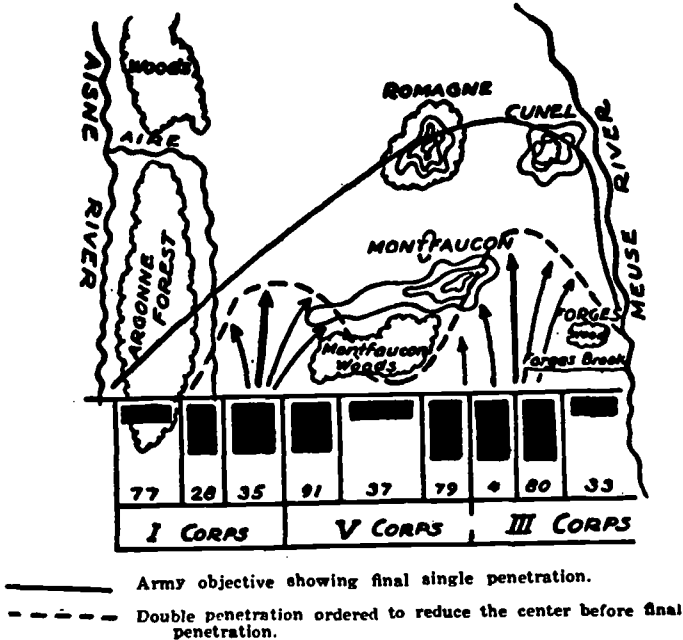

PLATE 31. THE MEUSE-ARGONNE OPERATIONS, U. S. FORCES, 1918.

The initial conception of the American Meuse-Argonne Offensive was based on this same idea, and the general procedure is identical with the operations at Villers-Cotteret: A drive into "open terrain," initially avoiding the difficult Montfaucon area, to be taken by subsequent encircling actions.

This offensive, while treated here from the viewpoint of *combination of direction*, can be viewed from other equally important angles: *concentration of mass on a decisive front*, embodying the principles of *objective, offensive and concentration*. The strategical importance of the American sector was second to none on the entire Western Front: ". . . the danger confronting the enemy made it imperative that he should hold in front of the American Army to the limit of his resources." (Pershing) Only fourteen days elapsed between St. Mihiel and the Meuse-Argonne—two major operations; the bulk of the troops and services employed in the St. Mihiel attack were again used on the Argonne front; at the end of the first day, at St. Mihiel, the transfer of combat units from the battlefield was begun. This concentration involved the withdrawal of eleven French and Italian divisions and the entrance of three American corps. About 220,000 men were moved out of the sector and 600,000 men into it, in addition to enormous quantities of supplies and ammunition. All movements were made under cover of darkness, by rail, truck transportation and marching. This was unquestionably the *greatest, single concentration in American military history*, to date; it is obvious that the most competent staff coordination was required; the task was executed with smoothness and precision and without the knowledge of the enemy. ". . . The details of the movements of troops connected with this concentration were worked out and their execution conducted under the able direction

of Colonel George C. Marshall, Jr., of the Operations Section, General Staff, First Army." (Pershing) This brilliant officer has since risen to the highest post in the American service, that of Chief of Staff.

13. **DIRECTION IN OFFENSIVE COMBAT.** To make a summary at this point: the previous situations are examples of the offensive against an *enemy in position*, to show the presence and the effect of the factor of "direction" or "combination of direction."

We shall now take up direction in the offensive *against an enemy in movement*; it presents a situation which ordinarily favors "combination of directions."

When two adversaries attack simultaneously in open warfare situations, spontaneous breaks or gaps develop frequently in the front of combat.

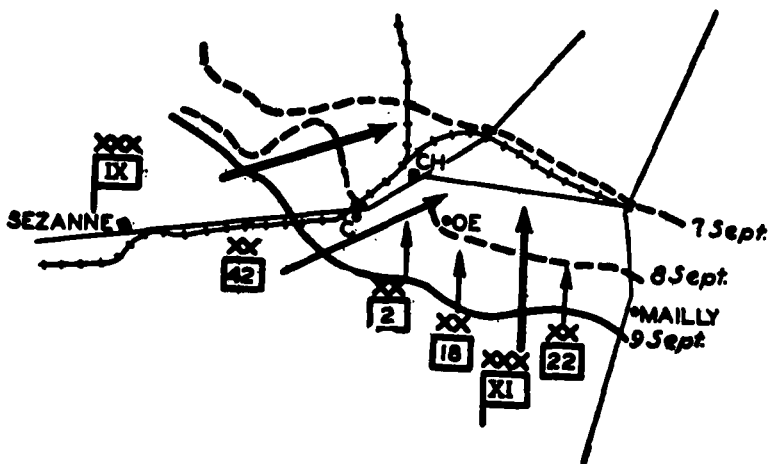

PLATE 32. THE BATTLE OF LA FERÉ CHAMPENOISE, 9 SEPTEMBER 1914.

The Battle of La Fere Champenoise, 9 September 1914, offers a good example.

On the evening of 7 September 1914, the front of the IX and XI Corps passed through Oyes—Sommesous. During the 8th and 9th, the Germans pushed their lines as far as the Maurinne Creek; a gap develops between Connantere (C) and Oevvry (OE). General Foch placed the 42d Division in army reserve in the vicinity of Pleurs. He decided to counterattack with the 42d Division through the gap between Connantere and Oevvry. The attack direction of this division was northeast. He ordered this attack to be supported on the right by the XI Corps and on the left by all available elements of the IX Corps; the axis of attack for the divisions in the XI Corps ran practically north; there you have a *combination of directions* made possible by a gap in the line.

This phenomenon of breaks or gaps in the combat front is frequent in occurrence and of special importance when two armies meet each other obliquely.

This is what occurred in the Battle of the Ardennes, in August 1914. The French and German armies collided at nearly right angles and from this resulted a fragmentation of the battle into several isolated combats, in the course of which one can clearly see *combination of directions* come into spectacular play.

Stripped of all details, the axes of attack in all examples shown are *combinations of direction* and variations of that simplest and most elementary of maneuvers, the *pincers attack*, the combination of *frontal* and *flank* attacks.

14. DISTRIBUTION OF FORCES. FRONTAGES.

In examining the second basic factor, that is *distribution of forces*, the official language of *Field Service Regulations*, is perfectly clear:

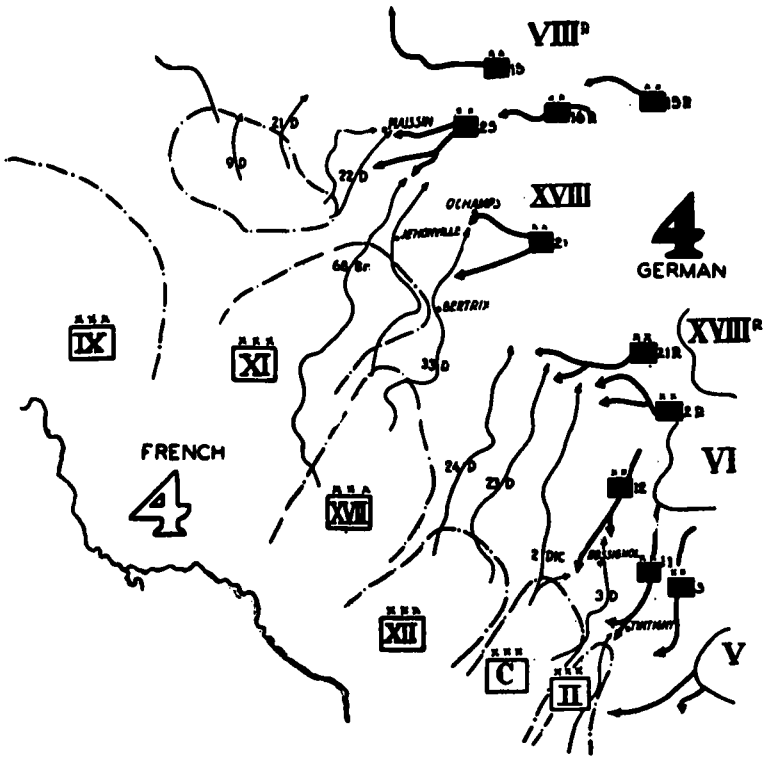

PLATE 33. OPERATIONS OF THE FRENCH FOURTH ARMY, 21-22 AUGUST 1914.

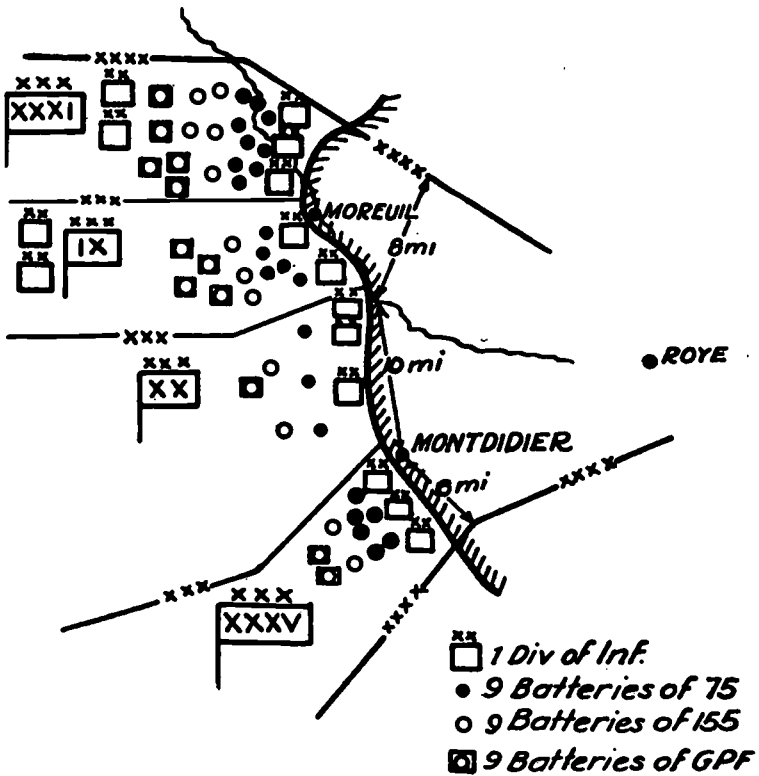

PLATE 34. MONTDIDIER, 8 AUGUST 1918. FIRST ARMY PLAN.

(5)

Par. 385: ". . . The necessity for concentrating the greatest possible force at the point of decisive action requires strict economy in the strength of forces assigned to secondary missions . . ."

That is a relatively recent idea. We find little of it in the combats of ancient time. Napoleon gave it a place on the battlefield, although it was chiefly in the domain of strategy that he made use of concentration of forces.

However, the procedure became of current use during the World War; under existing conditions the execution of an attack required so great a development of means and fires that it had to be strictly localized; there was never enough of matériel and man power to maintain offensive strength over the enormous fronts. The thought is still behind the present conception of a "main effort" or "main and secondary attack."

The distribution of forces along the front of the First French Army, on 8 August 1918, is typical of World War practices.

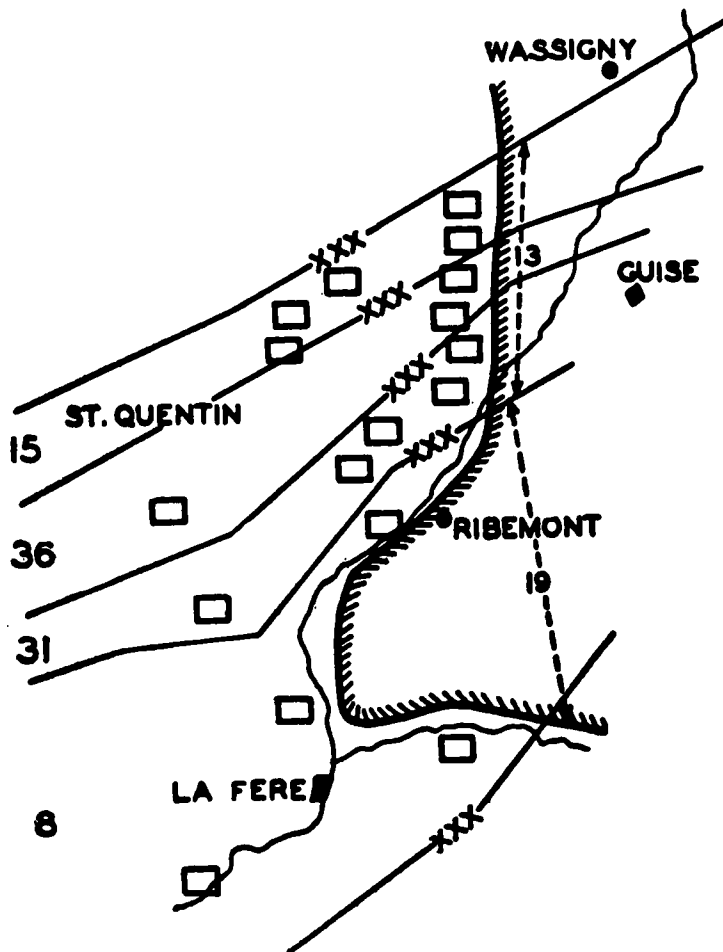

PLATE 35. FIRST PHASE, SECOND BATTLE OF GUISE, 17 OCTOBER 1918.

In the Moreuil sector, along the left wing of the army, representing about one-third of its front, the Army Commander concentrated one-half of his infantry and two-thirds of his artillery: 9 infantry divisions, 126 batteries of 75-mm, 72 batteries of howitzers and 72 batteries of heavier calibers (G.P.F.'s). This is cer-

tainly *strict economy* on *secondary missions* as well as *concentration* at the point of *decisive action*. There are any number of similar, convincing examples.

The same economy in the strength of forces assigned to secondary missions, in the clear language of *Field Service Regulations*, is very strikingly carried out in this operation. The VIII Corps held on a front of 19 miles with only four divisions, while the army massed three times that number of divisions behind an attack front of only 13 miles.

15. **FRONTAGES. COMBAT DENSITY. HISTORICAL EVOLUTION.** In reflecting on the examples, distribution of troops on variable frontages appears to be the practical application of the principle of economy of force with a view of creating mass at important points or sectors; once more one is confronted with the transfer of this principle to the modest scale of smaller units; the situations at Guise, Montdidier, Villers-Cotterets and the Argonne, applied to armies but within each army, corps and division, simply take a proportional part of the front. Within the division, regiments and battalions in turn, occupy fragments of the common front. Concentration as a term applied to larger units, in the *field of strategy*, becomes combat or troop density, in the *field of tactics*.

Distribution in depth and frontage are inter-dependent. In every deployment for action a decision will have to be made regarding *depth of formation* and *extension of front*.

Extended formations have great initial combat power (fire) and facilitate enveloping maneuver, but their energy is not constant without means to replace casualties. Distribution in depth makes it possible to initiate the combat with a part of the force, develop the situation and fight the action with another part in accord with the information obtained by the leading echelon and force a decision with the remainder. A formation in depth enables the commander to exercise a constant influence on the course of action.

In this connection, it is very natural to seek an expression of frontages in yards.

It is difficult, and sometimes undesirable, to establish rigid standards; a recent authoritative statement, in one of our service schools, is very pertinent: ⁸

“. . . The determination of frontages depends upon many considerations. The mission, strength, terrain, supporting forces, communication, condition of troops and characteristics of the enemy are some of the many factors that affect this determination. The variables involved are, to a large extent, local in their application and are of such a nature as to render it difficult and in some respects undesirable to set definite figures for maximum and minimum frontages; on the other hand, guide figures are desirable in order to effect economy of personnel, as well as to give higher commanders a gauge that may be used in assigning tasks to front-line units. For the purpose of establishing guide figures only, the following frontages for the war-strength battalion in the attack are used in the instruction at The Infantry School: *Strong attack*: 800 to 900 yards. *Secondary attack*: Usually not to exceed 1200 yards.”

As usual, the historical approach will throw light on any controversy and, in this case, it does furnish a competent basis of comparison and guide figures that are directly traceable, in origin, to battle conditions.

16. **INTERPRETATION OF DENSITY TABLE.** *a.* Any comparison requires a definite yardstick in order to avoid distortion; regardless of merit, a uniform yardstick will usually develop salient features. The yardstick employed here is *density per yard of front*, i.e., the actual battlefield frontage and total infantry employed thereon. Both line and depth (i.e., area) are *implied in this scheme*. *This line of thought is common to all foreign military literature.*

For example: The 1st Division, A. E. F., Soissons, 18 July 1918, attacked on a front of 2900 yards, with a rifle strength of 13,500; the troop density per yard of

⁸ Mimeo Circular, "Frontages: The Infantry Battalion," 1939, The Infantry School, Ft. Benning, Ga., Col. Courtney Hodges, Assistant-Commandant.

MANEUVER IN WAR

Year	Battle of Engagement	Belligerents	Density Per Yard		Remarks
			Inf.	Art.	
PRE-NAPOLEONIC PERIOD					
1757	Prag	Prussians	11.0		Muzzle-loader
NAPOLEONIC PERIOD					
1805	Austerlitz	French	7.1		Muzzle-loader
		Allies	6.1		
1807	Friedland	French	9.5		Muzzle-loader
1807	Wagram	French	7.7		Muzzle-loader
1809	Bautzen	French	9.5		
		Allies	5.5		
1815	Waterloo	French	10.8	46	Muzzle-loader (Musket)
		British	9.0	25	
POST-NAPOLEONIC PERIOD					
1859	Solferino	Franco-Sardinian	6.3	19	Muzzle-loader (Musket)
		Austrian	6.3	21	
1866	Custoza	Austrian	7.2	17	Muzzle-loader (Musket)
1866	Koniggratz	Prussian	8.4	39	Large caliber, Breechloader
		Austrian & Saxon	9.0	43	
1870	Worth	German	8.1	37	Large caliber, Breechloader
1870	Gravelotte-	German	12.3	46	Large caliber, Breechloader
	St. Privat	French	7.2	32	
1899	Colenso;	British	1.3	4	Small caliber, Magazine rifle
Dec 15	1st Battle				
1900	Colenso;	British	2.2	7.5	Small caliber, Magazine rifle
Feb 27	2d Battle				
1905	Mukden	Russian	.9	5	7.6-mm Magazine rifle opposed to 6.3-mm
Feb 20			2.7	15.5	
		Japanese	3.1	11.5	
1905	Mukden	West Russian	4.5	18	
Mar 3		Front Japanese	3.1	11.6	
		South Russian	1.5	6	
		Front Japanese	1.9	5.6	
1905	Mukden	West Russian	4.1	15.6	
Mar 7		Front Japanese	3.6	10.5	
AEF: AMERICAN OPERATIONS (QUIET FRONT)					
1918	St Die Sect.	5th Div	.37		Front of 32,500 yds. Rifle strengths approx: 12,000.
Aug 19					
1918	Baccarat Sect.	77th Div	.69		Front of 18,500 yds. Rifle strength: 12,800.
July 26					
1918	Lucy Sect.	89th Div.	.68		Front of 17,500 yds. Rifle strength: 12,000.
Aug 23					
1918	Alsace: East of Belfort	29th Div	.83		Front of 15,500 yds. Rifle strength: 12,800.
Aug 24					
1918	Sazerais Sector	1st Div	1.13		Front of 11,500 yds. Rifle strength: 13,000. Took over exact sector of a weaker French Division.
Aug 16					
AEF: AMERICAN OPERATIONS (ACTIVE FRONT)					
1918	Cantigny	1st Div	1.71		Front of 7,600 yds. Rifle strength: 13,000. German offensive anticipated.
June 4					
1918	Aisne-Marne (Fismes)	3d Corps	1.75		Two Divs., 28th and 77th, Front of 12,000. Rifle strength: 21,000. German reaction expected and further advance planned.
Aug 16					
1918	Thiaucourt	78th Div	1.62		Front of 7,600 yds. Rifle strength: 12,300. Division was holding against possible enemy reaction.
Sept 21					
AEF: AMERICAN OPERATIONS (ATTACK)					
1918	Soissons	1st Div	4.65		Front of 2,900 yds. Rifle strength: 13,500.
July 18					
1918	St. Mihiel	5th Div	5.16		Front of 2,500 yds. Rifle strength: 12,900. Division attacking over open ground in centre of main attack of First Army.
Sept 12					
1918	Argonne	5th Corps	3.21		Front of 11,500 yds. 79th, 37th, and 91st Divs. in line. Rifle strength: 37,500. Centre of main attack.
Sept 26					
1918	Le Cateau	2d Corps	4.08		Front of 4,000 yds. 27th and 30th Divs. in line. Rifle strength: 16,300.
Oct 17					
AEF: AMERICAN OPERATIONS (OPEN WARFARE)					
1918:	Argonne: East of Meuse	3d Corps	.85		Three Divs. in line. Rifle strength: 25,000. Front of 29,500 yds.
Nov 11					
1918	Argonne	5th Corps	.90		Two Divs. in line. Rifle strength: 18,000. Front of 20,000 yds.
Nov 11					

Sources: Balck, "Taktik," Vol. V, Sec. III and Vol. I, Sec. V-4. General Minarelli-Fitzgerald, "Infanterie Reflexiones." Col. F. N. Maude, "Evolution of Infantry Tactics." Monograph No. 4, W.P. Div., 1919, "Troop Frontages."

front was consequently 4.65; this coefficient, of course, does not mean that over four men were clustered on a single yard; it reveals, at once, a formation in depth for a sustained effort in attack.

Organization	Unit	Strength	Frontage	Density
1st Division	Battalion	1100	725	1.5
A. E. F.,	Regiment	3300	725	4.6*
18 July 1918	Division	13,500	2900	4.65

* The division attacked with four regiments in line, the regiments in column of battalions.

On another occasion, Sazerais Sector, 16 August 1918, this same division occupied a front *four times as large*, or 11,500 yards, with a rifle strength of 13,000 and a density coefficient of 1.13, or *one-fourth* the Soissons figure; this reveals, at once, occupation of a quiet sector for defense.

b. It is apparent that densities were not greatly diminished, in the period 1757 to 1905, although the breechloader appeared as early as 1866.

The Russo-Japanese and Boer War may not be conclusive, since defensive and offensive fluctuated markedly within a single engagement (Mukden).

c. World War densities, 12 September 1918, while lower, rise to 5.16 (St. Mihiel), which was the Russian density on 3 March 1904, Mukden, West Front.

d. A direct comparison between frontages of the 1st Division, A. E. F., at Soissons and the proposed Infantry School frontages (1939) with identical attack formations is rather interesting.

Organization	Unit	Strength	Frontage	Density
1st Division	Battalion	1100	725	1.5
A. E. F.,	Regiment	3300	725	4.6
1918	Division	13,500	2900	4.65
T. O. 7-11 to 77	Battalion	696	850*	0.8
War Dept.,	Regiment	2411	850	2.8
1939	Division	7233	2550	2.5

It is apparent that the resulting combat densities fall below World War coefficients for sustained efforts in attack against organized positions, but they are probably adequate in view of the possession of an increase in armament and fire power through the adoption of the M-1 rifle, improved light machine gun, medium and small-caliber mortars and improved antitank guns.

To test the validity of any comparison, one may ask if the type of action, as at Soissons, is obsolete. In its larger aspects, this is a challenge of World War experience.

It should be noted that the German defensive position at Soissons was relatively shallow; it was not organized to the degree of other fronts, such as the *Siegfried Stellungen*. The offensive operation was still in progress elsewhere in the Marne salient.

Spain and China have shown the eventual appearance of organized resistance on stabilized fronts. With all of Spain to fight over, the principal efforts settled on the Madrid, Teruel and Ebro fronts, requiring "breakthrough" measures of the pattern of 1918. In China, organized defensive lines had to be broken at Shanghai and in the Lung-hai. In the Civil War, with all of Virginia to roam over, the contestants settled on the Richmond-Petersburg defensive front.

The *problem of frontages* is closely connected with the *depletion in rifle strength*, noted by General Lynch^o as an undesirable characteristic of the latest (1939) organization.

Frontage and combat-density are *expressions of combat strength*; the average A. E. F. division had a very considerable rifle strength, far superior to the pro-

^o Average of: 800-900 yards; the formation is identical with the 1st Division, A. E. F., i. e., regiments 3 abreast, regiments in column of battalion.

MANEUVER IN WAR

	Frontage of attack	Divisions in front line	Frontage of attacking divisions in yards	Divisions in line and close reserve	Force per mile of front
Somme, March 1918 (German attack)					
Cojeul to Bapaume-Cambrai road	12 miles	10	2,100	18	1.5 divs.
La Vacquerie to La Fere	33 "	23	2,500	37	1.1 "
Total front of actual attack (a)	45	33	2,400	55	1.2 "
Lys, April 1918 (German attack)					
Ypres-Comines Canal to Frelinghien	6 "	4	2,600	6	1 "
Bois Grenier to La Bassee Canal	11 "	9	2,150	14	1.4 "
Total front of actual attack (b)	17 "	13	2,800	20	1.2 "
Aisne, June 1918 (German attack)					
Leuilly to Courcy	33 "	18	3,200	23	0.7 "
Montdidier-Noyon, June 1918 (German attack)					
Montdidier to Noyon	22 "	11	3,500	16	0.7 "
Somme, August 1918 (British and French attack)					
River Avre to Morlancourt	15 "	9	2,933	17	1.1 "

(a) The front of 8 miles from the Bapaume-Cambrai road to La Vacquerie was lightly held by four divisions.

(b) The 6-mile front from Frelinghien to Bois Grenier was very lightly held by one division.

The above figures show the strength of the force concentrated in line and close reserve for some of the attacks during the early portion of 1918. No account is taken of the portions of front which were not actually attacked, and, therefore, lightly held, nor of divisions which were some distance in rear and presumed to be in army or GHQ reserve.

Note: In the Somme battle each corps averaged $4\frac{1}{2}$ divisions and attacked on a front of 3 miles on the northern portion, and of 4 miles on the southern portion.

In the Lys battle each corps averaged $3\frac{1}{3}$ divisions and attacked on a front of about 3 miles.

In the Aisne and Montdidier-Noyon battles, each corps was composed of roughly 4 divisions and attacked on a front of $5\frac{1}{2}$ miles.

For the four battles the German attacking corps have averaged 4 divisions and have attacked on a 4-mile front with $2\frac{3}{4}$ divisions in reserve.

PLATE 37. FRONTAGES, WORLD WAR: ALLIED AND GERMAN ATTACKS.

portional infantry (rifle) strength of the modern organization: 12,800 against 7223. The "breakthrough" of the West Front in 1918 literally *consumed infantry*; the 1st Division at Soissons had to endure three days of consecutive combat. This *lasting power can be recognized in the density figure of 4.65*. Can greater or equal *staying power* be expected with reduced *man power* which is reflected in the shrunken densities of .8 to 2.8?

Place	Date	Number of Divs. in front line	Frontage per Div. in yards
Somme (British)	1916	13	1,700
Arras (British)	1917	16	1,800
Messines (British)	1917	12	1,700
3d Ypres (British)	1917	15	1,600
	March		
Somme (German)	1918	33	2,400
	April		
Lys (German)	1918	13	2,300
	May		
Aisne (German)	1918	18	3,200
	June		
Noyon-Montdidier (German)	1918	11	3,500
Champagne	July		
East of Rheims (German)	1918	15	3,050
Champagne	July		
West of Rheims (German)	1918	17	3,000
	August		
Somme (British)	1918	9	2,933

Note change in organization, from four (4) to three (3) battalions per regiment in this period, viz: (4) Somme, Arras, Messines, 3d Ypres; all others (3).

PLATE 38. SUMMARY OF FRONTAGES: ALLIED AND GERMAN ATTACKS.

General Lynch's brilliant article¹⁰ on the new infantry regiment "expressed concern over the reduced proportion of riflemen not only in the infantry regiment but in the whole army . . . the reduction in regimental strength has fallen almost wholly on the riflemen; a division of 12,000 men will have less than 3000 riflemen in rifle companies; a division of this strength will have little power to *carry the fight to the enemy* and the depletion incident to even minor combat will quickly reduce it to a wholly ineffective level."

⁹ Major General George A. Lynch, Chief of Infantry (1938). His administration will become known for a complete modernization of infantry, in organization, armament and equipment; not since the World War has American infantry had the benefit of such far-seeing and constructive leadership.

¹⁰ *The Infantry Journal*, March-April, 1939.

IV

THEORY OF MANEUVER

17. **THE STRUCTURE OF BATTLE.** The process of analysis is the isolation of elements; the process of synthesis is their fusion. In dismantling the structure of maneuver, as in previous paragraphs, there remains the obligation to assemble it again. It is evident that the military action at Montdidier, Guise or La Fere Champenoise consisted essentially in the application of the factors of direction and mass; mass was shown to be dependent on frontages and for the general purpose of "concentrating the greatest possible force at the point of decisive action."¹

Application implies control, unity of combat, and unity of direction, which is a function of the commander; ". . . the army commander himself conducts the battle . . . he gives the operation . . . unity of direction."²

It is desirable, at this point, to examine the structure of battle. Battle in the broadest sense should mean the *ensemble of operations*; the operation of a large unit is *not a single act*; it is an *aggregate of smaller, individual operations*. This thought has not always been accepted. There are, consequently, several theories on maneuver. At the base of each is found a special theory on the nature of decisive action.

One school of thought³ divides the battle into two acts: a period of preparation, with the object of wearing out the enemy; then, an act of force, due to the intervention of fresh troops reserved until that moment. *It is this act of force which constitutes the decisive period of battle.*

In the opinion of another school⁴ there is no single important issue in battle. The battle is the aggregate of a series of separate combats, the sum of which produces success.

In the first system, there seems to be a denial of the "preconceived maneuver" which will be shown presently as entirely workable; furthermore, the theory is predicated on the so-called decisive action, time and place, and it will be shown that decisive time and place are elusive and hard to fix.

The second system would seem to imply that the essential decision of the commander will be made in advance. The high command must adopt a positive solution, in advance,⁵ in order not to be led astray by events. Our own regulations appear to stress anticipation: "To command is to foresee"; consequently, in large units, the principal mission of the commander is to prepare the battle rather than to conduct it on the ground.

¹ Par. 385, F. S. R.

² *Manual for Commanders of Large Units*, Par. 42.

³ France.

⁴ Germany.

⁵ *Franco-Prussian War, 1870.*

At the beginning of the campaign of 1870 the French never decided definitely whether "to attack, to await attack, or maneuver in order to gain time." The initial collisions, in the Franco-Prussian War, leading to the battles of Saarbruck, Weissenburg, Worth and Spicheren are very characteristic. In every case, the French were acting without general plan. On the German side also, engagements which were intended for reconnaissance only, often developed into major operations, in spite of orders of the high command. The Battle of Worth is characteristic of this tendency: during the entire morning of August 6th the German divisions, arriving successively in the battle area, delivered a series of uncoordinated attacks.

This tendency is probably unavoidable in the so-called meeting engagements; forty-four years afterwards, similar phenomena could be observed in the Battles of the Frontiers, August 22, 1914, and at Ethe, Virton, Rossignol, Tintigny, etc.

As to the opening moves of the French, in 1870, the general dispositions of the troops were ordered before a general plan of action was decided on. ". . . absence of any scheme was the only characteristic of the French leadership at this time." (German Official History.)

"From the beginning of affairs, the mental attitude of the French leaders was defensive and they were ready to follow the German leader rather than to impose on them their will." (Bird: *Strategy of the Franco-German War.*)

Russo-Japanese War, 1904.

The Russian High Command operated just about like the French in 1870; they were vague and vacillating about a general plan. On the Yalu, Zasluch received contradictory orders as to his role.

It may be argued that the final conclusion in this theory implies a loss of control after the units are launched in their respective directions. That happens to be a fact!

There is nothing startling in this conclusion. It has already been officially conceded.⁶

“. . . the leader can materially influence the course of an action, once begun, only through the employment of his reserves . . .”⁷

To be consistent, the principal differentiation in the features of each system or theory of maneuver might be summarized as follows:

- | I | II | III |
|---|--|---|
| a. The battle must be conducted in its entirety, on the ground. | a. The battle cannot be conducted in its entirety, on the ground. ⁸ | a. The battle may be conducted, primarily with the intervention of reserves. |
| b. The decision is held in abeyance until the enemy is engaged. ⁹ | b. The decision is always made in advance. | b. The decision is generally made in advance. |
| c. The engagement of the forces is gradual; it comprises a period of preparation and a period of decisive action. | c. The engagement of the force is sudden ¹⁰ and its broad lines are fixed from the beginning; after that, there can be only changes in details. | c. The engagement of the forces is gradual, comprising a period of preparation and a period of decisive action. |

⁶ F. S. R., par. 397.

⁷ *The First Battle of Gaza, 1917.* The command arrangements for this important battle and the position of headquarters were defective: Dobell, who commanded all the troops in the field, was preoccupied and remained with the frontal attack (53d Division), Chetwode was with the mounted force and Murray, the C. in C., who had come up to El Arish, had a command post on his train. He became a mere spectator, since he had no troops directly under his orders and could consequently exercise little control over the fight.

During the first two battles of Gaza, the headquarters of the British force was still at Cairo, some 250 miles away. When Allenby took over command, he moved headquarters to the vicinity of Rafa.

The command situation and possibilities of command control as developed in the first battle of Gaza are very significant: they have a direct bearing on this business of "the battle can (or cannot) be conducted in its entirety, on the ground."

⁸ Note the difficulties in "conduct of battle" that arose in Gallipoli. The C. in C. was continually separated from his administrative staffs with undesirable, almost disastrous results.

In the landing at W-Beach, General Hare and some of his staff moved up with the leading troops; the general was wounded, no one knew where he was and there was consequently a great deal of confusion.

At the first Battle of Krithia, General Hunter Weston sent forward Brig. General Marshall with a more or less roving commission to superintend the advance. Marshall took with him a few officers to act as a temporary staff; having no fixed headquarters and telephone it was impossible for him to exercise adequate control over a two-mile front, and this delegation of divisional authority led to delay and confusion in the issue of orders and despatch of messengers. (Official History, Vol. I, p. 289.)

⁹ *French Doctrine, 1914:*

The French Army had absorbed the theory of the offensive to a point where it had become a disease; it was the offensive in every case and regardless of situation, the blind offensive—l'offensive à l'outrance; as a result, no attention was paid to effect of fire; the French army was thrown into battle with superb esprit but with a disdain of fire for which it had to pay dearly.

French Doctrine, 1938:

This war experience has had its effect on modern practices; the keynote of the modern regulations is "tactical prudence"; the first item is a strict centralized control; corps move from phase line to phase line; there is frequent interference in the business of lower headquarters; corps, for example, may prescribe the number of battalions to be used in the front line.

¹⁰ In Ic and IIc, there is a definite conflict in assumption: Is the engagement gradual or is it sudden? Historical experience tends to suddenness, as in meeting engagements. There is a feeling that this type of action has become impossible because of the efficiency of modern aerial reconnaissance.

The so-called meeting engagement, i. e., a collision of forces on the march, requires deployment from march column and is characterized by relative lack of information. Not all armies recognize this type of engagement officially and prescribe certain combat procedures.

While it is obvious that premature or piece-meal attacks of the leading echelon may result in partial or local defeats, and possibly force the hand of the commander, undue caution or a desire to refrain from the offensive until the development is complete may mean the loss of important tactical opportunities:

Auerstaedt, 1806: Prussians and French collided frontally, in march columns; the action developed through piece-meal employment of units as they arrived. Davout was finally successful, through a more rapid deployment of his forces and the skillful parry of all enemy movements.

Katzbach, 1813: The French crossed the Katzbach in several columns; the impression prevailed that no encounter would take place on that day; visibility was poor on account of rain and fog. The Allies, however, were ready for combat and vigorously attacked the heads of the French columns. Delayed and time-consuming development of the French march columns, failure to coordinate an attack, etc., brought on a French defeat.

Vionville, 1870: The German 5th Division emerged from the defile of Gorze, to collide with the French II Corps en route via Gravelotte. The division deployed from march column and attacked vigorously; this brisk, energetic action eventually slowed down the movement of the entire French army.

Elbe, August 22, 1914: In the dense fog that prevailed in the early morning hours, elements of the IV French Corps, advancing in two columns, ran into the Germans—a typical meeting engagement. The cavalry encountered early German machine-gun fire and was practically annihilated; the scattered remnants fell back through the village where they interfered with the passage of infantry. The infantry of the advance guard and leading brigade was fed

While not entirely outspoken, our own military literature seems generally to favor the third system (which is really a blend of the first and second theories) with the implication that the decision is made in advance, by grouping large units in accord with a preconceived maneuver idea but with the possibility of its modification and adaptation, according to the terrain and the reactions of the enemy.

These systems are the echo of the Napoleonic maneuver, which in its intellectual quality remains unchallenged to this day. It is covered in great detail in subsequent chapters.

A comparison of this brief tabulation of theories of maneuvers reveals certain controversial, even contradictory features, particularly as regards the "decision made in advance" or "held in abeyance," and the subject of "decisive action."

18. DECISIVE ACTION. POINT. PLACE. TIME. The inherent logic of a subject determines its own sequence. In touching on controversial features of the decision, i.e., scheme or plan of maneuver or the "broad lines of an engagement," we are brought face to face with the items "point, time and place of decisive action." These important terms (F.S.R.) have appeared previously:

Par. 379: "Concentration of superior forces, both on the ground and in the air, at the decisive place and time, creates the conditions most essential to decisive victory . . ."

Par. 385: ". . . concentrating the greatest possible force at the point of decisive action requires economy in . . . secondary missions."

The implications in Pars. 379 and 385 are that such concentrations are planned a priori; one cannot practice economy on secondary missions without having previously selected the decisive point for the assembly of superior forces. Obviously, this reasoning has a direct bearing on whether the decision is *held in abeyance* or *made in advance*.

What is meant by *decisive place and time*? By what signs can one recognize the *point of decisive action* and the *right moment*?

We may as well accept, without argument, that there is a *decisive time and place* in every battle—a moment when the balance swings decidedly to one side; this is an ordinary fact of experience. Without this feature, by its very definition, the battle would remain *indecisive*. Therefore, there is a decisive moment. If an important act has been accomplished at this moment, the point at which it occurred is, evidently, the point of decisive action.

As to this decisive action, we must regard it as the resultant of other actions that preceded it. Eliminate one of the events that occurred before it, and the decisive moment will be affected. And when the act that is considered as *decisive* is reduced to a simple tactical incident, such as the capturing of a crest by one or two companies, as at Nanshan,¹¹ or a distant flanking fire, as at Wafangou, is it not self-evident that this moment derives all of its importance from the general situation in which it was produced?

Let us suppose that a battle was stopped at the precise point we now consider "decisive," for example, at Austerlitz, at the moment of the capture of the Prat-

piece-meal into combat; the division staff was cut off in the village; for a long time no reports got through to the rear brigade or corps headquarters.

Bellefontaine, August 22, 1914. At 6:00 A.M., the 11th and 12th German Divisions advanced south; at the same hour, the 3d French Colonial Division moved north: a meeting engagement was inevitable. (Plate 33). Since the corps advanced in echelon, the right flank of this division appeared covered by the neighboring column of the II Corps; in reality, it could not be effectively protected since the head of that column was eight miles in rear. At 8:30 A.M. the west column made contact, and a sharp advance guard action developed. On the east, however, the German 11th Division advanced on a clear road. Until then, the valley of the Semois was covered by a dense fog; when it lifted at 9:00 A.M., the Germans from the height of Ansard saw at their feet an entire French division in march column. The German advance guard artillery opened fire at 1300 yards; by detaching a flank guard to delay the leading units of the French II Corps, the Germans threw their full strength against the flank of the French 3d Division.

¹¹ Russo-Japanese War, 1904.

zen plateau, or at Castiglione, at the moment of the entrance into line of Serrurier, or at the Ourcq on Sept. 8, 1914.

There is nothing to prevent the enemy from retiring in complete liberty; there is no victory, no decision, no decisive moment. While it is certain that there is a decisive moment, it results from the antecedents of combat; for that reason, we have only an indirect grasp on it; it is an elusive quantity.

On the other hand, there may be the possibility of creating tactical conditions, through maneuver, that may shape themselves to a crisis, to create a general setting that will eventually produce a decisive action. This point is demonstrable by reference to a spectacular historical incident.

●BRIEY

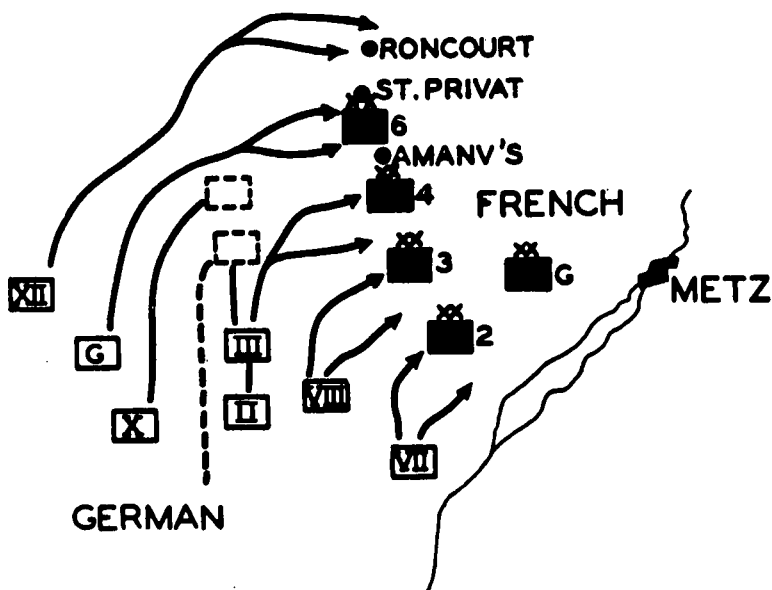

PLATE 39. THE BATTLE OF ST. PRIVAT, 18 AUGUST 1870.

Examine the situation at St. Privat, at about 7:00 A. M. The German Army engaged the French Army on a front of $12\frac{1}{2}$ miles. Near St. Privat, a German division was engaged frontally against the French VI Corps; another division, the 12th Saxon Division, executed a flank attack against the right of this French Corps. Today, we know that the attack of this division decided the fate of the battle; here then was the decisive time and place and the point of decisive action! How did this come about? Had the German commander previously chosen the time and place? Not at all! On the contrary, the German High Command at first believed the French right to be at Amanvillers, then at St. Privat and, finally, found it to be at Roncourt!

What results could have been expected had a plan of attack been based on the initial erroneous information? Perhaps nothing. But the general maneuver was so elastic and supple that these errors were of no importance. Routes and zone of advance of corps were merely modified to enlarge the front of attack.

The plan of the commander-in-chief was not a decisive flank attack at a *fixed, predetermined point*, like St. Privat, but a general maneuver of his entire force, the normal evolution of which was to be an attack on the French right, wherever this right might be found.

If we take the example of St. Privat literally—many others could be quoted—it would appear that the commander cannot foresee the decisive moment, nor does he necessarily have to act upon it.

In the light of this reasoning, what is the precise meaning of Par. 379? As a matter of fact, it only states that superior forces, i.e., mass, applied at the right time and place, create conditions essential for victory. While the language is more formal, this wishful statement is only a modern paraphrase of Forrest's pungent ". . . git tha fustest with the mostest men." The paragraph unfortunately does not state *when* place and time become decisive, and it has just been shown (St. Privat) that, as such, decisiveness has an elusive quality, that the so-called decisive moment or action is the result of all events that occurred before it, that it was generated by them, that it has become decisive only through its place in the ensemble of the action; in other words, that it is the product or resultant of the general maneuver.

Since the creation of mass at the decisive point requires preliminary arrangements, i.e., *planning*, the question immediately presents itself: How far in advance can the commander forecast his action or project his maneuver, and what effect will the projected maneuver have upon the form of its tactical execution?¹³ They are obviously interdependent; decisive action is merely another phase for *tactical effect* and, as shown, only one of a chain of preliminary acts that constitute the general framework of maneuver. There is a border line somewhere and the line of demarcation lies in that twilight zone between strategy and tactics.¹³

What is the American doctrine? Our official texts as a rule do not evade the issue but sometimes leave open a fatal avenue of interpretation and possible conflict.¹⁴

Premise

Par. 13. ". . . The commander-in-chief must foresee far in advance . . . future projects must be foreshadowed . . ."

Par. 27. ". . . The initial disposition of the army should conform to the projected maneuver."

Par. 41. ". . . Engaging the enemy permits the army commander to decide on his plan of action.

Conclusion

Suggests projects in advance.

Suggests maneuver project in advance.

Suggests plan of action depends on engaging the enemy.

Is this a contradiction? Involved, of course, is the general concept of maneuver; in one place, the commander conceives a maneuver far in advance; in another place, he apparently waits until the enemy is engaged.

This discrepancy is more apparent than real. Par. 41 represents the local *tactical application* of the general plan contained in Par. 27. Pars. 13 and 27 probably fall into the category of strategy and deal with movements *prior to battle*, while Par. 41 is a function of tactics and pertains to *conduct of battle*.

However, it can hardly be questioned that maneuver dispositions, under Pars. 13 and 27, will influence tactical action, under Par. 41, to a marked extent; it is not argued that tactical details can be fully decided at a distance from the battlefield but that the maneuver idea (concept) is bound to affect the broad lines of tactical action. This is demonstrable, as a historical fact, in a number of

¹³ See Chap. I, Par. 5 b.

¹³ Chap. II, Par. 8 b.

¹⁴ *Manual for Commanders of Large Units.*

examples.¹⁶ There is no real conflict in this thought, but, from the viewpoint of command function it marks the line of demarcation between large (corps) and small (division) units; a line has already been drawn between tactical and strategic maneuver—one involving concentration of fires, the other displacement of units.

Obviously the *project (forecast) of maneuver* is the *special problem* and responsibility of the commander of large units and is probably a distinguishing mark compared with lesser responsibilities involved in the command of smaller units.

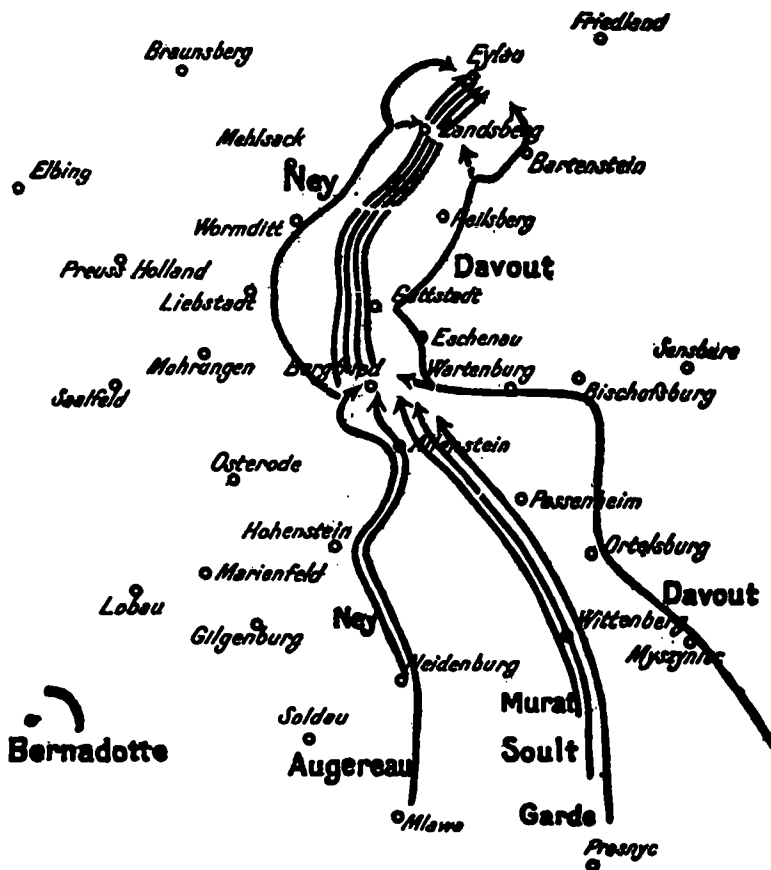

PLATE 40. THE MANEUVER OF EYLAU, 1807

If this distinction could be reduced to a key-word, the slogan for the division (and smaller units) might be "execution" and for the corps (army) "anticipation."

Granted that this business of concept of maneuver primarily concerns larger units, interior units in the prescribed zones of action are practically fighting in narrow corridors; however, the moment they are placed on a flank or on independent mission they are compelled to plan ahead and decide on a maneuver procedure. With modern equipment in motorization or mechanization, in which displacements of troops are made at high speeds, independent missions may become more and more frequent and speed of decision and maneuver concept will be demanded of so-called smaller units; there must be a "project of maneuver" regardless of the size of the unit.

¹⁶ Chap. IV, Par. 19, Eylau 1807. Castiglione, 1796, Lutzen, 1813.

19. THE PRECONCEIVED MANEUVER. History from start to finish shows that passivity of mind is the greatest single military menace; we must make at least a preliminary decision.

As an example, the operations of the French Imperial Army against the Russians, in the maneuver of Eylau, 1807, are characteristic of the relation between the maneuver idea and its execution.

While more recent historical examples are possibly preferable, there will be frequent reference to the Napoleonic period. The stabilized conditions of the World War represent a field comparatively limited in type. To one primarily interested in the war of movement and the mechanics of maneuver, the Napoleonic workmanship is unsurpassed. The great master operated with numbers, fluctuating between 125,000 and 250,000, which is approximately the strength of a reinforced American corps and field army, dealt with in certain of our courses.

The march began in January 1807; the final battle took place on 8 February 1807. On the battlefield of Eylau, Napoleon brought about a double envelopment in conjunction with a frontal attack. If you study the general march dispositions of the French with corps abreast, two flank groups, and a central mass, it is easy to see that the underlying idea of maneuver is preconceived from the beginning of the operations, namely: a central column to fix the enemy when found and two wing columns intended to close in on his flanks. It is this maneuver idea that governed all movements of the army.

The maneuver was attempted on three separate occasions in distinct localities: first at Bergfried, then at Landsberg and finally at Eylau. As soon as the enemy made a stand, the flank columns began to close in on the probable field of battle. In two instances, the enemy refused to fight or recognized the threatening envelopment. The reaction of the enemy, in this historical example, is highly interesting. It may be argued that there is no use in having a preconceived form of maneuver as long as the enemy is able to slip away. This is tantamount to dropping any plan. Furthermore, the problem was solved and a correct procedure formulated by a recognized master of his profession.

When the French columns closed in on Bergfried, and later on Landsberg, only to find that the bird had flown the cage, the "sheaf of the corps" was opened and the march resumed in the old formation, with all the tactical possibilities inherent in the initial disposition. One must acknowledge the enormous suppleness of this system! The maneuver idea is independent of the zone in which it will be effected; whether the battlefield be Bergfried, Landsberg, or Eylau—there would still be a frontal attack aided by two flank attacks.

It is *the idea* only, which was preconceived by Napoleon; its materialization took form later and upon the latest information. It has been demonstrated that the maneuver can be elastic and, up to a certain point, is adaptable to modifications in the situation, introduced by the enemy.

As one reflects upon this classical campaign, one has a perfect interpretation of Par. 37,¹⁸ and can see that there is no real contradiction in Par. 41—one represents the march disposition of the French army, dictated by a maneuver idea; the other the tactical application of the idea on the battle localities of Landsberg, Bergfried, and Eylau, or any other locality on which the Russians might have elected to make a stand.

The factor of anticipation, implied in high command, is of sufficient importance to trace it in an additional example: the well-known case of Castiglione.

This battle consisted of (a) a frontal combat by Augereau's and Massena's

¹⁸ *Manual for Commanders of Large Units.*

Divisions, to force the enemy to engage all his troops, and (b) an attack in flank by Serrurier's Division, initially kept 22 miles from the battlefield.

The battle, in its entirety, was conceived from the beginning. Serrurier's attack was not an inspiration of the moment after having seen the results of the preparatory combat; it was decided upon, in advance, and as an indispensable accompaniment and sequence of the preparatory combat itself.

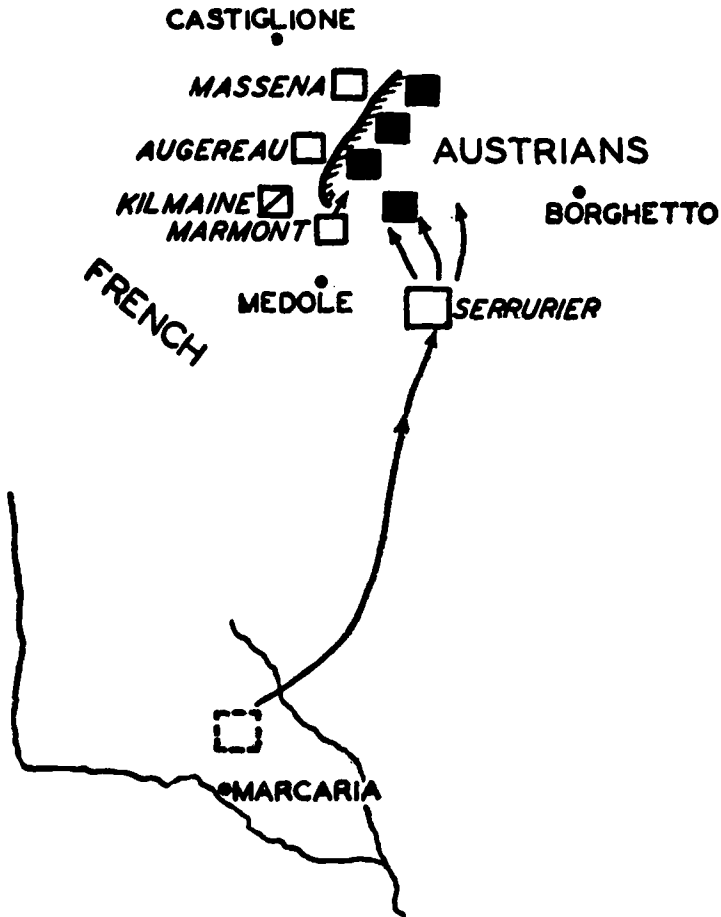

PLATE 41. BATTLE OF CASTIGLIONE, 1796.

The question might be asked: When shall one formulate a plan of maneuver? The answer is: The sooner the better! What made commanders great was the fact that they always had an initial plan and did not rely on improvisations of the moment.

There are numerous examples showing the suppleness of dispositions that are based on an initial maneuver idea, instead of a march into the unknown; for example, the situation at Lutzen, 1813.

In this situation Napoleon made a decision of extraordinary rapidity, the speed of which was remarked upon by many observers. As soon as his opponent's presence was reported in the vicinity of Pegau, he apparently did not even take time to reflect. He dictated his orders without hesitation, and the French Corps promptly changed direction to attack the Prussians in front and flank.

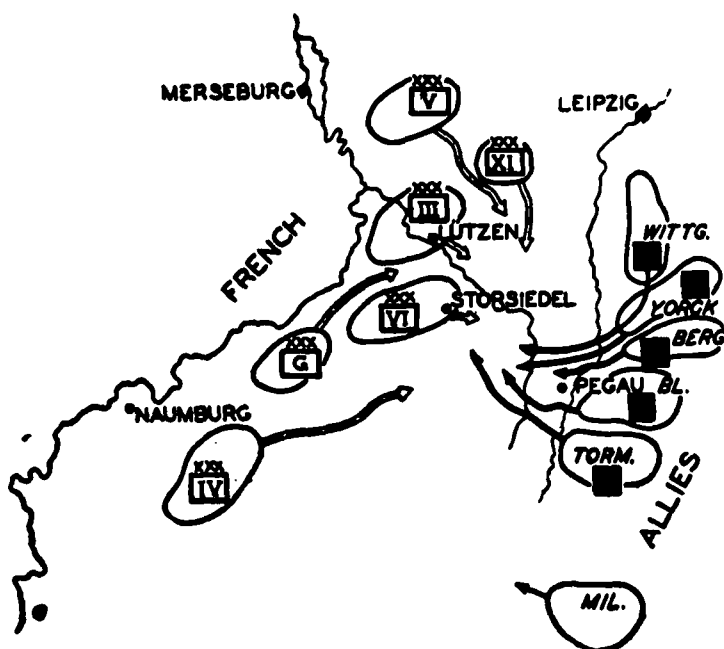

PLATE 42. BATTLE OF LUTZEN, 1813.

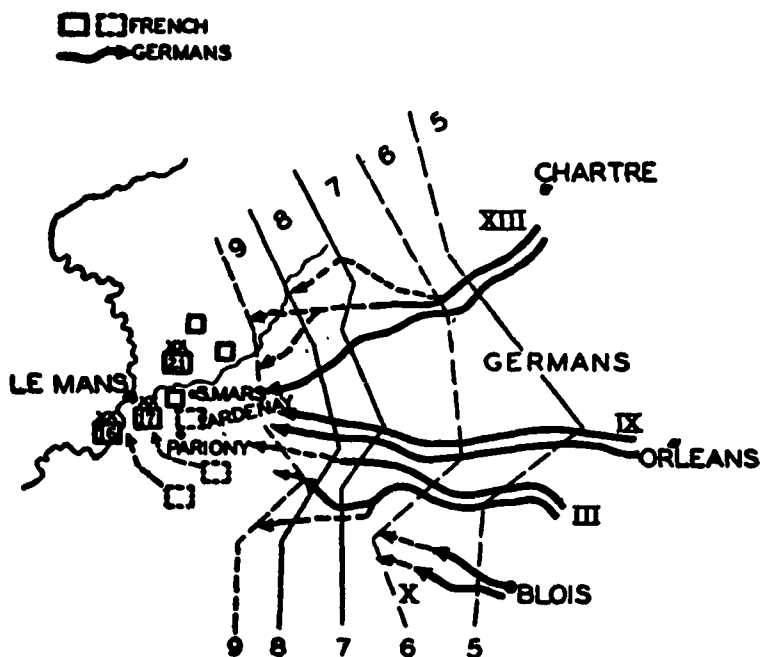

PLATE 43. MARCH OF THE GERMAN SECOND ARMY ON LE MANS, 1871.

Does this look like an improvised decision? Are formations of six corps changed on the spur of the moment?

It was evidently not through chance that these corps were echeloned so that they could face easily to the right. Nor was it by chance that a general direction was maintained in such a way that the enemy remained to the right of the general formation—a detail which is significant because the echelonment of the army would have been of no value had it been necessary to face towards the left instead.

As a matter of fact, the French army had been marching in this formation for several days. Napoleon was merely watching for a favorable opportunity. The whole secret of his rapidity lay in anticipation.

20. ADAPTATION OF THE PRECONCEIVED MANEUVER: The campaign of Eylau was selected because the enemy refused to stay put; the preconceived maneuver had to be started all over again. When confronted by an active enemy, there may be considerable difficulty in carrying through a maneuver from start to finish, without making modifications; this consideration can be reduced to simplest terms: either the maneuver can be modified and adapted or not; either the initial plan can be changed or it cannot be changed; then it is abandoned and a new plan is initiated. The procedure in changing or adapting a maneuver is evident in the next historical examples.

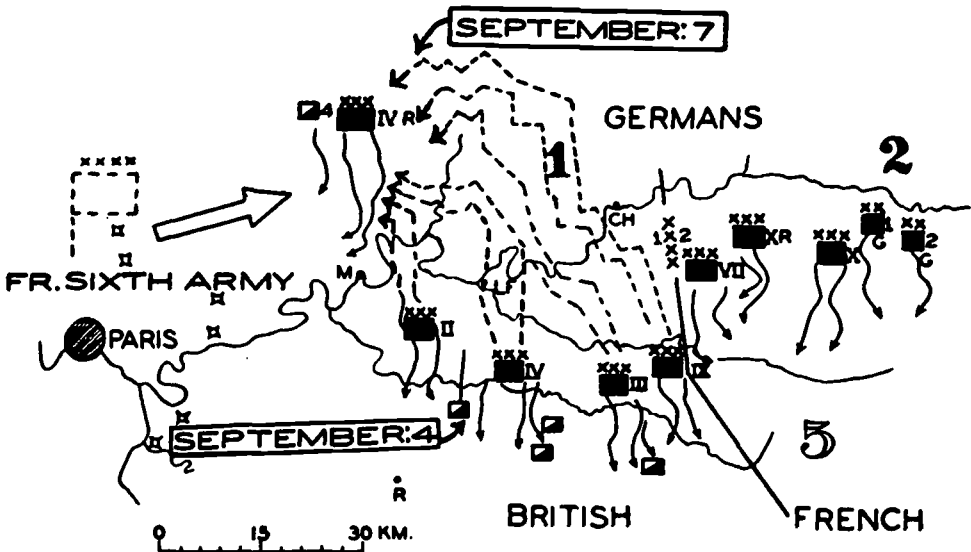

PLATE 44. MARCH OF THE GERMAN FIRST ARMY TO THE OURCQ. 1914.

a. Application to large units.

In the advance of the German Second Army on Le Mans, 1871, the initial directions of the German Corps had been:

XIII Corps: St. Mars le Briere

IX Corps: Ardenay

III Corps: Parigny l'Eveque

The initial idea of the Germans was a converging maneuver on the area east of Le Mans. In the meantime, the French commander completely evacuated this area and placed himself astride the Huisme River. Consequently, on arrival the Germans had to modify their initial march directions. They opened the sheaf of

their corps and developed a new and entirely different maneuver: a frontal attack by the two right corps and a flank attack by the left corps.

The operation was possible because they had been informed in time and the initial dispositions were flexible; but if the situation had demanded an envelopment of the French left wing, this would have been impracticable because the general convergence of the German column was too fully oriented toward the south.

These examples of preconceived maneuvers and their modification are merely a prelude to the common sense statement that the commander is not absolutely tied to an initial plan if it has become obviously unsuitable.

One of the most spectacular instances of the lightning-like adaptation of a preconceived maneuver to a changed tactical situation is found in the operations of the German First Army, in the period of 4-7 September, 1914.¹⁷

The relative positions held by the opposing forces on the eve of the Battle of the Marne appear on Plate 44. The German First Army, with corps abreast, was sharply oriented to the south, in roughly parallel columns and had crossed the Grand Morin; its IV Reserve Corps, echeloned to the right rear, was observing against Paris. Early on 5 September, this corps became heavily engaged with the newly formed French Sixth Army, which had debouched from Paris in a serious surprise attack against the German right flank. It became necessary during the night of 5-6 September to rush the II Corps to the support of the hard-pressed IV Reserve Corps. During the following day, the remaining corps were conducted, by forced marches, to the Ourcq; it was impossible to preserve the original order in line; each corps was directed by the shortest route to the most threatening portion of the new front; units became mixed; temporary groupings were resorted to, named after the corps commander on the spot.

The march performances in this situation were extraordinary; the IX Corps and the rear elements of the III Corps were shifted from the left wing of the army to the right, passing in rear of the entire new front; the IX Corps started from Esternay, at dawn of the 7th, and by midnight had covered a distance of 38 miles;¹⁸ on the next day, the 8th, the two corps were started again at 2:00 A. M. and except for a brief halt at noon covered again a distance of approximately 40 miles; on the morning of 9 September, this corps entered the battle, in a decisive manner, by enveloping Manoury's left wing and forcing it back.

The German army commander, von Kluck, fell a victim to the disillusionment following the first Battle of the Marne, but the maneuver of the Ourcq has the unmistakable touch of genius, the Napoleonic manner: a gigantic stream of supply and troop columns was pouring in a fixed direction; a strategic crisis of the first order stopped this movement and then reversed it; by a remarkable exertion of every intellectual, moral and physical force on the part of staffs and troops, the stream was made to flow again in an orderly fashion;¹⁹ in the midst of a highly complicated logistic problem, a new maneuver was conceived and initiated: a new front was created with the II, IV and III Corps along the Ourcq, to stop the French Sixth Army in conjunction with an enveloping attack against the French left by the IX Corps, which was progressing satisfactorily when G.H.Q. suspended the operations.

This extraordinary operation, replete with every conceivable lesson in the field of tactics and strategy, contains still another element of proof of the preeminent

¹⁷ Von Kuhl: *Movements and Supply of the German First Army*, August and September, 1914.

¹⁸ Von Kluck: *The March on Paris*, Chap. IV.

¹⁹ Compare this movement with the transfer of the American First Army from the St. Mihiel to the new Argonne front; these operations are similar in importance, size and logistic achievement; there is no better proof of the adequacy of the American staff work in 1918. Chap. III, Par. 12.

quality of the preconceived maneuver: the factors of time and space, and the bearing they have on the relation of small and large units. Small units are manipulated with comparative ease; errors can be adjusted or dispositions changed as speedily as the arrival of messengers that carry the order. Large units, however, once set in motion, do not conform readily to later modifications. There must be the fullest realization that any adaptation of means cannot be immediate or instantaneous: the change in plan of the First German Army was formulated as early as the evening of 5 September; it was not until three days later that the tactical dispositions of the IX Corps could become really effective. The maneuver of large units is not a single act; it is an aggregate of individual maneuvers and a succession of efforts.²⁰

The faculty of anticipation, which is expected in the commander of large units, must come into play and may assume the greatest importance.

In this precarious situation, the German First Army was confronted with the difficult task of executing a retrograde turning movement, from the old front facing south to a new front facing southwest. Such a movement can be executed in several ways.²¹ The entire army may be faced to the rear and then execute a left turn; in that solution, the various corps would consequently occupy the new front in reverse order.

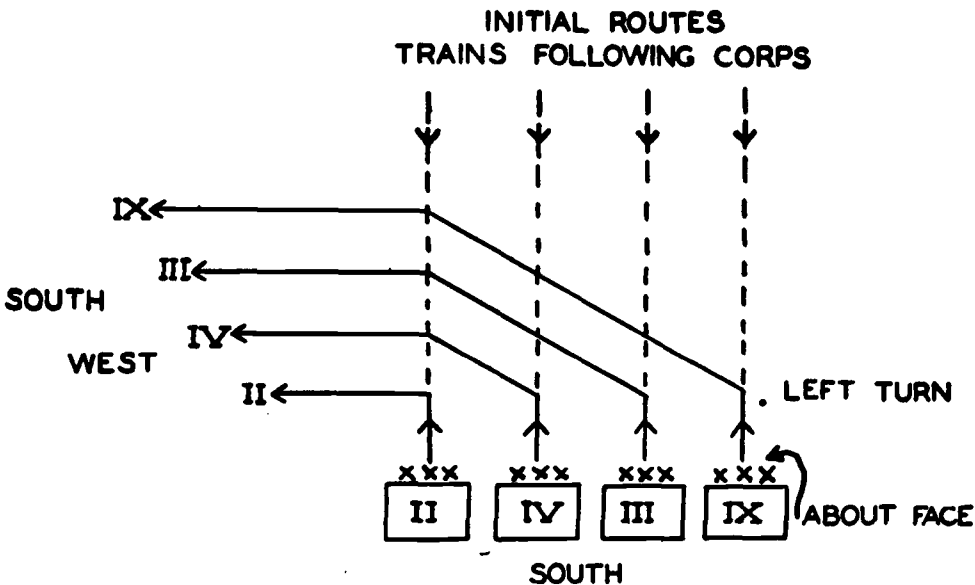

PLATE 45. REVERSAL OF CORPS COLUMNS.

The reversal of more or less compact troop columns is a difficult enough staff problem, in itself; its effect on the stream of trains, ammunition and supply columns, which ordinarily follow the corps routes from depots in the communications zone, will bring on endless logistic complications: the shift can be accomplished only by a crossing of columns, with all the friction attending such a movement.

If a new front were established by means of a flank march, the movement of troops and trains would be simplified, though slower; the army faces to the right

²⁰ See: Chap. IV, Par. 17.

²¹ Von Kuhl: *Movements First Army*, Chap. II, Sec. b.

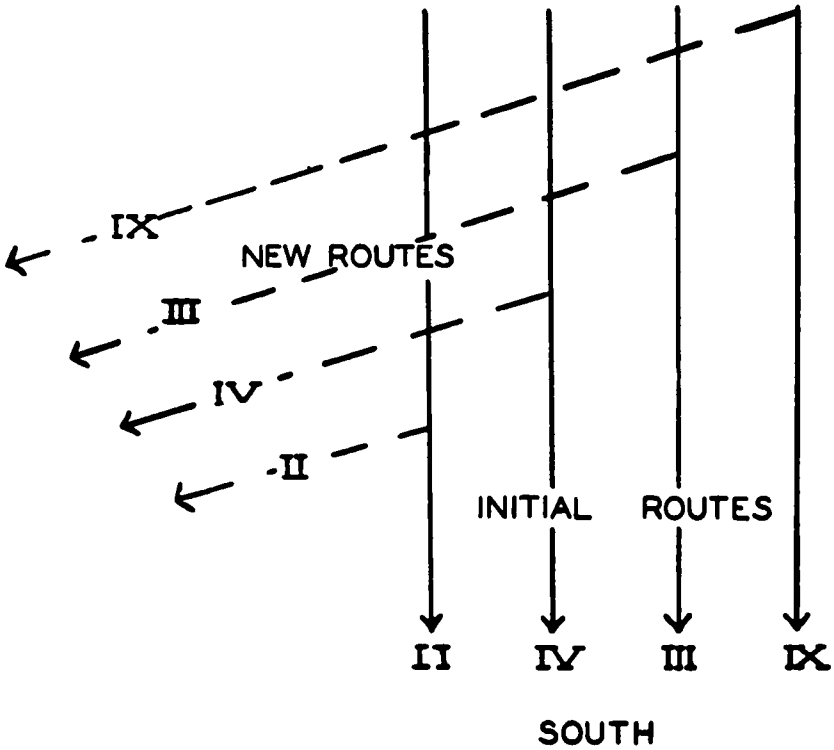

PLATE 46. CROSSING OF SUPPLY COLUMNS.

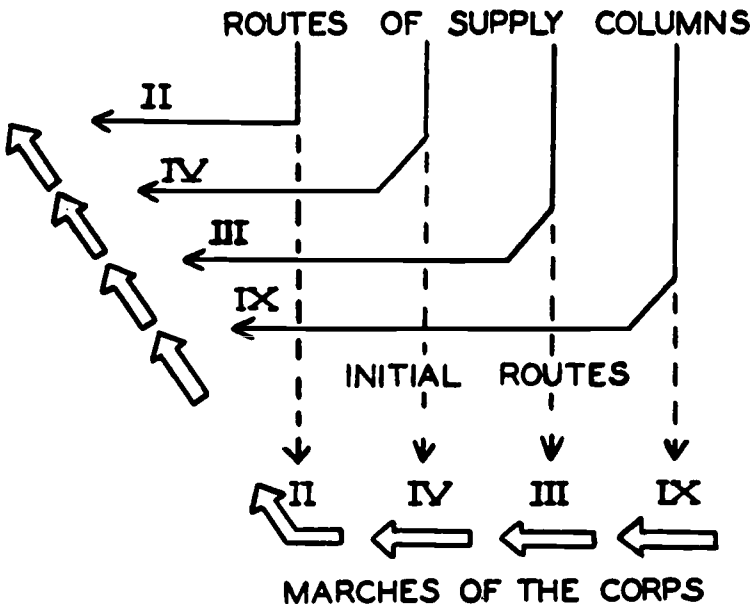

PLATE 47. THE CORPS IN A FLANK MARCH.

and then changes direction to the right; the order of corps, in line, will remain the same, the IX Corps still occupying its position on the left flank as before.

The initial supply lines and zones of advance can be retained; it is merely necessary to select new routes leading to the right, in the initial relative order.

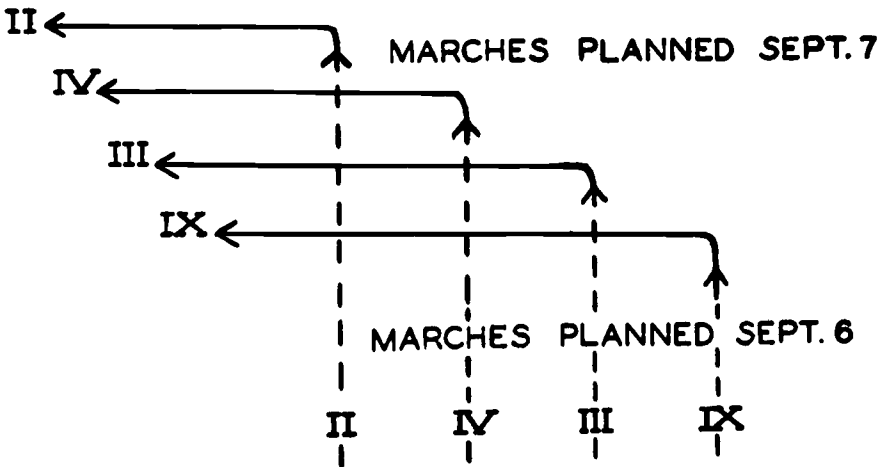

PLATE 48. A MOVEMENT BY ECHELON.

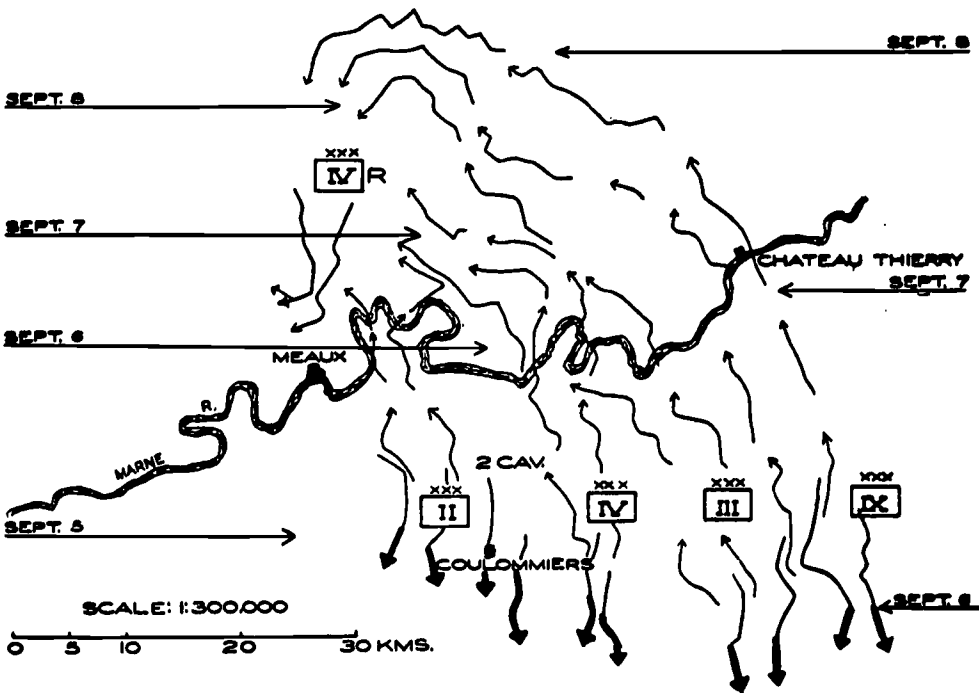

PLATE 49. ROUTES OF THE GERMAN FIRST ARMY, 5-8 SEPTEMBER 1914.

This solution is objectionable because it is time consuming and involves a flank march along the enemy front.

A movement, by echelon, pivoting on the initial left unit, represented a compromise solution and was adopted.

It was the intention of the army commander on 6 September to conduct the II Corps as far as the region northeast of Meaux, the IV Corps as far as Boué, the III Corps to La Ferte Gaucher, while the IX Corps remained in place, until the echelonment was completed. It was hoped to continue the maneuver on the following day, 7 September, have all corps change direction to the west and thus change the echelonment to a new front; as regards trains, it was only necessary to withdraw their columns a sufficient distance to the north, along their original routes, to clear them for the northward movements of the combat troops and then conform to the westerly movement of their corps.

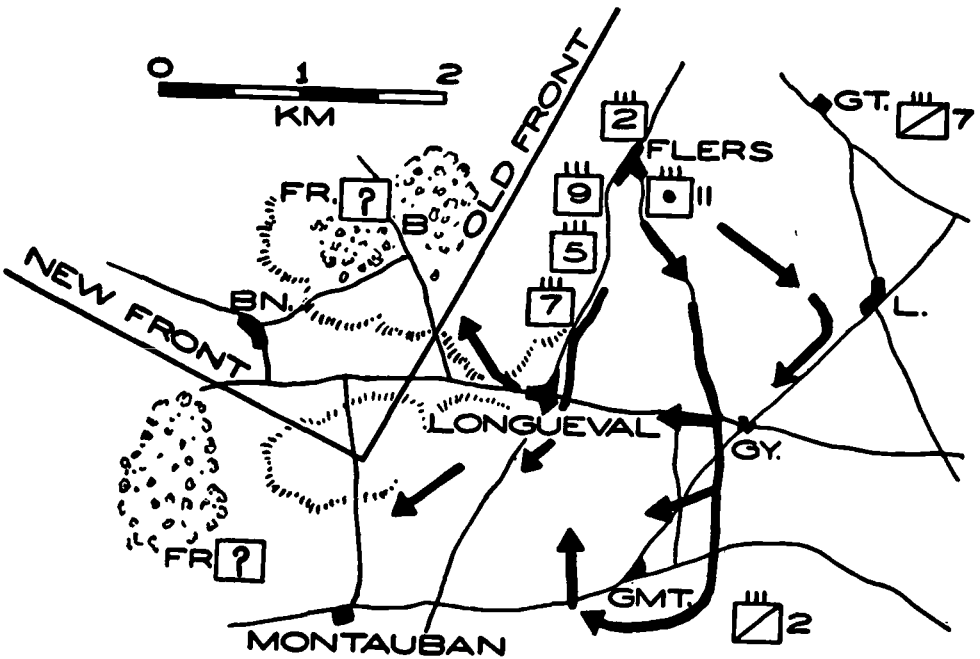

PLATE 50. THE 4TH BAVARIAN DIVISION. LONGUEVAL. 13 OCTOBER 1914.

This maneuver was never executed; events moved too fast. The flank attack from the direction of Paris seriously endangered the IV Reserve Corps; the II Corps was rushed to its assistance during the night 5-6 September; during the following days the remaining corps advanced on the Ourcq by forced marches; it was impossible to preserve the original order in line. The operation of ammunition and supply trains became exceedingly difficult. Army Headquarters was compelled to intervene in corps administrative arrangements and undertook to regulate all movements in daily orders.

b. Application to small units. As usual, there are no fundamental differences; the time element is more favorable: in the case of the First Army, corps were fed into the battle area successively at the rate of a corps a day; in the next example, the entry into line by regiments was reckoned by hours only; nevertheless, the shift to a new front, expressed in hours, is never a question of sleight of hand.

Units of the 4th Bavarian Division were facing northwest on the line: Longueval-Flers; they were completely deployed in shallow, linear formations, in the order: 7th, 5th, 9th Infantry and 2d Jaeger.²²

Orders for the next morning required a change of front to the southwest, to

assist in an encircling movement against Montauban. Ordinarily, a turn to the left would have changed the present front into a general march column via Longueval; however, enemy resistance was expected in the vicinity of Montauban and a partial development, in the new direction, was indicated; this required the formation of at least two columns; an order was issued to that effect at 9:50 A. M. Right column: 7th and 5th Inf., 1 Bn. 11th F.A., to assemble east of Longueval and advance on Montauban. Left column: 9th Inf. and 2d Jaeger, 2d Bn. 11th F.A., to advance via Ginchy (G'y)—Guillemont (G'mt).

The order was received at Flers at 10:45 A. M.; the dispatch consumed almost an hour, although it was but a distance of 6 kms. A "warning order" dispatched at 9:25 by motor did not arrive until 11:18 A. M. The reason for this delay was confusion as to the exact location of unit headquarters; this was a combat situation and staffs were in concealment.

The right column started out; they received information that the woods "B" northwest of Longueval were held by the French; it was clear that the march on Montauban was practicable only after this threat to the right flank was removed; the regiment changed direction at Longueval and deployed at 1:30 P. M. on the northwest edge of Longueval, for attack on woods "B."

The left column started out at 11:30 A. M. but ran into the 7th Cavalry and was delayed; enemy harassing fire, at that period, forced a cross-country march and it was not until 2:30 P. M. that this column reached Ginchy. The French held Montauban; artillery fire was heavy; Guillemont and Ginchy were in flames; enemy resistance had stiffened. The division commander, knowing the "larger picture," realized that these units were crowding to the south and that the new front, to be effective in the framework of the larger operation, would have to be re-oriented on the line B'n—Longueval. Staff officers, in motors, intercepted the columns; individual battalions and detachments were turned off by the shortest routes toward Longueval.

The left column, through its attack on woods "B," had actually cleared space for these movements. However, it was not until 5:00 P. M. that the units were approximately in line, on the new front. The march to the left flank and the development of the 4th Division had consumed 6 to 7 hours, although the road distances varied from 5 to 10 kms only. In peace-time maneuver situations, such movements are accomplished in short order and are calculated as involving a much lesser time element.

This tendency must be guarded against, in the light of combat experience. The units of this division had fought the day before, after forced marches, and needed reorganization; hostile harassing fires, crossing of units, burning villages and congested roads slowed down the rate of march and the development.

☛ "Change of attack direction by a deployed division." *Militär-Wochenblatt*, Sept. 11, 1931.

CENTRAL MANEUVER

21. A SCHEMATIC CLASSIFICATION OF MANEUVER. In the progress of investigation, a point is now reached where one can profitably examine the principal types of maneuver. Upon examination it will be found that these types are clearly derived from the initial basic factors of *combination of directions*, *relative distribution of forces*, and a *maneuver idea*, which controls the initial disposition or grouping of forces.

"Attack" is obviously the culminating point of maneuver, the final act in a drama based on maneuver, the *tactical expression* of the maneuver idea. The *embryo of attack* stirring uneasily in the march formations of the Imperial Army was shown in the advance on Eylau. The terms "penetration, envelopment, turning movement," ordinarily found in official texts, *describe the act*, as a form of execution. To penetrate—where? To envelop—what flank? There is an amplifying terminology possible that is not based on a *description of the act*, but rather on its *location*, on the vast battle fronts of modern armies; and that is a classification as *flank maneuvers*, on a flank or wing, and *central maneuvers*, in the center of the general dispositions. Under these headings, there are additional subdivisions of maneuver forms that have appeared on a thousand battlefields and in a thousand texts.

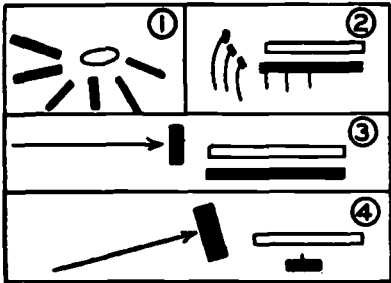

FLANK MANEUVER

1. Converging Attack
2. Close-in Envelopment
3. Wide Envelopment & Holding Attack
4. Flank Attack

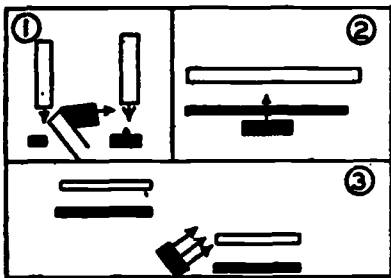

CENTRAL MANEUVER

1. Operation on Interior Lines
2. Penetration. (Break-through)
3. Dislocation. (Fragmentation of the front)

PLATE 51. SCHEMATIC CHART: TYPES OF MANEUVER.

At the outset, it should be noted that this text does not primarily seek to establish the superiority of one form or another. This is simply an endeavor to recognize the properties of each and to note their conditions of execution. However, *flank maneuvers* will eventually emerge as the most important maneuver form.¹

¹ F. S. R., Par. 435: The decisive results following successful action on the enemy's flank favor adoption of the enveloping form of attack whenever practicable.

As you reflect on the schematic diagram, it is apparent that each type of maneuver requires special preparatory dispositions.

For a *converging attack*, for instance, the units will have to be placed abreast and widely spaced at the start, or they will collide rather than converge. A point involved in spacing them is whether they converge in front or in rear of a hostile area.

For a *close-in envelopment*, the initial disposition involves a line approximately equal in extent to that of the enemy and the location of reserves in rear of the flank which is to be enveloped.²

For a *wide envelopment*, or turning movement,³ the enveloping mass must be detached rather early, in order to gain the necessary distance in an attack direction which completely clears the hostile flank.

Certain preliminary conditions appear as a characteristic of all types of maneuver.

This is just another angle to a general problem—a final argument, for the *prearranged maneuver*, which finds early expression in initial march formations. The close relation between initial dispositions and the subsequent maneuver has one glaring disadvantage, however—the preliminary disposition may reveal the projected maneuver. The enemy may recognize it by deduction. This is increasingly more important, as the efficiency of aerial reconnaissance has enormously increased. The air service is here to stay; it cannot possibly be excluded from any future strategical maneuver.

Apart from night marches, practically the only parry against the menace of aerial observation and the loss of surprise, consists in maintaining what might be termed an *amorphous* disposition—shapeless, not crystallized, but capable of rapid transformation at the last moment.

Numerous examples of this sort can be found in military history, particularly in the Napoleonic campaigns; of course, they are not useful in their archaic form, but they suggest the direction in which a modern solution may be sought.

22. OPERATION ON INTERIOR LINES. This maneuver was frequently resorted to in the past; the Napoleonic campaigns of 1796, 1813 and 1814 are examples. Hindenburg used it in Poland in 1914 and 1915. The system presupposes that the enemy is dispersed in groups which are too far separated to be able to participate in the same action; the idea is to defeat the enemy in detail, containing one fraction with a detachment while falling upon the other with the bulk of one's forces; this is merely an application of the old principle of economy of force.

The Austrians, under Beaulieu, and the Sardinians, under Colli, faced the French along the Appenines. Napoleon concentrated mass in the gap between the Allies. He first attacked the Austrians at Montenotte, driving them from their positions; the gap widened.

Containing the Austrians with a detached force, Napoleon immediately turned against the Sardinians and defeated them at Millesimo; the gap widened still more. The subsequent operations were characteristic maneuvers on interior lines, with Bonaparte reinforcing one or the other wing to create a local superiority.⁴

The apparent simplicity of the procedure may give one a false idea that it is

² An envelopment is effected by an extension of an attacking wing during the course of battle through the use of reserves.

³ F. S. R., Par. 435: According to the situation the decisive or main attack aims to envelop or turn a hostile flank.

⁴ F. S. R., Par. 438: When the enemy takes up a defensive position, the commander of the opposing forces always considers the possibility of turning the hostile position.

⁵ See Chap. VI.

easy! Great strength of soul and character are necessary to play such a desperate game. The campaign of Tannenberg is a brilliant modern example of the maneuver on interior lines.

First phase: Note the initial basic conditions which make such a maneuver profitable.

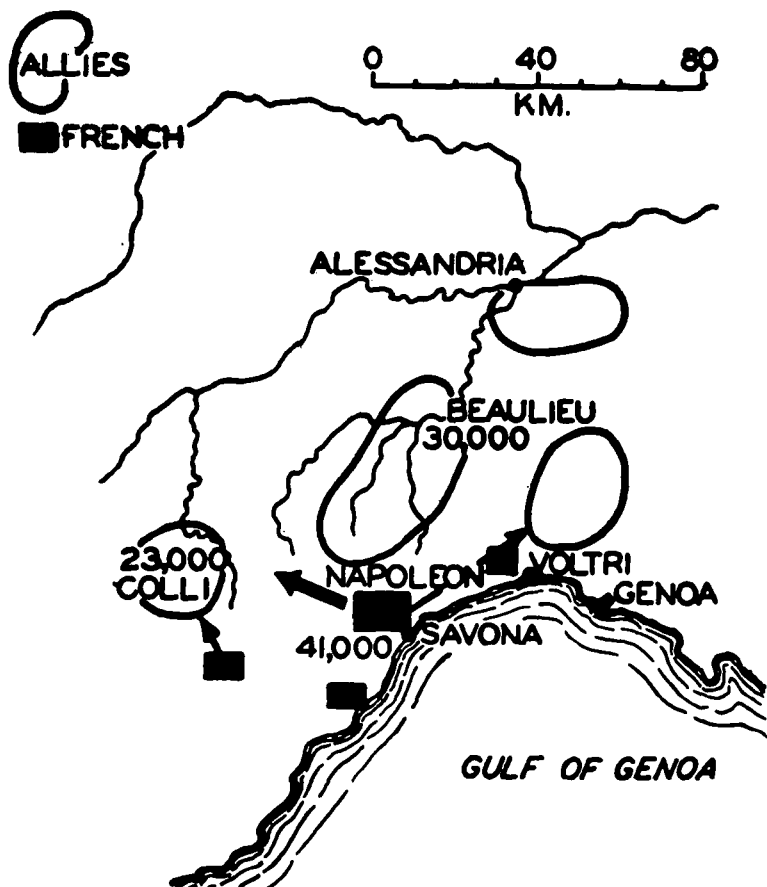

PLATE 52. THE CAMPAIGN OF ITALY, 1796.

a. The enemy is divided into two masses: one fragment cannot immediately support the other.

b. The separation is brought about by a terrain feature: a chain of lakes.

c. One fraction of the enemy is contained by detached forces, in a preliminary action.

d. Rapid concentration of mass is effected against the remaining fraction.

e. Its defeat is accomplished by a converging attack: a double envelopment.

Second phase: Note the immediate regrouping of the German forces for an attack on the initial enemy fraction with a view to defeating it in turn.

It is possible, however, that the dispersion of the enemy takes place in the course of battle and may lead to isolating a part of the enemy forces; the procedure against this fraction is then analogous to an operation on interior lines.

French military thought appears to be much impressed with this type of action and has given it a special name, "action of dislocation."

23. DISLOCATION: FRAGMENTATION OF THE FRONT. The French terminology means nothing more or less than "exploiting a gap in the line." Every recent war contains examples of fragmentation of the enemy's front and opportunities for exploiting it by maneuver.

1ST PHASE

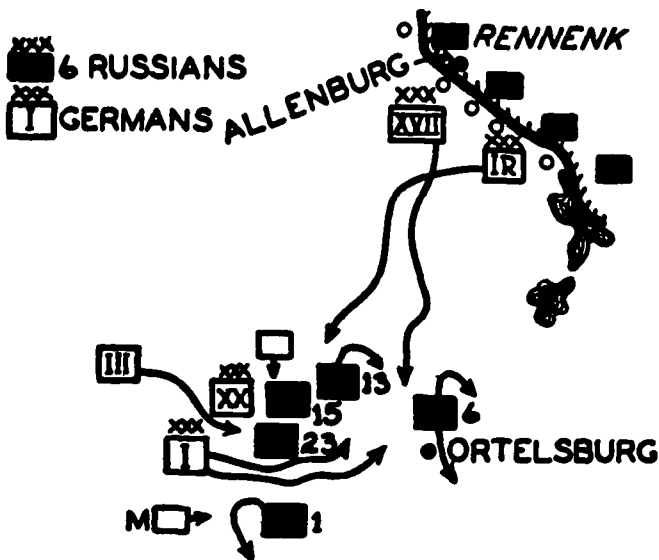

2D PHASE

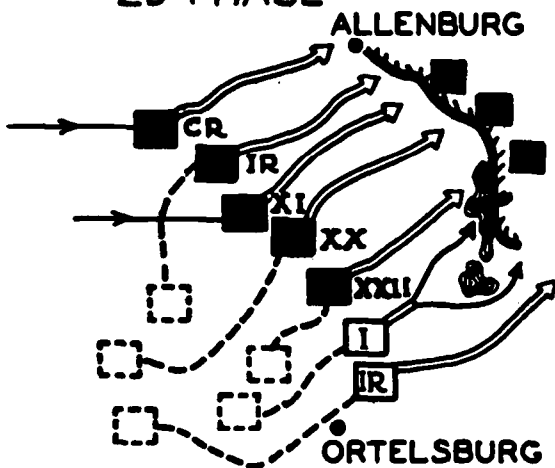

PLATE 53. TANNENBERG, AUGUST 1914: FIRST AND SECOND PHASES.

a. *The Russo-Japanese War, 1904.* Two days after the launching of the Japanese counteroffensive in the morning of 13 October, the Russian line was "dislocated" into three groups, echeloned on a front of approximately 30 miles. The Japanese, however, did not profit by this situation since they had already oriented their principal maneuver against the Russian right wing.

b. *The World War, 1914.* A more aggressive enemy took prompt advantage of a similar situation, on 22 August 1914, in the Battle of the Ardennes. The

French Fourth Army was advancing on a front of about 40 miles. Note the general dispositions of the corps, divisions and brigades in echelon, from northwest to southeast; each column, echeloned to the rear, was expected to protect the flank of the preceding column; due to delays in marching, numerous gaps developed and the east flank of certain columns became uncovered and exposed. The terrain was unfavorable; parallel bands of wooded zones extended, in general, across the direction of advance of the French, while the advance of the

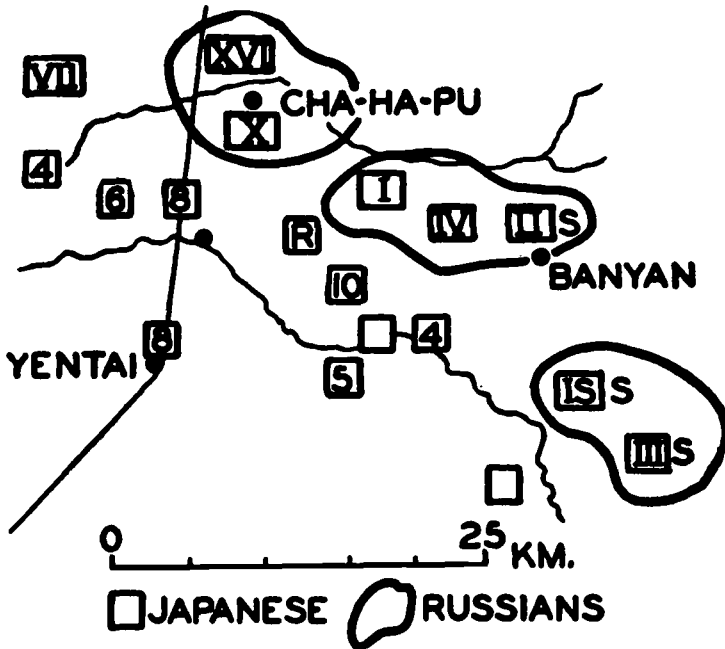

PLATE 54. THE BATTLE OF THE SHA-HO, 1904.

Germans, from east to west, was made in clearings; the routes of the French became virtual defiles in the forest. Liaison with neighboring units was practically impossible; this led to isolated actions; divisions and even brigades had to fight as if in separate compartments; the result was a series of isolated combats and defeat in detail.

Certain conditions seem to be present in all instances—extended fronts and compartmented terrain.

These are the same conditions that are prerequisites for the maneuver on interior lines.

In the Wars of 1866 and 1870, generally opposite circumstances were present. French and Austrians fought on comparatively narrow fronts and fought defensively. Maneuver against the center was not indicated; one can understand why the Germans preferred flank maneuvers.

The French professional regard for the tactical possibilities of "dislocation" is probably traceable to the dark days of August 1914 when their first successes along the Marne were due primarily to the exploitation of gaps in the line.

This situation and the march of the German First Army to the Ourcq have been covered in preceding paragraphs.⁵

⁵ See Chap. IV, Par. 18, Plates 44 to 50.

The withdrawal of the German III and IX Corps to support von Kluck in the battle of the Ourcq, had created a wide gap between the First and Second Armies; von Kluck's Army was split, one section facing west and heavily engaged with the French, the other attached to the right wing of von Bulow's Second Army and facing south.

The British Expeditionary Force and the French Fifth Army began to enter this gap; they had in front of them only Marwitz's cavalry fighting delaying actions on a wide front. ⁶

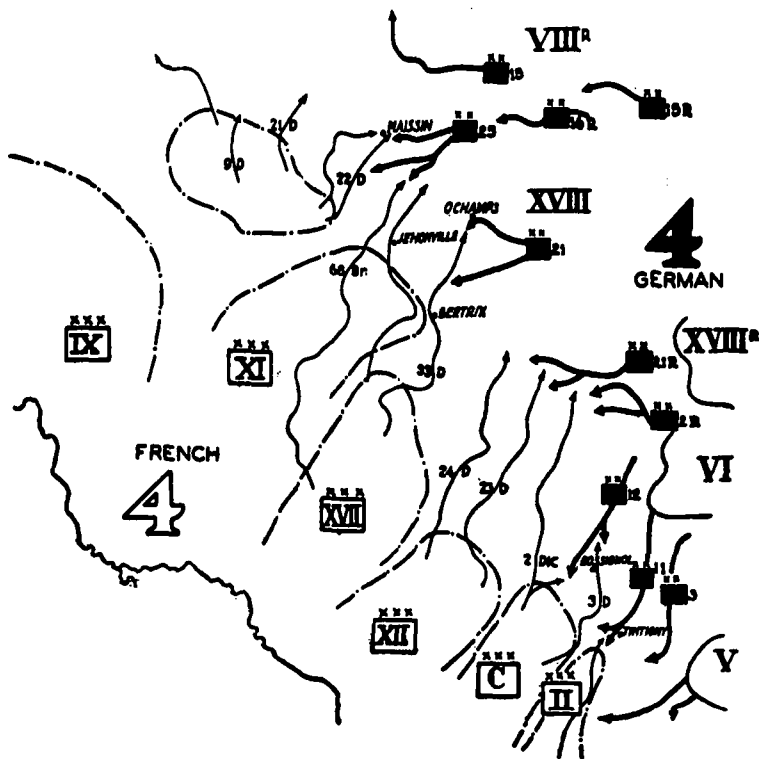

PLATE 55. THE BATTLE OF THE ARDENNES, 1914.

On this same front, there is another example of the exploitation of a gap in the line: von Kluck's movements had been pulling von Bulow more and more to the west; on 9 September, this displacement resulted in a gap between La Fere Champenoise ⁷ and the marshes of St. Gond; Foch recognized this gap and drew in his last division. ⁸

24. THE PENETRATION. *a. General considerations.* Military literature and official doctrine agree, perhaps reluctantly, to acknowledge and accept penetration as a form of attack. ⁹

⁶ The withdrawal of von Kluck's Corps and the resulting gap were having a bad effect on von Bulow. Bulow was a martinet, of some ability, who had established a reputation in the conduct of peace maneuvers; battle-field conditions and irregularities confused him; the gap, which von Kluck created with a gambler's nonchalance (which is also a distinguishing mark of great commanders) worried von Bulow, and maneuver rulings would certainly have called for a withdrawal.

⁷ See Chap. III, Par. 13, Plate 32.

⁸ This operation, while a typical situation of "dislocation," is made to appear in French accounts as the principal reason for the German withdrawal; the order for withdrawal was issued three hours before the 42d Division started and was well under way before the advance of the French began to be felt.

⁹ F. S. R., Par. 433: ". . . According to the situation, the main attack aims to envelop or turn a hostile flank or to penetrate the hostile front."

F. S. K., Par. 436: ". . . When the situation does not favor an enveloping attack, the attack is directed to a penetration of the hostile front."

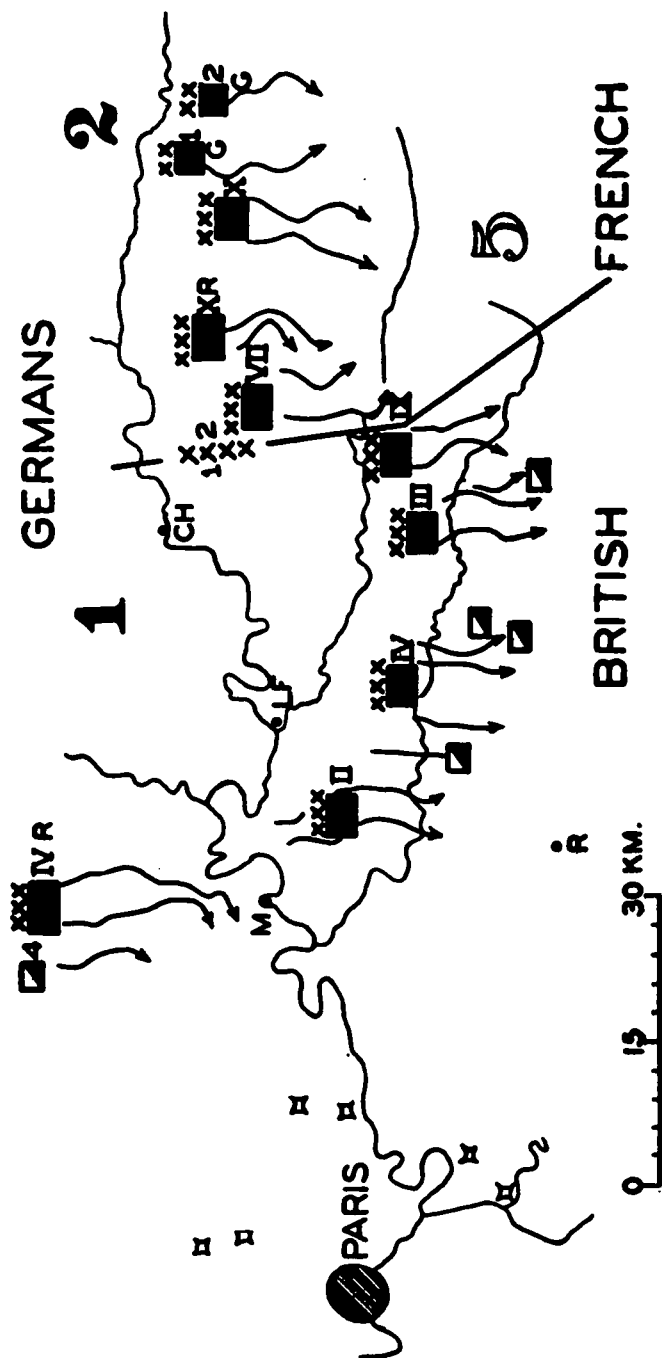

PLATE 56. SITUATION: GERMAN FIRST AND SECOND ARMIES, 4-5 SEPTEMBER 1914.

Through its World War experience on stabilized fronts, the present generation should be expert in "penetration"—a frontal attack leading to a breakthrough. It was found that a penetration is not in itself a decisive act; in the evolution of combat, it belongs to the preparatory phase.

In the wars of the ancients, the Greek phalanx and the Roman legion, composed of infantry, conducted what was a frontal attack pure and simple. The decision, if any, was invariably brought on by cavalry actions on the flanks. With the advent of firearms and more supple formations, such as the division, infantry was able to extend its former simple action of frontal attack to include maneuver in a combination of directions.

Napoleon used this supple instrument to the limit of its capacities. It is significant that the majority of his maneuvers were flank maneuvers. He did not hesitate to attempt an occasional breakthrough, but he found it to be an expensive undertaking. At Lutzen, he lost 30,000 men or as much as his enemies, but he could afford it less; at Waterloo, d'Erlon's Corps suffered 35 per cent losses in less than an hour. In the American Civil War our experience was very similar.

Just prior to the World War, the French and Germans held divergent views on the value of penetration. The French *Regulations on the Conduct of Large Units*, 1913, stated that "frontal attacks, leading to a tactical break-through, may lead to a decisive success."

The German school of thought, however, was not in favor of frontal attacks with a view to a penetration. This school was thoroughly indoctrinated with the views of Count Schlieffen, Chief of the German General Staff from 1891 to 1905. Schlieffen said, in substance: "Frontal attack is indecisive, since it merely drives the enemy to a new position . . . a new operation must be started. This may be all right if you have plenty of time—but not when you are counting minutes . . . do not attack frontally; the thing to do is to crush the enemy's flanks."

Count Schlieffen was not blind to certain possibilities of penetration. In a staff ride, he had occasion to remark: "Everybody wants to envelop—consequently, everybody extends their flanks. And so it goes on—until you are stretched to the limit—overextended. Then you think of a penetration. But where, at what point? Nowadays, there won't be any high point, from which the commander can observe the battle in its entirety and personally discover the weak spot in the enemy's lines."

Impressed with his views, the German armies of 1914 relied on flank maneuvers and attempted no penetration, except when the fluctuation of battle practically forced them to it, as was the situation of the German First Army in the first battle of the Marne in 1914.

In the paralysis of stabilized warfare, 1915 to 1917, the penetration became highly developed as the only remaining form of the attack and was practiced by all opponents; the following operations are characteristic American types.

b. The regiment in penetration: Cantigny, 28 May 1918.

Cantigny formed the apex of the German salient toward Amiens and was on the natural approach to cut the Amiens—Compiègne railroad. The sector was well organized and particularly strong in artillery support. The town contained numerous and strong machine-gun positions. Full advantage had been taken of the ruins, cellars, etc., to improve the defense. It was held, at the time, by the 82d German Reserve Division (271st and 272d Reserve Regiments).¹⁰

The 28th U. S. Infantry, Colonel H. E. Ely commanding, was designated to make the attack. As a concession to the psychological importance of this operation, extraordinary preparations were made to insure success. The attack was rehearsed in the rear areas, near Maisoncelle and St. Eusoye; the departure trenches were laid out and the town with its various important defenses patterned on the ground, in order to familiarize the command with distances and locations. The officers studied a relief map of the terrain around Cantigny, on a large sand

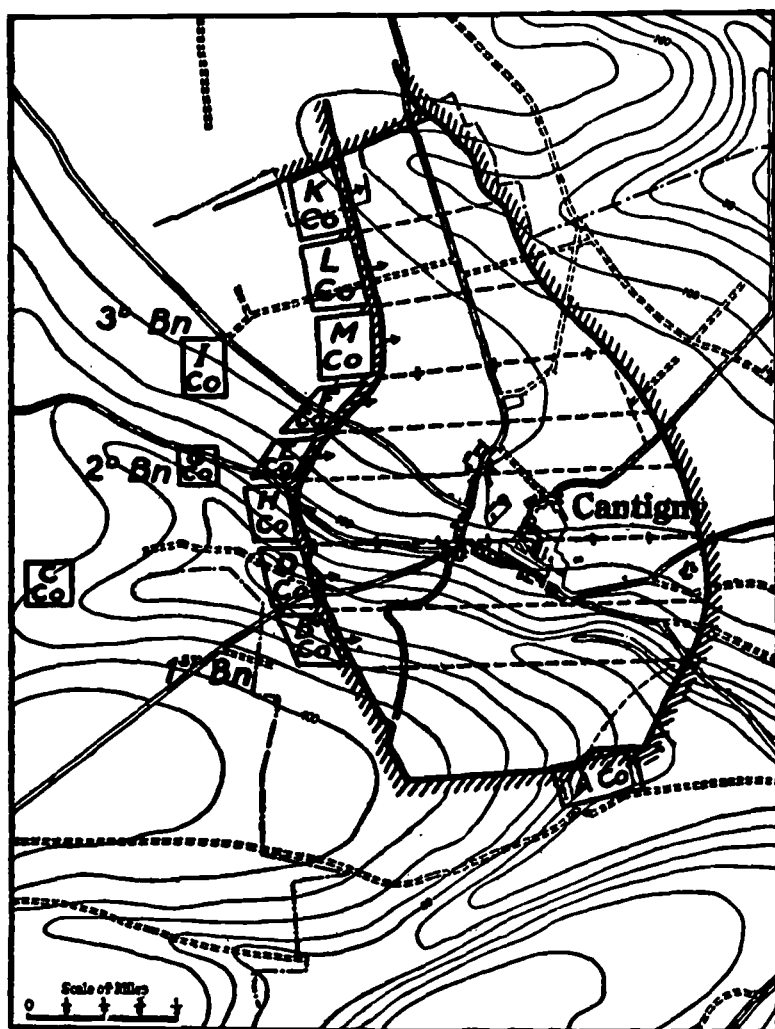

PLATE 57. THE CAPTURE OF CANTIGNY, 28 MAY 1918.

table, and recent oblique and direct airplane photographs and a sketch showing the location of important cellars, dugouts, and shelters were issued to include platoon commanders.²⁰

The plans for the attack were drawn by the American staff. So thorough were

²⁰ *History of First Division*, pp. 77-78.

²¹ Major J. V. Ware, Infantry, Historical Monograph. Infantry School. This officer was in command of Co. H, 28th Infantry during the attack.

the plans and orders issued that when submitted to the French corps commander for approval, no changes were found necessary.¹²

The formation of the regiment for the attack was with three battalions abreast, each battalion with three companies in line and one in reserve; one machine-gun company had been attached to each battalion. A section of flame-throwers, a group of 12 Schneider tanks, aviation, and certain artillery units were furnished by the French; the artillery support for the attack was markedly strong: 22 batteries 75-mm. guns, six of 155-mm., 178 heavy guns and howitzers, and 40 trench mortars, in addition to the organic divisional artillery.

After one hour of artillery preparation the attack was launched at 6:45 A. M., 28 May, under cover of a rolling barrage which advanced at the rate of 2-4 minutes per hundred meters. The advance was made with the precision of a peacetime maneuver.

The American infantry followed so close behind the barrage and supporting tanks that the enemy had no time to emerge from his shelters and was either killed or surrendered in considerable numbers. The objective was reached by 7:20 A. M. and the work of consolidation begun immediately. The reaction of the Germans against the American troops was extremely violent. Counterattacks were launched on the 28th, 29th and 30th, but were repulsed. The sudden withdrawal of the French supporting artillery, for service against the German drive of 28 May, enabled the stronger German artillery to concentrate a merciless fire on the new American position; most of the American losses occurred during that period. After 30 May, the fire gradually decreased and the sector became comparatively quiet. The 28th Infantry was relieved by the 16th Infantry (1 June). The losses incurred amounted to 43 officers and 1,022 men.

The facile demonstration at Cantigny greatly impressed the French;¹³ thereafter the Allies accepted the fact that the Americans could be depended upon.¹⁴

c. The Division in penetration: Soissons, 18 July 1918.

The position of the Germans in the Marne salient was inherently weak; it was out of the question to supply the large number of divisions in the salient for any length of time. The chief reliance was of necessity upon motor vehicles, and the supply of gasoline was limited. As early as June 6, General Pershing suggested to Marshal Pétain that "a blow at the enemy's line south of Soissons, if successful, would compel him to retire. I was very eager that our troops should be allowed to undertake such an attack."¹⁵

During the engagement along the Somme, Marshal Foch ordered preliminary

¹² The responsible staff officers, for this period: Colonel Campbell King, Chief of Staff, and Colonel Geo. C. Marshall, Asst. C. of S., G-3.

¹³ de Chambrun, p. 142: "Citation a l'ordre de notre 1ere Armée a la suite de l'opération de Cantigny. Régiment anime d'un magnifique esprit de l'offensive. Le 28 Mai 1918, sous les ordres du Colonel H. E. Ely s'est lancé avec un allant irrésistible a l'attaque d'un village fortement organisé. A atteint tous ses objectifs et a conservé le terrain conquis malgré des contre-attaques répétées."

¹⁴ Pershing "My Experiences" Vol. II, Chap. 30, p. 60: "It was a matter of pride to the whole A.E.F. that the troops of the 1st Div., in their first battle, and in the unusually trying situation that followed, displayed the fortitude and courage of veterans, held their gains and denied to the enemy the slightest advantage."

v. Giehl, pp. 23-24:

"In this phase of the War, the American troops furnished decisive assistance, to the Entente, which had exhausted its strength. If the French and British had been limited to their own resources, the Germans would probably have been able to finish them; at any rate, mutual exhaustion would have led to mutual concessions. But in this critical hour, the Entente received powerful aid.

p. 24. The impression which the Germans gained of Americans, in these early engagements, was entirely favourable.

The tactical training of the American infantry appeared deficient, and the American soldier was awkward and very careless. The artillery appeared more efficient and had the habit, to systematically search the battle field. But the physical condition of the men, equipment, and supply appeared to us extraordinary, and the personal bravery and initiative of certain individuals very great. The Americans were always engaged in small, offensive operations to harass and fatigue our weary troops, and stopped at nothing to gain their objectives. The Americans made a profound impression on the German soldier; this was due to the nervous exhaustion of our troops, fatigued by the excessive demands of the recent major offensives.

The military significance of the support of the Americans was not only based upon their mass, but more especially on their nervous resistance. These troops were characterized by absolute fitness, a physical and psychic superiority, combined with indifference to danger, probably based on inexperience.

¹⁵ Pershing, "Experiences." Vol. II, Chap. 32. p. 92.

concentrations in the region of Villers-Cotteret; the 4th and 28th U. S. Divisions, en route from the British front, were diverted to this point; the 2d, 3d, 26th and 42d were in that area, a force equivalent to 12 French divisions. To the XX Corps was allotted the critical part of the attack, to outflank the northeastern edge of the Forest of Retz, capture Chaudun and Vierzy, secure the plateau northeast of Hartennes and hold the southern outlet of the Ravine de Crise. The attack of the corps was made with divisions abreast—1st U. S., 1st Moroccan Division and 2d U. S. Division, in the order from north to south; the axis of attack was through Dommiers—Chaudun—Villemontoire. Marshal Foch approved the plan on 13 July. In order to insure secrecy, the concentration was to be completed in four days and the attack launched on the 18th.

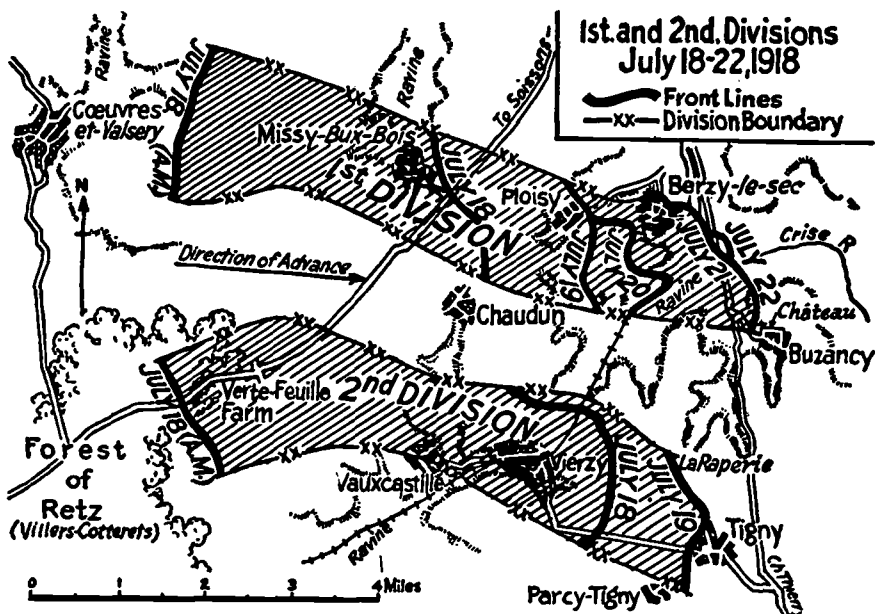

PLATE 58. THE ATTACK OF THE 1ST AND 2D U. S. DIVISIONS, 18-22 JULY 1918.

The 1st U. S. Division. The 1st Division was assigned to the XX Corps on 15 July, while in vicinity of Dammartin; it was entrucked and in position behind its zone of action on the 17th. The night march, to the line of departure, was made under extraordinary difficulties; a violent rainstorm turned the trails into a quagmire; the men were constantly slipping and falling into shell holes; the congestion toward the front was terrific—tanks, trucks, artillery intermingled with the exhausted soldiers.¹⁰ The rolling barrage started at 4:35 A. M. The division advanced with regiments abreast, regiments in column of battalions, in the order: 28th, 26th, 16th and 18th Infantry, from north to south, with the 153d French Division on the left, and the Moroccans on the right. The divisional artillery was reinforced by French guns, and supported by 48 French tanks, on a front of about 2,000 meters.

18 July. There was no artillery preparation; the Germans were taken by surprise. The first objective was reached about 5:30 A. M. and by 7:00 A. M. the 1st Brigade had seized part of the second objective. The German resistance began to stiffen; the wheat fields were dotted with machine guns, which were operated with reckless courage. The 2d Brigade was unable to advance, since the 153d

¹⁰ Major C. R. Huebner, Infantry. Historical Monograph. This officer, as Battalion Commander, participated with distinction in this entire operation.

French Division, on its left, made slow progress. The Missy-aux-Bois ravine proved to be a formidable obstacle. After desperate fighting the eastern slope of the ravine was finally reached about 10:30 A. M. Thereafter the advance was everywhere contested fiercely; the curious cave formation, in this vicinity, enabled enemy detachments to emerge and fire at the Americans from behind and slow down the attack. Such an incident took place in the sector of the 28th Infantry, which received fire from the vicinity of Mont d'Arcy; eventually 20 officers and several hundred men were taken from this cave. The left brigade was unable to reach its objective. In spite of this local check, the day had been successful; approximately 2,000 prisoners were taken and several batteries of artillery. At dark, the front line extended along the Missy Ravine, past Missy, to the final objective, one kilometer farther to the east and linked up with the Moroccans at Chaudun.

19 July. At 4:00 A. M., the next day, the attack was continued. The Germans had not been idle during the night; originally only one division, the 42d, had opposed the 1st U. S., during the day three other divisions, the 11th Bavarian, 34th and 28th Divisions were identified. The advance to the Paris—Soissons road was very costly. Violent machine-gun and artillery fire from Ploisy stopped the 2d Brigade, after advancing less than one kilometer from the Missy Ravine. The 1st Brigade also suffered heavy casualties and barely reached the ravine at Chazelle. After reorganization, late in the afternoon, at 5:30 P. M., the division was able to renew the assault and reach the western edge of the Ploisy Ravine. Severe hand-to-hand fighting continued throughout the night; the farm of Mt. de Courmelles was captured, lost and recaptured,¹⁷ and the fighting in the village of Ploisy was desperate. Casualties probably numbered 3,000, but the enemy losses were equally appalling and 35 officers and 1,000 men were captured; 20 field guns were taken at Ploisy and Chazelle.

20 July. The advance of the 153d French Division, as noted, had not kept pace with the 1st Division on the 18th or 19th. The strong point of Berzy-le-Sec was originally in the zone of action of this division. Orders for the 20th assigned Berzy to the 1st U. S. Division. After reorganization, during the night, the division renewed the attack on the 20th, but failed to take Berzy-le-Sec or to reach the Chateau-Thierry road. The 2d Brigade suffered serious casualties; the 1st Brigade, however, in conjunction with the Moroccans reached the vicinity of Bois Gerard, Visigneux, and Aconin Farm. The 153d French Division, on the left, and the Moroccan Division, on the right, were relieved by the 69th and 87th Divisions. The 2d U. S. Division was relieved by the French 58th Colonial Division. The 1st Division remained still on the line—the only one of the divisions that began the assault to remain unaided.

21 July. Berzy-le-Sec was the key point of the defense of the Chateau-Thierry—Soissons railroad; it was held by remnants of the German 6th, 34th, 42d and 11th Bavarian Divisions and was reinforced during the night by the 46th German Division.

With the brigade commander and his staff in the first wave, the feeble echelons moved to the attack. (Brig. Gen. B. B. Buck.) The 1st Brigade attacked at 4:45 AM, under cover of a rolling barrage, and reached the objectives on the height north of Buzancy; the 2d Brigade delayed its departure because the 69th French Division required an artillery preparation of three hours.¹⁸ The advance was made at 8:30 and proved most successful; by 9:15 AM, Berzy-le-Sec was in American hands, with important captures in men and matériel. At nightfall, the line ran

¹⁷ Soissons Monograph. Book 3, p. 16.

¹⁸ Soissons Monograph. Book 3, p. 18.

from east of Berzy-le-Sec to the Chateau-Thierry road, south of the Sucrerie, to north of Visigneux. That night the exhausted division heard news of impending relief by the 15th Scottish Division.

22 July. As the 87th French Division had failed to take Buzancy no further progress was practicable; the day was devoted to organizing the defensive line; the 26th Infantry took the Sucrerie and filled a gap between the 1st Brigade and the 28th Infantry. During the night 22-23 July, the division was relieved; about noon 23 July, trucks moved the remnants of the division to the Dammartin-en-Coele area.

The heroic endurance of this division during five days of bitter fighting must be considered as a remarkable performance; none but the best disciplined and seasoned troops could have preserved their cohesion under the losses sustained. All reserves were employed early on 21 July. It became necessary to use Engineers and form fresh reserves from elements of the trains and newly arrived replacements. The casualties of the division amounted to 285 officers and 7,655 men killed, wounded or missing. They included 75 per cent of the infantry field officers and 60 per cent of company officers. On 20 July, the 26th Infantry was commanded by a captain of less than two years' service.¹⁹ However, this gallant unit had accomplished its mission. The road and railroad south from Soissons was cut.

The German retreat from the Marne pocket was begun in haste. The division had advanced 11 kilometers, against five enemy divisions; it had captured 125 officers, 3,375 men, 75 artillery field pieces, 300 machine guns, 2,500 rifles and large quantities of small arms and artillery ammunition.²⁰

d. Smaller units in penetration. What about smaller units: the battalion, the company and platoon? What is their role in penetration?

In the attack on Cantigny,²¹ there is a pattern of parallel boundaries, nine companies of a single regiment fighting in corridors toward a limited objective. At Soissons there was a front of four regiments abreast, battalion with two companies abreast, and each regiment in column of battalions: a modern phalanx—2900 yards wide and several hundred yards deep.²²

An observer at Chaudun, in the zone of advance of the Moroccan Division, had a glimpse of this phalanx on the move:

"It was in the early afternoon of July 20th, a hot sunny day, that the first movement of our infantry, looking to an attack on Berzy-le-Sec, was revealed. The

¹⁹ *History of the 1st Division*, 1922. "Every battalion commander in the four infantry regiments was a casualty, and the 26th Infantry was commanded by a Captain of less than 2 years service." (Captain Barnwell R. Legge, of South Carolina.) p. 138.

²⁰ de Chambrun, p. 142. In recognition of the participation of the II American Corps, the Commander of the French Third Army issued the following order.

G. O. 218—July 30, 1918:

"Shoulder to shoulder with your French comrades you were thrown into the counter-offensive battle.

You rushed into the fight as into a fete. Your magnificent courage completely routed a surprised enemy and your indomitable tenacity checked the counterattacks of his fresh divisions.

91 guns, 7,200 prisoners, immense booty, 10 kilometers of country reconquered; this is your portion of the spoil of victory.

To attack him is to vanquish him. American comrades, I am grateful to you for the blood so generously spilled on the soil of my country. Mangin."

Giehrl. "Am. Exp. Korps." p. 33-34:

"The principle assault echelons which debouched from the Forest of Villers-Cotterets were formed by the 1st and 2d American Divisions, with the Moroccan Division. The American troops carried the main burden of the attack. When the Germans withdrew behind the Aisne, the American troops could claim a major share of in this success."

Pershing. "Experiences." Vol. II, Chap. 37, p. 161.

"Our 1st and 2d Divisions, with the Moroccan Division between them, had struck the decisive blow that turned the tide of War. Petain said, it could not have been done without our Divisions."

Hindenburg. pp. 348-349:

"Part of our troops, not required for defense, start harvesting in the wheatfields. They are surprised by a sudden gust of shells. Before they realize the situation, tanks appear in the high wheat. Our forward positions are pierced; the greatest danger threatens between the Ourcq and Soissons. Shattered remnants of our front lines put up a desperate resistance. Their heroism saved us from a catastrophe. The enemy has succeeded in penetrating our most sensitive area—the shoulder of the Marne salient, in the direction of Soissons. His pressure affects our only railroad line."

²¹ See Chap. II, Par. 8, Plate 27.

²² See Chap. III, Plate 36.

ground along the Paris-Soissons road, until then occupied only by some of our batteries and now deserted, save for their personnel, suddenly became alive with men. Under the torn boughs of the poplars and marching toward the southeast appeared a strong force of infantry. The composition of this force was not known to the observer and he was not aware of the impending attack. Field glasses were leveled in its direction to discover its identity. Meanwhile, more of the infantry appeared and it was seen that the men were in attack formation, except that they were moving by the flank. Their pace was slow and impressive—about that at which a barrage rolls. The faces of the infantry, in the shadow of the steel helmets, appeared black, and a French officer exclaimed, 'They are the *tirailleurs!*', referring to the Algerian regiment of the Moroccan Division on the right of the 1st Division. But further inspection showed they were not *tirailleurs*. They were the remnants of available reserves of the 1st Division after three days of terrific battle. On the breast of each man was the unmistakable box respirator, and the broad American bayonets flashed in the hot July sun. The wide column slowly wound down the grassy ravine toward the Crise. It was probably somewhat over a kilometer in length and three hundred meters wide. . . .

"Our leading waves now appeared approaching the crest of the ridge above Berzy-le-Sec, following the barrage. Each individual soldier in the attack was distinctly visible against the grassy hillsides. The whole mass was proceeding with the utmost regularity and precision. As the leading elements reached the crest of the ridge, a single battery of enemy 150-mm. howitzers opened fire with time shell, obviously with observed fire on the target. This battery was followed almost at once by many other batteries of 150-mm. and 105-mm. howitzers, all firing time shell. The accuracy of preparation of this fire was such that practically no adjustment was required, and, almost immediately, our infantry was shrouded in smoke and dust. Great gaps were left in the ranks as the shells crashed among them. Nevertheless, the advance continued in the most orderly way. It was noticed that the enemy's artillery diminished its range as our infantry advanced.

"Many of our infantry passed out of sight over the ridge, accompanied by the devastating fire of the enemy's artillery. Men struck by the enemy's fire either disappeared or ran aimlessly about and toppled over.

"Then began to be heard also the rattle of the enemy's machine guns. The attack had met the resistance of a strong position occupied in great force by the enemy. It could not be taken at this time by our worn soldiers, and, after this advance, they could go no farther. The thin lines lay down in shell holes, while long files of wounded hobbled painfully back.

"Then appeared a sight which at first seemed inexplicable. Individual men and groups of twos and threes began to wander about all over the field. They were the unit leaders, reorganizing their groups against counterattack.

"Thus the afternoon passed and night fell."²³

When boundaries are fixed, as they were then and now, the smaller unit goes forward to fight; as an interior unit it would appear that there will be little opportunity for Napoleonic concepts and planning, except to carry fire forward; that is particularly true of the attack on fortified positions. And yet, once out into the opening, the hostile shell pierced and elbow room available, maneuver possibilities present themselves in all echelons. Note the action of the 306th U. S. Infantry in an envelopment against St. Juvin, 14 October 1918, and that of Company C, 103d U. S. Infantry in the attack on Hill 190, 20 July 1918.²⁴ A number

²³ *History of the First Division.*

²⁴ Chap. I, Par. 5c, Plates 18 and 20.

of very interesting situations developed in the zone of action of one of the regiments at Soissons, the 28th U. S. Infantry:²⁵

(1) *The capture of St. Amand Farm.* The assault companies moved forward to the attack at 4:35 AM and soon closed on the barrage. By 5:30 the 3d Battalion reached the first objective, the road running northeast from Dommiers.

The assault companies continued their advance, following the barrage closely, until they reached a position about 200 meters west of the Raperie and the enemy's line of resistance. At this point, they met with heavy rifle and machine-gun fire, most of it coming from St. Amand Farm, which pinned them to the ground. On account of the level ground, the support platoons of both companies were forced to take cover from the enemy fire being directed at the assault lines. Something had to be done quickly to relieve this situation, as the barrage would stop only 15 minutes in front of the first objective. The support companies were not within supporting distance at this time, and the only unit which was available for maneuver was the scout platoon of the battalion. This platoon was composed of one lieutenant and 35 enlisted men. The men were all expert shots and had been selected on account of their good shooting ability and former bravery in action. The scout lieutenant was ordered to attack the Raperie with his platoon. Two squads of the platoon opened fire on it from the front, and the other two squads were maneuvered to a position on the flank from which enfilade fire could be delivered on it. As soon as fire was opened by the squads on the left flank, the two in front, led by the lieutenant, charged the enemy. One platoon of Company H, led by its lieutenant, joined this charge. Both lieutenants were severely wounded as they were about to close with the enemy, but the men, inspired by their leaders, continued the charge and succeeded in capturing the position. Five heavy machine guns and about 100 prisoners were captured in and around this strong point. The enemy's casualties had been very heavy on account of the accurate shooting of our men.

The capture of the strong point lessened the fire on our assault companies, and the advance was continued, the men firing from the shoulder as they moved forward in the high wheat.

(2) *The Caves of Mont d'Arly.* The 3d Battalion then took over the front line of the regiment at about 4:00 P. M. The 2d Battalion went into a support position on the eastern edge of the Missy-aux-Bois Ravine, just east of Breuil.

While the fighting was going on in the Missy-aux-Bois Ravine, it was discovered that great numbers of the enemy were emerging from a large cave in the vicinity of le Mont d'Arly and that they were firing on our troops from the rear. This cave had not been captured by the troops that had previously attacked and captured le Mont d'Arly. The reserve company, which had been left on the western edge of the Missy-aux-Bois Ravine, attacked the enemy at once and took them on the flank. The Germans were driven back in the cave, and they refused to surrender. It was impossible to bomb them out as the entrance was covered with machine guns from within. This made it necessary to lay siege to the entrance. The commander of the enemy garrison held out until about 4:00 P. M., when he came out under cover of a white flag and surrendered his entire force, consisting of twenty officers, including a commandant, and between three and four hundred men. Several horses, officers' mounts fully equipped, a great number of machine guns and trench mortars were also captured in this cave.

(3) *Saconin-et-Breuil.* The Missy Ravine presented a serious obstacle—deep, with a marshy bottom and about 900 yards wide; the strong defensive possibilities

²⁵ Lt. Col. Clarence R. Huebner. Personal experience report. This officer commanded the 2d Bn., 28th Inf., in this action, with conspicuous gallantry.

are obvious; the area was studded with enemy field guns and machine guns. Five of the French accompanying tanks were disabled by direct fire of 77-mm. guns located in the ravine. When the Americans reached the bottom of the ravine, they were stopped by direct enfilading fire from Breuil. Major Huebner directed Companies G and H on Breuil, along the east slope of the ravine; these units soon came under heavy fire from le Mont d'Arly and slowed down; casualties amounted to 50 per cent. Major Tack, the commander of the 3d Battalion, in rear, realized the gravity of the situation and brought his fresh units into the action.

(4) *Berzy-le-Sec*. On the fourth day of the attack, 21 July, the shattered remnants of the gallant 28th Infantry made their last and successful attack on Berzy-le-Sec. The regiment was disposed with the 1st and 2d Battalions, in line; the 3d Battalion in support; a sadly depleted battalion of the 18th Infantry took its place, in line with the 2d Battalion.

The regiment resorted to maneuver in a double envelopment: at 8:30 A. M. the first battalion moved around the north of the town, the second around the south; the Germans evacuated the position.

Our most reliable authority²⁶ very wisely remarks: ". . . a sharp distinction between the various classes of offensive situations and the methods employed cannot always be made. Each class may temporarily present aspects which are characteristic of the others."

This very conservative observation applies to the transition from penetration to break through—they are two of a kind: the difference is one of relative size, importance and intensity. Cantigny²⁷ represents a penetration while Meggido²⁸ is a breakthrough. Finally, military terminology²⁹ is by no means as clear-cut as the profession fondly believes it to be: penetration is a preparatory action that may (or may not) lead to a breakthrough . . .

25. THE BREAKTHROUGH. *a. General considerations. Principles.* The opening phases of the World War, in the period August-September 1914, are characteristic of a war of movement. The hectic character of these engagements presents a sharp contrast with the sudden paralysis that fell over these fronts in the years from 1915 to 1918—a period known as "stabilization."

It seemed scarcely possible that an extended front such as this could ever have developed in the short space of time between August and November 1914. In these days of motorization and mechanization, with "speed, mobility, maneuver" as key-words, it seems equally impossible that these lines should have become stationary. How did this come about? The enormous staying power of automatic defensive weapons, combined with field fortifications, made the frontal attack expensive. This lesson might have been observed in all previous wars, particularly our own Civil War.

The strategic and tactical solution to be attempted was a foregone conclusion: the envelopment, the flank maneuver, the turning movement.

Each opponent tried it. There began a series of attempts to envelop the enemy, who, in turn, extended his flanks, to meet and check this threat—on the Oise, Picardy, the Artois, and Flanders.

The only limits to this endless extension seemed an exhaustion in man power or an insurmountable natural obstacle—the sea. Both elements came into play,

²⁶ F. S. R., Par. 440.

²⁷ Chap. II, Plate 27.

²⁸ Chap. II, Plate 25.

²⁹ As a characteristic example of military ambiguity, note the term "corps", i. e., army corps, dental corps., esprit de corps, corps-troops, engineer corps, corps of officers, etc.

WEST FRONT 1914

THE PROGRESS OF THE ENVELOPING MOVEMENTS.

1. BATTLE OF THE OISE. SEPT. 19
2. BATTLE OF PICARDY. SEPT. 30
3. BATTLE OF THE ARTOIS. OCT. 7
4. BATTLE OF FLANDERS. NOV. 20

7482-1-30

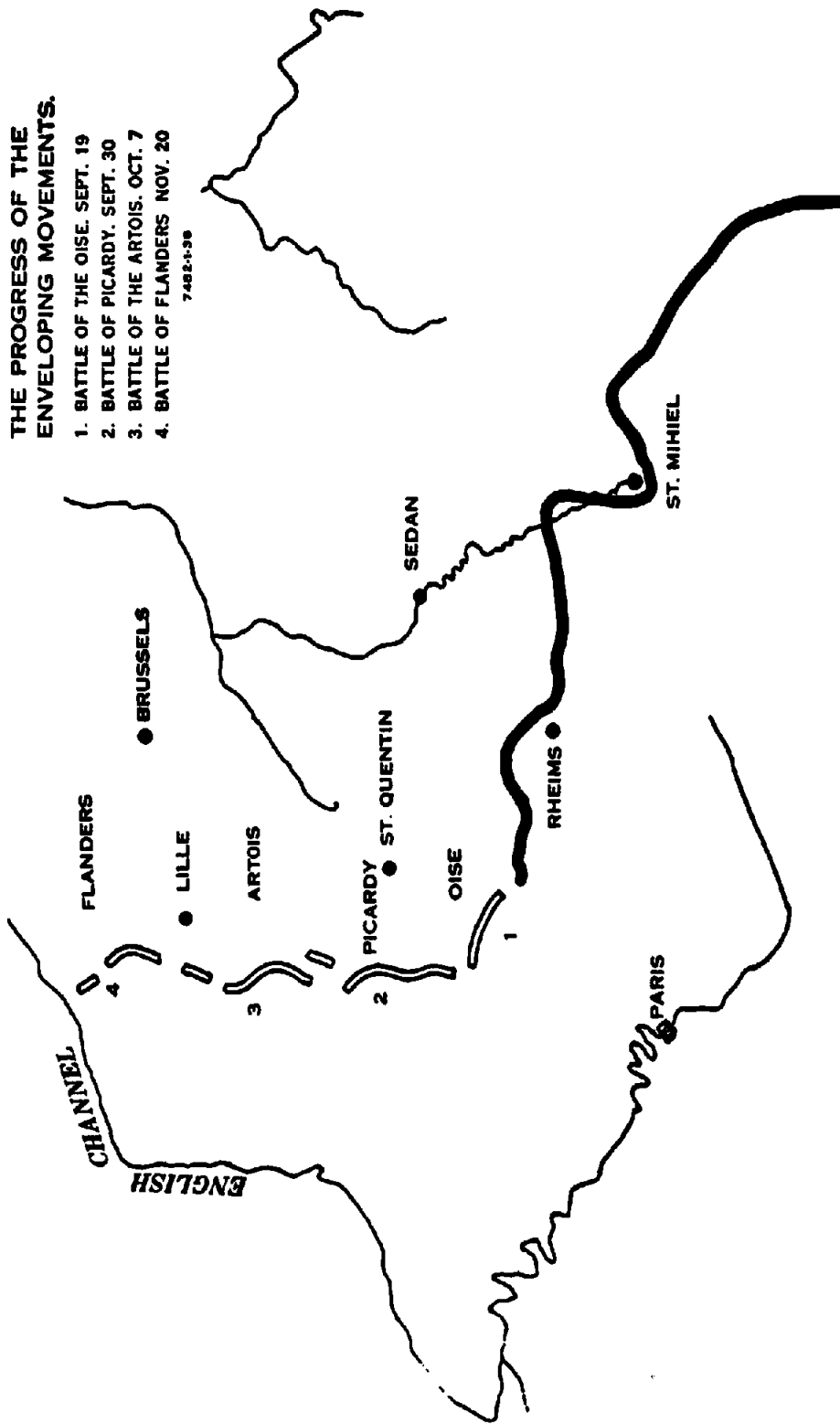

PLATE 59. WEST FRONT, 1914: THE RACE TO THE SEA.

Extracts: *Manual for Commanders of Large Units. Vol. I and Field Service Regulations, 1923*

- 1 M.C.L.U., Par. 25: To secure unity of command, two or more Armies operating upon the same front, must be placed under a higher commander
- 2 M.C.L.U., Par. 39: The depth to which an offensive can penetrate varies directly with the frontage on which an adequate offensive can be launched
- 3 F.S.R., Par. 436: The greatest distribution in depth is placed in front of the prospective points of penetration . . . after a penetration has been effected, forces must be available for attacking and enveloping the flanks created by the penetration . . . the mission of the troops designated for execution is to effect a complete breakthrough . . . they do not divert their strength to attack the flanks of the gap . . . reserves are assigned the mission of rolling up the flanks
- 4 F.S.R., Par. 473: The object of a major attack is to force the enemy into open ground with a view to his subsequent defeat by the application of the methods of open warfare . . . The objective and direction of attack are so selected that a successful offensive will render the enemy's general position untenable and force his withdrawal on a wide front
- 5 F.S.R., Par. 478: Especial consideration is given in the preparation for the attack to measures designed to insure continuity of action of the attacking troops
- 6 M.C.L.U., Par. 44: Often the battle against stabilized fronts must include the organization of several attacks
- 7 F.S.R., Par. 482: The concentration of the attacking divisions is carefully screened
- 8 M.C.L.U., Par. 44: To give the advantage of surprise, preparations are made in secret
- 9 M.C.L.U., Par. 43: The attack requires a mass of powerful artillery
- 10 F.S.R., Par. 483: A prolonged artillery preparation is destructive of the effect of surprise . . . the duration of the artillery preparation may vary from zero to eight hours
- 11 M.C.L.U., Par. 46: Immediate and intensive exploitation of the advantages gained is necessary to complete the enemy's disorganization
- 12 F.S.R., Par. 490: Pursuit of the enemy must be pushed to the utmost limit . . . no opportunity given him to reorganize . . . this cannot be accomplished by a straight pushing back of the hostile forces . . . direct pressure, is combined with outflanking maneuver

Command Principles and Methods

- 1 •Unity of Command: Grouping of Forces
- 2 •Echelonment in Depth: Creation of Mass
- 3 Operations against the Flanks of the Breakthrough
- 4 Designation of Forces for principal Missions
- 5 Designation of Forces for secondary Missions
- 6 •Objective and Direction of Attack for decisive Effect
- 7 •Continuity of Action: Successive Efforts
- 8 Secrecy of Preparations: Surprise
- 9 Artillery Preparation
- 10 •Exploitation of the Breakthrough: Pursuit
- Especially important from the viewpoint of G.H.Q. and High Command

and by December 1914 the opposing armies had dug in, in that incredible belt of trenches which stretched from the Channel to the Swiss border.

On the West Front, the story of the years from 1914 to 1918 is one of repeated desperate attempts to break the deadlock of trench warfare through the only remaining tactical methods of "penetration" or "breakthrough". Four conspicuous examples of "breakthrough operations" may show the characteristic form of this operation:

- (1) The breakthrough at Gorlice-Tarnow, May 1915: a success.
- (2) The second battle of the Aisne, April 1917: a failure.
- (3) The battle of Verdun, February 1916: a hybrid.
- (4) The tank attack at Cambrai, November 1917: a modern solution.

From this brief evaluation of "success" or "failure," it is apparent that this paragraph represents an analysis of "cause and effect?"³⁰

At first glance, it seems pointless to revive incidents of "stabilization," which is now generally regarded as an abnormality. However, "breakthrough" operations are not exclusive phenomena of stabilized fronts; they have appeared, as "local penetrations," in open warfare situations, sometimes within the framework of a single battle.

At any rate, our current military texts still accept "penetration" and "breakthrough" as normal military possibilities.

The question immediately presents itself: "What principles are involved in this type of operation—the breakthrough?" These principles are listed in Plate 60.

The whole method and procedure, in a breakthrough operation, is clearly described in these paragraphs.

It is equally obvious that these complex factors can be reduced to a list of "command principles," shown in the right column.

From this point on the analysis consists of the relatively simple task of tracing and checking the selected operations against this list of command principles with a view to determine to what extent they were applied. The record of this investigation should explain success or failure, as the case may be.

b. The breakthrough of Gorlice-Tarnow, May 1915. The Eastern Front held jointly by German and Austrian forces was defended by one and three-fourths million Russians and had the enormous extent of over 800 miles. In the spring of 1915, the situation was generally unfavorable for the Central Powers. On the Austrian front, the Russians had practically broken through the Carpathians and constituted an immediate, serious menace to Hungary. The problem of GHQ was to relieve the intolerable pressure in this area. In view of the stabilization that had set in, the operation of course had to take the form of a "breakthrough."

Where, on this enormous front, approximately equivalent to the distance from New York to Chicago, was the point of breakthrough and the reasons for its selection?

An advance from East Prussia in the north could hardly affect the Russians on the Carpathian front.

Frontal pressure against the face of the great salient seemed fruitless, leading only to a step-by-step withdrawal toward the east.

A breakthrough on the flank of the Carpathian front in the south, however, might remove the threat to Hungary. GHQ consequently decided on a breakthrough on the front: Gorlice-Tarnow.

Mass was provided by creating a new army,³¹ the Eleventh, under command

³⁰ See Chap. I, Par. 3. The role of the historical example. Like the analysis of the defense of river lines, the contents of this paragraph represent the correct approach to military history, through a process of comparative analysis as the only way to an understanding of the nature of war.

³¹ F. S. R., Par. 436.

of Mackensen, and hurling it against the Russian Third Army, which was over-extended in this area.

On 2 May 1915, the breakthrough was made on a narrow front of approximately 25 miles, with 6 corps abreast; over 700 artillery pieces, including heaviest calibers, supported the assault by intensive concentration of 4 hours; the brevity of this preparation was an aid to surprise.³² Chronologically, this was the first great breakthrough operation of the World War on a scale sufficiently large to bring about

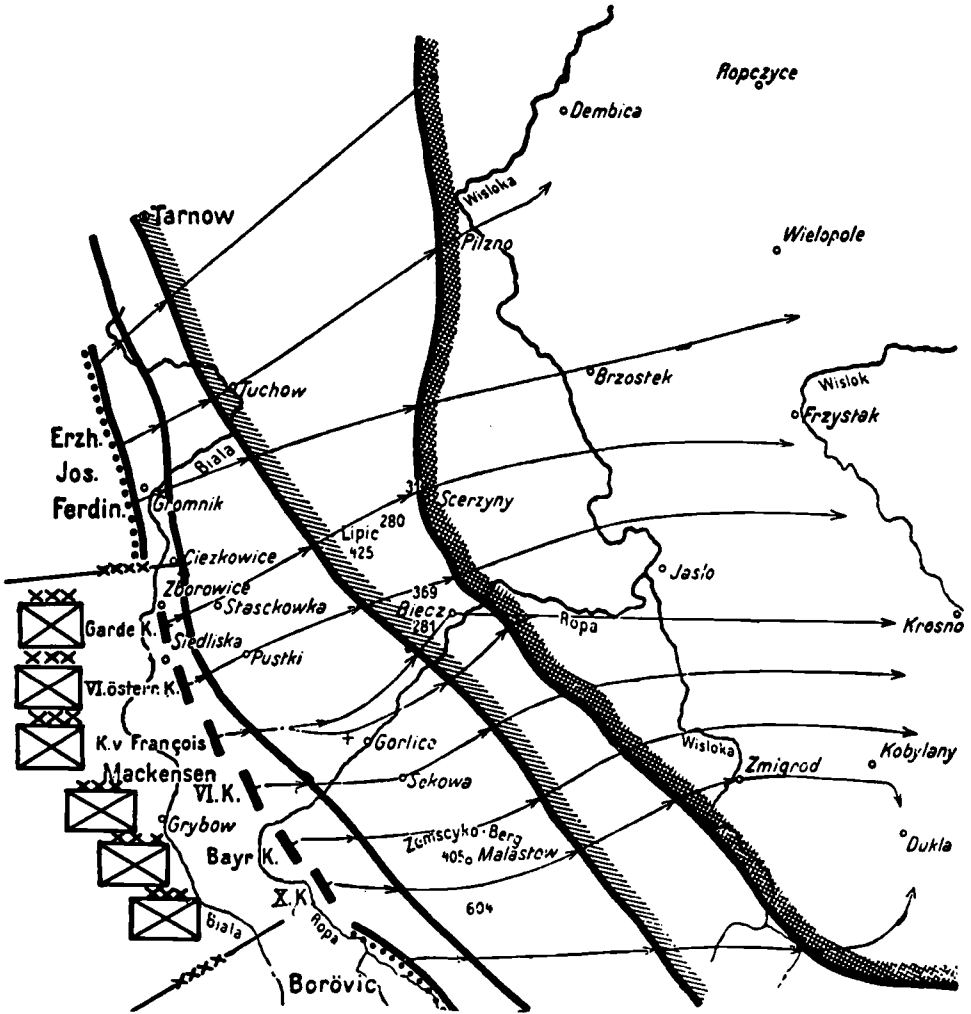

PLATE 61. THE BREAKTHROUGH AT GORLICE-TARNOW: 2-9 MAY 1915.

tremendous results. Within four days, the German-Austrian forces had penetrated to a depth of 50 miles and were in the open. Captures in prisoners amounted to over 100,000 and immense materiel was taken.³³ This breakthrough is classified as "a success." Compared with similar operations, as you will see presently, the

³² F. S. R., Par. 483.
³³ F. S. R., Par. 478.

net results of this breakthrough were immeasurably superior. Generally speaking, a majority of the listed principles were observed.

c. *The second battle of the Aisne: April 1917.* The Second Aisne Offensive, a breakthrough by another commander, is termed a "failure" because the front was not broken through and there was no decisive success.

The general situation on this West Front was similar to the Russian Front: a stabilized front and a demand for action through a breakthrough. Consequently, the problem and the objective were the same for Nivelle, the French commander, as they had been for Mackensen at Gorlice.

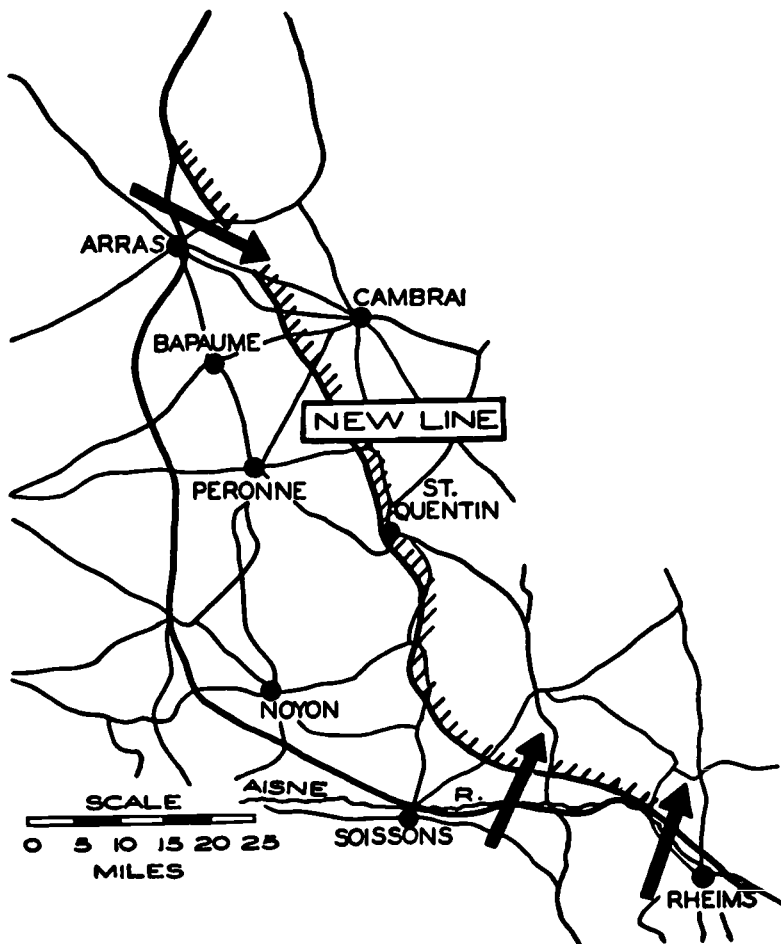

PLATE 62. THE ARRAS-SOISSONS SALIENT, 1917.

The plan called for a coordinated attack by the British on the Arras Front, to be followed by the French main attack on the Aisne, pinching out the German salient and bagging the occupants. This was a good plan and in accord with the command principles involved in breakthrough operations.³⁴

Mass was certainly provided for; behind the breakthrough fronts over a million men were made available.

³⁴ F. S. R., Par. 483.

Before the attack could begin, the Germans disrupted its foundation by evacuating the threatened salient and retiring to the newly fortified Hindenburg Line, leaving their foes to follow laboriously through an intervening desert created by an elaborate program of devastation. The withdrawal enabled the Germans to gain additional reserve divisions, dislocated the initial plans of the Allies and restricted the attacks to the flanks of the devastated areas.

The British struck first, at Arras; they obtained a very considerable success, capturing about 20,000 prisoners; however, three weeks of wire cutting followed by a five-day bombardment gave the Germans ample warning; after sweeping forward to a depth of 4 miles, the British were stopped by intact defenses in the rear.

The French attack on the Aisne, known as the Nivelle Offensive, was equally abortive in strategic results.

It was launched after an artillery preparation of ten days. At the close of the first day of the attack, however, it was evident that the breakthrough had failed, except the capture of the German first lines as far as the Chemin des Dames. The element of surprise was totally lacking,⁸⁶ and the Germans were eventually able to engage 40 divisions against 48 French divisions. The French losses for this type of operation were not excessive, but they were exaggerated in reports. The moral effect on the Government, the people and the army was disastrous. Nivelle was relieved from command.

It is difficult to charge this failure directly to Nivelle. Very abnormal conditions surrounded this operation. Haig was not satisfied with Nivelle's plan. This pessimistic view was shared by most of Nivelle's army and corps commanders. The plan became notorious and was discussed on the sidewalks of Paris.

In the opinion of most military critics, the principal cause of failure was lack of surprise, which enabled the Germans to match ample reserves against the French breakthrough mass.

d. The battle of Verdun: February 1916.

Gorlice and the Aisne Offensive were breakthrough operations, with clearly defined tactical and strategic characteristics. At Verdun, we are confronted with something novel in military history—and something monstrous. Falkenhayn, in turning to the West Front, decided on a major offensive effort. This was unavoidable because the Germans could not maintain the defensive as a policy. Time was working for the Allies.

Falkenhayn believed that France had almost reached the breaking point; if it could be demonstrated that her military power could not succeed, she might quit. To accomplish this, he planned to attract the shrinking French reserves to the defensive of an objective of great national importance which would gradually consume all available French man power. Such an objective he believed to be Verdun. In the execution of this plan, he specifically dismissed the breakthrough, in the form we saw at Gorlice, or as Nivelle planned it at the Aisne, i.e., as a "preliminary operation to a war of movement." In selecting the Verdun salient, Falkenhayn gauged the French temperament correctly; it was an area for the retention of which the French were willing to throw in every man they had; the defense of that little salient, scarcely 30 miles in width, became a point of national honor.

Falkenhayn, the adherent of the strategy of attrition, carried his ruling idea into tactics through a series of limited objectives. This was the plan at Verdun, if it can be called a plan at all—a continuous series of limited attacks which by

⁸⁶ F. S. R., Par. 483.

THE VERDUN SALIENT

Railroads

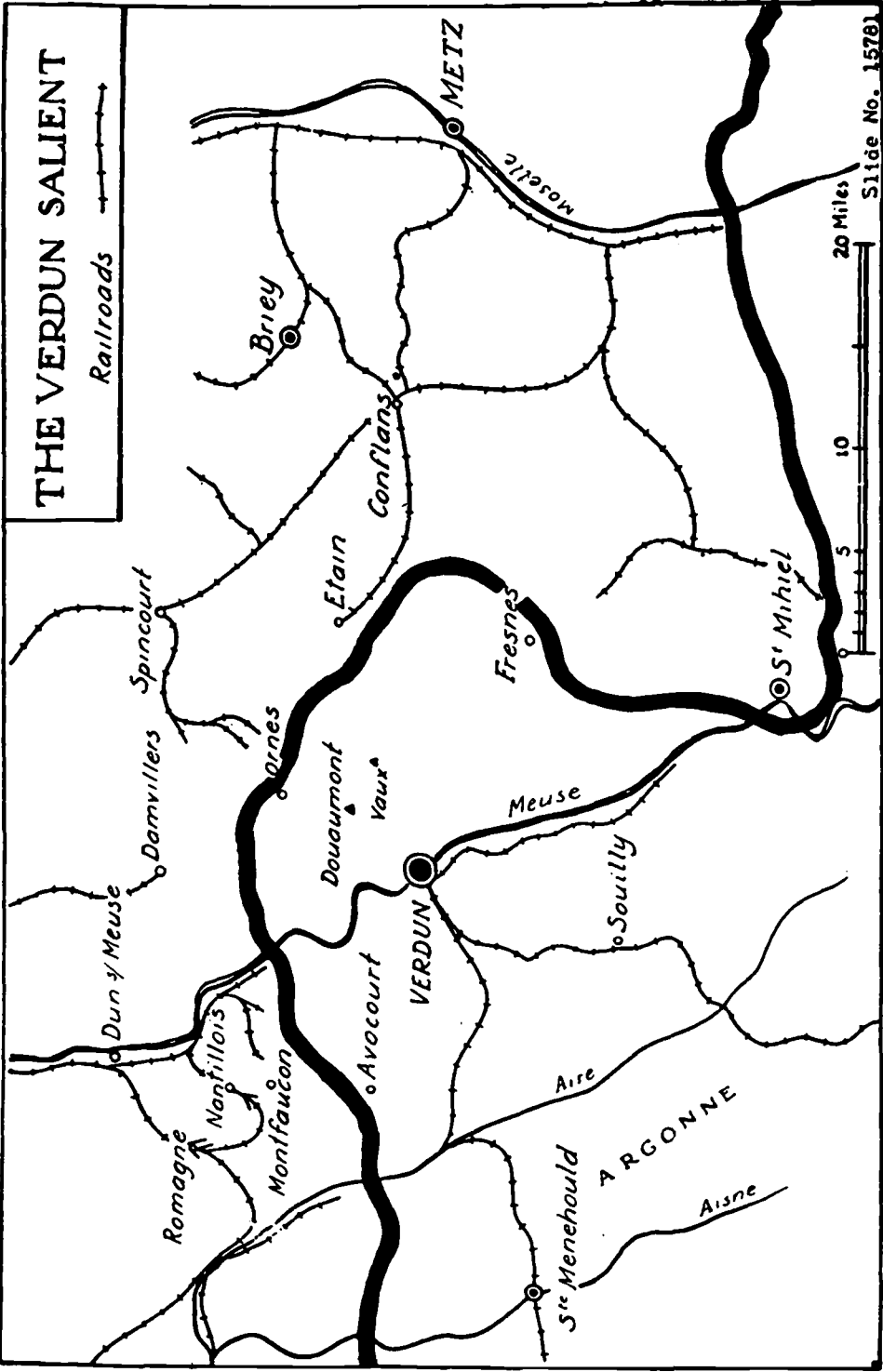

PLATE 63. THE VERDUN SALIENT, 1916.

Slide No. 15781

their menace should gradually draw all French reserves into the fire of German artillery. The attack began on 21 February. In four days the Germans made their maximum advances of approximately 6 miles; thereafter, the attack came to a virtual standstill, like the British at Arras or the French on the Chemin des Dames.

In his monstrous conception, Falkenhayn believed that he could bleed France white. He was wrong; the balance of attrition, in the final reckoning, was only slightly in favor of the Germans—283,000 against 315,000 for the French; an incredible strain on the man power of France, but almost equally disastrous for the Germans.

Stripped of sentiment, this operation represents the utter bankruptcy of generalship. It had no plan, no purpose except destruction—the slaughterhouse for a half a million cattle that were relentlessly driven through the chutes.³⁰

Verdun represents an expensive frontal attack under most adverse conditions.

The item of "objective" must be emphasized, as shown by a pertinent paragraph of our F. S. R. and the analogous views of a great French commander. The enterprise had no military or strategic objective; it was doomed to failure from its inception. It particularly ignored that cardinal provision of the purpose of the attack as means to regain maneuver.

F.S.R.

Par. 473. The object of a major attack is to force the enemy into open ground with a view to his subsequent defeat by the application of methods of open warfare . . .

Petain

The breakthrough is not the object but the means of delivering battle in open warfare . . .

e. The tank attack at Cambrai: November 1917.

The story would be incomplete without covering a highly important development which seems to also point the way to the future: tank versus machine gun.

It was the British solution to the deadlock of the trench barrier, by producing a machine invulnerable to machine guns and capable of crossing trenches, a weapon which would restore the balance upset by the new preponderance of defensive over offensive. The idea of a machine for this purpose was conceived by Colonel Swinton in October 1914 and came to maturity in the tank of 1916.

On 15 September 1916, in the closing days of the Battle of the Somme, this new instrument of war received its baptism of fire. This was one of the few attacks on the West Front, since 1914, that did not require a magnifying glass to detect its progress—but it is likely to become a veritable landmark in the history of war.

The eventual effect of the tank is best appreciated by the evidence of those who had to face it. Ludendorff spoke of the great tank surprise of 8 August 1918 as the "black day of the German Army in the history of the war . . ." and ". . . mass attacks by tanks remained hereafter our most dangerous enemies." More emphatic still is the comment of General von Zwehl: ". . . It was not the genius of Marshal Foch that beat us, but the tank . . ."

Many German regimental histories record similar impressions: ". . . the arrival of the tanks on the scene had the most shattering effect on the men.

³⁰ The ruthless expenditure of man power, in a final essence, is characteristic of all wars, modern or ancient. The romance of war, the hypnotism of patriotic cliché, cannot completely hide the commercial quality of this terrible business: the balance sheet of man power, the "credit entry" of replacements, the "debt entries" of dead, wounded and missing!

The Allies were no better than the Germans. Falkenhayn had his British counterpart, Sir Henry Wilson. Here is an interesting little annotation in the diary of this clever, and sometimes cynical staff officer:

"Macready came over to see Johnnie French and me, and brought casualty lists. Since July 1916, up to October 10 last, Haig has lost 900,000 in killed, wounded and missing, not sick, and of these 80,000 are missing. It appears that our monthly wastage in France is 50,000, and an optimistic estimate of intake is 30,000, though 25,000 will probably be nearer the mark. This shows a monthly deficit of 20,000 to 25,000. So that a year hence, with the past to guide us, we shall be 240,000-300,000 men deficient, all infantry; and we start today with a deficit of 48,000."

Monthly "wastage" and "intake"? Quite a bookkeeper, this lad Wilson!

They felt powerless against these monsters which crawled along the top of the trench enfiling it with continuous machine-gun fire”

The action on 15-17 September was merely a preliminary to a more important test—the tank surprise at Cambrai. At 6:20 A. M., 20 November 1917, 381 tanks rolled forward in a misty dawn without the courtesy of an artillery preparation to announce their coming.

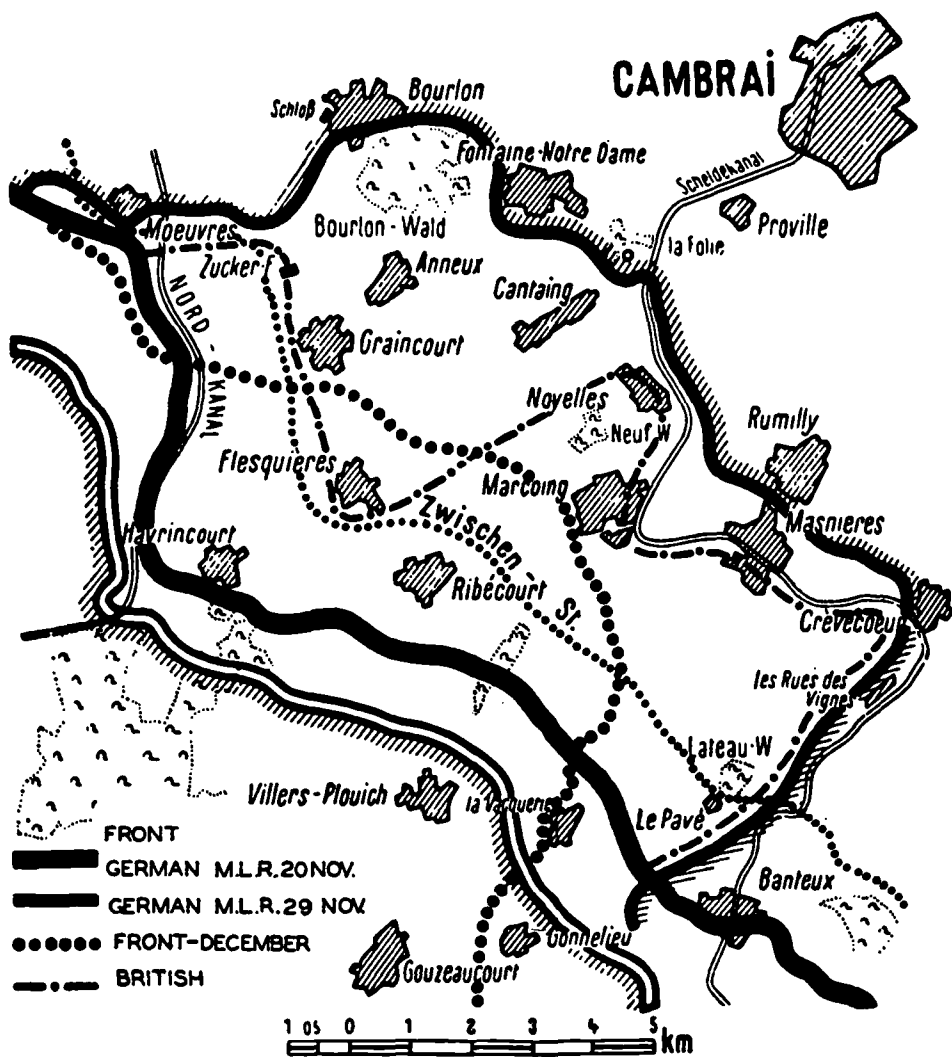

PLATE 64. THE BATTLE OF CAMBRAI: NOVEMBER-DECEMBER, 1917.

Within a single morning a penetration of five miles had been made—the equivalent of months of heavy fighting and heavier losses on the Somme and at the Third Battle of Ypres; the enemy's three main lines had been overrun—open country lay beyond; the German official report admits the fact “that a wide gap remained open for many hours, between Masnieres and Crevecoeur . . . it was great luck as no reinforcements could be expected to reach there before evening.”

But the British tank crews were exhausted; the infantry showed little capacity to make progress on their own;⁸⁷ and the cavalry divisions failed in their role of exploitation.

The next successful tank attack, the assault of 456 tanks at Amiens on 8 August, showed the same symptom, i.e., an initial surprise effect, a deep penetration, but the next day the attack flickered out as rapidly as it had blazed up. Why?

It is well to remember that the problem of maintaining continuity of advance was never solved in the World War.

Surprise and initial mass were provided for and achieved, but exploitation, through continuity of effort by fresh reserves was lacking.⁸⁸ It would appear that the tank, as a tactical instrument, is subject to the same laws of economy of force as any other military means; but its effectiveness was brilliantly proven, then and for the future.

Generally speaking, the factors: mass—objective—continuity of action, have applied in successful breakthrough actions. Modern trends in armament and methods will add rather than detract from these factors.

RECAPITULATION OF FACTORS

	Gorlice	Aisne	Verdun	Cambrai
Mass	•	•	—	•
Surprise	•	—	—	•
Objective	•	—	—	—
Direction	•	•	—	•
Continuity	•	•	•	—
Exploitation	•	—	—	—

⁸⁷ F. S. R., Par. 490.

⁸⁸ F. S. R., Par. 478.

VI

FLANK MANEUVER

26. **THE CONVERGING ATTACK.** In the analysis of previous historical examples, as at Montdidier, La Fere Champenoise, and the First Marne, the basic factors of mass and direction appear in the form of a combination of frontal attack with a flank attack, i.e., direction is not applied along a single axis but always in conjunction with an effort along another axis.¹ A concentric advance, i.e., a converging attack, belongs in this category.

The converging attack involves the advance of numerous columns concentrically oriented toward a probable battlefield. This system was considered as ideal by the prewar German regulations. The whole scheme is a matter of long, prior preparation and preconceived decision; the commander practically abandons personal direction of combat as soon as the principal columns are engaged.

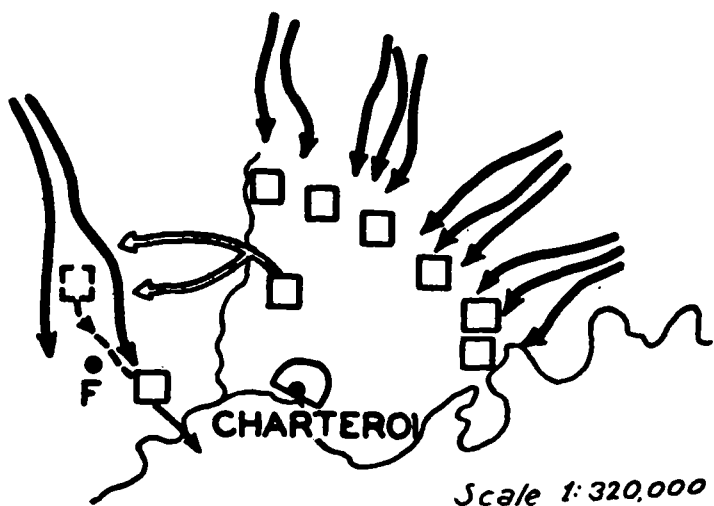

PLATE 65. THE BATTLE OF FLEURUS, 1794.

The action at Fleurus, 1794, represents a characteristic example: the concentric advance on Charteroi is unmistakable. The French, with 75,000 men, were disposed on a perimeter of about 15 miles. The Austrians attacked in several columns—a clear-cut example of a converging attack.

A military operation may be examined from a fixed viewpoint, in order to develop a single striking feature or angle; it is understood, of course, that this is a narrow interpretation; there are many features and diverse angles to a battle action; the design is not uniform; there are many facets. Fleurus lends itself primarily as an example of the converging attack, the concentric advance: the conversion of columns is unmistakable; the pattern is clean-cut and satisfactory (for pedagogy).

But we also find, in this same action, a neat example of the "exploitation of a gap in the line" (fragmentation): in the course of the action, the French left wing under Montaigne had to give way; it was promptly pursued by the nearest

¹ F. S. R., Par. 435.

Austrian column. The French center, however, held firm; this resulted in a local gap between the Austrian right and center. The French commander took immediate advantage of this situation and threw his reserve into the gap, to attack the Austrians in flank and rear; the maneuver succeeded perfectly.

The theoretical parry for the converging maneuver is: (a) an extension of the front at the moment of engagement—this was partly done in the French dispositions in the battle of Fleurus, or (b) a partial or complete evacuation of the battlefield so that the enemy columns converge on empty space—a blow in the air. This was the situation at Le Mans; as you recall, the German columns were

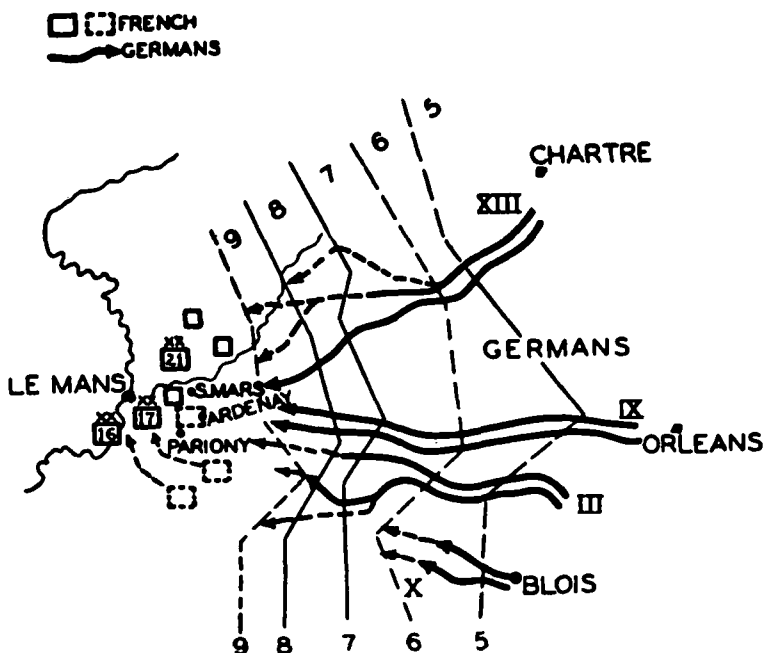

PLATE 66. THE BATTLE OF LE MANS, 1871.

to converge on Ardenay; the movement was in full progress when the French commander evacuated the initial battlefield. The Germans had to start another maneuver.

The use of the converging maneuver is chiefly in the realm of strategy, but it may appear, in lower echelons, in the details of a flank attack or wide envelopment.

a. *Frontal attack and envelopment.* A concentric advance by several columns on an objective of any size is obviously undertaken with a view to eventual envelopment.² We can safely agree that there is a close connection among all the acts that constitute a maneuver—as at Montdidier. In the “flank maneuver,” in particular, there is a repercussion of the frontal attack on the flank attack or envelopment, and vice versa;³ as usual, our basic text⁴ has clearly recognized the relationship between the frontal attack and the envelopment. In view of the

² See Chap. IV, Par. 19. “Preconceived Maneuver.”
³ F. S. R., Par. 434: “According to the situation . . . the main attack aims to envelop—or to penetrate.”
⁴ F. S. R., Par. 433: “. . . Enveloping and frontal attacks take place simultaneously or the enveloping attack is preceded by the frontal attack.”

relatively great importance of this form of attack, this entire subject is examined in detail in a later chapter.⁵

Sharp distinctions between the various classes of offensive situations cannot always be made; each class may temporarily present aspects which are characteristic of others.⁶

In the framework of a single operation, one can often trace the entire range and variation of several military actions, which are ordinarily regarded as distinct types. In the advance on the line: Adrianople—Kirk-Kilisse, in the Turco-Bulgarian Campaign of 1913, it is possible to list a number of so-called categories that merge imperceptibly:

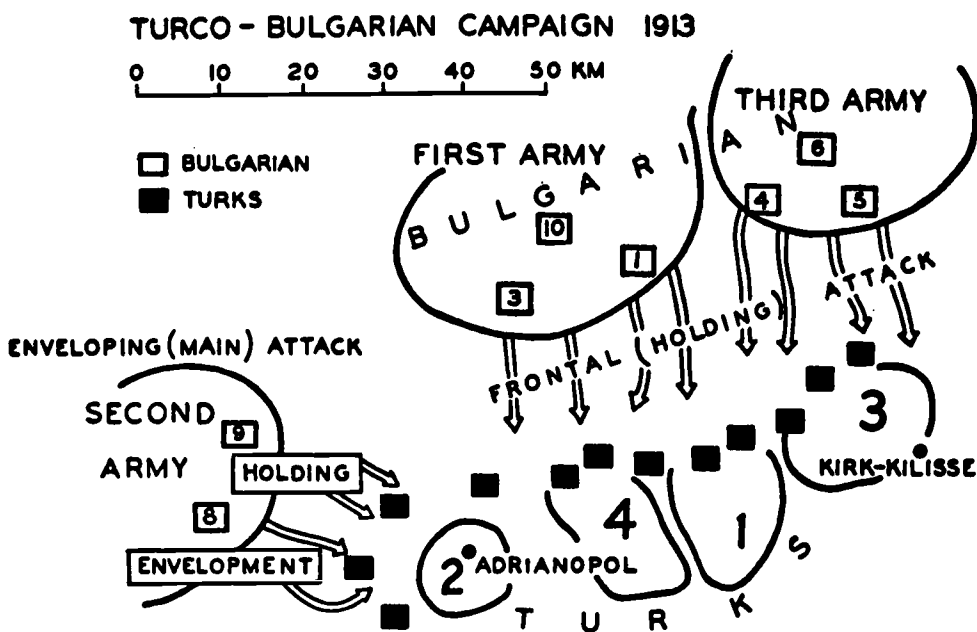

PLATE 67. THE TURCO-BULGARIAN CAMPAIGN, 1913.

(1) Converging attack: The advance of the First and Second Armies, against the Turkish left, appears as the concentric advance of numerous columns converging on Adrianople; a situation identical with the advance on Charleroi and Fleurus.

(2) Flank attack: In the ensemble of the armies, the Second Army is engaged in a flank attack.

(3) Main (decisive) attack and secondary (holding) attack: The First and Third Armies are engaged in a frontal (holding) attack while the Second Army is executing a main (enveloping) attack against the Turkish left (Adrianople).

It is noteworthy and characteristic that this dual action is repeated in lower echelons, viz: in the Second Army, note the 9th Division in a holding attack while the 8th envelops.

Smaller units have already been shown⁷ as operating on identical lines, viz: Regiment: The 306th U. S. Infantry: St. Juvin, 14 October 1918.

⁵ Chap. VIII, Pars. 36 and 37.

⁶ F. S. R., Par. 440.

⁷ Chap. I, Par. 5b.

Battalion: The 4th Battalion 365th French Infantry: Cuisy en Almont, 20 August 1918.

Company: Company C, 103d U. S. Infantry: Hill 190, 20 July 1918.

Platoon: St. Amand Farm: Soissons: 18 July 1918.

b. Turning movement. The line of demarcation between turning movement, wide envelopment and converging attack is vague—all require the concentric advance of separate columns on a common objective; characteristic examples have been shown elsewhere, viz: Beersheba, St. Juvin, Cuisy en Almont.

27. **THE ENVELOPMENT.** *a. General considerations.* An envelopment may be regarded as a converging maneuver in the area in which it is conducted. The principal inherent defect of the converging maneuver, however, lies in operating against an enemy who is not stationary. This disadvantage can be offset by conducting the envelopment in two phases: a first phase of finding the enemy and holding him where found, and a second phase of moving troops on his flank to envelop him.

If the enemy has reserves, he will certainly use them to extend his front, in proportion as we extend our own. This was done on a large scale in 1914, at the time of the race to the sea; the location of the flank changed continuously.

Current regulations⁸ give a clear picture of the form and execution of envelopments; a few general observations are added: the envelopment as a combat form is as old as the hills; it is known and practiced by the youngest platoon commander. The envelopment is the habitual maneuver of small units when they run into an enemy holding a non-continuous front. In these minor operations one sometimes notes a tendency to economize too much on the frontal attack and to expect the entire result from the virtues of the enveloping movement itself.

One must guard against a similar tendency in the manipulation of larger units. A great military thinker has made a very pertinent comment:

Foch: "We do not cause a real adversary to fall back, by a cleverly chosen direction. We can not immobilize him without an effective attack . . . War is positive in its nature, admits of only positive solutions. No effect without cause: if you desire the effect, develop the cause: apply force."

It can be stated confidently that: (a) the effect of the envelopment is chiefly proportional to the quantity of enemy troops taken in flank; (b) the envelopment is effective only on condition of being combined with an attack from another direction.

This brings us directly back again to one of our basic factors: combination of direction and, consequently, the ideal form of the flank maneuver appears as a frontal attack combined with a flank attack. This conception is emphatically not modern; two thousand years of warfare contain endless examples of its application!

It is proposed to cover this enormous space of time by selecting the dates of 216 B. C., 1756, 1817, 1863, 1866, and 1914—the maneuver of Hannibal, of Frederick II, of Simon Bolivar, of Robert E. Lee, of the elder Moltke and of Count Schlieffen.

Centuries have elapsed between the maneuver of Cannae, in 216 B. C. and the Schlieffen Plan of 1914, and yet they are definitely linked by a remarkable continuity of thought. Count Schlieffen, a Field-Marshal and for many years Chief of Staff of the Imperial German Army, made the battle of Cannae, fought in 216 B. C., the basis of a stupendous strategic doctrine that permeated the High-

⁸ F. S. R., Pars. 434-439.

Command of the German Army and controlled the intellectual orientation of an entire generation of army officers.⁹

With Cannae as a starting point, as a model for the *battle of annihilation*, the Count traced the factors present at Cannae through the major military conflicts of the nineteenth century, the Wars of Frederick II, Napoleon, the Austro-Prussian, and Franco-Prussian Wars. His work is not a presentation of military history but rather a document of instruction. The military operations he describes are problems of application, in pursuit of a central idea: the decisive character of the flank maneuver and the envelopment on a large scale.

It is one of the greatest of modern military books; it is great because of the position and prestige of its author and its influence on the conduct of the World War; it is modern, since no one can claim staff and command capacity without the background of the military theories herein developed.

b. The double envelopment. (1) *The Battle of Cannae, 216 B. C.* What elements were present in this battle, in which Hannibal, with inferior numbers destroyed a great Roman army? Stripped of all details, we can distinguish three phases:

- 1st: Hannibal's Army, arranged for battle, presents a convex front toward the Romans.
- 2d: On contact, Hannibal's center falls back slowly while the wings hold fast, so as to present, at the end of the movement, a concave front to the enemy.
- 3d: The wings of the Carthaginian Army, reinforced in the beginning, close in, in a double envelopment.

⁹ *Cannae*, by General Field-Marshal Count Alfred von Schlieffen. Authorized translation, C. & G. S. S., Ft. Leavenworth, Kansas, 1931. This monumental treatise on the art of war was published through the personal intervention of Major General S. Heintzelman and Colonel W. Burt, the Commandant and Assistant Commandant of the Command and General Staff School.

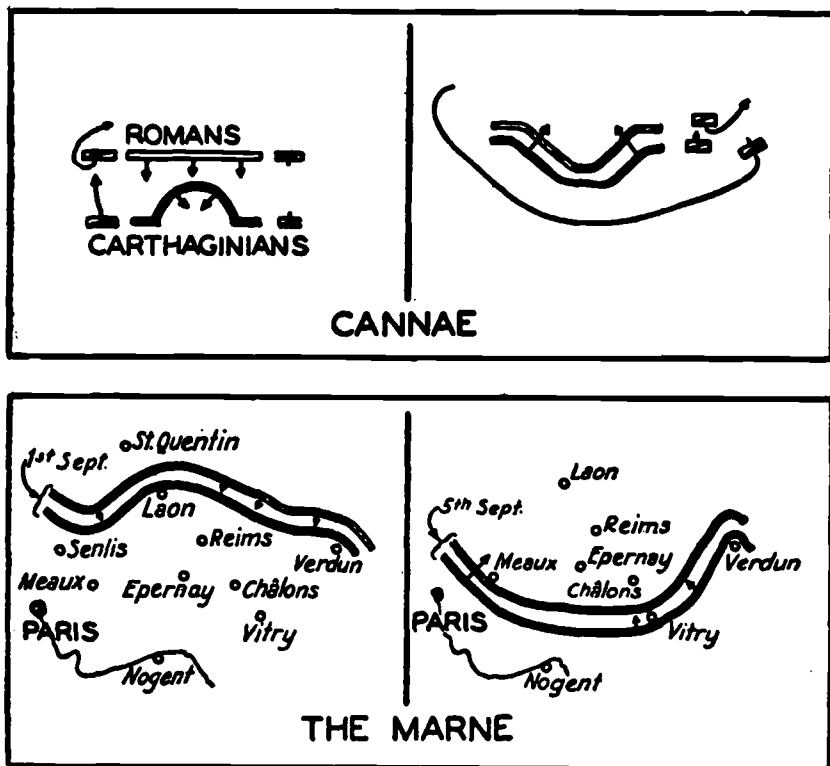

PLATE 68. CANNÆ AND THE MARNE.

It may sound like a paradox that in an age of machine guns and tanks, one should evoke the ghost of Roman and Carthaginian Armies. But there is a striking similarity between this maneuver and the situation in the first battle of the Marne: In the first phase the French Armies presented a convex front to the Germans; in the second phase the center fell back while the wings held fast at Paris and Verdun; in the third phase the left wing attacked from the direction of Paris and eventually forced the enemy to withdraw from the Marne.

The tactical details of the operation at Cannae are unimportant and antiquated, but one can easily recognize two maneuver conceptions that somehow seem to have survived the changes of centuries—in *idea*, one finds the Romans committed to a frontal attack—in *execution*, one finds a mass, disposed in great depth, without articulation and therefore incapable of maneuver; the flanks were protected by cavalry: if that protection was removed, the dispositions were such that a flank attack by the enemy could not be opposed by foot units in time or in space. By concentrating his forces on a restricted front, the Roman commander lost the benefit of a great initial, numerical superiority.

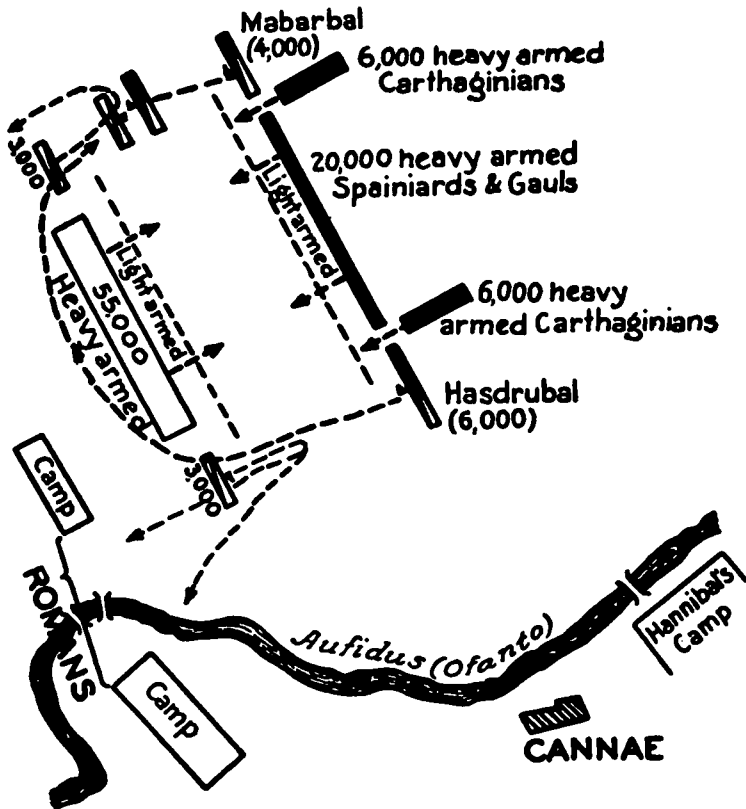

PLATE 69. BATTLE OF CANNAE: INITIAL SITUATION.

Hannibal, on the contrary, compensated for his numerical weakness by stretching his center to the limit, in order to be strong on the wings, where he sought a decision by a double envelopment in a *prearranged maneuver*.

These dispositions, flexible and articulated, contain the germ of the flank maneuver, which has already been defined as a combination of directions, i. e., a combination of an action *on a flank* closely coordinated in time and space with an action *on the front*.

Hannibal weakened his center at the risk of having it penetrated, in order to favor the maneuver of his wings, where he had prepared a local superiority of

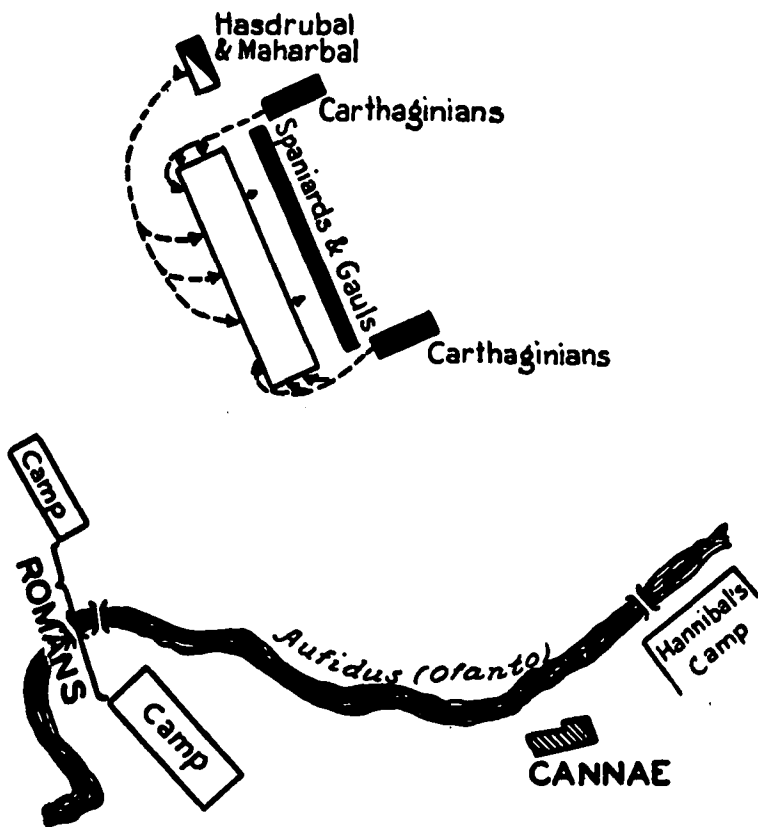

PLATE 70. BATTLE OF CANNAE: THE COLLISION.

means. As for his cavalry, he gave it a modern mission of exploitation, in a maneuver against the rear of the enemy dispositions and the pursuit of defeated units.

The victory was so decisive that this type of operation has since become known as a "Cannae."

(2) *The Battle of the Cowpens, 1781.* Committed to the proposition that there is a historical continuity of maneuver forms and ideas, it ought to be sufficient demonstration to bridge the gap of centuries in a virtual repetition of actions; it is entirely feasible to link the conception of Hannibal at Cannae, 216 B. C. with Morgan at the Cowpens in 1781 and Lawrence in the engagement of Tafia, 1918; the size, armament and composition of the opponents varied enormously from the Roman sword to the magazine rifle of the World War, but scheme of maneuver and tactical dispositions remained substantially the same.

In Cornwallis' campaign in South Carolina, Tarleton was detached to run

down Morgan; the British strength was about 1100, that of Morgan about 900. Morgan fell back to a place called the "Cowpens." ¹⁰

He placed the untrained militia under Pickens far in front, to deliver two volleys; after that, they could run around the left flank and in rear of the main body, where they could reform at leisure.

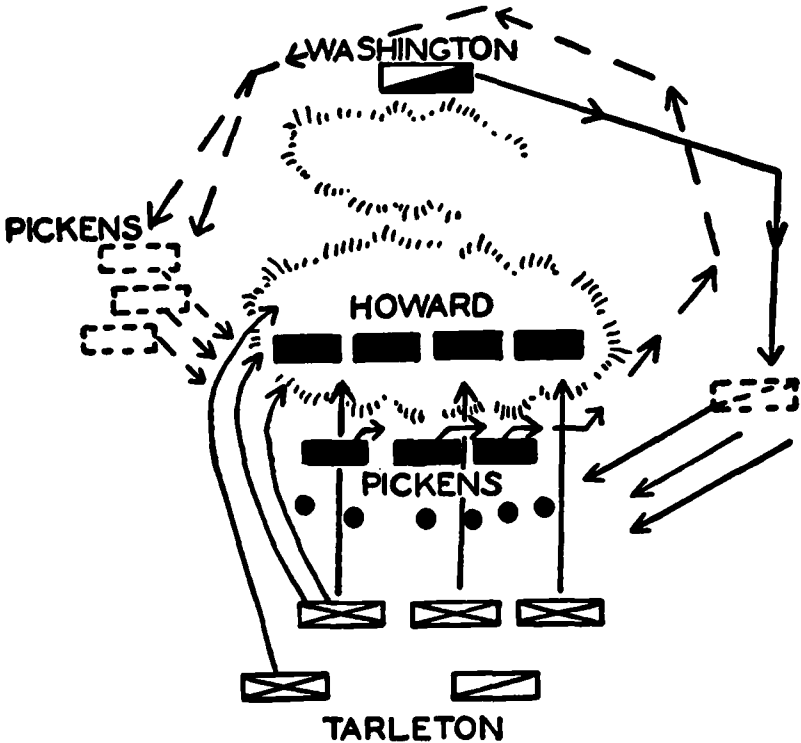

PLATE 71. THE BATTLE OF THE COWPENS, 1781.

About 150 yards in rear of the militia, Morgan placed picked troops under Howard on a slight hill; 150 yards farther back, he held his cavalry under Colonel Washington.

Tarleton attacked at sunrise; the militia received him better than expected and retreated as ordered; the British then attacked the second line of Americans, with the intent to envelop them; the greatest pressure seemed to be on the American right, which was refused. At that time, Washington's cavalry turned the British right flank and charged, while Pickens' militia, reassembled, had turned the British left flank and attacked also; the main line then delivered a burst of fire at 30 yards and charged the British. The confusion was terrific; Tarleton escaped but lost 230 men killed and wounded and 600 prisoners.

The analogy with Cannae is obvious: a preliminary action to drive in "light troops," the collision of the main bodies, the double envelopment, with cavalry, i. e., mobile troops, operating on at least one flank.

(3) *Tafila, 1918*. To complete the cycle of comparison and similarities, a small-unit operation of the World War period is quoted: Lawrence at Tafila. The forces engaged were even less than at the Cowpens—about 900 Turks and 600 Arabs.

¹⁰ Fiske.

The village of Tafilá became a military objective in the defense of the Jordan valley, and the Turks dispatched a small force, composed of three reduced-strength battalions, a troop of cavalry, 2 mountain guns and 26 machine guns, to capture it. It was held by a motley crew of Arab irregulars, under Sheriff Zeid and Major Lawrence.

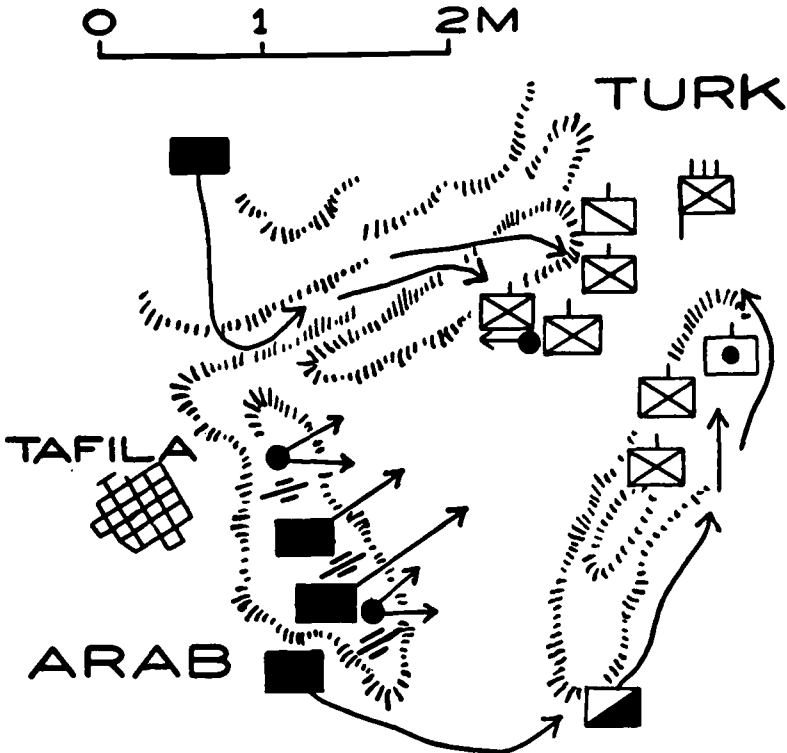

PLATE 72. THE ENGAGEMENT AT TAFILA, 24 JANUARY, 1918.

East of Tafilá, the terrain presented a roughly triangular plain, bounded by ridges; the Turks had to enter the apex of this triangle.

Lawrence chose the base ridge as his final defensive line. On the morning of 24 January, the Turks attacked the northern ridge, held by Tafilá townsmen and farmers, making rapid progress.

Through a personal reconnaissance, Lawrence had ascertained the ranges to targets in the plain; gradually reinforcing his defensive position, he slowed down the Turkish advance, principally by fire from this ridge; i. e., he pinned them down frontally. After establishing superiority of fire, Lawrence initiated an offensive maneuver: he sent a mounted detachment, reinforced with auto-rifles, around the Turkish left to gain the crest of the eastern ridge.

A group of about 100 men, arriving from a neighboring village, was sent around the Turkish right flank; surprise fire and attack, by the enveloping forces, was nicely coordinated with increased fire from the base ridge; when the flank attacks made themselves felt, the Turks began to waver; at this time, Lawrence made a show of a frontal attack, with a few remaining horsemen. The Turks fled, leaving 250 prisoners, abandoning machine guns, howitzers and baggage.

(4) *A modern Cannae.* It has been stated once before that in every maneuver

there are two things: a *speculative idea* and its realization on the ground. Now, while the realization is always dependent on the conditions of the moment, it often occurs that the fundamental idea varies but little throughout the centuries.

Trained by Schlieffen, indoctrinated with his conception of Cannae as a battle for decision, for annihilation, it is no coincidence that the Staff of the Eighth German Army, in the Battle of Tannenberg, maneuvered the Russian mass into the salient of Allenstein, restricted in maneuver space in an area which had all the earmarks of a mouse-trap and then crushed in their flanks by a series of flank maneuvers and envelopments.

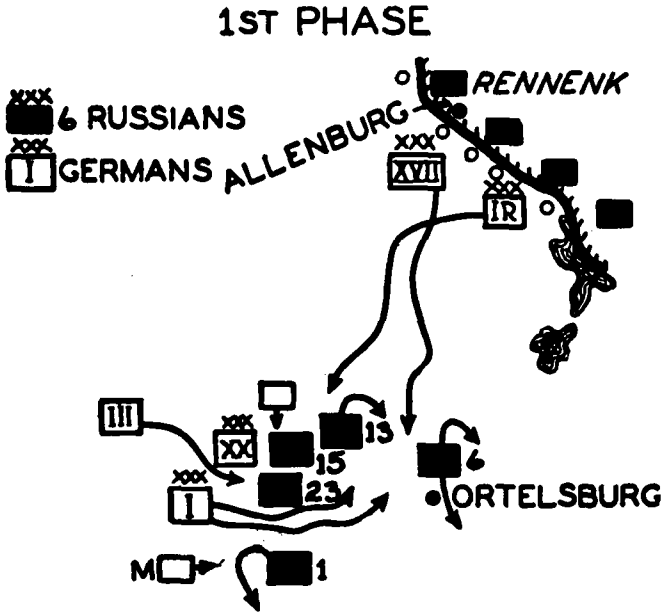

PLATE 73. TANNENBERG, 1914: FIRST PHASE.

This operation was a replica of Cannae, on a magnificent scale, with the Russian Second Army in the role of the Roman Legions caught in the deadly vice of Hannibal's maneuver. Now one understands why Schlieffen's epochal work should be a medium of instruction, and that it is not exactly a paradox that in an age of machine guns, tanks and aviation the ghosts of Roman and Carthaginian armies have been evoked.

At this point, attention is invited to the intervention of cavalry in this battle of Cannae: *it was a decisive intervention*. In the wars of antiquity and for centuries to come, infantry was condemned to purely frontal actions. The Greek Phalanx, as well as the Roman Legion, knew only one maneuver-form—the breakthrough, the frontal attack, the simple collision of two moving bodies. This action in itself was rarely wholly decisive; it was always the intervention of cavalry that brought on the decision because cavalry alone was capable of rapid maneuver, usually taking the form of a flank attack.

The development of firearms had the effect of thinning out the antique mass formations as a consequence of the establishment of a continuous line of fire on a broad front; this resulted in the so-called linear tactics of the seventeenth century. The linear formations of that period, however, were still preferably em-

ployed in frontal combat and not flexible enough for maneuver in the modern sense, and cavalry still remained the most effective means for decisive action.

c. *Frederick II.* Frederick II struck a fresh note in definitely employing infantry in maneuver. He consistently attempted to operate against the enemy's flank. His system was incomplete, however, since he failed to realize fully the indispensable correlation between the flank maneuver and the frontal attack.

The Battle of Leuthen in 1757 represents a typical example of his method.

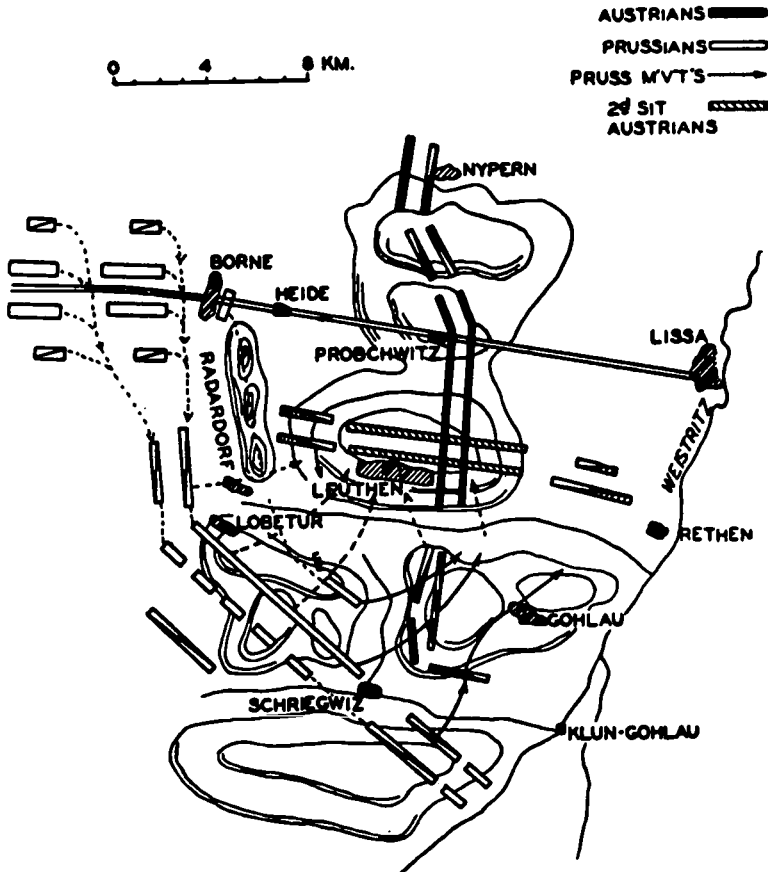

PLATE 74. THE BATTLE OF LEUTHEN, 5 DECEMBER, 1757.

The Austrian Army, 80,000 strong, was in line of battle, facing west. The Prussians reached the battlefield in the morning of 5 December 1757, with approximately 40,000 men. The King decided to make a decisive attack against the left flank of his opponent. He employed his advance guard to make a feint against the hostile center and right, while the mass of his army moved toward the enemy's left, by what was virtually a *flank march*. He then attacked the Austrian left wing by a series of successive efforts, which were successful principally because the Austrians were slow to conform to the new Prussian dispositions.

The plan of the attack was clearly a *maneuver against a hostile wing*. Stripped of all details, the execution may be termed a turning movement under cover of a diversion by the advance guards, in a threat against the enemy front. This front, however, was not "fixed," "pinned down," in the modern sense. Foch's

famous remark applies obviously to this case.¹¹ The mass of Frederick's Army was certainly placed in a "cleverly chosen direction," but the Austrians were not "immobilized" and were actually able to eventually change front to the south. It may be argued that the maneuver succeeded even though the principal attack was made in a single direction; that is true, but this case is the exception which proves the rule and the maneuver succeeded only because the enemy was passive and inept at maneuver.

Frederick II was the first to recognize this special circumstance, when he said

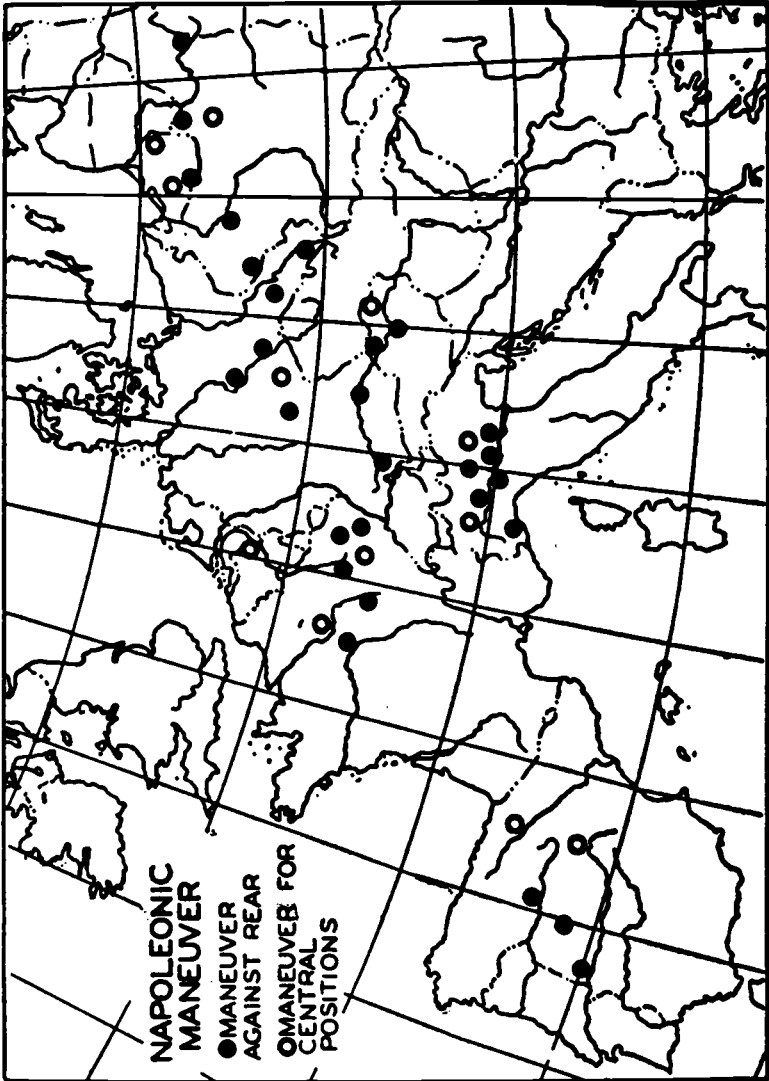

PLATE 75. THE NAPOLEONIC MANEUVER: ORIENTATION, LOCATION OF BATTLES AND CLASSIFICATION OF TYPES.

in his "Memoirs"; ". . . the method which I used was successful only because of the fault of my enemies, because of their sluggishness—and indolence . . ." Frederick's "turning movement" at Leuthen is sometimes spoken of as the

¹¹ Foch: "We do not cause a real adversary to fall back by a cleverly chosen direction. We cannot immobilize him without an effective attack . . . War is positive in its nature, admits of only positive solutions . . . No effect without cause: if you desire the effect, develop the cause: apply force . . ."

"oblique battle order"—a mere word that is utterly meaningless, since there is no particular military virtue attached to "obliquity."

d. *Napoleon I.* The next important milestone in the evolution of the art of war is represented by the Napoleonic period. The activities, views, methods and achievements of Napoleon I are so important to the military profession that we have made a minute and detailed examination of the methods of this extraordinary genius, to be presented in later chapters of this series: VII, "The Napoleonic Concept of Maneuver" and VIII, "The Napoleonic Concept of Battle."

For the sake of continuity, however, we shall present at this point only the sketchiest summary of his views:

(1) Napoleon may be said to have created the flank maneuver in its modern sense.

(2) He was a firm believer in the effect of flank maneuvers. "It is by turning the enemy and by operating on his flank, that battles are won."

(3) In the field of strategy, Napoleon opened most of his campaigns by a turning movement of his mass, directed against the enemy's flank and rear.

(4) In the field of Tactics we see the habitual employment of *close-in* and *wide envelopments*, viz:

(a) "This wide movement will bring us in a few days into Bavaria—several days' march in rear of the enemy, who has no time to lose to avoid complete destruction." (Bulletin, 7 October 1805)

(b) "Make a counter-attack, to draw the attention of the enemy while I maneuver to turn him." (Letter to King of Holland, 20 September 1806)

(c) "My intention is that Marshal Soult outflank the right of the enemy, turn it, and attack him, a maneuver which should assure us a certain and decisive success." (Letter to Murat, 12 October 1805)

(d) "I desire that General Lauriston assemble all his forces and march on Drehsa; having passed the Spree, he will find that he has turned the hostile position." (Order of 18 May 1813)

(e) "Maneuver in order to envelop the right of the enemy and attack from the rear." (Napoleon to Ney, 16 June 1815)

It is apparent from these random quotations that Napoleon practiced *combination of directions*, one of our basic factors! As to the remaining factor, *distribution of forces*, it was a Napoleonic maxim to be "strongest at the decisive point." He strove habitually for the creation of "mass": In the first wars of the Empire, he operated with a field army of approximately 200,000; he succeeded in assembling on the battlefield of Ulm 170,000, at Austerlitz 160,000, at Wagram 140,000; at Moscow he brought 130,000 against an equal number of the enemy, at Bautzen 160,000 against 100,000, at Leipzig 271,000 against 215,000.

These figures are indicative of *concentration of mass*, as a habitual tool of Napoleonic workmanship.

His views on the frontal attack are equally well known; he was prepared to sacrifice the units engaged frontally in order to immobilize the enemy and wear him down relentlessly. There is a famous—or shall we say notorious?—quotation that embodies ruthlessness, strength of character and veteran experience on a hundred battlefields: "Once having engaged the units nearest to the enemy, you have to let them go, without worrying too much about their good or bad fortune. Only you must be careful *not to yield* too easily to requests for help . . ."

This is as far as we care to go into an analysis of the Napoleonic maneuver at this time. Chapters VII and VIII of this series are allotted to a special study of this great genius and his masterly conduct as a commander of large units.

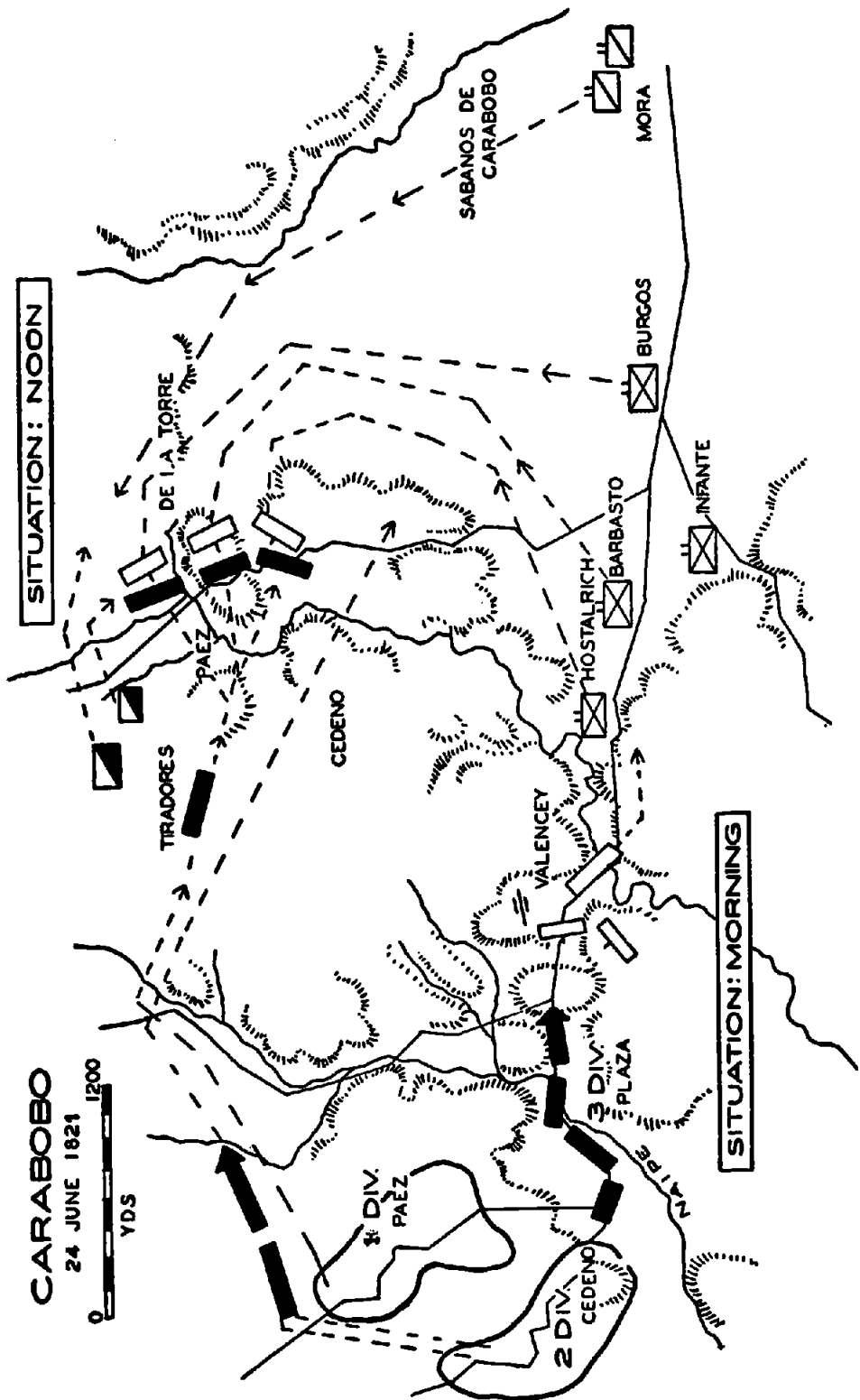

CARABOBO

24 JUNE 1821



SITUATION: NOON

SITUATION: MORNING

PLATE 76. THE BATTLE OF CARABOBO, 24 JUNE 1821.

e. *Simon Bolivar*. The enormous range and extent of the campaigns of this great South American commander have already been touched upon.¹²

Simon Bolivar, the Liberator, was a contemporary and friend of George Washington; in political purpose and military achievement, these great colonial leaders were very much alike: both fought wars of liberation at heavy odds, to free American colonies from European monarchical domination.

In an impressive sequence of successful strategical and tactical operations, the campaign of Carabobo is certainly among the more important.

Bolivar was a master in the application of the flank maneuver, the envelopment; he appreciated perfectly the decisive character of the flank attack and employed it on numerous occasions; he had to: operating precariously with limited resources, every blow delivered had to be effective!

On 24 June 1821, Bolivar's column had reached the broken country east of the Sabanos de Carabobo and was in an assembly position, in vicinity of the Casa del Naipe.¹³

His adversary, the Spanish General de la Torre, expected the Patriot column to advance along the roads from San Carlos or Pao, and the Royalists were disposed in depth to dispute the passage; the route of the Patriots represented a defile along its entire length, with considerable advantage on the side of the defender.

Bolivar made a prompt decision: an envelopment of the Spanish right flank, with the bulk of his forces, the 1st and 2d Divisions, in conjunction with a frontal or holding attack by the 3d Division.¹⁴

The enveloping force, under General Paez, started the movement at 11:00 o'clock and debouched on the Plains of Carabobo about noon.

When de la Torre recognized the threatening movement, he shifted the nearest battalions, Burgos, Hostalrich and Barbastro, to the north. The envelopment had difficult terrain to overcome; the leading unit, the Battalion "Apure," attacked four times; the next in column, the Battalion "Britannicos," containing American and British volunteers, had equally hard going; the Spanish cavalry also intervened and, for a time, the Patriots had to defend themselves in forming the traditional "square;" reinforcements of the "Tiradores" arrived in time to tip the scales; a subsequent charge by Paez's mounted bodyguard threw the Spaniards in confusion; reports indicate that the action did not last longer than an hour.

In the meantime, the Spanish unit guarding the defile, the Battalion "Valencey," withdrew and the 3d Patriot Division followed close on their heels; the pursuit was pushed with vigor.

It is obvious that the enveloping attack bore the brunt of this action and was the decisive factor; the frontal pressure was not sufficient to hold the Spanish forces; for a time Paez's situation was very critical, since de la Torre was able to shift the bulk of his forces in that direction; nevertheless, Bolivar forced the hand of his opponent and dictated the course of action from start to finish. This battle

¹² Chap. II, Plate 26.

¹³ Composition and relative strength of the opponents were as follows: Patriots: 9 battalions of infantry (4000), 10 squadrons of cavalry (2500). Royalists: 5 battalions of infantry (3500), 10 squadrons of cavalry (1700), 2 batteries of artillery (150).

¹⁴ This point has certain controversial aspects; some writers assume that only the 1st Division was ordered on the envelopment. General Lopez Contreras believes that Bolivar intended his entire army to move on the Spanish right—a disposition which resembles Frederick's attack at Leuthen—and that Cedeno's division could not make itself felt except through the "Tiradores," because of the general speed of the action and the congestion on narrow trails. Bolivar was with the enveloping troops; the 2d Division followed the 1st Division, and it is reasonable to assume that it was Bolivar's intention to use it. (General Eleazar Lopez Contreras: *Bolivar Conductor de Tropas*. Caracas, Venezuela, 1930. (Vicente Lecuna *La Campana de Carabobo y la diversion de Bermudez*. El Cojo Ilustrado. No. 304. 15 Dec. 1912.—Colonel Arturo Santana *La Campana de Carabobo*. Caracas. 1921.)

is a confirmation of the decisive character of the envelopment; it is as modern in its conception today as it was appropriate and effective in 1823.¹⁵

f. *Von Moltke the Elder.* After the eclipse of the Napoleonic star, the next great luminary to appear on the military horizon was the elder von Moltke, victor of the Wars of 1866 and 1870.

The extraordinary success obtained by the Prussian Armies in these wars brought into sharp relief the figure of the elder von Moltke. Regarded as a theorist by many of his cotemporaries, he conceived and conducted operations in the manner of Hannibal and Napoleon in which a battle of decision was sought by maneuver. The Campaign of 1866 against the Austrian Army is very characteristic of his method and is a classic example of the development of a flank maneuver on a large scale.



PLATE 77a. ARMY CONCENTRATIONS: AUSTRO-PRUSSIAN WAR, 1866.

In examining this general situation, it is apparent that the strategic concentration of the Prussian Armies was dictated by the railroad and road net leading to the hostile frontier.¹⁶

Von Moltke's plan of campaign involved the groupings of three armies or approximately twelve divisions. How would you group them? The railroad net, of the time, was deficient: if one north-to-south track is allotted to each army—and that is a very modest railroad allotment¹⁷—one can easily determine the resulting, suitable concentration areas, viz:

¹⁵ The relative dispositions of the 3d Division, in the secondary or holding attack, while the 1st and 2d Divisions were massed for the main or decisive attack, agree with current American regulations: F. S. R., Par. 434, and of course conforms to the principles of mass and direction, Chap. II, Par. 8.

¹⁶ As a general remark, this is applicable to all armies and every initial strategic war plan.

¹⁷ The logistic point involved is the physical limit of a single-track railway which affects train densities.

MANEUVER IN WAR

Line of Communications
 Berlin—Jüterbog—Dresden
 Kreuz—Frankfurt—Gorlitz
 Kreuz—Breslau—Neisse

Area
 Elbe Army
 First Army
 Second Army

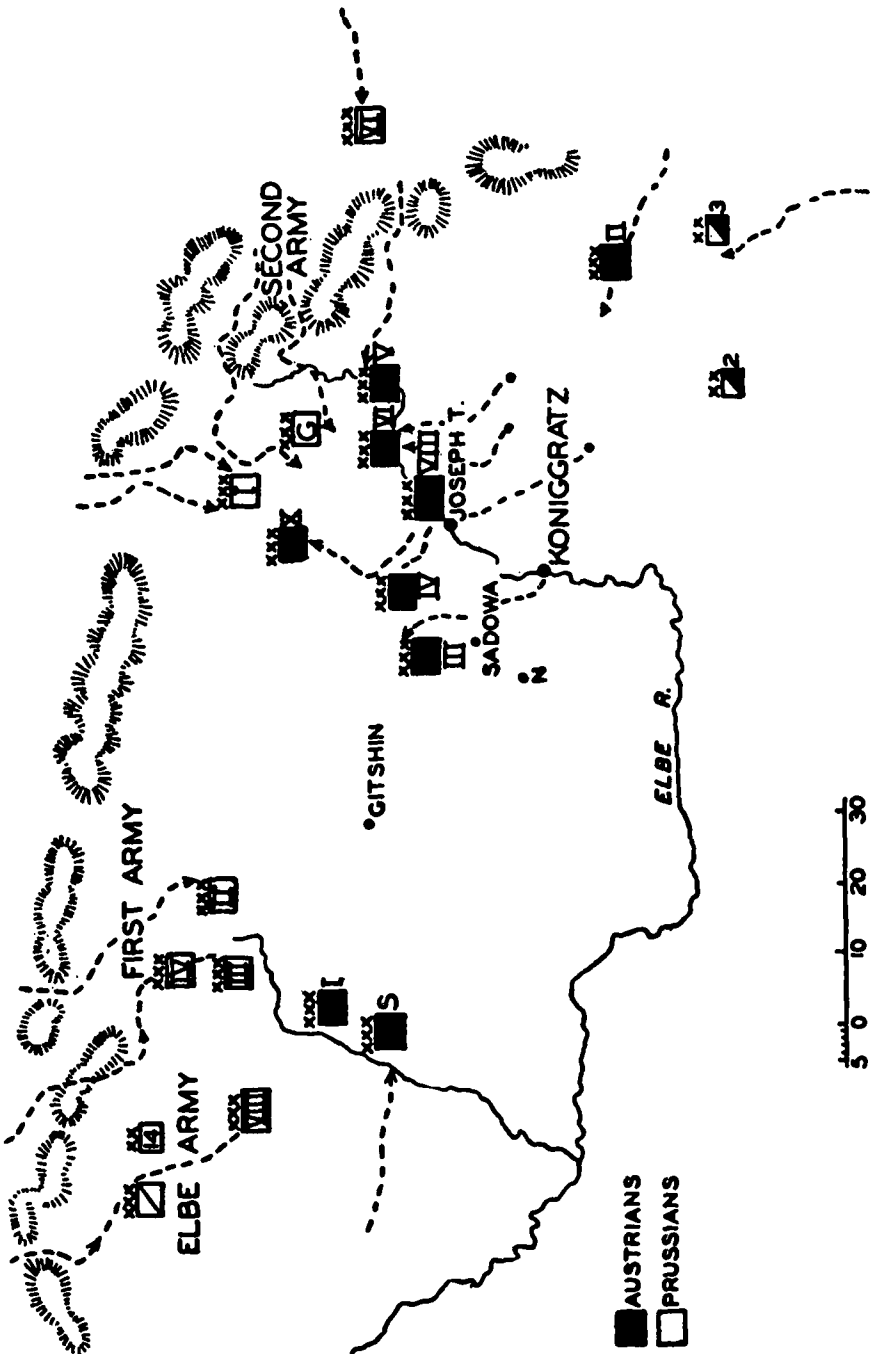

PLATE 77b. GENERAL SITUATION TO INCLUDE 27 JUNE 1866.

Those were the only suitable railroad lines which in turn affected the detraining points. As regards the Austrians, the possibilities of concentration were equally limited to certain railroad loops: Vienna—Lundenberg (L)—Olmutz, and an advanced area: Pardupitz (P)—Josephstadt (J)—Koniggratz (K)—Prag.

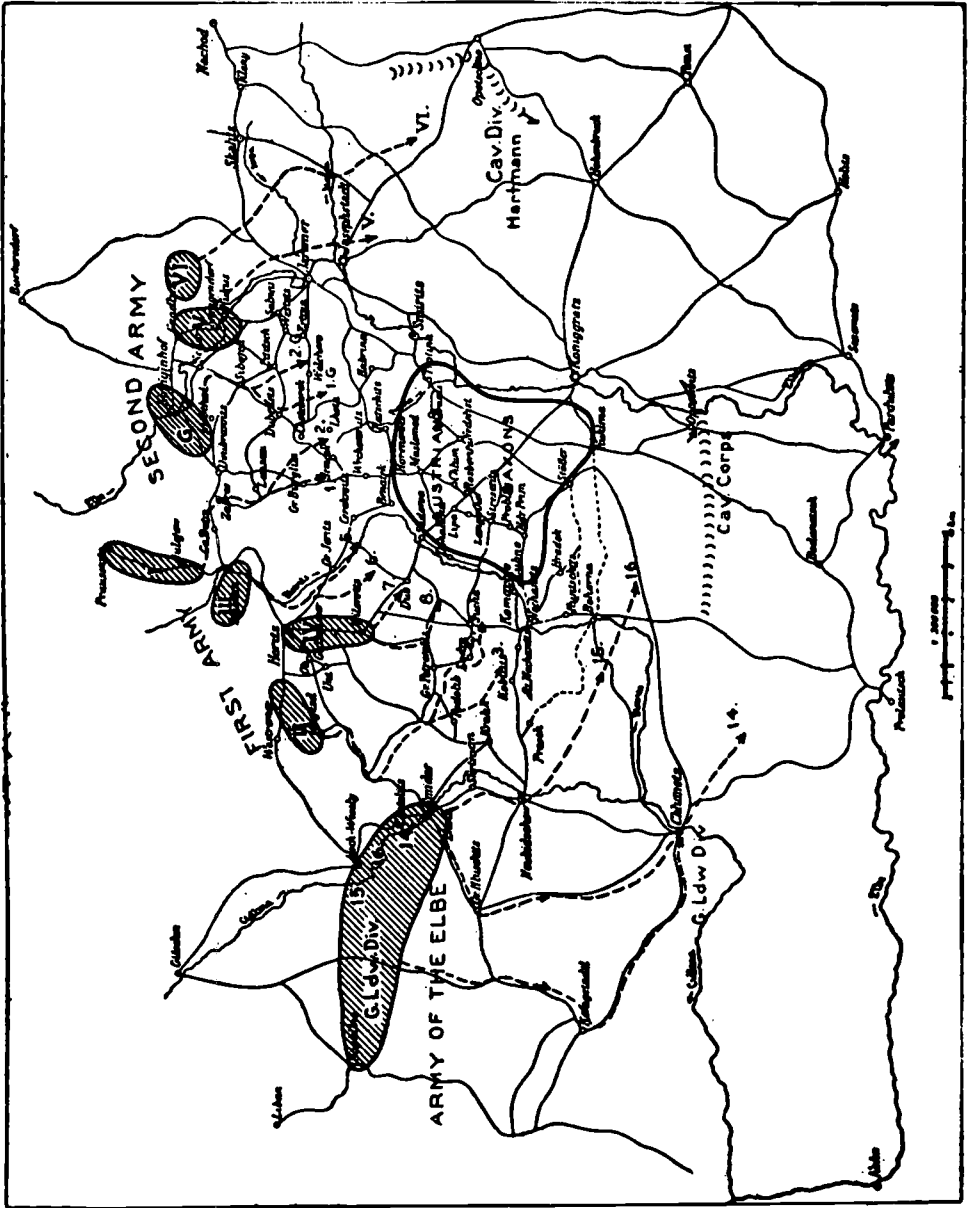

PLATE 78. LOCATION AND PLAN OF PRUSSIAN ARMIES, 1-3 JULY 1866.

Without going into logistic details, the relations of time and space, the presence of a mountain barrier and the limited rail and highway net, von Moltke planned a junction of the three armies somewhere in Bohemia. This junction was to be effected in a general strategic area, largely depending upon the eventual location of the Austrian concentration. The Prussian scheme of concentration was not

unknown to the Austrians; in fact, it could have been deduced from the Prussian railroad situation.

What plans were open to Austria to counteract or block the Prussian plans?

Prevent a debouchment of the Prussian Armies from the mountain passes. The rate of mobilization of the Prussian army was conceded to be superior to that of the Austrians. The arc of these mountains is something like 150 miles. The Prussian First Army had already crossed. The Austrian concentration was comparatively slower, and a desperate situation like this required maximum speed. Obviously there was no practical chance to block the debouchment of three Prussian Armies at all the passes.

With the First Army across the mountains, what was the next best move for the Austrians?

To contain the Second Army, which was still in the passes, and concentrate mass against the First Army, i.e., an application of the "maneuver on interior lines." This was done, but the Austrian X and VI Corps operating against the Second Army were not equal to the supreme importance of their delaying mission. This plan, with a strong probability of success, failed because an intermediate unit failed in execution. The chain was only as strong as its weakest link! After local, initial successes, the Austrian X and VI Corps fell back on their main army, and the debouchment of the Prussian Second Army was accomplished. As regards the Prussians, after clearing the mountains the possibilities of maneuver combinations are obvious: frontal attack by the Second Army and flank attacks by the First and Elbe Armies or vice versa.

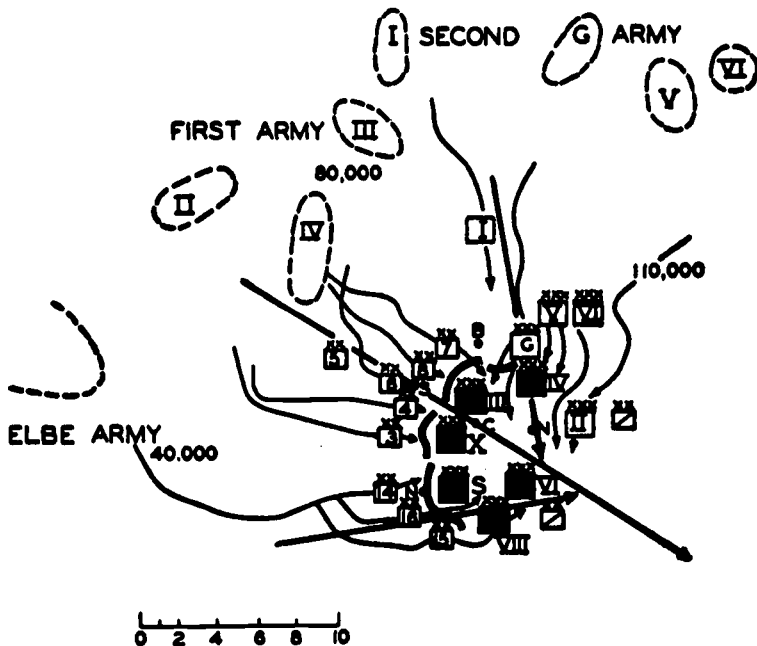

PLATE 79. THE BATTLE OF KONIGGRATZ, 3 JULY 1866.

For the next few days, the Austrian Army adopted a purely passive attitude, congested in a central locality confronted by the converging advance of numerous hostile columns, in a general disposition that contained endless possibilities of

maneuver: (a) double envelopment by the Prussian Second Army and the Army of Elbe, (b) frontal attack by the Prussian First Army and flank attack by the Second Army, (c) and even an encirclement—any number of possibilities, inherent in the force that maneuvers against a force that has gone on a passive defense.

These possibilities were clearly understood by von Moltke but only partially executed by his subordinates. It is evident that an encirclement could have been made by 3 July. The conception of such a maneuver aimed at a *battle of decision*, as at Cannae, but the vastness of the idea escaped von Moltke's subordinate commanders. Mass attacks against the front and accumulating reserves "for a rainy day" were considered more important than encircling movements or flank attacks. This refractory attitude on the part of his subordinates was perhaps natural, in view of a very curious circumstance that ought to be mentioned here: von Moltke was comparatively unknown to the rank and file of the army. It is a historical fact that a staff officer at Headquarters First Army questioned the authenticity of a certain order by saying: "It seems to be all right, but who is von Moltke?"

This is not improbable; we wager you have never heard of half of the officers now on duty on the General Staff in Washington.

Events moved swiftly. On 2 July the First Army encountered the Austrians in position on the west bank of the Bistritz and decided to attack the next morning. The Second Army was then still at a considerable distance from the probable battlefield. Von Moltke realized at once the incomplete coordination between the First and Second Armies and the possibility of defeat in detail and peremptorily ordered the immediate advance of the entire Second Army in an "attack against the right flank of the enemy."

The subsequent phases of the battle are well known:

- (a) Frontal attack by the First Army, maintained with difficulty.
- (b) Envelopment of the Austrian south flank by the Elbe Army in conjunction with the First Army.
- (c) General flank attack, made decisive by the mass of the Second Army, the whole scheme actually resulting in three separate actions at Nechanitz, Sadowa and Benatek.

However debatable may be the conception which governed the debouchment of the Prussian forces into Bohemia, it is certain that on 2 July the three armies were practically united, ready for battle and with ample maneuver space.

It is true that von Moltke's hand was forced to some extent by the initiative of the First Army, but his maneuver still remains as a typical concentric maneuver, involving turning movements and envelopments and culminating in a flank attack of maximum effectiveness.

Remember the analysis of maneuver and the basic factors: Direction—Mass. One must admire without reservation the "combination of directions" of the two armies:

Sadowa (S)—Chlum (C)
Horenoves—Nedelwitz (N)

As to mass, or distribution of forces, it was employed in a masterly fashion: an entire army was charged with the envelopment.

Of a total of 230,000, two-thirds were engaged in a maneuver for envelopment; 110,000, the mass of the Second Army, were employed in a flank attack.

The coordination of effort with respect to space is remarkable: this battle offers the rare example in modern history of the coordinated action of three armies, two of which were used to envelop the flanks of an enemy already worn down by an extended frontal combat.

The time factor may be open to criticism: the First Army attacked too early and made it difficult for the Second Army to intervene.

Before leaving the elder von Moltke, a historical fallacy as absurd as Frederick's alleged "oblique order" should be exploded, and that is the general assumption that Moltke's conduct of large units represents the principle of advance of separate masses and their conjunction *on the battlefield*, while Napoleon is said to represent the junction *prior to battle*; this is a purely artificial distinction. It is recognized that the initial separation of the Prussian Armies, prior to the debouchment into Bohemia, was primarily dictated by topographical conditions and a deficient railroad net; the junction of these armies was not planned precisely on the battlefield of Koniggratz but in a general strategic area. There is no essential difference between von Moltke's and Napoleon's methods other than the effect of modern conditions and the general progress in technical equipment.

g. *The American Civil War.* Immediately preceding the Austro-Prussian War of 1866, the American Civil War engaged the attention of the world. Certain special conditions set this stupendous conflict apart from the swift moving campaigns of Western Europe; it contains phenomena which are characteristic of the gradual conversion of a non-military nation into an armed camp. This transitional period may take only a few days with the professionalized armies of Europe, while it has always taken the United States a much longer period to get ready.

This was the most expensive training school to convert civilians into soldiers that has ever been devised—in fact, the U. S. Pension Bureau is still paying tuition for a large number of pupils.

During the Civil War, 2000 engagements were fought, of which 159 may be classed as battles.

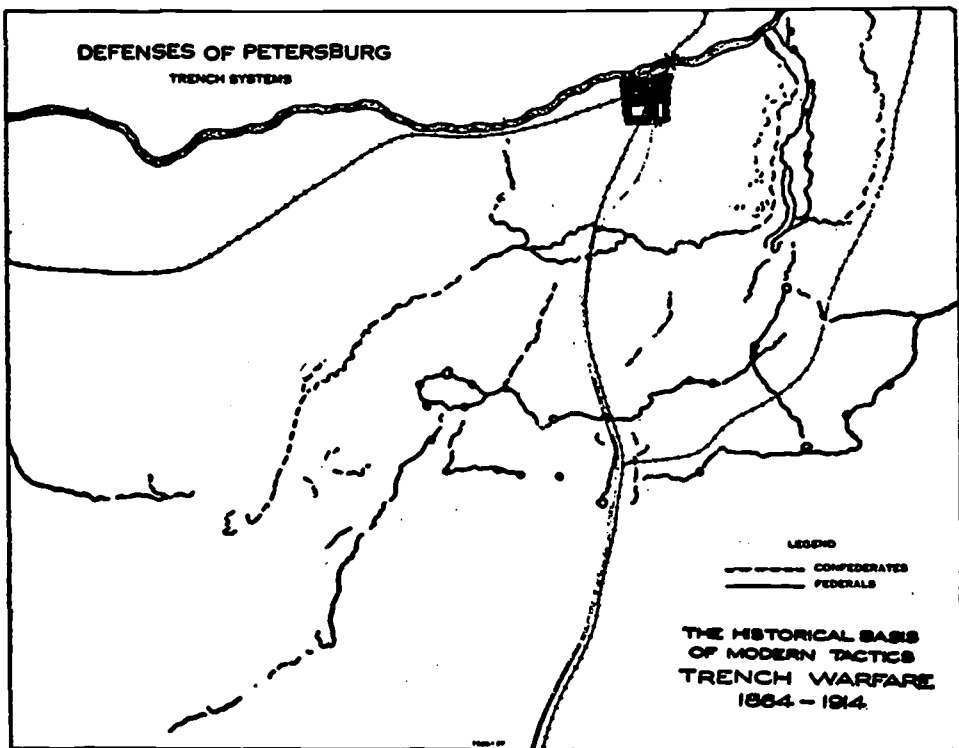

PLATE 80. THE DEFENSE OF PETERSBURG, 1864.

The Civil War was strongly affected by the development, increased range and accuracy of all weapons, a situation somewhat similar to the introduction of the needle-gun in the Austro-Prussian War of 1866. The result was the same: frontal attacks promptly became costly! When Grant assaulted Lee at Cold Harbor, his loss in twenty minutes was ten thousand while that of the defender was less than one thousand. At Fredericksburg, Burnside made six successive attempts to drive the enemy from his positions. At Mechanicsville, the Confederates tried to drive Porter from his positions by repeated frontal attacks; each time they were thrown back in disorder. In two months, from the Wilderness to the beginning of the siege of Petersburg, Grant lost 75,000 men—more than the whole Confederate Army he was attacking. The power of the defensive had increased enormously and became accentuated by the almost habitual use of field fortifications. This lesson might have been profitably remembered in the World War.

It was a foregone conclusion that envelopments would be attempted to avoid the costliness of frontal collisions: Second Bull Run, Mechanicsville, Chancellorsville, Nashville, and the Campaign of Atlanta are examples of wide envelopments; it is significant that in all cases the maneuver was successful, even though the execution was faulty; the only battle in which this type of maneuver failed, the first Battle of Bull Run, is the one in which the holding attack failed to carry out its mission.

h. The Russo-Japanese War. At the beginning of the twentieth century, someone might have reasonably asked if the wing or flank maneuver was applicable in the wars to come. We have already answered this by quoting World War operations tending to show that envelopment is still the most effective maneuver. The enormous progress in modern communications and means of transport seems to favor the envelopment, as it facilitates the rapid displacements of large units to distant points of the theatre of operations.

In retrospect, the Russo-Japanese War generally confirmed the efficacy of the envelopment. Kuroki's Army constantly outflanked the Russian left first in the hill country between the Yalu and the Lia-ho and then in the battle of Liao-Yang (July-August, 1904). The operations around Mukden also involved an envelopment of the Russian right by Nogi's Third Army (in reality 3 divisions) 24 February—7 March, 1905. As in previous wars, frontal attacks were found to be expensive and time consuming.

The envelopment appears to have proved its almost invariable effectiveness, and it was again to be demonstrated in 1914 and the World War.

i. Von Schlieffen. The strategic concentration and the almost instant collision of vast armies in 1914 brought Field-Marshal Count v. Schlieffen's name into the limelight as the master mind that formulated the initial plan of operations of the Imperial German Armies. In the light of events, as we know them, it is generally agreed that this stupendous plan had a good chance of success, if it had been followed in its entirety.

The execution of the "Schlieffen Plan," i.e., the details of the Battle of the Frontiers and the First Battle of the Marne, is common knowledge. This discussion will be limited to bringing out the characteristics of maneuver and the presence of our basic factors: direction and mass.

There is no doubt that in the evolution of this plan one is in the presence of a superior mind—perhaps a genius. It is true, the man was deprived of a great historical opportunity: Count Schlieffen died in 1913, one year before the crucial test of his ideas.

The "Schlieffen Plan" is only a label for a masterly study on the employment

of large units; every conceivable phase of the conduct, function and responsibilities of commanders of large units was considered in this stupendous undertaking.

In 1905, on his relief as Chief of Staff, after 15 years in this post, Schlieffen left a memorandum with his successor, the younger Moltke, which was, in fact, a mobilization plan for that year, a plan of campaign for the invasion of France and a scheme of maneuver for the German general attack on the ensemble of the French Armies.



PLATE 81. ORIENTATION MAP: FRANCE, 1914.

Schlieffen said textually: "France must be regarded as a huge fortress. The line of fortifications: Belfort—Epinal—Toul—Verdun, is practically invincible, while the section: Montmedy—Maubeuge—Dunkirchen, is incomplete and not initially occupied. It is through this gap that we must force an entrance into that fortress. After this, we shall encounter a second barrier, the line: Verdun—Rheims—Laon—Le Fere. This barrier, however, can be outflanked from the north . . . It is possible that the French armies will then form a defensive wing, behind the Oise, between La Fere and Paris. We contemplate passing Paris on the west and south and then attacking the French left flank to force the French Army in an easterly direction toward the Marne and Swiss border. The essential feature of this plan is a strong right wing, to force the enemy to retreat, by constant pressure and the continuous threat of envelopment."

The single, dominating feature of this plan was the envelopment, the successive turning movements. Schlieffen said: "The main attack must not be directed against a front—the thing to do is to crush in a flank. With flank, I do not mean

the extreme end of the enemy's front line, but the entire area in rear of his dispositions; the attack must be against his rear."

In the light of past events, authoritative military opinion, including the French, are agreed that this grandiose plan could have succeeded, as in fact it enjoyed a partial success. Why did it fail? Because of a violation of the basic factors of direction and mass. After reaching Amiens, there was a general conversion to the

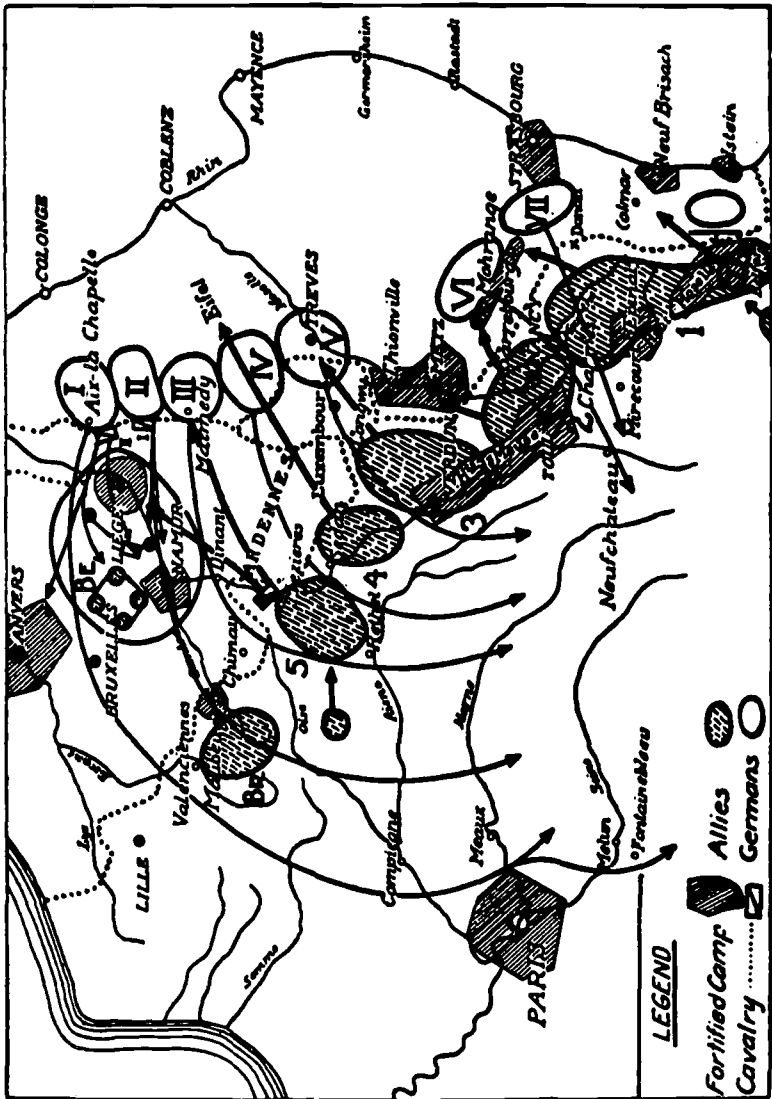

PLATE 8a. THE GERMAN ADVANCE, 1914.

south; the German enveloping wing became contracted; the possibility of envelopment, which consists primarily in overlapping the enemy's front, was thereby lost. The decisive character of direction was also lost! The German flank, instead of threatening an envelopment, became in turn subject to an envelopment from the direction of Paris.

This fateful change of direction, in the final essence, was due to violation of

mass. There is a legend that the dying Schlieffen gasped a last admonition: "Do not weaken the right wing." Be that as it may, Schlieffen, while he was alive, certainly provided for a strong enveloping wing—30 divisions! That mass was reduced by his successor, initially to 24 divisions without any provision for reinforcements, and its strength was successively frittered away on secondary missions until it had shrunk to 8 divisions on the Ourcq during the most hazardous moment of the entire war. Under Moltke, the ratio of the offensive wing to the defensive wing was 7 to 3, while under Schlieffen it had been 7 to 1. This shrinkage from 30 to 8 divisions is all that is needed to explain what has since become known as the "miracle of the Marne."

<i>Armies</i>	<i>1905</i>	<i>1914</i>
First and Second	11 Corps 7 Reserve corps	8 Corps 5 Reserve corps
Third and Fourth	6 Corps ½ Reserve corps	6 Corps 3 Reserve corps
Fifth	8 Corps 5 Reserve corps	3 Corps 2 Reserve corps
Sixth	3 Corps 1 Reserve corps	4 Corps 1 Reserve corps
Seventh	None	2 Corps 1 Reserve corps
Total	41½	35

This comparative tabulation of the initial composition and grouping of the German armies and the relative distribution of forces is proof that the Schlieffen Plan was substantially modified and how the enveloping wing was radically weakened; the cause of failure may be traced to this progressive modification, to a change of decisive direction and a violation of the principle of mass.

In the gradual collapse of the Schlieffen Plan, one can trace the initial presence of the basic factors of maneuver—direction and mass—as well as their gradual disappearance in a slow, almost imperceptible attrition, like rills of water vanishing in sand; as Hindenburg has very aptly expressed it: ". . . The Schlieffen Plan had been liquified, diluted, watered, thinned down beyond recognition."

28. **THE DEFENSIVE MANEUVER.** At this point in natural progression, it is advisable to cover a particular type of maneuver, which, at first glance, would seem to be a negation of all that has been said before, but which in reality is an indispensable form of warfare, predicated upon modern trends in armament and equipment, and that is the "Defensive Maneuver."

For generations, the offensive has been the fetish of the military profession; every other consideration had to give way to this traditional attitude. The staggering effectiveness of modern weapons, however, as a principal development of the World War, has given an enormous advantage to defensive action.

The increased possibilities of the defensive are beginning to be appreciated and have found a very definite echo in modern military literature. Extracts from some of our own texts follow:

M.C.L.U., Par. 21: "A large proportion of the decisive battles of history has been gained . . . by numerically inferior forces in defensive battles . . . over the greater part of fronts in contact during the greater part of the time, both sides are on the defensive. In war the mental attitude is habitually that of offense, but the physical attitude is habitually that of defense . . ."

F.S.R., Par. 385: ". . . the necessity for concentrating the greatest possible force at the point

of decisive action requires strict economy in the strength of forces assigned to secondary missions."

F.S.R., Par. 380: ". . . A defensive attitude is adopted . . . for the purpose of economizing forces on a front where a decision is not sought, in order to concentrate superior forces at the point of decisive action."

These statements appear to have a slight flavor of apology, where the defensive is concerned; apparently the defensive is still a stepchild, a military Cinderella,

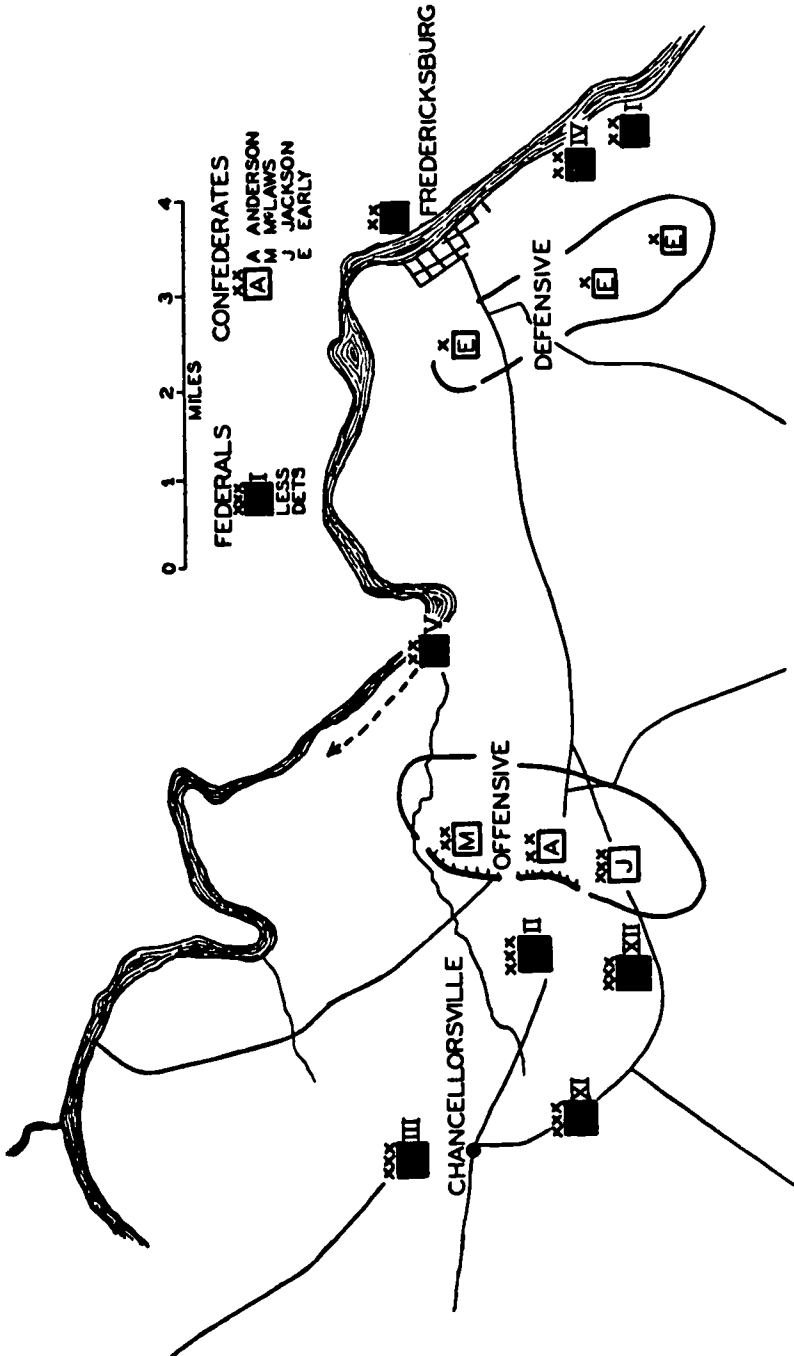

PLATE 83. GENERAL SITUATION: CHANCELLORSVILLE, 27 APRIL TO MAY 1863.

while it represents in reality the highest form of military leadership in establishing a proper balance between the defensive and the offensive. This thought seems to be supported by official recognition in the training manuals of all modern armies.

Great commanders have invariably appreciated that delicate balance, in critical

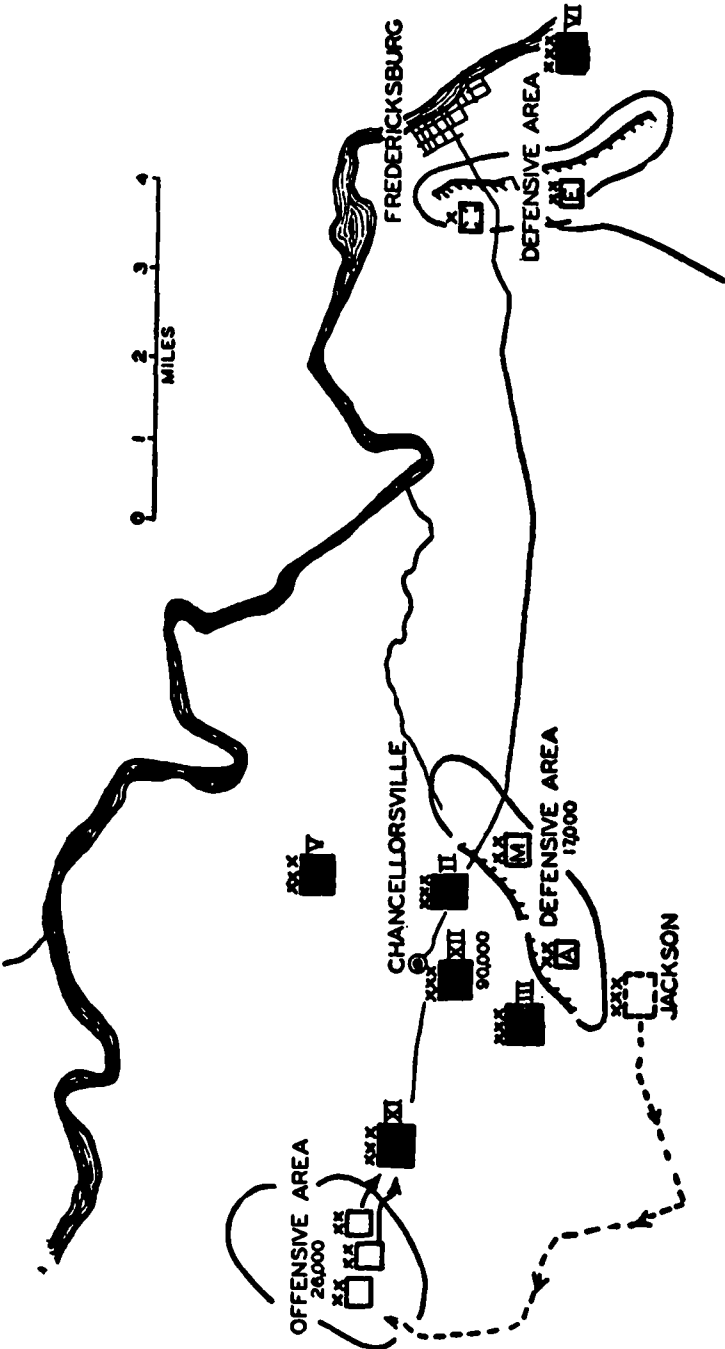

PLATE 84. THE BATTLE OF CHANCELLORSVILLE, 3 MAY 1863.

situations: Lee at Chancellorsville, Napoleon at Leipzig, Schlieffen confronted by the staggering problem of a war on two fronts.

The sequence of operations at Chancellorsville, 28 April to 5 May, 1863, represents an impressive example of Lee's genius. The Confederate Army, approximately 60,000 men, 6509 cavalry and 170 guns, poorly equipped, wretchedly clad, and living upon short rations, faced the Army of the Potomac of 122,000 infantry,

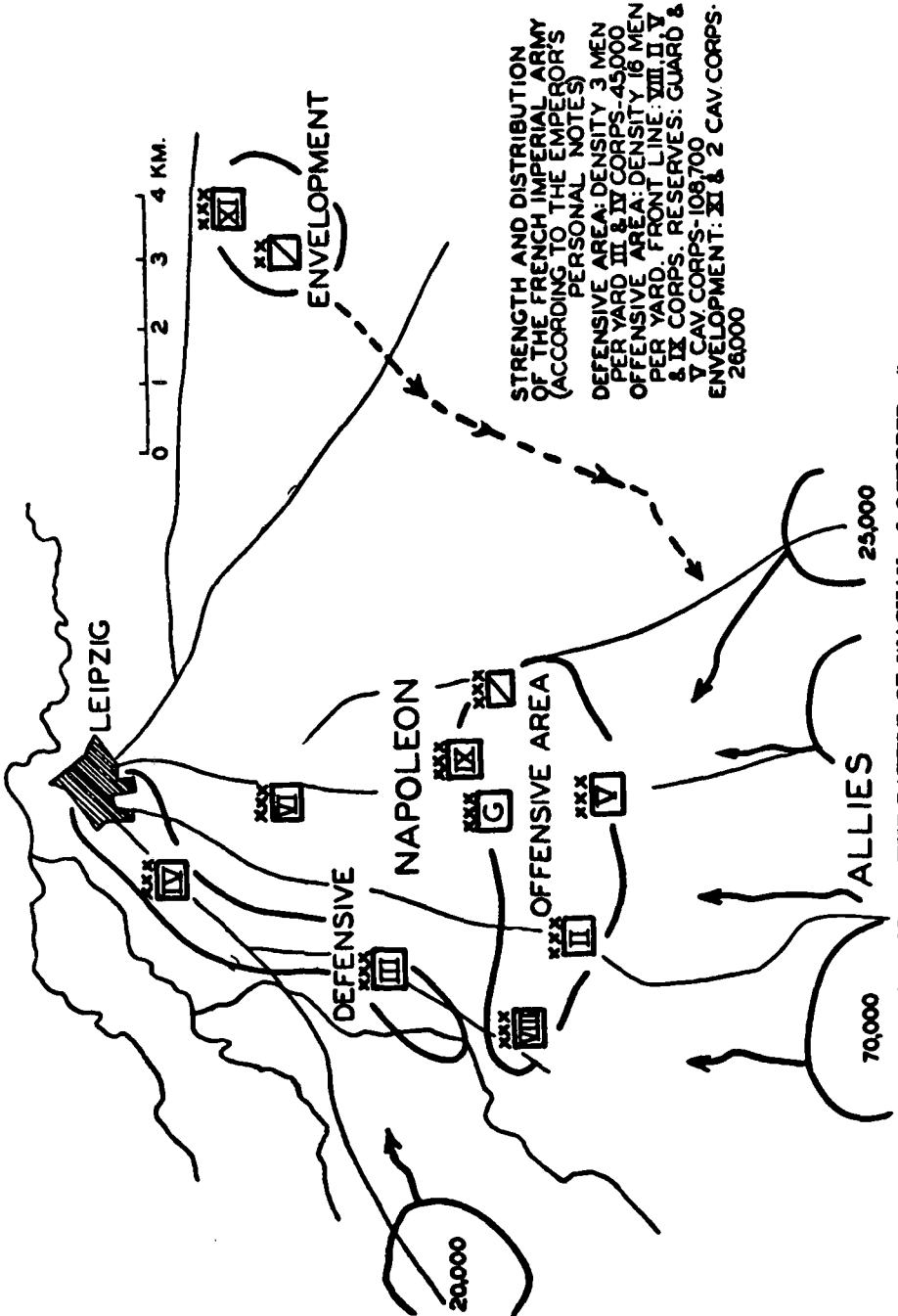

PLATE 85. THE BATTLE OF WACHAU, 16 OCTOBER, 1813.

12,000 cavalry, and 400 guns; the first movements began on 27 April, 1863, and the campaign ended with the Federal retreat on the night of 5 May.

The Federal commander obligingly equalized his numerical superiority in favor of his opponent by dividing his army into two almost equal parts, like the Russians at Tannenberg, with a view to containing Lee in vicinity of Fredericksburg, crossing the Rappahannock in Lee's rear and operating against him from Chancellorsville. Lee resolved to attack one of its wings. He left Early's division and one brigade to contain Sedgwick at Fredericksburg and moved his mass on Chancellorsville.

This initial strategic decision has all the ingredients of the philosophy of the defensive maneuver, i.e., to strip the defensive front to the bone in order to establish mass for offensive action elsewhere.

A similar decision for tactical effect was made on the battlefield of Chancellorsville. Lee contained the Federals frontally with about 17,000 men while Jackson's Corps of 26,000 men made a hazardous turning movement and rolled up the Federal right and rear. The relative distribution or density of forces between the defensive and offensive areas is highly characteristic of the defensive maneuver; the precarious situation of the Confederates, in a fight against overwhelming numbers, merely accentuates the extraordinary boldness and brilliance of Lee's decisions and movements.

The balance between offensive and defensive effort, expressed in troop densities, is also clearly seen in the dispositions of the French Imperial Army, in the Battle of Wachau, 16 October, 1813.

There is no hesitancy in placing Lee abreast of Napoleon and quoting the Campaign of Chancellorsville with that of Leipzig; in both cases the strategic problem was similar and the intellectual orientation of both commanders led them to reach identical decisions.

Napoleon was confronted by the concentric advance of several Allied Army groups, Schwartzberg, Blucher, Bennigsen. After a vain attempt to collar the Army of Silesia, in vicinity of Duben, Napoleon moved on Leipzig in order to strike Schwarzenberg before the latter could join Bennigsen—a typical operation on interior lines, predicated on widely dispersed enemy units.

A successful concentration of the Allies would have brought 311,000 men and 1330 guns on the prospective battlefield, while Napoleon could have mustered only 180,000 men and 734 guns.

In a masterly balance of offensive and defensive dispositions Napoleon contained the advance of Blucher and Bernadotte on his right and rear with a density of 3 men per yard of front, while the VIII, II, and V Corps faced the enemy frontally, with a density of 16 men per yard, and strong reserves were made available for the habitual breakthrough combined with a turning movement.

A century later, in 1914, another great military thinker was confronted by a similar problem, on a vaster scale, when Schlieffen decided to contain the Russians in the East while attempting a swift campaign of decision on the West Front.

The relative distribution of forces, on the vast fronts created by the international situation of Germany in August, 1914, represents still another example of the balance between offensive and defensive effort; the controlling thought, the philosophy of the defensive maneuver, were the same in the Wilderness in 1863, at Leipzig in 1813, and in Lorraine in 1914—a curious proof of the continuity of military speculation. It is as if a magnifying glass had been applied, the brigades at Chancellorsville being enlarged to corps at Leipzig and, finally, becoming army groups in 1914.

On the West Front itself we find a division into offensive and defensive areas; the strategic role assigned to the left wing, the German Fifth, Sixth, and Seventh Armies, is almost a paraphrase of Par. 385, F.S.R.: “. . . for the purpose of economizing forces on a front where a decision is not sought in order to concentrate superior forces at the point of decisive action . . .” The decision was sought by the German right wing, in the operative movements of the First, Second and Third Armies.

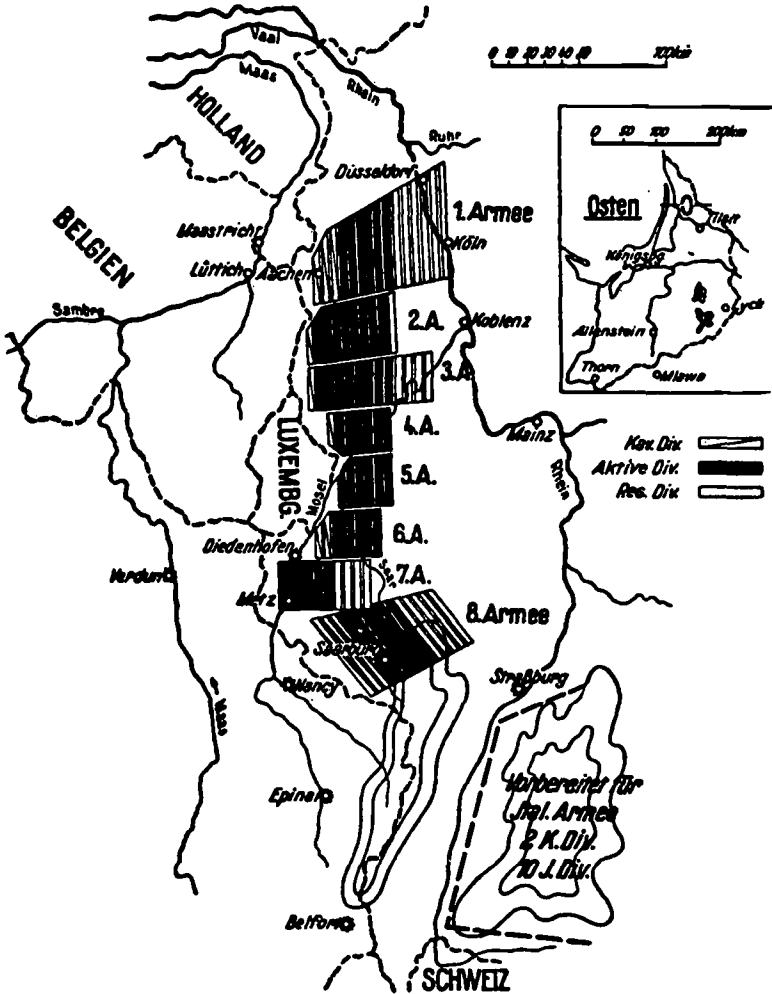

PLATE 86. DISTRIBUTION OF FORCES. THE SCHLIEFFEN PLAN, 1905.

29. ATTACK OR DEFENSE: RELATIVE TACTICAL VALUES. *a. Evolution in the World War period.* For centuries attack was synonymous with war. From the time of Frederick the Great through the Franco-Prussian War, 1870, defense was so exceptional that it had to be ordered. After that war, Moltke advocated the defense as a necessary preliminary to the attack in many instances. In the World War at the outset the defensive was in disrepute. The turning point of the war may in fact be found in 1914 on the West Front when the offensive was abandoned. The breaking off of the battle of the Marne may not have been necessary. But

the consequent impasse was not a transition to the defensive for its own sake but a mere temporary measure which became permanent because there were no reserves. In the German Army the Moltke idea of the defensive had been repudiated. Only the offensive was considered. There was no training in the defensive along the lines Moltke had laid down. There was no regard for the victories which had been won by other armies by a numerically inferior side employing the defensive, e.g., Kunersdorf, Hohenlinden, Caldiero, Austerlitz, Talavera, Busaco, Torres Vedras, Fuente de Honor, Albuera, San Cristobal, Dresden, Belle Alliance, St. Lucia, Custozza 1848 and 1866, the three Plevna battles, Sivin, and in the American Civil War the incomparable Campaign of Chancellorsville. From the Boer War's examples of the defensive, the lessons drawn were only those for the offensive; consequently, on the West Front the German Army persisted in the attitude that there was but one form of combat: the offensive.

In the regulations of the German Army today, the defensive has practically been abandoned. It survives (F. u. G. 12) only in the provision that "defense is justified against an enemy greatly superior in numbers, and then only as a temporary measure to enable the attack to be renewed, or to permit an attack at another point, or at a later time." These regulations do not countenance the doctrine that "the high command has entire freedom to decide whether to attack, defend, delay, or withdraw."

This viewpoint neglects a strategical method which has been employed successfully in many battles of the past and that was used successfully on a large scale in the World War (Hindenburg—Ludendorff on the Eastern Front), and which has had outstanding proponents in theory: Clausewitz, Moltke I.

Skepticism as to the attack, as the strongest form of combat, however, had become rife during the World War. The criticisms arose from the German offensives of 1918, the most carefully prepared of any that German troops have ever been engaged in. They began with the great battle in France. "For each kilometer of front there were 20 to 30 German batteries (an average of 100 guns), not including trench mortars. There was a German superiority of 25 to 30 divisions on the West Front. The comparative combat strength bespoke a success" (Ludendorff, *My War Experiences*). But there was no strategic success in spite of numerical superiority, high morale and excellent training. Why this failure, in view of Tannenberg and Gorlice, and the successful attacks of Frederick the Great's time?

There had, in fact, been a great change in the two forms of combat. A chief factor—the improvement in fire-arms—was appreciated by Field Marshal Moltke in 1861. He wrote: "The attack of a position has essentially become more difficult than the defense." The sentence ends " . . . the defensive during the first phases of a combat is a decisive advantage."

At the beginning of the World War and until Gorlice, machine guns were few. For a long time the Germans had superiority in heavy army artillery. Trench mortars had not yet been introduced. In spite of the increase in artillery the proportion of guns to combatants had not increased much; in Frederick the Great's battles there were on the average $3\frac{1}{2}$, in exceptional cases 7, cannons to 1000 combatants, as e.g., in the Battle of Torgau. Moreover the attacks resulted usually from meeting engagements, so that a planned defense had not been evolved. Conclusions had not yet been drawn from the outstanding results of the defensive on the East Front. There, weak German forces, with properly utilized machine gun fire, had caused attacks, such as Brussilov's in 1916, to break down.

Since that time, however, the number of machine guns and guns had increased tremendously on the West Front. At Tannenberg the Germans had had 4.7 F. A.

guns to each 1000 combatants, the Russians 3.3 guns (according to another authority respectively 2.9 and 2.1), while there were hardly $1\frac{1}{2}$ machine guns for this number of combatants. But in the great West Front battle the attacker was faced by 11 to 12 guns, 4 to 6 trench mortars, and 14 to 15 machine guns to each 1000 combatants.

Conversely, the improvement and increase in numbers of arms had also increased the combat strength of the attacker. He was less vulnerable, due to machine-gun and portable infantry shields and steel helmets.

It seemed plausible that this would result again in success by attack, e.g., at the end of 1917. At that time, the British attack of 20 November 1917 at Cambrai took place. On a front of 10 kilometers they not only succeeded in breaking through for a depth of 10 kilometers but "the Germans would not have succeeded in stopping this breakthrough if the British commander had exploited it" (Ludendorff).

Was the success of this attack to be attributed to the improvement and increase of firearms and the protection of armor? One knows that the heavy infantry shields had long ago been abandoned, that the steel helmet was only fully effective in the trenches, that machine guns were effective in attack, in spite of and not because of the shields. The rolling artillery barrage of the breakthrough was a two-edged sword and is not to be compared in effectiveness with the counter preparations and protective barrages of the defensive. What then occasioned this success? Five hundred tanks had decided this "tank battle." The defensive had secured a great advantage in the improvement of firearms, but this had been overcome by the Allies by not relying solely on the slowly-moving and vulnerable infantryman to carry fire and shock to the enemy. They had created an almost invulnerable mobile machine of attack which could "carry the fire" and which possessed, moreover, considerable shock power.

Since then, the effectiveness of tanks has been increased. It must be borne in mind how combat aviation aided the tank echelons by fire in the battle of the Somme; it must be realized how they strive today in developing attack aeroplanes with shock power.

In 1918 the Germans had only 15 tanks (besides 75 captured tanks) and did not value them as decisive factors; it becomes plain why the attack could no longer be considered as the strongest form of combat.

The continuous employment of the defensive as a salient form of combat was already in effect during the World War. Tannenberg is a conspicuous example of the efficacy of the defensive. There the eventual victory of three days of attack by the entire Eighth Army was made possible only by previous four days of defense by the reinforced XX Army Corps; otherwise, the Narew Army would not have been beaten since the Njemen Army could have intervened; in that precarious strategic situation, the defensive was relied on and chosen by the German High Command; they were not forced thereto by circumstances.

b. Relative tactical values: Offensive-Defensive. Statistical data regarding military operations are almost as numerous in military literature as they are erroneous! One of the best known studies on this subject is Berndt's *Numbers in War*.¹⁸ An analysis of losses, or percentages, in principal battles (to 1877-78) led this author to conclude that "future battles would be less costly;" this erroneous conclusion is partly accounted for by the gradual disappearance of cavalry from the modern battlefield. He failed to note that the number of engagements increased, which would render all wars in their entirety more expensive in human

¹⁸ Vienna, 1897.

life; each month of operations, for instance, brought the following relative losses: Wars of Frederick II: 1272 casualties; the Wars of 1813-15: 8625; the Franco-Prussian War: 22,177; more recent operations, the Balkan wars, the Russo-Japanese War and the Battles of the Frontiers (World War), all indicate a growing percentage of casualties.

Obviously, there is a limit to the practical application of statistical data: A comparison of psychological factors is difficult; military "genius" can hardly be defined through statistical methods or numerical comparison. The relativity of "victory" is sometimes hard to determine, since political effect is often out of proportion to military effort.

Yet, it would be desirable to develop some scheme of comparative analysis, in order to determine "relative success" in battle. There is available a special study¹⁹ which seems to point the way in a general principle: "The tactical value of a victory can be determined by dividing strength plus losses of the defeated by corresponding figures for the victor."

Gravelotte:	{	Defeated 113,000 men plus 13,000 casualties: $126,000 = 0.6$ <hr style="width: 80%; margin: 5px auto;"/> Victor 187,000 men plus 20,000 casualties: 207,000
Dresden:	{	Defeated 200,000 men plus 40,000 casualties: $240,000 = 2.18$ <hr style="width: 80%; margin: 5px auto;"/> Victor 100,000 men plus 10,000 casualties: 110,000

The objection may be made that this procedure merely covers a "tactical" factor; at any rate, it represents a method of comparison between the factor of "credit" (strength, battle efficiency) and "debit" (casualties, losses), in an attempt at establishing an organic relationship.

Bodart, however, overlooked a most important factor: the relative number of field pieces; (the artillery ratio is important, as at Magersfontein 4.12 per 1000 for the British, but only 2 per 1000 for the Boers). This suggests an amplification of Bodart's calculation, with reference to the battle of Dresden:

Artillery of Defeated:	316 guns	40 lost:	$356 = 1.24$
Artillery of Victor:	286 guns	0 lost:	286

Strike an average of both calculations (2.18 and 1.24) and determine 1.71 as the "relative index," for victory, in the case of Dresden. In more recent battles, the relative proportion of machine guns might be evaluated in an identical manner.

This approach is possibly open to criticism, in the field of tactics; however, in the absence of a better method, it admittedly represents a method of "comparative evaluation." In the following tabulation, a distinction is made between victory, as the result of attack, and through the defense; and a column is added showing the duration, in hours, of the action.

This tabulation is admittedly of a general nature. The great number of "relative" victories, through defensive operations, is probably surprising. It may be argued that only a limited number of "offensive victories" was quoted; according to Bodart's classification, however, they were battles with the highest "relative value," while the defensive battles were listed without distinction. It may be argued that victories through offensive action are far more numerous than through defensive action.

¹⁹ Dr. G. Bodart, *Military-Historical Encyclopedia*, Vienna, 1908.

OFFENSIVE VICTORIES				DEFENSIVE VICTORIES		
Name of Battle	Duration Hours	Relative Value	Date	Name of Battle	Duration Hours	Relative Value
Roszbach	2	2.35	1757	Kolin	5½	0.89
Leuthen	6	2.18	1757
.....	1759	Kunersdorf	6	0.98
.....	1800	Hohenlinden	6	1.26
Austerlitz	12	1.65	1805	Caldiero	7	1.00
.....	1809	Talavera	10	1.01
.....	1810	Busaco	12	1.70
.....	1811	Fuentes de Onor	26	1.22
.....	1811	Albuera	8	0.82
.....	1811	Sabugal	8	1.30
Beresina	76	1.55	1812	Salamanka	12	1.32
.....	1815	Waterloo	12	1.73
.....	1861	Bull Run	9	2.62
Vionville	10	1.88	1870	Beaume la Rolande ..	10	1.17
.....	1870	Champigny	7	2.44
.....	1870	Loigny-Voupry	8	1.46
St. Quentin	10	1.19	1871	An der Lisaine	72	2.73
.....	1877	1. Plewna	4	0.80
.....	1877	2. Plewna	10	1.78
Aladscha Dag.	8	0.55	1877	3. Plewna	48	4.50
.....	1877	Seidekian (Delibaba) ..	36	1.25
.....	1877	Sivin	10	2.25
.....	1881	Laings Neck	8	5.56
.....	1899	Colenso (14./15.2)	17	4.82
.....	1899	Magersfontein	12	3.09
.....	1900	Paardeberg (18.2)	12	3.21
Schaho	192	1.39	1904

PLATE 87. OFFENSIVE-DEFENSIVE: COMPARATIVE EVALUATION.

This is true, in a limited sense, in that victory was predicated on a superiority of numbers, in most cases, or were fought in meeting engagements, i.e., attack versus attack; this situation, however, is not the clean-cut differentiation between offensive and defensive method, which is established in the table above.

Superior generalship has frequently gained victory with inferior numbers, but the element of risk became accentuated. Frederick II won 5 attack victories, with inferior numbers, 2 with equal strength; but he had at least 2 failures: Kolin, Kunersdorf. Napoleon won only twice with inferior numbers and failed five times: Aspern, La Rothiere, Laon, Waterloo, Leipzig. Moltke deliberately avoided this risk; his victories were fought with a smaller or larger margin of superiority in numbers: Koniggratz (2.2: 2.1), Gravelotte (1.7: 1). Moltke appears to have recognized a principle ". . . the tactical defensive has gained an unmistakable advantage over the offensive, as a result of increased fire power."

An analysis of the column "Relative value" shows a decrease in value of attack victories and an increase in value of defense victories. This permits a conclusion, ". . . the attack of a position has become increasingly more difficult than its defense."

This tendency is unmistakable in all recent operations, with perhaps the exception of Vionville, 1870, and the Shaho, 1904, and, even then, local circumstances tend to show that these engagements were border-line cases: Vionville was a partial victory; the percentages of losses of the Prussians was much lighter; they remained in possession, however, of the field of battle. This same applies to the Shaho; the Russians could have won with a little more persistence, but the Army commander suspended the attack when he received unfavorable reports

from the IV Siberian Corps. There is one significant operation in this battle that more than ever demonstrates the increase in power of the defensive; a small force (Japanese Reserve Brigade) successfully resisted the pressure of the Russian III Corps, in the defense of the defile of Pensihu.

As regards duration, the attack appears to require more and more time; in the defense, this column shows some fluctuation but a decrease in more recent operations.

Is this theory sustained by operations in the World War? Again the defensive demonstrated inherent advantages. The Germans maintained the West Front defensively for 4 years. The reaction of their opponents had the same result: in a general aspect, the defense was able to withstand attacks for a total of 1478 days or 35,472 hours! The defensive has established itself as a combat method of unquestionable merit and profitable employment. Slowly, the true purpose and application of the defensive became recognized ("Instructions for defensive operations," 1916-17): ". . . the object of the defensive is not maintenance of terrain but maximum damage to the enemy, combined with economy of our own forces."

A rough summary of relative losses, the "price paid," clearly supports this contention: Allied casualties, approximately 7.4 millions. German forces in the West, approximately 4 millions—altogether a profitable balance.

The general characteristics of the Boer Wars of 1881 and 1899 are an additional argument for defensive operations, or defensive strategy: a militia, weak in artillery, is able to oppose a professional army, superior in every respect, merely because its tactics and strategy were orientated along defensive lines, in order to offset this initial inferiority.

The inevitable conclusions can be expressed as follows: The defensive is an

Period	Engagement	Dead & Wounded		Missing & Prisoners		Total Casualties	
		British	German	British	German	British	German
Aug.-Oct. 1915	Autumn battle, at La Bassee	84,000 = 31 of which 3546 officers	27,000 :10 of which 341 officers	10,700	5,800	95,000 = 29	33,000 :10
July-Dec. 1916	Battle of the Somme	434,000 = 22	194,000 :10	37,000	42,000	471,000 = 20	236,000 :10
1917	Only British attacks (Except closing phase of the tank battle) Flanders	708,000 = 18	349,000 :10	52,000	99,000	760,000 = 17	448,000 :10
March 21 to April 30, 1918	German attacks Spring Battle Armentieres Kemmel	209,000 = 10	309,000 :15	93,000	40,000	302,000 = 10	349,000 :11.5
August 1918	British attacks Aug. 8 & 21 & following	113,000 = 18	62,000 :10	9,000	77,000	122,000 = 9	139,000 :10
Sept. 1918	British attacks (Cambrai, Guise, Flanders)	105,000 = 18	57,000 :10	10,000	70,000	115,000 = 9	127,000 :10
Oct. 1918	Planned German Withdrawal Battles	109,000 = 25	44,000 :10	12,000	42,000	121,000 = 15	82,000 :10

These figures cover only the more important offensives of the later period of the World War. For simplicity, losses are totaled without distinction between officers and men. Quiet trench periods are omitted. The present material is to be found in "Statistics of the British Empire during the Great War," of the British War Office which has employed the German Reichsarchiv work as its source on German casualties.

The total casualties in the first four brackets are greater for the attacker than the defender. However, the proportion became less each time. In August-September 1918 the situation changes. In October 1918 the defender has more. To find an explanation of these facts it is necessary to examine the casualties in detail.

Dead and wounded are without exception greater for the attacker.

Prisoners are more numerous for the defender.

efficient and profitable form of combat for the weak. To make it an exclusive form is objectionable, as it will minimize the factor of morale; Moltke developed a "golden rule": ". . . clever strategy aims at forcing the enemy to attack a strong position, of our own choice, and then to assume the tactical offensive, when the enemy has become weakened by losses or exhaustion."

As you consider the forces at work in the kaleidoscope of military operations through the nineteenth century, maneuver forms appear as a derivation of two simple, basic elements: direction and mass.

There are endless variations in the application or fusion of these elements, reflected in the multiple function of high command; under that heading, we recognized the imperative need of anticipation: the preconceived maneuver.

As to relative merit in maneuver forms, it is apparent that the envelopment has been practiced universally and successfully since the wars of antiquity.

Considering the rarity of great commanders, experts in their dangerous craft, we were naturally forced to draw on history for comparative examples.

Do not be deceived that these examples are the ghosts of the dead who have no place in a world of the living! Ideas do not die! Intellectual values are imperishable!

The maneuver of Cannae was executed breast to breast; the Roman sword against Carthaginian arrows. In the course of centuries, it was executed with breech-loaders and machine guns, and it will appear again with armored cars and mechanized units.

Cannae 215 B.C. and Tannenberg 1914 are separated by time but not in substance!

THE NAPOLEONIC CONCEPT OF MANEUVER

30. A MODERN ORGANIZATION. It may seem as if we were taking a step in the wrong direction in returning to the beginning of the nineteenth century and Napoleon I—an about-face into the dim recesses of a past that has long been dead.

Fully aware that the advancements of modern technique have modified the complexion of battle and making a correct appraisal of antiquated tactical details, there must remain a profound conviction that it is still worth while to observe the workings of a superb professional mind, to savor the intellectual quality of his conceptions, to recognize that they have retained a distinct flavor of modernity and to determine why they have survived a century of warfare.¹

Finally, we are persuaded that the extraordinary refinement of the Napoleonic technique and his superb conduct of large masses are a natural corollary to a preliminary digest of strategical and tactical principles, and it is apparent that the Napoleonic concept of tactics and strategy fit perfectly into the framework of this general study.

While it is true that improvements in modern weapons have changed the complexion of the battlefield very considerably, the advance of armies, the march to battle, the strategic concentration and other operative problems have remained the same. In the Campaign of Ulm, Napoleon marched over 200,000 men from the English Channel to the valley of the Danube, a distance of approximately 800 miles. There is very little intellectual difference between that historical operation and an average, modern C.&G.S.S. map problem that starts the student in the vicinity of Baltimore with two corps and a mission requiring an advance on Gettysburg, or the actual concentrations in maneuver areas required currently as an annual feature of our Army maneuvers or Army command post exercises. In the tentative situations that develop in one as well as the other case, the question presents itself instantly: "What formation shall I adopt? Divisions abreast or in echelon? What routes are to be selected and why?" If we consider that improved communications have given us a marked advantage over Napoleon, then the very fact that he solved similar problems in an incomparably brilliant manner would seem to imply that the Napoleonic style may still be fashionable and worthy of imitation.²

Your attention is invited to the following tabulation, showing a typical Napoleonic organization—the forerunner, in fact, the foundation of all modern army organization. It is not too difficult to substitute the term "division," in the modern sense, for the Napoleonic "corps," in order to arrive approximately at the set-up of a modern field army, consisting of 2 corps, or 6 divisions.³

¹ It is claimed on good authority that the literature on Napoleon Bonaparte comprises approximately 40,000 separate titles, and the subject is apparently not yet exhausted; for obvious reasons, the French have been especially productive. There are able German and British interpretations, but the most modern note was probably struck by General Camon in his brilliant study *Le système de Guerre de Napoleon* (Berger-Levrault, 1923). The salient features of Camon's able theory are briefly covered in this chapter; it is significant that this theory is in accord with the central theme of the "Maneuver Element," especially as regards Chap. IV, Pars. 16, 17, 18 and 19.

² The subject is almost inescapable not only as a broad cultural background for all officers, but of specific application in our advanced service schools: the C.&G.S.S., Fort Leavenworth and the War College. Students are assigned command of divisions and corps almost over night, i. e., a theoretical test of capacity of forces ranging from 15,000 to 150,000 men; the manipulation of such masses, even on paper, requires a strategic imagination which might profitably feed on a study of the Napoleonic conduct of war.

³ On the subject of comparative strength, may we point out a very common error in the evacuation of military factors? The personnel total of any unit is never conclusive of its combat strength; that total should always be reduced to "rifle and automatic weapon strength," and should be expressed in terms of "volume of fire" or "capacity for effective fire." For example, the enormous total of the present American division (1934), i. e., 22,895 animals and men, will shrink to approximately 8064 rifles if a distinction is made between "effective" and "non-effective" rifles. Men whose assigned duties are such that they are unable to c in the fire fight are classed as "non-effective"; viz: orderlies, messengers, section leaders, artificers, tailors, etc.; under this classification, of 144 rifles in the American rifle company, only 108 are effective weapons.

NAPOLEONIC WARS 1796-1815—SYNOPTIC TABULATION* OF TYPICAL MANEUVERS AGAINST THE REAR OF AN ENEMY

Maneuver	Date and Duration	Situation of Enemy	Enemy L. of C., Direction of Retreat	Initial Disposition of Forces	Strategic Barrier (Cutting Enemy L. of C.)	Strategic Screen (Covering French Movements)	French Dabouchements	French Temporary Bases	Demonstration (to Deceive Enemy)	Decisive Battle	Results
Turin	1796, 12-28 April	Sardinian Army, in cantonments at the foot of the Alps and Apennines	Turin	Along the Alps and the Apennin to Savone	Heights at Mombarco	Alps and Apenninas	Col de Cadibone	Savone, then Ceva, then Coni	Serurier to Ceva	Mondovi	Armistice of Cherasco
Adda (Lodi)	1796, 5-11 May	Austrian Army before Valenza	Milan and Mantua	Toward Cherasco	Adda	Po (right bank)	Pontoon bridge at Piacenza	Piacenza	Serurier before Valenza	Lodi	Retreat of Beaulieu and abandonment of Sardes and Lombardie
Alpone (Villanova)	1796, 15-17 Nov.	Army of Alvinzi on the heights of Caldiero	Vicence	Vicinity Verona	Alpone (Villanova)	Adige (right bank)	Ronco (Adige) and d'Arcole (Alpone)	Arcole	Retreat of Alvinzi on Vicence
Stradella (Marengo)	1800, 14 May (passage of Alps by advance guard) 14 June (Marengo)	Vicinity of Genoa	Plaisance	Debouchment into Lombardy via the Grand-Saint Bernard	Defile of Stradella	Po	Pontoon bridge at Piacenza	Milan	Lannes towards Turin	Marengo	Convention of Alexandria relinquishing all of Lombardy
Lech (Ulm)	1805, 25 Oct.-20 Oct.	Passes of Black Forest	Augsburg	On the Rhine	Lech	Zone Munster-Donauwerth-Ingolstadt	Augsburg	Lannes on the Black Forest	Ulm	Capitulation of Ulm
Saale (Jena)	1806, 8-14 Oct.	En route to Thuringia	Berlin and Dresden	Cantonments in Bavaria	Saale	Franken-Wald	3 columns, Hof, Crotsch, Cobourg	Auma	On the Rhine by the King of Holland	Jena-Auerstedt	Destruction of Prussian Army
Narew (Pultusk)	1807, 22-29 Dec.	Russian Forces west of Narew	Towards the east	In front of Warsaw	Narew (Pultusk)	Warsaw	Bernadotte	Pultusk-Golymin	Retreat of Russians
Alle (Allenstein)	1808, 25 Jan.-3 Feb.	West of the Alle	Id.	West of the Narew	Alle (Allenstein)	Bernadotte on the Passage	Allenstein	Id.
Alle (Eylau)	1808, 5-7 Feb.	West of the Alle	Id.	Left bank of the Alle	Alle (Bartenstein)	Eylau, 7 February	Id.
Alle (Friedland)	1808, 7-14 June	Finally west of the Alle	Id. and towards Konigsberg	West of the Alle	Alle (Friedland)	Friedland, 14 June	Peace of Tilsit, 8 July
Isar (Landshut)	1809, 17-23 April	Archduke Charles from Landshut to Ratisbon	Landshut on Vienna	Between Ratisbon and Augsburg	Isar	Covering Forces	Augsburg	Davout	Eckmuhl, Ratisbon	Retreat of Archduke to Bohemia
March (Wagram)	1809, 23 April-6 July	Archduke Charles in Bohemia	Near Ratisbon	March	Danube (right bank)	Island of Lobau	Island of Lobau	Wagram	Retreat of Archduke to Moravia
Vilna (Vilna)	1812, 24 June-9 July	Russian forces east of Niemen	Vilna	Along the Niemen	Vilna (Vilna)	Kovno	Kovno	Army of Jerome
Dnieper (Smolensk)	1812, 11-19 August	Right bank of Dnieper west of Smolensk	Moscow	South of Whitebk	Dnieper	Bieski Forest	Rossasna	Orcha	Smolensk-Valou-tina	Retreat of Russians
Elster (Lutzen)	1813, 1-2 May	Left bank of the Elster	Dresden	Right bank of the Saale	Elster	The Saale	Leipzig	Vicinity of Hanover	Italian Army	Lutzen	Retreat of Allies
Brussels	1815, 15-18 June	English Army in cantonments southwest of Brussels	Bruxelles	Sambre, left bank	The Sambre	Charleroi	Waterloo

* Camon, *Comment Napoleon e contra son systeme de manevres.*

TYPICAL NAPOLEONIC ORGANIZATION

The Grand Army of 1805: Campaign of Ulm

Guards: BESSIERES	6,000
I Corps: BERNADOTTE	18,000
I Cavalry Division; 2 Infantry Divisions.	
II Corps: MARMONT	21,000
1 Cavalry Division; 3 Infantry Divisions.	
III Corps: DAVOUT	27,000
1 Cavalry Division; 3 Infantry Divisions.	
IV Corps: SOULT	41,000
1 Cavalry Division; 4 Infantry Divisions.	
V Corps: LANNES	18,000
VI Corps: NEY	24,000
Cavalry Reserve: MURAT	22,000
General Headquarters Reserve: VII Corps	14,000
Bavarian Corps	
Allied Contingent	
	8,000

31. NAPOLEON'S SYSTEM OF OPERATIONS. From his first campaign in 1796 to his last in 1815, Napoleon employed but two systems or types of operations:

- a. The maneuver against flank and rear of the enemy.
- b. The maneuver from a central position, i.e., operations on interior lines.

In the first system, he threw the mass of his army into the hostile zone of retreat to cut the enemy's line of communication, in order to force a decisive battle, i.e., a turning movement.

In the second system, he moved his army in a compact mass to a central position between enemy units not yet united in order to defeat them in detail, i.e., an operation on interior lines.

The orientation map shows the location of the principal Napoleonic battlefields and the characteristic types of maneuver employed thereon; the light dots represent operations on interior lines and the black dots operations against the rear.

It is quite apparent that while Napoleon employed the maneuver on interior lines on comparatively few occasions, he operated against the flank and rear of his opponent almost habitually.

Without considering the Peninsular War, Napoleon's Campaigns contain at least twenty-seven characteristic maneuvers against the hostile rear, but he attempted many others and planned still more, viz.:

- 1796—Lodi, Bassano, Arcole, Dolce
- 1800—Marengo
- 1805—Ulm, Hollabrunn
- 1806—Jena
- 1807—Pultusk, Allenstein, Friedland
- 1809—Landshut, Eckmuehl
- 1812—Vilna, Witebsk, Smolensk
- 1813—Leipzig, Bautzen, Dresden, Dueben
- 1914—Saint-Dizier, Brienne, Montmirail, Soissons, Mery-sur-Seine.

The strategic and tactical results of some of these operations were absolutely crushing or decisive, notably: Bassano, Arcole, Marengo, Ulm, Jena, Friedland, Landshut, Montmirail. There were others in which faulty execution or the result of unforeseen incidents did not produce the full effect. Nevertheless, all

succeeded in driving the enemy far to the rear and gaining large amounts of territory: Lodi, Castelnovo, Dolce, Hollabrunn. There was only one failure: St. Dizier.

32. THE MANEUVER AGAINST FLANK AND REAR. There is a justifiable reluctance to reduce military operations to a formula. The art of war is not of slow and continuous growth but the spasmodic product of genius. When a great soldier appears, art develops at so high a speed that few can follow its course. Genius is most difficult to gauge and in spite of all historical exactitude is apt to pass into the realm of romance.

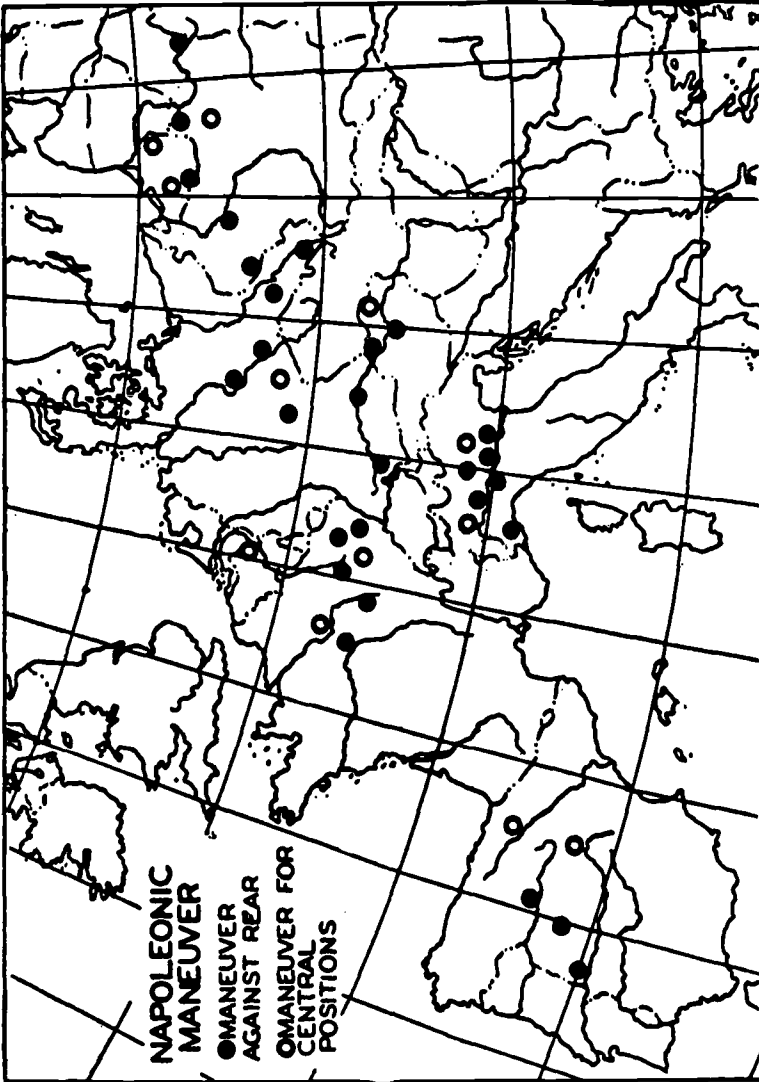

PLATE 99. ORIENTATION MAP: THE NAPOLEONIC MANEUVER.

Nevertheless, it would be extraordinary if military genius were not subject to basic laws, if it had no system or method when one knows that in the arts as well as in science, genius is the result of system and method.

As to the term "system," when certain operations, as a type, are repeated

twenty-seven times over a period of years, then the application of the term appears to be more than justified in the deliberate sense of its dictionary definition: "System: Orderly combination of parts or elements, into a whole, according to some rational principle."

The general idea underlying Napoleon's favorite and most effective system—the maneuver against the rear of the enemy—can be expressed as follows:

(1) Frontal pressure will rarely lead to a decision; the enemy can always withdraw, fight delaying actions in successive positions and finally escape.

(2) Through demonstrations by detached forces, the enemy is drawn away from his bases or capitol.

(3) In rapid, secret concentrations, the mass of the army is moved into the hostile zone of retreat by a march around the enemy's flank; if possible, this movement is under cover of a natural screen: mountain range, forest, etc.

(4) The objective is a position astride the enemy's line of communications in order to secure a strategic barrier, usually a river line, cutting off his avenues of retreat.

(5) This threat in rear is expected to produce a certain degree of demoralization and a reversal of enemy movements.

(6) Then turn against the enemy in a battle of your own choice, in time and location.

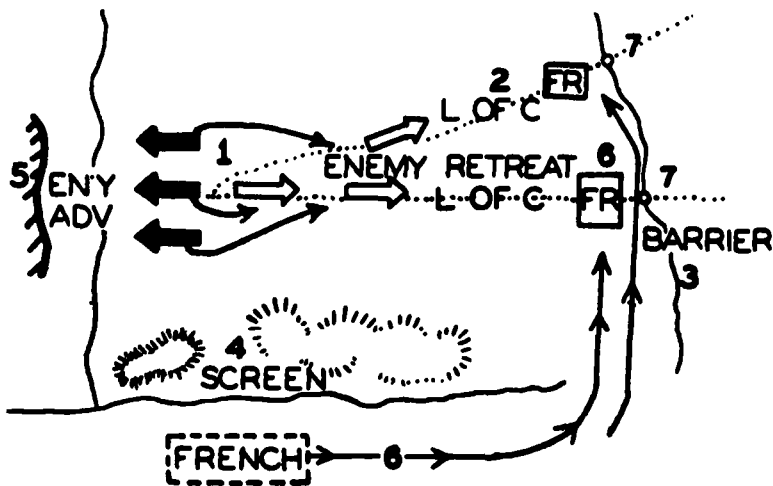

PLATE 91. SCHEMATIC DIAGRAM: MANEUVER AGAINST THE REAR OF THE ENEMY.

This conception can be reduced to a schematic diagram;⁴ it is like a stage setting; note the scenery, the "props":

(1) Initial movements of the enemy against the French frontier; demonstration to keep him occupied.

(2) Secret concentration of the French mass; movement around the enemy's flank into the hostile rear areas.

(3) Specifically—where? To a position astride the enemy's line of retreat, preferably resting on a natural barrier: a river line, for instance. It is this barrier which became the initial, strategic objective of Napoleon; he waged battle ordinarily only after he had secured it.

⁴ Camon.

(4) The enemy, aware of the threat to his rear, must make an about-face.

In this connection, it is well to visualize the complex organization of an army rear-area, its administrative and supply establishments, lines of communications, depots, dumps, distributing points and various echelons of supply; the movement and location of reserves, trains, service units, supply and evacuation facilities are all generally oriented in a forward direction: suddenly this flow of men and matériel must be reversed!⁵

In the Campaign of Jena, October 1806, the French Army had reached the zone of retreat of the Prussian Army, as planned. Napoleon wrote to Lannes:

"All intercepted letters indicate that the enemy has lost his head. They are holding war councils day and night. My army is united and astride their routes to Dresden and Berlin. It is now a question to defeat the enemy in detail and before he can unite."

He ordered Murat:

"Attack everything in sight; those are columns en route to some point of concentration. I have moved too fast for them to have received counter-orders; a few engagements like that, and the Prussian Army might be defeated without a general battle."

The presumptive demoralization of the enemy, however, was not the only advantage accruing from this maneuver. Special conditions at that time favored it: the French had developed a superior strategic mobility as compared with their opponents. The French carried several days of fire within units at the expense of Class-I supplies, which they obtained through foraging and requisitions or the capture of hostile depots. The Austrians and Prussians depended almost entirely on convoys and rear-establishments; consequently, they were extremely sensitive to threats against their communications.

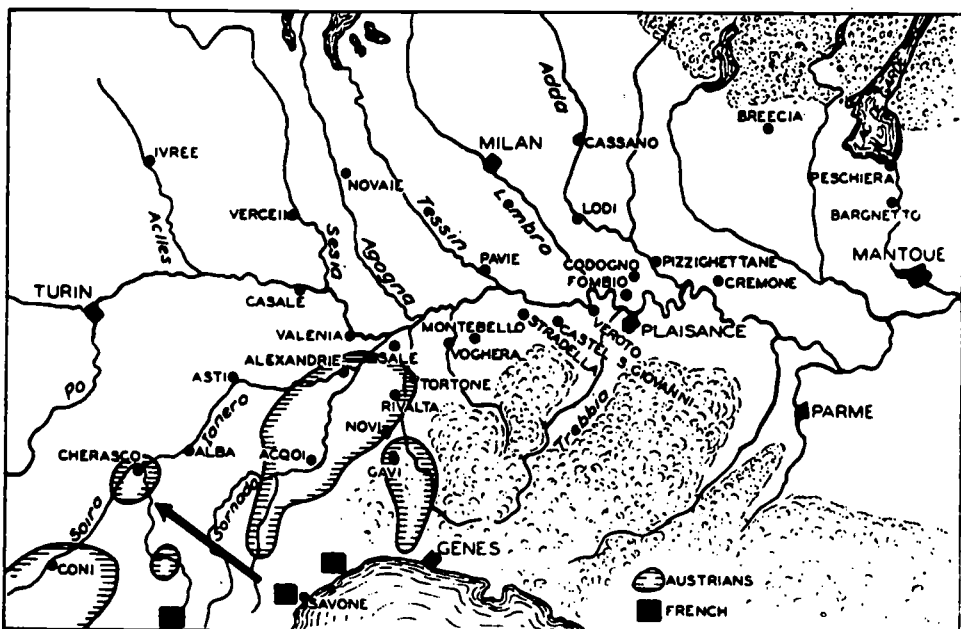

PLATE 92. THEATER OF WAR, LOMBARDY, 1796.

Finally, Napoleon did not employ this maneuver until he had sufficient strength to secure a local superiority of numbers.

Are modern armies less sensitive to threats against their communications? On

⁵ See Chap. IV, Plates 44-49.

the contrary, communications have become more vulnerable than ever. The entire Meuse-Argonne Offensive in which the American Army played such a distinguished part was based on a single idea: a threat to German communications, the 4-track railway line (Sedan-Mezières), and it worked in 1918 as an attack on communications did in 1796 or 1805 or 1806.

In covering briefly a few of Napoleon's principal maneuvers it is interesting to observe to what extent the factors shown on the schematic diagram apply.

a. *The maneuver of Lodi, 1796. General situation.*⁸ *Campaign of Italy, 1796.* Austrian and Sardinian forces opposed the French along the Appenines and the Alps. In a typical "operation on interior lines" directed against the point of junction of the Allied forces, Napoleon isolated the Sardinians and concluded an armistice with them. The Austrians continued to hold in the area: Acqui—Alexandrie—Tortone.

What was the decision of the French commander? The answer is contained in Napoleon's own sardonic words in his famous report to the French War Department, 29 April 1796:

"I have no doubt that you approve of my decisions. Here is one wing of a hostile army, agreeing to an armistice—in order to give me time to defeat the other."

It is obvious that in this particular situation every effort had to be made to defeat the Austrians before the Armistice with the Sardinians should elapse; in this situation the time factor had become all-important; a maneuver solution that was time-consuming was useless.

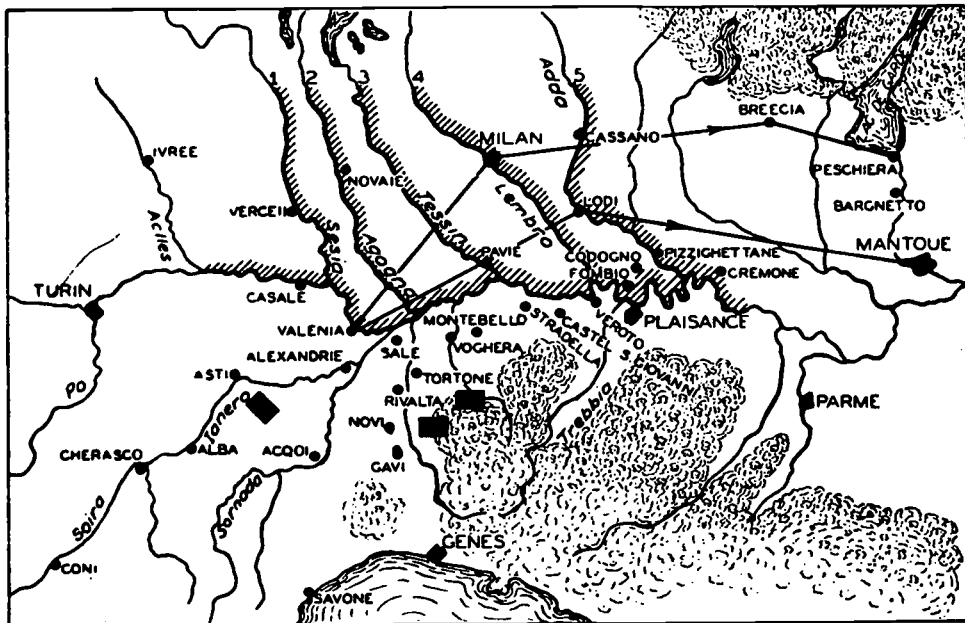

PLATE 93. AUSTRIAN LINES OF COMMUNICATIONS, LOMBARDY, 1796.

Now let us turn to the Austrian commander. What plans were open to him? Pending the expiration of the armistice he had to keep in mind the possibility of rejoining his ally; for the present there was the imperative necessity to fight the French by disputing every inch of ground.

⁸ See Chap. V, Plate 52.

In order to maintain a relationship with the schematic diagram (Plate 91) it is suggested that the factors involved are recalled, as a sort of check-list.

We have already covered the item, "initial dispositions;" we shall next examine the Austrian "supply establishments," their "lines of communication and retreat."

The Austrian main supply depots were located at Milan and Mantoue. Note that the route to Milan crossed a series of parallel river-lines, the Sesia, Agogna, Tessin, Lembro and Adda, that lent themselves to protracted defense or delaying actions and that the Po, an immense stream, would cover the Austrian south flank in the course of such an operation.

Note that the Adda represented a "strategic barrier" across the Austrian routes of withdrawal to the east, to their home territory and the strong fortifications of Mantua.

What plans were open to Napoleon? How did he propose to operate against the Austrians?

At least one plan open to him was to continue operations in the valley of the Tanaro, i.e., frontal pressure in the direction of Alexandria and attack the Austrians where found.

What objections, if any, may be made against this operation?

Napoleon's present task consisted in keeping the Allies divided and defeating one before the Armistice expired; this meant prompt, decisive action against the Austrians. Recall the analysis of the idea underlying the "maneuver against the enemy flank and rear." We then stated that ". . . frontal pressure can rarely lead to a decision; the opponent can withdraw from one position to another, causing loss of time and strength, and finally escape." Compare this statement, dated 1796, with Schlieffen's comment,⁷ dated 1905, in an argument against frontal attack: ". . . frontal attacks are indecisive, since they merely drive the enemy to a new position . . . and a new operation must be started. This is all right if you have plenty of time . . . but not when you are counting minutes . . . do not attack frontally; the thing to do is to crush the enemy's flanks . . ."

In this situation Napoleon was "counting minutes," a veritable race against time, against the date of expiration of an armistice.

As a matter of fact he adopted "frontal pressure" as it should be used, as a preliminary operation, as a demonstration or feint under cover of which he planned a more decisive stroke.

On 30 April, the Austrians evacuated their forward positions. Massena was ordered to push on in the direction of Alexandria and engage in "frontal pressure." Napoleon then formed a detached corps and directed it deeply into Austrian territory, to seize a crossing of the Po. His ultimate plan was fully revealed in his report to the French War Department, 6 May:

"My intention is to force a crossing of the Po, as close to Milan as possible, to avoid further obstacles to that city. By this movement, I turn the successive lines of defense which (the Austrians) have prepared along the Agogna and Tessin. I move on Plaisance today, and shall be between the enemy and his depots . . . I may be accused of being bold, but not of being slow . . ."

In this conception, one should have no difficulty in recognizing the salient factors: demonstration by Massena against Alexandria—Valenza to deceive the Austrians and keep them engaged frontally; a rapid march, under cover of a natural screen, the Po River, in order to place the mass of the French in rear of the enemy; the seizure of a strategic barrier, the line of the Adda, astride the Austrian communications. This agrees in every detail with the procedure previously shown on the schematic diagram; in other words, we are in the presence of a system!

⁷ See Chap. V, Par. 23d.

By 8 May, Napoleon was across the Po. He fought a sharp engagement with an Austrian detached force and secured the crossing of the Adda at Pizzighettane; he then moved north to seize Lodi and Cassano and cut off the last avenues of retreat left open to the Austrians.

The reaction of the Austrians was violent; the threat to the rear was sufficient to cause their retreat on Milan and Mantoue; their rear guards barely cleared the crossing at Lodi when the leading element of the French Army appeared there.

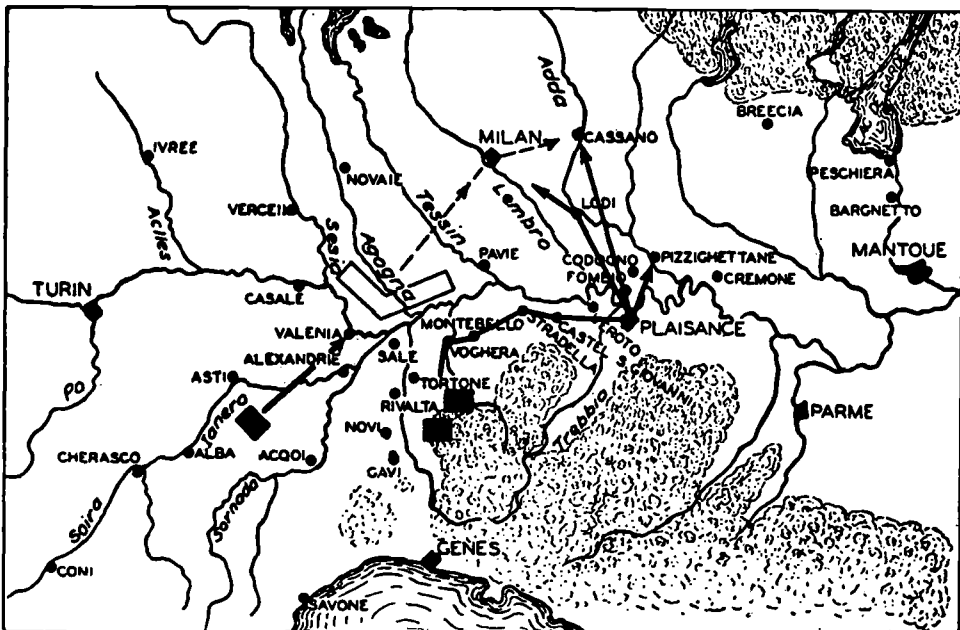

PLATE 94. ITALY, 1796: OPERATIONS 2 APRIL TO 8 MAY.

Napoleon was not able to intercept his opponent entirely; there were delays due to his lack of bridge equipment and the state of exhaustion of some of his units. Nevertheless, he had forced the Austrians to evacuate Lombardy in disorder and completely isolated their former ally, the Sardinians, with immediate political effect. Seemingly abandoned by the Austrians, the Sardinians promptly negotiated for a separate peace. The maneuver against the rear accomplished what direct frontal pressure against successive lines could never have achieved.

b. The maneuver of Ulm, 1805. In analyzing the maneuver of Lodi, only one of the many similar operations has been selected; many others could be mentioned if time and space were available. Advancing about ten years to the next example, in 1805, one recognizes the same general maneuver on a more ambitious scale.

The preliminaries of the campaign of Ulm, 1805, represent one of the most interesting examples of a command decision. Note the initial French concentrations along the channel with a view to attempting a landing in England. Suddenly evidence developed that Austria and Russia were making war-like preparations. By early September, Austrian armies were actually advancing west to the line of the Rhine. The Austrian strategic dispositions would indicate dispersion; at this stage of the game, this was understandable, as they were trying to cover both northern Italy and the Tyrol.

Requirement: Decision of Major General "A," i.e., Napoleon I.

MANEUVER IN WAR

Napoleon decided on a complete reversal of plans—to abandon the initial project of an invasion of England, for the time being, and by a colossal march of concentration to move his army from the Channel to the Rhine in order to turn against the Austro-Russian combination.

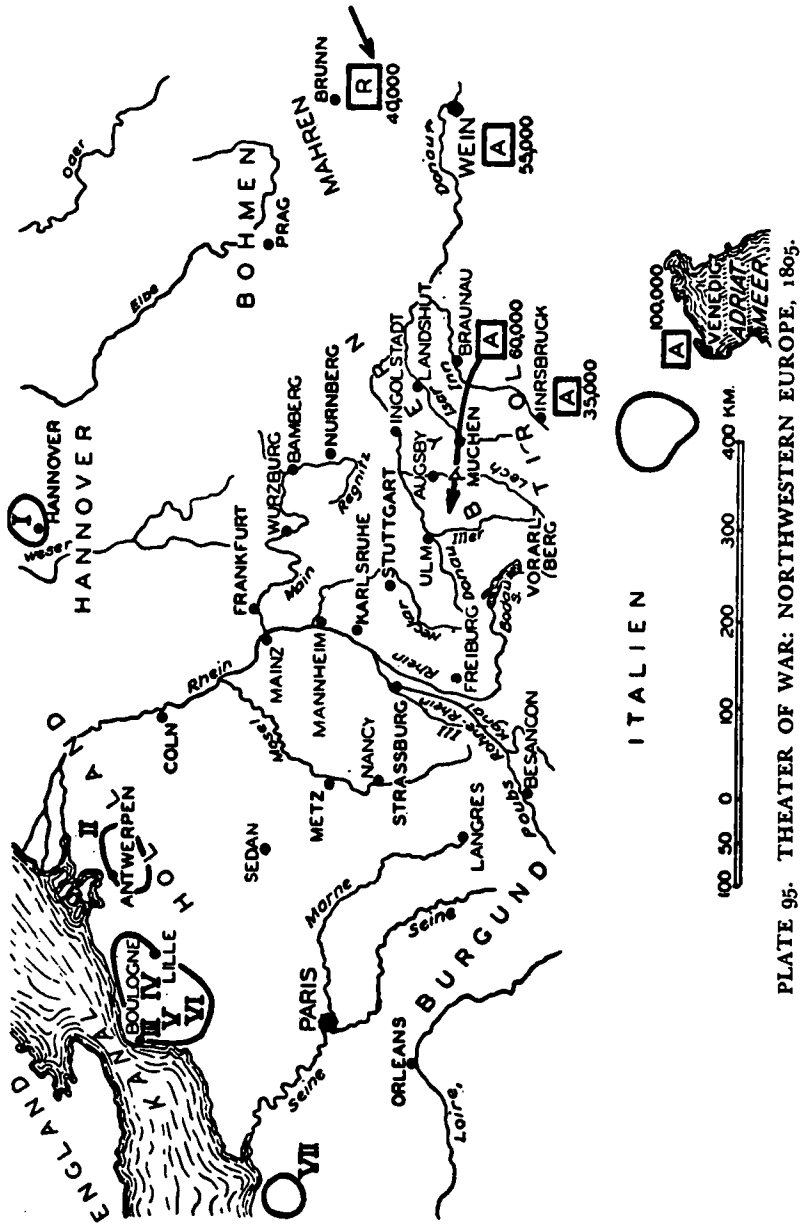

PLATE 95. THEATER OF WAR: NORTHWESTERN EUROPE, 1805.

This is an extraordinary example of strength of character, strategic imagination and boldness of conception. Napoleon's decision and the resulting campaign are perhaps the finest example of professional workmanship in recorded military history.

The next movements in this great military drama should be plain because you already know the secret of the Napoleonic system: a maneuver against the rear of the enemy.

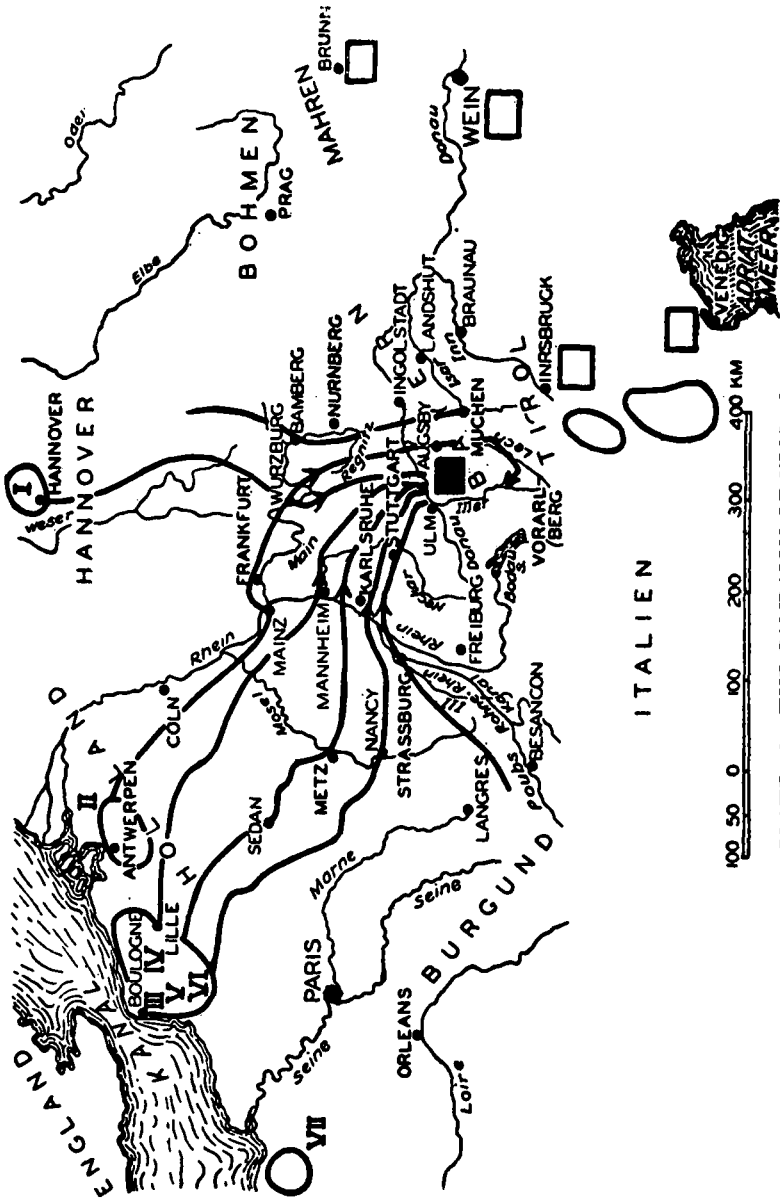

PLATE 96. THE CAMPAIGN OF ULM, 1805.

In a huge wheel to the south, which resembles the German advance into Belgium in 1914, his corps converge on the junction of the Danube, Iller and Lech. On 2 October, Napoleon wrote Bernadotte:

"If the Austrians delay, I expect to arrive on the Lech before them, cut their retreat and drive them into Tyrol."

On 3 October he wrote Soult:

"It is my intention to surround the enemy when he is encountered."

With his mass in vicinity of Augsburg, astride the Austrian communications, Napoleon initiated a concentric movement against his opponent. On 12 October, he was certain to be able to surround the Austrians and wrote Soult:

"It is not now a question of merely attacking the enemy; I now expect not a single man to escape—not a man to carry the news to Vienna . . ."

After a vague attempt to break through the tightening cordon, the Austrian First Army was forced to capitulate at Ulm.

As one views this campaign in its entirety, one is impressed with the fact that the final battle dispositions around Ulm seem almost visibly forecast in the strategic advance that began on the English Channel and terminated in a city in Bavaria, as if a gigantic hand had stretched across a continent to gather in the Austrian forces.

c. The maneuver of Jena, 1806.

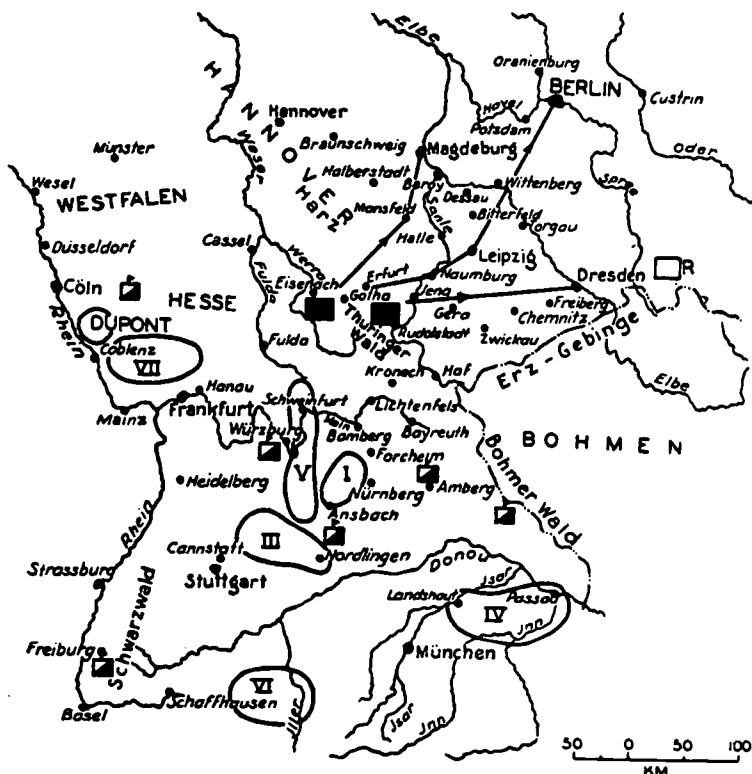

PLATE 97. GENERAL SITUATION OF THE FRENCH ARMIES, 1806.

Another example of the favorite Napoleonic maneuver is shown in his campaign against Prussia, culminating in her defeat at Jena and Auerstadt in 1806. The usual recapitulation of essential factors will be followed:

(1) *Initial dispositions.* Wide dispersion of French corps in cantonments. Initial Prussian concentrations, with a view to attacking the French in the western area; Russian support was arranged for and they were en route from the east.

(2) *Enemy lines of communications, supply bases, and avenues of retreat.*

(a) The route: Erfurt—Leipzig—Berlin.

(b) The route: Jena—Gera—Dresden, towards Russian reinforcements.

(c) The route: Eisenach—Mansfeld—Magdeburg.

Like the Austrians in 1796 and 1805, the Prussian Army was dependent on convoys and depots for supplies.

(3) *Strategic barrier*: A river line cutting the line of communication, in this particular situation the river Saale and its tributaries.

(4) *Strategic screen to cover the movements of the French*: The line of the Thuringer Wald; a belt of forests.

(5) *Demonstration to deceive the enemy*. Demonstration against Wesel by the King of Holland. Occupation of cantonments until the last moment, in order to give the impression that no offensive was contemplated.

(6) *Movement and objective of the French*: Rapid concentration by forced marches in the direction of Berlin and seizure of the crossings of the Saale, which control the avenues of retreat of the Prussian Armies on Leipzig and Dresden.

(7) *The decisive battle*: Converging movement against the enemy, who was retreating in several columns, and defeat of fractions in detail at Jena and Auerstadt.

d. *The model maneuver*. Throughout his career Napoleon maintained an absolute confidence in the efficacy of this maneuver against the rear of an enemy. We shall give a final proof that his views, his conception of this maneuver, were absolutely fixed to a degree of a system by quoting his own words.

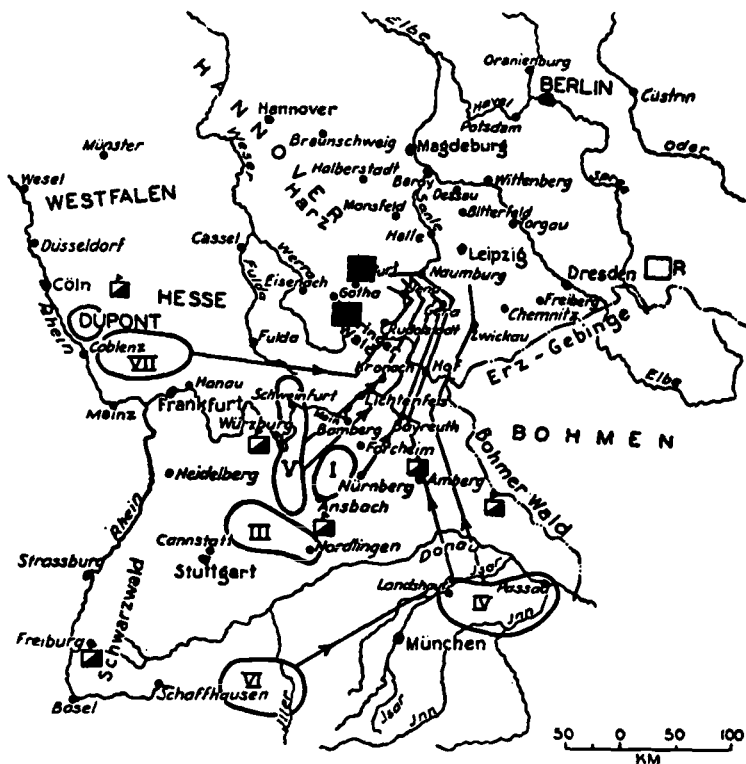

PLATE 98. THE ADVANCE ON JENA, 1806.

In 1813 Prince Eugene was holding the Adige with 40,000 men; the Austrians were between the Brenta and the Adige. The Prince wrote Napoleon for advice.

The master replied:

"Do not give up the Adige without a fight. This is the maneuver which I would undertake: Move via Brondolo-Mestre on Treviso and the Piave . . . You can expect incalculable results. The enemy communications run via Treviso and Conegliano; cut them . . . Perhaps I should not insist on this bold maneuver, but it is my style, my manner of doing things . . ."

So Napoleon had a "style," a "manner of doing things." A favorite system, that of a maneuver against the enemy's rear! A wide turning movement—and not the frontal pressure that head-on collision which for some inexplicable reason has become a favorite tactical solution by the average commander.



PLATE 99. EUGENE IN ITALY, 1813.

33. THE MANEUVER ON INTERIOR LINES. We are now ready to cover the second of Napoleon's favorite maneuvers, a maneuver from a central position, i.e., operations on interior lines.⁸ The operation is generally effective and deserves most respectful regard; its most modern application is to be found in the Battle of Tannenberg in 1914.

The "Orientation Map" (Plate 90) shows the relative frequency with which Napoleon resorted to operations on interior lines. Compared with operations against the enemy's rear, or turning movements, the ratio is approximately 7 to 3.

We propose to cover the initial phase of the Campaign of 1796 and the entry into the Campaign of 1815.

What constitutes the "maneuver from a central position?" When Napoleon had no effective superiority of strength or numbers or was unable to make the necessary concentration to that effect, he did not fall back to "position warfare" or a purely "defensive battle" but had recourse to maneuvers from a central position, or operations on interior lines. He sought to divide the opponent or profit from an initial division if it existed; he then maneuvered for a central position between enemy fractions in order to defeat them in detail, viz:

⁸ The French phraseology is "maneuver from a central position;" the inevitable French logic implies that there is, initially at least, a "position in readiness."

THE MANEUVER FROM A CENTRAL POSITION

- (a) Operation from a central position, as an "initial offensive":
The opening campaigns of 1796, 1812, and 1815.
- (b) The central position, as a "position of readiness":
1796—Operations at Castiglioni, Arcole, Rivoli. Central position: Mantoue.
1805—Before Austerlitz. Central position: Vienna.
1806—Before entry into Warsaw. Central position: Warsaw.
1809—Before Essling. Central position: Vienna.
1813—Fall Campaign. Central position: Goerlitz.
1914—Entire Campaign. Central position: Zone between Seine and Marne.

The characteristic execution of this maneuver, conceived as an "initial offensive," may be summarized as follows:

As an initial offensive stroke, Napoleon threw his mass into a gap existing in the enemy's dispositions. He attempted to destroy the separated fractions in detail by concentrating mass against one while containing the other until he could turn against the latter.

This maneuver ordinarily required a painstaking preparation in which certain essential factors must be satisfied in advance:

- (1) Selection of initial direction of offensive.
- (2) Selection of enemy fraction to be attacked.
- (3) Secondary operation, demonstration, to deceive the enemy as to the actual area of offensive.

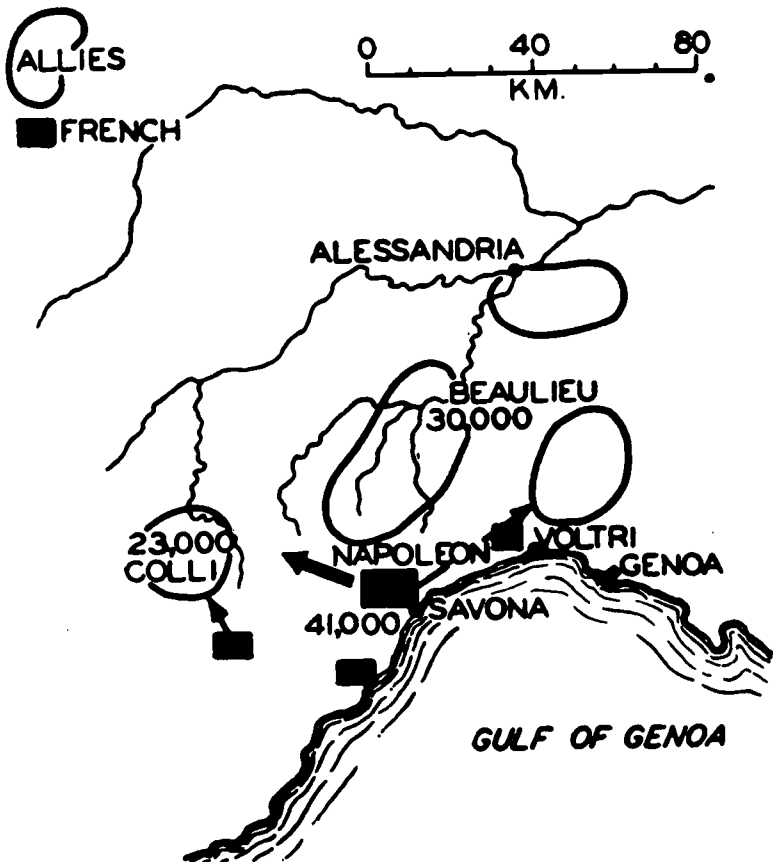

PLATE 100. CAMPAIGN OF ITALY, 1796.

- (4) Special measures to insure secrecy.
- (5) The strategic concentration.
- (6) Organization of alternate lines of operation.

a. *Campaign of 1796.* We propose to show the application of these elements in the Campaign of Italy, 1796.

In the opening phases of this campaign, Austrians and Sardinians opposed the French along the Appenines.

(1) Selection of initial direction of offensive: Napoleon decided on a breakthrough operation from Savona in the direction of the point of junction of the Austrians (Beaulieu) and Sardinians (Colli).

(2) Selection of enemy fraction to be attacked: Napoleon decided on attacking the Austrians in position at Montenotte.

(3) Secondary operation to deceive enemy as to the actual area of the offensive: Preparatory to the offensive stroke, Napoleon made demonstrations against Voltri to divert the Austrians, and frontally against the Sardinians up the valley of the Tanaro. The Austrians reacted to the threat on Voltri by making a detachment of approximately 10,000 men, thereby weakening their main forces proportionately.

(4) Special measures to insure secrecy: Secret concentration at Savona; a night march to Carcare for surprise attack at dawn. The Austrians were driven from their positions and fell back; a gap was created between the Allies.

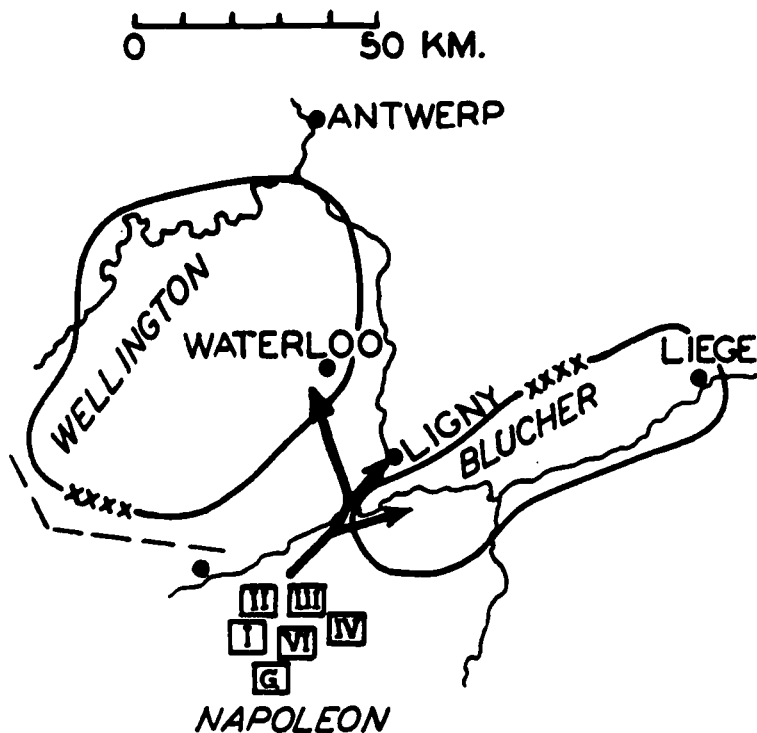

NAPOLEON

PLATE 101. CAMPAIGN OF 1815.

(5) Organization of alternate lines of operation: Containing the Austrians, Napoleon immediately turned on the Sardinians and defeated them at Millesimo; the gap widened still more. The operations from this point on are characteristic

"operations on interior lines," with Bonaparte reinforcing one or the other wing to create local superiority. The rest of the story has been told already in describing the maneuver of Lodi.*

b. Campaign of 1815. The next example, the entry into Campaign of 1815, reveals nothing that we do not already know as to method and execution.

In many respects this was a campaign of despair, and yet it might have succeeded! It is matchless in boldness of conception. It is an exact replica of the maneuver of 1796, but the reaction of Blucher and the Prussians was different in 1815 from that of Beaulieu and the Austrians in 1796. A curious coincidence—the same maneuver at the beginning and the end of an incomparable career!

Note the usual situation: a strategic disposition of the Allies that invited a strategic penetration. Napoleon decided to concentrate his forces rapidly and secretly, then throw this mass into the gap existing between the Allies, and defeat one or the other before they could effect a junction.

The opening moves were successful; Napoleon's concentration was completed before the Allies were fully aware of it. On 16 June 1815 he struck the Prussians at Ligny. The blow, however, was not decisive enough; instead of retreating east, Blucher made every effort to rejoin Wellington. If Blucher had retreated or remained impassive, the situation might have developed into an exact repetition of the maneuver of 1796. In the meantime Napoleon turned on Wellington, leaving to Grouchy the delicate task of pursuing or containing the Prussians. Grouchy failed in this infinitely important mission, and Waterloo was decided against Napoleon by the timely arrival of the Prussians who rejoined the British.

The question might be raised as to applicability and value of Napoleon's two favorite strategic maneuvers in modern warfare.

As regards the maneuver against the rear of an enemy, the communications of a modern army are probably today more vulnerable and its dependence on them greater than at any previous period in history. Mobility has been greatly increased by the use of armored fighting vehicles and motor transport, and nowadays mobile columns can be equipped for rapid movement at a rate relatively far greater, compared to the main force of the adversary, than would ever have been possible in Napoleon's time. In addition, they enjoy the valuable guidance and assistance of the air arm. We may say that under modern conditions the first Napoleonic maneuver may be adapted for use with a speed and efficiency of which its author could not have conceived.

The maneuver from a central position, on the other hand, depended for its success on obtaining a rapid and complete decision in the initial offensive actions. Under modern conditions this would probably prove less easy of attainment than in Napoleon's time. Modern means of information and signal communications tend to facilitate the cooperation and liaison of separated forces of the enemy and guard against defeat in detail. It seems that only under special circumstances would this second of the Napoleonic maneuvers retain its value today; e.g., if the enemy were very widely dispersed and his columns divided by difficult natural obstacles.

* Par. 32a, *supra*.

VIII

THE NAPOLEONIC CONCEPT OF BATTLE

34. THE TRANSITION FROM MANEUVER TO BATTLE. The Napoleonic concept of maneuver and his concept of battle are intellectually and originally related. The first deals with operations of a strategic character, while the other approaches the field of tactics, and yet they are closely interwoven, as strategy and tactics must be, a conception in which the strategic plan ripens into tactical execution on the battlefield.

That organic relationship is never more apparent than in the Napoleonic operations. Reflect on the Campaign of Ulm where the final battle around a little Bavarian city seems almost visibly forecast in those enormous marches of concentration that began on the English Channel.

Napoleon himself remarked on this interrelation:

"In the difficult art of war, the system of battle is already conceived in the system of operations, of the Campaign, as a whole; this is ordinarily not understood."¹

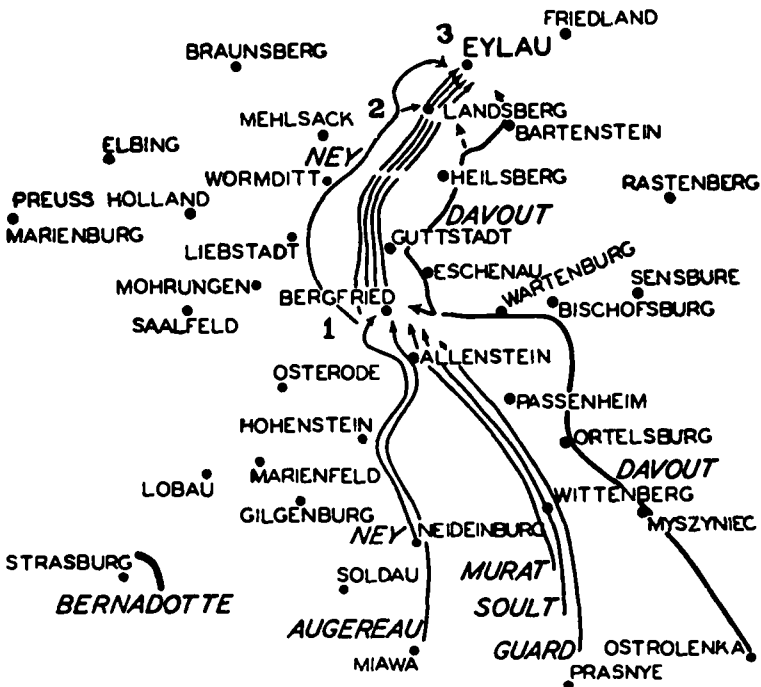

PLATE 102. THE MANEUVER OF EYLAU, 1807.

This thought is as applicable today as it was a hundred years ago; it is especially applicable to the control of large units, army, corps and divisions. The dispositions of such units are not easily changed. A platoon commander may change his mind and his small unit will react quickly; unfortunately, that is not the case with large units. Once those ponderous masses are launched, it is as if one had opened the floodgates of a mighty dam.

¹ Correspondence, Vol. XII, page 10,032. "Observations sur la relation officielle Russe de la Bataille d'Austerlitz."

The initial march dispositions of large units must conform to a plan, culminating in maneuver, and therein lies the enormous personal responsibility of the commander: the necessity for anticipation. That anticipation increases in direct ratio with an increase in the size of his unit. The brigade commander ordinarily will not have to think beyond the local combat zone, a zone limited by the effect of fire. The division commander may have to enlarge this to, let us say, a radius

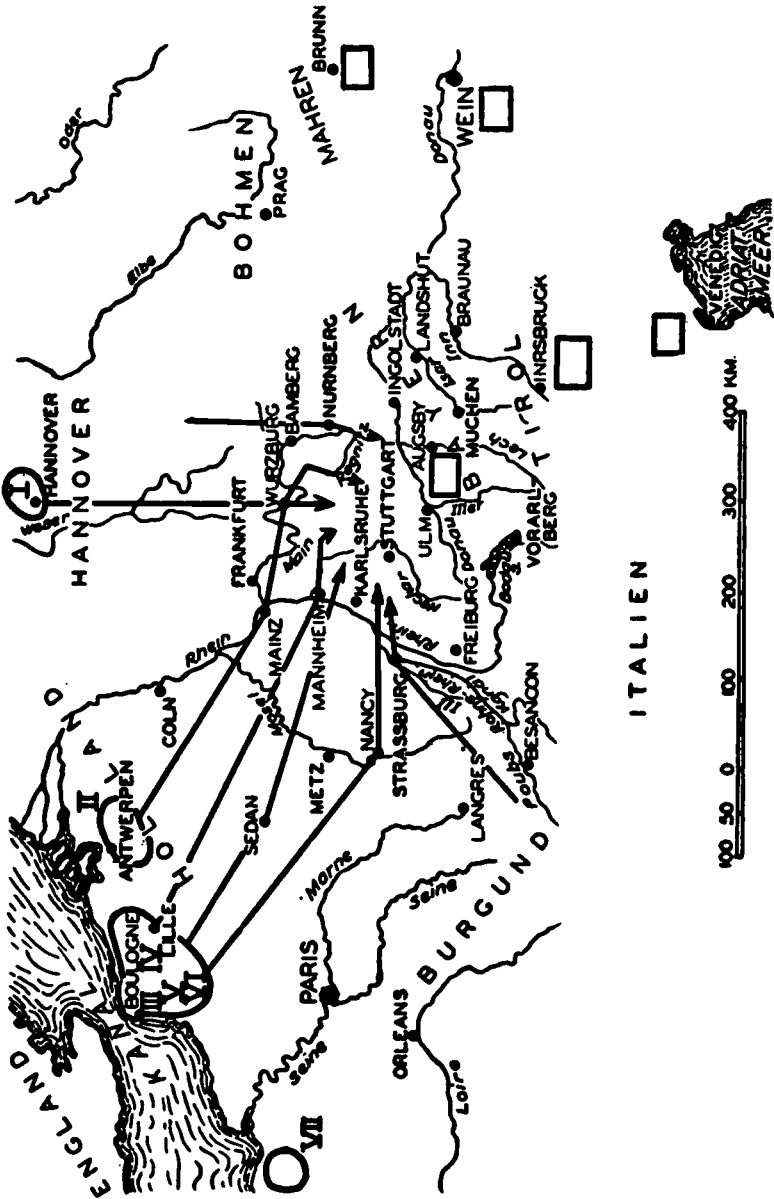

PLATE 109. THE CAMPAIGN OF ULM, 1805.

of action of one or two days; the corps increasingly so, and the army, to a radius of action comprising a theater of war.

It has been stated previously that there are two elements in a plan of maneuver:

(1) a speculative initial idea and (2) its realization on the ground. The operations leading to Eylau are a clear demonstration of this highly important distinction.

On the battlefield of Eylau, Napoleon brought about a double envelopment in conjunction with a frontal attack. If you examine critically the march-graph of the Imperial Army, it is apparent that this "speculative initial idea" governed the movements of the army and dictated the general march dispositions: central columns to fix and contain the enemy, and flank columns to close in on the enemy's flank as soon as he had been fixed by the central mass.

One can readily see the suppleness of this system and this formation. The maneuver idea is independent of the zone or area in which it will be executed: whether the battlefield be Bergfried, Landsberg, or Eylau, there is still a frontal attack aided by two flank attacks.

Since Napoleon attempted more than forty times a strategic operation against the enemy's rear, it is a foregone conclusion that something similar would be attempted on the field of battle.

In the Campaign of Ulm, 1805, the preliminary objective of the Napoleonic columns was a line astride the enemy's avenue of retreat to the east, i.e., mass placed in rear of his opponent; the final objective, however, was the Austrian Army in vicinity of Ulm; in his further advance, Napoleon retained his mass astride the main Austrian line of retreat toward Augsburg, while flank detachments closed in via the Danube and Memmingen.

In such a situation the enemy may either turn and fight or try to escape. The "mass" moves on him, while "flank detachments" intercept alternate lines of retreat or withdrawal. When the mass gains contact, it engages the enemy and

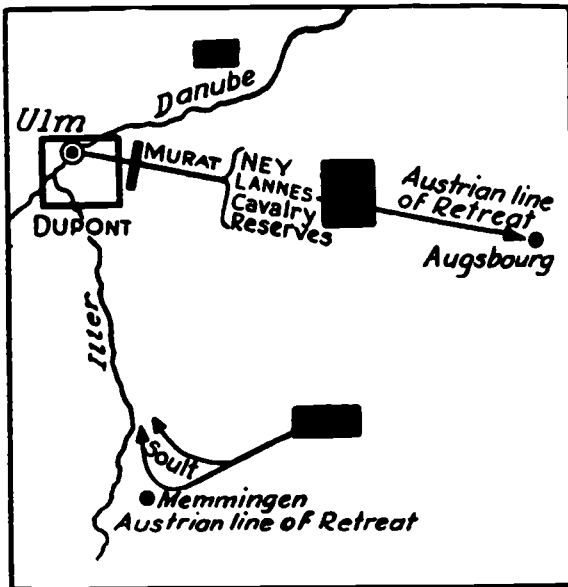

PLATE 104. THE BATTLE OF ULM.

pins him down while the flank detachments close in to decide the issue. As at Eylau, it is apparent that the strategic advance is already an initiation of later tactical dispositions, resulting in a frontal combat by the mass and envelopment or flank attacks by secondary or detached forces.

35. THE INTERNAL STRUCTURE OF BATTLE. In a step-by-step development of the internal structure of the Napoleonic battle you will find presently that you are already familiar with his basic ideas; as an interesting sidelight, it can be shown that many terms of the most modern application have either been directly coined by Napoleon or were used by him in a modern sense.

In general, the structure of the battle, the scheme of maneuver, is influenced by a basic principle frequently enunciated by Napoleon himself.

THE BASIC PRINCIPLE

"War of movement or siege operations have one idea in common; fire must be concentrated on a single point: once the breach is made, the equilibrium is broken, the rest is useless . . . do not dissipate your attacks but concentrate them."

There is a direct corollary to this basic thought: it is not necessary to be strong along the entire front or expect success all along the line. It is sufficient to effect, through a local powerful blow, a local disorganization which will bring about the collapse of the remaining front. This blow has been called the "principal attack," or, as we call it, "main attack."

L'attaque principale: Term used by Napoleon in his critique of the Battle of Minden. (Précis des Guerres de Frederic II, Vol. XXXII, page 203.)

The comparatively ancient thought is repeated in our latest official texts:

OLD WINE IN NEW BOTTLES

Napoleonic Version

" . . . Fire must be concentrated on a single point . . ." " . . . Do not dissipate your attacks, but concentrate them . . . "

Modern Version

Manual Commanders Large Units, 1930, page 39: " . . . tactical maneuver that will result in concentrating a superiority of fire and numbers at the vital point . . . "

Page 60: " . . . (Commander) seeks to deliver a main blow at some essential or weak point, by organizing a main attack upon which he concentrates a maximum effort . . . "

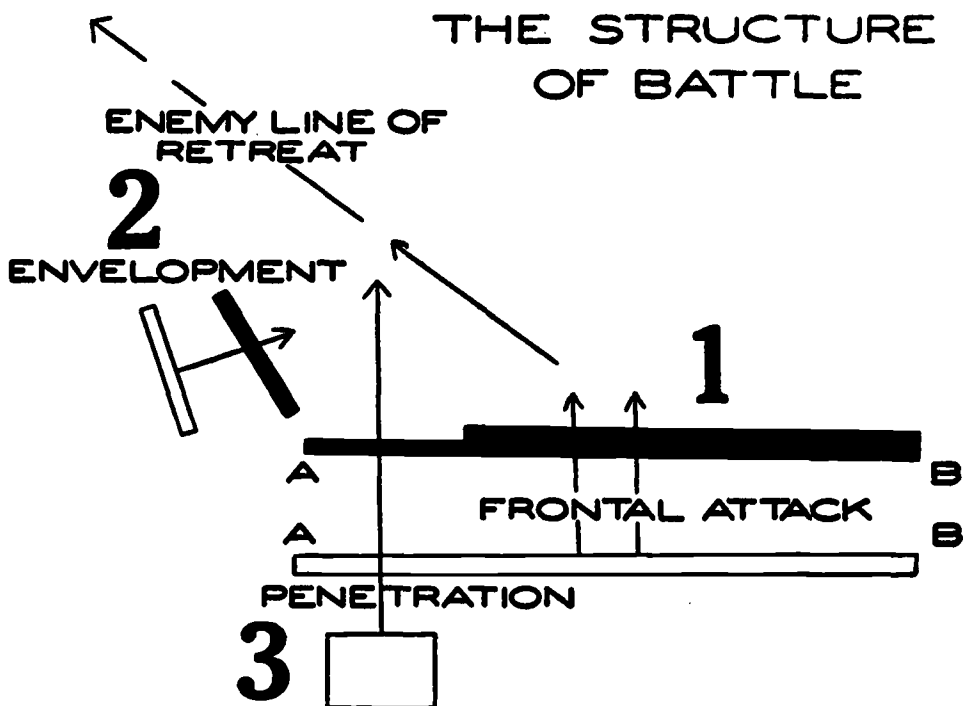

PLATE 105. THE STRUCTURE OF BATTLE.

One may even say, amongst professionals, that the Napoleonic principles are commonplace, but when one traces their execution, one is amazed at the skill, intelligence and brilliancy with which this great commander fitted a "principle" to local conditions!

The Napoleonic battle is oriented exclusively with reference to this main attack. Ordinarily one can distinguish three phases or acts:

- I. *First Phase: Preparation of the Main Attack:*
 1. Frontal or holding attack
 2. Operation on the flank of the enemy: Envelopment
- II. *Second Phase: Execution of the Main Attack:*
 3. Penetration
- III. *Third Phase: Exploitation of the Main Attack:*
 4. General direct pressure
 5. The strategic pursuit.

On the eve of battle, with contact established and sufficient information of the enemy dispositions, in the broadest meaning of the term, Napoleon determined his scheme of maneuver from which he rarely deviated.

This scheme of maneuver was oriented exclusively with reference to the main attack and the point or area in which this main attack was to be executed: that point was often fixed "in advance," and before battle.

Now where was this critical area located? Ordinarily on that wing of the enemy's disposition which was nearest his natural line of retreat or line of communication and at the point of junction of this wing with the enemy center.

In modern school language, this preliminary consideration could be termed "initial disposition for battle and the location of the main effort."

That phase of the action under the heading of "preparation" involved a holding attack. We are familiar with the tactical purpose of the holding attack: to contain the enemy, to force him to commit his reserves, to exhaust his combat power, and to prevent him from reinforcing the front where the main attack eventually is to take place; for this phase of the fight, Napoleon used troops sparingly.

With the holding attack under way, Napoleon staged an envelopment. Occasionally, his object was demoralization rather than tactical effect. He counted on the enemy's reaction to this threat: his use of his last reserves, if any, or—more important still—an extension of his flank. This extension might result in a gap or an over-extension, i.e., a distinct weakening of the enemy's line in that area. With the weakening process under way, Napoleon hurled a compact mass for a breakthrough, a penetration at that point. The envelopment was then shifted to cut the enemy's line of communication and make the victory decisive.

The role of the envelopment may consequently be defined as follows:

1. Exercise a demoralizing effect upon the enemy.
2. Produce over-extension of the enemy's flank, in a known area.
3. Fix the time of the main attack.
4. Close the enemy's line of retreat.

This is a very important point! The envelopment was used to create a soft spot, ripe for penetration! In the language of 1918, this is "soft-spot tactics"—with the enormous difference that the Napoleonic "soft-spot" was created as a calculated effect of his own dispositions and was not the soft-spot of 1918, left to chance discovery as the attack progressed.

A further important point is the ultimate use of the envelopment in the exploitation of the breakthrough. The envelopment was directed against the enemy line of retreat; in its ultimate purpose it was to establish a barrier to intercept the retreating fragments of the enemy.

A characteristic example of the role of the envelopment can be cited in the

operations around Allenstein—Bergfried, on the march to Eylau. In the "Bulletin of the Battle of Allenstein," Napoleon wrote:

This same thought is clearly expressed in our current regulations:²

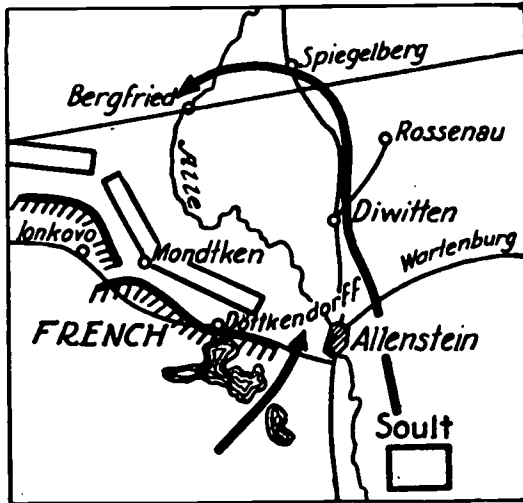

PLATE 106. BATTLE OF ALLENSTEIN, 1807.

" . . . Soult was ordered to move on the road to Guttstadt and to seize the bridge of Bergfried, and debouch on the rear of the enemy with his entire corps—a maneuver which would have given this battle a decisive character."

435. An enveloping attack will ordinarily be successful only when accompanied by a frontal attack sufficiently vigorous to force the enemy to commit a large part of his forces to frontal defense . . .

In the general case, the enemy's preparations to meet the envelopment of his flank can not be as completely organized as the defense of his front . . .

Successful envelopment directly endangers the enemy's lines of communication and opens the way for the decision.

The general attack is so timed that the enveloping and frontal attacks take place simultaneously or that the enveloping attack is preceded by the frontal attack designed to force the enemy to commit the greatest possible portion of his forces to frontal defense . . .

Every thought contained in these modern paragraphs represents distinguishing marks of the Napoleonic battle: the combination of frontal attack and envelopment, the effect of the envelopment, the timing of both attacks, or rather, their coordination in time and space—old wine in new bottles.

36. THE EXECUTION OF THE MAIN ATTACK. Now let us consider the main attack. It usually took the form of a penetration, a breakthrough operation. For this purpose, Napoleon set aside a "breakthrough mass" (*masse de rupture*). This mass must penetrate to the heart of the enemy position. Napoleon made this mass as strong as possible—ordinarily a corps reinforced by the artillery of his guard and the general cavalry reserve. The principle of concentration is everywhere apparent: a massing of fire, a concentration of artillery, an assault organized in depth and carried regardless of losses. The employment of artillery was modern; the technique of the breakthrough was modern.

The Battle of Friedland is typical of the Napoleonic employment of artillery: 120 guns were collected, then galloped to a distance of 800 yards from the enemy for fire by salvo; then they advanced by echelon to 300 yards, firing case-shot. One-half of the gun crews and two-thirds of the limbers were put out of action,

² F. S. R., U. S. Army, 1923.

but their mission was fulfilled: preparation for the breakthrough assault of the infantry.

The procedure at Wagram was similar: covered by a cavalry charge, 100 guns were brought close to the enemy for a murderous preparation fire; then the breakthrough mass was launched in the assault. In this case, the decision, however, was not exactly brought about by the breakthrough but rather through the effect of Davout's flank attack.

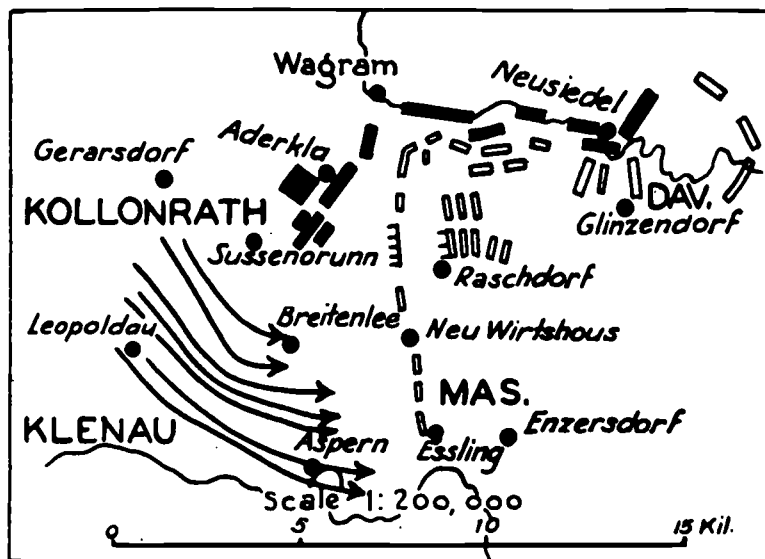

PLATE 107. BATTLE OF WAGRAM, 1809.

The breakthrough column was echeloned in great depth: 8 battalions in column of battalions, followed by 16 additional battalions echeloned to the right and left; behind this mass, the cavalry divisions of Nansouty and Walther and a reserve, furnished by 20 battalions of the Divisions Serras and Wrede. It was expected that the assault echelon would be "consumed," but the rear echelons were to roll up the flanks of the gap while the cavalry exploited the breakthrough. This is all quite "modern," or the modern version is quite "Napoleonic," whichever you prefer. Note Marshal Petain's Observations on the Battles of Champagne:

Our current regulations³ have something to say about this:

OLD WINE IN NEW BOTTLES

436. When the situation does not favor an enveloping attack, the main attack is directed with a view to a penetration of the hostile front. The greatest distribution in depth is placed in front of the prospective point of penetration . . . The penetration is to effect a complete breakthrough of the enemy's disposition so that he will be unable to reconstitute his front on a rearward line . . . reserves of corps and larger units are assigned the mission of rolling up the flanks of a gap created by penetration . . ."

Is there an essential difference in this paragraph and the Napoleonic conception? The language of the paragraph would seem to recommend penetration if envelopment was impracticable, i.e., either form of attack is regarded as exclusive of the other. Note that Napoleon used both and in close conjunction.

Note the reference to the "prospective point of penetration." We know that Napoleon fixed this point a priori and we know why: opposite the soft-spot of

³ F. S. R., U. S. Army, 1923.

the enemy disposition. And we further know that this soft-spot was brought about through over-extension or diversion of the enemy reserves, as a calculated direct effect of the envelopment. Consequently, there had to be an envelopment as an integral part of the maneuver. This feature appears to be the striking novelty in the Napoleonic set-up.

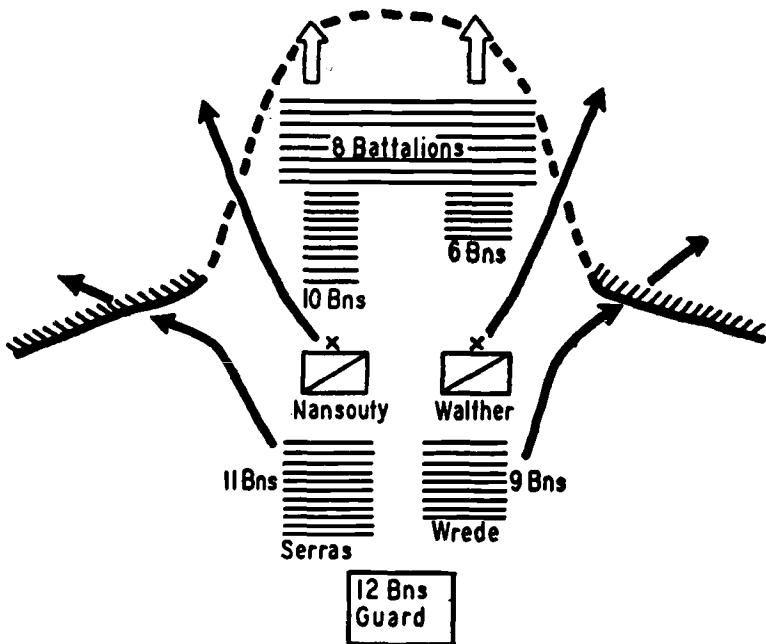

PLATE 108. WAGRAM, 1809: MACDONALD'S ASSAULT.

" . . . The 'breakthrough' is not the object but the means of arriving . . . at open warfare . . . by attacking the enemy upon one or both of the flanks, formed by a withdrawal of part of the front."

37. THE COORDINATION OF THE MAIN AND SECONDARY ATTACK. An equally important factor in the Napoleonic battle was the coordination, the accurate timing of the main attack and the envelopment. In the schematic diagram, they are marked successively 2 and 3. If unduly delayed, the envelopment may permit the enemy to endanger the holding attack; if premature, it may be stopped by available reserves. The exact timing, the obvious interrelation in this dual action, concerned Napoleon profoundly. One finds evidence of this preoccupation in each of his battle reports:

DECISIVE MOMENT

Bulletin de Bautzen:

"The 'moment to decide' the victory was already clear . . ."

Bulletin de Wachau:

" . . . The moment appeared to be decisive . . ." Castiglioni (*Correspondence*, Vol. XXIX, page 135):

" . . . Serrurier was to march at night, appear in rear of Wurmser's left, at daybreak. His fire was to be the signal for the principal attack. We expected a great moral effect from this surprise attack."

Bulletin de Wagram:

" . . . (Davout) was to turn the position of Neusiedel . . . the Duke of Raguse and Macdonald formed column, to attack Wagram at the moment when (Davout) debouched."

This ought to interpret sufficiently the factor of timing of the main attack, predicated upon the secondary or enveloping attack. As a rule, the envelopment

was subordinate to the main attack. But there were instances in which the envelopment was assigned the major role. Even if there is no question as to their relative importance, there is always a distinction between the principal and the secondary action, which is reflected in the distribution of troops between a principal and a secondary zone of combat. The maximum density of troops, of course, is laid in the principal zone of combat. This is just another way of stating the time-honored "principle of economy of force" and "mass". Our current regulations⁴ express it as follows:

434. ". . . troops are distributed . . . into two principal elements: A main or decisive attack in which the greatest possible offensive power is concentrated . . . and a secondary or holding attack designed to contain the enemy, force him to commit his reserves to action . . . prevent him from reinforcing the front attacked by the troops of decision."

38. THE EXPLOITATION OF THE MAIN ATTACK. This leads to the last act in the drama of battle: the exploitation of the main attack. The penetration may have affected only a portion of the enemy's line, certainly the wing against which the main attack was directed. But the penetration is carried through: "the breach is made; the equilibrium is disturbed . . ." At this point Napoleon ordered general direct pressure along the entire front even to the point of exhaustion, in order to facilitate the further action of his envelopment and initiate the strategic pursuit. This envelopment aimed generally at the enemy's line of communication or retreat, with a view to seizing a strategic barrier in order to intercept the retreating fragments of the enemy.

This function of the envelopment naturally forced the retreating enemy units to long detours greatly facilitating the strategic pursuit, which then became the mission of cavalry and horse artillery in strong cavalry formations, especially created by Napoleon. At Marengo, the Austrian Army had to capitulate. At Ulm, the remnants of Mack's Army were caught later by Murat. After Jena, every remnant of the Prussian Army was picked up in less than a month's time.

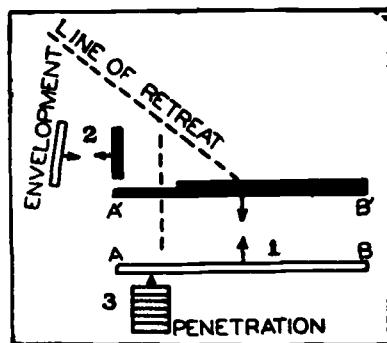

PLATE 109. THE STRUCTURE OF BATTLE.

As one reflects on the schematic diagram⁵ representing the structure of the Napoleonic battle, it is apparent that there is a sequence of events and a careful coordination of effort. The most striking single factor is the positive combination of main attack and envelopment and the deliberate attempt to create a soft-spot, as a calculated after-effect of this envelopment. The soft-spot of 1918 was left to chance, to be exploited when discovered; the soft-spot of 1807 was created as a part of a deliberate scheme of maneuver.

⁴ F. S. R., U. S. Army, 1923.

⁵ Camon.

This single measure is a stroke of genius. It explains the man, in part, who made his own opportunities in the most spectacular career known to mankind.

39. EXAMPLES OF THE NAPOLEONIC METHOD. *a. The Battle of Bautzen, 1813.* Now let us trace the internal structure of the Napoleonic battle in several concrete examples. We have selected the Battle of Bautzen, 20-21 May 1813 as one of the most characteristic types.

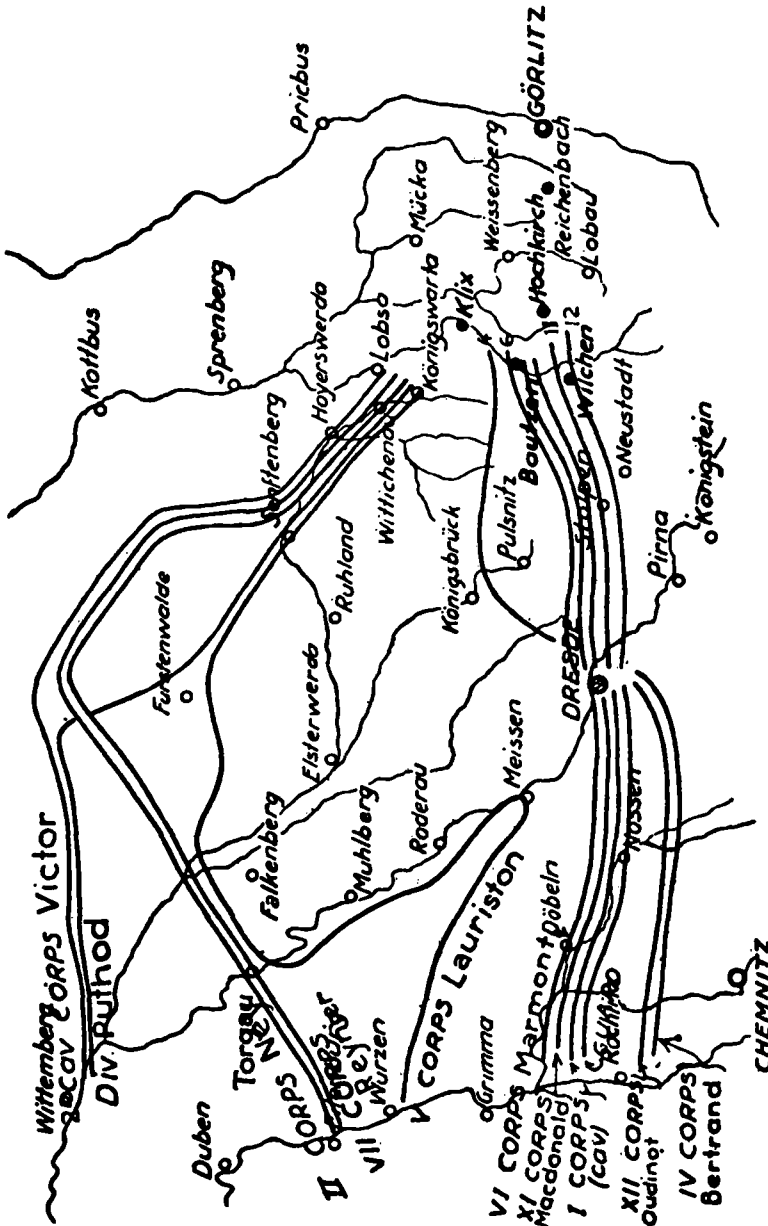

PLATE 110. THE STRATEGIC ADVANCE ON BAUTZEN, 1813.

Note the strategic advance of the French columns leading to the battlefield of Bautzen. We have previously mentioned the necessity for anticipation by higher commanders: "To command is to foresee." In large units, the principal mission

of high command is to prepare the battle and not to conduct it personally on the terrain. It was further demonstrated, as in the maneuver of Eylau, that the conception of maneuver was present beforehand and was clearly reflected in the strategic advance, and that what we term scheme of maneuver, ordinarily confined to battle, was already contained in embryo in the march dispositions of the French columns converging on the probable battle area. The advance on Bautzen is as good an example as the maneuver of Eylau.

It is obvious that the general plan of the Emperor for battle was forecast in his strategic march dispositions.

The enemy was reported in the area: Hochkirch—Klix—Bautzen—Wilchen. The Emperor decided to "fix" the enemy, i.e., to contain him frontally with 3 or 4 corps (Marmont, MacDonald, Oudinot) while Ney proceeded on a wide envelopment (turning movement) of the enemy right wing via Klix, to cut his communications and line of retreat to Bohemia. Supposing the enemy had been at intermediate points: Konigsbruck, Dresden, or Pirna? There would still have been a frontal attack combined with a wide envelopment of the enemy's right!

The Allies held a defensive position on the high ground between Dobereschautz and Bautzen. On 19 and 20 May, the French had gained contact all along the line. The arrival of Ney was timed for 21 May.

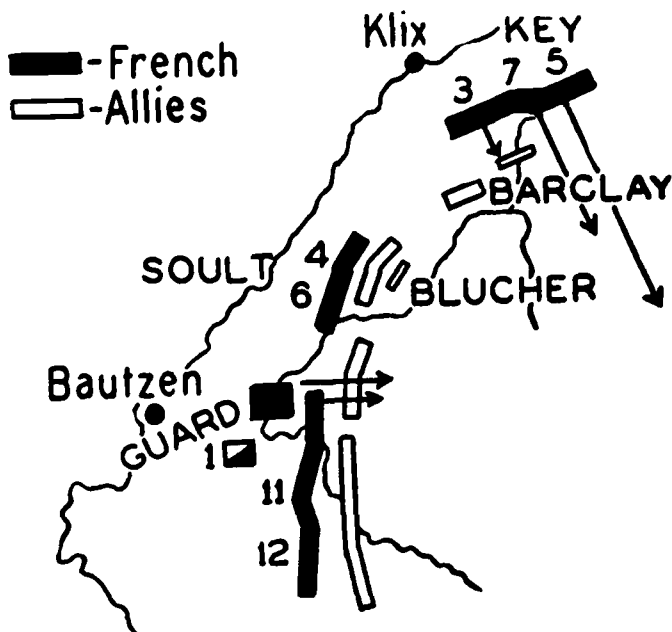

PLATE 111. THE BATTLE OF BAUTZEN, 21 MAY 1813.

The subsequent events developed according to the schematic diagram showing the structure of the Napoleonic battle. Check off the items:

- (1) *Holding attack*: Oudinot, MacDonald (2 corps).
- (2) *Envelopment*: Ney (3 corps), approximately 60,000. In this instance the envelopment was to be decisive in strength and effect; the center of gravity is in the envelopment rather than the so-called main attack.
- (3) *Main attack*: Soult and Bertrand (2 corps).
Reserve: Imperial Guard, 1 cavalry corps.

The set-up was perfect and promised a decisive battle. Ney, however, was several hours late in arriving and then became partially involved in a local struggle instead of marching straight on Hochkirch, astride the enemy's line of retreat.

The main attack was heavily opposed until the pressure of Ney's envelopment made itself felt. This is an interesting instance where gravity shifted from the so-called main attack to the envelopment. But it returned eventually; the Emperor threw in his Guard, i.e., his last reserves.

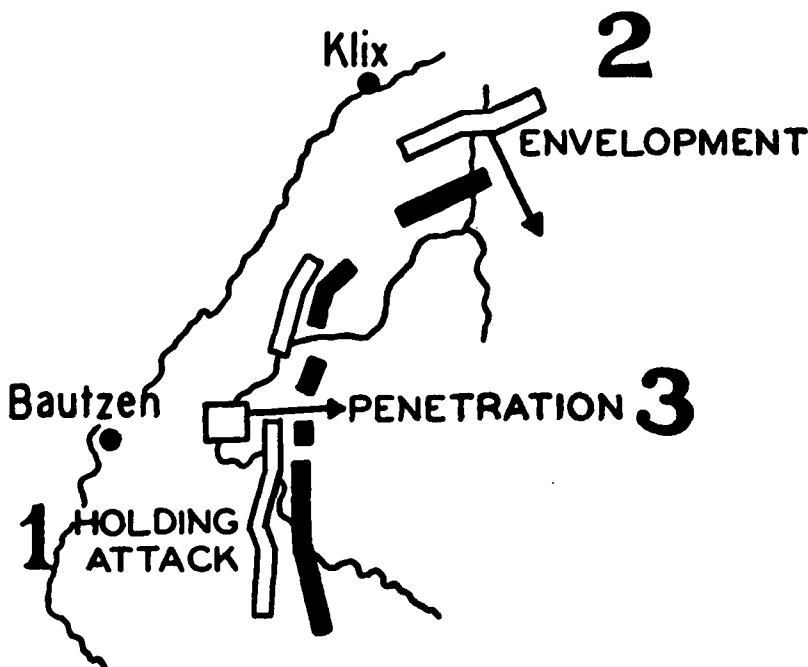

PLATE 112. THE BATTLE OF BAUTZEN: SCHEMATIC.

With their front broken, their right increasingly menaced, the Allies began a precipitate retreat. Napoleon did not reap the full fruit of this victory, however, as Ney had not reached his objectives and there was no cavalry for exploitation.

The conduct of battle was typical and followed in general the schematic sequence which we established previously.

b. The Battle of Ulm, 1805. The strategic background for this battle has already been covered.

On 8 October 1805, Napoleon had reached an area in rear of the Austrians, commanded by Mack. Mack was compelled to face east. Napoleon began a converging advance on Ulm, to surround Mack.

In Directive No. 9372, Napoleon wrote Murat:

"If the enemy remains in his present position, I expect to wage battle—not tomorrow but the day after!—in order to give Soult time to arrive in this vicinity. I want Soult to envelop his right—a turning movement that ought to give us decisive effect."

In the gradual development of this maneuver, a French central mass was placed astride the natural line of retreat of the Austrians and advanced towards them.

The sequence of events is normal—as we now understand Napoleonic normalcy:

(1) *Frontal or holding attack:* Corps Murat, Ney, and Lannes.

(2) *Envelopment* (Austrian south flank): Corps Soult, called from the south, where it had cut the last avenue of escape open to the Austrians.

MANEUVER IN WAR

(3) *Main attack: To start on arrival of Soult and directed against the Austrian line of retreat.*

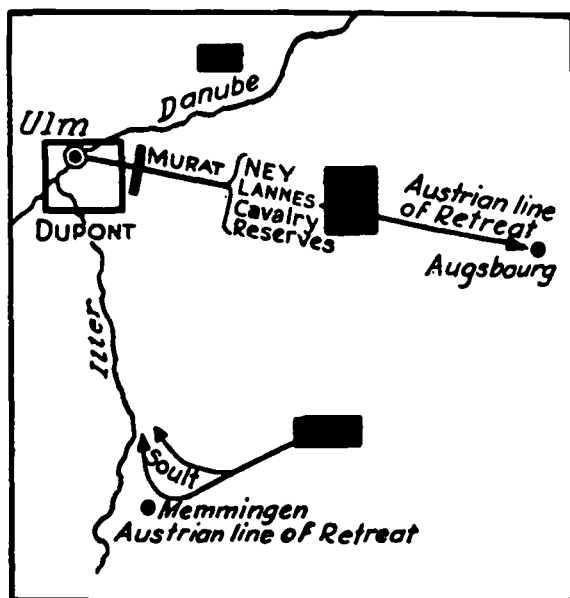

PLATE 113. THE BATTLE OF ULM, 1805.

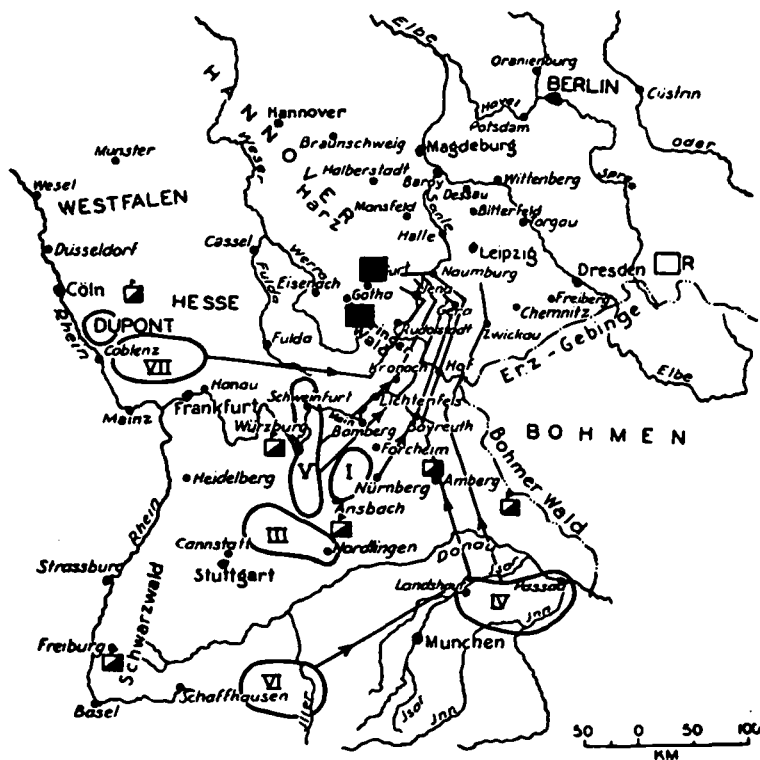

PLATE 114. THE ADVANCE ON JENA, 1806.

c. *The Battle of Jena, 1806.* You are already familiar with the background to the battle of Jena.

The Prussians were reported in the vicinity of Weimar. In swift concentration, the mass of the French reached their rear, intercepting their communications on Berlin and Dresden. Davout, with a secondary mass, was en route to Naumburg to cut their alternate retreat on Magdeburg.

Without waiting for Davout, Napoleon established contact with the Prussian main forces under Hohenlohe.

We have the usual procedure:

- (1) *Frontal or holding attack:* Angereau, Lannes, Ney.
- (2) *Envelopment:* Soult (enemy left).
- (3) *Main attack (against enemy left):* The Guard and Cavalry Reserves.

Hohenlohe was defeated; the subsequent strategic pursuit resulted in the total destruction of the entire Prussian Army.

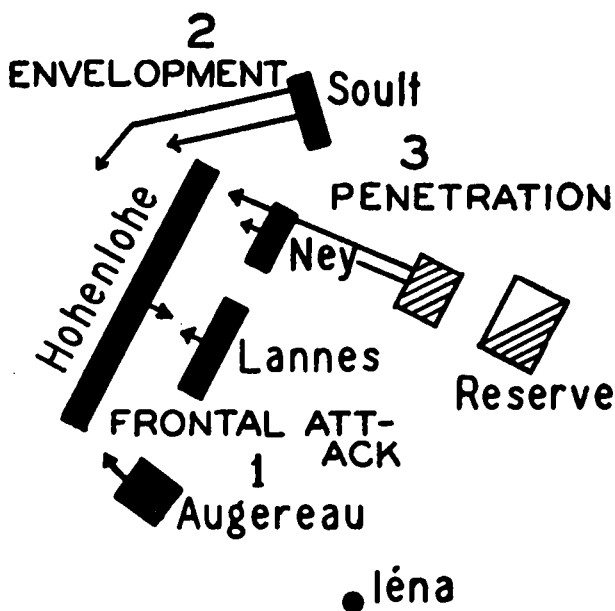

PLATE 115. THE BATTLE OF JENA, 1806.

d. *The Battle of Eylau, 8 February 1807.* You are already familiar with the maneuver of Eylau.

The Russians in retreat had reached the vicinity of Eylau. Napoleon marched with a central mass on that point. Flank columns under Ney cut the Russian communications to the west toward Dantzic, and Davout operated on their east flank.

In the evening of 7 February, Napoleon attacked the Russians in order to pin them to the ground. However, this was a cautiously conducted engagement, clearly a preliminary operation; he had no intention to risk the main battle until the afternoon of the following day, pending the intervention of his flank columns under Ney and Davout.

The Russians counter-attacked on the morning of 8 February. Nevertheless, Napoleon took his usual dispositions, although with reduced forces:

- (1) *Frontal or holding attack:* Soult's Corps, approximately 20,000 men in 3

divisions. They were extended over a wide front, but Napoleon made up this deficiency by employing his entire artillery.

(2) *Main attack (penetration)*: Angereau's Corps, approximately 12,000, and Murat's Cavalry of 10,000 sabers. Napoleon retained the Guard as general reserve, approximately 6000 men.

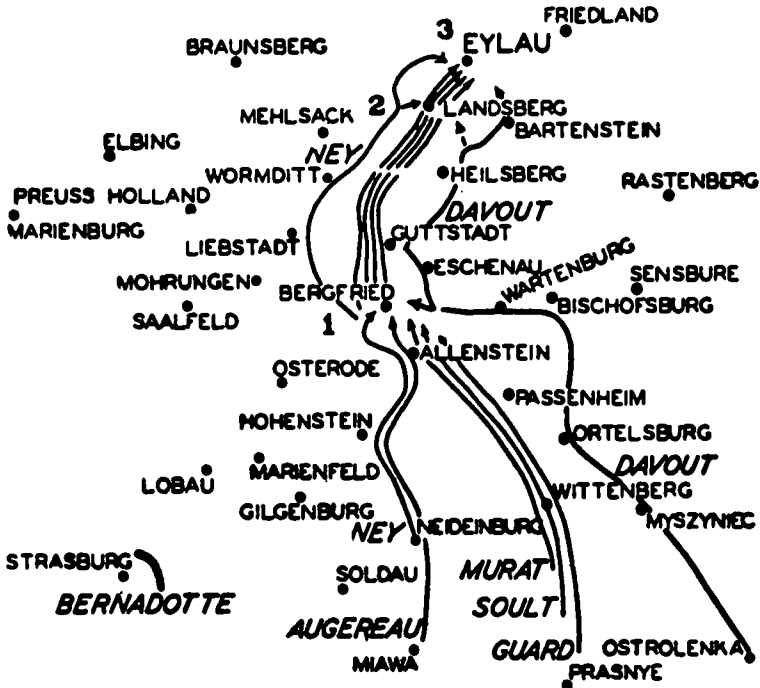

PLATE 116. THE MANEUVER OF EYLAU, 1807.

(3) *Envelopment*: Davout received orders to turn the Russian left with his 18,000 men; it was understood that Ney would turn their right if he arrived in time.

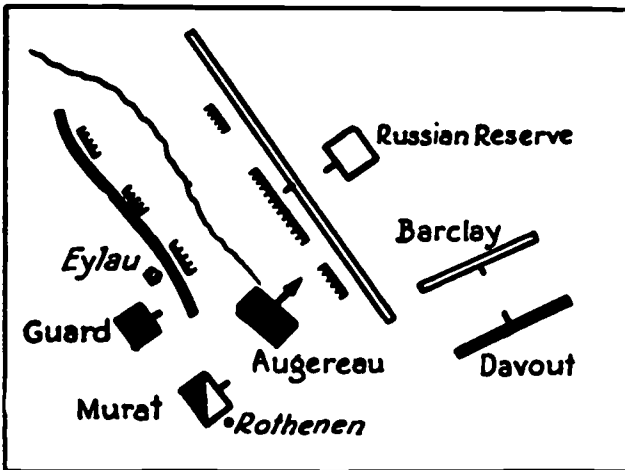

PLATE 117. THE BATTLE OF EYLAU, 1807.

At 10:00 o'clock the Emperor heard that the leading elements of Davout were arriving. He personally observed a shifting of the Russian reserves, evidently to meet the oncoming flank attack by Davout. It was at this junction that he ordered Angereau forward: Another example of the perfect timing, the close interrelation of main attack and envelopment.

However, Angereau's Corps lost direction in a heavy snow storm while Davout's advance was slowed down. The battle became indecisive until the arrival of Ney; then the Russians retreated.

40. SUMMARY AND CONCLUSIONS. In the analysis of the Napoleonic concept of maneuver, we have recognized the presence of two characteristic systems of operation employed by that great master: (1) the maneuver against the rear of the enemy, and (2) the maneuver from a central position, i.e., an operation on interior lines.

It is quite apparent from the orientation map that while Napoleon employed the maneuver on interior lines on comparatively few occasions only, he operated against the flank and rear of his opponent almost habitually.

One can obviously establish a parallel in his conduct of battle. The "maneuver against the rear of an enemy" becomes a turning movement, or a combination of frontal attack with an envelopment on the battlefield.

"The maneuver from a central position" is an operation on interior lines, which is the same in the field of tactics as it is in strategy.

We presume that we have given you a sufficient number of historical examples to show a comparative uniformity, or system, in the Napoleonic conduct of battle.

We could quote still more: Castiglioni (1796), Marengo (1800), Allenstein (1807), Friedland (1807), Wagram (1809), Lutzen (1813), Wachau (1813). These are all battles of the normal type, using the term "normal" in the sense of frequent application, and they fall in the category of operations against the enemy's flank and rear.

As regards battle from a central position, or operation on interior lines, there are only two clear-cut examples: Rivoli and Leipzig.

The procedure, in tactics, in this case, was identical with that in strategy: when Napoleon was forced to fight with inferiority of numbers or means he never considered a purely defensive attitude but had recourse to a difficult, almost desperate maneuver: operations on interior lines, an operation you are familiar with, containing with a minimum of force the converging columns of the enemy while concentrating a local mass to strike and defeat a selected enemy fragment, repeating this until an equilibrium in combat strength was reestablished. Napoleon ordinarily avoided the risk inherent in this maneuver; as stated before, there are really only two characteristic examples.

We may therefore conclude that battle from central position was exceptional and that Napoleon preferred a combination of frontal-attack, envelopment and penetration, which we have analyzed sufficiently to call it the normal or Napoleonic battle. We may further state that in this framework or system Napoleon employed every type of offensive action but their function was subordinate to a central idea, which can be expressed as follows:

THE SINE QUA NON

"The strategic and tactical methods of Napoleon were designed solely to create, in his enemy, a state of material and moral dislocation for which he had prepared means of exploitation."

MANEUVER IN RECENT WARS

INTRODUCTION

Excited by the international tension of these days, the public mind is concerned with the nature and probable characteristics of the next war. The nature of war is static: the conflict of collective interests, prejudice and hatreds, impelled by economic causes, with war as an instrument of national policy; armies and the military are mere tools of statecraft, and the impasse that explodes in war is created by civil authorities, politicians, legislatures and cabinets.

As regards the technical characteristics of war, there is no point in repeating the platitude that they are influenced by armaments and technical progress. The unmistakable tendencies of the wars of the nineteenth century are already outlined in this study; the answer lies in the well-defined direction of historical evolution: the war of 1940 is like the war of 1939, which followed the pattern of 1938! The historical continuity of maneuver forms and the secret of military success have already been demonstrated; the general characteristics and probable efficacy of modern armaments are pretty well established; they are confirmed in very recent wars, in China, in Spain, in Ethiopia.

Granted that in each case there were sharp variations in the relative combat value of the opponents, but this did not affect the manner, the method, the modern procedure with which the better equipped army operated, and it can still be stated that we know now how Japan or Spain or Italy will wage war, because we have seen them do it! As to other countries, in the absence of actual war, the annual maneuvers of foreign armies will generally reveal and forecast their manner of waging war.

This reasoning lends considerable importance to the recent campaigns in Abyssinia, China and, more particularly, in Spain; in those far-flung operations there is to be found not only the age-old story of political and economic conflict growing into armed collision but also the reappearance of characteristic maneuver concepts and maneuver forms that have not changed materially from the workmanship of other days.

The analysis of political antecedents was not initially in the purview of this technical study, and the writer has avoided the subject in previous chapters.

The complex nature of modern war, however, requires a reference to basic causes and motivations in political, economic and social fields. To ignore these elements, in ostrich fashion, would be like dwelling on the destructive quality of a high-explosive without including its chemical composition.

Obviously, modern history is still too controversial in some of its aspects to permit severe moral distinctions; contemporary history must remain largely a matter of individual interpretation; consequently, the opinions expressed in these chapters are strictly personal and do not necessarily represent the views of the War Department.

THE SPANISH CIVIL WAR, 1936-1939

41. **A POLITICAL IMPASSE.** On 12 July 1936, Calvo Sotelo, the leader of the Conservative Party in the Spanish Cortes, delivered a sharp attack on the radical government, listing an appalling series of political crimes chargeable to the anarchist-socialist elements in government; the cleavage between political parties had become irreconcilable.

When he finished his address, he had also signed his own death warrant. The Communist Party member, Dolores Ibarruri, known as the "pasionaria," a streamlined, 1936 model of the "canaille" of the French Revolution, rose and shrieked a sinister challenge: ". . . this man has spoken for the last time!" In the night of the 13-14, Sotelo was arrested in his home, driven to a lonely spot, in the best Chicago manner, and murdered by Fernando Cortes, an agent of the Guardia Civil.

The effect of this murder can best be appreciated by placing it squarely in an American setting: it was equivalent to the theoretical assassination of the recognized leader of one of our own political parties—an inconceivable situation in the United States, but for that very reason highly illuminating the desperate character of the Spanish internal situation and the moral quality of the so-called "Loyalists."

At this point Franco stepped into the picture: his radio from Morocco on the seventeenth was a declaration of civil war. Two-thirds of the regular army took sides at once.¹ Swift action before civil partisans could be organized—an important lesson in civil disturbances—brought control of Andalusia to Queipo de Llano in the south, of Asturias to Mola in the north; inexplicable delay on the part of General Fanjul cost him his life and that of a majority of his officers and led to the piece-meal massacre of the garrison of Madrid. Goded, who was to have led a motorized unit from Barcelona, found a mutinous garrison on his hands and was executed.

42. **CHRONOLOGY OF OPERATIONS.** Initially, the Insurgents advanced from the south in three columns, sweeping aside the poorly organized and disciplined Government militia, and in a comparatively short time had reached the foot of the Guadarrama Mountains; this advance was checked at the gates of Madrid.

Franco turned his attention to more favorable objectives and promptly captured the city of Malaga, 9 February 1937. Shifting his operations to the north, he captured Bilbao, Santander and Gijon successively and by 1 October 1937, the Asturian campaign was successfully completed.

From the viewpoint of high command, a certain quality of General Franco's is easily recognizable, that stamps him as a great commander; his elastic strategic dispositions, in shifting rapidly from one theater of operations to another, i. e., the *essence of maneuver*, when he recognized that natural or tactical obstacles made a continuation of the attack costly or fruitless, involving command deci-

¹ The initial strength of Franco was limited to immediately available Regulars, that sided with him, viz:

The Army of Morocco	35,000
The Continental Army	117,000
State Police	25,000

The troops in the Peninsula were scattered in various garrisons and eventually operated in separate theaters, viz: Andalusia, Asturias, etc. The government had started with 30,000 "Assault Guards," i. e., red militia and remnants of Regulars and police; both sides resorted to conscription, by annual classes, in territories under their control; initially, the advantage of potential man power lay with the government. With a year, both opponents were able to draft and organize over 200,000 men; by 1938 roughly half a million men were under arms, on various fronts.

sions of a high order, indicative of an inherent strength of character; in this respect, Franco compares most favorably with that type of generalship of the World War that poured hundreds of thousands into a localized conflict, as at Verdun or Messines Ridge or the Somme.

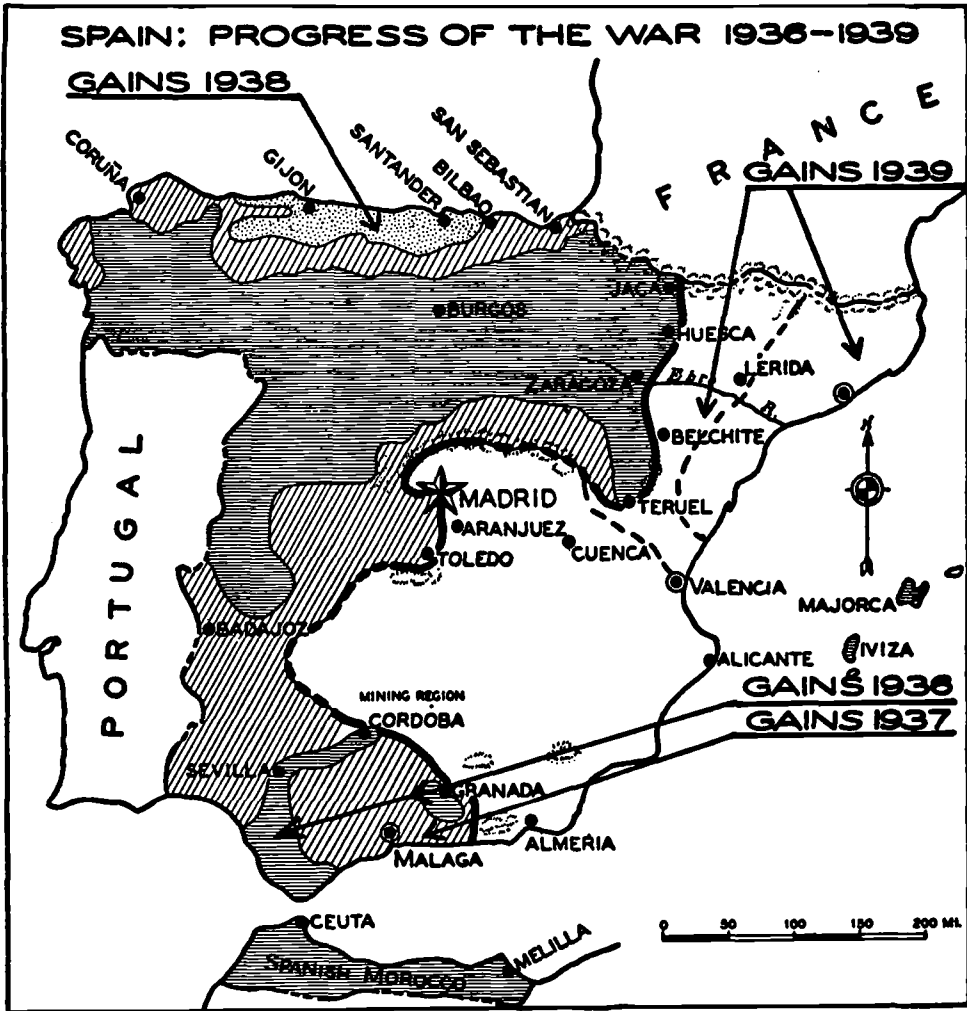

PLATE 118. PROGRESS OF CIVIL WAR IN SPAIN, 1936-1939.

The conception of movement, of maneuver, of the combination of frontal attack with the envelopment appears to have permeated all units of Franco's forces; we find its application in tactics as well as in strategy. The operations leading to the capture of Santander are characteristic. A competent observer, General Duval,² French Army, remarks: "With inadequate artillery and weak infantry, the Italian legions obtained decisive results in a few days, thanks to continuous movement, to maneuver along the heights against the flanks of the enemy, in a constant application of the envelopment. Can we learn from this? Yes, the triumph of mobility over inert mass, of attack over mere passive defense,

² Duval, *Les leçons de la guerre d'Espagne*, Paris, 1938.

the superiority of quality troops skilled in maneuver over those who seek an exclusive solution in the defense of trenches."

The capture of Bilbao, with a formidable defensive organization, shows an analogous procedure: direct assaults against heavily organized positions appeared futile and costly; the attack was planned with separate columns against various passes, with mobile reserves held in readiness, to exploit any weakness discovered; the exploitation habitually took the form of flanking actions. At dawn, reconnaissance detachments would develop the hostile position; artillery registration began discreetly; on the next clear day, strong artillery concentrations, including 260-mm and 305-mm howitzers, would be laid down and the infantry attacked on narrow fronts; the breach made, the shoulders were promptly rolled up; neighboring units then combined in flanking actions against the remaining defense segments.

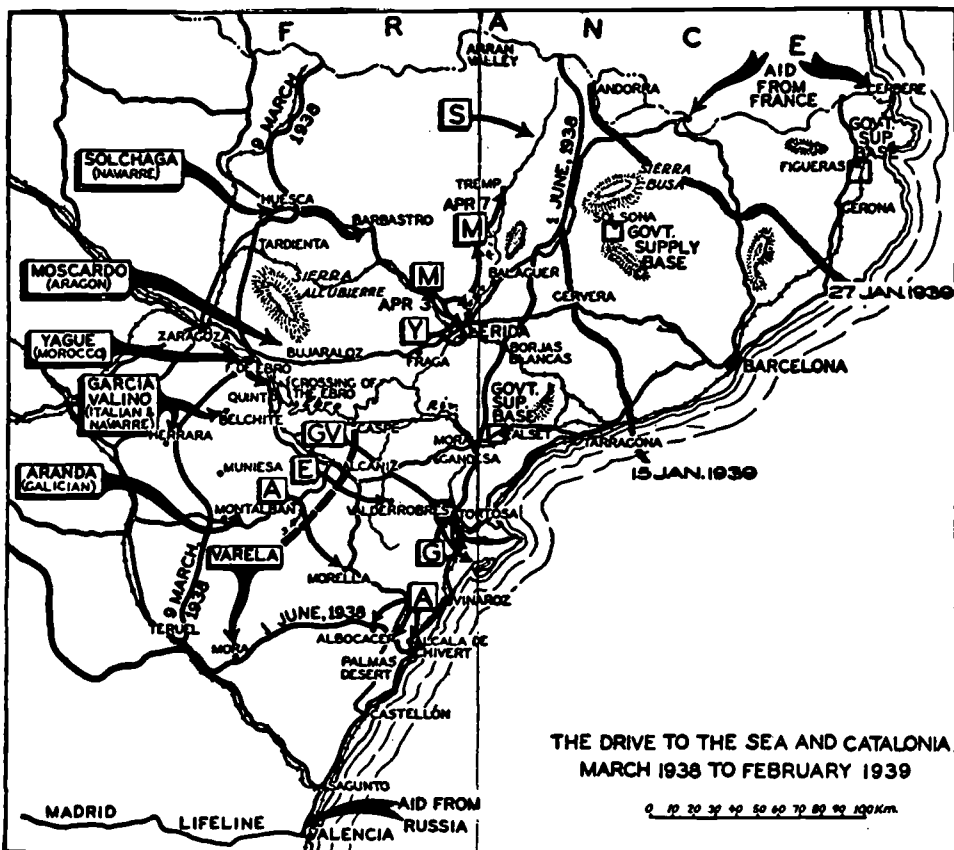

PLATE 119. THE DRIVE TO THE SEA, MARCH 1938 TO FEBRUARY 1939.

A temporary lull in ground operation followed the Asturian Campaign. On 15 December 1937, the Government launched a counter-offensive and captured Teruel. Sharply stung, the Insurgents reacted violently; operating in the dead of winter, they recaptured Teruel by 23 February 1938. Without let-up of pressure, preparations were then pushed for a drive to the Mediterranean. On 9 March 1938, Franco launched his overwhelming and spectacular offensive which struck hard, swift blows with lightning-like rapidity on a front of 125 miles and

in a little over a month captured 300 towns and villages. By 15 April, the Insurgents had reached the sea, at Vinaroz; the Spanish "Vicksburg" campaign had split enemy territory in two, with the strategic advantage of thereafter being able to turn against one fragment while containing the other.

The comparatively narrow corridor was widened in succeeding months by operations toward Sagunto and along the Ebro River. Red counter-attacks were local in effect and character, and by November 1938 the Government fell back definitely behind the line of the Ebro. Franco then made preparations for "the last push," against Barcelona and Catalonia. On Christmas day, the final offensive began and did not end until the French border was reached on 10 February 1939.

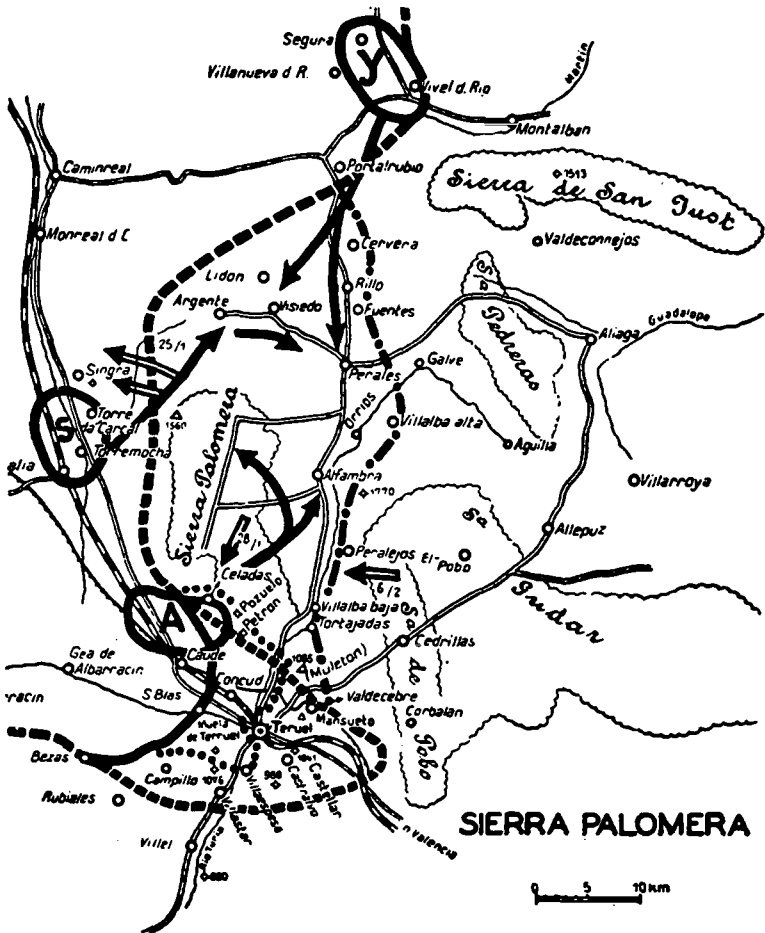

PLATE 120. THE OPERATIONS AGAINST THE SIERRA PALOMERA, 5-7 FEBRUARY 1938.

43. CHARACTERISTIC TYPES OF MANEUVER. It is not the purpose of this study to cover these operations in detail, other than to continue to develop the central theme of "maneuver."

This war has been followed with concentrated attention by the General Staffs of all armies; the nature of modern war was to be revealed, the efficacy of modern

armament and equipment tested. There is no doubt that tell-tale information was secured, that relative values were established for many controversial items—and yet, the extremists who expected everything from the air or mechanization were not fully sustained. There were special conditions that limited the full effectiveness of modern armament and final conclusions are not yet justified, but, as a general remark, this war follows a fairly consistent pattern and the historical continuity of maneuver forms is once more established: the combination of frontal attack and the envelopment, the invariable efficacy of the flank maneuver, the interplay of mass and direction in which these time-honored factors reappear, buttressed by the latest armament: tanks, motor transport and aviation.

a. Operations against the Sierra Palomera. This operation was a preliminary to the eventual recapture of Teruel, with the immediate objective of reducing the Sierra Palomera salient, which dominated the railroad to Saragossa.

The tactical possibilities of this prominent salient were apparently appreciated by the Reds; as early as 27 January, General Rojo launched the division "Karl Marx," in direction of Singra, in an abortive attack to cut the Saragossa railroad.

The Nationalists lost no time to retaliate with a counter-offensive. The grouping of forces was as follows:

General Yague (Y): 1 Moroccan Division, 1 Navarrese Division, the Legion,
1 Cavalry Division.

General Sanchez (S): 1 Navarrese Division.

General Aranda (A): 2 Galician Divisions, 1 Navarrese Division.

The factors of mass and direction are clearly present: the relative weight of the frontal or holding attack and the decisive envelopment are recognizable in the allotment of three divisions to the flanks of the salient (Generals Yague and Aranda) and a minimum of only one to its front (General Sanchez); the maneuver procedure is identical with the historical pattern described previously.³ The timing of the frontal attack, the progress of successive efforts, the superb coordination of widely spaced converging attacks, create a picture of maneuver concept, superior staff work and command capacity that can hardly be surpassed.

(1) *The frontal attack:* Sanchez attacked from assembly positions in vicinity of Torre de Carvel; by noon, he had captured the crest north of B.M. 1580 and by evening he had reached Argente.

(2) *The envelopment (north):* Under cover of a dense fog and supported by tanks, General Yague broke through Portalrubio and, without regard to his exposed left flank, pressed on to the vicinity of Fuentes; he captured 2000 prisoners.

(3) *The envelopment (south):* Aranda advanced in direction of Alfambra to get in rear of the defenders of the salient and cut their line of retreat; a Red counter-attack against Peralejos by the 151st and 157th Brigades was repulsed, and Alfambra was reached after heavy fighting.

(4) On the morning of the sixth, Aranda changed attack direction to the northeast, against the rear of the Red contingents held frontally by Sanchez.

(5) During the sixth and seventh, Yague's main column continued the advance south via Perales and established contact with Aranda, while Monasterio's Cavalry Division operated in the gap, in direction of Visiedo, and in close conjunction with attack aviation harassed and destroyed the retreating remnants of the "Karl Marx" Division.⁴

³ Chap. III, Pars. 10, 11, and 14; Chap. VI, Par. 26a; Chap. VIII, Pars. 36 and 37.

⁴ The decisive intervention of modern cavalry in the exploitation of a breakthrough and in pursuit should be noted in this action. Yague stated: "A large share of the credit for the success of this operation should go to Monasterio's cavalry veterans, who demonstrated so well their efficiency in our northern campaign and who have again repudiated the doubts some military authorities hold regarding cavalry's usefulness in modern war."

The net result of the three-day operations was the reduction of the salient, the capture of 70 field pieces, 600 machine guns and 12,000 prisoners; losses were estimated at 10,000 in killed or wounded.

b. Operations against the Sierra de San Just, April 1938. After the reduction of the Palomera salient and the subsequent recapture of Teruel, the next objective was another defensive bastion jutting into the narrow Nationalist corridor to the sea, the salient formed by the Sierra de Pobo, on the west, and the Sierra



PLATE 121. THE OPERATIONS AGAINST THE SIERRA DE SAN JUST, 23 APRIL-5 MAY 1938.

de San Just, on the north; the western face of this salient was the line: Portalrubio—Alfambra—Teruel, previously established by the brilliant attack on the Palomera salient, already described; this operation is consequently a continuation of the former and very typical of the step-by-step advance, in this period, where every ridge in mountainous country became a defensive line to be broken.

The plan of attack involved a scheme of maneuver characteristic of Franco's style of warfare, i.e., avoidance of expensive frontal attacks, the envelopment of tactically difficult areas and cooperation of advancing columns by mutually supporting flanking actions, as the opportunity presented itself. With such a concept of maneuver, it was obvious that the Sierras de Pobo and San Just would be enveloped.

The main effort was placed on the front: Perales—Fuentes Calientes, utilizing the existing road net, in three columns, and advance in the valley between the Sierras, on Villalba and Aliago. Envelopments by weaker forces were undertaken in the south from Teruel on Corbalán, and in the north from Molinos on Ejulve and Bordon. A column operating from Alfambra against Escorihuela furnished the traditional frontal attack, against the face of the Pobo, designed to pin the defenders to the ground until the envelopment became tactically effective.

At 8:00 A. M., 23 April, Varela fired a brief concentration of several hundred guns; the infantry advanced within 30 minutes, supported by successive waves of attack aviation.

An advance of approximately 9 miles was made on the first day by Sanchez'

82d Division via Culvas and by the right column via Calve; the frontal attack and the envelopment on the south slowed down, which would have the ultimate effect of making the progress of the main effort even more decisive. Heavy snows on the twenty-fourth made the going difficult, but Varela pressed down the corridor of Aliaga-Aguila; he hoped to cut off the garrison of San Just, in conjunction with the 106th Division coming from the north; this outfit, however, did not get far beyond Ejulve; it took this division until the twenty-eighth to reach Bordon, and the bulk of the Reds made their getaway.

Varela changed direction to the south, to complete the encirclement of the Sierra de Pobo (and the 22d Red Division); he took Jorcas and Ababuj on the twenty-sixth; when the weather cleared on 3 May, three Nationalist columns launched a reorganized attack and took El Pobo, Allepuz and Villaroja and cut the important Red communication via Cantavieja to the sea. The new front line stabilized, as shown on the map and, as so often before, a new bastion presented itself, the Sierra de Gudar, to be taken in the customary manner at a later date.



PLATE 122. THE REDUCTION OF THE ALBENTOSA SECTOR, 13 TO 22 JUNE 1938.

c. The reduction of the Albentosa Sector, June 1938. This operation was incidental to the drive on Sagunto. Franco took personal command. The salient was pronounced but was held by considerable Red forces, 40 battalions with 60 guns in heavily organized defensive positions, the XVII Corps on the north front, the XIII Corps on the west face of the salient, in vicinity of Sarrion, and two corps in general reserve.

The sequence and timing of successive efforts in the plan of attack are characteristic of Franco's method and represent an object lesson in staff coordination.

(1) Initially, pressure was applied against the east face of the salient, along the front of the Sierra Espadan, in the period 8 to 12 June, by Generals Valino (GV) and Aranda (A), to immobilize enemy forces.

(2) In the meantime, Franco assembled mass against the directly opposite face of the salient, on the line Mora de Rubielos—Sarrion—Manzanera. The grouping of forces was as follows:

General Berti: 3 Italian Divisions: Littorio, 23d March and Blue Arrow Divisions.

General Solchaga (S): 2 Navarrese Division and 82d Division.

General Varela (V): 3 mixed divisions.

(3) Berti attacked via Sarrion; Solchaga in direction of Manzanera. At 5:30 A. M., 13 June, 300 guns opened fire against the relatively narrow breakthrough front; at 6:00 A. M. a heavy concentration was placed on Sarrion with over 3000 shells, since it was known that the town contained staffs and reserves; at 7:00 A. M. bombers began to operate and within half an hour, the infantry followed. ⁵ Sarrion was taken by nightfall.

At this point, street fighting took place between tank units; with heavy going, an advance of 5 miles was accomplished that day.

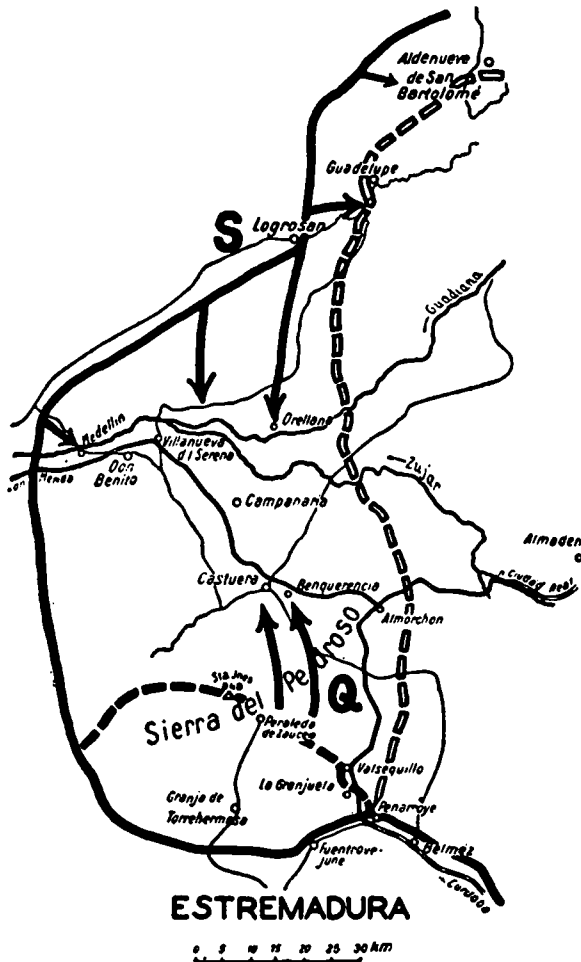

PLATE 123. THE OPERATIONS IN ESTREMADURA, 19-24 JULY 1938.

Various crests in vicinity of Sarrion were heavily organized with concrete emplacements; close support by infantry mortars made a slow progress possible.

⁵ This action contains an interesting example of infantry-tank cooperation; the second wave of breakthrough tanks carried infantry detachments, with light M. G. and hand grenades, who formed nuclei of resistance in disputed areas.

(4) Varela had instructions not to attack on the thirteenth in order not to force back the defenders of the north salient but await the progress of the breakthrough, which would eventually lead to an encirclement.

(5) The main effort was shifted to south of Sarrion, in Solchaga's zone of action; local heights were taken by envelopment and successive artillery concentrations.

(6) On the fifteenth and sixteenth an advance was ordered along the entire front. Alentosa was captured; a mechanized column drove into Barracas.

In the north, Varela took Mora de Rubielos and turned on Noguereles, across the mountain. The time was ripe to close the salient from the east.

(7) On the seventeenth, a column advanced west of Lucena via Castillo and Zucaina; in forced marches they reached the vicinity of Montan on the nineteenth and established contact with Varela's troops: the salient was cut off.

d. The operations in Estremadura, July 1938. This pattern of elastic warfare, so familiar and yet so modern in the tools of its workmanship, is repeated everywhere. While Palomera, San Just, Alentosa are characterized by a step-by-step advance in mountainous terrain, the same pattern was applied in other sections of Spain with equally smashing results.

The salient of Don Benito in Estremadura came within 40 miles of the frontier of Portugal; the Reds attempted to extend it, in the fall of 1937, and the Nationalists made a previous attempt against Medellin; then calm reigned in this area until 14 June 1938, when Queipo de Llano drove a salient into the Sierra del Pedrosa to Peralede de Zauco.

A month later, a more important offensive, prepared in strictest secrecy, was to net considerably more territory. The plan involved a double flank attack, or double envelopment, from the south by Queipo de Llano (Q), and from the north by General Saliquet (S) who had Monasterio's veteran cavalry division at his disposal, in view of great distances and lack of roads in this region.

(1) In the broiling heat, Saliquet started on the nineteenth, mopped up the area north of the Guadina, crossed this river at Orellana on the twentieth and pushed on to Campanaria.

(2) Queipo de Llano advanced on Benquerencia and Castuera, which he reached on the twenty-second; on the twenty-fourth he established contact with Saliquet at Campanaria, and the salient was cut off.

(3) A frontal attack via Medellin on Don Benito kept the defenders occupied until the town fell; the remnants began to withdraw, only to find their retreat cut off in the east.

By the twenty-eighth, 20,000 prisoners had been collected, with 112 guns of various caliber, 82 tanks and 1326 motor vehicles.

To protect the Almaden mercury mines, the Reds sent reinforcements in this region and a lull set in, since major operations had begun on the line of the lower Ebro.

44. THE EFFECT OF FOREIGN INTERVENTION. The Spanish cockpit was patronized by a number of "aficionados," who did a lot of spirited betting: the Russians, the French, the Germans and Italians; the British alone held aloof except for an occasional polite though futile gesture. The line of demarcation, of course, was strictly along political ideologies, i.e., communism versus totalitarianism, with a dash of strategic speculation on the part of the French, who may one day find the line of the Pyrenees in unfriendly hands; finally, the Blum government had never attempted to hide its parlor-pink coloring, while the Soviets would fish in troubled waters, as a matter of policy.

The extent of French and Russian assistance is recognizable in the tell-tale percentage of foreign materiel captured by the Insurgents in a single year: 125 tanks, 947 aircraft (809 of Russian and 138 of French manufacture), 533 artillery pieces, 1457 light and 1466 heavy machine guns, 75,347 rifles, 126,600 artillery projectiles, 105,000,000 rifle cartridges;⁶ in that period, the Reds lost 220,000 men in prisoners and an estimated 300,000 in killed and wounded; this is roughly equivalent to our Regular Army, National Guard and Organized Reserves combined.

Russian shipments via the Dardanelles from September 1936 to 30 July 1937 were reported to amount to two million tons, carried in 469 vessels.⁷ In this period, 800 field pieces, 800 tanks, 300 planes and 6000 motor vehicles were received from the Russians, not to mention 2000 technical advisers, in commissioned grades. These figures represent approximately organic equipment for a field army of 400,000. In a single month, August 1937, 161 freight steamers (103 British) docked in Spanish Mediterranean ports; 33 carried war material, 32 coal, 18 gasoline, 2 motor vehicles, and the balance miscellaneous freight.⁸

French support was equally important: during the crucial operations along the line of the Ebro (river operations), the Red attack was made possible only by bridge material that came via France; in a single month, August 1938, approximately 10,000 tons of war material reached Barcelona, containing 1700 tons in weapons and ammunition. Occasional glimpses of accurate daily data became available ". . . 155 motor trucks, loaded with 920 tons of supplies, for the Leftists, were speeding to Barcelona."⁹ ". . . four freight cars of machine guns and anti-aircraft guns, 38 cars of knocked-down tanks ready for assembly and other heavy equipment entered from France."¹⁰

". . . At the French frontier town of le Perthus, on the main road to Barcelona, this writer has watched for many days a seemingly endless stream of 10-ton trucks crossing into Spain. A customs official told me the daily average was 200 trucks . . . 2000 tons of war material entering Spain every day."¹¹

The seesaw of conflicting interests, of course, is a typical case of the pot calling the kettle black. The Germans and Italians were equally active in releasing men, materiel and equipment to Franco.

Apparently the Germans primarily furnished anti-aircraft guns, artillery, tanks and airplanes with cadres of technicians, in rotation. The Italians, on the other hand, maintained organized expeditionary divisions from the outset; their designations became known in early dispatches, viz: Littorio, Black Arrow, Green Arrow, 23d March., etc. The first year of the war was admittedly a critical one for Franco; the important if not decisive character of Italian support can be gauged by figures released in the semi-official *Forze Armate*. ". . . The period of mid-December 1936 to April 1937 was a period of most intense activity (for the Royal Italian Navy). In those four months there were transported to Spain about 100,000 men, 4370 motor vehicles, 40,000 tons of materiel and 750 cannons, in 52 ships which made 132 voyages and for the protection of which it was necessary to employ 30 war vessels which made 134 trips."

⁶ *Mil Wissenschaft Nachrichten*, 1938. Statistical Reports. G. H. O., Burgos, 1937.

⁷ Post war revelations throw a sidelight on the commercial character of Russian assistance: ". . . according to a communication dated Feb. 10, 1937, from the Spanish Republic's Ambassador in Moscow, Barcelino Pasqua, the amount of gold deposits in Russia was 501,079,529 grams of gold, approximately \$573,982,115 at \$35 an ounce for gold." (Luis Araquistain, Former Russian Ambassador to France.)

⁸ In the meantime, the communists and "fellow travellers" have been collecting pennies and dimes for Spain on the street corners of New York. *New York Herald-Tribune*, 19 June, 1939.

⁹ *Time*, April 5, 1938.

¹⁰ *Le Soir*, Paris, March, 1938.

¹¹ *Le Soir*, March 12, 1938.

¹² Axelson, *New York Times*, April 12, 1938.

¹³ Mathews, *New York Times*, June 8, 1939.

45. **TACTICS AND TECHNIQUE OF THE SEPARATE ARMS.** *a. Limiting factors.* While significant, the military characteristics of the war in Spain are not altogether applicable to war between first-class powers; there are many limiting factors to be considered, for example the divergence of equipment and combat value in units. The Italian Legionnaires and Nationalists conformed to modern doctrines of combat and were organized as modern regular-army units. Variation in quality was more pronounced with the Reds; generally speaking, armament and training were below the normal standards in corresponding infantry units of a modern army.

The numerical deficiency of artillery, in both armies, affected tactical movements; mass concentrations were comparatively rare.

In some sectors, defensive organization was strong and continuous because it covered vital objectives (Madrid, Saragossa, Huesca, Granada, etc.); in other sectors, there were only a series of observation posts, along roads, or small garrisons in villages.

b. Artillery. Initially, there was a shortage of artillery on both sides. The available amounts, for the entire Spanish Army, at the outbreak of the war are reported as approximately 175 batteries of light and medium artillery; 18 batteries were organic equipment for each of the 8 normal infantry divisions. Franco's Moroccan Army of 34,000 men disposed of 14 batteries only.¹² This lack of artillery was obviously responsible for the extensive use of bombardment aviation on what would ordinarily have been artillery missions. A contributory factor may be found in the prevailing mountainous terrain with defilades; the necessity of high angle fire, in such situations, for forward infantry, is reflected in the organic assignment of 65-mm howitzers to Franco's regiments.

The first noteworthy concentration of artillery occurred in the siege of Bilbao. General Duval estimates 32 batteries, others as high as 50, a very respectable massing of fire behind 40,000 combat troops; such a force is roughly the equivalent of two war-strength American divisions, with an organic allotment of only 36 batteries.¹³

Subsequently, there must have been a steady increase in the artillery ratios, until a massing of fire, in breakthrough areas, was possible that resembled the artillery densities on the West Front in 1918; such concentrations were the prelude to the attacks on the Sierra de Palomiera and on Sarrion.¹⁴

It is estimated that 30 to 40 batteries, principally of 75-mm and 155-mm, supported the Government attack on Brunete and Navalcarnero, 5 July 1937, with the added intervention of 100 to 150 planes. The Insurgent counteroffensive, two weeks later, was made with approximately 40,000 men and an artillery component of 40 batteries.

The reports of captured enemy materiel, already touched upon (Par. 43) list from 500 to 700 guns, i.e., 125 to 175 batteries; this figure represents a severe loss for any army in any war, but it is also indicative of artillery ratios of considerable strength. The employment of artillery is consequently in accord with prevailing doctrines and presents no startling innovation; it rather confirms the lessons of the World War: concentration of every available means of fire (artillery, aviation, tanks) upon a narrow front for a decisive breakthrough. As an acknowledgment of "historical continuity," the reader need not be reminded that this

¹² Duval. *Lecons de la guerre d'Espagne.*

¹³ Capt. Johnson, C. & G. S. S. *Quarterly*, No. 72.

¹⁴ Col. Lanza. *P. A. Journal*, June, 1938: "Two Italian divisions . . . had about 72 batteries, or 288 guns, in support, on a front of some 5 kms; the artillery preparation lasted 75 minutes with an average expenditure of not quite 2 rounds per minute . . ." These figures and frontages correspond roughly to the preparation fires on Sarrion for the operation in the Albentosa sector.

point was perfectly understood by Napoleon, who was a good artilleryman, first and last.¹⁵

In view of the limited number of guns available, as a general proposition, the organic artillery of divisions had often to take over both direct support and counterbattery fires; it was sometimes possible to satisfy both missions, but more often not. The problem of displacement forward, as the attack proceeded, was also difficult; pack batteries were reported doing this about as quickly as motorized units.

Infantry-artillery liaison became an early and important factor. Direct and continuous observation was important; the radio set of the observation-liaison parties gave good results. Situation sketches, with objectives and targets entered and suitably designated by symbols, were effective; requests for fire were then made by these symbols for predetermined durations.

c. Aviation. With mechanization, the air factor remains as the most challenging of modern question marks. The experience-tests in the Spanish laboratory are not conclusive, partly because of the comparatively modest extent of air operation—but there are enough straws in the wind!¹⁶

Aviation in Spain has carried out every conceivable flying mission, from troop-transport to bombardment. They launched the Insurgent movement by transporting between 5000 to 10,000 men, in tri-motor planes, from Morocco in August 1936.

Relative strength varied; in 1937, estimates credited the Nationalists with 600 first-class aircraft, the Government with a steadily declining number.

The equipment was modern, consisting of recent German, Italian, Russian and French types, viz:

	<i>German</i>	<i>Italian</i>	<i>Russian</i>	<i>French</i>
Pursuit	Messersmith-109	Fiat-1	Chato & Mosca	Potez & Type 510
Bombardment	Dornier-17	Savoia-79	Katiouška	Dewoitine

Nationalist pursuit averages speed of 225 miles per hour; some bombardment types exceed that, with loads ranging from 1650 to 4960 lbs.

The Government enjoyed a temporary superiority in the "Mosca" with a speed of 280 miles per hour and a rate of fire of 1800 rounds per minute from 2 M. G.

Reconnaissance: With types limited to pursuit and bombardment, the latter had to carry out reconnaissance missions; in general, information received as the result of photographic and visual reconnaissance of front-line activities was poor; information of rear areas, however, was satisfactory.

Bombing missions: Fast bombers, like the "Katiouška," performed their missions at high altitude and without pursuit protection; interception was rarely accomplished and losses remained negligible; such speed and range permitted strategic employment of aircraft in different theaters of operations. Based on Madrid, these aircraft operated against Bilbao and Santander at distances of 180 miles.¹⁷

Pursuit: The "Mosca" proved the importance of speed for pursuit aviation; on the other hand, some pilots preferred the Chato, with less speed, but greater

¹⁵ Chap. VIII, Par. 35.

¹⁶ General Armengaud, *French Army, La Guerre d'Espagne*.

¹⁷ Breerton, *C. & G. S. S. Quarterly*, No. 72.

maneuver capacity. Contrary to prevalent ideas, this great speed does not prevent attack of other aircraft from either front or rear; the strong armament (4 M. G.) of the "Chato" made it perfectly willing to accept attack from the front.

Cooperation with ground troops: Direct participation in the ground battle (as a "fifth arm," as Armangaud terms it) was a very characteristic feature of the war in Spain. Many infantry and staff officers are of the opinion that direct air support of infantry is essential; German opinion particularly favors this position.

In Spain, this use of aircraft had become almost habitual; low-flying bombers and flights of pursuit completed the artillery preparation, or extended it, and often rendered close support to the infantry in the assault. Observers believe that it was primarily aviation which blasted out the intrenched defenders of Bilbao. A Government colonel stated: "No enemy attack of any importance could have succeeded with artillery preparation alone . . . artillery fire had to lift as soon as the infantry was within 300 yards of our trenches . . . the aviation produced enormous moral and material effects . . . after several days of violent bombardment, the occupants of our front lines being buried, killed, or worn out, the hostile infantry took possession . . ." ¹⁸

¹⁸ Armangaud, *Revue Militaire Generale*, March, 1938.

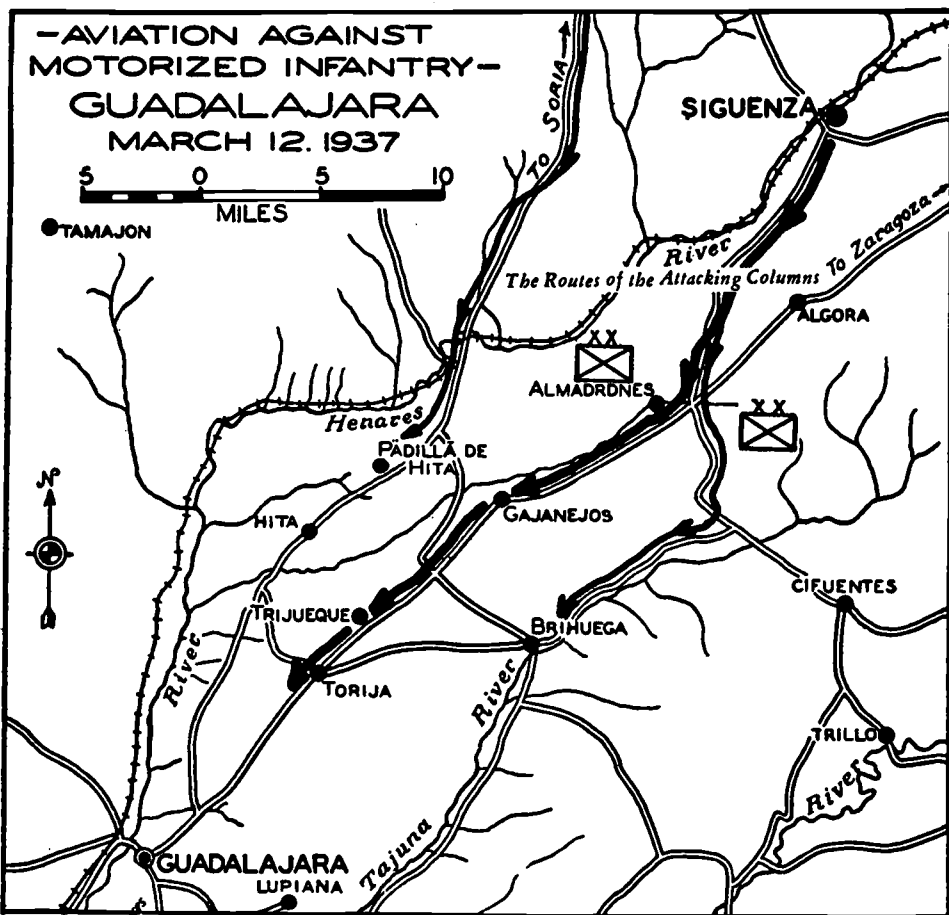

PLATE 124. THE MOTORIZED ADVANCE ON GUADALAJARA.

There is an opinion that on account of the speed of the modern plane, the results obtained by bombs upon small objectives such as bridges, cross-roads, etc., are largely a matter of chance; on the other hand, the bomber is most effective in beaten zones 500-600 yards long by 150-200 yards wide; it is regarded as "at least equal to artillery." A French observer¹⁹ states: "infantry stands up badly to bombs, particularly the 110 lbs., which is the standard projectile used by both sides."

An ideal target for air attack, of course, are columns of vehicles or men en route; the incident at Guadalajara has furnished a historical example of disturbing quality, although the harassment of Turkish troops after Meggido in 1918 already forecasts all sinister possibilities.

Aviation against motorized infantry. The operation on the Aragon front, known as the Battle of Guadalajara, deserves more attention than it has received. It represents the decisive intervention of air craft against motor columns and stands as a warning of the constant menace of air attack in modern warfare.

The Aragon front had remained a "quiet sector" until 8 March, when two Insurgent (Italian) divisions started a drive against Guadalajara; until 17 March only hasty Government reinforcements were available; in the meantime (specifically on 12 March) the ensuing battle was fought and won by air operations.

Approximately 20,000 men of Italian origin were shifted from the Insurgent Malaga front to the Aragon area on 2000 trucks, a distance of 500 miles. They were grouped into two "divisions," reinforced by "Ansaldo" light tanks and a few batteries of porté artillery.

The fighting quality of these units was open to question—volunteers from southern Italy, farmers, unemployed on public relief, poorly trained recruits, held loosely together by "black-shirt" cadres and staffs.

Concentrated on the line: La Tobe—Algora, the 2d Division encountered little resistance on this quiet front and advanced via Gajanejos, in 36 hours. One day, the tenth, was lost in waiting for the 1st Division advancing to the east. This delay was due to the obviously poor road net: Almadrones—Brihuega. The weather turned cold and rainy. The elevation of this inhospitable section of Aragon is over 3000 feet. On the eleventh, the long lines of motor trucks weathered a heavy storm by being tied to their paved routes; it was this column of about 1000 vehicles that became the target for Russian attack aviation the next day.

It must be noted that the terrain was ideal for an air attack: a barren, treeless plateau of 3000 feet elevation with a single, narrow paved highway running in an almost straight line from Torija to the north; the adjacent ground was water-logged and very muddy. There was no evidence of anti-aircraft protection in the 20-km. column and the troops were not skilled in defensive measures.

The Government assembled approximately 100 planes at the airdrome of Alcala-de-Henares, primarily Russian planes and Russian pilots; the composition of this striking force was as follows:

<i>No. of planes</i>	<i>Type</i>	<i>Armament</i>	<i>Bombs of 100 lbs.</i>
48	Monoplane I 15 Attack	2 M. G.*	2
48	Monoplane L 16 Pursuit	2 M. G.	2
24	Biplane R 5 Attack	4 M. G.	4
24	Monoplane S. B. "Katiouška"	2 M. G.	4

* Each M. G. was provided with 1,100 cartridges.

Apparently the bad weather prevented effective counter-operations by Insurgent planes; the extraordinary optimism of the column commander may have been a contributing factor.

¹⁹ Captain Poulain. *Journal R. U. S. I.*, 1938.

On the twelfth, this mass of aviation was launched in a surprise attack, under cover of a low ceiling and heavy clouds, all planes flying low. The 2d Division was caught strung out over 20 kms. along the highway to Saragossa.

The attack was staged in successive waves:

First—30 attack planes: I 15's

Second—40 mixed planes: I 15's and R 5

Third—45 pursuit planes: L 16's.

The L 16's were initially on protective missions but emptied their machine guns into the columns, toward the end of the action; over 500 bombs were dropped and 200,000 rounds fired. The motor column was stopped in its tracks, lack of lateral roads and the vile weather making escape or deployment impossible. Panic swept the command. An eyewitness reported ". . . along the straight highway, telegraph poles are blown up and the wires flutter like tendrils; everywhere demolished trucks and cadavers . . ."

On the thirteenth, 28 planes repeated the attack against fragments of the convoy, withdrawing to the north.

On the sixteenth the attack turned against Brihuega, in which the Italian 1st Division had found refuge; thirty R 5's and I 15's operated against this locality. On the eighteenth, Government infantry units made their first appearance and took Brihuega. The Italians withdrew via Almadrones. This movement was picked up on the nineteenth and 80 planes attacked with 600 bombs, and fired 100,000 rounds. By the twenty-first, the Insurgents were driven once more behind the initial line of departure.

The striking success of this air operation was partly due to feeble enemy aircraft reaction, unfavorable weather and terrain and the efficient cooperation of fast pursuit type on covering missions, enabling a maximum performance by the attack echelons.

Only fifteen years before, a similar disaster overtook the retreating Turkish columns in Palestine in the defile of Wadi-Fara, 1918. If column commanders recognize the necessity for security measures on the ground, in the form of advance or flank guards, they must also admit the necessity for "air-guards," in view of the air menace which has rendered march formations tactically far more vulnerable than any terrestrial consideration has ever suggested.

While capricious factors of chance were present in this operation, it has an ominous significance; it is hardly questionable that this column would have blundered through and reached Guadalajara, in spite of bad weather, road jams and poor traffic control, had it not been for this unexpected, terrific bolt of fire from the air.

What do 336 aviation machine guns, 200,000 rounds, and 38,600 lbs. of bombs represent in terms of infantry and artillery battalions and in "days of fire"?

In volume of fire, the Italian battalion of 650 men is roughly equivalent to that of 32 machine guns; 336 aviation guns consequently represent 10½ infantry battalions; a pound of bomb is roughly equivalent to an analogous weight in a 75-mm shell; the 38,600 lbs. of bombs dropped on these columns consequently represent one day of fire for a 75-mm F.A. battalion; the 200,000 rounds of M.G. ammunition fired in the attack roughly compare with one day of fire for an American infantry regiment. The air attack, therefore, was equivalent in fire power to the sudden flank attack of ten infantry battalions, reinforced by artillery, against six infantry battalions; it must be further considered that the comparative

"days of fire" were expended in the space of two hours—a terrific concentration by all ordinary standards.²⁰

Effect of bombardment on civil populations. The result of such attacks were very evident in Madrid. In the French bridge and University City areas, the appearance of these quarters vividly recalls Verdun, Arras and Rheims during the World War. Compared to the small number of aircraft employed, heavy losses have been inflicted on the civil population; the number of wounded is also relatively high; the effect of such bombardment would have been more serious had either force been employing chemicals.²¹

It is generally agreed that notwithstanding the usual press exaggerations, both opponents were restrained in their bombing of cities, since as Spaniards they had no real motive in destroying their country.

To interpret this restraint as proof that Douhet was wrong is stretching a point. The continuous bombardment of Barcelona, 16 to 18 March 1938, was a real test and the results were terrific.

In occasional bombardments of Madrid, 500 lb. bombs were employed with uniform results; these projectiles cut through old houses of six stories and steel and cement flooring from three to five stories; the destruction in narrow streets was considerable; it is arguable that the full potentiality of this weapon has not been remotely tested.

d. Antiaircraft defense. In 1937, General Armangaud²² reported: "The small automatic guns make the sky practically untenable up to medium altitude, within the limit of their range of action." A year later, General Niessel estimated losses due to anti-aircraft artillery²³ as 18 per cent.

While pursuit aviation has accounted for roughly three-fourths of enemy aircraft shot down, and antiaircraft artillery the remainder, it is generally recognized that this weapon has become very dangerous. The German 88-mm is very effective against high-flying craft to a range of 20,000 feet; the German 37-mm and the Swiss 20-mm Oerlikon are equally effective against low-flying planes.

e. Cavalry. Insurgent cavalry has become synonymous with Monasterio's cavalry division; this veteran cavalry commander and his Moroccan units played a consistent, quiet, effective role throughout this war. He carried out the traditional cavalry missions of reconnaissance, security, exploitation and pursuit, with an initial force of approximately 2000 sabers. The adaptation of this purely mounted force to a modern situation is revealing: motorized infantry and artillery, armored cars and tanks were gradually attached until this powerful unit was able to play a decisive role, on several occasions, particularly in the operations against the Sierra Palomera.

1936: This cavalry operated on the right flank of Franco's advance on Madrid on security missions.

On 6 November, it seized and held a position outside Madrid until the infantry came up.

1937: Cavalry elements assisted in various operations, on the Jarama River, at Bilbao, Santander and Gijon and, on a large scale, in the Sierra Palomera.

1938: At Herrera, 9 March, cavalry went through the gap opened by Valino's

²⁰ The debacle of Guadalajara has been made the basis of anti-Italian propaganda; any motor column, of any army, under these circumstances, would have suffered tremendously; our own maneuvers have shown such surprise attacks to be entirely feasible: daylight marches have become risky; the deadly potentialities of the air arm had better be faced!

²¹ Armangaud, Brereton, *C. & G. S. S. Quarterly*, No. 72.

²² *Revue des Deux Mondes*, 1937.

²³ *La France Militaire*, 1938.

Navarrese division and played havoc with enemy rear establishments; by the thirteenth it had advanced 40 miles.

Cavalry was used to cover the crossings of the Ebro and assist in the advance on Bujaraloz; a few days later, cavalry held the gap between the Moroccan Corps and Valino.

In the offensive of Estremadura, Monasterio was attached to Saliquet's force, in view of the limited road net and the great distances involved, in this lonely region.

Automotive vehicles apparently have not yet displaced horse cavalry, a conception which seems to be borne out by the campaign in Ethiopia as well.

f. Infantry. Due consideration must be given to certain deficiencies affecting infantry organization, training and equipment. In many cases the materiel was inefficient or inadequate; in others, it was improperly used and handled by partially trained personnel. The relative combat value of the opponents is not easily gauged; in many ways, the improvisation of armies was similar to the initial phases of the American Civil War.

(1) *Government: Militia:* The initial formations were based on armed labor organizations and conscripts. For a long time the combat value of the militia was practically nil; however, little by little a certain amount of training was acquired, although combat efficiency left much to be desired.

International Brigades: These units are characterized as volunteers from different countries with cadres formed by veterans of the World War. Outstanding successes obtained by the government have often been due to the international brigades which developed more or less rapidly into fairly cohesive fighting bodies.

(2) *Nationalist:* The foundation of General Franco's forces were:

Regular army units which in 1936 passed to the command of General Franco, approximately 50 per cent of the peace establishment.

Regular contingents from Morocco, principally the Foreign Legion but composed almost entirely of Spaniards and certain native forces.

Phalangists: civil contingents which were recruited initially (1933) to preserve order.

Requetes: Carlist volunteers recruited in Navarre.

Civil guards: Police contingents; very good troops similar to the French Gendarmerie and Garde Mobile.

Foreign contingents: Italian and German volunteers of undetermined numbers, estimated from 30,000 to 100,000 men.

The Italian Legion was composed of cadres and men from the Black Shirt Divisions, disbanded after the conquest of Abyssinia. The German volunteers were mostly specialists who operated modern German materiel; they were principally artillerymen and aviators, comparatively few serving in the infantry.

Moroccan troops were well trained and well equipped. The Italian volunteers had had war experience. The phalangists and the requestes, while courageous, were difficult to handle; in 1937 they were incorporated into regular infantry units.

(3) *Men, materiel and equipment:* The Spanish War has shown that infantry still plays the preponderant role in combat. As always, the infantryman gains, occupies and holds terrain and in the end determines success or failure.

The world-wide progress made in armament apparently has not made possible the substitution of the machine for the man. It is an error to believe that future wars will be conducted primarily with tanks, airplanes and guns.

Temporary results due to an overwhelming materiel have been obtained, but final success has never been secured by a commander who neglected to employ infantry to occupy and retain the conquered ground. Airplanes used in large numbers against ground troops may disperse them, demoralize them temporarily and inflict heavy losses; the same can be said of tanks or artillery, but when all is said and done infantry remains the deciding factor. Machine guns, accompanying weapons and tanks will give maximum results only when operated and employed by efficient infantry.

The rifle squad: The squad had an average strength of 10 men, with one automatic rifle. This strength came to be regarded as inadequate; in advancing the A-rifle for maneuver, the remaining rifle fire was considered too weak to neutralize opposition; recommendations tended toward two A-rifles and a squad strength of 14 men.

The rifle platoon: The platoon consisted of 3 squads and 3 A-rifles.

An adjustment of squad strength would result in 2 squads and 4 A-rifles, an increase in fire power and simplicity of control.

A tendency was noted to take up linear formations too early, resulting in fatigue and slow movements; it was found that units in line of columns reached the line of departure earlier and in good condition.

The rifle company: The company comprised 3 platoons. The company was the smallest unit with maneuver capacity. It was found that "maneuver," in the presence of the enemy, was difficult; decentralization, leaving platoon commanders certain latitude, was useful. The employment of the support platoon to pass through the forward platoon, and continue the attack, was so frequent as to become "typical."

The rifle battalion: It comprised 3 rifle companies and 1 M.G. company (9 guns). The battalion made a brilliant showing as the fundamental tactical unit of infantry; scarcity of mortars (high angle fire in direct support) made itself felt; this was compensated for, in part, by the use of accompanying guns (light artillery, caliber 65-mm).

The machine-gun company: The M.G. company was organized into 3 platoons of 3 guns each.

The attachment of a platoon to each rifle company became habitual for direct support.

The guns of reserve units were often employed for initial fires, in support of an attack.

At Santander, a battery of 20-mm rapid-fire cannon and a company of machine guns executed overhead fire at 1200 yards in support of a rifle battalion in attack; topographical conditions were ideal, since the attack advanced over a forward slope in plain view of the reserve unit; the cannon, a weapon of precision, was able to fire within a few yards of advance elements, while the machine guns suspended firing, as a safety factor since observation of fire was impossible; this points to the liberal use of tracer ammunition.

Infantry mortars: Organized in platoons, of 9 and 6 mortars, these units were assigned to regimental headquarters company; they were attached to battalions.

While most useful, these weapons consumed considerable ammunition; the problem of munition supply was always difficult.

(4) *Attack and defense:* It has been claimed that the Spanish War has demonstrated the superiority of the defense over the attack; this is an exaggeration!

If properly supported, trained infantry in the attack has obtained tactical results far and beyond those obtained by infantry remaining on the defensive.

Progress in materiel and armament favors the defense but cannot substitute the negative advantages of the defense for the positive advantages of the offense.

While infantry attack has become more and more difficult, it has not become impossible, for with improved infantry materiel, tanks, automatic arms, mortars, the task is greatly facilitated; while certain advantages, already foreseen, have accrued to the defense, the respective values of attack and defense have not been materially altered by events in the Spanish War.

Efficient defense requires ability above that possessed by improvised troops, and strong positions, weakly held, offer feeble resistance to a determined enemy. Reports by competent observers²⁴ on the "iron ring" at Bilbao, erected by the Basques in 1936-37, are significant: ". . . The defensive system was well built by specialists but did not resist the Nationalist attacks for two reasons:

"Trace and siting: though well conceived from a technical viewpoint and excellent construction, the defenses were tactically deficient due to poor siting, lack of continuity in the defense system, absence of good flanking fires, absolute ignorance of the employment of the reverse slope and lack of organization in depth except in certain localities.

"Defensive garrison: It is a gross error to think that a defensive position consists only of entrenchments.²⁵ The efficiency of a position depends upon the men who man it. The position of Bilbao was held by insufficient and untrained infantry. Instead of 70,000 men necessary to hold 70 kms. of trench system, the Basques had hardly 50,000."

(5) *Infantry and Stabilized Fronts*: While progress in armament does not clearly establish the supremacy of defense over attack, it does modify the form of warfare. Present armament, and especially that of the infantry, tends to stabilization.

Infantry was able to reestablish itself more easily and more promptly than heretofore on a position after a retrograde movement, providing it made full use of its automatic arms and accompanying weapons, was adequately supported by artillery and organized the terrain rapidly and judiciously.

(6) *Accompanying guns*: One battery of 65-mm was assigned per regiment, as accompanying gun; its tactical mission was to bridge the gap between the front line and the divisional artillery. Under pressure of the tank menace, this weapon was often employed as a purely anti-tank weapon, i.e., distribution to front lines. This dual mission was found to be confusing and undesirable; in the domain of the regiment, it was recognized that two types (for anti-tank and accompanying fires) were required.

(7) *Infantry antitank weapons*: Concerning antitank weapons, Spain has constituted a veritable proving ground, and antitank defense appears to have outstripped tank development.

The antitank weapons primarily operated by infantry which have given the best results are:

- The 13-mm Hotchkiss gun
- The 20-mm Oerlikon gun
- The 25-mm Hotchkiss gun
- The 47-mm P.A.K. German gun.

The characteristics of this armament are as follows:

²⁴ Major Andriot, French Army.
²⁵ General Duval, *Lecons*.

13-mm Hotchkiss gun:

Weight 200 kgs. (441 lbs.)
 Maximum rate of fire 450 rounds per minute
 Weight of projectile 52 grams (1.8 oz.)

The projectile contains no explosive charge; its power of penetration exceeds slightly that of the machine gun. Good results were obtained when vulnerable parts of the tank were hit.

20-mm Oerlikon gun:

Weight 300 kgs. (661 lbs.)
 Maximum rate of fire 300 rounds per minute
 Weight of projectile (tracer) .. 139 grams (4.9 oz.)
 Contains an explosive charge of 4 to 9 grams.

This small shell penetrates armor as follows:

15-mm thickness 1200 meters
 30-mm " 1500 meters
 40-mm " 300 meters

A 20-mm automatic rifle, model 1936, possessing the same characteristics as the gun up to a range of 500 meters, has been built by Oerlikon. It weighs 42 kgs. (93 lbs.) and is broken down into two parts for transportation, 20 and 22 kgs. respectively. It employs the same projectile as the gun.

25-mm Hotchkiss gun:

Weight 800 kgs. (1764 lbs.)
 Maximum rate of fire 180 rounds per minute
 Weight of projectile 330 grams (11.6 oz.)
 Explosive charge: 18 grams (0.6 oz.)

The weight of this gun makes handling difficult.

47-mm P.A.K. (Panzer-Abwehr-Kanone) German gun:

There is no definite information on the characteristics of this weapon; it is probably similar to the 37-mm anti-tank gun built by the Rhein-Metall Company, which is now being developed in an efficient American adaptation.

(8) *Mortars, light and medium calibers:* Due to insufficient artillery, the infantry mortar has been used to a large extent. It has been very efficient against troops occupying positions, defiladed against flat trajectory weapons.

(9) *Infantry defense against air attacks:* Infantry has often been attacked by low-flying airplanes, either during an attack or defense of a position. Such attacks have had great moral and material effect and have apparently demonstrated that antiaircraft fire is inefficient against low-flying ships, possibly due to surprise, effect on morale and speed.

The Spanish operations have shown that aviation will be used more and more to intervene in the ground attack; consequently, infantry antiaircraft defense must be perfected.

Antiaircraft guns: The 20-mm AA type was found to be highly effective; they were also used as an accompanying weapon, for precision fire, as described above, at Santander; this is probably the exception rather than the rule, since modern battle will keep these guns occupied with their basic missions.

g. Motorization. Motor transport has been used extensively by both sides. After initial improvisations and frequent mechanical breakdowns, both sides organized repair and maintenance echelons, auto parks and motor transport battalions. Concentrations and troop movements by motor were extensive; night movements became customary, especially after the sharp lesson of the Guadalajara debacle.

The secret Government concentrations (50,000) as a preliminary to the attack on Brunete were made possible by motor transport; on the other hand, Insurgent reinforcements (40,000) for the subsequent counter-offensive were also rushed up by motor vehicles.

In April 1938, a force of four infantry battalions, two F.A. battalions, one heavy battery, one anti-aircraft battery and anti-tank guns were moved at night, by motor, from Gandesa to Tortosa, over a 20-mile stretch of mountain roads, as timely reinforcements; there are many similar instances of the tactical use of motors.

The supply of Madrid, i.e., 800,000 inhabitants, for nearly two years, represents the greatest achievement of motor transport by successfully bridging the gap of 90 miles to the nearest Government railhead.

In spite of the Guadalajara debacle, troop movements by motor have been frequent and successful; in fact, they explain in part Franco's remarkable maneuver capacity. On a front of roughly 2000 miles, the Nationalists repulsed two counter-offensives, 300 miles apart, and staged five widely separated offensives beginning on the extreme south of their line and ending on the extreme north.

Motorization, however, is at best a logistic tool; a competent local observer,²⁶ warns against undue conclusions: ". . . completely motorized units are limited in number and usefulness and may become a hindrance . . . the idea of employing motorized detachments in the fighting zone must be rejected . . . the side which has the means to liberate itself from a dependence on wheels has an advantage . . . it is a question of correctly balancing animal and motor transport."

h. Tanks. Mechanization is one of the most controversial and baffling factors in modern warfare. Operations in Spain were watched with intense interest, hoping for final answer. In Spain, German and Italian tanks, the Fiat Ansaldo and the German 6-ton model, were pitted against Russian light (T-26) and medium (T-28) types; the general characteristics of these tanks are given in the following table:²⁷

A British observer believes that the German tanks have proved to be mediocre implements of war, and the Italian tanks even more so; that the Russian tanks have been generally superior to the others but have not obtained successes comparable with those of the World War. "Everywhere that tank attacks have encountered defensive elements in sufficient number and quality, the attacks have been broken up or become immobilized without accomplishing the mission. If, on the other hand, these elements of defense have been lacking or are no longer intact (owing to neutralization or destruction by an artillery preparation) the tanks habitually reach their objective with almost mathematical certainty."²⁸

"The Spanish War has shown also that the possibility and usefulness of great speed in combat have been greatly exaggerated. It was thought that speed would protect tanks from enemy fire, but this has not proved to be the case. In fact, at the speeds visualized (25 to 30 mph.), the precision of hostile fire becomes a trap and the fatigue of crews is such that they lose all idea of the friendly and hostile positions . . ."

Except for Franco's drive to the sea, employment of tanks in mass has apparently not been practiced; there were probably never enough of them to risk it. In that operation, tanks were employed by battalions. The impression prevails that limited numbers caused the tank to be considered a GHQ weapon by both sides, to be

²⁶ Colonel Canevari, Italian Army.

²⁷ Johnson, C. & G. S. S. *Quarterly*, No. 72.

²⁸ Major General E. Temperly.

GENERAL CHARACTERISTICS OF TANKS USED IN SPAIN

<i>Type</i>	<i>Length (feet)</i>	<i>Weight (tons)</i>	<i>Maxi- mum Speed (mph)</i>	<i>Maxi- mum Armor (inch)</i>	<i>Arma- ment</i>	<i>Crew</i>	<i>Rotating Turret</i>	<i>Radio</i>
INSURGENT								
German (light)	13	5-6	30	.60	2 MGs	2	Yes	No
Italian (Fiat-Ansaldo) (tankette)	10	3.6	27	.51	1 or 2 MGs	2	No	No
GOVERNMENT								
T-26 (light)	16	8-9	25	.67	1 45-mm gun and 1 MG or 2 MG	2-3	Yes	Occa- sionally
Russian modification of Vickers-Armstrong 6-ton A (the principal tank of Government army)								
T-28	21.6	18 or 20	20-25	1.0	1 45-mm gun and 3 MGs	5-6	Yes	Occa- sionally
(Russian-medium, modi- fication of Vickers 16-ton) (Believed to have been little used)								
Christie-Ruski 34	19	14	40 on tracks	.67	1 45-mm gun and 1 MG dual mounted	2-3	Yes	No
(Russian medium convertible)								
Renault (French light) ..	15	8	Slow	1.0	1 MG or 1 37-mm gun	2	Yes	No
Trubia (Spanish light) ...	?	6-8	?	.43	3 MGs	3	Yes	No

allotted to corps or divisions as circumstances dictated. In cooperation with infantry, tanks advanced in several waves, usually preceding the infantry.

In the domain of tactics, the experiences in Spain must be classed as inconclusive, but previous observations and principles have not been jeopardized thereby:

(1) From casual employment, in small numbers, the tendency toward larger, compact formations is unmistakable.

(2) Cooperation with infantry, as accompanying tanks, was habitual.

(3) Strong supporting fires were present on decisive fronts, as at Sarrion, and the objective was limited.

Cooperation with cavalry: Light tanks were employed with cavalry on security missions as well as in the attack. They appeared frequently as nuclei of advance guards and in protection of motor transport columns; they operated in conjunction with motorcyclist M.G. detachments.

In an attack in fairly open country negotiable by horses, the following formations were observed:

One squadron, in advance guard, followed by a company of tanks and motorized artillery 65-mm, moving by bounds.

Two squadrons advancing parallel to a road and clearing the road for the tanks.

When the leading squadron engaged the enemy, it dismounted, the 65-mm guns took position, the tank company attacked frontally while reserve squadrons, mounted, attacked the enemy in flank and rear.

It must be noted that antitank means were limited in this situation, and the enemy was on the defensive on a narrow front.

Cooperation with infantry: Coordination of movements, maneuver and rates of advance were difficult. Tanks generally left infantry far behind; in most cases, the line of departure was at least 1000 yards from the enemy. Tanks overran enemy positions without completely neutralizing their fires; the tank crews thought the enemy wiped out, as soon as they passed over him, and moved against further objectives, where they found themselves isolated and sometimes without fuel. As regards armament, there is a general impression that tanks equipped with cannon easily vanquished those armed with machine guns only; it was recommended that a certain proportion of tanks should always be armed with cannon, in the ratio of 1 to 3.

i. Antitank defense:

The whole problem of tank employment is closely linked with the efficacy of antitank weapons, which ranged from crude individual improvisations²⁹ to precision armament of special design.

A competent observer³⁰ remarked:

" . . . Of the five antitank guns used in Spain, viz: Hotchkiss 13-mm and 25-mm, Oerlikon 20-mm, German (Rhein-Metall) 37-mm and Bofors 40-mm, only the Oerlikon has really given satisfaction.

"The 13-mm Hotchkiss is eliminated because of its solid shot, the German 37-mm because of its slow rate of fire, the Hotchkiss 25-mm because of its excessive power. The 20-mm gun penetrates the one-inch armor of medium tanks within a range of 500 yards, and its rate of fire is practically double that of the 25-mm Hotchkiss gun while its weight is only a third of the weight of the latter; the 20-mm cannon might even be replaced by a rifle of the same caliber, which is now under study.

"Antitank defense apparently is primarily a matter of cannons using direct fire, and the first line of defense should have antitank weapons capable of providing protection at least against the more lightly armored machines."

It must be remembered that neither tank nor antitank means were strongly represented in Spain. The density of antitank guns, on any front, is insignificant with what can be put into action by French, German or Russian divisions; the same condition applies to tanks and their numerical ratios; in the Champagne maneuvers, in 1915, the French assembled over 5000 motor vehicles, of which 2200 were armored types, i.e., tanks. If we compare this formidable figure with the modest grouping of 40 to 80 tanks, in certain Spanish offensives, we can hardly venture to make sweeping deductions or forecasts, based on this limited experience.

However, statistics of losses by antitank fire can hardly be ignored. During 1937, the average loss in reported tank actions was 27.6 per cent; it is not entirely clear what proportion of this total is chargeable to mechanical breakdown and subsequent capture. This percentage can be directly compared with World-War rec-

²⁹ Bottles of gasoline covered with soaked rags are ignited and thrown at the rear armor of the tank; the bottle shatters, and burning gasoline spreads over the tank and to its vitals . . . another expedient is contrived by tying several grenades in a bundle; the pin is pulled from one grenade when the bundle is thrown at a tank track.

³⁰ Dr. Klotz, *Lecons Militaires de la Guerre en Espagne*.

ords.²¹ The average percentage of tank casualties throughout the war was 17.2 per cent, but individual percentages in local actions was higher, viz: If we accept the average percentage figures, there is no marked change in ratio of losses, in the period 1918 to 1939; the development of antitank defense apparently has kept pace with improvements in tank design and the net result may be a static combat condition.

The defensive remained all-powerful during the first three years of the World War. Then the appearance of the tank combined with fatigue of the adversary brought success to the Allies. Some concluded from this that the strength of the defensive had diminished and that decisive results could be obtained from brutal attacks by large mechanized forces.

In Spain, however, the antidote for the tank was reasonably demonstrated. The tank can no longer count on tactical or technical surprise; it has to fight on an equal basis with the antitank defense, and the theories proclaimed for the devastating power of Panzerdivisions and other massed armored formations used "independently" are apparently refuted by actual events.

Militiamen of mediocre military capacity have occasionally held up the offensives of units relatively superior in training and technical ability, and, in spite of the weakness of the troops engaged and the extent of front, there has developed a continuous stabilized front and a situation analogous to that of 1914-1918.

If this is a picture of the "next war," it is of some comfort to us; since we shall enter it, as in 1917, with improvised armies.

²¹ Lt. Col. Perre, *Revue d'Infanterie*, 1936.

La Malmaison: of 121 tanks engaged, 80 were immobilized, 52 were stopped by shell fire, i. e., 43 per cent, 28 broke down through mechanical failure.

Chateau Thierry: 585 Renaults, 190 St. Chamonds and 185 Schneiders were employed in a ten-day period; 37 per cent were knocked out.

April-Nov. 1918: Enemy action accounted for 29.7 per cent of the medium and 13.2 per cent of the light tanks engaged.

THE SINO-JAPANESE WAR

46. THE POLITICO-ECONOMIC BACKGROUND. *a. Red sickle or rising sun?* The geographical chart marked "Conflict of Empire" clearly shows the colliding directions in spheres of influence, propaganda, economic and colonial expansion of the great powers primarily interested in the Orient: Japan, Great Britain and Russia. While Anglo-Japanese differences have become more pronounced in this decade, the incontrovertible fact that Great Britain once sought and for years maintained a military alliance with Japan (1911-1922) permits an assumption that these differences may yet be amicably adjusted along the Singapore—Auckland line. The differences between Japan and the Soviets, however, are of a vastly more complicated character and involve a conflict in philosophy of government. The philosophy of the centralized monarchy of Japan is bound to be in continuous, sharp opposition to the communistic principle; any tolerance is inconceivable against the background of the racial, social and historical characteristics of Japan—it is a far cry from Meiji to Marx!

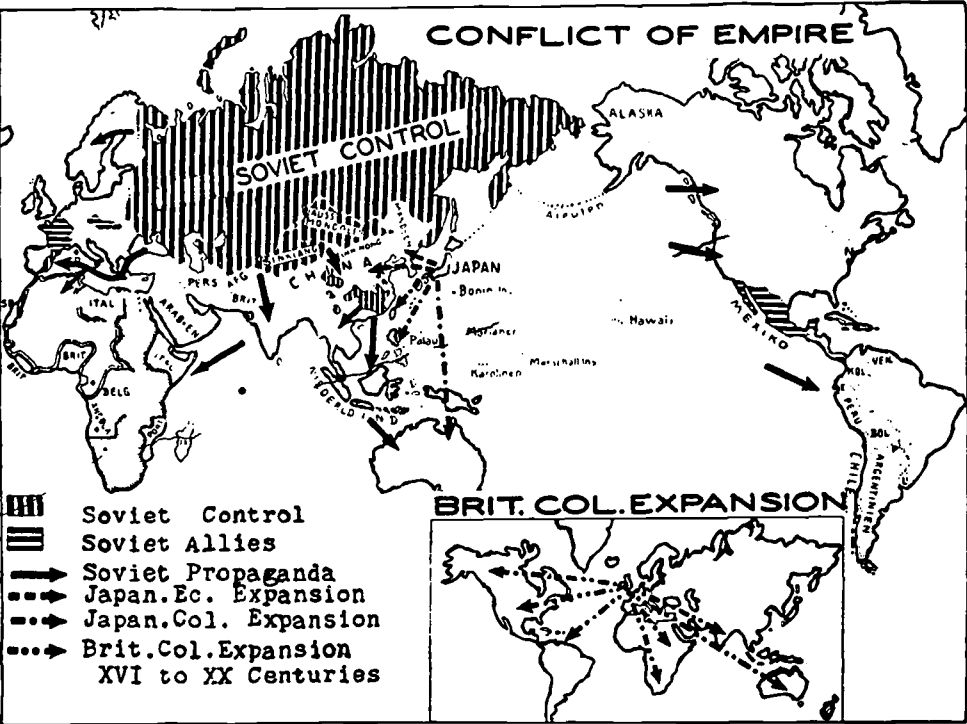

PLATE 125. CONFLICT OF EMPIRE.

The diagram "Conflict of Empire" shows plainly the precarious situation of Japan in relation to communism: its home territory and areas of influence are contiguous to Soviet territory or areas under Soviet influence; while not an exclusive factor, Japan's anti-communistic orientation has of course affected her

diplomatic policies; the comparatively recent Japanese expansion, on the mainland, was influenced by a natural desire to create a "buffer-zone" against communistic encroachment; it may as well be acknowledged that under this heading Japan assumes the role of champion of the capitalistic and monetary economy. A sentimental world may eventually have to choose between the "rising sun" and the "red sickle."¹

There are numerous other contributory factors, of course, primarily of an economic order; this grave problem is too complex to be covered in these pages; it is enough to recognize that the Japanese have convictions and are apparently willing to fight for them. However, the "Conflict of Empire" chart clearly reveals at least one major, basic element of conflict: population pressure and colonization space.

b. Population densities and colonial space. Great Britain, France, Russia and Holland control enormous territories, acquired in colonial, expansionist wars of past centuries, while Japan, Italy and Germany have entered this colonial race too late; the resulting population densities, exclusive of colonial space, range from 21 to 76 inhabitants per square mile for the former, and 137 to 460 for the latter;² the figure for Japan is nearer 800 if one considers the non-arable, mountainous sections of the island.³ In these appalling figures may be found a rational basis for the currently popular but wholly fictitious line of demarcation between "gangster" nations and the "democracies"—the former accused of incurably imperialistic, war-like tendencies, while the latter are credited with an enduring, peaceful disposition. The "Empire Chart" clearly reveals that the line of demarcation in reality is between powers with ample colonial space and those with limited territories, or, as it is popularly phrased, a conflict between the "have" and the "have-not" powers. It is important to note and easily demonstrable that the "haves" acquired their present favorable position through historical, unvarnished conquests and that the "have-nots" are merely attempting to follow suit at a belated hour; to attempt to make a moral issue out of this is sheer hypocrisy. A glance at the relative extent of the colonial conquests of Great Britain suggests that Japan's current enterprise is very modest, indeed, though Japan and England in their historical evolution share one common initial characteristic, in that they were both "little island-empires on the make."

c. Strategic raw materials. Population pressure or "ratio of population density to available space" is only one of many factors that drive nations on the warpath. Toward the end of the Bronze Age, great geographical disturbances drove the Nordic tribes southward, to escape the relentless advance of the ice barrier,⁴ just as the loss of arable land hurled the Cimbri into the Milanese plains in a later period. The great migrations of the fourth century were merely the recurring symptom of an old disease.

For the ancient world, it was the quest for land, for grazing space, that drove the nomad hordes to conquest; for our age, the possession of basic raw materials es-

¹ Theodore Roosevelt suggested to Viscount Kaneko in 1905 the establishment of a Japanese Monroe Doctrine for Asia. Secretary of State Lansing in 1917 recognized that "Japan has special interests in China, particularly in the part to which her possessions are contiguous." U. S. Ambassador Castle, in 1930, said that "Japan must be and will be the guardian of peace in the Pacific." The Japanese refer with approval to Article XXI of the Covenant of the League of Nations which expressly recognizes the American Monroe Doctrine as a regional understanding and interpret it as an international sanction of their own regional commitments in China. (Stephen Duggan, Ph.D., *The Two Americas*, p. 157.)

² According to the *Japan Yearbook*, based on the census of 1925, the population density per square mile of cultivated area was 374.1. The annual increase in population, since that date, is estimated at 700,000. *The World Almanac* for 1939 shows that density to be 460. This is among the world's highest; that of the United States is 16.0.

³ The percentage of arable land in Japan was estimated in 1930 at only 15.4; this ratio is lower than Switzerland, the Irish Free State (22), Belgium (40), or Italy (44). (R. Ishii, Ph.D., *Population Pressure*, U. of C. Press, pp. 63-64.)

⁴ The echo of that historical trek for the promised land reverberates through the "Edda," and the legend of "Götterdämmerung" is probably the memory of that arctic night.

sential to a modern, industrialized civilization becomes the dominating factor—a vicious cycle of conflicting interests, in which the pauper nations regard the others with sullen envy.

Coal, iron ore and crude oil are items of supreme importance. Japan's position, in this regard, is precarious and furnishes the impetus for her career of conquest; this urge is unintelligible to people, like those of the United States, who are not subject to such economic pressure, or to those of Great Britain, France and Russia who have, through timely conquests, procured potential economic reserves. Japan's situation as regards strategic raw materials is generally unsatisfactory.

Coal: There is an annual consumption of fifty million tons of hard coal for miscellaneous industrial requirements; as regards soft coal, 60 per cent of requirements comes from Korea and 35 per cent from Sakhalin.

Iron: The strategic reserves in iron ore are definitely limited: only 80 million tons in Japan proper, 4 million tons in Korea but an estimated 750 million tons in Manchukuo. Foreign imports have generally equalled home production, for years; this obvious dependence on foreign sources has resulted in Japan's acquisition of overseas properties, for exploitation, as in Australia, Queensland and the Malay Peninsula.

Oil: Japan's situation is precarious; the annual peace-time consumption is about three million tons against local, native production of one-fourth to one-half million tons only.

d. The eclipse of the white man. While conceding to Japan the economic necessities inherent in an industrialized state in quest of raw materials and markets, it is recognized generally that her record, as in Manchukuo of "squeezing" out competing foreign interests (i.e., a violation of the so-called "open-door" policy), is a tendency that augurs ill for the western powers.⁵

On the other hand, the checkered careers of Chinese war-lords, exploiting their temporary holdings, were no guaranty for peaceful economic development by any interested parties.

Japan's gravamen against China may be expressed in two words—treaty violations; Kawakami in *Japan Speaks* (1932) lists the more important cases, ranging from arbitrary increases in customs duties of a discriminatory character to the development of competitive enterprises and the persecution of Japanese subjects.

The advent of Sun-Yat-Sen brought on an ideological renaissance and the possibility of national unity; but within this ideology lurked the menace of communism, and Soviet influence was steadily active.

In the see-saw of conflicting interests, the Japanese attack crystallized patriotic feeling in a remarkable manner, and Chiang Kai-shek emerged, for the time being, as a truly national figure. Up to a certain point, national disaster has the power of fusion; but, if disaster is too continuous, disintegration may set in. The speed of the unexpected capture of Canton is highly suspicious and has all the earmarks of treason; apparently there are elements in Chiang's military and political entourage that will sell out while the chief is fighting with his back against the wall.

The general implications of the Sino-Japanese conflict are indeed menacing. The studied severity of the Japanese Tientsin "blockade" in which British citizens

⁵ Important current articles (*Saturday Evening Post*, May 7, 1938) represent this view; in the interest of impartial, historical investigation, it should be noted that the U. S. Department of Commerce Bulletin No. 859, on page 36, appears to contradict this conclusion:

Average annual sale of U. S. goods in Manchukuo 1926-1930	\$7,531,000
Sale of U. S. goods in Manchukuo in 1937	\$16,061,000

In the period 1926-1930 Manchukuo was under Chinese dictatorship rule; Japan occupied it in 1932; if the slump in world trade (i.e., the depression) is considered, the annual averages under Japanese rule were still \$7,930,353; in comparison with boom years, our trade in Manchukuo in 1935-36, was off 53 per cent (though steadily increasing), while in China proper it was off 65 per cent. (Ralph Townsend, *The High Cost of Hate*.)

were singled out for embarrassing treatment is more than a local gesture; in the Orient, where "face" is important above everything, an attack on and the possible collapse of British prestige is a very serious phenomenon. The alleged robbing of British women in Japanese police stations⁶ becomes an act of symbolism, which may mark the exit of the white man, the end of the Kipling saga, but the first blow by the colored world was struck at Adowa forty years ago when Italian soldiers fell under the assagais of Menelik;⁷ the sightless eyes of Baratieri's dead peered into the future and may have seen Japanese barricades around a British city and yellow fingers clawing at white women.

In this connection, the views of a competent French observer⁸ are interesting: ". . . the Japanese is not yellow like the Chinese or Mongol or Manchurian. He is not a merchant and if he is an industrialist, it is by necessity. His spirit is disciplined, religious, courageous, proud and artistic; it is like that of a conqueror, sailor, a great noble, or a commander. It is made to command and direct, not to submit. However, this spirit possesses the faculty of adaptation. In 1854, the Japanese delegates boarded an American naval vessel, which was a terrifying novelty to them; they restrained their astonishment, understood and ceded before an evidence of force. The local dignitary, the Daimio, who made this moral surrender, atoned for it by committing "hari-kiri." The Japanese has an overdeveloped sense of honor which does not permit him to allow an injury to go unavenged.

"Recognizing force, the Japanese patiently decided to become strong themselves—with the extraordinary intelligence that differentiates them from the other yellow peoples. They digested massive doses of new sciences; they created factories and shipyards. In 1894 the first trial came in the conquest of Corea, Formosa and the Liao-tung peninsula . . . Tomorrow most of China, Amur and perhaps Australia may pass under their control. . . . The Japanese are a people who know how to command . . . the majority of Chinese, in territories held by the Japanese (Manchukuo), do not want to fight . . . they can finally live in order and prosperity . . . having formed a homogeneous mass, Japan will speak, demand what it wants. How soon? Japan knows how to wait but will not forget. The whites have never missed an opportunity, in their blind vanity, to make the little Japanese drink bitter doses . . . the result will be the expulsion of the whites from the Far East . . . neither the Chinese individualist, nor the Soviet Union, nor the U. S. can do anything to change it. Only the complete, sincere, definitive union of all the whites, federated, for the life of the race, will have a chance of success in the physiognomy of the unpredictable future."

47. CHRONOLOGY OF OPERATION. *a. Japanese expansion: 1895-1938.* A characteristic "incident," the clash of outposts near Marco Polo's bridge on 7 July 1937, started the present undeclared Sino-Japanese war, but the foundations for it had been laid elsewhere, over a period of years. Startled readers of sensational journalism are not usually aware of the historical background of current events. Japan has had collisions with China before; Hideyoshi Toyotomi (1583-1589) conquered Korea and planned a further advance, via Peking in the north and via the Yangtse River in the south—a curious analogy with the modern campaign of 1938. His essential motive was to offset the menacing advent of European powers. History has borne out this medieval "estimate of a situation." The spectacular Japanese renaissance, the "Meiji," in the reign of Mutsuhito (1867-1912), brought on the

⁶ *New York Times*, July 1939, and miscellaneous newspaper reports, in apparent confirmation. *The Illustrated London News*, July 29, 1939.

⁷ See Chapter XI, Par. 55.

⁸ *Revue Militaire Generale* (France), July 1938.

greatest political-economic transformation of modern history: the development of a non-European power to world rank, in a single generation!

Inescapably so, empires are not established by conferences but by conquest; Rome and its great successor, England, have furnished the traditional pattern; Japan has merely followed in the footsteps of its Western European masters. England herself trained that formidable Japanese navy that now hovers over Chinese ports and blockades England's citizens.



PLATE 126. THE PROGRESS OF JAPANESE EXPANSION IN CHINA FROM 1895 TO 1938.

1. Formosa ceded by China in 1895. 2. Port Arthur and the Kwantung Peninsula acquired in 1905. 3. Sakhalin ceded by Russia in 1905. 4. Korea annexed in 1910. 5. Mukden captured in 1931. 6. Shanghai invaded in 1932 and 1936. 7. Manchuria converted into the new state of Manchukuo in 1933. 8. Jehol annexed by Manchukuo in 1935. 9. Anti-Soviet Government of East Hopei formed in 1935. 10. The current invasion of Chahar, Shansi, Hopei and Shantung. The shaded areas comprise the five Provinces of North-China and represent the probable objectives of the Japanese military effort.

In 1932 Japan risked an initial collision in Shanghai; it was a dress rehearsal for later and more serious attempts, though the Chinese defense of the city area was not without credit. In 1933, it strengthened its position in Manchukuo by adding Jehol. The Soviets were not idle; at the expense of China, they occupied Outer Mongolia; its capital, Ulan Bator, became headquarters of the XXXIII Russian Corps, as a token of sovereignty.⁹ Soviet influence supported Red Chinese

⁹ International protests were launched in the case of Manchukuo and Jehol, while this "grab" was ignored.

armies in South China and Kansu; Chiang Kai-shek waged several campaigns against them, on his own account. Japan regarded the spread of communist influence with a jaundiced eye; along the Amur and on the line Chabarowsk-Vladivostok, both opponents developed fortified positions; an eventual show-down was practicable only via Ulan-Bator against the Siberian railway. As a preliminary strategic condition for this plan, the Peking-Tientsin area was needed for military concentrations, and the five Chinese provinces, Shantung, Hopei, Chahar, Shensi and Suiyuan, had to be brought under Japanese influence.

This was the situation when a detachment of the 37th Chinese Division opened fire on a Japanese company engaged in night maneuvers on 7 July in the vicinity of the Marco Polo bridge.

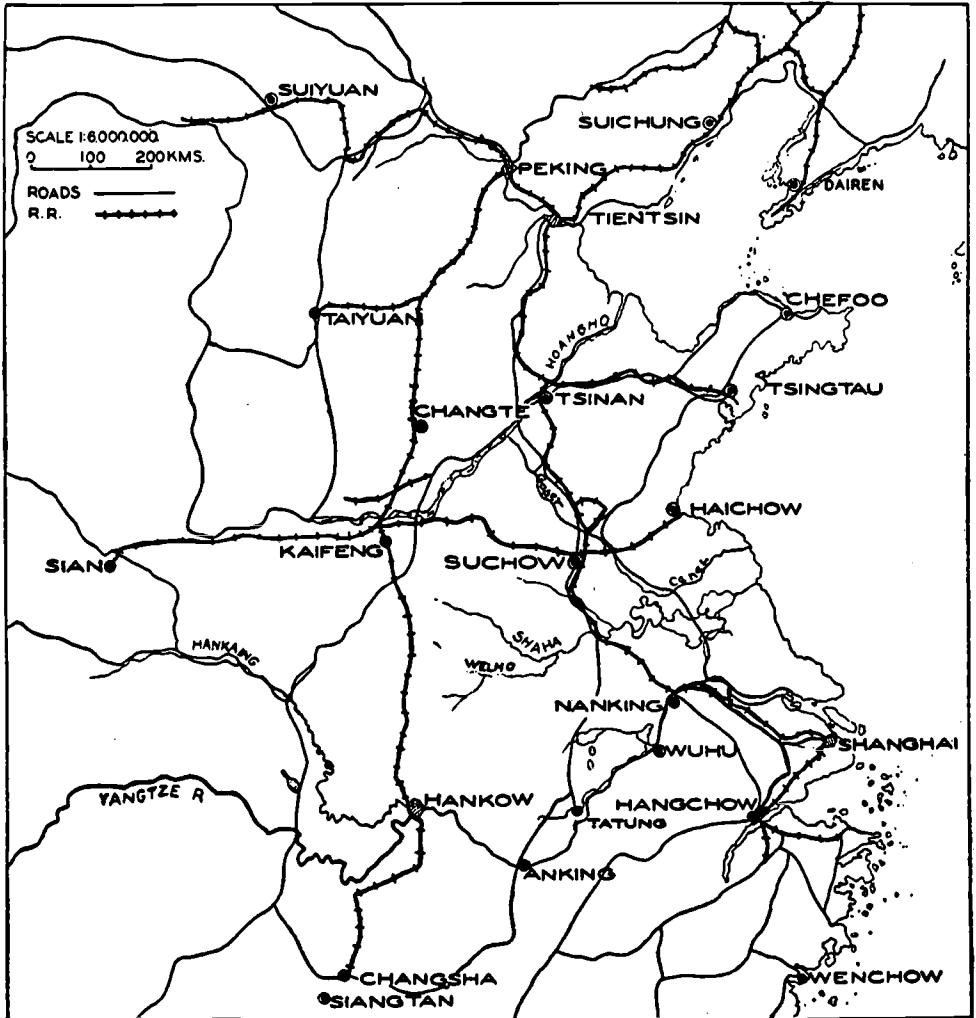

PLATE 127. SINO-JAPANESE THEATER OF WAR.

b. Concentration and strategic deployment. The sequence of operations follows an almost orthodox professional pattern, i.e., the step-by-step progress of modern war, from the seizure of suitable concentration areas, under the pro-

tection of covering forces (which may have to engage in serious preliminary fighting) to the strategic advance and development, in accord with a prearranged plan of campaign.

(1) Seizure of a concentration area. Armies are not assembled in haphazard fashion; serious administrative and logistic problems will have to be met, adequate road and railroad nets, shelter for the concentration and space for the eventual strategic deployment are required; the Peking-Tientsin area satisfied all requirements, as a line of departure of sufficient width, with rail lines to the zone of the interior (i.e., Manchukuo) and the Tientsin-Taku port, as an oversea's advance-base for shipments from Japan. In sharp, localized fighting, Japanese covering forces seized Peking and Tientsin, 26 and 29 July.

(2) Operations of the covering force. In the last weeks of July, Japanese covering forces drove their opponents¹⁰ south of the Yung-ting River; this secured a line of departure for the advance to the south, but the west flank of their concentration, in direction of Nankow, Suiyuan and the Soviets, remained open. The Chinese moved elements of the 89th division via Calgan and quickly occupied Nankow Pass. The Japanese sent a motorized column, 4000 men and 600 vehicles, initially as a covering force, and then threw mass against the position in a combination of frontal attack envelopment and took Nankow Pass.¹¹ The Japanese pressed south, in pursuit, while their Mongol ally, Prince Teh, took Calgan in rear of the Chinese defenders.

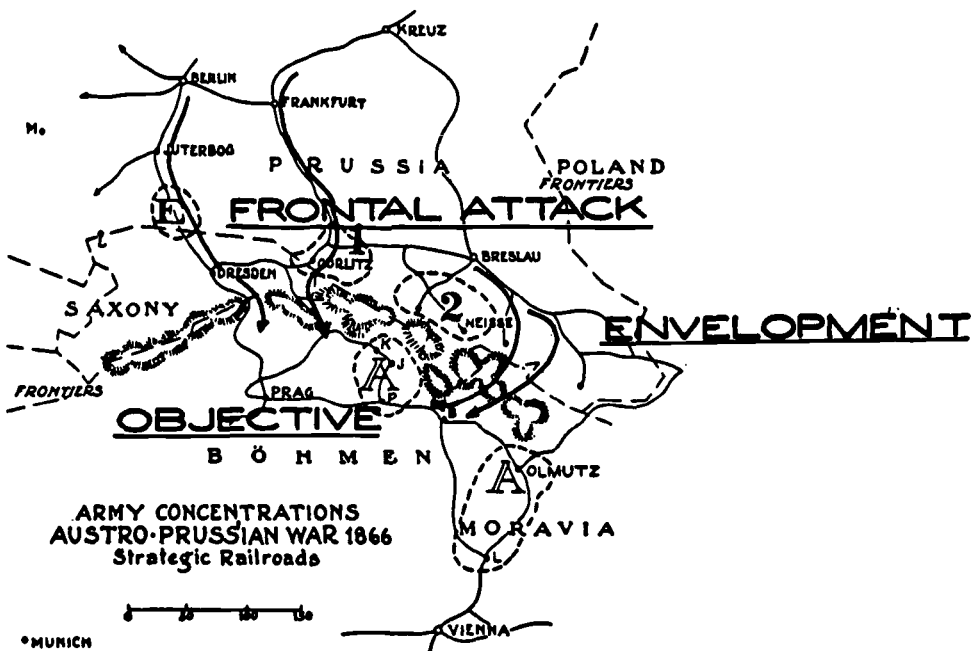

PLATE 128. THE WAR OF THE RAILROADS. A PARALLEL TO THE SINO-JAPANESE CONFLICT.

(3) The war of the railroads. With the south and west boundaries of the concentration area secured, the assembly of a field army of modern composition of 200,000 to 300,000 men proceeded methodically during August; the Japanese

¹⁰ The 29th Chinese Army (30, 31, 33, 37, 38 Div.); Japanese: 2 Manchurian, 3 Japanese Div.

¹¹ See Par. 52 and Plate 146.

were opposed, on a broad front of approximately 160 miles, by three times their number, but their opponents were inadequately organized, with incomplete artillery and transport.

The subsequent advance of the Japanese, i.e., the skeleton framework of their campaign, was strongly influenced by the existing rail net, in a country generally devoid of modern communications and adequate highways.

Four rail lines of the greatest strategical significance traverse North China:

The line: Peking—Suiyuan, via the Nankow Pass.

The line: Haichow—Suchow—Kaifeng—Sian, the so-called "Lunghai."

The line: Tientsin—Tsinan—Nanking, the so-called "Tsinpu."

The line: Peking—Kaifeng—Hankow, the so-called "Pinghan."

While motor transport has become an important item of modern high-speed

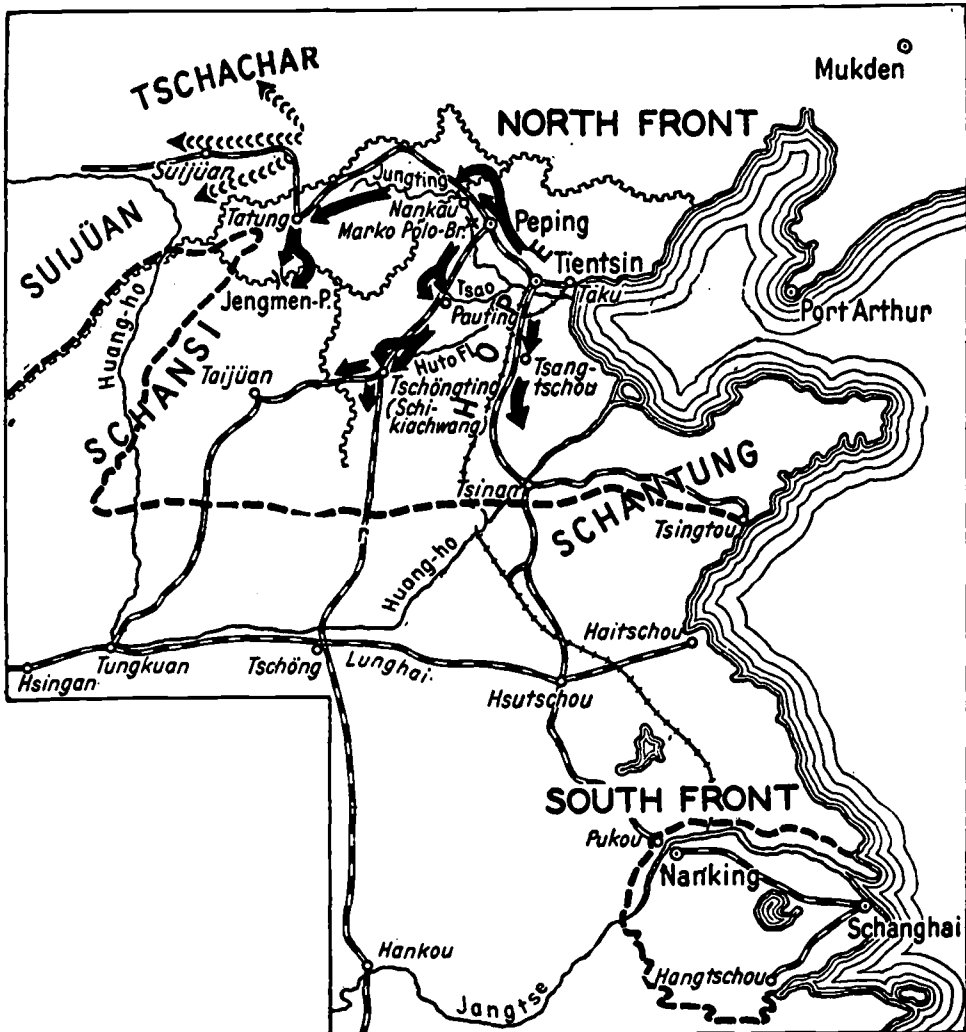

PLATE 129. OPERATIONS ON THE NORTH FRONT, 1937. SEQUENCE OF EVENTS.

July 7—Incident of Marco Polo bridge.

July 26—Seizure of Peking (Peping).

July 29—Chinese coup-de-main in Tientsin.

Aug. 29—Assault on Nankau Pass.

Sep. 13—The capture of Paoting.

Oct. 2—The combat at Jengmen Pass.

Oct. 10—The capture of Schikiachwang.

communication, it can only supplement but never replace railroads; a standard train of 45 cars will deliver 1500 tons; it would be uneconomical, for long hauls, to attempt this volume with trucks; the enormous consumption of class I, II and III supplies for several hundred thousand men is clearly dependent on "volume delivery," i. e., railroads. The World War shows numerous examples of operations undertaken solely for the control or interdiction of railways. The broad lines of the Japanese offensive, in this theater of war, were fixed by the available railroad net.

Once again, we can make a definite historical comparison with a campaign previously covered, viz: the advance of the Prussian armies into Bohemia, in 1866;¹² as in China, the concentration and advance of these armies was predetermined by a limited number of railroad lines; we also encounter the classical factors of frontal attack and envelopment and shall presently see them at play, in China, in the relation of the North and South fronts.

c. Operations on the North Front: 1937. The advance to the south to the Hoang-Ho was conducted in three columns: on the east, General Katsuki followed the "Tsinpu" railroad; in the center, General Nishio advanced along the "Pinghan"; in the west, Itagaki, initially based on Tatum on the Suiyuan railway, moved on Taiyuan into Shansi province. Prince Teh, Japan's Mongol ally, operated along the Suiyuan railway into Outer-Mongolia. The objective of these columns was the seizure of the Lunghai corridor and the control of the northern provinces.

The progress of the three main columns was comparatively swift; in less than three months, the Japanese had overrun approximately half of the northern provinces, a lineal advance of about 300 miles, along a 200-mile front.¹³ Each column encountered successive defensive positions of considerable strength: the east column at Tsang-tschau, 24 September, the center column at Pauting and Schikiachwang, 10 October, the west column at the Jengmen Pass; this column, incidentally, narrowly escaped destruction in a clever Chinese trap.

The initial operations of the Japanese columns advancing south of Peking and Tientsin along the "Pinghan" and "Tsinpu" railroads is characteristic of the war of the railroads and the nature of Japanese maneuver.

On 22 August, the 26th Chinese Army (6 divisions) held a front from Liulihö to vicinity of Tsinghai; the flanks, i. e., rail lines, were held strongly while the center, along the Hun-ho, was covered by one and one-half divisions only. Count Terachi, the Japanese commander in chief, decided on a breakthrough in the center, with preliminary enveloping attacks against the flanks.

The timing of the successive efforts in this scheme of maneuver is significant and affords a glimpse of how the elusive factor of surprise can still be attained in these days of modern observation facilities.

Sept. 11: The Japanese left wing took Matschang, wading hip-deep in flooded terrain, and advanced slowly on Tsangtschau. Chinese reserves were attracted to this front.

Sept. 15: The right wing began the attack against the strong positions of Fangchan and Liulihö. Chinese reserves were drawn to this area.

Sept. 16: The breakthrough is launched at Kuan, with the infantry supported by tanks, heavy artillery and attack aviation; reserves moved through the gap on Tschotschau, in rear of the weakened Chinese position, and took the town on 17 September; another detachment moved on Tinghsing to block the Chinese line of retreat.

¹² See Chap. VI, Par. 27f.

¹³ In order to gauge the remarkable logistic record established by the Japanese in this and other advances, it should be compared with an analogous operation in the World War, the brilliant advance of the Austro-German column after the breakthrough of Gorlice via Lemberg, in 1915. This offensive began on May 2; by the end of June, i. e., within two months, the front had been advanced 250 kms, under favorable climatic conditions. The advance of the Japanese to the vicinity of Changte amounted to 500 kms, i. e., twice the distance involved in the Gorlice offensive. In the west, the occupation of Pautu required an advance of 630 kms and the seizure of Taiyuan involved an advance of 550 kms, in mountainous territory. This astonishing record is not due to the use of motorization which was occasional only, but represents the march performance of foot troops, evidently in the nick of condition.

The Chinese 26th Army, seriously endangered by encirclement, barely made good its escape to the southwest. The Chinese High Command attempted to reorganize along the line: Yitschau—Tsangtschau; the Japanese continued pressure to the south, and this front was kept in motion until December.

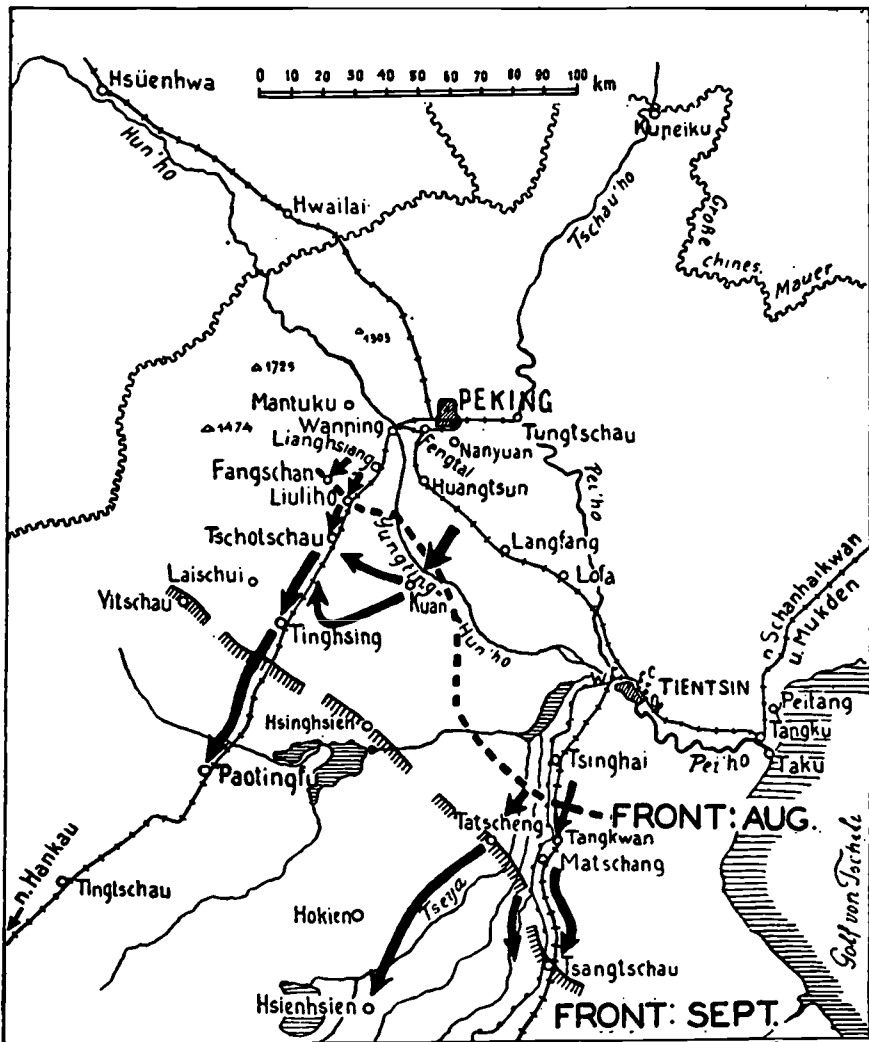

PLATE 130. INITIAL OFFENSIVE IN HOPEI, AUGUST-SEPTEMBER 1937.

The Japanese habitually employed the combination of frontal attack and envelopment; the double envelopment was not uncommon, in spite of their inferiority in numbers; the use of motorized columns for flanking operations appears again and again; the Japanese term this "fan-tactics"; the conception, of course, is not new: we have seen it in Napoleon's advance on Eylau.¹⁴ The units designated for flanking operations were relatively small, independent and organized as "combat teams," containing all arms, including aviation detachments; French observers report the similarity of these organic bodies to the "groupes

¹⁴ Chap. IV, Pars. 19 and 20.

mobiles" of the French in the Riff Campaign;¹⁵ the threat to flank and rear was usually sufficient to force the Chinese to withdraw; this is merely a confirmation of the Napoleonic concept of maneuver.¹⁶ The modern touch is furnished by habitual, close liaison of aviation with ground operations; air units intervened repeatedly in direct support of ground combat and, as in Spain, sometimes took over artillery missions.

This swift advance, based on railroads, slowed down in December, primarily because events on the South Front became of paramount interest.

d. Operations on the South Front: Shanghai-Nanking, 1937. On 9 August, Lieut. Ojama, a marine officer, was killed by Chinese police within the international settlement. Two days later, a Japanese naval squadron appeared before Shanghai and landed 4000 marines; thereafter, reinforcements had to be fed into this sector, until it became a major theater of operations. The storm broke on 13 August; fighting continued with increasing intensity for three and one-half months.

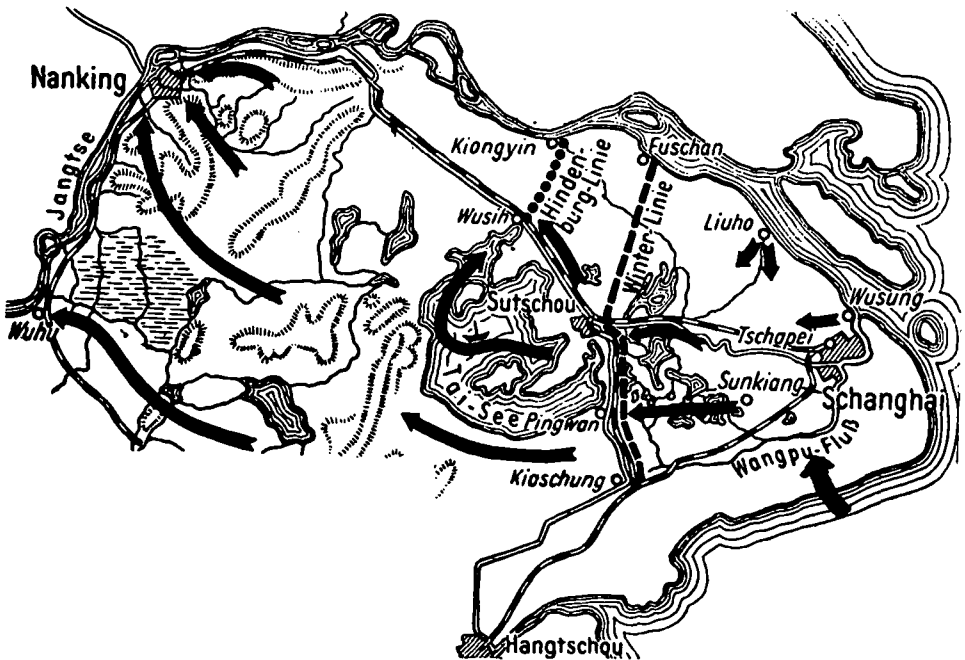

PLATE 131. OPERATIONS ON THE SOUTH FRONT, SHANGHAI-NANKING, 1937.

Aug. 13—Assault of Tschapei.

Aug. 23—Landing at Wusung.

Aug. 28—Landing at Liuhö.

Sep. 13—Attack on Liuhö—Shanghai Front.

Oct. 5-28—Attack on Liuhö—Suchow Front.

Nov. 9—Withdrawal to Winter-line.

Nov. 20—Attack on Winter-line.

Nov. 25—Japanese pursuit and advance on Nanking.

Dec. 12—Assault on Nanking.

Bridgehead operations. The Japanese were faced by markedly superior numbers from the outset.¹⁷ The character of their initial operations was clearly that of joint army-navy actions,¹⁸ landing operations, the establishment and expansion of bridgeheads for a coordinated, general advance into the interior.

¹⁵ M. Leuret in, *Strategie de la Guerre Sino-Japonaise*.

¹⁶ Chap. VII, Par. 32.

¹⁷ The Chinese 87, 88, 98, 59, 69 and Guards Divisions under command of General Tsaitine Kai, who conducted the defense of Shanghai in 1937.

¹⁸ A naval squadron of 20 units, Vice-Admiral Hasegawa commanding, intervened repeatedly in direct support of landing forces.

Under the protective fire from Japanese warships, the initial Japanese bridgeheads at Hongkiu Park and Yukong wharf were precariously held against immense pressure. The narrow bridgehead was enlarged by a landing nine miles north of Shanghai, at Wusung. Five days later, the flanking maneuver of 1932 was repeated and a landing effected at Liuho, in spite of notoriously unfavorable shore conditions.

From now on, the newly appointed Japanese commander, General Iwane Matsui, engaged in step-by-step fighting of increasing ferocity, gaining and losing ground on the front, Liuho—Shanghai. Both opponents steadily increased their forces until an estimated 120,000 Japanese were battering against 300,000 defenders in the Shanghai corridor.

September rains delayed a serious offensive in a veritable morass of canals; mechanized vehicles and heavy artillery were immobilized; supplies had to be handled by coolie carriers and 5000 pack animals—a nice example of Japanese foresight. Reinforced to 225,000, Matsui attacked late in October and forced the Chinese to rearward lines. On 6 November, the outflanking maneuver of Liuho was repeated: two divisions landed 30 miles behind the Chinese lines, and their south flank was opened. Shifting to the north on 13 November, that flank was then attacked, and the Chinese withdrew to the “winter-line,” a previously prepared strong position.

This position rested on the south on a series of lakes, regarded as a serious tactical obstacle; the resourceful Japanese enveloped this flank, employing flatboats and motor launches of Japanese make; simultaneously, a successful penetration of the center was staged in seizing Sutschou through a bold coup-de-main; this brought on the collapse of the “winter-line”; thereafter, the Chinese engaged in delaying action in successive positions; once again, the envelopment of a flank, the transport of troops across Tai Lake, turned the new position and by forced marches the Japanese reached Nanking on 12 December.¹⁰ A southern column took Wuhu, on the upper Yangtze, to cut off the retreat of the remnants of the Chinese forces, while the main body attacked the city of Nanking from three sides; the city fell within a few hours. Scenes of the wildest disorder ensued in a barbarous sack of the doomed city, which recalled the merciless record of Ghenghis Khan.

While the Chinese deny it, there is a prevailing opinion that the creation of the Shanghai Front was provoked by Chiang Kai-shek, against the advice of his foreign staff; it is possible that he did not care to send his best divisions north of the Yellow River; perhaps he hoped to embroil Japan with foreign powers who had heavy investments in Shanghai, sixth largest city in the world.

The Japanese would hardly have embarked on this expensive enterprise which clearly divided China into two separate theaters of operation, while a major effort already taxed their resources elsewhere; however, the net result was the framework of a strategic envelopment of stupendous size, in which the enveloping force operated on the axis: Shanghai—Sutschou—Nanking, while the frontal attack followed the present North Front to the Lunghai corridor; the historical analogy, suggesting itself immediately, is again the Austro-Prussian Campaign of 1866, in its decisive phases, i.e., the operation of the Prussian First and Second Armies against Königgratz.

e. Operations against the Lunghai corridor, 1938. (1) Tactical and strategical considerations. In the wake of the collapse of the Shanghai Army, its remnants withdrew in various directions; the Japanese High Command saw no reason to

¹⁰ On that date, the U.S.S. “Panay” was sunk by Japanese aircraft while anchored in the Yangtze River twelve miles above Nanking.

pursue them in a major effort. An immediate advance on Hankow presented a difficult line of communications except via the Yangtze River, which was still blocked by a number of booms.

An advance northward, in direction of Suchow, was of greater promise, especially if coordinated with an advance toward the south by the left wing of Terauchi's Northern Army. The Lunghai railroad, it will be recalled, is a great arterial line, a "rocade," linking the "Tsinpu" and "Pinghan" railroads, and represents in its western branch (Kaifeng-Sian) the gate to Russia and the point of entry of a continuous stream of war materiel.

A simultaneous, coordinated advance from the north and south would cut this

FRONTAL ATTACK-MAIN ATTACK

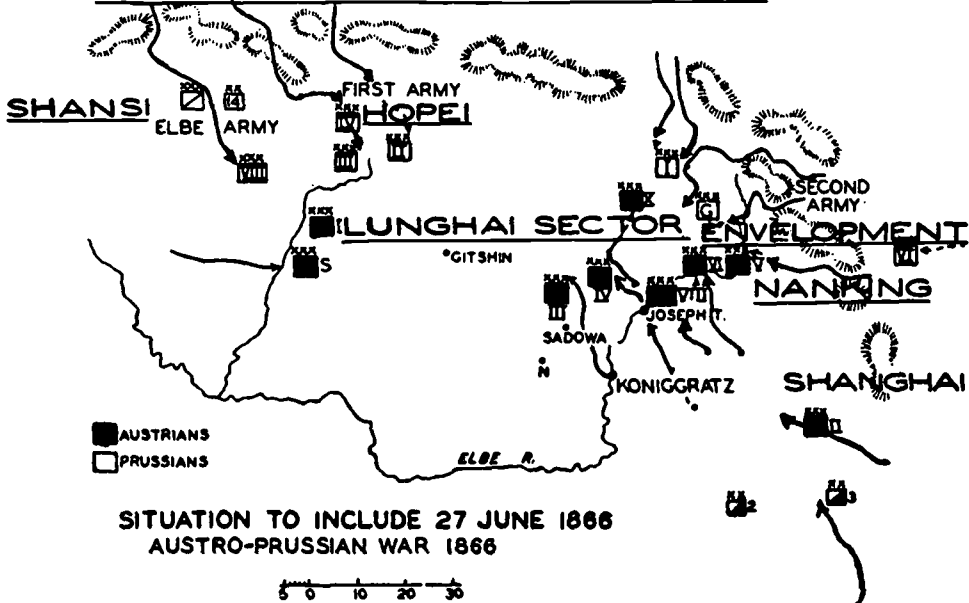

PLATE 138. THE WAR OF THE RAILROADS. A PARALLEL TO THE SINO-JAPANESE CONFLICT.

artery in vicinity of Suchow (Hsuchou), an important rail center, encircle the Chinese forces in that area, or push them westward; consequently, the Lunghai corridor became the next Japanese objective.

It is obvious that the capture of Suchow in itself could not have an immediate decisive effect; it was expected that Chinese reinforcements would pour into this area—and they did; Chiang Kai-shek made the defense of the Lunghai the great military issue of this war! In keeping with the characteristic feature of modern large-scale campaigns, battle is not a single act but the aggregate of many subsidiary acts, a series of progressive efforts coordinated in time, space and relative weight.²⁰ The entire length of the "Lunghai" was bound to be affected; Suchow became one of several objectives; indeed, the Kaifeng area farther west was even more important as the junction of the "Lunghai" with the "Pinghan" railroad over which all Chinese troops in the corridor were supplied from Hankow.

Reflecting on the military distances involved, the Napoleonic concept of the Japanese High Command was never more clearly demonstrated than when it shifted from the initial attack on Suchow, as it slowed down, to extend to the west

²⁰ Chap. IV, Para. 17 and 18.

and threaten the entire "Lunghai" front, with the main effort in direction of Kaifeng; when it was found later on that the mass of Chinese forces was committed within the corridor, the Japanese quickly shifted again, resumed operations in Shantung and forced a decision in the battle of Suchow. The subsequent advance west, in an envelopment, while the line of the Lunghai was contained frontally,

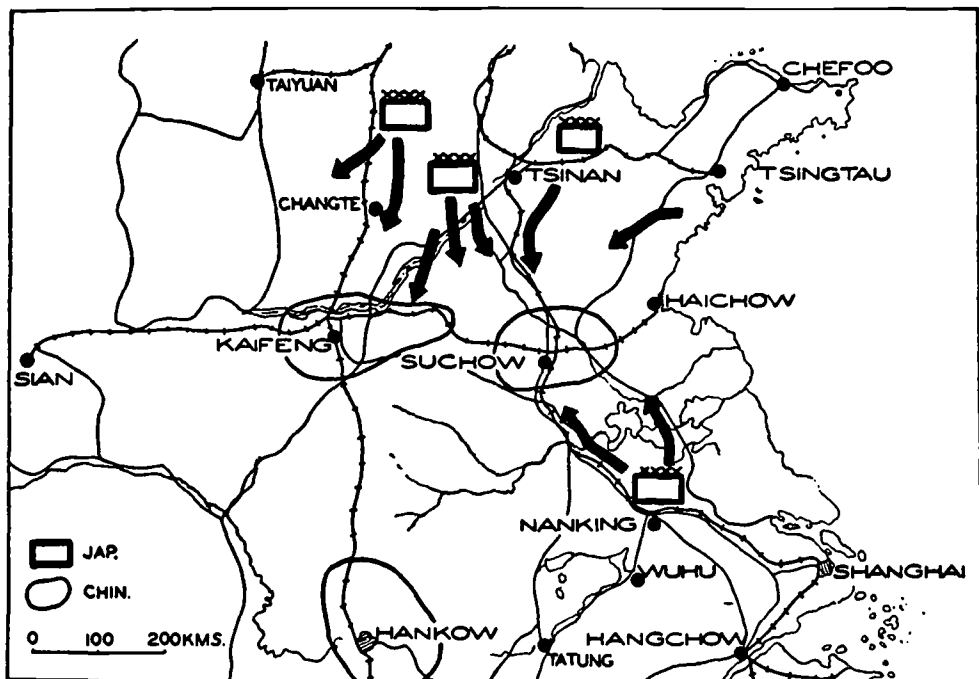

PLATE 133. OPERATIONS AGAINST THE LUNGHAI CORRIDOR, 1938.

cleared the corridor in hard fighting and opened the avenue for an advance on Hankow, the last stronghold of organized Chinese resistance. The timing, tactical characteristic, and sequence of these operations (1938) is interesting:

January	Japanese Left: Operations in Shantung (Envelopment)
February	Japanese Center: Advance on Kaifeng (Breakthrough)
March	Japanese Right: Operations in Shansi (Flank Security)
April	Japanese Left: The Chinese Counteroffensive: Tayerchwang (Defensive)
May	Japanese Left: A Japanese Major Offensive: Suchow (Main Effort)
June-July	Japanese Ensemble: The Envelopment of the Corridor (Pursuit)
Aug.-Oct.	Japanese Ensemble: Operations against Hankow (Exploitation)

(2) Operations in Shantung. The Japanese Second Army, in the north, faced Tsinan; the crossing of the Hoangho was effected on 23 December. Tsinan fell on the twenty-seventh; the Chinese Shantung divisions, under a lukewarm commander, offered feeble resistance. Tsingtau was taken and fresh troops started west from this port. The Japanese right wing, however, ran into stiff resistance along the Grand Canal; by mid February, the line stabilized on the front: Tsining-Yih sien.

The advance of the First Army from the south, in three columns, made fair progress initially; the Wai River line was reached by the end of January, but strong Chinese counterattack held their opponents thereafter on the front: Pengpu-Huntze Lake.

(3) Advance on Kaifeng-Chengchow. The advance of the Japanese First

and Second Army was not only stopped but seriously hampered by continuous Chinese counteroffensives; the Japanese estimated that this effort must have drawn forces from western "Lunghai"; consequently early in February, they reinforced their Third Army on the Changte Front and began an advance in several columns. They succeeded in reaching the north bank of the Hoangho and holding it generally in spite of serious Chinese counterattacks; this army thereafter remained in position as a threat to the vital Kaifeng-Chengchow area.

(4) Operations in Shansi. The Eighth Chinese Army (Communitic) and numerous guerrilla had been able to threaten all Japanese communications in this province, thereby constituting a constant threat against the right of the Japanese northern armies. Operating from Tayuan, the Japanese Fourth Army advanced generally along the Tayuan-Tungkwan Railroad and parallel mountain roads; elevations of 7000 feet give an indication of the terrain difficulties encountered; the Japanese detached a force from Changte, to take the Chinese in rear; this detachment covered 140 miles in six days. By the end of February, the Japanese reached the Hoangho and established an effective western barrier and flank security for the ensemble of their armies in the east.

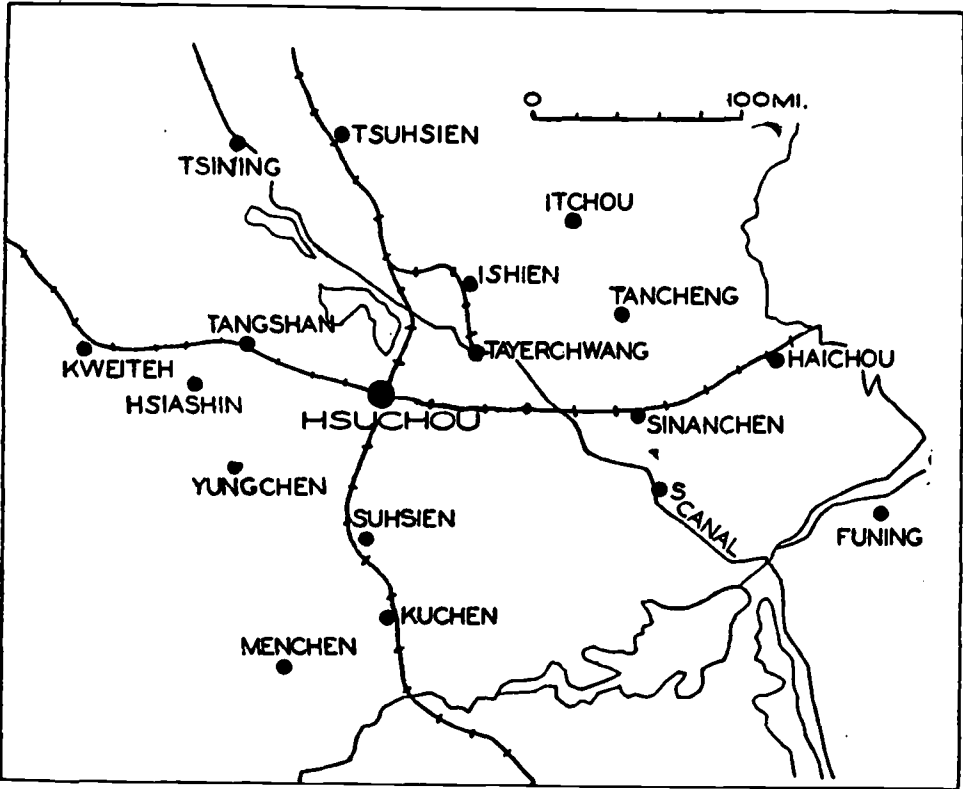

PLATE 134. THE HSUCHOU-TAYERCHWANG AREA, APRIL 1938.

(5) The Chinese Counteroffensive: Tayerchwang. The center of gravity shifted from the western end of the Lunghai to its eastern mouth and the railroad junction Hsuehchow.

In this sector the Japanese slowly continued south in the direction of Hsuehchow and reached the line: Tsining-Tayerchwang. Chiang Kai-shek, in the meanwhile,

had amassed enormous reinforcements in this area, evidently for a major counter-offensive; the numerical superiority over the Japanese forces was estimated at 6 to 1. In reckless attacks, the Chinese seriously endangered their opponents; the precarious Japanese communications to the north were cut repeatedly; Tayerchwang changed hands several times. For the first time in recent history a Japanese unit was to be defeated, although through overwhelming numbers. Japanese reinforcements, in particular the 10th (Isogai) and 11th (Itagaki) Divisions, attempted to regain lost terrain; in bitter fighting, from 27 March to 3 April, they took Tayerchwang only to find themselves completely cut off; escape to the east was blocked by inundations, since the Chinese had blown up the levees of the Grand Canal; 30 tanks, 77 field pieces and hundreds of trucks were mired; the Japanese lost heavily; only General Itagaki, with a few thousands, cut his way through to the north where he took up and held a defensive position at Ishien. The remnants of Isogai's Division were massacred.²¹



PLATE 135. TAYERHCHWANG, 3 APRIL 1938.

Stung to the quick, the Japanese rushed reinforcements to this front; both North and South Armies were increased by four divisions each;²² nevertheless, the Japanese were still confronted by superior numbers, an unsatisfactory ratio that prevailed throughout this war, and a tell-tale index of the efficacy of troops with adequate modern equipment over improvised organizations.

(6) Japanese major offensive: Hsuchou, May 1938. In the first week of May, both Japanese armies began a coordinated advance on Hsuchou, from the north and south; the five columns (corps) of the northern army, from right to left, advanced on the following objectives:

- First column: West of Tsining (TSI) on Kweiteh (KW)
- Second column: Vicinity Tsining on Tangshan (T)
- Third column: Tsining on Hsuchou
- Fourth column: Tsuh sien (TS) on Tayerchwang (TA)
- Fifth column: Itchou (IT)—Tancheng (TAN) on Sinanchen (S)

²¹ The moral effect of this set-back was considerable, but the tactical consequences were negligible and could not stop the Japanese in their final drive on Hsuchou.

²² The North Army was composed of ten divisions, operating in five columns. For the first time in the war, the Japanese employed several regular divisions, from Manchuria, which had been in positions of readiness for the ever-present, possible showdown with Soviet Russia.

The southern army started its advance: on the right, Satō's column reached Funing (F); his neighbor was stopped at Sunsien (S). The main column, following the Peking Railroad, ran into stiff resistance at Kuchen (K) and Menchen (M), but by a series of outflanking movements with motorized units pushed northward to Yungchen (Y) and finally Hsiashin (H); this column, with 40 tanks and heavy artillery, ran into a fresh Chinese division, poorly armed, and broke right through it; that night, 6000 Chinese attacked the Japanese, in bivouac, in corral formation, but were repulsed. The Chinese fought gallantly in every sector of this widely dispersed battle area.

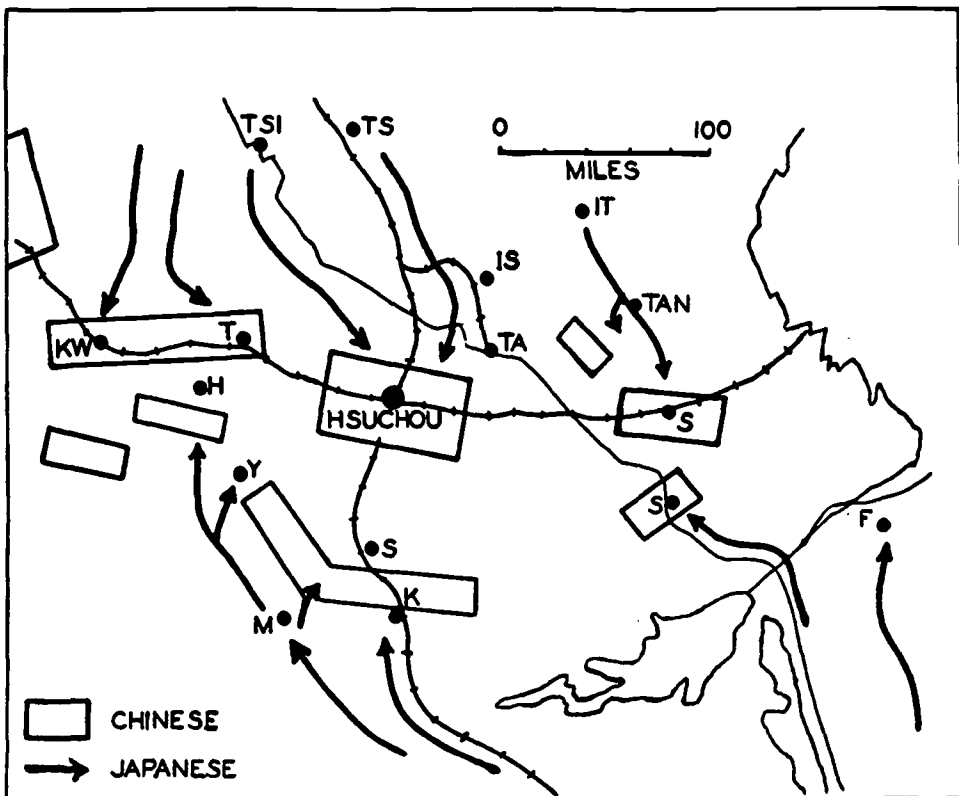

PLATE 136. THE JAPANESE MAJOR OFFENSIVE: HSUCHOU, MAY 1938.

In the north, the columns attempting to cut the Lunghai at Kweiteh (KW) and Tangshan (T) were repulsed. On the line Hsuehchiang-Tayerchwang (TA), the Japanese ran into a prepared position, and they were promptly slowed down. It was apparent that this front could not be broken easily and that gains would have to be made by the flanking columns; battering against organized positions, from 14 to 17 May, the third column slowly made headway: on the right, the fifth column fought against superior numbers, in a ratio of 1 to 5, but cut the "Lunghai" on 15 May, at Sinanchen. On the twentieth, contact was made with the leading elements of the southern army.

Elements of the left column of the southern army turned north on Suhsien and collided on 16 May with strong Chinese forces fighting desperately; these were divisions withdrawing from Hsuehchiang; the Japanese stood fast, but wide intervals

between adjacent units enabled the bulk of the Chinese to make a get-away to rallying positions in the west.²²

After 16 May, the northern army made definite progress, and the right and center reached the outskirts of Hsuchou (Hsutschau) on the nineteenth. The city fell after a heavy bombardment in which 200 aircraft participated; a surprisingly

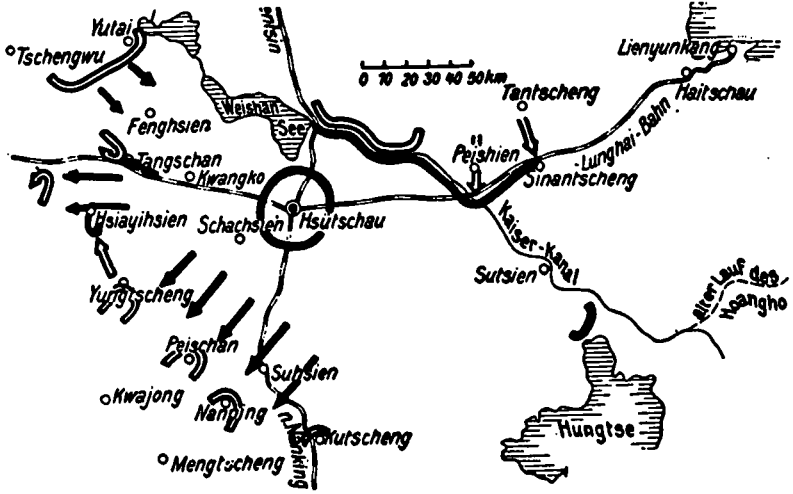

SITUATION: MAY 15, 1938

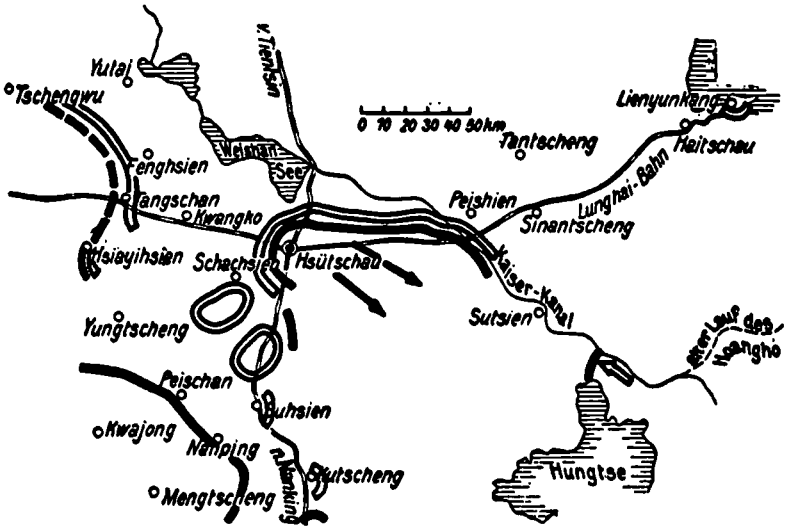

SITUATION: MAY 18, 1938

PLATE 137. THE BATTLE OF HSUCHOU, 15-18 MAY 1938.

small number of defenders fell into Japanese hands; the bulk of the garrison escaped in an incredible detour, slipping through Japanese columns. However, the great mass of Chinese divisions, containing the best available units, had been

²² The Chinese troops were ably led by General Li-Tsung-Yen.

severely handled in pitched engagements, and their morale and power of organized resistance were definitely lowered.

(7) The envelopment of the corridor. Within a few days of the fall of Hsuehou, the Japanese organized the pursuit along the axis of the "Lunghai," with Kaifeng as the next objective.²⁴

In accord with accepted procedure, in pursuit, detachments were sent on Tchu-kaikou to intercept the Chinese retreat on Hankow, while in the corridor itself the 14th Japanese Division²⁵ attempted to block the flood of retreating columns, far in rear, at Kaifeng; this place was taken on the twenty-fourth, but this small division found itself immediately confronted by overwhelming numbers and was surrounded. It held Kaifeng until the twenty-eighth, then broke through the cordon to the north; with incredible tenacity, this outfit battled for its life until pressure was relieved by the subsequent Japanese advance within the corridor itself.

This progress was contested step by step; heavy fighting took place at Kweiteh and Ningling.²⁶ The Japanese finally took Kaifeng on 6 June. It was calculable at the moment that the Chinese in the Tchengchau-Kaifeng area were trapped and their retreat on Hankow seriously threatened.

The Chinese High Command then made a grave decision: on 12 June, the levees of the Hoangho were ordered cut and the surrounding country was flooded for hundreds of square miles; the Hoangho, in this area, is at a level approximately 25 feet above the adjacent plains. This artificial disaster stopped any further Japanese operations in this sector but brought death and ruin to hundreds of Chinese villages and hamlets.

Equally determined and far more resourceful, the Japanese High Command promptly abandoned the line of the Lunghai and shifted its operative advance against Hankow, across high ground and along the Yangtze valley.

f. Operations against Hankow: 1938-1939. The Japanese Navy, while usually in the background of events, has engaged in effective joint army-navy action on numerous occasions, as at Shanghai and in the advance on Nanking; in the operations along the Yangtze, its intervention was to become of the utmost importance; this navigable river is a direct avenue of approach into Hankow; the Chinese had constructed a number of booms, supported by shore batteries and fortifications; it was the arduous task of the navy, over a period of months, to clear the river. By 12 June their work made possible the seizure of the city and port of Anking.

The Japanese plan involved a general advance along the axis: Hsuehou—Hankow, on the north, and an advance in the Yangtze valley, in the south, with the major effort probably on the south wing; the front of this advance was roughly 300 miles. The Chinese had organized positions for successive defense, utilizing the river to the utmost, especially in vicinity of Kiukiang, and the Lushan mountains, north and south thereof, with elevations ranging from 3000 to 6000 feet. The defenders, under General Tschen Tscheng, were estimated at 500,000 to 1,000,000 men.

The Japanese advanced in two columns in the river valley and along the foothills; the river column was continuously supported by naval units, and its action became an endless series of landing operations to reduce local resistance; the northern column had to cope with flood waters and fought a bitter, step-by-step advance. It took the better part of July to finally capture Kiukiang, the gateway to Hankow.

²⁴ See Plates 133 and 134.

²⁵ General Doihara, commanding, the "Lawrence" of China, for many years negotiator for the Japanese Government in North China.

²⁶ One hundred twenty-five thousand men, ably commanded by the Chinese General He Tsung.

It is characteristic of the Japanese maneuver concept that the advance in several columns, as a habitual formation, developed tactically into frontal pressure supported by envelopments and flanking operations; this is, of course, a planned procedure; there is a continuous alternating play of frontal attack and envelopment in units of all sizes. Viewing the advance up the Yangtze as a frontal assault,

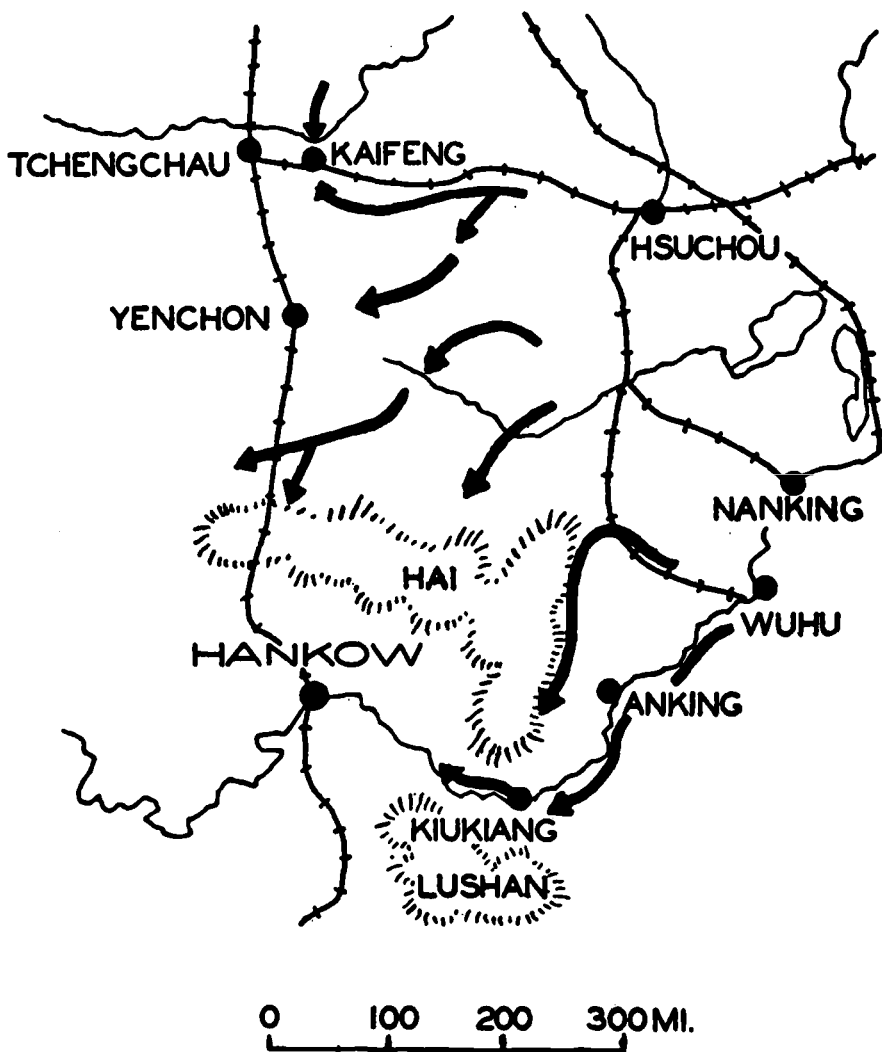

PLATE 138. THE ADVANCE ON HANKOW.

then the northern columns operating from Hopei represent the envelopment on a large scale; in August, these columns²⁷ were reinforced and proceeded to slug their way west, while the main effort, as a "breakthrough," continued on the line: Kiukiang—Hankow.

The Chinese poured more and more men into the Kiukiang²⁸ front. The Japanese, on the other hand, realized that a breakthrough at this point was unavoi-

²⁷ Prince Maruiko, commanding.

²⁸ One hundred thirty numbered divisions were identified in this general area, Kiang Kai-shek's last levee of organized units.

able, since the control of the Yangtze furnished a safe and reliable line of communication and simplified supply.

During October, the column operating on the river was able to push steadily forward, but the heaviest fighting fell to the columns branching to the south and southwest, with Nantschang and Tschangscha, as objectives, or at least the interception of the railway to Canton; bitter combats were reported north of Nantschang.

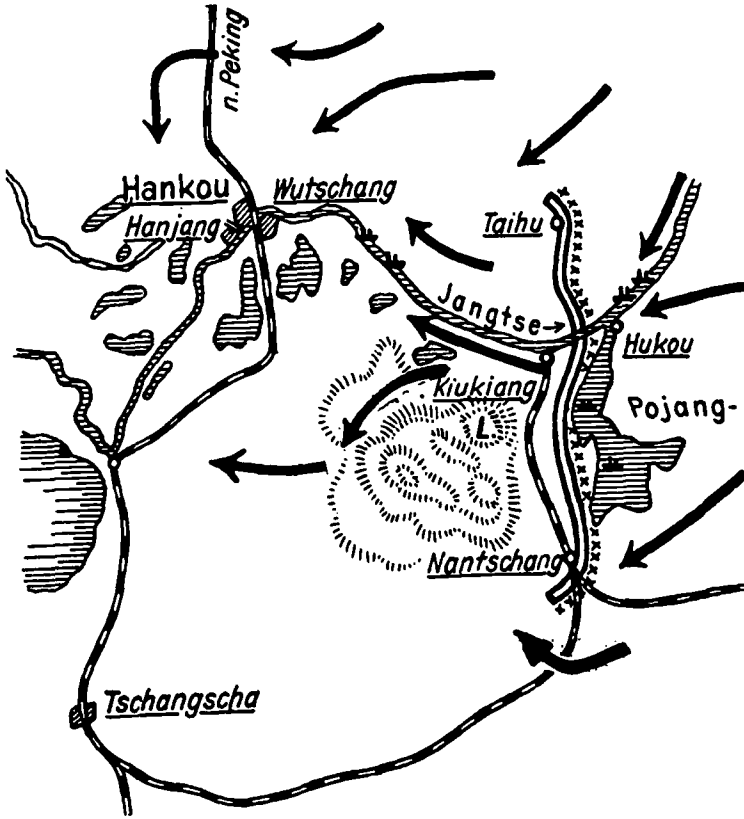

PLATE 139. THE CAPTURE OF HANKOW.

The final story is monotonous in a recital of stubborn rear-guard actions by the Chinese, of outflanking maneuvers by their mobile opponents. On 26 October, motorized Japanese elements entered Hankow, while the remnants of the Chinese armies were retreating into the western provinces, and Chiang Kai-shek set up his capital in Chungking. A few days before the fall of Hankow, another blow fell on the generalissimo; Canton, since the fall of Shanghai the principal remaining port of entry for the Chinese, was captured. Thereafter, the problem of supplies and ammunition must loom large on the horizon.

After cleaning up the Hankow area, the Japanese pushed south and took Youchow, about 100 miles south of Hankow, on 12 November; thereafter, a lull set in in this area until the spring of 1939 when the Japanese made a surprise move on Nanchang, took the city on 28 March and cut the last remaining railroad to the east coast. The Japanese have been consistent in their drives on widely scattered objectives; they not only sought the military defeat of the armed forces of the enemy but lost no opportunity to strangle him economically, in cutting every important line of communication and supplies.

The capture of Canton was perfectly timed to coincide with the critical phases of the great battle of Hankow, which strained Chinese man power to the utmost; many southern divisions were identified in this struggle, and the Japanese estimated that weakness existed in that area. The operation against Canton was a classical, joint army-navy action. The initial landings were at Bias-Bay, which

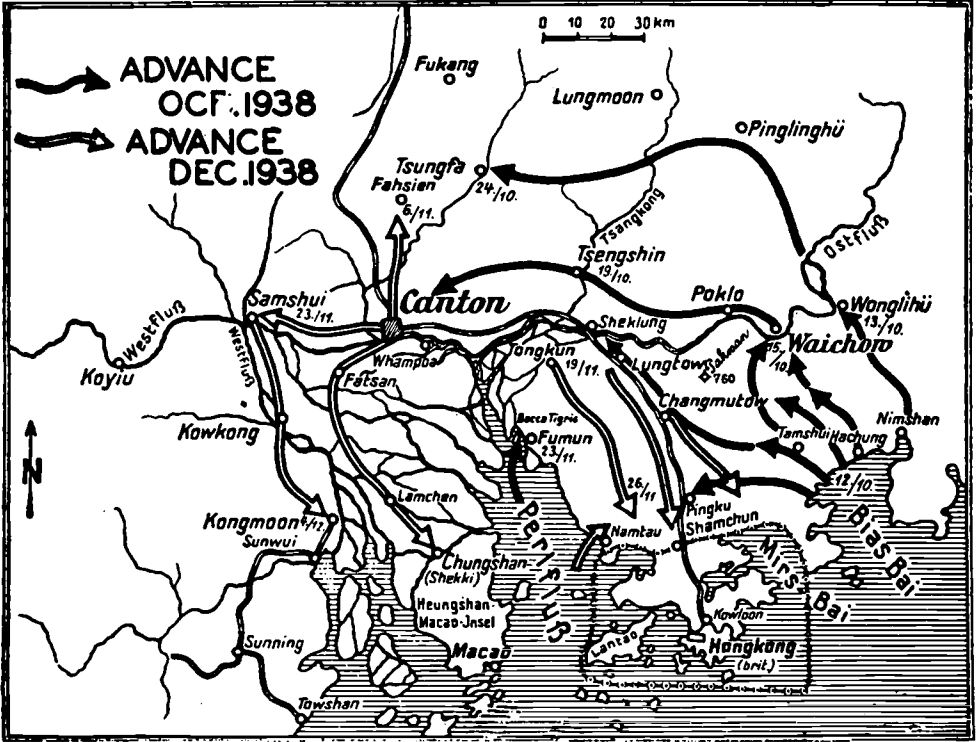

PLATE 140. THE CAPTURE OF CANTON.

had a bad reputation on account of swampy areas; the initial bridgehead was widened rapidly; by 15 October, the Japanese had 60,000 men available. The overland advance of this army, in several columns, proceeded without encountering serious resistance²⁹ while the fleet attacked the Boca Tigris forts and opened Pearl River. At 3:30 PM, 21 October, motorized advance guard elements entered the city. The Chinese fell back to a semicircular position about 100 miles north and west of Canton.

48. THE PROBLEM OF CHINESE SUPPLY. The fall of Canton represented the loss of the last remaining rail communication with the outside world; since the fall of Shanghai, 85 per cent of war shipments had entered via Hong Kong and Canton; the loss of this vital port of entry left only two practicable routes for supply: in the north, the ancient "silk-route" from Soviet territory with the terminal point at Sian; in the south, the caravan route from Yunnan to Lashio, in British-Burma, and the narrow-gauge railroad to Haiphong, French Indo-China. The northern route comprises a distance of 2000 miles, with mountains of 18,000 ft. and passes of

²⁹ The Japanese covered 190 kms in 8 days, an average of 21 kms a day, fighting several actions, over routes that had been demolished to some extent.

6,000 ft. elevation intervening; the caravan route to Yunnan has been improved for motor traffic since 1937 by a veritable army of thousands of Coolies.

This "life line" is by no means a modern, high-speed motor road, but an improvisation, with make-shift bridge and culvert construction. Apparently, this road is serviceable, since it is reported that 500 to 1500 motor vehicles operate on schedule, in groups of 10 trucks; there is a daily dispatch of three to six groups,

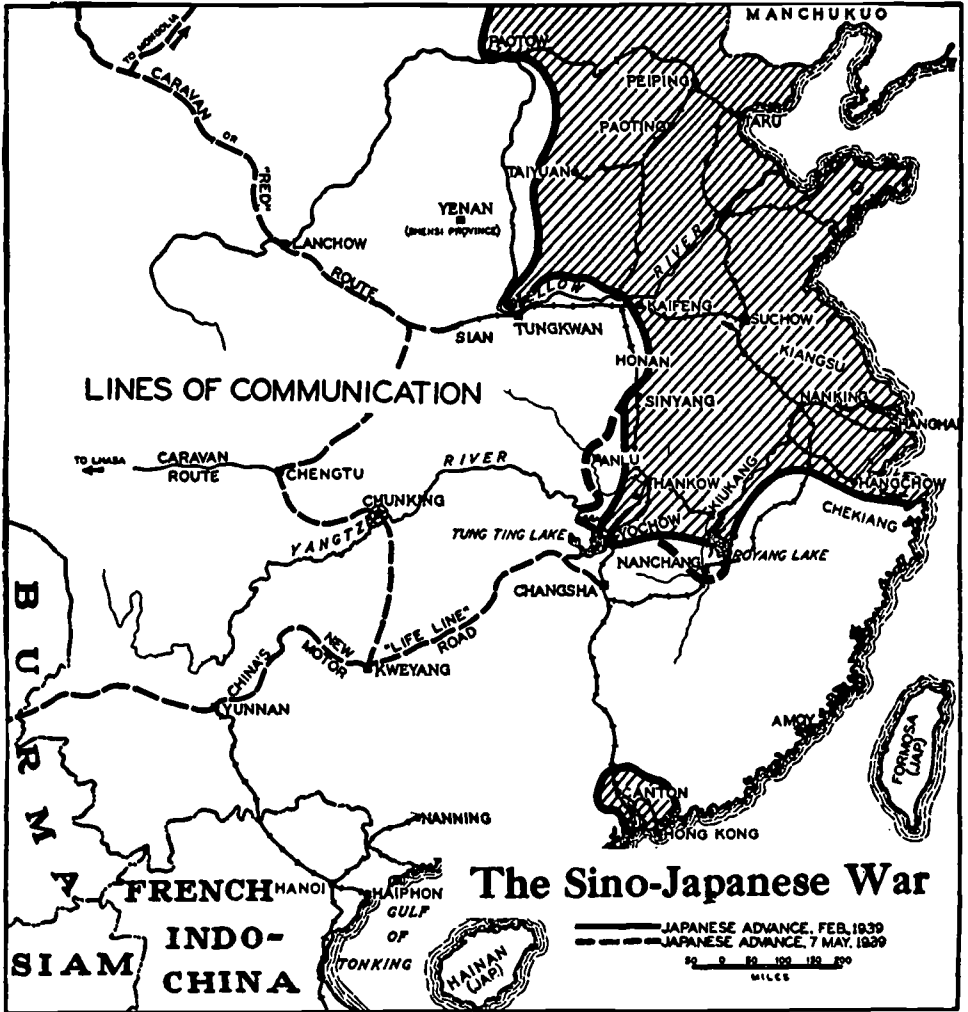

PLATE 141. LINES OF COMMUNICATIONS, 1939.

i. e., 30 to 60 trucks in convoys. Ten days are required ordinarily from Lashio to Yunnan, i. e., roughly 60 convoys are in continuous operation. The enterprise is managed as a civil commercial monopoly, the "Southwestern Transport Company, Rangoon." Assuming a conservative figure of 30 trucks (3 tons) arriving daily in Yunnan, the useful tonnage is from 75 to 150 tons; if this tonnage is restricted to munitions and weapons (Class II, III and IV), it might suffice for an average Chinese corps of two divisions.

The possibilities of adequate supply over this limited road net, in construction,

are at best accompanied by unusual difficulties. An American opinion ²⁰ puts this in a nutshell: ". . . Transfer the theater of war to the United States. An invader has occupied all territory east of the Mississippi; the battle line extends from Minneapolis to New Orleans, with base depots at Seattle, Los Angeles and Brownsville. The northern front is being supplied over a single motor road from Seattle to Kansas City, while the southern sector draws its munitions from Los Angeles and Brownsville. Kansas City and Tulsa, Oklahoma, are forward depots three to four hundred miles from the actual front lines. How long could 'West' operate offensively under such conditions?" ²¹

Average professional opinion would conclude that operations would henceforth be limited to the defensive and exclusive guerrilla operations, as a direct effect of this precarious supply factor.

49. A TUG-OF-WAR. GUERRILLAS AGAINST REGULARS. Guerrilla warfare is not to be underrated. Napoleon found it extremely dangerous in Spain, and the Grande Armee was as good or better in its days as the Japanese armies of today.

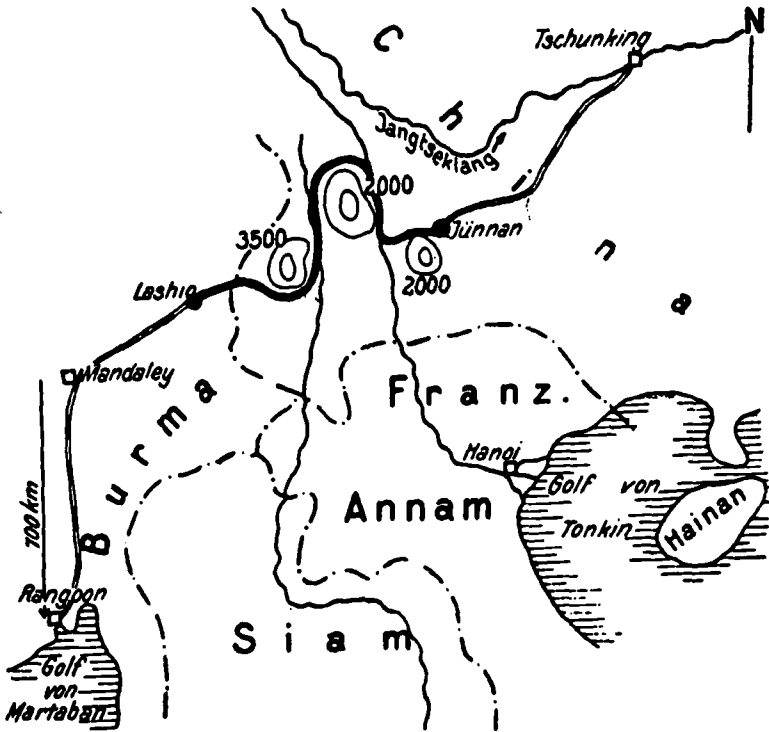

PLATE 149. THE "LIFE LINE": LASHIO-YUNNAN.

Armies of occupation in territories overrun by patriot bands are on continuous nerve-racking alert; such an army is not popular, at home, in enemy country, and with itself, and watchful waiting is apt to become very tiresome. Cavour once remarked: "You can do anything with bayonets except sit on them."

Chinese bands of considerable size appear to operate as guerrillas in rear of the Japanese forces and along their lines of communication. The extent of these activities can be judged from the record of Japanese operations; from October

²⁰ Major J. W. Coffey and Lieut. J. Rudolph, C. & G. S. S. *Quarterly*, No. 71, 1939.

²¹ See Plate 147.

to December 1938, over 200 separate expeditions, of varying size, had to be undertaken in central China.

The record for January, in Shantung, Hopei, Honan and Anwhei is 197; in Shansi, 327 separate actions.

As late as December, the "Pinghan" Railroad was repeatedly interrupted; sporadic fighting broke out in all western provinces, particularly in Shansi. The end is not in sight; the lot of Japanese units on lines of communication duty is not to be envied, but this sort of war is not apt to bring on a decision. The Japanese Regular, acclimated in victorious campaigns, is easily a match for the guerrilla, the "hit and run" fighter, but the nuisance value of this type of warfare is unquestionable.

The possibility of occasional counter-offensives is not excluded; there is still plenty of fight left in the Chinese. As late as April, coordinated attacks of considerable strength were delivered along the entire front from Shansi to Canton: operations against Kaifeng⁵², against Nanchan⁵³, and against the bridgehead of Canton.⁵⁴

Although these attacks were eventually brought to a standstill, they showed considerable vigor and took the Japanese by surprise. Chiang Kai-shek stated in a press interview on 18 April that "peace was out of the question . . . meanwhile the (Japanese) militarists are being dragged deeper and deeper into a swamp from which it will be difficult to extricate themselves . . . Japan will be reduced to the status of a second-class power as the result of the prolonged resistance of China."⁵⁵

50. STATISTICS OF CONQUEST. Japanese G. H. Q. communiques of the period,⁵⁶ furnish a bird's-eye view of the extent of operations, relative losses and extent of front,⁵⁷ viz:

Japanese losses:	47,133 killed.
Chinese losses:	Shanghai: 81,000
	Nanking: 83,000
	Hsuchou: 123,000
	Hankow: 195,000
	Guerrillas: 98,000
Captured material:	208,000 rifles
	11,000 M. G.
	12,000 sabers
	680 field pieces
	1200 trench mortars
	560 trucks
	2200 railroad cars
	13,000,000 rifle ammunition
	2,300,000 hand grenades
	817,000 shells
	1,700,000 mortar shells, etc.

The Japanese front had an extent of approximately 2,000 kms; this is about four times as long as the West Front during the World War. The front in South China is approximately 425 kms, i. e., twice as long as the front in the battle of Mukden, 1904-5. The area occupied by the Japanese comprises seven provinces: Chahar, Suiyuan, Hopei, Shantung, Kiangsu, Anwhei and Honan; this is an area

⁵² General Yu-hsueh-tchun.

⁵³ General Lo-tchoying.

⁵⁴ Regular Chinese divisions were identified as the 151, 152, 154, 159 and 160th.

⁵⁵ Journal, Royal United Service Institution, August 1939.

⁵⁶ For the first eighteen months of the war.

⁵⁷ *Militärwissenschaftliche Mitteilungen*, April 1939.

twice as big as the Japanese Empire, or about 1,151,696 square kms. The area of China still under Chiang Kai-shek is about 3,204,588 square kms; i. e., the Japanese area represents 46 per cent of the original domain. Compared with greater China, 15 per cent is occupied by the Japanese but within this space is located 39 per cent of China's total population.

51. CHARACTERISTIC TYPES OF MANEUVER. While the advantage in training and equipment is all on the Japanese side, the Chinese were generally able to throw a heavy superiority of numbers into the scale. Operating on the defensive, an inferiority in armament was not as noticeable, and once again, as at Shanghai, the defensive in organized positions proved a hard nut to crack. The Japanese solution was maneuver, generally a combination of frontal or holding attack combined with the envelopment and flank attack. We are, once more, in the presence of our traditional factors, mass and direction!

It is arguable that the Spanish Civil War, especially in its last phases, is more significant than the Sino-Japanese conflict, because the former employed more modern, latest type armament; nevertheless, the scale and range of operations of the Japanese armies represent the picture of modern war and the modern manipulation of large masses; every "type" of operation, if that term is permissible, is represented.

- | | | |
|---|---|-----------|
| 1. Assembly of field forces: the strategic concentration. | a. Seizure of Peking and Tientsin areas. | Plate 127 |
| 2. The operations of covering forces. | a. Seizure of Ying-ting River. | Plate 129 |
| | b. Attack and seizure of the Nankow Pass. | Plate 146 |
| | c. Initial landing operations in Shanghai. | Plate 131 |
| 3. The strategic advance in several columns. | a. The effect of the railroad net. | Plate 127 |
| | 1. Advance along Suiyuan RR. | and 128 |
| | 2. Advance on Tayuan. | Plate 129 |
| | 3. Advance along the Pinghan RR. | |
| 4. The collision: The battle on a broad front. | a. The front: Liuliho-Tsinghai. | Plate 130 |
| | b. The front: Liuho-Shanghai. | Plate 131 |
| | c. The "winter-line": Shanghai. | |
| | d. The battle of Hsuchou. | Plate 137 |
| Timing of successive efforts. | a. Initial offensive in Hopei. | Plate 130 |
| | 1. Japanese left wing: Matchang. | |
| | 2. Japanese right wing: Liuliho. | |
| | 3. Japanese center: Kuon. | |
| Frontal attack and envelopment. | a. Operations on the South Front. | Plate 131 |
| | 1. The Maneuver of Liuho. | |
| | 2. The envelopment of the "winter-line." | |
| | 3. The envelopment via Lake Tai. | |
| | b. Operations against the Lunghai corridor. | Plate 133 |
| | c. The capture of Hankow. | Plate 139 |
| | d. The capture of Canton. | Plate 140 |
| 5. Pursuit. Exploitation. | a. The advance on Nanking. | Plate 131 |
| | b. The envelopment of the Lunghai corridor. | Plate 133 |
| | c. The advance on Hankow. | Plate 138 |
| 6. Joint Army-Navy action. | a. Operations in vicinity of Shanghai. | Plate 131 |
| | b. Advance on Nanking. | |
| | c. Advance on Hankow. | Plate 138 |
| 7. Supply and logistics. | a. The problem of Chinese supply. | Plate 141 |
| | b. Relative distances: Sino-Japanese War. | Plate 147 |

No army, however, has a monopoly on maneuver or tactical combinations; the Chinese have made a good showing on several occasions, considering the lack of

MANEUVER IN WAR

trained officers and staffs. As an example, the operations of the 142d Chinese Division in northern Kiangsi, in the period 26 September to 16 October 1938, show flexibility, tactical skill and command capacity; this division was by no means an elite division.

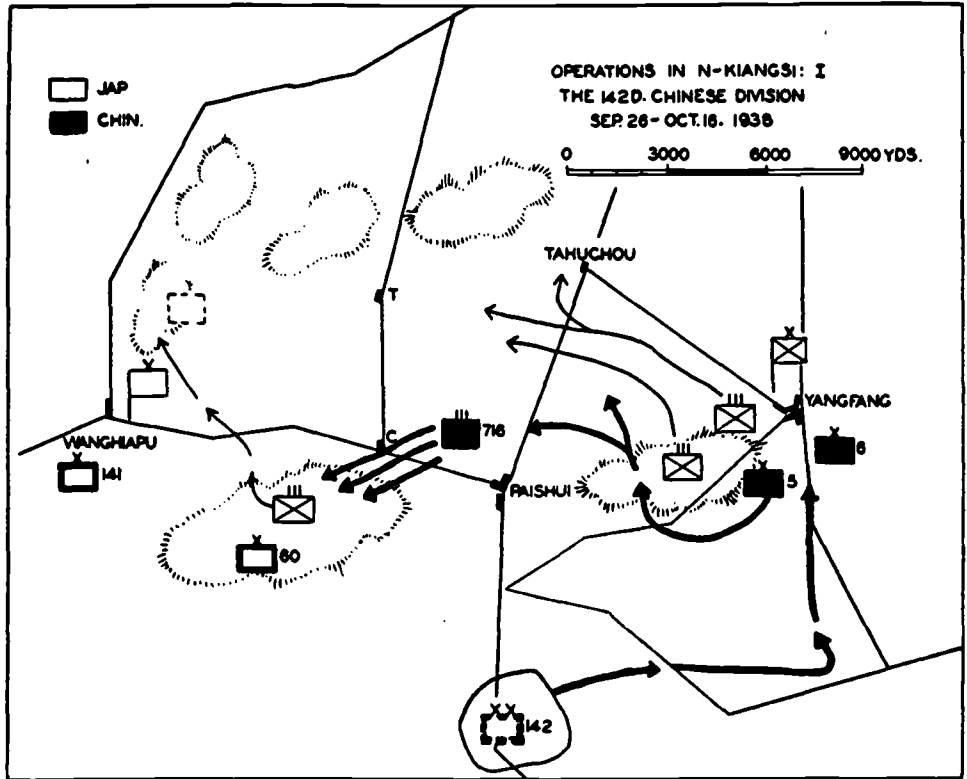

PLATE 143. THE 142D CHINESE DIVISION, 26 SEPTEMBER-16 OCTOBER 1938.

In a general advance to the south, two Japanese brigades had reached the vicinity of Wanghiapu and Yangfang; they encountered elements of the Chinese 141st and 60th Divisions east and west of Paishui and attacked; the Chinese held precariously.

On 25 September, Chinese reinforcements arrived from the south: the 142d Division, General Li Han-hun commanding. The division moved against the Japanese eastern column to positions below Yangfang and attacked on the twenty-sixth; the attack was continued for several days. The Japanese fell back, but they were still holding the high ground southwest of Chuchiatang (C).

At this point, the pursuing Chinese were ordered to remove the enemy from what was obviously a position threatening the flank of any further Chinese advance; the 716th Infantry was ordered to take the hill. One battalion was held in division reserve, leaving the regimental commander two rifle battalions, reinforced by a battery of 75-mm, two 37-mm guns and eight mortars.

Orders reached him at 3:00 PM; the line of departure was 2000 yards from his objective. Preceded by a screen of scouts, the companies advanced initially in column of twos. Darkness and rain set in, when the attack was launched; the support-

ing fire, however, was effective and greatly encouraged the men (who were evidently not used to efficient artillery support); the Japanese gave way, and the Chinese occupied the position at 10:00 PM.

On the next day, the pursuit continued, when reports reached the commander that fresh Japanese columns were advancing from east and west.

The 142d Division was hastily recalled and moved south via Paishui.

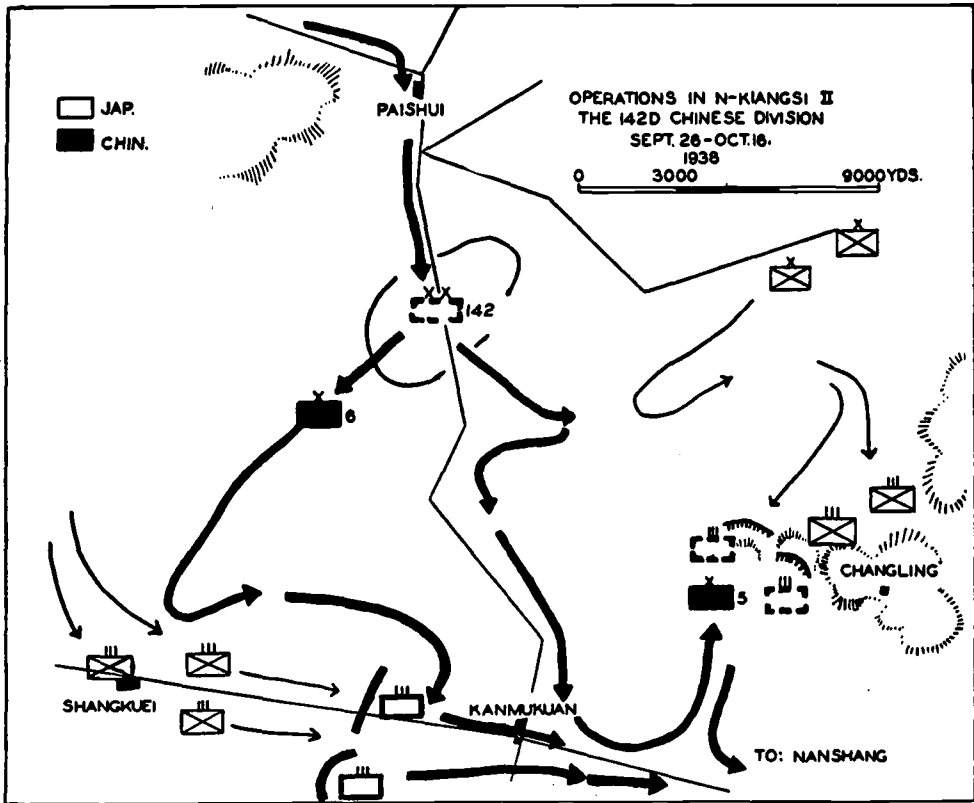

PLATE 144. THE 142D CHINESE DIVISION 26 SEPTEMBER-16 OCTOBER 1938.

By 4 October, the division was about 9 miles north of Kanmukuan; the 6th Brigade turned southwest to attack the Japanese main column in flank; the 5th Brigade turned east, made a demonstration against the Japanese columns and then, in a wide detour, gained the high ground west of Changling; they stopped a Japanese attack on the seventh and counterattacked on the eighth; by the tenth they had fought the Japanese to a standstill.

The 6th Brigade did not fare so well and was compelled to fight delaying actions to the eleventh. With remarkable coolness, the Chinese commander then shifted the 5th Brigade to assist the 6th; with their backs exposed to the Japanese eastern column, the division slipped away on the sixteenth in the direction of Nanshang.

52. TACTICS AND TECHNIQUE OF SEPARATE ARMS. *a. Aviation.* The Japanese employ current types of planes (pursuit, observation, attack, etc.) with bombing planes predominating; they are known as 87, 88, 91 and 92 types, principally of

Japanese manufacture; speed and armament vary from 150 to 180 miles per hour, twin M. G.'s and bomb loads of 1200 to 2200 lbs.⁸⁸

Bombardment aviation was primarily active against hostile airdromes; the Japanese employ incendiary and fragmentation bombs (20 to 100 lbs.) and high-explosive types (110 to 450 lbs.). Raids were carried out in relatively large groups of 30 to 40 planes.

Direct cooperation with ground forces, however, is no exception; besides power dives and M. G. fire, small fragmentation bombs (20 lbs.) are employed; each plane carries from 30 to 40 such bombs.

Initially, Chinese opposition was weak until foreign planes, especially Russian, became available; both sides claim to have scored success—the Chinese report downing 300 to 600 Japanese planes; the Japanese claim from 800 to 1100.

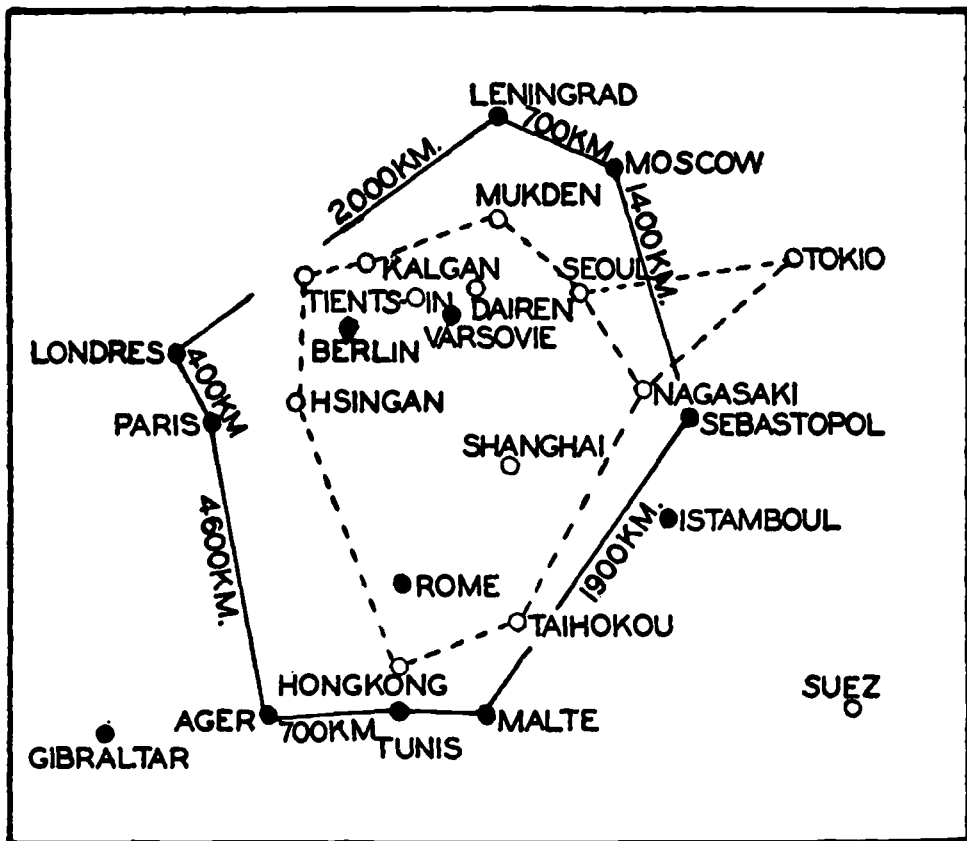

PLATE 145. AVIATION PERFORMANCE AND COMPARATIVE THEATERS OF WAR.

Japanese naval aviation, because of more modern equipment and longer flight ranges, has been very active; some remarkable long-distance missions are on record. Foreign observers, however, are not impressed with any outstanding achievement

⁸⁸ Japanese types: *Pursuit*: Nakadsuma 91, monoplane; motor: Jupiter VI and VII, 450 H.P.; ground speed: about 160 miles per hour; ceiling: 39,000 ft.; armament: 2 Vickers M.G. Kawasaki 92, biplane; motor: M.W.-VI, 600 H.P.; ground speed: 200 miles per hour; ceiling: 40,000 ft.; armament: 2 Vickers M.G. *Observation*: Kawassaki 88, 2-seater, biplane; motor: B.M.W.-VI, 600 H.P.; ground speed: about 130 miles per hour; ceiling: 26,000 ft.; armament: 4 M.G.'s. Mitsubishi 92, motor of same name, 420 H.P.; ground speed: 130 miles per hour; ceiling: 26,000 ft.; armament: 4 M.G.'s. *Bombardment (Light)*: Kawassaki 88, motor: B.M.W.-VI, 600 H.P. (Medium) Kawassaki 87, two motors: B.M.W.-VI. (Heavy Night Bomber) Junkers 5-38, four motors: Rolls-Royce 800 H.P. each; ground speed: 130 miles per hour; armament: 7 M.G.'s, 1 cannon. (Russian Sources.)

or innovations; this is partly due to quality in equipment and the vast extent of the theater of war; Plate 145 shows relative distances between the principal European airdromes in comparison with the approximate theater of operations in China:

In this area, from 800,000 to 1,000,000 men are locked in conflict, supported by about 1000 airplanes; considerable as these figures are, they dwindle in strategical and tactical significance when they are compared with an analogous situation in the western European theater of operations, where 25,000 airplanes could be set in motion to support 10,000,000 men.

b. Infantry. As in Spain, infantry still remains the basic arm. The march performance of both Japanese and Chinese infantry is of the highest order. The Chinese soldier has stood a severe test in Shanghai and in Hsuehou; the great strength of infantry, on the defensive, was again demonstrated, but maneuver and the offensive have always gained a decision.

The Japanese have given evidence of extraordinary tactical flexibility; it is recognized that they operated against superior numbers in practically every important battle; the adverse ratio was as high as 7 to 1. The available man power and partial training led the Chinese to adopt dense formations and solid fronts; these fronts were habitually turned by their opponents in the classical application of the factors of mass and direction. Japanese reports indicate that they operated in mobile detachments of 1500 to 3000 men, reinforced by artillery and tanks; frequently motorized, these combat groups were able to select favorable assembly areas and launch surprise attacks in decisive directions; a disposition, in echelon of other similar groups within the framework of divisions (corps), favored maneuver combinations and swift, tactical groupings.

Infantry weapons were adequate although high-angle, supporting fires were required in combat for villages and localities; mortars and grenade-projector units had to be organized for liberal attachment to infantry.

c. Artillery. The terrain imposed the use of high-angle fire, howitzers and mountain guns; the organic divisional artillery, deficient in this category, was reinforced according to need by special artillery groupments. Frequently, pack artillery was found most useful, especially in the western provinces. Heavy artillery support is characteristic of the Japanese attack, while Chinese failure is often traceable to a lack of artillery. The Japanese have employed medium and heavy calibers. The artillery-infantry team has been excellent, on the whole, in Japanese armies; a characteristic example of this team play, the terrain difficulties, as well as the capacity of the Japanese for maneuver is to be found in the operations of the Japanese 5th Division at Nankow Pass 3-24 August, 1937.

On 1 August the 5th Japanese Division, consisting of the 11th, 21st, 41st and 42d Infantry, was engaged in the Peking area. A regiment of the Chinese 89th Division occupied Nankow Pass and entrenched. This defile, 26 miles northwest of Peking, is a most important terrain feature and the natural gateway to Suiyuan. Oddly enough, the Japanese failed to occupy it initially.

On 10 August, they started a belated attack; the division had been reinforced by three batteries of 105-mm, two batteries of 75-mm, and 25 light and medium tanks.

While the preliminary movements were under way, heavy rains converted the plain over which the Japanese had to operate into a veritable quagmire; the pass itself is mountainous, with steep, rocky slopes.

The artillery was in action for several days, without seriously touching the Chinese defenders arranged in tiers of foxholes; the tanks were unable to operate. The walled town of Nankow was taken on the thirteenth, but the pass held out until the twenty-fourth; frontal attacks were repulsed several times; the Japanese

losses were 3000 killed and wounded. The Japanese finally resorted to an enveloping movement; two depleted battalions made their way over a difficult trail south-west of the pass; when they appeared in their rear, the Chinese defenders withdrew.

d. Mechanized and motorized units. The war found Japan in the midst of a partial program of motorization and mechanization; it was contemplated to form, within each division, a mechanized regiment, to consist of:

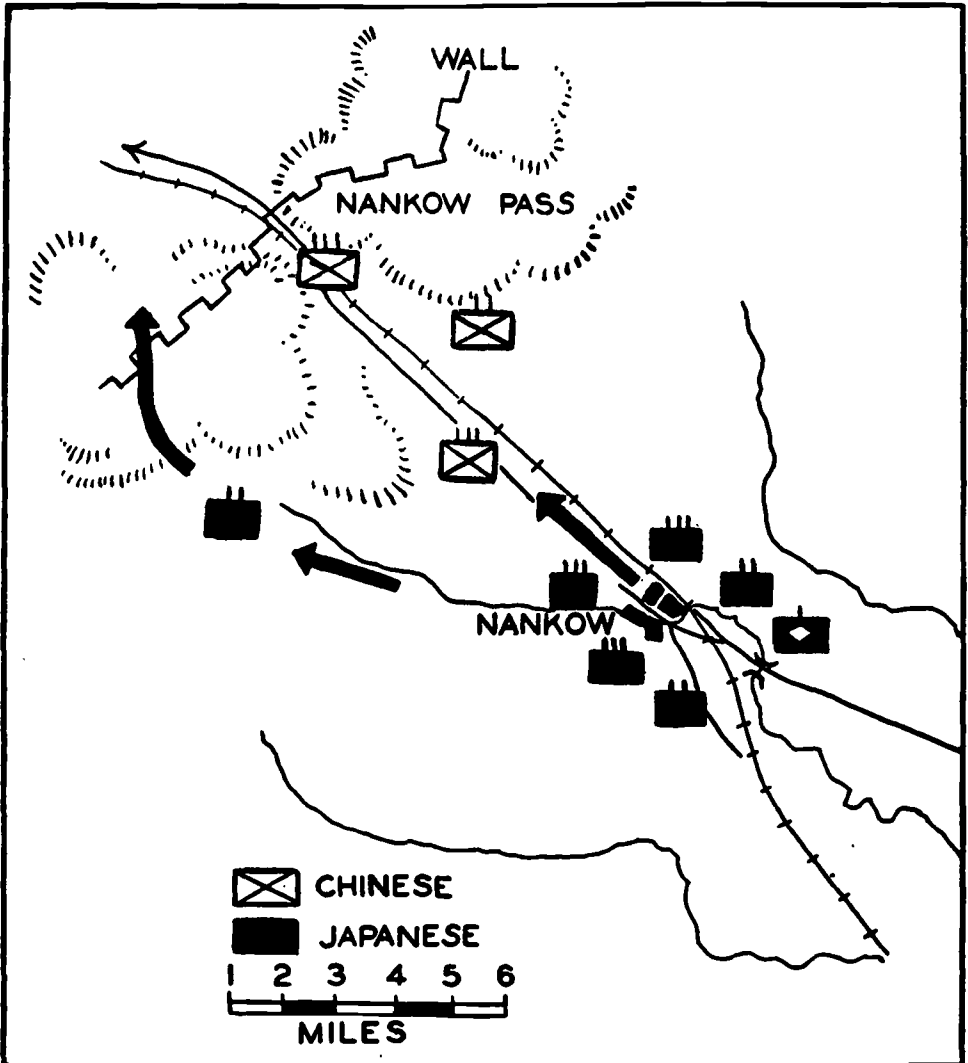

PLATE 146. THE OPERATIONS AT NANKOW PASS, 3-24 AUGUST, 1937.

- 1 Company light tanks: Carden-Lloyd VI
- 1 Company M. G., motorcyclist
- 1 Company armored cars, mixed
- 1 Battery F. A., motorized
- 8 Companies infantry, truck-drawn

There are several important examples of the use of such motor-mechanized units

or similar combinations, notably in the advance on Canton, on Hankow and in the far-flung operations in Shansi.

During the war, light and medium tanks were much in evidence, with several foreign models, viz: the French 2-C, the "Christie" and Vickers. In 1937 a new medium tank made its appearance, model 94, of 14 tons; it has a speed of about 30 miles per hour and is armed with a 37-mm gun and M. G., in turret mounts; the armor is reported to be from 6-mm to 12-mm in thickness. For reconnaissance purposes, a small 3-ton type, model 92, is employed; it has a speed of 30 miles per hour and is armed with one M. G. in a turret mount, with an all-around traverse; armor varies from 8-mm to 14-mm in thickness; this "tankette," or a similar low-silhouette model (chenilette), was also used for ammunition supply in fireswept zones.⁵⁹

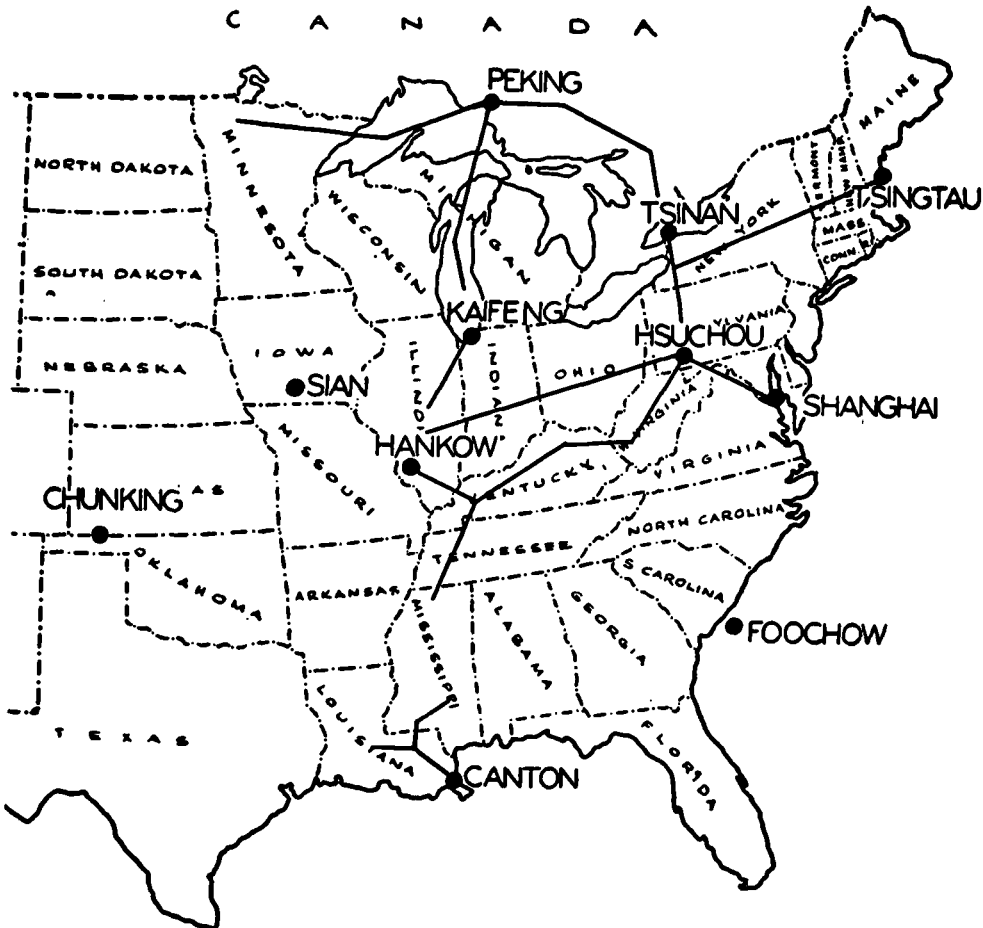

PLATE 147. RELATIVE DISTANCES IN VARIOUS SINO-JAPANESE CAMPAIGNS, 1937-1939.

53. FUTURE DEVELOPMENTS. The Sino-Japanese War is probably less revealing than the Spanish War; it lacks its technical character; there is nothing novel or startling in tactics except, perhaps, the remarkable endurance and march perform-

⁵⁹ *Militar Wochenblatt*, 1936.

ance of the Japanese soldier; perhaps this applies with equal force to the Chinese, who made a surprising showing, but it was the Japanese who generally had to fight against superior numbers.

The bombings of Shanghai, Hankow and, lately, Chungking were neither more nor less destructive than similar bombings of Barcelona, Teruel or Madrid, but Japanese aviation has flown some remarkable long-distance missions and their close-in reconnaissance must have been efficient and explains the frequently risky Japanese maneuvers, with relatively weak columns; except for Tayerchwan, they usually succeeded.

In the field of strategy, in staff work, in concept and execution of maneuver, however, the Japanese High Command has established a high performance record.

From a strictly professional viewpoint, the colossal range of Japanese operations is of Napoleonic proportions; note the lines of operation superimposed, to the same scale, over a map of the United States for a comparison of relative distances in miles: military performance of this character, extent and quality is proof of high efficiency in staffs and troops. There is an odd similarity between the Sino-Japanese War and the struggle of the Confederacy in the American Civil War; in the respective theaters of war, New Orleans and Washington are approximately in the same relative locations as Canton and Shanghai.

The "Anaconda" plan, which throttled the Confederacy by blockading its eastern ports while the drive on Vicksburg cut it in half, is duplicated in the seizures of Amoy, Foochow and Canton and the drive on Hankow. The American Civil War, so "modern" in many of its aspects, lasted four years; the decision then was brought about by economic pressure as much as by military factors; the South was dependent on imports of foreign war material, just as China is today.

Predictions are fashionable nowadays but not necessarily accurate. The problem of Chinese supply has been pointed out; it can be assumed, however, that British, French and Russian war materiel will continue to come in; in fact, foreign financial and material assistance may play as great a role in China as it did in Spain; it may also bring increasing international tension; the whole stage play in Tientsin is a gesture of resentment and protest by the Japanese General Staff against this foreign support. The British were singled out because they have more at stake and the volatile Americans are too dangerous to fool around with.

The last silver bullet may yet become decisive, but the Japanese government appears to understand this; extraordinary military, economic and financial measures are resorted to to prepare for a war of long duration; if the Japanese have underrated the power of Chinese resistance, the world in turn has underrated Japan's economic stamina.

The per capita debt of Japan is reported as \$76, that of the United States as \$300, and of Great Britain as \$825.

The current cost of the war is estimated at 6 billion yen; an additional 4 billions were asked for the year 1939-40; this considerable sum has been provided without foreign loans, so far, while China has received direct monetary credits from the United States and Great Britain; the estimated expenditures for 1939-40 appear impressive in yens but represent in dollars about \$1,500,000,000, which is only a fraction of the United States annual peace-time budget.

The Confederacy fought on a shoe-string for four years; the Germans in 1914-18 were able to carry on; these historical precedents make predictions uncertain.

Despite deficits, there are not so many signs of inflation in Japanese financial life as one would expect; the increase in the cost of living is less than 10 per cent since the beginning of the war, together with an increase of 17 per cent in the

retail price level. Japan's regulations about taking money out of the country are still more lenient than those of many European countries.

Japan's strength is self-sufficiency in food; the masses are not likely to feel any pinch of hunger. Its weakness is lack in strategic raw materials: oil, scrap iron, copper, lead, nickel. An embargo on these vital items⁴⁰ would not yield immediate results, since reserve stocks are undoubtedly available, but long-range pressure would be effective. Sanctions, however, are fraught with unpleasant consequences; they are not an easy half-way house between neutrality and war; it is hardly likely that the Japanese army and navy would bow to economic pressure and accept defeat without a struggle; it is for more probable that they would strike out for Netherlands-India, French Indo-China, the Philippines, Malaysia—any place within naval range which would provide oil, tin, rubber and iron.⁴¹

⁴⁰ The abrogation of current treaties is considered by many as the prelude of sanctions to be applied at a later date.

⁴¹ *Foreign Affairs*, April 1939, "Japan at War."

THE ITALO-ETHIOPIAN WAR

54. THE EVOLUTION OF AN AGGRESSOR. *a. A modern crusade.* In 1212, a shepherd boy named Stephen appeared in France and induced several thousand children to follow him into the Holy Land, in what has since become known as the Children's Crusade; in Germany, a boy named Nicolas likewise gathered 20,000 children for the same sentimental journey; both perished miserably; nothing was left of the pathetic columns save the legend of the Pied Piper of Hamelin.

This incredible story of mass hypnotism in an age of religious fervor is no more strange than the extraordinary crusade waged by Great Britain against Italy when fifty-two nations declared "sanctions" at the bidding of Anthony Eden. A flickering moral frenzy seems to have been evoked, when fifty-two hard-boiled chancelleries (who should have known better) were completely bowled over by the Ethiopian business, which became a moral issue overnight, when its historical characteristics and antecedents were anything but that.

b. The partition of Africa. The championship of Abyssinia by Great Britain has been cleverly interpreted in many places as a purely altruistic move, as an inescapable test of "collective security" represented by the League of Nations. The map of Africa is evidence of the cold-blooded partition of this immense continent amongst European powers—with the lion's share going to France and England. France and Britain, at times, were bitter competitors; frequently, their lines of penetration collided, as at Fashoda in 1898, when British and French soldiers faced each other belligerently.

The partition of Africa proceeded leisurely throughout the nineteenth century; the pace of conquest was accelerated in the eighties. The competitors played both ends against the middle; some areas were acquired by purchase (Kenya), others by intimidation, by setting one tribe against another (the Fanti against Ashantis), by cajoling local chiefs to accept a "protectorate" (Basutos and Bechuana), by outright "punitive expeditions" (Sudan). The character of these negotiations bordering on intrigue is obvious in a calm appraisal of method, viz: In 1836-37, large parties of emigrant Boers settled north of the Orange. Boers and Basutos proved bad neighbors. The British promptly proclaimed a "protectorate" over Basutoland. In 1848, the Basutos were induced, rather unwillingly, to renounce their claims to this territory. Boers and Basutos continued bickering; in 1865, the Boers defeated the Basutos and the latter applied to Great Britain, who proclaimed an annexation of Basutoland in 1868. These moves, of course, were designed to checkmate the expansion of Boer influence. Rather early in the game, the Boers, as competitors of England, were earmarked for eventual destruction, although they were clearly the first to settle in and open up South Africa. The Dutch settled at Cape of Good Hope as early as 1652; for 143 years thereafter, the Dutch East India Company developed this region but was ousted in 1795 by British occupation; the Cape was definitely ceded to the British in 1814.

The British shipped 5,000 immigrants, the "1820 settlers" whose sentimental attitudes toward natives weakened Boer control of negro slaves; with the Slave Emancipation Act of 1834, the Boers moved north, in a mass migration, known as the "Great Trek," and established the Republic of Natal (1838), the Transvaal Republic (1852), and the Orange Free State (1854). These were democratic organizations, developed by white men who only wanted to be left in peace to

develop their farms, which they had wrested from the wilderness and the jungle. British settlers infiltrated slowly, until the discovery of diamonds and the development of important mines brought a real avalanche of aliens and the claims of Great Britain to "protect" the interests of her nationals. The end was in sight;

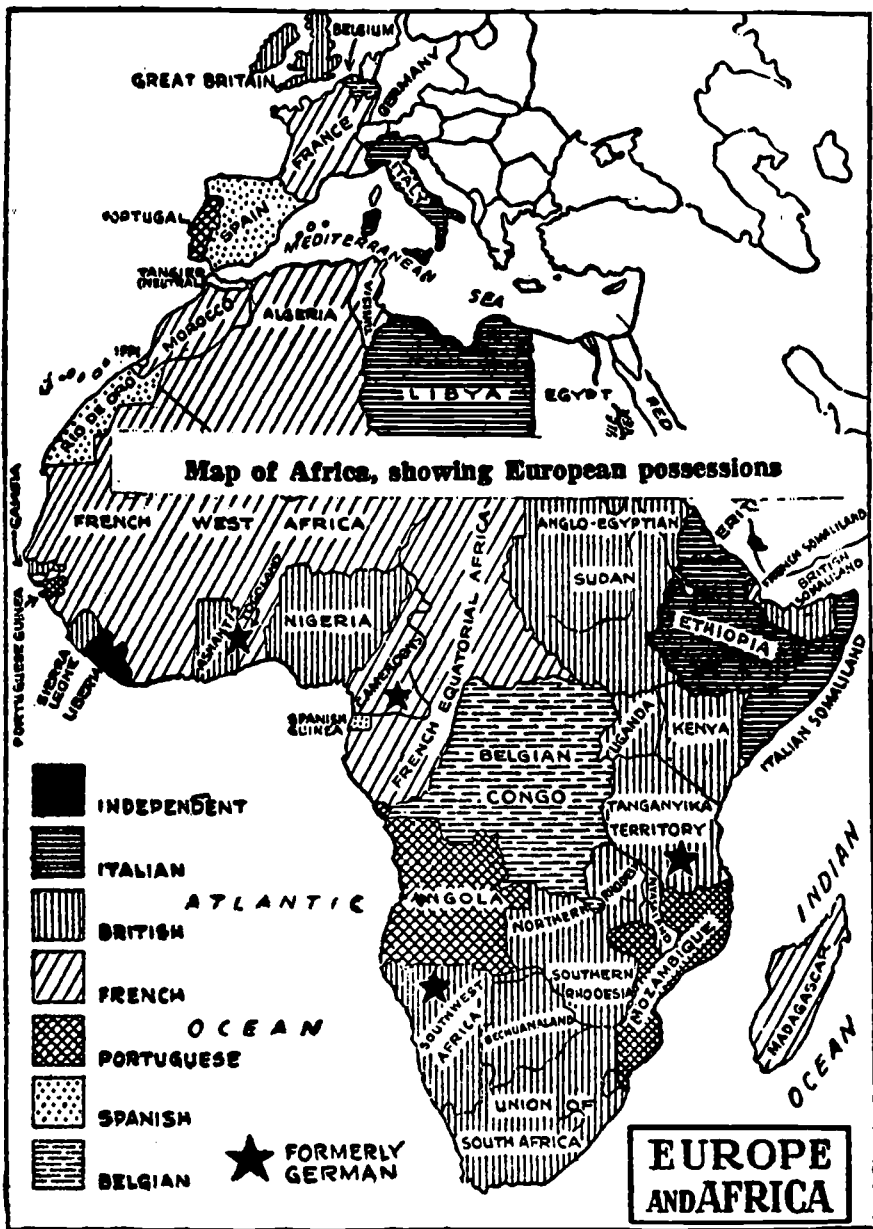

PLATE 148. THE PARTITION OF AFRICA, 1880-1930.

the obdurate Boer had to go; war was precipitated in 1899; the valiant Boer, of course, was no match against the enormous resources of a world-power. In a bitter struggle ending in 1902, the Boer "republics" disappeared and became "dominions" of Great Britain.

The other powers interested in Africa—the French, the Portuguese, the Belgians, Germans and Italians—followed the same pattern with minor variations; they played the game for all it was worth. At no time did it occur to them to become sentimental about it—with a single exception: it took the barbarities of the Congo “Free State” to disturb their mutual complaisance.

c. Italy's position in Ethiopia, 1869-1896. The aspirations of Italy in Ethiopia, as will be shown presently, had probably as good a foundation as similar claims by other powers in other regions, with an important difference; Italy came in late for this game of grab and was confronted by powers whose loot had acquired a patina of respectability through the effect of elapsed time.

A conservative opinion was expressed by a famous American statesman:¹

“. . . the action of Japan in Manchuria and Italy's proposed action in Ethiopia must be conceded to be quite in the fashion prior to 1914 . . . the Italian-Ethiopian question is but a rivulet in the vast stream of imperial politics emanating from the capitals of the great powers of Europe and sweeping, often at cross purposes, across the dark continent. . . .”

Unlike the traditional conquest-by-bayonet of many other powers, the original Italian colonies in Africa were acquired through purchase.²

Next, Italy obtained a certain preferential position through the treaty of Ucciali (1889) signed by Menelik, Emperor of Ethiopia.

Great Britain entered at once into a secret understanding with Italy (1891) in which each power recognized its relative sphere of influence; like all African “understandings” in this era of unvarnished conquest, this secret paper was a blueprint of eventual partition. No attention was paid to either France or Ethiopia at the time.³

The agreements of 1891 were confirmed and amplified in 1894; these agreements very definitely recognized almost all of Abyssinia as an Italian “sphere of influence.” A map, published in London with Foreign Office sanction, colors the whole of this area green, including Eritrea and Somaliland, and the whole area is called “Italian Abyssinia.”⁴

d. The Battle of Adua, 29 February 1896. There can be little doubt that the Italian invasion of Abyssinia in 1894 and 1896 was intended to put into effect these agreements with Britain, but with the help of French and Russian arms and ammunition⁵ Menelik's hordes administered a crushing defeat to the small Italian Expeditionary Force in the Battle of Adua, 29 February 1896.

This disastrous engagement has a number of interesting professional features, besides its international and racial significance, as the first major defeat of the white man at the hands of a colored mob.

On 12 February, Baratieri, governor of the Italian colony of Eritrea, had 21,000 men and 50 guns in the field, about 4,000 on lines of communications and 10,000 throughout the colony. Abyssinia is as mountainous as Switzerland; supplies had to be transported over 175 miles of mere trails. The *levee en masse*, which is the traditional Abyssinian mobilization, of course, was even more adversely affected by the supply problem; a vast mob of 100,000 warriors lived off the land like locusts, and when the countryside was exhausted had to move on.

Menelik had retired to Adowa on 4 February with approximately 100,000 men and provisions for only a few days. Baratieri could have marked time profitably,

¹ Newton D. Baker, war-time U. S. Secretary of War, in *Introduction to World Affairs, Pamphlet No. 12.*

² Eritrea, purchased 1869. Somaliland, purchased in 1892 from the Sultan of Zanzibar.

³ Work, *Ethiopia—A Pawn in European Diplomacy*, pp. 162, 264 and 281. *Introduction to World Affairs, Pamphlet No. 12*, pp. 28-29.

⁴ L. S. Wolf, *Empire and Commerce in Africa*. Also, Hertslet's *Map of Africa by Treaty*, 2d edition, 1891. Vol. I, p. 18, printed for His Majesty's Stationery Office by Harrison & Sons.

⁵ Work, *Ethiopia—A Pawn in European Diplomacy*, pp. 227, 288.

except for an embarrassing telegram from Rome, dispatched by no less a personage than the Prime Minister; this is a classical example of the precarious relation of soldier and statesman. His Excellency did not mince words; no doubt the situation presented no problem to him in the comfort of his luxurious office, and it was easy to sound clever and ironic over a glass of choice Asti-Spumante. He wired:

“This is a military phthisis and not a war . . . small skirmishes . . . a waste of heroism . . . it is clear to me that there is no fundamental plan in this campaign and I should like to see one formulated . . .”

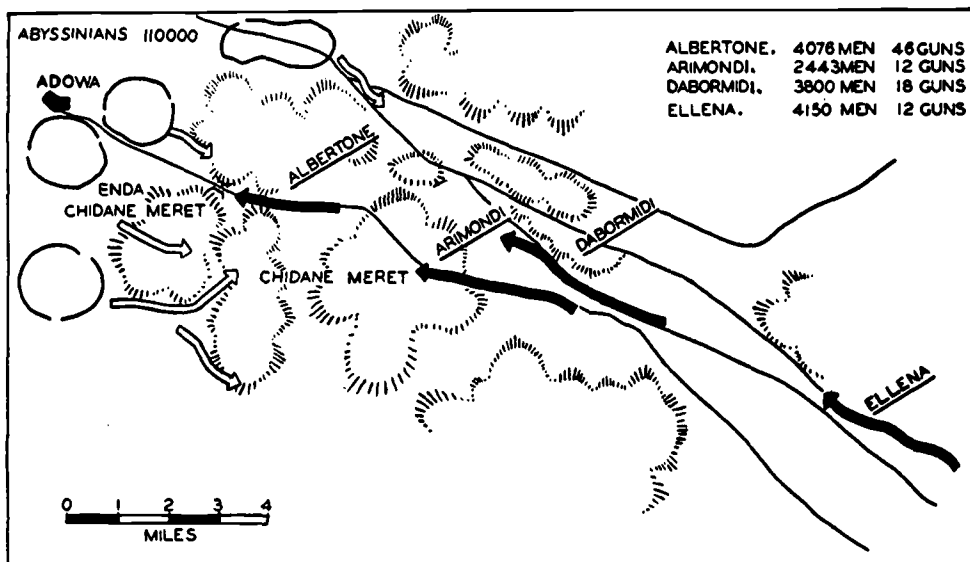

PLATE 149. THE ADVANCE ON ADUA, 29 FEBRUARY 1896.

Baratieri took the hint, as other men before him have taken hints, and ordered an advance; a forward movement might induce Menelik to attack. It is important to reflect that Baratieri intended to receive this attack in a strong organized position; instead his columns drifted into piecemeal attacks and final defeat. Baratieri started during the night, 29 February, in four mixed columns of approximately 4,000 men each; the leading columns were to secure a mutually supporting line, through the pass of Chidane Meret.

The lives of soldiers depend on little things; the rough operations map contained also an “Enda Chidane Meret,” where the enemy was ready for the kill. This four-letter word, Enda, spelled disaster! The left column kept on marching toward Enda, passed Chidane Meret and ran headlong into the enemy. Fighting under increasing pressure, Albertone’s battalions were slowly pushed back, enveloped and finally overrun by the bloodthirsty Shoans who pressed frontal attacks right up to the muzzles of the Italian guns. By 11:00 AM the fight in this area was over; a few survivors struggled to the rear; the gallant Sicilian batteries served their pieces until noon when, with ammunition expended, they perished to a man in hand-to-hand fighting.

With the left column destroyed, the savage horde swung toward the Italian center. Here, too, poor maps played a fatal role; Baratieri’s right column, Dabormidi commanding, drifted through the pass of Belah and a gap opened in the center of the Italian lines; the important spur of Belah was not occupied; the

enemy poured into the gap by the thousands, practically surrounded Baratieri's center position and menaced his right as well; the Amharas even broke in among the medical section, killing doctors, nurses and wounded.

By noon, the remnants of the center attempted a straggling retreat to the east. Dabormidi, on the right, hung on until 2:00 PM. The artillery had expended its day of fire, 130 rounds per gun. The Abyssinians drove forward until they were using the pack mules as cover from which to fire on the gunners and the supporting infantry; officers became special targets and nearly all of them were killed. De Amici fell mortally wounded; he directed his men to place him against the bole of a sycamore tree, and there he stayed. The desperate resistance of the remnants of Dabormidi's brigade made possible the escape of other units.

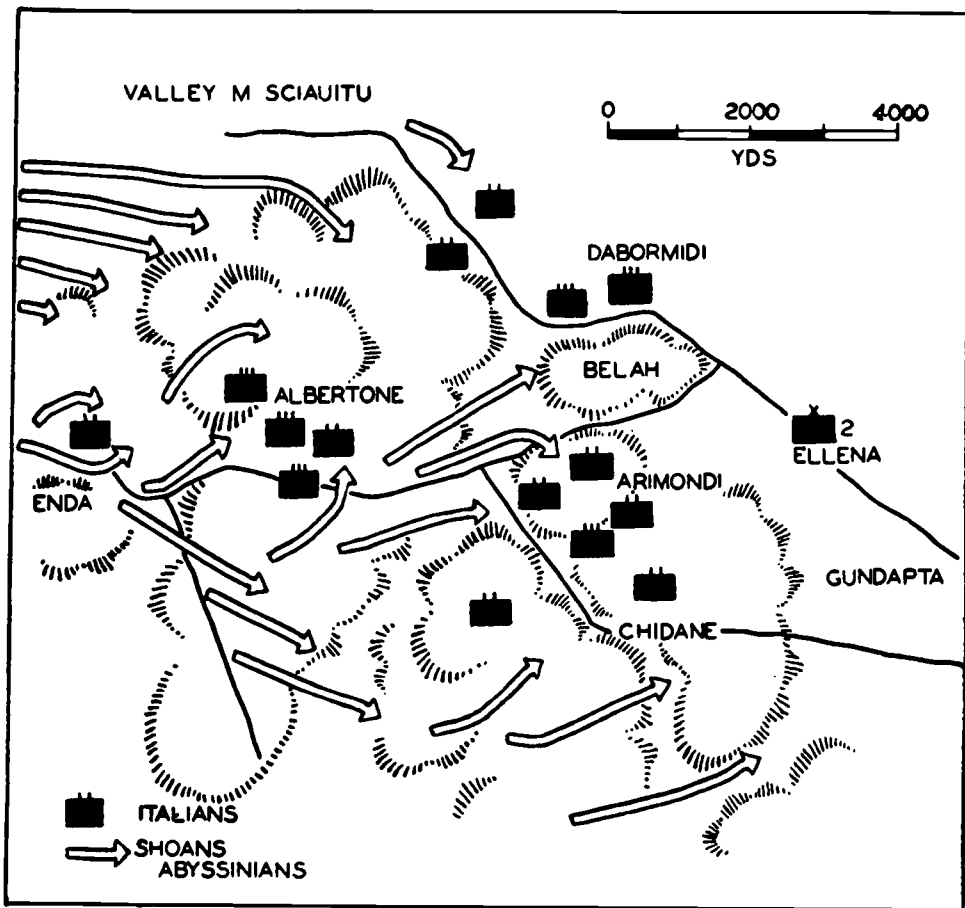

PLATE 150. ADUA, SITUATION AT 10:00 AM, 29 FEBRUARY 1896.

De Amici's sightless eyes soon looked on scenes of horror: the butchery and mutilation of the wounded!

Baratieri's despatch ⁶ to Rome gives a sad glimpse of panic:

" . . . all control was at an end and no orderly retirement could be organized . . . in vain our officers tried to halt the soldiers on any of the successive positions. The enemy bursting in on them and the Galla cavalry

⁶ Major B. Smith, C.E., *Infantry Journal*, 1935.

lashing about below . . . threw them in disorder. It was then that real losses began; the soldiers as if mad threw away their rifles . . . with the idea that if they were taken without arms they would not be emasculated . . ."

The rather unpleasant reference to Abyssinian anatomical practices, in violation of the conventions for the treatment of wounded and prisoners of war, is an important feature of this business, since the "moral factor" crops up again and again. A political organization addicted to this kind of barbarous behaviour is hardly eligible to membership in a league of nations, although short-sighted political rivalry led the French and Italians to promote that very membership in later years.

Apropos of the revolting incidents at Adowa, His Imperial Majesty, the Czar of Russia, graciously awarded to Menelik the highest Russian military decoration—the Grand Cordon of St. George!

This astonishing gesture speaks for itself and the mutual sincerity of Western European Powers, in that era!

Menelik's show of force at Adowa put an end, for the time being, to Italian aspirations; Abyssinian favors went pointedly to France and England instead.

Naturally, the memory of that tragic defeat rankled in the mind and heart of Italians—all people have such memories and nurse such rancors. Remember the "Alamo" and the "Maine"!

The loss of Baratieri's columns, however, had a deeper, transcendental significance; for the first time the prestige of the white man had been successfully challenged. The "world of color" from Timbuktu to Annam stirred uneasily in its slumber of traditional submission. When white men fell mutilated under the assegais of the Shoan horde, the dragon's teeth were sown that were to leap to life thereafter in all the murky corners of the savage world, in all the camp fires of rebellion where fanatic men of color exhorted other men of color—from Abd-el-Krim to the Faquir of Ipi. Historical judgment, freed from the emotional haze of the moment, will credit Mussolini with wiping out a memory of defeat by re-establishing the traditional military supremacy of the white race, for generations to come.

In 1906, when it was certain that the redoubtable Menelik was dying, a "new deal" became important. The three powers (France, Britain and Italy) tentatively agreed upon the division of economic exploitation of Abyssinia, without consulting, of course, the latter country. This "Tripartite Agreement" was another blue-print partition of Ethiopia; the signatories reaffirmed Italy's right to a "sphere of influence" covering practically the whole of Ethiopia.⁷ Menelik was not consulted, and the ratification of this treaty did not depend on his approval.

As in 1894, Britain had offered Italy control over Abyssinia in return for resistance to France, so in 1915 France and Britain together offered Italy opportunities in Abyssinia in return for assistance against Germany.

e. The Treaty of London: April 1915. In order to induce Italy to enter the World War on their side, the Allies promised a considerable share in the prospective loot. The Treaty of London, 1915, (the terms of which were not known to the United States prior to its entry into war) stipulated that Italy should receive "compensations in Ethiopia," if France and Britain acquired Germany's colonies; the relevant paragraph of the treaty was as follows:

"In the event of (the Allies) increasing their colonial territories in Africa at the expense of Germany, (the powers) agree in principle that Italy may

⁷ *World Affairs Pamphlet No. 12, p. 34. Work, Ethiopia—a Pawn in European Diplomacy, pp. 319, 321.*

claim some equitable compensation . . . relating . . . Eritrea, Somaliland and Libya . . ."

After Versailles, more than 1,000,000 square miles of African (German) territory passed under French and British control, while Italy received only minor and grudging boundary adjustments—a few square miles of British and French Somaliland and 2500 out of 35,000 shares in the Jibuti Railroad.

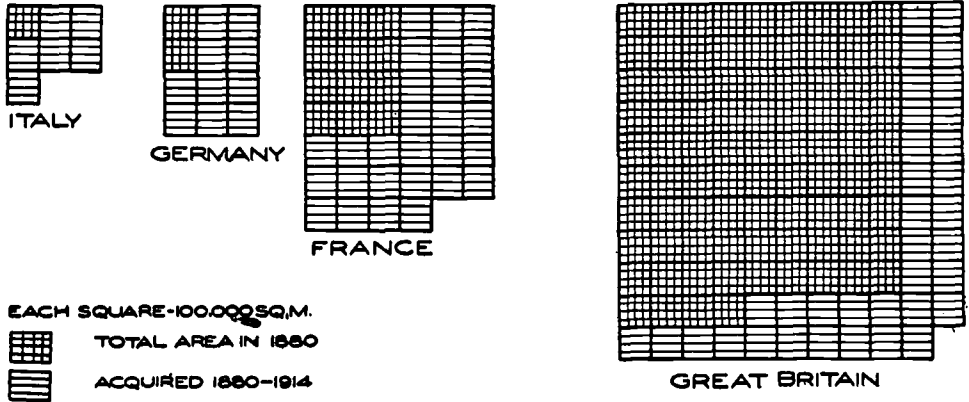

PLATE 151. RELATIVE COLONIAL ACQUISITIONS, 1880-1914.

Italy was never reconciled to this Machiavellan solution; it was a foregone conclusion that a strong government would challenge it. Mussolini represented such a government, and the Italo-Ethiopian claims were kept before the reluctant ex-Allies.

f. The Protocols of 1925 and 1935. In 1925 a British Conservative Government made a complete volte-face and agreed to the provision of the various previous protocols of 1891, 1894, 1906 and 1915, reaffirming, in principle, Italy's position, provided Britain obtained paramount hydraulic rights on the upper Nile and Lake Tana.⁸ This was a nice piece of long-range British planning. There is no immediate need of a greater water supply for Egypt; current supply of water is not fully utilized by local farmers; however, the capacity of Lake Tana, drained by the Blue Nile, could be increased to eight billion cubic yards of water, through suitable dam construction; this amount of water would irrigate the Nile valley for two years, even in the complete absence of rain. If a larger cotton market could be established (at the expense of American cotton), the irrigation of hitherto uncultivated lands in Egypt and the Sudan could be undertaken, supporting a much larger population.

Neither in 1906 nor in 1925 were Ethiopian wishes consulted; international morality did not once enter into the picture.

The French, in the meantime, had been lukewarm to these propositions, but on 7 January 1935, an important agreement was reached between Laval, Premier of France, and Mussolini. France, becoming apprehensive of Germany, tried to secure Italian benevolence, as in 1915, through certain concessions; there is little doubt that France promised Italy a free hand in the invasion of Ethiopia; the French semi-official press began to reassure Italy, and Laval's attitude was interpreted as benevolent.⁹

⁸ *World Affairs Pamphlet No. 12, p. 34.*

⁹ *Work, Ethiopia—a Pawn in European Diplomacy, p. 336.*

The British government was aware of these diplomatic conversations, since the name of one of its responsible ministers, Mr. Hoare, was definitely linked with these negotiations.

g. Sanctions versus aggression. The shortsightedness of France and Italy in supporting Ethiopian membership in the League of Nations in 1927 puts into strong relief the common sense of England, which expressed serious doubt that Ethiopia could be classed as a modern civilized country; this membership—a boomerang—was invoked against Italy in 1935.

Since 1925, when the tripartite agreement apparently had no visible effect, Italy had been restive; the feeling prevailed that her paramount interest in Ethiopia, clearly implied in the Treaty of Paris, was evaporating. Border clashes multiplied; the most serious occurred in the occupation of Ualual.

While this situation was being adjudicated by the League, Italy reinforced her African garrisons with a view to war. These Italian moves impressed Great Britain as a threat to her interests in the Mediterranean and in Egypt; she promptly reinforced her Mediterranean fleet and the garrisons of the Suez Canal zone. The character of Ethiopia as a League member now proved a magnificent asset; this matter was promptly pushed as a League responsibility. Italy invaded Abyssinia on 3 October and reached Adowa on the sixth. The League assembly was convened on 9 October and on the eleventh Italy was named as the "aggressor."¹⁰ Under Article XVI, "sanctions" were set up, i.e., a form of economic and financial siege, designed to deprive Italy of essential war materials, and 51 League members were induced to approve and execute the article.

The action of the League in naming an aggressor has furnished partisans the world over, in similar conflicts and rivalries, a matchless and effective propaganda slogan;¹¹ it has become an indispensable item in newspaper phraseology.

The Duke of Windsor, who as King of England has had most unusual opportunities to look candidly behind the scenes of international politics, objected to this brusque term in a radio appeal for tolerance; the casual classification of "aggressor" and "victim" has become a naive but deadly piece of prejudiced propaganda, on a par with the very clever appellation of "loyalists" in the Spanish Civil War, which has given an undeserved "moral tone" to the Barcelona Government and a "black eye" to Franco's political adherents.

The impartial historian will find it difficult and undesirable to apply this classification: in what category, for instance, should the Boer War, 1899-1901, be placed? What was France's position in her campaign in Morocco from 1910 to 1927? What is the moral distinction between the steam-roller conquests of the Boer Republic or Morocco and the Italian conquest of Abyssinia? If the latter represents "ruthless imperialism," what have the former represented? If conquest is reprehensible in 1937, as it should have been in 1899 and 1912, where and in what year of the intervening period was the turning point in international ethics and morality? Was it, by any chance, the year 1919 and the Treaty of Versailles? It is against the murky background of vacillating statesmanship, of international intrigue and shifting standard of morality that wars and military operations must be viewed; then they stand revealed as the final act in a drama that was written and conceived not by soldiers but by civilians.

55. CHRONOLOGY OF OPERATIONS. *a. A yardstick of comparison.* With the grip of economic "sanctions" tightening on the throat of Italy, Mussolini summoned his people in a grim mood to challenge an unfriendly world. To a thousand au-

¹⁰ *World's Almanac*, 1936.

¹¹ Italy was to be branded a second time, in 1938, in her occupation of Albania. The Treaty of Maurienne was not mentioned in the daily papers of the neutral world; that treaty expressly stipulated a free hand for Italy, in Albania, just as the Treaty of Paris had promised a free hand in Abyssinia.

diences, gathered on a thousand village greens, he urged the will to victory, in a plea born from the bitterness of political betrayal and disillusionment when he called the Ethiopian enterprise “. . . the war of the paupers, the disinherited, the proletarians!”

This may have been a campaign of the paupers—but it was executed on a scale of magnificence that would have satisfied the most opulent imperialist. It reminds one of the lavish plan of the B.E.F. in Egypt in 1915, and that most expensive enterprise, the A.E.F. in France, in 1917; apropos, the resemblance is more than superficial and practically inescapable: overseas expeditions follow a common pattern.

However, all things are relative; the comparatively limited resources of Italy make the vastness of this colonial undertaking all the more impressive.

In comparison, analogous colonial expeditions during the nineteenth century dwindle in importance, viz:

The French Expedition in Algiers	1830-1833
36,000 soldiers, 2700 marines	
The first British Expedition in Afghanistan	1839-1841
20,000 to 25,000 men	
The second British Expedition in Afghanistan	1878-1880
15,000 to 20,000 men	
The British Expedition in Zululand	1878-1879
15,000 men	
The French Expedition in Tunisia	1881-1883
32,000 men	
The French Expedition in Indo-China	1883-1884
9000 men	
The British Expedition in Egypt and Sudan	1882-1885
25,000 men, 7000 natives	
The French Expedition in Madagascar	1894-1895
18,000 men, 7000 natives	
Kitchener's Campaign in the Sudan	1896-1898
8200 British, 17,600 Egyptians	
The British Campaign against the Boers	1899-1902
50,000 to 80,000 men	
The French Campaign in the Riff	1925-1926
60,000 to 85,000	
The Italo-Ethiopian Campaign	1935-1936
400,000 men, 100,000 laborers	

Not even England has undertaken anything on that scale, in her colonial conquests. It is noteworthy that the campaigns cited above were time consuming, with an average of three years' duration, while the Italians finished the job in seven months!

b. Record of events in 1935 and 1936 in northern Abyssinia.

- 3 October 1935: Italian troops cross the border of Eritrea
- 5 October: Occupation of Adigrat
- 6 October: Occupation of Adua
- 15 October: Occupation of Aksum
- 8 November: Occupation of Makalle
- 18 November: Marshal Badoglio assumes command
- 12-17 January 1936: First Battle of Tembien
- 10-15 February: Battle of the Enderta

- 27 February-1 March: Second Battle of Tembien
- 28 February: Capture of Amba-Alagi
- 29 February-3 March: Battle of Schire
- 31 March-4 April: The Battle of Lake Ashangi
- 1 April: Occupation of Gondar
- 18 April: Occupation of Dessie
- 2 May: The Negus in flight to Djibouti
- 5 May: Italian troops enter Addis Ababa

c. Record of events in 1935 and 1936 in southern Abyssinia.

- 7 November 1935: The occupation of Gorraheii
- 12-16 January 1936: The Battle of Ganale-Doria
- 20 January: Occupation of Neghelli
- 14-30 April: Assault and capture of Sassah-Baneh
- 30 April: Occupation of Daghabur
- 5 May: Occupation of Harrar.

56. THE ORGANIZATION OF AN OVERSEAS EXPEDITION. *a. The theater of war: topographical data.* Abyssinia (or Ethiopia) is an inland country in the north-eastern part of Africa, with an area of roughly 350,000 square miles, or a little more than the states of Texas and Oklahoma combined; it is roughly triangular in shape, with an apex of 230 miles in the north and a base of 900 miles in the south. Between the upper Nile and the 40th meridian, there is an extensive region of mountains and valleys, with elevations in some instances of 15,000 feet; there are plateau formations of an average level of 7,000 feet dropping sharply to the east into the plains of the "Danakil" but with gentle slopes toward Italian Somaliland in the south; the deep gorges tend to give the plateau a character of natural military fortifications. The Danakil is a hot, barren desert, in places 300 feet below sea level, while southern Somaliland is a vast plateau of about 3000 feet elevation, covered with gray African bush. There are a few rivers of importance, the Taccaze in the north, the Doria and Webbe Shibeli in the south; the supply of water is limited, away from river lines, and presents a continuous military problem.

With this range of elevation, there are sharp climatic variations, from the healthy, bracing temperature of the highlands, to the stifling heat of the lower coastal regions. In Ethiopia, "winter" lasts from October to February; it is followed by a hot, dry period, until the beginning of the rainy season in June; this begins in the north, lasting until September, and gradually moves southward.

The effect of tropical rains on unimproved roads and trails can well be imagined, it was a serious military factor requiring special large-scale provisions for road construction and maintenance. In fact, like Caesar's legions, these modern Romans had to build their roads in order to fight.

b. Organization of the theater of war. The development of a plan of campaign is influenced by the military characteristics of the country (its topography and resources), its strategic objectives (the desire of the warring nation) and its capacity for war. In uncivilized countries, the terrain factor is apt to become decisive or at least to exercise an undue influence. In Ethiopia, only two lines of operation appeared feasible: in the north, from Massaua via Dessie on Addis Ababa; in the mountain ranges; the latter in gradually rising terrain but over semi-desert areas south, from Mogadiscio on Harrar. The former was shorter but across enormous with precarious lines of communications.

(1) The base ports: Massaua and Mogadiscio. The final consideration was technical: available port facilities for an oversea base, adequate for the logistic

requirements of an army of over 200,000 men; the only port that gave any promise of development was Massaua, in Eritrea, while Mogadiscio, an open roadstead on the Somali coast, was obviously limited. The port of Massaua was prepared to handle approximately 2000 tons per month, while Mogadiscio, with a lighterage service only, was accustomed to about 200 tons only; these modest figures were soon to be raised to 30,000 and even 60,000 tons, at Massaua and 2000 tons at

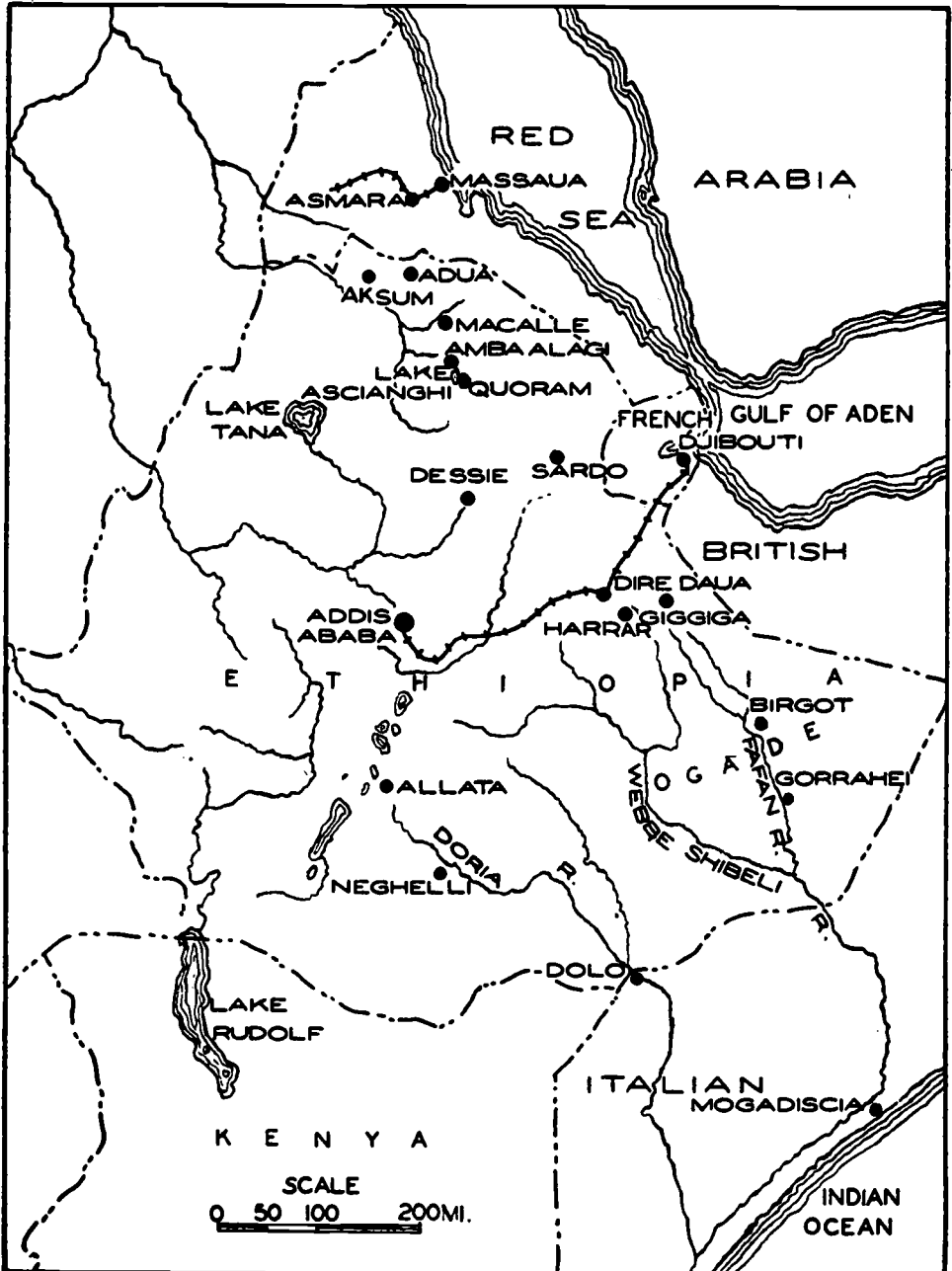

PLATE 152. ORIENTATION MAP, ABYSSINIA.

Mogadiscio. Instead of an occasional traveller, entire divisions were landed, thanks to prodigious efforts by the Royal Italian Navy, initially charged with the development of base-ports. Extensive construction was undertaken to improve docks, warehouse capacity, trackage and sidings, refrigerating plants, power installations, water supply, etc. The thoroughly creditable record of the navy is easily evident in the statistics of troop and materiel shipments.

LOGISTIC DATA: SHIPMENTS TO ERITREA AND SOMALIA 1935-1936

1935-36	Troops		Animals		Motor Vehicles		Supply (Tons)	
	Eritrea	Somalia	Eritrea	Somalia	Eritrea	Somalia	Eritrea	Somalia
February	207	5683	170	230	2	80	2152	4415
March	5270	4845	533	264	75	151	4625	5551
April	6651	6015	518	324	165	38	6770	2953
May	15685	953	1224	...	287	...	19094	1332
June	19811	...	1956	...	405	...	15536	...
July	13328	5043	897	1016	84	22	9563	6186
August	28087	1164	1552	735	461	61	16128	3361
September	47058	4685	2045	121	620	40	11429	3965
October	38047	5572	1197	214	631	61	47403	9355
November	25982	3496	965	201	246	66	16380	3049
December	17262	13948	1761	441	281	121	17664	3459
January	27145	1990	2781	88	554	448	23629	8841
February	9543	12568	674	2100	173	1207	15243	15581
March	20523	1550	2200	42	197	472	21759	4240
TOTAL	275497	67512	18473	5776	4182	2767	191235	77088

(2) Lines of communications. The efficiency of the navy in developing port facilities was matched by the terrestrial organization of lines of communications to the front.¹² It was essential to get the masses of troops out of the tropical heat of congested seaports into the interior, to intermediate camps in vicinity of Asmara and other assembly areas; the road net, however, was found to be entirely deficient. As early as July 1935, 30,000 laborers were engaged in road construction; this figure rose to 100,000, not to mention troops, who often changed the rifle for the spade. Dall'Ora planned 814 miles by October 1935, principally the enlargement of the main route: Massaua—Hefasit—Asmara and four parallel, secondary roads leading to the frontier. Toward the close of operations, 3540 kms of improved roads had been developed, of which 875 km were hard-surface, two-way roads. The rather inadequate single-track railroad from Asmara—Massaua, of 120 km, was stepped up to a daily traffic of 14 trains and extensive passing-sidings were built.

The road- and rail-net in Somaliland was worse than in the northern theater; there was only one railroad of 120 km, linking Mogadiscio with Villaggio Duca degli Abruzzi; this was extended to Bullo Burti by a narrow-gauge 60-cm track, with an initial train-density of four per day, of only 50 tons capacity. It was obvious that motor transport would have to do the bulk of the hauling; time-consuming construction or road maintenance was out of the question, in view of the local distances, viz: from Bender-Cassim to Rocca Littoria, 800 kms, Mogadiscio—Belet Uen, 365 kms, and Mogadiscio—Lugh Ferrandi, 420 kms. Main reliance was placed on track-laying vehicles and heavy duty tractors, to negotiate bad places. The roads remained, for the most part, trails.

(3) Initial air installations. At the outbreak of hostilities, there was only a limited number of airfields in operation: at Massaua, Asmara, Mogadiscio and Rocca Littoria. A main landing field was established at Gura (35 kms south of

¹² General Dall'Ora, commanding the S.O.S.

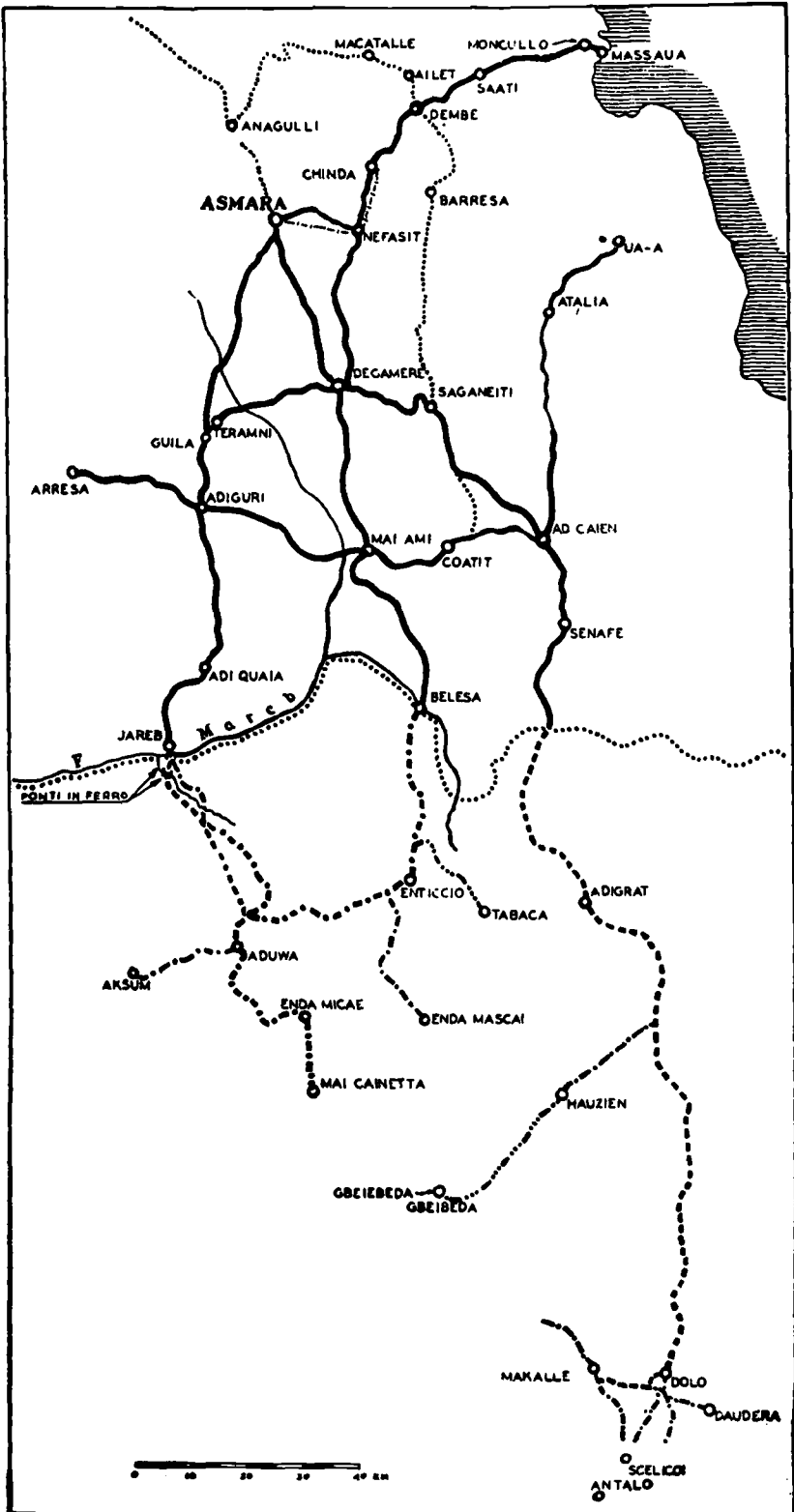

PLATE 153. ROADNET. NORTHERN THEATER OF OPERATIONS, 1936.

Asmara) and three smaller fields near the frontier. Initially, about 25 emergency fields had been spotted; at the end of hostilities, efficient airports had been developed, 29 in the north and 54 in Somaliland. Since the fields had to function in the rainy season, considerable construction was required; the air service operated 50 steamers and delivered 250,000 tons of material, equipment and supplies for their own consumption.

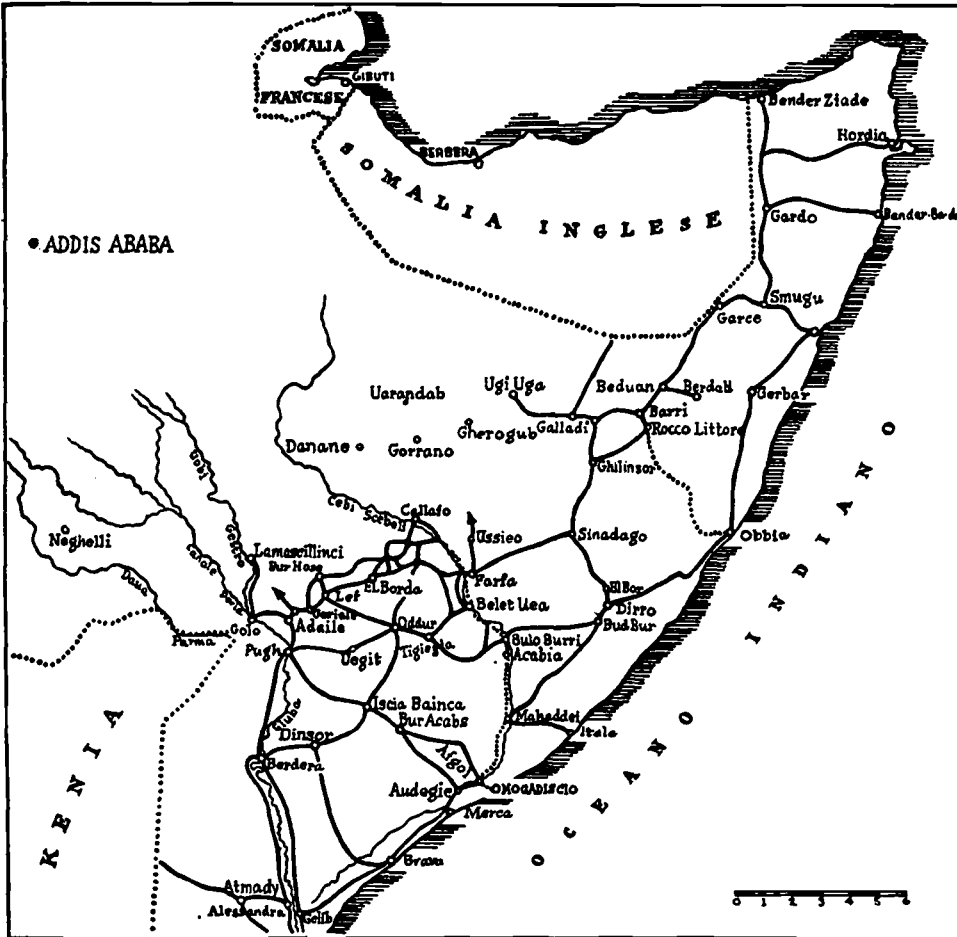

PLATE 154. ROADNET. SOUTHERN THEATER OF OPERATIONS, 1936.

c. Strategic organization of theaters of operation. In the northern theater of operations, based on Eritrea, the communication zone was divided into three command areas: the center, known as the "High Plateau," was the most important, and the main Italian effort was to be made along the axis: Asmara—Adowa—Macalle. To the west lay the "Western Lowland" sector, with headquarters at Barentu until April 1936, the mission of troops in this zone was defensive, in flank protection of the central zone; after that date, additional troops were brought in, to support the advance on Gondar. To the east of the plateau, the "Eastern Lowland" zone was designated, to include the barren Danakil; headquarters was located at Azbi, on the edge of the plateau; a detachment at Assab protected the air-bas

at that point; the initial mission of this sector was to furnish left flank protection for the major advance, in the center.

The southern theater, based on Somaliland, was divided into two principal sectors, the "Giuba" and the "Shibeli—Faf-Ogaden" sectors; headquarters of the Giuba sector was at Dolo. The mission of the troops in this area was to protect

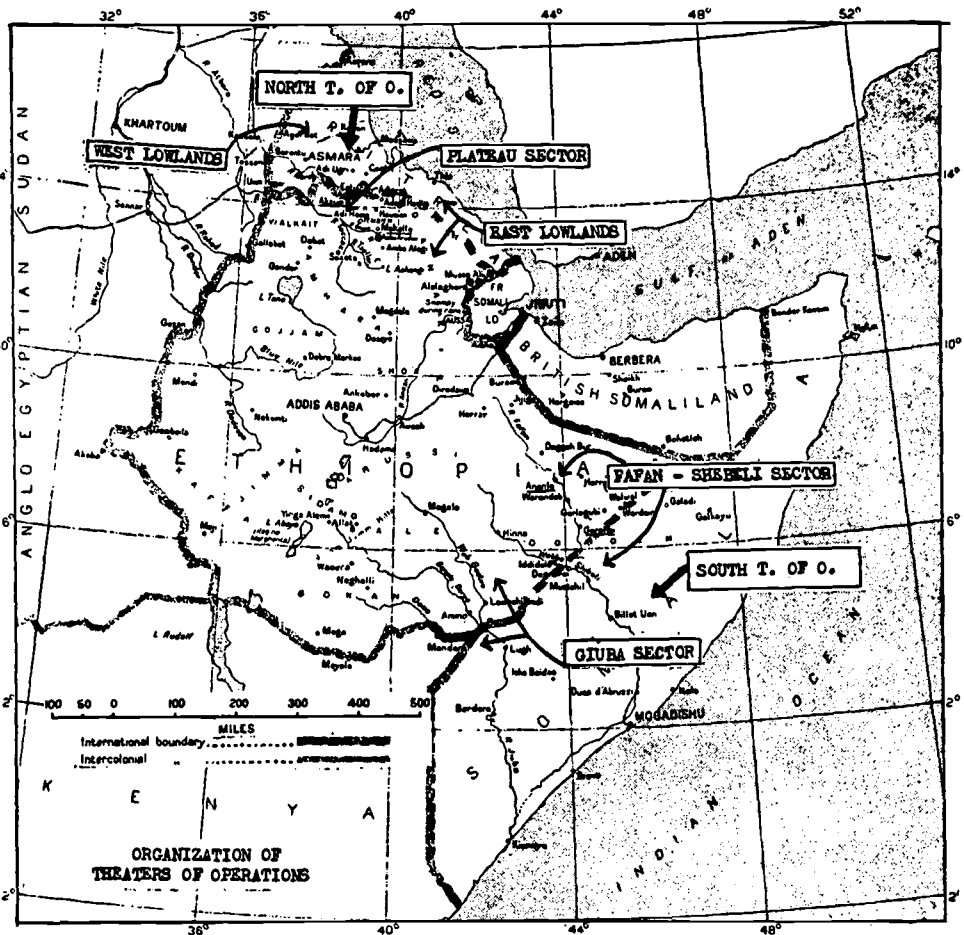

PLATE 155. ORGANIZATION OF THEATERS OF OPERATION, 1935.

the upper Giuba, the supply base at Dolo and the airdrome at Lugh-Ferrandi; prior to April 1936, troops in this zone were on a purely defensive mission. The "Faf" sub-sector, to the east, was more important, since it became the advance base for the movement on Harrar in May 1936. Still further to the east was the "Ogaden" sub-sector, important only for the group of water wells in that area. By occupying and defending initially the Gorrahei and Gherlogubi wells and the towns of Dagnerrei, Gheledi and Dolo, it was felt that no important Ethiopian advance could be made, due to lack of water. The southern T. of O. was clearly secondary; its mission would be amply fulfilled if it drew Ethiopians in force, and to that extent relieve pressure in the north. General Graziani, a brilliant regular, accomplished this mission by an "active defense" that not only protected Somalia but carried operations far inland.

In the north, General de Bono, close political friend of the Duce, was placed in command; after initial successes he was replaced in November by Marshal Badoglio, who carried the war to a smashing conclusion. The relations of de Bono and Badoglio in 1935 recall vaguely the relief of Murray by Allenby in the Campaign in Palestine in 1917; it is arguable that in each case the decisive results obtained by one were predicated on the careful administrative preparations of the other.

d. Initial grouping of forces. (1) Abyssinians. A semi-civilized, loosely-knit state, estimated in population from 7,000,000 to 12,000,000, Ethiopia was reported to be able to mobilize from 125,000 to 175,000. In 1896, Memelik operated with at least 100,000. The military organization was that of provincial "levees," brought to the theater of operations by local princes, the "ras." The Negus attempted a modernization, with the aid of foreign military missions²³ and managed to train an "Imperial Guard" as a nucleus, but the bulk of his forces consisted of armed mobs with resolute individual fighters, incapable of concerted strategic and tactical operations; the supply service, if it could be called that, was a mere dependence on local resources. However, Adua had shown the Abyssinian to be a dangerous and cruel foe, operating in formidable masses that far exceeded other historical colonial expeditions.

Certain large military groups developed under the following commanders: in Eritrea: Ras Imru (25,000), Ras Cassa (42,000), Ras Mulugheta (45,000), Ras Seyum (15,000), and the Imperial Army under the Negus (40,000); in Somaliland: Ras Nassibu (30,000).

(2) Italians. The comparatively weak colonial forces stationed in Eritrea and Somaliland were expanded and reinforced by metropolitan divisions, militia (Blackshirt) units, regular army staffs, corps and army troops. The organization was that of a modern field army, and the ensuing operations follow the pattern of modern, large-scale war, modified by existing geographical conditions, viz:

General Headquarters

Commander in Chief: General de Bono (to Nov. 1935) then Field Marshal Badoglio, Marchese di Sabotino.

Chief of Staff: General Gabba. Ass't.: General Cona.

Chief of Artillery: General Garavelli.

Chief of Engineers: General Caffo.

Chief S.O.S.: General Dall'Ora. Ass't.: Colonel Marfuggi.

Chief Medical Service: Professor Castellani.

The Army of Eritrea

Port of Massaua: Admiral Barone.

The Ist Army Corps

Commanding General: General Santini.

Chief of Staff: Colonel Van den Heuvel.

Artillery Commander: General Merzari.

The IId Army Corps

Commanding General: General Maravigna.

Chief of Staff: Colonel Pentimalli.

Artillery Commander: General Marzari.

The IIIId Army Corps

Commanding General: General Bastico.

Chief of Staff: Colonel Calderini.

²³ Swedish officers and Wehib Pasha, one-time general, Turkish Army, in the World War.

MANEUVER IN WAR

The IVth Army Corps

Commanding General: General Babbini.

Chief of Staff: Colonel Santovito.

Artillery Commander: General Labruna.

The Eritrean Native Corps

Commanding General: General Pirzio-Biroli.

Chief of Staff: Colonel Squero.

Artillery Commander: General Scarampi de Cairo.

The "fighting elements" of these corps were furnished by certain regular army and militia (Blackshirt) divisions and organic and corps artillery formations. The division comprised initially: Headquarters and military police (Carabinieri) and motor detachment, 3 Infantry Regiments, 1 Light Artillery Regiment (3 bns), 1 Motorized Ammunition Train, 1 Engineer Company, 1 Signal Company, 1 Searchlight Detachment, 1 Water Supply Detachment, Medical Detachment and Quartermaster Train (350 horses) and Quartermaster Battalion (250 motor vehicles); Strength: 550 officers, 17,000 men (8000 rifles), 450 MGs and 50 field pieces.

Regular Army Divisions:

The 19th Division "Gaviniana" (Florence)

The 30th Division "Sabauda" (Cagliari)

The 24th Division "Gran Sasso" (Chieti)

The 27th Division "Sila" (Chieti)

The 5th Division "Cosseria" (Imperia)

The 26th Division "Assietta" (Asti)

The Alpine Division "Pusteria"

Militia (Blackshirt) Formations:

The 1st Division "23 March"

The 2d Division "28 October"

The 3d Division "21 April"

The 4th Division "1st February"

In addition, the militia furnished special groupings (3 to 4 battalions), viz: 1st Group (General Diamanti), and 6th Group (General Montagna).

The Eritrean Native units were formed in permanent colonial brigades (125 officers, 200 white n.c.o's., 6500 native men, with 4000 rifles, 160 MG's and 12 guns).

These brigades were temporarily combined into:

The 1st Eritrean Division: General Pesenti, Comdg.

The 2d Eritrean Division: General Dalmazzo, Comdg.

The Army of Somalia

Commander in Chief: General Graziani

Chief of Staff: Colonel Miele, Colonel Olearo.

The 29th Division "Peloritana" (Messina)

Militia Division, mixed.

The 6th Militia Division "Tevere"

The Lybian Division

Native Somali Corps.

These units were of variable composition, for example, the initial divisions had 9 infantry battalions, 1 machine-gun battalion and 9 batteries, while the later divisions were reduced to 6 infantry battalions, 1 machine-gun battalion and 6

batteries; the artillery ranged from 77-mm field guns to 149-mm howitzers and 120-mm guns.

The air force consisted initially of: 2 reconnaissance groups of 10 squadrons, 1 naval squadron, 2 fighter groups of 6 squadrons, 6 bomber groups of 12 squadrons; the squadron was reduced to 6 machines. Subsequently, in Eritrea an air brigade was formed (General Matricardi, comdg.), with 3 bomber regiments (2 groups, each of 3 squadrons), 2 fighter squadrons and 8 reconnaissance squadrons; in Somalia (General Ranza, comdg.) 1 bomber regiment and 1 reconnaissance regiment.

57. THE CAMPAIGN IN THE NORTH: DE BONO AND BADOGLIO. *a. The occupation of Adigrat and Adua, 1 October 1935.* The initial Italian concentrations were close to the border; the units crossed, in the night 2-3 October, on a front of about 72 kms; their first objective was the line Adigrat—Enticcio—Adua, about 40 kms below the border; the advance was conducted in three columns; elements of the Eritrean Corps furnished flank and advance guards.

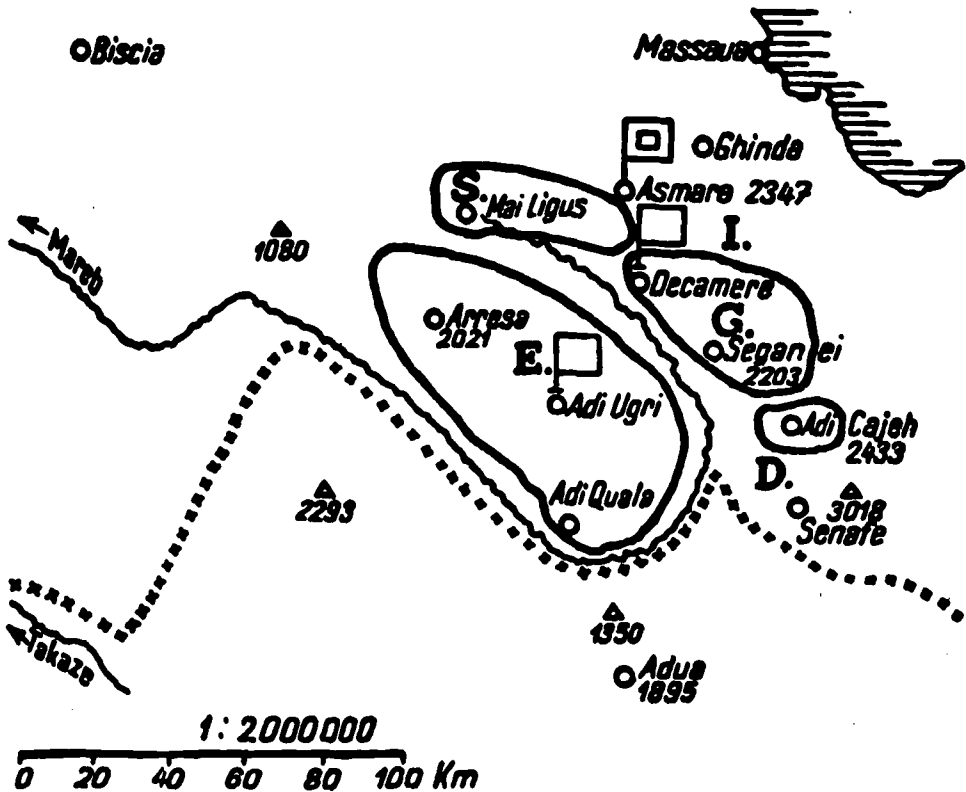

PLATE 156. THE INITIAL ITALIAN CONCENTRATION, 1 OCTOBER 1935.

The Abyssinian covering forces under Ras Seyum did not oppose any serious resistance. The pass Daro Tacle was held initially but abandoned when the division "Gavinana" deployed for an envelopment. Italian aviation executed distant reconnaissance as far as the Taccaze, while low-flying, close-in reconnaissance searched every fold in the ground. In the morning of 6 October, the 86th Infantry entered Adua; the first objective was reached.

A pause of a few days was necessary to convert the pack trails in this area into roads passable for motor transport; this activity became normal from now on, and it can be said, without exaggeration, that the advance of the Italian troops was predicated on the progress of road construction. An inkling of the problems involved is furnished by the fact that the road Asmara—Adigrat, as finally built,

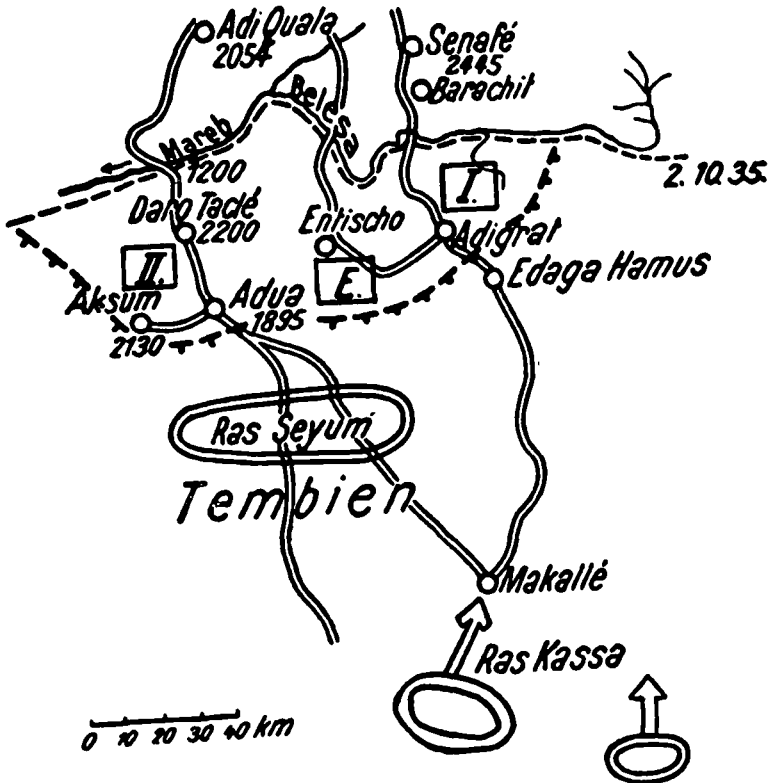

PLATE 157. THE INITIAL ITALIAN ADVANCE, 3-6 OCTOBER 1935.

contained 3500 curves. By the end of October, the lines of communication were sufficiently developed to undertake the second bound, in an advance on Makalle.

b. The occupation of Makalle, 8 November 1935. Utilizing the existing trails, the corps advanced in several columns, the Eritrean Corps via Entischo—Hausien—Makalle, the I Corps via Agula—Dolo.

The Abyssinians continued to fall back without offering serious resistance, although guerrillas were active in Schire and the Tembien. De Bono became apprehensive of his right flank and diverted the II Corps via Axum on the line of the Takkaze (Tacazze) River. The remaining corps reached Makalle on 8 November and established covering forces to the south.

The Tembien is a wild, mountainous region; Abyssinian bands had no trouble in infiltrating and repeatedly attacked the supply trains of the Eritrean Corps; considerable forces had to be used for close-in protection, in this area, thereby weakening the tip of the wedge at Makalle.

De Bono's left flank also experienced trouble. General Mariotti, commanding a flank detachment, crossed the barren Danakil, when he was attacked by the Abyssinian, Cassa Sebat, in a typical colonial surprise engagement.

With an enemy reported advancing, the unity of front of the Italian corps appeared jeopardized. At this point Marshal Badoglio¹⁴ stepped into the picture, replacing De Bono without prejudice.

It can hardly be argued that De Bono was not aware of the risks he was running in his bold advance to Makalle. However, political pressure had been brought to bear on him; we are once again in the twilight zone of the relation of soldier and statesman, when military judgment has to give way to political expediency—sometimes with disastrous results! And yet, in a race against time, Clausewitz' dictum

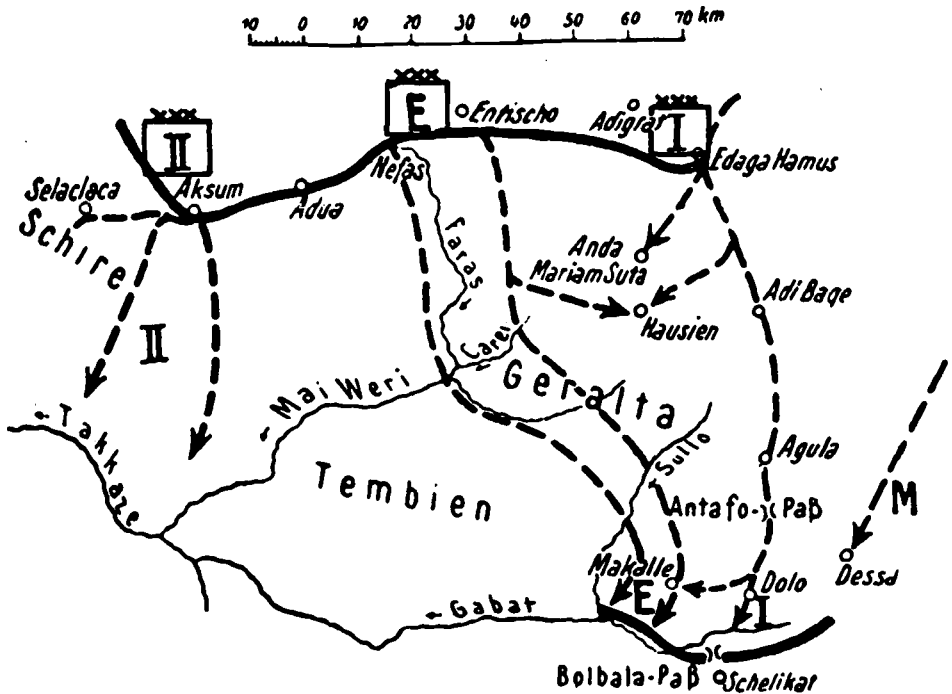

PLATE 158. THE ITALIAN ADVANCE, 26 OCTOBER-11 NOVEMBER 1935.

that war is an extension of national policy has yet to be refuted. De Bono advanced when Rome cabled ". . . There will not be complications in Europe before the English elections fixed for the middle of November. By that date all Tigre up to Makalle and beyond must be ours."¹⁵

c. The Abyssinian Attack on Mai Timchet and Dembeguina Pass, 14-16 December 1935. Badoglio could not influence the existing situation immediately, other than push the organization of rear areas and rapidly perfect his roadnet; the "wedge" of Makalle nevertheless was vulnerable on its west flank, especially since enemy pressure made itself increasingly felt; reinforcements enabled the formation of a III Corps, which gave the Eritrean Corps a chance to operate more actively in the Tembien.

Early in December, aviation reported the advance of several enemy columns in direction of the Taccaze.

The II Corps had maintained outposts on the Taccaze but ordered a reconnaissance of the south bank. As a typical coincidence of war, the Italians collided

¹⁴ Brilliant World War commander of the Italian Sixth Army. Conspicuously successful in the attack on Monte Sabotini, 6 June 1916. Assistant of Marshal Diaz, he reorganized the Italian Army after Caporetto. Chief of the Armistice Commission. Governor of Lybia and, since 1925, Chief of the General Staff.

¹⁵ A. C. Arnold, *The Italo-Abyssinian Campaign*.

with strong Abyssinian forces under Ayelu and were forced to retreat on the Dembeguina Pass, about 25 kms in their rear. Another Abyssinian force had crossed down river and threatened to reach the pass in advance of the retreating Italian units. A company of fast tanks hurried to their rescue but were, in turn, attacked in flank; caught in a narrow valley and unable to turn, many vehicles were lost when their ammunition ran out. Additional reinforcement reached the pass but after sharp fighting withdrew on Selaclaca. It was apparent that the Abyssinians

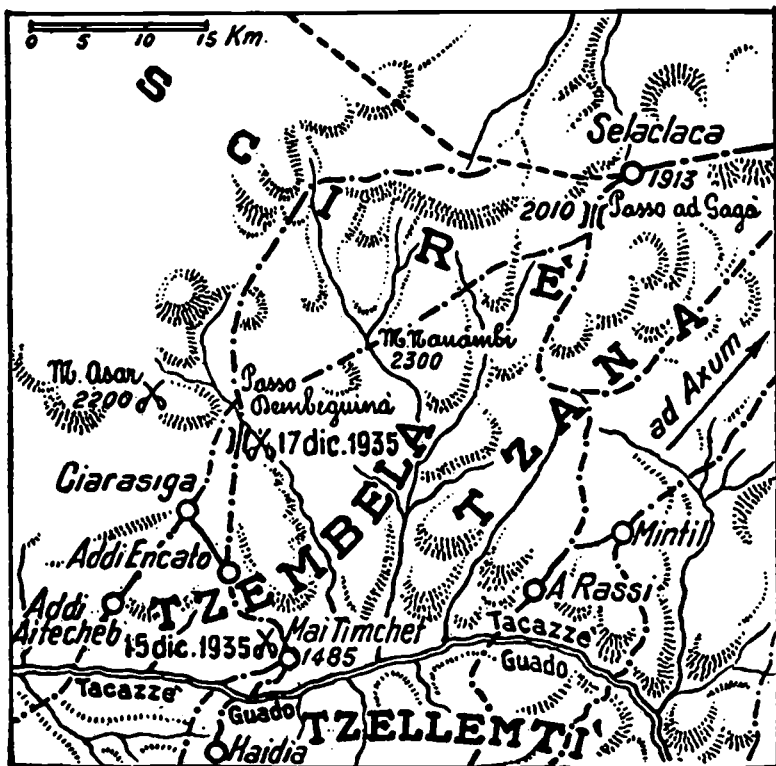

PLATE 159. MAI TIMCHET AND THE DEMBEGUINA PASS, 14-16 DECEMBER 1935.

meant business and had opened their own offensive. In the center, Ras Kassa also became active, especially in severe fighting in vicinity of Abbi-Addi and Mariam Quarar. South of Makalle, Ras Mulugueta remained comparatively passive. Nevertheless, the general strategic situation had certain ominous possibilities.

If the Abyssinians attacked along the entire front, Mulugueta might conceivably engage and pin down the I Corps in the Makalle area, while Ras Kassa pushed into the Tembien to cut the Italian communications and Ras Imru advanced north, through or past the II Corps into Eritrea. Badoglio decided to counter-attack while the Abyssinians were forming for this projected maneuver; the general dispositions of the enemy in echelon on a front of over 100 miles should conceivably present an opportunity for flank attack.

d. The First Battle of Tembien: 19-23 January 1936. The operation developed in two phases: first, the advance of the III corps, southwest of Makalle via Neguida and Debri, to control the valleys of the Gabat and Gheva, as a threat to Mulugueta's left as well as preventing him from side-slipping and joining Ras Kassa in the Tembien; and, second, a main effort by the Eritrean Corps against the flank of Ras Kassa; this mission developed into one of the most critical and savage battles

of the entire war and was brilliantly conducted by the able corps commander, General Pirzio-Biroli.

Pirzio-Biroli assigned the defense of Uarietu Pass to the black-shirt division "28 October" and ordered demonstrations to the south to attract Abyssinian forces

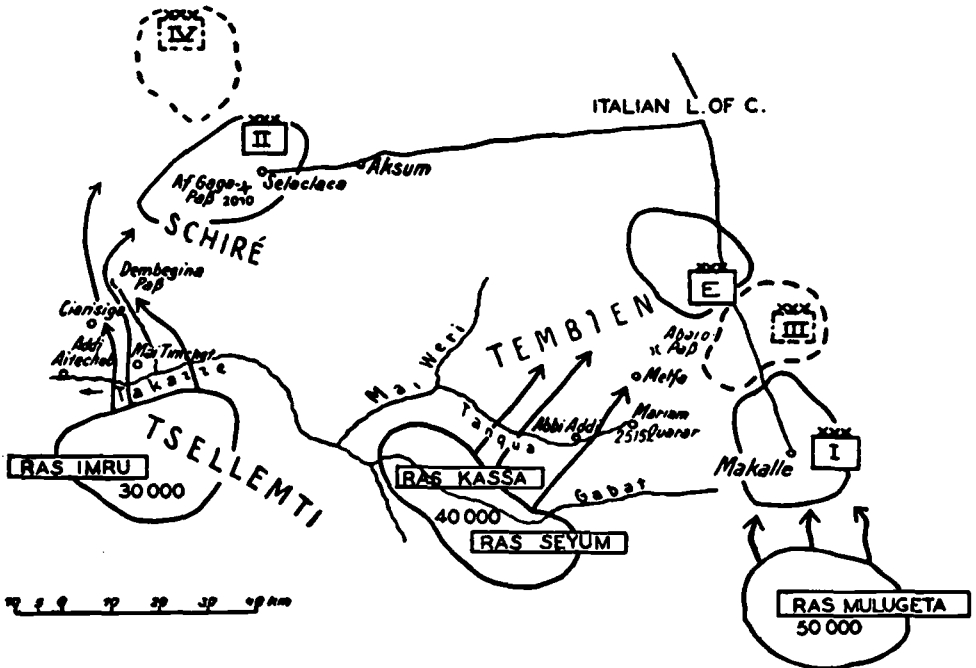

PLATE 160. GENERAL SITUATION, NORTHERN THEATER OF OPERATIONS, 15 DECEMBER 1935.

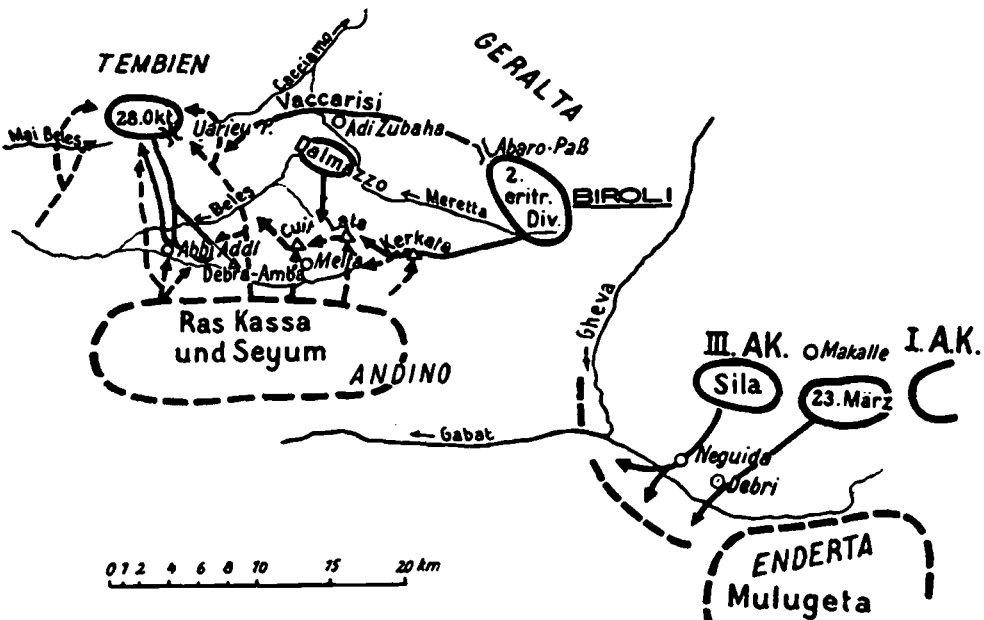

PLATE 161. THE FIRST BATTLE OF THE TEMBIEN, 19-23 JANUARY 1936.

frontally, while the 2d Eritrean division assembled in the Meretta valley for a decisive thrust against the Abyssinian right flank; the Italian advance began on the morning of the twentieth; the valley of the Beles appeared empty and the advance continued on the twenty-first. Then General Diamanti ran into trouble on the heights of Debra-Amba; the Abyssinians, in force, pursued; Diamanti barely made Uarietu Pass, and that important point was attacked savagely on the twenty-first and twenty-second—the black-shirt division had indeed attracted the bulk of Ras Kassa's forces!

In the meantime, the 2d Eritrean division took Mount Kerkara on the twentieth, and Lata on the twenty-first; then they were attacked heavily; Biroli, however, had

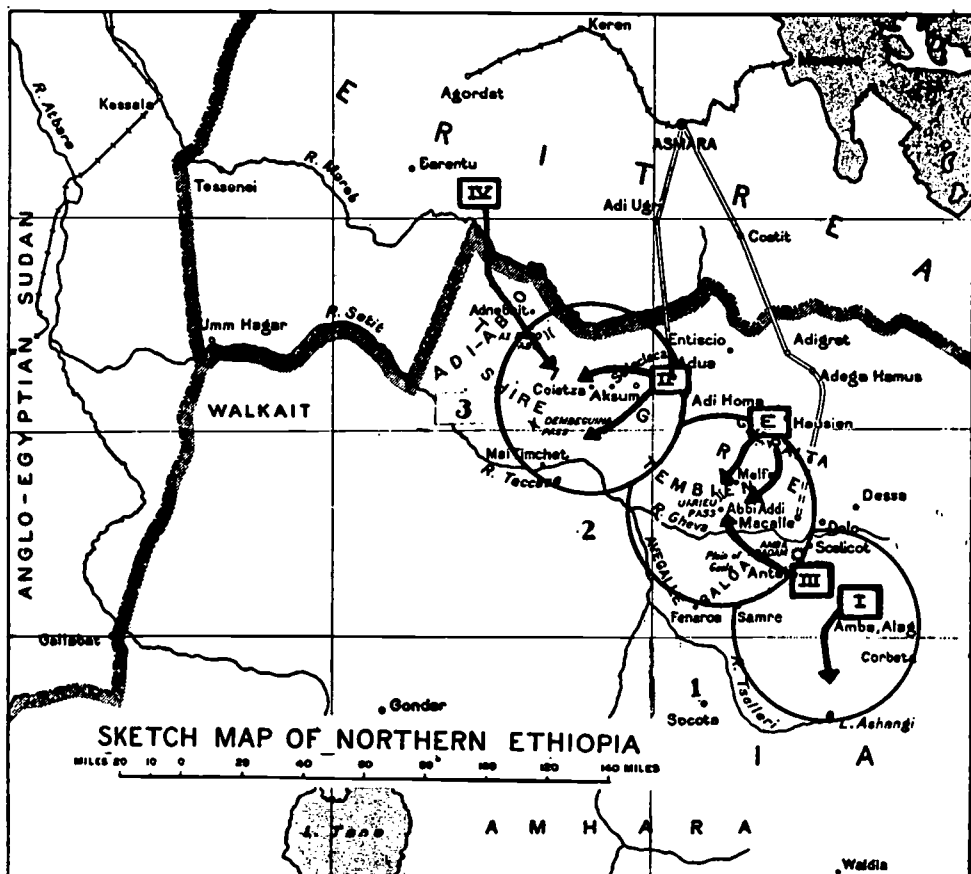

PLATE 162. MARSHAL BADOGLIO'S DECISIVE MANEUVER,
10 FEBRUARY-3 MARCH 1936.

sent a strong detachment, under Colonel Vaccarisi, via Addi Zubana to reestablish liaison with the hard-pressed garrison of Uarietu; this column, Prince Pignatelli in the lead, drove forward, reached the vicinity of the Pass at noon of the twenty-third and struck the Abyssinians in flank; this unexpected threat turned the tide. Full credit must also be given to the ceaseless attacks of Italian bombers, operating from a temporary field at Makalle.

Here is an interesting example of the combination of holding or secondary attack combined with a decisive flank attack; when the flank attack (2d Eritrean division) slowed down, it became a holding attack on its own local front while a

part of its forces (Vaccarisi's column) was used in an envelopment. The initial maneuver was "preconceived"; the second maneuver was "improvised" to meet changing local conditions, i. e., a flexible maneuver and elastic command decisions—fast, modern generalship!

e. Marshal Badoglio's decisive maneuver. Reinforcements enabled the Marshal to form the III and IV Corps; this latter corps was placed along the Mareb, in vicinity of Debrî Mariam, to operate in conjunction with the II Corps, now in the area Selaclaca—Aksum.

The principal enemy groupings had been more or less identified since 15 December; Badoglio contemplated a simultaneous attack along the entire front; he wired the Duce: "The machine is ready. I shall start it going, and it will not be allowed to stop."

In general terms, each operation involved a combination of frontal attack and envelopment. In the Schire, the II Corps was engaged frontally while the IV Corps attempted to envelop the enemy west flank. In the Tembien, the Eritrean Corps attacked frontally while the III Corps advanced from the southeast against the enemy flank and rear. In the Enderta, the I and III Corps operated in conjunction against the Amba Aradam, in a double envelopment; then the III Corps made an about face, to cooperate in the battle of the Tembien, while the I Corps took the Amba Alagi. It is obvious that this plan, over an extended front of about 100 miles, in a highland region, developed into locally distinct battles, nevertheless, the coordination of effort was remarkably fruitful—a credit to troops and staffs!

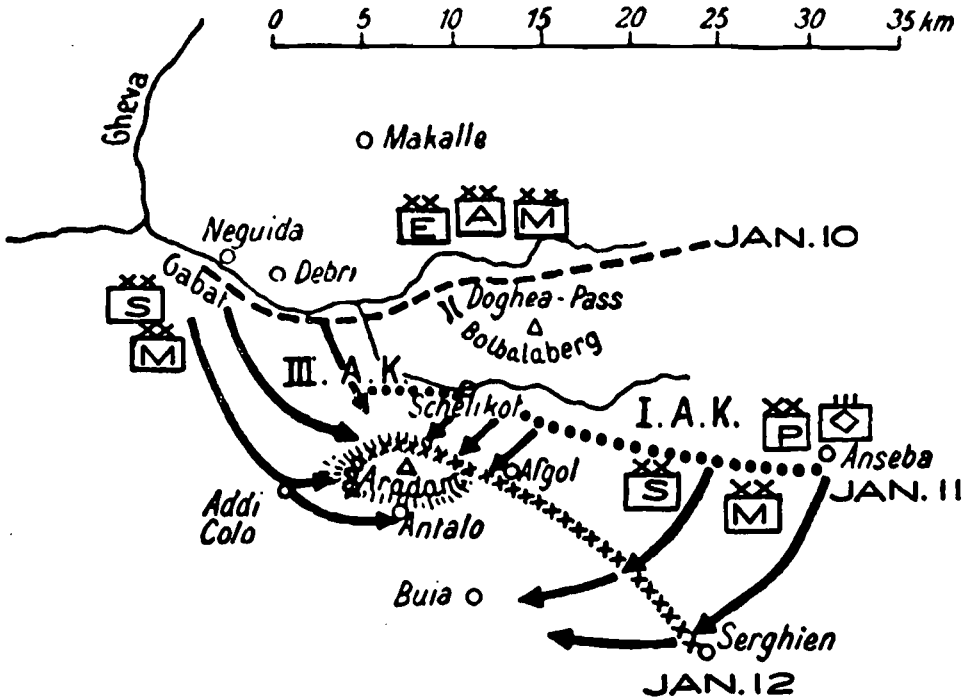

PLATE 163. THE BATTLE OF AMBA ARADAM, 10-15 FEBRUARY 1936.

(1) Operations in the Enderta: 10-27 February 1936. The sharp blow administered Ras Kassa and Seyum, in the Tembien, definitely secured the principal Italian communications via Makalle—Adigrat, besides testing the relative strength

and capacities of the opponents. The next step was to strike the nearest enemy grouping, under Mulugueta, who occupied a strong defensive position on the heights of the plateau of Amba Aradam, at an elevation of 6000 feet. It was clear that this formidable position could not be taken frontally but required a methodical offensive, through a double envelopment, which might lead to a complete encirclement.

(a) **The Battle of Amba Aradam: 10-15 February 1936.** The operation was conceived and executed in progressive phases, over a period of five days—a characteristic feature of a modern large-scale attack in which “battle” is the ensemble of a “series” of combats, coordinated but not necessarily contiguous; it is apparent from the sketch that the initial Italian deployment was on a front of 35 kms or 22 miles.

The Italians developed along the north bank of the Gabat, during the night of 8-9 February, with corps abreast, the I Corps on the left; on the tenth, both corps established bridgeheads across the river, to the heights of Doghea Pass. The attack began on the twelfth, with the main effort in the zone of action of the I Corps, which had been suitably reinforced by the division “Sabauda” (S), the militia division “3d January” (M) and the Alpine division “Pusteria” (P), in reserve. On the thirteenth, this attack had made good progress, and the III Corps began operations on the west slopes of Aradam. Badoglio ordered a pause on the fourteenth, under cover of an artillery preparation against the Aradam positions. A general assault, including frontal attacks, was initiated on the fifteenth, and by noon elements of the command of the Duke of Pistoia hoisted the tricolor of Italy on the crest of Aradam. By far the heaviest fighting, however, took place on the twelfth, in the zone of action of the Alpine Division and the Bersaglieri.

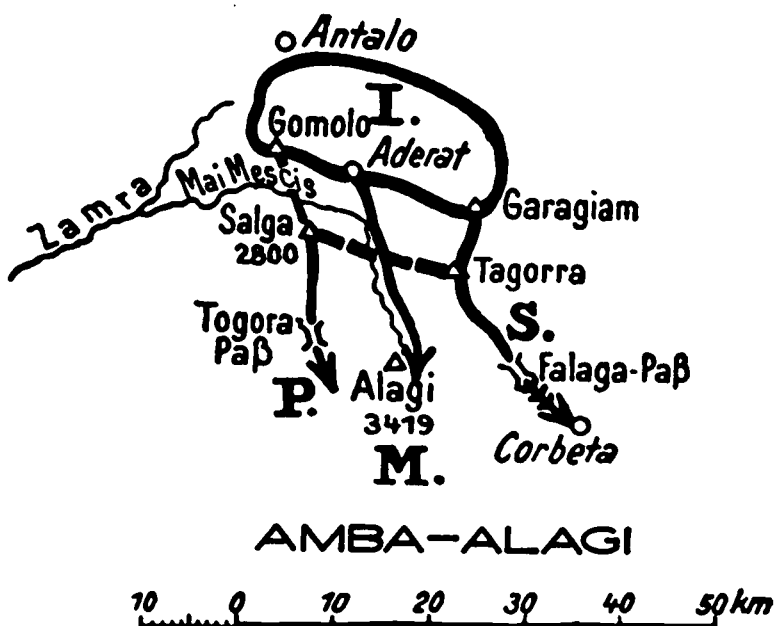

PLATE 164. THE CAPTURE OF AMBA ALAGI, 27 FEBRUARY 1936.

The complete encirclement of the enemy was not accomplished; Mulugueta had given a timely order for the withdrawal, but, as in the Tembien, the Abyssinians

had been badly shaken and must have realized that the bushwhacking days of Adua were over. The remnants of this army retreated to the south and occupied another strong position, on the mountain range of Amba Alagi, with elevations of 10,000 feet, a natural, intermediate delaying position on the road to Dessie. Badoglio advanced to the plain of Buia but halted there for reorganization and the opening phase of a major maneuver.

The III Corps was reconstituted and now was composed of the division "23 March (M)," the 1st Eritrean division, one infantry regiment and one battalion field artillery (division "Sila"), one battalion infantry and one squadron Eritrean cavalry; it made an about-face from its position on the west slope of the Aradam and advanced via Gargara on Gaela; to make this possible, roads were built, in forced labor, to a distance of 80 km in the space of four days only!

(b) The Capture of Amba Alagi: 28 February 1936. In the meantime, the I Corps began its advance on Amba Alagi on the twentieth; its present composition was the Alpine Division "Pusteria," the division "Sabauda" the division "Sila" (less detachments), the division "3 January," the 6th Militia group, the 8th Eritrean brigade, motorized corps artillery and fast tanks. On the twenty-sixth the corps advanced in three columns to the line: Salga—Tagorra; on the twenty-eighth it was ready for the assault, only to find that the enemy had retired to the south toward Lake Ascianghi. This was more or less unexpected and revealed the degree of demoralization of Mulugueta's army and the severe beating it had received on the Aradam.

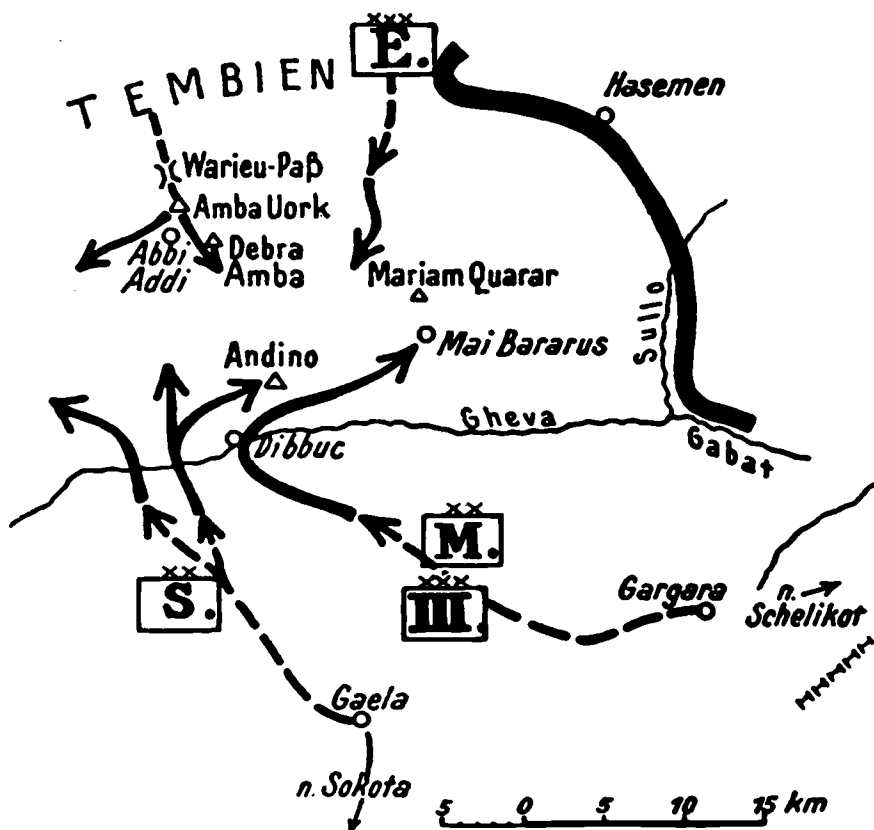

PLATE 165. THE SECOND BATTLE OF THE TEMBIEN, 27-29 FEBRUARY 1936.

(2) Operations in the Tembien: 27-29 February 1936. The second battle of the Tembien presented a more serious aspect. The attack was ordered for the twenty-seventh. In spite of improvised road construction, the III Corps had hard going; supply difficulties developed and several columns had to be supplied from the air. Nevertheless, Badoglio assigned progressive missions to each group for three days.

The Eritrean Corps was to debouch from the Uarieu Pass and take the hill position of Amba Uork, while the III Corps had to reach the Gheva River. The objectives for the twenty-eighth were Debra Amba and Mariam Quarar for the Eritrean Corps and Andino and Mai Bararus for the III Corps; on the twenty-ninth, elements of both corps were expected to join, in vicinity of Abbi Addi.

The program was carried out against heavy odds. The Alpini had a particularly hard nut to crack, in the capture of Amba Uork, which presented a practically vertical cliff of 1200 feet; mountaineers, under Captains Polo and Pollino, actually climbed this wall in 3½ hours and took the crest as a complete surprise for the Ethiopians; there, they hung on and repulsed a series of savage attacks. The III Corps also ran into severe resistance; there was heavy fighting around the Debra Amba. On the evening of the twenty-eighth, Ras Kassa gave in and began his retreat; when the Italians closed the ring on the twenty-ninth at Abbi Addi considerable enemy forces had made a getaway, although large numbers were taken prisoners.

The general effect, however, was unmistakable; the army of Ras Kassa, in slow dissolution, did not appear again in this campaign.

(3) Operations in the Schire: 29 February-3 March 1936. The third phase of this vast operation likewise failed of its ultimate accomplishment, but the tactical results were far-reaching. The plan was sound—a frontal attack on Coietza and Af Gaga Pass, by the II Corps, to pin down Ras Imru's main forces,

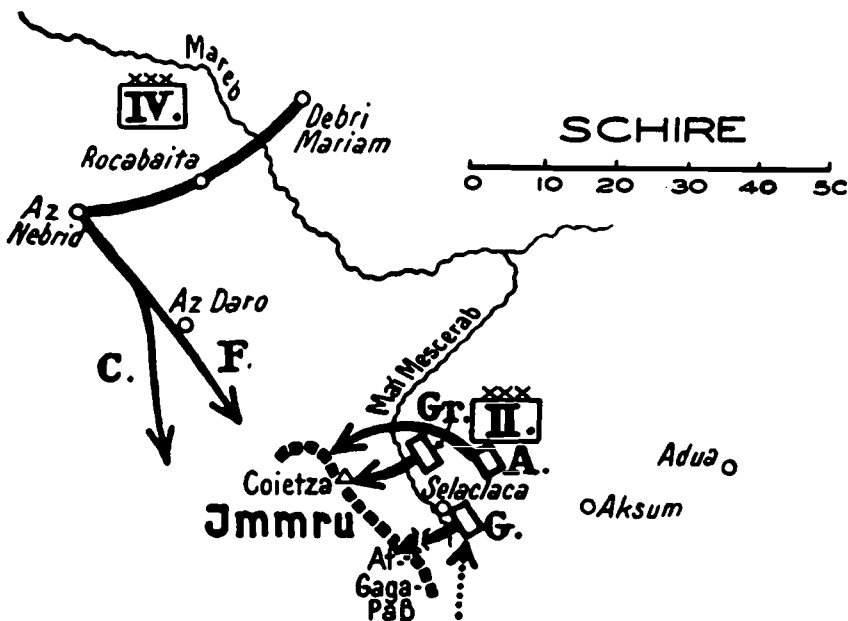

PLATE 166. THE ATTACK ON COIETZA AND AF GAGA PASS, 2-3 MARCH 1936.

Composition of the IV Corps: Division "Cosseria" (C) and division "1 February" (F). The II Corps: Division "21 April" (A), division "Gavinana" (G), and division "Gran Sasso" (Gr).

while the IV Corps, advancing from the west, would strike the enemy in flank and rear.

This is a clear-cut example of the preconceived maneuver; it has its counterpart in the maneuver of Castiglioni (1796), the function of the Prussian Second Army at Koniggratz (1866), or the intervention of Jackson's Corps at Chancellorsville, or any flank attack that required perfect timing and coordination with the frontal effort; timing is perhaps the most essential single factor in such an operation, and it was faulty timing, i.e., delay on the part of the Italian IV Corps, that spoiled a reasonable plan for encirclement.

On 29 February this corps crossed the Mescerab to attack the opposite heights of Coietza and Af Gaga Pass. Ras Imru counterattacked immediately and with great violence; in a slow advance, the corps was obliged to put all divisions in line. Hand-to-hand fighting was common; on 2 March, the division commander of the "Gran Sasso," the Duke of Bergamo, was in the front lines; General Appiotti and his staff were in the thick of close fighting. It was only when the 252d Legion took the crest of the Coietza, in the morning of the third, that Ras Imru began to fall back and under heavy losses crossed the Taccaze River for a further retreat to the south.

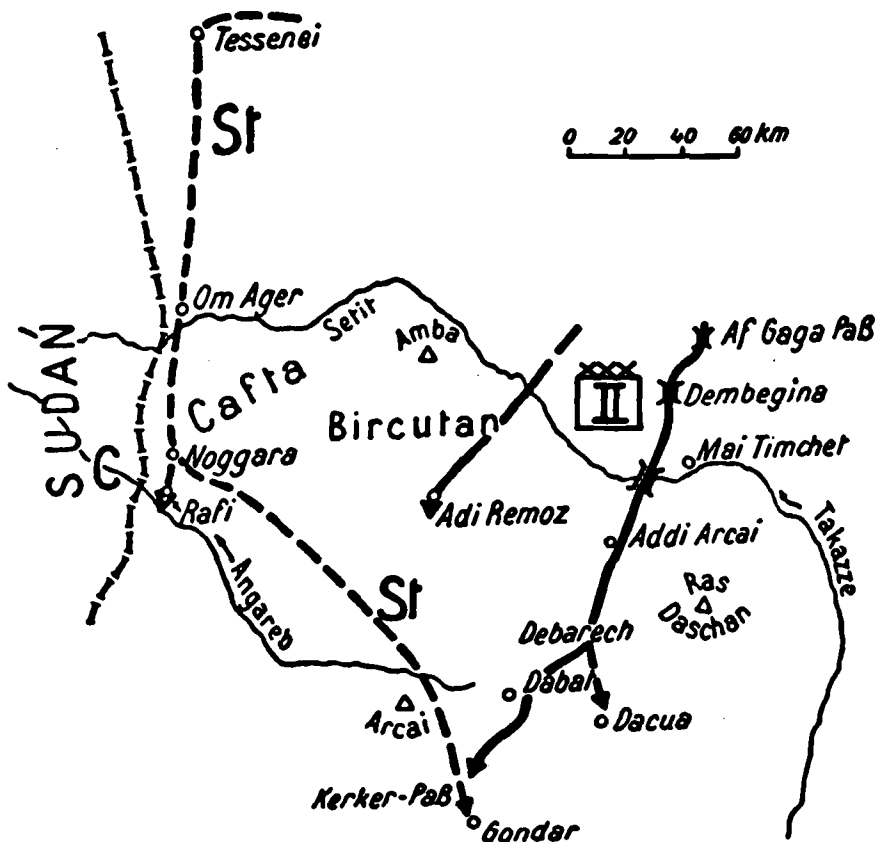

PLATE 167. STARACE'S ADVANCE ON GONDAR, 10-31 MARCH 1936.

In the meantime, the IV Corps, that should have intervened in a decisive direction, had taken no part in the fighting; its route led through a barren, mountain region without roads, and the march in the stifling tropical heat slowed down

considerably; as so often, this column of 20,000 men had to be supplied by air, including water and forage; when the exhausted troops finally reached the Taccaze, at Mai Timchet, the Abyssinians had already crossed to the south bank. The brunt of the bitter fighting was borne by the II Corps alone.

The ensemble of these operations represented a major tactical and strategical achievement: three Abyssinian armies had been defeated successively and driven from the field with every evidence of demoralization; there was only one important Abyssinian concentration remaining in the field, the Imperial Army, under the Negus, south of the Amba Alagi, in vicinity of Dessie. After a brief period of reorganization, Badoglio started the advance against the remaining foe with three corps, the II Corps via Socota, the I Corps on Lake Ascianghi, the Eritrean Corps in reserve following the I Corps. The IV Corps relieved the Eritrean Corps, in the Tembien, for the pacification of the province, while the II Corps moved slowly through Tigre in support of the motorized advance on Gondar and Lake Tana.

While the mass of Badoglio's army was oriented to the south on a comparatively narrow front, flank detachments in the east and west provided the necessary security, operating mainly in motor-mechanized columns.

f. Flank detachments: operations of motorized columns. (1) Starace's advance on Gondar: 10-31 March 1936. The secretary-general of the Fascist Party, General Achille Starace, was in command of this spectacular dash to Lake Tana. Five hundred motor vehicles were quietly assembled in Asmara; 3000 picked men were released from combat units on the front. The tactical organization of the flying column was as follows:

- 2 Battalions, Bersaglieri
- 1 Battalion, Militia "Mussolini"
- 1 Battalion F.A., 77-mm, motorized
- 1 Squadron M. G. motorcyclists
- 1 Squadron light tanks
- Engineer, signal, medical and QM detachments

Supplies for thirty days were carried along. The 41st Air Squadron was attached for reconnaissance.

The column started on 10 March and reached Om Agar in four days (380 kms). General Couture, who had held this sector in observation for some time, had advanced in the meantime to Rafi. Starace's column turned south-east and entered desert country. Enemy resistance was sporadic after they crossed the Angareb River, but the terrain gave trouble; in spite of feverish efforts, the mountain trail across Arcai and Kercher Pass (elevation 8400 feet) could not be negotiated by motor transport. Starace left his transport park behind, under cover of one battalion, and continued on foot with the remainder of his small force. The Italian High Command anticipated trouble and had dispatched elements of the II Corps via Addi Arcai—Dabat; the 3d Eritrean Brigade joined Starace and enabled him to enter Gondar on 1 April. His advance guard reached Lake Tana shortly thereafter and occupied the Gorgora peninsula. Remnants of Ras Imru's defeated army had fallen back before Starace's column and escaped southward.

(2) Ruggero's Advance on Sardo, 6-11 March 1936. At about the same time, a flying column crossed the incredible Danakil Desert, starting from Assab. A previous attempt in October 1935 had been stopped at Muss-Alli. The Danakil is an absolutely waterless desert, interspersed with lava ridges and sand dunes; to cross it, in any force, required painstaking logistic preparation. Colonel Ruggero, the local Italian commander, made these preparations. Intensive aerial recon-

naissance furnished maps and suitable routes; the supply was furnished by a special squadron of 25 transport planes; incidentally, the enormous heat compelled the aviators to deliver live animals in lieu of frozen meat. Four intermediate camps were established, organized and provisioned with rations for twenty days. The local tribe of the Haussa's had been propagandized and were ready to turn against the Abyssinians; the objective on this motor dash was the Haussa capital of Sardo, in the fertile plain of Gamarrei. The small column of several hundred men started on 6 March and reached Sardo successfully on the eleventh.

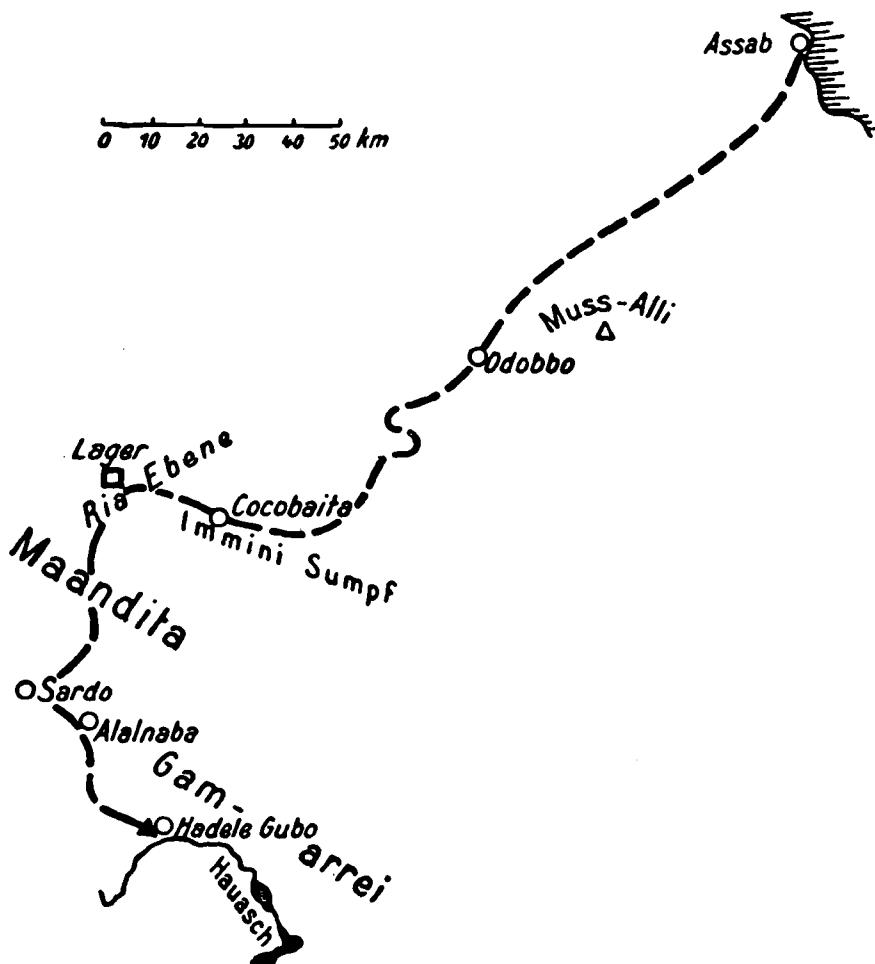

PLATE 168. RUGGERO'S ADVANCE ON SARDO, 6-11 MARCH 1936.

g. *The defeat of the Negus: Mai Cieu or Lake Ascianghi.* After the practical dissolution of Imru's, Kassa's and Mulugeta's forces, the only remaining organized army was that personally commanded by the Negus, estimated from 50,000 to 60,000 men.

This force became the next objective of the Italian Army. The III and I Corps advanced abreast; the Eritrean Corps echeloned to the east; division columns marched in the interval to "mop up." The I Corps reached the vicinity of Mai Cieu on 17 March and halted, since the enemy was reported just to the south, astride Agunberta Pass.

The III Corps, advancing on Socota to the west, had run into terrain difficulties; motor transport was delayed on account of sand, and 4000 white soldiers had to pack 60 tons of supplies for 36 miles for initial Class-I requirements.

Pending essential road construction, Badoglio decided, nevertheless, to attack the enemy and ordered an initial deployment.

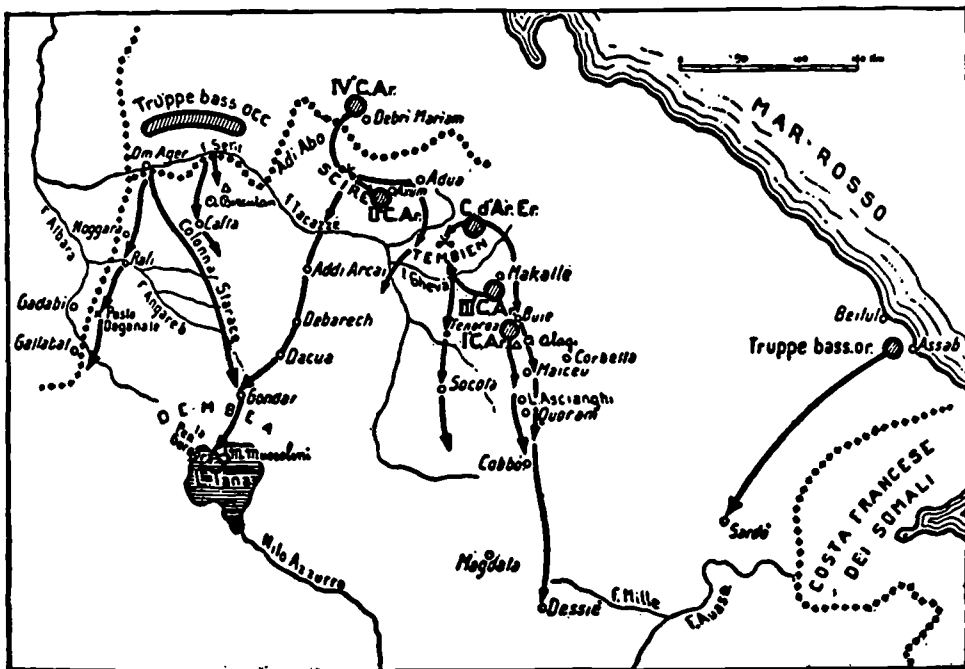

PLATE 169. THE GENERAL ADVANCE ON DESSIE, 5-14 APRIL 1936.

The I Corps placed the division "Pusteria" forward, its right resting on Bohora Pass, elevation 9000 feet, its left on Mecan Pass; the division established two sub-sectors, occupying the right with one battalion (11th Alpine), the left with three battalions (7th Alpine Regiment); the remaining units were echeloned in depth.

The front of the I Corps, Pirzio Biroli commanding, was extended to the east by the Eritrean Corps, which formed with two divisions abreast, the 2d division on the right; a detached post was established at Corbetta. In vicinity of the command post of the I Corps, at Belago, the divisions "Sabauda" and "3d January" and the 6th Militia brigade were held in reserve; still farther in rear, the division "Assieta" was on the march. G.H.Q. was not established, and General Santini exercised command.

It was apparent that the organization of the rear was incomplete; the terrain differed from the Tembien in that the ranges were heavily wooded. While the Italian forces took up their positions, reports became urgent that the Negus had advanced from Quoram to Agumberta Pass; a major attack was imminent. The Eritreans, tested in so many engagements, promptly organized for defense.

Fields of fire were difficult to develop in this wooded terrain; some units, notably the 3d Eritrean brigade, were in exposed, forward positions, hastily fortified.

The relative strength of sector troops was unfavorable; the 1st Eritrean division defended on a front on 5-8 kms, not including the detached post at Corbetta; this front had an artillery strength of only 8 batteries. That the Italians were not

entirely ready for a major attack is indicated by the fact that the artillery of the 2d Division ran short of ammunition during the day.

The Negus attacked along the entire front at dawn of the thirty-first; the attack developed into a series of assaults, at different time intervals and against different objectives; it is not clear if the Negus planned the sequence of operations or expected to develop a weak spot in the Italian ensemble. He found one but could not exploit it.

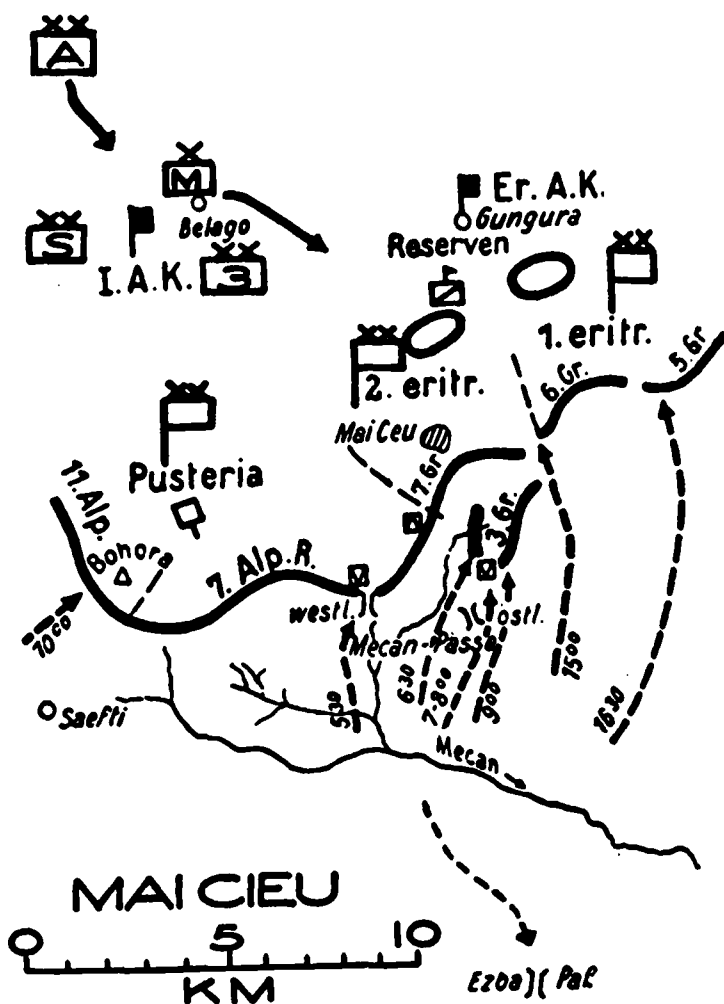

PLATE 170. THE BATTLE OF MAI CIEU. 1-3 APRIL 1936.

The 7th Alpine regiment received the first attack but it held. Shortly afterward an attack was directed against the 2d Eritrean division; the exposed flank of the 3d Eritrean brigade (10th battalion) was recognized as vulnerable and a major effort launched about 8 o'clock; several assaults were made, and by 9:30 this battalion had lost more than half its officers; the C. of S. of the division, Colonel Zuretti, intervened in person, with some reinforcements, and the position was held, in close combat, with the bayonet and hand grenade. At that time, an unsuccessful attack was launched in the west against Bohora. The enemy then shifted to

the east and attempted an infiltration between the 1st and 2d Eritrean divisions; once more the 3d brigade was hard pressed. The division commander, General Dalmazzo, sent an order to hold at all costs. Colonel Zuretti had fallen and Captain Tarantino, who commanded the 10th battalion, sent back a grim message: "We shall all be killed, but the dead will continue to fire." It was a fact that even the wounded continued to fight, in desperation. In this extremity, the division commander scraped together every man of the rear units, including cooks and clerks, and counterattacked with three battalions.

It worked; the enemy fell back. The rest of the front was also able to react, and by 2:00 PM both Mekan passes were in Italian hands. Toward 4:30 the enemy renewed the attack but failed to drive it home; thereafter, a lull set in; both sides rested on their positions for the evening.

In the morning there was desultory fighting, under cover of which the Negus retreated. The weather did not favor air activity during the battle, but on the next day it cleared and aviation was able to operate decisively against the retreating Abyssinian columns, caught in narrow defiles below Ascianghi. The fighting on the first had apparently shaken the enemy badly; the demoralizing pursuit by attack aviation practically destroyed the remnants.

h. Pursuit and the capture of Addis Ababa. With an enemy on the run, demoralized by savage and continuous air attacks, the time-honored principle of relentless pursuit, without pause, without breathing spell, to the last ounce of available strength, saw once more its historical application.

Badoglio promptly decided to pursue; immediately available, however, were only the I and the Eritrean Corps, then approaching Lake Ascianghi; the remain-

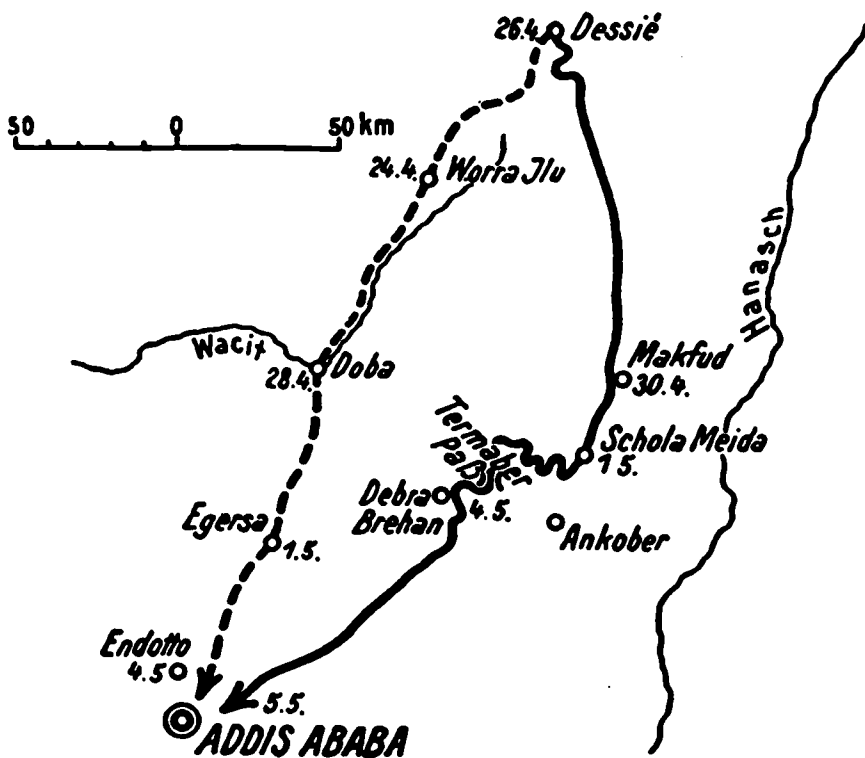

PLATE 171. THE ADVANCE ON ADDIS ABABA, 24 APRIL-5 MAY 1936.

ing corps were scattered over a wide front, from the Sudanese border via Lake Tana to Socola.

The main road to Addis Ababa could be reached by bridging a roadless gap between Mai Cieu and Quoram. Orders were issued to the Eritrean Corps advancing on foot to take Dessie without fail by the fifteenth; the I Corps, General Santini commanding, was to construct the road from Mai Cieu to Quoram by forced labor. Dall'Ora, S.O.S., received instruction to make available 1300 motor transport vehicles at Dessie by the twenty-second of the month; Badoglio planned to push this huge motor column on Addis Ababa, expecting to reach it by the thirtieth.

Pirzio Biroli began the advance on the ninth; the 2d Eritrean division, Dal-mazzo commanding, was in the lead; in six days, over mountainous terrain, the hard, seasoned Eritrean Corps covered 125 kms as the crow flies and were within a few hours of Dessie. Biroli developed in four columns for the encirclement of Dessie on the fifteenth but found the enemy gone. This corps was supplied from the air for several days.

Dall'Ora was as good or better than his word; by the seventeenth motor transportation began to arrive in the vicinity of Quoram; the general had managed to assemble 1600 vehicles; the division "Sabauda," the 1st battalion, militia division "3d January," three battalions light and medium artillery, motorized and engineer detachments entrucked and began the advance from Dessie on the twenty-fourth. The C. in C. had arrived by air as early as the twentieth.

The march dispositions involved two routes, a mountain trail via Doba, in the west, which was followed by a flank column under General Vaccarisi, and the principal motor column, on the east, via Mukfud and Debra; the composition of these columns was as follows:

Right column	Left column
1 Cavalry Squadron	1 Eritrean Battalion
1 Eritrean Brigade (1st)	1 Mtn. F.A. Battalion
1 Mtn. Battalion F.A.	Motor Transport
	1 Eritrean Brigade (2d)
	1 Squadron Lt. Tanks

There were approximately 10,000 men, native and white, with eleven batteries F.A. and some light tanks.

The march serials were timed so that both columns could cooperate on the line: Dobra—Termaber Pass, where enemy resistance was anticipated. Eventually, the motor serials would advance beyond the foot elements and enter Addis Ababa first.

Vaccarisi's column made forced marches of 40 kms per day, this on a mountain trail; the motorized units on the main route were barely able to keep up with the foot elements. The engineers, under Colonel Caniglia, made phantastic efforts; twenty-two fords, in swampy areas, had already been negotiated; the worst task was on the Termaber Pass, winding in precipitate curves from 3000 to 9450 feet elevation; many washouts had to be repaired and enormous retaining walls constructed. It was not until the fourth that the motor column got across; the Eritreans were already in sight of the capital when the motor elements arrived and made an entry, on the fifth; the Negus had fled to Djibuti, and marauders were pillaging in the city. Exit Haile Selassie—enter Vittorio Emanuele III!

58. THE CAMPAIGN IN THE SOUTH:¹⁶ GRAZIANI. *a. Initial operations: the protective force.* The strategic role assigned to the forces in Somalia was secondary; consequently, relatively smaller forces and resources were initially allotted to this

¹⁶ See Plate 154 for Orientation Map.

theater of operations. Nevertheless, it was in keeping with the soldierly qualities of the theater commander, General Graziani, that operations were conducted aggressively, with the result that considerable Ethiopian forces were drawn from the northern front and a series of remarkable, local successes were obtained. General Graziani, then 53 years old, had distinguished himself by reckless bravery during the World War and great capacity in colonial warfare; it was he who finally subjugated the Cyrenaica, in 1930-31, by a campaign that combined sheer audacity with the most painstaking logistic preparations.

Graziani had initially available the permanent Somali native formations, about twelve battalions, to which were added the regular division "Peloritana," two militia divisions, including the "Fevere" and a Libyan division, a total of approximately 50,000, of which only half was available for service at the front, since the enormous distances in this theater required an extensive line of communication service.

Ethiopian strength was estimated between 50,000 and 75,000 under Ras Nasibu, holding the waterholes and defiles of the river system, the Juba, Webbe Schebelle and Fafan.

Graziani did not waste any time; he improvised motorized columns and in October took the posts of Dolo, Mustahil, Gherlogubi and Damerei, on a broad

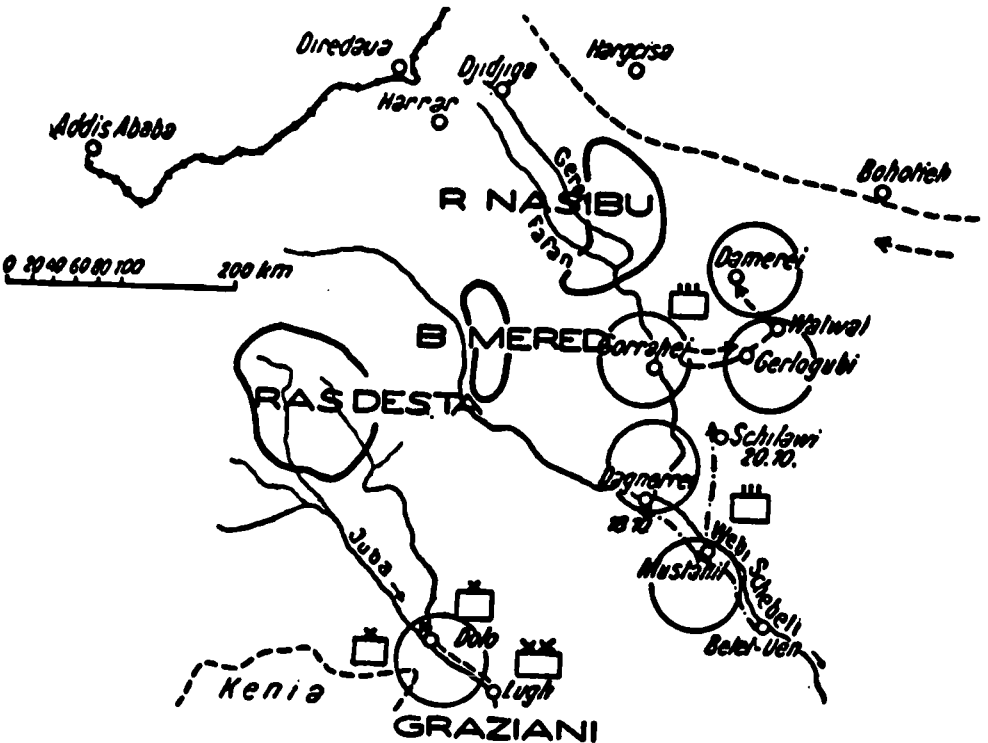

PLATE 178. GRAZIANI'S INITIAL OPERATIONS, OCTOBER-NOVEMBER 1935.

front of 500 kms, but he failed to get the important post of Gorrahei, which blocked the entrance into the valley of the Fafan.

Gorrahei became Graziani's next immediate objective. In order to cover his left flank, the capture of Dagnerrei became an intermediate step; it was taken on

the tenth, in a tactical pattern that Graziani thereafter employed on many occasions. The assault troops were brought up in night marches; attack aviation harassed the enemy previously; the assault was then launched under the protective fire of heavy bombardment aviation and motorized machine-gun units. The defeat of the Ethiopians brought in neighboring tribes, particularly the Sultan Olol Dinle, who became a useful ally thereafter.

Graziani organized a flying column, consisting of three Somali battalions, two guerrilla groups, one battalion of field artillery, one company of tanks, and one squadron of armored cars, under the command of Colonel Maletti. Once again, the assault was accompanied by heavy bombing concentrations, and Gorrahei was taken on 7 November. Flushed with success, this detachment attempted an advance up the valley of the Fafan but ran into an ambush at Gabrehor and was stopped.

At this time the Ethiopians under Ras Desta were reported advancing on Dolo; Graziani shifted the bulk of his forces to his left wing in anticipation and postponed further offensive operations in the Fafan valley. The reports of Ethiopian concentrations, while probably exaggerated, were of such a nature that the Italians organized for defense in the vicinity of Dolo. Ras Desta was advancing south, in the valley of Juba, with about 35,000 men; Ras Nassibu with 45,000 was reported along the upper Fafan; between Nassibu and Desta, Dedjasmaj Beiene Mered was located on the upper Scebeli with about 20,000 men.

As a diversion, Olol Dinle was ordered to attack Beiene Mered; provided with irregulars only, Dinle failed in the attempt but managed to immobilize Mered, which was the real object of his strategic mission.

b. The offensive against Ras Desta. The advance of Desta's main column along

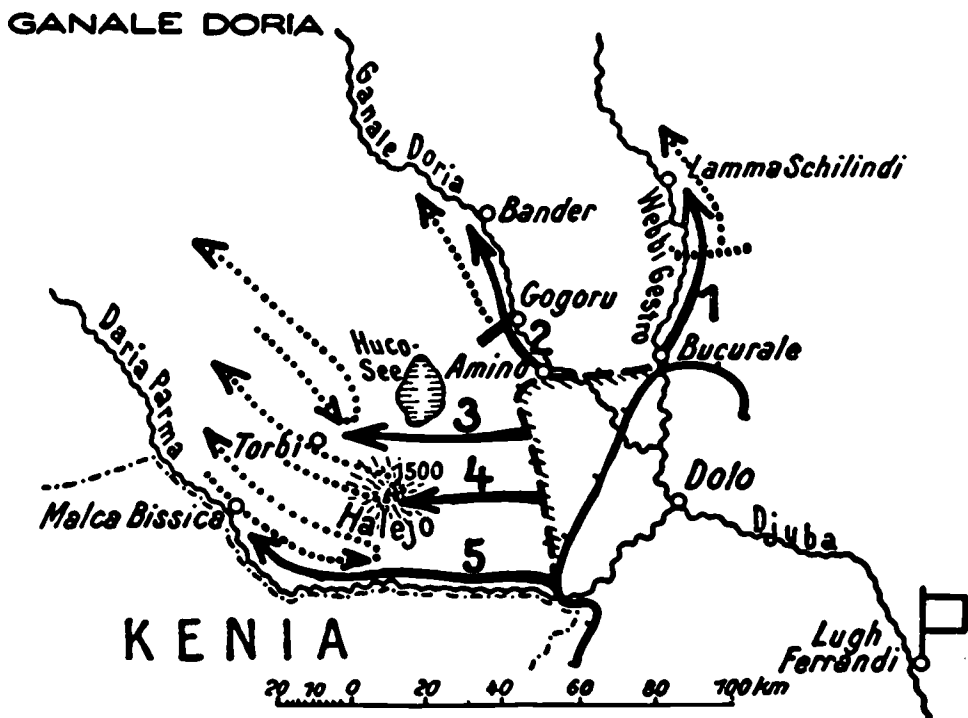

PLATE 173. THE BATTLE OF GANALE DORIA, 11-13 JANUARY 1936.

the Ganale Doria was observed on 1 January. Graziani advanced promptly and took Amino in order to control the area between the river and Lake Huco; the division "Peloritana" was then drawn forward, in a position in readiness. On the eleventh, Desta's leading elements collided with the Italian outposts.

(1) The Battle of Ganale Doria, 11-13 January 1936. The Italian plan ripened into swift execution: a frontal attack in the center, with flank columns securing the valleys of the Doria and Gestro.

The height of Halejo became the first objective. It was taken on the twelfth. Graziani, himself, conducted the main effort south of Lake Huco; tanks opened the way in the dense underbrush, and fighting was severe. Colonel Miele, the Chief of Staff, personally brought up artillery for flanking fire. The Abyssinian front broke, finally, when elements of the column in the Doria valley turned south from Gogoru and enveloped the enemy's north flank. Graziani recognized the enemy's demoralization and immediately organized for pursuit.

(2) The pursuit to Neghelli, 15-20 January 1936. A motor-mechanized force of 1100 vehicles was assembled, containing tanks and motorized artillery. Limited supplies were made available as follows: Class-I supplies, 300 tons; 40,000 gallons of water in 60 tank trucks; 300 tons of gasoline and 150 tons of ammunition. Seven thousand troops were entrucked, preceded by the machine-gun squadrons of the cavalry regiments "Aosta" and "Genoa." Attack aviation operated far in advance of the column, dispersing every enemy concentration. Graziani reached Filto on the seventeenth and Neghelli on the twentieth; this bold advance of 300 kms, in

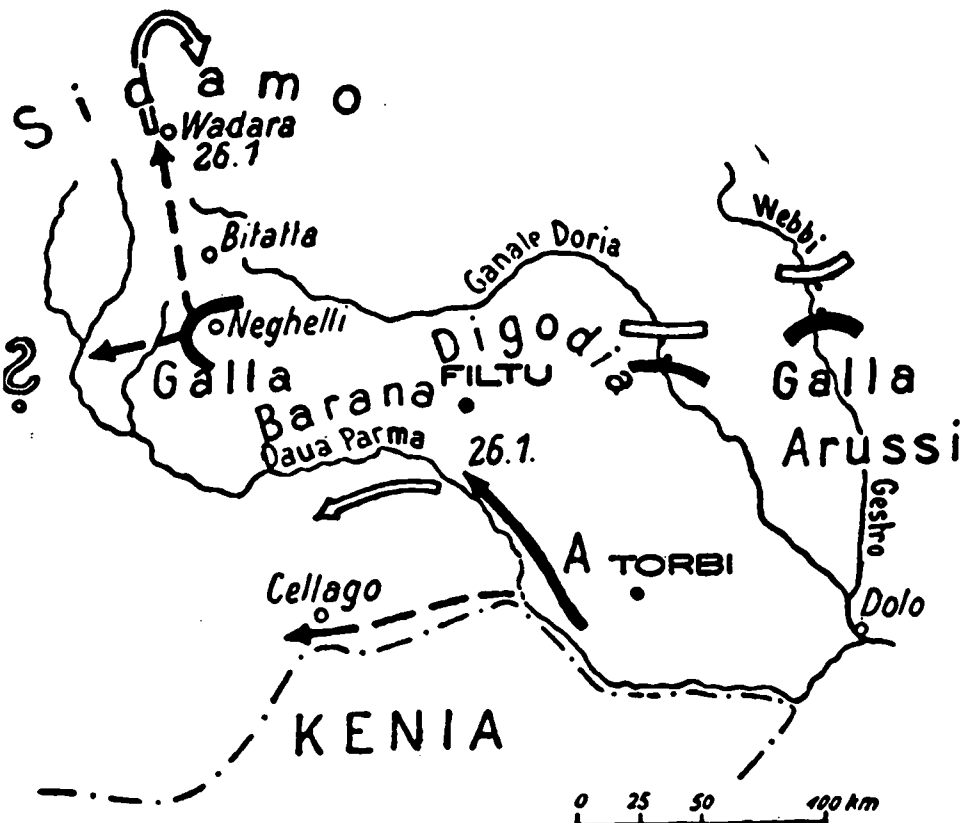

PLATE 174. THE ADVANCE ON NEGHELLI, 15-20 JANUARY 1936.

relentless pursuit into the heart of the enemy country, is a maneuver in the Napoleonic manner. General Agostini, commanding the southern flank-column, ran into hard fighting in the Daua Parma valley but continued successfully on his covering mission by an expedition from Malca Murri on Cellago. The remnants of Desta's forces made a stand in the difficult lake country along the route: Irghalem—Addis Ababa.

The temptation for a further dash straight to the enemy capital, must have been great; Graziani, however, had to consider the remaining Ethiopian concentrations under Mered and Nasibu and decided to hold the Neghelli area defensively while shifting his main forces to northern Ogaden for eventual operations in the direction of Harrar. The great talent of this commander is amply demonstrated by his amazing capacity to adjust to rapidly changing strategical conditions through maneuver.

Harrar
○

Djidjida
○

☐ Reserve

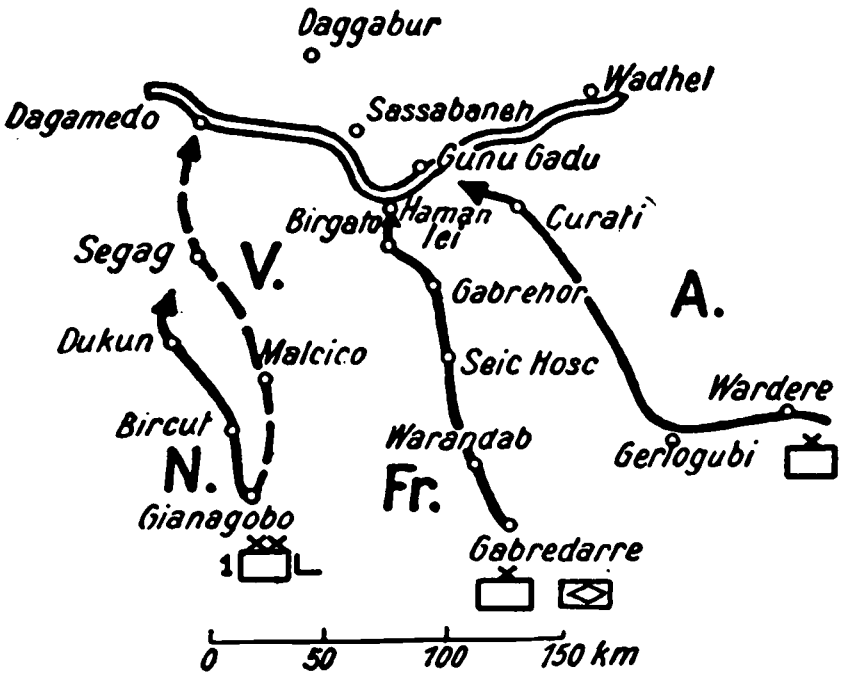

PLATE 175. THE ADVANCE ON SASSABANEH, APRIL 1936.

c. The offensive against Ras Nasibu, April 1936. In order to keep the Neghelli front secure, a purely passive defense was not sufficient; in the next two months

the Italians executed a number of raids and expeditions and sometimes ran into trouble, as the machine-gun squadron of the "Aosta" in its raid on Uardara, on 12 April. This is "active defense" in the best meaning of the term, and the general mission of flank security was amply fulfilled, permitting Graziani's concentration against his only remaining opponent, Ras Nasibu.

(1) The advance on Sassabaneh, April 1936. The general situation in the period January-March 1936 developed in three phases: (a) exploitation in the Neghelli area, (b) containing action against Beiene Mered in the Scabeli valley, and (c) concentration against Ras Nasibu in the Sassabaneh area.

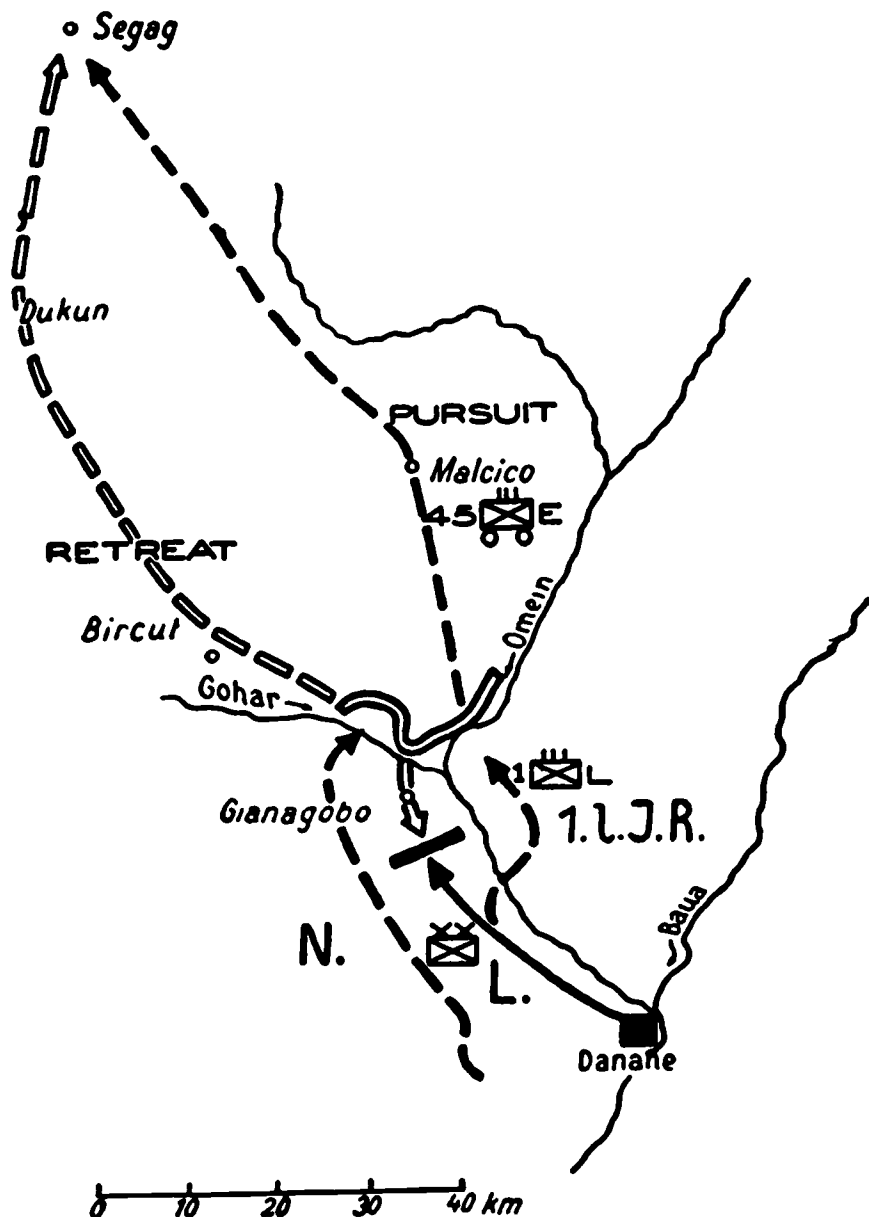

PLATE 176. THE BATTLE OF GIANAGOBO, 15-17 APRIL 1936.

The Italian intelligence reported three enemy groupings: (a) Ras Maconnen in vicinity of Bircut with 9000 men, (b) Ras Nasibu with 10,000 men in vicinity of Sassabaneh in a fortified position, and (c) a reserve force of 9000 men in vicinity of Djidjida; the entire area was fortified in the sense that every waterhole was organized for defense in considerable depth.

Graziani concentrated on a broad front about 50 miles south of the line Gianagobo—Gabredarre—Gerlogubi; he assembled a considerable park of motor vehicles; new wells were dug to insure a daily supply of 250,000 gallons of water. Reinforcements had been made available, through the arrival of the Lybian division and parts of the division "Tevere." Real resistance was not expected until the line Dagamedo—Sassabaneh—Wedhel had been reached.

Graziani planned an advance in three columns with the main effort to be made by the left column, General Nasi (N) commanding; the Lybian division, reinforced, was assigned to this column. The center column, General Frusci (Fr) commanding, was heavily motorized, comprising armored cars, tanks, and machine gun motorcycles, engineers (white) and some Somali battalions; the right column, General Agostini (A) commanding, contained Italian and native units. Graziani held out motorized reserves.

(2) The Battle of Gianagobo, 15-17 April 1936. In spite of the rainy season, the advance was begun on the fourteenth, under difficulties, and contact was not made with the main enemy position until the twenty-sixth. Air reconnaissance was profitable in spite of poor visibility, and indicated enemy strength opposite the center column, which was reinforced.

The left column, however, ran early into the enemy in a meeting engagement at Gianagobo on 15 April.

The Lybian Division became gradually committed; the enemy fought vigorously, even to attacking the Italians on the sixteenth; on the seventeenth, an envelopment by the 1st Lybian Infantry Regiment brought on the decision and the enemy retreated via Bircut.

Graziani released a motorized column, General Verné (V) commanding, consisting of the 45th Eritrean Battalion and certain native guerrillas, for pursuit, to intercept the enemy at Segag; this is the classical pattern of pursuit: direct pressure by the units in contact (Lybian Division) and encircling pursuit to intercept the enemy at a critical rearward point along his route of withdrawal. Verné's column was delayed by creeks in flood, and the bulk of the enemy was able to escape, but, in its advance, this column occupied Dagamedo as early as the twenty-third and was consequently on the flank of the main enemy position.

(3) The battle of Sassabaneh, 24-30 April 1936. (a) First phase: the situation to 25 April. The weather cleared on the twenty-third and attack aviation began a bombardment of enemy positions; the order for the attack was issued that night. Viewed from Gabrehor, the heights of Gumar, Dane and Birgot showed enemy trenches.

Graziani decided on a double envelopment: Verné (V), on the left, was ordered to close in to the east via Renda; Agostini (A), on the right, was to advance west via Gunagado; Frusci (F), in the center, was to attack on both sides of the Fafan River; he held out a motorized reserve, including General Navarra's detachment, further to the rear; the army reserve was intact. The attack was launched at 7:00 AM of the twenty-fourth, preceded by waves of attack aviation. The enemy was encountered in the dense undergrowth; snipers from the tree tops caused considerable losses; the brush was so thick in the center that Frusci's columns had to advance in single file. Armored cars finally made the heights and found that it was

covering an outpost position only and that the main line of resistance was in rear in vicinity of Hamanlei. As the terrain was clearer, the attack continued but was stopped frontally; the 6th Eritrean battalion suffered 40 per cent losses. Frusci called a halt to his frontal attack to await the effect of his enveloping forces.

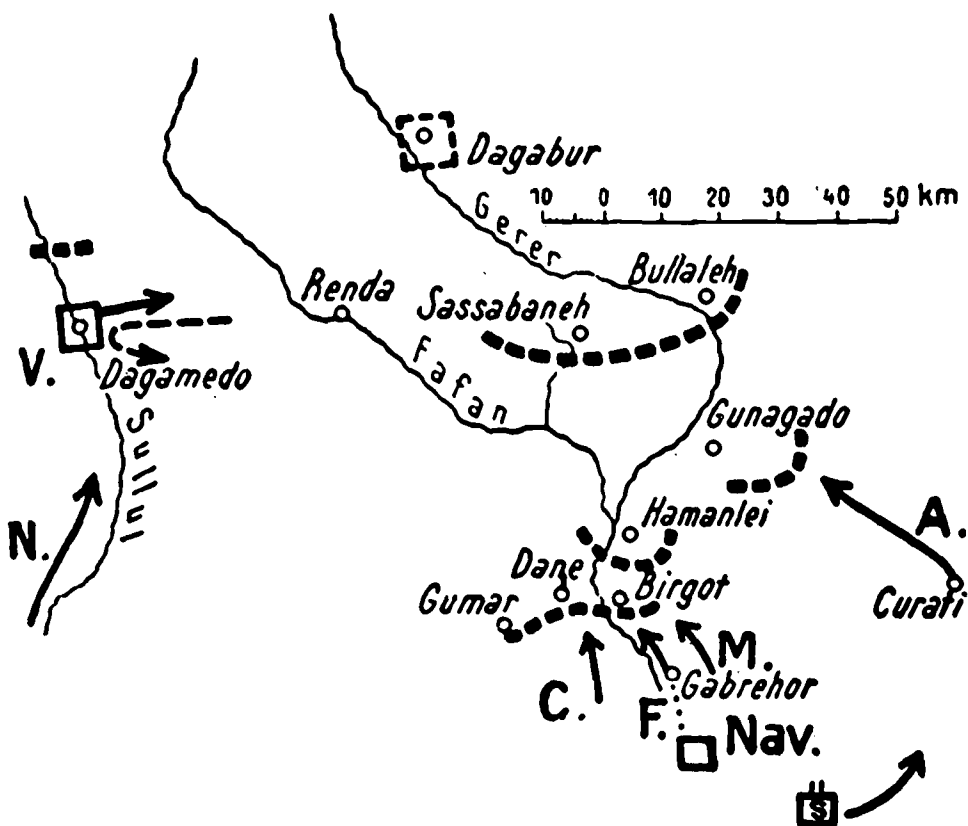

PLATE 177. SASSABANEH, SITUATION 24-25 APRIL 1936.

The envelopment, however, had run into stiff resistance which slowed down its advance appreciably; Verné, in the west, was counterattacked by the enemy and barely held his ground; Agostini reached Gunagado but encountered serious opposition; he received reinforcements in the form of a volunteer battalion (S) but could make no appreciable headway.

This left Frusci to his own resources; after some local reorganization he continued the attack on the twenty-fifth, relying mainly on his heavy supporting weapons. Fighting like demons, the Abyssinians counterattacked that day, getting uncomfortably close to division staffs. Nightfall indicated a weakening of attacks, and Frusci stubbornly ordered a further advance; he reached Hamanlei on the morning of the twenty-sixth. Verné was still fighting at Dagamedo; Agostini had made little headway, and the enemy was still at Sassabaneh.

(b) Second phase: the situation to 29 April. Graziani recognized that reorganization was indicated. On the 27-28 April, units and supply dispositions had been adjusted to a fresh plan: continuation of a frontal but secondary attack against Sassabaneh, while the Lybian division, motor-drawn, was to move on Dagabur, which was set as an objective for Agostini also; this "pincer movement"

was to catch Nasibu. The maneuver concept is a familiar one—recognizable in endless examples in previous chapters. The employment of motor transport, however, is a modern feature in an old pattern; its effect, naturally, was an increase in distances and mileage. This converging movement of widely separated units involved 280 kms for Nasi, 213 kms for Frusci, and 216 kms for Agostini—a neat problem in timing and coordination.

Apparently, the fight had been taken out of the Abyssinians, in what was probably the bloodiest battle of the entire war.

Agostini's column was the only one that ran into enemy resistance, at Bullaleh; the enemy had vanished; all columns reached Dagabur on the thirtieth.

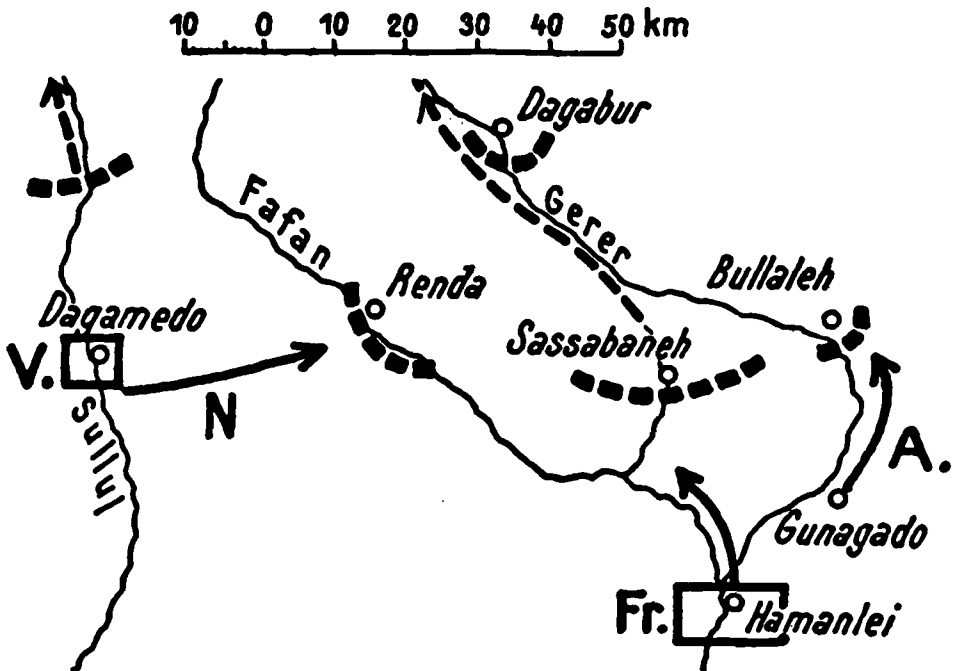

PLATE 178. SASSABANEH, SITUATION 29-30 APRIL 1936.

(4) Pursuit to Harrar: The end. It was typical of the hard-hitting Graziani not to stop at this point. In spite of persistent bad weather, the able commander ordered the pursuit pushed northward, to intercept the enemy between Harrar and Djidjida. Brushing aside local resistance, the main body moved up the valley of the Djerrerr while the Lybian division and Verné's motorized column advanced from Dagamedo via Golaski. Harrar was reached on 5 May. With a final effort, General Navarra pushed a detachment to Diredaau, reaching the railroad at 3:00 AM of the ninth, only to meet a battalion of the "Sabauda" that had entrained at Addis Ababa. This marked the end of organized resistance in Ethiopia; then followed a period of pacification and the far-sighted economic and administrative reorganization of the huge colonial empire.

59. CHARACTERISTIC TYPES OF MANEUVER. While laid in the tropics, this campaign is one of the fastest-moving, hardest-hitting colonial enterprises on record; the totally unexpected speed of the conquest was largely predicated on careful logistic preparations, on the one hand, and remarkable combat mobility

MANEUVER IN WAR

of troops and staffs, on the other hand. Except for necessary pauses to reorganize and perfect communications, the rhythm of maneuver was constant. We encounter the classical types of maneuver in a new, spectacular setting; modern armament exercised its effect in accelerating the rhythm of maneuver without changing its design; aviation intervened in combat and assisted in supply, while motor transport enabled rapid tactical and logistic displacements. The operation of motor-mechanized formations on independent missions is a noteworthy feature; their employment in pursuit, in the exploitation of a breakthrough, recalls the historical role of cavalry in a modern interpretation.

Type of Maneuver	Battle Location	Plate
1. Initial concentration	Corps grouping on frontier	156
2. Strategic advance in several columns	The occupation of Adigrat, Adua and Makalle	157 158
3. Coordination of corps and armies (a) Plan and sequence	Badoglio's decisive maneuver	162
4. Operations of corps:		
(a) Double envelopment	The battle of Amba Aradam	163
(b) Corps on a flank	The III Corps in the Tembien	161
(c) Converging attack	The second battle of Tembien	165
(d) Envelopment	The IV Corps in the Schire	166
(e) Frontal attack	The II Corps at Coietza	166
(f) Defense and counterattack	The battle of Mai-Cieù	170
5. Operations of divisions:		
(a) Secondary attack	First Battle of the Tembien Defense of Uarieù Pass	161
(b) Main attack	Flank attack ad Eritrean Division ad Division at Kerkara	
(1) Frontal attack	Vaccarisi's detachment	
(2) Envelopment		
(c) Frontal attack	The divisions of the II Corps at Coietza The division "28th October" at Abbi Addi Frusci at Sassabaneh	166 161 178
(d) Envelopment	The Lybian Division at Gianagobo Agostini and Verné at Sassabaneh The Lybian Division at Sassabaneh The 1st Lybian Regiment at Gianagobo	176 178 178 176
6. Motor-mechanized formations:		
(a) Independent	Starace on Gondar Ruggero on Sardo	167 168
(b) Pursuit	Verné at Gianagobo Pursuit to Neghelli	176 174
7. Aviation:		
(a) Supply	The advance on Sardo	168
(b) Direct support	Uarieù Pass: Tembien	161
(c) Pursuit	Mai Cieù	170

60. THE TACTICS AND TECHNIQUE OF THE SEPARATE ARMS. *a. Aviation.* There is a certain piquant anticlimax in a situation in which that army which has developed a very impressive tactical doctrine should find itself engaged in a theater of war and against an opponent which did not permit this doctrine to be applied or fully tested.

(1) Douhet in Abyssinia. The name of Douhet, the brilliant Italian exponent of "the doctrine of totalitarian, aggressive, aerial warfare," represents the greatest single influence to orient Italian military and naval aviation since the World War. The broad elements of Douhet's doctrine may be summarized briefly:

1. The war of the future will be a violent effort exploiting every moral, economic and military resource of the nation.
2. Faulty or inadequate initial organization of the armed forces may bring on inevitable defeat, since last-minute improvisations are impracticable in the swift-moving situations of the war of the future, the "blitzkrieg."
3. Strategy and tactics depend largely on the efficacy of armament; the paralysis of the World War was caused by the effect of modern automatic weapons.
4. Against the growing power of the defensive, a quick decision is hardly to be expected, with any tactical equality; naval operations are already subject to similar limitations.
5. The air arm alone seems capable of future expansion and refinement, and its tactical and strategical possibilities appear without limit. Aviation represents the most effective offensive weapon in existence today; consequently, aviation should be organized on a par with the traditional terrestrial and naval establishments, as a separate air force.

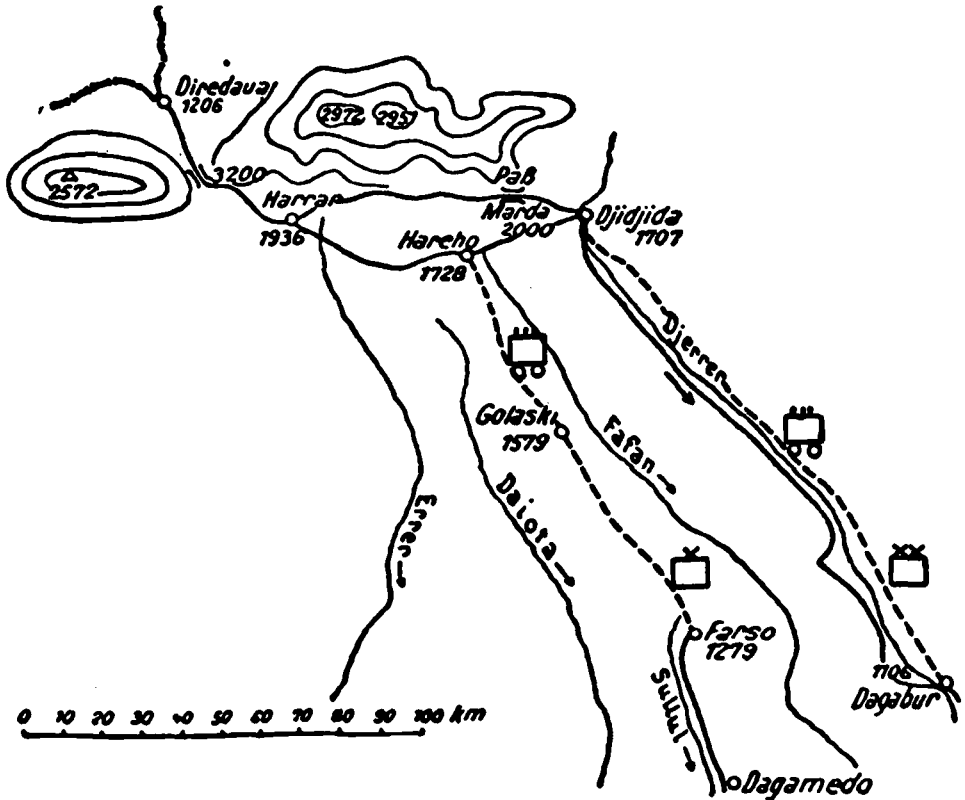

PLATE 179. THE PURSUIT TO HARRAR, 5 MAY 1936.

The inevitable conclusions to Douhet's ideas assign a purely defensive role to the army and navy, while a strategic decision is sought through the intervention of the air force in relentless attacks on vital strategic, economic and industrial areas rather than by combat operations against the hostile armies.

Douhet's ideas have aroused considerable professional attention and are reflected in the actual air organization of several important countries. It is consequently in the nature of a mild paradox that in Italy's first serious military effort since the World War, Douhet's principles could not be tested.

(2) Principal missions. The Abyssinian theater of war lacked the "elements" on which Douhet's theory is predicated. Here was a tropical terrain of vast extent, without "vital, sensitive strategic areas," in an economic, industrial or mili-

tary sense. No coercion or disruption of the civil population was possible; there were no "industrial establishments" of national importance, Abyssinian towns, widely scattered and economically unimportant, were not as vulnerable as European communities. Consequently, the air force in Abyssinia had to be content to function in close, direct cooperation with the ground forces, rather than on independent missions. This combat intervention, however, was found to be of very great importance; the air arm became an integral, indispensable part of the "bataglia manovrata" of the Italian High Command; its most spectacular successes were to be found in pursuit, in exploitation and in support of motor-mechanized operations.

Without opposition, the initial aerial missions, normal in a European theater of war, were not required, viz: intercept, counter-reconnaissance, the destruction of hostile airdromes and harassing missions against mobilization centers; in other words, the Italians had control of the air from the outset, a favorable condition which has to be fought for elsewhere and is by no means assured.

On the other hand, flight conditions in Africa are not exactly pleasant; in Eritrea, elevation and atmosphere were unfavorable; in Somalia, the heat and dust worked hardship.

Strategical reconnaissance, on the whole, was relatively easy, but close-in tactical reconnaissance became dangerous in mountainous terrain, deep valleys and canyons.

(3) Battle participation. In view of the mountainous terrain in Eritrea, it was inevitable that initially reconnaissance became the principal mission of the air force.

In Somalia, however, with comparatively open terrain, Graziani employed his air force from the start in direct support of the assault, by preliminary attacks and bombardment of the positions; the operations against Dagnerrei and Gorrahei are early and conspicuous examples of his aggressive tactics. Graziani's success suggested a similar employment in the north.

As the major battles developed, the increased participation of the air force is reflected in the amounts of ammunition expended. As early as December 1935, the headquarters of the Negus at Dessie was attacked by Italian squadrons; 7½ tons of explosives were dropped. In the battle of the Enderta this figure rose to 375 tons and 25,000 M.G. rounds, in the period 26 February to 10 March, 270 tons and 40,000 rounds, and during the days of Mai Cieu 240 tons and 66,000 rounds.

There was no instance of real "mass attack"; it appears that the grouping of planes ranged from 20 to 60 in single, major engagements. However, the statistical record of the few months of this campaign is indisputable proof of efficient and arduous service. On the basis of about 400 planes, not all modern, 7500 separate combat flights were executed in a total of 44,000 flying hours; these flights represented 872 bombing attacks, in which 1700 tons were dropped, 178 M.G. actions at low altitude, 830 distant reconnaissance missions and 2189 close reconnaissances; two hundred and fifty planes were hit by enemy fire and 87 pilots and mechanics sleep their last sleep in African soil.

The most spectacular instances of combat employment of aviation are to be found in the direct support of Somma's defense of the Uarieu Pass, 20-22 January 1936, in the Tembien, in Graziani's operations against Ras Nasibu and in the destructive pursuit of the Ethiopians from Dolo to Neghelli and from Mai Cieu to Addis Ababa.

(4) Aerial command posts. The Italian air force was a flexible instrument indeed: for the duration of the war the airplane became a mobile command post.

Marshal Badoglio and General Graziani, who held pilot certificates, made frequent reconnaissance flights and directed operations from the air; this example was followed by commanders of all echelons.

During the final operations, Badoglio's headquarters was flown from Makalle to Dessie, with all its services, personnel, records, radio, telegraph and telephone centers.

Following the capture of Addis Ababa, eight large bombardment planes, in relays, transported 21 officers and 788 men from Makalle to Addis Ababa, i.e., an entire battalion with its complete armament, ammunition, light and heavy machine guns, accoutrements and tentage; moreover, the battalion carried ten days' reserve rations and numerous spare articles, since it might have to take the field on arrival in Addis Ababa.

(5) Supply by air. The record of air activities would be incomplete without reporting on the important services rendered in the supply of combat units. Supply by air enabled large units to live, march, maneuver and fight in adverse terrain.

Without aviation, the march of the III Corps from Analo to Tembien, or that of the IV Corps across the desert region of Adi-Abo, could not even have been contemplated. The march of Starace's motor-mechanized column on Gondar and Ruggero's on Sardo were predicated on aerial supply; Starace's column obtained 219 tons, the Eritrean Corps 180 tons, in the period 7 to 30 April, and the garrison of Addis Ababa 450 tons. Time after time, entire squadrons dropped tons of food, water and ammunition; when the material was such that it could stand the shock, it was merely put in sacks filled with straw and thrown overboard. For more delicate provisions, the parachute was employed; as for water, it was placed in 50 gallon cylinders, with springs to absorb the shock. In Dankalie, live kids and sheep were delivered, since butchered meat would have spoiled in the desert heat.

In reflecting on these varied services, it is apparent that supply from the air alone enabled that freedom of movement, i.e., mobility for maneuver, which made certain tactical operations practicable and profitable. We have seen something of this sort on a more formidable scale in Poland, in 1939.

As to types of planes, the Italians employed older models initially, like the reconnaissance model "R 1," which would have been suicidal in a European theater; single-motor Caproni bombers "CA 111" were also used but were rapidly replaced by modern tri-motor "Savoia S 81" with a flight radius of four to six hours and a useful load of at least two tons.

(6) The use of gas. There have been contradictory reports on the use of gas; the Italian reports are naturally reticent but British sources, equally understandable, were quite positive.¹⁷ The defensive use of mustard gas, if true, is rather interesting: lines of communication into the Tembien and Schire were not only extended but highly vulnerable; the Abyssinian was a skillful and merciless raider; the vicious surprise attack on a labor camp of Gondrand & Cy, a civil contractor, on 13 February, far behind the combat front, represents a typical example of such a raid, accompanied by such revolting outrages¹⁸ that Geronimo's Apaches appear in comparison as sweet-mannered infants.

In order to guard against operations of this nature, especially in defiles, the commanding heights were sprayed with mustard gas.¹⁹

The use of gas in another combat situation was reported in the rather critical

¹⁷ Major General J. F. C. Fuller, British Army. Captain J. R. Kennedy, M.C. R.A. ret'd. Major Paul Murphy, Director: Chemical Defense Station, Porton. Edward J. Neil, Associated Press. Haile Selassie. *Time*, July 13, 1936.

¹⁸ Abyssinian Atrocities. League of Nations Publication. VII 3. 1936 Official. C. 123 M. 62 Geneva. March 19, 1936.

¹⁹ F. S. R., U. S. Army, 1923, Par. 419: "Gas may be employed in a limited measure for blocking defiles, river crossings, etc."

fight at Mai Timchet and Dembeguina Pass and the Italian withdrawal on Selaclaca. The force of the Ethiopian assault, under Ras Imru, was not fully appreciated at first though it directly menaced the Italian flank and the gateway into Eritrea. At this critical junction, the air service intervened; large bombers "dusted" Imru's columns of 40,000 men for four days with powdered mustard gas. The advance was stopped.

b. Artillery. This vital branch of the service established an enviable record in this arduous campaign. The Latin genius for improvisation came to the fore: the continental organization was promptly modified to suit the colonial theater of war. The normal organization in Italy was:

- 2 Battalions, 75-mm pack howitzers
- 1 Battalion, 75-mm guns, horse
- 1 Battalion, 100-mm howitzers, motorized

The modified organization provided for each division two battalions of pack howitzers 75-mm and relegated other calibers, 100-mm and 149-mm howitzers and 105-mm guns to the corps; all corps artillery was motorized or tractor-drawn; a total of 308 pieces was available in the northern army. Badoglio commented: "Artillery has done a lot; its effect in certain actions was decisive; mule-drawn artillery always delivered the guns where required; motorized units did remarkably well off roads; we may expect more from this type than was thought possible heretofore."

Since the threat of counter-battery and hostile air attacks was absent the Italian artillerists had freedom in the selection of positions; concealment and defile were not required and positions were selected with a view to direct fire at close ranges.

Artillery in movement was not immune to surprise attack. The operations in February 1936 near Selaclaca were not particularly happy for Italian arms; a battery of 75-mm howitzers was lost, with its accompanying infantry; however, the guns were retaken by counterattack, the next day.

The action of the remaining artillery was characteristic. The division "Gavinana" took up a defensive position; the divisional artillery placed its fire on the site of the defeated advance guard and kept the Ethiopians from removing the captured guns.

On 2 May, the enemy attacked. Excellent observation was available; the artillery was concentrated under centralized control and able to deliver intense concentrations at any desired point. The Abyssinians massed for a series of uncoordinated attacks, but each group came under concentrations and suffered tremendous casualties. When the enemy eventually retreated, the Italian artillery pursued by fire to the limit of their range and caught the Abyssinians in a series of defiles; the latter never recovered from this experience.

In that same operation a motorized battalion of 149-mm howitzers was rushed to Selaclaca, from Makalle, a distance of 500 kms, over the worst kind of terrain; it arrived on the third day and intervened effectively.

There are other instances of decisive intervention by artillery, at Ganale Doria and at Mai Cieu, when the guns were brought into the front lines.

c. Infantry. "Manovrare—manovrare!" was Graziani's constant request when he observed the Abyssinian tendency to mass attacks—a savage horde, rolling forward with hoarse cries, firing while marching, and eager for close combat with knife or sword. These attacks were launched with a view to surprise through a skillful use of cover. Initially, the Italian troops were not prepared for this type of warfare; the dispersion of the European battlefield was not entirely suitable;

formations that were too open were also vulnerable; the Abyssinians appreciated the technique of infiltration. The French, in the Riff, came to adopt a sort of "hollow-square" formation, to include the battalion, and dispositions in depth which, in turn, facilitated maneuver for counterattack; the Italians adopted this "bataillon carré" somewhat; nevertheless, there were many instances of the enemy penetrating between columns or gaps in the line and launching close-in surprise attacks. This danger was especially acute in the low brush of Somalia; visibility was poor; the soldiers talked of the "fog of thorns."

The service of security was arduous and difficult. Cavalry, as such, was available in limited numbers only, and the terrain did not encourage its use; in the desert regions camel corps were occasionally used. Native troops, the Eritrean and Askaris, were employed as flank columns because of their superior march capacity; at other times, reconnaissance aviation furnished security. When practicable, armored cars or light tanks were moved forward as covering screen, as in the advance on Adigrat, on the front of the I Corps.

In bivouac, the line of outposts was often strengthened by hasty field fortifications; when time was available, strongpoints and centers of resistance were developed, often with the attachment of artillery; this procedure applied in pauses in the campaign, as in the occupation of Aksum, Makalle, Neghelli and Dessie.

The Italians recognized that the envelopment and flank operations were particularly effective against the Abyssinians, who did not respond readily to changes in front, since they had no adequate organization for command or transmission of orders. A casual inspection of the Italian scheme of maneuver, in the majority of their engagements, reveals it to be the time-honored combination of frontal or holding attack, combined with the envelopment or flank attack.

As regards weapons, the Italians exploited their automatic arms and heavy infantry supporting weapons to the utmost: the light and medium infantry mortars proved very effective; the pack artillery 65-mm howitzers intervened often and sometimes in the front lines. Mariotti's column used hand grenades for the first time in the engagement of Azbi, and thereafter the grenade became a popular weapon. The small, portable flame-throwers, however, proved to be a disappointment.

The Abyssinians were frightened by artillery fire, but seemed oblivious of small-arms and auto-weapons fire, although the latter took terrific toll, so much so that in the Schire and at Sassabaneh, Imru's and Nasibu's hordes never recovered from the defeats eventually inflicted there.

While aviation and motor transport contributed powerful if not decisive aid in many critical combat situations, it was infantry, in its classical role of marching and fighting, in fire and movement, that smashed the Abyssinian armies.

d. Motorization. Marshal Badoglio was enthusiastic in his appraisal of the effect of motor transport on operations and supply. His skillful use of motor vehicles as tactical and logistic means is striking, considering that Italy was not heretofore in the forefront of motorization, although the industry had turned out quality products. The speed of this campaign, as a whole, and certain spectacular operations, in detail, Gondar, Sardo, Neghelli, were partly based on motor vehicles.

Vehicles in use varied in size from 1½-ton Chevrolets to 5-ton Fiats and Pavesi tractors; a total of 9350 vehicles were employed. Several thousand light trucks were purchased in foreign markets, in the United States and Egypt. The supply service in Somalia was based almost entirely on Fords; Graziani employed 2000 of them and would have used more, except for Mr. Ford's unexpected moral scruples.

All models were squipped with commercial bodies; no modifications were made

for military use other than the installation of removable planks and the equipment with oversize tires.

The Italian models included the 4-wheel Fiat and Ceirano, the 6-wheel Fiat with 4-wheel drive or half-track, Fiat and Lanza "Diesels" and the 4-wheel "auto-caretti"; this light vehicle had already proven itself in mountainous terrain; its climbing ability was easily 60 degrees, with a useful load of 2 tons.

Motorized artillery employed heavy tractors; heavy-duty models were available elsewhere. Graziani had to use them in his advance on Harrar; these tractors could haul 40 tons.

Maintenance presented the usual problem. A central repair shop was established in Asmara, in December; it began with repair facilities for about 100 major jobs per month, but this figure was increased to 800 per month. Army and corps established advance motor repair sections at Adigrat, Om Ager, Makalle and finally at Dessie and Addis Ababa, while mobile repair shops followed the tactical advance. After initial delays, these services appeared to function satisfactorily and were able to respond to occasional large-scale demands, as for the advance on Gondar and Addis Ababa. Gasoline and oil depots were established at twenty-four points, in the northern theater; in the period 1 April 1935 to 1 April 1936, thirteen million gallons were distributed.

The motor transport service was one of the largest and most important sections of the S. O. S.

A supply train consisted of 30 tractors and trailers; each tractor hauled two trailers with a capacity of 20 tons; each tractor had three drivers and the train operated 24 hours a day. Drivers were armed with rifles, and machine-gun mounts with all-around traverse were provided. Each train was commanded by an officer; upon arrival at destination, combat units were supplied by field trains composed of light trucks; there was no sharp distinction between combat and field trains.

As a rule, columns on the march were large, due to lack of roads. Front and flank security was provided by armored car detachments; motorized reconnaissance patrols were improvised, consisting usually of five armored cars, two trucks of infantry and one section of tanks.

In offensive situations, we have already seen the habitual use of motor-transported infantry units, in pursuit and encirclement; the rhythm of maneuver was strongly affected by available motor transport.

e. Engineers. An appraisal of motor transport performance, in tactical operations and in the service of supply, carries with it the implied consideration of communications, road-net and its construction and maintenance. The progressive expansion of military roads, in Somalia and northern Ethiopia, has already been mentioned²⁰; it has been said that the Italian soldier in this campaign used the spade as much as he did the rifle. This was literally true! In this semisavage country, roads were practically nonexistent, except for caravan trails. Consequently, the first concern of the engineer corps was the construction and maintenance of military roads; it did the job well and established standards that will be hard to equal.

Initially, troops, pioneers and engineers enlarged and hastily improved existing trails; then a large corps of civil laborers, on a contract basis, completed the jobs for permanence, in view of the eventual occupation of the country; the extent of this labor is readily apparent on the following statistical table.

Prior to the outbreak of hostilities, a road net for the strategic deployment was needed; by 12 December 1935, the roads: Asmara—Adua—Aksum, Asmara—Adi-

²⁰ Plates 133 and 134.

grat—Makalle, and Adigrat—Adua, were serviceable for two-way traffic. A similar record was made in Somalia on the road: Buloborti—Belet Uen.

In the framework of tactical operations, the engineers were equal to their tasks; after the battle of the Schire, a temporary bridge of 330 feet was thrown over the Taccaze at Mai Timchet; this was soon replaced on account of high water, raised 30 feet above water-level, and extended to a length of 500 feet; farther down river,

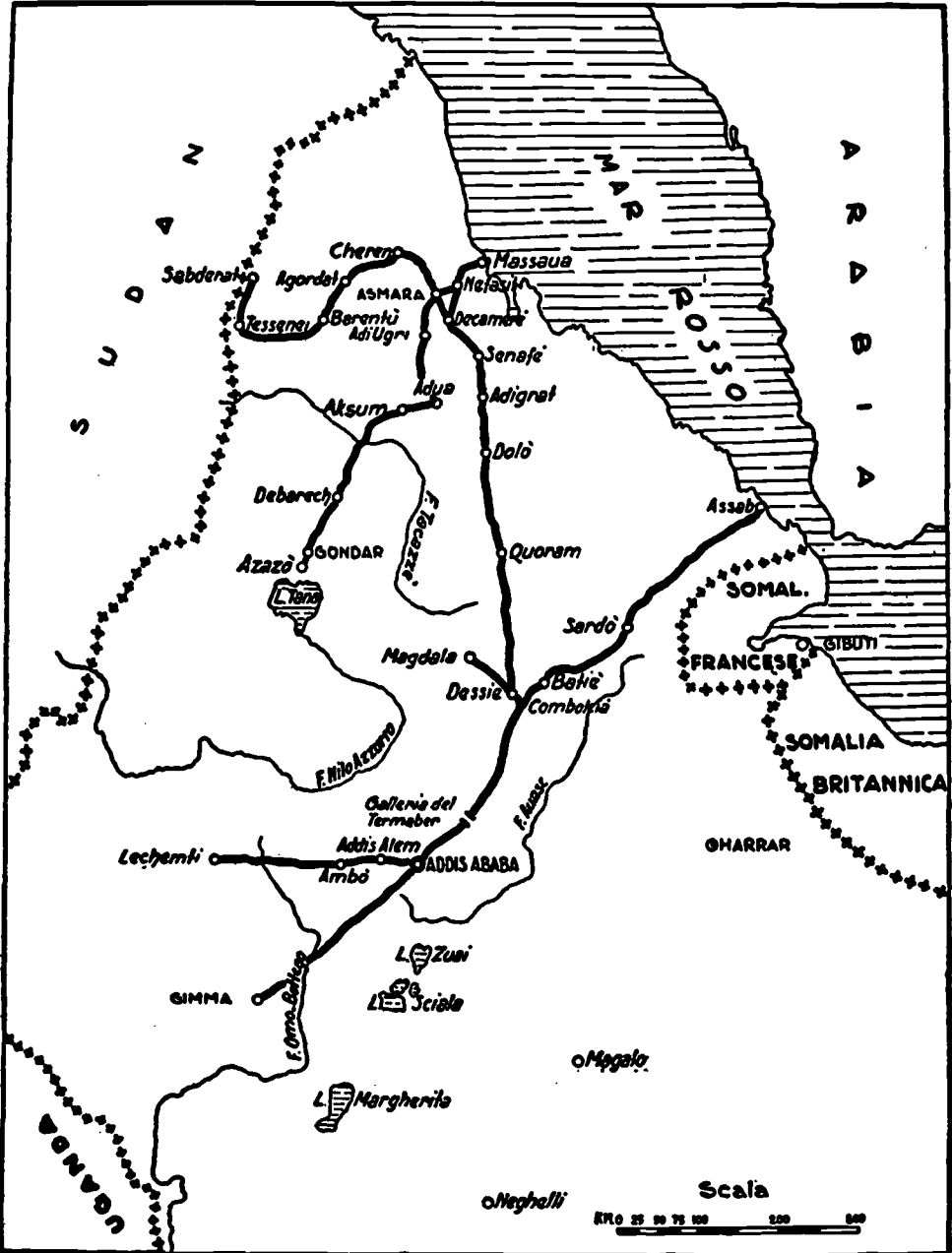

PLATE 180. MILITARY ROADS, NORTHERN ABYSSINIA.

the engineers built a railroad bridge of 540 feet in 56 days. Of equal importance, in semidesert country, was the provision for water; innumerable wells and reservoirs were constructed in the course of this campaign; the most modern installations were to be found in the base section and main depots, Massaua, Asmara and Mogadiscio.

STATISTICS OF ROAD CONSTRUCTION IN NORTHERN ABYSSINIA

	AA-A	A-G	AA-G	AA-L	A-D	A-B-S
Total length, km	1,110	580	530	385	353	344
Bridges	64	21	37	40	12	31
Culverts	2,667	1,193	1,515	1,040	965	759
Cuts: cm	4,330,000	2,543,000	3,513,000	1,320,000	550,000	3,175,000
Fills: cm	3,614,000	1,143,000	4,305,000	720,000	1,398,000	1,020,000
Masonry: mg	331,000	129,000	235,000	250,000	327,000	122,000
Foundation: mg	5,715,000	3,145,000	3,570,000	1,890,000	2,470,000	2,410,000
Macadam: mg	5,100,000	2,797,000	3,565,000	1,890,000	2,470,000	2,410,000
Labor—Italian: hrs	6,162,000	2,784,000	649,000	320,000	625,000	593,000
Labor—Native: hrs	1,991,000	583,000	983,000	3,090,000	375,000	676,000

Abbreviations: AA-A: Addis Ababa—Asmara. A-G: Asmara—Gondar. A-D: Assab—Dessie.
A-B-S: Asmara—Barentu—Sabderat. AA-G: Addis—Ababa—Gimma.
AA-L: Addis Ababa—Lakemti.

f. Mechanization. The mountainous terrain, in the north, was hardly suitable for the employment of tanks; medium and heavy tanks were not available; the so-called light tank Ansaldo-Fiat "Carro veloce" was used as far as practicable; the exact number is vague; there are estimates of 150 to 200 fast track-laying vehicles. In Somalia, the dense brush was almost as much of an obstacle as the precipitous slopes of the north. Armored cars (auto-blindate) armed with machine guns proved to be very useful. Graziani organized the machine-gun squadrons of several cavalry regiments into motorized machine-gun battalions, sometimes reinforced by tanks and motorized artillery detachments; they were very effective in the pursuit from Dolo on Neghelli.

Sometimes these detachments ran into trouble. The fixed turret, limiting fire to the front only, in the light tanks, was a dangerous technical defect; there are several instances when tank detachments, unable to turn on narrow trails, were overrun by Abyssinians and destroyed. Eventually, these tanks were able to function as accompanying tanks only.

g. Medical service. Perhaps nowhere is medical organization so important as in a colonial expedition; the Italian authorities did not fail in this undertaking; broad-scaled, liberal provisions were made in every category of personnel and equipment.

An international authority on tropical diseases, Dr. Castellani, was appointed Inspector General of the Medical Service.

The medical history of past colonial expeditions was discouraging; in the World War, malaria paralyzed the Allies in Macedonia; in the Struma Valley, there is a record of units with 90 per cent of officers and men stricken within one month of their arrival; in 1916, one-fourth of the Macedonian Expeditionary Force was hospitalized for malaria; the percentage of admissions increased in 1917; the Struma Valley, however, has a malarial season of only six months, while Ethiopia has a year round record! With a white army of 200,000-300,000 men, there were 1241 cases of primary malaria and 1093 admissions for relapses, with 25 deaths from pernicious forms.

On a par with malaria, dysentery is a dreaded scourge; both in the Boer War in 1900 and at Gallipoli in 1915, the British lost heavily through dysentery; the

French did not fare much better in Algeria, Tunisia, Tonkin and Madagascar. The Italian preparations were so efficient that only 450 cases were recorded, with only one death.

Every Italian soldier or laborer was chosen with care, to insure a high physical standard initially, and was inoculated against typhoid, paratyphoid and cholera. After arrival in the colonies, the troops were acclimated in rest camps, which in Eritrea were spaced from sea level to 6500 feet elevation. The men took three quinine tablets daily, one before each meal; they were required to wear tropical helmets, to abstain from alcohol until after sunset and to use one lemon a day. To combat vermin, the living quarters had cement floors and were disinfected daily. Ethiopia is a cholera country; the local population was systematically inoculated with Castellani's "tetra vaccine"; as the military advance progressed, control was organized to spot floaters and transients, drifting through the sanitary cordon. Every settlement was placed under health officers; an automobile service was installed to speed up prophylactic treatment, over a wide area. The cases of typhoid and paratyphoid numbered only 458, but with a high rate of fatality, 161 deaths, which could be expected in the tropics.

In previous colonial wars, disease has taken a greater toll than combat; in Abyssinia, the number of deaths from disease was lower than battle casualties, viz: 1099 battle deaths as compared to 599 deaths from disease.

The number and quality of medical establishments, of course, are responsible for this astonishing record. During the war period the armies established 135 base and field hospitals; each base hospital had medical and surgical wards, bacteriological laboratory and X-ray department; 55 mobile field hospitals, animal transported.

The navy had 20 hospitals and infirmaries along the coast and eight hospital ships, six of which were air-conditioned; in the aggregate, they provided 6000 beds. The air force maintained 22 infirmaries, and the colonial medical service had 30 hospitals and clinics already in operation in Eritrea and Somalia. The medical personnel comprised 2484 officers, 584 nurses and about 15,000 sanitary troops.

h. Signal communication. Radio transmission was very active and was developed to a high degree of efficiency. Telephone and telegraph communications were difficult to establish and maintain; termites proved to be a great menace and were able to destroy poles in a single day. This added a natural emphasis to radio communication.

Increased radius of transmission was obtained as compared to European conditions; the small sets were able to reach from a normal of 20 miles to an extended range of 50 miles; the model "R 4" from 80 miles to 175 miles. Permanent transmitting stations were established at Asmara and Enda Jesus; during the great battles in February-March, over 800 stations were in operation. The various motor columns maintained liaison by radio. During the last operations against Addis Ababa, the assignment and control of wave lengths was as follows: Vacarisi's column on a length of 20 kcs, the advance guard of the left column on wave 5, the motor serials of this column on 15 and 16, and the accompanying airplanes on 15. To the rear, Dessie could be reached on a length of 11, 12 and 16; Enda Jesus on 5, 11, 12; Asmara and Rome on 14.

Adverse light conditions in Somalia made the use of "blinker" apparatus impossible during daylight, but signal lamps were efficient at night, ranging from 20 to 50 miles on dark nights.

i. Supply service. The organization of the theaters of operations for supply followed the traditional pattern of base depots, intermediate and advance depots, roughly corresponding to army, corps and divisional installations; in the north,

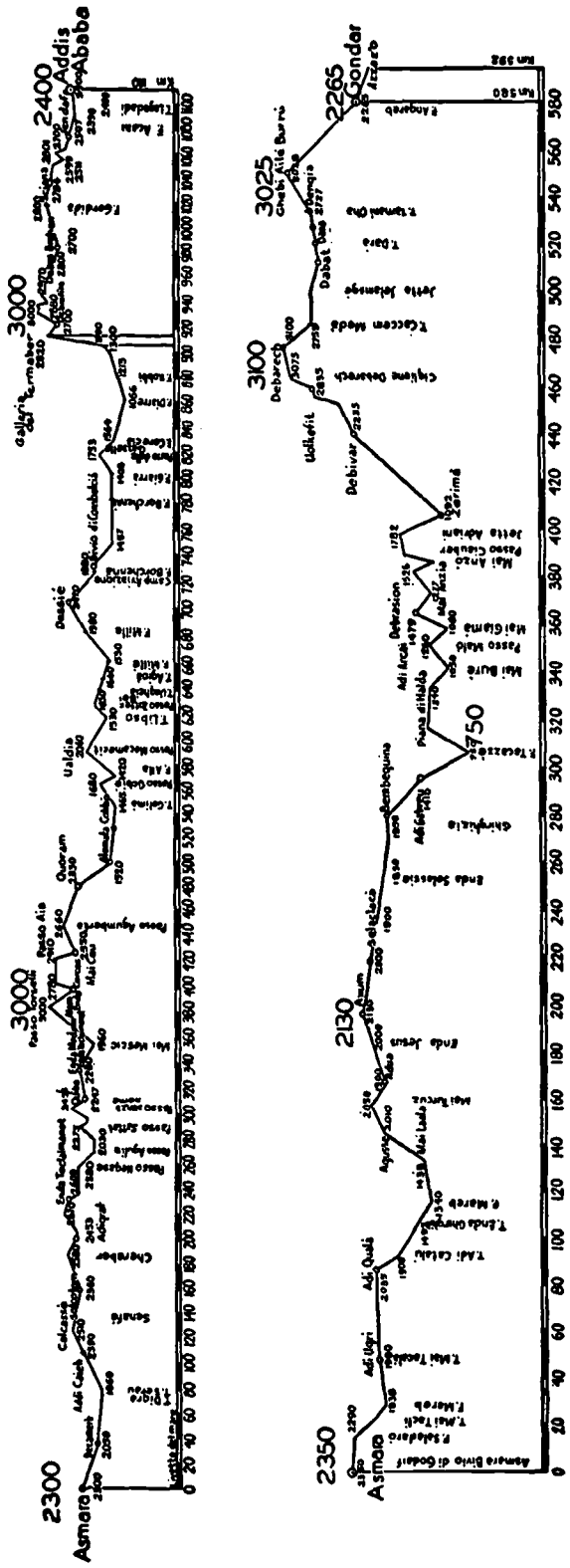

PLATE 181. FIG. 1. MILITARY ROADS, ABYSSINIA, PROFILES.

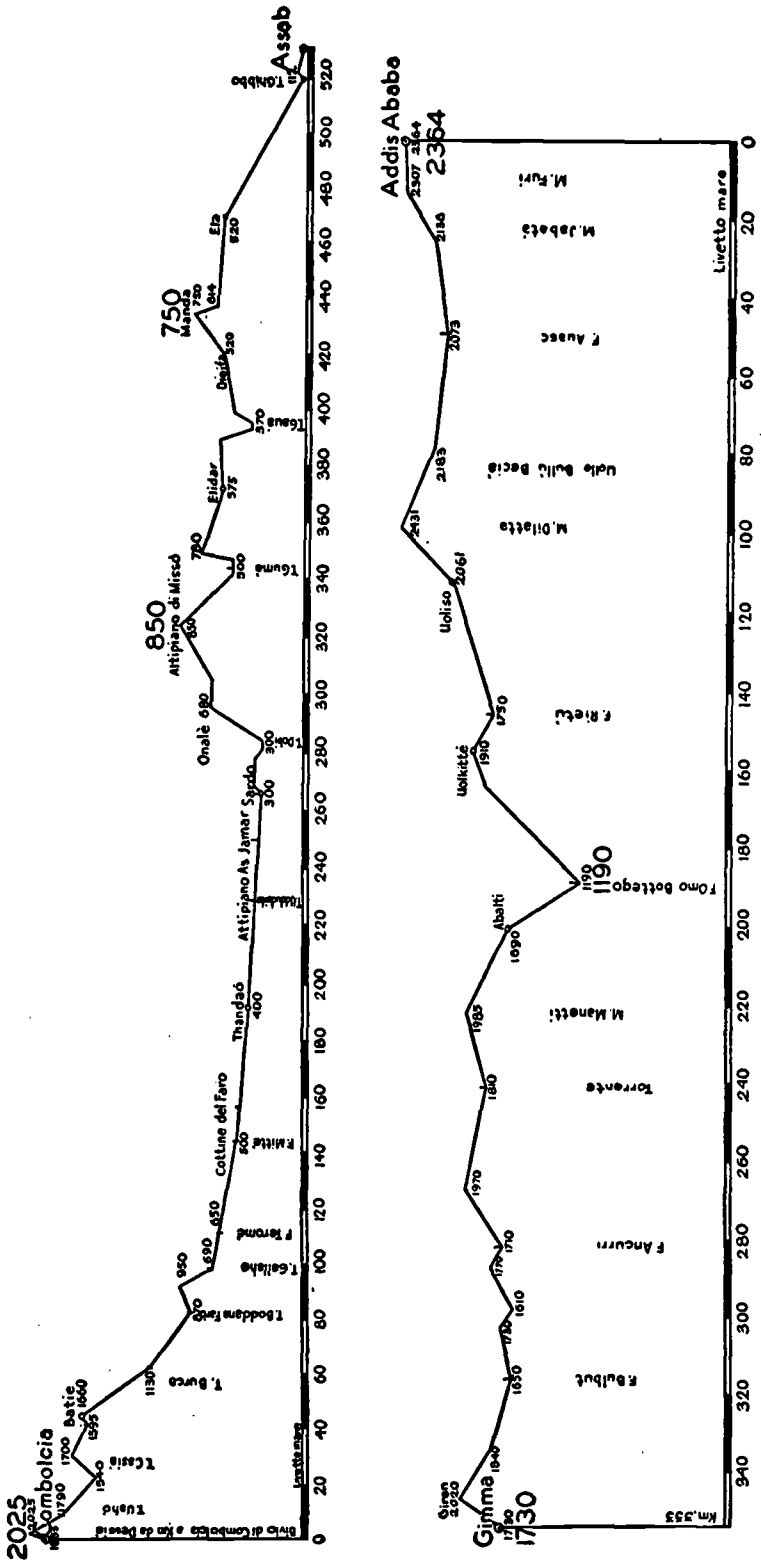

PLATE 181. FIG. 2. MILITARY ROADS, ABYSSINIA, PROFILES.

Asmara contained base depots; as the advance progressed, depots followed to Aksum, Adigrat and Makalle. In Somalia, the base was at Lugh Ferrandi, during the operations against Ras Desta and, later on, along the line: Dagnerrei—Gherlonghibi.

Advanced depots held a level of 10 to 20 days, depending on road facilities; on the Taccaze, supplies and ammunition were available for 80,000, including ten million rounds of ball cartridges, 1600 hand grenades, 45,000 mortar rounds and 65,000 artillery shells.

The service of supply was very efficient and conformed readily to changing tactical situations; there is a good example in the second battle of the Tembien; the III Corps changed direction and advanced from the south over difficult terrain; it was supplied by air for a few days, but a motor column was already waiting at Abbi Addi to supply it on reaching that vicinity. The columns in pursuit to Addis Ababa carried 20 days supplies in 1500 vehicles, organized in march serials of 200 each.

j. Badoglio on combined arms. In view of the tendency toward specialization and the feeling of branch superiority, it is interesting to note the opinion of Marshal Badoglio, the victor of Ethiopia, who appears to regard this highly successful campaign as a product of combined arms and coordinated employment of all branches. His views are set forth in his study on "La Guerra d'Etiopia" (Mondadori, 1936). He stated: "The war was won by combined arms and not by any specialties; granted that certain actions gave conspicuous opportunities to one or the other of the arms, however, the picture of modern war is one of coordinated employment of combined arms, under a single commander who aims at a single objective: Victory."

Nevertheless he acknowledged "the continuous refinements of technique which must be seconded by a corresponding evolution in organization."

Improvisation was the characteristic phenomena of this war; problems of supply as well as organization were involved. According to Badoglio, "The actual organization of large units may be determined by the objective of the operations and the peculiarity of the theater of operations." Ethiopia required light, mobile formations. The pre-war Italian division composed of three regiments, each with a M. G. battalion, "appeared too cumbersome;" equally objectionable were the numerous command echelons (*troppo complessi*); a division of two regiments might have been more adequate but involved too many administrative adjustments to be put into effect. Fire superiority was quoted as an essential and special allotment of automatic weapons became necessary; the term is relative, since it depends on the armament of the opponent; in general, Badoglio called for more and more weapons, artillery, M. G.'s. But all these requirements must be "balanced, and in accord with the terrain"; the armored vehicle, for instance, was not altogether suitable in this type of terrain, nor were the flame throwers; occasions arose when something had to be left back or eliminated, "Always a hard decision to make," requiring a fine sense of balance on the part of the commander.

Badoglio's comments on the separate arms are rather conservative, viz.: Artillery: "Artillery has done a lot; its effect in certain actions was decisive; mule-drawn artillery always delivered the guns where required; motorized units did remarkably well off roads; we may expect more, from this type, than was heretofore believed possible."

Pioneer-Engineers: "Pioneer detachments, of all units, and engineer formation must be increased, in every category."

Radio communication: "This type of communication was heavily taxed and

enlarged; in certain operations as many as 1000 installations were in use; reforms and simplifications are indicated."

Aviation: "This arm was active in all operations; the weapon of the future, but of greater service when in conjunction with the land armies; neither of them can wage war separately. The opportunities for effective employment depend on the general course of the situation; the C. in C. alone is capable of judging the proper time and mission." This seems to imply a guarded criticism of the relative "independence" of the Italian air arm.

Supply and Logistics: "The pre-war theoretical data have all been modified by events and demand complete over-haul and thorough revision; the capacity of all transport means, rate and length of marches, etc., have been under-estimated. Motor transport, in particular, has rendered incredible services and was employed when this was regarded as impracticable, by older standards."

XII

EPILOGUE

THE WAR OF THE FUTURE

The war of the future has suddenly materialized. It has revealed itself as the war of today, which in turn was buttressed on yesterday.

When German fliers dropped leaflets on Warsaw, in a brusque request for surrender, nine days after German forces had crossed into Poland, a stunned world held vaguely-formed impressions of the "Blitzkrieg," the "lightning war." The speed of that conquest was amazing—and yet, this advance on Warsaw represented a daily average rate of only 35 miles.¹ The Japanese have matched this, time and again, and so have the Italians in Ethiopia, Graziani in his drive on Neghelli, Starace on Gondar and Ruggero on Sardo. In August 1914, this record was practically equalled by German units of von Kluck's Army, in the right wing; and Jackson's Shenandoah Valley Campaign, in 1862, represents an average of 30 miles a day, including stiff fighting.

In the confusion of fragmentary reports, a faint pattern is already recognizable. The moot questions of the day are about to be answered: the relative power of the air, of mechanization and the capacity of anti-mechanized defense.

As in the Italian motorized dash on Gondar and Sardo, in Abyssinia, virtually independent German motor-mechanized formations have darted in and out of gaps in the ensemble of a far-flung battle front; the spectacular role of these formations resembles the traditional function of cavalry, i. e., mobile units operating around open flanks against the rear of the enemy, in conjunction with frontal, holding attacks by infantry. These are classical maneuver forms, in the Napoleonic pattern.

Obviously, the whole tempo of warfare has changed; every activity is accelerated. The sluggish opponent will defeat himself. The premium is on fast-thinking staffs and a military machine capable of operating at high speed. Behind speed, we know, there is an intricate machinery of supply and services that calls for professionals; the day of amateur soldiers is fading. The privates with marshal's batons in their knapsacks are going to have a hard road; their batons will have to be slide rules, for a while.

With all its modernity, this war, not yet ended, is rooted in the past. The phantastic fortifications on the West Front, 1939, are streamlined models of the Chinese wall of the fourteenth century, and their *raison d'être* is the same: fear of mobile hordes; the lessons of the Somme, 1917, and the Meuse-Argonne, 1918, are frozen in concrete in this west wall of 1939.

In the east, the campaign in Poland is an echo of 1866 and 1914, and the ghosts of Schlieffen and von Moltke stalk in the conference rooms of the German General Staff; the pattern of Cannae is impressed upon the youngest staff officer.

The whole campaign in the east was one of "maneuver"—an echo of the great, historical campaigns of Ulm, of Bautzen, of Koniggratz—once more history has pointed the finger, for those who care to see!

¹ The Seventh Cavalry Brigade (Mechanized), U. S. Army, (General Chaffee commanding), comprising over 600 motor vehicles, marched 1020 miles in six marches, following a route through Ohio, northern Pennsylvania and northern New York, to report for the Army Maneuvers in the Plattsburg area, in August 1939.

From the maneuver area, the brigade marched 350 miles to New York City; it traversed the immense metropolis down the West-side, north up Broadway and Fifth Avenue, and over the Queensboro Bridge.

On their return the brigade marched 390 miles in 36 hours, including a five-hour halt at Jeffersonville, to unload its track—and half-track vehicles.

Granted that these were marches under peace conditions, but the logistic performance remains of a high order. The Seventh Brigade represents only a beginning in motor-mechanization; the army is expected to operate at least 25,000 motor vehicles by 1940. The industrial capacity of this country is simply enormous. There is no lack of military talent: the brilliant technician, who manipulated half-a-million men on the chess board of eastern France in 1918, now heads the American Army; the service has already felt the vitalizing impact of an aggressive leadership and will have its "panzer-division" when, if and as required.