



# WELCOME

---

## S/P RATIO & DELIVERED LUMENS VS. TOTAL LUMENS



## PART 1

# Scotopic/Photopic Ratio

- **The issue:**  
Human perception of the lighted environment is driven by both **Photopic and Scotopic** vision.

... but ...

**Only Photopic** vision is typically considered applicable to light metering.

# HOW DO WE MEASURE LIGHT NOW?

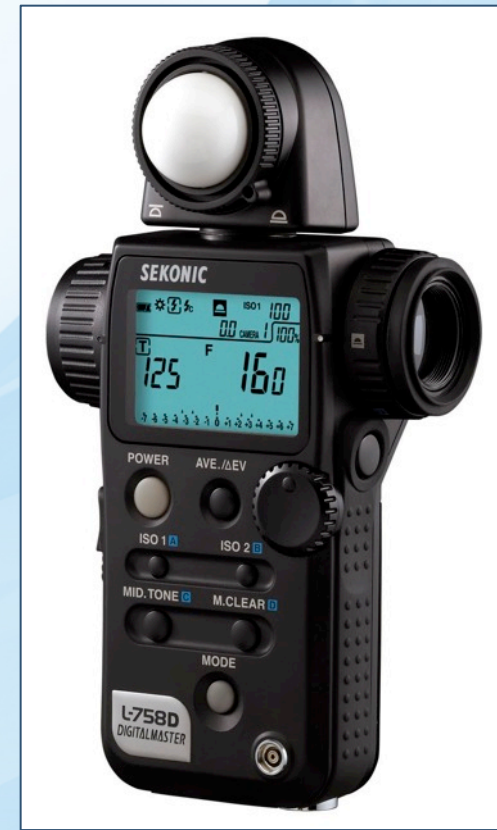

## Photopic:

- Known as light or daylight vision (“cones”)
- Higher sensitivity in “brighter” light
- Peak sensitivity towards “red” (550 nm)
- Basis for modern photometry (light metering)

## Scotopic:

- Known as dark or night vision (“rods”)
- Higher sensitivity and speed in different spectral range
- Peak sensitivity towards “blue” (500 nm)
- High color temperature lamps 5000K - 7000K

- **Rods are active in bright light and do contribute to the perception of brightness.**
- **Scotopic contributes to improved acuity but this is not yet well defined.**
- **Higher Scotopic sources can provide equivalent brightness with lower energy.**

---

**Now let's discuss S/P Ratio...**

## Combination of Scotopic & Photopic

- There is usually complexity, if not trouble, whenever we mix physics with biology.
- The physical side of things - the radiant power of a light source – is simply enough defined and is well-behaved.
- The biological side of things - the evoking of a visual sensation - is very hard to define and not at all well-behaved.

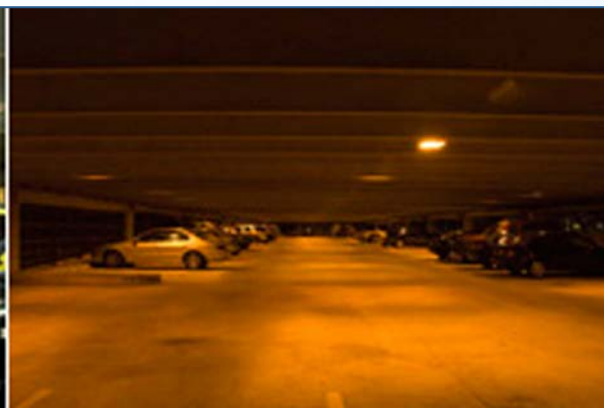





3000k - 52 CRI



3000k - 82 CRI

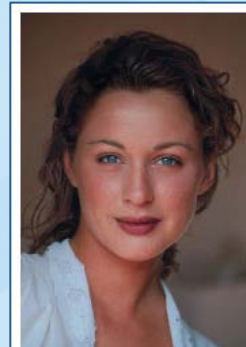

6500k - 82 CRI

Light Source	Scotopic / Photopic Ratio (S/P)
High Pressure Sodium (35W)	0.40
Low Pressure Sodium	0.20
Warm White Fluorescent	1.00
Cool White Fluorescent	1.46
Metal Halide (Sodium/Scandium)	1.49
Quartz Halogen (~3200° K)	1.50
4100°K LED/Fluorescent	1.54
5000°K LED/Fluorescent	1.96
6500°K LED/Fluorescent	2.14



**250W  
HPS**

$$= 24,500 \text{ X } 0.62 = 15,190$$

**Photopic Lumens**                      **S/P Ratio**                      **Scotopic Lumens**



**140W 5000K  
MaxLite LED  
Area Light**

$$= 8,400 \text{ X } 1.96 = 16,464$$

**Photopic Lumens**                      **S/P Ratio**                      **Scotopic Lumens**



## **PART 2**

---

# **DELIVERED LUMENS VS. TOTAL LUMENS**

## Total Lumens:

- Omni-directional light sources require 78% of the output to be redirected.

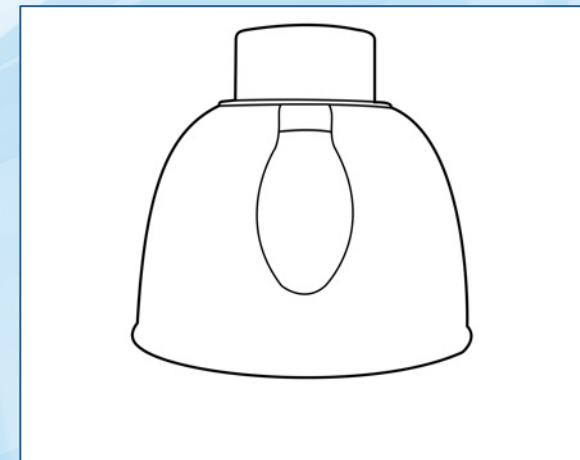
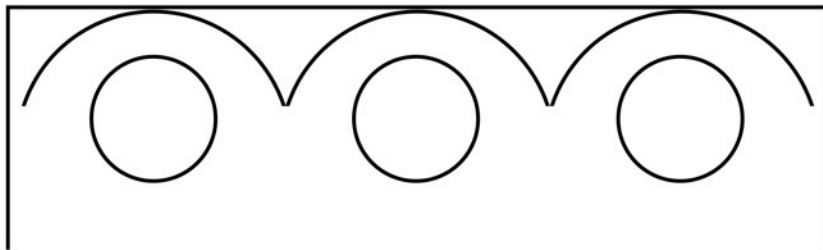

## Total Lumens:

- Omni-directional light sources require 78% of the output to be redirected.
- Majority of the reflections are directed back into the bulb. (light source)

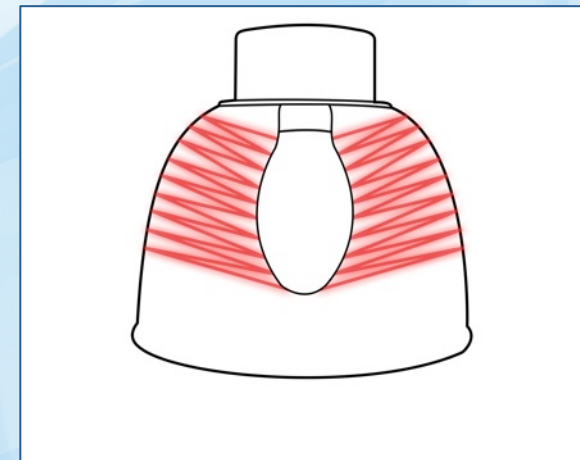
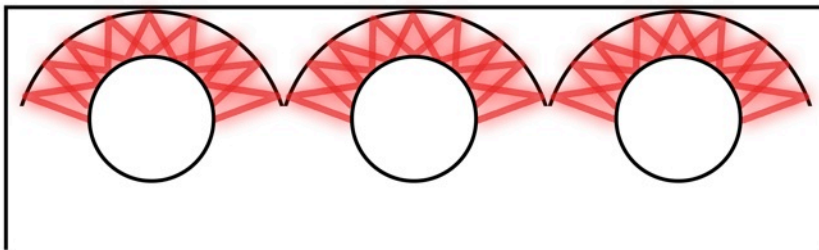

## Total Lumens:

- Omni-directional light sources require 78% of the output to be redirected.
- Majority of the reflections are directed back into the bulb. (light source)
- Energy is lost and compounded with every reflection.

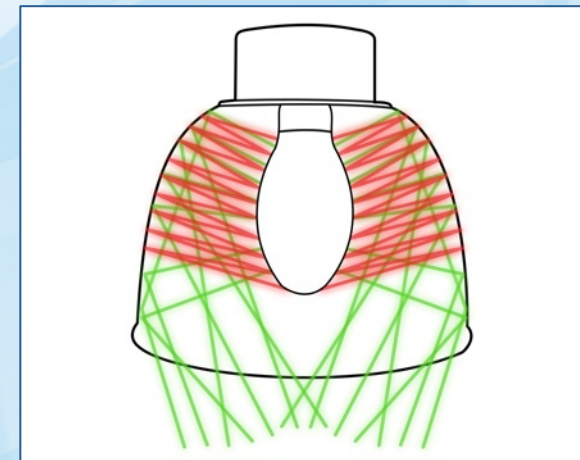
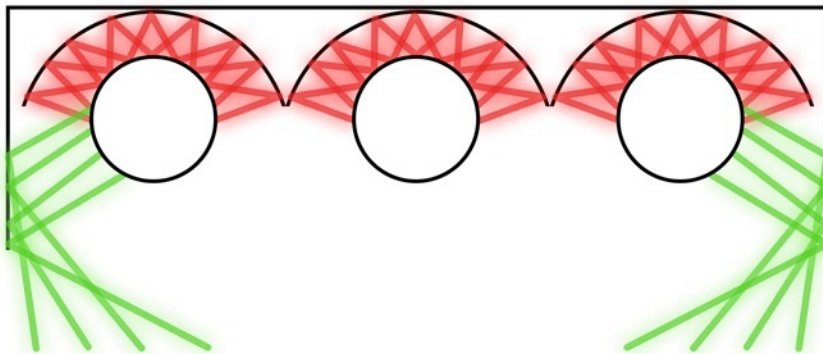

## Total Lumens:

- Omni-directional light sources require 78% of the output to be redirected.
- Majority of the reflections are directed back into the bulb. (light source)
- Energy is lost and compounded with every reflection.
- Most light traces require multiple reflections before hitting the work surface.

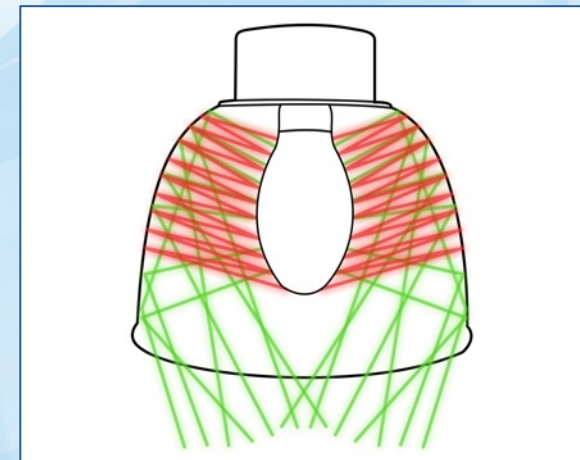
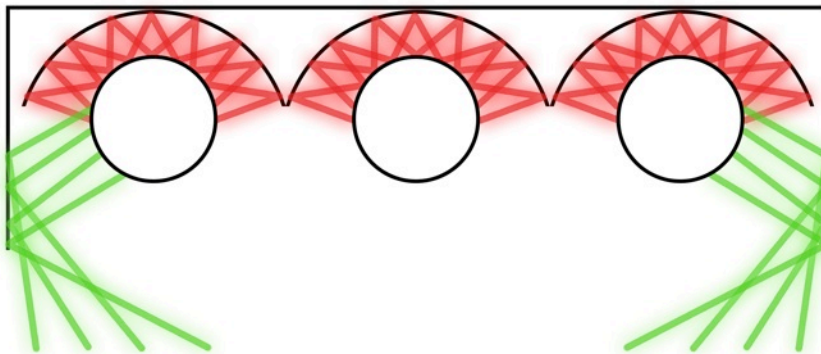

## Total Lumens:

- Omni-directional light sources require 78% of the output to be redirected.
- Majority of the reflections are directed back into the bulb. (light source)
- Energy is lost and compounded with every reflection.
- Most light traces require multiple reflections before hitting the work surface.
- Less than 14% of the source lumens trace directly to the work surface.

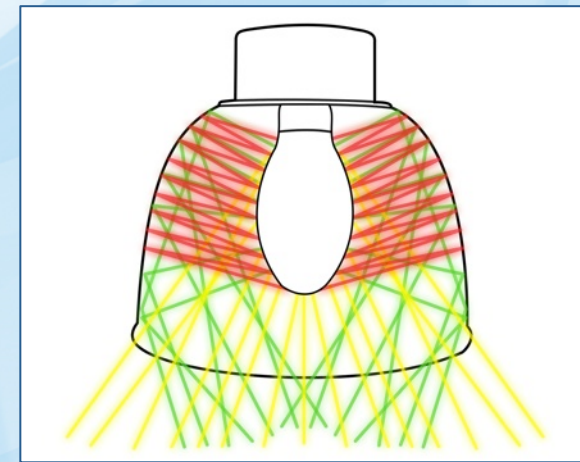
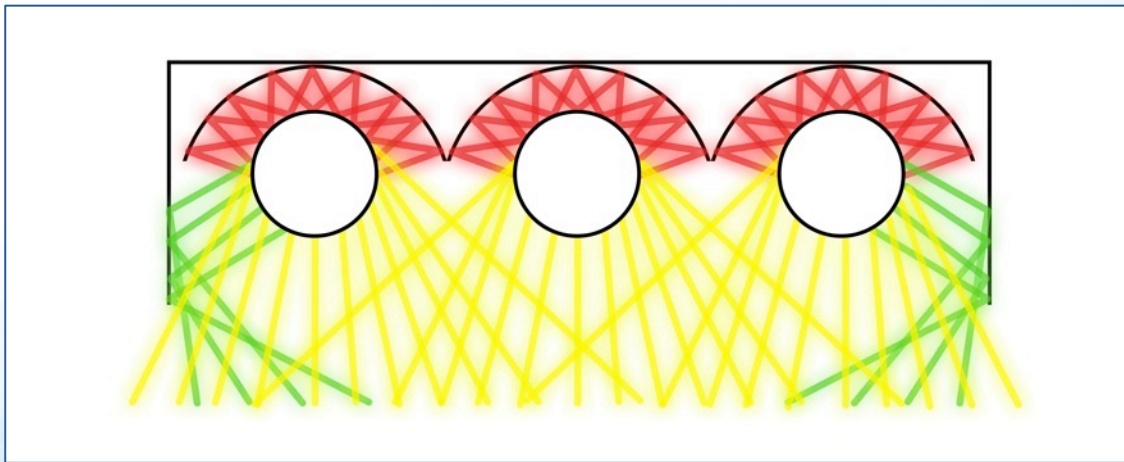



## Delivered Lumens:

- More than 94% of (mono) directional lumens are delivered.

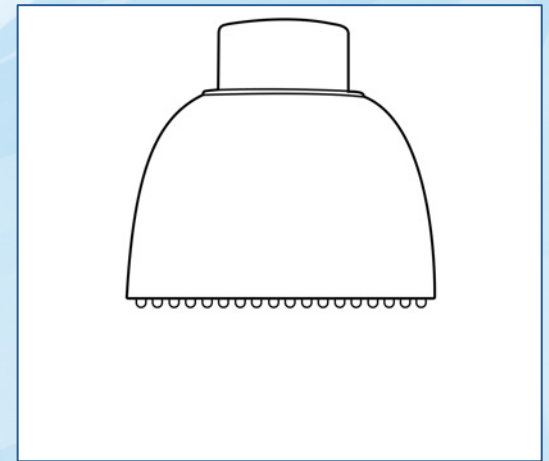
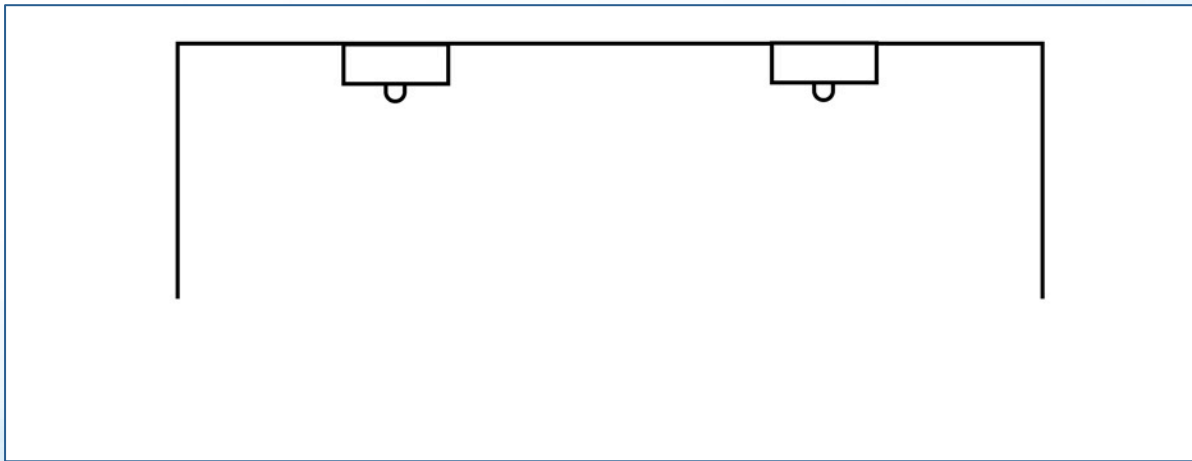

## Delivered Lumens:

- More than 94% of (mono) directional lumens are delivered.
- 80% of total lumen output is delivered directly to the work surface.

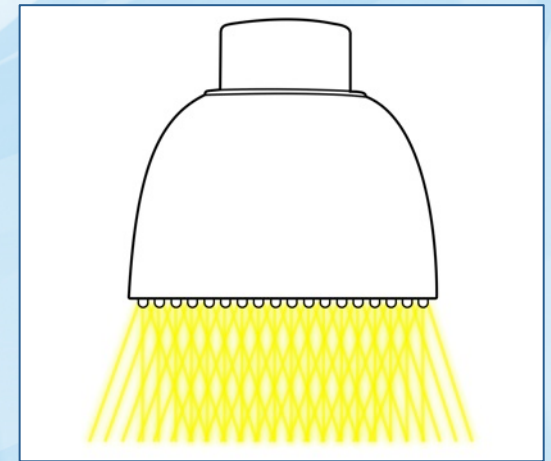
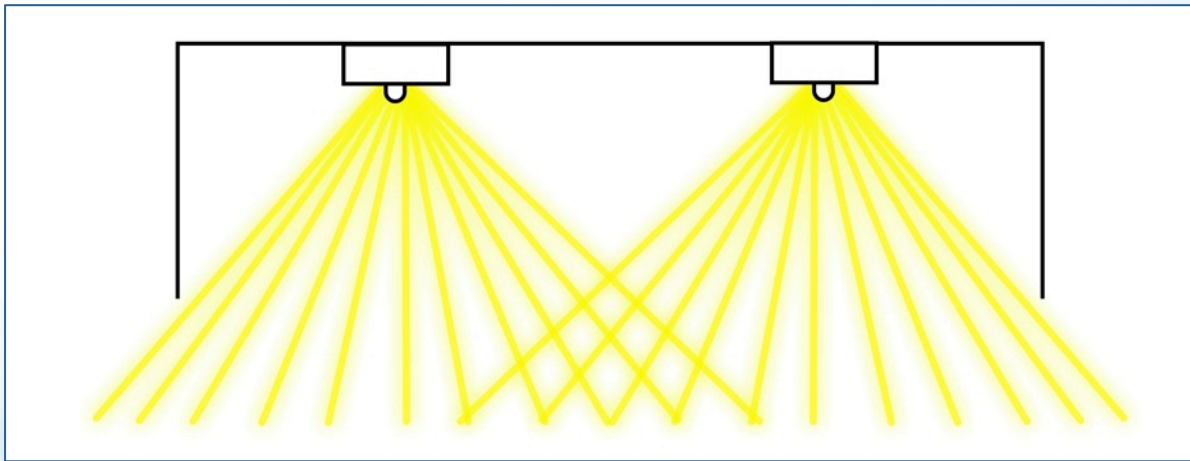

## Delivered Lumens:

- More than 94% of (mono) directional lumens are delivered.
- 80% of total lumen output is delivered directly to the work surface.
- The remaining 20% are reflected only once to the target.

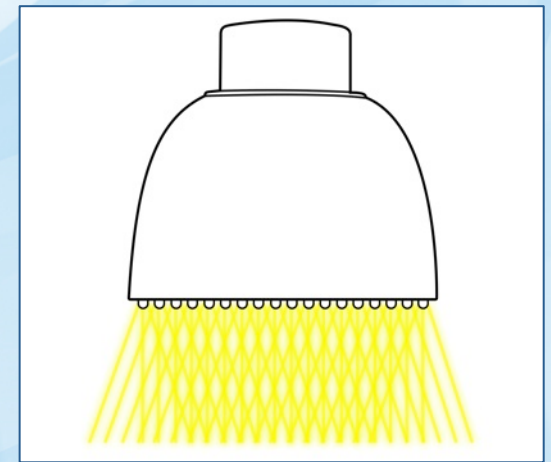
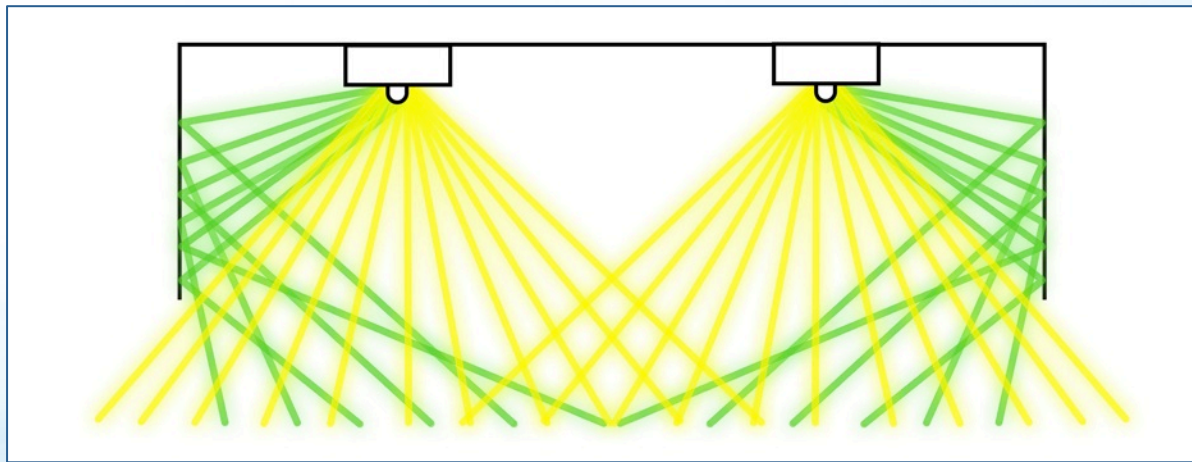

## Delivered Lumens:

- More than 94% of (mono) directional lumens are delivered.
- 80% of total lumen output is delivered directly to the work surface.
- The remaining 20% are reflected only once to the target.
- None of the lumens are reflected back into the bulb. (light source)

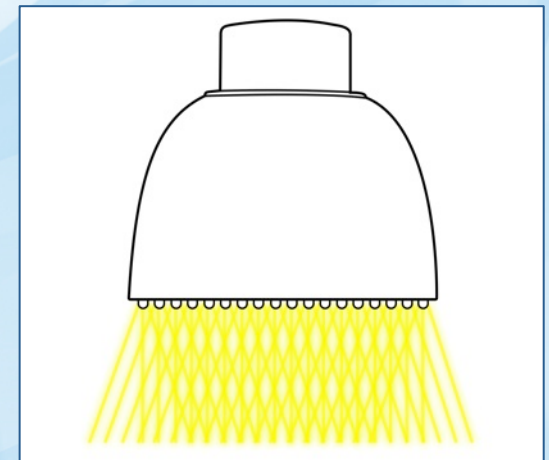
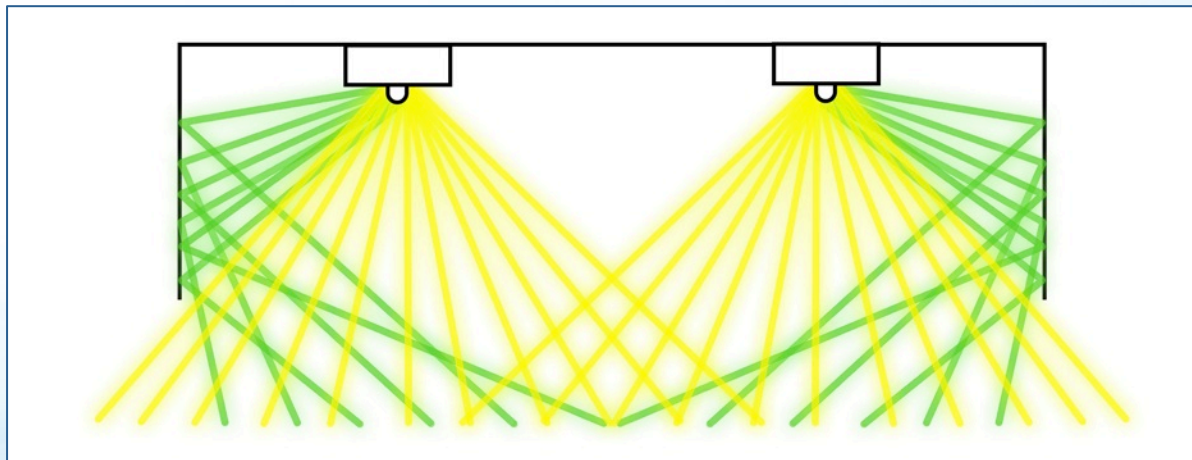

## Total Lumens:

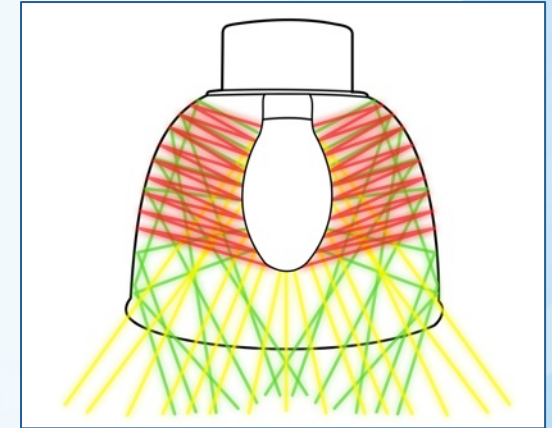
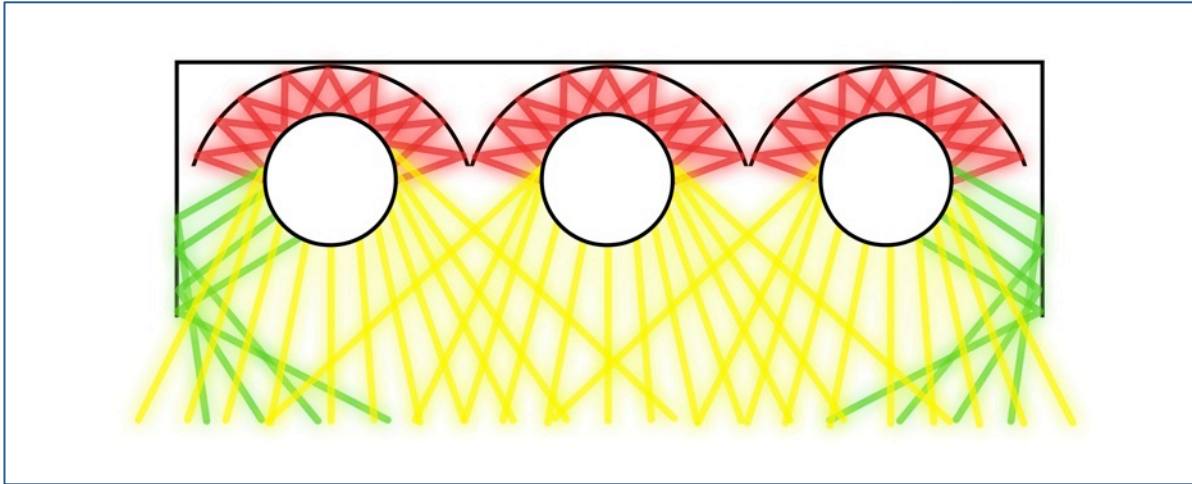

## Delivered Lumens:

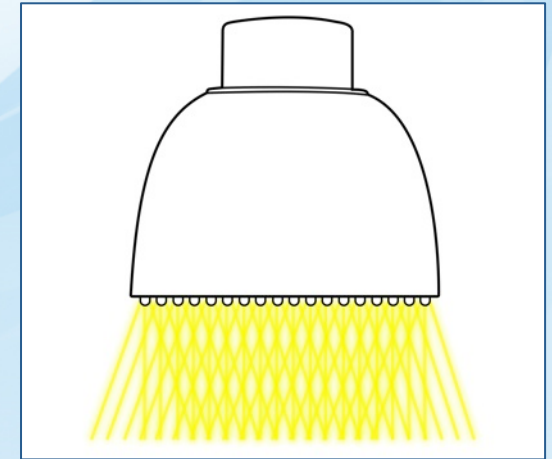
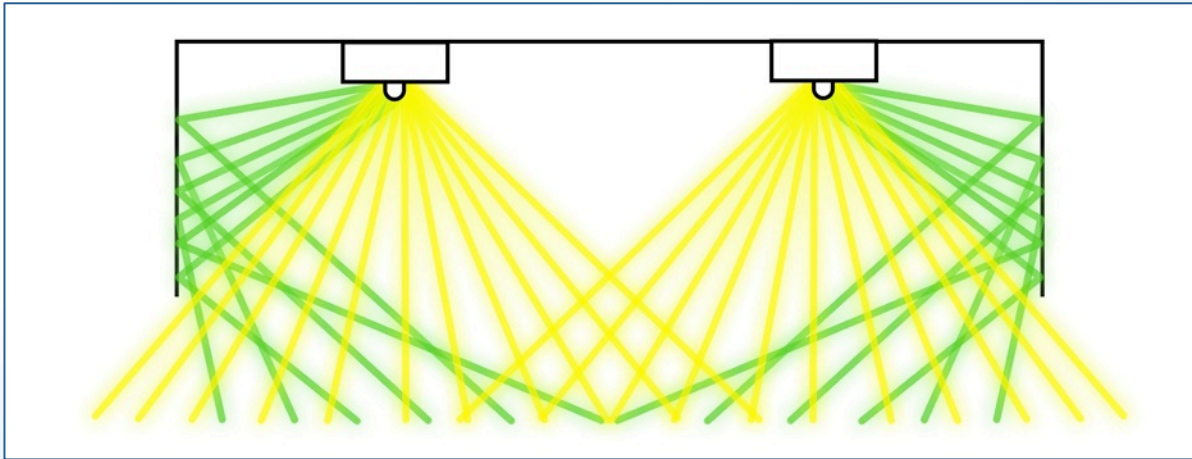

Instead of lumen output, the best and most relevant measurement for evaluating LED light fixtures and for making accurate comparisons with conventional light fixtures is **Delivered Light**. The formal term for measurements of delivered light is illuminance. Roughly speaking, illuminance is the intensity of light falling on a surface area. If the area is measured in square feet, the unit of illuminance is **Foot-Candles**. If measured in square meters, the unit of illuminance is lux.

**Plan View**  
Scale 1" = 8'

**DATA CENTER**  
60 X 60 X 10  
10X8 SPACING

**LUMINAIRE SCHEDULE**

Symbol	Label	Qty	Catalog Number	Description	Lamp	File	Lumens	LLF	Watts
☐	A	48	MLCP22D4050 MOUNTED @ 10' AFF.	WITH WHITE INTERIOR AND FROSTED PLASTIC FLAT LENS	240 LEDS LUMINAIRE OUTPUT = 3649 LMS	MLCP22D4050 IES	Absolute	0.95	37

**STATISTICS**

Description	Symbol	Avg	Max	Min	Max/Min	Avg/Min
2.5' AFF	☐	45.7 fc	52.9 fc	33.7 fc	1.6:1	1.4:1

**DISCLAIMER:** This calculation is based on the best information provided to MaxLite by the client. These findings should be verified by a certified electrical engineer as to their accuracy. Design changes such as wall, ceiling, floor heights and reflectances of all interior surfaces including partition walls may adversely affect the overall light levels. MaxLite is not responsible as to the veracity of these calculations, and should only be used as a design reference tool.

Calculated values include direct and interreflected components.

**Client**  
Date: Sep 10 2012  
Calc'd by: D DELGADO  
File No.: DATA-1 091012  
**1 of 1**

Delivered light aka **Delivered Lumens** describes how much useful light a light fixture can deliver to a task area discounting any wasted light. Light can be wasted in a number of ways: It can be partially blocked or dispersed within the fixture housing, it can be emitted in a direction away from the task area, or it can be lost through filtering, lensing, fixture positioning, or any of a number of other factors relevant to a specific installation.

A fixture's total lumen output does not account for wasted light. Because LED lighting fixtures are fundamentally directional, LED fixtures typically waste much less light than their conventional counterparts, and deliver more of their total light output to a task or target area. An LED light fixture with lower rated lumens, therefore, may deliver the same or more useful light in a specific application than a comparable conventional lighting fixture with a higher rated lumen output.

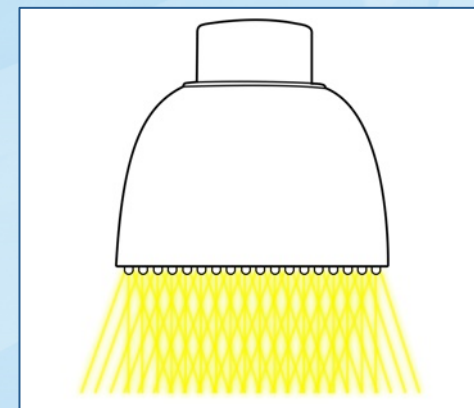
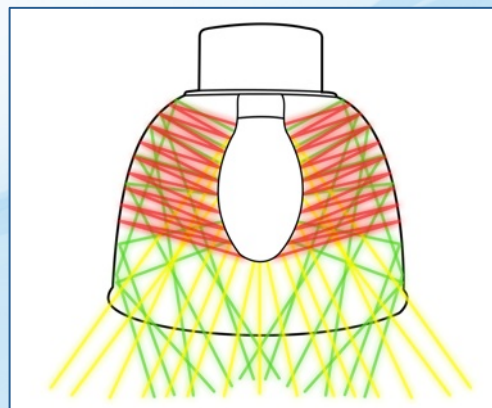

## Traditional Fixtures

Conventional lighting fixtures are tested using the relative photometry method. In relative photometry, luminaires and the lamps used within them are tested separately. Lamp and luminaire testing differ so much from one another, in fact, that lamp photometry engineering and luminaire photometry engineering are separate specialties, each with its own standards and practices. The total luminous flux and chromaticity (color) of a fixture's lamps are typically measured with integrating spheres, while the luminous intensity distribution and efficiency of the luminaires are usually measured with goniophotometers.





## LED Fixtures

Because LEDs are typically inseparable from the luminaires in which they act as light sources, relative photometry is inappropriate for measuring the light output of LED fixtures. Instead, LED fixtures are tested using absolute photometry. The approved procedures and testing conditions for absolute photometry are spelled out in Electrical and Photometric Measurements of Solid-State Lighting Products, publication **IES LM-79-08**, published by IESNA in early 2008.

In absolute photometry, only fixture lumens are measured, and not lamp lumens, because a separate measurement of the LEDs independent of the fixture is neither possible nor meaningful. Fixture efficiency, which compares lamp lumens to fixture lumens, therefore has no meaning for an LED lighting fixture.

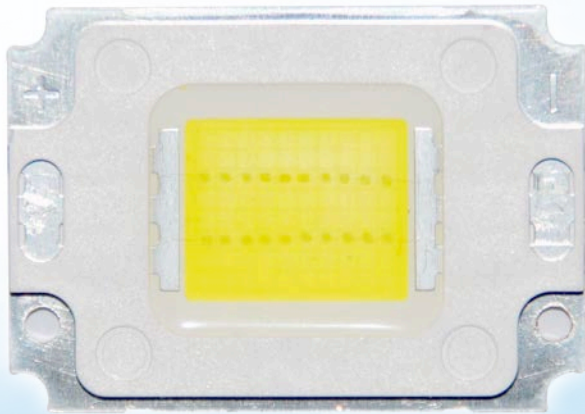

Specifiers, designers and distributors need to compare the total lamp lumens of a conventional lighting fixture with the total fixture lumens of an LED fixture. To make a valid comparison, you must reduce the measured lamp lumens of the conventional fixture by its efficiency. This reduction is typically reported in a Zonal Lumen Summary chart.

For example, the T2 under-cabinet fluorescent light fixtures, prominently reports 860 lumens for the two T2 lamps used within the fixture. However, the Zonal Lumen Summary chart reports 575 total fixture lumens, because the fixture outputs Only 66.9% of the total lamp lumens (66.9% of 860 = 575). That means that 33.1% of the light produced by the fixture’s lamps is wasted or lost within the fixture housing. When comparing a T2 under-cabinet fixture to an LED-based under-cabinet fixture designed for similar lighting applications, you should compare the LED-based fixture’s total lumens with the efficiency-corrected lumen total of the T2, not with its reported lamp lumens. The best way however is to have a lighting layout showing before and after fc’s.

Zone	Lumen	% Lamp	% Fixt.
0-30	113	12.1	19.6
0-40	199	23.1	34.6
0-60	382	44.4	66.3
0-90	534	62.1	92.8
90-120	38	4.4	92.8
90-130	40	4.7	7.0
90-150	41	4.8	7.2
90-180	41	4.8	7.2
<b>0-180</b>	<b>575</b>	<b>66.9</b>	<b>100.0</b>

*The total fixture lumens of a conventional lighting fixture, which accounts for fixture efficiency, should be used in comparisons with the lumen output of LED fixtures.*

# University.MaxLite.com



## MAXLITE LIGHTING & TECHNOLOGY UNIVERSITY



**Product Training  
Modules**



**Earn Your  
Lighting Degree**



**Other Lighting &  
Technology Resources**

The department function is to train and provide product training material for all MaxLite representatives, customers and employees. The goal of the department is to educate the staff and rep network to a full and complete understanding of our products, technologies, marketplace, and business environments. We endeavor to educate how and why lighting functions, repair and replacement, as well as compare to competitors or listing requirements. We will accomplish this by providing the tools and services proactively and as needed to supplement.

[Click here to get started!](#)

## Custom Product & Technology Training

Ask about our FREE custom webinar/training services!

- Lunch and Learn
- Breakfast and Learn
- Online via webinar
- Focus on a specific MaxLite product or a broad overview
- Focus on LED Technology or general lighting training
- Custom Presentations for your customers or staff



Email Greg Murphy at [gmurphy@maxlite.com](mailto:gmurphy@maxlite.com) for more info!

## MAXLITE'S UTILITY REBATE SERVICES

**MaxLite makes it easy to find and complete rebates for you and your customers!**

- C&I Rebate Finder
- Utility Rebate Flyers
- Custom Rebate Calculator
- DLC / ENERGY STAR / LDL Product Listings
- Utility Rebate Paperwork Service



Email Joe Pater at [jpater@maxlite.com](mailto:jpater@maxlite.com) for more info!

**Special thanks to Premier Lighting for their contribution to this presentation.**

**For your lighting needs: <http://www.premierltg.com>**

**FOR MORE INFORMATION ABOUT OTHER MAXLITE PRODUCTS, OR  
FOR LIGHTING QUESTIONS IN GENERAL; PLEASE CONTACT:**

**[info@maxlite.com](mailto:info@maxlite.com)**

**<http://www.maxlite.com>**

**1-800-555-5629**