

Catalog

Work- spaces

V/COUSTIC
INNOVATIVE ACOUSTIC SOLUTIONS

Credits

Copyright 2019 by Vicoustic

*No parts of this document might be copied and/or
published without the written consent of Vicoustic*

Catalog

Work- spaces

V/COUSTIC

INNOVATIVE ACOUSTIC SOLUTIONS

6 – 13

14 – 39

16 – 21

22 – 27

28 – 33

34 – 39

40 – 73

42 – 51

52 – 59

60 – 67

68 – 77

78 – 85

Vicoustic

VicOffice Line

Cloud

Desk Divider

Suspended Divider

Wall

VMT Line

Flat Panel

Vixagon

VicWallpaper

ViCloud Flat

ViCloud 3D

Vicoustic Provides innovative acoustic solutions

Vicoustic is a company in constant evolution with strong international expression, represented in more than 80 countries

Vicoustic understands sound - and we know what makes a truly exceptional acoustic and audio experience. Being at the forefront of acoustic technology, we combine engineered systems with stunning design to bring you sound that is free of compromises, but full of high quality performance.

A leading force in the industry, founded in 2007, Vicoustic is found in over 80 countries around the world. We understand the unique sound dynamics of a room or venue. So whether it's a Home Cinema, Hi-Fi room to a professional sound system for radio and television, our expertise for peak acoustic performance is second-to-none.

The products from Vicoustic deliver clever and innovative solutions to meet the demands of spaces which require a sophisticated soundscape. Taking on board the high standards of our customers, we continuously strive to manufacture products of superior functionality, adaptability, but all the while with a sustainable and environmentally conscious mind-set.

Quality at the heart of sound

Vicoustic is concerned with design, leading technology and sound solutions. And alongside this vision, our work is always underpinned by producing sound with materials and systems of the highest quality. We listen to our customers and take on board their acoustic needs, what we do is very personal. We are proud of our work and Vicoustic would never create something that we wouldn't use ourselves. Designed and manufactured in Portugal, our facilities underwent great transformation in 2015 to incorporate state of the art equipment and new production and coating systems. This ensured that Vicoustic was able to maintain the high quality standards expected of its products, increase production volumes, but also create those bespoke products for our custom projects. This is led by our own 'in-house' Quality Department, who oversee all aspects of quality from the company. The ability of Vicoustic to create individually designed items at a premium quality means that our products can meet the needs of most spaces (no matter how unusual) to ensure the best acoustics and environment to enjoy sound...we have it covered.

Vicoustic Team

From conception through to completion, we work closely with architects, engineers and designers to deliver a project successfully irrespective of complexity.

Our project team includes senior acoustic engineers and designers that are experts in taking you on your acoustic and design needs.

The pioneering hardware and software tools we have engineered have proved to be very reliable to support the integration of acoustic treatment and sound insulation solutions through a new-build or a refurbishing project.

Our Research and Development Team is also available to develop customized products to satisfy your needs.

Our customers will also be supported by our Sales, Marketing and Logistics teams to assist with transportation, communication and all information that may be required: pricing; installation guides; catalogues; etc.



Together we have proven that we can provide high levels of value to see our customers through the whole process of installing acoustic solutions.

This includes reliable and effective recommendations of products and support services throughout your whole project process from conception through to completion.



We do

- Custom Designed Products
- Room Design Recommendations
- Technical Support

Technology and rigorous in-house testing are the foundations for every Vicoustic Product

This is what makes Vicoustic a distinguished brand and leader in its sector

We believe that Vicoustic should constantly be paving the way, innovating and driving sound technologies to ensure that we are not only leading the field, but producing the best acoustics in every space we are acoustically curating. What makes us outliers in the industry is our 'Vicoustic Research Centre', inaugurated in 2012 alongside the Vicoustic HQ. We pride ourselves on developing and continuously advancing our technologies and ways of working to deliver the best product to our customers.

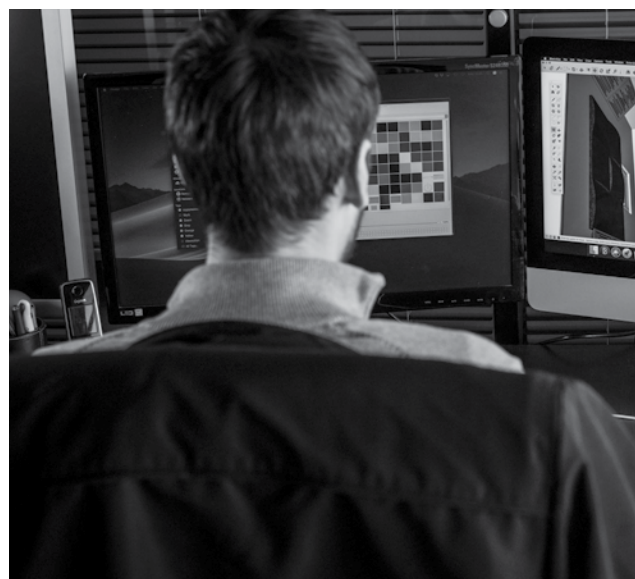

The Research Centre operates on a multidisciplinary platform: the 'Multifunctional Room' and the 'Innovative Acoustic Chamber'. We have a brilliant (and fun!) time using this centre to test our products and investigate and challenge the way we use audio and acoustic technologies.



The 'Multifunctional Room', lined with magnetic walls, allows us to assemble, mount and test different combinations of acoustic products quickly and efficiently. Not only does this allow us to analyse performance, quality and design, it also gives us the opportunity to share this learning with our Vicoustic partners across the world

The 'Innovative Acoustic Chamber' is a world leading testing facility. 4-ton mechanical walls allow us to adapt the size of the space to the bespoke requirements of our customer. With a specialized sound insulation system, we can develop product and test resonance, sound frequency and, best of all, curate that beautiful acoustic ambiance only made possible by emulating the space the system will eventually call home. The sound behaviour is captured using B&K microphones and each element of the acoustic can then be identified and tested so nothing is missed and everything can be fine-tuned. Our aim is to invest in programmes to optimise acoustic performance within specific architecture and interior spaces. This means we can produce aesthetically pleasing products, whilst also upholding key safety and environmental regulations.

Vicoustic Sustainability Approach

In the past decade, Vicoustic has been developing a strong concern in terms of creating new sustainable acoustic solutions

We are committed to making products in an environmentally friendly way. This is important to Vicoustic and an integral part of our product development. Following an extensive project looking into the sustainability of our creations, a substantial part of our products are now made using recycled or recyclable materials.

Most notably, Vicoustic has increased the use of VicPET Wool. A non-woven textile with superb acoustic performance, but predominantly made from recycled plastic bottles. 2018 sees a 3rd Vicoustic factory opening, meaning we are more determined than ever to use eco-friendly products in our lines.

But sustainability is not limited to manufacturing. Our aim for a greener product is also in the quality and durability of our creations and we aim for these to have a great, long and lasting life.

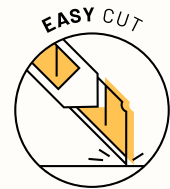

Vicoustic's continuing research and innovation in acoustic solutions, in its pursuit of new materials, led to the development of VicPET Wool

Instead of using commonplace raw materials, the latest Vicoustic line of products uses new and responsible raw materials that are predominantly made of recycled PET Bottles (65%), which are recyclable and low emitting materials (low VOC emissions).

Alongside being made of sustainable materials, these products maintain all necessary fire safety regulations and are classified as Class 1 according to OEKO-TEX 100 Standard, i.e. meeting the human-ecological requirements presently established for baby articles.

We, at Vicoustic, are doing all this in an innovative way, without compromising the acoustic performance or the design and quality of our products. Installing our new line of products not only will ensure you meet your acoustic needs, but can also promote the sustainable ambitions of your company and helps you earn the credits normally available in the Green Building Certification Schemes such as LEED (USA); WELL (UK); HQE (France); etc.



VicPET Wool

Properties

- Does not irritate skin or eyes
- Recyclable (100% PET)
- Good indoor air quality - zero emission of VOC's or formaldehyde
- No chemicals used
- Humidity resistant
- No dust generation during handling
- Class I acc. to Oeko-Tex 100 Standard

Description

- Non-woven product
- 100% polyester fibres
- Thermally bonded
- Colour: White or Black

Other features

- **Flammability:** Euroclass B, s1 d0
- **Thickness (range):** 20 to 80 mm
- **Weight:** 800 to 1600 grams/m²

VicOffice Line

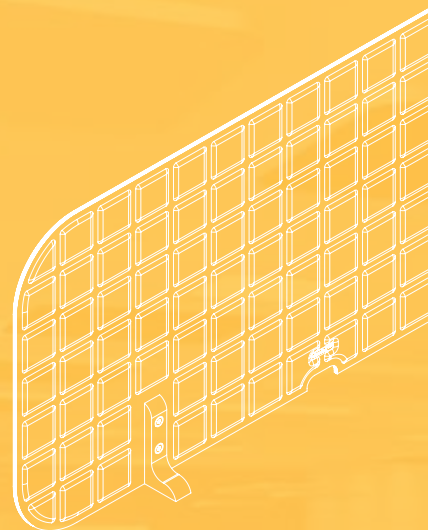

Desk Divider
22 – 27

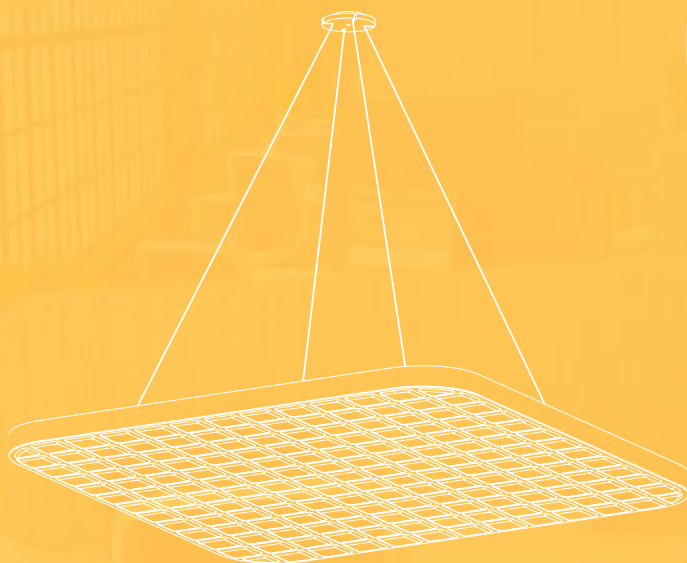

Cloud
16 – 21

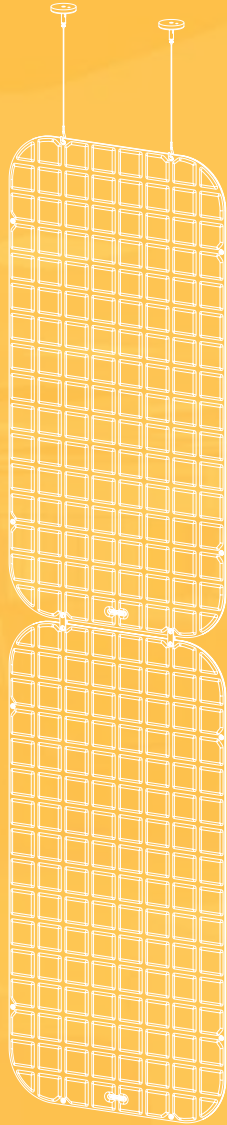
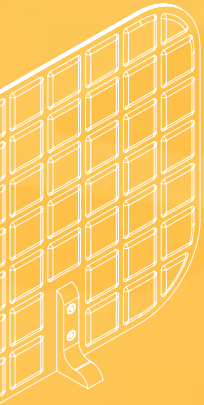

**Suspended
Divider**
28 — 33

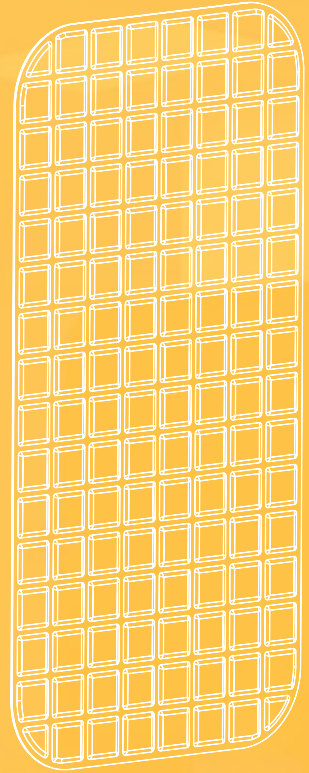

Wall
34 — 39

VicOffice **Cloud**





VicOffice Cloud

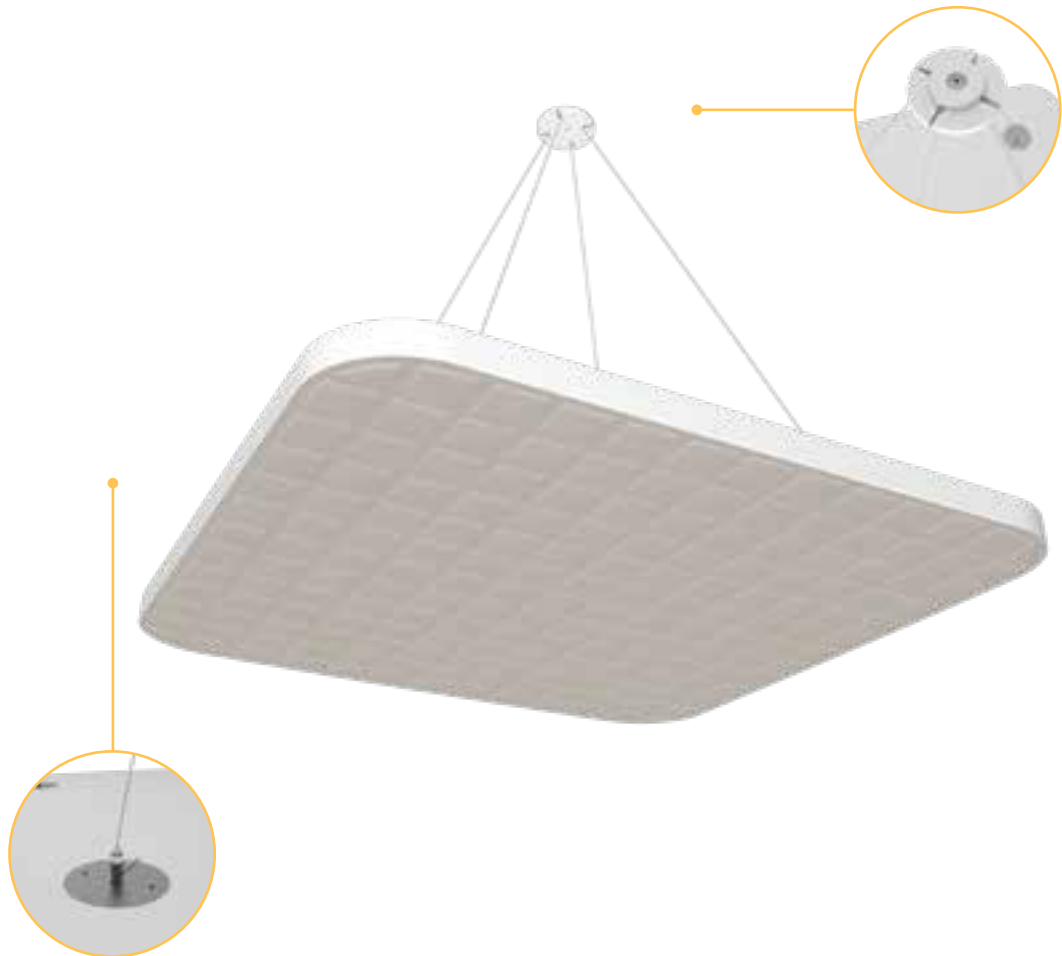

VicOffice Clouds are a simple and lightweight suspended acoustic solution ideal for open plan offices where great concentration of people is expected and background noise created by a room full of conversations can quickly build up. Being a suspended acoustic element, presents twice the area of absorbing material exposed than a common acoustic panel, making it a very effective solution.



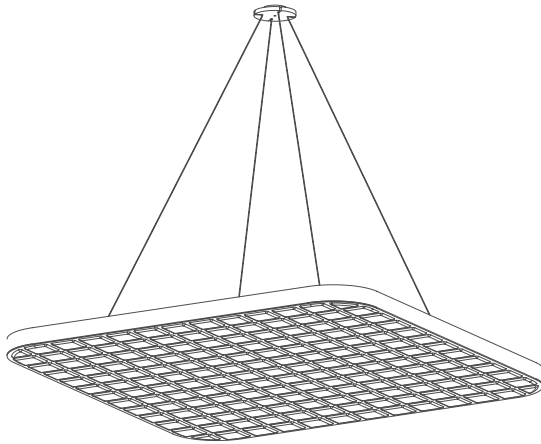

Dimensions*

1000 x 1000 x 45 mm / 39.4" x 39.4" x 1.8"

Package Information

1 unit/box

Box Dimensions

1155 x 1031 x 48 mm / 45.5" x 40.6" x 1.9"

**Please notice that the dimensions of these panels have a tolerance of +/- 2 mm*

Features

- Premium high density VicPET Wool
- High Performance in medium and high frequencies
- Light weight
- Easy to install
- Easy to clean and maintain

Technical Information

Raw Material

VicPET Wool

Fire Rate

Europe: N/A

USA: N/A

Accessories

VicOffice Mechanical and Magnetic Suspended Fixation

Solid colors

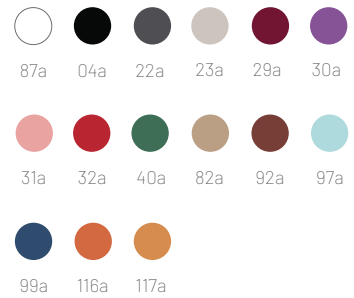

Performance

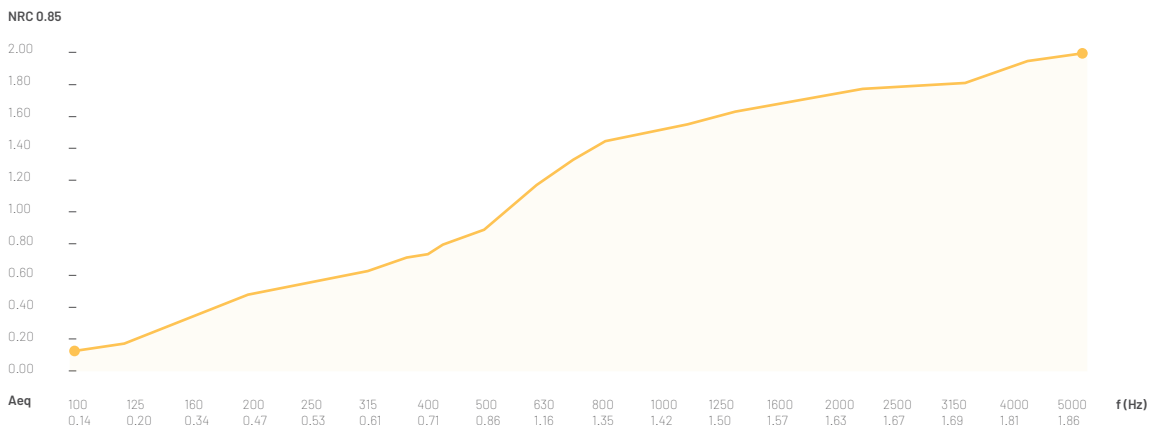



OEKO-TEX®
CONFIDENCE IN TEXTILES
STANDARD 100 

VicOffice Desk Divider

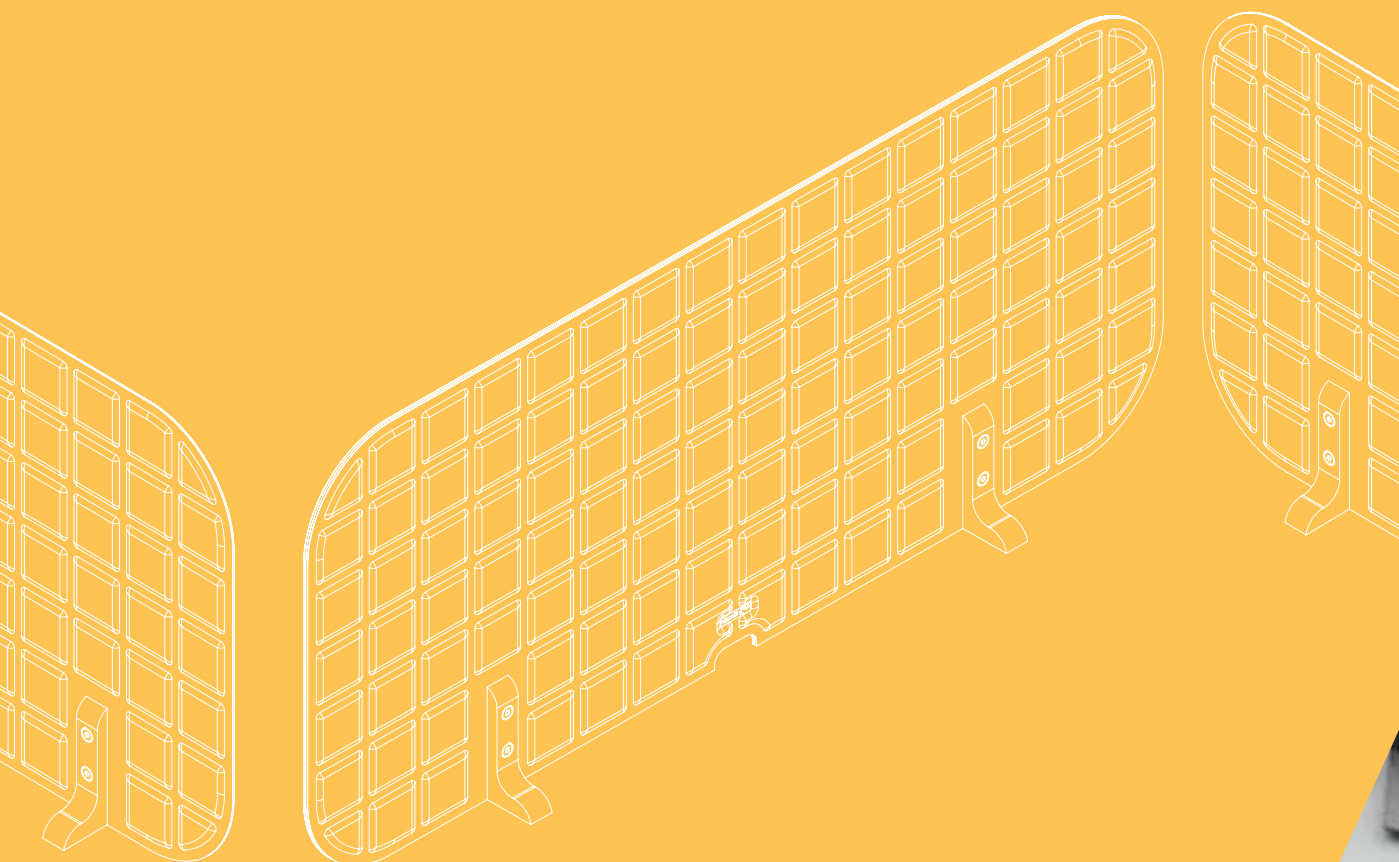





VicOffice Desk Divider



VicOffice Desk Divider was developed to help you managing privacy between working places. It will help you to visually divide working places and at the same time, since it has great sound absorption characteristics, it will help you controlling the acoustics of your office. VicOffice Desk Divider comes in different sizes to be compatible to different desk dimensions.

Desk Lat

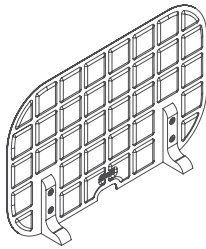

Dimensions*

- 1 614 x 389 x 10 mm / 24.2" x 15.3" x 0.4"
- 2 614 x 539 x 10 mm / 24.2" x 21.2" x 0.4"
- 3 764 x 389 x 10 mm / 30" x 15.3" x 0.4"
- 4 764 x 539 x 10 mm / 30" x 21.2" x 0.4"

Box Dimensions

- 1 625 x 404 x 47 mm / 24.6" x 15.9" x 1.9"
- 2 620 x 545 x 47 mm / 24.4" x 21.5" x 1.9"
- 3 778 x 404 x 55 mm / 30.6" x 15.9" x 0.4"
- 4 778 x 554 x 55 mm / 30.6" x 21.8" x 2.2"

Package Information

1 unit/box

**Please notice that the dimensions of these panels have a tolerance of +/- 2 mm*



Desk Top

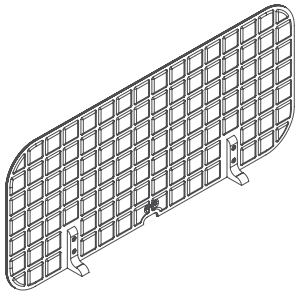

Dimensions*

- 1 914 x 389 x 10 mm / 36" x 15.3" x 0.4"
- 2 914 x 539 x 10 mm / 36" x 21.2" x 0.4"
- 3 1214 x 389 x 10 mm / 47.8" x 15.3" x 0.4"
- 4 1214 x 539 x 10 mm / 47.8" x 21.2" x 0.4"
- 5 1364 x 389 x 10 mm / 53.7" x 15.3" x 0.4"
- 6 1364 x 539 x 10 mm / 53.7" x 21.2" x 0.4"

Box Dimensions

- 1 928 x 404 x 55 mm / 36.5" x 15.9" x 2.2"
- 2 928 x 554 x 55 mm / 36.5" x 21.8" x 2.2"
- 3 1228 x 404 x 55 mm / 48.3" x 15.9" x 2.2"
- 4 1228 x 554 x 55 mm / 48.3" x 21.8" x 2.2"
- 5 1375 x 404 x 47 mm / 53.7" x 15.3" x 1.9"
- 6 1375 x 554 x 55 mm / 53.7" x 21.8" x 2.2"

Package Information

1 unit/box

*Please notice that the dimensions of these panels have a tolerance of +/- 2 mm

Features

- Premium high density VicPET Wool
- High Performance in medium and high frequencies
- Light weight
- Easy to install
- Easy to clean and maintain

Technical Information

Raw Material

VicPET Wool

Fire Rate

Europe: N/A

USA: N/A

Accessories

VicOffice Feet

Solid colors

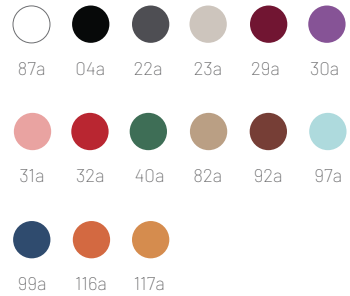

Performance

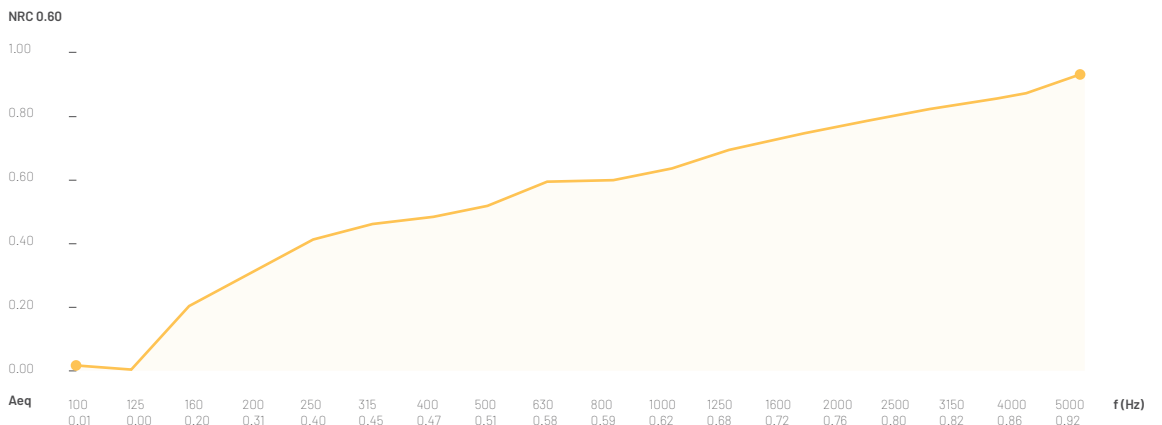

VicOffice Suspended Divider

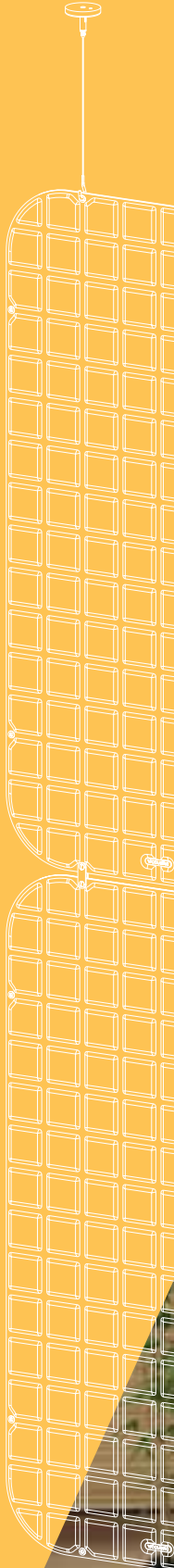
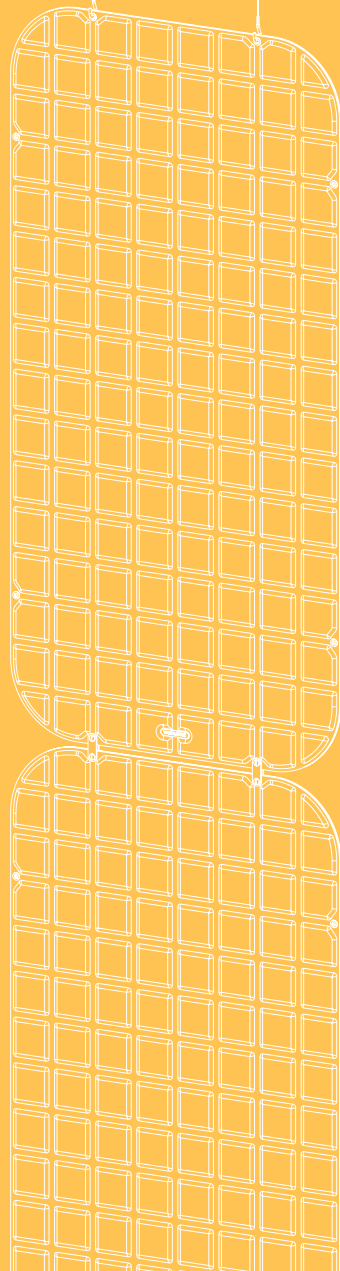
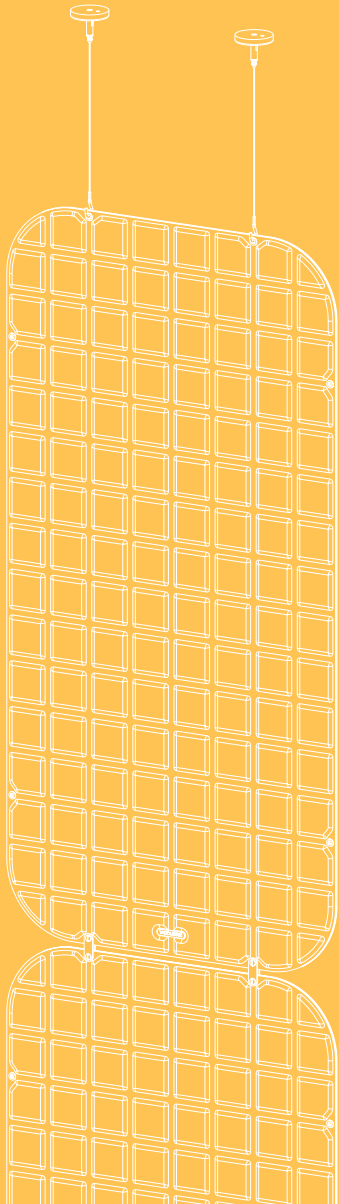



VicOffice Suspended Divider

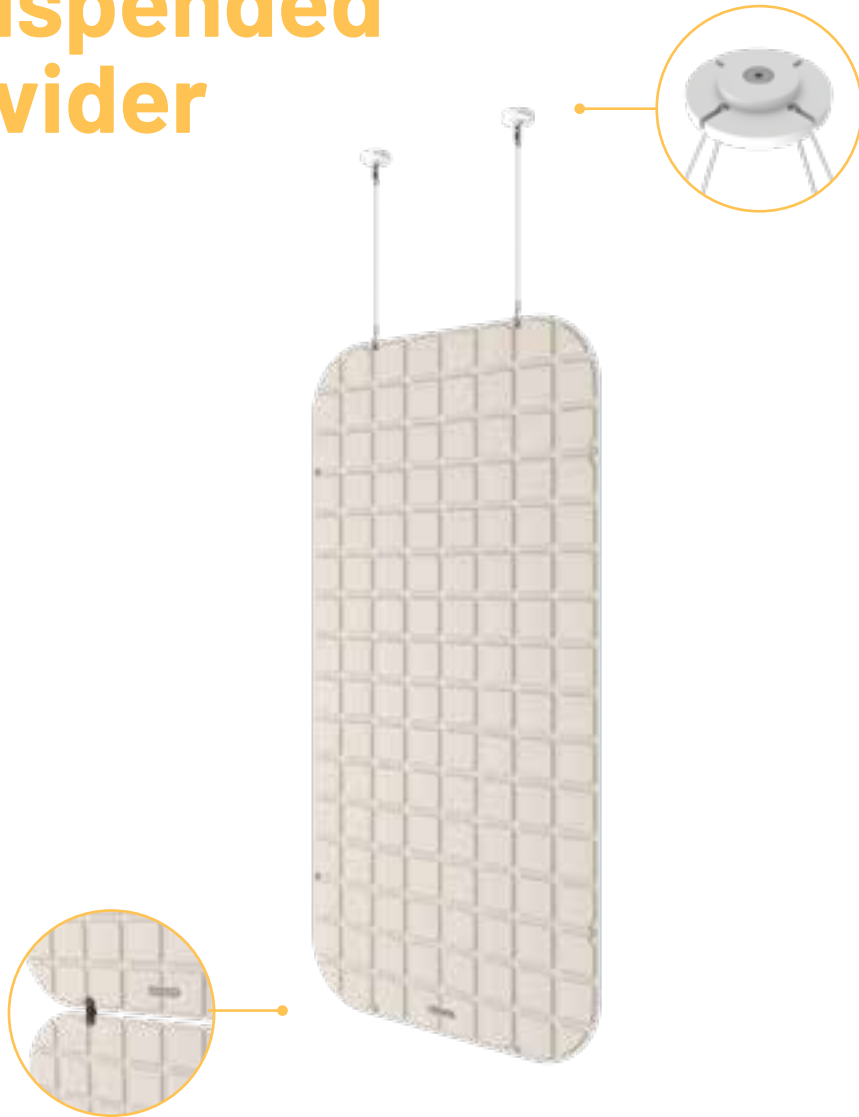

Sometimes you need to temporary divide your office to accommodate new spaces or better use existing ones. To do this, Vicoustic has developed **VicOffice Suspended Divider**. As the name says this acoustic panel is a suspended divider that will help you to visually divide your office and at the same time control its acoustics since it has great sound absorbing characteristics.





Features

- Premium high density VicPET Wool
- High Performance in medium and high frequencies
- Light weight
- Easy to install
- Easy to clean and maintain



Technical Information

Raw Material

VicPET Wool

Fire Rate

Europe: N/A

USA: N/A

Accessories

VicOffice Suspension Cables

Solid colors

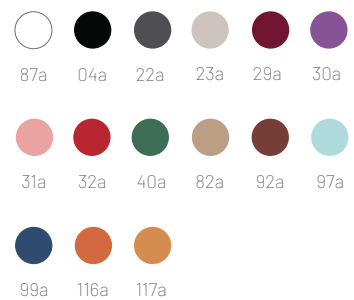

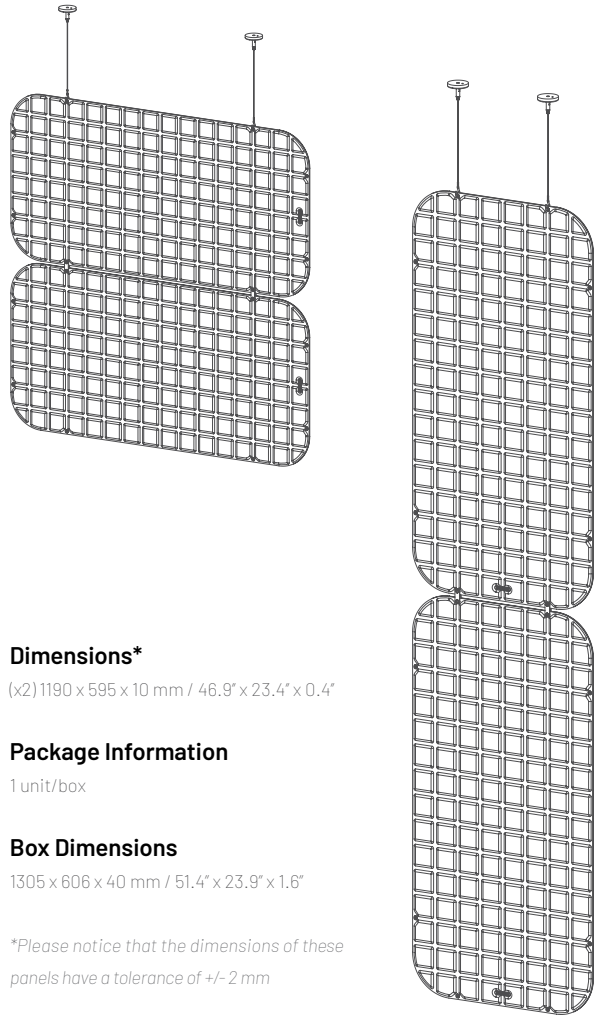

Dimensions*

(x2) 1190 x 595 x 10 mm / 46.9" x 23.4" x 0.4"

Package Information

1 unit/box

Box Dimensions

1305 x 606 x 40 mm / 51.4" x 23.9" x 1.6"

**Please notice that the dimensions of these panels have a tolerance of +/- 2 mm*

Performance

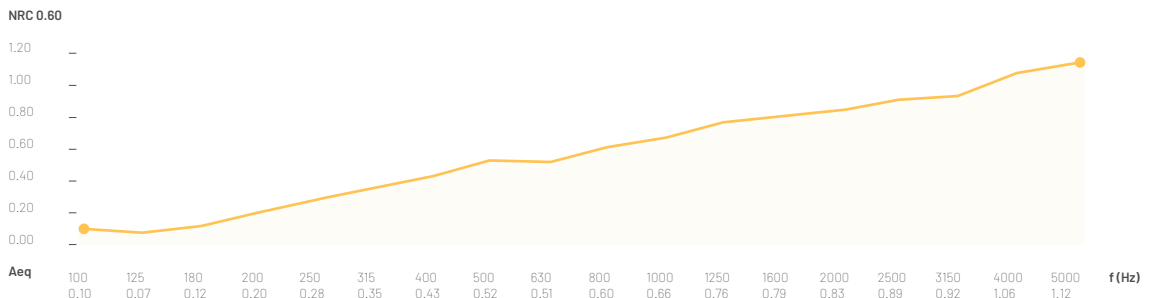

VicOffice **Wall**

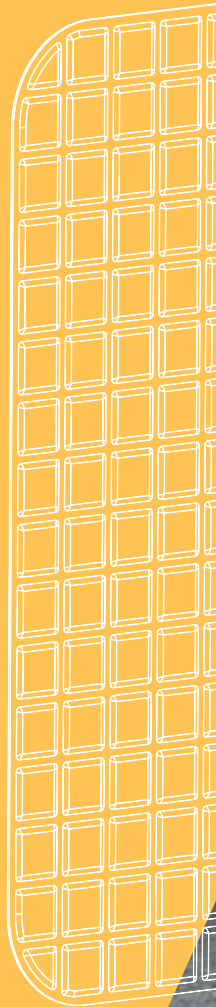
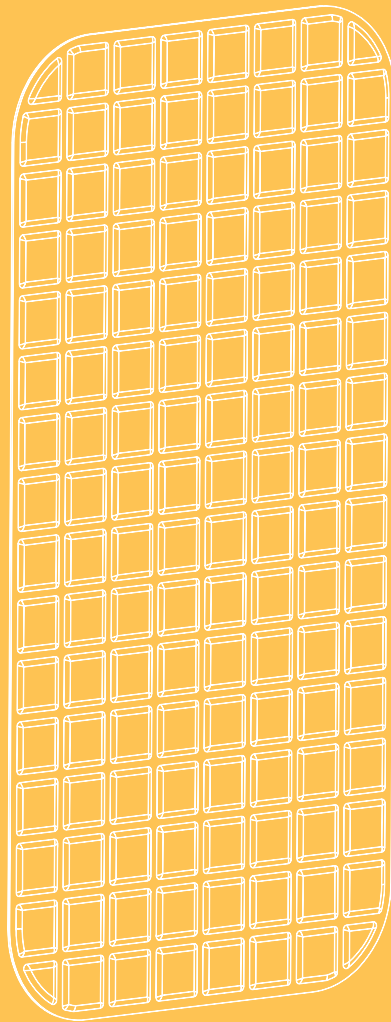
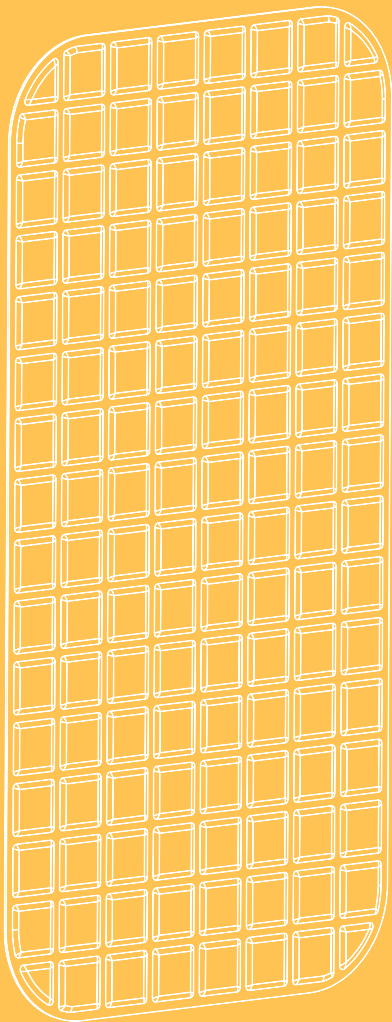





VicOffice Wall



VicOffice Wall is a thin acoustic panel that can be easily mounted and dismantled to any wall, without compromising the glazing cleaning process. Being a thin panel, and therefore having low performance on medium frequencies, Vicoustic has developed its installation mechanism to create an air-gap between the glaze and VicOffice Wall, and in this way increase its performance on the medium/high frequencies, exactly where speech frequencies occur.

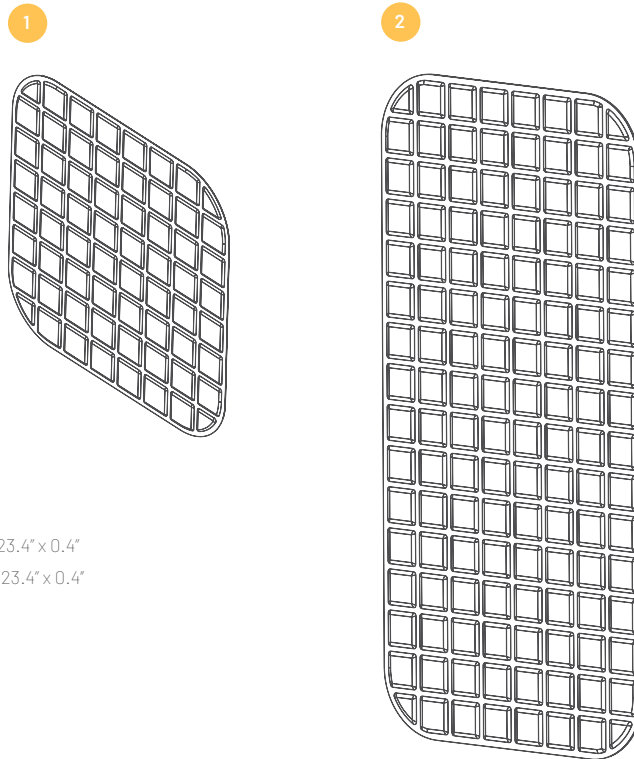

Dimensions*

- 1 595 x 595 x 10 mm / 23.4" x 23.4" x 0.4"
- 2 1190 x 595 x 10 mm / 46.9" x 23.4" x 0.4"

Package Information

1 unit/box

Box Dimensions

- 1 606 x 606 x 40 mm / 23.9" x 23.9" x 1.6"
- 2 1201 x 606 x 37 mm / 47.3 x 23.9" x 1.5"

**Please notice that the dimensions of these panels have a tolerance of +/- 2 mm*



Features

- Premium high density VicPET Wool
- High Performance in medium and high frequencies
- Light weight
- Easy to install
- Easy to clean and maintain

Technical Information

Raw Material

VicPET Wool

Fire Rate

Europe: N/A
USA: N/A

Accessories

VicOffice Brackets

Solid colors

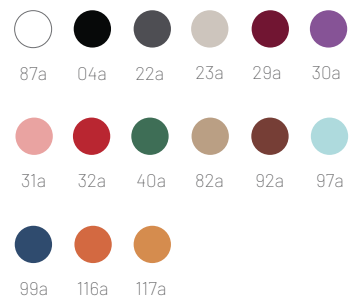



Performance

NRC 0.30

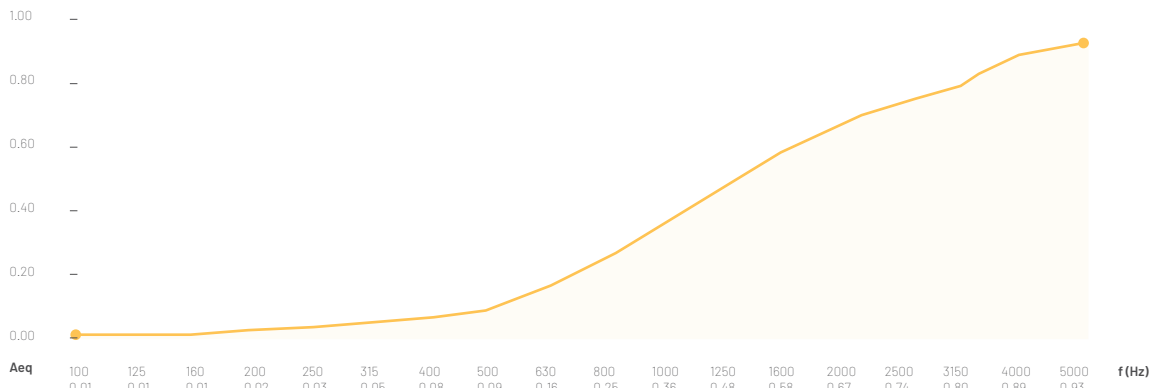

VMT Line

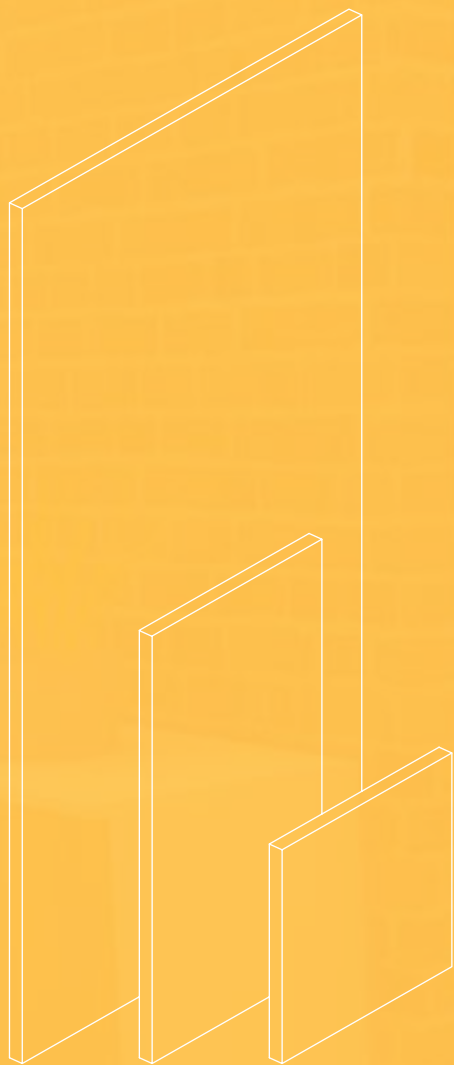

Flat Panel
42 – 51



Vixagon
52 – 59

VMT Flat Panel

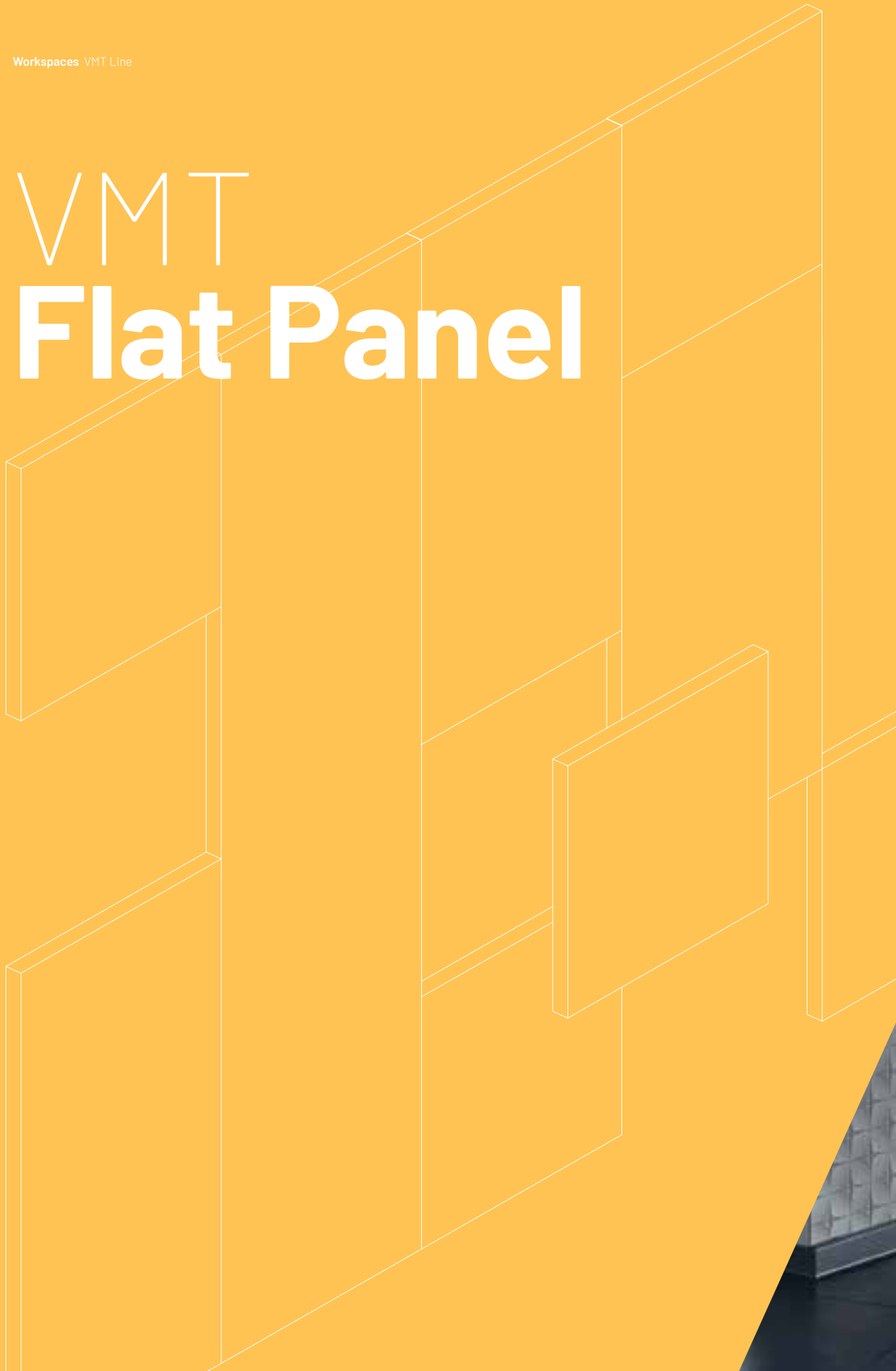



VMT Flat Panel

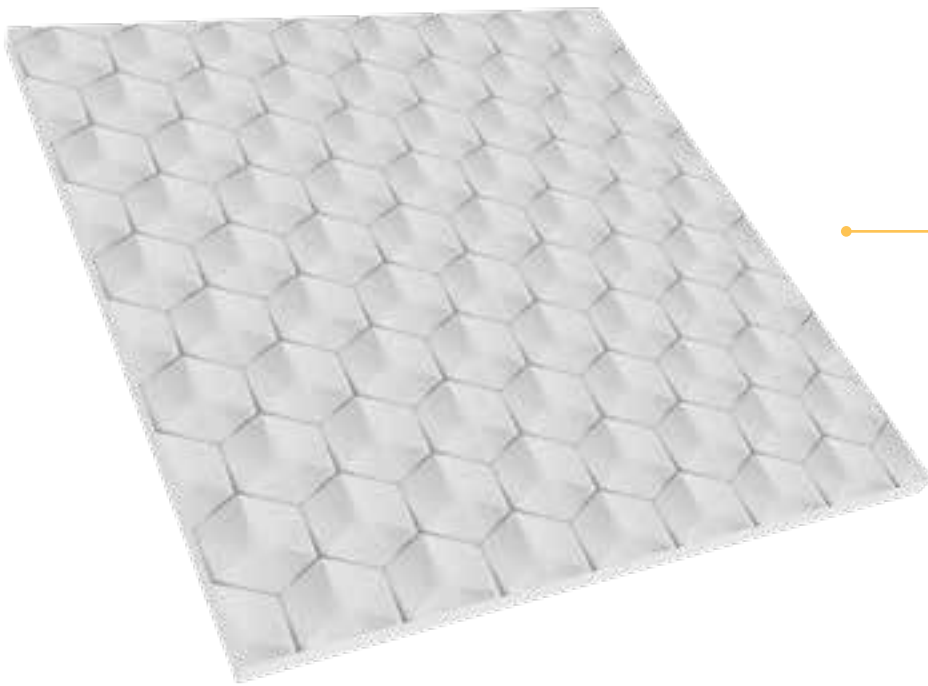

Flat Panel VMT panels are designed to perform primarily in the medium and high frequencies. Therefore, these panels provide a great acoustic solution to implement in any commercial or residential setting and can be used on ceilings and walls. The applications for Flat Panel VMT are infinite, making it perfect for both new construction and refurbishment projects.

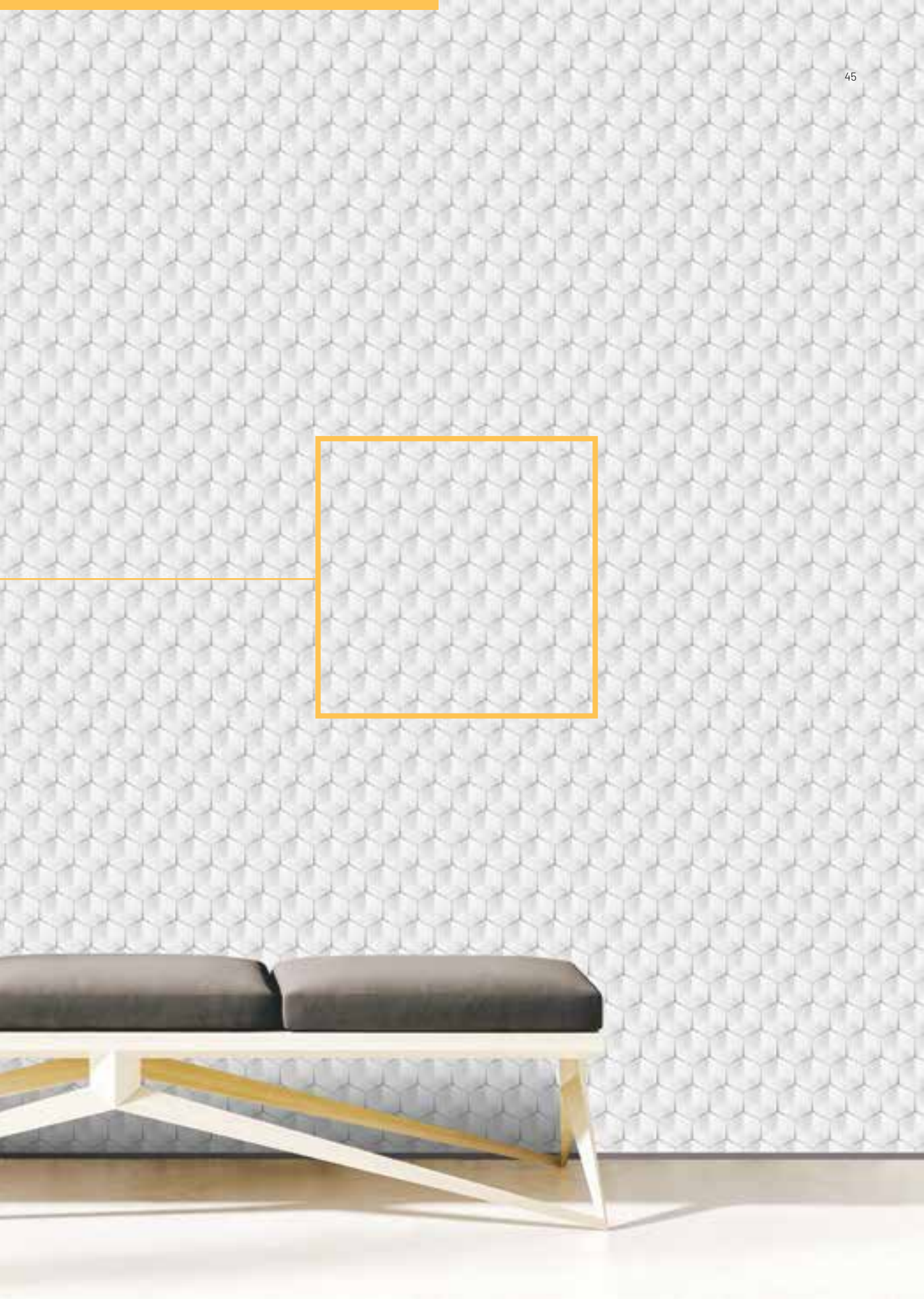

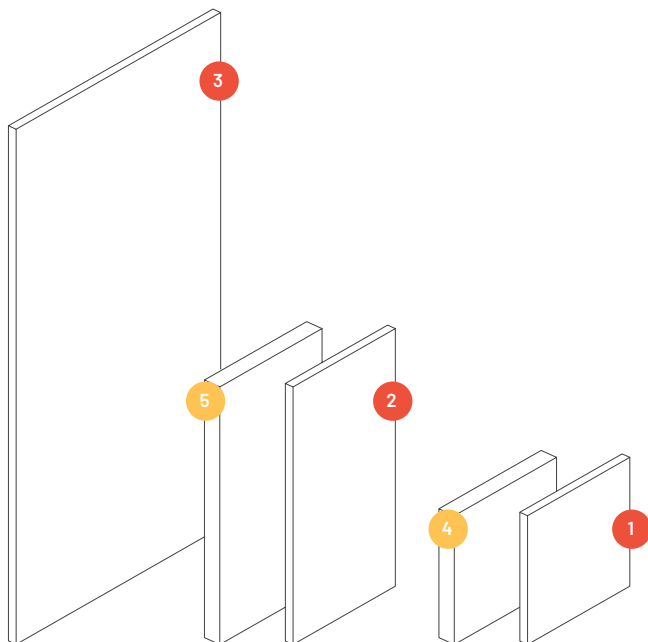

Dimensions*

- 1 595 x 595 x 20 mm / 23.4" x 23.4" x 0.8"
- 2 1190 x 595 x 20 mm / 46.8" x 23.4" x 0.8"
- 3 2380 x 1190 x 20 mm / 93.7" x 46.8" x 0.8"
- 4 595 x 595 x 40 mm / 23.4" x 23.4" x 1.6"
- 5 1190 x 595 x 40 mm / 46.8" x 23.4" x 1.6"

Package Information

- 1 2 3 8 units/box
- 4 5 8 units/box

Box Dimensions

- 1 665 x 675 x 195 mm / 26.2" x 26.6" x 7.8"
- 2 1260 x 675 x 190 mm / 49.6" x 26.6" x 7.5"
- 3 2470 x 1275 x 170 mm / 97.2" x 50.2" x 6.7"
- 4 665 x 675 x 355 mm / 26.2" x 26.6" x 14"
- 5 1260 x 675 x 355 mm / 49.6" x 26.6" x 14"

*Please notice that the dimensions of these panels have a tolerance of +/- 2 mm

Performance

NRC 40 mm: 0,60
NRC 20 mm: 0,55

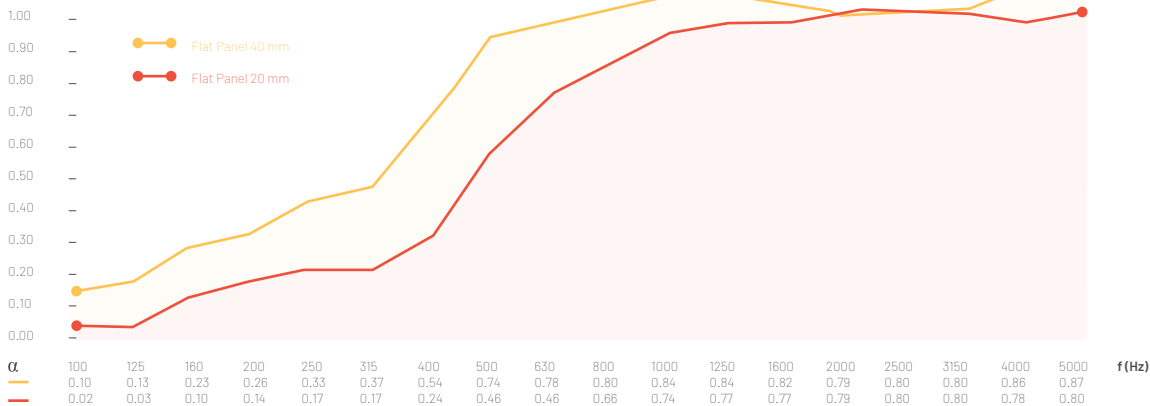

Features

- Light weight
- Easy to Install
- Easy to clean and maintain
- High Performance in medium and high frequencies

Technical Information

Raw Material

VicPET Wool

Fire Rate

Europe: Euroclass B -s2, d0

USA: Class A (ASTM-E84)

Canada: CAN/ULC S102, Flame Spread

Rating: 5, Smoke Developed

Classification: 115

Installation

Velcro (included), Flexi Glue Ultra, VicFix Magnetic, VicFix Frame, AluFrame VMT

Available Finishes

Collections

- Natural Stones **NEW**
- 3D
- Brick
- Concrete
- Doodle
- Floral
- Geometric
- Nature
- Tiles
- World

Solid colors

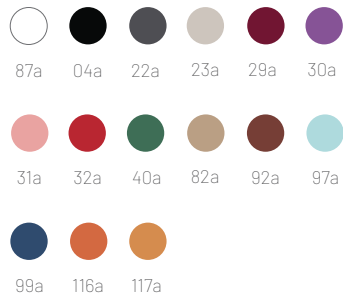

Natural Stones Collection

Calacatta
Carrara



Emperador
Dark



Fusion
Wow



Grey
Stone



Invisible
Grey

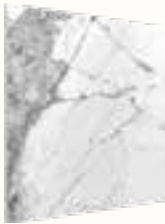

Travertino
Classico





Tiles

Collection

①



②



③



④



3D Collection

1



2



3



4



Brick Collection

1



2



3



4



Concrete Collection

1



2



3



4



Doodle Collection

1



2



3



4



Floral Collection

①



②



③



Geometric Collection

①



②

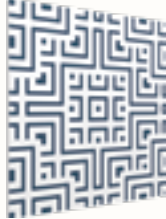

③

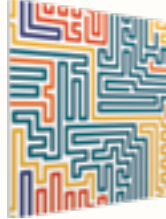

④



Nature Collection

①



②



③



World Collection

①



②



③



④



VMT **Vixagon**







VMT Vixagon



Vixagon VMT is a perfect solution to cushion and reduce sound levels in a cost-effective way. Vicoustic's standard patterns and solid colors for the Vixagon VMT are stylish and work in many different aesthetics and particularly in strongly designed architectural spaces. This product can be used on walls and ceilings and adapted easily owing to its unique shape.

A smaller and more compact version of Vixagon, Vixagon Mini, is also available, offering all of the same acoustic solutions, just in a smaller and more manageable size to create more intricate and creative patterns.

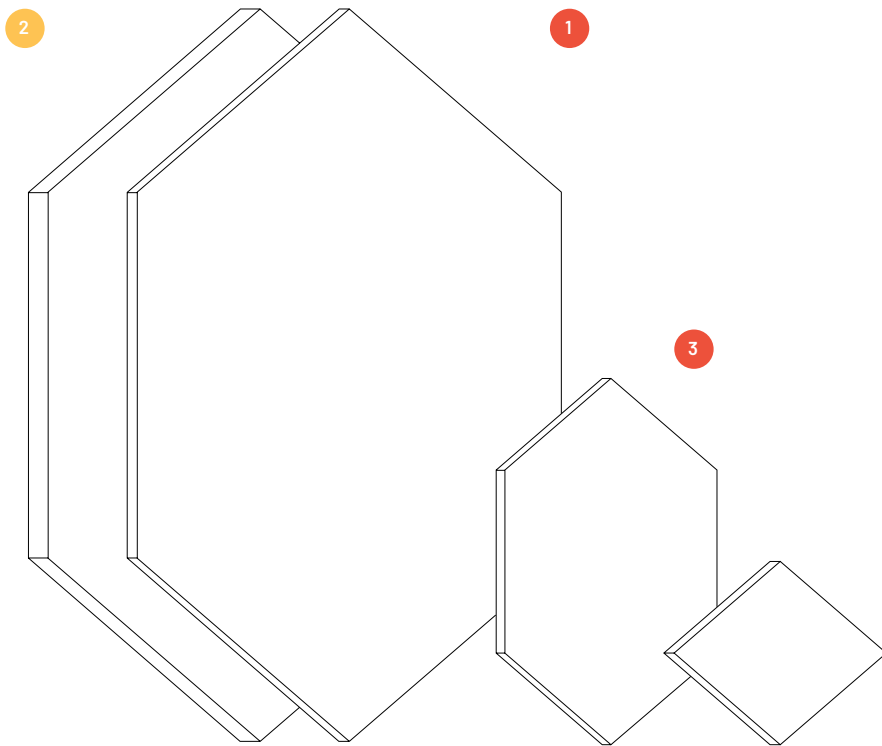

Dimensions*

- 1 700 x 606 x 20 mm / 27,56" x 23,86" x 0,8"
- 2 700 x 606 x 40 mm / 27,56" x 23,86" x 1,6"
- 3 350 x 303 x 20 mm / 13,78" x 11,93" x 0,8"

Package Information

- 1 12 units/box
- 2 6 units/box
- 3 36 + 36 units/box **

Box Dimensions

745 x 650 x 390 mm / 29.3" x 25.6" x 15.3"

** Please notice that the dimensions of these panels have a tolerance of +/- 2 mm.*

***The Vixagons Mini are packed in a really innovative way: we are using the same material as the product itself as packaging material. This will give the bonus of having extra Diamond shapes that can be used in conjunction with your Vixagon to create your art-work.*

Features

- Light weight
- Easy to Install
- Easy to clean and maintain
- High Performance in medium and high frequencies

Technical Information

Raw Material

VicPET Wool

Fire Rate

Euroclass B -s2, d0

Installation

Velcro (included), Flexi Glue Ultra



Available Finishes

Collections

- Natural Stones **NEW**
- Concrete
- Doodle
- Floral
- World
- Nature

Solid colors

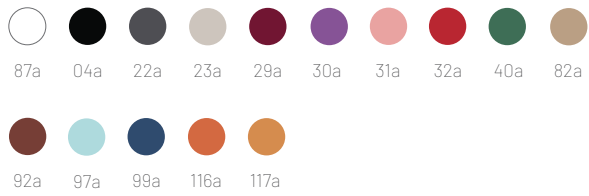

Performance

NRC 40 mm: 0,60

NRC 20 mm: 0,55

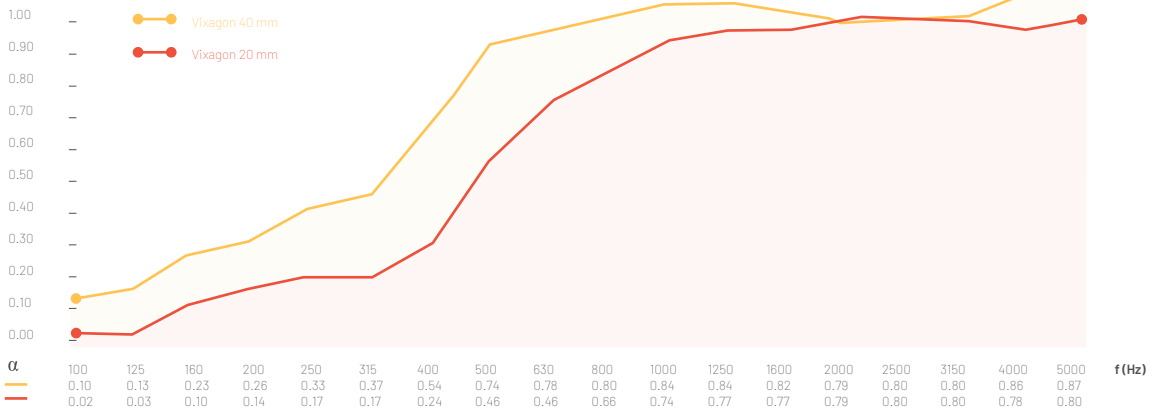

Natural Stones Collection

Calacatta Carrara



Emperador Dark



Fusion Wow



Grey Stone



Invisible Grey



Travertino Classico



Concrete Collection

1



2



3



4



Doodle Collection

①



②



③



Floral Collection

①



World Collection

①



Nature Collection

①



②



③



VMT VicWallpaper





VMT VicWallpaper



VicWallpaper is a revolutionary new way to manage acoustic and thermal isolation in both residential and commercial settings. Developed to perform on high frequencies, VicWallpaper is ideal for improving speech intelligibility in places such as meeting rooms, living rooms or classrooms. Manufactured in recycled EuroClass B PET, VicWallpaper VMT is easy and fast to install, not requiring any specialized and expensive labor.



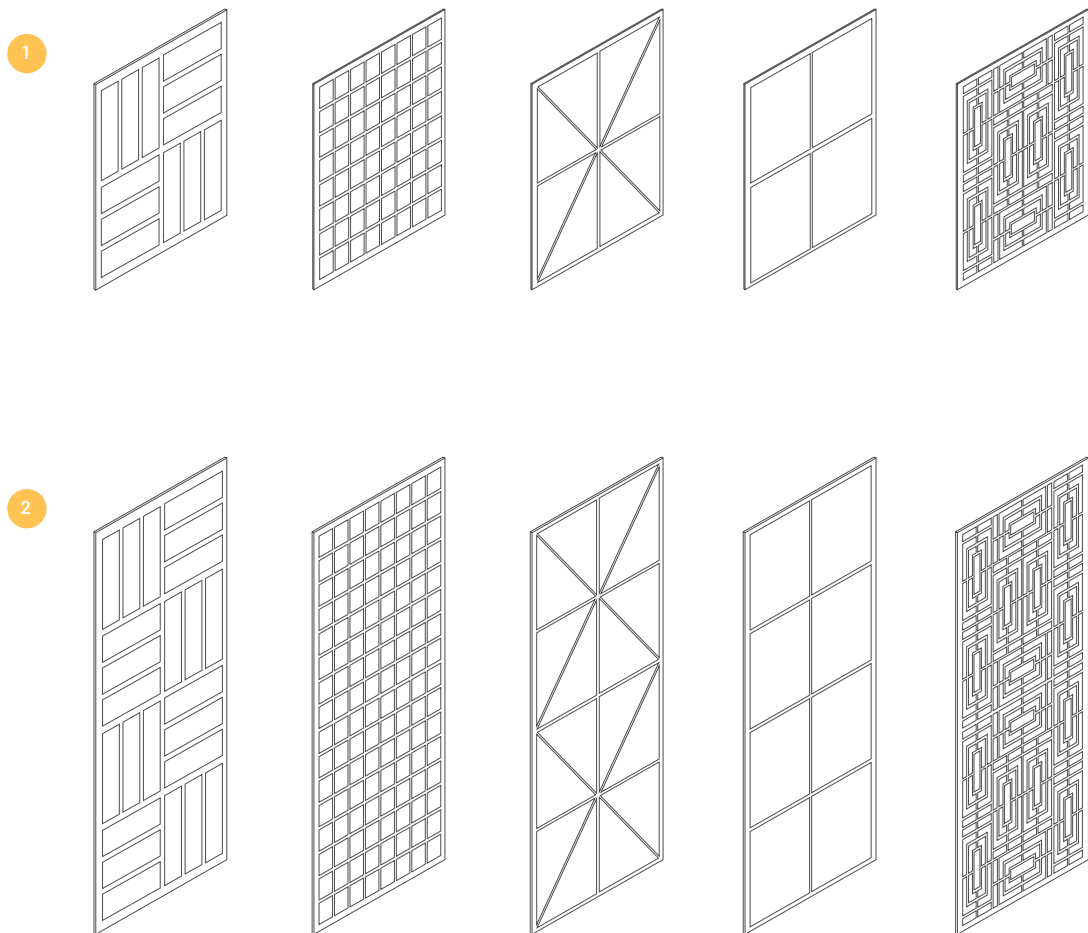

Dimensions*

- 1 595 x 595 x 15 mm / 23.4" x 23.4" x 0.6"
- 2 1190 x 595 x 15 mm / 46.8" x 23.4" x 0.6"

Package Information

8 unit/box

Box Dimensions

- 1 615 x 640 x 130 mm / 24.2" x 25.2" x 5.1"
- 2 1245 x 615 x 130 mm / 49" x 24.2" x 5.1"

Technical Information

Raw Material

VicPET Wool

Installation

Flexi Glue Ultra,
Double sided tape

Fire Rate

EuroClass B - s2, d0

Applications

- Large halls
- Office
- Residential
- Restaurants
- House of Worship
- Gyms
- Canteens
- Studios
- Lobbies
- And many more

*Please notice that the dimensions of these panels have a tolerance of +/- 2 mm



Available Finishes















Pattern Designs

- Deck
- Triangles
- Square 30
- Square 8
- Symmetric

Collections

- Concrete

Solid colors

			
87a	04a	22a	23a
			
29a	30a	31a	32a
			
40a	82a	92a	97a
			
99a	117a	116a	



Performance

NRC: 0,14

Sound Absorption Coefficient

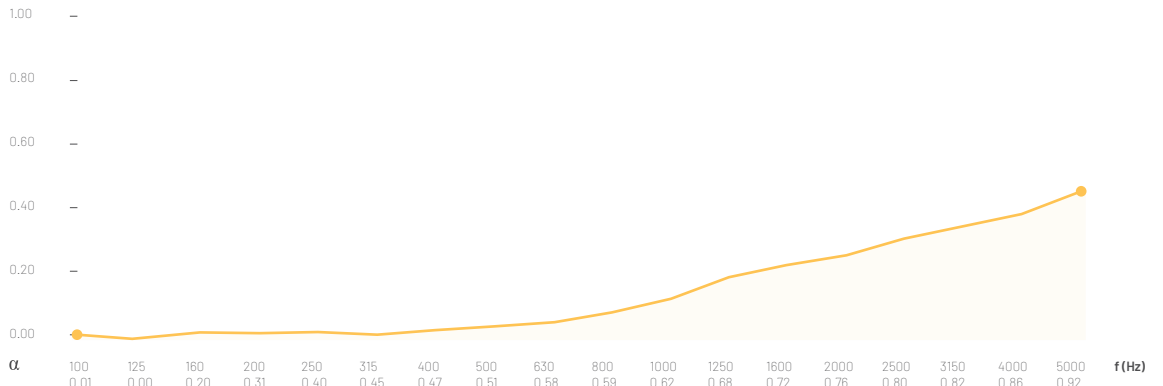

Pattern Designs

Deck



Square 8



Square 30



Symmetric



Triangles



Concrete Collection

①



②



③



④



VMT

ViCloud Flat







VMT

ViCloud Flat



ViCloud VMT is a simple and lightweight, suspended acoustic solution that is ideal for restaurants, open plan offices, convention centers, atriums, or any public space where there is a great concentration of people and where background noise, created by a room full of conversations, can quickly build up.

In addition, by using Vicoustic Virtual Material Technology, ViCloud VMT is customizable and adaptable to meet your architectural needs. For exquisite architectural soundscapes, that subtly align to your existing or newly renovate space, ViCloud VMT may just be the solution you need.

1 Square

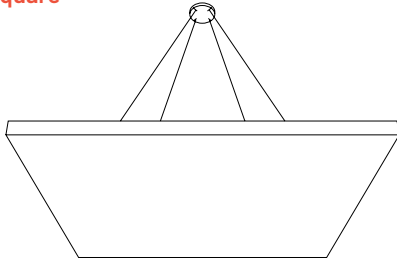

2 Hexagon

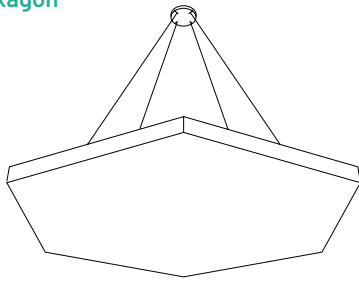

3 Round

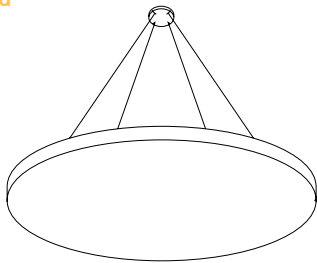

4 Petal

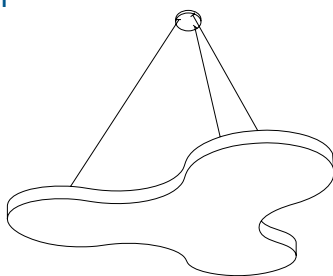



Dimensions*

- 1 1160 x 1160 x 40 mm / 45.7" x 45.7" x 1.6"
- 2 1160 x 1005 x 40 mm / 45.7" x 39.6" x 1.6"
- 3 Ø 1160 x 40 mm / Ø 45.7" x 1.6"
- 4 1160 x 1068 x 40 mm / 45.7" x 42" x 1.6"

Package Information

4 units/box

Box Dimensions

1267 x 1267 x 170 mm / 49.9" x 49.7" x 6.7"

**Please notice that the dimensions of these panels have a tolerance of +/- 2 mm*

Available Finishes

Collections

- Natural Stones NEW
- Concrete
- Doodle
- Floral
- Geometric
- Nature
- World

Solid colors

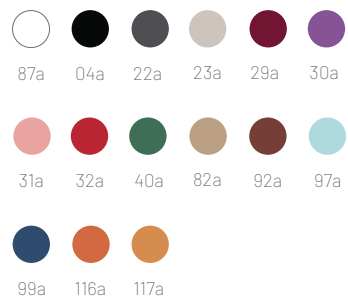



Performance
Over Rigid Surface

NRC: 0,85
AREA (m²)

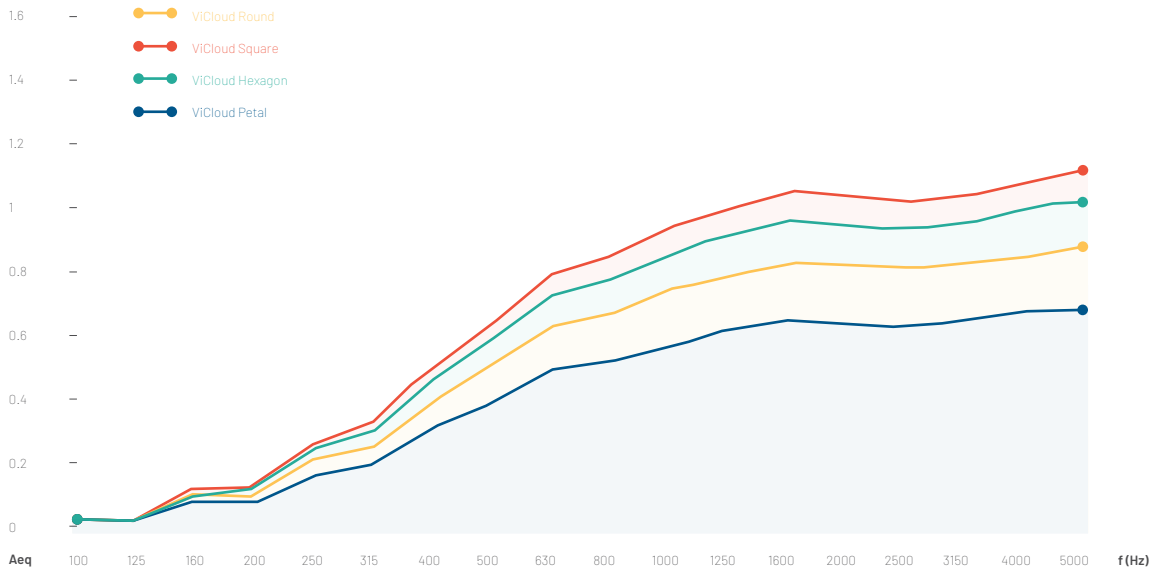



Features

- Premium high density VicPET Wool
- High Performance in medium and high frequencies
- Light weight
- Easy to install
- Easy to clean and maintain

Technical Information

Raw Material

VicPET Wool

Accessories

Magnetic and Mechanical Suspended Fixation (Included)



OEKO-TEX®
CONFIDENCE IN TEXTILES
STANDARD 100 

Performance

1m from soffit

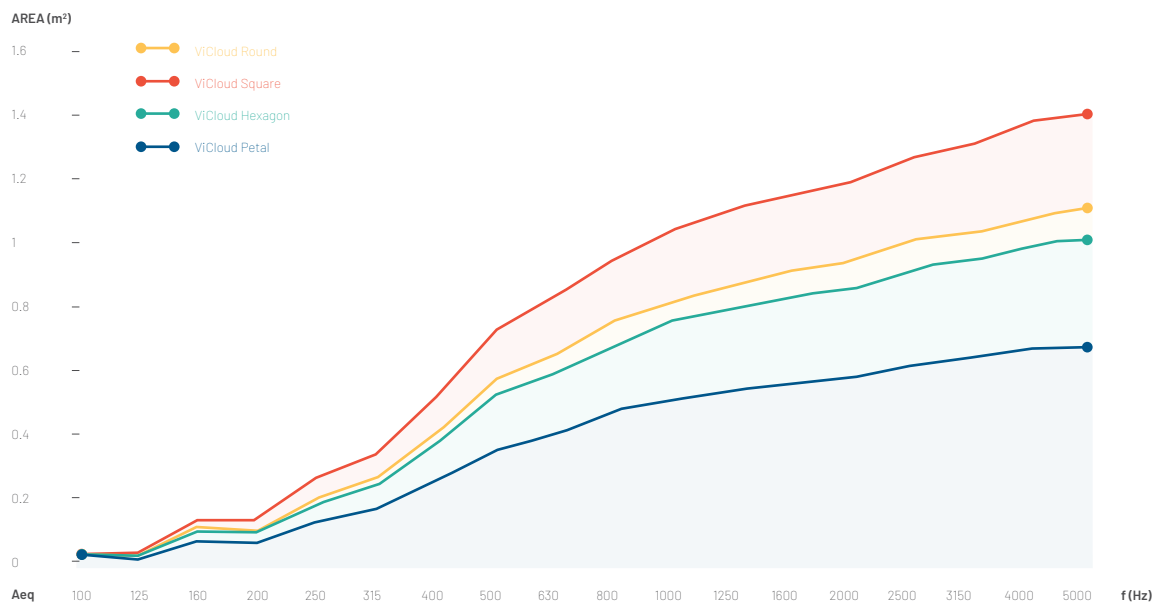

Natural Stones Collection

Calacatta Carrara



Emperador Dark



Fusion Wow



Grey Stone



Invisible Grey



Travertino Classico



Concrete Collection

1



2



3



4



Doodle Collection

1



2



3



Floral Collection



Geometric Collection



Nature Collection



World Collection



VMT

ViCloud 3D

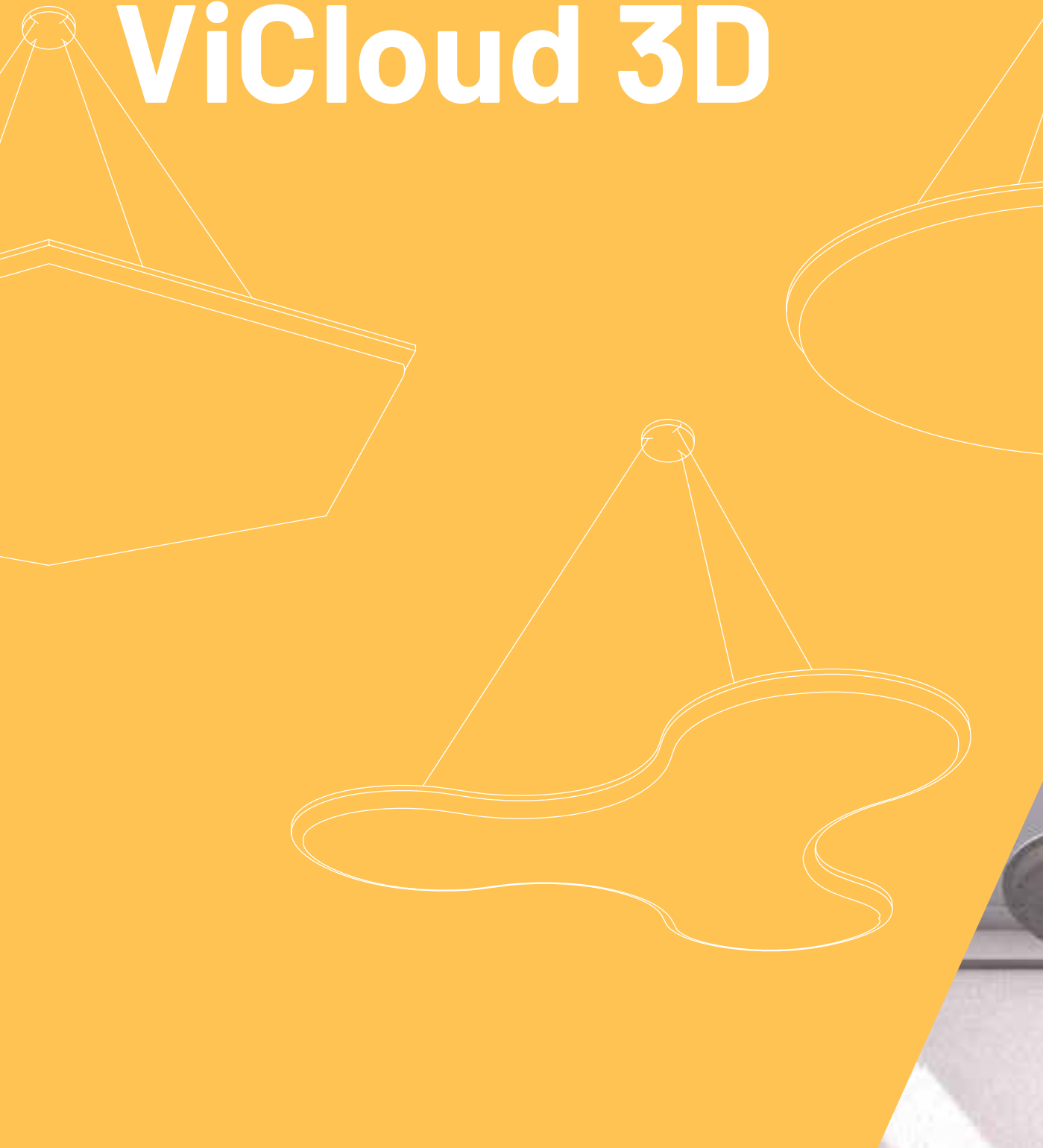



VMT ViCloud 3D

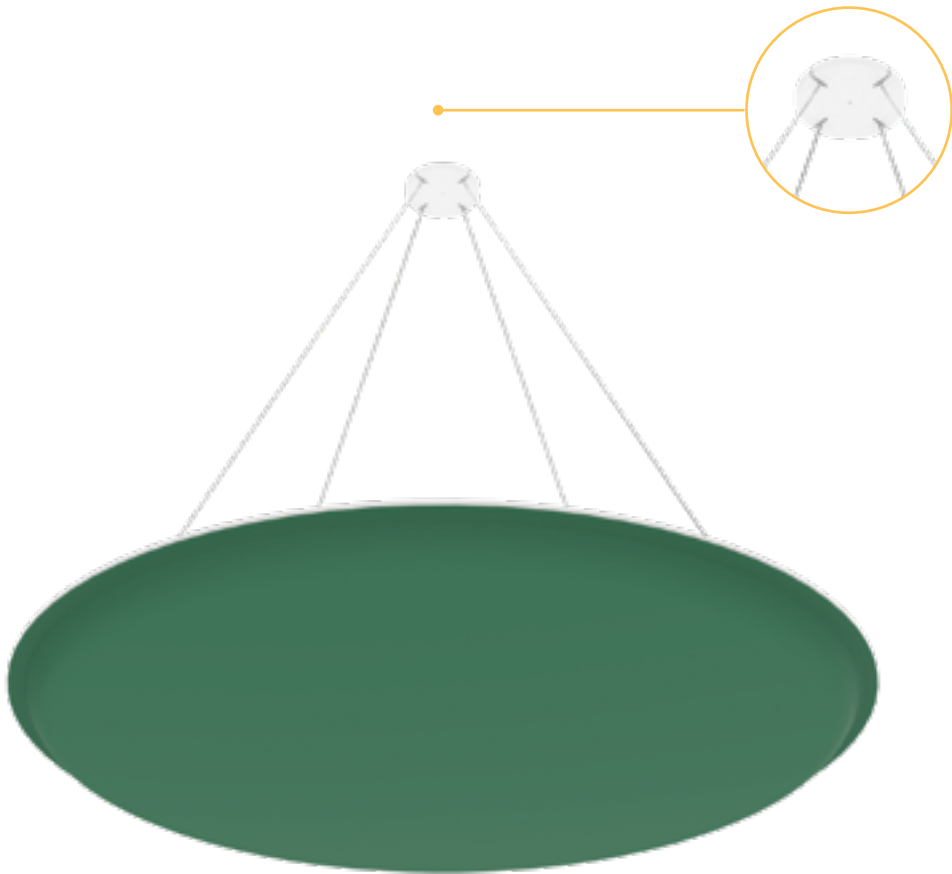

A lightweight and uncomplicated acoustic solution, the **ViCloud 3D** hangs suspended in the air to support and manage sound where there is a lot of background noise, conversation and disruptive sounds. Available in a range of shapes and colours, ViCloud 3D are ready to be installed without the need of professional assistance and in lots of different spaces.

Sustainable and extremely durable, these can significantly reduce excess noise in various settings.



1 Square

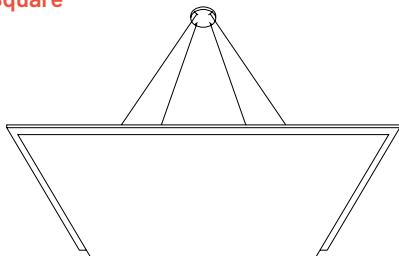

2 Hexagon

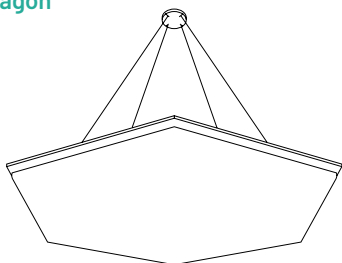

3 Round

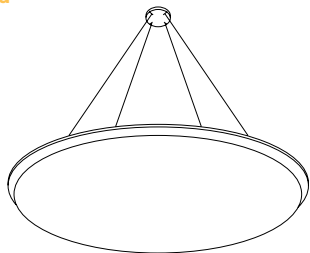

4 Petal

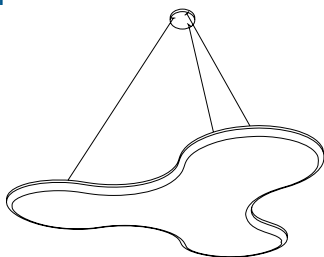

Dimensions*

- 1 1160 x 1160 x 40 mm / 45.7" x 45.7" x 1.6"
- 2 1160 x 1005 x 40 mm / 45.7" x 39.6" x 1.6"
- 3 Ø 1160 x 40 mm / Ø 45.7" x 1.6"
- 4 1160 x 1068 x 40 mm / 45.7" x 42" x 1.6"

Package Information

4 units/box

Box Dimensions

1267 x 1262 x 170 mm / 49.9" x 49.7" x 6.7"

Box Gross Weight

8,5 kg















**Please notice that the dimensions of these panels have a tolerance of +/- 2 mm*

Available Finishes

Collections

- Natural Stones NEW
- Concrete
- Doodle
- Floral
- Geometric
- Nature
- World

Solid colors

- | | | | | | |
|---|---|---|---|---|---|
|  |  |  |  |  |  |
| 87a | 04a | 22a | 23a | 29a | 30a |
|  |  |  |  |  |  |
| 31a | 32a | 40a | 82a | 92a | 97a |
|  |  |  | | | |
| 99a | 116a | 117a | | | |

Features

- Premium high density VicPET Wool
- High Performance in medium and high frequencies
- Light weight
- Easy to install
- Easy to clean and maintain

Technical Information

Raw Material

VicPET Wool

Fire Rate

Euro Class B S1, d0 (EM 13501-1)

Accessories

Mechanical and Magnetic Suspended Fixation (included)



Performance

NRC: 0,85

Equivalent Absorption Area m² (Sabine)

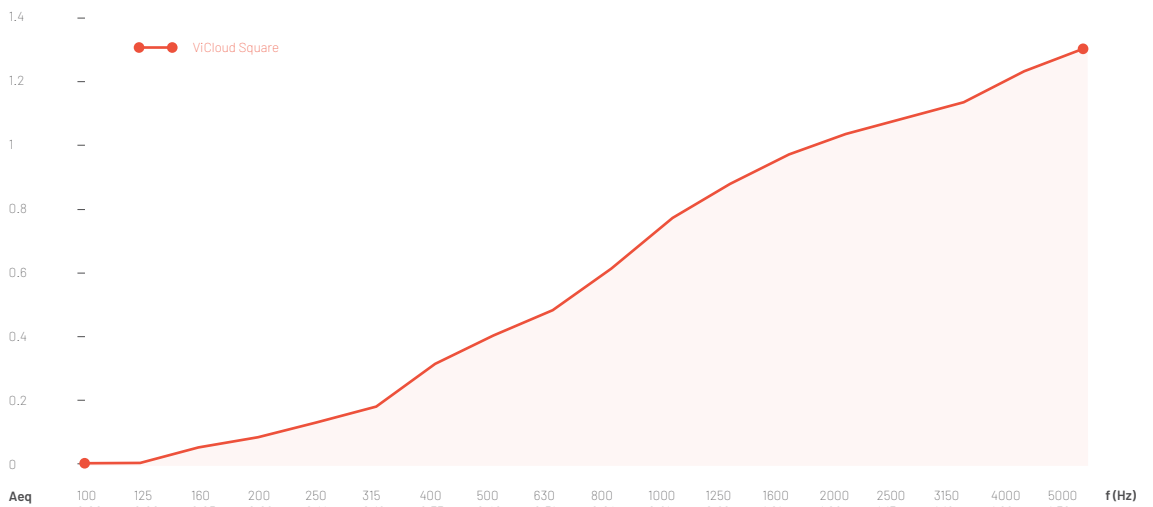

Natural Stones Collection

Calacatta Carrara



Emperador Dark



Fusion Wow



Grey Stone



Invisible Grey



Travertino Classico



Concrete Collection

1



2



3



4



Doodle Collection

1



2



3



Floral Collection



Geometric Collection



Nature Collection



World Collection







Production

Strategically located in the largest industrial cluster in Portugal



Packaging

Each individual panel is inspected, placed in plastic casing and boxed. Production and Logistic enhancements guarantee high quality control and fast expedition



Shipping

Vicoustic Acoustic Solutions are currently being shipped over 80 different countries worldwide



Installation

"Out of the box" solutions, easy to install

R&D and Logistics Facility

Avenida do Polo 3, Nº 159, Carvalhosa
4590-137 Paços de Ferreira, Portugal

P (+351) 255 136 746

M (+351) 917 851 019

Office

Rua Quinta do Bom Retiro Nº 16, Armazém 9
2820-690 Charneca da Caparica, Portugal

P (+351) 212 964 100

Info and Sales

E sales@vicoustic.com

Project Department

E projects@vicoustic.com

Marketing Department

E marketing@vicoustic.com

www.vicoustic.com

V/COUSTIC
INNOVATIVE ACOUSTIC SOLUTIONS